



2016  
**Natural Gas**  
Integrated Resource Plan  
Appendices

August 31, 2016



## **Safe Harbor Statement**

This document contains forward-looking statements. Such statements are subject to a variety of risks, uncertainties and other factors, most of which are beyond the Company's control, and many of which could have a significant impact on the Company's operations, results of operations and financial condition, and could cause actual results to differ materially from those anticipated.

For a further discussion of these factors and other important factors, please refer to the Company's reports filed with the Securities and Exchange Commission. The forward-looking statements contained in this document speak only as of the date hereof. The Company undertakes no obligation to update any forward-looking statement or statements to reflect events or circumstances that occur after the date on which such statement is made or to reflect the occurrence of unanticipated events. New risks, uncertainties and other factors emerge from time to time, and it is not possible for management to predict all of such factors, nor can it assess the impact of each such factor on the Company's business or the extent to which any such factor, or combination of factors, may cause actual results to differ materially from those contained in any forward-looking statement.

## TABLE OF CONTENTS: APPENDICES

Appendix	0.1	TAC Member List.....	Page 1
	0.2	Comments and Responses to the 2014 IRP .....	2
Appendix	1.1	Avista Corporation 2014 Natural Gas IRP Work Plan.....	4
	1.2	IRP Guideline Compliance Summaries .....	7
Appendix	2.1	Economic Outlook and Customer Count Forecast.....	22
	2.2	Customer Forecasts by Region .....	39
	2.3	Demand Coefficient Calculations .....	69
	2.4	Heating Degree Day Data .....	75
	2.5	Demand Sensitivities and Demand Scenarios.....	80
	2.6	Demand Forecast Sensitivities and Scenarios Descriptions .....	82
	2.7	Annual Demand, Avg Day Demand & Peak Day Demand (Net of DSM) .	85
	2.8	Demand Before and After DSM.....	89
	2.9	Detailed Demand Data.....	93
Appendix	3.1	Avista Gas CPA Report Final 4/23/2014 .....	103
	3.2	Environmental Externalities.....	164
Appendix	4.1	Current Transportation/Storage Rates and Assumptions .....	167
	4.2	Alternate Supply Scenarios .....	168
Appendix	5.1	Monthly Price Data by Basin .....	169
	5.2	Weighted Average Cost of Capital .....	175
	5.3	Supply Side Resource Options .....	176
	5.4	Avoided Costs Detail.....	177
Appendix	6.1	High Case Demand and Resources Selected Graphs.....	192
	6.2	Other Scenario Peak Day Demand Table .....	194
Appendix	7.1	Distribution System Modeling .....	198
	7.2	Oregon Capital Projects .....	202

Appendix	8.1	TAC Meeting #1 .....	214
	8.2	TAC Meeting #2 .....	299
	8.3	TAC Meeting #3 .....	396
	8.4	TAC Meeting #4 .....	533

**APPENDIX 0.1: TAC MEMBER LIST**

<b>ORGANIZATION</b>	<b>REPRESENTATIVES</b>	
<b>Applied Energy Group</b>	Bridget Kester	
<b>Avista</b>	Terrence Browne      Joe Miller Mike Dillon              Jody Morehouse Leslie Filer               Tom Pardee Ryan Finesilver          Karen Schuh Grant Forsyth            Kaylene Schultz James Gall                Eric Scott Alison Kenyon           Kerry Shroy John Lyons                Debbie Simock David Machado          Erik Soreng	
<b>Cascade Natural Gas Company</b>	Chris Robbins             Mark Sellers- Brian Robertson        Vaughn	
<b>Idaho Public Utility Commission</b>	Johanna Bell              Matt Elam Terri Carlock             Kevin Keyt Stacey Donohue         Rick Sterling	
<b>Northwest Gas Association</b>	Dan Kirschner              Connor Reiten	
<b>Northwest Industrial Gas Users</b>	Ed Finklea                  Chad Stokes	
<b>Northwest Natural Gas</b>	Ryan Bracken             Steve Storm Tammy Linver	
<b>Oregon Citizens Utility Board</b>	Nadine Hanhan             Jaime McGovern	
<b>Oregon Public Utility Commission</b>	Erik Colville              Max St. Brown Lisa Gorsuch	
<b>Puget Sound Energy</b>	Kacee Chandler	
<b>TransCanada</b>	Jay Story                    David White	
<b>Washington Utilities and Transportation Commission</b>	Chris McGuire	
<b>Williams Northwest Pipeline</b>	Mike Rasmuson             Ray Warner	

## APPENDIX 0.2: COMMENTS AND RESPONSES TO 2016 DRAFT INTEGRATED RESOURCE PLAN

The following table summarizes the significant comments on our DRAFT as submitted by TAC members and Avista's responses. These comments are those not directly incorporated into the primary document. The planning environment in this IRP cycle was especially challenging given some of the most challenging economic volatility seen in decades coupled with industry changing dynamics in natural gas production. We continued our robust, flexible demand forecasting methodology that captured a broad range of demand forecasts fully vetted with our TAC. This IRP produced reduced forecasted demand scenarios and no near term resource needs even in our most robust demand scenario. We appreciate the time and effort invested by all our TAC members throughout the IRP process. Many good suggestions have been made and we have incorporated those that enhance the document.

Document Reference[1]	Comment/Question	Avista Response
4 – SUPPLY SIDE RESOURCES	Page 13, first paragraph – The peak day is listed in Table 2 Executive Summary as being 362,000 Dth/day. Suggest adding text describing why Jackson Prairie deliverability of 492,232 Dth/day (398,667 plus the additional 95,565) is considerably greater than the peak day.	Avista has the ability to withdraw 401,290 from Jackson Prairie. 398,667 is Avista's owned storage capacity withdrawal amount. 95,565 is Avista's leased capacity from NWP with 2,623 of withdrawal. This does not represent the take away or transportation capacity from the facility to Avista's service territories. Please also refer to comment above. In order for Avista to maintain it's 1/3 ownership of Jackson Prairie the agreement has the three partners (Northwest Pipeline, Puget Sound Energy and Avista) and each will bear 1/3 of the operating costs as well as obtain 1/3 of the storage capacity both future and current.
6 – Alternate Scenarios, Portfolios and Stochastic Analysis	A problem from Avista's 2014 IRP remains in this draft 2016 IRP. While this problem will remedy itself in the future when a resource deficiency is found, Staff is concerned the integrity of past IRP analyses will be impugned when the problem is remedied. To avoid that result, Staff again suggests the portfolio evaluation/analysis and selection process description be revised to eliminate that problem	The Sendout model was loaded with the list of potential resources found in Chapter 6 Scenarios, Portfolios, Stochastic Analysis. The model would choose a different resource if given the opportunity to provide demand at lowest cost. If a new resource had been chosen a separate portfolio would have been created to compare the ability to serve demand via less cost and comparing against a total PVR. Alternate scenarios have been added to Chapter 6 to address this concern with accompanying text to explain the logic

<p>6 – Alternate Scenarios, Portfolios and Stochastic Analysis</p>	<p>The upsized compressor and increased operating pressure selected by the model are not mentioned in Chapter 7 Distribution Planning.</p>	<p>This is a compressor on the GTN pipeline not internal distribution as a fix to push more gas down the Medford Lateral from the GTN mainline.</p>
<p>7 – ALTERNATE SCENARIOS</p>	<p>1. Expand the text to comply with Order No. 16-109 in Docket UG 288, in which the Commission provided its expectations related to justification of distribution system projects, as follows:  “Finally, as part of the IRP-vetting process and subsequent rate proceedings, we expect that Avista conduct and present comprehensive analyses of its system upgrades. Such analyses should provide: (1) a comprehensive cost-benefit analysis of whether and when the investment should be built; (2) evaluation of a range of alternative build dates and the impact on reliability and customer rates; (3) credible evidence on the likelihood of disruptions based on historical experience; (4) evidence on the range of possible reliability incidents; (5) evidence about projected loads and customers in the area; and (6) adequate consideration of alternatives, including the use of interruptibility or increased demand-side measures to improve reliability and system resiliency.”</p>	<p>The distribution planning section of the IRP contains only a subset of all capital investment in Avista’s gas distribution systems. This is a planning document and the distribution projects included are projects that are planned over a relatively longer time horizon. Other capital investments may be driven by regulation, system maintenance, leak repair, franchise/right-of-way agreements, etc. These investments are not addressed in this section.</p>
<p>7 – DISTRIBUTION PLANNING</p>	<p>Page 8 Table 7.2 – suggest adding text to communicate that “Cost” is a planning level value that will likely change as the projects approach the time of implementation. Also suggest that estimating contingencies be included in derivation of the “Cost” to minimize instances where the values need to be revised. In addition to estimating contingencies, suggest adding text to discuss the sensitivity of distribution system project evaluation to changes in “Cost.”</p>	<p>“These projects are preliminary estimates of timing and costs of City Gate Station Upgrades...” Because all of the Gate Station projects are scheduled for 2019+ and have no cost assigned, contingencies to cost cannot be included.</p>
<p>8 – ACTION PLAN</p>	<p>2. Page 1, 2015-2016 Action Plan Review – the two Action Items listed were not Action Items but rather were ongoing activities. Please correct the text.</p>	<p>Action items addressed in 2015-2016 Action Plan Review are taken directly from the final Natural Gas IRP document filed in each commission on August 29, 2016. These actions are called out so Avista prefers to address them as actions.</p>

## **APPENDIX 1.1: AVISTA CORPORATION 2016 NATURAL GAS INTEGRATED RESOURCE PLAN WORK PLAN**

### **IRP WORK PLAN REQUIREMENTS**

Section 480-90-238 (4), of the natural gas Integrated Resource Plan (“IRP”) rules, specify requirements for the IRP Work Plan:

Not later than twelve months prior to the due date of a plan, the utility must provide a work plan for informal commission review. The work plan must outline the content of the integrated resource plan to be developed by the utility and the method for assessing potential resources.

Additionally, Section 480-90-238 (5) of the WAC states:

The work plan must outline the timing and extent of public participation.

### **OVERVIEW**

This Work Plan outlines the process Avista will follow to complete its 2016 Natural Gas IRP by August 31, 2016. Avista uses a public process to obtain technical expertise and guidance throughout the planning period via Technical Advisory Committee (TAC) meetings. The TAC will be providing input into assumptions, scenarios, and modeling techniques.

### **PROCESS**

The 2016 IRP process will be similar to that used to produce the previously published plan. Avista will use SENDOUT® (a PC based linear programming model widely used to solve natural gas supply and transportation optimization questions) to develop the risk adjusted least-cost resource mix for the 20 year planning period.

This plan will continue to include demand analysis, demand side management and avoided cost determination, existing and potential supply-side resource analysis, resource integration and alternative sensitivities and scenario analysis.

Additionally, Avista intends to incorporate action plan items identified in the 2018 Natural Gas IRP including more detailed demand analysis regarding use per customer, demand side management results and possible price elastic responses to evolving economic conditions, an updated assessment of conservation potential in our service territories, consideration of alternate forecasting methodologies, and the changing landscape of natural gas supply (i.e. shale gas, Canadian exports, and US LNG exports) and its implications to the planning process. Further details about Avista’s process for determining the risk adjusted least-cost resource mix is shown in Exhibit 1.



## TIMELINE

The following is Avista's TENTATIVE 2018 Natural Gas IRP timeline:

August 31, 2017	Work Plan filed with WUTC
January through April 2018	Technical Advisory Committee meetings (exact meeting dates <i>subject to change</i> ). Meeting topics will include:
January 25	Economic Drivers, Demand Forecast, and Demand Side Management
February 27	Existing Infrastructure and Supply Side Resources
March 29	Scenario Analysis, SENDOUT® Preliminary Results, and Natural Gas Prices
April 26	SENDOUT® Final Results and Draft Document Discussion
May 31, 2018	Draft of IRP document to TAC
June 30, 2018	Comments on draft due back to Avista
July 2018	TAC final review meeting (if necessary)
August 31, 2018	File finalized IRP document

**EXHIBIT 1: AVISTA'S 2018 NATURAL GAS IRP MODELING PROCESS**

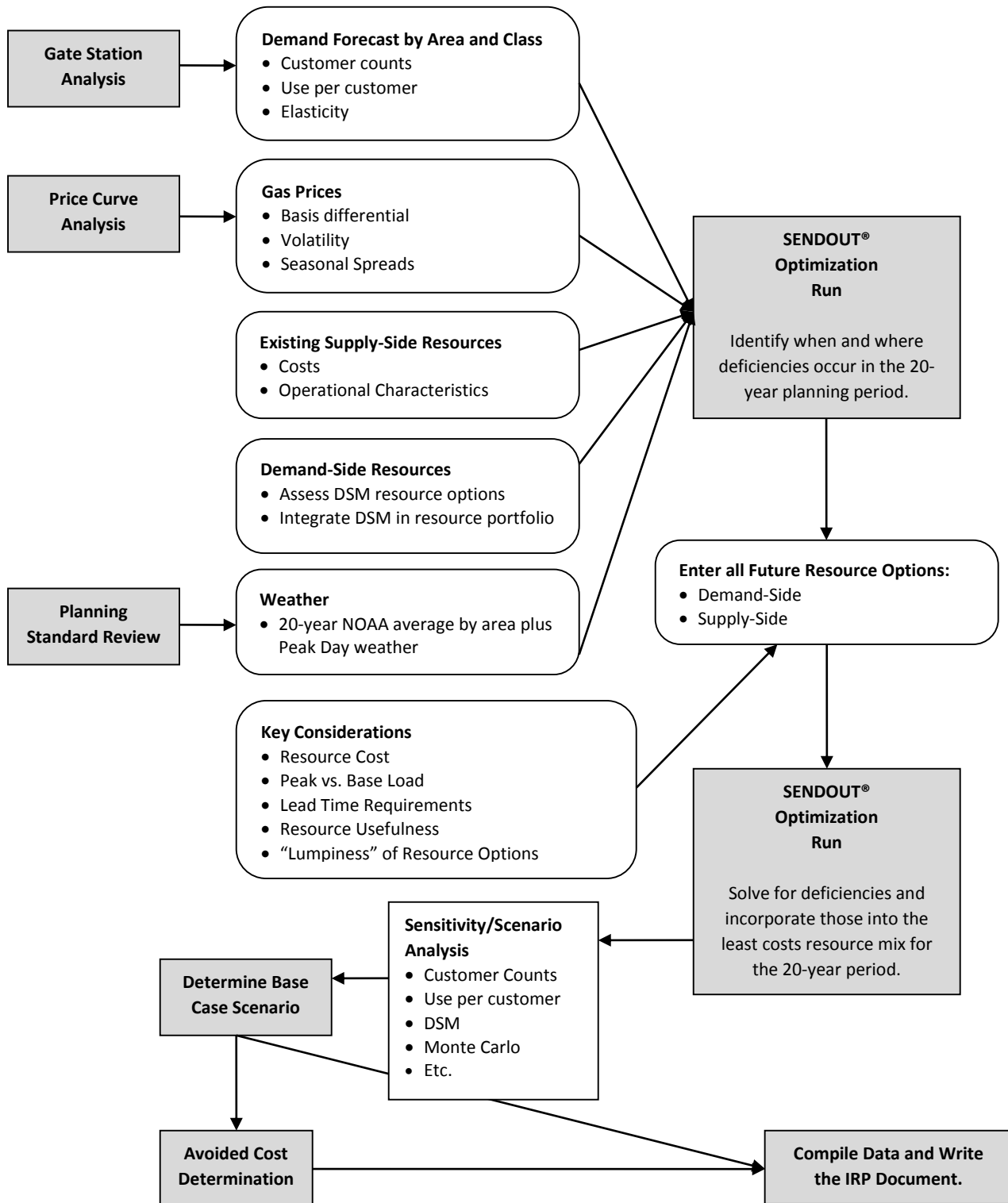

## APPENDIX 1.2: WASHINGTON PUBLIC UTILITY COMMISSION IRP POLICIES AND GUIDELINES – WAC 480-90-238

Rule	Requirement	Plan Citation
WAC 480-90-238(4)	Work plan filed no later than 12 months before next IRP due date.	Work plan submitted to the WUTC on August 31, 2015, See attachment to this Appendix 1.1.
WAC 480-90-238(4)	Work plan outlines content of IRP.	See work plan attached to this Appendix 0.1.
WAC 480-90-238(4)	Work plan outlines method for assessing potential resources. (See LRC analysis below)	See Appendix 1.1.
WAC 480-90-238(5)	Work plan outlines timing and extent of public participation.	See Appendix 1.1.
WAC 480-90-238(4)	Integrated resource plan submitted within two years of previous plan.	Last Integrated Resource Plan was submitted on August 31, 2014
WAC 480-90-238(5)	Commission issues notice of public hearing after company files plan for review.	TBD
WAC 480-90-238(5)	Commission holds public hearing.	TBD
WAC 480-90-238(2)(a)	Plan describes mix of natural gas supply resources.	See Chapter 4 on Supply Side Resources
WAC 480-90-238(2)(a)	Plan describes conservation supply.	See Chapter 3 on Demand Side Resources
WAC 480-90-238(2)(a)	Plan addresses supply in terms of current and future needs of utility and ratepayers.	See Chapter 4 on Supply Side Resources and Chapter 5 Integrated Resource Portfolio
WAC 480-90-238(2)(a)&(b)	Plan uses lowest reasonable cost (LRC) analysis to select mix of resources.	See Chapters 3 and 4 for Demand and Supply Side Resources. Chapters 5 and 6 details how Demand and Supply come together to select the least cost/best risk portfolio for ratepayers.
WAC 480-90-238(2)(b)	LRC analysis considers resource costs.	See Chapters 3 and 4 for Demand and Supply Side Resources. Chapters 5 and 6 details how Demand and Supply come together to select the least cost/best risk portfolio for ratepayers.
WAC 480-90-238(2)(b)	LRC analysis considers market-volatility risks.	See Chapter 4 on Supply Side Resources
WAC 480-90-238(2)(b)	LRC analysis considers demand side uncertainties.	See Chapter 2 Demand Forecasting
WAC 480-90-238(2)(b)	LRC analysis considers resource effect on system operation.	See Chapter 4 and Chapter 5
WAC 480-90-238(2)(b)	LRC analysis considers risks imposed on ratepayers.	See Chapter 4 procurement plan section. We seek to minimize but cannot eliminate price risk for our customers.
WAC 480-90-238(2)(b)	LRC analysis considers public policies regarding resource preference	See Chapter 2 demand scenarios

	adopted by Washington state or federal government.	
WAC 480-90-238(2)(b)	LRC analysis considers cost of risks associated with environmental effects including emissions of carbon dioxide.	See Chapters 2 and 5 on demand scenarios and Integrated Resource Portfolio
WAC 480-90-238(2)(b)	LRC analysis considers need for security of supply.	See Chapter 4 on Supply Side Resources
<b>Rule</b>	<b>Requirement</b>	<b>Plan Citation</b>
WAC 480-90-238(2)(c)	Plan defines conservation as any reduction in natural gas consumption that results from increases in the efficiency of energy use or distribution.	See Chapter 3 on Demand Side Resources
WAC 480-90-238(3)(a)	Plan includes a range of forecasts of future demand.	See Chapter 2 on Demand Forecast
WAC 480-90-238(3)(a)	Plan develops forecasts using methods that examine the effect of economic forces on the consumption of natural gas.	See Chapter 2 on Demand Forecast
WAC 480-90-238(3)(a)	Plan develops forecasts using methods that address changes in the number, type and efficiency of natural gas end-uses.	See Chapter 2 on Demand Forecast
WAC 480-90-238(3)(b)	Plan includes an assessment of commercially available conservation, including load management.	See Chapter 3 on Demand Side Management including demand response section.
WAC 480-90-238(3)(b)	Plan includes an assessment of currently employed and new policies and programs needed to obtain the conservation improvements.	See Chapter 3 and Appendix 3.1.
WAC 480-90-238(3)(c)	Plan includes an assessment of conventional and commercially available nonconventional gas supplies.	See Chapter 4 on Supply Side Resources
WAC 480-90-238(3)(d)	Plan includes an assessment of opportunities for using company-owned or contracted storage.	See Chapter 4 on Supply Side Resources
WAC 480-90-238(3)(e)	Plan includes an assessment of pipeline transmission capability and reliability and opportunities for additional pipeline transmission resources.	See Chapter 4 on Supply Side Resources
WAC 480-90-238(3)(f)	Plan includes a comparative evaluation of the cost of natural gas purchasing strategies, storage options, delivery resources, and improvements in conservation using a consistent method to calculate cost-effectiveness.	See Chapter 3 on Demand Side Resources and Chapter 4 on Supply Side Resources
WAC 480-90-238(3)(g)	Plan includes at least a 10 year long-range planning horizon.	Our plan is a comprehensive 20 year plan.
WAC 480-90-238(3)(g)	Demand forecasts and resource evaluations are integrated into the long range plan for resource acquisition.	Chapter 5 Integrated Resource Portfolio details how demand and supply come together to form the least cost/best risk portfolio.
WAC 480-90-238(3)(h)	Plan includes a two-year action plan that implements the long range plan.	See Section 8 Action Plan

WAC 480-90-238(3)(i)	Plan includes a progress report on the implementation of the previously filed plan.	See Section 8 Action Plan
WAC 480-90-238(5)	Plan includes description of consultation with commission staff. (Description not required)	See Section 0 Introduction
WAC 480-90-238(5)	Plan includes description of completion of work plan. (Description not required)	See Appendix 1.1.

## APPENDIX 1.2: IDAHO PUBLIC UTILITY COMMISSION IRP POLICIES AND GUIDELINES – ORDER NO. 2534

	DESCRIPTION OF REQUIREMENT	FULLFILLMENT OF REQUIREMENT
1	Purpose and Process. Each gas utility regulated by the Idaho Public Utilities Commission with retail sales of more than 10,000,000,000 cubic feet in a calendar year (except gas utilities doing business in Idaho that are regulated by contract with a regulatory commission of another State) has the responsibility to meet system demand at least cost to the utility and its ratepayers. Therefore, an “integrated resource plan” shall be developed by each gas utility subject to this rule.	Avista prepares a comprehensive 20 year Integrated Resource Plan every two years. Avista will be filing its 2016 IRP on or before August 31, 2016.
2	Definition. Integrated resource planning. “Integrated resource planning” means planning by the use of any standard, regulation, practice, or policy to undertake a systematic comparison between demand-side management measures and the supply of gas by a gas utility to minimize life-cycle costs of adequate and reliable utility services to gas customers. Integrated resource planning shall take into account necessary features for system operation such as diversity, reliability, dispatchability, and other factors of risk and shall treat demand and supply to gas consumers on a consistent and integrated basis.	Avista's IRP brings together dynamic demand forecasts and matches them against demand-side and supply-side resources in order to evaluate the least cost/best risk portfolio for its core customers. While the primary focus has been to ensure customer's needs are met under peak or design weather conditions, this process also evaluates the resource portfolio under normal/average operating conditions. The IRP provides the framework and methodology for evaluating Avista's natural gas demand and resources.
3	Elements of Plan. Each gas utility shall submit to the Commission on a biennial basis an integrated resource plan that shall include:	2016 IRP to be filed on or before August 31, 2016. The last IRP was filed on August 31, 2014.
	A range of forecasts of future gas demand in firm and interruptible markets for each customer class for one, five, and twenty years using methods that examine the effect of economic forces on the consumption of gas and that address changes in the number, type and efficiency of gas end-uses.	See <b>Chapter 2 - Demand Forecasts</b> and <b>Appendix 2 et.al.</b> for a detailed discussion of how demand was forecasted for this IRP.
	An assessment for each customer class of the technically feasible improvements in the efficient use of gas, including load management, as well as the policies and programs needed to obtain the efficiency improvements.	See <b>Chapter 3 - Demand Side Management</b> and <b>DSM Appendices 3 et.al.</b> for detailed information on the DSM potential evaluated and selected for this IRP and the operational implementation process.

	An analysis for each customer class of gas supply options, including: (1) a projection of spot market versus long-term purchases for both firm and interruptible markets; (2) an evaluation of the opportunities for using company-owned or contracted storage or production; (3) an analysis of prospects for company participation in a gas futures market; and (4) an assessment of opportunities for access to multiple pipeline suppliers or direct purchases from producers.	See <b>Chapter 4 - Supply-Side Resources</b> for details about the market, storage, and pipeline transportation as well as other resource options considered in this IRP. See also the procurement plan section in this same chapter for supply procurement strategies.
	A comparative evaluation of gas purchasing options and improvements in the efficient use of gas based on a consistent method for calculating cost-effectiveness.	See Methodology section of <b>Chapter 3 - Demand-Side Resources</b> where we describe our process on how demand-side and supply-side resources are compared on par with each other in the SENDOUT® model. Chapter 3 also includes how results from the IRP are then utilized to create operational business plans. Operational implementation may differ from IRP results due to modeling assumptions.
	The integration of the demand forecast and resource evaluations into a long-range (e.g., twenty-year) integrated resource plan describing the strategies designed to meet current and future needs at the lowest cost to the utility and its ratepayers.	See <b>Chapter 5 - Integrated Resource Portfolio</b> for details on how we model demand and supply coming together to provide the least cost/best risk portfolio of resources.
	A short-term (e.g., two-year) plan outlining the specific actions to be taken by the utility in implementing the integrated resource plan.	See <b>Chapter 8 - Action Plan</b> for actions to be taken in implementing the IRP.
<b>4</b>	Relationship Between Plans. All plans following the initial integrated resource plan shall include a progress report that relates the new plan to the previously filed plan.	Avista strives to meet at least bi-annually with Staff and/or Commissioners to discuss the state of the market, procurement planning practices, and any other issues that may impact resource needs or other analysis within the IRP.
<b>5</b>	Plans to Be Considered in Rate Cases. The integrated resource plan will be considered with other available information to evaluate the performance of the utility in rate proceedings before the Commission.	We prepare and file our plan in part to establish a public record of our plan.
<b>6</b>	Public Participation. In formulating its plan, the gas utility must provide an opportunity for public participation and comment and must provide methods that will be available to the public of validating predicted performance.	Avista held four Technical Advisory Committee meetings beginning in January and ending in April. See <b>Chapter 0 - Introduction</b> for more detail about public participation in the IRP process.

7	<p>Legal Effect of Plan. The plan constitutes the base line against which the utility's performance will ordinarily be measured. The requirement for implementation of a plan does not mean that the plan must be followed without deviation. The requirement of implementation of a plan means that a gas utility, having made an integrated resource plan to provide adequate and reliable service to its gas customers at the lowest system cost, may and should deviate from that plan when presented with responsible, reliable opportunities to further lower its planned system cost not anticipated or identified in existing or earlier plans and not undermining the utility's reliability.</p>	<p>See section titled "Avista's Procurement Plan" in <b>Chapter 4 - Supply-Side Resources</b>. Among other details we discuss plan revisions in response to changing market conditions.</p>
	<p>In order to encourage prudent planning and prudent deviation from past planning when presented with opportunities for improving upon a plan, a gas utility's plan must be on file with the Commission and available for public inspection. But the filing of a plan does not constitute approval or disapproval of the plan having the force and effect of law, and deviation from the plan would not constitute violation of the Commission's Orders or rules. The prudence of a utility's plan and the utility's prudence in following or not following a plan are matters that may be considered in a general rate proceeding or other proceedings in which those issues have been noticed.</p>	<p>See also section titled "Alternate Supply-Side Scenarios" in <b>Chapter 5 - Integrated Resource Portfolio</b> where we discuss different supply portfolios that are responsive to changing assumptions about resource alternatives.</p>



## APPENDIX 1.2: OREGON PUBLIC UTILITY COMMISSION IRP STANDARD AND GUIDELINES – ORDER 07- 002

<b>Guideline 1: Substantive Requirements</b>		
<b>1.a.1</b>	All resources must be evaluated on a consistent and comparable basis.	All resource options considered, including demand-side and supply-side are modeled in SENDOUT® utilizing the same common general assumptions, approach and methodology.
<b>1.a.2</b>	All known resources for meeting the utility's load should be considered, including supply-side options which focus on the generation, purchase and transmission of power – or gas purchases, transportation, and storage – and demand-side options which focus on conservation and demand response.	Avista considered a range of resources including demand-side management, distribution system enhancements, capacity release recalls, interstate pipeline transportation, interruptible customer supply, and storage options including liquefied natural gas. Chapter 3 and Appendix 3.1 documents Avista's demand-side management resources considered. Chapter 4 and Appendix 5.3 documents supply-side resources. Chapter 5 and 6 documents how Avista developed and assessed each of these resources.
<b>1.a.3</b>	Utilities should compare different resource fuel types, technologies, lead times, in-service dates, durations and locations in portfolio risk modeling.	Avista considered various combinations of technologies, lead times, in-service dates, durations, and locations. Chapter 5 provides details about the modeling methodology and results. Chapter 4 describes resource attributes and Appendix 5.3 summarizes the resources' lead times, in-service dates and locations.
<b>1.a.4</b>	Consistent assumptions and methods should be used for evaluation of all resources.	Appendix 5.2 documents general assumptions used in Avista's SENDOUT® modeling software. All portfolio resources both demand and supply-side were evaluated within SENDOUT® using the same sets of inputs.
<b>1.a.5</b>	The after-tax marginal weighted-average cost of capital (WACC) should be used to discount all future resource costs.	Avista applied its after-tax WACC of 4.34% to discount all future resource costs. (See general assumptions at Appendix 5.2)
<b>1.b.1</b>	Risk and uncertainty must be considered. Electric utilities only	Not Applicable
<b>1.b.2</b>	Risk and uncertainty must be considered. Natural gas utilities should consider demand (peak, swing and base-load), commodity supply and price, transportation availability and price, and costs to comply with any regulation of greenhouse gas (GHG) emissions.	<p>Risk and uncertainty are key considerations in long term planning. In order to address risk and uncertainties a wide range of sensitivity, scenario and portfolio analysis is completed. A description of risk associated with each scenario is included in Appendix 2.6.</p> <p>One of the key risks is the "flat demand" risk as described in Chapter 1. Avista performed 15 sensitivities on demand. From there five demand scenarios were developed (Table 1.1) for SENDOUT® modeling purposes. Monthly demand coefficients were developed for base, heating demand while peak demand was contemplated through modeling a weather planning standard of the coldest day on record (see heating degree day data in Appendix 2.4).</p>

		<p>Avista evaluated several price forecasts and selected high, medium and low price scenarios for modeling purposes. The annual average prices are then weighted by month using fundamental forecast data. Additionally, the Henry Hub price forecasts are basis adjusted using the same fundamental forecast data.</p> <p>Four supply scenarios were also evaluated, see Table 4.3. These supply scenarios were combined with demand scenarios in order to establish portfolios for evaluation. Ultimately 9 portfolios were evaluated (See Table 6.3 for the PVRR results).</p> <p>Avista stochastic modeling techniques for price and weather variables to analyze weather sensitivity and to quantify the risk to customers under varying price environments. While there continues to be some uncertainty around GHG emission, Avista considered GHG emissions regulatory compliance costs in Appendix 3.2. As currently modeled, we include a carbon adder to our price curve to capture the costs of emission regulation.</p>
	Utilities should identify in their plans any additional sources of risk and uncertainty.	Avista evaluated additional risks and uncertainties. Risks associated with the planning environment are detailed in Chapter 0 Introduction. Avista also analyzed demand risk which is detailed in Chapter 2. Chapter 3 discusses the uncertainty around how much DSM is achievable. Supply-side resource risks are discussed in Chapter 4. Chapter 5 and 6 discusses the variables modeled for scenario and stochastic risk analysis.
<b>1c</b>	The primary goal must be the selection of a portfolio of resources with the best combination of expected costs and associated risks and uncertainties for the utility and its customers.	Avista evaluated cost/risk tradeoffs for each of the risk analysis portfolios considered. See Chapter 5 and 6 plus supporting information in Appendix 2.6 for Avista's portfolio risk analysis and determination of the preferred portfolio.
	The planning horizon for analyzing resource choices should be at least 20 years and account for end effects. Utilities should consider all costs with a reasonable likelihood of being included in rates over the long term, which extends beyond the planning horizon and the life of the resource.	Avista used a 20-year study period for portfolio modeling. Avista contemplated possible costs beyond the planning period that could affect rates including end effects such as infrastructure decommission costs and concluded there were no significant costs reasonably likely to impact rates under different resource selection scenarios.
	Utilities should use present value of revenue requirement (PVRR) as the key cost metric. The plan should include analysis of current and estimated future costs of all long-lived resources such as power plants, gas storage facilities and pipelines, as well as all short-lived	Avista's SENDOUT® modeling software utilizes a PVRR cost metric methodology applied to both long and short-lived resources.

	resources such as gas supply and short-term power purchases.	
	To address risk, the plan should include at a minimum: 1) Two measures of PVRR risk: one that measures the variability of costs and one that measures the severity of bad outcomes. 2) Discussion of the proposed use and impact on costs and risks of physical and financial hedging.	Avista, through its stochastic analysis, modeled 200 scenarios around varying gas price inputs via Monte Carlo iterations developing a distribution of Total 20 year cost estimates utilizing SENDOUT®'s PVRR methodology. Chapter 6 further describes this analysis. The variability of costs is plotted against the Expected Case while the scenarios beyond the 95 <sup>th</sup> percentile capture the severity of outcomes. Chapter 4 discusses Avista's physical and financial hedging methodology.
	The utility should explain in its plan how its resource choices appropriately balance cost and risk.	Chapter 4, 5, and 6 describe various specific resource considerations and related risks, and describes what criteria we used to determine what resource combinations provide an appropriate balance between cost and risk.
<b>1d</b>	The plan must be consistent with the long-run public interest as expressed in Oregon and federal energy policies.	Avista considered current and expected state and federal energy policies in portfolio modeling. Chapter 5 describes the decision process used to derive portfolios, which includes consideration of state resource policy directions.
<b>Guideline 2: Procedural Requirements</b>		
<b>2a</b>	The public, including other utilities, should be allowed significant involvement in the preparation of the IRP. Involvement includes opportunities to contribute information and ideas, as well as to receive information. Parties must have an opportunity to make relevant inquiries of the utility formulating the plan.	Chapter 0 provides an overview of the public process and documents the details on public meetings held for the 2016 IRP. Avista encourages participation in the development of the plan, as each party brings a unique perspective and the ability to exchange information and ideas makes for a more robust plan.
	While confidential information must be protected, the utility should make public, in its plan, any non-confidential information that is relevant to its resource evaluation and action plan.	The entire IRP, as well as the TAC process, includes all of the non-confidential information the company used for portfolio evaluation and selection. Avista also provided stakeholders with non-confidential information to support public meeting discussions via email. The document and appendices will be available on the company website for viewing.
	The utility must provide a draft IRP for public review and comment prior to filing a final plan with the Commission.	Avista distributed a draft IRP document for external review to all TAC members on May 27, 2016 and requested comments by June 30, 2016.
<b>Guideline 3: Plan Filing, Review and Updates</b>		
<b>3a</b>	Utility must file an IRP within two years of its previous IRP acknowledgement order.	This Plan complies with this requirement as the 2014 Natural Gas IRP was acknowledged on March 2, 2015.
<b>3b</b>	Utility must present the results of its filed plan to the Commission at a public meeting prior to the deadline for written public comment.	Avista will work with Staff to fulfill this guideline following filing of the IRP.
<b>3c</b>	Commission staff and parties should complete their comments and	Pending

	recommendations within six months of IRP filing	
<b>3d</b>	The Commission will consider comments and recommendations on a utility's plan at a public meeting before issuing an order on acknowledgment. The Commission may provide the utility an opportunity to revise the plan before issuing an acknowledgment order	Pending
<b>3e</b>	The Commission may provide direction to a utility regarding any additional analyses or actions that the utility should undertake in its next IRP.	Pending
<b>3f</b>	Each utility must submit an annual update on its most recently acknowledged plan. The update is due on or before the acknowledgment order anniversary date. Once a utility anticipates a significant deviation from its acknowledged IRP, it must file an update with the Commission, unless the utility is within six months of filing its next IRP. The utility must summarize the update at a Commission public meeting. The utility may request acknowledgment of changes in proposed actions identified in an update	The annual update was submitted on March 1, 2016. The filing was primarily an informational filing only as Avista intends to file an updated IRP by August 31, 2016. In addition to the filing, Avista has provided updates and comparisons to its 2014 IRP during its 2016 IRP TAC meetings held on January 21, 2016, February 18, 2016, March 30, 2016, and April 21, 2016, in which Commission Staff and other TAC members were present. In addition the Company provided an update during its Natural Gas Quarterly update meeting held on March 3, 2016. No request for acknowledgement was required as no significant deviation from the 2014 IRP was anticipated.
<b>3g</b>	Unless the utility requests acknowledgement of changes in proposed actions, the annual update is an informational filing that: <ul style="list-style-type: none"> <li>   Describes what actions the utility has taken to implement the plan;</li> <li>   Provides an assessment of what has changed since the acknowledgment order that affects the action plan, including changes in such factors as load, expiration of resource contracts, supply-side and demand-side resource acquisitions, resource costs, and transmission availability; and</li> <li>   Justifies any deviations from the acknowledged action plan.</li> </ul>	The updates described in 3f above explained changes since acknowledgment of the 2014 IRP and an update of emerging planning issues. The updates did not request acknowledgement of any changes.
<b>Guideline 4: Plan Components</b>		
	At a minimum, the plan must include the following elements:	

<b>4a</b>	An explanation of how the utility met each of the substantive and procedural requirements.	This table summarizes guideline compliance by providing an overview of how Avista met each of the substantive and procedural requirements for a natural gas IRP.
<b>4b</b>	Analysis of high and low load growth scenarios in addition to stochastic load risk analysis with an explanation of major assumptions.	Avista developed six demand growth forecasts for scenario analysis. Stochastic variability of demand was also captured in the risk analysis. Chapter 1 describes the demand forecast data and Chapter 5 provides the scenario and risk analysis results. Appendix 5 details major assumptions.
<b>4c</b>	For electric utilities only	Not Applicable
<b>4d</b>	A determination of the peaking, swing and base-load gas supply and associated transportation and storage expected for each year of the plan, given existing resources; and identification of gas supplies (peak, swing and base-load), transportation and storage needed to bridge the gap between expected loads and resources.	Figures 6, 7, and 8 summarize graphically projected annual peak day demand and the existing and selected resources by year to meet demand for the expected case. Appendix 6.1 and 6.2 summarizes the peak day demand for the other demand scenarios.
<b>4e</b>	Identification and estimated costs of all supply-side and demand-side resource options, taking into account anticipated advances in technology	Chapter 3 and Appendix 3.1 identify the demand-side potential included in this IRP. Chapter 4 and 5 and Appendix 5.3 identify the supply-side resources.
<b>4f</b>	Analysis of measures the utility intends to take to provide reliable service, including cost-risk tradeoffs.	Chapter 5, 6, and 7 discusses the modeling tools, customer growth forecasting and cost-risk considerations used to maintain and plan a reliable gas delivery system. These Chapters also capture a summary of the reliability analysis process demonstrated at the second TAC meeting. Chapter 4 discusses the diversified infrastructure and multiple supply basin approach that acts to mitigate certain reliability risks. Appendix 2.6 highlights key risks associated with each portfolio.
<b>4g</b>	Identification of key assumptions about the future (e.g. fuel prices and environmental compliance costs) and alternative scenarios considered.	Appendix 5 and Chapter 5 describe the key assumptions and alternative scenarios used in this IRP.
<b>4h</b>	Construction of a representative set of resource portfolios to test various operating characteristics, resource types, fuels and sources, technologies, lead times, in-service dates, durations and general locations - system-wide or delivered to a specific portion of the system.	This Plan documents the development and results for portfolios evaluated in this IRP (see Table 4.3 for supply scenarios considered).
<b>4i</b>	Evaluation of the performance of the candidate portfolios over the range of identified risks and uncertainties.	We evaluated our candidate portfolio by performing stochastic analysis using SENDOUT® varying price under 200 different scenarios. Additionally, we test the portfolio of options with the use of SENDOUT® under deterministic scenarios where demand and price vary. For resources selected, we assess other risk factors such as varying lead times required and

		potential for cost overruns outside of the amounts included in the modeling assumptions.
<b>4j</b>	Results of testing and rank ordering of the portfolios by cost and risk metric, and interpretation of those results.	Avista's four distinct geographic Oregon service territories limit many resource option synergies which inherently reduces available portfolio options. Feasibility uncertainty, lead time variability and uncertain cost escalation around certain resource options also reduce reasonably viable options. Chapter 4 describes resource options reviewed including discussion on uncertainties in lead times and costs as well as viability and resource availability (e.g. LNG). Appendix 5.3 summarizes the potential resource options identifying investment and variable costs, asset availability and lead time requirements while results of resources selected are identified in Table 5.5 as well as graphically presented in Figure 5.18 and 5.19 for the Expected Case and Appendix 6.1 for the High Growth case.
<b>4k</b>	Analysis of the uncertainties associated with each portfolio evaluated	See the responses to 1.b above.
<b>4l</b>	Selection of a portfolio that represents the best combination of cost and risk for the utility and its customers	Avista evaluated cost/risk tradeoffs for each of the risk analysis portfolios considered. Chapter 5 and Appendix 2.6 show the company's portfolio risk analysis, as well as the process and determination of the preferred portfolio.
<b>4m</b>	Identification and explanation of any inconsistencies of the selected portfolio with any state and federal energy policies that may affect a utility's plan and any barriers to implementation	This IRP is presumed to have no inconsistencies.
<b>4n</b>	An action plan with resource activities the utility intends to undertake over the next two to four years to acquire the identified resources, regardless of whether the activity was acknowledged in a previous IRP, with the key attributes of each resource specified as in portfolio testing.	Chapter 8 presents the IRP Action Plan with focus on the following areas: <ul style="list-style-type: none"> <li>   Modeling</li> <li>   Supply/capacity</li> <li>   Forecasting</li> <li>   Regulatory communication</li> <li>   DSM</li> </ul>
<b>Guideline 5: Transmission</b>		
<b>5</b>	Portfolio analysis should include costs to the utility for the fuel transportation and electric transmission required for each resource being considered. In addition, utilities should consider fuel transportation and electric transmission facilities as resource options, taking into account their value for making additional purchases and sales, accessing less costly resources in remote	Not applicable to Avista's gas utility operations.

	locations, acquiring alternative fuel supplies, and improving reliability.	
<b>Guideline 6: Conservation</b>		
<b>6a</b>	Each utility should ensure that a conservation potential study is conducted periodically for its entire service territory.	AEG performed a conservation potential assessment study for our 2016 IRP. A discussion of the study is included in Chapter 3. The full study document is in Appendix 3.1. Avista incorporates a comprehensive assessment of the potential for utility acquisition of energy-efficiency resources into the regularly-scheduled Integrated Resource Planning process.
<b>6b</b>	To the extent that a utility controls the level of funding for conservation programs in its service territory, the utility should include in its action plan all best cost/risk portfolio conservation resources for meeting projected resource needs, specifying annual savings targets.	A discussion on the treatment of conservation programs is included in Chapter 3 while selection methodology is documented in Chapter 5. The action plan details conservation targets, if any, as developed through the operational business planning process. These targets are updated annually, with the most current avoided costs. Given the challenge of the low cost environment, current operational planning and program evaluation is still underway and targets for Oregon have not yet been set.
<b>6c</b>	To the extent that an outside party administers conservation programs in a utility's service territory at a level of funding that is beyond the utility's control, the utility should: 1) determine the amount of conservation resources in the best cost/ risk portfolio without regard to any limits on funding of conservation programs; and 2) identify the preferred portfolio and action plan consistent with the outside party's projection of conservation acquisition.	Not applicable. See the response for 5.b above.
<b>Guideline 7: Demand Response</b>		
<b>7</b>	Plans should evaluate demand response resources, including voluntary rate programs, on par with other options for meeting energy, capacity, and transmission needs (for electric utilities) or gas supply and transportation needs (for natural gas utilities).	Avista has periodically evaluated conceptual approaches to meeting capacity constraints using demand-response and similar voluntary programs. Technology, customer characteristics and cost issues are hurdles for developing effective programs. See Chapter 3 Demand Response section for more discussion.
<b>Guideline 8: Environmental Costs</b>		
<b>8</b>	Utilities should include, in their base-case analyses, the regulatory compliance costs they expect for CO <sub>2</sub> , NO <sub>x</sub> , SO <sub>2</sub> , and Hg emissions. Utilities should analyze the range of potential CO <sub>2</sub> regulatory costs in Order No. 93-695, from \$0 - \$40 (1990\$). In addition, utilities should perform sensitivity analysis on a range of reasonably possible cost adders for NO <sub>x</sub> , SO <sub>2</sub> , and Hg, if applicable.	Avista's current direct gas distribution system infrastructure does not result in any CO <sub>2</sub> , NO <sub>x</sub> , SO <sub>2</sub> , or Hg emissions. Upstream gas system infrastructure (pipelines, storage facilities, and gathering systems) do produce CO <sub>2</sub> emissions via compressors

		used to pressurize and move gas throughout the system. The Environmental Externalities discussion in Appendix 3.2 describes our analysis performed. See also the guidelines addendum reflecting revised guidance for environmental costs per Order 08-339.
<b>Guideline 9: Direct Access Loads</b>		
<b>9</b>	An electric utility's load-resource balance should exclude customer loads that are effectively committed to service by an alternative electricity supplier.	Not applicable to Avista's gas utility operations.
<b>Guideline 10: Multi-state utilities</b>		
<b>10</b>	Multi-state utilities should plan their generation and transmission systems, or gas supply and delivery, on an integrated-system basis that achieves a best cost/risk portfolio for all their retail customers.	The 2014 IRP conforms to the multi-state planning approach.
<b>Guideline 11: Reliability</b>		
<b>11</b>	Electric utilities should analyze reliability within the risk modeling of the actual portfolios being considered. Loss of load probability, expected planning reserve margin, and expected and worst-case unserved energy should be determined by year for top-performing portfolios. Natural gas utilities should analyze, on an integrated basis, gas supply, transportation, and storage, along with demand-side resources, to reliably meet peak, swing, and base-load system requirements. Electric and natural gas utility plans should demonstrate that the utility's chosen portfolio achieves its stated reliability, cost and risk objectives.	Avista's storage and transport resources while planned around meeting a peak day planning standard, also provides opportunities to capture off season pricing while providing system flexibility to meet swing and base-load requirements. Diversity in our transport options enables at least dual fuel source options in event of a transport disruption. For areas with only one fuel source option the cost of duplicative infrastructure is not feasible relative to the risk of generally high reliability infrastructure.
<b>Guideline 12: Distributed Generation</b>		
<b>12</b>	Electric utilities should evaluate distributed generation technologies on par with other supply-side resources and should consider, and quantify where possible, the additional benefits of distributed generation.	Not applicable to Avista's gas utility operations.
<b>Guideline 13: Resource Acquisition</b>		
<b>13a</b>	An electric utility should: identify its proposed acquisition strategy for each resource in its action plan; Assess the advantages and disadvantages of owning a resource instead of purchasing power from another party; identify any Benchmark Resources it plans to consider in competitive bidding.	Not applicable to Avista's gas utility operations.



<b>13b</b>	Natural gas utilities should either describe in the IRP their bidding practices for gas supply and transportation, or provide a description of those practices following IRP acknowledgment.	A discussion of Avista's procurement practices is detailed in Chapter 4.
<b>Guideline 8: Environmental Costs</b>		
<b>a.</b>	<b>BASE CASE AND OTHER COMPLIANCE SCENARIOS:</b> The utility should construct a base-case scenario to reflect what it considers to be the most likely regulatory compliance future for carbon dioxide (CO <sub>2</sub> ), nitrogen oxides, sulfur oxides, and mercury emissions. The utility also should develop several compliance scenarios ranging from the present CO <sub>2</sub> regulatory level to the upper reaches of credible proposals by governing entities. Each compliance scenario should include a time profile of CO <sub>2</sub> compliance requirements. The utility should identify whether the basis of those requirements, or "costs", would be CO <sub>2</sub> taxes, a ban on certain types of resources, or CO <sub>2</sub> caps (with or without flexibility mechanisms such as allowance or credit trading or a safety valve). The analysis should recognize significant and important upstream emissions that would likely have a significant impact on its resource decisions. Each compliance scenario should maintain logical consistency, to the extent practicable, between the CO <sub>2</sub> regulatory requirements and other key inputs.	Avista's current direct gas distribution system infrastructure does not result in any CO <sub>2</sub> , NO <sub>x</sub> , SO <sub>2</sub> , or Hg emissions. Upstream gas system infrastructure (pipelines, storage facilities, and gathering systems) do produce CO <sub>2</sub> emissions via compressors used to pressurize and move gas throughout the system.  The Environmental Externalities discussion in Appendix 3.2 describes our process for addressing these costs.
<b>b.</b>	<b>TESTING ALTERNATIVE PORTFOLIOS AGAINST THE COMPLIANCE SCENARIOS:</b> The utility should estimate, under each of the compliance scenarios, the present value of revenue requirement (PVRR) costs and risk measures, over at least 20 years, for a set of reasonable alternative portfolios from which the preferred portfolio is selected. The utility should incorporate end-effect considerations in the analyses to allow for comparisons of portfolios containing resources with economic or physical lives that extend beyond the planning period. The utility should also modify projected lifetimes as necessary to be consistent with the compliance scenario under analysis. In addition, the utility should include, if material, sensitivity analyses on a range of reasonably possible regulatory futures for nitrogen oxides, sulfur oxides, and mercury to further inform the preferred portfolio selection.	The Environmental Externalities discussion in Appendix 3.2 describes our process for addressing these costs.

## APPENDIX 2.1: ECONOMIC OUTLOOK AND CUSTOMER COUNT FORECAST

### I. Service Area Economic Performance and Outlook

Avista’s core service area for natural gas includes Eastern Washington, Northern Idaho, and Southwest Oregon. Smaller service islands are also located in rural South-Central Washington and Northeast Oregon. Our service area is dominated by four metropolitan statistical areas (MSAs): the Spokane-Spokane Valley, WA MSA (Spokane-Stevens counties); the Coeur d’Alene, ID MSA (Kootenai County); the Lewiston-Clarkson ID-WA, MSA (Nez Perce-Asotin counties); and the Medford, OR MSA (Jackson County). These four MSAs represent the primary demand for Avista’s natural gas and account for 75% of both customers (i.e., meters) and load. The remaining 25% of customers and load are spread over low density rural areas in all three states.

Figure 1: Employment and Population Recovery, December 2007- December 2015

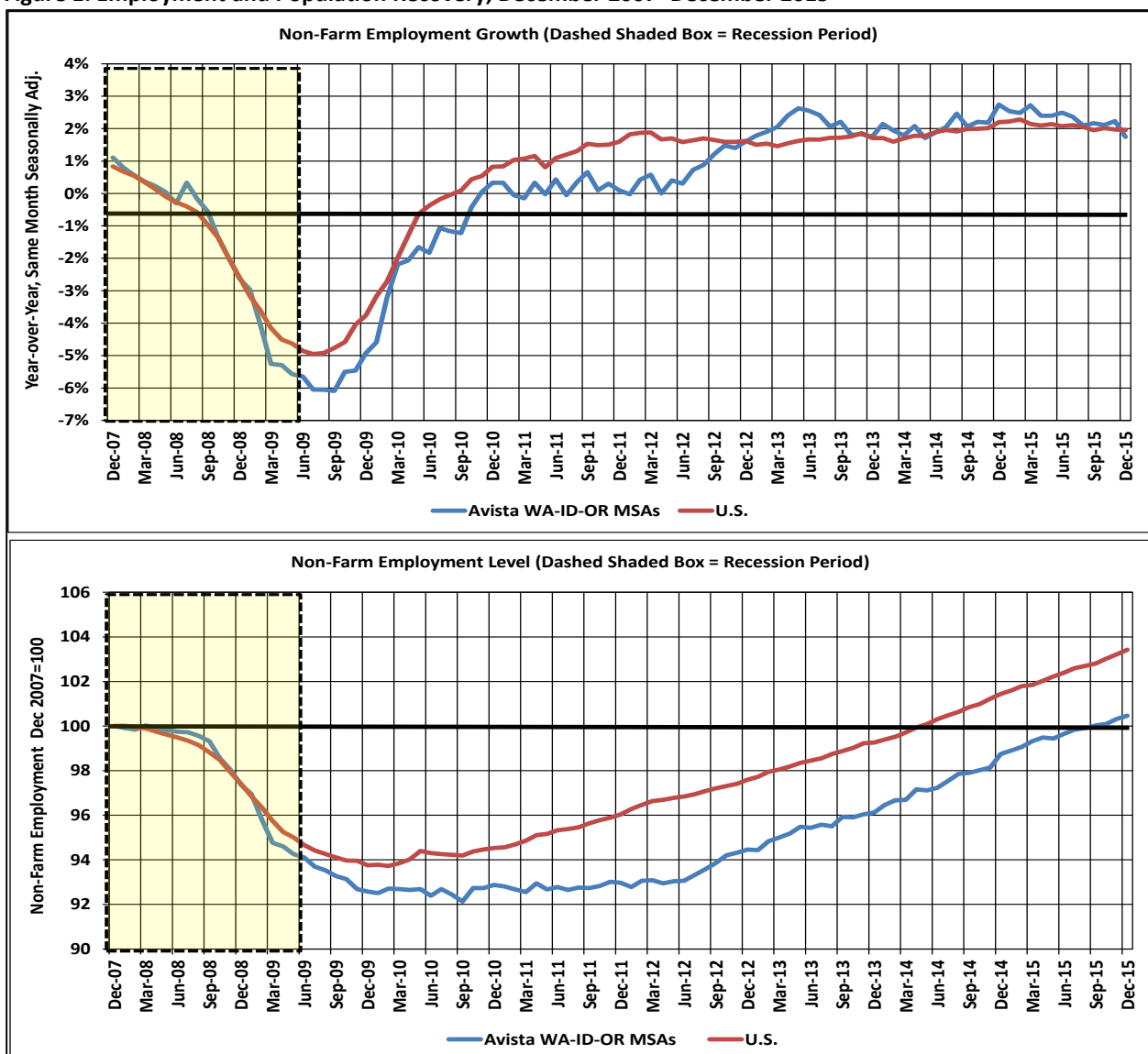

Data source: Employment from the BLS; population from the U.S. Census.

In the wake of the Great Recession, our service area recovered more slowly than the U.S. Although the U.S. recession officially ended in June 2009 (dated by the National Bureau of Economic Research), our service area did not start a significant employment recovery until the second half of 2012 (Figure 1, top and bottom graph).

However, by the start of 2015, year-over-year employment growth slightly exceeded U.S. growth and employment levels returned to pre-recession levels. As a result, service area population growth, which is significantly influenced by in-migration through employment opportunities, also improved in 2014 and 2015 (Figure 2).

**Figure 2: Avista MSA Annual Population Growth, 2005-2015**

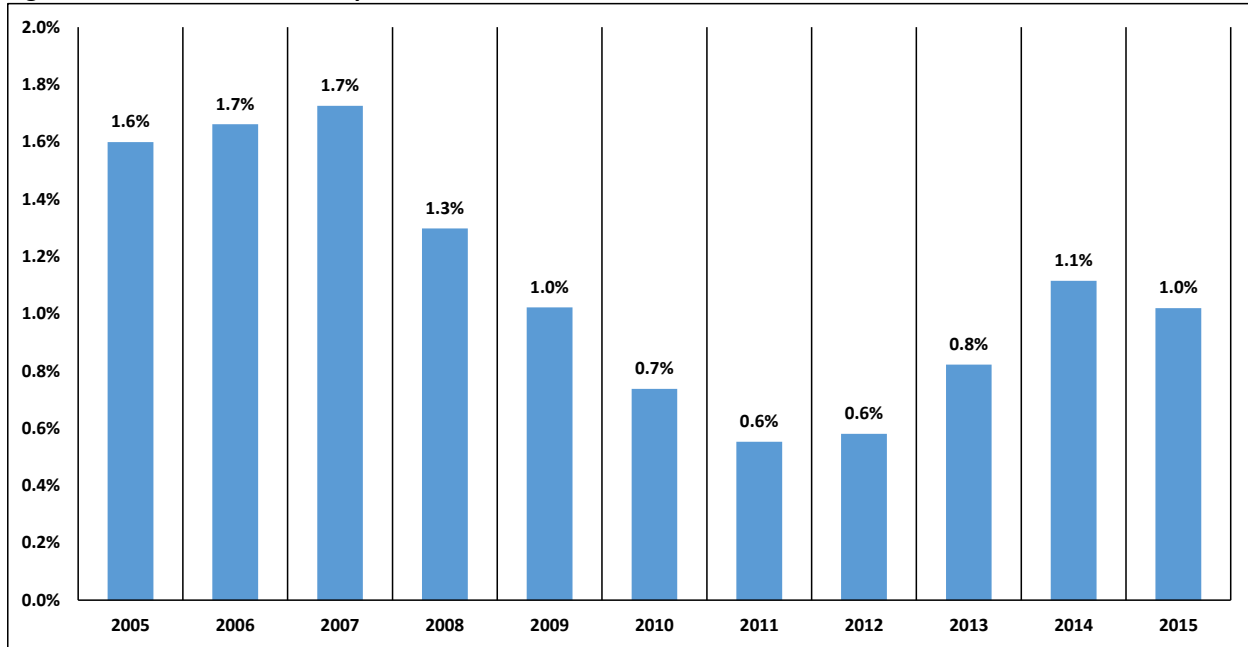

In 2011, Avista's MSA population growth fell to around 0.6%, the lowest since the late 1980s, but has increased to around 1% by 2014. This is important because population growth is a significant contributor to overall customer growth.

Figure 3 shows that compared to forecasted customer growth in the 2014 IRP, actual average customer growth over the 2014-2015 period has been slightly higher, reflecting stronger than expected service area growth. Given the improving economy and increased population growth, this IRP, compared to the 2014 IRP, shows an upward revision of approximately 5,500 forecasted customers in WA-ID and 7,000 in OR by 2035 (Figure 4). System-wide, this is an upward revision of approximately 12,500 customers. Table 1 shows the change in the customer forecast by class between the 2016 and 2014 IRPs for WA-ID, OR, and system-wide.

Figure 3: Comparison of 2014-IRP Customer Growth Forecasts to Actuals, 2014-2015

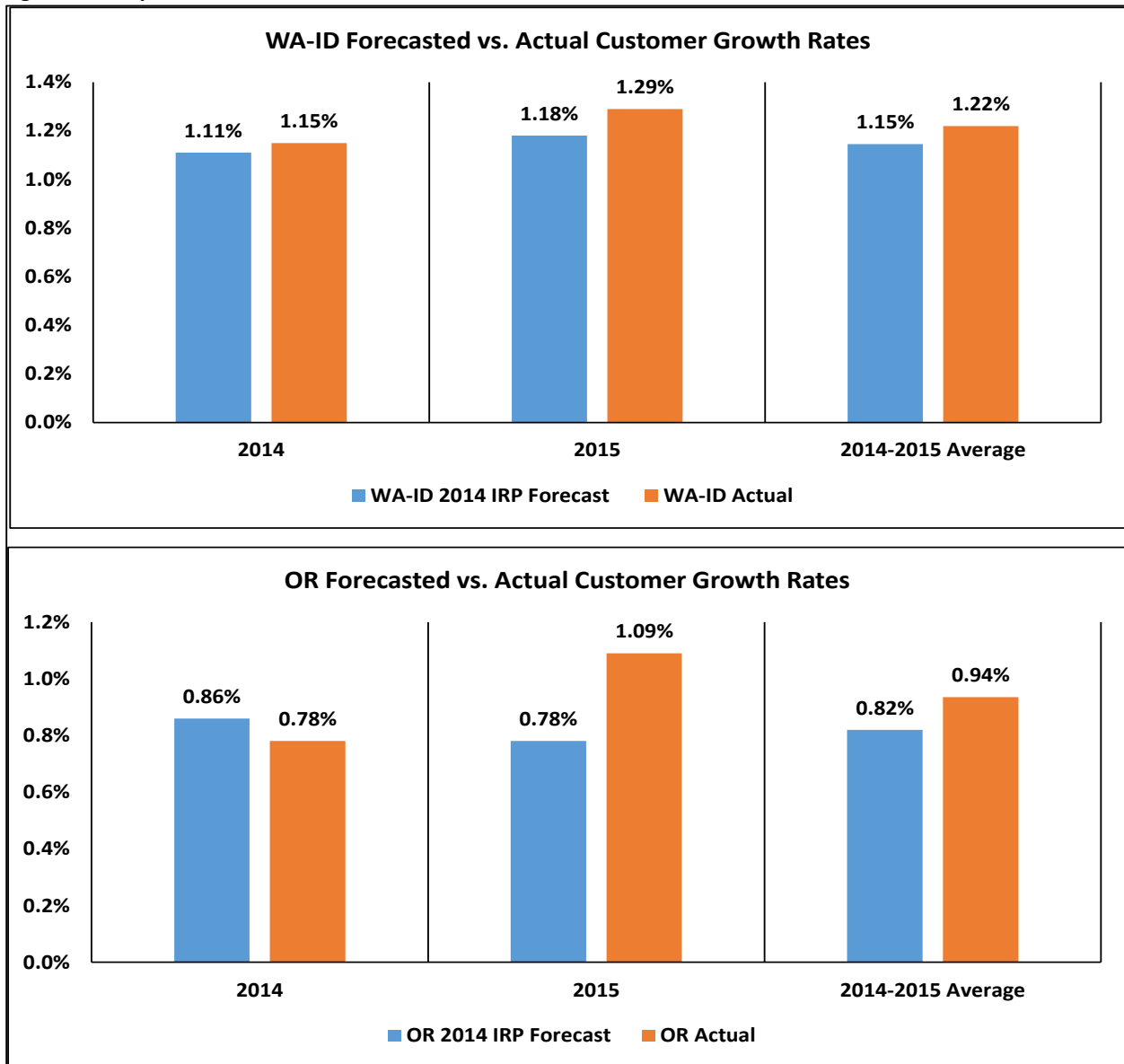

Data source: Company data.

Table 1: Change in Forecast between the 2016 IRP and 2014 IRP in 2035

Area	Residential	Commercial	Industrial	Total Change
WA-ID	+7,394	-1,928	+30	+5,496
OR	+6,980	+38	-1	+7,017
System	+14,374	-1,890	+29	+12,513

This upward revision in residential customers reflects two factors. First, the recent economic and population recovery has resulted in a higher population forecast, which is a significant forecast driver of residential customer growth. That is, population growth is a proxy for new household formation. Second, the forecast methodology for residential customers has been improved so that growth through retrofitting is better captured. In this context, retrofitting means existing households adding natural gas as an energy source. Therefore, new customers are generated through new households that build-in gas as an energy source and older households retrofitting with gas. This can be seen in Figure 5 (top graph WA-ID; bottom graph OR). Excluding the weak post-recession recovery period (2009-2011), annual residential customer growth exceeds population growth. The convergence of customer and population growth in the 2009-2011 period reflects a decline in retrofitting due to lower

discretionary spending by households. From 2005 to 2015, the average customer-population growth spread in WA-ID and OR was 0.5%.

**Figure 4: Comparison IRP Forecasted Customer Growth in WA-ID and OR, 2016-2035**

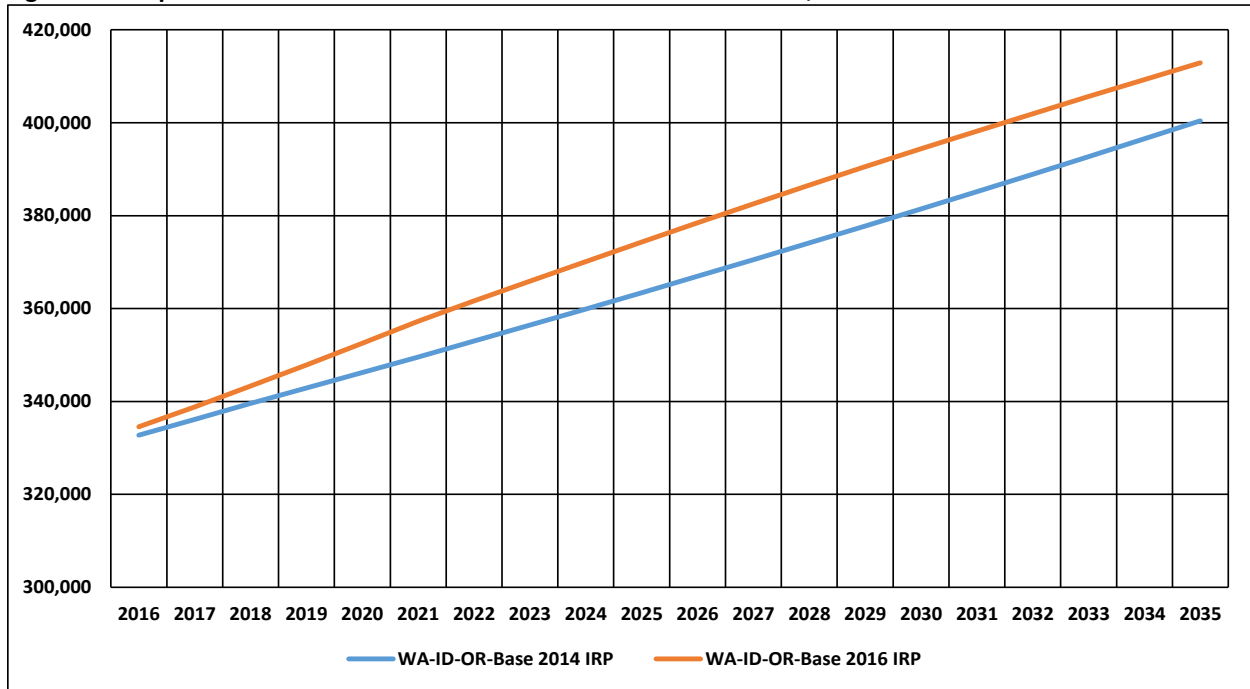

Data source: Company data.

Again referring to Table 1, although the improving economic conditions increased the forecast for residential customers, this is not the case for commercial customers in WA-ID. The current modeling approach for the majority of commercial customers *assumes* that residential customer growth is a driver of commercial customer growth. The use of residential customers as forecast driver for commercial customers reflects the historically high correlation between residential and commercial customer growth rates. However, in the case of WA-ID, the relative ratio of annual (firm) commercial customer growth to firm residential growth has been on a downward trend since 2009. This ratio is shown in Figure 6 for the 2005-2015 period and includes OR for comparison. Note that the ratios for both areas declined following the start of the great recession.

Figure 5: Customer and Population Growth, 2005-2015

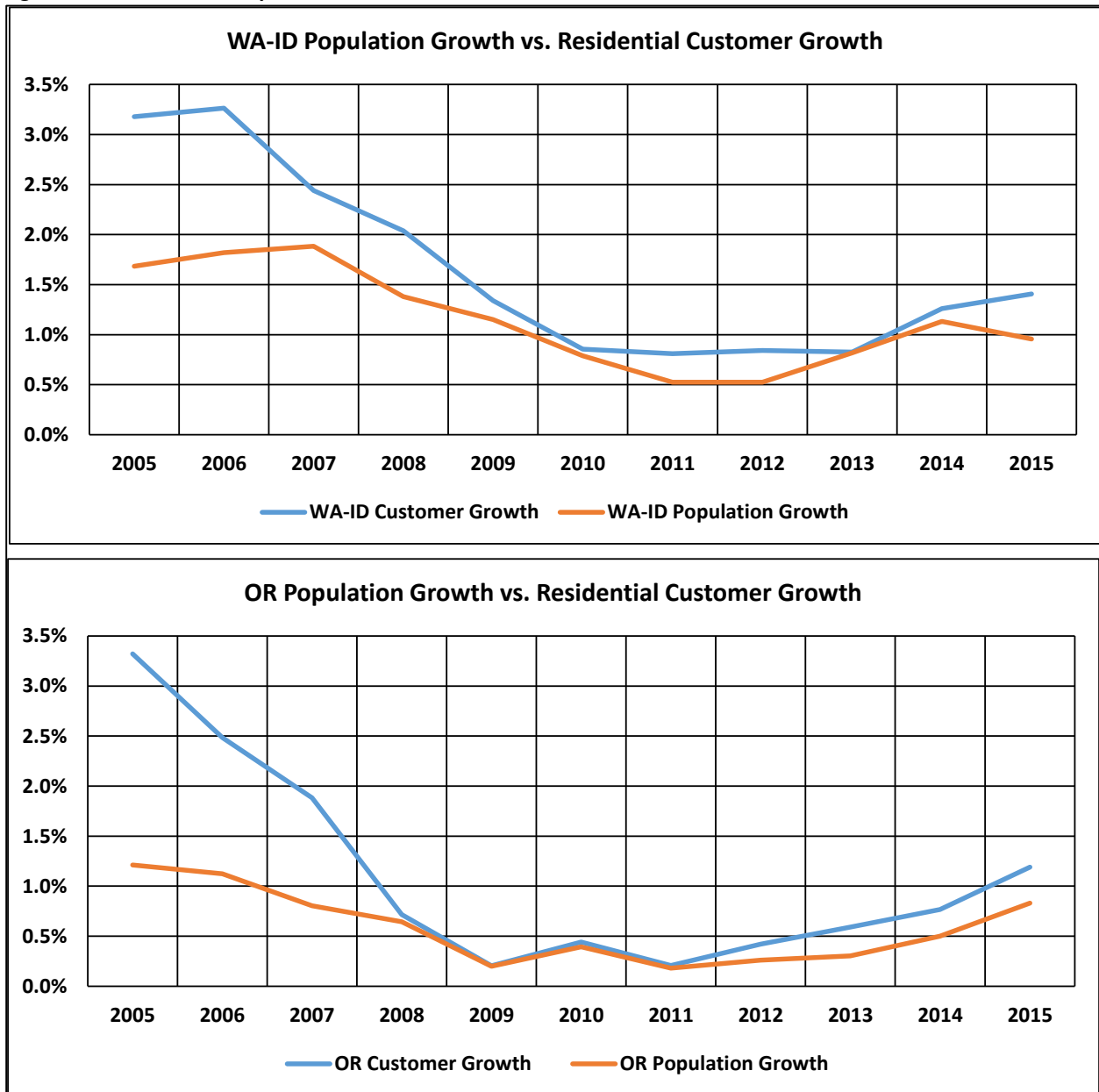

Data source: Company data.

OR's fell fairly dramatically, but rebounded starting in 2012. In contrast, WA-ID's continued its downward trend after a brief rebound in 2012. For an econometric forecasting perspective, this means a given increase in WA-ID residential customers is associated with a smaller change in commercial customers compared to the pre-Great Recession period. As a result, the upward revision in residential customers in WA-ID did not result in an upward revision in commercial customers.

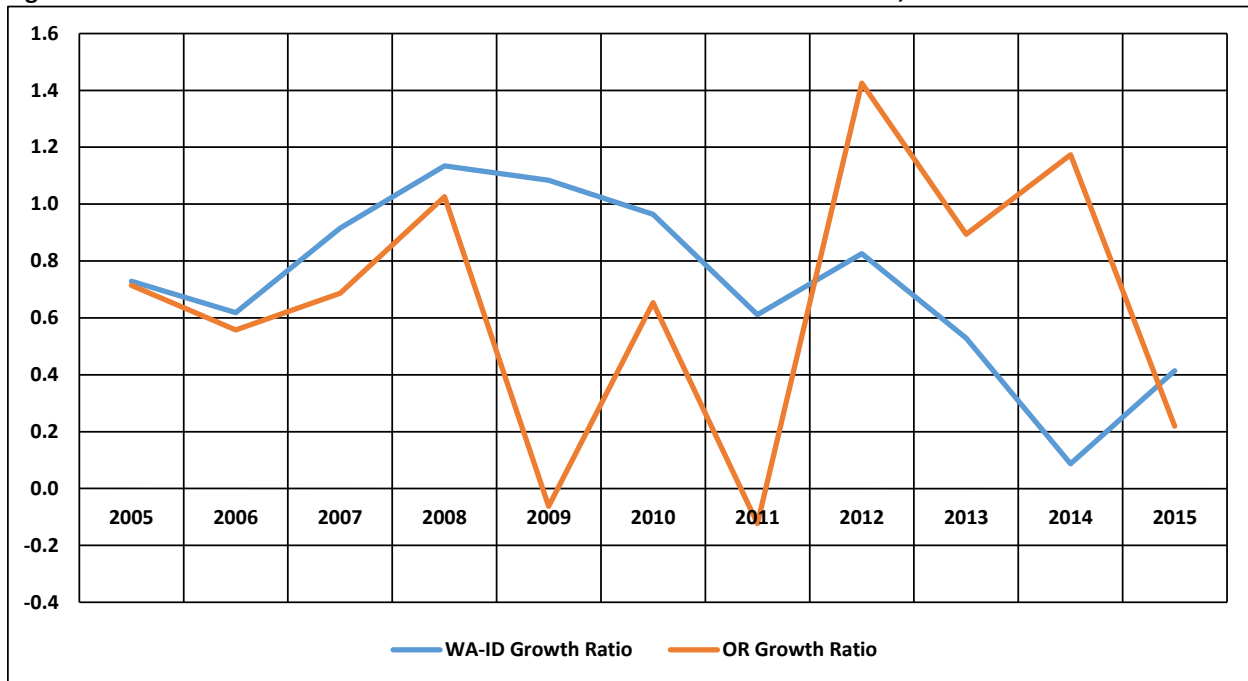
**Figure 6: Ratio of Commercial Customer Growth to Residential Customer Growth, 2005-2015**

Data source: Company data.

The forecast for system-wide industrial customers is slightly higher than the 2014 IRP. This reflects an increase in the WA-ID forecast; as of 2015, approximately 90% of industrial customers are in WA-ID. Figure 7 (top graph) shows total system-wide firm industrial customers since 2004. Following a sharp drop over the 2004-2006 period, firm industrial customers have remained stable at around 260. Separating out WA-ID and OR (middle graph), the number of firm customers in WA-ID continuously fell over the 2004-2011 period. In contrast, OR customers increased over the 2004-2011 period (bottom graph). However, since 2011 the customer counts in both regions have been relatively flat. That is, over the last five years there has been no appreciable change in firm industrial customers our service area. Therefore, in contrast to the 2014 IRP, the current forecast shows flat rather than declining industrial customers.

Figure 7: Industrial Customer Count, 2004-2015



Data source: Company data.



## II. IRP Forecast Process and Methodology

The customer forecasts are generated from forecasting models that are either regression models with ARIMA error corrections or simple smoothing models. The ARIMA error correction models are estimated using SAS/ETS software. The customer forecasts are used as input into Sendout® to generate the IRP load forecasts. Population growth is the key driver for the residential and commercial customer forecasts. Other variables include (1) seasonal dummy variables and (2) outlier dummy variables that control for extreme customer counts associated with double billing, software conversions, and customer movements from one billing schedule to another.

Population growth forecast is the key driver behind the customer forecast for residential schedules 101 in WA-ID and 410 in OR. These two schedules represent the majority of customers and, therefore, drive overall residential customer growth. Because of their size and growth potential, a multi-step forecasting process has been developed for the Spokane-Spokane Valley, Coeur d’Alene, and Medford MSAs. The process for forecasting population growth starts with an intermediate forecast horizon (six years). This intermediate forecast is typically used for the annual financial forecast. However, during IRP years, this intermediate forecast horizon is augmented with third party forecasts that cover the next twenty years. Starting with Figure 8, the six-year population forecast is a multi-step process that begins with a GDP forecast that drives the regional employment forecast, which in turn, drives a six year population forecast.

**Figure 8: Forecasting Population Growth, 2016-2021**

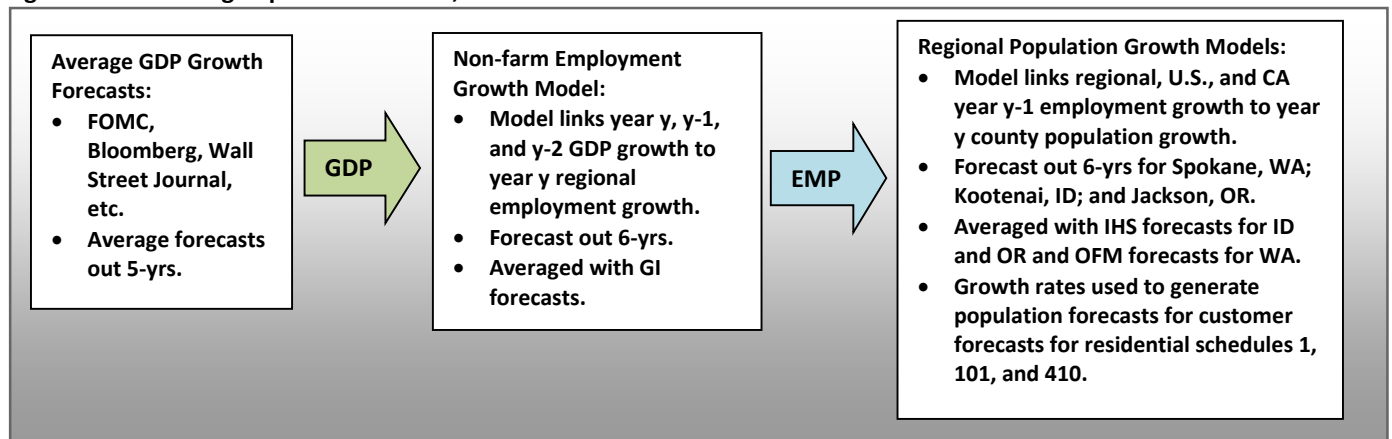

The forecasting models for regional employment growth are:

$$[1] GEMP_{y,SPK} = \vartheta_0 + \vartheta_1GGDP_{y,US} + \vartheta_2GGDP_{y-1,US} + \vartheta_3GGDP_{y-2,US} + \omega_{SC}D_{KC,1998-2000=1} + \omega_{SC}D_{HB,2005-2007=1} + \epsilon_{t,y}$$

$$[2] GEMP_{y,KOOT} = \delta_0 + \delta_1GGDP_{y,US} + \delta_2GGDP_{y-1,US} + \delta_3GGDP_{y-2,US} + \omega_{OL}D_{1994=1} + \omega_{OL}D_{2009=1} + \omega_{SC}D_{HB,2005-2007=1} + \epsilon_{t,y}$$

$$[3] GEMP_{y,JACK} = \phi_0 + \phi_1GGDP_{y,US} + \phi_2GGDP_{y-1,US} + \phi_3GGDP_{y-2,US} + \omega_{SC}D_{HB,2004-2005=1} + ARIMA\epsilon_{t,y}(1,0,0)(0,0,0)_{12}$$

SPK is Spokane, WA (Spokane MSA), KOOT is Kootenai, ID (Coeur d’Alene MSA), and JACK is for Jackson County, OR (Medford MSA).  $GEMP_y$  is employment growth in year y,  $GGDP_{y,US}$  is U.S. real GDP growth in year y.  $D_{KC}$  is a dummy variable for the collapse of Kaiser Aluminum in Spokane, and  $D_{HB}$  is a dummy for the housing bubble, specific to each region. The average GDP forecasts are used in the estimated model to generate five-year employment growth forecasts. The employment forecasts are then averaged with GI’s forecasts for the same counties so that:

$$[4] F_{Avg}(GEMP_{y,SPK}) = \frac{F(GEMP_{y,SPK}) + F(GGIEMP_{y,SPK})}{2}$$

$$[5] F_{Avg}(GEMP_{y,KOOT}) = \frac{F(GEMP_{y,KOOT}) + F(GGIEMP_{y,KOOT})}{2}$$

$$[6] F_{Avg}(GEMP_{y,JACK}) = \frac{F(GEMP_{y,JACK}) + F(GGIEMP_{y,JACK})}{2}$$

Averaging reduces the systematic errors of a single-source forecast. The averages [8.4] through [8.6] are used to generate the population growth forecasts, which are described next.

The forecasting models for regional population growth are:

$$[7] GPOP_{y,SPK} = \kappa_0 + \kappa_1 GEMP_{y-1,SPK} + \kappa_2 GEMP_{y-2,US} + \omega_{OL} D_{2001=1} + \epsilon_{t,y}$$

$$[8] GPOP_{y,KOOT} = \alpha_0 + \alpha_1 GEMP_{y-1,KOOT} + \alpha_2 GEMP_{y-2,US} + \omega_{OL} D_{1994=1} + \omega_{OL} D_{2002=1} + \omega_{SC} D_{HB,2007\uparrow=1} + \epsilon_{t,y}$$

$$[9] GPOP_{y,JACK} = \psi_0 + \psi_1 GEMP_{y-1,JACK} + \psi_2 GEMP_{y-2,CA} + \omega_{OL} D_{1991=1} + \omega_{SC} D_{HB,2004-2006=1} + \epsilon_{t,y}$$

$D_{2001=1}$  and  $D_{1991=1}$  are a dummy variables for recession impacts.  $GEMP_{y-1,US}$  is U.S. employment growth in year  $y-1$  and  $GEMP_{y-2}$ , and CA is California Employment growth in year  $y-1$ . Because of its close proximity to CA, CA employment growth is better predictor of Jackson, OR employment growth than U.S. growth. The averages [4] through [6] are used in [7] through [9] to generate population growth forecasts. These forecasts are combined with IHS's forecasts for Kootenai, ID and Jackson, OR and the Office for Financial Management (OFM) for Spokane, WA in the form of a simple average:

$$[10] F_{Avg}(GPOP_{y,SPK}) = \frac{F(GPOP_{y,SPK}) + F(GOFMPOP_{y,SPK})}{2}$$

$$[11] F_{Avg}(GPOP_{y,KOOT}) = \frac{F(GPOP_{y,KOOT}) + F(GGIPOP_{y,KOOT})}{2}$$

$$[12] F_{Avg}(GPOP_{y,JACK}) = \frac{F(GPOP_{y,JACK}) + F(GGIPOP_{y,JACK})}{2}$$

Here,  $F_{Avg}(GPOP_y)$  is used to forecast population to forecast residential customers in schedules 101 (WA-ID) and 410 (OR) for the Spokane, Kootenai, and Medford areas. In the case of Spokane, OFM forecasts are used because the IHS's forecasts exhibit a level and time-path that is inconsistent with recent population behavior. The population growth forecasts for the Douglas (Roseburg), Klamath (Klamath Falls); and Union (La Grande) counties come directly from IHS. Since all forecasted growth rates are annualized, they are converted to monthly rates as  $F_{Avg}(GPOP_{t,y}) = [1 + F_{Avg}(GPOP_y)]^{1/12} - 1$ . By way of example, the following is regression model for residential 101 customers for the Spokane region:

$$C_{t,y,WA101,r} = \alpha_0 + \tau POP_{t,y,SPK} + \omega_{SD} D_{t,y} + \omega_{SC} D_{Jan\ 2007\uparrow=1} + \gamma_{RAMP} T_{Jan\ 2007} + \omega_{OL} D_{Aug\ 2010=1} + \omega_{OL} D_{Sept\ 2012=1} + \omega_{OL} D_{Feb\ 2015=1} + \omega_{OL} D_{Oct\ 2015=1} + ARIMA\epsilon_{t,y}(9,1,0)(0,0,0)_{12}$$

Where:

$\tau POP_{t,y,SPK} = \tau$  is the coefficient to be estimated and  $POP_{t,y,SPK}$  is the interpolated population level in month  $t$ , in year  $y$ , for Spokane. The monthly interpolation of historical data assumes that between years, population accumulates following the standard population growth model:  $POP_{y,SPK} = POP_{y-1,SPK} e^r$ .

$\omega_{SD} D_{t,y} = \omega_{SD}$  is a vector of seasonal dummy (SD) coefficients to be estimated and  $D_{t,y}$  is a vector monthly seasonal dummies to account of customer seasonality.  $D_{t,y} = 1$  for the relevant month.

$\omega_{SC} D_{Jan\ 2007\uparrow=1} + \gamma_{Ramp} T_{Jan\ 2007} =$  structural change (SC) and trend (Ramp) coefficients and variables that control for the sharp fall in residential customer growth that cannot be fully accounted for by the population variable. This reflects the impact of the housing bubble collapse and the subsequent Great Recession.  $D_{Jan\ 2007\uparrow=1}$  takes a value of 1 over both the estimation and forecast period starting in January 2007, and  $T_{Jan\ 2007}$  is a linear time-trend that starts in January 2007 and continues over the estimation and forecast period.

$\omega_{OL} D_{Aug\ 2010=1} = \omega_{OL}$  outlier (OL) coefficient to be estimated and D is a dummy that equals 1 for August 2010. There are three additional outlier dummies that follow August 2010.

$ARIMA_{\epsilon,t,y}(9,1,0)(0,0,0)_{12}$  is the error correction applied to the model's initial error structure. This term follows the following from  $ARIMA_{\epsilon,t,y}(p,d,q)(p_k,d_k,q_k)_k$ . The term p is the autoregressive (AR) order, d is the differencing order, and q is the moving average (MA) order. The term  $p_k$  is the order of seasonal AR terms,  $d_k$  is the order of seasonal differencing, and  $q_k$  is the seasonal order of MA terms. The seasonal values are related to "k," which is the frequency of the data. With the current data set,  $k = 12$ .

The customer forecast is generated by inputting forecasted values of  $POP_{t,y,SPK}$  into the model estimated with historical data. All customer forecast equations are shown in the last section.

The above describes the population forecast for the annual six-year forecast. For IRP years, the customer forecast needs to be extended out an additional 15 years beyond the five-year forecast. This is done using the IHS population forecast for Kootenai, Jackson, Douglas, Klamath, and Union counties. That is, IHS is the sole source for forecasted population growth beyond the six-year time horizon generated by [10] through [12]. In the case of Spokane County, the forecast from Washington's Office of Financial Management (OFM) is instead of IHS's. The choice to use OFM's forecasts reflects the unusually sharp changes that have occurred in the IHS forecasts for the Spokane MSA over a short period of time. Figure 9 shows how much these forecasts have changed in level and shape since June 2012. Between the October 2015 and March 2016 forecasts, there was as significant change for the 2015-2019 period. There is no clear rationale for why IHS's forecasts can change so significantly between 2012 and 2016.

**Figure 10: Spokane MSA Forecast Comparison**

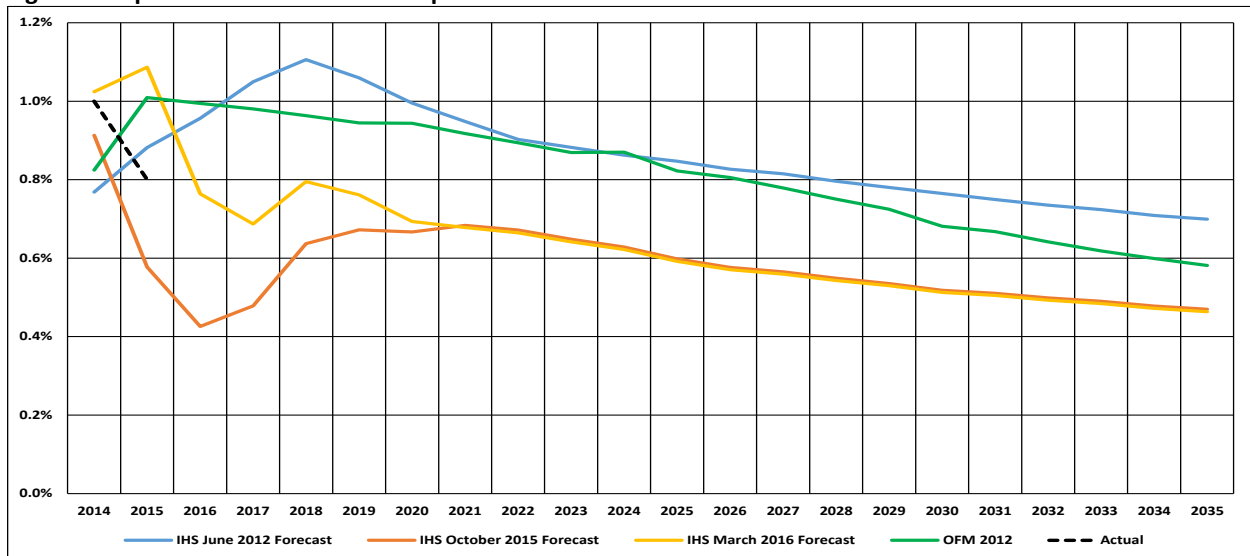

Data source: IHS, Washington State of Office of Financial Management, and U.S. Census.

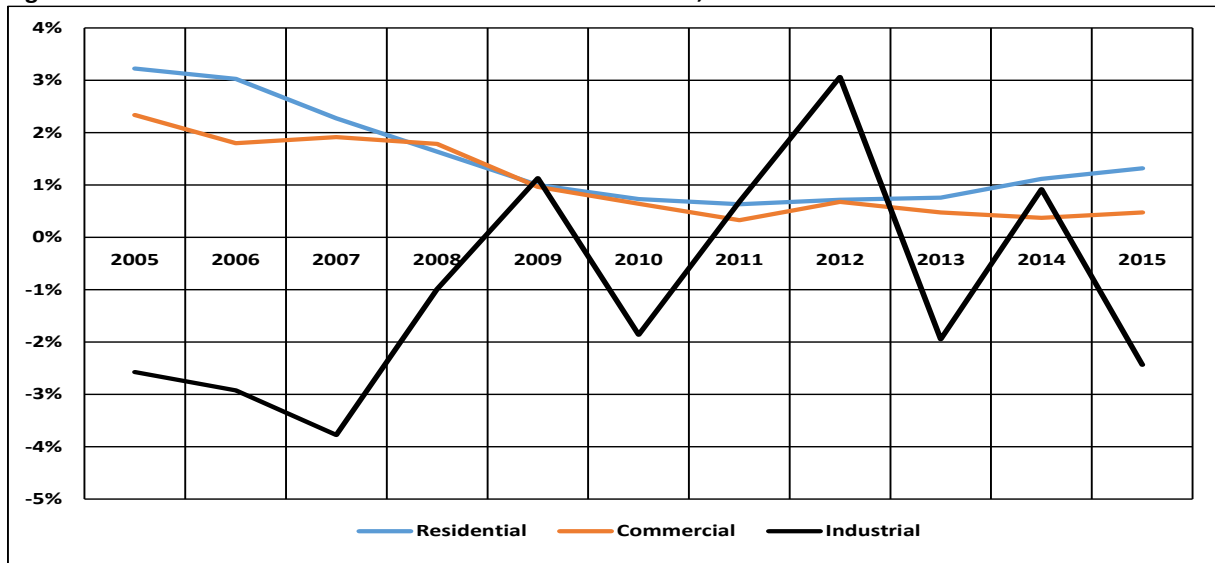
**Figure 10: Annual Customer Growth for the Three Rate Classes, 2005-2015**

Data source: Company data.

Figure 10 demonstrates that residential and commercial growth rates are highly correlated and maintain similar levels over the long-run—both classes’ growth rates averaged about 1% over this period. This growth is slightly higher than population growth because of the housing boom and existing households retrofitting with natural gas. However, by 2009, with the collapse of the housing bubble and increased natural gas saturation, customer growth moved closer to population growth.

In contrast, the behavior of Industrial customer growth looks quite different. Customer growth is both lower and more volatile. The average growth rate since 2005 is -1.0%, reflecting a trend of nearly flat or slowly declining customers, depending on the jurisdiction. In addition, the standard deviation of year-over-year growth is 2.1% compared to 0.9% for residential and 0.7% for commercial growth. The current IRP forecast reflects this historical trend of weak growth. Some energy industry analysts believe the U.S.’s increased supply of natural gas and oil will attract industrial production back from overseas locations. However, in this IRP, we do not assume plentiful energy supplies in the U.S. will alter long-run trends in industrial customer growth in our service area.

#### ***Establishing High-Low Cases for IRP Customer Forecast***

The customer forecasts for this IRP include high and low cases that set the expected bounds around the base-case. Table 2 shows the base, low, and high customer forecasts along with the underlying population growth assumption. The underlying population forecast is the primary driver for each of the three cases.

**Table 2: Alternative Growth Cases**

Area	Low Growth	Base Growth	High Growth
WA-ID:			
WA-ID Customers	0.6%	1.1%	1.5%
WA Population	0.4%	0.8%	1.2%
ID Population	1.0%	1.5%	2.0%
OR:			
OR Customers	0.7%	1.2%	1.6%
OR Population	0.4%	0.8%	1.3%
System:			
System Customers	0.7%	1.1%	1.5%
System Population	0.5%	0.9%	1.3%

### III. IRP Customer Forecast Equations

#### 1. Washington and Idaho Residential Forecasting Models by Schedule

WA residential customer forecasts:

$$[13] C_{t,y,WA101.r} = \alpha_0 + \tau POP_{t,y,SPK} + \omega_{SD} D_{t,y} + \omega_{SC} D_{Jan\ 2007 \uparrow = 1} + \gamma_{RAMP} T_{Jan\ 2007} + \omega_{OL} D_{Aug\ 2010 = 1} + \omega_{OL} D_{Sept\ 2012 = 1} + \omega_{OL} D_{Feb\ 2015 = 1} + \omega_{OL} D_{Oct\ 2015 = 1} + ARIMA_{\epsilon_{t,y}}(9,1,0)(0,0,0)_{12}$$

[13] Model notes:

1. SC dummy and ramping time trend control for a change in the time-path of customer growth starting in January 2007.

$$[14] C_{t,y,WA111.r} = \alpha_0 + \gamma_{RAMP} T_{Sept\ 2010} + \omega_{SC} D_{Oct\ 2011 \uparrow = 1} + \omega_{SC} D_{Oct\ 2013 \uparrow = 1} + \omega_{OL} D_{Mar\ 2005 = 1} + \omega_{OL} D_{Dec\ 2006 = 1} + \omega_{OL} D_{Jan\ 2007 = 1} + \omega_{OL} D_{Sept\ 2007 = 1} + \omega_{OL} D_{Nov\ 2007 = 1} + \omega_{OL} D_{Oct\ 2011 = 1} + \omega_{OL} D_{Jan\ 2015 = 1} + \omega_{OL} D_{Feb\ 2015 = 1} + \omega_{OL} D_{Apr\ 2015 = 1} + \omega_{OL} D_{Oct\ 2015 = 1} + ARIMA_{\epsilon_{t,y}}(1,1,0)(0,0,0)_{12} \text{ for } t, y = Feb\ 2007 \uparrow$$

[14] Model notes:

1. Ramping time trend controls for a change in the time-path of customer growth starting in the September 2010.
2. SC dummies control for a step-up in customers starting in October 2011 and October 2013.
3. Model is restricted to February 2007  $\uparrow$  because of a large step-up in customers.

Similarly for ID:

$$[15] C_{t,y,ID101.r} = \beta_0 + \tau POP_{t,y,KOOT} + \omega_{SD} D_{t,y} + \omega_{SC} D_{Jan\ 2007 \uparrow = 1} + \gamma_{RAMP} T_{Jan\ 2007} + \omega_{OL} D_{May\ 2005 = 1} + \omega_{OL} D_{Jul\ 2005 = 1} + \omega_{OL} D_{Oct\ 2005 = 1} + \omega_{OL} D_{Dec\ 2005 = 1} + \omega_{OL} D_{Jun\ 2006 = 1} + \omega_{OL} D_{Jan\ 2006 = 1} + \omega_{OL} D_{Jun\ 2007 = 1} + \omega_{OL} D_{Nov\ 2007 = 1} + \omega_{OL} D_{Aug\ 2009 = 1} + \omega_{OL} D_{Aug\ 2011 = 1} + \omega_{OL} D_{Sept\ 2011 = 1} + \omega_{OL} D_{Feb\ 2015 = 1} + ARIMA_{\epsilon_{t,y}}(2,1,0)(0,0,0)_{12}$$

[15] Model notes:

1. SC dummy and ramping time trend control for a change in the time-path of customer growth starting in January 2007.

$$[16] C_{t,y,ID111.r} = \beta_0 + \omega_{SC} D_{Dec\ 2008 \uparrow = 1} + \omega_{SC} D_{Dec\ 2011 \uparrow = 1} + \omega_{OL} D_{Nov\ 2008 = 1} + \omega_{OL} D_{Mar\ 2010 = 1} + \omega_{OL} D_{Feb\ 2011 = 1} + \omega_{OL} D_{Nov\ 2011 = 1} + \omega_{OL} D_{Mar\ 2015 = 1} + ARIMA_{\epsilon_{t,y}}(9,1,0)(0,0,0)_{12}$$

[16] Model notes:

1. SC dummies control for a step-up in customers starting in December 2008 and December 2011.

#### 2. Washington and Idaho Commercial Forecasting Models by Schedule

Commercial customer baseline forecasts are a mix of simple ARIMA and smoothing models. The WA models are:

$$[17] C_{t,y,WA101.c} = \alpha_0 + \alpha_1 C_{t,y,WA101.r} + \omega_{SD} D_{t,y} + \omega_{OL} D_{Feb\ 2015 = 1} + ARIMA_{\epsilon_{t,y}}(1,1,0)(0,0,0)_{12}$$

[17] Model notes:

1.  $C_{t,y,WA101.r}$  are residential customers from residential schedule 101. They are being used as a forecast driver because of the historical positive correlation between residential and commercial customer growth.

$$[18] C_{t,y,WA111.c} = \alpha_0 + \omega_{SD} D_{t,y} + \omega_{OL} D_{Jan\ 2007 = 1} + \omega_{OL} D_{Oct\ 2013 = 1} + \omega_{OL} D_{Feb\ 2015 = 1} + \omega_{OL} D_{Apr\ 2015 = 1} + \omega_{OL} D_{Dec\ 2015 = 1} + ARIMA_{\epsilon_{t,y}}(2,1,0)(0,0,0)_{12}$$

[18] Model notes:

1. Distribution of error terms not quite normal; however, they do pass the white-noise test.

$$[19] C_{t,y,WA121+122.c} = \frac{1}{12} \sum_{j=1}^{12} C_{t-j}$$

[19] Model notes:

1. Customer count is around 25 without any clear trend or seasonality. For unknown reasons, customer county volatility fell substantially in January 2012.
2. Due to the Compass software conversion, February 2015 is excluded from the historical data. The conversion resulted in a double counting of customers in February 2015. Therefore, including this month leads to a significant over-forecast of customers.

$$[20] C_{t,y,WA132.c} = C_{t-1}$$

[20] Model notes:

1. Stable customer count; no econometric model required. Customer count has been at 2 since December 2012.

Similarly for ID:

$$[21] C_{t,y,ID101.c} = \beta_0 + \beta_1 C_{t,y,ID101.r} + \omega_{SD} D_{t,y} + \omega_{SC} D_{Nov\ 2005\uparrow=1} + \omega_{SC} D_{Sep\ 2006\uparrow=1} + \omega_{SC} D_{Nov\ 2007\uparrow=1} + \omega_{OL} D_{Mar\ 2005=1} + \omega_{OL} D_{Jun\ 2005=1} + \omega_{OL} D_{Oct\ 2005=1} + \omega_{OL} D_{Dec\ 2005=1} + \omega_{OL} D_{Mar\ 2007=1} + \omega_{OL} D_{Feb\ 2015=1} + ARIMA\epsilon_{t,y} (0,1,0)(2,0,0)_{12}$$

[21] Model notes:

1.  $C_{t,y,ID101.r}$  are residential customers from residential schedule 101. They are being used as a forecast driver because of the historical positive correlation between residential and commercial customer growth.
2. SC dummies control for a step-up in customers in November 2005, September 2006, and November 2007.

$$[22] C_{t,y,ID111.c} = \text{Winter's Method} - \text{Additive}$$

$$[23] C_{t,y,ID132.c} = \frac{1}{12} \sum_{j=1}^{12} C_{t-j}$$

### 3. Washington and Idaho Industrial Forecasting Models by Schedule

Customer forecasts for WA:

$$[24] C_{t,y,WA101.i} = \alpha_0 + \omega_{OL} D_{Oct\ 2006=1} + \omega_{OL} D_{Jan\ 2007=1} + \omega_{OL} D_{Feb\ 2007=1} + \omega_{OL} D_{Dec\ 2013=1} + \omega_{OL} D_{Jan\ 2014=1} + \omega_{OL} D_{Jan\ 2015=1} + \omega_{OL} D_{Feb\ 2015=1} + ARIMA\epsilon_{t,y} (2,0,0)(0,0,0)_{12}$$

$$[25] C_{t,y,WA111.i} = \alpha_0 + \omega_{OL} D_{Sept\ 2005=1} + \omega_{OL} D_{Oct\ 2006=1} + \omega_{OL} D_{Dec\ 2006=1} + \omega_{OL} D_{Jan\ 2007=1} + \omega_{OL} D_{Feb\ 2007=1} + \omega_{OL} D_{Mar\ 2008=1} + \omega_{OL} D_{June\ 2014=1} + \omega_{OL} D_{Feb\ 2015=1} + \omega_{OL} D_{Oct\ 2015=1} + ARIMA\epsilon_{t,y} (1,0,0)(0,0,0)_{12}$$

$$[26] C_{t,y,WA121+122.i} = \frac{1}{12} \sum_{j=1}^{12} C_{t-j}$$

[26] Model notes:

1. Customer count for schedule 122 fell to zero in 2012. Schedule 121 customers fluctuate between 2 and 4 customers without any clear trend or seasonality.

Similarly for ID:

$$[27] C_{t,y,ID101.i} = \beta_0 + \omega_{SC} D_{Dec\ 2010\uparrow=1} + \omega_{SC} D_{Nov\ 2011\uparrow=1} + \omega_{OL} D_{Mar\ 2005=1} + \omega_{OL} D_{Aug\ 2005=1} + \omega_{OL} D_{Oct\ 2005=1} + \omega_{OL} D_{Feb\ 2006=1} + \omega_{OL} D_{Mar\ 2007=1} + \omega_{OL} D_{Dec\ 2008=1} + \omega_{OL} D_{Aug\ 2011=1} + \omega_{OL} D_{July\ 2014=1} + \omega_{OL} D_{Jan\ 2015=1} + \omega_{OL} D_{Feb\ 2015=1} + ARIMA\epsilon_{t,y} (4,0,0)(0,0,0)_{12}$$

[27] Model notes:

1. SC dummies control for step-downs in customers.

$$[28] C_{t,y,ID111.i} = \frac{1}{12} \sum_{j=1}^{12} C_{t-j}, \text{ restrict to data } t, y = \text{August } 2009 \uparrow$$

[28] Model notes:

1. Period of restriction reflects the restriction on the UPC model for this schedule.

2. Due to the Compass software conversion, February 2015 is excluded from the historical data. The conversion resulted in a double counting of customers in February 2015. Therefore, including this month leads to a significant over-forecast of customers.

$$[29] C_{t,y,1D112.i} = \frac{1}{12} \sum_{j=1}^{12} C_{t-j}$$

#### 4. Medford, OR Forecasting Models

The forecasting models for the Medford region (Jackson County) are given below for the residential, commercial, and industrial sectors:

Residential Sector, Customers:

$$[30] C_{t,y,MED410.r} = \alpha_0 + \alpha_1 POP_{t,y,JACKSON} + \omega_{SD} D_{t,y} + \omega_{SC} D_{Jan\ 2008 \uparrow =1} + \gamma_{RAMP} T_{Jan\ 2008} + \omega_{OL} D_{Nov\ 2004 =1} + \omega_{OL} D_{Dec\ 2004 =1} + \omega_{OL} D_{Dec\ 2005 =1} + \omega_{OL} D_{Feb\ 2015 =1} + ARIMA \epsilon_{t,y} (11,1,0)(0,0,0)_{12}$$

[30] Model notes:

1. SC dummy and ramping time trend control for a change in the time-path of customer growth starting in January 2008.

Commercial Sector, Customers:

$$[31] C_{t,y,MED420.c} = \alpha_0 + \alpha_1 C_{t,y,MED410.r} + \omega_{SD} D_{t,y} + \omega_{OL} D_{Dec\ 2004 =1} + \omega_{OL} D_{Sept\ 2005 =1} + \omega_{OL} D_{Nov\ 2009 =1} + \omega_{OL} D_{Feb\ 2015 =1} + ARIMA \epsilon_{t,y} (3,1,0)(1,0,0)_{12}$$

[31] Model notes:

1.  $C_{t,y,MED410.r}$  are residential customers from residential schedule 410. They are being used as a forecast driver because of the historical positive correlation between residential and commercial customer growth.

$$[32] C_{t,y,MED424.c} = C_{t,y-1} + 1$$

[32] Model notes:

1. Schedule adds about one customer per year.

2. Due to the Compass software conversion, February 2015 is excluded from the historical data. The conversion resulted in a double counting of customers in February 2015. Therefore, including this month leads to a significant over-forecast of customers.

$$[33] C_{t,y,MED444.c} = 1 \text{ if } (THM/C_{t,y})_{MED,440.c} > 0$$

[33] Model notes:

1. There is typically only one customer served by this schedule. Therefore, the customer forecast is automatically set to one whenever the load forecast is greater than zero.

Industrial Sector, Customers:

$$[34] C_{t,y,MED420.i} = \frac{1}{12} \sum_{j=1}^{12} C_{t-j}$$

[34] Model notes:

1. Data starts November 2006. Excluding outliers in November 2006, November 2009, and February 2011, the customer count fluctuates between 9 and 16 without any clear trend or seasonality. Changes in the customer count occur in steps between prolonged periods of stability.

$$[35] C_{t,y,MED424.i} = \frac{1}{12} \sum_{j=1}^{12} C_{t-j}$$

[35] Model notes:

1. Data starts January 2009. Excluding a January 2009 outlier, the customer count fluctuates between 1 and 3 without any clear trend or seasonality. Customer count is most frequently reported as 2.

#### 5. Roseburg, OR Forecasting Models

The forecasting models for the Roseburg region (Douglas County) are given below for the residential, commercial, and industrial sectors:

Residential Sector, Customers:

$$[36] C_{t,y,ROS410.r} = \varphi_0 + \varphi_1 POP_{t,y,DOUGLAS} + \omega_{SD} D_{t,y} + \omega_{SC} D_{Dec\ 2004=1} + \omega_{OL} D_{Nov\ 2004=1} + \omega_{OL} D_{Jan\ 2005=1} + \omega_{OL} D_{Nov\ 2005=1} + \omega_{OL} D_{Dec\ 2005=1} + \omega_{OL} D_{Nov\ 2006=1} + \omega_{OL} D_{Mar\ 2007=1} + \omega_{OL} D_{Dec\ 2007=1} + \omega_{OL} D_{Feb\ 2008=1} + \omega_{OL} D_{Nov\ 2009=1} + \omega_{OL} D_{Feb\ 2015=1} + ARIMA\epsilon_{t,y} (11,1,0)(0,0,0)_{12}$$

[36] Model notes:

1. POP is population for Douglas County, OR.
2. SC dummy controls for a step-up in customers starting in January 2004.

Commercial Sector, Customers:

$$[37] C_{t,y,ROS420.c} = \varphi_0 + \omega_{SD} D_{t,y} + \omega_{SC} D_{Dec\ 2004=1} + \omega_{OL} D_{Nov\ 2004=1} + \omega_{OL} D_{Jan\ 2008=1} + \omega_{OL} D_{Mar\ 2009=1} + \omega_{OL} D_{Feb\ 2015=1} + ARIMA\epsilon_{t,y} (12,1,0)(0,0,0)_{12}$$

[37] Model notes:

1. Model does not use schedule 410 customers as driver. This reflects the lack of correlation between residential 410 and commercial 420 customer growth.
2. The lack of correlation noted in Point 1 could reflect Roseburg's position between larger cities that offer a range of commercial activities. Competition from these cities may be inhibiting commercial growth in Roseburg.
3. SC dummy controls for a significant step-up in customers starting in December 2004.

$$[38] C_{t,y,ROS424.c} = \frac{1}{12} \sum_{j=1}^{12} C_{t-j}$$

Industrial Sector, Customers:

$$[39] C_{t,y,ROS420.i} = \frac{1}{12} \sum_{j=1}^{12} C_{t-j}$$

[39] Model notes:

1. Due to the Compass software conversion, February 2015 is excluded from the historical data. The conversion resulted in a double counting of customers in February 2015. Therefore, including this month leads to a significant over-forecast of customers.

$$[40] C_{t,y,ROS424.i} = \frac{1}{12} \sum_{j=1}^{12} C_{t-j}$$

[40] Model notes:

1. Schedule appears to have died. No customers are currently being reported.

## 6. Klamath Falls, OR Forecasting Models

The forecasting models for the Klamath Falls region (Klamath County) are given below for the residential, commercial, and industrial sectors:

Residential Sector, Customers:

$$[41] C_{t,y,KLM410.r} = \beta_0 + \beta_1 POP_{t,y,KLAMATH} + \omega_{SD} D_{t,y} + \omega_{OL} D_{Nov\ 2004=1} + \omega_{OL} D_{Feb\ 2015=1} + \omega_{OL} D_{Apr\ 2015=1} + ARIMA\epsilon_{t,y} (7,1,0)(0,0,0)_{12}$$

[41] Model notes:

1. POP is population for Klamath County.

Commercial Sector, Customers:



$$[42] C_{t,y,KLM420.c} = \beta_0 + \beta_1 C_{t,y,KLM410.r} + \omega_{SD} D_{t,y} + \omega_{OL} D_{Dec\ 2005=1} + \omega_{OL} D_{Oct\ 2006=1} + ARIMA\epsilon_{t,y} (11,1,0)(2,0,0)_{12}$$

[42] Model notes:

1.  $C_{t,y,KLM410.r}$  are residential customers from residential schedule 410. They are being used as a forecast driver because of the historical positive correlation between residential and commercial customer growth.

$$[43] C_{t,y,KLM424.c} = \frac{1}{12} \sum_{j=1}^{12} C_{t-j}$$

[43] Model notes:

1. Data starts January 2004. From January 2004 to March 2010, the customer count fluctuated between 19 and 24. Afterwards, the customer count has dropped to fluctuate between 11 and 16. There is no clear trend or seasonality.

Industrial Sector, Customers:

$$[44] C_{t,y,KLM420.i} = \frac{1}{12} \sum_{j=1}^{12} C_{t-j}$$

[44] Model notes:

1. Data starts December 2006. The customer count fluctuates between 4 and 9 without any clear trend or seasonality.

$$[45] C_{t,y,KLM424.i} = \frac{1}{12} \sum_{j=1}^{12} C_{t-j}$$

[45] Model notes:

1. Data starts April 2009. The customer count fluctuates between 1 and 4 without any clear trend or seasonality.

## 7. La Grande, OR Forecasting Models

The forecasting models for the La Grande region (Union County) are given below for the residential, commercial, and industrial sectors:

Residential Sector, Customers:

$$[46] C_{t,y,LaG410.r} = \theta_0 + \theta_1 POP_{t,y,UNION} + \omega_{SD} D_{t,y} + \omega_{OL} D_{Oct\ 2004=1} + \omega_{OL} D_{Dec\ 2009=1} + \omega_{OL} D_{Jul\ 2006=1} + \omega_{OL} D_{Feb\ 2015=1} + ARIMA\epsilon_{t,y} (9,1,0)(1,0,0)_{12}$$

[46] Model notes:

1. POP is population for Douglas County.

Commercial Sector, Customers:

$$[47] C_{t,y,LaG420.c} = \theta_0 + \theta_1 C_{t,y,LaG410.r} + \omega_{OL} D_{Dec\ 2008=1} + \omega_{OL} D_{Mar\ 2011=1} + ARIMA\epsilon_{t,y} (12,1,0)(0,0,0)_{12}$$

[47] Model notes:

1.  $C_{t,y,LaG410.r}$  are residential customers from residential schedule 410. They are being used as a forecast driver because of the historical positive correlation between residential and commercial customer growth.

$$[48] C_{t,y,LaG424.c} = \frac{1}{12} \sum_{j=1}^{12} C_{t-j}$$

[48] Model notes:

1. Data starts January 2007. The customer count fluctuates between 2 and 4 without any clear trend or seasonality. Changes in the customer count appear as steps after prolonged periods of stability.

$$[49] C_{t,y,LaG444.c} = \alpha \text{ if } (THM/C_{t,y})_{Lag,444.c} > 0$$

[49] Model notes:

1. Data starts September 2011. The customer forecast is a derivative of the schedule's load forecast.
2.  $\alpha$  = the average historical customer count when THM/C > 0. The value of  $\alpha$  is usually slightly greater than one.

Industrial Sector, Customers:

$$\begin{aligned}
 [50] \quad C_{t,y,La6444,i} = & \theta_0 + \omega_{SD}D_{t,y} + \omega_{OL}D_{Aug\ 2007=1} + \omega_{OL}D_{Sept\ 2008=1} + \omega_{OL}D_{Nov\ 2009=1} + \omega_{OL}D_{Jan\ 2010=1} + \\
 & + \omega_{OL}D_{Nov\ 2010=1} + \omega_{OL}D_{Aug\ 2011=1} + \omega_{OL}D_{Aug\ 2012=1} + \omega_{OL}D_{Nov\ 2012=1} + \omega_{OL}D_{Dec\ 2012=1} + \omega_{OL}D_{Jan\ 2013=1} + \\
 & + \omega_{OL}D_{Feb\ 2013=1} + \omega_{OL}D_{Jan\ 2014=1} + ARIMA\epsilon_{t,y}(9,0,0)(0,0,0)_{12}
 \end{aligned}$$

## APPENDIX 2.2: CUSTOMER FORECASTS BY REGION WASHINGTON AND IDAHO

	Washington and Idaho - Expected Growth			Washington and Idaho - High Growth			Washington and Idaho - Low Growth		
	Residential Customers	Commercial Customers	Industrial Customers	Residential Customers	Commercial Customers	Industrial Customers	Residential Customers	Commercial Customers	Industrial Customers
Nov-15	210,786	22,852	231	210,786	22,852	231	210,786	22,852	231
Dec-15	211,651	23,321	227	211,651	23,321	227	211,651	23,321	227
Jan-16	211,372	22,931	235	211,963	22,995	235	210,732	22,861	235
Feb-16	211,351	22,981	236	212,027	23,055	236	210,620	22,901	236
Mar-16	211,222	22,941	235	211,982	23,024	235	210,400	22,852	235
Apr-16	211,153	22,944	235	211,997	23,037	236	210,240	22,845	235
May-16	211,150	22,917	235	212,079	23,019	236	210,146	22,808	235
Jun-16	210,930	22,920	236	211,942	23,031	236	209,836	22,801	235
Jul-16	211,207	22,924	236	212,301	23,044	236	210,025	22,796	235
Aug-16	211,369	22,923	236	212,544	23,052	236	210,099	22,785	235
Sep-16	211,864	22,915	236	213,122	23,052	236	210,504	22,768	235
Oct-16	212,439	22,922	236	213,783	23,068	236	210,989	22,765	235
Nov-16	213,174	22,992	236	214,604	23,148	236	211,632	22,826	235
Dec-16	213,881	23,065	236	215,396	23,230	237	212,246	22,889	235
Jan-17	214,171	23,085	236	215,770	23,259	237	212,446	22,899	235
Feb-17	214,131	23,135	236	215,812	23,318	237	212,319	22,939	235
Mar-17	214,043	23,108	236	215,805	23,300	237	212,144	22,903	235
Apr-17	213,929	23,106	236	215,772	23,307	237	211,944	22,891	235
May-17	213,886	23,085	236	215,810	23,294	237	211,814	22,861	235
Jun-17	213,657	23,074	236	215,661	23,292	237	211,500	22,841	235
Jul-17	213,893	23,063	236	215,985	23,290	237	211,642	22,820	235
Aug-17	214,062	23,055	236	216,242	23,291	237	211,718	22,802	235
Sep-17	214,541	23,063	236	216,812	23,309	237	212,101	22,800	235
Oct-17	215,132	23,075	236	217,495	23,330	237	212,592	22,802	235
Nov-17	215,893	23,141	236	218,351	23,406	237	213,252	22,858	235
Dec-17	216,618	23,240	236	219,171	23,516	238	213,876	22,946	235
Jan-18	216,950	23,256	236	219,595	23,541	238	214,112	22,952	235
Feb-18	216,923	23,303	236	219,655	23,598	238	213,993	22,988	235
Mar-18	216,857	23,279	236	219,675	23,583	238	213,835	22,954	235
Apr-18	216,755	23,263	236	219,658	23,577	238	213,642	22,929	235
May-18	216,715	23,236	236	219,705	23,559	238	213,510	22,892	235
Jun-18	216,492	23,235	236	219,566	23,567	238	213,199	22,881	235
Jul-18	216,718	23,229	236	219,884	23,570	238	213,328	22,865	235
Aug-18	216,885	23,228	236	220,142	23,579	238	213,399	22,854	235
Sep-18	217,360	23,238	236	220,713	23,599	238	213,774	22,854	235
Oct-18	217,954	23,244	236	221,404	23,614	238	214,263	22,850	235
Nov-18	218,721	23,308	236	222,273	23,689	238	214,924	22,903	235
Dec-18	219,455	23,395	236	223,109	23,787	238	215,551	22,979	235
Jan-19	219,797	23,408	237	223,546	23,809	239	215,793	22,981	234
Feb-19	219,780	23,456	237	223,619	23,868	239	215,682	23,018	234

## APPENDIX 2.2: CUSTOMER FORECASTS BY REGION WASHINGTON AND IDAHO

	Washington and Idaho - Expected Growth			Washington and Idaho - High Growth			Washington and Idaho - Low Growth		
	Residential Customers	Commercial Customers	Industrial Customers	Residential Customers	Commercial Customers	Industrial Customers	Residential Customers	Commercial Customers	Industrial Customers
Mar-19	219,724	23,428	237	223,651	23,849	239	215,532	22,981	234
Apr-19	219,628	23,417	237	223,643	23,847	239	215,344	22,960	234
May-19	219,592	23,390	237	223,697	23,830	239	215,215	22,923	234
Jun-19	219,371	23,393	237	223,562	23,842	239	214,904	22,916	234
Jul-19	219,600	23,390	237	223,887	23,849	239	215,033	22,903	234
Aug-19	219,771	23,390	237	224,154	23,859	239	215,104	22,893	234
Sep-19	220,251	23,392	237	224,735	23,871	239	215,476	22,885	234
Oct-19	220,849	23,399	237	225,438	23,888	239	215,965	22,881	234
Nov-19	221,624	23,465	237	226,323	23,965	239	216,626	22,935	234
Dec-19	222,365	23,546	237	227,173	24,058	239	217,253	23,004	234
Jan-20	222,716	23,563	237	227,626	24,085	239	217,499	23,011	234
Feb-20	222,708	23,612	237	227,711	24,145	239	217,394	23,048	234
Mar-20	222,661	23,585	237	227,756	24,127	239	217,250	23,012	234
Apr-20	222,572	23,579	237	227,759	24,131	239	217,066	22,995	234
May-20	222,544	23,554	237	227,824	24,116	240	216,942	22,961	234
Jun-20	222,331	23,551	237	227,700	24,122	240	216,638	22,947	234
Jul-20	222,565	23,546	237	228,035	24,128	240	216,767	22,932	234
Aug-20	222,741	23,542	237	228,310	24,134	240	216,839	22,918	234
Sep-20	223,225	23,546	237	228,903	24,148	240	217,212	22,911	234
Oct-20	223,829	23,555	237	229,618	24,167	240	217,701	22,910	234
Nov-20	224,608	23,623	237	230,514	24,247	240	218,359	22,965	233
Dec-20	225,356	23,710	237	231,379	24,347	240	218,987	23,039	233
Jan-21	225,714	23,727	237	231,844	24,374	240	219,235	23,045	233
Feb-21	225,712	23,775	237	231,938	24,434	240	219,133	23,081	233
Mar-21	225,671	23,751	237	231,993	24,420	240	218,993	23,048	233
Apr-21	225,590	23,741	237	232,007	24,420	240	218,815	23,027	233
May-21	225,567	23,716	237	232,081	24,404	240	218,694	22,993	233
Jun-21	225,359	23,714	237	231,964	24,412	240	218,393	22,980	233
Jul-21	225,574	23,706	237	232,272	24,413	240	218,513	22,963	233
Aug-21	225,731	23,703	237	232,519	24,419	240	218,577	22,951	233
Sep-21	226,195	23,709	237	233,084	24,435	240	218,938	22,947	233
Oct-21	226,778	23,718	237	233,771	24,453	241	219,414	22,947	233
Nov-21	227,537	23,784	237	234,641	24,530	241	220,060	23,001	233
Dec-21	228,265	23,871	237	235,480	24,629	241	220,675	23,076	233
Jan-22	228,603	23,885	237	235,916	24,653	241	220,913	23,080	233
Feb-22	228,582	23,934	237	235,981	24,713	241	220,803	23,118	233
Mar-22	228,521	23,907	237	236,006	24,694	241	220,656	23,083	233
Apr-22	228,419	23,897	237	235,988	24,693	241	220,468	23,064	233
May-22	228,377	23,869	237	236,033	24,673	241	220,339	23,028	233
Jun-22	228,150	23,868	237	235,886	24,681	241	220,032	23,017	233

## APPENDIX 2.2: CUSTOMER FORECASTS BY REGION WASHINGTON AND IDAHO

	Washington and Idaho - Expected Growth			Washington and Idaho - High Growth			Washington and Idaho - Low Growth		
	Residential Customers	Commercial Customers	Industrial Customers	Residential Customers	Commercial Customers	Industrial Customers	Residential Customers	Commercial Customers	Industrial Customers
Jul-22	228,362	23,864	237	236,190	24,686	241	220,149	23,004	232
Aug-22	228,515	23,862	237	236,434	24,693	241	220,210	22,993	232
Sep-22	228,978	23,867	237	237,000	24,707	241	220,570	22,989	232
Oct-22	229,558	23,873	237	237,686	24,723	241	221,042	22,986	232
Nov-22	230,315	23,940	237	238,556	24,801	241	221,684	23,041	232
Dec-22	231,041	24,023	237	239,396	24,896	241	222,295	23,112	232
Jan-23	231,378	24,040	237	239,831	24,923	241	222,531	23,119	232
Feb-23	231,353	24,088	237	239,892	24,982	241	222,420	23,156	232
Mar-23	231,289	24,060	237	239,913	24,962	241	222,272	23,120	232
Apr-23	231,186	24,051	237	239,893	24,961	242	222,086	23,103	232
May-23	231,141	24,024	237	239,933	24,943	242	221,955	23,067	232
Jun-23	230,911	24,024	237	239,782	24,952	242	221,647	23,058	232
Jul-23	231,122	24,017	237	240,085	24,953	242	221,764	23,043	232
Aug-23	231,272	24,016	237	240,326	24,961	242	221,824	23,033	232
Sep-23	231,732	24,018	237	240,889	24,972	242	222,180	23,026	232
Oct-23	232,309	24,026	237	241,574	24,989	242	222,648	23,025	232
Nov-23	233,064	24,092	237	242,445	25,067	242	223,287	23,079	232
Dec-23	233,787	24,178	237	243,282	25,165	242	223,893	23,153	232
Jan-24	234,120	24,193	237	243,715	25,190	242	224,126	23,158	232
Feb-24	234,093	24,243	237	243,773	25,251	242	224,015	23,197	231
Mar-24	234,027	24,214	237	243,790	25,229	242	223,867	23,161	231
Apr-24	233,920	24,205	237	243,765	25,229	242	223,679	23,143	231
May-24	233,873	24,179	237	243,802	25,211	242	223,549	23,109	231
Jun-24	233,642	24,177	237	243,647	25,218	242	223,242	23,099	231
Jul-24	233,851	24,171	237	243,950	25,220	242	223,357	23,084	231
Aug-24	234,001	24,169	237	244,192	25,227	242	223,416	23,073	231
Sep-24	234,460	24,173	237	244,757	25,240	242	223,770	23,068	231
Oct-24	235,037	24,181	237	245,444	25,257	243	224,236	23,067	231
Nov-24	235,792	24,247	237	246,319	25,335	243	224,872	23,122	231
Dec-24	236,514	24,332	237	247,159	25,433	243	225,474	23,194	231
Jan-25	236,847	24,349	237	247,593	25,460	243	225,706	23,201	231
Feb-25	236,820	24,397	237	247,651	25,519	243	225,595	23,238	231
Mar-25	236,753	24,369	237	247,668	25,498	243	225,447	23,203	231
Apr-25	236,646	24,360	237	247,642	25,498	243	225,260	23,185	231
May-25	236,600	24,333	237	247,681	25,478	243	225,131	23,151	231
Jun-25	236,367	24,331	237	247,523	25,485	243	224,824	23,140	231
Jul-25	236,571	24,324	237	247,819	25,487	243	224,936	23,125	231
Aug-25	236,715	24,323	237	248,053	25,494	243	224,992	23,116	230
Sep-25	237,168	24,327	237	248,611	25,507	243	225,342	23,111	230
Oct-25	237,740	24,335	237	249,293	25,524	243	225,804	23,111	230

## APPENDIX 2.2: CUSTOMER FORECASTS BY REGION WASHINGTON AND IDAHO

	Washington and Idaho - Expected Growth			Washington and Idaho - High Growth			Washington and Idaho - Low Growth		
	Residential Customers	Commercial Customers	Industrial Customers	Residential Customers	Commercial Customers	Industrial Customers	Residential Customers	Commercial Customers	Industrial Customers
Nov-25	238,490	24,400	237	250,162	25,600	243	226,434	23,164	230
Dec-25	239,206	24,485	237	250,997	25,698	243	227,032	23,236	230
Jan-26	239,532	24,500	237	251,423	25,723	243	227,259	23,242	230
Feb-26	239,500	24,549	237	251,474	25,783	243	227,147	23,280	230
Mar-26	239,427	24,520	237	251,481	25,761	243	226,996	23,244	230
Apr-26	239,315	24,511	237	251,447	25,760	243	226,808	23,227	230
May-26	239,262	24,486	237	251,474	25,742	244	226,675	23,195	230
Jun-26	239,023	24,483	237	251,308	25,748	244	226,367	23,184	230
Jul-26	239,225	24,477	237	251,602	25,750	244	226,479	23,170	230
Aug-26	239,367	24,475	237	251,834	25,756	244	226,533	23,160	230
Sep-26	239,819	24,479	237	252,392	25,769	244	226,881	23,155	230
Oct-26	240,388	24,486	237	253,073	25,785	244	227,340	23,154	230
Nov-26	241,136	24,551	237	253,942	25,861	244	227,966	23,207	230
Dec-26	241,850	24,637	237	254,778	25,961	244	228,560	23,280	230
Jan-27	242,175	24,653	237	255,204	25,986	244	228,787	23,287	230
Feb-27	242,140	24,701	237	255,250	26,045	244	228,673	23,324	230
Mar-27	242,065	24,673	237	255,254	26,024	244	228,522	23,290	229
Apr-27	241,951	24,664	237	255,216	26,023	244	228,333	23,273	229
May-27	241,897	24,637	237	255,243	26,003	244	228,202	23,239	229
Jun-27	241,656	24,635	237	255,072	26,009	244	227,894	23,229	229
Jul-27	241,855	24,630	237	255,364	26,013	244	228,003	23,216	229
Aug-27	241,995	24,626	237	255,593	26,017	244	228,057	23,204	229
Sep-27	242,444	24,630	237	256,149	26,029	244	228,401	23,200	229
Oct-27	243,013	24,638	237	256,831	26,046	244	228,858	23,200	229
Nov-27	243,757	24,703	237	257,699	26,123	245	229,480	23,253	229
Dec-27	244,469	24,788	237	258,535	26,221	245	230,071	23,325	229
Jan-28	244,792	24,803	237	258,959	26,245	245	230,295	23,331	229
Feb-28	244,755	24,852	237	259,003	26,306	245	230,182	23,369	229
Mar-28	244,678	24,824	237	259,004	26,284	245	230,030	23,335	229
Apr-28	244,563	24,815	237	258,964	26,283	245	229,842	23,318	229
May-28	244,506	24,788	237	258,986	26,263	245	229,710	23,285	229
Jun-28	244,262	24,786	237	258,810	26,269	245	229,401	23,275	229
Jul-28	244,459	24,779	237	259,100	26,270	245	229,509	23,260	229
Aug-28	244,597	24,777	237	259,327	26,276	245	229,562	23,251	229
Sep-28	245,044	24,781	237	259,882	26,289	245	229,904	23,246	228
Oct-28	245,611	24,788	237	260,563	26,304	245	230,358	23,245	228
Nov-28	246,353	24,854	237	261,431	26,383	245	230,977	23,299	228
Dec-28	247,063	24,939	237	262,267	26,481	245	231,565	23,371	228
Jan-29	247,383	24,954	237	262,688	26,505	245	231,787	23,377	228
Feb-29	247,343	25,003	237	262,728	26,565	245	231,672	23,415	228

## APPENDIX 2.2: CUSTOMER FORECASTS BY REGION WASHINGTON AND IDAHO

	Washington and Idaho - Expected Growth			Washington and Idaho - High Growth			Washington and Idaho - Low Growth		
	Residential Customers	Commercial Customers	Industrial Customers	Residential Customers	Commercial Customers	Industrial Customers	Residential Customers	Commercial Customers	Industrial Customers
Mar-29	247,265	24,975	237	262,725	26,544	245	231,521	23,381	228
Apr-29	247,146	24,965	237	262,681	26,542	245	231,332	23,364	228
May-29	247,086	24,938	237	262,699	26,521	245	231,198	23,331	228
Jun-29	246,841	24,935	237	262,520	26,526	246	230,891	23,320	228
Jul-29	247,036	24,930	237	262,808	26,529	246	230,998	23,308	228
Aug-29	247,170	24,928	237	263,030	26,535	246	231,048	23,298	228
Sep-29	247,615	24,932	237	263,583	26,547	246	231,388	23,294	228
Oct-29	248,178	24,938	237	264,261	26,562	246	231,839	23,292	228
Nov-29	248,918	25,004	237	265,129	26,640	246	232,455	23,347	228
Dec-29	249,625	25,088	237	265,964	26,738	246	233,038	23,417	228
Jan-30	249,942	25,104	237	266,382	26,763	246	233,258	23,425	228
Feb-30	249,900	25,152	237	266,418	26,822	246	233,143	23,462	228
Mar-30	249,819	25,124	237	266,411	26,800	246	232,991	23,428	228
Apr-30	249,697	25,114	237	266,362	26,798	246	232,801	23,411	227
May-30	249,635	25,087	237	266,376	26,777	246	232,668	23,378	227
Jun-30	249,387	25,086	237	266,193	26,784	246	232,361	23,370	227
Jul-30	249,579	25,078	237	266,476	26,784	246	232,466	23,355	227
Aug-30	249,713	25,076	237	266,697	26,789	246	232,516	23,345	227
Sep-30	250,153	25,079	237	267,246	26,801	246	232,852	23,341	227
Oct-30	250,713	25,087	237	267,922	26,817	246	233,300	23,341	227
Nov-30	251,450	25,152	237	268,788	26,894	246	233,913	23,394	227
Dec-30	252,154	25,238	237	269,621	26,994	247	234,493	23,466	227
Jan-31	252,469	25,252	237	270,038	27,017	247	234,711	23,472	227
Feb-31	252,425	25,301	237	270,069	27,077	247	234,596	23,510	227
Mar-31	252,340	25,273	237	270,058	27,055	247	234,443	23,477	227
Apr-31	252,216	25,263	237	270,004	27,053	247	234,254	23,460	227
May-31	252,151	25,236	237	270,014	27,032	247	234,119	23,427	227
Jun-31	251,899	25,233	237	269,824	27,037	247	233,811	23,417	227
Jul-31	252,091	25,228	237	270,109	27,039	247	233,916	23,405	227
Aug-31	252,225	25,225	237	270,331	27,044	247	233,966	23,395	227
Sep-31	252,666	25,229	237	270,883	27,056	247	234,302	23,391	227
Oct-31	253,226	25,236	237	271,562	27,072	247	234,748	23,390	226
Nov-31	253,963	25,300	237	272,431	27,148	247	235,358	23,442	226
Dec-31	254,667	25,385	237	273,267	27,247	247	235,936	23,514	226
Jan-32	254,983	25,402	237	273,686	27,273	247	236,155	23,522	226
Feb-32	254,938	25,448	237	273,717	27,331	247	236,038	23,557	226
Mar-32	254,854	25,422	237	273,706	27,311	247	235,887	23,526	226
Apr-32	254,730	25,411	237	273,653	27,307	247	235,698	23,508	226
May-32	254,665	25,384	237	273,663	27,286	247	235,564	23,476	226
Jun-32	254,414	25,383	237	273,474	27,293	248	235,258	23,468	226
Jul-32	254,606	25,375	237	273,758	27,292	248	235,363	23,453	226

## APPENDIX 2.2: CUSTOMER FORECASTS BY REGION WASHINGTON AND IDAHO

	Washington and Idaho - Expected Growth			Washington and Idaho - High Growth			Washington and Idaho - Low Growth		
	Residential Customers	Commercial Customers	Industrial Customers	Residential Customers	Commercial Customers	Industrial Customers	Residential Customers	Commercial Customers	Industrial Customers
Aug-32	254,737	25,371	237	273,977	27,296	248	235,412	23,442	226
Sep-32	255,176	25,376	237	274,528	27,309	248	235,745	23,439	226
Oct-32	255,735	25,384	237	275,207	27,325	248	236,190	23,439	226
Nov-32	256,470	25,447	237	276,076	27,401	248	236,797	23,490	226
Dec-32	257,172	25,533	237	276,912	27,501	248	237,371	23,563	226
Jan-33	257,487	25,548	237	277,330	27,525	248	237,588	23,569	226
Feb-33	257,440	25,597	237	277,358	27,586	248	237,472	23,607	226
Mar-33	257,354	25,569	237	277,345	27,563	248	237,321	23,574	226
Apr-33	257,228	25,558	237	277,288	27,559	248	237,132	23,557	226
May-33	257,161	25,532	237	277,295	27,539	248	236,998	23,526	225
Jun-33	256,909	25,530	237	277,104	27,545	248	236,692	23,517	225
Jul-33	257,099	25,524	237	277,386	27,547	248	236,795	23,504	225
Aug-33	257,230	25,520	237	277,605	27,550	248	236,845	23,493	225
Sep-33	257,668	25,524	237	278,157	27,562	248	237,176	23,490	225
Oct-33	258,225	25,531	237	278,836	27,577	248	237,618	23,489	225
Nov-33	258,960	25,595	237	279,707	27,654	248	238,224	23,541	225
Dec-33	259,662	25,681	237	280,545	27,755	248	238,796	23,613	225
Jan-34	259,974	25,696	237	280,961	27,779	249	239,011	23,619	225
Feb-34	259,927	25,743	237	280,989	27,837	249	238,896	23,656	225
Mar-34	259,839	25,717	237	280,973	27,817	249	238,743	23,625	225
Apr-34	259,712	25,706	237	280,914	27,813	249	238,555	23,607	225
May-34	259,645	25,679	237	280,921	27,792	249	238,422	23,575	225
Jun-34	259,392	25,677	237	280,726	27,797	249	238,117	23,566	225
Jul-34	259,580	25,670	237	281,008	27,798	249	238,219	23,553	225
Aug-34	259,709	25,667	237	281,225	27,802	249	238,267	23,543	225
Sep-34	260,146	25,670	237	281,777	27,813	249	238,597	23,539	225
Oct-34	260,703	25,678	237	282,457	27,829	249	239,038	23,539	225
Nov-34	261,436	25,744	237	283,329	27,908	249	239,640	23,593	224
Dec-34	262,137	25,828	237	284,168	28,007	249	240,209	23,663	224
Jan-35	262,449	25,842	237	284,585	28,030	249	240,424	23,669	224
Feb-35	262,400	25,890	237	284,610	28,090	249	240,308	23,706	224
Mar-35	262,312	25,863	237	284,594	28,068	249	240,157	23,674	224
Apr-35	262,184	25,853	237	284,533	28,065	249	239,969	23,658	224
May-35	262,115	25,826	237	284,537	28,044	249	239,835	23,626	224
Jun-35	261,861	25,824	237	284,340	28,049	249	239,530	23,617	224
Jul-35	262,049	25,816	237	284,622	28,048	250	239,632	23,603	224
Aug-35	262,177	25,813	237	284,839	28,053	250	239,680	23,593	224
Sep-35	262,615	25,818	237	285,394	28,066	250	240,010	23,591	224
Oct-35	263,171	25,825	237	286,075	28,081	250	240,449	23,590	224
Nov-35	263,904	25,890	237	286,948	28,159	250	241,048	23,643	224
Dec-35	264,605	25,975	237	287,791	28,259	250	241,617	23,714	224



## APPENDIX 2.2: CUSTOMER FORECASTS BY REGION

### MEDFORD

	Medford - Expected Growth			Medford - High Growth			Medford - Low Growth		
	Residential Customers	Commercial Customers	Industrial Customers	Residential Customers	Commercial Customers	Industrial Customers	Residential Customers	Commercial Customers	Industrial Customers
Nov-15	52,922	6,658	15	52,922	6,658	15	52,922	6,658	15
Dec-15	53,276	6,675	15	53,276	6,675	15	53,276	6,675	15
Jan-16	53,448	6,720	16	53,632	6,743	16	53,247	6,695	16
Feb-16	53,447	6,748	16	53,658	6,775	16	53,218	6,719	16
Mar-16	53,523	6,747	16	53,761	6,777	16	53,265	6,714	16
Apr-16	53,613	6,725	16	53,877	6,758	16	53,325	6,688	16
May-16	53,668	6,739	16	53,959	6,776	17	53,351	6,699	16
Jun-16	53,657	6,737	16	53,975	6,777	17	53,312	6,694	16
Jul-16	53,552	6,717	16	53,895	6,760	17	53,180	6,670	16
Aug-16	53,460	6,709	16	53,827	6,755	16	53,061	6,659	16
Sep-16	53,356	6,686	16	53,748	6,735	17	52,931	6,633	16
Oct-16	53,517	6,689	16	53,936	6,741	17	53,063	6,632	16
Nov-16	53,818	6,725	16	54,265	6,781	17	53,334	6,664	16
Dec-16	54,124	6,774	16	54,599	6,833	17	53,609	6,710	16
Jan-17	54,379	6,796	16	54,882	6,859	17	53,834	6,728	16
Feb-17	54,432	6,825	16	54,962	6,891	17	53,859	6,753	16
Mar-17	54,533	6,819	16	55,090	6,889	17	53,931	6,744	16
Apr-17	54,648	6,817	16	55,232	6,889	17	54,016	6,738	16
May-17	54,660	6,812	16	55,271	6,888	17	54,000	6,730	16
Jun-17	54,586	6,801	16	55,222	6,880	17	53,899	6,715	16
Jul-17	54,432	6,784	16	55,093	6,866	17	53,719	6,695	16
Aug-17	54,288	6,771	16	54,973	6,856	17	53,549	6,679	16
Sep-17	54,194	6,752	16	54,904	6,840	17	53,428	6,657	16
Oct-17	54,367	6,761	16	55,106	6,853	17	53,571	6,662	16
Nov-17	54,705	6,804	16	55,475	6,900	17	53,875	6,701	16
Dec-17	55,072	6,854	16	55,874	6,954	17	54,208	6,747	16
Jan-18	55,382	6,885	16	56,216	6,989	17	54,485	6,773	16
Feb-18	55,467	6,917	16	56,329	7,024	17	54,540	6,801	16
Mar-18	55,580	6,914	16	56,471	7,025	17	54,622	6,795	16
Apr-18	55,668	6,904	16	56,587	7,018	17	54,680	6,781	16
May-18	55,639	6,902	16	56,585	7,019	17	54,623	6,776	16
Jun-18	55,527	6,890	16	56,498	7,011	17	54,485	6,761	16
Jul-18	55,338	6,868	16	56,333	6,992	17	54,270	6,736	16
Aug-18	55,184	6,855	16	56,204	6,982	17	54,091	6,719	16
Sep-18	55,103	6,836	16	56,148	6,966	17	53,983	6,697	16
Oct-18	55,307	6,845	16	56,383	6,978	17	54,154	6,702	16
Nov-18	55,693	6,890	16	56,805	7,028	17	54,503	6,743	16
Dec-18	56,104	6,944	16	57,251	7,086	17	54,876	6,792	16
Jan-19	56,440	6,974	16	57,622	7,120	17	55,176	6,818	16
Feb-19	56,532	7,007	16	57,744	7,157	17	55,236	6,846	16

## APPENDIX 2.2: CUSTOMER FORECASTS BY REGION

### MEDFORD

	Medford - Expected Growth			Medford - High Growth			Medford - Low Growth		
	Residential	Commercial	Industrial	Residential	Commercial	Industrial	Residential	Commercial	Industrial
	Customers	Customers	Customers	Customers	Customers	Customers	Customers	Customers	Customers
Mar-19	56,629	7,002	16	57,871	7,156	17	55,302	6,838	16
Apr-19	56,686	6,992	16	57,958	7,148	17	55,328	6,824	16
May-19	56,624	6,986	16	57,922	7,146	17	55,238	6,815	16
Jun-19	56,484	6,971	16	57,807	7,134	17	55,073	6,797	16
Jul-19	56,282	6,950	16	57,628	7,116	17	54,847	6,773	16
Aug-19	56,136	6,937	16	57,506	7,106	17	54,676	6,757	16
Sep-19	56,080	6,919	16	57,477	7,091	17	54,592	6,735	16
Oct-19	56,320	6,932	16	57,750	7,108	17	54,797	6,745	16
Nov-19	56,739	6,979	16	58,208	7,160	17	55,176	6,787	16
Dec-19	57,170	7,034	16	58,678	7,220	17	55,566	6,837	16
Jan-20	57,511	7,066	16	59,057	7,256	17	55,868	6,864	16
Feb-20	57,586	7,097	16	59,162	7,291	17	55,911	6,891	16
Mar-20	57,661	7,091	16	59,268	7,289	17	55,954	6,881	16
Apr-20	57,690	7,079	16	59,326	7,279	17	55,953	6,865	16
May-20	57,604	7,071	16	59,267	7,275	17	55,840	6,854	16
Jun-20	57,453	7,056	16	59,140	7,263	17	55,664	6,836	16
Jul-20	57,258	7,035	16	58,967	7,245	17	55,446	6,812	16
Aug-20	57,133	7,024	16	58,867	7,237	17	55,296	6,798	16
Sep-20	57,105	7,008	16	58,867	7,224	17	55,240	6,779	16
Oct-20	57,373	7,022	16	59,172	7,242	17	55,470	6,789	16
Nov-20	57,811	7,071	16	59,652	7,296	17	55,864	6,833	16
Dec-20	58,248	7,126	16	60,132	7,357	17	56,256	6,882	16
Jan-21	58,581	7,157	16	60,505	7,392	17	56,548	6,909	16
Feb-21	58,641	7,187	16	60,596	7,427	17	56,576	6,934	16
Mar-21	58,690	7,180	16	60,676	7,423	17	56,593	6,923	16
Apr-21	58,700	7,166	16	60,716	7,412	17	56,573	6,906	16
May-21	58,606	7,158	16	60,648	7,407	17	56,453	6,895	16
Jun-21	58,460	7,143	16	60,526	7,395	17	56,282	6,877	16
Jul-21	58,264	7,122	16	60,349	7,377	17	56,068	6,854	16
Aug-21	58,143	7,111	16	60,248	7,368	17	55,926	6,840	16
Sep-21	58,120	7,095	16	60,250	7,355	17	55,878	6,821	16
Oct-21	58,386	7,110	16	60,551	7,374	17	56,108	6,833	16
Nov-21	58,812	7,157	16	61,018	7,425	17	56,492	6,875	16
Dec-21	59,225	7,211	16	61,472	7,485	17	56,863	6,923	15
Jan-22	59,526	7,240	16	61,810	7,518	17	57,126	6,948	15
Feb-22	59,550	7,268	16	61,861	7,550	17	57,123	6,972	15
Mar-22	59,567	7,258	16	61,905	7,543	17	57,113	6,959	15
Apr-22	59,552	7,242	16	61,915	7,529	17	57,072	6,940	15
May-22	59,443	7,233	16	61,827	7,523	17	56,942	6,929	15
Jun-22	59,292	7,218	16	61,696	7,511	17	56,771	6,911	15

## APPENDIX 2.2: CUSTOMER FORECASTS BY REGION

### MEDFORD

	Medford - Expected Growth			Medford - High Growth			Medford - Low Growth		
	Residential Customers	Commercial Customers	Industrial Customers	Residential Customers	Commercial Customers	Industrial Customers	Residential Customers	Commercial Customers	Industrial Customers
Jul-22	59,108	7,198	16	61,529	7,493	17	56,571	6,889	15
Aug-22	58,999	7,187	16	61,440	7,484	17	56,442	6,876	15
Sep-22	58,984	7,173	16	61,449	7,473	17	56,403	6,859	15
Oct-22	59,249	7,187	16	61,749	7,490	17	56,632	6,870	15
Nov-22	59,664	7,234	16	62,207	7,542	17	57,004	6,911	15
Dec-22	60,061	7,287	16	62,645	7,601	17	57,358	6,959	15
Jan-23	60,341	7,314	16	62,962	7,632	17	57,601	6,982	15
Feb-23	60,348	7,340	16	62,995	7,662	17	57,583	7,004	15
Mar-23	60,352	7,330	16	63,024	7,655	17	57,561	6,991	15
Apr-23	60,333	7,314	16	63,029	7,640	17	57,518	6,972	15
May-23	60,229	7,305	16	62,945	7,634	18	57,394	6,961	15
Jun-23	60,086	7,291	16	62,821	7,623	18	57,233	6,945	15
Jul-23	59,915	7,271	16	62,667	7,605	18	57,046	6,923	15
Aug-23	59,817	7,261	16	62,589	7,597	18	56,928	6,910	15
Sep-23	59,804	7,247	16	62,600	7,586	18	56,891	6,894	15
Oct-23	60,065	7,261	16	62,898	7,603	18	57,115	6,904	15
Nov-23	60,471	7,307	16	63,348	7,655	18	57,477	6,945	15
Dec-23	60,855	7,359	16	63,775	7,712	18	57,817	6,992	15
Jan-24	61,124	7,386	16	64,082	7,743	18	58,048	7,014	15
Feb-24	61,124	7,411	16	64,107	7,773	18	58,023	7,035	15
Mar-24	61,129	7,401	16	64,138	7,765	18	58,003	7,022	15
Apr-24	61,116	7,385	16	64,149	7,751	18	57,965	7,004	15
May-24	61,022	7,377	16	64,076	7,746	18	57,851	6,994	15
Jun-24	60,890	7,364	16	63,962	7,736	18	57,702	6,978	15
Jul-24	60,728	7,345	16	63,817	7,719	18	57,523	6,957	15
Aug-24	60,634	7,335	16	63,743	7,711	18	57,410	6,945	15
Sep-24	60,619	7,321	16	63,752	7,699	18	57,371	6,929	15
Oct-24	60,873	7,334	16	64,045	7,716	18	57,587	6,938	15
Nov-24	61,270	7,380	16	64,487	7,768	18	57,938	6,979	15
Dec-24	61,646	7,431	16	64,909	7,824	18	58,268	7,024	15
Jan-25	61,911	7,458	16	65,213	7,856	18	58,494	7,046	15
Feb-25	61,912	7,483	16	65,240	7,885	18	58,470	7,067	15
Mar-25	61,922	7,473	16	65,276	7,878	18	58,454	7,054	15
Apr-25	61,919	7,458	16	65,298	7,865	18	58,426	7,037	15
May-25	61,834	7,451	16	65,234	7,861	18	58,321	7,028	15
Jun-25	61,710	7,438	16	65,129	7,850	18	58,179	7,012	15
Jul-25	61,550	7,419	16	64,985	7,833	18	58,004	6,992	15
Aug-25	61,453	7,409	16	64,908	7,826	18	57,888	6,979	15
Sep-25	61,432	7,394	16	64,911	7,813	18	57,844	6,962	15
Oct-25	61,677	7,407	16	65,195	7,829	18	58,050	6,971	15

## APPENDIX 2.2: CUSTOMER FORECASTS BY REGION

### MEDFORD

	Medford - Expected Growth			Medford - High Growth			Medford - Low Growth		
	Residential Customers	Commercial Customers	Industrial Customers	Residential Customers	Commercial Customers	Industrial Customers	Residential Customers	Commercial Customers	Industrial Customers
Nov-25	62,066	7,453	16	65,631	7,881	18	58,392	7,012	15
Dec-25	62,436	7,503	16	66,048	7,937	18	58,715	7,056	15
Jan-26	62,700	7,530	16	66,353	7,969	18	58,939	7,078	15
Feb-26	62,704	7,556	16	66,382	7,999	18	58,918	7,100	15
Mar-26	62,720	7,546	16	66,425	7,992	18	58,908	7,087	15
Apr-26	62,723	7,531	16	66,454	7,978	18	58,886	7,070	15
May-26	62,643	7,524	16	66,394	7,975	18	58,786	7,061	15
Jun-26	62,520	7,511	16	66,290	7,964	18	58,646	7,046	15
Jul-26	62,358	7,492	16	66,143	7,947	18	58,470	7,025	15
Aug-26	62,255	7,482	16	66,059	7,939	18	58,349	7,013	15
Sep-26	62,227	7,467	16	66,054	7,926	18	58,299	6,996	15
Oct-26	62,466	7,479	16	66,333	7,942	18	58,499	7,004	15
Nov-26	62,849	7,524	16	66,765	7,993	18	58,833	7,043	15
Dec-26	63,219	7,575	16	67,183	8,050	18	59,155	7,088	15
Jan-27	63,484	7,601	16	67,490	8,081	18	59,379	7,109	15
Feb-27	63,492	7,628	16	67,524	8,112	18	59,361	7,132	15
Mar-27	63,513	7,618	16	67,572	8,105	18	59,357	7,119	15
Apr-27	63,519	7,604	16	67,604	8,092	18	59,338	7,103	15
May-27	63,440	7,597	16	67,545	8,089	18	59,239	7,094	15
Jun-27	63,316	7,584	16	67,439	8,078	18	59,099	7,079	15
Jul-27	63,148	7,564	16	67,285	8,059	18	58,919	7,057	15
Aug-27	63,038	7,554	16	67,192	8,052	18	58,793	7,045	15
Sep-27	63,003	7,538	16	67,179	8,038	18	58,736	7,028	15
Oct-27	63,237	7,550	16	67,454	8,053	18	58,931	7,036	15
Nov-27	63,618	7,595	16	67,885	8,104	18	59,262	7,075	15
Dec-27	63,987	7,646	16	68,304	8,162	18	59,582	7,120	15
Jan-28	64,255	7,672	16	68,615	8,193	18	59,808	7,141	15
Feb-28	64,265	7,699	16	68,651	8,224	18	59,793	7,163	15
Mar-28	64,288	7,690	16	68,701	8,218	18	59,790	7,152	15
Apr-28	64,294	7,675	16	68,733	8,204	18	59,772	7,135	15
May-28	64,212	7,668	16	68,670	8,200	18	59,672	7,126	15
Jun-28	64,083	7,655	16	68,557	8,189	18	59,528	7,111	15
Jul-28	63,908	7,635	16	68,394	8,171	18	59,343	7,090	15
Aug-28	63,792	7,624	16	68,294	8,162	18	59,212	7,077	14
Sep-28	63,752	7,607	16	68,276	8,147	18	59,152	7,058	14
Oct-28	63,982	7,619	16	68,546	8,163	18	59,342	7,067	14
Nov-28	64,362	7,664	16	68,978	8,214	18	59,672	7,106	14
Dec-28	64,731	7,715	16	69,398	8,271	18	59,991	7,150	14
Jan-29	65,000	7,741	16	69,711	8,302	18	60,217	7,171	14
Feb-29	65,010	7,768	16	69,747	8,334	18	60,203	7,194	14

## APPENDIX 2.2: CUSTOMER FORECASTS BY REGION

### MEDFORD

	Medford - Expected Growth			Medford - High Growth			Medford - Low Growth		
	Residential Customers	Commercial Customers	Industrial Customers	Residential Customers	Commercial Customers	Industrial Customers	Residential Customers	Commercial Customers	Industrial Customers
Mar-29	65,031	7,758	16	69,794	8,326	18	60,199	7,182	14
Apr-29	65,034	7,744	16	69,822	8,314	18	60,178	7,165	14
May-29	64,948	7,736	16	69,754	8,308	18	60,076	7,156	14
Jun-29	64,813	7,723	16	69,634	8,297	18	59,927	7,141	14
Jul-29	64,633	7,702	16	69,464	8,278	18	59,739	7,119	14
Aug-29	64,512	7,691	16	69,358	8,269	18	59,604	7,106	14
Sep-29	64,469	7,675	16	69,336	8,254	18	59,542	7,088	14
Oct-29	64,699	7,687	16	69,607	8,270	18	59,732	7,097	14
Nov-29	65,079	7,731	16	70,040	8,320	18	60,061	7,135	14
Dec-29	65,450	7,782	16	70,463	8,378	18	60,380	7,179	14
Jan-30	65,718	7,809	16	70,776	8,410	19	60,605	7,201	14
Feb-30	65,728	7,835	16	70,811	8,441	19	60,591	7,223	14
Mar-30	65,747	7,826	16	70,856	8,434	19	60,586	7,212	14
Apr-30	65,746	7,811	16	70,880	8,420	19	60,562	7,195	14
May-30	65,655	7,803	16	70,806	8,415	19	60,456	7,185	14
Jun-30	65,515	7,789	16	70,679	8,403	19	60,304	7,169	14
Jul-30	65,331	7,768	16	70,504	8,383	19	60,113	7,148	14
Aug-30	65,206	7,757	16	70,392	8,374	19	59,977	7,135	14
Sep-30	65,161	7,740	16	70,367	8,358	19	59,914	7,117	14
Oct-30	65,389	7,752	16	70,636	8,374	19	60,102	7,125	14
Nov-30	65,768	7,796	16	71,069	8,424	19	60,428	7,163	14
Dec-30	66,137	7,847	16	71,492	8,482	19	60,745	7,207	14
Jan-31	66,404	7,874	16	71,804	8,514	19	60,969	7,230	14
Feb-31	66,410	7,900	16	71,834	8,545	19	60,952	7,251	14
Mar-31	66,425	7,890	16	71,874	8,537	19	60,944	7,239	14
Apr-31	66,419	7,875	16	71,891	8,523	19	60,917	7,222	14
May-31	66,322	7,867	16	71,810	8,518	19	60,806	7,213	14
Jun-31	66,177	7,852	16	71,676	8,505	19	60,651	7,196	14
Jul-31	65,990	7,831	16	71,497	8,484	19	60,459	7,175	14
Aug-31	65,863	7,820	16	71,382	8,475	19	60,322	7,162	14
Sep-31	65,816	7,803	16	71,353	8,459	19	60,258	7,144	14
Oct-31	66,043	7,815	16	71,622	8,475	19	60,445	7,153	14
Nov-31	66,421	7,859	16	72,055	8,526	19	60,770	7,190	14
Dec-31	66,788	7,910	16	72,476	8,584	19	61,084	7,234	14
Jan-32	67,052	7,936	16	72,786	8,615	19	61,304	7,256	14
Feb-32	67,054	7,962	16	72,811	8,646	19	61,285	7,277	14
Mar-32	67,064	7,952	16	72,845	8,637	19	61,273	7,265	14
Apr-32	67,053	7,936	16	72,856	8,622	19	61,242	7,248	14
May-32	66,953	7,928	16	72,770	8,617	19	61,129	7,238	14
Jun-32	66,805	7,913	16	72,633	8,603	19	60,973	7,222	14
Jul-32	66,615	7,892	16	72,448	8,583	19	60,779	7,201	14

## APPENDIX 2.2: CUSTOMER FORECASTS BY REGION

### MEDFORD

	Medford - Expected Growth			Medford - High Growth			Medford - Low Growth		
	Residential Customers	Commercial Customers	Industrial Customers	Residential Customers	Commercial Customers	Industrial Customers	Residential Customers	Commercial Customers	Industrial Customers
Aug-32	66,487	7,881	16	72,331	8,574	19	60,642	7,188	14
Sep-32	66,439	7,864	16	72,301	8,558	19	60,578	7,170	14
Oct-32	66,665	7,875	16	72,569	8,572	19	60,764	7,178	14
Nov-32	67,041	7,920	16	73,001	8,624	19	61,086	7,217	14
Dec-32	67,406	7,970	16	73,421	8,681	19	61,398	7,260	14
Jan-33	67,667	7,996	16	73,728	8,712	19	61,615	7,281	14
Feb-33	67,666	8,022	16	73,749	8,743	19	61,594	7,302	14
Mar-33	67,672	8,012	16	73,778	8,735	19	61,579	7,291	14
Apr-33	67,658	7,996	16	73,786	8,720	19	61,545	7,273	14
May-33	67,554	7,987	16	73,695	8,713	19	61,430	7,263	14
Jun-33	67,404	7,972	16	73,554	8,699	19	61,273	7,247	14
Jul-33	67,213	7,951	16	73,367	8,679	19	61,080	7,225	14
Aug-33	67,084	7,940	16	73,248	8,670	19	60,943	7,213	14
Sep-33	67,035	7,923	16	73,216	8,654	19	60,879	7,195	14
Oct-33	67,259	7,934	16	73,483	8,668	19	61,062	7,203	14
Nov-33	67,634	7,978	16	73,915	8,719	19	61,383	7,241	14
Dec-33	67,996	8,029	16	74,332	8,777	19	61,692	7,285	14
Jan-34	68,253	8,054	16	74,635	8,807	19	61,905	7,305	14
Feb-34	68,249	8,080	16	74,653	8,838	19	61,881	7,326	14
Mar-34	68,252	8,069	16	74,679	8,829	19	61,864	7,314	14
Apr-34	68,235	8,054	16	74,682	8,814	19	61,828	7,297	14
May-34	68,130	8,045	16	74,589	8,808	19	61,713	7,287	14
Jun-34	67,978	8,030	16	74,445	8,794	19	61,555	7,271	14
Jul-34	67,786	8,009	16	74,256	8,773	19	61,362	7,250	14
Aug-34	67,655	7,997	16	74,134	8,763	19	61,225	7,237	14
Sep-34	67,605	7,980	16	74,100	8,747	19	61,160	7,219	14
Oct-34	67,827	7,991	16	74,365	8,761	19	61,342	7,227	14
Nov-34	68,199	8,035	16	74,795	8,812	19	61,659	7,264	14
Dec-34	68,558	8,085	16	75,210	8,869	19	61,964	7,307	14
Jan-35	68,813	8,111	16	75,511	8,901	19	62,175	7,329	14
Feb-35	68,806	8,136	16	75,525	8,931	19	62,149	7,349	14
Mar-35	68,806	8,125	16	75,547	8,921	19	62,130	7,337	14
Apr-35	68,788	8,109	16	75,549	8,905	19	62,094	7,319	13
May-35	68,680	8,101	16	75,452	8,900	19	61,977	7,310	13
Jun-35	68,527	8,085	16	75,306	8,885	19	61,820	7,294	13
Jul-35	68,335	8,064	16	75,116	8,864	19	61,627	7,272	13
Aug-35	68,205	8,053	16	74,994	8,855	19	61,491	7,260	13
Sep-35	68,154	8,035	16	74,959	8,837	19	61,426	7,242	13
Oct-35	68,375	8,047	16	75,224	8,853	19	61,606	7,250	13
Nov-35	68,746	8,091	16	75,653	8,904	19	61,921	7,288	13
Dec-35	69,104	8,141	16	76,069	8,962	19	62,225	7,331	13

## APPENDIX 2.2: CUSTOMER FORECASTS BY REGION

### ROSEBURG

	Roseburg - Expected Growth			Roseburg - High Growth			Roseburg - Low Growth		
	Residential Customers	Commercial Customers	Industrial Customers	Residential Customers	Commercial Customers	Industrial Customers	Residential Customers	Commercial Customers	Industrial Customers
Nov-15	13,361	2,132	2	13,361	2,132	2	13,361	2,132	2
Dec-15	13,503	2,159	2	13,503	2,159	2	13,503	2,159	2
Jan-16	13,582	2,157	2	13,603	2,161	2	13,565	2,154	2
Feb-16	13,555	2,163	2	13,579	2,167	2	13,536	2,160	2
Mar-16	13,559	2,173	2	13,586	2,178	2	13,537	2,170	2
Apr-16	13,544	2,154	2	13,574	2,159	2	13,520	2,150	2
May-16	13,515	2,154	2	13,548	2,159	2	13,488	2,150	2
Jun-16	13,445	2,146	2	13,481	2,152	2	13,416	2,142	2
Jul-16	13,386	2,141	2	13,425	2,147	2	13,355	2,136	2
Aug-16	13,333	2,130	2	13,376	2,137	2	13,299	2,125	2
Sep-16	13,329	2,130	2	13,375	2,138	2	13,292	2,124	2
Oct-16	13,422	2,135	2	13,472	2,143	2	13,382	2,129	2
Nov-16	13,579	2,144	2	13,633	2,153	2	13,536	2,137	2
Dec-16	13,693	2,162	2	13,751	2,171	2	13,647	2,155	2
Jan-17	13,726	2,162	2	13,788	2,172	2	13,677	2,154	2
Feb-17	13,707	2,166	2	13,772	2,176	2	13,655	2,158	2
Mar-17	13,705	2,176	2	13,774	2,187	2	13,650	2,167	2
Apr-17	13,698	2,162	2	13,770	2,174	2	13,641	2,153	2
May-17	13,657	2,159	2	13,732	2,171	2	13,597	2,150	2
Jun-17	13,588	2,155	2	13,666	2,168	2	13,525	2,145	2
Jul-17	13,533	2,145	2	13,615	2,158	2	13,468	2,135	2
Aug-17	13,464	2,138	2	13,550	2,152	2	13,396	2,127	2
Sep-17	13,471	2,138	2	13,560	2,152	2	13,400	2,127	2
Oct-17	13,565	2,137	2	13,659	2,152	2	13,490	2,125	2
Nov-17	13,712	2,152	2	13,811	2,168	2	13,633	2,140	2
Dec-17	13,840	2,167	2	13,944	2,183	2	13,757	2,154	2
Jan-18	13,874	2,164	2	13,982	2,181	2	13,788	2,151	2
Feb-18	13,859	2,171	2	13,971	2,189	2	13,770	2,157	2
Mar-18	13,861	2,178	2	13,977	2,196	2	13,769	2,164	2
Apr-18	13,848	2,166	2	13,968	2,185	2	13,753	2,151	2
May-18	13,814	2,163	2	13,938	2,183	2	13,716	2,148	2
Jun-18	13,741	2,158	2	13,868	2,178	2	13,640	2,142	2
Jul-18	13,682	2,151	2	13,813	2,172	2	13,578	2,135	2
Aug-18	13,620	2,141	2	13,754	2,162	2	13,513	2,124	2
Sep-18	13,623	2,144	2	13,761	2,166	2	13,513	2,127	2
Oct-18	13,715	2,143	2	13,858	2,166	2	13,601	2,125	2
Nov-18	13,865	2,155	2	14,014	2,178	2	13,746	2,137	2
Dec-18	13,992	2,173	2	14,147	2,197	2	13,869	2,154	2
Jan-19	14,030	2,169	2	14,190	2,194	2	13,903	2,150	2
Feb-19	14,016	2,176	2	14,180	2,202	2	13,886	2,156	2

## APPENDIX 2.2: CUSTOMER FORECASTS BY REGION

### ROSEBURG

	Roseburg - Expected Growth			Roseburg - High Growth			Roseburg - Low Growth		
	Residential Customers	Commercial Customers	Industrial Customers	Residential Customers	Commercial Customers	Industrial Customers	Residential Customers	Commercial Customers	Industrial Customers
Mar-19	14,017	2,184	2	14,185	2,210	2	13,884	2,163	2
Apr-19	14,008	2,170	2	14,180	2,197	2	13,872	2,149	2
May-19	13,970	2,168	2	14,146	2,195	2	13,831	2,147	2
Jun-19	13,898	2,163	2	14,077	2,191	2	13,756	2,141	2
Jul-19	13,842	2,155	2	14,025	2,184	2	13,697	2,133	2
Aug-19	13,777	2,147	2	13,963	2,176	2	13,629	2,124	2
Sep-19	13,781	2,147	2	13,972	2,177	2	13,630	2,124	2
Oct-19	13,873	2,148	2	14,069	2,179	2	13,717	2,124	2
Nov-19	14,023	2,160	2	14,226	2,191	2	13,862	2,135	2
Dec-19	14,153	2,177	2	14,362	2,209	2	13,987	2,152	2
Jan-20	14,190	2,174	2	14,405	2,207	2	14,020	2,148	2
Feb-20	14,177	2,180	2	14,396	2,214	2	14,004	2,154	2
Mar-20	14,180	2,189	2	14,403	2,224	2	14,003	2,162	2
Apr-20	14,169	2,175	2	14,397	2,210	2	13,989	2,148	2
May-20	14,133	2,173	2	14,365	2,209	2	13,950	2,145	2
Jun-20	14,062	2,168	2	14,297	2,204	2	13,876	2,140	2
Jul-20	14,005	2,160	2	14,244	2,197	2	13,816	2,131	2
Aug-20	13,941	2,151	2	14,183	2,189	2	13,750	2,122	2
Sep-20	13,945	2,152	2	14,192	2,190	2	13,750	2,122	2
Oct-20	14,037	2,152	2	14,290	2,191	2	13,837	2,122	2
Nov-20	14,188	2,165	2	14,449	2,205	2	13,982	2,134	2
Dec-20	14,318	2,182	2	14,586	2,223	2	14,107	2,150	2
Jan-21	14,357	2,179	2	14,630	2,221	2	14,141	2,146	2
Feb-21	14,344	2,185	2	14,622	2,228	2	14,125	2,152	2
Mar-21	14,347	2,193	2	14,630	2,236	2	14,124	2,159	2
Apr-21	14,337	2,180	2	14,624	2,224	2	14,110	2,146	2
May-21	14,301	2,177	2	14,592	2,222	2	14,071	2,142	2
Jun-21	14,230	2,172	2	14,525	2,217	2	13,998	2,137	2
Jul-21	14,174	2,165	2	14,472	2,211	2	13,939	2,129	2
Aug-21	14,110	2,156	2	14,412	2,202	2	13,872	2,120	2
Sep-21	14,113	2,157	2	14,420	2,204	2	13,872	2,120	2
Oct-21	14,206	2,157	2	14,519	2,205	2	13,959	2,120	2
Nov-21	14,357	2,170	2	14,679	2,219	2	14,104	2,132	2
Dec-21	14,487	2,187	2	14,816	2,237	2	14,228	2,148	2
Jan-22	14,526	2,183	2	14,861	2,234	2	14,263	2,144	2
Feb-22	14,514	2,190	2	14,854	2,241	2	14,247	2,150	2
Mar-22	14,516	2,198	2	14,861	2,250	2	14,245	2,157	2
Apr-22	14,507	2,184	2	14,856	2,237	2	14,233	2,143	2
May-22	14,471	2,182	2	14,825	2,235	2	14,193	2,140	2
Jun-22	14,400	2,177	2	14,757	2,231	2	14,120	2,135	2



## APPENDIX 2.2: CUSTOMER FORECASTS BY REGION

### ROSEBURG

	Roseburg - Expected Growth			Roseburg - High Growth			Roseburg - Low Growth		
	Residential Customers	Commercial Customers	Industrial Customers	Residential Customers	Commercial Customers	Industrial Customers	Residential Customers	Commercial Customers	Industrial Customers
Jul-22	14,344	2,169	2	14,704	2,224	2	14,061	2,126	2
Aug-22	14,280	2,161	2	14,643	2,216	2	13,995	2,118	2
Sep-22	14,284	2,162	2	14,652	2,218	2	13,995	2,118	2
Oct-22	14,377	2,162	2	14,753	2,219	2	14,082	2,118	2
Nov-22	14,528	2,174	2	14,913	2,232	2	14,227	2,129	2
Dec-22	14,658	2,191	2	15,051	2,250	2	14,350	2,145	2
Jan-23	14,698	2,188	2	15,097	2,248	2	14,385	2,142	2
Feb-23	14,685	2,195	2	15,089	2,256	2	14,369	2,148	2
Mar-23	14,688	2,203	2	15,097	2,265	2	14,368	2,155	2
Apr-23	14,679	2,189	2	15,093	2,251	2	14,355	2,141	2
May-23	14,643	2,187	2	15,061	2,250	2	14,316	2,138	2
Jun-23	14,573	2,182	2	14,994	2,245	2	14,244	2,133	2
Jul-23	14,516	2,174	2	14,940	2,238	2	14,184	2,125	2
Aug-23	14,452	2,165	2	14,879	2,229	2	14,118	2,115	2
Sep-23	14,456	2,166	2	14,888	2,231	2	14,119	2,116	2
Oct-23	14,548	2,167	2	14,987	2,233	2	14,205	2,116	2
Nov-23	14,699	2,179	2	15,148	2,246	2	14,348	2,127	2
Dec-23	14,829	2,196	2	15,287	2,264	2	14,472	2,143	2
Jan-24	14,868	2,193	2	15,332	2,262	2	14,506	2,140	2
Feb-24	14,856	2,200	2	15,324	2,270	2	14,490	2,146	2
Mar-24	14,858	2,208	2	15,331	2,279	2	14,489	2,153	2
Apr-24	14,849	2,194	2	15,327	2,265	2	14,476	2,139	2
May-24	14,813	2,192	2	15,295	2,263	2	14,437	2,137	2
Jun-24	14,742	2,186	2	15,226	2,258	2	14,364	2,130	2
Jul-24	14,685	2,179	2	15,172	2,251	2	14,305	2,123	2
Aug-24	14,621	2,170	2	15,111	2,243	2	14,239	2,114	2
Sep-24	14,624	2,171	2	15,119	2,245	2	14,239	2,114	2
Oct-24	14,716	2,171	2	15,218	2,245	2	14,325	2,113	2
Nov-24	14,867	2,184	2	15,379	2,259	2	14,468	2,126	2
Dec-24	14,996	2,201	2	15,518	2,278	2	14,590	2,142	2
Jan-25	15,035	2,198	2	15,563	2,275	2	14,625	2,138	2
Feb-25	15,022	2,204	2	15,554	2,282	2	14,608	2,143	2
Mar-25	15,024	2,212	2	15,561	2,291	2	14,607	2,151	2
Apr-25	15,015	2,199	2	15,556	2,278	2	14,594	2,138	2
May-25	14,978	2,196	2	15,523	2,276	2	14,555	2,134	2
Jun-25	14,907	2,191	2	15,454	2,272	2	14,482	2,129	2
Jul-25	14,850	2,184	2	15,399	2,265	2	14,423	2,121	2
Aug-25	14,785	2,175	2	15,337	2,256	2	14,357	2,112	2
Sep-25	14,788	2,176	2	15,344	2,258	2	14,356	2,113	2
Oct-25	14,880	2,176	2	15,444	2,259	2	14,442	2,112	2

## APPENDIX 2.2: CUSTOMER FORECASTS BY REGION

### ROSEBURG

	Roseburg - Expected Growth			Roseburg - High Growth			Roseburg - Low Growth		
	Residential Customers	Commercial Customers	Industrial Customers	Residential Customers	Commercial Customers	Industrial Customers	Residential Customers	Commercial Customers	Industrial Customers
Nov-25	15,030	2,189	2	15,605	2,273	2	14,584	2,124	2
Dec-25	15,160	2,206	2	15,744	2,291	3	14,707	2,140	2
Jan-26	15,198	2,202	2	15,789	2,288	3	14,740	2,136	1
Feb-26	15,185	2,209	2	15,780	2,296	3	14,724	2,142	1
Mar-26	15,187	2,217	2	15,786	2,305	3	14,722	2,149	1
Apr-26	15,177	2,203	2	15,781	2,291	3	14,709	2,135	1
May-26	15,140	2,201	2	15,747	2,289	3	14,670	2,133	1
Jun-26	15,069	2,196	2	15,678	2,285	3	14,598	2,127	1
Jul-26	15,012	2,188	2	15,623	2,277	3	14,539	2,119	1
Aug-26	14,948	2,180	2	15,561	2,270	3	14,473	2,111	1
Sep-26	14,951	2,181	2	15,569	2,271	3	14,473	2,111	1
Oct-26	15,044	2,181	2	15,671	2,272	3	14,559	2,111	1
Nov-26	15,194	2,193	2	15,832	2,285	3	14,701	2,122	1
Dec-26	15,324	2,210	2	15,973	2,304	3	14,823	2,138	1
Jan-27	15,363	2,207	2	16,018	2,301	3	14,857	2,134	1
Feb-27	15,350	2,214	2	16,009	2,309	3	14,841	2,141	1
Mar-27	15,353	2,222	2	16,018	2,318	3	14,840	2,148	1
Apr-27	15,343	2,208	2	16,012	2,304	3	14,826	2,134	1
May-27	15,307	2,206	2	15,979	2,303	3	14,788	2,131	1
Jun-27	15,235	2,201	2	15,909	2,299	3	14,715	2,126	1
Jul-27	15,179	2,193	2	15,855	2,291	3	14,657	2,118	1
Aug-27	15,114	2,184	2	15,792	2,282	3	14,591	2,109	1
Sep-27	15,117	2,185	2	15,800	2,284	3	14,590	2,109	1
Oct-27	15,210	2,186	2	15,902	2,286	3	14,676	2,109	1
Nov-27	15,360	2,198	2	16,064	2,299	3	14,818	2,121	1
Dec-27	15,490	2,215	2	16,205	2,317	3	14,939	2,136	1
Jan-28	15,529	2,212	2	16,251	2,315	3	14,973	2,133	1
Feb-28	15,516	2,218	2	16,242	2,322	3	14,957	2,138	1
Mar-28	15,518	2,226	2	16,249	2,331	3	14,955	2,145	1
Apr-28	15,508	2,213	2	16,243	2,318	3	14,942	2,132	1
May-28	15,472	2,211	2	16,210	2,317	3	14,904	2,130	1
Jun-28	15,401	2,205	2	16,141	2,311	3	14,832	2,124	1
Jul-28	15,344	2,198	2	16,086	2,304	3	14,773	2,116	1
Aug-28	15,279	2,189	2	16,022	2,296	3	14,707	2,107	1
Sep-28	15,282	2,190	2	16,030	2,297	3	14,707	2,108	1
Oct-28	15,374	2,190	2	16,131	2,298	3	14,792	2,107	1
Nov-28	15,524	2,203	2	16,294	2,312	3	14,933	2,119	1
Dec-28	15,654	2,220	2	16,435	2,331	3	15,054	2,135	1
Jan-29	15,692	2,216	2	16,480	2,327	3	15,087	2,131	1
Feb-29	15,679	2,223	2	16,471	2,335	3	15,071	2,137	1

## APPENDIX 2.2: CUSTOMER FORECASTS BY REGION

### ROSEBURG

	Roseburg - Expected Growth			Roseburg - High Growth			Roseburg - Low Growth		
	Residential Customers	Commercial Customers	Industrial Customers	Residential Customers	Commercial Customers	Industrial Customers	Residential Customers	Commercial Customers	Industrial Customers
Mar-29	15,681	2,231	2	16,478	2,345	3	15,070	2,144	1
Apr-29	15,671	2,217	2	16,472	2,330	3	15,057	2,130	1
May-29	15,635	2,215	2	16,439	2,329	3	15,019	2,128	1
Jun-29	15,563	2,210	2	16,368	2,324	3	14,946	2,123	1
Jul-29	15,506	2,203	2	16,312	2,318	3	14,888	2,115	1
Aug-29	15,441	2,194	2	16,249	2,309	3	14,822	2,106	1
Sep-29	15,443	2,195	2	16,255	2,311	3	14,821	2,107	1
Oct-29	15,535	2,195	2	16,357	2,311	3	14,906	2,106	1
Nov-29	15,685	2,208	2	16,519	2,326	3	15,046	2,118	1
Dec-29	15,814	2,224	2	16,660	2,343	3	15,167	2,133	1
Jan-30	15,852	2,221	2	16,704	2,341	3	15,200	2,130	1
Feb-30	15,838	2,228	2	16,694	2,349	3	15,183	2,136	1
Mar-30	15,840	2,236	2	16,701	2,358	3	15,181	2,143	1
Apr-30	15,830	2,222	2	16,695	2,344	3	15,168	2,129	1
May-30	15,793	2,220	2	16,661	2,342	3	15,130	2,127	1
Jun-30	15,721	2,215	2	16,589	2,338	3	15,057	2,122	1
Jul-30	15,663	2,207	2	16,532	2,330	3	14,999	2,114	1
Aug-30	15,596	2,198	2	16,465	2,321	3	14,932	2,105	1
Sep-30	15,598	2,200	2	16,471	2,323	3	14,931	2,106	1
Oct-30	15,688	2,200	2	16,570	2,324	3	15,014	2,106	1
Nov-30	15,837	2,212	2	16,732	2,337	3	15,154	2,117	1
Dec-30	15,965	2,229	2	16,871	2,356	3	15,273	2,133	1
Jan-31	16,002	2,226	2	16,914	2,353	3	15,306	2,129	1
Feb-31	15,987	2,233	2	16,903	2,361	3	15,288	2,136	1
Mar-31	15,988	2,241	2	16,908	2,370	3	15,286	2,143	1
Apr-31	15,976	2,227	2	16,899	2,356	3	15,272	2,129	1
May-31	15,938	2,225	2	16,863	2,354	3	15,233	2,127	1
Jun-31	15,865	2,220	2	16,790	2,350	3	15,160	2,122	1
Jul-31	15,807	2,212	2	16,732	2,342	3	15,102	2,113	1
Aug-31	15,740	2,203	2	16,665	2,333	3	15,035	2,105	1
Sep-31	15,741	2,204	2	16,670	2,334	3	15,033	2,105	1
Oct-31	15,831	2,205	2	16,769	2,336	3	15,116	2,106	1
Nov-31	15,980	2,217	2	16,931	2,349	3	15,256	2,117	1
Dec-31	16,108	2,234	2	17,070	2,368	3	15,375	2,133	1
Jan-32	16,144	2,231	2	17,112	2,365	3	15,407	2,129	1
Feb-32	16,129	2,237	2	17,100	2,372	3	15,390	2,135	1
Mar-32	16,129	2,245	2	17,104	2,381	3	15,387	2,142	1
Apr-32	16,118	2,232	2	17,096	2,368	3	15,374	2,129	1
May-32	16,079	2,229	2	17,059	2,365	3	15,334	2,126	1
Jun-32	16,006	2,224	2	16,985	2,360	3	15,261	2,121	1
Jul-32	15,947	2,217	2	16,927	2,353	3	15,202	2,114	1

## APPENDIX 2.2: CUSTOMER FORECASTS BY REGION

### ROSEBURG

	Roseburg - Expected Growth			Roseburg - High Growth			Roseburg - Low Growth		
	Residential Customers	Commercial Customers	Industrial Customers	Residential Customers	Commercial Customers	Industrial Customers	Residential Customers	Commercial Customers	Industrial Customers
Aug-32	15,880	2,208	2	16,859	2,344	3	15,136	2,105	1
Sep-32	15,881	2,209	2	16,864	2,346	3	15,134	2,105	1
Oct-32	15,971	2,209	2	16,963	2,346	3	15,217	2,105	1
Nov-32	16,119	2,222	2	17,124	2,361	3	15,355	2,117	1
Dec-32	16,247	2,239	2	17,264	2,379	3	15,474	2,133	1
Jan-33	16,283	2,235	2	17,306	2,376	3	15,506	2,129	1
Feb-33	16,268	2,242	2	17,294	2,384	3	15,489	2,135	1
Mar-33	16,268	2,250	2	17,298	2,393	3	15,486	2,142	1
Apr-33	16,256	2,236	2	17,289	2,378	3	15,472	2,128	1
May-33	16,218	2,234	2	17,252	2,377	3	15,433	2,126	1
Jun-33	16,144	2,229	2	17,177	2,372	3	15,360	2,121	1
Jul-33	16,085	2,221	2	17,118	2,364	3	15,301	2,113	1
Aug-33	16,018	2,213	2	17,051	2,356	3	15,235	2,105	1
Sep-33	16,019	2,214	2	17,056	2,357	3	15,233	2,106	1
Oct-33	16,109	2,214	2	17,155	2,358	3	15,316	2,105	1
Nov-33	16,257	2,226	2	17,316	2,371	3	15,454	2,116	1
Dec-33	16,384	2,243	2	17,455	2,390	3	15,572	2,132	1
Jan-34	16,421	2,240	2	17,499	2,387	3	15,605	2,129	1
Feb-34	16,405	2,247	2	17,485	2,395	3	15,587	2,135	1
Mar-34	16,405	2,255	2	17,489	2,404	3	15,584	2,142	1
Apr-34	16,393	2,241	2	17,480	2,390	3	15,570	2,129	1
May-34	16,354	2,239	2	17,442	2,388	3	15,530	2,126	1
Jun-34	16,281	2,234	2	17,368	2,383	3	15,458	2,121	1
Jul-34	16,221	2,226	2	17,308	2,375	3	15,399	2,113	1
Aug-34	16,155	2,217	2	17,241	2,366	3	15,333	2,104	1
Sep-34	16,155	2,218	2	17,245	2,368	3	15,331	2,105	1
Oct-34	16,245	2,219	2	17,344	2,369	3	15,414	2,106	1
Nov-34	16,393	2,231	2	17,506	2,383	3	15,551	2,117	1
Dec-34	16,520	2,248	2	17,645	2,401	3	15,669	2,132	1
Jan-35	16,556	2,245	2	17,688	2,399	3	15,701	2,129	1
Feb-35	16,541	2,251	2	17,675	2,406	3	15,684	2,135	1
Mar-35	16,541	2,260	2	17,679	2,416	3	15,681	2,143	1
Apr-35	16,528	2,246	2	17,669	2,401	3	15,666	2,129	1
May-35	16,490	2,244	2	17,632	2,400	3	15,628	2,127	1
Jun-35	16,416	2,238	2	17,557	2,394	3	15,555	2,121	1
Jul-35	16,357	2,231	2	17,497	2,387	3	15,496	2,114	1
Aug-35	16,290	2,222	2	17,429	2,378	3	15,430	2,105	1
Sep-35	16,290	2,223	2	17,433	2,379	3	15,428	2,105	1
Oct-35	16,380	2,223	2	17,533	2,380	3	15,510	2,105	1
Nov-35	16,528	2,236	2	17,695	2,394	3	15,648	2,117	1
Dec-35	16,655	2,253	2	17,834	2,413	3	15,766	2,133	1

## APPENDIX 2.2: CUSTOMER FORECASTS BY REGION

### KLAMATH FALLS

	Klamath Falls - Expected Growth			Klamath Falls - High Growth			Klamath Falls - Low Growth		
	Residential Customers	Commercial Customers	Industrial Customers	Residential Customers	Commercial Customers	Industrial Customers	Residential Customers	Commercial Customers	Industrial Customers
Nov-15	14,242	1,689	7	14,242	1,689	7	14,242	1,689	7
Dec-15	14,380	1,707	7	14,380	1,707	7	14,380	1,707	7
Jan-16	14,409	1,708	8	14,409	1,708	8	14,409	1,708	8
Feb-16	14,448	1,720	8	14,448	1,720	8	14,448	1,720	8
Mar-16	14,438	1,715	8	14,438	1,715	8	14,438	1,715	8
Apr-16	14,445	1,707	8	14,445	1,707	8	14,445	1,707	8
May-16	14,427	1,701	8	14,427	1,701	8	14,427	1,701	8
Jun-16	14,333	1,700	8	14,333	1,700	8	14,333	1,700	8
Jul-16	14,255	1,695	8	14,259	1,695	8	14,251	1,694	8
Aug-16	14,172	1,690	8	14,180	1,690	8	14,163	1,688	8
Sep-16	14,165	1,688	8	14,177	1,689	8	14,152	1,686	8
Oct-16	14,302	1,688	8	14,318	1,689	8	14,284	1,685	8
Nov-16	14,440	1,703	8	14,460	1,705	8	14,417	1,700	8
Dec-16	14,560	1,715	8	14,584	1,717	8	14,532	1,711	8
Jan-17	14,630	1,728	8	14,658	1,731	8	14,598	1,724	8
Feb-17	14,657	1,730	8	14,689	1,733	8	14,620	1,725	8
Mar-17	14,654	1,727	8	14,690	1,731	8	14,612	1,722	8
Apr-17	14,634	1,721	8	14,674	1,725	8	14,588	1,715	8
May-17	14,599	1,719	8	14,643	1,724	8	14,548	1,713	8
Jun-17	14,510	1,715	8	14,558	1,720	8	14,455	1,708	8
Jul-17	14,425	1,708	8	14,477	1,714	8	14,365	1,700	8
Aug-17	14,348	1,702	8	14,404	1,708	8	14,284	1,694	8
Sep-17	14,352	1,700	8	14,413	1,707	8	14,282	1,691	8
Oct-17	14,499	1,705	8	14,565	1,712	8	14,423	1,696	8
Nov-17	14,649	1,719	8	14,721	1,727	8	14,567	1,709	8
Dec-17	14,772	1,729	8	14,849	1,738	8	14,684	1,718	8
Jan-18	14,842	1,742	8	14,924	1,751	8	14,749	1,731	8
Feb-18	14,868	1,744	8	14,955	1,754	8	14,769	1,732	8
Mar-18	14,860	1,743	8	14,951	1,753	8	14,756	1,730	8
Apr-18	14,835	1,741	8	14,931	1,752	8	14,726	1,728	8
May-18	14,798	1,735	8	14,898	1,746	8	14,684	1,721	8
Jun-18	14,708	1,729	8	14,812	1,741	8	14,589	1,715	8
Jul-18	14,625	1,722	8	14,734	1,734	8	14,501	1,707	8
Aug-18	14,552	1,716	8	14,665	1,729	8	14,423	1,700	8
Sep-18	14,560	1,717	8	14,678	1,730	8	14,426	1,701	8
Oct-18	14,711	1,726	8	14,835	1,740	8	14,570	1,709	8
Nov-18	14,863	1,737	8	14,993	1,752	8	14,715	1,719	8
Dec-18	14,986	1,747	8	15,123	1,762	8	14,831	1,728	8
Jan-19	15,056	1,762	8	15,198	1,778	8	14,895	1,743	8
Feb-19	15,080	1,766	8	15,228	1,783	8	14,913	1,746	8

## APPENDIX 2.2: CUSTOMER FORECASTS BY REGION

### KLAMATH FALLS

	Klamath Falls - Expected Growth			Klamath Falls - High Growth			Klamath Falls - Low Growth		
	Residential Customers	Commercial Customers	Industrial Customers	Residential Customers	Commercial Customers	Industrial Customers	Residential Customers	Commercial Customers	Industrial Customers
Mar-19	15,071	1,763	8	15,223	1,780	8	14,898	1,742	8
Apr-19	15,045	1,758	8	15,202	1,776	8	14,867	1,737	8
May-19	15,008	1,753	8	15,170	1,771	8	14,824	1,731	8
Jun-19	14,919	1,748	8	15,085	1,767	8	14,731	1,725	8
Jul-19	14,838	1,741	8	15,008	1,761	8	14,645	1,718	8
Aug-19	14,766	1,735	8	14,941	1,755	8	14,568	1,711	8
Sep-19	14,775	1,735	8	14,955	1,756	8	14,571	1,711	8
Oct-19	14,927	1,743	8	15,114	1,764	8	14,715	1,718	8
Nov-19	15,080	1,756	8	15,275	1,778	9	14,860	1,730	8
Dec-19	15,204	1,767	8	15,405	1,790	9	14,976	1,740	8
Jan-20	15,273	1,780	8	15,481	1,804	9	15,038	1,752	8
Feb-20	15,298	1,784	8	15,512	1,808	9	15,057	1,755	8
Mar-20	15,288	1,781	8	15,507	1,806	9	15,041	1,752	8
Apr-20	15,263	1,776	8	15,487	1,802	9	15,010	1,746	8
May-20	15,226	1,771	8	15,455	1,797	9	14,968	1,740	8
Jun-20	15,138	1,767	8	15,371	1,794	9	14,875	1,736	8
Jul-20	15,058	1,760	8	15,295	1,787	9	14,790	1,728	8
Aug-20	14,987	1,754	8	15,229	1,782	9	14,714	1,722	8
Sep-20	14,997	1,754	8	15,245	1,782	9	14,718	1,721	8
Oct-20	15,150	1,761	8	15,406	1,790	9	14,862	1,727	8
Nov-20	15,303	1,774	8	15,567	1,804	9	15,006	1,739	8
Dec-20	15,427	1,785	8	15,699	1,816	9	15,121	1,749	8
Jan-21	15,497	1,799	8	15,776	1,831	9	15,183	1,762	8
Feb-21	15,522	1,801	8	15,807	1,834	9	15,201	1,763	8
Mar-21	15,513	1,800	8	15,804	1,833	9	15,186	1,762	8
Apr-21	15,488	1,795	8	15,784	1,829	9	15,155	1,756	8
May-21	15,452	1,790	8	15,753	1,824	9	15,113	1,750	8
Jun-21	15,365	1,785	8	15,670	1,820	9	15,022	1,745	8
Jul-21	15,285	1,778	8	15,594	1,814	9	14,937	1,737	8
Aug-21	15,214	1,773	8	15,528	1,809	9	14,862	1,731	8
Sep-21	15,224	1,773	8	15,544	1,810	9	14,865	1,731	8
Oct-21	15,377	1,780	8	15,706	1,818	9	15,008	1,737	8
Nov-21	15,531	1,793	8	15,869	1,832	9	15,152	1,749	8
Dec-21	15,654	1,804	8	16,001	1,843	9	15,266	1,759	8
Jan-22	15,724	1,818	8	16,078	1,858	9	15,327	1,772	8
Feb-22	15,749	1,821	8	16,110	1,862	9	15,345	1,774	7
Mar-22	15,740	1,819	8	16,106	1,861	9	15,330	1,771	7
Apr-22	15,716	1,814	8	16,088	1,856	9	15,300	1,766	7
May-22	15,680	1,809	8	16,057	1,852	9	15,259	1,760	7
Jun-22	15,593	1,804	8	15,974	1,848	9	15,167	1,754	7

## APPENDIX 2.2: CUSTOMER FORECASTS BY REGION

### KLAMATH FALLS

	Klamath Falls - Expected Growth			Klamath Falls - High Growth			Klamath Falls - Low Growth		
	Residential Customers	Commercial Customers	Industrial Customers	Residential Customers	Commercial Customers	Industrial Customers	Residential Customers	Commercial Customers	Industrial Customers
Jul-22	15,513	1,797	8	15,898	1,841	9	15,083	1,747	7
Aug-22	15,443	1,792	8	15,832	1,837	9	15,009	1,741	7
Sep-22	15,453	1,792	8	15,848	1,837	9	15,012	1,740	7
Oct-22	15,606	1,799	8	16,011	1,845	9	15,154	1,746	7
Nov-22	15,760	1,812	8	16,175	1,859	9	15,297	1,758	7
Dec-22	15,884	1,823	8	16,308	1,871	9	15,411	1,768	7
Jan-23	15,954	1,837	8	16,386	1,886	9	15,472	1,781	7
Feb-23	15,979	1,840	8	16,418	1,890	9	15,489	1,783	7
Mar-23	15,971	1,838	8	16,416	1,889	9	15,475	1,780	7
Apr-23	15,946	1,833	8	16,397	1,884	9	15,444	1,775	7
May-23	15,911	1,828	8	16,367	1,880	9	15,404	1,769	7
Jun-23	15,824	1,823	8	16,283	1,875	9	15,313	1,764	7
Jul-23	15,744	1,817	8	16,207	1,870	9	15,229	1,757	7
Aug-23	15,673	1,811	8	16,140	1,864	9	15,154	1,751	7
Sep-23	15,684	1,811	8	16,157	1,865	9	15,158	1,750	7
Oct-23	15,836	1,819	8	16,319	1,874	9	15,299	1,757	7
Nov-23	15,990	1,831	8	16,484	1,887	9	15,441	1,768	7
Dec-23	16,114	1,842	8	16,618	1,899	9	15,554	1,778	7
Jan-24	16,183	1,856	8	16,695	1,914	9	15,614	1,790	7
Feb-24	16,208	1,859	8	16,727	1,918	9	15,632	1,792	7
Mar-24	16,200	1,857	8	16,725	1,917	9	15,618	1,790	7
Apr-24	16,175	1,852	8	16,705	1,912	9	15,587	1,784	7
May-24	16,139	1,847	8	16,674	1,908	9	15,546	1,779	7
Jun-24	16,052	1,842	8	16,591	1,903	9	15,456	1,773	7
Jul-24	15,972	1,836	8	16,514	1,898	9	15,372	1,767	7
Aug-24	15,901	1,830	8	16,446	1,892	9	15,298	1,760	7
Sep-24	15,911	1,830	8	16,462	1,893	9	15,301	1,759	7
Oct-24	16,063	1,838	8	16,625	1,902	9	15,441	1,766	7
Nov-24	16,216	1,850	8	16,789	1,915	9	15,582	1,777	7
Dec-24	16,339	1,861	8	16,923	1,927	9	15,694	1,787	7
Jan-25	16,409	1,875	8	17,001	1,942	9	15,755	1,800	7
Feb-25	16,433	1,878	8	17,032	1,946	9	15,772	1,802	7
Mar-25	16,424	1,876	8	17,028	1,945	9	15,757	1,799	7
Apr-25	16,399	1,871	8	17,008	1,940	9	15,727	1,794	7
May-25	16,363	1,866	8	16,977	1,936	9	15,686	1,788	7
Jun-25	16,276	1,861	8	16,893	1,931	9	15,596	1,783	7
Jul-25	16,195	1,854	8	16,814	1,924	9	15,513	1,775	7
Aug-25	16,123	1,849	8	16,745	1,920	9	15,438	1,770	7
Sep-25	16,133	1,849	8	16,761	1,920	9	15,441	1,769	7
Oct-25	16,285	1,856	8	16,925	1,928	9	15,581	1,775	7

## APPENDIX 2.2: CUSTOMER FORECASTS BY REGION

### KLAMATH FALLS

	Klamath Falls - Expected Growth			Klamath Falls - High Growth			Klamath Falls - Low Growth		
	Residential Customers	Commercial Customers	Industrial Customers	Residential Customers	Commercial Customers	Industrial Customers	Residential Customers	Commercial Customers	Industrial Customers
Nov-25	16,437	1,869	8	17,088	1,943	9	15,720	1,787	7
Dec-25	16,560	1,880	8	17,222	1,955	9	15,832	1,797	7
Jan-26	16,629	1,893	8	17,299	1,969	9	15,892	1,809	7
Feb-26	16,654	1,896	8	17,331	1,973	9	15,909	1,811	7
Mar-26	16,644	1,894	8	17,327	1,971	9	15,894	1,808	7
Apr-26	16,618	1,889	8	17,305	1,967	9	15,863	1,803	7
May-26	16,582	1,884	8	17,274	1,962	9	15,822	1,797	7
Jun-26	16,494	1,879	8	17,188	1,958	9	15,732	1,792	7
Jul-26	16,413	1,873	8	17,109	1,952	9	15,649	1,785	7
Aug-26	16,342	1,867	8	17,040	1,946	9	15,576	1,779	7
Sep-26	16,351	1,867	8	17,055	1,947	9	15,579	1,778	7
Oct-26	16,502	1,874	8	17,218	1,955	9	15,717	1,784	7
Nov-26	16,655	1,887	8	17,383	1,969	9	15,857	1,796	7
Dec-26	16,777	1,898	8	17,516	1,981	9	15,967	1,806	7
Jan-27	16,846	1,911	8	17,594	1,995	9	16,027	1,818	7
Feb-27	16,870	1,915	8	17,625	2,000	9	16,044	1,821	7
Mar-27	16,860	1,913	8	17,620	1,999	9	16,028	1,818	7
Apr-27	16,834	1,907	8	17,598	1,993	9	15,998	1,812	7
May-27	16,797	1,902	8	17,565	1,989	9	15,957	1,806	7
Jun-27	16,709	1,897	8	17,479	1,984	9	15,867	1,801	7
Jul-27	16,627	1,890	8	17,399	1,977	9	15,784	1,794	7
Aug-27	16,556	1,885	8	17,330	1,973	9	15,711	1,788	7
Sep-27	16,564	1,885	8	17,343	1,973	9	15,713	1,788	7
Oct-27	16,716	1,892	8	17,508	1,981	9	15,851	1,794	7
Nov-27	16,868	1,905	8	17,673	1,995	9	15,990	1,805	7
Dec-27	16,990	1,916	8	17,806	2,008	9	16,100	1,815	7
Jan-28	17,058	1,929	8	17,883	2,022	9	16,158	1,827	7
Feb-28	17,082	1,932	8	17,913	2,026	9	16,175	1,829	7
Mar-28	17,072	1,930	8	17,908	2,024	9	16,160	1,826	7
Apr-28	17,045	1,925	8	17,886	2,019	9	16,129	1,821	7
May-28	17,008	1,920	8	17,852	2,015	9	16,088	1,816	7
Jun-28	16,920	1,915	8	17,765	2,010	9	15,999	1,810	7
Jul-28	16,838	1,908	8	17,684	2,003	9	15,917	1,803	7
Aug-28	16,765	1,902	8	17,613	1,998	9	15,843	1,797	7
Sep-28	16,773	1,902	8	17,626	1,998	9	15,845	1,796	7
Oct-28	16,923	1,910	8	17,789	2,007	9	15,981	1,803	7
Nov-28	17,075	1,922	8	17,953	2,020	9	16,120	1,814	7
Dec-28	17,196	1,933	8	18,086	2,033	9	16,229	1,824	7
Jan-29	17,264	1,946	8	18,162	2,047	9	16,288	1,836	7
Feb-29	17,287	1,949	8	18,192	2,051	9	16,304	1,838	7



## APPENDIX 2.2: CUSTOMER FORECASTS BY REGION

### KLAMATH FALLS

	Klamath Falls - Expected Growth			Klamath Falls - High Growth			Klamath Falls - Low Growth		
	Residential Customers	Commercial Customers	Industrial Customers	Residential Customers	Commercial Customers	Industrial Customers	Residential Customers	Commercial Customers	Industrial Customers
Mar-29	17,276	1,947	8	18,185	2,049	9	16,289	1,835	7
Apr-29	17,249	1,942	8	18,162	2,044	9	16,258	1,830	7
May-29	17,211	1,937	8	18,127	2,040	9	16,217	1,825	7
Jun-29	17,122	1,932	8	18,038	2,035	9	16,128	1,819	7
Jul-29	17,038	1,925	8	17,954	2,028	9	16,044	1,812	7
Aug-29	16,965	1,919	8	17,882	2,022	9	15,970	1,806	7
Sep-29	16,972	1,919	8	17,894	2,023	9	15,972	1,806	7
Oct-29	17,122	1,926	8	18,057	2,031	9	16,109	1,812	7
Nov-29	17,273	1,939	8	18,221	2,045	10	16,246	1,823	7
Dec-29	17,393	1,949	8	18,352	2,056	10	16,354	1,832	7
Jan-30	17,460	1,963	8	18,427	2,071	10	16,412	1,845	7
Feb-30	17,482	1,966	8	18,455	2,075	10	16,428	1,847	7
Mar-30	17,470	1,964	8	18,447	2,073	10	16,412	1,845	7
Apr-30	17,443	1,958	8	18,424	2,068	10	16,382	1,838	7
May-30	17,404	1,953	8	18,387	2,063	10	16,341	1,833	7
Jun-30	17,314	1,948	8	18,297	2,058	10	16,251	1,828	7
Jul-30	17,231	1,941	8	18,214	2,051	10	16,169	1,821	7
Aug-30	17,157	1,935	8	18,140	2,045	10	16,095	1,815	7
Sep-30	17,164	1,935	8	18,152	2,046	10	16,097	1,814	7
Oct-30	17,314	1,942	8	18,315	2,054	10	16,233	1,820	7
Nov-30	17,464	1,955	8	18,478	2,068	10	16,369	1,832	7
Dec-30	17,585	1,966	8	18,611	2,080	10	16,477	1,842	7
Jan-31	17,652	1,979	8	18,686	2,094	10	16,535	1,853	7
Feb-31	17,673	1,982	8	18,713	2,098	10	16,550	1,856	7
Mar-31	17,662	1,980	8	18,706	2,097	10	16,535	1,853	7
Apr-31	17,634	1,975	8	18,681	2,092	10	16,504	1,848	7
May-31	17,595	1,969	8	18,645	2,086	10	16,463	1,842	7
Jun-31	17,505	1,964	8	18,554	2,081	10	16,374	1,837	7
Jul-31	17,422	1,957	8	18,471	2,074	10	16,292	1,830	7
Aug-31	17,349	1,952	8	18,398	2,070	10	16,219	1,824	7
Sep-31	17,356	1,951	8	18,410	2,069	10	16,221	1,823	7
Oct-31	17,506	1,959	8	18,574	2,078	10	16,356	1,830	7
Nov-31	17,657	1,971	8	18,739	2,091	10	16,492	1,841	7
Dec-31	17,777	1,982	8	18,871	2,104	10	16,599	1,850	7
Jan-32	17,844	1,995	8	18,947	2,118	10	16,657	1,862	7
Feb-32	17,867	1,998	8	18,977	2,122	10	16,674	1,864	6
Mar-32	17,855	1,996	8	18,969	2,120	10	16,657	1,862	6
Apr-32	17,827	1,991	8	18,944	2,115	10	16,626	1,856	6
May-32	17,789	1,986	8	18,909	2,110	10	16,586	1,851	6
Jun-32	17,699	1,981	8	18,818	2,106	10	16,497	1,846	6
Jul-32	17,616	1,973	8	18,734	2,098	10	16,415	1,838	6

## APPENDIX 2.2: CUSTOMER FORECASTS BY REGION

### KLAMATH FALLS

	Klamath Falls - Expected Growth			Klamath Falls - High Growth			Klamath Falls - Low Growth		
	Residential Customers	Commercial Customers	Industrial Customers	Residential Customers	Commercial Customers	Industrial Customers	Residential Customers	Commercial Customers	Industrial Customers
Aug-32	17,543	1,968	8	18,662	2,093	10	16,342	1,833	6
Sep-32	17,551	1,968	8	18,675	2,094	10	16,345	1,832	6
Oct-32	17,700	1,975	8	18,838	2,102	10	16,479	1,838	6
Nov-32	17,851	1,987	8	19,004	2,115	10	16,614	1,849	6
Dec-32	17,972	1,998	8	19,138	2,127	10	16,722	1,859	6
Jan-33	18,039	2,012	8	19,214	2,143	10	16,779	1,871	6
Feb-33	18,061	2,014	8	19,243	2,145	10	16,795	1,872	6
Mar-33	18,050	2,012	8	19,236	2,144	10	16,779	1,870	6
Apr-33	18,022	2,007	8	19,211	2,139	10	16,748	1,865	6
May-33	17,984	2,002	8	19,175	2,134	10	16,708	1,860	6
Jun-33	17,894	1,997	8	19,084	2,129	10	16,619	1,854	6
Jul-33	17,812	1,990	8	19,002	2,122	10	16,538	1,847	6
Aug-33	17,739	1,984	8	18,929	2,117	10	16,466	1,841	6
Sep-33	17,746	1,984	8	18,941	2,117	10	16,467	1,841	6
Oct-33	17,896	1,991	8	19,107	2,125	10	16,601	1,847	6
Nov-33	18,047	2,004	8	19,273	2,140	10	16,736	1,858	6
Dec-33	18,168	2,015	8	19,407	2,152	10	16,844	1,868	6
Jan-34	18,235	2,028	8	19,484	2,166	10	16,901	1,879	6
Feb-34	18,258	2,031	8	19,513	2,170	10	16,917	1,881	6
Mar-34	18,246	2,029	8	19,506	2,169	10	16,901	1,879	6
Apr-34	18,219	2,024	8	19,482	2,164	10	16,871	1,874	6
May-34	18,180	2,019	8	19,445	2,159	10	16,830	1,869	6
Jun-34	18,091	2,013	8	19,355	2,153	10	16,742	1,862	6
Jul-34	18,008	2,006	8	19,271	2,146	10	16,660	1,855	6
Aug-34	17,935	2,001	8	19,198	2,141	10	16,588	1,850	6
Sep-34	17,942	2,000	8	19,210	2,141	10	16,590	1,849	6
Oct-34	18,092	2,008	8	19,376	2,150	10	16,723	1,856	6
Nov-34	18,243	2,020	8	19,543	2,163	10	16,858	1,866	6
Dec-34	18,364	2,031	8	19,677	2,176	10	16,965	1,876	6
Jan-35	18,431	2,044	8	19,754	2,190	10	17,022	1,887	6
Feb-35	18,453	2,047	8	19,783	2,194	10	17,037	1,890	6
Mar-35	18,441	2,045	8	19,775	2,192	10	17,021	1,887	6
Apr-35	18,414	2,040	8	19,751	2,188	10	16,991	1,882	6
May-35	18,375	2,035	8	19,714	2,183	10	16,950	1,877	6
Jun-35	18,285	2,030	8	19,623	2,178	10	16,862	1,872	6
Jul-35	18,202	2,023	8	19,539	2,171	10	16,781	1,865	6
Aug-35	18,129	2,017	8	19,465	2,165	10	16,709	1,859	6
Sep-35	18,136	2,017	8	19,477	2,166	10	16,711	1,858	6
Oct-35	18,286	2,024	8	19,643	2,174	10	16,844	1,864	6
Nov-35	18,436	2,037	8	19,810	2,188	10	16,977	1,875	6
Dec-35	18,557	2,047	8	19,945	2,200	10	17,084	1,884	6

## APPENDIX 2.2: CUSTOMER FORECASTS BY REGION

### LA GRANDE

	La Grande - Expected Growth			La Grande - High Growth			La Grande - Low Growth		
	Residential Customers	Commercial Customers	Industrial Customers	Residential Customers	Commercial Customers	Industrial Customers	Residential Customers	Commercial Customers	Industrial Customers
Nov-15	6,571	905	2	6,571	905	2	6,571	905	2
Dec-15	6,623	915	2	6,623	915	2	6,623	915	2
Jan-16	6,680	909	1	6,689	910	1	6,673	908	1
Feb-16	6,666	911	2	6,676	912	2	6,658	910	2
Mar-16	6,651	912	1	6,662	913	1	6,642	910	1
Apr-16	6,642	910	1	6,655	911	1	6,632	908	1
May-16	6,634	907	1	6,648	909	1	6,623	905	1
Jun-16	6,620	904	1	6,635	906	1	6,608	902	1
Jul-16	6,589	903	1	6,606	905	1	6,576	901	1
Aug-16	6,556	901	3	6,574	904	3	6,542	899	3
Sep-16	6,545	899	7	6,565	902	7	6,530	897	7
Oct-16	6,579	901	7	6,600	903	7	6,562	898	6
Nov-16	6,654	901	3	6,677	904	3	6,636	898	3
Dec-16	6,695	909	2	6,720	912	2	6,676	906	2
Jan-17	6,714	911	1	6,741	914	1	6,693	908	1
Feb-17	6,711	913	2	6,739	917	2	6,689	910	2
Mar-17	6,694	913	1	6,724	918	1	6,671	910	1
Apr-17	6,681	913	1	6,713	918	1	6,657	910	1
May-17	6,677	911	1	6,710	916	1	6,651	908	1
Jun-17	6,651	907	1	6,686	912	1	6,624	904	1
Jul-17	6,609	906	1	6,645	911	2	6,581	902	1
Aug-17	6,581	905	3	6,619	910	3	6,551	901	3
Sep-17	6,574	903	7	6,614	908	7	6,543	899	7
Oct-17	6,619	905	6	6,661	910	7	6,586	900	6
Nov-17	6,691	904	3	6,736	910	3	6,656	899	3
Dec-17	6,737	912	2	6,784	919	2	6,701	907	2
Jan-18	6,758	915	1	6,807	921	1	6,720	910	1
Feb-18	6,755	917	2	6,806	924	2	6,716	911	2
Mar-18	6,741	917	1	6,794	924	1	6,700	911	1
Apr-18	6,726	917	1	6,781	924	1	6,684	911	1
May-18	6,715	915	1	6,771	922	1	6,671	909	1
Jun-18	6,684	911	1	6,742	919	1	6,639	905	1
Jul-18	6,640	910	1	6,700	918	2	6,594	903	1
Aug-18	6,614	908	3	6,676	917	3	6,566	902	2
Sep-18	6,606	906	7	6,670	915	7	6,557	900	7
Oct-18	6,656	908	6	6,722	917	7	6,605	901	6
Nov-18	6,731	908	3	6,800	917	3	6,678	901	3
Dec-18	6,778	916	2	6,849	925	2	6,723	908	2
Jan-19	6,802	918	1	6,876	928	1	6,745	910	1
Feb-19	6,800	920	2	6,876	931	2	6,741	912	2

## APPENDIX 2.2: CUSTOMER FORECASTS BY REGION

### LA GRANDE

	La Grande - Expected Growth			La Grande - High Growth			La Grande - Low Growth		
	Residential Customers	Commercial Customers	Industrial Customers	Residential Customers	Commercial Customers	Industrial Customers	Residential Customers	Commercial Customers	Industrial Customers
Mar-19	6,785	921	1	6,863	931	1	6,725	912	1
Apr-19	6,768	920	1	6,848	931	1	6,706	912	1
May-19	6,754	918	1	6,836	929	1	6,691	909	1
Jun-19	6,721	914	1	6,804	926	1	6,657	906	1
Jul-19	6,676	913	1	6,761	925	2	6,610	904	1
Aug-19	6,650	912	3	6,737	924	3	6,583	903	2
Sep-19	6,642	910	7	6,731	922	7	6,573	900	7
Oct-19	6,694	912	6	6,786	924	7	6,623	902	6
Nov-19	6,770	911	3	6,865	924	3	6,697	901	3
Dec-19	6,819	919	2	6,917	932	2	6,744	909	2
Jan-20	6,844	922	1	6,945	935	1	6,767	911	1
Feb-20	6,843	924	2	6,946	938	2	6,764	913	2
Mar-20	6,828	924	1	6,933	938	1	6,747	913	1
Apr-20	6,810	924	1	6,917	938	1	6,728	912	1
May-20	6,795	922	1	6,904	936	1	6,711	910	1
Jun-20	6,760	918	1	6,871	933	1	6,675	906	1
Jul-20	6,714	917	1	6,826	932	2	6,628	905	1
Aug-20	6,688	915	3	6,802	931	3	6,600	903	2
Sep-20	6,680	913	7	6,796	929	7	6,591	901	6
Oct-20	6,733	915	6	6,852	931	7	6,641	903	6
Nov-20	6,811	915	3	6,934	931	3	6,716	902	3
Dec-20	6,861	923	2	6,987	940	2	6,764	910	2
Jan-21	6,886	925	1	7,015	942	2	6,787	912	1
Feb-21	6,886	927	2	7,018	945	2	6,785	914	2
Mar-21	6,870	927	1	7,004	946	1	6,767	914	1
Apr-21	6,852	927	1	6,988	945	2	6,748	913	1
May-21	6,836	925	1	6,974	944	1	6,730	911	1
Jun-21	6,801	921	1	6,941	940	1	6,694	907	1
Jul-21	6,754	920	1	6,895	939	2	6,646	905	1
Aug-21	6,727	919	3	6,870	938	3	6,618	904	2
Sep-21	6,720	917	7	6,865	937	7	6,609	902	6
Oct-21	6,773	919	6	6,921	939	7	6,659	903	6
Nov-21	6,851	918	3	7,004	939	3	6,734	903	3
Dec-21	6,902	926	2	7,058	947	2	6,783	910	2
Jan-22	6,928	929	1	7,087	950	2	6,806	912	1
Feb-22	6,928	931	2	7,090	952	2	6,805	914	1
Mar-22	6,912	931	1	7,076	953	1	6,787	914	1
Apr-22	6,894	931	1	7,060	953	2	6,768	913	1
May-22	6,877	929	1	7,045	951	1	6,749	911	1
Jun-22	6,842	925	1	7,011	948	2	6,713	907	1

## APPENDIX 2.2: CUSTOMER FORECASTS BY REGION

### LA GRANDE

	La Grande - Expected Growth			La Grande - High Growth			La Grande - Low Growth		
	Residential Customers	Commercial Customers	Industrial Customers	Residential Customers	Commercial Customers	Industrial Customers	Residential Customers	Commercial Customers	Industrial Customers
Jul-22	6,794	924	1	6,964	947	2	6,664	906	1
Aug-22	6,767	922	3	6,939	946	3	6,636	904	2
Sep-22	6,760	920	7	6,934	944	7	6,627	902	6
Oct-22	6,814	922	6	6,992	946	7	6,678	904	6
Nov-22	6,892	922	3	7,074	946	3	6,753	903	3
Dec-22	6,943	930	2	7,129	955	2	6,801	911	2
Jan-23	6,969	932	1	7,158	957	2	6,825	913	1
Feb-23	6,969	934	2	7,161	960	2	6,823	915	1
Mar-23	6,954	934	1	7,148	961	1	6,806	915	1
Apr-23	6,935	934	1	7,131	960	2	6,786	914	1
May-23	6,918	932	1	7,116	959	1	6,767	912	1
Jun-23	6,883	928	1	7,082	955	2	6,731	908	1
Jul-23	6,835	927	1	7,035	954	2	6,683	906	1
Aug-23	6,808	926	3	7,009	953	3	6,655	905	2
Sep-23	6,800	924	7	7,003	951	7	6,646	903	6
Oct-23	6,854	925	6	7,061	953	7	6,697	904	6
Nov-23	6,932	925	3	7,143	953	3	6,772	904	3
Dec-23	6,983	933	2	7,198	962	2	6,820	911	2
Jan-24	7,010	935	1	7,228	965	2	6,845	913	1
Feb-24	7,010	938	2	7,230	967	2	6,843	915	1
Mar-24	6,994	938	1	7,216	968	1	6,826	915	1
Apr-24	6,975	938	1	7,198	968	2	6,806	915	1
May-24	6,958	936	1	7,183	966	1	6,788	913	1
Jun-24	6,922	932	1	7,148	962	2	6,751	909	1
Jul-24	6,874	931	1	7,100	961	2	6,703	907	1
Aug-24	6,847	929	3	7,074	960	3	6,675	906	2
Sep-24	6,839	927	7	7,068	958	7	6,666	904	6
Oct-24	6,893	929	6	7,125	960	7	6,717	905	6
Nov-24	6,971	929	3	7,208	960	3	6,792	905	3
Dec-24	7,022	937	2	7,262	969	2	6,840	912	2
Jan-25	7,049	939	1	7,292	971	2	6,865	914	1
Feb-25	7,049	941	2	7,294	974	2	6,863	916	1
Mar-25	7,032	941	1	7,279	974	1	6,845	916	0
Apr-25	7,014	941	1	7,262	974	2	6,827	916	1
May-25	6,996	939	1	7,245	972	1	6,808	914	0
Jun-25	6,960	935	1	7,210	969	2	6,771	910	1
Jul-25	6,912	934	1	7,162	968	2	6,723	909	1
Aug-25	6,885	933	3	7,136	967	3	6,696	907	2
Sep-25	6,877	931	7	7,129	965	7	6,687	905	6
Oct-25	6,931	932	6	7,187	967	7	6,738	906	6

## APPENDIX 2.2: CUSTOMER FORECASTS BY REGION

### LA GRANDE

	La Grande - Expected Growth			La Grande - High Growth			La Grande - Low Growth		
	Residential Customers	Commercial Customers	Industrial Customers	Residential Customers	Commercial Customers	Industrial Customers	Residential Customers	Commercial Customers	Industrial Customers
Nov-25	7,009	932	3	7,269	967	3	6,812	906	2
Dec-25	7,060	940	2	7,324	975	2	6,861	914	1
Jan-26	7,087	942	1	7,354	978	2	6,886	916	1
Feb-26	7,086	945	2	7,354	980	2	6,883	918	1
Mar-26	7,070	945	1	7,340	981	1	6,867	918	0
Apr-26	7,051	945	1	7,322	981	2	6,847	917	1
May-26	7,034	942	1	7,306	979	1	6,829	915	0
Jun-26	6,998	939	1	7,270	975	2	6,793	911	1
Jul-26	6,950	938	1	7,223	974	2	6,745	910	1
Aug-26	6,923	936	3	7,197	973	3	6,717	908	2
Sep-26	6,915	934	7	7,191	971	7	6,707	906	6
Oct-26	6,969	936	6	7,249	974	7	6,758	908	6
Nov-26	7,048	936	3	7,334	974	3	6,833	907	2
Dec-26	7,099	944	2	7,389	982	2	6,881	915	1
Jan-27	7,126	946	1	7,420	985	2	6,905	917	1
Feb-27	7,126	948	2	7,422	987	2	6,903	918	1
Mar-27	7,110	948	1	7,408	988	1	6,886	919	0
Apr-27	7,091	948	1	7,390	988	2	6,866	918	1
May-27	7,074	946	1	7,375	986	1	6,848	916	0
Jun-27	7,038	942	1	7,340	983	2	6,811	912	1
Jul-27	6,990	941	1	7,293	982	2	6,763	910	1
Aug-27	6,964	940	3	7,268	981	3	6,735	909	2
Sep-27	6,957	938	7	7,264	979	7	6,726	907	6
Oct-27	7,011	939	6	7,324	981	7	6,776	908	6
Nov-27	7,090	939	3	7,409	981	4	6,851	907	2
Dec-27	7,141	947	2	7,466	990	3	6,898	915	1
Jan-28	7,168	949	1	7,497	993	2	6,921	917	1
Feb-28	7,169	952	2	7,501	996	2	6,920	919	1
Mar-28	7,153	952	1	7,487	996	2	6,902	919	0
Apr-28	7,135	951	1	7,472	996	2	6,883	918	1
May-28	7,118	949	1	7,457	995	2	6,864	916	0
Jun-28	7,082	946	1	7,422	991	2	6,827	912	1
Jul-28	7,035	945	1	7,377	990	2	6,780	910	1
Aug-28	7,008	943	3	7,352	990	3	6,751	909	2
Sep-28	7,001	941	7	7,348	988	7	6,742	906	6
Oct-28	7,055	943	6	7,408	990	7	6,791	908	6
Nov-28	7,134	943	3	7,494	990	4	6,865	907	2
Dec-28	7,186	951	2	7,552	999	3	6,913	914	1
Jan-29	7,213	953	1	7,584	1,002	2	6,936	916	1
Feb-29	7,214	955	2	7,589	1,005	2	6,934	918	1

## APPENDIX 2.2: CUSTOMER FORECASTS BY REGION

### LA GRANDE

	La Grande - Expected Growth			La Grande - High Growth			La Grande - Low Growth		
	Residential Customers	Commercial Customers	Industrial Customers	Residential Customers	Commercial Customers	Industrial Customers	Residential Customers	Commercial Customers	Industrial Customers
Mar-29	7,198	955	1	7,576	1,005	2	6,917	918	0
Apr-29	7,180	955	1	7,560	1,006	2	6,897	917	1
May-29	7,164	953	1	7,547	1,004	2	6,879	915	0
Jun-29	7,128	949	1	7,512	1,000	2	6,842	911	1
Jul-29	7,080	948	1	7,465	1,000	2	6,794	910	1
Aug-29	7,054	947	3	7,441	999	3	6,766	908	2
Sep-29	7,046	945	7	7,435	997	7	6,756	906	6
Oct-29	7,101	946	6	7,496	999	7	6,807	907	6
Nov-29	7,180	946	3	7,583	999	4	6,880	907	2
Dec-29	7,231	954	2	7,640	1,008	3	6,927	914	1
Jan-30	7,258	956	1	7,672	1,011	2	6,951	916	1
Feb-30	7,259	959	2	7,676	1,014	2	6,949	918	1
Mar-30	7,243	959	1	7,662	1,014	2	6,932	918	0
Apr-30	7,225	958	1	7,647	1,014	2	6,912	917	1
May-30	7,208	956	1	7,632	1,013	2	6,894	915	0
Jun-30	7,172	953	1	7,597	1,009	2	6,857	911	1
Jul-30	7,124	951	1	7,549	1,008	2	6,809	909	1
Aug-30	7,098	950	3	7,524	1,007	3	6,782	908	2
Sep-30	7,090	948	7	7,518	1,005	7	6,773	906	6
Oct-30	7,144	950	6	7,578	1,008	7	6,823	907	6
Nov-30	7,223	950	3	7,665	1,008	4	6,896	907	2
Dec-30	7,274	957	2	7,722	1,016	3	6,943	914	1
Jan-31	7,301	960	1	7,753	1,019	2	6,967	916	1
Feb-31	7,302	962	2	7,757	1,022	2	6,966	918	1
Mar-31	7,286	962	1	7,743	1,023	2	6,948	918	0
Apr-31	7,267	962	1	7,725	1,023	2	6,928	917	1
May-31	7,250	960	1	7,710	1,021	2	6,910	915	0
Jun-31	7,215	956	1	7,676	1,017	2	6,875	911	1
Jul-31	7,167	955	1	7,627	1,016	2	6,827	910	1
Aug-31	7,140	954	3	7,601	1,015	3	6,800	908	2
Sep-31	7,132	952	7	7,595	1,013	7	6,790	906	6
Oct-31	7,186	953	6	7,655	1,016	7	6,840	907	6
Nov-31	7,265	953	3	7,742	1,016	4	6,913	907	2
Dec-31	7,316	961	2	7,799	1,024	3	6,960	914	1
Jan-32	7,343	963	1	7,830	1,027	2	6,984	916	1
Feb-32	7,343	966	2	7,833	1,030	3	6,982	918	1
Mar-32	7,327	966	1	7,818	1,031	2	6,965	918	0
Apr-32	7,309	965	1	7,801	1,030	2	6,946	918	1
May-32	7,292	963	1	7,786	1,029	2	6,929	915	0
Jun-32	7,256	960	1	7,750	1,025	2	6,893	912	0
Jul-32	7,208	958	1	7,701	1,024	2	6,845	910	1

## APPENDIX 2.2: CUSTOMER FORECASTS BY REGION

### LA GRANDE

	La Grande - Expected Growth			La Grande - High Growth			La Grande - Low Growth		
	Residential Customers	Commercial Customers	Industrial Customers	Residential Customers	Commercial Customers	Industrial Customers	Residential Customers	Commercial Customers	Industrial Customers
Aug-32	7,181	957	3	7,674	1,023	3	6,818	909	2
Sep-32	7,173	955	7	7,668	1,021	8	6,809	907	6
Oct-32	7,227	957	6	7,728	1,023	7	6,859	908	6
Nov-32	7,305	957	3	7,814	1,023	4	6,931	908	2
Dec-32	7,356	964	2	7,871	1,032	3	6,978	915	1
Jan-33	7,383	967	1	7,902	1,035	2	7,002	917	0
Feb-33	7,383	969	2	7,904	1,037	3	7,000	919	1
Mar-33	7,367	969	1	7,889	1,038	2	6,984	919	0
Apr-33	7,349	969	1	7,872	1,038	2	6,965	918	0
May-33	7,331	967	1	7,855	1,036	2	6,946	916	0
Jun-33	7,296	963	1	7,820	1,032	2	6,912	912	0
Jul-33	7,247	962	1	7,769	1,031	2	6,864	911	1
Aug-33	7,220	961	3	7,742	1,030	4	6,837	910	2
Sep-33	7,212	959	7	7,735	1,028	8	6,828	908	6
Oct-33	7,266	960	6	7,795	1,030	7	6,878	909	6
Nov-33	7,344	960	3	7,881	1,030	4	6,951	909	2
Dec-33	7,395	968	2	7,937	1,039	3	6,998	916	1
Jan-34	7,422	970	1	7,968	1,042	2	7,022	918	0
Feb-34	7,422	973	2	7,970	1,044	3	7,021	920	1
Mar-34	7,406	973	1	7,955	1,045	2	7,004	920	0
Apr-34	7,387	972	1	7,936	1,045	2	6,985	919	0
May-34	7,369	970	1	7,919	1,043	2	6,967	917	0
Jun-34	7,333	967	1	7,882	1,039	2	6,931	914	0
Jul-34	7,285	965	1	7,832	1,038	2	6,885	912	1
Aug-34	7,258	964	3	7,805	1,037	4	6,858	911	2
Sep-34	7,250	962	7	7,798	1,035	8	6,849	909	6
Oct-34	7,303	964	6	7,857	1,037	7	6,898	910	6
Nov-34	7,382	964	3	7,944	1,037	4	6,972	910	2
Dec-34	7,433	971	2	8,000	1,046	3	7,018	917	1
Jan-35	7,459	974	1	8,030	1,048	2	7,042	919	0
Feb-35	7,459	976	2	8,032	1,051	3	7,040	921	1
Mar-35	7,443	976	1	8,017	1,052	2	7,024	921	0
Apr-35	7,424	976	1	7,998	1,051	2	7,005	921	0
May-35	7,407	974	1	7,981	1,049	2	6,988	919	0
Jun-35	7,371	970	1	7,944	1,046	2	6,952	915	0
Jul-35	7,322	969	1	7,893	1,045	2	6,905	914	1
Aug-35	7,295	968	3	7,866	1,043	4	6,878	912	2
Sep-35	7,287	966	7	7,859	1,041	8	6,870	910	6
Oct-35	7,341	967	6	7,919	1,043	7	6,919	912	6
Nov-35	7,419	967	3	8,005	1,043	4	6,992	911	2
Dec-35	7,470	975	2	8,062	1,052	3	7,039	919	1



**APPENDIX 2.3: DEMAND COEFFICIENTS**

	January	February	March	April	May	June	July	August	September	October	November	December
<b>HEAT COEFFICIENTS</b>												
Wa/ld GTN   Residential	0.009115	0.009691	0.009640	0.009201	0.008856	0.006932	0.004328	0.002270	0.000460	-	0.002593	0.005685
Wa/ld GTN   Commercial	0.045820	0.048531	0.047842	0.046687	0.044178	0.033849	0.019700	0.014556	0.011801	0.010241	0.023682	0.033760
Wa/ld GTN   Ind FirmSale	0.215412	0.152320	0.126020	0.114955	0.101403	0.078492	0.031736	0.076517	0.110300	0.272741	0.213346	0.340669
Roseburg   Residential	0.008905	0.011119	0.010663	0.009336	0.008809	0.006690	0.003927	0.000703	-	-	0.000889	0.004459
Roseburg   Commercial	0.036924	0.046406	0.042371	0.035529	0.033628	0.025536	0.015176	0.001901	-	-	0.010122	0.025233
Roseburg   Ind FirmSale	0.340336	0.054838	0.007415	0.020643	0.026977	0.045050	0.045651	-	-	-	0.506292	0.346538
Medford NWP   Residential	0.009594	0.010785	0.011448	0.010223	0.009796	0.008492	0.006612	0.005004	-	-	0.004042	0.006459
Medford NWP   Commercial	0.041998	0.042667	0.044430	0.040690	0.038511	0.033825	0.027971	0.028062	-	-	0.036757	0.048551
Medford NWP   Ind FirmSale	0.209901	0.086477	0.035155	0.053651	0.046986	0.104066	0.136213	0.235645	-	-	0.363189	0.447082
La Grande   Residential	0.008533	0.009206	0.009405	0.008877	0.007709	0.006127	0.004591	0.003618	0.000067	0.010488	0.001186	0.003909
La Grande   Commercial	0.033467	0.040010	0.041932	0.039479	0.033702	0.025866	0.018115	0.015520	0.006124	0.067126	0.016674	0.019122
La Grande   Ind FirmSale	0.840288	-	0.026474	-	-	5.691441	3.208045	1.285492	6.500962	5.659814	5.662634	2.191302
Klam Falls   Residential	0.007452	0.008295	0.008391	0.007862	0.006821	0.005745	0.004117	0.002582	0.003205	0.000368	0.002503	0.004744
Klam Falls   Commercial	0.026946	0.029900	0.030291	0.027621	0.022675	0.018647	0.010962	0.005555	0.002757	0.006082	0.018054	0.020415
Klam Falls   Ind FirmSale	0.120660	0.079335	0.037059	0.046324	0.035493	0.038137	0.043085	0.027726	0.103616	0.081670	0.207286	0.138108
<b>BASE COEFFICIENTS</b>												
Wa/ld GTN   Residential	0.048644	0.048644	0.048644	0.048644	0.048644	0.048644	0.048644	0.048644	0.048644	0.048644	0.048644	0.048644
Wa/ld GTN   Commercial	0.354846	0.354846	0.354846	0.354846	0.354846	0.354846	0.354846	0.354846	0.354846	0.354846	0.354846	0.354846
Wa/ld GTN   Ind FirmSale	3.731146	3.731146	3.731146	3.731146	3.731146	3.731146	3.731146	3.731146	3.731146	3.731146	3.731146	3.731146
Roseburg   Residential	0.035119	0.035119	0.035119	0.035119	0.035119	0.035119	0.035119	0.035119	0.035119	0.035119	0.035119	0.035119
Roseburg   Commercial	0.267454	0.267454	0.267454	0.267454	0.267454	0.267454	0.267454	0.267454	0.267454	0.267454	0.267454	0.267454
Roseburg   Ind FirmSale	8.575943	8.575943	8.575943	8.575943	8.575943	8.575943	8.575943	8.575943	8.575943	8.575943	8.575943	8.575943
Medford NWP   Residential	0.044601	0.044601	0.044601	0.044601	0.044601	0.044601	0.044601	0.044601	0.044601	0.044601	0.044601	0.044601
Medford NWP   Commercial	0.340873	0.340873	0.340873	0.340873	0.340873	0.340873	0.340873	0.340873	0.340873	0.340873	0.340873	0.340873
Medford NWP   Ind FirmSale	3.268810	3.268810	3.268810	3.268810	3.268810	3.268810	3.268810	3.268810	3.268810	3.268810	3.268810	3.268810
La Grande   Residential	0.083340	0.083340	0.083340	0.083340	0.083340	0.083340	0.083340	0.083340	0.083340	0.083340	0.083340	0.083340
La Grande   Commercial	0.451054	0.451054	0.451054	0.451054	0.451054	0.451054	0.451054	0.451054	0.451054	0.451054	0.451054	0.451054
La Grande   Ind FirmSale	35.014023	35.014023	35.014023	35.014023	35.014023	35.014023	35.014023	35.014023	35.014023	35.014023	35.014023	35.014023
Klam Falls   Residential	0.037682	0.037682	0.037682	0.037682	0.037682	0.037682	0.037682	0.037682	0.037682	0.037682	0.037682	0.037682
Klam Falls   Commercial	0.273709	0.273709	0.273709	0.273709	0.273709	0.273709	0.273709	0.273709	0.273709	0.273709	0.273709	0.273709
Klam Falls   Ind FirmSale	3.329030	3.329030	3.329030	3.329030	3.329030	3.329030	3.329030	3.329030	3.329030	3.329030	3.329030	3.329030
<b>SUPER PEAK*</b>												
Wa/ld GTN   Residential	0.008164	0.008164										0.008164
Wa/ld GTN   Commercial	0.042704	0.042704										0.042704
Wa/ld GTN   Ind FirmSale	0.236134	0.236134										0.236134
Roseburg   Residential	0.008161	0.008161										0.008161
Roseburg   Commercial	0.036187	0.036187										0.036187
Roseburg   Ind FirmSale	0.247238	0.247238										0.247238
Medford NWP   Residential	0.008946	0.008946										0.008946
Medford NWP   Commercial	0.044405	0.044405										0.044405
Medford NWP   Ind FirmSale	0.247820	0.247820										0.247820
La Grande   Residential	0.007216	0.007216										0.007216
La Grande   Commercial	0.030866	0.030866										0.030866
La Grande   Ind FirmSale	1.010530	1.010530										1.010530
Klam Falls   Residential	0.006830	0.006830										0.006830
Klam Falls   Commercial	0.025754	0.025754										0.025754
Klam Falls   Ind FirmSale	0.112701	0.112701										0.112701
* Average of DEC JAN FEB heat coefficients												

**APPENDIX 2.3: WA/ID BASE COEFFICIENT CALCULATION**

WA-ID	
Average Actual Demand by Class	
Year	Month + 7 & 8
<b>2011</b>	
Average of Res Demand	10,797
Average of Com Demand	8,030
Average of Ind Demand	1,013
<b>2012</b>	
Average of Res Demand	10,365
Average of Com Demand	7,897
Average of Ind Demand	784
<b>2013</b>	
Average of Res Demand	10,005
Average of Com Demand	7,486
Average of Ind Demand	767
<b>2014</b>	
Average of Res Demand	10,044
Average of Com Demand	8,008
Average of Ind Demand	963
<b>2015</b>	
Average of Res Demand	9,824
Average of Com Demand	8,487
Average of Ind Demand	878
<b>Total Average of Res Demand</b>	<b>10,207</b>
<b>Total Average of Com Demand</b>	<b>7,982</b>
<b>Total Average of Ind Demand</b>	<b>881</b>

Year	Month + 7 & 8
<b>2011</b>	
Average of Res Cust	198,530
Average of Com Cust	22,195
Average of Ind Cust	228
<b>2012</b>	
Average of Res Cust	200,311
Average of Com Cust	22,395
Average of Ind Cust	232
<b>2013</b>	
Average of Res Cust	202,044
Average of Com Cust	22,527
Average of Ind Cust	228
<b>2014</b>	
Average of Res Cust	204,607
Average of Com Cust	22,469
Average of Ind Cust	238
<b>2015</b>	
Average of Res Cust	207,464
Average of Com Cust	22,586
Average of Ind Cust	234
<b>Total Average of Res Cust</b>	<b>202,591</b>
<b>Total Average of Com Cust</b>	<b>22,434</b>
<b>Total Average of Ind Cust</b>	<b>232</b>

Base Coefficients	
<i>(Actual Average Demand/Customer Count)</i>	
0.050382	Res Base Usage
0.355778	Com Base Usage
3.803840	Ind Base Usage

**APPENDIX 2.3: MEDFORD BASE COEFFICIENT CALCULATION**

<b>Medford</b>	
<b>Average Actual Demand by Class</b>	
	Month <input type="button" value="v"/>
	<b>± 7 &amp; 8</b>
Year <input type="button" value="v"/>	
<b>2011</b>	
Average of Res Demand	2,113
Average of Com Demand	1,836
Average of Ind Demand	34
<b>2012</b>	
Average of Res Demand	2,309
Average of Com Demand	1,979
Average of Ind Demand	33
<b>2013</b>	
Average of Res Demand	2,323
Average of Com Demand	2,160
Average of Ind Demand	43
<b>2014</b>	
Average of Res Demand	2,290
Average of Com Demand	2,253
Average of Ind Demand	54
<b>2015</b>	
Average of Res Demand	2,316
Average of Com Demand	2,303
Average of Ind Demand	60
<b>Total Average of Res Demand</b>	<b>2,270</b>
<b>Total Average of Com Demand</b>	<b>2,106</b>
<b>Total Average of Ind Demand</b>	<b>45</b>

	Month <input type="button" value="v"/>
	<b>± 7 &amp; 8</b>
Year <input type="button" value="v"/>	
<b>2011</b>	
Average of Res Cust	50,437
Average of Com Cust	6,404
Average of Ind Cust	17
<b>2012</b>	
Average of Res Cust	50,782
Average of Com Cust	6,454
Average of Ind Cust	18
<b>2013</b>	
Average of Res Cust	51,090
Average of Com Cust	6,516
Average of Ind Cust	16
<b>2014</b>	
Average of Res Cust	51,662
Average of Com Cust	6,592
Average of Ind Cust	17
<b>2015</b>	
Average of Res Cust	52,605
Average of Com Cust	6,596
Average of Ind Cust	15
<b>Total Average of Res Cust</b>	<b>51,315</b>
<b>Total Average of Com Cust</b>	<b>6,512</b>
<b>Total Average of Ind Cust</b>	<b>17</b>

<b>Base Coefficients</b>	
<i>(Actual Average Demand/Customer Count)</i>	
0.044240	Res Base Usage
0.323444	Com Base Usage
2.718981	Ind Base Usage

## APPENDIX 2.3: ROSEBURG BASE COEFFICIENT CALCULATION

Roseburg	
Average Actual Demand by Class	
Year	Month + 7 & 8
<b>2011</b>	
Average of Res Demand	844
Average of Com Demand	908
Average of Ind Demand	30
<b>2012</b>	
Average of Res Demand	653
Average of Com Demand	705
Average of Ind Demand	31
<b>2013</b>	
Average of Res Demand	551
Average of Com Demand	665
Average of Ind Demand	39
<b>2014</b>	
Average of Res Demand	400
Average of Com Demand	484
Average of Ind Demand	26
<b>2015</b>	
Average of Res Demand	430
Average of Com Demand	557
Average of Ind Demand	4
<b>Total Average of Res Demand</b>	<b>575</b>
<b>Total Average of Com Demand</b>	<b>664</b>
<b>Total Average of Ind Demand</b>	<b>26</b>

Year	Month + 7 & 8
<b>2011</b>	
Average of Res Cust	13,000
Average of Com Cust	2,097
Average of Ind Cust	2
<b>2012</b>	
Average of Res Cust	12,983
Average of Com Cust	2,119
Average of Ind Cust	2
<b>2013</b>	
Average of Res Cust	13,020
Average of Com Cust	2,120
Average of Ind Cust	3
<b>2014</b>	
Average of Res Cust	13,063
Average of Com Cust	2,127
Average of Ind Cust	3
<b>2015</b>	
Average of Res Cust	13,227
Average of Com Cust	2,130
Average of Ind Cust	2
<b>Total Average of Res Cust</b>	<b>13,058</b>
<b>Total Average of Com Cust</b>	<b>2,118</b>
<b>Total Average of Ind Cust</b>	<b>2</b>

**Base Coefficients***(Actual Average Demand/Customer Count)*

0.044071	Res Base Usage
0.313260	Com Base Usage
10.834402	Ind Base Usage

**APPENDIX 2.3: KLAMATH FALLS BASE COEFFICIENT CALCULATION**

<b>Klamath Falls</b>	
<b>Average Actual Demand by Class</b>	
	Month <input type="button" value="v"/> + 7 & 8
Year <input type="button" value="v"/>	
<b>2011</b>	
Average of Res Demand	528
Average of Com Demand	455
Average of Ind Demand	18
<b>2012</b>	
Average of Res Demand	522
Average of Com Demand	392
Average of Ind Demand	18
<b>2013</b>	
Average of Res Demand	531
Average of Com Demand	433
Average of Ind Demand	24
<b>2014</b>	
Average of Res Demand	515
Average of Com Demand	442
Average of Ind Demand	22
<b>2015</b>	
Average of Res Demand	531
Average of Com Demand	484
Average of Ind Demand	30
<b>Total Average of Res Demand</b>	<b>525</b>
<b>Total Average of Com Demand</b>	<b>441</b>
<b>Total Average of Ind Demand</b>	<b>23</b>

	Month <input type="button" value="v"/> + 7 & 8
Year <input type="button" value="v"/>	
<b>2011</b>	
Average of Res Cust	13,768
Average of Com Cust	1,627
Average of Ind Cust	7
<b>2012</b>	
Average of Res Cust	13,783
Average of Com Cust	1,626
Average of Ind Cust	7
<b>2013</b>	
Average of Res Cust	13,857
Average of Com Cust	1,646
Average of Ind Cust	8
<b>2014</b>	
Average of Res Cust	13,872
Average of Com Cust	1,652
Average of Ind Cust	8
<b>2015</b>	
Average of Res Cust	14,106
Average of Com Cust	1,667
Average of Ind Cust	7
<b>Total Average of Res Cust</b>	<b>13,877</b>
<b>Total Average of Com Cust</b>	<b>1,643</b>
<b>Total Average of Ind Cust</b>	<b>7</b>

<b>Base Coefficients</b>	
<i>(Actual Average Demand/Customer Count)</i>	
0.037852	Res Base Usage
0.268465	Com Base Usage
3.052322	Ind Base Usage

## APPENDIX 2.3: LA GRANDE BASE COEFFICIENT CALCULATION

La Grande	
Average Actual Demand by Class	
Year	Month <input type="button" value="▼"/>
	<input type="button" value="+ 7 &amp; 8"/>
<b>2011</b>	
Average of Res Demand	566
Average of Com Demand	407
Average of Ind Demand	18
<b>2012</b>	
Average of Res Demand	656
Average of Com Demand	448
Average of Ind Demand	8
<b>2013</b>	
Average of Res Demand	530
Average of Com Demand	380
Average of Ind Demand	63
<b>2014</b>	
Average of Res Demand	541
Average of Com Demand	389
Average of Ind Demand	165
<b>2015</b>	
Average of Res Demand	554
Average of Com Demand	441
Average of Ind Demand	122
<b>Total Average of Res Demand</b>	<b>569</b>
<b>Total Average of Com Demand</b>	<b>413</b>
<b>Total Average of Ind Demand</b>	<b>75</b>

Year	Month <input type="button" value="▼"/>
	<input type="button" value="+ 7 &amp; 8"/>
<b>2011</b>	
Average of Res Cust	6,428
Average of Com Cust	875
Average of Ind Cust	7
<b>2012</b>	
Average of Res Cust	6,479
Average of Com Cust	889
Average of Ind Cust	5
<b>2013</b>	
Average of Res Cust	6,456
Average of Com Cust	894
Average of Ind Cust	4
<b>2014</b>	
Average of Res Cust	6,496
Average of Com Cust	892
Average of Ind Cust	3
<b>2015</b>	
Average of Res Cust	6,547
Average of Com Cust	897
Average of Ind Cust	4
<b>Total Average of Res Cust</b>	<b>6,481</b>
<b>Total Average of Com Cust</b>	<b>889</b>
<b>Total Average of Ind Cust</b>	<b>4</b>

**Base Coefficients***(Actual Average Demand/Customer Count)*

0.087870	Res Base Usage
0.464582	Com Base Usage
17.488847	Ind Base Usage

**APPENDIX 2.4: HEATING DEGREE DAY DATA MONTHLY TABLES**

Temperature Pattern WA/ID													Annual
Gas Year ▾	Nov	Dec	Jan	Feb	Mar	Apr	May	Jun	Jul	Aug	Sep	Oct	Total
2015-2016	862	1,118	1,170	943	789	545	329	139	36	43	189	516	6,679
2016-2017	861	1,110	1,181	935	799	539	325	141	31	36	201	526	6,685
2017-2018	870	1,117	1,181	936	810	544	312	136	29	42	190	526	6,693
2018-2019	863	1,096	1,177	931	805	531	306	138	31	40	196	526	6,640
2019-2020	885	1,116	1,181	940	804	552	309	145	34	41	204	521	6,732
2020-2021	867	1,107	1,176	951	804	540	324	144	35	41	202	526	6,717
2021-2022	858	1,119	1,182	937	790	544	320	135	30	42	192	537	6,686
2022-2023	860	1,114	1,162	957	803	540	316	144	35	41	201	533	6,706
2023-2024	862	1,113	1,156	936	804	536	324	144	32	39	197	539	6,683
2024-2025	866	1,094	1,161	929	796	538	319	138	35	42	191	522	6,631
2025-2026	870	1,111	1,163	930	801	545	316	131	30	42	195	514	6,648
2026-2027	863	1,117	1,179	944	800	538	325	140	34	43	187	515	6,685
2027-2028	856	1,118	1,170	945	810	545	312	140	28	39	195	523	6,681
2028-2029	863	1,119	1,187	918	812	536	319	137	31	40	196	519	6,678
2029-2030	869	1,102	1,185	938	785	540	314	141	33	40	192	526	6,667
2030-2031	858	1,087	1,168	938	785	536	312	136	31	43	194	529	6,619
2031-2032	871	1,126	1,191	940	795	556	315	134	33	40	194	523	6,719
2032-2033	859	1,114	1,170	933	798	543	328	143	33	43	194	528	6,686
2033-2034	872	1,116	1,179	931	808	538	311	143	33	42	195	530	6,697
2034-2035	853	1,115	1,178	944	824	547	315	141	29	41	195	523	6,703

Temperature Pattern Klamath Falls													Annual
Gas Year ▾	Nov	Dec	Jan	Feb	Mar	Apr	May	Jun	Jul	Aug	Sep	Oct	Total
2015-2016	825	1,043	1,092	845	793	610	389	194	41	58	197	497	6,584
2016-2017	830	1,053	1,092	860	806	603	392	194	40	58	192	504	6,624
2017-2018	825	1,058	1,093	875	799	614	381	186	40	59	185	502	6,617
2018-2019	820	1,061	1,090	872	796	599	398	195	38	50	192	498	6,609
2019-2020	834	1,058	1,091	848	791	597	372	187	42	61	192	497	6,570
2020-2021	817	1,062	1,076	851	807	612	373	189	39	57	192	489	6,566
2021-2022	830	1,049	1,087	860	807	594	391	189	41	57	191	495	6,590
2022-2023	832	1,056	1,081	851	801	618	386	192	36	58	186	496	6,593
2023-2024	826	1,049	1,098	861	798	585	394	186	38	54	196	504	6,591
2024-2025	827	1,054	1,061	861	806	585	377	202	41	57	182	505	6,558
2025-2026	826	1,055	1,058	856	793	592	395	192	40	62	180	504	6,553
2026-2027	827	1,054	1,089	858	808	605	391	195	41	61	174	499	6,601
2027-2028	820	1,062	1,078	866	785	588	397	195	43	60	184	494	6,572
2028-2029	818	1,062	1,071	869	795	608	409	194	37	59	196	500	6,618
2029-2030	826	1,052	1,090	841	806	599	391	192	42	56	185	488	6,567
2030-2031	822	1,049	1,075	865	807	609	380	191	41	59	194	496	6,589
2031-2032	825	1,052	1,069	845	792	615	396	191	41	60	186	496	6,568
2032-2033	826	1,064	1,084	863	797	602	391	186	40	55	184	500	6,592
2033-2034	818	1,059	1,088	869	798	616	401	188	39	55	181	503	6,616
2034-2035	824	1,048	1,098	855	789	601	395	194	40	56	186	499	6,585

Temperature Pattern Medford													Annual
Gas Year ▾	Nov	Dec	Jan	Feb	Mar	Apr	May	Jun	Jul	Aug	Sep	Oct	Total
2015-2016	634	839	833	624	571	407	232	74	12	12	80	331	4,650
2016-2017	634	842	837	637	570	398	231	75	9	13	77	333	4,655
2017-2018	629	839	839	645	569	403	227	74	10	12	79	322	4,648
2018-2019	624	835	839	628	571	410	228	76	9	13	74	335	4,641
2019-2020	633	832	841	632	568	405	231	79	9	13	74	333	4,649
2020-2021	630	829	856	621	563	401	228	80	10	13	80	340	4,651
2021-2022	640	839	832	628	583	417	218	74	9	12	75	330	4,659
2022-2023	637	833	852	626	567	396	219	79	10	12	73	337	4,639
2023-2024	639	834	844	626	569	403	224	81	10	12	81	332	4,654
2024-2025	638	831	837	637	568	400	233	75	9	12	78	322	4,641
2025-2026	634	845	844	635	562	407	226	73	10	12	85	335	4,669
2026-2027	633	830	832	625	560	401	234	77	9	11	79	331	4,623
2027-2028	640	817	835	625	557	406	227	75	9	12	78	328	4,609
2028-2029	638	829	837	631	555	412	233	81	10	10	77	323	4,636
2029-2030	637	840	831	636	575	410	228	75	9	13	77	335	4,668
2030-2031	630	835	843	625	552	401	222	77	9	13	73	334	4,613
2031-2032	639	836	842	635	576	405	227	78	11	12	82	333	4,677
2032-2033	627	834	841	635	567	410	218	82	10	12	72	334	4,642
2033-2034	635	836	831	632	573	390	227	80	10	12	81	327	4,633
2034-2035	634	832	839	637	567	408	228	77	10	13	74	334	4,653

### APPENDIX 2.4: HEATING DEGREE DAY DATA MONTHLY TABLES

Temperature Pattern													Roseburg	Annual
Gas Year ▾	Nov	Dec	Jan	Feb	Mar	Apr	May	Jun	Jul	Aug	Sep	Oct	Total	
2015-2016	544	712	709	563	537	394	249	105	21	17	88	308	4,245	
2016-2017	541	715	712	580	536	397	245	103	21	16	88	303	4,259	
2017-2018	537	713	721	583	534	398	244	103	21	16	87	307	4,265	
2018-2019	536	714	719	567	536	394	250	101	22	17	87	311	4,252	
2019-2020	540	711	723	568	531	396	251	105	22	17	87	305	4,256	
2020-2021	540	704	736	557	528	392	252	98	20	15	81	302	4,226	
2021-2022	548	714	712	565	548	399	240	100	22	17	88	303	4,256	
2022-2023	544	703	727	564	527	396	252	107	20	18	85	298	4,241	
2023-2024	548	709	727	565	532	402	239	102	21	16	82	307	4,249	
2024-2025	548	705	715	575	530	401	250	104	23	16	84	312	4,263	
2025-2026	540	721	723	575	529	394	246	97	23	17	88	310	4,264	
2026-2027	539	705	707	563	524	410	247	97	20	16	86	309	4,223	
2027-2028	547	698	716	563	522	385	243	94	20	16	87	297	4,189	
2028-2029	547	707	721	567	518	388	248	98	19	16	88	302	4,219	
2029-2030	548	717	708	574	538	381	244	97	22	17	87	303	4,236	
2030-2031	536	709	720	562	515	399	237	101	19	17	83	299	4,198	
2031-2032	549	713	719	574	536	393	234	102	22	17	86	300	4,243	
2032-2033	532	709	721	574	526	395	240	99	22	16	83	312	4,230	
2033-2034	542	713	711	568	534	392	241	99	20	17	83	304	4,223	
2034-2035	542	706	717	578	532	381	243	94	22	18	86	301	4,221	

Temperature Pattern													LaGrande	Annual
Gas Year ▾	Nov	Dec	Jan	Feb	Mar	Apr	May	Jun	Jul	Aug	Sep	Oct	Total	
2015-2016	781	1,021	1,059	822	753	540	343	149	28	43	186	498	6,223	
2016-2017	781	1,020	1,044	844	742	543	339	150	25	41	181	490	6,198	
2017-2018	795	1,024	1,042	832	742	537	332	150	27	43	176	495	6,195	
2018-2019	787	1,025	1,046	833	745	534	347	142	28	41	181	496	6,206	
2019-2020	796	1,027	1,049	835	747	543	332	142	33	43	177	493	6,217	
2020-2021	789	1,024	1,058	837	750	545	343	145	32	41	184	484	6,230	
2021-2022	783	1,038	1,042	815	753	552	335	140	29	45	187	494	6,211	
2022-2023	795	1,027	1,055	827	737	538	338	135	27	43	179	488	6,190	
2023-2024	775	1,034	1,058	838	756	539	336	145	33	43	181	497	6,235	
2024-2025	780	1,030	1,052	842	746	539	343	148	30	41	179	494	6,223	
2025-2026	787	1,023	1,048	817	749	542	349	150	30	43	183	499	6,219	
2026-2027	795	1,027	1,056	831	746	548	344	146	27	44	185	496	6,245	
2027-2028	782	1,029	1,041	820	755	539	336	148	27	42	178	492	6,188	
2028-2029	775	1,025	1,037	827	744	544	334	141	30	43	177	497	6,173	
2029-2030	790	1,015	1,048	823	738	539	339	142	28	44	188	484	6,178	
2030-2031	781	1,024	1,038	821	742	538	339	145	28	43	180	485	6,164	
2031-2032	778	1,020	1,053	840	744	546	335	143	30	42	186	488	6,205	
2032-2033	783	1,020	1,060	824	744	547	339	143	27	38	181	498	6,207	
2033-2034	798	1,021	1,049	824	738	542	340	140	30	44	184	495	6,206	
2034-2035	774	1,013	1,039	832	733	549	336	143	31	40	184	490	6,163	



**APPENDIX 2.4: HEATING DEGREE DAILY MONTH BY AREA**

Temperature Pattern		WA/ID											
Day	Jan	Feb	Mar	Apr	May	Jun	Jul	Aug	Sep	Oct	Nov	Dec	
1	36	36	31	23	14	4	0	0	1	8	26	34	
2	36	35	30	25	14	6	0	0	1	12	26	34	
3	37	35	30	23	15	5	0	0	1	13	26	36	
4	36	33	29	22	15	4	0	0	1	12	26	36	
5	37	33	28	22	15	6	0	0	2	14	27	36	
6	36	33	28	20	15	7	0	0	3	13	25	36	
7	34	33	27	19	15	6	0	0	3	12	25	37	
8	34	33	28	19	13	7	0	0	3	14	25	37	
9	34	34	27	20	13	6	0	0	3	15	26	37	
10	35	34	26	20	13	7	0	0	3	16	27	35	
11	37	33	25	19	11	7	0	0	2	17	28	35	
12	37	31	24	20	10	5	0	0	0	17	27	34	
13	36	62	24	19	11	4	0	0	1	15	27	34	
14	34	72	24	21	8	4	0	0	1	15	29	35	
15	37	82	24	21	7	4	0	0	2	17	28	35	
16	37	67	24	18	7	3	0	0	4	17	28	35	
17	36	57	25	19	8	4	0	0	6	16	27	36	
18	35	31	25	20	8	5	0	0	6	17	29	51	
19	35	31	24	18	8	5	0	0	6	17	30	56	
20	35	31	24	16	10	4	0	0	8	17	30	61	
21	35	30	25	16	10	1	0	0	9	19	32	58	
22	36	30	24	16	10	1	0	0	7	18	34	53	
23	35	31	24	17	9	2	0	0	6	20	33	38	
24	35	34	24	17	7	1	0	0	6	21	33	37	
25	34	34	23	17	8	1	0	0	5	22	32	37	
26	35	35	24	16	8	0	0	0	7	23	33	38	
27	37	33	24	15	7	0	0	0	7	23	34	37	
28	36	32	24	16	8	0	0	0	7	22	34	36	
29	35	30	23	16	8	0	0	0	6	24	35	37	
30	34	65	21	15	6	0	0	0	7	24	34	39	
31	34	65	23	65	5	65	0	1	65	24	65	39	
<b>Total</b>	<b>1100</b>	<b>1255</b>	<b>786</b>	<b>630</b>	<b>316</b>	<b>174</b>	<b>0</b>	<b>1</b>	<b>189</b>	<b>534</b>	<b>941</b>	<b>1219</b>	

Temperature Pattern		Medford											
Day	Jan	Feb	Mar	Apr	May	Jun	Jul	Aug	Sep	Oct	Nov	Dec	
1	25	24	19	16	8	0	0	0	0	2	16	25	
2	25	23	20	16	8	1	0	0	0	4	17	24	
3	27	21	21	16	9	1	0	0	0	5	16	25	
4	26	21	20	15	9	0	0	0	0	5	17	25	
5	26	22	20	15	9	1	0	0	0	6	17	25	
6	26	21	19	14	9	0	0	0	0	5	16	25	
7	23	20	19	14	7	1	0	0	0	5	16	27	
8	24	23	18	14	8	1	0	0	0	5	18	26	
9	25	22	17	14	9	0	0	0	0	7	20	24	
10	25	22	18	13	8	1	0	0	0	9	19	26	
11	25	21	17	13	6	1	0	0	0	10	18	26	
12	25	20	16	13	5	0	0	0	0	9	18	25	
13	26	32	16	14	4	0	0	0	0	7	19	23	
14	26	36	16	15	3	0	0	0	0	7	18	25	
15	26	38	16	15	3	0	0	0	0	8	19	27	
16	26	32	16	13	3	0	0	0	0	7	20	27	
17	25	28	18	13	3	0	0	0	0	9	21	26	
18	25	20	16	13	4	0	0	0	0	9	21	50	
19	24	21	15	12	5	0	0	0	0	8	19	59	
20	26	21	15	11	5	0	0	0	0	10	21	61	
21	26	20	14	11	5	0	0	0	0	11	23	56	
22	25	21	15	10	6	0	0	0	0	10	23	55	
23	24	22	16	11	4	0	0	0	0	11	23	26	
24	24	20	15	10	4	0	0	0	0	12	23	27	
25	23	21	17	9	4	0	0	0	0	14	22	27	
26	24	22	16	9	2	0	0	0	1	14	24	27	
27	25	20	17	10	4	0	0	0	0	15	24	26	
28	24	20	17	10	4	0	0	0	0	14	23	25	
29	23	20	16	9	3	0	0	0	0	14	24	25	
30	24	65	15	8	0	0	0	0	0	14	25	27	
31	24	65	16	65	0	65	0	0	65	14	65	27	
<b>Total</b>	<b>772</b>	<b>804</b>	<b>526</b>	<b>441</b>	<b>161</b>	<b>72</b>	<b>0</b>	<b>0</b>	<b>66</b>	<b>280</b>	<b>665</b>	<b>949</b>	

**APPENDIX 2.4: HEATING DEGREE DAILY MONTH BY AREA**

Temperature Pattern LaGrande												
Day	Jan	Feb	Mar	Apr	May	Jun	Jul	Aug	Sep	Oct	Nov	Dec
1	34	34	28	22	15	5	0	0	2	9	25	30
2	32	33	25	23	15	6	0	0	3	12	23	31
3	35	32	28	22	15	6	0	0	3	13	23	33
4	34	29	27	21	15	4	0	0	2	13	22	33
5	34	29	25	22	15	6	0	0	2	14	23	34
6	33	29	26	20	15	7	0	0	3	13	20	32
7	30	29	25	20	14	6	0	0	4	12	22	33
8	30	30	26	19	14	7	0	0	4	13	22	33
9	30	31	23	20	15	7	0	0	5	13	23	33
10	31	31	23	19	14	8	0	0	3	16	24	31
11	32	29	23	19	11	7	0	0	4	17	25	32
12	33	28	22	18	11	6	0	0	2	16	25	31
13	31	61	21	18	10	4	0	0	3	14	25	29
14	31	68	22	21	9	4	0	0	2	14	26	31
15	34	74	22	21	9	3	0	0	3	16	26	31
16	33	61	21	18	8	4	0	0	5	16	25	33
17	33	60	23	17	8	4	0	0	6	15	25	34
18	31	28	22	19	9	6	0	0	7	16	27	51
19	30	28	22	18	9	6	0	0	6	15	25	58
20	31	28	22	16	10	5	0	0	8	16	26	64
21	32	27	23	16	12	3	0	0	9	19	28	58
22	34	26	22	16	11	2	0	0	9	18	29	51
23	32	28	23	16	10	3	0	0	8	18	30	34
24	32	29	22	18	8	3	0	0	7	20	29	33
25	31	29	21	16	9	3	0	0	8	21	29	34
26	33	30	23	15	9	1	0	0	9	22	30	34
27	34	29	24	14	8	0	0	0	8	22	30	33
28	33	27	22	16	10	0	0	0	9	19	30	31
29	33	27	21	17	8	0	0	0	8	21	30	33
30	31	65	21	16	8	0	0	1	7	20	30	35
31	32	65	21	65	6	65	0	2	65	22	65	35
<b>Total</b>	<b>999</b>	<b>1154</b>	<b>719</b>	<b>618</b>	<b>340</b>	<b>191</b>	<b>0</b>	<b>3</b>	<b>224</b>	<b>505</b>	<b>842</b>	<b>1128</b>

Temperature Pattern Klamath												
Day	Jan	Feb	Mar	Apr	May	Jun	Jul	Aug	Sep	Oct	Nov	Dec
1	33	33	29	26	18	8	0	0	3	11	25	32
2	34	32	29	26	17	9	0	0	2	13	26	32
3	35	30	31	25	17	9	0	0	4	15	25	34
4	36	30	30	25	18	9	0	0	5	15	26	35
5	35	31	28	25	17	9	0	0	6	14	25	34
6	33	30	27	23	17	9	0	0	6	13	24	33
7	31	30	28	23	16	9	0	0	4	13	26	35
8	32	31	27	24	17	10	0	0	4	14	28	35
9	33	31	26	24	18	9	0	0	6	16	30	35
10	33	31	27	23	17	10	0	0	5	17	28	35
11	33	30	25	22	15	9	0	0	3	18	27	36
12	34	29	25	23	14	8	0	0	3	17	26	34
13	34	42	25	23	13	7	0	0	4	15	27	33
14	35	51	25	25	11	6	0	0	6	15	27	36
15	34	54	23	24	12	5	0	0	7	16	27	37
16	33	53	25	22	13	6	0	0	9	17	27	35
17	34	47	26	22	13	7	0	0	10	17	28	36
18	33	30	25	23	13	7	0	0	9	17	28	35
19	32	31	24	22	13	8	0	0	9	17	26	62.5
20	33	31	23	20	14	6	0	0	8	19	27	72
21	35	29	23	19	13	5	0	1	8	20	30	66.5
22	36	30	24	19	14	6	0	1	9	18	31	57.5
23	34	31	25	19	13	5	0	1	8	20	32	53.5
24	33	30	24	19	12	5	0	0	8	21	33	35
25	32	31	25	19	12	4	0	1	10	22	31	34
26	32	32	26	18	11	4	0	1	10	23	33	36
27	33	30	26	17	11	1	0	1	9	23	33	34
28	33	30	26	19	12	0	0	0	8	22	33	33
29	32	32	25	19	11	0	0	0	8	23	34	34
30	32	65	24	18	9	0	0	3	10	23	32	36
31	34	65	25	65	7	65	0	3	65	24	65	37
<b>Total</b>	<b>1036</b>	<b>1112</b>	<b>801</b>	<b>721</b>	<b>428</b>	<b>255</b>	<b>0</b>	<b>12</b>	<b>266</b>	<b>548</b>	<b>920</b>	<b>1213</b>

**APPENDIX 2.4: HEATING DEGREE DAILY MONTH BY AREA**

Temperature Pattern		Roseburg										
Day	Jan	Feb	Mar	Apr	May	Jun	Jul	Aug	Sep	Oct	Nov	Dec
1	22	21	18	16	8	2	0	0	0	3	14	22
2	22	20	18	16	8	2	0	0	0	5	14	21
3	23	21	19	15	9	2	0	0	0	5	15	21
4	22	19	18	14	9	2	0	0	0	6	15	21
5	22	19	18	15	9	2	0	0	0	4	14	21
6	22	18	18	14	8	2	0	0	0	3	13	22
7	19	20	18	13	8	2	0	0	0	4	16	23
8	20	20	16	14	8	2	0	0	0	5	17	22
9	22	21	15	14	10	2	0	0	0	6	17	21
10	21	20	16	13	9	4	0	0	0	9	17	22
11	21	19	14	12	7	2	0	0	0	9	16	22
12	21	17	15	13	6	1	0	0	0	9	14	21
13	23	32	15	13	5	0	0	0	0	6	15	21
14	23	37	15	14	4	0	0	0	0	7	16	22
15	23	42	15	14	5	0	0	0	0	8	16	23
16	22	34	16	13	5	0	0	0	0	7	17	22
17	22	28	17	13	4	0	0	0	1	9	17	22
18	21	18	14	13	5	1	0	0	1	8	18	40
19	22	19	14	12	5	1	0	0	0	8	15	53
20	22	20	15	11	6	0	0	0	0	10	19	55
21	22	18	16	11	7	0	0	0	1	10	21	46
22	22	19	16	10	6	1	0	0	0	10	21	48
23	21	20	15	11	5	0	0	0	1	11	22	21
24	21	19	14	10	4	0	0	0	0	12	19	22
25	21	21	15	9	4	0	0	0	2	13	20	23
26	22	20	16	9	3	0	0	0	2	13	20	23
27	23	19	16	9	4	0	0	0	1	14	21	23
28	21	19	16	9	6	0	0	0	0	12	21	21
29	20	19	15	9	4	0	0	0	1	13	21	23
30	20	65	15	8	2	0	0	0	2	12	22	24
31	21	65	16	65	1	65	0	0	65	13	65	23
<b>Total</b>	<b>669</b>	<b>769</b>	<b>494</b>	<b>432</b>	<b>184</b>	<b>93</b>	<b>0</b>	<b>0</b>	<b>77</b>	<b>264</b>	<b>588</b>	<b>814</b>

**APPENDIX 2.5: DEMAND SENSITIVITIES  
SUMMARY OF ASSUMPTIONS – DEMAND SCENARIOS**

INPUT ASSUMPTIONS	DEMAND INFLUENCING - DIRECT				PRICE INFLUENCING - INDIRECT					
	Reference Case	Reference Plus Peak Case	Low Cust Growth	High Cust Growth	Peak plus DSM Case	Alternate Historical Case	Expected Elasticity	Low High Prices	Carbon Legislation	LNG / Methanol
Customer Growth Rate			Low Growth	High Growth						
Use per Customer	3 Year Historical	3 Year Historical	3 Year Historical	5% Growth Cumulative Historical	3 Year Historical	3 Year Historical	3 Year Historical	3 Year Historical	3 Year Historical	3 Year Historical
Weather										
Planning Standard	20 Year Normal	Coldest on Record	Coldest on Record	Coldest on Record	Coldest on Record	Coldest on Record	Coldest on Record	Coldest on Record	Coldest on Record	Coldest on Record
Demand Side Management										
Programs Included	No	No	No	No	Expected	Expected	Expected	No	No	No
Prices										
Price curve	Expected	Expected	Expected	Expected	Expected	Expected	Expected	Low	High	High/Medium/Low
Price curve adder (\$/Dth)	None	None	None	None	None	None	None			\$ .25 Adder After 5yrs
Elasticity	None	None	None	None	None	None	None	Expected	Expected	Expected

**RESULTS**

**FIRST YEAR UNSERVED**

WAI/D	N/A	N/A	N/A	N/A	N/A	N/A	N/A	N/A	N/A	N/A	N/A
Medford	N/A	2033	N/A	N/A	N/A	N/A	N/A	2033	N/A	N/A	N/A
Roseburg	N/A	N/A	N/A	N/A	N/A	N/A	N/A	N/A	N/A	N/A	N/A
Klamath	N/A	N/A	N/A	N/A	N/A	N/A	N/A	N/A	N/A	N/A	N/A
La Grande	N/A	N/A	N/A	N/A	N/A	N/A	N/A	N/A	N/A	N/A	N/A

## APPENDIX 2.5: DEMAND SCENARIOS PROPOSED SCENARIOS

Proposed Scenarios INPUT ASSUMPTIONS	Expected Case - Low Prices	Expected Case	High Growth & Low Prices	Low Growth & High Prices	Cold Day 20yr Weather Std
<b>Customer Growth Rate</b>	Reference Case Cust Growth Rates	Reference Case Cust Growth Rates	High Growth Rate	Low Growth Rate	Reference Case Cust Growth Rates
<b>Use per Customer</b>	3 yr Flat + Price Elast.	3 yr Flat + Price Elast.	3 yr Flat + Price Elast. + CNG/NGV	3 yr Flat + Price Elast.	3 yr Flat + Price Elast.
<b>Demand Side Management</b>	Yes	Yes	Yes	Yes	Yes
<b>Weather Planning Standard</b>	Coldest Day	Coldest Day	Coldest Day	Coldest Day	Alternate Planning Standard
<b>Prices</b>					
Price curve	Low	Expected	Low	High	Expected
Carbon Legislation (\$/Ton)	\$9.89 - 19.93	\$9.89 - 19.93	None	\$9.89 - 19.93	\$9.89 - 19.93
<b>RESULTS</b>					
<b>First Gas Year Unserved</b>					
WA/ID	N/A	N/A	2033	N/A	N/A
Medford	N/A	N/A	2027	N/A	N/A
Roseburg	N/A	N/A	2027	N/A	N/A
Klamath	N/A	N/A	2034	N/A	N/A
La Grande	N/A	N/A	2031	N/A	N/A
<b>Scenario Summary</b>					
	Evaluates the expected case attributes and combines it with the low price curve to determine whether low prices will drastically change case outcome.	Most aggressive peak planning case utilizing Average Case assumptions as a starting point and layering in coldest weather on record. The likelihood of occurrence is low.	Aggressive growth assumptions in order to evaluate when our earliest resource shortage could occur. Not likely to occur.	Stagnant growth assumptions in order to evaluate if a shortage does occur. Not likely to occur.	Evaluates adopting an alternate peak weather standard. Helps provide some bounds around our sensitivity to weather.
<b>Risk Assessment</b>					
<p>Higher or lower customer growth rates, which are heavily based on economic recovery. Higher or lower growth rates will lead to accelerated or delayed unserved demand. Looking at various growth assumptions off the Expected Case allows us to capture the risk in terms of the change in demand linked to customer growth.</p> <p>Higher or lower use per customer will also lead to accelerated or delayed unserved demand. Use per customer can differ in many ways. Direct use per customer influencers, such as demand side management, NGV/CNG usage, and derivation of the use per customer starting point (i.e. one year, three year, etc.). Again, varying these assumptions under our forecasting methodology allows us to quantify the change each assumption has to our forecast.</p> <p>Weather volatility and predictability are a key risk. As the most correlated direct demand influencer, varying weather assumptions is key to understanding the weather related risks.</p> <p>Indirect influencers including elasticity and price are also important assumptions. The two go hand in hand, as price changes it will influence how much customers consume. If forecasted prices remain relatively stable over the planning horizon, our current elasticity assumption will not provide much decreased usage. However, price adders or an overall steepening of the price curve will trigger a greater decline in usage due to the price elastic response. The magnitude of the elasticity adjustment is also important. We are using a long run elasticity factor as calculated by the AGA. We continue to evaluate this assumption and are looking to update the study as part of our Action Plan.</p>					

## APPENDIX 2.6: DEMAND FORECAST SENSITIVITIES AND SCENARIOS DESCRIPTIONS

### DEFINITIONS

**DYNAMIC DEMAND METHODOLOGY** – Avista’s demand forecasting approach wherein we 1) identify key demand drivers behind natural gas consumption, 2) perform sensitivity analysis on each demand driver, and 3) combine demand drivers under various scenarios to develop alternative potential outcomes for forecasted demand.

**DEMAND INFLUENCING FACTORS** – Factors that directly influence the volume of natural gas consumed by our core customers.

**PRICE INFLUENCING FACTORS** – Factors that, through price elasticity response, indirectly influence the volume of natural gas consumed by our core customers.

**REFERENCE CASE** – A baseline point of reference that captures the basic inputs for determining a demand forecast in SENDOUT® which includes number of customers, use per customer, average daily weather temperatures and expected natural gas prices.

**SENSITIVITIES** – Focused analysis of a specific natural gas demand driver and its impact on forecasted demand relative to the Reference Case when underlying input assumptions are modified.

**SCENARIOS** – Combination of natural gas demand drivers that make up a demand forecast.

Avista evaluates each sensitivities impact.

### SENSITIVITIES

The following Sensitivities were performed on identified demand drivers against the reference case for consideration in Scenario development. Note that Sensitivity assumptions reflect incremental adjustments we estimate are not captured in the underlying reference case forecast.

Following are the Demand Influencing (Direct) Sensitivities we evaluated:

**REFERENCE CASE PLUS PEAK** – Same assumptions as in the Reference Case with an adjustment made to normal weather to incorporate peak weather conditions. The peak weather data being the coldest day on record for each weather area.

**LOW & HIGH CUSTOMER GROWTH** – Discussed in detail in Appendix 2.1: Economic Outlook and Customer Count Forecast.

**NATURAL GAS VEHICLES (NGV) AND/OR COMPRESSED NATURAL GAS (CNG) VEHICLES** – NGV/CNG vehicles assumed to produce a 5% cumulative incremental demand over our 20 year planning horizon. Our assumption utilized market consumption estimates from an independent analysis on NGV/CNG vehicle viability. The analysis indicates significant challenges exist to widespread adoption but did provide a scenario for significant market penetration.

**ALTERNATE WEATHER STANDARD (COLDEST DAY 20 YRS)** – Peak Day weather temperature reduced to coldest average daily temperature (HDDs) experienced in the most recent 20 years in each region.

**DSM** – Reference case assumptions including the potential DSM identified by the Conservation Potential Assessment provided by Applied Energy Group. See Appendix 3.1 for full assessment report.

**PEAK PLUS DSM** – Reference plus peak weather assumptions including the potential DSM identified by the Conservation Potential Assessment provided by Applied Energy Group. See Appendix 3.1 for the full assessment report.

**ALTERNATE USE PER CUSTOMER** – Reference case use per customer was based upon three years of actual use per customer per heating degree day data. This sensitivity used five years of historical use per customer per heating degree day data.

Following are the Price Influencing (Indirect) Sensitivities we evaluated:

**EXPECTED ELASTICITY** – For our expected elasticity Sensitivity, we incorporate reduced consumption in response to higher natural gas prices utilizing a price elasticity study prepared by the American Gas Association.

**LOW & HIGH PRICES** – To capture a wide band of alternative prices forecasts, a Monte Carlo simulation using historical daily cash price data at the Henry Hub trading point dating back to 2009 was developed. From this simulation, a high and low price were selected from the derived 500 draws.

**CARBON LEGISLATION LOW CASE** – Assumes no carbon adder throughout the entire study horizon.

**CARBON LEGISLATION MEDIUM CASE** – Utilizes carbon cost adders quantified by independent analysis from Consultant #1. They identify both an adder reflecting carbon allowances as well as an adder to capture the effect of increased natural gas demand as more gas turbines come online to replace coal plants and back up wind generation. The allowance adder escalates from \$9.89/ton in 2018 to \$19.93/ton by 2035. This is the expected carbon adder utilized in our carbon case sensitivities.

**CARBON LEGISLATION HIGH CASE** – Utilizes carbon cost adders quantified by independent analysis from Consultant #1. They identify both an adder reflecting carbon allowances as well as an adder to capture the effect of increased natural gas demand as more gas turbines come online to replace coal plants and back up wind generation. The allowance adder escalates from \$15/ton in 2018 to \$43/ton by 2035.

**EXPORTED LNG** – Beginning in 2019, we apply an estimate of \$.25/mmbtu *incremental* adder each year to regional natural gas prices to capture upward price pressure because of exports of LNG to Asian and European countries. There is much uncertainty about the region price impact LNG will have. It is highly dependent on many things including which export facilities get built and the pipeline infrastructure used to serve them. There are several analyses that have been conducted where the price impact can be minimal to \$1.00/mmbtu.

## SCENARIOS

After identifying the above demand drivers and analyzing the various Sensitivities, we have developed the following demand forecast Scenarios:

**AVERAGE CASE** – This Scenario we believe represents the most likely average demand forecast modeled. We assume service territory customer growth rates consistent with the reference case, rolling 20 year normal weather in each service territory, our expected natural gas price forecast (blend of two consultants, along with the NYMEX forward strip), expected price elasticity, the CO2 cost adders from our **Carbon Legislation Medium Case** Sensitivity, and DSM. The Scenario does not include incremental cost adders for declining Canadian imports or drilling restrictions beyond what is incorporated in the selected price forecast.

**EXPECTED CASE** – This Scenario represents the peak demand forecast. We assume service territory customer growth rates consistent with the reference case, a weather standard of coldest day on record in each service territory, our expected natural gas price forecast (blend of two consultants, along with the NYMEX forward strip), expected price elasticity, DSM, and the CO2 cost adders from our **Carbon Legislation Medium Case** Sensitivity.

**HIGH GROWTH, LOW PRICE** – This Scenario models a rapid return to robust growth in part spurred on by low energy prices. We assume higher customer growth rates than the reference case, coldest day on record weather standard, incremental demand from NGV/CNG, our low natural gas price forecast, expected price elasticity, DSM, and no CO2 adders.

**LOW GROWTH, HIGH PRICE** – This Scenario models an extended period of slow economic growth in part resulting from high energy prices. We assume lower customer growth rates than the reference case, coldest day on record weather standard, our high natural gas price forecast, expected price elasticity, DSM, and CO2 adders from our **Carbon Legislation Medium Case** Sensitivity.

**ALTERNATE WEATHER STANDARD** – This Scenario models all the same assumptions as the **Expected Case** Scenario, except for the change in the weather planning standard from coldest day on record to coldest day in 20 years for each service territory. As noted in the Sensitivity analysis, this change does not affect the Klamath Falls and La Grande service territories, which have each experienced their coldest day on record within the last 20 years.

**EXPECTED GROWTH, LOW PRICES** – This Scenario models all the same assumptions as the **Expected Case** Scenario, except our low natural gas price forecast is used rather than our expected natural gas price forecast.

A case incorporating Exported LNG was not included in this IRP's scenario analysis. There is much uncertainty about the location and timing of exported LNG and its potential price impacts. The forecasters we subscribe to have incorporated some level of export LNG into their price forecasts and therefore our expected price curve does include an export LNG assumption. At this time, the effects of LNG are minimal given the robust North American supply picture. Avista will closely monitor developments with export LNG for the potential price and infrastructure impacts.



**APPENDIX 2.7: ANNUAL DEMAND, AVERAGE DAY DEMAND AND PEAK DAY DEMAND (NET OF DSM) – CASE AVERAGE**

Scenario	Gas Year	Annual Demand			Daily Demand			Peak Day Demand			Annual Demand Total System (MDth)	Daily Demand Total System (MDth/day)	Peak Day Demand Total System (MDth/day)
		Klam Falls (MDth)	Daily Demand Klamath (MDth/day)	Peak Day Demand Klamath (MDth/day)	Annual Demand La Grande (MDth)	Daily Demand La Grande (MDth/day)	Peak Day Demand La Grande (MDth/day)	Annual Demand Medford/Roseburg (MDth)	Daily Demand Medford/Roseburg (MDth/day)	Peak Day Demand Medford/Roseburg (MDth/day)			
Average Case	2015-2016	1,307.46	3.58	7.01	886.23	2.43	3.69	6,154.74	16.86	33.38			
Average Case	2016-2017	1,311.77	3.59	7.06	885.75	2.43	3.69	6,189.40	16.96	33.76			
Average Case	2017-2018	1,325.00	3.63	7.14	888.34	2.43	3.70	6,262.18	17.16	34.19			
Average Case	2018-2019	1,339.11	3.67	7.23	890.76	2.44	3.72	6,337.36	17.36	34.66			
Average Case	2019-2020	1,359.66	3.73	7.32	896.72	2.46	3.73	6,440.33	17.64	35.14			
Average Case	2020-2021	1,367.18	3.75	7.40	895.22	2.45	3.75	6,487.11	17.77	35.62			
Average Case	2021-2022	1,381.26	3.78	7.49	897.19	2.46	3.76	6,550.05	17.95	36.06			
Average Case	2022-2023	1,395.09	3.82	7.58	898.93	2.46	3.77	6,603.20	18.09	36.43			
Average Case	2023-2024	1,415.45	3.88	7.67	904.20	2.48	3.78	6,682.44	18.31	36.78			
Average Case	2024-2025	1,421.42	3.89	7.75	901.67	2.47	3.79	6,702.02	18.36	37.12			
Average Case	2025-2026	1,433.54	3.93	7.83	902.66	2.47	3.80	6,749.06	18.49	37.46			
Average Case	2026-2027	1,445.19	3.96	7.91	903.69	2.48	3.81	6,794.46	18.61	37.79			
Average Case	2027-2028	1,463.67	4.01	7.99	908.78	2.49	3.82	6,869.01	18.82	38.12			
Average Case	2028-2029	1,467.05	4.02	8.07	906.37	2.48	3.83	6,880.18	18.85	38.43			
Average Case	2029-2030	1,476.90	4.05	8.14	907.71	2.49	3.84	6,919.11	18.96	38.73			
Average Case	2030-2031	1,486.45	4.07	8.21	908.86	2.49	3.85	6,954.63	19.05	39.02			
Average Case	2031-2032	1,503.13	4.12	8.27	913.58	2.50	3.86	7,016.27	19.22	39.28			
Average Case	2032-2033	1,505.02	4.12	8.34	910.43	2.49	3.86	7,012.98	19.21	39.53			
Average Case	2033-2034	1,514.71	4.15	8.41	911.12	2.50	3.87	7,039.29	19.29	39.76			
Average Case	2034-2035	1,529.37	4.19	8.48	914.65	2.51	3.89	7,089.44	19.42	39.98			
Scenario	Gas Year	Annual Demand Oregon (MDth)	Daily Demand Oregon (MDth/day)	Peak Day Demand Oregon (MDth/day)	Annual Demand WAID (MDth)	Daily Demand WAID (MDth/day)	Peak Day Demand WAID (MDth/day)	Annual Demand Total System (MDth)	Daily Demand Total System (MDth/day)	Peak Day Demand Total System (MDth/day)			
Average Case	2015-2016	8,348.43	22.87	44.07	24,871.00	68.14	113.22	33,219.43	91.01	157.29			
Average Case	2016-2017	8,386.92	22.98	44.51	24,837.09	68.05	113.86	33,224.02	91.02	158.37			
Average Case	2017-2018	8,475.52	23.22	45.03	24,976.13	68.43	114.71	33,451.65	91.65	159.74			
Average Case	2018-2019	8,567.23	23.47	45.60	25,103.84	68.78	115.52	33,671.06	92.25	161.12			
Average Case	2019-2020	8,686.72	23.83	46.19	25,344.79	69.44	116.41	34,041.51	93.26	162.59			
Average Case	2020-2021	8,749.52	23.97	46.77	25,366.47	69.50	117.21	34,115.98	93.47	163.97			
Average Case	2021-2022	8,828.50	24.19	47.30	25,486.45	69.83	118.00	34,314.94	94.01	165.31			
Average Case	2022-2023	8,897.22	24.38	47.78	25,592.30	70.12	118.74	34,489.52	94.49	166.52			
Average Case	2023-2024	9,002.09	24.66	48.23	25,812.00	70.72	119.60	34,814.09	95.38	167.83			
Average Case	2024-2025	9,025.11	24.73	48.67	25,787.07	70.65	120.17	34,812.18	95.38	168.83			
Average Case	2025-2026	9,085.26	24.89	49.09	25,873.06	70.89	120.84	34,958.33	95.78	169.93			
Average Case	2026-2027	9,143.34	25.05	49.51	25,951.71	71.10	121.48	35,095.05	96.15	170.99			
Average Case	2027-2028	9,241.46	25.32	49.93	26,152.10	71.65	122.31	35,393.66	96.97	172.24			
Average Case	2028-2029	9,253.60	25.35	50.32	26,100.07	71.51	122.73	35,353.67	96.86	173.05			
Average Case	2029-2030	9,303.71	25.49	50.70	26,168.82	71.70	123.33	35,472.53	97.19	174.03			
Average Case	2030-2031	9,349.94	25.62	51.07	26,234.67	71.88	123.92	35,584.61	97.49	174.99			
Average Case	2031-2032	9,432.98	25.84	51.41	26,424.39	72.40	124.76	35,857.37	98.24	176.18			
Average Case	2032-2033	9,428.43	25.83	51.73	26,355.20	72.21	125.06	35,783.62	98.04	176.79			
Average Case	2033-2034	9,465.12	25.93	52.04	26,415.08	72.37	125.63	35,880.20	98.30	177.67			
Average Case	2034-2035	9,533.47	26.12	52.35	26,621.25	72.93	126.72	36,154.72	99.05	179.07			

**APPENDIX 2.7: ANNUAL DEMAND, AVERAGE DAY DEMAND AND PEAK DAY DEMAND (NET OF DSM) – CASE HIGH**

Scenario	Gas Year	Annual Demand (MWh)			Daily Demand (MDth/day)		Peak Day Demand (MDth/day)		Annual Demand Total System (MDth)	Daily Demand Total System (MDth/day)	Peak Day Demand System (MDth/day)
		Klam Falls	Klamath	Peak Day Klamath	Annual Demand La Grande	Daily Demand La Grande	Peak Day La Grande	Annual Demand Medford/Roseburg			
High Growth & Low Prices	2015-2016	1,349.73	3.70	13.33	918.43	2.52	8.08	6,413.03	17.57	72.03	
High Growth & Low Prices	2016-2017	1,357.65	3.72	13.45	922.11	2.53	8.11	6,491.09	17.78	73.39	
High Growth & Low Prices	2017-2018	1,377.26	3.77	13.66	929.60	2.55	8.18	6,607.72	18.10	74.75	
High Growth & Low Prices	2018-2019	1,398.50	3.83	13.89	937.30	2.57	8.25	6,729.56	18.44	76.23	
High Growth & Low Prices	2019-2020	1,426.65	3.91	14.12	948.81	2.60	8.33	6,881.14	18.85	77.74	
High Growth & Low Prices	2020-2021	1,442.42	3.95	14.36	953.16	2.61	8.40	6,978.25	19.12	79.31	
High Growth & Low Prices	2021-2022	1,465.24	4.01	14.61	961.18	2.63	8.48	7,090.10	19.42	80.78	
High Growth & Low Prices	2022-2023	1,487.92	4.08	14.87	968.93	2.65	8.55	7,189.37	19.70	82.08	
High Growth & Low Prices	2023-2024	1,517.69	4.16	15.12	980.15	2.69	8.62	7,317.08	20.05	83.34	
High Growth & Low Prices	2024-2025	1,532.57	4.20	15.37	982.95	2.69	8.69	7,383.17	20.23	84.60	
High Growth & Low Prices	2025-2026	1,553.76	4.26	15.62	989.23	2.71	8.75	7,478.73	20.49	85.87	
High Growth & Low Prices	2026-2027	1,574.08	4.31	15.85	996.00	2.73	8.81	7,571.68	20.74	87.09	
High Growth & Low Prices	2027-2028	1,601.86	4.39	16.09	1,008.35	2.76	8.90	7,697.57	21.09	88.34	
High Growth & Low Prices	2028-2029	1,613.46	4.42	16.31	1,013.56	2.78	8.99	7,755.46	21.25	89.56	
High Growth & Low Prices	2029-2030	1,631.50	4.47	16.53	1,022.65	2.80	9.07	7,842.82	21.49	90.74	
High Growth & Low Prices	2030-2031	1,649.15	4.52	16.74	1,031.03	2.82	9.16	7,925.77	21.71	91.88	
High Growth & Low Prices	2031-2032	1,674.66	4.59	16.95	1,042.87	2.86	9.24	8,036.70	22.02	92.97	
High Growth & Low Prices	2032-2033	1,684.57	4.62	17.16	1,045.79	2.87	9.31	8,076.24	22.13	94.01	
High Growth & Low Prices	2033-2034	1,703.05	4.67	17.38	1,052.34	2.88	9.37	8,147.85	22.32	95.03	
High Growth & Low Prices	2034-2035	1,726.45	4.73	17.60	1,061.45	2.91	9.45	8,242.27	22.58	96.00	
Scenario	Gas Year	Annual Demand (MWh)			Daily Demand (MDth/day)		Peak Day Demand (MDth/day)		Annual Demand Total System (MDth)	Daily Demand Total System (MDth/day)	Peak Day Demand System (MDth/day)
Scenario	Gas Year	Oregon	Oregon	Peak Day Oregon	Annual Demand WAID	Daily Demand WAID	Peak Day WAID				
High Growth & Low Prices	2015-2016	8,681.19	23.78	93.44	25,805.24	70.70	269.40	34,486.42	94.48	362.83	
High Growth & Low Prices	2016-2017	8,770.85	24.03	94.95	25,913.40	71.00	272.41	34,684.24	95.03	367.36	
High Growth & Low Prices	2017-2018	8,914.58	24.42	96.59	26,199.79	71.78	276.24	35,114.37	96.20	372.83	
High Growth & Low Prices	2018-2019	9,065.36	24.84	98.37	26,483.49	72.56	280.13	35,548.85	97.39	378.50	
High Growth & Low Prices	2019-2020	9,256.60	25.36	100.19	26,887.34	73.66	284.17	36,143.94	99.02	384.36	
High Growth & Low Prices	2020-2021	9,373.83	25.68	102.08	27,079.81	74.19	288.33	36,453.65	99.87	390.41	
High Growth & Low Prices	2021-2022	9,516.52	26.07	103.87	27,367.33	74.98	292.35	36,883.85	101.05	396.22	
High Growth & Low Prices	2022-2023	9,646.22	26.43	105.49	27,632.83	75.71	296.15	37,279.05	102.13	401.64	
High Growth & Low Prices	2023-2024	9,814.92	26.89	107.08	28,020.87	76.77	300.10	37,835.79	103.66	407.18	
High Growth & Low Prices	2024-2025	9,898.70	27.12	108.66	28,155.54	77.14	303.77	38,054.24	104.26	412.44	
High Growth & Low Prices	2025-2026	10,021.72	27.46	110.23	28,405.32	77.82	307.51	38,427.04	105.28	417.74	
High Growth & Low Prices	2026-2027	10,141.75	27.79	111.76	28,640.91	78.47	311.08	38,782.66	106.25	422.84	
High Growth & Low Prices	2027-2028	10,307.78	28.24	113.32	29,012.39	79.49	314.94	39,320.17	107.73	428.26	
High Growth & Low Prices	2028-2029	10,382.48	28.45	114.86	29,116.08	79.77	318.36	39,498.56	108.22	433.21	
High Growth & Low Prices	2029-2030	10,496.98	28.76	116.34	29,347.94	80.41	321.94	39,844.92	109.16	438.28	
High Growth & Low Prices	2030-2031	10,605.95	29.06	117.78	29,576.50	81.03	325.48	40,182.44	110.09	443.26	
High Growth & Low Prices	2031-2032	10,754.23	29.46	119.16	29,940.13	82.03	329.28	40,594.36	111.49	448.44	
High Growth & Low Prices	2032-2033	10,806.59	29.61	120.48	30,024.54	82.26	332.52	40,831.13	111.87	453.00	
High Growth & Low Prices	2033-2034	10,903.25	29.87	121.78	30,249.57	82.88	336.03	41,152.82	112.75	457.81	
High Growth & Low Prices	2034-2035	11,030.17	30.22	123.04	30,619.38	83.89	340.03	41,649.55	114.11	463.07	

**APPENDIX 2.7: ANNUAL DEMAND, AVERAGE DAY DEMAND AND PEAK DAY DEMAND (NET OF DSM) – CASE LOW**

Scenario	Gas Year	Annual Demand			Daily Demand		Peak Day Demand		Annual Demand		Daily Demand		Peak Day Demand	
		Klam Falls (MDth)	Klamath (MDth/day)	Peak Day Klamath (MDth/day)	Annual Demand La Grande (MDth)	Daily Demand La Grande (MDth/day)	Peak Day La Grande (MDth/day)	Annual Demand Medford/Roseburg (MDth)	Daily Demand Medford/Roseburg (MDth/day)	Peak Day Medford/Roseburg (MDth/day)	Annual Demand Total System (MDth)	Daily Demand Total System (MDth/day)	Peak Day Demand Total System (MDth/day)	
Low Growth & High Prices	2015-2016	1,348.33	3.69	13.33	914.51	2.51	8.05	6,367.16	17.44	72.01				
Low Growth & High Prices	2016-2017	1,211.58	3.32	11.66	835.86	2.29	7.06	5,759.73	15.78	62.87				
Low Growth & High Prices	2017-2018	1,210.37	3.32	11.65	831.02	2.28	7.02	5,758.34	15.78	62.81				
Low Growth & High Prices	2018-2019	1,204.88	3.30	11.59	823.39	2.26	6.94	5,737.68	15.72	62.50				
Low Growth & High Prices	2019-2020	1,216.48	3.33	11.68	825.24	2.26	6.95	5,792.53	15.87	63.02				
Low Growth & High Prices	2020-2021	1,216.22	3.33	11.76	820.24	2.25	6.95	5,797.14	15.88	63.52				
Low Growth & High Prices	2021-2022	1,221.72	3.35	11.84	818.44	2.24	6.95	5,818.88	15.94	63.98				
Low Growth & High Prices	2022-2023	1,226.10	3.36	11.92	816.04	2.24	6.95	5,830.38	15.97	64.31				
Low Growth & High Prices	2023-2024	1,236.58	3.39	12.00	817.29	2.24	6.96	5,866.79	16.07	64.66				
Low Growth & High Prices	2024-2025	1,229.77	3.37	12.01	809.27	2.22	6.92	5,829.62	15.97	64.64				
Low Growth & High Prices	2025-2026	1,232.98	3.38	12.08	806.92	2.21	6.93	5,836.13	15.99	64.94				
Low Growth & High Prices	2026-2027	1,236.45	3.39	12.16	804.51	2.20	6.93	5,843.50	16.01	65.26				
Low Growth & High Prices	2027-2028	1,245.50	3.41	12.23	804.82	2.20	6.93	5,874.32	16.09	65.57				
Low Growth & High Prices	2028-2029	1,238.49	3.39	12.25	796.28	2.18	6.90	5,836.34	15.99	65.60				
Low Growth & High Prices	2029-2030	1,239.71	3.40	12.30	792.36	2.17	6.89	5,832.73	15.98	65.78				
Low Growth & High Prices	2030-2031	1,239.73	3.40	12.34	788.12	2.16	6.87	5,822.35	15.96	65.88				
Low Growth & High Prices	2031-2032	1,245.82	3.41	12.38	787.38	2.16	6.86	5,835.59	15.99	65.99				
Low Growth & High Prices	2032-2033	1,241.82	3.40	12.44	781.32	2.14	6.86	5,805.62	15.91	66.21				
Low Growth & High Prices	2033-2034	1,241.91	3.40	12.48	777.78	2.13	6.85	5,790.86	15.87	66.27				
Low Growth & High Prices	2034-2035	1,248.19	3.42	12.54	777.83	2.13	6.86	5,805.84	15.91	66.40				
Scenario	Gas Year	Annual Demand			Daily Demand		Peak Day Demand		Annual Demand		Daily Demand		Peak Day Demand	
Low Growth & High Prices	2015-2016	8,630.00	23.64	93.40	25,642.02	70.25	267.57	34,272.02	93.90	360.97				
Low Growth & High Prices	2016-2017	7,807.17	21.39	81.60	22,832.78	62.56	232.97	30,639.96	83.95	314.56				
Low Growth & High Prices	2017-2018	7,799.73	21.37	81.48	22,681.64	62.14	231.90	30,481.37	83.51	313.38				
Low Growth & High Prices	2018-2019	7,765.95	21.28	81.03	22,428.46	61.45	229.60	30,194.42	82.72	310.63				
Low Growth & High Prices	2019-2020	7,834.26	21.46	81.65	22,495.98	61.63	230.43	30,330.24	83.10	312.08				
Low Growth & High Prices	2020-2021	7,833.60	21.46	82.22	22,369.14	61.29	231.09	30,202.73	82.75	313.31				
Low Growth & High Prices	2021-2022	7,859.04	21.53	82.78	22,339.69	61.20	231.88	30,198.73	82.74	314.66				
Low Growth & High Prices	2022-2023	7,872.52	21.57	83.18	22,289.23	61.07	232.45	30,161.74	82.63	315.64				
Low Growth & High Prices	2023-2024	7,920.65	21.70	83.62	22,347.63	61.23	233.34	30,268.28	82.93	316.96				
Low Growth & High Prices	2024-2025	7,868.66	21.56	83.58	22,103.30	60.56	232.60	29,971.96	82.11	316.18				
Low Growth & High Prices	2025-2026	7,876.02	21.58	83.95	22,042.22	60.39	233.17	29,918.24	81.97	317.12				
Low Growth & High Prices	2026-2027	7,884.47	21.60	84.35	21,986.39	60.24	233.84	29,870.86	81.84	318.19				
Low Growth & High Prices	2027-2028	7,924.63	21.71	84.74	22,028.20	60.35	234.70	29,952.83	82.05	319.44				
Low Growth & High Prices	2028-2029	7,871.11	21.56	84.75	21,791.63	59.70	234.14	29,662.75	81.27	318.89				
Low Growth & High Prices	2029-2030	7,864.80	21.55	84.97	21,702.78	59.46	234.45	29,567.58	81.01	319.40				
Low Growth & High Prices	2030-2031	7,860.21	21.51	85.08	21,593.12	59.16	234.45	29,443.33	80.67	319.53				
Low Growth & High Prices	2031-2032	7,868.80	21.56	85.24	21,592.48	59.16	234.87	29,461.27	80.72	320.10				
Low Growth & High Prices	2032-2033	7,828.76	21.45	85.51	21,420.67	58.69	235.19	29,249.43	80.14	320.69				
Low Growth & High Prices	2033-2034	7,810.55	21.40	85.60	21,314.53	58.40	235.28	29,125.08	79.79	320.88				
Low Growth & High Prices	2034-2035	7,831.86	21.46	85.79	21,377.10	58.57	236.18	29,208.96	80.02	321.97				

**APPENDIX 2.7: ANNUAL DEMAND, AVERAGE DAY DEMAND AND PEAK DAY DEMAND (NET OF DSM) – CASE COLDEST IN 20**

Scenario	Gas Year	Annual Demand			Daily Demand		Peak Day Demand		Annual Demand		Daily Demand		Peak Day Demand	
		Klam Falls (MDth)	Klamath (MDth/day)	Peak Day Klamath (MDth/day)	Annual Demand La Grande (MDth)	Daily Demand La Grande (MDth/day)	Peak Day La Grande (MDth/day)	Annual Demand Medford/Roseburg (MDth)	Daily Demand Medford/Roseburg (MDth/day)	Peak Day Medford/Roseburg (MDth/day)	Annual Demand Total System (MDth)	Daily Demand Total System (MDth/day)	Peak Day Demand Total System (MDth/day)	
Cold Day 20Yr Weather Std	2015-2016	1,345.06	3.69	13.33	914.36	2.51	8.06	6,387.16	17.50	64.24				
Cold Day 20Yr Weather Std	2016-2017	1,349.70	3.70	13.44	913.95	2.50	8.08	6,424.63	17.60	64.98				
Cold Day 20Yr Weather Std	2017-2018	1,363.40	3.74	13.67	916.70	2.51	8.12	6,500.90	17.81	65.84				
Cold Day 20Yr Weather Std	2018-2019	1,378.03	3.78	13.70	919.27	2.52	8.16	6,579.74	18.03	66.79				
Cold Day 20Yr Weather Std	2019-2020	1,399.11	3.83	13.94	925.39	2.54	8.20	6,686.40	18.32	67.75				
Cold Day 20Yr Weather Std	2020-2021	1,407.15	3.86	14.12	924.04	2.53	8.23	6,736.91	18.46	68.72				
Cold Day 20Yr Weather Std	2021-2022	1,421.76	3.90	14.30	926.16	2.54	8.27	6,803.21	18.64	69.61				
Cold Day 20Yr Weather Std	2022-2023	1,436.14	3.93	14.48	928.04	2.54	8.30	6,859.34	18.79	70.38				
Cold Day 20Yr Weather Std	2023-2024	1,457.04	3.99	14.66	933.46	2.56	8.34	6,941.48	19.02	71.11				
Cold Day 20Yr Weather Std	2024-2025	1,463.54	4.01	14.83	931.07	2.55	8.37	6,963.95	19.08	71.84				
Cold Day 20Yr Weather Std	2025-2026	1,476.18	4.04	15.00	932.21	2.55	8.40	7,013.90	19.22	72.56				
Cold Day 20Yr Weather Std	2026-2027	1,488.35	4.08	15.17	933.38	2.56	8.43	7,062.16	19.35	73.26				
Cold Day 20Yr Weather Std	2027-2028	1,507.33	4.13	15.33	938.62	2.57	8.46	7,139.54	19.56	73.95				
Cold Day 20Yr Weather Std	2028-2029	1,511.20	4.14	15.49	936.37	2.57	8.50	7,153.47	19.60	74.63				
Cold Day 20Yr Weather Std	2029-2030	1,521.51	4.17	15.63	937.86	2.57	8.53	7,195.07	19.71	75.28				
Cold Day 20Yr Weather Std	2030-2031	1,531.52	4.20	15.78	939.17	2.57	8.56	7,233.14	19.82	75.90				
Cold Day 20Yr Weather Std	2031-2032	1,548.66	4.24	15.93	944.04	2.59	8.60	7,297.20	19.99	76.49				
Cold Day 20Yr Weather Std	2032-2033	1,551.00	4.25	16.07	941.03	2.58	8.63	7,296.24	19.99	77.04				
Cold Day 20Yr Weather Std	2033-2034	1,561.16	4.28	16.22	941.87	2.58	8.66	7,324.78	20.07	77.56				
Cold Day 20Yr Weather Std	2034-2035	1,576.28	4.32	16.37	945.54	2.59	8.69	7,377.07	20.21	78.07				
Scenario	Gas Year	Annual Demand Oregon (MDth)	Daily Demand Oregon (MDth/day)	Peak Day Demand Oregon (MDth/day)	Annual Demand WAID (MDth)	Daily Demand WAID (MDth/day)	Peak Day WAID (MDth/day)	Annual Demand Total System (MDth)	Daily Demand Total System (MDth/day)	Peak Day Demand Total System (MDth/day)				
Cold Day 20Yr Weather Std	2015-2016	8,646.58	23.69	85.63	25,641.45	70.25	250.23	34,288.03	93.94	335.86				
Cold Day 20Yr Weather Std	2016-2017	8,688.28	23.80	86.50	25,611.86	70.17	252.01	34,300.14	93.97	338.51				
Cold Day 20Yr Weather Std	2017-2018	8,781.00	24.06	87.56	25,759.33	70.57	254.37	34,540.33	94.63	341.92				
Cold Day 20Yr Weather Std	2018-2019	8,877.04	24.32	88.71	25,895.46	70.95	256.68	34,772.50	95.27	345.39				
Cold Day 20Yr Weather Std	2019-2020	9,010.89	24.69	89.88	26,145.00	71.63	259.11	35,155.89	96.32	348.99				
Cold Day 20Yr Weather Std	2020-2021	9,068.09	24.84	91.07	26,175.55	71.71	261.49	35,243.65	96.56	352.56				
Cold Day 20Yr Weather Std	2021-2022	9,151.13	25.07	92.17	26,304.10	72.07	263.81	35,455.23	97.14	355.98				
Cold Day 20Yr Weather Std	2022-2023	9,223.52	25.27	93.16	26,418.18	72.38	266.01	35,641.71	97.65	359.17				
Cold Day 20Yr Weather Std	2023-2024	9,331.98	25.57	94.11	26,646.05	73.00	268.32	35,978.03	98.57	362.43				
Cold Day 20Yr Weather Std	2024-2025	9,358.57	25.64	95.03	26,629.26	72.96	270.34	35,987.83	98.60	365.38				
Cold Day 20Yr Weather Std	2025-2026	9,422.29	25.81	95.95	26,723.26	73.21	272.44	36,145.55	99.03	368.39				
Cold Day 20Yr Weather Std	2026-2027	9,483.88	25.98	96.85	26,809.74	73.45	274.47	36,293.62	99.43	371.32				
Cold Day 20Yr Weather Std	2027-2028	9,585.49	26.26	97.75	27,017.97	74.02	276.70	36,603.47	100.28	374.45				
Cold Day 20Yr Weather Std	2028-2029	9,601.04	26.30	98.61	26,973.72	73.90	278.51	36,574.76	100.20	377.12				
Cold Day 20Yr Weather Std	2029-2030	9,654.44	26.45	99.44	27,050.15	74.11	280.48	36,704.59	100.56	379.92				
Cold Day 20Yr Weather Std	2030-2031	9,703.83	26.59	100.24	27,123.62	74.31	282.42	36,827.45	100.90	382.67				
Cold Day 20Yr Weather Std	2031-2032	9,789.89	26.82	101.01	27,320.89	74.85	284.61	37,110.78	101.67	385.62				
Cold Day 20Yr Weather Std	2032-2033	9,788.27	26.82	101.73	27,259.24	74.68	286.26	37,047.51	101.50	387.99				
Cold Day 20Yr Weather Std	2033-2034	9,827.80	26.93	102.44	27,326.62	74.87	288.15	37,154.42	101.79	390.59				
Cold Day 20Yr Weather Std	2034-2035	9,898.89	27.12	103.13	27,540.25	75.45	290.57	37,439.14	102.57	393.70				

**APPENDIX 2.8: PEAK DAY DEMAND BEFORE AND AFTER DSM  
WA/ID**

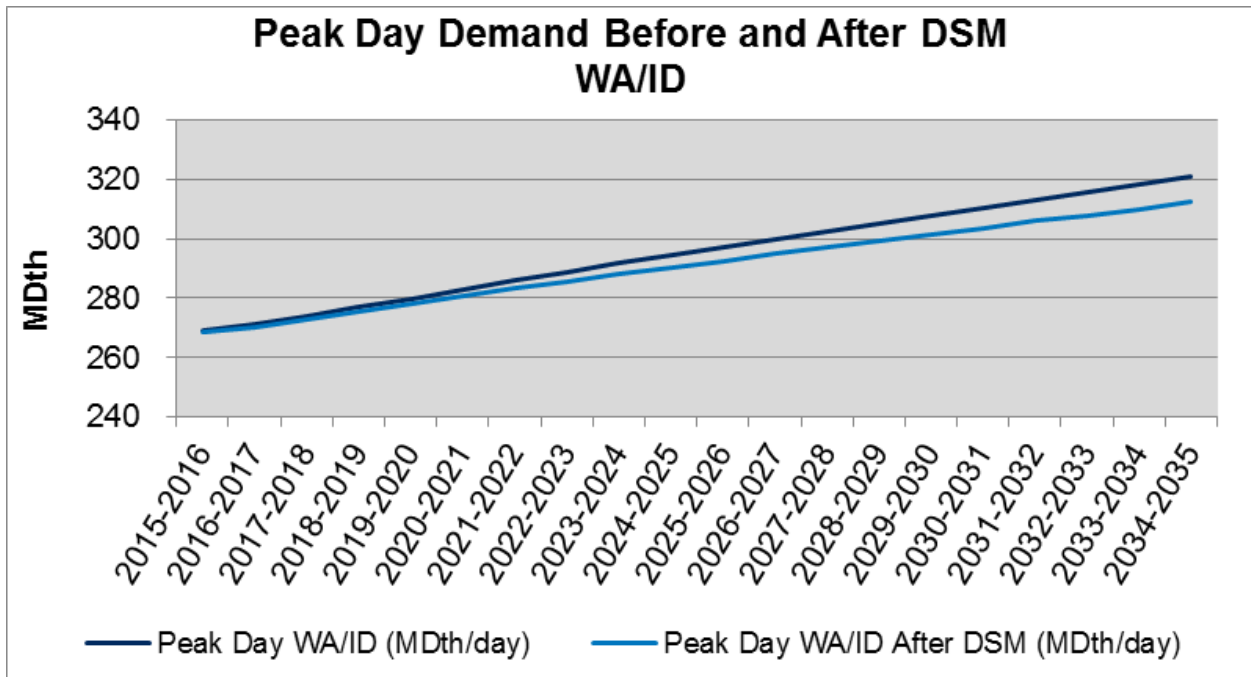
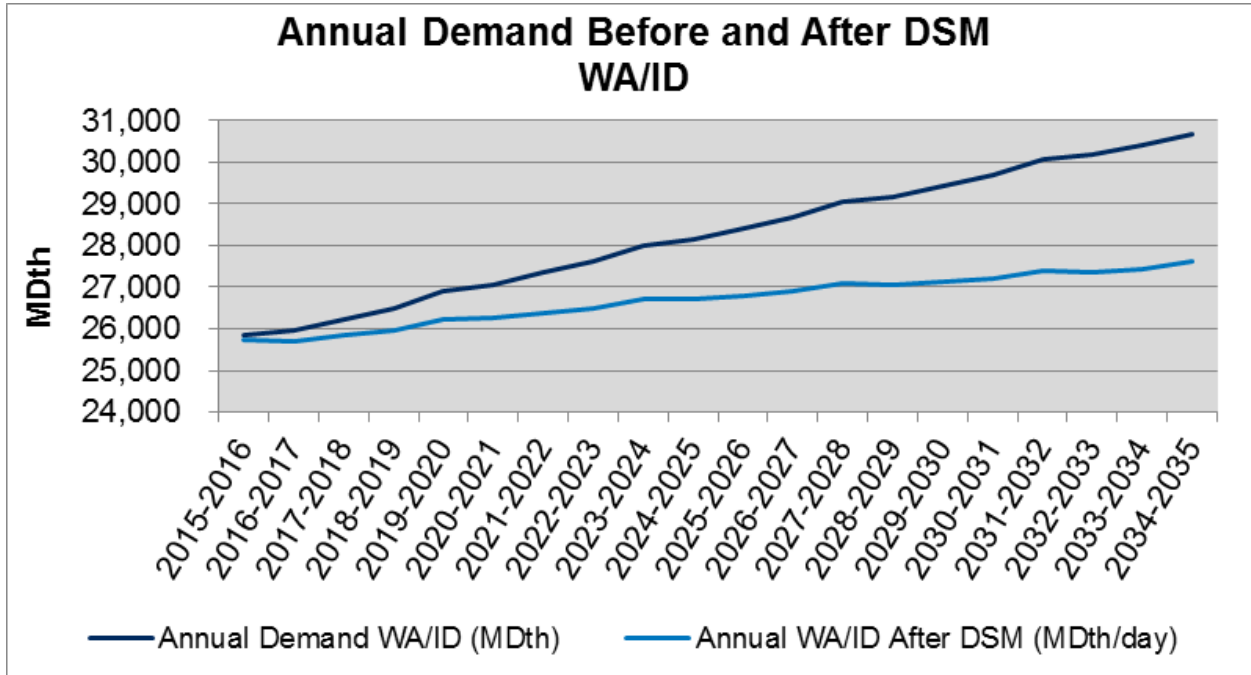

**APPENDIX 2.8: PEAK DAY DEMAND BEFORE AND AFTER DSM  
MEDFORD/ROSEBURG**

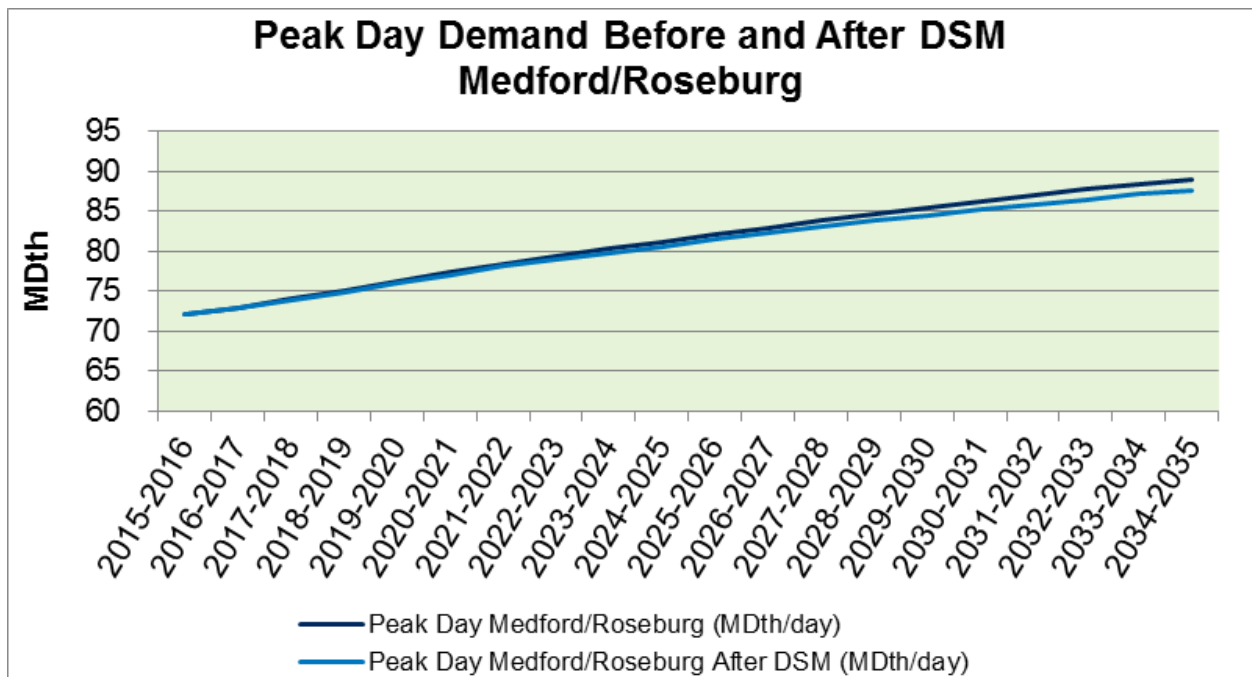
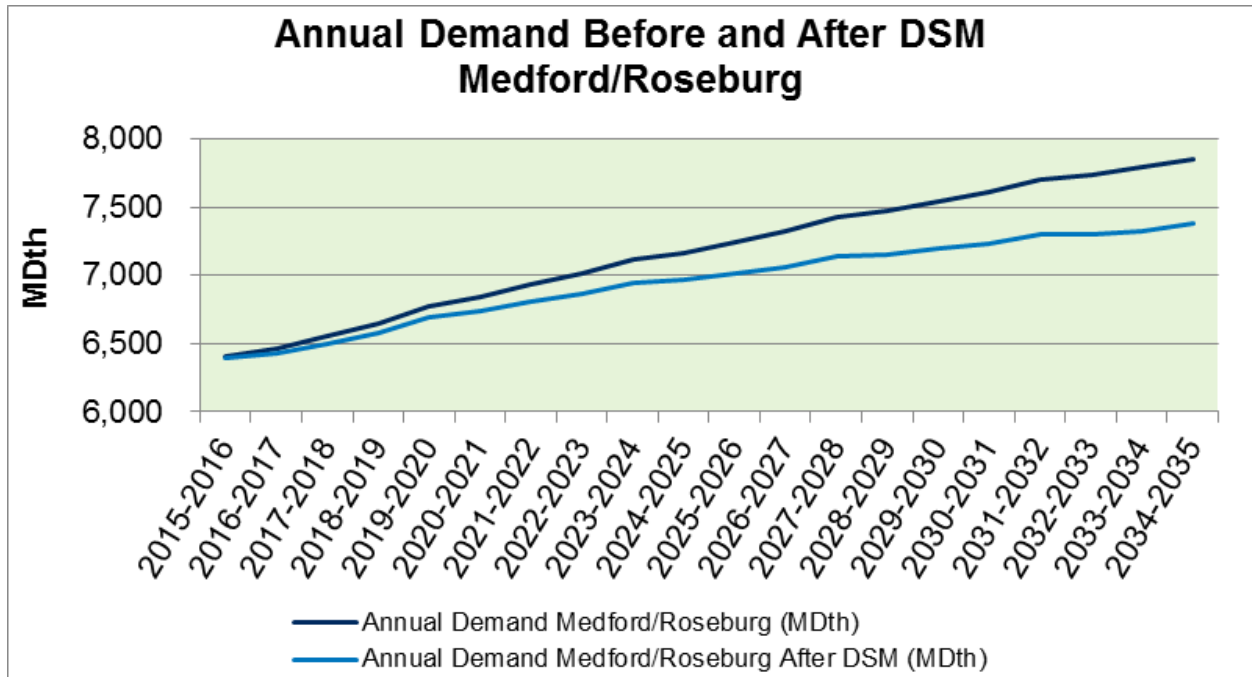

**APPENDIX 2.8: PEAK DAY DEMAND BEFORE AND AFTER DSM  
KLAMATH FALLS**

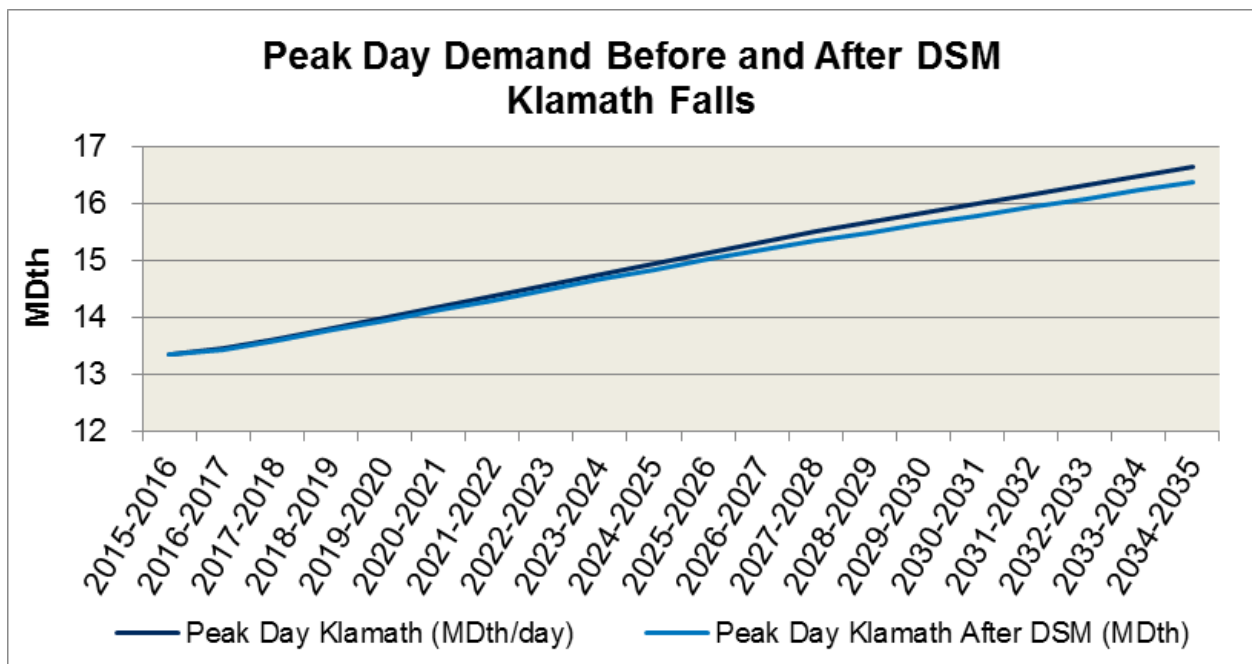
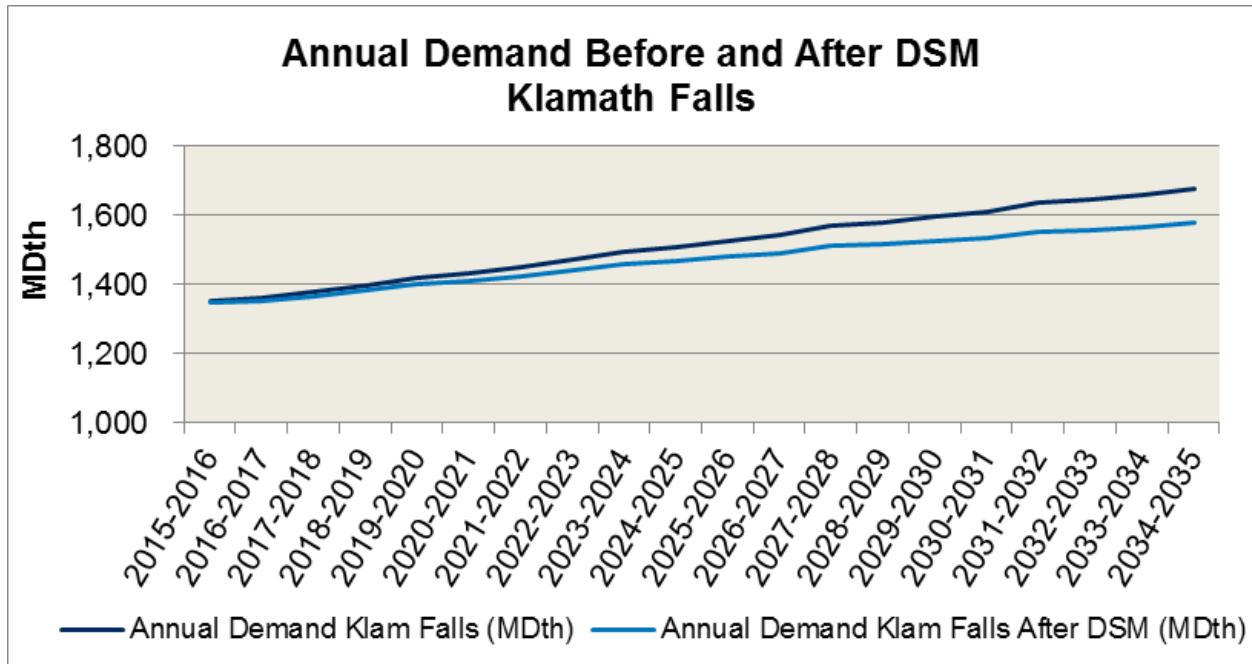

**APPENDIX 2.8: PEAK DAY DEMAND BEFORE AND AFTER DSM  
LA GRANDE**

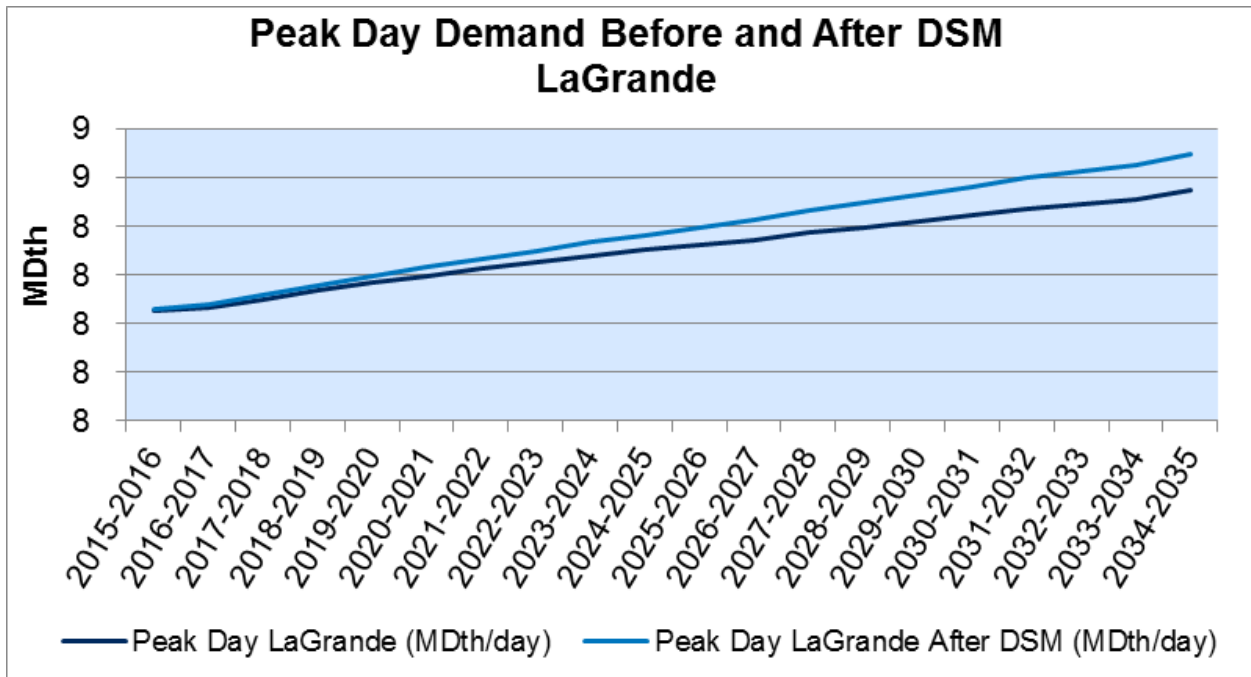
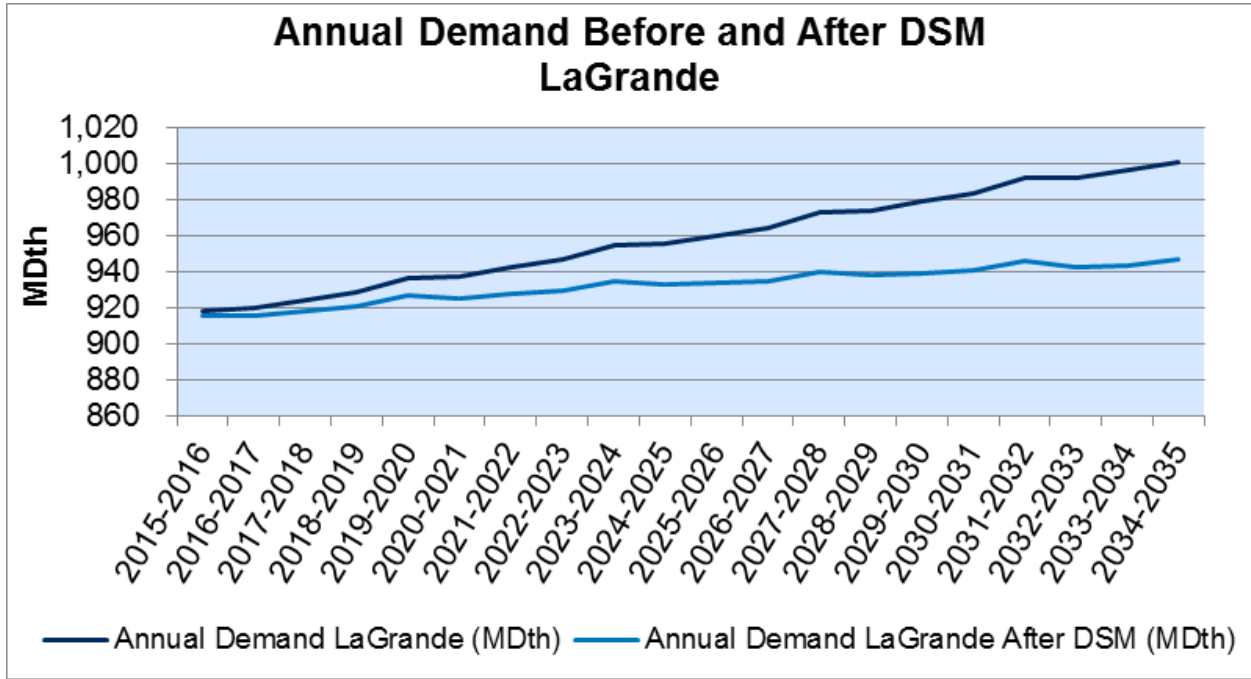



## APPENDIX 2.9: DETAILED DEMAND DATA EXPECTED MIX

Area	2015-2016:				2016-2017:				2017-2018:			
	Residential	Commercial	Ind FirmSale	Total	Residential	Commercial	Ind FirmSale	Total	Residential	Commercial	Ind FirmSale	Total
Klam Falls	878.84	456.42	13.31	1,348.57	883.84	455.69	13.71	1,353.23	895.19	458.09	13.70	1,366.98
La Grande	523.95	341.99	49.90	915.84	524.18	339.49	51.77	915.43	526.69	339.78	51.72	918.19
Medford GTN	2,179.41	1,398.52	18.60	3,596.53	2,201.01	1,403.03	18.92	3,622.96	2,237.36	1,416.04	18.92	3,672.31
Medford NWP	979.15	628.32	8.36	1,615.83	988.86	630.35	8.50	1,627.71	1,005.19	636.19	8.50	1,649.88
Roseburg	651.55	517.12	7.00	1,175.67	654.28	513.56	6.96	1,174.80	660.22	512.27	6.94	1,179.42
<b>OR Sub-Total</b>	<b>5,212.90</b>	<b>3,342.37</b>	<b>97.17</b>	<b>8,652.43</b>	<b>5,252.16</b>	<b>3,342.11</b>	<b>99.86</b>	<b>8,694.13</b>	<b>5,324.64</b>	<b>3,362.37</b>	<b>99.77</b>	<b>8,786.79</b>
Wa/ld Both	9,075.48	5,521.47	319.24	14,916.18	9,098.71	5,480.27	320.42	14,899.40	9,179.15	5,485.86	320.41	14,985.42
Wa/ld GTN	1,251.79	761.58	44.03	2,057.40	1,254.99	755.90	44.20	2,055.09	1,266.09	756.67	44.19	2,066.95
Wa/ld NWP	5,320.11	3,236.72	187.14	8,743.97	5,333.73	3,212.57	187.83	8,734.13	5,380.88	3,215.85	187.83	8,784.55
<b>WA/ID Sub-Total</b>	<b>15,647.38</b>	<b>9,519.77</b>	<b>550.41</b>	<b>25,717.56</b>	<b>15,687.44</b>	<b>9,448.74</b>	<b>552.44</b>	<b>25,688.61</b>	<b>15,826.12</b>	<b>9,458.37</b>	<b>552.43</b>	<b>25,836.92</b>
<b>Case Total</b>	<b>20,860.28</b>	<b>12,862.14</b>	<b>647.57</b>	<b>34,369.99</b>	<b>20,939.60</b>	<b>12,790.85</b>	<b>652.30</b>	<b>34,382.74</b>	<b>21,150.75</b>	<b>12,820.75</b>	<b>652.21</b>	<b>34,623.71</b>

Area	2018-2019:				2019-2020:				2020-2021:			
	Residential	Commercial	Ind FirmSale	Total	Residential	Commercial	Ind FirmSale	Total	Residential	Commercial	Ind FirmSale	Total
Klam Falls	906.72	461.25	13.69	1,381.66	922.88	466.18	13.72	1,402.79	930.50	466.70	13.68	1,410.88
La Grande	529.18	339.96	51.62	920.76	533.79	341.44	51.66	926.89	533.99	339.97	51.59	925.55
Medford GTN	2,275.51	1,428.93	18.91	3,723.35	2,323.97	1,447.29	18.94	3,790.20	2,352.68	1,453.80	18.88	3,825.37
Medford NWP	1,022.33	641.98	8.49	1,672.81	1,044.10	650.23	8.51	1,702.84	1,057.00	653.16	8.48	1,718.64
Roseburg	666.40	510.92	6.92	1,184.24	675.76	511.29	6.92	1,193.97	679.30	507.30	6.88	1,193.48
<b>OR Sub-Total</b>	<b>5,400.13</b>	<b>3,383.05</b>	<b>99.63</b>	<b>8,882.82</b>	<b>5,500.50</b>	<b>3,416.43</b>	<b>99.76</b>	<b>9,016.69</b>	<b>5,553.47</b>	<b>3,420.93</b>	<b>99.52</b>	<b>9,073.92</b>
Wa/ld Both	9,257.29	5,487.36	320.20	15,064.85	9,377.78	5,511.46	320.84	15,210.08	9,420.59	5,488.29	319.43	15,228.31
Wa/ld GTN	1,276.87	756.88	44.17	2,077.91	1,293.49	760.20	44.25	2,097.94	1,299.39	757.01	44.06	2,100.46
Wa/ld NWP	5,426.69	3,216.73	187.70	8,831.12	5,497.32	3,230.86	188.08	8,916.26	5,522.41	3,217.28	187.25	8,926.94
<b>WA/ID Sub-Total</b>	<b>15,960.85</b>	<b>9,460.97</b>	<b>552.06</b>	<b>25,973.89</b>	<b>16,168.59</b>	<b>9,502.52</b>	<b>553.17</b>	<b>26,224.28</b>	<b>16,242.39</b>	<b>9,462.58</b>	<b>550.74</b>	<b>26,255.71</b>
<b>Case Total</b>	<b>21,360.98</b>	<b>12,844.02</b>	<b>651.70</b>	<b>34,856.70</b>	<b>21,669.09</b>	<b>12,918.95</b>	<b>652.93</b>	<b>35,240.97</b>	<b>21,795.87</b>	<b>12,883.51</b>	<b>650.26</b>	<b>35,329.63</b>

Area	2021-2022:				2022-2023:				2023-2024:			
	Residential	Commercial	Ind FirmSale	Total	Residential	Commercial	Ind FirmSale	Total	Residential	Commercial	Ind FirmSale	Total
Klam Falls	942.55	469.32	13.67	1,425.54	954.61	471.70	13.66	1,439.97	971.13	476.10	13.69	1,460.92
La Grande	536.28	339.81	51.59	927.67	538.47	339.51	51.59	929.57	542.77	340.58	51.65	934.99
Medford GTN	2,385.62	1,463.65	18.87	3,868.14	2,413.83	1,471.44	18.86	3,904.14	2,451.23	1,484.50	18.90	3,954.64
Medford NWP	1,071.80	657.58	8.48	1,737.86	1,084.48	661.08	8.48	1,754.03	1,101.28	666.95	8.49	1,776.72
Roseburg	685.82	505.13	6.86	1,197.81	692.31	502.62	6.84	1,201.77	701.75	502.13	6.84	1,210.72
<b>OR Sub-Total</b>	<b>5,622.07</b>	<b>3,435.48</b>	<b>99.47</b>	<b>9,157.02</b>	<b>5,683.69</b>	<b>3,446.36</b>	<b>99.43</b>	<b>9,229.48</b>	<b>5,768.15</b>	<b>3,470.26</b>	<b>99.58</b>	<b>9,337.99</b>
Wa/ld Both	9,497.09	5,487.32	318.94	15,303.36	9,566.75	5,484.84	318.41	15,370.00	9,676.67	5,507.15	318.82	15,502.63
Wa/ld GTN	1,309.94	756.87	43.99	2,110.81	1,319.55	756.53	43.92	2,120.00	1,334.71	759.61	43.98	2,138.29
Wa/ld NWP	5,567.26	3,216.71	186.97	8,970.93	5,608.09	3,215.25	186.65	9,010.00	5,672.53	3,228.33	186.89	9,087.75
<b>WA/ID Sub-Total</b>	<b>16,374.30</b>	<b>9,460.90</b>	<b>549.90</b>	<b>26,385.10</b>	<b>16,494.40</b>	<b>9,456.62</b>	<b>548.98</b>	<b>26,500.00</b>	<b>16,683.91</b>	<b>9,495.08</b>	<b>549.69</b>	<b>26,728.68</b>
<b>Case Total</b>	<b>21,996.37</b>	<b>12,896.38</b>	<b>649.37</b>	<b>35,542.12</b>	<b>22,178.09</b>	<b>12,902.98</b>	<b>648.41</b>	<b>35,729.48</b>	<b>22,452.06</b>	<b>12,965.34</b>	<b>649.26</b>	<b>36,066.67</b>

Area	2024-2025:				2025-2026:				2026-2027:			
	Residential	Commercial	Ind FirmSale	Total	Residential	Commercial	Ind FirmSale	Total	Residential	Commercial	Ind FirmSale	Total
Klam Falls	977.72	476.11	13.64	1,467.47	988.49	478.03	13.64	1,480.16	998.86	479.88	13.63	1,492.37
La Grande	542.26	338.76	51.59	932.61	543.84	338.33	51.59	933.75	545.49	337.86	51.58	934.93
Medford GTN	2,467.10	1,485.67	18.84	3,971.61	2,492.86	1,492.53	18.83	4,004.22	2,517.84	1,499.09	18.82	4,035.75
Medford NWP	1,108.41	667.47	8.47	1,784.35	1,119.98	670.56	8.46	1,799.00	1,131.21	673.50	8.46	1,813.16
Roseburg	704.42	497.35	6.80	1,208.58	709.90	494.56	6.78	1,211.24	715.33	491.69	6.76	1,213.78
<b>OR Sub-Total</b>	<b>5,799.91</b>	<b>3,465.36</b>	<b>99.34</b>	<b>9,364.62</b>	<b>5,855.07</b>	<b>3,474.01</b>	<b>99.30</b>	<b>9,428.37</b>	<b>5,908.72</b>	<b>3,482.02</b>	<b>99.25</b>	<b>9,489.99</b>
Wa/ld Both	9,695.50	5,480.64	317.22	15,493.36	9,753.71	5,478.07	316.56	15,548.34	9,807.58	5,475.50	315.86	15,598.95
Wa/ld GTN	1,337.31	755.95	43.75	2,137.02	1,345.34	755.60	43.66	2,144.60	1,352.77	755.24	43.57	2,151.58
Wa/ld NWP	5,683.57	3,212.79	185.96	9,082.31	5,717.69	3,211.28	185.57	9,114.55	5,749.27	3,209.78	185.16	9,144.21
<b>WA/ID Sub-Total</b>	<b>16,716.37</b>	<b>9,449.38</b>	<b>546.94</b>	<b>26,712.69</b>	<b>16,816.74</b>	<b>9,444.95</b>	<b>545.80</b>	<b>26,807.49</b>	<b>16,909.62</b>	<b>9,440.52</b>	<b>544.59</b>	<b>26,894.74</b>
<b>Case Total</b>	<b>22,516.29</b>	<b>12,914.74</b>	<b>646.28</b>	<b>36,077.31</b>	<b>22,671.80</b>	<b>12,918.96</b>	<b>645.10</b>	<b>36,235.86</b>	<b>22,818.35</b>	<b>12,922.54</b>	<b>643.84</b>	<b>36,384.73</b>

## APPENDIX 2.9: DETAILED DEMAND DATA EXPECTED MIX

Area	2027-2028:				2028-2029:				2029-2030:			
	Residential	Commercial	Ind FirmSale	Total	Residential	Commercial	Ind FirmSale	Total	Residential	Commercial	Ind FirmSale	Total
Klam Falls	1,013.91	483.84	13.66	1,511.40	1,018.60	483.10	13.61	1,515.31	1,027.67	484.40	13.60	1,525.67
La Grande	549.70	338.84	51.65	940.18	549.43	336.92	51.58	937.93	551.45	336.40	51.58	939.44
Medford GTN	2,553.18	1,511.59	18.86	4,083.63	2,565.19	1,511.31	18.80	4,095.31	2,587.15	1,516.61	18.79	4,122.54
Medford NWP	1,147.08	679.12	8.47	1,834.68	1,152.48	679.00	8.45	1,839.92	1,162.34	681.37	8.44	1,852.16
Roseburg	724.07	490.92	6.76	1,221.75	726.08	485.95	6.72	1,218.75	731.18	482.97	6.70	1,220.85
<b>OR Sub-Total</b>	<b>5,987.94</b>	<b>3,504.31</b>	<b>99.39</b>	<b>9,591.64</b>	<b>6,011.78</b>	<b>3,496.28</b>	<b>99.16</b>	<b>9,607.22</b>	<b>6,059.79</b>	<b>3,501.75</b>	<b>99.11</b>	<b>9,660.66</b>
Wa/ld Both	9,905.61	5,498.42	316.14	15,720.17	10,157.79	5,964.84	272.10	16,394.73	9,956.47	5,469.60	313.66	15,739.72
Wa/ld GTN	1,366.29	758.40	43.60	2,168.30	1,401.07	822.74	37.53	2,261.34	1,373.31	754.43	43.26	2,171.00
Wa/ld NWP	5,806.74	3,223.21	185.32	9,215.27	5,954.56	3,496.63	159.51	9,610.70	5,836.55	3,206.32	183.87	9,226.73
<b>WA/ID Sub-Total</b>	<b>17,078.65</b>	<b>9,480.04</b>	<b>545.06</b>	<b>27,103.75</b>	<b>17,513.42</b>	<b>10,284.21</b>	<b>469.14</b>	<b>28,266.77</b>	<b>17,166.33</b>	<b>9,430.34</b>	<b>540.79</b>	<b>27,137.45</b>
<b>Case Total</b>	<b>23,066.58</b>	<b>12,984.35</b>	<b>644.45</b>	<b>36,695.39</b>	<b>23,525.20</b>	<b>13,780.49</b>	<b>568.30</b>	<b>37,873.99</b>	<b>23,226.12</b>	<b>12,932.09</b>	<b>639.90</b>	<b>36,798.11</b>

Area	2030-2031:				2031-2032:				2032-2033:			
	Residential	Commercial	Ind FirmSale	Total	Residential	Commercial	Ind FirmSale	Total	Residential	Commercial	Ind FirmSale	Total
Klam Falls	1,036.52	485.61	13.59	1,535.72	1,050.60	488.68	13.62	1,552.90	1,054.50	487.22	13.57	1,555.29
La Grande	553.32	335.84	51.58	940.75	557.45	336.53	51.65	945.62	556.72	334.33	51.58	942.63
Medford GTN	2,607.75	1,521.20	18.78	4,147.72	2,638.29	1,530.54	18.81	4,187.64	2,644.60	1,527.00	18.75	4,190.35
Medford NWP	1,171.60	683.44	8.44	1,863.47	1,185.32	687.63	8.45	1,881.40	1,188.15	686.04	8.43	1,882.62
Roseburg	735.80	479.95	6.68	1,222.42	743.49	478.46	6.68	1,228.62	744.20	472.89	6.64	1,223.73
<b>OR Sub-Total</b>	<b>6,104.98</b>	<b>3,506.04</b>	<b>99.07</b>	<b>9,710.09</b>	<b>6,175.15</b>	<b>3,521.83</b>	<b>99.21</b>	<b>9,796.19</b>	<b>6,188.17</b>	<b>3,507.47</b>	<b>98.97</b>	<b>9,794.61</b>
Wa/ld Both	10,001.73	5,468.16	312.88	15,782.77	10,093.08	5,491.61	312.93	15,897.62	10,087.42	5,463.91	310.97	15,862.30
Wa/ld GTN	1,379.55	754.23	43.16	2,176.93	1,392.15	757.46	43.16	2,192.78	1,391.37	753.64	42.89	2,187.90
Wa/ld NWP	5,863.08	3,205.47	183.41	9,251.97	5,916.63	3,219.22	183.44	9,319.29	5,913.32	3,202.98	182.29	9,298.59
<b>WA/ID Sub-Total</b>	<b>17,244.37</b>	<b>9,427.86</b>	<b>539.44</b>	<b>27,211.67</b>	<b>17,401.87</b>	<b>9,468.28</b>	<b>539.54</b>	<b>27,409.69</b>	<b>17,392.10</b>	<b>9,420.53</b>	<b>536.16</b>	<b>27,348.79</b>
<b>Case Total</b>	<b>23,349.35</b>	<b>12,933.90</b>	<b>638.51</b>	<b>36,921.76</b>	<b>23,577.02</b>	<b>12,990.12</b>	<b>638.75</b>	<b>37,205.88</b>	<b>23,580.27</b>	<b>12,928.00</b>	<b>635.13</b>	<b>37,143.40</b>

Area	2033-2034:				2034-2035:			
	Residential	Commercial	Ind FirmSale	Total	Residential	Commercial	Ind FirmSale	Total
Klam Falls	1,063.67	488.25	13.56	1,565.49	1,075.10	491.99	13.56	1,580.65
La Grande	558.28	333.61	51.58	943.47	560.98	334.59	51.58	947.15
Medford GTN	2,661.38	1,529.49	18.74	4,209.60	2,682.89	1,539.57	18.74	4,241.20
Medford NWP	1,195.69	687.16	8.42	1,891.27	1,205.36	691.69	8.42	1,905.47
Roseburg	748.29	469.45	6.61	1,224.35	754.40	469.84	6.61	1,230.85
<b>OR Sub-Total</b>	<b>6,227.31</b>	<b>3,507.95</b>	<b>98.92</b>	<b>9,834.19</b>	<b>6,278.73</b>	<b>3,527.68</b>	<b>98.92</b>	<b>9,905.32</b>
Wa/ld Both	10,128.43	5,463.40	309.97	15,901.81	10,223.55	5,492.78	309.81	16,026.14
Wa/ld GTN	1,397.02	753.57	42.76	2,193.35	1,410.14	757.63	42.73	2,210.50
Wa/ld NWP	5,937.35	3,202.68	181.71	9,321.75	5,993.12	3,219.91	181.61	9,394.64
<b>WA/ID Sub-Total</b>	<b>17,462.81</b>	<b>9,419.66</b>	<b>534.44</b>	<b>27,416.91</b>	<b>17,626.81</b>	<b>9,470.31</b>	<b>534.15</b>	<b>27,631.28</b>
<b>Case Total</b>	<b>23,690.12</b>	<b>12,927.61</b>	<b>633.36</b>	<b>37,251.10</b>	<b>23,905.54</b>	<b>12,997.99</b>	<b>633.07</b>	<b>37,536.60</b>

## APPENDIX 2.9: DETAILED DEMAND DATA

### LOW GROWTH HIGH PRICE

Area	2015-2016:				2016-2017:				2017-2018:			
	Residential	Commercial	Ind FirmSale	Total	Residential	Commercial	Ind FirmSale	Total	Residential	Commercial	Ind FirmSale	Total
Klam Falls	878.73	456.34	13.25	1,348.33	784.79	413.85	12.94	1,211.58	785.84	411.79	12.74	1,210.37
La Grande	523.38	341.60	49.54	914.51	476.91	311.28	47.68	835.86	475.28	309.11	46.64	831.02
Medford GTN	2,171.64	1,392.98	18.54	3,583.15	1,954.24	1,271.50	17.93	3,243.67	1,960.80	1,268.08	17.71	3,246.59
Medford NWP	975.66	625.83	8.33	1,609.82	877.99	571.25	8.06	1,457.30	880.94	569.72	7.96	1,458.61
Roseburg	650.80	516.46	6.93	1,174.19	583.95	468.19	6.62	1,058.76	583.64	463.08	6.42	1,053.14
<b>OR Sub-Total</b>	<b>5,200.21</b>	<b>3,333.21</b>	<b>96.59</b>	<b>8,630.00</b>	<b>4,677.88</b>	<b>3,036.07</b>	<b>93.22</b>	<b>7,807.17</b>	<b>4,686.50</b>	<b>3,021.76</b>	<b>91.47</b>	<b>7,799.73</b>
Wa/ld Both	9,048.98	5,504.45	318.94	14,872.37	8,044.49	4,898.26	300.26	13,243.01	8,013.36	4,843.68	298.32	13,155.35
Wa/ld GTN	1,248.13	759.23	43.99	2,051.36	1,109.59	675.62	41.42	1,826.62	1,105.29	668.09	41.15	1,814.53
Wa/ld NWP	5,304.57	3,226.74	186.97	8,718.29	4,715.74	2,871.39	176.02	7,763.15	4,697.49	2,839.40	174.87	7,711.76
<b>WA/ID Sub-Total</b>	<b>15,601.68</b>	<b>9,490.43</b>	<b>549.90</b>	<b>25,642.02</b>	<b>13,869.82</b>	<b>8,445.27</b>	<b>517.69</b>	<b>22,832.78</b>	<b>13,816.14</b>	<b>8,351.17</b>	<b>514.34</b>	<b>22,681.64</b>
<b>Case Total</b>	<b>20,801.89</b>	<b>12,823.64</b>	<b>646.49</b>	<b>34,272.02</b>	<b>18,547.70</b>	<b>11,481.34</b>	<b>610.92</b>	<b>30,639.96</b>	<b>18,502.63</b>	<b>11,372.93</b>	<b>605.81</b>	<b>30,481.37</b>

Area	2018-2019:				2019-2020:				2020-2021:			
	Residential	Commercial	Ind FirmSale	Total	Residential	Commercial	Ind FirmSale	Total	Residential	Commercial	Ind FirmSale	Total
Klam Falls	783.45	408.90	12.53	1,204.88	793.17	410.93	12.39	1,216.48	795.15	408.89	12.19	1,216.22
La Grande	472.03	305.89	45.47	823.39	474.50	306.08	44.66	825.24	472.94	303.57	43.74	820.24
Medford GTN	1,960.85	1,260.45	17.47	3,238.77	1,988.78	1,267.45	17.34	3,273.57	1,999.20	1,263.80	17.12	3,280.12
Medford NWP	880.96	566.29	7.85	1,455.10	893.51	569.43	7.79	1,470.73	898.19	567.80	7.69	1,473.68
Roseburg	581.16	456.43	6.22	1,043.82	587.22	454.96	6.04	1,048.23	588.03	449.48	5.84	1,043.34
<b>OR Sub-Total</b>	<b>4,678.46</b>	<b>2,997.96</b>	<b>89.54</b>	<b>7,765.95</b>	<b>4,737.18</b>	<b>3,008.85</b>	<b>88.22</b>	<b>7,834.26</b>	<b>4,753.50</b>	<b>2,993.53</b>	<b>86.56</b>	<b>7,833.60</b>
Wa/ld Both	7,945.45	4,767.49	295.58	13,008.51	7,996.43	4,755.97	295.26	13,047.67	7,978.70	4,702.37	293.03	12,974.10
Wa/ld GTN	1,095.92	657.58	40.77	1,794.28	1,102.96	656.00	40.73	1,799.68	1,100.51	648.60	40.42	1,789.53
Wa/ld NWP	4,657.68	2,794.73	173.27	7,625.68	4,687.56	2,787.99	173.09	7,648.63	4,677.17	2,756.56	171.78	7,605.51
<b>WA/ID Sub-Total</b>	<b>13,699.05</b>	<b>8,219.80</b>	<b>509.61</b>	<b>22,428.46</b>	<b>13,786.95</b>	<b>8,199.96</b>	<b>509.08</b>	<b>22,495.98</b>	<b>13,756.38</b>	<b>8,107.53</b>	<b>505.23</b>	<b>22,369.14</b>
<b>Case Total</b>	<b>18,377.50</b>	<b>11,217.77</b>	<b>599.15</b>	<b>30,194.42</b>	<b>18,524.13</b>	<b>11,208.81</b>	<b>597.30</b>	<b>30,330.24</b>	<b>18,509.88</b>	<b>11,101.06</b>	<b>591.80</b>	<b>30,202.73</b>

Area	2021-2022:				2022-2023:				2023-2024:			
	Residential	Commercial	Ind FirmSale	Total	Residential	Commercial	Ind FirmSale	Total	Residential	Commercial	Ind FirmSale	Total
Klam Falls	801.00	408.70	12.02	1,221.72	806.22	408.03	11.84	1,226.10	815.60	409.27	11.71	1,236.58
La Grande	473.29	302.26	42.89	818.44	473.32	300.68	42.04	816.04	475.53	300.51	41.24	817.29
Medford GTN	2,014.60	1,263.93	16.94	3,295.47	2,025.55	1,262.12	16.76	3,304.43	2,045.26	1,265.36	16.63	3,327.25
Medford NWP	905.11	567.85	7.61	1,480.57	910.03	567.04	7.53	1,484.60	918.88	568.50	7.47	1,494.85
Roseburg	591.51	445.68	5.64	1,042.84	594.56	441.34	5.45	1,041.35	600.45	438.96	5.27	1,044.69
<b>OR Sub-Total</b>	<b>4,785.51</b>	<b>2,988.43</b>	<b>85.10</b>	<b>7,859.04</b>	<b>4,809.69</b>	<b>2,979.20</b>	<b>83.62</b>	<b>7,872.52</b>	<b>4,855.73</b>	<b>2,982.60</b>	<b>82.32</b>	<b>7,920.65</b>
Wa/ld Both	7,994.38	4,670.94	291.71	12,957.02	8,000.69	4,636.81	290.25	12,927.75	8,045.32	4,626.57	289.73	12,961.62
Wa/ld GTN	1,102.67	644.27	40.24	1,787.18	1,103.54	639.56	40.03	1,783.14	1,109.70	638.15	39.96	1,787.81
Wa/ld NWP	4,686.36	2,738.14	171.00	7,595.49	4,690.06	2,718.13	170.14	7,578.34	4,716.22	2,712.13	169.84	7,598.19
<b>WA/ID Sub-Total</b>	<b>13,783.41</b>	<b>8,053.34</b>	<b>502.94</b>	<b>22,339.69</b>	<b>13,794.30</b>	<b>7,994.50</b>	<b>500.43</b>	<b>22,289.23</b>	<b>13,871.24</b>	<b>7,976.85</b>	<b>499.54</b>	<b>22,347.63</b>
<b>Case Total</b>	<b>18,568.92</b>	<b>11,041.77</b>	<b>588.04</b>	<b>30,198.73</b>	<b>18,604.00</b>	<b>10,973.70</b>	<b>584.05</b>	<b>30,161.74</b>	<b>18,726.97</b>	<b>10,959.45</b>	<b>581.86</b>	<b>30,268.28</b>

Area	2024-2025:				2025-2026:				2026-2027:			
	Residential	Commercial	Ind FirmSale	Total	Residential	Commercial	Ind FirmSale	Total	Residential	Commercial	Ind FirmSale	Total
Klam Falls	812.99	405.29	11.49	1,229.77	817.28	404.38	11.32	1,232.98	821.70	403.61	11.15	1,236.45
La Grande	472.05	296.96	40.26	809.27	471.96	295.55	39.41	806.92	471.88	294.06	38.57	804.51
Medford GTN	2,038.17	1,254.11	16.38	3,308.67	2,046.96	1,251.60	16.20	3,314.76	2,055.95	1,249.30	16.03	3,321.29
Medford NWP	915.70	563.44	7.36	1,486.50	919.65	562.31	7.28	1,489.24	923.69	561.28	7.20	1,492.17
Roseburg	598.00	431.38	5.07	1,034.45	600.28	426.97	4.87	1,032.13	602.73	422.63	4.68	1,030.05
<b>OR Sub-Total</b>	<b>4,836.91</b>	<b>2,951.19</b>	<b>80.56</b>	<b>7,868.66</b>	<b>4,856.13</b>	<b>2,940.80</b>	<b>79.09</b>	<b>7,876.02</b>	<b>4,875.96</b>	<b>2,930.89</b>	<b>77.63</b>	<b>7,884.47</b>
Wa/ld Both	7,976.79	4,556.38	286.73	12,819.91	7,974.78	4,524.52	285.19	12,784.49	7,973.22	4,495.21	283.68	12,752.11
Wa/ld GTN	1,100.25	628.47	39.55	1,768.26	1,099.97	624.07	39.34	1,763.38	1,099.75	620.03	39.13	1,758.91
Wa/ld NWP	4,676.05	2,670.98	168.09	7,515.12	4,674.87	2,652.30	167.18	7,494.36	4,673.95	2,635.12	166.30	7,475.37
<b>WA/ID Sub-Total</b>	<b>13,753.09</b>	<b>7,855.84</b>	<b>494.37</b>	<b>22,103.30</b>	<b>13,749.62</b>	<b>7,800.89</b>	<b>491.71</b>	<b>22,042.22</b>	<b>13,746.92</b>	<b>7,750.36</b>	<b>489.10</b>	<b>21,986.39</b>
<b>Case Total</b>	<b>18,590.01</b>	<b>10,807.03</b>	<b>574.93</b>	<b>29,971.96</b>	<b>18,605.76</b>	<b>10,741.69</b>	<b>570.80</b>	<b>29,918.24</b>	<b>18,622.88</b>	<b>10,681.25</b>	<b>566.73</b>	<b>29,870.86</b>

## APPENDIX 2.9: DETAILED DEMAND DATA LOW GROWTH HIGH PRICE

Area	2027-2028:				2028-2029:				2029-2030:			
	Residential	Commercial	Ind FirmSale	Total	Residential	Commercial	Ind FirmSale	Total	Residential	Commercial	Ind FirmSale	Total
Klam Falls	829.89	404.59	11.01	1,245.50	827.03	400.66	10.79	1,238.49	829.81	399.28	10.62	1,239.71
La Grande	473.52	293.53	37.77	804.82	469.83	289.62	36.83	796.28	468.96	287.43	35.97	792.36
Medford GTN	2,073.14	1,251.89	15.89	3,340.92	2,065.09	1,240.80	15.66	3,321.55	2,069.47	1,236.51	15.48	3,321.46
Medford NWP	931.41	562.44	7.14	1,500.99	927.79	557.46	7.04	1,492.29	929.76	555.54	6.95	1,492.25
Roseburg	607.86	420.04	4.50	1,032.40	605.41	412.80	4.29	1,022.50	606.88	408.03	4.10	1,019.01
<b>OR Sub-Total</b>	<b>4,915.82</b>	<b>2,932.50</b>	<b>76.31</b>	<b>7,924.63</b>	<b>4,895.16</b>	<b>2,901.35</b>	<b>74.61</b>	<b>7,871.11</b>	<b>4,904.89</b>	<b>2,886.80</b>	<b>73.12</b>	<b>7,864.80</b>
Wa/ld Both	8,006.61	4,486.72	283.02	12,776.36	7,935.51	4,423.54	280.09	12,639.15	7,918.39	4,390.87	278.35	12,587.61
Wa/ld GTN	1,104.36	618.86	39.04	1,762.26	1,094.55	610.14	38.63	1,743.33	1,092.19	605.64	38.39	1,736.22
Wa/ld NWP	4,693.53	2,630.15	165.91	7,489.59	4,651.85	2,593.11	164.19	7,409.15	4,641.82	2,573.96	163.17	7,378.95
<b>WA/ld Sub-Total</b>	<b>13,804.50</b>	<b>7,735.73</b>	<b>487.96</b>	<b>22,028.20</b>	<b>13,681.92</b>	<b>7,626.80</b>	<b>482.92</b>	<b>21,791.63</b>	<b>13,652.40</b>	<b>7,570.47</b>	<b>479.91</b>	<b>21,702.78</b>
<b>Case Total</b>	<b>18,720.33</b>	<b>10,668.23</b>	<b>564.28</b>	<b>29,952.83</b>	<b>18,577.07</b>	<b>10,528.14</b>	<b>557.53</b>	<b>29,662.75</b>	<b>18,557.29</b>	<b>10,457.26</b>	<b>553.03</b>	<b>29,567.58</b>

Area	2030-2031:				2031-2032:				2032-2033:			
	Residential	Commercial	Ind FirmSale	Total	Residential	Commercial	Ind FirmSale	Total	Residential	Commercial	Ind FirmSale	Total
Klam Falls	831.73	397.56	10.44	1,239.73	838.13	397.40	10.30	1,245.82	837.66	394.06	10.10	1,241.82
La Grande	467.86	285.17	35.09	788.12	468.99	284.12	34.27	787.38	466.82	281.11	33.39	781.32
Medford GTN	2,071.20	1,230.91	15.29	3,317.41	2,081.92	1,229.56	15.15	3,326.63	2,076.84	1,219.53	14.93	3,311.30
Medford NWP	930.54	553.02	6.87	1,490.43	935.36	552.41	6.80	1,494.57	933.07	547.90	6.71	1,487.68
Roseburg	607.56	403.05	3.90	1,014.52	611.14	399.54	3.72	1,014.39	609.96	393.17	3.52	1,006.64
<b>OR Sub-Total</b>	<b>4,908.90</b>	<b>2,869.71</b>	<b>71.60</b>	<b>7,850.21</b>	<b>4,935.54</b>	<b>2,863.02</b>	<b>70.24</b>	<b>7,868.80</b>	<b>4,924.35</b>	<b>2,835.76</b>	<b>68.65</b>	<b>7,828.76</b>
Wa/ld Both	7,892.35	4,355.20	276.46	12,524.01	7,906.68	4,341.60	275.35	12,523.64	7,857.20	4,294.09	272.70	12,423.99
Wa/ld GTN	1,088.60	600.72	38.13	1,727.45	1,090.58	598.84	37.98	1,727.40	1,083.75	592.29	37.61	1,713.65
Wa/ld NWP	4,626.55	2,553.05	162.06	7,341.66	4,634.95	2,545.08	161.41	7,341.44	4,605.95	2,517.22	159.86	7,283.03
<b>WA/ld Sub-Total</b>	<b>13,607.50</b>	<b>7,508.97</b>	<b>476.65</b>	<b>21,593.12</b>	<b>13,632.20</b>	<b>7,485.53</b>	<b>474.75</b>	<b>21,592.48</b>	<b>13,546.90</b>	<b>7,403.60</b>	<b>470.17</b>	<b>21,420.67</b>
<b>Case Total</b>	<b>18,516.40</b>	<b>10,378.68</b>	<b>548.25</b>	<b>29,443.33</b>	<b>18,567.74</b>	<b>10,348.55</b>	<b>544.98</b>	<b>29,461.27</b>	<b>18,471.25</b>	<b>10,239.37</b>	<b>538.81</b>	<b>29,249.43</b>

Area	2033-2034:				2034-2035:			
	Residential	Commercial	Ind FirmSale	Total	Residential	Commercial	Ind FirmSale	Total
Klam Falls	839.85	392.15	9.92	1,241.91	845.13	393.31	9.76	1,248.19
La Grande	466.13	279.12	32.53	777.78	467.06	279.09	31.68	777.83
Medford GTN	2,076.80	1,212.82	14.75	3,304.37	2,083.81	1,214.86	14.58	3,313.25
Medford NWP	933.05	544.89	6.62	1,484.57	936.21	545.81	6.55	1,488.56
Roseburg	610.56	388.05	3.32	1,001.92	613.78	387.10	3.15	1,004.03
<b>OR Sub-Total</b>	<b>4,926.38</b>	<b>2,817.03</b>	<b>67.14</b>	<b>7,810.55</b>	<b>4,945.99</b>	<b>2,820.16</b>	<b>65.71</b>	<b>7,831.86</b>
Wa/ld Both	7,830.22	4,261.56	270.65	12,362.43	7,865.82	4,263.33	269.57	12,398.72
Wa/ld GTN	1,080.03	587.80	37.33	1,705.16	1,084.94	588.05	37.18	1,710.17
Wa/ld NWP	4,590.13	2,498.16	158.65	7,246.94	4,611.00	2,499.19	158.02	7,268.21
<b>WA/ld Sub-Total</b>	<b>13,500.38</b>	<b>7,347.52</b>	<b>466.63</b>	<b>21,314.53</b>	<b>13,561.77</b>	<b>7,350.57</b>	<b>464.77</b>	<b>21,377.10</b>
<b>Case Total</b>	<b>18,426.76</b>	<b>10,164.54</b>	<b>533.78</b>	<b>29,125.08</b>	<b>18,507.75</b>	<b>10,170.73</b>	<b>530.48</b>	<b>29,208.96</b>

## APPENDIX 2.9: DETAILED DEMAND DATA

### HIGH GROWTH LOW PRICE

Area	2015-2016:				2016-2017:				2017-2018:			
	Residential	Commercial	Ind FirmSale	Total	Residential	Commercial	Ind FirmSale	Total	Residential	Commercial	Ind FirmSale	Total
Klam Falls	879.42	456.91	13.40	1,349.73	886.26	457.41	13.98	1,357.65	901.22	461.87	14.17	1,377.26
La Grande	525.19	342.86	50.38	918.43	527.22	341.59	53.30	922.11	531.92	343.36	54.32	929.60
Medford GTN	2,188.06	1,405.08	18.70	3,611.84	2,224.48	1,419.59	19.22	3,663.29	2,275.38	1,442.37	19.42	3,737.17
Medford NWP	983.04	631.27	8.40	1,622.71	999.40	637.79	8.63	1,645.83	1,022.27	648.02	8.72	1,679.02
Roseburg	652.93	518.47	7.08	1,178.48	657.86	516.88	7.23	1,181.97	666.35	517.78	7.40	1,191.53
<b>OR Sub-Total</b>	<b>5,228.65</b>	<b>3,354.58</b>	<b>97.95</b>	<b>8,681.19</b>	<b>5,295.23</b>	<b>3,373.25</b>	<b>102.37</b>	<b>8,770.85</b>	<b>5,397.13</b>	<b>3,413.41</b>	<b>104.04</b>	<b>8,914.58</b>
Wa/ld Both	9,105.46	5,541.59	319.99	14,967.04	9,176.71	5,530.67	322.39	15,029.77	9,305.69	5,566.49	323.70	15,195.88
Wa/ld GTN	1,255.93	764.36	44.14	2,064.42	1,265.75	762.85	44.47	2,073.07	1,283.54	767.79	44.65	2,095.98
Wa/ld NWP	5,337.68	3,248.52	187.58	8,773.78	5,379.45	3,242.12	188.99	8,810.56	5,455.06	3,263.11	189.76	8,907.93
<b>WA/ID Sub-Total</b>	<b>15,699.06</b>	<b>9,554.47</b>	<b>551.71</b>	<b>25,805.24</b>	<b>15,821.92</b>	<b>9,535.64</b>	<b>555.84</b>	<b>25,913.40</b>	<b>16,044.29</b>	<b>9,597.39</b>	<b>558.10</b>	<b>26,199.79</b>
<b>Case Total</b>	<b>20,927.71</b>	<b>12,909.05</b>	<b>649.66</b>	<b>34,486.42</b>	<b>21,117.14</b>	<b>12,908.90</b>	<b>658.21</b>	<b>34,684.24</b>	<b>21,441.43</b>	<b>13,010.80</b>	<b>662.14</b>	<b>35,114.37</b>

Area	2018-2019:				2019-2020:				2020-2021:			
	Residential	Commercial	Ind FirmSale	Total	Residential	Commercial	Ind FirmSale	Total	Residential	Commercial	Ind FirmSale	Total
Klam Falls	916.82	467.32	14.36	1,398.50	937.37	474.69	14.58	1,426.65	949.84	477.85	14.73	1,442.42
La Grande	536.84	345.16	55.30	937.30	544.04	348.34	56.43	948.81	547.02	348.70	57.44	953.16
Medford GTN	2,329.05	1,465.54	19.62	3,814.20	2,393.73	1,494.55	19.87	3,908.15	2,439.32	1,511.97	20.01	3,971.30
Medford NWP	1,046.38	658.43	8.81	1,713.63	1,075.45	671.46	8.93	1,755.84	1,095.93	679.29	8.99	1,784.21
Roseburg	675.36	518.80	7.58	1,201.74	687.75	521.64	7.77	1,217.15	694.56	520.25	7.93	1,222.74
<b>OR Sub-Total</b>	<b>5,504.46</b>	<b>3,455.24</b>	<b>105.67</b>	<b>9,065.36</b>	<b>5,638.33</b>	<b>3,510.69</b>	<b>107.58</b>	<b>9,256.60</b>	<b>5,726.67</b>	<b>3,538.06</b>	<b>109.11</b>	<b>9,373.83</b>
Wa/ld Both	9,435.79	5,599.81	324.82	15,360.42	9,610.88	5,656.98	326.81	15,594.66	9,711.36	5,668.18	326.75	15,706.29
Wa/ld GTN	1,301.49	772.39	44.80	2,118.68	1,325.64	780.27	45.08	2,150.99	1,339.50	781.82	45.07	2,166.39
Wa/ld NWP	5,531.32	3,282.65	190.41	9,004.39	5,633.96	3,316.16	191.58	9,141.70	5,692.87	3,322.73	191.54	9,207.14
<b>WA/ID Sub-Total</b>	<b>16,268.60</b>	<b>9,654.85</b>	<b>560.04</b>	<b>26,483.49</b>	<b>16,570.48</b>	<b>9,753.41</b>	<b>563.46</b>	<b>26,887.34</b>	<b>16,743.73</b>	<b>9,772.72</b>	<b>563.36</b>	<b>27,079.81</b>
<b>Case Total</b>	<b>21,773.06</b>	<b>13,110.09</b>	<b>665.71</b>	<b>35,548.85</b>	<b>22,208.81</b>	<b>13,264.09</b>	<b>671.04</b>	<b>36,143.94</b>	<b>22,470.39</b>	<b>13,310.78</b>	<b>672.47</b>	<b>36,453.65</b>

Area	2021-2022:				2022-2023:				2023-2024:			
	Residential	Commercial	Ind FirmSale	Total	Residential	Commercial	Ind FirmSale	Total	Residential	Commercial	Ind FirmSale	Total
Klam Falls	967.06	483.26	14.92	1,465.24	984.36	488.46	15.11	1,487.92	1,006.50	495.84	15.35	1,517.69
La Grande	552.21	350.44	58.53	961.18	557.28	352.02	59.62	969.93	564.42	354.93	60.80	980.15
Medford GTN	2,488.57	1,532.30	20.22	4,041.08	2,532.03	1,549.99	20.42	4,102.43	2,585.61	1,573.46	20.67	4,179.74
Medford NWP	1,118.05	688.42	9.08	1,815.56	1,137.58	696.37	9.17	1,843.12	1,161.65	706.91	9.29	1,877.86
Roseburg	704.56	520.79	8.10	1,233.46	714.55	520.98	8.28	1,243.81	727.72	523.29	8.48	1,259.48
<b>OR Sub-Total</b>	<b>5,830.45</b>	<b>3,575.21</b>	<b>110.86</b>	<b>9,516.52</b>	<b>5,925.80</b>	<b>3,607.82</b>	<b>112.61</b>	<b>9,646.22</b>	<b>6,045.90</b>	<b>3,654.43</b>	<b>114.59</b>	<b>9,814.92</b>
Wa/ld Both	9,844.66	5,700.76	327.64	15,873.05	9,968.46	5,730.12	328.46	16,027.04	10,135.92	5,785.90	330.28	16,252.10
Wa/ld GTN	1,357.88	786.31	45.19	2,189.39	1,374.96	790.36	45.30	2,210.63	1,398.06	798.06	45.56	2,241.67
Wa/ld NWP	5,771.01	3,341.82	192.06	9,304.89	5,843.58	3,359.04	192.54	9,395.16	5,941.75	3,391.74	193.61	9,527.10
<b>WA/ID Sub-Total</b>	<b>16,973.55</b>	<b>9,828.89</b>	<b>564.89</b>	<b>27,367.33</b>	<b>17,187.00</b>	<b>9,879.52</b>	<b>566.31</b>	<b>27,632.83</b>	<b>17,475.72</b>	<b>9,975.70</b>	<b>569.45</b>	<b>28,020.87</b>
<b>Case Total</b>	<b>22,804.00</b>	<b>13,404.10</b>	<b>675.75</b>	<b>36,883.85</b>	<b>23,112.80</b>	<b>13,487.34</b>	<b>678.91</b>	<b>37,279.05</b>	<b>23,521.63</b>	<b>13,630.12</b>	<b>684.04</b>	<b>37,835.79</b>

Area	2024-2025:				2025-2026:				2026-2027:			
	Residential	Commercial	Ind FirmSale	Total	Residential	Commercial	Ind FirmSale	Total	Residential	Commercial	Ind FirmSale	Total
Klam Falls	1,018.41	498.67	15.49	1,532.57	1,034.61	503.46	15.69	1,553.76	1,050.14	508.06	15.88	1,574.08
La Grande	566.40	354.73	61.83	982.95	570.42	355.88	62.93	989.23	574.79	357.17	64.04	996.00
Medford GTN	2,617.04	1,584.62	20.82	4,222.48	2,659.19	1,601.94	21.03	4,282.16	2,700.20	1,618.77	21.23	4,340.19
Medford NWP	1,175.77	711.93	9.35	1,897.06	1,194.71	719.71	9.45	1,923.87	1,213.13	727.27	9.54	1,949.94
Roseburg	733.89	521.11	8.64	1,263.63	742.95	520.94	8.82	1,272.70	751.91	520.64	9.00	1,281.55
<b>OR Sub-Total</b>	<b>6,111.51</b>	<b>3,671.05</b>	<b>116.14</b>	<b>9,898.70</b>	<b>6,201.88</b>	<b>3,701.94</b>	<b>117.91</b>	<b>10,021.72</b>	<b>6,290.17</b>	<b>3,731.91</b>	<b>119.67</b>	<b>10,141.75</b>
Wa/ld Both	10,209.33	5,790.84	330.04	16,330.21	10,323.85	5,820.46	330.77	16,475.09	10,431.66	5,848.64	331.43	16,611.73
Wa/ld GTN	1,408.18	798.74	45.52	2,252.44	1,423.98	802.82	45.62	2,272.43	1,438.85	806.71	45.71	2,291.27
Wa/ld NWP	5,984.78	3,394.63	193.47	9,572.88	6,051.91	3,411.99	193.90	9,657.81	6,115.11	3,428.51	194.29	9,737.91
<b>WA/ID Sub-Total</b>	<b>17,602.29</b>	<b>9,984.21</b>	<b>569.04</b>	<b>28,155.54</b>	<b>17,799.75</b>	<b>10,035.28</b>	<b>570.30</b>	<b>28,405.32</b>	<b>17,985.62</b>	<b>10,083.86</b>	<b>571.43</b>	<b>28,640.91</b>
<b>Case Total</b>	<b>23,713.80</b>	<b>13,655.27</b>	<b>685.17</b>	<b>38,054.24</b>	<b>24,001.62</b>	<b>13,737.21</b>	<b>688.21</b>	<b>38,427.04</b>	<b>24,275.79</b>	<b>13,815.77</b>	<b>691.10</b>	<b>38,782.66</b>

## APPENDIX 2.9: DETAILED DEMAND DATA HIGH GROWTH LOW PRICE

Area	2027-2028:				2028-2029:				2029-2030:			
	Residential	Commercial	Ind FirmSale	Total	Residential	Commercial	Ind FirmSale	Total	Residential	Commercial	Ind FirmSale	Total
Klam Falls	1,070.79	514.95	16.12	1,601.86	1,080.40	516.79	16.27	1,613.46	1,094.37	520.67	16.46	1,631.50
La Grande	582.64	360.48	65.23	1,008.35	586.26	361.03	66.27	1,013.56	592.25	363.01	67.39	1,022.65
Medford GTN	2,752.96	1,642.30	21.49	4,416.75	2,780.71	1,652.04	21.64	4,454.39	2,819.12	1,667.76	21.84	4,508.73
Medford NWP	1,236.84	737.85	9.65	1,984.34	1,249.31	742.22	9.72	2,001.25	1,266.56	749.28	9.81	2,025.66
Roseburg	764.61	522.67	9.20	1,296.48	770.23	520.24	9.36	1,299.82	779.05	519.84	9.54	1,308.43
<b>OR Sub-Total</b>	<b>6,407.84</b>	<b>3,778.25</b>	<b>121.69</b>	<b>10,307.78</b>	<b>6,466.91</b>	<b>3,792.32</b>	<b>123.25</b>	<b>10,382.48</b>	<b>6,551.36</b>	<b>3,820.57</b>	<b>125.04</b>	<b>10,496.98</b>
Wa/ld Both	10,589.01	5,905.03	333.15	16,827.19	10,646.38	5,908.17	332.78	16,887.33	10,750.43	5,937.95	333.43	17,021.81
Wa/ld GTN	1,460.55	814.49	45.95	2,320.99	1,468.47	814.92	45.90	2,329.29	1,482.82	819.03	45.99	2,347.84
Wa/ld NWP	6,207.35	3,461.57	195.29	9,864.21	6,240.98	3,463.41	195.08	9,899.47	6,301.98	3,480.86	195.46	9,978.30
<b>WA/ld Sub-Total</b>	<b>18,256.92</b>	<b>10,181.08</b>	<b>574.39</b>	<b>29,012.39</b>	<b>18,355.83</b>	<b>10,186.49</b>	<b>573.76</b>	<b>29,116.08</b>	<b>18,535.23</b>	<b>10,237.84</b>	<b>574.88</b>	<b>29,347.94</b>
<b>Case Total</b>	<b>24,664.76</b>	<b>13,959.33</b>	<b>696.09</b>	<b>39,320.17</b>	<b>24,822.74</b>	<b>13,978.81</b>	<b>697.01</b>	<b>39,498.56</b>	<b>25,086.59</b>	<b>14,058.41</b>	<b>699.92</b>	<b>39,844.92</b>

Area	2030-2031:				2031-2032:				2032-2033:			
	Residential	Commercial	Ind FirmSale	Total	Residential	Commercial	Ind FirmSale	Total	Residential	Commercial	Ind FirmSale	Total
Klam Falls	1,108.07	524.42	16.66	1,649.15	1,127.49	530.27	16.90	1,674.66	1,136.19	531.33	17.05	1,684.57
La Grande	597.76	364.75	68.51	1,031.03	605.46	367.67	69.73	1,042.87	607.68	367.33	70.77	1,045.79
Medford GTN	2,855.97	1,682.67	22.05	4,560.68	2,903.56	1,702.79	22.32	4,628.66	2,924.52	1,708.66	22.46	4,655.64
Medford NWP	1,283.12	755.98	9.91	2,049.00	1,304.50	765.02	10.03	2,079.54	1,313.91	767.66	10.09	2,091.67
Roseburg	787.15	519.22	9.72	1,316.09	798.39	520.17	9.93	1,328.49	802.16	516.68	10.09	1,328.93
<b>OR Sub-Total</b>	<b>6,632.06</b>	<b>3,847.04</b>	<b>126.85</b>	<b>10,605.95</b>	<b>6,739.40</b>	<b>3,885.93</b>	<b>128.91</b>	<b>10,754.23</b>	<b>6,784.46</b>	<b>3,891.67</b>	<b>130.47</b>	<b>10,806.59</b>
Wa/ld Both	10,852.38	5,967.92	334.06	17,154.37	11,004.70	6,024.98	335.59	17,365.27	11,052.65	6,026.60	334.98	17,414.23
Wa/ld GTN	1,496.88	823.16	46.08	2,366.12	1,517.89	831.03	46.29	2,395.21	1,524.50	831.26	46.20	2,401.96
Wa/ld NWP	6,361.74	3,498.44	195.83	10,056.01	6,451.03	3,531.89	196.73	10,179.64	6,479.14	3,532.83	196.37	10,208.34
<b>WA/ld Sub-Total</b>	<b>18,711.01</b>	<b>10,289.53</b>	<b>575.97</b>	<b>29,576.50</b>	<b>18,973.62</b>	<b>10,387.90</b>	<b>578.61</b>	<b>29,940.13</b>	<b>19,056.30</b>	<b>10,390.69</b>	<b>577.55</b>	<b>30,024.54</b>
<b>Case Total</b>	<b>25,343.07</b>	<b>14,136.56</b>	<b>702.81</b>	<b>40,182.44</b>	<b>25,713.02</b>	<b>14,273.83</b>	<b>707.52</b>	<b>40,694.36</b>	<b>25,840.76</b>	<b>14,282.36</b>	<b>708.02</b>	<b>40,831.13</b>

Area	2033-2034:				2034-2035:			
	Residential	Commercial	Ind FirmSale	Total	Residential	Commercial	Ind FirmSale	Total
Klam Falls	1,150.68	535.13	17.24	1,703.05	1,167.40	541.60	17.45	1,726.45
La Grande	612.05	368.38	71.91	1,052.34	617.39	371.02	73.04	1,061.45
Medford GTN	2,956.89	1,721.12	22.67	4,700.69	2,993.61	1,740.99	22.89	4,757.49
Medford NWP	1,328.46	773.26	10.19	2,111.90	1,344.96	782.18	10.28	2,137.43
Roseburg	809.53	515.46	10.27	1,335.26	818.86	518.02	10.48	1,347.35
<b>OR Sub-Total</b>	<b>6,857.62</b>	<b>3,913.34</b>	<b>132.28</b>	<b>10,903.25</b>	<b>6,942.22</b>	<b>3,953.81</b>	<b>134.15</b>	<b>11,030.17</b>
Wa/ld Both	11,151.67	6,057.67	335.41	17,544.75	11,304.35	6,118.24	336.65	17,759.24
Wa/ld GTN	1,538.16	835.54	46.26	2,419.97	1,559.22	843.89	46.43	2,449.55
Wa/ld NWP	6,537.19	3,551.05	196.62	10,284.85	6,626.69	3,586.55	197.35	10,410.59
<b>WA/ld Sub-Total</b>	<b>19,227.02</b>	<b>10,444.26</b>	<b>578.29</b>	<b>30,249.57</b>	<b>19,490.26</b>	<b>10,548.69</b>	<b>580.44</b>	<b>30,619.38</b>
<b>Case Total</b>	<b>26,084.64</b>	<b>14,357.61</b>	<b>710.57</b>	<b>41,152.82</b>	<b>26,432.47</b>	<b>14,502.49</b>	<b>714.58</b>	<b>41,649.55</b>

## APPENDIX 2.9: DETAILED DEMAND DATA AVERAGE MIX

Area	2015-2016:				2016-2017:				2017-2018:			
	Residential	Commercial	Ind FirmSale	Total	Residential	Commercial	Ind FirmSale	Total	Residential	Commercial	Ind FirmSale	Total
Klam Falls	850.06	444.21	13.19	1,307.46	854.74	443.45	13.58	1,311.77	865.67	445.75	13.57	1,325.00
La Grande	505.58	330.86	49.79	886.23	505.70	328.40	51.66	885.75	508.09	328.65	51.60	888.34
Medford GTN	2,094.68	1,356.35	18.43	3,469.46	2,115.07	1,360.38	18.74	3,494.18	2,149.88	1,372.86	18.73	3,541.47
Medford NWP	941.09	609.38	8.28	1,558.74	950.25	611.18	8.42	1,569.85	965.89	616.79	8.41	1,591.10
Roseburg	621.74	497.82	6.98	1,126.54	624.15	494.28	6.94	1,125.37	629.75	492.94	6.92	1,129.62
<b>OR Sub-Total</b>	<b>5,013.14</b>	<b>3,238.63</b>	<b>96.66</b>	<b>8,348.43</b>	<b>5,049.90</b>	<b>3,237.69</b>	<b>99.33</b>	<b>8,386.92</b>	<b>5,119.28</b>	<b>3,257.00</b>	<b>99.24</b>	<b>8,475.52</b>
Wa/ld Both	8,762.08	5,348.54	314.56	14,425.18	8,782.21	5,307.62	315.68	14,405.51	8,858.55	5,311.94	315.67	14,486.15
Wa/ld GTN	1,208.56	737.73	43.39	1,989.68	1,211.34	732.09	43.54	1,986.97	1,221.87	732.68	43.54	1,998.09
Wa/ld NWP	5,136.39	3,135.35	184.40	8,456.14	5,148.19	3,111.36	185.05	8,444.61	5,192.94	3,113.90	185.05	8,491.88
<b>WA/ID Sub-Total</b>	<b>15,107.03</b>	<b>9,221.63</b>	<b>542.34</b>	<b>24,871.00</b>	<b>15,141.75</b>	<b>9,151.07</b>	<b>544.27</b>	<b>24,837.09</b>	<b>15,273.36</b>	<b>9,158.52</b>	<b>544.25</b>	<b>24,976.13</b>
<b>Case Total</b>	<b>20,120.17</b>	<b>12,460.25</b>	<b>639.01</b>	<b>33,219.43</b>	<b>20,191.65</b>	<b>12,388.76</b>	<b>643.60</b>	<b>33,224.02</b>	<b>20,392.64</b>	<b>12,415.52</b>	<b>643.49</b>	<b>33,451.65</b>

Area	2018-2019:				2019-2020:				2020-2021:			
	Residential	Commercial	Ind FirmSale	Total	Residential	Commercial	Ind FirmSale	Total	Residential	Commercial	Ind FirmSale	Total
Klam Falls	876.78	448.78	13.56	1,339.11	892.50	453.57	13.59	1,359.66	899.68	453.96	13.54	1,367.18
La Grande	510.46	328.79	51.51	890.76	514.96	330.22	51.55	896.72	515.04	328.71	51.47	895.22
Medford GTN	2,186.38	1,385.19	18.72	3,590.29	2,233.15	1,402.98	18.76	3,654.89	2,260.17	1,408.92	18.70	3,687.79
Medford NWP	982.29	622.33	8.41	1,613.03	1,003.30	630.32	8.43	1,642.05	1,015.44	632.99	8.40	1,656.83
Roseburg	635.60	491.55	6.90	1,134.05	644.61	491.88	6.90	1,143.39	647.78	487.84	6.86	1,142.49
<b>OR Sub-Total</b>	<b>5,191.50</b>	<b>3,276.63</b>	<b>99.10</b>	<b>8,567.23</b>	<b>5,288.52</b>	<b>3,308.97</b>	<b>99.22</b>	<b>8,696.72</b>	<b>5,338.10</b>	<b>3,312.43</b>	<b>98.98</b>	<b>8,749.52</b>
Wa/ld Both	8,932.48	5,312.30	315.45	14,560.22	9,048.65	5,335.24	316.09	14,699.98	9,087.02	5,310.86	314.68	14,712.55
Wa/ld GTN	1,232.07	732.73	43.51	2,008.31	1,248.09	735.90	43.60	2,027.58	1,253.38	732.53	43.40	2,029.32
Wa/ld NWP	5,236.28	3,114.11	184.92	8,535.30	5,304.38	3,127.56	185.29	8,617.23	5,326.87	3,113.26	184.47	8,624.60
<b>WA/ID Sub-Total</b>	<b>15,400.82</b>	<b>9,159.14</b>	<b>543.87</b>	<b>25,103.84</b>	<b>15,601.12</b>	<b>9,198.70</b>	<b>544.98</b>	<b>25,344.79</b>	<b>15,667.27</b>	<b>9,156.65</b>	<b>542.55</b>	<b>25,366.47</b>
<b>Case Total</b>	<b>20,592.32</b>	<b>12,435.76</b>	<b>642.97</b>	<b>33,671.06</b>	<b>20,889.63</b>	<b>12,507.67</b>	<b>644.20</b>	<b>34,041.51</b>	<b>21,005.38</b>	<b>12,469.08</b>	<b>641.53</b>	<b>34,115.98</b>

Area	2021-2022:				2022-2023:				2023-2024:			
	Residential	Commercial	Ind FirmSale	Total	Residential	Commercial	Ind FirmSale	Total	Residential	Commercial	Ind FirmSale	Total
Klam Falls	911.27	456.44	13.54	1,381.26	922.88	458.69	13.53	1,395.09	938.94	462.95	13.56	1,415.45
La Grande	517.21	328.51	51.47	897.19	519.29	328.17	51.47	898.93	523.47	329.19	51.53	904.20
Medford GTN	2,291.59	1,418.24	18.69	3,728.51	2,318.50	1,425.57	18.68	3,762.74	2,354.64	1,438.17	18.72	3,811.53
Medford NWP	1,029.56	637.18	8.40	1,675.13	1,041.64	640.47	8.39	1,690.51	1,057.88	646.14	8.41	1,712.43
Roseburg	653.93	485.63	6.84	1,146.41	660.04	483.08	6.83	1,149.95	669.11	482.55	6.82	1,158.48
<b>OR Sub-Total</b>	<b>5,403.56</b>	<b>3,326.00</b>	<b>98.94</b>	<b>8,828.50</b>	<b>5,462.35</b>	<b>3,335.98</b>	<b>98.90</b>	<b>8,897.22</b>	<b>5,544.05</b>	<b>3,359.00</b>	<b>99.04</b>	<b>9,002.09</b>
Wa/ld Both	9,159.26	5,308.69	314.19	14,782.14	9,224.82	5,305.07	313.65	14,843.54	9,330.68	5,326.21	314.06	14,970.96
Wa/ld GTN	1,263.35	732.23	43.34	2,038.92	1,272.39	731.73	43.26	2,047.38	1,286.99	734.65	43.32	2,064.96
Wa/ld NWP	5,369.22	3,111.99	184.18	8,665.39	5,407.65	3,109.87	183.87	8,701.38	5,469.71	3,122.26	184.11	8,776.08
<b>WA/ID Sub-Total</b>	<b>15,791.83</b>	<b>9,152.92</b>	<b>541.70</b>	<b>25,486.45</b>	<b>15,904.86</b>	<b>9,146.66</b>	<b>540.78</b>	<b>25,592.30</b>	<b>16,087.38</b>	<b>9,183.13</b>	<b>541.49</b>	<b>25,812.00</b>
<b>Case Total</b>	<b>21,195.39</b>	<b>12,478.91</b>	<b>640.64</b>	<b>34,314.94</b>	<b>21,367.20</b>	<b>12,482.64</b>	<b>639.68</b>	<b>34,489.52</b>	<b>21,631.43</b>	<b>12,542.13</b>	<b>640.53</b>	<b>34,814.09</b>

Area	2024-2025:				2025-2026:				2026-2027:			
	Residential	Commercial	Ind FirmSale	Total	Residential	Commercial	Ind FirmSale	Total	Residential	Commercial	Ind FirmSale	Total
Klam Falls	945.08	462.83	13.51	1,421.42	955.41	464.62	13.50	1,433.54	965.35	466.34	13.49	1,445.19
La Grande	522.86	327.33	51.47	901.67	524.33	326.85	51.47	902.66	525.87	326.35	51.47	903.69
Medford GTN	2,369.26	1,438.88	18.66	3,826.80	2,393.77	1,445.29	18.64	3,857.70	2,417.52	1,451.40	18.63	3,887.55
Medford NWP	1,064.45	646.46	8.38	1,719.29	1,075.46	649.33	8.38	1,733.17	1,086.13	652.08	8.37	1,746.58
Roseburg	671.41	477.73	6.79	1,155.93	676.53	474.89	6.77	1,158.19	681.60	471.98	6.74	1,160.33
<b>OR Sub-Total</b>	<b>5,573.07</b>	<b>3,353.23</b>	<b>98.81</b>	<b>9,025.11</b>	<b>5,625.50</b>	<b>3,361.00</b>	<b>98.76</b>	<b>9,085.26</b>	<b>5,676.48</b>	<b>3,368.15</b>	<b>98.72</b>	<b>9,143.34</b>
Wa/ld Both	9,345.48	5,298.56	312.47	14,956.50	9,399.72	5,294.85	311.81	15,006.38	9,449.72	5,291.16	311.11	15,051.99
Wa/ld GTN	1,289.03	730.84	43.10	2,062.97	1,296.51	730.32	43.01	2,069.85	1,303.41	729.82	42.91	2,076.14
Wa/ld NWP	5,478.38	3,106.05	183.17	8,767.60	5,510.18	3,103.88	182.78	8,796.84	5,539.49	3,101.72	182.37	8,823.58
<b>WA/ID Sub-Total</b>	<b>16,112.89</b>	<b>9,135.44</b>	<b>538.74</b>	<b>25,787.07</b>	<b>16,206.41</b>	<b>9,129.05</b>	<b>537.60</b>	<b>25,873.06</b>	<b>16,292.62</b>	<b>9,122.69</b>	<b>536.40</b>	<b>25,951.71</b>
<b>Case Total</b>	<b>21,685.96</b>	<b>12,488.67</b>	<b>637.55</b>	<b>34,812.18</b>	<b>21,831.91</b>	<b>12,490.05</b>	<b>636.37</b>	<b>34,958.33</b>	<b>21,969.09</b>	<b>12,490.85</b>	<b>635.11</b>	<b>35,095.05</b>

## APPENDIX 2.9: DETAILED DEMAND DATA AVERAGE MIX

Area	2027-2028:				2028-2029:				2029-2030:			
	Residential	Commercial	Ind FirmSale	Total	Residential	Commercial	Ind FirmSale	Total	Residential	Commercial	Ind FirmSale	Total
Klam Falls	979.97	470.17	13.52	1,463.67	984.26	469.31	13.48	1,467.05	992.93	470.50	13.47	1,476.90
La Grande	529.97	327.28	51.53	908.78	529.58	325.32	51.47	906.37	531.48	324.76	51.47	907.71
Medford GTN	2,451.63	1,463.47	18.67	3,933.77	2,462.47	1,462.75	18.61	3,943.83	2,483.29	1,467.62	18.60	3,969.51
Medford NWP	1,101.46	657.50	8.39	1,767.35	1,106.33	657.18	8.36	1,771.87	1,115.68	659.37	8.36	1,783.40
Roseburg	689.98	471.17	6.74	1,167.89	691.62	466.16	6.70	1,164.49	696.37	463.14	6.68	1,166.20
<b>OR Sub-Total</b>	<b>5,753.01</b>	<b>3,389.59</b>	<b>98.86</b>	<b>9,241.46</b>	<b>5,774.25</b>	<b>3,380.72</b>	<b>98.63</b>	<b>9,253.60</b>	<b>5,819.75</b>	<b>3,385.38</b>	<b>98.58</b>	<b>9,303.71</b>
Wa/ld Both	9,543.88	5,312.95	311.38	15,168.22	9,543.57	5,284.81	309.66	15,138.04	9,587.13	5,281.89	308.90	15,177.91
Wa/ld GTN	1,316.40	732.82	42.95	2,092.17	1,316.35	728.94	42.71	2,088.01	1,322.36	728.54	42.61	2,093.51
Wa/ld NWP	5,594.69	3,114.49	182.53	8,891.71	5,594.51	3,097.99	181.52	8,874.02	5,620.04	3,096.28	181.08	8,897.40
<b>WA/ID Sub-Total</b>	<b>16,454.97</b>	<b>9,160.27</b>	<b>536.86</b>	<b>26,152.10</b>	<b>16,454.44</b>	<b>9,111.74</b>	<b>533.89</b>	<b>26,100.07</b>	<b>16,529.53</b>	<b>9,106.70</b>	<b>532.59</b>	<b>26,168.82</b>
<b>Case Total</b>	<b>22,207.99</b>	<b>12,549.85</b>	<b>635.72</b>	<b>35,393.56</b>	<b>22,228.69</b>	<b>12,492.46</b>	<b>632.52</b>	<b>35,353.67</b>	<b>22,349.28</b>	<b>12,492.09</b>	<b>631.17</b>	<b>35,472.53</b>

Area	2030-2031:				2031-2032:				2032-2033:			
	Residential	Commercial	Ind FirmSale	Total	Residential	Commercial	Ind FirmSale	Total	Residential	Commercial	Ind FirmSale	Total
Klam Falls	1,001.41	471.58	13.46	1,486.45	1,015.11	474.54	13.49	1,503.13	1,018.61	472.97	13.44	1,505.02
La Grande	533.23	324.16	51.47	908.86	537.24	324.80	51.53	913.58	536.40	322.56	51.47	910.43
Medford GTN	2,502.79	1,471.81	18.59	3,993.19	2,532.31	1,480.75	18.63	4,031.69	2,537.64	1,476.83	18.57	4,033.04
Medford NWP	1,124.44	661.25	8.35	1,794.04	1,137.70	665.26	8.37	1,811.34	1,140.10	663.50	8.34	1,811.95
Roseburg	700.66	460.07	6.66	1,167.39	708.04	458.55	6.66	1,173.24	708.44	452.93	6.62	1,167.99
<b>OR Sub-Total</b>	<b>5,862.54</b>	<b>3,388.87</b>	<b>98.53</b>	<b>9,349.94</b>	<b>5,930.40</b>	<b>3,403.90</b>	<b>98.67</b>	<b>9,432.98</b>	<b>5,941.20</b>	<b>3,388.79</b>	<b>98.44</b>	<b>9,428.43</b>
Wa/ld Both	9,628.65	5,279.33	308.12	15,216.11	9,716.29	5,301.68	308.18	15,326.15	9,706.92	5,272.87	306.22	15,286.01
Wa/ld GTN	1,328.09	728.18	42.50	2,098.77	1,340.18	731.27	42.51	2,113.95	1,338.89	727.29	42.24	2,108.42
Wa/ld NWP	5,644.38	3,094.78	180.62	8,919.79	5,695.75	3,107.88	180.66	8,984.29	5,690.27	3,090.99	179.51	8,960.77
<b>WA/ID Sub-Total</b>	<b>16,601.13</b>	<b>9,102.30</b>	<b>531.25</b>	<b>26,234.67</b>	<b>16,752.22</b>	<b>9,140.83</b>	<b>531.34</b>	<b>26,424.39</b>	<b>16,736.08</b>	<b>9,091.16</b>	<b>527.96</b>	<b>26,355.20</b>
<b>Case Total</b>	<b>22,463.66</b>	<b>12,491.17</b>	<b>629.78</b>	<b>35,584.61</b>	<b>22,682.62</b>	<b>12,544.73</b>	<b>630.01</b>	<b>35,857.37</b>	<b>22,677.27</b>	<b>12,479.96</b>	<b>626.40</b>	<b>35,783.62</b>

Area	2033-2034:				2034-2035:			
	Residential	Commercial	Ind FirmSale	Total	Residential	Commercial	Ind FirmSale	Total
Klam Falls	1,027.40	473.88	13.43	1,514.71	1,038.44	477.50	13.43	1,529.37
La Grande	537.85	321.80	51.47	911.12	540.45	322.73	51.47	914.65
Medford GTN	2,553.49	1,478.95	18.55	4,051.00	2,574.12	1,488.69	18.55	4,081.36
Medford NWP	1,147.22	664.46	8.34	1,820.01	1,156.49	668.83	8.34	1,833.65
Roseburg	712.23	449.45	6.60	1,168.28	718.04	449.80	6.59	1,174.43
<b>OR Sub-Total</b>	<b>5,978.19</b>	<b>3,388.54</b>	<b>98.39</b>	<b>9,465.12</b>	<b>6,027.53</b>	<b>3,407.55</b>	<b>98.38</b>	<b>9,533.47</b>
Wa/ld Both	9,744.26	5,271.27	305.22	15,320.75	9,835.72	5,299.55	305.05	15,440.33
Wa/ld GTN	1,344.04	727.07	42.10	2,113.21	1,356.65	730.97	42.08	2,129.70
Wa/ld NWP	5,712.15	3,090.06	178.92	8,981.13	5,765.77	3,106.64	178.82	9,051.23
<b>WA/ID Sub-Total</b>	<b>16,800.44</b>	<b>9,088.40</b>	<b>526.24</b>	<b>26,415.08</b>	<b>16,958.14</b>	<b>9,137.16</b>	<b>525.95</b>	<b>26,621.25</b>
<b>Case Total</b>	<b>22,778.63</b>	<b>12,476.94</b>	<b>624.63</b>	<b>35,880.20</b>	<b>22,985.67</b>	<b>12,544.72</b>	<b>624.34</b>	<b>36,154.72</b>



## APPENDIX 2.9: DETAILED DEMAND DATA COLDEST IN 20 YEARS

Area	2015-2016:				2016-2017:				2017-2018:			
	Residential	Commercial	Ind FirmSale	Total	Residential	Commercial	Ind FirmSale	Total	Residential	Commercial	Ind FirmSale	Total
Klam Falls	876.38	455.38	13.30	1,345.06	881.35	454.65	13.70	1,349.70	892.67	457.04	13.69	1,363.40
La Grande	523.11	341.47	49.79	914.36	523.33	338.97	51.66	913.95	525.83	339.26	51.60	916.70
Medford GTN	2,181.91	1,399.90	18.59	3,600.40	2,203.59	1,404.39	18.91	3,626.89	2,240.02	1,417.44	18.90	3,676.36
Medford NWP	980.28	628.94	8.35	1,617.57	990.02	630.96	8.50	1,629.47	1,006.38	636.82	8.49	1,651.70
Roseburg	647.79	514.41	6.99	1,169.19	650.46	510.85	6.95	1,168.27	656.36	509.55	6.94	1,172.84
<b>OR Sub-Total</b>	<b>5,209.46</b>	<b>3,340.10</b>	<b>97.03</b>	<b>8,646.58</b>	<b>5,248.76</b>	<b>3,339.81</b>	<b>99.71</b>	<b>8,688.28</b>	<b>5,321.27</b>	<b>3,360.11</b>	<b>99.63</b>	<b>8,781.00</b>
Wa/ld Both	9,047.29	5,505.91	318.84	14,872.04	9,070.21	5,464.64	320.02	14,854.88	9,150.28	5,470.12	320.02	14,940.41
Wa/ld GTN	1,247.90	759.44	43.98	2,051.32	1,251.06	753.74	44.14	2,048.95	1,262.11	754.50	44.14	2,060.75
Wa/ld NWP	5,303.58	3,227.60	186.91	8,718.09	5,317.02	3,203.41	187.60	8,708.03	5,363.95	3,206.62	187.60	8,758.17
<b>WA/ID Sub-Total</b>	<b>15,598.77</b>	<b>9,492.95</b>	<b>549.73</b>	<b>25,641.45</b>	<b>15,638.30</b>	<b>9,421.80</b>	<b>551.76</b>	<b>25,611.86</b>	<b>15,776.34</b>	<b>9,431.24</b>	<b>551.76</b>	<b>25,759.33</b>
<b>Case Total</b>	<b>20,808.22</b>	<b>12,833.05</b>	<b>646.76</b>	<b>34,288.03</b>	<b>20,887.05</b>	<b>12,761.61</b>	<b>651.48</b>	<b>34,300.14</b>	<b>21,097.60</b>	<b>12,791.35</b>	<b>651.38</b>	<b>34,540.33</b>

Area	2018-2019:				2019-2020:				2020-2021:			
	Residential	Commercial	Ind FirmSale	Total	Residential	Commercial	Ind FirmSale	Total	Residential	Commercial	Ind FirmSale	Total
Klam Falls	904.16	460.19	13.68	1,378.03	920.29	465.11	13.71	1,399.11	927.87	465.62	13.67	1,407.15
La Grande	528.32	339.44	51.51	919.27	532.93	340.91	51.55	925.39	533.12	339.44	51.47	924.04
Medford GTN	2,278.23	1,430.34	18.89	3,727.47	2,326.73	1,448.72	18.93	3,794.38	2,355.49	1,455.25	18.87	3,829.61
Medford NWP	1,023.55	642.62	8.49	1,674.66	1,045.34	650.87	8.51	1,704.72	1,058.26	653.81	8.48	1,720.55
Roseburg	662.50	508.20	6.92	1,177.61	671.82	508.56	6.92	1,187.30	675.31	504.56	6.88	1,186.75
<b>OR Sub-Total</b>	<b>5,396.76</b>	<b>3,380.79</b>	<b>99.49</b>	<b>8,877.04</b>	<b>5,497.11</b>	<b>3,414.17</b>	<b>99.61</b>	<b>9,010.89</b>	<b>5,550.05</b>	<b>3,418.67</b>	<b>99.37</b>	<b>9,068.09</b>
Wa/ld Both	9,228.04	5,471.52	319.80	15,019.37	9,348.14	5,495.51	320.45	15,164.10	9,390.55	5,472.24	319.04	15,181.82
Wa/ld GTN	1,272.83	754.69	44.11	2,071.64	1,289.40	758.00	44.20	2,091.60	1,295.25	754.79	44.01	2,094.04
Wa/ld NWP	5,409.54	3,207.44	187.47	8,804.46	5,479.94	3,221.51	187.85	8,889.30	5,504.80	3,207.86	187.02	8,899.69
<b>WA/ID Sub-Total</b>	<b>15,910.42</b>	<b>9,433.66</b>	<b>551.39</b>	<b>25,895.46</b>	<b>16,117.48</b>	<b>9,475.02</b>	<b>552.50</b>	<b>26,145.00</b>	<b>16,190.60</b>	<b>9,434.89</b>	<b>550.06</b>	<b>26,175.55</b>
<b>Case Total</b>	<b>21,307.18</b>	<b>12,814.44</b>	<b>650.87</b>	<b>34,772.50</b>	<b>21,614.59</b>	<b>12,889.20</b>	<b>652.11</b>	<b>35,155.89</b>	<b>21,740.65</b>	<b>12,853.57</b>	<b>649.43</b>	<b>35,243.65</b>

Area	2021-2022:				2022-2023:				2023-2024:			
	Residential	Commercial	Ind FirmSale	Total	Residential	Commercial	Ind FirmSale	Total	Residential	Commercial	Ind FirmSale	Total
Klam Falls	939.88	468.22	13.66	1,421.76	951.90	470.59	13.65	1,436.14	968.38	474.98	13.68	1,457.04
La Grande	535.41	339.28	51.47	926.16	537.59	338.98	51.47	928.04	541.88	340.05	51.53	933.46
Medford GTN	2,388.44	1,465.10	18.86	3,872.40	2,416.68	1,472.91	18.85	3,908.44	2,454.11	1,485.98	18.89	3,958.97
Medford NWP	1,073.07	658.23	8.47	1,739.78	1,085.75	661.74	8.47	1,755.97	1,102.57	667.61	8.49	1,778.67
Roseburg	681.79	502.39	6.86	1,191.03	688.22	499.88	6.84	1,194.94	697.62	499.38	6.84	1,203.83
<b>OR Sub-Total</b>	<b>5,618.58</b>	<b>3,433.22</b>	<b>99.33</b>	<b>9,151.13</b>	<b>5,680.15</b>	<b>3,444.09</b>	<b>99.28</b>	<b>9,223.52</b>	<b>5,764.56</b>	<b>3,467.99</b>	<b>99.43</b>	<b>9,331.98</b>
Wa/ld Both	9,466.67	5,471.16	318.55	15,256.38	9,535.96	5,468.57	318.01	15,322.55	9,645.51	5,490.78	318.43	15,454.71
Wa/ld GTN	1,305.75	754.64	43.94	2,104.33	1,315.30	754.29	43.86	2,113.45	1,330.42	757.35	43.92	2,131.68
Wa/ld NWP	5,549.43	3,207.23	186.74	8,943.39	5,590.04	3,205.72	186.42	8,982.18	5,654.26	3,218.73	186.66	9,059.66
<b>WA/ID Sub-Total</b>	<b>16,321.84</b>	<b>9,433.03</b>	<b>549.22</b>	<b>26,304.10</b>	<b>16,441.31</b>	<b>9,428.57</b>	<b>548.30</b>	<b>26,418.18</b>	<b>16,630.19</b>	<b>9,466.86</b>	<b>549.01</b>	<b>26,646.05</b>
<b>Case Total</b>	<b>21,940.43</b>	<b>12,866.25</b>	<b>648.55</b>	<b>35,455.23</b>	<b>22,121.45</b>	<b>12,872.67</b>	<b>647.58</b>	<b>35,641.71</b>	<b>22,394.75</b>	<b>12,934.85</b>	<b>648.44</b>	<b>35,978.03</b>

Area	2024-2025:				2025-2026:				2026-2027:			
	Residential	Commercial	Ind FirmSale	Total	Residential	Commercial	Ind FirmSale	Total	Residential	Commercial	Ind FirmSale	Total
Klam Falls	974.94	474.97	13.63	1,463.54	985.67	476.89	13.62	1,476.18	996.00	478.73	13.61	1,488.35
La Grande	541.37	338.23	51.47	931.07	542.95	337.79	51.47	932.21	544.59	337.32	51.47	933.38
Medford GTN	2,470.01	1,487.15	18.83	3,975.99	2,495.81	1,494.03	18.82	4,008.66	2,520.83	1,500.60	18.81	4,040.24
Medford NWP	1,109.71	668.14	8.46	1,786.32	1,121.30	671.23	8.46	1,800.99	1,132.55	674.18	8.45	1,815.18
Roseburg	700.24	494.60	6.80	1,201.64	705.67	491.80	6.78	1,204.25	711.06	488.92	6.76	1,206.73
<b>OR Sub-Total</b>	<b>5,796.28</b>	<b>3,463.09</b>	<b>99.20</b>	<b>9,358.57</b>	<b>5,851.40</b>	<b>3,471.74</b>	<b>99.15</b>	<b>9,422.29</b>	<b>5,905.02</b>	<b>3,479.76</b>	<b>99.10</b>	<b>9,483.88</b>
Wa/ld Both	9,663.98	5,464.16	316.83	15,444.97	9,721.83	5,461.49	316.17	15,499.49	9,775.36	5,458.82	315.47	15,549.65
Wa/ld GTN	1,332.96	753.68	43.70	2,130.34	1,340.94	753.31	43.61	2,137.86	1,348.33	752.94	43.51	2,144.78
Wa/ld NWP	5,665.09	3,203.13	185.73	9,053.95	5,699.00	3,201.56	185.34	9,085.91	5,730.38	3,200.00	184.93	9,115.31
<b>WA/ID Sub-Total</b>	<b>16,662.03</b>	<b>9,420.97</b>	<b>546.26</b>	<b>26,629.26</b>	<b>16,761.78</b>	<b>9,416.36</b>	<b>545.12</b>	<b>26,723.26</b>	<b>16,854.07</b>	<b>9,411.76</b>	<b>543.91</b>	<b>26,809.74</b>
<b>Case Total</b>	<b>22,458.31</b>	<b>12,884.06</b>	<b>645.45</b>	<b>35,987.83</b>	<b>22,613.17</b>	<b>12,888.11</b>	<b>644.27</b>	<b>36,145.55</b>	<b>22,759.09</b>	<b>12,891.52</b>	<b>643.02</b>	<b>36,293.62</b>

## APPENDIX 2.9: DETAILED DEMAND DATA COLDEST IN 20 YEARS

Area	2027-2028:				2028-2029:				2029-2030:			
	Residential	Commercial	Ind FirmSale	Total	Residential	Commercial	Ind FirmSale	Total	Residential	Commercial	Ind FirmSale	Total
Klam Falls	1,011.01	482.67	13.64	1,507.33	1,015.67	481.93	13.60	1,511.20	1,024.70	483.22	13.59	1,521.51
La Grande	548.79	338.30	51.53	938.62	548.52	336.38	51.47	936.37	550.54	335.85	51.47	937.86
Medford GTN	2,556.20	1,513.12	18.85	4,088.17	2,568.25	1,512.86	18.79	4,099.89	2,590.24	1,518.16	18.78	4,127.18
Medford NWP	1,148.44	679.81	8.47	1,836.72	1,153.85	679.69	8.44	1,841.98	1,163.73	682.07	8.44	1,854.24
Roseburg	719.76	488.14	6.76	1,214.65	721.71	483.17	6.72	1,211.60	726.77	480.19	6.70	1,213.65
<b>OR Sub-Total</b>	<b>5,984.20</b>	<b>3,502.05</b>	<b>99.25</b>	<b>9,585.49</b>	<b>6,008.01</b>	<b>3,494.02</b>	<b>99.01</b>	<b>9,601.04</b>	<b>6,055.98</b>	<b>3,499.49</b>	<b>98.97</b>	<b>9,654.44</b>
Wa/ld Both	9,873.04	5,481.64	315.74	15,670.43	9,876.22	5,454.52	314.02	15,644.76	9,923.21	5,452.61	313.26	15,689.09
Wa/ld GTN	1,361.80	756.09	43.55	2,161.44	1,362.24	752.35	43.31	2,157.90	1,368.72	752.08	43.21	2,164.01
Wa/ld NWP	5,787.65	3,213.38	185.09	9,186.11	5,789.51	3,197.48	184.08	9,171.06	5,817.06	3,196.36	183.64	9,197.05
<b>WA/ID Sub-Total</b>	<b>17,022.49</b>	<b>9,451.11</b>	<b>544.38</b>	<b>27,017.97</b>	<b>17,027.96</b>	<b>9,404.34</b>	<b>541.41</b>	<b>26,973.72</b>	<b>17,108.99</b>	<b>9,401.05</b>	<b>540.11</b>	<b>27,050.15</b>
<b>Case Total</b>	<b>23,006.69</b>	<b>12,953.15</b>	<b>643.63</b>	<b>36,603.47</b>	<b>23,035.97</b>	<b>12,898.36</b>	<b>640.43</b>	<b>36,574.76</b>	<b>23,164.97</b>	<b>12,900.54</b>	<b>639.08</b>	<b>36,704.59</b>

Area	2030-2031:				2031-2032:				2032-2033:			
	Residential	Commercial	Ind FirmSale	Total	Residential	Commercial	Ind FirmSale	Total	Residential	Commercial	Ind FirmSale	Total
Klam Falls	1,033.53	484.41	13.58	1,531.52	1,047.58	487.47	13.61	1,548.66	1,051.44	486.00	13.56	1,551.00
La Grande	552.40	335.30	51.47	939.17	556.53	335.98	51.53	944.04	555.79	333.78	51.47	941.03
Medford GTN	2,610.86	1,522.77	18.76	4,152.40	2,641.43	1,532.12	18.80	4,192.35	2,647.77	1,528.59	18.74	4,195.10
Medford NWP	1,173.00	684.14	8.43	1,865.57	1,186.73	688.34	8.45	1,883.52	1,189.58	686.76	8.42	1,884.75
Roseburg	731.35	477.15	6.67	1,215.17	739.00	475.66	6.67	1,221.33	739.67	470.09	6.63	1,216.39
<b>OR Sub-Total</b>	<b>6,101.13</b>	<b>3,503.78</b>	<b>98.92</b>	<b>9,703.83</b>	<b>6,171.26</b>	<b>3,519.57</b>	<b>99.06</b>	<b>9,789.89</b>	<b>6,184.24</b>	<b>3,505.21</b>	<b>98.83</b>	<b>9,788.27</b>
Wa/ld Both	9,968.14	5,451.07	312.48	15,731.70	10,059.16	5,474.42	312.54	15,846.11	10,053.16	5,446.62	310.58	15,810.36
Wa/ld GTN	1,374.92	751.87	43.10	2,169.89	1,387.47	755.09	43.11	2,185.67	1,386.64	751.26	42.84	2,180.74
Wa/ld NWP	5,843.39	3,195.46	183.18	9,222.03	5,896.75	3,209.14	183.21	9,289.10	5,893.23	3,192.85	182.06	9,268.14
<b>WA/ID Sub-Total</b>	<b>17,186.45</b>	<b>9,398.40</b>	<b>538.77</b>	<b>27,123.62</b>	<b>17,343.37</b>	<b>9,438.65</b>	<b>538.86</b>	<b>27,320.89</b>	<b>17,333.03</b>	<b>9,390.73</b>	<b>535.48</b>	<b>27,259.24</b>
<b>Case Total</b>	<b>23,287.58</b>	<b>12,902.18</b>	<b>637.69</b>	<b>36,827.45</b>	<b>23,514.64</b>	<b>12,958.22</b>	<b>637.92</b>	<b>37,110.78</b>	<b>23,517.27</b>	<b>12,895.93</b>	<b>634.30</b>	<b>37,047.51</b>

Area	2033-2034:				2034-2035:			
	Residential	Commercial	Ind FirmSale	Total	Residential	Commercial	Ind FirmSale	Total
Klam Falls	1,060.58	487.03	13.55	1,561.16	1,071.98	490.75	13.55	1,576.28
La Grande	557.34	333.06	51.47	941.87	560.04	334.03	51.47	945.54
Medford GTN	2,664.57	1,531.08	18.73	4,214.39	2,686.11	1,541.18	18.73	4,246.02
Medford NWP	1,197.13	687.88	8.41	1,893.42	1,206.80	692.42	8.41	1,907.63
Roseburg	743.72	466.64	6.61	1,216.97	749.79	467.02	6.61	1,223.42
<b>OR Sub-Total</b>	<b>6,223.34</b>	<b>3,505.68</b>	<b>98.78</b>	<b>9,827.80</b>	<b>6,274.72</b>	<b>3,525.40</b>	<b>98.77</b>	<b>9,898.89</b>
Wa/ld Both	10,093.84	5,446.02	309.58	15,849.44	10,188.63	5,475.30	309.41	15,973.34
Wa/ld GTN	1,392.25	751.18	42.70	2,186.13	1,405.33	755.21	42.68	2,203.22
Wa/ld NWP	5,917.08	3,192.49	181.48	9,291.05	5,972.65	3,209.66	181.38	9,363.68
<b>WA/ID Sub-Total</b>	<b>17,403.17</b>	<b>9,389.69</b>	<b>533.76</b>	<b>27,326.62</b>	<b>17,566.60</b>	<b>9,440.17</b>	<b>533.47</b>	<b>27,540.25</b>
<b>Case Total</b>	<b>23,626.51</b>	<b>12,895.37</b>	<b>632.54</b>	<b>37,154.42</b>	<b>23,841.33</b>	<b>12,965.57</b>	<b>632.24</b>	<b>37,439.14</b>

## **APPENDIX 3.1: AVISTA GAS CPA REPORT 4/21/2016**



# Avista Natural Gas Conservation Potential Assessment Results

April 21, 2016

# Topics

- Overview of analysis approach
- Results for each state
  - Market characterization
  - Baseline projection
  - Conservation potential estimates

# Overview of Analysis Approach

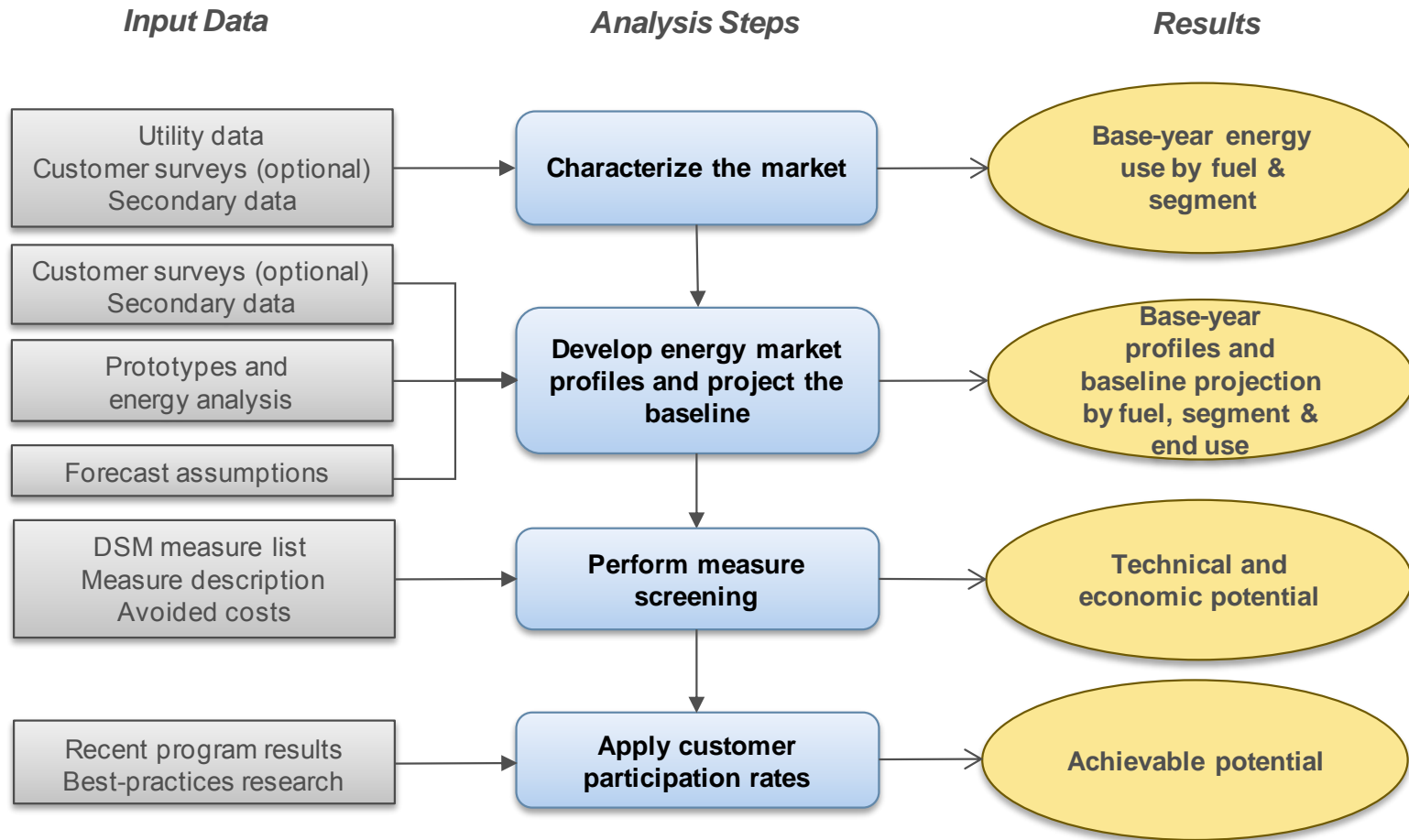

# Overview of Analysis Approach

Dimension	Segmentation Variable	Description
1	State	Washington, Idaho, Oregon
2	Sector	Residential, commercial, industrial
3	Segment	<p><b>Residential:</b> single family, multi family, mobile homes and low income</p> <p><b>Commercial:</b> office, restaurant, retail, grocery, school, college, health, lodging, warehouse, miscellaneous</p> <p><b>Industrial:</b> total</p>
4	Vintage	Existing and new construction
5	End uses	Heating, water heat, process, etc. (as appropriate by sector)
6	Appliances/end uses and technologies	Technologies such as furnaces, boilers, water heaters, etc.
7	Equipment efficiency levels for new purchases	Baseline and higher-efficiency options as appropriate for each technology



Washington



# High-level Market Characterization - Washington

2015 Natural Gas Sales by Sector

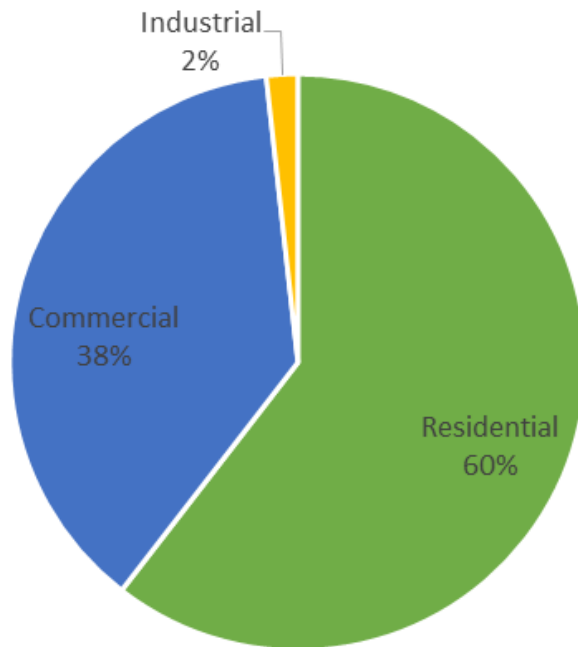

Segment	Annual Sales (DTh)	% of Sales
Residential	9,188,898	60%
Commercial	5,734,759	38%
Industrial	268,452	2%
<b>Total</b>	<b>30,375</b>	<b>100%</b>

# Residential Market Characterization - Washington

Washington	2015 Sales (DTh)	# of Customers	Average Use per Household (Therms/HH)
Single Family	6,016,941	85,875	701
Multifamily	349,141	7,909	441
Mobile Home	299,264	5,085	589
Low Income	2,523,553	42,372	596
<b>Washington Total</b>	<b>9,188,898</b>	<b>141,241</b>	<b>651</b>

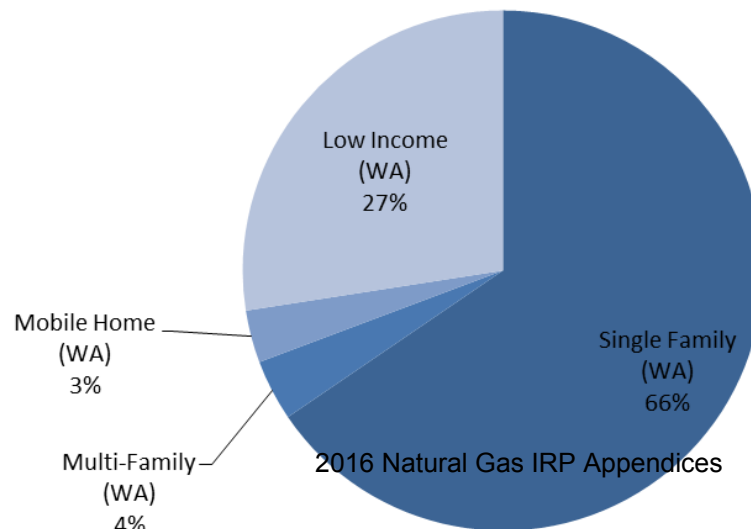

# Residential Market Profiles - Washington

Base-year annual energy use by segment and end use

Annual Use by End Use

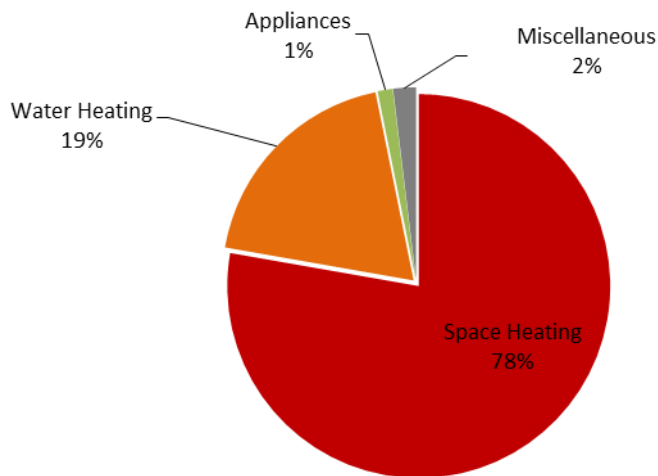

Annual Intensity for Average Household

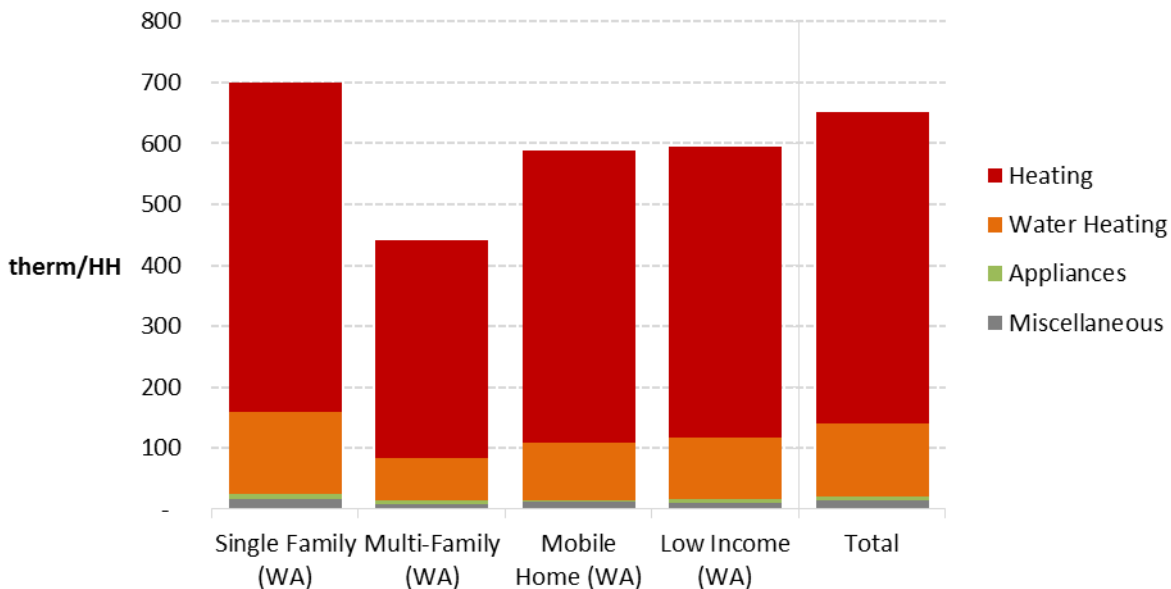

**Data Sources:**

- GenPOP Survey
- RBSA
- Utility billing data
- AEG Market Profiles Database
- Secondary data as needed to fill gaps

# Residential Energy Market Profile - Washington

- This market profile represents the residential sector as a whole. Individual segment market profiles are provided in the report.
- Saturations were developed using the GenPOP residential survey as the primary data source.

		Washington				
		Total				
Total Households:						141,241
		DTh				9,188,898
End Use	Technology	Saturation	UEC (Therms)	Intensity (Therms/	Usage (DTh)	
Space Heating	Furnace	88.2%	509.5	449.1	6,343,260	
Space Heating	Boiler	2.3%	609.8	13.8	194,390	
Space Heating	Other Heating	9.6%	488.4	46.8	661,509	
Water Heating	Water Heater	56.6%	211.0	119.4	1,686,433	
Appliances	Clothes Dryer	9.9%	27.3	2.7	38,181	
Appliances	Stove/Oven	8.5%	57.3	4.9	68,899	
Miscellaneous	Pool Heater	0.7%	217.5	1.6	22,019	
Miscellaneous	Miscellaneous	100.0%	12.3	12.3	174,206	
<b>Total</b>				<b>650.6</b>	<b>9,188,898</b>	

# Residential Baseline Projection - Washington

- Baseline projection provides foundation for estimating potential future savings from conservation initiatives and reflects
  - Household growth and electricity price forecasts (from Avista)
  - Appliance standards in place at end of 2015 (AEG database)
  - Frozen efficiency
  - Does not include future utility programs
- Baseline projection increases 38% between 2015 and 2036, or an average of 1.5% per year

**Residential Baseline Energy Projection (DTh)**

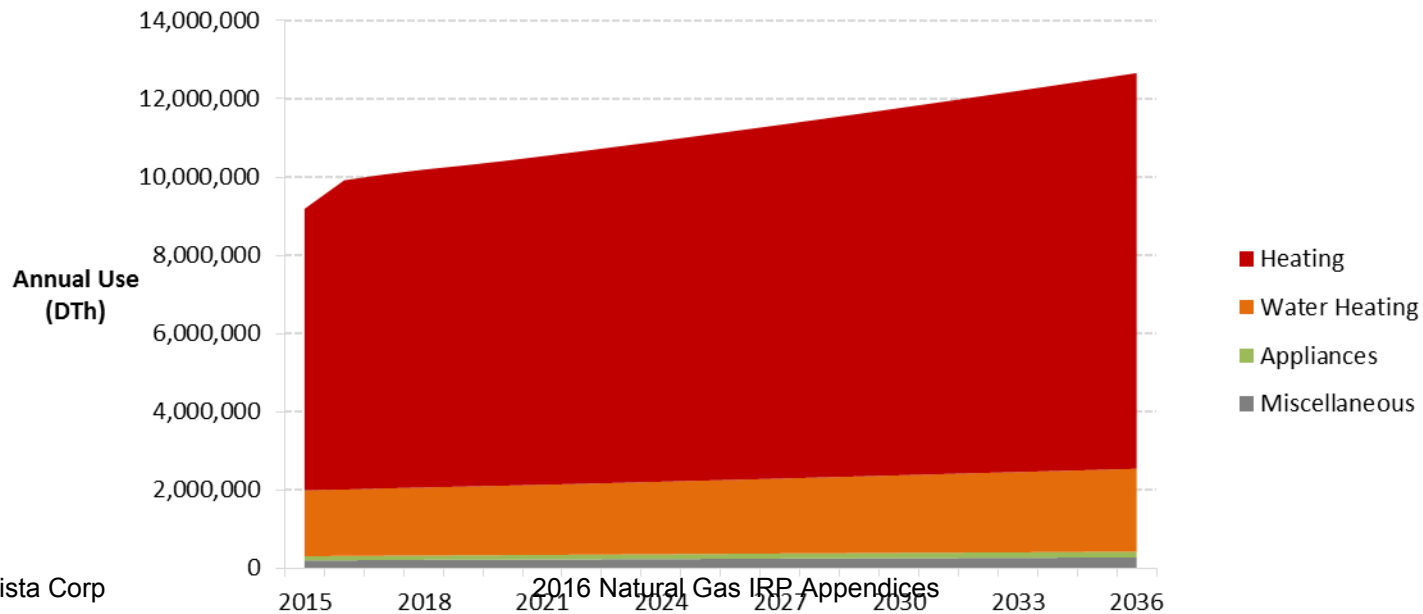

# Residential Savings Potential - Washington

From 2017 to 2018, cumulative achievable potential energy savings are 62,492 DTh or 0.6% of the baseline.

By 2036, cumulative savings are almost 10% of the baseline projection, or about 0.5% per year.

	2017	2018	2021	2026	2036
<b>Baseline Projection (DTh)</b>	<b>10,067,567</b>	<b>10,191,025</b>	<b>10,534,588</b>	<b>11,198,918</b>	<b>12,661,346</b>
<b>Cumulative Savings (DTh)</b>					
Achievable Potential	27,598	62,492	207,653	497,074	1,226,734
Economic Potential	132,960	267,157	678,668	1,382,067	2,721,626
Technical Potential	187,192	377,121	956,051	1,951,370	3,828,466
<b>Energy Savings (% of Baseline)</b>					
Achievable Potential	0.3%	0.6%	2.0%	4.4%	9.7%
Economic Potential	1.3%	2.6%	6.4%	12.3%	21.5%
Technical Potential	1.9%	3.7%	9.1%	17.4%	30.2%

Uses the UCT cost effectiveness test

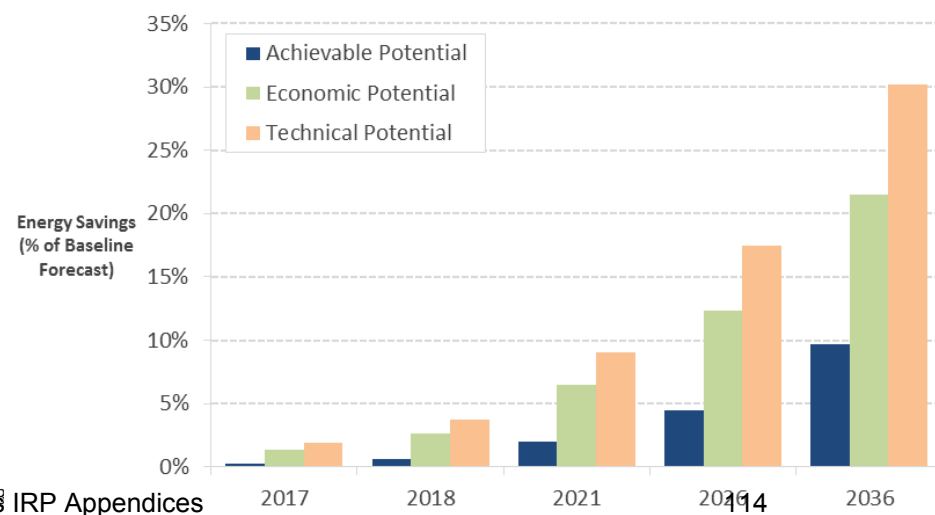
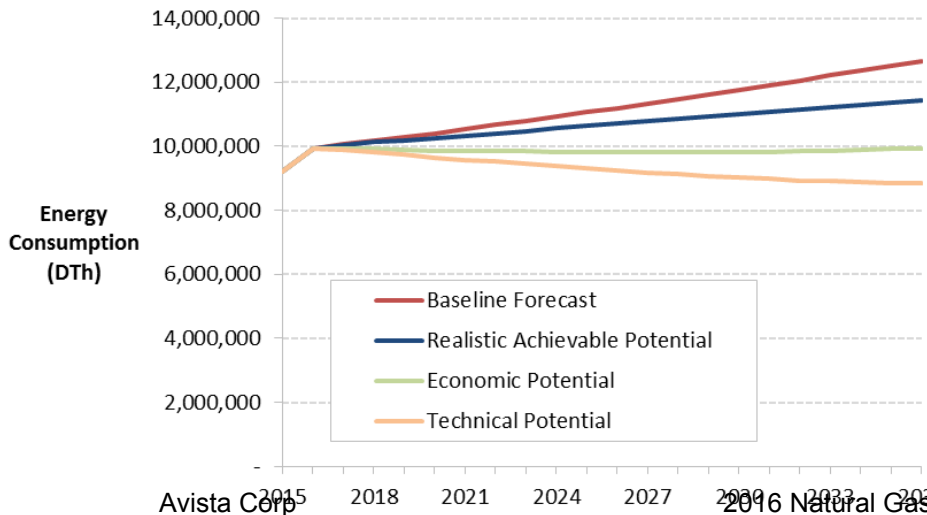

# Residential Savings Potential - Washington

Cumulative achievable potential in 2018

Cumulative Achievable Potential in 2018

Rank	Measure / Technology	2018 Achievable Savings (Cum. DTh)	% of Total
1	Windows - High Efficiency	20,516	32.8%
2	Heating – Furnace (EF 0.98)	19,873	31.8%
3	Furnace - Maintenance	4,025	6.4%
4	Water Heater - Low-Flow Showerheads	3,270	5.2%
5	Water Heater - Temperature Setback	2,983	4.8%
6	Insulation - Ceiling	2,914	4.7%
7	Ducting - Repair and Sealing	2,243	3.6%
8	Water Heating - Water Heater (EF 0.67)	1,831	2.9%
9	Thermostat - Programmable/Interactive	1,797	2.9%
10	Water Heater - Pipe Insulation	1,582	2.5%
11	Heating – Boiler (EF 0.98)	527	0.8%
12	Water Heater - Faucet Aerators	484	0.8%
13	Boiler - Maintenance	248	0.4%
14	Boiler - Pipe Insulation	199	0.3%
15	Insulation - Wall Sheathing	1	0.0%
	<b>Total</b>	<b>62,492</b>	<b>100%</b>

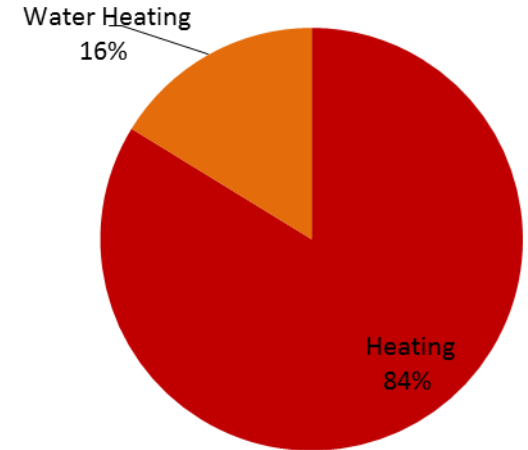

Cumulative Achievable Potential (DTh)

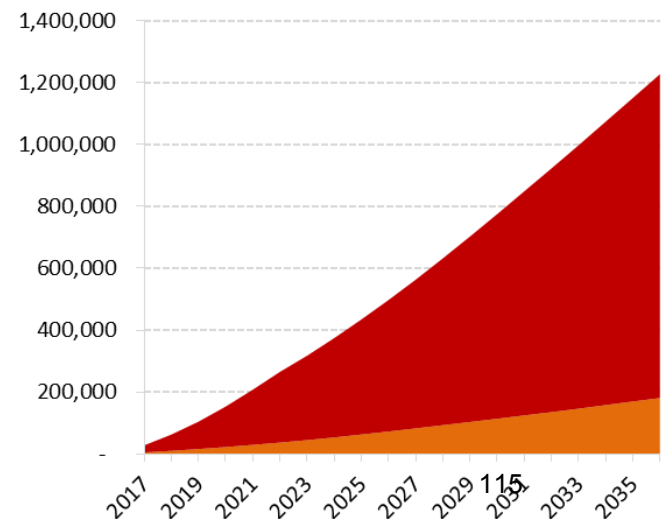

# Commercial Market Characterization - Washington

Washington	2015 Sales (DTh)	Floor Space (sq. ft.)	Intensity (therms/sqft)
Office	608,320	23,532,683	0.26
Restaurant	357,257	1,615,817	2.21
Retail	609,276	20,141,347	0.30
Grocery	253,760	4,311,977	0.59
School	472,964	11,620,730	0.41
College	439,038	5,467,474	0.80
Health	648,945	9,103,062	0.71
Lodging	353,904	6,773,279	0.52
Warehouse	272,231	13,377,462	0.20
Miscellaneous	1,719,065	32,222,397	0.53
<b>Washington Total</b>	<b>5,734,759</b>	<b>128,166,227</b>	<b>0.45</b>

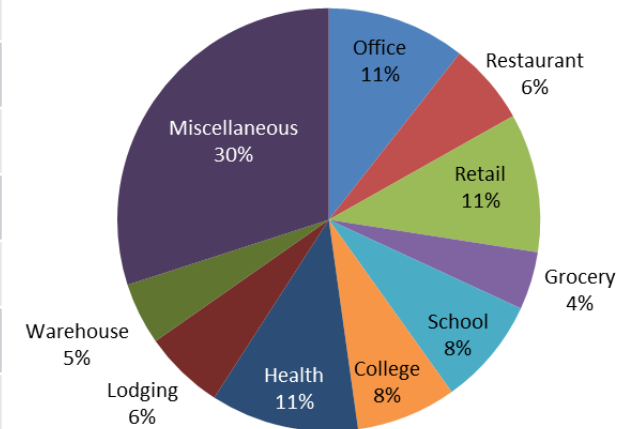



# Commercial Market Profiles - Washington

Base-year annual energy use by segment and end use

Annual Use by End Use

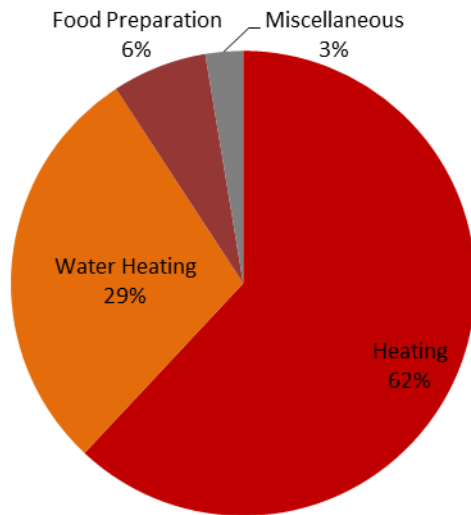

Annual Intensity per Square Foot

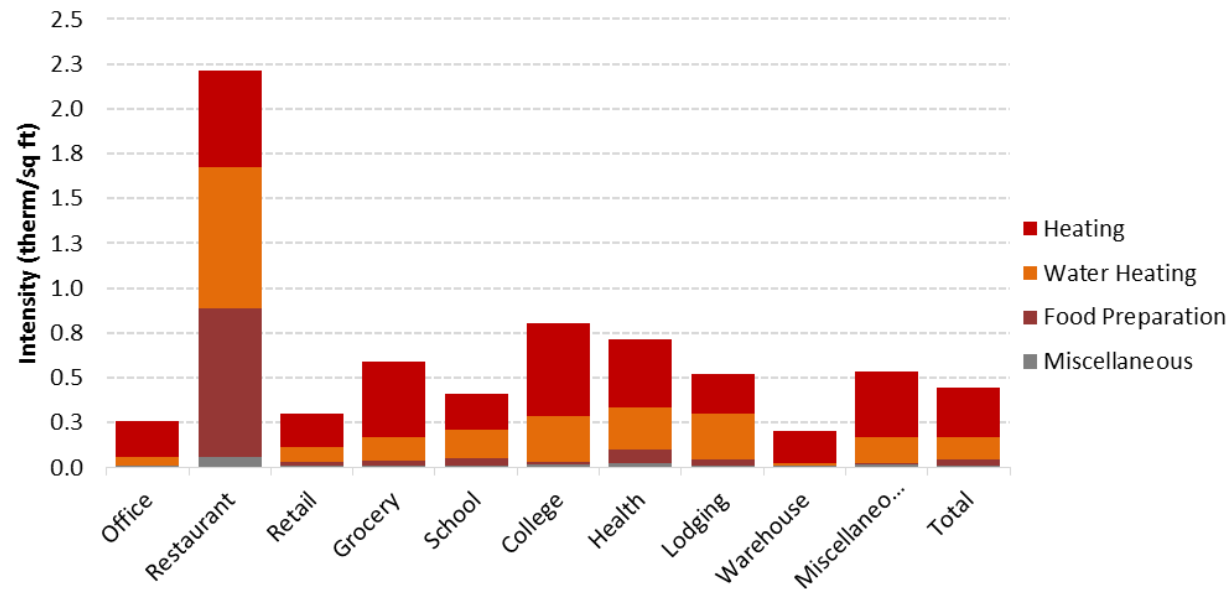

## Data Sources:

- CBSA
- Utility billing data
- AEG Market Profiles Database
- Secondary data as needed to fill gaps

# Commercial Energy Market Profile - Washington

- This market profile represents the Commercial sector as a whole. Individual segment market profiles are provided in the report.
- Saturations were developed using the CBSA survey as the primary data source.

## Gas Market Profiles

End Use	Technology	Saturation	EUI (therm)	Intensity (therm/Sqft)	Usage (DTh)
Heating	Furnace	54.3%	0.21	0.11	1,467,831
Heating	Boiler	33.1%	0.48	0.16	2,030,710
Heating	Unit Heater	4.7%	0.09	0.00	55,570
Water Heating	Water Heater	68.7%	0.19	0.13	1,651,292
Food Preparation	Oven	25.1%	0.02	0.00	56,768
Food Preparation	Fryer	7.5%	0.12	0.01	114,766
Food Preparation	Broiler	13.7%	0.04	0.01	67,939
Food Preparation	Griddle	16.7%	0.03	0.00	61,216
Food Preparation	Range	18.3%	0.03	0.01	69,753
Food Preparation	Steamer	2.0%	0.03	0.00	8,759
Food Preparation	Commercial Food Prep Other	0.1%	0.01	0.00	69
Miscellaneous	Pool Heater	0.9%	0.00	0.00	356
Miscellaneous	Other Miscellaneous	100.0%	0.01	0.01	149,731
<b>Total</b>				<b>0.45</b>	<b>5,734,759</b>

# Commercial Baseline Projection - Washington

- Baseline projection provides foundation for estimating potential future savings from conservation initiatives and reflects
  - Customer growth (from Avista)
  - Building Codes and appliance standards in place at end of 2015 (AEG database)
  - Frozen efficiency
  - Does not include future utility programs
- Baseline projection increases 23% between 2015 and 2036, or an average of 1% per year

Commercial Baseline Energy Projection (DTh)

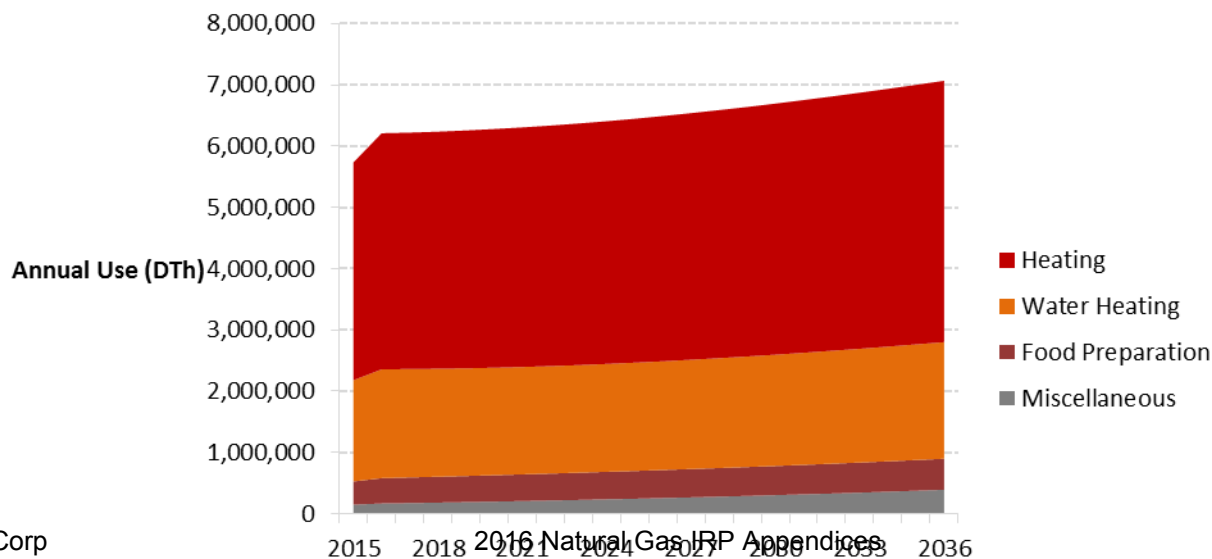

# Estimating Conservation Potential

- The study analyzed 100 measures covering residential, commercial and industrial sectors.
- Cost-effectiveness screening to estimate economic potential was done using utility cost test for Washington and Idaho, and using the TRC for Oregon
- Customer adoption or “ramp rates” are needed to estimate achievable potential. The study used regional ramp rates to start and then calibrated based on Avista’s program history
- The study uses AEG’s LoadMAP model to estimate potential

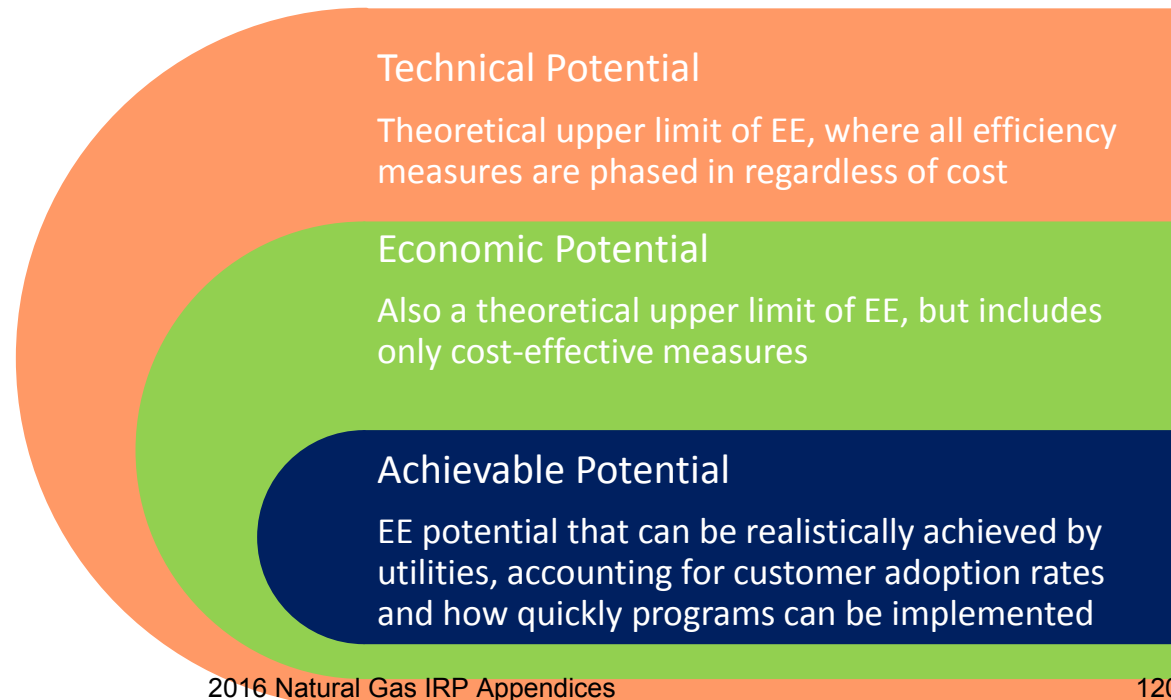

# Commercial Savings Potential - Washington

From 2017 to 2018, cumulative achievable potential energy savings are 53,246 DTh or 0.9% of the baseline.

By 2036, cumulative savings are over 12% of the baseline projection, or about 0.7% per year.

	2017	2018	2021	2026	2036
<b>Baseline Projection (DTh)</b>	<b>6,220,478</b>	<b>6,236,027</b>	<b>6,305,231</b>	<b>6,490,547</b>	<b>7,066,197</b>
<b>Cumulative Savings (DTh)</b>					
Achievable Potential	22,978	53,246	176,816	413,219	878,225
Economic Potential	70,810	140,765	339,275	637,762	1,124,744
Technical Potential	108,572	214,053	512,953	960,878	1,686,375
<b>Energy Savings (% of Baseline)</b>					
Achievable Potential	0.4%	0.9%	2.8%	6.4%	12.4%
Economic Potential	1.1%	2.3%	5.4%	9.8%	15.9%
Technical Potential	1.7%	3.4%	8.1%	14.8%	23.9%

Uses the UCT cost effectiveness test

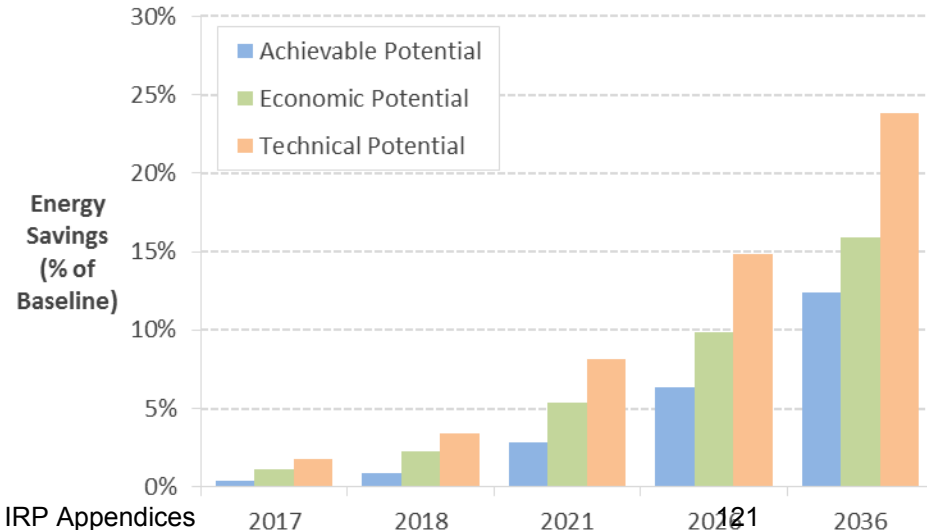
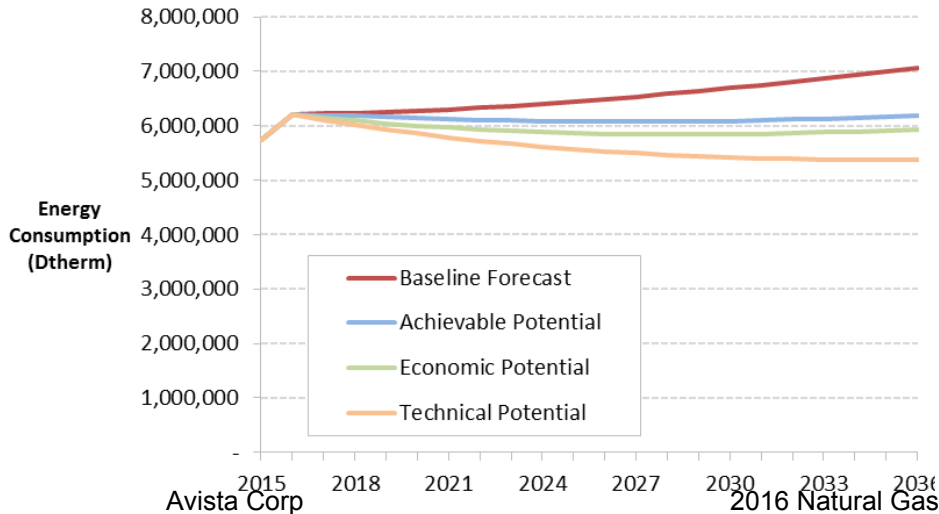

# Commercial Savings Potential - Washington

Cumulative achievable potential in 2018

Cumulative Achievable Potential in 2018

Rank	Measure / Technology	2018 Achievable Savings (Cum. DTh)	% of Total
1	Retrocommissioning	13,476	25.3%
2	Heating – Boiler (EF 0.96)	11,887	22.3%
3	Gas Boiler - Hot Water Reset	5,159	9.7%
4	Heating – Furnace (EF 0.96)	4,102	7.7%
5	Insulation - Ceiling	3,360	6.3%
6	Water Heating - Water Heater (Tankless)	2,826	5.3%
7	Water Heater - Faucet Aerators/Low Flow Nozzles	2,150	4.0%
8	Water Heater - Central Controls	1,979	3.7%
9	Strategic Energy Management	1,784	3.4%
10	Water Heater - Pre-Rinse Spray Valve	1,564	2.9%
11	Gas Boiler - Parallel Positioning Control	1,540	2.9%
12	Food Preparation – Fryer (ENERGY STAR)	740	1.4%
13	Steam Trap Maintenance	657	1.2%
14	Food Preparation - Oven (ENERGY STAR)	386	0.7%
15	HVAC - Shut Off Damper	304	0.6%
16	Food Preparation - Griddle (ENERGY STAR)	235	0.4%
17	Windows - High Efficiency	223	0.4%
18	Water Heater - Pipe Insulation	204	0.4%
19	Food Preparation - Steamer (ENERGY STAR)	184	0.3%
20	Heating - Unit Heater (Condensing)	171	0.3%
<b>Total</b>		<b>52,973</b>	<b>99.4%</b>

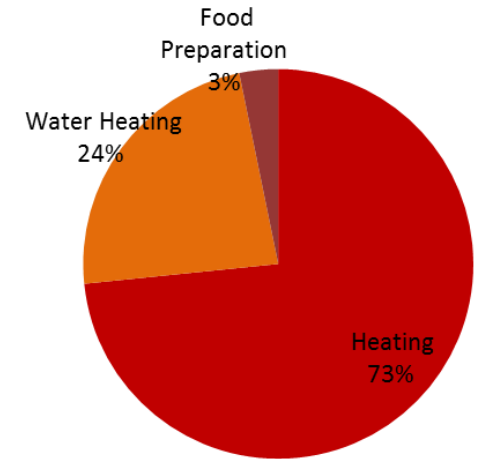

Cumulative Achievable Potential (DTh)

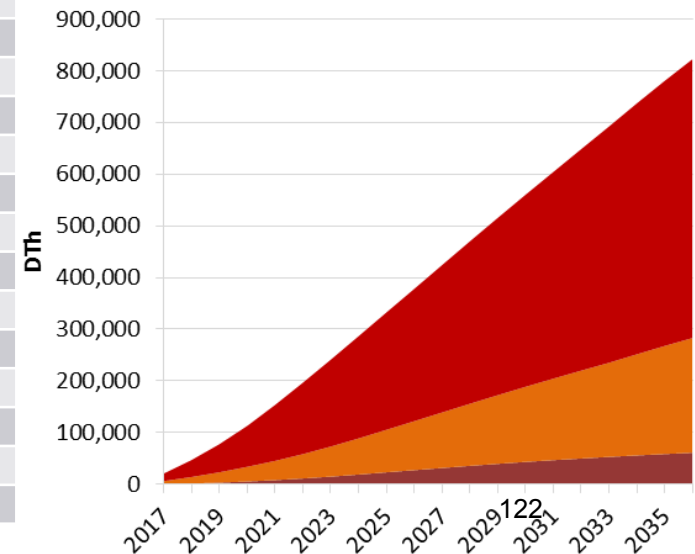

AVC Corp 2016 Natural Gas Efficiency Appendices

# Industrial Energy Market Profile - Washington

- This market profile represents the Industrial sector as a whole. The industrial sector is not large enough to warrant further segmentation.

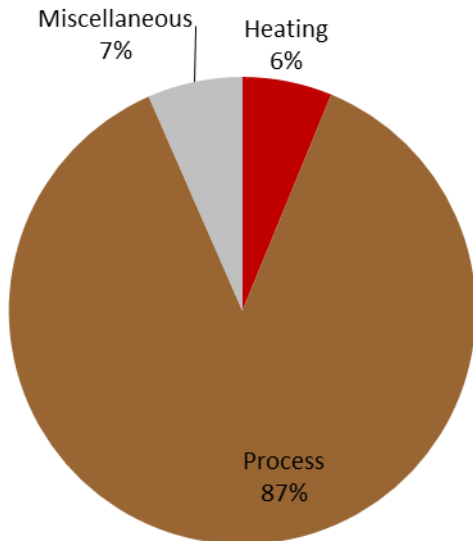

## Washington Industrial

Total Sq Ft: 3,567,948

DTh 268,452

End Use	Technology	Saturation	EUI (Therms)	Intensity (Therms/sqft)	Usage (Dth)
Space Heating	Furnace	56.5%	0.028	0.02	5,563
Space Heating	Boiler	34.4%	0.089	0.03	10,891
Space Heating	Other Heating	4.9%	0.014	0.00	239
Process	Process Heating	100.0%	0.369	0.37	131,596
Process	Process Boiler	100.0%	0.282	0.28	100,538
Process	Process Cooling	100.0%	0.001	0.00	407
Process	Other Process	100.0%	0.004	0.00	1,580
Other	Other Uses	100.0%	0.049	0.05	17,638
<b>Total</b>				<b>0.75</b>	<b>268,452</b>

# Industrial Baseline Projection - Washington

- Baseline projection provides foundation for estimating potential future savings from conservation initiatives and reflects
  - Customer growth (from Avista)
  - Building Codes and appliance standards in place at end of 2015 (AEG database)
  - Frozen efficiency
  - Does not include future utility programs
- Baseline projection increases 35% between 2015 and 2036, or an average of 1.4% per year

Industrial Baseline Energy Projection (DTh)

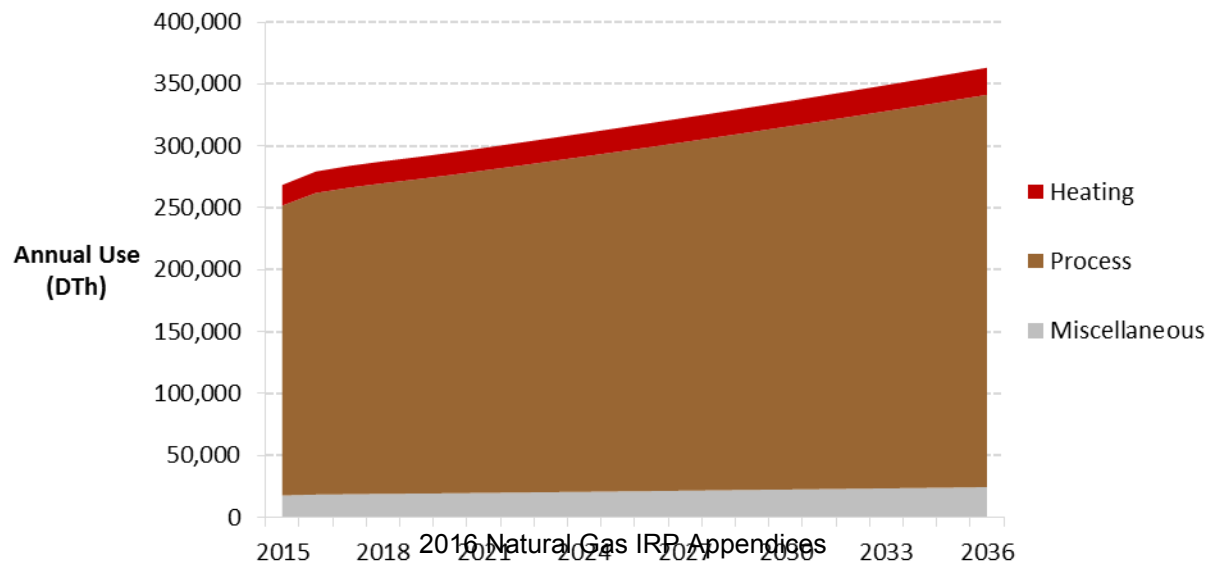



# Industrial Savings Potential - Washington

From 2017 to 2018, cumulative achievable potential energy savings are 777 DTh or 0.3% of the baseline.

By 2036, cumulative savings are 2.3% of the baseline projection, or about 0.1% per year.

Uses the UCT cost effectiveness test

	2017	2018	2021	2026	2036
<b>Baseline Projection (DTh)</b>	<b>283,824</b>	<b>287,571</b>	<b>298,345</b>	<b>318,546</b>	<b>363,144</b>
<b>Cumulative Savings (DTh)</b>					
Achievable Potential	383	777	1,993	4,050	8,414
Economic Potential	876	1,757	4,413	8,941	18,457
Technical Potential	3,195	6,425	16,314	33,603	71,042
<b>Energy Savings (% of Baseline)</b>					
Achievable Potential	0.1%	0.3%	0.7%	1.3%	2.3%
Economic Potential	0.3%	0.6%	1.5%	2.8%	5.1%
Technical Potential	1.1%	2.2%	5.5%	10.5%	19.6%

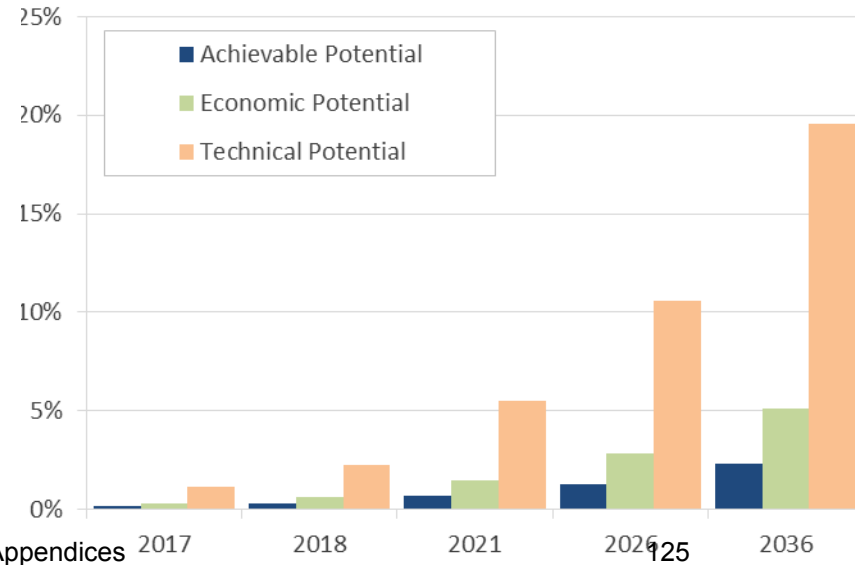
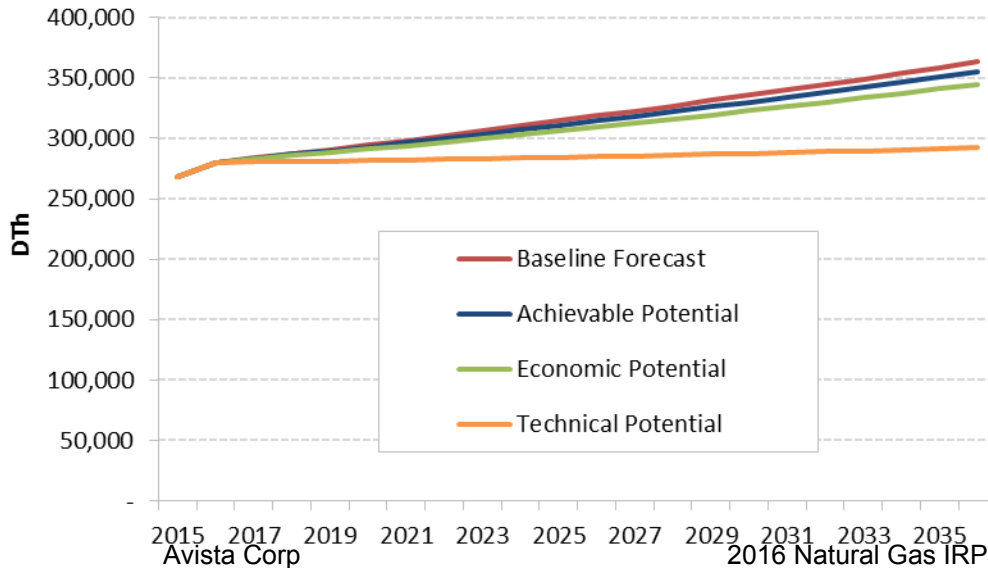

Avista Corp

2016 Natural Gas IRP Appendices

125

# Industrial Savings Potential - Washington

Cumulative achievable potential in 2018

Cumulative Achievable Potential in 2018

Rank	Measure / Technology	2018 Achievable Savings (Cum. DTh)	% of Total
1	Custom	415	53.5%
2	Boiler - Hot Water Reset	205	26.4%
3	Boiler - Parallel Positioning Control	97	12.5%
4	Boiler - Maintenance	46	5.9%
5	Steam Trap Maintenance	11	1.5%
6	Gas Furnace - Maintenance	2	0.3%
	<b>Total</b>	<b>777</b>	<b>100.0%</b>

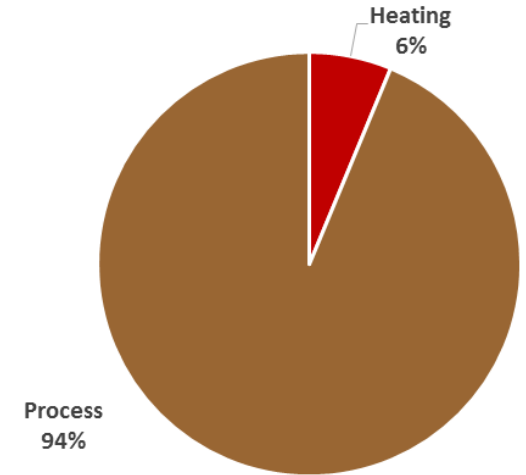

Cumulative Achievable Potential (DTh)

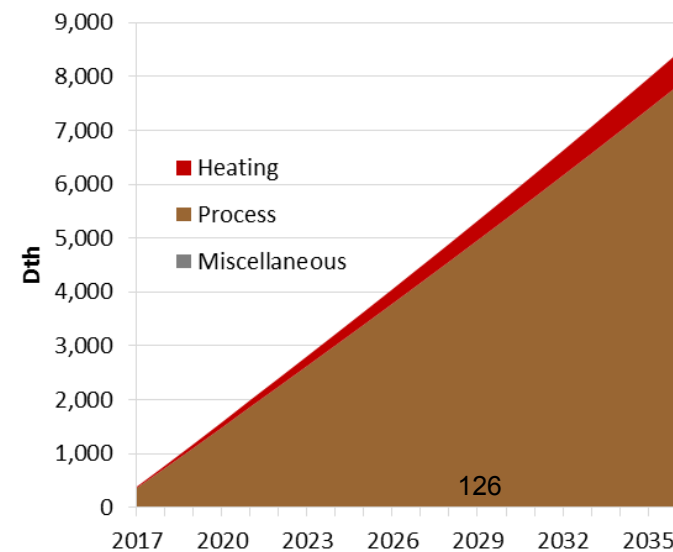

Idaho

# High-level Market Characterization - Idaho

2015 Natural Gas Sales by Sector

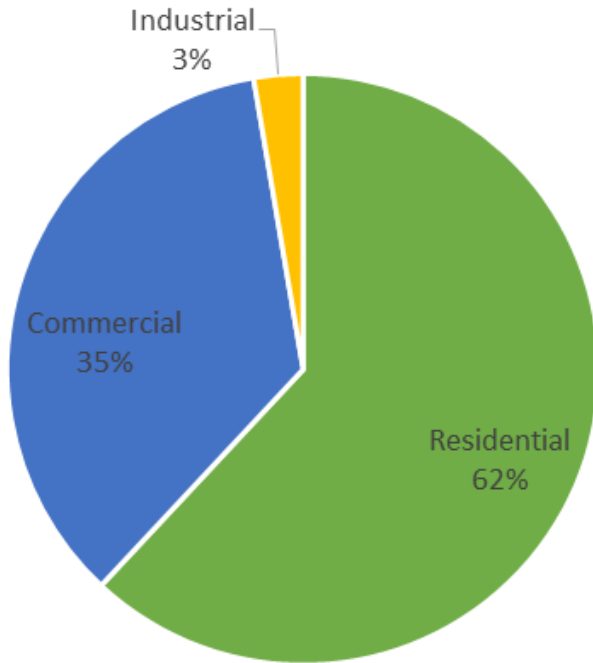

Segment	Annual Sales (DTh)	% of Sales
Residential	4,304,740	62%
Commercial	2,456,621	35%
Industrial	187,203	3%
<b>Total</b>	<b>6,948,564</b>	<b>100%</b>

# Residential Market Characterization - Idaho

Idaho	2015 Sales (DTh)	# of Customers	Average Use per Household (Therms/HH)
Single Family	2,814,373	42,852	657
Multifamily	142,894	3,454	414
Mobile Home	174,973	3,172	552
Low Income	1,172,501	21,003	558
<b>Idaho Total</b>	<b>4,304,740</b>	<b>70,481</b>	<b>611</b>

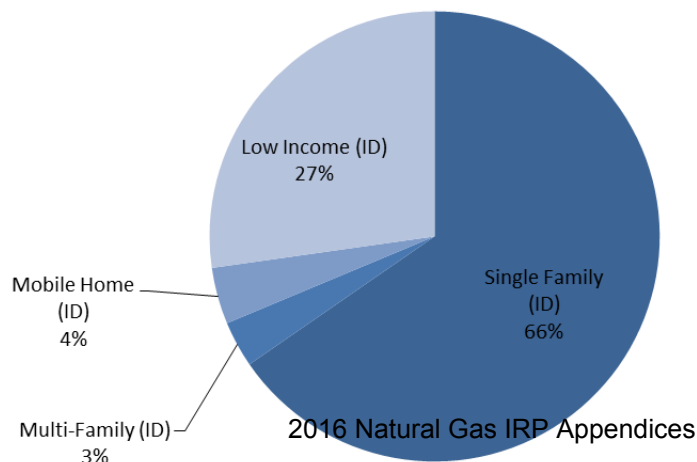

# Residential Market Profiles - Idaho

Base-year annual energy use by segment and end use

Annual Use by End Use

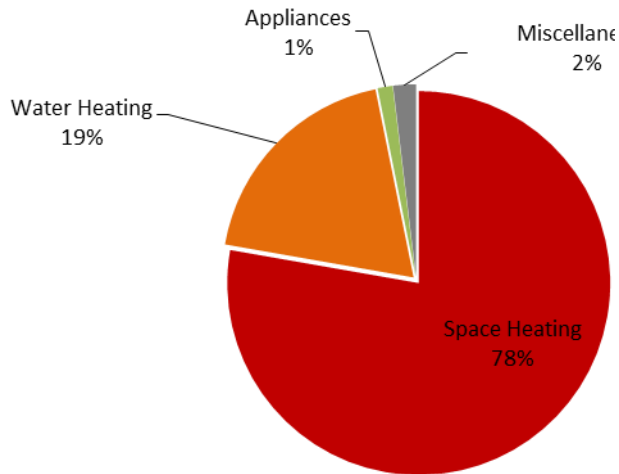

Annual Intensity for Average Household

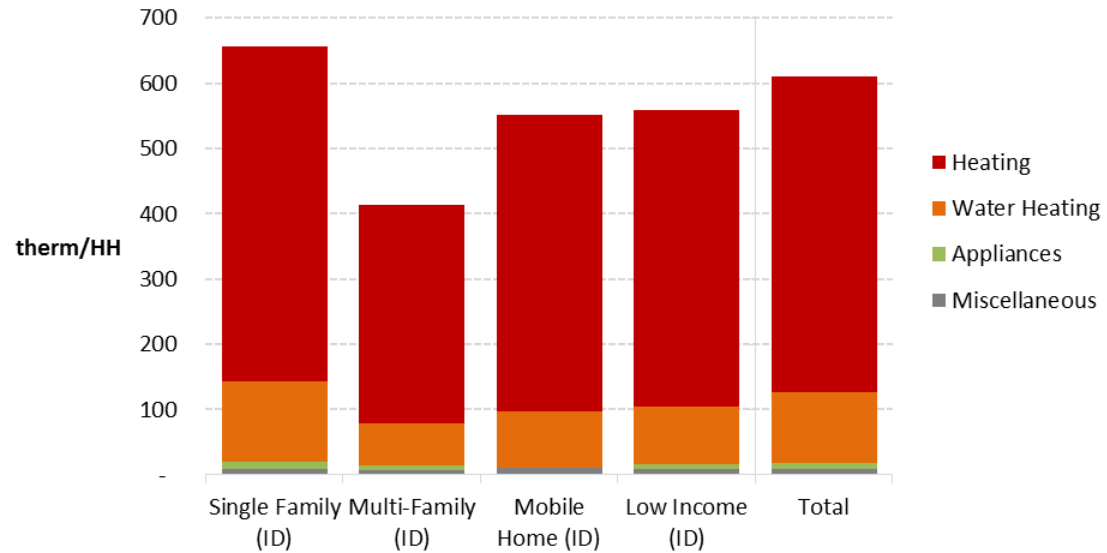

**Data Sources:**

- GenPOP Survey
- RBSA
- Utility billing data
- AEG Market Profiles Database
- Secondary data as needed to fill gaps

# Residential Energy Market Profile - Idaho

- This market profile represents the residential sector as a whole. Individual segment market profiles are provided in the report.
- Saturations were developed using the GenPOP residential survey as the primary data source.

		Idaho				
		Total				
Total Households:						70,481
		DTh				4,304,740
End Use	Technology	Saturation	UEC (Therms)	Intensity (Therms/	Usage (DTh)	
Space Heating	Furnace	84.2%	484.5	407.8	2,873,917	
Space Heating	Boiler	2.0%	579.2	11.8	83,322	
Space Heating	Other Heating	13.8%	466.4	64.4	453,852	
Water Heating	Water Heater	54.3%	200.8	109.1	768,890	
Appliances	Clothes Dryer	9.2%	29.0	2.7	18,876	
Appliances	Stove/Oven	9.2%	60.1	5.5	39,043	
Miscellaneous	Pool Heater	0.3%	217.4	0.6	4,134	
Miscellaneous	Miscellaneous	100.0%	8.9	8.9	62,706	
<b>Total</b>				<b>610.8</b>	<b>4,304,740</b>	

# Residential Baseline Projection - Idaho

- Baseline projection provides foundation for estimating potential future savings from conservation initiatives and reflects
  - Household growth and electricity price forecasts (from Avista)
  - Appliance standards in place at end of 2015 (AEG database)
  - Frozen efficiency
  - Does not include future utility programs
- Baseline projection increases 44% between 2015 and 2036, or an average of 1.7% per year

**Residential Baseline Energy Projection (DTh)**

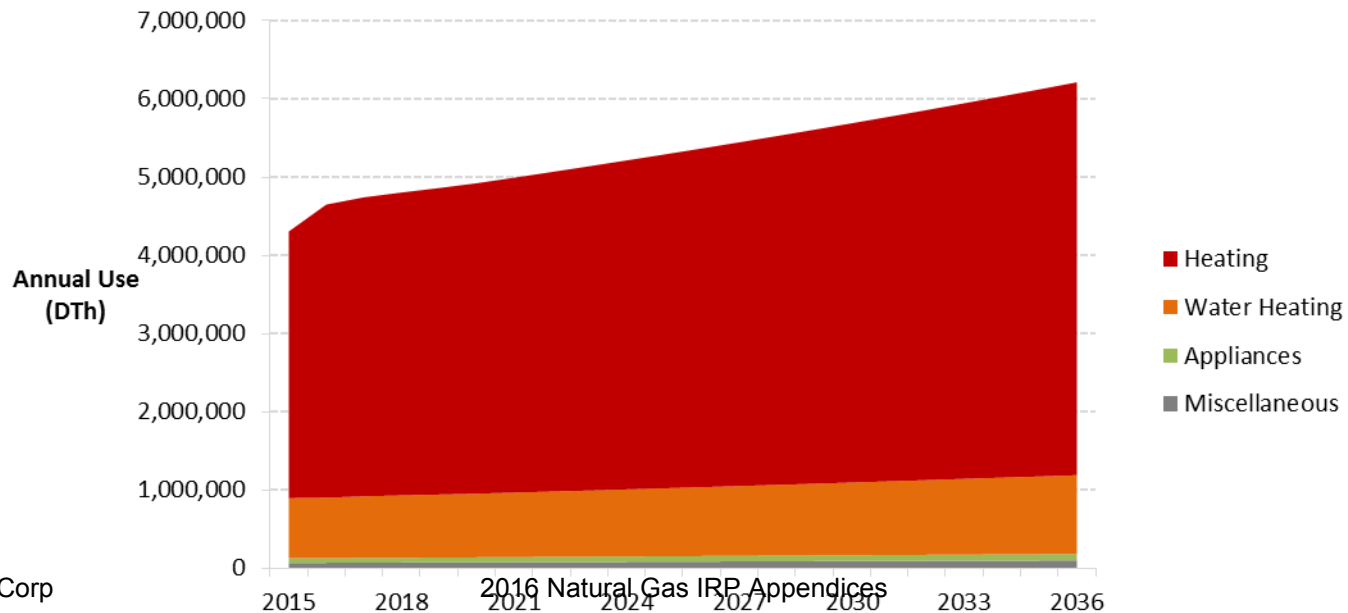



# Residential Savings Potential - Idaho

From 2017 to 2018, cumulative achievable potential energy savings are 62,492 DTh or 0.6% of the baseline.

By 2036, cumulative savings are almost 10% of the baseline projection, or about 0.5% per year.

	2017	2018	2021	2026	2036
<b>Baseline Projection (DTh)</b>	<b>4,741,736</b>	<b>4,802,813</b>	<b>4,992,555</b>	<b>5,366,588</b>	<b>6,213,091</b>
<b>Cumulative Savings (DTh)</b>					
Achievable Potential	11,138	25,406	85,812	208,875	536,817
Economic Potential	53,686	108,042	276,801	577,890	1,198,833
Technical Potential	82,162	165,579	422,556	873,781	1,776,196
<b>Energy Savings (% of Baseline)</b>					
Achievable Potential	0.2%	0.5%	1.7%	3.9%	8.6%
Economic Potential	1.1%	2.2%	5.5%	10.8%	19.3%
Technical Potential	1.7%	3.4%	8.5%	16.3%	28.6%

Uses the UCT cost effectiveness test

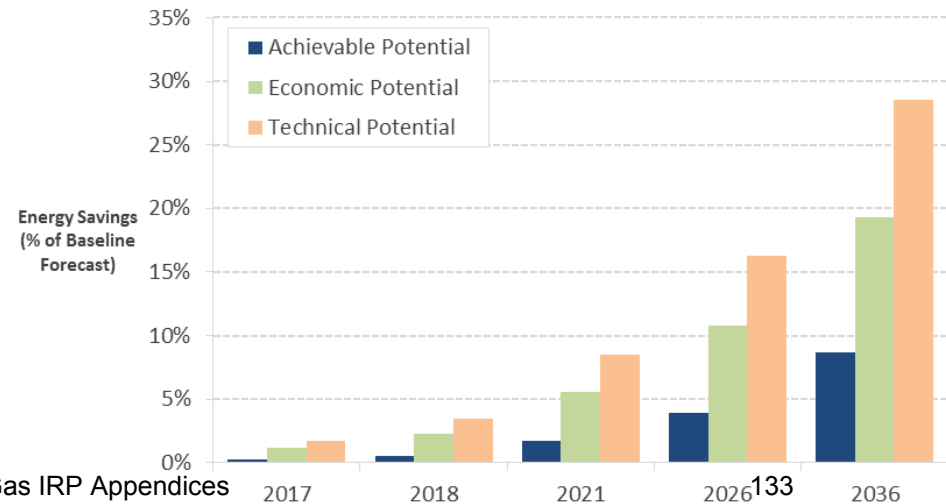
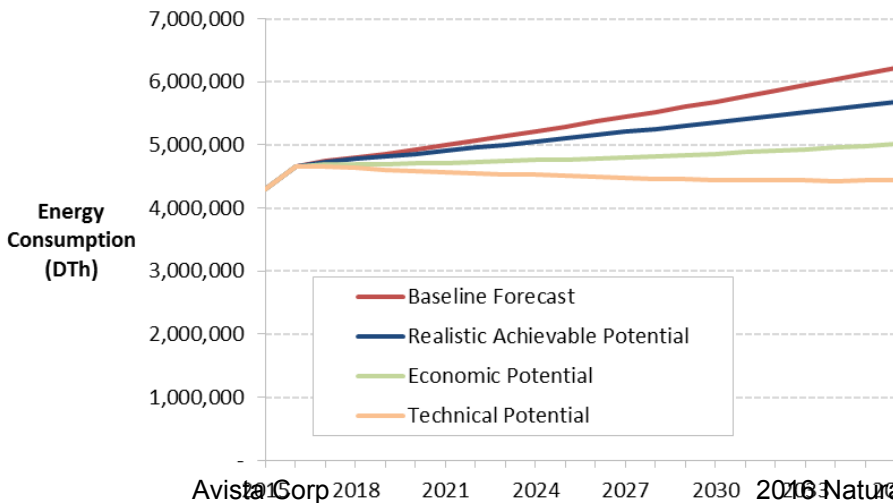

# Residential Savings Potential - Idaho

Cumulative achievable potential in 2018

Rank	Measure / Technology	2018 Achievable Savings (Cum. DTh)	% of Total
1	Windows - High Efficiency	9,778	38.5%
2	Heating – Furnace (EF 0.98)	6,692	26.3%
3	Furnace - Maintenance	1,821	7.2%
4	Water Heater - Low-Flow Showerheads	1,480	5.8%
5	Insulation - Ceiling	1,379	5.4%
6	Water Heater - Temperature Setback	1,365	5.4%
7	Thermostat - Programmable/Interactive	861	3.4%
8	Water Heater - Pipe Insulation	725	2.9%
9	Water Heating - Water Heater (EF 0.67)	660	2.6%
10	Heating – Boiler (EF 0.98)	235	0.9%
11	Water Heater - Faucet Aerators	219	0.9%
12	Boiler - Maintenance	106	0.4%
13	Boiler - Pipe Insulation	86	0.3%
	<b>Total</b>	<b>25,406</b>	<b>100%</b>

Cumulative Achievable Potential in 2018

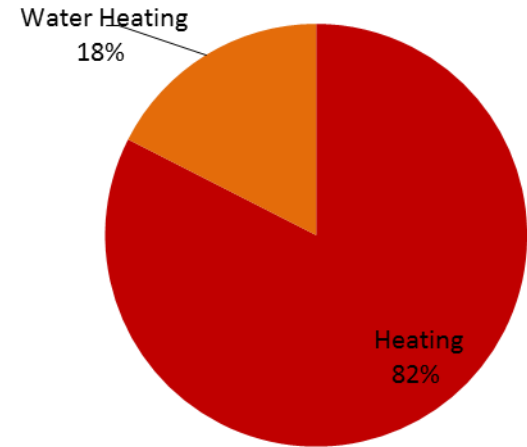

Cumulative Achievable Potential (DTh)

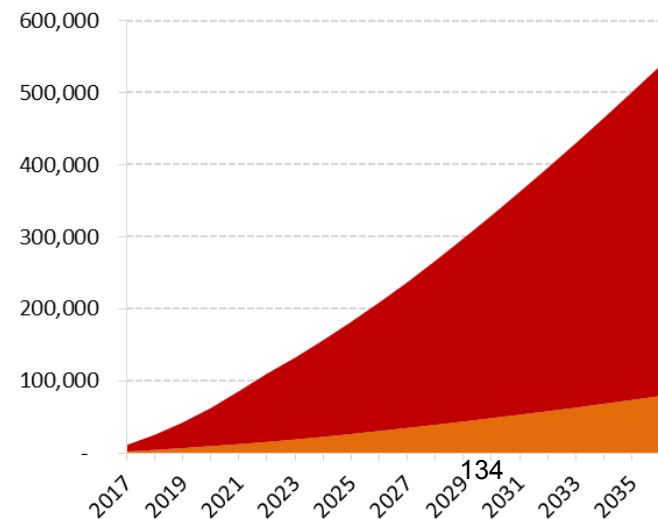

# Commercial Market Characterization - Idaho

Idaho	2015 Sales (DTh)	Floor Space (sq. ft.)	Intensity (therms/sqft)
Office	214,228	8,388,655	0.26
Restaurant	55,373	253,503	2.18
Retail	314,742	10,531,910	0.30
Grocery	97,810	1,682,340	0.58
School	387,333	9,633,126	0.40
College	360,160	4,540,014	0.79
Health	222,359	3,157,269	0.70
Lodging	135,614	2,627,216	0.52
Warehouse	110,269	5,484,890	0.20
Miscellaneous	558,735	10,601,048	0.53
<b>Idaho Total</b>	<b>2,456,621</b>	<b>56,899,971</b>	<b>0.43</b>

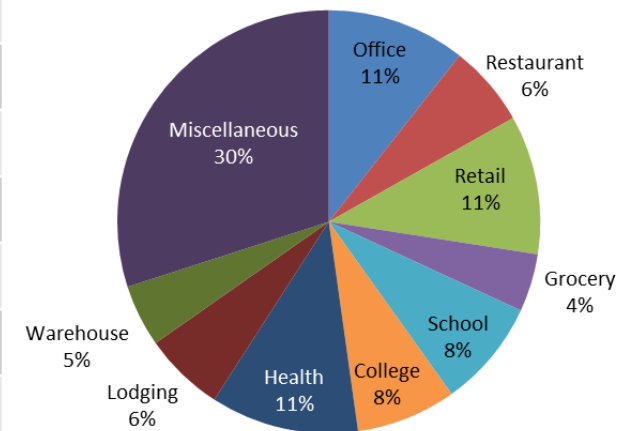

# Commercial Market Profiles - Idaho

Base-year annual energy use by segment and end use

Annual Use by End Use

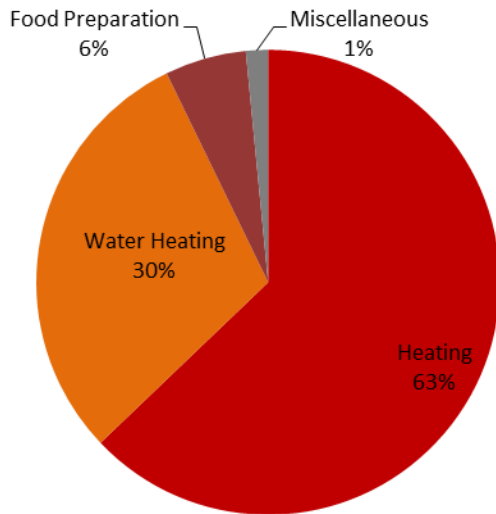

Annual Intensity per Square Foot

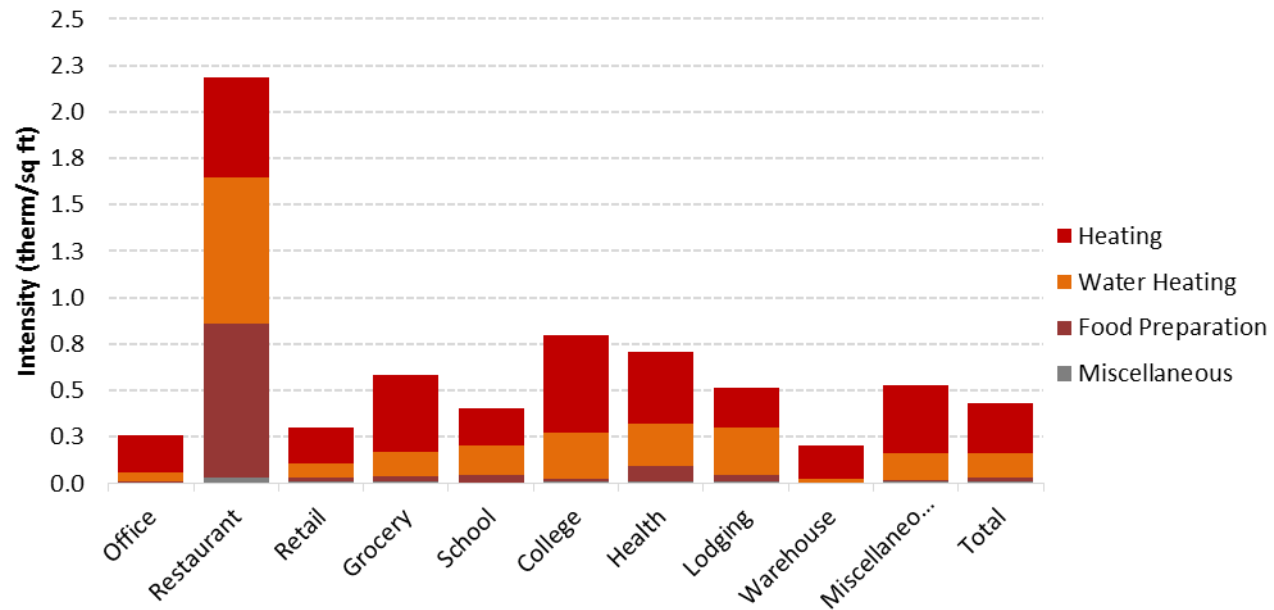

**Data Sources:**

- CBSA
- Utility billing data
- AEG Market Profiles Database
- Secondary data as needed to fill gaps

# Commercial Energy Market Profile - Idaho

- This market profile represents the Commercial sector as a whole. Individual segment market profiles are provided in the report.
- Saturations were developed using the CBSA survey as the primary data source.

## Gas Market Profiles

End Use	Technology	Saturation	EUI (therm)	Intensity (therm/Sqft)	Usage (DTh)
Heating	Furnace	51.2%	0.20	0.10	588,380
Heating	Boiler	36.0%	0.45	0.16	930,819
Heating	Unit Heater	4.9%	0.09	0.00	25,385
Water Heating	Water Heater	69.3%	0.19	0.13	734,648
Food Preparation	Oven	24.5%	0.02	0.00	27,505
Food Preparation	Fryer	7.7%	0.09	0.01	40,765
Food Preparation	Broiler	14.0%	0.03	0.00	22,933
Food Preparation	Griddle	16.3%	0.02	0.00	20,023
Food Preparation	Range	18.3%	0.02	0.00	23,972
Food Preparation	Steamer	3.0%	0.02	0.00	4,249
Food Preparation	Commercial Food Prep Other	0.1%	0.00	0.00	29
Miscellaneous	Pool Heater	0.8%	0.00	0.00	119
Miscellaneous	Other Miscellaneous	100.0%	0.01	0.01	37,793
<b>Total</b>				<b>0.43</b>	<b>2,456,621</b>

# Commercial Baseline Projection - Idaho

- Baseline projection provides foundation for estimating potential future savings from conservation initiatives and reflects
  - Customer growth (from Avista)
  - Building Codes and appliance standards in place at end of 2015 (AEG database)
  - Frozen efficiency
  - Does not include future utility programs
- Baseline projection increases 23% between 2015 and 2036, or an average of 1% per year

**Commercial Baseline Energy Projection (DTh)**

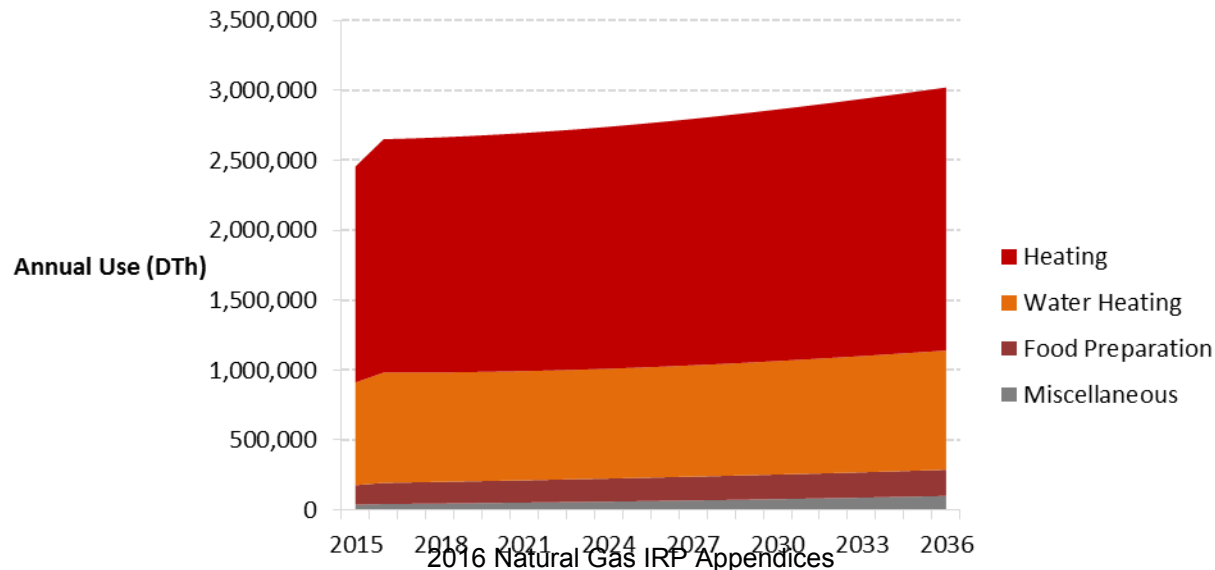

# Commercial Savings Potential - Idaho

From 2017 to 2018, cumulative achievable potential energy savings are 21,619 DTh or 0.8% of the baseline.

By 2036, cumulative savings are almost 12% of the baseline projection, or about 0.6% per year.

	2017	2018	2021	2026	2036
<b>Baseline Projection (DTh)</b>	<b>2,656,853</b>	<b>2,664,007</b>	<b>2,695,763</b>	<b>2,776,753</b>	<b>3,021,253</b>
<b>Cumulative Savings (DTh)</b>					
Achievable Potential	9,311	21,619	72,680	170,883	359,503
Economic Potential	29,135	58,035	140,114	263,474	459,135
Technical Potential	47,785	94,237	226,002	423,332	744,715
<b>Energy Savings (% of Baseline)</b>					
Achievable Potential	0.4%	0.8%	2.7%	6.2%	11.9%
Economic Potential	1.1%	2.2%	5.2%	9.5%	15.2%
Technical Potential	1.8%	3.5%	8.4%	15.2%	24.6%

Uses the UCT cost effectiveness test

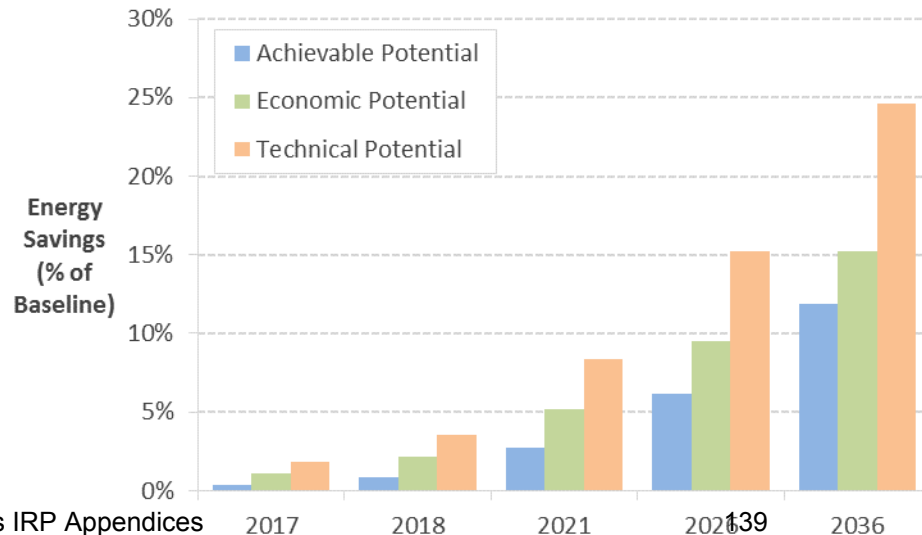
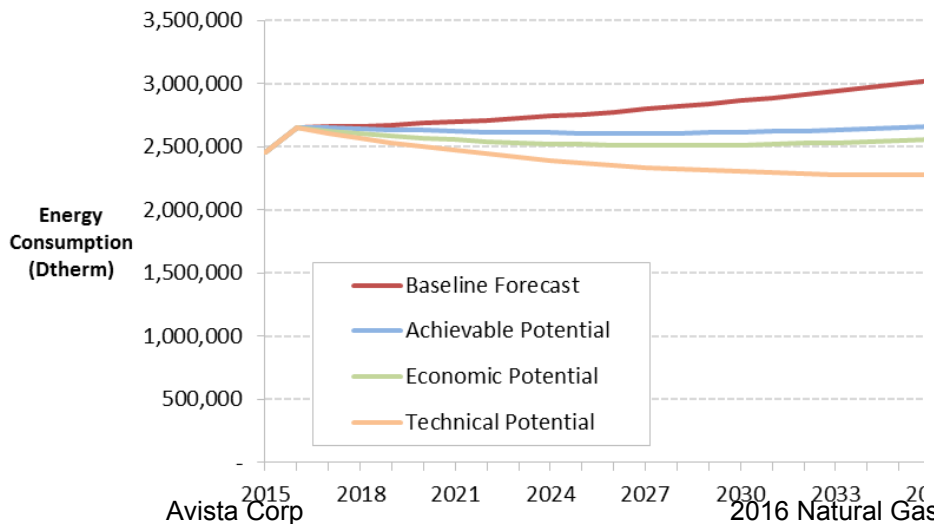

# Commercial Savings Potential - Idaho

Cumulative achievable potential in 2018

Cumulative Achievable Potential in 2018

Rank	Measure / Technology	2018 Achievable Savings (Cum. DTh)	% of Total
1	Retrocommissioning	5,761	26.6%
2	Heating – Boiler (EF 0.96)	4,812	22.3%
3	Gas Boiler - Hot Water Reset	2,364	10.9%
4	Heating – Furnace (EF 0.96)	1,919	8.9%
5	Water Heating - Water Heater (Tankless)	1,343	6.2%
6	Insulation - Ceiling	1,105	5.1%
7	Water Heater - Faucet Aerators/Low Flow Nozzles	955	4.4%
8	Water Heater - Central Controls	892	4.1%
9	Water Heater - Pre-Rinse Spray Valve	631	2.9%
10	Gas Boiler - Parallel Positioning Control	598	2.8%
11	Steam Trap Maintenance	294	1.4%
12	Food Preparation – Fryer (ENERGY STAR)	264	1.2%
13	Food Preparation – Oven (ENERGY STAR)	188	0.9%
14	Water Heater - Pipe Insulation	91	0.4%
15	Food Preparation - Steamer (ENERGY STAR)	90	0.4%
16	Food Preparation - Griddle (ENERGY STAR)	77	0.4%
17	Windows - High Efficiency	77	0.4%
18	Food Preparation - Broiler (ENERGY STAR)	55	0.3%
19	Heating - Unit Heater (Condensing)	47	0.2%
20	HVAC - Duct Repair and Sealing	27	0.1%
<b>Total</b>		<b>21,592</b>	<b>99.9%</b>

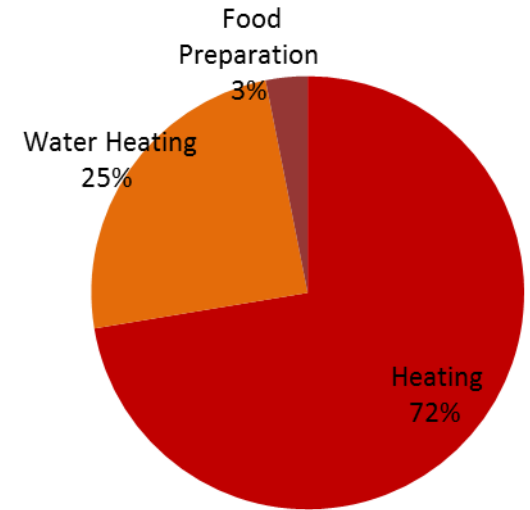

Cumulative Achievable Potential (DTh)

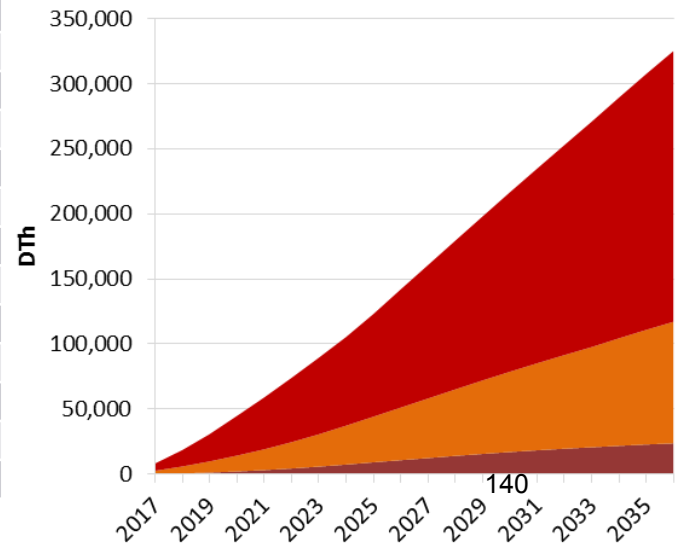

2016 Natural Gas Utility Appendices



# Industrial Energy Market Profile - Idaho

- This market profile represents the Industrial sector as a whole. The industrial sector is not large enough to warrant further segmentation.

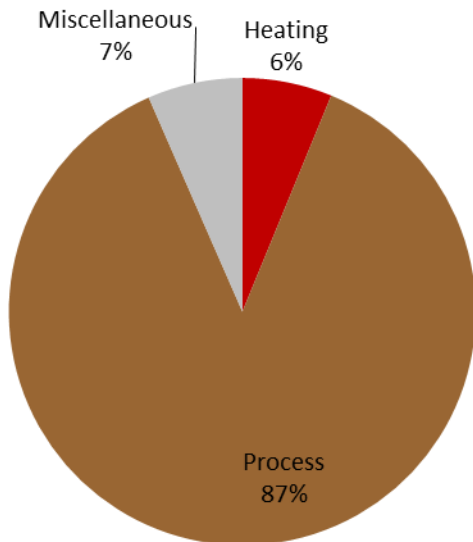

**Idaho  
Industrial**

Total Sq Ft: **2,596,257**

---

DTh **187,203**

---

End Use	Technology	Saturation	EUI (Therms)	Intensity (Therms/sqft)	Usage (Dth)
Space Heating	Furnace	56.5%	0.026	0.01	3,879
Space Heating	Boiler	34.4%	0.085	0.03	7,595
Space Heating	Other Heating	4.9%	0.013	0.00	167
Process	Process Heating	100.0%	0.353	0.35	91,768
Process	Process Boiler	100.0%	0.270	0.27	70,109
Process	Process Cooling	100.0%	0.001	0.00	284
Process	Other Process	100.0%	0.004	0.00	1,102
Other	Other Uses	100.0%	0.047	0.05	12,299
<b>Total</b>				<b>0.72</b>	<b>187,203</b>

# Industrial Baseline Projection - Idaho

- Baseline projection provides foundation for estimating potential future savings from conservation initiatives and reflects
  - Customer growth (from Avista)
  - Building Codes and appliance standards in place at end of 2015 (AEG database)
  - Frozen efficiency
  - Does not include future utility programs
- Baseline projection increases 70% between 2015 and 2036, or an average of 2.5% per year

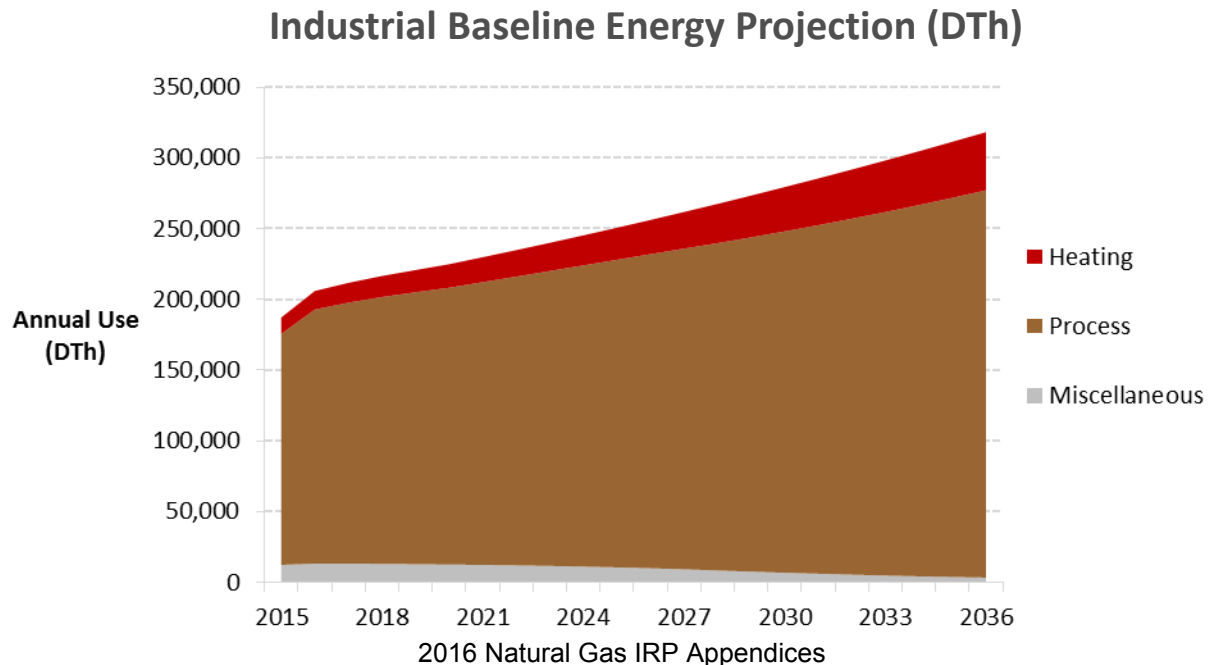

# Industrial Savings Potential - Idaho

From 2017 to 2018, cumulative achievable potential energy savings are 641 DTh or 0.3% of the baseline.

By 2036, cumulative savings are 4.3% of the baseline projection, or about 0.1% per year.

	2017	2018	2021	2026	2036
<b>Baseline Projection (DTh)</b>	<b>211,629</b>	<b>216,490</b>	<b>229,739</b>	<b>256,083</b>	<b>318,182</b>
<b>Cumulative Savings (DTh)</b>					
Achievable Potential	306	641	1,809	4,411	13,717
Economic Potential	700	1,450	4,005	9,723	29,846
Technical Potential	2,446	5,049	13,661	31,578	81,807
<b>Energy Savings (% of Baseline)</b>					
Achievable Potential	0.1%	0.3%	0.8%	1.7%	4.3%
Economic Potential	0.3%	0.7%	1.7%	3.8%	9.4%
Technical Potential	1.2%	2.3%	5.9%	12.3%	25.7%

Uses the UCT cost effectiveness test

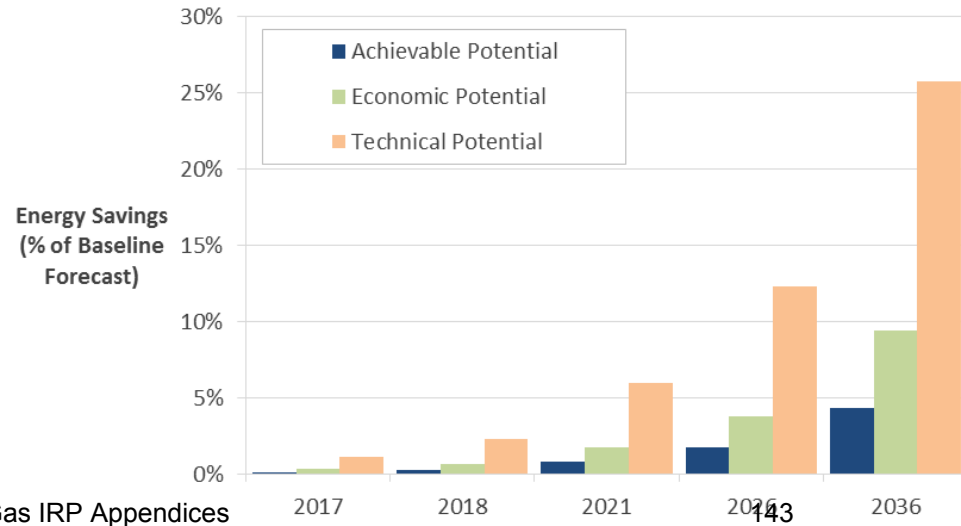
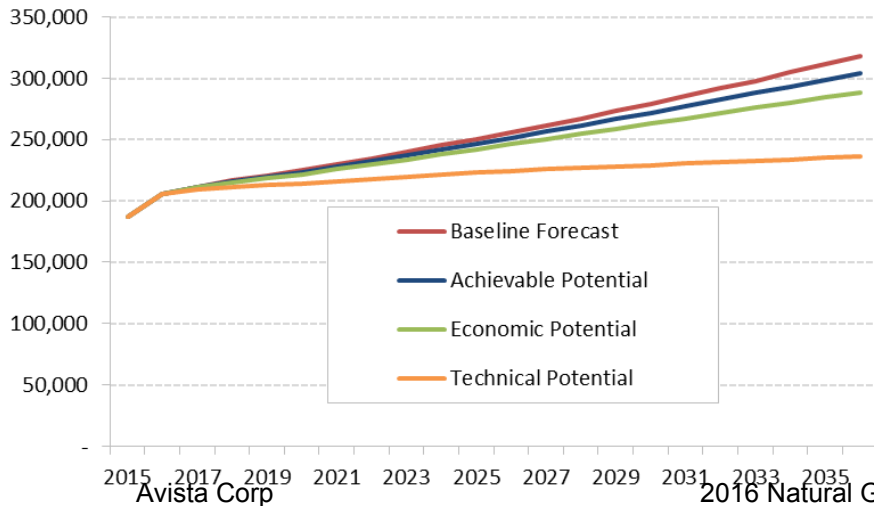

# Industrial Savings Potential- Idaho

Cumulative achievable potential in 2018

Rank	Measure / Technology	2018 Achievable Savings (Cum. DTh)	% of Total
1	Custom	338	52.7%
2	Boiler - Hot Water Reset	171	26.7%
3	Boiler - Parallel Positioning Control	81	12.7%
4	Boiler - Maintenance	39	6.0%
5	Steam Trap Maintenance	10	1.5%
6	Gas Furnace - Maintenance	2	0.3%
	<b>Total</b>	<b>641</b>	<b>100.0%</b>

Cumulative Achievable Potential in 2018

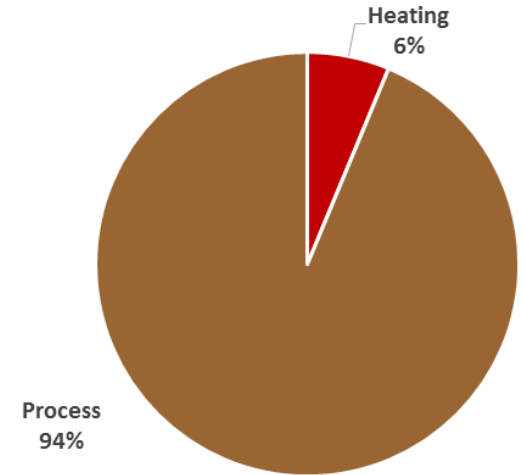

Cumulative Achievable Potential (DTh)

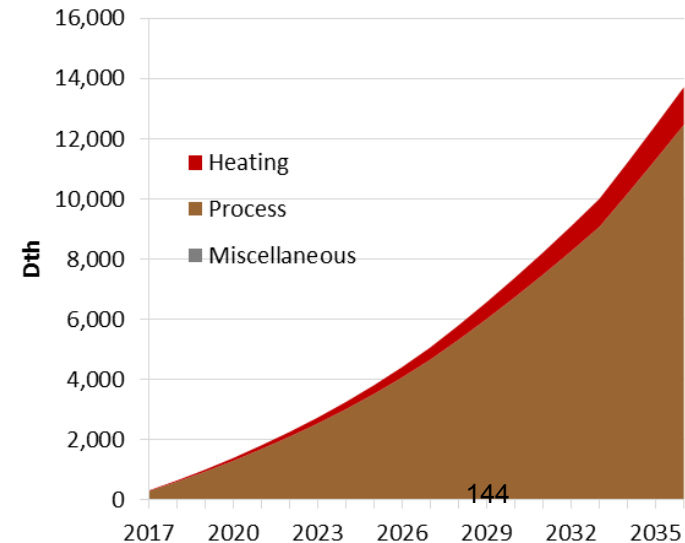



Oregon

# High-level Market Characterization - Oregon

2015 Natural Gas Sales by Sector

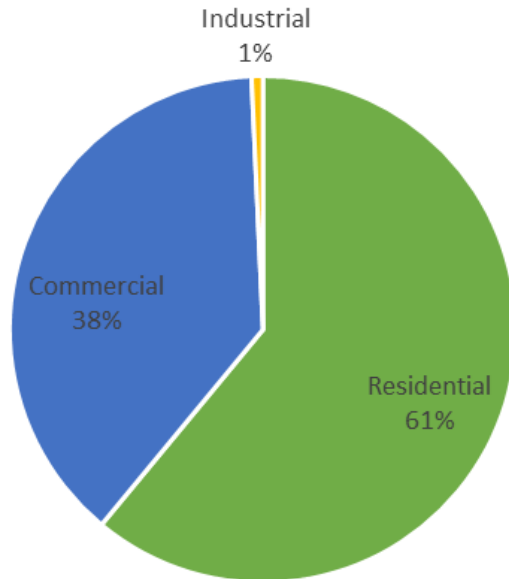

Segment	Annual Sales (DTh)	% of Sales
Residential	4,303,206	61%
Commercial	2,699,252	38%
Industrial	51,369	1%
<b>Total</b>	<b>7,053,827</b>	<b>100%</b>

# Residential Market Characterization - Oregon

Oregon	2015 Sales (DTh)	# of Customers	Average Use per Household (Therms/HH)
Single Family	2,811,856	53,617	524
Multifamily	81,940	2,480	330
Mobile Home	271,183	6,156	441
Low Income	1,138,226	25,534	446
<b>Oregon Total</b>	<b>4,303,206</b>	<b>87,787</b>	<b>490</b>

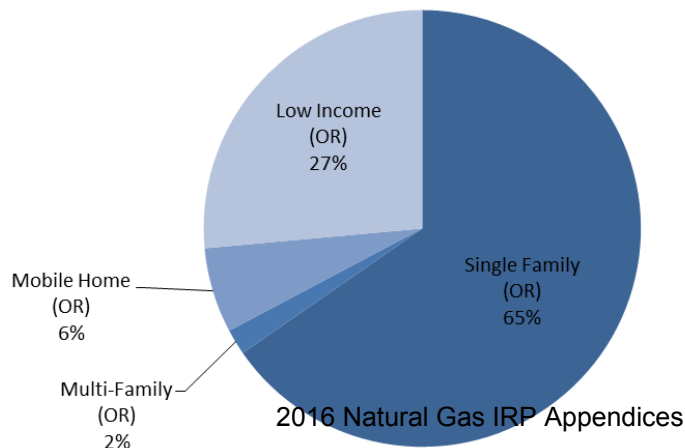

# Residential Market Profiles - Oregon

Base-year annual energy use by segment and end use

Annual Use by End Use

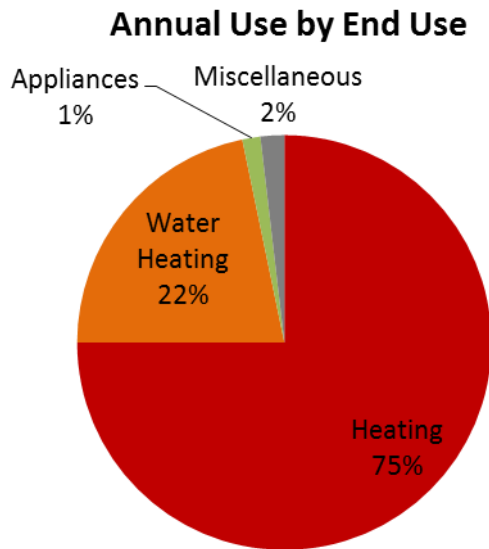

Annual Intensity for Average Household

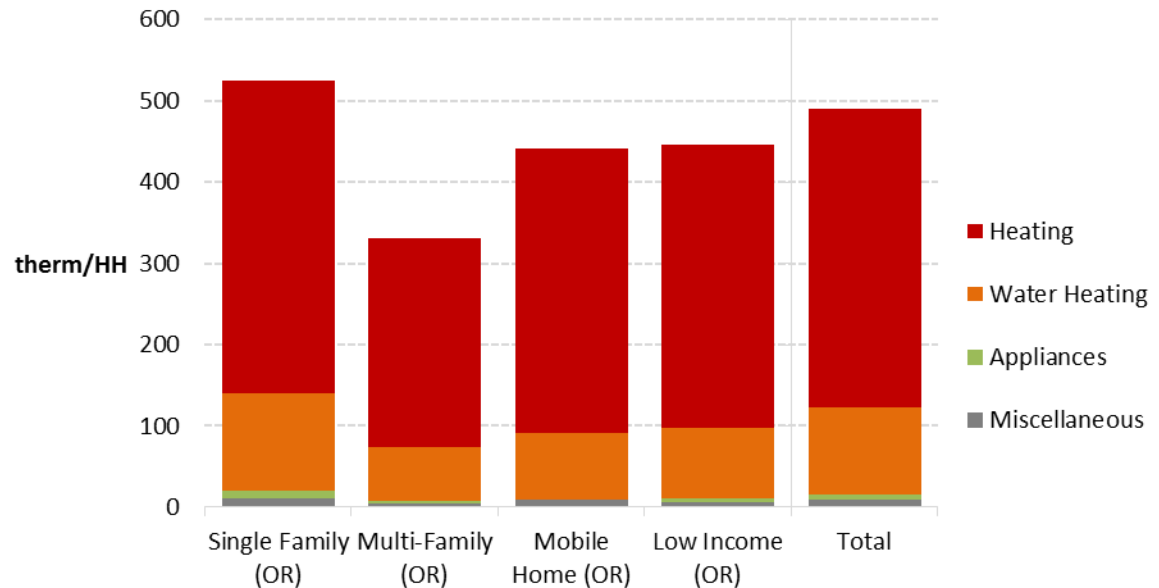

**Data Sources:**

- RBSA
- Utility billing data
- AEG Market Profiles Database
- Secondary data as needed to fill gaps



# Residential Energy Market Profile - Oregon

- This market profile represents the residential sector as a whole. Individual segment market profiles are provided in the report.
- Saturations were developed using the RBSA survey as the primary data source.

<b>Oregon</b>					
<b>Total</b>					
		Total Households:		87,787	
		DTh		4,303,206	
End Use	Technology	Saturation	UEC (Therms)	Intensity (Therms/	Usage (DTh)
Space Heating	Furnace	85.7%	368.1	315.3	2,767,781
Space Heating	Boiler	2.2%	433.3	9.3	82,038
Space Heating	Other Heating	12.2%	353.1	43.0	377,705
Water Heating	Water Heater	55.3%	192.8	106.6	935,460
Appliances	Clothes Dryer	7.6%	29.6	2.2	19,643
Appliances	Stove/Oven	7.8%	60.2	4.7	41,124
Miscellaneous	Pool Heater	0.5%	217.5	1.1	9,457
Miscellaneous	Miscellaneous	100.0%	8.0	8.0	69,999
<b>Total</b>				<b>490.2</b>	<b>4,303,206</b>

# Residential Baseline Projection - Oregon

- Baseline projection provides foundation for estimating potential future savings from conservation initiatives and reflects
  - Household growth and electricity price forecasts (from Avista)
  - Appliance standards in place at end of 2015 (AEG database)
  - Frozen efficiency
  - Does not include future utility programs
- Baseline projection increases 30% between 2015 and 2036, or an average of 1.2% per year

**Residential Baseline Energy Projection (DTh)**

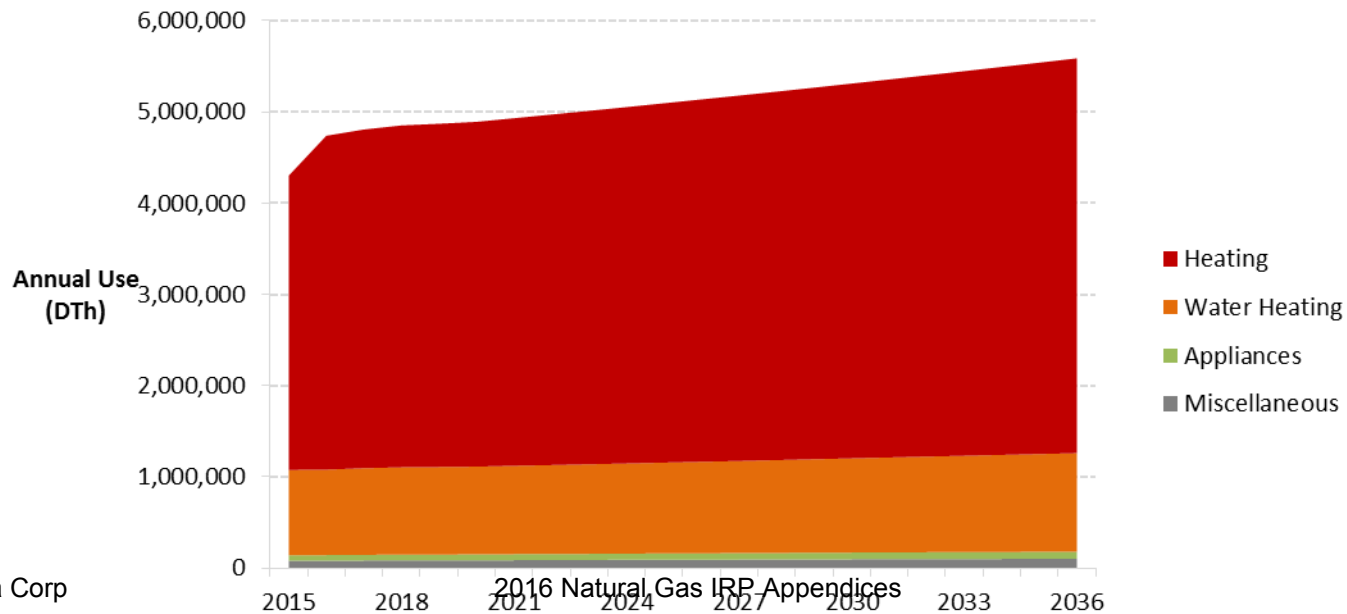

# Residential Savings Potential - Oregon

From 2017 to 2018, cumulative achievable potential energy savings are 13,839 DTh or 0.3% of the baseline.

By 2036, cumulative savings are almost 5% of the baseline projection, or about 0.2% per year.

	2017	2018	2021	2026	2036
<b>Baseline Projection (DTh)</b>	<b>4,808,069</b>	<b>4,852,168</b>	<b>4,931,394</b>	<b>5,137,402</b>	<b>5,588,507</b>
<b>Cumulative Savings (DTh)</b>					
Achievable Potential	6,507	13,839	38,671	94,086	260,939
Economic Potential	21,867	44,161	111,658	228,569	483,538
Technical Potential	83,073	167,062	418,531	844,811	1,615,605
<b>Energy Savings (% of Baseline)</b>					
Achievable Potential	0.1%	0.3%	0.8%	1.8%	4.7%
Economic Potential	0.5%	0.9%	2.3%	4.4%	8.7%
Technical Potential	1.7%	3.4%	8.5%	16.4%	28.9%

Uses the TRC cost effectiveness test

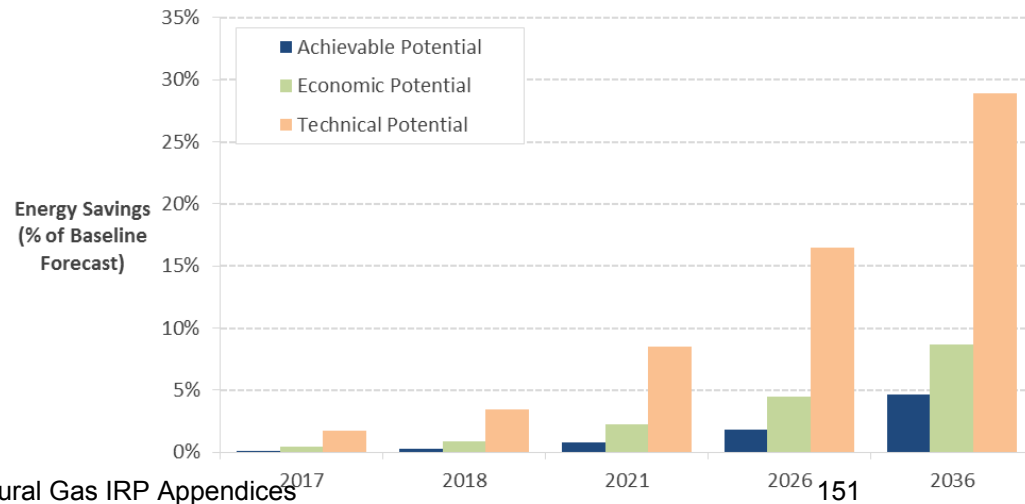
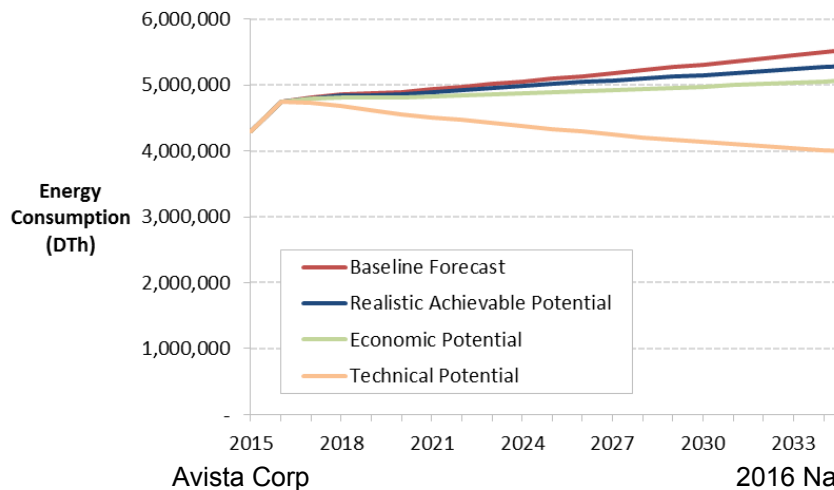

# Residential Savings Potential - Oregon

Cumulative achievable potential in 2018

Rank	Measure / Technology	2018 Achievable Savings (Cum. DTh)	% of Total
1	Heating - Furnace	7,400	53.5%
2	Water Heater - Low-Flow Showerheads	1,743	12.6%
3	Water Heater - Temperature Setback	1,640	11.9%
4	Furnace - Maintenance	1,477	10.7%
5	Water Heater - Pipe Insulation	871	6.3%
6	Water Heater - Faucet Aerators	257	1.9%
7	Windows - High Efficiency	235	1.7%
8	Boiler - Maintenance	108	0.8%
9	Boiler - Pipe Insulation	86	0.6%
10	Heating – Boiler (EF 0.98)	22	0.2%
	<b>Total</b>	<b>13,839</b>	<b>100%</b>

Cumulative Achievable Potential in 2018

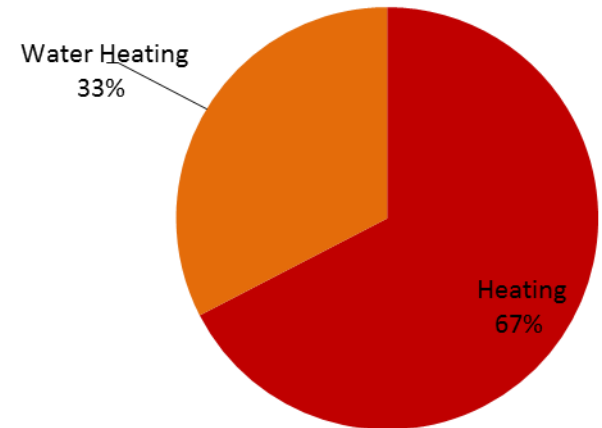

Cumulative Achievable Potential (DTh)

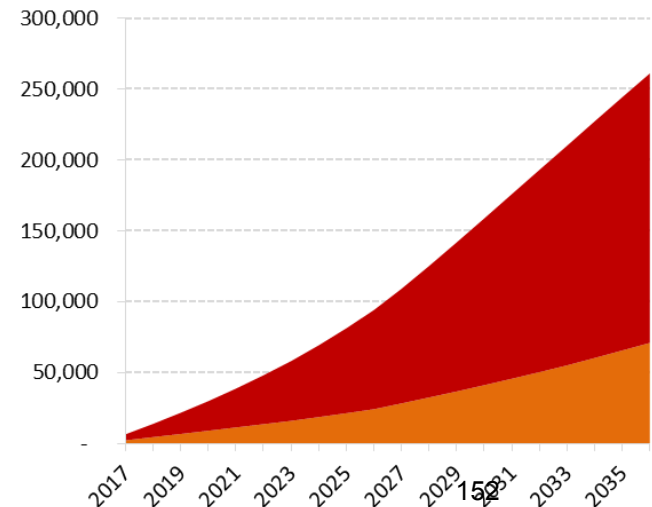

# Commercial Market Characterization - Oregon

Oregon	2015 Sales (DTh)	Floor Space (sq. ft.)	Intensity (therms/sqft)
Office	406,757	8,388,655	0.16
Restaurant	302,349	253,503	1.39
Retail	401,181	10,531,910	0.19
Grocery	173,578	1,682,340	0.37
School	273,450	9,633,126	0.26
College	34,880	4,540,014	0.50
Health	401,052	3,157,269	0.45
Lodging	174,610	2,627,216	0.33
Warehouse	143,426	5,484,890	0.13
Miscellaneous	387,969	10,601,048	0.34
<b>Oregon Total</b>	<b>2,699,252</b>	<b>56,899,971</b>	<b>0.27</b>

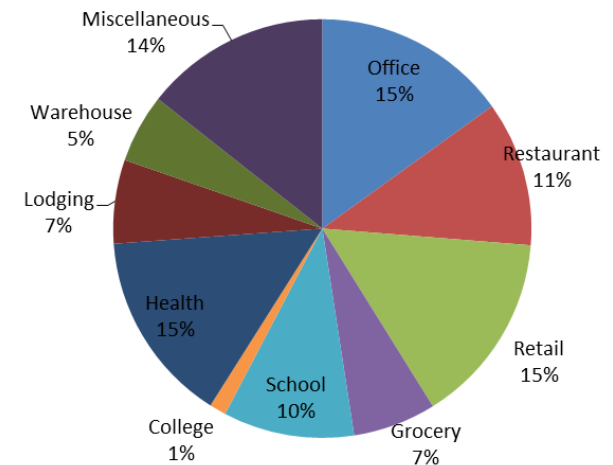

# Commercial Market Profiles - Oregon

Base-year annual energy use by segment and end use

Annual Use by End Use

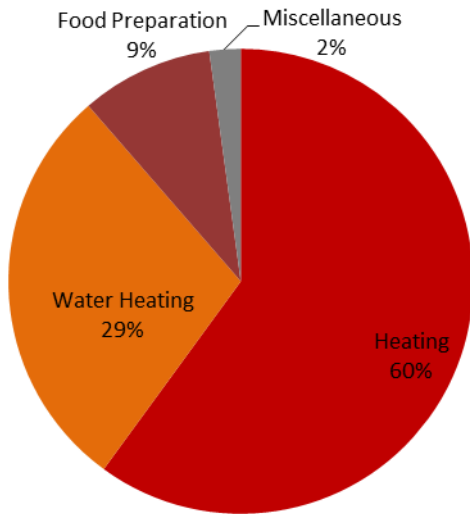

Annual Intensity per Square Foot

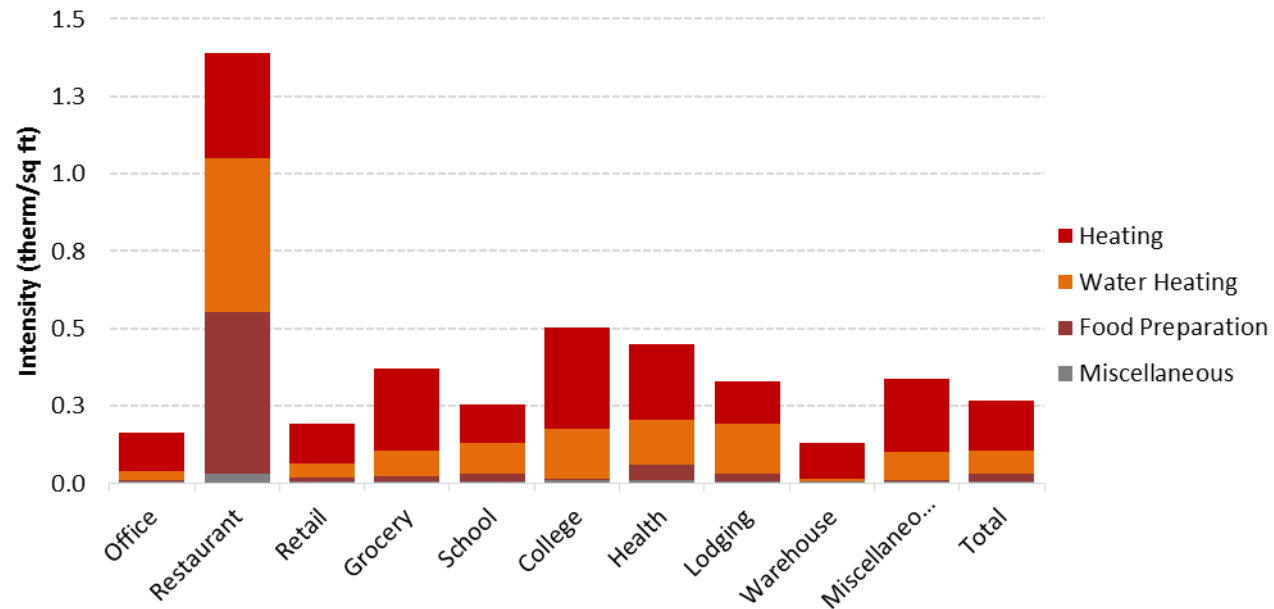

**Data Sources:**

- CBSA
- Utility billing data
- AEG Market Profiles Database
- Secondary data as needed to fill gaps

# Commercial Energy Market Profile - Oregon

- This market profile represents the Commercial sector as a whole. Individual segment market profiles are provided in the report.
- Saturations were developed using the CBSA survey as the primary data source.

End Use	Technology	Saturation	EUI (therm)	Intensity (therm/Sqft)	Usage (DTh)
Heating	Furnace	55.1%	0.13	0.07	749,027
Heating	Boiler	31.4%	0.26	0.08	840,061
Heating	Unit Heater	5.3%	0.06	0.00	31,476
Water Heating	Water Heater	64.0%	0.12	0.08	771,366
Food Preparation	Oven	16.8%	0.02	0.00	31,288
Food Preparation	Fryer	8.7%	0.09	0.01	79,140
Food Preparation	Broiler	9.9%	0.05	0.00	45,962
Food Preparation	Griddle	12.7%	0.03	0.00	40,695
Food Preparation	Range	13.8%	0.03	0.00	46,098
Food Preparation	Steamer	1.7%	0.03	0.00	5,395
Food Preparation	Commercial Food Prep Other	0.0%	0.02	0.00	38
Miscellaneous	Pool Heater	0.7%	0.00	0.00	115
Miscellaneous	Other Miscellaneous	100.0%	0.01	0.01	58,592
<b>Total</b>				<b>0.27</b>	<b>2,699,252</b>

# Commercial Baseline Projection - Oregon

- Baseline projection provides foundation for estimating potential future savings from conservation initiatives and reflects
  - Customer growth (from Avista)
  - Building Codes and appliance standards in place at end of 2015 (AEG database)
  - Frozen efficiency
  - Does not include future utility programs
- Baseline projection increases 38% between 2015 and 2036, or an average of 1.5% per year

**Commercial Baseline Energy Projection (DTh)**

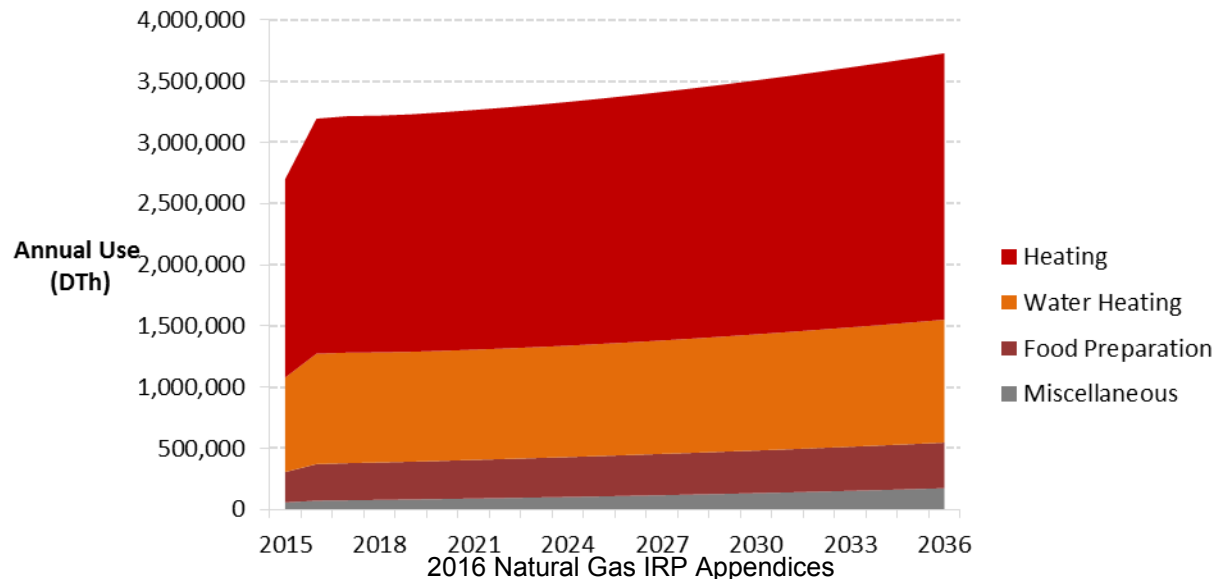



# Commercial Savings Potential - Oregon

From 2017 to 2018, cumulative achievable potential energy savings are 17,527 DTh or 0.5% of the baseline.

By 2036, cumulative savings are almost 10% of the baseline projection, or about 0.5% per year.

	2017	2018	2021	2026	2036
<b>Baseline Projection (DTh)</b>	<b>3,215,033</b>	<b>3,219,537</b>	<b>3,264,933</b>	<b>3,383,711</b>	<b>3,729,054</b>
<b>Cumulative Savings (DTh)</b>					
Achievable Potential	7,921	17,527	54,701	142,594	363,123
Economic Potential	22,299	44,184	110,800	228,191	470,854
Technical Potential	56,697	109,388	262,836	500,789	919,302
<b>Energy Savings (% of Baseline)</b>					
Achievable Potential	0.2%	0.5%	1.7%	4.2%	9.7%
Economic Potential	0.7%	1.4%	3.4%	6.7%	12.6%
Technical Potential	1.8%	3.4%	8.1%	14.8%	24.7%

Uses the TRC cost effectiveness test

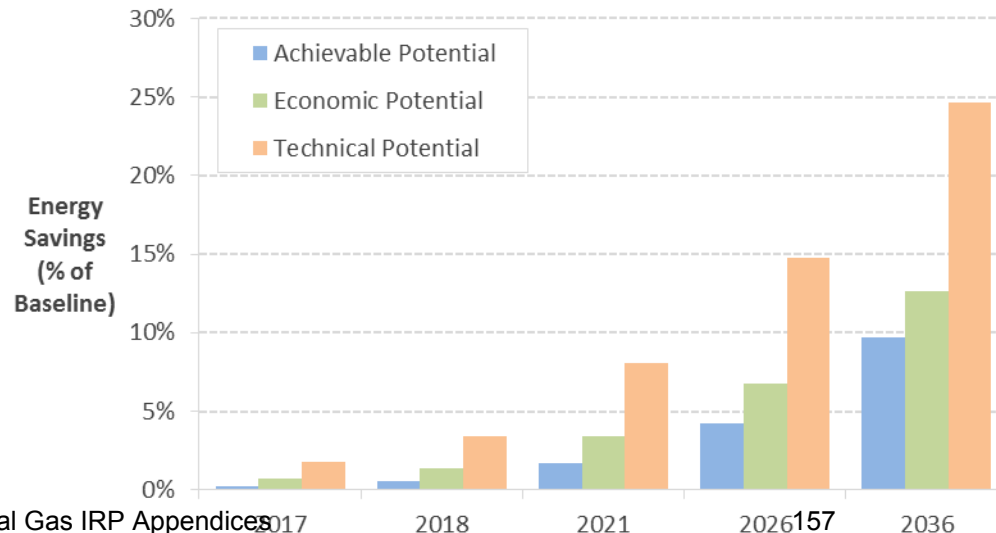
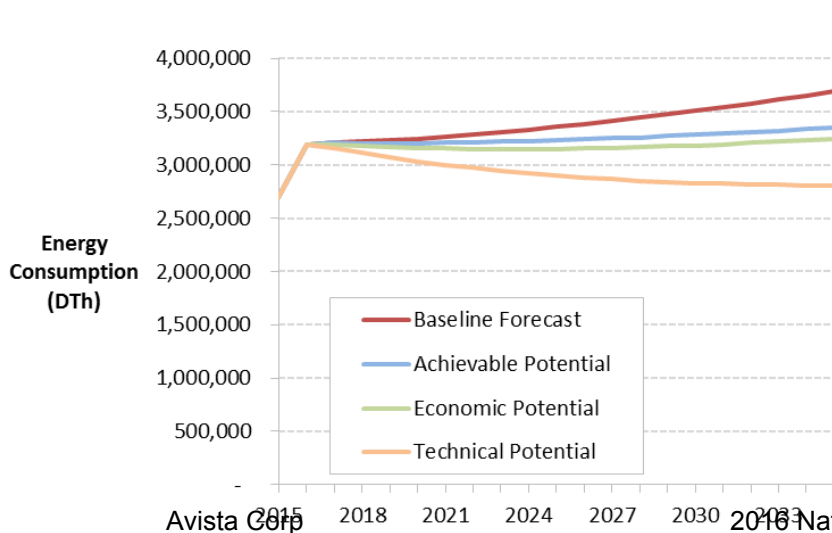

# Commercial Savings Potential - Oregon

Cumulative achievable potential in 2018

Cumulative Achievable Potential in 2018

Rank	Measure / Technology	2018 Achievable Savings (Cum. DTh)	% of Total
1	Retrocommissioning	5,781	33.0%
2	Gas Boiler - Hot Water Reset	1,954	11.2%
3	Water Heater - Central Controls	1,711	9.8%
4	Heating - Boiler	1,700	9.7%
5	Water Heating - Water Heater	1,316	7.5%
6	Commissioning	1,162	6.6%
7	Water Heater - Faucet Aerators/Low Flow Nozzles	1,098	6.3%
8	Water Heater - Pre-Rinse Spray Valve	1,009	5.8%
9	Food Preparation - Fryer	519	3.0%
10	Steam Trap Maintenance	384	2.2%
11	Food Preparation - Oven	215	1.2%
12	Food Preparation - Griddle	160	0.9%
13	Windows - High Efficiency	144	0.8%
14	Food Preparation - Steamer	115	0.7%
15	Water Heater - Pipe Insulation	106	0.6%
16	Water Heater - Drainwater Heat Recovery	68	0.4%
17	HVAC - Duct Repair and Sealing	46	0.3%
18	Food Preparation - Broiler	37	0.2%
19	Gas Boiler - Parallel Positioning Control	2	0.0%
20	Food Preparation - Range	0	0.0%
<b>Total</b>		<b>17,527</b>	<b>100.0%</b>

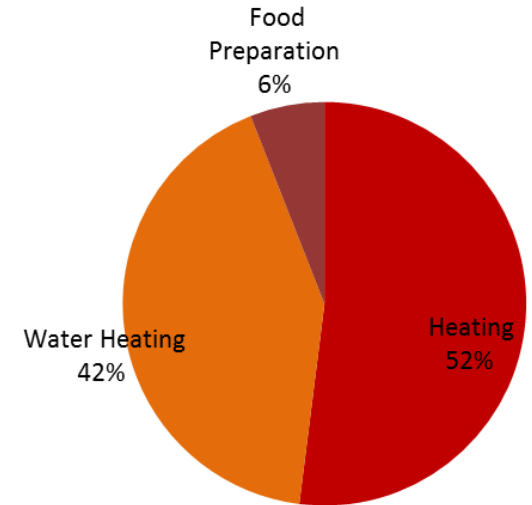

Cumulative Achievable Potential (DTh)

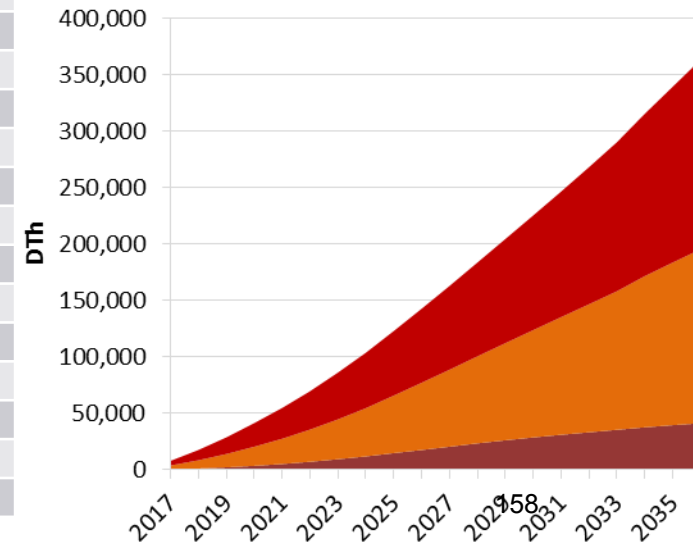

Avista Corp

2016 Natural Gas IRP Appendix 6

# Industrial Energy Market Profile - Oregon

- This market profile represents the Industrial sector as a whole. The industrial sector is not large enough to warrant further segmentation.

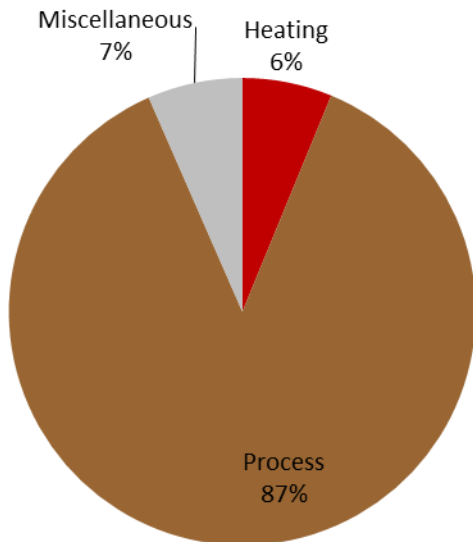

## Oregon

### Industrial

Total Sq Ft: 744,804

DTh 51,369

End Use	Technology	Saturation	EUI (Therms)	Intensity (Therms/sqft)	Usage (Dth)
Space Heating	Furnace	56.5%	0.025	0.01	1,064
Space Heating	Boiler	34.4%	0.081	0.03	2,084
Space Heating	Other Heating	4.9%	0.013	0.00	46
Process	Process Heating	100.0%	0.338	0.34	25,181
Process	Process Boiler	100.0%	0.258	0.26	19,238
Process	Process Cooling	100.0%	0.001	0.00	78
Process	Other Process	100.0%	0.004	0.00	302
Other	Other Uses	100.0%	0.045	0.05	3,375
<b>Total</b>				<b>0.69</b>	<b>51,369</b>

# Industrial Baseline Projection - Oregon

- Baseline projection provides foundation for estimating potential future savings from conservation initiatives and reflects
  - Customer growth (from Avista)
  - Building Codes and appliance standards in place at end of 2015 (AEG database)
  - Frozen efficiency
  - Does not include future utility programs
- Baseline projection increases 31% between 2015 and 2036, or an average of 1.4% per year

Industrial Baseline Energy Projection (DTh)

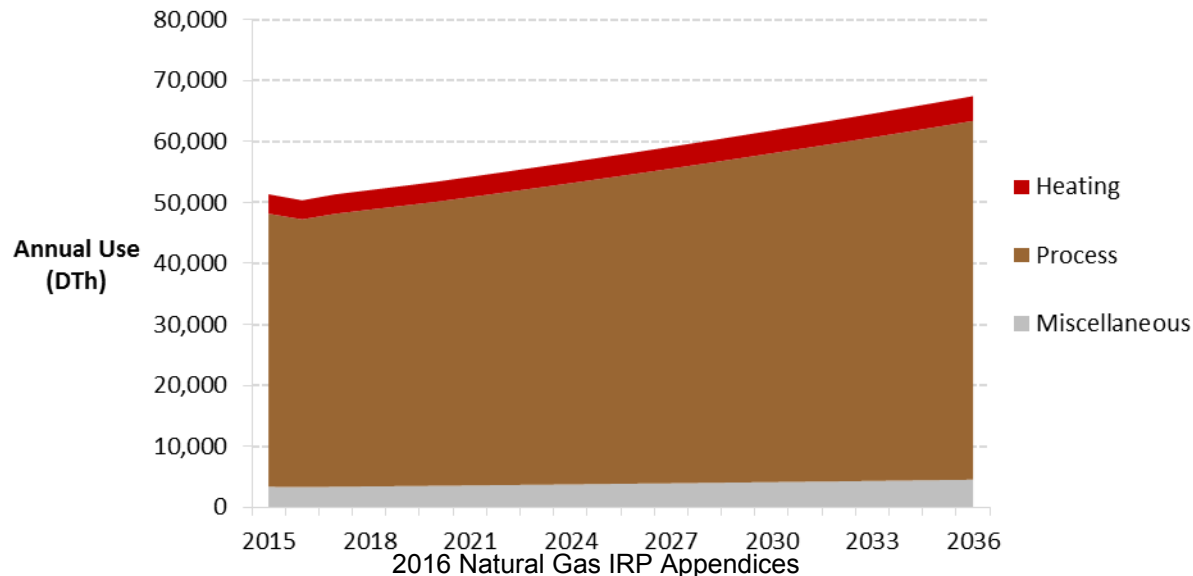

# Industrial Savings Potential - Oregon

From 2017 to 2018, cumulative achievable potential energy savings are 641 DTh or 0.3% of the baseline.

By 2036, cumulative savings are 4.3% of the baseline projection, or about 0.1% per year.

	2017	2018	2021	2026	2036
<b>Baseline Projection (DTh)</b>	<b>51,346</b>	<b>52,041</b>	<b>54,200</b>	<b>58,303</b>	<b>67,465</b>
<b>Cumulative Savings (DTh)</b>					
Achievable Potential	73	147	379	773	1,622
Economic Potential	166	333	839	1,707	3,557
Technical Potential	602	1,209	3,078	6,371	13,602
<b>Energy Savings (% of Baseline)</b>					
Achievable Potential	0.0%	0.1%	0.2%	0.3%	0.5%
Economic Potential	0.1%	0.2%	0.4%	0.7%	1.1%
Technical Potential	0.3%	0.6%	1.3%	2.5%	4.3%

Uses the TRC cost effectiveness test

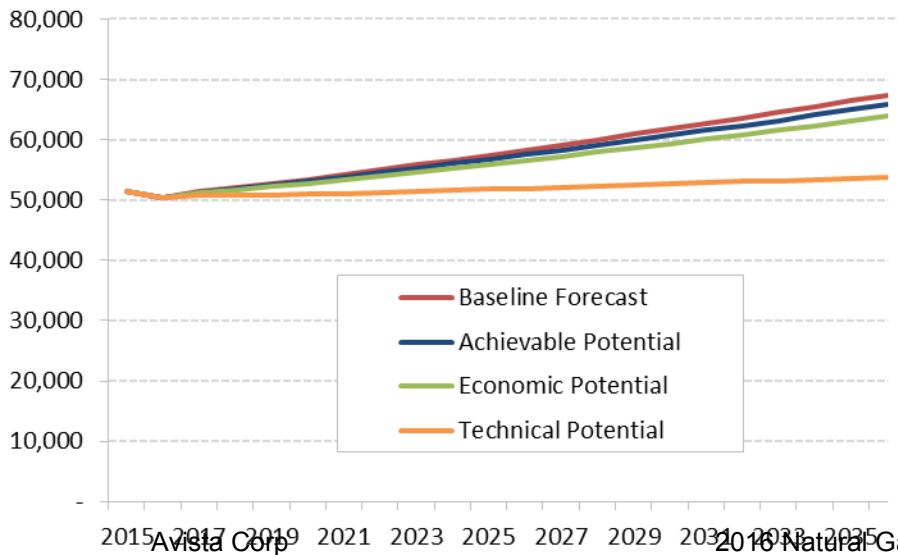

# Industrial Savings Potential- Oregon

Cumulative achievable potential in 2018

Cumulative Achievable Potential in 2018

Rank	Measure / Technology	2018 Achievable Savings (Cum. DTh)	% of Total
1	Custom	338	52.7%
2	Boiler - Hot Water Reset	171	26.7%
3	Boiler - Parallel Positioning Control	81	12.7%
4	Boiler - Maintenance	39	6.0%
5	Steam Trap Maintenance	10	1.5%
6	Gas Furnace - Maintenance	2	0.3%
	<b>Total</b>	<b>641</b>	<b>100.0%</b>

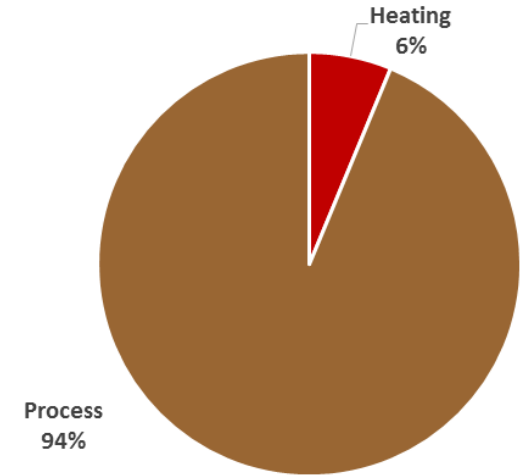

Cumulative Achievable Potential (DTh)

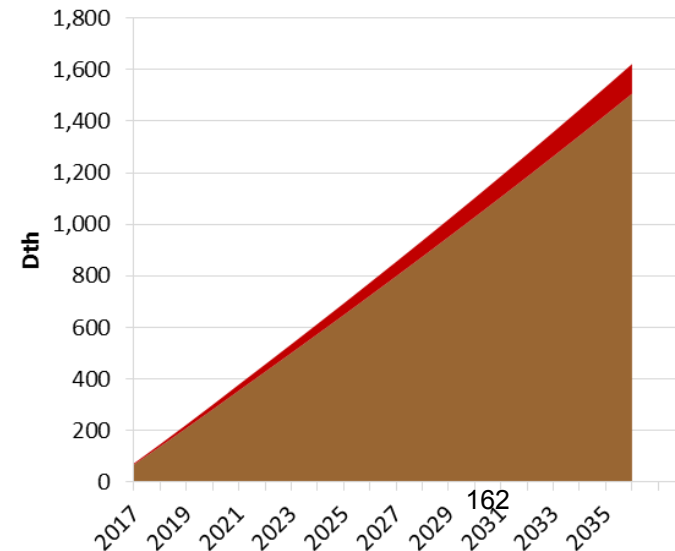



**Thank You!**

Ingrid Rohmund

[irohmund@appliedenergygroup.com](mailto:irohmund@appliedenergygroup.com)

Bridget Kester

[bkester@appliedenergygroup.com](mailto:bkester@appliedenergygroup.com)

Fuong Nguyen

[fnguyen@appliedenergygroup.com](mailto:fnguyen@appliedenergygroup.com)

Joe Reilly

[jreilly@appliedenergygroup.com](mailto:jreilly@appliedenergygroup.com)

## APPENDIX 3.2: ENVIRONMENTAL EXTERNALITIES OVERVIEW (OREGON JURISDICTION ONLY)

The methodology for determining avoided costs from reduced incremental natural gas usage considers commodity and variable transportation costs only. These avoided cost streams do not include environmental externality costs related to the gathering, transmission, distribution or end-use of natural gas.

Per traditional economic theory and industry practice, an environmental externality factor is typically added to the avoided cost when there is an opportunity to displace traditional supply-side resources with an alternative resource with no adverse environmental impact.

### REGULATORY GUIDANCE

The Oregon Public Utility Commission (OPUC) issued Order 93-965 (UM-424) to address how utilities should consider the impact of environmental externalities in planning for future energy resources. The Order required analysis on the potential natural gas cost impacts from emitting carbon dioxide (CO<sub>2</sub>) and nitric-oxide (NO<sub>x</sub>).

The OPUC's Order No. 07-002 in Docket UM 1056 (Investigation Into Integrated Resource Planning) established the following guideline for the treatment of environmental costs used by energy utilities that evaluate demand-side and supply-side energy choices:

UM 1056, Guideline 8 - Environmental Costs

*“Utilities should include, in their base-case analyses, the regulatory compliance costs they expect for carbon dioxide (CO<sub>2</sub>), nitrogen oxides (NO<sub>x</sub>), sulfur oxides (SO<sub>2</sub>), and mercury (Hg) emissions. Utilities should analyze the range of potential CO<sub>2</sub> regulatory costs in Order No. 93-695, from \$0 - \$40 (1990\$). In addition, utilities should perform sensitivity analysis on a range of reasonably possible cost adders for nitrogen oxides (NO<sub>x</sub>), sulfur dioxide (SO<sub>2</sub>), and mercury (Hg), if applicable.*

In June 2008, the OPUC issued Order 08-338 (UM1302) which revised UM1056, Guideline 8. The revised guideline requires the utility should construct a base case portfolio to reflect what it considers to be the most likely regulatory compliance future for the various emissions. Additionally the guideline requires the utility to develop several compliance scenarios ranging from the present CO<sub>2</sub> regulatory level to the upper reaches of credible proposals and each scenario should include a time profile of CO<sub>2</sub> costs. The utility is also required to include a “trigger point” analysis in which the utility must determine at what level of carbon costs its selection of portfolio resources would be significantly different.

### ANALYSIS

Unlike electric utilities, environmental cost issues rarely impact a natural gas utility's supply-side resource options. This is because the only supply-side energy resource is natural gas. The utility cannot choose between say "dirty" coal-fired generation and "clean" wind energy sources. The supply-side implication of environmental externalities generally relates to combustion of fuel to move or compress natural gas. Avista's direct gas distribution system infrastructure relies solely on the upstream line pressure of the interstate pipeline transportation network to distribute natural gas to its customers and thus does not directly combust fuels that result in any CO<sub>2</sub>, NO<sub>x</sub>, SO<sub>2</sub>, or Hg emissions.



Upstream gas system infrastructure (pipelines, storage facilities, and gathering systems), however, do produce CO<sub>2</sub> emissions via compressors used to pressurize and move natural gas. Accessing CO<sub>2</sub> emissions data on these upstream activities to perform detailed meaningful analysis is challenging. In the 2009 Natural Gas IRP there was significant momentum regarding GHG legislation and the movement towards the creation of carbon cap and trade markets or tax structure. Since then, the momentum has slowed significantly. Where there is still a focus on reducing GHG emissions and improving the nation’s carbon footprint, the timing of implementing a carbon cap and trade/tax framework has been delayed. Additionally, the pricing level of the framework has been greatly reduced.. Whichever structure ultimately gets implemented, Avista believes the cost pass through mechanisms for upstream gas system infrastructure will not make a difference in supply-side resource selection although the amount of cost pass through could differ widely.

Table 3.2.1 summarizes a range of environmental cost adders we believe capture several compliance futures including our expected scenario. The CO<sub>2</sub> cost adders reflect outlooks we obtained from one of our consultants, and following discussion and feedback from the TAC, have been incorporated into our Expected, Low Growth/High Price, and Alternate Planning Standard portfolios.

The guidelines also call for a trigger point analysis that reflects a “turning point” at which an alternate resource portfolio would be selected at different carbon cost adders levels. Because natural gas is the only supply resource applicable to LDC’s any alternate resource portfolio selection would be a result of delivery methods of natural gas to customers. Conceptually, there could be differing levels of cost adders applicable to pipeline transported supply versus in service territory LNG storage gas. From a practical standpoint however, the differences in these relative cost adders would be very minor and would not change supply-side resource selection regardless of various carbon cost adder levels. We do acknowledge there is influence to the avoided costs which would impact the cost effectiveness of demand-side measures in the DSM business planning process.

## **CONSERVATION COST ADVANTAGE**

For this IRP, we also incorporated a 10 percent environmental externality factor into our assessment of the cost-effectiveness of existing demand-side management programs. Our assessment of prospective demand-side management opportunities is based on an avoided cost stream that includes this 10 percent factor.

Environmental externalities were evaluated in the IRP by adding the cost per therm equivalent of the externality cost values to supply-side resources as described in OPUC Order No. 93-965. Avista found that the environmental cost adders had no impact on the company’s supply-side choices, although they did impact the level of demand-side measures that could be cost-effective to acquire.

## **REGULATORY FILING**

Avista will file revised cost-effectiveness limits (CELs) based upon the updated avoided costs available from this IRP process within the prescribed regulatory timetable.

**TABLE 3.2.1: ENVIRONMENTAL EXTERNALITIES COST ADDER ANALYSIS (2015\$)**

		2020	2025	2030	2035		
Expected Carbon Case	NOx	\$/ton	\$ 2,500	\$ 2,500	\$ 2,500	\$ 2,500	
		\$/lb	\$ 1.25	\$ 1.25	\$ 1.25	\$ 1.25	
		lbs/therm	0.008	0.008	0.008	0.008	
		NOx Adder \$/therm	\$ 0.01	\$ 0.01	\$ 0.01	\$ 0.01	
		CO2	\$/ton	\$ 10.55	\$ 11.71	\$ 14.99	\$ 19.93
	\$/lb	\$ 0.0053	\$ 0.0059	\$ 0.0075	\$ 0.0100		
	lbs/therm	11.64	11.64	11.64	11.64		
	CO2 Adder \$/therm	\$ 0.06	\$ 0.07	\$ 0.09	\$ 0.12		
	<b>Total</b>	<b>Total Adders \$/therm</b>	<b>\$ 0.07</b>	<b>\$ 0.08</b>	<b>\$ 0.10</b>	<b>\$ 0.13</b>	
			<b>2020</b>	<b>2025</b>	<b>2030</b>	<b>2035</b>	
	High Carbon Case	NOx	\$/ton	\$ 2,500	\$ 2,500	\$ 2,500	\$ 2,500
			\$/lb	\$ 1.25	\$ 1.25	\$ 1.25	\$ 1.25
			lbs/therm	0.008	0.008	0.008	0.008
NOx Adder \$/therm			\$ 0.01	\$ 0.01	\$ 0.01	\$ 0.01	
CO2			\$/ton	\$ 25.88	\$ 30.73	\$ 36.50	\$ 43.35
\$/lb		\$ 0.0129	\$ 0.0154	\$ 0.0182	\$ 0.0217		
lbs/therm		11.64	11.64	11.64	11.64		
CO2 Adder \$/therm		\$ 0.15	\$ 0.18	\$ 0.21	\$ 0.25		
<b>Total</b>		<b>Total Adders \$/therm</b>	<b>\$ 0.16</b>	<b>\$ 0.19</b>	<b>\$ 0.22</b>	<b>\$ 0.26</b>	
		<b>2020</b>	<b>2025</b>	<b>2030</b>	<b>2035</b>		
Low Carbon Low NOx		NOx	\$/ton	\$ 500	\$ 500	\$ 500	\$ 500
			\$/lb	\$ 0.25	\$ 0.25	\$ 0.25	\$ 0.25
			lbs/therm	0.008	0.008	0.008	0.008
	NOx Adder \$/therm		\$ 0.00	\$ 0.00	\$ 0.00	\$ 0.00	
	CO2		\$/ton	\$ -	\$ -	\$ -	\$ -
	\$/lb	\$ -	\$ -	\$ -	\$ -		
	lbs/therm	11.64	11.64	11.64	11.64		
	CO2 Adder \$/therm	\$ -	\$ -	\$ -	\$ -		
	<b>Total</b>	<b>Total Adders \$/therm</b>	<b>\$ 0.00</b>	<b>\$ 0.00</b>	<b>\$ 0.00</b>	<b>\$ 0.00</b>	

## APPENDIX 4.1: CURRENT TRANSPORTATION/STORAGE RATES AND ASSUMPTIONS

<b>Current Tariff Rates (1)</b>			
	<b><u>Reservation</u></b>	<b><u>Commodity</u></b>	<b><u>Fuel Rate</u></b>
<b>TransCanada NGTL System Firm Rates (2)</b>			
FT-D Demand Rate Alberta-B.C. Border	\$5.08CAD/GJ/month	N/a	N/a
<b>TransCanada Foothills BC System Firm Rates (3)</b>			
FT A/BC to Kingsgate	\$2.48CAD/GJ/month	N/a	1.60%
<b>GTN FTS-1 Rates</b>			
Mileage Based - Representative Example			
Kingsgate to Spokane	\$0.081391/Dth/day	\$0.001733/Dth/day	0.0036% per Dth/mile
Kingsgate to Malin	\$0.3/Dth/day	\$0.009799/Dth/day	0.0036% per Dth/mile
Medford Lateral	\$0.247709/Dth/day	\$0.002291/Dth/day	N/a
<b>Spectra Energy/Westcoast System Firms Rates (4)</b>			
Postage Stamp Rates			
Station 2 to Huntingdon/Sumas	\$365.16CAD/10 <sup>3</sup> m <sup>3</sup> /month	N/a	N/a
<b>Williams NWP</b>			
Postage Stamp Rates			
TF-1	\$0.40888/Dth/day	\$0.03/Dth/day	1.19%
TF-2	\$0.40888/Dth/day	\$0.03/Dth/day	1.19%
SGS-2F	\$0.01558/Dth/day	\$0.00057/Dth/day	N/a
(1) Rates and Fuel reported are from current tariffed rates in the established currency and energy units of each pipeline			
(2) Rate does not reflect current term-differentiation or Abandonment Surcharge			
(3) Rate does not include Abandonment Surcharge			
(4) Rate changes annually			

**APPENDIX 4.2: ALTERNATE SUPPLY SCENARIOS**

	<u>Existing Resources</u>	<u>Existing + Expected Available</u>	<u>GTN Fully Subscribed</u>
<b>INPUT ASSUMPTIONS</b>			
<b>Resources</b>	Currently contracted capacity net of long term releases	Currently contracted capacity net of long term releases	Currently contracted capacity net of long term releases
		Currently available GTN	
		Capacity Release Recalls	Capacity Release Recalls
		NWP Expansions	NWP Expansions
		Satellite LNG	Satellite LNG
<b>Rates</b>	Current Rates	Current Rates	Current Rates

## APPENDIX 5.1: MONTHLY PRICE DATA BY BASIN

### EXPECTED PRICE

Scenario	Index	Gas Year	2014\$											
			Nov	Dec	Jan	Feb	Mar	Apr	May	Jun	Jul	Aug	Sep	Oct
Expected Case	AECO	2015-2016	\$1.91	\$1.63	\$2.05	\$1.84	\$1.77	\$1.74	\$1.72	\$1.74	\$1.78	\$1.87	\$1.86	\$1.86
Expected Case	AECO	2016-2017	\$2.03	\$2.19	\$2.36	\$2.33	\$2.24	\$2.13	\$2.11	\$2.08	\$2.11	\$2.19	\$2.16	\$2.17
Expected Case	AECO	2017-2018	\$2.39	\$2.50	\$3.20	\$3.14	\$2.84	\$2.63	\$2.56	\$2.52	\$2.57	\$2.61	\$2.64	\$2.66
Expected Case	AECO	2018-2019	\$2.90	\$3.03	\$3.10	\$3.06	\$2.63	\$2.43	\$2.43	\$2.46	\$2.52	\$2.57	\$2.66	\$2.70
Expected Case	AECO	2019-2020	\$2.97	\$3.12	\$3.18	\$3.16	\$2.86	\$2.56	\$2.56	\$2.56	\$2.58	\$2.61	\$2.66	\$2.65
Expected Case	AECO	2020-2021	\$3.07	\$3.22	\$3.26	\$3.32	\$2.99	\$2.70	\$2.72	\$2.71	\$2.66	\$2.70	\$2.94	\$2.96
Expected Case	AECO	2021-2022	\$3.22	\$3.35	\$3.39	\$3.44	\$3.03	\$2.77	\$2.79	\$2.78	\$2.78	\$2.82	\$2.87	\$2.88
Expected Case	AECO	2022-2023	\$3.14	\$3.21	\$3.17	\$3.22	\$2.89	\$2.74	\$2.79	\$2.79	\$2.81	\$2.83	\$3.02	\$3.03
Expected Case	AECO	2023-2024	\$3.42	\$3.51	\$3.51	\$3.51	\$3.20	\$2.97	\$2.98	\$2.97	\$3.07	\$3.11	\$3.23	\$3.24
Expected Case	AECO	2024-2025	\$3.70	\$3.78	\$3.81	\$3.81	\$3.45	\$3.17	\$3.26	\$3.25	\$3.33	\$3.36	\$3.49	\$3.47
Expected Case	AECO	2025-2026	\$3.93	\$4.09	\$3.79	\$3.79	\$3.27	\$3.11	\$3.19	\$3.18	\$3.28	\$3.34	\$3.42	\$3.43
Expected Case	AECO	2026-2027	\$4.00	\$3.98	\$3.75	\$3.75	\$3.33	\$3.20	\$3.24	\$3.27	\$3.37	\$3.42	\$3.64	\$3.67
Expected Case	AECO	2027-2028	\$4.21	\$4.28	\$4.15	\$4.14	\$3.65	\$3.55	\$3.58	\$3.59	\$3.69	\$3.71	\$3.87	\$3.90
Expected Case	AECO	2028-2029	\$4.37	\$4.51	\$4.41	\$4.42	\$3.90	\$3.75	\$3.82	\$3.80	\$3.83	\$3.86	\$4.01	\$4.01
Expected Case	AECO	2029-2030	\$4.48	\$4.63	\$4.54	\$4.59	\$4.04	\$3.88	\$3.90	\$3.94	\$4.04	\$4.07	\$4.20	\$4.24
Expected Case	AECO	2030-2031	\$4.74	\$4.96	\$4.74	\$4.78	\$4.19	\$4.09	\$4.11	\$4.12	\$4.18	\$4.21	\$4.37	\$4.39
Expected Case	AECO	2031-2032	\$4.80	\$5.06	\$4.95	\$4.94	\$4.42	\$4.26	\$4.28	\$4.29	\$4.30	\$4.38	\$4.46	\$4.49
Expected Case	AECO	2032-2033	\$4.91	\$5.22	\$4.95	\$4.99	\$4.38	\$4.26	\$4.25	\$4.28	\$4.37	\$4.44	\$4.51	\$4.54
Expected Case	AECO	2033-2034	\$4.99	\$5.30	\$5.05	\$5.08	\$4.44	\$4.32	\$4.31	\$4.33	\$4.39	\$4.42	\$4.56	\$4.57
Expected Case	AECO	2034-2035	\$4.96	\$5.28	\$5.05	\$5.06	\$4.60	\$4.44	\$4.43	\$4.32	\$4.37	\$4.49	\$4.60	\$4.59
Expected Case	Malin	2015-2016	\$2.20	\$2.03	\$2.49	\$2.34	\$2.28	\$2.22	\$2.26	\$2.31	\$2.37	\$2.40	\$2.41	\$2.44
Expected Case	Malin	2016-2017	\$2.71	\$2.84	\$2.91	\$2.86	\$2.77	\$2.64	\$2.64	\$2.68	\$2.74	\$2.74	\$2.80	\$2.84
Expected Case	Malin	2017-2018	\$3.02	\$3.08	\$3.61	\$3.57	\$3.33	\$3.15	\$3.15	\$3.17	\$3.23	\$3.27	\$3.29	\$3.35
Expected Case	Malin	2018-2019	\$3.47	\$3.59	\$3.67	\$3.63	\$3.31	\$3.19	\$3.18	\$3.19	\$3.21	\$3.28	\$3.35	\$3.38
Expected Case	Malin	2019-2020	\$3.52	\$3.61	\$3.69	\$3.66	\$3.39	\$3.28	\$3.21	\$3.20	\$3.23	\$3.31	\$3.32	\$3.32
Expected Case	Malin	2020-2021	\$3.56	\$3.66	\$3.77	\$3.77	\$3.46	\$3.37	\$3.36	\$3.33	\$3.40	\$3.46	\$3.48	\$3.53
Expected Case	Malin	2021-2022	\$3.79	\$3.87	\$3.97	\$3.98	\$3.59	\$3.48	\$3.45	\$3.43	\$3.49	\$3.51	\$3.53	\$3.54
Expected Case	Malin	2022-2023	\$3.80	\$3.88	\$3.95	\$3.97	\$3.62	\$3.48	\$3.48	\$3.48	\$3.50	\$3.56	\$3.56	\$3.57
Expected Case	Malin	2023-2024	\$3.89	\$3.99	\$4.00	\$3.97	\$3.65	\$3.60	\$3.58	\$3.56	\$3.59	\$3.69	\$3.70	\$3.72
Expected Case	Malin	2024-2025	\$4.06	\$4.18	\$4.24	\$4.24	\$3.89	\$3.83	\$3.80	\$3.79	\$3.85	\$3.91	\$3.91	\$3.92
Expected Case	Malin	2025-2026	\$4.28	\$4.54	\$4.27	\$4.30	\$3.84	\$3.74	\$3.71	\$3.71	\$3.78	\$3.85	\$3.86	\$3.88
Expected Case	Malin	2026-2027	\$4.31	\$4.52	\$4.36	\$4.37	\$3.93	\$3.82	\$3.79	\$3.79	\$3.84	\$3.91	\$3.92	\$4.00
Expected Case	Malin	2027-2028	\$4.46	\$4.67	\$4.53	\$4.53	\$4.10	\$4.01	\$3.99	\$3.98	\$4.03	\$4.10	\$4.11	\$4.16
Expected Case	Malin	2028-2029	\$4.60	\$4.82	\$4.77	\$4.78	\$4.32	\$4.20	\$4.18	\$4.15	\$4.17	\$4.22	\$4.24	\$4.27
Expected Case	Malin	2029-2030	\$4.73	\$4.98	\$4.88	\$4.91	\$4.46	\$4.30	\$4.30	\$4.30	\$4.33	\$4.41	\$4.47	\$4.51
Expected Case	Malin	2030-2031	\$5.01	\$5.25	\$5.03	\$5.06	\$4.61	\$4.46	\$4.42	\$4.42	\$4.46	\$4.53	\$4.60	\$4.63
Expected Case	Malin	2031-2032	\$5.08	\$5.32	\$5.23	\$5.23	\$4.73	\$4.61	\$4.54	\$4.53	\$4.56	\$4.66	\$4.71	\$4.75
Expected Case	Malin	2032-2033	\$5.23	\$5.46	\$5.23	\$5.25	\$4.77	\$4.63	\$4.55	\$4.55	\$4.66	\$4.74	\$4.77	\$4.82
Expected Case	Malin	2033-2034	\$5.32	\$5.62	\$5.40	\$5.41	\$4.86	\$4.72	\$4.69	\$4.68	\$4.73	\$4.80	\$4.82	\$4.84
Expected Case	Malin	2034-2035	\$5.31	\$5.63	\$5.39	\$5.41	\$4.86	\$4.72	\$4.74	\$4.72	\$4.80	\$4.86	\$4.87	\$4.89
Expected Case	Rockies	2015-2016	\$2.01	\$1.81	\$2.32	\$2.21	\$2.17	\$2.16	\$2.18	\$2.22	\$2.27	\$2.34	\$2.37	\$2.42
Expected Case	Rockies	2016-2017	\$2.63	\$2.76	\$2.84	\$2.81	\$2.69	\$2.55	\$2.58	\$2.62	\$2.66	\$2.69	\$2.75	\$2.77
Expected Case	Rockies	2017-2018	\$2.91	\$3.01	\$3.57	\$3.53	\$3.28	\$3.11	\$3.09	\$3.11	\$3.15	\$3.20	\$3.25	\$3.26
Expected Case	Rockies	2018-2019	\$3.40	\$3.52	\$3.59	\$3.56	\$3.25	\$3.14	\$3.13	\$3.13	\$3.15	\$3.22	\$3.26	\$3.29
Expected Case	Rockies	2019-2020	\$3.44	\$3.53	\$3.61	\$3.59	\$3.33	\$3.22	\$3.17	\$3.17	\$3.18	\$3.25	\$3.27	\$3.25
Expected Case	Rockies	2020-2021	\$3.49	\$3.60	\$3.70	\$3.70	\$3.42	\$3.32	\$3.31	\$3.33	\$3.35	\$3.41	\$3.43	\$3.46
Expected Case	Rockies	2021-2022	\$3.71	\$3.82	\$3.90	\$3.90	\$3.54	\$3.43	\$3.42	\$3.42	\$3.43	\$3.46	\$3.47	\$3.47
Expected Case	Rockies	2022-2023	\$3.72	\$3.83	\$3.86	\$3.89	\$3.54	\$3.43	\$3.43	\$3.41	\$3.42	\$3.51	\$3.52	\$3.51
Expected Case	Rockies	2023-2024	\$3.81	\$3.93	\$3.90	\$3.88	\$3.60	\$3.55	\$3.54	\$3.52	\$3.55	\$3.65	\$3.66	\$3.68
Expected Case	Rockies	2024-2025	\$4.00	\$4.15	\$4.19	\$4.18	\$3.86	\$3.80	\$3.76	\$3.75	\$3.81	\$3.87	\$3.87	\$3.87
Expected Case	Rockies	2025-2026	\$4.20	\$4.49	\$4.23	\$4.24	\$3.80	\$3.71	\$3.67	\$3.68	\$3.73	\$3.81	\$3.81	\$3.82
Expected Case	Rockies	2026-2027	\$4.23	\$4.45	\$4.29	\$4.29	\$3.87	\$3.78	\$3.75	\$3.75	\$3.80	\$3.86	\$3.87	\$3.92
Expected Case	Rockies	2027-2028	\$4.35	\$4.59	\$4.45	\$4.45	\$4.03	\$3.96	\$3.94	\$3.92	\$3.97	\$4.04	\$4.05	\$4.08
Expected Case	Rockies	2028-2029	\$4.50	\$4.75	\$4.68	\$4.70	\$4.24	\$4.15	\$4.12	\$4.10	\$4.10	\$4.15	\$4.18	\$4.19
Expected Case	Rockies	2029-2030	\$4.66	\$4.89	\$4.80	\$4.82	\$4.38	\$4.27	\$4.25	\$4.25	\$4.27	\$4.36	\$4.39	\$4.45
Expected Case	Rockies	2030-2031	\$4.94	\$5.18	\$4.95	\$4.98	\$4.53	\$4.41	\$4.38	\$4.37	\$4.41	\$4.48	\$4.52	\$4.56
Expected Case	Rockies	2031-2032	\$5.01	\$5.24	\$5.15	\$5.15	\$4.66	\$4.57	\$4.49	\$4.47	\$4.50	\$4.59	\$4.62	\$4.67
Expected Case	Rockies	2032-2033	\$5.14	\$5.39	\$5.16	\$5.18	\$4.69	\$4.57	\$4.49	\$4.50	\$4.53	\$4.64	\$4.70	\$4.74
Expected Case	Rockies	2033-2034	\$5.22	\$5.49	\$5.26	\$5.27	\$4.79	\$4.67	\$4.62	\$4.60	\$4.61	\$4.71	\$4.76	\$4.76
Expected Case	Rockies	2034-2035	\$5.20	\$5.47	\$5.24	\$5.26	\$4.78	\$4.67	\$4.68	\$4.63	\$4.69	\$4.78	\$4.82	\$4.81

## APPENDIX 5.1: MONTHLY PRICE DATA BY BASIN

### EXPECTED PRICE

			2014\$											
Expected Case	Stanfield	2015-2016	\$2.17	\$1.98	\$2.42	\$2.27	\$2.19	\$2.15	\$2.19	\$2.23	\$2.27	\$2.34	\$2.34	\$2.37
Expected Case	Stanfield	2016-2017	\$2.63	\$2.76	\$2.88	\$2.85	\$2.72	\$2.58	\$2.58	\$2.64	\$2.67	\$2.68	\$2.73	\$2.78
Expected Case	Stanfield	2017-2018	\$2.94	\$3.03	\$3.58	\$3.54	\$3.29	\$3.14	\$3.09	\$3.12	\$3.15	\$3.20	\$3.25	\$3.27
Expected Case	Stanfield	2018-2019	\$3.39	\$3.50	\$3.58	\$3.54	\$3.24	\$3.11	\$3.11	\$3.10	\$3.13	\$3.20	\$3.26	\$3.29
Expected Case	Stanfield	2019-2020	\$3.43	\$3.51	\$3.59	\$3.56	\$3.29	\$3.21	\$3.14	\$3.11	\$3.16	\$3.23	\$3.25	\$3.24
Expected Case	Stanfield	2020-2021	\$3.47	\$3.56	\$3.67	\$3.67	\$3.37	\$3.30	\$3.28	\$3.25	\$3.32	\$3.38	\$3.39	\$3.44
Expected Case	Stanfield	2021-2022	\$3.70	\$3.78	\$3.87	\$3.88	\$3.50	\$3.41	\$3.38	\$3.36	\$3.41	\$3.43	\$3.42	\$3.44
Expected Case	Stanfield	2022-2023	\$3.70	\$3.78	\$3.84	\$3.87	\$3.53	\$3.41	\$3.40	\$3.39	\$3.42	\$3.48	\$3.49	\$3.48
Expected Case	Stanfield	2023-2024	\$3.80	\$3.89	\$3.95	\$3.86	\$3.58	\$3.55	\$3.52	\$3.49	\$3.52	\$3.61	\$3.62	\$3.67
Expected Case	Stanfield	2024-2025	\$4.00	\$4.12	\$4.16	\$4.17	\$3.83	\$3.79	\$3.75	\$3.74	\$3.78	\$3.85	\$3.84	\$3.86
Expected Case	Stanfield	2025-2026	\$4.23	\$4.48	\$4.21	\$4.24	\$3.79	\$3.69	\$3.66	\$3.66	\$3.71	\$3.80	\$3.81	\$3.83
Expected Case	Stanfield	2026-2027	\$4.26	\$4.47	\$4.30	\$4.30	\$3.88	\$3.78	\$3.76	\$3.76	\$3.81	\$3.87	\$3.88	\$3.95
Expected Case	Stanfield	2027-2028	\$4.42	\$4.62	\$4.46	\$4.47	\$4.04	\$3.97	\$3.95	\$3.93	\$3.98	\$4.04	\$4.05	\$4.10
Expected Case	Stanfield	2028-2029	\$4.55	\$4.75	\$4.68	\$4.71	\$4.25	\$4.16	\$4.14	\$4.11	\$4.10	\$4.16	\$4.17	\$4.20
Expected Case	Stanfield	2029-2030	\$4.67	\$4.90	\$4.81	\$4.84	\$4.39	\$4.27	\$4.26	\$4.26	\$4.29	\$4.35	\$4.42	\$4.44
Expected Case	Stanfield	2030-2031	\$4.93	\$5.18	\$4.96	\$4.99	\$4.56	\$4.42	\$4.39	\$4.38	\$4.43	\$4.49	\$4.54	\$4.55
Expected Case	Stanfield	2031-2032	\$5.02	\$5.25	\$5.16	\$5.16	\$4.66	\$4.57	\$4.48	\$4.49	\$4.52	\$4.62	\$4.65	\$4.69
Expected Case	Stanfield	2032-2033	\$5.17	\$5.40	\$5.15	\$5.18	\$4.71	\$4.60	\$4.51	\$4.51	\$4.62	\$4.69	\$4.69	\$4.75
Expected Case	Stanfield	2033-2034	\$5.25	\$5.55	\$5.32	\$5.34	\$4.80	\$4.68	\$4.65	\$4.64	\$4.68	\$4.74	\$4.75	\$4.77
Expected Case	Stanfield	2034-2035	\$5.24	\$5.55	\$5.31	\$5.34	\$4.80	\$4.65	\$4.69	\$4.67	\$4.73	\$4.78	\$4.79	\$4.83
Expected Case	Sumas	2015-2016	\$2.16	\$1.93	\$2.39	\$2.19	\$2.04	\$1.96	\$1.86	\$1.89	\$1.90	\$2.02	\$2.17	\$2.23
Expected Case	Sumas	2016-2017	\$2.49	\$2.80	\$2.84	\$2.78	\$2.66	\$2.50	\$2.48	\$2.44	\$2.49	\$2.55	\$2.62	\$2.60
Expected Case	Sumas	2017-2018	\$2.87	\$3.04	\$3.55	\$3.49	\$3.24	\$3.04	\$2.81	\$2.81	\$2.85	\$2.97	\$3.01	\$3.15
Expected Case	Sumas	2018-2019	\$3.29	\$3.44	\$3.54	\$3.51	\$3.15	\$2.94	\$2.86	\$2.80	\$2.87	\$3.00	\$3.08	\$3.17
Expected Case	Sumas	2019-2020	\$3.32	\$3.45	\$3.52	\$3.51	\$3.23	\$3.06	\$2.95	\$2.85	\$2.97	\$3.06	\$3.13	\$3.16
Expected Case	Sumas	2020-2021	\$3.39	\$3.50	\$3.62	\$3.66	\$3.35	\$3.19	\$3.12	\$3.04	\$3.15	\$3.23	\$3.32	\$3.36
Expected Case	Sumas	2021-2022	\$3.57	\$3.63	\$3.74	\$3.75	\$3.46	\$3.31	\$3.21	\$3.19	\$3.22	\$3.30	\$3.37	\$3.37
Expected Case	Sumas	2022-2023	\$3.60	\$3.63	\$3.70	\$3.76	\$3.48	\$3.33	\$3.24	\$3.24	\$3.26	\$3.37	\$3.41	\$3.40
Expected Case	Sumas	2023-2024	\$3.70	\$3.84	\$3.83	\$3.80	\$3.52	\$3.43	\$3.31	\$3.31	\$3.34	\$3.49	\$3.55	\$3.57
Expected Case	Sumas	2024-2025	\$3.89	\$3.94	\$4.07	\$4.10	\$3.78	\$3.66	\$3.55	\$3.51	\$3.58	\$3.71	\$3.75	\$3.75
Expected Case	Sumas	2025-2026	\$4.05	\$4.30	\$4.04	\$4.06	\$3.68	\$3.57	\$3.45	\$3.41	\$3.52	\$3.65	\$3.67	\$3.67
Expected Case	Sumas	2026-2027	\$4.09	\$4.29	\$4.12	\$4.13	\$3.78	\$3.64	\$3.59	\$3.54	\$3.63	\$3.71	\$3.77	\$3.89
Expected Case	Sumas	2027-2028	\$4.32	\$4.59	\$4.47	\$4.47	\$3.98	\$3.90	\$3.79	\$3.81	\$3.85	\$3.99	\$4.03	\$4.07
Expected Case	Sumas	2028-2029	\$4.55	\$4.76	\$4.71	\$4.73	\$4.25	\$4.11	\$4.00	\$3.98	\$4.00	\$4.12	\$4.14	\$4.18
Expected Case	Sumas	2029-2030	\$4.68	\$4.92	\$4.82	\$4.85	\$4.40	\$4.22	\$4.16	\$4.18	\$4.18	\$4.32	\$4.42	\$4.47
Expected Case	Sumas	2030-2031	\$4.96	\$5.20	\$4.97	\$5.01	\$4.56	\$4.37	\$4.30	\$4.31	\$4.32	\$4.45	\$4.55	\$4.58
Expected Case	Sumas	2031-2032	\$5.03	\$5.27	\$5.18	\$5.18	\$4.68	\$4.52	\$4.44	\$4.43	\$4.41	\$4.57	\$4.64	\$4.69
Expected Case	Sumas	2032-2033	\$5.17	\$5.41	\$5.17	\$5.19	\$4.71	\$4.54	\$4.42	\$4.42	\$4.46	\$4.63	\$4.69	\$4.78
Expected Case	Sumas	2033-2034	\$5.31	\$5.62	\$5.41	\$5.41	\$4.83	\$4.65	\$4.55	\$4.53	\$4.55	\$4.70	\$4.76	\$4.80
Expected Case	Sumas	2034-2035	\$5.30	\$5.63	\$5.41	\$5.43	\$4.84	\$4.68	\$4.65	\$4.59	\$4.65	\$4.77	\$4.82	\$4.85

## APPENDIX 5.1: MONTHLY PRICE DATA BY BASIN

### HIGH GROWTH LOW PRICE

		2014\$												
Scenario	Index	Gas Year	Nov	Dec	Jan	Feb	Mar	Apr	May	Jun	Jul	Aug	Sep	Oct
High Growth & Low Prices	AECO	2015-2016	\$ 1.91	\$ 1.63	\$ 1.82	\$ 1.88	\$ 1.50	\$ 1.22	\$ 1.43	\$ 1.48	\$ 1.98	\$ 1.87	\$ 1.29	\$ 1.56
High Growth & Low Prices	AECO	2016-2017	\$ 1.23	\$ 0.86	\$ 1.56	\$ 1.71	\$ 1.42	\$ 1.25	\$ 1.55	\$ 1.48	\$ 1.97	\$ 1.85	\$ 1.32	\$ 1.44
High Growth & Low Prices	AECO	2017-2018	\$ 1.35	\$ 0.96	\$ 1.71	\$ 1.84	\$ 1.47	\$ 1.23	\$ 1.42	\$ 1.42	\$ 1.93	\$ 1.75	\$ 1.30	\$ 1.35
High Growth & Low Prices	AECO	2018-2019	\$ 1.32	\$ 1.07	\$ 1.60	\$ 1.74	\$ 1.28	\$ 1.01	\$ 1.28	\$ 1.37	\$ 1.89	\$ 1.71	\$ 1.20	\$ 1.41
High Growth & Low Prices	AECO	2019-2020	\$ 1.33	\$ 0.99	\$ 1.61	\$ 1.75	\$ 1.41	\$ 1.03	\$ 1.30	\$ 1.36	\$ 1.87	\$ 1.70	\$ 1.40	\$ 1.37
High Growth & Low Prices	AECO	2020-2021	\$ 1.37	\$ 1.05	\$ 1.64	\$ 1.84	\$ 1.47	\$ 1.10	\$ 1.38	\$ 1.42	\$ 1.83	\$ 1.66	\$ 1.34	\$ 1.44
High Growth & Low Prices	AECO	2021-2022	\$ 1.36	\$ 1.02	\$ 1.56	\$ 1.76	\$ 1.40	\$ 1.06	\$ 1.35	\$ 1.40	\$ 1.89	\$ 1.73	\$ 1.32	\$ 1.43
High Growth & Low Prices	AECO	2022-2023	\$ 1.25	\$ 0.85	\$ 1.36	\$ 1.55	\$ 1.25	\$ 1.01	\$ 1.32	\$ 1.38	\$ 1.88	\$ 1.70	\$ 1.40	\$ 1.62
High Growth & Low Prices	AECO	2023-2024	\$ 1.58	\$ 1.03	\$ 1.63	\$ 1.80	\$ 1.50	\$ 1.12	\$ 1.39	\$ 1.44	\$ 2.02	\$ 1.85	\$ 1.51	\$ 1.53
High Growth & Low Prices	AECO	2024-2025	\$ 1.58	\$ 1.16	\$ 1.68	\$ 1.83	\$ 1.50	\$ 1.08	\$ 1.43	\$ 1.48	\$ 2.02	\$ 1.85	\$ 1.61	\$ 1.54
High Growth & Low Prices	AECO	2025-2026	\$ 1.51	\$ 1.03	\$ 1.61	\$ 1.75	\$ 1.37	\$ 1.10	\$ 1.43	\$ 1.47	\$ 2.03	\$ 1.88	\$ 1.50	\$ 1.54
High Growth & Low Prices	AECO	2026-2027	\$ 1.55	\$ 0.93	\$ 1.50	\$ 1.64	\$ 1.34	\$ 1.10	\$ 1.41	\$ 1.49	\$ 2.05	\$ 1.89	\$ 1.61	\$ 1.70
High Growth & Low Prices	AECO	2027-2028	\$ 1.64	\$ 1.10	\$ 1.74	\$ 1.87	\$ 1.50	\$ 1.27	\$ 1.56	\$ 1.63	\$ 2.18	\$ 1.99	\$ 1.50	\$ 1.74
High Growth & Low Prices	AECO	2028-2029	\$ 1.71	\$ 1.19	\$ 1.80	\$ 1.93	\$ 1.57	\$ 1.29	\$ 1.70	\$ 1.68	\$ 2.19	\$ 2.02	\$ 1.67	\$ 1.76
High Growth & Low Prices	AECO	2029-2030	\$ 1.66	\$ 1.40	\$ 1.81	\$ 1.99	\$ 1.59	\$ 1.32	\$ 1.60	\$ 1.70	\$ 2.24	\$ 2.06	\$ 1.81	\$ 1.78
High Growth & Low Prices	AECO	2030-2031	\$ 1.67	\$ 1.43	\$ 1.87	\$ 2.05	\$ 1.62	\$ 1.41	\$ 1.69	\$ 1.76	\$ 2.26	\$ 2.08	\$ 1.79	\$ 1.84
High Growth & Low Prices	AECO	2031-2032	\$ 1.80	\$ 1.28	\$ 1.88	\$ 2.04	\$ 1.72	\$ 1.46	\$ 1.82	\$ 1.80	\$ 2.27	\$ 2.15	\$ 1.77	\$ 1.84
High Growth & Low Prices	AECO	2032-2033	\$ 1.67	\$ 1.43	\$ 1.92	\$ 2.09	\$ 1.69	\$ 1.48	\$ 1.85	\$ 1.81	\$ 2.34	\$ 2.20	\$ 1.62	\$ 1.84
High Growth & Low Prices	AECO	2033-2034	\$ 1.90	\$ 1.32	\$ 1.92	\$ 2.09	\$ 1.64	\$ 1.43	\$ 1.70	\$ 1.78	\$ 2.29	\$ 2.12	\$ 1.96	\$ 1.85
High Growth & Low Prices	AECO	2034-2035	\$ 1.67	\$ 1.33	\$ 1.95	\$ 2.09	\$ 1.83	\$ 1.56	\$ 1.80	\$ 1.74	\$ 2.24	\$ 2.14	\$ 1.78	\$ 1.82
High Growth & Low Prices	Malin	2015-2016	\$ 2.20	\$ 2.03	\$ 2.26	\$ 2.38	\$ 2.01	\$ 1.70	\$ 1.97	\$ 2.05	\$ 2.57	\$ 2.40	\$ 1.84	\$ 2.14
High Growth & Low Prices	Malin	2016-2017	\$ 1.91	\$ 1.51	\$ 2.12	\$ 2.25	\$ 1.95	\$ 1.76	\$ 2.08	\$ 2.08	\$ 2.60	\$ 2.41	\$ 1.96	\$ 2.11
High Growth & Low Prices	Malin	2017-2018	\$ 1.98	\$ 1.54	\$ 2.12	\$ 2.27	\$ 1.97	\$ 1.75	\$ 2.01	\$ 2.07	\$ 2.59	\$ 2.41	\$ 1.94	\$ 2.04
High Growth & Low Prices	Malin	2018-2019	\$ 1.88	\$ 1.63	\$ 2.16	\$ 2.31	\$ 1.97	\$ 1.77	\$ 2.03	\$ 2.09	\$ 2.58	\$ 2.43	\$ 1.89	\$ 2.08
High Growth & Low Prices	Malin	2019-2020	\$ 1.88	\$ 1.48	\$ 2.11	\$ 2.25	\$ 1.93	\$ 1.74	\$ 1.94	\$ 2.00	\$ 2.52	\$ 2.40	\$ 2.05	\$ 2.03
High Growth & Low Prices	Malin	2020-2021	\$ 1.86	\$ 1.49	\$ 2.14	\$ 2.29	\$ 1.94	\$ 1.76	\$ 2.02	\$ 2.03	\$ 2.58	\$ 2.42	\$ 1.88	\$ 2.01
High Growth & Low Prices	Malin	2021-2022	\$ 1.92	\$ 1.55	\$ 2.14	\$ 2.30	\$ 1.96	\$ 1.76	\$ 2.01	\$ 2.05	\$ 2.59	\$ 2.42	\$ 1.97	\$ 2.10
High Growth & Low Prices	Malin	2022-2023	\$ 1.91	\$ 1.51	\$ 2.14	\$ 2.31	\$ 1.97	\$ 1.75	\$ 2.00	\$ 2.07	\$ 2.57	\$ 2.43	\$ 1.94	\$ 2.17
High Growth & Low Prices	Malin	2023-2024	\$ 2.04	\$ 1.50	\$ 2.13	\$ 2.26	\$ 1.94	\$ 1.74	\$ 1.99	\$ 2.03	\$ 2.54	\$ 2.43	\$ 1.97	\$ 2.02
High Growth & Low Prices	Malin	2024-2025	\$ 1.95	\$ 1.55	\$ 2.11	\$ 2.26	\$ 1.93	\$ 1.74	\$ 1.97	\$ 2.02	\$ 2.54	\$ 2.40	\$ 2.03	\$ 1.99
High Growth & Low Prices	Malin	2025-2026	\$ 1.86	\$ 1.47	\$ 2.09	\$ 2.26	\$ 1.94	\$ 1.73	\$ 1.95	\$ 2.01	\$ 2.53	\$ 2.39	\$ 1.94	\$ 1.99
High Growth & Low Prices	Malin	2026-2027	\$ 1.86	\$ 1.47	\$ 2.11	\$ 2.26	\$ 1.94	\$ 1.72	\$ 1.96	\$ 2.02	\$ 2.52	\$ 2.38	\$ 1.90	\$ 2.03
High Growth & Low Prices	Malin	2027-2028	\$ 1.89	\$ 1.50	\$ 2.11	\$ 2.27	\$ 1.95	\$ 1.73	\$ 1.97	\$ 2.02	\$ 2.52	\$ 2.38	\$ 1.74	\$ 2.01
High Growth & Low Prices	Malin	2028-2029	\$ 1.95	\$ 1.50	\$ 2.15	\$ 2.30	\$ 1.99	\$ 1.74	\$ 2.05	\$ 2.03	\$ 2.52	\$ 2.38	\$ 1.91	\$ 2.02
High Growth & Low Prices	Malin	2029-2030	\$ 1.91	\$ 1.74	\$ 2.15	\$ 2.31	\$ 2.02	\$ 1.75	\$ 2.00	\$ 2.05	\$ 2.53	\$ 2.41	\$ 2.07	\$ 2.05
High Growth & Low Prices	Malin	2030-2031	\$ 1.94	\$ 1.71	\$ 2.17	\$ 2.33	\$ 2.03	\$ 1.78	\$ 2.00	\$ 2.05	\$ 2.54	\$ 2.40	\$ 2.02	\$ 2.07
High Growth & Low Prices	Malin	2031-2032	\$ 2.09	\$ 1.53	\$ 2.17	\$ 2.33	\$ 2.03	\$ 1.80	\$ 2.08	\$ 2.04	\$ 2.53	\$ 2.43	\$ 2.01	\$ 2.10
High Growth & Low Prices	Malin	2032-2033	\$ 1.99	\$ 1.68	\$ 2.19	\$ 2.35	\$ 2.08	\$ 1.85	\$ 2.15	\$ 2.08	\$ 2.63	\$ 2.50	\$ 1.87	\$ 2.12
High Growth & Low Prices	Malin	2033-2034	\$ 2.22	\$ 1.64	\$ 2.27	\$ 2.42	\$ 2.07	\$ 1.84	\$ 2.08	\$ 2.13	\$ 2.63	\$ 2.50	\$ 2.23	\$ 2.12
High Growth & Low Prices	Malin	2034-2035	\$ 2.02	\$ 1.67	\$ 2.29	\$ 2.44	\$ 2.09	\$ 1.84	\$ 2.10	\$ 2.14	\$ 2.66	\$ 2.51	\$ 2.05	\$ 2.13
High Growth & Low Prices	Rockies	2015-2016	\$ 2.01	\$ 1.81	\$ 2.10	\$ 2.25	\$ 1.90	\$ 1.64	\$ 1.89	\$ 1.96	\$ 2.47	\$ 2.34	\$ 1.79	\$ 2.12
High Growth & Low Prices	Rockies	2016-2017	\$ 1.83	\$ 1.43	\$ 2.05	\$ 2.20	\$ 1.87	\$ 1.67	\$ 2.03	\$ 2.02	\$ 2.52	\$ 2.36	\$ 1.90	\$ 2.04
High Growth & Low Prices	Rockies	2017-2018	\$ 1.88	\$ 1.46	\$ 2.07	\$ 2.23	\$ 1.92	\$ 1.71	\$ 1.96	\$ 2.02	\$ 2.51	\$ 2.35	\$ 1.90	\$ 1.95
High Growth & Low Prices	Rockies	2018-2019	\$ 1.82	\$ 1.55	\$ 2.09	\$ 2.23	\$ 1.91	\$ 1.72	\$ 1.98	\$ 2.04	\$ 2.52	\$ 2.36	\$ 1.80	\$ 1.99
High Growth & Low Prices	Rockies	2019-2020	\$ 1.80	\$ 1.40	\$ 2.03	\$ 2.18	\$ 1.88	\$ 1.68	\$ 1.91	\$ 1.97	\$ 2.47	\$ 2.34	\$ 2.00	\$ 1.97
High Growth & Low Prices	Rockies	2020-2021	\$ 1.79	\$ 1.43	\$ 2.07	\$ 2.22	\$ 1.90	\$ 1.71	\$ 1.97	\$ 2.03	\$ 2.53	\$ 2.37	\$ 1.83	\$ 1.94
High Growth & Low Prices	Rockies	2021-2022	\$ 1.85	\$ 1.50	\$ 2.07	\$ 2.22	\$ 1.91	\$ 1.72	\$ 1.97	\$ 2.04	\$ 2.54	\$ 2.37	\$ 1.92	\$ 2.03
High Growth & Low Prices	Rockies	2022-2023	\$ 1.82	\$ 1.47	\$ 2.05	\$ 2.22	\$ 1.90	\$ 1.70	\$ 1.95	\$ 2.00	\$ 2.49	\$ 2.38	\$ 1.90	\$ 2.11
High Growth & Low Prices	Rockies	2023-2024	\$ 1.97	\$ 1.44	\$ 2.03	\$ 2.17	\$ 1.89	\$ 1.70	\$ 1.95	\$ 1.99	\$ 2.50	\$ 2.39	\$ 1.94	\$ 1.98
High Growth & Low Prices	Rockies	2024-2025	\$ 1.89	\$ 1.53	\$ 2.06	\$ 2.20	\$ 1.90	\$ 1.71	\$ 1.94	\$ 1.99	\$ 2.50	\$ 2.36	\$ 1.99	\$ 1.94
High Growth & Low Prices	Rockies	2025-2026	\$ 1.78	\$ 1.42	\$ 2.04	\$ 2.19	\$ 1.90	\$ 1.69	\$ 1.91	\$ 1.98	\$ 2.48	\$ 2.35	\$ 1.89	\$ 1.93
High Growth & Low Prices	Rockies	2026-2027	\$ 1.78	\$ 1.40	\$ 2.04	\$ 2.18	\$ 1.88	\$ 1.69	\$ 1.92	\$ 1.97	\$ 2.48	\$ 2.32	\$ 1.84	\$ 1.95
High Growth & Low Prices	Rockies	2027-2028	\$ 1.78	\$ 1.41	\$ 2.03	\$ 2.18	\$ 1.88	\$ 1.69	\$ 1.91	\$ 1.96	\$ 2.46	\$ 2.33	\$ 1.68	\$ 1.92
High Growth & Low Prices	Rockies	2028-2029	\$ 1.84	\$ 1.42	\$ 2.07	\$ 2.22	\$ 1.90	\$ 1.70	\$ 2.00	\$ 1.98	\$ 2.45	\$ 2.32	\$ 1.84	\$ 1.93
High Growth & Low Prices	Rockies	2029-2030	\$ 1.84	\$ 1.66	\$ 2.07	\$ 2.22	\$ 1.93	\$ 1.72	\$ 1.96	\$ 2.00	\$ 2.47	\$ 2.36	\$ 2.00	\$ 2.00
High Growth & Low Prices	Rockies	2030-2031	\$ 1.87	\$ 1.64	\$ 2.08	\$ 2.24	\$ 1.95	\$ 1.73	\$ 1.95	\$ 2.00	\$ 2.49	\$ 2.35	\$ 1.94	\$ 2.01
High Growth & Low Prices	Rockies	2031-2032	\$ 2.02	\$ 1.46	\$ 2.09	\$ 2.25	\$ 1.96	\$ 1.77	\$ 2.03	\$ 1.99	\$ 2.47	\$ 2.36	\$ 1.93	\$ 2.03
High Growth & Low Prices	Rockies	2032-2033	\$ 1.89	\$ 1.61	\$ 2.12	\$ 2.28	\$ 1.99	\$ 1.78	\$ 2.10	\$ 2.03	\$ 2.49	\$ 2.40	\$ 1.80	\$ 2.04
High Growth & Low Prices	Rockies	2033-2034	\$ 2.13	\$ 1.51	\$ 2.13	\$ 2.29	\$ 2.00	\$ 1.79	\$ 2.01	\$ 2.04	\$ 2.51	\$ 2.41	\$ 2.17	\$ 2.05
High Growth & Low Prices	Rockies	2034-2035	\$ 1.91	\$ 1.52	\$ 2.14	\$ 2.29	\$ 2.01	\$ 1.79	\$ 2.04	\$ 2.05	\$ 2.55	\$ 2.43	\$ 1.99	\$ 2.04

## APPENDIX 5.1: MONTHLY PRICE DATA BY BASIN

### HIGH GROWTH LOW PRICE

		2014\$												
High Growth & Low Prices	Stanfield	2015-2016	\$2.17	\$1.98	\$2.19	\$2.31	\$1.92	\$1.63	\$1.90	\$1.97	\$2.47	\$2.34	\$1.77	\$2.07
High Growth & Low Prices	Stanfield	2016-2017	\$1.84	\$1.43	\$2.09	\$2.23	\$1.91	\$1.71	\$2.02	\$2.04	\$2.52	\$2.34	\$1.89	\$2.05
High Growth & Low Prices	Stanfield	2017-2018	\$1.91	\$1.48	\$2.09	\$2.23	\$1.92	\$1.74	\$1.95	\$2.02	\$2.51	\$2.35	\$1.90	\$1.96
High Growth & Low Prices	Stanfield	2018-2019	\$1.81	\$1.54	\$2.07	\$2.22	\$1.89	\$1.70	\$1.96	\$2.01	\$2.50	\$2.34	\$1.80	\$2.00
High Growth & Low Prices	Stanfield	2019-2020	\$1.79	\$1.38	\$2.01	\$2.15	\$1.84	\$1.68	\$1.87	\$1.91	\$2.45	\$2.33	\$1.98	\$1.96
High Growth & Low Prices	Stanfield	2020-2021	\$1.78	\$1.40	\$2.05	\$2.18	\$1.86	\$1.69	\$1.94	\$1.96	\$2.50	\$2.34	\$1.78	\$1.92
High Growth & Low Prices	Stanfield	2021-2022	\$1.84	\$1.45	\$2.04	\$2.19	\$1.88	\$1.70	\$1.94	\$1.98	\$2.52	\$2.34	\$1.86	\$2.00
High Growth & Low Prices	Stanfield	2022-2023	\$1.81	\$1.41	\$2.04	\$2.20	\$1.88	\$1.68	\$1.93	\$1.98	\$2.49	\$2.36	\$1.87	\$2.08
High Growth & Low Prices	Stanfield	2023-2024	\$1.96	\$1.41	\$2.07	\$2.15	\$1.88	\$1.69	\$1.94	\$1.97	\$2.46	\$2.35	\$1.90	\$1.96
High Growth & Low Prices	Stanfield	2024-2025	\$1.89	\$1.50	\$2.04	\$2.19	\$1.88	\$1.70	\$1.93	\$1.98	\$2.47	\$2.34	\$1.96	\$1.93
High Growth & Low Prices	Stanfield	2025-2026	\$1.81	\$1.42	\$2.02	\$2.19	\$1.88	\$1.68	\$1.90	\$1.95	\$2.46	\$2.34	\$1.89	\$1.94
High Growth & Low Prices	Stanfield	2026-2027	\$1.81	\$1.41	\$2.05	\$2.19	\$1.89	\$1.69	\$1.93	\$1.99	\$2.48	\$2.34	\$1.85	\$1.98
High Growth & Low Prices	Stanfield	2027-2028	\$1.85	\$1.44	\$2.04	\$2.20	\$1.89	\$1.70	\$1.93	\$1.96	\$2.47	\$2.32	\$1.68	\$1.94
High Growth & Low Prices	Stanfield	2028-2029	\$1.89	\$1.42	\$2.07	\$2.23	\$1.92	\$1.71	\$2.02	\$1.99	\$2.45	\$2.32	\$1.83	\$1.95
High Growth & Low Prices	Stanfield	2029-2030	\$1.85	\$1.67	\$2.08	\$2.24	\$1.95	\$1.72	\$1.96	\$2.01	\$2.49	\$2.35	\$2.02	\$1.98
High Growth & Low Prices	Stanfield	2030-2031	\$1.86	\$1.65	\$2.10	\$2.26	\$1.98	\$1.74	\$1.96	\$2.02	\$2.50	\$2.36	\$1.97	\$2.00
High Growth & Low Prices	Stanfield	2031-2032	\$2.03	\$1.47	\$2.09	\$2.25	\$1.96	\$1.77	\$2.03	\$2.00	\$2.49	\$2.39	\$1.96	\$2.04
High Growth & Low Prices	Stanfield	2032-2033	\$1.92	\$1.61	\$2.11	\$2.28	\$2.01	\$1.81	\$2.11	\$2.04	\$2.58	\$2.45	\$1.80	\$2.05
High Growth & Low Prices	Stanfield	2033-2034	\$2.16	\$1.57	\$2.19	\$2.35	\$2.01	\$1.80	\$2.04	\$2.09	\$2.58	\$2.44	\$2.15	\$2.06
High Growth & Low Prices	Stanfield	2034-2035	\$1.95	\$1.60	\$2.20	\$2.36	\$2.02	\$1.78	\$2.06	\$2.09	\$2.59	\$2.43	\$1.97	\$2.06
High Growth & Low Prices	Sumas	2015-2016	\$2.16	\$1.93	\$2.16	\$2.23	\$1.76	\$1.44	\$1.57	\$1.63	\$2.10	\$2.02	\$1.60	\$1.93
High Growth & Low Prices	Sumas	2016-2017	\$1.70	\$1.47	\$2.05	\$2.16	\$1.84	\$1.63	\$1.92	\$1.84	\$2.35	\$2.21	\$1.78	\$1.87
High Growth & Low Prices	Sumas	2017-2018	\$1.84	\$1.49	\$2.05	\$2.19	\$1.88	\$1.64	\$1.67	\$1.72	\$2.21	\$2.12	\$1.66	\$1.84
High Growth & Low Prices	Sumas	2018-2019	\$1.70	\$1.48	\$2.04	\$2.19	\$1.80	\$1.52	\$1.71	\$1.71	\$2.24	\$2.14	\$1.62	\$1.87
High Growth & Low Prices	Sumas	2019-2020	\$1.68	\$1.32	\$1.94	\$2.10	\$1.78	\$1.52	\$1.68	\$1.65	\$2.25	\$2.15	\$1.86	\$1.88
High Growth & Low Prices	Sumas	2020-2021	\$1.69	\$1.33	\$2.00	\$2.17	\$1.83	\$1.58	\$1.78	\$1.74	\$2.33	\$2.19	\$1.71	\$1.84
High Growth & Low Prices	Sumas	2021-2022	\$1.71	\$1.31	\$1.91	\$2.06	\$1.83	\$1.60	\$1.77	\$1.81	\$2.32	\$2.21	\$1.82	\$1.92
High Growth & Low Prices	Sumas	2022-2023	\$1.71	\$1.27	\$1.89	\$2.09	\$1.84	\$1.61	\$1.77	\$1.83	\$2.33	\$2.25	\$1.79	\$2.00
High Growth & Low Prices	Sumas	2023-2024	\$1.86	\$1.36	\$1.96	\$2.09	\$1.82	\$1.58	\$1.72	\$1.79	\$2.28	\$2.23	\$1.82	\$1.86
High Growth & Low Prices	Sumas	2024-2025	\$1.77	\$1.32	\$1.94	\$2.12	\$1.82	\$1.57	\$1.72	\$1.75	\$2.27	\$2.19	\$1.87	\$1.82
High Growth & Low Prices	Sumas	2025-2026	\$1.63	\$1.23	\$1.85	\$2.02	\$1.78	\$1.56	\$1.69	\$1.71	\$2.27	\$2.19	\$1.74	\$1.78
High Growth & Low Prices	Sumas	2026-2027	\$1.64	\$1.23	\$1.87	\$2.02	\$1.79	\$1.55	\$1.76	\$1.77	\$2.31	\$2.18	\$1.74	\$1.92
High Growth & Low Prices	Sumas	2027-2028	\$1.75	\$1.41	\$2.05	\$2.21	\$1.83	\$1.63	\$1.77	\$1.84	\$2.34	\$2.27	\$1.66	\$1.92
High Growth & Low Prices	Sumas	2028-2029	\$1.90	\$1.44	\$2.09	\$2.25	\$1.92	\$1.65	\$1.87	\$1.86	\$2.35	\$2.29	\$1.80	\$1.93
High Growth & Low Prices	Sumas	2029-2030	\$1.86	\$1.68	\$2.09	\$2.25	\$1.96	\$1.67	\$1.87	\$1.94	\$2.39	\$2.31	\$2.02	\$2.01
High Growth & Low Prices	Sumas	2030-2031	\$1.89	\$1.66	\$2.11	\$2.27	\$1.98	\$1.69	\$1.88	\$1.94	\$2.39	\$2.32	\$1.97	\$2.02
High Growth & Low Prices	Sumas	2031-2032	\$2.04	\$1.49	\$2.12	\$2.28	\$1.98	\$1.72	\$1.98	\$1.95	\$2.38	\$2.34	\$1.95	\$2.04
High Growth & Low Prices	Sumas	2032-2033	\$1.93	\$1.62	\$2.14	\$2.29	\$2.02	\$1.76	\$2.02	\$1.95	\$2.43	\$2.39	\$1.80	\$2.08
High Growth & Low Prices	Sumas	2033-2034	\$2.21	\$1.64	\$2.28	\$2.42	\$2.03	\$1.77	\$1.94	\$1.98	\$2.45	\$2.40	\$2.17	\$2.08
High Growth & Low Prices	Sumas	2034-2035	\$2.01	\$1.68	\$2.31	\$2.45	\$2.07	\$1.81	\$2.01	\$2.01	\$2.52	\$2.42	\$2.00	\$2.08



## APPENDIX 5.1: MONTHLY PRICE DATA BY BASIN

### LOW GROWTH HIGH PRICE

		2014\$												
Scenario	Index	Gas Year	Nov	Dec	Jan	Feb	Mar	Apr	May	Jun	Jul	Aug	Sep	Oct
Low Growth_High Prices	AECO	2015-2016	\$1.91	\$1.63	\$7.19	\$7.41	\$7.42	\$4.22	\$4.17	\$4.47	\$4.14	\$4.29	\$3.53	\$4.29
Low Growth_High Prices	AECO	2016-2017	\$3.78	\$5.33	\$6.93	\$7.25	\$7.01	\$4.25	\$4.22	\$4.48	\$4.13	\$4.28	\$3.48	\$4.26
Low Growth_High Prices	AECO	2017-2018	\$3.86	\$5.40	\$7.59	\$7.89	\$7.92	\$4.74	\$4.68	\$4.93	\$4.61	\$4.70	\$3.98	\$4.76
Low Growth_High Prices	AECO	2018-2019	\$4.43	\$5.96	\$7.50	\$7.81	\$7.58	\$4.54	\$4.56	\$4.90	\$4.59	\$4.68	\$3.99	\$4.79
Low Growth_High Prices	AECO	2019-2020	\$4.46	\$6.00	\$7.52	\$7.84	\$7.88	\$4.57	\$4.59	\$4.90	\$4.58	\$4.68	\$3.99	\$4.77
Low Growth_High Prices	AECO	2020-2021	\$4.51	\$6.07	\$7.56	\$7.94	\$7.26	\$4.65	\$4.68	\$4.98	\$4.56	\$4.65	\$4.12	\$4.91
Low Growth_High Prices	AECO	2021-2022	\$4.46	\$5.98	\$7.50	\$7.87	\$7.91	\$4.63	\$4.66	\$4.97	\$4.62	\$4.73	\$4.03	\$4.83
Low Growth_High Prices	AECO	2022-2023	\$4.38	\$5.85	\$7.31	\$7.67	\$6.32	\$4.59	\$4.65	\$4.97	\$4.62	\$4.71	\$4.15	\$4.96
Low Growth_High Prices	AECO	2023-2024	\$4.61	\$6.08	\$7.60	\$7.94	\$8.02	\$4.71	\$4.73	\$5.04	\$4.78	\$4.87	\$4.25	\$5.03
Low Growth_High Prices	AECO	2024-2025	\$4.69	\$6.13	\$7.66	\$7.97	\$8.03	\$4.69	\$4.78	\$5.09	\$4.79	\$4.88	\$4.27	\$5.05
Low Growth_High Prices	AECO	2025-2026	\$4.71	\$6.10	\$7.60	\$7.91	\$7.91	\$4.72	\$4.79	\$5.09	\$4.81	\$4.93	\$4.27	\$5.06
Low Growth_High Prices	AECO	2026-2027	\$4.77	\$6.01	\$7.53	\$7.83	\$7.32	\$4.76	\$4.81	\$5.15	\$4.87	\$4.97	\$4.44	\$5.23
Low Growth_High Prices	AECO	2027-2028	\$4.89	\$6.23	\$7.80	\$8.11	\$7.87	\$4.96	\$4.99	\$5.32	\$5.04	\$5.12	\$4.53	\$5.34
Low Growth_High Prices	AECO	2028-2029	\$4.95	\$6.35	\$7.90	\$8.21	\$7.78	\$5.03	\$5.10	\$5.41	\$5.09	\$5.18	\$4.59	\$5.40
Low Growth_High Prices	AECO	2029-2030	\$4.99	\$6.39	\$7.96	\$8.30	\$8.29	\$5.10	\$5.12	\$5.47	\$5.18	\$5.27	\$4.66	\$5.47
Low Growth_High Prices	AECO	2030-2031	\$5.04	\$6.50	\$8.07	\$8.41	\$8.37	\$5.24	\$5.26	\$5.58	\$5.25	\$5.34	\$4.75	\$5.56
Low Growth_High Prices	AECO	2031-2032	\$5.08	\$6.57	\$8.12	\$8.45	\$7.32	\$5.33	\$5.34	\$5.67	\$5.30	\$5.45	\$4.81	\$5.62
Low Growth_High Prices	AECO	2032-2033	\$5.14	\$6.67	\$8.21	\$8.55	\$7.50	\$5.40	\$5.40	\$5.73	\$5.43	\$5.55	\$4.88	\$5.67
Low Growth_High Prices	AECO	2033-2034	\$5.19	\$6.72	\$8.27	\$8.60	\$7.36	\$5.41	\$5.43	\$5.75	\$5.44	\$5.53	\$4.92	\$5.73
Low Growth_High Prices	AECO	2034-2035	\$5.23	\$6.78	\$8.36	\$8.67	\$8.22	\$5.60	\$5.58	\$5.78	\$5.44	\$5.61	\$4.98	\$5.76
Low Growth_High Prices	Malin	2015-2016	\$2.20	\$2.03	\$7.63	\$7.92	\$7.93	\$4.69	\$4.71	\$5.04	\$4.73	\$4.83	\$4.08	\$4.88
Low Growth_High Prices	Malin	2016-2017	\$4.46	\$5.98	\$7.48	\$7.78	\$7.54	\$4.76	\$4.74	\$5.08	\$4.76	\$4.83	\$4.11	\$4.93
Low Growth_High Prices	Malin	2017-2018	\$4.49	\$5.98	\$8.00	\$8.32	\$8.41	\$5.26	\$5.27	\$5.58	\$5.27	\$5.36	\$4.62	\$5.45
Low Growth_High Prices	Malin	2018-2019	\$4.99	\$6.52	\$8.07	\$8.38	\$8.27	\$5.30	\$5.31	\$5.63	\$5.28	\$5.39	\$4.67	\$5.47
Low Growth_High Prices	Malin	2019-2020	\$5.01	\$6.48	\$8.03	\$8.34	\$8.41	\$5.29	\$5.23	\$5.54	\$5.23	\$5.38	\$4.64	\$5.44
Low Growth_High Prices	Malin	2020-2021	\$5.01	\$6.51	\$8.07	\$8.39	\$7.74	\$5.32	\$5.32	\$5.59	\$5.30	\$5.41	\$4.66	\$5.48
Low Growth_High Prices	Malin	2021-2022	\$5.02	\$6.51	\$8.08	\$8.41	\$8.46	\$5.33	\$5.32	\$5.62	\$5.33	\$5.42	\$4.69	\$5.49
Low Growth_High Prices	Malin	2022-2023	\$5.04	\$6.51	\$8.09	\$8.43	\$7.04	\$5.33	\$5.33	\$5.65	\$5.31	\$5.45	\$4.70	\$5.50
Low Growth_High Prices	Malin	2023-2024	\$5.07	\$6.55	\$8.09	\$8.40	\$8.47	\$5.34	\$5.33	\$5.63	\$5.30	\$5.45	\$4.71	\$5.52
Low Growth_High Prices	Malin	2024-2025	\$5.06	\$6.53	\$8.09	\$8.40	\$8.47	\$5.35	\$5.33	\$5.63	\$5.31	\$5.43	\$4.69	\$5.51
Low Growth_High Prices	Malin	2025-2026	\$5.06	\$6.55	\$8.08	\$8.42	\$8.48	\$5.35	\$5.32	\$5.63	\$5.31	\$5.44	\$4.71	\$5.51
Low Growth_High Prices	Malin	2026-2027	\$5.07	\$6.56	\$8.13	\$8.45	\$7.92	\$5.38	\$5.36	\$5.67	\$5.34	\$5.46	\$4.72	\$5.57
Low Growth_High Prices	Malin	2027-2028	\$5.14	\$6.62	\$8.18	\$8.50	\$8.32	\$5.43	\$5.40	\$5.71	\$5.38	\$5.50	\$4.77	\$5.61
Low Growth_High Prices	Malin	2028-2029	\$5.18	\$6.66	\$8.26	\$8.57	\$8.19	\$5.48	\$5.46	\$5.76	\$5.42	\$5.55	\$4.83	\$5.66
Low Growth_High Prices	Malin	2029-2030	\$5.24	\$6.74	\$8.30	\$8.62	\$8.72	\$5.53	\$5.52	\$5.83	\$5.48	\$5.62	\$4.93	\$5.74
Low Growth_High Prices	Malin	2030-2031	\$5.31	\$6.78	\$8.36	\$8.69	\$8.78	\$5.60	\$5.57	\$5.88	\$5.53	\$5.66	\$4.97	\$5.80
Low Growth_High Prices	Malin	2031-2032	\$5.37	\$6.83	\$8.41	\$8.74	\$7.63	\$5.68	\$5.61	\$5.91	\$5.57	\$5.74	\$5.05	\$5.88
Low Growth_High Prices	Malin	2032-2033	\$5.46	\$6.91	\$8.49	\$8.82	\$7.89	\$5.78	\$5.70	\$6.00	\$5.72	\$5.85	\$5.13	\$5.94
Low Growth_High Prices	Malin	2033-2034	\$5.51	\$7.04	\$8.62	\$8.94	\$7.79	\$5.82	\$5.80	\$6.11	\$5.77	\$5.90	\$5.19	\$6.00
Low Growth_High Prices	Malin	2034-2035	\$5.58	\$7.12	\$8.69	\$9.02	\$8.48	\$5.88	\$5.88	\$6.18	\$5.86	\$5.98	\$5.25	\$6.07
Low Growth_High Prices	Rockies	2015-2016	\$2.01	\$1.81	\$7.46	\$7.78	\$7.82	\$4.64	\$4.63	\$4.96	\$4.63	\$4.77	\$4.03	\$4.86
Low Growth_High Prices	Rockies	2016-2017	\$4.38	\$5.89	\$7.41	\$7.74	\$7.46	\$4.67	\$4.69	\$5.02	\$4.68	\$4.78	\$4.06	\$4.86
Low Growth_High Prices	Rockies	2017-2018	\$4.39	\$5.90	\$7.95	\$8.28	\$8.36	\$5.22	\$5.21	\$5.53	\$5.18	\$5.29	\$4.58	\$5.37
Low Growth_High Prices	Rockies	2018-2019	\$4.92	\$6.44	\$7.99	\$8.31	\$8.20	\$5.26	\$5.26	\$5.57	\$5.22	\$5.33	\$4.58	\$5.38
Low Growth_High Prices	Rockies	2019-2020	\$4.93	\$6.40	\$7.94	\$8.27	\$8.36	\$5.23	\$5.20	\$5.51	\$5.18	\$5.32	\$4.59	\$5.37
Low Growth_High Prices	Rockies	2020-2021	\$4.93	\$6.44	\$8.00	\$8.32	\$7.69	\$5.27	\$5.28	\$5.59	\$5.25	\$5.36	\$4.61	\$5.41
Low Growth_High Prices	Rockies	2021-2022	\$4.94	\$6.46	\$8.01	\$8.33	\$8.41	\$5.29	\$5.29	\$5.61	\$5.27	\$5.37	\$4.63	\$5.42
Low Growth_High Prices	Rockies	2022-2023	\$4.95	\$6.47	\$8.00	\$8.34	\$6.97	\$5.28	\$5.28	\$5.58	\$5.24	\$5.40	\$4.66	\$5.44
Low Growth_High Prices	Rockies	2023-2024	\$4.99	\$6.49	\$7.99	\$8.31	\$8.42	\$5.30	\$5.29	\$5.59	\$5.25	\$5.42	\$4.68	\$5.48
Low Growth_High Prices	Rockies	2024-2025	\$5.00	\$6.50	\$8.04	\$8.35	\$8.44	\$5.32	\$5.29	\$5.60	\$5.27	\$5.39	\$4.65	\$5.45
Low Growth_High Prices	Rockies	2025-2026	\$4.98	\$6.50	\$8.03	\$8.35	\$8.44	\$5.31	\$5.28	\$5.60	\$5.26	\$5.40	\$4.65	\$5.46
Low Growth_High Prices	Rockies	2026-2027	\$4.99	\$6.49	\$8.06	\$8.38	\$7.87	\$5.34	\$5.32	\$5.63	\$5.30	\$5.41	\$4.67	\$5.48
Low Growth_High Prices	Rockies	2027-2028	\$5.03	\$6.54	\$8.09	\$8.42	\$8.25	\$5.38	\$5.35	\$5.65	\$5.32	\$5.45	\$4.71	\$5.52
Low Growth_High Prices	Rockies	2028-2029	\$5.07	\$6.58	\$8.18	\$8.49	\$8.11	\$5.43	\$5.40	\$5.72	\$5.35	\$5.48	\$4.76	\$5.57
Low Growth_High Prices	Rockies	2029-2030	\$5.17	\$6.65	\$8.22	\$8.54	\$8.63	\$5.49	\$5.48	\$5.78	\$5.42	\$5.57	\$4.85	\$5.68
Low Growth_High Prices	Rockies	2030-2031	\$5.24	\$6.71	\$8.28	\$8.61	\$8.71	\$5.56	\$5.52	\$5.83	\$5.48	\$5.60	\$4.90	\$5.73
Low Growth_High Prices	Rockies	2031-2032	\$5.30	\$6.75	\$8.33	\$8.66	\$7.56	\$5.64	\$5.56	\$5.86	\$5.51	\$5.66	\$4.97	\$5.80
Low Growth_High Prices	Rockies	2032-2033	\$5.36	\$6.84	\$8.42	\$8.74	\$7.81	\$5.71	\$5.64	\$5.95	\$5.58	\$5.76	\$5.06	\$5.87
Low Growth_High Prices	Rockies	2033-2034	\$5.42	\$6.90	\$8.48	\$8.80	\$7.71	\$5.77	\$5.73	\$6.02	\$5.65	\$5.82	\$5.13	\$5.93
Low Growth_High Prices	Rockies	2034-2035	\$5.47	\$6.96	\$8.54	\$8.87	\$8.40	\$5.83	\$5.82	\$6.09	\$5.75	\$5.89	\$5.20	\$5.98

## APPENDIX 5.1: MONTHLY PRICE DATA BY BASIN

### LOW GROWTH HIGH PRICE

		2014\$												
Low Growth_High Prices	Stanfield	2015-2016	\$2.17	\$1.98	\$7.56	\$7.84	\$7.84	\$4.63	\$4.64	\$4.97	\$4.63	\$4.77	\$4.01	\$4.80
Low Growth_High Prices	Stanfield	2016-2017	\$4.39	\$5.90	\$7.45	\$7.77	\$7.49	\$4.70	\$4.69	\$5.03	\$4.68	\$4.77	\$4.05	\$4.87
Low Growth_High Prices	Stanfield	2017-2018	\$4.42	\$5.92	\$7.97	\$8.29	\$8.37	\$5.25	\$5.21	\$5.53	\$5.18	\$5.29	\$4.58	\$5.37
Low Growth_High Prices	Stanfield	2018-2019	\$4.92	\$6.43	\$7.98	\$8.29	\$8.19	\$5.23	\$5.23	\$5.54	\$5.20	\$5.31	\$4.58	\$5.38
Low Growth_High Prices	Stanfield	2019-2020	\$4.92	\$6.39	\$7.93	\$8.24	\$8.32	\$5.22	\$5.16	\$5.46	\$5.16	\$5.30	\$4.57	\$5.36
Low Growth_High Prices	Stanfield	2020-2021	\$4.92	\$6.41	\$7.97	\$8.28	\$7.65	\$5.25	\$5.25	\$5.52	\$5.22	\$5.33	\$4.57	\$5.38
Low Growth_High Prices	Stanfield	2021-2022	\$4.93	\$6.41	\$7.98	\$8.30	\$8.38	\$5.27	\$5.25	\$5.55	\$5.25	\$5.34	\$4.58	\$5.39
Low Growth_High Prices	Stanfield	2022-2023	\$4.94	\$6.42	\$7.99	\$8.32	\$6.95	\$5.27	\$5.26	\$5.56	\$5.24	\$5.37	\$4.62	\$5.41
Low Growth_High Prices	Stanfield	2023-2024	\$4.98	\$6.46	\$8.04	\$8.29	\$8.40	\$5.29	\$5.27	\$5.56	\$5.22	\$5.38	\$4.64	\$5.46
Low Growth_High Prices	Stanfield	2024-2025	\$5.00	\$6.47	\$8.02	\$8.34	\$8.42	\$5.31	\$5.28	\$5.58	\$5.24	\$5.38	\$4.62	\$5.44
Low Growth_High Prices	Stanfield	2025-2026	\$5.01	\$6.49	\$8.01	\$8.35	\$8.43	\$5.30	\$5.26	\$5.57	\$5.25	\$5.39	\$4.66	\$5.46
Low Growth_High Prices	Stanfield	2026-2027	\$5.02	\$6.50	\$8.07	\$8.38	\$7.87	\$5.35	\$5.33	\$5.64	\$5.30	\$5.42	\$4.68	\$5.51
Low Growth_High Prices	Stanfield	2027-2028	\$5.10	\$6.57	\$8.11	\$8.44	\$8.26	\$5.39	\$5.37	\$5.66	\$5.33	\$5.45	\$4.71	\$5.54
Low Growth_High Prices	Stanfield	2028-2029	\$5.12	\$6.59	\$8.17	\$8.51	\$8.13	\$5.44	\$5.42	\$5.73	\$5.35	\$5.49	\$4.75	\$5.59
Low Growth_High Prices	Stanfield	2029-2030	\$5.18	\$6.67	\$8.23	\$8.56	\$8.65	\$5.49	\$5.49	\$5.79	\$5.44	\$5.56	\$4.88	\$5.66
Low Growth_High Prices	Stanfield	2030-2031	\$5.23	\$6.72	\$8.29	\$8.62	\$8.74	\$5.56	\$5.53	\$5.84	\$5.49	\$5.61	\$4.92	\$5.72
Low Growth_High Prices	Stanfield	2031-2032	\$5.31	\$6.77	\$8.33	\$8.67	\$7.57	\$5.64	\$5.55	\$5.88	\$5.53	\$5.69	\$5.00	\$5.82
Low Growth_High Prices	Stanfield	2032-2033	\$5.39	\$6.85	\$8.41	\$8.75	\$7.82	\$5.74	\$5.66	\$5.97	\$5.67	\$5.80	\$5.06	\$5.88
Low Growth_High Prices	Stanfield	2033-2034	\$5.45	\$6.97	\$8.54	\$8.87	\$7.72	\$5.77	\$5.76	\$6.07	\$5.72	\$5.85	\$5.11	\$5.94
Low Growth_High Prices	Stanfield	2034-2035	\$5.51	\$7.05	\$8.61	\$8.94	\$8.42	\$5.81	\$5.84	\$6.12	\$5.79	\$5.89	\$5.17	\$6.00
Low Growth_High Prices	Sumas	2015-2016	\$2.16	\$1.93	\$7.53	\$7.76	\$7.69	\$4.43	\$4.31	\$4.63	\$4.26	\$4.45	\$3.84	\$4.66
Low Growth_High Prices	Sumas	2016-2017	\$4.25	\$5.93	\$7.41	\$7.70	\$7.43	\$4.62	\$4.59	\$4.84	\$4.51	\$4.64	\$3.93	\$4.69
Low Growth_High Prices	Sumas	2017-2018	\$4.35	\$5.93	\$7.93	\$8.24	\$8.32	\$5.15	\$4.92	\$5.23	\$4.89	\$5.06	\$4.34	\$5.26
Low Growth_High Prices	Sumas	2018-2019	\$4.81	\$6.37	\$7.94	\$8.26	\$8.10	\$5.06	\$4.99	\$5.24	\$4.94	\$5.11	\$4.41	\$5.26
Low Growth_High Prices	Sumas	2019-2020	\$4.81	\$6.33	\$7.85	\$8.18	\$8.26	\$5.07	\$4.97	\$5.20	\$4.97	\$5.13	\$4.45	\$5.28
Low Growth_High Prices	Sumas	2020-2021	\$4.83	\$6.34	\$7.92	\$8.27	\$7.62	\$5.14	\$5.08	\$5.30	\$5.05	\$5.18	\$4.50	\$5.30
Low Growth_High Prices	Sumas	2021-2022	\$4.81	\$6.27	\$7.85	\$8.17	\$8.33	\$5.17	\$5.08	\$5.38	\$5.06	\$5.21	\$4.53	\$5.32
Low Growth_High Prices	Sumas	2022-2023	\$4.84	\$6.27	\$7.84	\$8.22	\$6.91	\$5.19	\$5.09	\$5.41	\$5.08	\$5.26	\$4.55	\$5.33
Low Growth_High Prices	Sumas	2023-2024	\$4.88	\$6.41	\$7.92	\$8.22	\$8.34	\$5.17	\$5.06	\$5.38	\$5.04	\$5.25	\$4.56	\$5.36
Low Growth_High Prices	Sumas	2024-2025	\$4.88	\$6.29	\$7.92	\$8.27	\$8.36	\$5.18	\$5.07	\$5.35	\$5.04	\$5.23	\$4.53	\$5.33
Low Growth_High Prices	Sumas	2025-2026	\$4.83	\$6.30	\$7.84	\$8.18	\$8.33	\$5.17	\$5.05	\$5.33	\$5.05	\$5.24	\$4.51	\$5.31
Low Growth_High Prices	Sumas	2026-2027	\$4.85	\$6.32	\$7.89	\$8.21	\$7.77	\$5.20	\$5.16	\$5.43	\$5.13	\$5.26	\$4.57	\$5.46
Low Growth_High Prices	Sumas	2027-2028	\$4.99	\$6.54	\$8.12	\$8.44	\$8.20	\$5.32	\$5.21	\$5.53	\$5.20	\$5.40	\$4.69	\$5.51
Low Growth_High Prices	Sumas	2028-2029	\$5.13	\$6.60	\$8.20	\$8.52	\$8.13	\$5.39	\$5.28	\$5.60	\$5.25	\$5.45	\$4.73	\$5.57
Low Growth_High Prices	Sumas	2029-2030	\$5.19	\$6.68	\$8.24	\$8.56	\$8.66	\$5.44	\$5.39	\$5.71	\$5.33	\$5.52	\$4.88	\$5.69
Low Growth_High Prices	Sumas	2030-2031	\$5.27	\$6.73	\$8.30	\$8.63	\$8.73	\$5.51	\$5.45	\$5.76	\$5.38	\$5.57	\$4.92	\$5.75
Low Growth_High Prices	Sumas	2031-2032	\$5.32	\$6.78	\$8.36	\$8.69	\$7.58	\$5.59	\$5.51	\$5.82	\$5.42	\$5.65	\$4.99	\$5.82
Low Growth_High Prices	Sumas	2032-2033	\$5.39	\$6.86	\$8.43	\$8.76	\$7.83	\$5.69	\$5.57	\$5.87	\$5.52	\$5.74	\$5.05	\$5.90
Low Growth_High Prices	Sumas	2033-2034	\$5.50	\$7.03	\$8.63	\$8.94	\$7.75	\$5.74	\$5.66	\$5.95	\$5.59	\$5.80	\$5.13	\$5.96
Low Growth_High Prices	Sumas	2034-2035	\$5.57	\$7.13	\$8.71	\$9.03	\$8.46	\$5.84	\$5.79	\$6.04	\$5.72	\$5.89	\$5.20	\$6.02

## APPENDIX 5.2: WEIGHTED AVERAGE COST OF CAPITAL

<b>Avista Corporation Capital Structure and Overall Rate of Return</b>				
<b>WASHINGTON</b>				
<b>From 2015 Rate Case Settlement</b>				
<b>Cost of Capital</b>	<b>Percent of Total Capital</b>	<b>Cost</b>	<b>Component</b>	<b>After Tax</b>
L/T Debt	51.50%	5.20%	2.68%	1.74%
Common Equity	48.50%	9.50%	4.61%	4.61%
<b>TOTAL</b>	<b>100.00%</b>		<b>7.29%</b>	<b>6.35%</b>
<b>IDAHO</b>				
<b>Agreed-upon Cost of Capital</b>	<b>Percent of Total Capital</b>	<b>Cost</b>	<b>Component</b>	
L/T Debt	50.00%	5.34%	2.67%	1.74%
Common Equity	50.00%	9.50%	4.75%	4.75%
<b>TOTAL</b>	<b>100.00%</b>		<b>7.42%</b>	<b>6.49%</b>
<b>OREGON</b>				
<b>Agreed-upon Cost of Capital</b>	<b>Percent of Total Capital</b>	<b>Cost</b>	<b>Component</b>	
L/T Debt	50.00%	5.52%	2.76%	1.79%
Common Equity	50.00%	9.40%	4.70%	4.70%
<b>TOTAL</b>	<b>100.00%</b>		<b>7.46%</b>	<b>6.49%</b>
2015 Year End Gas Net Rate Base AMA				
WA	\$ 269,072	46%		
ID	\$ 126,932	22%		
OR	\$ 189,415	32%		
	\$ 585,419			
<b>System Weighted Average Cost of Capital (Nominal)*</b>				<b>6.42%</b>
GDP price deflator				2.00%
<b>Real After Tax WACC</b>				<b>4.34%</b>

### APPENDIX 5.3: POTENTIAL SUPPLY SIDE RESOURCE OPTIONS

Available Supply Resources	Size	Cost/Rates	Availability	Notes
Capacity Release Recall	27,000 Dth	NWPL Rate	2018	Recall of previously released capacity
Unsubscribed GTN Capacity	Up to 50,000 Dth	GTN Rate plus Upstream TCPL	Now	Currently available unsubscribed capacity from Kingsgate to Stanfield or Malin plus associated Alberta transport
NWP Expansion	Up to 50,000 Dth	\$0.74 / Dth	2018	Expansion from Sumas to JP
Citygate Deliveries	Variable	Varies	Now	Represents the ability to buy a delivered product from another utility or marketer. Limited counterparties
Satellite LNG	90,000 Dth w/30,000 Dth deliverability	\$12.3 Million capital cost plus \$665K O&M	2018	Provides for peaking services and alleviates the need for costly pipeline expansions. \$3,000 per m3. O&M assumed at 5.4%
Medford Lateral Exp	50,000 Dth	\$10M / GTN estimated rate	2018	Additional compression to facilitate more gas to flow from mainline GTN to Medford.
Malin Backhauls	50,000	GTN Rate	Now	Currently available

Future Supply Resources	Size	Cost/Rates	Availability	Notes
Co. Owned LNG	600,000 Dth w/ 150,000 of deliverability	\$75 Million plus \$2 Million annual O&M	2022	On site, in service territory liquefaction and vaporization facility
Various pipelines – Pacific Connector, Cross-Cascades, etc.	Varies	Precedent Agreement Rates	2020	Requires additional mainline capacity on NWPL or GTN to get to service territory
Large Scale LNG	Varies	Commodity less Fuel	2020	Speculative, needs pipeline transport
In Ground Storage	Varies	Varies	Varies	Requires additional mainline transport to get to service territory

### APPENDIX 5.4: EXPECTED CASE AVOIDED COST

Annual Avoided Costs 1/ 2014\$												
Scenario	Gas Year	Klam Falls	La Grande	Medford GTN	Medford NWP	Roseburg	Wa/Id Both	Wa/Id GTN	Wa/Id NWP	WA/ID Annual	OR Annual	
Expected Case	2015-2016	\$ 1.88	\$ 2.17	\$ 1.88	\$ 1.88	\$ 1.88	\$ 1.88	\$ 1.84	\$ 2.16	\$ 1.96	\$ 1.94	
Expected Case	2016-2017	\$ 2.27	\$ 2.97	\$ 2.27	\$ 2.27	\$ 2.27	\$ 2.31	\$ 2.20	\$ 2.95	\$ 2.49	\$ 2.41	
Expected Case	2017-2018	\$ 2.79	\$ 3.45	\$ 2.79	\$ 2.79	\$ 2.79	\$ 2.79	\$ 2.72	\$ 3.44	\$ 2.99	\$ 2.92	
Expected Case	2018-2019	\$ 2.80	\$ 3.54	\$ 2.80	\$ 2.80	\$ 2.80	\$ 2.83	\$ 2.74	\$ 3.52	\$ 3.03	\$ 2.95	
Expected Case	2019-2020	\$ 2.88	\$ 3.62	\$ 2.88	\$ 2.88	\$ 2.88	\$ 2.93	\$ 2.83	\$ 3.61	\$ 3.12	\$ 3.03	
Expected Case	2020-2021	\$ 3.04	\$ 3.77	\$ 3.04	\$ 3.04	\$ 3.04	\$ 3.09	\$ 2.97	\$ 3.76	\$ 3.27	\$ 3.18	
Expected Case	2021-2022	\$ 3.15	\$ 3.90	\$ 3.15	\$ 3.15	\$ 3.15	\$ 3.16	\$ 3.05	\$ 3.87	\$ 3.36	\$ 3.30	
Expected Case	2022-2023	\$ 3.15	\$ 3.91	\$ 3.15	\$ 3.15	\$ 3.15	\$ 3.13	\$ 3.01	\$ 3.88	\$ 3.34	\$ 3.30	
Expected Case	2023-2024	\$ 3.35	\$ 3.97	\$ 3.35	\$ 3.35	\$ 3.35	\$ 3.38	\$ 3.27	\$ 3.95	\$ 3.53	\$ 3.48	
Expected Case	2024-2025	\$ 3.61	\$ 4.14	\$ 3.61	\$ 3.61	\$ 3.61	\$ 3.61	\$ 3.53	\$ 4.12	\$ 3.75	\$ 3.71	
Expected Case	2025-2026	\$ 3.59	\$ 4.10	\$ 3.59	\$ 3.59	\$ 3.59	\$ 3.58	\$ 3.53	\$ 4.06	\$ 3.72	\$ 3.69	
Expected Case	2026-2027	\$ 3.66	\$ 4.17	\$ 3.66	\$ 3.66	\$ 3.66	\$ 3.66	\$ 3.59	\$ 4.11	\$ 3.79	\$ 3.76	
Expected Case	2027-2028	\$ 3.97	\$ 4.38	\$ 3.97	\$ 3.97	\$ 3.97	\$ 3.95	\$ 3.91	\$ 4.34	\$ 4.06	\$ 4.05	
Expected Case	2028-2029	\$ 4.17	\$ 4.54	\$ 4.17	\$ 4.17	\$ 4.17	\$ 4.13	\$ 4.11	\$ 4.50	\$ 4.25	\$ 4.24	
Expected Case	2029-2030	\$ 4.33	\$ 4.73	\$ 4.33	\$ 4.33	\$ 4.33	\$ 4.30	\$ 4.26	\$ 4.70	\$ 4.42	\$ 4.41	
Expected Case	2030-2031	\$ 4.54	\$ 4.87	\$ 4.54	\$ 4.54	\$ 4.54	\$ 4.50	\$ 4.46	\$ 4.84	\$ 4.60	\$ 4.60	
Expected Case	2031-2032	\$ 4.68	\$ 4.97	\$ 4.68	\$ 4.68	\$ 4.68	\$ 4.64	\$ 4.61	\$ 4.94	\$ 4.73	\$ 4.73	
Expected Case	2032-2033	\$ 4.73	\$ 5.03	\$ 4.73	\$ 4.73	\$ 4.73	\$ 4.69	\$ 4.65	\$ 5.01	\$ 4.78	\$ 4.79	
Expected Case	2033-2034	\$ 4.78	\$ 5.15	\$ 4.78	\$ 4.78	\$ 4.78	\$ 4.75	\$ 4.70	\$ 5.13	\$ 4.86	\$ 4.86	
Expected Case	2034-2035	\$ 4.82	\$ 5.05	\$ 4.82	\$ 4.82	\$ 4.82	\$ 4.79	\$ 4.74	\$ 5.01	\$ 4.85	\$ 4.87	
Winter Avoided Costs 1/ 2014\$												
Scenario	Gas Year	Klam Falls	La Grande	Medford GTN	Medford NWP	Roseburg	Wa/Id Both	Wa/Id GTN	Wa/Id NWP	WA/ID Winter	OR Winter	
Expected Case	2015-2016	\$ 1.87	\$ 2.09	\$ 1.87	\$ 1.87	\$ 1.87	\$ 2.00	\$ 1.79	\$ 2.09	\$ 1.96	\$ 1.91	
Expected Case	2016-2017	\$ 2.31	\$ 2.97	\$ 2.31	\$ 2.31	\$ 2.31	\$ 2.42	\$ 2.14	\$ 2.94	\$ 2.50	\$ 2.44	
Expected Case	2017-2018	\$ 2.70	\$ 3.41	\$ 2.70	\$ 2.70	\$ 2.70	\$ 2.77	\$ 2.48	\$ 3.40	\$ 2.88	\$ 2.85	
Expected Case	2018-2019	\$ 3.15	\$ 3.55	\$ 3.15	\$ 3.15	\$ 3.15	\$ 3.26	\$ 3.01	\$ 3.51	\$ 3.26	\$ 3.23	
Expected Case	2019-2020	\$ 3.22	\$ 3.64	\$ 3.22	\$ 3.22	\$ 3.22	\$ 3.36	\$ 3.09	\$ 3.60	\$ 3.35	\$ 3.30	
Expected Case	2020-2021	\$ 3.33	\$ 3.78	\$ 3.33	\$ 3.33	\$ 3.33	\$ 3.49	\$ 3.19	\$ 3.75	\$ 3.48	\$ 3.42	
Expected Case	2021-2022	\$ 3.60	\$ 3.91	\$ 3.60	\$ 3.60	\$ 3.60	\$ 3.63	\$ 3.33	\$ 3.85	\$ 3.61	\$ 3.66	
Expected Case	2022-2023	\$ 3.58	\$ 3.93	\$ 3.58	\$ 3.58	\$ 3.58	\$ 3.54	\$ 3.22	\$ 3.86	\$ 3.54	\$ 3.65	
Expected Case	2023-2024	\$ 3.76	\$ 4.01	\$ 3.76	\$ 3.76	\$ 3.76	\$ 3.81	\$ 3.51	\$ 3.97	\$ 3.76	\$ 3.81	
Expected Case	2024-2025	\$ 3.98	\$ 4.18	\$ 3.98	\$ 3.98	\$ 3.98	\$ 4.01	\$ 3.79	\$ 4.12	\$ 3.97	\$ 4.02	
Expected Case	2025-2026	\$ 4.19	\$ 4.24	\$ 4.19	\$ 4.19	\$ 4.19	\$ 4.10	\$ 4.07	\$ 4.14	\$ 4.10	\$ 4.20	
Expected Case	2026-2027	\$ 4.18	\$ 4.30	\$ 4.18	\$ 4.18	\$ 4.18	\$ 4.11	\$ 4.04	\$ 4.13	\$ 4.09	\$ 4.20	
Expected Case	2027-2028	\$ 4.41	\$ 4.48	\$ 4.41	\$ 4.41	\$ 4.41	\$ 4.36	\$ 4.30	\$ 4.38	\$ 4.34	\$ 4.43	
Expected Case	2028-2029	\$ 4.60	\$ 4.67	\$ 4.60	\$ 4.60	\$ 4.60	\$ 4.54	\$ 4.50	\$ 4.58	\$ 4.54	\$ 4.61	
Expected Case	2029-2030	\$ 4.72	\$ 4.84	\$ 4.72	\$ 4.72	\$ 4.72	\$ 4.70	\$ 4.61	\$ 4.76	\$ 4.69	\$ 4.75	
Expected Case	2030-2031	\$ 5.02	\$ 5.09	\$ 5.02	\$ 5.02	\$ 5.02	\$ 4.94	\$ 4.91	\$ 4.99	\$ 4.95	\$ 5.03	
Expected Case	2031-2032	\$ 5.09	\$ 5.20	\$ 5.09	\$ 5.09	\$ 5.09	\$ 5.07	\$ 5.00	\$ 5.13	\$ 5.06	\$ 5.12	
Expected Case	2032-2033	\$ 5.23	\$ 5.33	\$ 5.23	\$ 5.23	\$ 5.23	\$ 5.18	\$ 5.13	\$ 5.24	\$ 5.19	\$ 5.25	
Expected Case	2033-2034	\$ 5.33	\$ 5.48	\$ 5.33	\$ 5.33	\$ 5.33	\$ 5.28	\$ 5.22	\$ 5.35	\$ 5.28	\$ 5.36	
Expected Case	2034-2035	\$ 5.32	\$ 5.46	\$ 5.32	\$ 5.32	\$ 5.32	\$ 5.25	\$ 5.19	\$ 5.32	\$ 5.25	\$ 5.35	

1/ Avoided costs are before Environmental Externalities adder.

### APPENDIX 5.4: LOW GROWTH CASE AVOIDED COST

Annual Avoided Costs 1/ 2014\$												
Scenario	Gas Year	Klam Falls	La Grande	Medford GTN	Medford NWP	Roseburg	Wa/ld Both	Wa/ld GTN	Wa/ld NWP	WA/ID Annual	OR Annual	
Low Growth & High Prices	2015-2016	\$ 4.68	\$ 5.03	\$ 4.68	\$ 4.68	\$ 4.68	\$ 4.63	\$ 4.61	\$ 4.98	\$ 4.74	\$ 4.75	
Low Growth & High Prices	2016-2017	\$ 5.09	\$ 5.72	\$ 5.08	\$ 5.08	\$ 5.08	\$ 4.99	\$ 5.00	\$ 5.70	\$ 5.23	\$ 5.21	
Low Growth & High Prices	2017-2018	\$ 5.57	\$ 6.20	\$ 5.57	\$ 5.57	\$ 5.57	\$ 5.46	\$ 5.48	\$ 6.16	\$ 5.70	\$ 5.69	
Low Growth & High Prices	2018-2019	\$ 5.59	\$ 6.27	\$ 5.58	\$ 5.58	\$ 5.58	\$ 5.49	\$ 5.50	\$ 6.24	\$ 5.75	\$ 5.72	
Low Growth & High Prices	2019-2020	\$ 5.63	\$ 6.27	\$ 5.63	\$ 5.63	\$ 5.63	\$ 5.52	\$ 5.55	\$ 6.23	\$ 5.77	\$ 5.76	
Low Growth & High Prices	2020-2021	\$ 5.63	\$ 6.26	\$ 5.62	\$ 5.62	\$ 5.62	\$ 5.53	\$ 5.55	\$ 6.25	\$ 5.78	\$ 5.75	
Low Growth & High Prices	2021-2022	\$ 5.66	\$ 6.35	\$ 5.66	\$ 5.66	\$ 5.66	\$ 5.55	\$ 5.58	\$ 6.31	\$ 5.81	\$ 5.80	
Low Growth & High Prices	2022-2023	\$ 5.50	\$ 6.22	\$ 5.49	\$ 5.49	\$ 5.49	\$ 5.33	\$ 5.41	\$ 6.15	\$ 5.63	\$ 5.64	
Low Growth & High Prices	2023-2024	\$ 5.79	\$ 6.34	\$ 5.79	\$ 5.79	\$ 5.79	\$ 5.68	\$ 5.71	\$ 6.31	\$ 5.90	\$ 5.90	
Low Growth & High Prices	2024-2025	\$ 5.82	\$ 6.29	\$ 5.82	\$ 5.82	\$ 5.82	\$ 5.71	\$ 5.73	\$ 6.27	\$ 5.90	\$ 5.91	
Low Growth & High Prices	2025-2026	\$ 5.81	\$ 6.25	\$ 5.81	\$ 5.81	\$ 5.81	\$ 5.70	\$ 5.72	\$ 6.23	\$ 5.88	\$ 5.89	
Low Growth & High Prices	2026-2027	\$ 5.79	\$ 6.20	\$ 5.78	\$ 5.78	\$ 5.78	\$ 5.69	\$ 5.70	\$ 6.21	\$ 5.87	\$ 5.87	
Low Growth & High Prices	2027-2028	\$ 6.01	\$ 6.34	\$ 6.00	\$ 6.00	\$ 6.00	\$ 5.91	\$ 5.92	\$ 6.35	\$ 6.06	\$ 6.07	
Low Growth & High Prices	2028-2029	\$ 6.07	\$ 6.37	\$ 6.06	\$ 6.06	\$ 6.06	\$ 5.97	\$ 5.98	\$ 6.38	\$ 6.11	\$ 6.12	
Low Growth & High Prices	2029-2030	\$ 6.18	\$ 6.48	\$ 6.17	\$ 6.17	\$ 6.17	\$ 6.06	\$ 6.09	\$ 6.47	\$ 6.21	\$ 6.23	
Low Growth & High Prices	2030-2031	\$ 6.27	\$ 6.53	\$ 6.27	\$ 6.27	\$ 6.27	\$ 6.16	\$ 6.18	\$ 6.53	\$ 6.29	\$ 6.32	
Low Growth & High Prices	2031-2032	\$ 6.25	\$ 6.48	\$ 6.24	\$ 6.24	\$ 6.24	\$ 6.15	\$ 6.16	\$ 6.48	\$ 6.26	\$ 6.29	
Low Growth & High Prices	2032-2033	\$ 6.33	\$ 6.56	\$ 6.32	\$ 6.32	\$ 6.32	\$ 6.12	\$ 6.25	\$ 6.45	\$ 6.27	\$ 6.37	
Low Growth & High Prices	2033-2034	\$ 6.35	\$ 6.64	\$ 6.35	\$ 6.35	\$ 6.35	\$ 6.12	\$ 6.26	\$ 6.51	\$ 6.30	\$ 6.41	
Low Growth & High Prices	2034-2035	\$ 6.50	\$ 6.65	\$ 6.49	\$ 6.49	\$ 6.49	\$ 6.37	\$ 6.40	\$ 6.59	\$ 6.46	\$ 6.52	
Winter Avoided Costs 1/ 2014\$												
Scenario	Gas Year	Klam Falls	La Grande	Medford GTN	Medford NWP	Roseburg	Wa/ld Both	Wa/ld GTN	Wa/ld NWP	WA/ID Winter	OR Winter	
Low Growth & High Prices	2015-2016	\$ 1.88	\$ 2.14	\$ 1.88	\$ 1.88	\$ 1.88	\$ 2.02	\$ 1.79	\$ 2.14	\$ 1.98	\$ 1.93	
Low Growth & High Prices	2016-2017	\$ 4.78	\$ 5.71	\$ 4.79	\$ 4.79	\$ 4.79	\$ 4.69	\$ 4.63	\$ 5.71	\$ 5.01	\$ 4.97	
Low Growth & High Prices	2017-2018	\$ 4.85	\$ 5.74	\$ 4.85	\$ 4.85	\$ 4.85	\$ 4.75	\$ 4.70	\$ 5.74	\$ 5.06	\$ 5.03	
Low Growth & High Prices	2018-2019	\$ 5.42	\$ 6.12	\$ 5.42	\$ 5.42	\$ 5.42	\$ 5.32	\$ 5.27	\$ 6.11	\$ 5.57	\$ 5.56	
Low Growth & High Prices	2019-2020	\$ 5.44	\$ 6.04	\$ 5.44	\$ 5.44	\$ 5.44	\$ 5.36	\$ 5.31	\$ 6.04	\$ 5.57	\$ 5.56	
Low Growth & High Prices	2020-2021	\$ 5.50	\$ 6.02	\$ 5.50	\$ 5.50	\$ 5.50	\$ 5.42	\$ 5.37	\$ 6.02	\$ 5.60	\$ 5.60	
Low Growth & High Prices	2021-2022	\$ 5.44	\$ 6.01	\$ 5.44	\$ 5.44	\$ 5.44	\$ 5.35	\$ 5.30	\$ 6.00	\$ 5.55	\$ 5.55	
Low Growth & High Prices	2022-2023	\$ 5.35	\$ 6.15	\$ 5.35	\$ 5.35	\$ 5.35	\$ 5.24	\$ 5.19	\$ 6.12	\$ 5.52	\$ 5.51	
Low Growth & High Prices	2023-2024	\$ 5.56	\$ 6.08	\$ 5.56	\$ 5.56	\$ 5.56	\$ 5.47	\$ 5.42	\$ 6.08	\$ 5.66	\$ 5.66	
Low Growth & High Prices	2024-2025	\$ 5.61	\$ 5.91	\$ 5.61	\$ 5.61	\$ 5.61	\$ 5.54	\$ 5.49	\$ 5.90	\$ 5.64	\$ 5.67	
Low Growth & High Prices	2025-2026	\$ 5.62	\$ 5.88	\$ 5.62	\$ 5.62	\$ 5.62	\$ 5.54	\$ 5.49	\$ 5.87	\$ 5.63	\$ 5.67	
Low Growth & High Prices	2026-2027	\$ 5.61	\$ 5.93	\$ 5.61	\$ 5.61	\$ 5.61	\$ 5.52	\$ 5.47	\$ 5.93	\$ 5.64	\$ 5.68	
Low Growth & High Prices	2027-2028	\$ 5.77	\$ 6.09	\$ 5.77	\$ 5.77	\$ 5.77	\$ 5.69	\$ 5.64	\$ 6.09	\$ 5.81	\$ 5.83	
Low Growth & High Prices	2028-2029	\$ 5.85	\$ 6.14	\$ 5.85	\$ 5.85	\$ 5.85	\$ 5.78	\$ 5.73	\$ 6.14	\$ 5.88	\$ 5.90	
Low Growth & High Prices	2029-2030	\$ 5.90	\$ 6.26	\$ 5.90	\$ 5.90	\$ 5.90	\$ 5.82	\$ 5.77	\$ 6.26	\$ 5.95	\$ 5.97	
Low Growth & High Prices	2030-2031	\$ 5.97	\$ 6.31	\$ 5.97	\$ 5.97	\$ 5.97	\$ 5.90	\$ 5.85	\$ 6.31	\$ 6.02	\$ 6.03	
Low Growth & High Prices	2031-2032	\$ 6.02	\$ 6.35	\$ 6.02	\$ 6.02	\$ 6.02	\$ 5.96	\$ 5.91	\$ 6.35	\$ 6.07	\$ 6.09	
Low Growth & High Prices	2032-2033	\$ 6.10	\$ 6.42	\$ 6.10	\$ 6.10	\$ 6.10	\$ 6.04	\$ 5.99	\$ 6.42	\$ 6.15	\$ 6.16	
Low Growth & High Prices	2033-2034	\$ 6.16	\$ 6.50	\$ 6.16	\$ 6.16	\$ 6.16	\$ 6.09	\$ 6.04	\$ 6.50	\$ 6.21	\$ 6.23	
Low Growth & High Prices	2034-2035	\$ 6.22	\$ 6.56	\$ 6.22	\$ 6.22	\$ 6.22	\$ 6.14	\$ 6.09	\$ 6.56	\$ 6.26	\$ 6.28	

1/ Avoided costs are before Environmental Externalities added.

### APPENDIX 5.4: HIGH GROWTH CASE AVOIDED COST

Annual Avoided Costs 1/ 2014\$												
Scenario	Gas Year	Klam Falls	La Grande	Medford GTN	Medford NWP	Roseburg	Wa/ld Both	Wa/ld GTN	Wa/ld NWP	WA/ID Annual	OR Annual	
High Growth & Low Prices	2015-2016	\$ 1.69	\$ 2.02	\$ 1.69	\$ 1.69	\$ 1.69	\$ 1.70	\$ 1.65	\$ 2.01	\$ 1.79	\$ 1.75	
High Growth & Low Prices	2016-2017	\$ 1.57	\$ 2.13	\$ 1.57	\$ 1.57	\$ 1.57	\$ 1.60	\$ 1.49	\$ 2.12	\$ 1.74	\$ 1.68	
High Growth & Low Prices	2017-2018	\$ 1.57	\$ 2.14	\$ 1.57	\$ 1.57	\$ 1.57	\$ 1.59	\$ 1.50	\$ 2.13	\$ 1.74	\$ 1.69	
High Growth & Low Prices	2018-2019	\$ 1.53	\$ 2.15	\$ 1.53	\$ 1.53	\$ 1.53	\$ 1.55	\$ 1.42	\$ 2.13	\$ 1.70	\$ 1.65	
High Growth & Low Prices	2019-2020	\$ 1.55	\$ 2.14	\$ 1.55	\$ 1.55	\$ 1.55	\$ 1.57	\$ 1.44	\$ 2.12	\$ 1.71	\$ 1.67	
High Growth & Low Prices	2020-2021	\$ 1.59	\$ 2.15	\$ 1.59	\$ 1.59	\$ 1.59	\$ 1.60	\$ 1.48	\$ 2.12	\$ 1.73	\$ 1.70	
High Growth & Low Prices	2021-2022	\$ 1.59	\$ 2.23	\$ 1.59	\$ 1.59	\$ 1.59	\$ 1.59	\$ 1.46	\$ 2.20	\$ 1.75	\$ 1.72	
High Growth & Low Prices	2022-2023	\$ 1.58	\$ 2.26	\$ 1.58	\$ 1.58	\$ 1.58	\$ 1.54	\$ 1.40	\$ 2.22	\$ 1.72	\$ 1.72	
High Growth & Low Prices	2023-2024	\$ 1.68	\$ 2.20	\$ 1.68	\$ 1.68	\$ 1.68	\$ 1.69	\$ 1.55	\$ 2.17	\$ 1.80	\$ 1.78	
High Growth & Low Prices	2024-2025	\$ 1.68	\$ 2.13	\$ 1.68	\$ 1.68	\$ 1.68	\$ 1.71	\$ 1.58	\$ 2.10	\$ 1.80	\$ 1.77	
High Growth & Low Prices	2025-2026	\$ 1.64	\$ 2.08	\$ 1.64	\$ 1.64	\$ 1.64	\$ 1.67	\$ 1.54	\$ 2.04	\$ 1.75	\$ 1.73	
High Growth & Low Prices	2026-2027	\$ 1.67	\$ 2.11	\$ 1.67	\$ 1.67	\$ 1.67	\$ 1.68	\$ 1.54	\$ 2.05	\$ 1.75	\$ 1.76	
High Growth & Low Prices	2027-2028	\$ 1.77	\$ 2.09	\$ 7.23	\$ 7.23	\$ 7.23	\$ 1.78	\$ 1.67	\$ 2.09	\$ 1.84	\$ 5.11	
High Growth & Low Prices	2028-2029	\$ 1.83	\$ 2.12	\$ 7.30	\$ 7.30	\$ 7.30	\$ 1.84	\$ 1.73	\$ 2.10	\$ 1.89	\$ 5.17	
High Growth & Low Prices	2029-2030	\$ 1.87	\$ 2.19	\$ 7.35	\$ 7.35	\$ 7.35	\$ 1.88	\$ 1.77	\$ 2.18	\$ 1.94	\$ 5.22	
High Growth & Low Prices	2030-2031	\$ 1.91	\$ 7.66	\$ 12.86	\$ 12.86	\$ 12.86	\$ 1.92	\$ 1.81	\$ 2.18	\$ 1.97	\$ 9.63	
High Growth & Low Prices	2031-2032	\$ 1.94	\$ 7.64	\$ 12.86	\$ 12.86	\$ 12.86	\$ 7.41	\$ 1.84	\$ 7.63	\$ 5.63	\$ 9.63	
High Growth & Low Prices	2032-2033	\$ 1.95	\$ 7.67	\$ 12.89	\$ 12.89	\$ 12.89	\$ 7.43	\$ 1.85	\$ 7.67	\$ 5.65	\$ 9.66	
High Growth & Low Prices	2033-2034	\$ 1.97	\$ 7.72	\$ 12.92	\$ 12.92	\$ 12.92	\$ 7.44	\$ 1.86	\$ 7.71	\$ 5.67	\$ 9.69	
High Growth & Low Prices	2034-2035	\$ 7.45	\$ 7.67	\$ 12.92	\$ 12.92	\$ 12.92	\$ 7.44	\$ 1.85	\$ 7.66	\$ 5.65	\$ 10.77	
Winter Avoided Costs 1/ 2014\$												
Scenario	Gas Year	Klam Falls	La Grande	Medford GTN	Medford NWP	Roseburg	Wa/ld Both	Wa/ld GTN	Wa/ld NWP	WA/ID Winter	OR Winter	
High Growth & Low Prices	2015-2016	\$ 1.87	\$ 1.98	\$ 1.87	\$ 1.87	\$ 1.87	\$ 1.96	\$ 1.79	\$ 1.98	\$ 1.91	\$ 1.89	
High Growth & Low Prices	2016-2017	\$ 1.31	\$ 2.07	\$ 1.31	\$ 1.31	\$ 1.31	\$ 1.38	\$ 1.06	\$ 2.07	\$ 1.50	\$ 1.46	
High Growth & Low Prices	2017-2018	\$ 1.45	\$ 2.06	\$ 1.45	\$ 1.45	\$ 1.45	\$ 1.48	\$ 1.17	\$ 2.06	\$ 1.57	\$ 1.58	
High Growth & Low Prices	2018-2019	\$ 1.51	\$ 2.04	\$ 1.51	\$ 1.51	\$ 1.51	\$ 1.56	\$ 1.21	\$ 2.04	\$ 1.60	\$ 1.62	
High Growth & Low Prices	2019-2020	\$ 1.52	\$ 1.91	\$ 1.52	\$ 1.52	\$ 1.52	\$ 1.53	\$ 1.18	\$ 1.91	\$ 1.54	\$ 1.60	
High Growth & Low Prices	2020-2021	\$ 1.54	\$ 1.91	\$ 1.55	\$ 1.55	\$ 1.55	\$ 1.57	\$ 1.22	\$ 1.88	\$ 1.56	\$ 1.62	
High Growth & Low Prices	2021-2022	\$ 1.56	\$ 1.96	\$ 1.56	\$ 1.56	\$ 1.56	\$ 1.57	\$ 1.21	\$ 1.92	\$ 1.57	\$ 1.64	
High Growth & Low Prices	2022-2023	\$ 1.55	\$ 2.06	\$ 1.55	\$ 1.55	\$ 1.55	\$ 1.45	\$ 1.06	\$ 2.02	\$ 1.51	\$ 1.66	
High Growth & Low Prices	2023-2024	\$ 1.70	\$ 2.03	\$ 1.71	\$ 1.71	\$ 1.71	\$ 1.70	\$ 1.32	\$ 1.99	\$ 1.67	\$ 1.77	
High Growth & Low Prices	2024-2025	\$ 1.61	\$ 1.95	\$ 1.63	\$ 1.63	\$ 1.63	\$ 1.75	\$ 1.39	\$ 1.88	\$ 1.67	\$ 1.69	
High Growth & Low Prices	2025-2026	\$ 1.55	\$ 1.81	\$ 1.57	\$ 1.57	\$ 1.57	\$ 1.64	\$ 1.28	\$ 1.73	\$ 1.55	\$ 1.61	
High Growth & Low Prices	2026-2027	\$ 1.63	\$ 1.84	\$ 1.64	\$ 1.64	\$ 1.64	\$ 1.61	\$ 1.25	\$ 1.76	\$ 1.54	\$ 1.68	
High Growth & Low Prices	2027-2028	\$ 1.75	\$ 1.86	\$ 34.52	\$ 34.52	\$ 34.52	\$ 1.72	\$ 1.39	\$ 1.86	\$ 1.66	\$ 21.43	
High Growth & Low Prices	2028-2029	\$ 1.77	\$ 1.91	\$ 34.54	\$ 34.54	\$ 34.54	\$ 1.80	\$ 1.47	\$ 1.91	\$ 1.73	\$ 21.46	
High Growth & Low Prices	2029-2030	\$ 1.91	\$ 2.06	\$ 34.67	\$ 34.67	\$ 34.67	\$ 1.90	\$ 1.55	\$ 2.06	\$ 1.84	\$ 21.60	
High Growth & Low Prices	2030-2031	\$ 1.90	\$ 2.06	\$ 67.42	\$ 67.42	\$ 67.42	\$ 1.92	\$ 1.57	\$ 2.06	\$ 1.85	\$ 41.24	
High Growth & Low Prices	2031-2032	\$ 1.85	\$ 2.00	\$ 67.38	\$ 67.38	\$ 67.38	\$ 1.93	\$ 1.56	\$ 2.00	\$ 1.83	\$ 41.20	
High Growth & Low Prices	2032-2033	\$ 1.87	\$ 2.04	\$ 67.39	\$ 67.39	\$ 67.39	\$ 1.95	\$ 1.57	\$ 2.04	\$ 1.85	\$ 41.21	
High Growth & Low Prices	2033-2034	\$ 2.00	\$ 2.12	\$ 67.52	\$ 67.52	\$ 67.52	\$ 2.02	\$ 1.63	\$ 2.13	\$ 1.93	\$ 41.34	
High Growth & Low Prices	2034-2035	\$ 34.70	\$ 2.14	\$ 67.47	\$ 67.47	\$ 67.47	\$ 1.97	\$ 1.52	\$ 2.15	\$ 1.88	\$ 47.85	

1/ Avoided costs are before Environmental Externalities added.

### APPENDIX 5.4: CARBON LEGISLATION – MEDIUM CASE AVOIDED COST

Annual Avoided Costs 1/ 2014\$												
Scenario	Gas Year	Klam Falls	La Grande	Medford GTN	Medford NWP	Roseburg	Wa/ld Both	Wa/ld GTN	Wa/ld NWP	WAID Annual	OR Annual	
Carbon Legislation - Medium Case	2015-2016	\$ 1.88	\$ 2.17	\$ 1.88	\$ 1.88	\$ 1.88	\$ 1.89	\$ 1.84	\$ 2.16	\$ 1.96	\$ 1.94	
Carbon Legislation - Medium Case	2016-2017	\$ 2.28	\$ 2.97	\$ 2.28	\$ 2.28	\$ 2.28	\$ 2.31	\$ 2.20	\$ 2.95	\$ 2.49	\$ 2.41	
Carbon Legislation - Medium Case	2017-2018	\$ 2.78	\$ 3.45	\$ 2.78	\$ 2.78	\$ 2.78	\$ 2.78	\$ 2.72	\$ 3.44	\$ 2.98	\$ 2.91	
Carbon Legislation - Medium Case	2018-2019	\$ 2.79	\$ 3.53	\$ 2.79	\$ 2.79	\$ 2.79	\$ 2.81	\$ 2.74	\$ 3.51	\$ 3.02	\$ 2.94	
Carbon Legislation - Medium Case	2019-2020	\$ 2.88	\$ 3.61	\$ 2.88	\$ 2.88	\$ 2.88	\$ 2.90	\$ 2.83	\$ 3.60	\$ 3.11	\$ 3.02	
Carbon Legislation - Medium Case	2020-2021	\$ 3.03	\$ 3.76	\$ 3.03	\$ 3.03	\$ 3.03	\$ 3.06	\$ 2.97	\$ 3.75	\$ 3.26	\$ 3.18	
Carbon Legislation - Medium Case	2021-2022	\$ 3.11	\$ 3.88	\$ 3.11	\$ 3.11	\$ 3.11	\$ 3.13	\$ 3.05	\$ 3.87	\$ 3.35	\$ 3.27	
Carbon Legislation - Medium Case	2022-2023	\$ 3.10	\$ 3.89	\$ 3.10	\$ 3.10	\$ 3.10	\$ 3.11	\$ 3.01	\$ 3.87	\$ 3.33	\$ 3.26	
Carbon Legislation - Medium Case	2023-2024	\$ 3.33	\$ 3.96	\$ 3.33	\$ 3.33	\$ 3.33	\$ 3.35	\$ 3.27	\$ 3.95	\$ 3.52	\$ 3.46	
Carbon Legislation - Medium Case	2024-2025	\$ 3.59	\$ 4.10	\$ 3.59	\$ 3.59	\$ 3.59	\$ 3.59	\$ 3.53	\$ 4.08	\$ 3.73	\$ 3.69	
Carbon Legislation - Medium Case	2025-2026	\$ 3.59	\$ 4.06	\$ 3.59	\$ 3.59	\$ 3.59	\$ 3.56	\$ 3.53	\$ 4.04	\$ 3.71	\$ 3.68	
Carbon Legislation - Medium Case	2026-2027	\$ 3.66	\$ 4.13	\$ 3.66	\$ 3.66	\$ 3.66	\$ 3.64	\$ 3.59	\$ 4.10	\$ 3.78	\$ 3.76	
Carbon Legislation - Medium Case	2027-2028	\$ 3.97	\$ 4.34	\$ 3.97	\$ 3.97	\$ 3.97	\$ 3.93	\$ 3.91	\$ 4.33	\$ 4.06	\$ 4.05	
Carbon Legislation - Medium Case	2028-2029	\$ 4.17	\$ 4.50	\$ 4.17	\$ 4.17	\$ 4.17	\$ 4.12	\$ 4.11	\$ 4.48	\$ 4.23	\$ 4.24	
Carbon Legislation - Medium Case	2029-2030	\$ 4.33	\$ 4.68	\$ 4.33	\$ 4.33	\$ 4.33	\$ 4.28	\$ 4.26	\$ 4.67	\$ 4.40	\$ 4.40	
Carbon Legislation - Medium Case	2030-2031	\$ 4.53	\$ 4.84	\$ 4.53	\$ 4.53	\$ 4.53	\$ 4.49	\$ 4.46	\$ 4.83	\$ 4.59	\$ 4.59	
Carbon Legislation - Medium Case	2031-2032	\$ 4.68	\$ 4.94	\$ 4.68	\$ 4.68	\$ 4.68	\$ 4.62	\$ 4.61	\$ 4.92	\$ 4.72	\$ 4.73	
Carbon Legislation - Medium Case	2032-2033	\$ 4.72	\$ 5.01	\$ 4.72	\$ 4.72	\$ 4.72	\$ 4.68	\$ 4.65	\$ 5.00	\$ 4.78	\$ 4.78	
Carbon Legislation - Medium Case	2033-2034	\$ 4.77	\$ 5.12	\$ 4.77	\$ 4.77	\$ 4.77	\$ 4.74	\$ 4.70	\$ 5.12	\$ 4.85	\$ 4.84	
Carbon Legislation - Medium Case	2034-2035	\$ 4.82	\$ 5.11	\$ 4.82	\$ 4.82	\$ 4.82	\$ 4.78	\$ 4.74	\$ 5.10	\$ 4.87	\$ 4.88	
Winter Avoided Costs 1/ 2014\$												
Scenario	Gas Year	Klam Falls	La Grande	Medford GTN	Medford NWP	Roseburg	Wa/ld Both	Wa/ld GTN	Wa/ld NWP	WAID Annual	OR Annual	
Carbon Legislation - Medium Case	2015-2016	\$ 1.87	\$ 2.09	\$ 1.87	\$ 1.87	\$ 1.87	\$ 2.01	\$ 1.79	\$ 2.09	\$ 1.96	\$ 1.91	
Carbon Legislation - Medium Case	2016-2017	\$ 2.32	\$ 2.97	\$ 2.32	\$ 2.32	\$ 2.32	\$ 2.42	\$ 2.14	\$ 2.94	\$ 2.50	\$ 2.45	
Carbon Legislation - Medium Case	2017-2018	\$ 2.61	\$ 3.41	\$ 2.61	\$ 2.61	\$ 2.61	\$ 2.74	\$ 2.48	\$ 3.40	\$ 2.87	\$ 2.77	
Carbon Legislation - Medium Case	2018-2019	\$ 3.12	\$ 3.54	\$ 3.12	\$ 3.12	\$ 3.12	\$ 3.22	\$ 3.01	\$ 3.49	\$ 3.24	\$ 3.20	
Carbon Legislation - Medium Case	2019-2020	\$ 3.19	\$ 3.62	\$ 3.19	\$ 3.19	\$ 3.19	\$ 3.31	\$ 3.09	\$ 3.59	\$ 3.33	\$ 3.28	
Carbon Legislation - Medium Case	2020-2021	\$ 3.30	\$ 3.77	\$ 3.30	\$ 3.30	\$ 3.30	\$ 3.42	\$ 3.19	\$ 3.75	\$ 3.45	\$ 3.39	
Carbon Legislation - Medium Case	2021-2022	\$ 3.47	\$ 3.89	\$ 3.47	\$ 3.47	\$ 3.47	\$ 3.56	\$ 3.33	\$ 3.85	\$ 3.58	\$ 3.55	
Carbon Legislation - Medium Case	2022-2023	\$ 3.42	\$ 3.91	\$ 3.42	\$ 3.42	\$ 3.42	\$ 3.48	\$ 3.22	\$ 3.86	\$ 3.52	\$ 3.52	
Carbon Legislation - Medium Case	2023-2024	\$ 3.63	\$ 3.99	\$ 3.63	\$ 3.63	\$ 3.63	\$ 3.75	\$ 3.51	\$ 3.95	\$ 3.74	\$ 3.70	
Carbon Legislation - Medium Case	2024-2025	\$ 3.91	\$ 4.12	\$ 3.91	\$ 3.91	\$ 3.91	\$ 3.94	\$ 3.79	\$ 4.08	\$ 3.94	\$ 3.95	
Carbon Legislation - Medium Case	2025-2026	\$ 4.19	\$ 4.20	\$ 4.19	\$ 4.19	\$ 4.19	\$ 4.07	\$ 4.07	\$ 4.11	\$ 4.08	\$ 4.19	
Carbon Legislation - Medium Case	2026-2027	\$ 4.18	\$ 4.19	\$ 4.18	\$ 4.18	\$ 4.18	\$ 4.09	\$ 4.04	\$ 4.10	\$ 4.08	\$ 4.18	
Carbon Legislation - Medium Case	2027-2028	\$ 4.41	\$ 4.41	\$ 4.41	\$ 4.41	\$ 4.41	\$ 4.33	\$ 4.30	\$ 4.34	\$ 4.32	\$ 4.41	
Carbon Legislation - Medium Case	2028-2029	\$ 4.60	\$ 4.60	\$ 4.60	\$ 4.60	\$ 4.60	\$ 4.51	\$ 4.50	\$ 4.53	\$ 4.51	\$ 4.60	
Carbon Legislation - Medium Case	2029-2030	\$ 4.72	\$ 4.74	\$ 4.72	\$ 4.72	\$ 4.72	\$ 4.64	\$ 4.61	\$ 4.68	\$ 4.64	\$ 4.73	
Carbon Legislation - Medium Case	2030-2031	\$ 5.02	\$ 5.05	\$ 5.02	\$ 5.02	\$ 5.02	\$ 4.93	\$ 4.91	\$ 4.98	\$ 4.94	\$ 5.02	
Carbon Legislation - Medium Case	2031-2032	\$ 5.09	\$ 5.14	\$ 5.09	\$ 5.09	\$ 5.09	\$ 5.02	\$ 5.00	\$ 5.08	\$ 5.03	\$ 5.10	
Carbon Legislation - Medium Case	2032-2033	\$ 5.23	\$ 5.30	\$ 5.23	\$ 5.23	\$ 5.23	\$ 5.16	\$ 5.13	\$ 5.24	\$ 5.18	\$ 5.24	
Carbon Legislation - Medium Case	2033-2034	\$ 5.33	\$ 5.39	\$ 5.33	\$ 5.33	\$ 5.33	\$ 5.25	\$ 5.22	\$ 5.32	\$ 5.26	\$ 5.34	
Carbon Legislation - Medium Case	2034-2035	\$ 5.32	\$ 5.38	\$ 5.32	\$ 5.32	\$ 5.32	\$ 5.22	\$ 5.19	\$ 5.30	\$ 5.24	\$ 5.33	

1/ Avoided costs are before Environmental Externalities added.



### APPENDIX 5.4: COLD DAY 20 YR WEATHER STANDARD AVOIDED COST

Annual Avoided Costs 1/ 2014\$												
Scenario	Gas Year	Klam Falls	La Grande	Medford GTN	Medford NWP	Roseburg	Wa/lid Both	Wa/lid GTN	Wa/lid NWP	WA/ID Annual	OR Annual	
Cold Day 20yr Weather Std	2015-2016	\$ 1.88	\$ 2.17	\$ 1.88	\$ 1.88	\$ 1.88	\$ 1.88	\$ 1.84	\$ 2.16	\$ 1.96	\$ 1.94	
Cold Day 20yr Weather Std	2016-2017	\$ 2.27	\$ 2.96	\$ 2.27	\$ 2.27	\$ 2.27	\$ 2.31	\$ 2.20	\$ 2.95	\$ 2.49	\$ 2.41	
Cold Day 20yr Weather Std	2017-2018	\$ 2.80	\$ 3.45	\$ 2.80	\$ 2.80	\$ 2.80	\$ 2.79	\$ 2.72	\$ 3.44	\$ 2.99	\$ 2.93	
Cold Day 20yr Weather Std	2018-2019	\$ 2.80	\$ 3.54	\$ 2.80	\$ 2.80	\$ 2.80	\$ 2.83	\$ 2.74	\$ 3.52	\$ 3.03	\$ 2.95	
Cold Day 20yr Weather Std	2019-2020	\$ 2.88	\$ 3.62	\$ 2.88	\$ 2.88	\$ 2.88	\$ 2.93	\$ 2.83	\$ 3.60	\$ 3.12	\$ 3.03	
Cold Day 20yr Weather Std	2020-2021	\$ 3.04	\$ 3.77	\$ 3.04	\$ 3.04	\$ 3.04	\$ 3.08	\$ 2.97	\$ 3.75	\$ 3.27	\$ 3.18	
Cold Day 20yr Weather Std	2021-2022	\$ 3.13	\$ 3.89	\$ 3.13	\$ 3.13	\$ 3.13	\$ 3.16	\$ 3.05	\$ 3.87	\$ 3.36	\$ 3.29	
Cold Day 20yr Weather Std	2022-2023	\$ 3.15	\$ 3.91	\$ 3.15	\$ 3.15	\$ 3.15	\$ 3.13	\$ 3.01	\$ 3.87	\$ 3.34	\$ 3.30	
Cold Day 20yr Weather Std	2023-2024	\$ 3.36	\$ 3.97	\$ 3.36	\$ 3.36	\$ 3.36	\$ 3.38	\$ 3.27	\$ 3.95	\$ 3.53	\$ 3.48	
Cold Day 20yr Weather Std	2024-2025	\$ 3.61	\$ 4.14	\$ 3.61	\$ 3.61	\$ 3.61	\$ 3.61	\$ 3.53	\$ 4.12	\$ 3.75	\$ 3.72	
Cold Day 20yr Weather Std	2025-2026	\$ 3.59	\$ 4.09	\$ 3.59	\$ 3.59	\$ 3.59	\$ 3.58	\$ 3.53	\$ 4.06	\$ 3.72	\$ 3.69	
Cold Day 20yr Weather Std	2026-2027	\$ 3.66	\$ 4.16	\$ 3.66	\$ 3.66	\$ 3.66	\$ 3.66	\$ 3.59	\$ 4.11	\$ 3.79	\$ 3.76	
Cold Day 20yr Weather Std	2027-2028	\$ 3.97	\$ 4.38	\$ 3.97	\$ 3.97	\$ 3.97	\$ 3.95	\$ 3.91	\$ 4.34	\$ 4.06	\$ 4.05	
Cold Day 20yr Weather Std	2028-2029	\$ 4.17	\$ 4.54	\$ 4.17	\$ 4.17	\$ 4.17	\$ 4.13	\$ 4.11	\$ 4.50	\$ 4.25	\$ 4.24	
Cold Day 20yr Weather Std	2029-2030	\$ 4.33	\$ 4.71	\$ 4.33	\$ 4.33	\$ 4.33	\$ 4.30	\$ 4.26	\$ 4.69	\$ 4.41	\$ 4.41	
Cold Day 20yr Weather Std	2030-2031	\$ 4.54	\$ 4.87	\$ 4.54	\$ 4.54	\$ 4.54	\$ 4.50	\$ 4.46	\$ 4.84	\$ 4.60	\$ 4.60	
Cold Day 20yr Weather Std	2031-2032	\$ 4.68	\$ 4.97	\$ 4.68	\$ 4.68	\$ 4.68	\$ 4.64	\$ 4.61	\$ 4.94	\$ 4.73	\$ 4.74	
Cold Day 20yr Weather Std	2032-2033	\$ 4.73	\$ 5.03	\$ 4.73	\$ 4.73	\$ 4.73	\$ 4.69	\$ 4.65	\$ 5.01	\$ 4.78	\$ 4.79	
Cold Day 20yr Weather Std	2033-2034	\$ 4.79	\$ 5.15	\$ 4.79	\$ 4.79	\$ 4.79	\$ 4.75	\$ 4.70	\$ 5.12	\$ 4.86	\$ 4.86	
Cold Day 20yr Weather Std	2034-2035	\$ 4.83	\$ 5.05	\$ 4.83	\$ 4.83	\$ 4.83	\$ 4.79	\$ 4.74	\$ 5.01	\$ 4.85	\$ 4.87	
Winter Avoided Costs 1/ 2014\$												
Scenario	Gas Year	Klam Falls	La Grande	Medford GTN	Medford NWP	Roseburg	Wa/lid Both	Wa/lid GTN	Wa/lid NWP	WA/ID Annual	OR Annual	
Cold Day 20yr Weather Std	2015-2016	\$ 1.86	\$ 2.09	\$ 1.86	\$ 1.86	\$ 1.86	\$ 2.00	\$ 1.79	\$ 2.09	\$ 1.96	\$ 1.91	
Cold Day 20yr Weather Std	2016-2017	\$ 2.29	\$ 2.97	\$ 2.29	\$ 2.29	\$ 2.29	\$ 2.42	\$ 2.14	\$ 2.94	\$ 2.50	\$ 2.43	
Cold Day 20yr Weather Std	2017-2018	\$ 2.69	\$ 3.41	\$ 2.69	\$ 2.69	\$ 2.69	\$ 2.77	\$ 2.48	\$ 3.40	\$ 2.88	\$ 2.84	
Cold Day 20yr Weather Std	2018-2019	\$ 3.12	\$ 3.55	\$ 3.12	\$ 3.12	\$ 3.12	\$ 3.26	\$ 3.01	\$ 3.51	\$ 3.26	\$ 3.21	
Cold Day 20yr Weather Std	2019-2020	\$ 3.19	\$ 3.63	\$ 3.19	\$ 3.19	\$ 3.19	\$ 3.36	\$ 3.09	\$ 3.60	\$ 3.35	\$ 3.28	
Cold Day 20yr Weather Std	2020-2021	\$ 3.30	\$ 3.77	\$ 3.30	\$ 3.30	\$ 3.30	\$ 3.49	\$ 3.19	\$ 3.75	\$ 3.48	\$ 3.40	
Cold Day 20yr Weather Std	2021-2022	\$ 3.52	\$ 3.90	\$ 3.52	\$ 3.52	\$ 3.52	\$ 3.63	\$ 3.33	\$ 3.85	\$ 3.61	\$ 3.59	
Cold Day 20yr Weather Std	2022-2023	\$ 3.55	\$ 3.92	\$ 3.55	\$ 3.55	\$ 3.55	\$ 3.54	\$ 3.22	\$ 3.86	\$ 3.54	\$ 3.63	
Cold Day 20yr Weather Std	2023-2024	\$ 3.74	\$ 4.01	\$ 3.74	\$ 3.74	\$ 3.74	\$ 3.81	\$ 3.51	\$ 3.97	\$ 3.76	\$ 3.80	
Cold Day 20yr Weather Std	2024-2025	\$ 3.97	\$ 4.17	\$ 3.97	\$ 3.97	\$ 3.97	\$ 4.01	\$ 3.79	\$ 4.12	\$ 3.97	\$ 4.01	
Cold Day 20yr Weather Std	2025-2026	\$ 4.16	\$ 4.23	\$ 4.16	\$ 4.16	\$ 4.16	\$ 4.10	\$ 4.07	\$ 4.14	\$ 4.10	\$ 4.18	
Cold Day 20yr Weather Std	2026-2027	\$ 4.15	\$ 4.29	\$ 4.15	\$ 4.15	\$ 4.15	\$ 4.11	\$ 4.04	\$ 4.13	\$ 4.09	\$ 4.18	
Cold Day 20yr Weather Std	2027-2028	\$ 4.39	\$ 4.48	\$ 4.39	\$ 4.39	\$ 4.39	\$ 4.36	\$ 4.30	\$ 4.38	\$ 4.34	\$ 4.41	
Cold Day 20yr Weather Std	2028-2029	\$ 4.59	\$ 4.66	\$ 4.59	\$ 4.59	\$ 4.59	\$ 4.54	\$ 4.50	\$ 4.58	\$ 4.54	\$ 4.61	
Cold Day 20yr Weather Std	2029-2030	\$ 4.71	\$ 4.81	\$ 4.71	\$ 4.71	\$ 4.71	\$ 4.68	\$ 4.61	\$ 4.73	\$ 4.68	\$ 4.73	
Cold Day 20yr Weather Std	2030-2031	\$ 5.02	\$ 5.09	\$ 5.02	\$ 5.02	\$ 5.02	\$ 4.94	\$ 4.91	\$ 4.99	\$ 4.95	\$ 5.03	
Cold Day 20yr Weather Std	2031-2032	\$ 5.09	\$ 5.20	\$ 5.09	\$ 5.09	\$ 5.09	\$ 5.07	\$ 5.00	\$ 5.13	\$ 5.06	\$ 5.11	
Cold Day 20yr Weather Std	2032-2033	\$ 5.23	\$ 5.33	\$ 5.23	\$ 5.23	\$ 5.23	\$ 5.18	\$ 5.13	\$ 5.24	\$ 5.19	\$ 5.25	
Cold Day 20yr Weather Std	2033-2034	\$ 5.32	\$ 5.48	\$ 5.32	\$ 5.32	\$ 5.32	\$ 5.27	\$ 5.22	\$ 5.33	\$ 5.27	\$ 5.35	
Cold Day 20yr Weather Std	2034-2035	\$ 5.32	\$ 5.46	\$ 5.32	\$ 5.32	\$ 5.32	\$ 5.25	\$ 5.19	\$ 5.32	\$ 5.25	\$ 5.35	

1/ Avoided costs are before Environmental Externalities added.

### APPENDIX 5.4: WASHINGTON AND IDAHO AVOIDED COSTS - LOW GROWTH/HIGH PRICE CASE

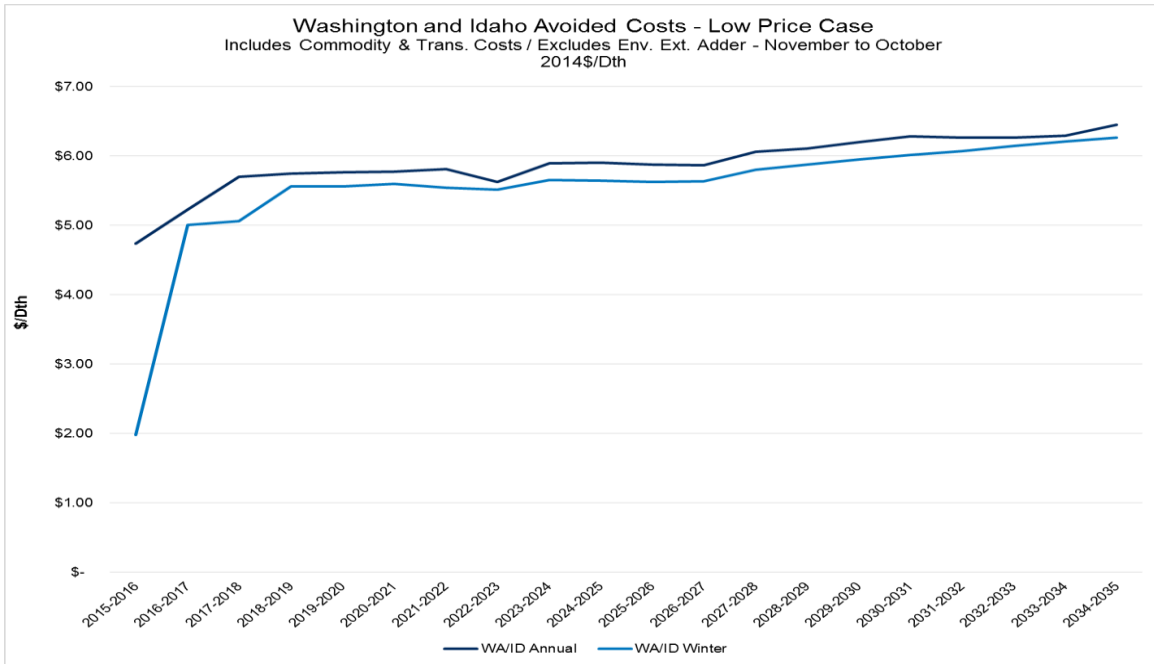

### APPENDIX 5.4: NATURAL GAS OREGON AVOIDED COSTS - LOW GROWTH/HIGH PRICE CASE

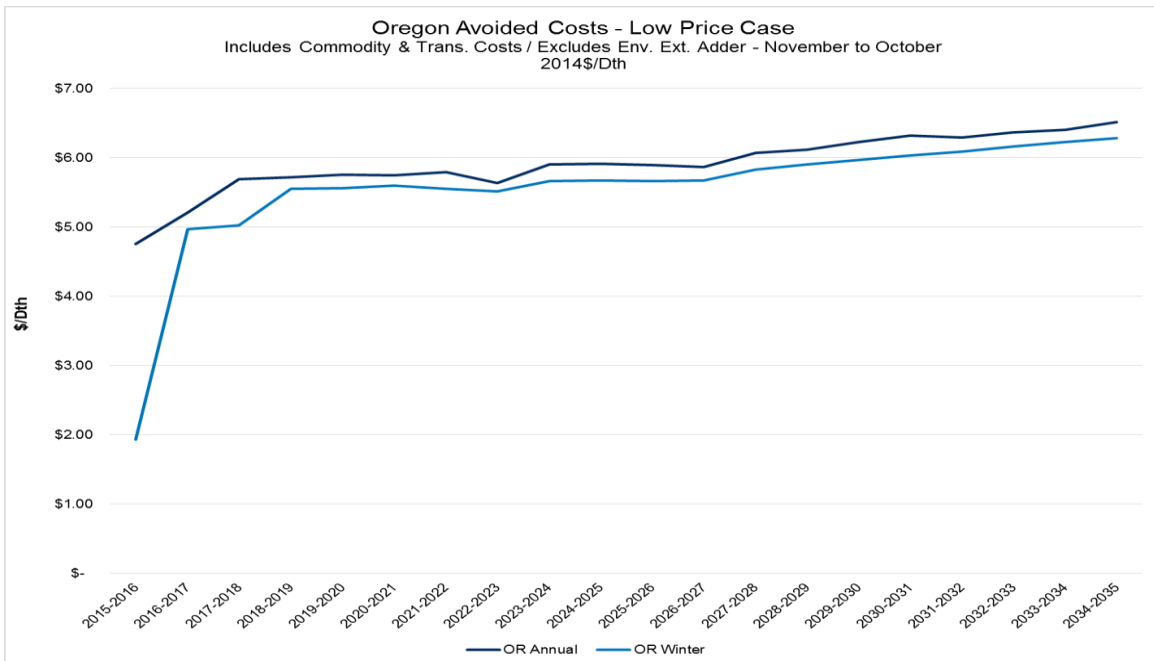

## APPENDIX 5.4: LOW GROWTH – HIGH PRICE MONTHLY DETAIL

Monthly Avoided Costs 1/ 2014\$													
Scenario	Gas Year	Month	Klam Falls	La Grande	Medford GTN	Medford NWP	Roseburg	Wa/l'd Both	Wa/l'd GTN	Wa/l'd NWP	WA/ID Annual	OR Annual	
Low Growth_High Prices	2015-2016	Nov	\$ 1.96	\$ 2.16	\$ 1.96	\$ 1.96	\$ 1.96	\$ 1.93	\$ 1.93	\$ 2.16	\$ 2.01	\$ 2.00	
Low Growth_High Prices	2015-2016	Dec	\$ 1.80	\$ 2.11	\$ 1.80	\$ 1.80	\$ 1.80	\$ 2.10	\$ 1.65	\$ 2.11	\$ 1.95	\$ 1.86	
Low Growth_High Prices	2015-2016	Jan	\$ 7.38	\$ 7.41	\$ 7.38	\$ 7.38	\$ 7.38	\$ 7.28	\$ 7.28	\$ 7.28	\$ 7.28	\$ 7.38	
Low Growth_High Prices	2015-2016	Feb	\$ 7.60	\$ 7.72	\$ 7.60	\$ 7.60	\$ 7.60	\$ 7.35	\$ 7.50	\$ 7.35	\$ 7.40	\$ 7.63	
Low Growth_High Prices	2015-2016	Mar	\$ 7.62	\$ 7.71	\$ 7.62	\$ 7.62	\$ 7.62	\$ 7.46	\$ 7.52	\$ 7.59	\$ 7.52	\$ 7.64	
Low Growth_High Prices	2015-2016	Apr	\$ 4.33	\$ 4.73	\$ 4.33	\$ 4.33	\$ 4.33	\$ 4.27	\$ 4.27	\$ 4.73	\$ 4.42	\$ 4.41	
Low Growth_High Prices	2015-2016	May	\$ 4.29	\$ 4.70	\$ 4.29	\$ 4.29	\$ 4.29	\$ 4.23	\$ 4.23	\$ 4.70	\$ 4.38	\$ 4.37	
Low Growth_High Prices	2015-2016	Jun	\$ 4.59	\$ 4.70	\$ 4.59	\$ 4.59	\$ 4.59	\$ 4.53	\$ 4.53	\$ 4.70	\$ 4.58	\$ 4.61	
Low Growth_High Prices	2015-2016	Jul	\$ 4.25	\$ 4.70	\$ 4.25	\$ 4.25	\$ 4.25	\$ 4.19	\$ 4.19	\$ 4.70	\$ 4.36	\$ 4.34	
Low Growth_High Prices	2015-2016	Aug	\$ 4.41	\$ 4.70	\$ 4.41	\$ 4.41	\$ 4.41	\$ 4.35	\$ 4.35	\$ 4.70	\$ 4.46	\$ 4.47	
Low Growth_High Prices	2015-2016	Sep	\$ 3.63	\$ 4.63	\$ 3.63	\$ 3.63	\$ 3.63	\$ 3.57	\$ 3.57	\$ 4.70	\$ 3.95	\$ 3.83	
Low Growth_High Prices	2015-2016	Oct	\$ 4.41	\$ 5.13	\$ 4.41	\$ 4.41	\$ 4.41	\$ 4.35	\$ 4.35	\$ 5.13	\$ 4.61	\$ 4.55	
Low Growth_High Prices	2016-2017	Nov	\$ 3.88	\$ 4.81	\$ 3.88	\$ 3.88	\$ 3.88	\$ 3.83	\$ 3.83	\$ 4.81	\$ 4.15	\$ 4.07	
Low Growth_High Prices	2016-2017	Dec	\$ 5.66	\$ 6.58	\$ 5.66	\$ 5.66	\$ 5.66	\$ 5.52	\$ 5.40	\$ 6.58	\$ 5.83	\$ 5.84	
Low Growth_High Prices	2016-2017	Jan	\$ 7.11	\$ 7.11	\$ 7.11	\$ 7.11	\$ 7.11	\$ 7.02	\$ 7.02	\$ 7.02	\$ 7.02	\$ 7.11	
Low Growth_High Prices	2016-2017	Feb	\$ 7.44	\$ 7.55	\$ 7.29	\$ 7.29	\$ 7.29	\$ 7.07	\$ 7.34	\$ 7.07	\$ 7.16	\$ 7.37	
Low Growth_High Prices	2016-2017	Mar	\$ 7.19	\$ 7.35	\$ 7.19	\$ 7.19	\$ 7.19	\$ 7.08	\$ 7.10	\$ 7.27	\$ 7.15	\$ 7.22	
Low Growth_High Prices	2016-2017	Apr	\$ 4.36	\$ 5.08	\$ 4.36	\$ 4.36	\$ 4.36	\$ 4.30	\$ 4.30	\$ 5.08	\$ 4.56	\$ 4.51	
Low Growth_High Prices	2016-2017	May	\$ 4.33	\$ 5.08	\$ 4.33	\$ 4.33	\$ 4.33	\$ 4.27	\$ 4.27	\$ 5.08	\$ 4.54	\$ 4.48	
Low Growth_High Prices	2016-2017	Jun	\$ 4.60	\$ 5.09	\$ 4.60	\$ 4.60	\$ 4.60	\$ 4.53	\$ 4.53	\$ 5.09	\$ 4.72	\$ 4.69	
Low Growth_High Prices	2016-2017	Jul	\$ 4.24	\$ 5.09	\$ 4.24	\$ 4.24	\$ 4.24	\$ 4.18	\$ 4.18	\$ 5.09	\$ 4.48	\$ 4.41	
Low Growth_High Prices	2016-2017	Aug	\$ 4.39	\$ 5.09	\$ 4.39	\$ 4.39	\$ 4.39	\$ 4.33	\$ 4.33	\$ 5.09	\$ 4.58	\$ 4.53	
Low Growth_High Prices	2016-2017	Sep	\$ 3.57	\$ 4.73	\$ 3.57	\$ 3.57	\$ 3.57	\$ 3.52	\$ 3.52	\$ 5.09	\$ 4.04	\$ 3.80	
Low Growth_High Prices	2016-2017	Oct	\$ 4.38	\$ 5.21	\$ 4.38	\$ 4.38	\$ 4.38	\$ 4.32	\$ 4.32	\$ 5.21	\$ 4.61	\$ 4.54	
Low Growth_High Prices	2017-2018	Nov	\$ 3.97	\$ 4.93	\$ 3.97	\$ 3.97	\$ 3.97	\$ 3.91	\$ 3.91	\$ 4.93	\$ 4.25	\$ 4.16	
Low Growth_High Prices	2017-2018	Dec	\$ 5.71	\$ 6.53	\$ 5.71	\$ 5.71	\$ 5.71	\$ 5.57	\$ 5.47	\$ 6.53	\$ 5.85	\$ 5.87	
Low Growth_High Prices	2017-2018	Jan	\$ 7.78	\$ 7.78	\$ 7.78	\$ 7.78	\$ 7.78	\$ 7.68	\$ 7.68	\$ 7.68	\$ 7.68	\$ 7.78	
Low Growth_High Prices	2017-2018	Feb	\$ 8.09	\$ 8.19	\$ 8.06	\$ 8.06	\$ 8.06	\$ 7.74	\$ 7.99	\$ 7.74	\$ 7.82	\$ 8.09	
Low Growth_High Prices	2017-2018	Mar	\$ 8.12	\$ 8.15	\$ 8.11	\$ 8.11	\$ 8.11	\$ 7.90	\$ 8.01	\$ 7.96	\$ 7.96	\$ 8.12	
Low Growth_High Prices	2017-2018	Apr	\$ 4.87	\$ 5.66	\$ 4.87	\$ 4.87	\$ 4.87	\$ 4.80	\$ 4.80	\$ 5.66	\$ 5.09	\$ 5.02	
Low Growth_High Prices	2017-2018	May	\$ 4.80	\$ 5.52	\$ 4.80	\$ 4.80	\$ 4.80	\$ 4.74	\$ 4.74	\$ 5.52	\$ 5.00	\$ 4.95	
Low Growth_High Prices	2017-2018	Jun	\$ 5.06	\$ 5.52	\$ 5.06	\$ 5.06	\$ 5.06	\$ 4.99	\$ 4.99	\$ 5.52	\$ 5.17	\$ 5.15	
Low Growth_High Prices	2017-2018	Jul	\$ 4.73	\$ 5.52	\$ 4.73	\$ 4.73	\$ 4.73	\$ 4.66	\$ 4.66	\$ 5.52	\$ 4.95	\$ 4.89	
Low Growth_High Prices	2017-2018	Aug	\$ 4.82	\$ 5.52	\$ 4.82	\$ 4.82	\$ 4.82	\$ 4.75	\$ 4.75	\$ 5.52	\$ 5.01	\$ 4.96	
Low Growth_High Prices	2017-2018	Sep	\$ 4.09	\$ 5.29	\$ 4.09	\$ 4.09	\$ 4.09	\$ 4.03	\$ 4.03	\$ 5.52	\$ 4.53	\$ 4.33	
Low Growth_High Prices	2017-2018	Oct	\$ 4.89	\$ 5.85	\$ 4.89	\$ 4.89	\$ 4.89	\$ 4.82	\$ 4.82	\$ 5.85	\$ 5.17	\$ 5.08	
Low Growth_High Prices	2018-2019	Nov	\$ 4.55	\$ 5.29	\$ 4.55	\$ 4.55	\$ 4.55	\$ 4.48	\$ 4.48	\$ 5.29	\$ 4.75	\$ 4.69	
Low Growth_High Prices	2018-2019	Dec	\$ 6.26	\$ 6.92	\$ 6.26	\$ 6.26	\$ 6.26	\$ 6.13	\$ 6.03	\$ 6.91	\$ 6.36	\$ 6.39	
Low Growth_High Prices	2018-2019	Jan	\$ 7.69	\$ 7.69	\$ 7.69	\$ 7.69	\$ 7.69	\$ 7.59	\$ 7.59	\$ 7.59	\$ 7.59	\$ 7.69	
Low Growth_High Prices	2018-2019	Feb	\$ 8.01	\$ 8.12	\$ 7.84	\$ 7.84	\$ 7.84	\$ 7.65	\$ 7.91	\$ 7.65	\$ 7.74	\$ 7.93	
Low Growth_High Prices	2018-2019	Mar	\$ 7.78	\$ 7.93	\$ 7.78	\$ 7.78	\$ 7.78	\$ 7.66	\$ 7.68	\$ 7.85	\$ 7.73	\$ 7.81	
Low Growth_High Prices	2018-2019	Apr	\$ 4.67	\$ 5.67	\$ 4.67	\$ 4.67	\$ 4.67	\$ 4.60	\$ 4.60	\$ 5.67	\$ 4.96	\$ 4.87	
Low Growth_High Prices	2018-2019	May	\$ 4.68	\$ 5.64	\$ 4.68	\$ 4.68	\$ 4.68	\$ 4.62	\$ 4.62	\$ 5.64	\$ 4.96	\$ 4.87	
Low Growth_High Prices	2018-2019	Jun	\$ 5.03	\$ 5.64	\$ 5.03	\$ 5.03	\$ 5.03	\$ 4.97	\$ 4.97	\$ 5.64	\$ 5.19	\$ 5.15	
Low Growth_High Prices	2018-2019	Jul	\$ 4.71	\$ 5.64	\$ 4.71	\$ 4.71	\$ 4.71	\$ 4.65	\$ 4.65	\$ 5.64	\$ 4.98	\$ 4.90	
Low Growth_High Prices	2018-2019	Aug	\$ 4.80	\$ 5.64	\$ 4.80	\$ 4.80	\$ 4.80	\$ 4.74	\$ 4.74	\$ 5.64	\$ 5.04	\$ 4.97	
Low Growth_High Prices	2018-2019	Sep	\$ 4.09	\$ 5.27	\$ 4.09	\$ 4.09	\$ 4.09	\$ 4.04	\$ 4.04	\$ 5.64	\$ 4.57	\$ 4.33	
Low Growth_High Prices	2018-2019	Oct	\$ 4.92	\$ 5.83	\$ 4.92	\$ 4.92	\$ 4.92	\$ 4.85	\$ 4.85	\$ 5.83	\$ 5.18	\$ 5.10	
Low Growth_High Prices	2019-2020	Nov	\$ 4.58	\$ 5.26	\$ 4.58	\$ 4.58	\$ 4.58	\$ 4.52	\$ 4.52	\$ 5.26	\$ 4.76	\$ 4.72	
Low Growth_High Prices	2019-2020	Dec	\$ 6.27	\$ 6.80	\$ 6.27	\$ 6.27	\$ 6.27	\$ 6.17	\$ 6.07	\$ 6.79	\$ 6.35	\$ 6.38	
Low Growth_High Prices	2019-2020	Jan	\$ 7.72	\$ 7.72	\$ 7.72	\$ 7.72	\$ 7.72	\$ 7.62	\$ 7.62	\$ 7.62	\$ 7.62	\$ 7.72	
Low Growth_High Prices	2019-2020	Feb	\$ 8.04	\$ 8.15	\$ 8.01	\$ 8.01	\$ 8.01	\$ 7.67	\$ 7.93	\$ 7.67	\$ 7.76	\$ 8.05	
Low Growth_High Prices	2019-2020	Mar	\$ 8.09	\$ 8.10	\$ 8.08	\$ 8.08	\$ 8.08	\$ 7.84	\$ 7.98	\$ 7.88	\$ 7.90	\$ 8.09	
Low Growth_High Prices	2019-2020	Apr	\$ 4.70	\$ 5.66	\$ 4.70	\$ 4.70	\$ 4.70	\$ 4.63	\$ 4.63	\$ 5.66	\$ 4.97	\$ 4.89	
Low Growth_High Prices	2019-2020	May	\$ 4.71	\$ 5.60	\$ 4.71	\$ 4.71	\$ 4.71	\$ 4.65	\$ 4.65	\$ 5.60	\$ 4.96	\$ 4.89	
Low Growth_High Prices	2019-2020	Jun	\$ 5.04	\$ 5.60	\$ 5.04	\$ 5.04	\$ 5.04	\$ 4.97	\$ 4.97	\$ 5.60	\$ 5.18	\$ 5.15	
Low Growth_High Prices	2019-2020	Jul	\$ 4.70	\$ 5.60	\$ 4.70	\$ 4.70	\$ 4.70	\$ 4.64	\$ 4.64	\$ 5.60	\$ 4.96	\$ 4.88	
Low Growth_High Prices	2019-2020	Aug	\$ 4.80	\$ 5.60	\$ 4.80	\$ 4.80	\$ 4.80	\$ 4.74	\$ 4.74	\$ 5.60	\$ 5.03	\$ 4.96	
Low Growth_High Prices	2019-2020	Sep	\$ 4.09	\$ 5.28	\$ 4.09	\$ 4.09	\$ 4.09	\$ 4.04	\$ 4.04	\$ 5.60	\$ 4.56	\$ 4.33	
Low Growth_High Prices	2019-2020	Oct	\$ 4.90	\$ 5.90	\$ 4.90	\$ 4.90	\$ 4.90	\$ 4.83	\$ 4.83	\$ 5.90	\$ 5.19	\$ 5.10	
Low Growth_High Prices	2020-2021	Nov	\$ 4.63	\$ 5.25	\$ 4.63	\$ 4.63	\$ 4.63	\$ 4.57	\$ 4.57	\$ 5.25	\$ 4.80	\$ 4.76	
Low Growth_High Prices	2020-2021	Dec	\$ 6.33	\$ 6.77	\$ 6.33	\$ 6.33	\$ 6.33	\$ 6.24	\$ 6.14	\$ 6.77	\$ 6.38	\$ 6.42	
Low Growth_High Prices	2020-2021	Jan	\$ 7.76	\$ 7.76	\$ 7.76	\$ 7.76	\$ 7.76	\$ 7.66	\$ 7.66	\$ 7.66	\$ 7.66	\$ 7.76	
Low Growth_High Prices	2020-2021	Feb	\$ 8.14	\$ 8.23	\$ 7.98	\$ 7.98	\$ 7.98	\$ 7.73	\$ 8.04	\$ 7.73	\$ 7.83	\$ 8.06	
Low Growth_High Prices	2020-2021	Mar	\$ 7.45	\$ 7.58	\$ 7.45	\$ 7.45	\$ 7.45	\$ 7.36	\$ 7.36	\$ 7.52	\$ 7.41	\$ 7.48	
Low Growth_High Prices	2020-2021	Apr	\$ 4.78	\$ 5.72	\$ 4.78	\$ 4.78	\$ 4.78	\$ 4.71	\$ 4.71	\$ 5.72	\$ 5.05	\$ 4.97	
Low Growth_High Prices	2020-2021	May	\$ 4.80	\$ 5.72	\$ 4.80	\$ 4.80	\$ 4.80	\$ 4.74	\$ 4.74	\$ 5.72	\$ 5.06	\$ 4.99	
Low Growth_High Prices	2020-2021	Jun	\$ 5.11	\$ 5.72	\$ 5.11	\$ 5.11	\$ 5.11	\$ 5.04	\$ 5.04	\$ 5.72	\$ 5.27	\$ 5.23	
Low Growth_High Prices	2020-2021	Jul	\$ 4.68	\$ 5.72	\$ 4.68	\$ 4.68	\$ 4.68	\$ 4.61	\$ 4.61	\$ 5.72	\$ 4.98	\$ 4.89	
Low Growth_High Prices	2020-2021	Aug	\$ 4.77	\$ 5.72	\$ 4.77	\$ 4.77	\$ 4.77	\$ 4.71	\$ 4.71	\$ 5.72	\$ 5.04	\$ 4.96	
Low Growth_High Prices	2020-2021	Sep	\$ 4.23	\$ 5.20	\$ 4.23	\$ 4.23	\$ 4.23	\$ 4.17	\$ 4.17	\$ 5.72	\$ 4.69	\$ 4.42	
Low Growth_High Prices	2020-2021	Oct	\$ 5.04	\$ 5.80	\$ 5.04	\$ 5.04	\$ 5.04	\$ 4.97	\$ 4.97	\$ 5.80	\$ 5.25	\$ 5.19	
Low Growth_High Prices	2021-2022	Nov	\$ 4.58	\$ 5.25	\$ 4.58	\$ 4.58	\$ 4.58	\$ 4.51	\$ 4.51	\$ 5.25	\$ 4.76	\$ 4.71	
Low Growth_High Prices	2021-2022	Dec	\$ 6.27	\$ 6.74	\$ 6.27	\$ 6.27	\$ 6.27	\$ 6.15	\$ 6.06	\$ 6.72	\$ 6.31	\$ 6.37	
Low Growth_High Prices	2021-2022	Jan	\$ 7.70	\$ 7.70	\$ 7.70	\$ 7.70	\$ 7.70	\$ 7.59	\$ 7.59	\$ 7.59	\$ 7.59	\$ 7.70	
Low Growth_High Prices	2021-2022	Feb	\$ 8.07	\$ 8.20	\$ 8.04	\$ 8.04	\$ 8.04	\$ 7.66	\$ 7.96	\$ 7.66	\$ 7.76	\$ 8.08	
Low Growth_High Prices	2021-2022	Mar	\$ 8.11	\$ 8.13	\$ 8.10	\$ 8.10	\$ 8.10	\$ 7.82	\$ 8.00	\$ 7.86	\$ 7.89	\$ 8.11	
Low Growth_High Prices	2021-2022	Apr	\$ 4.75	\$ 5.81	\$ 4.75	\$ 4.75	\$ 4.75	\$ 4.69	\$ 4.69	\$ 5.81	\$ 5.06	\$ 4.97	
Low Growth_High Prices	2021-2022	May	\$ 4.79	\$ 5.79	\$ 4.79	\$ 4.79	\$ 4.79	\$ 4.72	\$ 4.72	\$ 5.79	\$ 5.08	\$ 4.99	
Low Growth_High Prices	2021-2022	Jun	\$ 5.10	\$ 5.79	\$ 5.10	\$ 5.10	\$ 5.10	\$ 5.03	\$ 5.03	\$ 5.79	\$ 5.29	\$ 5.24	
Low Growth_High Prices	2021-2022	Jul	\$ 4.74	\$ 5.79	\$ 4.74	\$ 4.74	\$ 4.74	\$ 4.68	\$ 4.68	\$ 5.79	\$ 5.05	\$ 4.95	
Low Growth_High Prices	2021-2022	Aug	\$ 4.85	\$ 5.79	\$ 4.85	\$ 4.85	\$ 4.85	\$ 4.79	\$ 4.79	\$ 5.79	\$ 5.12	\$ 5.04	
Low Growth_High Prices	2021-2022	Sep	\$ 4.14	\$ 5.33	\$ 4.14	\$ 4.14	\$ 4.14	\$ 4.08	\$ 4.08	\$ 5.79	\$ 4.65	\$ 4.38	
Low Growth_High Prices	2021-2022	Oct	\$ 4.96	\$ 5.91	\$ 4.96	\$ 4.96	\$ 4.96	\$ 4.89	\$ 4.89	\$ 5.91	\$ 5.23	\$ 5.15	

1/ Avoided costs are before Environmental Externalities added.

# APPENDIX 5.4: LOW GROWTH – HIGH PRICE MONTHLY DETAIL

Monthly Avoided Costs 1/ 2014\$												
Scenario	Gas Year	Month	Klam Falls	La Grande	Medford GTN	Medford NWP	Roseburg	Wa/ld Both	Wa/ld GTN	Wa/ld NWP	WA/ID Annual	OR Annual
Low Growth_High Prices	2022-2023	Nov	\$ 4.50	\$ 5.40	\$ 4.50	\$ 4.50	\$ 4.50	\$ 4.43	\$ 4.43	\$ 5.40	\$ 4.76	\$ 4.68
Low Growth_High Prices	2022-2023	Dec	\$ 6.18	\$ 6.87	\$ 6.18	\$ 6.18	\$ 6.18	\$ 6.02	\$ 5.93	\$ 6.83	\$ 6.26	\$ 6.32
Low Growth_High Prices	2022-2023	Jan	\$ 7.50	\$ 7.50	\$ 7.50	\$ 7.50	\$ 7.50	\$ 6.94	\$ 7.41	\$ 6.94	\$ 7.10	\$ 7.50
Low Growth_High Prices	2022-2023	Feb	\$ 7.87	\$ 8.07	\$ 7.77	\$ 7.77	\$ 7.77	\$ 7.21	\$ 7.77	\$ 7.21	\$ 7.39	\$ 7.85
Low Growth_High Prices	2022-2023	Mar	\$ 6.48	\$ 6.67	\$ 6.48	\$ 6.48	\$ 6.48	\$ 6.40	\$ 6.40	\$ 6.67	\$ 6.49	\$ 6.52
Low Growth_High Prices	2022-2023	Apr	\$ 4.71	\$ 5.89	\$ 4.71	\$ 4.71	\$ 4.71	\$ 4.65	\$ 4.65	\$ 5.89	\$ 5.06	\$ 4.95
Low Growth_High Prices	2022-2023	May	\$ 4.77	\$ 5.81	\$ 4.77	\$ 4.77	\$ 4.77	\$ 4.71	\$ 4.71	\$ 5.81	\$ 5.08	\$ 4.98
Low Growth_High Prices	2022-2023	Jun	\$ 5.10	\$ 5.82	\$ 5.10	\$ 5.10	\$ 5.10	\$ 5.03	\$ 5.03	\$ 5.82	\$ 5.29	\$ 5.24
Low Growth_High Prices	2022-2023	Jul	\$ 4.75	\$ 5.82	\$ 4.75	\$ 4.75	\$ 4.75	\$ 4.68	\$ 4.68	\$ 5.82	\$ 5.06	\$ 4.96
Low Growth_High Prices	2022-2023	Aug	\$ 4.84	\$ 5.82	\$ 4.84	\$ 4.84	\$ 4.84	\$ 4.77	\$ 4.77	\$ 5.82	\$ 5.12	\$ 5.04
Low Growth_High Prices	2022-2023	Sep	\$ 4.26	\$ 5.25	\$ 4.26	\$ 4.26	\$ 4.26	\$ 4.21	\$ 4.21	\$ 5.82	\$ 4.74	\$ 4.46
Low Growth_High Prices	2022-2023	Oct	\$ 5.09	\$ 5.82	\$ 5.09	\$ 5.09	\$ 5.09	\$ 5.02	\$ 5.02	\$ 5.82	\$ 5.29	\$ 5.23
Low Growth_High Prices	2023-2024	Nov	\$ 4.73	\$ 5.26	\$ 4.73	\$ 4.73	\$ 4.73	\$ 4.66	\$ 4.66	\$ 5.26	\$ 4.86	\$ 4.84
Low Growth_High Prices	2023-2024	Dec	\$ 6.36	\$ 6.88	\$ 6.36	\$ 6.36	\$ 6.36	\$ 6.25	\$ 6.16	\$ 6.88	\$ 6.43	\$ 6.47
Low Growth_High Prices	2023-2024	Jan	\$ 7.80	\$ 7.79	\$ 7.80	\$ 7.80	\$ 7.80	\$ 7.69	\$ 7.69	\$ 7.79	\$ 7.69	\$ 7.80
Low Growth_High Prices	2023-2024	Feb	\$ 8.14	\$ 8.26	\$ 8.14	\$ 8.14	\$ 8.14	\$ 7.75	\$ 8.04	\$ 7.75	\$ 7.85	\$ 8.16
Low Growth_High Prices	2023-2024	Mar	\$ 8.23	\$ 8.24	\$ 8.22	\$ 8.22	\$ 8.22	\$ 7.93	\$ 8.12	\$ 7.97	\$ 8.01	\$ 8.23
Low Growth_High Prices	2023-2024	Apr	\$ 4.84	\$ 5.73	\$ 4.84	\$ 4.84	\$ 4.84	\$ 4.77	\$ 4.77	\$ 5.73	\$ 5.09	\$ 5.02
Low Growth_High Prices	2023-2024	May	\$ 4.85	\$ 5.73	\$ 4.85	\$ 4.85	\$ 4.85	\$ 4.78	\$ 4.78	\$ 5.73	\$ 5.10	\$ 5.03
Low Growth_High Prices	2023-2024	Jun	\$ 5.17	\$ 5.73	\$ 5.17	\$ 5.17	\$ 5.17	\$ 5.10	\$ 5.10	\$ 5.73	\$ 5.31	\$ 5.28
Low Growth_High Prices	2023-2024	Jul	\$ 4.90	\$ 5.74	\$ 4.90	\$ 4.90	\$ 4.90	\$ 4.84	\$ 4.84	\$ 5.74	\$ 5.14	\$ 5.07
Low Growth_High Prices	2023-2024	Aug	\$ 5.00	\$ 5.74	\$ 5.00	\$ 5.00	\$ 5.00	\$ 4.94	\$ 4.94	\$ 5.74	\$ 5.20	\$ 5.15
Low Growth_High Prices	2023-2024	Sep	\$ 4.37	\$ 5.21	\$ 4.37	\$ 4.37	\$ 4.37	\$ 4.31	\$ 4.31	\$ 5.74	\$ 4.78	\$ 4.53
Low Growth_High Prices	2023-2024	Oct	\$ 5.16	\$ 5.79	\$ 5.16	\$ 5.16	\$ 5.16	\$ 5.09	\$ 5.09	\$ 5.79	\$ 5.33	\$ 5.29
Low Growth_High Prices	2024-2025	Nov	\$ 4.82	\$ 5.17	\$ 4.82	\$ 4.82	\$ 4.82	\$ 4.75	\$ 4.75	\$ 5.17	\$ 4.89	\$ 4.89
Low Growth_High Prices	2024-2025	Dec	\$ 6.38	\$ 6.63	\$ 6.38	\$ 6.38	\$ 6.38	\$ 6.30	\$ 6.21	\$ 6.62	\$ 6.37	\$ 6.43
Low Growth_High Prices	2024-2025	Jan	\$ 7.86	\$ 7.86	\$ 7.86	\$ 7.86	\$ 7.86	\$ 7.76	\$ 7.76	\$ 7.76	\$ 7.76	\$ 7.86
Low Growth_High Prices	2024-2025	Feb	\$ 8.18	\$ 8.28	\$ 8.16	\$ 8.16	\$ 8.16	\$ 7.81	\$ 8.07	\$ 7.81	\$ 7.90	\$ 8.19
Low Growth_High Prices	2024-2025	Mar	\$ 8.24	\$ 8.25	\$ 8.24	\$ 8.24	\$ 8.24	\$ 7.99	\$ 8.13	\$ 8.02	\$ 8.05	\$ 8.24
Low Growth_High Prices	2024-2025	Apr	\$ 4.81	\$ 5.77	\$ 4.81	\$ 4.81	\$ 4.81	\$ 4.75	\$ 4.75	\$ 5.77	\$ 5.09	\$ 5.01
Low Growth_High Prices	2024-2025	May	\$ 4.91	\$ 5.68	\$ 4.91	\$ 4.91	\$ 4.91	\$ 4.84	\$ 4.84	\$ 5.68	\$ 5.12	\$ 5.07
Low Growth_High Prices	2024-2025	Jun	\$ 5.22	\$ 5.68	\$ 5.22	\$ 5.22	\$ 5.22	\$ 5.15	\$ 5.15	\$ 5.68	\$ 5.33	\$ 5.31
Low Growth_High Prices	2024-2025	Jul	\$ 4.92	\$ 5.68	\$ 4.92	\$ 4.92	\$ 4.92	\$ 4.85	\$ 4.85	\$ 5.68	\$ 5.13	\$ 5.07
Low Growth_High Prices	2024-2025	Aug	\$ 5.01	\$ 5.68	\$ 5.01	\$ 5.01	\$ 5.01	\$ 4.95	\$ 4.95	\$ 5.68	\$ 5.19	\$ 5.15
Low Growth_High Prices	2024-2025	Sep	\$ 4.39	\$ 5.13	\$ 4.39	\$ 4.39	\$ 4.39	\$ 4.33	\$ 4.33	\$ 5.68	\$ 4.78	\$ 4.54
Low Growth_High Prices	2024-2025	Oct	\$ 5.19	\$ 5.70	\$ 5.19	\$ 5.19	\$ 5.19	\$ 5.12	\$ 5.12	\$ 5.70	\$ 5.31	\$ 5.29
Low Growth_High Prices	2025-2026	Nov	\$ 4.84	\$ 5.05	\$ 4.84	\$ 4.84	\$ 4.84	\$ 4.77	\$ 4.77	\$ 5.05	\$ 4.86	\$ 4.88
Low Growth_High Prices	2025-2026	Dec	\$ 6.37	\$ 6.68	\$ 6.37	\$ 6.37	\$ 6.37	\$ 6.27	\$ 6.18	\$ 6.67	\$ 6.37	\$ 6.43
Low Growth_High Prices	2025-2026	Jan	\$ 7.79	\$ 7.79	\$ 7.79	\$ 7.79	\$ 7.79	\$ 7.69	\$ 7.69	\$ 7.69	\$ 7.69	\$ 7.79
Low Growth_High Prices	2025-2026	Feb	\$ 8.11	\$ 8.23	\$ 8.08	\$ 8.08	\$ 8.08	\$ 7.75	\$ 8.01	\$ 7.75	\$ 7.83	\$ 8.12
Low Growth_High Prices	2025-2026	Mar	\$ 8.12	\$ 8.15	\$ 8.11	\$ 8.11	\$ 8.11	\$ 7.89	\$ 8.01	\$ 7.95	\$ 7.95	\$ 8.12
Low Growth_High Prices	2025-2026	Apr	\$ 4.84	\$ 5.74	\$ 4.84	\$ 4.84	\$ 4.84	\$ 4.78	\$ 4.78	\$ 5.74	\$ 5.10	\$ 5.02
Low Growth_High Prices	2025-2026	May	\$ 4.92	\$ 5.65	\$ 4.92	\$ 4.92	\$ 4.92	\$ 4.85	\$ 4.85	\$ 5.65	\$ 5.12	\$ 5.07
Low Growth_High Prices	2025-2026	Jun	\$ 5.22	\$ 5.65	\$ 5.22	\$ 5.22	\$ 5.22	\$ 5.15	\$ 5.15	\$ 5.65	\$ 5.32	\$ 5.31
Low Growth_High Prices	2025-2026	Jul	\$ 4.94	\$ 5.65	\$ 4.94	\$ 4.94	\$ 4.94	\$ 4.87	\$ 4.87	\$ 5.65	\$ 5.13	\$ 5.08
Low Growth_High Prices	2025-2026	Aug	\$ 5.06	\$ 5.66	\$ 5.06	\$ 5.06	\$ 5.06	\$ 4.99	\$ 4.99	\$ 5.66	\$ 5.21	\$ 5.18
Low Growth_High Prices	2025-2026	Sep	\$ 4.38	\$ 5.14	\$ 4.38	\$ 4.38	\$ 4.38	\$ 4.32	\$ 4.32	\$ 5.66	\$ 4.77	\$ 4.53
Low Growth_High Prices	2025-2026	Oct	\$ 5.19	\$ 5.66	\$ 5.19	\$ 5.19	\$ 5.19	\$ 5.12	\$ 5.12	\$ 5.66	\$ 5.30	\$ 5.29
Low Growth_High Prices	2026-2027	Nov	\$ 4.89	\$ 5.04	\$ 4.89	\$ 4.89	\$ 4.89	\$ 4.83	\$ 4.83	\$ 5.04	\$ 4.90	\$ 4.92
Low Growth_High Prices	2026-2027	Dec	\$ 6.31	\$ 6.80	\$ 6.31	\$ 6.31	\$ 6.31	\$ 6.19	\$ 6.09	\$ 6.79	\$ 6.36	\$ 6.41
Low Growth_High Prices	2026-2027	Jan	\$ 7.72	\$ 7.72	\$ 7.72	\$ 7.72	\$ 7.72	\$ 7.62	\$ 7.62	\$ 7.62	\$ 7.62	\$ 7.72
Low Growth_High Prices	2026-2027	Feb	\$ 8.04	\$ 8.18	\$ 7.94	\$ 7.94	\$ 7.94	\$ 7.68	\$ 7.93	\$ 7.68	\$ 7.76	\$ 8.00
Low Growth_High Prices	2026-2027	Mar	\$ 7.51	\$ 7.69	\$ 7.51	\$ 7.51	\$ 7.51	\$ 7.41	\$ 7.41	\$ 7.63	\$ 7.49	\$ 7.55
Low Growth_High Prices	2026-2027	Apr	\$ 4.89	\$ 5.74	\$ 4.89	\$ 4.89	\$ 4.89	\$ 4.82	\$ 4.82	\$ 5.74	\$ 5.13	\$ 5.06
Low Growth_High Prices	2026-2027	May	\$ 4.93	\$ 5.65	\$ 4.93	\$ 4.93	\$ 4.93	\$ 4.87	\$ 4.87	\$ 5.65	\$ 5.13	\$ 5.08
Low Growth_High Prices	2026-2027	Jun	\$ 5.28	\$ 5.65	\$ 5.28	\$ 5.28	\$ 5.28	\$ 5.21	\$ 5.21	\$ 5.65	\$ 5.36	\$ 5.36
Low Growth_High Prices	2026-2027	Jul	\$ 5.00	\$ 5.65	\$ 5.00	\$ 5.00	\$ 5.00	\$ 4.93	\$ 4.93	\$ 5.65	\$ 5.17	\$ 5.13
Low Growth_High Prices	2026-2027	Aug	\$ 5.11	\$ 5.65	\$ 5.11	\$ 5.11	\$ 5.11	\$ 5.04	\$ 5.04	\$ 5.65	\$ 5.24	\$ 5.22
Low Growth_High Prices	2026-2027	Sep	\$ 4.56	\$ 4.99	\$ 4.56	\$ 4.56	\$ 4.56	\$ 4.49	\$ 4.49	\$ 5.65	\$ 4.88	\$ 4.64
Low Growth_High Prices	2026-2027	Oct	\$ 5.37	\$ 5.78	\$ 5.37	\$ 5.37	\$ 5.37	\$ 5.30	\$ 5.30	\$ 5.78	\$ 5.46	\$ 5.45
Low Growth_High Prices	2027-2028	Nov	\$ 5.02	\$ 5.19	\$ 5.02	\$ 5.02	\$ 5.02	\$ 4.96	\$ 4.96	\$ 5.19	\$ 5.03	\$ 5.06
Low Growth_High Prices	2027-2028	Dec	\$ 6.48	\$ 6.96	\$ 6.48	\$ 6.48	\$ 6.48	\$ 6.40	\$ 6.30	\$ 6.96	\$ 6.56	\$ 6.58
Low Growth_High Prices	2027-2028	Jan	\$ 8.00	\$ 8.00	\$ 8.00	\$ 8.00	\$ 8.00	\$ 7.90	\$ 7.90	\$ 7.90	\$ 7.90	\$ 8.00
Low Growth_High Prices	2027-2028	Feb	\$ 8.32	\$ 8.36	\$ 8.23	\$ 8.23	\$ 8.23	\$ 7.95	\$ 8.21	\$ 7.95	\$ 8.04	\$ 8.27
Low Growth_High Prices	2027-2028	Mar	\$ 8.07	\$ 8.20	\$ 8.07	\$ 8.07	\$ 8.07	\$ 7.96	\$ 7.97	\$ 8.13	\$ 8.02	\$ 8.10
Low Growth_High Prices	2027-2028	Apr	\$ 5.10	\$ 5.78	\$ 5.10	\$ 5.10	\$ 5.10	\$ 5.03	\$ 5.03	\$ 5.78	\$ 5.28	\$ 5.23
Low Growth_High Prices	2027-2028	May	\$ 5.13	\$ 5.70	\$ 5.13	\$ 5.13	\$ 5.13	\$ 5.06	\$ 5.06	\$ 5.70	\$ 5.27	\$ 5.24
Low Growth_High Prices	2027-2028	Jun	\$ 5.46	\$ 5.70	\$ 5.46	\$ 5.46	\$ 5.46	\$ 5.39	\$ 5.39	\$ 5.70	\$ 5.49	\$ 5.51
Low Growth_High Prices	2027-2028	Jul	\$ 5.17	\$ 5.70	\$ 5.17	\$ 5.17	\$ 5.17	\$ 5.10	\$ 5.10	\$ 5.70	\$ 5.30	\$ 5.27
Low Growth_High Prices	2027-2028	Aug	\$ 5.25	\$ 5.70	\$ 5.25	\$ 5.25	\$ 5.25	\$ 5.18	\$ 5.18	\$ 5.70	\$ 5.35	\$ 5.34
Low Growth_High Prices	2027-2028	Sep	\$ 4.65	\$ 4.98	\$ 4.65	\$ 4.65	\$ 4.65	\$ 4.59	\$ 4.59	\$ 5.70	\$ 4.96	\$ 4.72
Low Growth_High Prices	2027-2028	Oct	\$ 5.48	\$ 5.79	\$ 5.48	\$ 5.48	\$ 5.48	\$ 5.41	\$ 5.41	\$ 5.79	\$ 5.53	\$ 5.54
Low Growth_High Prices	2028-2029	Nov	\$ 5.08	\$ 5.30	\$ 5.08	\$ 5.08	\$ 5.08	\$ 5.01	\$ 5.01	\$ 5.30	\$ 5.11	\$ 5.12
Low Growth_High Prices	2028-2029	Dec	\$ 6.59	\$ 6.95	\$ 6.59	\$ 6.59	\$ 6.59	\$ 6.52	\$ 6.43	\$ 6.95	\$ 6.63	\$ 6.66
Low Growth_High Prices	2028-2029	Jan	\$ 8.11	\$ 8.11	\$ 8.11	\$ 8.11	\$ 8.11	\$ 8.00	\$ 8.00	\$ 8.00	\$ 8.00	\$ 8.11
Low Growth_High Prices	2028-2029	Feb	\$ 8.42	\$ 8.46	\$ 8.32	\$ 8.32	\$ 8.32	\$ 8.06	\$ 8.31	\$ 8.06	\$ 8.14	\$ 8.37
Low Growth_High Prices	2028-2029	Mar	\$ 7.98	\$ 8.09	\$ 7.98	\$ 7.98	\$ 7.98	\$ 7.87	\$ 7.87	\$ 8.03	\$ 7.93	\$ 8.00
Low Growth_High Prices	2028-2029	Apr	\$ 5.16	\$ 5.85	\$ 5.16	\$ 5.16	\$ 5.16	\$ 5.09	\$ 5.09	\$ 5.85	\$ 5.34	\$ 5.30
Low Growth_High Prices	2028-2029	May	\$ 5.24	\$ 5.73	\$ 5.24	\$ 5.24	\$ 5.24	\$ 5.16	\$ 5.16	\$ 5.73	\$ 5.35	\$ 5.33
Low Growth_High Prices	2028-2029	Jun	\$ 5.56	\$ 5.73	\$ 5.56	\$ 5.56	\$ 5.56	\$ 5.48	\$ 5.48	\$ 5.73	\$ 5.56	\$ 5.59
Low Growth_High Prices	2028-2029	Jul	\$ 5.22	\$ 5.73	\$ 5.22	\$ 5.22	\$ 5.22	\$ 5.15	\$ 5.15	\$ 5.73	\$ 5.34	\$ 5.32
Low Growth_High Prices	2028-2029	Aug	\$ 5.32	\$ 5.73	\$ 5.32	\$ 5.32	\$ 5.32	\$ 5.25	\$ 5.25	\$ 5.73	\$ 5.41	\$ 5.40
Low Growth_High Prices	2028-2029	Sep	\$ 4.72	\$ 5.03	\$ 4.72	\$ 4.72	\$ 4.72	\$ 4.65	\$ 4.65	\$ 5.73	\$ 5.01	\$ 4.78
Low Growth_High Prices	2028-2029	Oct	\$ 5.54	\$ 5.84	\$ 5.54	\$ 5.54	\$ 5.54	\$ 5.46	\$ 5.46	\$ 5.84	\$ 5.59	\$ 5.60

1/ Avoided costs are before Environmental Externalities adder.

## APPENDIX 5.4: LOW GROWTH – HIGH PRICE MONTHLY DETAIL

Monthly Avoided Costs 1/ 2014\$												
Scenario	Gas Year	Month	Klam Falls	La Grande	Medford GTN	Medford NWP	Roseburg	Wa/l'd Both	Wa/l'd GTN	Wa/l'd NWP	WA/ID Annual	OR Annual
Low Growth_High Prices	2029-2030	Nov	\$ 5.13	\$ 5.45	\$ 5.13	\$ 5.13	\$ 5.13	\$ 5.06	\$ 5.06	\$ 5.45	\$ 5.19	\$ 5.19
Low Growth_High Prices	2029-2030	Dec	\$ 6.64	\$ 7.04	\$ 6.64	\$ 6.64	\$ 6.64	\$ 6.57	\$ 6.47	\$ 7.04	\$ 6.69	\$ 6.72
Low Growth_High Prices	2029-2030	Jan	\$ 8.16	\$ 8.16	\$ 8.16	\$ 8.16	\$ 8.16	\$ 8.06	\$ 8.06	\$ 8.06	\$ 8.06	\$ 8.16
Low Growth_High Prices	2029-2030	Feb	\$ 8.52	\$ 8.56	\$ 8.49	\$ 8.49	\$ 8.49	\$ 8.12	\$ 8.41	\$ 8.12	\$ 8.22	\$ 8.51
Low Growth_High Prices	2029-2030	Mar	\$ 8.51	\$ 8.53	\$ 8.50	\$ 8.50	\$ 8.50	\$ 8.28	\$ 8.40	\$ 8.33	\$ 8.34	\$ 8.51
Low Growth_High Prices	2029-2030	Apr	\$ 5.24	\$ 5.89	\$ 5.24	\$ 5.24	\$ 5.24	\$ 5.17	\$ 5.17	\$ 5.89	\$ 5.41	\$ 5.37
Low Growth_High Prices	2029-2030	May	\$ 5.26	\$ 5.76	\$ 5.26	\$ 5.26	\$ 5.26	\$ 5.19	\$ 5.19	\$ 5.76	\$ 5.38	\$ 5.36
Low Growth_High Prices	2029-2030	Jun	\$ 5.62	\$ 5.77	\$ 5.62	\$ 5.62	\$ 5.62	\$ 5.54	\$ 5.54	\$ 5.77	\$ 5.62	\$ 5.65
Low Growth_High Prices	2029-2030	Jul	\$ 5.32	\$ 5.75	\$ 5.32	\$ 5.32	\$ 5.32	\$ 5.25	\$ 5.25	\$ 5.77	\$ 5.42	\$ 5.41
Low Growth_High Prices	2029-2030	Aug	\$ 5.41	\$ 5.77	\$ 5.41	\$ 5.41	\$ 5.41	\$ 5.33	\$ 5.33	\$ 5.77	\$ 5.48	\$ 5.48
Low Growth_High Prices	2029-2030	Sep	\$ 4.79	\$ 5.18	\$ 4.79	\$ 4.79	\$ 4.79	\$ 4.72	\$ 4.72	\$ 5.77	\$ 5.07	\$ 4.87
Low Growth_High Prices	2029-2030	Oct	\$ 5.61	\$ 5.99	\$ 5.61	\$ 5.61	\$ 5.61	\$ 5.54	\$ 5.54	\$ 5.99	\$ 5.69	\$ 5.69
Low Growth_High Prices	2030-2031	Nov	\$ 5.17	\$ 5.54	\$ 5.17	\$ 5.17	\$ 5.17	\$ 5.10	\$ 5.10	\$ 5.54	\$ 5.25	\$ 5.25
Low Growth_High Prices	2030-2031	Dec	\$ 6.73	\$ 7.04	\$ 6.74	\$ 6.74	\$ 6.74	\$ 6.68	\$ 6.58	\$ 7.04	\$ 6.77	\$ 6.80
Low Growth_High Prices	2030-2031	Jan	\$ 8.28	\$ 8.28	\$ 8.28	\$ 8.28	\$ 8.28	\$ 8.17	\$ 8.17	\$ 8.17	\$ 8.17	\$ 8.28
Low Growth_High Prices	2030-2031	Feb	\$ 8.63	\$ 8.65	\$ 8.60	\$ 8.60	\$ 8.60	\$ 8.23	\$ 8.52	\$ 8.23	\$ 8.33	\$ 8.61
Low Growth_High Prices	2030-2031	Mar	\$ 8.59	\$ 8.61	\$ 8.58	\$ 8.58	\$ 8.58	\$ 8.38	\$ 8.48	\$ 8.44	\$ 8.43	\$ 8.59
Low Growth_High Prices	2030-2031	Apr	\$ 5.38	\$ 5.90	\$ 5.38	\$ 5.38	\$ 5.38	\$ 5.30	\$ 5.30	\$ 5.90	\$ 5.50	\$ 5.48
Low Growth_High Prices	2030-2031	May	\$ 5.40	\$ 5.81	\$ 5.40	\$ 5.40	\$ 5.40	\$ 5.33	\$ 5.33	\$ 5.81	\$ 5.49	\$ 5.48
Low Growth_High Prices	2030-2031	Jun	\$ 5.73	\$ 5.81	\$ 5.73	\$ 5.73	\$ 5.73	\$ 5.65	\$ 5.65	\$ 5.81	\$ 5.70	\$ 5.74
Low Growth_High Prices	2030-2031	Jul	\$ 5.39	\$ 5.81	\$ 5.39	\$ 5.39	\$ 5.39	\$ 5.31	\$ 5.31	\$ 5.81	\$ 5.48	\$ 5.47
Low Growth_High Prices	2030-2031	Aug	\$ 5.48	\$ 5.81	\$ 5.48	\$ 5.48	\$ 5.48	\$ 5.40	\$ 5.40	\$ 5.81	\$ 5.54	\$ 5.54
Low Growth_High Prices	2030-2031	Sep	\$ 4.87	\$ 5.20	\$ 4.87	\$ 4.87	\$ 4.87	\$ 4.81	\$ 4.81	\$ 5.81	\$ 5.14	\$ 4.94
Low Growth_High Prices	2030-2031	Oct	\$ 5.71	\$ 6.01	\$ 5.71	\$ 5.71	\$ 5.71	\$ 5.63	\$ 5.63	\$ 6.01	\$ 5.76	\$ 5.77
Low Growth_High Prices	2031-2032	Nov	\$ 5.22	\$ 5.61	\$ 5.22	\$ 5.22	\$ 5.22	\$ 5.15	\$ 5.15	\$ 5.61	\$ 5.30	\$ 5.30
Low Growth_High Prices	2031-2032	Dec	\$ 6.80	\$ 7.06	\$ 6.80	\$ 6.80	\$ 6.80	\$ 6.75	\$ 6.66	\$ 7.06	\$ 6.82	\$ 6.85
Low Growth_High Prices	2031-2032	Jan	\$ 8.33	\$ 8.33	\$ 8.33	\$ 8.33	\$ 8.33	\$ 8.22	\$ 8.22	\$ 8.22	\$ 8.22	\$ 8.33
Low Growth_High Prices	2031-2032	Feb	\$ 8.67	\$ 8.70	\$ 8.60	\$ 8.60	\$ 8.60	\$ 8.28	\$ 8.56	\$ 8.28	\$ 8.37	\$ 8.63
Low Growth_High Prices	2031-2032	Mar	\$ 7.51	\$ 7.58	\$ 7.51	\$ 7.51	\$ 7.51	\$ 7.41	\$ 7.41	\$ 7.52	\$ 7.45	\$ 7.52
Low Growth_High Prices	2031-2032	Apr	\$ 5.47	\$ 5.96	\$ 5.47	\$ 5.47	\$ 5.47	\$ 5.40	\$ 5.40	\$ 5.96	\$ 5.58	\$ 5.57
Low Growth_High Prices	2031-2032	May	\$ 5.48	\$ 5.81	\$ 5.48	\$ 5.48	\$ 5.48	\$ 5.41	\$ 5.41	\$ 5.81	\$ 5.54	\$ 5.55
Low Growth_High Prices	2031-2032	Jun	\$ 5.82	\$ 5.81	\$ 5.81	\$ 5.81	\$ 5.81	\$ 5.74	\$ 5.74	\$ 5.81	\$ 5.76	\$ 5.81
Low Growth_High Prices	2031-2032	Jul	\$ 5.45	\$ 5.81	\$ 5.45	\$ 5.45	\$ 5.45	\$ 5.37	\$ 5.37	\$ 5.81	\$ 5.52	\$ 5.52
Low Growth_High Prices	2031-2032	Aug	\$ 5.59	\$ 5.81	\$ 5.59	\$ 5.59	\$ 5.59	\$ 5.52	\$ 5.52	\$ 5.81	\$ 5.62	\$ 5.64
Low Growth_High Prices	2031-2032	Sep	\$ 4.93	\$ 5.26	\$ 4.93	\$ 4.93	\$ 4.93	\$ 4.87	\$ 4.87	\$ 5.81	\$ 5.18	\$ 5.00
Low Growth_High Prices	2031-2032	Oct	\$ 5.76	\$ 6.10	\$ 5.76	\$ 5.76	\$ 5.76	\$ 5.69	\$ 5.69	\$ 6.10	\$ 5.82	\$ 5.83
Low Growth_High Prices	2032-2033	Nov	\$ 5.27	\$ 5.68	\$ 5.27	\$ 5.27	\$ 5.27	\$ 5.20	\$ 5.20	\$ 5.68	\$ 5.36	\$ 5.36
Low Growth_High Prices	2032-2033	Dec	\$ 6.89	\$ 7.14	\$ 6.89	\$ 6.89	\$ 6.89	\$ 6.84	\$ 6.75	\$ 7.14	\$ 6.91	\$ 6.94
Low Growth_High Prices	2032-2033	Jan	\$ 8.43	\$ 8.43	\$ 8.43	\$ 8.43	\$ 8.43	\$ 8.32	\$ 8.32	\$ 7.99	\$ 7.83	\$ 8.43
Low Growth_High Prices	2032-2033	Feb	\$ 8.77	\$ 8.79	\$ 8.69	\$ 8.69	\$ 8.69	\$ 7.78	\$ 8.66	\$ 7.78	\$ 8.07	\$ 8.73
Low Growth_High Prices	2032-2033	Mar	\$ 7.69	\$ 7.78	\$ 7.69	\$ 7.69	\$ 7.69	\$ 7.59	\$ 7.59	\$ 7.72	\$ 7.64	\$ 7.71
Low Growth_High Prices	2032-2033	Apr	\$ 5.54	\$ 6.08	\$ 5.54	\$ 5.54	\$ 5.54	\$ 5.47	\$ 5.47	\$ 6.08	\$ 5.67	\$ 5.65
Low Growth_High Prices	2032-2033	May	\$ 5.54	\$ 5.85	\$ 5.54	\$ 5.54	\$ 5.54	\$ 5.46	\$ 5.46	\$ 5.85	\$ 5.59	\$ 5.60
Low Growth_High Prices	2032-2033	Jun	\$ 5.88	\$ 5.85	\$ 5.85	\$ 5.85	\$ 5.85	\$ 5.80	\$ 5.80	\$ 5.85	\$ 5.82	\$ 5.85
Low Growth_High Prices	2032-2033	Jul	\$ 5.57	\$ 5.85	\$ 5.57	\$ 5.57	\$ 5.57	\$ 5.50	\$ 5.50	\$ 5.85	\$ 5.61	\$ 5.63
Low Growth_High Prices	2032-2033	Aug	\$ 5.70	\$ 5.85	\$ 5.70	\$ 5.70	\$ 5.70	\$ 5.62	\$ 5.62	\$ 5.85	\$ 5.70	\$ 5.73
Low Growth_High Prices	2032-2033	Sep	\$ 5.01	\$ 5.34	\$ 5.01	\$ 5.01	\$ 5.01	\$ 4.94	\$ 4.94	\$ 5.85	\$ 5.24	\$ 5.07
Low Growth_High Prices	2032-2033	Oct	\$ 5.82	\$ 6.18	\$ 5.82	\$ 5.82	\$ 5.82	\$ 5.74	\$ 5.74	\$ 6.18	\$ 5.89	\$ 5.89
Low Growth_High Prices	2033-2034	Nov	\$ 5.33	\$ 5.75	\$ 5.33	\$ 5.33	\$ 5.33	\$ 5.25	\$ 5.25	\$ 5.75	\$ 5.42	\$ 5.41
Low Growth_High Prices	2033-2034	Dec	\$ 6.97	\$ 7.23	\$ 6.97	\$ 6.97	\$ 6.97	\$ 6.90	\$ 6.80	\$ 7.23	\$ 6.98	\$ 7.02
Low Growth_High Prices	2033-2034	Jan	\$ 8.48	\$ 8.48	\$ 8.48	\$ 8.48	\$ 8.48	\$ 7.48	\$ 8.37	\$ 7.48	\$ 7.78	\$ 8.48
Low Growth_High Prices	2033-2034	Feb	\$ 8.83	\$ 8.85	\$ 8.75	\$ 8.75	\$ 8.75	\$ 7.70	\$ 8.71	\$ 7.70	\$ 8.04	\$ 8.79
Low Growth_High Prices	2033-2034	Mar	\$ 7.55	\$ 7.71	\$ 7.55	\$ 7.55	\$ 7.55	\$ 7.45	\$ 7.45	\$ 7.65	\$ 7.52	\$ 7.58
Low Growth_High Prices	2033-2034	Apr	\$ 5.55	\$ 6.18	\$ 5.55	\$ 5.55	\$ 5.55	\$ 5.48	\$ 5.48	\$ 6.18	\$ 5.71	\$ 5.68
Low Growth_High Prices	2033-2034	May	\$ 5.57	\$ 5.99	\$ 5.57	\$ 5.57	\$ 5.57	\$ 5.49	\$ 5.49	\$ 5.99	\$ 5.66	\$ 5.65
Low Growth_High Prices	2033-2034	Jun	\$ 5.91	\$ 5.99	\$ 5.91	\$ 5.91	\$ 5.91	\$ 5.83	\$ 5.83	\$ 5.99	\$ 5.88	\$ 5.92
Low Growth_High Prices	2033-2034	Jul	\$ 5.58	\$ 5.96	\$ 5.58	\$ 5.58	\$ 5.58	\$ 5.50	\$ 5.50	\$ 5.99	\$ 5.67	\$ 5.66
Low Growth_High Prices	2033-2034	Aug	\$ 5.67	\$ 6.00	\$ 5.67	\$ 5.67	\$ 5.67	\$ 5.60	\$ 5.60	\$ 6.00	\$ 5.73	\$ 5.74
Low Growth_High Prices	2033-2034	Sep	\$ 5.05	\$ 5.44	\$ 5.05	\$ 5.05	\$ 5.05	\$ 4.99	\$ 4.99	\$ 6.00	\$ 5.32	\$ 5.13
Low Growth_High Prices	2033-2034	Oct	\$ 5.88	\$ 6.24	\$ 5.88	\$ 5.88	\$ 5.88	\$ 5.80	\$ 5.80	\$ 6.24	\$ 5.95	\$ 5.95
Low Growth_High Prices	2034-2035	Nov	\$ 5.37	\$ 5.82	\$ 5.37	\$ 5.37	\$ 5.37	\$ 5.30	\$ 5.30	\$ 5.82	\$ 5.47	\$ 5.46
Low Growth_High Prices	2034-2035	Dec	\$ 7.03	\$ 7.27	\$ 7.03	\$ 7.03	\$ 7.03	\$ 6.96	\$ 6.86	\$ 7.27	\$ 7.03	\$ 7.08
Low Growth_High Prices	2034-2035	Jan	\$ 8.57	\$ 8.57	\$ 8.57	\$ 8.57	\$ 8.57	\$ 8.32	\$ 8.46	\$ 8.32	\$ 8.37	\$ 8.57
Low Growth_High Prices	2034-2035	Feb	\$ 8.89	\$ 8.90	\$ 8.79	\$ 8.79	\$ 8.79	\$ 8.42	\$ 8.77	\$ 8.42	\$ 8.54	\$ 8.83
Low Growth_High Prices	2034-2035	Mar	\$ 8.43	\$ 8.49	\$ 8.43	\$ 8.43	\$ 8.43	\$ 8.32	\$ 8.32	\$ 8.43	\$ 8.36	\$ 8.44
Low Growth_High Prices	2034-2035	Apr	\$ 5.75	\$ 6.17	\$ 5.75	\$ 5.75	\$ 5.75	\$ 5.67	\$ 5.67	\$ 6.17	\$ 5.84	\$ 5.83
Low Growth_High Prices	2034-2035	May	\$ 5.72	\$ 5.93	\$ 5.72	\$ 5.72	\$ 5.72	\$ 5.65	\$ 5.65	\$ 5.93	\$ 5.74	\$ 5.76
Low Growth_High Prices	2034-2035	Jun	\$ 5.93	\$ 5.93	\$ 5.93	\$ 5.93	\$ 5.93	\$ 5.85	\$ 5.85	\$ 5.93	\$ 5.87	\$ 5.93
Low Growth_High Prices	2034-2035	Jul	\$ 5.58	\$ 5.73	\$ 5.58	\$ 5.58	\$ 5.58	\$ 5.51	\$ 5.51	\$ 5.73	\$ 5.58	\$ 5.61
Low Growth_High Prices	2034-2035	Aug	\$ 5.75	\$ 5.73	\$ 5.73	\$ 5.73	\$ 5.73	\$ 5.68	\$ 5.68	\$ 5.73	\$ 5.69	\$ 5.74
Low Growth_High Prices	2034-2035	Sep	\$ 5.11	\$ 5.11	\$ 5.11	\$ 5.11	\$ 5.11	\$ 5.04	\$ 5.04	\$ 5.11	\$ 5.07	\$ 5.11
Low Growth_High Prices	2034-2035	Oct	\$ 5.91	\$ 6.31	\$ 5.91	\$ 5.91	\$ 5.91	\$ 5.83	\$ 5.83	\$ 6.31	\$ 5.99	\$ 5.99

1/ Avoided costs are before Environmental Externalities adder.

# APPENDIX 5.4: EXPECTED MONTHLY DETAIL

Monthly Avoided Costs 1/ 2014\$												
Scenario	Gas Year	Month	Klam Falls	La Grande	Medford GTN	Medford NWP	Roseburg	Wa/ld Both	Wa/ld GTN	Wa/ld NWP	WA/ID Annual	OR Annual
Expected Case	2015-2016	Nov	\$ 1.96	\$ 2.10	\$ 1.96	\$ 1.96	\$ 1.96	\$ 1.93	\$ 1.93	\$ 2.10	\$ 1.99	\$ 1.99
Expected Case	2015-2016	Dec	\$ 1.78	\$ 2.07	\$ 1.78	\$ 1.78	\$ 1.78	\$ 2.07	\$ 1.65	\$ 2.07	\$ 1.93	\$ 1.84
Expected Case	2015-2016	Jan	\$ 2.11	\$ 2.15	\$ 2.11	\$ 2.11	\$ 2.11	\$ 2.11	\$ 2.08	\$ 2.11	\$ 2.10	\$ 2.12
Expected Case	2015-2016	Feb	\$ 1.92	\$ 2.20	\$ 1.92	\$ 1.92	\$ 1.92	\$ 1.96	\$ 1.86	\$ 2.13	\$ 1.98	\$ 1.98
Expected Case	2015-2016	Mar	\$ 1.83	\$ 2.11	\$ 1.83	\$ 1.83	\$ 1.83	\$ 1.80	\$ 1.80	\$ 2.11	\$ 1.90	\$ 1.88
Expected Case	2015-2016	Apr	\$ 1.79	\$ 2.22	\$ 1.79	\$ 1.79	\$ 1.79	\$ 1.76	\$ 1.76	\$ 2.22	\$ 1.92	\$ 1.88
Expected Case	2015-2016	May	\$ 1.78	\$ 2.11	\$ 1.78	\$ 1.78	\$ 1.78	\$ 1.75	\$ 1.75	\$ 2.11	\$ 1.87	\$ 1.84
Expected Case	2015-2016	Jun	\$ 1.79	\$ 2.11	\$ 1.79	\$ 1.79	\$ 1.79	\$ 1.76	\$ 1.76	\$ 2.11	\$ 1.88	\$ 1.85
Expected Case	2015-2016	Jul	\$ 1.83	\$ 2.11	\$ 1.83	\$ 1.83	\$ 1.83	\$ 1.80	\$ 1.80	\$ 2.11	\$ 1.90	\$ 1.89
Expected Case	2015-2016	Aug	\$ 1.92	\$ 2.11	\$ 1.92	\$ 1.92	\$ 1.92	\$ 1.89	\$ 1.89	\$ 2.11	\$ 1.96	\$ 1.96
Expected Case	2015-2016	Sep	\$ 1.92	\$ 2.11	\$ 1.92	\$ 1.92	\$ 1.92	\$ 1.88	\$ 1.88	\$ 2.11	\$ 1.96	\$ 1.95
Expected Case	2015-2016	Oct	\$ 1.91	\$ 2.66	\$ 1.91	\$ 1.91	\$ 1.91	\$ 1.88	\$ 1.88	\$ 2.66	\$ 2.14	\$ 2.06
Expected Case	2016-2017	Nov	\$ 2.08	\$ 2.93	\$ 2.08	\$ 2.08	\$ 2.08	\$ 2.10	\$ 2.05	\$ 2.93	\$ 2.36	\$ 2.25
Expected Case	2016-2017	Dec	\$ 2.53	\$ 3.01	\$ 2.53	\$ 2.53	\$ 2.53	\$ 2.72	\$ 2.22	\$ 2.95	\$ 2.63	\$ 2.63
Expected Case	2016-2017	Jan	\$ 2.47	\$ 2.97	\$ 2.47	\$ 2.47	\$ 2.47	\$ 2.86	\$ 2.39	\$ 2.94	\$ 2.73	\$ 2.57
Expected Case	2016-2017	Feb	\$ 2.48	\$ 3.02	\$ 2.48	\$ 2.48	\$ 2.48	\$ 2.61	\$ 2.36	\$ 2.95	\$ 2.64	\$ 2.59
Expected Case	2016-2017	Mar	\$ 2.31	\$ 2.94	\$ 2.31	\$ 2.31	\$ 2.31	\$ 2.27	\$ 2.27	\$ 2.94	\$ 2.49	\$ 2.43
Expected Case	2016-2017	Apr	\$ 2.19	\$ 2.94	\$ 2.19	\$ 2.19	\$ 2.19	\$ 2.16	\$ 2.16	\$ 2.94	\$ 2.42	\$ 2.34
Expected Case	2016-2017	May	\$ 2.17	\$ 2.94	\$ 2.17	\$ 2.17	\$ 2.17	\$ 2.14	\$ 2.14	\$ 2.94	\$ 2.40	\$ 2.32
Expected Case	2016-2017	Jun	\$ 2.14	\$ 2.94	\$ 2.14	\$ 2.14	\$ 2.14	\$ 2.11	\$ 2.11	\$ 2.94	\$ 2.39	\$ 2.30
Expected Case	2016-2017	Jul	\$ 2.17	\$ 2.94	\$ 2.17	\$ 2.17	\$ 2.17	\$ 2.14	\$ 2.14	\$ 2.94	\$ 2.41	\$ 2.33
Expected Case	2016-2017	Aug	\$ 2.25	\$ 2.94	\$ 2.25	\$ 2.25	\$ 2.25	\$ 2.22	\$ 2.22	\$ 2.94	\$ 2.46	\$ 2.39
Expected Case	2016-2017	Sep	\$ 2.23	\$ 2.94	\$ 2.23	\$ 2.23	\$ 2.23	\$ 2.19	\$ 2.19	\$ 2.94	\$ 2.44	\$ 2.37
Expected Case	2016-2017	Oct	\$ 2.23	\$ 3.09	\$ 2.23	\$ 2.23	\$ 2.23	\$ 2.20	\$ 2.20	\$ 3.09	\$ 2.50	\$ 2.40
Expected Case	2017-2018	Nov	\$ 2.46	\$ 3.40	\$ 2.46	\$ 2.46	\$ 2.46	\$ 2.47	\$ 2.42	\$ 3.40	\$ 2.76	\$ 2.64
Expected Case	2017-2018	Dec	\$ 2.94	\$ 3.43	\$ 2.94	\$ 2.94	\$ 2.94	\$ 3.06	\$ 2.54	\$ 3.41	\$ 3.00	\$ 3.04
Expected Case	2017-2018	Jan	\$ 3.29	\$ 3.45	\$ 3.29	\$ 3.29	\$ 3.29	\$ 3.42	\$ 3.24	\$ 3.42	\$ 3.36	\$ 3.32
Expected Case	2017-2018	Feb	\$ 3.23	\$ 3.51	\$ 3.23	\$ 3.23	\$ 3.23	\$ 3.31	\$ 3.18	\$ 3.42	\$ 3.30	\$ 3.28
Expected Case	2017-2018	Mar	\$ 2.92	\$ 3.40	\$ 2.92	\$ 2.92	\$ 2.92	\$ 2.87	\$ 2.87	\$ 3.40	\$ 3.05	\$ 3.01
Expected Case	2017-2018	Apr	\$ 2.70	\$ 3.52	\$ 2.70	\$ 2.70	\$ 2.70	\$ 2.66	\$ 2.66	\$ 3.52	\$ 2.95	\$ 2.87
Expected Case	2017-2018	May	\$ 2.64	\$ 3.40	\$ 2.64	\$ 2.64	\$ 2.64	\$ 2.60	\$ 2.60	\$ 3.40	\$ 2.86	\$ 2.79
Expected Case	2017-2018	Jun	\$ 2.59	\$ 3.40	\$ 2.59	\$ 2.59	\$ 2.59	\$ 2.55	\$ 2.55	\$ 3.40	\$ 2.83	\$ 2.75
Expected Case	2017-2018	Jul	\$ 2.64	\$ 3.40	\$ 2.64	\$ 2.64	\$ 2.64	\$ 2.60	\$ 2.60	\$ 3.40	\$ 2.87	\$ 2.79
Expected Case	2017-2018	Aug	\$ 2.68	\$ 3.40	\$ 2.68	\$ 2.68	\$ 2.68	\$ 2.64	\$ 2.64	\$ 3.40	\$ 2.89	\$ 2.82
Expected Case	2017-2018	Sep	\$ 2.72	\$ 3.40	\$ 2.72	\$ 2.72	\$ 2.72	\$ 2.68	\$ 2.68	\$ 3.40	\$ 2.92	\$ 2.86
Expected Case	2017-2018	Oct	\$ 2.73	\$ 3.72	\$ 2.73	\$ 2.73	\$ 2.73	\$ 2.69	\$ 2.69	\$ 3.72	\$ 3.03	\$ 2.93
Expected Case	2018-2019	Nov	\$ 2.98	\$ 3.50	\$ 2.98	\$ 2.98	\$ 2.98	\$ 2.99	\$ 2.94	\$ 3.50	\$ 3.14	\$ 3.09
Expected Case	2018-2019	Dec	\$ 3.31	\$ 3.61	\$ 3.31	\$ 3.31	\$ 3.31	\$ 3.53	\$ 3.07	\$ 3.53	\$ 3.38	\$ 3.37
Expected Case	2018-2019	Jan	\$ 3.19	\$ 3.55	\$ 3.19	\$ 3.19	\$ 3.19	\$ 3.51	\$ 3.14	\$ 3.51	\$ 3.39	\$ 3.27
Expected Case	2018-2019	Feb	\$ 3.16	\$ 3.61	\$ 3.16	\$ 3.16	\$ 3.16	\$ 3.30	\$ 3.10	\$ 3.51	\$ 3.30	\$ 3.25
Expected Case	2018-2019	Mar	\$ 2.70	\$ 3.50	\$ 2.70	\$ 2.70	\$ 2.70	\$ 2.66	\$ 2.66	\$ 3.50	\$ 2.94	\$ 2.86
Expected Case	2018-2019	Apr	\$ 2.50	\$ 3.52	\$ 2.50	\$ 2.50	\$ 2.50	\$ 2.46	\$ 2.46	\$ 3.52	\$ 2.81	\$ 2.70
Expected Case	2018-2019	May	\$ 2.50	\$ 3.50	\$ 2.50	\$ 2.50	\$ 2.50	\$ 2.46	\$ 2.46	\$ 3.50	\$ 2.81	\$ 2.70
Expected Case	2018-2019	Jun	\$ 2.53	\$ 3.50	\$ 2.53	\$ 2.53	\$ 2.53	\$ 2.50	\$ 2.50	\$ 3.50	\$ 2.83	\$ 2.73
Expected Case	2018-2019	Jul	\$ 2.59	\$ 3.50	\$ 2.59	\$ 2.59	\$ 2.59	\$ 2.55	\$ 2.55	\$ 3.50	\$ 2.87	\$ 2.77
Expected Case	2018-2019	Aug	\$ 2.64	\$ 3.50	\$ 2.64	\$ 2.64	\$ 2.64	\$ 2.60	\$ 2.60	\$ 3.50	\$ 2.90	\$ 2.81
Expected Case	2018-2019	Sep	\$ 2.74	\$ 3.50	\$ 2.74	\$ 2.74	\$ 2.74	\$ 2.70	\$ 2.70	\$ 3.50	\$ 2.96	\$ 2.89
Expected Case	2018-2019	Oct	\$ 2.78	\$ 3.71	\$ 2.78	\$ 2.78	\$ 2.78	\$ 2.73	\$ 2.73	\$ 3.71	\$ 3.06	\$ 2.96
Expected Case	2019-2020	Nov	\$ 3.05	\$ 3.58	\$ 3.05	\$ 3.05	\$ 3.05	\$ 3.10	\$ 3.01	\$ 3.58	\$ 3.23	\$ 3.16
Expected Case	2019-2020	Dec	\$ 3.38	\$ 3.70	\$ 3.38	\$ 3.38	\$ 3.38	\$ 3.61	\$ 3.16	\$ 3.62	\$ 3.46	\$ 3.44
Expected Case	2019-2020	Jan	\$ 3.27	\$ 3.64	\$ 3.27	\$ 3.27	\$ 3.27	\$ 3.61	\$ 3.22	\$ 3.61	\$ 3.48	\$ 3.35
Expected Case	2019-2020	Feb	\$ 3.25	\$ 3.69	\$ 3.25	\$ 3.25	\$ 3.25	\$ 3.49	\$ 3.20	\$ 3.61	\$ 3.43	\$ 3.33
Expected Case	2019-2020	Mar	\$ 2.94	\$ 3.58	\$ 2.94	\$ 2.94	\$ 2.94	\$ 2.89	\$ 2.89	\$ 3.58	\$ 3.12	\$ 3.06
Expected Case	2019-2020	Apr	\$ 2.64	\$ 3.62	\$ 2.64	\$ 2.64	\$ 2.64	\$ 2.60	\$ 2.60	\$ 3.62	\$ 2.94	\$ 2.83
Expected Case	2019-2020	May	\$ 2.64	\$ 3.58	\$ 2.64	\$ 2.64	\$ 2.64	\$ 2.60	\$ 2.60	\$ 3.58	\$ 2.93	\$ 2.83
Expected Case	2019-2020	Jun	\$ 2.63	\$ 3.58	\$ 2.63	\$ 2.63	\$ 2.63	\$ 2.59	\$ 2.59	\$ 3.58	\$ 2.92	\$ 2.82
Expected Case	2019-2020	Jul	\$ 2.65	\$ 3.58	\$ 2.65	\$ 2.65	\$ 2.65	\$ 2.61	\$ 2.61	\$ 3.58	\$ 2.94	\$ 2.84
Expected Case	2019-2020	Aug	\$ 2.68	\$ 3.58	\$ 2.68	\$ 2.68	\$ 2.68	\$ 2.64	\$ 2.64	\$ 3.58	\$ 2.96	\$ 2.86
Expected Case	2019-2020	Sep	\$ 2.74	\$ 3.58	\$ 2.74	\$ 2.74	\$ 2.74	\$ 2.70	\$ 2.70	\$ 3.58	\$ 2.99	\$ 2.91
Expected Case	2019-2020	Oct	\$ 2.73	\$ 3.75	\$ 2.73	\$ 2.73	\$ 2.73	\$ 2.69	\$ 2.69	\$ 3.75	\$ 3.04	\$ 2.93
Expected Case	2020-2021	Nov	\$ 3.15	\$ 3.74	\$ 3.15	\$ 3.15	\$ 3.15	\$ 3.24	\$ 3.11	\$ 3.74	\$ 3.36	\$ 3.27
Expected Case	2020-2021	Dec	\$ 3.50	\$ 3.81	\$ 3.50	\$ 3.50	\$ 3.50	\$ 3.73	\$ 3.26	\$ 3.75	\$ 3.58	\$ 3.56
Expected Case	2020-2021	Jan	\$ 3.40	\$ 3.86	\$ 3.40	\$ 3.40	\$ 3.40	\$ 3.75	\$ 3.31	\$ 3.75	\$ 3.60	\$ 3.49
Expected Case	2020-2021	Feb	\$ 3.42	\$ 3.83	\$ 3.42	\$ 3.42	\$ 3.42	\$ 3.66	\$ 3.37	\$ 3.77	\$ 3.60	\$ 3.50
Expected Case	2020-2021	Mar	\$ 3.07	\$ 3.74	\$ 3.07	\$ 3.07	\$ 3.07	\$ 3.03	\$ 3.03	\$ 3.74	\$ 3.27	\$ 3.21
Expected Case	2020-2021	Apr	\$ 2.78	\$ 3.74	\$ 2.78	\$ 2.78	\$ 2.78	\$ 2.74	\$ 2.74	\$ 3.74	\$ 3.07	\$ 2.97
Expected Case	2020-2021	May	\$ 2.79	\$ 3.74	\$ 2.79	\$ 2.79	\$ 2.79	\$ 2.75	\$ 2.75	\$ 3.74	\$ 3.08	\$ 2.98
Expected Case	2020-2021	Jun	\$ 2.79	\$ 3.74	\$ 2.79	\$ 2.79	\$ 2.79	\$ 2.75	\$ 2.75	\$ 3.74	\$ 3.08	\$ 2.98
Expected Case	2020-2021	Jul	\$ 2.73	\$ 3.75	\$ 2.73	\$ 2.73	\$ 2.73	\$ 2.69	\$ 2.69	\$ 3.75	\$ 3.04	\$ 2.93
Expected Case	2020-2021	Aug	\$ 2.77	\$ 3.75	\$ 2.77	\$ 2.77	\$ 2.77	\$ 2.73	\$ 2.73	\$ 3.75	\$ 3.07	\$ 2.97
Expected Case	2020-2021	Sep	\$ 3.02	\$ 3.75	\$ 3.02	\$ 3.02	\$ 3.02	\$ 2.98	\$ 2.98	\$ 3.75	\$ 3.23	\$ 3.17
Expected Case	2020-2021	Oct	\$ 3.04	\$ 3.83	\$ 3.04	\$ 3.04	\$ 3.04	\$ 3.00	\$ 3.00	\$ 3.83	\$ 3.28	\$ 3.20
Expected Case	2021-2022	Nov	\$ 3.31	\$ 3.85	\$ 3.31	\$ 3.31	\$ 3.31	\$ 3.40	\$ 3.27	\$ 3.85	\$ 3.51	\$ 3.42
Expected Case	2021-2022	Dec	\$ 3.88	\$ 3.97	\$ 3.88	\$ 3.88	\$ 3.88	\$ 3.86	\$ 3.39	\$ 3.86	\$ 3.70	\$ 3.90
Expected Case	2021-2022	Jan	\$ 3.65	\$ 4.01	\$ 3.65	\$ 3.65	\$ 3.65	\$ 3.87	\$ 3.43	\$ 3.87	\$ 3.72	\$ 3.72
Expected Case	2021-2022	Feb	\$ 3.56	\$ 3.98	\$ 3.56	\$ 3.56	\$ 3.56	\$ 3.78	\$ 3.48	\$ 3.88	\$ 3.71	\$ 3.64
Expected Case	2021-2022	Mar	\$ 3.12	\$ 3.85	\$ 3.12	\$ 3.12	\$ 3.12	\$ 3.07	\$ 3.07	\$ 3.85	\$ 3.33	\$ 3.26
Expected Case	2021-2022	Apr	\$ 2.85	\$ 3.93	\$ 2.85	\$ 2.85	\$ 2.85	\$ 2.81	\$ 2.81	\$ 3.93	\$ 3.18	\$ 3.07
Expected Case	2021-2022	May	\$ 2.87	\$ 3.85	\$ 2.87	\$ 2.87	\$ 2.87	\$ 2.83	\$ 2.83	\$ 3.85	\$ 3.17	\$ 3.07
Expected Case	2021-2022	Jun	\$ 2.86	\$ 3.85	\$ 2.86	\$ 2.86	\$ 2.86	\$ 2.82	\$ 2.82	\$ 3.85	\$ 3.16	\$ 3.06
Expected Case	2021-2022	Jul	\$ 2.86	\$ 3.85	\$ 2.86	\$ 2.86	\$ 2.86	\$ 2.82	\$ 2.82	\$ 3.85	\$ 3.16	\$ 3.06
Expected Case	2021-2022	Aug	\$ 2.90	\$ 3.85	\$ 2.90	\$ 2.90	\$ 2.90	\$ 2.85	\$ 2.85	\$ 3.85	\$ 3.19	\$ 3.09
Expected Case	2021-2022	Sep	\$ 2.95	\$ 3.85	\$ 2.95	\$ 2.95	\$ 2.95	\$ 2.91	\$ 2.91	\$ 3.85	\$ 3.22	\$ 3.13
Expected Case	2021-2022	Oct	\$ 2.96	\$ 3.94	\$ 2.96	\$ 2.96	\$ 2.96	\$ 2.91	\$ 2.91	\$ 3.94	\$ 3.25	\$ 3.15

1/ Avoided costs are before Environmental Externalities adder.

### APPENDIX 5.4: EXPECTED MONTHLY DETAIL

Monthly Avoided Costs 1/ 2014\$												
Scenario	Gas Year	Month	Klam Falls	La Grande	Medford GTN	Medford NWP	Roseburg	Wa/l'd Both	Wa/l'd GTN	Wa/l'd NWP	WA/ID Annual	OR Annual
Expected Case	2022-2023	Nov	\$ 3.23	\$ 3.86	\$ 3.23	\$ 3.23	\$ 3.23	\$ 3.32	\$ 3.18	\$ 3.86	\$ 3.45	\$ 3.35
Expected Case	2022-2023	Dec	\$ 3.91	\$ 4.01	\$ 3.91	\$ 3.91	\$ 3.91	\$ 3.75	\$ 3.25	\$ 3.87	\$ 3.62	\$ 3.93
Expected Case	2022-2023	Jan	\$ 3.72	\$ 4.03	\$ 3.72	\$ 3.72	\$ 3.72	\$ 3.67	\$ 3.21	\$ 3.86	\$ 3.58	\$ 3.78
Expected Case	2022-2023	Feb	\$ 3.39	\$ 4.03	\$ 3.39	\$ 3.39	\$ 3.39	\$ 3.65	\$ 3.26	\$ 3.90	\$ 3.60	\$ 3.52
Expected Case	2022-2023	Mar	\$ 2.97	\$ 3.86	\$ 2.97	\$ 2.97	\$ 2.97	\$ 2.93	\$ 2.93	\$ 3.86	\$ 3.24	\$ 3.15
Expected Case	2022-2023	Apr	\$ 2.81	\$ 4.01	\$ 2.81	\$ 2.81	\$ 2.81	\$ 2.77	\$ 2.77	\$ 4.01	\$ 3.19	\$ 3.05
Expected Case	2022-2023	May	\$ 2.87	\$ 3.86	\$ 2.87	\$ 2.87	\$ 2.87	\$ 2.83	\$ 2.83	\$ 3.86	\$ 3.17	\$ 3.07
Expected Case	2022-2023	Jun	\$ 2.87	\$ 3.86	\$ 2.87	\$ 2.87	\$ 2.87	\$ 2.83	\$ 2.83	\$ 3.86	\$ 3.17	\$ 3.07
Expected Case	2022-2023	Jul	\$ 2.88	\$ 3.86	\$ 2.88	\$ 2.88	\$ 2.88	\$ 2.84	\$ 2.84	\$ 3.86	\$ 3.18	\$ 3.08
Expected Case	2022-2023	Aug	\$ 2.91	\$ 3.86	\$ 2.91	\$ 2.91	\$ 2.91	\$ 2.86	\$ 2.86	\$ 3.86	\$ 3.20	\$ 3.10
Expected Case	2022-2023	Sep	\$ 3.10	\$ 3.86	\$ 3.10	\$ 3.10	\$ 3.10	\$ 3.06	\$ 3.06	\$ 3.86	\$ 3.32	\$ 3.25
Expected Case	2022-2023	Oct	\$ 3.11	\$ 3.86	\$ 3.11	\$ 3.11	\$ 3.11	\$ 3.06	\$ 3.06	\$ 3.86	\$ 3.33	\$ 3.26
Expected Case	2023-2024	Nov	\$ 3.52	\$ 3.93	\$ 3.52	\$ 3.52	\$ 3.52	\$ 3.61	\$ 3.47	\$ 3.93	\$ 3.67	\$ 3.60
Expected Case	2023-2024	Dec	\$ 4.00	\$ 4.09	\$ 4.00	\$ 4.00	\$ 4.00	\$ 4.00	\$ 3.56	\$ 4.00	\$ 3.85	\$ 4.02
Expected Case	2023-2024	Jan	\$ 3.67	\$ 4.08	\$ 3.67	\$ 3.67	\$ 3.67	\$ 3.99	\$ 3.55	\$ 3.99	\$ 3.85	\$ 3.75
Expected Case	2023-2024	Feb	\$ 3.62	\$ 4.02	\$ 3.62	\$ 3.62	\$ 3.62	\$ 3.86	\$ 3.56	\$ 3.96	\$ 3.79	\$ 3.70
Expected Case	2023-2024	Mar	\$ 3.29	\$ 3.92	\$ 3.29	\$ 3.29	\$ 3.29	\$ 3.24	\$ 3.24	\$ 3.92	\$ 3.47	\$ 3.42
Expected Case	2023-2024	Apr	\$ 3.05	\$ 3.97	\$ 3.05	\$ 3.05	\$ 3.05	\$ 3.01	\$ 3.01	\$ 3.97	\$ 3.33	\$ 3.23
Expected Case	2023-2024	May	\$ 3.06	\$ 3.93	\$ 3.06	\$ 3.06	\$ 3.06	\$ 3.01	\$ 3.01	\$ 3.93	\$ 3.32	\$ 3.23
Expected Case	2023-2024	Jun	\$ 3.05	\$ 3.94	\$ 3.05	\$ 3.05	\$ 3.05	\$ 3.01	\$ 3.01	\$ 3.94	\$ 3.32	\$ 3.23
Expected Case	2023-2024	Jul	\$ 3.16	\$ 3.94	\$ 3.16	\$ 3.16	\$ 3.16	\$ 3.11	\$ 3.11	\$ 3.94	\$ 3.39	\$ 3.32
Expected Case	2023-2024	Aug	\$ 3.20	\$ 3.94	\$ 3.20	\$ 3.20	\$ 3.20	\$ 3.15	\$ 3.15	\$ 3.94	\$ 3.41	\$ 3.34
Expected Case	2023-2024	Sep	\$ 3.32	\$ 3.94	\$ 3.32	\$ 3.32	\$ 3.32	\$ 3.28	\$ 3.28	\$ 3.94	\$ 3.50	\$ 3.45
Expected Case	2023-2024	Oct	\$ 3.33	\$ 3.98	\$ 3.33	\$ 3.33	\$ 3.33	\$ 3.28	\$ 3.28	\$ 3.98	\$ 3.51	\$ 3.46
Expected Case	2024-2025	Nov	\$ 3.80	\$ 4.09	\$ 3.80	\$ 3.80	\$ 3.80	\$ 3.85	\$ 3.75	\$ 4.09	\$ 3.89	\$ 3.86
Expected Case	2024-2025	Dec	\$ 4.16	\$ 4.26	\$ 4.16	\$ 4.16	\$ 4.16	\$ 4.16	\$ 3.83	\$ 4.16	\$ 4.05	\$ 4.18
Expected Case	2024-2025	Jan	\$ 3.91	\$ 4.26	\$ 3.91	\$ 3.91	\$ 3.91	\$ 4.15	\$ 3.86	\$ 4.15	\$ 4.05	\$ 3.98
Expected Case	2024-2025	Feb	\$ 3.92	\$ 4.21	\$ 3.92	\$ 3.92	\$ 3.92	\$ 4.08	\$ 3.86	\$ 4.13	\$ 4.02	\$ 3.97
Expected Case	2024-2025	Mar	\$ 3.55	\$ 4.09	\$ 3.55	\$ 3.55	\$ 3.55	\$ 3.50	\$ 3.50	\$ 4.09	\$ 3.69	\$ 3.66
Expected Case	2024-2025	Apr	\$ 3.26	\$ 4.24	\$ 3.26	\$ 3.26	\$ 3.26	\$ 3.21	\$ 3.21	\$ 4.24	\$ 3.56	\$ 3.45
Expected Case	2024-2025	May	\$ 3.35	\$ 4.09	\$ 3.35	\$ 3.35	\$ 3.35	\$ 3.30	\$ 3.30	\$ 4.09	\$ 3.56	\$ 3.49
Expected Case	2024-2025	Jun	\$ 3.34	\$ 4.09	\$ 3.34	\$ 3.34	\$ 3.34	\$ 3.29	\$ 3.29	\$ 4.09	\$ 3.56	\$ 3.49
Expected Case	2024-2025	Jul	\$ 3.42	\$ 4.09	\$ 3.42	\$ 3.42	\$ 3.42	\$ 3.37	\$ 3.37	\$ 4.09	\$ 3.61	\$ 3.56
Expected Case	2024-2025	Aug	\$ 3.45	\$ 4.09	\$ 3.45	\$ 3.45	\$ 3.45	\$ 3.40	\$ 3.40	\$ 4.09	\$ 3.63	\$ 3.58
Expected Case	2024-2025	Sep	\$ 3.59	\$ 4.09	\$ 3.59	\$ 3.59	\$ 3.59	\$ 3.54	\$ 3.54	\$ 4.09	\$ 3.72	\$ 3.69
Expected Case	2024-2025	Oct	\$ 3.57	\$ 4.10	\$ 3.57	\$ 3.57	\$ 3.57	\$ 3.52	\$ 3.52	\$ 4.10	\$ 3.71	\$ 3.67
Expected Case	2025-2026	Nov	\$ 4.04	\$ 4.10	\$ 4.04	\$ 4.04	\$ 4.04	\$ 4.02	\$ 3.98	\$ 4.10	\$ 4.03	\$ 4.05
Expected Case	2025-2026	Dec	\$ 4.33	\$ 4.38	\$ 4.33	\$ 4.33	\$ 4.33	\$ 4.18	\$ 4.15	\$ 4.18	\$ 4.17	\$ 4.34
Expected Case	2025-2026	Jan	\$ 3.89	\$ 4.29	\$ 3.89	\$ 3.89	\$ 3.89	\$ 4.16	\$ 3.84	\$ 4.16	\$ 4.05	\$ 3.97
Expected Case	2025-2026	Feb	\$ 3.90	\$ 4.22	\$ 3.90	\$ 3.90	\$ 3.90	\$ 4.07	\$ 3.84	\$ 4.13	\$ 4.01	\$ 3.96
Expected Case	2025-2026	Mar	\$ 3.36	\$ 4.06	\$ 3.36	\$ 3.36	\$ 3.36	\$ 3.31	\$ 3.31	\$ 4.06	\$ 3.56	\$ 3.50
Expected Case	2025-2026	Apr	\$ 3.20	\$ 4.11	\$ 3.20	\$ 3.20	\$ 3.20	\$ 3.15	\$ 3.15	\$ 4.11	\$ 3.47	\$ 3.38
Expected Case	2025-2026	May	\$ 3.28	\$ 4.00	\$ 3.28	\$ 3.28	\$ 3.28	\$ 3.23	\$ 3.23	\$ 4.00	\$ 3.49	\$ 3.42
Expected Case	2025-2026	Jun	\$ 3.26	\$ 4.00	\$ 3.26	\$ 3.26	\$ 3.26	\$ 3.22	\$ 3.22	\$ 4.00	\$ 3.48	\$ 3.41
Expected Case	2025-2026	Jul	\$ 3.37	\$ 4.00	\$ 3.37	\$ 3.37	\$ 3.37	\$ 3.32	\$ 3.32	\$ 4.00	\$ 3.55	\$ 3.50
Expected Case	2025-2026	Aug	\$ 3.43	\$ 4.00	\$ 3.43	\$ 3.43	\$ 3.43	\$ 3.38	\$ 3.38	\$ 4.00	\$ 3.59	\$ 3.54
Expected Case	2025-2026	Sep	\$ 3.51	\$ 4.00	\$ 3.51	\$ 3.51	\$ 3.51	\$ 3.46	\$ 3.46	\$ 4.00	\$ 3.64	\$ 3.61
Expected Case	2025-2026	Oct	\$ 3.52	\$ 4.00	\$ 3.52	\$ 3.52	\$ 3.52	\$ 3.47	\$ 3.47	\$ 4.00	\$ 3.66	\$ 3.62
Expected Case	2026-2027	Nov	\$ 4.11	\$ 4.11	\$ 4.11	\$ 4.11	\$ 4.11	\$ 4.06	\$ 4.05	\$ 4.08	\$ 4.07	\$ 4.11
Expected Case	2026-2027	Dec	\$ 4.24	\$ 4.49	\$ 4.24	\$ 4.24	\$ 4.24	\$ 4.17	\$ 4.03	\$ 4.17	\$ 4.12	\$ 4.29
Expected Case	2026-2027	Jan	\$ 3.90	\$ 4.32	\$ 3.90	\$ 3.90	\$ 3.90	\$ 4.15	\$ 3.80	\$ 4.15	\$ 4.03	\$ 3.98
Expected Case	2026-2027	Feb	\$ 3.86	\$ 4.26	\$ 3.86	\$ 3.86	\$ 3.86	\$ 4.06	\$ 3.79	\$ 4.13	\$ 4.00	\$ 3.94
Expected Case	2026-2027	Mar	\$ 3.42	\$ 4.08	\$ 3.42	\$ 3.42	\$ 3.42	\$ 3.37	\$ 3.37	\$ 4.08	\$ 3.61	\$ 3.55
Expected Case	2026-2027	Apr	\$ 3.28	\$ 4.16	\$ 3.28	\$ 3.28	\$ 3.28	\$ 3.24	\$ 3.24	\$ 4.16	\$ 3.54	\$ 3.46
Expected Case	2026-2027	May	\$ 3.33	\$ 4.08	\$ 3.33	\$ 3.33	\$ 3.33	\$ 3.28	\$ 3.28	\$ 4.08	\$ 3.54	\$ 3.48
Expected Case	2026-2027	Jun	\$ 3.36	\$ 4.08	\$ 3.36	\$ 3.36	\$ 3.36	\$ 3.31	\$ 3.31	\$ 4.08	\$ 3.56	\$ 3.50
Expected Case	2026-2027	Jul	\$ 3.46	\$ 4.08	\$ 3.46	\$ 3.46	\$ 3.46	\$ 3.41	\$ 3.41	\$ 4.08	\$ 3.64	\$ 3.59
Expected Case	2026-2027	Aug	\$ 3.52	\$ 4.08	\$ 3.52	\$ 3.52	\$ 3.52	\$ 3.47	\$ 3.47	\$ 4.08	\$ 3.67	\$ 3.63
Expected Case	2026-2027	Sep	\$ 3.74	\$ 4.08	\$ 3.74	\$ 3.74	\$ 3.74	\$ 3.68	\$ 3.68	\$ 4.08	\$ 3.81	\$ 3.80
Expected Case	2026-2027	Oct	\$ 3.77	\$ 4.20	\$ 3.77	\$ 3.77	\$ 3.77	\$ 3.72	\$ 3.72	\$ 4.20	\$ 3.88	\$ 3.85
Expected Case	2027-2028	Nov	\$ 4.33	\$ 4.33	\$ 4.33	\$ 4.33	\$ 4.33	\$ 4.29	\$ 4.27	\$ 4.33	\$ 4.29	\$ 4.33
Expected Case	2027-2028	Dec	\$ 4.50	\$ 4.64	\$ 4.50	\$ 4.50	\$ 4.50	\$ 4.43	\$ 4.33	\$ 4.43	\$ 4.39	\$ 4.53
Expected Case	2027-2028	Jan	\$ 4.26	\$ 4.61	\$ 4.26	\$ 4.26	\$ 4.26	\$ 4.41	\$ 4.20	\$ 4.41	\$ 4.34	\$ 4.33
Expected Case	2027-2028	Feb	\$ 4.25	\$ 4.43	\$ 4.25	\$ 4.25	\$ 4.25	\$ 4.34	\$ 4.19	\$ 4.37	\$ 4.30	\$ 4.29
Expected Case	2027-2028	Mar	\$ 3.75	\$ 4.31	\$ 3.75	\$ 3.75	\$ 3.75	\$ 3.70	\$ 3.70	\$ 4.31	\$ 3.90	\$ 3.86
Expected Case	2027-2028	Apr	\$ 3.64	\$ 4.35	\$ 3.64	\$ 3.64	\$ 3.64	\$ 3.59	\$ 3.59	\$ 4.35	\$ 3.84	\$ 3.78
Expected Case	2027-2028	May	\$ 3.68	\$ 4.31	\$ 3.68	\$ 3.68	\$ 3.68	\$ 3.62	\$ 3.62	\$ 4.31	\$ 3.85	\$ 3.80
Expected Case	2027-2028	Jun	\$ 3.69	\$ 4.31	\$ 3.69	\$ 3.69	\$ 3.69	\$ 3.64	\$ 3.64	\$ 4.31	\$ 3.86	\$ 3.82
Expected Case	2027-2028	Jul	\$ 3.79	\$ 4.31	\$ 3.79	\$ 3.79	\$ 3.79	\$ 3.73	\$ 3.73	\$ 4.31	\$ 3.93	\$ 3.89
Expected Case	2027-2028	Aug	\$ 3.81	\$ 4.31	\$ 3.81	\$ 3.81	\$ 3.81	\$ 3.76	\$ 3.76	\$ 4.31	\$ 3.94	\$ 3.91
Expected Case	2027-2028	Sep	\$ 3.97	\$ 4.31	\$ 3.97	\$ 3.97	\$ 3.97	\$ 3.92	\$ 3.92	\$ 4.31	\$ 4.05	\$ 4.04
Expected Case	2027-2028	Oct	\$ 4.00	\$ 4.33	\$ 4.00	\$ 4.00	\$ 4.00	\$ 3.95	\$ 3.95	\$ 4.33	\$ 4.07	\$ 4.07
Expected Case	2028-2029	Nov	\$ 4.49	\$ 4.53	\$ 4.49	\$ 4.49	\$ 4.49	\$ 4.46	\$ 4.42	\$ 4.53	\$ 4.47	\$ 4.49
Expected Case	2028-2029	Dec	\$ 4.71	\$ 4.81	\$ 4.71	\$ 4.71	\$ 4.71	\$ 4.63	\$ 4.57	\$ 4.63	\$ 4.61	\$ 4.73
Expected Case	2028-2029	Jan	\$ 4.53	\$ 4.81	\$ 4.53	\$ 4.53	\$ 4.53	\$ 4.62	\$ 4.47	\$ 4.62	\$ 4.57	\$ 4.58
Expected Case	2028-2029	Feb	\$ 4.53	\$ 4.65	\$ 4.53	\$ 4.53	\$ 4.53	\$ 4.57	\$ 4.47	\$ 4.58	\$ 4.54	\$ 4.56
Expected Case	2028-2029	Mar	\$ 4.01	\$ 4.52	\$ 4.01	\$ 4.01	\$ 4.01	\$ 3.95	\$ 3.95	\$ 4.52	\$ 4.14	\$ 4.11
Expected Case	2028-2029	Apr	\$ 3.85	\$ 4.56	\$ 3.85	\$ 3.85	\$ 3.85	\$ 3.79	\$ 3.79	\$ 4.56	\$ 4.05	\$ 3.99
Expected Case	2028-2029	May	\$ 3.92	\$ 4.43	\$ 3.92	\$ 3.92	\$ 3.92	\$ 3.87	\$ 3.87	\$ 4.43	\$ 4.05	\$ 4.02
Expected Case	2028-2029	Jun	\$ 3.90	\$ 4.43	\$ 3.90	\$ 3.90	\$ 3.90	\$ 3.85	\$ 3.85	\$ 4.43	\$ 4.04	\$ 4.01
Expected Case	2028-2029	Jul	\$ 3.94	\$ 4.43	\$ 3.94	\$ 3.94	\$ 3.94	\$ 3.88	\$ 3.88	\$ 4.43	\$ 4.07	\$ 4.04
Expected Case	2028-2029	Aug	\$ 3.96	\$ 4.43	\$ 3.96	\$ 3.96	\$ 3.96	\$ 3.91	\$ 3.91	\$ 4.43	\$ 4.08	\$ 4.06
Expected Case	2028-2029	Sep	\$ 4.11	\$ 4.43	\$ 4.11	\$ 4.11	\$ 4.11	\$ 4.06	\$ 4.06	\$ 4.43	\$ 4.18	\$ 4.18
Expected Case	2028-2029	Oct	\$ 4.12	\$ 4.43	\$ 4.12	\$ 4.12	\$ 4.12	\$ 4.06	\$ 4.06	\$ 4.43	\$ 4.18	\$ 4.18

1/ Avoided costs are before Environmental Externalities adder.

## APPENDIX 5.4: EXPECTED MONTHLY DETAIL

Monthly Avoided Costs 1/ 2014\$												
Scenario	Gas Year	Month	Klam Falls	La Grande	Medford GTN	Medford NWP	Roseburg	Wa/ld Both	Wa/ld GTN	Wa/ld NWP	WA/ID Annual	OR Annual
Expected Case	2029-2030	Nov	\$ 4.60	\$ 4.71	\$ 4.60	\$ 4.60	\$ 4.60	\$ 4.59	\$ 4.54	\$ 4.71	\$ 4.61	\$ 4.62
Expected Case	2029-2030	Dec	\$ 4.84	\$ 4.97	\$ 4.84	\$ 4.84	\$ 4.84	\$ 4.81	\$ 4.69	\$ 4.81	\$ 4.77	\$ 4.87
Expected Case	2029-2030	Jan	\$ 4.71	\$ 4.96	\$ 4.71	\$ 4.71	\$ 4.71	\$ 4.80	\$ 4.59	\$ 4.80	\$ 4.73	\$ 4.76
Expected Case	2029-2030	Feb	\$ 4.71	\$ 4.81	\$ 4.71	\$ 4.71	\$ 4.71	\$ 4.76	\$ 4.65	\$ 4.76	\$ 4.72	\$ 4.73
Expected Case	2029-2030	Mar	\$ 4.15	\$ 4.70	\$ 4.15	\$ 4.15	\$ 4.15	\$ 4.09	\$ 4.09	\$ 4.70	\$ 4.30	\$ 4.26
Expected Case	2029-2030	Apr	\$ 3.98	\$ 4.64	\$ 3.98	\$ 3.98	\$ 3.98	\$ 3.92	\$ 3.92	\$ 4.64	\$ 4.16	\$ 4.11
Expected Case	2029-2030	May	\$ 4.00	\$ 4.64	\$ 4.00	\$ 4.00	\$ 4.00	\$ 3.95	\$ 3.95	\$ 4.64	\$ 4.18	\$ 4.13
Expected Case	2029-2030	Jun	\$ 4.05	\$ 4.64	\$ 4.05	\$ 4.05	\$ 4.05	\$ 3.99	\$ 3.99	\$ 4.64	\$ 4.21	\$ 4.17
Expected Case	2029-2030	Jul	\$ 4.14	\$ 4.59	\$ 4.14	\$ 4.14	\$ 4.14	\$ 4.09	\$ 4.09	\$ 4.64	\$ 4.27	\$ 4.23
Expected Case	2029-2030	Aug	\$ 4.18	\$ 4.64	\$ 4.18	\$ 4.18	\$ 4.18	\$ 4.12	\$ 4.12	\$ 4.64	\$ 4.29	\$ 4.27
Expected Case	2029-2030	Sep	\$ 4.32	\$ 4.65	\$ 4.32	\$ 4.32	\$ 4.32	\$ 4.26	\$ 4.26	\$ 4.65	\$ 4.39	\$ 4.38
Expected Case	2029-2030	Oct	\$ 4.36	\$ 4.75	\$ 4.36	\$ 4.36	\$ 4.36	\$ 4.30	\$ 4.30	\$ 4.75	\$ 4.45	\$ 4.44
Expected Case	2030-2031	Nov	\$ 4.86	\$ 4.93	\$ 4.86	\$ 4.86	\$ 4.86	\$ 4.84	\$ 4.80	\$ 4.93	\$ 4.86	\$ 4.88
Expected Case	2030-2031	Dec	\$ 5.17	\$ 5.25	\$ 5.17	\$ 5.17	\$ 5.17	\$ 5.04	\$ 5.03	\$ 5.04	\$ 5.04	\$ 5.18
Expected Case	2030-2031	Jan	\$ 4.94	\$ 5.13	\$ 4.94	\$ 4.94	\$ 4.94	\$ 5.03	\$ 4.80	\$ 5.03	\$ 4.95	\$ 4.97
Expected Case	2030-2031	Feb	\$ 4.91	\$ 5.01	\$ 4.91	\$ 4.91	\$ 4.91	\$ 4.97	\$ 4.85	\$ 4.97	\$ 4.93	\$ 4.93
Expected Case	2030-2031	Mar	\$ 4.31	\$ 4.90	\$ 4.31	\$ 4.31	\$ 4.31	\$ 4.25	\$ 4.25	\$ 4.90	\$ 4.46	\$ 4.43
Expected Case	2030-2031	Apr	\$ 4.20	\$ 4.74	\$ 4.20	\$ 4.20	\$ 4.20	\$ 4.15	\$ 4.15	\$ 4.74	\$ 4.34	\$ 4.31
Expected Case	2030-2031	May	\$ 4.22	\$ 4.72	\$ 4.22	\$ 4.22	\$ 4.22	\$ 4.16	\$ 4.16	\$ 4.72	\$ 4.35	\$ 4.32
Expected Case	2030-2031	Jun	\$ 4.24	\$ 4.71	\$ 4.24	\$ 4.24	\$ 4.24	\$ 4.18	\$ 4.18	\$ 4.73	\$ 4.36	\$ 4.33
Expected Case	2030-2031	Jul	\$ 4.29	\$ 4.73	\$ 4.29	\$ 4.29	\$ 4.29	\$ 4.23	\$ 4.23	\$ 4.73	\$ 4.40	\$ 4.38
Expected Case	2030-2031	Aug	\$ 4.33	\$ 4.73	\$ 4.33	\$ 4.33	\$ 4.33	\$ 4.27	\$ 4.27	\$ 4.73	\$ 4.42	\$ 4.41
Expected Case	2030-2031	Sep	\$ 4.49	\$ 4.73	\$ 4.49	\$ 4.49	\$ 4.49	\$ 4.43	\$ 4.43	\$ 4.73	\$ 4.53	\$ 4.54
Expected Case	2030-2031	Oct	\$ 4.51	\$ 4.82	\$ 4.51	\$ 4.51	\$ 4.51	\$ 4.45	\$ 4.45	\$ 4.82	\$ 4.57	\$ 4.57
Expected Case	2031-2032	Nov	\$ 4.93	\$ 5.08	\$ 4.93	\$ 4.93	\$ 4.93	\$ 4.95	\$ 4.86	\$ 5.08	\$ 4.96	\$ 4.96
Expected Case	2031-2032	Dec	\$ 5.26	\$ 5.32	\$ 5.26	\$ 5.26	\$ 5.26	\$ 5.18	\$ 5.13	\$ 5.18	\$ 5.16	\$ 5.27
Expected Case	2031-2032	Jan	\$ 5.08	\$ 5.30	\$ 5.08	\$ 5.08	\$ 5.08	\$ 5.17	\$ 5.01	\$ 5.17	\$ 5.12	\$ 5.12
Expected Case	2031-2032	Feb	\$ 5.08	\$ 5.16	\$ 5.08	\$ 5.08	\$ 5.08	\$ 5.11	\$ 5.01	\$ 5.11	\$ 5.08	\$ 5.09
Expected Case	2031-2032	Mar	\$ 4.53	\$ 4.98	\$ 4.53	\$ 4.53	\$ 4.53	\$ 4.47	\$ 4.47	\$ 4.98	\$ 4.64	\$ 4.62
Expected Case	2031-2032	Apr	\$ 4.37	\$ 4.88	\$ 4.37	\$ 4.37	\$ 4.37	\$ 4.31	\$ 4.31	\$ 4.88	\$ 4.50	\$ 4.47
Expected Case	2031-2032	May	\$ 4.39	\$ 4.79	\$ 4.39	\$ 4.39	\$ 4.39	\$ 4.33	\$ 4.33	\$ 4.79	\$ 4.48	\$ 4.47
Expected Case	2031-2032	Jun	\$ 4.40	\$ 4.75	\$ 4.40	\$ 4.40	\$ 4.40	\$ 4.34	\$ 4.34	\$ 4.79	\$ 4.49	\$ 4.47
Expected Case	2031-2032	Jul	\$ 4.41	\$ 4.79	\$ 4.41	\$ 4.41	\$ 4.41	\$ 4.35	\$ 4.35	\$ 4.79	\$ 4.50	\$ 4.49
Expected Case	2031-2032	Aug	\$ 4.50	\$ 4.79	\$ 4.50	\$ 4.50	\$ 4.50	\$ 4.43	\$ 4.43	\$ 4.79	\$ 4.55	\$ 4.55
Expected Case	2031-2032	Sep	\$ 4.58	\$ 4.79	\$ 4.58	\$ 4.58	\$ 4.58	\$ 4.52	\$ 4.52	\$ 4.79	\$ 4.61	\$ 4.62
Expected Case	2031-2032	Oct	\$ 4.61	\$ 4.96	\$ 4.61	\$ 4.61	\$ 4.61	\$ 4.54	\$ 4.54	\$ 4.96	\$ 4.68	\$ 4.68
Expected Case	2032-2033	Nov	\$ 5.04	\$ 5.19	\$ 5.04	\$ 5.04	\$ 5.04	\$ 5.06	\$ 4.98	\$ 5.19	\$ 5.07	\$ 5.07
Expected Case	2032-2033	Dec	\$ 5.41	\$ 5.48	\$ 5.41	\$ 5.41	\$ 5.41	\$ 5.30	\$ 5.28	\$ 5.30	\$ 5.29	\$ 5.42
Expected Case	2032-2033	Jan	\$ 5.19	\$ 5.36	\$ 5.19	\$ 5.19	\$ 5.19	\$ 5.29	\$ 5.02	\$ 5.29	\$ 5.20	\$ 5.22
Expected Case	2032-2033	Feb	\$ 5.12	\$ 5.24	\$ 5.12	\$ 5.12	\$ 5.12	\$ 5.22	\$ 5.05	\$ 5.22	\$ 5.16	\$ 5.14
Expected Case	2032-2033	Mar	\$ 4.50	\$ 5.09	\$ 4.50	\$ 4.50	\$ 4.50	\$ 4.44	\$ 4.44	\$ 5.09	\$ 4.65	\$ 4.62
Expected Case	2032-2033	Apr	\$ 4.37	\$ 4.93	\$ 4.37	\$ 4.37	\$ 4.37	\$ 4.31	\$ 4.31	\$ 4.93	\$ 4.52	\$ 4.48
Expected Case	2032-2033	May	\$ 4.36	\$ 4.81	\$ 4.36	\$ 4.36	\$ 4.36	\$ 4.30	\$ 4.30	\$ 4.81	\$ 4.47	\$ 4.45
Expected Case	2032-2033	Jun	\$ 4.40	\$ 4.81	\$ 4.40	\$ 4.40	\$ 4.40	\$ 4.33	\$ 4.33	\$ 4.81	\$ 4.49	\$ 4.48
Expected Case	2032-2033	Jul	\$ 4.49	\$ 4.77	\$ 4.49	\$ 4.49	\$ 4.49	\$ 4.42	\$ 4.42	\$ 4.81	\$ 4.55	\$ 4.54
Expected Case	2032-2033	Aug	\$ 4.56	\$ 4.81	\$ 4.56	\$ 4.56	\$ 4.56	\$ 4.49	\$ 4.49	\$ 4.81	\$ 4.60	\$ 4.61
Expected Case	2032-2033	Sep	\$ 4.64	\$ 4.81	\$ 4.64	\$ 4.64	\$ 4.64	\$ 4.57	\$ 4.57	\$ 4.81	\$ 4.65	\$ 4.67
Expected Case	2032-2033	Oct	\$ 4.67	\$ 5.04	\$ 4.67	\$ 4.67	\$ 4.67	\$ 4.60	\$ 4.60	\$ 5.04	\$ 4.75	\$ 4.74
Expected Case	2033-2034	Nov	\$ 5.12	\$ 5.29	\$ 5.12	\$ 5.12	\$ 5.12	\$ 5.16	\$ 5.06	\$ 5.29	\$ 5.17	\$ 5.16
Expected Case	2033-2034	Dec	\$ 5.53	\$ 5.67	\$ 5.53	\$ 5.53	\$ 5.53	\$ 5.40	\$ 5.37	\$ 5.40	\$ 5.39	\$ 5.55
Expected Case	2033-2034	Jan	\$ 5.29	\$ 5.47	\$ 5.29	\$ 5.29	\$ 5.29	\$ 5.38	\$ 5.11	\$ 5.38	\$ 5.29	\$ 5.32
Expected Case	2033-2034	Feb	\$ 5.21	\$ 5.34	\$ 5.21	\$ 5.21	\$ 5.21	\$ 5.32	\$ 5.14	\$ 5.32	\$ 5.26	\$ 5.24
Expected Case	2033-2034	Mar	\$ 4.55	\$ 5.21	\$ 4.55	\$ 4.55	\$ 4.55	\$ 4.49	\$ 4.49	\$ 5.21	\$ 4.73	\$ 4.69
Expected Case	2033-2034	Apr	\$ 4.43	\$ 5.07	\$ 4.43	\$ 4.43	\$ 4.43	\$ 4.37	\$ 4.37	\$ 5.07	\$ 4.60	\$ 4.56
Expected Case	2033-2034	May	\$ 4.43	\$ 4.96	\$ 4.43	\$ 4.43	\$ 4.43	\$ 4.37	\$ 4.37	\$ 4.96	\$ 4.57	\$ 4.54
Expected Case	2033-2034	Jun	\$ 4.45	\$ 4.96	\$ 4.45	\$ 4.45	\$ 4.45	\$ 4.38	\$ 4.38	\$ 4.96	\$ 4.58	\$ 4.55
Expected Case	2033-2034	Jul	\$ 4.51	\$ 4.91	\$ 4.51	\$ 4.51	\$ 4.51	\$ 4.45	\$ 4.45	\$ 4.96	\$ 4.62	\$ 4.59
Expected Case	2033-2034	Aug	\$ 4.54	\$ 4.96	\$ 4.54	\$ 4.54	\$ 4.54	\$ 4.48	\$ 4.48	\$ 4.96	\$ 4.64	\$ 4.62
Expected Case	2033-2034	Sep	\$ 4.68	\$ 4.96	\$ 4.68	\$ 4.68	\$ 4.68	\$ 4.61	\$ 4.61	\$ 4.96	\$ 4.73	\$ 4.73
Expected Case	2033-2034	Oct	\$ 4.69	\$ 5.06	\$ 4.69	\$ 4.69	\$ 4.69	\$ 4.62	\$ 4.62	\$ 5.06	\$ 4.77	\$ 4.76
Expected Case	2034-2035	Nov	\$ 5.10	\$ 5.26	\$ 5.10	\$ 5.10	\$ 5.10	\$ 5.13	\$ 5.03	\$ 5.26	\$ 5.14	\$ 5.13
Expected Case	2034-2035	Dec	\$ 5.54	\$ 5.66	\$ 5.54	\$ 5.54	\$ 5.54	\$ 5.37	\$ 5.35	\$ 5.37	\$ 5.36	\$ 5.57
Expected Case	2034-2035	Jan	\$ 5.25	\$ 5.47	\$ 5.25	\$ 5.25	\$ 5.25	\$ 5.35	\$ 5.12	\$ 5.35	\$ 5.27	\$ 5.29
Expected Case	2034-2035	Feb	\$ 5.20	\$ 5.41	\$ 5.20	\$ 5.20	\$ 5.20	\$ 5.39	\$ 5.13	\$ 5.39	\$ 5.30	\$ 5.24
Expected Case	2034-2035	Mar	\$ 4.72	\$ 5.06	\$ 4.72	\$ 4.72	\$ 4.72	\$ 4.66	\$ 4.66	\$ 5.06	\$ 4.79	\$ 4.79
Expected Case	2034-2035	Apr	\$ 4.56	\$ 4.99	\$ 4.56	\$ 4.56	\$ 4.56	\$ 4.50	\$ 4.50	\$ 4.99	\$ 4.66	\$ 4.65
Expected Case	2034-2035	May	\$ 4.55	\$ 4.72	\$ 4.55	\$ 4.55	\$ 4.55	\$ 4.49	\$ 4.49	\$ 4.72	\$ 4.56	\$ 4.58
Expected Case	2034-2035	Jun	\$ 4.43	\$ 4.72	\$ 4.43	\$ 4.43	\$ 4.43	\$ 4.37	\$ 4.37	\$ 4.72	\$ 4.49	\$ 4.49
Expected Case	2034-2035	Jul	\$ 4.49	\$ 4.72	\$ 4.49	\$ 4.49	\$ 4.49	\$ 4.43	\$ 4.43	\$ 4.72	\$ 4.53	\$ 4.54
Expected Case	2034-2035	Aug	\$ 4.61	\$ 4.72	\$ 4.61	\$ 4.61	\$ 4.61	\$ 4.55	\$ 4.55	\$ 4.72	\$ 4.61	\$ 4.63
Expected Case	2034-2035	Sep	\$ 4.72	\$ 4.72	\$ 4.72	\$ 4.72	\$ 4.72	\$ 4.66	\$ 4.66	\$ 4.72	\$ 4.68	\$ 4.72
Expected Case	2034-2035	Oct	\$ 4.71	\$ 5.12	\$ 4.71	\$ 4.71	\$ 4.71	\$ 4.65	\$ 4.65	\$ 5.12	\$ 4.80	\$ 4.79

1/ Avoided costs are before Environmental Externalities adder.



### APPENDIX 5.4: HIGH GROWTH – LOW PRICE MONTHLY DETAIL

Monthly Avoided Costs 1/ 2014\$													WA/ID Annual	OR Annual
Scenario	Gas Year	Month	Klam Falls	La Grande	Medford GTN	Medford NWP	Roseburg	Wa/Id Both	Wa/Id GTN	Wa/Id NWP				
High Growth_Low Prices	2015-2016	Nov	\$ 1.96	\$ 1.96	\$ 1.96	\$ 1.96	\$ 1.96	\$ 1.93	\$ 1.93	\$ 1.96			\$ 1.94	\$ 1.96
High Growth_Low Prices	2015-2016	Dec	\$ 1.77	\$ 2.00	\$ 1.77	\$ 1.77	\$ 1.77	\$ 1.99	\$ 1.65	\$ 1.99			\$ 1.88	\$ 1.82
High Growth_Low Prices	2015-2016	Jan	\$ 1.88	\$ 1.99	\$ 1.88	\$ 1.88	\$ 1.88	\$ 1.96	\$ 1.85	\$ 1.96			\$ 1.93	\$ 1.90
High Growth_Low Prices	2015-2016	Feb	\$ 1.93	\$ 2.09	\$ 1.93	\$ 1.93	\$ 1.93	\$ 1.96	\$ 1.90	\$ 2.00			\$ 1.96	\$ 1.96
High Growth_Low Prices	2015-2016	Mar	\$ 1.55	\$ 1.97	\$ 1.55	\$ 1.55	\$ 1.55	\$ 1.52	\$ 1.52	\$ 1.97			\$ 1.67	\$ 1.63
High Growth_Low Prices	2015-2016	Apr	\$ 1.26	\$ 1.97	\$ 1.26	\$ 1.26	\$ 1.26	\$ 1.24	\$ 1.24	\$ 1.97			\$ 1.48	\$ 1.40
High Growth_Low Prices	2015-2016	May	\$ 1.48	\$ 1.97	\$ 1.48	\$ 1.48	\$ 1.48	\$ 1.45	\$ 1.45	\$ 1.97			\$ 1.62	\$ 1.58
High Growth_Low Prices	2015-2016	Jun	\$ 1.52	\$ 1.97	\$ 1.52	\$ 1.52	\$ 1.52	\$ 1.50	\$ 1.50	\$ 1.97			\$ 1.65	\$ 1.61
High Growth_Low Prices	2015-2016	Jul	\$ 2.03	\$ 2.01	\$ 2.01	\$ 2.01	\$ 2.01	\$ 2.00	\$ 2.00	\$ 2.01			\$ 2.01	\$ 2.02
High Growth_Low Prices	2015-2016	Aug	\$ 1.92	\$ 1.97	\$ 1.92	\$ 1.92	\$ 1.92	\$ 1.89	\$ 1.89	\$ 1.97			\$ 1.92	\$ 1.93
High Growth_Low Prices	2015-2016	Sep	\$ 1.33	\$ 1.97	\$ 1.33	\$ 1.33	\$ 1.33	\$ 1.31	\$ 1.31	\$ 1.97			\$ 1.53	\$ 1.46
High Growth_Low Prices	2015-2016	Oct	\$ 1.61	\$ 2.36	\$ 1.61	\$ 1.61	\$ 1.61	\$ 1.58	\$ 1.58	\$ 2.36			\$ 1.84	\$ 1.76
High Growth_Low Prices	2016-2017	Nov	\$ 1.27	\$ 2.09	\$ 1.27	\$ 1.27	\$ 1.27	\$ 1.29	\$ 1.25	\$ 2.09			\$ 1.54	\$ 1.43
High Growth_Low Prices	2016-2017	Dec	\$ 1.35	\$ 2.05	\$ 1.35	\$ 1.35	\$ 1.35	\$ 1.46	\$ 0.88	\$ 2.05			\$ 1.46	\$ 1.49
High Growth_Low Prices	2016-2017	Jan	\$ 1.71	\$ 2.13	\$ 1.71	\$ 1.71	\$ 1.71	\$ 2.06	\$ 1.59	\$ 2.10			\$ 1.91	\$ 1.79
High Growth_Low Prices	2016-2017	Feb	\$ 1.82	\$ 2.21	\$ 1.82	\$ 1.82	\$ 1.82	\$ 1.92	\$ 1.74	\$ 2.11			\$ 1.92	\$ 1.90
High Growth_Low Prices	2016-2017	Mar	\$ 1.47	\$ 2.10	\$ 1.47	\$ 1.47	\$ 1.47	\$ 1.44	\$ 1.44	\$ 2.10			\$ 1.66	\$ 1.59
High Growth_Low Prices	2016-2017	Apr	\$ 1.29	\$ 2.10	\$ 1.29	\$ 1.29	\$ 1.29	\$ 1.27	\$ 1.27	\$ 2.10			\$ 1.55	\$ 1.45
High Growth_Low Prices	2016-2017	May	\$ 1.60	\$ 2.10	\$ 1.60	\$ 1.60	\$ 1.60	\$ 1.57	\$ 1.57	\$ 2.10			\$ 1.75	\$ 1.70
High Growth_Low Prices	2016-2017	Jun	\$ 1.53	\$ 2.10	\$ 1.53	\$ 1.53	\$ 1.53	\$ 1.50	\$ 1.50	\$ 2.10			\$ 1.70	\$ 1.64
High Growth_Low Prices	2016-2017	Jul	\$ 2.03	\$ 2.10	\$ 2.03	\$ 2.03	\$ 2.03	\$ 2.00	\$ 2.00	\$ 2.10			\$ 2.03	\$ 2.04
High Growth_Low Prices	2016-2017	Aug	\$ 1.91	\$ 2.10	\$ 1.91	\$ 1.91	\$ 1.91	\$ 1.88	\$ 1.88	\$ 2.10			\$ 1.95	\$ 1.95
High Growth_Low Prices	2016-2017	Sep	\$ 1.36	\$ 2.10	\$ 1.36	\$ 1.36	\$ 1.36	\$ 1.34	\$ 1.34	\$ 2.10			\$ 1.59	\$ 1.51
High Growth_Low Prices	2016-2017	Oct	\$ 1.49	\$ 2.36	\$ 1.49	\$ 1.49	\$ 1.49	\$ 1.46	\$ 1.46	\$ 2.36			\$ 1.76	\$ 1.66
High Growth_Low Prices	2017-2018	Nov	\$ 1.40	\$ 2.10	\$ 1.40	\$ 1.40	\$ 1.40	\$ 1.42	\$ 1.37	\$ 2.10			\$ 1.63	\$ 1.54
High Growth_Low Prices	2017-2018	Dec	\$ 1.51	\$ 2.02	\$ 1.51	\$ 1.51	\$ 1.51	\$ 1.54	\$ 0.97	\$ 2.03			\$ 1.51	\$ 1.61
High Growth_Low Prices	2017-2018	Jan	\$ 1.83	\$ 2.14	\$ 1.83	\$ 1.83	\$ 1.83	\$ 2.12	\$ 1.73	\$ 2.12			\$ 1.99	\$ 1.89
High Growth_Low Prices	2017-2018	Feb	\$ 1.91	\$ 2.23	\$ 1.91	\$ 1.91	\$ 1.91	\$ 2.00	\$ 1.86	\$ 2.13			\$ 2.00	\$ 1.97
High Growth_Low Prices	2017-2018	Mar	\$ 1.52	\$ 2.10	\$ 1.52	\$ 1.52	\$ 1.52	\$ 1.49	\$ 1.49	\$ 2.10			\$ 1.70	\$ 1.64
High Growth_Low Prices	2017-2018	Apr	\$ 1.27	\$ 2.10	\$ 1.27	\$ 1.27	\$ 1.27	\$ 1.24	\$ 1.24	\$ 2.10			\$ 1.53	\$ 1.43
High Growth_Low Prices	2017-2018	May	\$ 1.47	\$ 2.11	\$ 1.47	\$ 1.47	\$ 1.47	\$ 1.44	\$ 1.44	\$ 2.11			\$ 1.66	\$ 1.60
High Growth_Low Prices	2017-2018	Jun	\$ 1.46	\$ 2.11	\$ 1.46	\$ 1.46	\$ 1.46	\$ 1.44	\$ 1.44	\$ 2.11			\$ 1.66	\$ 1.59
High Growth_Low Prices	2017-2018	Jul	\$ 1.99	\$ 2.11	\$ 1.99	\$ 1.99	\$ 1.99	\$ 1.95	\$ 1.95	\$ 2.11			\$ 2.01	\$ 2.01
High Growth_Low Prices	2017-2018	Aug	\$ 1.81	\$ 2.11	\$ 1.81	\$ 1.81	\$ 1.81	\$ 1.78	\$ 1.78	\$ 2.11			\$ 1.89	\$ 1.87
High Growth_Low Prices	2017-2018	Sep	\$ 1.34	\$ 2.11	\$ 1.34	\$ 1.34	\$ 1.34	\$ 1.31	\$ 1.31	\$ 2.11			\$ 1.58	\$ 1.49
High Growth_Low Prices	2017-2018	Oct	\$ 1.39	\$ 2.39	\$ 1.39	\$ 1.39	\$ 1.39	\$ 1.37	\$ 1.37	\$ 2.39			\$ 1.71	\$ 1.59
High Growth_Low Prices	2018-2019	Nov	\$ 1.36	\$ 2.11	\$ 1.36	\$ 1.36	\$ 1.36	\$ 1.48	\$ 1.34	\$ 2.11			\$ 1.64	\$ 1.51
High Growth_Low Prices	2018-2019	Dec	\$ 1.65	\$ 1.98	\$ 1.65	\$ 1.65	\$ 1.65	\$ 1.64	\$ 1.08	\$ 1.97			\$ 1.57	\$ 1.72
High Growth_Low Prices	2018-2019	Jan	\$ 1.93	\$ 2.23	\$ 1.93	\$ 1.93	\$ 1.93	\$ 2.10	\$ 1.62	\$ 2.11			\$ 1.94	\$ 1.99
High Growth_Low Prices	2018-2019	Feb	\$ 1.84	\$ 2.26	\$ 1.84	\$ 1.84	\$ 1.84	\$ 2.05	\$ 1.76	\$ 2.15			\$ 1.98	\$ 1.93
High Growth_Low Prices	2018-2019	Mar	\$ 1.32	\$ 2.11	\$ 1.32	\$ 1.32	\$ 1.32	\$ 1.30	\$ 1.30	\$ 2.11			\$ 1.57	\$ 1.48
High Growth_Low Prices	2018-2019	Apr	\$ 1.04	\$ 2.11	\$ 1.04	\$ 1.04	\$ 1.04	\$ 1.02	\$ 1.02	\$ 2.11			\$ 1.39	\$ 1.26
High Growth_Low Prices	2018-2019	May	\$ 1.32	\$ 2.11	\$ 1.32	\$ 1.32	\$ 1.32	\$ 1.30	\$ 1.30	\$ 2.11			\$ 1.57	\$ 1.48
High Growth_Low Prices	2018-2019	Jun	\$ 1.41	\$ 2.11	\$ 1.41	\$ 1.41	\$ 1.41	\$ 1.39	\$ 1.39	\$ 2.11			\$ 1.63	\$ 1.55
High Growth_Low Prices	2018-2019	Jul	\$ 1.94	\$ 2.11	\$ 1.94	\$ 1.94	\$ 1.94	\$ 1.91	\$ 1.91	\$ 2.11			\$ 1.98	\$ 1.98
High Growth_Low Prices	2018-2019	Aug	\$ 1.77	\$ 2.12	\$ 1.77	\$ 1.77	\$ 1.77	\$ 1.74	\$ 1.74	\$ 2.12			\$ 1.86	\$ 1.84
High Growth_Low Prices	2018-2019	Sep	\$ 1.24	\$ 2.12	\$ 1.24	\$ 1.24	\$ 1.24	\$ 1.22	\$ 1.22	\$ 2.12			\$ 1.52	\$ 1.42
High Growth_Low Prices	2018-2019	Oct	\$ 1.45	\$ 2.40	\$ 1.45	\$ 1.45	\$ 1.45	\$ 1.43	\$ 1.43	\$ 2.40			\$ 1.75	\$ 1.64
High Growth_Low Prices	2019-2020	Nov	\$ 1.37	\$ 2.09	\$ 1.37	\$ 1.37	\$ 1.37	\$ 1.50	\$ 1.35	\$ 2.09			\$ 1.64	\$ 1.52
High Growth_Low Prices	2019-2020	Dec	\$ 1.66	\$ 1.75	\$ 1.66	\$ 1.66	\$ 1.66	\$ 1.56	\$ 1.01	\$ 1.74			\$ 1.44	\$ 1.68
High Growth_Low Prices	2019-2020	Jan	\$ 1.95	\$ 2.21	\$ 1.95	\$ 1.95	\$ 1.95	\$ 2.11	\$ 1.63	\$ 2.13			\$ 1.95	\$ 2.00
High Growth_Low Prices	2019-2020	Feb	\$ 1.84	\$ 2.24	\$ 1.84	\$ 1.84	\$ 1.84	\$ 2.05	\$ 1.77	\$ 2.16			\$ 1.99	\$ 1.92
High Growth_Low Prices	2019-2020	Mar	\$ 1.45	\$ 2.13	\$ 1.45	\$ 1.45	\$ 1.45	\$ 1.42	\$ 1.42	\$ 2.13			\$ 1.66	\$ 1.59
High Growth_Low Prices	2019-2020	Apr	\$ 1.06	\$ 2.13	\$ 1.06	\$ 1.06	\$ 1.06	\$ 1.04	\$ 1.04	\$ 2.13			\$ 1.40	\$ 1.28
High Growth_Low Prices	2019-2020	May	\$ 1.34	\$ 2.13	\$ 1.34	\$ 1.34	\$ 1.34	\$ 1.31	\$ 1.31	\$ 2.13			\$ 1.59	\$ 1.50
High Growth_Low Prices	2019-2020	Jun	\$ 1.40	\$ 2.13	\$ 1.40	\$ 1.40	\$ 1.40	\$ 1.38	\$ 1.38	\$ 2.13			\$ 1.63	\$ 1.55
High Growth_Low Prices	2019-2020	Jul	\$ 1.92	\$ 2.13	\$ 1.92	\$ 1.92	\$ 1.92	\$ 1.89	\$ 1.89	\$ 2.13			\$ 1.97	\$ 1.97
High Growth_Low Prices	2019-2020	Aug	\$ 1.75	\$ 2.13	\$ 1.75	\$ 1.75	\$ 1.75	\$ 1.73	\$ 1.73	\$ 2.13			\$ 1.86	\$ 1.83
High Growth_Low Prices	2019-2020	Sep	\$ 1.44	\$ 2.13	\$ 1.44	\$ 1.44	\$ 1.44	\$ 1.41	\$ 1.41	\$ 2.13			\$ 1.65	\$ 1.58
High Growth_Low Prices	2019-2020	Oct	\$ 1.41	\$ 2.45	\$ 1.41	\$ 1.41	\$ 1.41	\$ 1.39	\$ 1.39	\$ 2.45			\$ 1.74	\$ 1.62
High Growth_Low Prices	2020-2021	Nov	\$ 1.41	\$ 2.07	\$ 1.41	\$ 1.41	\$ 1.41	\$ 1.53	\$ 1.39	\$ 2.07			\$ 1.66	\$ 1.55
High Growth_Low Prices	2020-2021	Dec	\$ 1.66	\$ 1.75	\$ 1.67	\$ 1.67	\$ 1.67	\$ 1.61	\$ 1.07	\$ 1.71			\$ 1.46	\$ 1.69
High Growth_Low Prices	2020-2021	Jan	\$ 2.07	\$ 2.34	\$ 2.07	\$ 2.07	\$ 2.07	\$ 2.14	\$ 1.66	\$ 2.15			\$ 1.98	\$ 2.13
High Growth_Low Prices	2020-2021	Feb	\$ 1.93	\$ 2.26	\$ 1.93	\$ 1.93	\$ 1.93	\$ 2.11	\$ 1.86	\$ 2.19			\$ 2.05	\$ 2.00
High Growth_Low Prices	2020-2021	Mar	\$ 1.52	\$ 2.15	\$ 1.52	\$ 1.52	\$ 1.52	\$ 1.49	\$ 1.49	\$ 2.15			\$ 1.71	\$ 1.64
High Growth_Low Prices	2020-2021	Apr	\$ 1.13	\$ 2.15	\$ 1.13	\$ 1.13	\$ 1.13	\$ 1.11	\$ 1.11	\$ 2.15			\$ 1.46	\$ 1.34
High Growth_Low Prices	2020-2021	May	\$ 1.42	\$ 2.15	\$ 1.42	\$ 1.42	\$ 1.42	\$ 1.39	\$ 1.39	\$ 2.15			\$ 1.65	\$ 1.56
High Growth_Low Prices	2020-2021	Jun	\$ 1.46	\$ 2.15	\$ 1.46	\$ 1.46	\$ 1.46	\$ 1.44	\$ 1.44	\$ 2.15			\$ 1.68	\$ 1.60
High Growth_Low Prices	2020-2021	Jul	\$ 1.89	\$ 2.15	\$ 1.89	\$ 1.89	\$ 1.89	\$ 1.86	\$ 1.86	\$ 2.15			\$ 1.95	\$ 1.94
High Growth_Low Prices	2020-2021	Aug	\$ 1.71	\$ 2.15	\$ 1.71	\$ 1.71	\$ 1.71	\$ 1.68	\$ 1.68	\$ 2.15			\$ 1.84	\$ 1.80
High Growth_Low Prices	2020-2021	Sep	\$ 1.38	\$ 2.15	\$ 1.38	\$ 1.38	\$ 1.38	\$ 1.35	\$ 1.35	\$ 2.15			\$ 1.62	\$ 1.53
High Growth_Low Prices	2020-2021	Oct	\$ 1.49	\$ 2.30	\$ 1.49	\$ 1.49	\$ 1.49	\$ 1.46	\$ 1.46	\$ 2.30			\$ 1.74	\$ 1.65
High Growth_Low Prices	2021-2022	Nov	\$ 1.41	\$ 2.12	\$ 1.41	\$ 1.41	\$ 1.41	\$ 1.53	\$ 1.38	\$ 2.12			\$ 1.68	\$ 1.55
High Growth_Low Prices	2021-2022	Dec	\$ 1.70	\$ 1.81	\$ 1.71	\$ 1.71	\$ 1.71	\$ 1.62	\$ 1.04	\$ 1.72			\$ 1.46	\$ 1.73
High Growth_Low Prices	2021-2022	Jan	\$ 2.18	\$ 2.41	\$ 2.18	\$ 2.18	\$ 2.18	\$ 2.06	\$ 1.58	\$ 2.22			\$ 1.96	\$ 2.23
High Growth_Low Prices	2021-2022	Feb	\$ 1.88	\$ 2.34	\$ 1.88	\$ 1.88	\$ 1.88	\$ 2.14	\$ 1.78	\$ 2.25			\$ 2.06	\$ 1.97
High Growth_Low Prices	2021-2022	Mar	\$ 1.45	\$ 2.22	\$ 1.45	\$ 1.45	\$ 1.45	\$ 1.42	\$ 1.42	\$ 2.22			\$ 1.69	\$ 1.60
High Growth_Low Prices	2021-2022	Apr	\$ 1.10	\$ 2.22	\$ 1.10	\$ 1.10	\$ 1.10	\$ 1.08	\$ 1.08	\$ 2.22			\$ 1.46	\$ 1.32
High Growth_Low Prices	2021-2022	May	\$ 1.39	\$ 2.22	\$ 1.39	\$ 1.39	\$ 1.39	\$ 1.37	\$ 1.37	\$ 2.23			\$ 1.65	\$ 1.56
High Growth_Low Prices	2021-2022	Jun	\$ 1.45	\$ 2.23	\$ 1.45	\$ 1.45	\$ 1.45	\$ 1.42	\$ 1.42	\$ 2.23			\$ 1.69	\$ 1.60
High Growth_Low Prices	2021-2022	Jul	\$ 1.94	\$ 2.23	\$ 1.94	\$ 1.94	\$ 1.94	\$ 1.91	\$ 1.91	\$ 2.23			\$ 2.02	\$ 2.00
High Growth_Low Prices	2021-2022	Aug	\$ 1.78	\$ 2.23	\$ 1.78	\$ 1.78	\$ 1.78	\$ 1.75	\$ 1.75	\$ 2.23			\$ 1.91	\$ 1.87
High Growth_Low Prices	2021-2022	Sep	\$ 1.36	\$ 2.23	\$ 1.36	\$ 1.36	\$ 1.36	\$ 1.34	\$ 1.34	\$ 2.23			\$ 1.63	\$ 1.53
High Growth_Low Prices	2021-2022	Oct	\$ 1.48	\$ 2.47	\$ 1.48	\$ 1.48	\$ 1.48	\$ 1.45	\$ 1.45	\$ 2.47			\$ 1.79	\$ 1.68

1/ Avoided costs are before

## APPENDIX 5.4: HIGH GROWTH – LOW PRICE MONTHLY DETAIL

Monthly Avoided Costs 1/														
2014\$														
Scenario	Gas Year	Month	Klam Falls	La Grande	Medford GTN	Medford NWP	Roseburg	Wa/ld Both	Wa/ld GTN	Wa/ld NWP	WA/ID Annual	OR Annual		
High Growth_Low Prices	2022-2023	Nov	\$ 1.29	\$ 2.23	\$ 1.29	\$ 1.29	\$ 1.29	\$ 1.41	\$ 1.27	\$ 2.23	\$ 1.64	\$ 1.48		
High Growth_Low Prices	2022-2023	Dec	\$ 1.81	\$ 1.90	\$ 1.81	\$ 1.81	\$ 1.81	\$ 1.48	\$ 0.86	\$ 1.81	\$ 1.38	\$ 1.83		
High Growth_Low Prices	2022-2023	Jan	\$ 2.23	\$ 2.49	\$ 2.23	\$ 2.23	\$ 2.23	\$ 1.86	\$ 1.38	\$ 2.23	\$ 1.82	\$ 2.28		
High Growth_Low Prices	2022-2023	Feb	\$ 1.71	\$ 2.39	\$ 1.71	\$ 1.71	\$ 1.71	\$ 2.08	\$ 1.57	\$ 2.27	\$ 1.97	\$ 1.84		
High Growth_Low Prices	2022-2023	Mar	\$ 1.29	\$ 2.23	\$ 1.29	\$ 1.29	\$ 1.29	\$ 1.27	\$ 1.27	\$ 2.23	\$ 1.59	\$ 1.48		
High Growth_Low Prices	2022-2023	Apr	\$ 1.04	\$ 2.26	\$ 1.04	\$ 1.04	\$ 1.04	\$ 1.02	\$ 1.02	\$ 2.26	\$ 1.44	\$ 1.29		
High Growth_Low Prices	2022-2023	May	\$ 1.36	\$ 2.23	\$ 1.36	\$ 1.36	\$ 1.36	\$ 1.34	\$ 1.34	\$ 2.23	\$ 1.64	\$ 1.54		
High Growth_Low Prices	2022-2023	Jun	\$ 1.43	\$ 2.23	\$ 1.43	\$ 1.43	\$ 1.43	\$ 1.40	\$ 1.40	\$ 2.23	\$ 1.68	\$ 1.59		
High Growth_Low Prices	2022-2023	Jul	\$ 1.93	\$ 2.23	\$ 1.93	\$ 1.93	\$ 1.93	\$ 1.90	\$ 1.90	\$ 2.23	\$ 2.01	\$ 1.99		
High Growth_Low Prices	2022-2023	Aug	\$ 1.75	\$ 2.24	\$ 1.75	\$ 1.75	\$ 1.75	\$ 1.72	\$ 1.72	\$ 2.24	\$ 1.90	\$ 1.85		
High Growth_Low Prices	2022-2023	Sep	\$ 1.44	\$ 2.24	\$ 1.44	\$ 1.44	\$ 1.44	\$ 1.42	\$ 1.42	\$ 2.24	\$ 1.69	\$ 1.60		
High Growth_Low Prices	2022-2023	Oct	\$ 1.67	\$ 2.44	\$ 1.67	\$ 1.67	\$ 1.67	\$ 1.64	\$ 1.64	\$ 2.44	\$ 1.91	\$ 1.82		
High Growth_Low Prices	2023-2024	Nov	\$ 1.63	\$ 2.20	\$ 1.63	\$ 1.63	\$ 1.63	\$ 1.79	\$ 1.60	\$ 2.20	\$ 1.87	\$ 1.74		
High Growth_Low Prices	2023-2024	Dec	\$ 1.78	\$ 1.87	\$ 1.79	\$ 1.79	\$ 1.79	\$ 1.61	\$ 1.04	\$ 1.79	\$ 1.48	\$ 1.80		
High Growth_Low Prices	2023-2024	Jan	\$ 2.09	\$ 2.40	\$ 2.09	\$ 2.09	\$ 2.09	\$ 2.13	\$ 1.66	\$ 2.24	\$ 2.01	\$ 2.15		
High Growth_Low Prices	2023-2024	Feb	\$ 1.90	\$ 2.30	\$ 1.90	\$ 1.90	\$ 1.90	\$ 2.22	\$ 1.83	\$ 2.26	\$ 2.10	\$ 1.98		
High Growth_Low Prices	2023-2024	Mar	\$ 1.54	\$ 2.19	\$ 1.54	\$ 1.54	\$ 1.54	\$ 1.52	\$ 1.52	\$ 2.19	\$ 1.74	\$ 1.67		
High Growth_Low Prices	2023-2024	Apr	\$ 1.15	\$ 2.19	\$ 1.15	\$ 1.15	\$ 1.15	\$ 1.13	\$ 1.13	\$ 2.19	\$ 1.48	\$ 1.36		
High Growth_Low Prices	2023-2024	May	\$ 1.43	\$ 2.19	\$ 1.43	\$ 1.43	\$ 1.43	\$ 1.40	\$ 1.40	\$ 2.19	\$ 1.67	\$ 1.58		
High Growth_Low Prices	2023-2024	Jun	\$ 1.49	\$ 2.19	\$ 1.49	\$ 1.49	\$ 1.49	\$ 1.46	\$ 1.46	\$ 2.19	\$ 1.70	\$ 1.63		
High Growth_Low Prices	2023-2024	Jul	\$ 2.08	\$ 2.19	\$ 2.08	\$ 2.08	\$ 2.08	\$ 2.04	\$ 2.04	\$ 2.19	\$ 2.09	\$ 2.10		
High Growth_Low Prices	2023-2024	Aug	\$ 1.91	\$ 2.19	\$ 1.91	\$ 1.91	\$ 1.91	\$ 1.87	\$ 1.87	\$ 2.19	\$ 1.98	\$ 1.96		
High Growth_Low Prices	2023-2024	Sep	\$ 1.56	\$ 2.19	\$ 1.56	\$ 1.56	\$ 1.56	\$ 1.53	\$ 1.53	\$ 2.19	\$ 1.75	\$ 1.68		
High Growth_Low Prices	2023-2024	Oct	\$ 1.58	\$ 2.25	\$ 1.58	\$ 1.58	\$ 1.58	\$ 1.55	\$ 1.55	\$ 2.25	\$ 1.78	\$ 1.71		
High Growth_Low Prices	2024-2025	Nov	\$ 1.63	\$ 2.02	\$ 1.63	\$ 1.63	\$ 1.63	\$ 1.77	\$ 1.61	\$ 2.02	\$ 1.80	\$ 1.71		
High Growth_Low Prices	2024-2025	Dec	\$ 1.59	\$ 1.89	\$ 1.62	\$ 1.62	\$ 1.62	\$ 1.74	\$ 1.18	\$ 1.75	\$ 1.56	\$ 1.67		
High Growth_Low Prices	2024-2025	Jan	\$ 2.07	\$ 2.39	\$ 2.07	\$ 2.07	\$ 2.07	\$ 2.18	\$ 1.71	\$ 2.19	\$ 2.03	\$ 2.13		
High Growth_Low Prices	2024-2025	Feb	\$ 1.92	\$ 2.28	\$ 1.92	\$ 1.92	\$ 1.92	\$ 2.20	\$ 1.85	\$ 2.22	\$ 2.09	\$ 1.99		
High Growth_Low Prices	2024-2025	Mar	\$ 1.54	\$ 2.16	\$ 1.54	\$ 1.54	\$ 1.54	\$ 1.52	\$ 1.52	\$ 2.16	\$ 1.73	\$ 1.67		
High Growth_Low Prices	2024-2025	Apr	\$ 1.12	\$ 2.12	\$ 1.12	\$ 1.12	\$ 1.12	\$ 1.10	\$ 1.10	\$ 2.12	\$ 1.44	\$ 1.32		
High Growth_Low Prices	2024-2025	May	\$ 1.48	\$ 2.12	\$ 1.48	\$ 1.48	\$ 1.48	\$ 1.45	\$ 1.45	\$ 2.12	\$ 1.68	\$ 1.61		
High Growth_Low Prices	2024-2025	Jun	\$ 1.53	\$ 2.12	\$ 1.53	\$ 1.53	\$ 1.53	\$ 1.50	\$ 1.50	\$ 2.12	\$ 1.71	\$ 1.65		
High Growth_Low Prices	2024-2025	Jul	\$ 2.08	\$ 2.12	\$ 2.08	\$ 2.08	\$ 2.08	\$ 2.05	\$ 2.05	\$ 2.12	\$ 2.07	\$ 2.09		
High Growth_Low Prices	2024-2025	Aug	\$ 1.90	\$ 2.12	\$ 1.90	\$ 1.90	\$ 1.90	\$ 1.87	\$ 1.87	\$ 2.12	\$ 1.96	\$ 1.95		
High Growth_Low Prices	2024-2025	Sep	\$ 1.66	\$ 2.12	\$ 1.66	\$ 1.66	\$ 1.66	\$ 1.63	\$ 1.63	\$ 2.12	\$ 1.80	\$ 1.75		
High Growth_Low Prices	2024-2025	Oct	\$ 1.59	\$ 2.14	\$ 1.59	\$ 1.59	\$ 1.59	\$ 1.56	\$ 1.56	\$ 2.14	\$ 1.76	\$ 1.70		
High Growth_Low Prices	2025-2026	Nov	\$ 1.56	\$ 1.83	\$ 1.56	\$ 1.56	\$ 1.56	\$ 1.66	\$ 1.53	\$ 1.83	\$ 1.67	\$ 1.61		
High Growth_Low Prices	2025-2026	Dec	\$ 1.55	\$ 1.79	\$ 1.57	\$ 1.57	\$ 1.57	\$ 1.61	\$ 1.04	\$ 1.63	\$ 1.43	\$ 1.61		
High Growth_Low Prices	2025-2026	Jan	\$ 2.00	\$ 2.40	\$ 2.00	\$ 2.00	\$ 2.00	\$ 2.11	\$ 1.63	\$ 2.13	\$ 1.95	\$ 2.08		
High Growth_Low Prices	2025-2026	Feb	\$ 1.85	\$ 2.28	\$ 1.85	\$ 1.85	\$ 1.85	\$ 2.18	\$ 1.78	\$ 2.18	\$ 2.05	\$ 1.93		
High Growth_Low Prices	2025-2026	Mar	\$ 1.41	\$ 2.13	\$ 1.41	\$ 1.41	\$ 1.41	\$ 1.40	\$ 1.38	\$ 2.13	\$ 1.64	\$ 1.55		
High Growth_Low Prices	2025-2026	Apr	\$ 1.13	\$ 2.08	\$ 1.13	\$ 1.13	\$ 1.13	\$ 1.11	\$ 1.11	\$ 2.08	\$ 1.44	\$ 1.32		
High Growth_Low Prices	2025-2026	May	\$ 1.48	\$ 2.08	\$ 1.48	\$ 1.48	\$ 1.48	\$ 1.45	\$ 1.45	\$ 2.08	\$ 1.66	\$ 1.60		
High Growth_Low Prices	2025-2026	Jun	\$ 1.52	\$ 2.08	\$ 1.52	\$ 1.52	\$ 1.52	\$ 1.49	\$ 1.49	\$ 2.08	\$ 1.69	\$ 1.63		
High Growth_Low Prices	2025-2026	Jul	\$ 2.09	\$ 2.08	\$ 2.09	\$ 2.09	\$ 2.09	\$ 2.05	\$ 2.05	\$ 2.09	\$ 2.06	\$ 2.09		
High Growth_Low Prices	2025-2026	Aug	\$ 1.93	\$ 2.09	\$ 1.93	\$ 1.93	\$ 1.93	\$ 1.90	\$ 1.90	\$ 2.09	\$ 1.96	\$ 1.96		
High Growth_Low Prices	2025-2026	Sep	\$ 1.55	\$ 2.09	\$ 1.55	\$ 1.55	\$ 1.55	\$ 1.52	\$ 1.52	\$ 2.09	\$ 1.71	\$ 1.65		
High Growth_Low Prices	2025-2026	Oct	\$ 1.58	\$ 2.09	\$ 1.58	\$ 1.58	\$ 1.58	\$ 1.56	\$ 1.56	\$ 2.09	\$ 1.73	\$ 1.69		
High Growth_Low Prices	2026-2027	Nov	\$ 1.60	\$ 1.81	\$ 1.60	\$ 1.60	\$ 1.60	\$ 1.68	\$ 1.57	\$ 1.81	\$ 1.69	\$ 1.64		
High Growth_Low Prices	2026-2027	Dec	\$ 1.66	\$ 1.86	\$ 1.67	\$ 1.67	\$ 1.67	\$ 1.53	\$ 0.94	\$ 1.71	\$ 1.39	\$ 1.71		
High Growth_Low Prices	2026-2027	Jan	\$ 2.04	\$ 2.56	\$ 2.04	\$ 2.04	\$ 2.04	\$ 2.00	\$ 1.52	\$ 2.09	\$ 1.87	\$ 2.14		
High Growth_Low Prices	2026-2027	Feb	\$ 1.77	\$ 2.27	\$ 1.77	\$ 1.77	\$ 1.77	\$ 2.14	\$ 1.68	\$ 2.14	\$ 1.98	\$ 1.87		
High Growth_Low Prices	2026-2027	Mar	\$ 1.38	\$ 2.09	\$ 1.38	\$ 1.38	\$ 1.38	\$ 1.37	\$ 1.36	\$ 2.09	\$ 1.61	\$ 1.53		
High Growth_Low Prices	2026-2027	Apr	\$ 1.14	\$ 2.09	\$ 1.14	\$ 1.14	\$ 1.14	\$ 1.12	\$ 1.12	\$ 2.09	\$ 1.44	\$ 1.33		
High Growth_Low Prices	2026-2027	May	\$ 1.45	\$ 2.09	\$ 1.45	\$ 1.45	\$ 1.45	\$ 1.42	\$ 1.42	\$ 2.09	\$ 1.65	\$ 1.58		
High Growth_Low Prices	2026-2027	Jun	\$ 1.54	\$ 2.09	\$ 1.54	\$ 1.54	\$ 1.54	\$ 1.51	\$ 1.51	\$ 2.09	\$ 1.71	\$ 1.65		
High Growth_Low Prices	2026-2027	Jul	\$ 2.11	\$ 2.09	\$ 2.09	\$ 2.09	\$ 2.09	\$ 2.08	\$ 2.08	\$ 2.09	\$ 2.08	\$ 2.10		
High Growth_Low Prices	2026-2027	Aug	\$ 1.95	\$ 2.09	\$ 1.95	\$ 1.95	\$ 1.95	\$ 1.92	\$ 1.92	\$ 2.09	\$ 1.97	\$ 1.98		
High Growth_Low Prices	2026-2027	Sep	\$ 1.66	\$ 2.09	\$ 1.66	\$ 1.66	\$ 1.66	\$ 1.63	\$ 1.63	\$ 2.09	\$ 1.79	\$ 1.75		
High Growth_Low Prices	2026-2027	Oct	\$ 1.75	\$ 2.20	\$ 1.75	\$ 1.75	\$ 1.75	\$ 1.72	\$ 1.72	\$ 2.20	\$ 1.88	\$ 1.84		
High Growth_Low Prices	2027-2028	Nov	\$ 1.71	\$ 1.91	\$ 1.71	\$ 1.71	\$ 1.71	\$ 1.78	\$ 1.67	\$ 1.91	\$ 1.79	\$ 1.75		
High Growth_Low Prices	2027-2028	Dec	\$ 1.79	\$ 1.81	\$ 66.26	\$ 66.26	\$ 66.26	\$ 1.67	\$ 1.12	\$ 1.81	\$ 1.53	\$ 40.48		
High Growth_Low Prices	2027-2028	Jan	\$ 2.03	\$ 2.36	\$ 2.03	\$ 2.03	\$ 2.03	\$ 2.16	\$ 1.76	\$ 2.16	\$ 2.02	\$ 2.10		
High Growth_Low Prices	2027-2028	Feb	\$ 1.96	\$ 2.23	\$ 1.96	\$ 1.96	\$ 1.96	\$ 2.18	\$ 1.90	\$ 2.18	\$ 2.09	\$ 2.01		
High Growth_Low Prices	2027-2028	Mar	\$ 1.55	\$ 2.10	\$ 1.55	\$ 1.55	\$ 1.55	\$ 1.53	\$ 1.52	\$ 2.10	\$ 1.72	\$ 1.66		
High Growth_Low Prices	2027-2028	Apr	\$ 1.31	\$ 2.10	\$ 1.31	\$ 1.31	\$ 1.31	\$ 1.29	\$ 1.29	\$ 2.10	\$ 1.56	\$ 1.47		
High Growth_Low Prices	2027-2028	May	\$ 1.60	\$ 2.10	\$ 1.60	\$ 1.60	\$ 1.60	\$ 1.58	\$ 1.58	\$ 2.10	\$ 1.75	\$ 1.70		
High Growth_Low Prices	2027-2028	Jun	\$ 1.68	\$ 2.10	\$ 1.68	\$ 1.68	\$ 1.68	\$ 1.65	\$ 1.65	\$ 2.10	\$ 1.80	\$ 1.76		
High Growth_Low Prices	2027-2028	Jul	\$ 2.24	\$ 2.22	\$ 2.22	\$ 2.22	\$ 2.22	\$ 2.21	\$ 2.21	\$ 2.22	\$ 2.21	\$ 2.22		
High Growth_Low Prices	2027-2028	Aug	\$ 2.05	\$ 2.10	\$ 2.05	\$ 2.05	\$ 2.05	\$ 2.02	\$ 2.02	\$ 2.10	\$ 2.05	\$ 2.06		
High Growth_Low Prices	2027-2028	Sep	\$ 1.55	\$ 1.92	\$ 1.55	\$ 1.55	\$ 1.55	\$ 1.52	\$ 1.52	\$ 2.10	\$ 1.72	\$ 1.62		
High Growth_Low Prices	2027-2028	Oct	\$ 1.79	\$ 2.14	\$ 1.79	\$ 1.79	\$ 1.79	\$ 1.76	\$ 1.76	\$ 2.14	\$ 1.89	\$ 1.86		
High Growth_Low Prices	2028-2029	Nov	\$ 1.80	\$ 2.04	\$ 1.80	\$ 1.80	\$ 1.80	\$ 1.86	\$ 1.74	\$ 2.04	\$ 1.88	\$ 1.84		
High Growth_Low Prices	2028-2029	Dec	\$ 1.74	\$ 1.79	\$ 66.24	\$ 66.24	\$ 66.24	\$ 1.75	\$ 1.20	\$ 1.79	\$ 1.58	\$ 40.45		
High Growth_Low Prices	2028-2029	Jan	\$ 2.07	\$ 2.37	\$ 2.07	\$ 2.07	\$ 2.07	\$ 2.16	\$ 1.82	\$ 2.16	\$ 2.05	\$ 2.13		
High Growth_Low Prices	2028-2029	Feb	\$ 2.03	\$ 2.26	\$ 2.03	\$ 2.03	\$ 2.03	\$ 2.20	\$ 1.98	\$ 2.20	\$ 2.12	\$ 2.08		
High Growth_Low Prices	2028-2029	Mar	\$ 1.62	\$ 2.11	\$ 1.62	\$ 1.62	\$ 1.62	\$ 1.64	\$ 1.59	\$ 2.11	\$ 1.78	\$ 1.72		
High Growth_Low Prices	2028-2029	Apr	\$ 1.33	\$ 2.11	\$ 1.33	\$ 1.33	\$ 1.33	\$ 1.31	\$ 1.31	\$ 2.11	\$ 1.57	\$ 1.49		
High Growth_Low Prices	2028-2029	May	\$ 1.75	\$ 2.11	\$ 1.75	\$ 1.75	\$ 1.75	\$ 1.72	\$ 1.72	\$ 2.11	\$ 1.85	\$ 1.82		
High Growth_Low Prices	2028-2029	Jun	\$ 1.73	\$ 2.11	\$ 1.73	\$ 1.73	\$ 1.73	\$ 1.70	\$ 1.70	\$ 2.11	\$ 1.84	\$ 1.80		
High Growth_Low Prices	2028-2029	Jul	\$ 2.25	\$ 2.23	\$ 2.23	\$ 2.23	\$ 2.23	\$ 2.22	\$ 2.22	\$ 2.23	\$ 2.22	\$ 2.23		
High Growth_Low Prices	2028-2029	Aug	\$ 2.08	\$ 2.11	\$ 2.08	\$ 2.08	\$ 2.08	\$ 2.05	\$ 2.05	\$ 2.11	\$ 2.07	\$ 2.09		
High Growth_Low Prices	2028-2029	Sep	\$ 1.72	\$ 2.07	\$ 1.72	\$ 1.72	\$ 1.72	\$ 1.69	\$ 1.69	\$ 2.11	\$ 1.83	\$ 1.79		
High Growth_Low Prices	2028-2029	Oct	\$ 1.81	\$ 2.15	\$ 1.81	\$ 1.81	\$ 1.81	\$ 1.78	\$ 1.78	\$ 2.15	\$ 1.90	\$ 1.88		

1/ Avoided costs are before Environmental Externalities adder.

## APPENDIX 5.4: HIGH GROWTH – LOW PRICE MONTHLY DETAIL

Monthly Avoided Costs 1/ 2014\$														
Scenario	Gas Year	Month	Klam Falls	La Grande	Medford GTN	Medford NWP	Roseburg	Wa/ld Both	Wa/ld GTN	Wa/ld NWP	WA/ID Annual	OR Annual		
High Growth_Low Prices	2029-2030	Nov	\$ 1.78	\$ 2.08	\$ 1.78	\$ 1.78	\$ 1.78	\$ 1.85	\$ 1.68	\$ 2.08	\$ 1.87	\$ 1.84		
High Growth_Low Prices	2029-2030	Dec	\$ 2.03	\$ 2.05	\$ 66.49	\$ 66.49	\$ 66.49	\$ 1.94	\$ 1.41	\$ 2.05	\$ 1.80	\$ 40.71		
High Growth_Low Prices	2029-2030	Jan	\$ 2.06	\$ 2.39	\$ 2.06	\$ 2.06	\$ 2.06	\$ 2.22	\$ 1.83	\$ 2.22	\$ 2.09	\$ 2.13		
High Growth_Low Prices	2029-2030	Feb	\$ 2.07	\$ 2.29	\$ 2.07	\$ 2.07	\$ 2.07	\$ 2.24	\$ 2.03	\$ 2.24	\$ 2.17	\$ 2.11		
High Growth_Low Prices	2029-2030	Mar	\$ 1.64	\$ 2.16	\$ 1.64	\$ 1.64	\$ 1.64	\$ 1.66	\$ 1.61	\$ 2.16	\$ 1.81	\$ 1.75		
High Growth_Low Prices	2029-2030	Apr	\$ 1.37	\$ 2.16	\$ 1.37	\$ 1.37	\$ 1.37	\$ 1.34	\$ 1.34	\$ 2.16	\$ 1.62	\$ 1.53		
High Growth_Low Prices	2029-2030	May	\$ 1.65	\$ 2.16	\$ 1.65	\$ 1.65	\$ 1.65	\$ 1.62	\$ 1.62	\$ 2.16	\$ 1.80	\$ 1.75		
High Growth_Low Prices	2029-2030	Jun	\$ 1.75	\$ 2.16	\$ 1.75	\$ 1.75	\$ 1.75	\$ 1.72	\$ 1.72	\$ 2.16	\$ 1.87	\$ 1.83		
High Growth_Low Prices	2029-2030	Jul	\$ 2.31	\$ 2.28	\$ 2.28	\$ 2.28	\$ 2.28	\$ 2.27	\$ 2.27	\$ 2.28	\$ 2.27	\$ 2.29		
High Growth_Low Prices	2029-2030	Aug	\$ 2.12	\$ 2.17	\$ 2.12	\$ 2.12	\$ 2.12	\$ 2.09	\$ 2.09	\$ 2.17	\$ 2.11	\$ 2.13		
High Growth_Low Prices	2029-2030	Sep	\$ 1.86	\$ 2.17	\$ 1.86	\$ 1.86	\$ 1.86	\$ 1.83	\$ 1.83	\$ 2.17	\$ 1.94	\$ 1.92		
High Growth_Low Prices	2029-2030	Oct	\$ 1.84	\$ 2.26	\$ 1.84	\$ 1.84	\$ 1.84	\$ 1.81	\$ 1.81	\$ 2.26	\$ 1.96	\$ 1.92		
High Growth_Low Prices	2030-2031	Nov	\$ 1.84	\$ 2.13	\$ 1.84	\$ 1.84	\$ 1.84	\$ 1.87	\$ 1.69	\$ 2.13	\$ 1.90	\$ 1.90		
High Growth_Low Prices	2030-2031	Dec	\$ 1.95	\$ 1.98	\$ 130.87	\$ 130.87	\$ 130.87	\$ 1.97	\$ 1.45	\$ 1.98	\$ 1.80	\$ 79.31		
High Growth_Low Prices	2030-2031	Jan	\$ 2.17	\$ 2.35	\$ 2.17	\$ 2.17	\$ 2.17	\$ 2.23	\$ 1.90	\$ 2.23	\$ 2.12	\$ 2.21		
High Growth_Low Prices	2030-2031	Feb	\$ 2.13	\$ 73.63	\$ 2.13	\$ 2.13	\$ 2.13	\$ 2.26	\$ 2.09	\$ 2.26	\$ 2.20	\$ 16.43		
High Growth_Low Prices	2030-2031	Mar	\$ 1.67	\$ 2.17	\$ 1.67	\$ 1.67	\$ 1.67	\$ 1.68	\$ 1.64	\$ 2.17	\$ 1.83	\$ 1.77		
High Growth_Low Prices	2030-2031	Apr	\$ 1.46	\$ 2.11	\$ 1.46	\$ 1.46	\$ 1.46	\$ 1.43	\$ 1.43	\$ 2.17	\$ 1.68	\$ 1.59		
High Growth_Low Prices	2030-2031	May	\$ 1.74	\$ 2.17	\$ 1.74	\$ 1.74	\$ 1.74	\$ 1.71	\$ 1.71	\$ 2.17	\$ 1.87	\$ 1.83		
High Growth_Low Prices	2030-2031	Jun	\$ 1.81	\$ 2.17	\$ 1.81	\$ 1.81	\$ 1.81	\$ 1.78	\$ 1.78	\$ 2.17	\$ 1.91	\$ 1.88		
High Growth_Low Prices	2030-2031	Jul	\$ 2.32	\$ 2.30	\$ 2.30	\$ 2.30	\$ 2.30	\$ 2.29	\$ 2.29	\$ 2.30	\$ 2.29	\$ 2.30		
High Growth_Low Prices	2030-2031	Aug	\$ 2.14	\$ 2.17	\$ 2.14	\$ 2.14	\$ 2.14	\$ 2.11	\$ 2.11	\$ 2.17	\$ 2.13	\$ 2.15		
High Growth_Low Prices	2030-2031	Sep	\$ 1.85	\$ 2.15	\$ 1.85	\$ 1.85	\$ 1.85	\$ 1.82	\$ 1.82	\$ 2.17	\$ 1.94	\$ 1.91		
High Growth_Low Prices	2030-2031	Oct	\$ 1.89	\$ 2.24	\$ 1.89	\$ 1.89	\$ 1.89	\$ 1.86	\$ 1.86	\$ 2.24	\$ 1.99	\$ 1.96		
High Growth_Low Prices	2031-2032	Nov	\$ 1.95	\$ 2.19	\$ 1.95	\$ 1.95	\$ 1.95	\$ 2.05	\$ 1.83	\$ 2.19	\$ 2.03	\$ 2.00		
High Growth_Low Prices	2031-2032	Dec	\$ 1.75	\$ 1.81	\$ 130.70	\$ 130.70	\$ 130.70	\$ 1.81	\$ 1.30	\$ 1.81	\$ 1.64	\$ 79.13		
High Growth_Low Prices	2031-2032	Jan	\$ 2.18	\$ 2.36	\$ 2.18	\$ 2.18	\$ 2.18	\$ 2.24	\$ 1.91	\$ 2.24	\$ 2.13	\$ 2.21		
High Growth_Low Prices	2031-2032	Feb	\$ 2.12	\$ 71.20	\$ 2.12	\$ 2.12	\$ 2.12	\$ 71.14	\$ 2.08	\$ 71.14	\$ 48.12	\$ 15.94		
High Growth_Low Prices	2031-2032	Mar	\$ 1.77	\$ 2.18	\$ 1.77	\$ 1.77	\$ 1.77	\$ 1.80	\$ 1.74	\$ 2.18	\$ 1.91	\$ 1.85		
High Growth_Low Prices	2031-2032	Apr	\$ 1.50	\$ 2.14	\$ 1.50	\$ 1.50	\$ 1.50	\$ 1.48	\$ 1.48	\$ 2.16	\$ 1.71	\$ 1.63		
High Growth_Low Prices	2031-2032	May	\$ 1.87	\$ 2.16	\$ 1.87	\$ 1.87	\$ 1.87	\$ 1.84	\$ 1.84	\$ 2.16	\$ 1.95	\$ 1.93		
High Growth_Low Prices	2031-2032	Jun	\$ 1.85	\$ 2.17	\$ 1.85	\$ 1.85	\$ 1.85	\$ 1.82	\$ 1.82	\$ 2.17	\$ 1.94	\$ 1.92		
High Growth_Low Prices	2031-2032	Jul	\$ 2.33	\$ 2.31	\$ 2.31	\$ 2.31	\$ 2.31	\$ 2.30	\$ 2.30	\$ 2.31	\$ 2.30	\$ 2.31		
High Growth_Low Prices	2031-2032	Aug	\$ 2.21	\$ 2.19	\$ 2.19	\$ 2.19	\$ 2.19	\$ 2.18	\$ 2.18	\$ 2.19	\$ 2.18	\$ 2.19		
High Growth_Low Prices	2031-2032	Sep	\$ 1.82	\$ 2.14	\$ 1.82	\$ 1.82	\$ 1.82	\$ 1.79	\$ 1.79	\$ 2.17	\$ 1.91	\$ 1.88		
High Growth_Low Prices	2031-2032	Oct	\$ 1.89	\$ 2.27	\$ 1.89	\$ 1.89	\$ 1.89	\$ 1.86	\$ 1.86	\$ 2.27	\$ 2.00	\$ 1.97		
High Growth_Low Prices	2032-2033	Nov	\$ 1.86	\$ 2.17	\$ 1.86	\$ 1.86	\$ 1.86	\$ 1.98	\$ 1.69	\$ 2.17	\$ 1.95	\$ 1.92		
High Growth_Low Prices	2032-2033	Dec	\$ 1.87	\$ 1.91	\$ 130.80	\$ 130.80	\$ 130.80	\$ 1.91	\$ 1.45	\$ 1.91	\$ 1.76	\$ 79.24		
High Growth_Low Prices	2032-2033	Jan	\$ 2.17	\$ 2.38	\$ 2.17	\$ 2.17	\$ 2.17	\$ 2.23	\$ 1.95	\$ 2.23	\$ 2.13	\$ 2.21		
High Growth_Low Prices	2032-2033	Feb	\$ 2.17	\$ 73.66	\$ 2.17	\$ 2.17	\$ 2.17	\$ 73.61	\$ 2.13	\$ 73.61	\$ 49.78	\$ 16.47		
High Growth_Low Prices	2032-2033	Mar	\$ 1.74	\$ 2.17	\$ 1.74	\$ 1.74	\$ 1.74	\$ 1.77	\$ 1.71	\$ 2.17	\$ 1.88	\$ 1.83		
High Growth_Low Prices	2032-2033	Apr	\$ 1.52	\$ 2.15	\$ 1.52	\$ 1.52	\$ 1.52	\$ 1.50	\$ 1.50	\$ 2.17	\$ 1.72	\$ 1.65		
High Growth_Low Prices	2032-2033	May	\$ 1.91	\$ 2.17	\$ 1.91	\$ 1.91	\$ 1.91	\$ 1.88	\$ 1.88	\$ 2.17	\$ 1.98	\$ 1.96		
High Growth_Low Prices	2032-2033	Jun	\$ 1.86	\$ 2.17	\$ 1.86	\$ 1.86	\$ 1.86	\$ 1.83	\$ 1.83	\$ 2.17	\$ 1.95	\$ 1.92		
High Growth_Low Prices	2032-2033	Jul	\$ 2.41	\$ 2.38	\$ 2.38	\$ 2.38	\$ 2.38	\$ 2.37	\$ 2.37	\$ 2.38	\$ 2.37	\$ 2.39		
High Growth_Low Prices	2032-2033	Aug	\$ 2.26	\$ 2.24	\$ 2.24	\$ 2.24	\$ 2.24	\$ 2.23	\$ 2.23	\$ 2.24	\$ 2.23	\$ 2.24		
High Growth_Low Prices	2032-2033	Sep	\$ 1.67	\$ 2.04	\$ 1.67	\$ 1.67	\$ 1.67	\$ 1.64	\$ 1.64	\$ 2.18	\$ 1.82	\$ 1.74		
High Growth_Low Prices	2032-2033	Oct	\$ 1.90	\$ 2.30	\$ 1.90	\$ 1.90	\$ 1.90	\$ 1.87	\$ 1.87	\$ 2.30	\$ 2.01	\$ 1.98		
High Growth_Low Prices	2033-2034	Nov	\$ 2.03	\$ 2.24	\$ 2.03	\$ 2.03	\$ 2.03	\$ 2.15	\$ 1.92	\$ 2.24	\$ 2.10	\$ 2.07		
High Growth_Low Prices	2033-2034	Dec	\$ 1.96	\$ 2.02	\$ 130.90	\$ 130.90	\$ 130.90	\$ 1.90	\$ 1.34	\$ 2.02	\$ 1.75	\$ 79.34		
High Growth_Low Prices	2033-2034	Jan	\$ 2.22	\$ 2.40	\$ 2.22	\$ 2.22	\$ 2.22	\$ 2.28	\$ 1.94	\$ 2.28	\$ 2.17	\$ 2.26		
High Growth_Low Prices	2033-2034	Feb	\$ 2.17	\$ 73.71	\$ 2.17	\$ 2.17	\$ 2.17	\$ 73.66	\$ 2.13	\$ 73.66	\$ 49.82	\$ 16.48		
High Growth_Low Prices	2033-2034	Mar	\$ 1.69	\$ 2.22	\$ 1.69	\$ 1.69	\$ 1.69	\$ 1.73	\$ 1.66	\$ 2.22	\$ 1.87	\$ 1.80		
High Growth_Low Prices	2033-2034	Apr	\$ 1.48	\$ 2.21	\$ 1.48	\$ 1.48	\$ 1.48	\$ 1.45	\$ 1.45	\$ 2.22	\$ 1.71	\$ 1.62		
High Growth_Low Prices	2033-2034	May	\$ 1.75	\$ 2.22	\$ 1.75	\$ 1.75	\$ 1.75	\$ 1.73	\$ 1.73	\$ 2.22	\$ 1.89	\$ 1.85		
High Growth_Low Prices	2033-2034	Jun	\$ 1.83	\$ 2.22	\$ 1.83	\$ 1.83	\$ 1.83	\$ 1.80	\$ 1.80	\$ 2.22	\$ 1.94	\$ 1.91		
High Growth_Low Prices	2033-2034	Jul	\$ 2.36	\$ 2.33	\$ 2.33	\$ 2.33	\$ 2.33	\$ 2.32	\$ 2.32	\$ 2.33	\$ 2.33	\$ 2.34		
High Growth_Low Prices	2033-2034	Aug	\$ 2.18	\$ 2.22	\$ 2.18	\$ 2.18	\$ 2.18	\$ 2.15	\$ 2.15	\$ 2.23	\$ 2.17	\$ 2.19		
High Growth_Low Prices	2033-2034	Sep	\$ 2.02	\$ 2.23	\$ 2.02	\$ 2.02	\$ 2.02	\$ 1.99	\$ 1.99	\$ 2.23	\$ 2.07	\$ 2.06		
High Growth_Low Prices	2033-2034	Oct	\$ 1.90	\$ 2.31	\$ 1.90	\$ 1.90	\$ 1.90	\$ 1.87	\$ 1.87	\$ 2.31	\$ 2.02	\$ 1.98		
High Growth_Low Prices	2034-2035	Nov	\$ 1.87	\$ 2.21	\$ 1.87	\$ 1.87	\$ 1.87	\$ 2.03	\$ 1.70	\$ 2.21	\$ 1.98	\$ 1.94		
High Growth_Low Prices	2034-2035	Dec	\$ 66.48	\$ 2.07	\$ 130.95	\$ 130.95	\$ 130.95	\$ 1.90	\$ 1.35	\$ 2.09	\$ 1.78	\$ 92.28		
High Growth_Low Prices	2034-2035	Jan	\$ 2.23	\$ 2.39	\$ 2.23	\$ 2.23	\$ 2.23	\$ 2.29	\$ 1.98	\$ 2.29	\$ 2.18	\$ 2.26		
High Growth_Low Prices	2034-2035	Feb	\$ 2.19	\$ 73.70	\$ 2.19	\$ 2.19	\$ 2.19	\$ 73.64	\$ 2.14	\$ 73.64	\$ 49.81	\$ 16.49		
High Growth_Low Prices	2034-2035	Mar	\$ 1.88	\$ 2.21	\$ 1.88	\$ 1.88	\$ 1.88	\$ 1.90	\$ 1.85	\$ 2.21	\$ 1.99	\$ 1.95		
High Growth_Low Prices	2034-2035	Apr	\$ 1.61	\$ 2.08	\$ 1.61	\$ 1.61	\$ 1.61	\$ 1.59	\$ 1.59	\$ 2.08	\$ 1.75	\$ 1.71		
High Growth_Low Prices	2034-2035	May	\$ 1.85	\$ 2.08	\$ 1.85	\$ 1.85	\$ 1.85	\$ 1.82	\$ 1.82	\$ 2.08	\$ 1.91	\$ 1.90		
High Growth_Low Prices	2034-2035	Jun	\$ 1.79	\$ 2.08	\$ 1.79	\$ 1.79	\$ 1.79	\$ 1.76	\$ 1.76	\$ 2.08	\$ 1.87	\$ 1.85		
High Growth_Low Prices	2034-2035	Jul	\$ 2.30	\$ 2.28	\$ 2.28	\$ 2.28	\$ 2.28	\$ 2.27	\$ 2.27	\$ 2.28	\$ 2.27	\$ 2.28		
High Growth_Low Prices	2034-2035	Aug	\$ 2.20	\$ 2.18	\$ 2.18	\$ 2.18	\$ 2.18	\$ 2.17	\$ 2.17	\$ 2.18	\$ 2.17	\$ 2.18		
High Growth_Low Prices	2034-2035	Sep	\$ 1.83	\$ 2.08	\$ 1.83	\$ 1.83	\$ 1.83	\$ 1.80	\$ 1.80	\$ 2.08	\$ 1.90	\$ 1.88		
High Growth_Low Prices	2034-2035	Oct	\$ 1.88	\$ 2.32	\$ 1.88	\$ 1.88	\$ 1.88	\$ 1.85	\$ 1.85	\$ 2.32	\$ 2.00	\$ 1.96		

1/ Avoided costs are before Environmental Externalities added.

## APPENDIX 6.1: HIGH GROWTH CASES SELECTED RESOURCES VS. PEAK DAY DEMAND EXISTING PLUS EXPECTED AVAILABLE

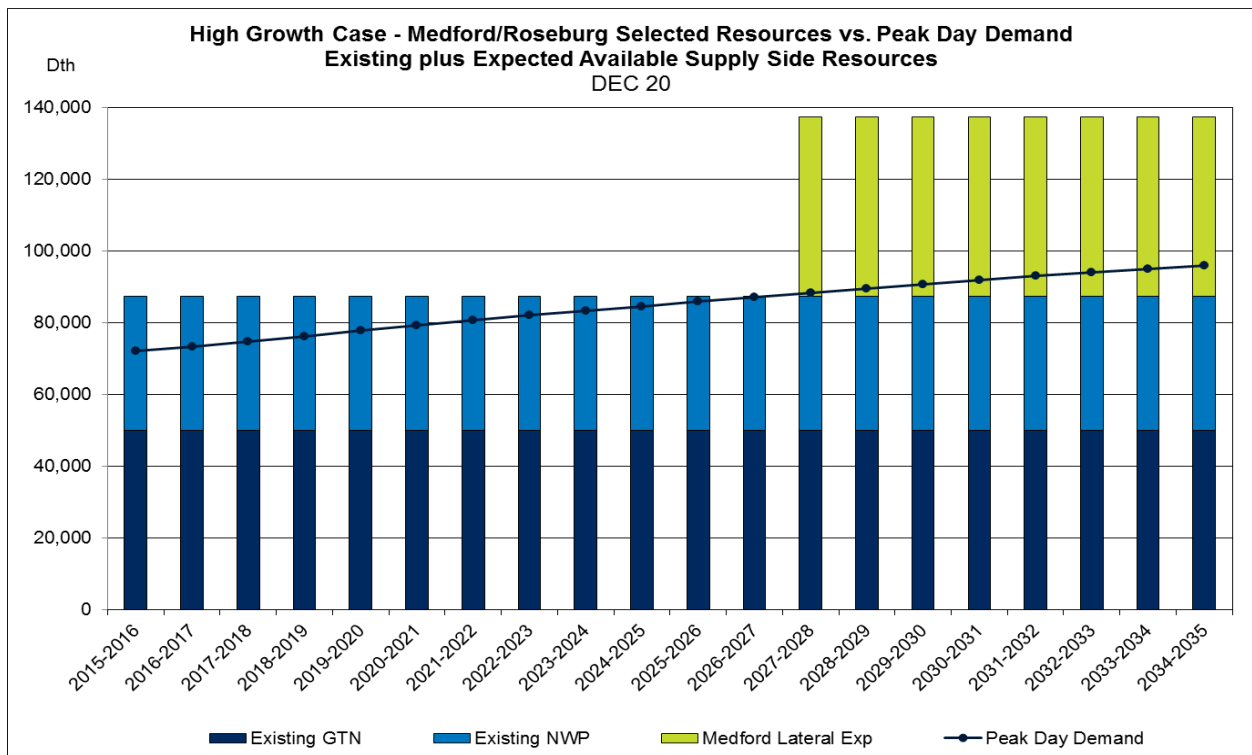
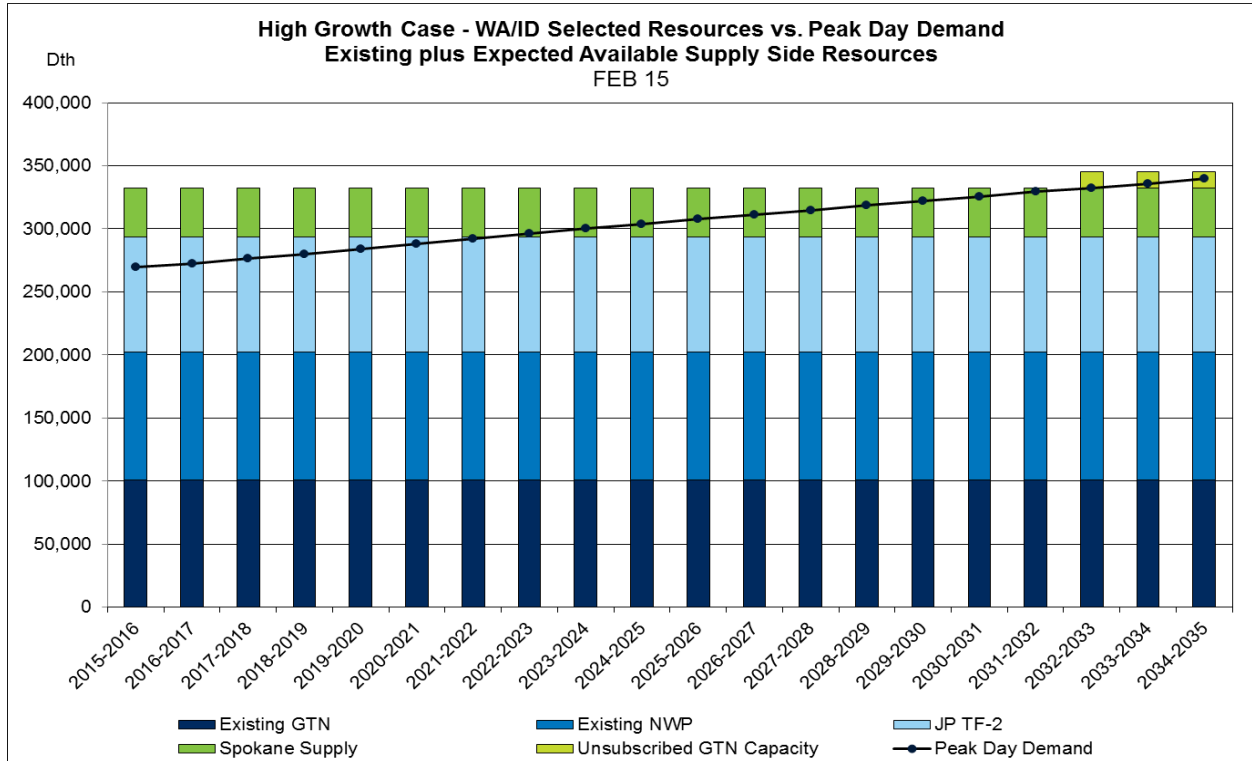

## APPENDIX 6.1: HIGH GROWTH CASES SELECTED RESOURCES VS. PEAK DAY DEMAND EXISTING PLUS EXPECTED AVAILABLE

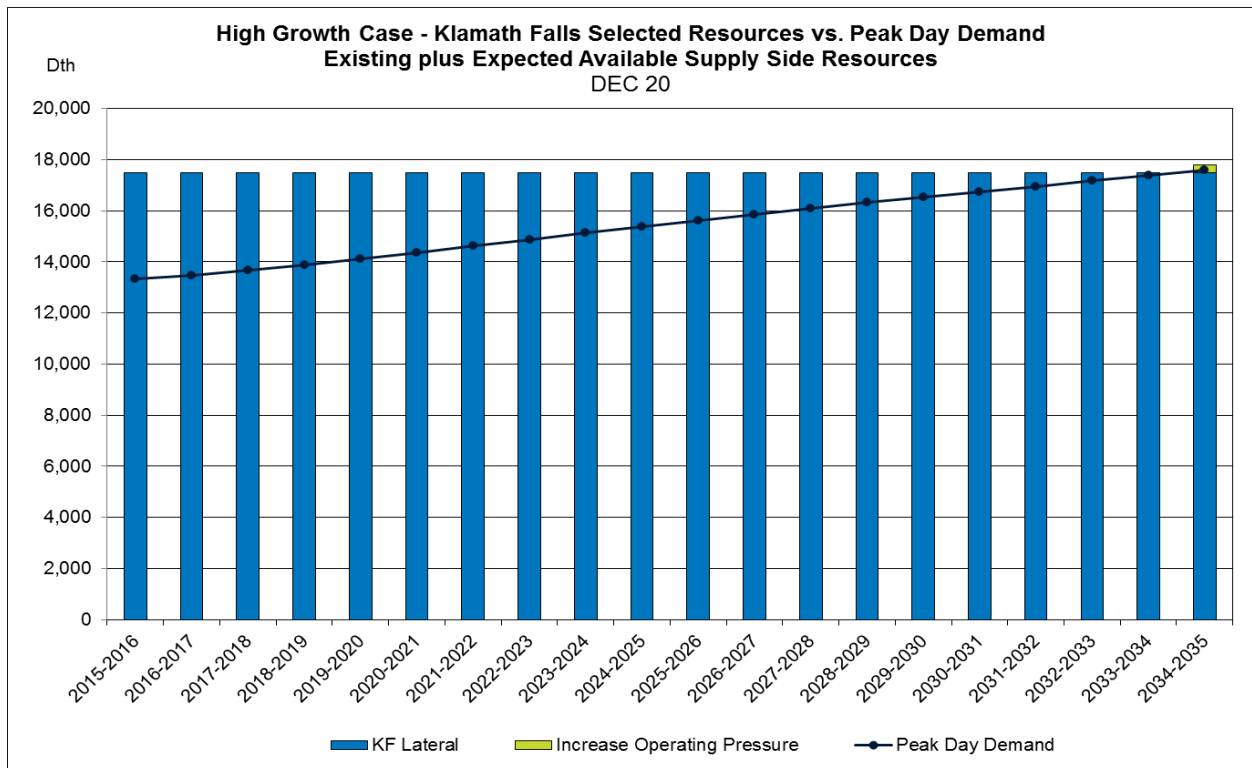
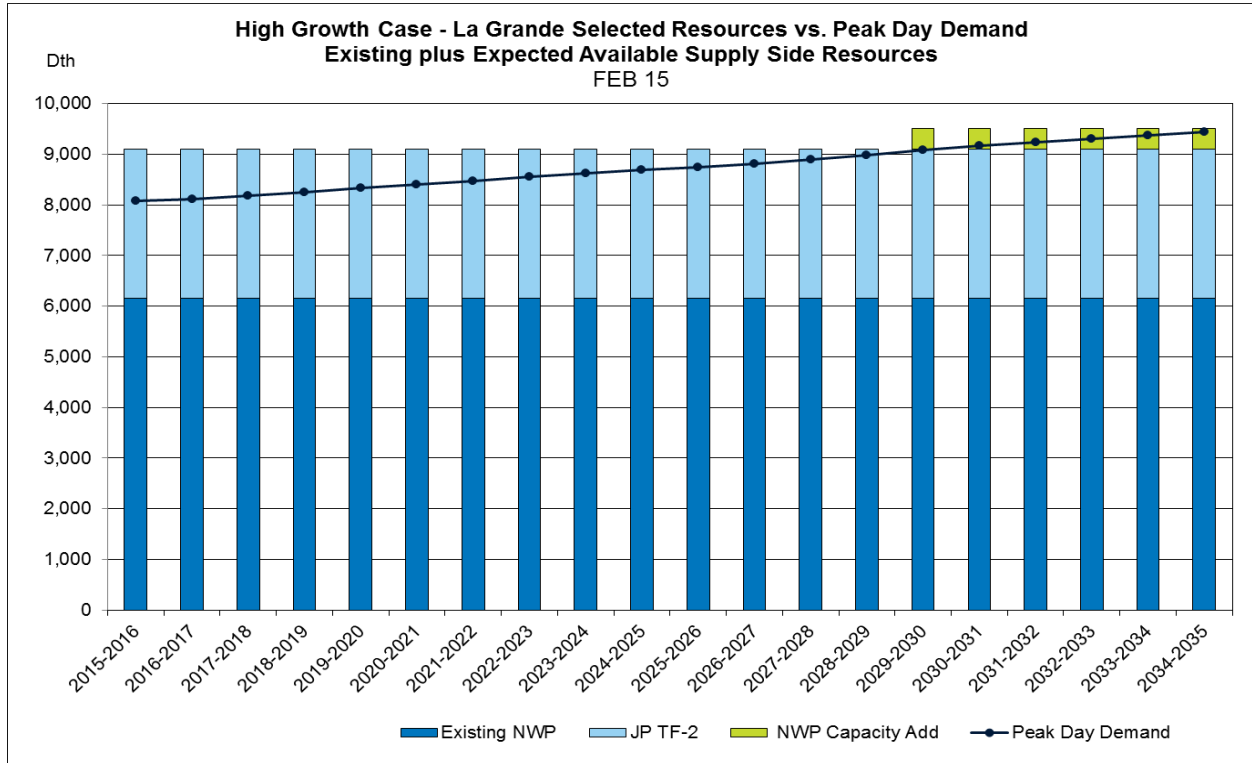

## APPENDIX 6.2: PEAK DAY DEMAND TABLE

### HIGH GROWTH

Peak Day Demand - Served and Unserved (MDth/d)										
Before Resource Additions & Net of DSM Savings										
Scenario	Gas Year	LaGrande			LaGrande %	WAID Served	WAID Unserved	WAID Total	WAID % of Peak	
		Served	Unserved	Total	of Peak Day				Day Served	Day Unserved
High Growth_Low Prices	2015-2016	8.07	-	8.07	100%	268.99	-	268.99	100%	100%
High Growth_Low Prices	2016-2017	8.10	-	8.10	100%	271.70	-	271.70	100%	100%
High Growth_Low Prices	2017-2018	8.16	-	8.16	100%	275.19	-	275.19	100%	100%
High Growth_Low Prices	2018-2019	8.23	-	8.23	100%	278.70	-	278.70	100%	100%
High Growth_Low Prices	2019-2020	8.30	-	8.30	100%	282.34	-	282.34	100%	100%
High Growth_Low Prices	2020-2021	8.37	-	8.37	100%	286.10	-	286.10	100%	100%
High Growth_Low Prices	2021-2022	8.44	-	8.44	100%	289.71	-	289.71	100%	100%
High Growth_Low Prices	2022-2023	8.50	-	8.50	100%	293.10	-	293.10	100%	100%
High Growth_Low Prices	2023-2024	8.57	-	8.57	100%	296.62	-	296.62	100%	100%
High Growth_Low Prices	2024-2025	8.62	-	8.62	100%	299.85	-	299.85	100%	100%
High Growth_Low Prices	2025-2026	8.68	-	8.68	100%	303.12	-	303.12	100%	100%
High Growth_Low Prices	2026-2027	8.73	-	8.73	100%	306.24	-	306.24	100%	100%
High Growth_Low Prices	2027-2028	8.81	-	8.81	100%	309.62	-	309.62	100%	100%
High Growth_Low Prices	2028-2029	8.89	-	8.89	100%	312.57	-	312.57	100%	100%
High Growth_Low Prices	2029-2030	8.97	-	8.97	100%	315.67	-	315.67	100%	100%
High Growth_Low Prices	2030-2031	8.98	0.06	9.04	99%	318.74	-	318.74	100%	100%
High Growth_Low Prices	2031-2032	6.73	2.38	9.11	74%	322.05	-	322.05	100%	100%
High Growth_Low Prices	2032-2033	6.51	2.66	9.17	71%	322.02	2.78	324.80	99%	99%
High Growth_Low Prices	2033-2034	6.50	2.72	9.23	70%	321.82	6.01	327.83	98%	98%
High Growth_Low Prices	2034-2035	8.95	0.35	9.30	96%	319.61	12.14	331.75	96%	96%

Scenario	Gas Year	Klamath Falls			Klamath	Medford/Roseburg Served	Medford/Roseburg Unserved	Medford/Roseburg Total	Medford/Roseburg	
		Served	Unserved	Falls Total	Falls % of Peak Day				% of Peak Day Served	% of Peak Day Unserved
High Growth_Low Prices	2015-2016	13.32	-	13.32	100%	71.97	-	71.97	100%	100%
High Growth_Low Prices	2016-2017	13.43	-	13.43	100%	73.29	-	73.29	100%	100%
High Growth_Low Prices	2017-2018	13.63	-	13.63	100%	74.61	-	74.61	100%	100%
High Growth_Low Prices	2018-2019	13.85	-	13.85	100%	76.04	-	76.04	100%	100%
High Growth_Low Prices	2019-2020	14.07	-	14.07	100%	77.51	-	77.51	100%	100%
High Growth_Low Prices	2020-2021	14.31	-	14.31	100%	79.02	-	79.02	100%	100%
High Growth_Low Prices	2021-2022	14.54	-	14.54	100%	80.43	-	80.43	100%	100%
High Growth_Low Prices	2022-2023	14.78	-	14.78	100%	81.66	-	81.66	100%	100%
High Growth_Low Prices	2023-2024	15.02	-	15.02	100%	82.86	-	82.86	100%	100%
High Growth_Low Prices	2024-2025	15.26	-	15.26	100%	84.05	-	84.05	100%	100%
High Growth_Low Prices	2025-2026	15.49	-	15.49	100%	85.23	-	85.23	100%	100%
High Growth_Low Prices	2026-2027	15.71	-	15.71	100%	86.38	-	86.38	100%	100%
High Growth_Low Prices	2027-2028	15.93	-	15.93	100%	87.18	0.37	87.55	100%	100%
High Growth_Low Prices	2028-2029	16.14	-	16.14	100%	87.10	1.59	88.69	98%	98%
High Growth_Low Prices	2029-2030	16.34	-	16.34	100%	87.02	2.77	89.79	97%	97%
High Growth_Low Prices	2030-2031	16.53	-	16.53	100%	86.93	3.92	90.85	96%	96%
High Growth_Low Prices	2031-2032	16.72	-	16.72	100%	86.85	5.01	91.85	95%	95%
High Growth_Low Prices	2032-2033	16.92	-	16.92	100%	86.76	6.05	92.81	93%	93%
High Growth_Low Prices	2033-2034	17.12	-	17.12	100%	86.68	7.06	93.74	92%	92%
High Growth_Low Prices	2034-2035	17.24	0.10	17.33	99%	86.66	8.03	94.70	92%	92%

## APPENDIX 6.2: PEAK DAY DEMAND TABLE

### LOW GROWTH

Peak Day Demand - Served and Unserved (MDth/d)									
Before Resource Additions & Net of DSM Savings									
Scenario	Gas Year	LaGrande			LaGrande			WAID Total	WAID % of Peak Day Served
		Served	Unserved	Total	Day Served	WAID Served	WAID Unserved		
Low Growth_High Prices	2015-2016	8.05	-	8.05	100%	267.17	-	267.17	100%
Low Growth_High Prices	2016-2017	7.05	-	7.05	100%	232.26	-	232.26	100%
Low Growth_High Prices	2017-2018	7.00	-	7.00	100%	230.85	-	230.85	100%
Low Growth_High Prices	2018-2019	6.92	-	6.92	100%	228.16	-	228.16	100%
Low Growth_High Prices	2019-2020	6.92	-	6.92	100%	228.60	-	228.60	100%
Low Growth_High Prices	2020-2021	6.92	-	6.92	100%	228.86	-	228.86	100%
Low Growth_High Prices	2021-2022	6.91	-	6.91	100%	229.25	-	229.25	100%
Low Growth_High Prices	2022-2023	6.90	-	6.90	100%	229.40	-	229.40	100%
Low Growth_High Prices	2023-2024	6.90	-	6.90	100%	229.85	-	229.85	100%
Low Growth_High Prices	2024-2025	6.86	-	6.86	100%	228.67	-	228.67	100%
Low Growth_High Prices	2025-2026	6.86	-	6.86	100%	228.78	-	228.78	100%
Low Growth_High Prices	2026-2027	6.85	-	6.85	100%	228.99	-	228.99	100%
Low Growth_High Prices	2027-2028	6.84	-	6.84	100%	229.38	-	229.38	100%
Low Growth_High Prices	2028-2029	6.80	-	6.80	100%	228.35	-	228.35	100%
Low Growth_High Prices	2029-2030	6.78	-	6.78	100%	228.16	-	228.16	100%
Low Growth_High Prices	2030-2031	6.75	-	6.75	100%	227.70	-	227.70	100%
Low Growth_High Prices	2031-2032	6.73	-	6.73	100%	227.64	-	227.64	100%
Low Growth_High Prices	2032-2033	6.72	-	6.72	100%	227.47	-	227.47	100%
Low Growth_High Prices	2033-2034	6.70	-	6.70	100%	227.07	-	227.07	100%
Low Growth_High Prices	2034-2035	6.71	-	6.71	100%	227.90	-	227.90	100%

Scenario	Gas Year	Klamath Falls			Klamath Falls			Medford/Roseburg Total	Medford/Roseburg % of Peak Day Served
		Served	Unserved	Total	Peak Day Served	Medford/Roseburg Served	Medford/Roseburg Unserved		
Low Growth_High Prices	2015-2016	13.32	-	13.32	100%	71.95	-	71.95	100%
Low Growth_High Prices	2016-2017	11.64	-	11.64	100%	62.78	-	62.78	100%
Low Growth_High Prices	2017-2018	11.63	-	11.63	100%	62.67	-	62.67	100%
Low Growth_High Prices	2018-2019	11.55	-	11.55	100%	62.32	-	62.32	100%
Low Growth_High Prices	2019-2020	11.63	-	11.63	100%	62.78	-	62.78	100%
Low Growth_High Prices	2020-2021	11.70	-	11.70	100%	63.23	-	63.23	100%
Low Growth_High Prices	2021-2022	11.77	-	11.77	100%	63.63	-	63.63	100%
Low Growth_High Prices	2022-2023	11.83	-	11.83	100%	63.90	-	63.90	100%
Low Growth_High Prices	2023-2024	11.90	-	11.90	100%	64.18	-	64.18	100%
Low Growth_High Prices	2024-2025	11.90	-	11.90	100%	64.09	-	64.09	100%
Low Growth_High Prices	2025-2026	11.96	-	11.96	100%	64.31	-	64.31	100%
Low Growth_High Prices	2026-2027	12.02	-	12.02	100%	64.55	-	64.55	100%
Low Growth_High Prices	2027-2028	12.07	-	12.07	100%	64.78	-	64.78	100%
Low Growth_High Prices	2028-2029	12.08	-	12.08	100%	64.73	-	64.73	100%
Low Growth_High Prices	2029-2030	12.11	-	12.11	100%	64.83	-	64.83	100%
Low Growth_High Prices	2030-2031	12.13	-	12.13	100%	64.85	-	64.85	100%
Low Growth_High Prices	2031-2032	12.16	-	12.16	100%	64.88	-	64.88	100%
Low Growth_High Prices	2032-2033	12.20	-	12.20	100%	65.00	-	65.00	100%
Low Growth_High Prices	2033-2034	12.22	-	12.22	100%	64.98	-	64.98	100%
Low Growth_High Prices	2034-2035	12.27	-	12.27	100%	65.09	-	65.09	100%

## APPENDIX 6.2: PEAK DAY DEMAND TABLE COLDEST IN 20 YEARS

Peak Day Demand - Served and Unserved (MDth/d) Before Resource Additions & Net of DSM Savings											
Scenario	Gas Year	LaGrande			LaGrande % of Peak Day			WAI/D			WAI/D % of Peak Day Served
		Served	Unserved	Total	Served	WAI/D Served	WAI/D Unserved	WAI/D Total			
Cold Day 20yr Weather Std	2015-2016	8.05	-	8.05	100%	249.82	-	249.82	100%		
Cold Day 20yr Weather Std	2016-2017	8.07	-	8.07	100%	251.31	-	251.31	100%		
Cold Day 20yr Weather Std	2017-2018	8.10	-	8.10	100%	253.32	-	253.32	100%		
Cold Day 20yr Weather Std	2018-2019	8.14	-	8.14	100%	255.25	-	255.25	100%		
Cold Day 20yr Weather Std	2019-2020	8.17	-	8.17	100%	257.27	-	257.27	100%		
Cold Day 20yr Weather Std	2020-2021	8.20	-	8.20	100%	259.27	-	259.27	100%		
Cold Day 20yr Weather Std	2021-2022	8.23	-	8.23	100%	261.18	-	261.18	100%		
Cold Day 20yr Weather Std	2022-2023	8.25	-	8.25	100%	262.96	-	262.96	100%		
Cold Day 20yr Weather Std	2023-2024	8.28	-	8.28	100%	264.84	-	264.84	100%		
Cold Day 20yr Weather Std	2024-2025	8.30	-	8.30	100%	266.42	-	266.42	100%		
Cold Day 20yr Weather Std	2025-2026	8.32	-	8.32	100%	268.06	-	268.06	100%		
Cold Day 20yr Weather Std	2026-2027	8.35	-	8.35	100%	269.63	-	269.63	100%		
Cold Day 20yr Weather Std	2027-2028	8.37	-	8.37	100%	271.39	-	271.39	100%		
Cold Day 20yr Weather Std	2028-2029	8.40	-	8.40	100%	272.72	-	272.72	100%		
Cold Day 20yr Weather Std	2029-2030	8.42	-	8.42	100%	274.21	-	274.21	100%		
Cold Day 20yr Weather Std	2030-2031	8.45	-	8.45	100%	275.68	-	275.68	100%		
Cold Day 20yr Weather Std	2031-2032	8.47	-	8.47	100%	277.38	-	277.38	100%		
Cold Day 20yr Weather Std	2032-2033	8.49	-	8.49	100%	278.54	-	278.54	100%		
Cold Day 20yr Weather Std	2033-2034	8.51	-	8.51	100%	279.95	-	279.95	100%		
Cold Day 20yr Weather Std	2034-2035	8.55	-	8.55	100%	282.29	-	282.29	100%		

Scenario	Gas Year	Klamath Falls			Klamath Falls % of Peak Day			Medford/Roseburg			Medford/Roseburg % of Peak Day Served
		Served	Unserved	Total	Served	Medford/Roseburg Served	Medford/Roseburg Unserved	Medford/Roseburg Total			
Cold Day 20yr Weather Std	2015-2016	13.32	-	13.32	100%	64.18	-	64.18	100%		
Cold Day 20yr Weather Std	2016-2017	13.42	-	13.42	100%	64.88	-	64.88	100%		
Cold Day 20yr Weather Std	2017-2018	13.57	-	13.57	100%	65.70	-	65.70	100%		
Cold Day 20yr Weather Std	2018-2019	13.73	-	13.73	100%	66.60	-	66.60	100%		
Cold Day 20yr Weather Std	2019-2020	13.90	-	13.90	100%	67.51	-	67.51	100%		
Cold Day 20yr Weather Std	2020-2021	14.06	-	14.06	100%	68.43	-	68.43	100%		
Cold Day 20yr Weather Std	2021-2022	14.23	-	14.23	100%	69.26	-	69.26	100%		
Cold Day 20yr Weather Std	2022-2023	14.39	-	14.39	100%	69.96	-	69.96	100%		
Cold Day 20yr Weather Std	2023-2024	14.56	-	14.56	100%	70.63	-	70.63	100%		
Cold Day 20yr Weather Std	2024-2025	14.72	-	14.72	100%	71.28	-	71.28	100%		
Cold Day 20yr Weather Std	2025-2026	14.88	-	14.88	100%	71.92	-	71.92	100%		
Cold Day 20yr Weather Std	2026-2027	15.03	-	15.03	100%	72.55	-	72.55	100%		
Cold Day 20yr Weather Std	2027-2028	15.17	-	15.17	100%	73.17	-	73.17	100%		
Cold Day 20yr Weather Std	2028-2029	15.31	-	15.31	100%	73.76	-	73.76	100%		
Cold Day 20yr Weather Std	2029-2030	15.44	-	15.44	100%	74.33	-	74.33	100%		
Cold Day 20yr Weather Std	2030-2031	15.57	-	15.57	100%	74.87	-	74.87	100%		
Cold Day 20yr Weather Std	2031-2032	15.70	-	15.70	100%	75.37	-	75.37	100%		
Cold Day 20yr Weather Std	2032-2033	15.83	-	15.83	100%	75.83	-	75.83	100%		
Cold Day 20yr Weather Std	2033-2034	15.96	-	15.96	100%	76.28	-	76.28	100%		
Cold Day 20yr Weather Std	2034-2035	16.10	-	16.10	100%	76.77	-	76.77	100%		



**APPENDIX 6.2: ALTERNATE SUPPLY RESOURCES**

<b>Available Supply Resources</b>	<b>Size</b>	<b>Cost/Rates</b>	<b>Availability</b>	<b>Notes</b>
Capacity Release Recall	27,000 Dth	NWPL Rate	2018	Recall of previously released capacity
Unsubscribed GTN Capacity	Up to 50,000 Dth	GTN Rate plus Upstream TCPL	Now	Currently available unsubscribed capacity from Kingsgate to Stanfield or Malin plus associated Alberta transport
NWP Expansion	Up to 50,000 Dth	\$0.74 / Dth	2018	Expansion from Sumas to JP
Citygate Deliveries	Variable	Varies	Now	Represents the ability to buy a delivered product from another utility or marketer. Limited counterparties
Satellite LNG	90,000 Dth w/30,000 Dth deliverability	\$12.3 Million capital cost plus \$665K O&M	2018	Provides for peaking services and alleviates the need for costly pipeline expansions. \$3,000 per m3. O&M assumed at 5.4%
Medford Lateral Exp	50,000 Dth	\$10M / GTN estimated rate	2018	Additional compression to facilitate more gas to flow from mainline GTN to Medford.
Malin Backhauls	50,000	GTN Rate	Now	Currently available

<b>Future Supply Resources</b>	<b>Size</b>	<b>Cost/Rates</b>	<b>Availability</b>	<b>Notes</b>
Co. Owned LNG	600,000 Dth w/ 150,000 of deliverability	\$75 Million plus \$2 Million annual O&M	2022	On site, in service territory liquefaction and vaporization facility
Various pipelines – Pacific Connector, Cross-Cascades, etc.	Varies	Precedent Agreement Rates	2020	Requires additional mainline capacity on NWPL or GTN to get to service territory
Large Scale LNG	Varies	Commodity less Fuel	2020	Speculative, needs pipeline transport
In Ground Storage	Varies	Varies	Varies	Requires additional mainline transport to get to service territory

## **APPENDIX 7.1: DISTRIBUTION SYSTEM MODELING**

### **OVERVIEW**

The primary goal of distribution system planning is to design for present needs and to plan for future expansion in order to serve demand growth. This allows Avista to satisfy current demand-serving requirements, while taking steps toward meeting future needs. Distribution system planning identifies potential problems and areas of the distribution system that require reinforcement. By knowing when and where pressure problems may occur, the necessary reinforcements can be incorporated into normal maintenance. Thus, more costly reactive and emergency solutions can be avoided.

### **COMPUTER MODELING**

When designing new main extensions, computer modeling can help determine the optimum size facilities for present and future needs. Undersized facilities are costly to replace, and oversized facilities incur unnecessary expenses to Avista and its customers.

### **THEORY AND APPLICATION OF STUDY**

Natural gas network load studies have evolved in the last decade to become a highly technical and useful means of analyzing the operation of a distribution system. Using a pipeline fluid flow formula, a specified parameter of each pipe element can be simultaneously solved. Through years of research, pipeline equations have been refined to the point where solutions obtained closely represent actual system behavior.

Avista conducts network load studies using GL Noble Denton's Synergi® 4.8.0 software. This computer-based modeling tool runs on a Windows operating system and allows users to analyze and interpret solutions graphically.

### **CREATING A MODEL**

To properly study the distribution system, all natural gas main information is entered (length, pipe roughness and size) into the model. "Main" refers to all pipelines supplying services. Nodes are placed at all pipe intersections, beginnings and ends of mains, changes in pipe diameter/material, and to identify all large customers. A model element connects two nodes together. Therefore, a "to node" and a "from node" will represent an element between those two nodes. Almost all of the elements in a model are pipes.

Regulators are treated like adjustable valves in which the downstream pressure is set to a known value. Although specific regulator types can be entered for realistic behavior, the expected flow passing through the actual regulator is determined and the modeled regulator is forced to accommodate such flows.

### **FLUID MECHANICS OF THE MODEL**

Pipe flow equations are used to determine the relationships between flow, pressure drop, diameter and pipe length. For all models, the Fundamental Flow equation (FM) is used due to its demonstrated reliability.

Efficiency factors are used to account for the equivalent resistance of valves, fittings and angle changes within the distribution system. Starting with a 95 percent factor, the efficiency can be changed to fine tune the model to match field results.

Pipe roughness, along with flow conditions, creates a friction factor for all pipes within a system. Thus, each pipe may have a unique friction factor, minimizing computational errors associated with generalized friction values.

## LOAD DATA

All studies are considered steady state; all natural gas entering the distribution system must equal the natural gas exiting the distribution system at any given time.

Customer loads are obtained from Avista’s customer billing system and converted to an algebraic format so loads can be generated for various conditions. Customer Management Module (CMM), an add-on application for Synergi, processes customer usage history and generates a base load (non-temperature dependent) and heat load (varying with temperature) for each customer.

In the event of a peak day or an extremely cold weather condition, it is assumed that all curtailable loads are interrupted. Therefore, the models will be conducted with only core loads.

## DETERMINING NATURAL GAS CUSTOMERS’ MAXIMUM HOURLY USAGE

### DETERMINING DESIGN PEAK HOURLY LOAD

The design peak hourly load for a customer is estimated by adding the hourly base load and the hourly heat load for a design temperature. This estimate reflects highest system hourly demands, as shown in Table 1:

Peak Hourly Base Load	+	Peak Hourly Heat Load	=	Peak Hourly Load
-----------------------	---	-----------------------	---	------------------

This method differs from the approach that is used for IRP peak day load planning. The primary reason for this difference is due to the importance of responding to hourly peaking in the distribution system, while IRP resource planning focuses on peak day requirements to the city gate.

## APPLYING LOADS

Having estimated the peak loads for all customers in a particular service area, the model can be loaded. The first step is to assign each load to the respective node or element.

## GENERATING LOADS

Temperature-based and non-temperature-based loads are established for each node or element, thus loads can be varied based on any temperature (HDD). Such a tool is necessary to evaluate the difference in flow and pressure due to different weather conditions.

## GEOGRAPHIC INFORMATION SYSTEM (GIS)

Several years ago Avista converted the natural gas facility maps to GIS. While the GIS can provide a variety of map products, the true power lies in the analytical capabilities. A GIS consists of three components: spatial operations, data association and map representation.

A GIS allows analysts to conduct spatial operations (relating a feature or facility to another geographically). A spatial operation is possible if a facility displayed on a map maintains a relationship to other facilities. Spatial relationships allow analysts to perform a multitude of queries, including:

- Identify electric customers adjacent to natural gas mains who are not currently using natural gas
- Display the number of customers assigned to particular pipes in Emergency Operating Procedure zones (geographical areas defined to aid in the safe isolation in the event of an emergency)
- Classify high-pressure pipeline proximity criteria

The second component of the GIS is data association. This allows analysts to model relationships between facilities displayed on a map to tabular information in a database. Databases store facility information, such as pipe size, pipe material, pressure rating, or related information (e.g., customer databases, equipment databases and work management systems). Data association allows interactive queries within a map-like environment.

Finally, the GIS provides a means to create maps of existing facilities in different scales, projections and displays. In addition, the results of a comparative or spatial analysis can be presented pictorially. This allows users to present complex analyses rapidly and in an easy-to-understand method.

### **BUILDING SYNERGI® MODELS FROM A GIS**

The GIS can provide additional benefits through the ease of creation and maintenance of load studies. Avista can create load studies from the GIS based on tabular data (attributes) installed during the mapping process.

### **MAINTENANCE USING A GIS**

The GIS helps maintain the existing distribution facility by allowing a design to be initiated on a GIS. Currently, design jobs for the company's natural gas system are managed through Avista's Maximo tool. Once jobs are completed, the as-built information is automatically updated on GIS, eliminating the need to convert physical maps to a GIS at a later date. Because the facility is updated, load studies can remain current by refreshing the analysis.

### **DEVELOPING A PRESENT CASE LOAD STUDY**

In order for any model to have accuracy, a present case model has to be developed that reflects what the system was doing when downstream pressures and flows are known. To establish the present case, pressure recording instruments located throughout the distribution system are used.

These field instruments record pressure and temperature throughout the winter season. Various locations recording simultaneously are used to validate the model. Customer loads on Synergi® are generated to correspond with actual temperatures recorded on the instruments. An accurate model's downstream pressures will match the corresponding field instrument's pressures. Efficiency factors are adjusted to further refine the model's pressures and better match the actual conditions.

Since telemetry at the gate stations record hourly flow, temperature and pressure, these values are used to validate the model. All loads are representative of the average daily temperature and are defined as hourly flows. If the load generating method is truly accurate, all natural gas entering the actual system (physical) equals total natural gas demand solved by the simulated system (model).

### **DEVELOPING A PEAK CASE LOAD STUDY**

Using the calculated peak loads, a model can be analyzed to identify the behavior during a peak day. The efficiency factors established in the present case are used throughout subsequent models.

## **ANALYZING RESULTS**

After a model has been balanced, several features within the Synergi® model are used to interpret results. Color plots are generated to depict flow direction, pressure, and pipe diameter with specific break points. Reinforcements can be identified by visual inspection. When user edits are completed and the model is re-balanced, pressure changes can be visually displayed, helping identify optimum reinforcements.

## **PLANNING CRITERIA**

In most instances, models resulting in node pressures below 15 psig indicate a likelihood of distribution low pressure, and therefore necessitate reinforcements. For most Avista distribution systems, a minimum of 15 psig will ensure deliverability as natural gas exits the distribution mains and travels through service pipelines to a customer's meter. Some Avista distribution areas operate at lower pressures and are assigned a minimum pressure of 5 psig for model results. Given a lower operating pressure, service pipelines in such areas are sized accordingly to maintain reliability.

## **DETERMINING MAXIMUM CAPACITY FOR A SYSTEM**

Using a peak day model, loads can be prorated at intervals until area pressures drop to 15 psig. At that point, the total amount of natural gas entering the system equals the maximum capacity before new construction is necessary. The difference between natural gas entering the system in this scenario and a peak day model is the maximum additional capacity that can be added to the system.

Since the approximate natural gas usage for the average customer is known, it can be determined how many new customers can be added to the distribution system before necessitating system reinforcements. The above models and procedures are utilized with new construction proposals or pipe reinforcements to determine the potential increase in capacity.

## **FIVE-YEAR FORECASTING**

The intent of the load study forecasting is to predict the system's behavior and reinforcements necessary within the next five years. Various Avista personnel provide information to determine where and why certain areas may experience growth.

By combining information from Avista's demand forecast, IRP planning efforts, regional growth plans and area developments, proposals for pipeline reinforcements and expansions are evaluated with Synergi®.

## Appendix 7.2

Oregon Public Utility Commission Order No. 16-109 (the Order) included the following language:

Finally, as part of the IRP-vetting process and subsequent rate proceedings, we expect that Avista conduct and present comprehensive analyses of its system upgrades. Such analyses should provide: (1) a comprehensive cost-benefit analysis of whether and when the investment should be built; (2) evaluation of a range of alternative build dates and the impact on reliability and customer rates; (3) credible evidence on the likelihood of disruptions based on historical experience; (4) evidence on the range of possible reliability incidents; (5) evidence about projected loads and customers in the area; and (6) adequate consideration of alternatives, including the use of interruptibility or increased demand-side measures to improve reliability and system resiliency.

In order to address this portion of the Order, Avista has prepared this appendix, which includes documentation addressing the six points above for each of the natural gas distribution system enhancements included in the 2016 Natural Gas Integrated Resource Plan (IRP) for Avista's Oregon service territory. Each of these three enhancement projects represents a significant, discrete project which is out of the ordinary course of business (that is to say, different from ongoing capital investment to address Federal or State regulatory requirements, relocation of pipe or facilities as requested by others, failed pipe or facilities, etc., all of which occur routinely over time and which are discussed below).

The routine, ongoing capital investments can be loosely classified in the following categories (which are not mutually exclusive):

- Safety – Ongoing safety related capital investment includes the repair or replacement of obsolete or failed pipe and facilities. This category includes, but is not necessarily limited to, investment to address deteriorated or isolated steel pipe, cathodic protection, and the replacement of pipeline which has been built over, as well as the remedy of shallow pipe or the repair or replacement of leaking pipe.
- System Maintenance – Ongoing capital investment related to system maintenance includes replacement of facilities or pipe that has reached the end of their useful lives, as well as other general investment required to maintain Avista's ability to reliably serve customers.
- Relocation Requested by Others – Ongoing capital investment related to relocation requested by others falls primarily into two categories, relocation requested by other parties which is required under the terms of our franchise agreements (such as

relocations required to accommodate road or highway construction or relocation), or relocation requested by customers or others (in which case the customer would be responsible for the cost of the immediate request, but in which case Avista may perform additional work, such as the replacement of a steel service with polyethylene to reduce future maintenance or cathodic protection requirements on that pipe).

- Mandated System Investment – Ongoing capital investment in this category is driven by Federal or State regulatory requirements, such as investment that results from TIMP/DIMP programs, among other programs.

Avista's Aldyl-A replacement program has been addressed in substantial detail in Oregon Public Utility Commission Docket UG-246, Avista/500-501.

## **La Grande High Pressure Reinforcement**

1. A comprehensive cost-benefit analysis of whether and when the investment should be built

High pressure reinforcements are primarily driven by load studies, whereby an inability to reliably serve customers on a design day drives investment needs. (Evidence regarding the inability to reliably serve customers on a design day is given in #4, below.) Given this, the threshold consideration regarding a high pressure reinforcement is driven primarily by models indicating an inability to serve customers on a design day, rather than a strict application of cost-benefit analysis. Said differently, to a customer, the loss of natural gas service on a design day (74 HDD, or average daily temperature of -9° Fahrenheit, in La Grande) is not a question of cost-benefit, but rather of physical safety and comfort.

2. Evaluation of a range of alternative build dates and the impact on reliability and customer rates

As discussed in #1, above, the identification of areas in need of reinforcement is the primary threshold consideration that establishes the need for and timing of planned completion. The number/scope of reinforcement projects that are completed in any given year may be constrained by such things as the availability of project management, skilled labor, and the need to complete other critical-path projects first in order to enable the functionality of the given project. Because of these constraints, the areas of concern within Avista's natural gas distribution systems are risk-ranked against each other, to ensure that the areas of highest risk are corrected first.

In the case of this La Grande High Pressure Reinforcement, there were a number of system capacity issues in the La Grande area, including gate station capacity constraints at both the La Grande city gate station (station #0815) and the Ladd Canyon gate station (station #0817), as well as low design day pressures identified for the cities of Elgin and Union, Oregon.

In the evaluation of these capacity constraints and low design day pressures, three critical points were identified—the La Grande city gate station, the Ladd Canyon gate station, and the remaining system pressure at the end of the high pressure pipeline connecting Elgin to the distribution system (where a minimum design pressure of 100 psig is required to serve Elgin on a design day, but where the actual pressure on a design day was found to be 35 psig). The evaluation further identified that increasing the capacity of the La Grande gate station would alleviate the gate station constraint, but would not address the low pressure at Elgin. However, the evaluation found that replacement of the Ladd Canyon gate station and the investment in the La Grande High Pressure Reinforcement project would alleviate all three critical points, requiring only two projects. This analysis resulted in the lowest cost solution, given that this solution avoids the need to upsize the La Grande city gate station to address that gate station's capacity constraint.



Given the interrelated nature of these critical points and the two projects, the investment in the La Grande High Pressure Reinforcement could not occur until the new Ladd Canyon gate station (station #7080) was completed (this station was placed in service in December 2015).

At existing rates, an incremental addition of \$1 million to distribution gross plant would result in an increase in billed revenue to Oregon customers of approximately one-tenth of one percent of present billed revenue.

### 3. Credible evidence on the likelihood of disruptions based on historical experience

As discussed in *Chapter 7: Distribution Planning* in the Natural Gas IRP, the distribution scenario decision-making process relies upon the analyses performed on each of Avista's LDC systems under design day conditions to identify areas where potential outages may occur.

Avista's design heating degree day for distribution system modeling is determined using the coldest day on record for each given service area. This practice is consistent with the peak day demand forecast utilized in Avista's natural gas Integrated Resource Plan, in the "Weather Forecast" section of Chapter 2, which explains the methodology for determining the peak day demand forecast as follows:

The peak day demand forecast includes adjustments to average weather to reflect a five-day cold weather event. This consists of adjusting the middle day of the five-day cold weather event to the coldest temperature on record for a service territory....

The IRP, in the "Weather Forecast" section of Chapter 2, goes on to describe the coldest days on record for each of the Oregon service areas, stating the following:

Medford experienced the coldest day on record, a 61 HDD, on Dec. 9, 1972. This is equal to an average daily temperature of 4 degrees Fahrenheit. Medford has experienced only one 61 HDD in the last 40 years; however, it has also experienced 59 and 58 HDD events on Dec. 8, 1972 and Dec. 21, 1990, respectively.

The other three areas in Oregon have similar weather days. For Klamath Falls, a 72 HDD occurred on Dec. 8, 2013; in La Grande a 74 HDD occurred on Dec. 23, 1983; and a 55 HDD occurred in Roseburg on Dec. 22, 1990. As with Washington/Idaho and Medford, these days are the peak day weather standard for modeling purposes.

The IRP also addresses the appropriateness of the use of the coldest day on record as the planning standard, stating, in the "Weather Forecast" section of Chapter 2:

Utilizing a peak planning standard of the coldest temperature on record may seem aggressive given a temperature experienced rarely, or only once. Given the potential impacts of an extreme weather event on customers' personal safety and property damage to customer appliances and Avista's infrastructure, it is a prudent regionally

accepted planning standard. While remote, peak days do occur, as on Dec. 8, 2013, when Avista matched the previous peak HDD [72 HDD] in Klamath Falls.

Prior to the December 8, 2013 design heating degree day in Klamath Falls, Oregon, the previous design heating degree day in Klamath Falls had occurred on December 21, 1990. Further, in the 20 years preceding the completion of Avista's 2012 Natural Gas IRP, the coldest day in 20 years in Klamath Falls had been a 64 heating degree day.

These factors, along with the recent December 8, 2013 design heating degree day, demonstrate that the absence of a design heating degree day in the past 20 years does not mean that a design heating degree day will not happen. In fact, this further confirms that the design heating degree day is a prudent planning standard.

#### 4. Evidence on the range of possible reliability incidents

The following pages illustrate the results of the Synergi™ study with regards to the aforementioned low pressure on a design day at Elgin, Oregon. As discussed in Avista testimony in Docket No. UG-288 (Avista/1500, Webb/20), the system pressure upon reaching Elgin is less than 35 psig on a design day, while the system design criteria dictate that the pressure should be 100 psig at this point in order to reliably serve Elgin. Given the substantial disparity between 35 psig and 100 psig, the low system pressure upon reaching Elgin is likely to persist at temperatures higher than the design day temperature (i.e., the probability of losing customers in this area is relatively higher). Similarly, given that the system demand on the La Grande gate station on a design day is modeled to be 158% of physical capacity (as shown in Appendix 7.1), the capacity shortfall at the La Grande gate station is likely to persist at higher temperatures than the design day temperature.

Both of these factors contributed to the identification of this project as a high priority for completion.

#### 5. Evidence about projected loads and customers in the area

Given that the Synergi™ load studies used to determine the need for reinforcement or other remedy are based upon existing system load, this reinforcement investment determination was necessary to serve existing loads, irrespective of projected loads and customers in the area.

While the determination that a project is necessary to support the distribution system is made irrespective of projected customer or load growth, as discussed in the materials included in Appendix 7.1, once a project need has been identified through the load studies, expected growth in load or customers in the area is considered (when available) in appropriately scoping the project in order to avoid the incremental cost of having to perform incremental reinforcement in a given area that would likely be required if this information were not considered.

6. Adequate consideration of alternatives, including the use of interruptibility or increased demand-side measures to improve reliability and system resiliency

As discussed in Avista testimony in Docket No. UG-288 (Avista/1500, Webb/20), while it is true that loads can be interrupted or curtailed in the event of supply or capacity shortfalls, the load studies performed to model the Company's natural gas distribution system on design days consider only firm load. That is to say, Avista's design heating degree day models presume that all interruptible customers have already been interrupted, and only firm loads are being served. Therefore, the capacity deficits shown in the previously discussed load studies could not be alleviated through interruption.

Additionally, as discussed in the "Conservation Resources" section of Chapter 7 (Distribution Planning) of the IRP:

The evaluation of distribution system constraints includes consideration of targeted conservation resources to reduce or delay distribution system enhancements. The consumer is still the ultimate decision-maker regarding the purchase of a conservation measure. Because of this, Avista attempts to influence conservation through the DSM measures discussed in Chapter 3 – Demand-Side Resources, but does not depend on estimates of peak day demand reductions from conservation to eliminate near-term distribution system constraints. Over the longer-term, targeted conservation programs may provide a cumulative benefit that could offset potential constraint areas and may be an effective strategy.

Thus, while Avista certainly considers the importance of demand-side measures, and encourages such conservation programs, the conservation benefits accomplished by demand-side measures occur over a longer period than would be required to prudently address the existing, near-term distribution system constraints.

## **Klamath Falls (#2703) Gate Station**

1. A comprehensive cost-benefit analysis of whether and when the investment should be built

Gate station upgrades are primarily driven by the City Gate Analysis (as discussed in the materials included in Appendix 7.1), whereby a capacity constraint impacting Avista's ability to reliably serve customers drives investment needs. (Evidence regarding the inability to reliably serve customers on a design day is given in #4, below.) Given this, the threshold consideration regarding gate station investment is driven primarily by models indicating a capacity deficit on a design day, rather than a strict application of cost-benefit analysis. Said differently, to a customer, the loss of natural gas service on a design day (72 HDD, or average daily temperature of -7° Fahrenheit, in Klamath Falls) is not a question of cost-benefit, but rather of physical safety and comfort.

2. Evaluation of a range of alternative build dates and the impact on reliability and customer rates

As discussed in #1, above, the identification of capacity shortfalls on a design day is the primary threshold consideration that establishes the need for and timing of planned completion. The number/scope of reinforcement projects that are completed in any given year may be constrained by such things as the availability of project management, skilled labor, and the need to complete other critical-path projects first in order to enable the functionality of the given project. Because of these constraints, the areas of concern within Avista's natural gas distribution systems are risk-ranked against each other, to ensure that the areas of highest risk are corrected first.

Given that the capacity constraint at the Klamath Falls gate station (Station #2703) was modeled to be 106% on a design day as of the most recent City Gate Analysis (a relatively small capacity constraint), and the relative risk ranking compared with other natural gas distribution projects, this project has been included in planning considerations, with planned completion slated for 2019 or later. The assessed capacity constraint will continue to be regularly evaluated, and an increase in the assessed shortfall might warrant acceleration of the project, while a reduction in demand that eliminates the shortfall would defer the project.

At existing rates, an incremental addition of \$1 million to distribution gross plant would result in an increase in billed revenue to Oregon customers of approximately one-tenth of one percent of present billed revenue.

3. Credible evidence on the likelihood of disruptions based on historical experience

As discussed in *Chapter 7: Distribution Planning* in the Natural Gas IRP, the distribution scenario decision-making process relies upon the analyses performed on each of Avista's LDC systems under design day conditions to identify areas where potential outages may occur.

Avista’s design heating degree day for distribution system modeling is determined using the coldest day on record for each given service area. This practice is consistent with the peak day demand forecast utilized in Avista’s natural gas Integrated Resource Plan, in the “Weather Forecast” section of Chapter 2, which explains the methodology for determining the peak day demand forecast as follows:

The peak day demand forecast includes adjustments to average weather to reflect a five-day cold weather event. This consists of adjusting the middle day of the five-day cold weather event to the coldest temperature on record for a service territory....

The IRP, in the “Weather Forecast” section of Chapter 2, goes on to describe the coldest days on record for each of the Oregon service areas, stating the following:

Medford experienced the coldest day on record, a 61 HDD, on Dec. 9, 1972. This is equal to an average daily temperature of 4 degrees Fahrenheit. Medford has experienced only one 61 HDD in the last 40 years; however, it has also experienced 59 and 58 HDD events on Dec. 8, 1972 and Dec. 21, 1990, respectively.

The other three areas in Oregon have similar weather days. For Klamath Falls, a 72 HDD occurred on Dec. 8, 2013; in La Grande a 74 HDD occurred on Dec. 23, 1983; and a 55 HDD occurred in Roseburg on Dec. 22, 1990. As with Washington/Idaho and Medford, these days are the peak day weather standard for modeling purposes.

The IRP also addresses the appropriateness of the use of the coldest day on record as the planning standard, stating, in the “Weather Forecast” section of Chapter 2:

Utilizing a peak planning standard of the coldest temperature on record may seem aggressive given a temperature experienced rarely, or only once. Given the potential impacts of an extreme weather event on customers’ personal safety and property damage to customer appliances and Avista’s infrastructure, it is a prudent regionally accepted planning standard. While remote, peak days do occur, as on Dec. 8, 2013, when Avista matched the previous peak HDD [72 HDD] in Klamath Falls.

Prior to the December 8, 2013 design heating degree day in Klamath Falls, Oregon, the previous design heating degree day in Klamath Falls had occurred on December 21, 1990. Further, in the 20 years preceding the completion of Avista’s 2012 Natural Gas IRP, the coldest day in 20 years in Klamath Falls had been a 64 heating degree day.

These factors, along with the recent December 8, 2013 design heating degree day, demonstrate that the absence of a design heating degree day in the past 20 years does not mean that a design heating degree day will not happen. In fact, this further confirms that the design heating degree day is a prudent planning standard.

#### 4. Evidence on the range of possible reliability incidents

Given that the system demand on the Klamath Falls gate station on a design day is modeled to be 106% of physical capacity, the capacity shortfall at the Klamath Falls gate station primarily exists at temperatures near the design day temperature. (See TAC Meeting #3 materials, “City Gate Analysis Results,” for tables documenting the results of the most recent City Gate Analysis).

5. Evidence about projected loads and customers in the area

Given that the City Gate Analysis used to determine the need for reinforcement or other remedy is based upon existing system load, gate station upgrade investment decisions are made upon the basis of existing customers, irrespective of projected loads and customers in the area.

6. Adequate consideration of alternatives, including the use of interruptibility or increased demand-side measures to improve reliability and system resiliency

While it is true that loads can be interrupted or curtailed in the event of supply or capacity shortfalls, the City Gate Analysis performed to model gate station capacity deficits on design days consider only firm load. That is to say, Avista’s City Gate Analysis models presume that all interruptible customers have already been interrupted, and only firm loads are being served. Therefore, the capacity deficits shown in the City Gate Analysis could not be alleviated through interruption.

Additionally, as discussed in the “Conservation Resources” section of Chapter 7 (Distribution Planning) of the IRP:

The evaluation of distribution system constraints includes consideration of targeted conservation resources to reduce or delay distribution system enhancements. The consumer is still the ultimate decision-maker regarding the purchase of a conservation measure. Because of this, Avista attempts to influence conservation through the DSM measures discussed in Chapter 3 – Demand-Side Resources, but does not depend on estimates of peak day demand reductions from conservation to eliminate near-term distribution system constraints. Over the longer-term, targeted conservation programs may provide a cumulative benefit that could offset potential constraint areas and may be an effective strategy.

Thus, while Avista certainly considers the importance of demand-side measures, and encourages such conservation programs, the conservation benefits accomplished by demand-side measures occur over a longer period than would be required to prudently address the existing, near-term gate station constraints.

## **Sutherlin (#2626) Gate Station**

1. A comprehensive cost-benefit analysis of whether and when the investment should be built

Gate station upgrades are primarily driven by the City Gate Analysis (as discussed in the materials included in Appendix 7.1), whereby a capacity constraint impacting Avista's ability to reliably serve customers drives investment needs. (Evidence regarding the inability to reliably serve customers on a design day is given in #4, below.) Given this, the threshold consideration regarding gate station investment is driven primarily by models indicating a capacity deficit on a design day, rather than a strict application of cost-benefit analysis. Said differently, to a customer, the loss of natural gas service on a design day (55 HDD, or average daily temperature of 10° Fahrenheit, in Roseburg) is not a question of cost-benefit, but rather of physical safety and comfort.

2. Evaluation of a range of alternative build dates and the impact on reliability and customer rates

As discussed in #1, above, the identification of capacity shortfalls on a design day is the primary threshold consideration that establishes the need for and timing of planned completion. The number/scope of reinforcement projects that are completed in any given year may be constrained by such things as the availability of project management, skilled labor, and the need to complete other critical-path projects first in order to enable the functionality of the given project. Because of these constraints, the areas of concern within Avista's natural gas distribution systems are risk-ranked against each other, to ensure that the areas of highest risk are corrected first.

Given that the capacity constraint at the Sutherlin gate station (Station #2626) was modeled to be 102% on a design day as of the most recent City Gate Analysis (a relatively small capacity constraint), and the relative risk ranking compared with other natural gas distribution projects, this project has been included in planning considerations, with planned completion slated for 2019 or later. The assessed capacity constraint will continue to be regularly evaluated, and an increase in the assessed shortfall might warrant acceleration of the project, while a reduction in demand that eliminates the shortfall would defer the project.

At existing rates, an incremental addition of \$1 million to distribution gross plant would result in an increase in billed revenue to Oregon customers of approximately one-tenth of one percent of present billed revenue.

3. Credible evidence on the likelihood of disruptions based on historical experience

As discussed in *Chapter 7: Distribution Planning* in the Natural Gas IRP, the distribution scenario decision-making process relies upon the analyses performed on each of Avista's LDC systems under design day conditions to identify areas where potential outages may occur.

Avista’s design heating degree day for distribution system modeling is determined using the coldest day on record for each given service area. This practice is consistent with the peak day demand forecast utilized in Avista’s natural gas Integrated Resource Plan, in the “Weather Forecast” section of Chapter 2, which explains the methodology for determining the peak day demand forecast as follows:

The peak day demand forecast includes adjustments to average weather to reflect a five-day cold weather event. This consists of adjusting the middle day of the five-day cold weather event to the coldest temperature on record for a service territory....

The IRP, in the “Weather Forecast” section of Chapter 2, goes on to describe the coldest days on record for each of the Oregon service areas, stating the following:

Medford experienced the coldest day on record, a 61 HDD, on Dec. 9, 1972. This is equal to an average daily temperature of 4 degrees Fahrenheit. Medford has experienced only one 61 HDD in the last 40 years; however, it has also experienced 59 and 58 HDD events on Dec. 8, 1972 and Dec. 21, 1990, respectively.

The other three areas in Oregon have similar weather days. For Klamath Falls, a 72 HDD occurred on Dec. 8, 2013; in La Grande a 74 HDD occurred on Dec. 23, 1983; and a 55 HDD occurred in Roseburg on Dec. 22, 1990. As with Washington/Idaho and Medford, these days are the peak day weather standard for modeling purposes.

The IRP also addresses the appropriateness of the use of the coldest day on record as the planning standard, stating, in the “Weather Forecast” section of Chapter 2:

Utilizing a peak planning standard of the coldest temperature on record may seem aggressive given a temperature experienced rarely, or only once. Given the potential impacts of an extreme weather event on customers’ personal safety and property damage to customer appliances and Avista’s infrastructure, it is a prudent regionally accepted planning standard. While remote, peak days do occur, as on Dec. 8, 2013, when Avista matched the previous peak HDD [72 HDD] in Klamath Falls.

Prior to the December 8, 2013 design heating degree day in Klamath Falls, Oregon, the previous design heating degree day in Klamath Falls had occurred on December 21, 1990. Further, in the 20 years preceding the completion of Avista’s 2012 Natural Gas IRP, the coldest day in 20 years in Klamath Falls had been a 64 heating degree day.

These factors, along with the recent December 8, 2013 design heating degree day, demonstrate that the absence of a design heating degree day in the past 20 years does not mean that a design heating degree day will not happen. In fact, this further confirms that the design heating degree day is a prudent planning standard.

#### 4. Evidence on the range of possible reliability incidents



Given that the system demand on the Sutherlin gate station on a design day is modeled to be 102% of physical capacity, the capacity shortfall at the Klamath Falls gate station primarily exists at temperatures near the design day temperature. (See TAC Meeting #3 materials, “City Gate Analysis Results,” for tables documenting the results of the most recent City Gate Analysis).

5. Evidence about projected loads and customers in the area

Given that the City Gate Analysis used to determine the need for reinforcement or other remedy is based upon existing system load, gate station upgrade investment decisions are made upon the basis of existing customers, irrespective of projected loads and customers in the area.

6. Adequate consideration of alternatives, including the use of interruptibility or increased demand-side measures to improve reliability and system resiliency

While it is true that loads can be interrupted or curtailed in the event of supply or capacity shortfalls, the City Gate Analysis performed to model gate station capacity deficits on design days consider only firm load. That is to say, Avista’s City Gate Analysis models presume that all interruptible customers have already been interrupted, and only firm loads are being served. Therefore, the capacity deficits shown in the City Gate Analysis could not be alleviated through interruption.

Additionally, as discussed in the “Conservation Resources” section of Chapter 7 (Distribution Planning) of the IRP:

The evaluation of distribution system constraints includes consideration of targeted conservation resources to reduce or delay distribution system enhancements. The consumer is still the ultimate decision-maker regarding the purchase of a conservation measure. Because of this, Avista attempts to influence conservation through the DSM measures discussed in Chapter 3 – Demand-Side Resources, but does not depend on estimates of peak day demand reductions from conservation to eliminate near-term distribution system constraints. Over the longer-term, targeted conservation programs may provide a cumulative benefit that could offset potential constraint areas and may be an effective strategy.

Thus, while Avista certainly considers the importance of demand-side measures, and encourages such conservation programs, the conservation benefits accomplished by demand-side measures occur over a longer period than would be required to prudently address the existing, near-term gate station constraints.



# 2016 Avista Natural Gas IRP

Technical Advisory Committee Meeting  
January 21, 2016  
Portland, Oregon  
St. Helens A

# Agenda

- Introductions & Logistics
- Purpose of IRP and Avista's IRP Process
- Avista's Demand Overview and 2014 IRP Revisited
- Economic Outlook and Customer Count Forecast
- Demand Forecast Methodology
- Dynamic Demand Forecasting
- Demand Side Management
- Questions/Wrap Up

# 2016 IRP Timeline

- **August 31, 2015** – Work Plan filed with WUTC
- **January through April 2016** – Technical Advisory Committee meetings. Meeting topics will include:
  - **Demand Forecast and Demand Side Management – January 21**
  - Supply/Infrastructure, Natural Gas Pricing, and Potential Case Discussion– *February 18*
  - Distribution Planning, SENDOUT® Preliminary Output Results and Further Case Discussion – *March 16*
  - SENDOUT® results – *April 21*
- **May 30, 2016** – Draft of IRP document to TAC
- **June 30, 2016** – Comments on draft due back to Avista
- **July 2016** – TAC final review meeting (if necessary)
- **August 31, 2016** – File finalized IRP document

# Purpose of Gas Integrated Resource Planning

- Comprehensive long-range resource planning tool
- Fully integrates forecasted demand requirements with potential demand side and supply side resources
- Process determines the least cost, risk adjusted means for meeting demand requirements for our firm residential, commercial and industrial customers
- Responsive to Idaho, Oregon and Washington rules and/or orders

# Avista's IRP Process

- Comprehensive analysis bringing demand forecasting and existing and potential supply-side and demand-side resources together into a 20-year, risk adjusted least-cost plan
- Considers:
  - Customer growth and usage
  - Weather planning standard
  - Demand-side management opportunities
  - Existing and potential supply-side resource options
  - Risk
  - Public participation through Technical Advisory Committee meetings (TAC)
  - Distribution upgrades
- 2014 IRP filed in all three jurisdictions on



# Avista's Demand Overview and 2014 IRP Re-Visited

Tom Pardee  
Manager of Natural Gas Planning

# Avista's Demand Overview



# Service Territory and Customer Overview

- Serves electric and natural gas customers in eastern Washington and northern Idaho, and natural gas customers in southern and eastern Oregon
  - Population of service area 1.5 million
    - ▶ 371,000 electric customers
    - ▶ 330,000 natural gas customers
- Has one of the smallest carbon footprints among America's 100 largest investor-owned utilities
- Committed to environmental stewardship and efficient use of resources

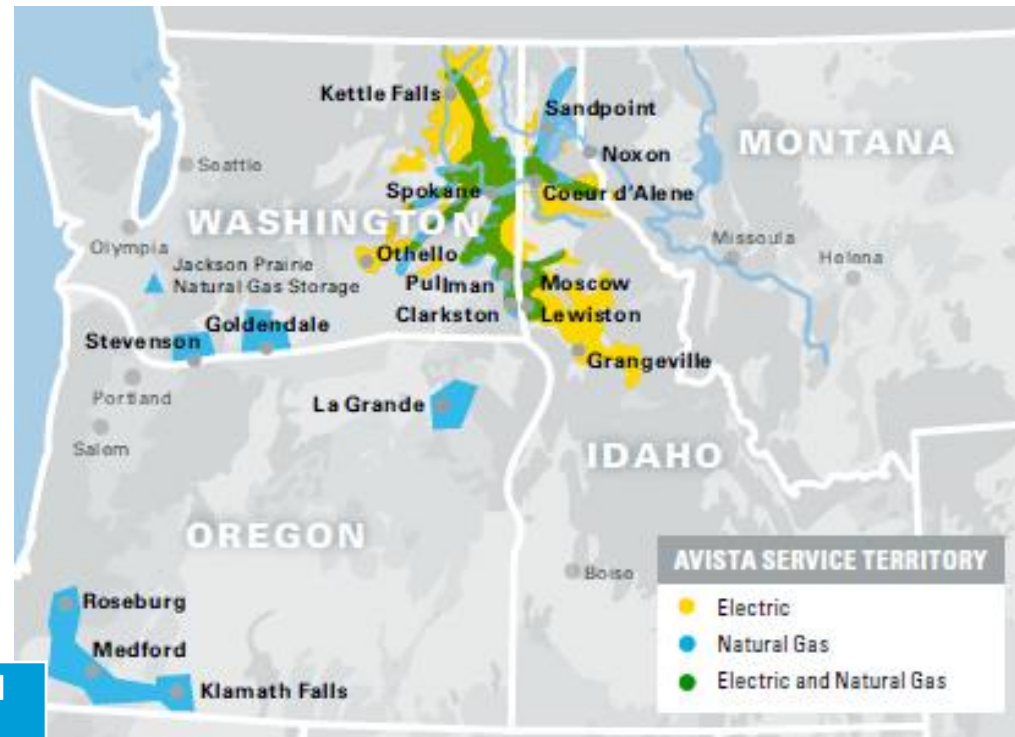

State	Total Customers	% of Total
Washington	156,000	46%
Oregon	99,000	30%
Idaho	79,000	24%
<b>Total</b> Avista Corp	<b>334,000</b>	<b>100%</b>

# 2015 Customer Make Up and Demand Mix

**Customer Make up  
WA-ID**

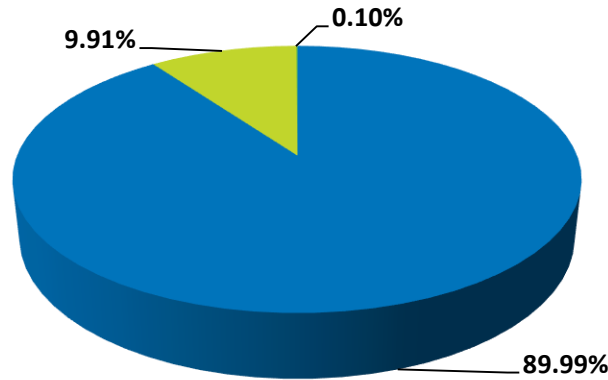

**Customer Make Up  
Oregon**

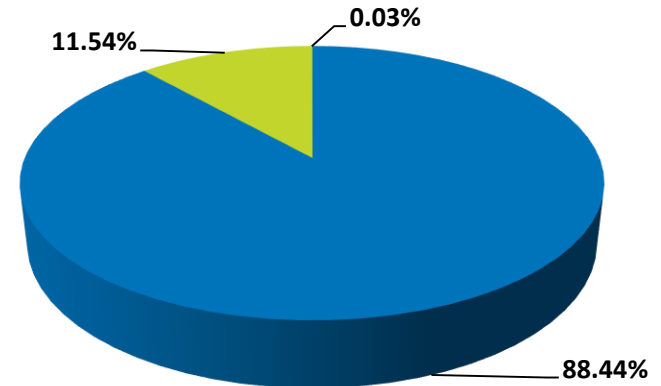

**Annual Demand  
WA-ID**

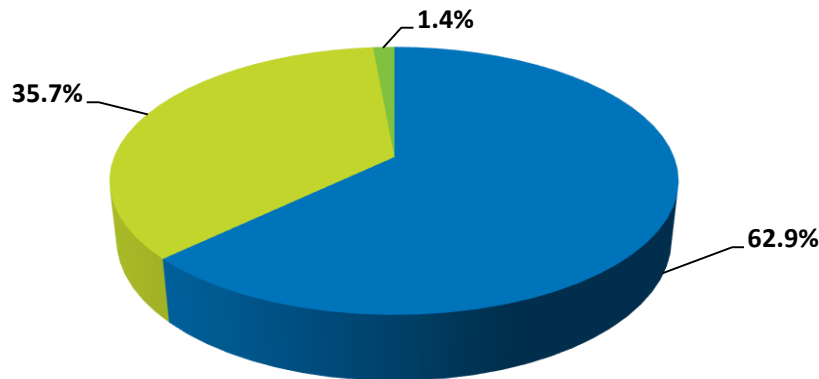

**Annual Demand  
Oregon**

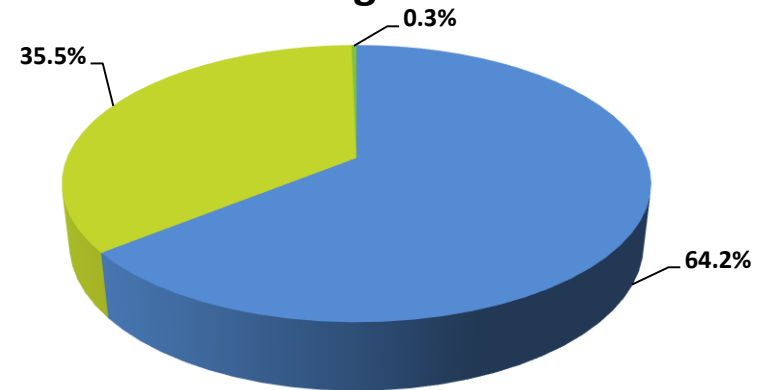

# Historical Demand Mix

## WA-ID

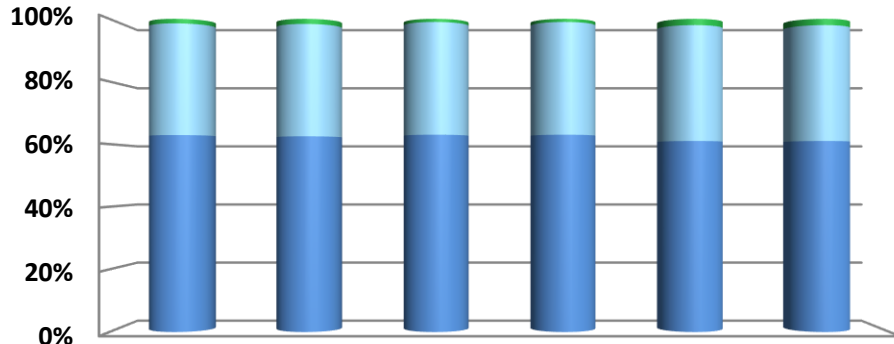

	2015	2014	2013	2012	2011	2010
Industrial	1%	2%	1%	1%	2%	2%
Commercial	36%	36%	36%	36%	37%	37%
Residential	63%	63%	63%	63%	61%	61%

## Medford/Roseburg

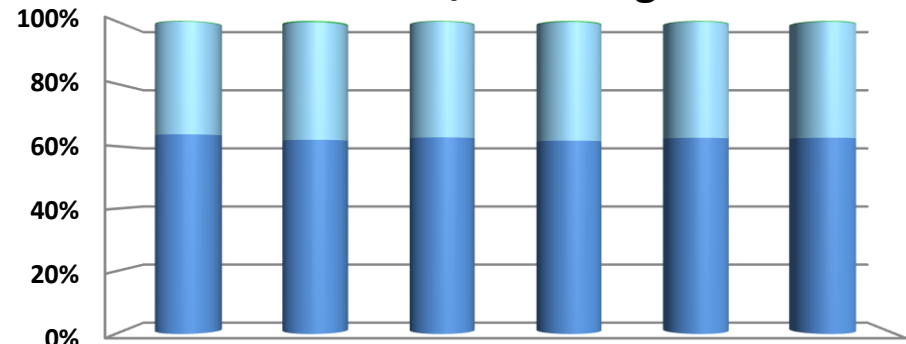

	2015	2014	2013	2012	2011	2010
Industrial	0%	0%	0%	0%	0%	0%
Commercial	36%	38%	37%	38%	37%	37%
Residential	64%	62%	63%	62%	63%	63%

## Klamath Falls

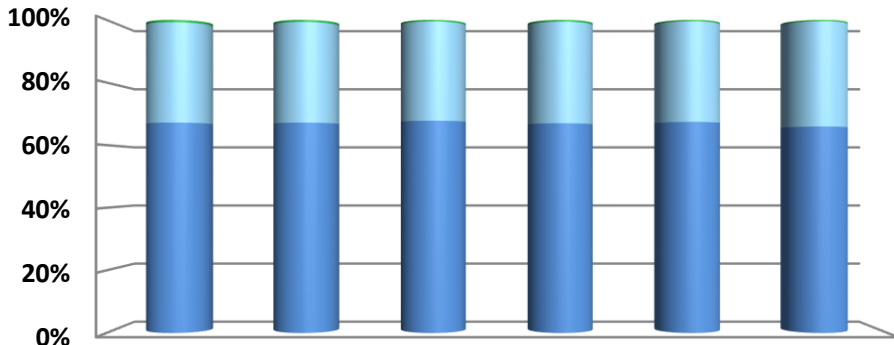

	2015	2014	2013	2012	2011	2010
Industrial	1%	1%	1%	1%	0%	0%
Commercial	32%	32%	32%	32%	32%	34%
Residential	67%	67%	68%	67%	67%	66%

## LaGrande

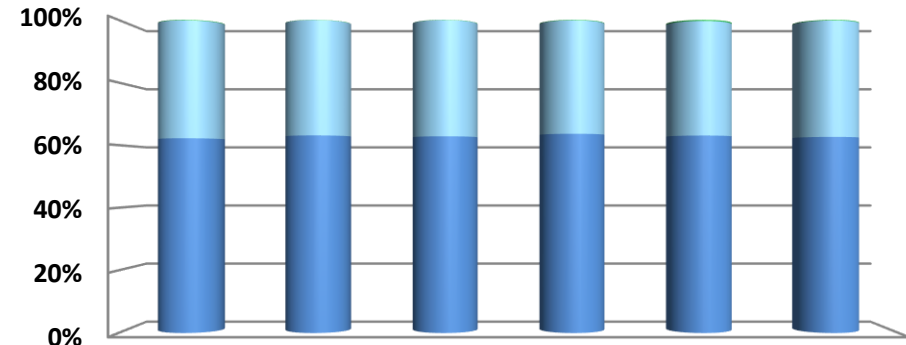

	2015	2014	2013	2012	2011	2010
Industrial	0%	0%	0%	0%	0%	0%
Commercial	38%	37%	37%	36%	37%	37%
Residential	62%	63%	63%	64%	63%	63%

# Seasonal Demand Profiles

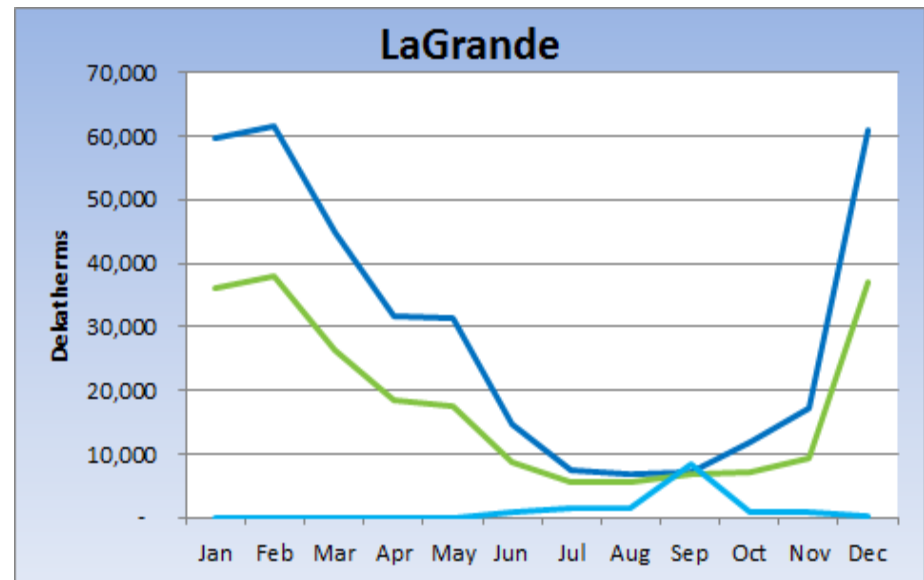
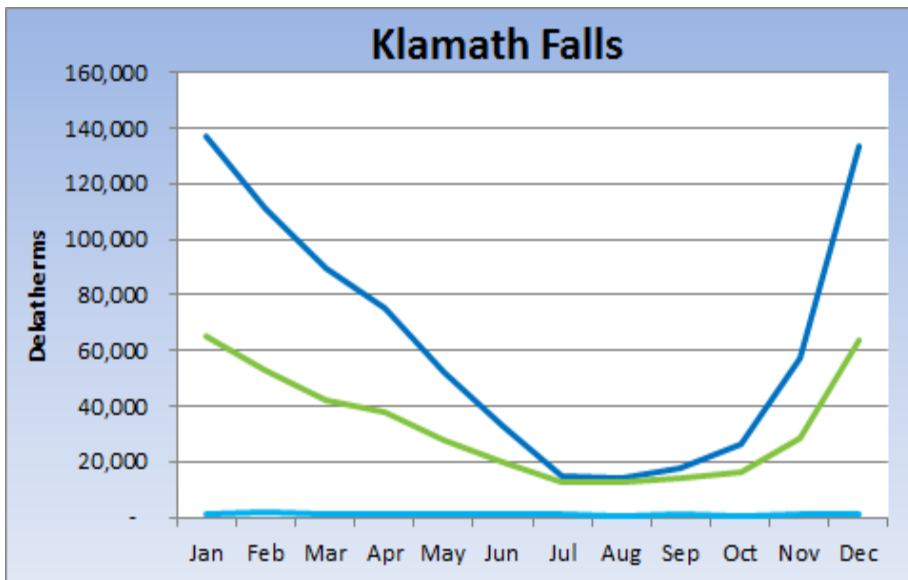
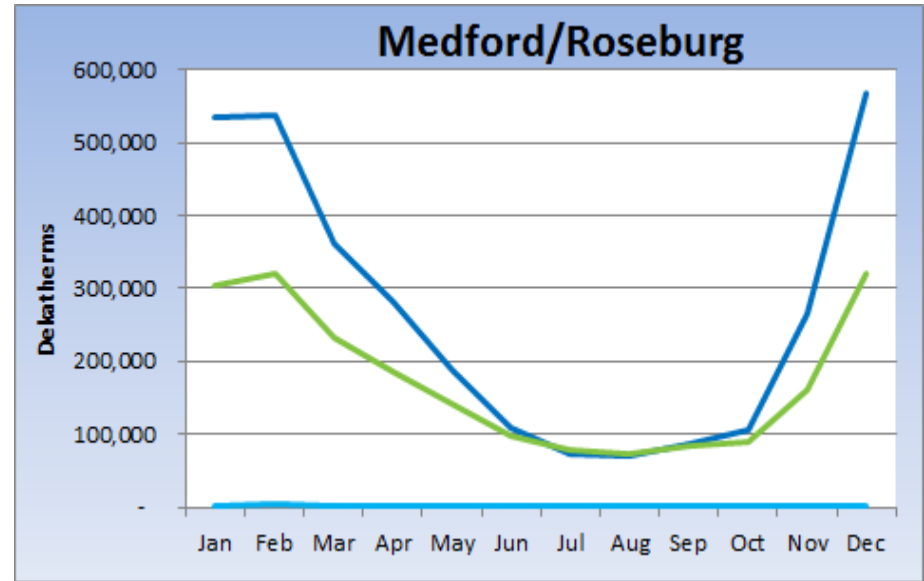
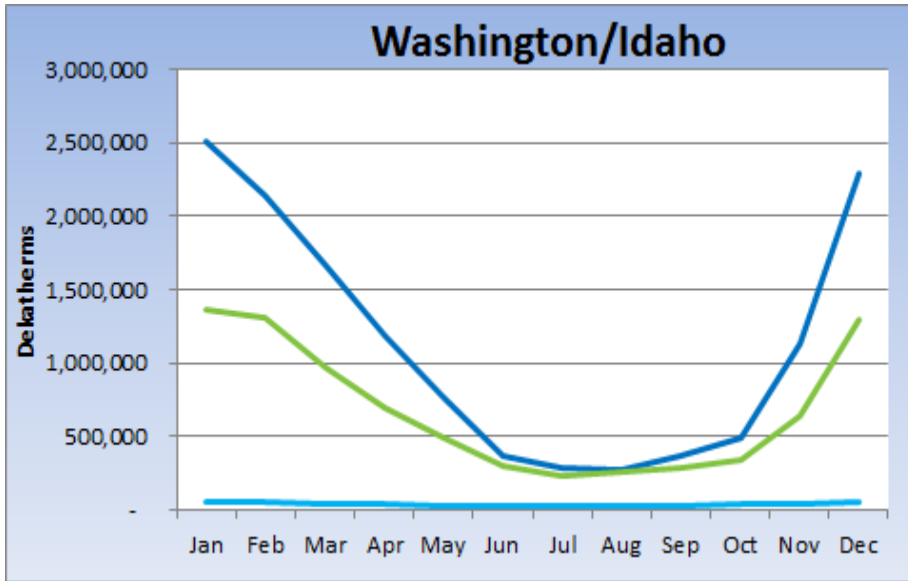

# Daily Demand Profiles

## WA-ID

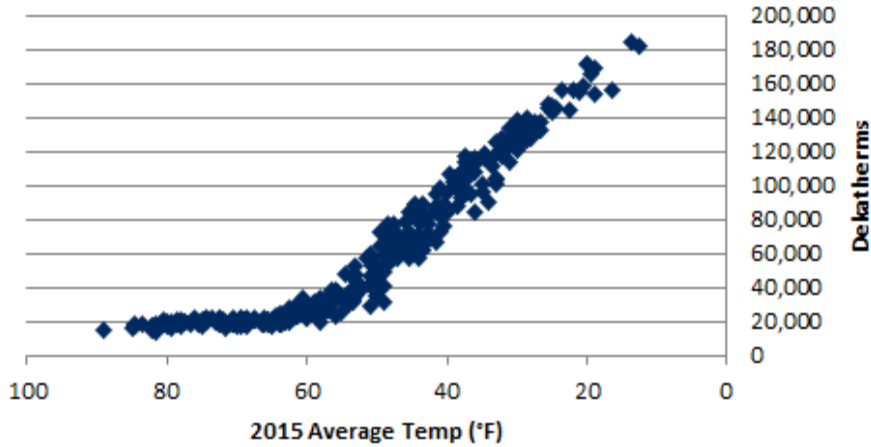

## Medford/Roseburg

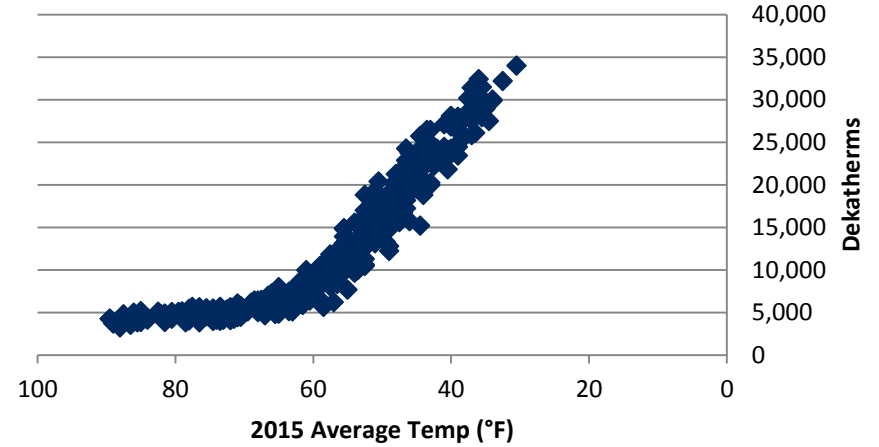

## Klamath Falls

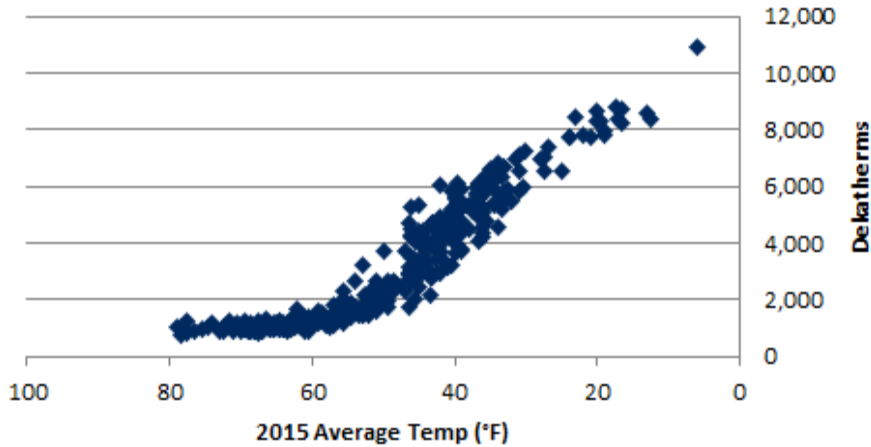

## LaGrande

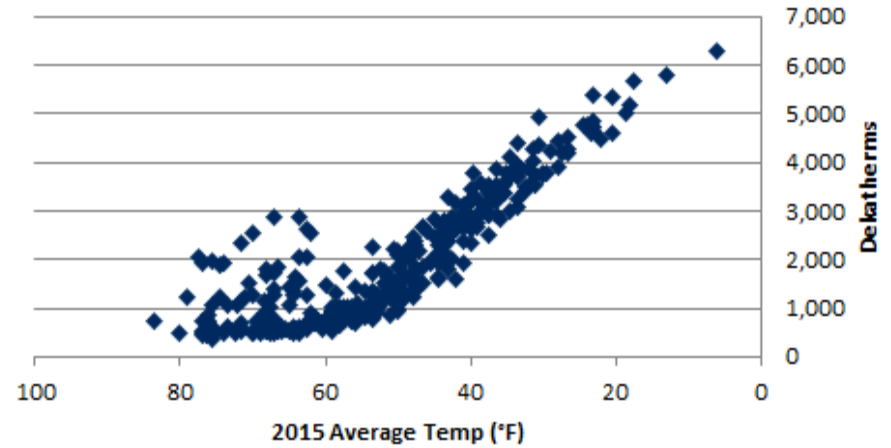

# Avista's 2014 Natural Gas IRP Re-Visited

## Washington/Idaho IRP Forecast vs. Actual (Residential Use per Customer and Customer Count)

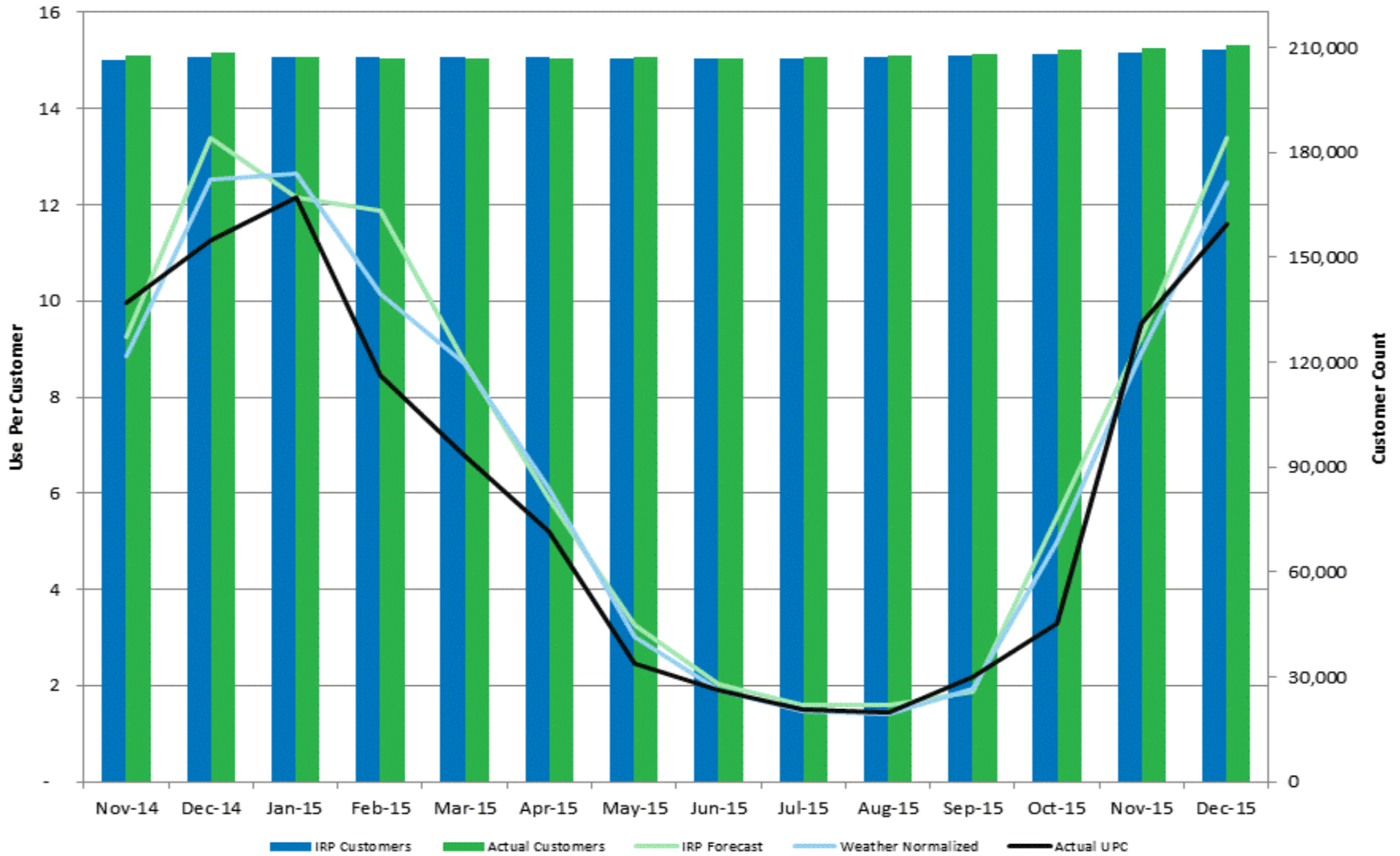

## Oregon IRP Forecast vs. Actual (Residential Use per Customer and Customer Count)

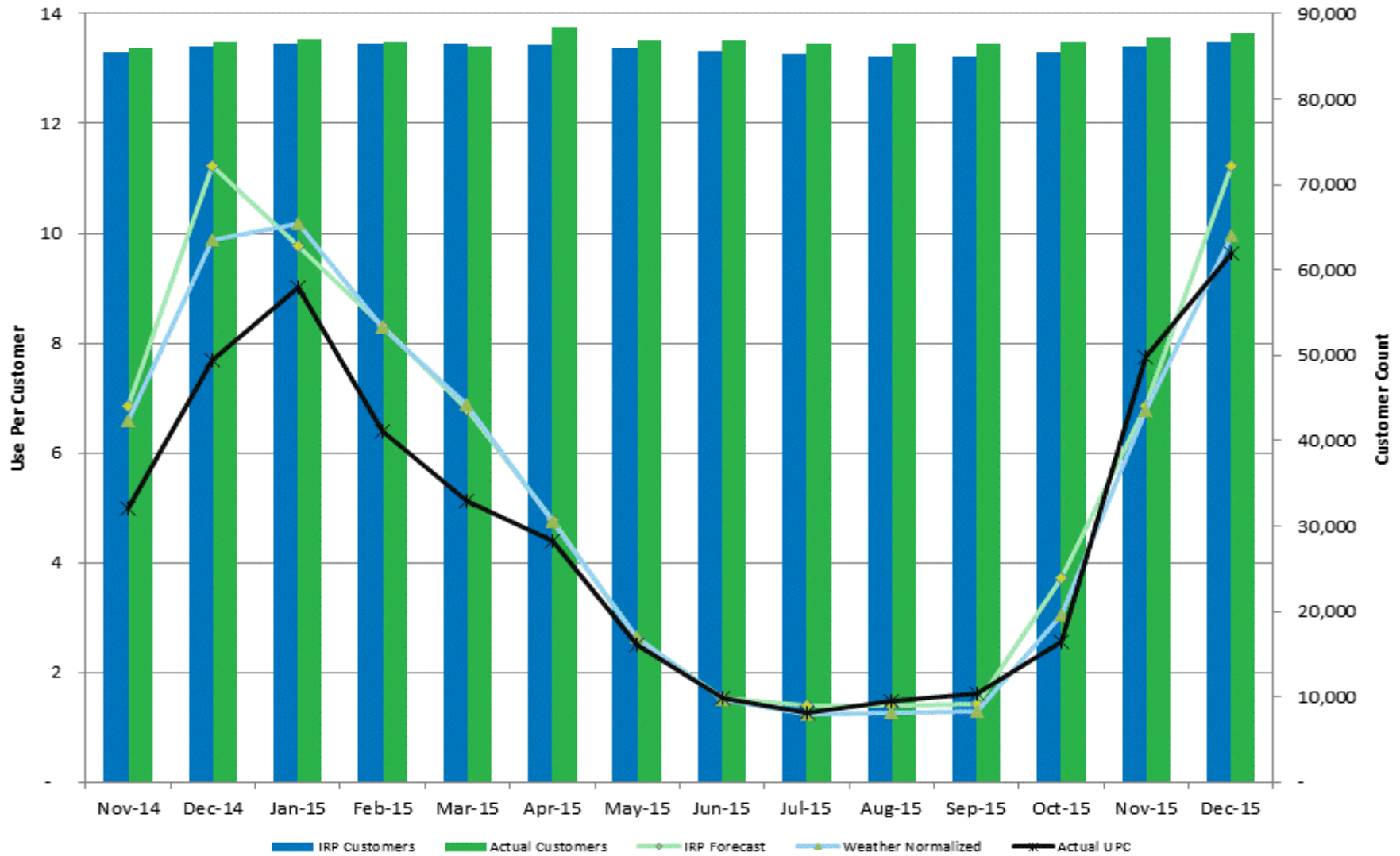



## Washington/Idaho IRP Forecast vs. Actual (Commercial Use per Customer and Customer Count)

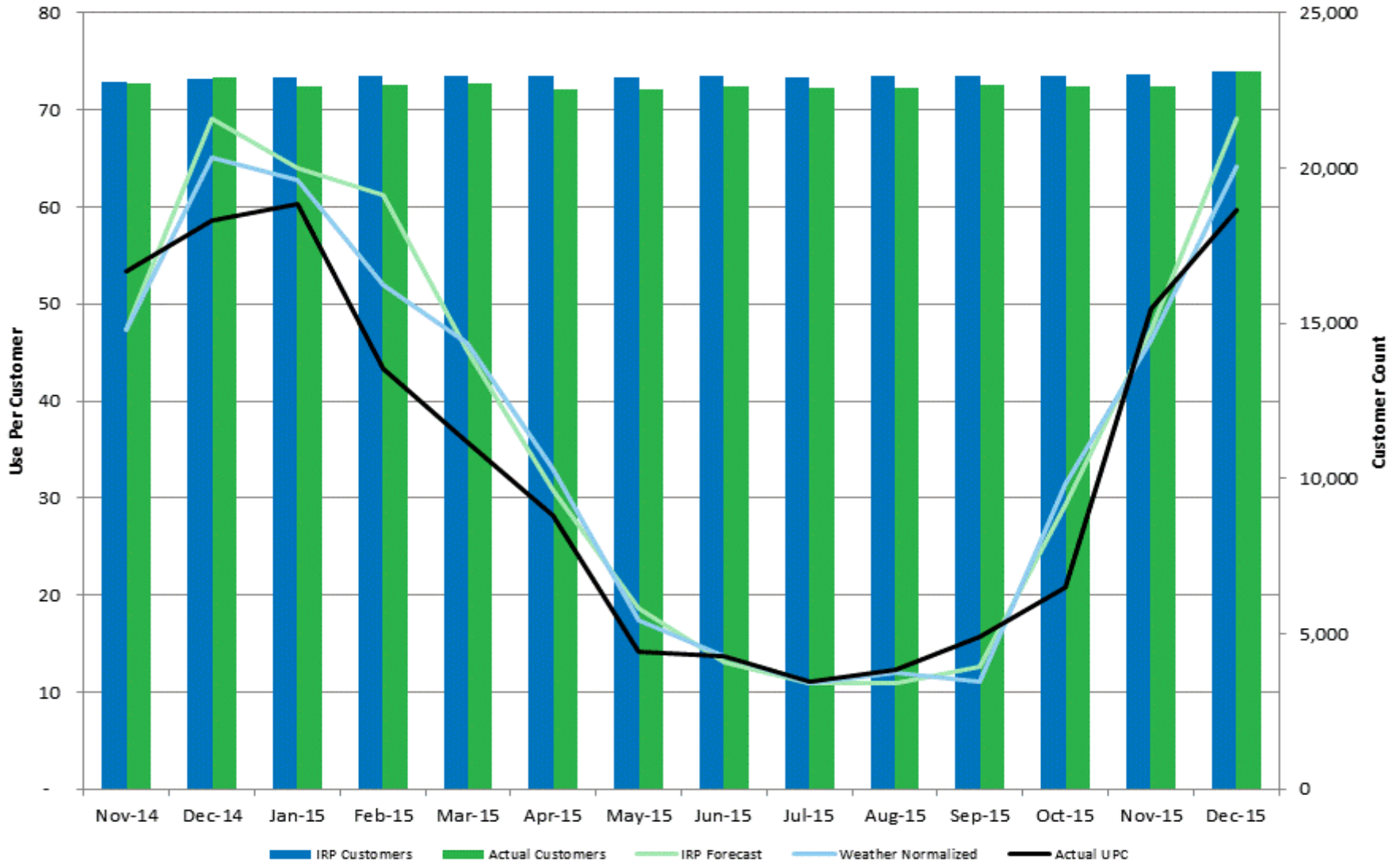

## Oregon IRP Forecast vs. Actual (Commercial Use per Customer and Customer Count)

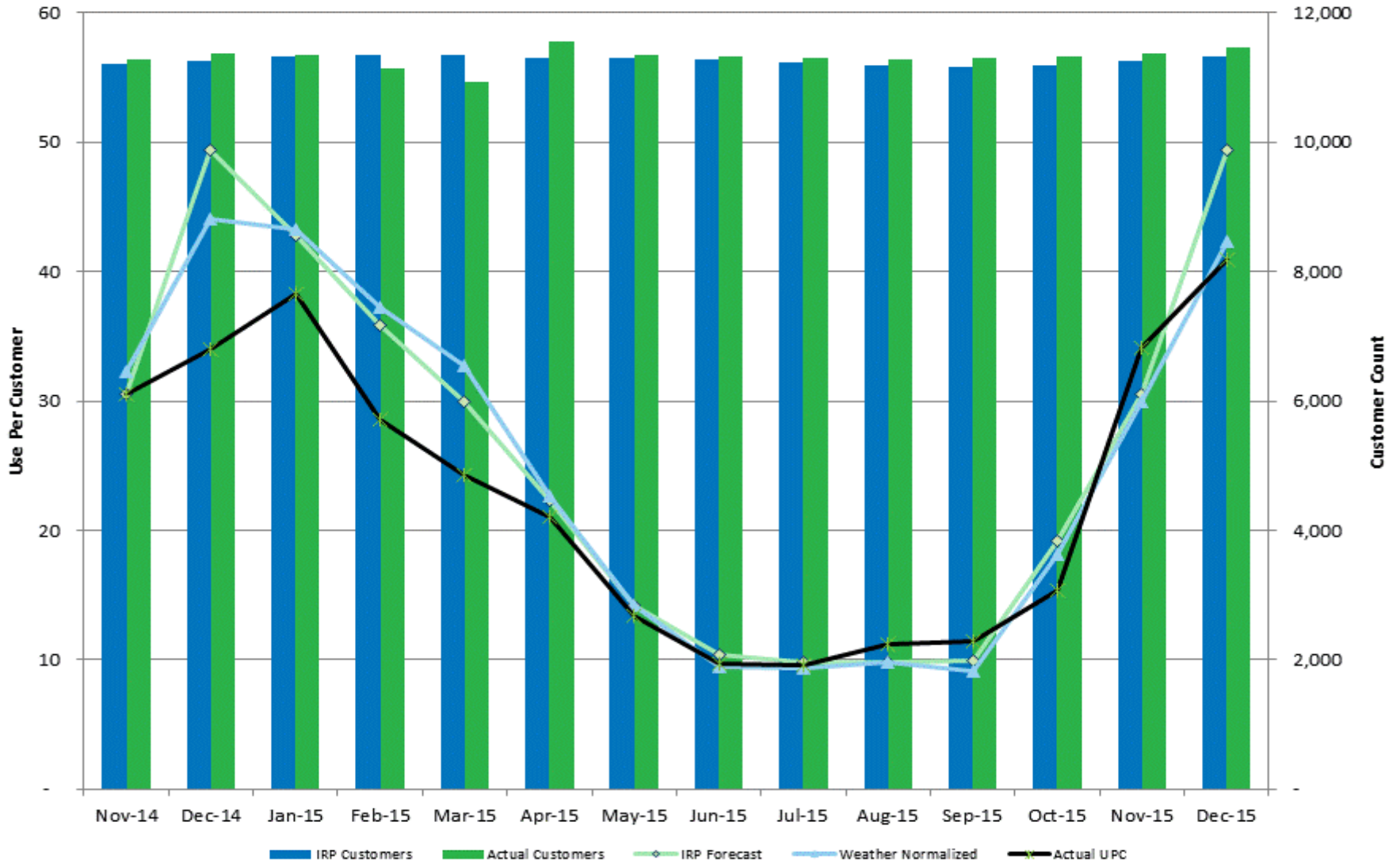

## Washington/Idaho IRP Forecast vs. Actual (Industrial Use per Customer and Customer Count)



## Oregon IRP Forecast vs. Actual (Industrial Use per Customer and Customer Count)

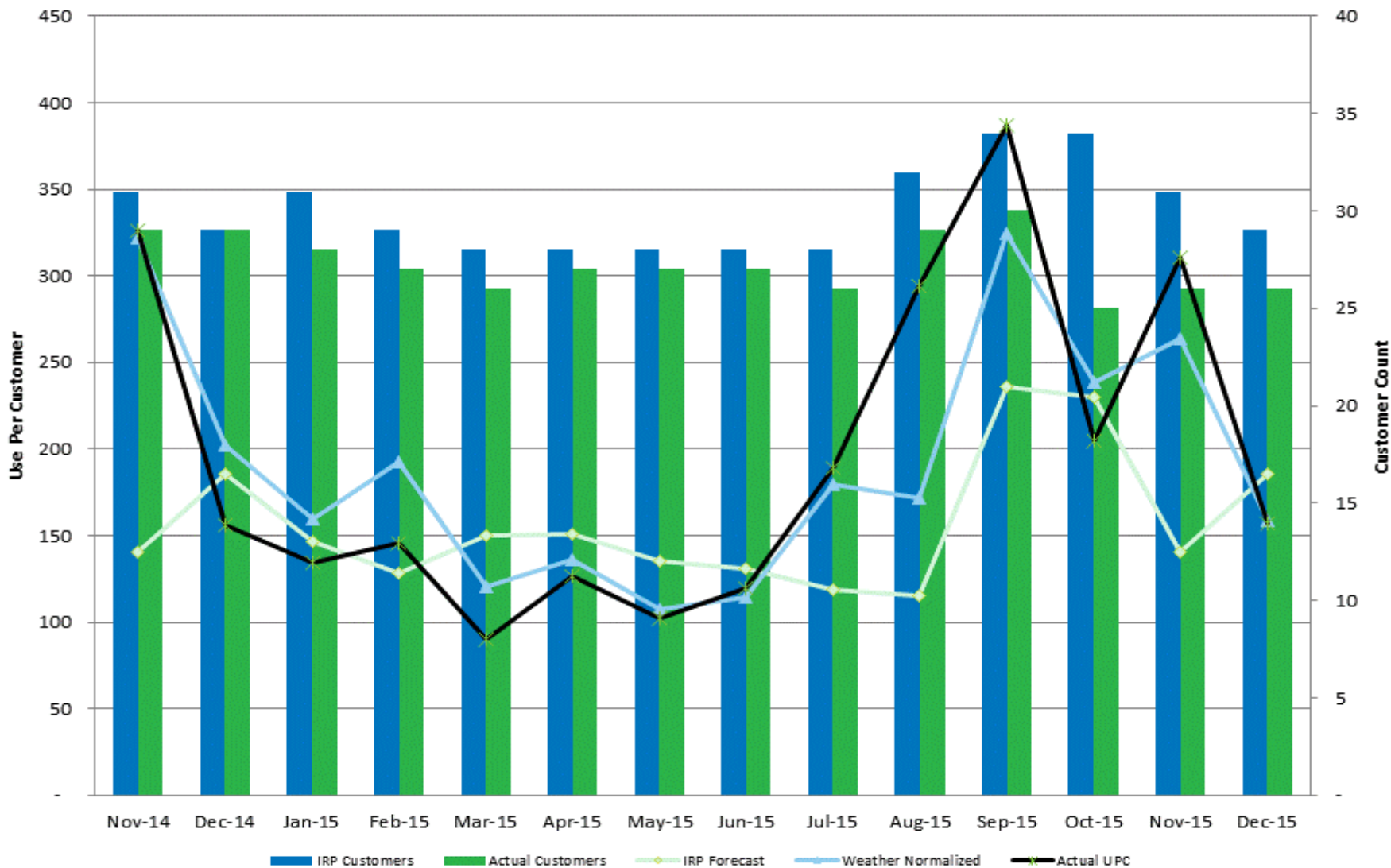

# Year First Unserved

## Scenario Comparisons

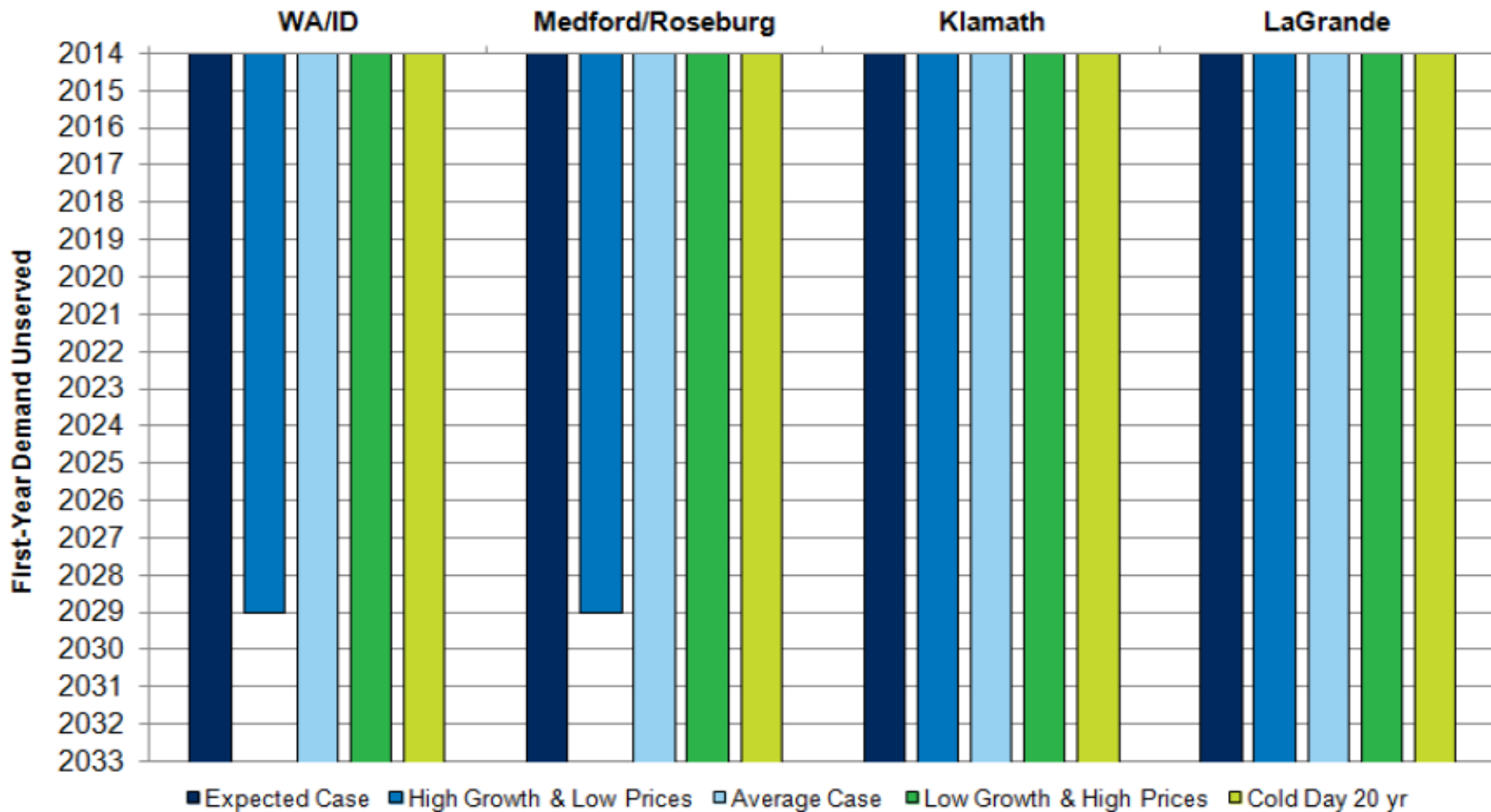

# Best Cost/Risk Resources

Figure 5: Expected Case – WA/ID Existing Resources vs. Peak Day Demand (Net of DSM)

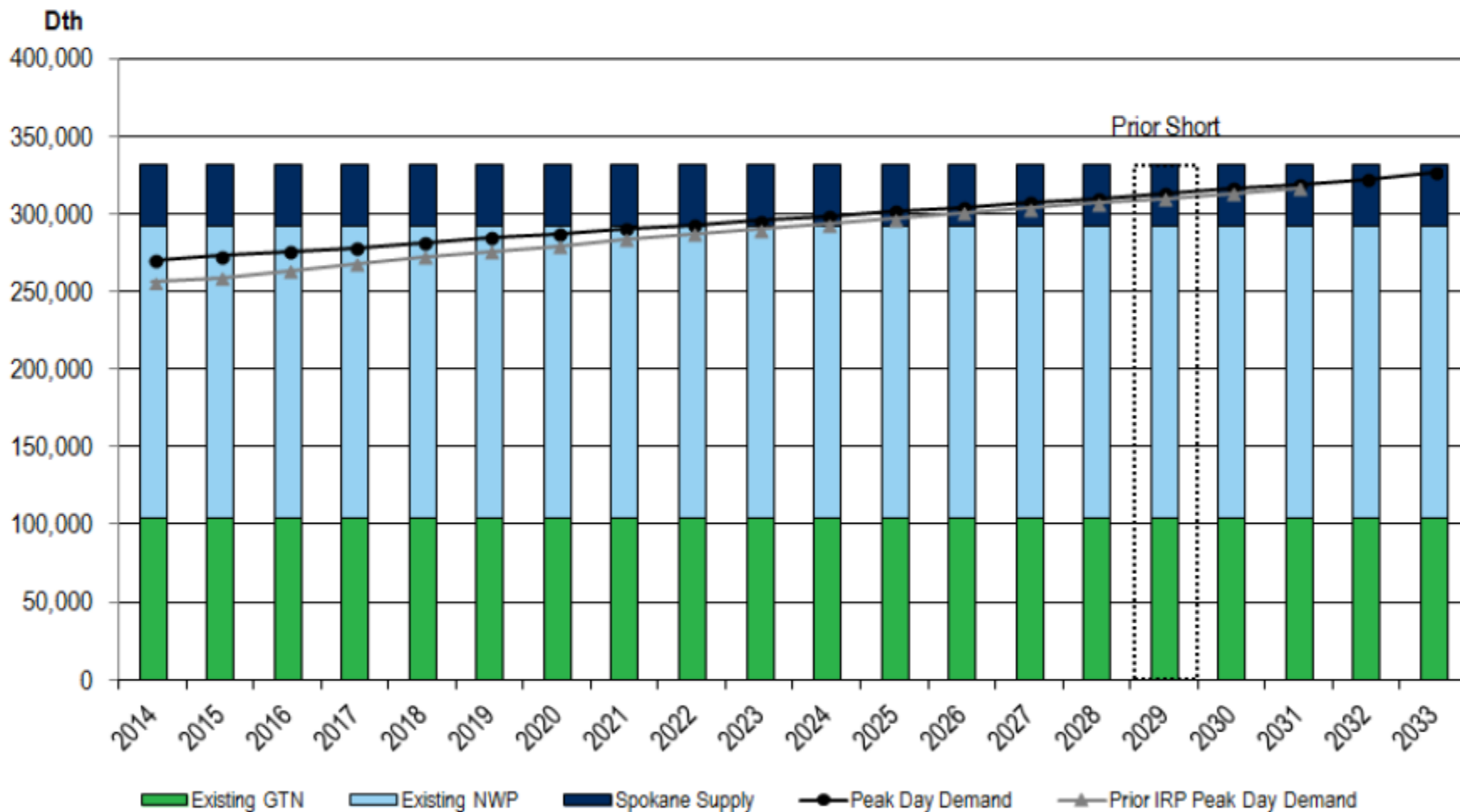

# Best Cost/Risk Resources

## Expected Case – Medford/Roseburg

**Figure 6: Expected Case – Medford/Roseburg Existing Resources vs. Peak Day Demand (Net of DSM)**

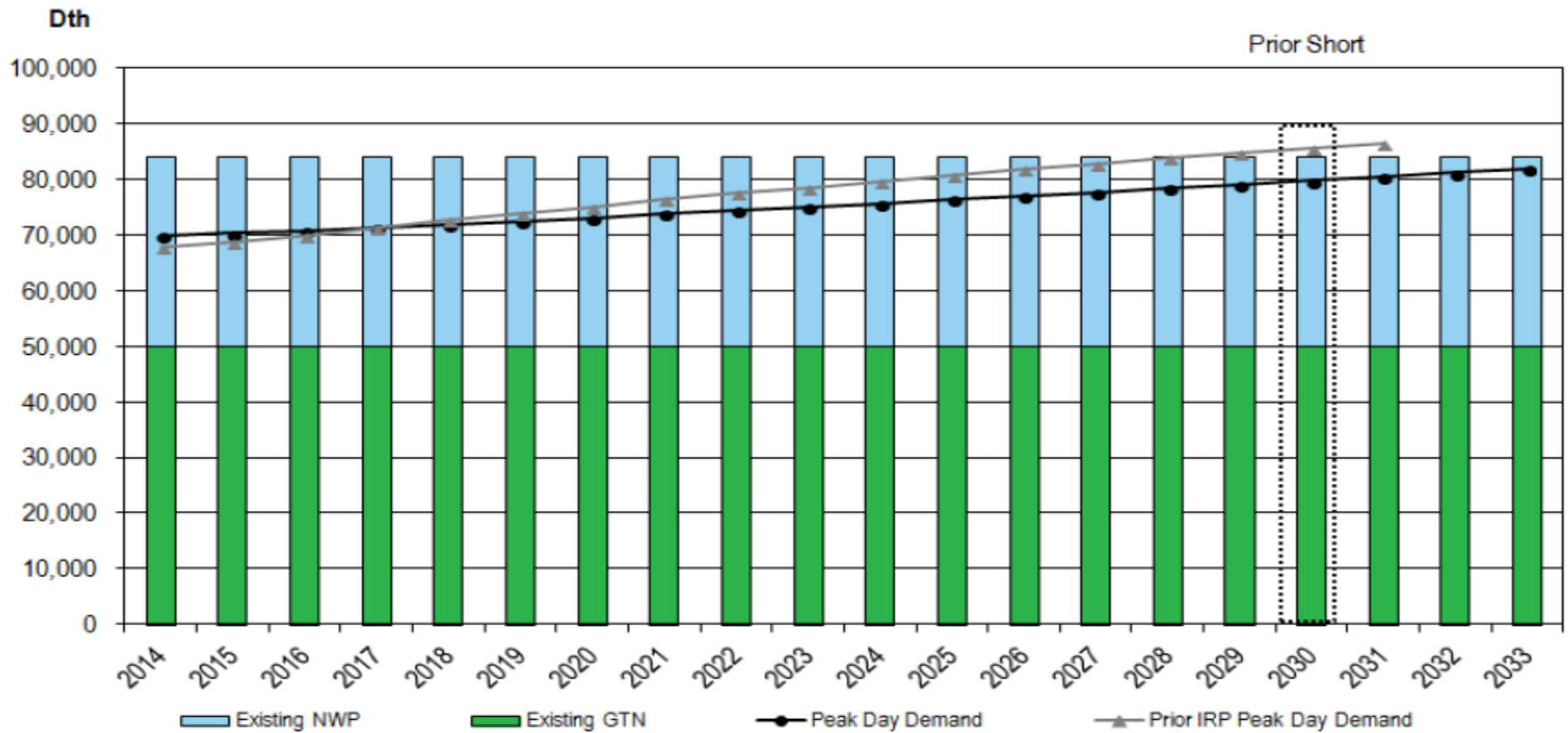

# Best Cost/Risk Resources

## Expected Case – Klamath Falls

Figure 7: Expected Case – Klamath Falls Existing Resources vs. Peak Day Demand (Net of DSM)

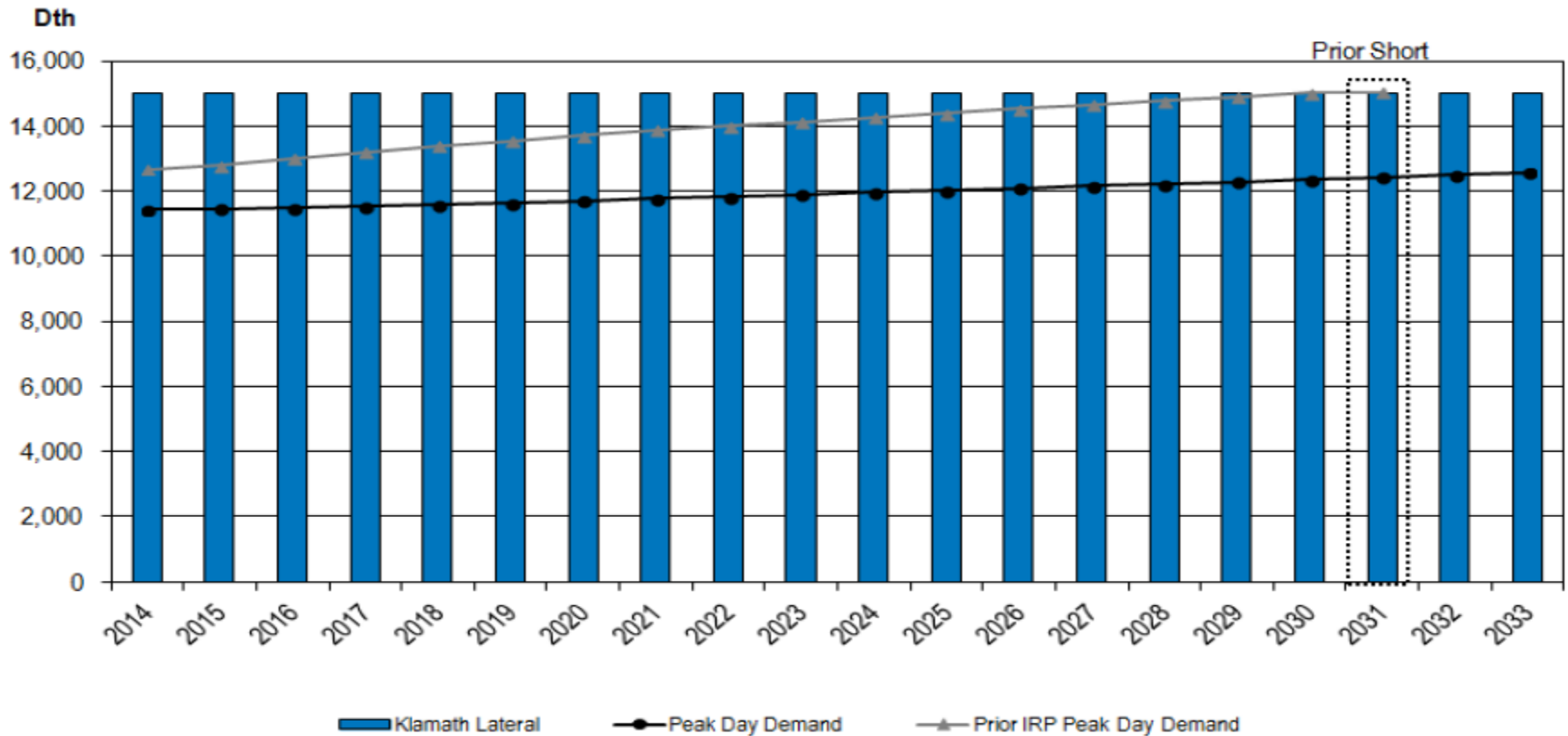



# Our Biggest Risk Last IRP

## “Flat Demand” Risk

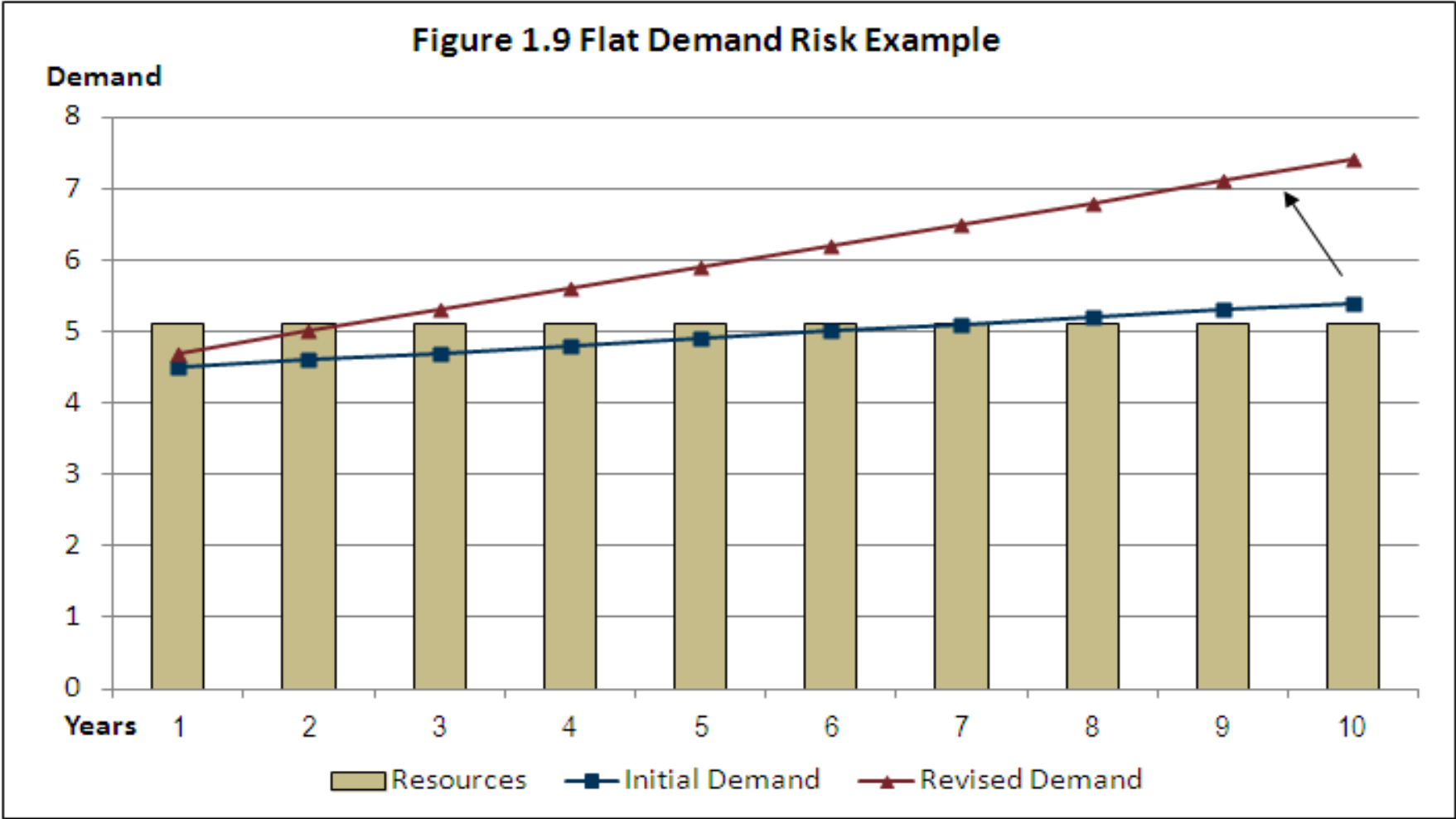

## Near Term Action Items

- Demand trend monitoring
- Demand side management cost effectiveness and targets
- Gate station analysis

## On-going Action Items

- Price elasticity study inquiry
- NGV/CNG and other demand potential
- Supply side resource trends/availability
- Meet regularly with Commission Staff



# Avista Natural Gas Forecasting

Grant D. Forsyth, Ph.D.  
Chief Economist  
[Grant.Forsyth@avistacorp.com](mailto:Grant.Forsyth@avistacorp.com)

# Load Forecasts-Two Step Process

- First, forecast customers (C) by month by schedule (s) by residential (r), commercial (c), industrial (i)—for example,  $C_{t,y,s,r}$
- Forecast use per customer (U) by month by schedule by class—for example,  $U_{t,y,s,r}$
- Load forecast (L) is the product of the two:

$$L_{t,y,s,r} = C_{t,y,s,r} \times U_{t,y,s,r}$$

For weather sensitive schedules a 20-yr MA defines normal weather.

# The Basic Forecast Approach

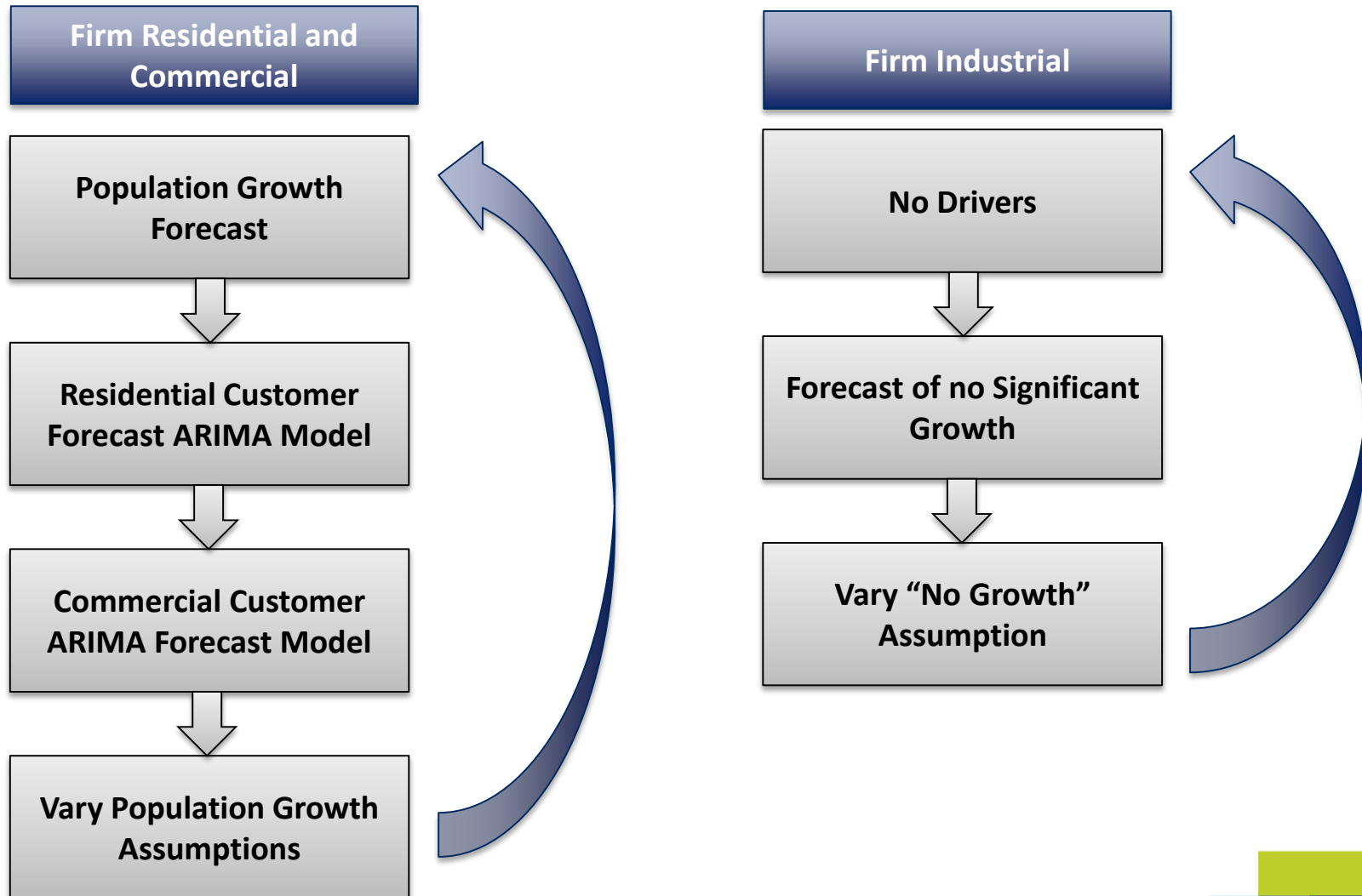

# System Industrial Customers, 2004-2015

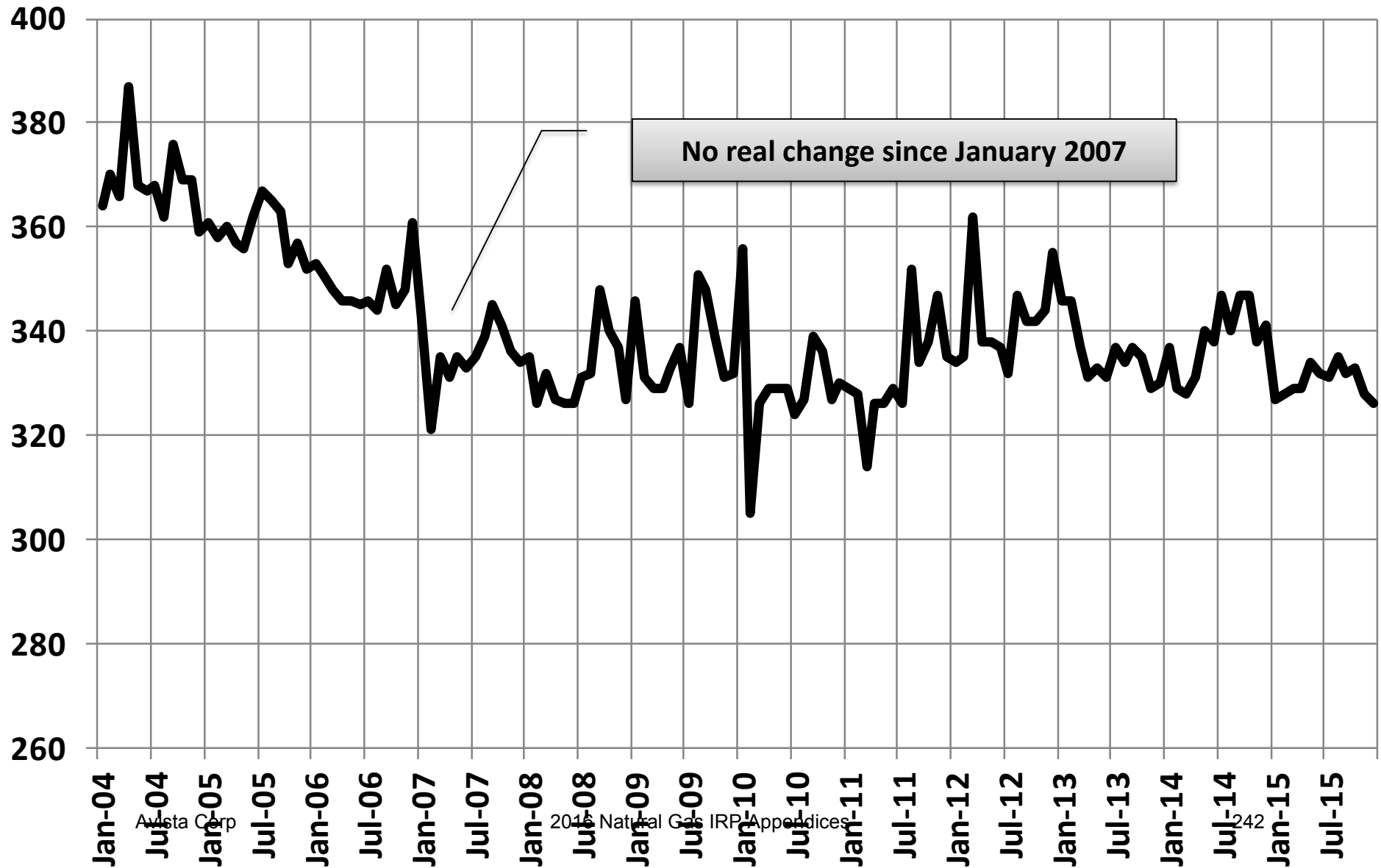

# Getting to Population as a Driver, 2016-2021 & 2022-2035

2016-2021 For Spokane, WA; Kootenai, ID, and Jackson, OR counties

**Average GDP Growth Forecasts:**

- IMF, FOMC, Bloomberg, etc.
- Average forecasts out 5-yrs.

GDP

**Non-farm Employment Growth Model:**

- Model links year y, y-1, and y-2 GDP growth to year y regional employment growth.
- Forecast out 5-yrs.
- Averaged with GI forecasts.

EMP

**Regional Population Growth Models:**

- Model links regional, U.S., and CA year y-1 employment growth to year y county population growth.
- Forecast out 6-yrs for Spokane, WA; Kootenai, ID; and Jackson, OR.
- Averaged with IHS forecasts.
- Growth rates used to generate population forecasts for customer forecasts for residential schedules 101 and 410.

Kootenai and Jackson: IHS population growth forecasts for 2022-2035

Spokane: OFM population growth forecasts for 2022-2035

OR Douglas, Klamath, and Douglas counties: IHS population growth forecasts for 2016-2035

Interpolation assumes:  $P_N = P_0 e^{rN}$

# The Relationship Between Classes

Residential customer growth is approximately equal to population growth in the long-run.

Commercial customer growth is highly correlated with residential growth in the long-run.

Year-over-year Growth, Gas Correlations by Class, Jan. 2006-May 2013

Customers	Residential	Commercial	Industrial		Load	Residential	Commercial	Industrial
Residential	1.00				Residential	1.00		
Commercial	0.83	1.00			Commercial	0.94	1.00	
Industrial	-0.44	-0.35	1.00		Industrial	0.33	0.34	1.00

Industrial's correlation to residential is lower and negative. Customer numbers stable or slightly declining.



# WA-ID Region Firm Customers: 2016 IRP and 2014 IRP

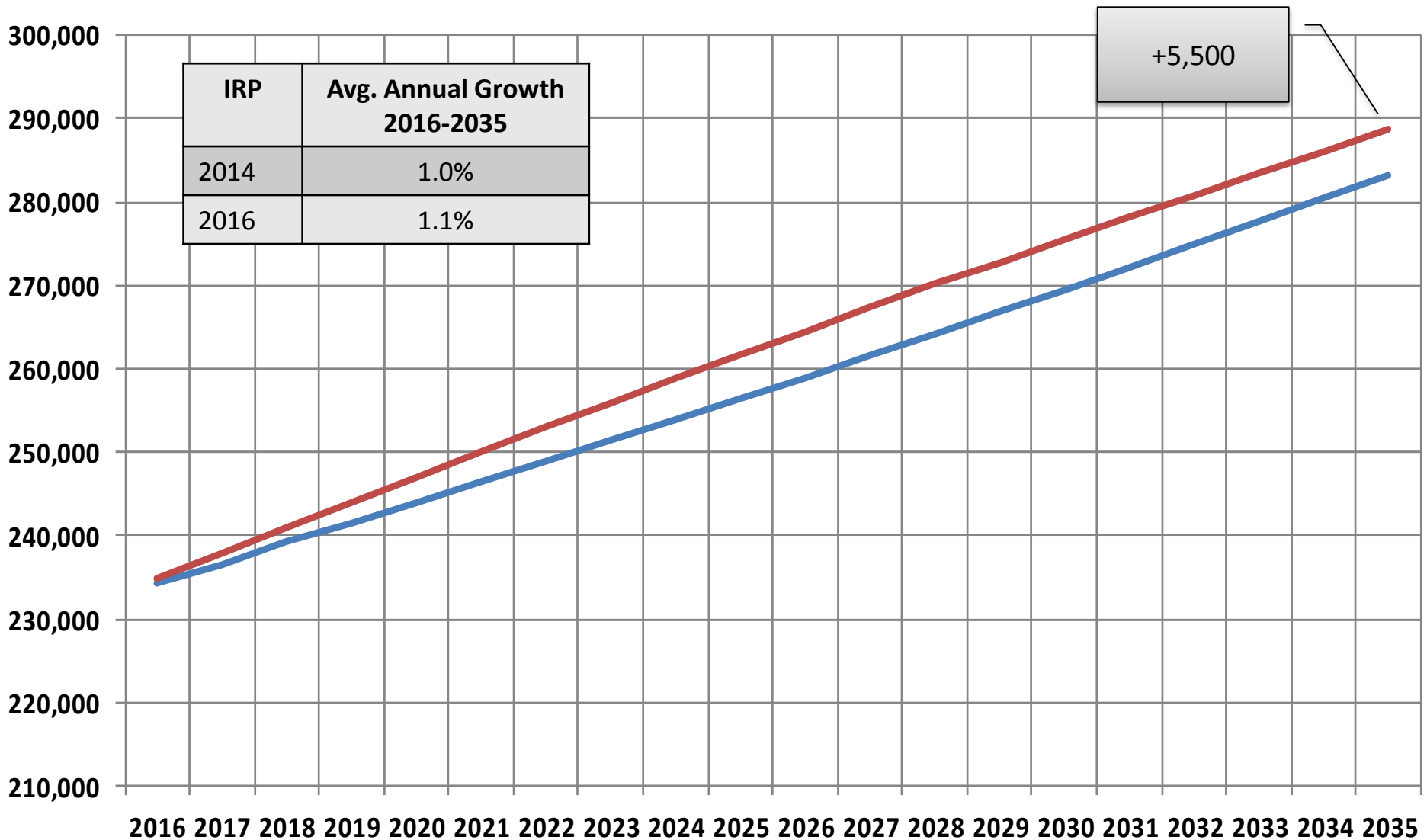

IRP	Avg. Annual Growth 2016-2035
2014	1.0%
2016	1.1%

+5,500

# OR Region Firm Customers: 2016 IRP and 2014 IRP

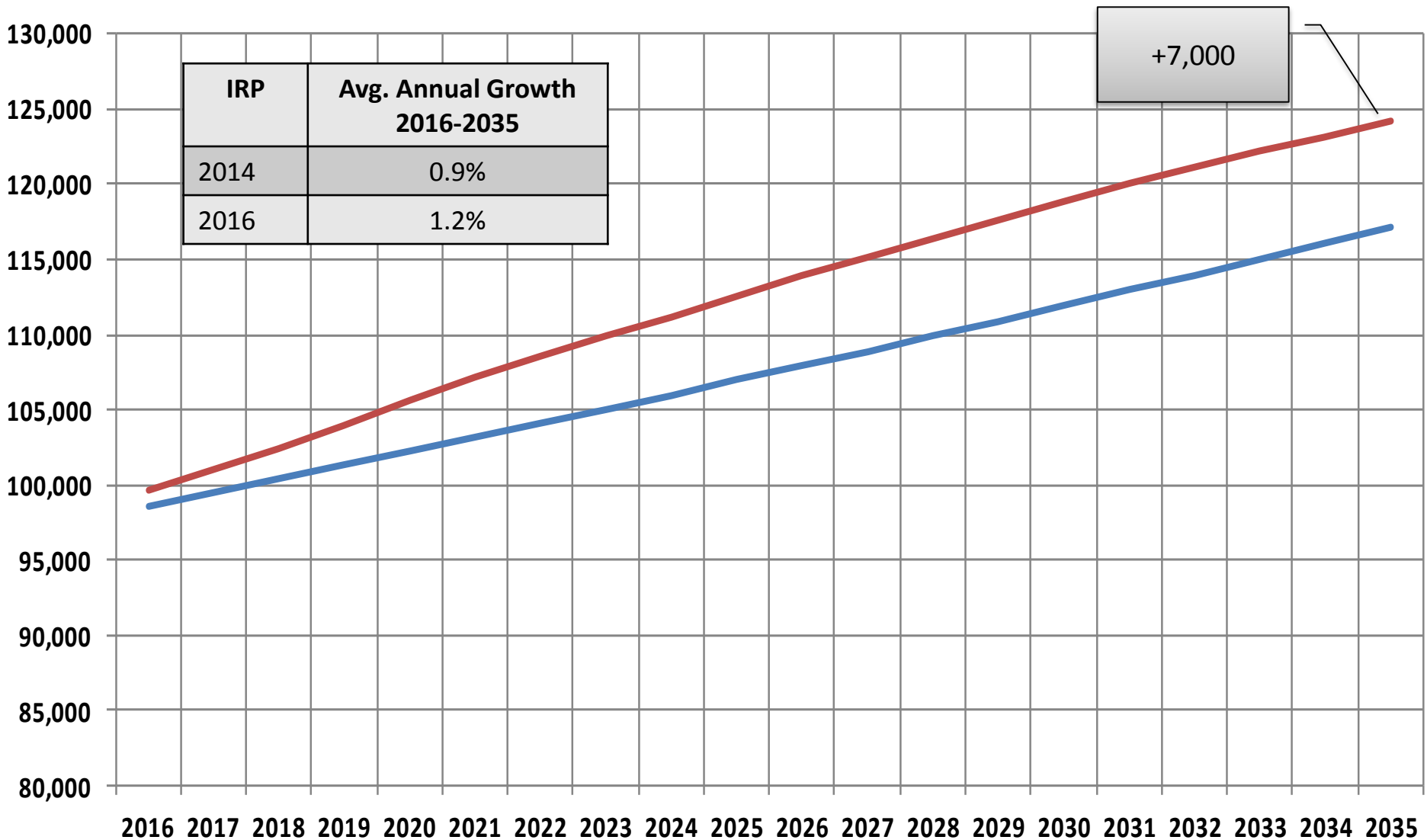

# System Firm Customers: 2016 IRP and 2014 IRP

IRP	Avg. Annual Growth 2016-2035
2014	1.0%
2016	1.1%

+12,500

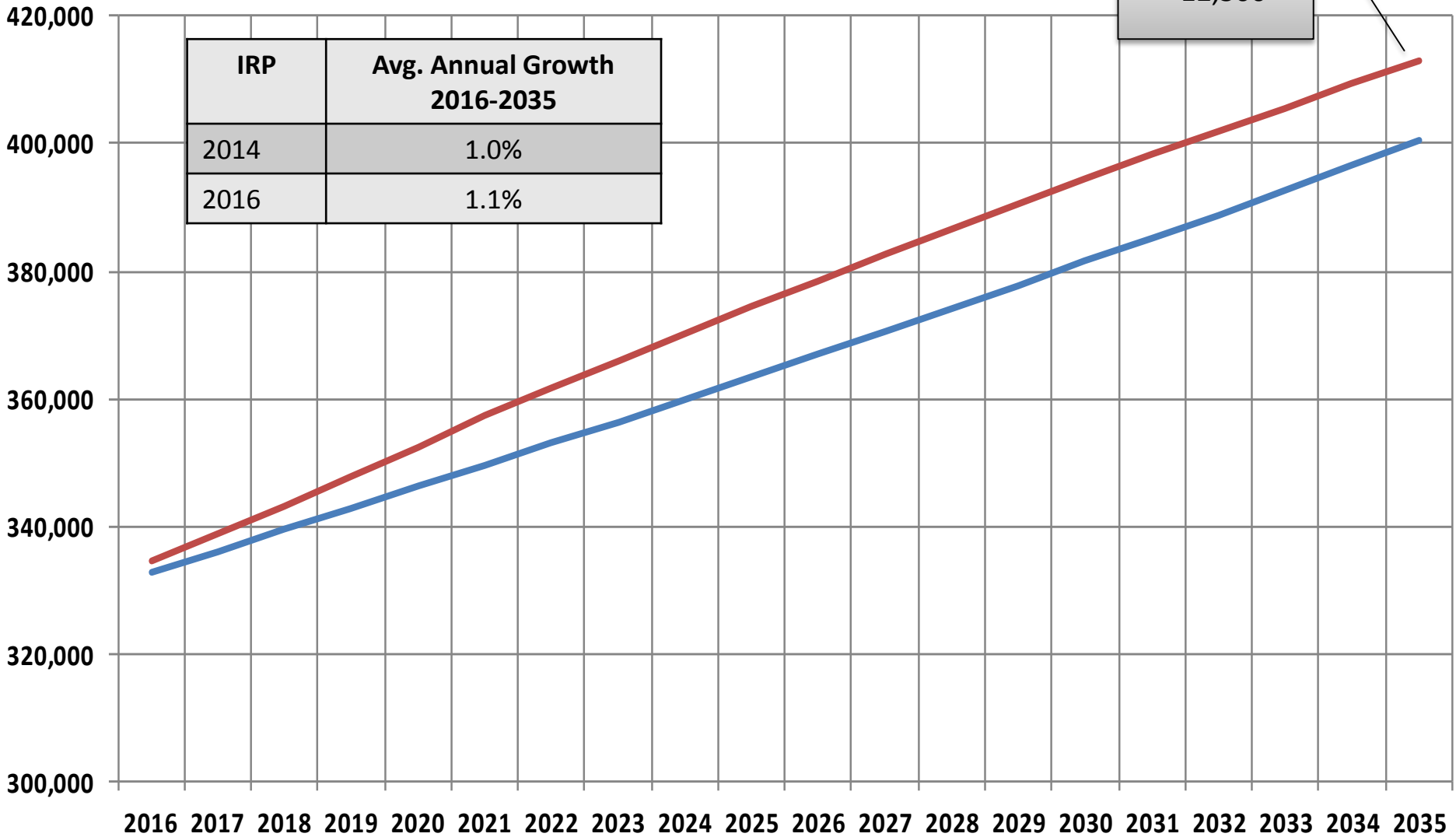

# WA-ID Region Firm Customer Range, 2016-2035

Variable	Low Growth	Base Growth	High Growth
Customers	0.6%	1.1%	1.5%
WA Population	0.4%	0.8%	1.2%
ID Population	1.0%	1.5%	2.0%
WA-ID Population	0.6%	1.0%	1.4%

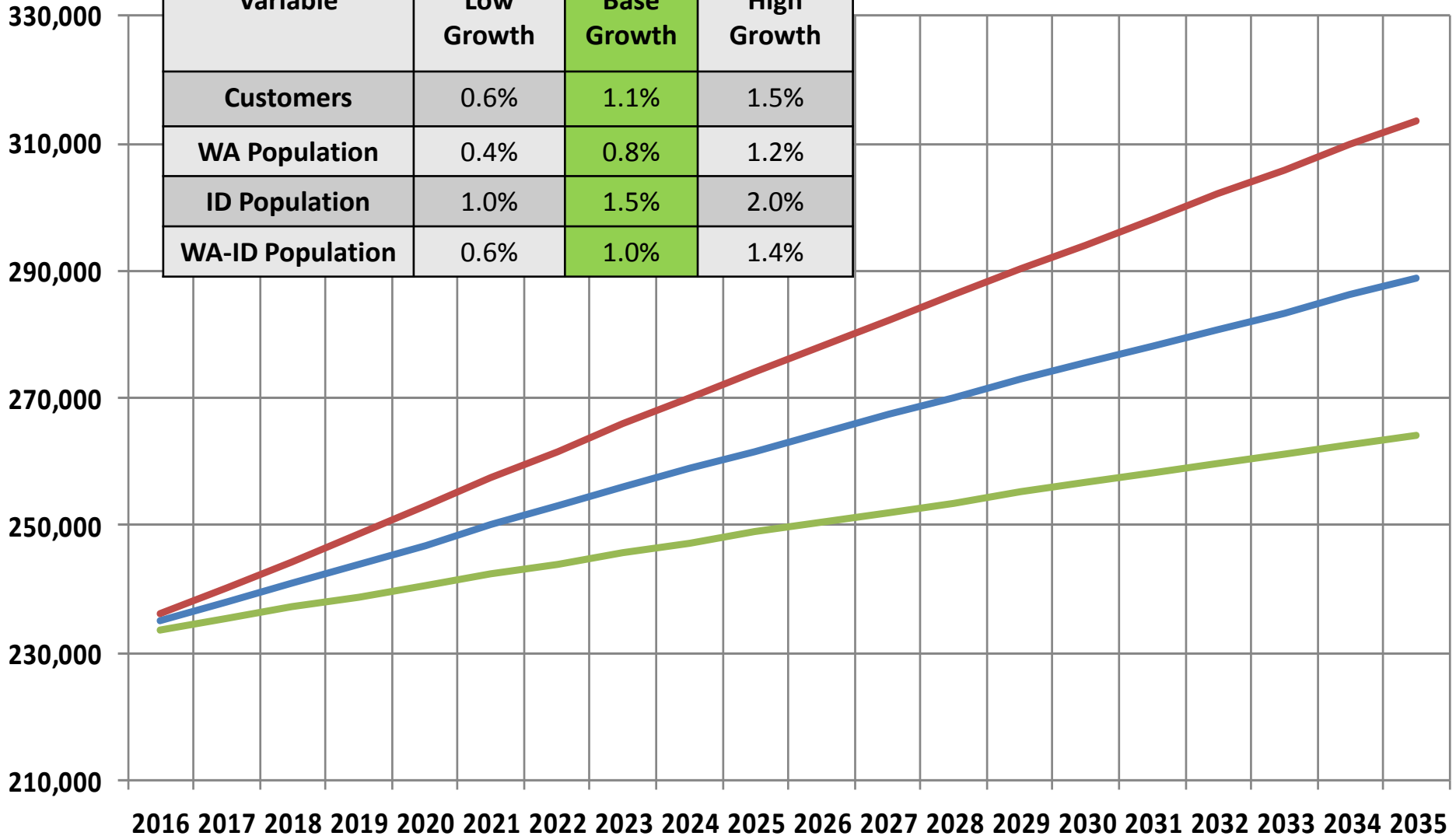

# OR Region Firm Customer Range, 2016-2035

Variable	Low Growth	Base Growth	High Growth
Customers	0.7%	1.2%	1.6%
Population	0.4%	0.8%	1.3%

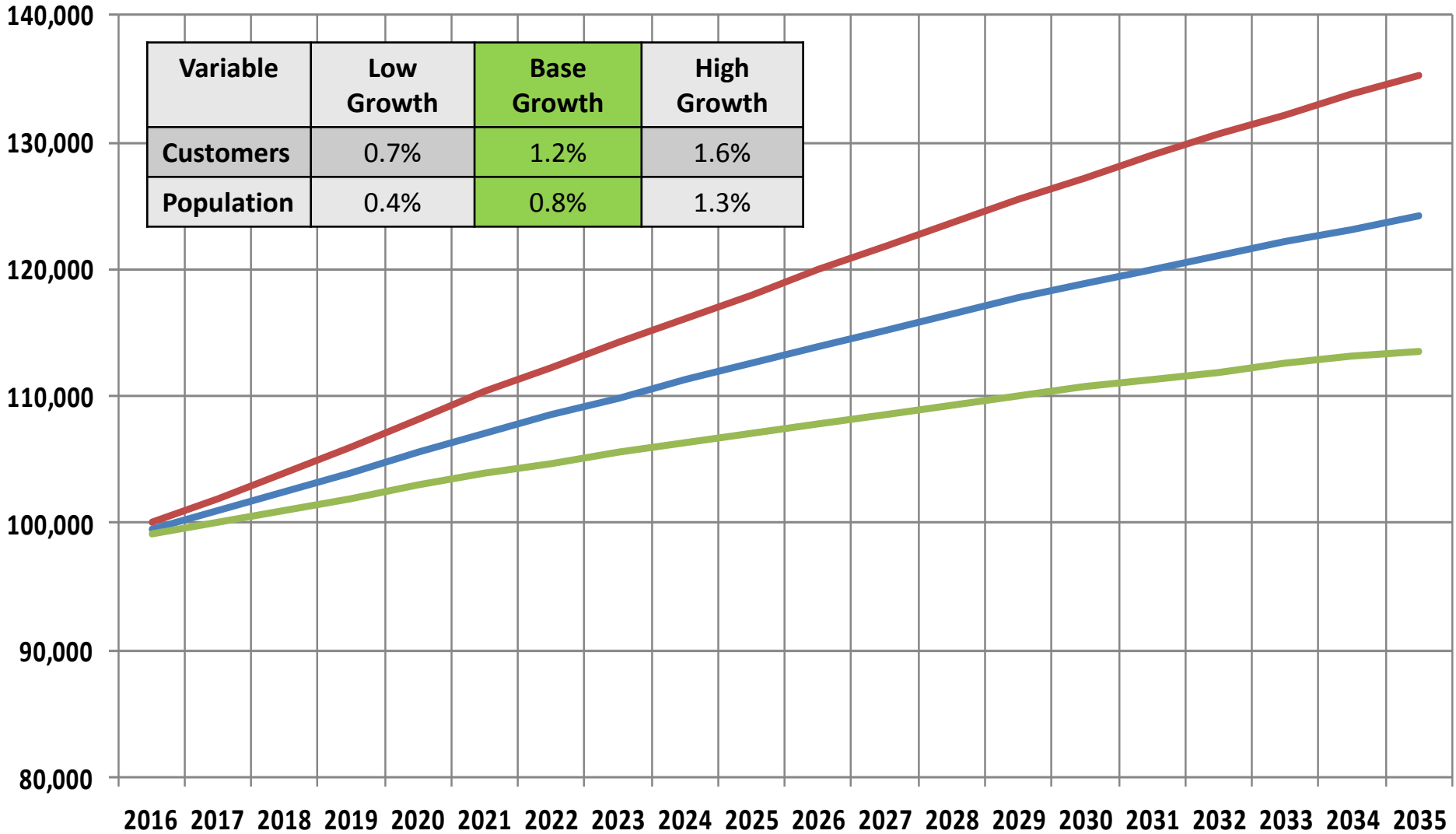

# System Firm Customer Range, 2016-2035

Variable	Low Growth	Base Growth	High Growth
Customers	0.7%	1.1%	1.5%
Population	0.5%	0.9%	1.3%

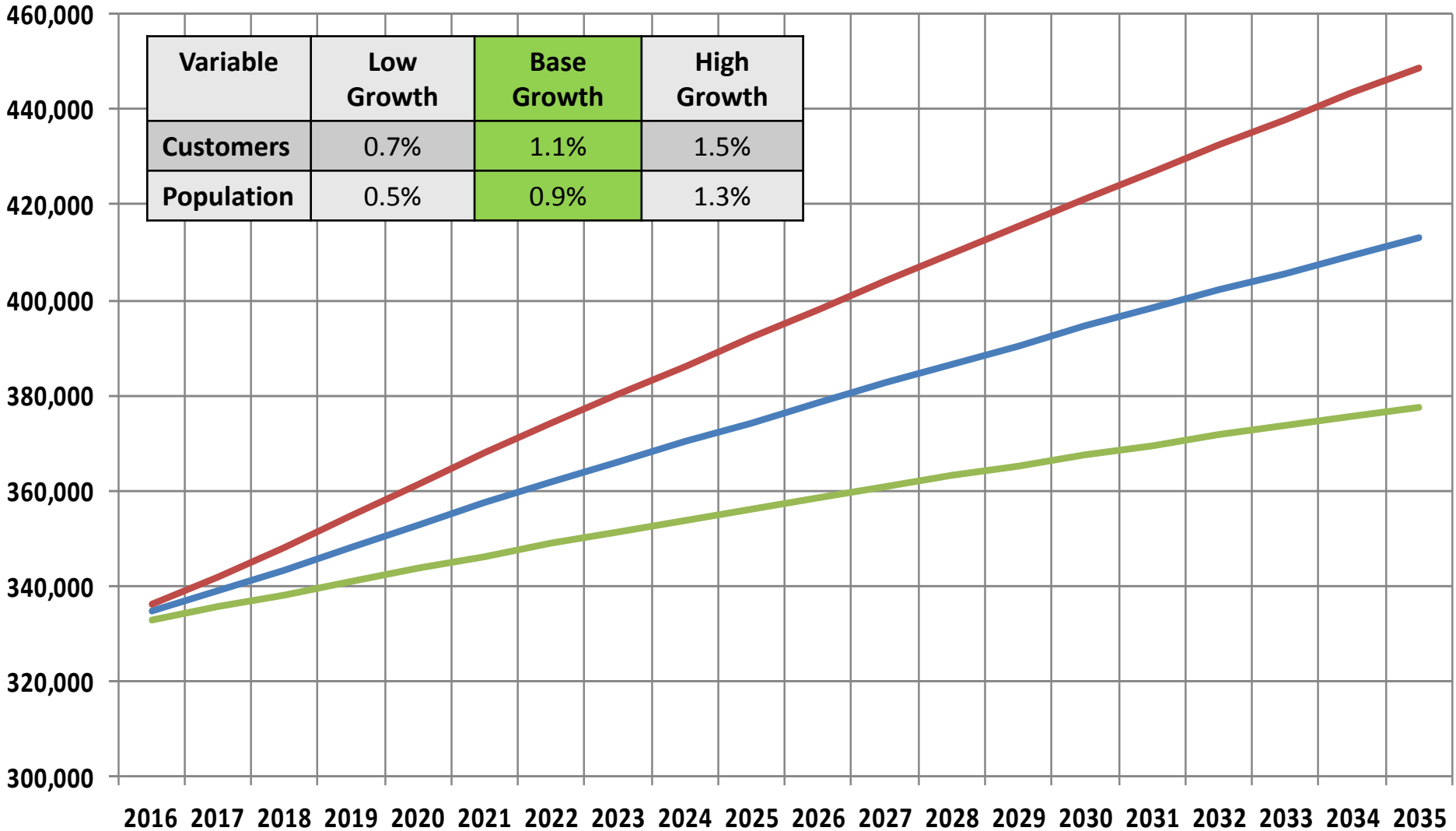

# Summary of Growth Rates

System	Base-Case	High	Low
Res	1.2%	1.6%	0.7%
Com	0.7%	1.1%	0.2%
Ind	0.0%	0.4%	-0.4%
<b>Total</b>	<b>1.1%</b>	<b>1.5%</b>	<b>0.7%</b>
<b>WA</b>			
Base-Case	High	Low	
Res	1.0%	1.4%	0.6%
Com	0.7%	1.1%	0.3%
Ind	0.0%	0.3%	-0.2%
<b>Total</b>	<b>1.0%</b>	<b>1.4%</b>	<b>0.6%</b>
<b>ID</b>			
Base-Case	High	Low	
Res	1.4%	1.8%	0.9%
Com	0.4%	0.9%	-0.1%
Ind	0.0%	0.3%	-0.3%
<b>Total</b>	<b>1.3%</b>	<b>1.7%</b>	<b>0.8%</b>
<b>OR</b>			
Base-Case	High	Low	
Res	1.2%	1.6%	0.8%
Com	0.8%	1.2%	0.3%
Ind	0.0%	1.1%	-1.4%
<b>Total</b>	<b>1.2%</b>	<b>1.6%</b>	<b>0.7%</b>



# Demand Forecast Methodology

Tom Pardee  
Manager of Natural Gas Planning



# Natural Gas Demand Forecasting

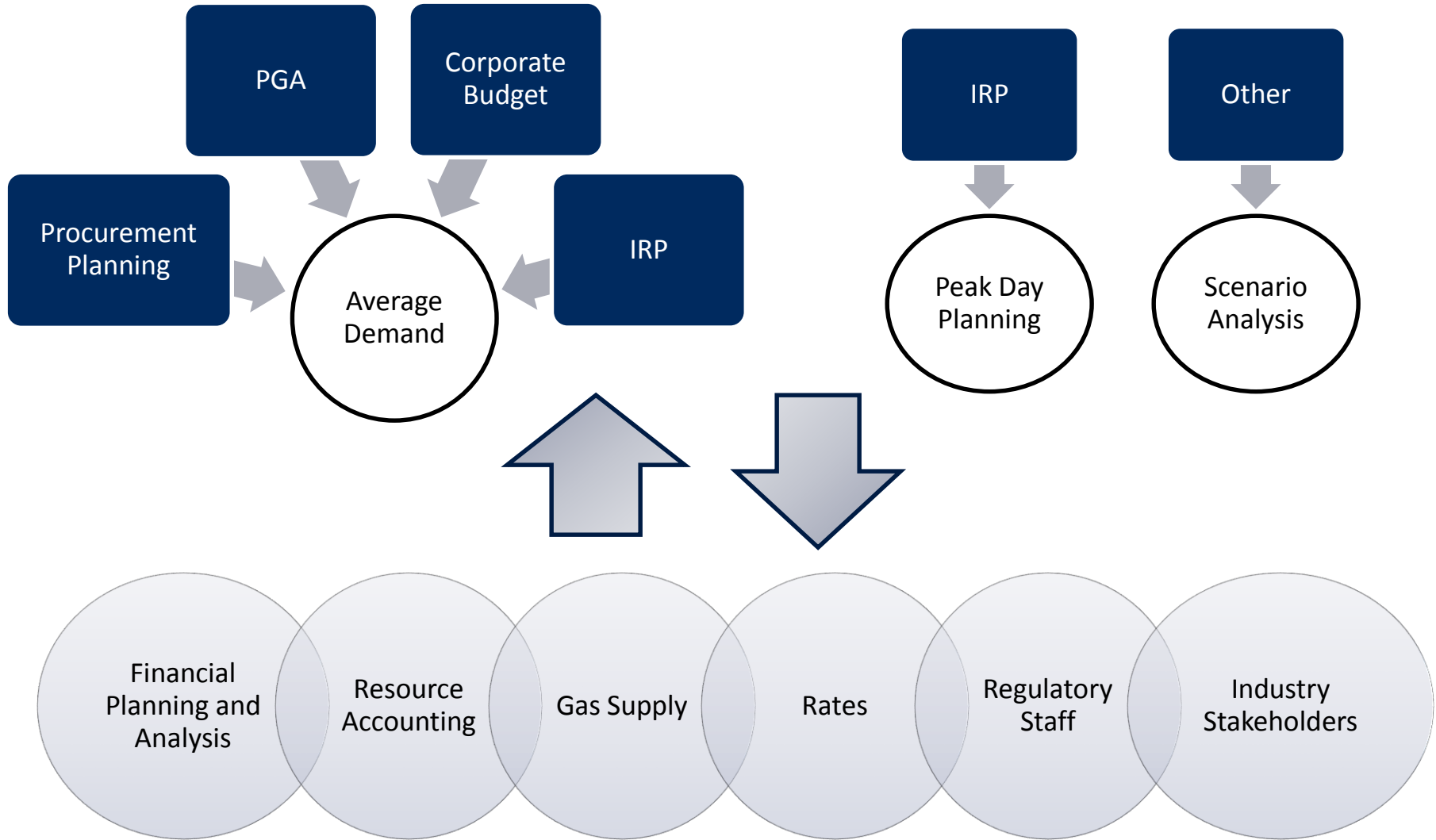

# What goes into the Natural Gas Demand Forecast?

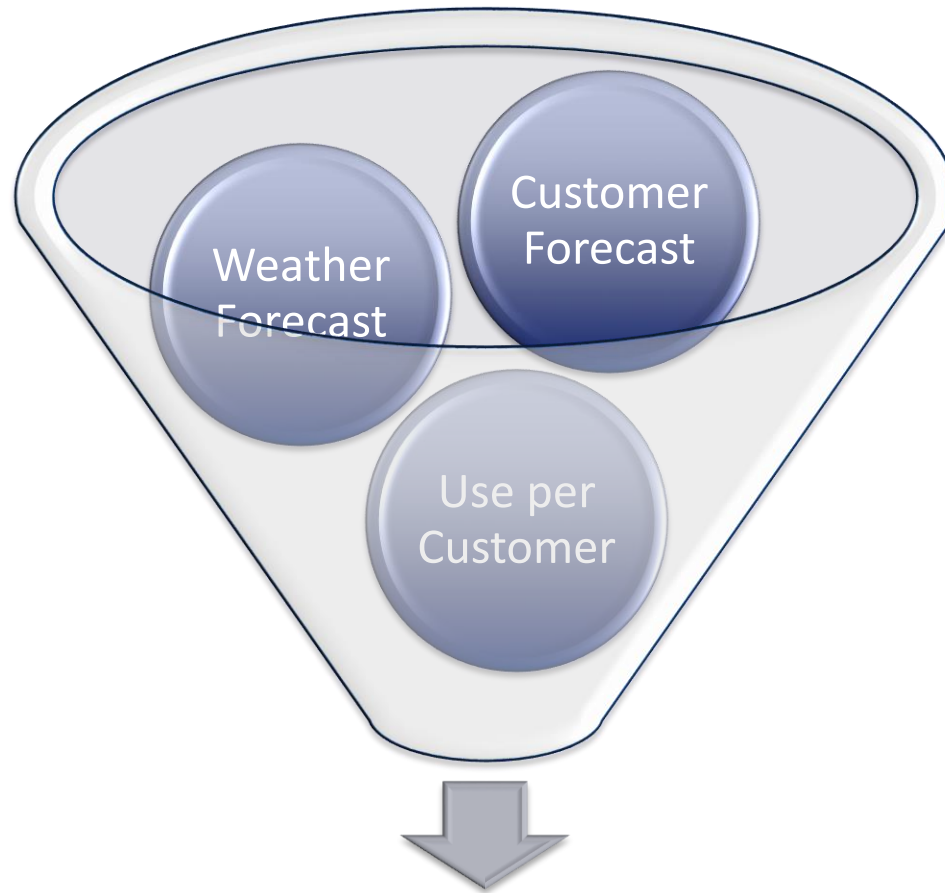

Natural Gas Demand Forecast

# The Customer Forecast

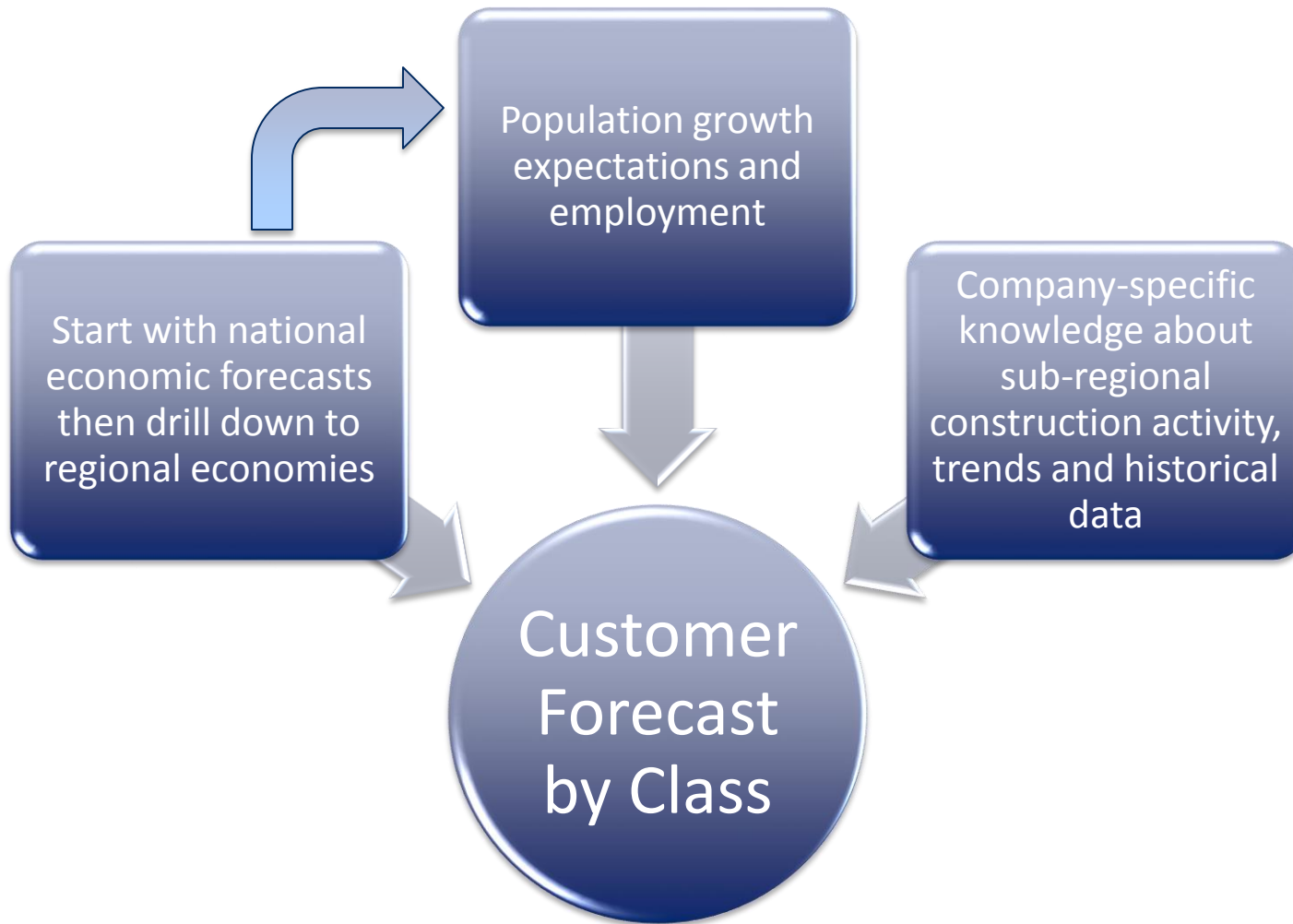

# The Weather Forecast

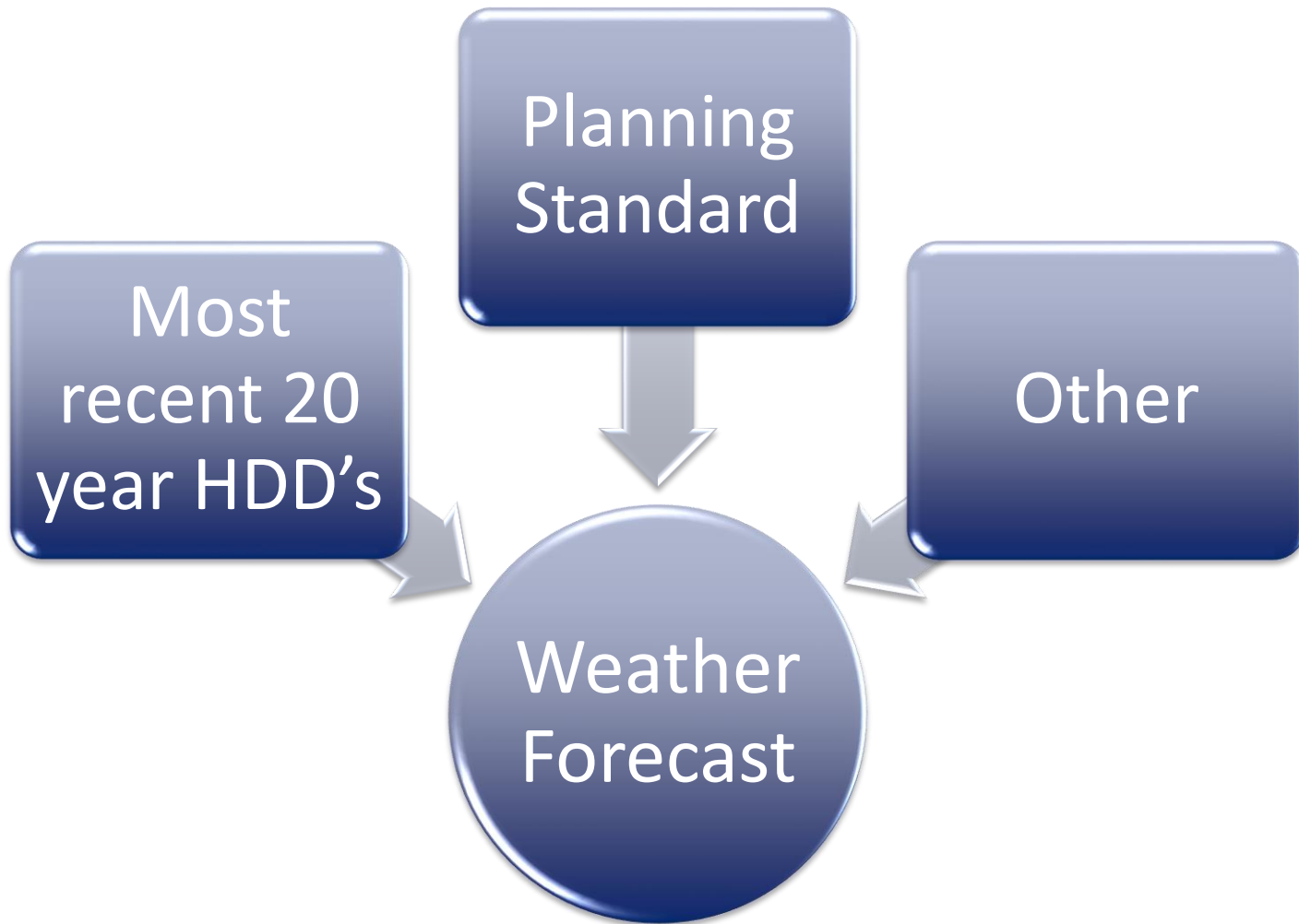

# Weather

- NOAA 20 year actual average daily HDD's (1996-2015)
- Peak weather includes two winter storms (5 day duration), one in December and one in February
- Planning Standard – coldest day on record
- Sensitivity around planning standard including
  - Normal/Average
  - Coldest in 20 years
  - Monte Carlo simulation

# The Use per Customer Forecast

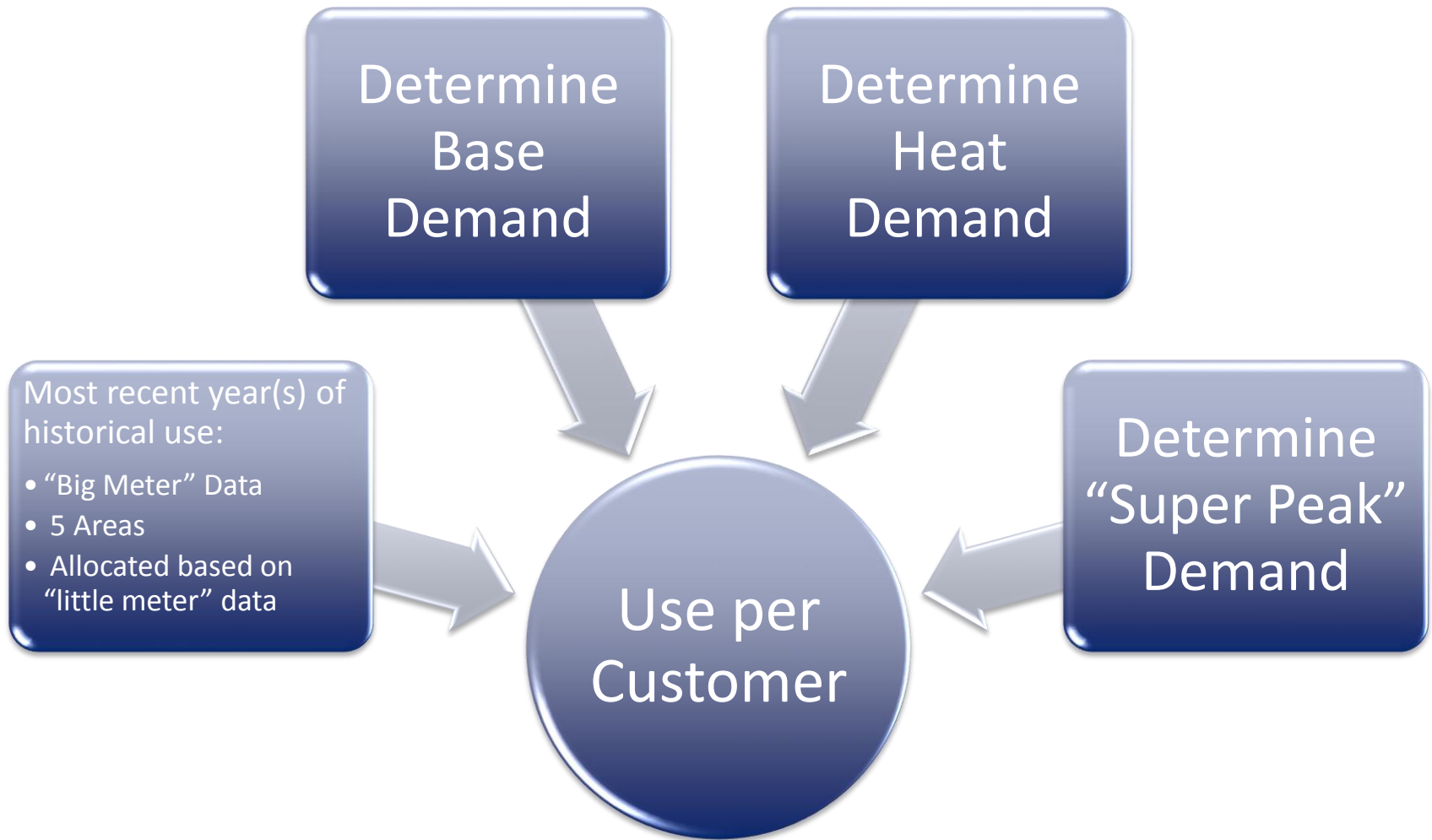

# The Use per Customer Forecast cont.

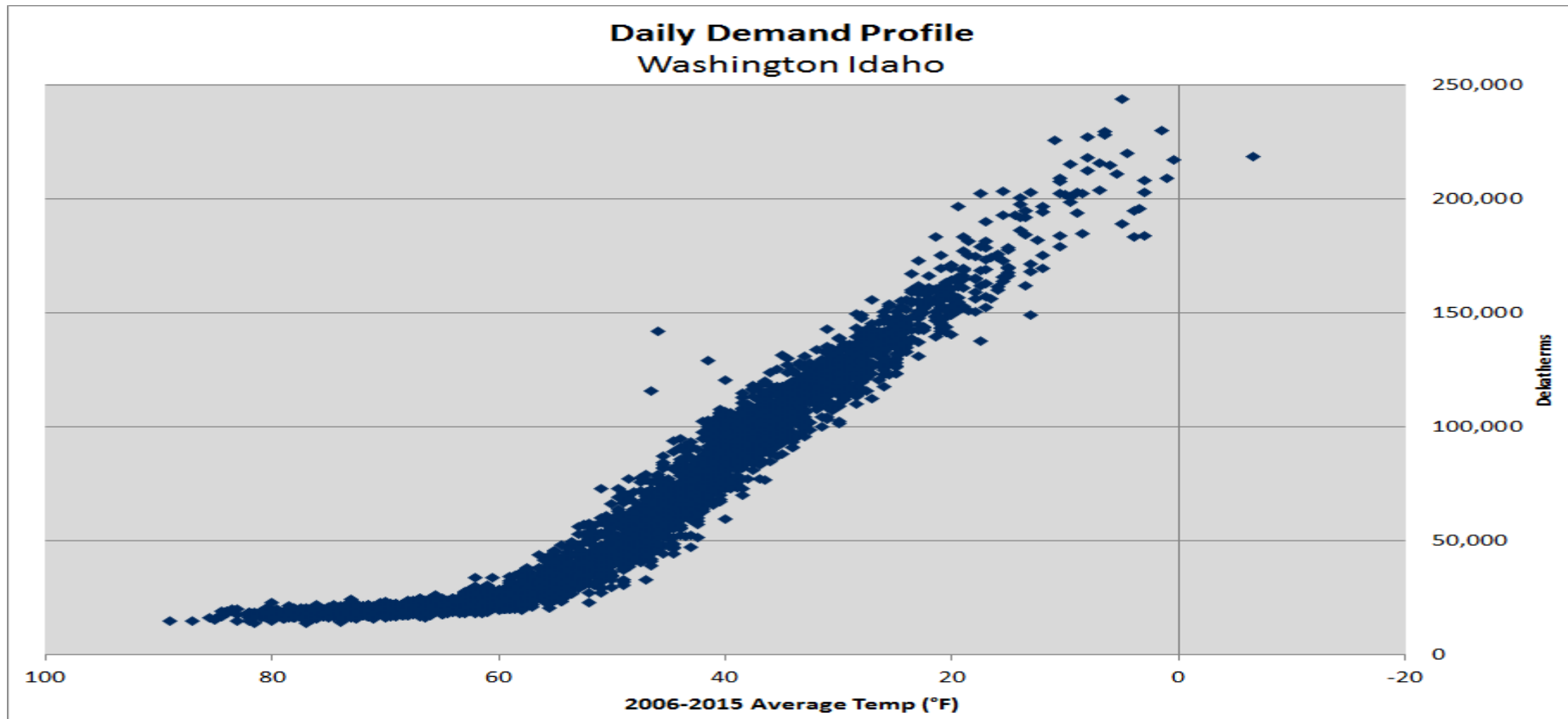

- Historical data is used to determine initial base and heat coefficients.
- Adjustments are made to incorporate DSM and price elastic responses.

# Use per Customer per HDD WA/ID Residential

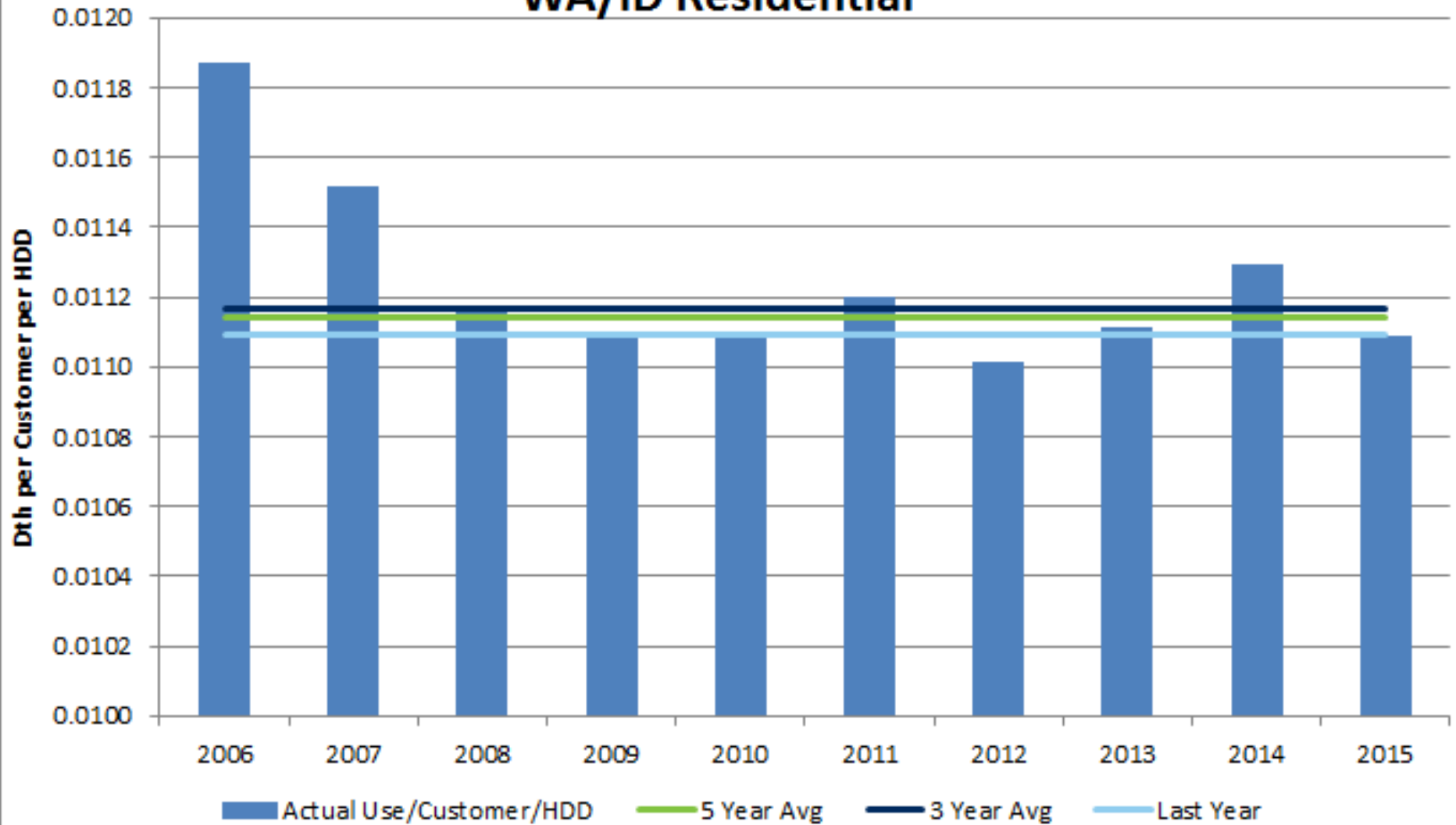



## Use per Customer per HDD Medford Residential

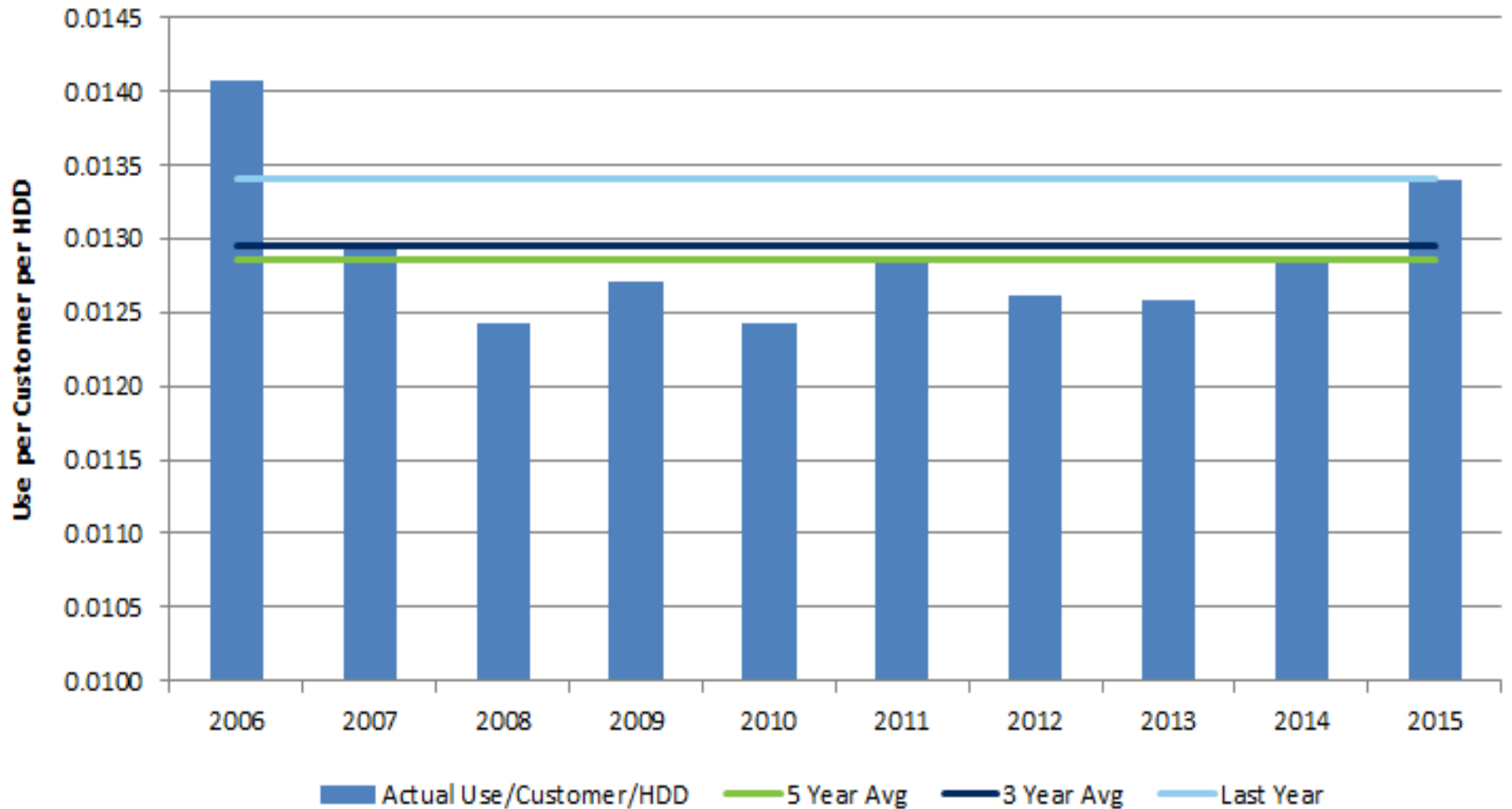

# Use per Customer per HDD Roseburg Residential

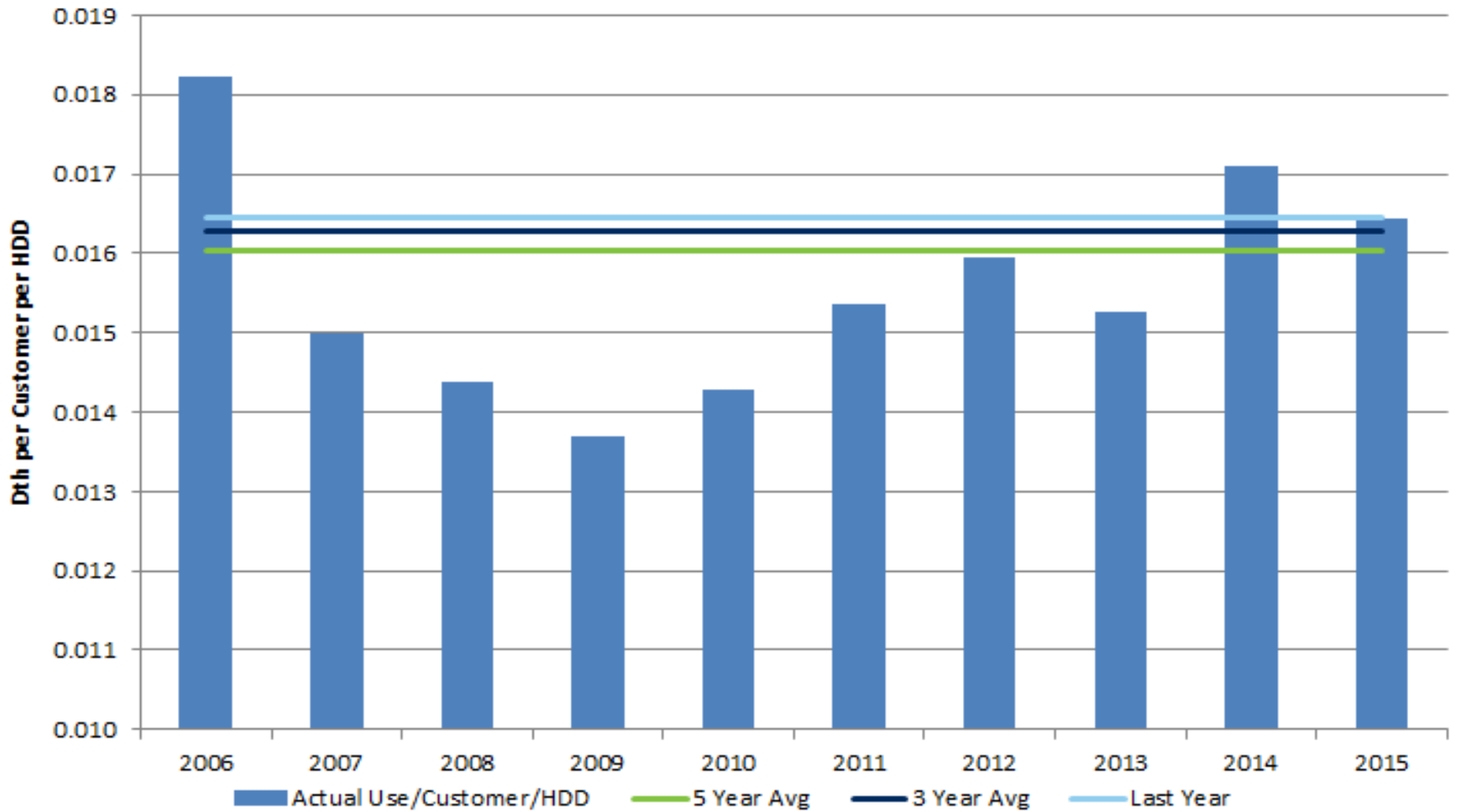

## Use per Customer per HDD LaGrande Residential

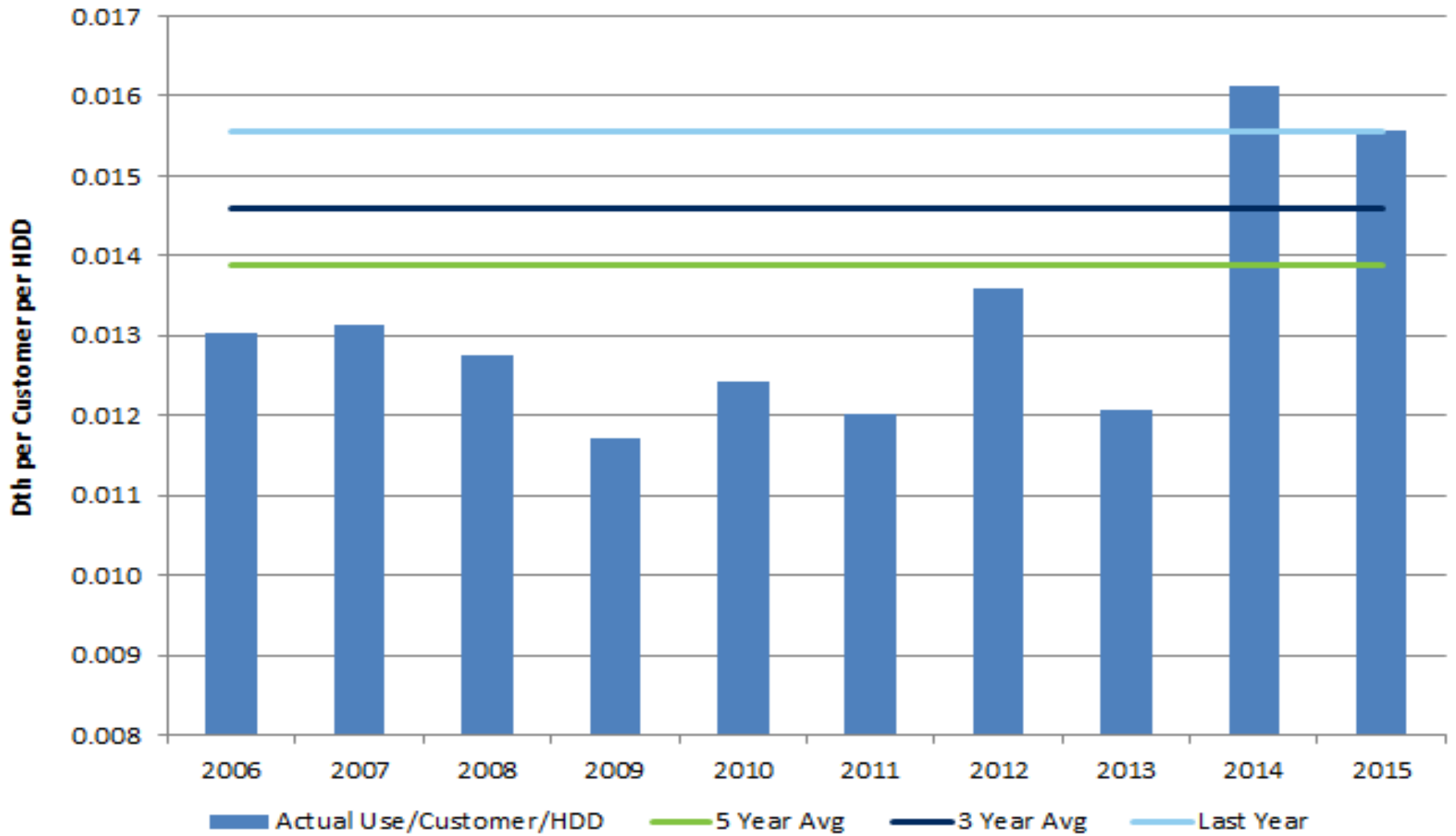

# Use per Customer per HDD

## Klamath Falls Residential

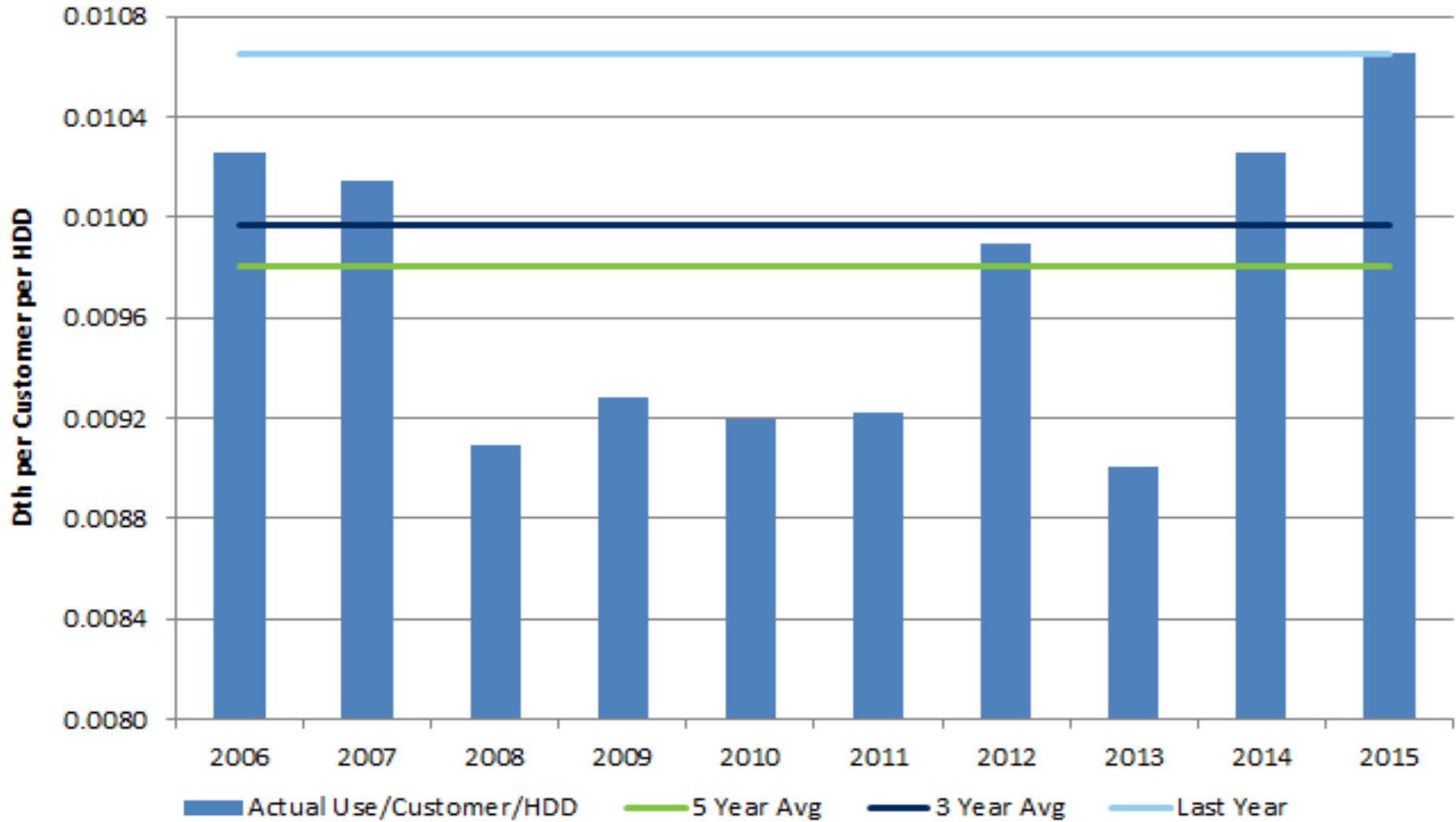

# Demand Modeling Equation – a closer look

SENDOUT® requires inputs expressed in the below format to compute daily demand in dekatherms. The **base** and **weather sensitive** usage (degree-day usage) factors are developed outside the model and capture a variety of demand usage assumptions.

**Table 3.2 Basic Demand Formula**

$\# \text{ of customers } \times \text{ Daily } \mathbf{base} \text{ usage} / \text{ customer}$ <p style="text-align: center;"><b>Plus</b></p> $\# \text{ of customers } \times \text{ Daily } \mathbf{weather \ sensitive} \text{ usage} / \text{ customer}$
---

# Developing a Reference Case

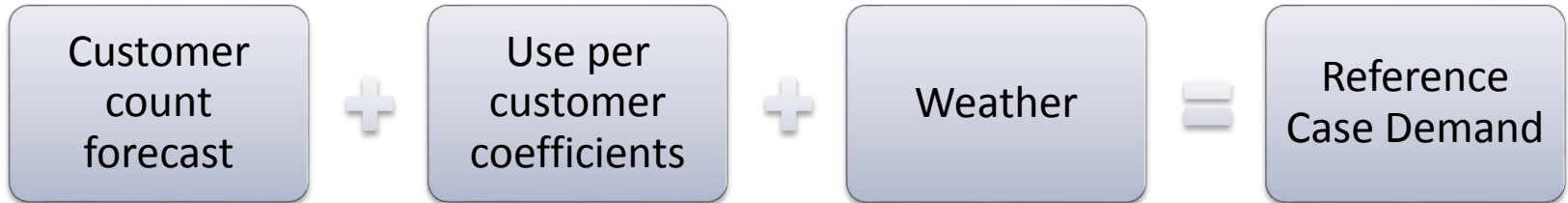

## 1. Customer annual growth rates:

Area	Residential	Commercial	Industrial
Washington - Idaho	1.1%	0.6%	0.0%
Klamath Falls	1.3%	0.9%	0.0%
LaGrande	0.6%	0.4%	0.1%
Medford	1.3%	1.0%	0.0%
Roseburg	1.1%	0.2%	0.0%

2. Use per customer coefficients – Flat all classes, 5 year, 3 year or last year average use per HDD per customer

3. Weather planning standard – coldest day on record

- WA/ID 82; Medford 61; Roseburg 55; Klamath 72; La Grande 74



# Dynamic Demand Methodology

Tom Pardee  
Manager of Natural Gas Planning

# Dynamic Demand Methodology

## Demand Influencing

- Conditions that **DIRECTLY** affect core customer volume consumed



## Price Influencing

- *PRICE SENSITIVE* conditions that, through price elasticity, **INDIRECTLY** affect core customer volume consumed





# Demand Drivers

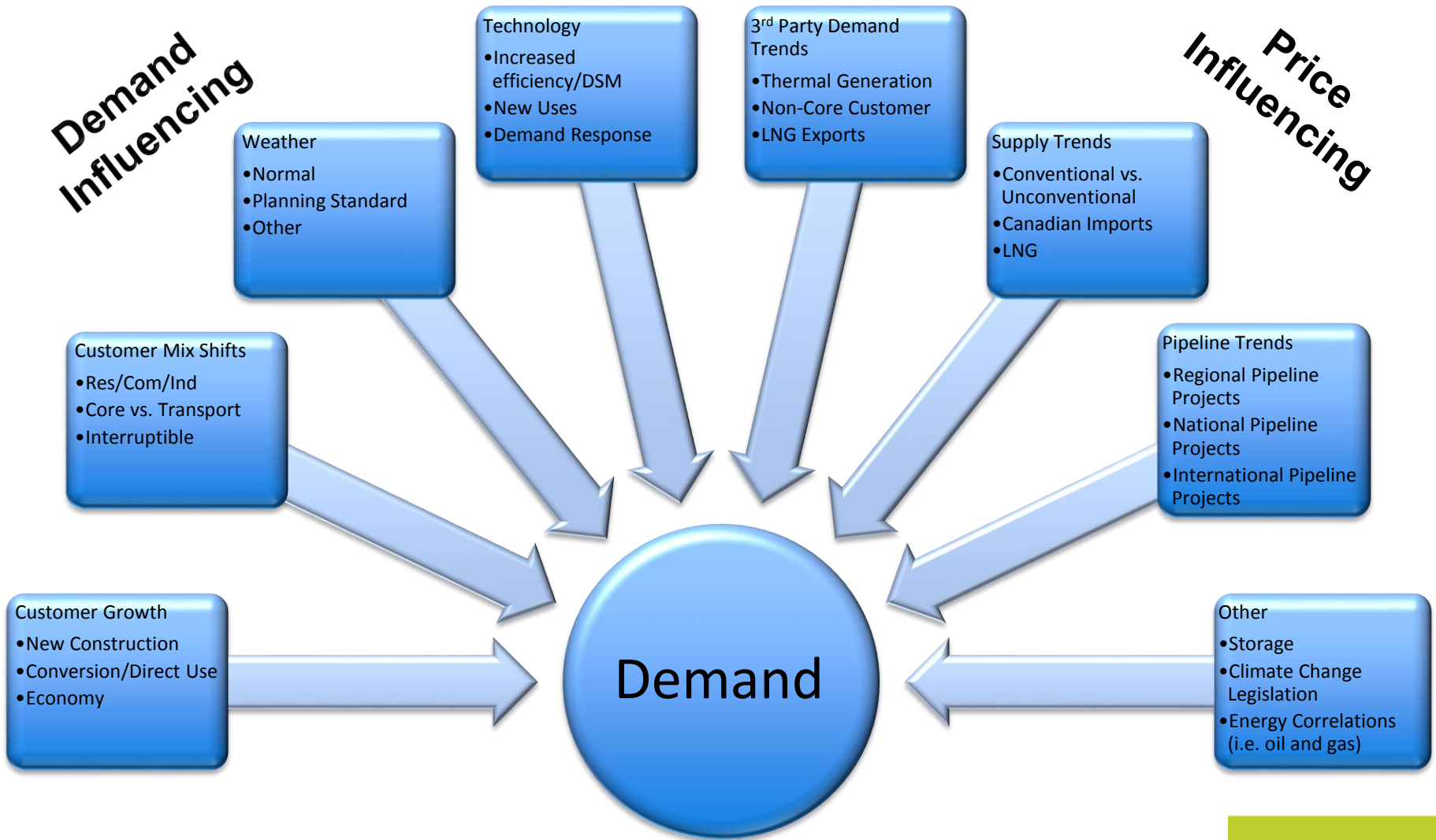

# Customer Growth and Mix – Demand Influencing

- Key driver in demand growth
- Can change the timing and/or location of resource needs
- Currently we model expected, high, and low growth scenarios
- New construction vs. conversions
- Residential/Commercial/Industrial vs. Transportation
- New uses – CNG/NGV

# Weather Standard – Demand Influencing

- Has the potential to significantly change timing of resource needs
- Significant qualitative considerations
  - No infrastructure response time if standard exceeded
  - Significant safety and property damage risks
- Current Peak HDD Planning Standards
  - WA/ID 82
  - Medford 61
  - Roseburg 55
  - Klamath 72
  - La Grande 74

# Technology – Demand Influencing

- Demand side management initiatives will reduce demand **HOWEVER**, it is dependent upon customers willingness/ability to participate.
- Development of new uses for natural gas
  - CNG
  - NGV
  - LNG
  - ???NG
- Demand response (Smart Grid)
- New technologies in Demand Side Management

# Price Elasticity Factors Defined

- Price elasticity is usually expressed as a numerical factor that defines the relationship of a consumer's consumption change in response to price change.
- Typically, the factor is a **negative** number as consumers normally **reduce** their consumption in response to **higher** prices or will **increase** their consumption in response to **lower** prices.
- For example, a price elasticity factor of -0.13 means:
  - A 10% price **increase** will prompt a 1.3% consumption **decrease**
  - A 10% price **decrease** will prompt a 1.3% consumption **increase**

# Price Elasticity

- Establishes factors for use in other price influencing scenarios
- Very complex relationship – we use historical data however.....
  - Historical data has DSM, rate changes (PGA, general rate, etc.), economic conditions, technological changes, etc.
  - History is not necessarily the best predictor of future behavior

# 2007 AGA Study Results

- **American Gas Assn Study**

- National results
  - Short-run -0.09
  - Long-run -0.18
- Pacific & Mtn Region results
  - Short-run -0.07 & -0.07
  - long-run -0.12 & -0.10
- Min-Max range
  - Short-run +0.01 to -0.13
  - Long-run -.01 to -.29

- **Avista Specific Results**

- Oregon
  - Short-run -0.08
  - long-run -0.13
- Idaho
  - Short-run -0.05
  - long-run -0.10
- Washington
  - Short-run -0.12
  - long-run -0.14

# Price Elasticity Assumptions From 2014 IRP

Elasticity Assumption	Real Price annual increase within 30%
High	Negative .20
Expected	Negative .15
Low	No response



# 3<sup>rd</sup> Party Demand Trends – Price Influencing

- Gas fired generation – the largest contributor to future growth
- Coal plant retirements driving gas for power
- CNG/NGV Transportation Fleets
- Export LNG
- Non-firm customer trends

# Supply Trends – Price Influencing

- Shale is Everywhere
- LNG Export
- Basis - Location, location, location

# Pipeline Trends – Price Influencing

- Regional Pipeline Proposals
  - N-Max/Palomar – cross Cascades pipeline (NWN, GTN and NWP)
  - Pacific Connector – from Jordan Cove LNG to various interconnects in the Pacific Northwest (Williams, Fort Chicago Energy Partners, and PG&E)
  - Trail West (GTN to NWP – Molalla area)
- National Pipeline Proposals
- International Pipeline Proposals (GTN to NWP)

# Other Supply Issues – Price Influencing

- Storage
- Climate Change and Carbon Legislation
- Energy Correlations

# Sensitivities, Scenarios, Portfolios

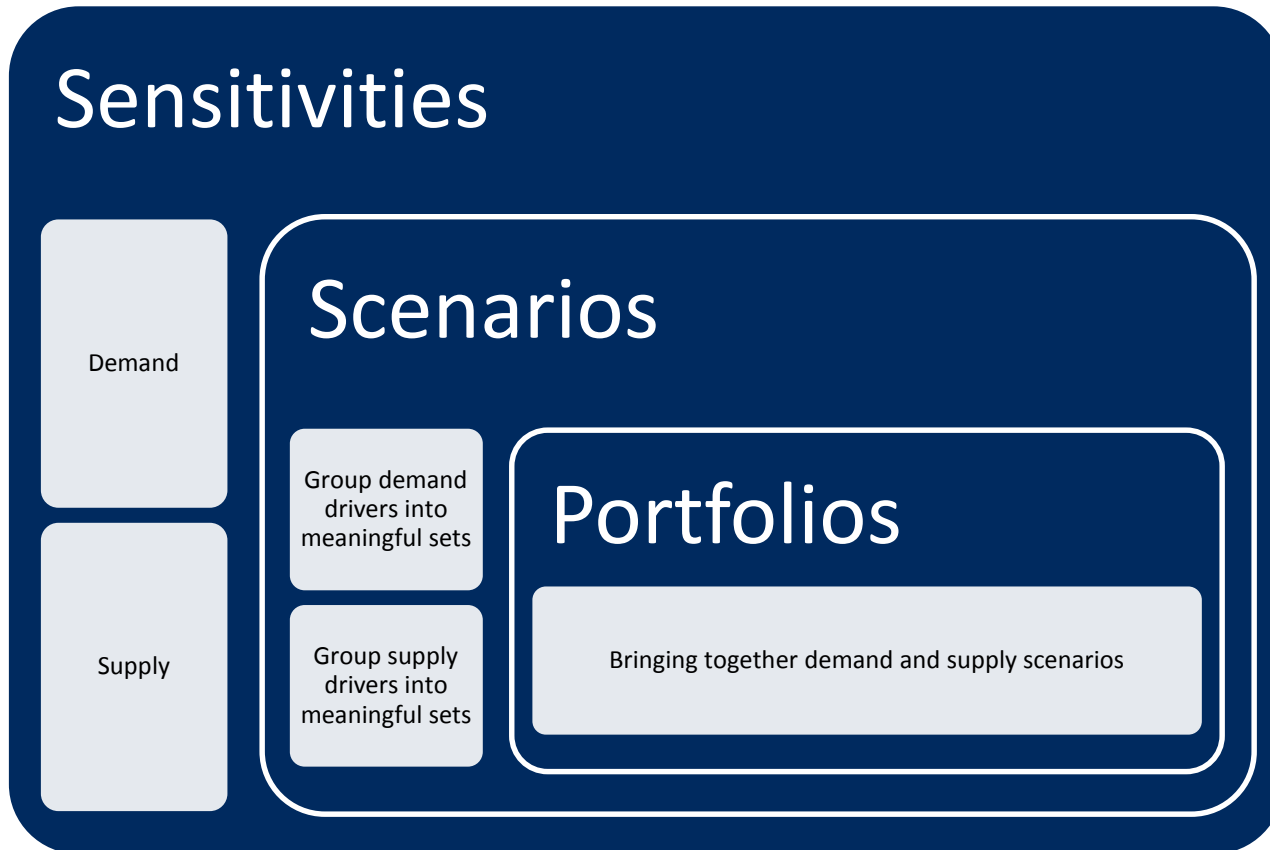

# Demand Sensitivities from 2014 IRP

Model Sensitivities			DEMAND INFLUENCING - DIRECT							PRICE INFLUENCING - INDIRECT				
	Reference	Reference	Low Cust	High Cust	CNG/NGV	Alternate	DSM	Peak plus	Alterante	Expect	Low	High	Carbon	Exported
	Case	Plus Peak Case	Growth	Growth	Vehicles	Weather Std	Case	Case	Historical UPC Case	Elasticity	Prices	Prices	Legislation	LNG
<b>INPUT ASSUMPTIONS</b>														
<b>Customer Growth Rate</b>														
Residential	WA/ID													
Residential	Medford													
Residential	Roseburg													
Residential	Klamath													
Residential	La Grande													
Commercial	WA/ID													
Commercial	Medford													
Commercial	Roseburg													
Commercial	Klamath													
Commercial	La Grande													
<b>Use per Customer</b>	3 Year Historical	3 Year Historical	3 Year Historical	3 Year Historical	15% Growth Cumulative	3 Year Historical	3 Year Historical	3 Year Historical	5 Year Historical	3 Year Historical	3 Year Historical	3 Year Historical	3 Year Historical	3 Year Historical
<b>Weather</b>														
Planning Standard	20 Year Normal	Coldest on Record	Coldest on Record	Coldest on Record	Coldest on Record	Coldest 20yr	Normal	Coldest on Record	Coldest on Record	Coldest on Record	Coldest on Record	Coldest on Record	Coldest on Record	Coldest on Record
<b>Demand Side Management Programs Included</b>	No	No	No	No	No	No	Expected	Expected	No	No	No	No	No	No
<b>Prices</b>														
Price curve	Expected	Expected	Expected	Expected	Expected	Expected	Expected	Expected	Expected	Expected	Low	High	Expected	Expected
Price curve adder (\$/Dth)	None	None	None	None	None	None	None	None	None					\$.50 Adder After 5yrs
Elasticity	None	None	None	None	None	None	None	None	None	Expected	Expected	Expected	Expected	Expected
Carbon Adder (\$/Ton)	None	None	None	None	None	None	None	None	None					

## What do we want to consider for 2016?

# Mix and Match to Make Scenarios



# The Goal – A Bunch of Meaningful Lines

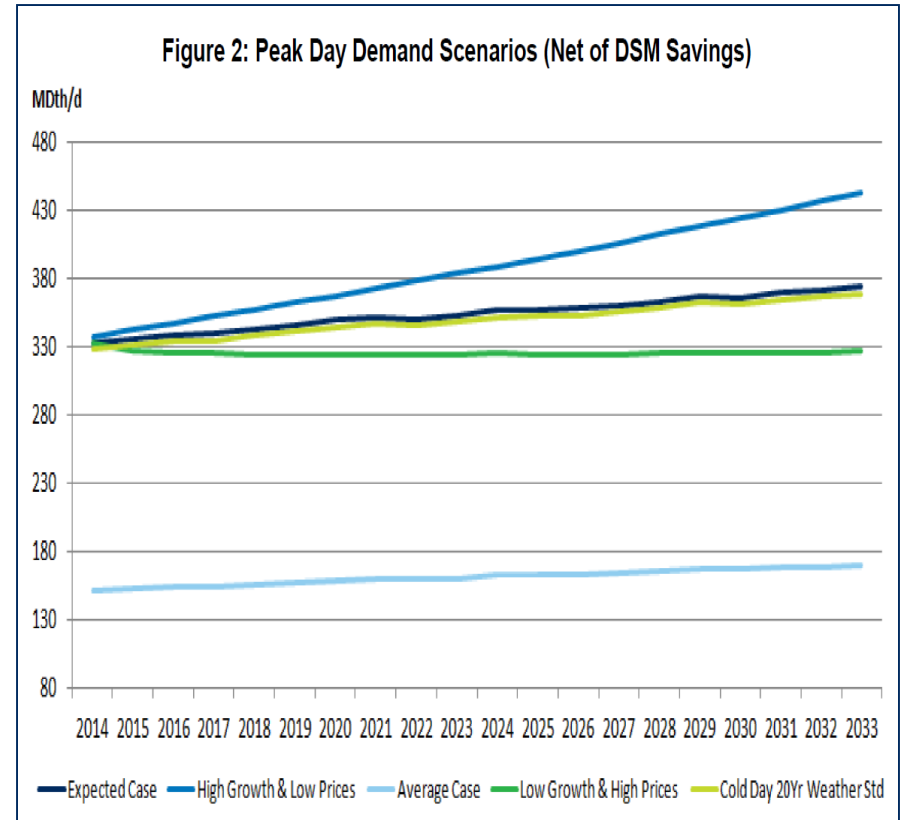
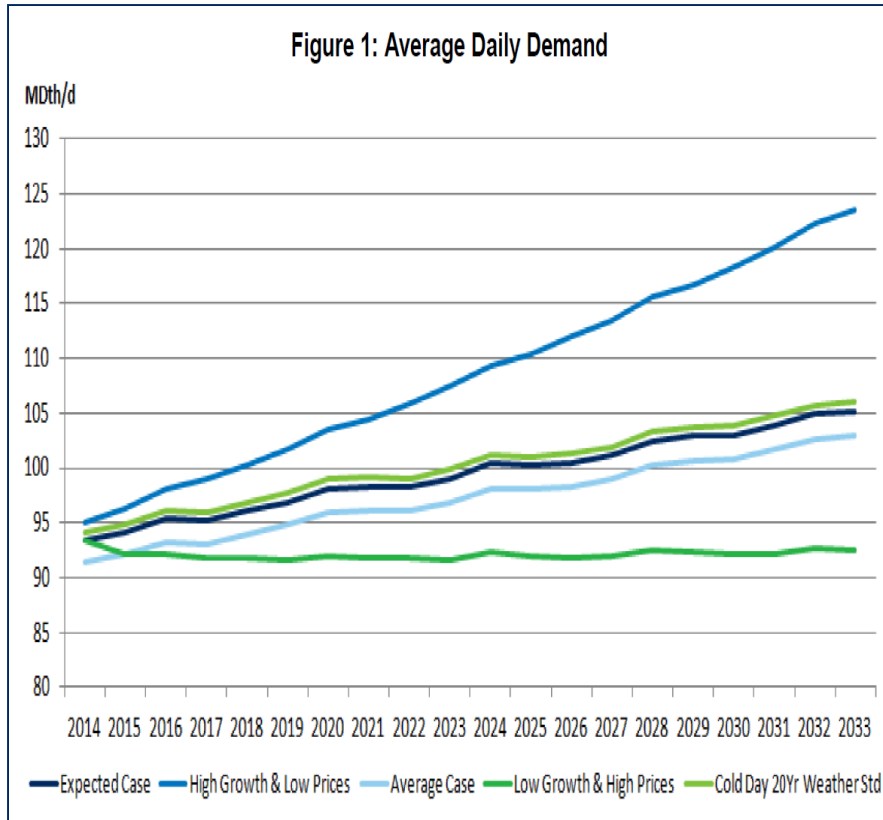



# Forecast Methodology Considerations

- Know the goal – what is the purpose of the forecast?
- Know your data – what you have, what you need
- Is there sufficient quantitative data available?
- Is the change small or large?
- Is there conflict among decision makers?
- Are the relationships among variables complicated?
- Have there been similar situations?



# Demand Side Management

Mike Dillon

DSM Planning and Analytics Manager

# Agenda

- DSM in the last IRP
  - Target/Acquisition
- What's happened since the last IRP
- What's different with avoided costs?
- Proposed DSM modeling methodology
- Business planning process

# DSM in the 2014 IRP – Annual (WA/ID)

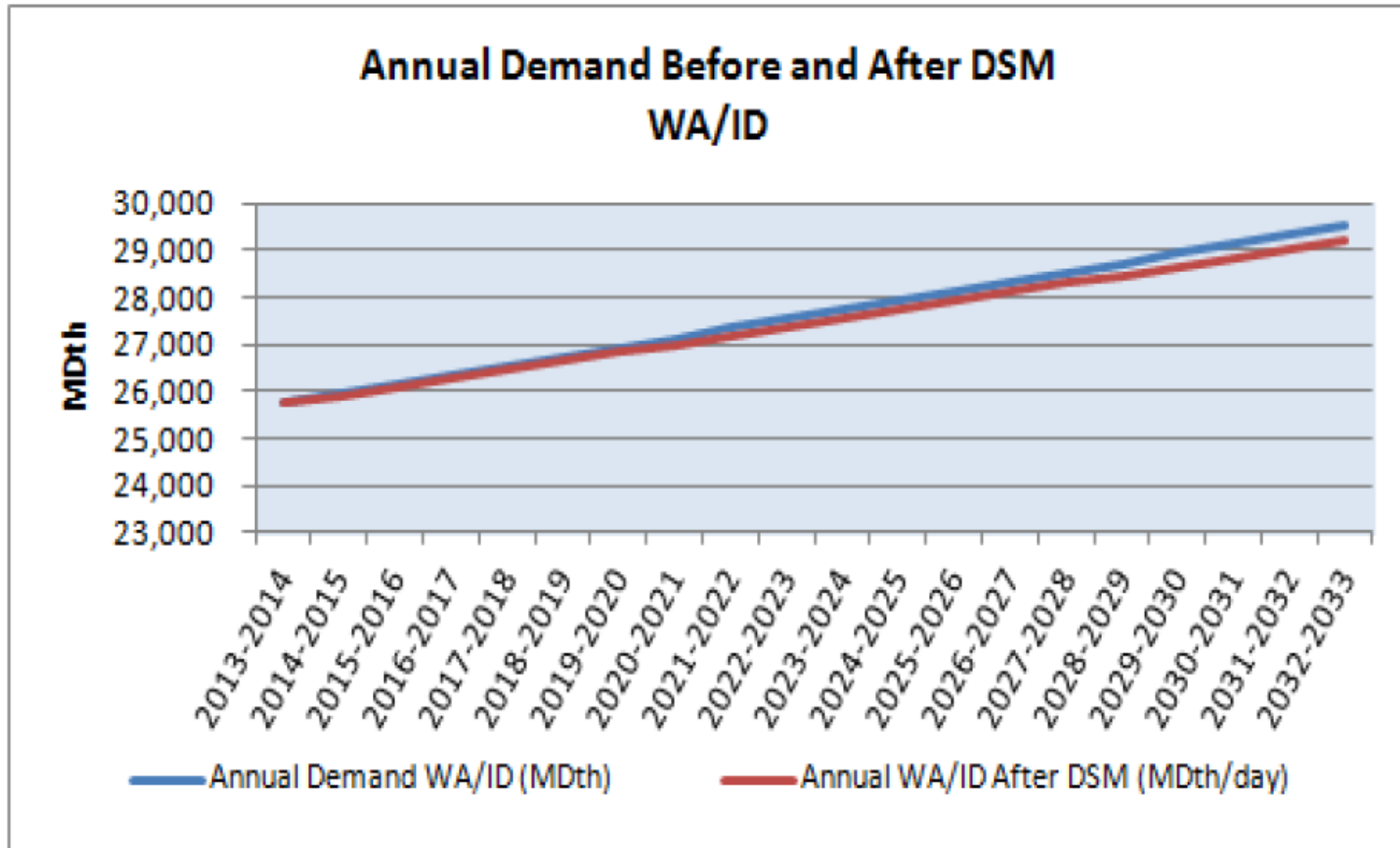

# DSM in the 2014 IRP – Peak Day (WA/ID)

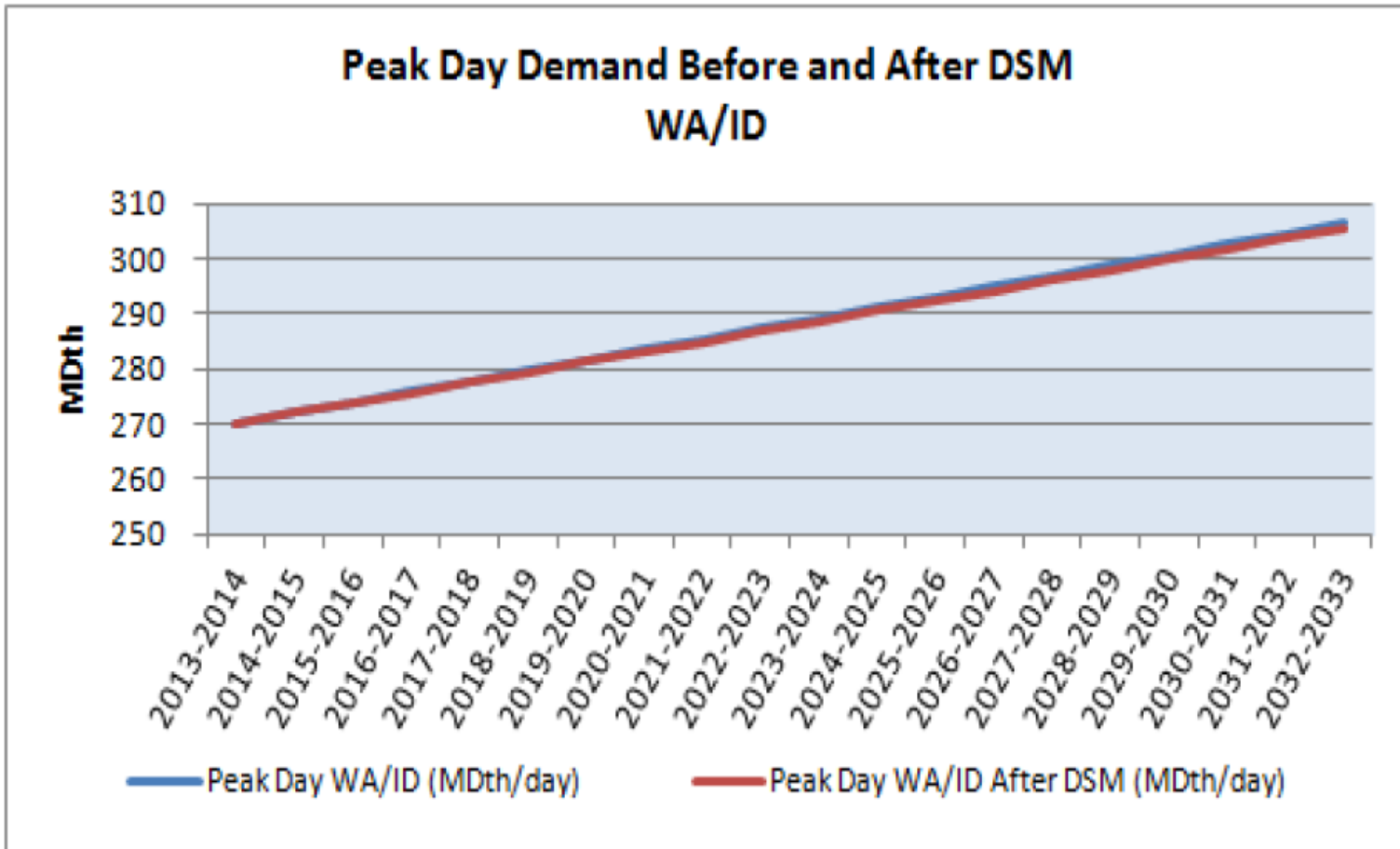

# DSM in the 2014 IRP – Annual (OR)

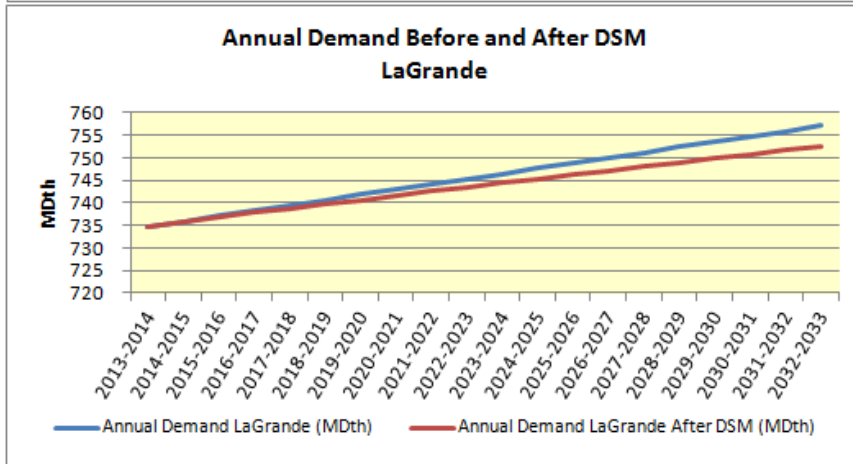
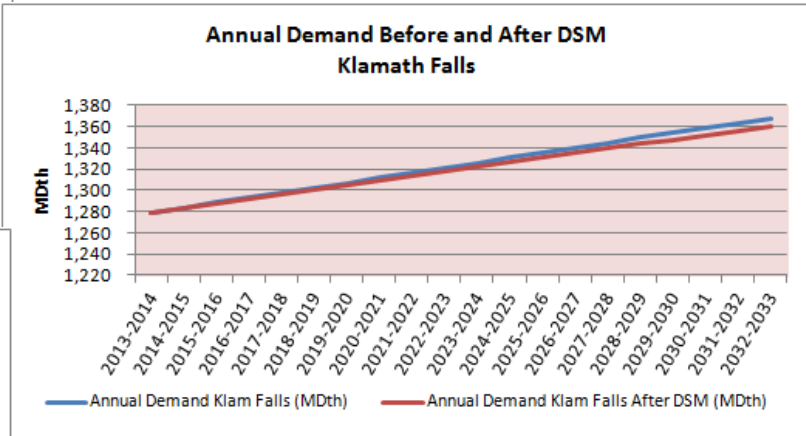
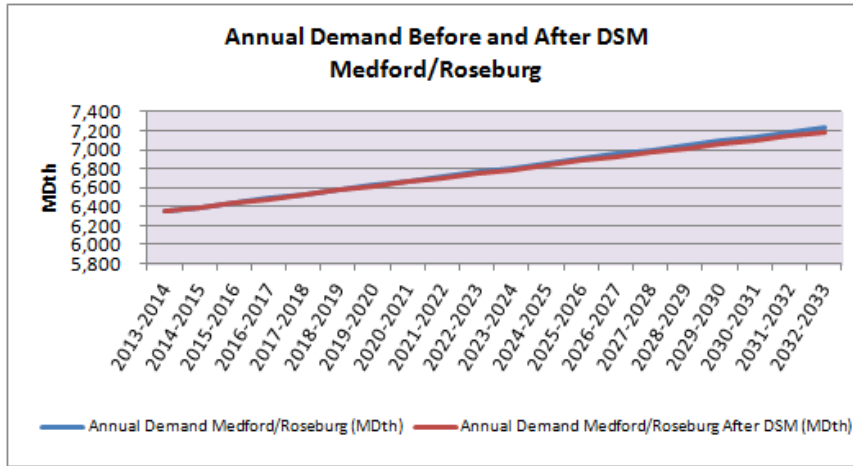

# DSM in the 2014 IRP – Peak Day (OR)

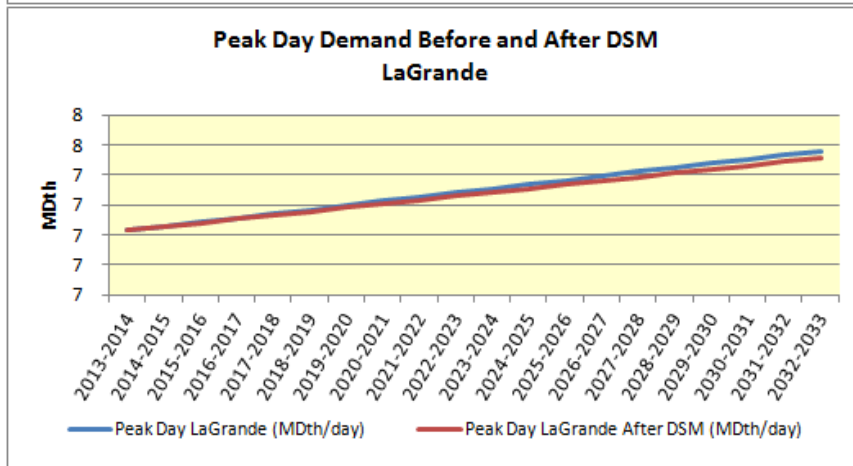
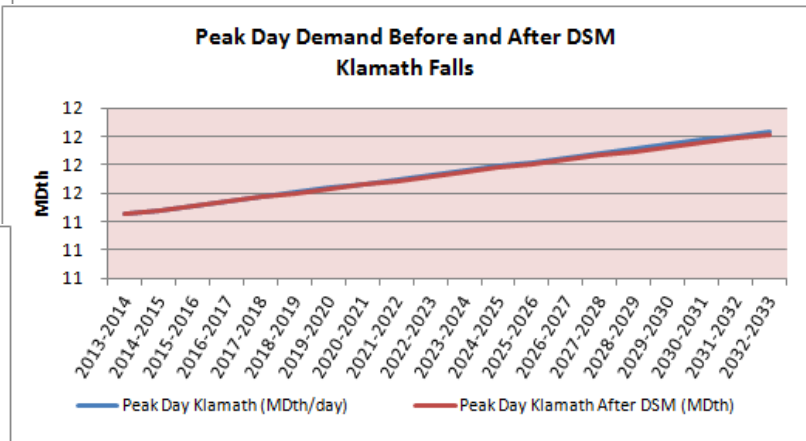
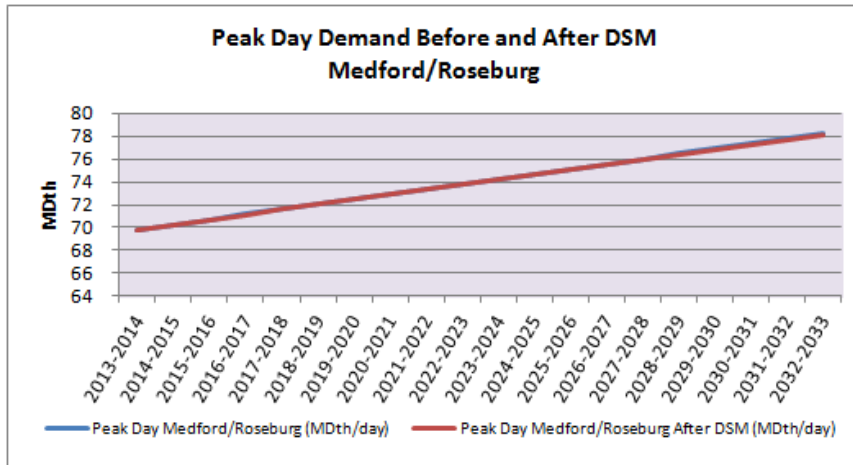

# 2014 IRP DSM Targets

- 2015 targets & (Unverified) acquisition (achievable potential)

State	Therms	Target	% Achieved
• Idaho	-	-	-
Oregon	207,036	161,000	128.6%
Washington	780,530	602,010	129.7%



# Recap of Recent History

- Relook at components of conservation avoided costs and compare with other gas utilities
  - Include total cost to deliver from well to meter (Schedule 150 Demand)
  - Estimated Carbon Tax in Washington (assumptions could already be dated)
  - Working with Natural Gas Planning on analyzing the value of conservation in deferring pipeline investments
- Idaho – Schedule 190 resumed 1/1/16
- Oregon – As part of GRC, Oregon non-LI transition to ETO
- Washington – Proposed Initiatives, Potential Legislation and Executive Orders... Oh My!

# Henry Hub vs. Levelized Avoided Costs

## Monthly Henry Hub vs. Levelized IRP Avoided Costs

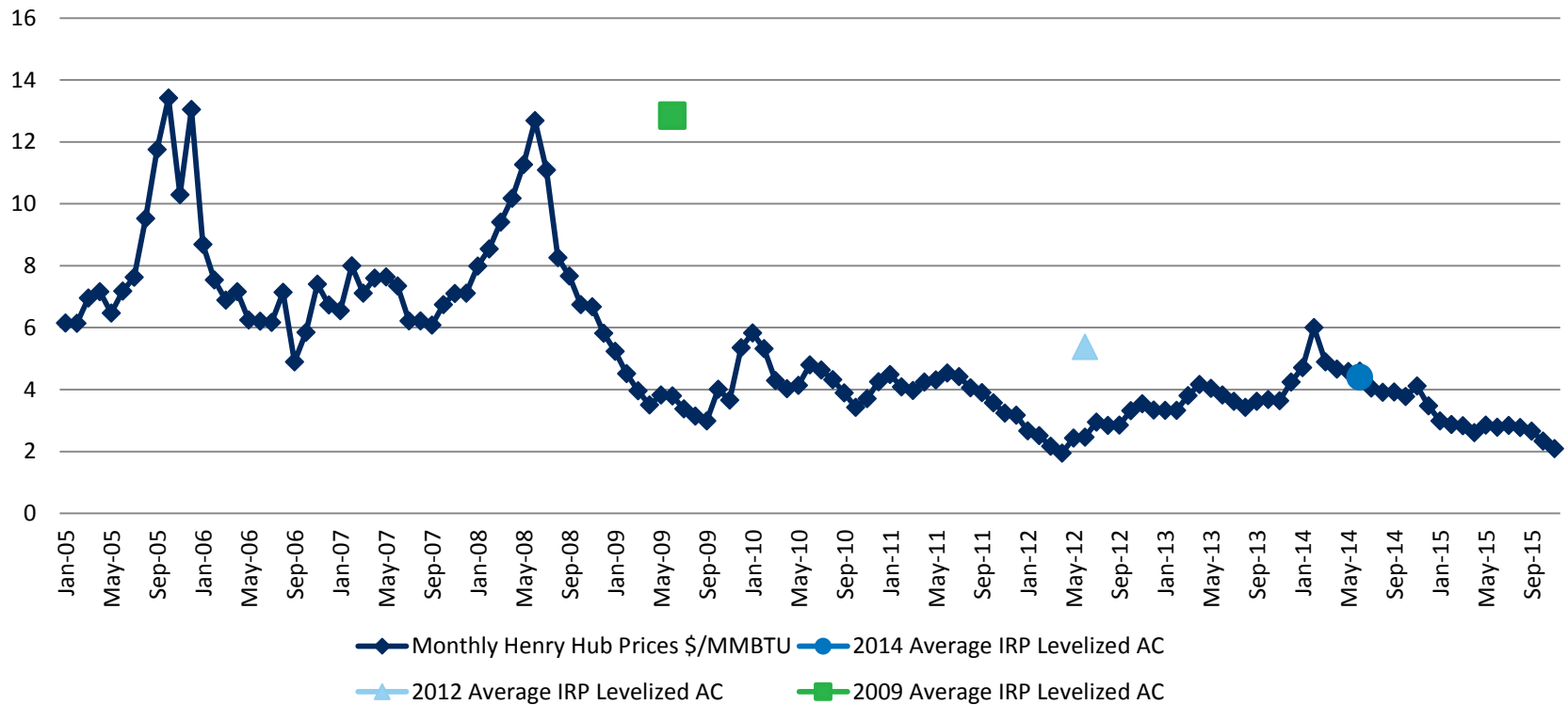

# Proposed DSM Modeling Methodology

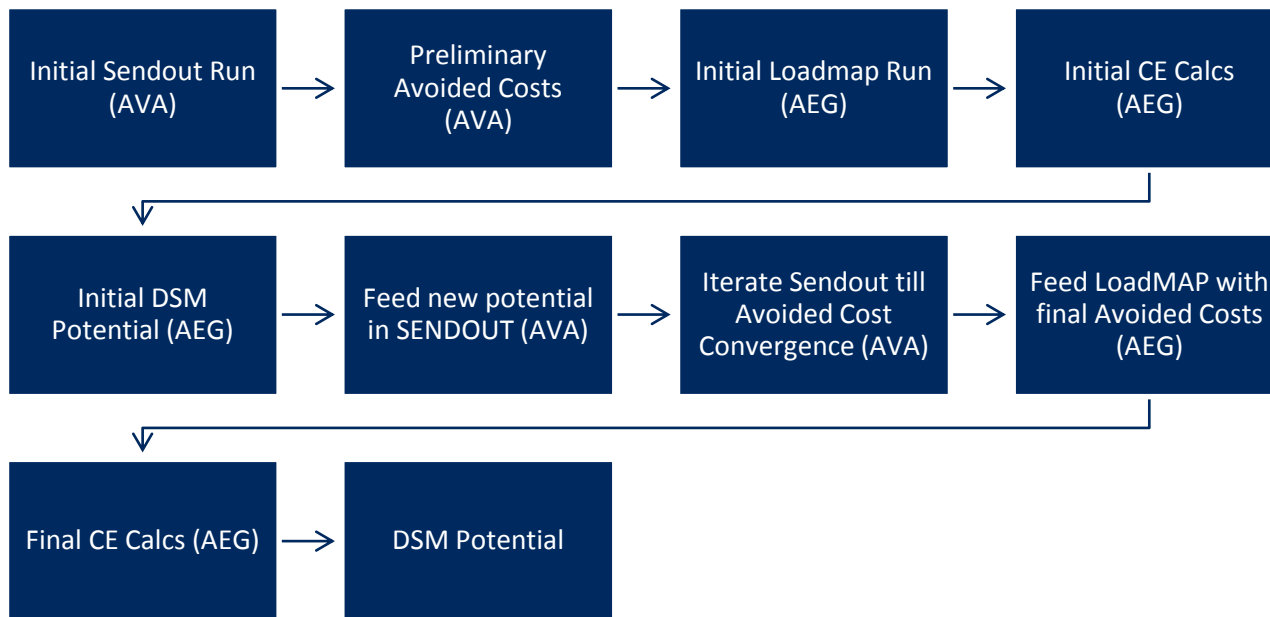

# Business Planning Process

- IRP generated target (CPA achievable potential)
- Bottom-up evaluation of all measures regardless of cost-effectiveness
- Forecast throughput for the following year
- Add in non-incentive utility costs
- Evaluate with final avoided costs
- Update Business Plan Annually for throughput, estimated budgets and cost-effectiveness by state and fuel.

# 2016 IRP Timeline

- **August 31, 2015** – Work Plan filed with WUTC
- **January through April 2016** – Technical Advisory Committee meetings. Meeting topics will include:
  - Demand Forecast and Demand Side Management – January 21
  - **Supply/Infrastructure, Natural Gas Pricing, and Potential Case Discussion– February 18**
  - Distribution Planning, SENDOUT® Preliminary Output Results and Further Case Discussion – *March 16*
  - SENDOUT® results – *April 21*
- **May 30, 2016** – Draft of IRP document to TAC
- **June 30, 2016** – Comments on draft due back to Avista
- **July 2016** – TAC final review meeting (if necessary)
- **August 31, 2016** – File finalized IRP document

# Tentative Agenda for the Next TAC Meeting

- Natural Gas Prices
- Supply Side Resources (Current and Future)
  - Transportation
  - Storage
  - Other
- Gate Station Analysis



# 2016 Avista Natural Gas IRP

Technical Advisory Committee Meeting  
February 18, 2016  
Spokane, WA

# Agenda

- Introductions & Logistics
- Update from TransCanada and Williams
- Regional and Avista's Supply Side Resources
- Storage and Transportation Optimization
- Transport Modeling in Sendout
- Solving Unserved Demand
- Carbon Legislation



# 2016 IRP Timeline

- **August 31, 2015** – Work Plan filed with WUTC
- **January through April 2016** – Technical Advisory Committee meetings. Meeting topics will include:
  - Demand Forecast and Demand Side Management – January 21
  - **Supply/Infrastructure and Potential Case Discussion– February 18**
  - Distribution Planning, Natural Gas Pricing, SENDOUT® Preliminary Output Results and Further Case Discussion – March 30
  - SENDOUT® results – *April 21*
- **May 30, 2016** – Draft of IRP document to TAC
- **June 30, 2016** – Comments on draft due back to Avista
- **July 2016** – TAC final review meeting (if necessary)
- **August 31, 2016** – File finalized IRP document



## TransCanada Infrastructure Update

### Avista TAC Meeting

Capacities, Tolls, Projects  
February 18, 2016

# TransCanada Corporation (TSX/NYSE: TRP)

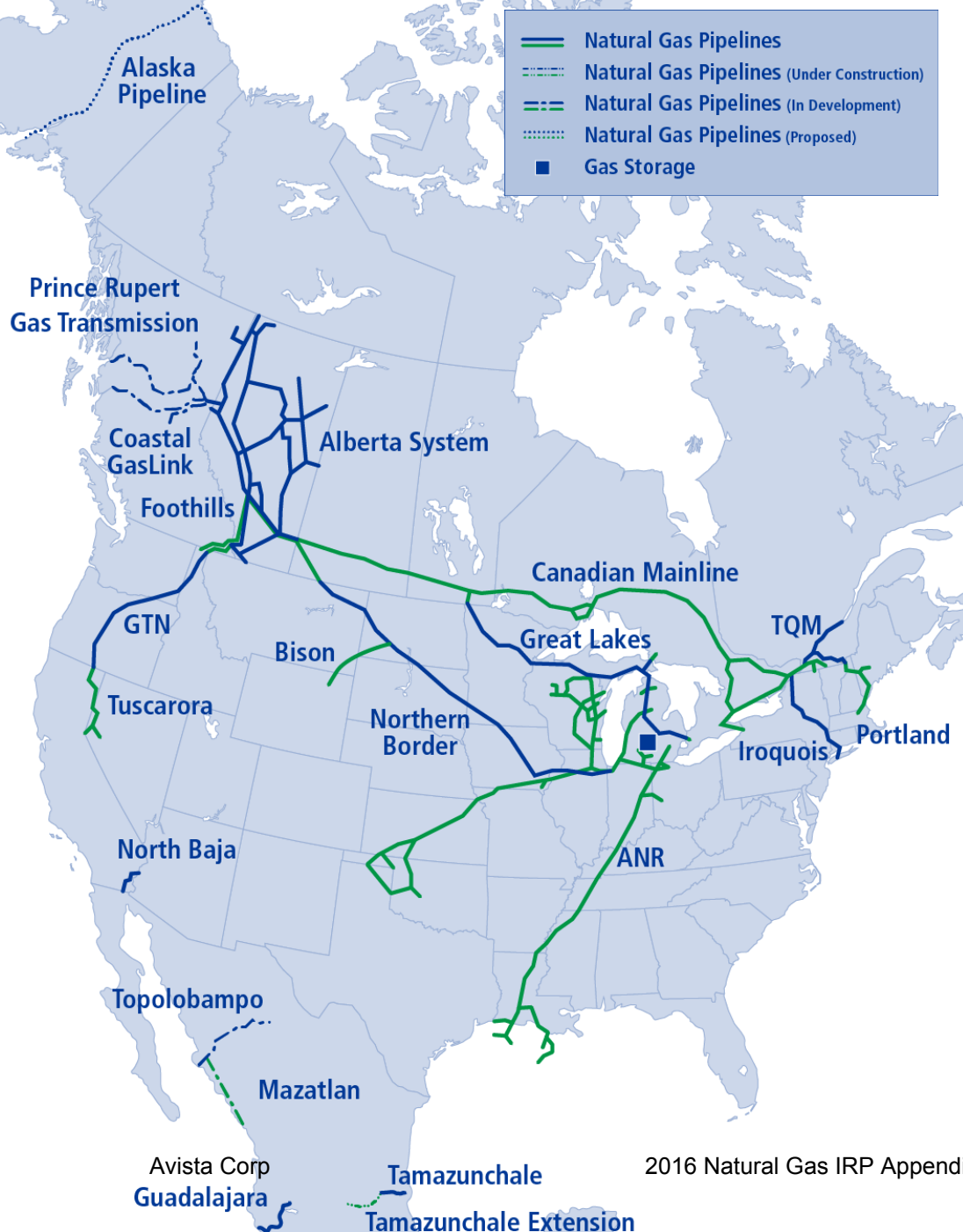

- 57,000 km (35,500 mi) of wholly owned natural gas pipeline
- Interests in an additional 11,500 km (7,000 mi) of natural gas pipeline
- 250 Bcf of regulated natural gas storage capacity
- Unparalleled connections from traditional and emerging basins to growing markets
- Average daily volume of approximately 14 Bcf/d of North American demand

# NGTL System

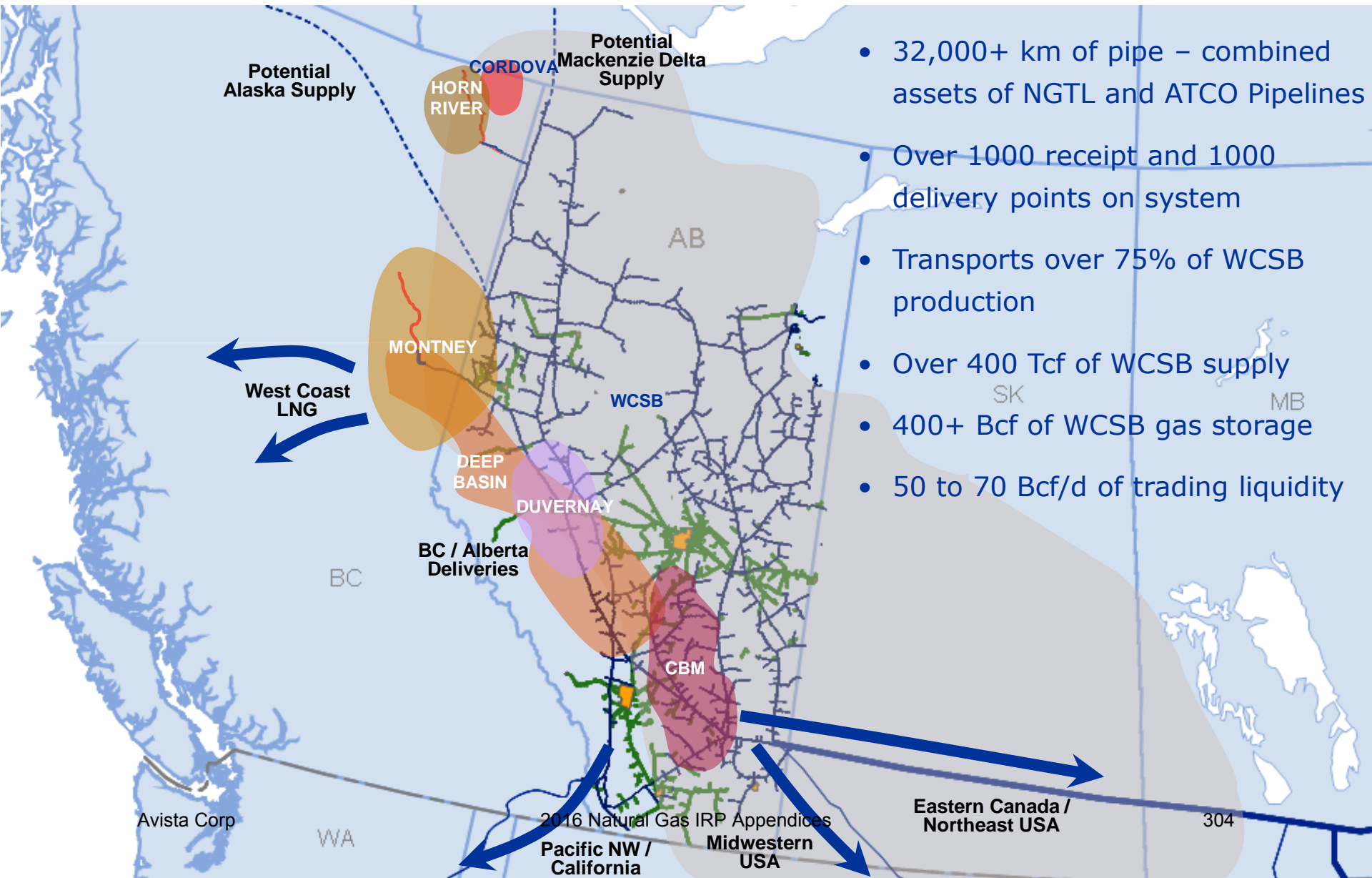

- 32,000+ km of pipe – combined assets of NGTL and ATCO Pipelines
- Over 1000 receipt and 1000 delivery points on system
- Transports over 75% of WCSB production
- Over 400 Tcf of WCSB supply
- 400+ Bcf of WCSB gas storage
- 50 to 70 Bcf/d of trading liquidity

# Prince Rupert Gas Transmission (Proposed)

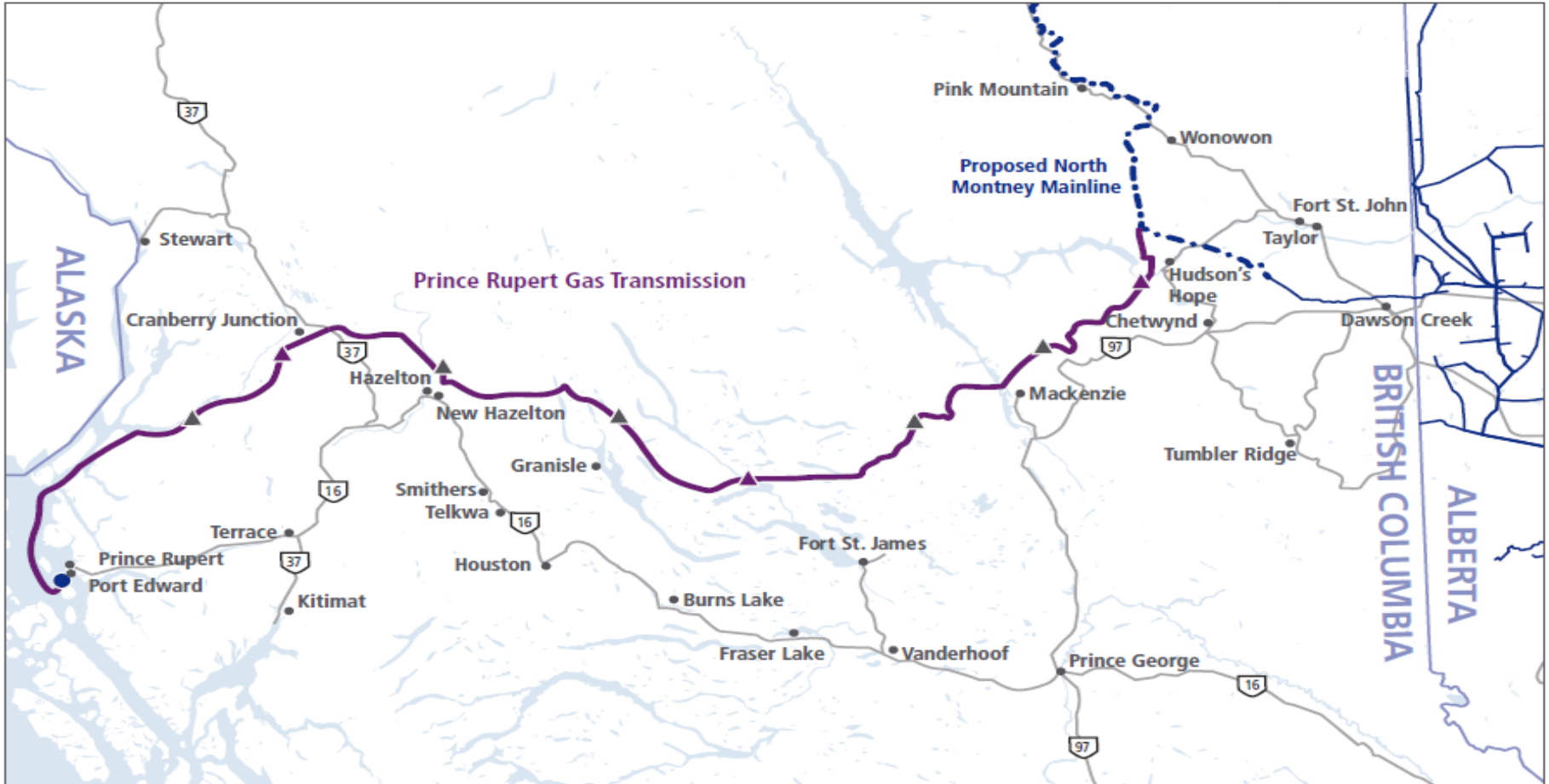

<p><b>Prince Rupert Gas Transmission</b></p> <ul style="list-style-type: none"> <li><span style="color: purple;">—</span> Prince Rupert Gas Transmission (PRGT) Proposed Route</li> <li><span style="color: purple;">▲</span> Initial Build Compressor Station</li> <li><span style="color: purple;">▲</span> Potential Future Compressor Station</li> </ul>	<p><b>Other</b></p> <ul style="list-style-type: none"> <li><span style="color: blue;">●</span> Proposed Pacific NorthWest LNG Export Facility (3rd party)</li> <li><span style="color: blue;">—</span> TransCanada's NOVA Gas Transmission Ltd. (NGTL) Existing System</li> <li><span style="color: blue;">- - -</span> Proposed North Montney Mainline Project</li> <li><span style="border: 1px solid black; border-radius: 50%; padding: 2px;">  </span> Highways</li> <li><span style="color: black;">●</span> Cities and Towns</li> </ul>
--	--

Avista Corp      2016 Natural Gas IRP Appendices

# Coastal Gas Link Pipeline (Proposed)

Coastal GasLink Map

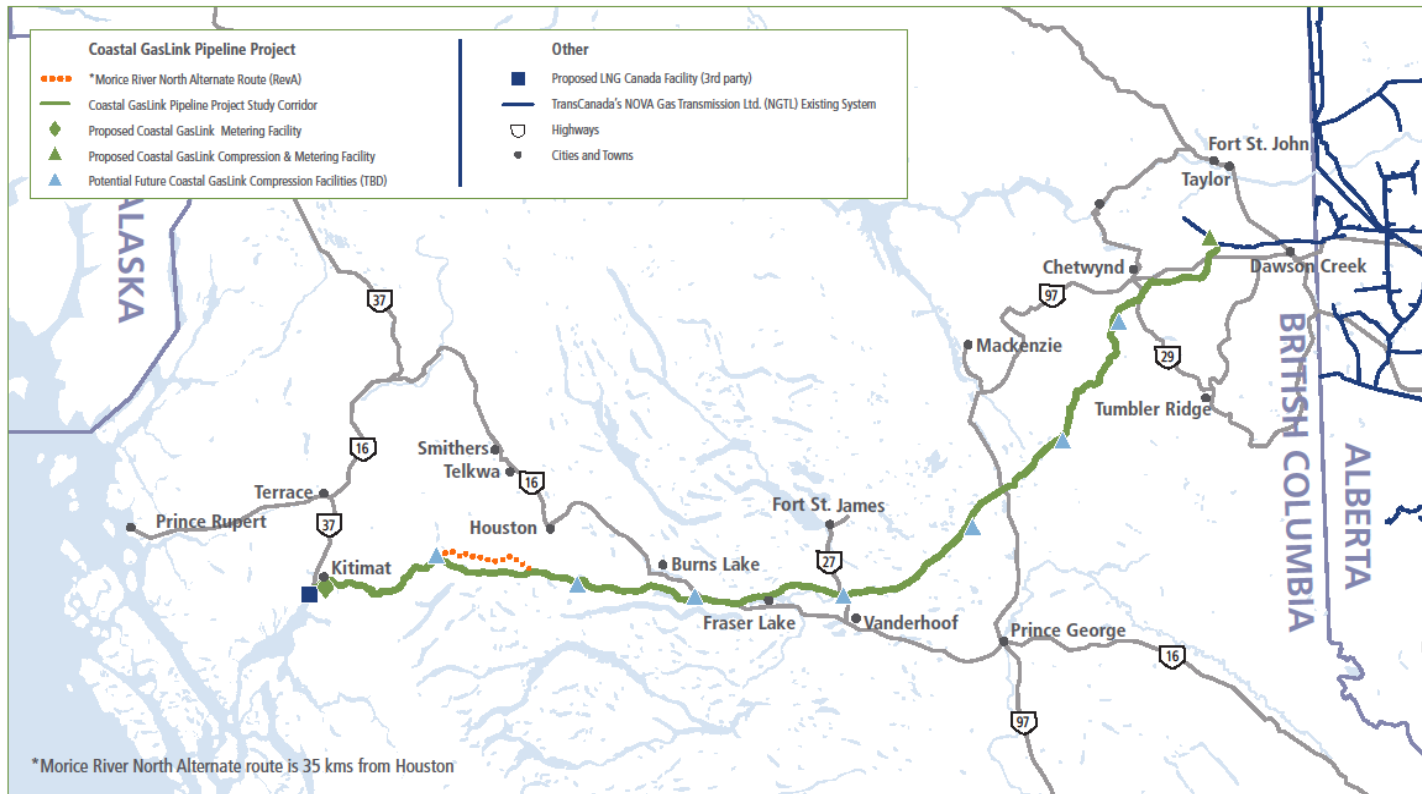

# NGTL Mainline Facilities for Specific Area Requirements

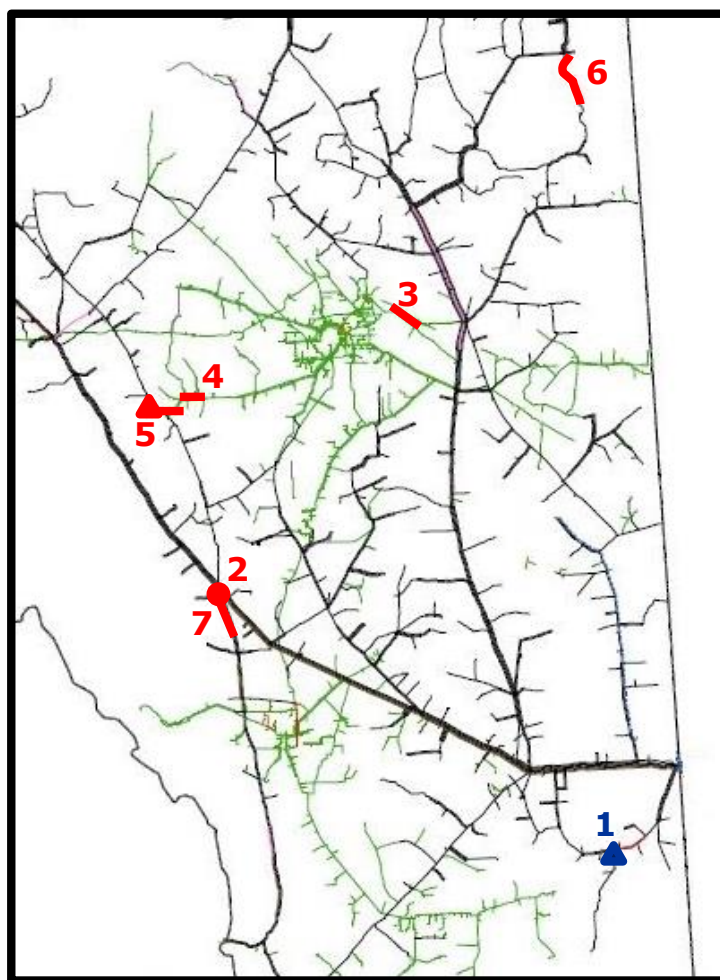

<u>MAP I.D.</u>	<u>PREVIOUSLY APPLIED FOR FACILITIES</u>	<u>DESCRIPTION</u>	<u>TARGET IN-SERVICE DATE</u>	<u>CAPITAL COST (\$Millions)</u>
1	Medicine Hat Compressor Station	3.5 MW	Apr-17	66
<b>TOTAL</b>				<b>66</b>
<b><u>NEW FACILITIES</u></b>				
2	James River Interchange Modifications	-	Aug-16	6
3	ATCO Pipelines Inland Looping	19 km NPS 24	Nov-16	45
4	ATCO Pembina Expansion Phases 1 & 2	20.2 km NPS 24	Nov-16	60
5	Lodgepole Unit Addition	5.0 MW	Nov-17	62
6	South Kirby Expansion Project	39 km NPS 24	Apr-18	137
7	Western Alberta Mainline Loop	33km NPS 42	Nov-18	240
<b>TOTAL</b>				<b>550</b>

Approved    
 Applied-for    
 To Be Applied-for

**LEGEND:**

- Proposed Facility
- ▲ Proposed Compressor
- Proposed Pipe

# Western Alberta Mainline Loop

## Purpose of the facility:

- To meet increasing design flow requirements underpinned by FT-D Group 1, 2, and 3 contracts

## FT-D Contracts:

- Total FT-D Group 1: 61,669 10<sup>3</sup>m<sup>3</sup>/d (2,331 TJ/d)

## Scope:

- Western Alberta Mainline Loop– 33 km NPS 42

## Estimated Cost:

- Total: ~\$240 Million

## Capacity:

- Expected Existing Capacity: ~60 10<sup>6</sup>m<sup>3</sup>/d (2,118 mmcf/d)
- Incremental Capacity: ~10 10<sup>6</sup>m<sup>3</sup>/d (353 mmcf/d)

## Schedule:

- NEB s.58 Application – Q4 2016
- In-service Q4 2018

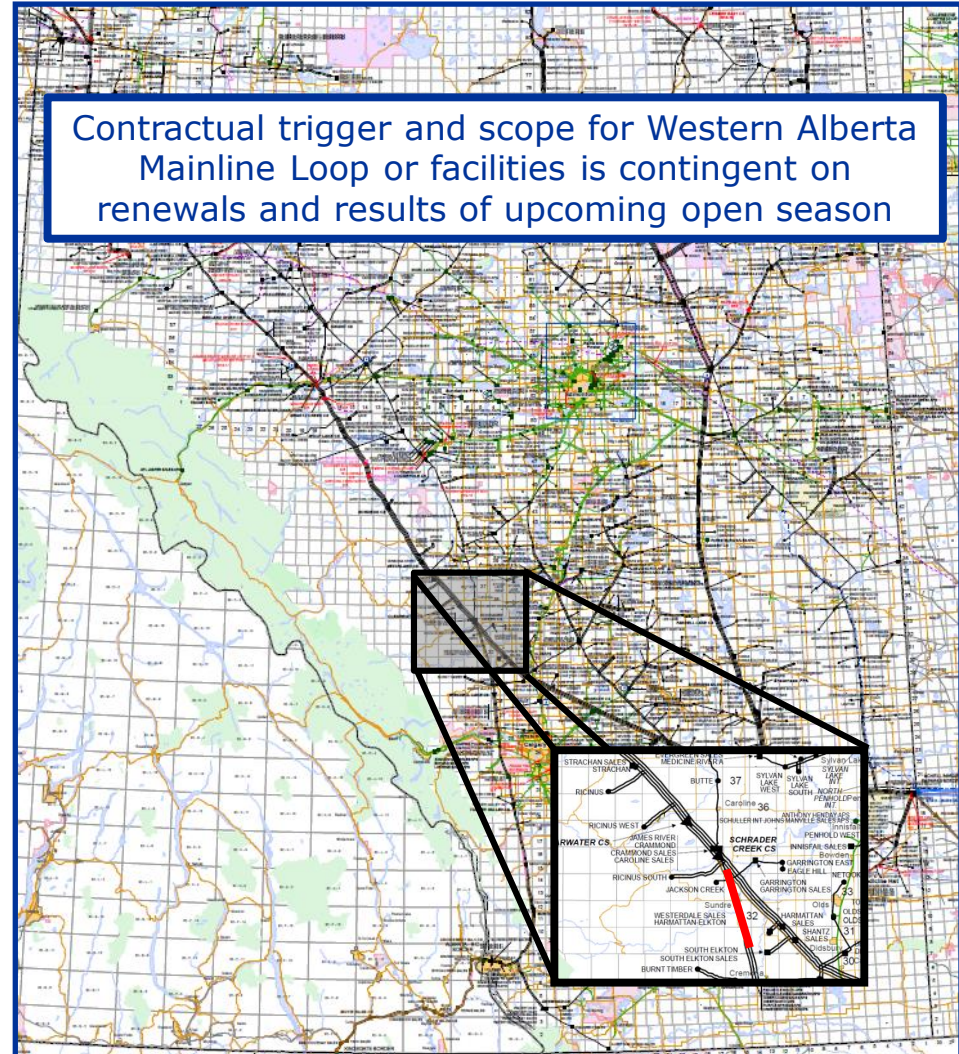



# GTN System Map

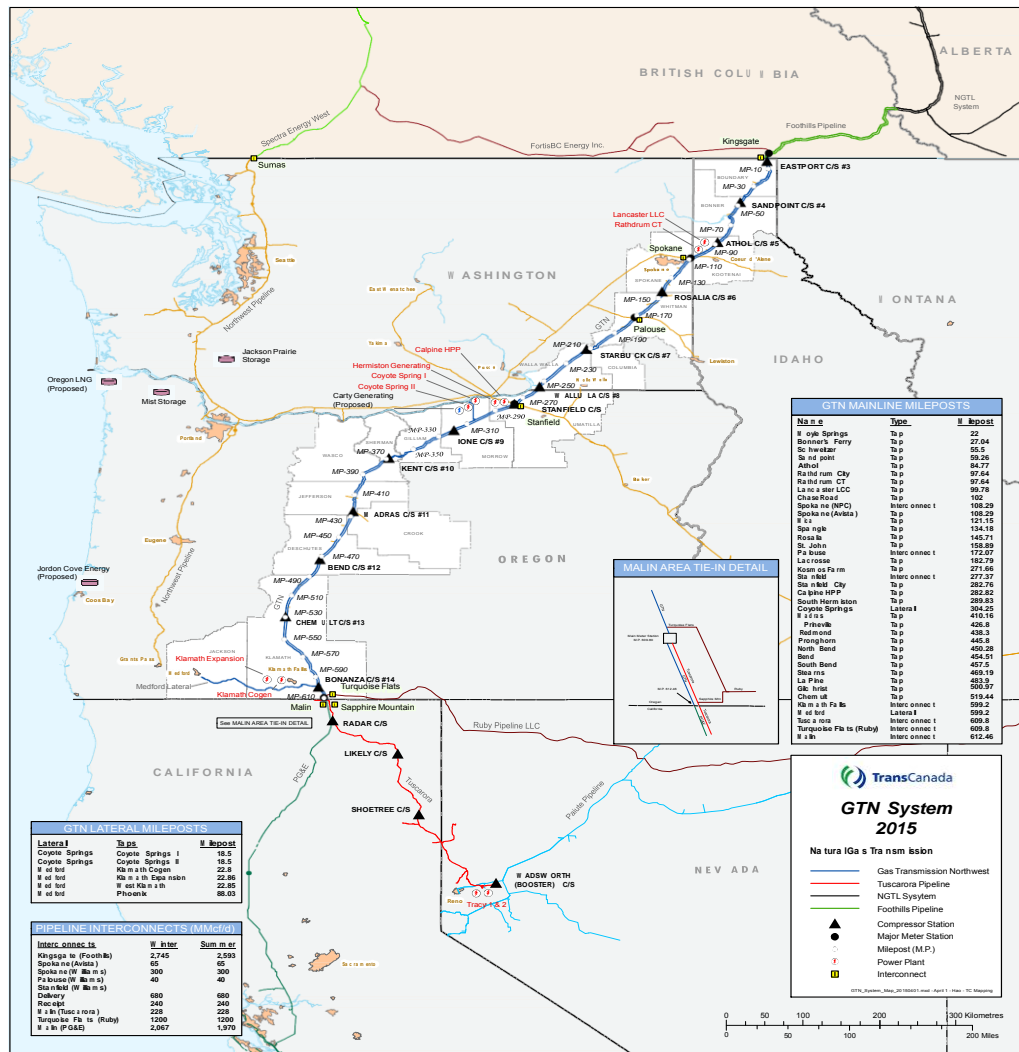

**GTN LATERAL MILEPOSTS**

Lateral	Start	End
Coyote Springs	18.5	18.5
Coyote Springs #1	18.5	18.5
Coyote Springs #2	18.5	18.5
W. of Red	22.86	22.86
W. of Red	22.86	22.86
W. of Red	22.86	22.86
Phoenik	68.03	68.03

**PIPELINE INTERCONNECTS (MMcfd)**

Interconnect	W. Inter	Sum Inter
Kingsgate (Foothills)	2,745	2,593
Spokane (Aveco)	65	65
Spokane (W. Main)	300	300
Palouse (W. Main)	40	40
Stanfield (W. Main)	680	680
Dalbey	240	240
Rockport	228	228
W. of Red (Aveco)	1,200	1,200
Turquoise Falls (Ruby)	2,067	1,970

**GTN MAINLINE MILEPOSTS**

Mainline	Start	End
W. of Red	22	22
Bonanza	27.04	27.04
Spokane	55.5	55.5
Stanfield	59.26	59.26
Adish	64.77	64.77
Railroad City	67.64	67.64
Railroad City	67.64	67.64
Laurel LCC	69.78	69.78
Chase Road	102	102
Spokane (NPC)	108.29	108.29
Spokane (Aveco)	108.29	108.29
Spokane	121.15	121.15
Spokane	134.18	134.18
Rosa	145.71	145.71
St. John	158.89	158.89
Palouse	172.07	172.07
Laurel	182.79	182.79
Kamath	271.69	271.69
Stanfield	277.37	277.37
Stanfield	282.76	282.76
Calpine HPP	282.82	282.82
South Harmon	289.83	289.83
Laurel	304.25	304.25
Stanfield	416.16	416.16
Stanfield	426.8	426.8
Radmond	438.3	438.3
Pranghorn	445.8	445.8
North Bend	450.28	450.28
Beid	454.51	454.51
South Bend	457.5	457.5
Stanfield	469.19	469.19
Laurel	483.97	483.97
Chem	519.44	519.44
OG Inter	595.2	595.2
W. of Red	599.2	599.2
Tule Lake	609.8	609.8
Turquoise Falls (Ruby)	609.8	609.8
W. of Red	612.46	612.46

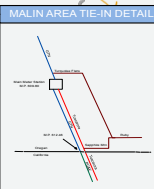

**TransCanada**  
**GTN System 2015**

Na tura Iga s Tra nsm ission

- Gas Transmission Northwest
- Tule Lake Pipeline
- NGTL System
- Foothills Pipeline
- Compressor Station
- Major Meter Station
- Milepost (M.P.)
- Power Plant
- Interconnect

0 50 100 150 200 250 Kilometers  
0 50 100 150 200 Miles

# Currently Available GTN Capacity



Available Firm Capacity  
System & Capacity Management



The figures below represent the seasonal minimum capacity available. For monthly details view Page 2.

Data as of: 1/15/2016

Unit of measurement: Dth

Assume ROFR Renewal	Winter	Summer	Winter	Summer
	2015-16	2016	2016-17	2017
Kingsgate to Stanfield	993,257	1,110,914	1,035,257	1,110,914
Stanfield to Malin	954,898	972,948	996,898	972,948
Stanfield Receipt Capacity	214,560	214,560	214,560	214,560
Stanfield Delivery Capacity	430,527	455,527	430,527	455,527
Comments/Updates				

Assume ROFR Turnback	Winter	Summer	Winter	Summer
	2015-16	2016	2016-17	2017
Kingsgate to Stanfield	1,041,357	1,110,914	1,558,295	1,613,810
Stanfield to Malin	958,498	972,948	1,374,736	1,345,026
Stanfield Receipt Capacity	214,560	214,560	214,560	214,560
Stanfield Delivery Capacity	430,527	455,527	430,527	455,527
Comments/Updates				

This data represents information available at the time of production and is subject to change. As new information becomes available updated capacities will be distributed accordingly.

# Historical GTN Rates

Rates Effective June 1, 2015							
Point to Point Maximum Unit Rates (\$ per Dth) <sup>1</sup>							
Rate Schedule	Miles of Haul	Daily Non-Mileage Reservation	Daily Mileage Reservation*	Delivery*	Total Unit Base Rate (c+d+e)	ACA	Total Unit Rate (f + g)
(a)	(b)	(c)	(d)	(e)	(f)	(g)	(h)
<b>FTS</b>							
King-Malin	612.46	0.039216	0.305005	0.009799	0.354020	0.001400	0.355420
King-Stan	277.37	0.039216	0.138130	0.004438	0.181784	0.001400	0.183184
King-Spok	108.29	0.039216	0.053928	0.001733	0.094877	0.001400	0.096277
King-Tusc	609.80	0.039216	0.303680	0.009757	0.352653	0.001400	0.354053
Stan-Malin	335.09	0.039216	0.166875	0.005361	0.211452	0.001400	0.212852
<b>PAL</b>					0.278124		0.278124
<b>ITS/STF<sup>2</sup></b>							
King-Malin							
Peak	612.46				0.491586	0.001400	0.492986
Off Peak	612.46				0.308369	0.001400	0.309769
King-Stan							
Peak	277.37				0.252667	0.001400	0.254067
Off Peak	277.37				0.158249	0.001400	0.159649
Stan-Malin							
Peak	335.09				0.293821	0.001400	0.295221
Off Peak	335.09				0.184107	0.001400	0.185507
<b>FTS - Extensions</b>							
<b>Medford</b>							
Med-Med Ext Mtr	88.10	0.005498	0.289849	0.002291	0.297638	0.001400	0.299038
Med-W. Klamath Tap	22.85	0.005498	0.075177	0.000594	0.081269	0.001400	0.082669
<b>Coyle-Spokane</b>							
CS-CS Ext Mtr	18.50	0.001420	0.026122	0.000000	0.027542	0.001400	0.028942

# Current GTN Rates (1/1/16 – 12/31/19)



Phase 1 Settlement Rates Effective January 1, 2016							
Point to Point Maximum Unit Rates (\$ per Dth) <sup>1</sup>							
Rate Schedule	Miles of Haul	Daily Non-Mileage Reservation	Daily Mileage Reservation*	Delivery*	Total Unit Base Rate (c+d+e)	ACA	Total Unit Rate (f + g)
(a)	(b)	(c)	(d)	(e)	(f)	(g)	(h)
<b>FTS</b>							
King-Malin	612.46	0.034393	0.265808	0.009799	0.310000	0.001400	0.311400
King-Stan	277.37	0.034393	0.120379	0.004438	0.159210	0.001400	0.160610
King-Spok	108.29	0.034393	0.046998	0.001733	0.083124	0.001400	0.084524
King-Tusc	609.80	0.034393	0.264653	0.009757	0.308803	0.001400	0.310203
Stan-Malin	335.09	0.034393	0.145429	0.005361	0.185183	0.001400	0.186583
<b>PAL</b>					0.243541		0.243541
<b>ITS/STF<sup>2</sup></b>							
<b>King-Malin</b>							
Peak	612.46				0.430325	0.001400	0.431725
Off Peak	612.46				0.269891	0.001400	0.271291
<b>King-Stan</b>							
Peak	277.37				0.221229	0.001400	0.222629
Off Peak	277.37				0.138536	0.001400	0.139936
<b>Stan-Malin</b>							
Peak	335.09				0.257246	0.001400	0.258646
Off Peak	335.09				0.161162	0.001400	0.162562
<b>FTS - Extensions:</b>							
<b>Medford</b>							
Med-Med Ext Mtr	88.10	0.004641	0.243068	0.002291	0.250000	0.001400	0.251400
Med-W. Klamath Tap	22.85	0.004641	0.063043	0.000594	0.068278	0.001400	0.069678
<b>Coyote Springs</b>							
CS-CS Ext Mtr	18.50	0.001283	0.023717	0.000000	0.025000	0.001400	0.026400

# GTN Average Day System Throughput

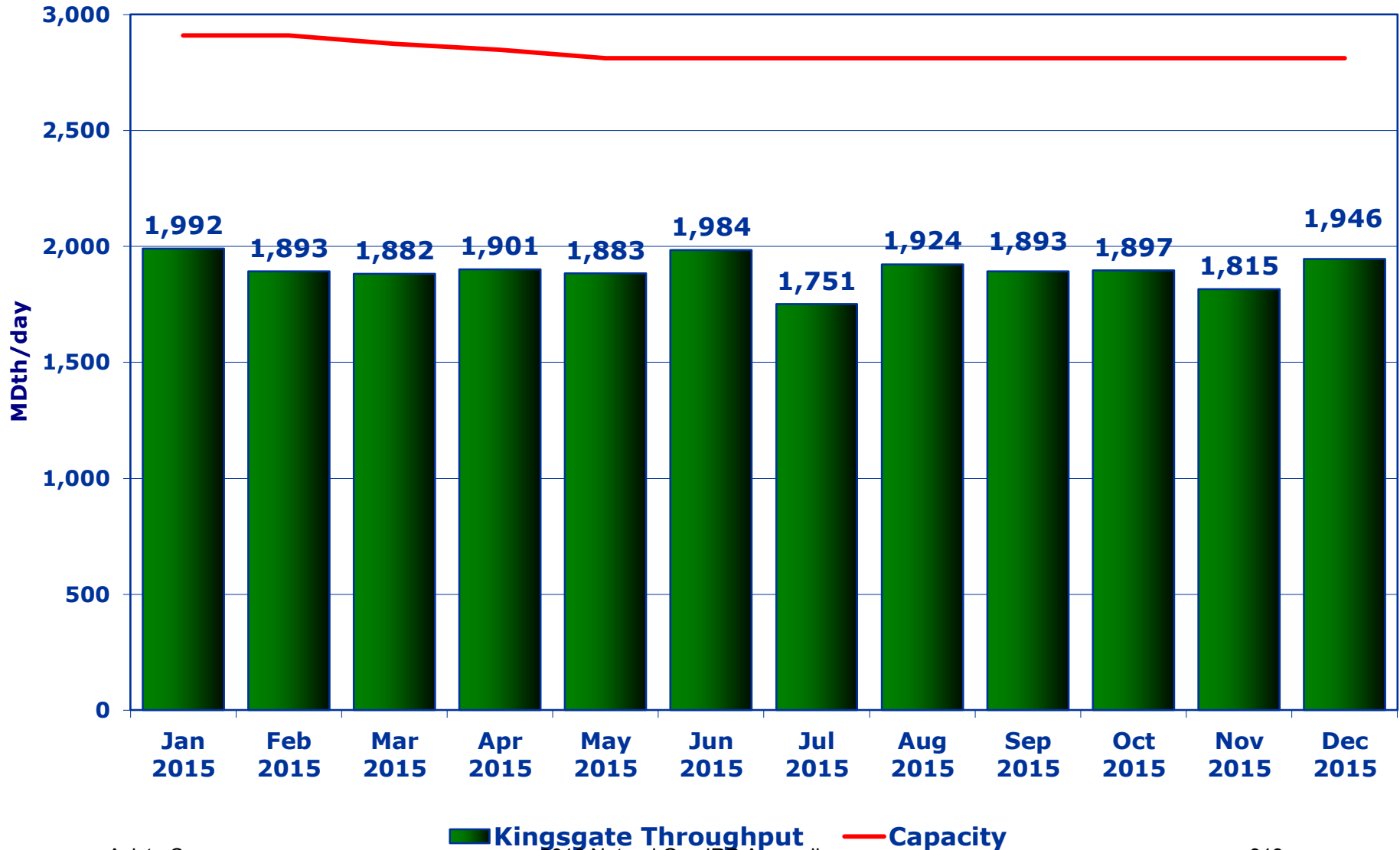

# Trail West Pipeline (Proposed)



- 106 mile, 30 -36" pipeline
- Receipt point from GTN mainline near Madras
- Delivery points into NWN and NWP at Molalla
- Compression-based expandability up to approximately 1Bcf/d
- Open Season Q4 2016
- In-Service: Nov. 2021

# Northwest Pipeline Avista IRP Technical Advisory Committee

Spokane, WA

February 18, 2016



# Agenda

System Overview

Collaboration

Reliability Efforts

Future Resources

Rate Case



# System Overview

# Northwest Pipeline (NWP)

Backbone of the Pacific Northwest gas delivery system

## > Prolific supply sources

- Rockies, San Juan, Western Canadian Sedimentary Basin, emerging BC shales

## > Steady market growth along I-5

## > Long-term firm peak transportation capacity of 3.8 TBtu/d

## > Assets

- 3,900 miles of pipeline and 41 compressor stations
  - Jackson Prairie Storage (25.6 Bcf capacity with 1.1 Bcf/d withdrawal capability)
    - NWP balancing 2.1 Bcf of capacity
    - NWP balancing 104,000 Dth/d of w/d
  - Clay Basin Storage
    - NWP balancing 3.2 Bcf of capacity
  - Plymouth LNG Storage
    - Customers hold 2.4 Bcf of capacity and withdrawal capability of 305,300 Dth/d



# Bi-Directional Pipeline

- > Northwest is a bi-directional pipeline that relies on both physical and displacement capacity to meet its contractual commitments
- > Benefits of a bi-directional pipeline:
  - > Provides access to the lowest priced supply basin in the region
  - > Built-in redundancy
  - > Lower transportation costs
  - > Lower fuel rates

# Ten-Year Supply Trend

## Northwest Pipeline's 10-year Supply Diversity

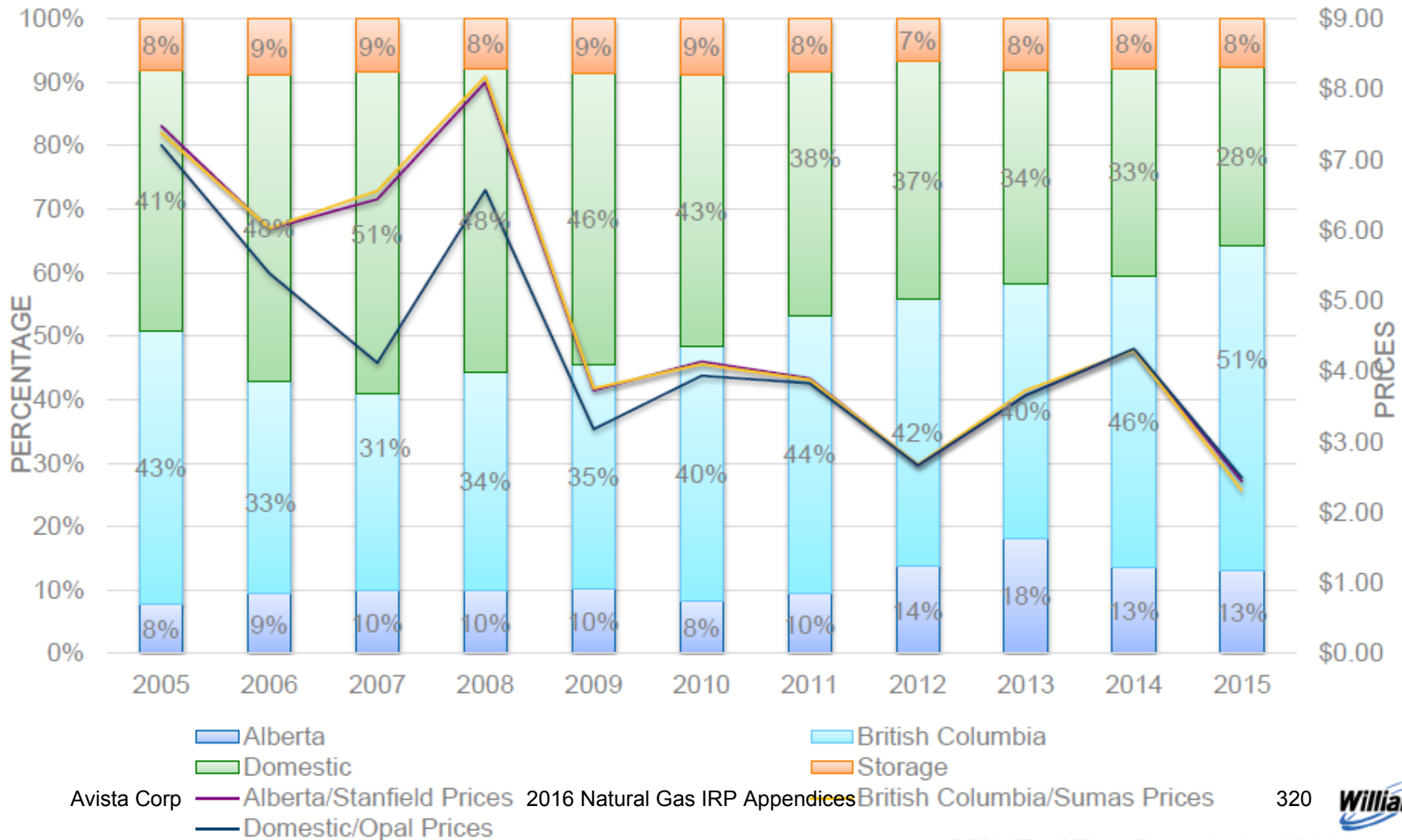

Avista Corp 2016 Natural Gas IRP Appendices British Columbia/Sumas Prices



# 2015 Demand by Destination

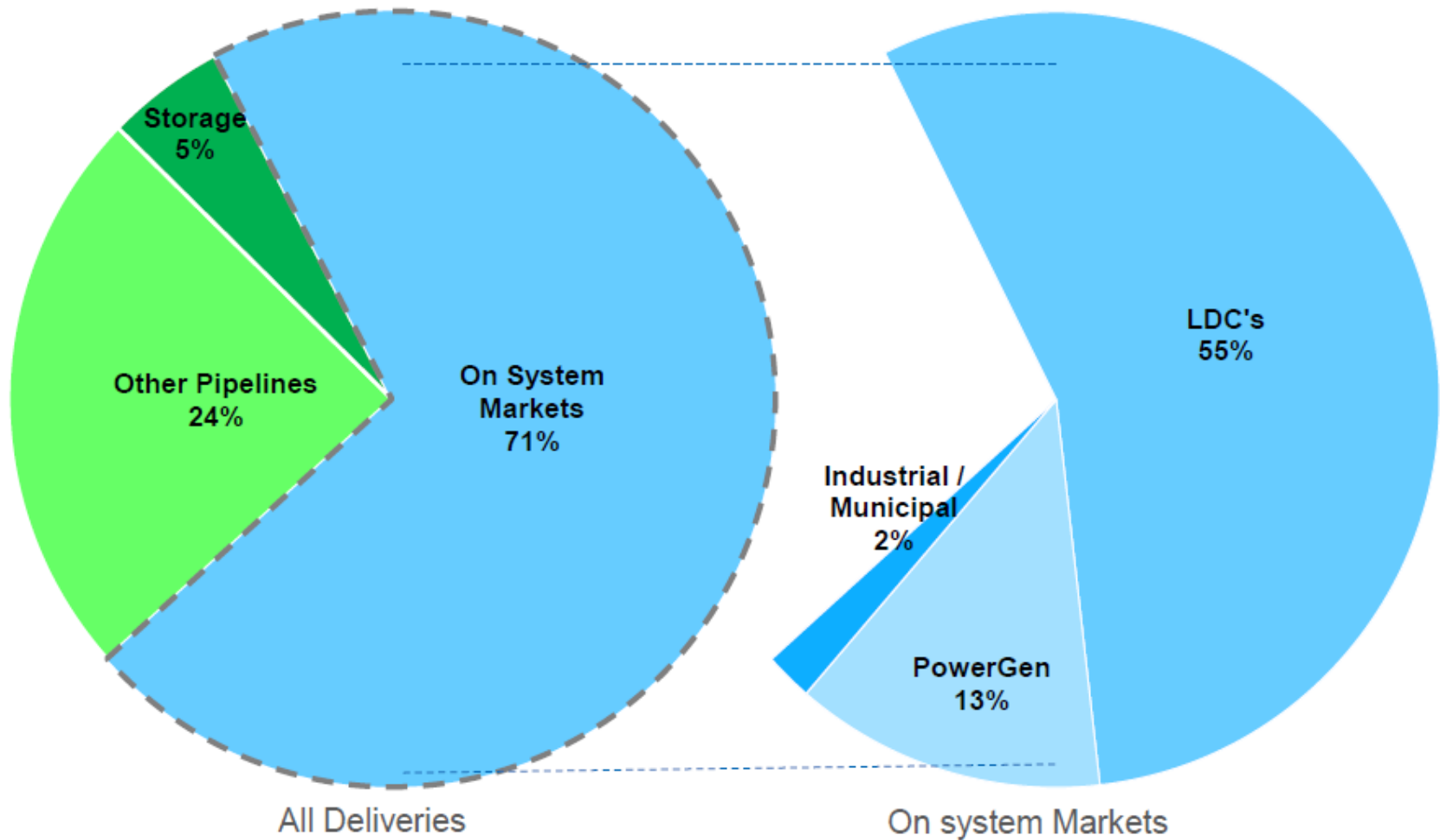

# Capacity Utilization

- > Northwest is fully contracted at the maximum tariff rates, with the exception of some small short-haul packages on the south-end of the system
- > Demand to bring on supply from Sumas flowing South through points such as Chehalis, Roosevelt and Plymouth, has greatly increased over the past few years
- > Demand to bring on supply from the Rockies has decreased, however, continues to be healthy during the winter heating season

# Chehalis

## Average Daily Chehalis Throughput (South Flow)

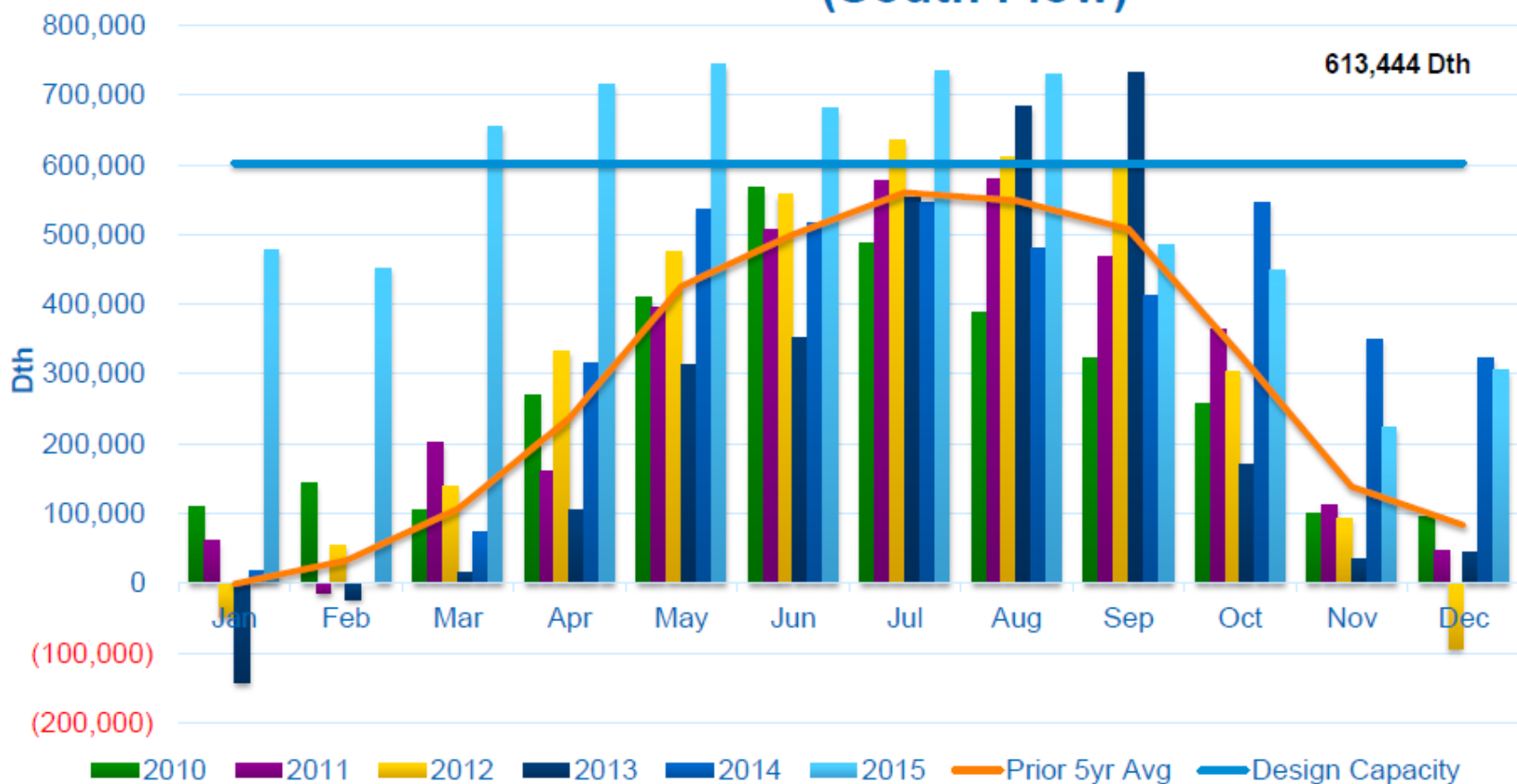

■ 2010   
 ■ 2011   
 ■ 2012   
 ■ 2013   
 ■ 2014   
 ■ 2015   
 — Prior 5yr Avg   
 — Design Capacity

# Roosevelt

## Average Daily Roosevelt Throughput (West Flow)

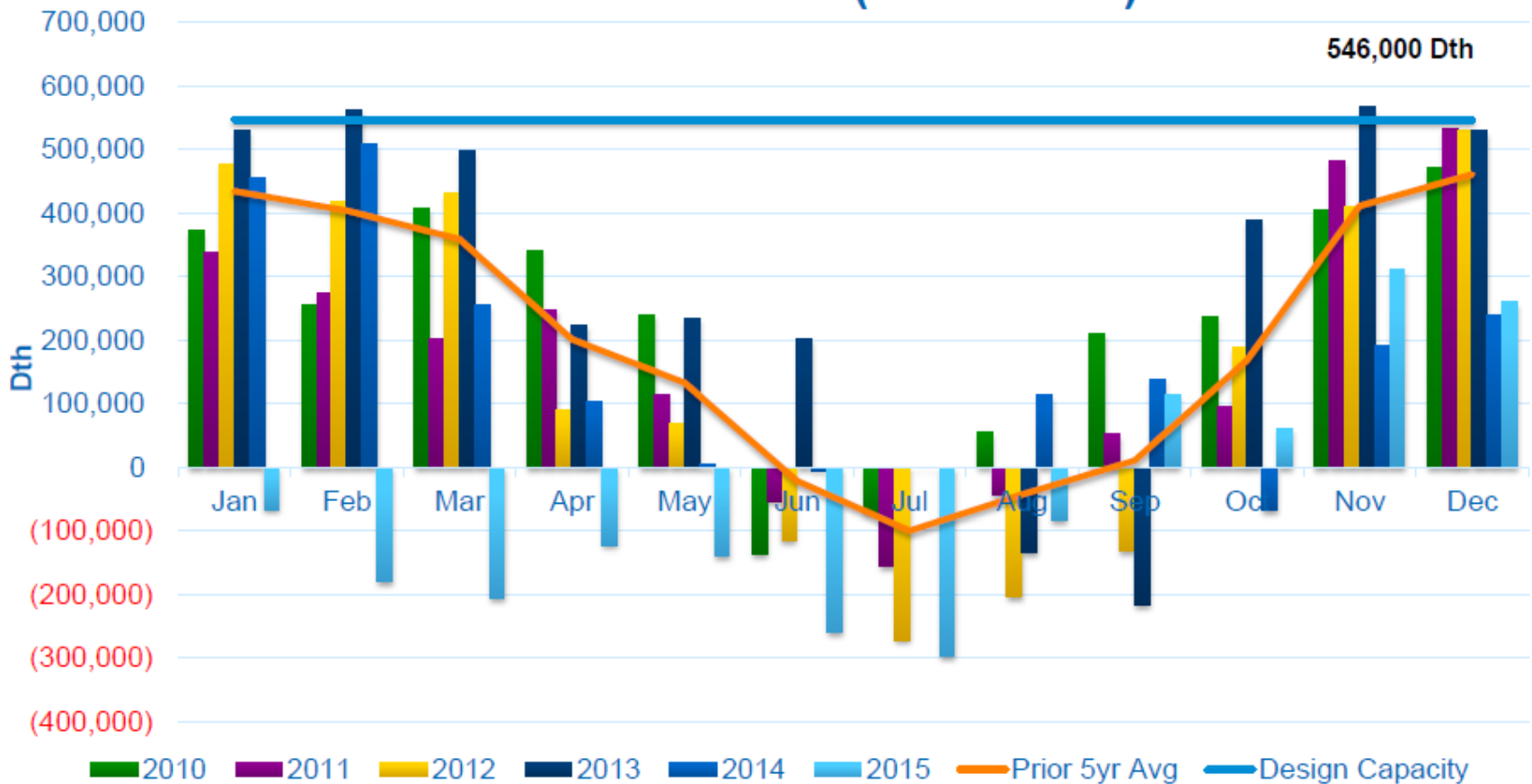



# Plymouth

## Average Daily Plymouth South Throughput (North Flow)

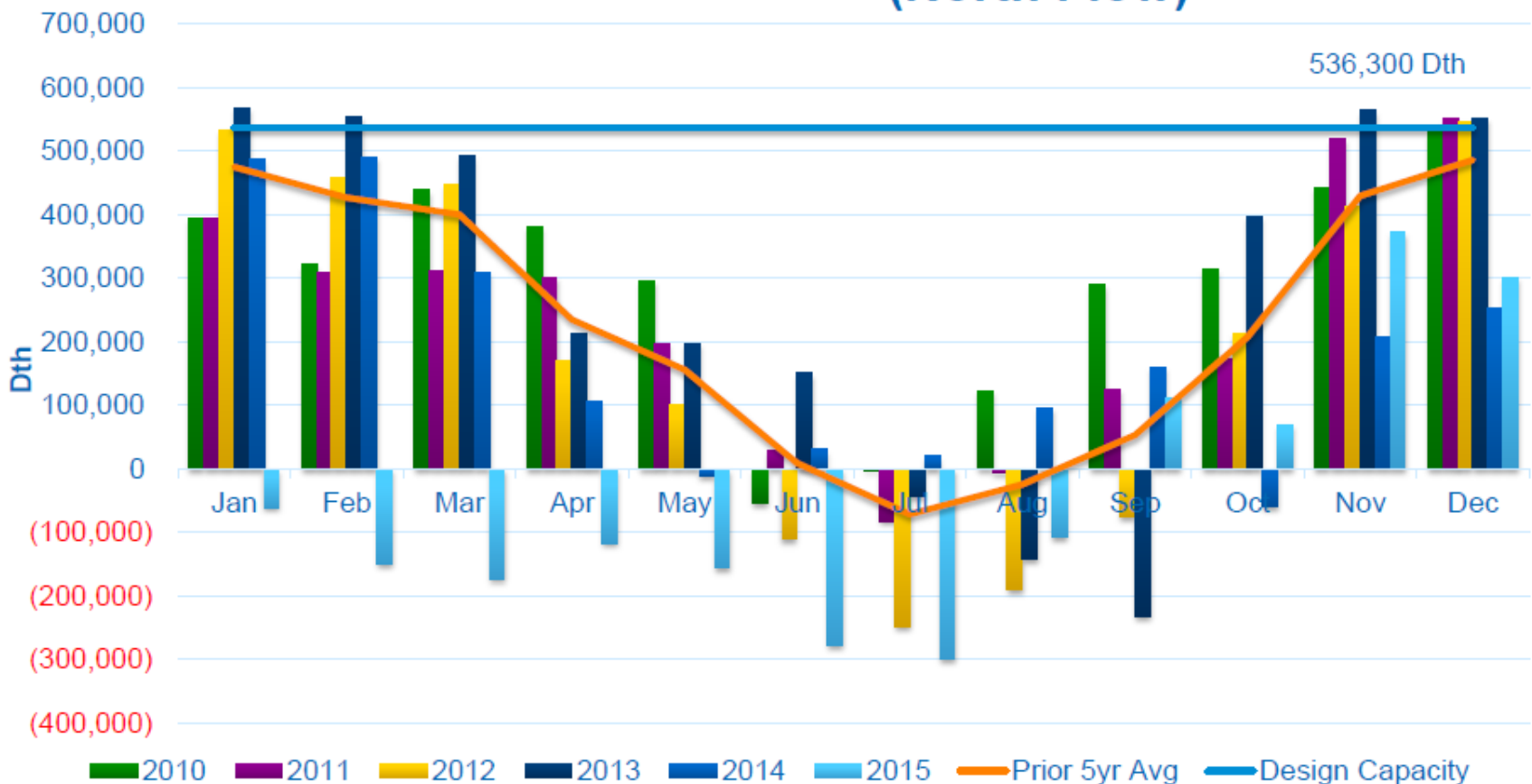

# Kemmerer

## Average Daily Kemmerer Throughput (North Flow)

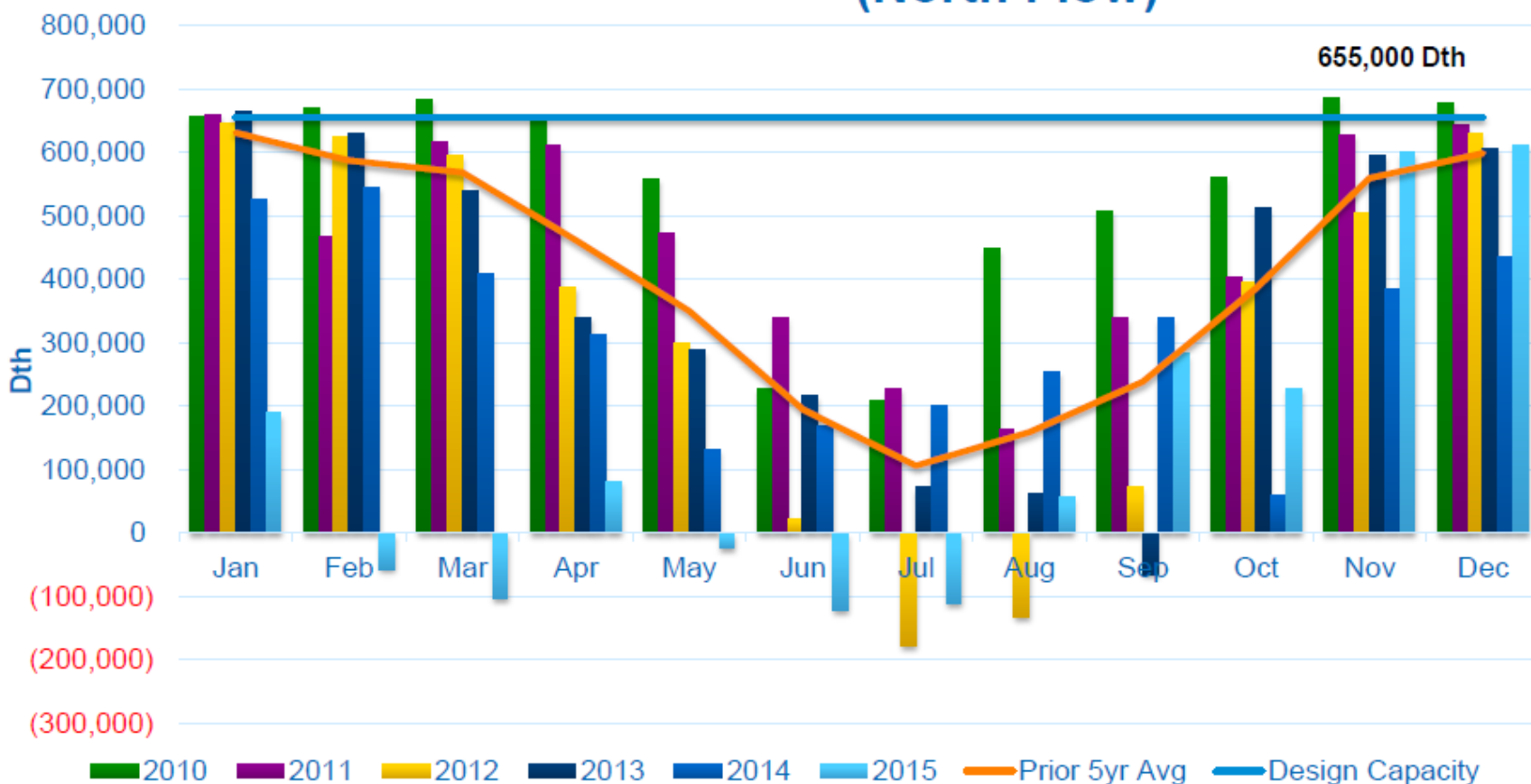

# Collaboration

# Collaboration through Shipper Advisory Board (SAB) Meetings

- > Northwest has established a SAB that meets regularly
  
- > Purpose of the SAB
  - Inform customers of items that may impact facilities and rates
  - Obtain support for tariff filings prior to filing them with the Commission
  - Develop positions on FERC NOPR's
  - Discuss industry trends

# Collaboration Results In Unique Solutions

## > Operational Flow Orders (OFOs)

- Eliminate the need for facilities to meet peak-day loads
- Order of operational remedies: (1) scheduling/entitlements, (2) contract specific, (3) realignment, then (4) must flow

## > Reliability Settlement

- Established reservation credits if outages exceed the threshold
- OFOs limited to resolving displacement concerns
- Additional mobile compression facilities added to enhance service reliability and flexibility

## > Displacement Settlement

- Installation of new facilities to reduce Wyoming to Idaho north flow displacement
- New contract prohibition

# Collaboration through Customer Surveys

- > Northwest continues to incorporate feedback from its customer surveys to improve its processes. For example:
  - In response to low customer survey scores in the mid-1990s, Northwest:
    - Adopted a single-point-of-contact business model;
    - Developed Passage to comport with the single-point-of-contact model by integrating contracting, capacity release, nominations, confirmations, scheduling, imbalance management, measurement, invoicing, etc. into one system

# Collaboration with Individual Customers

- > Avista has unique contracting requirements in order to meet its peak-day demands in Washington, Oregon and Idaho
- > To meet these unique requirements Avista holds capacity with excess MDDOs that provide delivery point flexibility to transport gas to various markets as needed
- > Northwest and Avista have worked together to assist Avista in:
  - > locking up segmented capacity for the long-term in order to;
    - > mitigate its transportation costs; and
    - > maximize its excess MDDO flexibility
  - > meeting projected peak-day capacity shortfalls without adding additional facilities; and
  - > meeting an immediate new load by installing a mobile meter station until a permanent meter station could be designed and placed into service.

# Collaboration Works

> In obtaining contract extensions

**Northwest Pipeline Average Remaining Contract Life History  
(Revenue Weighted)**

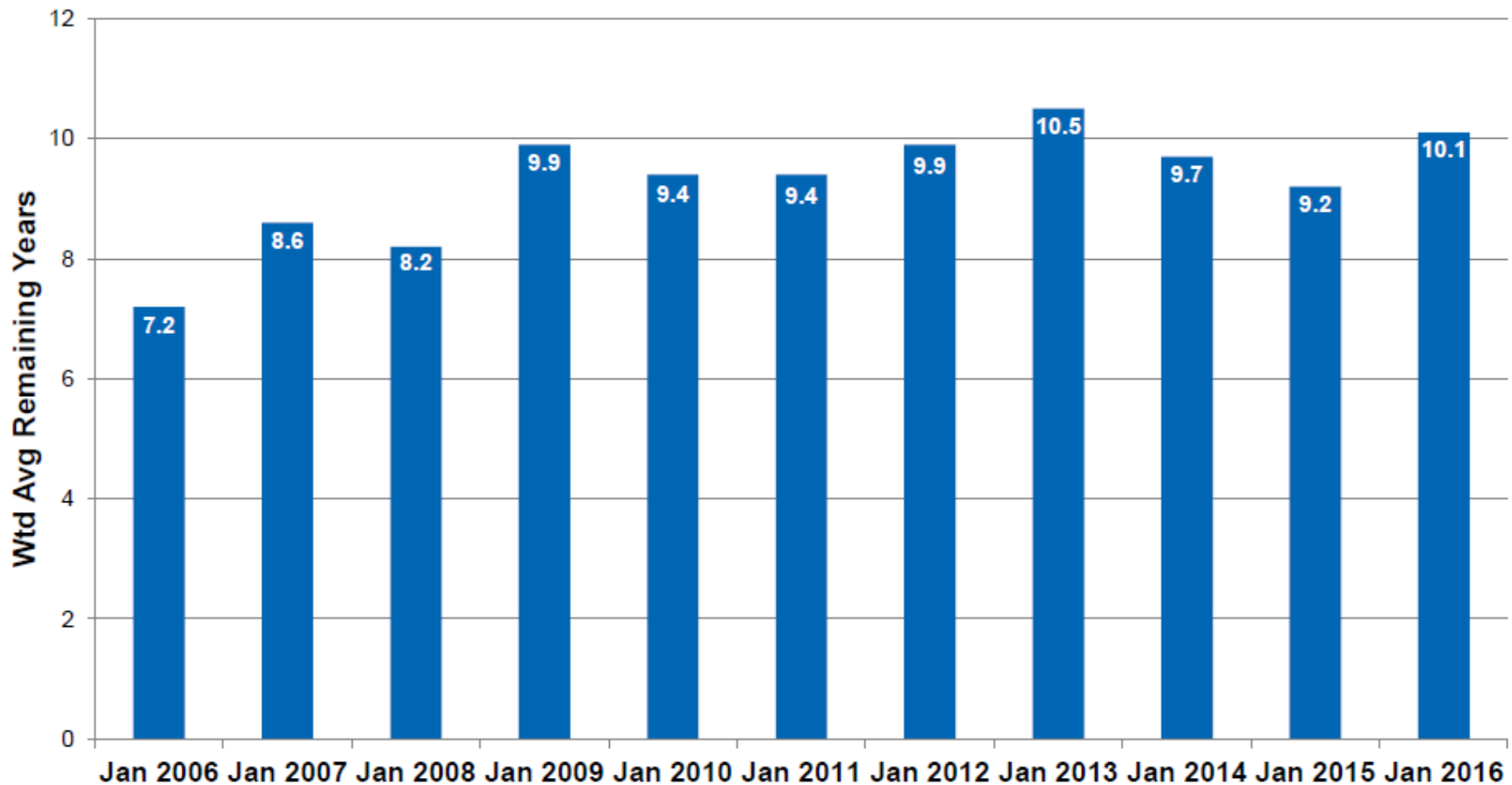

Avista Corp

2016 Natural Gas IRP Appendices

332

Avista's average contract life is 12.81 years





# Collaboration Works

## > In settling rate cases

- Northwest and its customers were able to settle the last two rate cases (2006 and 2013) in a timely and efficient manner due to collaboration and trust
  - Individual customer and SAB meetings were held to discuss impact of major expenditures prior to filing (e.g., Capacity Replacement and Rockies Expansion)
  - Agreements were reached to handle unknown cost variances (e.g., integrity related costs and federal corporate income tax rate)
  - Strong and ongoing relationships with our customers has helped in building trust and mutual respect



# Collaboration Works

> In improving customer satisfaction

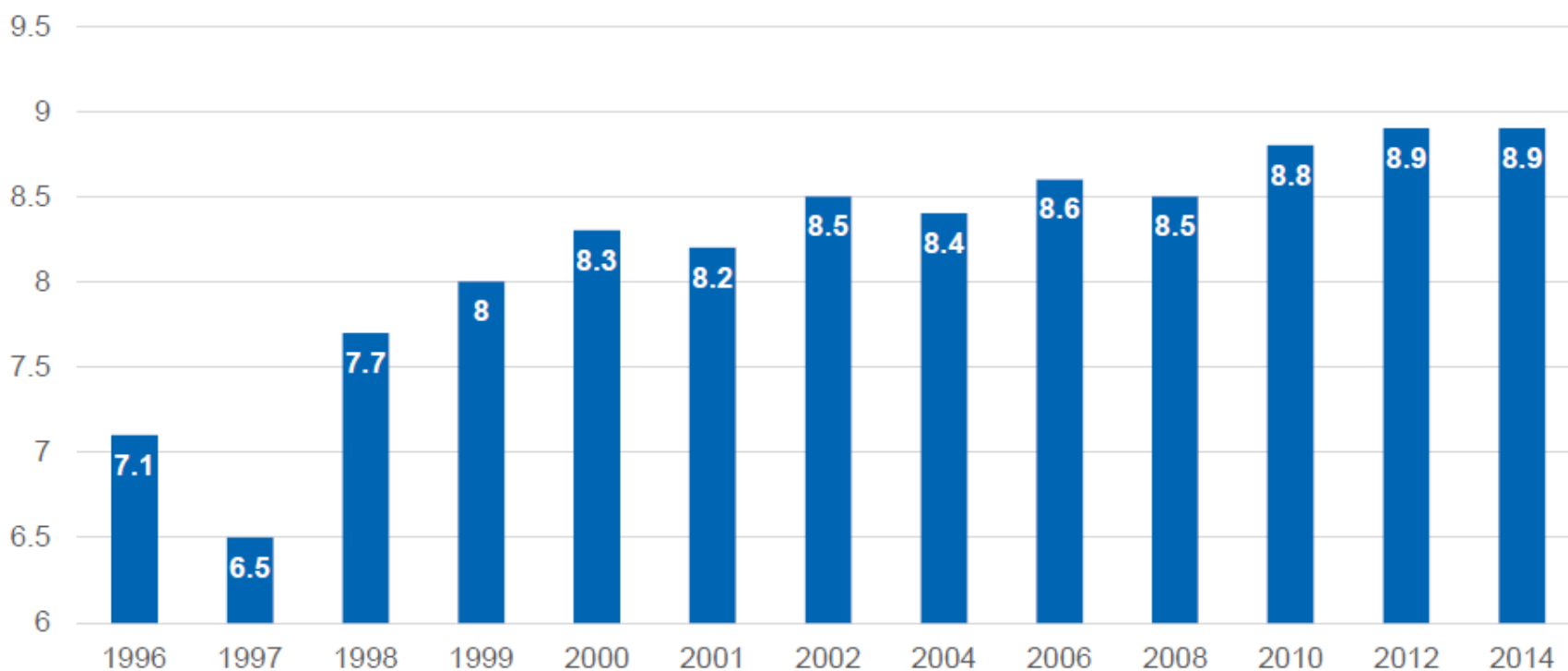

# Reliability Efforts

## Measuring Reliability

- > This takes into account planned and unplanned outages.
  - ❖ 2014 – 99.90 percent
  - ❖ 2015 – 100 percent

# Ways Northwest Mitigates Impacts

- > Work planning/scheduling
- > Communication with customers, markets and interconnects
- > Planning with individual customers at meter sites or laterals
- > Stopple and bypass for construction tie-in work where redundant looping is not available
- > Utilize system balancing to the extent possible

# Total Miles of First Time Assessments

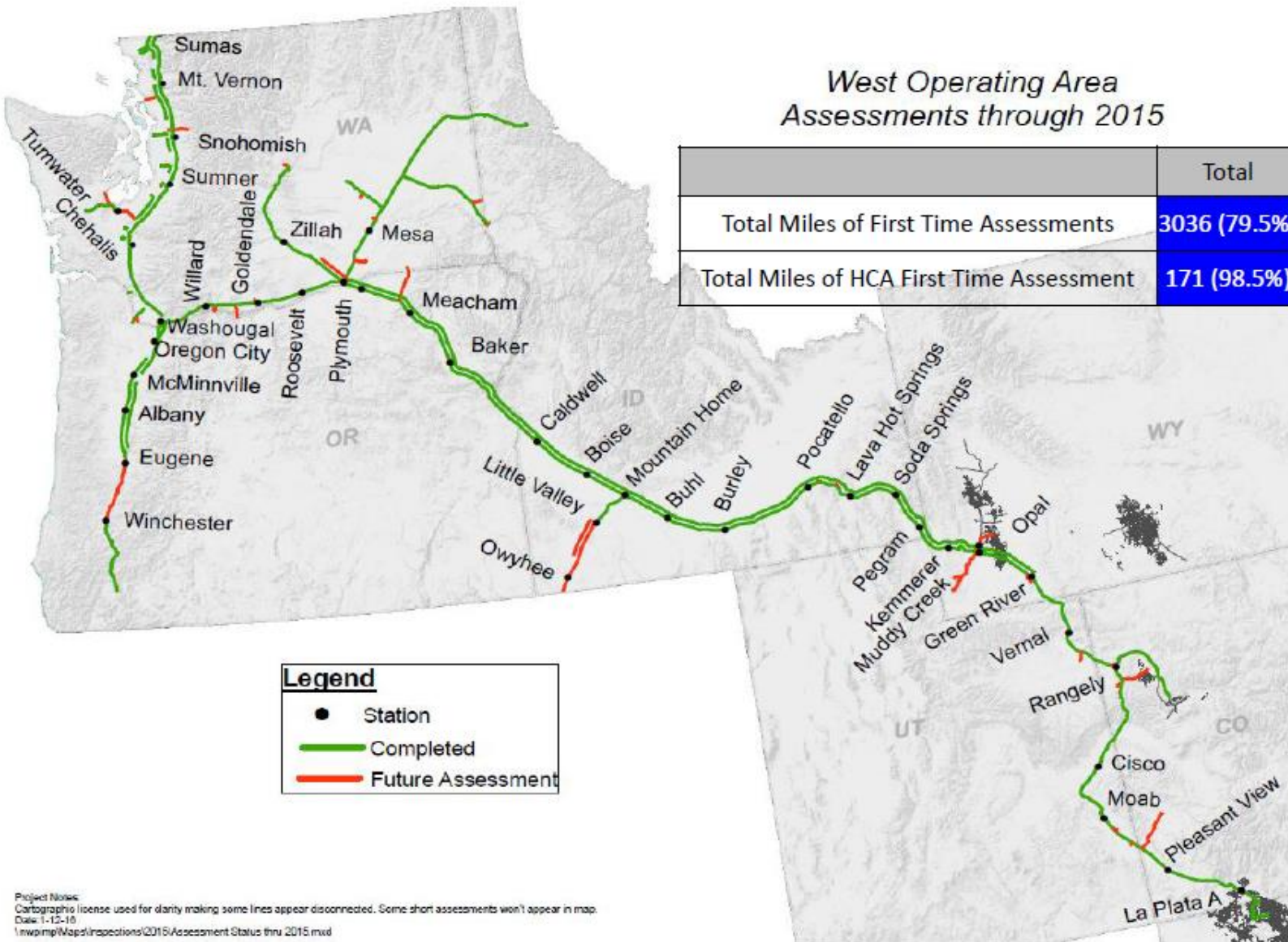

Project Notes:  
 Cartographic license used for clarity making some lines appear disconnected. Some short assessments won't appear in map.  
 Date: 1-12-16  
 I:\wmp\Maps\inspections\2015\Assessment Status thru 2015.mxd

# Reliability

- > Northwest Geotechnical Monitoring Program
- > Mobile Compression Program / Solar Agreement
- > Valve Automation



# Future Resources



## Overview –

- > Pacific Connector
- > Grants Pass
- > Washington Expansion

# Overview –

- > Pacific Connector
- > Grants Pass
- > Washington Expansion

# Pacific Connector Gas Pipeline Project (PCGP)

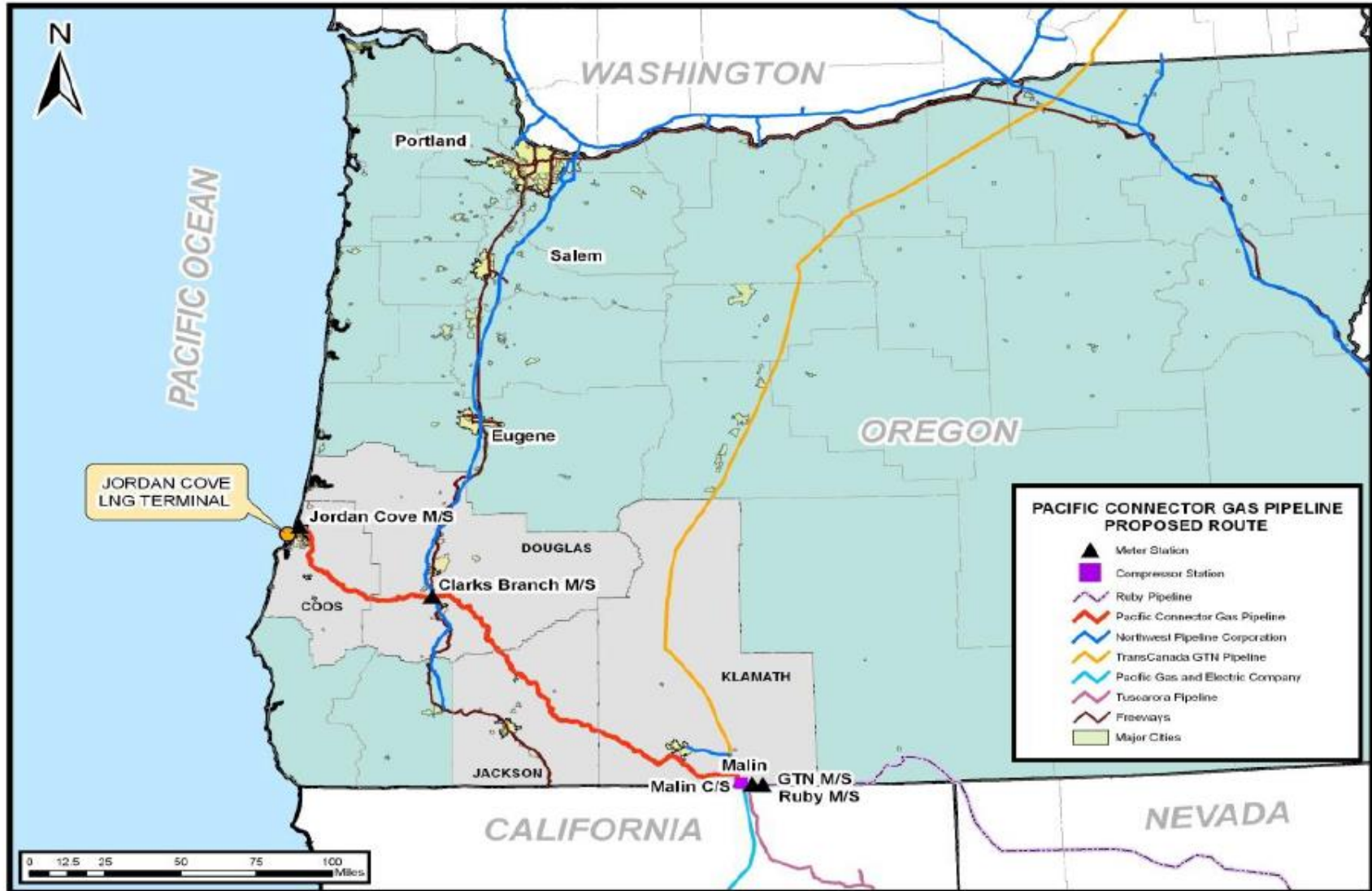

## PCGP Cont'd

- > 232-mile 36-inch diameter pipeline with a 41,000 HP (ISO rated) compressor station
- > Provides up to 1,060,000 Dekatherms per day (Dth/d) of firm transportation
- > Jointly owned 50/50 by Williams Partners Operating, LLC and Veresen Inc.
- > Estimated FERC filed capital cost of \$1.74 billion
- > Target 1<sup>st</sup> Quarter 2016 to execute binding precedent agreements
- > Target 1<sup>st</sup> Quarter 2016 FERC certificate
- > 4<sup>th</sup> Quarter 2020 In-Service (for pipeline)

# Grants Pass

## > Project Summary

- Grants Pass Clark Branch Interconnect
- capital cost \$5-10 million

## > No./So. Bound capacity

## > In-Service 4Q2020

## > Design

- Compression station piping modifications
- Potential meter upgrades

## > Open Season

- Tentative April PCGP open season
- Potential Summer Grants Pass open season

Name	Point ID #	Milepost	Potential Increased Throughput PCGP
Washougal C/S			289,466
Clark	299	0.2	239,052
Camas JR	300	3.75	239,052
Washougal	301	3.76	239,052
Reynolds Metals	302	3.8	239,052
Portland Northeast	303	7.26	239,052
Gresham	304	10.7	239,052
Johnson Creek	305	10.8	239,052
Sandy	306	15.85	239,052
Portland Southeast	307	19.56	239,052
Oregon City Compressor Station	308	21.06	239,052
Oregon City	309	28	239,052
Molalla #2	310	38.6	239,052
Molalla Receipt	672	38.63	239,052
Molalla	312	38.64	239,052
McMinnville Compressor Station	316	53.09	51,900
Albany Compressor Station	328	83.46	51,900
Eugene Compressor Station	337	10.04	51,900
Winchester Compressor Station	346	62.2	51,900
Winchester Plywood	347	62.29	51,900
Dr. Gamble Farm	348	64.16	51,900
Roseburg	351	69.3	51,900
Coos County Meter Station	670	72.11	51,900
Austin Williams	352	73.6	51,900
Winston - Dillard	353	74.61	51,900
Hasbargen Herman	354	76.1	51,900
Round Priarie (Roseburg Lumber)	355	78.57	51,900
Garren Roy	356	79.51	51,900
Woods Elmer	357	80.3	51,900
Clarks Branch	TBD	80.4	
Weaver Gilbert	358	86.51	
Myrtle Creek/Riddle	359	87.13	76,196
Canyonville	361	92.46	46,190
Glendale	701	106.88	23,931
Merlin	365	126.95	14,660
Grants Pass	366	131.54	13,490



Assumes no meter constraints and some small modifications to compressor station piping along the lateral



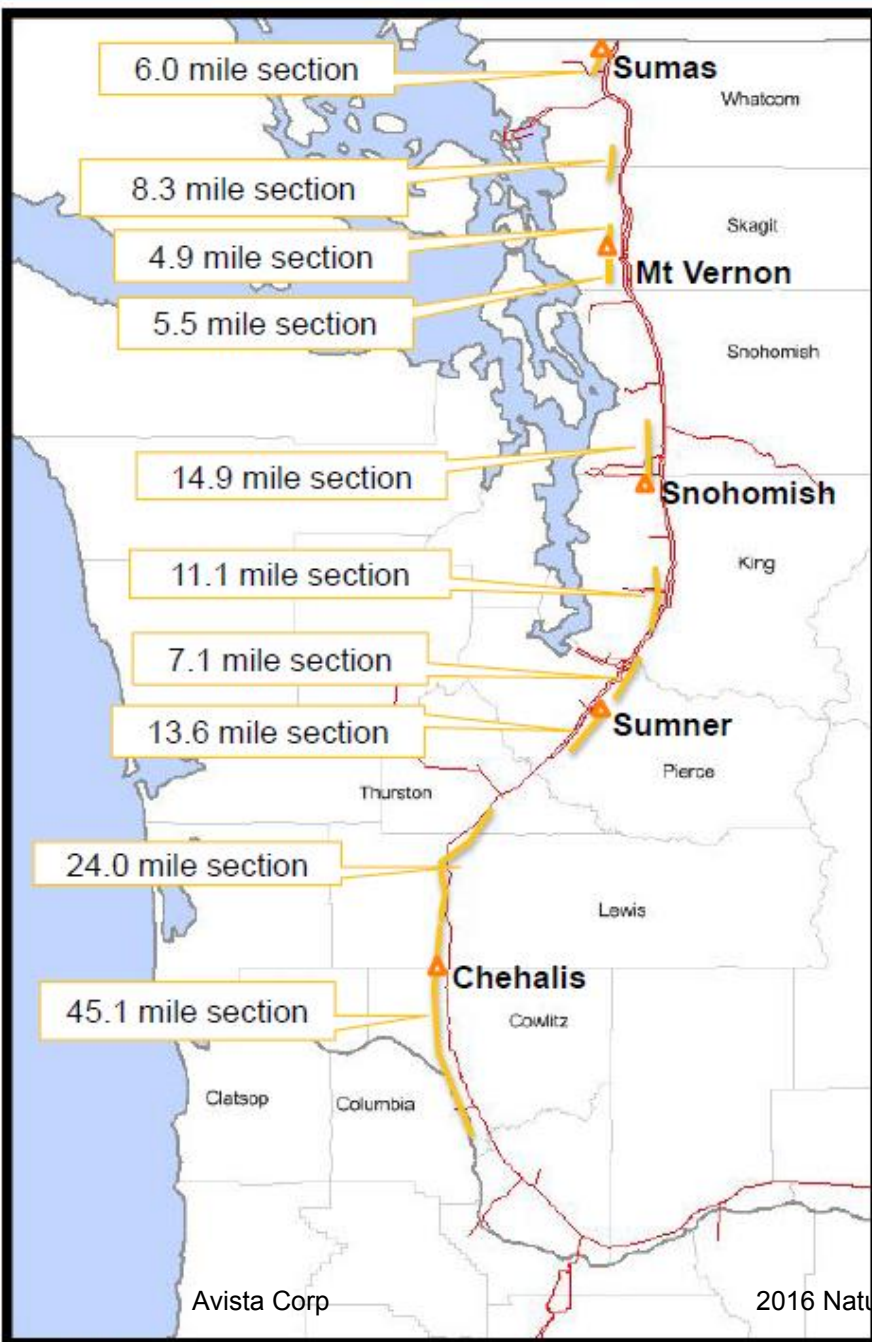

## Washington Expansion Project

- > FERC application filed 2013 (CP13-507)
- > 140 miles of 36-inch diameter loop line with:
  - 750,000 Dth/d of firm transportation
  - 89,620 incremental horsepower required along I-5
- > Estimated cost \$1.1 billion
- > Targeted in-service date November 2019
  - Potential regional loads with in-service dates phased-in

# Northwest Innovation Works Projects

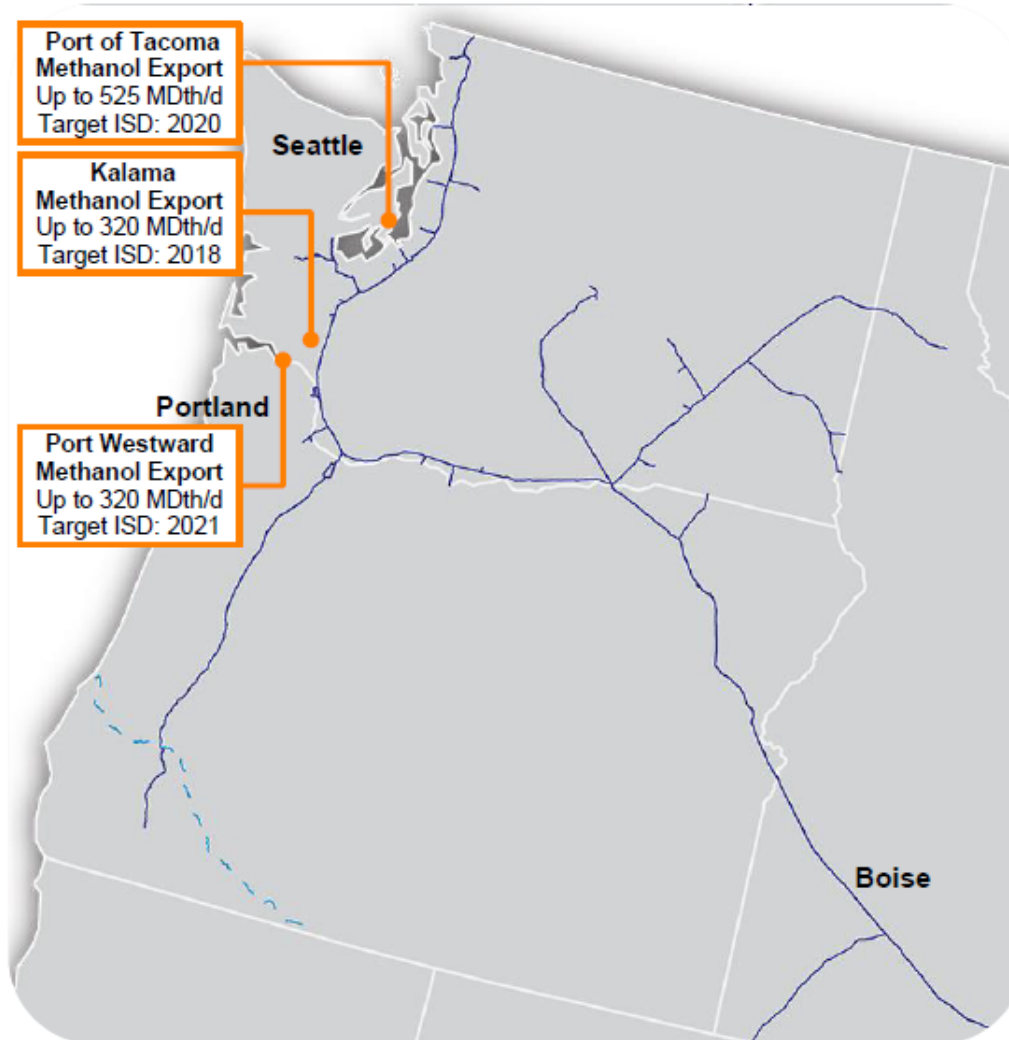

- > Port of Tacoma Lateral
  - 10-mile up to 30-inch diameter green-field delivery lateral
- > Port of Kalama Lateral
  - 3.1-mile 20-inch diameter pipeline
  - Expecting FERC certificate Q2 2016
- > Laterals interconnect with Northwest's existing mainline

# Rate Case



# Rate Case

- > Current Rate Case Settlement provides:
  - \$466.5 million annual cost of service
  - Transportation rate of \$0.44 / Dth
  - Allows NWP to file for new rates to be effective as early as 1/1/2016 and requires NWP to file for new rates to be effective by 1/1/2018
  
- > Upcoming Rate Case Pre-Filing Settlement schedule:
  - April 22, 2015 -- Shippers (22 of them) indicated willingness to participate in pre-filing settlement discussions
  - Third Quarter 2016 -- Detailed pre-filing discussions commence
  - March 2017 -- Settlement must be final or filed rate case will be necessary

# Rate Case Timeline

Rate Case RP17-XXX Timeline (Customer Discussions, Per Previous Settlement)

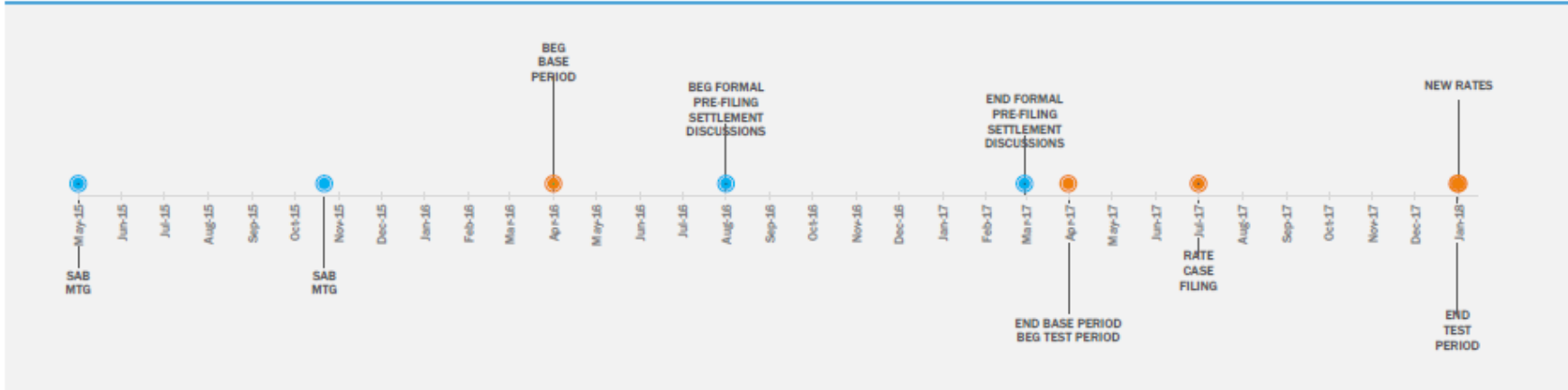

SAB – Shipper Advisory Board



# Regional and Avista's Supply Side Resources

Eric Scott

Manager of Natural Gas Resources

# Connecting Supply and Storage with Customers

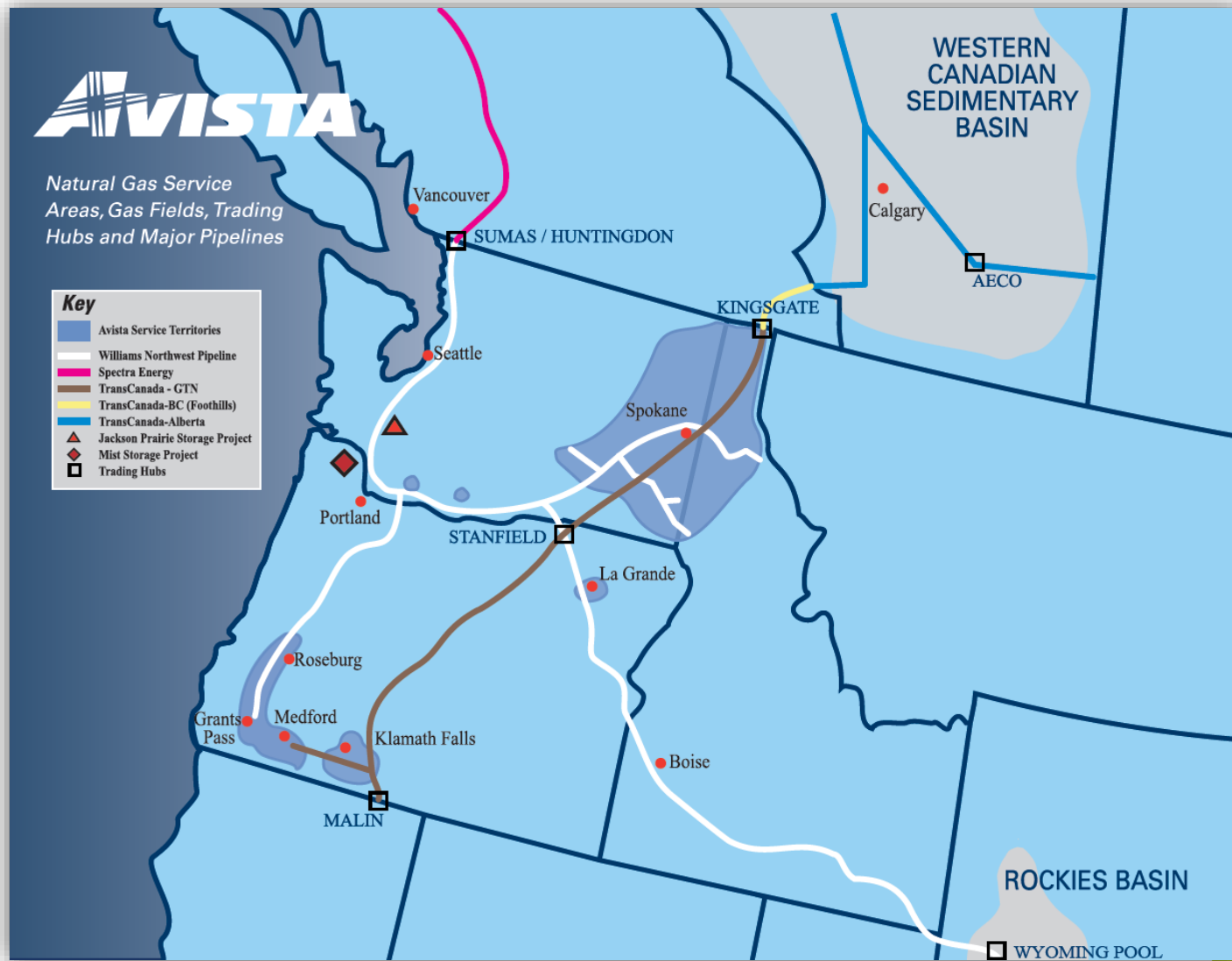

# Regional Transportation Resources

- **TransCanada Alberta (NOVA)**
  - Transporting gas out of Alberta, Canada
- **TransCanada BC (ANG)**
  - Transporting gas through BC, Canada to US
- **Spectra Energy (WestCoast)**
  - Transporting gas from western BC Canada to US
- **Gas Transmission Northwest (GTN)**
  - Transporting gas from Canada/US border to CA
- **Williams Pipeline West (NWP)**
  - Transporting gas from western BC and US Rockies
- **El Paso Ruby Pipeline**
  - Transporting gas from the Rockies to Malin

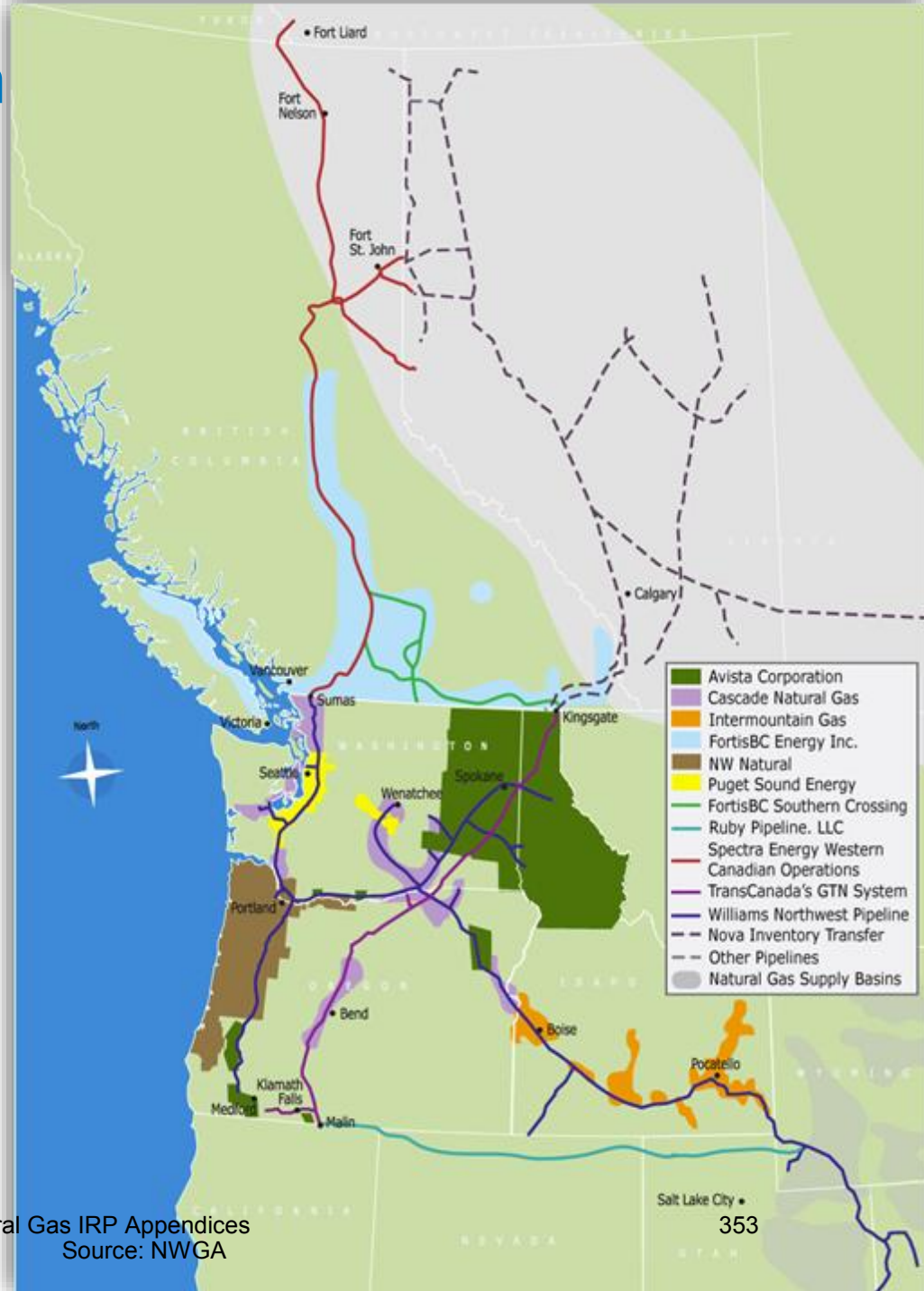

# Interstate Pipeline Resources

- The Integrated Resource Plan (IRP) brings together the various components necessary to ensure proper resource planning for reliable service to utility customers.
- One of the key components for natural gas service is interstate pipeline transportation. Low prices, firm supply and storage resources are rendered meaningless to a utility customer without the ability to transport the gas reliably during cold weather events.
- Acquiring firm interstate pipeline transportation provides the most reliable delivery of supply.

# Pipeline Contracting

Simply stated: The right to move (transport) a specified amount of gas from Point A to Point B



# Rate Structure

Straight Fixed Variable (SFV)

- Pipeline charges a higher demand charge and a lower variable or commodity charge

Enhanced fixed variable

- Pipeline charges a lower demand charge and a higher variable or commodity charge

Postage Stamp Rate

- Pay the same demand and variable costs regardless of how far the gas is transported

Mileage Based

- Pay a variable and demand charge based on how far the gas is transported



# Types of Pipeline Contracts

## Firm Transport

- Contractual rights to:
  - Receive
  - Transport
  - Deliver
- From point A to point B

## Interruptible Transport

- Contractual rights to:
  - Receive
  - Transport
  - Deliver
- From point A to Point B *AFTER FIRM TRANSPORT HAS BEEN SCHEDULED – and can be BUMPED later!*

## Seasonal Transport

- Firm service available for limited periods (Nov-Mar) or for a limited amount (TF2 on NWP)
  - Usually matched, paired or utilized with storage.

## Alternate Firm Transport

- The use of firm transport outside of the primary path
- Priority rights below firm
- Priority rights above interruptible

# Segmentation

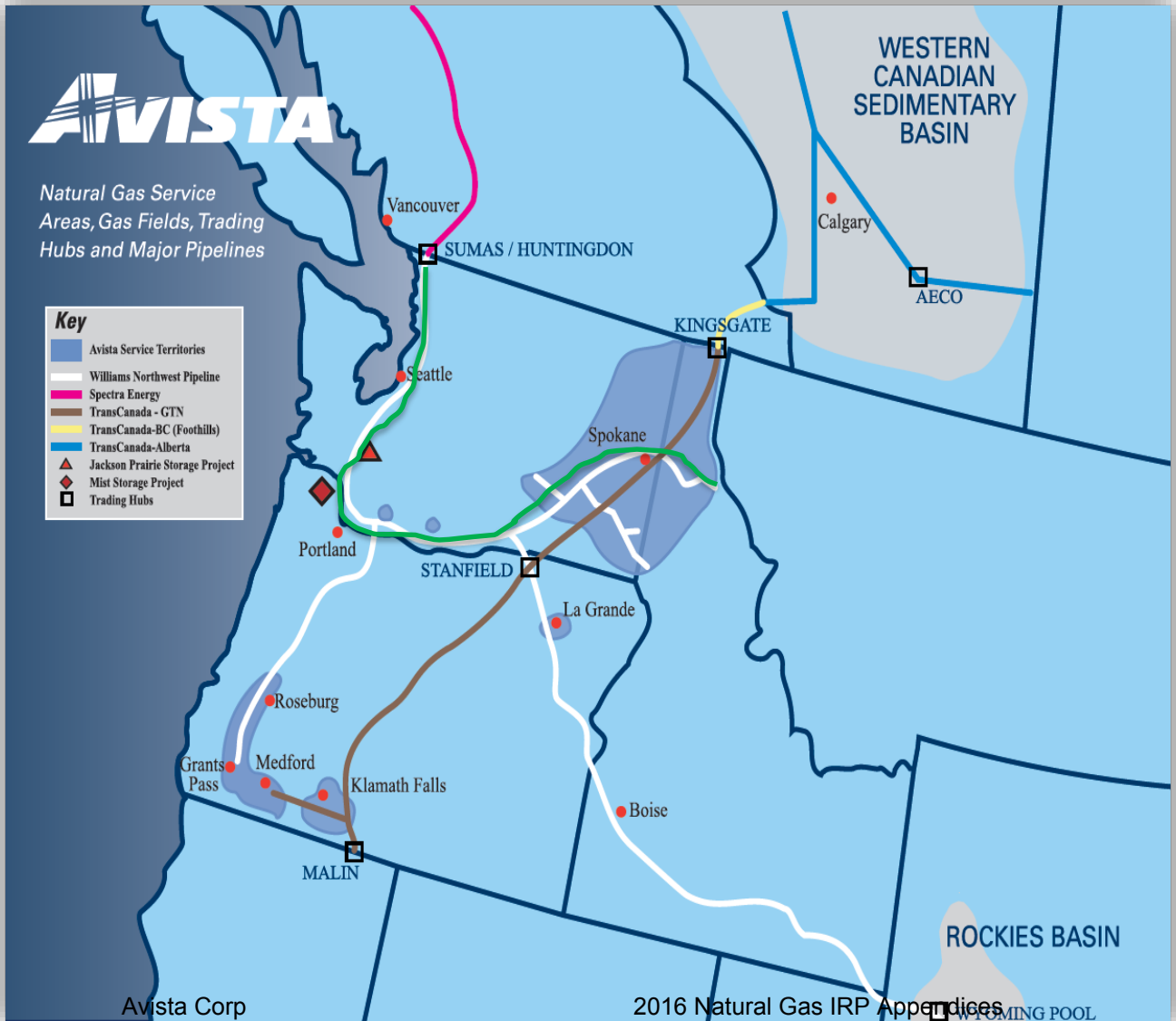

**Primary Path:**  
Sumas to CDA  
10,000 Dth/day  
Guaranteed  
Delivery

# Segmentation

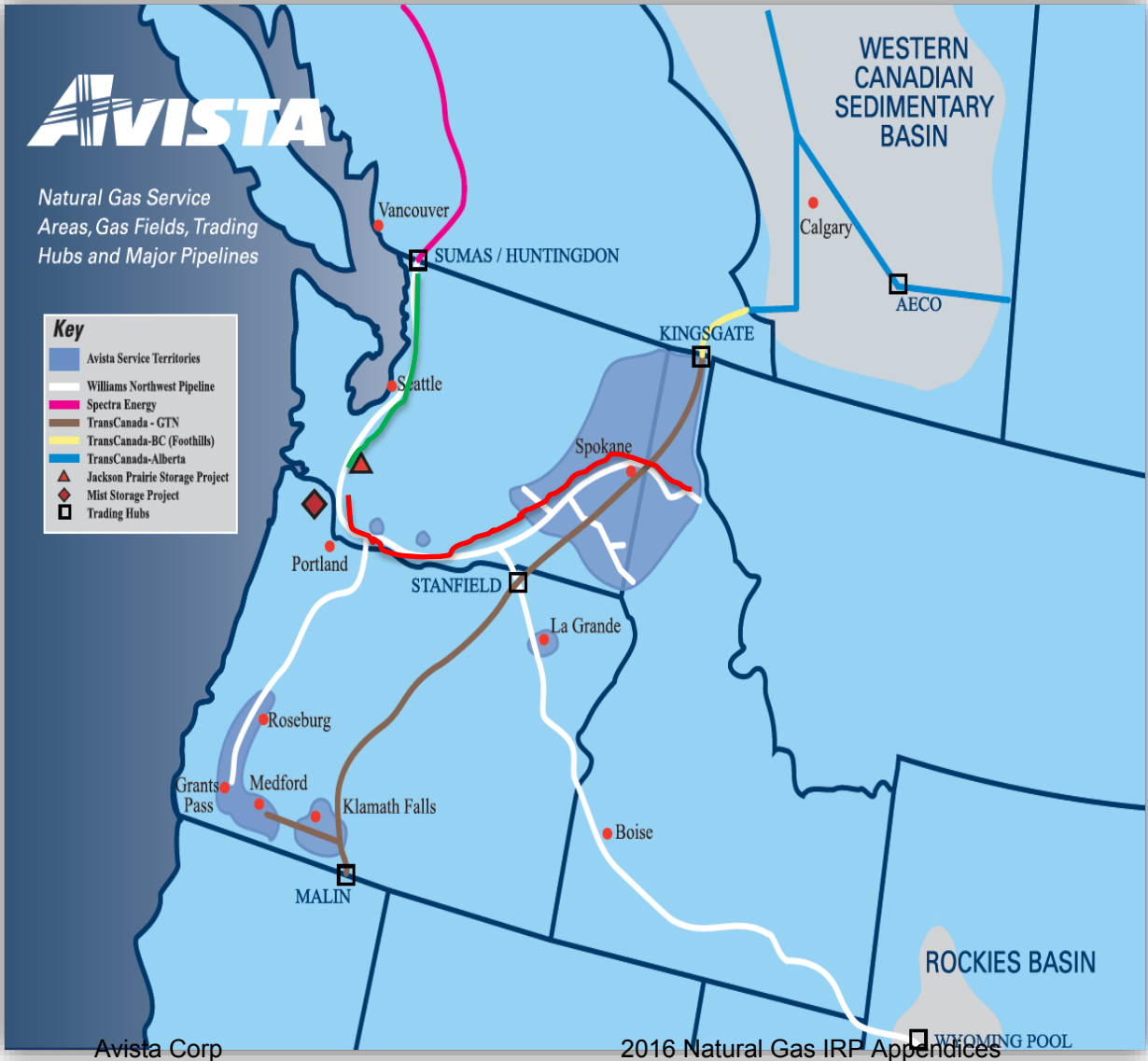

**Segment:**  
Sumas to JP – FIRM  
10,000 Dth/day

JP to CDA – FIRM  
10,000 Dth/day

# Contract Provisions - NWP

- Grandfathered Unilateral Evergreen (TF-1, TF-2, SGS-2F)
  - Roll-over 1 year
  - Shipper has sole option to extend or renew
- Standard Unilateral Evergreen
  - Roll-over 1 year
  - 5 year termination provision
- Standard Bi-lateral Evergreen
  - Either transporter OR shipper may terminate

# Contract Provisions - GTN

- Bilateral Evergreen
  - Either transporter OR shipper may terminate contract
- Unilateral Evergreen
  - Shipper alone may terminate contract
- Right of First Refusal (ROFR)
  - Provides “last look”

# Capacity Releases





Time	Duration	Rate
Short	3 days – 5 months	\$.03-\$.05
Annual	1 year	\$.03-\$.41 (full rate)
Long	2 years – 31.5 years	\$.41 (full rate)

Example:

AVA released 35,000 Dths/day at full tariff rate to Clark PUD until 10/31/2025 recapturing over \$5.2mm annually all of which goes to customers.

# Natural Gas Liquids - Extraction

- Wet natural gas from AB/BC has many liquid components that may be taken from stream. Each component is used in industrial processes and has value.
- Avista negotiates with an extraction plant near Calgary to purchase these liquids components.

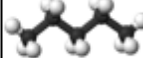
NGL Attribute Summary				
Natural Gas Liquid	Chemical Formula	Applications	End Use Products	Primary Sectors
Ethane	$C_2H_6$ 	Ethylene for plastics production; petrochemical feedstock	Plastic bags; plastics; anti-freeze; detergent	Industrial
Propane	$C_3H_8$ 	Residential and commercial heating; cooking fuel; petrochemical feedstock	Home heating; small stoves and barbeques; LPG	Industrial, Residential, Commercial
Butane	$C_4H_{10}$ 	Petrochemical feedstock; blending with propane or gasoline	Synthetic rubber for tires; LPG; lighter fuel	Industrial, Transportation
Isobutane	$C_4H_{10}$ 	Refinery feedstock; petrochemical feedstock	Alkylate for gasoline; aerosols; refrigerant	Industrial
Pentane	$C_5H_{12}$ 	Natural gasoline; blowing agent for polystyrene foam	Gasoline; polystyrene; solvent	Transportation
Pentanes Plus*	Mix of $C_5H_{12}$ and heavier	Blending with vehicle fuel; exported for bitumen production in oil sands	Gasoline; ethanol blends; oil sands production	Transportation

# Natural Gas Liquids - Extraction

- Formula =  $[0.XX * \{ \text{Sum}((72\% \times C3) + (12\% \times NC4) + (9\% \times IC4) + (7\% \times (WTI/42))) - \text{gas price} \} - \$0.XX]$

	2013	2014	2015
Liquids revenue (\$CAD)	\$2,323,000	\$2,510,000	\$840,000

**All the revenue goes directly to reducing the price of natural gas for our customers in all of our service areas!**



# Natural Gas Liquids - Extraction

## Oil and Liquids Prices

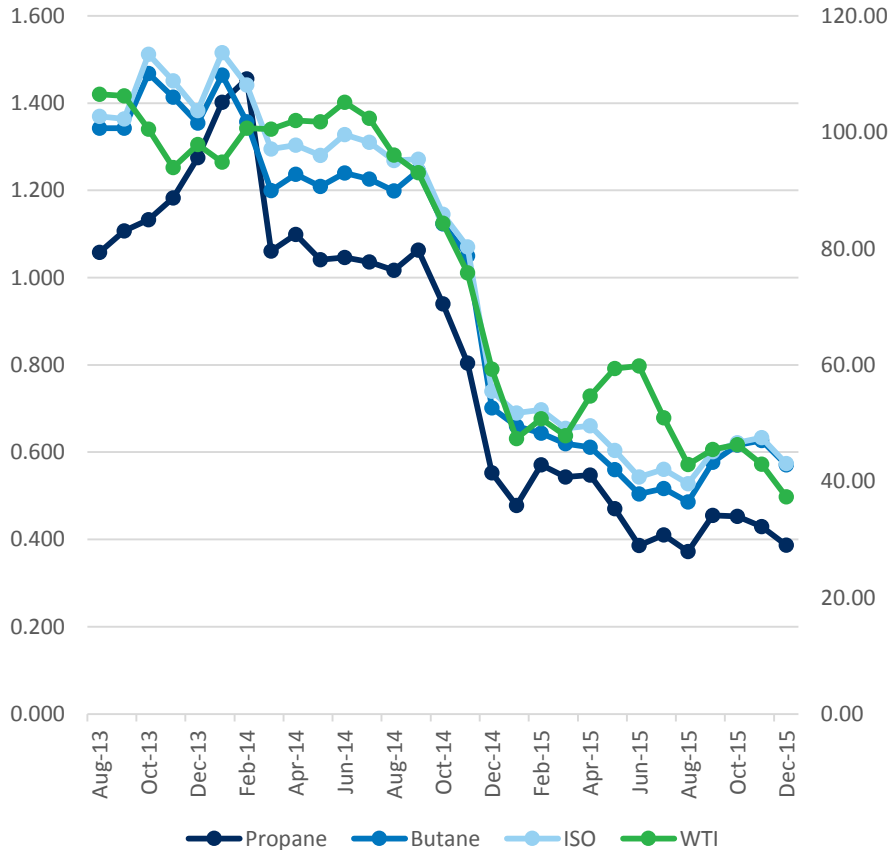

## Oil Prices and Liquid Extraction

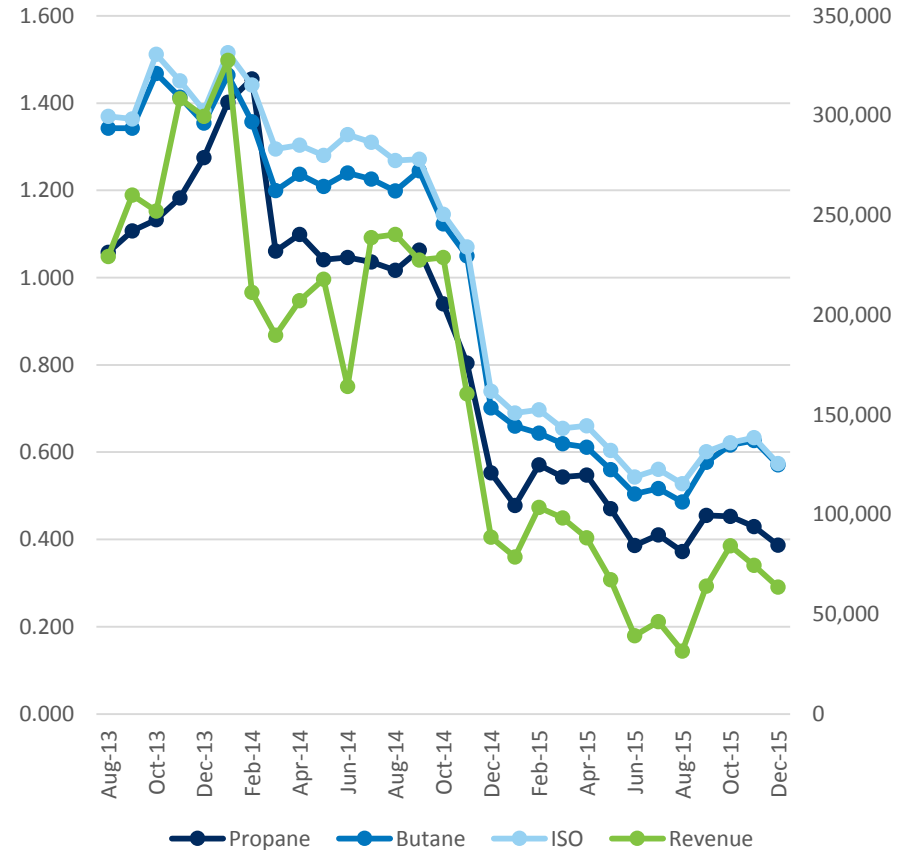



# Storage and Transportation Optimization

Leslie Filer  
Manager of Natural Gas Acquisition

# Year First Unserved

## Scenario Comparisons

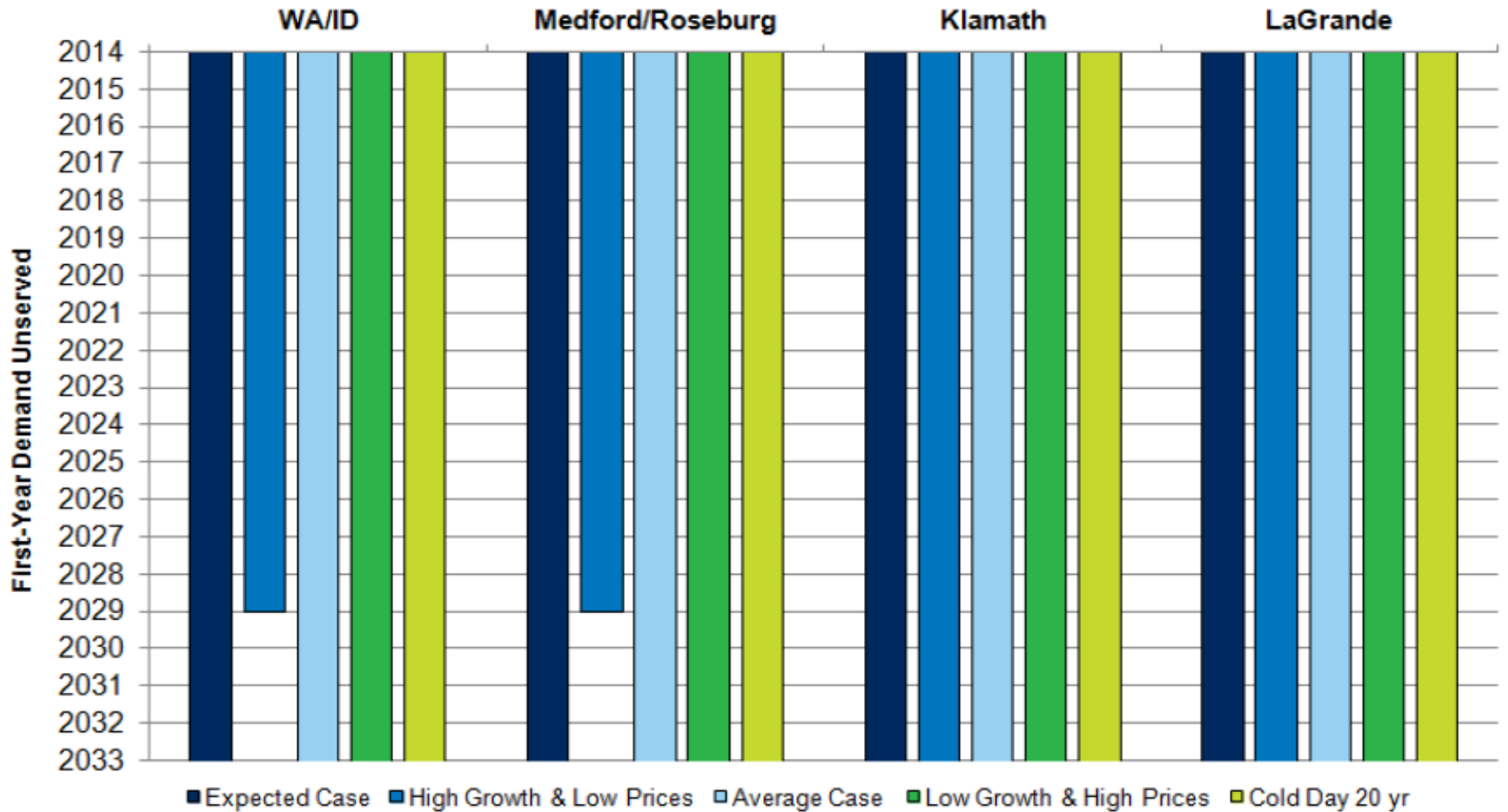

# Storage – A valuable asset

- Peaking resource
- Improves reliability
- Enables capture of price spreads between time periods
- Enables efficient counter cyclical utilization of transportation (i.e. summer injections)
- May require transportation to service territory
- In-service territory storage offers most flexibility

# The Facility

- Jackson Prairie is a series of deep, underground reservoirs – basically thick, porous sandstone deposits.
- The sand layers lie approximately 1,000 to 3,000 feet below the ground surface.
- Large compressors and pipelines are employed to both inject and withdraw natural gas at 54 wells spread across the 3,200 acre facility.

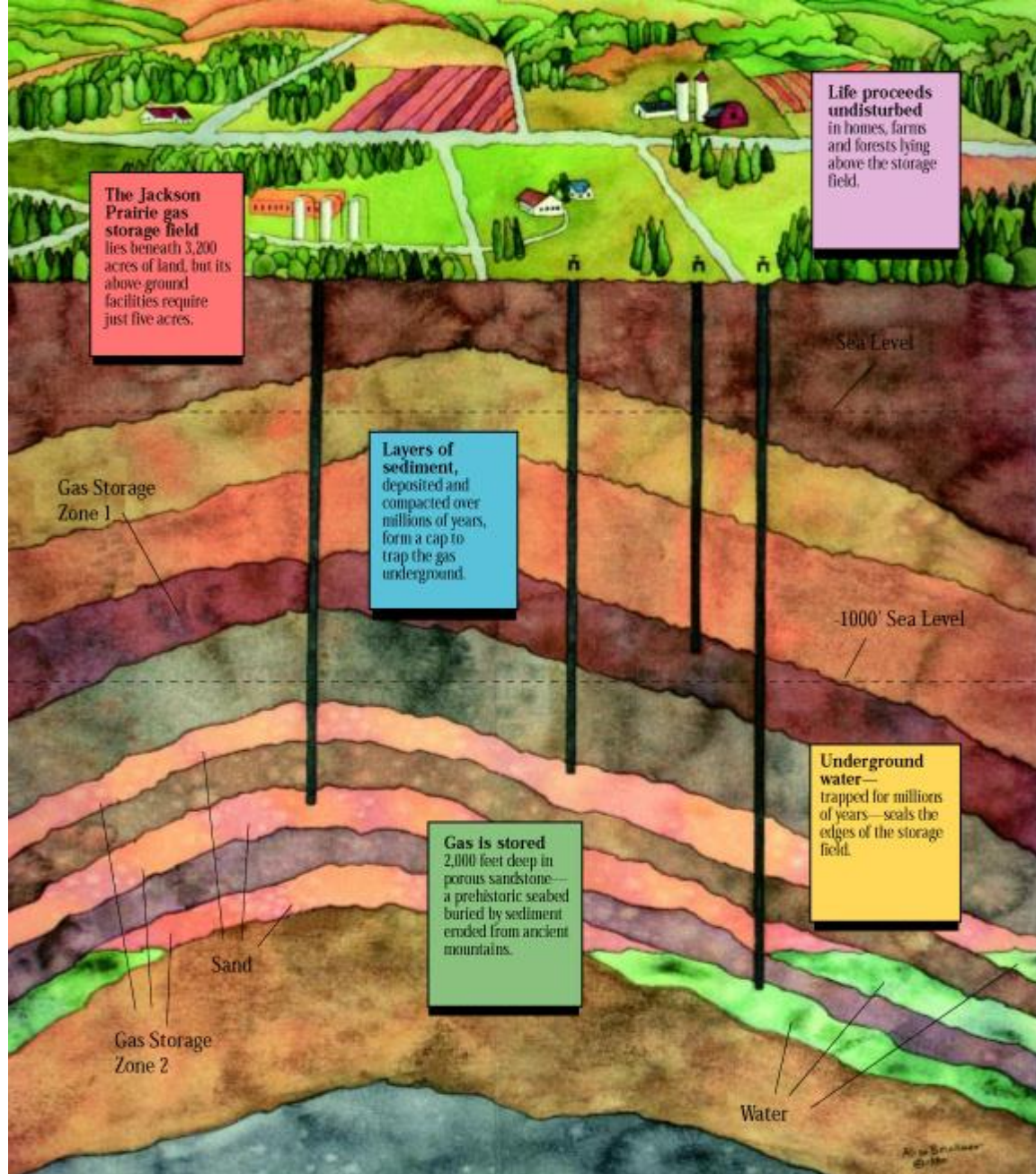

# Jackson Prairie Interesting Energy Comparisons

## 1.2 Bcf per day (energy equivalent)

- 10 coal trains with 100 - 50 ton cars each
- 29 - 500 MW gas-fired power plants
- 13 Hanford-sized nuclear power plants
- 2 Grand Coulee-sized hydro plants (biggest in US)

## 46 Bcf of stored gas

- 12" pipeline 11,000,000 miles long (226,000 miles to the moon)
- 1,400 Safeco Fields (Baseball Stadiums)
- Average flow of the Columbia River for 2 days
- Cube - 3,550 feet on a side

# Avista's Storage Resources

## **Washington and Idaho Owned Jackson Prairie**

- 7.7 Bcf of Capacity with approximately 346,000 Dth/d of deliverability

## **Oregon**

### **Owned Jackson Prairie**

- 823,000 Dth of Capacity with approximately 52,000 Dth/d of deliverability

### **Leased Jackson Prairie**

- 95,565 Dth of Capacity with approximately 2,654 Dth/d of deliverability

# Optimization

**op·ti·mize**  (öp'tə-mīz')

*tr.v.* op·ti·mized, op·ti·miz·ing, op·ti·miz·es

1. To make as perfect or effective as possible.
2. *Computers* To increase the computing speed and efficiency of (a program), as by rewriting instructions.
3. To make the most of.

- Optimization helps Avista to recover costs, for our customers, on assets when not in use for load.



# Storage Optimization

## Example of Storage Opt Deals

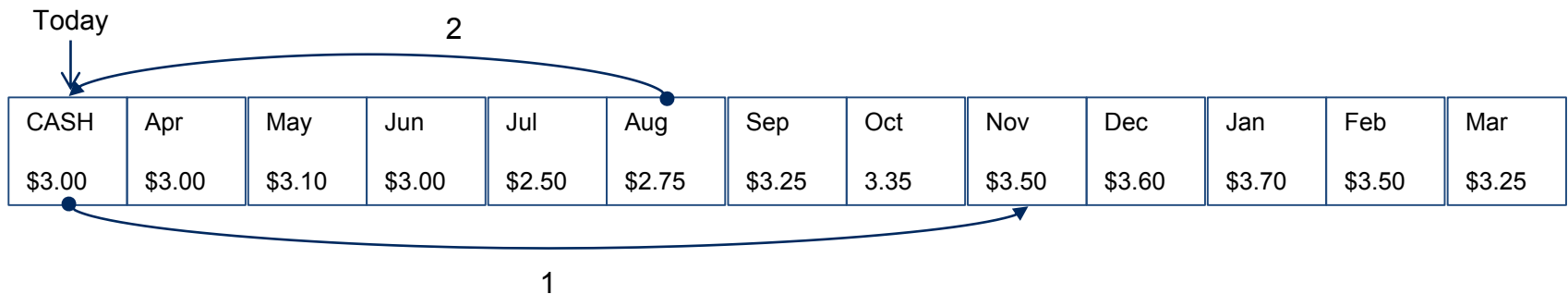
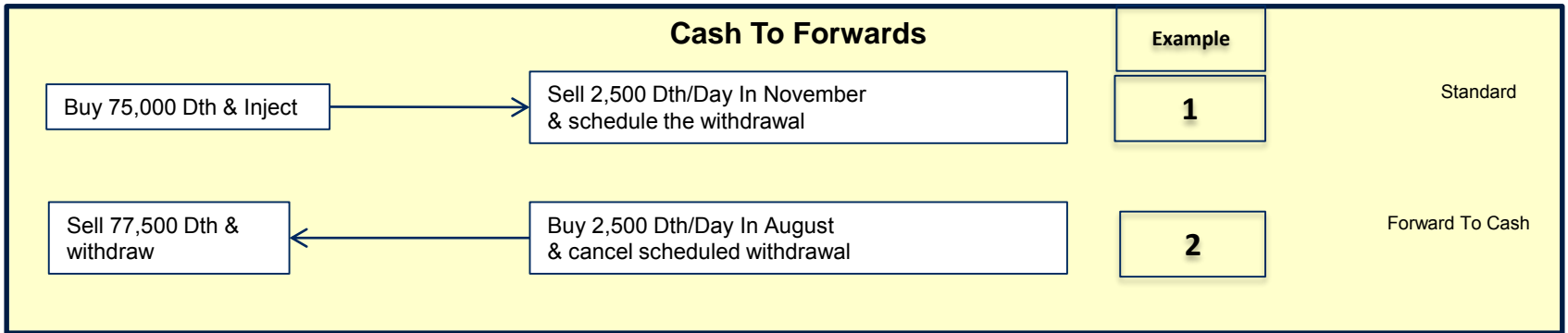

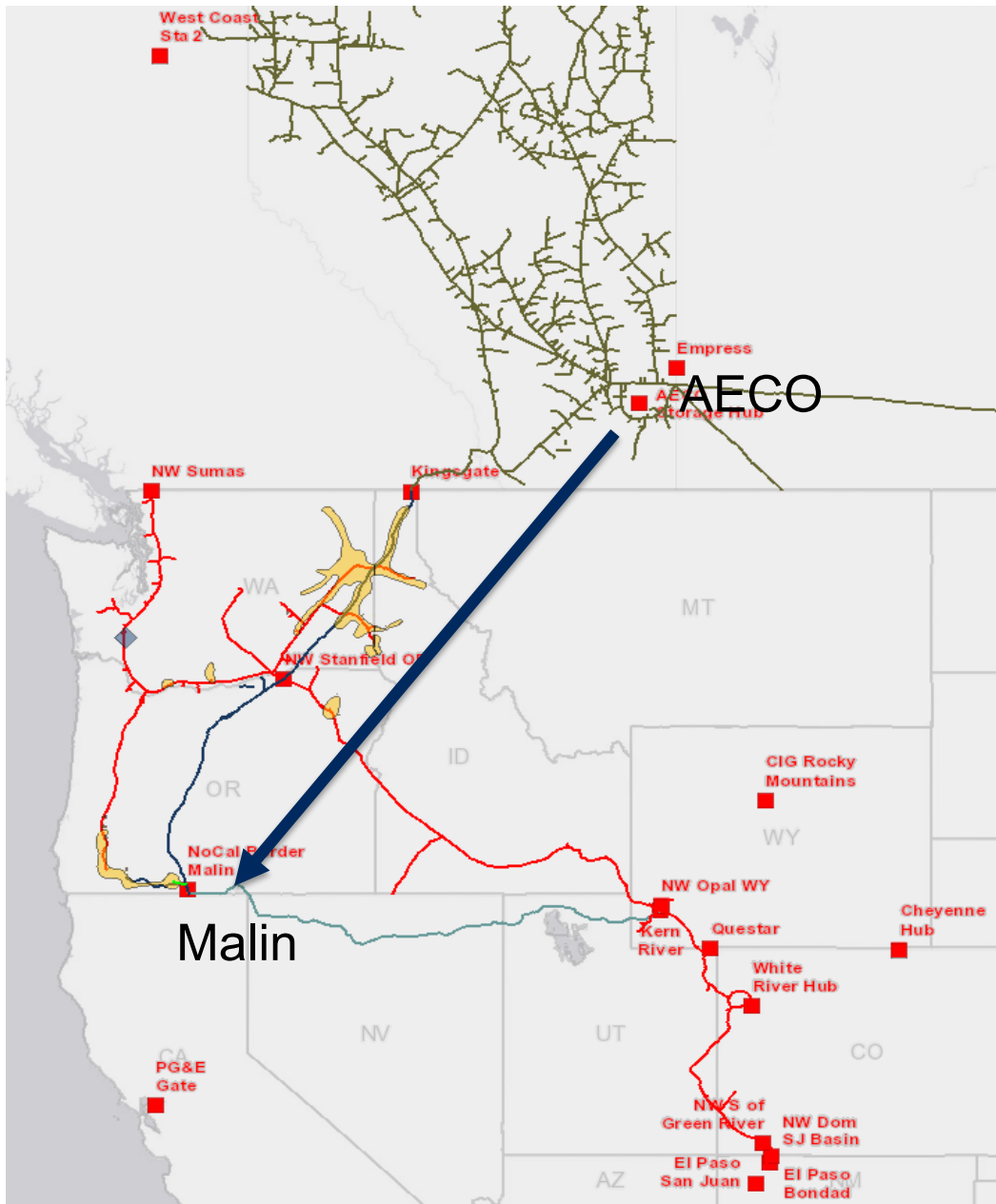

## Transportation Optimization

AECO to MALIN

Demand \$.45

Cost to transport .10

\*AECO = \$1.45

MALIN = \$2.00

$\$.55 - \$.10 = \$.45$

Lowered cost to ratepayers by \$.45

This is referred to as a location spread.

# Optimization Overall

- Combine all optimization to create more value
- Optimization has the following effects on rates:
  - WA/ID
    - For every \$2.5M of optimization, rates decrease by ~1%
  - OR
    - For every \$1M of optimization, rates decrease by ~1%



# Transportation Modeling in Sendout and solving unserved demand

Tom Pardee

Manager of Natural Gas Planning

# Modeling Transportation In SENDOUT®

- Start with a point in time look at each jurisdiction's resources
  - Contracts – Receipt and Delivery Points
  - Rates
- Contractual vs. Operational
  - Contractual can be overly restrictive
  - Operational can be overly flexible
- Incorporating operational realities into our modeling can defer the need to acquire new resources.
- Gas Supply's job is to get gas from the supply basin to the pipeline citygate.
- Gas Engineering/Distribution's job is to take gas from the pipeline gate to our customers.
- The **major** limiting factor is receipt quantity – how much can you bring into the system?

# Modeling Challenges

- Supply needs to get gas to the gate.
- Contracts were created years ago, based on demand projections at that point in time.
- Stuff happens (i.e. growth differs from forecast).
- Sum of receipt quantity and aggregated delivery quantity don't identify resource deficiency for quite some time however.....
- The aggregated look can mask individual city gate issues, and the disaggregated look can create deficiencies where they don't exist.
- In many cases operational capacity is greater than contracted.
- Transportation resources are interconnected (two pipes can serve one area).
- WARNING – we need to be mindful of the modeling limitations.

# What is in SENDOUT®?

## Inside:

- Demand forecasts at an aggregated level
- Existing firm transportation resources and current rates
  - Receipt point to aggregated delivery points/“zone”
  - Jurisdictional considerations
  - Long term capacity releases
- Potential resources, both supply and demand side

# What is outside SENDOUT®?

## Outside:

- Gate station analysis
  - Forecasted demand behind the gate
    - Growth rates consistent with IRP assumptions
    - Actual hourly/daily city gate flow data
  - Gate station MDDO's
  - Gate station operational capacities



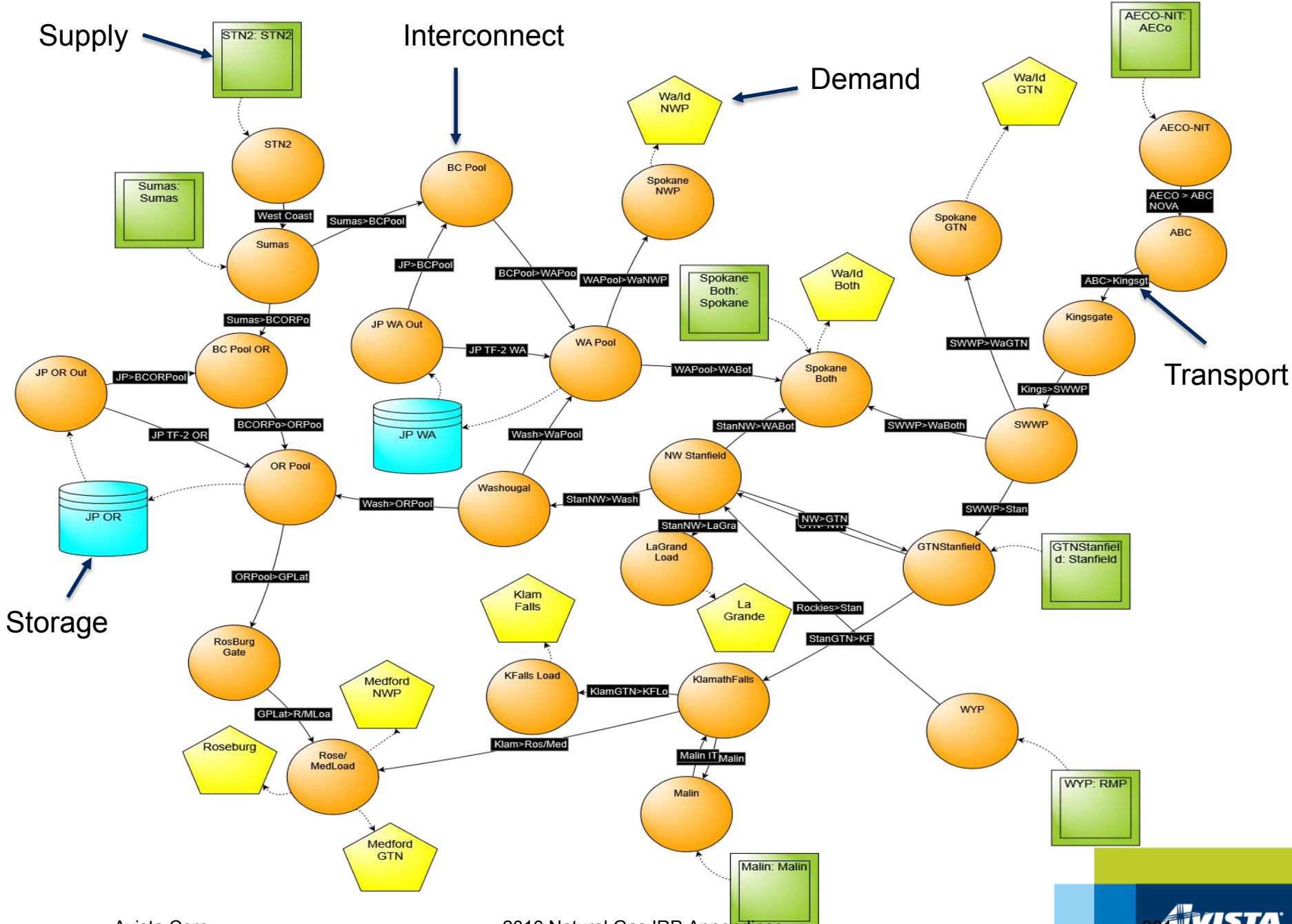

# Solving Unserved Demand

# When unserved demand does show up.....

There are a few questions we need to ask:

1. Why is the demand unserved?
2. What is the magnitude of the short? (i.e Are we 1 Dth or 1000 Dth's short?)
3. What are my options to meet it?

# When current resources don't meet demand what do we consider?

- Transport capacity release recalls
- “Firm” backhauls
- Contract for existing available transportation
- Expansions of current pipelines
- Peaking arrangements with other utilities (swaps/mutual assistance agreements) or marketers
- In-service territory storage
- Satellite/Micro LNG (storage inside service territory)
- Large scale LNG with corresponding pipeline build into our service territory
- Structured products/exchange agreements delivered to city gates
- Biogas
- Avista distribution system enhancements
- Demand side management

# New Resource Risk Considerations

- Does it get supply to the gate?
- Is it reliable/firm?
- Does it have a long lead time?
- How much does it cost?
  - New build vs. depreciated cost
  - The rate pancake
- Is it a base load resource or peaking?
- How many dekatherms do I need?
- What is the “shape” of resource?
- Is it tried and true technology, new technology, or yet to be discovered?
- Who else will be competing for the resource?

# Sensitivities, Scenarios, Portfolios

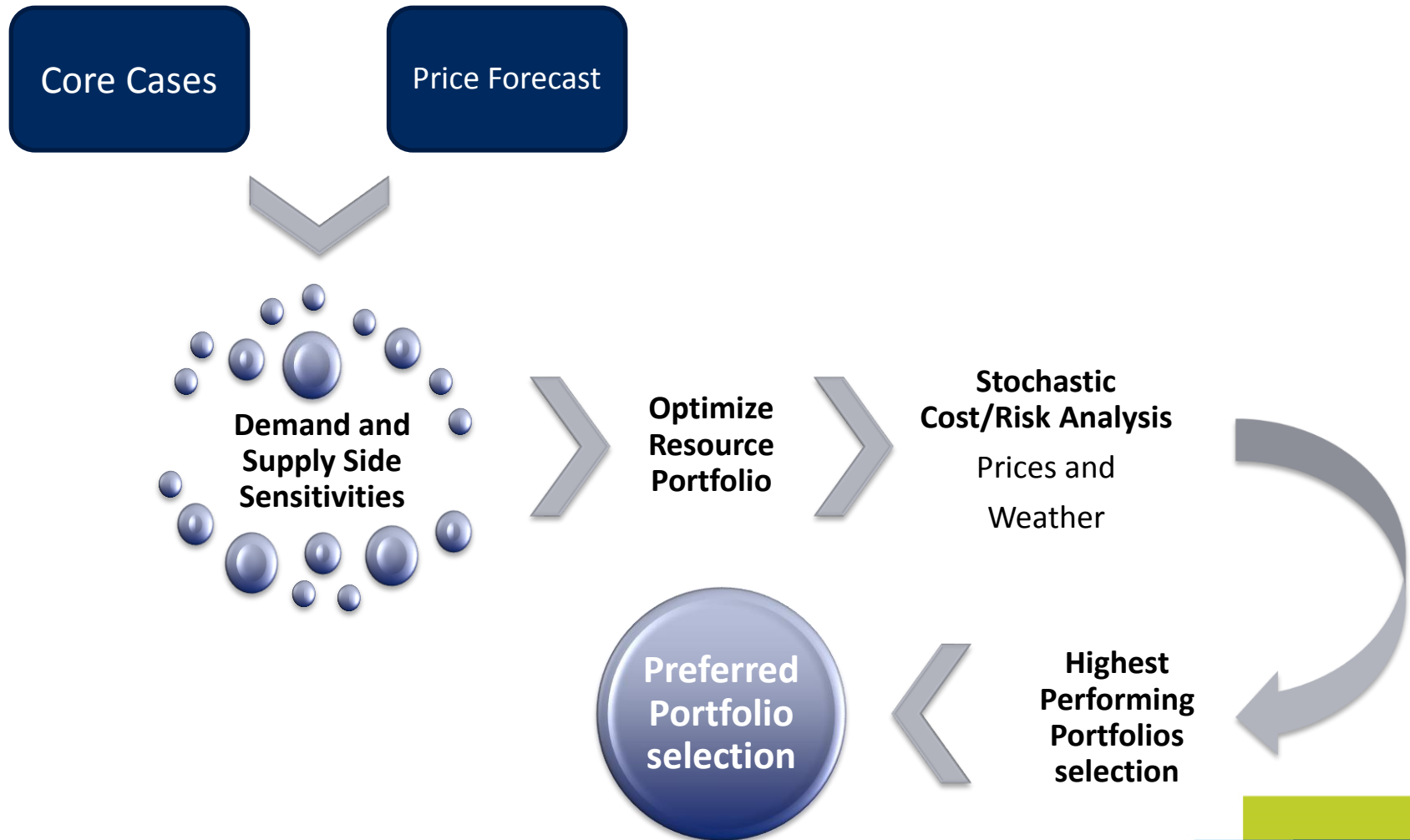

# Supply Scenarios for the 2016 IRP

Supply Scenarios
?????
?????
?????
?????

- Do they get gas to the gate?
- Does this affect pricing at the basins?
- Rank the risk of these scenarios.



# 2016 Natural Gas IRP Carbon Issues

John Lyons, Ph.D.  
Second Technical Advisory Committee Meeting  
February , 2015



# Carbon Laws and Regulations

- Mixed bag of federal and state laws and proposals
- Regulatory mandates
- Cap and trade programs
- Carbon taxes
- Focus tends to be on electric generation
  - Some proposals (Washington I-732) and laws (California AB32) directly impact the natural gas markets or the distribution companies

# Federal

- Many past attempts, current focus under a regulatory model through the Clean Air Act (CAA)
- Clean Power Plan (CPP) – reduce greenhouse gas emissions from covered existing power plants 32 percent below 2005 levels by 2030 under section 111(d) of the CAA through three building blocks:
  1. Improve heat rate of coal plants
  2. Increase utilization of natural gas-fired plants and reduce coal plant use
  3. Increase use of renewable resources
- CPP stayed by US Supreme Court on February 9, 2016
- Oral arguments June 2, 2016 at DC Circuit Court of Appeals

# Idaho

- No active or proposed greenhouse gas legislation
- Provided comments about the CPP and the federal implementation plan
- Were working towards submitting a state implementation plan by September 2016 – no official word on the current plans with the stay from the Supreme Court. Will probably stop working on the plan until the outcome of the court case is known.

# Oregon

- HB 4036: “Coal to Clean” bill voted out of committee
  - 50 percent renewable by 2040
  - Eliminate coal power in rates by 2030
  - Compromise to a ballot measure
- SB 1574: replace greenhouse gas emission goal with a cap and trade program for 2025. Probably dead for this session.
- HB 4068: repeal greenhouse gas emissions goals and require Environmental Quality Commission to adopt goals for 2025 and limits for 2035 and 2050. Officially dead for this session

# Washington

- I-732 Initiative to the Legislature
  - Revenue neutral \$25 per metric ton tax escalating 3.5 percent per year plus inflation until \$100 per ton in 2016 dollars
  - Taxes natural gas
  - Hearings held on I-732, but expected to go to the November ballot
  - Other proposals have been discussed for alternatives
- Possible competing ballot initiative
- Clean Air Rule proposal

# Questions?

# 2016 IRP Timeline

- **August 31, 2015** – Work Plan filed with WUTC
- **January through April 2016** – Technical Advisory Committee meetings. Meeting topics will include:
  - Demand Forecast and Demand Side Management – January 21
  - Supply/Infrastructure and Potential Case Discussion– February 18
  - **Distribution Planning, Natural Gas Pricing, SENDOUT® Preliminary Output Results and Further Case Discussion – March 30**
  - SENDOUT® results – *April 21*
- **May 30, 2016** – Draft of IRP document to TAC
- **June 30, 2016** – Comments on draft due back to Avista
- **July 2016** – TAC final review meeting (if necessary)
- **August 31, 2016** – File finalized IRP document



# 2016 Avista Natural Gas IRP

Technical Advisory Committee Meeting  
March 30, 2016  
Spokane, WA



# Agenda

- Introductions & Logistics
- CNG/NGV Initiatives
- Distribution System Planning
- Gate Station Analysis
- Procurement Planning
- Natural Gas Pricing
- Preliminary Results and Scenario Discussion

## Following TAC #3 Meeting:

- Sendout overview

# 2016 IRP Timeline

- **August 31, 2015** – Work Plan filed with WUTC
- **January through April 2016** – Technical Advisory Committee meetings. Meeting topics will include:
  - Demand Forecast and Demand Side Management – January 21
  - Supply/Infrastructure and Potential Case Discussion– February 18
  - **Distribution Planning, Natural Gas Pricing, SENDOUT® Preliminary Output Results and Further Case Discussion – March 30**
  - SENDOUT® results – *April 21*
- **May 30, 2016** – Draft of IRP document to TAC
- **June 30, 2016** – Comments on draft due back to Avista
- **July 2016** – TAC final review meeting (if necessary)
- **August 31, 2016** – File finalized IRP document



# Compressed Natural Gas Services

Marc Schaffner, Strategic Initiatives Manager

Natural Gas Technical Advisory Committee

March 30, 2016

# Natural Gas Reserves and Utilization

## U.S. Natural Gas Reserves

- The U.S.'s total recoverable resource base at 2,515 trillion cubic feet
- Projected to meet total domestic demand over the next 100 years
- PGC's year-end estimate for 2014 rose 5.5 percent from 2012

*Source: Potential Gas Committee (PGC)*



## Natural Gas Vehicles (NGV) Worldwide

- Estimated 15.2 million natural gas vehicles (NGVs)
- Asia and Middle East 8.8M, South America 4.3 M, Africa .16M and North America .14M
- The U.S. is number 17 in the world with less than 1 percent of the NGVs in use

## NGVs on U.S. Highways

- Estimated 150,000 NGVs on U.S. highways
- Estimated 15,000 NGVs were added to U.S. highways in 2012

*Source: U.S. Department of Energy*

# U.S. CNG Infrastructure

About 1,620 Private and Public Refueling Stations

<5% in Washington, Oregon and Idaho

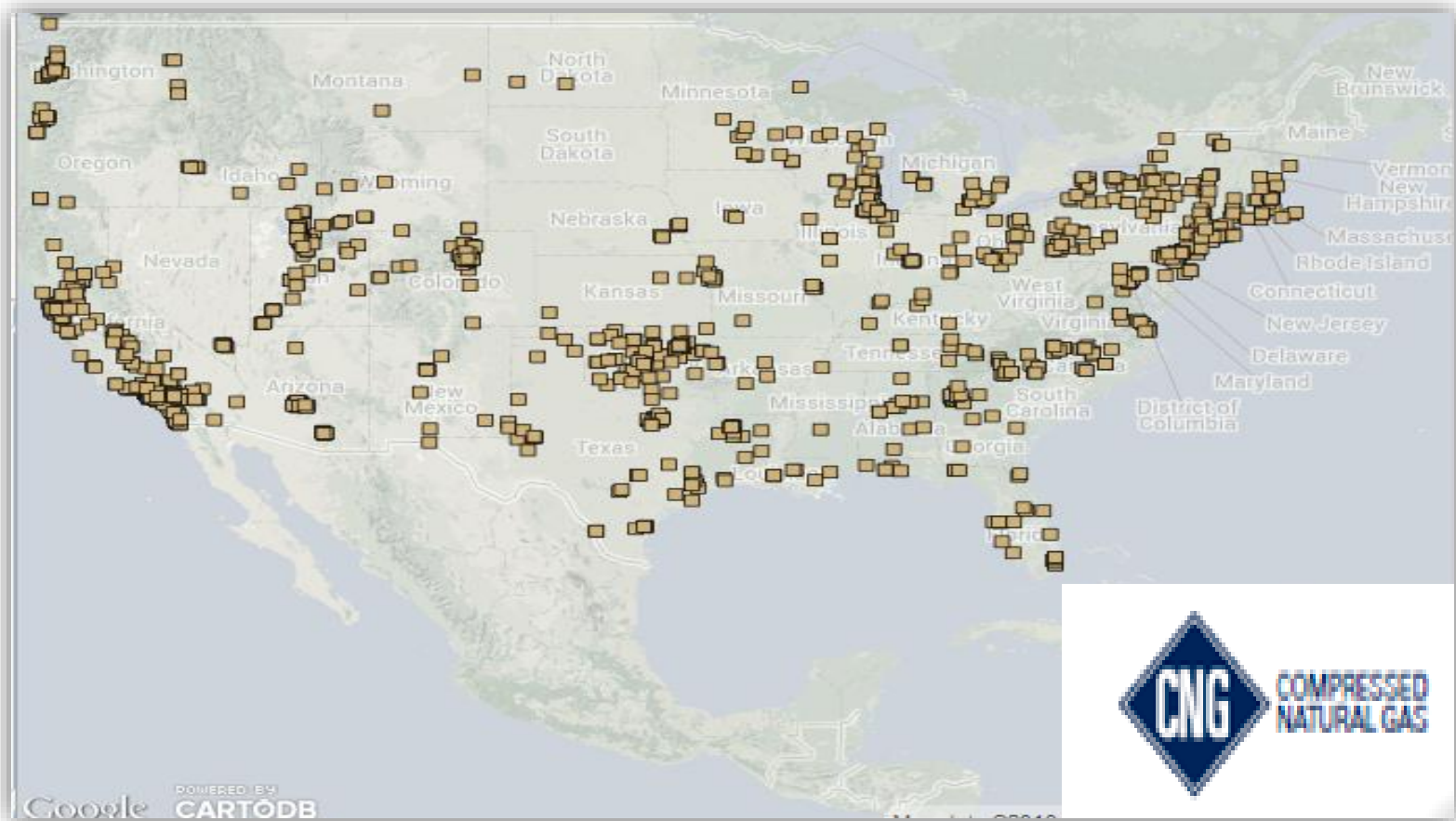

Source: U.S. Department of Energy, February 2016

Avista Corp

2016 Natural Gas IRP Appendices

# U.S. CNG Infrastructure

About 900 are Public Refueling Stations

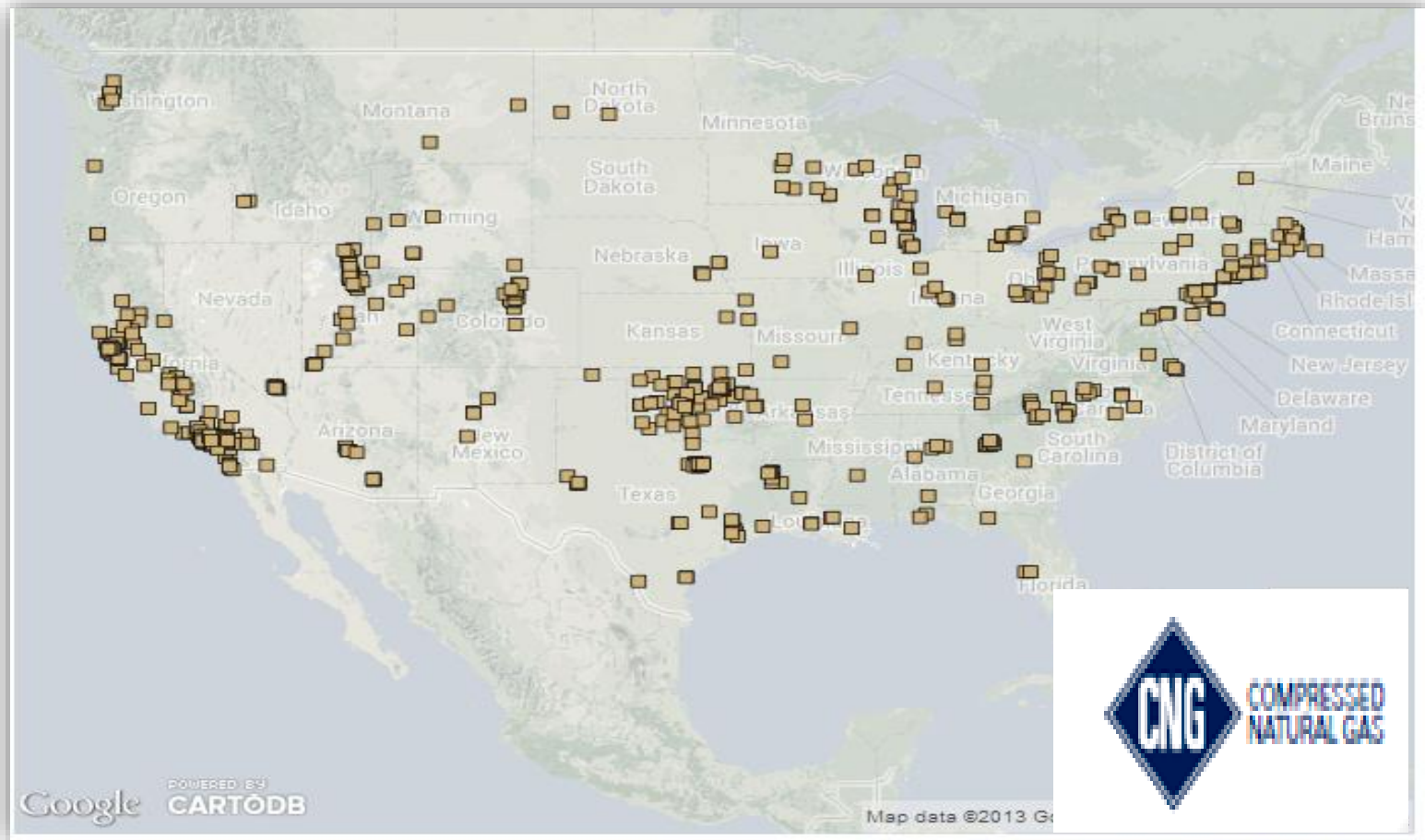

Source: U.S. Department of Energy, February 2016

Avista Corp

2016 Natural Gas IRP Appendices

# The Benefits of Compressed Natural Gas

## Environmentally responsible

- It's clean and efficient
- 25% less greenhouse gas emissions than gasoline or diesel
- A vital part of an alternative transportation portfolio

## Cost effective

- Lowers fuel costs
- Tax credits and incentives



## Reduces dependency on imported fuel sources

- Natural gas is an abundant, domestic resource

## A clean fueling solution across an increasing range of NGV classes

- Aimed at extending benefits to commercial fleet operators

## Mobilizes safe and reliable CNG equipment

- 85 light duty NGVs
- CNG refueling infrastructure

# Avista's Investment in CNG

- Over the past 25 years Avista has fueled light duty vehicles, service continuity equipment and fork lifts with CNG
- Ten of our gas operating centers have maintained private CNG refueling infrastructure over that time period
- 2011, we began devising plans to upgrade CNG infrastructure at our highest volume service centers in Washington and Idaho
- 2012, we completed construction of a new refueling station at our Mission Avenue service center in Spokane, WA
- 2013, we completed a second Spokane refueling station at our Dollar Road gas service center
- 2014, we finished construction of a new refueling station at our electric and gas operations center in Coeur d' Alene, ID



**Mission Avenue Refueling Station - Spokane**



# Avista's CNG Refueling Stations

CNG Refueling Location	Project Status	Compression Capability	Storage Capacity
Mission Avenue SC Spokane, Wash.	Completed 2012	125 HP Compressor 202 SCFM	280 GGE at 4500 psi
Dollar Road SC Spokane, Wash.	Completed 2013	125 HP Compressor 202 SCFM	280 GGE at 4500 psi
Coeur d'Alene SC Coeur d'Alene, Idaho	Completed 2014	(2) 50 HP Compressors 75 SCFM	280 GGE at 4500 psi

**TABLE 2**  
**National Average Retail Fuel Prices**  
**Conventional and Alternative Fuels, October 2015\***

Fuel Type <sup>4</sup>	July 2015	October 2015	Change in Price July-October	Units of Measurement
Gasoline (E10)	\$2.82	\$2.35	-\$0.47	per gallon
Diesel	\$2.93	\$2.59	-\$0.34	per gallon
CNG	\$2.12	\$2.09	-\$0.03	per GGE
Ethanol (E85)	\$2.36	\$2.18	-\$0.18	per gallon
Propane**	\$2.90	\$2.90	\$0.00	per gallon
Biodiesel (B20)	\$2.93	\$2.66	-\$0.27	per gallon
Biodiesel (B99/ B100)	\$3.55	\$3.40	-\$0.15	per gallon

\*Includes public and private stations

\*\*Includes primary and secondary stations

Source: Clean Cities Alternative Fuel Price Report, October 2015

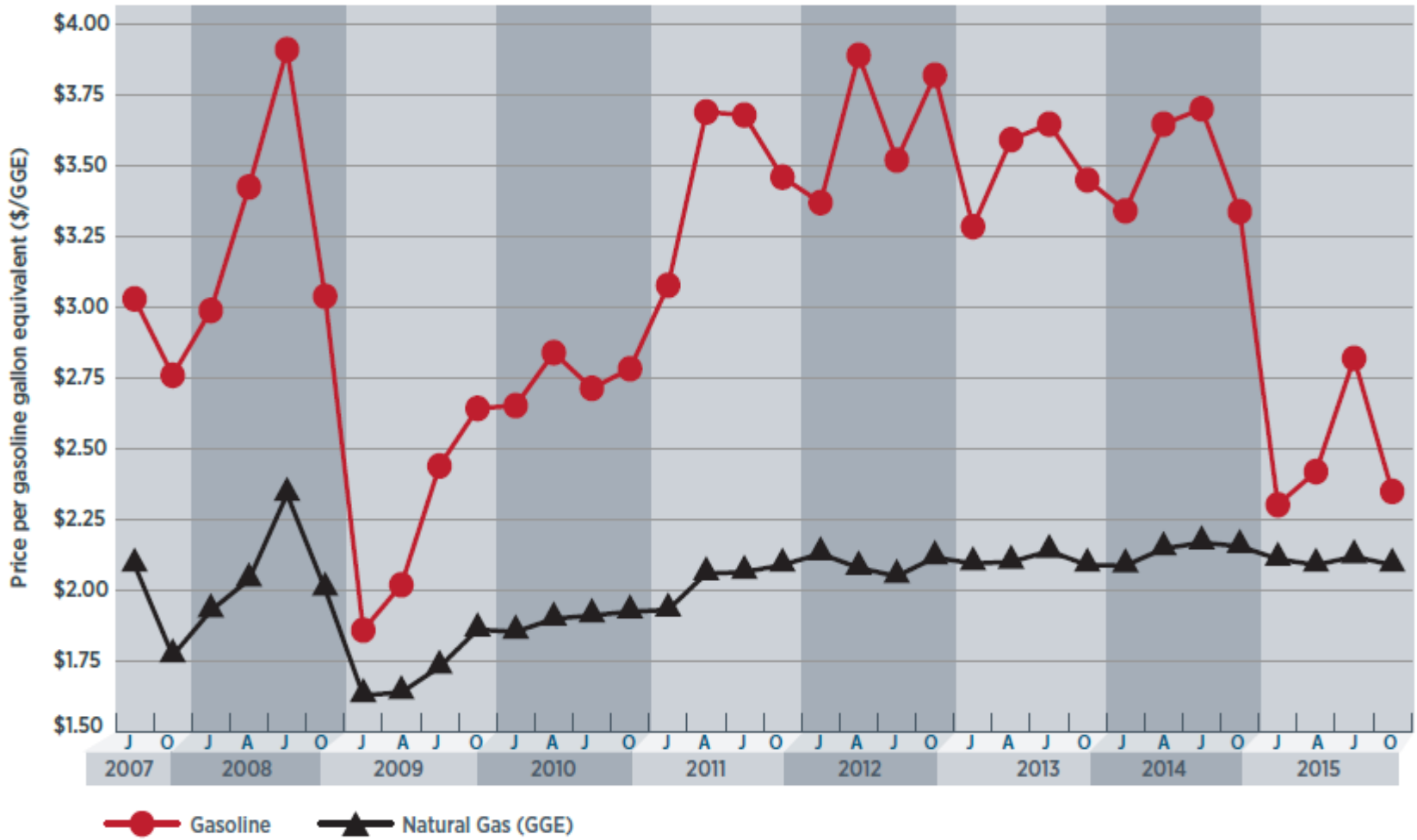

**FIGURE 3**  
**HISTORICAL COMPRESSED NATURAL GAS (CNG) PRICES VERSUS GASOLINE**

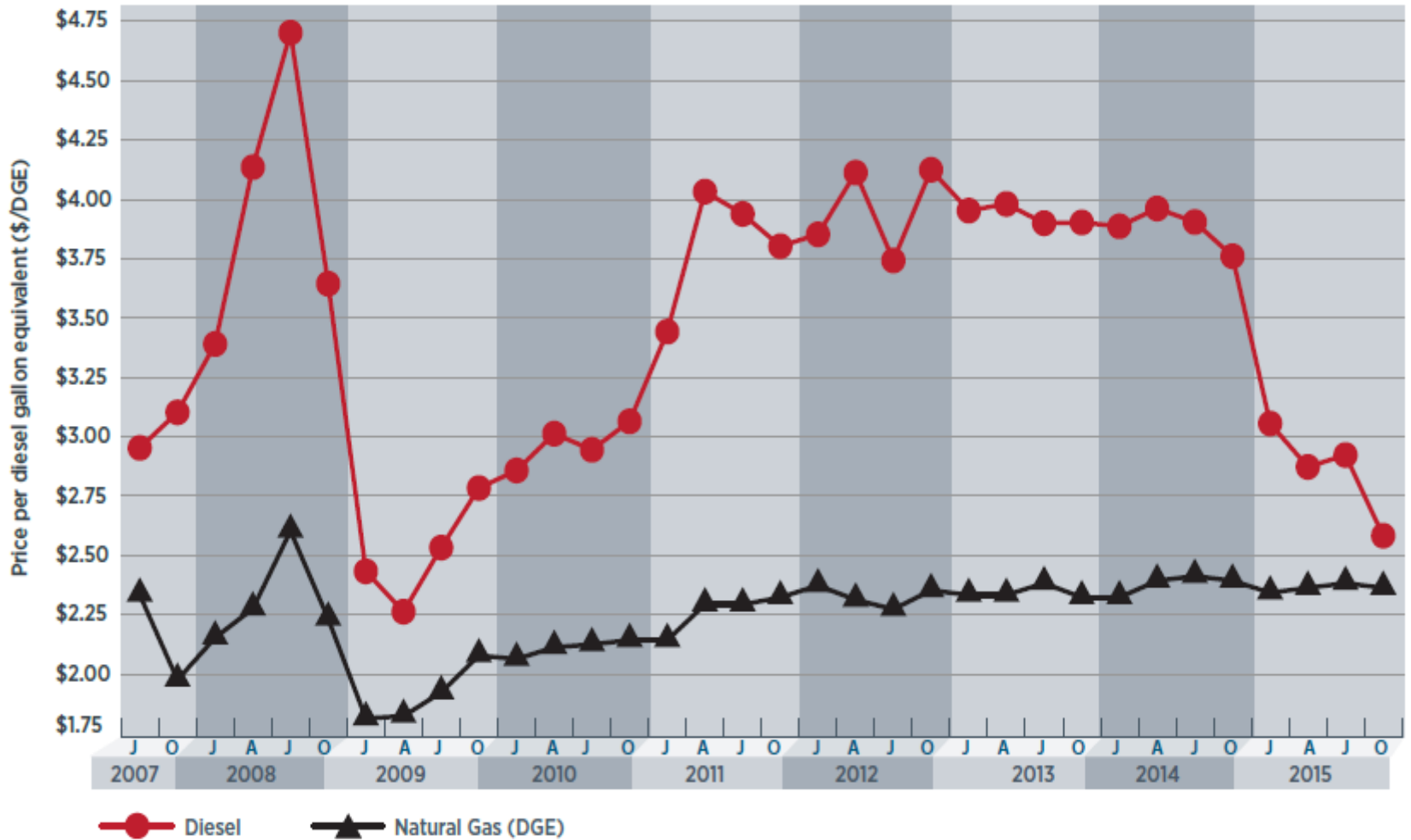

**FIGURE 5**  
**HISTORICAL COMPRESSED NATURAL GAS (CNG) PRICES VERSUS DIESEL**

Source: Clean Cities Alternative Fuel Price Report, October 2015

# Natural Gas Vehicle Investment Recovery\*

## Waste Hauling NGV

Customer Investment	\$35,000 per vehicle
Miles per gallon	3
Annual mileage	25,000
CNG per gallon	\$2.00
Diesel per gallon	\$4.00
Estimated payback	25 months
Annual fuel savings	\$16,800



\* Q1 2014

# Natural Gas Vehicle Investment Recovery\*

## Waste Hauling NGV

Customer Investment	\$35,000 per vehicle
Miles per gallon	3
Annual mileage	25,000
CNG per gallon	\$2.09
Diesel per gallon	\$2.59
Estimated payback	7.75 years
Annual fuel savings	\$4,583



\* Q4 2015

# Avista CNG Services Tariffs

- February 2015, we established a Compressed Natural Gas Service tariff (Schedule 441) in Oregon; which allows us to provide Company-owned CNG refueling infrastructure for transportation sited on the customer's premise
- We have secured (“non-tariffed”) authority, provided by WUTC staff, to serve NGV operators in the same way (as Schedule 441 Oregon) in Washington
- Effective May 22, 2015, we established a Backup and Supplemental Compressed Natural Gas Service tariff (Schedule 149) that allows Avista to fuel (under contract) NGV fleet operators

# Thank You





# Appendix

# Avista Contributors

Energy Solutions  
Account Executives

Customer Solutions  
Regional Business Managers

Government Relations  
Lobbyists

Legal Counsel  
Risk  
Real Estate

Contract Administration

Real Estate  
Legal  
Property Acquisition

Regulatory  
Rates & Tariffs

Treasury  
Billing Analysis

Financial Planning &  
Analysis

Facilities  
Project Management

Fleet  
NGV Management  
CNG Infrastructure Maintenance

Distribution Infrastructure  
Gas Engineering

# Organizational Capability

## What are we learning?

- The value of broad-based collaboration occurring across a dynamic natural gas for transportation marketplace. Private & public sector customers, industry associations, government, contractors and vendors

## What skills are we developing?

- NGV acquisition and maintenance
- CNG fueling infrastructure planning, construction and maintenance
- CNG/NGV consultation

## What value does Avista's CNG capability provide our employees, customers and business community?

- A more robust portfolio of energy offerings
- Enhanced revenue and cost saving opportunities for regional businesses
- An innovative, sustainable way to positively affect environmental quality and energy independence



# Distribution System Planning

Terrence Browne, Senior Gas Planning Engineer

Natural Gas Technical Advisory Committee  
March 30, 2016

# Mission

- Using technology to plan and design a safe, reliable, and economical distribution system



# Gas Distribution Planning Game Plan

- Review
- Scope of Gas Distribution Planning
- SynerGi Load Study Tool
- Planning Criteria
- Interpreting Results
- Long-term Planning Objectives
- Historical Temperatures
- Monitoring Our System
- The (Customer) Forecast
- Gate Station Capacity Review
- Project Examples

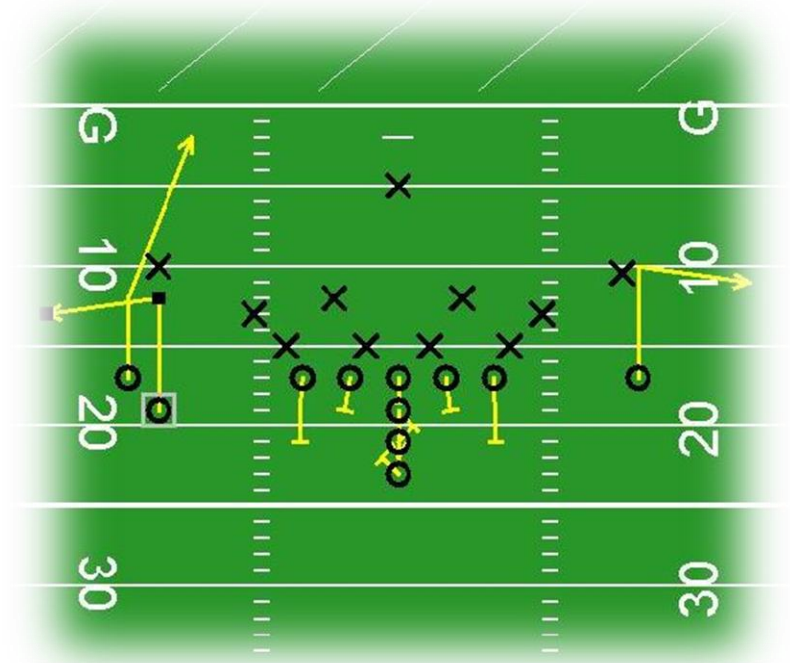

# Service Territory and Customer Overview

- Serves electric and natural gas customers in eastern Washington and northern Idaho, and natural gas customers in southern and eastern Oregon
  - Population of service area 1.5 million
    - ▶ 370,000 electric customers
    - ▶ 330,000 natural gas customers

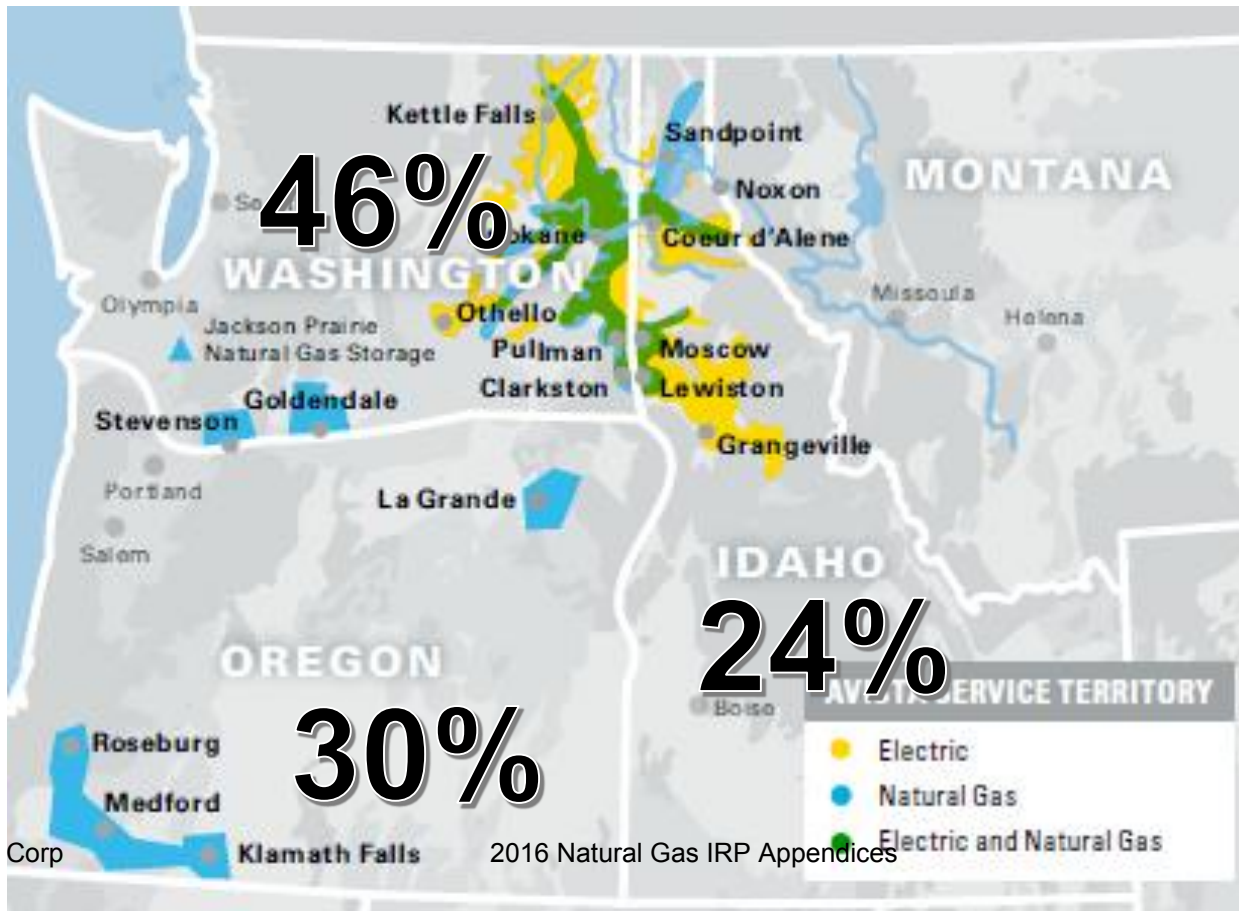

# Daily Demand Profiles

## WA-ID

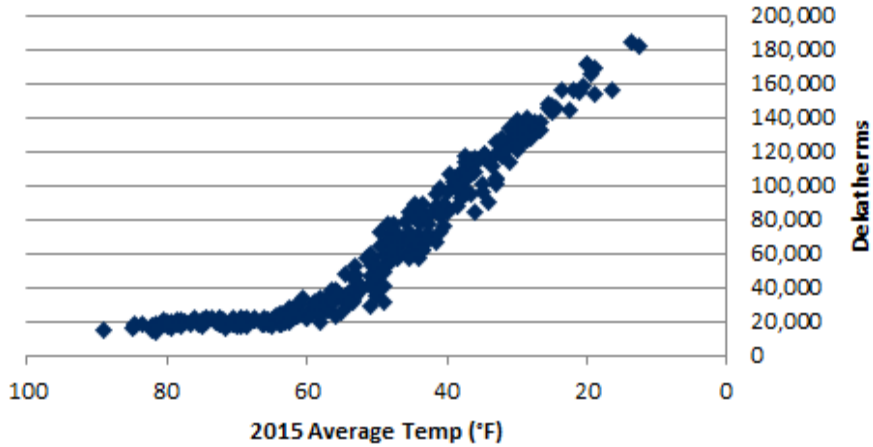

## Medford/Roseburg

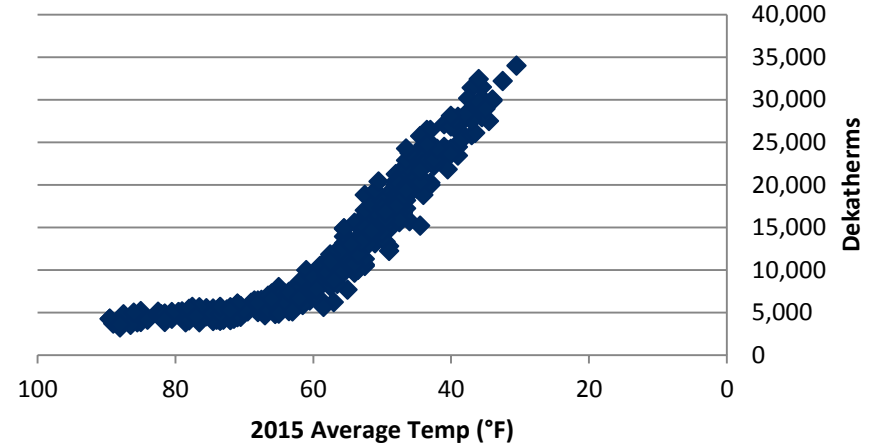

## Klamath Falls

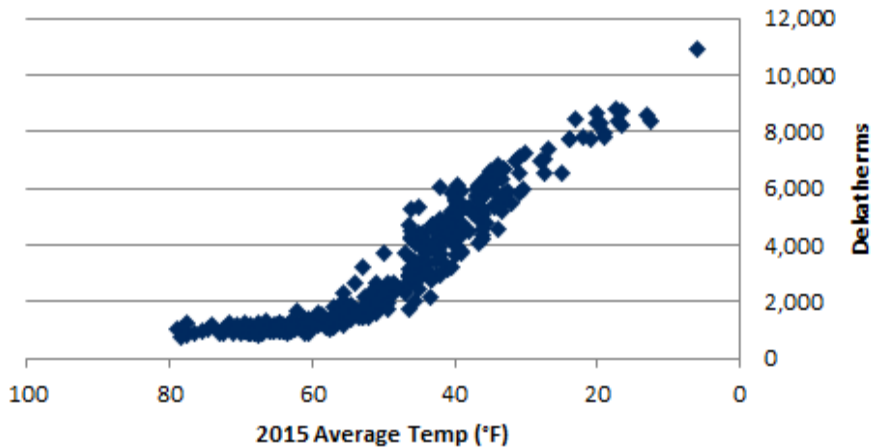

## LaGrande

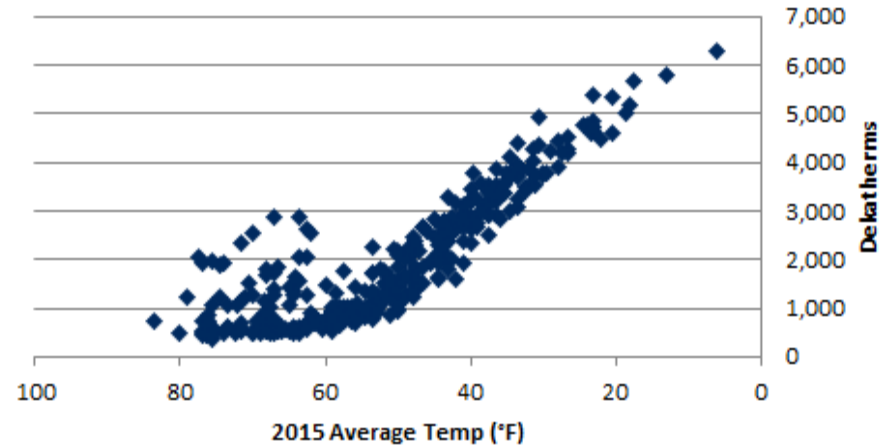



# Seasonal Demand Profiles

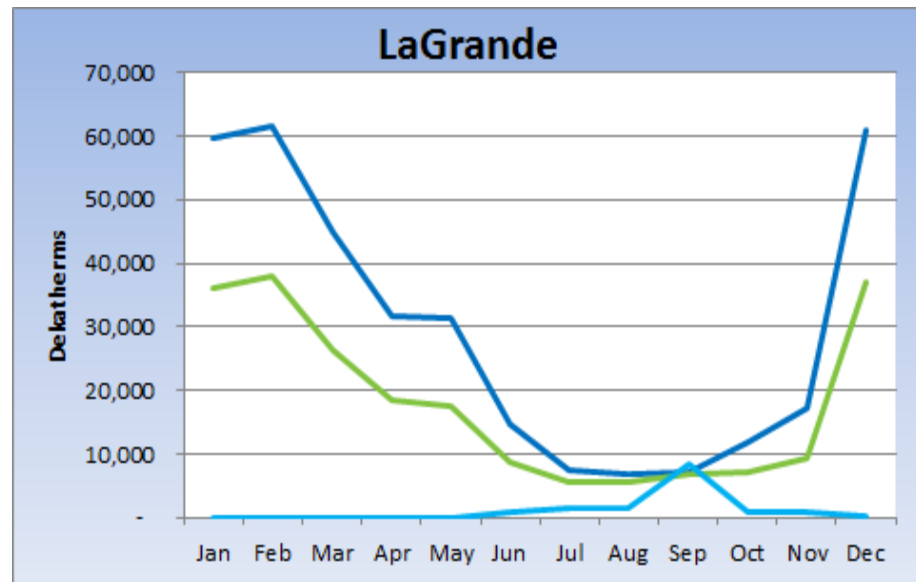
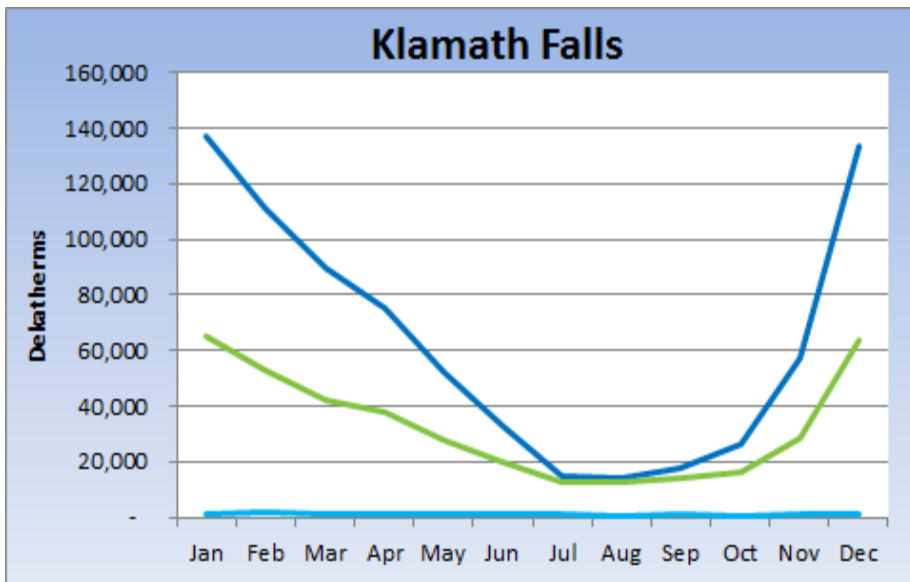
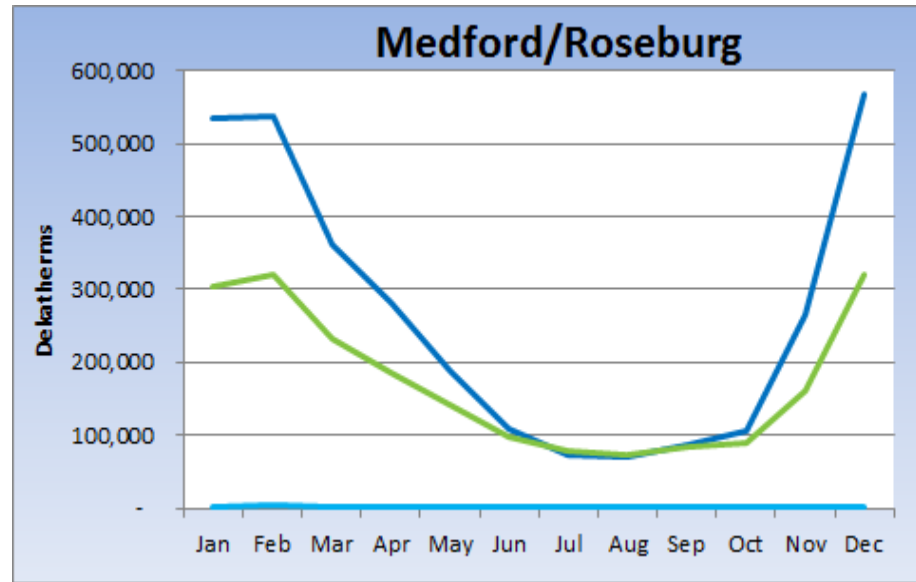
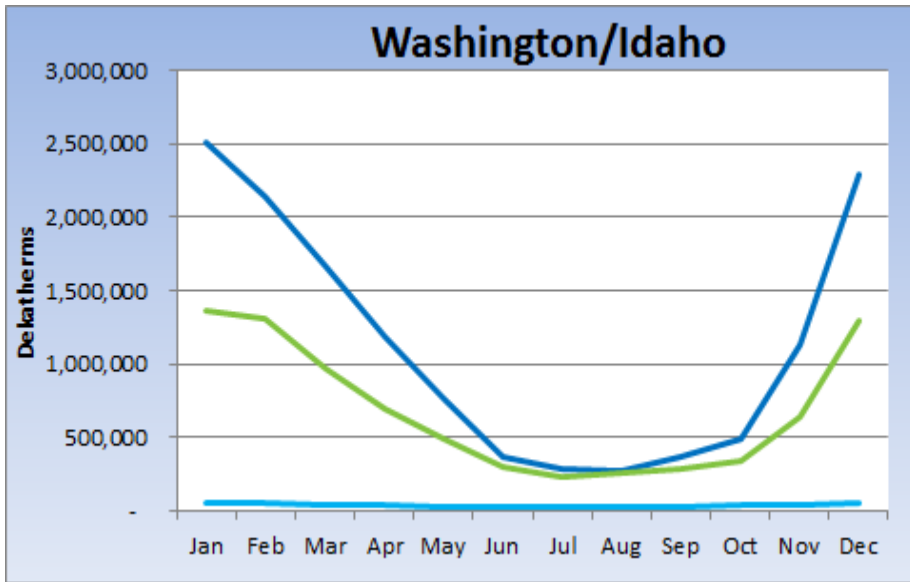

# Our Planning Models

- 122 cities
- 40 load study models

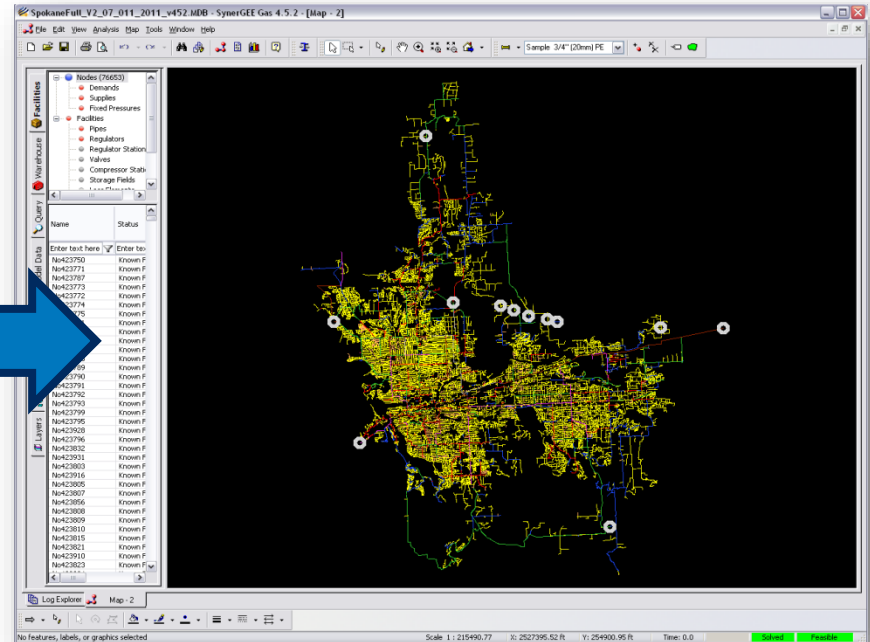
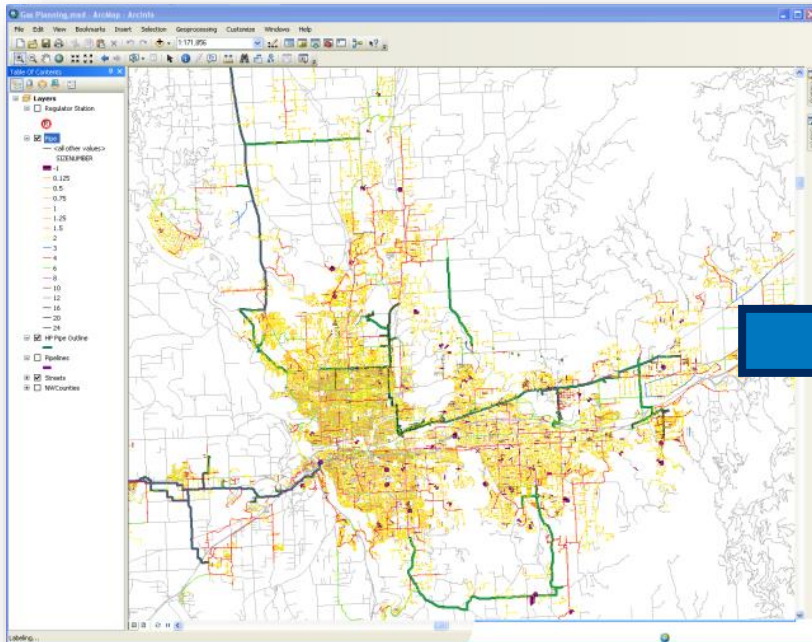

# 5 Variables for Any Given Pipe

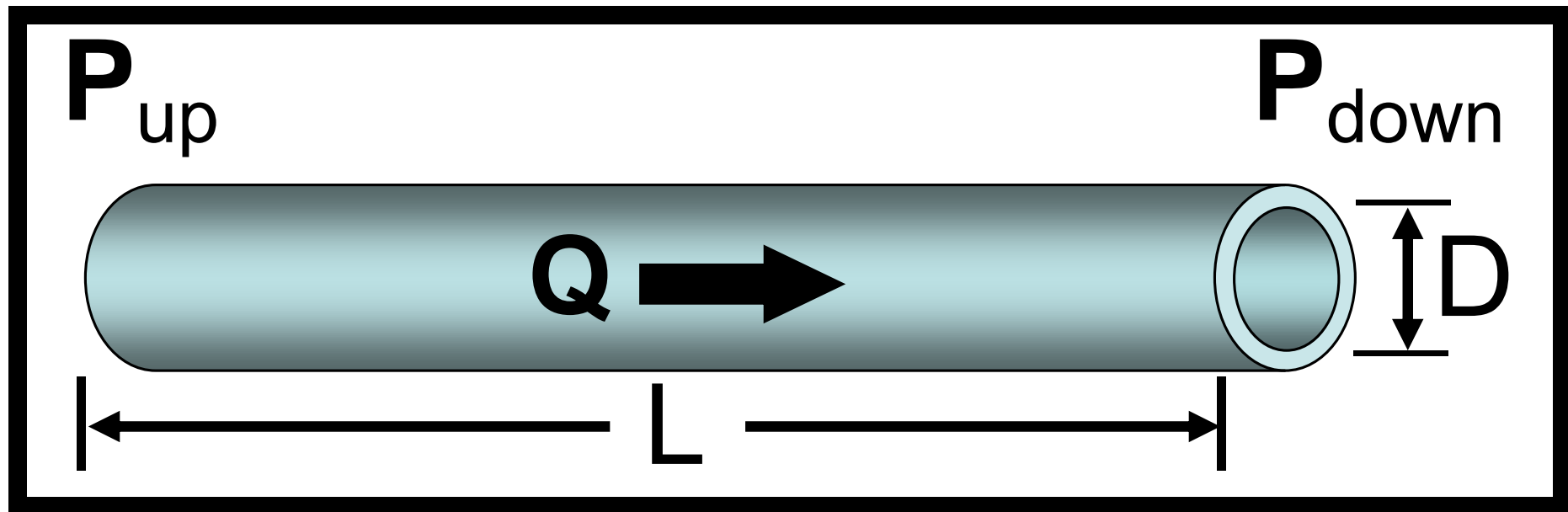

# Scope of Gas Distribution Planning

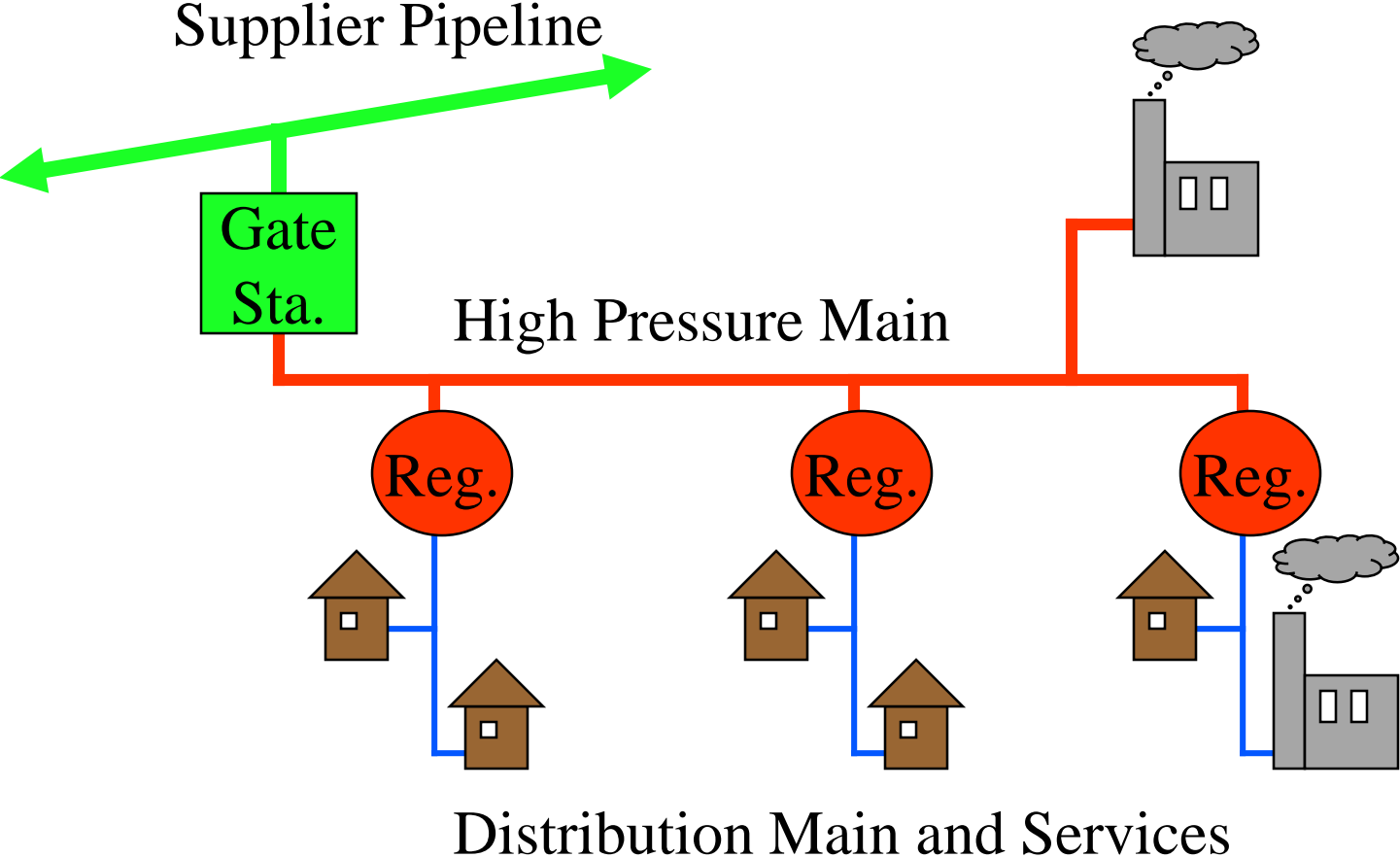

# Scope of Gas Distrib. Planning cont.

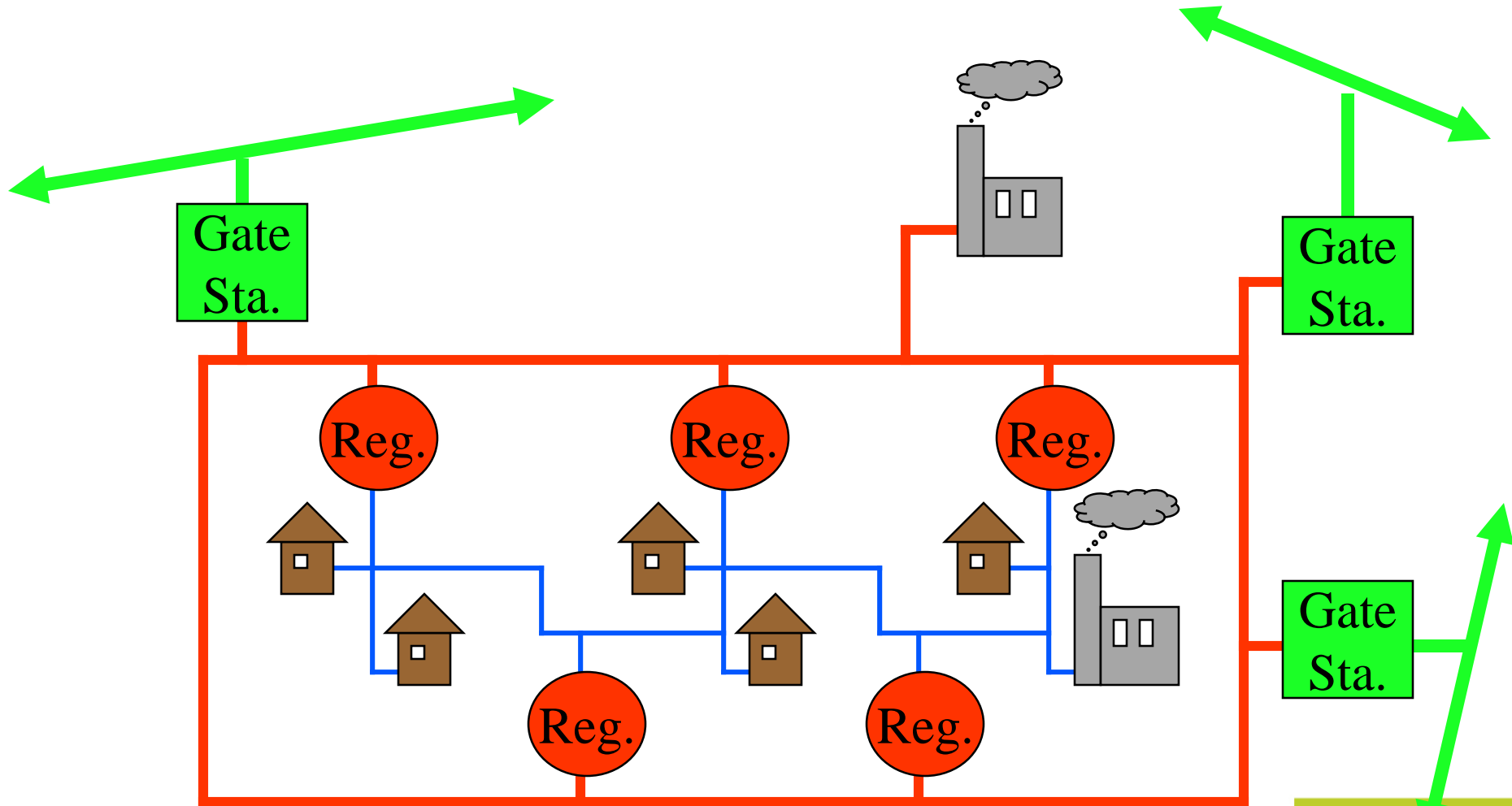

# SynerGi (SynerGEE, Stoner) Load Study

- Simulate distribution behavior
- Identify low pressure areas
- Coordinate reinforcements with expansions
- Measure reliability

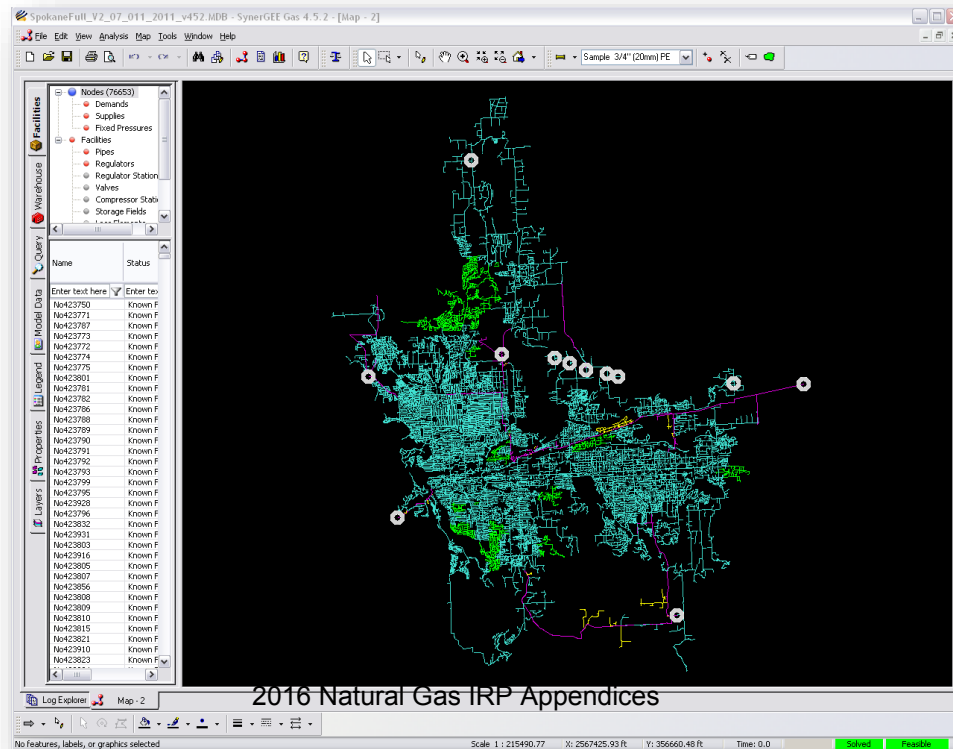

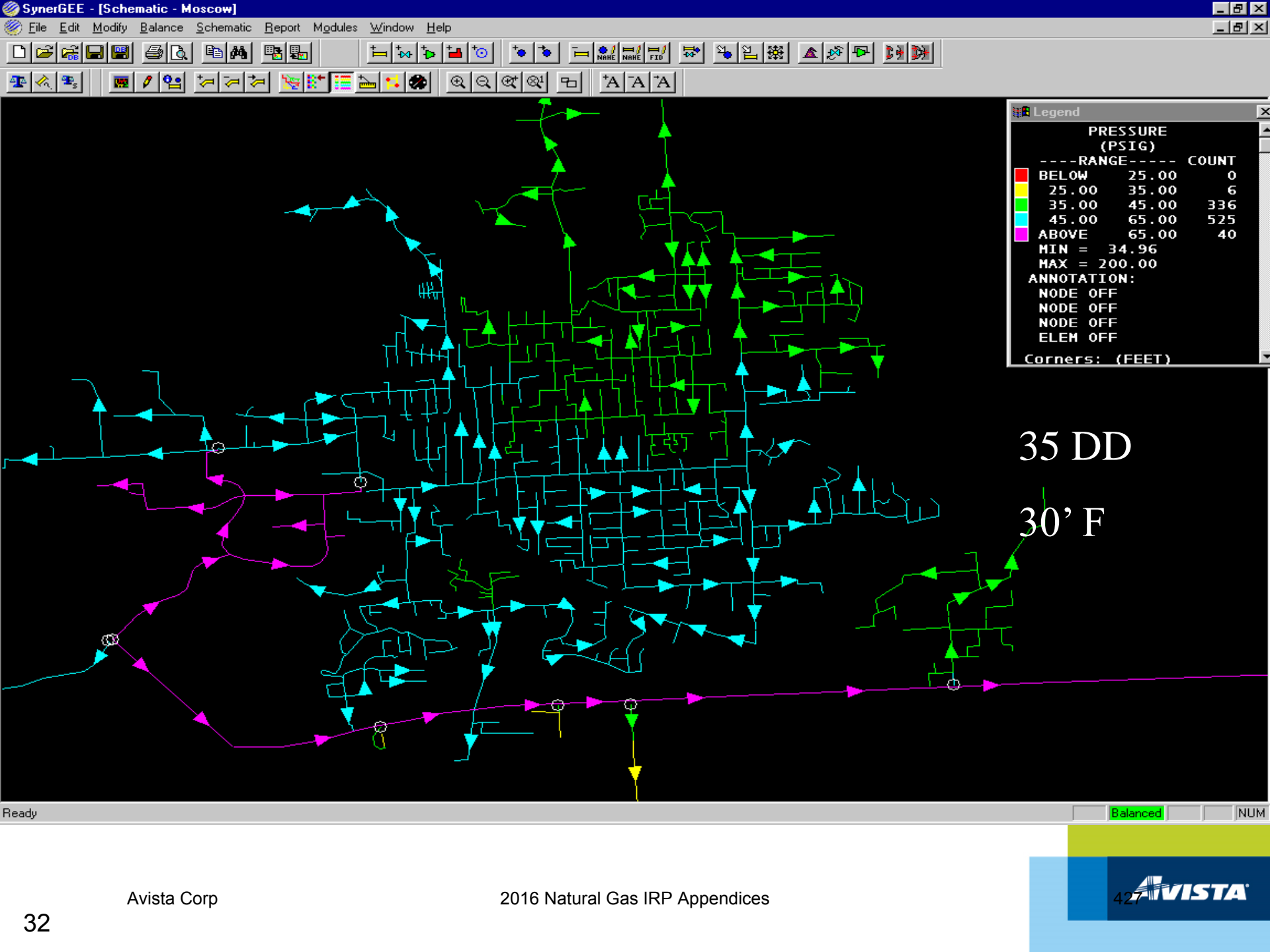

# Preparing a Load Study

- Estimating Customer Usage
- Creating a Pipeline Network
- Join Customer Loads to Pipes
- Convert to Load Study





# Estimating Customer Usage

- Gathering Data
  - Days of service
  - Degree Days
  - Usage
  - Name, Address, Revenue Class, Rate Schedule...



# Estimating Customer Usage cont.

- Degree Days
  - Heating (HDD)
  - Cooling (CDD)
- Temperature - Usage Relationship
  - Load vs. HDD's
  - Base Load (constant)
  - Heat Load (variable)
  - High correlation with residential

Avg. Daily Temperature ('Fahrenheit)	Heating Degree Days (HDD)	Cooling Degree Days (CDD)
85		20
80		15
75		10
70		5
65	0	0
60	5	
55	10	
50	15	
45	20	
40	25	
35	30	
30	35	
25	40	
20	45	
15	50	
10	55	
5	60	
4	61	
0	65	
-5	70	
-10	75	
-15	80	
-17	82	

A	B	C	D	E	F	G	H	I
Begin Date	Read Date	RBC	Dys Svc	Deg Dys	Usage	Therm/Day	DD/day	mcfh/day
01-23-2002	02-22-2002	RR	30	971	2775	92.5	32.36667	0.58
12-21-2001	01-23-2002	RR	33	1195	2567	77.78788	36.21212	0.49
11-20-2001	12-21-2001	RR	31	1028	2547	82.16129	33.16129	0.51
10-24-2001	11-20-2001	RR	27	586	1379	51.07407	21.7037	0.32
09-24-2001	10-24-2001	RR	30	491	1208	40.26667	16.36667	0.25
08-22-2001	09-24-2001	RR	33	67	715	21.66667	2.030303	0.14
07-24-2001	08-22-2001	RY	29	19	432	14.89655	0.655172	0.09
06-22-2001	07-24-2001	RR	32	41	611	19.09375	1.28125	0.12
05-24-2001	06-22-2001	RR	29	219	736	25.37931	7.551724	0.16
04-23-2001	05-24-2001	RY	31	368	1301	41.96774	11.87097	0.26
03-23-2001	04-23-2001	RR	31	734	1913	61.70968	23.67742	0.39
02-22-2001	03-23-2001	RR	29	826	2538	87.51724	28.48276	0.55
01-24-2001	02-22-2001	RY	29	1113	3153	108.7241	38.37931	0.68
12-19-2000	01-24-2001	RY	36	1347	3668	101.8889	37.41667	0.64
11-16-2000	12-19-2000	RY	33	1340	3573	108.2727	40.60606	0.68
10-18-2000	11-16-2000	RR	29	884	2424	83.58621	30.48276	0.52
09-20-2000	10-18-2000	RR	28	408	1738	62.07143	14.57143	0.39
08-22-2000	09-20-2000	RY	29	169	1139	39.27586	5.827586	0.25

# Load vs. Temperature

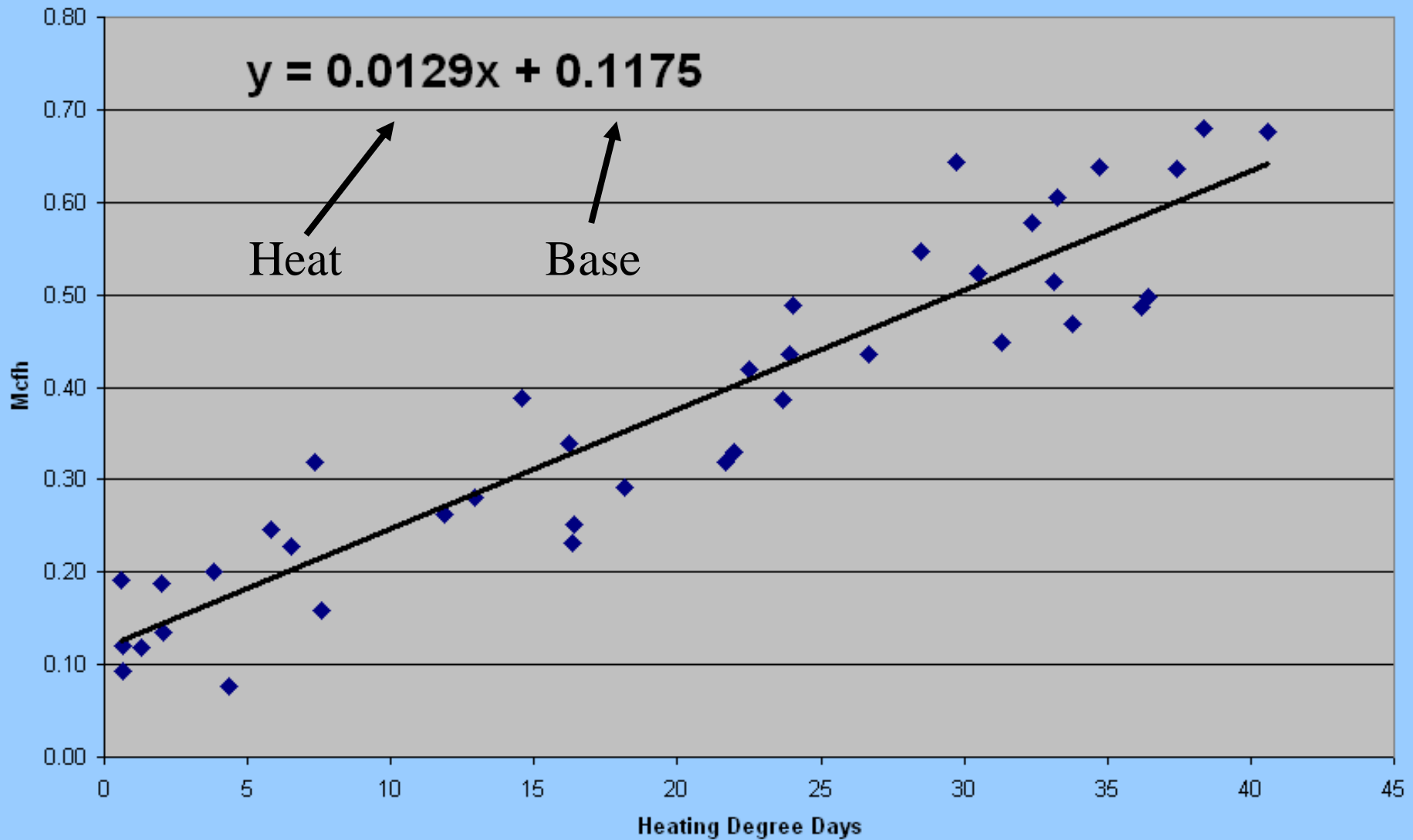

# Estimating Customer Usage cont.

- Peaking Factor
  - Peaking Factor = 6.25% of daily load
  - “Observed ratio” of greatest hourly flow to total daily flow at Gate Stations
- Industrial Customers
  - Model maximum hourly usage per Contractual Agreement
  - Firm Transportation customers only
  - Low Temperature-Usage correlation

# Creating a Pipeline Model

- Elements
  - Pipes, regulators, valves
  - Attributes: Length, internal diameter, roughness
- Nodes
  - Sources, usage points, pipe ends
  - Attributes: Flow, pressure

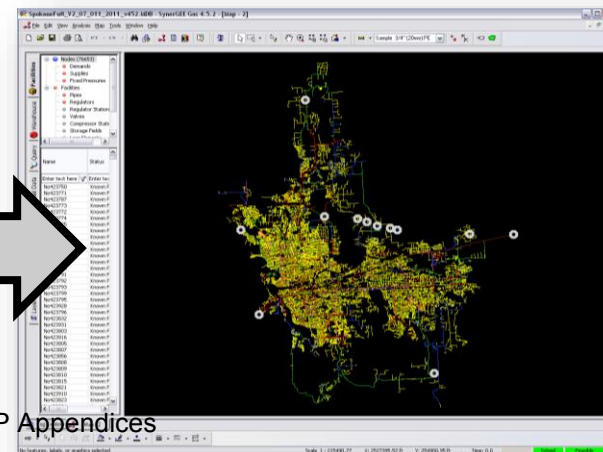
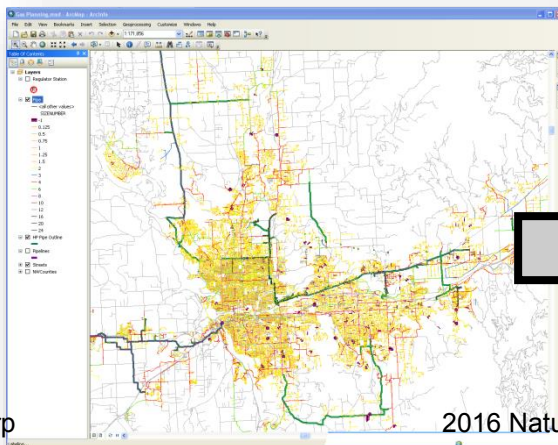

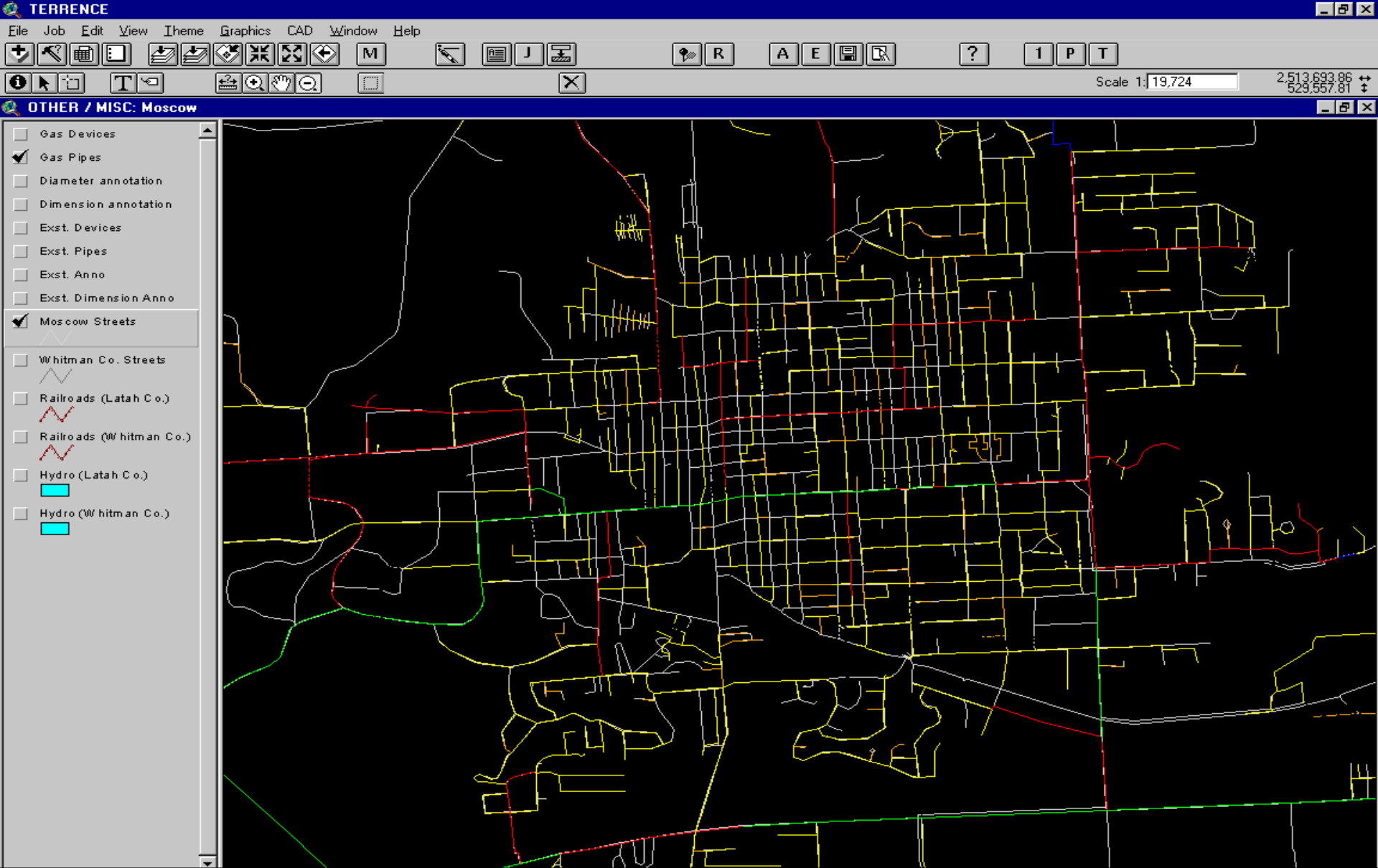

TERRENCE

File Job Edit View Theme Graphics CAD Window Help

Scale 1: 26,170 2,526,466.09 532,193.61

Attributes of Gas Pipes

Length	Gas	Gas_id	Equip_type	Equip_sub	Equipment	Cased_inc	Lock_id	Phase_id	Object_id	Ver_id	Ver_end	Dir	Diameter	Year_inst	Joint_use	U
608.82431	4	1	GLS	MPLN	650089771	N	0	0	0	0	0	0	4.00	1999	JT/N	
679.06094	5	1	GLS	MPLN	650089772	N	0	0	0	0	0	0	2.00	1999	JT/N	
1463.75313	6	1	GLS	MSLN	650089774	N	0	0	0	0	0	0	2.00	1999	JT/N	
193.35819	6	1	GLS	MSLN	650089775	N	0	0	0	0	0	0	2.00	1999	JT/N	
435.19989	9	2	GLS	MPLN	650089776	N	0	0	0	0	0	0	2.00	1999	JT/N	
1090.20677	10	1	GLS	MPLN	650089781	N	0	0	0	0	0	0	4.00	1999	JT/N	
522.75341	11	2	GLS	MPLN	650089782	N	0	0	0	0	0	0	2.00	1999	JT/N	
1255.57481	12	2	GLS	MPLN	650089783	N	0	0	0	0	0	0	4.00	1999	JT/N	
822.95617	13	3	GLS	MPLN	650089784	N	0	0	0	0	0	0	4.00	1999	JT/N	
845.53503	14	2	GLS	MSLN	650089785	N	0	0	0	0	0	0	2.00	1999	JT/N	
269.16499	15	3	GLS	MSLN	650089786	N	0	0	0	0	0	0	2.00	1999	JT/N	

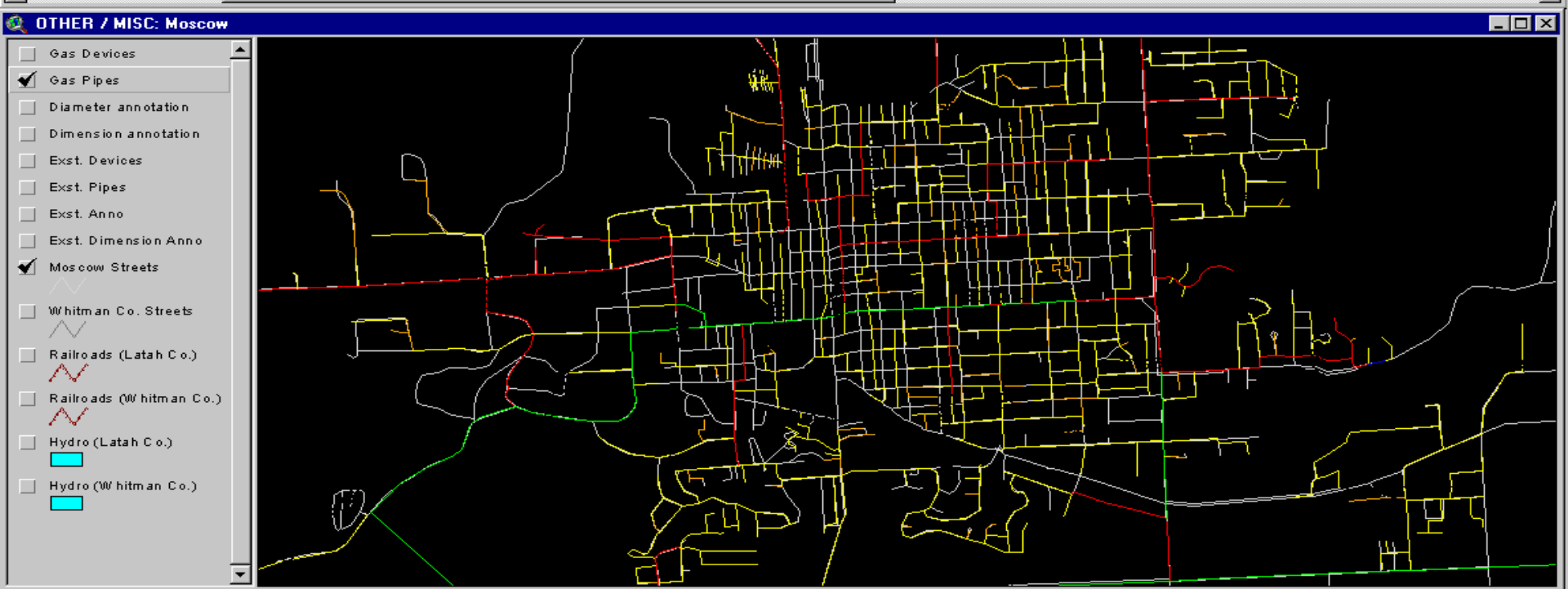



# Join Customer Loads to a Model

- Residential and commercial loads are assigned to ***pipes***
- Industrial or other large loads are assigned to ***nodes***

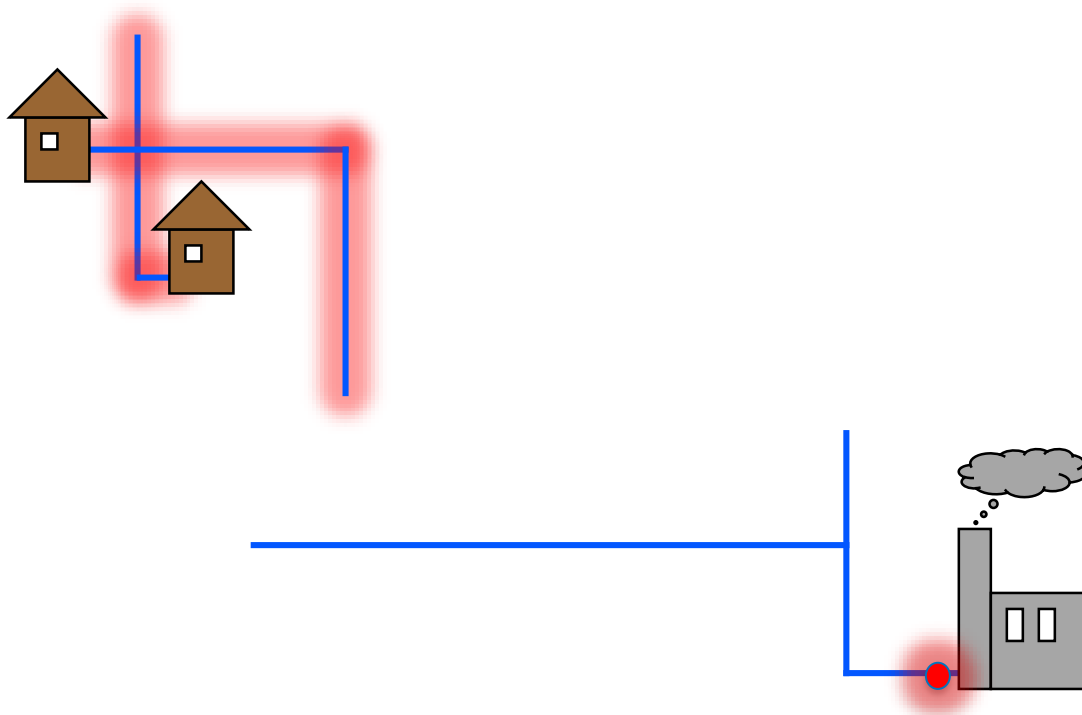

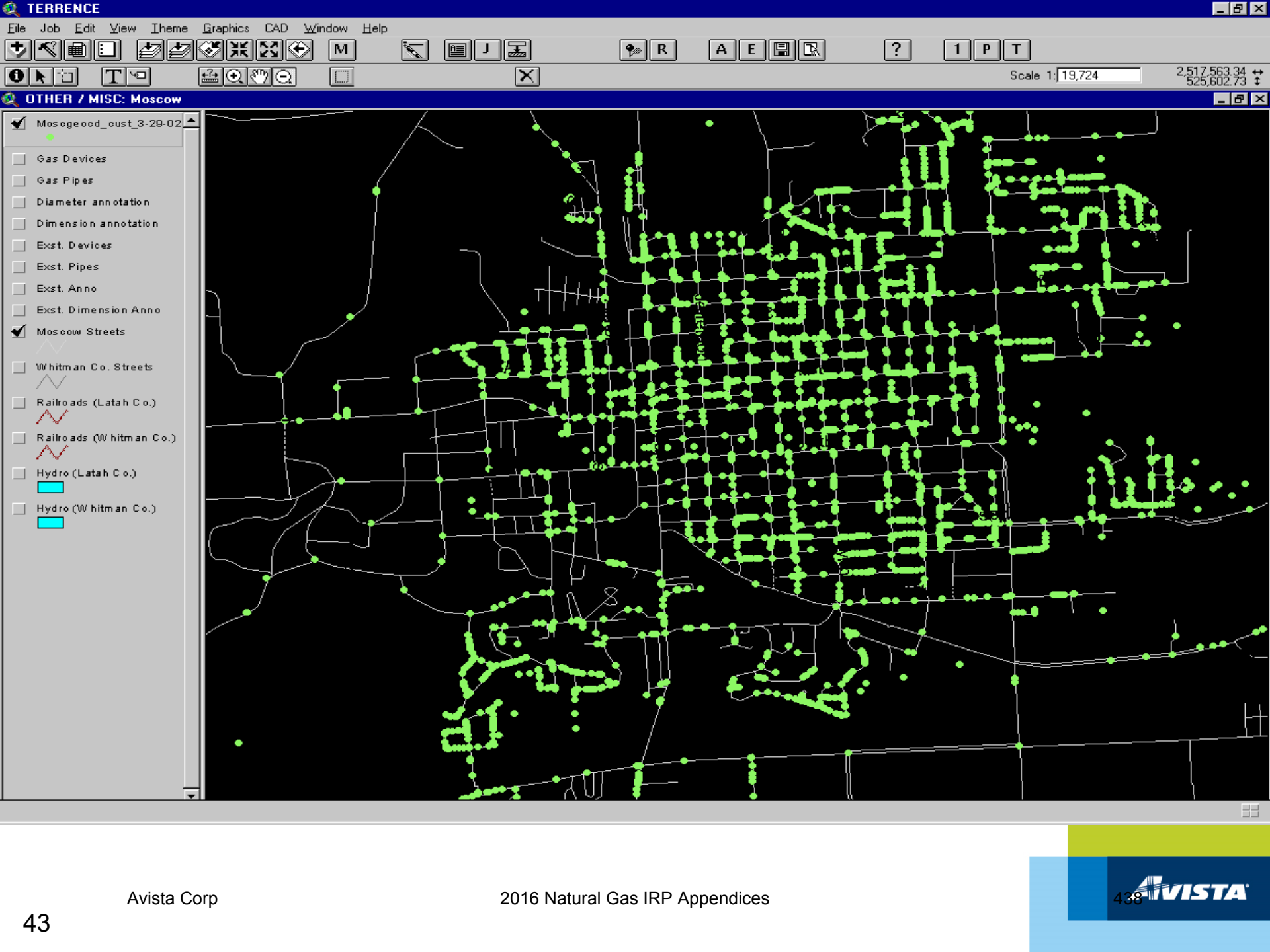

- Mosogood\_cust\_3-29-02
- Gas Devices
- Gas Pipes
- Diameter annotation
- Dimension annotation
- Exst. Devices
- Exst. Pipes
- Exst. Anno
- Exst. Dimension Anno
- Moscow Streets
- Whitman Co. Streets
- Railroads (Latah Co.)
- Railroads (Whitman Co.)
- Hydro (Latah Co.)
- Hydro (Whitman Co.)



TERRENCE

File Job Edit View Theme Graphics CAD Window Help

Scale 1:26,170 2,512,479.69 533,887.53

Attributes of Moscoeood\_cust\_3-29-02.shp

Matched	Customer_n	House_num	Street_nm	Flural_srv	G	Geocd_g	Avg_usage	Avg_days_o	Avg_degree	Avg_dte
False	U OF I			U OF I LIFE SCIENCE BLDG	G		586.000000	31.000000	32.000000	2001-08-27 00
False	U OF I			MINES 7TH ST & LINE ST	G		0.000000	31.000000	32.000000	2001-08-27 00
False	U OF I			ART & ARCH BLDG	G		210.000000	31.000000	32.000000	2001-08-27 00
False	UNIVERSITY OF IDAHO			ANIMAL DISEASE RESEARCH	G		4558.000000	31.000000	32.000000	2001-08-27 00
False	U OF I			AQUACULTURE INSTITUTE	G		92.000000	31.000000	32.000000	2001-08-27 00
False	U OF I			POULTRY	G		0.000000	31.000000	32.000000	2001-08-27 00
False	U OF I			KIBBIE STADIUM	G		688.000000	31.000000	32.000000	2001-08-27 00
False	B P O E NO 249	3080	HIGHWAY 8		G		6.000000	28.000000	17.000000	2001-08-20 00
False	B P O E NO 249	3080	HIGHWAY 8		G		71.000000	28.000000	17.000000	2001-08-20 00
False	U OF I			MACHINE SHED	G		0.000000	29.000000	17.000000	2001-08-20 00
False	JAMESON COMMERCIAL PR			PEPPERMILL/DR BOWEN	G		9.000000	23.000000	32.000000	2001-08-07 00





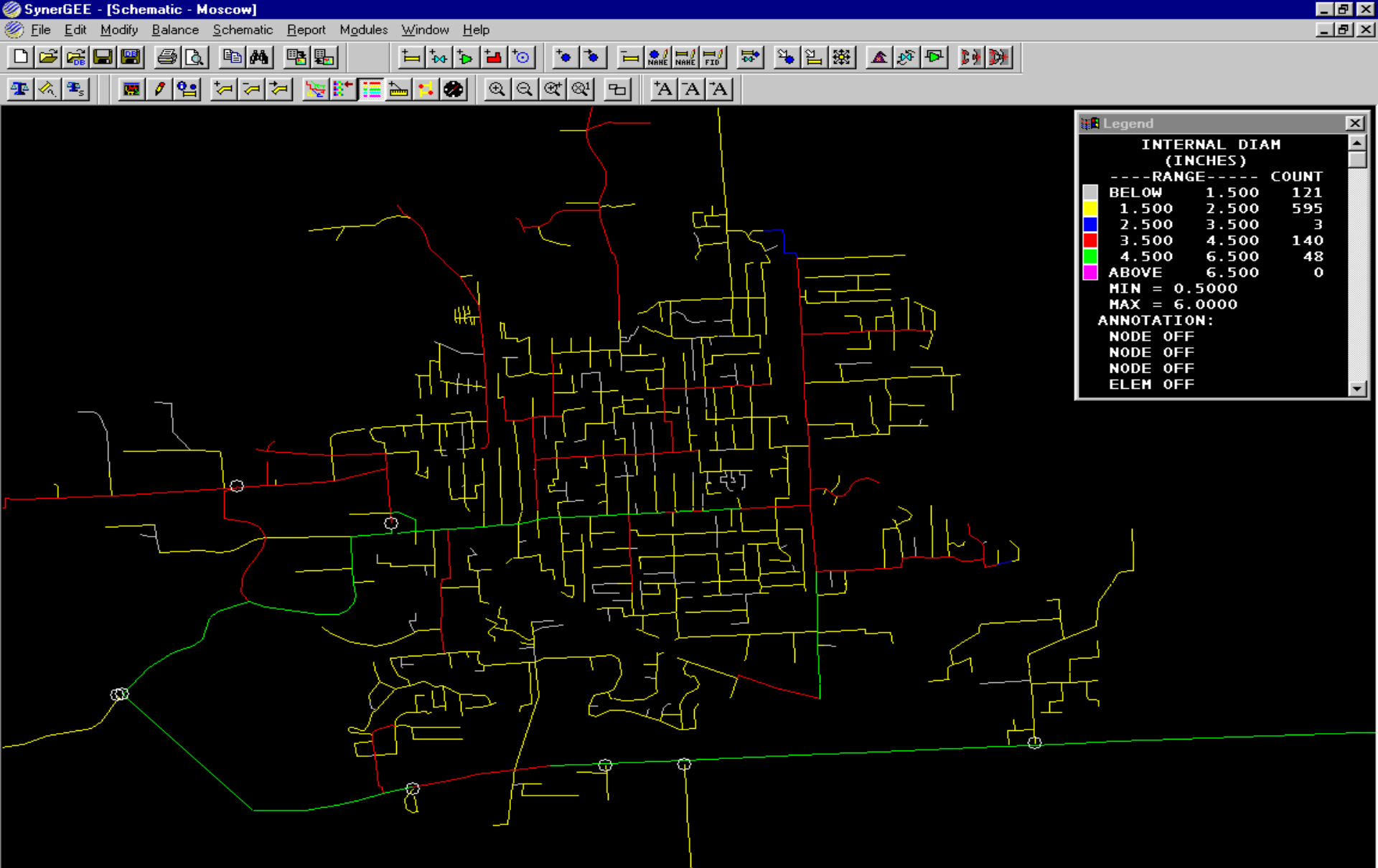

Ready Balanced NUM

# Balancing Model

- Simulate system for any temperature
  - HDD's
- Solve for pressure at all nodes



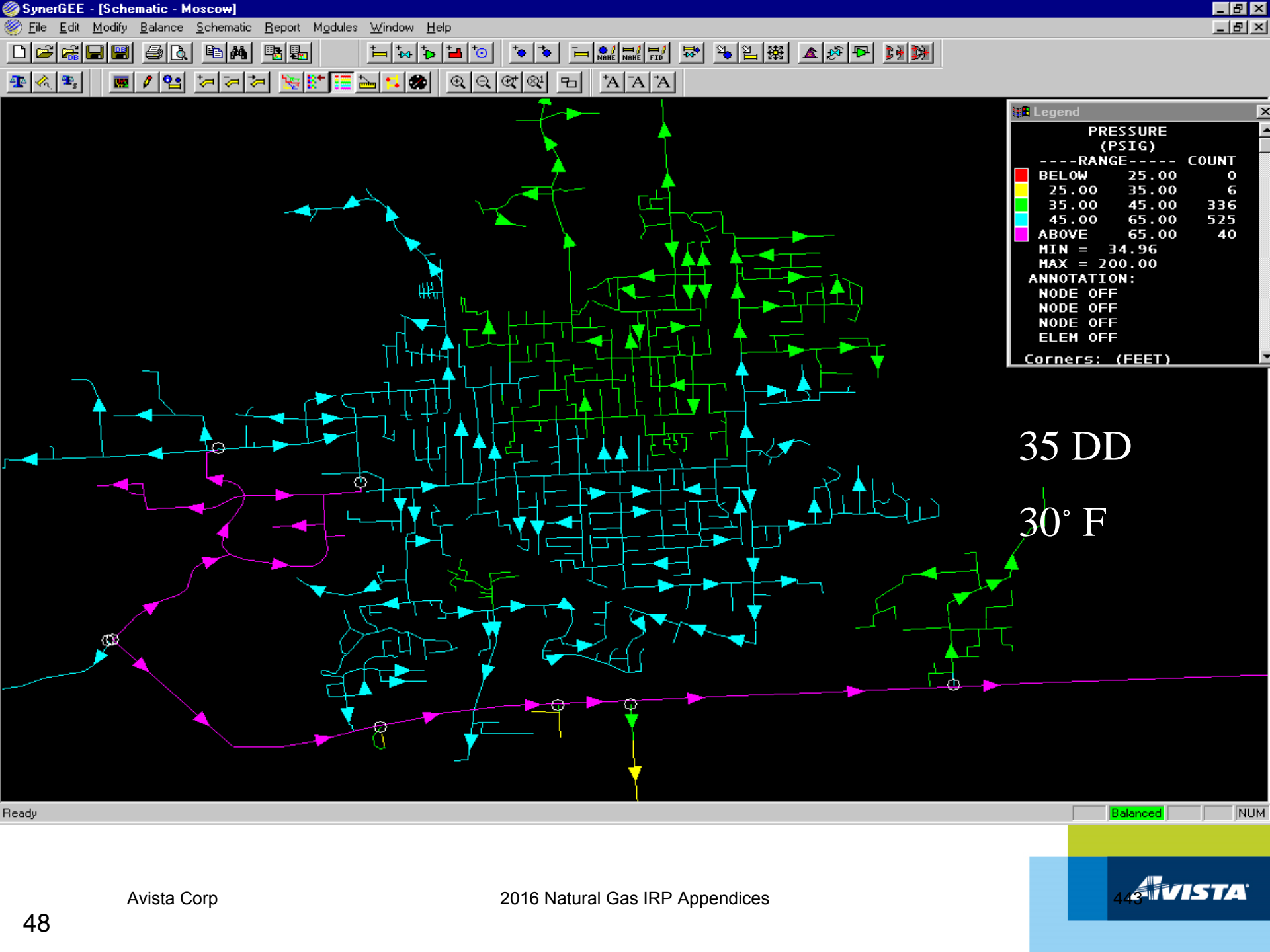

# Validating Model

- Simulate recorded condition
- Pressure Recorders
  - Do calculated results match field data?
- Gate Station Telemetry
  - Do calculated results match source data?
- Possible Errors
  - Missing pipe
  - Source pressure changed
  - Industrial loads



# Validating Model cont.

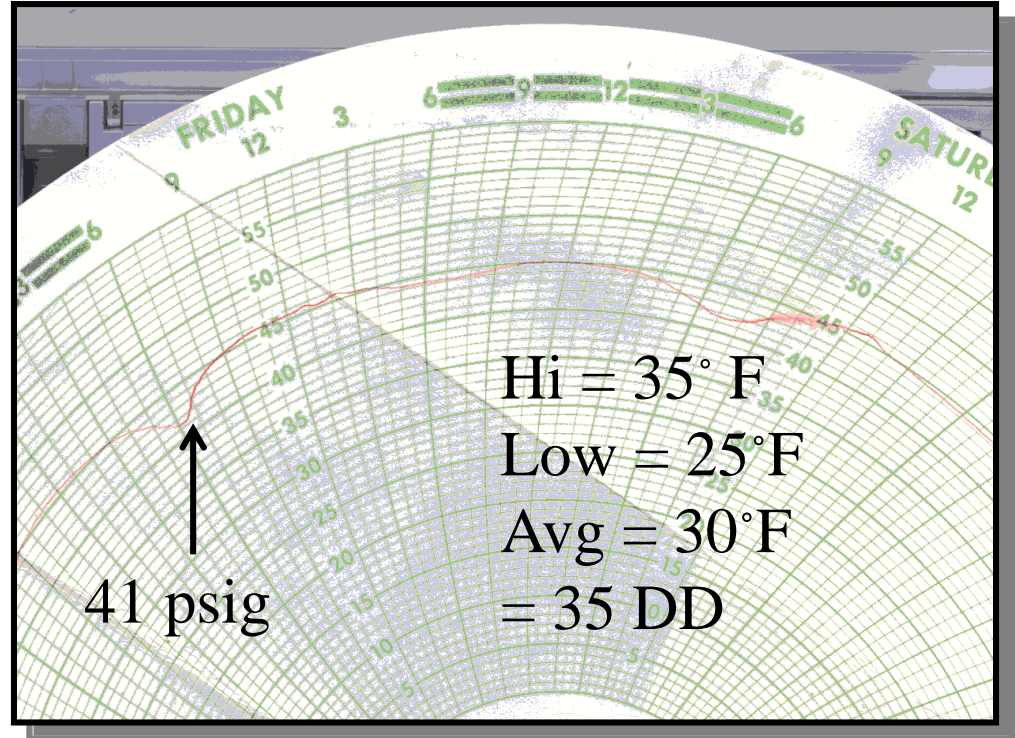
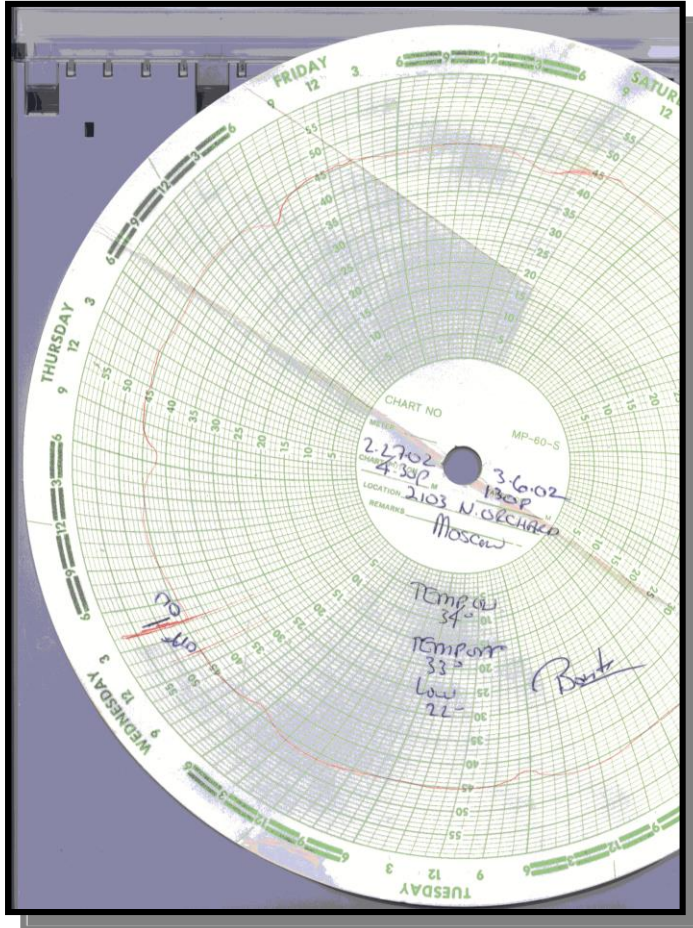

Location: N. Orchard, Moscow ID

Observation Date: Friday, March 1st

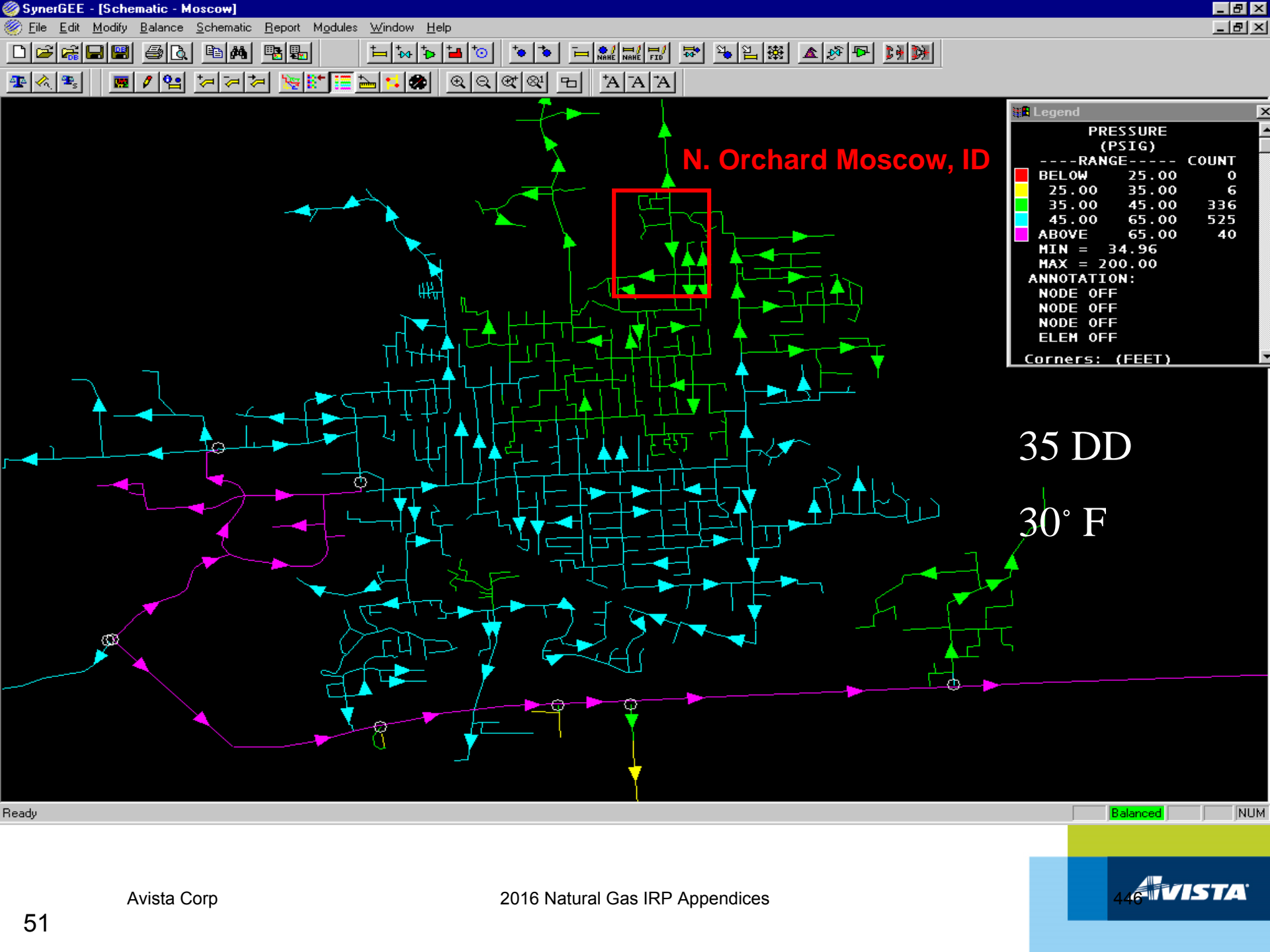

N. Orchard Moscow, ID

Legend

PRESSURE (PSIG)		
---RANGE---	COUNT	
BELOW 25.00	25.00	0
35.00 35.00	35.00	6
45.00 45.00	45.00	336
65.00 65.00	65.00	525
ABOVE 65.00	65.00	40

MIN = 34.96  
MAX = 200.00  
ANNOTATION:  
NODE OFF  
NODE OFF  
NODE OFF  
ELEM OFF  
Corners: (FEET)

35 DD

30° F

Ready

Balanced

NUM

# Planning Criteria

- Reliability during design HDD
  - Spokane 82 HDD
  - Medford 61 HDD
  - Klamath Falls 72 HDD
  - La Grande 74 HDD
  - Roseburg 55 HDD
- Maintain minimum of 15 psig in system at all times
  - 5 psig in lower MAOP areas

# Planning Criteria

- Reliability during design HDD
  - Spokane **82 HDD** (*avg. daily temp. -17' F*)
  - Medford **61 HDD** (*avg. daily temp. 4' F*)
  - Klamath Falls **72 HDD** (*avg. daily temp. -7' F*)
  - La Grande **74 HDD** (*avg. daily temp. -9' F*)
  - Roseburg **55 HDD** (*avg. daily temp. 10' F*)
- Maintain minimum of 15 psig in system at all times
  - 5 psig in lower MAOP areas

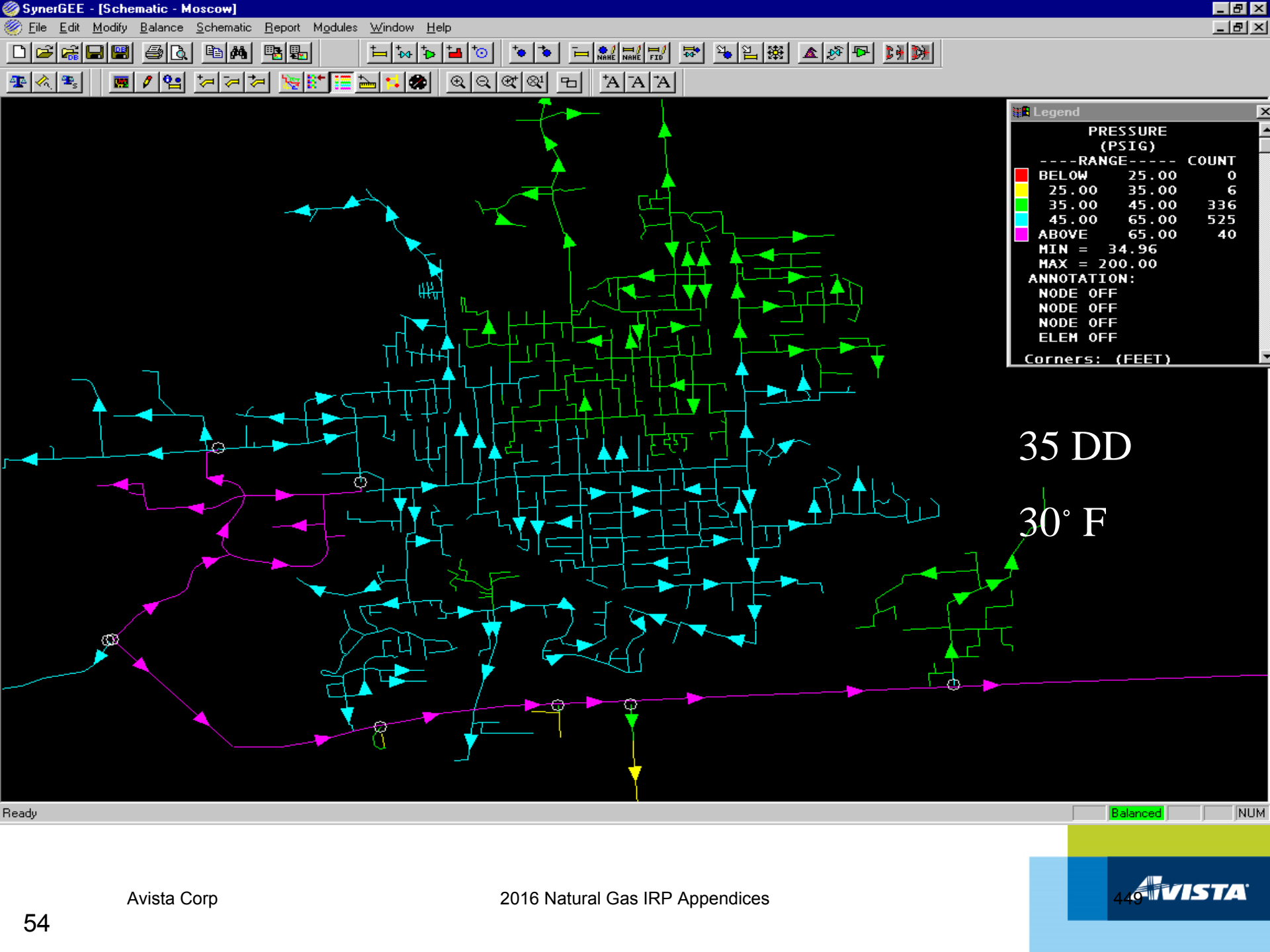

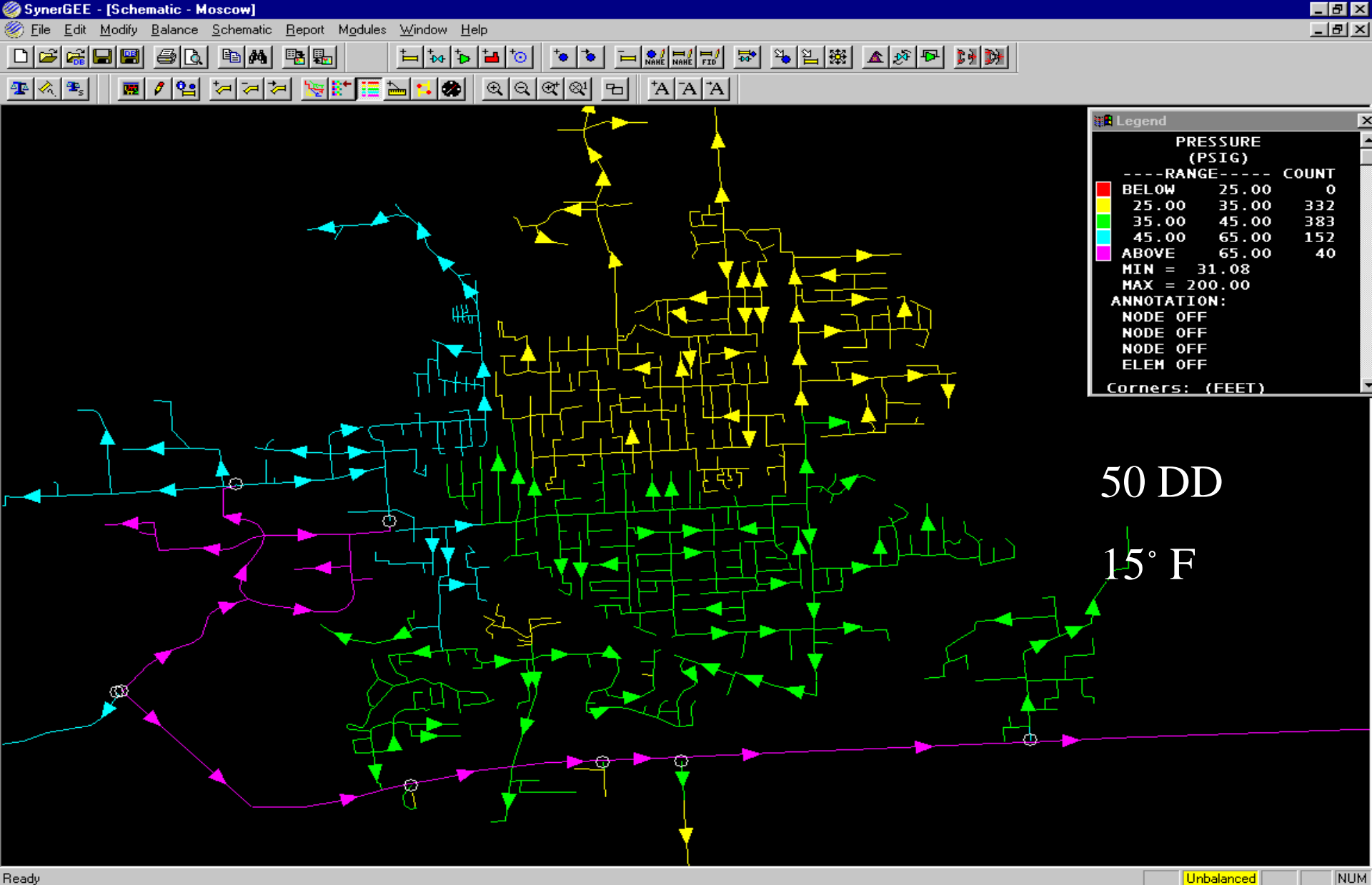

Ready

Unbalanced

NUM

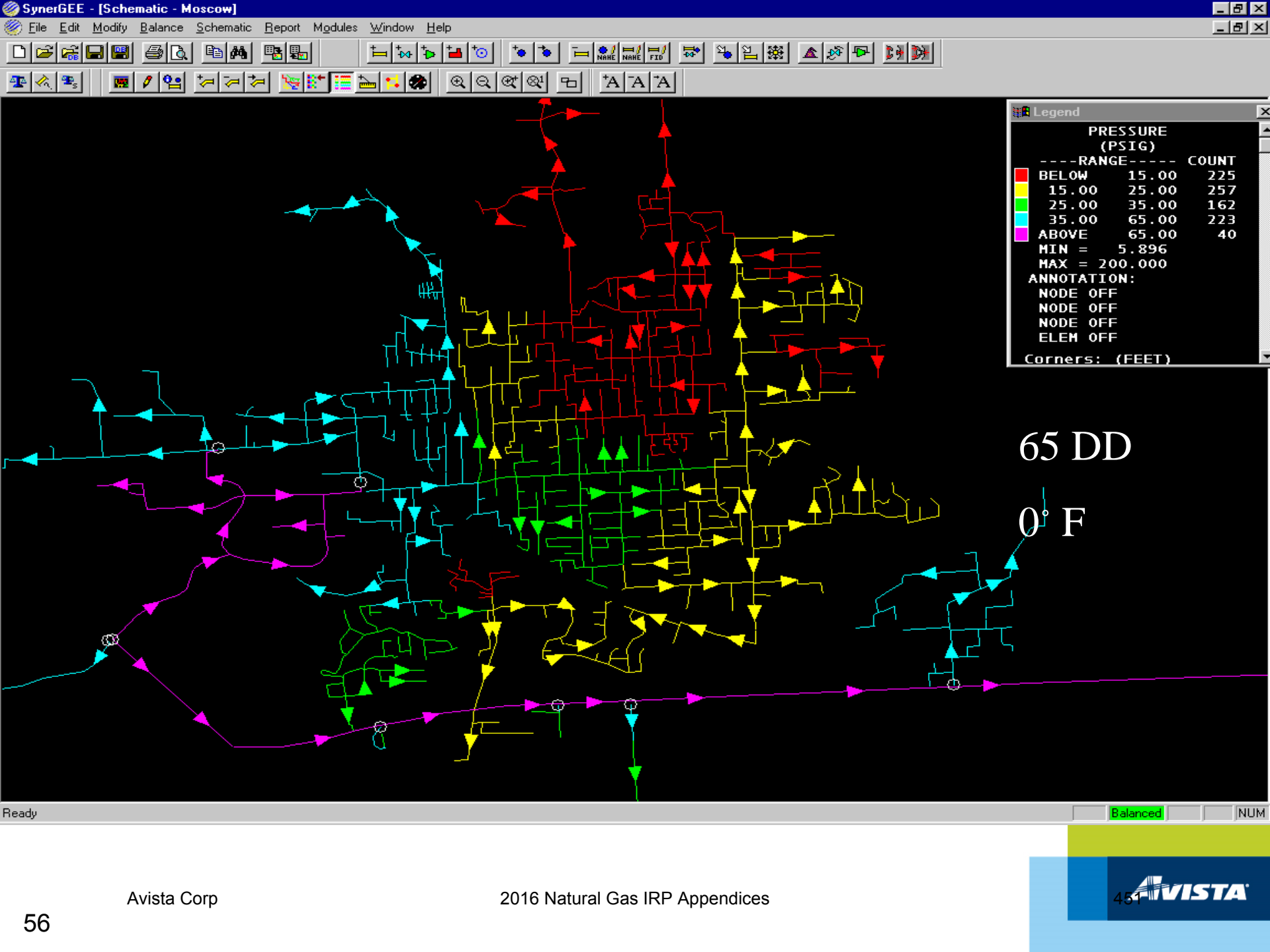

# Interpreting Results

- Identify Low Pressure Areas
  - Number of feeds
  - Proximity to source
- Looking for Most Economical Solution
  - Length (minimize)
  - Construction obstacles (minimize)
  - Customer growth (maximize)





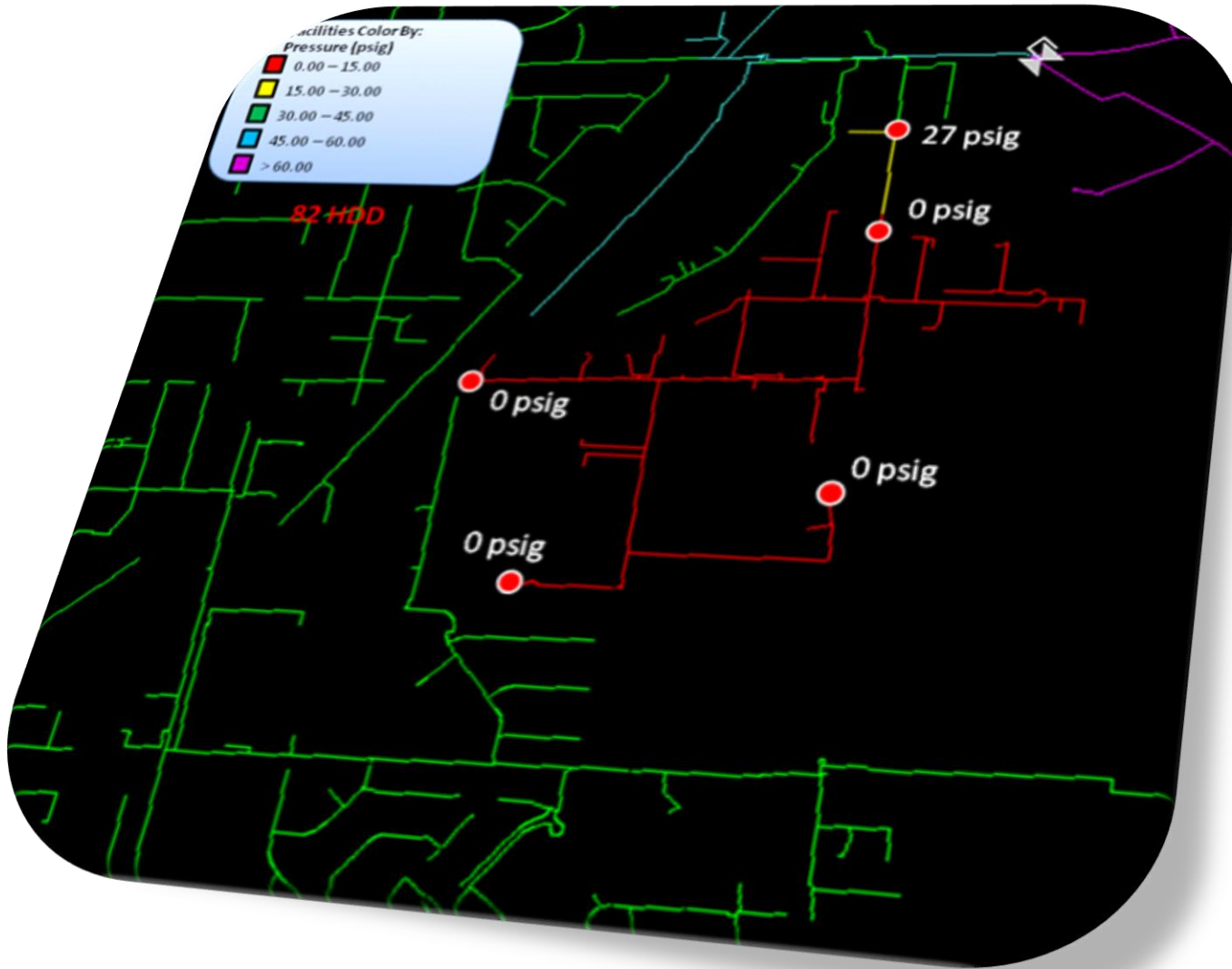

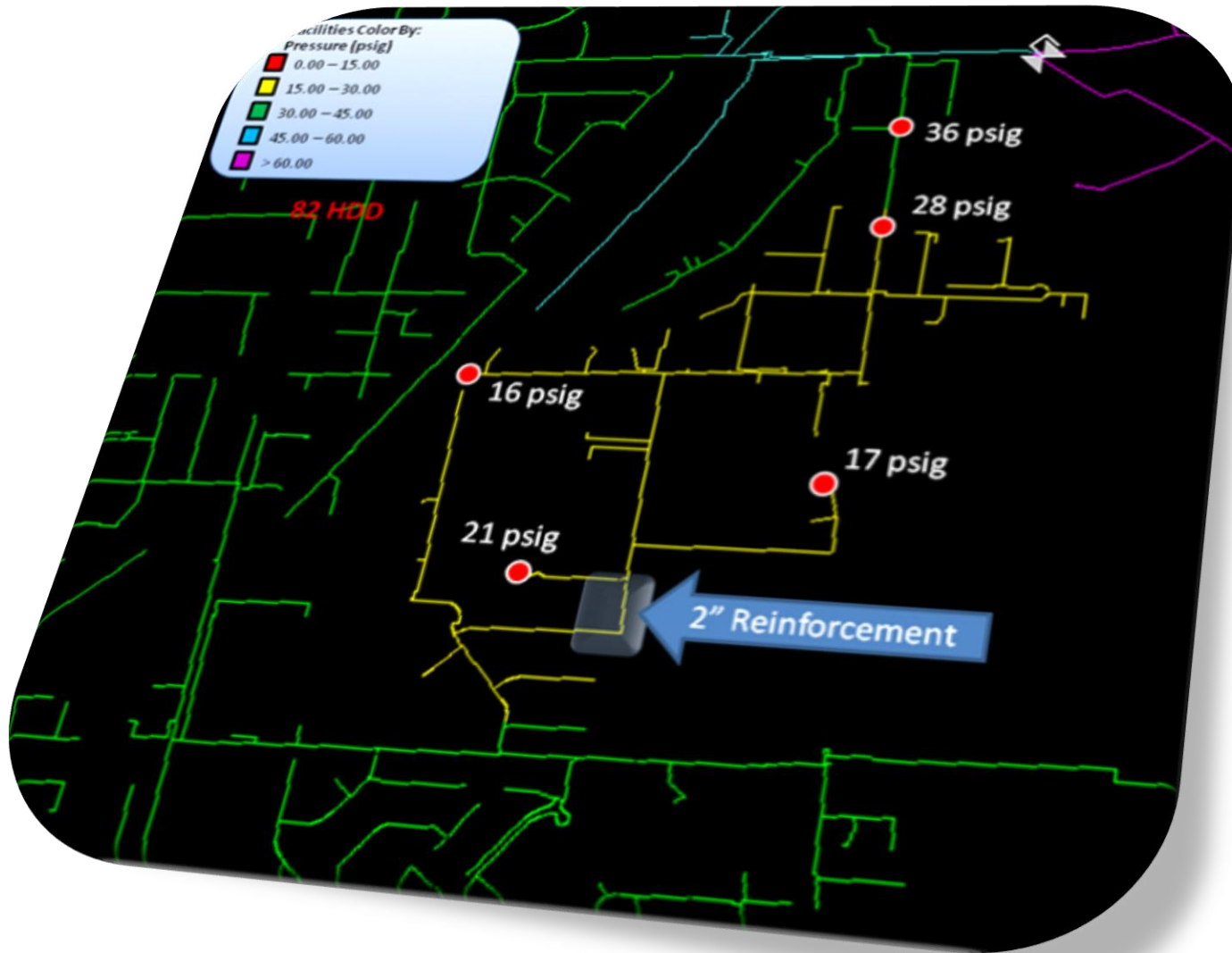

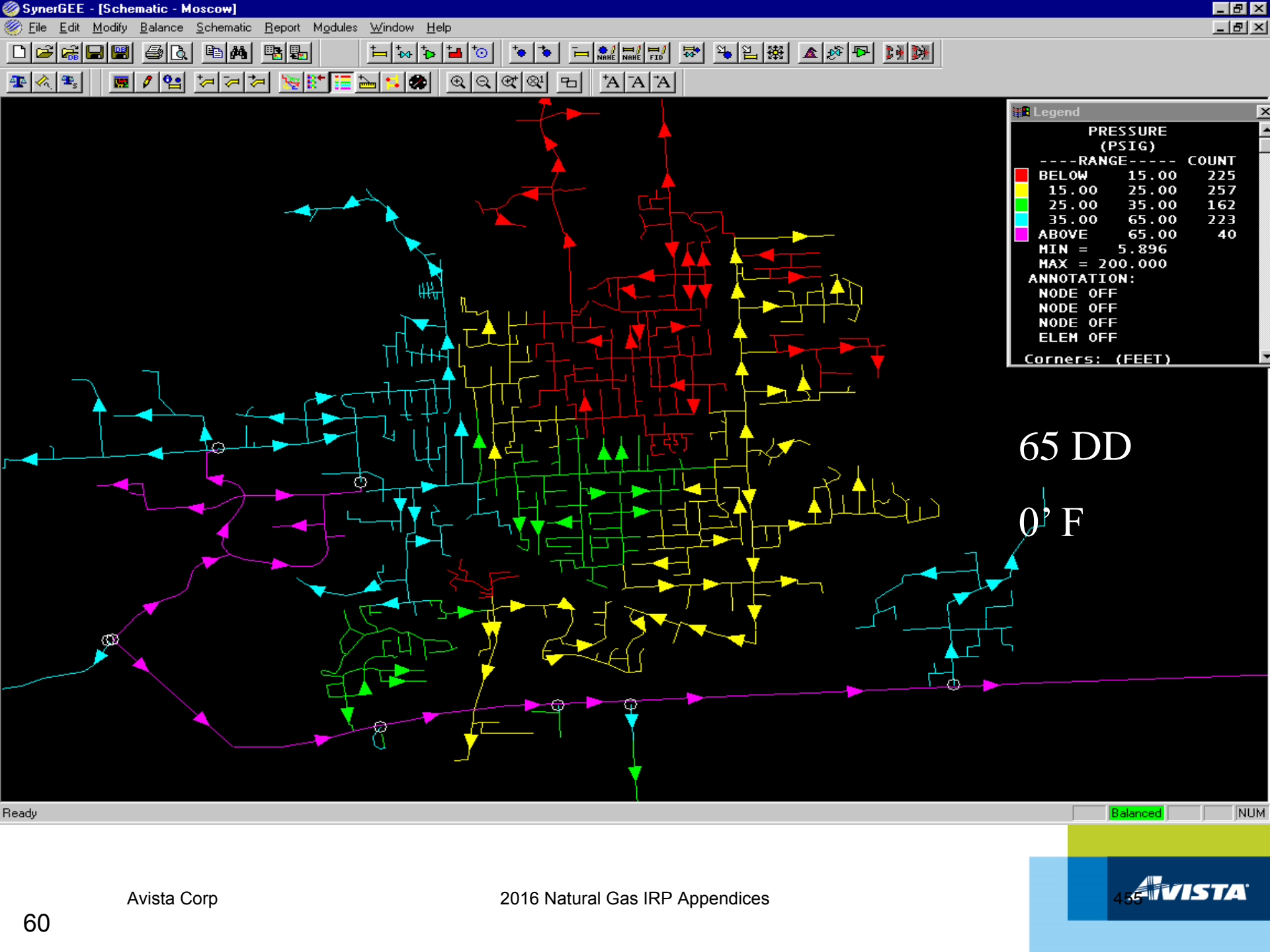

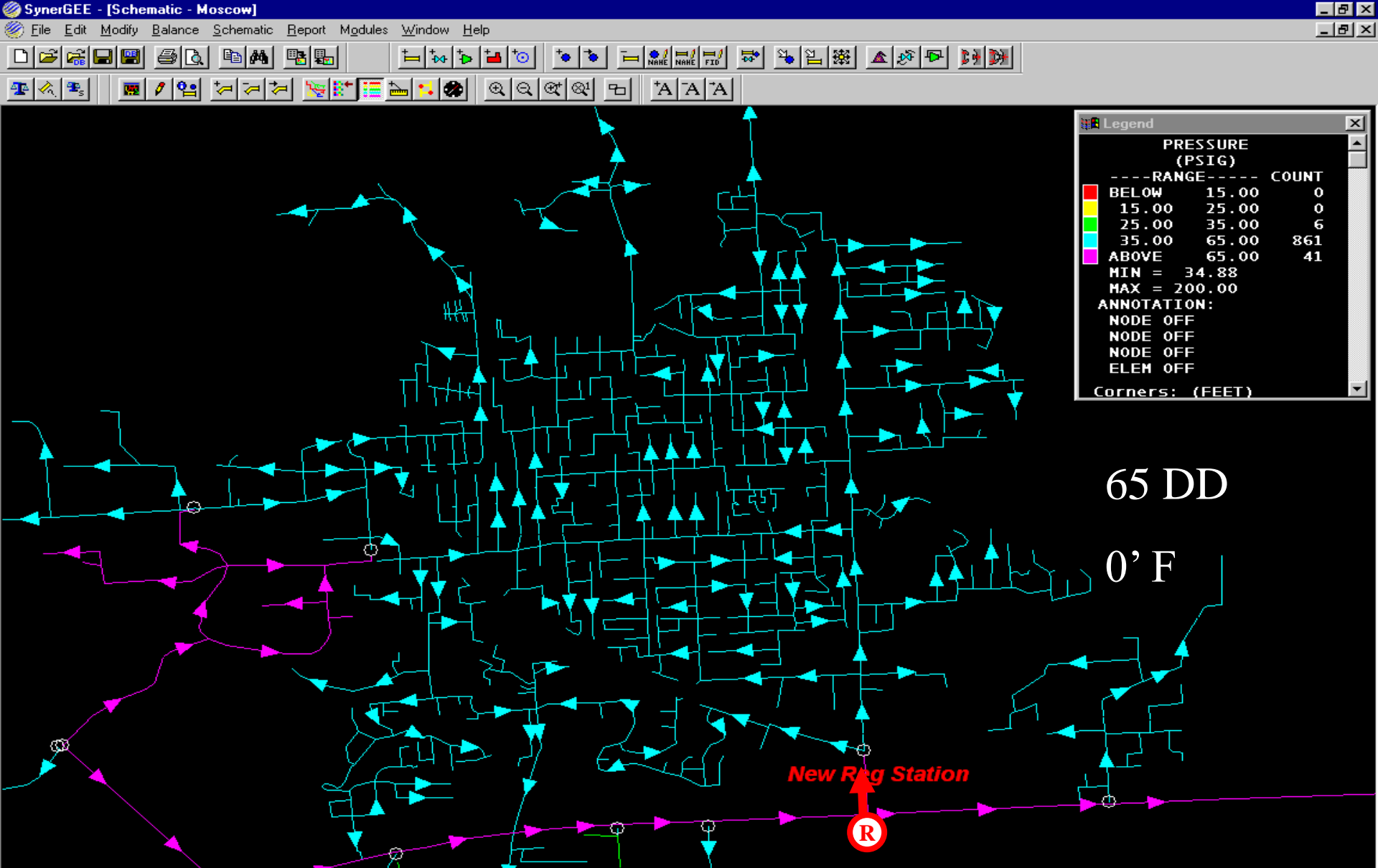

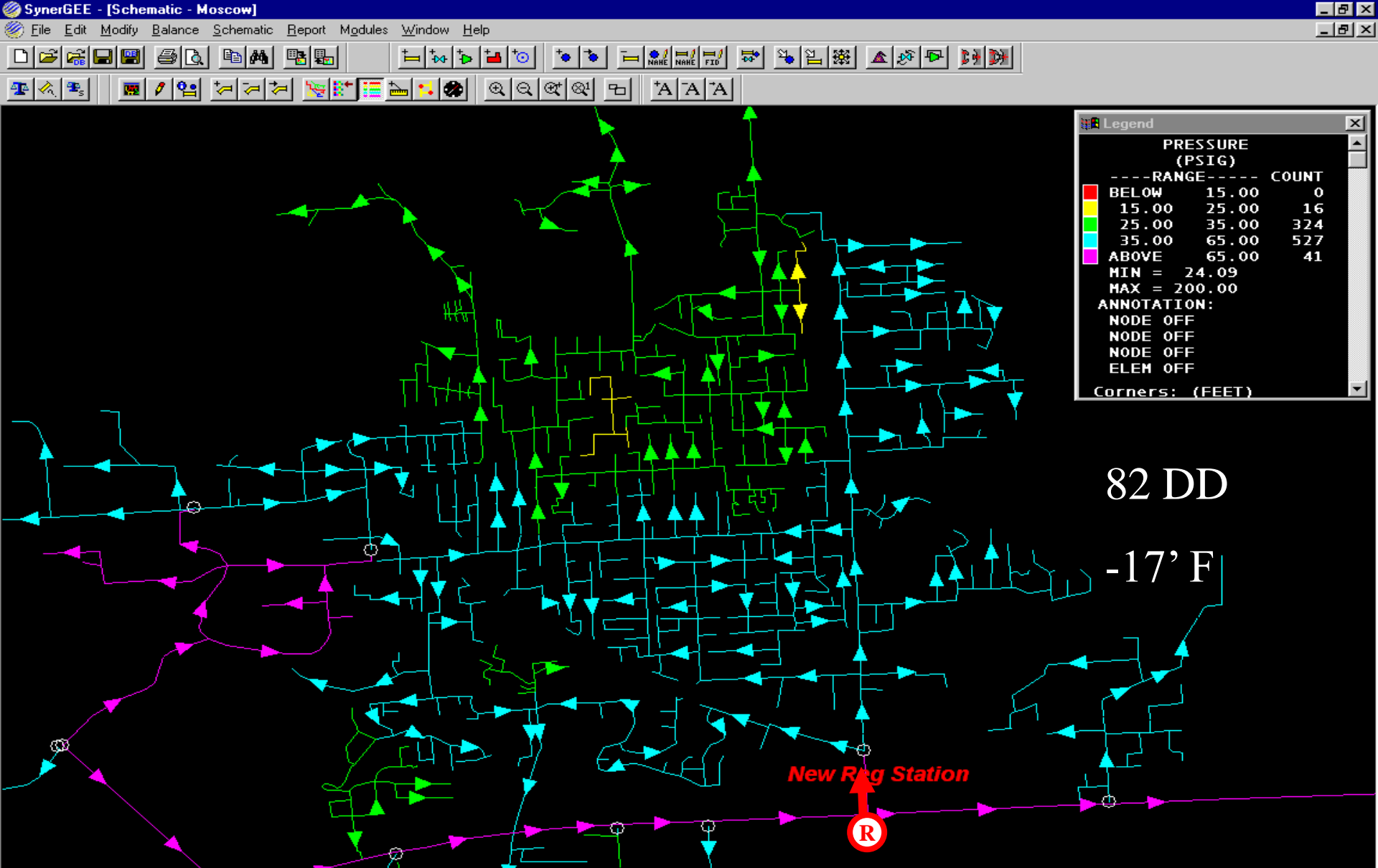

Ready Balanced NUM

# Long-term Planning Objectives

- Future Growth/Expansion
- Design Day Conditions
- Facilitate Customer Installation Targets



# Historical Temperatures



# Historical Temperatures

- Reliability during design HDD
  - Spokane **82 HDD** (*avg. daily temp. -17' F*)
  - Medford **61 HDD** (*avg. daily temp. 4' F*)
  - Klamath Falls **72 HDD** (*avg. daily temp. -7' F*)
  - La Grande **74 HDD** (*avg. daily temp. -9' F*)
  - Roseburg **55 HDD** (*avg. daily temp. 10' F*)



# Historical Temperatures



- Reliability during design HDD
  - Spokane **82 HDD** (*avg. daily temp. -17' F*)
    - 11/23/10: 64 HDD
  - Medford **61 HDD** (*avg. daily temp. 4' F*)
  - Klamath Falls **72 HDD** (*avg. daily temp. -7' F*)
  - La Grande **74 HDD** (*avg. daily temp. -9' F*)
  - Roseburg **55 HDD** (*avg. daily temp. 10' F*)

# Historical Temperatures



- Reliability during design HDD
  - Spokane **82 HDD** (*avg. daily temp. -17' F*)
    - 11/23/10: 64 HDD
    - 12/6/13 and 12/8/13: 58 HDD
  - Medford **61 HDD** (*avg. daily temp. 4' F*)
    - 12/8/13: 52 HDD
  - Klamath Falls **72 HDD** (*avg. daily temp. -7' F*)
    - 12/8/13: 72 HDD
  - La Grande **74 HDD** (*avg. daily temp. -9' F*)
    - 12/8/13: 65 HDD
  - Roseburg **55 HDD** (*avg. daily temp. 10' F*)



# Historical Temperatures

- Reliability during design HDD
  - Spokane **82 HDD** (*avg. daily temp. -17' F*)
    - 11/23/10: 64 HDD
    - 12/6/13 and 12/8/13: 58 HDD
    - 1/1/16: 55 HDD
  - Medford **61 HDD** (*avg. daily temp. 4' F*)
    - 12/8/13: 52 HDD
  - Klamath Falls **72 HDD** (*avg. daily temp. -7' F*)
    - 12/8/13: 72 HDD
    - 1/2/16: 62 HDD
  - La Grande **74 HDD** (*avg. daily temp. -9' F*)
    - 12/8/13: 65 HDD
  - Roseburg **55 HDD** (*avg. daily temp. 10' F*)



# Monitoring Our System

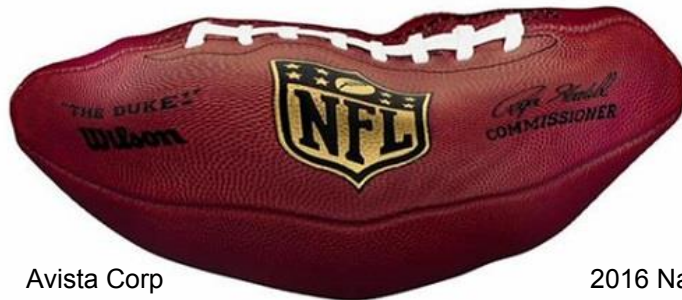

# Monitoring Our System

- Validates our Load Studies
- Mechanical >>> Electronic
  - Daily Feedback
  - Real time if necessary

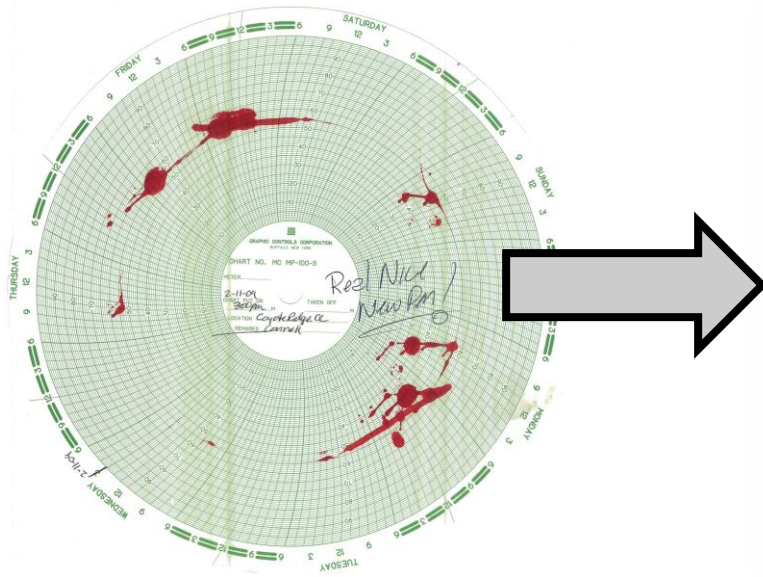

# Post Falls State Line

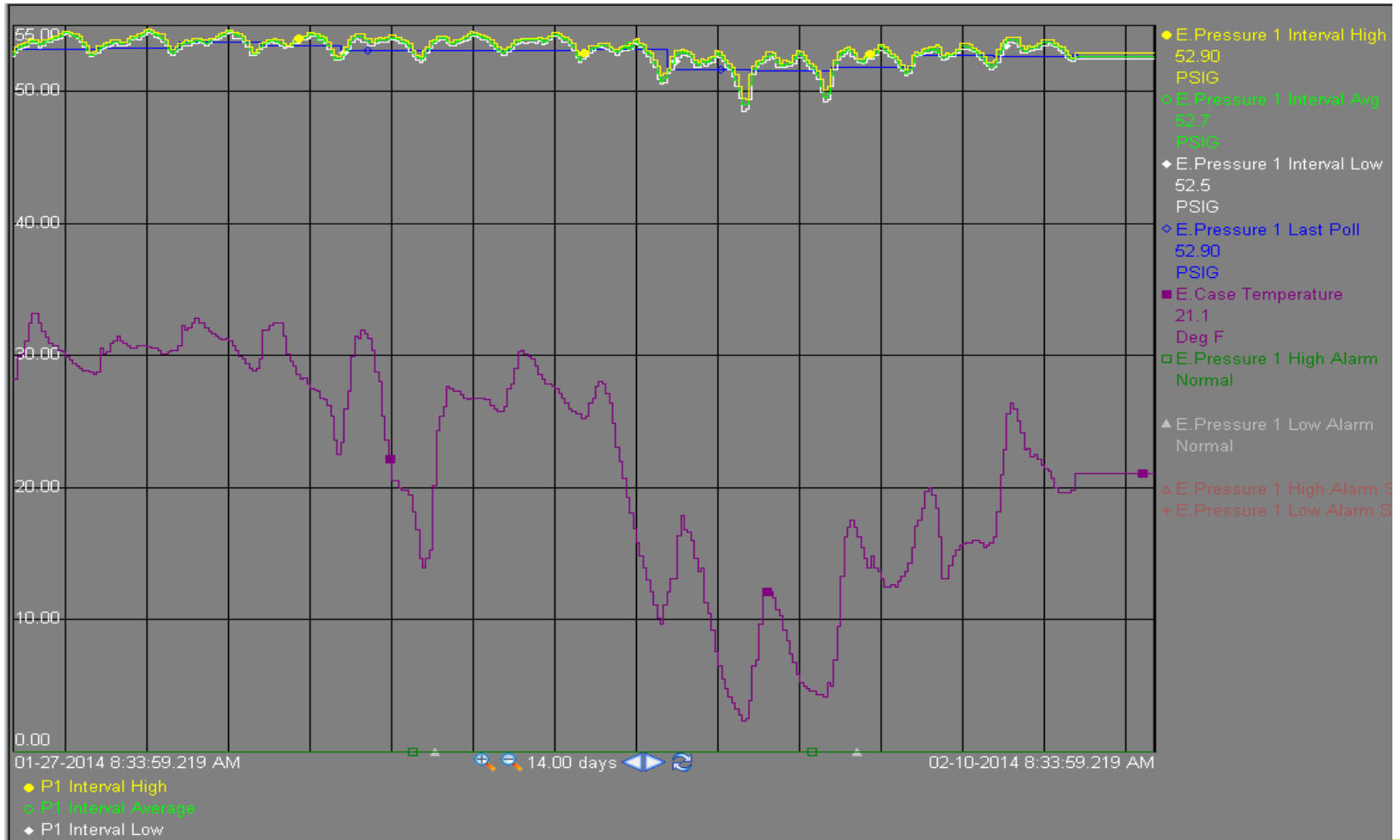

# Hayden Lake

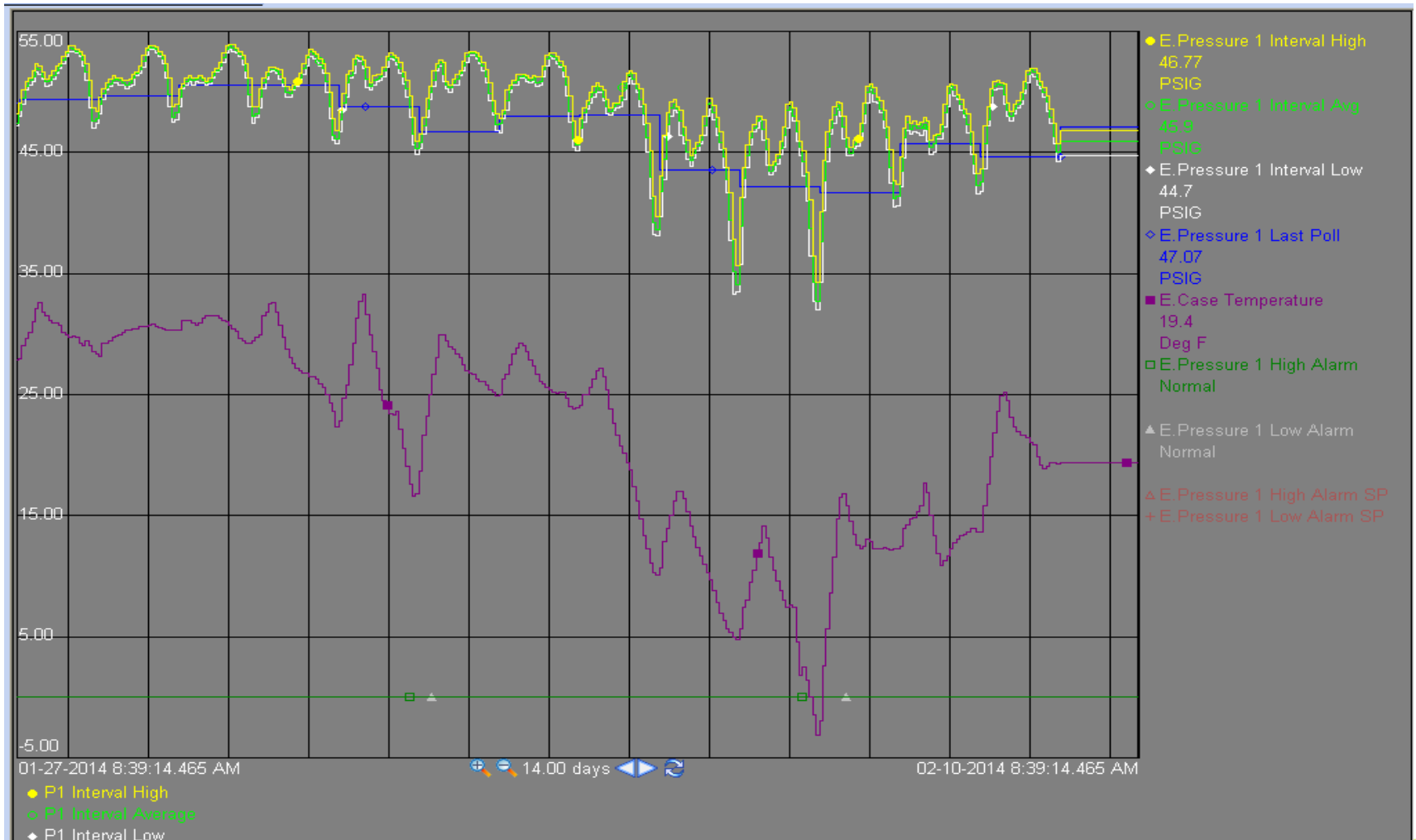

# South Hayden Lake

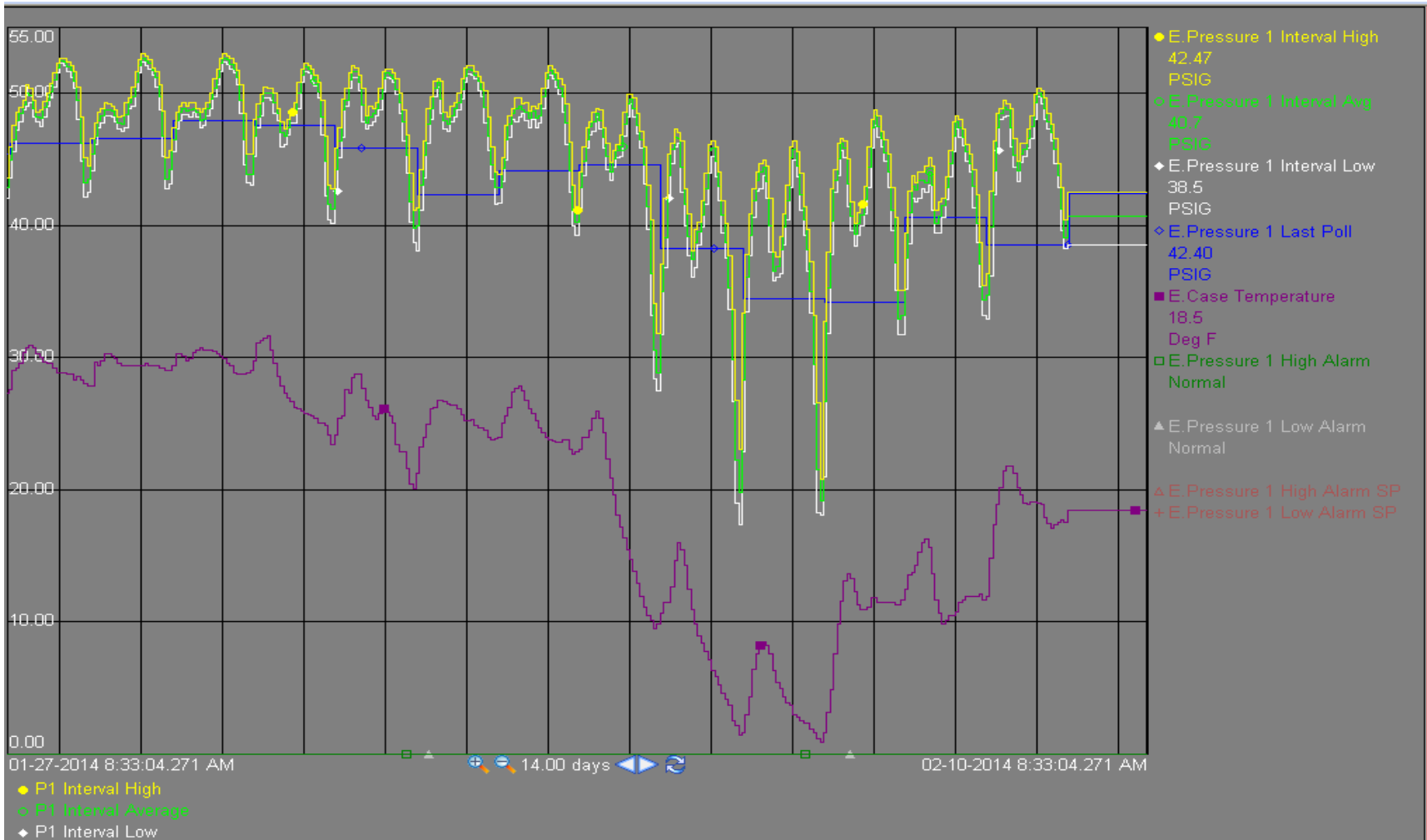



# Real-time Pressure & Flow Monitoring

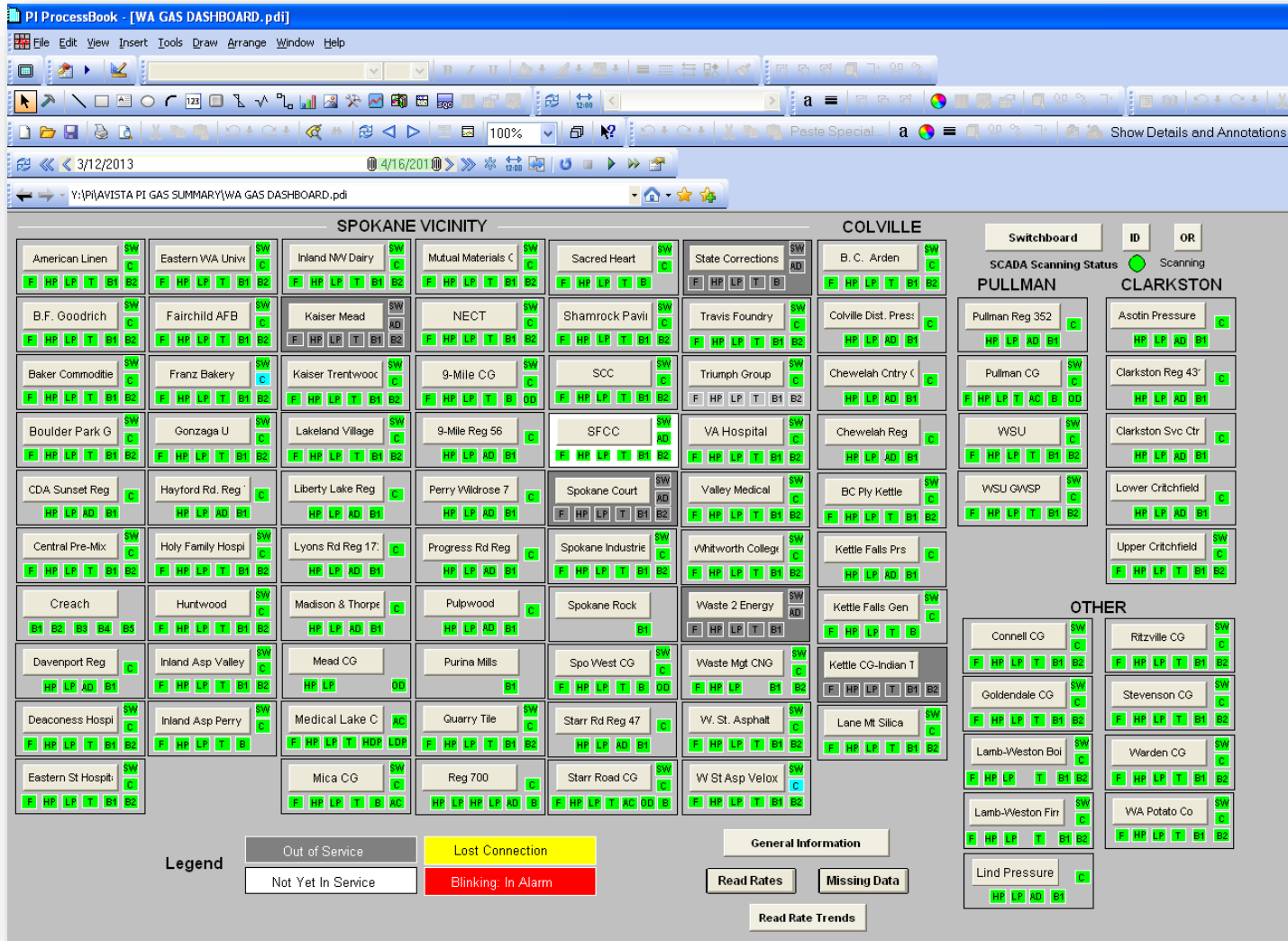

# One-line Diagrams

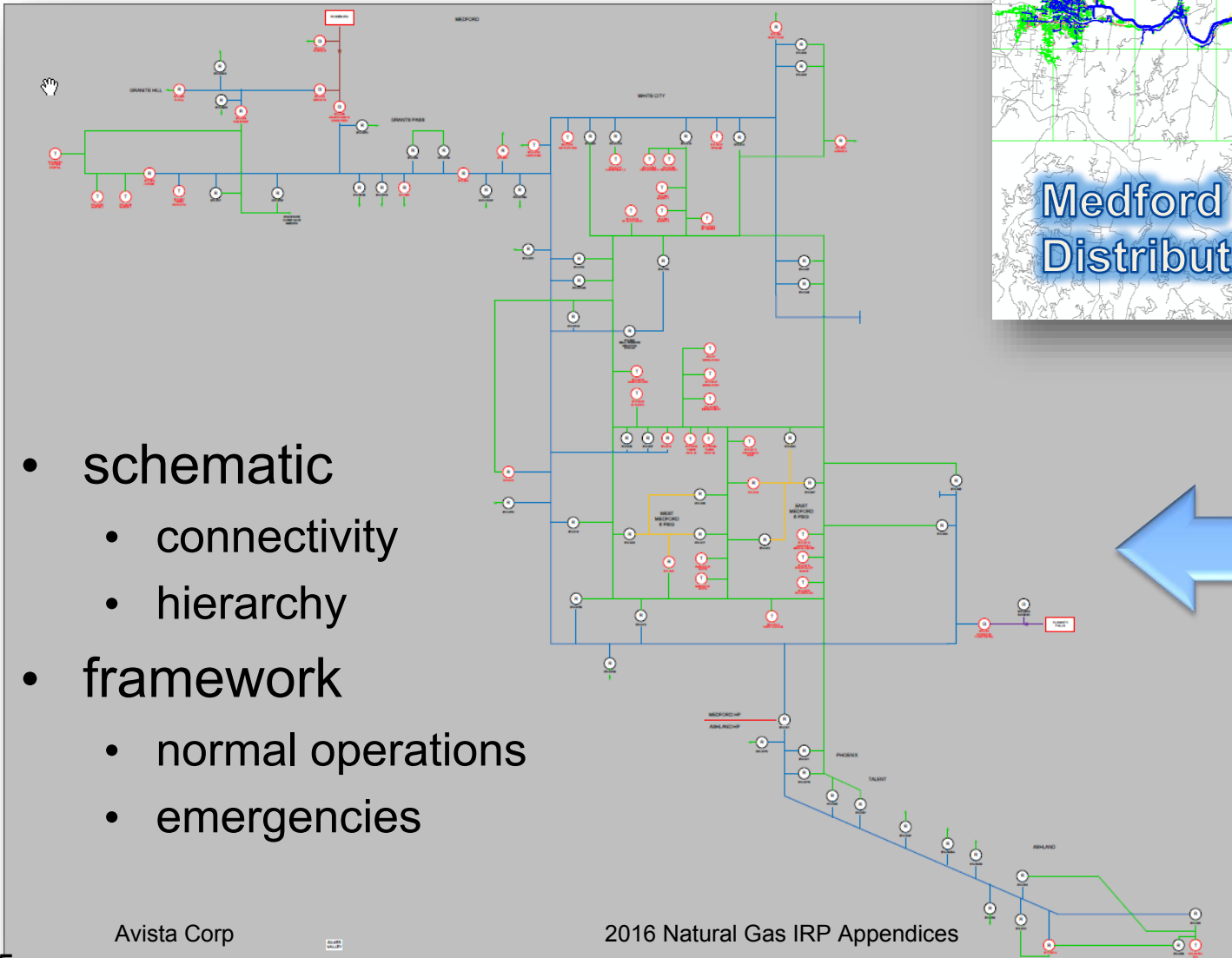
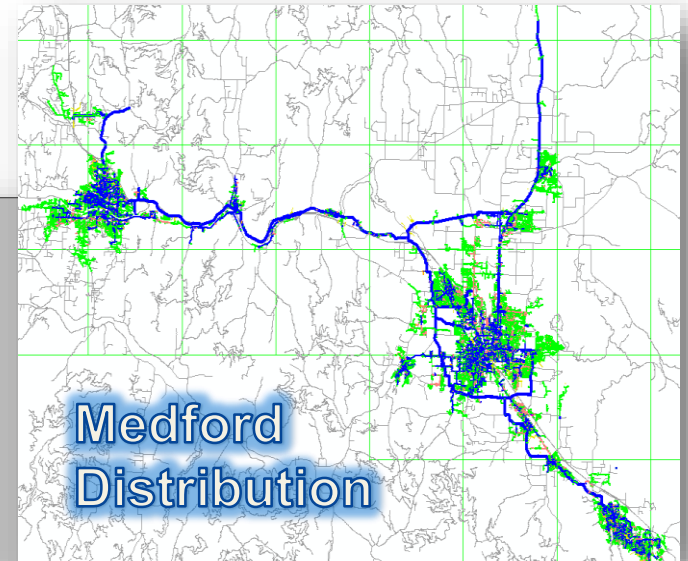

- schematic
  - connectivity
  - hierarchy
- framework
  - normal operations
  - emergencies

# Sprechen El Similar Lingua

- Translating the Forecast
- Gas Planning Layers
- Gate Station Capacity Review



# WA-ID Region Firm Customers: 2016 IRP and 2014 IRP

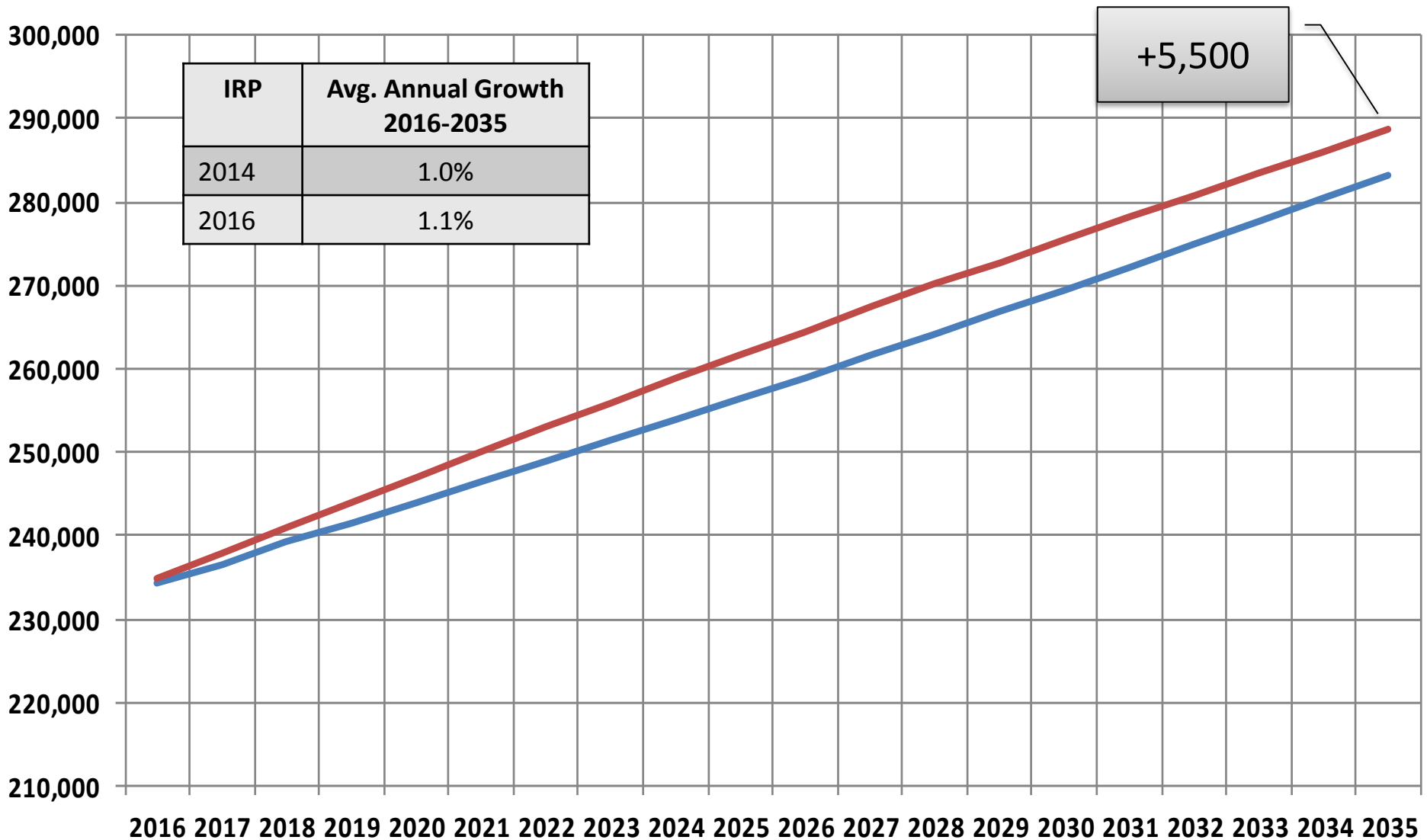

# OR Region Firm Customers: 2016 IRP and 2014 IRP

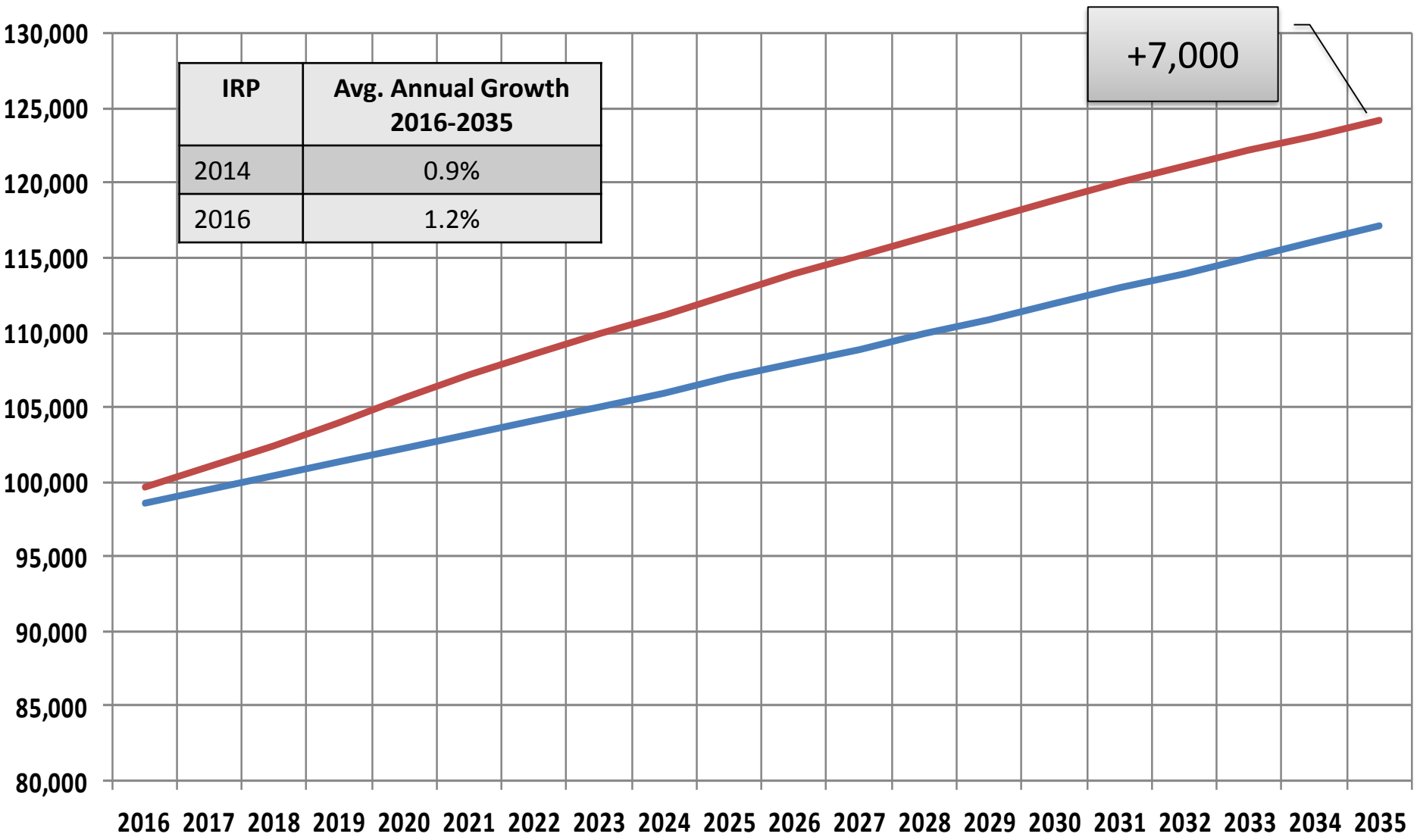

# System Firm Customers: 2016 IRP and 2014 IRP

IRP	Avg. Annual Growth 2016-2035
2014	1.0%
2016	1.1%

+12,500

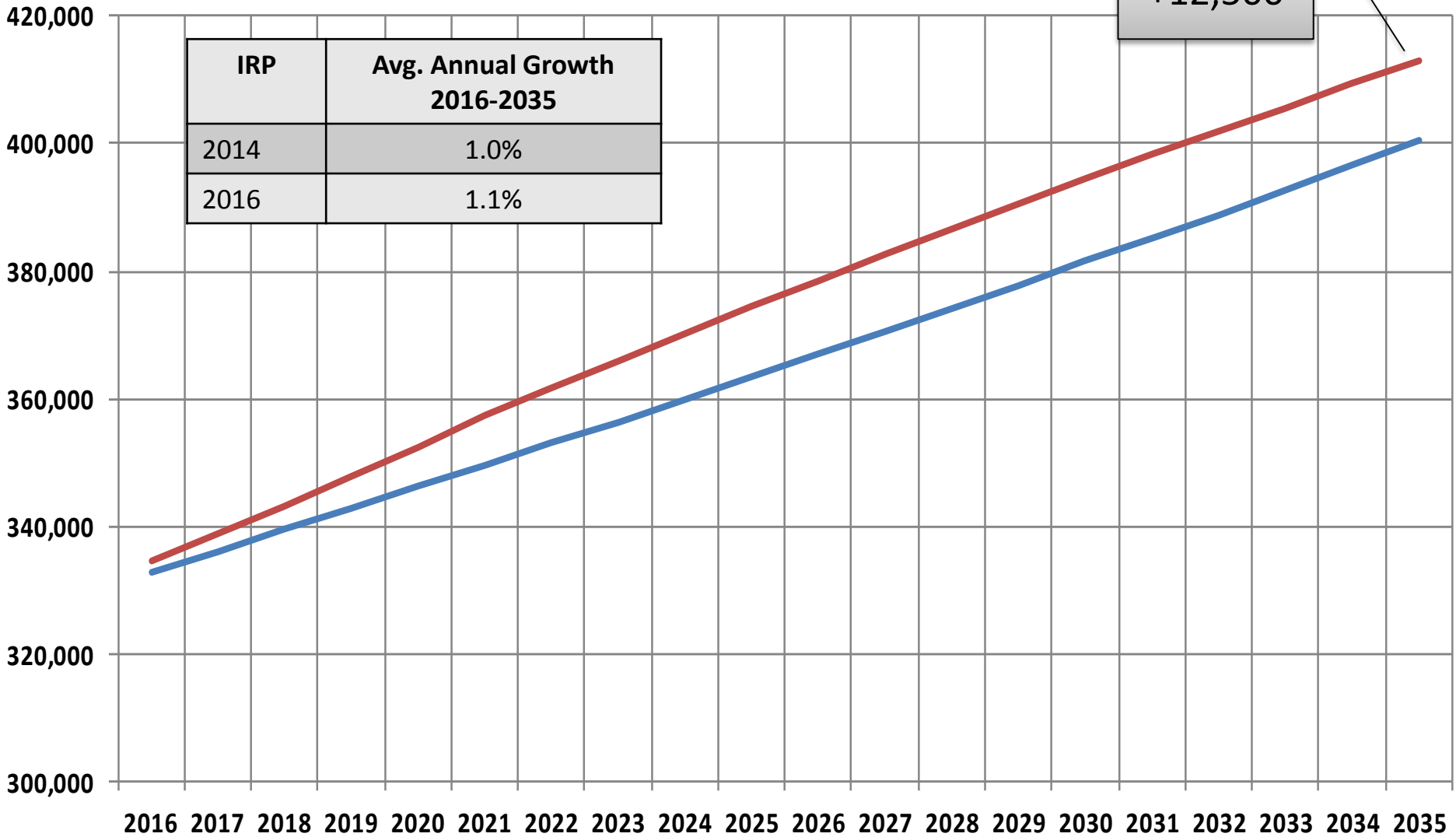

# Strategic Gas Growth Projects

Project Name	AREA	STATUS	Forecasted Connects (3yr)
Forker Road	Spokane	Complete	15
Rolling Hills Estates	Roseburg	5,000 ft constructed, 65% complete Est. Comp date Feb 2016	164
Connell - NW Davis St.	Spokane	Complete	15
Debbie Drive	Klamath Falls	Complete	27
West side of Kenwood St	Roseburg	Complete	5
Bonanza	Klamath Falls	In construction Est. Comp date April 2016 – River Crossing Permit	152
Ridge Road	Spokane	Complete	12
N Newport Hwy	Spokane	Waiting for Gas Engineering	3
Midland Rd	Klamath Falls	Complete	90
Austin Road - Phase I	Spokane	Complete	14
Austin Road - Phase II	Spokane	Complete	30
Austin Road - Phase III	Spokane	Starting December 15, 2015	21
Sunwest	Airway Heights	Starting Jan-Feb 2016	30
Santa Maria Estates	Roseburg	Est. start date mid March 2016	40
Linda Way	Post Falls	Complete	12
Kooken Estates	Roseburg	Est. start date June/July 2016	38
Round Lake	Klamath Falls	Est. start date June/July 2016	128
Neyland Rd	Spokane	Completed	8
Winch Rd – Wild Ridge	Coeur 'd Alene	Complete	21
<b>TOTAL</b>			<b>825</b>

# 22 Home Development in Warden, WA

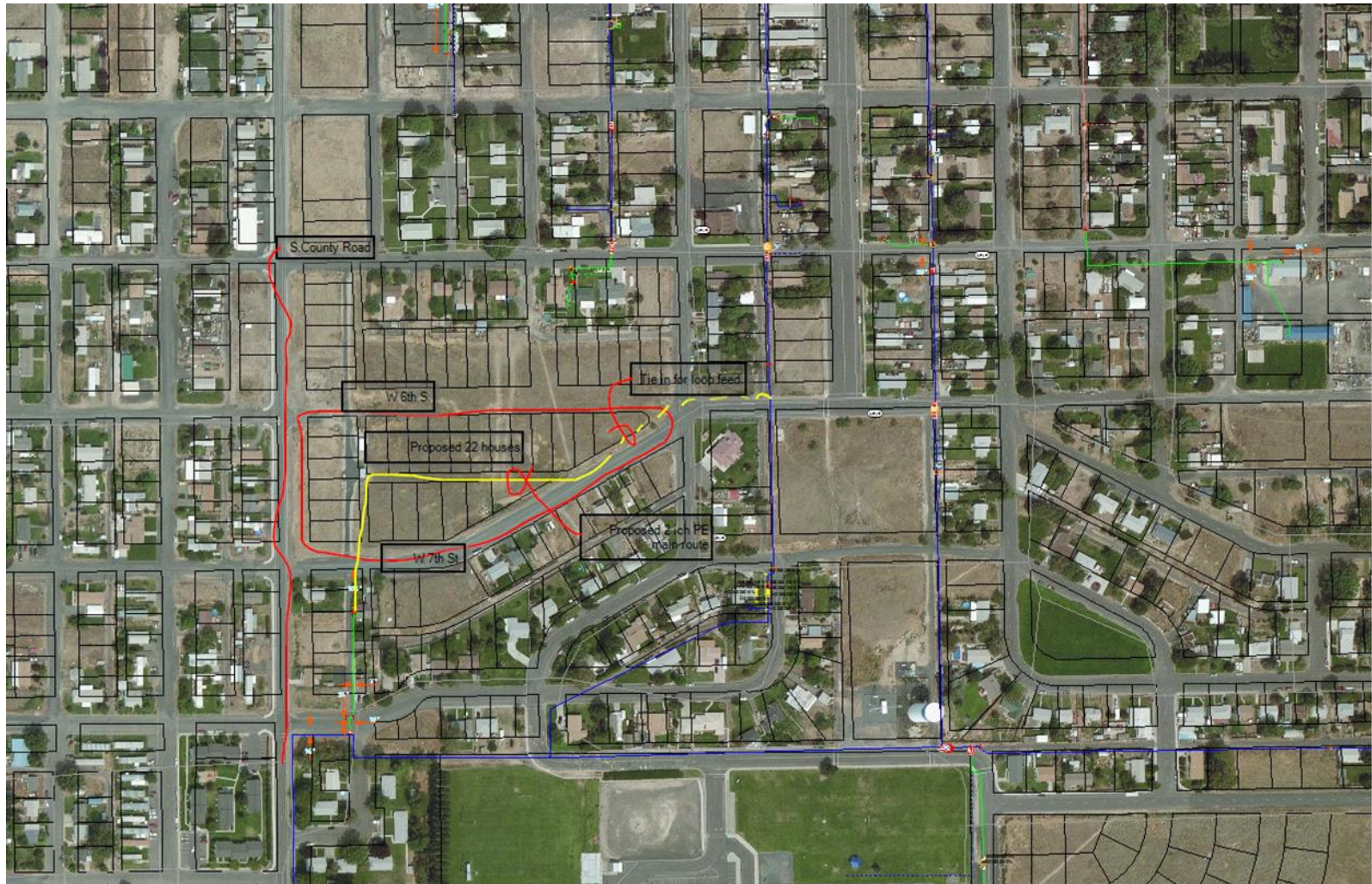



# Gas Planning Layers

- Gas Planning Proposals
- Gas Planning AOI

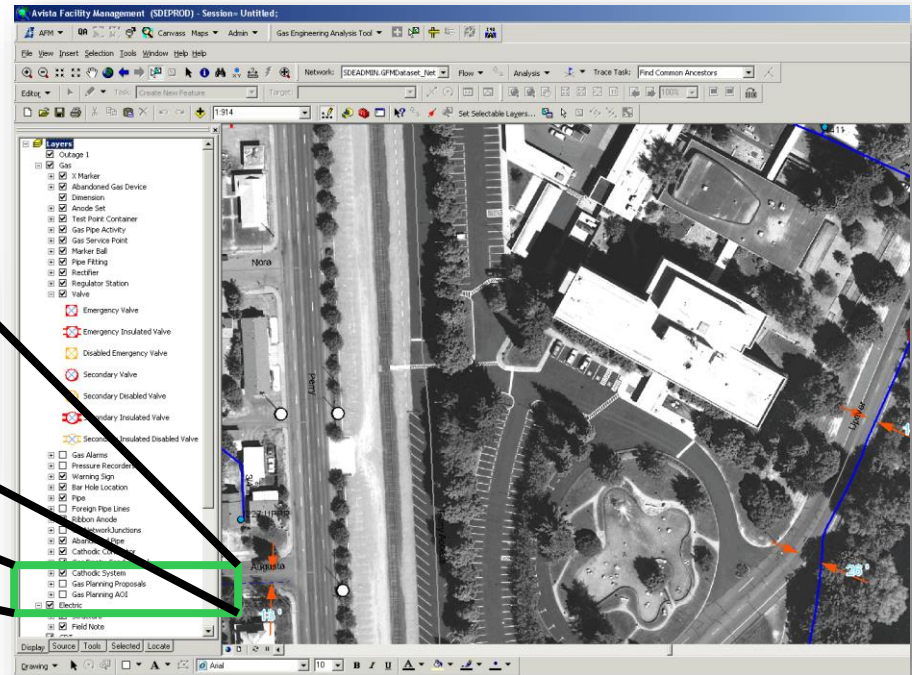
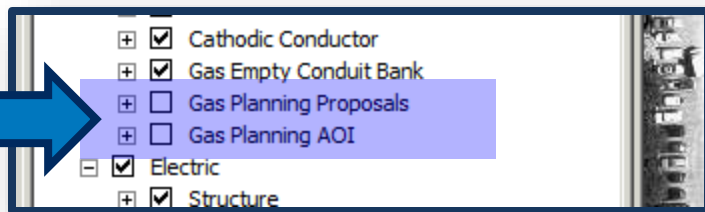

# Gas Planning Proposals

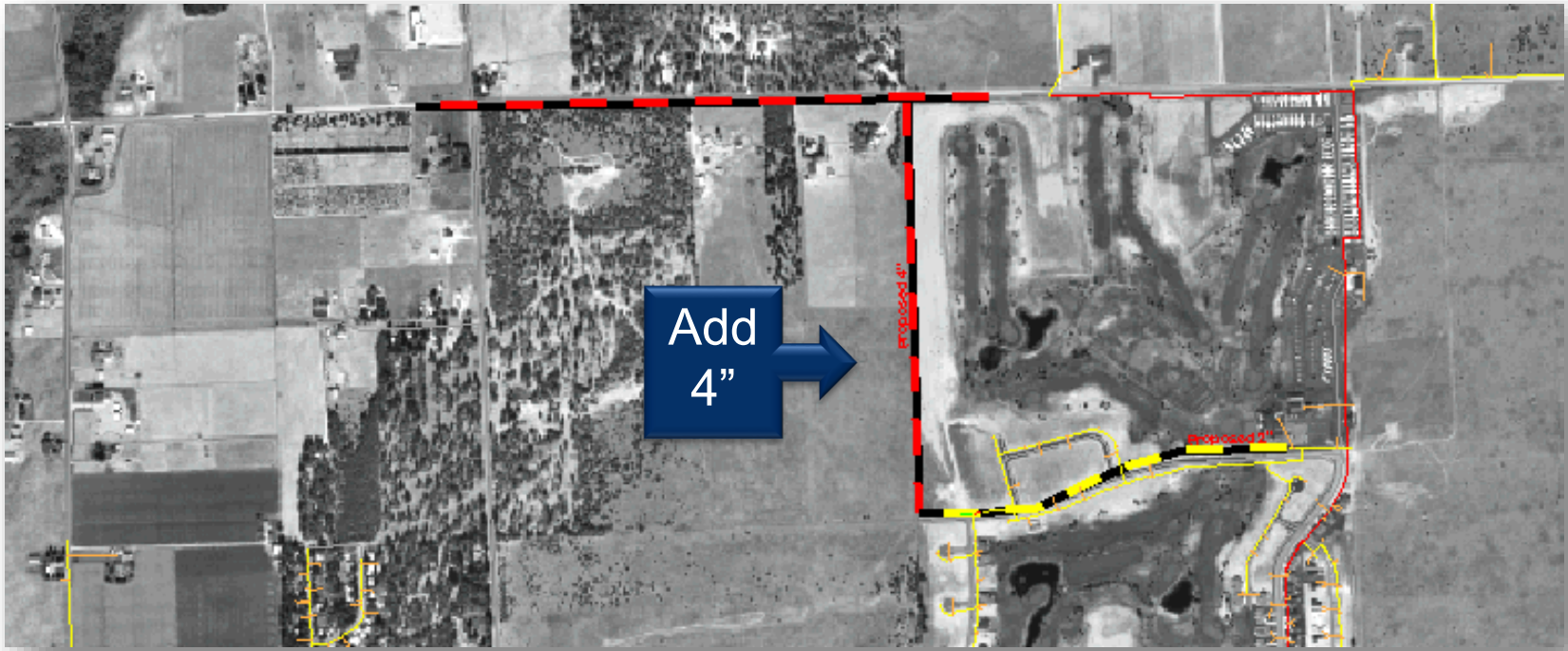

Gas Planning Proposals

SIZE NUMBER

2"

4"

6"

>6"

Avista Corp

# Gas Planning AOI

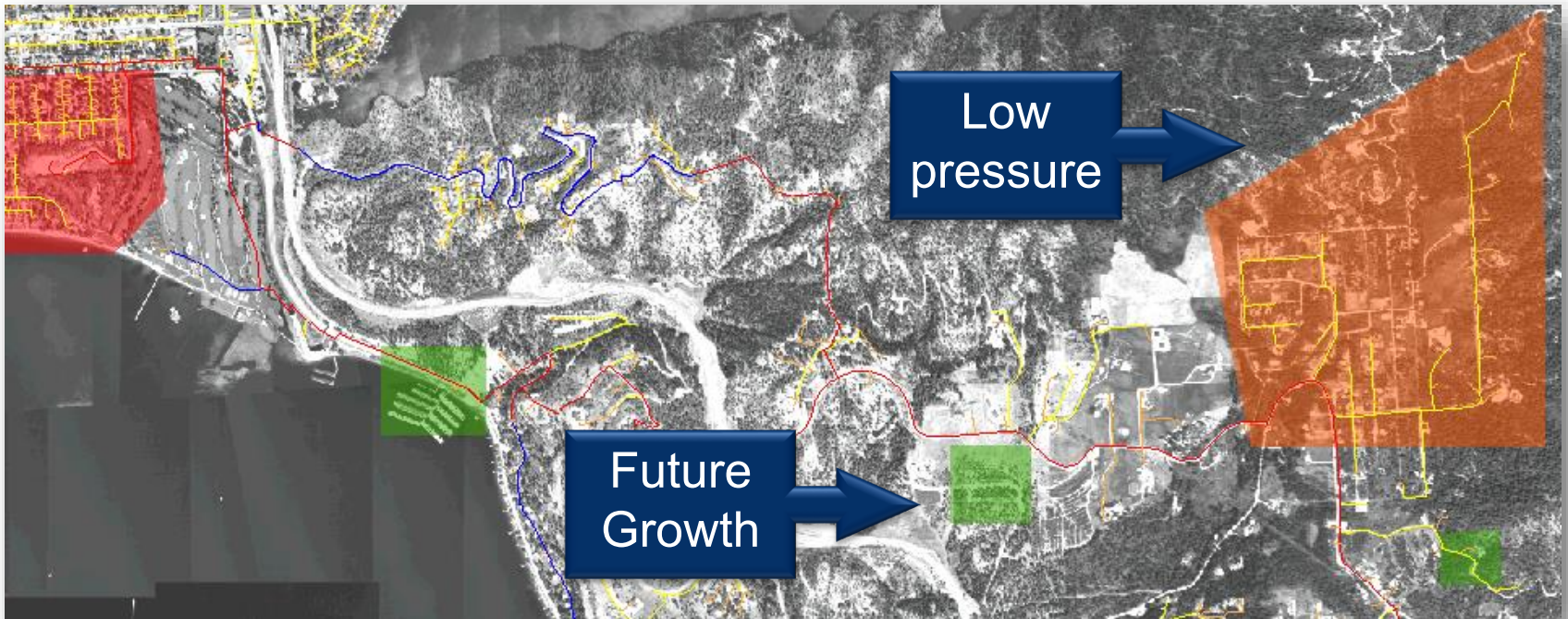

- Gas Planning AOI
  - Area Type
  - Critical Pressure
  - Low Pressure
  - Miscellaneous
  - New Developments
- Avista Corp



# City Gate Analysis Results

Terrence Browne, Senior Gas Planning Engineer

Natural Gas Technical Advisory Committee

March 26, 2014

# City Gate Analysis Issues to Address

- MDQ vs. MDDO
- Our gate vs. Pipeline gate
- Operational capacity vs. contracted capacity
- Pipeline differences
  - Zonal vs. Point Specific
  - Laterals and Mainlines

# Forecasting Demand Behind the Gate

- Our IRP desire has always been to forecast to as granular a level as possible using the available data.
- Attempts to forecast demand behind the gate using existing forecasting methodology has been challenging.
  - Revenue data does not have daily meter reads for core customers making regression analysis on a use per HDD per customer difficult.
  - DSM would become more burdensome than it already is.
  - Some towns can be served by multiple pipelines and the mix can change over time.

# Forecasting Demand Behind the Gate cont.

While there are challenges, there is modeling that we can do to help identify more granular city gate deficiencies.

- Utilize daily/hourly pipeline flow data from each meter station to estimate what demand could be on a peak day or any heating degree day.
- Apply growth factors to estimate what the demand could grow to consistent with IRP assumptions/methodology.

# Gate Station Capacity Review



NORTHWEST PIPELINE GP  
DELIVERY AND RECEIPT POINT SYSTEM MAP  
DWG. NO. 1000.3-68 - February 2011



DELIVERY POINTS				DELIVERY POINTS			
ZONE	NAME	STATUS	COORDINATES	ZONE	NAME	STATUS	COORDINATES
ZONE 07	...	...	...	ZONE 07	...	...	...
ZONE 09	...	...	...	ZONE 09	...	...	...
ZONE 10	...	...	...	ZONE 10	...	...	...
ZONE 11	...	...	...	ZONE 11	...	...	...
ZONE 12	...	...	...	ZONE 12	...	...	...
ZONE 16	...	...	...	ZONE 16	...	...	...
ZONE 20	...	...	...	ZONE 20	...	...	...
ZONE 24	...	...	...	ZONE 24	...	...	...
ZONE 26	...	...	...	ZONE 26	...	...	...
ZONE ME	...	...	...	ZONE ME	...	...	...
ZONE KM	...	...	...	ZONE KM	...	...	...
ZONE MC	...	...	...	ZONE MC	...	...	...
ZONE GR	...	...	...	ZONE GR	...	...	...

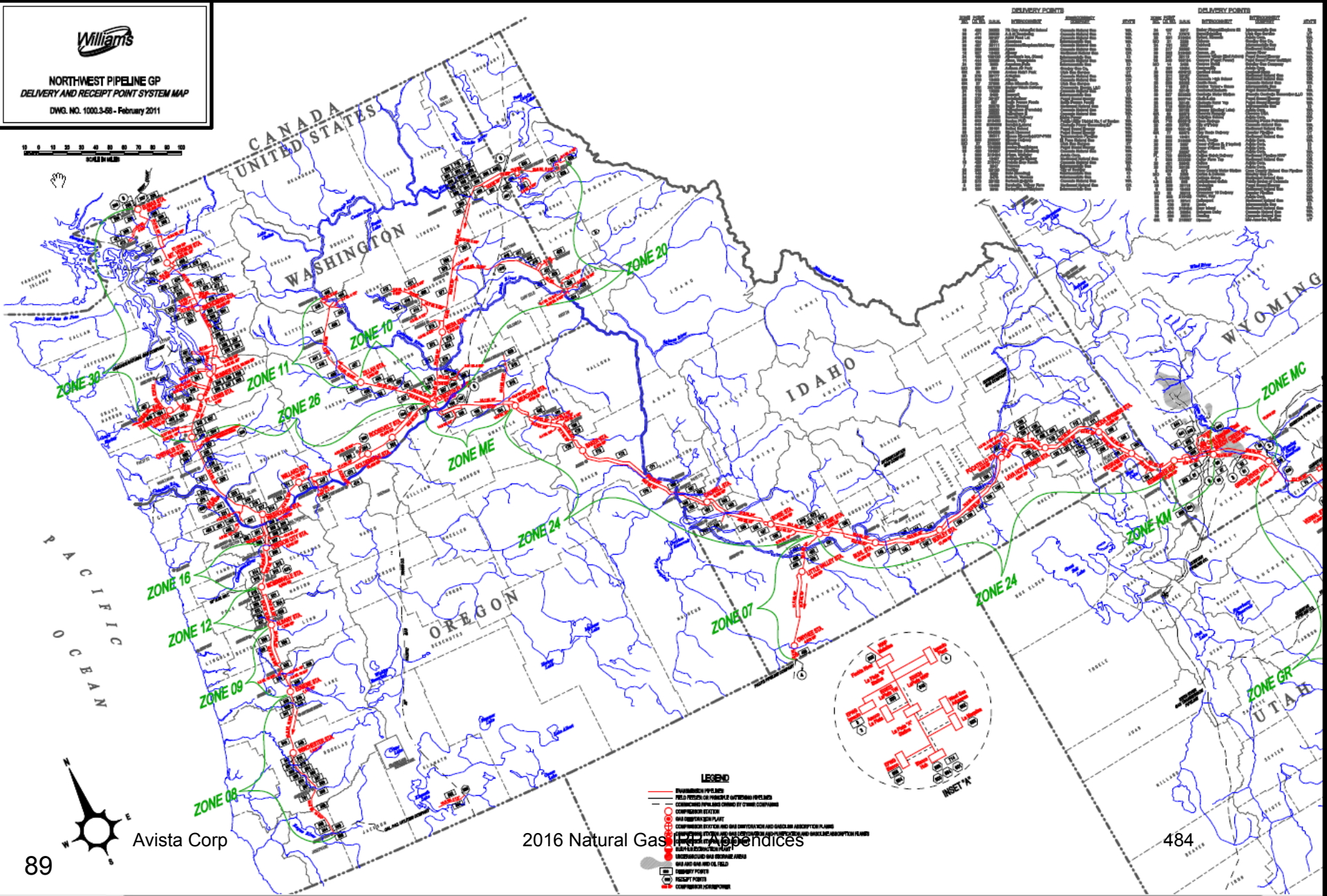

**LEGEND**

- INVESTMENT PIPELINES
- FIELD RECEIPT OR RECEIPT POINTS (EXCEPT COMPRESSOR STATIONS OWNED BY OTHER COMPANIES)
- COMPRESSOR STATIONS OWNED BY OTHER COMPANIES
- COMPRESSOR STATIONS
- COMPRESSOR STATIONS WITH GAS DELIVERY AND GASOLINE ABSORPTION PLANS
- COMPRESSOR STATIONS WITH GAS DELIVERY AND GASOLINE ABSORPTION PLANS
- UNDERGROUND GAS STORAGE AREAS
- WELL HEADS AND WELLS
- RECEIPT POINTS
- COMPRESSOR HEADSTATIONS



# Gate Station Capacity Review cont.

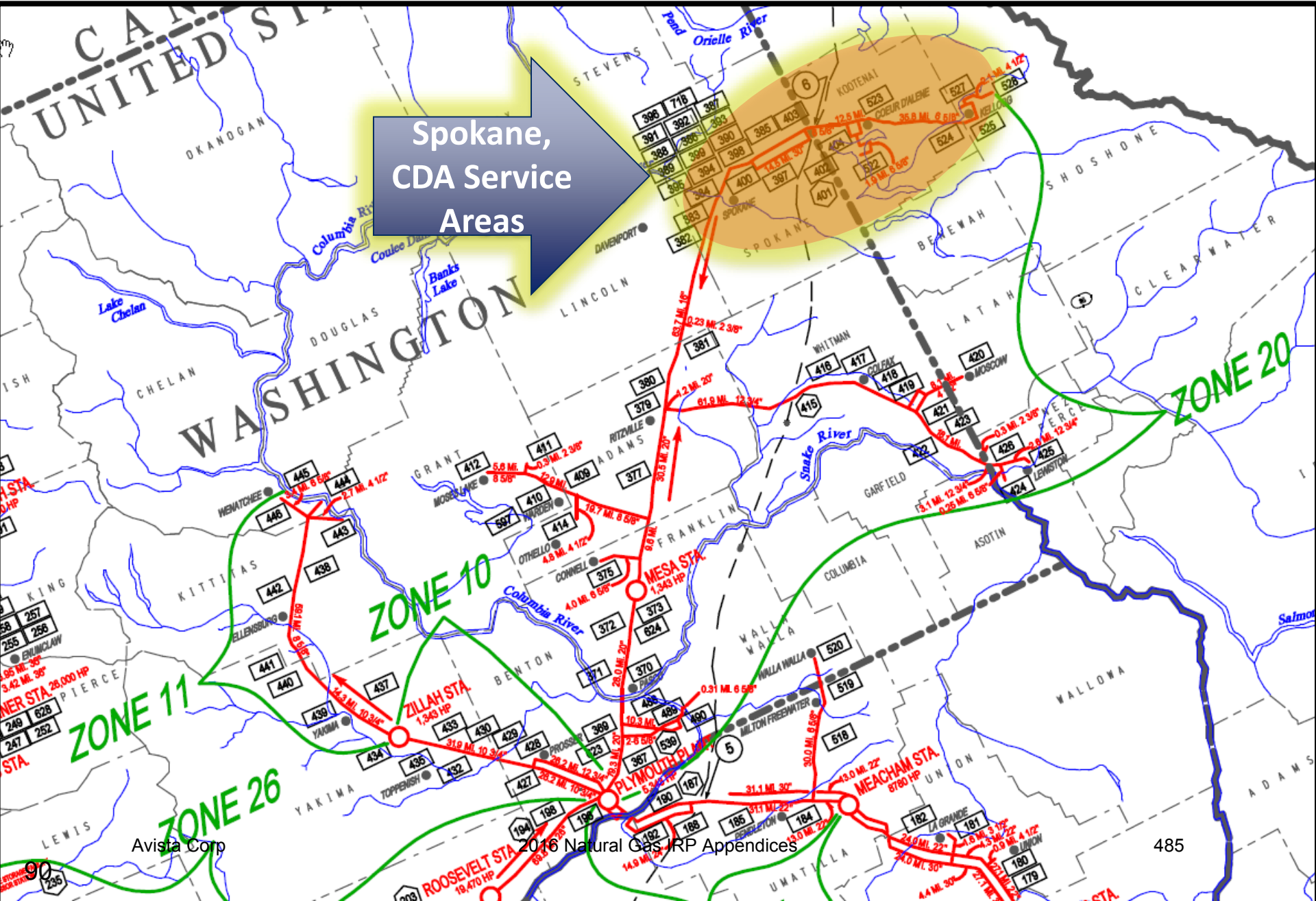

# Gate Station Capacity Review

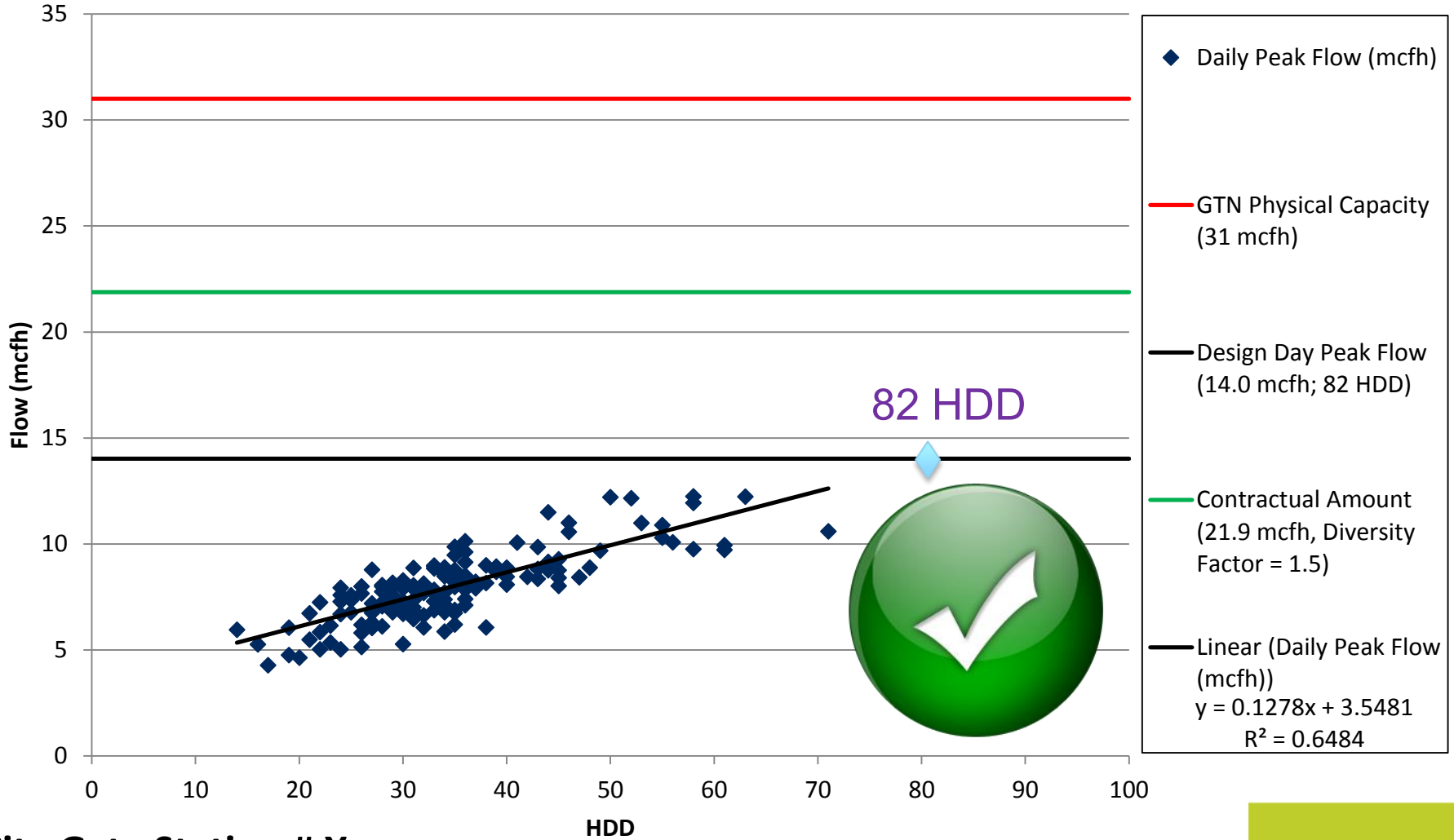

## City Gate Station # X

# Gate Station Capacity Review

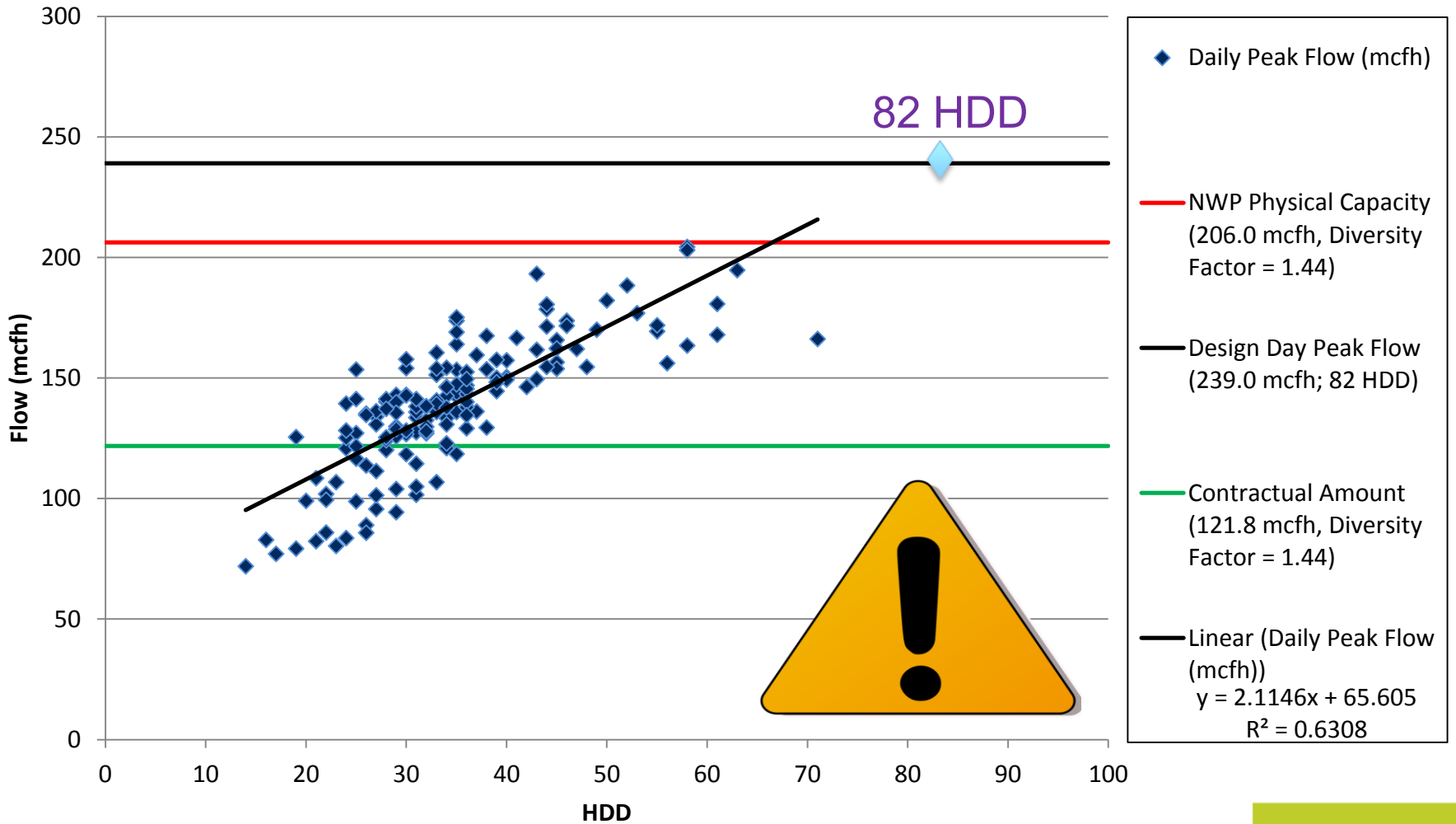

City Gate Station # Y

# Gate Station Capacity Review: WA

DESIGN DAY DEMAND: % OF PHYSICAL CAPACITY

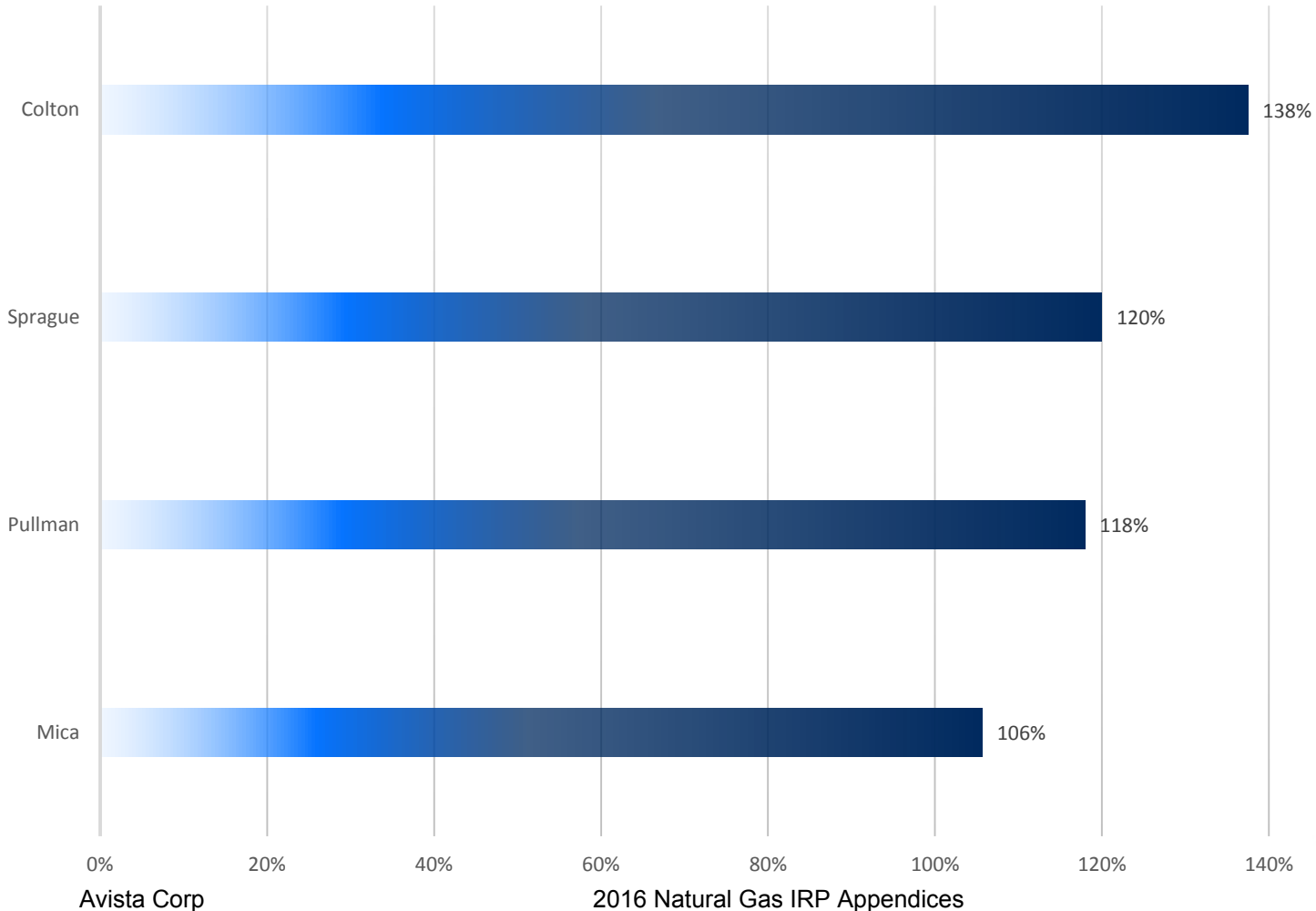

160%

488



# Gate Station Capacity Review: OR

## DESIGN DAY DEMAND: % OF PHYSICAL CAPACITY

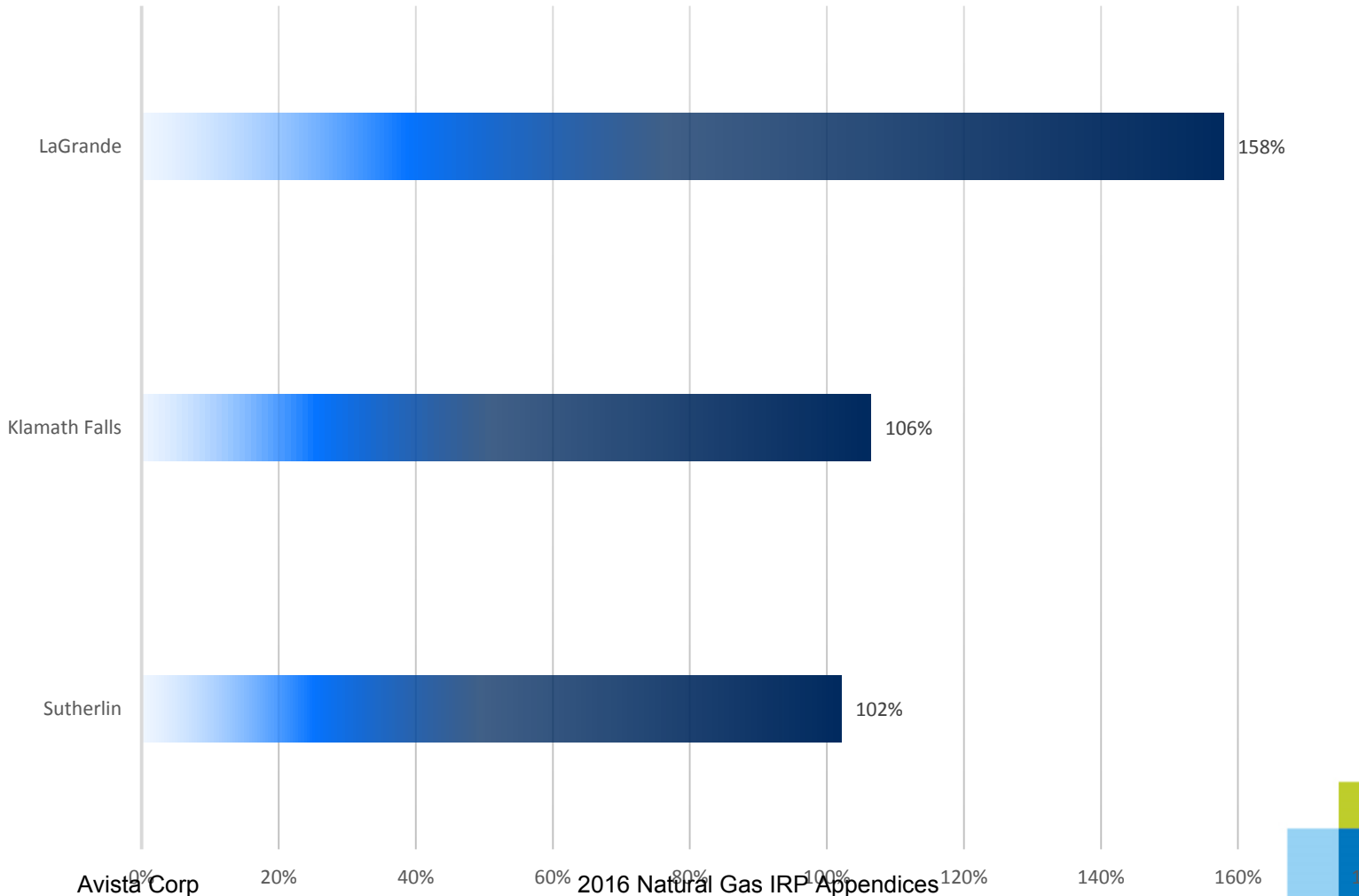

# Gate Station Capacity Review: ID

DESIGN DAY DEMAND: % OF PHYSICAL CAPACITY

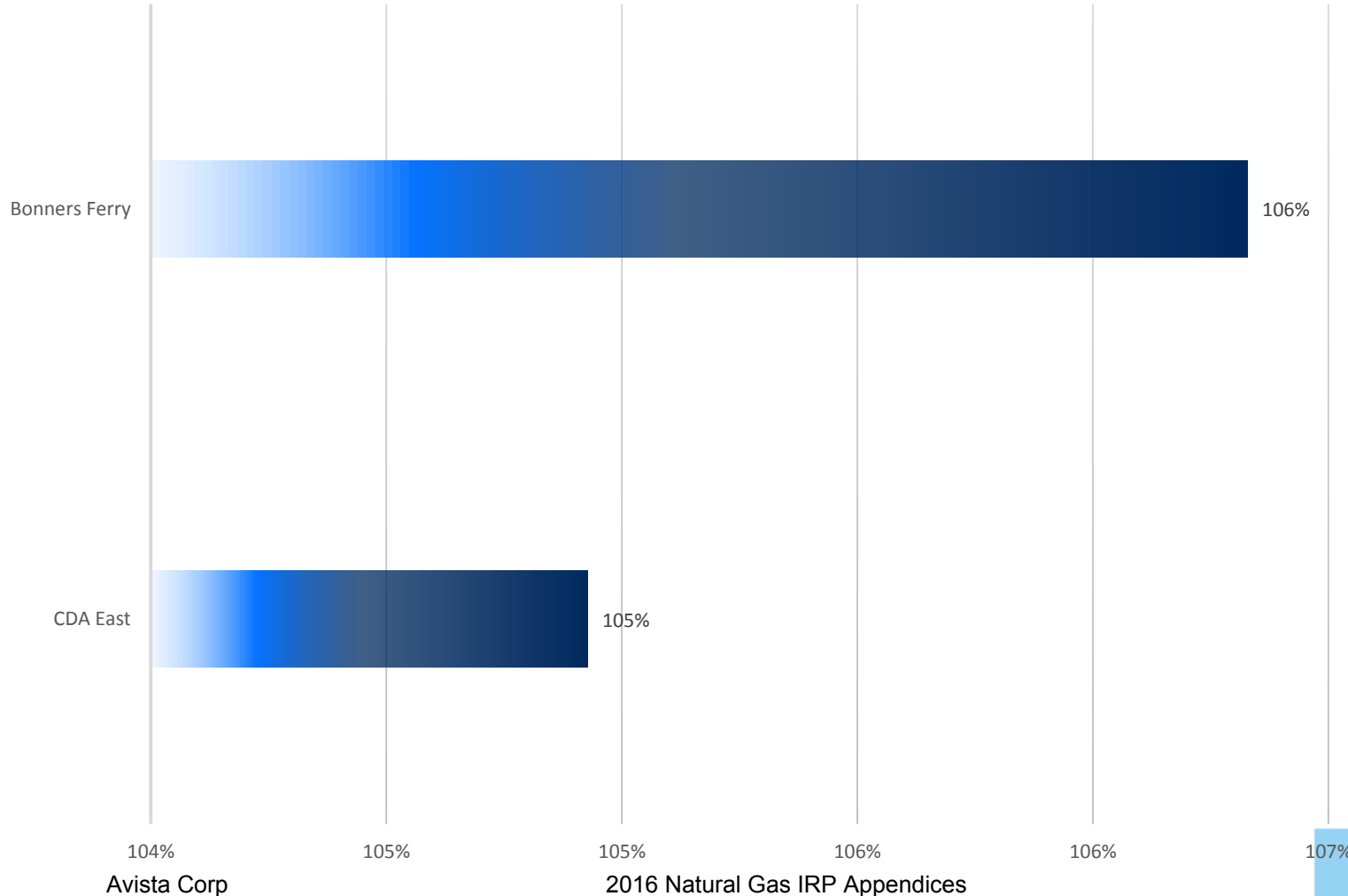



# Natural Gas Prices

Tom Pardee  
Manager of Natural Gas Planning

# What Drives the Natural Gas Market?

## *Natural Gas Spot Prices (AECO)*

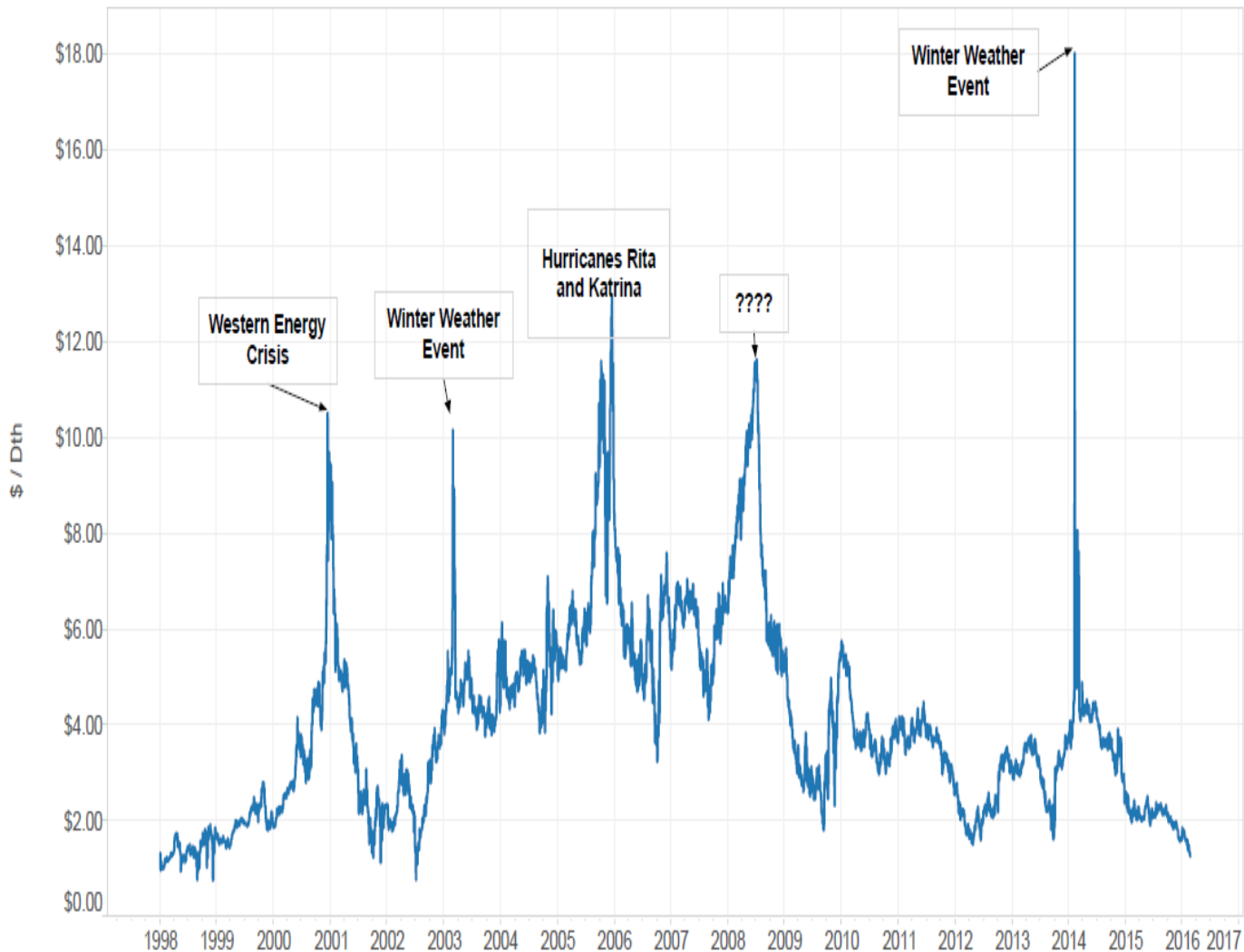

- ▶ **Supply**
  - Type: Conventional vs. Non-conventional
  - Location
  - Cost
- ▶ **Demand**
  - Residential/Commercial/Industrial
  - Power Generation
  - Natural Gas Vehicles
- ▶ **Legislation**
  - Environmental
- ▶ **Energy Correlations**
  - Oil vs. Gas
  - Coal vs. Gas
  - Natural Gas Liquids
- ▶ **Weather**
- ▶ **Storage**



# Short Term Market Perspective

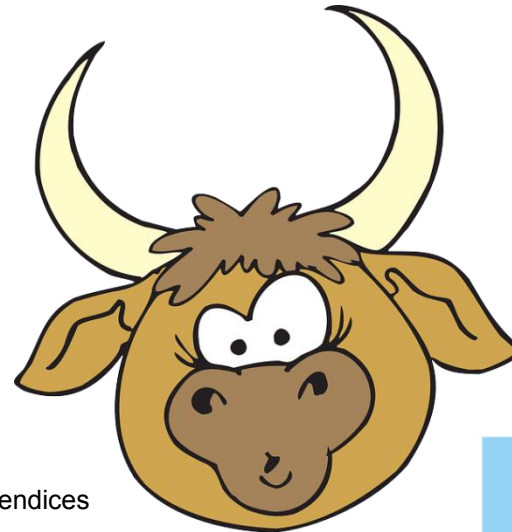
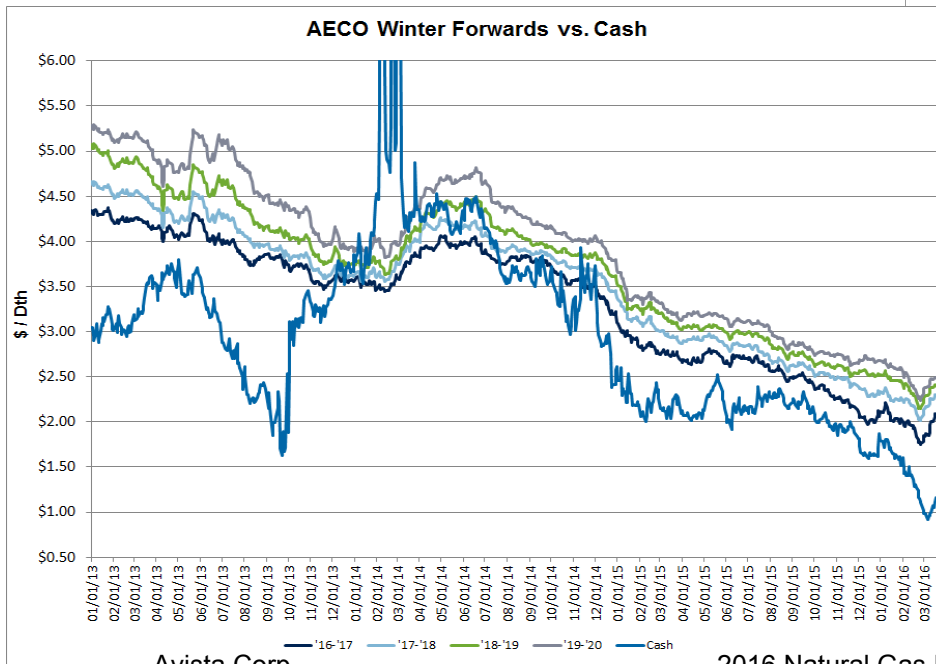
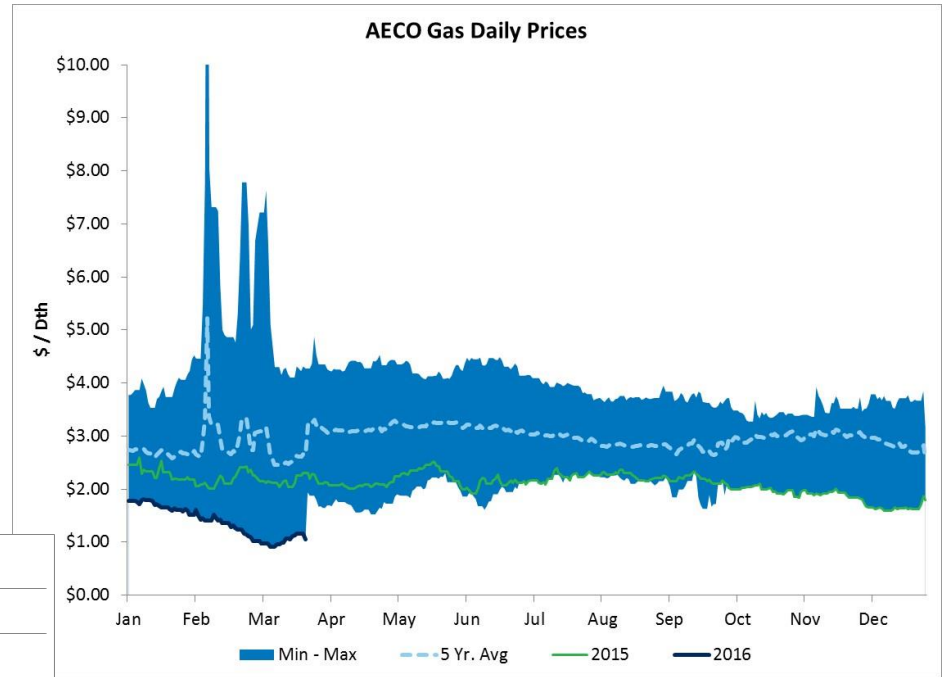
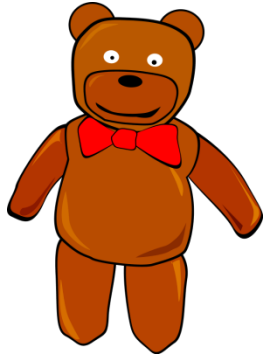

# The Short Term Fundamentals

## Bulls

- Dwindling rig counts
- Economic recovery
- LNG & Methanol Plants
- Weather – Normal is now bullish
- Power Demand



## Bears

- Demand is weak
- Storage is full
- Oil Prices are near 10+ year lows
- Record Production
- Increased drilling efficiency
- Stealth/Ghost Wells



# The Long Term Fundamentals

## Demand

- Economy (Recession, Depression, Inflation, etc.)
- Industrial Demand
- Power Generation
- LNG, NGV, CNG

## US Natural Gas Supply and Production

- Resource Base
- Drilling Efficiency
- Associated Gas

## Global Dynamics – LNG Imports and Exports

## North American Storage Capacity

## Correlation (or lack thereof) with other energy products

## The Environment

- Carbon Legislation
- Fracking
- Renewable Portfolio Standards



# The Changing the Flow Dynamics

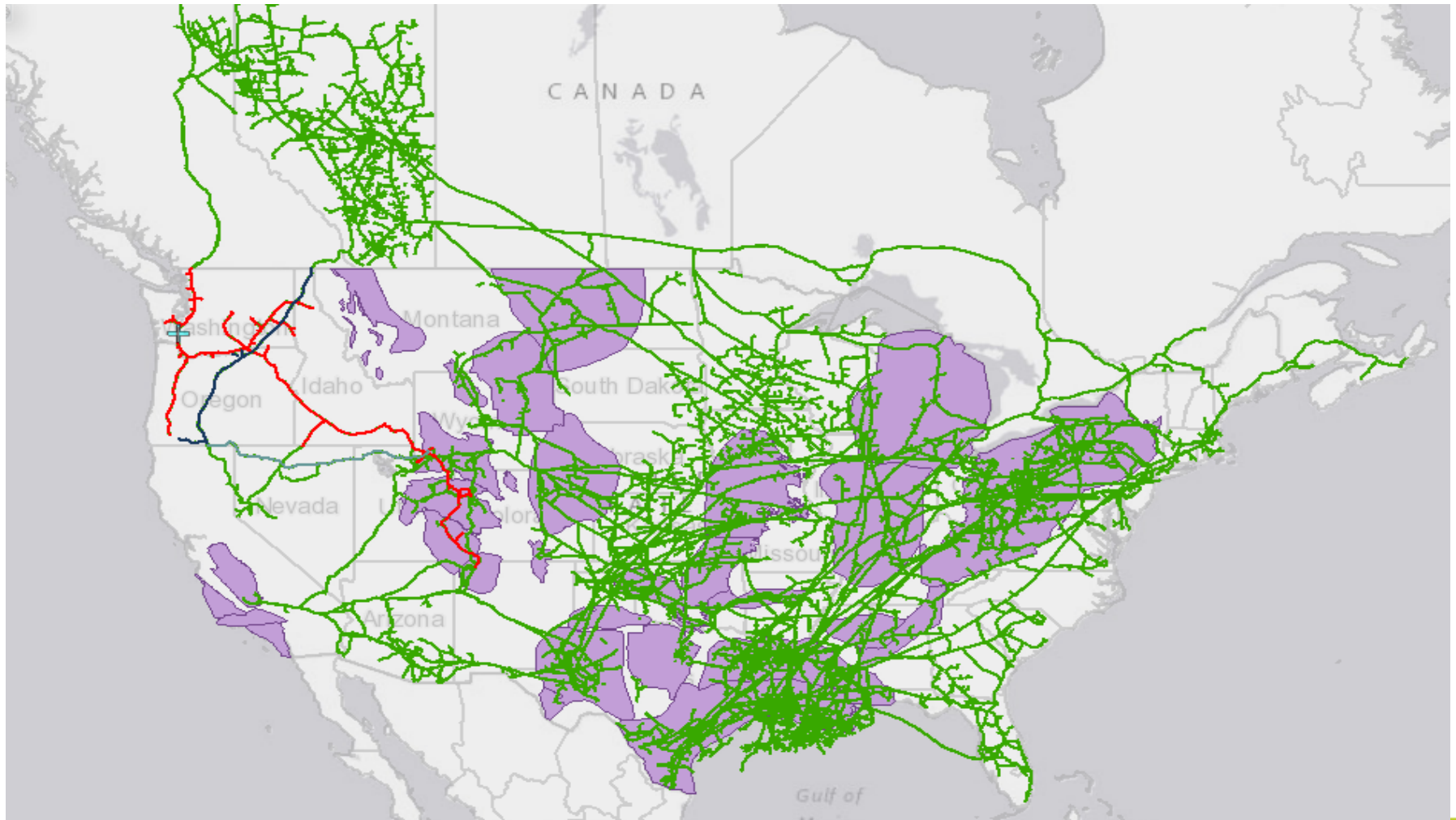

# Forecasted Natural Gas Production

## Lower 48 supply outlook

### The Northeast will continue to fuel production growth through 2030

- The Marcellus and Utica will grow their share of US Lower 48 dry from 27% in 2015 to 44% by 2025 as infrastructure build-out allows for more resource to get to market.
- Additionally, associated gas fuels 10 bcfd of net growth between 2017 and 2024 once oil price recover late this decade

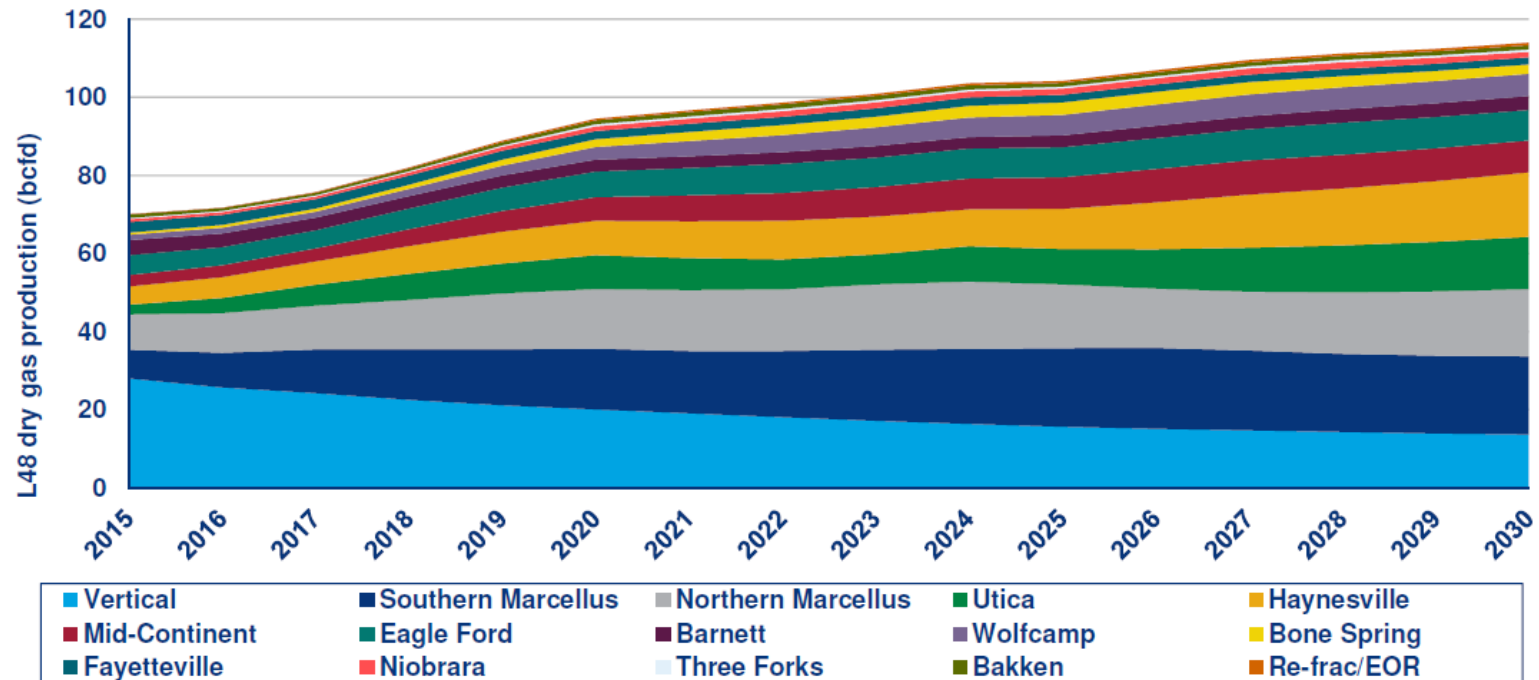

Source: Wood Mackenzie

# Canadian Production

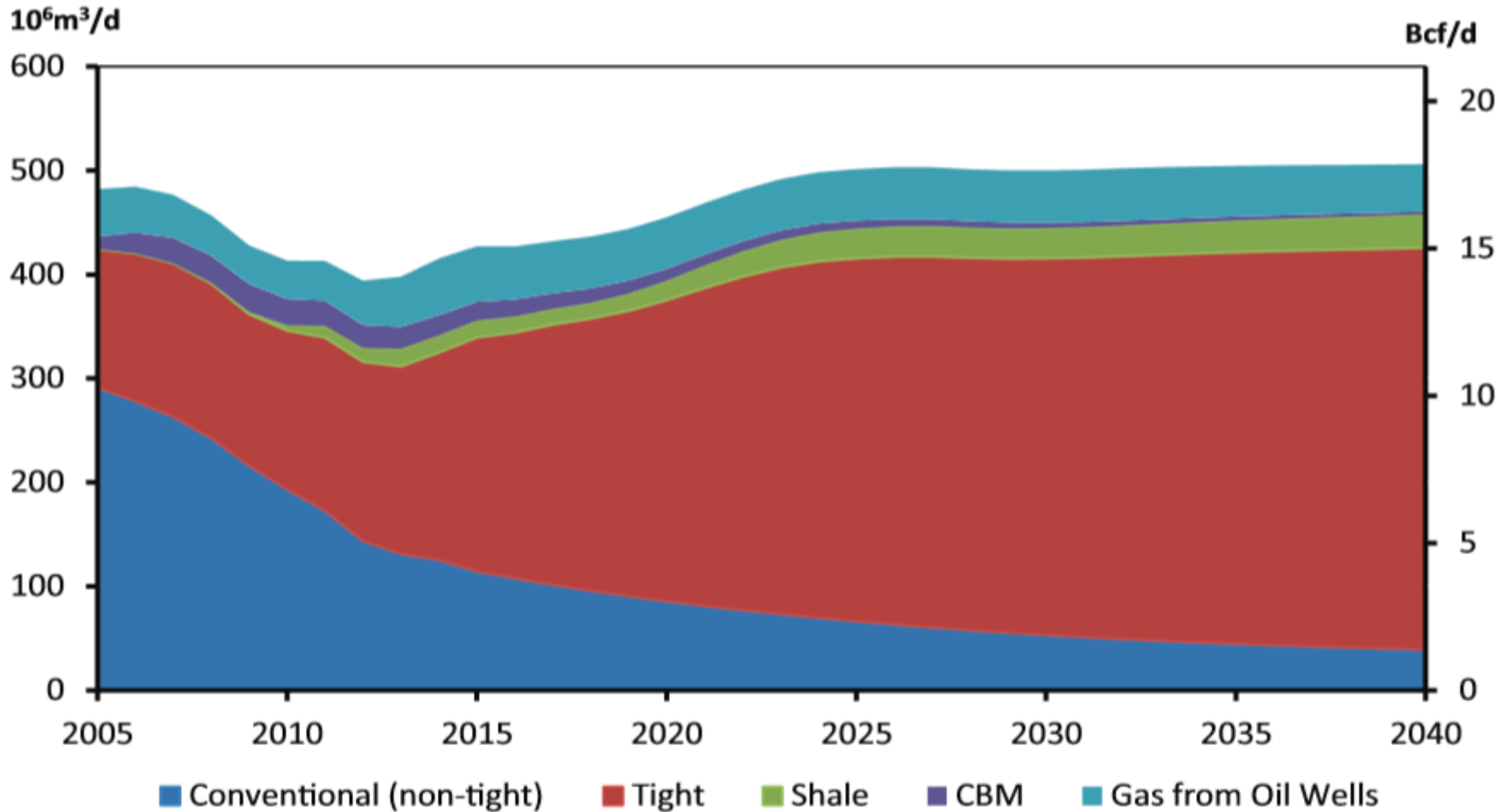

## North American LNG Export Terminals *Proposed*

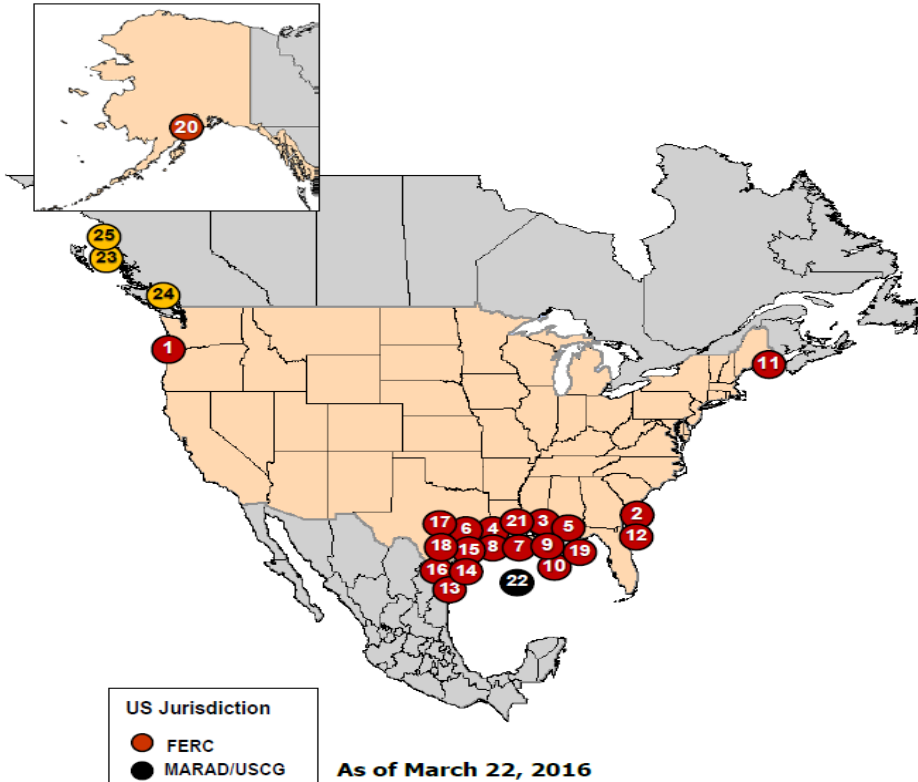

### PROPOSED TO FERC

#### Pending Applications:

1. Astoria, OR: 1.25 Bcfd (Oregon LNG) (CP09-6)
2. Elba Island, GA: 0.35 Bcfd (Southern LNG Company) (CP14-103)
3. Lake Charles, LA: 1.07 Bcfd (Magnolia LNG) (CP14-347)
4. Sabine Pass, TX: 2.1 Bcfd (ExxonMobil – Golden Pass) (CP14-517)
5. Pascagoula, MS: 1.5 Bcfd (Gulf LNG Liquefaction) (CP15-521)
6. Freeport, TX: 0.34 Bcfd (Freeport LNG Dev) (CP15-518)
7. Cameron Parish, LA: 1.41 Bcfd (Venture Global Calcasieu Pass) (CP15-550)
8. Hackberry, LA: 1.41 Bcfd (Sempra - Cameron LNG) (CP15-560)

#### Projects in Pre-filing:

9. Plaquemines Parish, LA: 1.07 Bcfd (CE FLNG) (PF13-11)
10. Plaquemines Parish, LA: 0.30 Bcfd (Louisiana LNG) (PF14-17)
11. Robbinston, ME: 0.45 Bcfd (Kestrel Energy – Downeast LNG) (PF14-19)
12. Jacksonville, FL: 0.075 Bcfd (Eagle LNG Partners) (PF15-7)
13. Brownsville, TX: 0.54 Bcfd (Texas LNG Brownsville) (PF15-14)
14. Brownsville, TX: 0.94 Bcfd (Annova LNG Brownsville) (PF15-15)
15. Port Arthur, TX: 1.4 Bcfd (Port Arthur LNG) (PF15-18)
16. Brownsville, TX: 3.6 Bcfd (Rio Grande LNG – NextDecade) (PF15-20)
17. Freeport, TX: 0.72 Bcfd (Freeport LNG Dev) (PF15-25)
18. Corpus Christi, TX: 1.4 Bcfd (Cheniere – Corpus Christi LNG) (PF15-26)
19. Plaquemines Parish, LA: 2.80 Bcfd (Venture Global LNG) (PF15-27)
20. Nikiski, AK: 2.55 Bcfd (ExxonMobil, ConocoPhillips, BP, TransCanada and Alaska Gasline) (PF14-21)
21. Cameron Parish, LA: 1.84 Bcfd (G2 LNG) (PF16-2)

### PROPOSED TO U.S.-MARAD/COAST GUARD

22. Gulf of Mexico: 1.8 Bcfd (Delfin LNG)

### PROPOSED CANADIAN SITES

23. Kitimat, BC: 1.28 Bcfd (Apache Canada Ltd.)
24. Douglas Island, BC: 0.23 Bcfd (BC LNG Export Cooperative)
25. Prince Rupert Island, BC: 2.74 Bcfd (Pacific Northwest LNG)

Source: FERC

# Oil and Gas Rigs & Production

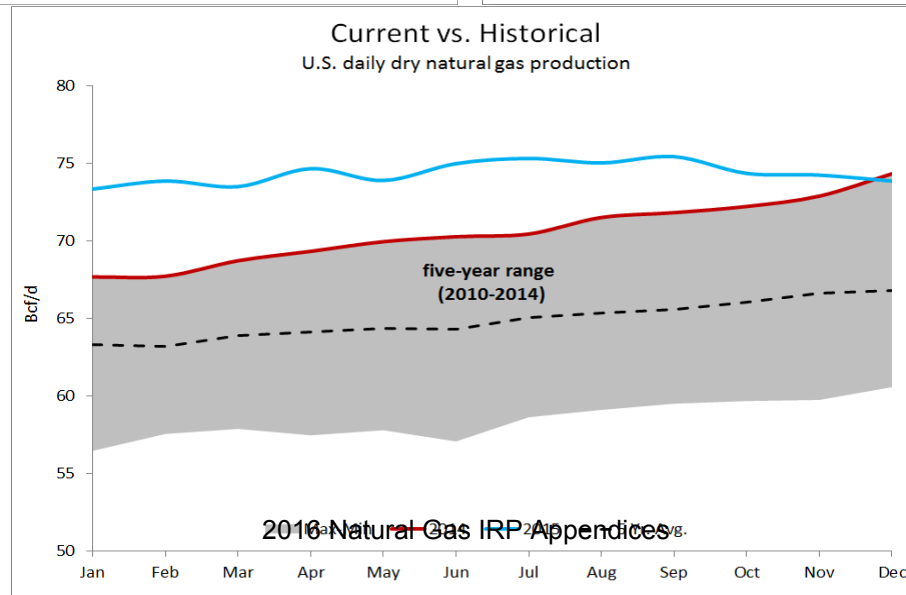
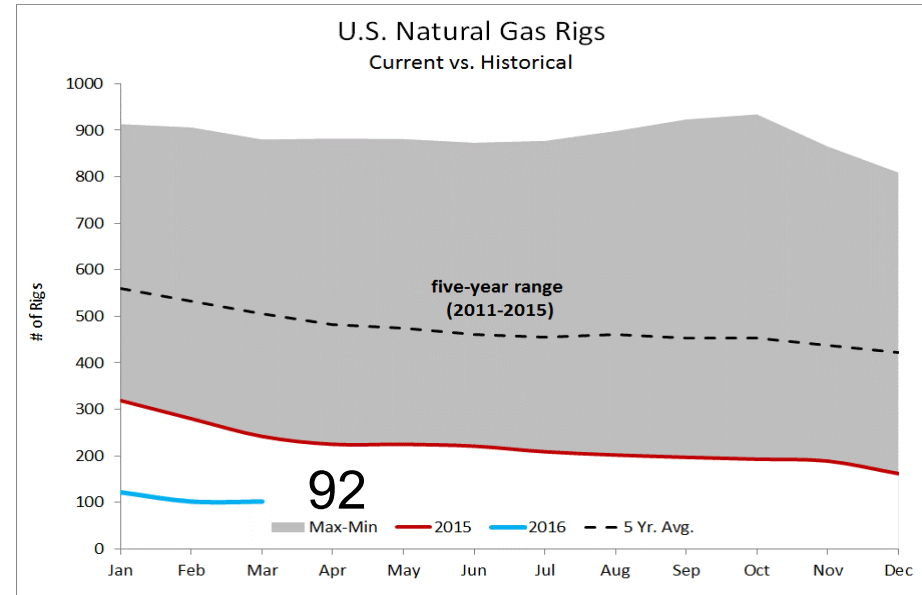
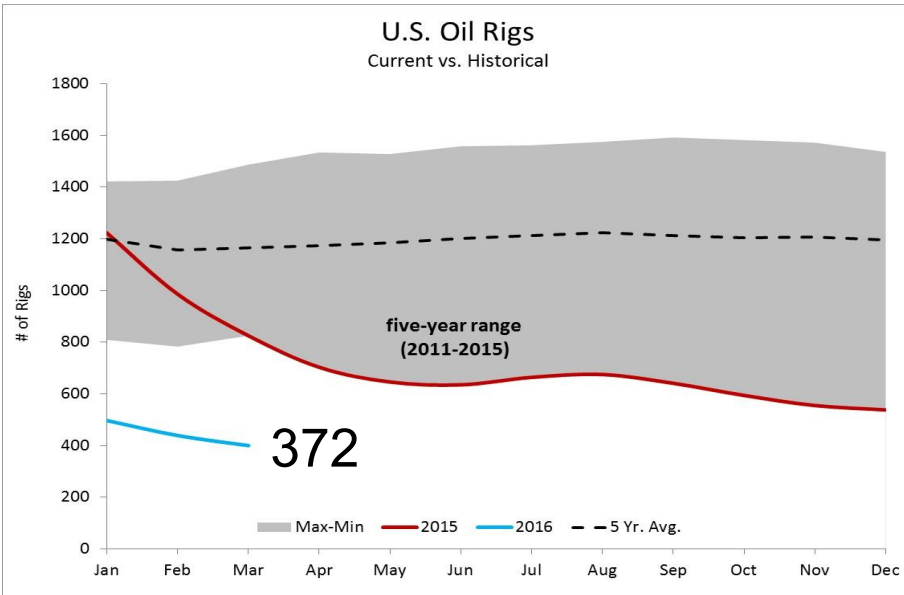



# US – Drilling efficiency

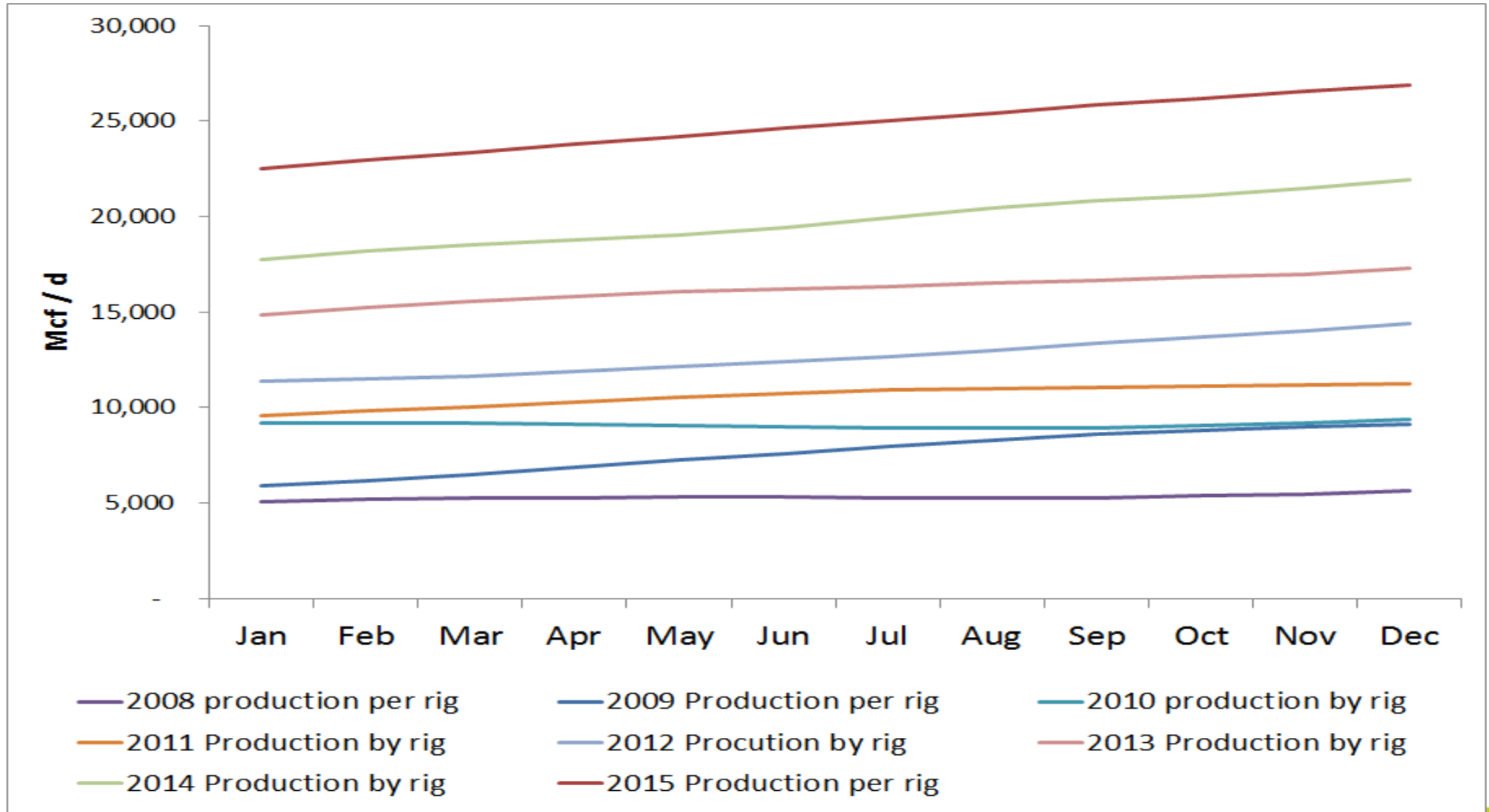

Avista Corp • EIA DPR - 7 most prolific areas in the US, which account for all natural gas production growth during 2011 - 2014

# How prices affect IRP Planning?

- Major component of the total cost
- Change in price **can** trigger price elastic response
- **THE** major piece of avoided costs and therefore cost effectiveness of DSM
- Can change resource selection based on basin differentials
- Storage utilization

# IRP Natural Gas Price Forecast Methodology

1. Two fundamental forecasts (Consultant #1 & Consultant #2)
2. Forward prices
3. Year 1 - forward price only
4. Year 2 - 75% forward price / 25% average consultant forecasts
5. Year 3 - 50% forward price / 50% average consultant forecasts
6. Year 4 – 6 25% forward price / 75% average consultant forecasts
7. Year 7 - 50% average consultant without CO2 / 50% average consultant with CO2

## Fundamental Forecasts vs. Actual Prices Henry Hub

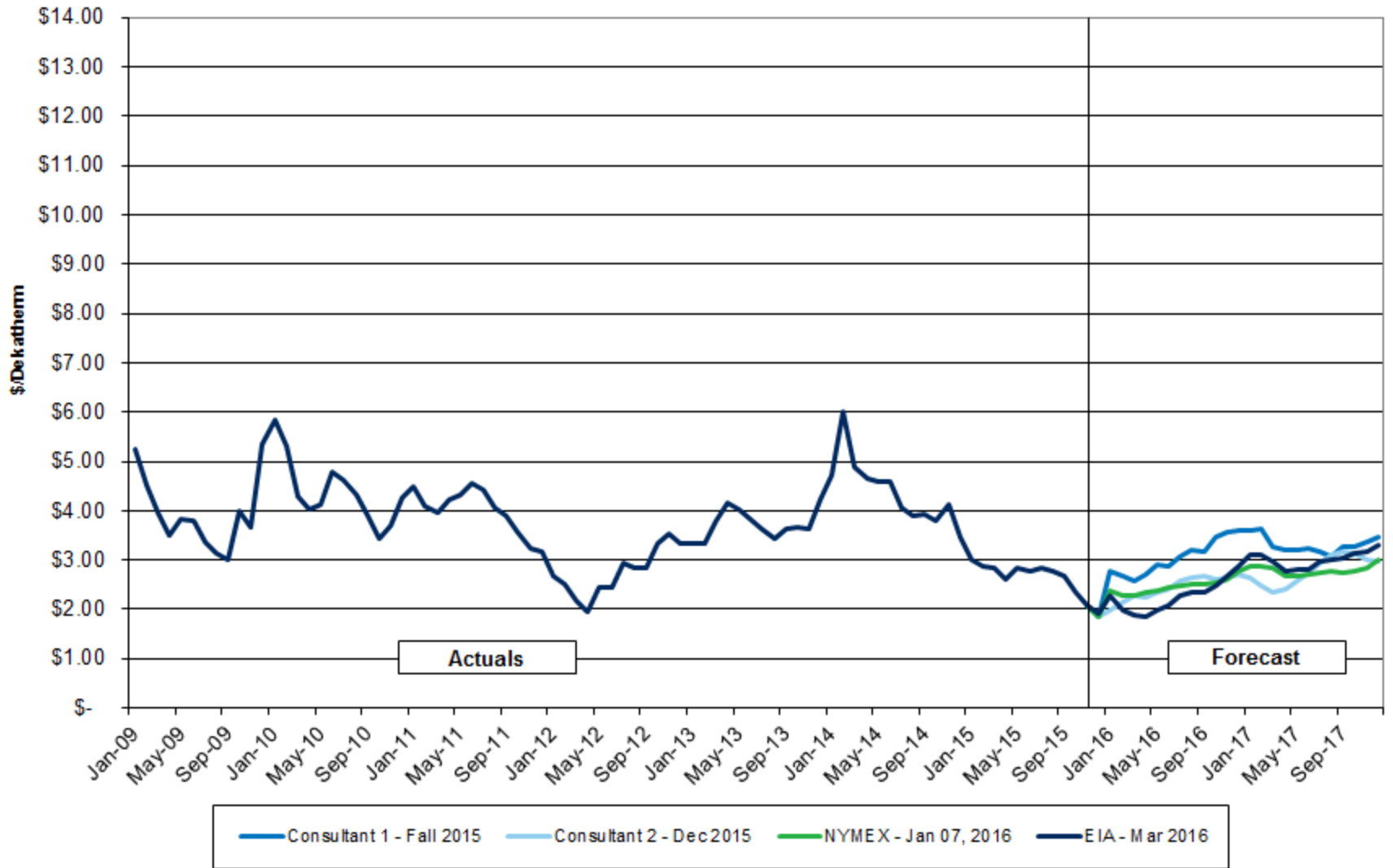

# 2014 IRP

## Low – Med – High

### REAL

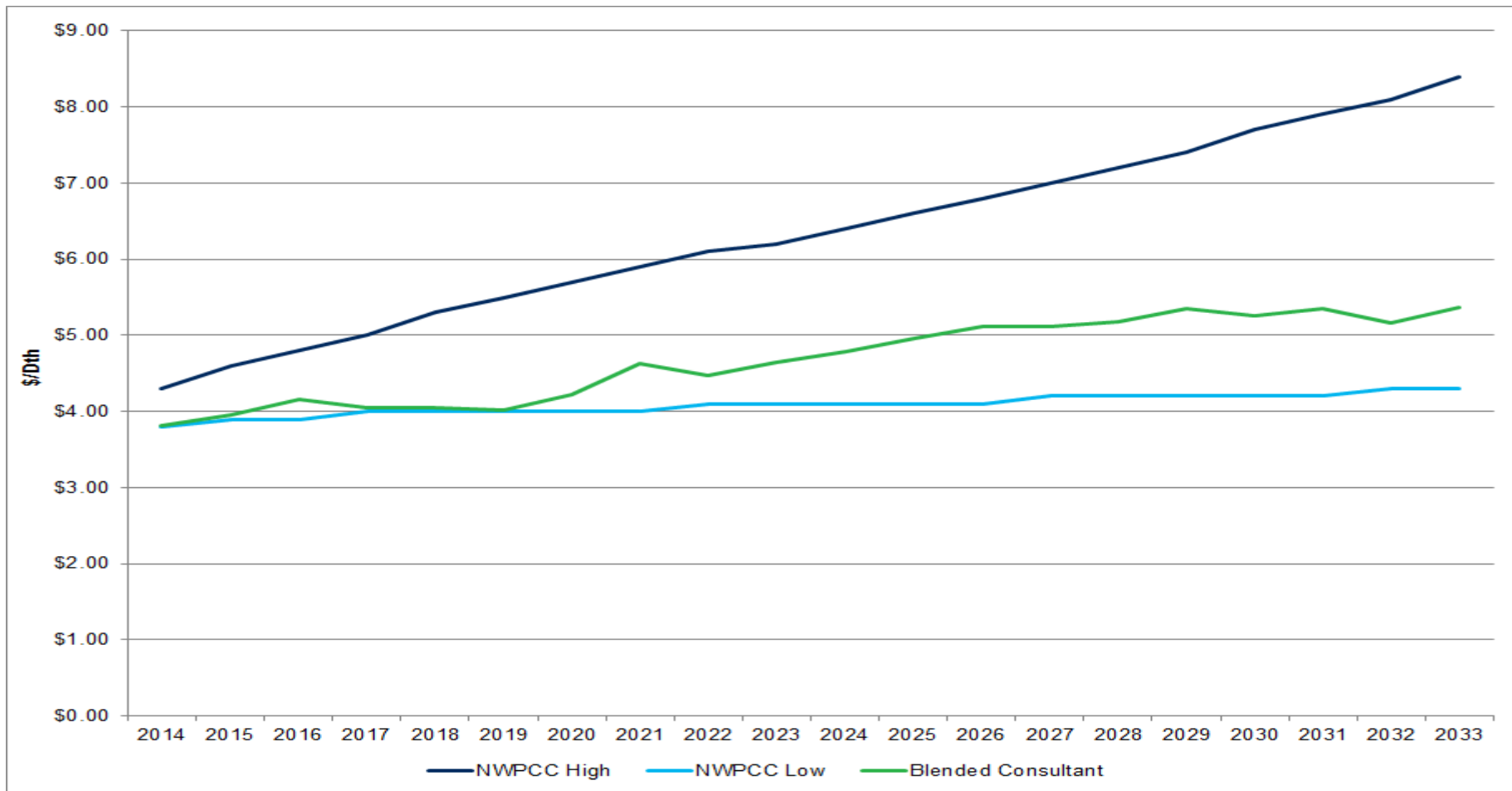

# 2016 IRP

## Low – Med – High

### REAL

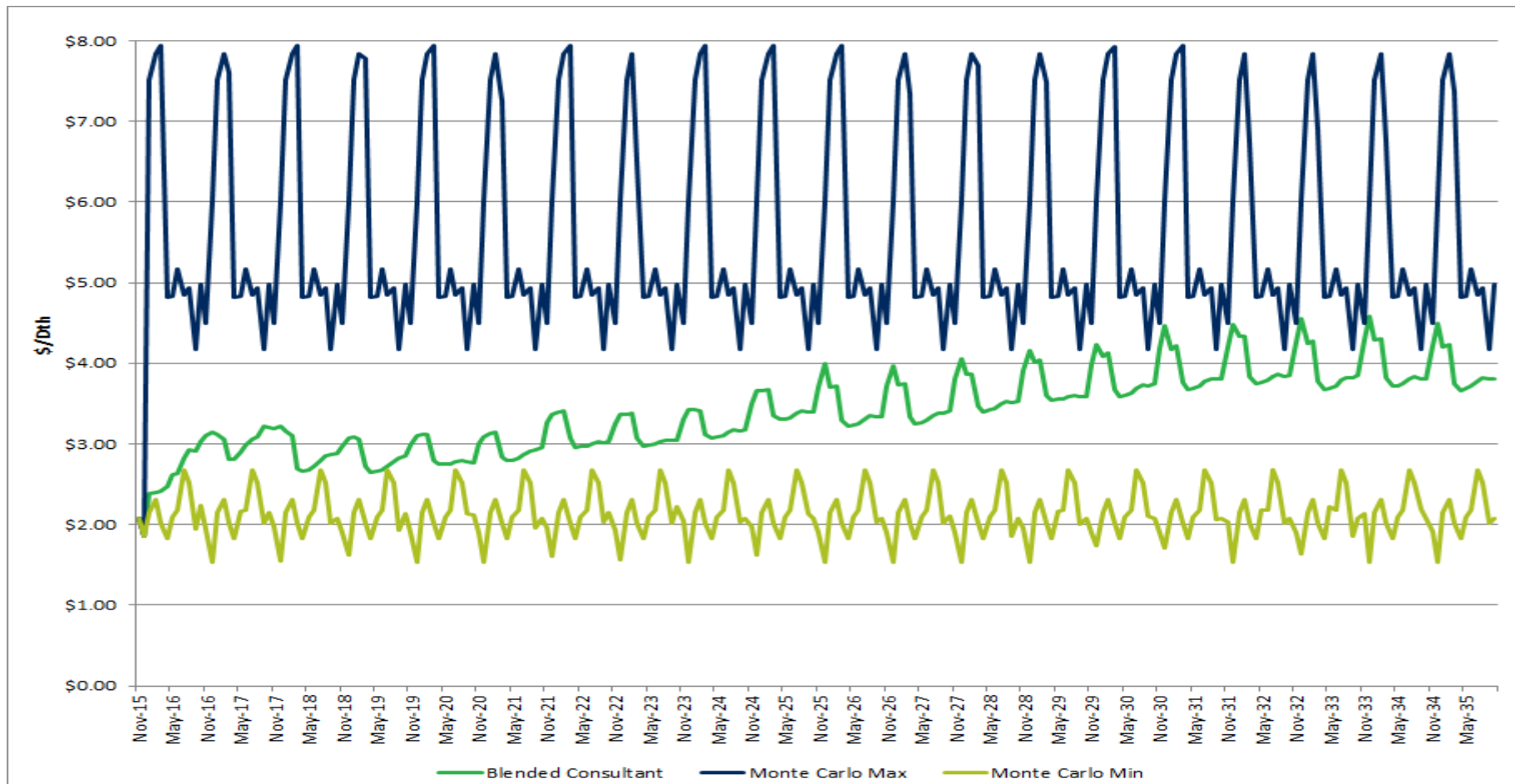

# Carbon Adder – Expected

- Includes carbon pricing from 2026-2035 from our consultant
- Avista added pricing starting from 2018 to address incremental adders from legislation in our service territory jurisdictions.
  - We assume floor pricing the same as California’s cap and trade of \$10 back at the programs initial auction in 2013.

\$ / Metric Tonne			
	Starting Price	Ending Price	Years
Low	\$ -	\$ -	2015-2035
Likely Policy	\$ 10.00	\$ 19.85	2018-2035
2015 Electric IRP	\$ 12.03	\$ 25.00	2020-2035
i-732	\$ 15.00	\$ 46.44	2018-2035
<b>Expected</b>	<b>\$ 9.89</b>	<b>\$ 19.93</b>	<b>2018-2035</b>

# Carbon Prices

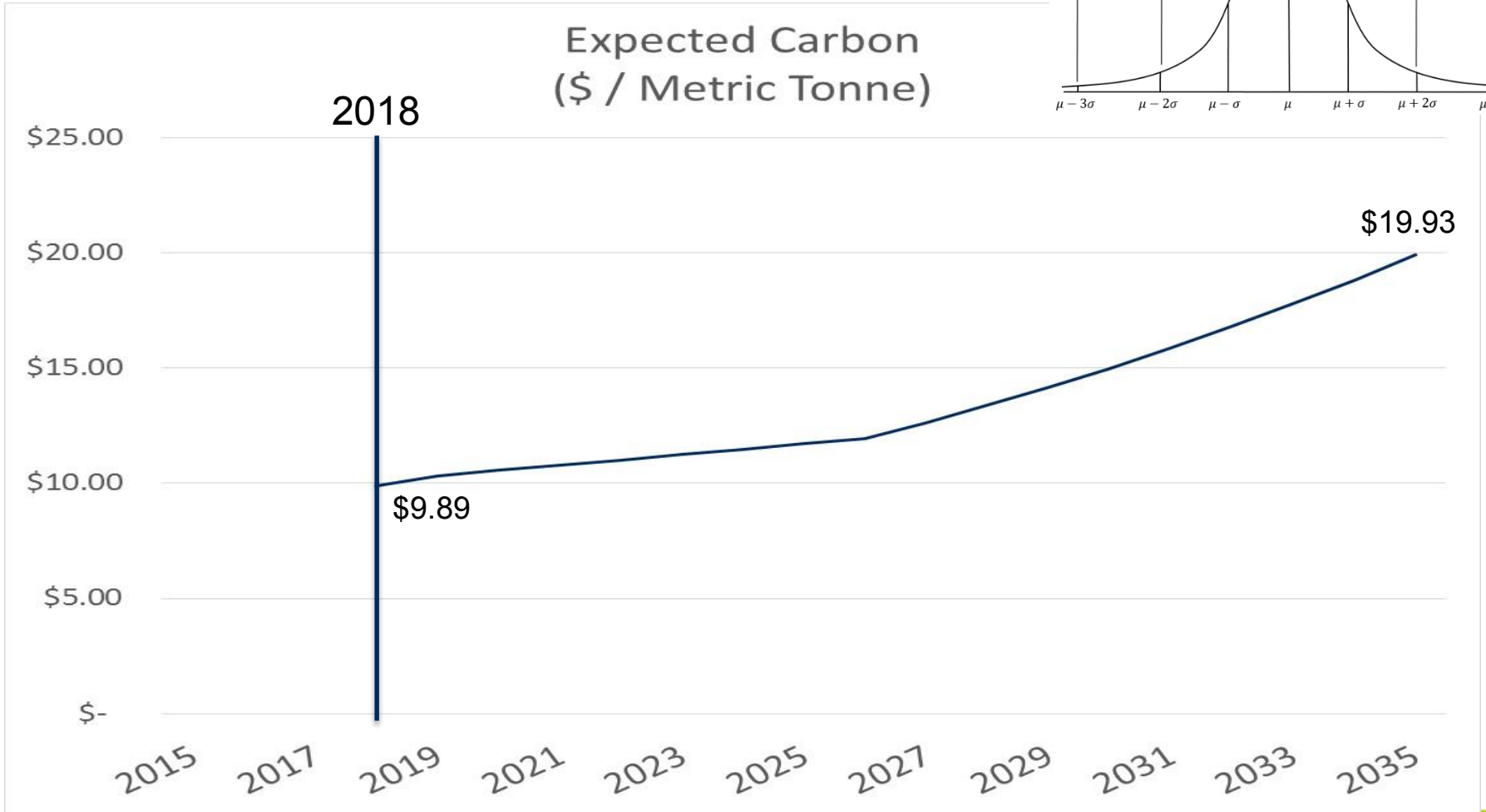
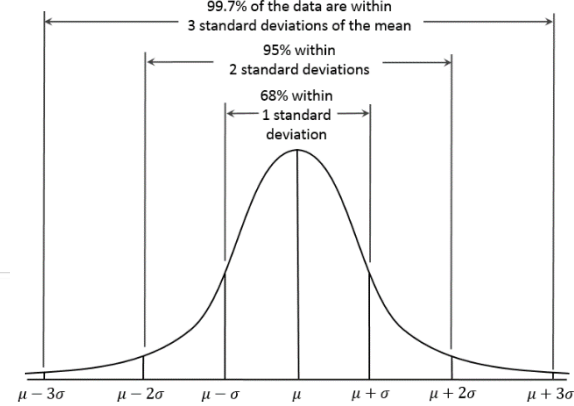

Expected = 2 Sigma of "Likely Policy" & No carbon & i-732 @ equally distributed between remaining probability



# Base Price with carbon adders

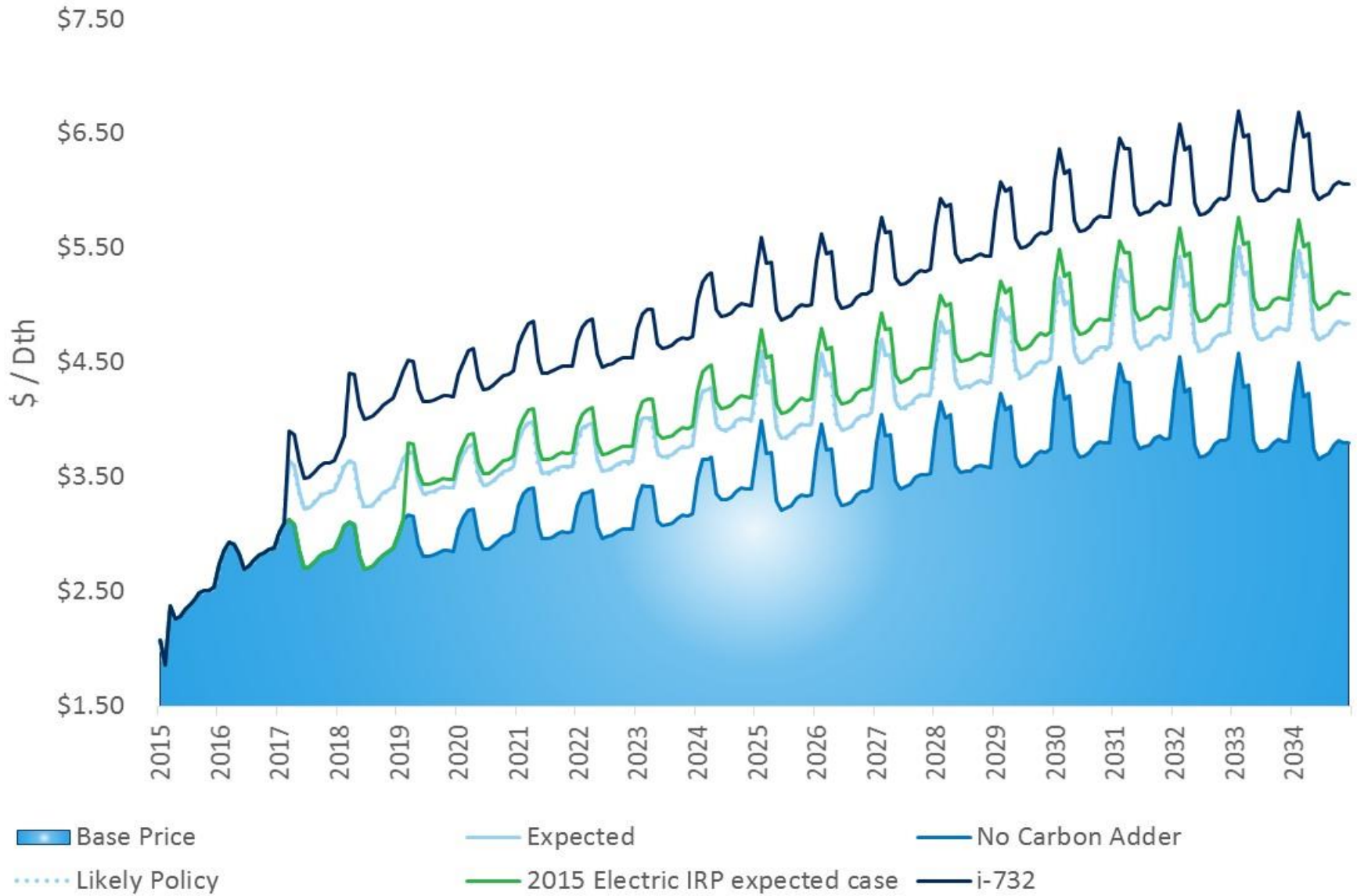

# Regional Price Assumptions

Regional Price as a percent of Henry Hub Price					
	AECO	Sumas	Rockies	Malin	Stanfield
Consultant1 Forecast Average	89.9%	98.8%	95.4%	101.4%	100.4%
Consultant2 Forecast Average	85.3%	94.2%	96.7%	98.6%	96.8%
Historic Cash Three Yr Average	86.8%	97.2%	97.1%	99.6%	97.5%
Prior IRP	82.5%	90.8%	88.9%	94.5%	92.1%

# Monthly Price Shape

Monthly Price as a percent of Average Price						
	Jan	Feb	Mar	Apr	May	Jun
Consult1	113.2%	113.8%	92.8%	90.7%	91.5%	92.0%
Consult2	99.9%	99.7%	98.7%	97.1%	97.7%	98.6%
Prior IRP	102.9%	102.9%	99.2%	97.4%	97.7%	98.4%
	Jul	Aug	Sep	Oct	Nov	Dec
Consult1	93.5%	94.5%	94.3%	95.3%	109.7%	118.9%
Consult2	100.5%	101.7%	102.1%	102.1%	100.6%	101.3%
Prior IRP	99.3%	99.5%	99.6%	99.4%	100.8%	103.2%



# Procurement Planning

Tom Pardee, Manager of Natural Gas Planning

Natural Gas Technical Advisory Committee  
March 16, 2016

# Procurement Plan Philosophy

## •Mission

•*To provide a diversified portfolio of reliable supply and a level of price certainty in volatile markets.*

- We cannot accurately predict what natural gas prices will do, however we can use experience, market intelligence, and fundamental market analysis to structure and guide our procurement strategies.
- Our goal is to develop a plan that utilizes customer resources (storage and transportation), layers in pricing over time for stability (time averaging), allows discretion to take advantage of pricing opportunities should they arise, and appropriately manages risk.

# Comprehensive Review of Previous Plan

Review conducted with SOG includes:

- Mission statement and approach
- Current and future market dynamics
- Hedge type and percentage
- Resources available (i.e. storage and transportation)
- Hedge windows (how many, how long)
- Long term hedging approach
- Storage utilization
- Analysis (volatility, past performance, scenarios, etc.)
- Market opportunities



# A Thorough Evaluation of Risks



# Procurement Plan Structure

- The procurement plan incorporates a portfolio approach that is diversified in terms of:
  - **Components:** The plan utilizes a mix of index, fixed price, and storage transactions.
  - **Transaction Dates:** Hedge windows are developed to distribute the transactions throughout the plan.
  - **Supply Basins:** Plan to primarily utilize AECO, execute at lowest price basis at the time.
  - **Delivery Periods:** Hedges are completed in annual and/or seasonal timeframes. Long-term hedges may be executed.
- Transactions are executed pursuant to a plan and process; however, the procurement plan allows Avista to be flexible to market conditions and opportunistic when appropriate.



# PROCUREMENT PLAN MIX ALL JURISDICTIONS

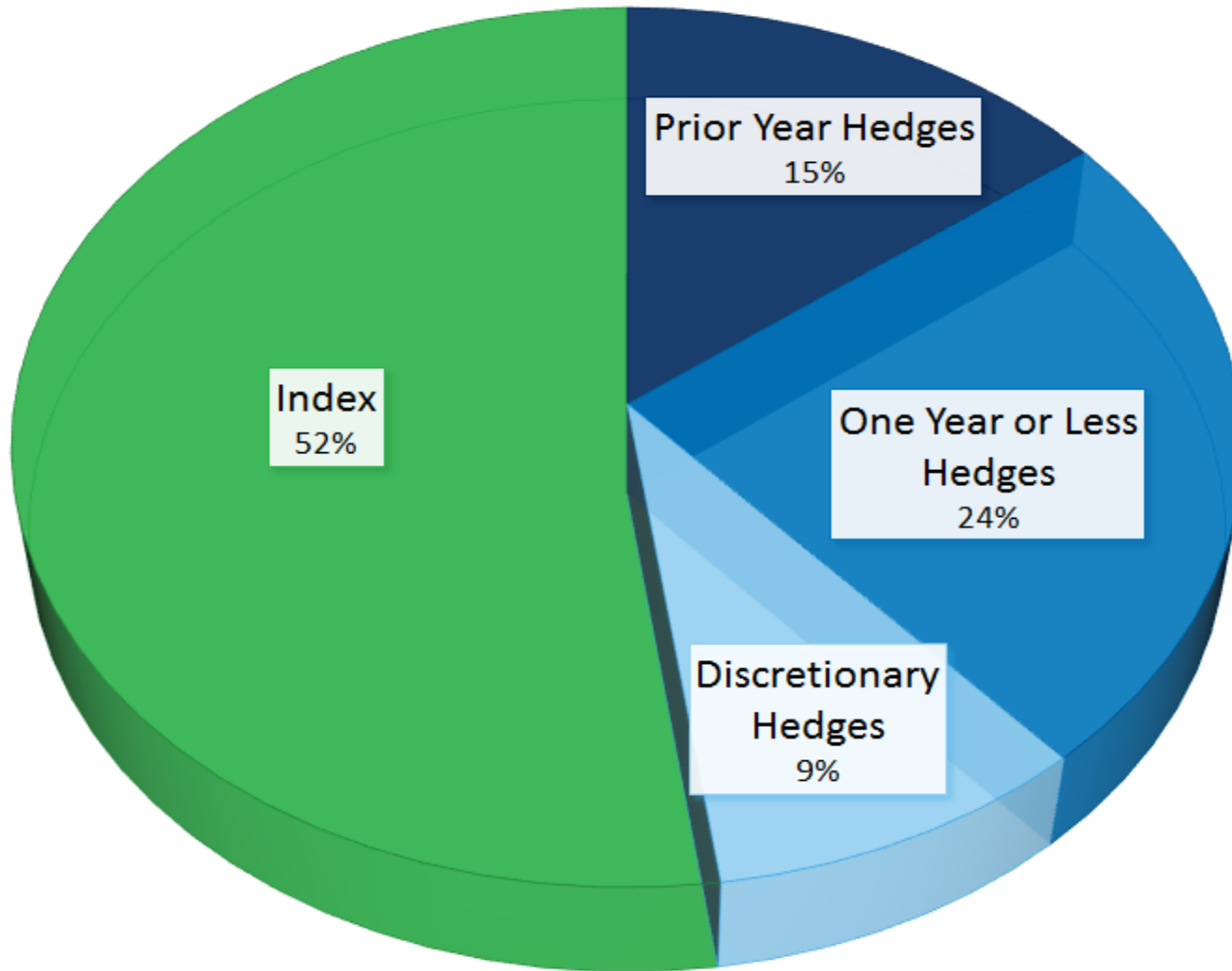



# Preliminary Modeling Results

Tom Pardee, Manager of Natural Gas Planning

Natural Gas Technical Advisory Committee  
March 26, 2014

# Developing a Reference Case

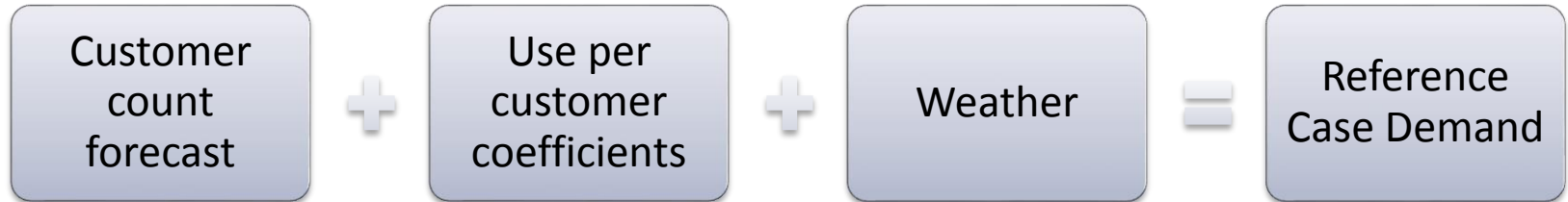

## 1. Customer annual growth rates:

System	Base-Case	High	Low
<b>Res</b>	1.2%	1.6%	0.7%
<b>Com</b>	0.7%	1.1%	0.2%
<b>Ind</b>	0.0%	0.4%	-0.4%
<b>Total</b>	1.1%	1.5%	0.7%
<b>WA</b>	<b>Base-Case</b>	<b>High</b>	<b>Low</b>
<b>Res</b>	1.0%	1.4%	0.6%
<b>Com</b>	0.7%	1.1%	0.3%
<b>Ind</b>	0.0%	0.3%	-0.2%
<b>Total</b>	1.0%	1.4%	0.6%
<b>ID</b>	<b>Base-Case</b>	<b>High</b>	<b>Low</b>
<b>Res</b>	1.4%	1.8%	0.9%
<b>Com</b>	0.4%	0.9%	-0.1%
<b>Ind</b>	0.0%	0.3%	-0.3%
<b>Total</b>	1.3%	1.7%	0.8%
<b>OR</b>	<b>Base-Case</b>	<b>High</b>	<b>Low</b>
<b>Res</b>	1.2%	1.6%	0.8%
<b>Com</b>	0.8%	1.2%	0.3%
<b>Ind</b>	0.0%	1.1%	-1.4%
<b>Total</b>	1.2%	1.6%	0.7%

## 2. Use per customer coefficients –3 year average use per HDD per customer

## 3. Weather planning standard – coldest day on record

- WA/ID 82; Medford 61; Roseburg 55; Klamath 72; La Grande 74

# Reference Demand Case

Year	2014	2016	Delta
1	33,249	33,368	0%
2	33,538	33,582	0%
3	33,996	33,958	0%
4	34,174	34,339	0%
5	34,520	34,881	1%
6	34,850	35,125	1%
7	35,335	35,501	0%
8	35,513	35,861	1%
9	35,849	36,376	1%
10	36,189	36,571	1%
11	36,693	36,921	1%
12	36,878	37,267	1%
13	37,228	37,775	1%
14	37,582	37,947	1%
15	38,106	38,279	0%
16	38,300	38,604	1%
17	38,664	39,098	1%
18	39,032	39,244	1%
19	39,577	39,558	0%
20	39,779	39,870	0%

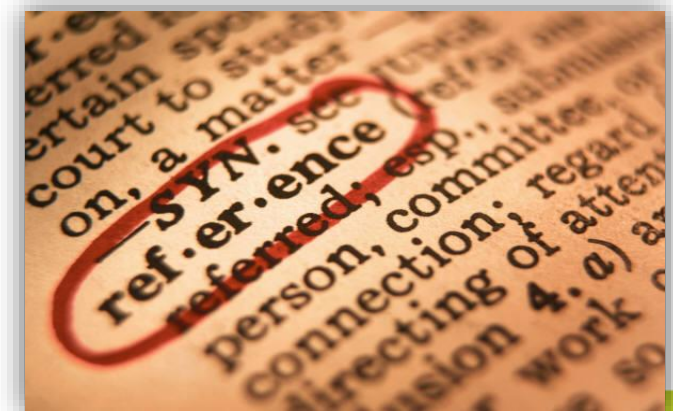
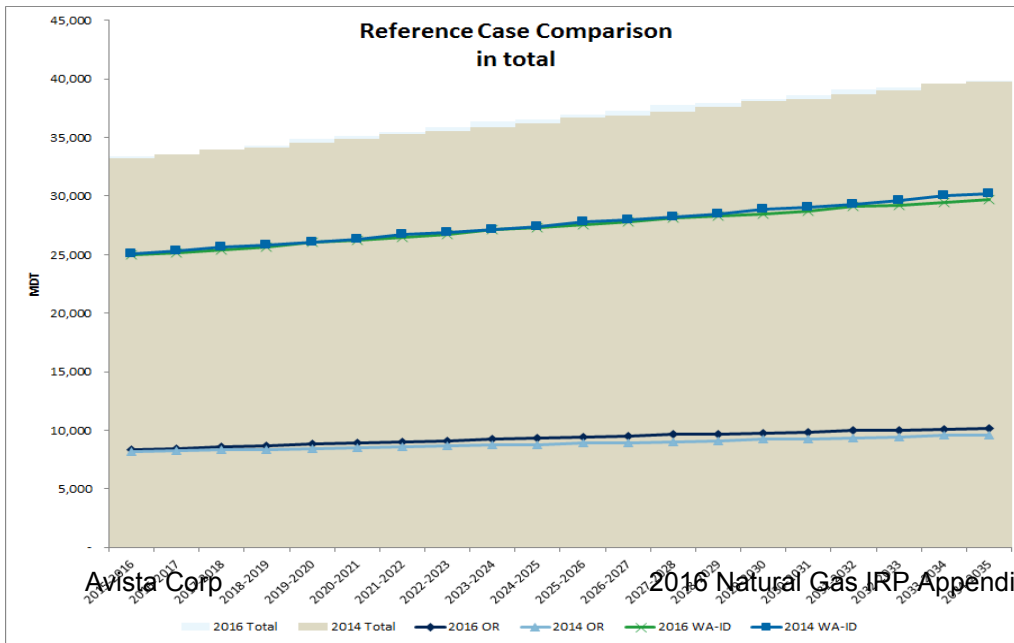
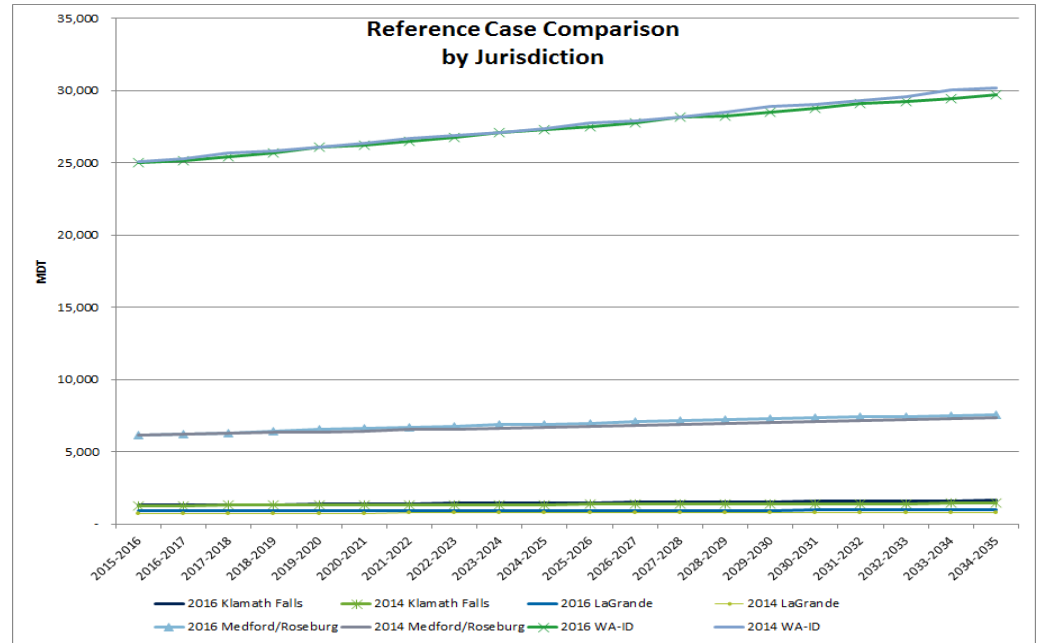

# Demand Sensitivities

INPUT ASSUMPTIONS	Reference Case	Reference Plus Peak Case	DEMAND INFLUENCING - DIRECT							PRICE INFLUENCING - INDIRECT				
			Low Cust	High Cust	CNG/NGV	Alternate	DSM	Peak plus	Alterante	Expected	Low	High	Carbon	LNG /
			Growth	Growth	Vehicles	Weather Std	Case	DSM	Historical	Elasticity	Prices	Prices	Legislation	Methanol
Customer Growth Rate			Low Growth	High Growth										
Use per Customer	3 Year Historical	3 Year Historical	3 Year Historical	3 Year Historical	5% Growth Cumulative	3 Year Historical	3 Year Historical	3 Year Historical	5 Year Historical	3 Year Historical	3 Year Historical	3 Year Historical	3 Year Historical	3 Year Historical
Weather Planning Standard	20 Year Normal	Coldest on Record	Coldest on Record	Coldest on Record	Coldest on Record	Coldest in 20yrs	Normal	Coldest on Record	Coldest on Record	Coldest on Record	Coldest on Record	Coldest on Record	Coldest on Record	Coldest on Record
Demand Side Management Programs Included	No	No	No	No	No	No	Expected	Expected	No	No	No	No	No	No
Prices Price curve	Expected	Expected	Expected	Expected	Expected	Expected	Expected	Expected	Expected	Expected	Low	High	High/Medium/Low	Expected
Price curve adder (\$/Dth)	None	None	None	None	None	None	None	None	None				High/Medium/Low	\$ .25 Adder After 5yrs
Elasticity	None	None	None	None	None	None	None	None	None	Expected	Expected	Expected	Expected	Expected

# Demand Sensitivities- Preliminary Results

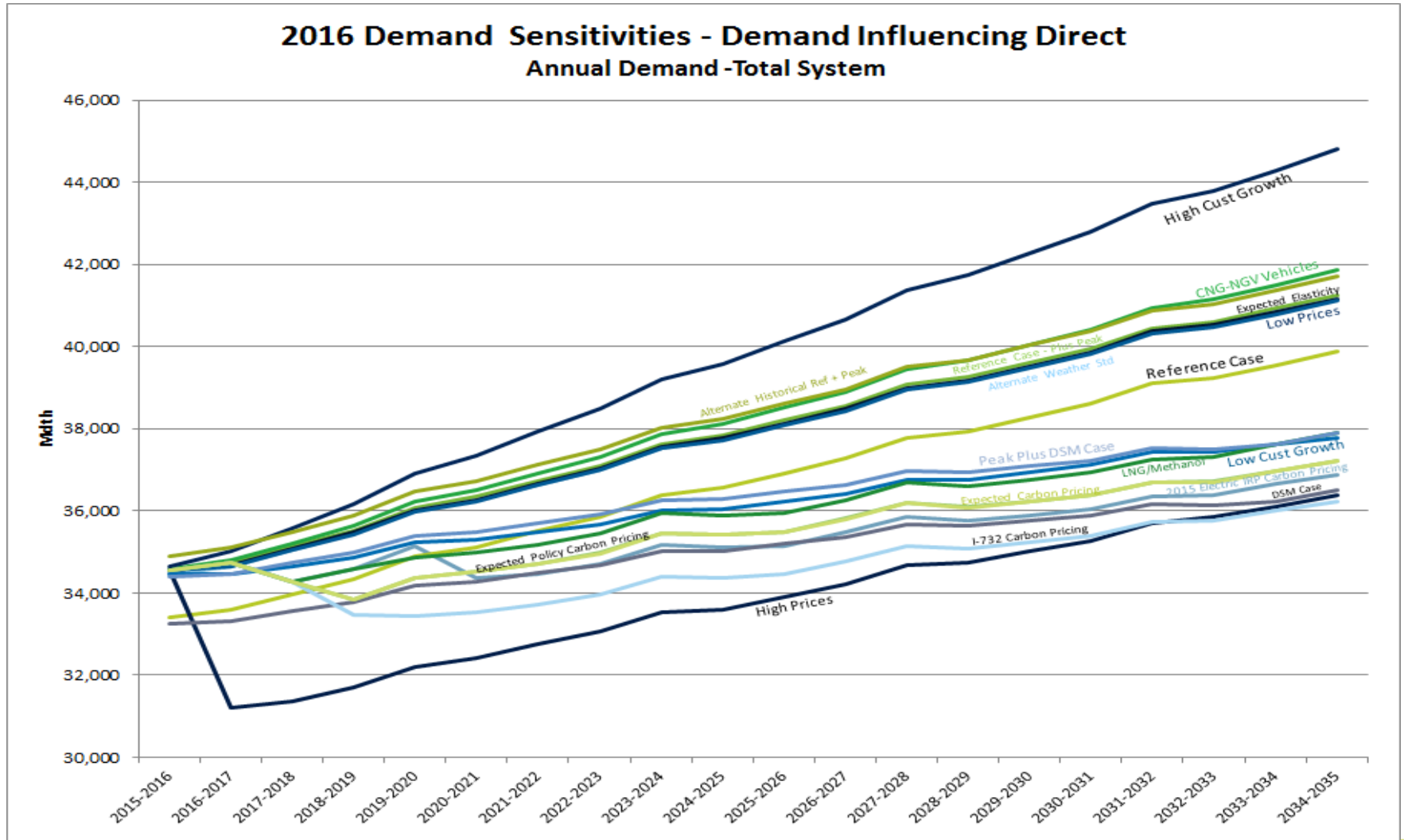

# Mix and Match to Make Scenarios



# Demand Scenarios – Proposed

<b>Proposed Scenarios</b> INPUT ASSUMPTIONS	<b>Expected Case</b>	<b>High Growth &amp; Low Prices</b>	<b>Low Growth &amp; High Prices</b>	<b>Cold Day 20yr Weather Std</b>	<b>Average Case</b>
<b>Customer Growth Rate</b>	Reference Case Cust Growth Rates	High Growth Rate	Low Growth Rate	Reference Case Cust Growth Rates	Reference Case Cust Growth Rates
<b>Use per Customer</b>	3 yr Flat + Price Elast.	3 yr Flat + Price Elast. + CNG/NGV	3 yr Flat + Price Elast.	3 yr Flat + Price Elast.	3 yr Flat + Price Elast.
<b>Demand Side Management</b>	Yes	Yes	Yes	Yes	Yes
<b>Weather Planning Standard</b>	Coldest Day	Coldest Day	Coldest Day	Alternate Planning Standard	Normal
<b>Prices</b>					
Price curve	Expected	Low	High	Expected	Expected
Carbon Legislation (\$/Ton)	\$9.89 - 19.93	None	\$9.89 - 19.93	\$9.89 - 19.93	\$9.89 - 19.93



# Weather Modeling

# Planning Standard Assumptions

Area	Coldest in 20 Year HDD	Coldest on Record HDD
WA-ID	76	82
Klamath Falls	72	72
La Grande	74	74
Medford	54	61
Roseburg	48	55

## Coldest on Record Dates

WA/ID – December 30, 1968

Medford – December 9, 1972

Roseburg – December 22, 1990

Klamath Falls – December 8, 2013

La Grande – December 23, 1983

# WA-ID

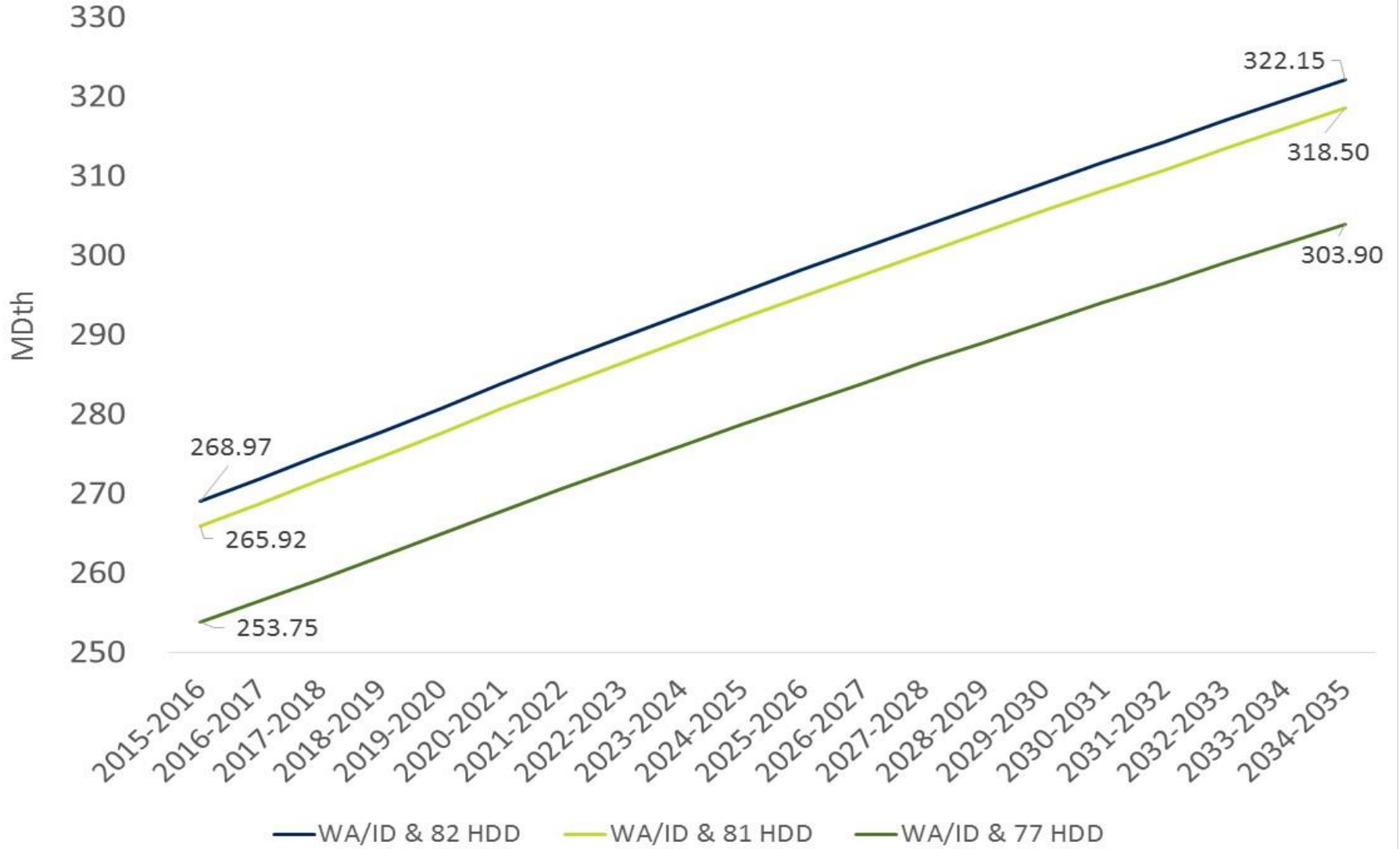

# Medford

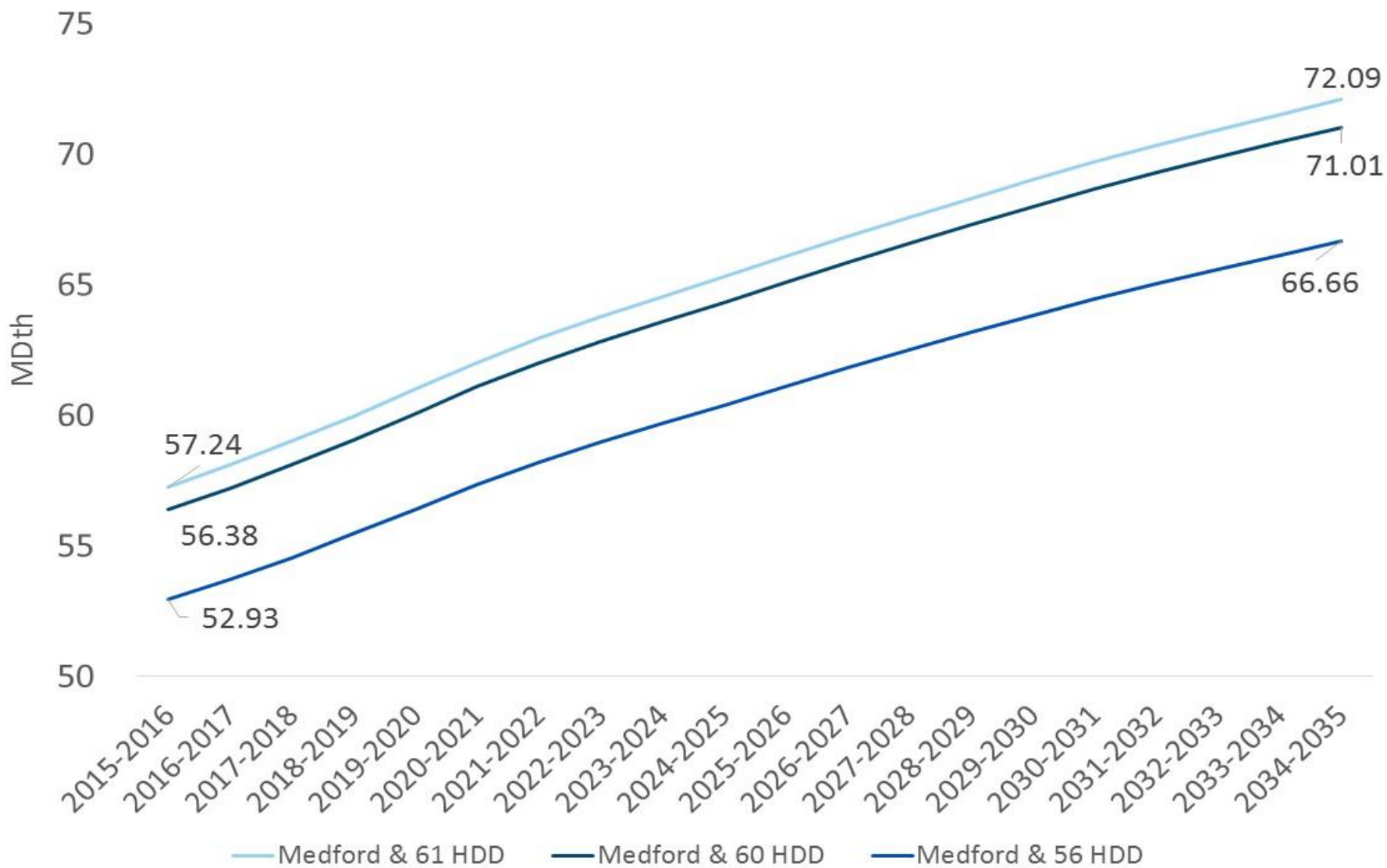

# Roseburg

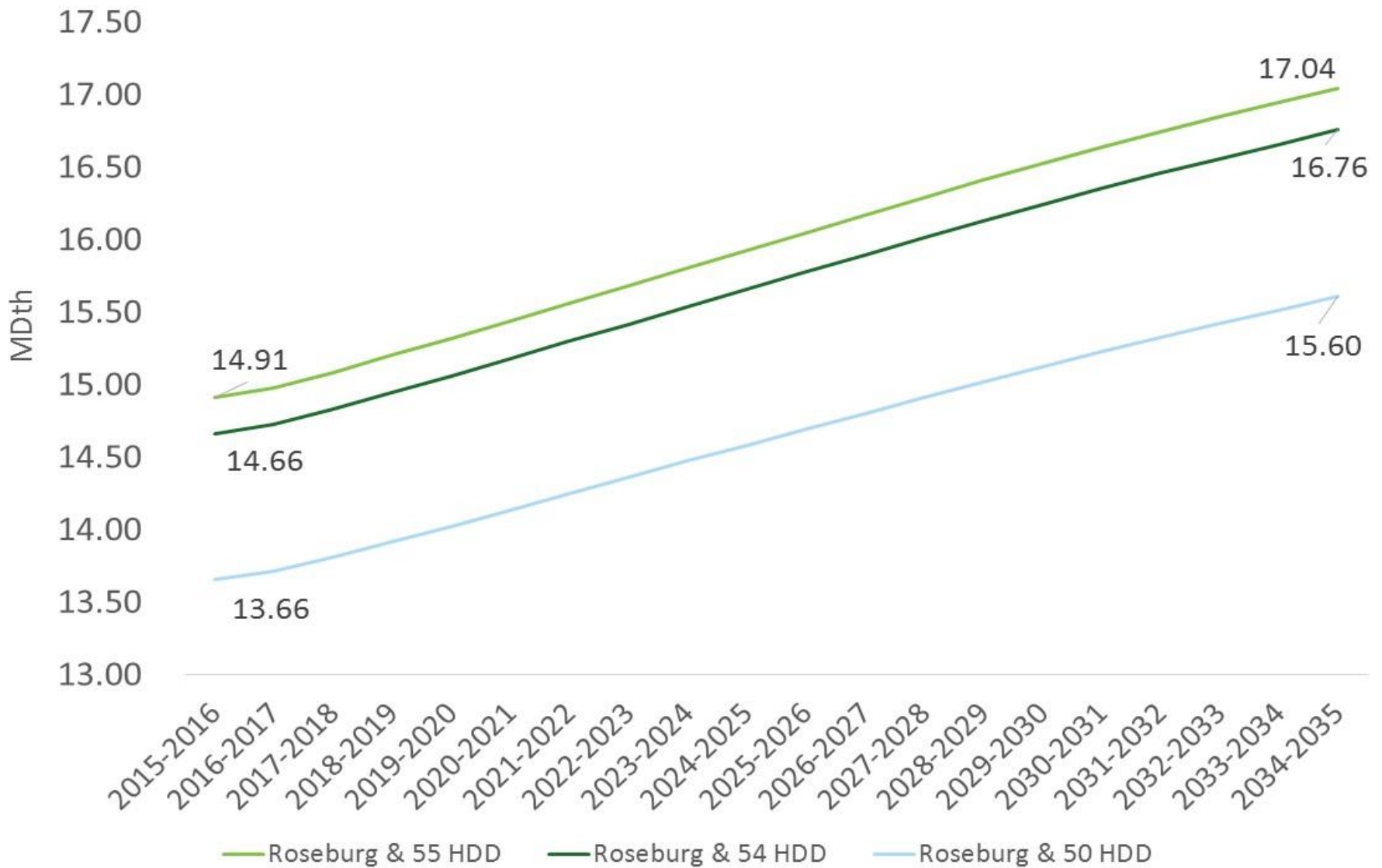

# Klamath Falls

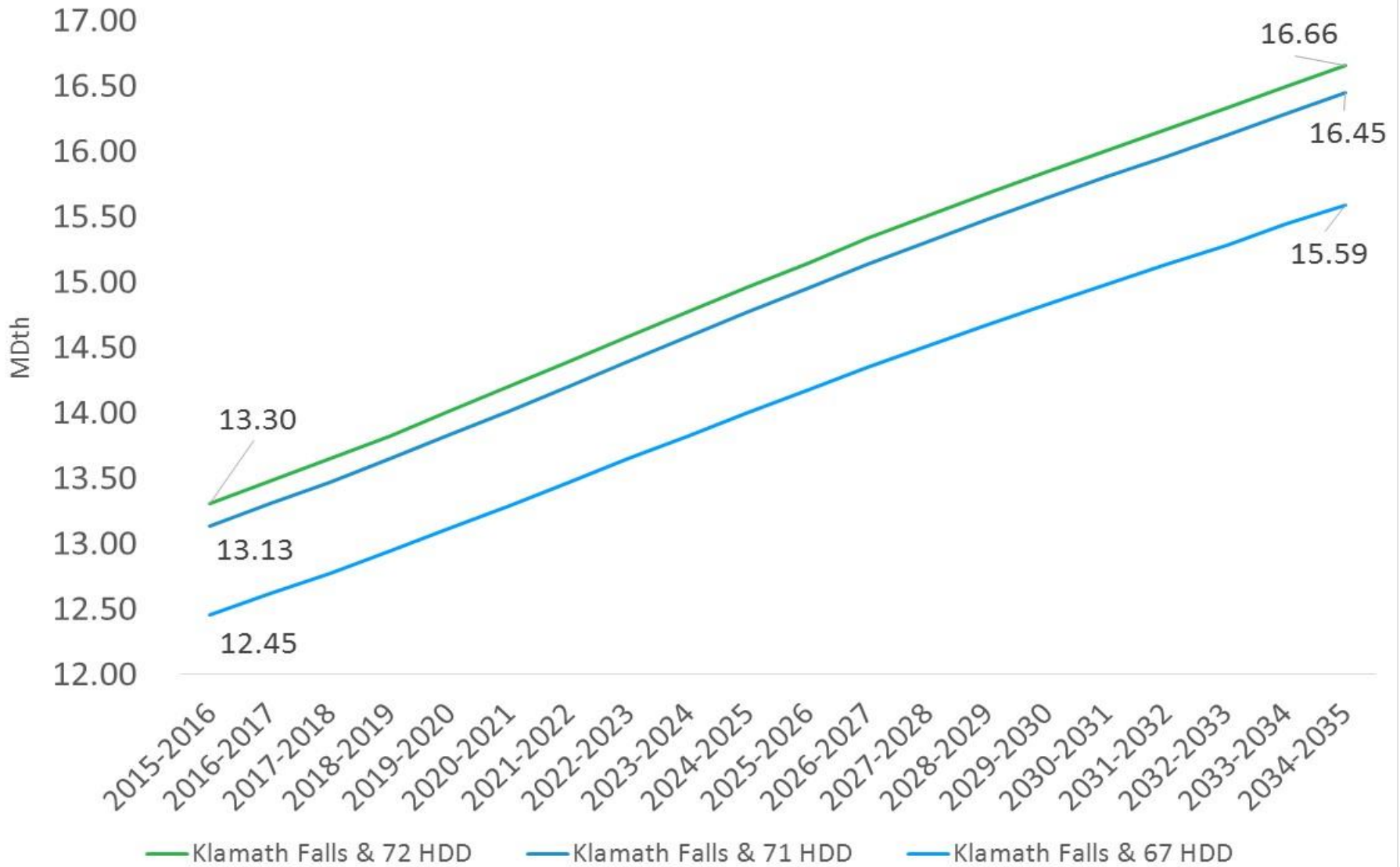

# La Grande

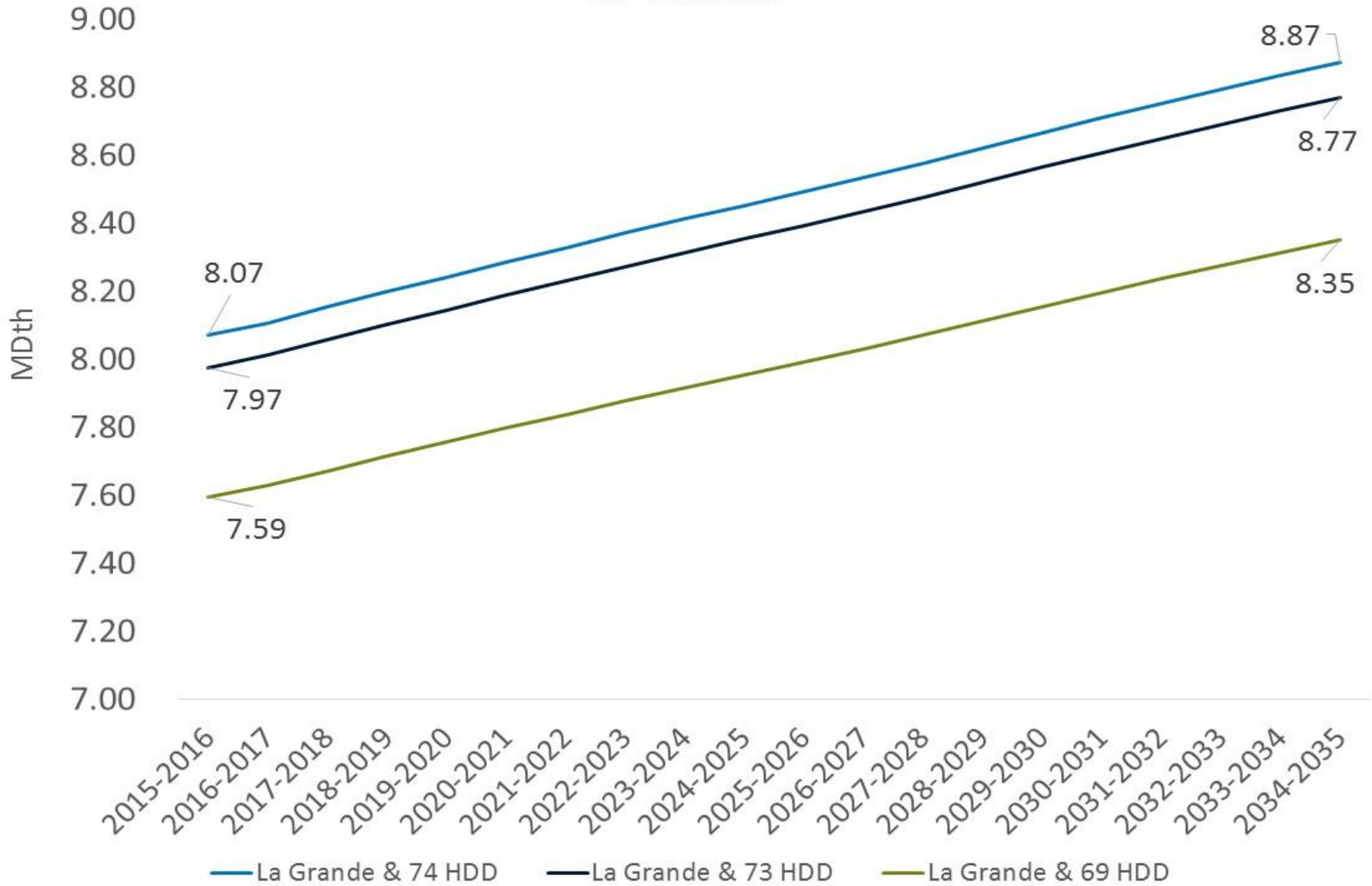

# 2016 IRP Timeline

- **August 31, 2015** – Work Plan filed with WUTC
- **January through April 2016** – Technical Advisory Committee meetings. Meeting topics will include:
  - Demand Forecast and Demand Side Management – January 21
  - Supply/Infrastructure and Potential Case Discussion– February 18
  - Distribution Planning, Natural Gas Pricing, SENDOUT® Preliminary Output Results and Further Case Discussion – March 30
  - **SENDOUT® results – April 21**
- **May 30, 2016** – Draft of IRP document to TAC
- **June 30, 2016** – Comments on draft due back to Avista
- **July 2016** – TAC final review meeting (if necessary)
- **August 31, 2016** – File finalized IRP document





# 2016 Avista Natural Gas IRP

Technical Advisory Committee Meeting  
April 21, 2016  
Spokane, WA

# Agenda

- Introductions & Logistics
- Avista Natural Gas Conservation Potential Assessment Results
- Assumptions Review
- Demand Sensitivities and Scenarios Updates
- Supply Side Resource Options
- Stochastic Analysis
- Key Issues & Document Discussion

# 2016 IRP Timeline

- **August 31, 2015** – Work Plan filed with WUTC
- **January through April 2016** – Technical Advisory Committee meetings. Meeting topics will include:
  - Demand Forecast and Demand Side Management – January 21
  - Supply/Infrastructure and Potential Case Discussion– February 18
  - Distribution Planning, Natural Gas Pricing, SENDOUT® Preliminary Output Results and Further Case Discussion – March 30
  - **SENDOUT® results – April 21**
- **May 30, 2016** – Draft of IRP document to TAC
- **June 30, 2016** – Comments on draft due back to Avista
- **July 2016** – TAC final review meeting (if necessary)
- **August 31, 2016** – File finalized IRP document



# Avista Natural Gas Conservation Potential Assessment Results

April 21, 2016

# Topics

- Overview of analysis approach
- Results for each state
  - Market characterization
  - Baseline projection
  - Conservation potential estimates

# Overview of Analysis Approach

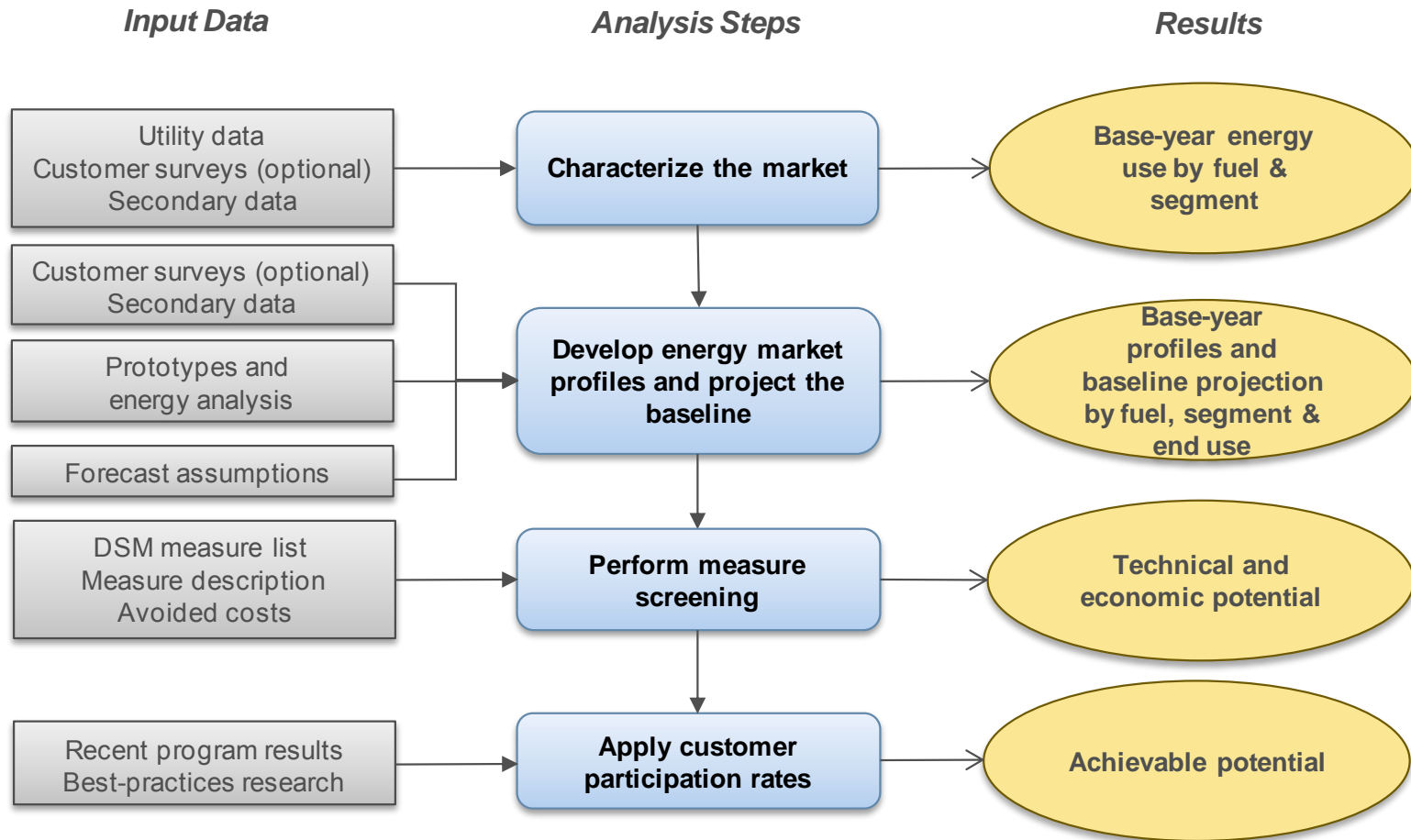

# Overview of Analysis Approach

Dimension	Segmentation Variable	Description
1	State	Washington, Idaho, Oregon
2	Sector	Residential, commercial, industrial
3	Segment	<p><b>Residential:</b> single family, multi family, mobile homes and low income</p> <p><b>Commercial:</b> office, restaurant, retail, grocery, school, college, health, lodging, warehouse, miscellaneous</p> <p><b>Industrial:</b> total</p>
4	Vintage	Existing and new construction
5	End uses	Heating, water heat, process, etc. (as appropriate by sector)
6	Appliances/end uses and technologies	Technologies such as furnaces, boilers, water heaters, etc.
7	Equipment efficiency levels for new purchases	Baseline and higher-efficiency options as appropriate for each technology

# Washington



# High-level Market Characterization - Washington

2015 Natural Gas Sales by Sector

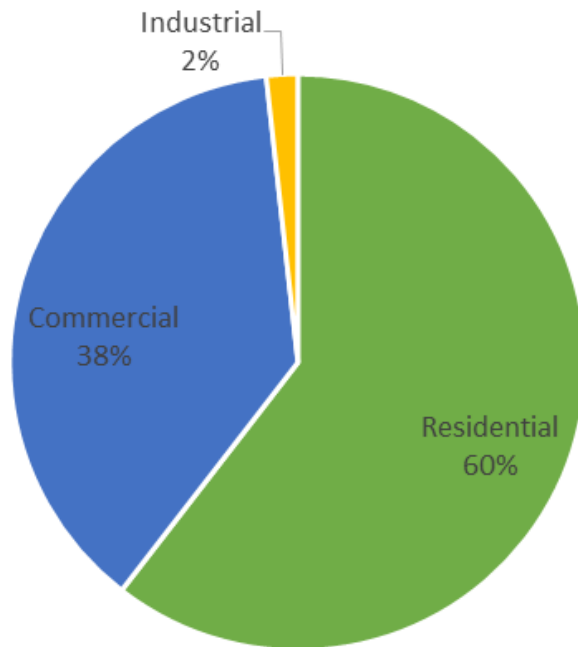

Segment	Annual Sales (DTh)	% of Sales
Residential	9,188,898	60%
Commercial	5,734,759	38%
Industrial	268,452	2%
<b>Total</b>	<b>30,375</b>	<b>100%</b>

# Residential Market Characterization - Washington

Washington	2015 Sales (DTh)	# of Customers	Average Use per Household (Therms/HH)
Single Family	6,016,941	85,875	701
Multifamily	349,141	7,909	441
Mobile Home	299,264	5,085	589
Low Income	2,523,553	42,372	596
<b>Washington Total</b>	<b>9,188,898</b>	<b>141,241</b>	<b>651</b>

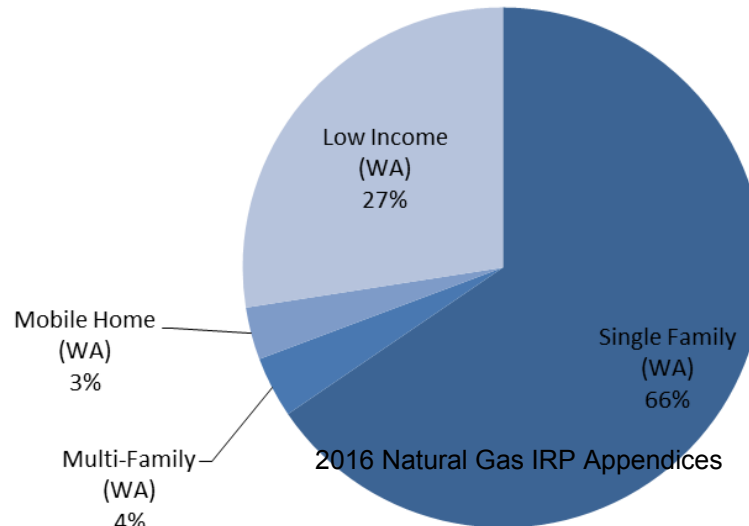

# Residential Market Profiles - Washington

Base-year annual energy use by segment and end use

**Annual Use by End Use**

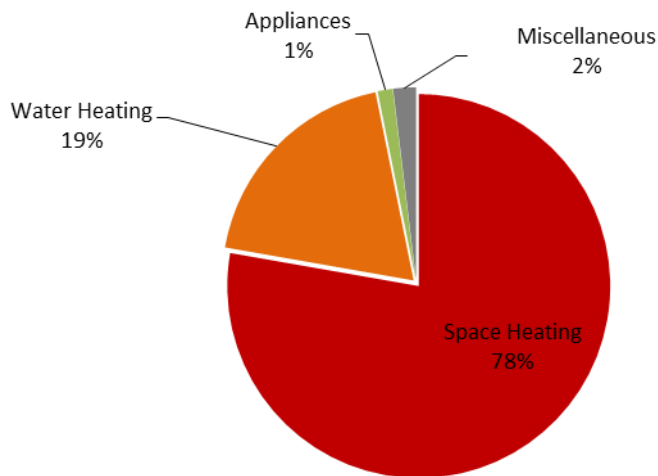

**Annual Intensity for Average Household**

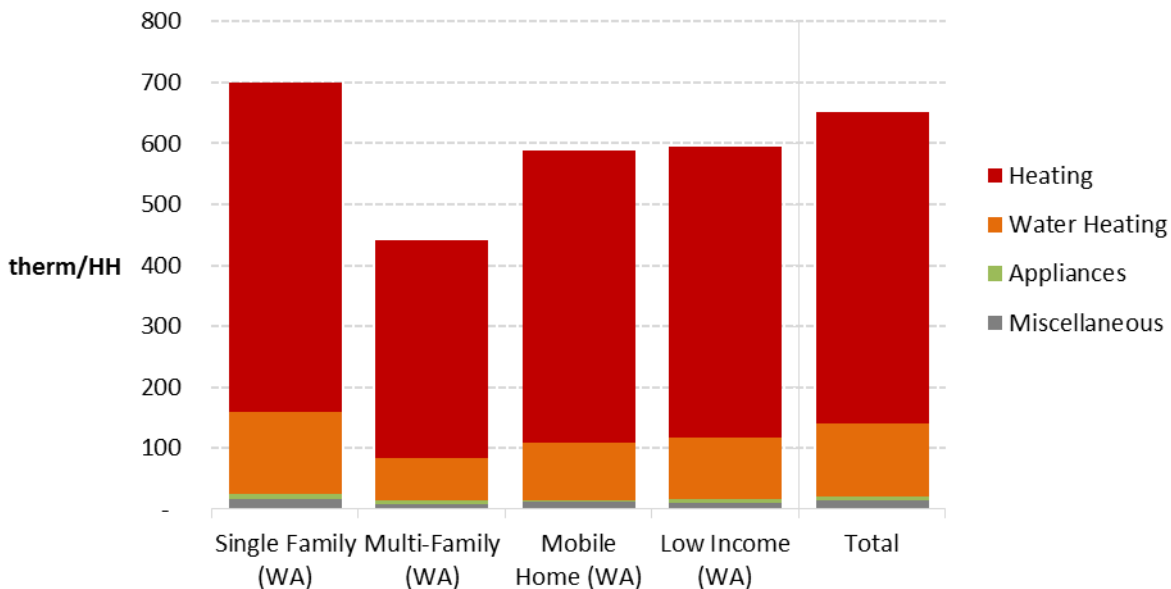

**Data Sources:**

- GenPOP Survey
- RBSA
- Utility billing data
- AEG Market Profiles Database
- Secondary data as needed to fill gaps

# Residential Energy Market Profile - Washington

- This market profile represents the residential sector as a whole. Individual segment market profiles are provided in the report.
- Saturations were developed using the GenPOP residential survey as the primary data source.

		Washington				
		Total				
Total Households:						141,241
		DTh				9,188,898
End Use	Technology	Saturation	UEC (Therms)	Intensity (Therms/	Usage (DTh)	
Space Heating	Furnace	88.2%	509.5	449.1	6,343,260	
Space Heating	Boiler	2.3%	609.8	13.8	194,390	
Space Heating	Other Heating	9.6%	488.4	46.8	661,509	
Water Heating	Water Heater	56.6%	211.0	119.4	1,686,433	
Appliances	Clothes Dryer	9.9%	27.3	2.7	38,181	
Appliances	Stove/Oven	8.5%	57.3	4.9	68,899	
Miscellaneous	Pool Heater	0.7%	217.5	1.6	22,019	
Miscellaneous	Miscellaneous	100.0%	12.3	12.3	174,206	
<b>Total</b>				<b>650.6</b>	<b>9,188,898</b>	

# Residential Baseline Projection - Washington

- Baseline projection provides foundation for estimating potential future savings from conservation initiatives and reflects
  - Household growth and electricity price forecasts (from Avista)
  - Appliance standards in place at end of 2015 (AEG database)
  - Frozen efficiency
  - Does not include future utility programs
- Baseline projection increases 38% between 2015 and 2036, or an average of 1.5% per year

**Residential Baseline Energy Projection (DTh)**

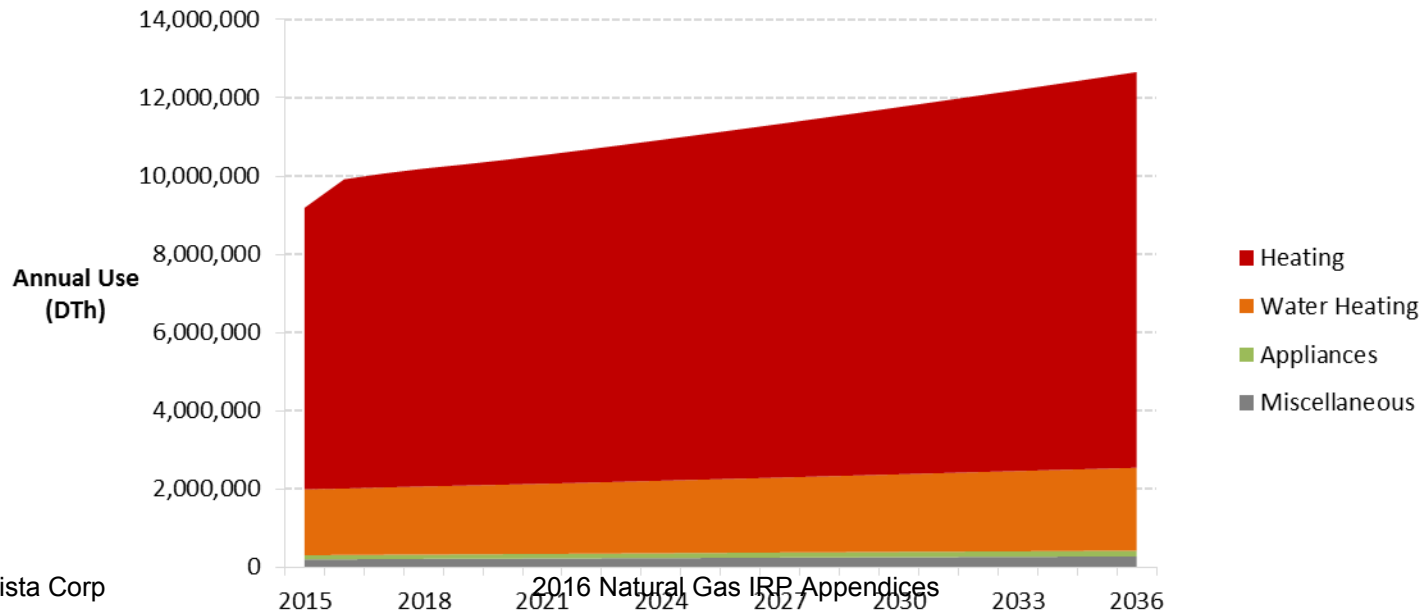

# Residential Savings Potential - Washington

From 2017 to 2018, cumulative achievable potential energy savings are 62,492 DTh or 0.6% of the baseline.

By 2036, cumulative savings are almost 10% of the baseline projection, or about 0.5% per year.

	2017	2018	2021	2026	2036
<b>Baseline Projection (DTh)</b>	<b>10,067,567</b>	<b>10,191,025</b>	<b>10,534,588</b>	<b>11,198,918</b>	<b>12,661,346</b>
<b>Cumulative Savings (DTh)</b>					
Achievable Potential	27,598	62,492	207,653	497,074	1,226,734
Economic Potential	132,960	267,157	678,668	1,382,067	2,721,626
Technical Potential	187,192	377,121	956,051	1,951,370	3,828,466
<b>Energy Savings (% of Baseline)</b>					
Achievable Potential	0.3%	0.6%	2.0%	4.4%	9.7%
Economic Potential	1.3%	2.6%	6.4%	12.3%	21.5%
Technical Potential	1.9%	3.7%	9.1%	17.4%	30.2%

Uses the UCT cost effectiveness test

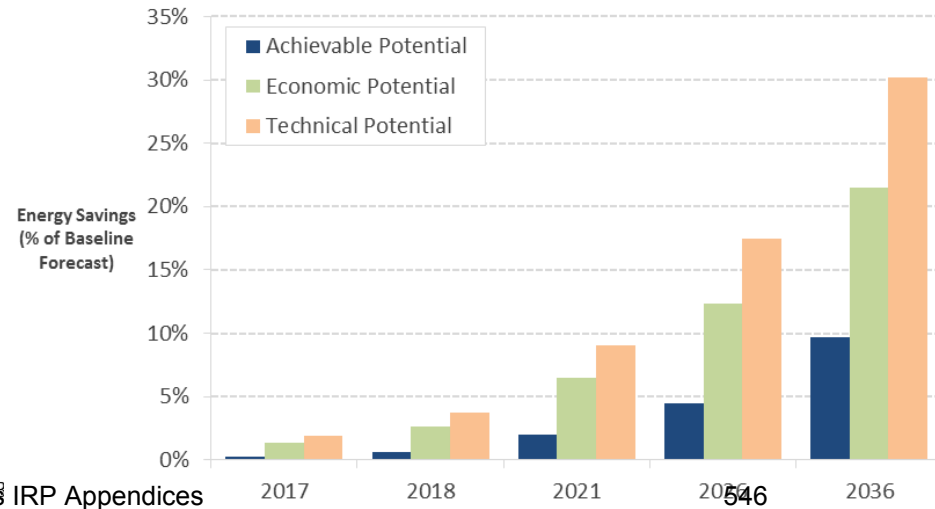
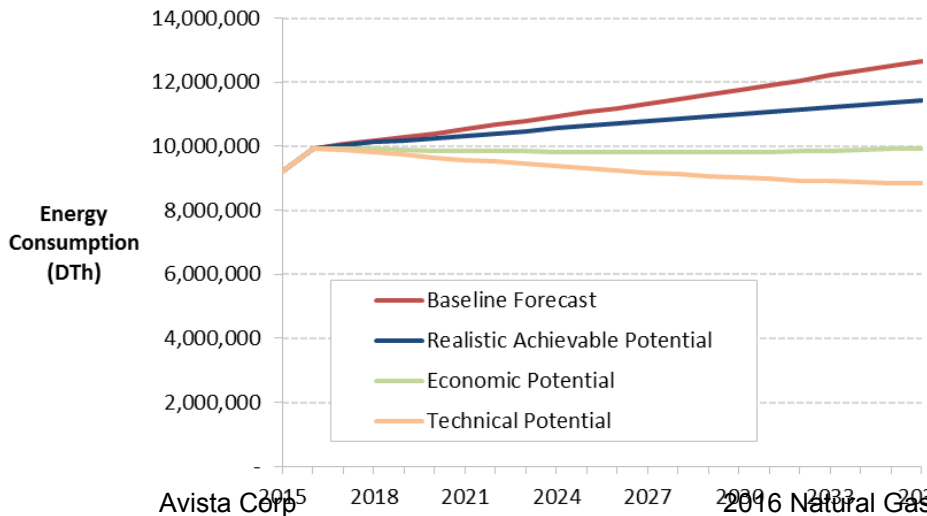

# Residential Savings Potential - Washington

Cumulative achievable potential in 2018

Rank	Measure / Technology	2018 Achievable Savings (Cum. DTh)	% of Total
1	Windows - High Efficiency	20,516	32.8%
2	Heating – Furnace (EF 0.98)	19,873	31.8%
3	Furnace - Maintenance	4,025	6.4%
4	Water Heater - Low-Flow Showerheads	3,270	5.2%
5	Water Heater - Temperature Setback	2,983	4.8%
6	Insulation - Ceiling	2,914	4.7%
7	Ducting - Repair and Sealing	2,243	3.6%
8	Water Heating - Water Heater (EF 0.67)	1,831	2.9%
9	Thermostat - Programmable/Interactive	1,797	2.9%
10	Water Heater - Pipe Insulation	1,582	2.5%
11	Heating – Boiler (EF 0.98)	527	0.8%
12	Water Heater - Faucet Aerators	484	0.8%
13	Boiler - Maintenance	248	0.4%
14	Boiler - Pipe Insulation	199	0.3%
15	Insulation - Wall Sheathing	1	0.0%
	<b>Total</b>	<b>62,492</b>	<b>100%</b>

Cumulative Achievable Potential in 2018

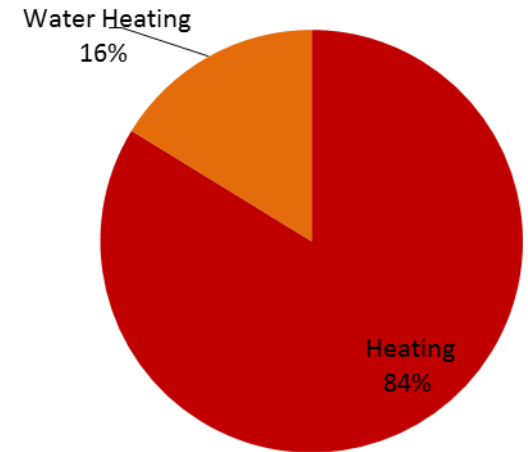

Cumulative Achievable Potential (DTh)

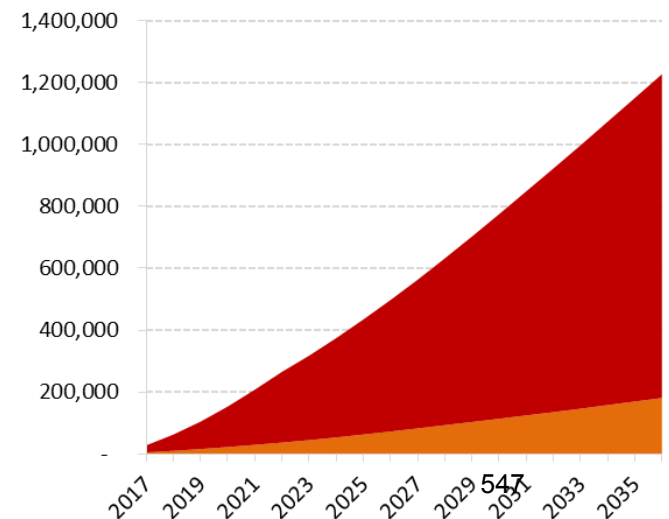

# Commercial Market Characterization - Washington

Washington	2015 Sales (DTh)	Floor Space (sq. ft.)	Intensity (therms/sqft)
Office	608,320	23,532,683	0.26
Restaurant	357,257	1,615,817	2.21
Retail	609,276	20,141,347	0.30
Grocery	253,760	4,311,977	0.59
School	472,964	11,620,730	0.41
College	439,038	5,467,474	0.80
Health	648,945	9,103,062	0.71
Lodging	353,904	6,773,279	0.52
Warehouse	272,231	13,377,462	0.20
Miscellaneous	1,719,065	32,222,397	0.53
<b>Washington Total</b>	<b>5,734,759</b>	<b>128,166,227</b>	<b>0.45</b>

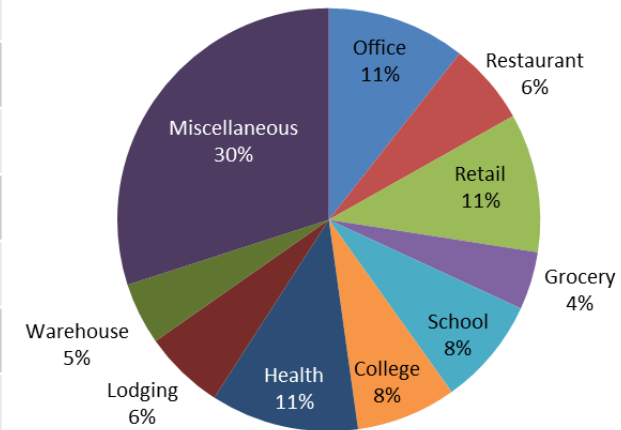



# Commercial Market Profiles - Washington

Base-year annual energy use by segment and end use

Annual Use by End Use

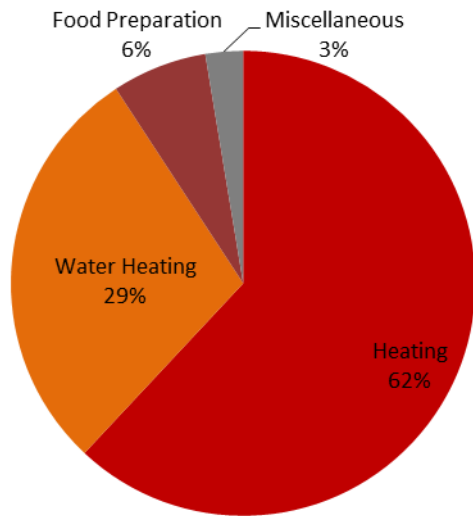

Annual Intensity per Square Foot

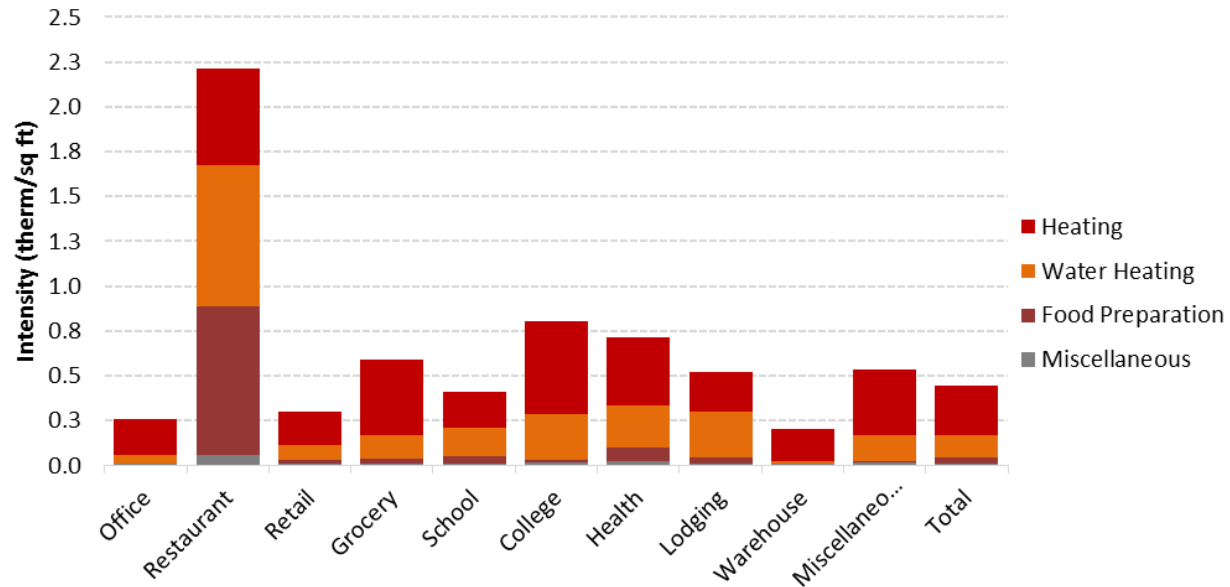

**Data Sources:**

- CBSA
- Utility billing data
- AEG Market Profiles Database
- Secondary data as needed to fill gaps

# Commercial Energy Market Profile - Washington

- This market profile represents the Commercial sector as a whole. Individual segment market profiles are provided in the report.
- Saturations were developed using the CBSA survey as the primary data source.

## Gas Market Profiles

End Use	Technology	Saturation	EUI (therm)	Intensity (therm/Sqft)	Usage (DTh)
Heating	Furnace	54.3%	0.21	0.11	1,467,831
Heating	Boiler	33.1%	0.48	0.16	2,030,710
Heating	Unit Heater	4.7%	0.09	0.00	55,570
Water Heating	Water Heater	68.7%	0.19	0.13	1,651,292
Food Preparation	Oven	25.1%	0.02	0.00	56,768
Food Preparation	Fryer	7.5%	0.12	0.01	114,766
Food Preparation	Broiler	13.7%	0.04	0.01	67,939
Food Preparation	Griddle	16.7%	0.03	0.00	61,216
Food Preparation	Range	18.3%	0.03	0.01	69,753
Food Preparation	Steamer	2.0%	0.03	0.00	8,759
Food Preparation	Commercial Food Prep Other	0.1%	0.01	0.00	69
Miscellaneous	Pool Heater	0.9%	0.00	0.00	356
Miscellaneous	Other Miscellaneous	100.0%	0.01	0.01	149,731
<b>Total</b>				<b>0.45</b>	<b>5,734,759</b>

# Commercial Baseline Projection - Washington

- Baseline projection provides foundation for estimating potential future savings from conservation initiatives and reflects
  - Customer growth (from Avista)
  - Building Codes and appliance standards in place at end of 2015 (AEG database)
  - Frozen efficiency
  - Does not include future utility programs
- Baseline projection increases 23% between 2015 and 2036, or an average of 1% per year

**Commercial Baseline Energy Projection (DTh)**

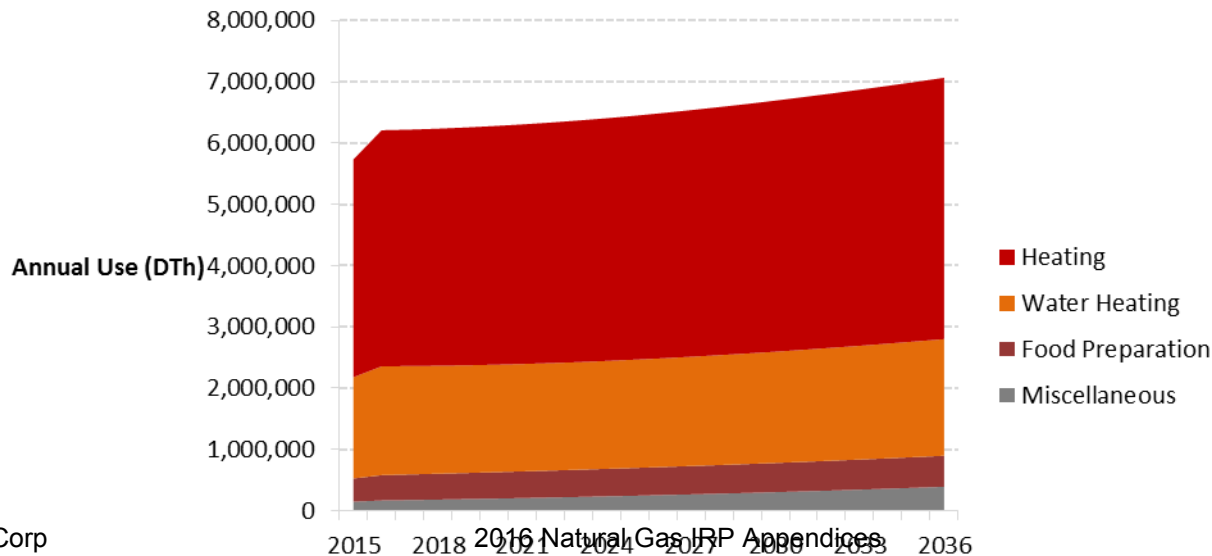

# Estimating Conservation Potential

- The study analyzed 100 measures covering residential, commercial and industrial sectors.
- Cost-effectiveness screening to estimate economic potential was done using utility cost test for Washington and Idaho, and using the TRC for Oregon
- Customer adoption or “ramp rates” are needed to estimate achievable potential. The study used regional ramp rates to start and then calibrated based on Avista’s program history
- The study uses AEG’s LoadMAP model to estimate potential

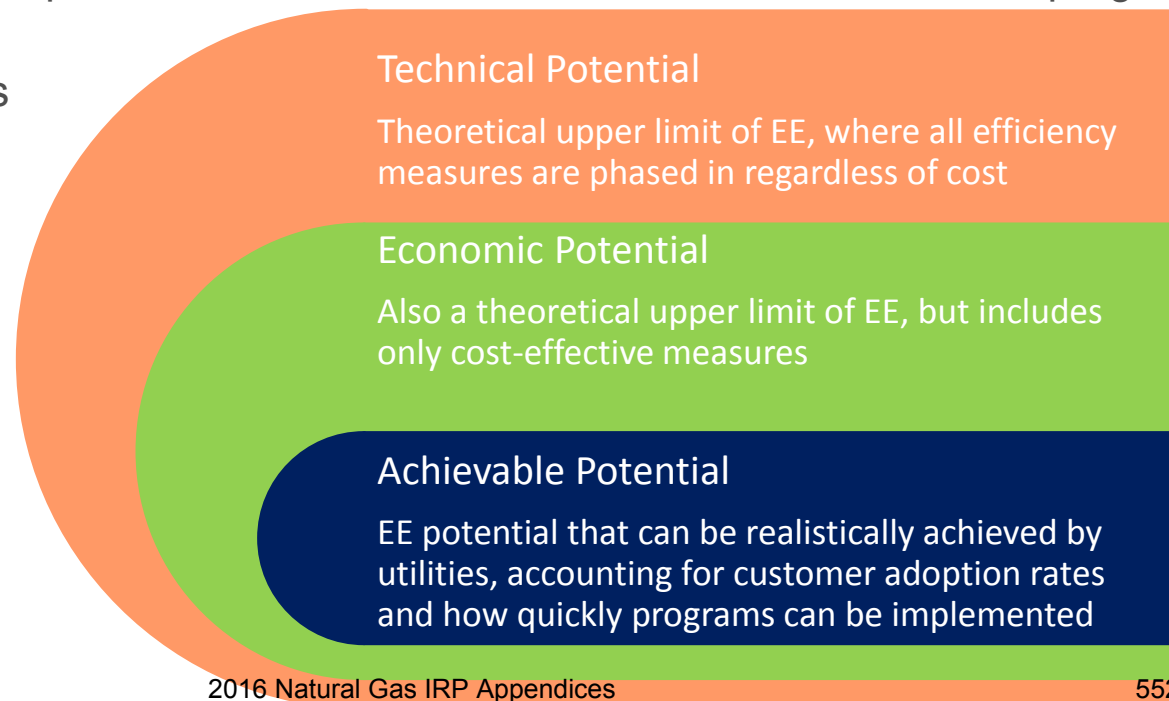

# Commercial Savings Potential - Washington

From 2017 to 2018, cumulative achievable potential energy savings are 53,246 DTh or 0.9% of the baseline.

By 2036, cumulative savings are over 12% of the baseline projection, or about 0.7% per year.

	2017	2018	2021	2026	2036
<b>Baseline Projection (DTh)</b>	<b>6,220,478</b>	<b>6,236,027</b>	<b>6,305,231</b>	<b>6,490,547</b>	<b>7,066,197</b>
<b>Cumulative Savings (DTh)</b>					
Achievable Potential	22,978	53,246	176,816	413,219	878,225
Economic Potential	70,810	140,765	339,275	637,762	1,124,744
Technical Potential	108,572	214,053	512,953	960,878	1,686,375
<b>Energy Savings (% of Baseline)</b>					
Achievable Potential	0.4%	0.9%	2.8%	6.4%	12.4%
Economic Potential	1.1%	2.3%	5.4%	9.8%	15.9%
Technical Potential	1.7%	3.4%	8.1%	14.8%	23.9%

Uses the UCT cost effectiveness test

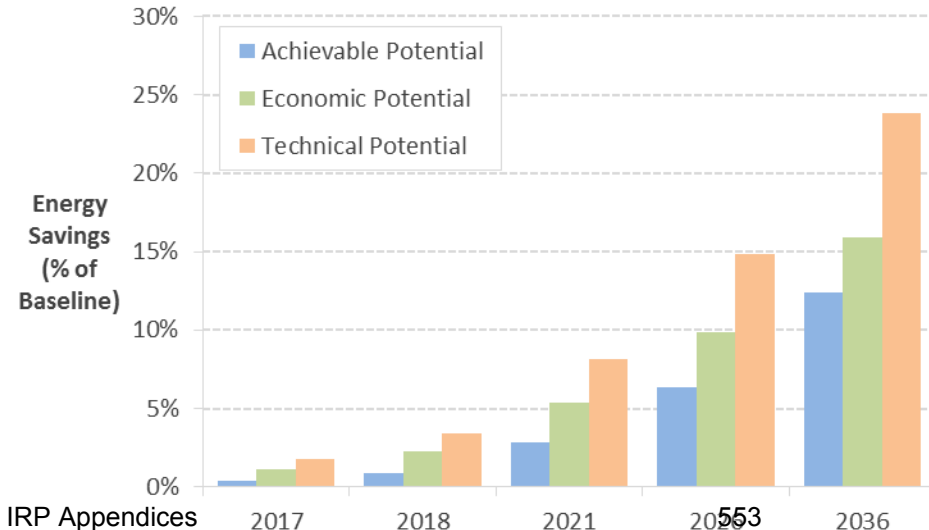
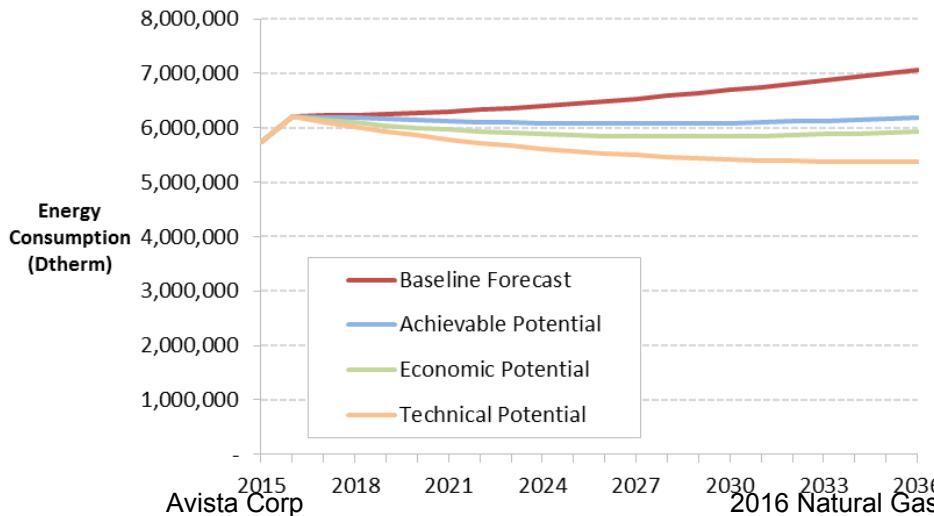

# Commercial Savings Potential - Washington

Cumulative achievable potential in 2018

Cumulative Achievable Potential in 2018

Rank	Measure / Technology	2018 Achievable Savings (Cum. DTh)	% of Total
1	Retrocommissioning	13,476	25.3%
2	Heating – Boiler (EF 0.96)	11,887	22.3%
3	Gas Boiler - Hot Water Reset	5,159	9.7%
4	Heating – Furnace (EF 0.96)	4,102	7.7%
5	Insulation - Ceiling	3,360	6.3%
6	Water Heating - Water Heater (Tankless)	2,826	5.3%
7	Water Heater - Faucet Aerators/Low Flow Nozzles	2,150	4.0%
8	Water Heater - Central Controls	1,979	3.7%
9	Strategic Energy Management	1,784	3.4%
10	Water Heater - Pre-Rinse Spray Valve	1,564	2.9%
11	Gas Boiler - Parallel Positioning Control	1,540	2.9%
12	Food Preparation – Fryer (ENERGY STAR)	740	1.4%
13	Steam Trap Maintenance	657	1.2%
14	Food Preparation - Oven (ENERGY STAR)	386	0.7%
15	HVAC - Shut Off Damper	304	0.6%
16	Food Preparation - Griddle (ENERGY STAR)	235	0.4%
17	Windows - High Efficiency	223	0.4%
18	Water Heater - Pipe Insulation	204	0.4%
19	Food Preparation - Steamer (ENERGY STAR)	184	0.3%
20	Heating - Unit Heater (Condensing)	171	0.3%
<b>Total</b>		<b>52,973</b>	<b>99.4%</b>

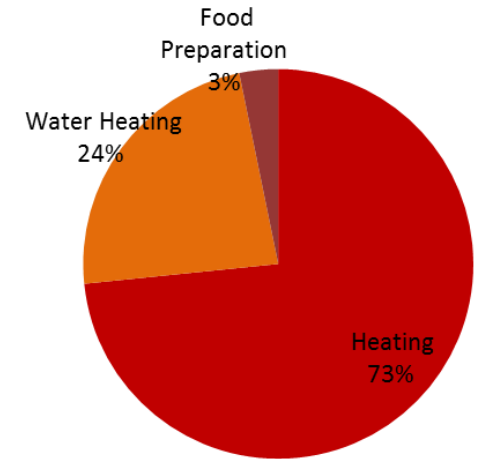

Cumulative Achievable Potential (DTh)

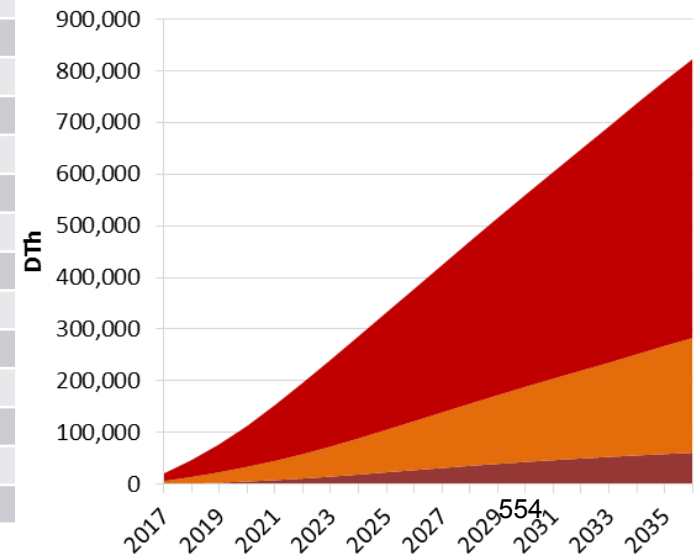

AVC Corp 2016 Natural Gas Efficiency Appendices

# Industrial Energy Market Profile - Washington

- This market profile represents the Industrial sector as a whole. The industrial sector is not large enough to warrant further segmentation.

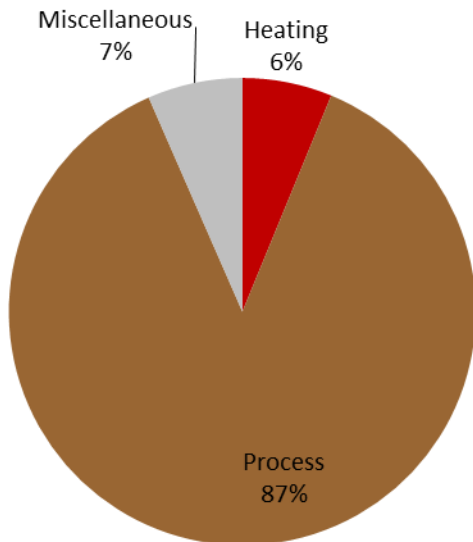

## Washington

### Industrial

Total Sq Ft: 3,567,948

DTh 268,452

End Use	Technology	Saturation	EUI (Therms)	Intensity (Therms/sqft)	Usage (Dth)
Space Heating	Furnace	56.5%	0.028	0.02	5,563
Space Heating	Boiler	34.4%	0.089	0.03	10,891
Space Heating	Other Heating	4.9%	0.014	0.00	239
Process	Process Heating	100.0%	0.369	0.37	131,596
Process	Process Boiler	100.0%	0.282	0.28	100,538
Process	Process Cooling	100.0%	0.001	0.00	407
Process	Other Process	100.0%	0.004	0.00	1,580
Other	Other Uses	100.0%	0.049	0.05	17,638
<b>Total</b>				<b>0.75</b>	<b>268,452</b>

# Industrial Baseline Projection - Washington

- Baseline projection provides foundation for estimating potential future savings from conservation initiatives and reflects
  - Customer growth (from Avista)
  - Building Codes and appliance standards in place at end of 2015 (AEG database)
  - Frozen efficiency
  - Does not include future utility programs
- Baseline projection increases 35% between 2015 and 2036, or an average of 1.4% per year

**Industrial Baseline Energy Projection (DTh)**

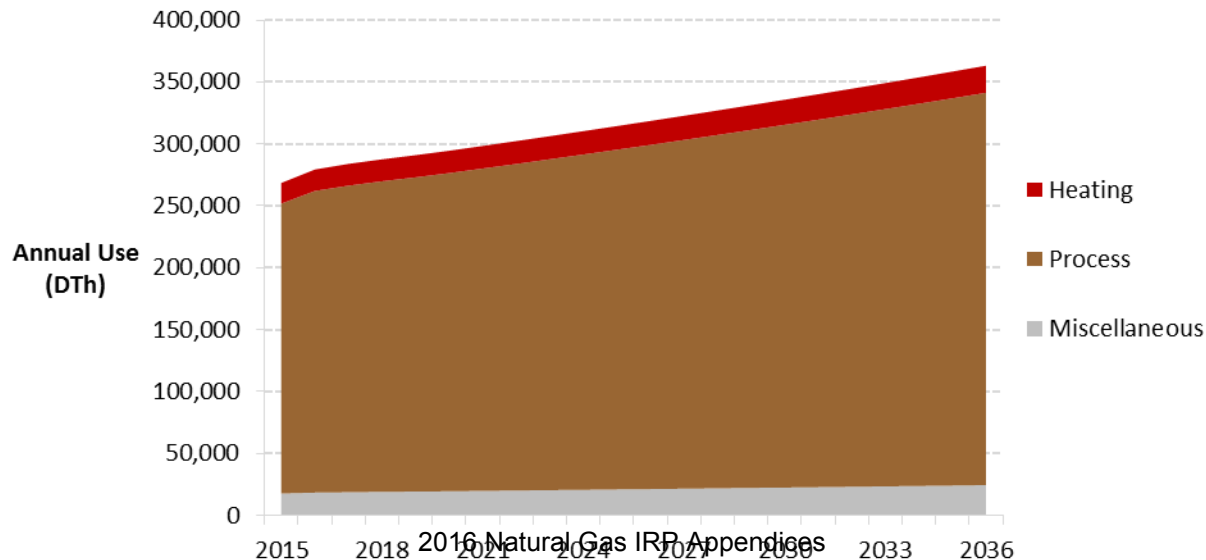



# Industrial Savings Potential - Washington

From 2017 to 2018, cumulative achievable potential energy savings are 777 DTh or 0.3% of the baseline.

By 2036, cumulative savings are 2.3% of the baseline projection, or about 0.1% per year.

Uses the UCT cost effectiveness test

	2017	2018	2021	2026	2036
<b>Baseline Projection (DTh)</b>	<b>283,824</b>	<b>287,571</b>	<b>298,345</b>	<b>318,546</b>	<b>363,144</b>
<b>Cumulative Savings (DTh)</b>					
Achievable Potential	383	777	1,993	4,050	8,414
Economic Potential	876	1,757	4,413	8,941	18,457
Technical Potential	3,195	6,425	16,314	33,603	71,042
<b>Energy Savings (% of Baseline)</b>					
Achievable Potential	0.1%	0.3%	0.7%	1.3%	2.3%
Economic Potential	0.3%	0.6%	1.5%	2.8%	5.1%
Technical Potential	1.1%	2.2%	5.5%	10.5%	19.6%

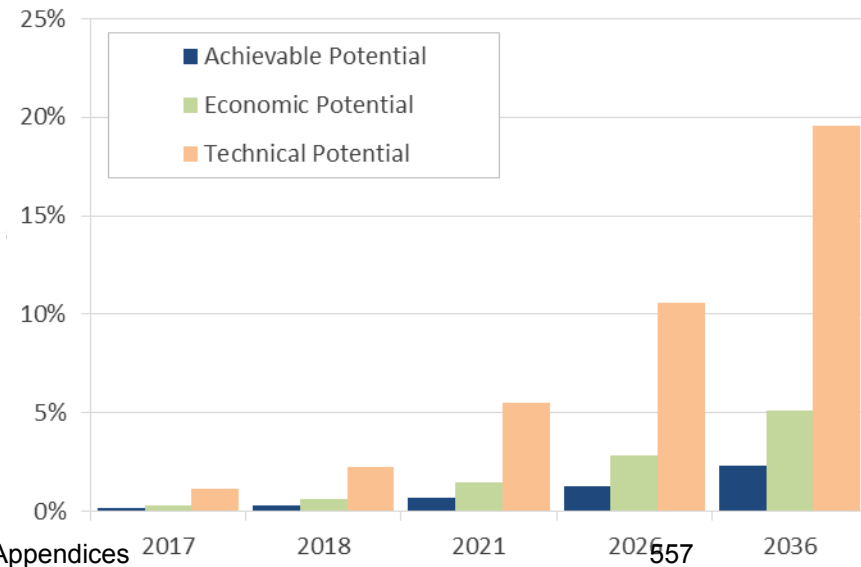
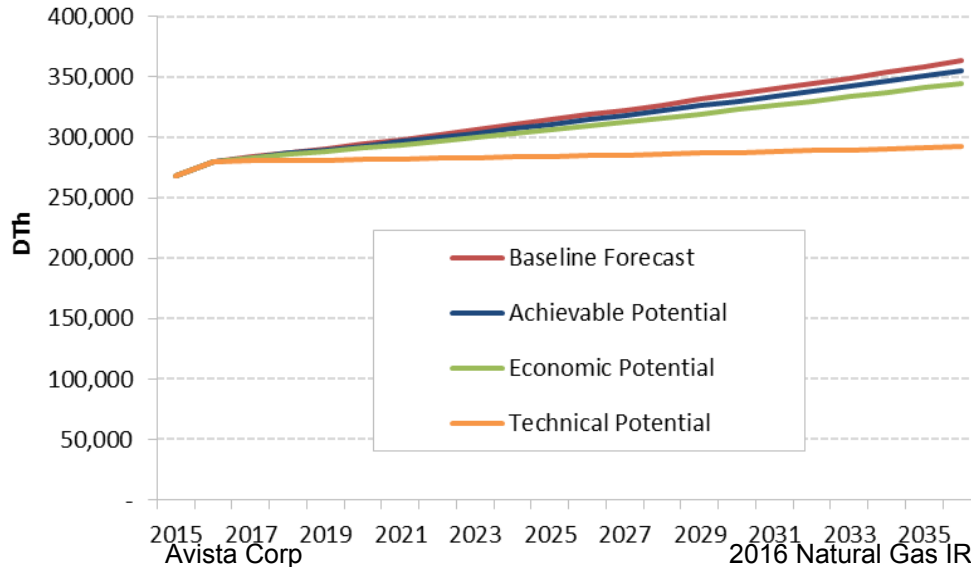

# Industrial Savings Potential - Washington

Cumulative achievable potential in 2018

Cumulative Achievable Potential in 2018

Rank	Measure / Technology	2018 Achievable Savings (Cum. DTh)	% of Total
1	Custom	415	53.5%
2	Boiler - Hot Water Reset	205	26.4%
3	Boiler - Parallel Positioning Control	97	12.5%
4	Boiler - Maintenance	46	5.9%
5	Steam Trap Maintenance	11	1.5%
6	Gas Furnace - Maintenance	2	0.3%
	<b>Total</b>	<b>777</b>	<b>100.0%</b>

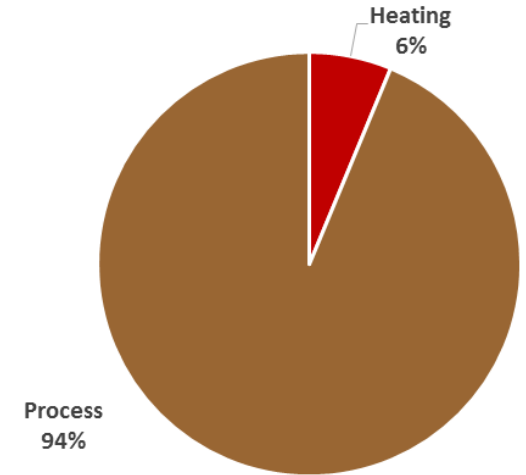

Cumulative Achievable Potential (DTh)

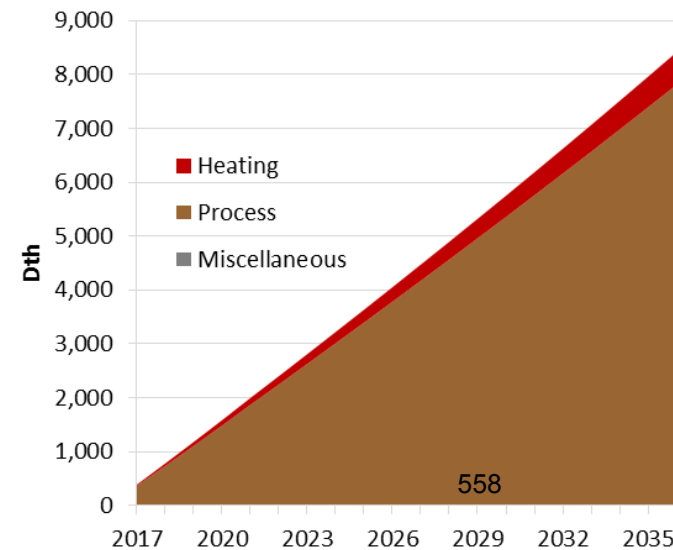



# Idaho

# High-level Market Characterization - Idaho

**2015 Natural Gas Sales by Sector**

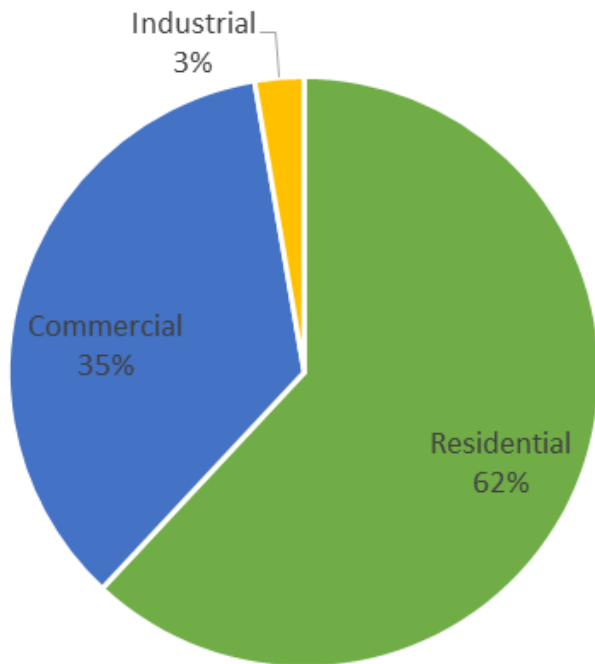

Segment	Annual Sales (DTh)	% of Sales
Residential	4,304,740	62%
Commercial	2,456,621	35%
Industrial	187,203	3%
<b>Total</b>	<b>6,948,564</b>	<b>100%</b>

# Residential Market Characterization - Idaho

Idaho	2015 Sales (DTh)	# of Customers	Average Use per Household (Therms/HH)
Single Family	2,814,373	42,852	657
Multifamily	142,894	3,454	414
Mobile Home	174,973	3,172	552
Low Income	1,172,501	21,003	558
<b>Idaho Total</b>	<b>4,304,740</b>	<b>70,481</b>	<b>611</b>

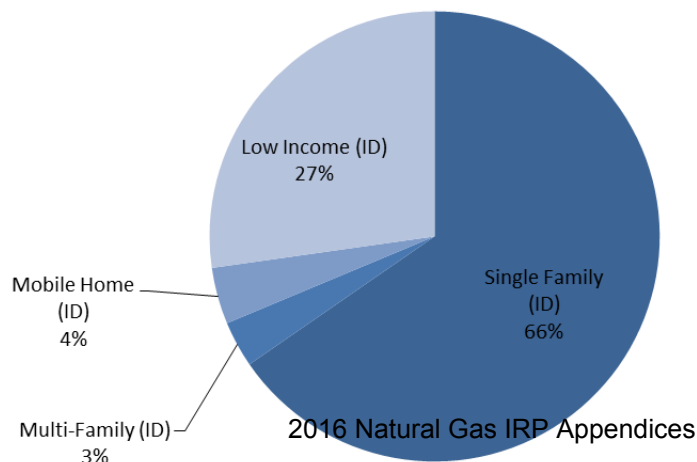

# Residential Market Profiles - Idaho

Base-year annual energy use by segment and end use

**Annual Use by End Use**

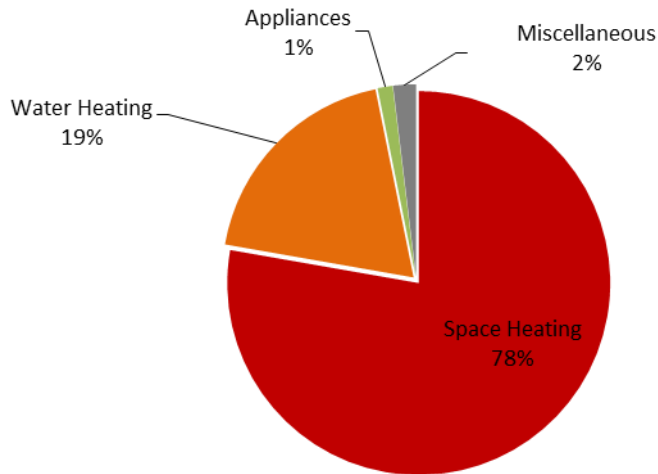

**Annual Intensity for Average Household**

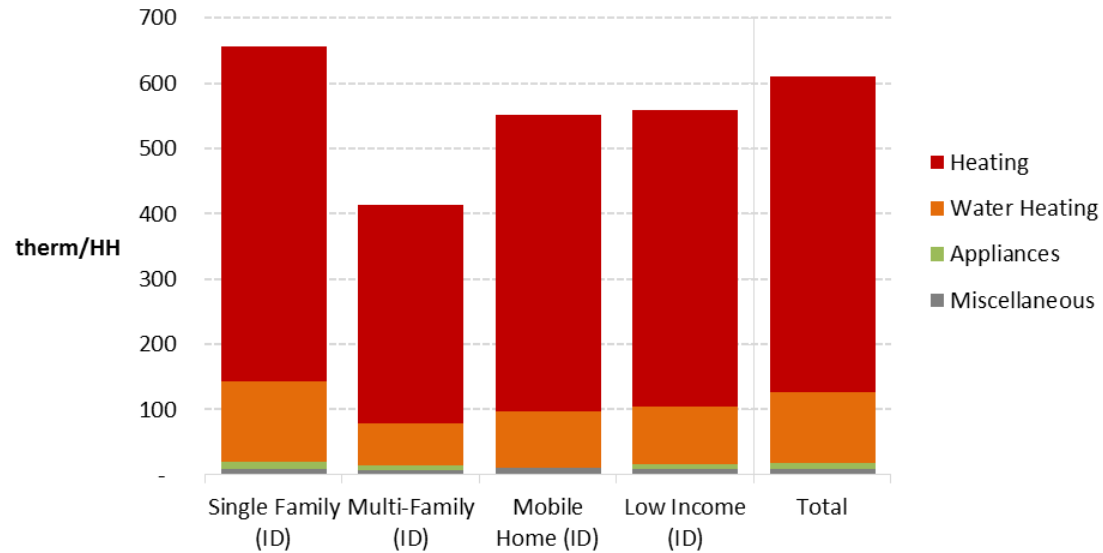

**Data Sources:**

- GenPOP Survey
- RBSA
- Utility billing data
- AEG Market Profiles Database
- Secondary data as needed to fill gaps

# Residential Energy Market Profile - Idaho

- This market profile represents the residential sector as a whole. Individual segment market profiles are provided in the report.
- Saturations were developed using the GenPOP residential survey as the primary data source.

		Idaho				
		Total				
Total Households:						70,481
		DTh				4,304,740
End Use	Technology	Saturation	UEC (Therms)	Intensity (Therms/	Usage (DTh)	
Space Heating	Furnace	84.2%	484.5	407.8	2,873,917	
Space Heating	Boiler	2.0%	579.2	11.8	83,322	
Space Heating	Other Heating	13.8%	466.4	64.4	453,852	
Water Heating	Water Heater	54.3%	200.8	109.1	768,890	
Appliances	Clothes Dryer	9.2%	29.0	2.7	18,876	
Appliances	Stove/Oven	9.2%	60.1	5.5	39,043	
Miscellaneous	Pool Heater	0.3%	217.4	0.6	4,134	
Miscellaneous	Miscellaneous	100.0%	8.9	8.9	62,706	
<b>Total</b>				<b>610.8</b>	<b>4,304,740</b>	

# Residential Baseline Projection - Idaho

- Baseline projection provides foundation for estimating potential future savings from conservation initiatives and reflects
  - Household growth and electricity price forecasts (from Avista)
  - Appliance standards in place at end of 2015 (AEG database)
  - Frozen efficiency
  - Does not include future utility programs
- Baseline projection increases 44% between 2015 and 2036, or an average of 1.7% per year

**Residential Baseline Energy Projection (DTh)**

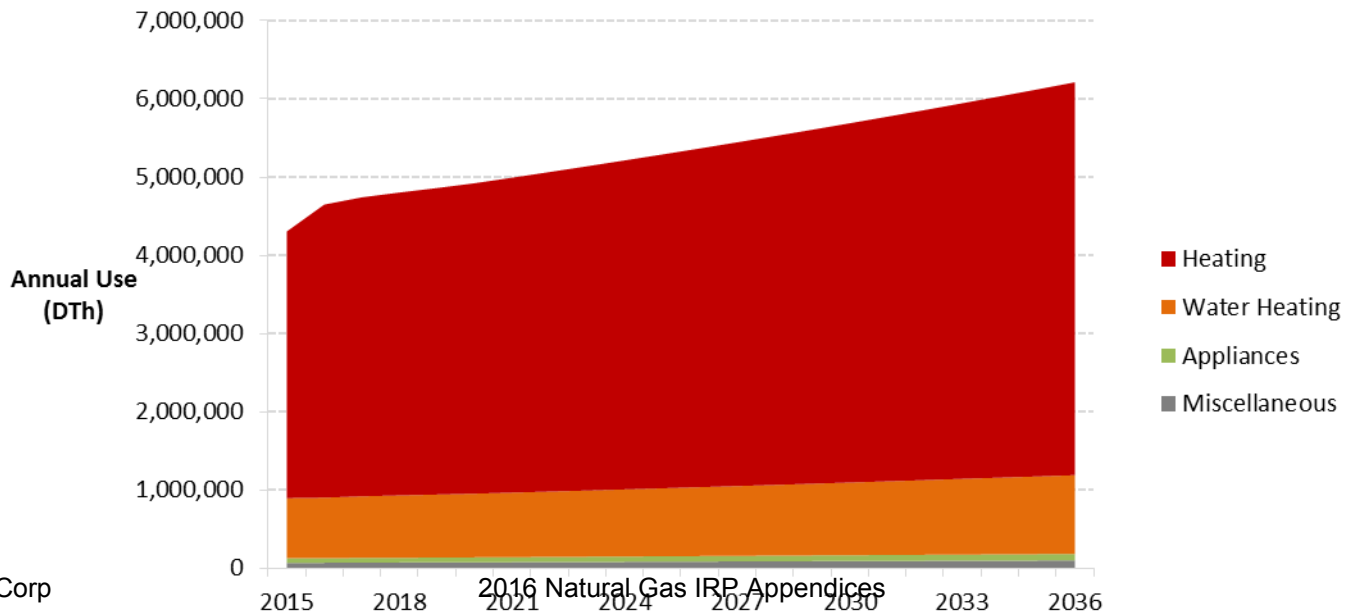



# Residential Savings Potential - Idaho

From 2017 to 2018, cumulative achievable potential energy savings are 62,492 DTh or 0.6% of the baseline.

By 2036, cumulative savings are almost 10% of the baseline projection, or about 0.5% per year.

	2017	2018	2021	2026	2036
<b>Baseline Projection (DTh)</b>	<b>4,741,736</b>	<b>4,802,813</b>	<b>4,992,555</b>	<b>5,366,588</b>	<b>6,213,091</b>
<b>Cumulative Savings (DTh)</b>					
Achievable Potential	11,138	25,406	85,812	208,875	536,817
Economic Potential	53,686	108,042	276,801	577,890	1,198,833
Technical Potential	82,162	165,579	422,556	873,781	1,776,196
<b>Energy Savings (% of Baseline)</b>					
Achievable Potential	0.2%	0.5%	1.7%	3.9%	8.6%
Economic Potential	1.1%	2.2%	5.5%	10.8%	19.3%
Technical Potential	1.7%	3.4%	8.5%	16.3%	28.6%

Uses the UCT cost effectiveness test

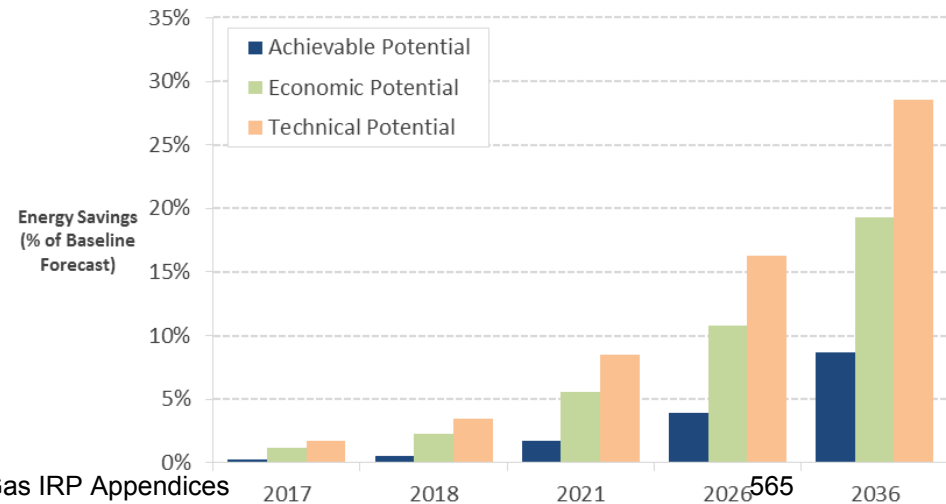
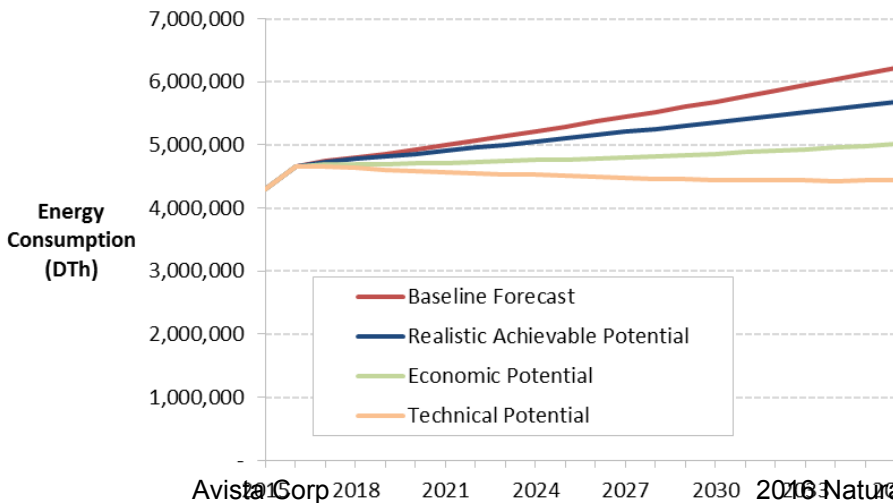

# Residential Savings Potential - Idaho

Cumulative achievable potential in 2018

Rank	Measure / Technology	2018 Achievable Savings (Cum. DTh)	% of Total
1	Windows - High Efficiency	9,778	38.5%
2	Heating – Furnace (EF 0.98)	6,692	26.3%
3	Furnace - Maintenance	1,821	7.2%
4	Water Heater - Low-Flow Showerheads	1,480	5.8%
5	Insulation - Ceiling	1,379	5.4%
6	Water Heater - Temperature Setback	1,365	5.4%
7	Thermostat - Programmable/Interactive	861	3.4%
8	Water Heater - Pipe Insulation	725	2.9%
9	Water Heating - Water Heater (EF 0.67)	660	2.6%
10	Heating – Boiler (EF 0.98)	235	0.9%
11	Water Heater - Faucet Aerators	219	0.9%
12	Boiler - Maintenance	106	0.4%
13	Boiler - Pipe Insulation	86	0.3%
	<b>Total</b>	<b>25,406</b>	<b>100%</b>

Cumulative Achievable Potential in 2018

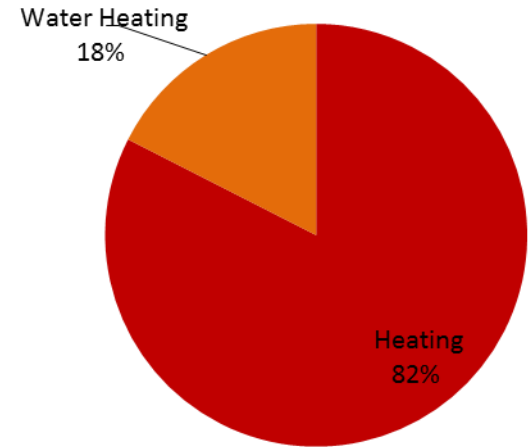

Cumulative Achievable Potential (DTh)

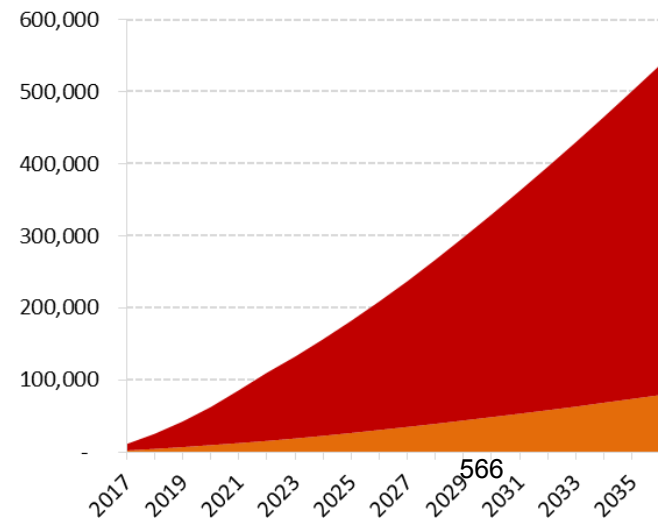

# Commercial Market Characterization - Idaho

Idaho	2015 Sales (DTh)	Floor Space (sq. ft.)	Intensity (therms/sqft)
Office	214,228	8,388,655	0.26
Restaurant	55,373	253,503	2.18
Retail	314,742	10,531,910	0.30
Grocery	97,810	1,682,340	0.58
School	387,333	9,633,126	0.40
College	360,160	4,540,014	0.79
Health	222,359	3,157,269	0.70
Lodging	135,614	2,627,216	0.52
Warehouse	110,269	5,484,890	0.20
Miscellaneous	558,735	10,601,048	0.53
<b>Idaho Total</b>	<b>2,456,621</b>	<b>56,899,971</b>	<b>0.43</b>

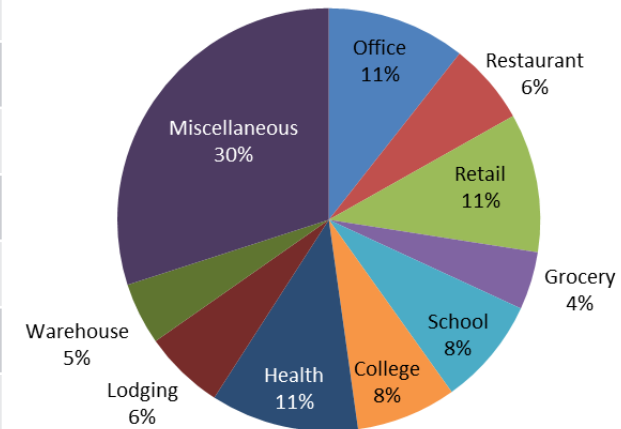

# Commercial Market Profiles - Idaho

Base-year annual energy use by segment and end use

Annual Use by End Use

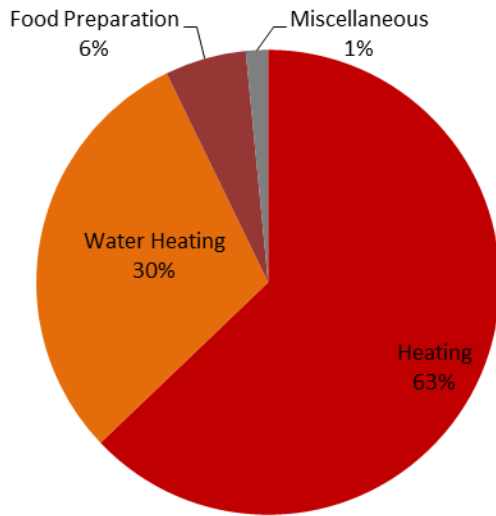

Annual Intensity per Square Foot

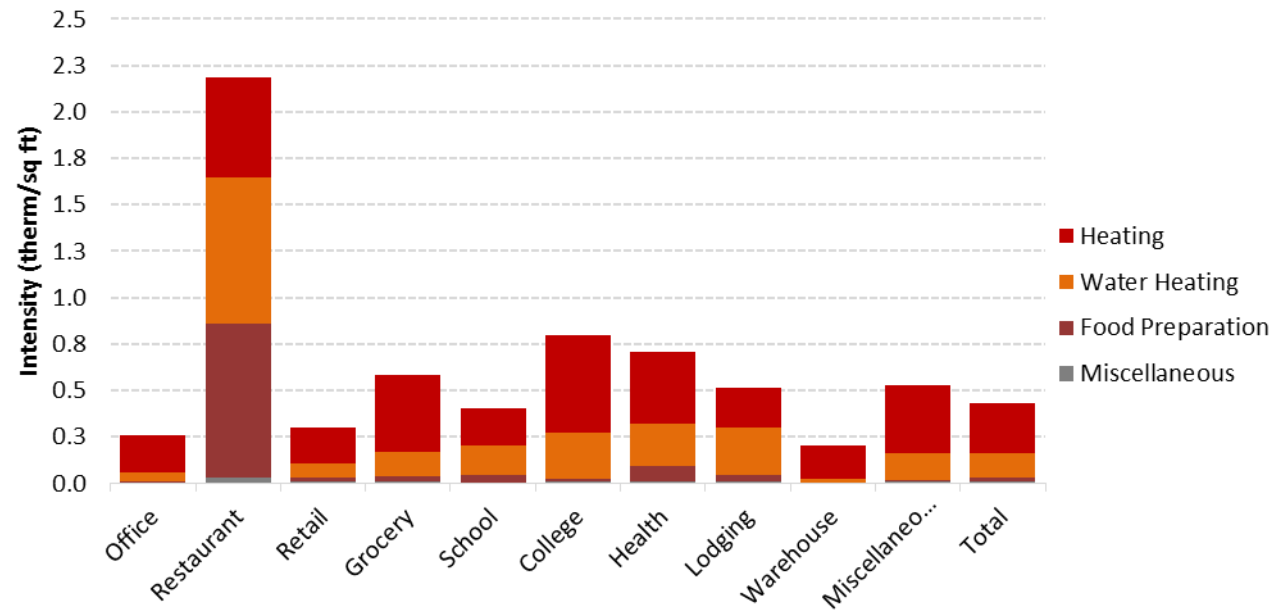

**Data Sources:**

- CBSA
- Utility billing data
- AEG Market Profiles Database
- Secondary data as needed to fill gaps

# Commercial Energy Market Profile - Idaho

- This market profile represents the Commercial sector as a whole. Individual segment market profiles are provided in the report.
- Saturations were developed using the CBSA survey as the primary data source.

## Gas Market Profiles

End Use	Technology	Saturation	EUI (therm)	Intensity (therm/Sqft)	Usage (DTh)
Heating	Furnace	51.2%	0.20	0.10	588,380
Heating	Boiler	36.0%	0.45	0.16	930,819
Heating	Unit Heater	4.9%	0.09	0.00	25,385
Water Heating	Water Heater	69.3%	0.19	0.13	734,648
Food Preparation	Oven	24.5%	0.02	0.00	27,505
Food Preparation	Fryer	7.7%	0.09	0.01	40,765
Food Preparation	Broiler	14.0%	0.03	0.00	22,933
Food Preparation	Griddle	16.3%	0.02	0.00	20,023
Food Preparation	Range	18.3%	0.02	0.00	23,972
Food Preparation	Steamer	3.0%	0.02	0.00	4,249
Food Preparation	Commercial Food Prep Other	0.1%	0.00	0.00	29
Miscellaneous	Pool Heater	0.8%	0.00	0.00	119
Miscellaneous	Other Miscellaneous	100.0%	0.01	0.01	37,793
<b>Total</b>				<b>0.43</b>	<b>2,456,621</b>

# Commercial Baseline Projection - Idaho

- Baseline projection provides foundation for estimating potential future savings from conservation initiatives and reflects
  - Customer growth (from Avista)
  - Building Codes and appliance standards in place at end of 2015 (AEG database)
  - Frozen efficiency
  - Does not include future utility programs
- Baseline projection increases 23% between 2015 and 2036, or an average of 1% per year

**Commercial Baseline Energy Projection (DTh)**

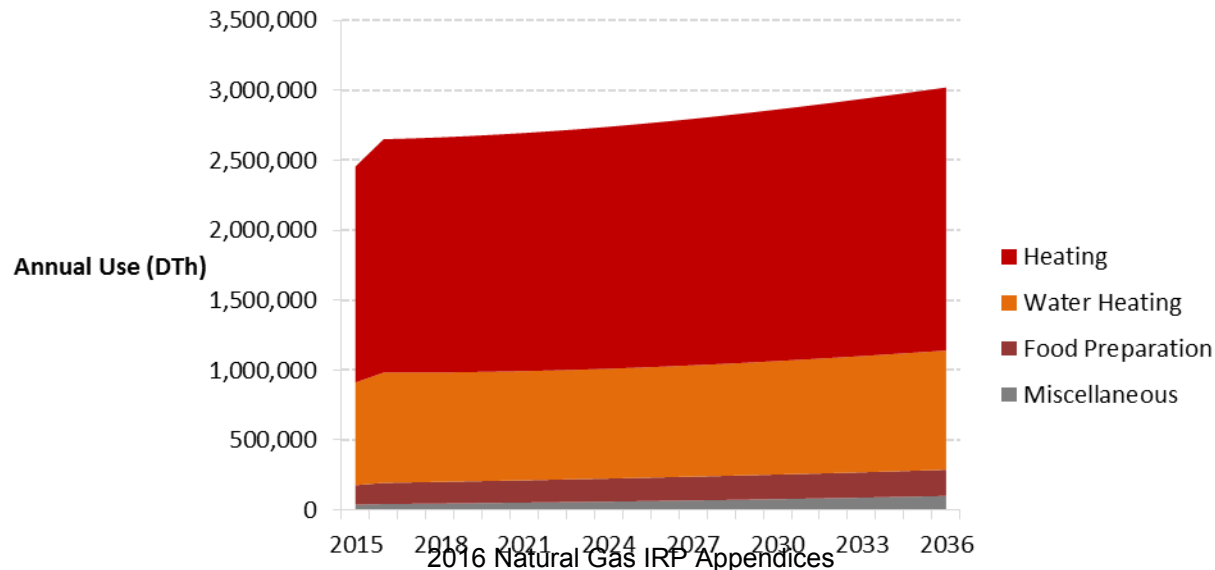

# Commercial Savings Potential - Idaho

From 2017 to 2018, cumulative achievable potential energy savings are 21,619 DTh or 0.8% of the baseline.

By 2036, cumulative savings are almost 12% of the baseline projection, or about 0.6% per year.

	2017	2018	2021	2026	2036
<b>Baseline Projection (DTh)</b>	<b>2,656,853</b>	<b>2,664,007</b>	<b>2,695,763</b>	<b>2,776,753</b>	<b>3,021,253</b>
<b>Cumulative Savings (DTh)</b>					
Achievable Potential	9,311	21,619	72,680	170,883	359,503
Economic Potential	29,135	58,035	140,114	263,474	459,135
Technical Potential	47,785	94,237	226,002	423,332	744,715
<b>Energy Savings (% of Baseline)</b>					
Achievable Potential	0.4%	0.8%	2.7%	6.2%	11.9%
Economic Potential	1.1%	2.2%	5.2%	9.5%	15.2%
Technical Potential	1.8%	3.5%	8.4%	15.2%	24.6%

Uses the UCT cost effectiveness test

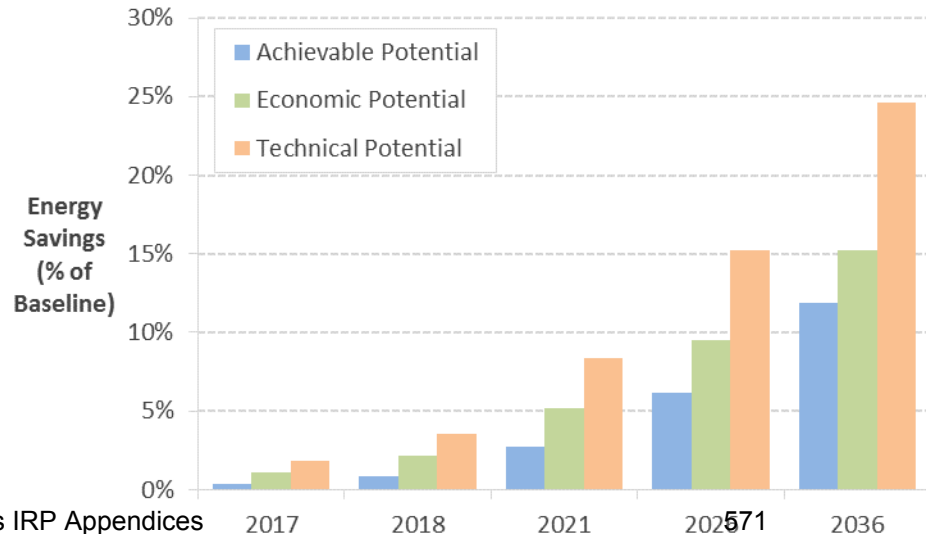
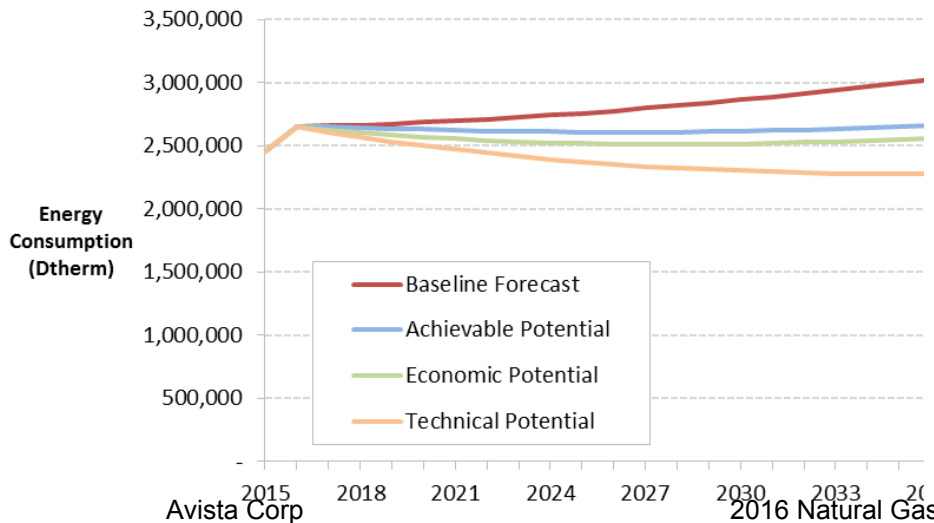

# Commercial Savings Potential - Idaho

Cumulative achievable potential in 2018

Cumulative Achievable Potential in 2018

Rank	Measure / Technology	2018 Achievable Savings (Cum. DTh)	% of Total
1	Retrocommissioning	5,761	26.6%
2	Heating – Boiler (EF 0.96)	4,812	22.3%
3	Gas Boiler - Hot Water Reset	2,364	10.9%
4	Heating – Furnace (EF 0.96)	1,919	8.9%
5	Water Heating - Water Heater (Tankless)	1,343	6.2%
6	Insulation - Ceiling	1,105	5.1%
7	Water Heater - Faucet Aerators/Low Flow Nozzles	955	4.4%
8	Water Heater - Central Controls	892	4.1%
9	Water Heater - Pre-Rinse Spray Valve	631	2.9%
10	Gas Boiler - Parallel Positioning Control	598	2.8%
11	Steam Trap Maintenance	294	1.4%
12	Food Preparation – Fryer (ENERGY STAR)	264	1.2%
13	Food Preparation – Oven (ENERGY STAR)	188	0.9%
14	Water Heater - Pipe Insulation	91	0.4%
15	Food Preparation - Steamer (ENERGY STAR)	90	0.4%
16	Food Preparation - Griddle (ENERGY STAR)	77	0.4%
17	Windows - High Efficiency	77	0.4%
18	Food Preparation - Broiler (ENERGY STAR)	55	0.3%
19	Heating - Unit Heater (Condensing)	47	0.2%
20	HVAC - Duct Repair and Sealing	27	0.1%
<b>Total</b>		<b>21,592</b>	<b>100%</b>

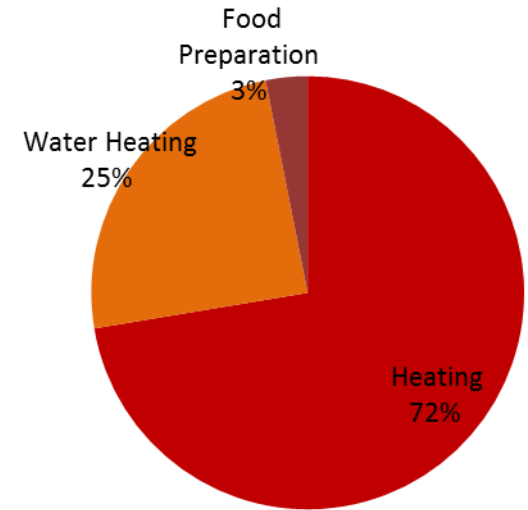

Cumulative Achievable Potential (DTh)

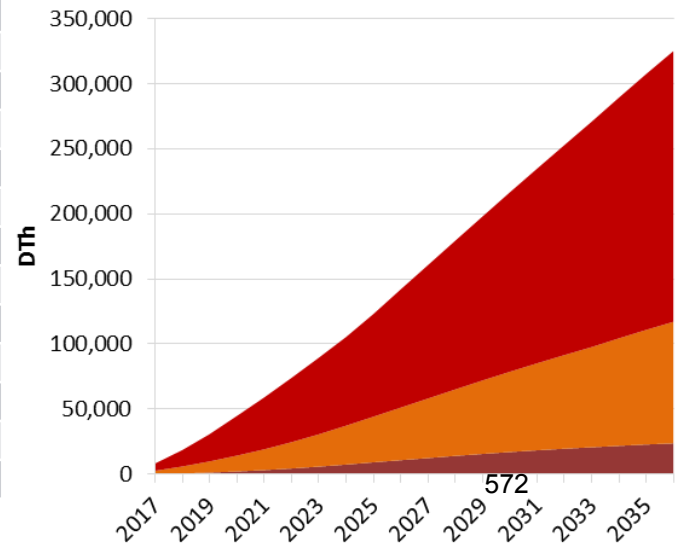



# Industrial Energy Market Profile - Idaho

- This market profile represents the Industrial sector as a whole. The industrial sector is not large enough to warrant further segmentation.

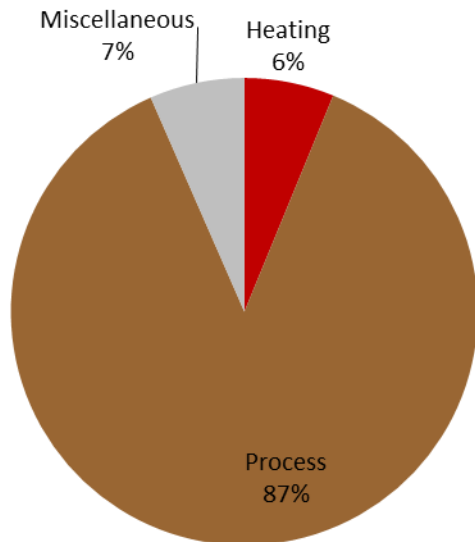

**Idaho  
Industrial**

Total Sq Ft: **2,596,257**

---

DTh **187,203**

---

End Use	Technology	Saturation	EUI (Therms)	Intensity (Therms/sqft)	Usage (Dth)
Space Heating	Furnace	56.5%	0.026	0.01	3,879
Space Heating	Boiler	34.4%	0.085	0.03	7,595
Space Heating	Other Heating	4.9%	0.013	0.00	167
Process	Process Heating	100.0%	0.353	0.35	91,768
Process	Process Boiler	100.0%	0.270	0.27	70,109
Process	Process Cooling	100.0%	0.001	0.00	284
Process	Other Process	100.0%	0.004	0.00	1,102
Other	Other Uses	100.0%	0.047	0.05	12,299
<b>Total</b>				<b>0.72</b>	<b>187,203</b>

# Industrial Baseline Projection - Idaho

- Baseline projection provides foundation for estimating potential future savings from conservation initiatives and reflects
  - Customer growth (from Avista)
  - Building Codes and appliance standards in place at end of 2015 (AEG database)
  - Frozen efficiency
  - Does not include future utility programs
- Baseline projection increases 70% between 2015 and 2036, or an average of 2.5% per year

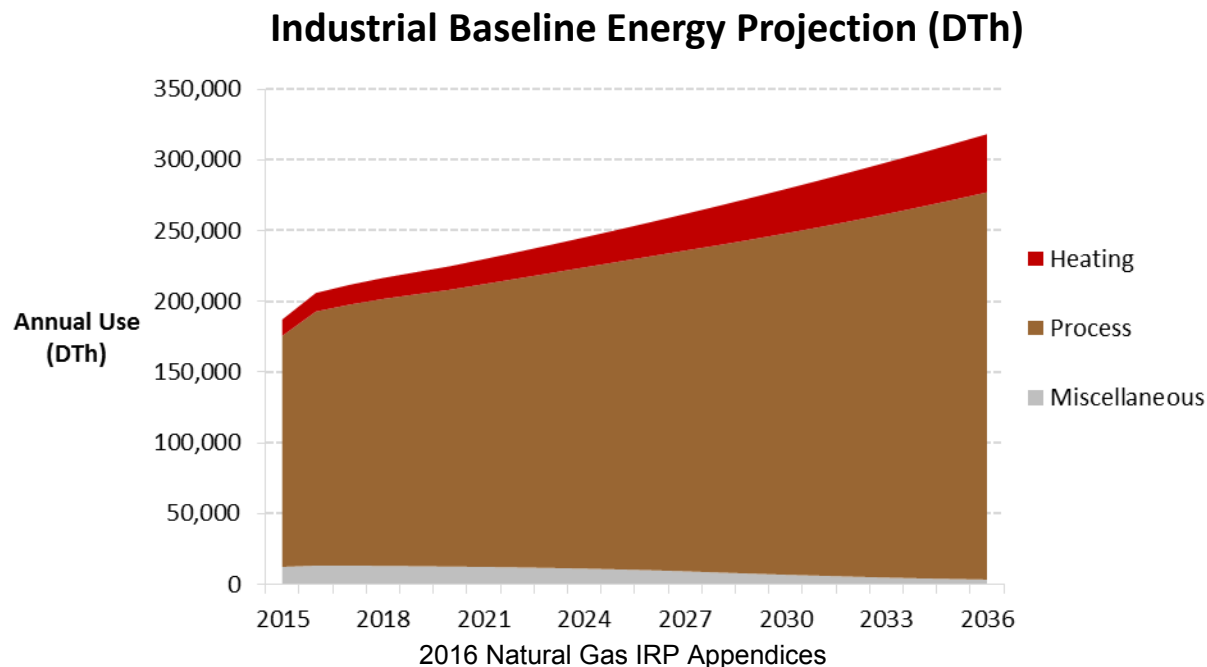

# Industrial Savings Potential - Idaho

From 2017 to 2018, cumulative achievable potential energy savings are 641 DTh or 0.3% of the baseline.

By 2036, cumulative savings are 4.3% of the baseline projection, or about 0.1% per year.

	2017	2018	2021	2026	2036
<b>Baseline Projection (DTh)</b>	<b>211,629</b>	<b>216,490</b>	<b>229,739</b>	<b>256,083</b>	<b>318,182</b>
<b>Cumulative Savings (DTh)</b>					
Achievable Potential	306	641	1,809	4,411	13,717
Economic Potential	700	1,450	4,005	9,723	29,846
Technical Potential	2,446	5,049	13,661	31,578	81,807
<b>Energy Savings (% of Baseline)</b>					
Achievable Potential	0.1%	0.3%	0.8%	1.7%	4.3%
Economic Potential	0.3%	0.7%	1.7%	3.8%	9.4%
Technical Potential	1.2%	2.3%	5.9%	12.3%	25.7%

Uses the UCT cost effectiveness test

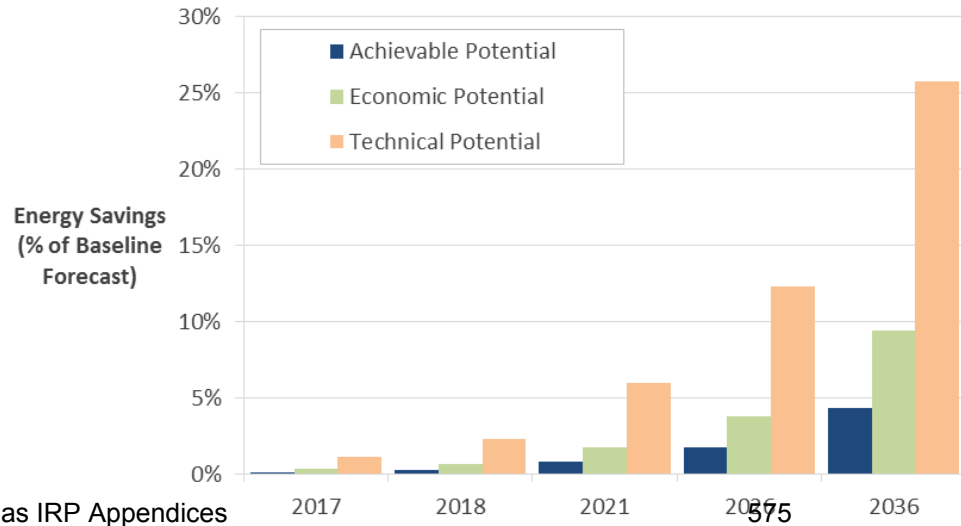
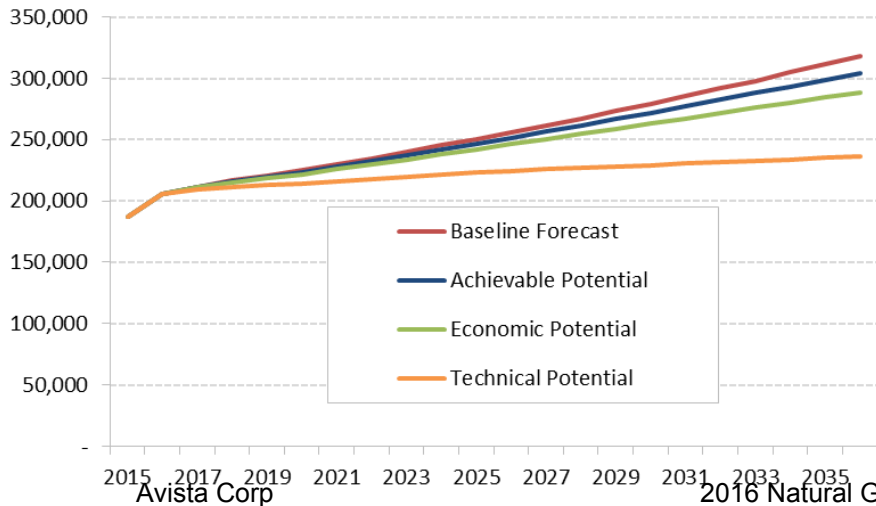

# Industrial Savings Potential- Idaho

Cumulative achievable potential in 2018

Cumulative Achievable Potential in 2018

Rank	Measure / Technology	2018 Achievable Savings (Cum. DTh)	% of Total
1	Custom	338	52.7%
2	Boiler - Hot Water Reset	171	26.7%
3	Boiler - Parallel Positioning Control	81	12.7%
4	Boiler - Maintenance	39	6.0%
5	Steam Trap Maintenance	10	1.5%
6	Gas Furnace - Maintenance	2	0.3%
	<b>Total</b>	<b>641</b>	<b>100.0%</b>

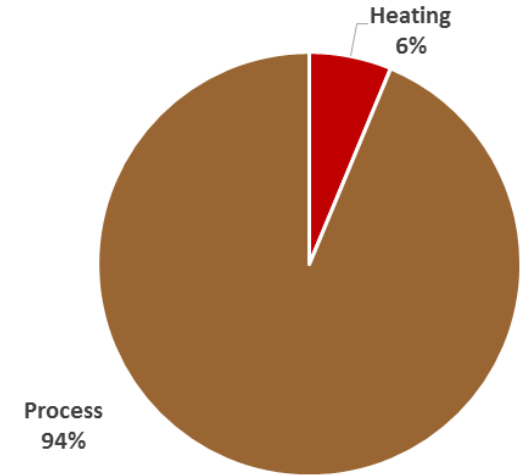

Cumulative Achievable Potential (DTh)

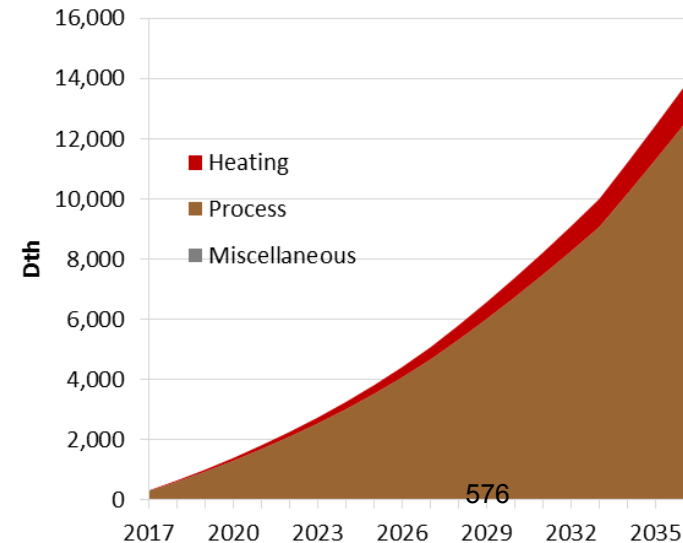



# Oregon

# High-level Market Characterization - Oregon

**2015 Natural Gas Sales by Sector**

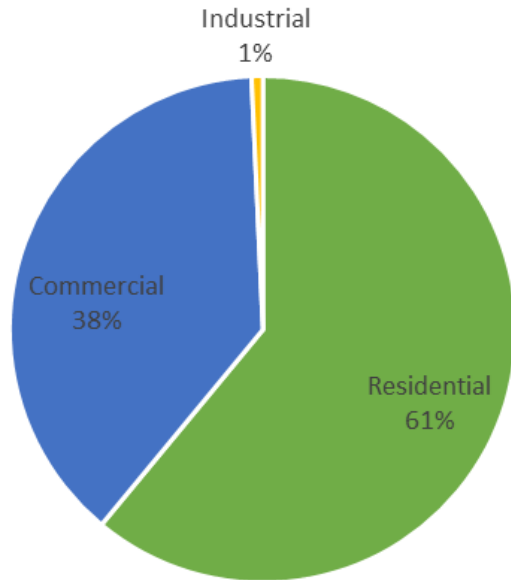

Segment	Annual Sales (DTh)	% of Sales
Residential	4,303,206	61%
Commercial	2,699,252	38%
Industrial	51,369	1%
<b>Total</b>	<b>7,053,827</b>	<b>100%</b>

# Residential Market Characterization - Oregon

Oregon	2015 Sales (DTh)	# of Customers	Average Use per Household (Therms/HH)
Single Family	2,811,856	53,617	524
Multifamily	81,940	2,480	330
Mobile Home	271,183	6,156	441
Low Income	1,138,226	25,534	446
<b>Oregon Total</b>	<b>4,303,206</b>	<b>87,787</b>	<b>490</b>

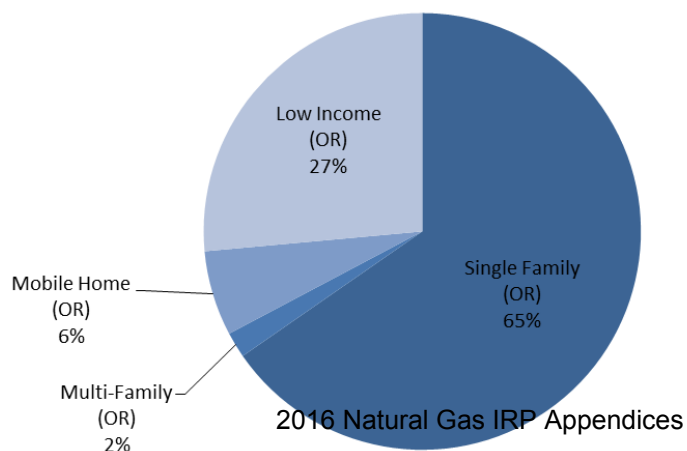

# Residential Market Profiles - Oregon

Base-year annual energy use by segment and end use

Annual Use by End Use

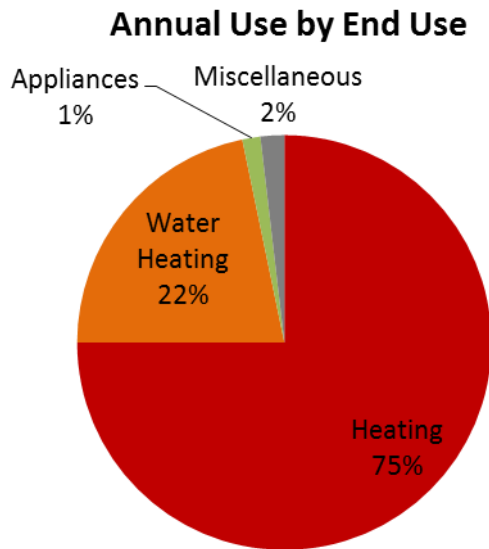

Annual Intensity for Average Household

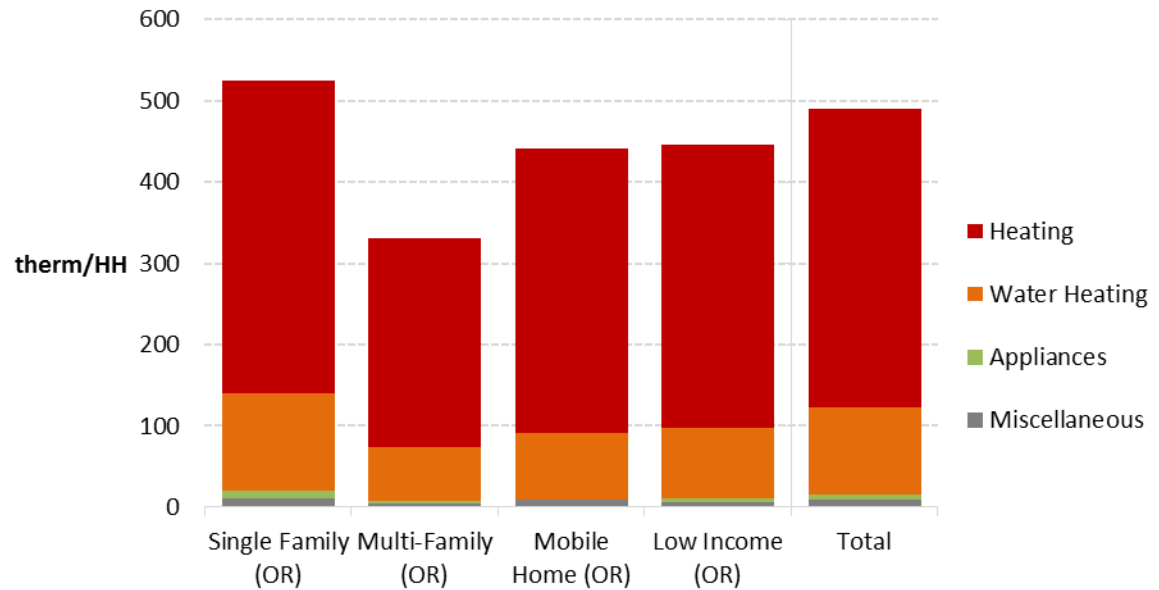

**Data Sources:**

- RBSA
- Utility billing data
- AEG Market Profiles Database
- Secondary data as needed to fill gaps



# Residential Energy Market Profile - Oregon

- This market profile represents the residential sector as a whole. Individual segment market profiles are provided in the report.
- Saturations were developed using the RBSA survey as the primary data source.

<b>Oregon</b>					
<b>Total</b>					
		Total Households:		87,787	
		DTh		4,303,206	
End Use	Technology	Saturation	UEC (Therms)	Intensity (Therms/	Usage (DTh)
Space Heating	Furnace	85.7%	368.1	315.3	2,767,781
Space Heating	Boiler	2.2%	433.3	9.3	82,038
Space Heating	Other Heating	12.2%	353.1	43.0	377,705
Water Heating	Water Heater	55.3%	192.8	106.6	935,460
Appliances	Clothes Dryer	7.6%	29.6	2.2	19,643
Appliances	Stove/Oven	7.8%	60.2	4.7	41,124
Miscellaneous	Pool Heater	0.5%	217.5	1.1	9,457
Miscellaneous	Miscellaneous	100.0%	8.0	8.0	69,999
<b>Total</b>				<b>490.2</b>	<b>4,303,206</b>

# Residential Baseline Projection - Oregon

- Baseline projection provides foundation for estimating potential future savings from conservation initiatives and reflects
  - Household growth and electricity price forecasts (from Avista)
  - Appliance standards in place at end of 2015 (AEG database)
  - Frozen efficiency
  - Does not include future utility programs
- Baseline projection increases 30% between 2015 and 2036, or an average of 1.2% per year

**Residential Baseline Energy Projection (DTh)**

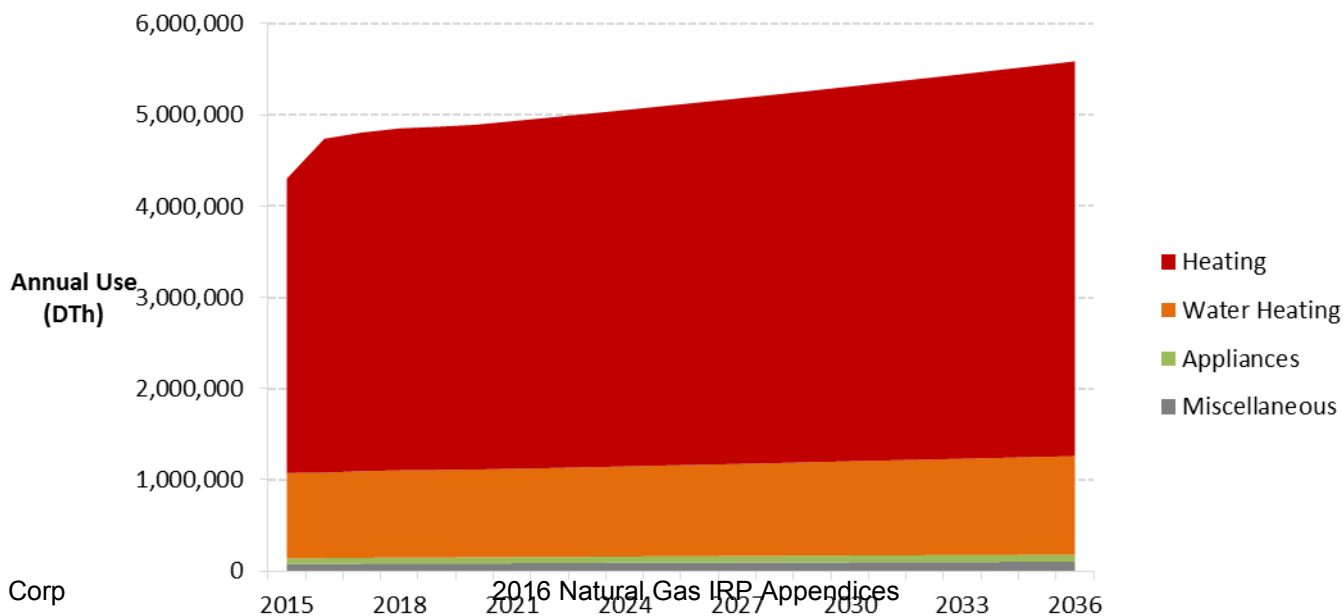

# Residential Savings Potential - Oregon

From 2017 to 2018, cumulative achievable potential energy savings are 13,839 DTh or 0.3% of the baseline.

By 2036, cumulative savings are almost 5% of the baseline projection, or about 0.2% per year.

	2017	2018	2021	2026	2036
<b>Baseline Projection (DTh)</b>	<b>4,808,069</b>	<b>4,852,168</b>	<b>4,931,394</b>	<b>5,137,402</b>	<b>5,588,507</b>
<b>Cumulative Savings (DTh)</b>					
Achievable Potential	6,507	13,839	38,671	94,086	260,939
Economic Potential	21,867	44,161	111,658	228,569	483,538
Technical Potential	83,073	167,062	418,531	844,811	1,615,605
<b>Energy Savings (% of Baseline)</b>					
Achievable Potential	0.1%	0.3%	0.8%	1.8%	4.7%
Economic Potential	0.5%	0.9%	2.3%	4.4%	8.7%
Technical Potential	1.7%	3.4%	8.5%	16.4%	28.9%

Uses the TRC cost effectiveness test

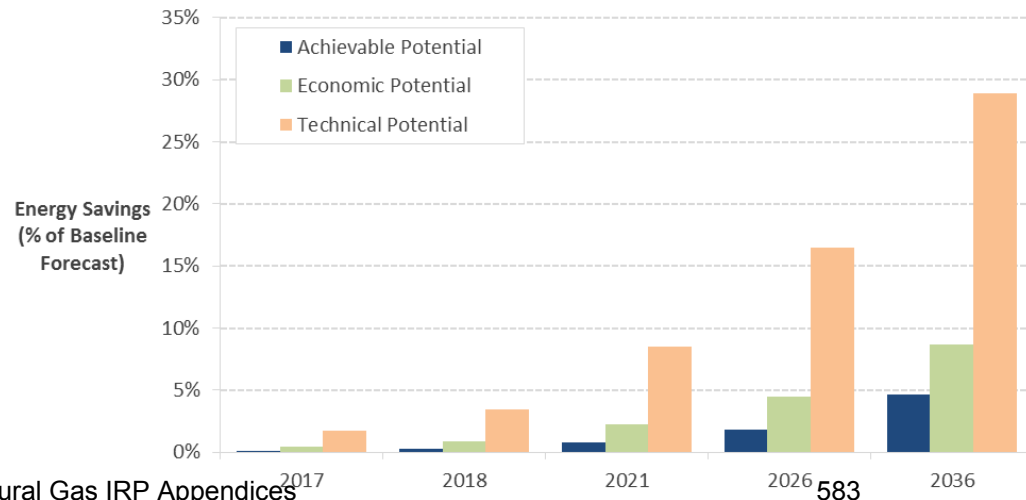
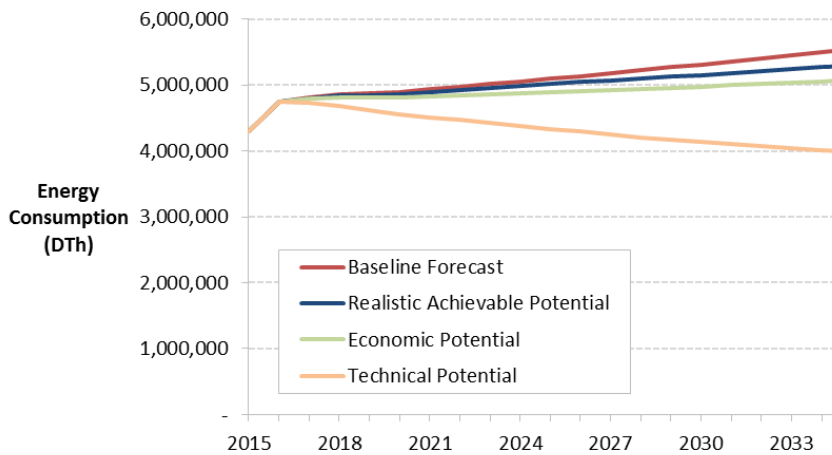

# Residential Savings Potential - Oregon

Cumulative achievable potential in 2018

Cumulative Achievable Potential in 2018

Rank	Measure / Technology	2018 Achievable Savings (Cum. DTh)	% of Total
1	Heating - Furnace	7,400	53.5%
2	Water Heater - Low-Flow Showerheads	1,743	12.6%
3	Water Heater - Temperature Setback	1,640	11.9%
4	Furnace - Maintenance	1,477	10.7%
5	Water Heater - Pipe Insulation	871	6.3%
6	Water Heater - Faucet Aerators	257	1.9%
7	Windows - High Efficiency	235	1.7%
8	Boiler - Maintenance	108	0.8%
9	Boiler - Pipe Insulation	86	0.6%
10	Heating – Boiler (EF 0.98)	22	0.2%
	<b>Total</b>	<b>13,839</b>	<b>100%</b>

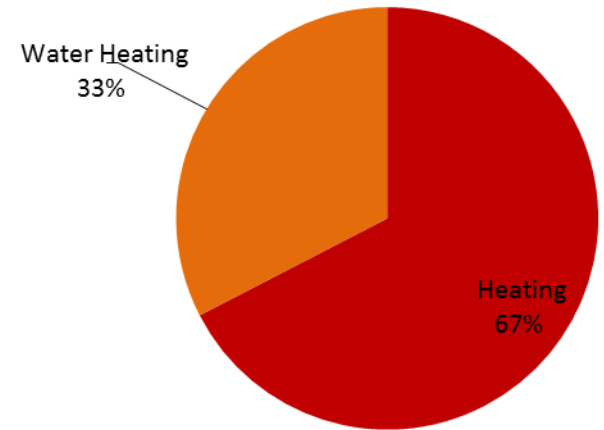

Cumulative Achievable Potential (DTh)

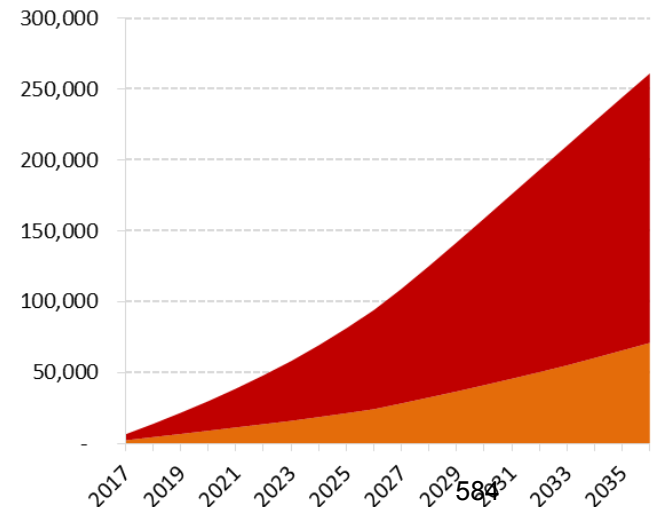

# Commercial Market Characterization - Oregon

Oregon	2015 Sales (DTh)	Floor Space (sq. ft.)	Intensity (therms/sqft)
Office	406,757	8,388,655	0.16
Restaurant	302,349	253,503	1.39
Retail	401,181	10,531,910	0.19
Grocery	173,578	1,682,340	0.37
School	273,450	9,633,126	0.26
College	34,880	4,540,014	0.50
Health	401,052	3,157,269	0.45
Lodging	174,610	2,627,216	0.33
Warehouse	143,426	5,484,890	0.13
Miscellaneous	387,969	10,601,048	0.34
<b>Oregon Total</b>	<b>2,699,252</b>	<b>56,899,971</b>	<b>0.27</b>

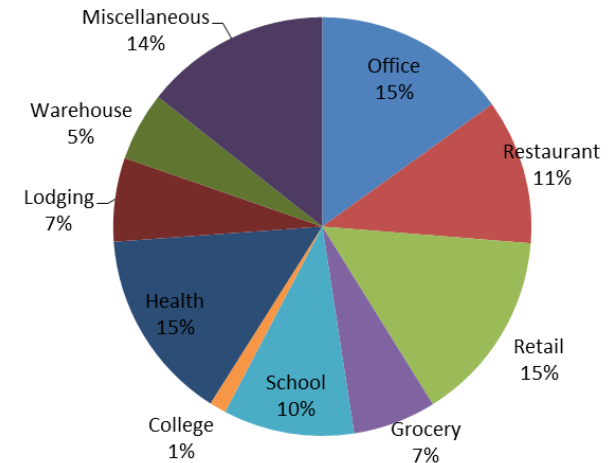

# Commercial Market Profiles - Oregon

Base-year annual energy use by segment and end use

**Annual Use by End Use**

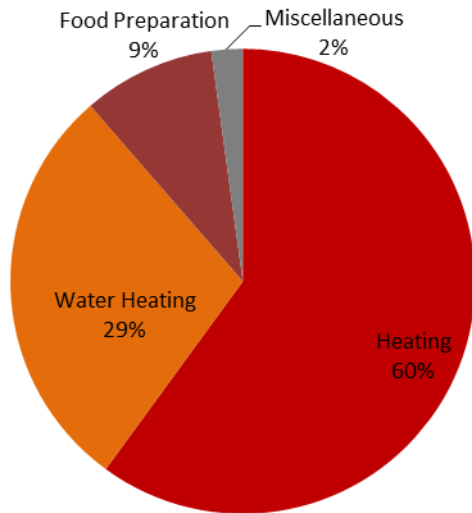

**Annual Intensity per Square Foot**

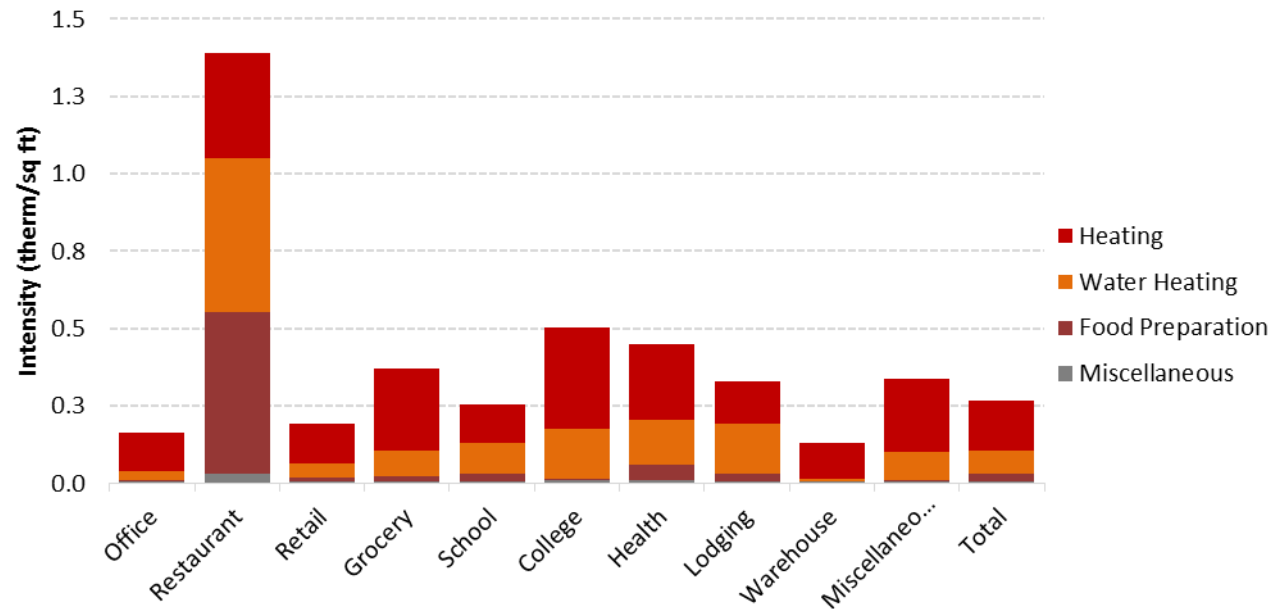

**Data Sources:**

- CBSA
- Utility billing data
- AEG Market Profiles Database
- Secondary data as needed to fill gaps

# Commercial Energy Market Profile - Oregon

- This market profile represents the Commercial sector as a whole. Individual segment market profiles are provided in the report.
- Saturations were developed using the CBSA survey as the primary data source.

End Use	Technology	Saturation	EUI (therm)	Intensity (therm/Sqft)	Usage (DTh)
Heating	Furnace	55.1%	0.13	0.07	749,027
Heating	Boiler	31.4%	0.26	0.08	840,061
Heating	Unit Heater	5.3%	0.06	0.00	31,476
Water Heating	Water Heater	64.0%	0.12	0.08	771,366
Food Preparation	Oven	16.8%	0.02	0.00	31,288
Food Preparation	Fryer	8.7%	0.09	0.01	79,140
Food Preparation	Broiler	9.9%	0.05	0.00	45,962
Food Preparation	Griddle	12.7%	0.03	0.00	40,695
Food Preparation	Range	13.8%	0.03	0.00	46,098
Food Preparation	Steamer	1.7%	0.03	0.00	5,395
Food Preparation	Commercial Food Prep Other	0.0%	0.02	0.00	38
Miscellaneous	Pool Heater	0.7%	0.00	0.00	115
Miscellaneous	Other Miscellaneous	100.0%	0.01	0.01	58,592
<b>Total</b>				<b>0.27</b>	<b>2,699,252</b>

# Commercial Baseline Projection - Oregon

- Baseline projection provides foundation for estimating potential future savings from conservation initiatives and reflects
  - Customer growth (from Avista)
  - Building Codes and appliance standards in place at end of 2015 (AEG database)
  - Frozen efficiency
  - Does not include future utility programs
- Baseline projection increases 38% between 2015 and 2036, or an average of 1.5% per year

**Commercial Baseline Energy Projection (DTh)**

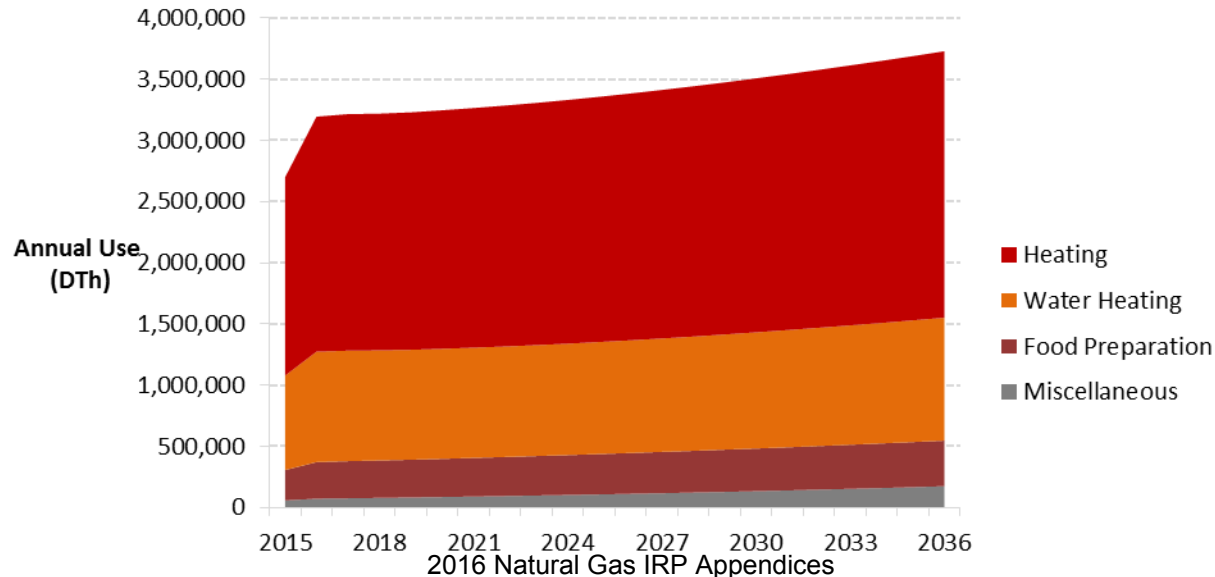



# Commercial Savings Potential - Oregon

From 2017 to 2018, cumulative achievable potential energy savings are 17,527 DTh or 0.5% of the baseline.

By 2036, cumulative savings are almost 10% of the baseline projection, or about 0.5% per year.

	2017	2018	2021	2026	2036
<b>Baseline Projection (DTh)</b>	<b>3,215,033</b>	<b>3,219,537</b>	<b>3,264,933</b>	<b>3,383,711</b>	<b>3,729,054</b>
<b>Cumulative Savings (DTh)</b>					
Achievable Potential	7,921	17,527	54,701	142,594	363,123
Economic Potential	22,299	44,184	110,800	228,191	470,854
Technical Potential	56,697	109,388	262,836	500,789	919,302
<b>Energy Savings (% of Baseline)</b>					
Achievable Potential	0.2%	0.5%	1.7%	4.2%	9.7%
Economic Potential	0.7%	1.4%	3.4%	6.7%	12.6%
Technical Potential	1.8%	3.4%	8.1%	14.8%	24.7%

Uses the TRC cost effectiveness test

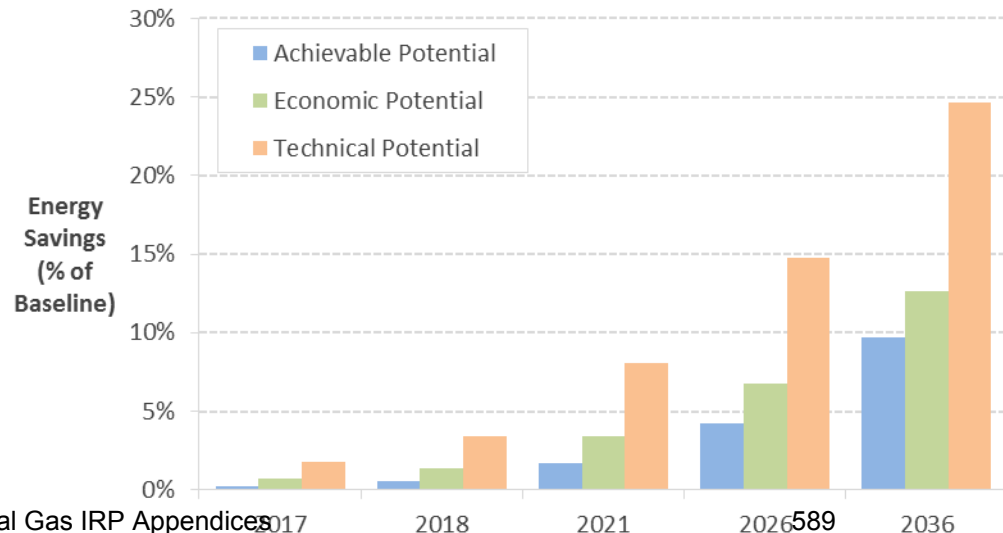
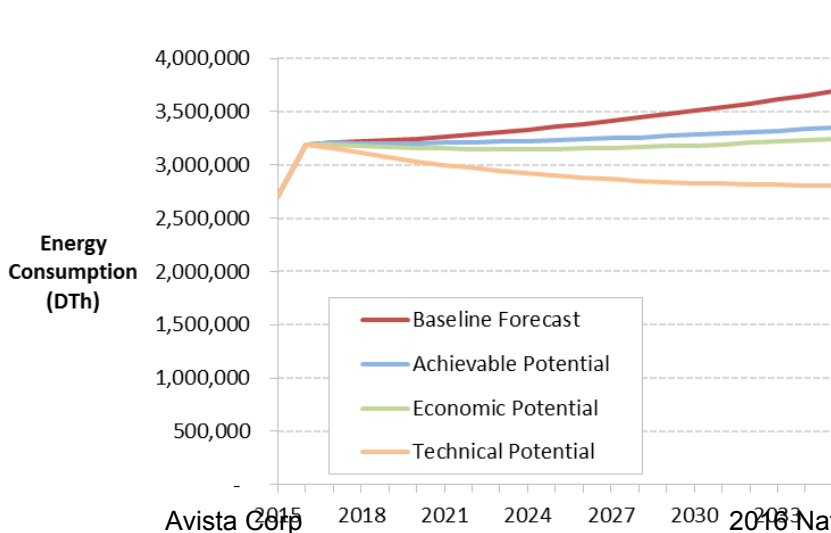

# Commercial Savings Potential - Oregon

Cumulative achievable potential in 2018

Rank	Measure / Technology	2018 Achievable Savings (Cum. DTh)	% of Total
1	Retrocommissioning	5,781	33.0%
2	Gas Boiler - Hot Water Reset	1,954	11.2%
3	Water Heater - Central Controls	1,711	9.8%
4	Heating - Boiler	1,700	9.7%
5	Water Heating - Water Heater	1,316	7.5%
6	Commissioning	1,162	6.6%
7	Water Heater - Faucet Aerators/Low Flow Nozzles	1,098	6.3%
8	Water Heater - Pre-Rinse Spray Valve	1,009	5.8%
9	Food Preparation - Fryer	519	3.0%
10	Steam Trap Maintenance	384	2.2%
11	Food Preparation - Oven	215	1.2%
12	Food Preparation - Griddle	160	0.9%
13	Windows - High Efficiency	144	0.8%
14	Food Preparation - Steamer	115	0.7%
15	Water Heater - Pipe Insulation	106	0.6%
16	Water Heater - Drainwater Heat Recovery	68	0.4%
17	HVAC - Duct Repair and Sealing	46	0.3%
18	Food Preparation - Broiler	37	0.2%
19	Gas Boiler - Parallel Positioning Control	2	0.0%
20	Food Preparation - Range	0	0.0%
<b>Total</b>		<b>17,527</b>	<b>100.0%</b>

Cumulative Achievable Potential in 2018

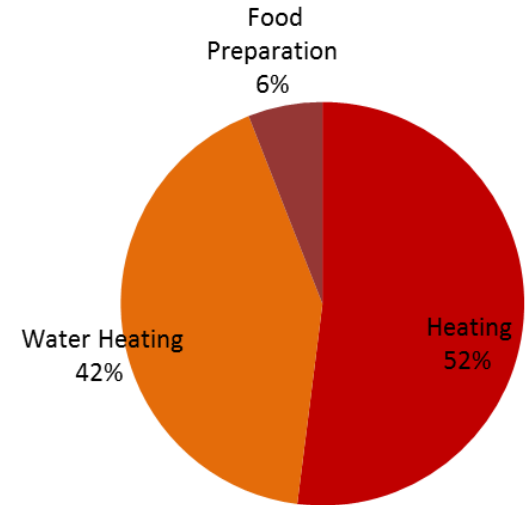

Cumulative Achievable Potential (DTh)

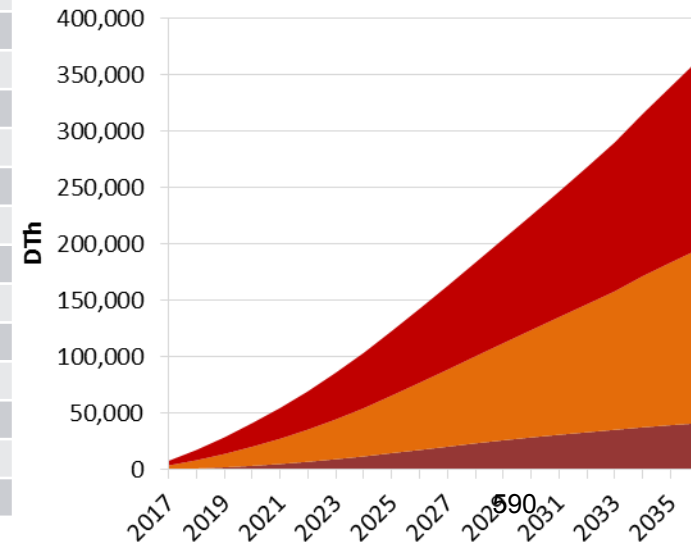

# Industrial Energy Market Profile - Oregon

- This market profile represents the Industrial sector as a whole. The industrial sector is not large enough to warrant further segmentation.

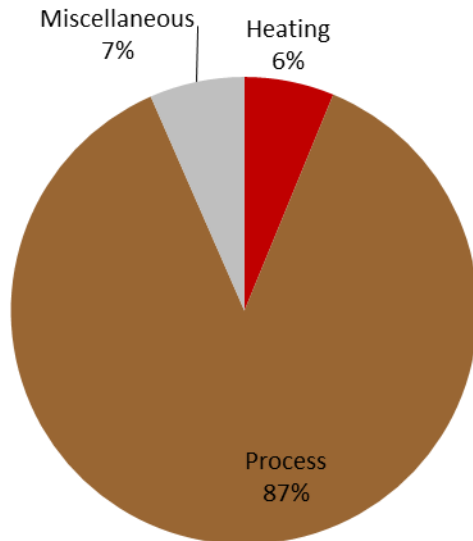

## Oregon

### Industrial

Total Sq Ft: 744,804

DTh 51,369

End Use	Technology	Saturation	EUI (Therms)	Intensity (Therms/sqft)	Usage (Dth)
Space Heating	Furnace	56.5%	0.025	0.01	1,064
Space Heating	Boiler	34.4%	0.081	0.03	2,084
Space Heating	Other Heating	4.9%	0.013	0.00	46
Process	Process Heating	100.0%	0.338	0.34	25,181
Process	Process Boiler	100.0%	0.258	0.26	19,238
Process	Process Cooling	100.0%	0.001	0.00	78
Process	Other Process	100.0%	0.004	0.00	302
Other	Other Uses	100.0%	0.045	0.05	3,375
<b>Total</b>				<b>0.69</b>	<b>51,369</b>

# Industrial Baseline Projection - Oregon

- Baseline projection provides foundation for estimating potential future savings from conservation initiatives and reflects
  - Customer growth (from Avista)
  - Building Codes and appliance standards in place at end of 2015 (AEG database)
  - Frozen efficiency
  - Does not include future utility programs
- Baseline projection increases 31% between 2015 and 2036, or an average of 1.4% per year

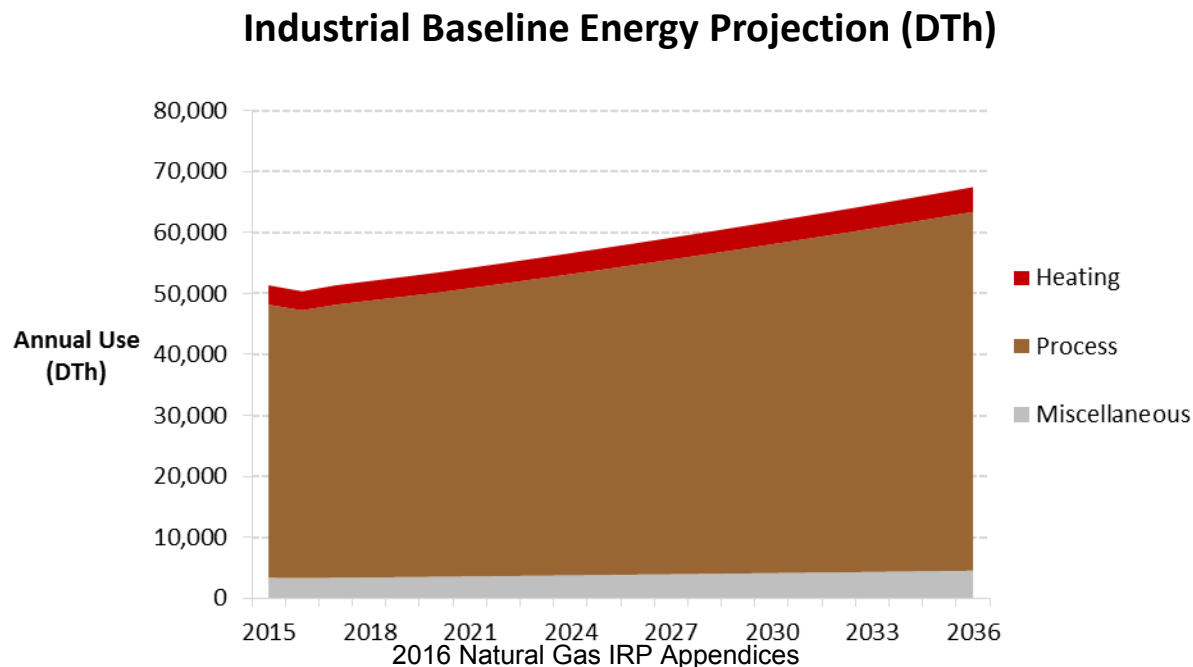

# Industrial Savings Potential - Oregon

From 2017 to 2018, cumulative achievable potential energy savings are 641 DTh or 0.3% of the baseline.

By 2036, cumulative savings are 4.3% of the baseline projection, or about 0.1% per year.

	2017	2018	2021	2026	2036
<b>Baseline Projection (DTh)</b>	<b>51,346</b>	<b>52,041</b>	<b>54,200</b>	<b>58,303</b>	<b>67,465</b>
<b>Cumulative Savings (DTh)</b>					
Achievable Potential	73	147	379	773	1,622
Economic Potential	166	333	839	1,707	3,557
Technical Potential	602	1,209	3,078	6,371	13,602
<b>Energy Savings (% of Baseline)</b>					
Achievable Potential	0.0%	0.1%	0.2%	0.3%	0.5%
Economic Potential	0.1%	0.2%	0.4%	0.7%	1.1%
Technical Potential	0.3%	0.6%	1.3%	2.5%	4.3%

Uses the TRC cost effectiveness test

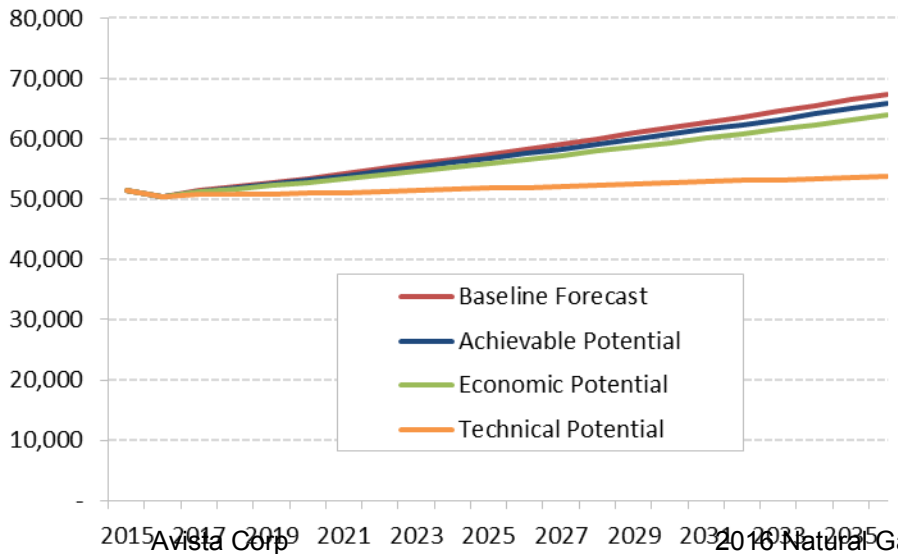

# Industrial Savings Potential- Oregon

Cumulative achievable potential in 2018

Cumulative Achievable Potential in 2018

Rank	Measure / Technology	2018 Achievable Savings (Cum. DTh)	% of Total
1	Custom	338	52.7%
2	Boiler - Hot Water Reset	171	26.7%
3	Boiler - Parallel Positioning Control	81	12.7%
4	Boiler - Maintenance	39	6.0%
5	Steam Trap Maintenance	10	1.5%
6	Gas Furnace - Maintenance	2	0.3%
	<b>Total</b>	<b>641</b>	<b>100.0%</b>

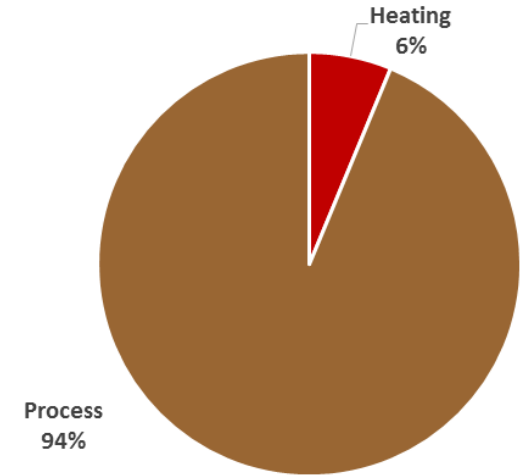

Cumulative Achievable Potential (DTh)

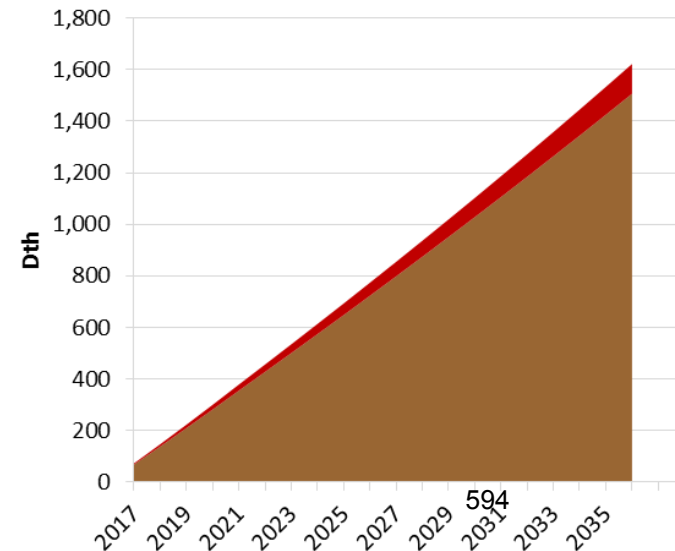



**Thank You!**

Ingrid Rohmund

[irohmund@appliedenergygroup.com](mailto:irohmund@appliedenergygroup.com)

Bridget Kester

[bkester@appliedenergygroup.com](mailto:bkester@appliedenergygroup.com)

Fuong Nguyen

[fnguyen@appliedenergygroup.com](mailto:fnguyen@appliedenergygroup.com)

Joe Reilly

[jreilly@appliedenergygroup.com](mailto:jreilly@appliedenergygroup.com)



# Assumptions Review



# Developing a Reference Case

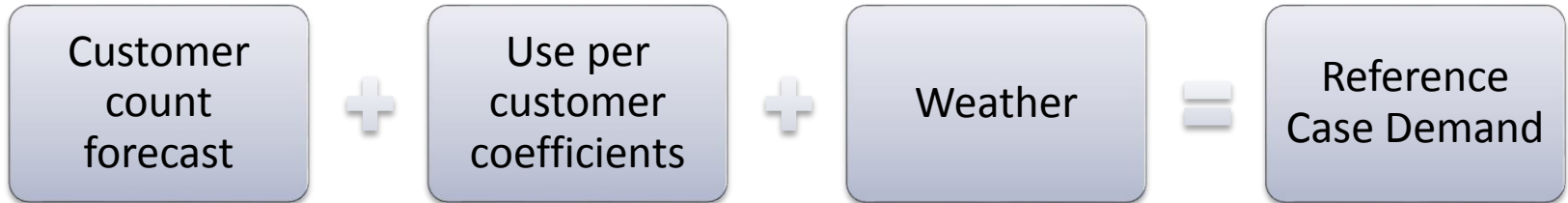

## 1. Customer annual growth rates:

System	Base-Case	High	Low
<b>Res</b>	1.2%	1.6%	0.7%
<b>Com</b>	0.7%	1.1%	0.2%
<b>Ind</b>	0.0%	0.4%	-0.4%
<b>Total</b>	1.1%	1.5%	0.7%
<b>WA</b>	<b>Base-Case</b>	<b>High</b>	<b>Low</b>
<b>Res</b>	1.0%	1.4%	0.6%
<b>Com</b>	0.7%	1.1%	0.3%
<b>Ind</b>	0.0%	0.3%	-0.2%
<b>Total</b>	1.0%	1.4%	0.6%
<b>ID</b>	<b>Base-Case</b>	<b>High</b>	<b>Low</b>
<b>Res</b>	1.4%	1.8%	0.9%
<b>Com</b>	0.4%	0.9%	-0.1%
<b>Ind</b>	0.0%	0.3%	-0.3%
<b>Total</b>	1.3%	1.7%	0.8%
<b>OR</b>	<b>Base-Case</b>	<b>High</b>	<b>Low</b>
<b>Res</b>	1.2%	1.6%	0.8%
<b>Com</b>	0.8%	1.2%	0.3%
<b>Ind</b>	0.0%	1.1%	-1.4%
<b>Total</b>	1.2%	1.6%	0.7%

## 2. Use per customer coefficients –3 year average use per HDD per customer

## 3. Weather planning standard – coldest day on record

- WA/ID 82; Medford 61; Roseburg 55; Klamath 72; La Grande 74

# WA-ID Region Firm Customers: 2016 IRP and 2014 IRP

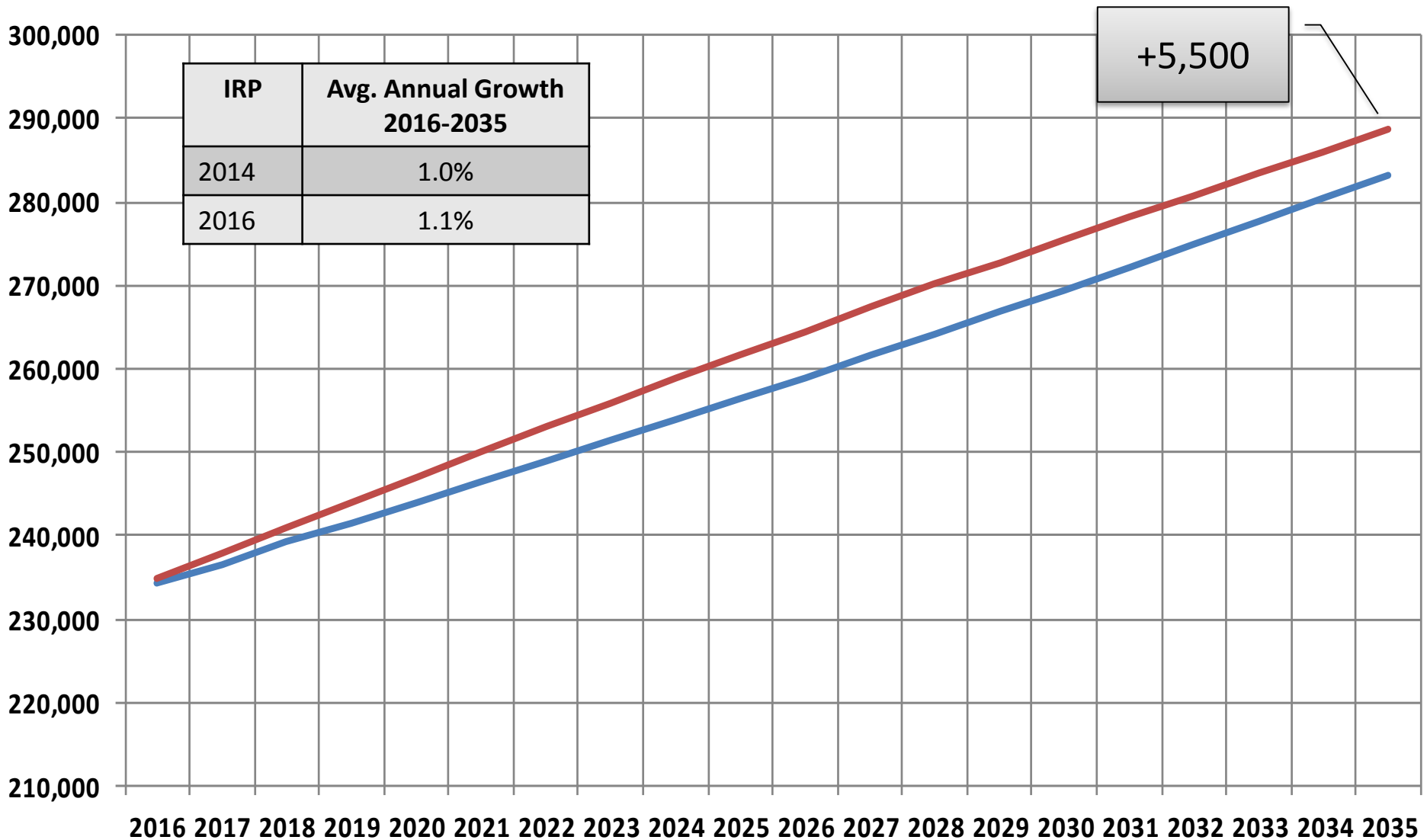

# OR Region Firm Customers: 2016 IRP and 2014 IRP

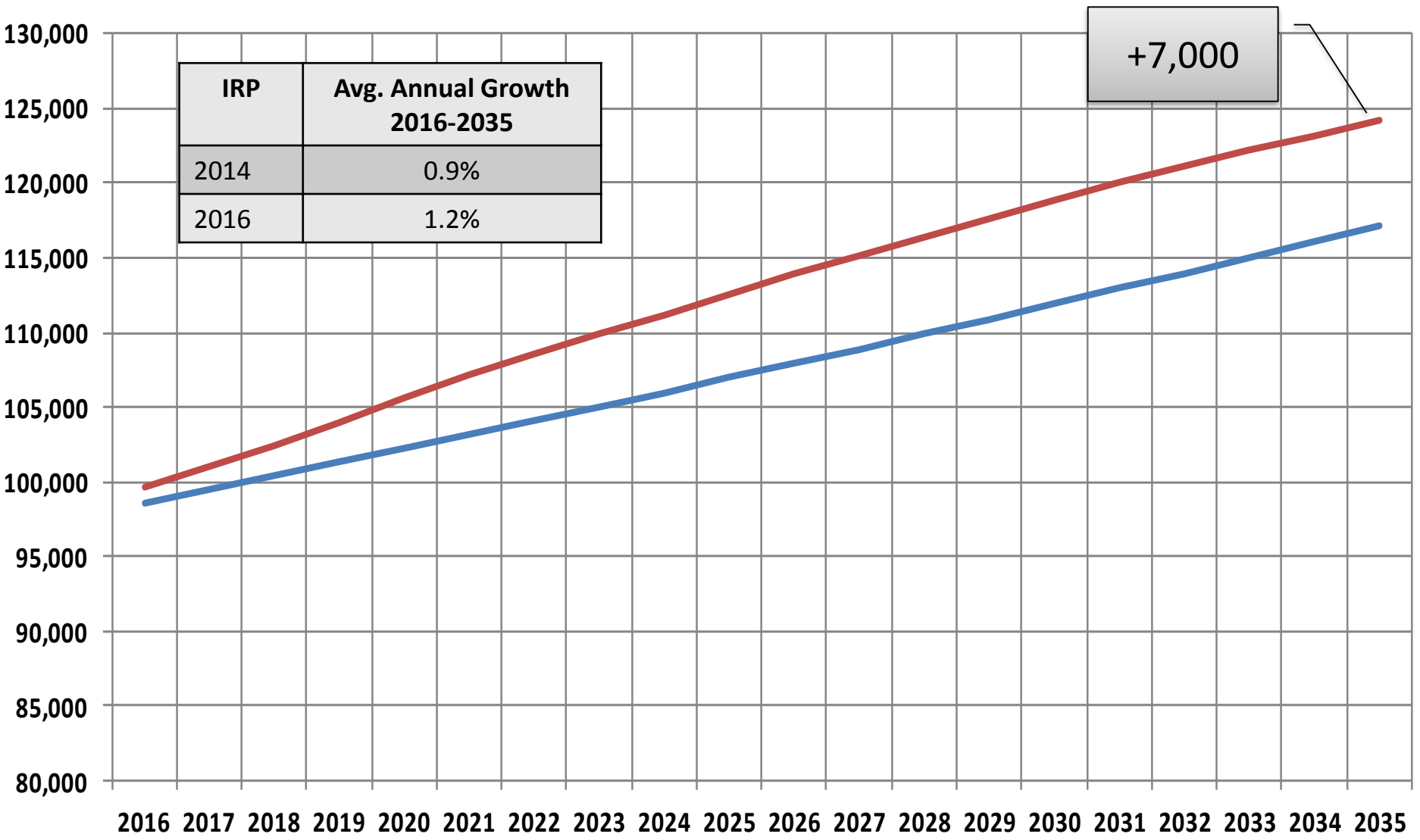

# System Firm Customers: 2016 IRP and 2014 IRP

IRP	Avg. Annual Growth 2016-2035
2014	1.0%
2016	1.1%

+12,500

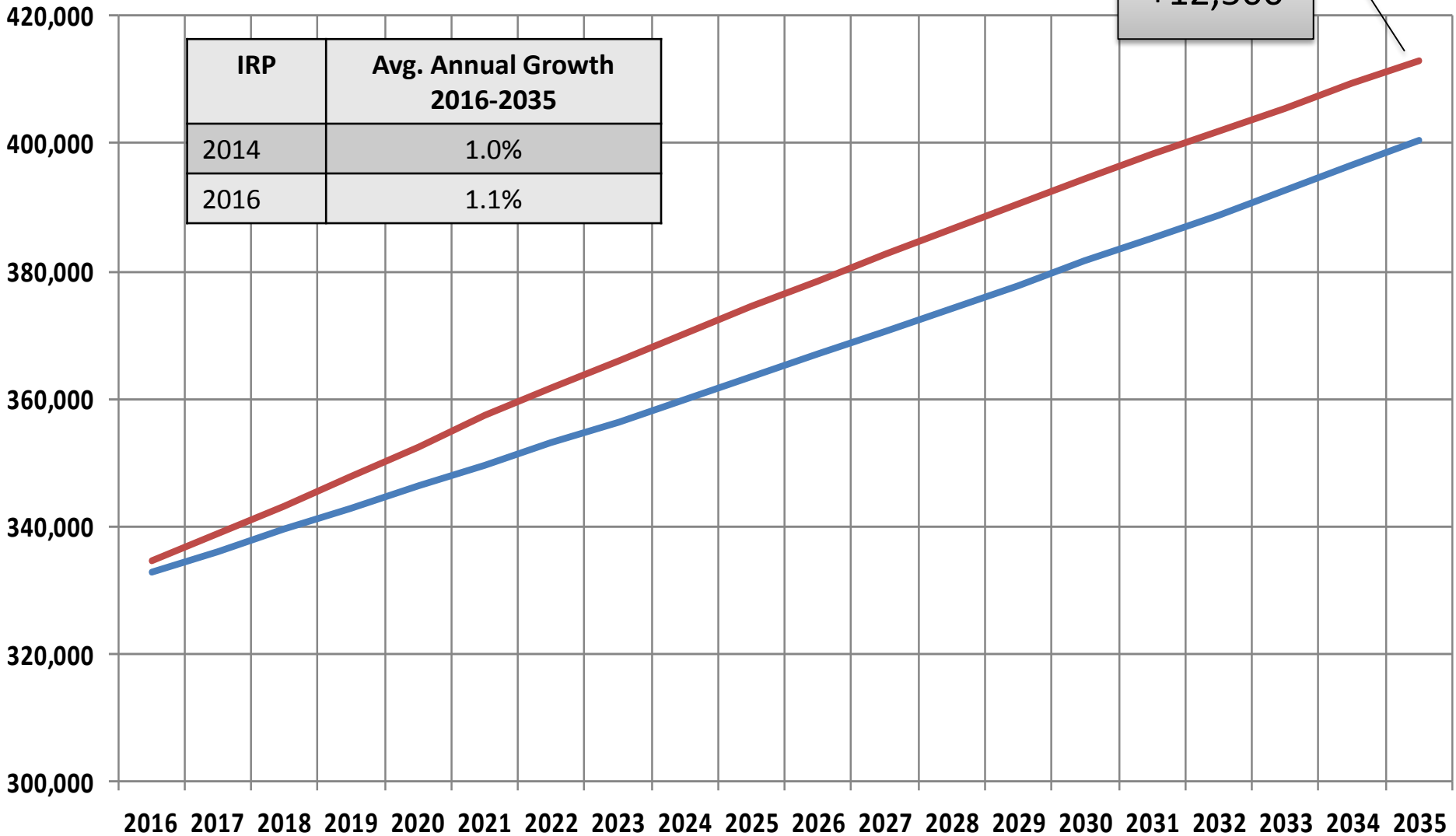

# 2016 IRP

## Low – Med – High

### REAL

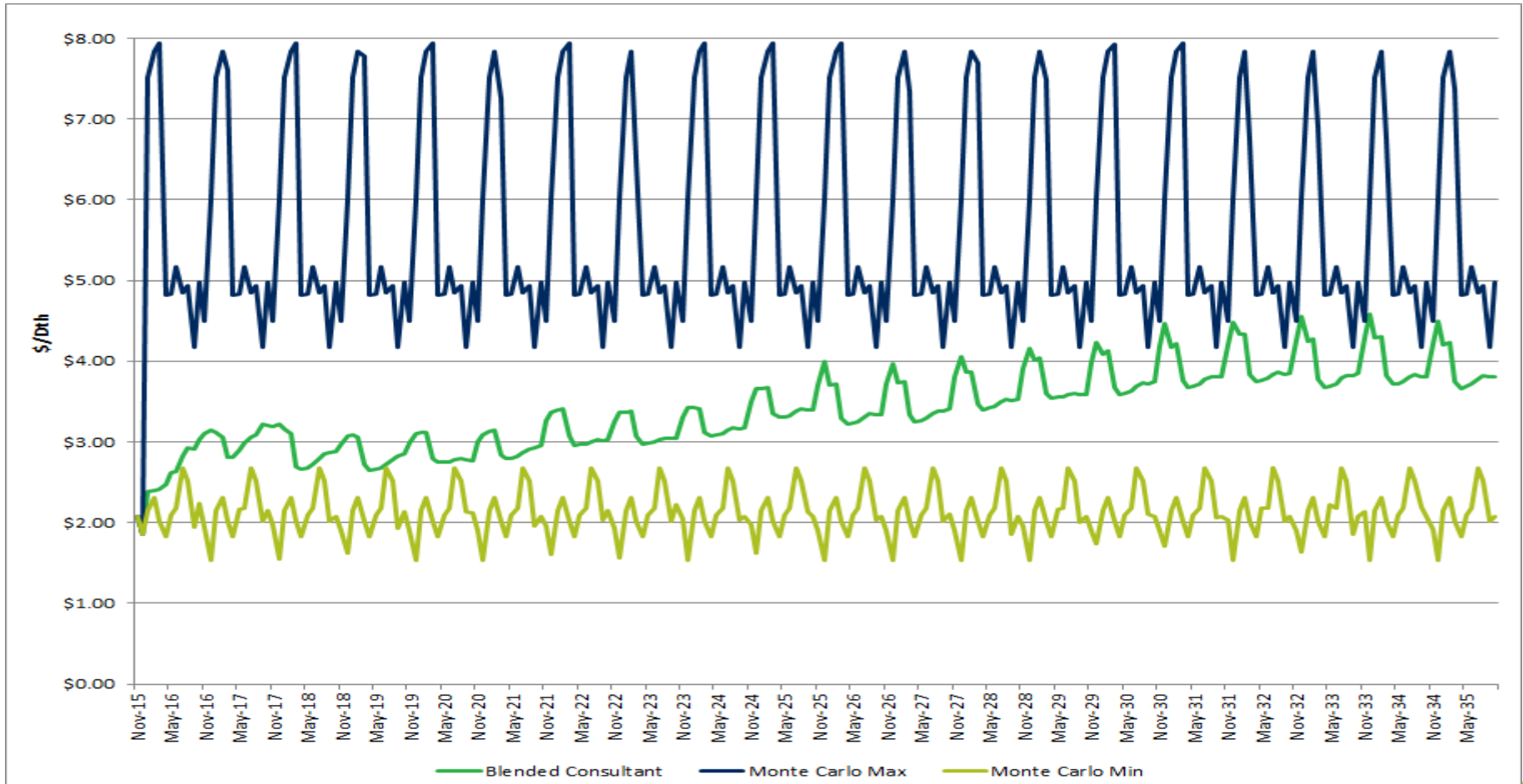

# Price Elasticity: What does the research show?

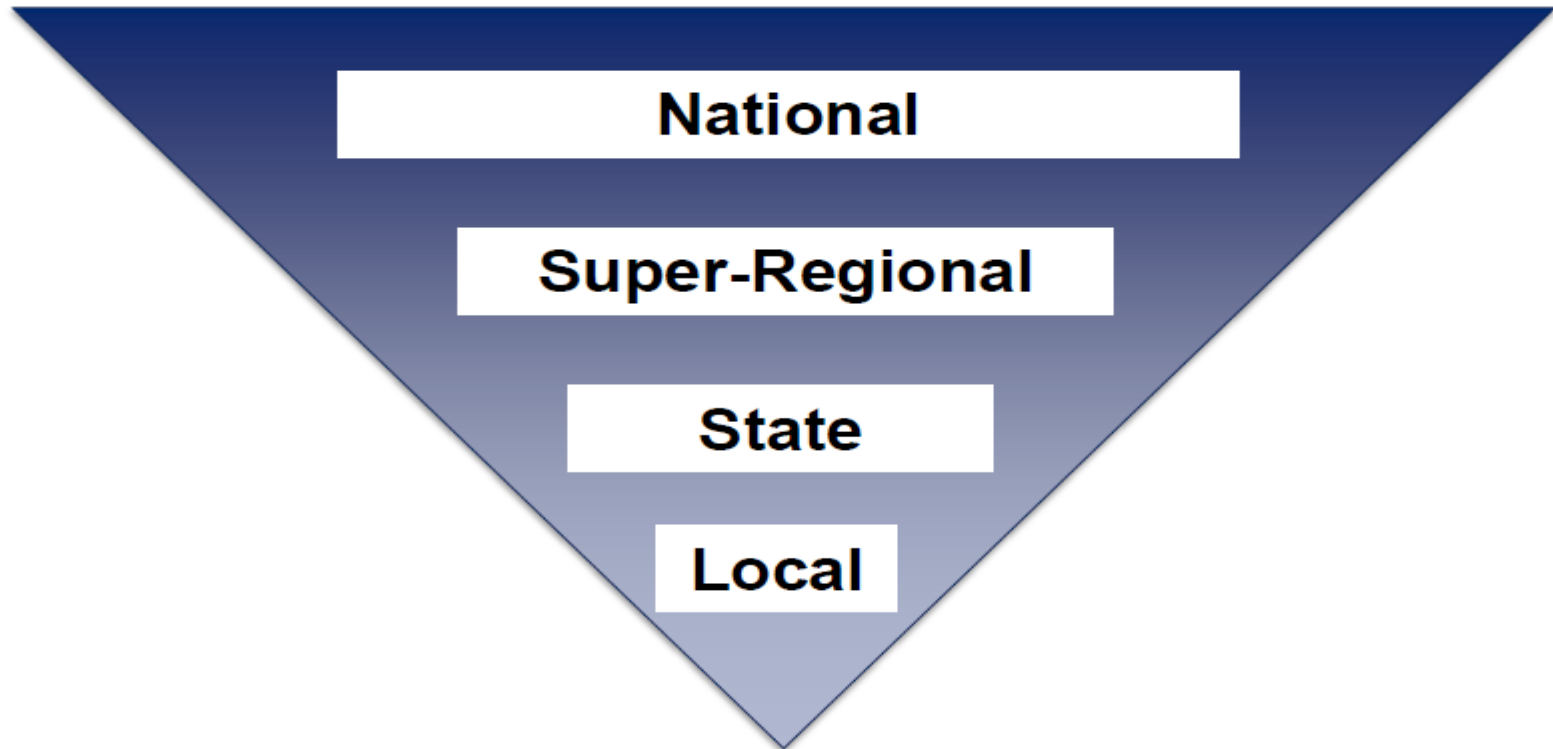

**Statistical significance of own-price becomes more uncertain as geographic area of measurement shrinks.\***

\*Bernstein, M.A. and J. Griffin (2005). *Regional Differences in Price-Elasticity of Demand for Energy*, Rand Corporation

# Price Elasticity Proposed Assumptions

- The data is a mixed bag at best:
  - 8 of 9 super regions have statistically significant short and long run elasticity's.
  - At a state level only 10 of 50 show statistical significant elasticity's.
  - In some cases, the estimated elasticity's are positive.
- We incorporated a  $-.15$  price elastic response for our expected elasticity assumption.

# Carbon Adder – Expected

- Includes carbon pricing from 2026-2035 from our consultant
- Avista added pricing starting from 2018 to address incremental adders from legislation in our service territory jurisdictions.
  - We assume floor pricing the same as California’s cap and trade of \$10 back at the programs initial auction in 2013.

\$ / Metric Tonne			
	Starting Price	Ending Price	Years
Low	\$ -	\$ -	2015-2035
Likely Policy	\$ 10.00	\$ 19.85	2018-2035
2015 Electric IRP	\$ 12.03	\$ 25.00	2020-2035
i-732	\$ 15.00	\$ 46.44	2018-2035
<b>Expected</b>	<b>\$ 9.89</b>	<b>\$ 19.93</b>	<b>2018-2035</b>



# Planning Standard Assumptions

Area	Coldest in 20 Year HDD	Coldest on Record HDD
WA-ID	76	82
Klamath Falls	72	72
La Grande	74	74
Medford	54	61
Roseburg	48	55

## Coldest on Record Dates

WA/ID – December 30, 1968  
 Medford – December 9, 1972  
 Roseburg – December 22, 1990  
 Klamath Falls – December 21, 1990  
 LaGrande – December 23, 1983



# Demand Sensitivities & Scenarios Update

# Sensitivities, Scenarios, Portfolios

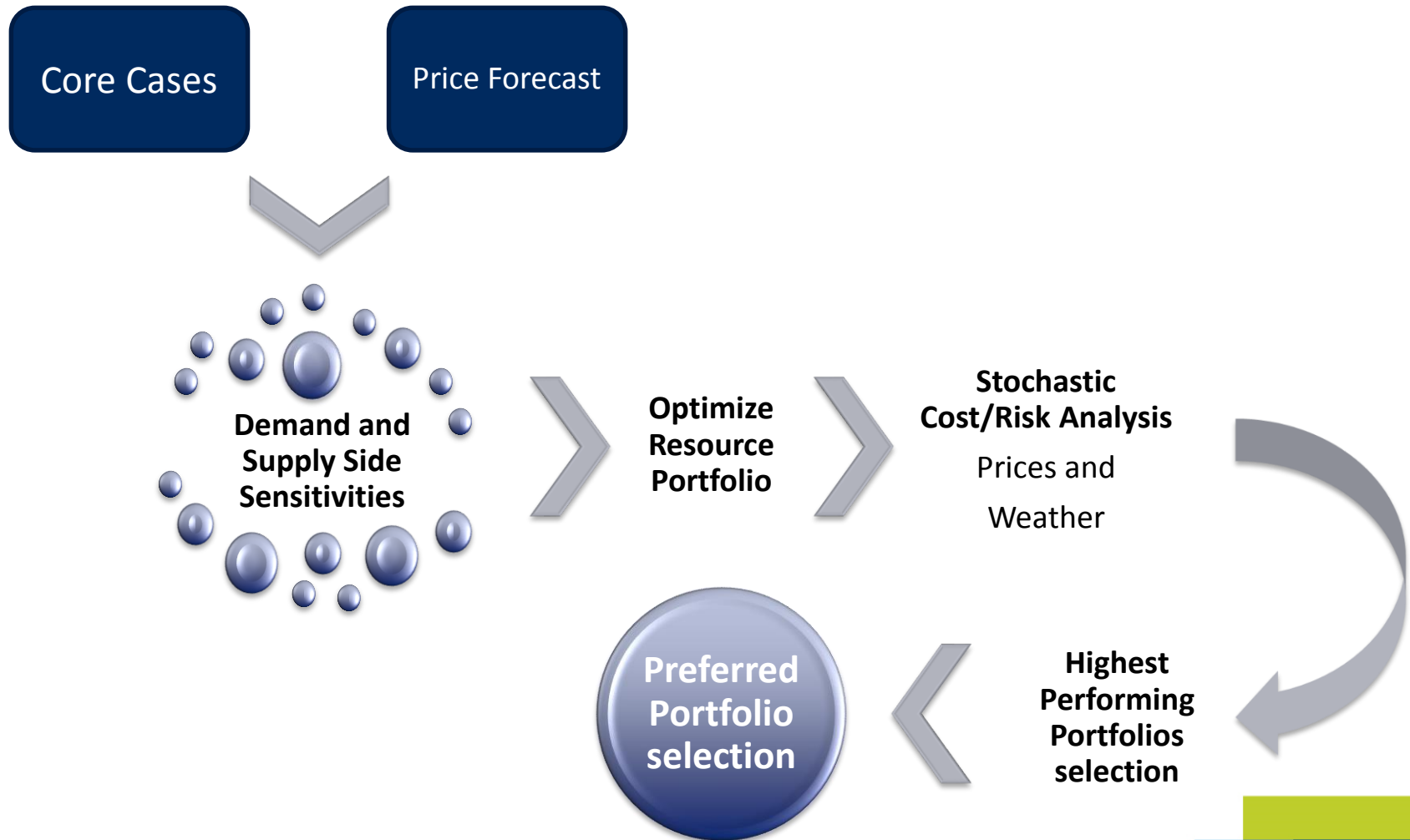

# Sensitivity Analysis

# 2016 Demand Sensitivities - Demand Influencing Direct Annual Demand - Total System

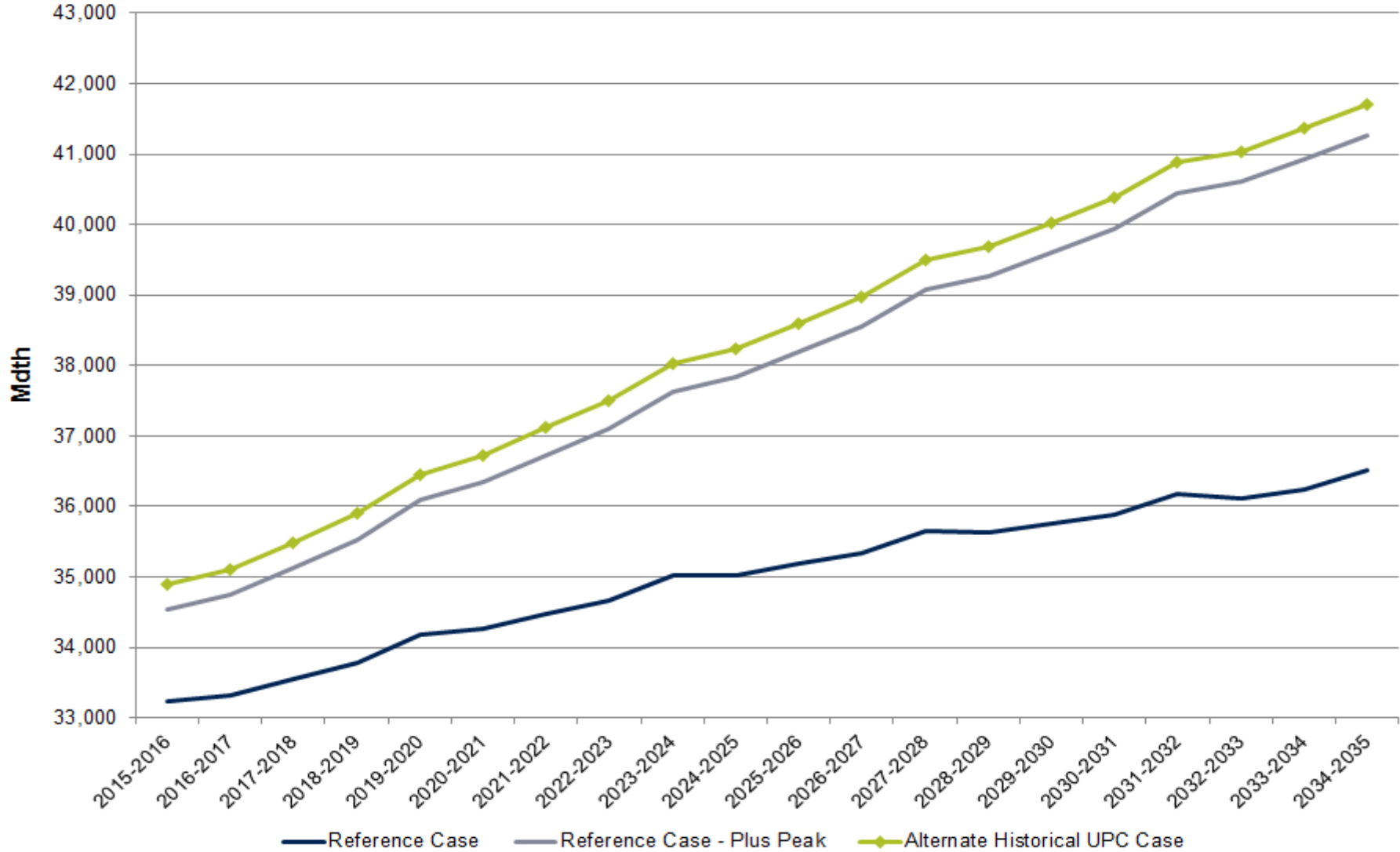

# 2016 Demand Sensitivity Analysis - Direct Annual Demand

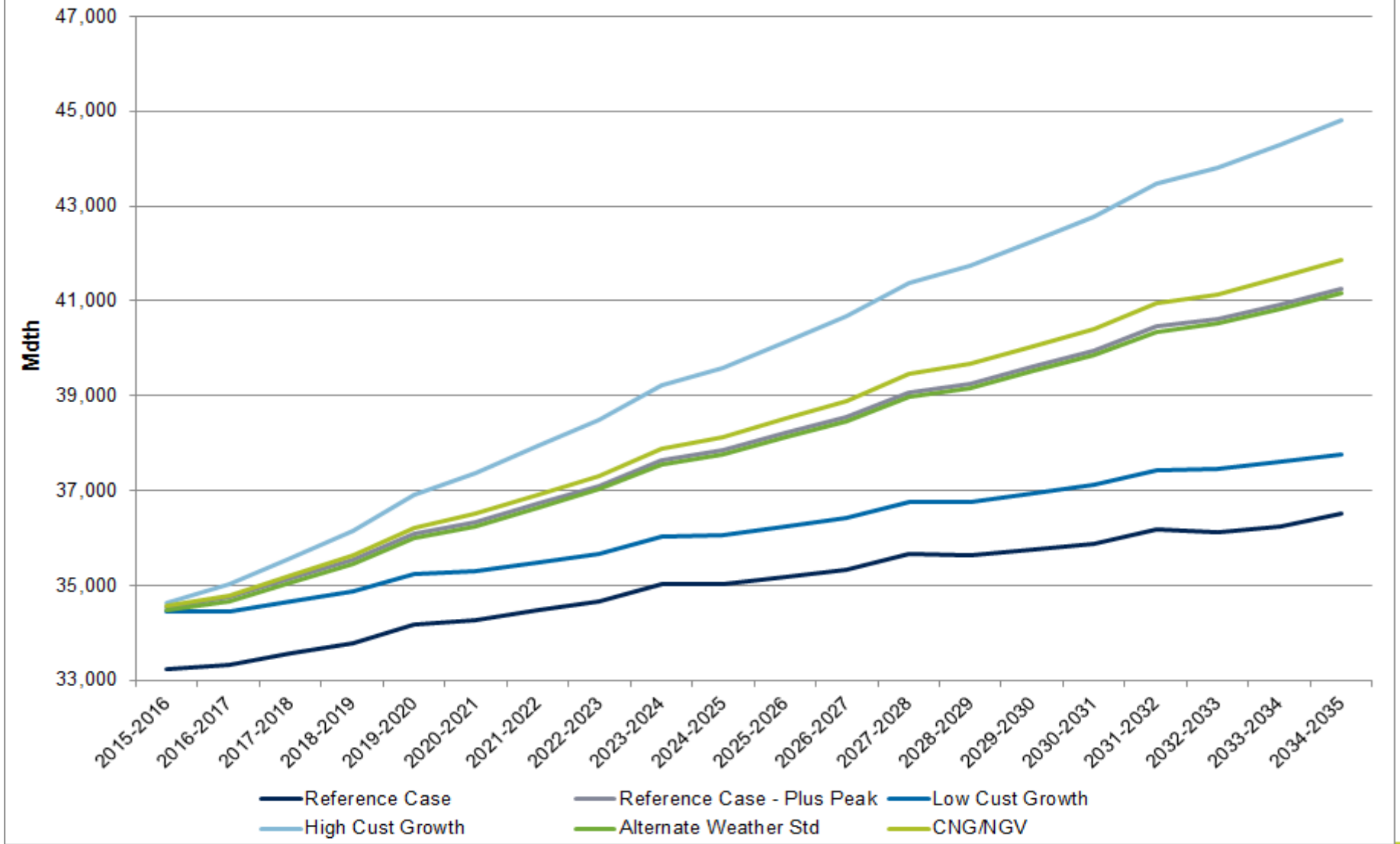

# Peak Day (Feb 15) - Demand Sensitivities

3 Year Use per Customer vs. 5 Year Use per Customer

WA/ID

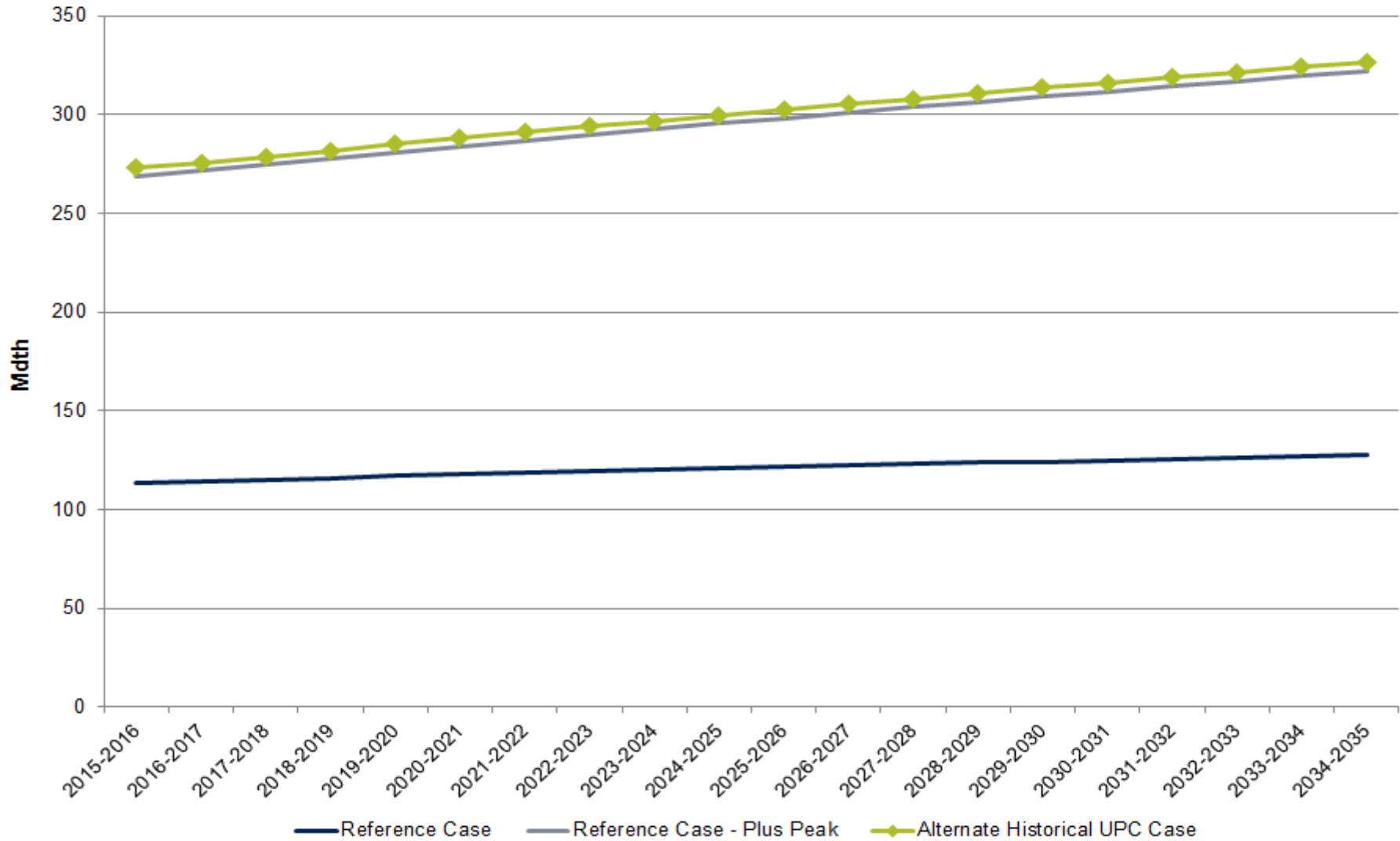

# Peak Day (Feb 15) - Demand Sensitivities

3 Year Use per Customer

WA/ID

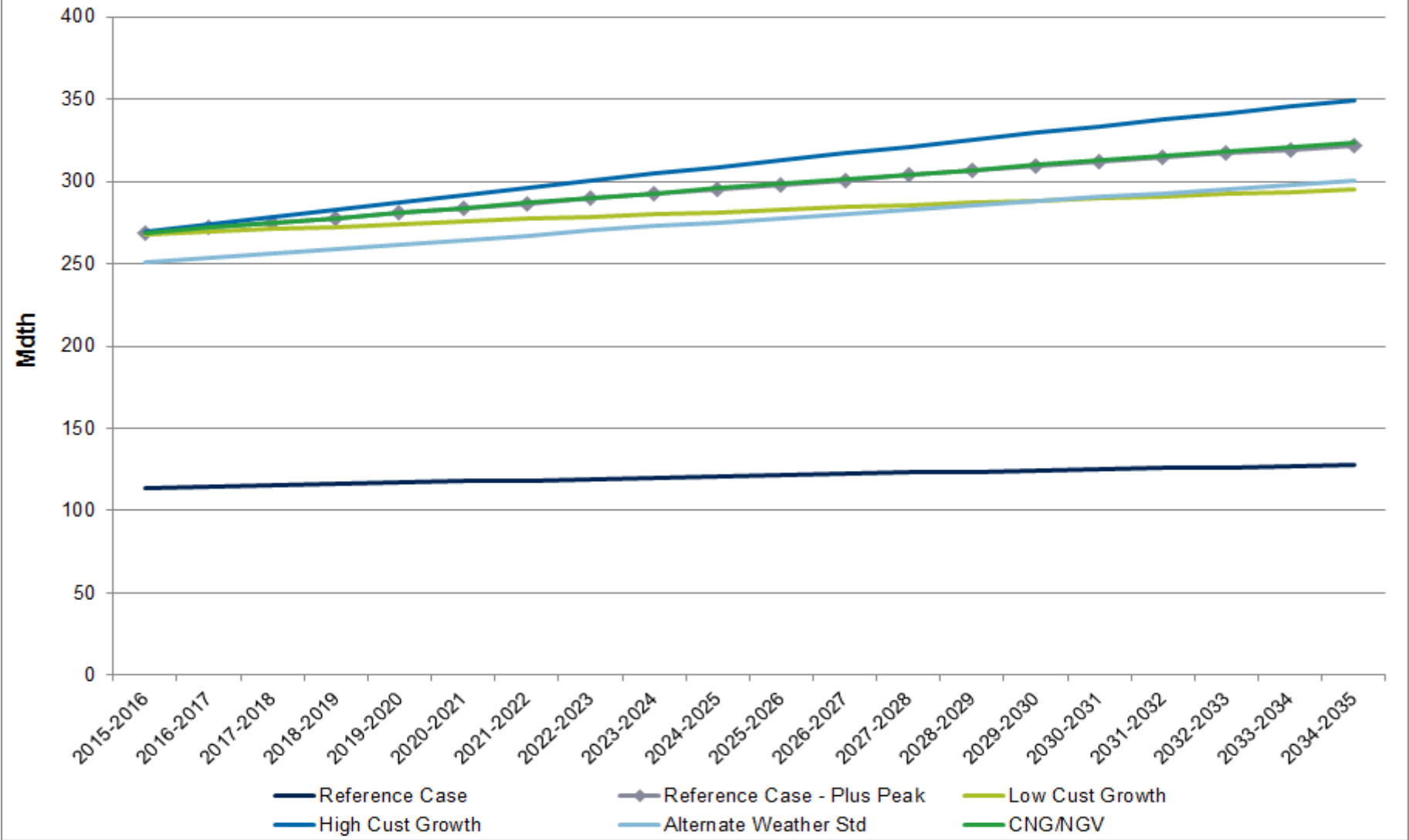



# Peak Day (Dec 20) - Demand Sensitivities

3 Year Use per Customer vs. 5 Year Use per Customer

Medford/Roseburg

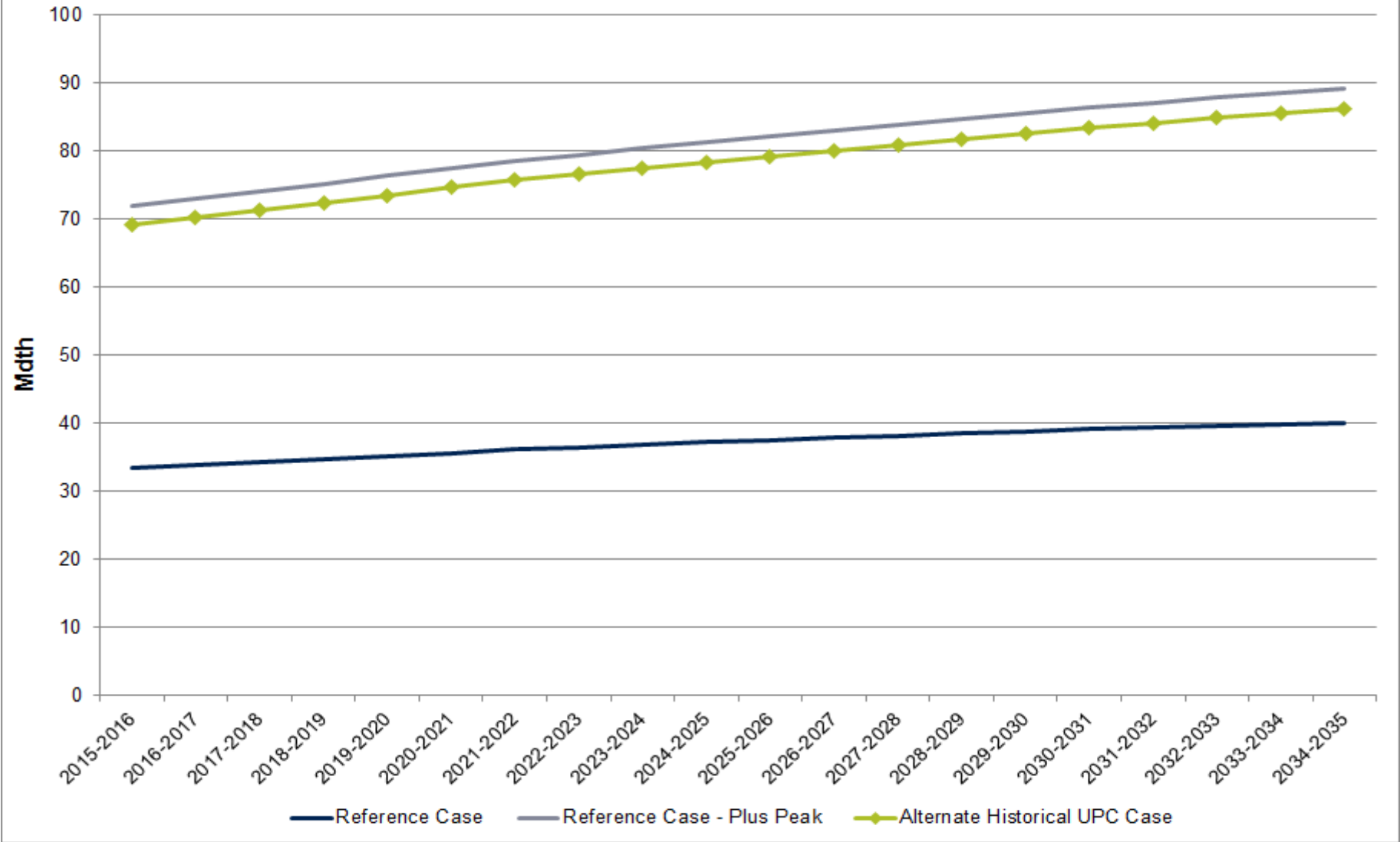

# Peak Day (Dec 20) - Demand Sensitivities

3 Year Use per Customer  
Medford/Roseburg

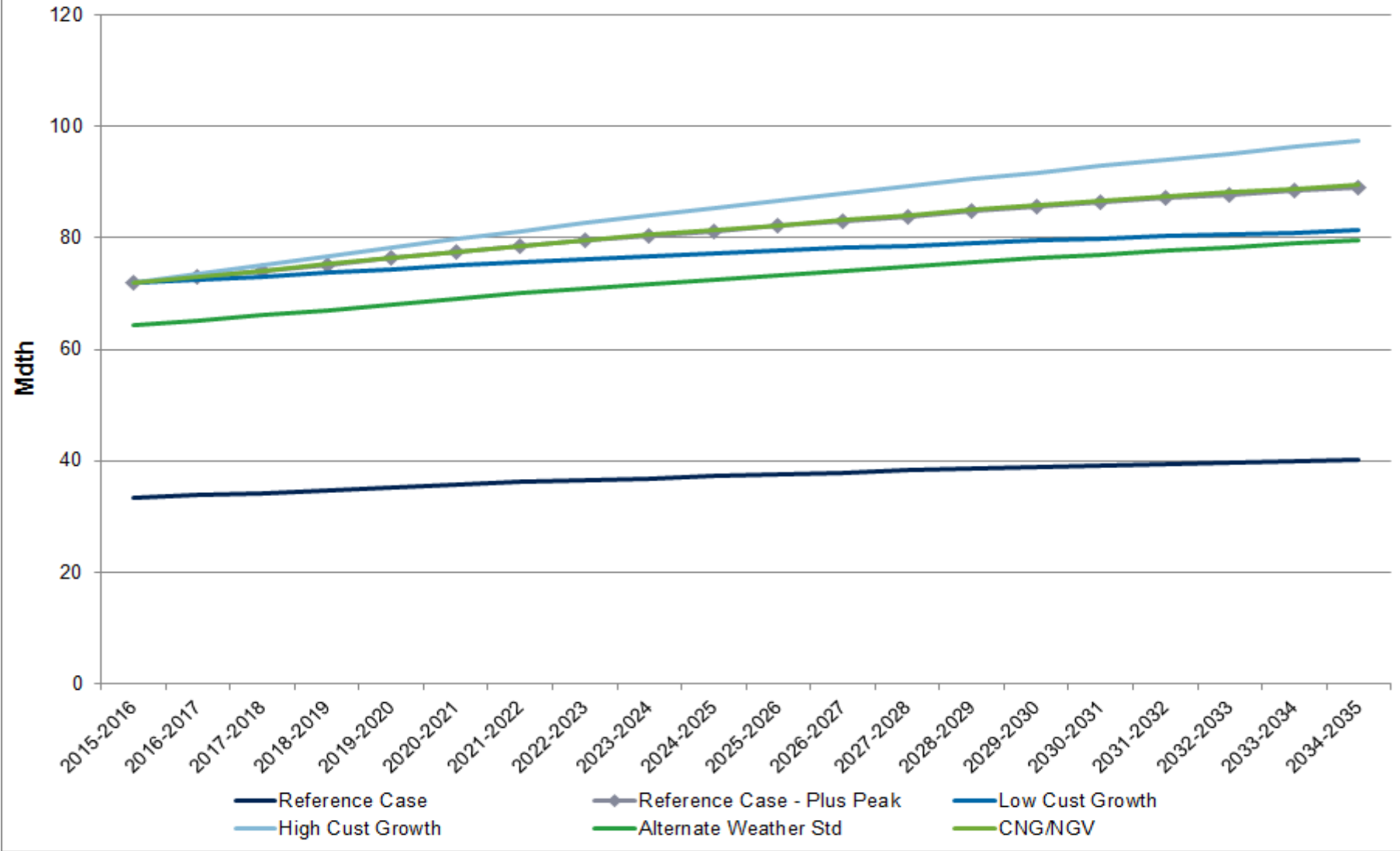

# Peak Day (Feb 15) - Demand Sensitivities

3 Year Use per Customer

WA/ID

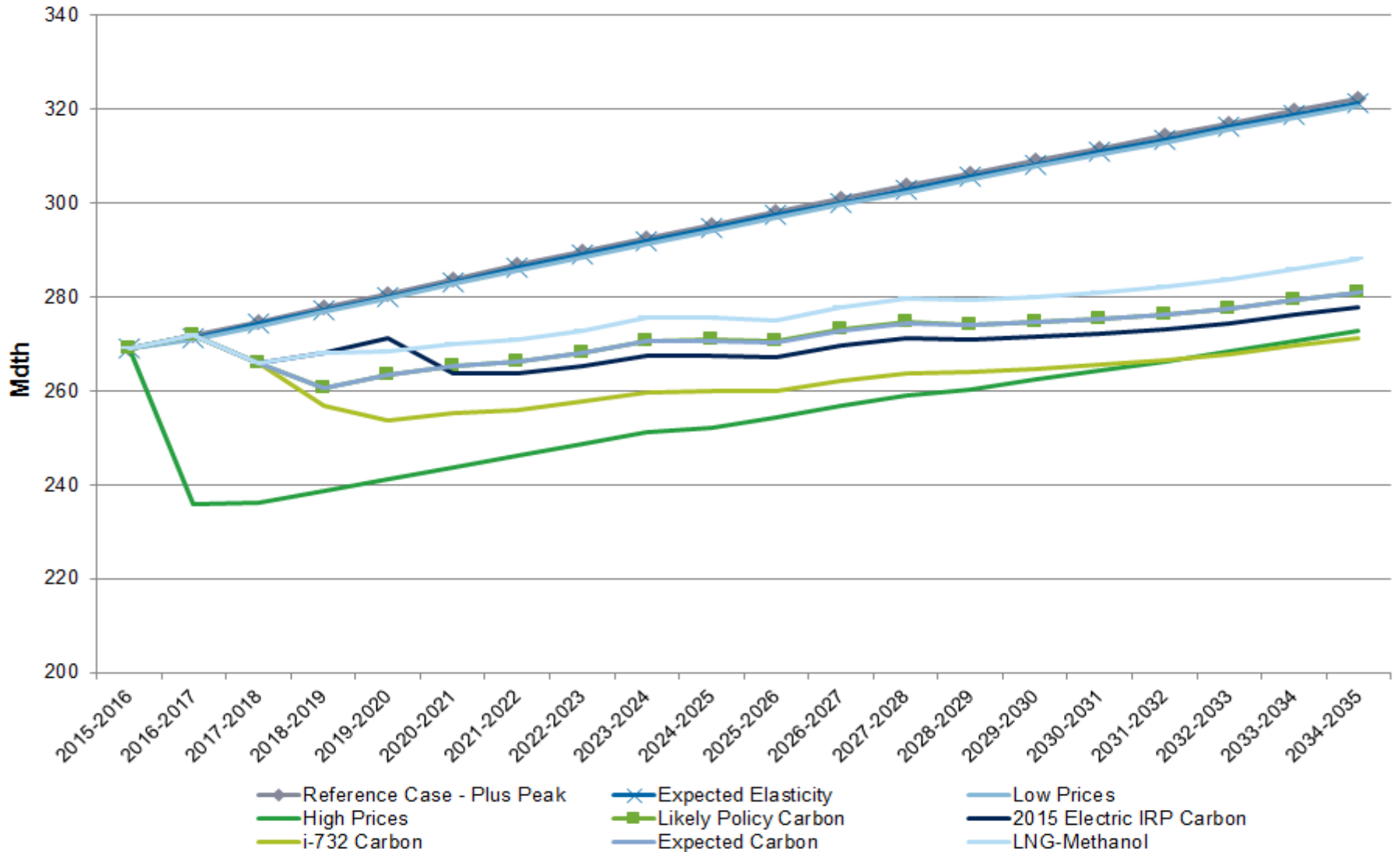

# Peak Day (Dec 20) - Demand Sensitivities

3 Year Use per Customer  
Medford/Roseburg

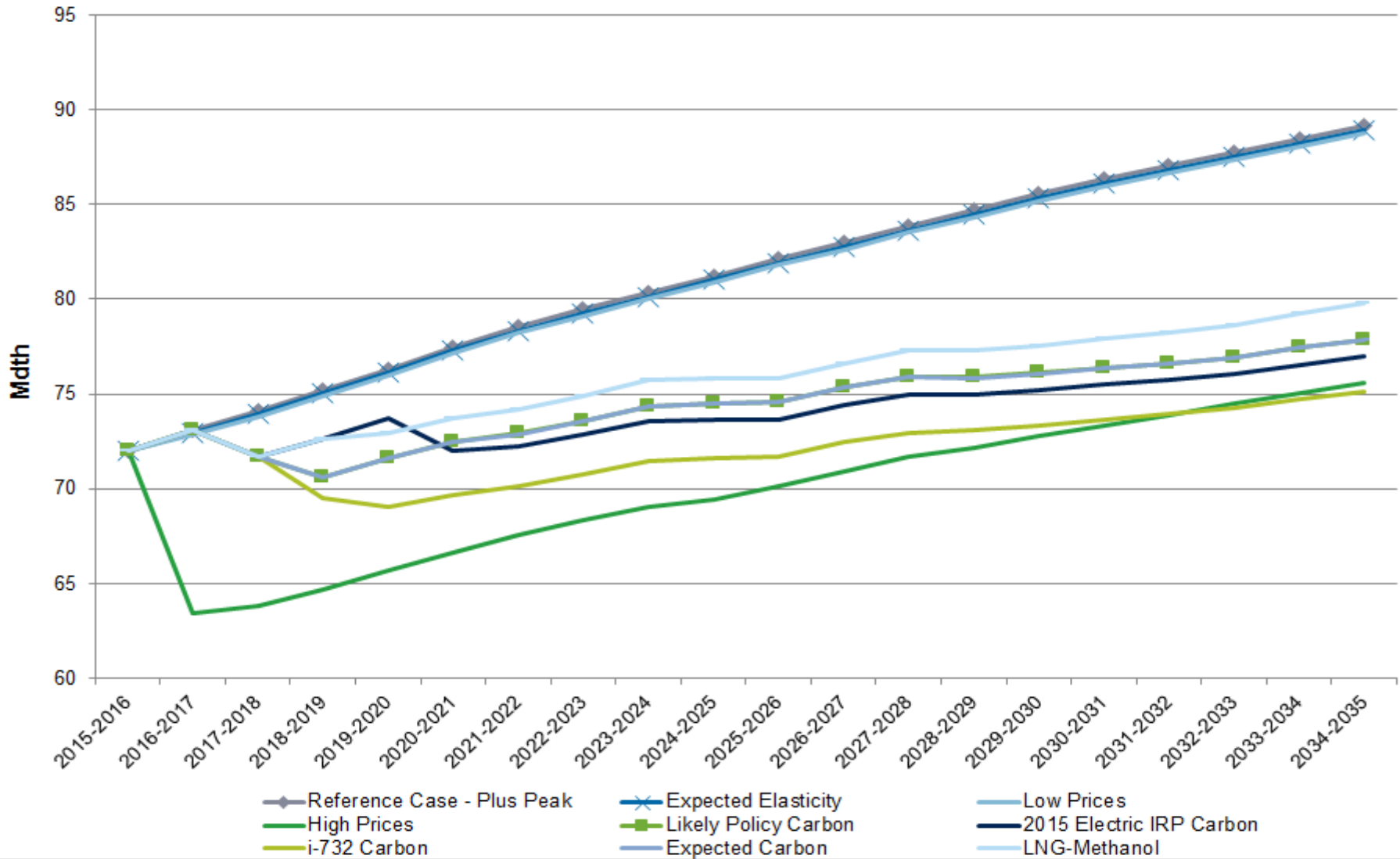

# First Year Peak Demand Not Met with Existing Resources Sensitivity Comparisons

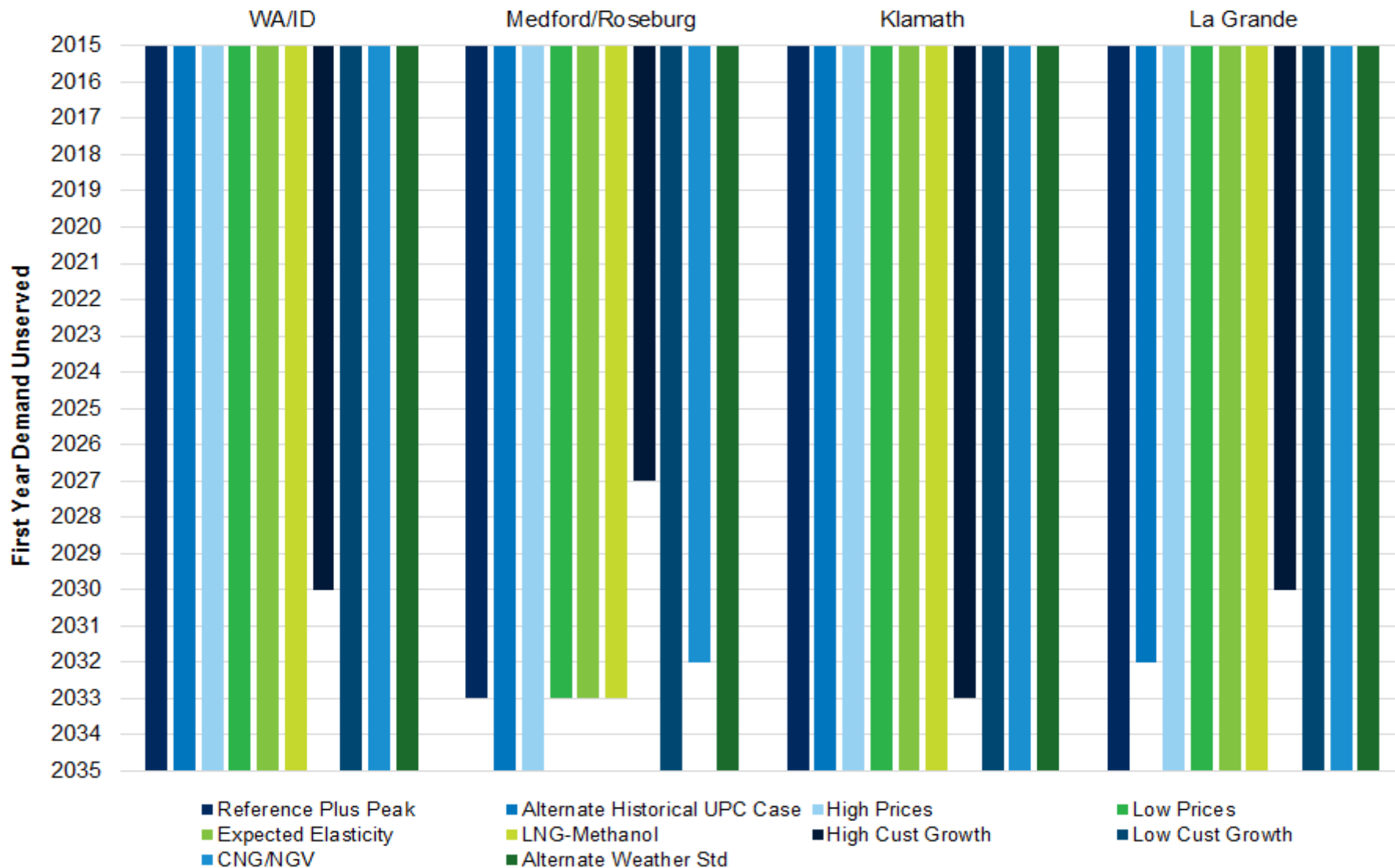

# Scenario Analysis

# Proposed Scenarios

<b>Proposed Scenarios</b> INPUT ASSUMPTIONS	<b>Expected Case - Low Prices</b>	<b>Expected Case</b>	<b>High Growth &amp; Low Prices</b>	<b>Low Growth &amp; High Prices</b>	<b>Cold Day 20yr Weather Std</b>	<b>Average Case</b>
<b>Customer Growth Rate</b>	Reference Case Cust Growth Rates	Reference Case Cust Growth Rates	High Growth Rate	Low Growth Rate	Reference Case Cust Growth Rates	Reference Case Cust Growth Rates
<b>Use per Customer</b>	3 yr Flat + Price Elast.	3 yr Flat + Price Elast.	3 yr Flat + Price Elast. + CNG/NGV	3 yr Flat + Price Elast.	3 yr Flat + Price Elast.	3 yr Flat + Price Elast.
<b>Demand Side Management</b>	Yes	Yes	Yes	Yes	Yes	Yes
<b>Weather Planning Standard</b>	Coldest Day	Coldest Day	Coldest Day	Coldest Day	Alternate Planning Standard	Normal
<b>Prices</b>						
Price curve	Low	Expected	Low	High	Expected	Expected
Carbon Legislation (\$/Ton)	\$9.89 - 19.93	\$9.89 - 19.93	None	\$9.89 - 19.93	\$9.89 - 19.93	\$9.89 - 19.93
<b>RESULTS</b>						
<b>First Gas Year Unserved</b>						
WA/ID	N/A	N/A	2033	N/A	N/A	N/A
Medford	N/A	N/A	2027	N/A	N/A	N/A
Roseburg	N/A	N/A	2027	N/A	N/A	N/A
Klamath	N/A	N/A	2034	N/A	N/A	N/A
La Grande	N/A	N/A	2031	N/A	N/A	N/A

# Existing Resources vs. Peak Day Demand

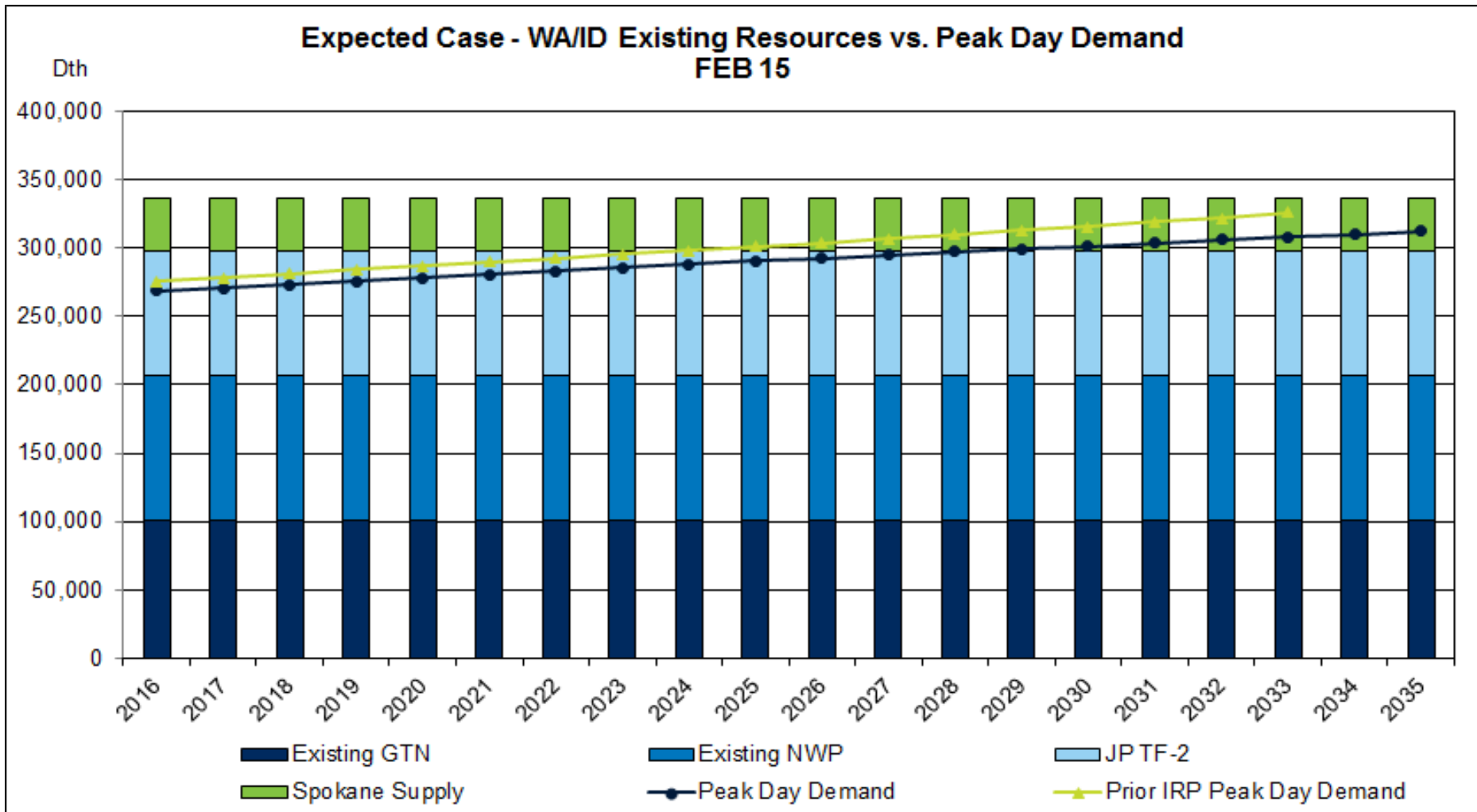



# Existing Resources vs. Peak Day Demand

## Expected Case – Medford/Roseburg (DRAFT)

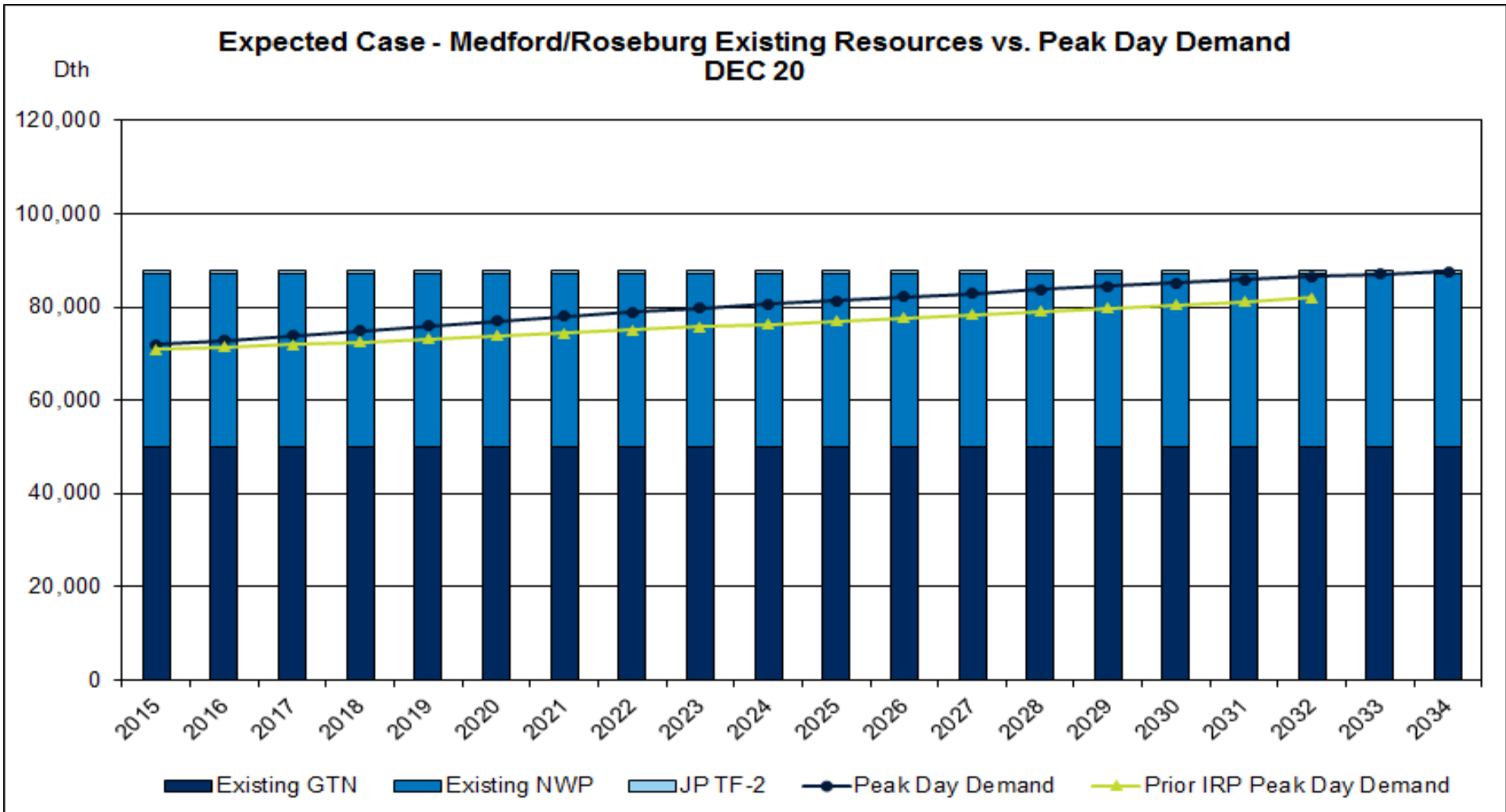

# Existing Resources vs. Peak Day Demand

## Expected Case – Klamath Falls (DRAFT)

Expected Case - Klamath Falls Existing Resources vs. Peak Day Demand  
DEC 20

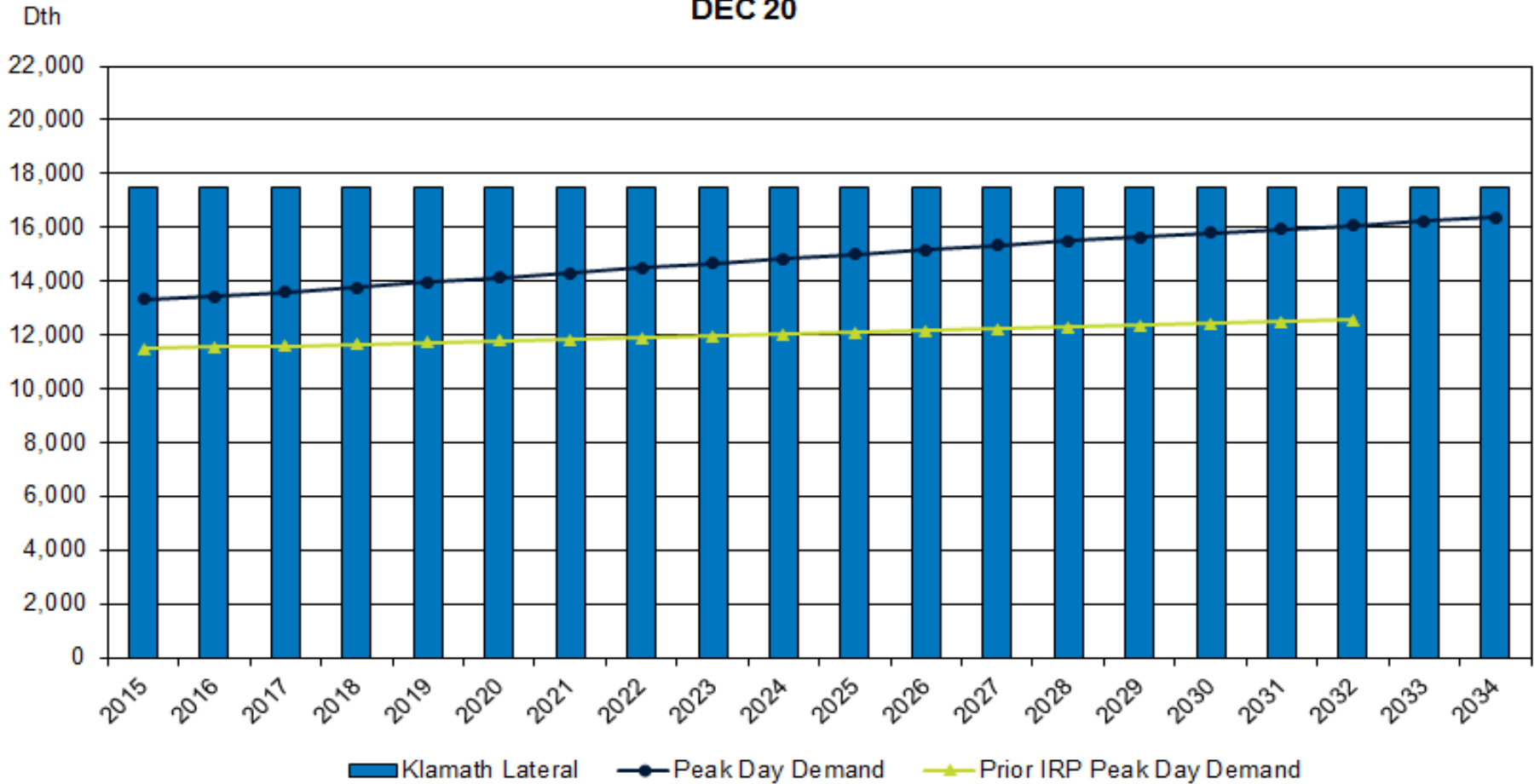

# Existing Resources vs. Peak Day Demand

## Expected Case – La Grande (DRAFT)

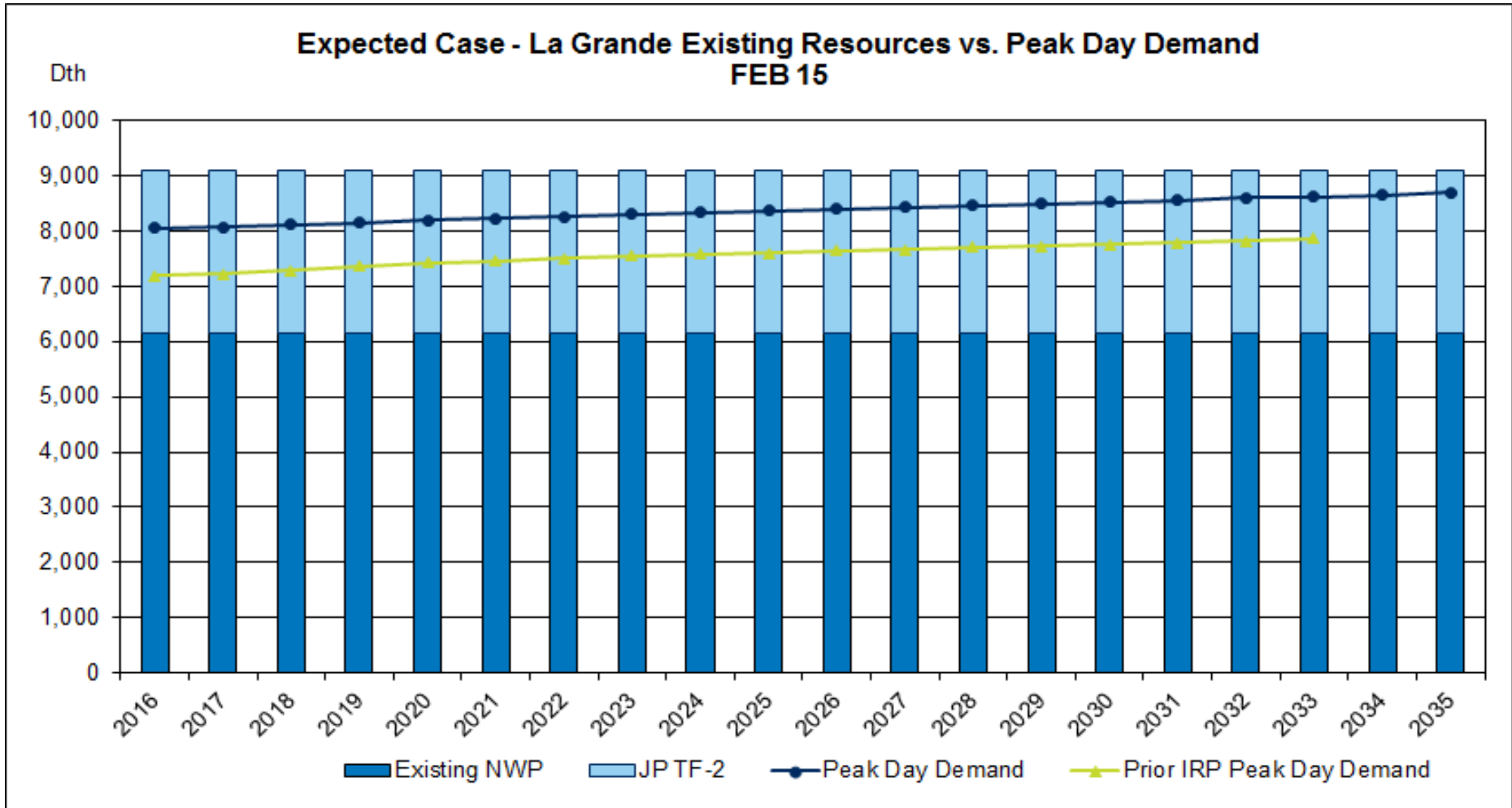

## Peak Day (Feb 15) - 2016 IRP Demand Scenarios WA/ID

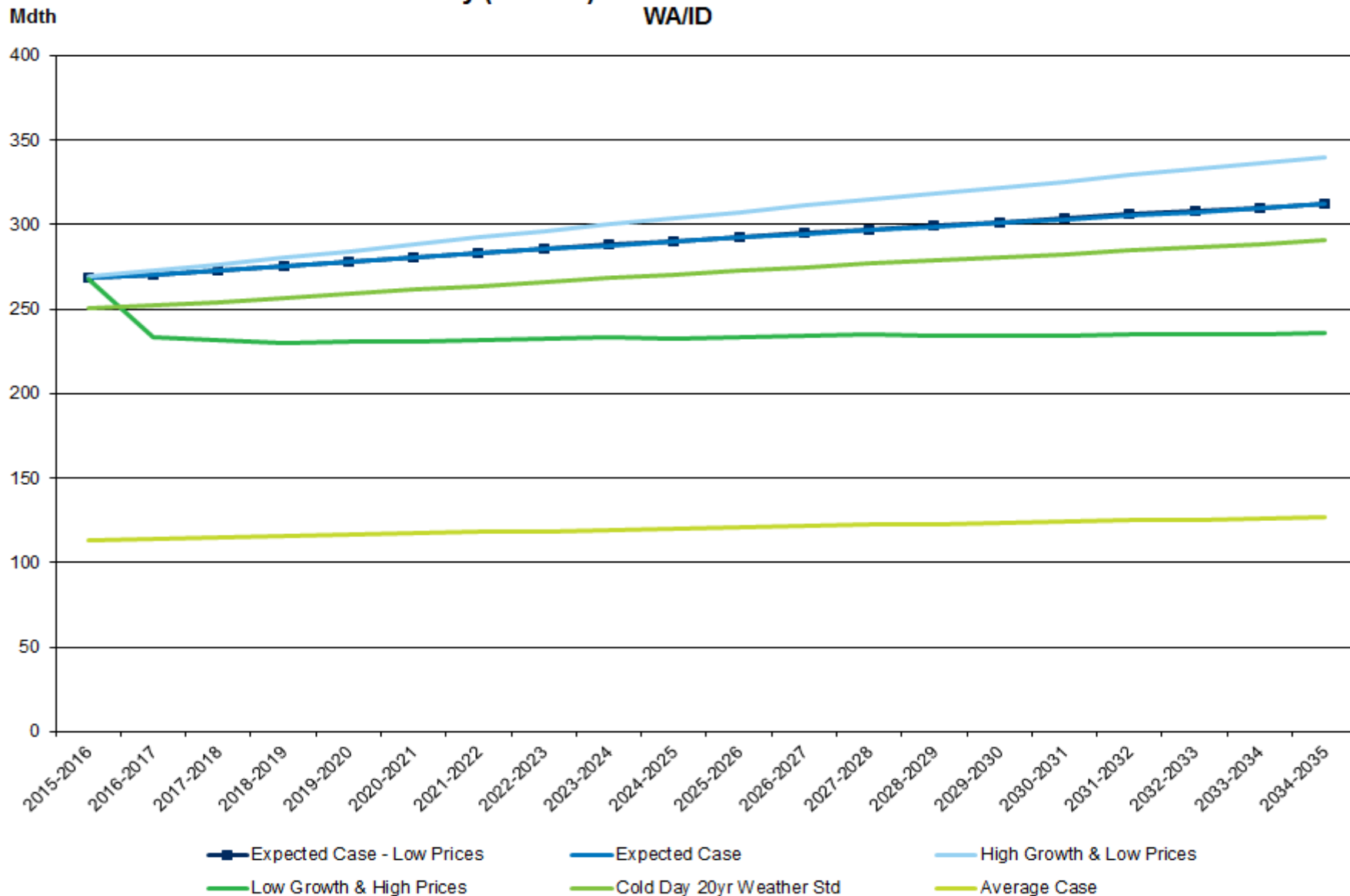

# Peak Day (Dec 20) - 2016 IRP Demand Scenarios Medford/Roseburg

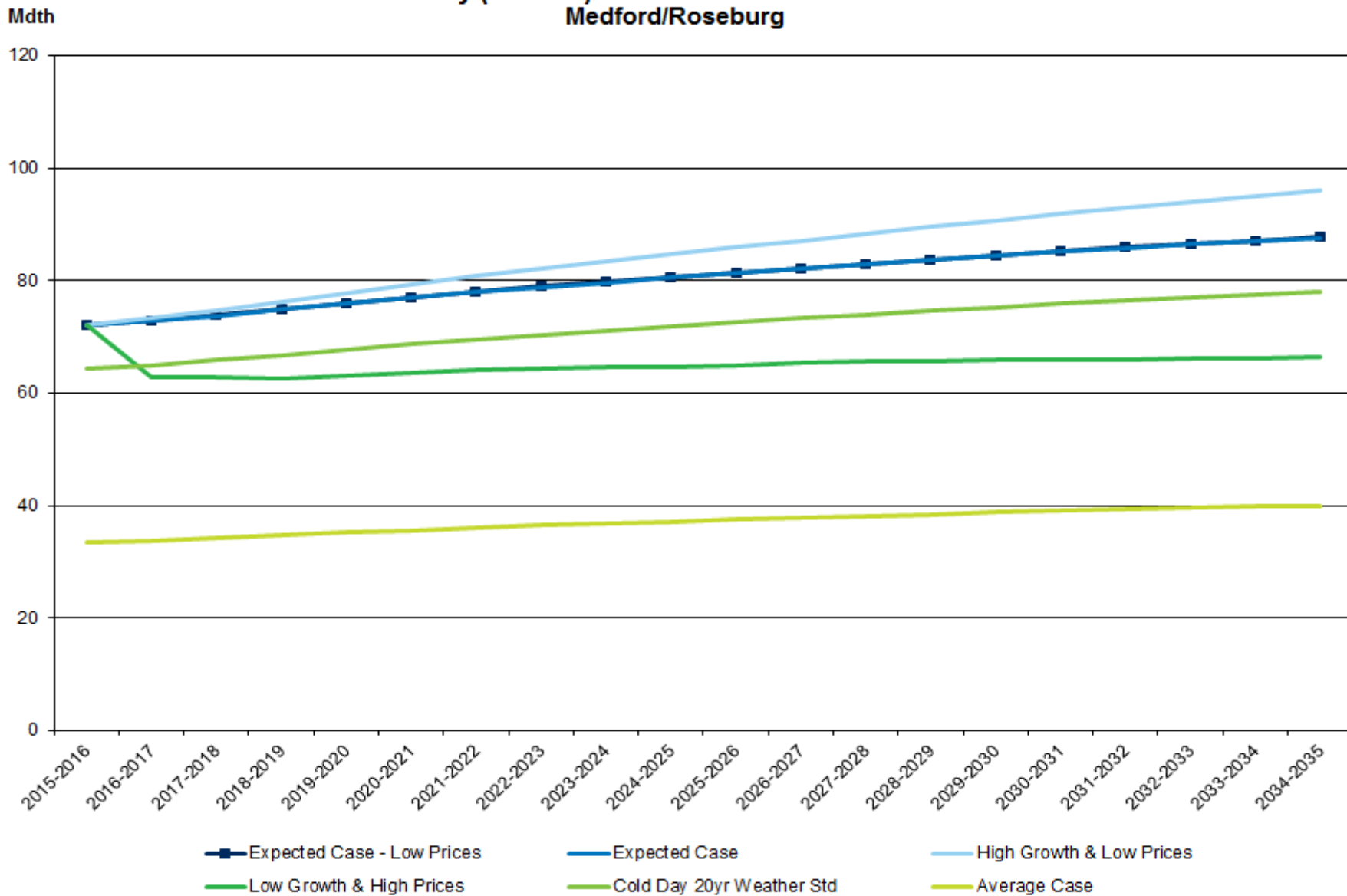

# First Year Peak Demand Not Met with Existing Resources Scenario Comparisons

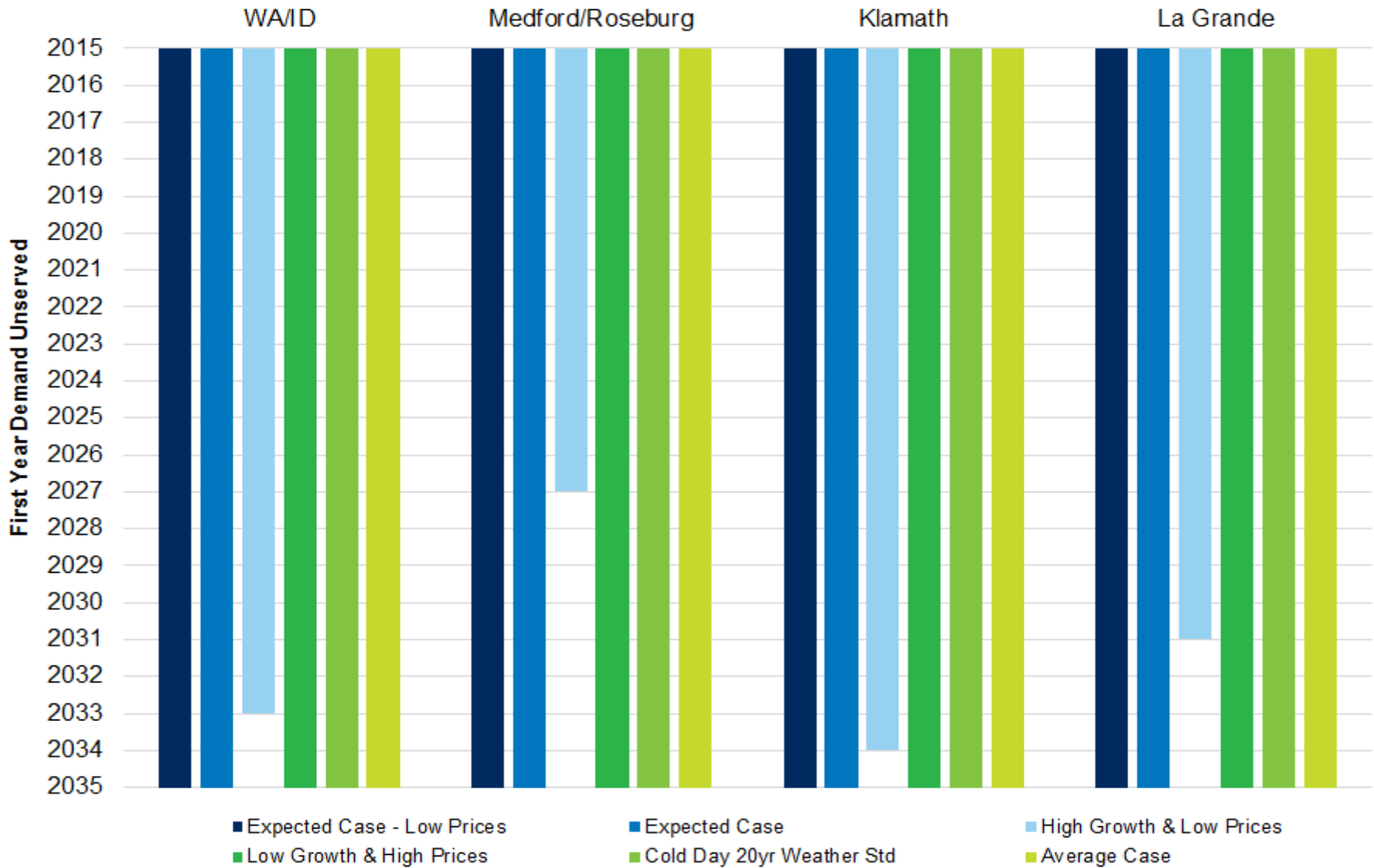

# Resource Options for Meeting Unserved Demand

# Potential New Supply Resources Considerations

- Availability
  - By Region – which region(s) can the resource be utilized?
  - Lead time considerations – when will it be available?
- Type of Resource
  - Peak vs. Base load
  - Firm or Non-Firm
  - “Lumpiness”
- Usefulness
  - Does it get the gas where we need it to be?
  - Last mile issues
- Cost



# Supply Resources Available

Additional Resource	Size	Cost/Rates	Availability	Notes
Capacity Release Recall	27,000 Dth	NWPL Rate	2018	Recall of previously released capacity
Unsubscribed GTN Capacity	Up to 50,000 Dth	GTN Rate plus Upstream TCPL	Now	Currently available unsubscribed capacity from Kingsgate to Stanfield or Malin plus associated Alberta transport
NWP Expansion	Up to 50,000 Dth	\$0.74 / Dth	2018	Expansion from Sumas to JP
Citygate Deliveries	Variable	Varies	Now	Represents the ability to buy a delivered product from another utility or marketer.  Limited counterparties
Satellite LNG	90,000 Dth w/30,000 Dth deliverability	\$7 Million capital cost plus \$375K O&M	2018	Provides for peaking services and alleviates the need for costly pipeline expansions.

# Supply Resources Available

Additional Resource	Size	Cost/Rates	Availability	Notes
Medford Lateral Exp	50,000 Dth	\$10M / GTN Rate	2018	Additional compression to facilitate more gas to flow from mainline GTN to Medford.
Malin Backhauls	50,000	GTN Rate	Now	Currently available

# Future Supply Resources

## Other Resources Considered

Additional Resource	Size	Cost/Rates	Availability	Notes
Co. Owned LNG	600,000 Dth w/ 150,000 of deliverability	\$75 Million plus \$2 Million annual O&M	2022	On site, in service territory liquefaction and vaporization facility
Various pipelines – Pacific Connector, Cross-Cascades, etc.	Varies	Precedent Agreement Rates	2020	Requires additional mainline capacity on NWPL or GTN to get to service territory
Large Scale LNG	Varies	Commodity less Fuel	2020	Speculative, needs pipeline transport
In Ground Storage	Varies	Varies	Varies	Requires additional mainline transport to get to service territory

# DSM Avoided Cost

- Avoided cost determined by comparison to the marginal supply side resources to meet incremental demand, primarily commodity costs.
- Preliminary avoided costs were provided to AEG for cost effectiveness testing and development of the DSM acquirable potential.
- Potential is then input into SENDOUT® and avoided costs are re-evaluated.

## Avoided Cost Comparison 2014 IRP vs. 2016 IRP

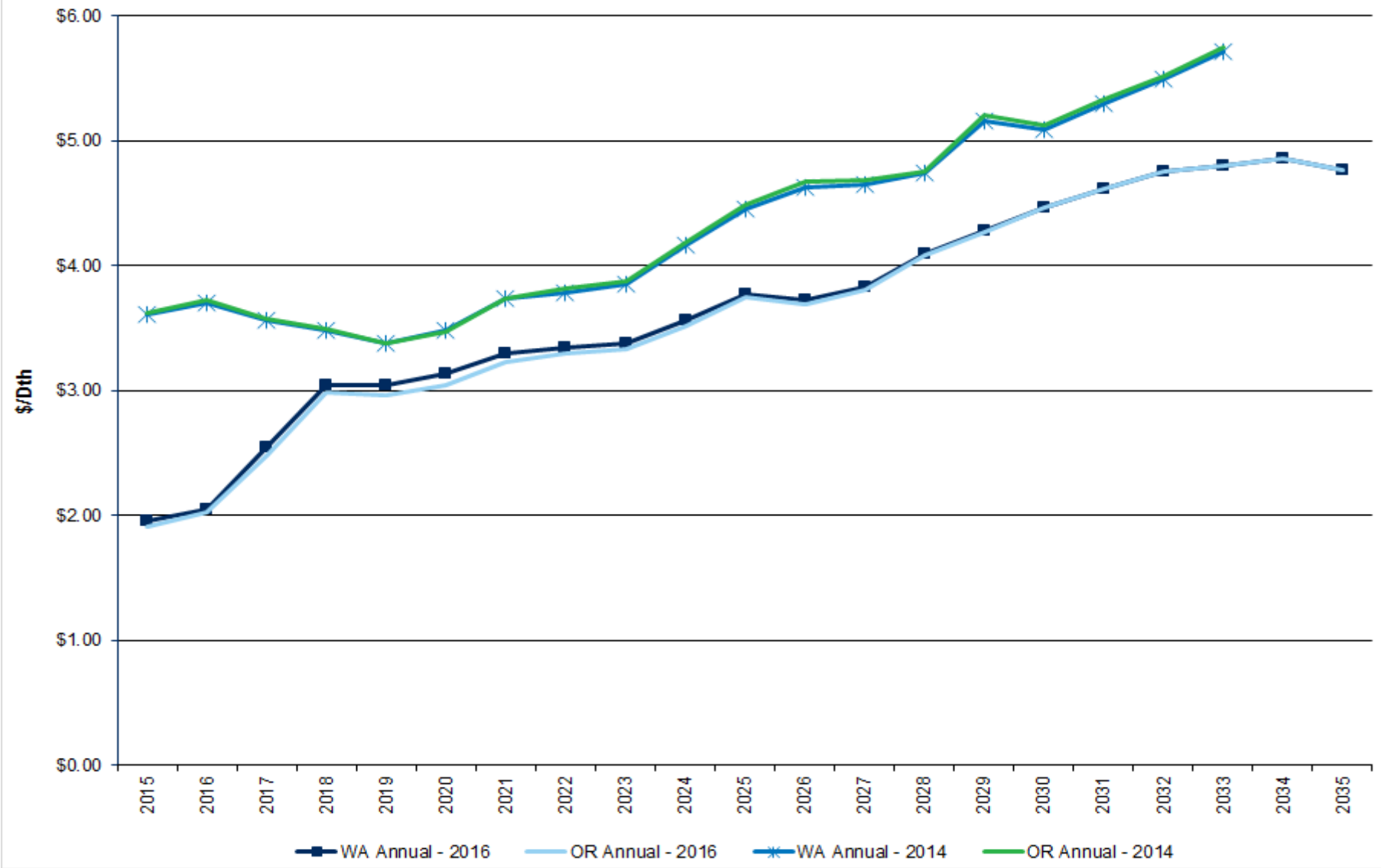



# Stochastic Analysis

# What is it?

- Stochastic vs. Deterministic
- Facilitates a statistical approach to analysis
- Reiterative runs of SENDOUT (e.g. 200 “Draws”)
- Utilizes statistically generated price curves and weather patterns derived from historical data
- Develops a distribution of the “draws” results
  - Normal (Weather) and lognormal (Index) distribution

# Analytical Objectives

- Weather
  - Validate reasonableness of our weather planning standard
  - Compare demand and unserved results
  - Quantify potential alternate weather planning standards via comparison of alternate aggregate NPV portfolio costs
- Price
  - Substantiate preferred portfolio selection (commodity cost perspective)
  - Compare distribution of aggregate NPV cost to preferred portfolio



# VectorGas™ Reports

## EXAMPLE ONLY

### Avista 20 Year Total Cost

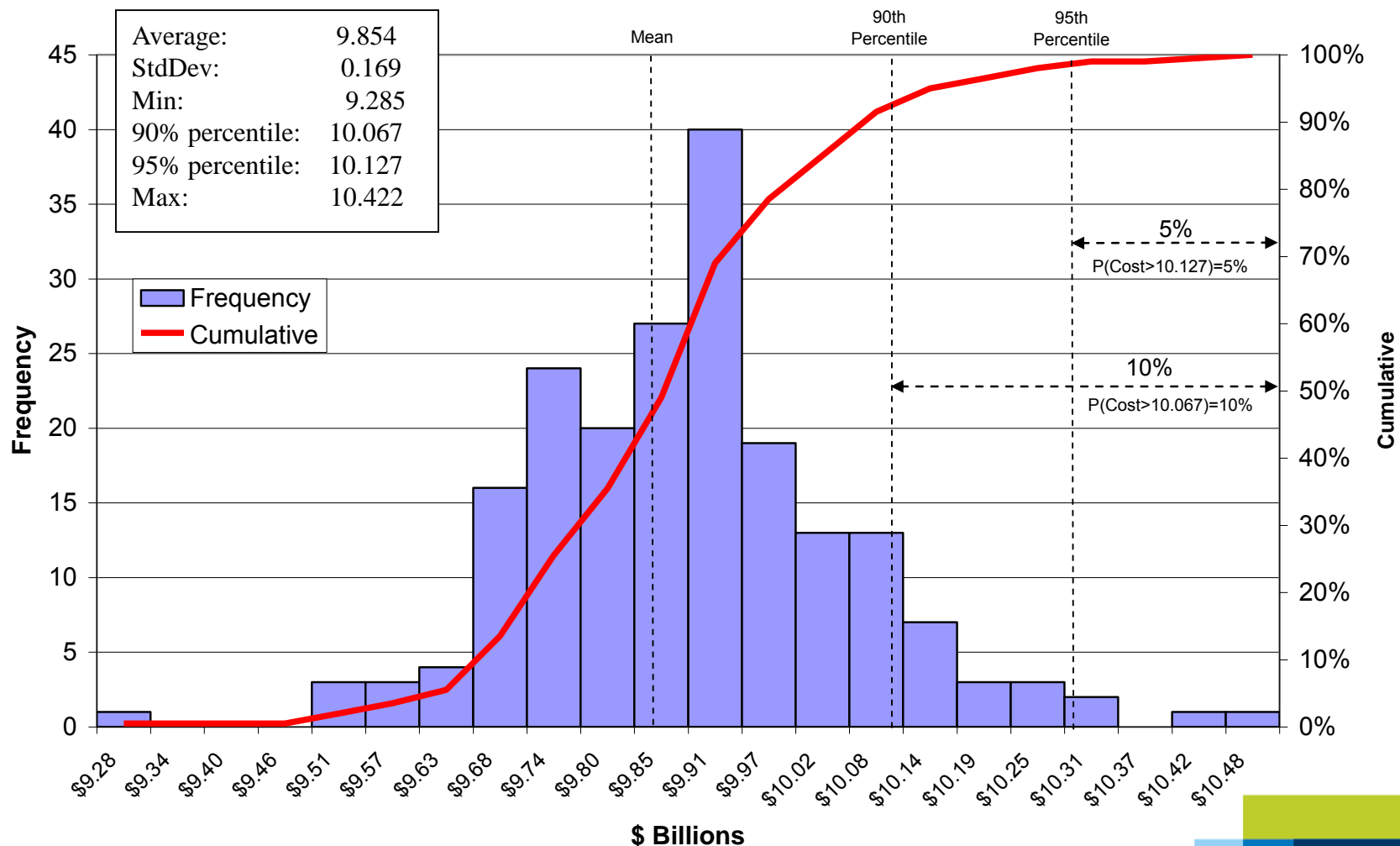

# Sample Weather Pattern

## Medford HDDs - Four example draws

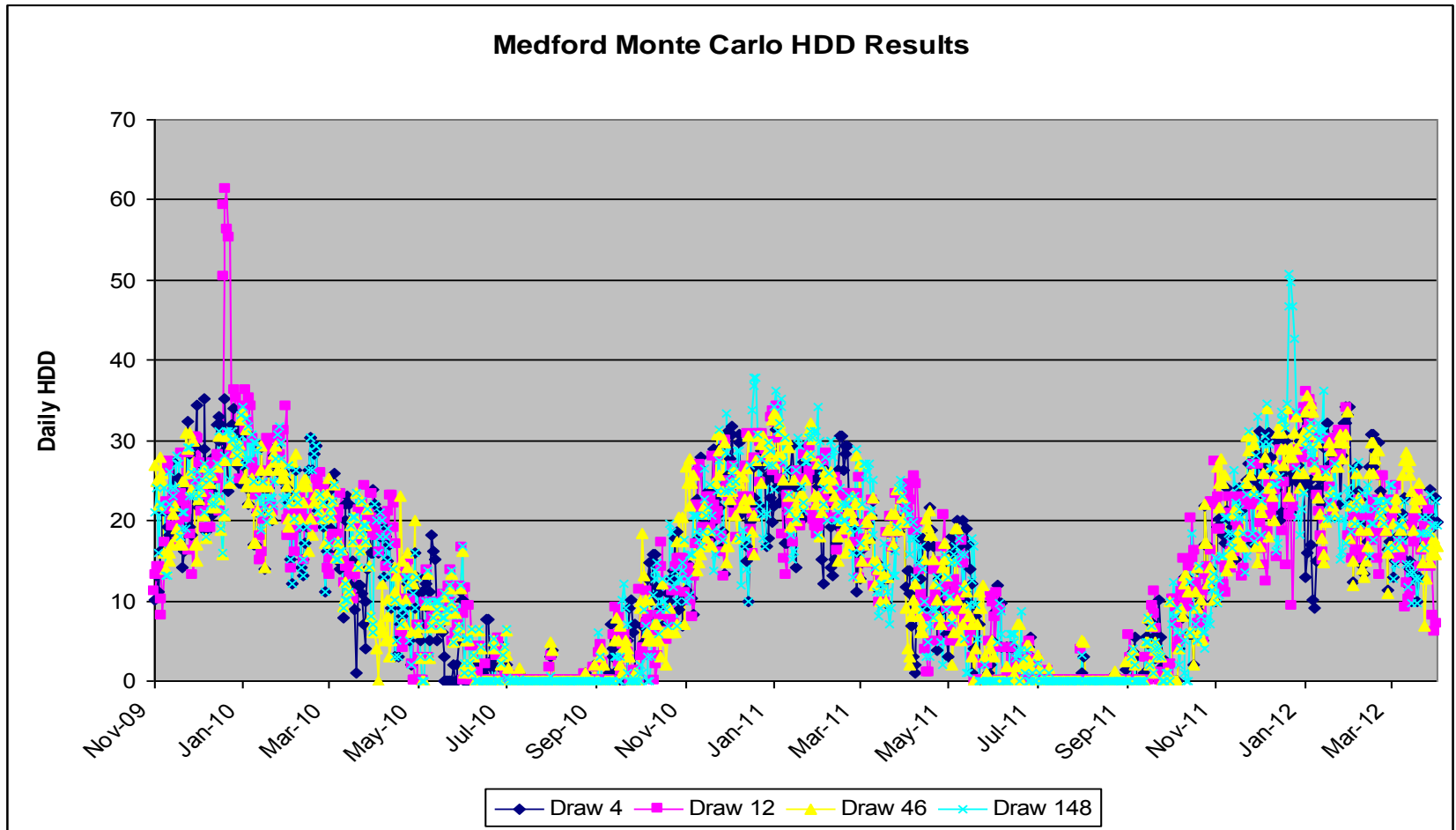



# Key Issues / Document Discussion

# Highlights of the 2016 IRP

- No near-term resource needs under most scenarios.
- Higher long term customer growth rates.
- Updated DSM potential and resultant avoided costs.
- Lower prices.

# 2014 IRP Acknowledgement Comments

- Include a section that discusses the ongoing management of Avista's surplus capacity
- Provide more detail on the distribution model results and analysis that identify specific distribution system needs
- Provide the resource portfolio solution that fills any demand not served for each scenario
- Ensure that the entity performing the Conservation Potential Assessment (CPA) evaluates the effect of the temporary operation under a Utility Cost Test (UCT) cost-effectiveness metric on near-term, achievable conservation potential, while maintaining the longer-term assumption that Avista will eventually be reverting back to a TRC test cost-effectiveness metric.
- Evaluation of state-specific resource needs when a resource deficiency is identified
- The appropriateness of using a 1 in 572 event for peak day planning
- The need for stress-testing the Company's storage resources during a peak event in a high-demand year

# 2014 IRP Acknowledgement Comments

- As part of its next IRP process, Avista must convene workshops with Staff and stakeholders to explore how best to model major resource acquisitions and major capital investments.
- For the next IRP, Avista must work with Staff and stakeholders to resolve forecasting methodology concerns, and seek to identify the most reliable methodology so that future resource needs may be clearly identified.
- In its next IRP, Avista must include a clear presentation of how Avista decides which distribution system projects to include in the IRP, and a clear description of the included projects, along with a justification for recommending or proceeding with the projects.
- As part of its next IRP process, Avista must convene discussions with Staff and stakeholders to discuss potential impacts associated with: (1) new regulations to reduce methane emissions; and (2) potential increases in natural gas prices stemming from increased demand for natural gas for generation under Section 111 (d) of the Clean Air Act.

# Key Questions

- **Low Demand?**
  - What are the impacts on consumption? Temporary or permanent change?
- **Low Prices**
  - Cheap gas for 20 years?
- **Environmental Impacts**
  - Carbon Tax?
  - Hydraulic Fracturing Bans?
- **Market**
  - Increasing production?
  - Increasing drilling efficiency?
  - Increasing demand from power?

# 2016 IRP Timeline

- **August 31, 2015** – Work Plan filed with WUTC
- **January through April 2016** – Technical Advisory Committee meetings. Meeting topics will include:
  - Demand Forecast and Demand Side Management – January 21
  - Supply/Infrastructure and Potential Case Discussion– February 18
  - Distribution Planning, Natural Gas Pricing, SENDOUT® Preliminary Output Results and Further Case Discussion – March 30
  - SENDOUT® results – April 21
  - **May 30, 2016 – Draft of IRP document to TAC**
- **June 30, 2016** – Comments on draft due back to Avista
- **July 2016** – TAC final review meeting (if necessary)
- **August 31, 2016** – File finalized IRP document