



PacifiCorp Energy
Naughton Power Plant
Wyoming

Lighting Upgrade Audit/Study
November 2013



Executive Summary

PacifiCorp Energy hired Evergreen Consulting Group to conduct a lighting audit at the Naughton plant located in 1450 Naughton Rd, Kemmerer, WY 83101. Site visits were conducted on August 26th -27th, 2013 and the following 3 recommendation phases for lighting upgrades are contained in this report.

- **T12 Lighting Upgrade:** Typical 1.5” diameter fluorescent tubes (4’ or 8’ lengths, some U-tubes) should be replaced with longer life, high performance T8 linear fluorescent. Scope includes de-lamping most 4 and 3 lamp fixture due to the improved light output of the retrofit kits. T-12 lamps are phasing out and will be more expensive to maintain both on energy consumption and maintenance. Project will improve “quality of light,” reduce maintenance by 75 - 85 percent over current levels, and allow for some controls in areas where fixtures don’t need 24 hour operation (or occupancy). LED fixtures are an option (or retrofit kits), but costs are more than the T8 technology with similar life of lamps. There are approximately 614 T12 fixtures recommended for upgrade.
- **Turbine Deck:** Currently illuminated with 1,000-Watt (W) metal-halide lamps that have a 40 percent lamp lumen depreciation and a lamp life rated at 20,000 hours. Due to the high mounting height and long life LED high bays are recommended. LEDs also come with long life typically at 60,000 hours or more. Due to directionality of the LED lamps, uniformity is attained beyond standard fluorescent or high intensity discharge lamps allowing for somewhat lower foot-candles but with better visibility in space. Project will improve “quality of light,” reduce maintenance by 60 percent over current levels, and allow for fixture mount occupancy sensors (if required). If taking in to account life cycle cost and any incremental cost difference (between high intensity discharge and fluorescent) LED should be considered for a long life cycle solution.

Industrial Fixtures: The primary fixtures are 175W metal halide or 150W high pressure sodium industrial low bay fixtures hanging throughout the entire facility. The recommended upgrade is a LED retrofit kit where the bottom portion of the housing is changed out on existing fixture. The new LED fixture is 78W and lasts approximately 60,000 hours (L70) compared to the existing fixtures 15,000 - 24,000 hour lamp life. In addition to this specific location, these fixture types are typical at other PacifiCorp Energy power plants, and for cost savings to PacifiCorp, it is recommended that a bulk ordering agreement for the same fixture types be set up to share material orders in similar breakouts for all locations.

- **Exterior fixtures** are broken out as their own phase. These high intensity discharge fixtures can be upgraded with various fixture types. Some will match the typical low bay LED retrofits (78W Type RLB1) while some will be similar to Type AL1, WP1-2, FL4-5, and RW1 fixtures. Plant personal or contractor will determine fixture mounting hardware prior to ordering as well as verify fixture types.



Table 1: Breakout of Lighting Upgrades for phasing purposes

Recommended Breakout	Number of light fixtures	Rough Budget \$	kWh Savings
T-12 Lighting Upgrade	614	\$71,300	323,400
Turbine Deck & Industrial Fixtures	1951*	\$1,623,700	2,781,533
Exterior Lighting	537	\$461,200	579,089
Totals	3102**	\$2,156,140	3,684,022

**Industrial fixtures represent 78W LED replacement fixtures and include lighting controls*

***Estimated total does not include all light fixtures throughout the plant. Misc. fixtures can be added to each phase as desired*

Benefits of Recommendations

Why invest in lighting? The economics of the internal savings is not included in this report. PacifiCorp is unable to utilize Rocky Mountain Power’s incentive unless they are physically paying a utility bill with an eligible industrial rate. Additionally, the actual cost of energy (in lighting tool) is not the “sell rate” to commercial/industrial customers for PacifiCorp Energy. So, once internal rates for power generation are applied, we don’t expect projects to net on “energy savings alone” under a typical 2 years to make this an automatic capital investment. However, looking at the long-term benefits there are significant values for investing in these recommended lighting upgrades that should be added to energy costs:

- 1) The kWh (energy units) and kW (demand) are real and can be re-sold to PacifiCorp end-users
- 2) Maintenance savings for both hard and soft costs are significant. Recommendations above should reduce 75 – 85 percent of the current lighting maintenance expenses each year for the next 10 years (and nominal increases thereafter).
- 3) Reduced safety risk to maintenance staff (minimizes access to restricted access areas/heights/lifts and lighting over process equipment).
- 4) Quality of light: New technology improves the color, enhances visibility and human comfort. Existing lighting has a color accuracy of 50 – 65 percent; recommended lighting has a color accuracy of 80 – 90 percent. Term in lighting is called CRI (color rendering index).
- 5) Increases productivity and safety by providing clearer distinction in colors (e.g., instrumentation wiring) and small details of equipment, etc.
- 6) Computer glare is reduced especially in the office areas. Additionally, current IES (Illuminating Engineering Society) light level recommendations can be met in those offices with these recommendations.
- 7) Make power available for other equipment: These projects are base load reductions, meaning power for panels and transformers are reduced and allow mores options to be used for new connections/loads or equipment, besides reducing stress on existing panels or overload situations.



- 8) In some cases, insurance premiums could qualify for reductions with some project improvements.
- 9) Net payback, once included cost benefits factors above (especially adding the human factors), and should meet all PacifiCorp's internal rates-of-returns to invest in all power plants. This report cannot identify the physical dollars associated to all these internal pieces to form a final financial calculation. But based in the nature that these power plants are long-term facilities and even if basic energy savings only net paybacks look longer to invest with more expensive LED technology, the secondary benefits on maintenance and improve working environment should make these projects a high priority on capital investments. The recommended technologies also provide 15 - 20 years equipment life for new fixtures and 12 - 15 years of equipment life on retrofits (for existing fixtures) before replacements or next capital investments should need to be reconsidered.

Lighting Audit Report

The Naughton Power Plant located at 1450 Naughton Plant Rd, Kemmerer, WY is comprised of three generating units with the total generating capability of 700+ megawatts. It has extensive interior and exterior industrial grated levels. The plant turned 50-years old in 2013. Operating hours are 24-hours a day, 365 days a year with the plant office operating from Monday-Friday.

A lighting audit for the Naughton Power Plant was performed by Dan Kuhl, LC of Evergreen Consulting Group. The entire facility consists of coal conveyer belts, mechanical, service walkways, offices, labs, maintenance shops, generating units, cooling towers and other miscellaneous buildings. The lighting audit encompasses all of Units 1-3 including every common area. The majority of the facility consists of lower wattage 175W metal halide and some high pressure sodium low bay fixtures that provide general ambient lighting. Other wattages and lamp types typical of an industrial power plant are in use but the 175W "plant standard" is the most common with approximately 2,000+ units installed. Older T12 lamps are also prevalent throughout the plant. These T12s fluorescent lamps with magnetic ballasts should be changed out in 2014 as replacement lamps are getting harder to find and the costs are increasing.

It was observed that most of the existing lighting equipment is at end-of-life and will require extensive maintenance or replacement in the near future. Local staff have started installing some new metal halide fixtures, and while this has helped improve the overall light levels, this technology matches the existing inefficient lighting with higher long term maintenance compared to current technology available. The best option for continued replacement of the existing lights (due to light loss, CRI, lamp life and maintenance), is new (or retrofit) LED fixtures (also known as solid state lighting). In addition, there are several areas throughout the facility that do not have any existing light fixtures permanently installed. These should be identified by staff so that during the retrofit, new fixtures can be included with bids.

This facility has very significant energy savings opportunities. The savings are a good faith estimate and can change depending upon what is actually installed. Final numbers can be accounted for in the post-inspection process after installation is completed.



Recommendations

Detail Lighting Survey: Appendix B contains a large spreadsheet (known as Lighting Tool) on each area showing baseline and proposed fixtures (recommended). Included in this appendix are four Lighting tools:

1. One - master spreadsheet with all baseline opportunities (all fixtures surveyed).
2. Three – breakout spreadsheets with baselines of your T12 fixtures, turbine and industrial area, and exterior lighting.

Recommended Fixtures: Appendix C contains specification sheets of the typical fixture type being recommended. No specific manufacturer is required and an “or-equal” alternative can be used for bid purposes.

- **De-lamping 4’ T12 to T8 retrofit kits:** The typical 4’ T12 fluorescent fixtures should be replaced with 2-lamp T8 CEE high performance ballast/lamp de-lamping kits. These kits fit inside the existing fixture housing and re-position the lamp holders for the new lamps and optimizing how much light projected out of the fixture. They increase the efficiency of the fixture using reflectors and lenses to give recommended light levels as needed for each area of the offices. Plant area T12’s are typical 8’ slim-line or high output fluorescent fixture that will be either de-lamped or retrofitted with 4’ T8 lamps using a “kit” which allows for easy installation without removing the “body” of the fixture. The 8’ lamps will be eliminated also, which is a significant maintenance expense and storage concern.
- **Crouse Hinds** – Currently, the plant has over 2,700 low bay industrial fixtures using either 175W metal halide or 150W high-pressure sodium. It is recommended to replace these with a retrofit kit that uses the existing back box when retrofitting the fixture, thereby reducing the labor time to replace. These retrofit kits are available from Dialight or Crouse-Hinds (at the time of this report). Other manufactures may have an equal product. Alternatives could be looked at as a cost saving measure only, which would be a LED screw-in retrofit hybrid kit. This would save money but not provide the “engineered” lighting pattern as described for the recommended retrofit option. Plant would need to do their due-diligence before approving the LED screw-in option (test for example).
- **LED High Bay fixtures:** We strongly recommend the plant select a high quality LED high bay fixture to replace the turbine area’s existing high bay high intensity discharge (HID) lamps. Maintenance reduction, long life, safety, and lighting quality are all drivers here. Recently new fixtures designed specifically for high ceiling applications have been introduced to the market and would meet the space requirements for light levels, uniformity, and quality of light that the turbine area requires. In the turbine area, the existing average FC is 55-60, which is higher than IES recommends (@30FC). Caution should be taken when recommending a new fixture and light level. Uniformity and higher quality light (CRI) is highly recommended if reducing FC’s. It is recommended that the plant review multiple products before choosing a fixture for this area.
- **Exterior fixtures:** This area would receive a standard replacement with most recommended products changing to a new LED fixture. Time will need to be spent determining the proper fixtures that use the correct optics, wattage, and fixture design. Since the market has been using LED fixtures of this type for a few years now, it has



matured faster than other LED sectors, driving the price down where the incremental cost difference between existing technologies and LED are minimal.

- **Why CEE/DLC:** The fixtures recommended above can be found on the Consortium for Energy Efficiency (CEE) and Designlights Consortium (DLC) listed fixtures. The utility programs require these listed products for lamps/ballast and LED related products. These not only protect the owner from lower performance products being installed but also insure that they get the best available technology in the market for their buildings.

CEE uses NEMA (National Electrical Manufacturers Association) premium ballast specification and minimum lamp efficiency standards to identify the longest lasting and higher quality linear fluorescent lamps (U-tube and 4' lamps only are listed). By ordering CEE listed products (there are over 1,000+), your lamp life and quality will be maximized while saving energy and reducing maintenance costs. Estimated costs shown do include these products. Note: For all interior T8 lamps, it is recommended to use longer life 28W lamps (84,000 estimated hours). For all T8 ballasts, it is recommended to use "program start" ballasts in conjunction with these same lamps. Program start ballasts, besides being recommended where occupancy sensors are used, provide exact voltage and pre-heat the fluorescent lamp cathode, which extends the life of the lamps.

DLC is a national list for LED fixtures and retrofit kits that provides minimum performance standards to help identify less desirable products in the market. Because LED is an emerging technology and has experienced early products failures, a national standard was developed.

Recommended Maintenance and Life of Lighting: The primary fixtures are shown for comparison on life of lamps compared to existing.

- Existing T12 lighting at this location have an average lamp life of **12,000 - 20,000 hours** (based on size or brand of lamps). This is typically **1.5 to 2.5 years** before replacement.
- Recommended T8 lighting: Recommended new lamps replacing the T12 lamps have **84,000 hours or 9 years** life span between burnouts. Adding controls will extend these fixtures longer than 9 years if currently operating 24-hours a day. Office fixtures operating only M-F, could have 15-20 year life before burn-outs. Paying 1 - 2 dollars more for these lamps are well worth the investment up-front over the standard T8 lamps.
- Existing 175W metal halide fixtures have a lamp life of **12,000 hours or 1.5 years** before they burn out.
- Existing 150W high-pressure sodium fixtures have a lamp life of **24,000 hours or 2.8 years** before they burn out.
- Recommended LED fixtures have a useful (L70) life of **60,000+ hours or 7+ years**. Definition of "useful" is when the lumen output is at 70 percent of initial light output. LED lamps will keep burning, provide light past this useful life, and therefore offer some additional benefit over lamps that burn out; however, replacement/updates should be considered at the 70 percent light output mark.
- Existing 400W metal halide (high bay) fixtures have a lamp life of **20,000 hours or 2.8 years**. Metal halide lamps have multiple drawbacks: poor color rendering (CRI), short lamp life and steep lamp lumen depreciation (40% loss in light levels). Because of this, this plant is experiencing excessive maintenance (cost/time) and low light levels from existing light fixtures compared to today's technology options.



- Recommended LED high bay fixtures have **60,000 hours** typical useful life (L70). You also get a product that uses less energy to deliver useful lumens (light) on your task with better uniformity than existing high intensity discharge as well as more light with this direct source of lighting. A side benefit is that these turn on “instantly” rather than having a 5 to 10 minute wait for a fixture to come up to full brightness allowing for controls to be added in storage areas that will extend the longevity of the fixture (years) and energy savings for not being used 24-hours/day.

Costs/Budgets

Appendix D contains the detail cost breakout and shows all assumptions or logic for material and labor by fixture type.

Costs are an estimate only (budgeting) and disregard any notations to any utility incentive or dollar savings per year values in attached lighting tools. These values are only applicable if the power plant was able to participate in the Rocky Mountain Power *FinAnswer Express/wattsmart* Business incentive program. Any \$ values (savings or incentive) shown in attachments should be ignored; lighting tools are only used for calculating kW and kWh savings and identifying the fixture types by space.

Logic for cost estimates:

Most fixtures were budgeted at one hour per installation averages. Some will take longer but some will take less time. Labor cost was based at \$80 an hour, which is a typical hourly wage for electricians. Cost could be adjusted up or down depending on your evaluation of local labor rates and the difficulty of each installation; spreadsheets are provided to make those adjustments internally. Individual costs do not include such things as disposal, scaffolding, permitting, safety requirements, or cost of shut down if needed; but other contingency amounts were provided on a total that may be leveraged to cover some of these expenses. PacifiCorp Energy may have other contingency factors not provided for in this report that should be added as necessary based on location of site, security restriction time for contractors, and regional bidding environment of local/remote resources availability.

Cost reduction options:

For the purposes of this lighting survey/audit and ease of installation, the Crouse Hinds retrofit fixture was used for cost estimating. Other manufacturers (Dialight) have or may have a cost effective alternative that may meet the owner’s needs with a lower installed cost than the Crouse Hinds fixture. It is recommended that these options be researched or Evergreen Consulting could assist in doing the research.

Upon request, we have changed the recommended the lighting fixture type from a fluorescent to a LED for the main open turbine area (when compared to the original preliminary report copies). A 511W (watt) LED high bay fixture is recommended as it offers the best maintenance option and longer life desired by facility owners and maintenance personal.

The costs can range dramatically on a project of this size and complexity. LEDs were considered for the plant standard 175W metal halide general low bays and for most of the 1,000W metal halide high bays fixtures, as this would be the simplest and easiest to replace. Pricing is higher for this product technology (LED) but should be considered for its ease of change out and probability of substantial price reduction if pre-negotiated with the manufacturer prior to purchase for multiple plants (locations). We recommend arranging a national purchase agreement to consolidate same fixture purchases for all power plants over a 1 - 2 year time period purchasing window.



Appendix A

Fixture Summary Page



Fixture Legend

Fixture Codes

Code	Technology	Description
FCIT9	Fluorescent	Circleline T9
FLE	Fluorescent	Linear Exit
FUT12	Fluorescent	U Tube T12
FUT8	Fluorescent	U Tube T8
FUT8CEE	Fluorescent	U Tube CEE T8
FCE	Fluorescent	Compact Exit
FCM	Fluorescent	Compact Medium Base
FCP	Fluorescent	Compact Pin Base
FCPWP	Fluorescent	Compact Pin Base Wall Pack
FCMG	Fluorescent	Compact Mogul Base
FCGU24	Fluorescent	Compact GU24
FLT8	Fluorescent	Linear T8
FLT8CEE	Fluorescent	Linear CEE T8
FLT8CEEHB	Fluorescent	Linear CEE T8 High Bay
FLT10	Fluorescent	Linear T10
FLT12	Fluorescent	Linear T12
FLT12HO	Fluorescent	Linear T12HO
FLT12VHO	Fluorescent	Linear T12VHO
FLT17	Fluorescent	Linear T17
FLT5	Fluorescent	Linear T5
FLT5HO	Fluorescent	Linear T5HO
FLT5HOHB	Fluorescent	Linear T5HO High Bay
FCCFL	Fluorescent	Cold Cathode
CMH	HID	Ceramic Metal Halide
HPS	HID	High Pressure Sodium
MV	HID	Mercury Vapor
MH	HID	Metal Halide
MHPS	HID	Metal Halide Pulse Start
ICE	Incandescent	Exit
ICH	Incandescent	Halogen
ICMB	Incandescent	Medium Base
ICMG	Incandescent	Mogul Base
INRB	Induction	Remote-Ballasted
INSB	Induction	Self-Ballasted
LEDSMC	LED	Surface Mount Canopy
LEDE	LED	Exit
LEDHB	LED	High Bay
LEDSI	LED	Integral Screw-in
LEDPM	LED	Pole Mount
LEDDL	LED	Recessed Downlight
LEDWP	LED	Wall Pack
PE	Photoluminescent	Exit

Ballast Codes

Code	Ballast Type
CEE IS	CEE Instant Start
CEE ISDIM	CEE Dimmable Instant Start
CEE PS/PRSDIM	CEE Dimmable Program Start
CEE RS/PRS	CEE Rapid Start
IS	Instant Start
IS(E)	Efficient Instant Start
RS/PRS	Rapid/Program Start
RS/PRS(E)	Efficient Rapid/Program Start
MG	Magnetic
MG(E)	Efficient Magnetic
MGPH	Magnetic Pre-Heat
CWA	Constant Wattage Autotransformer
HIDLF	HID Low Freq Ballast
INDN	Induction (Non-integral)
LR	Linear Reactor
RL	Regulated Lag
SCWA	Super CWA

Ballast Factor Codes

Code	Description
L	Low (BF ≤ 0.85)
N	Normal (0.85 < BF ≤ 1.0)
H	High (BF > 1.0)
CEE L	CEE Low (BF ≤ 0.85)
CEE N	CEE Normal (0.85 < BF ≤ 1.0)
CEE H	CEE High (BF > 1.0)

Controls/Sensor Codes

Code	Description
Integral	Integral
Occupancy	Occupancy
Daylighting	Daylighting
Ad. Daylighting	Advanced Daylighting
Time Clock	Time Clock
Dup. Occ	Duplicate Occupancy
Dup. DL	Duplicate Daylighting
Dup. Ad. DL	Duplicate Advanced Daylighting
Dup. TC	Duplicate Time Clock

Additional Information

[RMP: DLC, Energy Star, LDL Links and Information](#)

[PP: DLC, Energy Star, LDL Links and Information](#)

Naughton Power Plant - All Lighting

Fixture Summary & Count

Fluorescent

FLT8CEE-28W x 2L x 4'-CEE RS/PRS CEE N	503
FLT8-17W x 3L x 2'-IS L	4
FLT8CEE-28W x 4L x 4'-CEE RS/PRS CEE N	62
FLT8CEEHB-32W x 4L x 4'-CEE IS CEE H	45

HID

Induction

LED

LEDHB-213W	67
------------	----

Other

CUST: LEDHB-78W	2058
CUST: LEDHB-511W	123
CUST: 121W LED Flood Lite	66
CUST: LEDWP-47W	86
CUST: LED Flood 158W	88

Controls

Occupancy	45
Integral	187

Naughton Power Plant - T12 Phase

Fixture Summary & Count

Fluorescent

FLT8CEE-28W x 2L x 4'-CEE RS/PRS CEE N	503
FLT8-17W x 3L x 2'-IS L	4
FLT8CEE-28W x 4L x 4'-CEE RS/PRS CEE N	62
FLT8CEEHB-32W x 4L x 4'-CEE IS CEE H	45

HID

Induction

LED

Other

Controls

Occupancy	43
Integral	105

Naughton Power Plant - Industrial & Turbine Phase

Fixture Summary & Count

Fluorescent

HID

Induction

LED

LEDHB-213W	67
------------	----

Other

CUST: LEDHB-78W	1779
-----------------	------

CUST: LEDHB-511W	78
------------------	----

CUST: 121W LED Flood Lite	20
---------------------------	----

CUST: LEDWP-47W	7
-----------------	---

Controls

Integral	82
----------	----

Occupancy	2
-----------	---

Naughton Power Plant - Exterior Phase

Fixture Summary & Count

Fluorescent

HID

Induction

LED

Other

CUST: LEDWP-47W	79
CUST: LEDHB-511W	45
CUST: LEDHB-78W	279
CUST: LED Flood 158W	88
CUST: 121W LED Flood Lite	46

Controls

Appendix B

Lighting Tools





**ROCKY MOUNTAIN
POWER**

Let's turn the answers on.

V 070113.5.3

Wyoming FinAnswer Express Program

07/01/13 Effective Date

You Can Now Use The Project Information Tab

Project ID	
Lighting Coordinator	Dan Kuhl
Tool Prepared by	Dan Kuhl
Project Manager	
Account Manager	

Customer Information

Project Name	Naughton Power Plant - Entire Scope		
Business Name	PacifiCorp Energy		
Installation Address	1450 Naughton Plant Rd.		
City, State, Zip	Kemmerer	WY	83101
Contact, Title	Ryan Witbeck		
Phone, Email		Ryan.Witbeck@Pacifcorp.com	
Account, Meter, Rate			48T
Participant is:	<input checked="" type="checkbox"/> Acct Holder <input checked="" type="checkbox"/> Elect. User <input checked="" type="checkbox"/> Building Owner		
Business Type	Other		

Contractor Information

Contact		<input type="checkbox"/> EEA Participant
Business Name		
Address		
City, State, Zip		
Phone, Email		

Payee Information

Incentive Should Be Addressed To:	Installation Address		
Business Name	PacifiCorp Energy		
Attention	Ryan Witbeck		
Check Reference			
Address	1450 Naughton Plant Rd.		
City, State, Zip	Kemmerer	WY	83101

Eligibility Information

Business Name			
Address			
City, State, Zip			
Account #			
Meter Base #, Rate			

Processing Information

Construction Type	Retrofit	Stage	Preliminary
-------------------	----------	-------	-------------

Project Cost

Material	Labor	Other	Total Project Cost
\$1,900,200.00	\$239,440.00	\$16,500.00	\$2,156,140.00

Space Type & Size

Calculation Method	Whole Building	Allowed Wattage	360,000	
1 Other		FT ² 600,000	0.60	W/FT ²
		FT ²		W/FT ²
		FT ²		W/FT ²
		FT ²		W/FT ²
		FT ²		W/FT ²
Other		FT ² 600,000	0.60	W/FT ²

Lighting Operation Schedule

# of Holidays Closed?	Day	A	B	C	D	E
0	Mon	24.0	12.0	12.0		
Op Weeks Per Year	Tue	24.0	12.0	12.0		
	Wed	24.0	12.0	12.0		
"S" is for a seasonal operational schedule	Thu	24.0	12.0	12.0		
	Fri	24.0	12.0	12.0		
	Sat	24.0	4.0	12.0		
S is for 0 hrs/year	Sun	24.0	0.0	12.0		
X is for 8760 hrs/year	Total	8,760	3,337	4,380		
Y is for 4380 hrs/year						

Additional Information

--

Category	66W - FCP-25W x 21-MG 29W - FCP-25W-MG 50W - FCP-26W x 21-IS H 54W - FCP-26W x 21-IS N 66W - FCP-26W x 21-MG 99W - FCP-26W x 3L-MG 150W - FCP-26W x 6I -IS H 27W - FCP-26W-IS H 28W - FCP-26W-IS N 30W - FCP-26W-MG 31W - FCP-27W-MG	<input type="button" value="Add Fixture"/> <input type="button" value="Remove Fixture"/> <input type="button" value="Clear Filter"/> <input type="button" value="Build Fixture"/> <input type="button" value="Reset"/>	511 W - CUST: 1 FDHB-511W 458W - MH-400W-CWA 99W - FI T8CFE-28W x 4l x 4'-CFF P 121 W - CUST: 121W I FD Flood lite 98 W - CUST: 1 FD HR 98w 78 W - CUST: LEDHB-78W 120W - FI T12-34W x 4l x 4'-IS N 216W - FI T5HO-49W x 4l x 4'-RS/P 98 W - CUST: 1 FD Flood light 79 W - CUST: 1 FD Flood 79W 158 W - CUST: 1 FD Flood 158W	 <p>Let's turn the answers on.</p>									
Fixture				<p>Savings Information</p> <p>3,684,022 kWh Saved Per Year</p> <p>Lighting Power Density</p> <table border="1"> <tr> <td>0.60</td> <td>Code</td> <td>35.3%</td> </tr> <tr> <td>0.99</td> <td>Existing</td> <td>Better Than Code LPD</td> </tr> <tr> <td>0.39</td> <td>Proposed</td> <td></td> </tr> </table>	0.60	Code	35.3%	0.99	Existing	Better Than Code LPD	0.39	Proposed	
0.60	Code	35.3%											
0.99	Existing	Better Than Code LPD											
0.39	Proposed												
Lamp													
Lamp (W)													
Lamp Qty				<p>↓↓Project Tracking↓↓</p> <p>Preliminary</p> <p>Pre-Inspection</p> <p>Agreement Needed</p>									
Ballast													
Factor													
<p>49W - FLT8CEE-28W x 2L x 4'-CEE RS/PRS CEE N</p> <p>Fluorescent Linear T8 CEE (28W x 2L x 4') 1 CEE Rapid/Program Start Ballast (0.85 < BF < 1.0)</p> <p>Standard Incentive (8.2% of Cost Paid By Incentive)</p>				Contracted									

Preliminary **Naughton Power Plant - Entire Scope**

Line Number	108 Out Of 127 Lines Used		Existing				Proposed				Notes
	Exterior	Schedule	Qty	Controls	Interior Fixture Wattage	Interior Space Wattage	Qty	Controls	Interior Fixture Wattage	Interior Space Wattage	
1	A	Entry Building	8		144	1,152	8		49	392	L&B Type BNLO1 & Type L2
2	B	OFFICE Hallway2ndflr	27		144	3,888	27		49	1,323	L&B Type BNLO1 & Type L2
3	B	Office- HallwayDavidO	4		144	576	4	Occupancy	49	196	L&B Type BNLO1 & Type L2
4	B	Office Rm119	4		144	576	4	Occupancy	49	196	L&B Type BNLO1 & Type L2
5	B	Office Rm120	4		144	576	4	Occupancy	49	196	L&B Type BNLO1 & Type L2
6	B	Office Mens RR	2		144	288	2	Occupancy	49	98	L&B Type BNLO1 & Type L2
7	B	Office Mens RR	2		63	126	2	Occupancy	43	86	Ballast and Lamp Change-Out
8	B	Office Womens RR	2		63	126	2	Occupancy	43	86	Ballast and Lamp Change-Out
9	B	Office Womens RR	2		144	288	2	Occupancy	49	98	L&B Type BNLO1 & Type L2
10	B	Office Rm 108	4		144	576	4	Occupancy	49	196	L&B Type BNLO1 & Type L2
11	B	Office Rm 103	4		144	576	4	Occupancy	49	196	L&B Type BNLO1 & Type L2
12	B	Office Rm 101/102	9		144	1,296	9	Occupancy	49	441	L&B Type BNLO1 & Type L2
13	B	Office Rm 107	4		144	576	4	Occupancy	49	196	L&B Type BNLO1 & Type L2
14	B	Office Supply Room	2		144	288	2	Occupancy	49	98	L&B Type BNLO1 & Type L2
15	B	Office Cyrstal	4		144	576	4	Occupancy	49	196	L&B Type BNLO1 & Type L2
16	B	Office Conf Rm109	8		144	1,152	8	Occupancy	49	392	L&B Type BNLO1 & Type L2
17	B	Office 2nd flr Rm 214	4		144	576	4	Occupancy	49	196	L&B Type BNLO1 & Type L2
18	B	Office Liz Har Files	21		144	3,024	21	Occupancy	49	1,029	L&B Type BNLO1 & Type L2

19	B	Office Rm 212	FLT12-34W x 4L x 4'-2 MG(E)	4	144	576	FLT8CEE-28W x 2L x 4'-CEE RS/PRS CEE N	4	Occupancy	49	196	L&B Type BNLO1 & Type L2
20	B	Office Janica Dever	FLT12-34W x 4L x 4'-2 MG(E)	3	144	432	FLT8CEE-28W x 2L x 4'-CEE RS/PRS CEE N	3	Occupancy	49	147	L&B Type BNLO1 & Type L2
21	B	Office Envir. Dept.	FLT12-34W x 4L x 4'-2 MG(E)	10	144	1,440	FLT8CEE-28W x 2L x 4'-CEE RS/PRS CEE N	10	Occupancy	49	490	L&B Type BNLO1 & Type L2
22	B	Office Rm 208	FLT12-34W x 4L x 4'-2 MG(E)	4	144	576	FLT8CEE-28W x 2L x 4'-CEE RS/PRS CEE N	4	Occupancy	49	196	L&B Type BNLO1 & Type L2
23	B	Office Empty Rm	FLT12-34W x 4L x 4'-2 MG(E)	4	144	576	FLT8CEE-28W x 2L x 4'-CEE RS/PRS CEE N	4	Occupancy	49	196	L&B Type BNLO1 & Type L2
24	B	Office Rm 204	FLT12-34W x 4L x 4'-2 MG(E)	4	144	576	FLT8CEE-28W x 2L x 4'-CEE RS/PRS CEE N	4	Occupancy	49	196	L&B Type BNLO1 & Type L2
25	B	Office Rm 205	FLT12-34W x 4L x 4'-2 MG(E)	4	144	576	FLT8CEE-28W x 2L x 4'-CEE RS/PRS CEE N	4	Occupancy	49	196	L&B Type BNLO1 & Type L2
26	B	Office Michael Tully	FLT12-34W x 4L x 4'-2 MG(E)	4	144	576	FLT8CEE-28W x 2L x 4'-CEE RS/PRS CEE N	4	Occupancy	49	196	L&B Type BNLO1 & Type L2
27	B	Office Empty Office	FLT12-34W x 4L x 4'-2 MG(E)	4	144	576	FLT8CEE-28W x 2L x 4'-CEE RS/PRS CEE N	4	Occupancy	49	196	L&B Type BNLO1 & Type L2
28	B	Office Ryan Whitbeck	FLT12-34W x 4L x 4'-2 MG(E)	5	144	720	FLT8CEE-28W x 2L x 4'-CEE RS/PRS CEE N	5	Occupancy	49	245	L&B Type BNLO1 & Type L2
29	B	Office 2nd Flr. Hallway	FLT12-34W x 4L x 4'-2 MG(E)	5	144	720	FLT8CEE-28W x 2L x 4'-CEE RS/PRS CEE N	5		49	245	L&B Type BNLO1 & Type L2
30	B	Office Computer Rm	FLT12-34W x 4L x 4'-2 MG(E)	8	144	1,152	FLT8CEE-28W x 2L x 4'-CEE RS/PRS CEE N	8	Occupancy	49	392	L&B Type BNLO1 & Type L2
31	B	Office Kitchen Area	FLT12-34W x 4L x 4'-2 MG(E)	6	144	864	FLT8CEE-28W x 2L x 4'-CEE RS/PRS CEE N	6	Occupancy	49	294	L&B Type BNLO1 & Type L2
32	B	Office Locked Rm	FLT12-34W x 4L x 4'-2 MG(E)	5	144	720	FLT8CEE-28W x 2L x 4'-CEE RS/PRS CEE N	5	Occupancy	49	245	L&B Type BNLO1 & Type L2
33	B	Office Bob Wood	FLT12-34W x 4L x 4'-2 MG(E)	5	144	720	FLT8CEE-28W x 2L x 4'-CEE RS/PRS CEE N	5	Occupancy	49	245	L&B Type BNLO1 & Type L2
34	B	Office Mens Locker	FLT12-34W x 4L x 4'-2 MG(E)	15	144	2,160	FLT8CEE-28W x 2L x 4'-CEE RS/PRS CEE N	15		49	735	L&B Type BNLO1 & Type L2
35	B	Office Kim Rm	FLT12-34W x 4L x 4'-2 MG(E)	3	144	432	FLT8CEE-28W x 2L x 4'-CEE RS/PRS CEE N	3	Occupancy	49	147	L&B Type BNLO1 & Type L2
36	B	Office Wash Machine	FLT12-34W x 4L x 4'-2 MG(E)	4	144	576	FLT8CEE-28W x 2L x 4'-CEE RS/PRS CEE N	4	Occupancy	49	196	L&B Type BNLO1 & Type L2
37	B	Wm locker Rm	FLT12-34W x 4L x 4'-2 MG(E)	12	144	1,728	FLT8CEE-28W x 2L x 4'-CEE RS/PRS CEE N	12		49	588	L&B Type BNLO1 & Type L2
38	B	Office Lunch Rm	FLT12-34W x 4L x 4'-2 MG(E)	11	144	1,584	FLT8CEE-28W x 2L x 4'-CEE RS/PRS CEE N	11	Occupancy	49	539	L&B Type BNLO1 & Type L2
39	B	Office Break Rm	FLT12-34W x 4L x 4'-2 MG(E)	6	144	864	FLT8CEE-28W x 2L x 4'-CEE RS/PRS CEE N	6	Occupancy	49	294	L&B Type BNLO1 & Type L2
40												
41		UNIT #1										UNIT #1
42	A	UNIT #1 Belt Line	HPS-150W	10	188	1,880	CUST: LEDHB-78W	10		78	780	Crouse Hinds Retrofit Kit to match existing - Type RLB1
43	A	UNIT #1 Belt Line	MH-175W-CWA	72	215	15,480	CUST: LEDHB-78W	72		78	5,616	Crouse Hinds Retrofit Kit to match existing - Type RLB1
44	A	TRANSFER TOWER- Conveyor Belt - Exterior	HPS-150W	15	188	2,820	CUST: LEDHB-78W	15		78	1,170	Crouse Hinds Retrofit Kit to match existing - Type RLB1
45	A	T-Chlor	MH-175W-CWA	4	215	860	CUST: LEDHB-78W	4		78	312	Crouse Hinds Retrofit Kit to match existing - Type RLB1
46	A	Storage Shed	HPS-150W	8	188	1,504	CUST: LEDHB-78W	8		78	624	Crouse Hinds Retrofit Kit to match existing - Type RLB1

47	A	Gas Fill Up	HPS-150W	4		188	752	CUST: LEDHB-78W	4		78	312	Crouse Hinds Retrofit Kit to match existing - Type RLB1
48	A	EQUIP SHOP	MH-400W-CWA	8		458	3,664	LEDHB-213W	8		213	1,704	Type HB1
49	A	Equip Shop-Truck Storage	MH-400W-CWA	12		458	5,496	LEDHB-213W	12		213	2,556	Type HB1
50	A	OIL STORAGE	MH-175W-CWA	8		215	1,720	CUST: LEDHB-78W	8		78	624	Crouse Hinds Retrofit Kit to match existing - Type RLB1
51	A	NEW SCRUBBER STACK	HPS-150W	110		188	20,680	CUST: LEDHB-78W	110		78	8,580	Crouse Hinds Retrofit Kit to match existing - Type RLB1
52	A	Adjacent building to Scrubber stack	MH-400W-CWA	36		458	16,488	CUST: LEDHB-78W	36	Integral	78	2,808	Crouse Hinds Retrofit Kit to match existing - Type RLB1
53	A	Parking garage light	MH-175W-CWA	22		215	4,730	CUST: LEDHB-78W	22		78	1,716	Crouse Hinds Retrofit Kit to match existing - Type RLB1
54	A	Scrubber Tower #1 Bldg	MH-175W-CWA	6		215	1,290	CUST: LEDHB-78W	6		78	468	Crouse Hinds Retrofit Kit to match existing - Type RLB1
55	A	INSULATION ABATEMENT	MH-400W-CWA	6		458	2,748	CUST: LEDHB-78W	6	Integral	78	468	Crouse Hinds Retrofit Kit to match existing - Type RLB1
56	A	Insulation Abatement	FLT12HO-95W x 2L x 8'-MG(E)	2		207	414	FLT8CEE-28W x 4L x 4'-CEE RS/PRS CEE N	1		99	99	Refl Kit, L&B - Type SK2, BNLO2, L2
57	A	Insulation Abatement-Back Room	FLT12-34W x 4'-MG(E)	18		43	774	FLT8CEE-28W x 2L x 4'-CEE RS/PRS CEE N	18		49	882	L&B Type BNLO1 & Type L2
58	A	Insulation Abatement-Tool room	FLT12HO-110W x 8'-MG	1		121	121	FLT8CEE-28W x 4L x 4'-CEE RS/PRS CEE N	1	Integral	99	99	Refl Kit, L&B - Type SK2, BNLO2, L2
59	A	Insulation Abatement-RR	FLT12-34W x 4'-MG(E)	2		43	86	FLT8CEE-28W x 2L x 4'-CEE RS/PRS CEE N	2	Occupancy	49	98	L&B Type BNLO1 & Type L2
60	A	MAINTENANCE BUILDING	MH-1000W-CWA	24		1,080	25,920	CUST: LEDHB-511W	24	Occupancy	511	12,264	Type HB6
61	A	Maintenance Building-Parameter wall mt.	MH-175W-CWA	20		215	4,300	CUST: 121W LED Flood Lite	20		121	2,420	Type FL4
62	A	Maintenance Building-High Bay	MH-400W-CWA	6		458	2,748	LEDHB-213W	6		213	1,278	Type HB1
63	A	WAREHOUSE-High Bays	MH-400W-CWA	40		458	18,320	LEDHB-213W	40	Integral	213	8,520	Type HB1
64	A	Warehouse-Office	FLT12-34W x 4'-MG(E)	5		43	215	FLT8CEE-28W x 2L x 4'-CEE RS/PRS CEE N	5	Occupancy	49	245	L&B Type BNLO1 & Type L2
65	A	Warehouse-Lower Shelf Rows	FLT12HO-95W x 2L x 8'-MG(E)	59		207	12,213	FLT8CEE-28W x 4L x 4'-CEE RS/PRS CEE N	59	Integral	99	5,841	Refl Kit, L&B - Type SK2, BNLO2, L2
66	A	Warehouse E.	FLT12-60W x 2L x 8'-MG(E)	16		123	1,968	FLT8CEE-28W x 4L x 4'-CEE RS/PRS CEE N	1		99	99	Refl Kit, L&B - Type SK2, BNLO2, L2
67	A	Warehouse E.	FLT12-34W x 4L x 4'-2 MG	66		144	9,504	FLT8CEEHB-32W x 4L x 4'-CEE IS CEE H	45	Integral	142	6,390	Type BHLO2 & L1
68	A	MAINTENANCE OFFICE-Lunch	FLT12-34W x 4L x 4'-2 MG	12		144	1,728	FLT8CEE-28W x 2L x 4'-CEE RS/PRS CEE N	12	Occupancy	49	588	L&B Type BNLO1 & Type L2
69	A	Maintenance Office-Hallway High Ceiling	MH-1000W-CWA	9		1,080	9,720	CUST: LEDHB-511W	9		511	4,599	Type HB6
70	A	Maintenance Office-Hallway Office	FLT12-34W x 4L x 4'-2 MG	12		144	1,728	FLT8CEE-28W x 2L x 4'-CEE RS/PRS CEE N	12		49	588	L&B Type BNLO1 & Type L2
71	A	Maintenance Office-Washing machine	FLT12-34W x 4L x 4'-2 MG	8		144	1,152	FLT8CEE-28W x 2L x 4'-CEE RS/PRS CEE N	8	Occupancy	49	392	L&B Type BNLO1 & Type L2
72	A	Maintenance Office-Private Offices	FLT12-34W x 4L x 4'-2 MG	8		144	1,152	FLT8CEE-28W x 2L x 4'-CEE RS/PRS CEE N	8	Occupancy	49	392	L&B Type BNLO1 & Type L2
73	A	Maintenance Office-Warehouse Offices	FLT12-34W x 4L x 4'-2 MG	27		144	3,888	FLT8CEE-28W x 2L x 4'-CEE RS/PRS CEE N	27	Occupancy	49	1,323	L&B Type BNLO1 & Type L2
74	A	Maintenance Office-Hallway	FLT12-34W x 4L x 4'-2 MG	3		144	432	FLT8CEE-28W x 2L x 4'-CEE RS/PRS CEE N	3		49	147	L&B Type BNLO1 & Type L2

75	A	Maintenance Office-Mens/Women RR	FLT12-34W x 2L x 4'-MG(E)	8		72	576	FLT8CEE-28W x 2L x 4'-CEE RS/PRS CEE N	8	Occupancy	49	392	L&B Type BNLO1 & Type L2
76	A	Maintenance Office-Lunch Rm.	FLT12-34W x 4L x 4'-2 MG	24		144	3,456	FLT8CEE-28W x 2L x 4'-CEE RS/PRS CEE N	24	Occupancy	49	1,176	L&B Type BNLO1 & Type L2
77	A	Maintenance Office-Private Offices	FLT12-34W x 4L x 4'-2 MG	15		144	2,160	FLT8CEE-28W x 2L x 4'-CEE RS/PRS CEE N	15	Occupancy	49	735	L&B Type BNLO1 & Type L2
78	A	Maintenance Shop-Stairwell	FLT12-34W x 2L x 4'-MG	6		72	432	FLT8CEE-28W x 2L x 4'-CEE RS/PRS CEE N	6		49	294	L&B Type BNLO1 & Type L2
79	A	Maintenance Shop-Hallway 1st/2nd floor	FLT12-34W x 2L x 4'-MG	26		72	1,872	FLT8CEE-28W x 2L x 4'-CEE RS/PRS CEE N	26		49	1,274	L&B Type BNLO1 & Type L2
80	A	Maintenance Shop-Mens Locker	FLT12-34W x 4'-MG(E)	39		43	1,677	FLT8CEE-28W x 2L x 4'-CEE RS/PRS CEE N	39		49	1,911	L&B Type BNLO1 & Type L2
81	A	Maintenance Shop-Mens Locker-Wall	FLT12-34W x 2L x 4'-MG	14		72	1,008	FLT8CEE-28W x 2L x 4'-CEE RS/PRS CEE N	14		49	686	L&B Type BNLO1 & Type L2
82	A	ELECTRICAL SHOP	FLT12-34W x 4'-MG(E)	13		43	559	FLT8CEE-28W x 2L x 4'-CEE RS/PRS CEE N	13		49	637	L&B Type BNLO1 & Type L2
83	A	Electrical Shop	FLT12-34W x 2L x 4'-MG	5		72	360	FLT8CEE-28W x 2L x 4'-CEE RS/PRS CEE N	5		49	245	L&B Type BNLO1 & Type L2
84	A	TURBINE ROOM	MH-1000W-CWA	36		1,080	38,880	CUST: LEDHB-511W	36		511	18,396	Type HB6
85	A	Turbine Rm-Crane Lights	MH-1000W-CWA	5		1,080	5,400	CUST: LEDHB-511W	5		511	2,555	Type HB6
86	A	PRECEP #1,#2,#3(Plant Standard)	MH-175W-CWA	223		215	47,945	CUST: LEDHB-78W	223		78	17,394	Type RLB1
87	+ C	Precep -Wallpacks - Exterior	MH-175W-CWA	22		215	4,730	CUST: LEDWP-47W	22		47	1,034	Type WP1
88	A	GENERATING UNITS #1, #2, #3(Plant Standard) Includes Bunker and Boiler	MH-175W-CWA	1233		215	265,095	CUST: LEDHB-78W	1233		78	96,174	Type RLB1
89													
90	A	GENERATING UNITS #1, #2, #3(Plant Standard) Includes Bunker and Boiler	HPS-150W	22		188	4,136	CUST: LEDHB-78W	22		78	1,716	Type RLB1
91	C	GENERATING UNITS #1, #2, #3 Includes Bunker and Boiler/- Wallpacks	MH-175W-CWA	7		215	1,505	CUST: LEDWP-47W	7		47	329	Type WP1
92	A	SILO	MH-1000W-CWA	4		1,080	4,320	CUST: LEDHB-511W	4		511	2,044	LED High Bay to match Turbine room. May require special mounting hardware - Type HB6
93	A	Silo-Entry Add	LEDHB-213W	0		213	0	LEDHB-213W	1	Occupancy	213	213	This fixture added to entry area for safety. 4 lamp High Bay - Type HB1
94	+ C	OUTDOOR LIGHTING-High	MH-1000W-CWA	36		1,080	38,880	CUST: LEDHB-511W	36		511	18,396	High Mast Light - LED 511w
95	+ C	Outdoor Lighting-Various locations-Plant Standard	MH-175W-CWA	79		215	16,985	CUST: LEDHB-78W	79		78	6,162	Type RLB1
96	+ C	Outdoor Lighting-Various locations-Plant Standard	HPS-150W	37		188	6,956	CUST: LEDHB-78W	37		78	2,886	Type RLB1

97	+	C	Outdoor Lighting-Floods	HPS-1000W	9		1,100	9,900	CUST: LEDHB-511W	9		511	4,599	LED Flood 511w
98	+	C	Outdoor Lighting-Floods	HPS-400W	37		465	17,205	CUST: LED Flood 158W	37		158	5,846	Type FL3
99	+	C	Outdoor Lighting-Wallpacks	MH-175W-CWA	31		215	6,665	CUST: LEDWP-47W	31		47	1,457	Type WP1
100	+	C	Outdoor Lighting-Wallpacks	MH-250W-CWA	26		295	7,670	CUST: LEDWP-47W	26		47	1,222	Type WP1
101	+	C	Outdoor Lighting-Cobra Heads	HPS-250W	46		295	13,570	CUST: 121W LED Flood Lite	46		121	5,566	Type FL4
102	+	C	Outdoor Lighting-Floods(Halogen)	ICH-500W	37		500	18,500	CUST: LED Flood 158W	37		158	5,846	Type FL3
103	+	A	SCRUBBER STACKS(Plant Standard)Exterior	MH-175W-CWA	128		215	27,520	CUST: LEDHB-78W	128		78	9,984	Type RLB1
104		A	MCC Rm	FLT12-34W x 2L x 4'-MG	12		72	864	FLT8CEE-28W x 2L x 4'-CEE RS/PRS CEE N	12		49	588	L&B Type BNLO1 & Type L2
105		A	Generator Room	FLT12-20W x 2L x 2'-MG	3		50	150	FLT8CEE-28W x 2L x 4'-CEE RS/PRS CEE N	3		49	147	L&B Type BNLO1 & Type L2
106		A	Mens/Women RR	FLT12-20W x 2L x 2'-MG	2		50	100	FLT8CEE-28W x 2L x 4'-CEE RS/PRS CEE N	2		49	98	L&B Type BNLO1 & Type L2
107		A	Small Blg. Off Scrubber	FLT12-34W x 2L x 4'-MG	4		72	288	FLT8CEE-28W x 2L x 4'-CEE RS/PRS CEE N	4		49	196	L&B Type BNLO1 & Type L2
108	+	C	UNIT 3 COOLING TOWER-Stantion - MTExterior	MH-175W-CWA	23		215	4,945	CUST: LEDHB-78W	23		78	1,794	Type RLB1
109	+	C	UNIT 3 COOLING TOWER-Floods-Exterior	HPS-400W	7		465	3,255	CUST: LED Flood 158W	7		158	1,106	Type FL3
110	+	C	UNIT 2 COOLING TOWER-Flood-Exterior	HPS-400W	7		465	3,255	CUST: LED Flood 158W	7		158	1,106	Type FL3
111	+	C	UNIT 1 COOLING TOWER-Stantion Mt. - Exterior	MH-175W-CWA	12		215	2,580	CUST: LEDHB-78W	12		78	936	Type RLB1
112														
113														
114														
115														
116														
117														
118														
119														
120														
121														
122														
123														
124														
125														
126														



**ROCKY MOUNTAIN
POWER**

Let's turn the answers on.

V 070113.5.3

Wyoming FinAnswer Express Program

07/01/13 Effective Date

You Can Now Use The Project Information Tab

Project ID	
Lighting Coordinator	Dan Kuhl
Tool Prepared by	Dan Kuhl
Project Manager	
Account Manager	

Customer Information

Project Name	Naughton Power Plant - T12 Lighting (only)		
Business Name	PacifiCorp Energy		
Installation Address	1450 Naughton Plant Rd.		
City, State, Zip	Kemmerer	WY	83101
Contact, Title	Ryan Witbeck		
Phone, Email		Ryan.Witbeck@Pacifcorp.com	
Account, Meter, Rate			48T
Participant is:	<input checked="" type="checkbox"/> Acct Holder <input checked="" type="checkbox"/> Elect. User <input checked="" type="checkbox"/> Building Owner		
Business Type	Other		

Contractor Information

Contact		<input type="checkbox"/> EEA Participant
Business Name		
Address		
City, State, Zip		
Phone, Email		

Payee Information

Incentive Should Be Addressed To:	Installation Address		
Business Name	PacifiCorp Energy		
Attention	Ryan Witbeck		
Check Reference			
Address	1450 Naughton Plant Rd.		
City, State, Zip	Kemmerer	WY	83101

Eligibility Information

Business Name			
Address			
City, State, Zip			
Account #			
Meter Base #, Rate			

Processing Information

Construction Type	Retrofit	Stage	Preliminary
-------------------	----------	-------	-------------

Project Cost

Material	Labor	Other	Total Project Cost
\$62,830.00	\$7,920.00	\$550.00	\$71,300.00

Space Type & Size

Calculation Method	Whole Building	Allowed Wattage	360,000	
1 Other		FT ² 600,000	0.60	W/FT ²
		FT ²		W/FT ²
		FT ²		W/FT ²
		FT ²		W/FT ²
		FT ²		W/FT ²
Other		FT ² 600,000	0.60	W/FT ²

Lighting Operation Schedule

# of Holidays Closed?	Day	A	B	C	D	E
0	Mon	24.0	12.0	12.0		
Op Weeks Per Year	Tue	24.0	12.0	12.0		
	Wed	24.0	12.0	12.0		
"S" is for a seasonal operational schedule	Thu	24.0	12.0	12.0		
	Fri	24.0	12.0	12.0		
	Sat	24.0	4.0	12.0		
S is for 0 hrs/year	Sun	24.0	0.0	12.0		
X is for 8760 hrs/year	Total	8,760	3,337	4,380		
Y is for 4380 hrs/year						

Additional Information

--

Category	66W - FCP-25W x 2L- 29W - FCP-25W-MG 50W - FCP-26W x 2L- 54W - FCP-26W x 2L- 66W - FCP-26W x 2L- 99W - FCP-26W x 3L- 150W - FCP-26W x 6L	<input type="button" value="Add Fixture"/> <input type="button" value="Remove"/> <input type="button" value="Clear Filter"/> <input type="button" value="Build Fixture"/> <input type="button" value="Reset"/>	511 W - CUST: LEDHE 458W - MH-400W-CW 99W - FLT8CEE-28W 121 W - CUST: 121W 98 W - CUST: LED HB 78 W - CUST: 1 FDHR 120W - FLT12-34W x	 <p>Let's turn the answers on.</p> <p>↓ ↓ Project Tracking ↓ ↓</p> <p>Preliminary</p> <p>Pre-Inspection</p> <p>Agreement Needed</p> <p>Contracted</p> <p>Post-Inspection</p> <p>Final Review Needed</p> <p>↓ ↓ Project Notes ↓ ↓</p>									
Fixture													
Lamp													
Lamp (W)													
Lamp Qty													
Ballast													
Factor													
<p>49W - FLT8CEE-28W x 2L x 4'-CEE RS/PRS CEE N</p> <p>Fluorescent Linear T8 CEE (28W x 2L x 4') 1 CEE Rapid/Program Start Ballast (0.85 < BF < 1.0)</p> <p>Standard Incentive [56.8% of Cost Paid By Incentive]</p>				<p>Savings Information</p> <p>323,400 kWh Saved Per Year</p> <p>Lighting Power Density</p> <table border="1"> <tr> <td>0.60</td> <td>Code</td> <td>89.7%</td> </tr> <tr> <td>0.14</td> <td>Existing</td> <td>Better Than Code LPD</td> </tr> <tr> <td>0.06</td> <td>Proposed</td> <td></td> </tr> </table>	0.60	Code	89.7%	0.14	Existing	Better Than Code LPD	0.06	Proposed	
0.60	Code	89.7%											
0.14	Existing	Better Than Code LPD											
0.06	Proposed												

Preliminary Naughton Power Plant - T12 Lighting (only)

Line Number	66 Out Of 127 Lines Used		Existing				Proposed				Notes
	Exterior	Schedule	Qty	Controls	Fixture Wattage	Space Wattage	Qty	Controls	Fixture Wattage	Space Wattage	
1	A	Entry Building	8		144	1,152	8		49	392	L&B Type BNLO1 & Type L2
2	B	OFFICE Hallway2ndflr	27		144	3,888	27		49	1,323	L&B Type BNLO1 & Type L2
3	B	Office-HallwayDavidO	4		144	576	4	Occupancy	49	196	L&B Type BNLO1 & Type L2
4	B	Office Rm119	4		144	576	4	Occupancy	49	196	L&B Type BNLO1 & Type L2
5	B	Office Rm120	4		144	576	4	Occupancy	49	196	L&B Type BNLO1 & Type L2
6	B	Office Mens RR	2		144	288	2	Occupancy	49	98	L&B Type BNLO1 & Type L2
7	B	Office Mens RR	2		63	126	2	Occupancy	43	86	Ballast and Lamp Change-Out
8	B	Office Womens RR	2		63	126	2	Occupancy	43	86	Ballast and Lamp Change-Out
9	B	Office Womens RR	2		144	288	2	Occupancy	49	98	L&B Type BNLO1 & Type L2
10	B	Office Rm 108	4		144	576	4	Occupancy	49	196	L&B Type BNLO1 & Type L2
11	B	Office Rm 103	4		144	576	4	Occupancy	49	196	L&B Type BNLO1 & Type L2
12	B	Office Rm 101/102	9		144	1,296	9	Occupancy	49	441	L&B Type BNLO1 & Type L2
13	B	Office Rm 107	4		144	576	4	Occupancy	49	196	L&B Type BNLO1 & Type L2
14	B	Office Supply Room	2		144	288	2	Occupancy	49	98	L&B Type BNLO1 & Type L2
15	B	Office Cyrstal	4		144	576	4	Occupancy	49	196	L&B Type BNLO1 & Type L2
16	B	Office Conf Rm109	8		144	1,152	8	Occupancy	49	392	L&B Type BNLO1 & Type L2
17	B	Office 2nd flr Rm 214	4		144	576	4	Occupancy	49	196	L&B Type BNLO1 & Type L2
18	B	Office Liz Har Files	21		144	3,024	21	Occupancy	49	1,029	L&B Type BNLO1 & Type L2

19	B	Office Rm 212	FLT12-34W x 4L x 4'-2 MG(E)	4	144	576	FLT8CEE-28W x 2L x 4'-CEE RS/PRS CEE N	4	Occupancy	49	196	L&B Type BNLO1 & Type L2
20	B	Office Janica Dever	FLT12-34W x 4L x 4'-2 MG(E)	3	144	432	FLT8CEE-28W x 2L x 4'-CEE RS/PRS CEE N	3	Occupancy	49	147	L&B Type BNLO1 & Type L2
21	B	Office Envir. Dept.	FLT12-34W x 4L x 4'-2 MG(E)	10	144	1,440	FLT8CEE-28W x 2L x 4'-CEE RS/PRS CEE N	10	Occupancy	49	490	L&B Type BNLO1 & Type L2
22	B	Office Rm 208	FLT12-34W x 4L x 4'-2 MG(E)	4	144	576	FLT8CEE-28W x 2L x 4'-CEE RS/PRS CEE N	4	Occupancy	49	196	L&B Type BNLO1 & Type L2
23	B	Office Empty Rm	FLT12-34W x 4L x 4'-2 MG(E)	4	144	576	FLT8CEE-28W x 2L x 4'-CEE RS/PRS CEE N	4	Occupancy	49	196	L&B Type BNLO1 & Type L2
24	B	Office Rm 204	FLT12-34W x 4L x 4'-2 MG(E)	4	144	576	FLT8CEE-28W x 2L x 4'-CEE RS/PRS CEE N	4	Occupancy	49	196	L&B Type BNLO1 & Type L2
25	B	Office Rm 205	FLT12-34W x 4L x 4'-2 MG(E)	4	144	576	FLT8CEE-28W x 2L x 4'-CEE RS/PRS CEE N	4	Occupancy	49	196	L&B Type BNLO1 & Type L2
26	B	Office Michael Tully	FLT12-34W x 4L x 4'-2 MG(E)	4	144	576	FLT8CEE-28W x 2L x 4'-CEE RS/PRS CEE N	4	Occupancy	49	196	L&B Type BNLO1 & Type L2
27	B	Office Empty Office	FLT12-34W x 4L x 4'-2 MG(E)	4	144	576	FLT8CEE-28W x 2L x 4'-CEE RS/PRS CEE N	4	Occupancy	49	196	L&B Type BNLO1 & Type L2
28	B	Office Ryan Whitbeck	FLT12-34W x 4L x 4'-2 MG(E)	5	144	720	FLT8CEE-28W x 2L x 4'-CEE RS/PRS CEE N	5	Occupancy	49	245	L&B Type BNLO1 & Type L2
29	B	Office 2nd Flr. Hallway	FLT12-34W x 4L x 4'-2 MG(E)	5	144	720	FLT8CEE-28W x 2L x 4'-CEE RS/PRS CEE N	5		49	245	L&B Type BNLO1 & Type L2
30	B	Office Computer Rm	FLT12-34W x 4L x 4'-2 MG(E)	8	144	1,152	FLT8CEE-28W x 2L x 4'-CEE RS/PRS CEE N	8	Occupancy	49	392	L&B Type BNLO1 & Type L2
31	B	Office Kitchen Area	FLT12-34W x 4L x 4'-2 MG(E)	6	144	864	FLT8CEE-28W x 2L x 4'-CEE RS/PRS CEE N	6	Occupancy	49	294	L&B Type BNLO1 & Type L2
32	B	Office Locked Rm	FLT12-34W x 4L x 4'-2 MG(E)	5	144	720	FLT8CEE-28W x 2L x 4'-CEE RS/PRS CEE N	5	Occupancy	49	245	L&B Type BNLO1 & Type L2
33	B	Office Bob Wood	FLT12-34W x 4L x 4'-2 MG(E)	5	144	720	FLT8CEE-28W x 2L x 4'-CEE RS/PRS CEE N	5	Occupancy	49	245	L&B Type BNLO1 & Type L2
34	B	Office Mens Locker	FLT12-34W x 4L x 4'-2 MG(E)	15	144	2,160	FLT8CEE-28W x 2L x 4'-CEE RS/PRS CEE N	15		49	735	L&B Type BNLO1 & Type L2
35	B	Office Kim Rm	FLT12-34W x 4L x 4'-2 MG(E)	3	144	432	FLT8CEE-28W x 2L x 4'-CEE RS/PRS CEE N	3	Occupancy	49	147	L&B Type BNLO1 & Type L2
36	B	Office Wash Machine	FLT12-34W x 4L x 4'-2 MG(E)	4	144	576	FLT8CEE-28W x 2L x 4'-CEE RS/PRS CEE N	4	Occupancy	49	196	L&B Type BNLO1 & Type L2
37	B	Wm locker Rm	FLT12-34W x 4L x 4'-2 MG(E)	12	144	1,728	FLT8CEE-28W x 2L x 4'-CEE RS/PRS CEE N	12		49	588	L&B Type BNLO1 & Type L2
38	B	Office Lunch Rm	FLT12-34W x 4L x 4'-2 MG(E)	11	144	1,584	FLT8CEE-28W x 2L x 4'-CEE RS/PRS CEE N	11	Occupancy	49	539	L&B Type BNLO1 & Type L2
39	B	Office Break Rm	FLT12-34W x 4L x 4'-2 MG(E)	6	144	864	FLT8CEE-28W x 2L x 4'-CEE RS/PRS CEE N	6	Occupancy	49	294	L&B Type BNLO1 & Type L2
40		UNIT #1										
41	A	Insulation Abatement	FLT12HO-95W x 2L x 8'-MG(E)	2	207	414	FLT8CEE-28W x 4L x 4'-CEE RS/PRS CEE N	1		99	99	Refl Kit, L&B - Type SK2, BNLO2, L2
42	A	Insulation Abatement-Back Room	FLT12-34W x 4'-MG(E)	18	43	774	FLT8CEE-28W x 2L x 4'-CEE RS/PRS CEE N	18		49	882	L&B Type BNLO1 & Type L2
43	A	Insulation Abatement-Tool room	FLT12HO-110W x 8'-MG	1	121	121	FLT8CEE-28W x 4L x 4'-CEE RS/PRS CEE N	1	Integral	99	99	Refl Kit, L&B - Type SK2, BNLO2, L2
44	A	Insulation Abatement-RR	FLT12-34W x 4'-MG(E)	2	43	86	FLT8CEE-28W x 2L x 4'-CEE RS/PRS CEE N	2	Occupancy	49	98	L&B Type BNLO1 & Type L2
45	A	Warehouse-Office	FLT12-34W x 4'-MG(E)	5	43	215	FLT8CEE-28W x 2L x 4'-CEE RS/PRS CEE N	5	Occupancy	49	245	L&B Type BNLO1 & Type L2
46	A	Warehouse-Lower Shelf Rows	FLT12HO-95W x 2L x 8'-MG(E)	59	207	12,213	FLT8CEE-28W x 4L x 4'-CEE RS/PRS CEE N	59	Integral	99	5,841	Refl Kit, L&B - Type SK2, BNLO2, L2

47	A	Warehouse E.	FLT12-60W x 2L x 8'-MG(E)	16		123	1,968	FLT8CEE-28W x 4L x 4'-CEE RS/PRS CEE N	1		99	99	Refi Kit, L&B - Type SK2, BNLO2, L2
48	A	Warehouse E.	FLT12-34W x 4L x 4'-2 MG	66		144	9,504	FLT8CEEHB-32W x 4L x 4'-CEE IS CEE H	45	Integral	142	6,390	Type BHLO2 & L1
49	A	MAINTENANCE OFFICE-Lunch	FLT12-34W x 4L x 4'-2 MG	12		144	1,728	FLT8CEE-28W x 2L x 4'-CEE RS/PRS CEE N	12	Occupancy	49	588	L&B Type BNLO1 & Type L2
50	A	Maintenance Office-Hallway Office	FLT12-34W x 4L x 4'-2 MG	12		144	1,728	FLT8CEE-28W x 2L x 4'-CEE RS/PRS CEE N	12		49	588	L&B Type BNLO1 & Type L2
51	A	Maintenance Office-Washing machine	FLT12-34W x 4L x 4'-2 MG	8		144	1,152	FLT8CEE-28W x 2L x 4'-CEE RS/PRS CEE N	8	Occupancy	49	392	L&B Type BNLO1 & Type L2
52	A	Maintenance Office-Private Offices	FLT12-34W x 4L x 4'-2 MG	8		144	1,152	FLT8CEE-28W x 2L x 4'-CEE RS/PRS CEE N	8	Occupancy	49	392	L&B Type BNLO1 & Type L2
53	A	Maintenance Office-Warehouse Offices	FLT12-34W x 4L x 4'-2 MG	27		144	3,888	FLT8CEE-28W x 2L x 4'-CEE RS/PRS CEE N	27	Occupancy	49	1,323	L&B Type BNLO1 & Type L2
54	A	Maintenance Office-Hallway	FLT12-34W x 4L x 4'-2 MG	3		144	432	FLT8CEE-28W x 2L x 4'-CEE RS/PRS CEE N	3		49	147	L&B Type BNLO1 & Type L2
55	A	Maintenance Office-Mens/Women RR	FLT12-34W x 2L x 4'-MG(E)	8		72	576	FLT8CEE-28W x 2L x 4'-CEE RS/PRS CEE N	8	Occupancy	49	392	L&B Type BNLO1 & Type L2
56	A	Maintenance Office-Lunch Rm.	FLT12-34W x 4L x 4'-2 MG	24		144	3,456	FLT8CEE-28W x 2L x 4'-CEE RS/PRS CEE N	24	Occupancy	49	1,176	L&B Type BNLO1 & Type L2
57	A	Maintenance Office-Private Offices	FLT12-34W x 4L x 4'-2 MG	15		144	2,160	FLT8CEE-28W x 2L x 4'-CEE RS/PRS CEE N	15	Occupancy	49	735	L&B Type BNLO1 & Type L2
58	A	Maintenance Shop-Stairwell	FLT12-34W x 2L x 4'-MG	6		72	432	FLT8CEE-28W x 2L x 4'-CEE RS/PRS CEE N	6		49	294	L&B Type BNLO1 & Type L2
59	A	Maintenance Shop-Hallway 1st/2nd floor	FLT12-34W x 2L x 4'-MG	26		72	1,872	FLT8CEE-28W x 2L x 4'-CEE RS/PRS CEE N	26		49	1,274	L&B Type BNLO1 & Type L2
60	A	Maintenance Shop-Mens Locker	FLT12-34W x 4'-MG(E)	39		43	1,677	FLT8CEE-28W x 2L x 4'-CEE RS/PRS CEE N	39		49	1,911	L&B Type BNLO1 & Type L2
61	A	Maintenance Shop-Mens Locker-Wall	FLT12-34W x 2L x 4'-MG	14		72	1,008	FLT8CEE-28W x 2L x 4'-CEE RS/PRS CEE N	14		49	686	L&B Type BNLO1 & Type L2
62	A	ELECTRICAL SHOP	FLT12-34W x 4'-MG(E)	13		43	559	FLT8CEE-28W x 2L x 4'-CEE RS/PRS CEE N	13		49	637	L&B Type BNLO1 & Type L2
63	A	Electrical Shop	FLT12-34W x 2L x 4'-MG	5		72	360	FLT8CEE-28W x 2L x 4'-CEE RS/PRS CEE N	5		49	245	L&B Type BNLO1 & Type L2
64	A	MCC Rm	FLT12-34W x 2L x 4'-MG	12		72	864	FLT8CEE-28W x 2L x 4'-CEE RS/PRS CEE N	12		49	588	L&B Type BNLO1 & Type L2
65	A	Generator Room	FLT12-20W x 2L x 2'-MG	3		50	150	FLT8CEE-28W x 2L x 4'-CEE RS/PRS CEE N	3		49	147	L&B Type BNLO1 & Type L2
66	A	Mens/Women RR	FLT12-20W x 2L x 2'-MG	2		50	100	FLT8CEE-28W x 2L x 4'-CEE RS/PRS CEE N	2		49	98	L&B Type BNLO1 & Type L2
67	A	Small Blg. Off Scrubber	FLT12-34W x 2L x 4'-MG	4		72	288	FLT8CEE-28W x 2L x 4'-CEE RS/PRS CEE N	4		49	196	L&B Type BNLO1 & Type L2
68													
69													
70													
71													
72													
73													
74													
75													
76													
77													



Let's turn the answers on.

V 070113.5.3

Wyoming FinAnswer Express Program

07/01/13 Effective Date

You Can Now Use The Project Information Tab

Project ID	
Lighting Coordinator	Danita Skoglund
Tool Prepared by	Dan Kuhl
Project Manager	
Account Manager	

Customer Information

Project Name	Naughton Power Plant - Industrial & Turbine Areas (ONLY)		
Business Name	PacifiCorp Energy		
Installation Address	1450 Naughton Plant Rd.		
City, State, Zip	Kemmerer	WY	83101
Contact, Title	Ryan Witbeck		
Phone, Email		Ryan.Witbeck@Pacifcorp.com	
Account, Meter, Rate			48T
Participant is:	<input checked="" type="checkbox"/> Acct Holder <input type="checkbox"/> Elect. User <input type="checkbox"/> Building Owner		
Business Type	Other		

Processing Information

Construction Type	Retrofit	Stage	Preliminary
-------------------	----------	-------	-------------

Project Cost

Material	Labor	Other	Total Project Cost
\$1,430,900.00	\$180,310.00	\$12,430.00	\$1,623,640.00

Space Type & Size

Calculation Method	Whole Building	Allowed Wattage	360,000	
1 Other		FT ² 600,000	0.60	W/FT ²
		FT ²		W/FT ²
		FT ²		W/FT ²
		FT ²		W/FT ²
		FT ²		W/FT ²
Other		FT ² 600,000	0.60	W/FT ²

Contractor Information

Contact	EEA Participant		
Business Name			
Address			
City, State, Zip			
Phone, Email			

Lighting Operation Schedule

# of Holidays Closed?	Day	A	B	C	D	E
0	Mon	24.0	12.0	12.0		
Op Weeks Per Year	Tue	24.0	12.0	12.0		
	Wed	24.0	12.0	12.0		
"S" is for a seasonal operational schedule	Thu	24.0	12.0	12.0		
	Fri	24.0	12.0	12.0		
	Sat	24.0	4.0	12.0		
S is for 0 hrs/year	Sun	24.0	0.0	12.0		
X is for 8760 hrs/year	Total	8,760	3,337	4,380		
Y is for 4380 hrs/year						

Payee Information

Incentive Should Be Addressed To:	Installation Address		
Business Name	PacifiCorp Energy		
Attention	Ryan Witbeck		
Check Reference			
Address	1450 Naughton Plant Rd.		
City, State, Zip	Kemmerer	WY	83101

Eligibility Information

Business Name			
Address			
City, State, Zip			
Account #			
Meter Base #, Rate			

Additional Information

--	--	--	--	--	--	--

Category	66W - FCP-25W x 21-MG 29W - FCP-25W-MG 50W - FCP-26W x 21-IS H 54W - FCP-26W x 21-IS N 66W - FCP-26W x 21-MG 99W - FCP-26W x 3L-MG 150W - FCP-26W x 6L-IS H 27W - FCP-26W-IS H 28W - FCP-26W-IS N 30W - FCP-26W-MG 31W - FCP-27W-MG	<input type="button" value="Add Fixture"/> <input type="button" value="Remove Fixture"/> <input type="button" value="Clear Filter"/> <input type="button" value="Build Fixture"/> <input type="button" value="Reset"/>	511 W - CUST: 1 FDHB-511W 458W - MH-400W-CWA 99W - FI T8CFE-28W x 4l x 4'-CFF P 121 W - CUST: 121W 1 FD Flood Lite 98 W - CUST: 1 FD HB 98w 78 W - CUST: LEDHB-78W 120W - FI T12-34W x 4l x 4'-IS N 216W - FI T5HO-49W x 4l x 4'-RS/P 98 W - CUST: 1 FD Flood light 79 W - CUST: 1 FD Flood 79W 158 W - CUST: 1 FD Flood 158W	 <p>Let's turn the answers on.</p>	
Fixture				Savings Information	
Lamp				2,781,533 kWh Saved	
Lamp (W)				Per Year	
Lamp Qty				Lighting Power Density	
Ballast				0.60 Code	45.7%
Factor				0.85 Existing	Better Than Code LPD
				0.33 Proposed	
49W - FLT8CEE-28W x 2L x 4'-CEE RS/PRS CEE N					
Fluorescent Linear T8 CEE (28W x 2L x 4') 1 CEE Rapid/Program Start Ballast (0.85 < BF < 1.0)					
#VALUE!					

Preliminary **Naughton Power Plant - Industrial & Turbine Areas (ONLY)**

Line Number	27 Out Of 127 Lines Used		Existing				Proposed				Notes			
	Exterior	Schedule	Space Description	Fixture	Qty	Controls	Interior	Space	Fixture	Qty		Controls	Interior	Space
							508,401					195,640		
							0					0		
1			UNIT #1											UNIT #1
2	A		UNIT #1 Belt Line	HPS-150W	10		188	1,880	CUST: LEDHB-78W	10		78	780	Crouse Hinds Retrofit Kit to match existing - Type RLB1
3	A		UNIT #1 Belt Line	MH-175W-CWA	72		215	15,480	CUST: LEDHB-78W	72		78	5,616	Crouse Hinds Retrofit Kit to match existing - Type RLB1
4	A		TRANSFER TOWER- Conveyor Belt - Exterior	HPS-150W	15		188	2,820	CUST: LEDHB-78W	15		78	1,170	Crouse Hinds Retrofit Kit to match existing - Type RLB1
5	A		T-Chlor	MH-175W-CWA	4		215	860	CUST: LEDHB-78W	4		78	312	Crouse Hinds Retrofit Kit to match existing - Type RLB1
6	A		Storage Shed	HPS-150W	8		188	1,504	CUST: LEDHB-78W	8		78	624	Crouse Hinds Retrofit Kit to match existing - Type RLB1
7	A		Gas Fill Up	HPS-150W	4		188	752	CUST: LEDHB-78W	4		78	312	Crouse Hinds Retrofit Kit to match existing - Type RLB1
8	A		EQUIP SHOP	MH-400W-CWA	8		458	3,664	LEDHB-213W	8		213	1,704	Type HB1
9	A		Equip Shop-Truck Storage	MH-400W-CWA	12		458	5,496	LEDHB-213W	12		213	2,556	Type HB1
10	A		OIL STORAGE	MH-175W-CWA	8		215	1,720	CUST: LEDHB-78W	8		78	624	Crouse Hinds Retrofit Kit to match existing - Type RLB1
11	A		NEW SCRUBBER STACK	HPS-150W	110		188	20,680	CUST: LEDHB-78W	110		78	8,580	Crouse Hinds Retrofit Kit to match existing - Type RLB1
12	A		Adjacent building to Scrubber stack	MH-400W-CWA	36		458	16,488	CUST: LEDHB-78W	36	Integral	78	2,808	Crouse Hinds Retrofit Kit to match existing - Type RLB1
13	A		Parking garage light	MH-175W-CWA	22		215	4,730	CUST: LEDHB-78W	22		78	1,716	Crouse Hinds Retrofit Kit to match existing - Type RLB1
14	A		Scrubber Tower #1 Bldg	MH-175W-CWA	6		215	1,290	CUST: LEDHB-78W	6		78	468	Crouse Hinds Retrofit Kit to match existing - Type RLB1
15	A		INSULATION ABATEMENT	MH-400W-CWA	6		458	2,748	CUST: LEDHB-78W	6	Integral	78	468	Crouse Hinds Retrofit Kit to match existing - Type RLB1
16	A		MAINTENANCE BUILDING	MH-1000W-CWA	24		1,080	25,920	CUST: LEDHB-511W	24	Occupancy	511	12,264	Type HB6
17	A		Maintenance Building- parameter wall mt.	MH-175W-CWA	20		215	4,300	CUST: 121W LED Flood Lite	20		121	2,420	Type FL4
18	A		Maintenance Building- High Bay	MH-400W-CWA	6		458	2,748	LEDHB-213W	6		213	1,278	Type HB1



**ROCKY MOUNTAIN
POWER**

Let's turn the answers on.

V 070113.5.3

Wyoming FinAnswer Express Program

07/01/13 Effective Date

You Can Now Use The Project Information Tab

Project ID	
Lighting Coordinator	Dan Kuhl
Tool Prepared by	Dan Kuhl
Project Manager	
Account Manager	

Customer Information

Project Name	Naughton Power Plant - Exterior ONLY		
Business Name	PacifiCorp Energy		
Installation Address	1450 Naughton Plant Rd.		
City, State, Zip	Kemmerer	WY	83101
Contact, Title	Ryan Witbeck		
Phone, Email		Ryan.Witbeck@Pacifcorp.com	
Account, Meter, Rate			48T
Participant is:	<input checked="" type="checkbox"/> Acct Holder <input checked="" type="checkbox"/> Elect. User <input checked="" type="checkbox"/> Building Owner		
Business Type	Other		

Contractor Information

Contact		<input type="checkbox"/> EEA Participant
Business Name		
Address		
City, State, Zip		
Phone, Email		

Payee Information

Incentive Should Be Addressed To:	Installation Address		
Business Name	PacifiCorp Energy		
Attention	Ryan Witbeck		
Check Reference			
Address	1450 Naughton Plant Rd.		
City, State, Zip	Kemmerer	WY	83101

Eligibility Information

Business Name			
Address			
City, State, Zip			
Account #			
Meter Base #, Rate			

Processing Information

Construction Type	Retrofit	Stage	Preliminary
-------------------	----------	-------	-------------

Project Cost

Material	Labor	Other	Total Project Cost
\$406,400.00	\$51,250.00	\$3,550.00	\$461,200.00

Space Type & Size

Calculation Method	Whole Building	Allowed Wattage	360,000	
1 Other		FT ² 600,000	0.60	W/FT ²
		FT ²		W/FT ²
		FT ²		W/FT ²
		FT ²		W/FT ²
		FT ²		W/FT ²
Other		FT ² 600,000	0.60	W/FT ²

Lighting Operation Schedule

# of Holidays Closed?	Day	A	B	C	D	E
0	Mon	24.0	12.0	12.0		
Op Weeks Per Year	Tue	24.0	12.0	12.0		
	Wed	24.0	12.0	12.0		
"S" is for a seasonal operational schedule	Thu	24.0	12.0	12.0		
	Fri	24.0	12.0	12.0		
	Sat	24.0	4.0	12.0		
S is for 0 hrs/year	Sun	24.0	0.0	12.0		
X is for 8760 hrs/year	Total	8,760	3,337	4,380		
Y is for 4380 hrs/year						

Additional Information

--	--	--	--	--	--	--

Category	66W - FCP-26W x 21 -MG	25 W - FI T8CFE-32W x 4'-CFE TS	<input type="button" value="Add Fixture"/> <input type="button" value="Remove Fixture"/> <input type="button" value="Clear Filter"/> <input type="button" value="Build Fixture"/> <input type="button" value="Reset"/>	25 W - FI T8CFE-32W x 4'-CFE TS 48 W - FI T8CFE-32W x 21 x 4'-CFE 74 W - FI T8CFE-32W x 31 x 4'-CFE 95 W - FI T8CFE-32W x 41 x 4'-CFE 142 W - FI T8CFEHR-32W x 41 x 4'-CFE 213 W - FI T8CFEHR-32W x 61 x 4'-CFE 216W - FI T5HOHR-51W x 41 x 4'-CFE 348W - FI T5HOHR-51W x 61 x 4'-CFE 351W - FI T5HOHR-54W x 61 x 4'-CFE 43W - FI T12-34W x 4'-MG(F) 121W - FI T12HO-110W x 8'-MG	ROCKY MOUNTAIN POWER <i>Let's turn the answers on.</i>
Fixture	29W - FCP-26W-MG				
Lamp	50W - FCP-26W x 21 -TS H				
Lamp (W)	54W - FCP-26W x 21 -TS N				
Lamp Qty	66W - FCP-26W x 21 -MG				
Ballast	99W - FCP-26W x 31 -MG				
Factor	150W - FCP-26W x 61 -TS H				
	27W - FCP-26W-TS H				
	28W - FCP-26W-TS N				
	30W - FCP-26W-MG				
	31W - FCP-27W-MG				

Savings Information
579,089 kWh Saved
Per Year

Lighting Power Density
0.60 Code 100.0%
0.00 Existing **Better Than Code**
0.00 Proposed **LPD**

511W - CUST: LEDHB-511W
Custom Fixture
Standard Incentive (12.8% of Cost Paid By Incentive)

Preliminary **Naughton Power Plant - Exterior ONLY**

Line Number	Exterior	Schedule	Existing				Proposed				Type			
			Fixture	Qty	Controls	Space Wattage	Fixture	Qty	Controls	Space Wattage				
15 Out Of 127 Lines Used			Interior 0				Interior 0							
Space Description			Exterior 182,616				Exterior 67,940							
1												UNIT #1		
2	+	C	Precep -Wallpacks - Exterior	MH-175W-CWA	22		215	4,730	CUST: LEDWP-47W	22		47	1,034	Type WP1
3	+	C	OUTDOOR LIGHTING-High Mast	MH-1000W-CWA	36		1,080	38,880	CUST: LEDHB-511W	36		511	18,396	High Mast Light - LED 511w
4	+	C	Outdoor Lighting-Various locations-Plant Standard	MH-175W-CWA	79		215	16,985	CUST: LEDHB-78W	79		78	6,162	Type RLB1
5	+	C	Outdoor Lighting-Various locations-Plant Standard	HPS-150W	37		188	6,956	CUST: LEDHB-78W	37		78	2,886	Type RLB1
6	+	C	Outdoor Lighting-Floods	HPS-1000W	9		1,100	9,900	CUST: LEDHB-511W	9		511	4,599	LED Flood 511w
7	+	C	Outdoor Lighting-Floods	HPS-400W	37		465	17,205	CUST: LED Flood 158W	37		158	5,846	Type FL3
8	+	C	Outdoor Lighting-Wallpacks	MH-175W-CWA	31		215	6,665	CUST: LEDWP-47W	31		47	1,457	Type WP1
9	+	C	Outdoor Lighting-Wallpacks	MH-250W-CWA	26		295	7,670	CUST: LEDWP-47W	26		47	1,222	Type WP1
10	+	C	Outdoor Lighting-Cobra Heads	HPS-250W	46		295	13,570	CUST: 121W LED Flood Lite	46		121	5,566	Type FL4
11	+	C	Outdoor Lighting-Floods(Halogen)	ICH-500W	37		500	18,500	CUST: LED Flood 158W	37		158	5,846	Type FL3
12	+	A	SCRUBBER STACKS(Plant Standard)Exterior	MH-175W-CWA	128		215	27,520	CUST: LEDHB-78W	128		78	9,984	Type RLB1
13	+	C	UNIT 3 COOLING TOWER-Stantion - MTEExterior	MH-175W-CWA	23		215	4,945	CUST: LEDHB-78W	23		78	1,794	Type RLB1
14	+	C	UNIT 3 COOLING TOWER-Floods-Exterior	HPS-400W	7		465	3,255	CUST: LED Flood 158W	7		158	1,106	Type FL3
15	+	C	UNIT 2 COOLING TOWER-Flood-Exterior	HPS-400W	7		465	3,255	CUST: LED Flood 158W	7		158	1,106	Type FL3
16	+	C	UNIT 1 COOLING TOWER-Stantion Mt. - Exterior	MH-175W-CWA	12		215	2,580	CUST: LEDHB-78W	12		78	936	Type RLB1

Appendix C

Fixture Specification Sheets



PacifiCorp Power Plant Projects Fixture Schedule

Fixture Type	Manufacturer	Catalog Number	Description	Other Lighting Tool Descriptions
BNLO1	Osram Sylvania	QTP2x32T8/UNV PSN-TC # 51402	2L program start NLO Ballast	
BNLO2	Osram Sylvania	QTP4x32T8/UNV PSN-SC # 51404	4L program start NLO Ballast	
BHLO2	Osram Sylvania	QHE 4x32T8/UNV PSH-HT # 49455	4L program start HLO Ballast	
FL3	Lithonia	DSXF3 LED 8 A530/40K MSP MVOLT THK DDBXD	158w LED flood light	
FL4	Crouse Hinds	PFM9L CY/UNV1 76	121w LED flood light	
HB1	Lithonia	IBL 18L WD LP740 DLC	213w LED high bay	
HB6	Lithonia	IBL 48L WD LP740 DLC	515w LED high bay	
L1	Osram Sylvania	FO32/841/XPS/ECO3 # 21681	21681 HPT8 lamp 32w	
L2	Osram Sylvania	FO28/841/XP/XL/ECO3 # 22167	22167 HPT8 lamp 28w	
RLB1	Crouse Hinds	PVM7LDM2/UNV1	78W Retrofit low bay-Indust	
SK2	Lithonia	AVRK8 2 32 CW42 1/4 BINP WHR	HPT8 strip kit with reflector	
WP1	Lithonia	DSXW1 LED 20C 700 40K T3M MVOLT DDBXD	47w LED wall pack	
T8-17W			2 foot linear T8 17W 2'x2' kit	FLT8-17W x 3L x 2'-IS(E) L
IC			integral occupancy sensor	
W-OCC			Wireless occupancy sensor	



D-Series Size 1 LED Wall Luminaire



DESIGNLIGHTS
CONSORTIUM



Catalog
Number

Notes

Type

Hit the Tab key or mouse over the page to see all interactive elements.

d-series

Specifications Luminaire

Width: 13-3/4" (34.9 cm) **Weight:** 12 lbs (5.4 kg)

Depth: 10" (25.4 cm)

Height: 6-3/8" (16.2 cm)

Back Box (BBW, ELCW)

Width: 13-3/4" (34.9 cm) **BBW Weight:** 5 lbs (2.3 kg)

Depth: 4" (10.2 cm) **ELCW Weight:** 10 lbs (4.5 kg)

Height: 6-3/8" (16.2 cm)

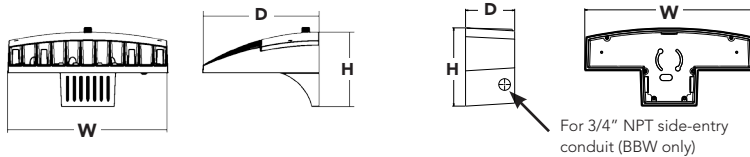

Introduction

The D-Series Wall luminaire is a stylish, fully integrated LED solution for building-mount applications. It features a sleek, modern design and is carefully engineered to provide long-lasting, energy-efficient lighting with a variety of optical and control options for customized performance.

With an expected service life of over 20 years of nighttime use and up to 74% in energy savings over comparable 250W metal halide luminaires, the D-Series Wall is a reliable, low-maintenance lighting solution that produces sites that are exceptionally illuminated.

Ordering Information

EXAMPLE: DSXW1 LED 20C 1000 40K T3M MVOLT DBBXTD

Series	Performance Package	Distribution	Voltage	Mounting	Control Options	Other Options	Finish (required)
DSXW1 LED							
DSXW1 LED	LEDs 10C 10 LEDs (one engine) 20C 20 LEDs (two engines) Drive current 350 350 mA 530 530 mA 700 700 mA 1000 1000 mA (1 A) Color temperature 30K 3000K 40K 4000K 50K 5000K	T2S Type II Short T2M Type II Medium T3S Type III Short T3M Type III Medium T4M Type IV Medium TFTM Forward Throw Medium	MVOLT 120 ¹ 208 ¹ 240 ¹ 277 ¹	Shipped included (blank) Surface mounting bracket BBW Surface-mounted back box (for conduit entry) ²	Shipped installed PE Photoelectric cell, button type ³ DMG 0-10V dimming driver (no controls) PIR 180° motion/ambient light sensor, <15' mtg ht ^{4,6} PIRH 180° motion/ambient light sensor, 15-30' mtg ht ^{3,6} ELCW Emergency battery backup (includes external component enclosure) ⁷	Shipped installed SF Single fuse (120, 277V) ⁸ DF Double fuse (208, 240V) ⁸ HS House-side shield ⁹ Shipped separately BSW Bird-deterrent spikes ⁹ WG Wire guard ⁹ VG Vandal guard ⁹	DBBXTD Dark bronze DBLXD Black DNAXD Natural aluminum DWHXD White DSSXD Sandstone DDBTXD Textured dark bronze DBLBXD Textured black DNATXD Textured natural aluminum DWHGXD Textured white DSSTXD Textured sandstone

NOTES

- MVOLT driver operates on any line voltage from 120-277V (50/60 Hz). Specify 120, 208, 240 or 277 options only when ordering with fusing (SF, DF options), or photocontrol (PE option).
- Back box ships installed on fixture. Cannot be field installed. Cannot be ordered as an accessory.
- Photocontrol (PE) requires 120, 208, 240 or 277 voltage option. Not available with motion/ambient light sensors (PIR or PIRH).
- Specifies the Sensor Switch SBR-10-ODP control; see Motion Sensor Guide for details. Includes ambient light sensor. Not available with "PE" option (button type photocell). Dimming driver standard.
- Specifies the Sensor Switch SBR-6-ODP control; see Motion Sensor Guide for details. Includes ambient light sensor. Not available with "PE" option (button type photocell). Dimming driver standard.
- Not available with 20 LED/1000 mA configuration (DSXW1 LED 20C 1000).
- Not compatible with conduit entry applications. Not available with BBW mounting option.
- Single fuse (SF) requires 120 or 277 voltage option. Double fuse (DF) requires 208 or 240 voltage option.
- Also available as a separate accessory; see Accessories information.

Accessories

Ordered and shipped separately.

DSXWHS U	House-side shield (one per light engine)
DSXWBSW U	Bird-deterrent spikes
DSXW1WG U	Wire guard accessory
DSXW1VG U	Vandal guard accessory



Performance Data

Lumen Output

Lumen values are from photometric tests performed in accordance with IESNA LM-79-08. Data is considered to be representative of the configurations shown, within the tolerances allowed by Lighting Facts. Actual wattage may differ by +/- 8% when operating between 120-480V +/- 10%. Contact factory for performance data on any configurations not shown here.

LEDs	Drive Current (mA)	Performance Package	System Watts	Dist. Type	40K (4000K, 70 CRI)					50K (5000K, 65 CRI)										
					Lumens	B	U	G	LPW	Lumens	B	U	G	LPW						
															T2S	1724	1	0	1	86
										T2M	1729	1	0	1	86	1812	1	0	1	91
										T3S	1709	1	0	1	85	1792	1	0	1	90
										T3M	1753	1	0	1	88	1838	1	0	1	92
										T4M	1753	1	0	1	88	1837	1	0	1	92
										TFTM	1766	1	0	1	88	1851	1	0	1	93
										T2S	2234	1	0	1	83	2341	1	0	1	87
										T2M	2241	1	0	1	83	2349	1	0	1	87
										T3S	2216	1	0	1	82	2322	1	0	1	86
										T3M	2272	1	0	1	84	2381	1	0	1	88
										T4M	2272	1	0	1	84	2381	1	0	1	88
										TFTM	2289	1	0	1	85	2399	1	0	1	89
										T2S	2992	1	0	1	75	3136	1	0	1	78
										T2M	3001	1	0	1	75	3146	1	0	1	79
										T3S	2967	1	0	1	74	3110	1	0	1	78
										T3M	3043	1	0	1	76	3189	1	0	1	80
										T4M	3043	1	0	1	76	3189	1	0	1	80
										TFTM	3066	1	0	1	77	3213	1	0	1	80
										T2S	3545	1	0	1	98	3715	1	0	1	103
										T2M	3556	1	0	1	99	3727	1	0	1	104
										T3S	3515	1	0	1	98	3685	1	0	1	102
										T3M	3606	1	0	2	100	3779	1	0	2	105
										T4M	3605	1	0	1	100	3779	1	0	1	105
										TFTM	3632	1	0	1	101	3807	1	0	1	106
										T2S	4357	1	0	1	93	4566	1	0	1	97
										T2M	4370	1	0	1	93	4580	1	0	1	97
										T3S	4320	1	0	1	92	4528	1	0	1	96
										T3M	4431	1	0	2	94	4644	1	0	2	99
										T4M	4430	1	0	1	94	4644	1	0	2	99
										TFTM	4464	1	0	1	95	4678	1	0	1	100
										T2S	5745	2	0	2	77	6020	2	0	2	80
										T2M	5763	1	0	2	77	6039	2	0	2	81
										T3S	5697	1	0	1	76	5970	1	0	2	80
										T3M	5843	1	0	2	78	6123	2	0	2	82
										T4M	5843	1	0	2	78	6123	1	0	2	82
										TFTM	5887	1	0	2	78	6169	1	0	2	82

Lumen Ambient Temperature (LAT) Multipliers

Use these factors to determine relative lumen output for average ambient temperatures from 0-40°C (32-104°F).

Ambient	Lumen Multiplier
0°C	1.02
10°C	1.01
20°C	1.00
25°C	1.00
30°C	1.00
40°C	0.98

Projected LED Lumen Maintenance

Data references the extrapolated performance projections for the DSXW1 LED 20C 1000 platform in a 25°C ambient, based on 10,000 hours of LED testing (tested per IESNA LM-80-08 and projected per IESNA TM-21-11).

To calculate LLF, use the lumen maintenance factor that corresponds to the desired number of operating hours below. For other lumen maintenance values, contact factory.

Operating Hours	0	25,000	50,000	100,000
Lumen Maintenance Factor	1.0	0.95	0.93	0.88

Electrical Load

LEDs	Drive Current (mA)	System Watts	Current (A)					
			120	208	240	277	347	480
10C	350	14 W	0.13	0.07	0.06	0.06	-	-
	530	20 W	0.19	0.11	0.09	0.08	-	-
	700	27 W	0.25	0.14	0.13	0.11	-	-
	1000	40 W	0.37	0.21	0.19	0.16	-	-
20C	350	25 W	0.23	0.13	0.12	0.10	-	-
	530	36 W	0.33	0.19	0.17	0.14	-	-
	700	47 W	0.44	0.25	0.22	0.19	-	-
	1000	75 W	0.69	0.40	0.35	0.30	-	-

Photometric Diagrams

To see complete photometric reports or download .ies files for this product, visit Lithonia Lighting's D-Series Wall Size 1 homepage.

Isofootcandle plots for the DSXW1 LED 20C 1000 40K. Distances are in units of mounting height (15').

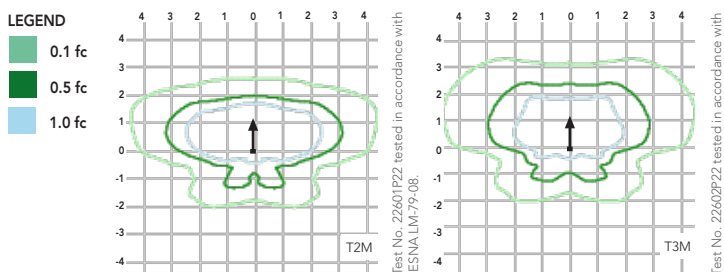

Distribution overlay comparison to 250W metal halide.

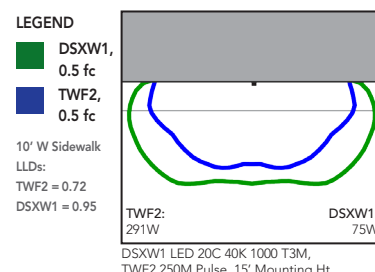

FEATURES & SPECIFICATIONS

INTENDED USE

The energy savings, long life and easy-to-install design of the D-Series Wall Size 1 make it the smart choice for building-mounted doorway and pathway illumination for nearly any facility.

CONSTRUCTION

Two-piece die-cast aluminum housing has integral heat sink fins to optimize thermal management through conductive and convective cooling. Modular design allows for ease of maintenance. The LED driver is mounted to the door to thermally isolate it from the light engines for low operating temperature and long life. Housing is completely sealed against moisture and environmental contaminants.

FINISH

Exterior parts are protected by a zinc-infused Super Durable TGIC thermoset powder coat finish that provides superior resistance to corrosion and weathering. A tightly controlled multi-stage process ensures a minimum 3 mils thickness for a finish that can withstand extreme climate changes without cracking or peeling. Available in textured and non-textured finishes.

OPTICS

Precision-molded proprietary acrylic lenses provide multiple photometric distributions tailored specifically to building mounted applications. Light engines are available in 3000K (80 min. CRI),

4000K (70 min. CRI) or 5000K (65 min. CRI) configurations.

ELECTRICAL

Light engine(s) consist of 10 high-efficacy LEDs mounted to a metal-core circuit board to maximize heat dissipation and promote long life (L88/100,000 hrs at 25°C). Class 1 electronic drivers have a power factor >90%, THD <20%, and an expected life of 100,000 hours. Surge protection device meets a minimum Category C Low (per ANSI/IEEE C62.41.2).

INSTALLATION

Included universal mounting bracket attaches securely to any 4" round or square outlet box for quick and easy installation. Luminaire has a slotted gasket wireway and attaches to the mounting bracket via corrosion-resistant screws.

LISTINGS

CSA certified to U.S. and Canadian standards. Rated for -40°C minimum ambient.

WARRANTY

Five year limited warranty. Full warranty terms located at www.acuitybrands.com/CustomerResources/Terms_and_conditions.aspx.

Note: Specifications subject to change without notice.



FEATURES & SPECIFICATIONS

INTENDED USE - The AVRK series retrofit kits are designed to convert existing 4' and 8' fluorescent strip fixtures to state of the art energy-efficient fluorescent lamp and ballast technology along with high performance reflectors for enhanced light output. Retrofitting older fixtures can greatly reduce energy consumption and lamp replacement costs while improving light. The channels are shipped fully assembled and pre-wired to allow fast, easy installation with minimal labor. Choice of channel widths ensures compatibility with the broadest range of existing fixtures. The AVRK strip reflector conversion kit maximizes fixture efficiency and provides enhanced uniform light distribution.

CONSTRUCTION - One-piece 4' or 8' nominal channels are formed from rugged corrosion resistant aluminum for durability and light weight. All channel aluminum is painted with high-reflectance white paint. Reflectors are precision formed aluminum with highly reflective white paint or 95% reflective specular aluminum. The AVRK is available in two channel widths designed to fit most commercial fluorescent strip fixtures, and the kit installs with simple hand tools. The conversion kit includes a "quick access" aluminum ballast cover secured to the channel with captive quarter-turn fasteners. The snap-in rotary lampholders, ballasts, and ballast quick-disconnect plug are shipped prewired for quick installation. Reflector panels (4' sections) attach to channel with captive quarter-turn fasteners.

ELECTRICAL - Standard ballast is high-efficiency, CEE (Consortium for Energy Efficiency) qualified NEMA premium, instant start, <10% THD, universal voltage and sound rated A. Suggested lamps are high-lumen, long-life super T8 lamps which contribute to optimizing system performance. Optional program start and step-dim bi-level ballasts are available as well as several ballast factor options to maximize energy savings and to allow the amount of light to be balanced to the application. Rotary lampholders and ballast disconnect plug are prewired to ballast assembly.

INSTALLATION - Two channel widths are available for optimum fit to the broadest range of commercial strip fixtures. One-piece aluminum covers with snap-in rotary lampholders attach to the existing channel using provided Tek screws. Ballast is factory mounted to the "quick access" plate and pre-wired to the lampholders. After wiring connection is made to included ballast disconnect plug, ballast access plate secures to channel cover with captive quarter-turn fasteners. Reflector panels (4' sections) attach to channel with captive quarter-turn fasteners.

Installation is designed for maximum speed and simplicity.

LISTING - UL classified for luminaire conversion, retrofit.

WARRANTY — 1-year limited warranty. Complete warranty terms located at: www.acuitybrands.com/CustomerResources/Terms_and_conditions.aspx.

Note: Specifications subject to change without notice.

Catalog Number
Notes
Type

AVRK

Assembled Strip retrofit kit
1 or 2 Lamp
4' or 8'
Energy saving T8

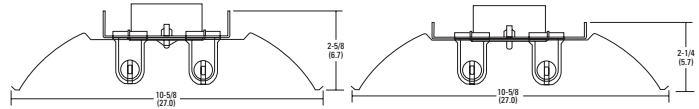
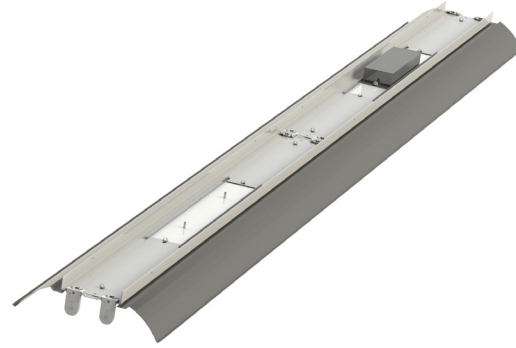

ORDERING INFORMATION

For shortest lead times, configure products using **bold options**.

Example: AVRK8 2 32 CW42 1/4 BINP WHR

Series	Number of lamps	Wattage	Width	Ballast configuration	Ballast type	Reflector type
AVRK4 4' long, no uplight	1	32	CW42	AVRK4 / AVRKA4	BINP	WHR
AVRK8 8' long, no uplight	2		CW50	(blank) 1 or 2-lamp ballast	BIHP	SSR
AVRKA4 4' long, 10% uplight				AVRK8 / AVRKA8	BILP	
AVRKA8 8' long, 10% uplight				(blank) Two 2-lamp ballast	BPNP	
				1/4 One 4-lamp ballast	BPHP	
					BPLP	
					BSNP ¹	

Notes

- Not available as 1/4.
- AVRK channels and reflectors will ship separately for field installation. Example:
(qty 1) AVRK8 2 32 CW42 BINP SSR ships as
(qty 1) AVRK8 2 32 CW42 1/4 BINP L/REFL
(qty 2) AVRK 4FT SSR REFL

Ideal for general high bay/low bay illumination

The Champ® Pro PVM Family

Champ® Pro PVM Series Luminaires are designed to provide full-spectrum, crisp, white light with a true IES type V distribution. Five versions of the PVM Series are available, providing ideal solutions for a wide range of applications.

Champ® Pro PVM Model	Equivalent HID Luminaire	Typical Energy Savings / Lifetime
PVM3L	70W-100W	Up to 70%
PVM5L	100W-150W	reduction in energy
PVM7L	150W-175W	costs and 60,000
PVM9L	175W-200W	hours of continuous
PVM11L	200W-400W	operation!

Certifications and Compliances:

- UL1598
- UL1598A
- cUL
- NEMA 4X; IP66
- DesignLights Consortium® approved for select models (refer to Ordering Information for details)

LED System:

- High brightness light emitting diode (LED) arrays
- Color temperature: 3000K (CRI 82) where a warmer color is preferred and 5600K (CRI 65) where a cooler color is required
- Advanced heat sink design ensures LED does not exceed manufacturer's temperature ratings across all specified ambient conditions

Ordering Information:

Mounting Style	3L Series†	5L Series†	7L Series†	9L Series†	11L Series†
Luminaire Less Mounting Module	PVM3LDM2/UNV1	PVM5LDM2/UNV1	PVM7LDM2/UNV1	PVM9LDM2/UNV1	PVM11LDM1/UNV
3/4" Pendant	PVM3L2ADM2/UNV1	PVM5L2ADM2/UNV1	PVM7L2ADM2/UNV1	PVM9L2ADM2/UNV1	PVM11L2ADM1/UNV
1" Pendant	PVM3L3ADM2/UNV1	PVM5L3ADM2/UNV1	PVM7L3ADM2/UNV1	PVM9L3ADM2/UNV1	PVM11L3ADM1/UNV
3/4" Cone Pendant	PVM3L2BDM2/UNV1	PVM5L2BDM2/UNV1	PVM7L2BDM2/UNV1	PVM9L2BDM2/UNV1	PVM11L2BDM1/UNV
1" Cone Pendant	PVM3L3BDM2/UNV1	PVM5L3BDM2/UNV1	PVM7L3BDM2/UNV1	PVM9L3BDM2/UNV1	PVM11L3BDM1/UNV
3/4" Flexible Pendant	PVM3L2HADM2/UNV1	PVM5L2HADM2/UNV1	PVM7L2HADM2/UNV1	PVM9L2HADM2/UNV1	PVM11L2HADM1/UNV
3/4" Ceiling Mount Thru Feed	PVM3L2CDM2/UNV1	PVM5L2CDM2/UNV1	PVM7L2CDM2/UNV1	PVM9L2CDM2/UNV1	PVM11L2CDM1/UNV
1" Ceiling Mount Thru Feed	PVM3L3CDM2/UNV1	PVM5L3CDM2/UNV1	PVM7L3CDM2/UNV1	PVM9L3CDM2/UNV1	PVM11L3CDM1/UNV
3/4" Wall Mount Thru Feed	PVM3L2TWD2/UNV1	PVM5L2TWD2/UNV1	PVM7L2TWD2/UNV1	PVM9L2TWD2/UNV1	PVM11L2TWD1/UNV
1" Wall Mount Thru Feed	PVM3L3TWD2/UNV1	PVM5L3TWD2/UNV1	PVM7L3TWD2/UNV1	PVM9L3TWD2/UNV1	PVM11L3TWD1/UNV
1/2" Stanchion 25°	PVM3LJDM2/UNV1	PVM5LJDM2/UNV1	PVM7LJDM2/UNV1	PVM9LJDM2/UNV1	PVM11LJDM1/UNV
1/2" Stanchion	PVM3LPDM2/UNV1	PVM5LPDM2/UNV1	PVM7LPDM2/UNV1	PVM9LPDM2/UNV1	PVM11LPDM1/UNV

†DesignLights Consortium approved models. Cool white only. 3L through 9L models approved at 120V only. For 120 VAC option, replace DM2/UNV1 with DM2/120*. 11L model approved at 120-277V.

For 347 VAC option, replace DM2/UNV1 with DM3/347. For 480 VAC option, replace DM2/UNV1 with DM4/480. **NOTE: Requires additional enclosure for use with 11L series.**

For warm white color temperature, use W designation after luminaire style (Example: PVM3LWDM2/UNV1). **NOTE: Not available for 9L series.**

*5 year limited warranty. Refer to page 2 of the D-0413 authorized distributor price book for Cooper Crouse-Hinds standard Terms and Conditions.

Standard Materials:

- Lamp housing and adapter – die cast aluminum with Corro-free™ epoxy powder coat
- Lens – heat- and impact-resistant glass
- Gaskets – silicone
- External hardware – stainless steel
- Factory-sealed, no external seals required



Drivers:

Model	3L - 9L	11L
Standard	90-305 VAC, 50 / 60 Hz; 108-250 VDC	100-240, 277 VAC
Option 1	347 VAC Model	347 VAC Kit Available
Option 2	480 VAC Model	480 VAC Kit Available

Electrical Ratings:

	PVM3L	PVM5L	PVM7L	PVM9L	PVM11L
Voltage Range, VAC	100-277V	100-277V	100-277V	100-277V	100-240, 277V
Frequency	50 / 60 Hz	50 / 60 Hz	50 / 60 Hz	50 / 60 Hz	50 / 60 Hz
Input Power	46 Watts	60 Watts	78 Watts	94 Watts	134 Watts
Input Amps (Max.)	0.5	0.7	0.8	0.98	1.7
Voltage Range, VDC	108-250	108-250	108-250	108-250	Not Available
Power Factor	>0.90	>0.90	>0.90	>0.90	>0.90

Champ® Pro PVM Series Luminaires

UL/cUL Listed
NEMA 4X
IP66

2L

Ideal for general high bay/low bay illumination

Options:

Description

Wire guard with captive mounting hardware	P3001
Trunnion mount with redundant pin locking mechanism	S812 K1
Quick Clip for quick installation	S890
Diffused lens reduces glare in applications where the user may have direct visual contact with the light source	S891
Teflon coating on lens for additional shatter protection	S896
Polycarbonate lens available in applications where glass is prohibited	S903

Dimensions:

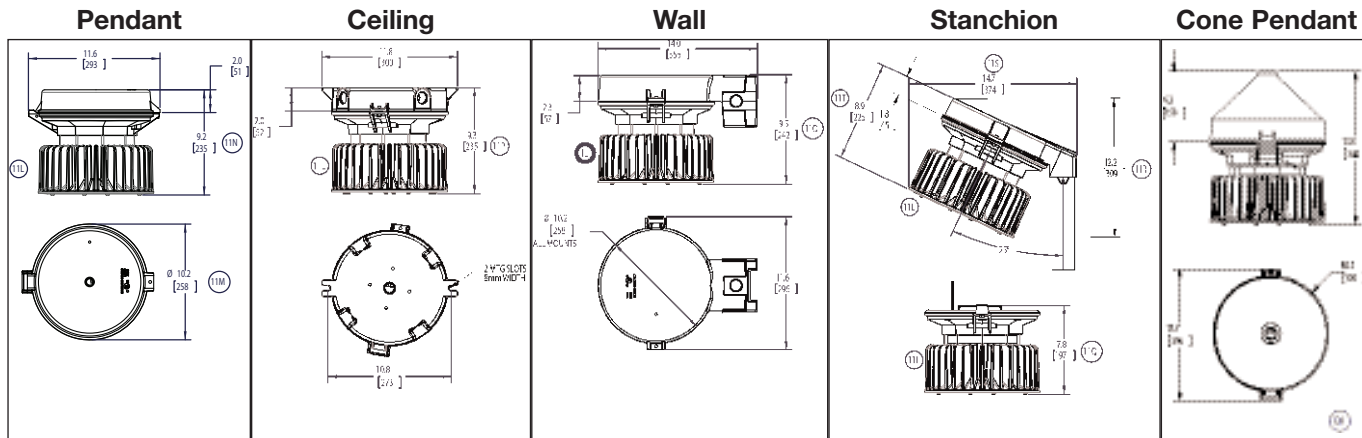

Family Tree:

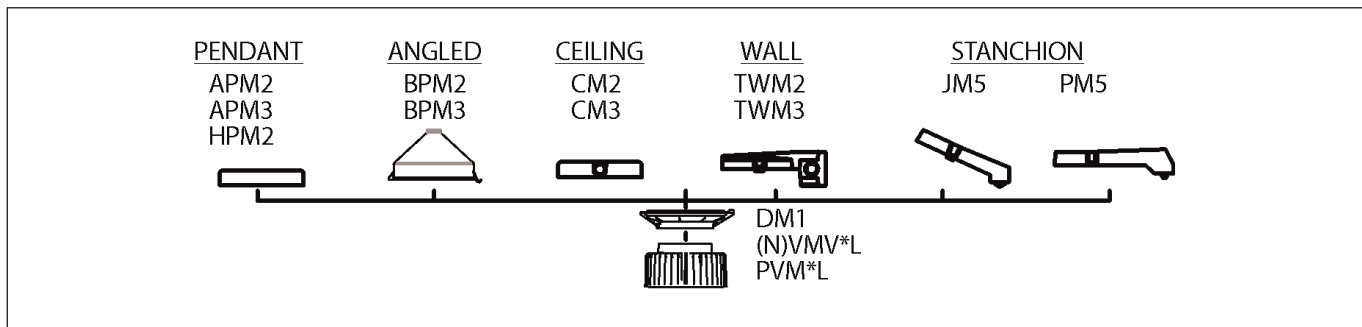

Weights:

Net Luminaire Weight: 17.8 lb. 8.07 kg.

Mounting Module add (lb.)

Pendant	1.25	0.57
Cone Pendant	4.00	1.81
Flexible Pendant	1.50	0.68
Ceiling	2.75	1.25
Wall	4.50	2.04
Angle Stanchion	3.50	1.59
Straight Stanchion	4.50	2.04

Ambient Temperature:

Champ® Pro PVM Model	Max. Temp. °C
PVM3L	55
PVM5L	55
PVM7L	55
PVM9L	55
PVM11L	40

2L

Champ® Pro PVM Series Luminaires

UL/cUL Listed
NEMA 4X
IP66

Ideal for general high bay/low bay illumination

Photometric Data:

Champ® Pro 78 Watt* - PVM7L

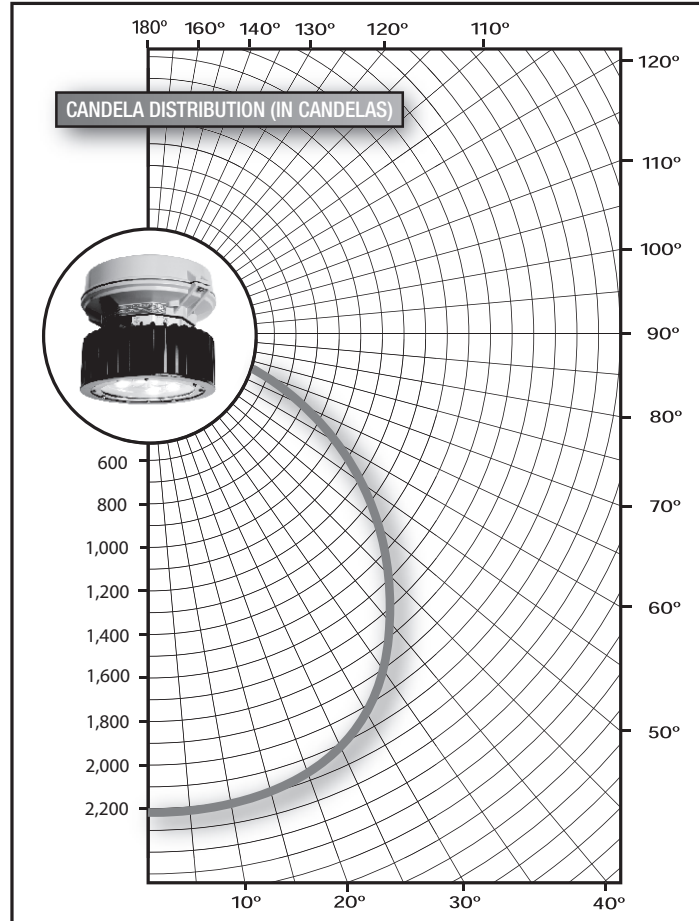

CANDELAS		ZONAL LUMENS		
VERTICAL ANGLE	FRONT SIDE	ZONE	WITH LUMENS	% LUMEN
0	2245	0-10	212	4%
5	2234	10-20	612	10%
15	2167	20-30	941	15%
25	2041	30-40	1155	18%
35	1846	40-50	1207	19%
45	1566	50-60	1077	17%
55	1207	60-70	764	12%
65	775	70-80	286	5%
75	251	80-90	13	0%
85	0	90-100	0	0%
90	0	100-120	0	0%
		Total	6267	100%

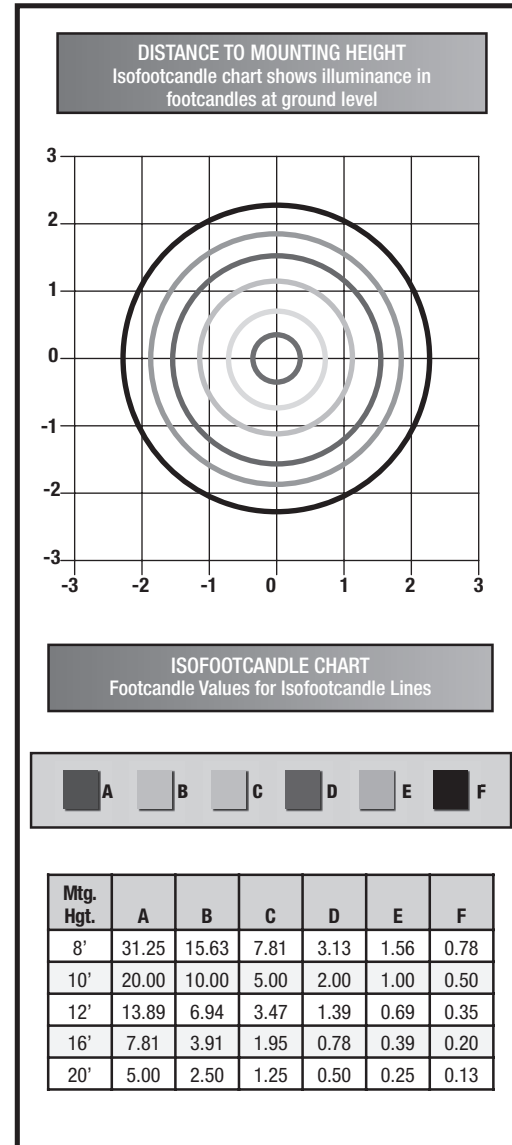

LUMEN OUTPUT FOR CHAMP® LED LUMINAIRES

Luminaire Series	System Watts	Lumens
PVM3L	46	3748
PVM5L	60	4654
PVM7L	78	6267
PVM9L	94	7085
PVM11L	134	8880

*Testing performed in accordance with IES LM-79-08.

OCTRON® 800 XP® XL ECOLOGIC®3

EXtended Performance EXtended Life Fluorescent Lamps



SYLVANIA OCTRON 800 XP XL ECOLOGIC3 lamps feature eXtended Life benefits of up to 75,000 hours life on instant start ballasts and 84,000 hours life on programmed rapid start ballasts. The life ratings reflect up to 88% longer life than T8 XP or XV lamps, which is the equivalent of an additional 8 years of maintenance-free lighting for typical operating cycles of 4,000 hours per year.

OCTRON 800 XP XL 32W lamps deliver 14% more light than standard 700 series T8 lamp on normal ballast factor, instant start electronic ballasts. OCTRON 800 XP XL SUPERSAVER lamps provide up to 22% energy savings over standard 32 watt OCTRON lamps. Combining these lamps with QUICKTRONIC high efficiency instant start, low power ballasts will result in up to 42% energy savings over energy saving T12 magnetically ballasted fluorescent systems. Pair with QUICKTRONIC electronic ballast for the industry's first and most comprehensive QUICK 60+® System Warranty.

Key Features & Benefits

- Available in full wattage (32W) and reduced wattage SUPERSAVER® types
- Energy savings compared to standard 32W T8 lamp
 - Up to 12.5% with the 28W XP/XL/SS
 - Up to 22% with the 25W XP/XL/SS
- Up to 96% mean lumens
- Dimmable (see application note 4)
- Lead-free and RoHS compliant
- Made in USA
- Retrofit lamp for existing T8 instant start systems
 - Up to 75,000 hours average life @ 12 hours per start
- Operate 800 XP XL SUPERSAVER lamps on SYLVANIA's QUICKTRONIC® PROStart® programmed rapid start ballasts
 - 84,000 hours average life @ 12 hours per start
- SUPERSAVER 25W and 28W types meet CEE reduced wattage T8 specifications



SYLVANIA OCTRON T8 ECOLOGIC3 fluorescent lamps pass the Federal Toxicity Characteristic Leaching Procedure (TCLP) criteria for classification as non-hazardous waste in most states².

ECOLOGIC3 represents a more comprehensive approach to sustainability encompassing high efficiency, long life and RoHS/TCLP compliance.

Complies with European Union Restriction of Hazardous Substances Directive (Directive 2002/95/EC)

1. TCLP test results are based on NEMA LL Series standards and are available on request.
2. Lamp disposal regulations may vary; check your local & state regulations.

Product Offering

Lamp Type	Wattage	CCT
OCTRON 800 XP XL		
FO32/800/XP/XL/ECO3	32	3500K, 4100K & 5000K
OCTRON 800 XP XL SUPERSAVER		
FO28/800XP/XL/SS/ECO3	28	3000K, 3500K, 4100K & 5000K
FO32/25W/800/XP/XL/SS/ECO3	25	3500K & 4100K

Application Information

Applications

- Education
- Healthcare
- Industrial
- Office
- Retail

Application Notes

1. SUPERSAVER (SS) lamps are recommended to be used on T8 F32 Instant or Programmed Rapid Start ballasts with minimum open circuit voltage of 550V RMS at the lamp.
 - a. Electronically ballasted fixture configurations which operate lamps remotely, such as Master/Satellite applications, can cause reduction of lamp open circuit voltage, in the remote fixture, below the minimum required for reliable lamp starting. For more information, please call 1-800-LIGHTBULB and ask for Ballast Technical Assistance or call your fixture manufacturer.
 - b. Not recommended to be used: (1) in remotely ballasted fixtures with lamp open circuit voltages below 550V, (2) in air handling fixtures, (3) on low power factor ballasts or (4) inverter operated emergency lighting systems unless any of the above equipment is specifically listed for SUPERSAVER (SS) lamps. Any of the above situations could result in lamp starting and stabilization problems, or system compatibility issues.
2. If a 28W SUPERSAVER lamp is exposed to drafts and/or the ambient temperature falls below 60°F (70°F for 25W lamp), striation (a rhythmic pulsing pattern of light running down the tube) and/or reduction in lamp brightness may occur. While visually disconcerting, neither behavior is damaging to the lamp and removing the cause (draft or temperature) will return the lamp to normal operation.
3. Fixture must conform to ANSI C78.81 – 2005 requirements for luminaire design.
4. Contact OSRAM SYLVANIA for approved dimming ballasts.

Specification Data

Fixture Description:	Type
Project/Job:	
SYLVANIA lamp:	
SYLVANIA ballast:	
Notes:	

Ordering Information

Item Number	Ordering Abbreviation	Watts	Bulb	Base	Initial Lumens	Mean Lumens ¹	lm/W	Avg. Rated Life				CCT	CRI
								Instant Start 3 hrs/ start	Instant Start 12 hrs/ start	Programmed Rapid Start 3 hrs/ start	Programmed Rapid Start 12 hrs/ start		
21576	F032/835/XP/XL/EC03	32	T8	Med Bi-Pin	2950	2830	92	36,000	52,000	65,000	67,000	3500K	85
21577	F032/841/XP/XL/EC03	32	T8	Med Bi-Pin	2950	2830	92	36,000	52,000	65,000	67,000	4100K	85
22002	F032/850/XP/XL/EC03	32	T8	Med Bi-Pin	2950	2830	92	36,000	52,000	65,000	67,000	5000K	81
22166	F028/835/XP/XL/SS/EC03	28	T8	Med Bi-Pin	2600	2470	93	50,000	75,000	80,000	84,000	3500K	85
22167	F028/841/XP/XL/SS/EC03	28	T8	Med Bi-Pin	2600	2470	93	50,000	75,000	80,000	84,000	4100K	85
22326	F028/850/XP/XL/SS/EC03	28	T8	Med Bi-Pin	2600	2470	93	50,000	75,000	80,000	84,000	5000K	81
22349	F032/25W/830/XP/XL/SS/EC03	25	T8	Med Bi-Pin	2400	2280	96	50,000	75,000	80,000	84,000	3000K	85
22222	F032/25W/835/XP/XL/SS/EC03	25	T8	Med Bi-Pin	2400	2280	96	50,000	75,000	80,000	84,000	3500K	85
22223	F032/25W/841/XP/XL/SS/EC03	25	T8	Med Bi-Pin	2400	2280	96	50,000	75,000	80,000	84,000	4100K	85

1. Measured at 40% of rated life.

Ordering Guide

FO	28	/	8	41	XP/XL	/	SS	/	EC03
Fluorescent	Wattage		CRI ≥ 81	Color	EXtended		SUPERSAVER		ECOLOGIC3
OCTRON	25, 28, 32			Temperature	Performance				
				30 = 3000K	EXtended				
				35 = 3500K	Life				
				41 = 4100K					
				50 = 5000K					

Lamp Dimensions

	(A) Max. Overall Length (in.)	(B) Base Face to Opposite Pin (in.)	(C) Max. Base Face to Base Face (in.)	(D) Max. Outside Diameter (in.)
F032, F028, F032/25W	47.78"	Min. 47.41" Max. 47.5"	47.22"	1.1"

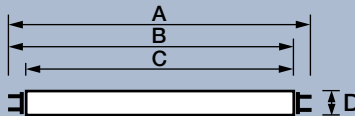

Related Literature

For maximum energy savings consider pairing with the following electronic ballasts:

Ballast Technology Applications & Specification Guide (Literature Code: ECS-SPECGUIDE2013)

QUICKTRONIC® High Efficiency NEMA Premium Guide (Literature Code: ECS112)

QUICK 60+ System Warranty (Literature Code: ECS140)

Sample Specification

Lamp(s) shall be OCTRON® XP® XL (32W, SUPERSAVER® XL 28W, SUPERSAVER XL 25W) ECOLOGIC®3 4-foot lamp(s) having medium bi-pin bases. Lamp(s) shall be designed to pass the Federal TCLP test in force at the time of manufacture. Lamp(s) shall have an average rated life of (36,000 - 67,000 hrs on 32W and 50,000 - 84,000 hrs on 28W and 25W) at 3 hours per start when operated on T8 (instant start, programmed start ballasts), (2950, 2600, 2400) initial lumens, 96% lumen maintenance on the 32W and 95% lumen maintenance on the 28 and 25W a correlated color temperature of (3000K, 3500K, 4100K, 5000K) and a CRI of (85, 81). The OCTRON ECOLOGIC3 lamp(s) shall be operated on QUICKTRONIC® electronic, high frequency ballasts with complete system warranty from the manufacturer covering lamps and ballast.

United States

OSRAM SYLVANIA

100 Endicott Street
Danvers, MA 01923
1-800-LIGHTBULB

Trade

Phone: 800-255-5042
Fax: 800-255-5043

National Accounts

Phone: 800-562-4671
Fax: 800-562-4674

OEM/Special Markets

Phone: 800-762-7191
Fax: 800-762-7192

Retail

Phone: 800-842-7010
Fax: 800-842-7011

SYLVANIA Lighting Services

Phone: 800-323-0572
Fax: 800-537-0784

Display/Optic

Phone: 888-677-2627
Fax: 855-543-1043

Canada

OSRAM SYLVANIA LTD.

2001 Drew Road
Mississauga, ON L5S 1S4
1-800-LIGHTBULB

Trade

Phone: 800-263-2852
Fax: 800-667-6772

OEM/Special Markets/Display/Optic

Phone: 800-265-2852
Fax: 800-667-6772

Retail

Phone: 800-720-2852
Fax: 800-667-6772

SYLVANIA Lighting Services

Phone: 800-663-4268
Fax: 866-239-1278

Mexico

OSRAM MEXICO

Tultitlan/Edo de Mexico
Phone: 011-52-55-58-99-18-50

ENCELIUM Technologies

United States

Phone: 201-928-2400
Fax: 201-928-4028

Canada

Phone: 905-731-7678
Fax: 905-731-1401

OCTRON® XPS® ECOLOGIC®3

EXtended Performance Super Fluorescent Lamps



SYLVANIA OCTRON Extended Performance Super ECOLOGIC3 (XPS) lamps deliver the highest performance of all OCTRON lamps with initial and mean lumens that are up to 11% higher and substantially longer lamp life than standard T8 fluorescent lamps. These lamps are available in 2, 3, and 4-foot lengths, in a choice of correlated color temperatures with high lumen maintenance of 94%.

When OCTRON XPS ECOLOGIC lamps are operated on existing instant start ballasts as a retrofit lamp, they deliver higher lumen output than the installed system. In new installations paired with QUICKTRONIC PSX ballasts, 2-lamp systems deliver light levels comparable to 3-lamp 700 series T8 lamps, while maximizing energy savings and lamp life.

Key Features & Benefits

- Highest lumen 4-foot OCTRON T8 lamps
- Also available in 2-foot (FO17) and 3-foot (FO25) sizes
- Longer lamp life than standard T8 lamps
 - 40,000 hours rated life @ 12 hrs/start on instant start ballast
 - 42,000 hours rated life @ 12 hrs/start on programmed rapid start ballasts
- 94% Lumen maintenance
- TCLP compliant
- Lead free glass
- Made in USA
- QUICK 60+® system warranty when paired with QUICKTRONIC® electronic ballasts
- Meets CEE Standards



SYLVANIA OCTRON 800 XPS ECOLOGIC3 fluorescent lamps are designed to satisfy the Federal Toxicity Characteristic Leaching Procedure (TCLP¹) criteria for classification as non-hazardous waste in most states.²

ECOLOGIC3 represents a more comprehensive approach to sustainability encompassing high efficiency, long life and RoHS/TCLP compliance.

¹ TCLP test results are based on NEMA LL Series standards and are available on request.

² Regulations may vary. Check your local and state regulations.

Product Offering

Ordering Abbreviation	Watts	Nominal Length (in)	CCT
FO17/800/XPS/ECO3	17	24	3000K, 3500K, 4100K
FO25/800/XPS/ECO3	25	36	3000K, 3500K, 4100K
FO32/800/XPS/ECO3	32	48	3000K, 3500K, 4100K, 5000K, 6500K

Application Information

Applications

- Hospitals
- Industrial
- Office
- Retail
- Schools

Application Notes

1. Minimum lamp starting temperature determined by ballast.
2. Operation below 50°F may affect lumen output or lamp operation.
3. For cold temperature applications, use in enclosed fixtures or use tube guards to maximize lamp performance.
4. Good ballast to socket to lamp contact essential for correct operation of system.
5. Actual lamp life dependent on ballast type, switching cycle and hours of operation per start.
6. These lamps may help facilitate compliance with national energy codes such as ASHRAE/IES 90.1 or IECC and state energy codes such as California Title 24. For more information contact your local building inspection office.



Ordering Information

Item Number	Ordering Abbreviation	Nominal Length (in)	Initial Lumens	Mean Lumens ¹	Lumens per Watt	Average Rated Life				CCT	CRI	
						Instant Start 3 hrs/ start	Instant Start 12 hrs/ start	Programmed Rapid Start 3 hrs/ start	Programmed Rapid Start 12 hrs/ start			
22150	F017/830/XPS/EC03	17	24	1400	1316	82	24,000	40,000	40,000	42,000	3000K	85
22151	F017/835/XPS/EC03	17	24	1400	1316	82	24,000	40,000	40,000	42,000	3500K	85
22152	F017/841/XPS/EC03	17	24	1400	1316	82	24,000	40,000	40,000	42,000	4100K	85
22153	F025/830/XPS/EC03	25	36	2200	2068	88	24,000	40,000	40,000	42,000	3000K	85
22154	F025/835/XPS/EC03	25	36	2200	2068	88	24,000	40,000	40,000	42,000	3500K	85
22155	F025/841/XPS/EC03	25	36	2200	2068	88	24,000	40,000	40,000	42,000	4100K	85
21680	F032/830/XPS/EC03	32	48	3100	2914	97	24,000	40,000	40,000	42,000	3000K	85
21697	F032/835/XPS/EC03	32	48	3100	2914	97	24,000	40,000	40,000	42,000	3500K	85
21681	F032/841/XPS/EC03	32	48	3100	2914	97	24,000	40,000	40,000	42,000	4100K	85
21660	F032/850/XPS/EC03	32	48	3100	2914	97	24,000	40,000	40,000	42,000	5000K	81
21659	F032/865/XPS/EC03	32	48	3000	2820	94	24,000	40,000	40,000	42,000	6500K	81

1. Measured at 40% of rated life.

Ordering Guide

FO	32	/	8	35	XPS	/	EC03
Fluorescent OCTRON®	Wattage: 17, 25, or 32 watts		8 = 81-85 CRI	30 = 3000K 35 = 3500K 41 = 4100K 50 = 5000K 65 = 6500K	EXtended Performance Super		ECOLOGIC3

Lamp Dimensions

Item Number	(A) Max. Overall Length (in.)	(B) Base Face to Opposite Pin (in.)		(C) Max. Base Face to Base Face (in.)	(D) Max. Outside Diameter (in.)
		Min.	Max.		
F017	23.78	23.41	23.50	23.22	1.1
F025	35.78	35.40	35.50	35.22	1.1
F032	47.78	47.41	47.50	47.22	1.1

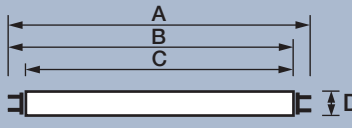

Technical Information

Lumen Maintenance OCTRON XP, OCTRON XPS, OCTRON & F40/CW

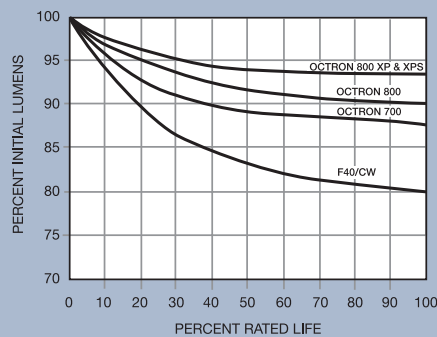

Related Literature

For optimum system performance and warranty pair with these QUICKTRONIC® Systems:

- High Efficiency NEMA Premium QUICKTRONIC® T8 Brochure (Literature Code: ECS112)
- Ballast Technology Applications & Specification Guide (Literature Code: ECS-ELECTRONIC2009)
- QUICK 60+® System Warranty (Literature Code: ECS140)

Specification Data

Fixture Description
Type
Project/Job
SYLVANIA lamp
SYLVANIA ballast
Notes

Sample Specification

Lamp(s) shall be (a) OCTRON® EXtended Performance Super XPS®/EC03 2-foot, 3-foot, or 4-foot lamp(s) having medium bi-pin bases. Lamps shall pass the existing Federal TCLP limits. Lamp(s) shall have initial lumens of (1400, 2200, 3100, 3000), an average rated life of (24,000, 40,000) hours on (instant start, programmed rapid start) ballasts, a CRI of (85, 81), 94% lumen maintenance and a correlated color temperature of (3000K, 3500K, 4100K or 6500K). Lamps shall be operated on QUICKTRONIC ballasts with complete system warranty from the manufacturer covering lamps and ballasts.

United States
OSRAM SYLVANIA
100 Endicott Street
Danvers, MA 01923

Trade
Phone: 1-800-255-5042
Fax: 1-800-255-5043

National Accounts
Phone: 1-800-562-4671
Fax: 1-800-562-4674

OEM/Special Markets
Phone: 1-800-762-7191
Fax: 1-800-762-7192

Display/Optic
Phone: 1-888-677-2627
Fax: 1-800-762-7192

Canada
OSRAM SYLVANIA LTD.
2001 Drew Road
Mississauga, ON L5S 1S4

Trade
Phone: 1-800-263-2852
Fax: 1-800-667-6772

OEM/Special Markets/Display/Optic
Phone: 1-800-265-2852
Fax: 1-800-667-6772

www.sylvania.com
Page 39 of 62

FEATURES & SPECIFICATIONS

INTENDED USE — Ideal one-for-one replacement of conventional high bay systems such as HID and fluorescent. Applications include warehousing, manufacturing and other large indoor spaces with mounting heights up to 60'. **Certain airborne contaminants can diminish integrity of acrylic.** [Click here for Acrylic Environmental Compatibility table for suitable uses.](#)

CONSTRUCTION — Die-formed aluminum alloy chassis with integrated fins for superior cooling through natural convection. The channel is made of heavy-duty code gauge (20-gauge) steel which is powder coated after fabrication. The assembly is rigidly designed to resist twisting and bowing. Access plate on the back of the channel housing allows quick and easy wiring.

OPTICS — Narrow and wide distributions available to meet both horizontal and vertical light level requirements. Reflectors feature precision-formed optics utilizing reflective Alanod® MIRO-5° aluminum. Semi-diffuse lens optional to provide glare control and LED protection.

ELECTRICAL — 89% lumen maintenance at 60,000 hours; predicted life of more than 100,000 hours. Thermally protected driver standard with 0-10V dimming.

LISTINGS — CSA Certified to U.S. and Canadian safety standards. Damp location listed. Suitable for ambient temperatures from -40°F (-40°C) to 131°F (55°C). Patent pending.

WARRANTY — 5-year limited warranty. Complete warranty terms located at www.acuitybrands.com/CustomerResources/Terms_and_conditions.aspx

Actual performance may differ as a result of end-user environment and application.

Actual wattage may differ by +/-1% when operating between 120-277V +/-10%.

Note: Specifications subject to change without notice.

Catalog Number
Notes
Type



LED High Bay

IBL

Unlensed (standard)
9-24L pictured



Patent Pending

Lensed (optional)
36-48L pictured



ORDERING INFORMATION

Lead times will vary depending on options selected. Consult with your sales representative.

Example: IBL 18L WD LP740 DLC

IBL Series	Lumens	Distribution	Lens	Voltage	Color temperature ²
IBL	9L 9,000 lumens	WD Wide ND Narrow	(blank) No shielding SD125 Semi-diffuse acrylic	(blank) MVOLT; 120-277V HVOLT 347V-480V 120 120V 277 277V	LP740 DLC 70 CRI, 4000K CCT
	12L 12,000 lumens				LP750 DLC 70 CRI, 5000K CCT
	18L 18,000 lumens				LP740 70 CRI, 4000K CCT LP750 70 CRI, 5000K CCT
Options					Finish
GLR	Internal fast-blow fuse ^{3,4}	Cord sets: ⁹	Motion sensors:		(blank) Gloss white with textured dark gray accents
OUTCTR	Wiring leads pulled through back center of fixture	CS1W Straight plug, 120V ¹⁰	MSE360 360° motion sensor embedded, high bay ^{11,12}		DWH Gloss white
OCS	RELOC® OnePass® 5' installed ³	CS3W Twist-lock, 120V ¹⁰	MSE360LB 360° motion sensor embedded, low bay ^{11,12}		
IMP	Integrated modular plug ^{5,6}	CS7W Straight plug, 277V ¹⁰	MSIPEP Aisle motion sensor, photo sensor, pre-wired ³		
I2412	IOTA emergency LED battery pack for 32°F to 104°F (0°C to 40°C) ambient ^{7,8}	CS11W Twist-lock, 277V ¹⁰	MSI360PED 360° motion sensor, photo sensor, pre-wired ³		
SPD	Surge protector ³	CS25W Twist-lock, 347V ¹⁰	MSI Aisle motion sensor, pre-wired ³		
WGX	Standard wire guard, installed	CS97W Twist-lock, 480V ¹⁰	MSI360 360° motion sensor, pre-wired ³		
		CS93W 600 SO white cord, no plug (no voltage required)	MSID Aisle motion sensor, pre-wired, HI/LO dimming control ³		
			MSI360D 360° motion sensor, pre-wired, HI/LO dimming control ³		
			NMSI nLight, aisle motion sensor, pre-wired ³		
			NMSI360 nLight enabled, 360° motion sensor, pre-wired ³		
			nEPP5D nLight dimming module ^{3,13}		

Accessories: Order as separate catalog number.

Mounting:

IBAC120 M20	Aircraft cable 10' with hook (one pair)
IBAC240 M20	Aircraft cable 20' with hook (one pair)
IBHMP	Hook monopoint
ZACVH	Aircraft 10' V hanger (one pair) ⁹
IBLPMP	Pendant monopoint splice box, includes side covers for use with 9L-24L
IBLPMPHB	Pendant monopoint splice box, includes side covers (3/4" hub) for use with 9L-24L.
IBLPMP48	Pendant monopoint splice box, includes side covers for use with 36L and 48L
IBLPMPHB48	Pendant monopoint splice box, includes side covers (3/4" hub) for use with 36L and 48L
HC36	Hanger chain, 36" ^{9,8}
THUN	Tong hanger bracket (one pair) ^{9,14}

Cord sets and sensors for IMP option:

CS1WIMP	Straight plug, 120V ^{9,10,15}
CS3WIMP	Twist-lock, 120V ^{9,10,15}
CS7WIMP	Straight plug, 277V ^{9,10,15}
CS11WIMP	Twist-lock, 277V ^{9,10,15}
CS25WIMP	Twist-lock 347V ^{9,10,15}
CS93WIMP	600V SO white cord, no plug (no voltage required) ^{9,15}
CS97WIMP	Twist-lock 480V ^{9,10,15}
MSIIMP	Aisle sensor ^{6,15}
MSI360IMP	360° sensor ^{6,15}

Field-installable door and lens assemblies:

DLIBL SD125	Semi-diffuse acrylic lens for use 9L - 24L
DLIBL48 SD125	Semi-diffuse acrylic lens for use with 36L and 48L
Wire guards:	
WGIBL	Wire guard for use with 9L - 24L
WGIBL48	Wire guard for use with 36L and 48L

See footnotes on page 2.

IBL LED High Bay

Notes

- 1 Fixtures more than 24" wide can interfere with the operation of some fire sprinkler systems. Verify specific installation requirements with local fire official and insurance carrier. Emergency battery packs are not available with 36L or 48L.
- 2 Select product configurations are Design Lights Consortium (DLC) qualified; does not apply to 9L packages or 12 ND SD125 LP740 configuration.
- 3 Specify voltage.
- 4 Not available with 347 voltage.
- 5 Must be factory-installed.
- 6 Must have "IMP" power cord to power fixture.
- 7 Must specify voltage. 120V or 277V only. Not available with cordset w/plug or OUTCTR option.
- 8 Not available with 36L or 48L lumen package. When using THUN option maximum ambient temperature is 35°C.
- 9 All cord sets are 18/3, 6', white.
- 10 Cord sets are voltage specific. Specify voltage. Other configurations available. Consult factory.
- 11 Specify voltage; 120, 277 or 347 only.
- 12 Not available with battery pack.
- 13 Consult factory for dimming of 208, 347 or 480V fixtures.
- 14 95°F (35°C) maximum ambient temperature when using the THUN.
- 15 Must have IMP option on fixture.



9L, 18L, and 36L lumen packages



12L, 24L, and 48L lumen packages

To create the 9L, 18L, and 36L lumen packages, the PCBA (LED board) is depopulated from the endcaps inward. The first LED is 5-1/2" from the end cap on those units, compared to 1-1/8" on the 12L, 24L, and 48L product.

DIMENSIONS

Dimensions may vary with options or accessories.

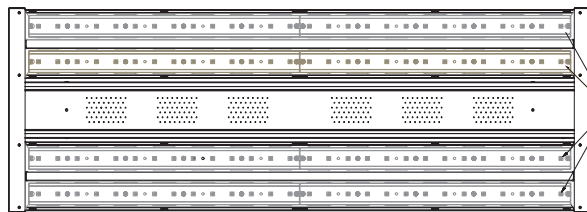

18L, and 24L utilize two drivers wired inboard/outboard
36L and 48L (not shown) utilize four drivers wired inboard/outboard

24L & 18L HAS 4 ROWS OF LEDs
12L & 9L HAS 2 ROWS OF LEDs
36L AND 48L (NOT SHOWN) HAVE 8 ROWS OF LEDs

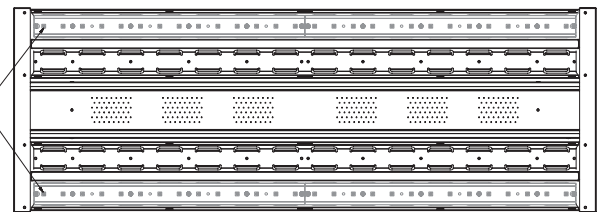

9L and 12L utilize one driver

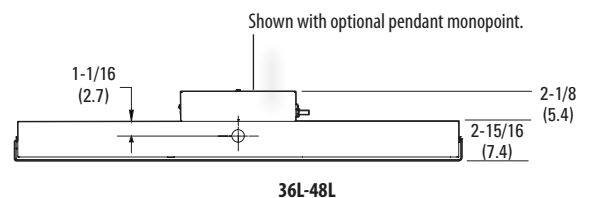
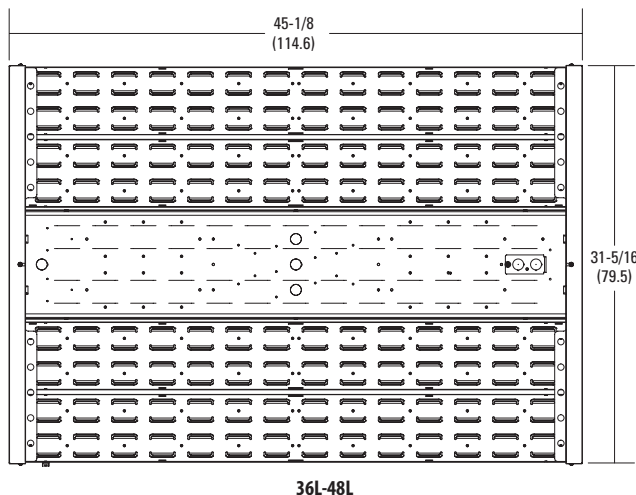
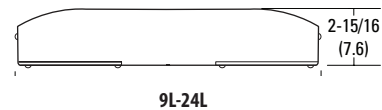
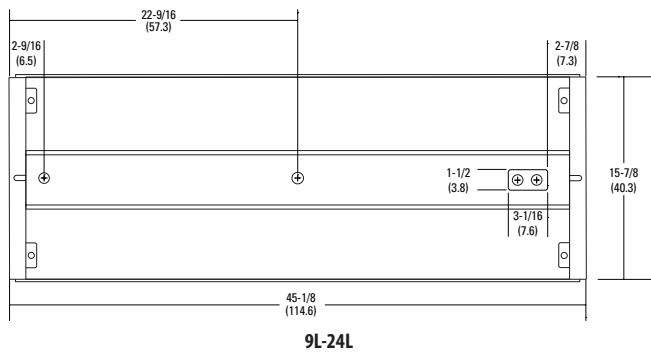

OPERATIONAL DATA

Lumen Package	Ambient Rating (120V - 277V)	Ambient Rating (347V / 480V)	Distribution	Delivered Lumens 5000K CCT @ 77°F (25°C) Ambient Temperature	Delivered Lumens 4000K CCT @ 77°F (25°C) Ambient Temperature	Lumen Multiplier @ 104°F (40°C) Ambient Temperature	Lumen Multiplier @ 104°F (40°C) Ambient w/SD125 Lens Kit
9L	-40°F to 131°F (-40°C to 55°C)	-40°F to 104°F (-40°C to 40°C)	WD	10,039	9,794	0.98	0.901
			ND	8,888	8,671	0.98	0.950
12L	-40°F to 131°F (-40°C to 55°C)	-40°F to 104°F (-40°C to 40°C)	WD	13,055	11,702	0.98	0.901
			ND	11,558	10,360	0.98	0.950
18L	-40°F to 131°F (-40°C to 55°C)	-40°F to 104°F (-40°C to 40°C)	WD	19,893	19,406	0.98	0.901
			ND	17,612	17,181	0.98	0.950
24L	-40°F to 131°F (-40°C to 55°C)	-40°F to 104°F (-40°C to 40°C)	WD	24,052	23,463	0.98	0.901
			ND	21,294	20,772	0.98	0.950
36L	-40°F to 131°F (-40°C to 55°C)	-40°F to 104°F (-40°C to 40°C)	WD	36,805	36,480	0.98	0.901
			ND	35,599	35,284	0.98	0.950
48L	-40°F to 131°F (-40°C to 55°C)	-40°F to 104°F (-40°C to 40°C)	WD	46,856	46,443	0.98	0.901
			ND	45,320	44,920	0.98	0.950

CHARACTERISTICS

Lumen Package	Wattage				Length	Width	Depth	Weight without Lens (Lens kit adds approx. 7 lbs.)	Comparable Light Source
	120V	277V	347V	480V					
					Dimensions are shown in inches (centimeters) unless otherwise noted.				
9L	103	98	107	106	45 (114.3)	15-3/4 (40.0)	3-1/4 (8.3)	12.5 lbs. (5.7 kg)	2-lamp T5HO
12L	134	131	142	141	45 (114.3)	15-3/4 (40.0)	3-1/4 (8.3)	12.5 lbs. (5.7 kg)	4-lamp T8, 250W HID
18L	213	199	213	211	45 (114.3)	15-3/4 (40.0)	3-1/4 (8.3)	17.5 lbs. (7.9 kg)	4-lamp T5HO, 6-lamp T8, 400W HID
24L	262	258	284	281	45 (114.3)	15-3/4 (40.0)	3-1/4 (8.3)	17.5 lbs. (7.9 kg)	6-lamp T5HO, 8-lamp T8
36L	423	417	459	454	45 (114.3)	31-1/3 (79.5)	3-1/4 (8.3)	35 lbs. (15.9 kg)	8-lamp T5HO, 750 HID
48L	531	511	562	557	45 (114.3)	31-1/3 (79.5)	3-1/4 (8.3)	35 lbs. (15.9 kg)	10-lamp T5HO, 1000W HID

PROJECTED LUMEN MAINTENANCE

Operating Hours	0	10,000	20,000	25,000	35,000	50,000	60,000	75,000	100,000
Lumen Maintenance Factor	1	0.96	0.95	0.94	0.93	0.91	0.89	0.87	0.84

LUMENS VS. AMBIENT TEMPERATURE

Ambient °C	Ambient °F	Lumen Multiplier
0	32	1.02
5	41	1.015
10	50	1.01
15	59	1.008
20	68	1.005
25	77	1
30	86	0.995
35	95	0.985
40	104	0.98
45	113	0.97
50	122	0.965
55	131	0.96

PHOTOMETRICS

See www.lithonia.com.

SENSORS AND CONTROLS

Sensors are an excellent way to maximize the return on your high bay lighting investment. I-BEAM LED fixtures can be equipped with an occupancy sensor, photocell, nLight® or nWiFi™. These devices are factory-installed and require minimal labor to set up during fixture installation.

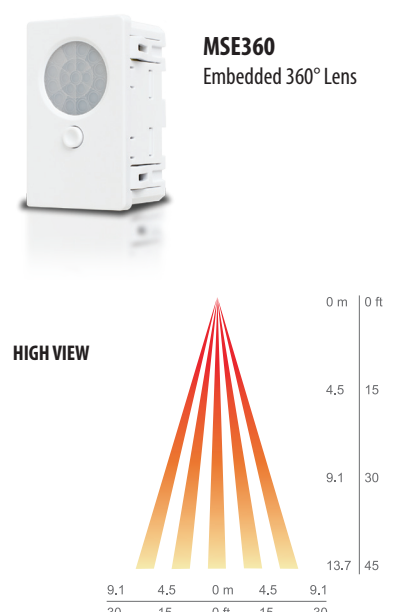
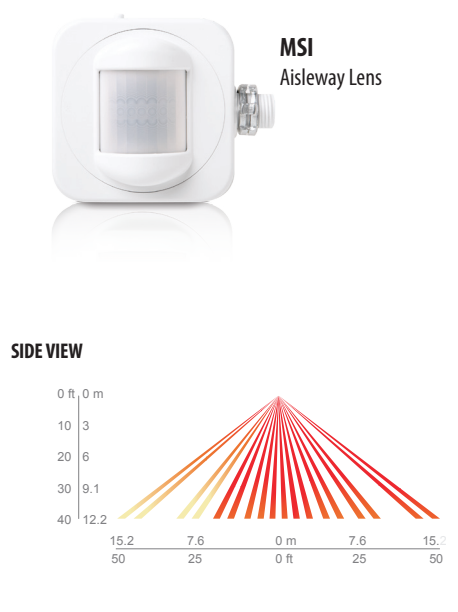
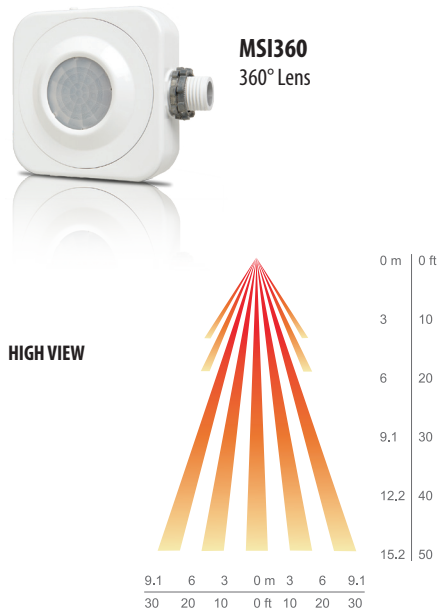

MSI360: The Sensor Switch CMRB 6 open-area sensor has 360° coverage and can be integrated with a photocell (PE) for further energy savings.

Mounting Location: End Plate

- Best choice for 15 to 45 ft (4.57 to 13.72 m) mounting heights
- 15 to 20 ft (4.57 to 6.10 m) radial coverage overlaps area lit by a typical high bay fixture

MSI: The Sensor Switch CMRB 50 aisleway sensor offers a dedicated sensor and extended range, compared to competitive products.

Mounting Location: End Plate

- Provides 50° bi-directional and 10° wide coverage pattern
- 1.2x mounting height equals approximate detection range in either direction
- Sensor lens turret rotates 90° in order to easily adjust the direction of the view pattern

MSE360: The Sensor Switch SFR 5 open-area sensor is embedded in the fixture, making it less intrusive than traditional sensors.

Mounting Location: Center Channel

- Recommended for fixtures that have a 1.0 spacing-to-mounting height ratio or less
- Use provided masking kit to mask off a portion of the view pattern for end-of-aisle applications or, to trim sensor's side viewing to create a rectangular pattern for center-of-aisle viewing only.



All I-BEAM LED fixtures can be equipped with nLight. nLight is an exclusive and revolutionary system that cost-effectively combines time-based and sensor-based lighting controls. The digital interface allows for quick, easy modifications to time delays, photocell sensitivity and light levels at the individual fixture level.

nWiFi for nLight adds conventional WiFi technology to nLight devices, such as occupancy sensors and relays, enabling them to seamlessly communicate with both wired and wireless nLight lighting control zones. This powerful new nLight technology further simplifies installation and reduces hardware costs.

OPTIONS AND ACCESSORIES

The I-BEAM LED fixture offers numerous options for almost every electrical and optical component, including a long list of field-installable accessories.

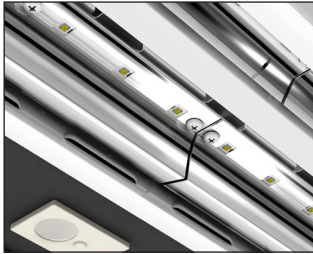

REFLECTORS

Wide distribution is formed with 93% reflective white paint. Narrow distribution is formed with Alanod® MIRO®.



INTEGRATED ELECTRICAL OPTIONS

Channel sized to accept emergency components, surge protector, fusing and embedded sensors.



WIRE GUARD (external)

Field- or factory-installed. Protects light engine from impact. Mounting hardware included.

Factory-installed option:
WGX

Field-installed options:
WGIBL
WGIBL48



DIFFUSER

Field- or factory-installed. Available in semi-diffuse acrylic. Mounting hardware included.

Factory-installed option:
SD125

Field-installed option:
DLIBL SD125
DLIBL48 SD125



EMBEDDED OCCUPANCY SENSOR

Can be placed in the channel cover which reduces the risk of sensor damage compared to non-embedded sensors.

Factory-installed option:
MSE360

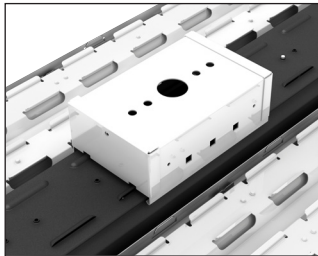

PENDANT MONOPOINT BRACKET

Accepts 3/4" rigid conduit for single-point mounting. The bracket can be adjusted to help counterbalance fixture to offset weight variance from end to end.

Order as:
IBLPMP
IBLPMPHB
IBLPMP48
IBLPMPHB48

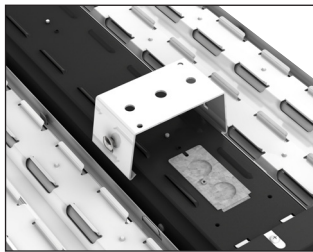

SURFACE MOUNT BRACKET

Rigidly attach I-BEAM LED to a hard ceiling. Can be placed anywhere along fixture.

Order as:
THUN (not for use in ambient temperatures exceeding 95°F (35°C), or on the 36L or 48L)

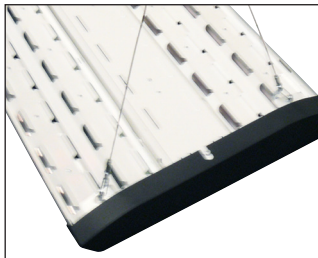

HANGERS

Several lengths of aircraft cables and chains available; with or without V-hooks.

Order as:
IBAC120 M20
IBHMP
For others, see accessories on page 1.

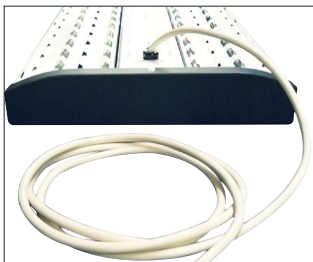

CORD SETS

Available in several lengths with or without molded plug. White is standard.

For available options, see ordering information on page 1.

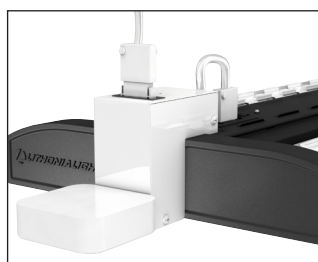

INTEGRATED MODULAR PLUG (IMP)

Must be factory-installed and allows for field installation of various modular accessories including cordsets, motion sensors, photocells and LC&D X-point™ relays.

FEATURES & SPECIFICATIONS

INTENDED USE — The I-BEAM® IBZ fluorescent high bay is ideal for new construction and renovation projects. It is a one-for-one replacement of common metal halide high bay systems. Applications include manufacturing, warehousing, commercial and industrial facilities. The IBZ fixture performs well at mounting heights from 15'-40'. **Certain airborne contaminants can diminish integrity of acrylic.** [Click here for Acrylic Environmental Compatibility table for suitable uses.](#)

CONSTRUCTION — The highly configurable design of the IBZ high bay allows for a multitude of fixture options that can either be factory- or field-installed. In addition to the reliable operation of IBZ fixtures, the reflectors tightly control the distribution of light and effectively manage lamp heat to increase the overall efficiency. The result is superior optics in either narrow distribution for aisles, or wide distribution for general lighting. Installation is made quick and easy with IBZ hanging accessories such as the aircraft cable and single-point mounting bracket. IBZ fixtures can be factory-wired to have both sensors and cord sets, further reducing installation time. The configurability, performance and ease of installation make IBZ fixtures the preferred choice for fluorescent high bay lighting.

Channel is formed of heavy-duty code-gauge (22-gauge) steel to stand up to the most demanding elements. Lamp holder assembly protects from incidental damage or movement of sockets during handling and installation. Sockets include secure positioning rotating collars with enclosed contacts. Access plate on the back of the channel housing allows quick and easy wiring. Finish: Channel is high-gloss white baked enamel; five-stage iron phosphate pretreatment ensures superior paint adhesion and rust resistance.

OPTICS — Two optical systems are available. Narrow distribution is ideal for narrow or aisle lighting applications and features precision-formed segmented optics utilizing specular aluminum reflector. Provides 95% reflectivity and warranted for 25 years. Wide distribution includes high-reflectance white finish for general or open areas.

ELECTRICAL — Thermally protected, resetting, Class P, HPF, A+ sound-rated electronic ballast. AWM TFM or THHN wire used throughout rated for required temperatures. Ballast disconnect (BDP) is standard unless EL14 or cordset is requested.

INSTALLATION — Suitable for suspension by chain, cable, surface-mounting bracket, hook monopoint or single (pendant) monopoint. Surface mounting not recommended without optional surface mounting bracket.

LISTINGS — CSA Certified to U.S. and Canadian safety standards (UL1598 and CSA 250.0-08 for 25C ambient operation). Suitable for damp locations.

WARRANTY — 1-year limited warranty. Complete warranty terms located at www.acuitybrands.com/CustomerResources/Terms_and_conditions.aspx

Actual performance may differ as a result of end-user environment and application.

Note: Specifications subject to change without notice.

Catalog Number
Notes
Type



Fluorescent High Bay

IBZ

4-, 6- or 8-lamp T8
Patent Pending



SPECIFICATIONS				
	Length	Width	Depth	Weight
4-lamp	48-1/16 (1221)	13-1/4 (337)	2-3/8 (60)	16 lbs. (7.3 kg)
6-lamp	48-1/16 (1221)	18-1/8 (460)	2-3/8 (60)	20 lbs. (9.1 kg)
8-lamp	48-1/16 (1221)	23-7/8 (606)	2-3/8 (60)	25 lbs. (11.3 kg)

All dimensions are inches (millimeters) unless otherwise specified and may vary with options or accessories.

DIMENSIONS

Dimensions may vary with options or accessories.

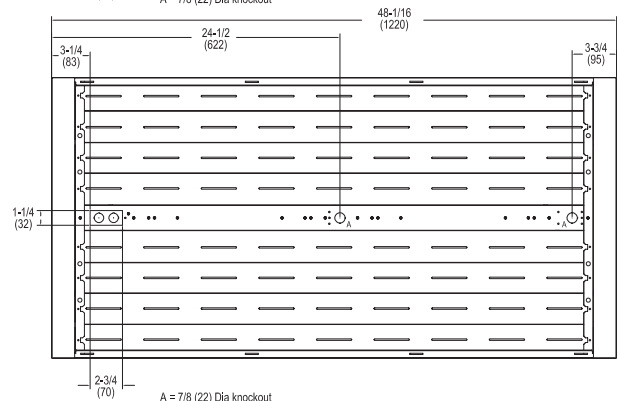
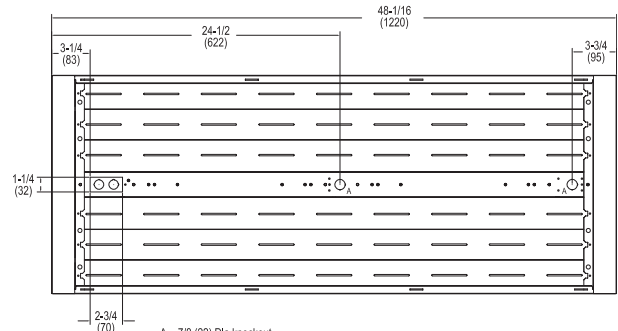
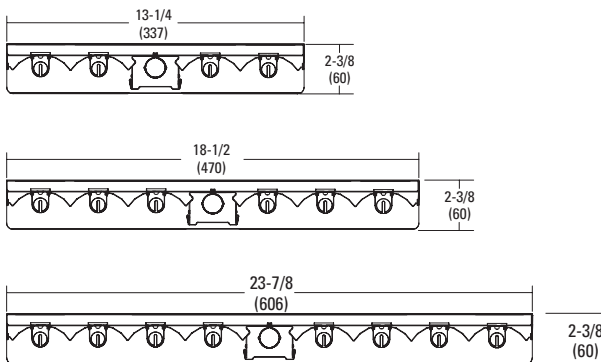

IBZ Fluorescent High Bay, T8

ORDERING INFORMATION

For shortest lead times, configure products using **standard options (shown in bold)**.

Example: IBZ 432L

IBZ Series	Lamp type	Distribution	Shielding ²	Voltage	Ballast configuration
IBZ <i>For tandem double-length unit, add prefix "T". Ex: TIBZ</i>	Lamps installed ¹ 432L 4-lamp 32W T8 632L 6-lamp 32W T8 832L 8-lamp 32W T8 Unlamped 432 4-lamp 32W T8 632 6-lamp 32W T8 832 8-lamp 32W T8	(blank) Narrow distribution, ≤5% uplight NDU Narrow distribution, enhanced uplight, ≤13% uplight WD Wide distribution, ≤5% uplight WDU Wide distribution, enhanced uplight, ≤13% uplight	(blank) No shielding A12125 Pattern 12 acrylic, 0.125" ³ ACL Clear acrylic, 0.125" ³ PCL125 Clear polycarbonate, 0.125" ³	(blank) MVOLT; 120-277V	(blank) Standard configuration

Ballast	Lamp color	Options	Cord sets:	Motion sensors:
(blank) T8 electronic, instant start, 1.15-1.20 BF GEB10IS T8 electronic ballast, ≤10% THD, instant start, .88 BF GEB10PS T8 electronic ballast, ≤10% THD, programmed rapid start, .88 BF GEB10PSH T8 electronic ballast, ≤10% THD, programmed rapid start, 1.15-1.20 BF	(blank) F32T8/841 LP835 F32T8/835 LP850 F32T8/850	GLR Internal fast-blow fuse ^{4,5} GMF Internal slow-blow fuse ^{4,5} EL14 Emergency battery pack ^{4,6,7} EL14SD Emergency battery pack w/ self-diagnostics ^{4,6,7} I162 1250 lumens per lamp battery ^{4,6,8} OUTCTR Wiring leads pulled through back center of fixture ² OCS RELOC® OnePass® 5" installed ⁴ IMP Integrated modular plug ^{9,10} FSP Integral full side panels HBBSIC Chain hanger (pair) HBBS36IC Chain hanger with 36" chain (pair)	CS1W Straight plug, 120V ^{11,12} CS3W Twist-lock, 120V ^{11,12} CS7W Straight plug, 277V ^{11,12} CS11W Twist-lock, 277V ^{11,12} CS25W Twist-lock, 347V ^{11,12} CS97W Twist-lock, 480V ^{11,12} CS93W 600 SO white cord, no plug (no voltage required) ¹¹	MSI Aisle motion sensor, pre-wired ¹³ MSI360 360° motion sensor, pre-wired ¹³ MSE360 360° motion sensor, embedded ¹⁴ MSE360LB 360° motion sensor, embedded ¹⁵ XP1 XPoint single relay ¹⁶ XP2 XPoint double relay ¹⁶ Wireguards: WGX External wireguard installed 2WGX Dual wireguard for top and bottom protection ¹⁷

Accessories: Order as separate catalog number.

Mounting:	Field-installable door and lens assemblies: ^{2,19}	Cord sets and sensors for IMP option:	Wireguards:
IBAC120 M20 Aircraft cable 10' with hook (one pair)	DLIBZ14 A12125 4-lamp pattern 12 acrylic lens, 0.125" ^{2,19}	CS1WIMP Straight plug, 120V ^{11,12}	WGIBZ14 Standard 4-lamp wireguard
IBAC240 M20 Aircraft cable 20' with hook (one pair)	DLIBZ14 ACL 4-lamp clear acrylic lens ^{2,19}	CS3WIMP Twist-lock, 120V ^{11,12}	WGIBZ19 Standard 6-lamp wireguard
IBHMP Hook monopoint	DLIBZ14 PCL125 4-lamp clear polycarbonate lens, 0.125" ^{2,19}	CS7WIMP Straight plug, 277V ^{11,12}	WGIBZ24 Standard 8-lamp wireguard
IBZACVH Aircraft 10' V hanger (one pair)	DLIBZ19 A12125 6-lamp pattern 12 acrylic lens, 0.125" ^{2,19}	CS11WIMP Twist-lock, 277V ^{11,12}	
IBZTFC Tandem coupler and 8' side panel	DLIBZ19 ACL 6-lamp clear acrylic lens ^{2,19}	CS25WIMP Twist-lock, 347V	
IBZPMP Pendant monopoint splice box, includes side covers ¹⁸	DLIBZ19 PCL125 6-lamp clear polycarbonate lens, 0.125" ^{2,19}	CS93WIMP 600V SO white cord, no plug (no voltage required) ¹¹	
IBZPMPHB Pendant monopoint splice box, includes side covers (3/4" hub) ¹⁸	DLIBZ24 ACL 8-lamp clear acrylic lens ^{2,19}	CS97WIMP Twist-lock, 480V	
HBBS36 Chain hanger, 36" (one pair)	DLIBZ24 PCL125 8-lamp clear polycarbonate lens, 0.125" ^{2,19}	MSIIMP Aisle sensor ^{10,20}	
IBZSMB Surface-mounting bracket (one pair)		MSI360IMP 360° sensor ^{10,20}	

Notes

- Lamps installed are F32T8/841 unless otherwise specified.
- Not available with MSE360 or MSE360LB options.
- For wireguard in door frame, add "WG" to shielding. Ex: A12125WG.
- Specify voltage.
- Not available with 347 voltage.
- Battery options require a BACKPACK™ installed by the factory in order to accommodate the size of the battery. The BACKPACK is NOT field installable. May only be surface mounted using IBZSMB. Not available with pendant mount using IBZPMP or IBZ PMPHB. Not available with IMP.
- Output in emergency mode varies with ambient temperature (911 lumens at 45°C). Single-lamp operation only. 120 or 277 voltage only.
- Max 3000 lumens when used with T8 lamps up to 55°C ambient temperature. Not available with IMP. 120 or 277 voltage only.
- Must be factory-installed. Not available on TIBZ 16-lamp configurations.
- Must have "IMP" power cord to power fixture.
- All cord sets are 18/3, 6', white.
- Cord sets are voltage specific. Specify voltage. Other configurations available. Consult factory.
- Specify voltage; 120, 208, 240, 277, 347 or 480.
- Recommended for heights of 30-40'. Not available with lensed units. 120, 277 or 347 voltage only.
- Recommended for heights up to 20'. Not available with lensed units. 120, 277 or 347 voltage only.
- Contact LC&D for additional system components required.
- External bottom wireguard factory installed. External top wireguard shipped separately for field installation. Not available with IBZPMP.
- When ordering IBZPMP, two-ballast configurations are recommended. Ex: 2/2. Not available with tandem units. Not available with any battery pack.
- Add WG to nomenclature if wire guard is to be installed in door frame, ex: DLIBZ14 A12125WG.
- 120 or 277 voltage only.

STANDARD BALLAST CONFIGURATIONS			
	4 - lamp	6 - lamp	8 - lamp
T8 instant start (1.15 - 1.20 bf)	Two 2 - lamp ballasts	Two 3 - lamp ballasts	Two 4 - lamp ballasts
T8 instant start (.88 bf)	One 4 - lamp ballast	One 4 - lamp and one 2 - lamp ballast	Two 4 - lamp ballasts
T8 program rapid start (1.15 - 1.20 bf)	Two 2 - lamp ballasts	Two 3 - lamp ballast	One 2 - lamp and two 3 - lamp ballasts
T8 program rapid start (.88 bf)	One 4 - lamp ballast	One 4 - lamp and one 2 - lamp ballast	Two 4 - lamp ballasts

FEATURES & SPECIFICATIONS

INTENDED USE — Ideal one-for-one replacement of conventional high bay systems such as HID and fluorescent. Applications include warehousing, manufacturing and other large indoor spaces with mounting heights up to 60'. **Certain airborne contaminants can diminish integrity of acrylic.** [Click here for Acrylic Environmental Compatibility table for suitable uses.](#)

CONSTRUCTION — Die-formed aluminum alloy chassis with integrated fins for superior cooling through natural convection. The channel is made of heavy-duty code gauge (20-gauge) steel which is powder coated after fabrication. The assembly is rigidly designed to resist twisting and bowing. Access plate on the back of the channel housing allows quick and easy wiring.

OPTICS — Narrow and wide distributions available to meet both horizontal and vertical light level requirements. Reflectors feature precision-formed optics utilizing reflective Alanod® MIRO-5° aluminum. Semi-diffuse lens optional to provide glare control and LED protection.

ELECTRICAL — 89% lumen maintenance at 60,000 hours; predicted life of more than 100,000 hours. Thermally protected driver standard with 0-10V dimming.

LISTINGS — CSA Certified to U.S. and Canadian safety standards. Damp location listed. Suitable for ambient temperatures from -40°F (-40°C) to 131°F (55°C). Patent pending.

WARRANTY — 5-year limited warranty. Complete warranty terms located at www.acuitybrands.com/CustomerResources/Terms_and_conditions.aspx

Actual performance may differ as a result of end-user environment and application.

Actual wattage may differ by +/-1% when operating between 120-277V +/-10%.

Note: Specifications subject to change without notice.

Catalog Number
Notes
Type



LED High Bay

IBL

Unlensed (standard)
9-24L pictured



Patent Pending

Lensed (optional)
36-48L pictured



ORDERING INFORMATION

Lead times will vary depending on options selected. Consult with your sales representative.

Example: IBL 18L WD LP740 DLC

IBL Series	Lumens	Distribution	Lens	Voltage	Color temperature ²
IBL	9L 9,000 lumens 12L 12,000 lumens 18L 18,000 lumens 24L 24,000 lumens 36L 36,000 lumens ¹ 48L 48,000 lumens ¹	WD Wide ND Narrow	(blank) No shielding SD125 Semi-diffuse acrylic	(blank) MVOLT; 120-277V HVOLT 347V-480V 120 120V 277 277V	LP740 DLC 70 CRI, 4000K CCT LP750 DLC 70 CRI, 5000K CCT LP740 70 CRI, 4000K CCT LP750 70 CRI, 5000K CCT
Options					Finish
GLR	Internal fast-blow fuse ^{3,4}	Cord sets: ⁹	Motion sensors:	(blank) Gloss white with textured dark gray accents	
OUTCTR	Wiring leads pulled through back center of fixture	CS1W Straight plug, 120V ¹⁰	MSE360 360° motion sensor embedded, high bay ^{11,12}	DWH Gloss white	
OCS	RELOC® OnePass® 5' installed ³	CS3W Twist-lock, 120V ¹⁰	MSE360LB 360° motion sensor embedded, low bay ^{11,12}		
IMP	Integrated modular plug ^{5,6}	CS7W Straight plug, 277V ¹⁰	MSIPED Aisle motion sensor, photo sensor, pre-wired ³		
I2412	IOTA emergency LED battery pack for 32°F to 104°F (0°C to 40°C) ambient ^{7,8}	CS11W Twist-lock, 277V ¹⁰	MSI360PED 360° motion sensor, photo sensor, pre-wired ³		
SPD	Surge protector ³	CS25W Twist-lock, 347V ¹⁰	MSI Aisle motion sensor, pre-wired ³		
WGX	Standard wire guard, installed	CS97W Twist-lock, 480V ¹⁰	MSI360 360° motion sensor, pre-wired ³		
		CS93W 600 SO white cord, no plug (no voltage required)	MSID Aisle motion sensor, pre-wired, HI/LO dimming control ³		
			MSI360D 360° motion sensor, pre-wired, HI/LO dimming control ³		
			NMSI nLight, aisle motion sensor, pre-wired ³		
			NMSI360 nLight enabled, 360° motion sensor, pre-wired ³		
			nEPP5D nLight dimming module ^{3,13}		

Accessories: Order as separate catalog number.

Mounting:

IBAC120 M20	Aircraft cable 10' with hook (one pair)
IBAC240 M20	Aircraft cable 20' with hook (one pair)
IBHMP	Hook monopoint
ZACVH	Aircraft 10' V hanger (one pair) ⁹
IBLPMP	Pendant monopoint splice box, includes side covers for use with 9L-24L
IBLPMPHB	Pendant monopoint splice box, includes side covers (3/4" hub) for use with 9L-24L.
IBLPMP48	Pendant monopoint splice box, includes side covers for use with 36L and 48L
IBLPMPHB48	Pendant monopoint splice box, includes side covers (3/4" hub) for use with 36L and 48L
HC36	Hanger chain, 36" ^{9,8}
THUN	Tong hanger bracket (one pair) ^{8,14}

Cord sets and sensors for IMP option:

CS1WIMP	Straight plug, 120V ^{9,10,15}
CS3WIMP	Twist-lock, 120V ^{9,10,15}
CS7WIMP	Straight plug, 277V ^{9,10,15}
CS11WIMP	Twist-lock, 277V ^{9,10,15}
CS25WIMP	Twist-lock 347V ^{9,10,15}
CS93WIMP	600V SO white cord, no plug (no voltage required) ^{9,15}
CS97WIMP	Twist-lock 480V ^{9,10,15}
MSIIMP	Aisle sensor ^{6,15}
MSI360IMP	360° sensor ^{6,15}

Field-installable door and lens assemblies:

DLIBL SD125	Semi-diffuse acrylic lens for use 9L - 24L
DLIBL48 SD125	Semi-diffuse acrylic lens for use with 36L and 48L
Wire guards:	
WGIBL	Wire guard for use with 9L - 24L
WGIBL48	Wire guard for use with 36L and 48L

See footnotes on page 2.

IBL LED High Bay

Notes

- 1 Fixtures more than 24" wide can interfere with the operation of some fire sprinkler systems. Verify specific installation requirements with local fire official and insurance carrier. Emergency battery packs are not available with 36L or 48L.
- 2 Select product configurations are Design Lights Consortium (DLC) qualified; does not apply to 9L packages or 12 ND SD125 LP740 configuration.
- 3 Specify voltage.
- 4 Not available with 347 voltage.
- 5 Must be factory-installed.
- 6 Must have "IMP" power cord to power fixture.
- 7 Must specify voltage. 120V or 277V only. Not available with cordset w/plug or OUTCTR option.
- 8 Not available with 36L or 48L lumen package. When using THUN option maximum ambient temperature is 35°C.
- 9 All cord sets are 18/3, 6', white.
- 10 Cord sets are voltage specific. Specify voltage. Other configurations available. Consult factory.
- 11 Specify voltage; 120, 277 or 347 only.
- 12 Not available with battery pack.
- 13 Consult factory for dimming of 208, 347 or 480V fixtures.
- 14 95°F (35°C) maximum ambient temperature when using the THUN.
- 15 Must have IMP option on fixture.



9L, 18L, and 36L lumen packages



12L, 24L, and 48L lumen packages

To create the 9L, 18L, and 36L lumen packages, the PCBA (LED board) is depopulated from the endcaps inward. The first LED is 5-1/2" from the end cap on those units, compared to 1-1/8" on the 12L, 24L, and 48L product.

DIMENSIONS

Dimensions may vary with options or accessories.

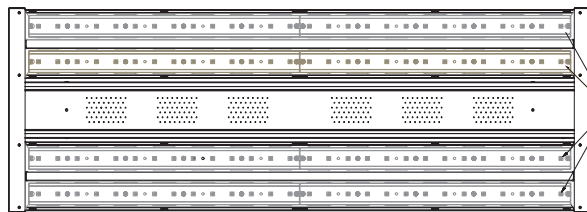

18L, and 24L utilize two drivers wired inboard/outboard
36L and 48L (not shown) utilize four drivers wired inboard/outboard

24L & 18L HAS 4 ROWS OF LEDs
12L & 9L HAS 2 ROWS OF LEDs
36L AND 48L (NOT SHOWN) HAVE 8 ROWS OF LEDs

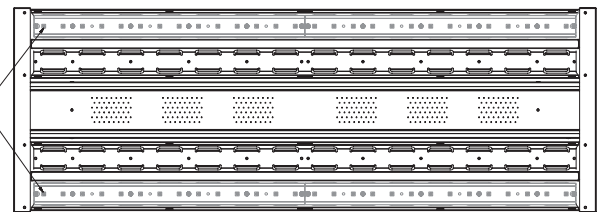

9L and 12L utilize one driver

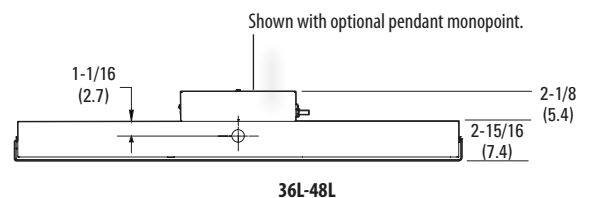
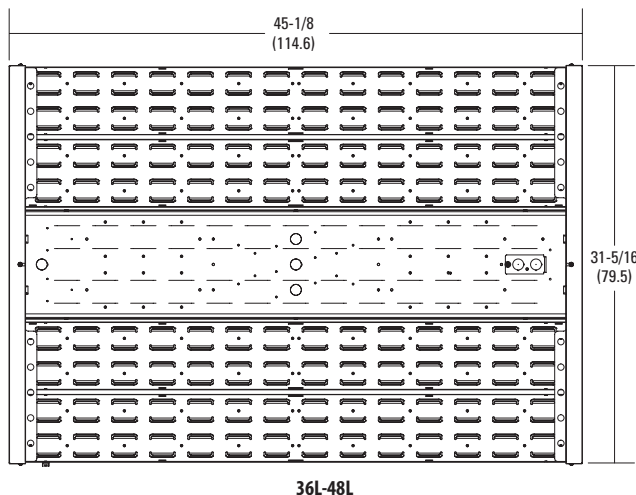
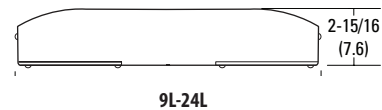
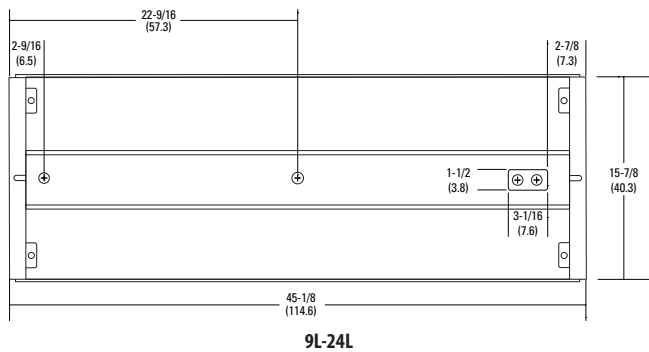

OPERATIONAL DATA

Lumen Package	Ambient Rating (120V - 277V)	Ambient Rating (347V / 480V)	Distribution	Delivered Lumens 5000K CCT @ 77°F (25°C) Ambient Temperature	Delivered Lumens 4000K CCT @ 77°F (25°C) Ambient Temperature	Lumen Multiplier @ 104°F (40°C) Ambient Temperature	Lumen Multiplier @ 104°F (40°C) Ambient w/SD125 Lens Kit
9L	-40°F to 131°F (-40°C to 55°C)	-40°F to 104°F (-40°C to 40°C)	WD	10,039	9,794	0.98	0.901
			ND	8,888	8,671	0.98	0.950
12L	-40°F to 131°F (-40°C to 55°C)	-40°F to 104°F (-40°C to 40°C)	WD	13,055	11,702	0.98	0.901
			ND	11,558	10,360	0.98	0.950
18L	-40°F to 131°F (-40°C to 55°C)	-40°F to 104°F (-40°C to 40°C)	WD	19,893	19,406	0.98	0.901
			ND	17,612	17,181	0.98	0.950
24L	-40°F to 131°F (-40°C to 55°C)	-40°F to 104°F (-40°C to 40°C)	WD	24,052	23,463	0.98	0.901
			ND	21,294	20,772	0.98	0.950
36L	-40°F to 131°F (-40°C to 55°C)	-40°F to 104°F (-40°C to 40°C)	WD	36,805	36,480	0.98	0.901
			ND	35,599	35,284	0.98	0.950
48L	-40°F to 131°F (-40°C to 55°C)	-40°F to 104°F (-40°C to 40°C)	WD	46,856	46,443	0.98	0.901
			ND	45,320	44,920	0.98	0.950

CHARACTERISTICS

Lumen Package	Wattage				Length	Width	Depth	Weight without Lens (Lens kit adds approx. 7 lbs.)	Comparable Light Source
	120V	277V	347V	480V					
	Dimensions are shown in inches (centimeters) unless otherwise noted.								
9L	103	98	107	106	45 (114.3)	15-3/4 (40.0)	3-1/4 (8.3)	12.5 lbs. (5.7 kg)	2-lamp T5HO
12L	134	131	142	141	45 (114.3)	15-3/4 (40.0)	3-1/4 (8.3)	12.5 lbs. (5.7 kg)	4-lamp T8, 250W HID
18L	213	199	213	211	45 (114.3)	15-3/4 (40.0)	3-1/4 (8.3)	17.5 lbs. (7.9 kg)	4-lamp T5HO, 6-lamp T8, 400W HID
24L	262	258	284	281	45 (114.3)	15-3/4 (40.0)	3-1/4 (8.3)	17.5 lbs. (7.9 kg)	6-lamp T5HO, 8-lamp T8
36L	423	417	459	454	45 (114.3)	31-1/3 (79.5)	3-1/4 (8.3)	35 lbs. (15.9 kg)	8-lamp T5HO, 750 HID
48L	531	511	562	557	45 (114.3)	31-1/3 (79.5)	3-1/4 (8.3)	35 lbs. (15.9 kg)	10-lamp T5HO, 1000W HID

PROJECTED LUMEN MAINTENANCE

Operating Hours	0	10,000	20,000	25,000	35,000	50,000	60,000	75,000	100,000
Lumen Maintenance Factor	1	0.96	0.95	0.94	0.93	0.91	0.89	0.87	0.84

LUMENS VS. AMBIENT TEMPERATURE

Ambient °C	Ambient °F	Lumen Multiplier
0	32	1.02
5	41	1.015
10	50	1.01
15	59	1.008
20	68	1.005
25	77	1
30	86	0.995
35	95	0.985
40	104	0.98
45	113	0.97
50	122	0.965
55	131	0.96

PHOTOMETRICS

See www.lithonia.com.

SENSORS AND CONTROLS

Sensors are an excellent way to maximize the return on your high bay lighting investment. I-BEAM LED fixtures can be equipped with an occupancy sensor, photocell, nLight® or nWiFi™. These devices are factory-installed and require minimal labor to set up during fixture installation.

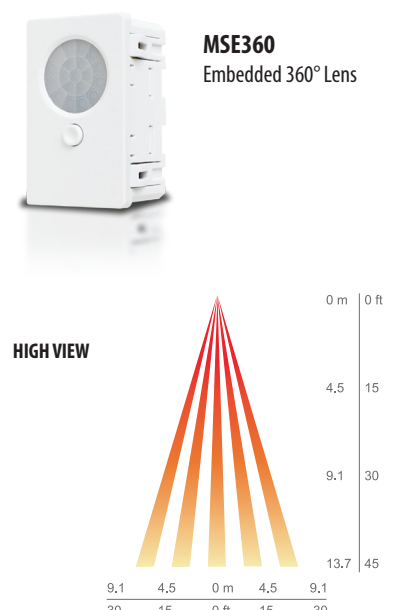
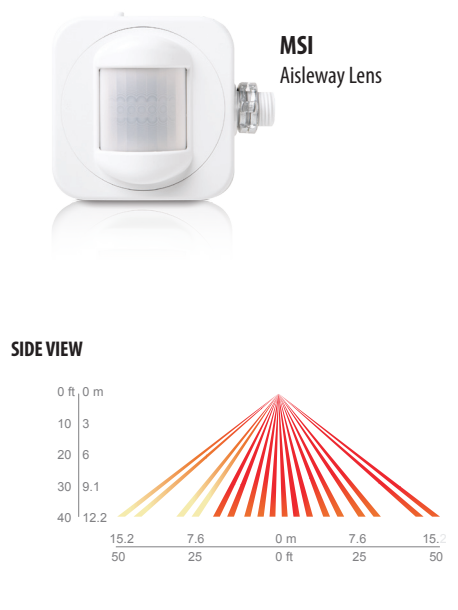
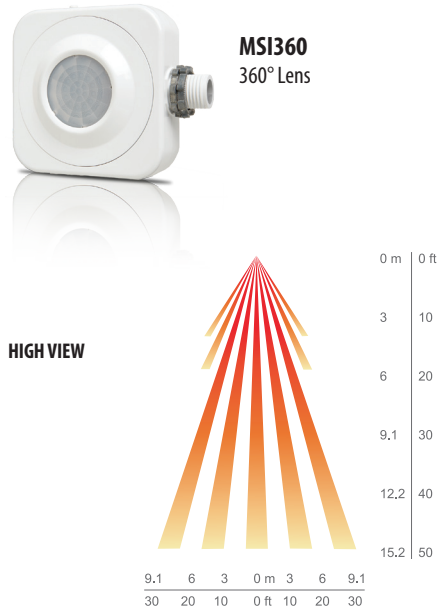

MSI360: The Sensor Switch CMRB 6 open-area sensor has 360° coverage and can be integrated with a photocell (PE) for further energy savings.

Mounting Location: End Plate

- Best choice for 15 to 45 ft (4.57 to 13.72 m) mounting heights
- 15 to 20 ft (4.57 to 6.10 m) radial coverage overlaps area lit by a typical high bay fixture

MSI: The Sensor Switch CMRB 50 aisleway sensor offers a dedicated sensor and extended range, compared to competitive products.

Mounting Location: End Plate

- Provides 50° bi-directional and 10° wide coverage pattern
- 1.2x mounting height equals approximate detection range in either direction
- Sensor lens turret rotates 90° in order to easily adjust the direction of the view pattern

MSE360: The Sensor Switch SFR 5 open-area sensor is embedded in the fixture, making it less intrusive than traditional sensors.

Mounting Location: Center Channel

- Recommended for fixtures that have a 1.0 spacing-to-mounting height ratio or less
- Use provided masking kit to mask off a portion of the view pattern for end-of-aisle applications or, to trim sensor's side viewing to create a rectangular pattern for center-of-aisle viewing only.



All I-BEAM LED fixtures can be equipped with nLight. nLight is an exclusive and revolutionary system that cost-effectively combines time-based and sensor-based lighting controls. The digital interface allows for quick, easy modifications to time delays, photocell sensitivity and light levels at the individual fixture level.

nWiFi for nLight adds conventional WiFi technology to nLight devices, such as occupancy sensors and relays, enabling them to seamlessly communicate with both wired and wireless nLight lighting control zones. This powerful new nLight technology further simplifies installation and reduces hardware costs.

OPTIONS AND ACCESSORIES

The I-BEAM LED fixture offers numerous options for almost every electrical and optical component, including a long list of field-installable accessories.

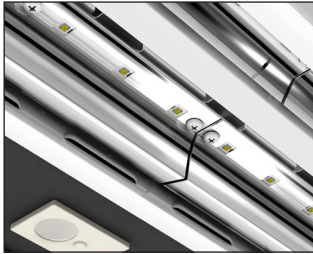

REFLECTORS

Wide distribution is formed with 93% reflective white paint. Narrow distribution is formed with Alanod® MIRO®.



INTEGRATED ELECTRICAL OPTIONS

Channel sized to accept emergency components, surge protector, fusing and embedded sensors.



WIRE GUARD (external)

Field- or factory-installed. Protects light engine from impact. Mounting hardware included.

Factory-installed option:
WGX

Field-installed options:
WGIBL
WGIBL48



DIFFUSER

Field- or factory-installed. Available in semi-diffuse acrylic. Mounting hardware included.

Factory-installed option:
SD125

Field-installed option:
DLIBL SD125
DLIBL48 SD125



EMBEDDED OCCUPANCY SENSOR

Can be placed in the channel cover which reduces the risk of sensor damage compared to non-embedded sensors.

Factory-installed option:
MSE360

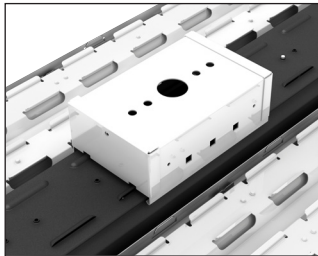

PENDANT MONOPOINT BRACKET

Accepts 3/4" rigid conduit for single-point mounting. The bracket can be adjusted to help counterbalance fixture to offset weight variance from end to end.

Order as:
IBLPMP
IBLPMPHB
IBLPMP48
IBLPMPHB48

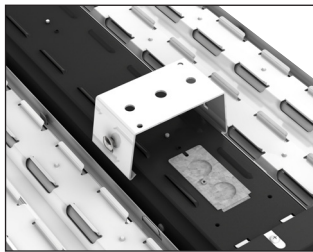

SURFACE MOUNT BRACKET

Rigidly attach I-BEAM LED to a hard ceiling. Can be placed anywhere along fixture.

Order as:
THUN (not for use in ambient temperatures exceeding 95°F (35°C), or on the 36L or 48L)

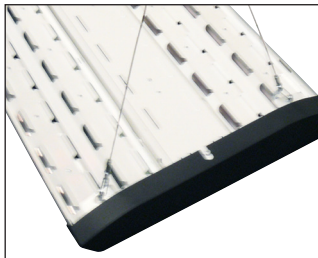

HANGERS

Several lengths of aircraft cables and chains available; with or without V-hooks.

Order as:
IBAC120 M20
IBHMP
For others, see accessories on page 1.

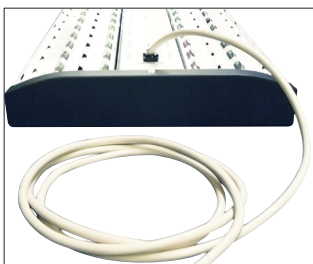

CORD SETS

Available in several lengths with or without molded plug. White is standard.

For available options, see ordering information on page 1.

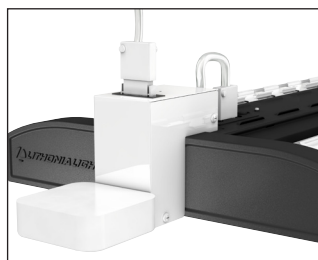

INTEGRATED MODULAR PLUG (IMP)

Must be factory-installed and allows for field installation of various modular accessories including cordsets, motion sensors, photocells and LC&D X-point™ relays.

2L Champ® Pro PFM Series Luminaires

Perfect for outdoor/indoor flood illumination

UL/cUL Listed
NEMA 4X
IP66

Type FL4
PFM9L CY/UNV1 76

The Champ® Pro PFM Family

Champ® Pro PFM Series Floodlights are designed to provide full-spectrum, crisp, white light. Five versions of the Champ PFM LED are available, providing ideal solutions for a wide range of applications.

Champ® Pro PFM Model	Equivalent MH HID Lamp	Energy Savings
PFM5L	100W-150W	Up to 62%!
PFM7L	150W-175W	
PFM9L	175W-250W	
PFM11L	250W-400W	
PFM13L	400W	

Certifications and Compliances:

- UL1598
- UL1598A
- cUL
- NEMA 4X; IP66
- DesignLights Consortium® approved for select models (refer to Ordering Information for details)

Drivers:

Model	5L - 13L
Standard	90-305 VAC, 50 / 60 Hz; 108-250 VDC
Option 1	347 VAC Model
Option 2	480 VAC Model

Standard Materials:

- Housing – copper-free aluminum with Corro-free™ epoxy powder coat
- Lens – shatter-resistant glass
- Gaskets – silicone
- External hardware – stainless steel
- Factory-sealed, no external seals required

LED System:

- High brightness light emitting diode (LED) arrays
- Color temperature: 3000K (CRI 82) and 5600K (CRI 65) options available
- Advanced heat sink design ensures LED does not exceed manufacturer's temperature ratings across all specified ambient conditions



Electrical Ratings:

	PFM5L	PFM7L	PFM9L	PFM11L	PFM13L
Voltage Range, VAC	100-277V 50-60 Hz 347 / 480V 60 Hz				
Voltage Range, VDC	108-250	108-250	108-250	108-250	108-250
Input Power (Nom.)	64	89	121	149	179
Input Amps (Max.)	0.550	0.800	1.083	1.608	1.608
Power Factor	>0.85	>0.85	>0.85	>0.85	>0.85

Ordering Information:

Color Temperature	5L Series	7L Series	9L Series	11L Series	13L Series
Cool Color Temperature	PFM5LCY/UNV1 76	PFM7LCY/UNV1 76	PFM9LCY/UNV1 76	PFM11LCY/UNV1 76	PFM13LCY/UNV1 76
	PFM5LCY/120 76*	PFM7LCY/120 76*	PFM9LCY/120 76*	PFM11LCY/120 76*	PFM13LCY/120 76*
Warm Color Temperature	PFM5LWY/UNV1 76	PFM7LWY/UNV1 76	PFM9LWY/UNV1 76	PFM11LWY/UNV1 76	PFM13LWY/UNV1 76

For 347 VAC option, replace /UNV1 with /347. For 480 VAC option, replace /UNV1 with /480.

To order fixture without optics, remove '76' from the end of the catalog number.

*5 year limited warranty. Refer to page 2 of the D-0413 authorized distributor price book for Cooper Crouse-Hinds standard Terms and Conditions. DesignLights Consortium approved models. Cool white only.

Options:

Description	Suffix
Fused (only applies to UNV1 model, not available for 347V or 480V; NOT marine or cUL Listed)	S658
Two conduit/cable glands of like thread installed	S886

Accessories:

Description	Catalog No. Sold Separately
Bolt-on visor (sold separately)	DSV1
Bolt-on wire guard (sold separately)	P61
Floodlight slipfitter (sold separately)	SFA6
Slipfitter wall mount adapter (sold separately)	SWB6

Champ® Pro PFM Series Luminaires

UL/cUL Listed
NEMA 4X
IP66

2L

Perfect for outdoor/indoor flood illumination

Dimensions:

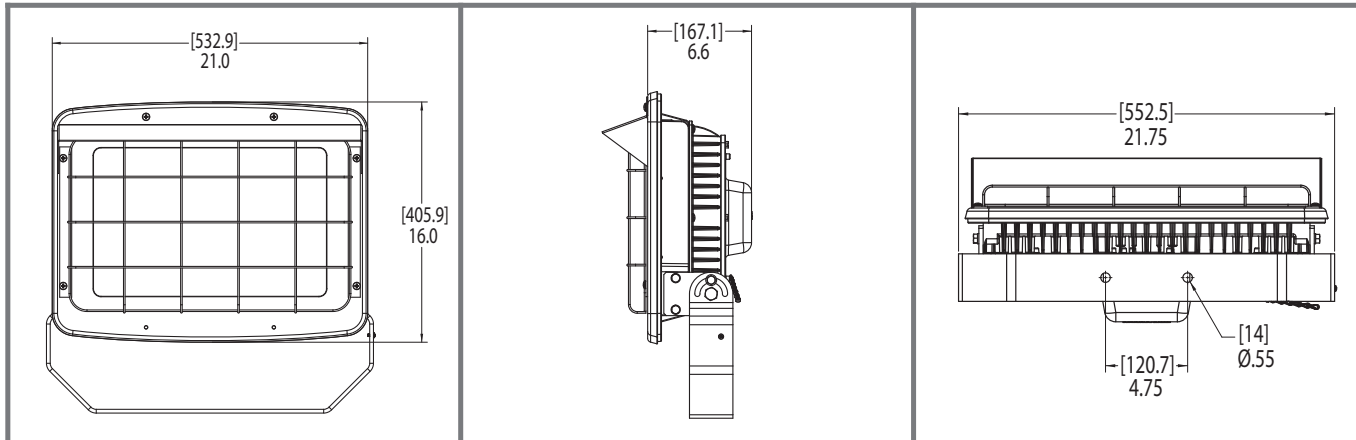

Weights:

Model	Lbs.
5L	39.11
7L	39.16
9L	39.73
11L	40.35
13L	40.35

Ambient Temperature:

Champ® Pro PFM Model	Max. Temp. °C
PFM5L	55
PFM7L	55
PFM9L	55
PFM11L	40
	55
PFM13L	40
	55

Photometric Data:

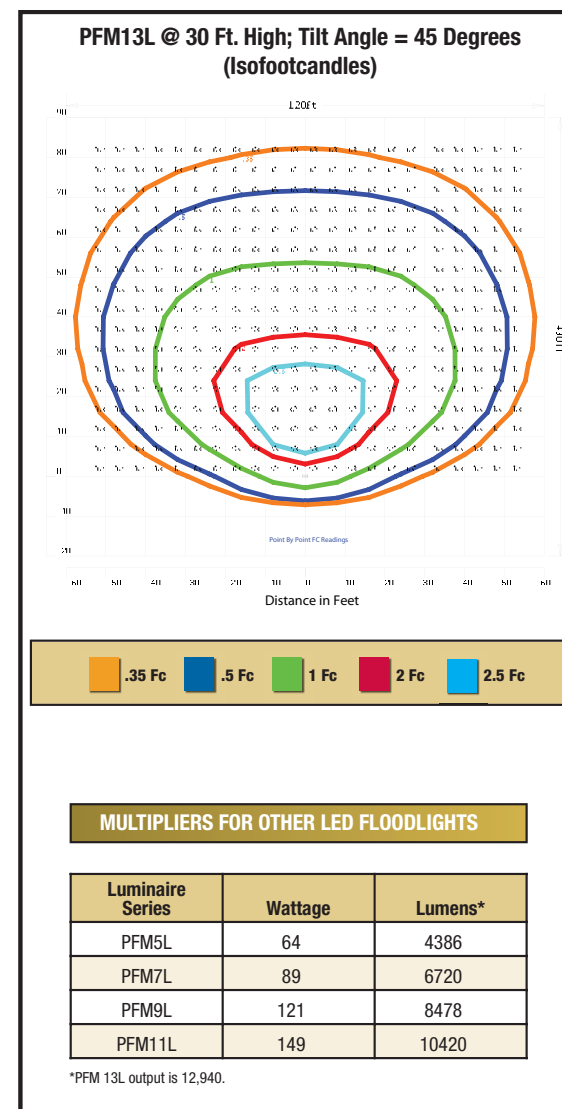

2L



d³series

D-Series Size 3 LED Flood Luminaire



Catalog
Number

Notes

Type

Hit the Tab key or mouse over the page to see all interactive elements.

Specifications

EPA:	1.4 ft ² (0.13 m ²)
Depth:	5" (12.7 cm)
Width:	13" (33.0 cm)
Height:	13-5/8" (34.6 cm)
Overall Height:	17-1/2" (44.5 cm)
Weight:	21 lbs (9.5 kg)

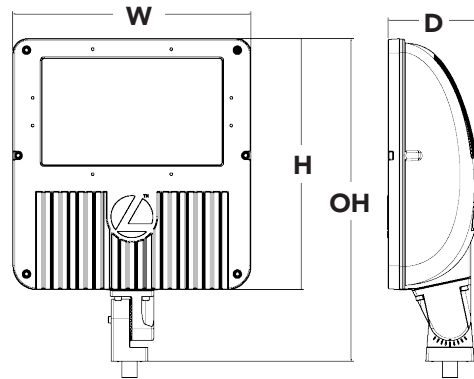

Introduction

The D-Series Size 3 Flood features precision optics to beautifully illuminate a variety of applications as its sleek, compact styling blends seamlessly with its environment.

The D-Series Flood reflector systems and cutting-edge chip-on-board LED technology produce low field-to-beam ratios for minimal spill light and incredible photometric performance. It's the ideal long-life replacement for 250 - 400W metal halide floods, with typical energy savings of 67% and expected service life of over 100,000 hours.

Ordering Information

EXAMPLE: DSXF3 LED 8 A530/40K FL MVOLT THK DDBXD

Series	Light Engines	Performance Package	Distribution	Voltage	Mounting	Options	Finish (required)
DSXF3 LED	6 Six COB engines 8 Eight COB engines	530 mA options: A530/30K 3000K A530/40K 4000K A530/50K 5000K	NSP Narrow spot MSP Medium spot MFL Medium flood FL Flood WFL Wide flood WFR Wide flood, rectangular HMF Horizontal medium flood	MVOLT 120 ¹ 208 ¹ 240 ¹ 277 ¹ 347 480	Shipped included THK Knuckle with 3/4" NPT threaded pipe YKC62 Yoke with 16-3 SO cord IS Integral slipfitter (fits 2-3/8" O.D. tenon) Shipped separately ² FTS CG6 Tenon slipfitter (fits 2-3/8" to 2-7/8" O.D. tenon. YKC62 required)	Shipped installed PER NEMA twist-lock receptacle only (no controls) DMG 0-10V dimming driver (no controls) DCR Dimmable and controllable via ROAM® (no controls) ³ SF Single fuse (120, 277, 347V) ⁴ DF Double fuse (208, 240, 480V) ⁴ WTB Utility terminal block Shipped separately ² UBV Upper/bottom visor (universal) FV Full visor VG Vandal guard WG Wire guard SC Shorting cap ⁵ DLL127F 1.5 JU Photocell - SSL twist-lock (120-277V) ⁵ DLL347F 1.5 CUL JU Photocell - SSL twist-lock (347V) ⁵ DLL480F 1.5 CUL JU Photocell - SSL twist-lock (480V) ⁵	DDBXD Dark bronze DBLXD Black DNAXD Natural aluminum DWHXD White

Accessories

Ordered and shipped separately.

FTS CG6 DDBXD U	Slipfitter for 2-3/8" to 2-7/8" O.D. tenons; mates with yoke mount (specify finish)	DSXF3UBV DDBXD U	Upper/bottom visor accessory (specify finish)
FRWB DDBXD U	Radius wall bracket, 2-3/8" O.D. tenon (specify finish)	DSXF3FV DDBXD U	Full visor accessory (specify finish)
FSPB DDBXD U	Steel square pole bracket, 2-3/8" O.D. tenon (specify finish)	DSXF3VG U	Vandal guard accessory
		DSXF3WG U	Wire guard accessory

For more mounting options, visit our [Floodlighting Accessories](#) pages.
For more control options, visit [DTL](#) and [ROAM](#) online.

NOTES

- MVOLT driver operates on any line voltage from 120-277V. Specify 120, 208, 240 or 277 options only when ordering with fusing (SF, DF options).
- Also available as separate accessories; see Accessories information at left.
- Specifies a ROAM® enabled luminaire with 0-10V dimming capability; PER option required. Not available with 347 or 480V. Additional hardware and services required for ROAM® deployment; must be purchased separately. Call 1-800-442-6745 or email: sales@roamservices.net.
- Single fuse (SF) requires 120, 277 or 347 voltage option. Double fuse (DF) requires 208, 240 or 480 voltage option.
- Requires luminaire to be specified with PER option. Ordered and shipped as a separate line item.



Performance Data

Lumen Output

Lumen values are from photometric tests performed in accordance with IESNA LM-79-08. Data is considered to be representative of the configurations shown, within the tolerances allowed by Lighting Facts. Actual wattage may differ by +/- 8% when operating between 120-480V +/- 10%. Contact factory for performance data on any configurations not shown here.

Light Engines	Drive Current (mA)	Performance Package	System Watts	Dist. Type	Field Angle		Beam Angle		40K (4000K, 70 CRI)			50K (5000K, 67 CRI)		
					°H	°V	°H	°V	Max Cd	Lumens	LPW	Max Cd	Lumens	LPW
6	530	A530/--K	115W	NSP	48	49	19	19	39,299	7471	65	39,177	7448	65
				MSP	50	48	24	23	36,284	8373	73	36,171	8347	73
				MFL	60	60	47	46	15,104	8948	78	15,057	8920	78
				FL	85	84	63	62	9985	9730	85	9954	9700	84
				WFL	106	106	71	72	7488	10,230	89	7465	10,199	89
				WFR	107	88	85	64	7460	10,461	91	7436	10,429	91
				HMF	100	62	80	13	6779	3301	29	6758	3290	29
8	530	A530/--K	158W	NSP	48	49	19	19	51,658	9820	62	51,496	9790	62
				MSP	50	48	24	23	47,694	11,006	70	47,546	10,971	69
				MFL	60	60	47	46	19,854	11,761	74	19,792	11,725	74
				FL	85	84	63	62	13,125	12,790	81	13,084	12,750	81
				WFL	106	106	71	72	9843	13,448	85	9812	13,406	85
				WFR	107	88	85	64	9805	13,751	87	9775	13,708	87
				HMF	100	62	80	13	8911	4338	27	8883	4325	27

Lumen Ambient Temperature (LAT) Multipliers

Use these factors to determine relative lumen output for average ambient temperatures from 0-40°C (32-104°F).

Ambient	Lumen Multiplier
0°C	1.05
10°C	1.03
20°C	1.01
25°C	1.00
30°C	0.99
40°C	0.97

Projected LED Lumen Maintenance

Data references the extrapolated performance projections for the **DSXF LED 8 A530** platform in a **25°C ambient**, based on 8400 hours of LED testing (tested per IESNA LM-80-08 and projected per IESNA TM-21-11).

To calculate LLF, use the lumen maintenance factor that corresponds to the desired number of operating hours below. For other lumen maintenance values, contact factory.

Operating Hours	0	25,000	50,000	100,000
Lumen Maintenance Factor	1.0	0.94	0.90	0.84

Electrical Load

Light Engines	Drive Current (mA)	System Watts	Current (A)					
			120	208	240	277	347	480
6	530	115W	1.06	0.61	0.53	0.46	0.37	0.27
8	530	158W	1.46	0.84	0.73	0.63	0.51	0.37

Photometric Diagrams

To see complete photometric reports or download .ies files for this product, visit Lithonia Lighting's [D-Series Flood Size 3 homepage](#).

Isocandela plots for the DSXF3 LED 8 A530/40K.

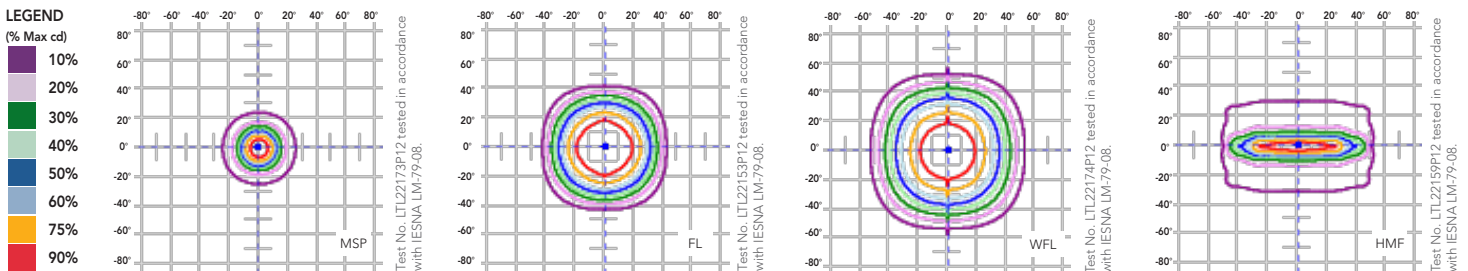

FEATURES & SPECIFICATIONS

INTENDED USE

The sleek design of the D-Series Size 3 Flood reflects the embedded high performance LED technology. It is ideal for wallwash, security and general area lighting in many commercial and institutional applications.

CONSTRUCTION

Die-cast aluminum housing has integral heat sink fins to optimize thermal management through conductive and convective cooling. The LED driver is mounted in direct contact with the casting to promote low operating temperature and long life. Housing is completely sealed against moisture and environmental contaminants (IP65). Low EPA (1.4 ft²) for optimized wind loading.

FINISH

Exterior parts are protected by a zinc-infused Super Durable TGIC thermoset powder coat finish that provides superior resistance to corrosion and weathering. A tightly controlled multi-stage process ensures a minimum 3 mils thickness for a finish that can withstand extreme climate changes without cracking or peeling.

OPTICS

A variety of precision-molded vacuum-metallized specular reflectors are engineered for superior field-to-beam ratios, uniformity and spacing. Light engines are available in 3000K (80 CRI min.), 4000K (70 CRI min.) or 5000K (67 CRI min.) configurations. Optional visors offer additional versatility.

ELECTRICAL

Light engines consist of chip-on-board (COB) LEDs directly coupled to the housing to maximize heat dissipation and promote long life (100,000 hrs at 25°C, L84). Class 1 electronic driver has a power factor >90%, THD <20%, and has an expected life of 100,000 hours with <1% failure rate. (Eight-engine unit uses two drivers.) Surge protection meets a minimum Category C Low operation (per ANSI/IEEE C62.41.2).

INSTALLATION

Integral adjustable knuckle with 3/4-14 NPT threaded pipe, or yoke mounting, facilitates quick and easy installation to a variety of mounting accessories. This secure connection enables the D-Series Size 3 to withstand up to a 1.5 G vibration load rating per ANSI C136.31.

LISTINGS

CSA certified to U.S. and Canadian standards. Luminaire is IP65 rated. Rated for -40°C minimum ambient.

WARRANTY

Five year limited warranty. Full warranty terms located at www.acuitybrands.com/CustomerResources/Terms_and_conditions.aspx.

Note: Specifications subject to change without notice.



QUICKTRONIC® PROStart® PSN T8 Universal Voltage Systems

Professional Series



Normal Ballast Factor

QTP T8 PSN

Lamp / Ballast Guide

Primary Systems

- 32W T8 OCTRON® lamps
- 1-lamp QTP1x32T8/UNV PSN-TC
- 2-lamp QTP2x32T8/UNV PSN-TC
- 3-lamp QTP3x32T8/UNV PSN-SC
- 4-lamp QTP4x32T8/UNV PSN-SC

Also operates:

- FB032, FB031, F025, FB024, F017, FB016, F030/SS, FB030/SS (30W), FB029/SS, F028/SS (28W) & F025/SS (25W)

Key System Features

- PROStart® Programmed Rapid Start
 - Increase lamp life
 - Ideal for occupancy sensors
- NEMA Premium Electronic Ballast Program compliant
- Low profile enclosures:
 - 1.00" high "Thin Can"
 - 1.18" high "Small Can"
- Min. Starting Temp:
 - 0°F (-18°C) for T8 lamps
 - 60°F (16°C) for Energy Saving T8 lamps
- Operates at >40kHz to avoid interference with infrared control systems
- Universal Input Voltage (120-277V)
- RoHS compliant
- Lead-free solder, printed circuit board and manufacturing process



Application Information

SYLVANIA QUICKTRONIC PROStart T8 ballasts

are ideally suited for:

- Any applications where extended lamp life is required to reduce maintenance costs
- Energy retrofits
- Occupancy sensors
- Building control systems

SYLVANIA QUICKTRONIC PROStart programmed rapid start electronic ballasts operate linear U-bend SUPERSAVER® equivalent T8 lamps in applications where extended lamp life is required.

QUICKTRONIC PROStart ballasts utilize a micro-controller based circuit to apply a precise amount of cathode heat prior to starting the lamp. This ensures that the cathodes have reached optimum temperature before the lamp is started. Once the lamp has ignited, the ballast eliminates the cathode voltage which optimizes system efficiencies similar to instant start ballasts.

QUICKTRONIC PROStart ballasts are NEMA Premium Electronic Ballast Program compliant. The program promotes the use of high efficiency T8 electronic ballasts by meeting or exceeding the Ballast Efficiency Factors, (BEF) established by the CEE, (Consortium for Energy Efficiency). For additional information on this program go to: www.cee1.org or www.nema.org

System Information

QUICKTRONIC PROStart ballasts provide optimum starting conditions to provide over 100,000 switching cycles for occupancy sensor and building control system applications.

QUICKTRONIC PSN UNV operates from 120V through 277V, eliminating "wrong voltage" wiring errors and reducing the number of models in inventory by half.

In addition to substantial energy savings, QUICKTRONIC PSN ballasts deliver an optimized programmed start which extends lamp life. This advanced starting process drastically reduces the amount of cathode sputtering, resulting in improved lamp life in all applications including short start cycles.

QUICK 60+® warranty coverage is included when you use SYLVANIA lamps and ballasts together as a system. See the QUICK 60+ warranty bulletin for complete details.

The QUICKTRONIC PROStart ballasts are ideally suited for applications requiring extended lamp life. In short cycle applications, our PROStart ballasts will deliver three times the number of start cycles compared to electronic Instant Start ballasts.



All SYLVANIA Professional Series (QTP) electronic ballasts feature high power quality (<10% THD), lightweight, low profile designs.

This product is also offered in new banded packaging and pallet packs.

- Distributor-friendly for easy stocking

and individual ballast sales

- Reduced waste
- Easy removable bands
- No tangled wires

These ballasts are also RoHS compliant and feature lead-free solder, printed circuit boards and manufacturing process.

Lamp & Ballast Type	Input Power (W)	Initial Lumens	Initial LPW	Mean System Lumens	Relative Mean Light Output	% Energy Savings	% Lamp Life
2-F032/700 QTP 2x32 ISN	59	4930	84	4435	Baseline	Baseline	Baseline
2-F032/800/XP QTP 2x32 ISN	59	5280	89	4965	112%	0%	100%
2-F032/800/XP QTP 2x 32 PSN	59	5280	89	4965	112%	0%	150%
2-F028/SS QTP 2x32 PSN	52	4800	92	4510	102%	12%	150%

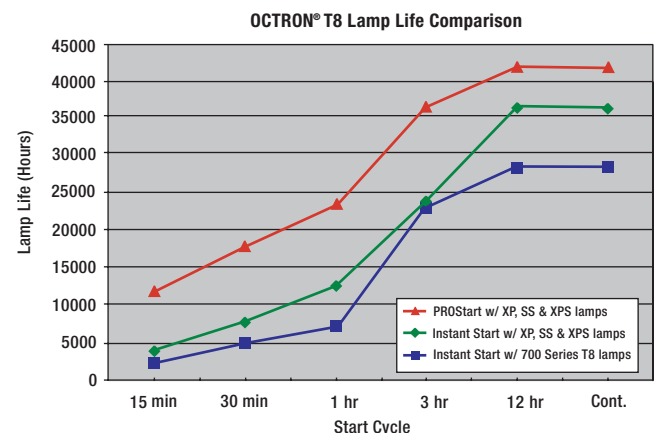

SPECIFICATION DATA

Catalog #	Date	Type
Project	Prepared by	
Comments		

PROStart® Programmed Rapid Start Systems UNV (120-277V)



Item Number	OSRAM SYLVANIA Description	Input Current (AMPS)	Lamp Type	Rated Lumens (lm)	No. of Lamps	Ballast Factor (BF)	System Lumens	Mean Lumens	Input Wattage (W)	System Efficacy (lm/W)	BEF ¹
51399	QTP 1x32T8/UNV PSN-TC Banded Pack	0.26/0.11	F032/700	2800	1	0.88	2465	2220	31/30	79/82	2.93
		0.26/0.11	F032/XP	3000	1	0.88	2640	2480	31/30	85/88	2.93
		0.24/0.10	F030/SS	2850	1	0.88	2510	2360	29/28	87/90	3.14
		0.23/0.09	F028/SS	2725	1	0.88	2400	2255	27/26	89/92	3.38
51401	Pallet Pack	0.20/0.09	F025/SS	2475	1	0.88	2175	2045	24/23	91/95	3.83
51402	QTP 2x32T8/UNV PSN-TC Banded Pack	0.50/0.21	F032/700	2800	2	0.88	4930	4435	59/56	84/88	1.57
		0.50/0.21	F032/XP	3000	2	0.88	5280	4965	59/56	89/94	1.57
		0.47/0.20	F030/SS	2850	2	0.88	5015	4715	55/53	91/95	1.66
		0.45/0.19	F028/SS	2725	2	0.88	4800	4510	52/49	92/98	1.80
		0.39/0.17	F025/SS	2475	2	0.88	4355	4095	46/44	95/99	2.00
51405	10-Pack										
51406	Pallet Pack										
51403	QTP 3x32T8/UNV PSN-SC Banded Pack	0.74/0.31	F032/700	2800	3	0.88	7390	6655	88/85	84/87	1.04
		0.74/0.31	F032/XP	3000	3	0.88	7920	7445	88/85	90/93	1.04
		0.70/0.29	F030/SS	2850	3	0.88	7525	7075	83/80	91/94	1.10
		0.65/0.27	F028/SS	2725	3	0.88	7195	6760	77/75	93/96	1.17
		0.58/0.25	F025/SS	2475	3	0.88	6535	6140	69/68	95/96	1.29
51410	10-Pack										
51411	Pallet Pack										
51404	QTP 4x32T8/UNV PSN-SC Banded Pack	0.99/0.41	F032/700	2800	4	0.88	9855	8870	118/113	83/87	0.78
		0.99/0.41	F032/XP	3000	4	0.88	10,560	9925	118/113	90/94	0.78
		0.93/0.39	F030/SS	2850	4	0.88	10,030	9430	111/106	90/95	0.83
		0.88/0.36	F028/SS	2725	4	0.88	9590	9015	104/99	92/97	0.89
		0.77/0.32	F025/SS	2475	4	0.88	8710	8190	92/90	95/97	0.98
51415	10-Pack										
51416	Pallet Pack										

Banded Pack, (add "B" to Description). Banded Pack and 10-Pack contain 10 pieces each. Pallet Pack contains 840 pieces, (add "-PAL" to Description).

1: Ballast Efficiency Factor (BEF) shown = (Ballast Factor x 100) divided by Input Power (Note: calculation based on lowest wattage value).

1 lamp

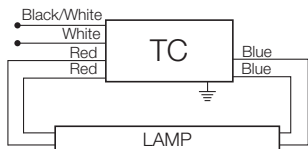

2 lamp

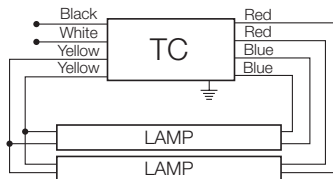

3 lamp

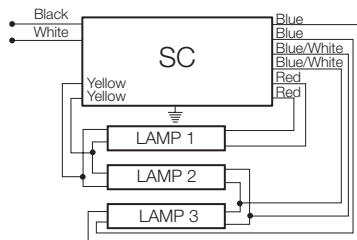

4 lamp

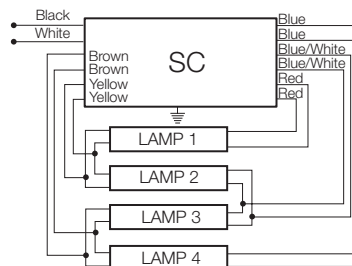

Dimensions "TC & SC" Enclosure:

"SC" Overall: 9.5" L x 1.68" W x 1.18" H

"TC" Overall: 9.5" L x 1.68" W x 1.00" H

Mounting: 8.90"

Weight: 1.6 lbs each

Wiring:

Leads only
(no connectors provided)

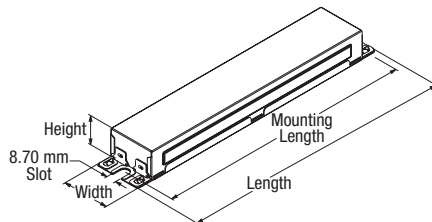

Item Number	51402	QTP	2	x	32T8	/	UNV	PSN	TC	Enclosure Type (TC or SC)
QUICKTRONIC PROFESSIONAL										Starting Type/Ballast Factor – PROStart/Normal BF
Number of Lamps (1, 2, 3, 4)										Line Voltage (120-277V)
Primary Lamp Type (F32T8)										

Normal Ballast Factor

T8 PROStart® PSN UNV

Professional Series

Performance Guide

Data based upon SYLVANIA OCTRON® lamps shown. QUICKTRONIC® QTP PROStart ballasts are also compatible with other lamp manufacturers equivalent lamp types that meet ANSI specifications. QTP PROStart ballasts will also operate F17 & F25, SUPERSAVER® & U-Bend equivalent T8 lamps. Complete performance data is available in the QUICKSYSTEMS section of the SYLVANIA Ballast Technology & Specification Guide.

Specifications

Data based on F32T8

- Starting Method: Programmed Rapid-Start
- Ballast Factor: 0.88
- Circuit Type: Series
- Lamp Frequency: >40 kHz
- Lamp CCF: Less than 1.6
- Starting Temp:²
 - 0°F (-18°C) for OCTRON T8 lamps;
 - 60°F (16°C) for SUPERSAVER® T8 lamps
- Input Frequency: 50/60 Hz
- Low THD: <10%
- Power Factor: >98%
- Voltage Range: ±10% of 120-277V rated line (108-305V)

- UL Listed Class P, Type 1, Outdoor CSA Certified
- 70°C Max Case Temp.
- FCC 47CFR Part 18 Non-Consumer Class A Sound Rating
- RoHS Compliant³
- NEMA Premium Electronic Ballast Program compliant
- ANSI C62.41 Cat A. Transient GFCI compatible
- Emergency ballast compatible
- Remote Mounting (Max. wire length from ballast case to lamp holder):
 - 20 ft: full wattage T8s
 - 10 ft: energy saving T8s
 - 4 ft: 25W energy saving T8s

(keep blue wires short, ie. lamp(s) attached to the blue leads to remain in the fixture that houses the ballast).

2 Operation below 50°F (10°C) may affect light output or lamp operation – see "Low Temp. Starting" definition.

3 Complies with European Union Restriction of Hazardous Substances Directive (Directive EC 2002/95)

System Life / Warranty

QUICKTRONIC products are covered by the QUICK 60+® warranty, a comprehensive lamp and ballast system warranty. For additional details, refer to the QUICK 60+ warranty bulletin.

OSRAM SYLVANIA
National Customer Service and Sales Center
1-800-LIGHTBULB
(1-800-544-4828)
www.sylvania.com

Specifications subject to change without notice.

QTP T8 PSN

©2011 OSRAM SYLVANIA

QUICKTRONIC® PROStart® T8 High Ambient Temperature



**Type CC, Lamp Striation Control
& Parallel Operation
High Ballast Factor**

High Efficiency Series

QHE T8 PSH

Lamp / Ballast Guide

Primary Systems

- 32W T8 - OCTRON®
- 2-lamp QHE2x32T8/UNV PSH-HT
- 3-lamp QHE3x32T8/UNV PSH-HT
- 4-lamp QHE4x32T8/UNV PSH-HT

Also operates:

- FB032, FB031, F030/SS (30W), F028/SS (28W), F025/SS (25W), FB030/SS (30W), FB029/SS (29W), F025, FB024, F017 & FB016

Key System Features

- **High Efficiency Systems** over 90% efficient
- NEMA Premium Ballast compliant
- PROStart Programmed Rapid Start
 - Extends lamp life
- High ballast factor: 1.15
- **Parallel operation**, (one lamp out, remaining lamps stay lit)
- 90°C maximum case temp.
- UL Type CC
- LSC (Lamp Striation Control)
- Universal input voltage (120-277V)
- Min. Starting Temp:
 - 0°F/-18°C for T8 lamps
 - 60°F/16°C for Energy Saving T8 lamps



Application Information

SYLVANIA QUICKTRONIC PROStart T8 is ideally suited for:

- High bay
- Warehouses
- Applications where extended lamp life is required to reduce maintenance costs
- Areas where frequent switching is desired
- Occupancy sensor usage
- Building control systems
- Areas that are underlit

SYLVANIA QUICKTRONIC PROStart

programmed rapid start electronic T8 ballasts offer eight major advantages:

1. **Operate 32W linear and U-bend equivalent T8 lamps** at High Efficiency and high ballast factor which increases light levels while optimizing system performance.
2. **Longer Lamp Life:** System PSH, (Programmed Start High Ballast Factor) is the first SYLVANIA high ballast factor model to extend lamp life which is ideal for applications where long lamp life is desired to reduce maintenance costs.
3. **High Ambient Temperature:** specifically designed for those applications where the ballast is subjected to higher ambient temperatures, such as high bays in industrial installations.
4. **Parallel Circuitry:** keeps remaining lamps lit if one or more go out. First SYLVANIA PROStart ballast to offer parallel lamp operation.
5. **Available in 2, 3 & 4-lamp models** which allows great flexibility for various light levels in high bay applications to replace HID or T12HO lighting systems.
6. **NEMA Premium Ballast (NPB) program compliant.** The NPB program promotes

System Information

SYLVANIA QUICKTRONIC High Efficiency (QHE) System advantages:

- Operate from 120V through 277V
 - Eliminates "wrong voltage" errors
 - Reduces inventory by 50%
- Utilizes Programmed Rapid Start operation for:
 - Highest System Efficacy
 - Longer Life
 - Over 100,000 switching cycles for occupancy sensor and building control systems applications.
- Operate at >42Hz to reduce potential interference with infrared control systems



the use of high efficiency T8 electronic ballasts by meeting or exceeding the Ballast Efficiency Factors, (BEF) established by the CEE, (Consortium for Energy Efficiency). For additional information on this program go to: www.cee1.org or www.nema.org

7. **UL Type CC compliant:** ballasts utilize a micro-controller based circuit to reduce arcing caused by loose connections or improper lamp pin to socket connections.

8. **Lamp Striation Control (LSC):** T8 energy saving lamps should be operated above 60°F, but under certain conditions the lamps may striate. LSC circuitry may minimize or eliminate this condition; however there are limited applications where LSC circuitry may not entirely mitigate lamp striations. (Please consult lamp manufacturers for additional details.)

Lamp & Ballast Type	Input Power (W)	Initial LPW	Mean Fixture* Lumens	Relative Fixture* Output	% Energy Savings	% Lamp Life @3hrs/start
M400/U Magnetic Ballast	452	61	17,784	Baseline	Baseline	Baseline
3-F96T12HO Magnetic Ballast	360	58	16,875	95%	20%	60%
6-F032/800/XPS 2-QHE3x32 PSH	220	83	17,090	96%	51%	180%

*Based on Fixture Efficiency: 76% for M400/U and 85% for T12HO and F032T8 lamps.

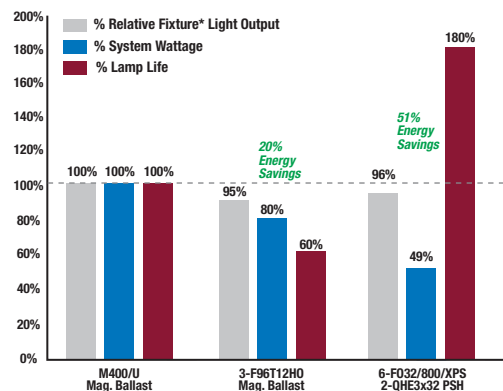

SPECIFICATION DATA

Catalog #	Date	Type
Project	Prepared by	
Comments		

High Efficiency Type CC, Lamp Striation Control & High Ambient (120-277V)



Item Number	OSRAM SYLVANIA Description	Input Current (AMPS)	Lamp Type	Rated Lumens (lm)	No. of Lamps	Ballast Factor (BF)	System Lumens	Mean Lumens	Input Power (W)	System Efficacy (lm/W)	BEF ¹
49450 49459	QHE2x32T8/UNV-PSH-HT Banded Pack Pallet Pack	0.60/0.27	F032/700	2800	2	1.15	6440	5795	72/70	89/92	1.64
		0.60/0.27	F032/XP	3000	2	1.15	6900	6485	72/70	96/99	1.64
		0.57/0.25	F030/SS	2850	2	1.15	6555	6160	69/67	95/98	1.72
		0.53/0.23	F028/SS	2725	2	1.15	6270	5890	63/62	100/101	1.85
		0.47/0.20	F025/SS	2475	2	1.15	5695	5350	56/55	102/104	2.09
		0.46/0.20	F025/XP	2175	2	1.16	5045	4740	55	92	2.11
49453 49460	QHE3x32T8/UNV-PSH-HT Banded Pack Pallet Pack	0.94/0.40	F032/700	2800	3	1.15	9660	8695	110/108	88/89	1.06
		0.94/0.40	F032/XP	3000	3	1.15	10,350	9730	110/108	94/96	1.06
		0.88/0.37	F030/SS	2850	3	1.15	9835	9245	104/101	95/97	1.14
		0.81/0.34	F028/SS	2725	3	1.15	9400	8835	95/93	99/101	1.24
		0.72/0.31	F025/SS	2475	3	1.15	8540	8025	85/84	100/102	1.37
		0.70/0.30	F025/XP	2175	3	1.17	7635	7175	83/82	92/93	1.43
49455 49470	QHE4x32T8/UNV-PSH-HT Banded Pack Pallet Pack	1.22/0.53	F032/700	2800	4	1.15	12,880	11,590	143/141	90/91	0.82
		1.22/0.53	F032/XP	3000	4	1.15	13,800	12,970	143/141	97/98	0.82
		1.13/0.49	F030/SS	2850	4	1.15	13,110	12,325	132/130	99/101	0.88
		1.06/0.46	F028/SS	2725	4	1.15	12,535	11,785	124/123	101/102	0.93
		0.95/0.41	F025/SS	2475	4	1.15	11,385	10,700	112/110	102/104	1.05
		0.91/0.40	F025/XP	2175	4	1.17	10,180	9570	107/106	95/96	1.10
		0.63/0.28	F017/XP	1375	4	1.18	6490	6100	73	89	1.62

Banded pack contains 10 pieces, (add "-B" to Description). Pallet Pack contains 500 pieces, (add "-PAL" to Description).
 1: Ballast Efficiency Factor (BEF) shown = (Ballast Factor x 100) divided by Input Power (Note: calculation based on lowest wattage value).

QHE T8 PSH

Specifications
Data based on F32T8

Starting Method: Programmed Rapid-Start
 Ballast Factor: 1.15
 Circuit Type: Parallel
 Lamp Frequency: >40 kHz
 Lamp CCF: Less than 1.7
 Starting Temp:²
 0°F (-18°C) for OCTRON T8 lamps;
 60°F (16°C) for SUPERSAVER® T8 lamps
 Input Frequency: 50/60 Hz
 THD: <10%
 Power Factor: >98%
 Voltage Range: ±10% of 120-277V rated line (108-305V)

UL Listed Class P, Type 1 Outdoor
 UL Type CC Rated
 Lamp Striation Control (LSC)
 CSA Certified
High Ambient Applications:
 90°C Max. Case Temp. (3 yr. warranty)
Standard Ambient Applications:
 70°C Max. Case Temp. (5 yr. warranty)
 FCC 47CFR Part 18 Non-Consumer
 Class A Sound Rating
 ANSI C62.41 Cat A. Transient Protection
 GFCI compatible
 Emergency ballast compatible
 Remote Mounting (Max. wire length from ballast case to lampholder):
 • 20 ft: full wattage T8s
 • 10 ft: energy saving T8s
 • 4 ft: 25W energy saving T8s
² Operation below 50°F (10°C) may affect light output or lamp operation – see "Low Temp. Starting" definition.

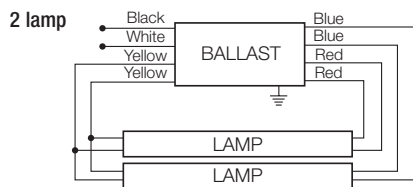

QUICKTRONIC 2x32

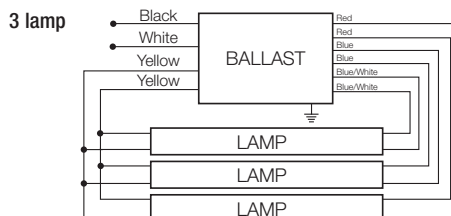

QUICKTRONIC 3x32

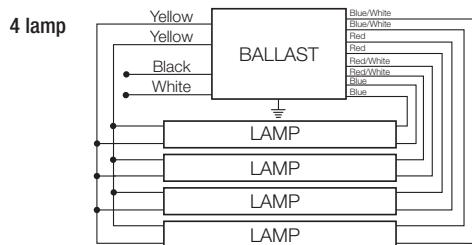

QUICKTRONIC 4x32

Dimensions 2 & 3-lamp:
 Overall: 9.5" L x 2.38" W x 1.6" H
 Mounting: 8.90"
 Weight: 1.6 lbs each (approx.)

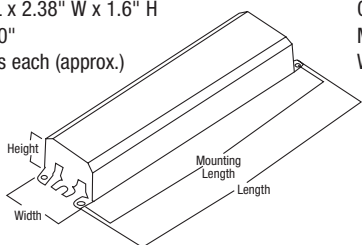

Dimensions 4-lamp:
 Overall: 11.75" L x 2.38" W x 1.6" H
 Mounting: 11.13"
 Weight: 2.9 lbs each (approx.)

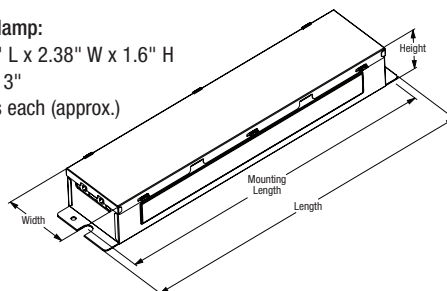

System Life / Warranty

QUICKTRONIC products are covered by our QUICK 60+® warranty, a comprehensive lamp and ballast system warranty. For additional details, refer to our QUICK 60+ warranty bulletin.

OSRAM SYLVANIA
 National Customer Service and Sales Center
 1-800-LIGHTBULB
 (1-800-544-4828)
 www.sylvania.com

Item Number	49450 QHE 2 x 32T8 / UNV PSH HT	High Case Temp. Rating
QUICKTRONIC High Efficiency		Starting Type/Ballast Factor
Number of Lamps (2, 3, 4)		Line Voltage (120-277V)
Primary Lamp Wattage		

Appendix D

Budget Breakout



Total Lighting Project Budget (100% all fixtures)

Lighting Calculator Code	Fixture Type	Description	Qty	lamp/fix. qty	lamp/fix cost	total lamp/fix cost	ballast/fix cost	measure cost (no mark-up)	Distributor Net Cost (no mark-up)	Mark up (%)	Marked Up Total (per unit)	Measure total	Unit Labor rate (\$)	Total Labor (\$)	Other Costs/Contingency (\$)
FLT8CEE-28W x 2L X 4'-CEE RS/PRS CEE N	BNLO1 & L2	2L PRS NLO	503	2	\$6	\$13	\$20	\$33	\$16,795	122%	\$41	\$20,490	\$ 40	\$ 20,120	\$ 1,000
FLT8CEE-28W x 4L X 4'-CEE RS/PRS CEE N	BNLO2 & L2	4L PRS NLO	62	4	\$6	\$26	\$19	\$45	\$2,794	122%	\$55	\$3,408	\$ 40	\$ 2,480	\$ -
FLT8CEEHB-32W x 4L X 4'-CEE IS CEE H	BHLO2 & L1	4L IS HLO	45	4	\$5	\$19	\$10	\$29	\$1,289	125%	\$36	\$1,611	\$ 80	\$ 3,600	\$ 500
FLT8-17W x 3L x 2'-IS(E) L	T8-17W	2L 2x2 F17W T8	4	2	\$6	\$12	\$75	\$87	\$348	125%	\$109	\$435	\$ 40	\$ 160	\$ -
CUST: LEDHB-78W	RLB1	78w LED high bay	2058	1	\$618	\$618		\$618	\$1,271,844	120%	\$742	\$1,526,213	\$ 80	\$ 164,640	\$ 10,000
CUST: LEDHB-511W	HB6	511w LED high bay	123	1	\$600	\$600		\$600	\$73,800	120%	\$720	\$88,560	\$ 120	\$ 14,760	\$ 2,000
CUST: LEDHB-213W	HB1	213w LED high bay	67	1	\$450	\$450		\$450	\$30,150	122%	\$549	\$36,783	\$ 120	\$ 8,040	\$ 1,000
CUST: LEDWP-47W	WP1	47w LED wall pack	86	1	\$325	\$325		\$325	\$27,950	122%	\$397	\$34,099	\$ 80	\$ 6,880	\$ -
CUST: LED Flood 121w	FL4	121w LED Flood	66	1	\$820	\$820		\$820	\$54,120	120%	\$984	\$64,944	\$ 80	\$ 5,280	\$ 1,000
CUST: LED Flood 158w	FL3	158w LED Flood	88	1	\$997	\$997		\$997	\$87,736	120%	\$1,196	\$105,283	\$ 80	\$ 7,040	\$ 1,000
Integral controls		ordered with fixture	187	1	\$60	\$60		\$60	\$11,220	122%	\$73	\$13,688	\$ 20	\$ 3,740	\$ -
Occupancy controls		Wireless	45	1	\$85	\$85		\$85	\$3,825	122%	\$104	\$4,667	\$ 60	\$ 2,700	\$ -

* Contingency and other costs include lifts, scaffolding, or other misc. materials/spares.

\$1,424,970
DNC

\$1,900,181
with markup

\$ 239,440
Labor total

\$ 16,500
Other total

Fixture Count (+sensors) **3334**

material price shown in lighting tool (rounded) \$1,900,200

Labor \$ 239,440

\$ 16,500

Grand Total all phases all budgeted costs = \$ 2,156,140