

**BEFORE THE WASHINGTON
UTILITIES AND TRANSPORTATION COMMISSION**

Docket UW-240151

Washington Utilities & Transportation Commission v. Cascadia Water, LLC

**RESPONSE OF PUBLIC COUNSEL TO CASCADIA WATER
DATA REQUEST NO(s). 001-006**

Request No: 006
Directed to: Public Counsel
Date Received: January 28, 2025
Date Produced: February 4, 2025
Prepared by: Public Counsel
Witnesses: Scott Duren, Stefan de Villiers

CASCADIA DATA REQUEST NO. 006 TO PUBLIC COUNSEL

Please refer to Exh. SD-3CT, page 12, lines 6-8, specifically: “the Draft Peninsula Water System Plan from May 2024 only analyzes the new booster pumps that were undergoing installation at that time.” Does Public Counsel have a copy of the referenced “Draft Peninsula Water System Plan from May 2024”? If so, when did Public Counsel receive a copy of it and from whom? Please produce a copy of that document.

RESPONSE

Yes, Public Counsel has a draft copy of the Peninsula Water System Plan dated May 2024. Public Counsel received a copy of that document on November 23, 2024, from the Water Consumer Advocates of Washington. Please see the attached copy of that document.

EMAIL TO: stevetodd1864@gmail.com

Cc: vickinapa@sbcglobal.net

SUBJECT: ESTATES DRAFT WSP DATED 5-2024

Contents: (In order)

- a. Letter from DOH to Dale Metzger, contractor assigning DOH #24-0612 to draft WSP
- b. Original 1994 WSP
- c. Estates Service Area – color map showing water lines by size
- d. DRAFT WSP
 1. Basic format – 59 pages
 2. ATEC Filters SUBMITTAL 3 PGS
****WHY IS SUBMITTAL IN DRAFT WSP IF SYSTEM PURCHASED?**
 3. Sanitary Survey (2018 report/ 2021 report not used – why?)
 4. Cross connection Control Records (never seen this before)
 5. 2022 consumer consumption reports - WHY 2022 & not later
 6. Adjacent System Notification Letters ** Dale Metzger notified for Main Farm HOA?
 7. Appendix A Water Facility Inventory form
 8. Appendix C Susceptibility Assessment (NEW never seen before)
 9. Appendix I Well Head Protection Plan
 10. Appendix J Water loss Control Action Plan (metering comments)
 11. Appendix L Water Quality Results (water testing)

IMPORTANT

- 12. Appendix N Water System Inventory (Components, age, value, etc)**

From: [DOH EPH DW SWRO Admin](#)
To: djmetzger5@gmail.com
Cc: [Robert Bennion](#); [Kindall, Abbey](#)
Bcc: [Grimm, Regina \(DOH\)](#)
Subject: >>>Acceptance of Initial Submittal (Fee Letter) for Estates Inc_24-0612<<<
Date: Friday, June 28, 2024 3:37:00 PM
Attachments:

Estates Inc
08166
Clallam
WSP Pt B Update
24-0612

Dear Dale Metzger:

This project has been assigned the project #**24-0612**. Please include this number on all future correspondence or additional submittals pertaining to this project. **Please send all correspondence and documents to swro.admin@doh.wa.gov for processing.**

Upon completion of an ODW review, we will send you a comment letter, by e-mail, identifying items that need to be addressed or an approval letter. You will also receive an invoice for the review fee. The base fee includes two reviews of the project. Additional reviews, if required, will be invoiced separately.

The department's review of your design will not confer or guarantee any right to a specific quantity of water. Our review will be based on your representation of available water quantity. If the Washington Department of Ecology, a local planning agency, or other authority responsible for determining water rights and water system adequacy determines that you have use of less water than you represent, the number of approved connections may be reduced commensurate with the actual amount of water and your legal right to use it.

Project approval is required before you start any water system construction. Failure to obtain the required approvals may subject you to enforcement actions that may include civil penalties. ODW is under no obligation to accept or approve any component installed or constructed prior to approval, and you may be required to expose system components for our inspection and rebuild or replace, if necessary, to meet our requirements.

If you have any questions, please contact Ben Majors at (564) 669-0855 or by e-mail at ben.majors@doh.wa.gov. Again, please add the project number to all documents and correspondence and return to swro.admin@doh.wa.gov.

Thank you,

Admin Support
Southwest Drinking Water Regional Operations



STATE OF WASHINGTON

DEPARTMENT OF HEALTH

SOUTHWEST DRINKING WATER OPERATIONS

2411 Pacific Ave. • P.O. Box 47823 • Olympia, Washington 98504-7823 • (206) 664-0768

September 23, 1994

Thomas A. Lederman
Estates Water Systems, Inc.
474 West Hemlock Street
Sequim, Washington 98382

Subject: Estates Water System, ID #081669,
Clallam County; Water System Plan;
DOH Project #029303

Dear Mr. Lederman:

The water system plan for the above project has been reviewed, and in accordance with the provisions of WAC 246-290 is **APPROVED**. The approval issued herein is based on conformance with current standards outlined in WAC 246-290, revised April 1993. Future changes in the rules may be more stringent and require facility modification or corrective action.

This approval shall be in effect for six years from the date of this letter unless:

Major system improvements are contemplated which are not addressed in the WSP; changes occur in the basic planning data affecting improvements identified in the WSP; and/or the Department requests an updated WSP.

This WSP shall be updated every six years. However, if only minor alterations to the existing WSP are considered necessary, a minor amendment may be submitted to the department for approval. Future project reports and construction documents submitted to this Department for approval will not be considered for approval unless the project is addressed in the WSP.

In addition to this approval, since this WSP was started the planning requirements have increased significantly. Therefore, the WSP that is being approved at this time does not meet the standards of WSP's that are being required today. The

Estates Water Systems, Inc.
September 23, 1994
Page Two

next update of this WSP in 6 years will be required to address all new requirements. Because the WSP does not include some of the new requirements please be aware that:

1. That all community water systems are now required to develop wellhead protection programs consistent with DOH guidelines (information enclosed). You should complete these requirements under the required time schedule provided in the enclosed information.
2. That there are new federal Safe Drinking Water Act (SDWA) requirements which there are significant financial impacts. The information below attempts to clarify some of the recent changes to the state regulations and the forthcoming requirements under the SDWA:

Phase 2/5 Inorganic and Organic Monitoring: In addition to the triennial Phase 2/5 inorganics monitoring, beginning in 1993, annual nitrate samples are now required. Also, any systems which have asbestos cement (AC) pipe within the distribution will be required to sample for asbestos one time in 1995. Organics (VOC's and SOC's) monitoring will depend upon any applicable waivers resulting from a susceptibility assessment to be conducted by the system in 1994. If the system does not apply for a waiver and conduct a susceptibility assessment, increased organics monitoring may result at large cost. Please contact Belle Fuchs, Water Quality Program Manager, at (206) 586-5179 for more details regarding inorganics and organics monitoring.

Lead and Copper Rule: Although DOH has not currently scheduled lead and copper monitoring for systems serving less than 500 people, the following information would be valuable for planning purposes: a discussion of the sample site selection process; the number of tap samples required under the Lead and Copper Rule; the cost of monitoring; and a discussion any historical corrosion-related problems. We have enclosed information on the Lead and Copper Rule for your reference.

Estates Water Systems, Inc.
September 23, 1994
Page Three

Thank you for preparing and securing approval of the Estates Water System Plan. Regulations establishing a schedule of fees for review of planning, engineering and construction documents were adopted January 3, 1993 (WAC 246-290-990). An itemized bill for \$850.00 is enclosed. If you have any questions or concerns please contact Sean Orr at (206) 664-3952).

Sincerely,



Sean Orr
WSDOH Regional Planner
Southwest Drinking Water Operations

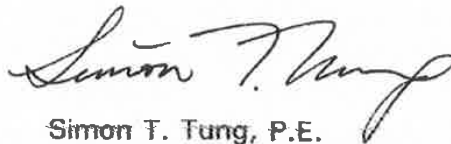

Simon T. Tung, P.E.
WSDOH Special Projects Engineer
Southwest Drinking Water Operations

SO:STT:clu

Enclosures

cc: Clallam County Environmental Health
Polaris Engineering
Bill Liechty, DOH
Rich Siffert, DOH

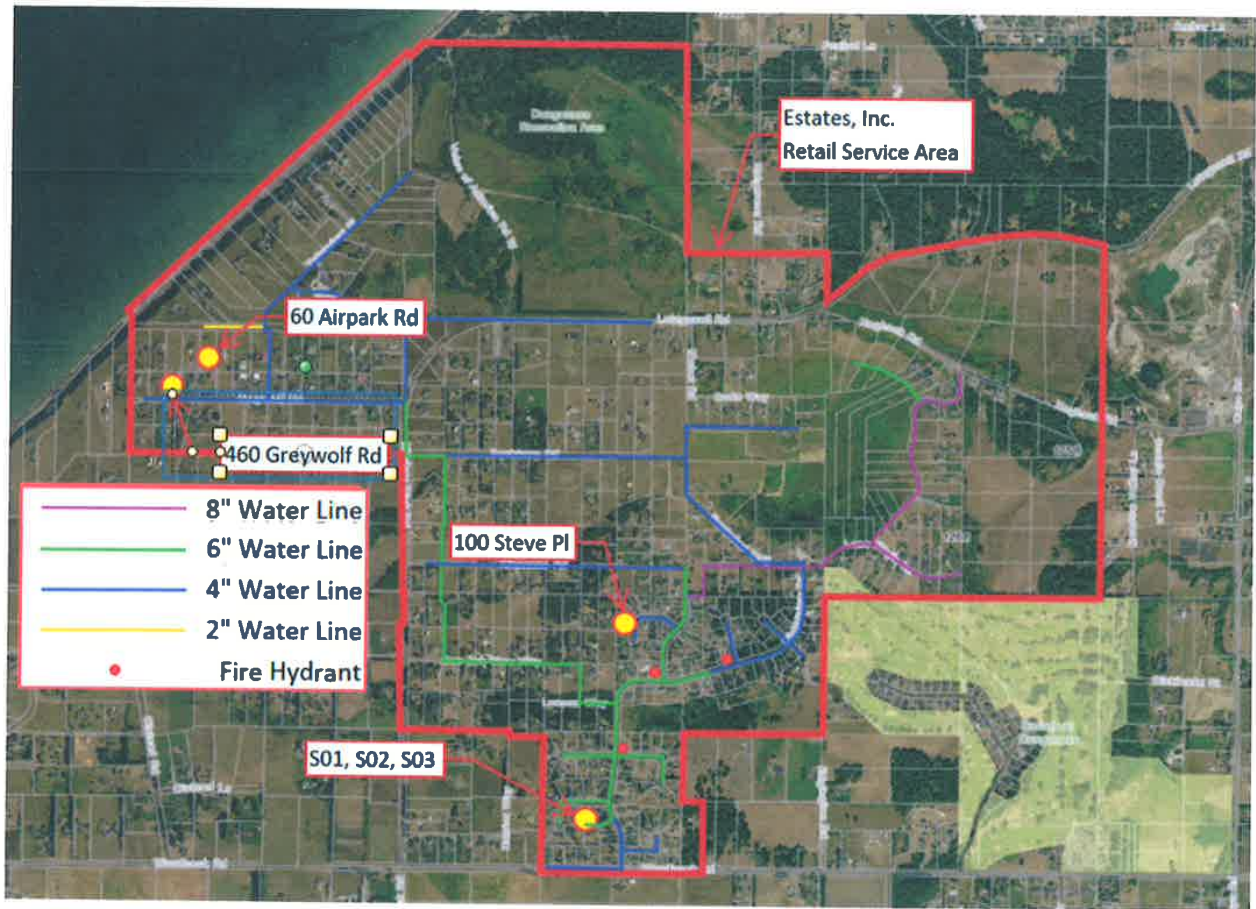

CASCADIA WATER™
WASHINGTON STATE – SOUTHWEST REGION
PART B – ESTATES, INC.

PO Box 549
Freeland, WA 98249



May 2024

Owner:
Cascadia Water
PO Box 549
Freeland, WA 98249

System Contact:
Culley Lehman
Phone: (360) 578-7044

For Submittal to:
Washington State
Department of Health
Southwest Drinking Water
Operations
PO Box 47823
Olympia, WA 98504-7823

Facet

Seattle | Kirkland | Mount Vernon | Whidbey Island | Federal Way | Spokane

PO Box 1132
Freeland, WA 98249
Tel 360.331.4131



CERTIFICATE OF ENGINEER
Water System Plan for Estates, Inc
a system owned by Cascadia Water, LLC.

The technical material and data contained within this report has been prepared by or under the direction of the following registered professional engineer(s), licensed in accordance with the laws of the State of Washington to practice in the State of Washington.



TABLE OF CONTENTS

1 Description of Water system..... 1

1.1 System History and Background..... 1

1.1.1 Water System Name and ID Number..... 1

1.1.2 Type of Ownership and Management 1

1.1.3 Management Structure 1

1.1.4 Water System Operations 1

1.1.5 Estates Staff 2

1.1.6 Engineer..... 2

1.1.7 Water System Financial Accounting..... 2

1.2 System History and Background..... 2

1.2.1 Geography and Topography 4

1.2.2 Climate 5

1.2.3 Neighboring/Adjacent Water Systems..... 5

1.3 Inventory of Existing Facilities..... 5

1.4 Existing Service Area Characteristics 5

1.4.1 Description of Service Area 5

1.4.2 Existing Zoning and Land Use 6

1.5 Service Area Boundary and Franchise Agreements..... 6

1.6 Consistency from Local Planning 6

2 Basic Planning Data and Water Demand Forecasting..... 7

2.1 Current Water Use..... 7

2.1.1 Current Population..... 7

2.1.2 Water Production and Usage History 7

2.1.2.1 Distribution System Leakage 8

2.1.3 Equivalent Residential Units..... 9

2.1.4 Average Day Demand..... 9

2.1.5 Maximum Day Demand..... 9

2.1.6 Peak Hour Demand 9

2.2 Projected Land Use, Future Population, and Demand Forecasting..... 10

2.2.1 Projected Land Use 11

2.2.2 Projected Connections 11

2.2.3 Projected Demand 11

3 System Analysis 12

3.1 System Design Standards..... 12

3.2 Water Quality Parameters and Analysis 12

3.2.1 Water Testing 13

3.2.2 Bacteriological Testing 14

3.2.3 Inorganic Chemical Testing..... 14

3.2.4 Physical Characteristics 15

3.2.5 Disinfection Byproducts (DBP)..... 16

3.2.6 Radionuclides..... 16

3.2.7 Volatile Organic Chemicals (VOCs)..... 16

3.2.8 Synthetic Organic Chemicals (SOCs) 18

3.2.9 Seawater Intrusion..... 18

3.2.10 Source Water Quality 18

| | | |
|---------|--|----|
| 3.2.11 | Finished Water Quality..... | 19 |
| 3.3 | System Description and Analysis..... | 19 |
| 3.3.1 | Existing System Configurations..... | 19 |
| 3.3.2 | Water Rights | 21 |
| 3.3.3 | Source..... | 21 |
| 3.3.3.1 | Current Facility Age and Estimate of Future Life Expectancy..... | 22 |
| 3.3.3.2 | Condition and Capacity of Transmission Mains | 22 |
| 3.3.4 | Treatment..... | 22 |
| 3.3.5 | Storage | 23 |
| 3.3.5.1 | Current Facility Age and Estimate of Future Life Expectancy..... | 23 |
| 3.3.6 | Booster Pumps and Pressure Tanks | 23 |
| 3.3.6.1 | Current Facility Age and Estimate of Future Life Expectancy..... | 24 |
| 3.3.7 | Distribution..... | 24 |
| 3.3.7.1 | Length, Diameter, and Type of Pipe | 24 |
| 3.3.8 | Hydraulic Analysis of Distribution System..... | 24 |
| 3.3.8.1 | Existing Distribution System – Peak Hour Demand..... | 25 |
| 3.3.8.2 | Existing Distribution System – Fire Flow & MDD..... | 25 |
| 3.3.8.3 | Future Distribution System – PHD..... | 25 |
| 3.3.8.4 | Future Distribution System – Fire Flow & MDD | 26 |
| 3.4 | Capacity Analysis | 26 |
| 3.4.1 | Water Right Capacity Based on Annual Volume..... | 26 |
| 3.4.2 | Water Right Capacity Based on Instantaneous Flow | 27 |
| 3.4.3 | Source Capacity Based on Maximum Day Demand..... | 28 |
| 3.4.4 | System Capacity Based on Treatment..... | 28 |
| 3.4.5 | System Capacity Based on Booster Pump Capacity..... | 29 |
| 3.4.5.1 | Pressure Tanks..... | 29 |
| 3.4.6 | System Capacity Based on Existing Storage Volumes | 30 |
| 3.4.6.1 | Operational Storage..... | 30 |
| 3.4.6.2 | Equalizing Storage | 30 |
| 3.4.6.3 | Dead Storage..... | 31 |
| 3.4.6.4 | Standby Storage | 31 |
| 3.4.6.5 | Fire Suppression Storage | 32 |
| 3.4.6.6 | Storage Summary | 32 |
| 3.4.6.7 | Water Age and Turnover..... | 32 |
| 3.4.7 | Summary of System Capacities..... | 33 |
| 3.5 | Selection and Justification of Improvement Projects..... | 33 |
| 3.5.1 | Source Needs..... | 34 |
| 3.5.2 | Treatment Needs | 34 |
| 3.5.3 | Storage Needs..... | 34 |
| 3.5.4 | Booster Pump Needs..... | 34 |
| 3.5.5 | Distribution Needs | 34 |
| 3.5.6 | Control and Telemetry Needs..... | 35 |
| 3.5.7 | Non-Facility Needs..... | 35 |
| 4 | Water use efficiency program and water resource Analysis | 37 |
| 4.1 | Water Use Efficiency Program..... | 37 |
| 4.1.1 | Water Loss Control Action Plan | 37 |
| 4.1.1.1 | Goals | 37 |
| 4.2 | Source of Supply Analysis..... | 37 |

| | | |
|-------|---|----|
| 4.2.1 | Enhanced Conservation Measures..... | 38 |
| 4.2.2 | Water Rights Changes | 38 |
| 4.2.3 | Interties | 38 |
| 4.3 | Water Right Evaluation | 38 |
| 4.3.1 | Existing Water Rights | 38 |
| 4.3.2 | Water Right Self-Assessment..... | 38 |
| 5 | Source Water Protection..... | 39 |
| 5.1 | Introduction | 39 |
| 5.1.1 | Wellhead PFAS Sampling..... | 39 |
| 5.2 | Wellhead Protection Program..... | 39 |
| 6 | Operation and Maintenance Program..... | 40 |
| 6.1.1 | ATEC Manganese Filtration System | 40 |
| 6.2 | Water System Management and Personnel | 40 |
| 6.3 | Operator Certification..... | 40 |
| 6.4 | Routine Operating Procedures and Preventative Maintenance | 40 |
| 6.5 | Water Quality Sampling Procedures & Program | 44 |
| 6.5.1 | Bacteriological Detection Procedures | 44 |
| 6.5.2 | Organic Compound Detection Procedures..... | 45 |
| 6.5.3 | Organic Compound Detection Procedures..... | 46 |
| 6.5.4 | Radionuclide Detection Procedures..... | 46 |
| 6.5.5 | Pressure Loss in Distribution System | 46 |
| 6.6 | Coliform Monitoring Program | 47 |
| 6.7 | Emergency Program | 47 |
| 6.8 | Cross-Connection Control Program..... | 48 |
| 6.8.1 | Procedures for Hazard Evaluations | 48 |
| 6.8.2 | Eliminating or Controlling Cross-Connections | 49 |
| 6.8.3 | Backflow Preventer Inspection, Testing, and Repairs | 49 |
| 6.8.4 | Quality Assurance Program | 50 |
| 6.8.5 | Responding to Backflow Incidents | 50 |
| 6.9 | Record Keeping and Reporting..... | 50 |
| 6.10 | Summary of O&M Deficiencies | 50 |
| 7 | Distribution Facilities Design and Construction Standards..... | 51 |
| 7.1 | Technical Specifications and Design Standards..... | 51 |
| 8 | Improvement Program | 52 |
| 8.1 | Prioritizing Projects..... | 52 |
| 8.2 | Identification of System Improvements Projects | 52 |
| 8.2.1 | Source..... | 53 |
| 8.2.2 | Treatment..... | 53 |
| 8.2.3 | Storage | 53 |
| 8.2.4 | Distribution..... | 53 |
| 8.2.5 | Controls | 55 |
| 8.2.6 | Capital Improvements from Previous WSP | 56 |
| 8.2.7 | Developer Extensions..... | 56 |
| 8.2.8 | Non-Facility Improvements | 56 |
| 8.3 | Selection of Alternatives..... | 56 |
| 8.4 | Improvement Schedule..... | 57 |
| 8.5 | Improvement Project Funding | 57 |
| 9 | Financial Program | 58 |

| | | |
|------|--|----|
| 10 | Miscellaneous Documents | 59 |
| 10.1 | County/Adjacent Utility Correspondence | 59 |
| 10.2 | State Environmental Policy Act (SEPA) Determination..... | 59 |
| 10.3 | Agreements | 59 |

LIST OF FIGURES

| | | |
|------------|---|----|
| Figure 1-1 | Estates Inc. Retail Service Areas | 3 |
| Figure 1-2 | Estates Inc. Critical Areas | 4 |
| Figure 1-3 | Neighboring Water Systems | 5 |
| Figure 2-1 | Estates Seasonal Demand | 8 |
| Figure 3-1 | Estates Distribution System Schematic | 20 |
| Figure 8-1 | Estates Inc. Retail Service Areas | 54 |

DRAFT

LIST OF TABLES

| | | |
|------------|--|----|
| Table 2-1 | Water Production and Usage | 7 |
| Table 2-2 | Historical Water Consumption and Loss..... | 8 |
| Table 2-3 | Equivalent Residential Unit Calculations | 9 |
| Table 2-4 | Peak Hour Demand (PHD) Equation Coefficients..... | 10 |
| Table 2-5 | Group A Peak Hour Demand (PHD) Based on MDD | 10 |
| Table 2-6 | Projected Annual Demand Based on ADD | 11 |
| Table 3-1 | Water Quality Monitoring Schedule..... | 13 |
| Table 3-2 | Inorganic Chemical Maximum Contaminant Levels (MCLs)..... | 14 |
| Table 3-3 | Physical Characteristics..... | 15 |
| Table 3-4 | Relative Hardness..... | 15 |
| Table 3-5 | Radionuclides MCLs..... | 16 |
| Table 3-6 | Volatile Organic Chemicals (VOCs) MCLs..... | 17 |
| Table 3-7 | Synthetic Organic Chemicals (SOCs) MCLs..... | 18 |
| Table 3-8 | Source Type, Location, and Use Information..... | 22 |
| Table 3-9 | Booster Pump Pressure Settings | 24 |
| Table 3-10 | Distribution System Piping | 24 |
| Table 3-11 | Storage Components..... | 32 |
| Table 3-12 | Connection Limiting Factors | 33 |
| Table 3-13 | Potential Improvements Prioritization Categories | 33 |
| Table 3-14 | Prioritized Potential System Improvements Needs | 36 |
| Table 6-1 | Water System Staff Certifications..... | 40 |
| Table 6-2 | Drinking Water Operations & Maintenance (O&M) Schedule | 41 |
| Table 6-3 | Coliform & E.coli Detection Response Procedures | 45 |
| Table 6-4 | Coliform & E.coli Detection Response Procedures | 47 |
| Table 6-5 | Emergency Contact List..... | 48 |

APPENDICES

APPENDIX AWater Facility Inventory Form (WFI)
APPENDIX BService Area Map
APPENDIX CMiscellaneous System Documents
APPENDIX DCounty Zoning and Land Use Maps
APPENDIX EWater Right Certificates
APPENDIX FWater Right Self-Assessment
APPENDIX GWell Logs
APPENDIX HWell Site Approval
APPENDIX IWell Head Protection Plan
APPENDIX JWater Loss Control Action Plan
APPENDIX KWater Quality Monitoring Schedule
APPENDIX LWater Quality Results
APPENDIX MColiform Monitoring Plan
APPENDIX NWater System Inventory
APPENDIX OSystem Equipment Specifications
APPENDIX PSystem Capacity Calculations
APPENDIX QHydraulic Models
APPENDIX RSystem Operations & Maintenance
APPENDIX SCorrespondence
APPENDIX TWater System Drawings

ABBREVIATIONS

| | |
|-------|---|
| AC | Asbestos Cement |
| AF | Auditor's File |
| ADD | Average Day Demand |
| App | Approved |
| APWA | American Public Works Association |
| AWWA | American Water Works Association |
| BMPs | Best Management Practices |
| CCC | Cross-Connection Control |
| CCS | Cross-Connection Control Specialist |
| CFR | Code of Federal Regulations |
| CIP | Capital Improvement Plan |
| CWSP | Coordinated Water System Plan |
| CWSSA | Critical Water Supply Service Area |
| DOH | Washington State Department of Health |
| DOE | Washington State Department of Ecology |
| DS | Dead Storage |
| DSL | Distribution System Leakage |
| ERU | Equivalent Residential Unit |
| ES | Equalizing Storage |
| Ex | Existing |
| FSS | Fire Suppression Storage |
| gpm | Gallons Per Minute |
| GMA | Growth Management Act |
| GW | Ground Water Under the Influence of Surface Water |
| HGL | Hydraulic Grade Line |
| ID | Identification |
| ICC | Island County Code |
| LID | Local Improvement District |
| LLC | Limited Liability Corporation |
| MCL | Maximum Contaminant Level |
| MDD | Maximum Day Demand |
| MMADD | Maximum Month Average Day Demand |
| mg/L | Milligram per liter |
| NFPA | National Fire Protection Association |
| No. | Number |
| OS | Operational Storage |
| PE | Professional Engineer |
| PHD | Peak Hour Demand |
| ppb | Part Per Billion |
| psi | Pounds Per Square Inch |
| PVC | Polyvinyl Chloride |
| OFM | State Office of Financial Management |
| RCW | Revised Code of Washington |
| SAL | State Advisory Level |
| SBS | Standby Storage |
| SDWA | Safe Drinking Water Act |
| SOC | Synthetic Organic Chemical |
| SWI | Seawater Intrusion |
| UTC | Utilities and Transportation Commission |

| | |
|-------|---|
| UBI | Unified Business Identifier |
| VOC | Volatile Organic Chemical |
| WAC | Washington Administrative Code |
| WDM | Water Distribution Manager |
| WDS | Water Distribution Specialist |
| WFI | Water Facilities Inventory |
| WHPA | Wellhead Protection Area |
| WQMS | Water Quality Monitoring Schedule |
| WRIA | Water Resources Inventory Area |
| WSP | Water System Plan |
| WTPO | Water Treatment Plant Operator |
| WSDOT | Washington State Department of Transportation |
| WUE | Water Use Efficiency |

DRAFT

1 DESCRIPTION OF WATER SYSTEM

This chapter addresses the Estates, Inc. (hereafter “Water System”) ownership and management, system background, inventory of existing facilities, related plans, existing service area characteristics, future service area, service area agreement, service area policies, satellite management agencies, and conditions of service.

1.1 System History and Background

The following sections summarize the water system name and ID number, type of ownership, management structure, certified operator, engineer, and WFI.

1.1.1 Water System Name and ID Number

Water System Name: Estates Inc.
Water System ID No: 08166 9

1.1.2 Type of Ownership and Management

Estates, Inc. is owned by Cascadia Water, LLC (Cascadia), a private investor-owned utility company consisting of water systems located throughout the State of Washington. Cascadia is a wholly owned subsidiary of NW Natural Water Company, LLC.

1.1.3 Management Structure

Cascadia Water, LLC was formed in November of 2018 through the acquisition and combination of Lehman Enterprises, Inc. on Whidbey Island. Cascadia is a for-profit corporation incorporated in the State of Washington. As noted above, Cascadia is a wholly owned subsidiary of NW Natural Water Co. Because Cascadia owns multiple water systems with a combined number of customers greater than 100, its systems are regulated by the Washington Utilities and Transportation Commission (UTC).

1.1.4 Water System Operations

Daily operation and compliance for all water systems is handled internally by Cascadia. These services include meter reading, billing, and general accounting. Contact information for Cascadia is provided below:

Cascadia Water
Mailing Address:
PO Box 549, Freeland, WA 98249
Physical Address:
18181 SR 525, Freeland WA 98249
Phone: (360) 331.7388
E-Mail: info@cascadiawater.com

1.1.5 Estates Staff

| Name | Position | Certification |
|---------------|----------------------|-------------------------|
| Culley Lehman | General Manager | WDM 2 |
| Adam Lehman | System Operator | CCS, WDM 3, WDS, WTPO 1 |
| Dale Metzger | System Operator | WDM 2 |
| | | |
| Amy Lehman | Office Manager | - |
| Stephani Long | Office Administrator | - |

1.1.6 Engineer

Water system engineer of record:

Facet, Inc.
Jeff Tasoff, P.E., Principal/Civil Engineer
Additional Principals: Erik Davido, P.E. and Quin Clements, P.E.
P.O. Box 1132
Freeland, WA 98249
Phone: (360) 331-4131 x203
Email: JTasoff@facetnw.com or QClements@facetnw.com

The Water System's engineer performs the following services:

1. Identifying source, storage, or water distribution system needs and improvements;
2. Analyzing alternate solutions to address the identified needs and improvements;
3. Assuring that the system configuration will function properly, be efficient, and economical;
4. Preparing detailed construction documents to implement the selected improvements;
5. Assisting in obtaining plan approval and obtaining bids from contractors to perform the work;
6. Inspecting and testing the quality of the contractor's work and making necessary reports and recommendations to the water system;
7. Completing Washington State Department of Health (WSDOH) certification documents to the extent that the engineer has direct knowledge of the as-built facilities; and
8. Review developer's extension to ensure proposed projects meet Cascadia Water's standards and future system needs.

1.1.7 Water System Financial Accounting

Cascadia provides billing services and maintains customer records, including water usage for all water systems. Cascadia also maintains each of the systems' financial records, estimates future budgetary needs, and proposes changes to the water rate structure. Cascadia is a private water company operating within Washington State that has 100 or more connections and/or charges more than \$557 a year per customer, it is regulated by the Washington Utilities and Transportation Commission (UTC). The UTC reviews the budgets, expenses, and profits of a water system to govern utility rates for customers. The latest tariff results from the UTC and system budgets are presented in the Part A Water System Plan for Cascadia Water.

1.2 System History and Background

Estates Water System Inc. is located within unincorporated Clallam County, and serves the area bounded on the north by the Strait of Juan de Fuca and Lotzgesell Road, in the east by Dungeness Golf Course, in the south by Woodcock Road and in the west by Kitchen-Dick Road. The location of the

service area is shown in Figure 1-1. The existing served connections are currently single-family residential units.

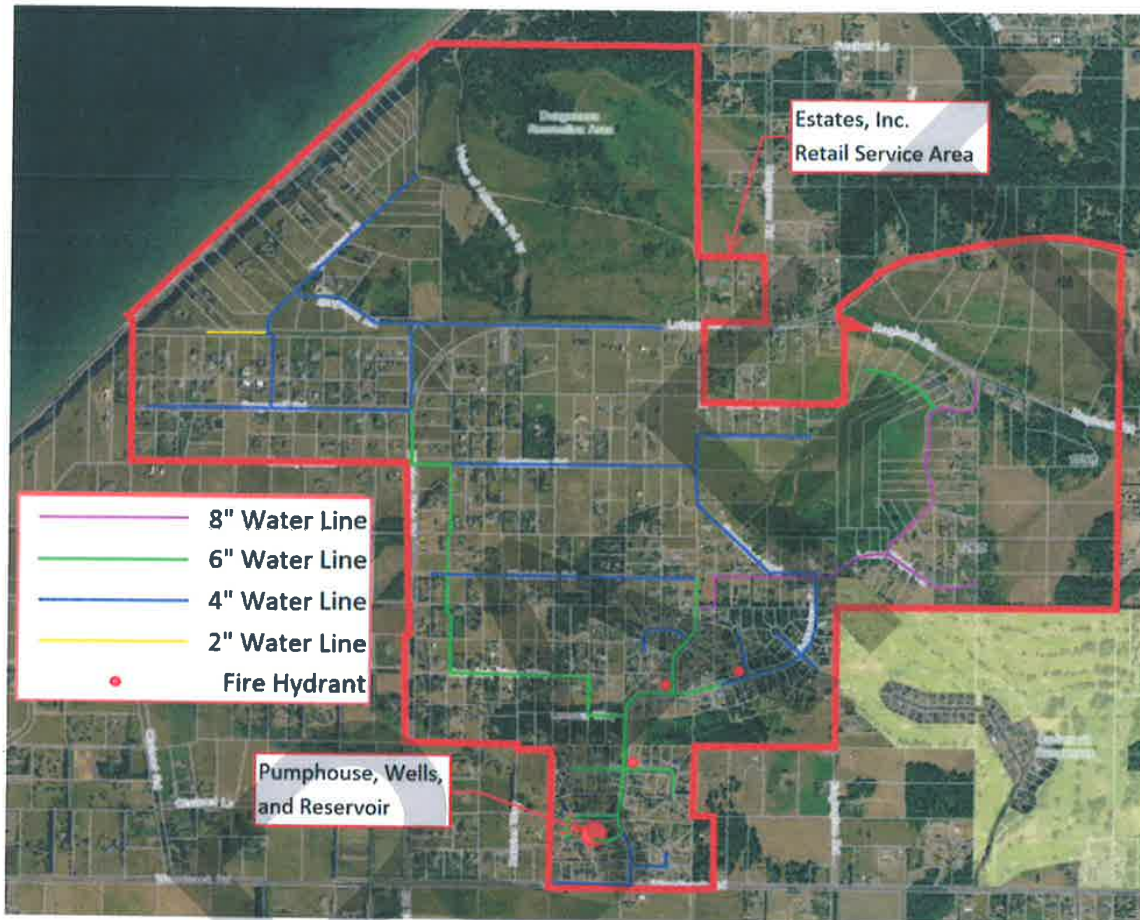

Figure 1-1 Estates Inc. Retail Service Areas

The original water system was constructed in the early 1970s for the Mountain Park Subdivision in Sequim, Washington. The original system included a single well, pressure tanks and distribution piping. Following the original construction, in the late 1970s, the water system was expanded to serve Divisions I, II and III of Dungeness Estates. Due to this expansion, a 2nd well was drilled, along with the construction of a 30,000-gallon reservoir and an extension to the existing distribution piping. In 1982, the owners purchased the Estate Water System and expanded it to serve all three divisions of Blue-Ribbon Farms and the County Park. Because of this expansion, a 145,000-gallon reservoir was constructed, both existing wells were deepened, and the distribution piping was again extended. The newly deepened wells could produce 200 gallons per minute (gpm) and 225-gpm for Well #1 and #2 respectively. In 1990, water meters were installed at every service connection which allowed the Department of Health (DOH) to approve 480 connections for Estates Water Systems Inc. Following this approval, subsequent water conservation allowed the Department of Ecology (DOE) to then approve 540 connections in their water right.

In 2023 Estates began removing the two partially buried reservoir and pumphouse. A new -158,000-gallon reservoir is being installed. In addition, a new booster pump pressurization system, and manganese treatment facility is being installed onsite with the reservoir and system sources. Currently, Estates has 367 active connections and contains two wells. The wells (Wells #1 and #2) 200-gpm and- 225 gpm respectively.

1.2.1 Geography and Topography

The communities served by Estates are located in the northeast portion of Clallam County along the coast of the Salish Sea, about 5 miles northwest of Sequim. The geography throughout the area consists of various plats with single-family residences and rural fields along coastal bluffs. The system is located on the northern shoreline with steep slopes that create a natural boundary down to the sea. Aside from the slope down to the Salish Sea, the service area for the system is generally flat with elevations that range from 120- to 140-feet feet above sea level.

There are various streams, ponds, wetlands and other geohazard areas located throughout the current retail service area. These items are shown in Figure 1-2.

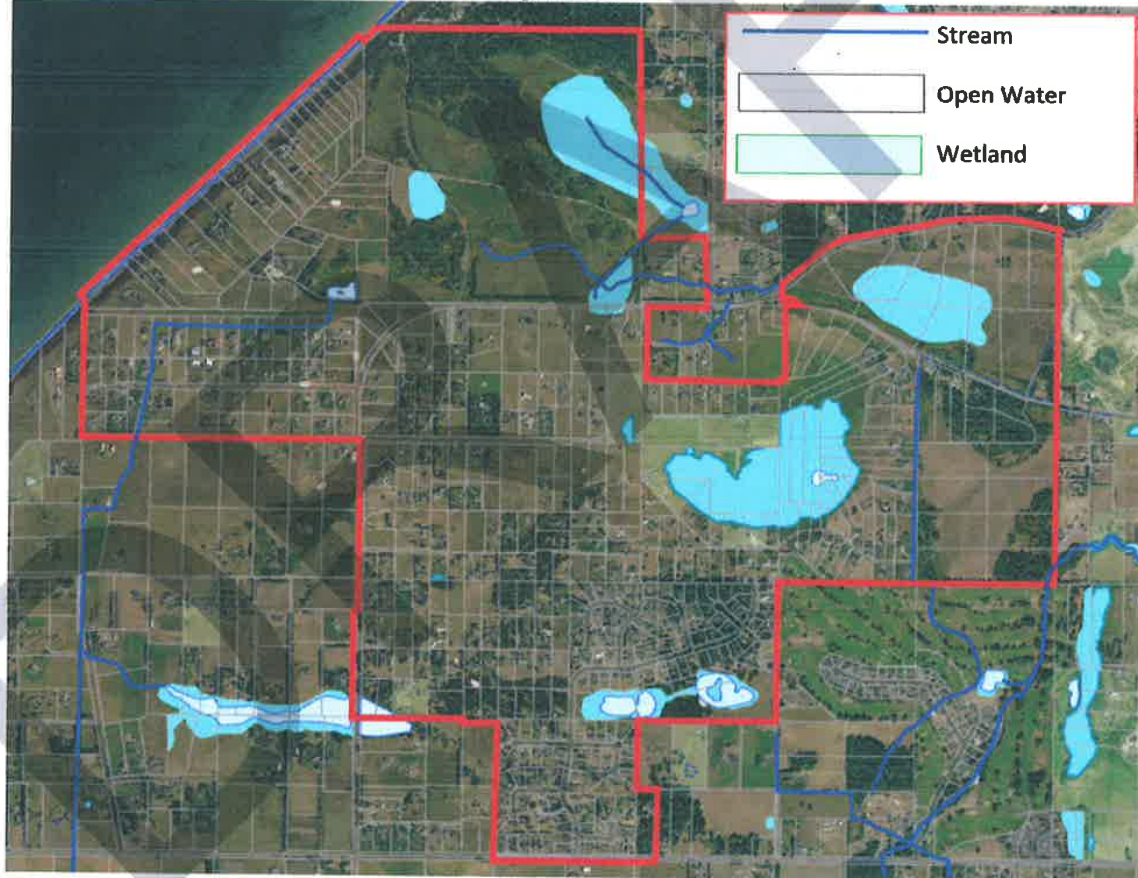

Figure 1-2 Estates Inc. Critical Areas

1.2.2 Climate

The climate within Clallam is mild year-round with an average temperature of 70-degrees Fahrenheit in the hottest months of the summer and 35-degrees in the coldest months of the winter. Rainfall for Clallam County is on the high end with approximately 60-inches of rain per year.

1.2.3 Neighboring/Adjacent Water Systems

The current service area map for the system is included in Appendix B. Estates is located near other Group A community water systems. The Dungeness Golf Course & Mountain Vista Water System (Water System ID 20453 D) is located approximately 500-feet east of the Estates service area. Per exhibits in the 1994 Water System Plan, there is an existing easement for emergency/future intertie with the Dungeness Golf Course water system. The intertie does not currently exist and will be discussed in further detail in subsequent sections of this report.

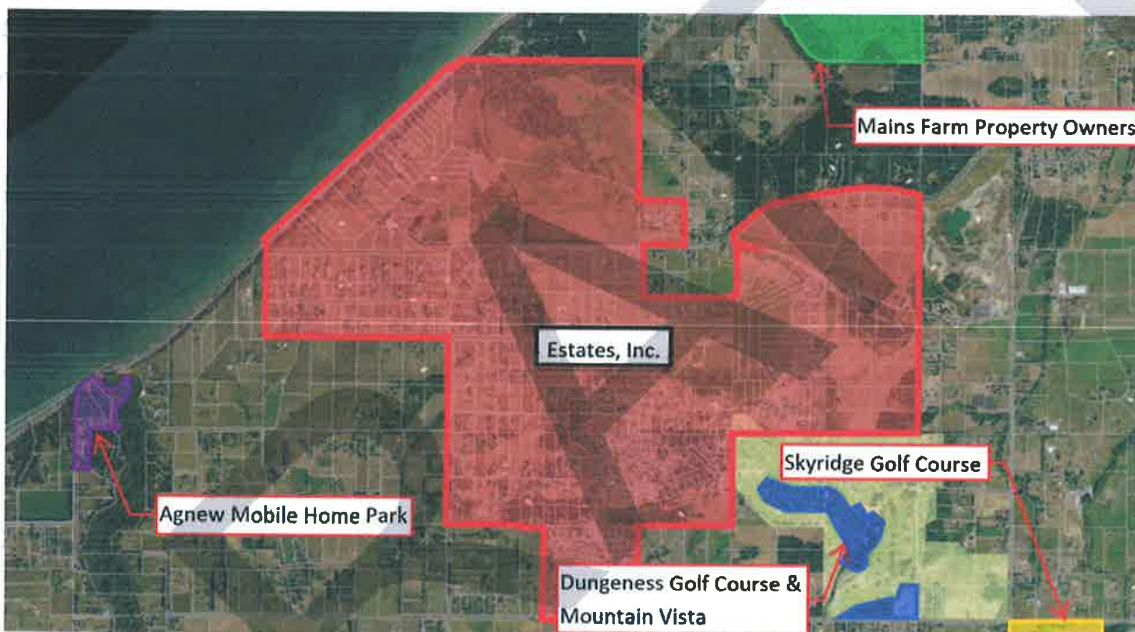

Figure 1-3 Neighboring Water Systems

1.3 Inventory of Existing Facilities

A detailed inventories for the system is provided in Appendix O and Chapter 3 discusses the system's existing facilities in greater detail.

1.4 Existing Service Area Characteristics

General descriptions of the service area characteristics and existing zoning/land use are discussed in the following sections.

1.4.1 Description of Service Area

The retail service area for Estates is located approximately 5 miles west of Sequim, Washington and encompasses approximately 920 acres. The northwestern boundary is the Salish Sea just west of the Dungeness Recreation Area. The system encompasses various plats with the southernmost boundary of

the service area being Woodcock Road. The service area boundary is shown on the map in Figure 1-1 and is included in Appendix B.

1.4.2 Existing Zoning and Land Use

The service area contains various Clallam County zoning areas. A portion of the Clallam County zoning map is provided in Appendix D. The following zoning categories are included in the service area with the corresponding section from the Clallam County Code (CCC):

- Parks and Recreation (PR): CCC 33.07.070
- Rural Neighborhood Conversion (NC): CCC 33.10.015
- Rural Low (R5): CCC 33.10.020
- Rural (R1): CCC 33.10.040

The service area primarily consists of rurally zoned areas. The way these areas can be developed depends on their various zoning classifications. The CCC should be consulted for additional information.

1.5 Service Area Boundary and Franchise Agreements.

Currently there is no available documentation for a Service Area Agreement and/or Franchise Agreement for Clallam County. Prior to the purchase of the water system by Cascadia Water, the franchise agreement had expired. Cascadia is in the process of providing the county with the necessary documents to renew the franchise agreement.

1.6 Consistency from Local Planning

Concurrent with the state submittal, the Water System Plan will be coordinated with Clallam County to ensure consistency with the county planning requirements.

2 BASIC PLANNING DATA AND WATER DEMAND FORECASTING

Current and projected planning data/parameters are discussed in this Chapter. There are currently 365 active residential connections, 2 active non-residential connections, and 480 approved connections for the Estates Water System. The system provides service mostly to single-family residential customers; therefore, this report will use the terms service connection and ERU interchangeably.

This plan evaluates three planning phases. Phase 1 is the six-year planning window from 2023 to 2029. Phase 2 is for the extended planning period of 2029 to 2043. Phase 3 covers the long-term planning from the year 2044 and beyond. This chapter and the next will provide data to support an increase in the number of service connections that can be supported by the system.

2.1 Current Water Use

The current population, service connections, water use, and Equivalent Residential Units (ERUs) are discussed in the following sections for Estates.

2.1.1 Current Population

Estates currently serves 365 full-time single-family residences and 2 non-residential connections. The full-time residential population is estimated to be 913 residents. The 2 non-residential connections consist of the Dungeness Recreation Area and the Five Acre School.

Dungeness Recreation Area

The Dungeness Recreation Area is a 216-acre park which contains 66 campsites, restrooms, and showers. The temporary and transient population served is estimated as 1000 people in the summer months of May through September and 250 people for all other months.

Five Acre School

The Five Acre School is an independent school that serves preschool through 6th grade which typically operates from September through mid-June. The regular non-residential population served by the school is estimated to be 25 people. These numbers are based on the current Water Facility Inventory (WFI), which was last updated in October of 2022. A copy of the WFI is included in Appendix A.

2.1.2 Water Production and Usage History

Water usage data from 2020 through 2022 was analyzed to determine current design values for the distribution system. The capacity calculation provided in Appendix P provides a detailed summary of the demands based on water use data. The data is summarized in Table 2-1.

Table 2-1 Water Production and Usage

| Year | Annual Production (gallons) | Annual Usage (gallons) | Annual Residential Usage (gallons) | Residential Max. Month (gallons) | Annual ADD (gpd/ERU) | MMADD (gpd/ERU) | MDD (gpd/ERU) |
|------|-----------------------------|------------------------|------------------------------------|----------------------------------|----------------------|-----------------|---------------|
| 2020 | 34,169,631 | 30,968,696 | 30,075,584 | 5,388,777 | 220 | 462 | 625 |
| 2021 | 33,432,421 | 31,152,330 | 30,123,830 | 5,276,080 | 220 | 451 | 610 |
| 2022 | 31,027,488 | 28,075,507 | 27,299,083 | 4,696,458 | 200 | 397 | 535 |

There is a seasonal demand which occurs during the summer months as irrigation increases and the demand at the Dungeness Recreation Area increases. Variations in consumption rates reflect changes in weather conditions, community activities, and habits of the population. The seasonal changes in the water demand are shown in Figure 2-1.

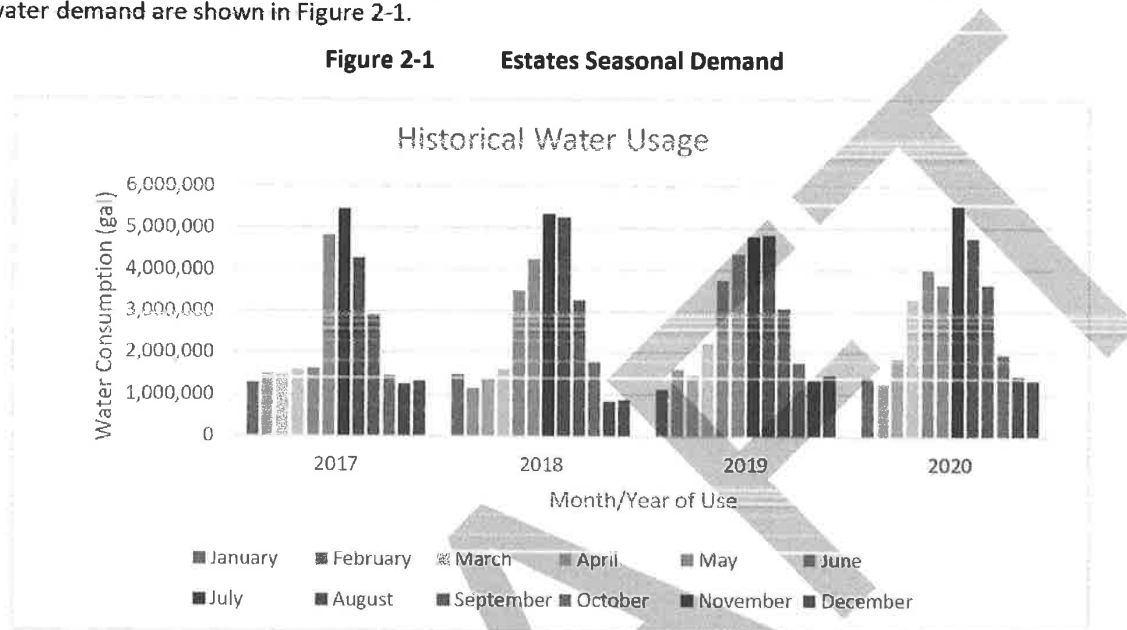

Knowledge of seasonal variations in water demand can help planning personnel better serve customers and properly maintain the distribution system.

Data from Figure 2-1 shows that the highest seasonal use occurs during the months of July through October. This is typical for most municipalities, as irrigation requirements significantly increase due to warmer temperatures. The following sections summarize the system production, water loss, service connections, and consumer demands. The following sections summarize the production, water loss, ADD, ERUs, MDD, and PHD calculations.

2.1.2.1 Distribution System Leakage

Distribution system leakage (DSL) is the difference between the amount of water produced and authorized consumption in a system. The DSL for Estates has been variable from year to year as shown in Table 2-2. All connections on the system are metered. Replacement of aging infrastructure is proposed over the short to medium term to assist in accurately measuring leakage. Although the 3-year average for DSL is below the 10% threshold, Cascadia Water has developed a water loss control action plan.

Table 2-2 Historical Water Consumption and Loss

| Year | Annual Production (gallons) | Annual Withdrawal (acre-feet) | Annual Consumption (gallons) | Leakage (gallons) | DSL |
|------|-----------------------------|-------------------------------|------------------------------|-------------------|------|
| 2020 | 34,169,631 | 104.9 | 30,968,696 | 3,200,935 | 9.4% |
| 2021 | 33,432,421 | 102.6 | 31,152,330 | 2,280,091 | 6.8% |
| 2022 | 31,027,488 | 95.2 | 28,075,507 | 2,951,200 | 9.5% |

2.1.3 Equivalent Residential Units

Water systems, including Estates, are often comprised of various types of connections including residential, commercial, industrial, etc. To properly assess the capacity of a system, connections are referred to as Equivalent Residential Units (ERUs). An ERU is a system-specific unit of measure used to express the amount of water consumed by a typical full-time single-family residence (WAC 246-290-010).

To properly assess the number of ERUs associated with Distribution System Loss and the two non-residential connections, consumption data from the last three years was analyzed. The calculations are provided in Appendix P and are summarized in Table 2-3.

Table 2-3 Equivalent Residential Unit Calculations

| Type | Connections | Annual Avg. Usage (gpd/conn.) | Avg. Month Max. Usage (gpd/conn.) | MDD (gpd/conn.) | ERUs |
|---------------|-------------|-------------------------------|-----------------------------------|-----------------|------------|
| Residential | 365 | 219 | 453 | 630 | 379 |
| Park | 1 | 2,203 | 4,662 | 6,293 | 10 |
| School | 1 | 261 | 261 | 352 | 1 |
| DSL | - | 7,701 | - | - | 30 |
| Total: | | | | | 420 |

2.1.4 Average Day Demand

Average day demand (ADD) is the typical demand of a full-time single-family residence. For Estates, it has been calculated by total volume of authorized consumption from residential meters in one year divided by the number of days in the year and the number of ERUs associated with the full-time single-family residences. Water usage data from customer accounts was analyzed from 2020 through 2022 to determine current design values for the system. The water use data for these periods is provided in Appendix P and is summarized in Table 2-1. The ADD design value for Estates is 220 gallons per day per ERU (gpd/ERU).

2.1.5 Maximum Day Demand

Maximum day demand (MDD) is ideally determined by meter readings and is the largest single-day usage of water based upon production. MDD could not be determined from actual water use data due to lack of daily source meter readings. Therefore, a multiplier of 1.35 is used to estimate MDD from maximum monthly average day demand (MADD) per Section 3.4.1 of DOH Water System Design Manual, 2019 edition (Design Manual). Water usage data from customer accounts was analyzed from 2020 through 2022 to determine current design values for the system. The water use data for these periods is provided in Appendix R and is summarized in Table 2-1. The MDD design value for Estates is 630 gallons per day per ERU (gpd/ERU).

2.1.6 Peak Hour Demand

Peak Hour Demand (PHD) was calculated in accordance with Section 3.4.2 of the Design Manual. Equation 3-1 from the Design Manual uses the MDD and the number of potential connections to determine the PHD flowrate.

Equation 2-1

$$PHD = \frac{MDD}{1440} [(C)(N) + F] + 18$$

- PHD = Peak Hourly Demand (gallons per minute)
- N = number of potential connections
- C = coefficient based on system size
- F = coefficient based on system size
- MDD = Maximum Daily Demand (gpd/ERU)

The coefficients used in the above formula are dependent upon the number of connections served as summarized in Table 2-4.

Table 2-4 Peak Hour Demand (PHD) Equation Coefficients

| Range of ERUs | C | F |
|---------------|-----|-----|
| 15-50 | 3.0 | 0 |
| 51-100 | 2.5 | 25 |
| 101-250 | 2.0 | 75 |
| 251-500 | 1.8 | 125 |
| 501-1,000,000 | 1.6 | 225 |

The design MDD of 630 gpd/ERU, Equation 3-1 and the values provided in Table 2-4 were used to calculate the PHD for years 2023, 2029, and 2043 and the maximum system physical capacity of 512 ERUs. The calculated PHD values are summarized in Table 2-5.

Table 2-5 Group A Peak Hour Demand (PHD) Based on MDD

| Year | N (ERUs) | MDD (gpd/ERU) | Coefficient Associated with Range of ERUs | Factor Associated with Range of ERUs | PHD (gpm) |
|----------|----------|---------------|---|--------------------------------------|-----------|
| 2023 | 420 | 630 | 1.8 | 125 | 403 |
| 2029 | 446 | 630 | 1.8 | 125 | 424 |
| 2043 | 512 | 630 | 1.6 | 225 | 444 |
| Maximum* | 512 | 630 | 1.6 | 225 | 475 |

*Max = Maximum number of ERUs that the system can support based on the capacity analysis calculations provided in Appendix P.

The PHD calculations assume the maximum possible ERUs based on the projected future system and the maximum possible number of connections purported by this Water System Plan. For the purpose of design in the distribution system, the PHD based on the calculated capacity of 512 ERUs will be used which corresponds to the projected growth in 20-years. The PHD design value for Estates is 475 gallons per minute (gpm).

2.2 Projected Land Use, Future Population, and Demand Forecasting

The projected land use, future population, and water demand forecasting for Estates, Inc. is discussed in the following sections.

2.2.1 Projected Land Use

As discussed in Section 1, the Water System’s existing service area primarily provides service to land zoned as various rural designations (See CCC 33.10). There is potential for growth within the existing service area as previously subdivided (but undeveloped) plots undergo development. A vicinity map showing the location of the retail service area for Estates is provided in Appendix B.

Site specific fire flow requirements for individual development projects are determined by Clallam County through its development review processes. There is a potential for Rural Cluster Developments, and commercial (nonresidential) development within the service area. However, the timeframe for development of these subdivided plots is currently unknown.

2.2.2 Projected Connections

The estimated number of connections for 2029 and 2043 were determined by using a 1.0% population growth rate to establish the number of future residents served and 2.5 residents per residential connection as recommended by DOH. The 1.0% population growth rate used for this report is a conservative estimation based off the current growth rate of 0.73% indicated in the Clallam County Census and the available lots in the service area. Equation 2-1 and the values provided in Table 2-5 were used to calculate the PHD for 2023, 2029, 2043, the current number of DOH approved connections, and the maximum system physical capacity.

2.2.3 Projected Demand

Projected demands are based on ERU projections and trends in the annual production of ADD. The project source withdrawal for annual production is summarized in Table 2-6 based on the number of projected ERUs discussed in Section 2.1.6.

Table 2-6 Projected Annual Demand Based on ADD

| Year | N (ERUs) | ADD (gpd/ERU) | Annual Withdrawal (gallons) | Annual Withdrawal (ac-ft) |
|------|----------|---------------|-----------------------------|---------------------------|
| 2023 | 420 | 220 | 33,726,000 | 103.5 |
| 2029 | 443 | 220 | 35,800,829 | 109.9 |
| 2043 | 512 | 220 | 41,152,129 | 126.3 |

Projections are based on the increase in the proposed ERUs at a rate of 1.0% and trends in Annual Production and the ADD. The ADD is assumed to be level as the increase in consumer demand can be offset by the steps currently underway and those that will be implemented to reduce the DSL.

3 SYSTEM ANALYSIS

This chapter summarizes the analysis of the existing systems to determine if the system facilities are capable of supplying sufficient quality and quantity of water to meet existing and projected demands as identified in Chapter 2. Improvements to the system required to meet projected demands are discussed in the final section of this chapter.

3.1 System Design Standards

See Part A of the Cascadia Water – Water System Plan for the Southwest region.

3.2 Water Quality Parameters and Analysis

Groundwater wells provide the source water for the water system and therefore they are required to comply with the water quality requirements specified in WAC 246-290 Part 4 – Water Quality, which includes requirements from the Code of Federal Regulations (CFR) Title 40.

It is required that purveyors of the community water system have one complete analysis from each water source every thirty-six months. A selection of recent water quality test results is included in Appendix L and additional information is available on the DOH Sentry website:

<https://fortress.wa.gov/doh/eh/portal/odw/si/Intro.aspx>

Waivers are available to modify some of the testing requirements noted below. The DOH will provide the system with a water quality monitoring schedule (WQMS) that summarizes the specific testing requirements for that system. A copy of the system's WQMS is provided in Appendix K. See Section 3.2.1 below for additional information. Required water quality monitoring locations and schedules, as specified in WAC 246-290 and 40 CFR, are summarized in Table 3-1.

Table 3-1 Water Quality Monitoring Schedule

| Constituent | Sample Location | Schedule/Frequency |
|---|---|-------------------------------------|
| Asbestos | One sample from the routine coliform sampling sites that contains asbestos concrete pipe. | Waiver One sample every 9 years |
| Bacteriological | From representative points throughout distribution system. | One sampler per month |
| Complete Inorganic Chemical & Physical | From a point representative of the source(s), after treatment, and prior to entry to the distribution system. | Waiver One sample every 9 years |
| Lead/Copper | From the distribution system at targeted sample tap locations. | Ten sample every 3 years |
| Nitrate/Nitrite | From a point representative of the source(s), after treatment, and prior to entry to the distribution system. | One sample annually |
| Potential Trihalomethanes – Ground Water * | From two representative points in the distribution system. | Annually at 2 locations |
| Radionuclides | From the source(s). | One sample every 6 years |
| Volatile Organic Chemicals (VOCs) | From a point representative of the source(s), after treatment, and prior to entry to distribution system. | Waiver One sample every 6 years. |
| Synthetic Organic Chemicals (SOCs Herbicides) | From a point representative of the source(s), after treatment, and prior to entry to distribution system. | Waiver One sample every 9 years |
| Synthetic Organic Chemicals (SOCs Pesticides) | From a point representative of the source(s), after treatment, and prior to entry to distribution system. | Waiver One sample every 3 years |
| Synthetic Organic Chemicals (SOCs including EDB and other soil contaminants, Dioxin, Endothall, Diquat, Glyphosate, Insecticides) | From a point representative of the source, after treatment, and prior to entry to distribution system. | Complete Waiver Granted |
| Per- & Polyfluoroalkyl (PFAS) | From a point representative of the source, after treatment, and prior to entry to distribution system. | One sample every 3 years |

*Currently the water system is not chlorinating but chlorination may be added as future oxidation and filtration equipment or for preventative disinfection. If chlorination is used, then these testing requirements may need to be implemented.

3.2.1 Water Testing

The latest water quality testing results are provided for each system in Appendix L. The testing schedule for each system is provided in Appendix K. The frequency of testing for each system is dependent on size, past testing results, and system configuration. The following tests are performed throughout the system:

- Radionuclides
- Arsenic

- Lead & Copper
- Synthetic Organic Chemicals
- Volatile Organic Chemicals
- Bacteriological
- Asbestos
- Iron
- Manganese
- Nitrates

3.2.2 Bacteriological Testing

The State requires that systems serving up to 1,000 people have a minimum of one routine bacteriological analysis per month. The sample is to be taken from the distribution system. When any samples with a coliform presence are collected during the previous month, the purveyor must take five (5) repeat samples. If those samples do not contain any presence of coliform bacteria, the sampling may revert to the statutory number of samples per month. If coliform bacteria are detected, four (4) follow-up samples are required the same month, then five (5) routine samples the following month if the four (4) follow-up tests are negative; otherwise, DOH will specify follow-up requirements. The Coliform Monitoring Plan, provided in Appendix M, provides the sampling points that will be used within the system.

3.2.3 Inorganic Chemical Testing

WAC 246-290 and CFR 40 specify testing for primary and secondary inorganic chemicals. The maximum contaminant levels (MCLs) and latest source test results for inorganic chemicals (IOCs) are summarized in Table 3-2.

Table 3-2 Inorganic Chemical Maximum Contaminant Levels (MCLs)

| PRIMARY INORGANIC CHEMICALS | | | |
|-----------------------------|---|-------------------------------|--|
| Substance | MCLs (mg/L) | State Reporting Limits (mg/L) | IOC Results ^A Well Field S03 (mg/L) |
| Antimony (Sb) | 0.0060 | 0.0030 | LT |
| Arsenic (As) | 0.0104 | 0.0010 | LT |
| Asbestos | 7 million fibers/liter (longer than 10 microns) | - | - |
| Barium (Ba) | 2.0000 | 0.1000 | LT |
| Beryllium (Be) | 0.0040 | 0.0003 | LT |
| Cadmium (Cd) | 0.0050 | 0.0010 | LT |
| Chromium (Cr) | 0.1000 | 0.0070 | LT |
| Copper (Cu) | * | 0.0200 | LT |
| Cyanide (HCN) | 0.2000 | 0.0500 | LT |
| Lead (Pb) | * | 0.0010 | LT |
| Mercury (Hg) | 0.0020 | 0.0002 | LT |
| Nickel (Ni) | 0.1000 | 0.0050 | LT |
| Nitrate (as N) | 10.00 | 0.5000 | LT |
| Nitrite (as N) | 1.0 | 0.1000 | LT |
| Selenium (Se) | 0.0500 | 0.0020 | LT |
| Sodium (Na) | * | 5.00 | 11.30 |
| Thallium (Tl) | 0.0020 | 0.0010 | LT |

| SECONDARY INORGANIC CHEMICALS | | | |
|-------------------------------|--------|--------|--------|
| Chloride (Cl) | 250.0 | 20.00 | LT |
| Fluoride (F) | 4.00 | 0.2000 | LT |
| Iron (Fe) | 0.3000 | 0.1000 | LT |
| Manganese (Mn) | 0.0500 | 0.0100 | 0.1800 |
| Silver (Ag) | 0.1000 | 0.1000 | LT |
| Sulfate (SO ₄) | 250.00 | 50.00 | LT |
| Zinc (Zn) | 5.00 | 0.2000 | 0.6200 |

A: Testing results less than the state reporting limit are entered as LT

Although the State Board of Health has not established MCLs for copper, lead, and sodium; there is sufficient public health significance connected with copper, lead, and sodium levels to require inclusion in inorganic chemical and physical source monitoring. For lead and copper, the EPA has established distribution system related levels at which a system is required to consider corrosion control. These levels, called "action levels," are 0.015 mg/L for lead and 1.3 mg/L for copper and are applied to the highest concentration in ten percent of all samples collected from the distribution system. The EPA has also established a recommended level of 20 mg/L for sodium as a level of concern for those consumers that may be restricted for daily sodium intake in their diets.

3.2.4 Physical Characteristics

WAC 246-290 and CFR 40 specify testing physical characteristics. The MCLs for physical characteristics are summarized in Table 3-3.

Table 3-3 Physical Characteristics

| Substance | Secondary MCLs | Physical characteristics Results |
|------------------------------|----------------|----------------------------------|
| Color | 15 Color Units | 15 CU |
| Specific Conductivity | 700 umhos/cm | 315 umhos/cm |
| Total Dissolved Solids (TDS) | 500 mg/L | N/A |

The generally accepted classification of hardness is summarized in Table 3-4. An MCL for hardness has not been established. In general, water having a hardness of less than 100 mg/L is not considered hard for ordinary domestic use. The system's hardness concentration was measured at 129 mg/L and is considered hard.

Table 3-4 Relative Hardness

| Description | Concentration of CaCO ₃ |
|-----------------|------------------------------------|
| Soft | 0-60 mg/L |
| Moderately hard | 61-120 mg/L |
| Hard | 121-180 mg/L |
| Very hard | 181-350 mg/L |
| Saline/Brackish | > 350 mg/L |

The water hardness impacts the corrosivity of water and it may have negative impacts on lead and copper levels in delivered water. If water softening is desired in the future, lead and copper testing should be performed to ensure that water corrosivity concerns do not become an issue.

3.2.5 Disinfection Byproducts (DBP)

When chlorine is added to drinking water to serve as a disinfectant for various organisms, a residual must be maintained throughout the distribution system. However, chlorine is a very active substance, and it reacts with naturally occurring substances to form compounds known as disinfection byproducts (DBPs). The most common DBPs that develop when chlorine is used for disinfection are trihalomethanes (THMs), and haloacetic acids (HAAs).

The Stage 2 Disinfectants and Disinfection Byproducts Rule regulates the concentration of disinfectant chemicals and byproducts that may be present in the distribution system water. These chemical species are considered primary contaminants. Testing for DBPs is performed annually unless the MCL is exceeded, in which case a running annual average (RAA) is used for comparison against the MCL. The number of samples is dependent on system size. Each of the locational running annual average (LRAA) results must be in compliance.

The concentrations of each of the trihalomethane compounds (trichloromethane, dibromochloromethane, bromodichloromethane, and tribromomethane) are totaled to determine the total trihalomethanes (TTHM) level. The MCL for TTHM is 0.080 mg/L. The concentrations of each of the five haloacetic acid compounds (monochloroacetic acid, dichloroacetic acid, trichloroacetic acid, bromoacetic acid, and dibromoacetic acid) are totaled to determine the haloacetic acids (HAA5s) level. The MCL for HAA5 is 0.060 mg/L.

At the time this Water System Plan is being prepared, Estates is in the process of installing a manganese filtration system which uses chlorine as an oxidant and disinfectant. Following installation of the treatment system, Estates will commence monitoring for disinfection byproducts on an annual basis at two locations in the distribution system as noted in the DOH approval letter for Project #22-0805.

3.2.6 Radionuclides

The State considers radionuclides primary contaminants. The MCLs for radionuclides and the latest source test results are summarized in Table 3-5.

Table 3-5 Radionuclides MCLs

| Substance | MCL (pCi/L) | State Reporting Limit (pCi/L) | Radionuclides Results ^A (pCi/L) |
|---|-------------|-------------------------------|--|
| Radium-226 | 3.0 | | - |
| Combined Radium-226 and Radium-228 | 5.0 | 1.00 | LT |
| Gross alpha particle activity (excluding uranium) | 15.0 | 3.0 | LT |

A: Testing results less than the state reporting limit are entered as LT

The State specifies that the average annual concentration shall not produce an annual dose equivalent to the total body or any internal organ greater than four millirem/year.

3.2.7 Volatile Organic Chemicals (VOCs)

The State requires that public water systems sample and evaluate Volatile Organic Chemicals (VOCs). If there are violations of the MCLs for any constituent, they must be addressed for elimination immediately. If there are no violations of the MCLs, the purveyor must sample again for VOCs after twelve months. If no VOCs (excluding THMs) are verified after the initial twelve months of monitoring, purveyors of community water systems shall monitor each source at least once every thirty-six months. The VOC MCLs and latest system test results are summarized in Table 3-6.

Table 3-6 Volatile Organic Chemicals (VOCs) MCLs

| Contaminant | MCL (µg/L) | State Reporting Limits (µg/L) | VOC Results (µg/L) |
|----------------------------|---------------|---|---|
| Vinyl chloride | 2.0 | All VOC State Action Limits are 0.5 ug/L | All VOC Results LESS THAN STATE ACTION LIMIT |
| Benzene | 5.0 | | |
| Carbon tetrachloride | 5.0 | | |
| 1,2-Dichloroethane | 5.0 | | |
| Trichloroethylene | 5.0 | | |
| para-Dichlorobenzene | | | |
| 1,1-Dichloroethylene | 7.0 | | |
| 1,1,1-Trichloroethane | 200.0 | | |
| cis-1,2-Dichloroethylene | 7.0 | | |
| 1,2-Dichloropropane | 5.0 | | |
| 1,4 Dichlorobenzene | 75.0 | | |
| Ethylbenzene | 700 | | |
| Monochlorobenzene | 100 | | |
| o-Dichlorobenzene | 600 | | |
| Styrene | 100 | | |
| Tetrachloroethylene | 5.0 | | |
| Toluene | 1000.0 | | |
| trans-1,2-Dichloroethylene | 100.0 | | |
| Xylenes (total) | 10,000.0 | | |
| Chloride(Dichloromethane) | 5.00 | | |
| 1,2,4-Trichlorobenzene | 70.0 | | |
| 1,1,2-Trichloroethane | 5.0 | | |

3.2.8 Synthetic Organic Chemicals (SOCs)

The synthetic organic chemical (SOC) MCLs are summarized in Table 3-7.

Table 3-7 Synthetic Organic Chemicals (SOCs) MCLs

| Contaminant | MCL (µg/L) | State Reporting Limits (µg/L) | SOC Results ^A (µg/L) |
|---------------------------|--------------------|-------------------------------|---------------------------------|
| Toxaphene | 3.0000 | 1.000 | LT |
| 2,4,5-TP | 50.0000 | 0.2000 | LT |
| Benzo[a]pyrene | 0.2000 | 0.0200 | 0.0400 |
| Dalapon | 200.000 | 1.000 | LT |
| Di(2-ethylhexyl)adipate | 400.0000 | 0.6000 | 1.3000 |
| Di(2-ethylhexyl)phthalate | 6.0000 | 0.6000 | 1.3000 |
| Dinoseb | 7.0000 | 0.2000 | LT |
| Diquat * | 20.0000 | - | - |
| Endothall * | 0.1 | - | - |
| Endrin | 2.000 | 0.0100 | LT |
| Glyphosate * | 0.7 | - | - |
| Hexachlorobenzene | 1.0000 | 0.1000 | LT |
| Hexachlorocyclopentadiene | 50.0 | 0.1000 | LT |
| Oxamyl (Vydate) ** | 200.00 | - | 4.000 |
| Picloram | 500.00 | 0.1000 | LT |
| 2,3,7,8-TCDD (Dioxin) * | 3x10 ⁻⁸ | - | - |

* The DOH has granted complete waivers for dioxin, endothall, glyphosate, and diquat.

** The DOH has granted complete waiver for these insecticides but latest test results are included.

A: Testing results less than the state reporting limit are entered as LT

3.2.9 Seawater Intrusion

Due to the existence of seawater intrusion (SWI) in many wells located on the shorelines of Washington State, the possibility of seawater intrusion into the potable water aquifers must be investigated on a regular basis. The Design Manual identifies wells at risk for SWI as those wells that are located within ½ mile of the shoreline and pump water from a depth below sea level, and within ½ mile of a groundwater source with chloride concentrations over 100 mg/L. Department of Ecology may condition water right permits to provide for reduced pumping rates or may require a water system to abandon sources if seawater intrusion threatens senior water right permits. Estates' groundwater wells are located approximately 1.5 miles away from nearest shoreline. Chloride concentration has consistently measured less than 5 mg/L. Estates is considered low risk for seawater intrusion. It is recommended that the system continue testing its well field for chloride to check for any long-term trends in the aquifer.

3.2.10 Source Water Quality

A wellhead protection plan was developed to help identify items and situations that could possibly pose a threat to the water quality of the system. A copy of the Wellhead Protection Plan is included in Appendix I.

The primary contaminant of concern for the water system is manganese, which is a naturally occurring contaminant common in groundwater sources. Currently Estates is in the process of installing a manganese oxidation/filtration system with a chemical feed of sodium hypochlorite (NaOCl) as the oxidant.

3.2.11 Finished Water Quality

Water quality samples from the distribution system show adequate water quality. Lead and copper concentrations were measured at less than 0.001- and 0.02-mg/L respectively. Total coliform concentrations are measured monthly, with the most recent results indicating that coliform is absent. Where water quality improvements have been identified a capital improvement project has been identified and scheduled for the immediate term. See Chapter 8 for additional information.

3.3 System Description and Analysis

Potential system improvements were determined by analysis of system components, testing, past studies, review of water system inventories, consultation with the system operator regarding needed improvements, and longer-term goals for the systems. The distribution systems' needs by functional group are summarized in the following sections.

3.3.1 Existing System Configurations

The system is currently supplied by two groundwater wells. The wells are located on Clallam County Parcel 043004510880, owned by Cascadia Water. The parcel is provided access off of Ridgeview Drive via an access easement. The two wells function in a lead/lag alternating orientation. Estates has a water right with a maximum instantaneous withdrawal rate of 500-gpm so both wells can physically and legally be operated at the same time. The well lot also contains a single reservoir that is currently under construction. The reinforced concrete reservoir is 30-feet in diameter and 33-feet tall with an approximate volume of 174,500-gallons. Well function is controlled by reservoir levels which are relayed to system controls by a pressure transducer. Pressurization of the distribution system is provided by booster pumps located in a pumphouse that is situated on the parcel with the wells and reservoir.

Raw water from Well #2 is pumped into the pumphouse where it is dosed with sodium hypochlorite prior to being conveyed through an ATEC filter system with five (5) filter vessels. Each filter vessel is 30-inches in diameter and 60-inches tall. The ATEC filter system treats raw water from Well #2 for elevated levels of manganese prior to being discharged into the storage reservoir. Raw water from Well #1 is dosed with sodium hypochlorite for disinfection, bypasses filtration, and is conveyed into the storage reservoir.

Treated water from the wells is stored in the 174,500-gallon reinforced concrete reservoir. An 8-inch suction line from the storage reservoir is supplied into the distribution system by four (4) booster pumps. Each pump is a 15 hp Grundfos LC 20709 pump. System booster pump specifications are included in Appendix O. System pressures are maintained and pump protection is provided by three (3) 370-gallon pressure tanks (See Appendix O for Pressure Tank specifications). Distribution piping consists of 2-, 4-, and 6-inch water mains. A distribution system map is provided in Appendix T. Figure 3-1 provides a schematic of the system operations from the source wells to the distribution system. The hydraulic grade line (HGL) of the distribution system is 260-feet based upon the finished floor elevation of the pumphouse (135 feet).

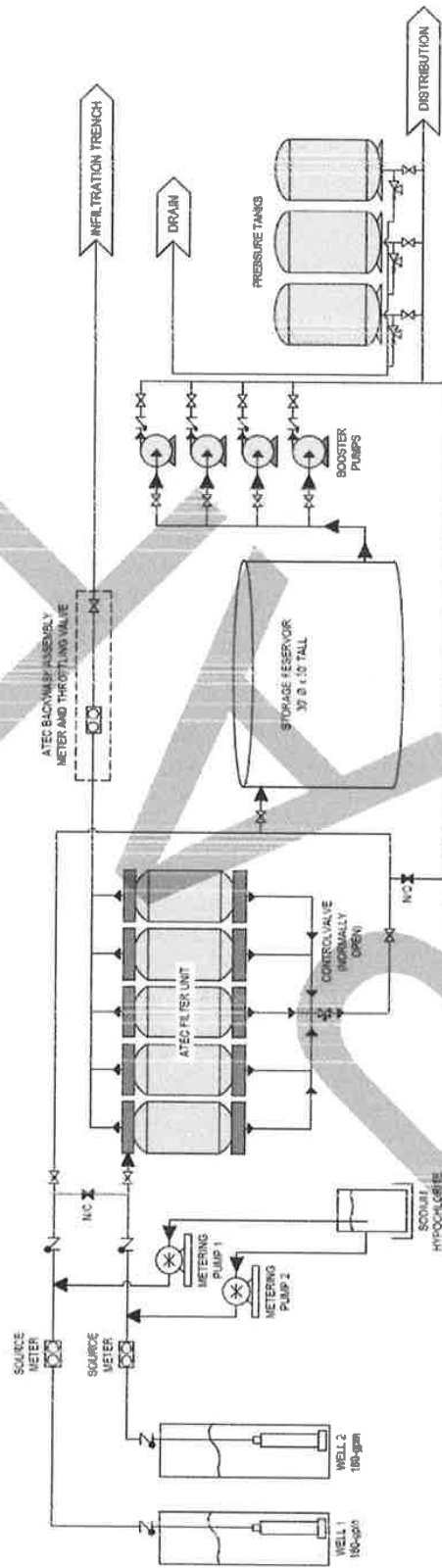

Figure 3-1 Estates Distribution System Schematic

3.3.2 Water Rights

Washington State Department of Ecology (DOE) issued Ground Water Certificate G2-27484 C (Priority Date February 14, 1989) to Estates Water Systems, Inc. This water right authorizes an instantaneous withdrawal of 500-gpm and a maximum annual withdrawal of 240 acre-feet for the Water System. A copy of the water right is provided in Appendix E. A water rights self-assessment for Estates, Inc. is provided in Appendix F.

3.3.3 Source

Estates is served by two groundwater wells that are located on Clallam County parcel 043004510880. This parcel is owned by Cascadia Water and has access from the water system located off Ridgeview Drive in the southern portion of the service area. DOH requirements for ground water sources specify that the well shall be located, constructed, and maintained in a manner which will ensure the minimum possibility of contamination, and be so situated and developed as to prevent surface water from entering the well. To ensure adequate sanitary control in the vicinity of the well, water systems must control all land within a radius of 100-feet of the well field, except that the systems shall control land of a greater or lesser size or of a different shape than is defined by a 100-foot radius where an evaluation of geological and hydrological data, well construction details, and other relevant factors indicates that a control area of different size or shape will assure adequate sanitary control in the vicinity of the well. Cascadia Water owns the property which makes up the sanitary control radius. Bacteriological, chemical, and physical water quality requirements are discussed in Section 3.2 and water quality results are included in Appendix L.

Well 1 was drilled in 1982 to a final depth of 607-feet to serve as a primary source. The initial pump test for Well 1 was conducted in November 1982. That test recorded a static water level of 58-feet below the top of well. It also conducted a stepped pump test with a maximum rate of withdrawal of 201 gpm with a corresponding drawdown of 17-feet. A copy of the well log and corresponding pump test is included in Appendix G.

Well 2 was initially drilled in 1974 to a depth of 86-feet with a static water level of 41-feet 1-inch. In 1983, Well 2 was deepened to a depth of 462-feet with a static water level of 57-feet below the top of well. A stepped pump test was conducted in May 1983 with a rate of withdrawal of 225 gpm with a corresponding drawdown of 31-feet. A copy of the well log and corresponding pump test is included in Appendix G. Additional detailed information regarding each source is summarized in Table 3-8.

Table 3-8 Source Type, Location, and Use Information

| | Well 1 | Well 4 |
|-------------------------|------------------------------------|------------------------------------|
| Source Type | Well (Non GWI) | Well (Non GWI) |
| DOE Tag | ACA573 | ACA574 |
| Source Location | Sec 4 T30N R04W | Sec 4 T30N R04W |
| Purpose of Use | Domestic Water Supply – Primary | Domestic Water Supply – Primary |
| Place of Use | See Water Right | See Water Right |
| Year of Installation | 1982 | 1983 |
| App. Capacity (gpm) | 201 | 225 |
| Ex. Capacity (gpm) | 180 | 180 |
| Pump Size (hp – gpm) | 7.5 hp – 180 gpm | 7.5 hp – 180 gpm |
| Casing Size | 6”/4” | 8” |
| Ground Elev. (ft) | 135 | 135 |
| Well Depth (ft) | 607 | 462 |
| Static Water Depth (ft) | 58 | 58 |
| Top of Screen (ft) | 197 | 436 |
| Bottom of Screen (ft) | 592 | 462 |
| Drawdown (ft) | 17 | 31 |

3.3.3.1 Current Facility Age and Estimate of Future Life Expectancy

Both groundwater sources are approximately 40-years old. The anticipated useful life of wells will vary depending on numerous factors. It is recommended that the static water level and pumping water levels be measured and recorded annually to monitor the status of both the wells and the installed pumps. The static water levels, pumping rates, and drawdown levels will help to determine timelines and priorities for replacement.

Depending on the operating conditions of the well pumps (i.e., if the head/flow and cycle times are within manufacturer recommendations), the well pumps should last through the Phase I planning cycle. However, as submersible pumps may fail without much warning, it is recommended that documentation on the installed submersible pumps and adequate reserves be kept on hand to fund and facilitate an emergency well pump replacement.

3.3.3.2 Condition and Capacity of Transmission Mains

The transmission mains from groundwater wells to the pumphouse and reservoir are being replaced as part of the improvements project currently in process. The transmission mains and well site piping should last through the long-term planning period of this Water System Plan.

3.3.4 Treatment

As part of the improvements project currently being installed at Estates (DOH Project #22-0805), a manganese (Mn) filter system is being installed to treat raw water from Well 2. The Mn filter system consists of raw water, from Well 2, being pumped through an ATEC filter system with five (5) filter vessels. Each filter vessel is 2.5-feet in diameter, has a surface area of 4.9-square feet, and contains 16-cubic feet of filter media (42-inches). The filter media is a manganese dioxide coated media. The typical

operating mode, referred to as catalytic oxidation, includes continuous feeding of chlorine to oxidize the iron, manganese, and any other constituents that have a chlorine demand (e.g., hydrogen sulfide, ammonia). Additional chlorine (at residual between 0.5 to 1.0 mg/L leaving the filters) is required to continuously regenerate the media. The system is capable of filtering 200-gpm, which should provide sufficient capacity for Well 2.

3.3.5 Storage

Water storage is necessary for multiple reasons. These reasons include an adequate storage volume to meet the daily fluctuations in demand, a sufficient volume to allow adequate runtime for pumps and the treatment system(s), an emergency reserve in case the supply system should fail, and to provide a large volume of water for potential firefighting needs.

The water system storage is provided by a 174,500-gallon reservoir located on Clallam County parcel 043004510880. This reservoir is part of the improvement project currently being constructed at the water system. The reservoir is 30-feet in diameter and is 33-feet tall. The reservoir has a base elevation of 132.75-feet above sea-level.

The system reservoir provides the following storage components:

- Operational Storage (OS) – Section 3.4.6.1
- Equalizing Storage (ES) – Section 3.4.6.2
- Standby Storage (SB) – Section 3.4.6.4
- Dead Storage (DS) – Section 3.4.6.3

The storage capacity of the system is discussed in subsequent subsections.

3.3.5.1 *Current Facility Age and Estimate of Future Life Expectancy*

Concrete storage reservoirs that employ the latest construction standards are anticipated to have a useful lifespan of at least 70-years. The useful lifespan of the reservoir under construction at Estates should surpass the planning periods of this Water System Plan.

3.3.6 Booster Pumps and Pressure Tanks

The distribution system is pressurized by four (4) booster pumps fed from the 174,500-gallon reservoir. System pressures are maintained, and pump protection is provided by three (3) 370-gallon pressure tanks. These pumps and pressure tanks are currently being installed as part of the 2023 improvements project. Each pump is a 15 hp Grundfos LC 20709 pump.

The four booster pumps will operate on an alternating lead/lag 1/lag 2/lag 3 configuration where the starting and lag pumps will alternate with each pump-start. The proposed pressure settings are summarized in Table 3-9 and pump curves associated with the proposed equipment are included in Appendix O

Table 3-9 Booster Pump Pressure Settings

| (4) 15 hp Grundfos LC 20709 | | | | |
|------------------------------------|----------------------------------|------------------------------|----------------------------------|------------------------------|
| Pump Position | On Settings | | Off Settings | |
| | Pressure - psi (ft) - | Pump Rate - gpm - | Pressure - psi (ft) - | Pump Rate - gpm - |
| Lead Pump | 55-psi (127.1) | 295 gpm | 65-psi (150.2) | 190 gpm |
| Lag #1 | 50-psi (115.5) | 327 gpm | 60-psi (138.6) | 255 gpm |
| Lag #2 | 45-psi (104.0) | 358 gpm | 55-psi (127.1) | 295 gpm |
| Lag #3 | 40-psi (92.4) | 385 gpm | 50-psi (115.5) | 327 gpm |

3.3.6.1 Current Facility Age and Estimate of Future Life Expectancy

The useful lifespan of the new booster pumps system under construction at Estates should surpass the 20-year planning period of this Water System Plan.

3.3.7 Distribution

Mains throughout the systems are tapped for the individual service connections. The following sections provide additional details on the distribution system.

3.3.7.1 Length, Diameter, and Type of Pipe

A comprehensive inventory of each system, including distribution system piping, is provided in Appendix O. A summary of the water mains in the distribution system are provided in Table 3-10.

Table 3-10 Distribution System Piping

| | PVC Pipe Diameter | | | | |
|--------------------|--------------------------|---------------|---------------|---------------|--------------|
| | 2-inch | 4-inch | 6-inch | 8-inch | Total |
| Pipe Length (feet) | 2,850 | 21,600 | 9,000 | 400 | 33,850 |

There are three (3) fire-hydrants located on the system within the Dungeness Estates Subdivision. The standard pipe diameter for future watermain replacements should be a minimum of 6-inches for looped portions of the system and 8-inches for dead end mains.

3.3.8 Hydraulic Analysis of Distribution System

Hydraulic analyses were done for the distribution system using the hydraulic modeling software EPANet. The model uses the Hazen-Williams equation to estimate head-losses throughout the system. Models were developed for both the existing system and the system following distribution system improvements at approximately 2043 in accordance with Section 6.1.4 of the Design Manual. For both the existing and future scenario hydraulic models were run for (1) the system at PHD and also for (2) the fire flow demand with MDD.

PHD Scenario:

The PHD scenario models the system at the calculated demands that the system is expected to undergo during normal operation. Per the Design Manual, water systems are required to be capable of providing the PHD to the system while maintaining a required minimum pressure of 30 psi at all service connections. For the PHD scenarios, the reservoir levels are set to the bottom of equalizing storage, and

booster pumps are set at the on pressure for the 1st lag pump at 50 psi (115 feet TDH). This pressure setting provides a hydraulic grade line of 255-feet.

Fire Flow & MDD Scenario:

For the fire flow scenario model, the distribution system is required to be capable of providing the MDD with fire flow demand at a hydrant while maintaining a required minimum pressure of 20 psi at all service connections. For the fire flow scenarios, the reservoir levels are set to the bottom of fire suppression storage. Booster pumps are set at the on pressure for the 2nd lag pump at 45 psi (104 feet TDH). This pressure setting provides a hydraulic grade line of 244-feet. Data from each of the scenarios is provided in Appendix Q. The results are summarized in the subsections below.

3.3.8.1 Existing Distribution System – Peak Hour Demand

For the PHD model, the demands are distributed throughout the system and reservoir levels are set at the bottom of equalizing storage. In this scenario, the distribution system has service pressures in excess of the required minimum of 30-psi. The lowest pressure service connections are located along Bon Jon View Way (Node 30 in the hydraulic model) with pressures just under 40-psi.

3.3.8.2 Existing Distribution System – Fire Flow & MDD

For the Fire Flow model, the MDD demands are distributed throughout the system and reservoir levels are set at the bottom of fire suppression storage. In this scenario, most of the system has service pressures in excess of the required minimum of 20-psi. Various portions of the distribution system are not able to provide the minimum required service pressures when fire flow is applied at the hydrant located along the 4-inch water main located at the intersection of Ridge View Drive and Nello Place. This deficiency in the current system is due to the undersized 4-inch water main installed along Ridge View Drive between Secluded Way and 300-feet west of Percy Lane. There are significant portions of the existing distribution system that do not have hydrants installed and would not be capable of providing fire flow. These portions of the system include the following:

- Lotzgesell Road – This road serves the northern boundary of the system including Five Acre School and Dungeness Recreation Area. The head loss in the 4-inch main while providing residential fire flow (500-pgm) is excessive and causes reduced service pressures throughout the distribution system.
- Northwest Corner – Greywolf Road, Maynard Place, and Tyler View Place. The head loss in the 4-inch main while providing residential fire flow (500-pgm) is excessive and causes reduced service pressures throughout the distribution system.
- Eastern Portion of Buckhorn Road – The 4-inch water main along Buckhorn Road would have excessive head loss while operating at fire flow levels reducing pressures in the area to below 20-psi.

Section 3.3.8.4 and 3.5.5 further discuss future capital improvements to address these system deficiencies.

3.3.8.3 Future Distribution System – PHD

The hydraulic model for the distribution system was updated with the distribution system improvements listed in Chapter 8. In addition, demand was increased to correspond to those associated with the capacity of the system. In this scenario, the distribution system has service pressures in excess

of the required minimum of 30-psi. The lowest pressure service connections are located along Bon Jon View Way (Node 30 in the hydraulic model) with pressures just under 40-psi.

3.3.8.4 Future Distribution System – Fire Flow & MDD

The distribution system improvements listed in Chapter 8 replaced and increased water main sizing in multiple portions of the distribution system. The following portions of the system were previously unable to provide the minimum required fire flow:

- Ridge View Drive (Between Secluded Way and Percy Lane) – The 4-inch water main along Ridge View Drive is replaced with 8-inch water mains. The increased water main size provides sufficient capacity to meet system demands.
- Lotzgesell Road – All the watermains along Lotzgesell Road should be replaced with 8-inch water mains. The eastern end of Lotzgesell Road should be looped around to the water main at Dungeness Greens Way via Hogback Road. This project would involve the installation of approximately 5,500-feet of watermain but would provide a valuable loop to the distribution system and additional flow to the northwest portion.
- Northwest Corner (Greywolf Road, Maynard Place, and Tyler View Place) – The 4-inch water mains along all roads will need to be increased to 8-inches. In addition, the water main connecting the eastern portions of Greywolf Road and Maynard Place should be replaced and connected to the improvements along Lotzgesell Road.
- Eastern Portion of Buckhorn Road – With the improvements along both Ridge View Drive, Lotzgesell Road, and a connection of the line from Buckhorn to Lotzgesell, the flow capacity to this section of the system will be capable of providing 500-gpm while maintaining service pressures.

In addition to the above noted areas, the planned capital improvements increase fire flow capacity throughout additional portions of the system and future distribution system areas.

3.4 Capacity Analysis

The system capacity was calculated in accordance with the DOH Water System Design Manual (June 2020) using the equations/procedures in Chapter 4: Water System Capacity Analysis.

The capacity calculations are based on the accepted design values as outlined in Chapter 2 for both Average Daily Demand (ADD) and Maximum Daily Demand (MDD). The capacities were calculated and expressed in terms of Equivalent Residential Units (ERUs) based on existing system parameters. System consumption data, including ADD and MDD expressed in terms of gallons per day per ERU, were used throughout the system capacity calculations. The analysis shows that Estates, Inc. has the physical and legal capacity to serve 654 ERUs, limited by the booster pump capacity.

3.4.1 Water Right Capacity Based on Annual Volume

The water right for the system allows for an annual withdrawal of 240 acre-feet per year (78,198,912-gallons). Equation 4-4b in the Design Manual was used to determine the number of ERUs based upon Average Daily Demand (ADD) and water right:

Equation 4-4b:

$$N = \frac{(Q_a)}{(ERU_{ADD})(365)}$$

$$N = \frac{240 \text{ acre} \cdot \frac{\text{ft}}{\text{yr}} \cdot \frac{43,560 \text{ ft}^2}{\text{acre}} \cdot 7.48 \frac{\text{gal}}{\text{ft}^3}}{365 \text{ days/yr} \cdot 220 \frac{\text{gpd}}{\text{ERU}}} = 974 \text{ ERUs}$$

Where,

N = ERUs Supported

V_a = Annual Volume (gallons/year)

Q_a = Annual Volume (gallons/year)

t_a = time that the source (Qi) delivers flow in a 24-hour period (minutes)

ERU_{ADD} = ADD value per ERU (Section 2.1.4)

ADD was determined to be 220 gpd/ERU (See Section 2.1.4) and the established water right annual withdrawal volume of 240 ac-ft/yr (See Section 3.3.2) as the annual volume (V_a). Therefore, the number of total ERUs capable of being supported based on ADD and the allowed annual withdrawal volume calculates to 974 ERUs.

3.4.2 Water Right Capacity Based on Instantaneous Flow

The water right for Estates allows for an instantaneous pumping rate of 500 gallons per minute. Equation 4-4a in the WSDOH Design Manual was used to determine the number of ERUs based upon Maximum Daily Demand (MDD) and water right:

Equation 4-4a:

$$N = \frac{(Q_{ai})}{(ERU_{MDD})} = \frac{\sum_a^1(Q_a)(t_a)}{(ERU_{MDD})}$$

$$N = \frac{500 \text{ gpm} \cdot 1,440 \text{ minutes/day}}{630 \text{ gpd/ERU}} = 1,143 \text{ ERUs}$$

Where:

N = ERUs Supported

V_a = Annual Volume (gallons/year)

Q_a = Annual Volume (gallons/year)

t_a = Annual Volume (gallons/year)

ERU_{MDD} = MDD value per ERU (Section 2.1.5)

MDD was determined to be 630 gpd/ERU (Section 2.1.5) and the current water right instantaneous pumping rate of 500 gallons per minute (See Section 3.3.2) as the annual volume (V_a). Therefore, the number of total ERUs that can be supported based on MDD and the allowed instantaneous pumping rate calculates to 1,143 ERUs.

3.4.3 Source Capacity Based on Maximum Day Demand

The Design Manual Section 4.4.2.7 outlines the evaluation procedure to the number of ERUs that can be supported based upon source capacity and MDD. The Design Manual provides Equation 4-3 for the evaluation.

Equation 4-3:

$$N = \frac{V_t}{ERU_{MDD}} = \frac{\sum(Q_i)(t_i)}{ERU_{MDD}}$$

$$N = \frac{360 \text{ gpm} \cdot 1,200 \text{ minutes/day}}{630 \text{ gpd/ERU}} = 686 \text{ ERUs}$$

Where:

N = ERUs Supported

Q_i = Delivery rate of source (gallons per minute)

t_i = Time that the source (Q_i) delivers flow in a 24-hour period (minutes)

ERU_{MDD} = MDD value per ERU (Section 2.1.5)

Section 3.10.4 of the Design Manual recommends against designs based on pumping 24-hours per day to meet future MDD. An assumed 20 hours per day of pumping provides a factor of safety and an increased ability to meet unexpected demands. Therefore, the number of ERUs that can be supported by the system's sources is 686 ERUs.

3.4.4 System Capacity Based on Treatment

Equation 4-3 from the WSDOH Design Manual was used to evaluate the allowable ERUs associated with the treatment capacity and MDD.

Equation 4-3:

$$N = \frac{\sum(Q_i)(t_i)}{ERU_{MDD}}$$

$$N = \frac{(380 \text{ gpm})[(24\text{hrs})(60\text{min/hr})]}{630 \text{ gpd/ERU}} = 869 \text{ ERUs}$$

Where:

N = ERUs Supported

Q_i = Delivery rate of source (gallons per minute)

t_i = Time that the source (Q_i) delivers flow in a 24-hour period (minutes)

ERU_{MDD} = MDD value per ERU (Section 2.1.5)

The delivery rate of Well 1 (180-gpm) does not require treatment and will bypass the filtration system. The treatment system for Well 2 has a capacity of 200-gpm which allows for some increase in production from Well 2. The full delivery rate from the treated sources is the sum of Well 1 and the Mn treatment facility (200-gpm) 380-gpm thus supporting 869 ERUs.

3.4.5 System Capacity Based on Booster Pump Capacity

Booster pumps are needed to meet the system’s peak hour demand and a combination of fire flow and maximum day demand (MDD) in the distribution systems. Equation 3-1 may be used to determine the number of ERUs available based on booster pump capacity.

With one of the four booster pumps out of service, the pumps can provide fire flow and MDD at 45-psi (104-foot TDH) at a rate of 358-gpm per pump (See Table 3-9). The combined capacity of the remaining three (3) pumps is 1,074-gpm. With a fire flow demand of 500-gpm, the remaining 574-gpm of pumping rate is available to meet MDD.

Equation 3-1:

$$N = \frac{\left[\frac{1440(Q_B - 18)}{MDD - F} \right]}{C}$$

$$N = \frac{\left[\frac{1440(574 - 18)}{630 - 225} \right]}{1.6} = 654 \text{ ERUs}$$

Where:

- N = Number of ERUs
- Q_B = Booster Pump Capacity, (gallons/minute)
- MDD = Maximum Daily Demand per ERU (gpd/ERU)
- F = PHD Coefficient from Table 2-4
- C = PHD Coefficient from Table 2-4

With a system MDD of 630 gpd/ERU the three (3) operating pumps are able to support 654 ERUs. A full set of capacity calculations are included in Appendix P.

3.4.5.1 Pressure Tanks

The proposed improvements will have three (3) vertically oriented hydropneumatic tanks, each with a minimum volume of 370-gallons. The tanks provide the necessary pump protection for the proposed booster pumps. Equation 9-1 from the DOH Design Manual was used to determine the minimum pressure tank volume needed for the system.

Design Manual Equation 9-1:

$$T \geq \frac{(R)(Q_p)}{(N_c)(V_B)}$$

Where:

- R = $\frac{15(P_1 + 14.7)(P_2 + 14.7)}{(P_1 - P_2)/(P_2 + 9.7)}$
- T = Total number of pressure tanks (gallons)
- P₁ = Pump-Off pressure for water system operation (psi)
- P₂ = Pump-On pressure for water system operation (psi)
- N_c = Number of pump operating cycles per hour (6 cycles per alternating pump)
- Q_p = Pump delivery capacity at the midpoint of the selected pressure range (gpm)

The lead pump for the system has on/off pressure settings of 55-psi and 65-psi. Q_p was found to be 255-gpm at 60-psi. The number of pump cycles per hour, NC, was assumed to be 24 total cycles per hour, or 6 cycles per hour per alternating pump. Using 370-gallon Amtrol WX-455C bladder tanks, the minimum number of bladder tanks is three. The pressure tanks should have a minimum acceptance volume of 240 gallons which would equate to minimum pump run time of 1 minute. This meets minimum run time recommendations from the pump manufacturer. Data regarding the proposed pressure tanks are included in Appendix O.

3.4.6 System Capacity Based on Existing Storage Volumes

Water storage is necessary for multiple reasons. These reasons include an adequate storage volume to meet the daily fluctuations in demand, a sufficient volume to allow adequate runtime for pumps and the treatment system(s), an emergency reserve in case the supply system should fail, and to provide a large volume water for potential firefighting needs.

The capacity for the distribution system was analyzed to determine the necessary storage volumes associated with the reservoir. A complete set of calculations are included in Appendix P. The following storage components were analyzed and reported:

- Operational Storage (OS) – Section 3.4.6.1
- Equalizing Storage (ES) – Section 3.4.6.2
- Standby Storage (SBS) – Section 3.4.6.4
- Fire Suppression Storage (FSS) – Section 3.4.6.5
- Dead Storage (DS) – Section 3.4.6.3

Each component of storage for the system is discussed in the following subsections.

3.4.6.1 Operational Storage

Operational storage (OS) is the volume of the reservoir devoted to supplying the water system while under normal operating conditions. OS is the height difference between where the well pumps are turned on and off. OS levels should be set in order to prevent the excess cycling of well pumps. The lead well pump turns on at a height of 30.75-feet and turns off at 32.25-feet, providing 1.5-feet of OS.

$$OS = 1.5 \text{ foot} \cdot (5,287) \frac{\text{gallons}}{\text{foot}} = 7,931 \text{ gallons}$$

The total OS of 7,931-gallons provides a minimum run time of 40-minutes for the wells and treatment system.

3.4.6.2 Equalizing Storage

Equalizing Storage (ES) is defined as the volume of storage needed to supplement the sources when the peak hourly demand exceeds the total source pumping capacity. Since the PHD exceeds the combined well pumping capacity for the system ES is required to meet the peak demand period for the water system. ES is calculated from Equation 7-1 of the Design Manual:

$$ES \text{ (gallons)} = (\text{PHD}-Q_s) \times 150 \text{ minutes}$$

$$ES \text{ (gallons)} = (475-360) \times 150 \text{ minutes} = 17,226 \text{ gallons}$$

Where:

PHD = peak hour demand (Section 2.1.6 above);
 Qs = well pump capacity,

The required equalizing storage for the Estates water system is 17,226-gallons.

3.4.6.3 Dead Storage

Dead storage (DS) is the portion of the reservoir that is not usable for storage. Dead storage includes the volume at the top that is needed for installation of the overflow pipe and the offset at the bottom of the tank that is used for silt accumulation. Approximately 9-inches is provided at the top of the reservoir for the overflow pipe (freeboard) and an additional 6-inches at the bottom of the tank for a silt stop. The total DS of 1.25-feet is provided in the reservoir for a total of 6,608-gallons. See the “Storage Capacity Calculations” provided in Appendix P.

3.4.6.4 Standby Storage

Standby Storage (SB) volume is intended to provide continued water supply during abnormal operating conditions, such as structural, electrical, mechanical, or treatment process failures; or source contamination (WAC 246-290-420). As noted in the Design Manual, the degree to which SB is incorporated into reservoir design “is a direct reflection of the consumers’ expectations of water service during abnormal operating conditions” (Design Manual Section 7.1.1.3).

The Design Manual recommends SB volume to be greater than MDD in most systems. However, for water systems with multiple sources, such as Estates, SB may be reduced if a source is considered to be continuously available and provides redundancy and resilience for the water system. To satisfy the requirements of WAC 246-290-420 the DOH recommends a minimum SB of 200 gallons per day per ERU (Design Manual Section 4.4.3.2). Therefore, the minimum SB volume for Estates is calculated as shown:

$$SB_{min} = (SB_i)(N)(t_d) = (200)(512)(1) = 102,400 \text{ gallons}$$

Where:

SB_{min} = minimum recommended standby storage (gallons);

SB_i = Selected volume of standby storage per consumer expectations (gpd/ERU);

N = Number of system ERUs;

t_d = Number of days selected to meet consumer expectations (days),

The minimum standby storage volume for the system to be able to support 512 ERUs at the end of the 20-year planning period would be 102,400 gallons. For 512 ERUs the storage reservoir would exceed this recommendation with 142,715 gallons available. Equation 4-7 of the Design Manual is provided to calculate ERUs based on SB.

Design Manual Equation 4-7:

$$N = \frac{SB}{(SB_i)(t_d)} = \frac{142,715 \text{ gal}}{(200 \text{ gpd/ERU})(1 \text{ day})} = 713 \text{ ERUs}$$

Where:

N = Number of system ERUs based on ERU_{MDD} value;

SB = Total volume of available standby storage (gallons);

SB_i = Selected volume of standby storage per consumer expectations (gpd/ERU);

t_d = Number of days selected to meet consumer expectations (days),

The minimum recommended volumes are appropriate for Estates since it has redundant sources that have backup power supply. Both available sources meet the DOH definition for continuously available sources per Section 7.1.3 of the Design Manual. The available SB of 142,715 for the system can support 713 ERUs.

3.4.6.5 Fire Suppression Storage

Fire Suppression Storage (FSS) level depends on the maximum flow rate and duration which is set by the local fire protection authority who determines a fire flow requirement for water systems. Fire flow requirements for residential communities in Clallam County are 500 gpm for 45 minutes, or 22,500 gallons of storage. Per WAC 246-290-235(4) systems may consolidate or nest SB and FSS volumes with the larger of the two volumes being the minimum available. The available SB volume exceeds the required FSS of 22,500 gallons so the reservoirs provide adequate FSS. The provided storage volumes are summarized in Table 3-11 below.

$$FSS = 500 \text{ gpm} \cdot 45 \text{ minutes} = 22,500 \text{ gallons}$$

3.4.6.6 Storage Summary

The provided storage volumes, assuming the projected number of ERUs at the end of the 20-year planning period (512 ERUs), are summarized in Table 3-11.

Table 3-11 Storage Components

| Component | Volume (gallons) | Height (feet) |
|-----------------------------------|------------------|---------------|
| Top Dead Storage | 3,965 | 0.75 |
| Operational Storage | 7,931 | 1.5 |
| Equalizing Storage | 17,226 | 3.3 |
| Standby Storage | 142,715 | 27.0 |
| Fire Suppression (nested with SB) | (22,500) | (4.25) |
| Bottom Dead Storage | 2,644 | 0.5 |
| Total | 174,481 | 33.0 |

3.4.6.7 Water Age and Turnover

Water age may sometimes become a problem in storage reservoirs, especially when the system is not at its maximum design capacity. The average age of water in the reservoir is calculated based upon annual average day demand of 220 gpd/ERU and the current number of ERUs on the distribution system. The storage volume used is the total volume of the reservoir minus the top dead storage and the operational storage.

$$Water \text{ Age} = \frac{Storage \text{ Volume}}{ADD_{min} \cdot ERU} = \frac{162,585 \text{ gallons}}{220 \text{ gpm/ERU} \cdot 420 \text{ ERU}} = 1.76 \text{ days}$$

It is recommended that the complete turnover of water should occur at least every three to five days. Currently, the water age for the system is 1.68 days, which is below the minimum three-day recommendation.

3.4.7 Summary of System Capacities

An analysis of the system components, water rights and well capacities was performed to determine which factor provided the system’s connection limit. The calculations for this are summarized in Table 3-12:

Table 3-12 Connection Limiting Factors

| Components | Limiting Factor | Potential Connections |
|-------------------------------------|-----------------|-----------------------|
| Annual Water Right (V_a) | V_a & ADD | 974 |
| Instantaneous Water Right (Q_i) | Q_i & MDD | 1,143 |
| Instantaneous Source Production | Q_s & MDD | 686 |
| Booster Pump Capacity | Q_b & MDD | 654 |
| Treatment System | Q_T & MDD | 869 |
| System Storage (SB Volume) | SB Volume | 713 |

The water system was analyzed to estimate the maximum number of ERUs that can be supported by each relevant system component, and to determine which components limit the system’s capacity. The current limiting factor for the system is the booster pump capacity and MDD volume at 654 ERUs. It is anticipated that this ERU capacity will surpass the 20-year planning period for Estates.

3.5 Selection and Justification of Improvement Projects

System needs discussed in this chapter were selected and prioritized based on the categories shown in Table 3-13:

Table 3-13 Potential Improvements Prioritization Categories

| Category | Description | Time Frame |
|------------------|--|--------------------------|
| Emergency | Improvement needed to eliminate a health risk or serious physical risk to the system | Now |
| Immediate | Improvement that should be investigated, initiated, and/or completed as soon as possible to minimize potential risk or to get process started for future needs | Within 1 year |
| Near Term | Improvement that improves capacity, flow, or redundancy | 1 to 2 years |
| Medium Range | Improvement that is not necessary near term but will improve system enough that it should not be long term | 2 to 6 years |
| Long Range | Improvement that is needed in the future | 6+ years |
| Budget Providing | Non-critical improvement that can occur anytime budget providing | Anytime budget providing |

The time frames shown in Table 3-13 are for guidance purposes and are subject to change based on such factors as regulations, emerging system concerns, and available financing from Cascadia Water.

Based on the analysis of each system and their existing components included in this chapter, potential system improvements were prioritized based on the categories in Table 3-13 and are summarized in Table 3-14.

3.5.1 Source Needs

The system currently has sufficient sources and source production to meet the measured and projected demands of the consumers through the 20-year planning period. However, at the end of the 20-year period both groundwater sources will be approximately 60 years old and planning for replacement of the sources will likely be necessary at that time.

The system and its operator should incorporate annual monitoring of the system sources into their standard operations and maintenance. Annually the static water level, pump rates, and corresponding drawdown should be measured and evaluated to assist in assessing the health of the aquifer and well.

Well pumps will likely need to be in the long-range planning for the system. Replacement well pumps should be selected to provide a production rate of 200-gpm at the required total dynamic head to pass-through treatment and into the top of the reservoir.

3.5.2 Treatment Needs

As part of the 2023 system improvements project (DOH Project #22-0805), the system is installing a manganese oxidation and filtration system. This system will treat elevated levels of manganese in Well 2 with a treatment capacity of 200-gpm. This treatment system has the capacity to meet the projected demands of the system through the 20-year planning period.

3.5.3 Storage Needs

As part of the 2023 system improvements project (DOH Project #22-0805), the system is installing a 174,500-gallon reinforced concrete reservoir. It is anticipated that the concrete reservoir will have a useful lifespan of approximately 75-years. The reservoir has been designed to provide sufficient storage to supply the physical and legal capacity of the water system. No additional storage needs are anticipated for the system through the 20-year planning period.

3.5.4 Booster Pump Needs

As part of the 2023 system improvements project (DOH Project #22-0805), the system is installing a four (4) booster pumps pressurization system to supply the full distribution system. The booster pump configuration is detailed in Section 3.3.6. There are not any additional booster pump needs anticipated for the system through the 20-year planning period outside of standard operations and maintenance for the new system.

3.5.5 Distribution Needs

The Estates distribution system requires a variety of upgrades to ensure that adequate service levels are maintained for customers, particularly with regards to fire flow capacity. The northern and northwestern portions of the distribution system are served by 4-inch water mains which do not have sufficient capacity to meet MDD and fire flow demand if/when fire hydrants are installed. Future water main replacements should incorporate a minimum size of 8-inches and prioritize loops in the system. The following projects should be planned for within the next 20 years.

- Providing a loop in the system from the east end of Buckhorn Road within the utility/access easement associated with Nisbet Road. This will provide a valuable loop to Lotzgesell Road in the immediate to near term for the system.
- Replacement of the 4-inch water main along Ridge View Drive from Secluded Way to approximately 300-feet west of Percy Lane. This portion of water main, totaling approximately 1,700-feet, should be replaced with 8-inch water mains.
- When the 4-inch water main along Ridge View Drive is replaced, the water mains associated with Lone Eagle Lane to Secluded Way should be connected to provide additional reliability to the system.
- Connecting the watermain at the intersection of Dungeness Greens Way and Hogback Road to the east end of Lotzgesell Road. This connection should be an 8-inch diameter main totaling approximately 2,000-feet. This project will provide a valuable loop to the system using the newest portion of the distribution system along Dungeness Greens Way.
- Replacement of the 4-inch water main along Lotzgesell Road, totaling approximately 3,400-feet of pipe. This portion of the distribution system should be increased to 8-inch diameter water mains to enable fire flow capacity to the northern portion of the system including Five Acre School and the Dungeness Recreation Area.
- Replacement of the 4-inch water mains along Greywolf Road, Maynard Road, Tyler View Place, and the associated connecting lines with new 8-inch water mains. This project would replace approximately 6,200-feet of distribution main and enable fire flow capacity to the northwest portion of the service area.

Table 3-14 and Chapter 8 provide additional details regarding the budgeting and anticipated timeline for the water main replacement projects.

3.5.6 Control and Telemetry Needs

As part of the improvements currently under construction at Estates, the new controls will integrate a supervisory control and data acquisition (SCADA) system that can be monitored from a central location. The SCADA system allows the operators to more efficiently monitor the many systems located throughout Clallam and the neighboring counties. The SCADA system provides the functionality to monitor and adjust well pump run status, booster pump run status, system pressures, treatment system status, reservoir elevation, source production values, and alarm status.

Cascadia Water is planning to provide security improvements to their individual systems. The security improvements include site fencing around pumphouses and reservoirs, intrusion alarms on storage tanks, reservoir hatches, and pumphouse doors.

3.5.7 Non-Facility Needs

Cascadia is in the process of installing remote read meters to replace/upgrade existing meters. The remote read meters would reduce labor costs associated with meter reading and would have the capability to alert customers of potential leaks on their property. Meter replacement projects will be prioritized based on the age of existing meters, systems with higher distribution system leakage, ease of installation and potential labor savings. Source meters will also be routinely replaced scheduled to ensure accuracy of well production data.

Table 3-14 Prioritized Potential System Improvements Needs

| # | Prioritization | Component | Component Description | Cost |
|---|-----------------------|--------------|--|--------------------------|
| 1 | Immediate (2023/2024) | Non-Facility | Water meters throughout the system will be replaced with remote read meters. | \$250,000 \$700/meter |
| 2 | Near Term (2024/2025) | Distribution | Connect/Loop the water mains associated with Lone Eagle Lane and Secluded Way to provide additional reliability to the system. | \$50,000 |
| 3 | Near Term (2025) | Distribution | Nisbet Road – Loop the distribution system from the western most portion of Buckhorn Road up to Five Acre School on Lotzgesell Road. This section of main will be installed in an easement along Nisbet Road totalling approximately 1,400-feet. | \$280,000 |
| 4 | Near Term (2025/2026) | Distribution | Connecting the watermain at the intersection of Dungeness Greens Way and Hogback Road to the east end of Lotzgesell Road. This connection should be an 8-inch diameter main totaling approximately 2,000-feet. This project will provide a valuable loop to the system using the newest portion of the distribution system along Dungeness Greens Way. | \$400,000 |
| 5 | Near Term (2025/2026) | Distribution | Replacement of the 4-inch water main along Lotzgesell Road, totaling approximately 3,400-feet of pipe. This portion of the distribution system should be increased to 8-inch diameter water mains to enable fire flow capacity to the northing portion of the system including Five Acre School and the Dungeness Recreation Area. | \$680,000 |
| 6 | Near Term (2025/2026) | Distribution | Replacement of the 4-inch water mains along Greywolf Road, Maynard Road, Tyler View Place, and the associated connecting lines with new 8-inch water mains. This project would replace approximately 6,200-feet of distribution main and enable fire flow capacity to the northwest portion of the service area. | \$1,250,000 |
| 7 | Medium Term (2030) | Distribution | Replacement of the 4-inch water main along Ridge View Drive from Secluded Way to approximately 300-feet west of Percy Lane. This portion of water main, totaling approximately 1,700-feet, should be replaced with 8-inch water mains. | \$400,000 |

4 WATER USE EFFICIENCY PROGRAM AND WATER RESOURCE ANALYSIS

4.1 Water Use Efficiency Program

Western Washington even with abundant precipitation does not have an unlimited supply of fresh potable water as highlighted by recent decisions by the Department of Ecology to close basins in Skagit and Whatcom counties from allowing new exempt wells and stopping the issuance of new water rights. The Estates water system is located in Clallam County which experiences approximately 60-inches of rain per year, although actual precipitation for specific areas can vary depending on the location within the county.

These events highlighted the need to establish measures for both short term emergency and long term systematic per capita water use reduction. Cascadia has consistently encouraged water conservation through a variety of methods and plans. These follow state legislated guidelines to do as much as possible to encourage more conservation.

A general mandate has been made by RCW 90.03.005, RCW 90.03.400, RCW 90.54.020 and RCW 90.54.180 for water use efficiencies in Washington State water systems. RCW 43.20.230 makes a specific directive to DOH to incorporate procedures and guidelines relating to the conservation of water during the approval procedures of system plans.

Cascadia recognizes that water is a valuable and essential natural resource that needs to be managed wisely. The main objectives of this water conservation program are:

Increase awareness among water users of the importance of conserving water and of the methods available to achieve reductions in their water use. Replacement of water meters to accurately measure distribution system water loss. The most recent available WUE reports for the System report a 3-year annual average DSL of 9.1%.

4.1.1 Water Loss Control Action Plan

Cascadia is required to establish a water use reduction goal as part of its Water Loss Control Action Plan to address distribution system losses. The action plan to be implemented contains various aspects with the intent of obtaining accurate data, identifying real losses, and improving system efficiency. The water systems will implement several water use efficiency measures which are covered in the WLCAP included in Appendix J.

4.1.1.1 Goals

As part of this Water System Plan, Estates has set a Water Use Efficiency (WUE) goal as part of their conservation program. The purpose of their conservation program is to further reduce distribution system leakage and the reduction of the growth adjusted maximum day demand.

The second goal is to reduce the growth adjusted maximum day demand by a minimum of 1.5% within ten years. Cascadia plans to accomplish this goal by reducing DSL as part of their first goal and as they further educate customers regarding the resource and methods for conservation.

4.2 Source of Supply Analysis

The Department of Ecology requires water systems to demonstrate serious consideration of all options prior to issuing new or expanded water rights. The purpose of a source of supply analysis is to evaluate

opportunities to obtain or optimize the use of existing sources already developed and evaluate other innovative methods to meet water needs.

A source of supply analysis is required of any system that will be pursuing water rights within 20 years of approval of their WSP as defined by the water demand forecast. The Estates water systems have adequate water rights currently and are not projected to require additional rights within the 20-year planning period. Systems that are not pursuing additional water rights are also encouraged to conduct a source of supply analysis; however, it is not required. A copy of the system's Water Right Self-Assessment is included in Appendix F.

4.2.1 Enhanced Conservation Measures

As discussed in Section 4.1, Estates will implement water use efficiency measures with the goal of reducing MDD and DSL system wide.

4.2.2 Water Rights Changes

As further discussed in Section 4.3, Estates is not projected to pursue additional water rights within the six-year planning period. Therefore, no changes in water rights are foreseen.

4.2.3 Interties

The system has no current interties. Interties may be a cost-effective way of providing system redundancy in the event of a line break or source production issues. In the past, Estates has considered an intertie with the Dungeness Golf Court & Mountain Vista (Water System ID: 20453). The system will continue to evaluate a potential emergency intertie project that would provide an alternative water supply. An intertie with another water purveyor would only be considered if:

- The water quality meets State/Federal water quality standards, and
- The water chemistry is compatible with the existing water quality of the system, and
- The hydraulic grade is consistent with the system's pressures or can feasibly/economically be boosted as necessary, and
- The system has adequate capacity to support the intertie, and
- Both systems are able to maintain compliance with their water rights.

4.3 Water Right Evaluation

The following sections summarize the Estates water right evaluation.

4.3.1 Existing Water Rights

Ground Water Certificate G2-27484 C (Priority Date February 14, 1989) to Estates Water Systems, Inc. This water right authorizes an instantaneous withdrawal of 500-gpm and a maximum annual withdrawal of 240 acre-feet for the Water System. A copy of the water right is provided in Appendix E.

4.3.2 Water Right Self-Assessment

The "Water Rights Self-Assessment Form for Water System Plan" provided by the DOH has been completed for the System is included in Appendix F

5 SOURCE WATER PROTECTION

5.1 Introduction

Protection of the source of the water supply is of utmost concern for public water systems. Groundwater supplies can be susceptible to contamination from surface sources such as underground storage tanks (UST), pesticides, industrial and commercial activity, accidental spills, and nitrates from septic systems or leaky sewer pipes. To protect these groundwater resources, The Safe Drinking Water Act requires all states to develop a wellhead protection program (WPP) for all Group A public water systems.

The purpose of this source protection program is to provide the System with a proactive program for preventing groundwater contamination. Source protection programs in Washington must include:

- A delineated Sanitary Control Area (SCA) around each source.
- An inventory of potential contamination sources in the wellhead protection area that could threaten the aquifer used by the well.
- Documentation showing the water system sent delineation and inventory findings to the required entities.
- Contingency plans for providing alternate drinking water sources if contamination does occur.
- Coordination with local emergency responders for appropriate spill or incident response measures.

5.1.1 Wellhead PFAS Sampling

The DOH requires all Group-A water systems to complete PFAS sampling by December of 2025. The Water System is scheduled to perform PFAS sampling in 2024. The two groundwater sources are completed in relatively deep aquifers, and typically protected by glacial till or clay confining layers. These confining layers slow the transport of potential contaminants and allow for their natural degradation.

5.2 Wellhead Protection Program

Estates will implement a WPP which will incorporate the following:

- Periodic monitoring of the existing wells for any sudden change in water quality.
- Sending informational flyers out to water customers outlining proper storage and use of common household chemicals, yard and lawn fertilizers, pesticides, and herbicides.
- Posting signs identifying the system source pollution control zones.
- Providing letters to property owners within the capture zones regarding the presence of the system source wells

The System sources are groundwater wells. The wells' physical parameters are discussed in Section 3.3.3. The Estates WHPP is attached in Appendix I.

6 OPERATION AND MAINTENANCE PROGRAM

The Estates Operation and Maintenance Program Manual (O&M Manual) is intended to be used as a standalone document. A copy of the O&M Manuals shall be maintained on site at the system as well as Cascadia offices. The O&M Manual includes pertinent contact information, worksheets, and operational procedures. The O&M Manual also includes the Water Shortage Plan, Emergency Response Plan, and the Cross-Connection Control Plan.

6.1.1 ATEC Manganese Filtration System

As part of the current improvements to Estates, a new oxidation and filtration system is being installed by ATEC Systems to remove iron and manganese. The Operations & Maintenance Manual for the ATEC treatment equipment will be kept on file at the pumphouse. The ATEC O&M Manual is a stand-alone document which is included in this WSP by reference. The manual outlines system characteristics, standard operating procedures, and troubleshooting of various issues. Various tasks from the manual are included in Table 6-2.

6.2 Water System Management and Personnel

Cascadia Water hires knowledgeable and certified staff to operate and maintain their owned systems. Cascadia Water is a wholly owned subsidiary of NW Natural Water Company, LLC. Cascadia staff consists of a qualified system manager, certified operators, and maintenance staff. These staff are responsible for the day-to-day operation and maintenance of Cascadia's water systems.

6.3 Operator Certification

The duties of certified waterworks operators are defined in WAC 246-292. Table 6-1 lists the titles and certifications for positions in Cascadia's staff that maintain Estates. Staff should continually maintain certifications through continuing education as required by each certification.

Table 6-1 Water System Staff Certifications

| Operator | Position | Certifications |
|---------------|-----------------|-------------------------|
| Culley Lehman | General Manager | WDM 2 |
| Adam Lehman | System Operator | CCS, WDM 3, WDS, WTPO 1 |
| Dale Metzger | System Operator | WDM 2 |

6.4 Routine Operating Procedures and Preventative Maintenance

Periodic maintenance of all components of the Water System is necessary to ensure continuous, uninterrupted service. General maintenance of many items may include checking set-points, security items, and screens, painting exposed surfaces, lubricating moving parts, cleaning, rebuilding, and assessing overall operation for major repairs or replacement. Such maintenance should at minimum include the tasks outlined in Table 6-2.

Table 6-2 Drinking Water Operations & Maintenance (O&M) Schedule

| Daily |
|--|
| Pump Houses |
| ▪ Record production and source meter readings (actual and digital) |
| ▪ Record pump hours, calculate daily run times for booster and well pumps |
| ▪ Check chlorine (NaOCl) drums levels. Rebatch as needed |
| ▪ Chlorine Residuals (total and free) from 2 different locations in the system, record, and make Cl ₂ adjustments as needed |
| ▪ Visual premises check – correct or report any problems |
| ▪ Hydropneumatic Tanks: Monitor Pressure fluctuation during a cycle (cut-in cut-out pressures) and number of cycles per hour |
| ▪ Hydropneumatic Tanks: Monitor air to water ratio |
| Reservoirs |
| ▪ Record reservoir levels |
| ▪ Pressure checks (incoming system, outgoing system, pressure tanks) |
| ▪ Verify reservoir level(s) on tank match level at pump house |
| ▪ Visual premises check – correct or report any problems |
| Treatment & System Controls |
| ▪ Iron and Manganese Filter System: Monitor Pressure drop across the system with gauges upstream and downstream of the contact tank and at the system discharge. Backwash as necessary if pressure drop is outside recommended range |
| ▪ ATEC filter system: Check the HMI screen to monitor treatment systems and chlorination residuals leaving ATEC filter system. |
| ▪ Visual premises check – correct or report any problems |
| Weekly |
| Pump Houses |
| ▪ Operate all pumps manually |
| ▪ Pump facilities should be visually checked at least weekly. |
| ▪ Visual inspection of well heads – correct or report problems |
| ▪ Generator – check fuel levels (fill as needed) |
| ▪ Generator – check and record hours |
| ▪ Generator – verify auto test is operating properly |
| Reservoirs |
| ▪ Perimeter check – correct or report problems |

| Monthly |
|--|
| General System O&M |
| <ul style="list-style-type: none"> ▪ Well water level and chloride measurement for each source ▪ Bacteria Testing: 1 sample required per month. See Coliform Monitoring Plan ▪ Chlorination Report (due to WSDOH the 10th of each month) ▪ Static and pumping level measurements ▪ Flow/production calculations ▪ Temperature and pH samples from individual wells and reservoir ▪ Hydropneumatic Tanks: Check water or air leakage of tanks associated pipes and fittings |
| Every Two Months |
| <ul style="list-style-type: none"> ▪ Shut off/on services with delinquent & unresolved bills |
| Quarterly |
| Pump Houses |
| <ul style="list-style-type: none"> ▪ Lab testing for monitoring Manganese ▪ All Valves: Open and close the valves to make sure they are not seized. ▪ Booster Pumps: Check the integrity of the pump's foundation and check the hold down bolts for tightness. ▪ Booster Pumps: Conduct a motor inspection: Clean? Grease free of dirt? Blockage? Ohmmeter periodically to see if winding insulation is OK. ▪ Hydropneumatic Tanks: Check compressor intake air filters ▪ Hydropneumatic Tanks: Monitor the condition of the tank support and ensure tanks are firmly mounted to the floor. |
| Bi-Annually |
| General System O&M |
| <ul style="list-style-type: none"> ▪ Water main flushing (see Flushing Plan) ▪ Source meter testing, maintenance, and calibration ▪ Water Use Efficiency – review production and consumption data to identify presence of any leaks ▪ Hydropneumatic Tanks: Tanks should be checked to ensure the pre-charge pressure is properly maintained. ▪ By January 31st and April 30th of each year: submit the year's chloride and conductivity chemical analysis results to DOE [per Water Right Provisions] ▪ By January 31st and April 30th of each year: submit the year's depth to static water level measurements to DOE [per Water Right Provisions] |
| Annually |
| General System O&M |
| <ul style="list-style-type: none"> ▪ Cross-connection control – Verify high/medium risk customers have submitted test reports for backflow devices |

| |
|---|
| ▪ Hydropneumatic Tanks: Check whether there is sediment in the tanks |
| ▪ Water Use Efficiency (due July 1) |
| ▪ Consumer Confidence Report (due July 1) |
| ▪ Operator Continuing Education |
| ▪ All electrical contacts in the pump control systems should be tightened once a year. |
| ▪ Blow-off inspection and exercising |
| ▪ Fire hydrant inspection and exercising (performed by Fire Department) |
| ▪ Backflow prevention device inspection |
| ▪ Line valve inspection and exercising |
| ▪ Chlorine Contact Tank: Backwash and Rinse Chlorine Contact Tank |
| ▪ Iron and Manganese Filters: Backwash and Rinse Filter |
| Every 3 Years |
| ▪ Reservoir inspection and cleaning by underwater divers |
| ▪ Air valve inspections (air release, air/vacuum, and combination air valves) |
| ▪ Large customer meter testing and replacement |
| As Needed |
| ▪ Water Quality Monitoring as required by WSDOH |
| ▪ Cross-Connection Control (CCC) – Identify new risk customers; require CCC installation of devices according to CCC plan |
| ▪ Meter Reads |
| ▪ Meter Installation / Testing / replacement (as needed) |
| ▪ Meter box maintenance |
| ▪ Leak checks/detection. Maintain record of leaks |
| ▪ System leak repair / pair / service line replacement |
| ▪ Repair supply ordering |
| ▪ Fire hydrant maintenance |
| ▪ As-Built records should be kept on each water line in the system |
| ▪ Pumps and motors should be inspected and maintained in accordance with the manufacturer's recommendations |
| ▪ Lawn maintenance and weed trimming of facilities, near hydrants, etc. |
| ▪ Respond / troubleshoot customer complaints |
| Treatment & System Controls |
| ▪ Chlorine injection pumps: Need to be manually adjusted and consistent with the flow rate setpoint established for raw water pumps system. |

| As Triggered |
|--|
| <ul style="list-style-type: none"> ▪ Emergency Shutdown <u>Trigger:</u> Emergency conditions (fire, leak, etc.) <u>Action:</u> Activate local emergency shutdown buttons. Notify the owner/general manager. |
| <ul style="list-style-type: none"> ▪ Respond to fault conditions and shutdown notifications. <u>Trigger:</u> PLC sends text message and email notifications for fault conditions and shutdowns <u>Action:</u> Respond to notification by investigating conditions at the Water System |
| <ul style="list-style-type: none"> ▪ Replace Hydropneumatic Tank butyl rubber bladder. <u>Trigger:</u> Bladder failure, such as due to abnormal pressure drop <u>Action:</u> Investigate issue and potentially replace butyl rubber bladder |

If the Water System has received approval of a comprehensive plan or abbreviated water system plan by the DOH and has submitted and received approval of standard construction specifications, then detailed plans and specifications for distribution mains need not be submitted individually for approval. If such approval is obtained, only alterations to the plan need be submitted to the DOH.

The DOH also requires bacteriological samples to be taken and that chemical analyses of Estates' supply sources be made often enough to assure compliance. Water quality requirements are listed in detail in Section 3.2. It's good practice to have paper cards on file or an electronic database with information that includes the type of meter and its serial number, date of installation, and maintenance performed. In addition, operators have found that a service record for each resident is valuable for maintaining a complete system record. This record can be valuable when attempting to repair or locate service lines or when attempting to see if breakage or leaks follow a pattern.

6.5 Water Quality Sampling Procedures & Program

The Water Quality Monitoring requirements are set forth in WAC 246-290-300 and were discussed in Chapter 3 of this plan. The regulations cover sampling frequencies for bacteriological, inorganic chemical and organic chemical samples as well as radionuclides, volatile organic compounds (VOC), and secondary chemical and physical contaminants.

Samples must be analyzed in laboratories approved by the DOH. A minimum of one bacteriological sample per month is required. For the groundwater well field, one inorganic chemical sample is required every three years. Currently, Estates has an established waiver for IOC samples to be taken every nine years. Organic and VOC samples are necessary only when required by the DOH. The Water System organic sampling has an established waiver for every three and six years, while VOC testing has a waiver for every six years. Radionuclides must be sampled during four consecutive quarters, once every six years. Sampling for secondary chemical and physical contaminants must occur once every three years. Table 3-1 provides a description of required samples and frequency.

The MCL's for the various substances are listed in Section 3.2. If these levels are exceeded at any time, the procedures in Section 6.5.1 must be followed. (These procedures are described in more detail in the State Board of Health Drinking Water Regulations).

6.5.1 Bacteriological Detection Procedures

Coliform treatment Level 1 technique is triggered when the Water System has two or more total coliform-positive samples in the same month. The Level 1 technique is also triggered if the Water System fails to take every required repeat sample after any single total coliform-positive routine sample. The

notifications required by the Water System vary depending on the type of violation that occurs. Table 6-3 outlines the testing results, repeat sample results and the type of violation associated with each scenario:

Table 6-3 Coliform & E.coli Detection Response Procedures

| Routine Sample 1 | Routine Sample 2 | Repeat Samples ^A | Violation |
|--|--|--|---------------------------|
| Coliform Detected No E.coli/Fecal | No Detection | No Detections | No Violation |
| Coliform Detected No E.coli/Fecal | Coliform Detected No E.coli/Fecal | No Detections | Non-Acute Violation |
| Coliform Detected No E.coli/Fecal | No Detection | Coliform Detected | Non-Acute Violation |
| Coliform Detected No E.coli/Fecal | No Detection | Coliform Detected E.coli/Fecal Detected | Acute Violation |
| Coliform Detected E.coli/Fecal Detected | No Detection | No Detections | No Violation ^B |
| Coliform Detected E.coli/Fecal Detected | No Detection | Coliform or E.coli/ Fecal Detected | Acute Violation |
| Coliform Detected E.coli/Fecal Detected | Coliform Detected E.coli/Fecal Detected | No Detections | Non-Acute Violation |

A. Each detection will require 3 repeat samples taken as noted in the Water System’s Coliform Monitoring Plan

B. Although not considered a violation, The WSDOH should be contacted following routine results.

A non-acute violation requires public notification as soon as is practical but must be performed within 30 days. The WSDOH must be notified, and certification forms submitted within 10 days. For an acute violation, the public must be notified within 24 hours with a boil water advisory. The DOH must be notified, and certification forms submitted within 10 days.

6.5.2 Organic Compound Detection Procedures

The procedures to comply with the DOH requirements in the event of a MCL exceedance for an Inorganic Chemical (IOC), Volatile Organic Chemical (VOC), or Synthetic Organic Chemical (SOC) detection are outlined in the steps below.

1. The WSDOH must be notified, and the testing frequency is increased to a quarterly interval.
- 2.(A) If the running annual average is less than the MCL there isn’t considered to be a violation and the system should continue testing as instructed by the WSDOH.
- 2.(B) If the running annual average is greater than the MCL the violation must be reported to the WSDOH within 48-hours.
3. Following notification of the violation, the WSDOH determines if the violation poses an acute health risk.
- 4.(A) If the violation is determined to be an acute health risk by the WSDOH the Water System must notify the public within 24-hours with a Tier 1 Public Notice (Notice to the public via publication and TV).
- 4.(B) If the violation is determined not to be an acute health risk by the WSDOH the Water System must notify the public within 30-days with a Tier 2 Public Notice (Newspaper notice, or mailing).
5. Following the violation, the Water System will take actions as directed by the WSDOH.

Nitrates and Nitrites are subject to a separate process by the DOH as noted in Section 6.5.3. Currently the Water System has varied waivers for testing parameters as detailed in Table 3-1. The following steps should be taken in the event of an MCL exceedance for either IOC or VOC.

6.5.3 Organic Compound Detection Procedures

Nitrate and nitrite are classified as inorganic constituents but are subject to a separate process from other IOCs. The responses to an MCL violation are outlined in WAC 246-290-320 (3)(b). If the nitrate or nitrite MCL is exceeded, a confirmation sample is required. In the case of any nitrate/nitrite MCL exceedance the WSDOH should be notified of the violation. Compliance actions will then be based on the average of the routine and confirmation samples. Quarterly monitoring would be required if the average result is greater than 5.0 mg/L. The Water System will follow any subsequent actions in accordance with guidance from the WSDOH.

6.5.4 Radionuclide Detection Procedures

The Water System has a waiver to test for radionuclides every 6-years for the established well field (S03). Pursuant to 40 CFR 141.26, any MCL violation must be reported to the WSDOH. The Water System will provide public notice in accordance with the WSDOH standards and the WSDOH will be notified if there are any Radionuclide Detections over the MCL.

6.5.5 Pressure Loss in Distribution System

When disruptions to the distribution system occur which lead to pressure-loss, the following procedures will be followed:

- a. Investigation of the cause for pressure loss: The primary cause of pressure loss in the distribution system is due to breaks in water mains. Other potential causes include the failure of the distribution system pump or inadequate water levels at the reservoir.
- b. Repair the failed system: Once the cause of pressure loss is identified the system should be repaired to restore pressurization in the system.
- c. Identify Impacted Customers.
- d. Contact Impacted Customers: Service connections impacted by the pressure loss event will be notified.
- e. Contact the DOH: In the case of a significant loss of pressure to the distribution system, the DOH will be notified. Coordinating with the DOH, the Water System will determine the necessary advisories and testing procedures for the event.
- f. Collect Samples: After normal operating pressures have been restored the Water System will collect bacteriological samples to determine which maintenance procedures should be followed regarding flushing of the system, disinfection, and repeat sampling.
- g. Notify Customers: Once resolved, customers will be notified that drinking water is safe for use.

Cascadia Water operator will follow the protocols found in Table 6-4 in assessing proper procedures during water main break events.

Table 6-4 Water Main Break Response Procedures

| | i | ii | iii | iv |
|-------------------------------|--|---|---|--|
| Pressure During Break | Positive pressure maintained during break | Positive pressure maintained during break | Loss of pressure at break site or limited water system depressurization elsewhere | Loss of pressure at break site and depressurization elsewhere in the system |
| Pressure During Repair | Positive pressure maintained during repair | Positive pressure maintained at break site until pipe exposed & trench dewatered. Shutdown limited to immediate valved off area. No Loss of pressure elsewhere in system. | Loss of pressure at the while the pipe is buried or submerged / Or no pressure loss at break site, but pressure loss elsewhere in system. | Loss of pressure at break site while the pipe is still buried or submerged and/or widespread depressurization. |
| Contamination Risk | Unlikely | Limited Possibility | Significant Possibility | Likely or Certain |
| Boil Water Advisory | No | No | Yes | Yes |
| Coliform Sampling | No | No | Yes | Yes |

6.6 Coliform Monitoring Program

Group A public water systems are required to develop a written coliform monitoring plan and to collect samples according to that plan. The plan consists of a map of sampling locations and a description of sampling procedures. The DOH has put together two manuals; "Preparation of a Coliform Monitoring Plan" and "Coliform Monitoring." These manuals provide guidance for preparation of a coliform monitoring plan and the required frequency of sample collection. The samples must be received and analyzed by a laboratory within 30 hours from the time collected. When any sample results in a coliform presence, a "set" of repeat samples must be collected within 24 hours of notification. For the system that collects one routine sample per month, three repeat samples are required. The following procedure should be followed in collecting the three repeat samples:

- Collect the first "repeat" sample from the same location as the previous coliform presence sample was taken.
- Collect a second "repeat" sample at a site within five service connections in either direction down the distribution pipeline from the previously mentioned coliform presence location.
- Collect a third "repeat" sample from a site within five service connections down the distribution pipeline in the opposite direction (starting from the first repeat sample location).

6.7 Emergency Program

The ability of the Water System to sustain operations during emergency events and/or respond to emergency situations is important. The goal is to quickly react to emergency conditions, adjust the system to maintain safe and adequate service to the greatest extent feasible, and to return the system to entirely normal operations as rapidly as possible. Depending upon the nature and severity of an emergency event, certain components of the system are going to be more vulnerable and subject to failure than others. This

plan addresses the operation of Estates under such conditions. The Water System must also be prepared to notify the potentially affected public if an emergency arises. Depending upon the urgency, the affected public may be notified through any of one or a combination of methods such as the following:

- Posted notices at publicly visible locations.
- Public notices in newspapers circulating in the local vicinity.
- Announcements over local radio and television stations.
- Police loudspeaker - roaming system.
- Door-to-door delivery of announcements and personal contact.
- E-mail to community residents.

All announcements should inform the public what situation has occurred, what intermediate measures must be taken by them (i.e., conservation methods, where to go for water, or what to do with their water prior to consumption) and when they can expect to see the system return to normal operation.

If there is an outage over 24-hours in duration notify the Southwest Drinking Water Operations Office of the DOH. In case of emergency the DOH may order Estates to provide notification by newspaper and to radio and television stations where such notice is required to protect public health. The Water System shall keep detailed and complete records of all public notification occurrences to document compliance with this section.

Table 6-5 Emergency Contact List

| Emergency Contact | Contact Information |
|---|---|
| Culley Lehman, Manager Cascadia Water, LLC | Cell: 360-661-7781 |
| Buried Cable Locations | 1-800-424-5555 |
| Jeff Tasoff, PE | Office: 360-331-4131 ext. 203 Cell: 360-914-0682 |
| DOH After Hours Hotline | 1-877-481-4901 |
| DOE Spill Response | 1-800-424-8802 |
| Clallam County Public Health | 360-417-2274 |
| Fire/Police/Medical Emergencies | 911 |

6.8 Cross-Connection Control Program

Estates has developed a cross-connection control program as required under WAC 246-290-100 and outlined under WAC 246-290-490. A copy of the Cross-Connection Control Program is included in Appendix C.

The system's responsibility for cross-connection control shall begin with its water supply sources, including storage, distribution facilities, and end at the point of delivery to each customer's water system, which is the water meter. The plan for Estates is outlined below. The rules and regulations are provided in the tariff for Cascadia are included in the Appendix of the Cascadia Water – Water System Plan Part A. In general, the tariff outline requirements for cross-connection control. Cascadia Water is in the process of surveying consumers and the Water System to determine the potential cross-connection devices currently connected to the system. This process should be completed by the end of 2025 for the system.

6.8.1 Procedures for Hazard Evaluations

As a condition of new connections to the water system, an initial evaluation to assess the degree of cross-connection hazard posed by the consumer's premises to the distribution system shall be conducted by

Cascadia. Cascadia shall determine the method of backflow protection required, if any. The required method of backflow protection shall be installed and a satisfactory test result by a qualified backflow assembly tester shall be provided by the consumer to Cascadia before water service is provided.

As a condition of continued water service, annual evaluation should be conducted on existing connections with water use characteristics that pose potential hazardous cross-connection conditions to the Estates distribution system. These potential uses can include, but are not limited to:

- Outdoor pools
- Livestock storage
- Sprinkler systems
- Premises with heat exchangers and/or solar potable hot water systems
- Premises with fire systems using chemicals.

As a condition of continued water service, the system will evaluate connections that have had a potential change in use.

6.8.2 Eliminating or Controlling Cross-Connections

When cross-connections cannot be eliminated they shall be controlled by installation of approved backflow prevention devices commensurate with the degree of hazard.

The Estates Cross-Connection Control Program shall consist of premises isolation at or near the service connection or an alternative location acceptable to the Water System, between the service connection and the first point of any hazard. The Water System shall ensure that an approved reduced pressure backflow assembly (or reduced pressure detector assembly) is installed for all premises posing a high degree of cross-connection hazard, including those listed in Section 6.8.1.

At a minimum, the system shall require a double check valve assembly (or double check detector assembly) installed in accordance with WAC 51-46-0603 of the Unified Plumbing Code for premises posing a low degree of cross-connection hazards.

Cascadia prohibits interconnection of any private water supply with the Water System's distribution system. Cascadia policy requires that the owner of a property or any person residing thereon receiving water service from Estates shall not connect, directly or indirectly, the water service line, or any part of the plumbing of such structure receiving water service from Estates.

6.8.3 Backflow Preventer Inspection, Testing, and Repairs

All backflow prevention assemblies are subject to annual inspection and testing by a DOH certified backflow assembly tester.

As a condition of continued water service, customers shall make their premises, to which water is supplied, accessible to a state certified backflow assembly tester for inspection and testing annually to determine whether backflow prevention assemblies are properly installed, maintained and are operational. Estates may deny or discontinue water service to any customer failing to cooperate in the installation, inspection, testing, maintenance, or repair of approved backflow prevention devices pursuant to WAC 246-290-490.

The system will promptly notify property owners with known potential cross-connections. The system shall also notify on an annual basis all customers with approved backflow prevention devices of the need for an annual inspection.

6.8.4 Quality Assurance Program

Cascadia Water shall require backflow prevention assemblies to be models included on the current list of backflow prevention assemblies approved for use in Washington State. Existing backflow prevention assemblies installed on the system not on the current list of backflow prevention assemblies approved for use in Washington State may be allowed by the Water System if the following applies:

- The backflow prevention assembly was included on the list of backflow prevention assemblies approved for use in Washington State and/or Uniform Building Code list of approved backflow prevention assemblies at the time of installation;
- The backflow prevention assembly has been properly maintained;
- The backflow prevention assembly is commensurate with Cascadia's assessed degree of hazard as determined by Cascadia in its sole discretion; and
- The backflow prevention assembly has been inspected and tested annually and has successfully passed the annual tests.

Cascadia requires that an unlisted backflow prevention assembly be replaced by an approved assembly commensurate with the degree of hazard, when the unlisted assembly:

- Is moved; or
- Cannot be repaired using spare parts from the original manufacturer.

6.8.5 Responding to Backflow Incidents

In the case of a backflow incident in the Water System's distribution system, the water system operator shall notify Cascadia Water and the local DOH as soon as possible, but no later than the end of the next business day, when a backflow incident is known to have:

- Contaminated Cascadia's public water system.
- Occurred within the premises of a customer served by Estates.

6.9 Record Keeping and Reporting

Record keeping and reporting requirements are given in WAC 246-290-480 for all public water systems. All files are retained at the offices of Cascadia Water. Customer complaints are maintained by Cascadia and are brought to the monthly meetings of the elected water boards for review.

6.10 Summary of O&M Deficiencies

Cascadia continually strives to improve O&M procedures for the Water System. There are no specific improvements planned that need to be addressed at this time.

7 DISTRIBUTION FACILITIES DESIGN AND CONSTRUCTION STANDARDS

7.1 Technical Specifications and Design Standards

Cascadia has created technical specifications and standard details which are included in the Part A Water System Plan for Cascadia Water.

DRAFT

8 IMPROVEMENT PROGRAM

The purpose of this chapter is to incorporate the needs of the distribution system, as identified in previous chapters, into an improvement program. The Capital Improvement Plan (CIP) presented in this chapter has been developed in accordance with the requirements identified in WAC 246-290-100.

The development of a comprehensive plan and improvement program provides orderly maintenance and improvement to the system. Population and water demand forecasts and existing system analyses, discussed in previous chapters, were used to formulate the following CIP. Each water systems' design criteria were included in the formation of the plan.

The distribution system piping was also reviewed with a hydraulic analysis to determine the necessity of replacing older water mains and providing sufficient fire flow capacity. Considerations included material condition, size, and capacity. The following sections summarize Estate's CIP which is organized in two basic elements: 1) Prioritizing Improvement Projects, and 2) Improvement Schedule.

Planning Phase 1 (6 years; 2020 - 2026)

It is anticipated that the system will serve approximately 443 ERUs by the end of 2029. Based on the capacity analysis detailed in Section 3.4, the system's current infrastructure appears adequate to meet the anticipated growth outside of the desire to improve fire flow capacity to various portions of the system. Following the immediate replacement projects under way, the System will prioritize looping portions of their distribution system and replacing and/or extending existing watermains.

Planning Phase 2 (20-year horizon; 2026 - 2040)

It is anticipated that the System will potentially serve 512 ERUs connections over the next 20-year planning period. During this phase, replacing/upgrading the distribution system is anticipated to continue to be a priority. Due to the large costs associated with water main replacement it is important to initiate the financial plans in Phase 1 that will enable these projects to be completed during Phase 2. Other capital projects will consist of maintenance, repair, and replacement of the existing facilities, providing treatment, and fire flow needs. The owners should be aware of those future needs to ensure that sufficient funding is available to address necessary repairs/replacements to aging infrastructure that are needed in future phases.

Planning Phase 3 (20+ years, 2040 and beyond)

As indicated above, build-out for many of the water systems is estimated to occur during Phase 2. As the systems continue to grow in Phase 3, the primary challenge may be developing additional sources of supply. In Phase 3, replacement/upgrade of the remaining distribution system is anticipated.

8.1 Prioritizing Projects

A three-step process was used to develop the Cascadia CIP. These steps are identification of potential system improvements, evaluation of the alternatives, and selection of alternatives. Potential system improvements/needs are identified in Section 3.5 and summarized in Table 3-14. This Section summarizes projects addressing the potential system improvements/needs, evaluation of the improvements alternatives, and selection of improvements.

8.2 Identification of System Improvements Projects

Section 3.5 identifies the potential system needs categorized by each system functional group (or component). Each aspect of the water system was analyzed, and a draft list of potential improvements was developed to address existing or anticipated system deficiencies. When applicable, alternative improvements were developed for each deficiency. The alternatives were determined in consideration

of meeting DOH and specific water system standards, improving reliability of the water system, and minimizing capital and operating costs. The following sections summarize potential improvement projects addressing the needs in each of the system functional groups.

8.2.1 Source

Currently Estates is installing improvements to their sources which include new source meters, emergency generator installation, and pumphouse piping. It is anticipated that these improvements will meet the needs of the system through the long-term planning period of this water system plan.

Wells should be analyzed to determine their efficacy compared to when the well was originally installed and tested. If a well's performance is diminishing, then rehabilitation or replacement will be considered. This analysis should include a yearly test to determine static and dynamic water levels. Further information is included in the Operations and Maintenance Program outlined in Chapter 6.

8.2.2 Treatment

As part of the current improvement project underway at Estates (DOH Project #22-0805), the system is installing a manganese (Mn) filter system to treat raw water from Well 2. The system is capable of filtering 200-gpm, which should provide sufficient capacity for Well 2. It is anticipated that these improvements will meet the needs of the system through the long-term planning period of this water system plan.

8.2.3 Storage

The current improvements project replaces the two buried reservoirs with an above ground reservoir totaling 158,000 gallons. This project will address the significant findings identified in the latest sanitary survey provided on 1/12/2022 (See Appendix C) which noted leaking and structural deficiencies in the old reservoirs. The new above ground reservoir has been sized to meet system needs through the long-term planning period of this water system plan.

8.2.4 Distribution

The water system has portions of the distribution system piping that are aging and will need replacing. In addition, there are portions of the system that do not provide adequate flow to meet residential fire demands for Clallam County. The waterline replacement project will include upsizing to meet fire flow requirements and current code requirements. As-built drawings should be created or updated to show existing and new piping installations. Watermain replacements will be an ongoing improvement over several years. Specifics of various water main improvement projects are listed below and are identified with a number (i.e. D1). Figure 8-1 identifies the location and the assumed extents of the proposed improvements which are called out by their corresponding project number.

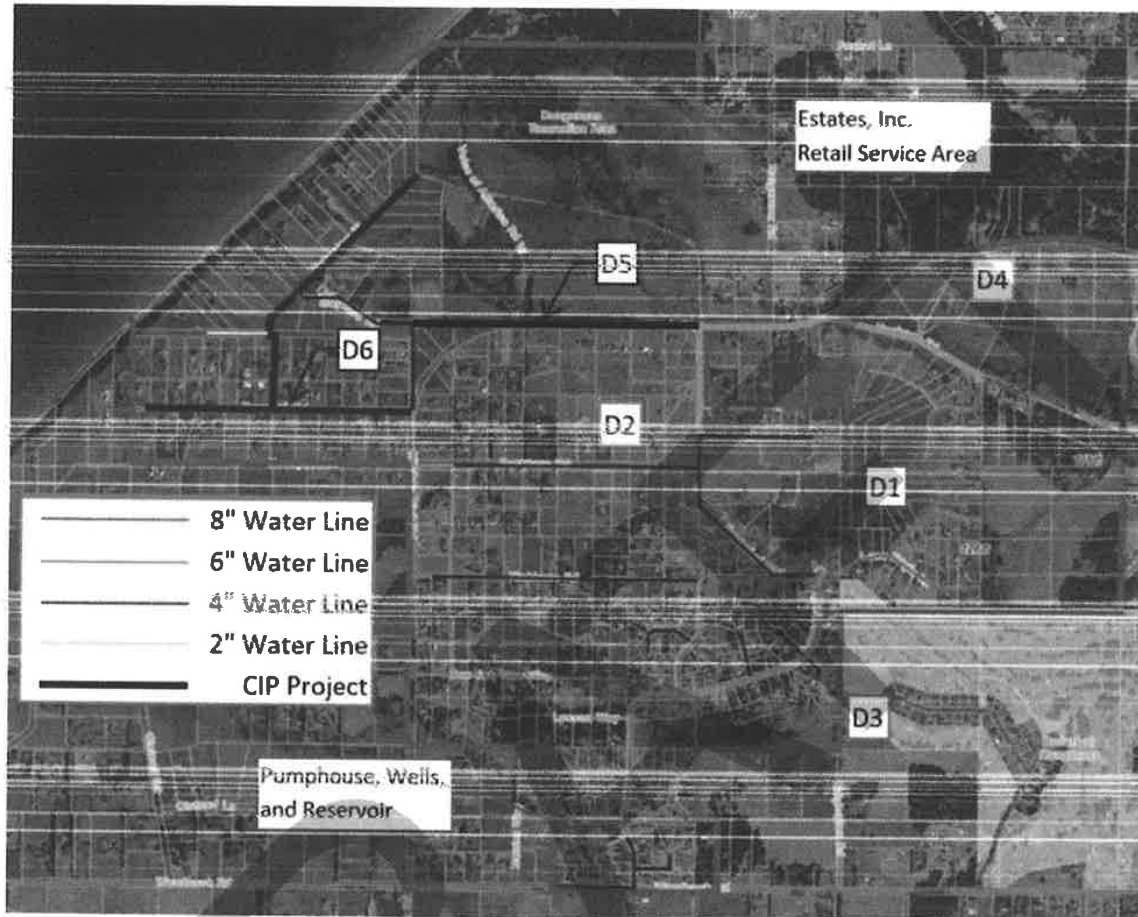

Figure 8-1 Estates Inc. Retail Service Areas

D1: Lone Eagle Lane & Secluded Way Loop – Current Planning Period

The water main along Ridge View Drive does not continue along Lone Eagle Lane and Dungeness Greens Way. Those roads are served by a line off of Nicole Place and an easement to Secluded Way. Providing a connection between the water main running up Lone Eagle Lane and Secluded Way will provide additional reliability to various portions of the distribution system.

D2: Nisbet Road Loop – Current Planning Period

The water main along Buckhorn Road extends to serve the residences along Buds Way. This water main should be continued up to connect with the water main in Lotzgesell Road. This will provide an additional loop to the northern end of the distribution system, provide better circulation down Lotzgesell Road and provide additional flow until future projects are able to be implemented. This project will total approximately 950-feet of 6-inch water main installation.

D3: Ridge View Drive 4-Inch Water Main Replacement – Current Planning Period

As noted in Chapter 3, various portions of the distribution system are unable to provide the residential fire flow due to inadequate water main sizing in portions of the distribution system. Currently, the fire hydrant located at the intersection of Ridge View Drive and Josephine Place is served by the 4-inch water main along Ridge View Drive which is unable to provide sufficient fire flow capacity. The 4-inch section of water main along Ridge View Drive from Secluded Way to approximately 300-feet west of Percy Lane should be replaced with an 8" water main connecting into the newer water main along Lone Eagle Lane. This portion of water main replacement totals approximately 1,700-feet.

D4: Distribution System Loop from Dungeness Greens Way and Lotzgesell Road – Current Planning Period

The northern portion of the distribution system has limited capacity to provide residential fire flow requirements in accordance with Clallam County standards. There are various routes that could be pursued to increase flow to this portion of the system. Depending on consumer demands and future expansion within the service area the likely route would be to extend the 8-inch water main from the intersection of Dungeness Greens Way and Hogback Road to the east end of Lotzgesell Road. This connection should be an 8-inch diameter main totaling approximately 2,000-feet. This project will provide a valuable loop to the system using the newest portion of the distribution system along Dungeness Greens Way.

D5: Lotzgesell Road Water Main Replacement – Current Planning Period

As noted above, the northern portion of the distribution has water main sizes that limit fire flow capacity. Following the completion of the loop noted in project D3 (along Hogback Road), the 4- inch water main along Lotzgesell Road should be replaced with an 8-inch diameter water main. This project would total approximately 3,400-feet of pipe. This portion of the distribution system will (combined with Project D2 and D3) enable fire flow capacity to the northern portion of the system including Five Acre School and the Dungeness Recreation Area.

D6: Lotzgesell Road Water Main Replacement – Current Planning Period

With the completion of projects D2 through D4, the potential to bring fire flow capacity to the residences in the northwest portion of the service area becomes possible. Once again, there are various routes that could be used to extend capacity depending on the extent and budget available. If the maximum number of residences would want to be served, the water mains along Greywolf Road, Maynard Road, Tyler View Place, and the associated connecting lines will need to be replaced with new 8-inch water mains. This project would replace approximately 6,200-feet of distribution main and enable fire flow capacity to the northwest portion of the service area.

Meter Replacement – Current Planning Period

A system wide replacement of existing service meters with remote read meters is recommended to ensure accurate consumption data, decrease labor costs, provide real time tracking of consumption, and the ability to spot leaks and system problems. The implementation of this improvement project is currently underway. The goal would be to replace all system meters. This will ensure that the system is able to accurately track water usage and charge their customers based on actual water used.

8.2.5 Controls

Cascadia Water is in the process of integrating SCADA (Supervisory Control and Data Acquisition) integration into the Estates water system. As part of the current improvement project underway at Estates (DOH Project #22-0805), the system is installing a new reservoir, treatment system, and booster

pumps with the associated controls and electrical components. These control improvements will switch the reservoir controls to pressure transducers to support the installation of a system wide SCADA network. It is anticipated that these improvements will meet the needs of the system through the long-term planning period of this water system plan.

8.2.6 Capital Improvements from Previous WSP

The previous WSP for Estates dates to 1994. Projects in that plan were identified in two phases. Those phases are identified below with notes associated with each phase.

Phase 1:

Phase I did not specify a specific project but noted that it will generally include line extensions, future loops, and pumping system upgrades to serve remaining land within service area. Phase I may also include additional water conservation measures as demand increases for the system.

Phase 1 also specified the consideration for providing a standby generator or diesel pump to provide pressure during power outages.

Following the 1994 WSP the system extended the water line up Lone Eagle Lane and Dungeness Greens Way. There were no additional loops installed as part of this work.

Standby generators have recently been installed by Cascadia Water to power the booster pumps and well pumps during power outages. These systems will be upgraded as needed with the improvements currently being installed.

Phase 2:

Phase 2 included projects specifically needed to support the previously proposed Dungeness West development which was to be installed in the northeast service area. This development was not constructed and the noted improvements were never implemented.

8.2.7 Developer Extensions

Developer extensions are listed in the CIP to identify major water main improvements above and beyond normal looped water main improvements that land developers typically construct for the direct benefit of their project. These specific improvements should be incorporated into future land development activities along property frontage or within land development itself. Alignment for these improvements may be adjusted to local topography and land use.

No developer extensions have been identified for the current planning period. However, the system is interested in a potential expansion of the water systems and would entertain and support developer extensions when feasible.

8.2.8 Non-Facility Improvements

Potential non-facility improvements include continued promotion of conservation policies, clarification of the systems Water Rights, and updates to the water system's procedures and policies to ensure that the integrity of the water distribution system are maintained.

8.3 Selection of Alternatives

The discussions of projects for supply, storage and distribution are contained within Chapter 3 and summarized in Section 8.2 above. The sequence and scheduling of projects was developed by following a general priority outline balanced with the review of the current and projected financial resources of

each water system. These financial resources are further detailed in Chapter 9. The considerations in selecting projects included:

- Health Standards
- Land Use
- Quantity
- Reliability
- Costs
- Regional Benefit
- Environmental Effects
- Flexibility
- Implementation
- Life Expectancy
- Risk

8.4 Improvement Schedule

WAC 246-290-100 specifies that the WSP shall plan improvements for at least 20 years into the future with an annual schedule of improvements at least 6 years into the future. The DOH Planning Handbook states that the improvement schedule should be based on one or more of the following schedule considerations:

- Identified Deficiencies
- Growth
- Fixed Dates Financial Priority
- Milestones
- Ongoing Programs
- Availability of Outside Funding
- Major Facilities
- Critical Facilities
- Distribution Facilities
- Non-Facilities
- Timing of Improvements
- Location of Improvements

The improvement projects shown in Tables 3-14 were developed based on the above factors and the prioritization system presented in Section 3.5.

8.5 Improvement Project Funding

As further detailed in Chapter 9, it is projected that all planned capital improvement projects scheduled for the next 20 years may be funded by projected cash reserves.

9 FINANCIAL PROGRAM

Cascadia Water is a rate supported investor-owned utility (IOU) incorporated in the State of Washington which operates numerous systems throughout the state of Washington. All charges and fees for their systems are established in the Cascadia Water Company Tariff (Tariff) submitted to the Washington Utilities and Transportation Commission (UTC). The summary of the financial program for Cascadia Water is provided in the Cascadia Water – Water System Plan – Part A.

DRAFT

10 MISCELLANEOUS DOCUMENTS

This Chapter summarizes supportive documents and agreements that are not otherwise discussed in other sections of the Water System Plan.

10.1 County/Adjacent Utility Correspondence

Clallam County was notified of this updated Water System Plan. In addition to Island County, the following adjacent Utilities were also notified:

- Dungeness Golf Course & Mountain Vista (20453D)
- Mains Farm Property Owners (50400N)

Correspondence that supports the updating of the Plan is provided in Appendix S.

10.2 State Environmental Policy Act (SEPA) Determination

A State Environmental Policy Act (SEPA) checklist is not required as Estates serves less than 1,000 connections. Therefore, the documentation has not been included with the Plan.

10.3 Agreements

A copy of any agreements between Estates and the Clallam County are included in Appendix C.

**ATEC Filters
SUBMITTAL**

**Cascadia
Water Estates**





3/25/2024

RE: ATEC SCOPE Letter, Cascadia Water Estates

ATEC Water Systems LLC scope of supply includes the following items:

| ITEM | TYPE/DESCRIPTION/MODEL |
|--|---|
| PROJECT NAME: | North and South Wells Water Treatment Facility |
| DELIVERY DATE: | TBD |
| OPERATING PRESSURE | >120 PSI |
| CONTRACTOR NAME | Justin Madsen |
| CONTRACTOR CONTACT | |
| ATEC MODEL | 5-60-30 |
| CONTACT TANK | None |
| FILTER SIZE/SIDEWALL HEIGHT | 60" |
| FILTER BACKWASH VALVE | Bermad 3x3x3-350-P 3-Way valves |
| FILTER CONTROLLER | FM8 UL |
| FILTER SOLENOID TREE | 5 standard peterpaul 24 volt |
| MEDIA TYPE | Pyrolox |
| MEDIA VOLUME/WEIGHT | 86 cu ft/11,000 lbs |
| MEDIA BAGS/SUPERSACKS | 4 Supersacks |
| INLET HEADER PIPING SIZE/ARRANGEMENT | 4" Epoxy Coated Steel headers with 6" flange connection |
| OUTLET HEADER PIPING SIZE ARRANGEMENT | 4" Epoxy Coated Steel headers with 6" flange connection |
| BACKWASH HEADER PIPING SIZE | 3" Epoxy Coated Steel Headers |
| BACKWASH SPOOL | 1 included |
| BACKWASH FLOW METER | Provided by Contractor |
| <input type="checkbox"/> PRESSURE GAUGE: | 1 set- 1/2" SST pipe & fittings, 4 1/2" dial face |
| <input type="checkbox"/> EQUIPMENT COLOR: | TBD |
| SAMPLE PORTS: | |
| <input type="checkbox"/> TREATED: | standard |
| <input type="checkbox"/> COMPOSITE: | 2 - 3/4" threaded ports on Inlet and Outlet |
| <input type="checkbox"/> OTHER: | |
| OPTIONAL VALVES: | |
| <input type="checkbox"/> AIR RELIEF VACUUM BREAKER: | |
| <input type="checkbox"/> PRESSURE RELIEF: | |
| <input type="checkbox"/> PRESSURE SUSTAINING: | |
| <input type="checkbox"/> OTHER: | |

| | |
|--|--------------------------|
| <input type="checkbox"/> SPECIAL REQUIREMENTS: | |
| <input type="checkbox"/> PILOT TEST: | Included |
| DRAWING DATED/ATTACHED | 03/25/2024 |
| WARRANTY | Per Specification 461000 |
| ADDITIONAL ITEMS | Per Specification 461000 |

ATEC's Scope includes the following exceptions to the project specifications:

1. None

ATEC Water Systems
1690 Lana Way, Bldg A
Hollister, CA 95023

Phone (831) 637-9264

Contact:
Lee Odell
COO
lodell@atecwatersystems.com

Sanitary Survey



STATE OF WASHINGTON
DEPARTMENT OF HEALTH
 SOUTHWEST DRINKING WATER REGIONAL OPERATIONS
 P.O. Box 47823 Olympia, Washington 98504-7823
 TDD Relay 1-800-833-6388

| | | |
|---|---|---------------|
| May 15, 2018 Eric Thomas Post Office Box 3246 Sequim Washington 98382-5016 | Estates Inc. Water System ID #081669 | |
| | County: | Clallam |
| | System Type: | Community |
| | Operating Permit Color: | Green |
| | Surveyor: | Jocelyne Gray |
| | Inspection Date: | May 2, 2018 |

Thank you and Dale Metzger for meeting with me to conduct a survey of this water system. Sanitary surveys are the Office of Drinking Water's (ODW) way to inspect public water systems through a field visit. ODW is also able to offer technical assistance to help utilities improve their system operations and ensure that public health is protected.

This report documents the findings of this survey. Deficiencies that need your attention are summarized below. As you correct the items, send me documentation that demonstrates the items have been completed as directed. Include the system name, ID number, and the date the deficiencies were corrected. You can send them to me by e-mail at jocelyne.gray@doh.wa.gov or by mail at PO Box 47823, Olympia, Washington 98504-7823.

If you are not able to correct these deficiencies, you must submit a Corrective Action Plan by the date assigned describing how and when the work will be completed.

SIGNIFICANT DEFICIENCIES* - BY JUNE 29, 2018

1. Replace a portion of the gasket on Tank 2 that no longer creates a seal, WAC 246-290-235(1)(a).
2. ~~There were openings in the electrical junction box at Well 1. Two screws were missing and the opening for the wires is unsealed. Completed in the field during survey: the two screw holes were sealed with putty and the wiring opening was filled with steel wool. Photos on Page 11. Thank you for completing this on May 2, 2018.~~

SIGNIFICANT FINDINGS - NONE FOUND**

OBSERVATIONS

3. Contact a concrete tank manufacturer about appropriate exterior concrete reservoir sealants, WAC 246-290-235(1)(a).
4. Develop a Coliform Monitoring Plan (CMP) in compliance with the Revised Total Coliform Rule (RTCR) and the Ground Water Rule (GWR), WAC 246-290-300(3)(b). There is a template on the Coliform Monitoring webpage:
<https://www.doh.wa.gov/CommunityandEnvironment/DrinkingWater/Contaminants/Coliform/PreparingaColiformMonitoringPlan/LargeorMultipleSource>.

Cross-Connection Control Records

FINAL

STATE OF WASHINGTON
DEPARTMENT OF HEALTH
DRINKING WATER DIVISION
**CROSS CONNECTION CONTROL PROGRAM
OPERATIONS SURVEY**

Purpose of Survey:

Cross connections are recognized as one of the principal causes of drinking water contamination. WAC 246-290-490 requires that water purveyors develop and implement a cross-connection control program acceptable to the Department. This survey is intended to provide information so that the Department may better assist the purveyors in development and implementation of their programs.

Instructions for Completing the Survey:

This survey must be completed by each water system with one hundred (100) or more service connections. This survey should be returned even if you do not have a cross connection control program.

1.0 System Identification:

1.1 System Name:

ESTATES WATER SYSTEMS, INC.

1.1.1 System ID No:

081669

1.1.2 County:

CLALLAM

1.1.3 Street Address

474 W HEMLOCK ST. SEQUIM, WA 98382

1.1.4 Mailing Address:

PO Box 531

1.1.5 City, State, Zip:

SEQUIM WA 98382

1.2 System Owner:

ESTATES WATER SYSTEMS, INC.

1.2.1 Street Address:

474 W HEMLOCK ST SEQUIM WA 98382

1.2.2 Mailing Address:

474 WHEMLOCK ST SEQUIM WA 98362

1.2.3 City, State, Zip: SEQUIM, WA 98362

1.2.4 Phone: 683 - 7000

1.3 System Contact Person: THOMAS LEDERMAN

1.3.1 Title: PRESIDENT

1.3.2 Day Phone: 683 - 7000

1.3.3 Evening Phone: 683 - 7000

2.0 Cross Connection Control Program Description:

2.1 Does your water system have an active cross connection control program?

Yes No

(If no, please complete elements 4.0 and 5.0 of this survey and return to the Department at the address indicated at the end of this survey form. If yes, please continue.)

2.2 Who operates the cross connection control program?

Owner OR Contract Operator

Name: Bruce Cramer

Address: 474 W. Hemlock

Certification Number: NA

Certification Types: NA

Other Qualifications: Experienced Manager, Cont
Bruce Cramer oversees all installations &
monitors system performance

3.0 Staffing:

3.1 Name those who are responsible for the operation of the cross connection control program.

| NAME & TITLE | CERTIFICATION TYPE AND NUMBER | PHONE |
|--------------|-------------------------------|----------|
| Bruce Cramer | | 683-6400 |
| David Tice | | 681-7000 |
| Ed Chartier | WDM1 No 5098 | 683-6328 |
| | | |

4.0 Water System Information:

(This section to be completed by ALL water systems.)

4.1 Approximate size of service area 1.25 square miles + County Park

4.2 Number of services in your service area: 181 active (June 1994)

| | |
|---|-----------------|
| 4.2.1 Residential services | 181 |
| 4.2.2 Commercial services | 0 |
| 4.2.3 Residential services | — |
| 4.2.4 Fire protection services separate from domestic service | 0 |
| 4.2.5 Landscape irrigation services | 0 |
| 4.2.6 Agricultural irrigation services | 0 |
| 4.2.7 Other <u>Seasonal County Park</u> | <u>S.E.R.U.</u> |

4.3 Number of approved backflow assemblies on record in your water service area

| | |
|--|---|
| 4.3.1 Reduced Pressure Backflow Assemblies | 0 |
| 4.3.2 Double Check Valve Assemblies | 0 |
| 4.3.3 Pressure Vacuum Breaker Assemblies | 0 |
| 4.3.4 Approved Air Gaps | 0 |

Note: check valves installed with each meter set

4.4 Does your water system serve water to the following types of premises?

| PREMISES TYPE | YES | NO |
|--|-----|----|
| 4.4.1 Beverage bottling plants | | ✓ |
| 4.4.2 Car washes | | ✓ |
| 4.4.3 Chemical Plants | | ✓ |
| 4.4.4 Food processing plants | | ✓ |
| 4.4.5 Hospitals, medical centers, or clinics | | ✓ |
| 4.4.6 Laboratories | | ✓ |
| 4.4.7 Metal plating facilities | | ✓ |
| 4.4.8 Mortuaries | | ✓ |
| 4.4.9 Nursing homes | | ✓ |
| 4.4.10 Petroleum processing or storage plants | | ✓ |
| 4.4.11 Piers or docks | | ✓ |
| 4.4.12 Radioactive material processing plants | | ✓ |
| 4.4.13 Nuclear plants | | ✓ |
| 4.4.14 Sewer lift stations | | ✓ |
| 4.4.15 Sewage treatment plants | | ✓ |
| 4.4.16 Tall buildings (buildings over 30 feet) | | ✓ |
| 4.4.17 Premises with unapproved auxiliary supply | | ✓ |
| 4.4.18 Others (Specify) | | ✓ |

4.5 Does your water system provide a single service to premises with fire sprinkler systems?

| TYPE | YES | NO |
|----------------------------|-----|----|
| 4.5.1 Commercial | | ✓ |
| 4.5.2 Residential | | ✓ |
| 4.5.3 Single Family | | ✓ |
| 4.5.4 Other (Specify type) | | ✓ |

5.0 Administrative authority

(This section to be completed by all water systems with 100 or more connections)

5.1 Does your water system have administrative authority to have a cross connection program? (ordinance power, restrictive covenants, etc.)

Yes ___ No

(If yes, please attach a copy.)

5.2 Does your administrative authority include:

| ADMINISTRATIVE AUTHORITY | YES | NO |
|--|-----|-------------------------------------|
| Reference to WAC 246-290-490 ? | | <input checked="" type="checkbox"/> |
| The right to discontinue water service if the customer fails to cooperate in the installation, maintenance, testing, or inspection of backflow assemblies ? | | <input checked="" type="checkbox"/> |
| A statement that the installation or maintenance of any cross connection which would endanger the water quality of the public water supply is prohibited ? | | <input checked="" type="checkbox"/> |
| The authority to discontinue water service to any premises if an immediate hazard to health is caused by a cross connection ? | | <input checked="" type="checkbox"/> |
| A statement that furnishing water service to a premises is contingent upon a customer providing cross connection control approved by the appropriate health agency ? | | <input checked="" type="checkbox"/> |
| A statement that the water service to any premises with a private, unapproved water source shall be protected against backflow or the water source discontinued ? | | <input checked="" type="checkbox"/> |

6.0 Cross Connection Control Operations Policy.

6.1 Does your water system have a standard operating policy for the cross connection control program? *we reference "Cross Connection Control Manual 5th Edition" published by AWWA*
 Yes No ___ ****If yes, please attach a copy.**

6.2 Does your water system cross connection control program have detailed installation standards? *YES. FOR EACH SERVICE*
 Yes No ___

6.3 Does your water system cross connection control program have a backflow incident plan?
 Yes ___ No ****If yes, please attach a copy.**

7.0 Cross Connection Control Inspection Program

7.1 Does your water system cross connection control program actively inspect for actual or potential cross connections between the public water supply and non-potable substances.

Yes X No ___

7.2 Does the inspection program include:

7.2.1 Plan reviews to determine need for backflow protection on:

7.2.1.1 New construction?

Yes X No ___

7.2.1.2 Remodels? Yes X No ___

7.2.1.3 If yes, please provide information about the person conducting the review

Name BRUCE CRAMER Title V.P.

7.2.2 Site inspections to assure that needed backflow protection is properly installed on:

7.2.2.1 New Construction? Yes X No ___

*SINGLE CHECK
... VALVES ON
ALL NEW SERVICES*

7.2.2.2 Remodels? Yes ___ No X

7.2.2.3 Name of person conducting the inspection:

BRUCE CRAMER

Title: V.P.

Certification Number: _____

Other qualifications: OWNER / EXP. DEVELOPER

7.3 Does the inspection program include periodic re-inspection of existing high hazard premises?

Yes ___ No X *NO HIGH HAZARDS ON THIS SYSTEM*

8.0 Cross Connection Control Program Records System

8.1 Does the water system cross connection control program have a records system?

Yes X No ___

8.1.1 Who maintains the records? BRUCE CRAMER, TOM LEDERMAN

8.1.2 Is this person Certified as a CCS 1? YES (NO)

8.1.3 Where are the records stored? 479 W. Hemlock
SEQUIM WA

8.2 Does the records system consist of:

8.2.1 Computer files? Yes ___ No X

8.2.2 Hard copy files? Yes X No ___

8.3 Do the files contain:

8.3.1 Correspondence? Yes X No ___

8.3.2 Copies of requirements from plan reviews for of backflow protection?

Yes ___ No X

8.3.3 Backflow assembly information? Yes X No ___

9.0 Cross Connection Control Program Testing Requirements

9.1 Does the water system cross connection control program require that backflow assemblies be tested?

9.1.1 Initially after installation? Yes ___ No X

9.1.2 At least annually? Yes ___ No X

9.1.3 After each repair? Yes ___ No X

9.1.4 If "NO" to any of above, please explain:

Emphasis is on installation AND certification of construction

9.2 Does the water system cross connection control program periodically check on and monitor Backflow Assembly Testers working in the service area?

Yes ___ No X

9.3 Does the water supply cross connection control program require annual verification of accuracy of testing equipment?

Yes ___ No X

9.3.1 If "Yes", what is required for verification?

9.4 Does the water system cross connection control program follow up on reported failures of backflow assemblies and require corrective actions?

Yes ___ No X

9.4.1 If "Yes", is this documented in the records system?

Yes ___ No ___

9.5 Does the water system cross connection control program require annual inspection of water trucks using fire hydrants in the service area?

Yes ___ No X

DEPARTMENT OF HEALTH
DIVISION OF DRINKING WATER
AIR INDUSTRIAL CENTER # 3
PO BOX 47822
OLYMPIA WA 98504-7822

BULK RATE
U.S. POSTAGE PAID
Washington State
Department of Printing

*****S-DIGIT 983
S800 7 1
ESTATES WATER SYSTEMS, INC
THOMAS A. LEDERMAN
474 W HEMLOCK ST
SEQUIM WA 98382-3771

J.L. Apperson, P. E.
Washington State Department of Health
Drinking Water Division
P.O. Box 47822
Olympia, WA 98504-7822

Thank you for your cooperation in completing this survey form. If you have any questions concerning this survey, please call Jim Apperson at (206) 664-8096. Please complete this form and return it by April 4, 1994 to:

2022 Consumer Consumption



CASCADIA WATER
Average Usage
 Grouped by: Account No
 From 1/1/2022 Through 12/31/2022

Limited to : Route No 13 - OP-Estates

| Service Account No | Units | No of Bills | Total Usage | Average |
|--------------------|-----------------|-------------|-------------|------------|
| WATER (WTR) | Cubic Ft | | | |
| 00000003001 | | 6 | 5,700.0000 | 950.0000 |
| 00000003002 | | 6 | 6,600.0000 | 1,100.0000 |
| 00000003003 | | 6 | 6,200.0000 | 1,033.3333 |
| 00000003004 | | 6 | 1,800.0000 | 300.0000 |
| 00000003005 | | 6 | 12,200.0000 | 2,033.3333 |
| 00000003006 | | 6 | 5,100.0000 | 850.0000 |
| 00000003007 | | 6 | 6,200.0000 | 1,033.3333 |
| 00000003008 | | 6 | 3,800.0000 | 633.3333 |
| 00000003009 | | 6 | 2,000.0000 | 333.3333 |
| 00000003010 | | 6 | 9,900.0000 | 1,650.0000 |
| 00000003011 | | 6 | 3,400.0000 | 566.6667 |
| 00000003012 | | 6 | 4,800.0000 | 800.0000 |
| 00000003013 | | 6 | 4,300.0000 | 716.6667 |
| 00000003014 | | 6 | 3,200.0000 | 533.3333 |
| 00000003015 | | 6 | 11,700.0000 | 1,950.0000 |
| 00000003016 | | 6 | 8,000.0000 | 1,333.3333 |
| 00000003017 | | 2 | 800.0000 | 400.0000 |
| 00000003018 | | 6 | 3,000.0000 | 500.0000 |
| 00000003019 | | 6 | 4,700.0000 | 783.3333 |
| 00000003020 | | 6 | 6,300.0000 | 1,050.0000 |
| 00000003021 | | 6 | 7,800.0000 | 1,300.0000 |
| 00000003022 | | 6 | 8,600.0000 | 1,433.3333 |
| 00000003023 | | 6 | 6,000.0000 | 1,000.0000 |
| 00000003024 | | 6 | 3,100.0000 | 516.6667 |
| 00000003025 | | 6 | 8,100.0000 | 1,350.0000 |
| 00000003026 | | 6 | 12,300.0000 | 2,050.0000 |
| 00000003027 | | 6 | 12,500.0000 | 2,083.3333 |
| 00000003028 | | 6 | 3,100.0000 | 516.6667 |
| 00000003029 | | 6 | 3,700.0000 | 616.6667 |
| 00000003030 | | 6 | 19,000.0000 | 3,166.6667 |
| 00000003031 | | 6 | 7,700.0000 | 1,283.3333 |
| 00000003032 | | 6 | 14,400.0000 | 2,400.0000 |
| 00000003033 | | 6 | 2,800.0000 | 466.6667 |
| 00000003034 | | 6 | 7,500.0000 | 1,250.0000 |

| Service Account No | Units | No of Bills | Total Usage | Average |
|--------------------|-------|-------------|-------------|------------|
| 00000003035 | | 6 | 4,300.0000 | 716.6667 |
| 00000003036 | | 6 | 3,300.0000 | 550.0000 |
| 00000003037 | | 6 | 11,700.0000 | 1,950.0000 |
| 00000003038 | | 6 | 1,700.0000 | 283.3333 |
| 00000003039 | | 6 | 4,900.0000 | 816.6667 |
| 00000003040 | | 6 | 8,200.0000 | 1,366.6667 |
| 00000003041 | | 6 | 8,100.0000 | 1,350.0000 |
| 00000003042 | | 6 | 3,500.0000 | 583.3333 |
| 00000003043 | | 6 | 3,200.0000 | 533.3333 |
| 00000003044 | | 6 | 9,300.0000 | 1,550.0000 |
| 00000003045 | | 6 | 8,200.0000 | 1,366.6667 |
| 00000003046 | | 6 | 20,500.0000 | 3,416.6667 |
| 00000003047 | | 6 | 4,800.0000 | 800.0000 |
| 00000003048 | | 4 | 13,900.0000 | 3,475.0000 |
| 00000003049 | | 6 | 6,400.0000 | 1,066.6667 |
| 00000003050 | | 6 | 21,000.0000 | 3,500.0000 |
| 00000003051 | | 6 | 15,300.0000 | 2,550.0000 |
| 00000003052 | | 6 | 3,800.0000 | 633.3333 |
| 00000003053 | | 6 | 7,200.0000 | 1,200.0000 |
| 00000003054 | | 6 | 10,500.0000 | 1,750.0000 |
| 00000003055 | | 6 | 11,700.0000 | 1,950.0000 |
| 00000003056 | | 1 | 100.0000 | 100.0000 |
| 00000003057 | | 3 | 4,800.0000 | 1,600.0000 |
| 00000003058 | | 6 | 5,700.0000 | 950.0000 |
| 00000003059 | | 6 | 26,200.0000 | 4,366.6667 |
| 00000003060 | | 6 | 17,800.0000 | 2,966.6667 |
| 00000003061 | | 6 | 3,000.0000 | 500.0000 |
| 00000003062 | | 6 | 11,300.0000 | 1,883.3333 |
| 00000003063 | | 6 | 3,400.0000 | 566.6667 |
| 00000003064 | | 6 | 6,900.0000 | 1,150.0000 |
| 00000003065 | | 6 | 21,800.0000 | 3,633.3333 |
| 00000003066 | | 6 | 7,300.0000 | 1,216.6667 |
| 00000003067 | | 6 | 5,700.0000 | 950.0000 |
| 00000003068 | | 6 | 16,700.0000 | 2,783.3333 |
| 00000003069 | | 6 | 1,800.0000 | 300.0000 |
| 00000003070 | | 6 | 5,500.0000 | 916.6667 |
| 00000003071 | | 6 | 3,400.0000 | 566.6667 |
| 00000003072 | | 6 | 10,000.0000 | 1,666.6667 |
| 00000003073 | | 6 | 400.0000 | 66.6667 |
| 00000003074 | | 6 | 6,200.0000 | 1,033.3333 |
| 00000003075 | | 6 | 2,500.0000 | 416.6667 |
| 00000003076 | | 6 | 2,000.0000 | 333.3333 |

| Service Account No | Units | No of Bills | Total Usage | Average |
|--------------------|-------|-------------|-------------|------------|
| 00000003077 | | 6 | 7,500.0000 | 1,250.0000 |
| 00000003078 | | 6 | 8,000.0000 | 1,333.3333 |
| 00000003079 | | 6 | 37,200.0000 | 6,200.0000 |
| 00000003080 | | 6 | 21,400.0000 | 3,566.6667 |
| 00000003081 | | 6 | 4,300.0000 | 716.6667 |
| 00000003082 | | 6 | 8,500.0000 | 1,416.6667 |
| 00000003083 | | 6 | 10,100.0000 | 1,683.3333 |
| 00000003084 | | 6 | 5,700.0000 | 950.0000 |
| 00000003085 | | 6 | 6,200.0000 | 1,033.3333 |
| 00000003086 | | 6 | 2,200.0000 | 366.6667 |
| 00000003087 | | 2 | 1,900.0000 | 950.0000 |
| 00000003088 | | 6 | 7,000.0000 | 1,166.6667 |
| 00000003089 | | 6 | 7,100.0000 | 1,183.3333 |
| 00000003090 | | 6 | 1,400.0000 | 233.3333 |
| 00000003091 | | 6 | 5,200.0000 | 866.6667 |
| 00000003092 | | 6 | 8,900.0000 | 1,483.3333 |
| 00000003093 | | 3 | 1,100.0000 | 366.6667 |
| 00000003094 | | 6 | 3,300.0000 | 550.0000 |
| 00000003095 | | 6 | 5,400.0000 | 900.0000 |
| 00000003096 | | 6 | 8,000.0000 | 1,333.3333 |
| 00000003097 | | 6 | 3,400.0000 | 566.6667 |
| 00000003098 | | 6 | 7,800.0000 | 1,300.0000 |
| 00000003099 | | 6 | 5,000.0000 | 833.3333 |
| 00000003100 | | 6 | 3,700.0000 | 616.6667 |
| 00000003101 | | 6 | 10,600.0000 | 1,766.6667 |
| 00000003103 | | 6 | 7,300.0000 | 1,216.6667 |
| 00000003104 | | 3 | 2,600.0000 | 866.6667 |
| 00000003105 | | 6 | 9,300.0000 | 1,550.0000 |
| 00000003106 | | 6 | 3,900.0000 | 650.0000 |
| 00000003107 | | 6 | 7,000.0000 | 1,166.6667 |
| 00000003108 | | 6 | 4,800.0000 | 800.0000 |
| 00000003109 | | 6 | 6,800.0000 | 1,133.3333 |
| 00000003110 | | 6 | 6,000.0000 | 1,000.0000 |
| 00000003111 | | 6 | 4,300.0000 | 716.6667 |
| 00000003112 | | 6 | 1,600.0000 | 266.6667 |
| 00000003113 | | 6 | 5,300.0000 | 883.3333 |
| 00000003114 | | 6 | 6,000.0000 | 1,000.0000 |
| 00000003115 | | 5 | 7,500.0000 | 1,500.0000 |
| 00000003116 | | 6 | 13,000.0000 | 2,166.6667 |
| 00000003117 | | 6 | 19,500.0000 | 3,250.0000 |
| 00000003118 | | 6 | 6,700.0000 | 1,116.6667 |
| 00000003119 | | 6 | 3,600.0000 | 600.0000 |

| Service Account No | Units | No of Bills | Total Usage | Average |
|--------------------|-------|-------------|-------------|-------------|
| 00000003120 | | 6 | 1,700.0000 | 283.3333 |
| 00000003121 | | 6 | 6,900.0000 | 1,150.0000 |
| 00000003122 | | 6 | 39,600.0000 | 6,600.0000 |
| 00000003123 | | 6 | 6,200.0000 | 1,033.3333 |
| 00000003124 | | 6 | 3,000.0000 | 500.0000 |
| 00000003125 | | 6 | 36,100.0000 | 6,016.6667 |
| 00000003126 | | 6 | 6,500.0000 | 1,083.3333 |
| 00000003127 | | 6 | 11,000.0000 | 1,833.3333 |
| 00000003128 | | 6 | 4,200.0000 | 700.0000 |
| 00000003129 | | 6 | 4,300.0000 | 716.6667 |
| 00000003130 | | 6 | 25,100.0000 | 4,183.3333 |
| 00000003131 | | 4 | 15,200.0000 | 3,800.0000 |
| 00000003132 | | 6 | 7,900.0000 | 1,316.6667 |
| 00000003133 | | 6 | 22,600.0000 | 3,766.6667 |
| 00000003134 | | 6 | 8,100.0000 | 1,350.0000 |
| 00000003135 | | 6 | 5,400.0000 | 900.0000 |
| 00000003136 | | 6 | 18,600.0000 | 3,100.0000 |
| 00000003137 | | 6 | 11,800.0000 | 1,966.6667 |
| 00000003138 | | 6 | 34,129.0000 | 5,688.1667 |
| 00000003139 | | 6 | 5,700.0000 | 950.0000 |
| 00000003140 | | 6 | 6,500.0000 | 1,083.3333 |
| 00000003141 | | 6 | 10,000.0000 | 1,666.6667 |
| 00000003142 | | 6 | 1,600.0000 | 266.6667 |
| 00000003143 | | 6 | 5,000.0000 | 833.3333 |
| 00000003144 | | 6 | 10,200.0000 | 1,700.0000 |
| 00000003145 | | 6 | 2,400.0000 | 400.0000 |
| 00000003146 | | 6 | 15,700.0000 | 2,616.6667 |
| 00000003147 | | 6 | 3,500.0000 | 583.3333 |
| 00000003148 | | 6 | 10,200.0000 | 1,700.0000 |
| 00000003149 | | 6 | 7,300.0000 | 1,216.6667 |
| 00000003150 | | 6 | 15,700.0000 | 2,616.6667 |
| 00000003151 | | 6 | 88,500.0000 | 14,750.0000 |
| 00000003152 | | 6 | 6,000.0000 | 1,000.0000 |
| 00000003153 | | 6 | 2,800.0000 | 466.6667 |
| 00000003154 | | 6 | 12,400.0000 | 2,066.6667 |
| 00000003155 | | 6 | 6,600.0000 | 1,100.0000 |
| 00000003156 | | 6 | 10,400.0000 | 1,733.3333 |
| 00000003157 | | 6 | 16,000.0000 | 2,666.6667 |
| 00000003158 | | 6 | 26,400.0000 | 4,400.0000 |
| 00000003159 | | 6 | 5,100.0000 | 850.0000 |
| 00000003160 | | 6 | 10,700.0000 | 1,783.3333 |
| 00000003161 | | 6 | 5,400.0000 | 900.0000 |

| Service Account No | Units | No of Bills | Total Usage | Average |
|--------------------|-------|-------------|-------------|------------|
| 00000003162 | | 6 | 11,800.0000 | 1,966.6667 |
| 00000003163 | | 6 | 12,500.0000 | 2,083.3333 |
| 00000003164 | | 6 | 2,200.0000 | 366.6667 |
| 00000003165 | | 6 | 7,500.0000 | 1,250.0000 |
| 00000003166 | | 6 | 27,400.0000 | 4,566.6667 |
| 00000003167 | | 6 | 3,100.0000 | 516.6667 |
| 00000003168 | | 6 | 21,700.0000 | 3,616.6667 |
| 00000003169 | | 6 | 6,000.0000 | 1,000.0000 |
| 00000003170 | | 6 | 2,500.0000 | 416.6667 |
| 00000003172 | | 6 | 12,900.0000 | 2,150.0000 |
| 00000003173 | | 6 | 11,800.0000 | 1,966.6667 |
| 00000003174 | | 6 | 4,500.0000 | 750.0000 |
| 00000003175 | | 6 | 900.0000 | 150.0000 |
| 00000003176 | | 6 | 3,100.0000 | 516.6667 |
| 00000003177 | | 6 | 31,100.0000 | 5,183.3333 |
| 00000003178 | | 6 | 1,800.0000 | 300.0000 |
| 00000003179 | | 6 | 6,100.0000 | 1,016.6667 |
| 00000003180 | | 6 | 8,600.0000 | 1,433.3333 |
| 00000003181 | | 6 | 7,700.0000 | 1,283.3333 |
| 00000003182 | | 6 | 7,000.0000 | 1,166.6667 |
| 00000003183 | | 6 | 8,300.0000 | 1,383.3333 |
| 00000003184 | | 6 | 2,800.0000 | 466.6667 |
| 00000003185 | | 6 | 5,900.0000 | 983.3333 |
| 00000003186 | | 3 | 4,700.0000 | 1,566.6667 |
| 00000003187 | | 6 | 7,300.0000 | 1,216.6667 |
| 00000003188 | | 6 | 1,300.0000 | 216.6667 |
| 00000003189 | | 6 | 9,100.0000 | 1,516.6667 |
| 00000003190 | | 6 | 4,400.0000 | 733.3333 |
| 00000003191 | | 6 | 2,900.0000 | 483.3333 |
| 00000003192 | | 3 | 200.0000 | 66.6667 |
| 00000003193 | | 6 | 6,600.0000 | 1,100.0000 |
| 00000003194 | | 6 | 5,000.0000 | 833.3333 |
| 00000003195 | | 6 | 7,200.0000 | 1,200.0000 |
| 00000003196 | | 6 | 21,200.0000 | 3,533.3333 |
| 00000003197 | | 6 | 32,800.0000 | 5,466.6667 |
| 00000003198 | | 6 | 9,700.0000 | 1,616.6667 |
| 00000003199 | | 6 | 16,300.0000 | 2,716.6667 |
| 00000003200 | | 6 | 6,300.0000 | 1,050.0000 |
| 00000003201 | | 6 | 21,000.0000 | 3,500.0000 |
| 00000003202 | | 6 | 11,900.0000 | 1,983.3333 |
| 00000003203 | | 6 | 10,400.0000 | 1,733.3333 |
| 00000003204 | | 6 | 11,200.0000 | 1,866.6667 |

| Service Account No | Units | No of Bills | Total Usage | Average |
|--------------------|-------|-------------|-------------|------------|
| 00000003205 | | 6 | 6,600.0000 | 1,100.0000 |
| 00000003206 | | 6 | 3,300.0000 | 550.0000 |
| 00000003207 | | 6 | 37,800.0000 | 6,300.0000 |
| 00000003208 | | 6 | 3,500.0000 | 583.3333 |
| 00000003209 | | 6 | 3,200.0000 | 533.3333 |
| 00000003210 | | 6 | 16,300.0000 | 2,716.6667 |
| 00000003211 | | 6 | 13,420.0000 | 2,236.6667 |
| 00000003212 | | 6 | 5,300.0000 | 883.3333 |
| 00000003213 | | 6 | 3,900.0000 | 650.0000 |
| 00000003214 | | 6 | 6,200.0000 | 1,033.3333 |
| 00000003216 | | 6 | 33,500.0000 | 5,583.3333 |
| 00000003217 | | 6 | 4,200.0000 | 700.0000 |
| 00000003218 | | 5 | 3,900.0000 | 780.0000 |
| 00000003219 | | 6 | 5,500.0000 | 916.6667 |
| 00000003220 | | 6 | 3,300.0000 | 550.0000 |
| 00000003221 | | 6 | 3,300.0000 | 550.0000 |
| 00000003222 | | 6 | 3,600.0000 | 600.0000 |
| 00000003223 | | 6 | 11,400.0000 | 1,900.0000 |
| 00000003224 | | 6 | 9,500.0000 | 1,583.3333 |
| 00000003225 | | 6 | 48,200.0000 | 8,033.3333 |
| 00000003226 | | 6 | 3,800.0000 | 633.3333 |
| 00000003227 | | 6 | 6,300.0000 | 1,050.0000 |
| 00000003228 | | 6 | 6,700.0000 | 1,116.6667 |
| 00000003229 | | 6 | 53,700.0000 | 8,950.0000 |
| 00000003230 | | 6 | 3,200.0000 | 533.3333 |
| 00000003231 | | 6 | 9,500.0000 | 1,583.3333 |
| 00000003232 | | 6 | 9,900.0000 | 1,650.0000 |
| 00000003233 | | 6 | 6,500.0000 | 1,083.3333 |
| 00000003234 | | 6 | 10,200.0000 | 1,700.0000 |
| 00000003235 | | 6 | 12,700.0000 | 2,116.6667 |
| 00000003236 | | 6 | 4,300.0000 | 716.6667 |
| 00000003237 | | 6 | 4,100.0000 | 683.3333 |
| 00000003238 | | 6 | 6,500.0000 | 1,083.3333 |
| 00000003239 | | 6 | 5,200.0000 | 866.6667 |
| 00000003240 | | 5 | 4,700.0000 | 940.0000 |
| 00000003241 | | 6 | 4,500.0000 | 750.0000 |
| 00000003242 | | 6 | 28,300.0000 | 4,716.6667 |
| 00000003243 | | 3 | 5,600.0000 | 1,866.6667 |
| 00000003245 | | 6 | 5,200.0000 | 866.6667 |
| 00000003246 | | 2 | 0.0000 | 0.0000 |
| 00000003247 | | 6 | 2,000.0000 | 333.3333 |
| 00000003248 | | 6 | 2,200.0000 | 366.6667 |

| Service Account No | Units | No of Bills | Total Usage | Average |
|--------------------|-------|-------------|-------------|-------------|
| 00000003295 | | 6 | 6,800.0000 | 1,133.3333 |
| 00000003296 | | 6 | 13,900.0000 | 2,316.6667 |
| 00000003297 | | 6 | 5,200.0000 | 866.6667 |
| 00000003298 | | 6 | 64,800.0000 | 10,800.0000 |
| 00000003299 | | 5 | 3,200.0000 | 640.0000 |
| 00000003301 | | 6 | 6,700.0000 | 1,116.6667 |
| 00000003303 | | 6 | 5,200.0000 | 866.6667 |
| 00000003304 | | 6 | 8,800.0000 | 1,466.6667 |
| 00000003305 | | 6 | 11,600.0000 | 1,933.3333 |
| 00000003307 | | 6 | 2,900.0000 | 483.3333 |
| 00000003308 | | 6 | 3,000.0000 | 500.0000 |
| 00000003309 | | 6 | 3,400.0000 | 566.6667 |
| 00000003310 | | 4 | 4,000.0000 | 1,000.0000 |
| 00000003311 | | 6 | 3,500.0000 | 583.3333 |
| 00000003312 | | 6 | 10,200.0000 | 1,700.0000 |
| 00000003313 | | 6 | 7,600.0000 | 1,266.6667 |
| 00000003314 | | 6 | 5,702.0000 | 950.3333 |
| 00000003315 | | 6 | 5,500.0000 | 916.6667 |
| 00000003316 | | 6 | 3,300.0000 | 550.0000 |
| 00000003317 | | 6 | 4,400.0000 | 733.3333 |
| 00000003318 | | 6 | 63,900.0000 | 10,650.0000 |
| 00000003319 | | 6 | 5,600.0000 | 933.3333 |
| 00000003320 | | 6 | 0.0000 | 0.0000 |
| 00000003321 | | 6 | 4,100.0000 | 683.3333 |
| 00000003322 | | 6 | 4,300.0000 | 716.6667 |
| 00000003323 | | 6 | 2,100.0000 | 350.0000 |
| 00000003324 | | 6 | 6,600.0000 | 1,100.0000 |
| 00000003325 | | 6 | 5,600.0000 | 933.3333 |
| 00000003326 | | 6 | 2,600.0000 | 433.3333 |
| 00000003327 | | 6 | 4,800.0000 | 800.0000 |
| 00000003328 | | 6 | 22,000.0000 | 3,666.6667 |
| 00000003329 | | 6 | 15,400.0000 | 2,566.6667 |
| 00000003330 | | 7 | 1,500.0000 | 214.2857 |
| 00000003331 | | 4 | 0.0000 | 0.0000 |
| 00000003332 | | 6 | 0.0000 | 0.0000 |
| 00000003333 | | 6 | 1,400.0000 | 233.3333 |
| 00000003334 | | 4 | 0.0000 | 0.0000 |
| 00000003335 | | 2 | 1,400.0000 | 700.0000 |
| 00000003336 | | 4 | 364.0000 | 91.0000 |
| 00000003337 | | 6 | 8,700.0000 | 1,450.0000 |
| 00000003338 | | 4 | 2,700.0000 | 675.0000 |
| 00000003339 | | 6 | 13,700.0000 | 2,283.3333 |

| Service Account No | Units | No of Bills | Total Usage | Average |
|--------------------|-------|-------------|-------------|------------|
| 00000003340 | | 6 | 30,600.0000 | 5,100.0000 |
| 00000003341 | | 6 | 28,900.0000 | 4,816.6667 |
| 00000003342 | | 6 | 6,900.0000 | 1,150.0000 |
| 00000003343 | | 6 | 5,400.0000 | 900.0000 |
| 00000003344 | | 6 | 5,800.0000 | 966.6667 |
| 00000003345 | | 6 | 32,400.0000 | 5,400.0000 |
| 00000003346 | | 6 | 25,600.0000 | 4,266.6667 |
| 00000003347 | | 6 | 10,000.0000 | 1,666.6667 |
| 00000003348 | | 6 | 3,500.0000 | 583.3333 |
| 00000003349 | | 3 | 5.0000 | 1.6667 |
| 00000003350 | | 6 | 25,800.0000 | 4,300.0000 |
| 00000003351 | | 6 | 6,100.0000 | 1,016.6667 |
| 00000003352 | | 6 | 4,600.0000 | 766.6667 |
| 00000003353 | | 6 | 7,400.0000 | 1,233.3333 |
| 00000003354 | | 6 | 21,200.0000 | 3,533.3333 |
| 00000003355 | | 6 | 9,600.0000 | 1,600.0000 |
| 00000003356 | | 6 | 6,000.0000 | 1,000.0000 |
| 00000003357 | | 2 | 2,000.0000 | 1,000.0000 |
| 00000003358 | | 6 | 2,700.0000 | 450.0000 |
| 00000003359 | | 6 | 1,100.0000 | 183.3333 |
| 00000003360 | | 6 | 30,300.0000 | 5,050.0000 |
| 00000003361 | | 6 | 6,800.0000 | 1,133.3333 |
| 00000003362 | | 6 | 2,500.0000 | 416.6667 |
| 00000003363 | | 2 | 0.0000 | 0.0000 |
| 00000003364 | | 6 | 4,200.0000 | 700.0000 |
| 00000003365 | | 6 | 17,100.0000 | 2,850.0000 |
| 00000003366 | | 6 | 11,800.0000 | 1,966.6667 |
| 00000003367 | | 6 | 4,800.0000 | 800.0000 |
| 00000003368 | | 6 | 5,000.0000 | 833.3333 |
| 00000003369 | | 6 | 5,600.0000 | 933.3333 |
| 00000003371 | | 6 | 4,600.0000 | 766.6667 |
| 00000003372 | | 6 | 0.0000 | 0.0000 |
| 00000003373 | | 6 | 16,100.0000 | 2,683.3333 |
| 00000003374 | | 6 | 20,400.0000 | 3,400.0000 |
| 00000003375 | | 6 | 7,800.0000 | 1,300.0000 |
| 00000003377 | | 6 | 10,700.0000 | 1,783.3333 |
| 00000003378 | | 6 | 6,700.0000 | 1,116.6667 |
| 00000003379 | | 6 | 1,700.0000 | 283.3333 |
| 00000003380 | | 6 | 14,900.0000 | 2,483.3333 |
| 00000003381 | | 1 | 0.0000 | 0.0000 |
| 00000003382 | | 6 | 11,000.0000 | 1,833.3333 |
| 00000003383 | | 6 | 14,500.0000 | 2,416.6667 |

| Service Account No | Units | No of Bills | Total Usage | Average |
|---|-------|--------------|-----------------------|-------------------|
| 00000003384 | | 6 | 11,500.0000 | 1,916.6667 |
| 00000003385 | | 6 | 7,400.0000 | 1,233.3333 |
| 00000003386 | | 6 | 5,600.0000 | 933.3333 |
| 00000003387 | | 6 | 17,700.0000 | 2,950.0000 |
| 00000003388 | | 6 | 600.0000 | 100.0000 |
| 00000003389 | | 6 | 14,800.0000 | 2,466.6667 |
| 00000003401 | | 6 | 87,500.0000 | 14,583.3333 |
| 000003017.01 | | 5 | 1,100.0000 | 220.0000 |
| 000003048.01 | | 2 | 500.0000 | 250.0000 |
| 000003056.01 | | 7 | 7,800.0000 | 1,114.2857 |
| 000003057.01 | | 4 | 1,500.0000 | 375.0000 |
| 000003087.01 | | 5 | 10,500.0000 | 2,100.0000 |
| 000003093.01 | | 4 | 5,600.0000 | 1,400.0000 |
| 000003102.01 | | 6 | 2,400.0000 | 400.0000 |
| 000003104.01 | | 1 | 400.0000 | 400.0000 |
| 000003104.02 | | 2 | 100.0000 | 50.0000 |
| 000003131.01 | | 2 | 1,400.0000 | 700.0000 |
| 000003171.01 | | 4 | 0.0000 | 0.0000 |
| 000003186.01 | | 4 | 2,200.0000 | 550.0000 |
| 000003192.02 | | 5 | 7,700.0000 | 1,540.0000 |
| 000003215.01 | | 7 | 31,900.0000 | 4,557.1429 |
| 000003243.02 | | 3 | 900.0000 | 300.0000 |
| 000003244.01 | | 6 | 11,000.0000 | 1,833.3333 |
| 000003260.01 | | 6 | 1,800.0000 | 300.0000 |
| 000003263.01 | | 4 | 3,000.0000 | 750.0000 |
| 000003271.02 | | 6 | 6,900.0000 | 1,150.0000 |
| 000003287.01 | | 6 | 2,000.0000 | 333.3333 |
| 000003300.01 | | 6 | 4,700.0000 | 783.3333 |
| 000003306.01 | | 6 | 900.0000 | 150.0000 |
| 000003310.01 | | 2 | 1,100.0000 | 550.0000 |
| 000003335.02 | | 4 | 2,700.0000 | 675.0000 |
| 000003335.03 | | 2 | 0.0000 | 0.0000 |
| 000003338.01 | | 2 | 1,500.0000 | 750.0000 |
| 000003381.01 | | 6 | 5,500.0000 | 916.6667 |
| Grand Total for WATER - Cubic Ft | | 2,304 | 3,753,410.0000 | 1,629.0842 |

| Service Account No | Units | No of Bills | Total Usage | Average |
|--------------------|-------|-------------|-------------|-------------|
| 00000003249 | | 6 | 8,300.0000 | 1,383.3333 |
| 00000003250 | | 6 | 41,900.0000 | 6,983.3333 |
| 00000003251 | | 6 | 18,100.0000 | 3,016.6667 |
| 00000003252 | | 6 | 4,300.0000 | 716.6667 |
| 00000003253 | | 6 | 6,200.0000 | 1,033.3333 |
| 00000003254 | | 6 | 4,700.0000 | 783.3333 |
| 00000003255 | | 6 | 10,700.0000 | 1,783.3333 |
| 00000003256 | | 6 | 12,600.0000 | 2,100.0000 |
| 00000003258 | | 6 | 7,500.0000 | 1,250.0000 |
| 00000003259 | | 6 | 6,700.0000 | 1,116.6667 |
| 00000003261 | | 6 | 2,100.0000 | 350.0000 |
| 00000003262 | | 6 | 4,700.0000 | 783.3333 |
| 00000003263 | | 3 | 2,800.0000 | 933.3333 |
| 00000003264 | | 6 | 3,600.0000 | 600.0000 |
| 00000003265 | | 6 | 5,400.0000 | 900.0000 |
| 00000003266 | | 6 | 46,400.0000 | 7,733.3333 |
| 00000003267 | | 6 | 11,700.0000 | 1,950.0000 |
| 00000003268 | | 6 | 3,400.0000 | 566.6667 |
| 00000003269 | | 6 | 11,300.0000 | 1,883.3333 |
| 00000003270 | | 6 | 73,100.0000 | 12,183.3333 |
| 00000003272 | | 6 | 5,200.0000 | 866.6667 |
| 00000003273 | | 6 | 22,600.0000 | 3,766.6667 |
| 00000003274 | | 6 | 2,090.0000 | 348.3333 |
| 00000003275 | | 6 | 26,600.0000 | 4,433.3333 |
| 00000003276 | | 6 | 3,300.0000 | 550.0000 |
| 00000003277 | | 6 | 8,500.0000 | 1,416.6667 |
| 00000003278 | | 6 | 5,600.0000 | 933.3333 |
| 00000003279 | | 6 | 13,400.0000 | 2,233.3333 |
| 00000003280 | | 6 | 6,200.0000 | 1,033.3333 |
| 00000003281 | | 6 | 5,300.0000 | 883.3333 |
| 00000003282 | | 6 | 4,000.0000 | 666.6667 |
| 00000003283 | | 6 | 3,400.0000 | 566.6667 |
| 00000003284 | | 6 | 2,500.0000 | 416.6667 |
| 00000003285 | | 6 | 200.0000 | 33.3333 |
| 00000003286 | | 6 | 9,700.0000 | 1,616.6667 |
| 00000003288 | | 6 | 16,200.0000 | 2,700.0000 |
| 00000003289 | | 6 | 7,200.0000 | 1,200.0000 |
| 00000003290 | | 6 | 15,000.0000 | 2,500.0000 |
| 00000003291 | | 6 | 2,100.0000 | 350.0000 |
| 00000003292 | | 6 | 7,200.0000 | 1,200.0000 |
| 00000003293 | | 6 | 12,200.0000 | 2,033.3333 |
| 00000003294 | | 6 | 4,100.0000 | 683.3333 |

School & Campground Consumption Data



CASCADIA WATER Meter Reading History

Sort Order: Customer No.

From: 1/1/2020 Through: 12/31/2020

Limited to : Account No 3210 Location No 3210

| Location No. | Customer No. | Customer Name | Service Address | Route No. | Service Category | Serial No. | Read Type | Sequence | Reading | Read Date | Bill Date | Code |
|--------------|--------------|------------------|---------------------|------------|------------------|------------|-----------|----------|------------|-----------|-----------|-------------|
| 3210 | 3210 | FIVE ACRE SCHOOL | 515 LOTZGESELL ROAD | OP-Estates | Water | 03210 | VOL | 421 | 585,000.00 | 12/3/2020 | 12/4/2020 | Actual Read |
| | | | | | | 03210 | VOL | 421 | 583,100.00 | 9/30/2020 | 10/7/2020 | Actual Read |
| | | | | | | 03210 | VOL | 421 | 580,400.00 | 7/31/2020 | 8/7/2020 | Actual Read |
| | | | | | | 03210 | VOL | 421 | 580,300.00 | 5/31/2020 | 6/5/2020 | Actual Read |
| | | | | | | 03210 | VOL | 421 | 580,300.00 | 3/31/2020 | 4/10/2020 | Actual Read |
| | | | | | | 03210 | VOL | 421 | 578,900.00 | 2/4/2020 | 2/11/2020 | Actual Read |

From: 1/1/2021 Through: 12/31/2021

Limited to : Account No 3210 Location No 3210

| Location No. | Customer No. | Customer Name | Service Address | Route No. | Service Category | Serial No. | Read Type | Sequence | Reading | Read Date | Bill Date | Code |
|--------------|--------------|------------------|---------------------|------------|------------------|------------|-----------|----------|------------|-----------|------------|-------------|
| 3210 | 3210 | FIVE ACRE SCHOOL | 515 LOTZGESELL ROAD | OP-Estates | Water | 03210 | VOL | 421 | 599,500.00 | 12/1/2021 | 12/14/2021 | Actual Read |
| | | | | | | 03210 | VOL | 421 | 598,200.00 | 10/1/2021 | 10/7/2021 | Actual Read |
| | | | | | | 03210 | VOL | 421 | 596,000.00 | 7/31/2021 | 8/15/2021 | Actual Read |
| | | | | | | 03210 | VOL | 421 | 593,100.00 | 5/31/2021 | 6/7/2021 | Actual Read |
| | | | | | | 03210 | VOL | 421 | 588,800.00 | 4/1/2021 | 4/7/2021 | Actual Read |
| | | | | | | 03210 | VOL | 421 | 586,500.00 | 1/30/2021 | 2/4/2021 | Actual Read |

From: 1/1/2022 Through: 12/31/2022

Limited to : Account No 3210 Location No 3210

| Location No. | Customer No. | Customer Name | Service Address | Route No. | Service Category | Serial No. | Read Type | Sequence | Reading | Read Date | Bill Date | Code |
|--------------|--------------|------------------|---------------------|------------|------------------|------------|-----------|----------|------------|------------|------------|-------------|
| 3210 | 3210 | FIVE ACRE SCHOOL | 515 LOTZGESELL ROAD | OP-Estates | Water | 03210 | VOL | 421 | 615,800.00 | 11/30/2022 | 12/8/2022 | Actual Read |
| | | | | | | 03210 | VOL | 421 | 612,300.00 | 9/30/2022 | 10/13/2022 | Actual Read |
| | | | | | | 03210 | VOL | 421 | 605,800.00 | 7/31/2022 | 8/22/2022 | Actual Read |
| | | | | | | 03210 | VOL | 421 | 603,400.00 | 5/31/2022 | 6/14/2022 | Actual Read |
| | | | | | | 03210 | VOL | 421 | 601,800.00 | 3/31/2022 | 4/12/2022 | Actual Read |
| | | | | | | 03210 | VOL | 421 | 600,100.00 | 1/31/2022 | 2/2/2022 | Actual Read |

* Denotes Reversed Read



CASCADIA WATER
Meter Reading History

Sort Order: Customer No.

From: 1/1/2020 Through: 12/31/2020

Limited to : Account No 3401 Location No 3401

| Location No. | Customer No. | Customer Name | Service Address | Route No. | Service Category | Serial No. | Read Type | Sequence | Reading | Read Date | Bill Date | Code |
|--------------|--------------|------------------|---------------------|------------|------------------|------------|-----------|----------|--------------|-----------|-----------|-------------|
| 3401 | 3401 | CLALLAM CO PARKS | 430 LOTZGESELL ROAD | OP-Estates | Water | 03401 | VOL | 410 | 1,456,900.00 | 12/3/2020 | 12/4/2020 | Actual Read |
| | | | | | | 03401 | VOL | 410 | 1,443,200.00 | 9/30/2020 | 10/7/2020 | Actual Read |
| | | | | | | 03401 | VOL | 410 | 1,413,800.00 | 7/31/2020 | 8/7/2020 | Actual Read |
| | | | | | | 03401 | VOL | 410 | 1,382,500.00 | 5/31/2020 | 6/5/2020 | Actual Read |
| | | | | | | 03401 | VOL | 410 | 1,370,700.00 | 3/31/2020 | 4/10/2020 | Actual Read |
| | | | | | | 03401 | VOL | 410 | 1,358,100.00 | 2/4/2020 | 2/11/2020 | Actual Read |

From: 1/1/2021 Through: 12/31/2021

Limited to : Account No 3401 Location No 3401

| Location No. | Customer No. | Customer Name | Service Address | Route No. | Service Category | Serial No. | Read Type | Sequence | Reading | Read Date | Bill Date | Code |
|--------------|--------------|------------------|---------------------|------------|------------------|------------|-----------|----------|--------------|-----------|------------|-------------|
| 3401 | 3401 | CLALLAM CO PARKS | 430 LOTZGESELL ROAD | OP-Estates | Water | 03401 | VOL | 410 | 1,579,900.00 | 12/1/2021 | 12/14/2021 | Actual Read |
| | | | | | | 03401 | VOL | 410 | 1,558,000.00 | 10/1/2021 | 10/7/2021 | Actual Read |
| | | | | | | 03401 | VOL | 410 | 1,545,600.00 | 7/31/2021 | 8/15/2021 | Actual Read |
| | | | | | | 03401 | VOL | 410 | 1,507,700.00 | 5/31/2021 | 6/7/2021 | Actual Read |
| | | | | | | 03401 | VOL | 410 | 1,487,500.00 | 4/1/2021 | 4/7/2021 | Actual Read |
| | | | | | | 03401 | VOL | 410 | 1,474,100.00 | 1/30/2021 | 2/4/2021 | Actual Read |

From: 1/1/2022 Through: 12/31/2022

Limited to : Account No 3401 Location No 3401

| Location No. | Customer No. | Customer Name | Service Address | Route No. | Service Category | Serial No. | Read Type | Sequence | Reading | Read Date | Bill Date | Code |
|--------------|--------------|------------------|---------------------|------------|------------------|------------|-----------|----------|--------------|------------|------------|-------------|
| 3401 | 3401 | CLALLAM CO PARKS | 430 LOTZGESELL ROAD | OP-Estates | Water | 03401 | VOL | 410 | 1,667,400.00 | 11/30/2022 | 12/8/2022 | Actual Read |
| | | | | | | 03401 | VOL | 410 | 1,657,300.00 | 9/30/2022 | 10/13/2022 | Actual Read |
| | | | | | | 03401 | VOL | 410 | 1,632,000.00 | 7/31/2022 | 8/22/2022 | Actual Read |
| | | | | | | 03401 | VOL | 410 | 1,604,600.00 | 5/31/2022 | 6/14/2022 | Actual Read |
| | | | | | | 03401 | VOL | 410 | 1,592,400.00 | 3/31/2022 | 4/12/2022 | Actual Read |
| | | | | | | 03401 | VOL | 410 | 1,586,200.00 | 1/31/2022 | 2/2/2022 | Actual Read |

* Denotes Reversed Read

Adjacent System Notification Letters



June 20, 2024

MAINS FARM PROPERTY OWNERS
DALE METZGER, MANAGER
PO BOX 92
SEQUIM, WA 98382

Re: Cascadia Water – Estates, Inc. - Water System Plan (WSP) Update

Dear Mr. Metzger,

Cascadia Water, which owns the Estates, Inc. water system, is in the process of updating their Water System Plan (WSP). The Washington State Department of Health requests that adjacent water systems be notified of the update process and be allowed to review and comment on the development of the WSP. A digital copy of the updated WSP can be made available upon request to Facet, Inc. by contacting Robert Bennion, P.E. using the information provided below.

Please let us know if you have any questions, comments, or concerns regarding the WSP update.

Sincerely,

Facet, Inc.

A handwritten signature in black ink, appearing to read 'Robert Bennion', is written over the typed name.

Robert Bennion, P.E.
Civil Engineer
p: (360) 331-4131 x206
e: rbennion@facetnw.com

Seattle
9706 4th Ave NE, Suite 300
Seattle, WA 98115
tel 206.523.0024

Mount Vernon
2210 Riverside Dr, Suite 110
Mount Vernon, WA 98273
tel 360.899.1110

Federal Way
31620 23rd Ave S, Suite 307
Federal Way, WA 98003
tel 253.237.7770

Whidbey Island
1796 E Main St, Suite 105
Freeland, WA 98249
tel 360.331.4131



June 20, 2024

DUNGENESS GOLF COURSE AND MT VISTA
ATTN: SOLMAR WATER SYSTEMS, INC.
KATE M O'CLAIRE, MANAGER
PO BOX 1989
SEQUIM, WA 98382

Re: Cascadia Water – Estates, Inc. - Water System Plan (WSP) Update

Dear Kate O'Claire,

Cascadia Water, which owns the Estates, Inc. water system, is in the process of updating their Water System Plan (WSP). The Washington State Department of Health requests that adjacent water systems be notified of the update process and be allowed to review and comment on the development of the WSP. A digital copy of the updated WSP can be made available upon request to Facet, Inc. by contacting Robert Bennion, P.E. using the information provided below.

Please let us know if you have any questions, comments, or concerns regarding the WSP update.

Sincerely,

Facet, Inc.

A handwritten signature in black ink, appearing to read 'Robert Bennion'.

Robert Bennion, P.E.
Civil Engineer
p: (360) 331-4131 x206
e: rbennion@facetnw.com

Seattle
9706 4th Ave NE, Suite 300
Seattle, WA 98115
tel 206.523.0024

Mount Vernon
2210 Riverside Dr, Suite 110
Mount Vernon, WA 98273
tel 360.899.1110

Federal Way
31620 23rd Ave S, Suite 307
Federal Way, WA 98003
tel 253.237.7770

Whidbey Island
1796 E Main St, Suite 105
Freeland, WA 98249
tel 360.331.4131

DRAFT

APPENDIX A
Water Facility Inventory Form (WFI)

WATER FACILITIES INVENTORY (WFI) FORM - Continued

| | | | | |
|------------------------------------|--------------------------------------|-----------------------------|----------------------|------------------------|
| 1. SYSTEM ID NO. 08166 9 | 2. SYSTEM NAME ESTATES INC | 3. COUNTY CLALLAM | 4. GROUP A | 5. TYPE Comm |
|------------------------------------|--------------------------------------|-----------------------------|----------------------|------------------------|

| | ACTIVE SERVICE CONNECTIONS | DOH USE ONLY CALCULATED ACTIVE CONNECTIONS | DOH USE ONLY APPROVED CONNECTIONS |
|---|----------------------------|---|--------------------------------------|
| 25. SINGLE FAMILY RESIDENCES (How many of the following do you have?) | | 365 | 654 |
| A. Full Time Single Family Residences (Occupied 180 days or more per year) | 365 | | |
| B. Part Time Single Family Residences (Occupied less than 180 days per year) | 0 | | |
| 26. MULTI-FAMILY RESIDENTIAL BUILDINGS (How many of the following do you have?) | | | |
| A. Apartment Buildings, condos, duplexes, barracks, dorms | 0 | | |
| B. Full Time Residential Units in the Apartments, Condos, Duplexes, Dorms that are occupied more than 180 days/year | 0 | | |
| C. Part Time Residential Units in the Apartments, Condos, Duplexes, Dorms that are occupied less than 180 days/year | 0 | | |
| 27. NON-RESIDENTIAL CONNECTIONS (How many of the following do you have?) | | | |
| A. <i>Recreational Services and/or Transient Accommodations (Campsites, RV sites, hotel/motel/overnight units)</i> | 1 | 1 | 0 |
| B. Institutional, Commercial/Business, School, Day Care, Industrial Services, etc. | 1 | 1 | 0 |
| 28. TOTAL SERVICE CONNECTIONS | | 367 | 654 |

| |
|---|
| 29. FULL-TIME RESIDENTIAL POPULATION |
| A. How many residents are served by this system 180 or more days per year? 913 |

| 30. PART-TIME RESIDENTIAL POPULATION | JAN | FEB | MAR | APR | MAY | JUN | JUL | AUG | SEP | OCT | NOV | DEC |
|---|-----|-----|-----|-----|-----|-----|-----|-----|-----|-----|-----|-----|
| A. How many part-time residents are present each month? | | | | | | | | | | | | |
| B. How many days per month are they present? | | | | | | | | | | | | |

| 31. TEMPORARY & TRANSIENT USERS | JAN | FEB | MAR | APR | MAY | JUN | JUL | AUG | SEP | OCT | NOV | DEC |
|--|-----|-----|-----|-----|------|------|------|------|------|-----|-----|-----|
| A. How many total visitors, attendees, travelers, campers, patients or customers have access to the water system each month? | 250 | 250 | 250 | 250 | 1000 | 1000 | 1000 | 1000 | 1000 | 250 | 250 | 250 |
| B. How many days per month is water accessible to the public? | 30 | 30 | 30 | 30 | 30 | 30 | 30 | 30 | 30 | 30 | 30 | 30 |

| 32. REGULAR NON-RESIDENTIAL USERS | JAN | FEB | MAR | APR | MAY | JUN | JUL | AUG | SEP | OCT | NOV | DEC |
|---|-----|-----|-----|-----|-----|-----|-----|-----|-----|-----|-----|-----|
| A. If you have schools, daycares, or businesses connected to your water system, how many students daycare children and/or employees are present each month? | 25 | 25 | 25 | 25 | 25 | | | | 25 | 25 | 25 | 25 |
| B. How many days per month are they present? | 20 | 20 | 20 | 20 | 20 | | | | 15 | 20 | 20 | 20 |

| 33. ROUTINE COLIFORM SCHEDULE | JAN | FEB | MAR | APR | MAY | JUN | JUL | AUG | SEP | OCT | NOV | DEC |
|---|-----|-----|-----|-----|-----|-----|-----|-----|-----|-----|-----|-----|
| Requirement is exception from WAC 246-290 | 1 | 1 | 1 | 1 | 1 | 1 | 1 | 1 | 1 | 1 | 1 | 1 |

| | | | |
|---|------------------|-----------------|---------------------------|
| 34. NITRATE SCHEDULE (One Sample per source by time period) | QUARTERLY | ANNUALLY | ONCE EVERY 3 YEARS |
|---|------------------|-----------------|---------------------------|

35. Reason for Submitting WFI:

Update - Change
 Update - No Change
 Inactivate
 Re-Activate
 Name Change
 New System
 Other _____

36. I certify that the information stated on this WFI form is correct to the best of my knowledge.

SIGNATURE: _____ DATE: _____

PRINT NAME: _____ TITLE: _____

Appendix C – Susceptibility Assessment



Ground Water Contamination Susceptibility Assessment Survey Form

Complete **one** form for **each** ground water source (well, wellfield, spring) used in your water system (photocopy as necessary).

PART I: System Information

Well owner/manager: Cascadia Water, LLC

Water system name: Estates, Inc.

County: Clallam

Water system ID number: 08166 9 Source number: S03

Well depth: 467 feet

Source name: WF (S01 & S02)

WA well identification tag number: ACA573 ACA574

Well not tagged

Number of connections: 367 Population served: 913

Township: 30N Range: 04W

Section: 04 ¼ ¼ Section: SE SE

Latitude/longitude (if available): _____ / _____

How was latitude/longitude determined?

_____ Global positioning device _____ survey _____ topographical map
other: _____

*Please refer the instructions for details and explanations of all questions in Parts II through V.

PART II: Well Construction and Source Information

1) Date well originally constructed: Well 1: Unknown Well 2: 12 / 23 / 1974
last reconstruction: Well 1: 12 / 3 / 1982 Well 2: 5 / 6 / 1983

Information unavailable

2) Well driller: Stoican Drilling Co, Inc.

Well driller unknown

3) Type of well: Drilled: rotary bored cable (percussion) Dug
___ other: spring(s) lateral collector (Ranney)
 driven jetted other:

4) Well report available Yes (attach copy to form) No

5) Average pumping rate: 400 (gallons/min)

Source of information WFI, Pump Tests

If not documented, how was pumping rate determined? _____

Pumping rate unknown

6) Is this source treated?

If so, what type of treatment:

disinfection filtration carbon filter air stripper other

Purpose of treatment (describe materials to be removed or controlled by treatment):

Chlorine is available if coliform is detected.

7) If source is chlorinated, is a chlorine residual maintained: Yes No

Residual level: _____ (At the point closest to the source.)

PART III: Hydrogeologic Information

1) Depth to top of open interval: [check one]

<20 ft 20-50ft 50-100ft 100-200ft >200ft

information unavailable

2) Depth to ground water (static water level):

<20ft 20-50ft 50-100ft >100ft

flowing well/spring (artesian)

How was water level determined?

well log other _____

depth to ground water unknown

3) If source is a flowing well or spring, what is the confining pressure:

_____ psi (pounds per square inch) or

_____ feet above wellhead

4) If source is a flowing well or spring, is there a surface impoundment, reservoir, or catchment associated with this source: Yes No

5) Wellhead elevation (height above mean sea level): 140 feet

How was elevation determined? topographic map Drilling/Well Log altimeter

other: _____

information unavailable

6) Confining layers: (This can be completed only for those sources with a drilling log, well log or geologic report describing subsurface conditions. Please refer to assistance package for example.)

x evidence of a confining layer in well log

_____ no evidence of a confining layer in well log

If there is evidence of a confining layer, is the depth to ground water more than 20 feet above the **bottom** of the **lowest confining layer**? Yes No

information unavailable

7) Sanitary setback:

< 100ft* 100-120ft 120-200 ft >200ft

* If less than 100ft, describe the site conditions:

8) Wellhead construction:

wellhead enclosed in a wellhouse

controlled access (describe): Wellhouse is locked and can only be accessed by owner/operator.

other uses for wellhouse (describe): _____

no wellhead control

9) Surface seal:

>18 ft

<18 ft (no Department of Ecology approval)

<18 ft (Approved by Ecology, include documentation)

depth of seal unknown

no surface seal

10) Annual rainfall (inches per year):

<10 in/yr 10-25 in/yr >25 in/yr

PART IV: Mapping Your Ground Water Resource

1) Annual volume of water pumped: 4,165,000 (gallons)

How was this determined?

meter

estimated: pumping rate (_____)

pump capacity (_____)

other: _____

2) "Calculated Fixed Radius" estimate of ground water movement:
(see Instruction Packet)

6-month ground water travel time: 611 feet

1-year ground water travel time: 863 feet

5-year ground water travel time: 1,931 feet

10-year ground water travel time: 2,730 feet

Information available on length of screened/open interval?

Yes No

Length of screened/open interval: Well 1: 186 ft Well 2: 10 ft

3) Is there a river, lake, pond, stream, or other obvious surface water body within the 6-month time of travel boundary?

Yes No (mark and identify on map)

4) Is there a stormwater and/or wastewater facility, treatment lagoon, or holding pond located within the 6-month time of travel boundary?

Yes No (mark and identify on map)

Comments: _____

PART V: Assessment of Water Quality

1) Regional sources of risk to ground water:

Please indicate if any of the following are present within a circular area around your water source having a radius up to and including the five-year ground water travel time. If you do not know if one of the following is present, mark the "unknown" space.

| | <u>6-month</u> | <u>1-year</u> | <u>5-year</u> | <u>unknown</u> |
|---|----------------|---------------|---------------|----------------|
| • likely pesticide application | _____ | <u> x </u> | <u> x </u> | <u> x </u> |
| • stormwater injection wells | _____ | _____ | _____ | _____ |
| • other injection wells | _____ | _____ | _____ | _____ |
| • abandoned ground water well | _____ | _____ | _____ | _____ |
| • landfills, dumps, disposal areas | _____ | _____ | _____ | _____ |
| • known hazardous materials clean-up site | _____ | _____ | <u> x </u> | _____ |
| • water system(s) with known quality problems | _____ | _____ | _____ | _____ |
| • population density >1 house/acre | <u> x </u> | <u> x </u> | <u> x </u> | <u> x </u> |
| • residences commonly have septic tanks | <u> x </u> | <u> x </u> | <u> x </u> | <u> x </u> |
| • Wastewater treatment lagoons | _____ | _____ | _____ | _____ |
| • sites used for land application of waste | _____ | _____ | _____ | _____ |

Mark and identify on map any of the risks listed above which are located within the 6-month time of travel boundary. (Please include a map of the wellhead and time of travel areas with this form. Please locate and mark any of the following.)

If other recorded or potential sources of ground water contamination exist within the ten-year time of travel circular zone around your water supply, please describe:

2) **Source-specific water quality records:** For each type of test below, mark the row that applies to the sample results for this source. Consider all the sample results from the past 12 years. (MCLs are noted next to the specific test or listed in assistance package.)

A. Nitrate: (Nitrate MCL = 10 mg/l)

- Results greater than MCL _____
- <2 mg/liter nitrate _____
- 2-5 mg/liter nitrate x
- <5 mg/liter nitrate _____
- Nitrate sampling records unavailable _____

B. VOCs: (VOC detection level is 0.5 ug/l or 0.0005 mg/l)

- Results greater than MCL or SAL _____
- VOCs detected at least once _____
- VOCs never detected x
- VOC sampling records unavailable _____

C. EDB/DBCP:

(EDB MCL = 0.05 ug/l or 0.00005 mg/l, DBCP MCL = 0.2 ug/l or 0.0002 mg/l.)

- EDB/DBCP detected below MCL at least once _____
- EDB/DBCP detected above MCL at least once _____
- EDB/DBCP never detected _____
- EDB/DBCP tests required but not yet completed _____
- EDB/DBCP tests not required x

D. Other SOC (Pesticides):

- Other SOC detected
(pesticides and other synthetic organic chemicals) _____
- Other SOC tests performed but none detected
(list test methods in comments) x
- Other SOC tests not performed _____

If any SOC in addition to EDB/DBCP were detected, please identify and date. If other SOC tests were performed, but no SOC detected, list test methods here: _____

 HERB1, INSECT1, PEST1 test panels used

E. Bacterial contamination:

Any bacterial detection(s) in the past 3 years in samples taken from the source (not distribution sampling records)? x

Has source (in past 3 years) had a bacteriological contamination problem found in distribution samples that was attributed to the source? x

Source sampling records for bacteria unavailable

PART VI: Geographic or Hydrologic Factors Contributing to a Non-Circular Zone of Contribution

The following questions will help identify those ground water systems which may not be accurately represented by the calculated fixed radius (CFR) method described in Part IV. For these sources, the CFR areas should be used as a preliminary delineation of the critical time of travel zones for that source. As a system develops its Wellhead Protection Plan for these sources, a more detailed delineation method should be considered.

1) Is there evidence of obvious hydrologic boundaries within the 10-year time of travel zone of the CFR? (Does the largest circle extend over a stream, river, lake, up a steep hillside, and/or over a mountain or ridge?)

Yes No

Describe with references to map produced in Part IV:

2) Aquifer Material:

A) Does the drilling log, well log or other geologic/engineering reports identify that the well is located in an area where the underground conditions are identified as fractured rock and/or basalt terrain?

Yes No

B) Does the drilling log, well log or other geologic/engineering reports indicate that the well is located in an area where the underground conditions are primarily identified as coarse sand and gravel?

Yes No

3) Is the source located in an aquifer with a high horizontal flow rate? (These can include sources located on flood plains of large rivers, artesian wells with high water pressure, and/or shallow flowing wells and springs.)

Yes No

4) Are there other high capacity wells (agricultural, municipal and/or industrial) located within the CFRs?

a) Presence of ground water extraction wells removing more than approximately 500 gal/min within...

| | YES | NO | unknown |
|----------------------------|-------|----------------|---------|
| <6-month travel time | _____ | <u>x</u> _____ | _____ |
| 6 month—1 year travel time | _____ | <u>x</u> _____ | _____ |
| 1—5 year travel time | _____ | <u>x</u> _____ | _____ |
| 5—10 year travel time | _____ | <u>x</u> _____ | _____ |

b) Presence of ground water recharge wells (dry wells) or heavy irrigation within...

| | YES | NO | unknown |
|-----------------------|-------|----------------|---------|
| <1-year travel time | _____ | <u>x</u> _____ | _____ |
| 1—5 year travel time | _____ | <u>x</u> _____ | _____ |
| 5—10 year travel time | _____ | <u>x</u> _____ | _____ |

Please identify or describe additional hydrologic or geographic conditions that you believe may affect the shape of the zone of contribution for this source. Where possible, reference them to locations on the map produced in Part IV.

FORM COMPLETED BY:

Print Name

Date

Signature

APPENDIX I
Well Head Protection Plan

DRAFT

1. OVERVIEW

The Estates, Inc. Water System (system) is located in Clallam County west of Sequim, Washington. The service area includes portions of Sections 3 and 4 of Township 30 North, Range 4 West, and Sections 32, 33, and 34 of Township 31 North, Range 4 West of the Willamette Meridian. Groundwater is the single source of water currently used within the service area. The system is served by two (2) existing groundwater wells, Well 1 (S01 - DOE Well Tag ID #ACA573) and Well #2 (S02 - DOE Well Tag ID #ACA574). The two sources are in the southern portion of the water system on Clallam County Parcel 043004-510880. Well #1 and Well 2 are designated as a well field (S03) with a capacity of 400 gpm. Well information is summarized in Table 1.

Table 1 – Well Information

| | Well 1 | Well 2 |
|--------------------------------|---------------------------|---------------------------|
| Source Type | Well (Non GWI) | Well (Non GWI) |
| DOE Tag | ACA573 | ACA574 |
| Source Location | Sec 4 T30N R04W | Sec 4 T30N R04W |
| Purpose of Use | Community Domestic Supply | Community Domestic Supply |
| Year Deepened | 1982 | 1983 |
| Pump Test Capacity (gpm) | 201 | 225 |
| Casing Size | 6"/4" | 8"/6"/5" |
| Ground Elev. (ft) | 140 | 140 |
| Bottom Well Depth (ft) | 607 | 462 |
| Static Water Depth (ft) | 58 | 58 |
| Depth to Top of Screen (ft) | 197 | 436 |
| Depth to Bottom of Screen (ft) | 592 | 445 |
| Drawdown (ft) | 17 | 31 |

1.1 Well Information

Estates is served by two groundwater wells that are located on Clallam County parcel 043004510880. This parcel is owned by Cascadia Water and has access off of the water system located off Ridgeview Drive in the southern portion of the service area.

Well 1 was drilled in 1982 to a final depth of 607-feet to serve as a primary source. The initial pump test for Well 1 was conducted in November 1982. That test recorded a static water level of 58-feet below the top of well. It also conducted a stepped pump test with a maximum rate of withdrawal of 201 gpm with a corresponding drawdown of 17-feet. A copy of the well log and corresponding pump test is included in Appendix A. Currently Well 1 is served by a 7.5-HP Berkeley submersible pump (Model 6S2AH-2) which supplies approximately 180 gpm at a total dynamic head of 80 feet.

Well 2 was initially drilled in 1974 to a depth of 86-feet with a static water level of 41-feet 1-inch. Later in 1983 Well 2 was deepened to a depth of 462-feet with a static water level of 57-feet below the top of well. A stepped pump test was conducted in May 1983 with a rate of withdrawal of 225 gpm with a corresponding drawdown of 31-feet. A copy of the well log and corresponding pump test is included in

Appendix A. Currently Well 2 is served by a 7.5-HP Berkeley submersible pump (Model 6S2AM-3) which supplies approximately 180 gpm at a total dynamic head of 80 feet.

The wells alternate in operation and are triggered by the float switches in the storage reservoir. Both wells have dedicated fill lines to the reservoir. A aerial view of the well site with the reservoir and pumphouse is provided in Figure 1.



Figure 1 - Well Locations and Well Site Layout

1.1.1 Water Rights

The Washington State Department of Ecology (DOE) has issued two water rights to the Estates water system. Water Right Certificate G2-27344 C (Priority Date: June 6, 1988) and G2-27484 C (Priority Date: February 14, 1989) allow the system a maximum instantaneous withdrawal (Q_i) of 500 gpm and a maximum withdrawal volume (Q_a) of 240 acre-feet per year (ac-ft/yr). The point of withdrawal for Well #1 is 880 feet west and 490 feet north of the southeast corner of Section 4, while the point of withdrawal for Well #2 is 900 feet west and 490 feet north of the southeast corner of Section 4. Copies of the system's certificates are provided in Appendix B.

1.1.2 Seawater Intrusion

Due to the existence of seawater intrusion (SWI) in many wells located on the shorelines of Washington State, the possibility of seawater intrusion into the potable water aquifers must be investigated on a regular basis. The DOE may condition water right permits to provide for reduced pumping rates or may require a water system to abandon sources if seawater intrusion threatens senior water right permits.

Department of Health Water System Design Manual 2019 hereon will be referred to as *The Design Manual*, identifies wells are at risk for intrusion if the well is located within $\frac{1}{2}$ mile of the shoreline and pump water

from a depth below sea level, and within ½ mile of a groundwater source with chloride concentrations over 100 mg/L.

Both of the Estates wells are located over 1 mile from the shoreline of the Puget Sound and pump water from a depth below sea level, so they are not considered “at risk for intrusion” per the DOH Design Manual criteria. In addition, the most recent Chloride values from the combined sources was less than 20 gm/L.

1.2 Sanitary Control Area

Clallam County (the County) has inspected and approved Well #1 and Well #2 well site locations. A copy of the well site approval and the sanitary survey is provided in Appendix A. The wells are located to minimize the possibility of contamination and to prevent surface water from entering the well. The existing wells have an established declaration of covenant recorded with the County, which is included in Appendix A. The 100-foot pollution control radius for Well 1 is contained within the system controlled parcel. The 100-foot pollution control radius for Well 2 is partially within the system controlled parcel but extends into neighboring parcels where homes are located.

Each well has a casing that extends 1-foot above the ground surface and a small shed that surrounds it, preventing surface water from affecting the well. Additionally, the wells are completed in a confined aquifer whose confining layer protects the wells from surface water contamination. The potential for subsurface domestic contamination from the nearby residence is also low because of the confining layer protecting the aquifer. If domestic contamination did occur, it could include septic, gas, pesticides, fertilizers, etc. See the Contaminant Source Inventory in Appendix D for more information regarding potential contaminants. The 100-foot sanitary control radius for each well is shown in Figure 2.

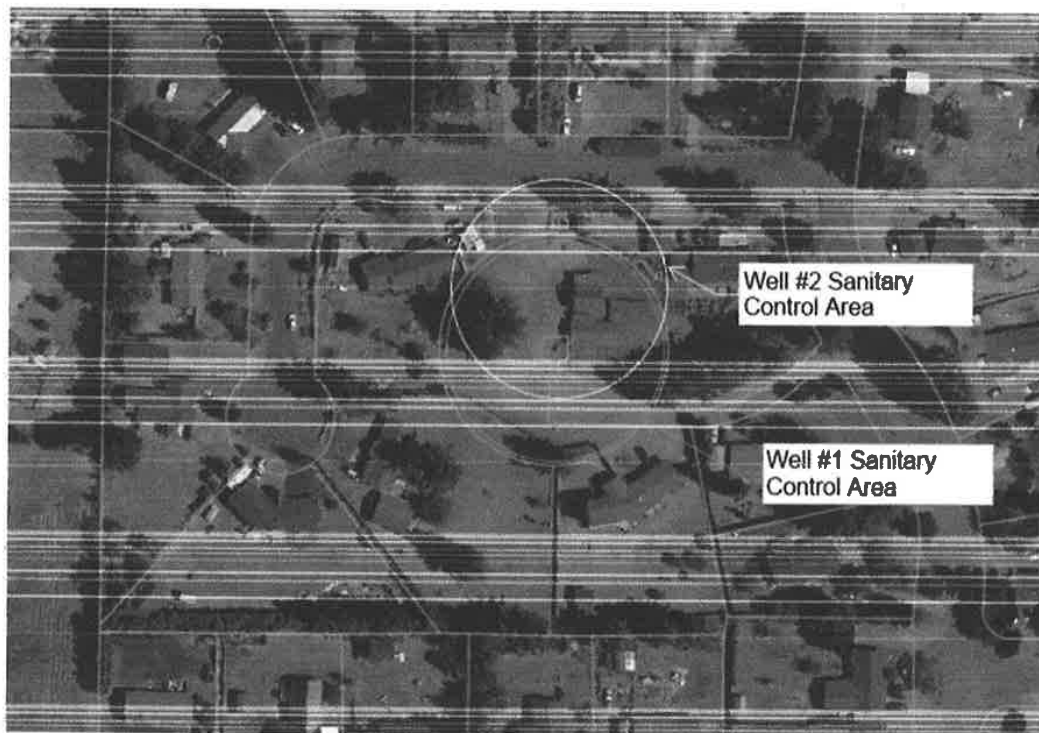

Figure 2 - Sanitary Control Area

2. WELLHEAD PROTECTION AREA

2.1 Wellhead Protection Area Delineation

The wellhead protection area (WHPA) delineation was calculated using the calculated fixed radius method. The following equation from the DOH Wellhead Protection Program Guidance Document was used to calculate the Wellhead Protection Area Zones, using the fixed radii method, as follows:

$$r = \sqrt{\frac{Q t}{\pi n H}}$$

Where:

- r = Calculated Fixed Radii (feet)
- Q = Pumping Rate of Well (cubic feet per year)
- t = Travel Time to Well (0.5, 1, 5, 10 years)
- π = pi
- n = Aquifer Porosity = 0.22
- H = Open Interval of Length of Well Perforations (feet)

The pumping rate for the well (Q) was calculated from the system’s total annual demand at full build-out at 1,463,904 cubic feet (cf). Assuming a 50% split between the two wells, since the existing wells share the annual demand, the estimated annual volume of water pumped from each well is about 2,576,470 cf/year. This was determined using the following equation:

$$ADD \left(\frac{gpd}{ERU} \right) * Maximum ERUs * 365 days / 2$$

$$\frac{220 \frac{gpd}{ERU} * 480 ERUs * 365 days}{2} = 19,272,000 gallons = 2,576,470 cf per year$$

Table 2 shows the results of the well’s calculated fixed radius based on the different travel times. The site topology indicated no complicated geologic factors or ground/surface water interactions that would necessitate a calculation method other than the calculated fixed radius method for delineating the source water protection areas. The resulting wellhead protection area zones (based on travel times) are shown in Figure 4 below.

Table 2 – Calculated Fixed Radii

| Condition | Source | Water Demand (cf/yr) | n | H (ft) | Calculated Fixed Radius (feet) Based on Travel Times | | | |
|------------------------|--------|----------------------|-----|--------|---|------|-------|-------|
| | | | | | 6 mo | 1-yr | 5-yr | 10-yr |
| Anticipated Withdrawal | S03 | 2,576,470 | .22 | 10 | 611 | 863 | 1,931 | 2,730 |

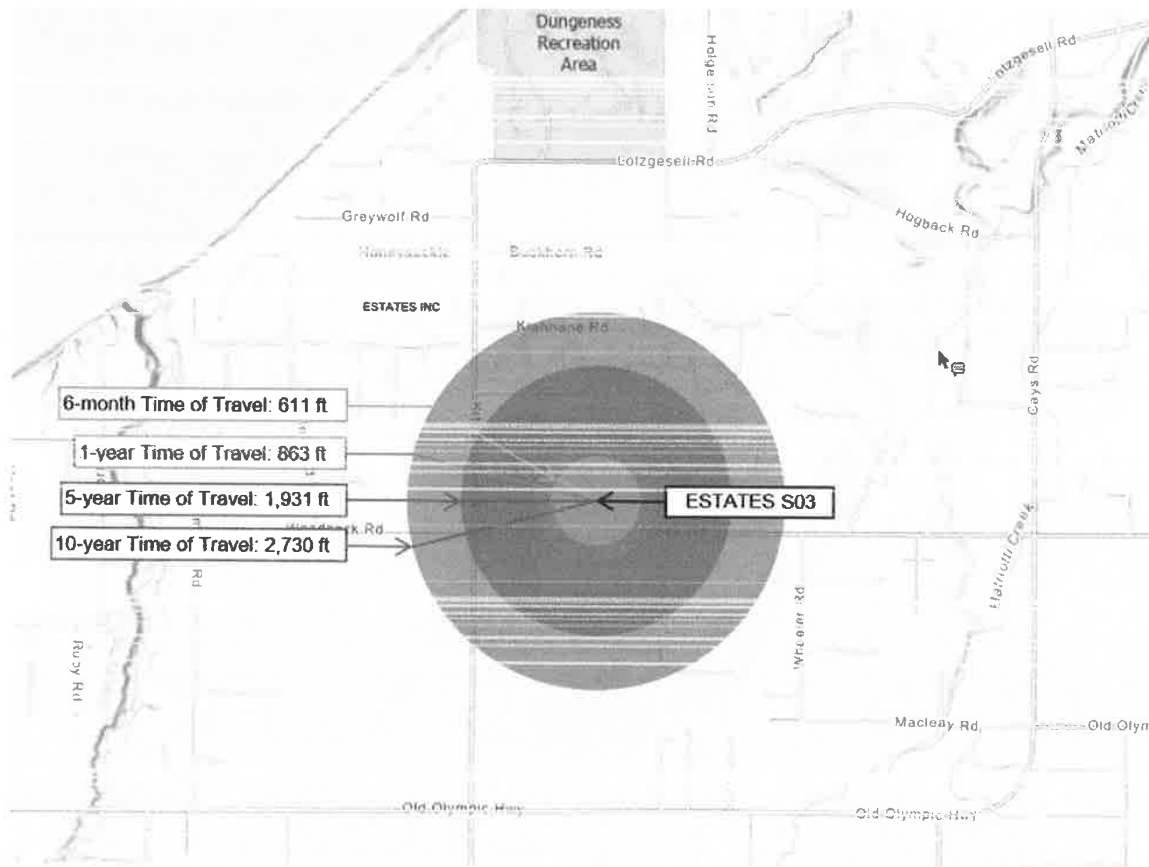

Figure 4 – Wellhead Protection Areas

2.2 Land Use and Zoning

Land use and zoning within the wellhead protection areas can help identify contaminants related to certain land uses. The land use within Zone 1 (1 year) and Zone 3 (10 year) wellhead protection areas of the existing sources is residential and parkland. The zoning is also R1, AR, NC, and R5. The results are summarized in Table 3. The land contained within the wellhead protection areas is mostly residential. This poses some risk from on-site septic systems, storage of household chemicals, and fertilizers as detailed in Appendix D.

Table 2-1 - Land Use Within Wellhead Protection Areas

| | Zone 1 (1 year travel time) | Zone 3 (10 year travel time) |
|--------|-----------------------------|------------------------------|
| Source | R1, AR, NC | R1, AR, NC, R5 |
| S03 | 54 acres | 538 acres |

2.3 Potential Contaminants

A Contaminant Source Inventory was completed to best account for any possible sources of groundwater contamination within the wellhead protection area for the two wells. The inventory includes all potential contaminant sources within Zone 1 (the 1-year time of travel (total)) and high-risk potential contaminant sources within Zone 3 (the 10-year time of travel (total)).

The following information was used for developing the contaminant source inventory:

- Department of Health Source Water Assessment Program (SWAP) maps
- US EPA Drinking Water Mapping Application to Protect Source Waters (DWMAPS)
- Department of Ecology Toxic Cleanup Program maps
- Jefferson County Public Land Records GIS Maps and Aerial Imagery
- Knowledge of Septic System Use in the Area

The potential contaminants list from the Washington State Department of Health (WSDOH) Wellhead Protection Program Guidance Document (June 2017) was used in identifying the potential contaminants near the wells. The potential contaminants grouped in a high, medium, and low risk ranking and prioritization system are included in the Contaminant Source Inventory, which is found in Appendix D. Additional descriptions are provided in the 'Description' column in the inventory for each item as applicable.

2.4 Groundwater Contaminant Susceptibility Assessment

A susceptibility assessment form was prepared to support this plan and to determine susceptibility level of each well. This form is required of all groundwater-based Group A systems and is useful in determining the minimum definition for the WHPA. The well field is classified as low susceptibility. This form is attached in Appendix E.

2.5 Notifications

Regulatory agencies, local government entities, facility operators, customers, and landowners within the identified capture zones will receive the WHPA notification letters. Sample letters can be found in Appendix F. All notification letters should discuss the well's susceptibility rating, what the rating means, and the number of people the System serves.

Within one year of defining WHPA boundaries, water systems must notify in writing the potential groundwater contaminant sources identified within their WHPA – and the agencies or jurisdictions that regulate those sources within the WHPA. The potential groundwater contaminant sources identified within the System's WHPA are listed in Table 3 along with the relevant regulators. In summary, Cascadia Water LLC, as the water system's owner should notify the residents of the Discovery Bay Village water system of their responsibility to protect their drinking water supply (groundwater wells) by properly managing potential contaminates.

Table 3 – Potential Groundwater Contaminant Sources and Regulators

| Potential Groundwater Contaminant Source | Owner/Operator of Source | Regulatory Agency |
|---|--|---------------------|
| Septic Tanks/Pipes, Lawn Fertilizers/Pesticides, Hazardous Waste, Residential Disposal, Burn Sites, etc | Residents of Discovery Bay Village Community | Cascadia Water, LLC |

APPENDIX J
Water Loss Control Action Plan

DRAFT

**Water Loss Control Action Plan
Estates, Inc.**

May 2024

1. WATER LOSS CONTROL ACTION PLAN (WLCAP)

The Distribution System Leakage (DSL) of the Estates, Inc. water system (Estates) has been noted at just under 10% per the annual Water Use Efficiency (WUE) reports in recent years with an average DSL of 9.1% over the past three years. A water system's DSL of greater than 10% is greater than the threshold which requires a Water Loss Control Action Plan (WLCAP). This document is a preventative measure to safeguard this critical resource for the community.

Cascadia is required to establish a water use reduction goal as part of its WLCAP to address distribution system losses. The action plan to be implemented contains various aspects with the intent of obtaining accurate data, identifying real losses, and improving the system efficiency. The water systems will implement several water use efficiency measures

1.1 HISTORY OF PAST WLCAP GOALS

Prior to ownership transferring to Cascadia Water, the system had not adopted a Water Use Efficiency (WUE) goal for over a decade. However, their yearly water use efficiency reports had noted that they had been "been sending out water conservation cards in their bills since 2001." The newly developed Water System Plan being submitted in 2024 implements new goals for the system.

2. WATER LOSS CONTROL ACTION ITEMS

2.1 ACCURATE DATA COLLECTION – WATER METERING

The System sources and treatment facilities are metered. The source meters are multiple times a week for the production wells. The meters are periodically tested and repaired or replaced as needed.

Cascadia requires the installation of water meters on all service connections. An estimate is made for the water used for flushing, system cleaning, and fire department use. Meter readings are taken on a bimonthly basis and are used to determine customer water use and charges. Replacement of old/outdated meters on an on-going basis will occur to assist in obtaining accurate consumption usage data. The replacement of meters will be incorporated into the system's WLCAP.

2.2 IDENTIFY REAL WATER LOSSES

With the newly installed, accurate meters Cascadia will be able to identify real water losses in the system. The accurate data will allow the prioritization of proposed water line replacement projects. Accurate consumption data will also allow for large consumers of the water to be billed appropriate for their water use and encourage conservancy throughout the systems.

2.3 LEAK DETECTION PROGRAM

Water lost through a utility's transmission and distribution system is typically referred to as "Distribution System Leakage (DSL)". A system audit compares the amount of water produced from the source to the amount of water sold to customers. Cascadia performs a bimonthly analysis of source water produced in comparison with water sold to detect increases in the DSL.

Cascadia's leak detection program includes monitoring for leaks in the system and quickly repairing them when identified. Cascadia promptly investigates any reports of leaks from customers and actively investigates aberrations in consumption by customers.

The WUE Annual Performance Reports for the system is submitted to the state. The most recent WUE indicates that the 3-year annual average for DSL at Estates is 9.1% which is below the 10% DSL threshold indicated by the

**Water Loss Control Action Plan
Estates, Inc.**

May 2024

DOH. However, the data for the most recently reported year reports a DSL of 10.5%. This WLCAP has been developed as Cascadia to ensure proper stewardship of this valuable resource for the water system.

This Water System Plan includes various projects to assess and reduce potential factors contributing to the water loss in Cascadia's distribution systems including replacement of aging water lines and replacement of older meters that may no longer be functioning properly.

2.4 WATER PRESSURE

The water pressure within the system must be at a minimum of 30-psi at all service connections during peak demand. The System is also required to provide fire flow maintain a minimum of 20-psi at all points throughout the distribution system during a fire suppression event. A maximum pressure of 80-psi in the distribution system is advisable to prevent water loss through over-pressurized services.

2.5 FLUSHING MAINS

A portion of the routine maintenance performed on the System is to periodically flush the distribution systems. Silt and organic debris accumulate in the system over time and must be flushed out on a regular basis. Estimates on the amount of water used during flushing operations will be used to determine the DSL rate.

2.6 INFORMATIONAL MESSAGES

~~Cascadia will include informational brochures and/or letters on the need for conservation with customer billing statements on occasion. Billing statements will also include periodic messages encouraging conservation.~~

Cascadia will relay information about upcoming water conservation meetings to their customers. Cascadia will capitalize on studies conducted by larger water systems, such as the Snohomish County PUD and the City of Everett, and the DOH. These studies will be used to evaluate the latest water conservation techniques. These techniques will be analyzed for their applicability to the Water System and how they may best be implemented.

2.7 PLUMBING FIXTURE REPLACEMENT

Cascadia, through the attachment of informational literature to the customer billing statement, can encourage the use of low water use fixtures in homes. It also plans to provide new customers with informational materials on water saving plumbing.

2.8 WATER USE FOR LANDSCAPING

Lawn and landscape watering are the largest uses of water during the summer months. Education on the amount of water needed to sustain healthy plant life is an effective conservation tool. Cascadia plans to provide customers with literature on lawn watering during the spring of each year. Cascadia also plans to distribute literature offering recommendations for establishing a water conserving landscape. A listing of drought tolerant plants will be provided along with suggestions for plant placement and watering.

Cascadia has also established a rate structure, as shown in their tariff, that encourages prudent use of water in the yard and garden. This is particularly important for the Estates system since there are a appreciable number of connections who have high seasonal usage.

3. WATER USE EFFICIENCY GOALS

The Estates has two major goals with their conservation program: further reduction in distribution system leakage and the reduction of the growth adjusted maximum day demand.

**Water Loss Control Action Plan
Estates, Inc.**

May 2024

The System would like to reduce distribution system losses below 8.0% within five years. Reductions in the DSL will be accomplished through the capital improvements outlined in Chapter 8 which proposes the replacement of aging infrastructure in the water system based on analyzed and observed deficiencies.

The second goal is to reduce the growth adjusted maximum day demand by a minimum of 1.5% within ten years. Cascadia plans on accomplishing this goal by reducing DSL as part of their first goal and as they further educate customers regarding the resource and methods for conservation

DRAFT

APPENDIX L
Water Quality Results



Division of Environmental Health
Office of Drinking Water

Help

View Sample Detail - WSID 081669 - ESTATES INC

Collect Date 8/11/2021
 Lab Number 910
 Lab Name Spectra Laboratories - Kitsap, LLC
 Sample Number 97001
 Source 03
 Analyte Group IOC-INORGANIC CONTAMINANTS
 Test Panel NIT-NITRATE SUITE
 Sample Location wh
 Sample Type Pre-Treatment / Raw

Result Range, A/P, Units: Mouse over for full description

| Analyte DOH Num | Analyte Name | Result Range | Result Quantity | Maximum Contaminant Level | State Reporting Limit | Units |
|-----------------|--------------|--------------|-----------------|---------------------------|-----------------------|-------|
| 0020 | NITRATE-N | LT | 0.5000 | 10.0000 | 0.5000 | mg/L |

Records 1 - 1 of 1

[Home Page](#) | [Find Water Systems](#) | [Find Water Quality](#) | [Downloads/Reports](#)

[DOH Home](#) | [Community and Environment](#) | [Drinking Water Home](#) | [Drinking Water Contacts](#)
[Access Local Health](#) | [Privacy Notice](#) | [Disclaimer/Copyright Information](#)

Links to external resources are provided as a public service and do not imply endorsement by the Washington State Department of Health

Department of Health, Office of Drinking Water

Street Address:

243 Israel Road, S.E. 2nd floor
 Tumwater, WA 98501

Mail:

PO BOX 47822
 Olympia, WA 98504-7822

Comments or questions regarding this Web site? Send email to [Environmental Health Application Testing and Support](#)



**Division of Environmental Health
 Office of Drinking Water**

Help

View Sample Detail - WSID 081669 - ESTATES INC

Collect Date 5/19/2020
 Lab Number 094
 Lab Name Eurofins Eaton LLC - Pomona
 Sample Number 30025
 Source 03
 Analyte Group RAD-RADIONUCLIDES
 Test Panel RAD-RADIONUCLIDES
 Sample Location wh
 Sample Type Pre-Treatment / Raw

Result Range, A/P, Units: Mouse over for full description

| Analyte DOH Num | Analyte Name | Result Range | Result Quantity | Maximum Contaminant Level | State Reporting Limit | Units |
|-----------------|--------------|--------------|-----------------|---------------------------|-----------------------|-------|
| 0165 | GROSS ALPHA | LT | 3.0000 | | 3.0000 | pCi/L |
| 0166 | RADIUM 228 | LT | 1.0000 | 5.0000 | 1.0000 | pCi/L |

Records 1 - 2 of 2

[Home Page](#) | [Find Water Systems](#) | [Find Water Quality](#) | [Downloads/Reports](#)

[DOH Home](#) | [Community and Environment](#) | [Drinking Water Home](#) | [Drinking Water Contacts](#)
[Access Local Health](#) | [Privacy And Copyright Information](#) |

Links to external resources are provided as a public service and do not imply endorsement by the Washington State Department of Health

Department of Health, Office of Drinking Water

Street Address:

243 Israel Road S.E., 2nd floor
 Tumwater, WA 98501

Mail:

PO BOX 47822
 Olympia, WA 98504-7822

Comments or questions regarding this Web site? Send email to [Environmental Health Application Testing and Support](#)



**Division of Environmental Health
 Office of Drinking Water**

[Help](#)

View Sample Detail - WSID 081669 - ESTATES INC

Collect Date 4/10/2023
 Lab Number 218
 Lab Name BSK Associates
 Sample Number 26001
 Source 03
 Analyte Group SOC-SYNTHETIC ORGANIC CONTAMINANTS
 Test Panel HERB1-CHLOROPHOXY HERBICIDES
 Sample Location whr
 Sample Type Unknown

Result Range, A/P, Units: Mouse over for full description

| Analyte DOH Num | Analyte Name | Result Range | Result Quantity | Maximum Contaminant Level | State Reporting Limit | Units |
|-----------------|-------------------------|--------------|-----------------|---------------------------|-----------------------|-------|
| 0037 | 2,4 - D | LT | 0.1000 | 70.0000 | 0.1000 | ug/L |
| 0038 | 2,4,5 TP (SILVEX) | LT | 0.2000 | 50.0000 | 0.2000 | ug/L |
| 0134 | PENTACHLOROPHENOL | LT | 0.0400 | 1.0000 | 0.0400 | ug/L |
| 0135 | 2,4 DB | LT | 1.0000 | | 1.0000 | ug/L |
| 0136 | 2,4,5 T | LT | 0.4000 | | 0.4000 | ug/L |
| 0137 | DALAPON | LT | 1.0000 | 200.0000 | 1.0000 | ug/L |
| 0138 | DICAMBA | LT | 0.2000 | | 0.2000 | ug/L |
| 0139 | DINOSEB | LT | 0.2000 | 7.0000 | 0.2000 | ug/L |
| 0140 | PICLORAM | LT | 0.1000 | 500.0000 | 0.1000 | ug/L |
| 0220 | BENTAZON | LT | 0.5000 | | 0.5000 | ug/L |
| 0221 | DICHLORPROP | LT | 0.5000 | | 0.5000 | ug/L |
| 0223 | ACIFLUORFEN | LT | 2.0000 | | 2.0000 | ug/L |
| 0225 | DCPA ACID METABOLITES | LT | 0.1000 | | 0.1000 | ug/L |
| 0226 | 3,5 DICHLORBENZOIC ACID | LT | 0.5000 | | 0.5000 | ug/L |

Records 1 - 14 of 14

[Home Page](#) | [Find Water Systems](#) | [Find Water Quality](#) | [Downloads/Reports](#)

[DOH Home](#) | [Community and Environment](#) | [Drinking Water Home](#) | [Drinking Water Contacts](#)
[Access Local Health](#) | [Privacy And Copyright Information](#) |

Links to external resources are provided as a public service and do not imply endorsement by the Washington State Department of Health

Department of Health, Office of Drinking Water

Street Address:

243 Israel Road S.E. 2nd floor
 Tumwater, WA 98501

Mail:

PO BOX 47822
 Olympia, WA 98504-7822



**Division of Environmental Health
 Office of Drinking Water**

Help

View Sample Detail - WSID 081669 - ESTATES INC

Collect Date 4/10/2023
 Lab Number 218
 Lab Name BSK Associates
 Sample Number 26001
 Source 03
 Analyte Group SOC-SYNTHETIC ORGANIC
 CONTAMINANTS
 Test Panel PEST1-GENERAL PESTICIDE SUITE
 Sample Location wh
 Sample Type Unknown

Result Range, A/P, Units: Mouse over for full description

| Analyte DOH Num | Analyte Name | Result Range | Result Quantity | Maximum Contaminant Level | State Reporting Limit | Units |
|-----------------|----------------------------|--------------|-----------------|---------------------------|-----------------------|-------|
| 0033 | ENDRIN | LT | 0.0100 | 2.0000 | 0.0100 | ug/L |
| 0034 | LINDANE (BHC - GAMMA) | LT | 0.0200 | 0.2000 | 0.0200 | ug/L |
| 0035 | METHOXYCHLOR | LT | 0.1000 | 40.0000 | 0.1000 | ug/L |
| 0036 | TOXAPHENE | LT | 1.0000 | 3.0000 | 1.0000 | ug/L |
| 0118 | ALDRIN | LT | 0.1000 | | 0.1000 | ug/L |
| 0122 | CHLORDANE (TOTAL) | LT | 0.2000 | 2.0000 | 0.2000 | ug/L |
| 0123 | DIELDRIN | LT | 0.1000 | | 0.1000 | ug/L |
| 0126 | HEPTACHLOR | LT | 0.0400 | 0.4000 | 0.0400 | ug/L |
| 0127 | HEPTACHLOR EPOXIDE | LT | 0.0200 | 0.2000 | 0.0200 | ug/L |
| 0128 | HEXACHLOROBENZENE | LT | 0.1000 | 1.0000 | 0.1000 | ug/L |
| 0129 | HEXACHLOROCYCLO PENTADIENE | LT | 0.1000 | 50.0000 | 0.1000 | ug/L |
| 0173 | AROCHLOR 1221 | LT | 20.0000 | | 20.0000 | ug/L |
| 0174 | AROCHLOR 1232 | LT | 0.5000 | | 0.5000 | ug/L |
| 0175 | AROCHLOR 1242 | LT | 0.3000 | | 0.3000 | ug/L |
| 0176 | AROCHLOR 1248 | LT | 0.1000 | | 0.1000 | ug/L |
| 0177 | AROCHLOR 1254 | LT | 0.1000 | | 0.1000 | ug/L |
| 0178 | AROCHLOR 1260 | LT | 0.2000 | | 0.2000 | ug/L |
| 0180 | AROCHLOR 1016 | LT | 0.0800 | | 0.0800 | ug/L |

Records 1 - 18 of 18

[Home Page](#) | [Find Water Systems](#) | [Find Water Quality](#) | [Downloads/Reports](#)

[DOH Home](#) | [Community and Environment](#) | [Drinking Water Home](#) | [Drinking Water Contacts](#)
[Access Local Health](#) | [Privacy And Copyright Information](#) |

Links to external resources are provided as a public service and do not imply endorsement by the Washington State Department of Health



Division of Environmental Health
Office of Drinking Water

Help

View Sample Detail - WSID 081669 - ESTATES INC

Collect Date 8/19/2019
 Lab Number 010
 Lab Name Spectra Laboratories - Kitsap, LLC
 Sample Number 43102
 Source 03
 Analyte Group IOC-INORGANIC CONTAMINANTS
 Test Panel IOC-COMPLETE INORGANIC ANALYSIS
 Sample Location wh
 Sample Type Unknown

Result Range, A/P, Units: Mouse over for full description

| Analyte DOH Num | Analyte Name | Result Range | Result Quantity | Maximum Contaminant Level | State Reporting Limit | Units |
|-----------------|--------------|--------------|-----------------|---------------------------|-----------------------|----------|
| 0010 | MANGANESE | EQ | 0.1800 | 0.0500 | 0.0100 | mg/L |
| 0009 | LEAD | EQ | 0.0010 | | 0.0010 | mg/L |
| 0014 | SODIUM | EQ | 11.3000 | | 5.0000 | mg/L |
| 0015 | HARDNESS | EQ | 162.0000 | | 10.0000 | mg/L |
| 0016 | CONDUCTIVITY | EQ | 316.0000 | 700.0000 | 70.0000 | Umhos/cm |
| 0017 | TURBIDITY | EQ | 0.3000 | | 0.1000 | NTU |
| 0024 | ZINC | EQ | 0.6200 | 5.0000 | 0.2000 | mg/L |
| 0004 | ARSENIC | LT | 0.0010 | 0.0104 | 0.0010 | mg/L |
| 0005 | BARIUM | LT | 0.1000 | 2.0000 | 0.1000 | mg/L |
| 0006 | CADMIUM | LT | 0.0010 | 0.0050 | 0.0010 | mg/L |
| 0007 | CHROMIUM | LT | 0.0070 | 0.1000 | 0.0070 | mg/L |
| 0008 | IRON | LT | 0.1000 | 0.3000 | 0.1000 | mg/L |
| 0011 | MERCURY | LT | 0.0002 | 0.0020 | 0.0002 | mg/L |
| 0012 | SELENIUM | LT | 0.0020 | 0.0500 | 0.0020 | mg/L |
| 0013 | SILVER | LT | 0.1000 | 0.1000 | 0.1000 | mg/L |
| 0018 | COLOR | LT | 15.0000 | 15.0000 | 15.0000 | CU |
| 0019 | FLUORIDE | LT | 0.2000 | 4.0000 | 0.2000 | mg/L |
| 0020 | NITRATE-N | LT | 0.5000 | 10.0000 | 0.5000 | mg/L |
| 0021 | CHLORIDE | LT | 20.0000 | 250.0000 | 20.0000 | mg/L |
| 0022 | SULFATE | LT | 50.0000 | 250.0000 | 50.0000 | mg/L |
| 0023 | COPPER | LT | 0.0200 | | 0.0200 | mg/L |
| 0110 | BERYLLIUM | LT | 0.0003 | 0.0040 | 0.0003 | mg/L |
| 0111 | NICKEL | LT | 0.0050 | 0.1000 | 0.0050 | mg/L |
| 0112 | ANTIMONY | LT | 0.0030 | 0.0060 | 0.0030 | mg/L |
| 0113 | THALLIUM | LT | 0.0010 | 0.0020 | 0.0010 | mg/L |

Records 1 - 25 of 28



**Division of Environmental Health
 Office of Drinking Water**

Help

View Sample Detail - WSID 081669 - ESTATES INC

Collect Date 8/19/2019
 Lab Number 010
 Lab Name Spectra Laboratories - Kitsap, LLC
 Sample Number 43102
 Source 03
 Analyte Group IOC-INORGANIC CONTAMINANTS
 Test Panel IOC-COMPLETE INORGANIC ANALYSIS
 Sample Location wh
 Sample Type Unknown

Result Range, A/P, Units: Mouse over for full description

| Analyte DOH Num | Analyte Name | Result Range | Result Quantity | Maximum Contaminant Level | State Reporting Limit | Units |
|-----------------|-----------------------|--------------|-----------------|---------------------------|-----------------------|-------|
| 0114 | NITRITE-N | LT | 0.1000 | 1.0000 | 0.1000 | mg/L |
| 0116 | CYANIDE | LT | 0.0500 | 0.2000 | 0.0500 | mg/L |
| 0161 | TOTAL NITRATE/NITRITE | LT | 0.5000 | | 0.5000 | mg/L |

Records 25 - 28 of 28

[Home Page](#) | [Find Water Systems](#) | [Find Water Quality](#) | [Downloads/Reports](#)

[DOH Home](#) | [Community and Environment](#) | [Drinking Water Home](#) | [Drinking Water Contacts](#)
[Access Local Health](#) | [Privacy And Copyright Information](#) |

Links to external resources are provided as a public service and do not imply endorsement by the Washington State Department of Health

Department of Health, Office of Drinking Water

Street Address:

243 Israel Road S.E., 2nd floor
 Tumwater, WA 98501

Mail:

PO BOX 47822
 Olympia, WA 98504-7822

Comments or questions regarding this Web site? Send email to [Environmental Health Application Testing and Support](#)



**Division of Environmental Health
Office of Drinking Water**

Help

View Sample Detail - WSID 081669 - ESTATES INC

Collect Date 9/28/2021
 Lab Number 094
 Lab Name Eurofins Eaton LLC - Monrovia
 Sample Number 80713
 Source 03
 Analyte Group VOC-VOLATILE ORGANIC CONTAMINANTS
 Test Panel VOC1-VOLATILE ORGANIC
 Sample Location wh
 Sample Type Pre-Treatment / Raw

Result Range, A/P, Units: Mouse over for full description

| Analyte DOH Num | Analyte Name | Result Range | Result Quantity | Maximum Contaminant Level | State Reporting Limit | Units |
|-----------------|-------------------------------------|--------------|-----------------|---------------------------|-----------------------|-------|
| 0027 | CHLOROFORM | LT | 0.5000 | | 0.5000 | ug/L |
| 0028 | BROMODICHLOROMETHANE | LT | 0.5000 | | 0.5000 | ug/L |
| 0029 | DIBROMOCHLOROMETHANE | LT | 0.5000 | | 0.5000 | ug/L |
| 0030 | BROMOFORM | LT | 0.5000 | | 0.5000 | ug/L |
| 0045 | VINYL CHLORIDE | LT | 0.5000 | 2.0000 | 0.5000 | ug/L |
| 0046 | 1,1 DICHLOROETHYLENE | LT | 0.5000 | 7.0000 | 0.5000 | ug/L |
| 0047 | 1,1,1 TRICHLOROETHANE | LT | 0.5000 | 200.0000 | 0.5000 | ug/L |
| 0048 | CARBON TETRACHLORIDE | LT | 0.5000 | 5.0000 | 0.5000 | ug/L |
| 0049 | BENZENE | LT | 0.5000 | 5.0000 | 0.5000 | ug/L |
| 0050 | 1,2 DICHLOROETHANE | LT | 0.5000 | 5.0000 | 0.5000 | ug/L |
| 0051 | TRICHLOROETHYLENE | LT | 0.5000 | 5.0000 | 0.5000 | ug/L |
| 0052 | 1,4 DICHLOROBENZENE | LT | 0.5000 | 75.0000 | 0.5000 | ug/L |
| 0053 | CHLOROMETHANE | LT | 0.5000 | | 0.5000 | ug/L |
| 0054 | BROMOMETHANE | LT | 0.5000 | | 0.5000 | ug/L |
| 0056 | METHYLENE CHLORIDE(DICHLOROMETHANE) | LT | 0.5000 | 5.0000 | 0.5000 | ug/L |
| 0057 | TRANS- 1,2 DICHLOROETHYLENE | LT | 0.5000 | 100.0000 | 0.5000 | ug/L |
| 0058 | 1,1 DICHLOROETHANE | LT | 0.5000 | | 0.5000 | ug/L |
| 0060 | CIS- 1,2 DICHLOROETHYLENE | LT | 0.5000 | 70.0000 | 0.5000 | ug/L |
| 0062 | 1,1 DICHLOROPROPENE | LT | 0.5000 | | 0.5000 | ug/L |
| 0063 | 1,2 DICHLOROPROPANE | LT | 0.5000 | 5.0000 | 0.5000 | ug/L |
| 0064 | DIBROMOMETHANE | LT | 0.5000 | | 0.5000 | ug/L |
| 0066 | TOLUENE | LT | 0.5000 | 1000.0000 | 0.5000 | ug/L |
| 0067 | 1,1,2 TRICHLOROETHANE | LT | 0.5000 | 5.0000 | 0.5000 | ug/L |
| 0068 | TETRACHLOROETHYLENE | LT | 0.5000 | 5.0000 | 0.5000 | ug/L |
| 0070 | 1,3 DICHLOROPROPANE | LT | 0.5000 | | 0.5000 | ug/L |

Records 1 - 25 of 56



Division of Environmental Health
 Office of Drinking Water

Help

View Sample Detail - WSID 081669 - ESTATES INC

Collect Date 9/28/2021
 Lab Number 094
 Lab Name Eurofins Eaton LLC - Pomona
 Sample Number 80713
 Source 03
 Analyte Group VOC-VOLATILE ORGANIC CONTAMINANTS
 Test Panel VOC1-VOLATILE ORGANIC
 Sample Location wh
 Sample Type Pre-Treatment / Raw

Result Range, A/P, Units: Mouse over for full description

| Analyte DOH Num | Analyte Name | Result Range | Result Quantity | Maximum Contaminant Level | State Reporting Limit | Units |
|-----------------|-----------------------------|--------------|-----------------|---------------------------|-----------------------|-------|
| 0071 | CHLOROBENZENE | LT | 0.5000 | 100.0000 | 0.5000 | ug/L |
| 0072 | 1,1,1,2 TETRACHLOROETHANE | LT | 0.5000 | | 0.5000 | ug/L |
| 0073 | ETHYLBENZENE | LT | 0.5000 | 700.0000 | 0.5000 | ug/L |
| 0074 | M/P XYLENES (MCL FOR TOTAL) | LT | 0.5000 | | 0.5000 | ug/L |
| 0075 | O- XYLENE (MCL FOR TOTAL) | LT | 0.5000 | | 0.5000 | ug/L |
| 0076 | STYRENE | LT | 0.5000 | 100.0000 | 0.5000 | ug/L |
| 0078 | BROMOBENZENE | LT | 0.5000 | | 0.5000 | ug/L |
| 0079 | 1,2,3 TRICHLOROPROPANE | LT | 0.5000 | | 0.5000 | ug/L |
| 0080 | 1,1,2,2 TETRACHLOROETHANE | LT | 0.5000 | | 0.5000 | ug/L |
| 0081 | O- CHLOROTOLUENE | LT | 0.5000 | | 0.5000 | ug/L |
| 0082 | P- CHLOROTOLUENE | LT | 0.5000 | | 0.5000 | ug/L |
| 0083 | M- DICHLOROBENZENE | LT | 0.5000 | | 0.5000 | ug/L |
| 0084 | 1,2 DICHLOROBENZENE | LT | 0.5000 | 600.0000 | 0.5000 | ug/L |
| 0085 | TRICHLOROFLUOROMETHANE | LT | 0.5000 | | 0.5000 | ug/L |
| 0086 | BROMOCHLOROMETHANE | LT | 0.5000 | | 0.5000 | ug/L |
| 0087 | ISOPROPYLBENZENE | LT | 0.5000 | | 0.5000 | ug/L |
| 0088 | N-PROPYLBENZENE | LT | 0.5000 | | 0.5000 | ug/L |
| 0089 | 1,3,5 TRIMETHYLBENZENE | LT | 0.5000 | | 0.5000 | ug/L |
| 0090 | TERT- BUTYLBENZENE | LT | 0.5000 | | 0.5000 | ug/L |
| 0091 | 1,2,4 TRIMETHYLBENZENE | LT | 0.5000 | | 0.5000 | ug/L |
| 0092 | SEC- BUTYLBENZENE | LT | 0.5000 | | 0.5000 | ug/L |
| 0093 | P-ISOPROPYLTOLUENE | LT | 0.5000 | | 0.5000 | ug/L |
| 0094 | N-BUTYLBENZENE | LT | 0.5000 | | 0.5000 | ug/L |
| 0095 | 1,2,4 TRICHLOROBENZENE | LT | 0.5000 | 70.0000 | 0.5000 | ug/L |
| 0096 | NAPHTHALENE | LT | 0.5000 | | 0.5000 | ug/L |

Records 26 - 50 of 56



**Division of Environmental Health
 Office of Drinking Water**

Help

View Sample Detail - WSID 081669 - ESTATES INC

Collect Date 9/28/2021
 Lab Number 094
 Lab Name Eurofins Eaton LLC - Pomona
 Sample Number 80713
 Source 03
 Analyte Group VOC-VOLATILE ORGANIC CONTAMINANTS
 Test Panel VOC1-VOLATILE ORGANIC
 Sample Location wh
 Sample Type Pre-Treatment / Raw

Result Range, A/P, Units: Mouse over for full description

| Analyte DOH Num | Analyte Name | Result Range | Result Quantity | Maximum Contaminant Level | State Reporting Limit | Units |
|-----------------|-------------------------|--------------|-----------------|---------------------------|-----------------------|-------|
| 0097 | HEXACHLOROBUTADIENE | LT | 0.5000 | | 0.5000 | ug/L |
| 0098 | 1,2,3 TRICHLORO BENZENE | LT | 0.5000 | | 0.5000 | ug/L |
| 0104 | DICHLORODIFLUOROMETHANE | LT | 0.5000 | | 0.5000 | ug/L |
| 0154 | 1,3 DICHLOROPROPENE | LT | 0.5000 | | 0.5000 | ug/L |
| 0160 | TOTAL XYLENES | LT | 0.5000 | 10000.0000 | 0.5000 | ug/L |
| 0031 | TOTAL TRIHALOMETHANE | ND | | 80.4000 | | ug/L |

Records 51 - 56 of 56

[Home Page](#) | [Find Water Systems](#) | [Find Water Quality](#) | [Downloads/Reports](#)

[DOH Home](#) | [Community and Environment](#) | [Drinking Water Home](#) | [Drinking Water Contacts](#)
[Access Local Health](#) | [Privacy And Copyright Information](#) |

Links to external resources are provided as a public service and do not imply endorsement by the Washington State Department of Health

Department of Health, Office of Drinking Water

Street Address:

243 Israel Road S.E. 2nd floor
 Tumwater, WA 98501

Mail:

PO BOX 47822
 Olympia, WA 98504-7822

Comments or questions regarding this Web site? Send email to [Environmental Health Application Testing and Support](#)



**Division of Environmental Health
Office of Drinking Water**

Help

View Sample Detail - WSID 081669 - ESTATES INC

Collect Date 8/11/2021
 Lab Number 010
 Lab Name Spectra Laboratories - Kitsap, LLC
 Sample Number 97001
 Source 03
 Analyte Group IOC-INORGANIC CONTAMINANTS
 Test Panel NIT-NITRATE SUITE
 Sample Location wh
 Sample Type Pre-Treatment / Raw

Result Range, A/P, Units: Mouse over for full description

| Analyte DOH Num | Analyte Name | Result Range | Result Quantity | Maximum Contaminant Level | State Reporting Limit | Units |
|-----------------|--------------|--------------|-----------------|---------------------------|-----------------------|-------|
| 0020 | NITRATE-N | LT | 0.5000 | 10.0000 | 0.5000 | mg/L |

Records 1 - 1 of 1

[Home Page](#) | [Find Water Systems](#) | [Find Water Quality](#) | [Downloads/Reports](#)

[DOH Home](#) | [Community and Environment](#) | [Drinking Water Home](#) | [Drinking Water Contacts](#)
[Access Local Health](#) | [Privacy Notice](#) | [Disclaimer/Copyright Information](#)

Links to external resources are provided as a public service and do not imply endorsement by the Washington State Department of Health

Department of Health, Office of Drinking Water

Street Address:

243 Israel Road, S.E. 2nd floor
 Tumwater, WA 98501

Mail:

PO BOX 47822
 Olympia, WA 98504-7822

Comments or questions regarding this Web site? Send email to [Environmental Health Application Testing and Support](#)

APPENDIX N
Water System Inventory

Component Inventory and Assessment

| Component | Component Information | Installed Date | Effective Life | Condition Rating | Critical Number | Remaining Life | Replacement Cost/Unit | Quantity | Unit | Total Cost | Inflation Rate | Replace in 5 Years? | Future Cost | 5-Year Replacement Cost |
|--|--|----------------|----------------|------------------|-----------------|----------------|-----------------------|----------|------|--------------|----------------|---------------------|--------------|-------------------------|
| Water System: Estates | | | | | | | | | | | | | | |
| System ID: 081869 | | | | | | | | | | | | | | |
| Operator: Cascadia Water | | | | | | | | | | | | | | |
| Operator Address: PO Box 549, Freeland, WA 98249 | | | | | | | | | | | | | | |
| Prepared By: Robert Bennion, PE. | | | | | | | | | | | | | | |
| Well #1 | 5" x 4", 607' Depth | 1982 | 80 | 2 | 2 | 39.9 | \$ 30,000 | 1 | LS | \$ 30,000 | 2.0% | No | \$ 66,110 | \$ - |
| Well #1 Pump | Berkeley Model 65AH-2, 7.5 HP | 2015 | 20 | 1 | 2 | 15 | \$ 6,000 | 1 | LS | \$ 6,000 | 2.0% | No | \$ 8,075 | \$ - |
| Well #2 | 5", 46.2' Depth | 1974 | 80 | 1 | 2 | 34 | \$ 30,000 | 1 | LS | \$ 30,000 | 2.0% | No | \$ 58,820 | \$ - |
| Well #2 Pump | Berkeley Model 652AM-3, 7.5 HP | 2015 | 20 | 1 | 2 | 15 | \$ 6,000 | 1 | LS | \$ 6,000 | 2.0% | No | \$ 8,075 | \$ - |
| Well Meter | Sensus OMNI 2" Meter | 2023 | 25 | 2 | 1 | 26.6 | \$ 2,500 | 2 | EA | \$ 5,000 | 2.0% | No | \$ 8,467 | \$ - |
| Well Controls | | 2023 | 15 | 1 | 2 | 18 | \$ 5,000 | 1 | LS | \$ 5,000 | 2.0% | No | \$ 7,141 | \$ - |
| Wellhouse Enclosure (4x4) | | 1982 | 75 | 5 | 5 | 18.5 | \$ 1,000 | 2 | EA | \$ 2,000 | 2.0% | No | \$ 2,885 | \$ - |
| Reservoir | 30" Diameter x 33" Tall 158,000 Gallons | 2023 | 80 | 1 | 1 | 83 | \$ 2 | 158,000 | GAL | \$ 316,000 | 2.0% | No | \$ 1,634,938 | \$ - |
| Reservoir Controls | | 2023 | 25 | 1 | 2 | 28 | \$ 5,000 | 1 | LS | \$ 5,000 | 2.0% | No | \$ 8,705 | \$ - |
| Pressure Tanks | 370 Gallon | 2023 | 30 | 1 | 3 | 33 | \$ 12,500 | 3 | EA | \$ 37,500 | 2.0% | No | \$ 72,084 | \$ - |
| Booster Pumps | (4) 10 HP Grundfos | 2023 | 25 | 1 | 2 | 28 | \$ 20,000 | 4 | EA | \$ 80,000 | 2.0% | No | \$ 139,282 | \$ - |
| Booster Pump Controls | | 2023 | 25 | 1 | 2 | 28 | \$ 25,000 | 1 | LS | \$ 25,000 | 2.0% | No | \$ 43,526 | \$ - |
| Distribution System Piping | 8" PVC | 1994 | 85 | 3 | 4 | 47 | \$ 175 | 5,520 | LF | \$ 966,000 | 2.0% | No | \$ 2,459,831 | \$ - |
| Distribution System Piping | 6" PVC | 1982 | 85 | 3 | 4 | 38 | \$ 150 | 9,695 | LF | \$ 1,454,250 | 2.0% | No | \$ 3,062,002 | \$ - |
| Distribution System Piping | 4" PVC | 1975 | 85 | 4 | 5 | 28 | \$ 150 | 23,220 | LF | \$ 3,483,000 | 2.0% | No | \$ 6,063,987 | \$ - |
| Distribution System Piping | 2" PVC | 1975 | 85 | 4 | 5 | 28 | \$ 100 | 2,850 | LF | \$ 285,000 | 2.0% | No | \$ 496,192 | \$ - |
| Hydrants | | 1982 | 50 | 4 | 4 | 8 | \$ 5,000 | 3 | EA | \$ 15,000 | 2.0% | No | \$ 17,715 | \$ - |
| Gate Valves | 8" Valve | 1994 | 75 | 3 | 4 | 39.2 | \$ 2,500 | 4 | EA | \$ 10,000 | 2.0% | No | \$ 21,733 | \$ - |
| Gate Valves | 6" Valve | 1986 | 75 | 3 | 4 | 32.8 | \$ 2,500 | 6 | EA | \$ 15,000 | 2.0% | No | \$ 28,720 | \$ - |
| Gate Valves | 4" Valve | 1975 | 75 | 4 | 5 | 21 | \$ 2,500 | 15 | EA | \$ 37,500 | 2.0% | No | \$ 56,837 | \$ - |

| Item | Year | Quantity | Unit | Value | Category | Cost | Rate | Need | Term | Upgrade | Costs |
|---|------|----------|------|-------|----------|------------|------|------|------|--------------|---|
| Gate Valves | 1975 | 75 | 4 | 5 | EA | \$ 22,500 | 2.0% | No | | \$ 34,102 | \$ - |
| Meters | 2020 | 20 | 4 | 5 | EA | \$ 91,750 | 2.0% | No | | \$ 121,062 | \$ - |
| Air-release Valves | 1982 | 20 | 3 | 4 | EA | \$ 5,000 | 2.0% | Yes | | \$ 5,000 | \$ 5,000 |
| Blow-offs | 1982 | 20 | 3 | 4 | EA | \$ 15,000 | 2.0% | Yes | | \$ 15,000 | \$ 15,000 |
| Treatment System | 2023 | 80 | 1 | 3 | EA | \$ 450,000 | 2.0% | No | | \$ 2,828,235 | \$ - |
| Pumphouse (20x20ft Pole Building) | 1994 | 50 | 2 | 4 | SF | \$ 70,000 | 2.0% | No | | \$ 109,947 | \$ - |
| Generator | 2023 | 50 | 1 | 3 | EA | \$ 10,000 | 2.0% | No | | \$ 28,563 | \$ - |
| Propane Tank | 2020 | 30 | 1 | 3 | EA | \$ 5,000 | 2.0% | No | | \$ 9,057 | \$ - |
| Total System Value: \$ 7,482,500 | | | | | | | | | | | Estimated Need-Term Upgrade Costs: \$ 20,000 |