

Appendix A

IRP PROCESS

2023 WA IRP

Appendix A contains Cascade's Stakeholder Engagement document as well as Technical Advisory Group (TAG) presentations and the minutes. The purpose of the Stakeholder Engagement document is to lay out expectations that stakeholders can expect from the Company during the IRP process and vice versa. Cascade's TAG presentations and minutes can be found in this document as well on the Company's website at: <https://www.cngc.com/rates-services/rates-tariffs/washington-integrated-resource-plan/>



In the Community to Serve®

CASCADE NATURAL GAS STAKEHOLDER ENGAGEMENT DESIGN DOCUMENT

Abstract

This document contains the rational, assumptions, and explanation behind the Stakeholder Engagement process of Cascade's IRP Process

Table of Contents

I. Introduction	1
II. Purpose	1
III. Principles.....	1
IV. Context.....	2
V. Mutual Expectations	2
VI. Desired End-Result.....	3
VII. Conclusion	4

Introduction

Cascade welcomes input from technical experts and the interested public in developing its Integrated Resource Plan (IRP). Cascade seeks to employ best industry practices and recognizes external participation can add incremental improvements.

Cascade recognizes stakeholders have a multitude of projects before them. This Design Document is intended to assist in optimizing participation by interested parties to yield a solid IRP to the benefit of customers and the Company.

Purpose

The goal of the IRP process is to produce a plan that addresses meeting long-term load giving consideration to the best combination of expected costs and associated risks and uncertainties for the utility and its customers. Cascade strongly believes this process is best accomplished with input from all stakeholders.

The purpose of this document is to align perspectives for maximizing the effectiveness, influence, and amount of contributions from stakeholders in an environment of robust workloads by all parties. The stakeholder engagement process is summarized in Box #1.

Box #1: From OPUC 5/15/18 Workshop

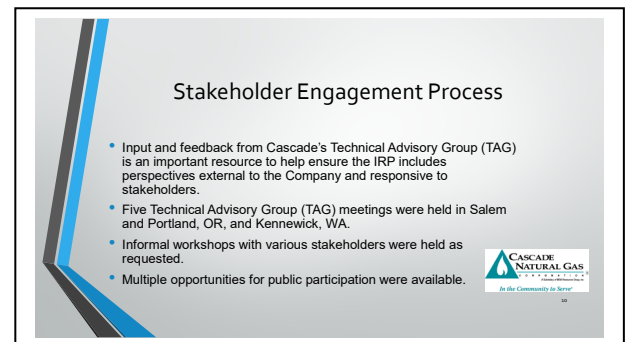

Principles

Cascade applies the following four principles throughout this Design Document and the overall IRP process.

- A quality stakeholder engagement process is an iterative activity that requires collaboration and commitment

- Input from diverse perspectives improves the resulting IRP
- Removing barriers to participation and communicating in clear language with solid data is critical
- Transparency, and availability of Cascade staff for associated discussions, is central to the IRP process

Context

This Design Document is provided with the understanding that some organizations (e.g., Commission Staffs) may rotate its members through its various utility's IRP processes as well as onboard new Staff. Thus, beyond memorializing Cascade's commitments, this Document can be a primer for analyst-to-analyst mutual expectations.

Cascade's perspective is to capture the benefits of interested parties' knowledge by seeking to implement best-practices of stakeholder engagement, beyond this simply being a regulatory requirement.

Mutual Expectations

The Company will commit to the following series of actions for an efficient process to enhance stakeholders' participation. In turn, Cascade hopes that participating stakeholders will agree to general expectations on their part. The following Cascade and Stakeholder commitments are intended to coordinate communication throughout the IRP process and lay out mutual expectations.

Cascade Commitments

1. The Company will provide reasonable accommodations for people with disabilities. Additionally, the Company will reasonably accommodate items such as requests for meeting locations, audio and visual capabilities, and other items requested by external stakeholders
2. Publishing an annual schedule of meetings, for calendaring and coordination purposes, to be included in the workplan
3. Publish a brief section that lists the recommendations from the previous Commission IRP acknowledgement
4. Providing meeting materials (agenda and PowerPoint) approximately 7 days in advance of meetings
5. Responding to pre- or post-meeting communication going over information of interest to stakeholders
6. Offering separate workshops (e.g., forecasting, SENDOUT®, DSM) as requested
7. Keeping a running list of action items from Technical Advisory Group (TAG) meetings that need to be further addressed if not directly related to the then-meeting topic or if more time is required to respond
8. Provide TAG minutes that include the action items from bullet #7 as well as any upcoming deadlines for feedback on the IRP.
9. Allowing for open, inclusive, and balanced participation and information sharing

10. Recognizing that some parties may not have the industry knowledge or the resources to devote to analyzing all aspects of the IRP and that their interest may be one of breadth
11. Understanding TAG members can and should speak up if they need more information or if the time for discussion is too short and merits further discussion
12. Responding to questions in a reasonable time period
13. Noting when confidential information has been requested (or provided) and associated treatment
14. Seeking perspectives on inputs and results of the components of the IRP
15. Present information in a clear and transparent manner

Cascade Requests of Stakeholders

1. Ask questions of the Company on technical and methodological aspects
2. Be a point of contact within their organization to distribute information to peers or let Cascade know who should be on Cascades' direct distribution list.
3. Provide organizational positions, opinions, or perspectives to all stakeholders on various issues, while recognizing the following bullet point #4. (This is particularly relevant for organizations that have different lead analysts assigned to different companies or who have relatively new Staff members participating in any given IRP process.)
4. All should understand that some (e.g., Commission Staffs) organizational representatives cannot bind their organizations (i.e., Commissioners) but are making best efforts to provide relevant information
5. Recognize relative informality of the meetings and ability to interject for clarification and understanding
6. These requests of stakeholders are not to say, "speak now or forever hold your peace" or to put undue pressure on others' timelines and workload; rather these are ways to maximize the effectiveness of the stakeholders' comments, which optimizes the process. Again, comments received earlier in the process can better influence the final draft document.
7. When possible, provide feedback to meeting materials in advance of the meeting, to give Company representatives time to prepare information for an informed discussion.
8. Review bullet points #5 and #8 of Cascade's Commitments to ensure all action items are included and have been satisfactorily responded to by Cascade.

Desired End-Result

A well-planned and executed stakeholder engagement process would have all technical and methodological issues examined in meetings prior to parties later providing comments on the final draft document. This is the proverbial win-win-win situation. Commission Staffs and interested parties would have full understanding of the Company's data and analytical approaches. These studies can be refined through analyst-to-analyst discussions. Consideration of new approaches can be put to the forefront for current or future IRPs, based on budgets and benefit to customers. The Company benefits by gaining access to perspectives perhaps not otherwise known. Commission Staff and others may be aware of emerging policies and approaches given the breadth of their interactions with Commissioners and new issues. As Cascade strives to implement best planning practices, as depicted in Box #2, stakeholders can provide advice based on what they've seen in the industry.

The Company has and will continue to encourage stakeholder feedback, questions, and suggestions to assist Cascade in producing an IRP that meets the regulatory requirements and Cascade's customers' needs. Cascade prefers to receive feedback as early as possible in the process (e.g., in the course of its technical advisory group meetings or soon thereafter) so that the Company has a better opportunity to address questions or analyze/apply more stakeholder suggestions. Cascade recognizes that all parties are extremely busy, but strongly believes that stakeholder participation is crucial from the outset.

Box #2: From WUTC 6/18/18 Workshop

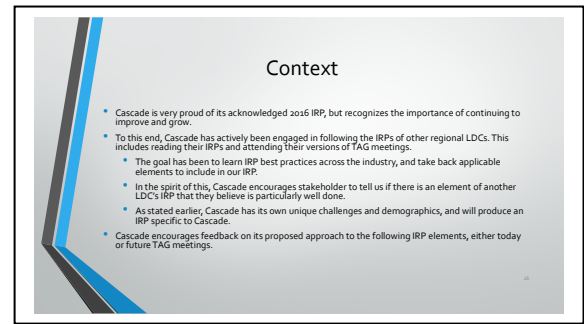

The above recognizes that key analytical components of the IRP—such as the demand forecast—need to be “locked down” at least midway through the process so that resource integration can be addressed. Interested parties can best influence these components earlier, rather than later, in the process.

Conclusion

While Cascade "owns" and is responsible for the IRP, the Company desires to have involvement from stakeholders to provide a diversity of perspectives. A best practices IRP is informed by perspectives, analyses and access to concerns and approaches that the Company may not have considered. Some stakeholders participate in multiple IRP processes and have a line-of-sight that may not be available to Cascade, despite the Company monitoring other utilities' IRPs and associated processes.

Cascade recognizes parties will submit sometimes-detailed comments at the conclusion of the stakeholder involvement process in advance of Commission acknowledgement. The Company's hope is that the guidelines contained in this Document will allow stakeholders to demonstrate to the Commission their work in the final IRP while concurring with its conclusions given the parties' influence.



In the Community to Serve®

Integrated Resource Plan Technical Advisory Group Meeting #1

MARCH 30, 2022

MICROSOFT TEAMS/TELECONFERENCE

Agenda

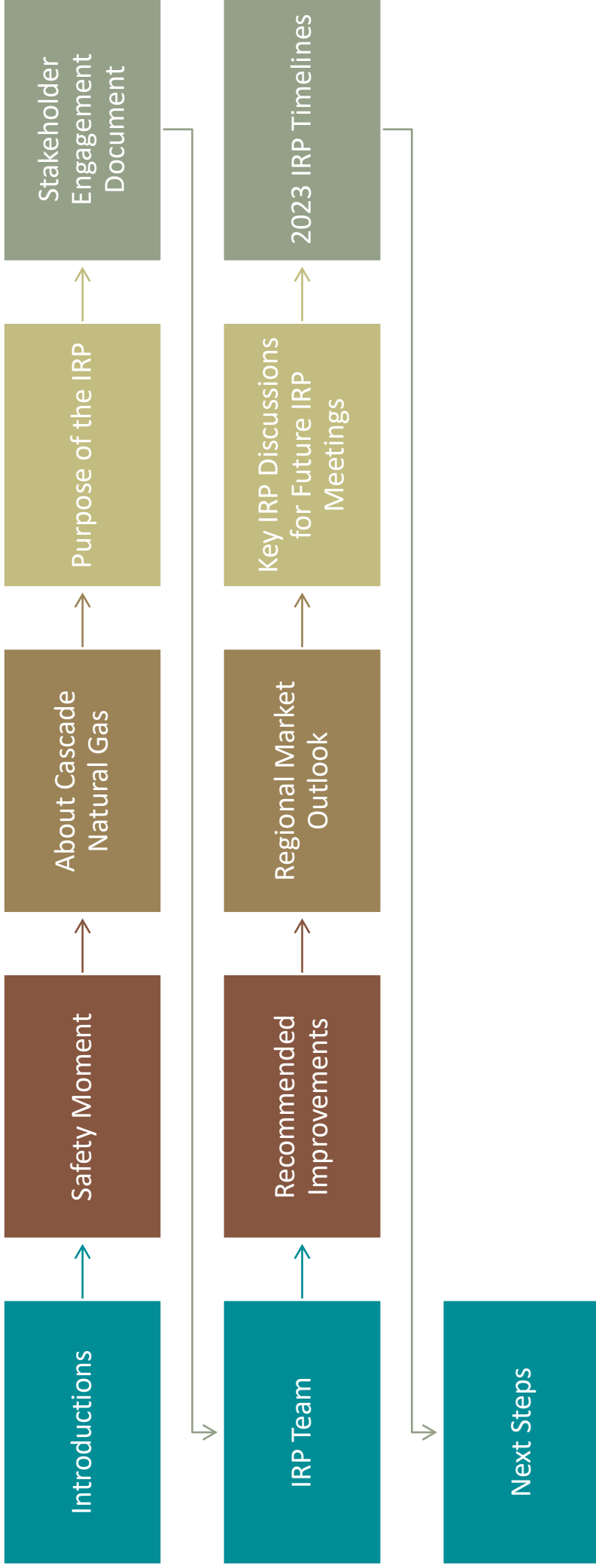

Safety Moment

Careful Cleaning

Keeping our homes and workspaces clean and tidy can come with hazards. Staying safe while keeping your spaces clean can be done by following a few simple steps:



A Little History Lesson...

- Prior to 1955, natural gas was virtually unheard-of in the Pacific Northwest. Seeing an opportunity, Lester Pettit, Spencer Clark, and Stewart Matthews led a group of associates to form a company that would rise to the challenge. Cascade Natural Gas Corporation was incorporated January 2, 1953.
- In July 2007, Cascade was acquired by MDU Resources headquartered in Bismarck, ND.
 - Founded in 1924 as an electric utility.
 - Core businesses are construction, gas & electric utilities, and pipeline.
 - Approximately 13,000 employees, operating in 43 states.
 - Operates four utilities across eight states:
 - Montana-Dakota Utilities Co.
 - Great Plains Natural Gas Co.
 - Cascade Natural Gas Corporation
 - Intermountain Gas Co.



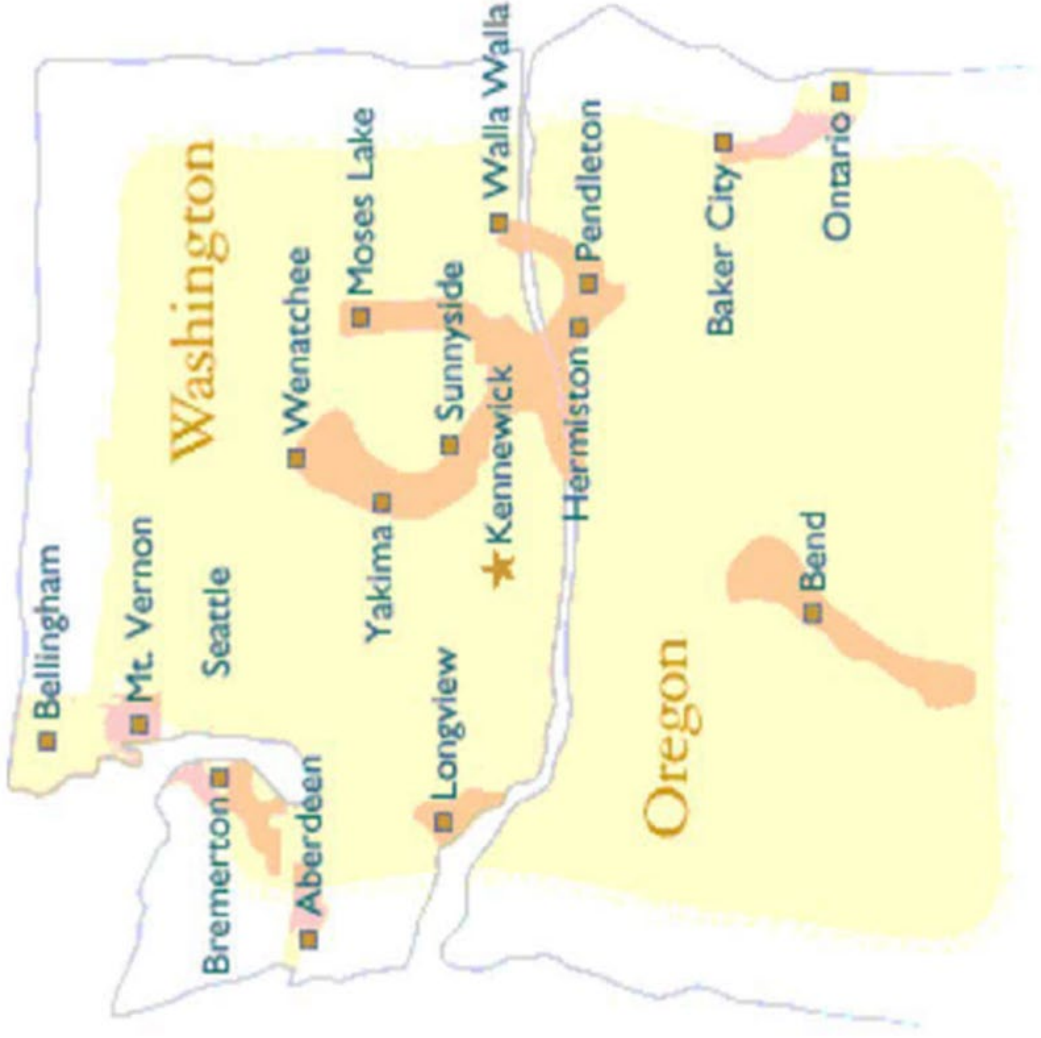

Today We Are...

Cascade serves more than 305,500 customers in 95 communities – 67 of which are in Washington and 28 in Oregon. Cascade’s service areas are concentrated in western and central Washington and central and eastern Oregon.

Cascade serves a diverse territory covering more than 32,000 square miles and 700 highway miles from one end of the system to the other. Interstate pipelines transmit Cascade’s natural gas from production areas in the Rocky Mountains and western Canada.



In the Community to Serve®

Purpose of IRP

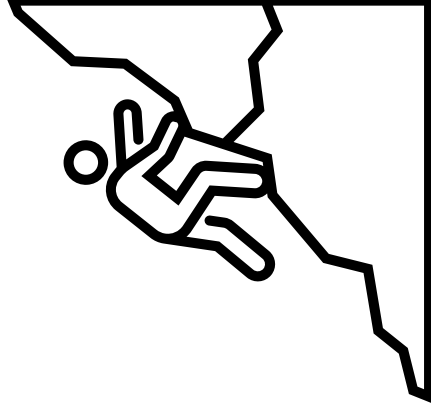

Washington

- IRP Guidelines from WUTC WAC 480-90-238.

Oregon

- IRP Guidelines under Order No. 07-002 as set forth in the Oregon Administrative Rule (OAR) 860-027-0400.

Cascade's Basic Philosophy

- Primary purpose of Cascade's long-term resource planning process has been, and continues to be, to inform and guide the Company's resource acquisition process, consistent with state regulatory requirements.
- Input and feedback from the Company's Technical Advisory Group (TAG) is an important resource to help ensure that CNGC's IRP is developed from a broader perspective than Cascade could have on its own.
- As the scope of the IRP continues to expand, Cascade is committed to securing and supporting the appropriate internal and external resources necessary to work with all stakeholders to produce an Integrated Resource Plan that meets the requirements of Washington and Oregon.

IRP Guidelines and Content

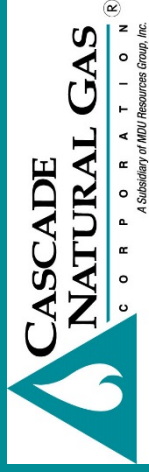

In the Community to Serve®

Stakeholder Engagement Document

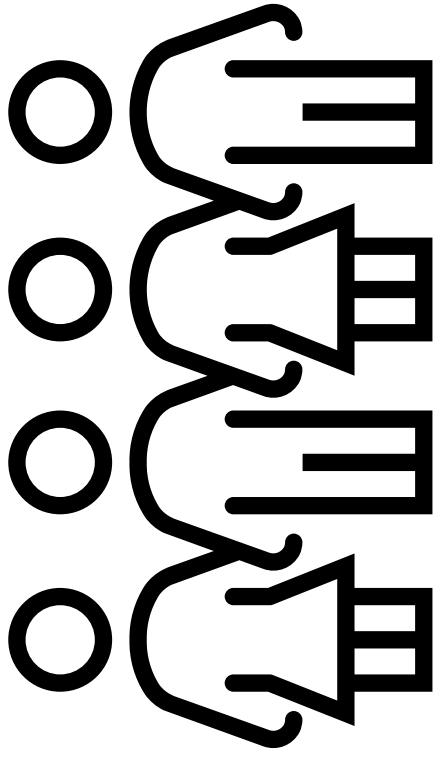



In the Community to Serve®

CASCADE NATURAL GAS STAKEHOLDER ENGAGEMENT DESIGN DOCUMENT

“Cascade seeks to employ best industry practices and recognizes external participation can add incremental improvements.

Cascade recognizes stakeholders have a multitude of projects before them. This Design Document is intended to assist in optimizing participation by interested parties to yield a solid IRP to the benefit of customers and the Company.”

Abstract
This document contains the rational, assumptions, and explanation behind the Stakeholder Engagement process of Cascade’s IRP Process

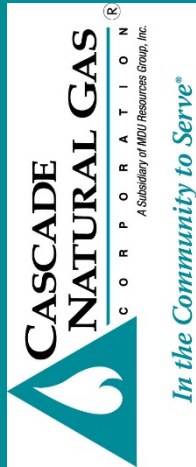

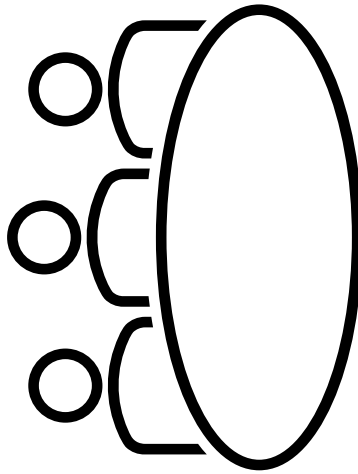

IRP Team

INTERNAL TEAM MEMBERS OF CNGC'S INTEGRATED RESOURCE PLAN

LAST NAME	FIRST NAME	TITLE	COMPANY
Archer	Pam	Regulatory Analyst IV	Cascade
Blattner	Lori	Director, Regulatory Affairs	Cascade/Intermountain
Burin	Kary	Supervisor, Energy Efficiency	Cascade
Campbell	Kathleen	Senior Engineer	MDU
Chiles	Mark	Vice President, Customer Service and Regulatory Affairs	Intermountain
Connell	Kevin	Director, Gas Supply	MDU
Cowlshaw	Monica	Manager, Energy Efficiency & Community Outreach	Cascade
Cunnington	Brian	Manager, Industrial Services	Cascade
Darras	Patrick	Vice President, Engineer & Operations Services	MDU
Davis	Ashton	Resource Planning Economist II, Gas Supply	Cascade
Folsom	Bruce	Consultant	Bruce W Folsom Consulting LLC
Goodman	Chad	Enterprise Endpoint Administrator, Associate	MDU
Hodges	Becky	Financial Analyst IV	Cascade
Hoyle	Brian	Financial Analyst II	Cascade
Krebsbach	Abbie	Director, Environmental	MDU

INTERNAL TEAM MEMBERS OF CNGC'S INTEGRATED RESOURCE PLAN

LAST NAME	FIRST NAME	TITLE	COMPANY
Madison	Scott	Executive Vice President, Business Development and Gas Supply	MDU
McGreal	Devin	Senior Resource Planning Economist, Gas Supply	Cascade
Myhrum	Isaac	Regulatory Analyst II, Regulatory Affairs	Cascade
Nygard	Tammy	Controller	MDU
Parvinen	Mike	Manager, Regulatory Affairs II	Cascade
Robbins	Chris	Manager, Gas Supply and Control- CNGC/IGC	Cascade/ Intermountain
Robertson	Brian	Supervisor, Resource Planning, Gas Supply	Cascade
Sellers-Vaughn	Mark	Manager, Supply Resource Planning	Cascade
Senger	Garret	Executive Vice President, Regulatory, Customer Service and Administration	MDU
Sorensen	Renie	Manager, Engineering	Cascade
Spector	Alyn	Manager, Conservation Policy	Cascade
Stone	Carolyn	Gas Supply Analyst III	Cascade
Storvick	Jon	Conservation Analyst II	Cascade
Goodman	Chad	Enterprise Endpoint Administrator, Associate	MDU
Wood	Eric	Supervisor, Gas Supply	Cascade/ Intermountain

Recommended IRP Improvements from WUTC

Impact of Legislation Enacted in 2021	Impacts of COVID-19 Pandemic	Peak Day Standard	Impacts of Climate Change
Upstream Greenhouse Gas Emission Accounting	Avoided Cost Formula	Impacts of Electrification and Natural Gas “Bans”	Renewable Natural Gas Modeling and Evaluation Tool
Validation of Methods	Encouraging Participation in the IRP Process by Additional Stakeholders		

Docket UG-190714 WUTC Comments: <https://www.utc.wa.gov/casedocket/2019/190714/docsets>

Recommended IRP Improvements from OPUC

Include price as an explanatory variable in its demand forecast

Publish variables included in the model as part of an appendix

Provide an update to the Company's current and proposed future efforts to use DSM in avoiding infrastructure upgrades and hold a workshop to describe these efforts in the next IRP cycle

Include an explanation of how the Washington RNG program may interact with programs being developed for customers in Oregon and whether RNG programs developed in Oregon might be used to comply with laws in other states

Revisit the stochastic modeling and reduce the frequency of Enbridge rupture type events in its Sumas gas price forecasts

In a 2022 IRP Technical Advisory Group (TAG) meeting, incorporate gas price forecasts and price shocks into the discussion and work with Staff and stakeholders to potentially update its methodology

Continue to work with Staff and stakeholders through UM 1893 on refining distribution costs avoided through energy efficiency for use in its 2022 IRP

Host a workshop with Staff prior to or at the beginning of the 2022 cycle to consider options for improved communication among the Company and stakeholders

LC 76 Staff Final Order: <https://apps.puc.state.or.us/orders/2021ords/21-127.pdf>

Regional Market Outlook

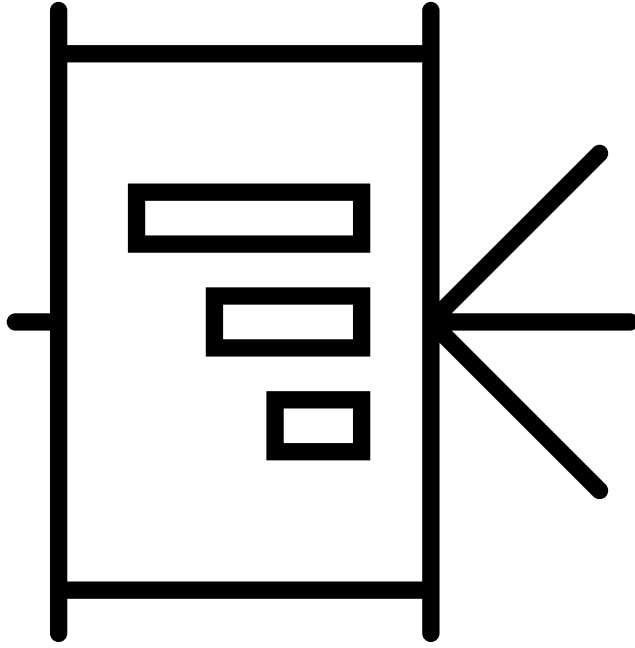

Regional Market Outlook – Long Term

The EIA's Annual Energy Outlook for 2022 was released earlier this month. The reference case shows “projected natural gas prices stay below \$4.00 per million British thermal units (MMBtu) for most of the projection period.” This lines up with Cascade’s price forecast. ¹

According to the EIA’s 2022 Annual Energy Outlook, natural gas exports will continue to grow through 2025, and natural gas production will ramp up after 2025 in order to meet the growing export demand. ¹

The EIA expects natural gas consumption to grow but only because natural gas prices are expected to remain low. The industrial sector is projected to be the largest share. ¹

CNGC Price Forecast as of 03/16/2022

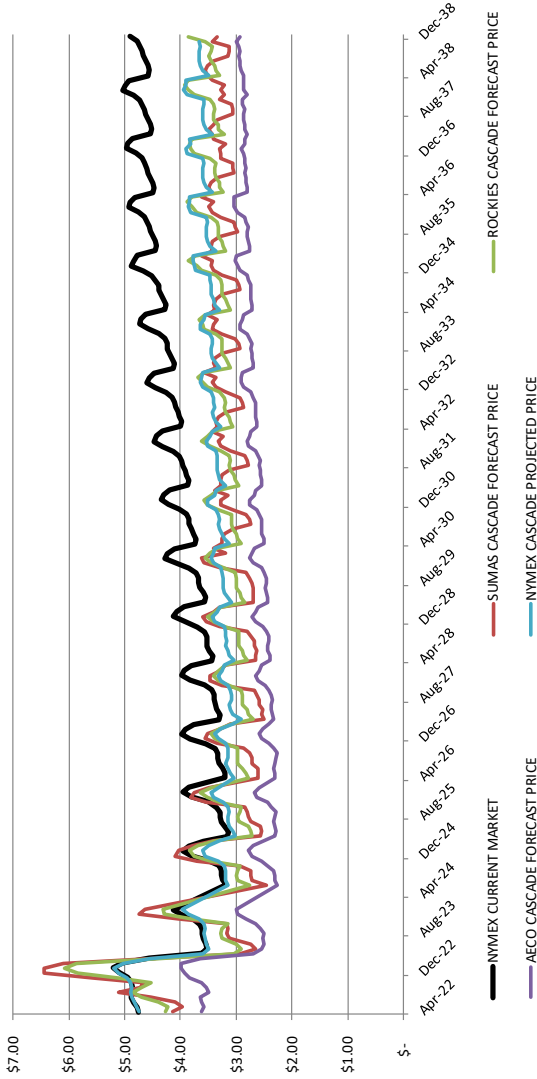

Natural Gas: Henry Hub Spot Price

Case: AEO2022 Reference case

2021 \$/MMBtu

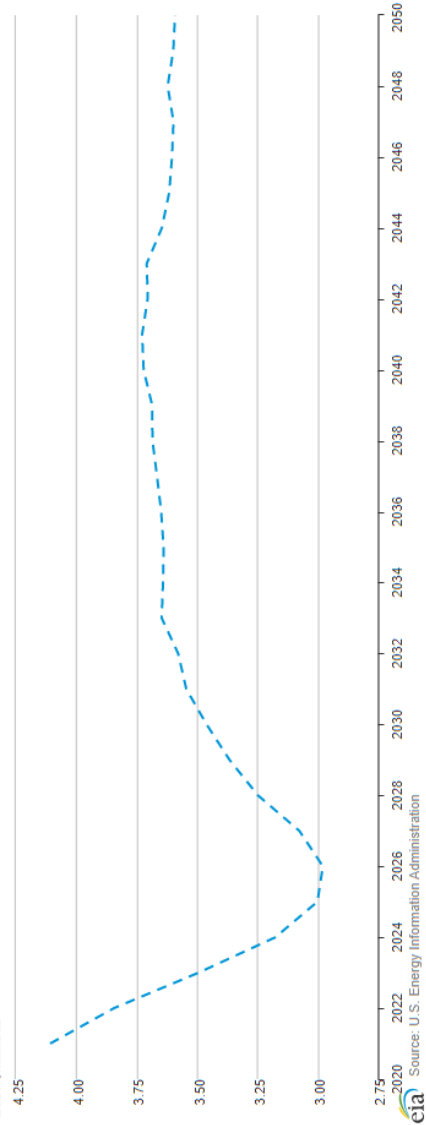

¹ Annual Energy Outlook 2022 - U.S. Energy Information Administration (EIA)

Regional Market Outlook Short-Term

Both OR and WA legislative sessions ended early March. Cascade is continuing to monitor any bills that relate to natural gas, such as ones that address greenhouse gas emissions in new buildings.

According to Cascade’s hedging consultant, “Recurring winter weather and dramatic geopolitical uncertainty have placed a spotlight on global gas supply and resulted in an elevated risk premium in NYMEX prices throughout 2022.”

February 2022 saw record high natural gas price volatility at 179.1%, based on rolling front-month contracts. With the market volatility in the near term, Cascade’s hedging program is more important than ever.¹

Figure 14. Natural gas historical volatility annualized percentage

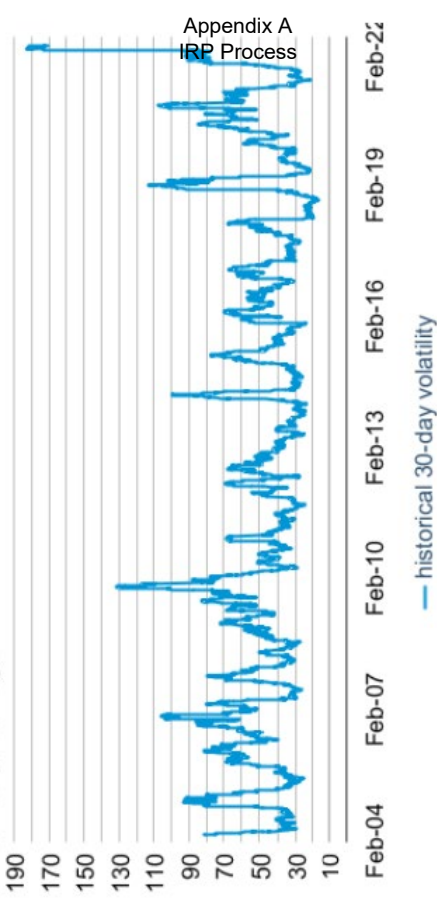

¹ Short-Term Energy Outlook - U.S. Energy Information Administration (EIA)

Key IRP Discussions for Future IRP Meetings

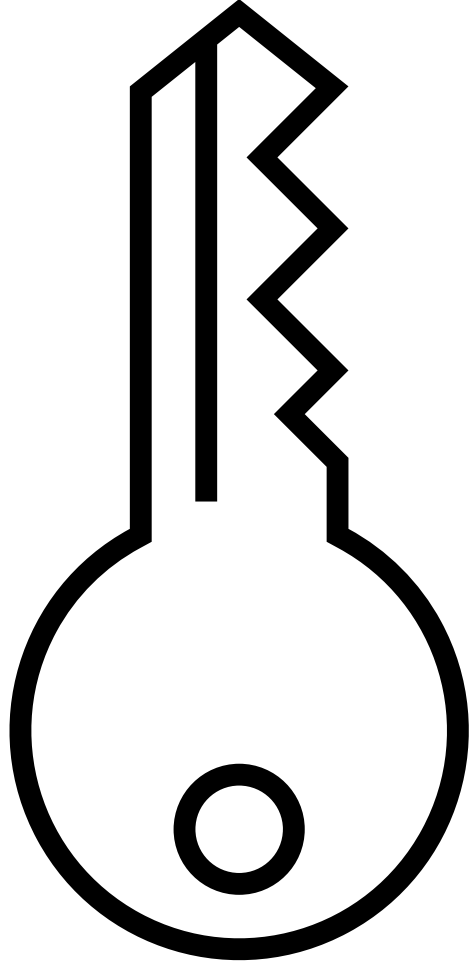

Load Forecast



The Company currently utilizes an Autoregressive Integrated Moving Average (ARIMA) methodology with Fourier terms to predict customer count and usage.



Cascade uses a 60-degree reference temperature to calculate HDDs.



Multiple scenarios are analyzed such as high/low growth, warm/cold weather, peak day events, etc.



Cascade has continued to evaluate other potential predictors. This IRP will see price introduced as a potential regressor for use-per-customer. Cascade also performs cross-validation on its models to ensure accurate forecasts and assumptions are being made.

Customer Forecast

Model: $C^{CG,Class} = \alpha_0 + \alpha_1 \text{Pop}^{CG} + \alpha_2 \text{Emp}^{CG} + \text{Fourier}(k) + \text{ARIMA}\varepsilon(p,d,q)$

Model Notes:

C = Customers; CG = Citygate; Class = Residential, Commercial, Industrial, or Interruptible;
 ARIMA $\varepsilon(p,d,q)$ = Indicates that the model has p autoregressive terms, d difference terms, and q moving average terms; Pop = Population; Emp = Employment; Fourier(k) = Captures seasonality of k number of seasons.

Use-Per-Customer Forecast



Model:

$$\text{Therms/C}_{\text{CG,Class}} = \alpha_0 + \alpha_1 \text{HDD}_{\text{CG,D}} + \alpha_2 \text{Wind}_{\text{CG,D}} + \alpha_3 I_w + \text{ARIMA}\epsilon(p,d,q)$$



Model Notes:

Therms/C = Therms per customer; CG = Citygate; Class = Residential, Commercial, Industrial, or Interruptible; HDD = Heating Degree Days; Wind=Average Windspeed; D= Day; I_w = Indicator Variable set to 1 if it is a weekend; ARIMA ϵ (p,d,q) = Indicates that the model has p autoregressive terms, d difference terms, and q moving average terms.



New variable to introduce as possible regressor: Price

Hedging

Cascade has continued to strengthen the qualitative and quantitative analytics that have informed its hedging practices, to the benefit of its customers.

- The Company entered into a call option in August of 2021, the first of Cascade’s modern hedging program, which proved to be very beneficial during elevated winter pricing in 2021.
- The Retrospective reports of the 2021 and 2020 Annual Hedge Plans reported gains of \$4.6 million in the 2020-2021 hedge season, and \$1.5 million in the 2019-2020 hedge season.
- The 2022 Annual Hedge Plan, which will include the 2021-2022 retrospective report, will be filed on or before September 15th, 2022.

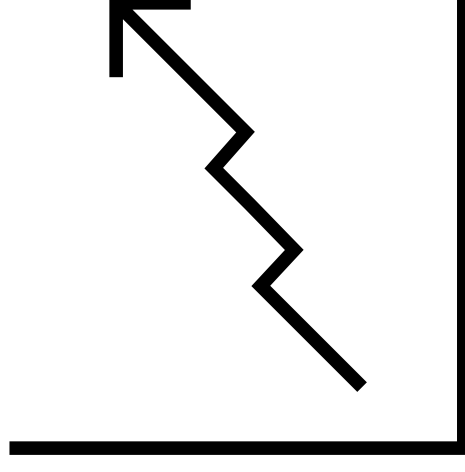

Cascade is continuing to work towards refining its avoided cost calculation by incorporating feedback from stakeholders.

- The Company will now apply the 10% environmental adder as recommended by the Northwest Power and Conservation Council to all elements of the avoided cost.
- The Company is reevaluating its distribution system cost calculation methodology, which will be discussed further in TAG 3.
- The Company is also considering modifications to its risk premium calculation, to align the process its other risk-based calculations.

Avoided Cost

Discussion question: Avoided Cost in a post CCA/CPP world?

Avoided Cost Formula

$$AC_{nominal} = (TC_f + TC_v + SC_f + SC_v + CC + C_{Compliance}) + (DSC * HM) + RP * E_{adder}$$

Where:

$AC_{nominal}$ = The nominal avoided cost for a given year. To put this into real dollars you must apply the following: $Avoided\ Cost / (1 + discount\ rate)^{Years}$ from the reference year.

TC_f = Incremental Fixed Transportation Costs

TC_v = Variable Transportation Costs

SC_f = Incremental Fixed Storage Costs

SC_v = Variable Storage Costs

CC = Commodity Costs

$C_{Compliance}$ = Carbon Compliance Costs, SCC for both states

E_{adder} = Environmental Adder, as recommended by the Northwest Power and Conservation Council

DSC = Distribution System Costs

HM = Hourly Modifier

RP = Risk Premium



Energy Efficiency

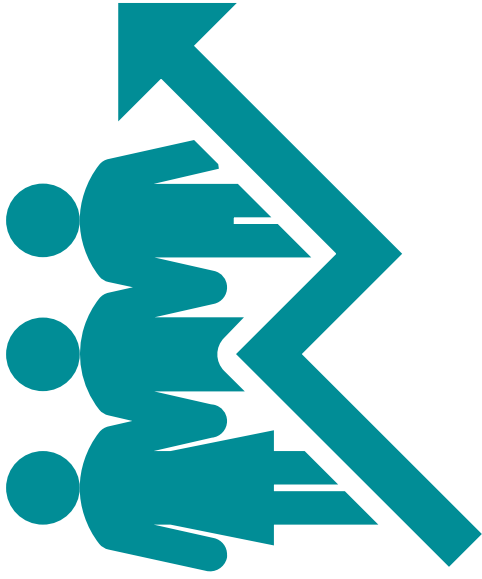

We are restructuring our Energy Efficiency (EE) department into a regional Western Team. Goal is to assess and leverage resources to meet increasing sustainability requirements

Electrification would impact Cascade's savings potential across both states

Oregon Demand Side Management

- Energy Trust to submit savings potential end of August for the IRP forecast
- In light of Department of Environmental Quality's Climate Protection Program and 2050 carbon reduction goals Energy Trust can accelerate uptake of discretionary efficiency resources based on budget and testing for impact
- Cascade is reviewing how to provide and fund EE to Transport customers. We are exploring how to determine potential, and Energy Trust is open to serving them through a variety of options depending on regulatory direction
- We are seeking to expand our engagement and are working on targeted opportunities in select communities
- Energy Trust is planning scenarios to adjust EE projections based on assumptions to changing gas loads through electrification

Energy Efficiency

Washington Demand Side Management

- This is the first IRP where Cascade is working from a Biennial Conservation Plan pursuant to RCW 80.28.380. Per Conditions in Docket UG-210838 this includes requirements to:
 - Inform its Conservation Advisory Group (CAG) members of IRP meetings addressing the Company's gas price forecasts and resource cost assumptions
 - To focus on public engagement, in coordination with the Resource Planning Team
 - Evaluation, Measurement and Verification including ongoing third-party review
 - Current Conservation Potential Assessment (CPA) is from 2021, next CPA will be in 2023
- Proposed WA State code change and local electrification through natural gas bans will affect potential identified through LoadMAP and will need to be addressed in the IRP

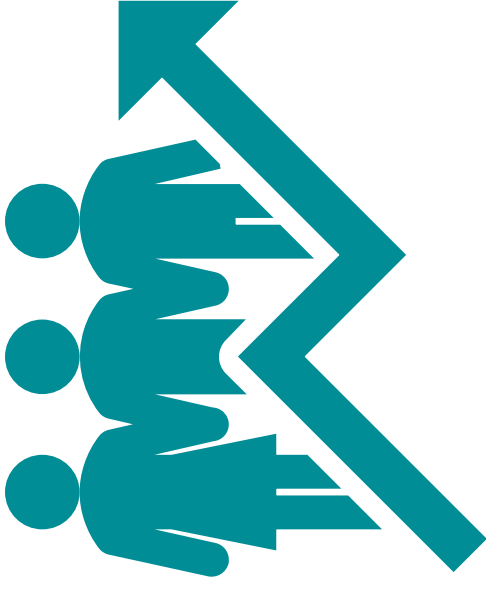

Decarbonization Planning



Compliance with Washington's CCA and Oregon CPP are a key tenet of Cascade's 2023 IRP



The Company is exploring a number of ways to reduce its emissions from both a demand-side and supply-side perspective



Accounting for upstream emissions varies by state



The Company is optimistic that it will be able to use its new resource optimization software to set emissions reduction targets as a hard constraint in its resource integration modeling

Environmental Policy



Provide environmental regulatory interpretation and compliance support and policy review for all Company facilities and operations across all eight states.



Collaborate across the company and with many external stakeholders on decarbonization planning and sustainability strategies.



There are six full time employees - scientists, engineers, a certified hazardous material manager, and are expanding the department to support decarbonization and sustainability programs for Cascade and across company.



Review and draft the Environmental Policy section of IRP in collaboration with the resource planning team.

Renewables

Cascade is in the planning stages of program development of RNG supply for customers per HB1257 and SB98 and associated rules and policy statements.

Cascade is getting several inquiries from the developers of prospective RNG projects in both Washington and Oregon. Cascade is having ongoing discussions and weighing each opportunity.

Cascade is also actively pursuing RNG projects.

Distribution System Planning



2023 IRP includes a discussion of the elements utilized in distribution system planning to determine needed system enhancements.



Cascade will provide all planned WA and OR projects for the next five years.



Cascade encourages stakeholder feedback related to distribution system planning.



Distribution system modeling utilizes Synergi, which is a separate model from the upstream modeling.

Stochastic Analysis



Resource Integration



As discussed earlier, Cascade will be overhauling its resource integration process to ensure compliance with emissions reduction requirements



The Company is changing its approach to both portfolio analysis and scenario/sensitivity modeling to allow for a more holistic approach to resource integration

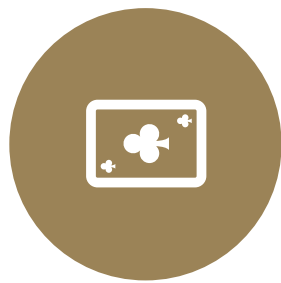

Cascade will evaluate the Value at Risk (VaR) of the candidate portfolio in each scenario to ensure that the extrinsic risk of the portfolio is within tolerable levels.



Cascade will detail its determination of future long-term resource needs, its analysis of the expected costs and associated risks of the alternatives to meet those needs, and its action plan to select the best portfolio of resources to meet those needs.

Resource Integration

2023 IRP Proposed Scenarios	Scenario						High Price - Interrupted Supply	Other?
	Base Case - OR-CPP and WA-CCA	Carbon Neutral by 2050	Limited RNG availability	Electrification	High Customer Case	High Price - Interrupted Supply		
Customer Growth		Current Expectations		No new customers after 2030	High Customer Counts	Current Expectations		
Energy Efficiency	CPA Projections		High CPA Projections			CPA Projections		
Renewable Natural Gas	Expected Availability	Expected - High Avail.	Low Availability	Expected - High Avail.		Expected Availability		
Hydrogen	Expected Availability	Expected - High Avail.	Low Availability	Expected - High Avail.		Expected Availability		
Natural Gas Bans	Current Bans			Additional Bans	Current Bans	Current Bans		
Natural Gas Price	Expected Price	Adjusted Price?	Expected Price	Adjusted Price?	Adjusted Price?	High Price		

2023 WA IRP Schedule

Process Items	Process Elements	Date
TAG 1 (Combined)	Process, Key Points, IRP Team, Timeline, Regional Market Outlook, Planned Scenarios and Sensitivities, Plan for dealing with issues raised in the 2020 IRP	3/30/2022
TAG 2 (Combined)	Demand and Customer Forecast and Non-Core Outlook, Drilling down into segments of demand forecast. Upstream Pipeline presentation.	5/18/2022
TAG 3 (WA)	Distribution System Planning, Alternative Resources, Price Forecast, Avoided Costs, Current Supply Resources, Transport Issues.	6/29/2022
TAG 4 (WA)	Carbon Impacts, Energy Efficiency, Bio-Natural Gas, Preliminary Resource Integration Results.	8/10/2022
TAG 5 (WA)	Final Integration Results, finalization of plan components, Proposed new 2- to 4-year Action Plan.	9/28/2022
Draft of 2022 IRP distributed (WA)	Filing of Draft IRP	11/24/2022
Comments due on draft from all stakeholders (WA)	Comments due from Stakeholders	1/13/2023
TAG 6, if needed (WA)	An additional TAG if needed based on comments from Stakeholders	2/1/2023
IRP filing (WA)	IRP Final Filing	2/24/2023

Original 2023 OR IRP Schedule

Process Items	Process Elements	Date
TAG 1 (Combined)	Process, Key Points, IRP Team, Timeline, Regional Market Outlook, Planned Scenarios and Sensitivities, Plan for dealing with issues raised in the 2020 IRP	3/30/2022
TAG 2 (Combined)	Demand and Customer Forecast and Non-Core Outlook, Drilling down into segments of demand forecast. Upstream Pipeline presentation.	5/18/2022
TAG 3 (OR)	Distribution System Planning, Alternative Resources, Price Forecast, Avoided Costs, Current Supply Resources, Transport Issues.	7/13/2022
TAG 4 (OR)	Carbon Impacts, Energy Efficiency (ETO), Bio-Natural Gas, Preliminary Resource Integration Results.	8/24/2022
TAG 5 (OR)	Final Integration Results, finalization of plan components, Proposed new 4-year Action Plan.	10/12/2022
Draft of 2022 IRP distributed (OR)	Filing of Draft IRP	12/8/2022
Comments due on draft from all stakeholders (OR)	Comments due from Stakeholders	1/27/2023
TAG 6, if needed (OR)	An additional TAG if needed based on comments from Stakeholders	2/15/2023
IRP filing (OR)	IRP Final Filing	3/17/2023

Updated 2023 OR IRP Schedule

Process Items	Process Elements	Date
TAG 1 (Combined)	Process, Key Points, IRP Team, Timeline, Regional Market Outlook, Planned Scenarios and Sensitivities, Plan for dealing with issues raised in the 2020 IRP	3/30/2022
TAG 2 (Combined)	Demand and Customer Forecast and Non-Core Outlook, Drilling down into segments of demand forecast. Upstream Pipeline presentation.	5/18/2022
TAG 3 (OR)	Distribution System Planning, Alternative Resources, Price Forecast, Avoided Costs, Current Supply Resources, Transport Issues.	7/14/2022
TAG 4 (OR)	Carbon Impacts, Energy Efficiency (ETO), Bio-Natural Gas, Preliminary Resource Integration Results.	9/21/2022
TAG 5 (OR)	Final Integration Results, finalization of plan components, Proposed new 4-year Action Plan.	11/9/2022
Draft of 2022 IRP distributed (OR)	Filing of Draft IRP	1/5/2023
Comments due on draft from all stakeholders (OR)	Comments due from Stakeholders	2/24/2023
TAG 6, if needed (OR)	An additional TAG if needed based on comments from Stakeholders	3/15/2023
IRP filing (OR)	IRP Final Filing	4/14/2023



Questions/Next Steps



Review Plans for TAG 2 Discussion

Demand and Customer Forecast.

Non-Core Forecast.

Pipeline Capacity Overview.

Next TAG is Wednesday, May 18th.



In the Community to Serve®

Integrated Resource Plan Technical Advisory Group Meeting #1

MARCH 30, 2022

MICROSOFT TEAMS/TELECONFERENCE



In the Community to Serve®

TAG #1 – TAG Meeting

Date & time: 03/30/2022, 9:00 AM to 12:20 PM

Location: Microsoft Teams Meeting

Presenters: Brian Robertson, Devin McGreal, Ashton Davis, Monica Cowlshaw, Chanda Marek, Abbie Krebsbach, Kathleen Campbell, & Bruce Folsom

In attendance: Ashton Davis, Katherine (Kathy) Moyd, Devin McGreal, Bruce Folsom, Abbie Krebsbach, Renie Sorensen, Byron Harmon, Zachariah Baker, Scott Madison, Pamela Archer, Eric Wood, Monica Cowlshaw, Carolyn Stone, Brian Robertson, Chris Robbins, Kathleen Campbell, Chad Stokes, Kevin Connell, Mark Sellers-Vaughn, Isaac Myhrum, Andrew Rector, Brian Hoyle, Chanda Marek, Mike Goetz, Haixiao Huang, Kary Burin, Jon Storvick, Corey Dahl, Carra Sahler, Michael Parvinen, Patrick Darras, Matt Steele, Michael Brutocao, Vincent Morales, Benjamin Zwirek

Scott Madison, Executive Vice President of Business Development & Gas Supply, opened the meeting by welcoming and thanking stakeholders for participating in Cascade’s IRP Process.

Presentation #1 – Safety Moment (Brian Robertson)

- Brian Robertson gave a quick safety moment on cleaning.

Presentation #2 – A LITTLE HISTORY LESSON (Brian Robertson)

- Brian gave a short presentation on Cascade’s history and an introduction to the Company’s diverse system.

Presentation #3 – PURPOSE OF THE IRP (Brian Robertson)

- Brian discussed that the IRP is a requirement by both Oregon and Washington, but it’s also an opportunity for Cascade to produce a Company plan that gets informed by internal and external parties. Brian also mentioned that the IRP helps inform rather than make decisions.

Presentation #4 – IRP Stakeholder Engagement (Bruce Folsom and Brian Robertson)

- Bruce gave a quick introduction to the stakeholder engagement document, specifically around the history and purpose of the document.
- Brian then went through the document and covered the main items of the Stakeholder Engagement document, specifically the major principles as well as the Company and Stakeholder expectations.

Question: Andrew Rector asked if there were any significant changes to the Stakeholder Engagement document since last year?

Answer: Yes, Cascade met with both WUTC and OPUC regarding the stakeholder engagement document and received several productive edits to the document.

Presentation #5 – IRP Team (Brian Robertson)

- Brian gave a brief introduction to recognize the internal IRP team at Cascade.

Presentation #6 – Recommended Improvements (Brian Robertson)

- Brian covered the recommended improvements that Staff and Stakeholders had provided from the previous IRP. These topics included items from all aspects of the IRP such as load forecast, avoided cost, demand side management, distribution system planning, legislation changes, and several other topics.
- Cascade has committed to discussing these topics during TAGs 2-5 in depth to ensure we've met any concerns and attended to recommendations laid out by Staff and Stakeholders.
- Andrew suggested Cascade look at how other LDCs in our region are modeling climate change in their IRPs. Cascade will provide an update on climate change modeling in TAG 2. Andrew also asked that Cascade provide information on where Cascade is with renewable natural gas at some point during Cascade's IRP process.

Question: Byron Harmon asked what type of reflection or improvements that Cascade gained from the Company's attempt to hold a TAG meeting in Bend, OR.

Answer: Cascade noted that the Company would definitely like to try the same method again. Cascade also mentioned that other methods were looked into, but the less expensive options were going to be the first options explored.

- Andrew made a comment that reaching out to community-based organizations could be a good idea, which Cascade agreed with. Cascade will provide an update on this in TAG 2.

Question: Zach Baker asked why Cascade planned to discuss DSM and avoiding infrastructure through TAG meetings rather than a workshop, as recommended by Staff.

Answer: Brian explained that this topic should be and is described throughout future TAG meetings and a workshop would just be a repeat of future TAG meetings. Zach mentioned that he'll run this by OPUC folks and let Cascade know their thoughts later.

Presentation #7 – Regional Market Intelligence (Ashton Davis)

- Ashton Davis gave a short presentation on short-term outlook and a long-term outlook, mainly around pricing in regions that impact Cascade.

Presentation #8 – Aspects of the IRP (Ashton Davis, Devin McGreal, Monica Cowlshaw, Abbie Krebsbach, Chanda Marek, Kathleen Campbell)

- Ashton introduced the load forecast and gave a high-level introduction to Cascade's demand and customer forecast methodologies and formulas.

Question: Kathy Moyd asked about hybrid heat pumps and asked about hybrid heat pumps and how that may impact demand.

Answer: Ashton explained how something that's not already built into the historical data can be difficult to forecast. Ashton pointed out there may be ways to model but it won't be simple. Devin also noted that hybrid heat pump impacts may take a few years to materialize so Cascade has a bit of luxury before any actionable decisions will need to be made. Monica also added that this is something the Energy Efficiency group is looking into but likely not this year.

- Devin McGreal then introduced Cascade's approach and changes to hedging.

- Devin went on to discuss avoided cost and the different calculations that go into producing an avoided cost.

Question: Devin asked an open question around avoided cost in a post CCA/ CPP world.

Answer: Andrew suggested that it may help to reach out to the other utilities to see what they were doing, and possibly an hour-long work session with other utilities on this subject could help. Cascade will look into how other utilities may be doing this and, if needed, will reach out to the UM-1893 stakeholder group to see if there have been any discussions on this topic in Oregon.

- Monica Cowlshaw presented on Energy Efficiency over the next two slides. Monica mentioned that the goal is to leverage our internal resources and then look at some of the increasing sustainability requirements that the company is seeing in both Washington and Oregon and where they align with the Energy Efficiency Department and then where we coordinate with our other departments within the organization.
- Abbie Krebsbach then presented on Decarbonization Planning as well as Environmental Policy. Abbie noted that the IRP scope will change for this IRP, compared to past IRPs, because of the decarbonization planning in the CCA and CPP.

Question: Carra Sahler wanted to confirm that Cascade would go ahead and plan for the CPP despite the challenge that Cascade and other utilities filed against the CPP.

Answer: Abbie said yes. The rule is in place and Cascade will comply with the CPP despite the challenge Cascade filed.

- Chanda Marek gave a quick introduction to renewable natural gas and what type of RNG projects Cascade are currently exploring and evaluating. Chanda noted that the RNG projects we've been dealing with are mostly within Washington and Oregon.
- Kathleen Campbell gave a quick introduction to distribution system modeling and the Synergi modeling.
- Devin then discussed the stochastic modeling Cascade will be performing this IRP and later presented at TAGs 4 and 5. Devin also discussed how everything that was previously discussed comes together in the Resource Integration piece. Finally, Devin described the scenarios Cascade plans to run and opened it up to see if stakeholders had other scenarios.
- Based on stakeholder comments, Devin made some clarifying comments on portfolio modeling as well as modeling emissions and the differences between the two states.

Question: Byron asked if Cascade's modeling would consider path dependency issues that can arise when evaluating short term versus long-term avoided costs

Answer: Devin explained that when it comes to avoided costs the Company is somewhat restricted by regulatory requirements, specifically in Oregon. Regarding the resource integration process, the Company strives to make holistic optimization decisions to account for both short and long-term needs

Presentation #9 – 2022 IRP Schedule (Brian Robertson)

- Brian went through the WA TAG schedule as well as the OR TAG schedule and discussed the changes to the OR TAG schedule. Brian asked for feedback on the scheduling changes and will try to lock down the new dates the following week.
- Brian noted that the next TAG meeting will take place on May 18th.

The Meeting was Adjourned

Per Cascade Commitment #8 (Stakeholder Engagement Design Document, 2/22,2022: "Provide TAG minutes that include the action items from bullet #7 as well as any upcoming deadlines for feedback on the IRP"), here are the additional action items to track, coming out of the TAG 1 meeting:

1. Status and applicability of hybrid heat pumps on Cascade's system
2. Oregon PUC Staff to report back whether two TAGs substituting for one Workshop is acceptable
3. Look into how other utilities address avoided cost in a post CCA/ CPP world
4. Provide an update on climate change modeling in TAG 2
5. Provide an update on reaching out to community-based organizations in TAG 2

These are in addition to Slides #13 and 14 in the TAG 1 presentation deck (responsive to Cascade Commitment #7 in the Design Document: "Keeping a running list of action items from Technical Advisory Group (TAG) meetings that need to be further addressed if not directly related to the then-meeting topic or if more time is required to respond").



In the Community to Serve®

Integrated Resource Plan Technical Advisory Group Meeting #2

MAY 18, 2022

MICROSOFT TEAMS/TELECONFERENCE

Agenda

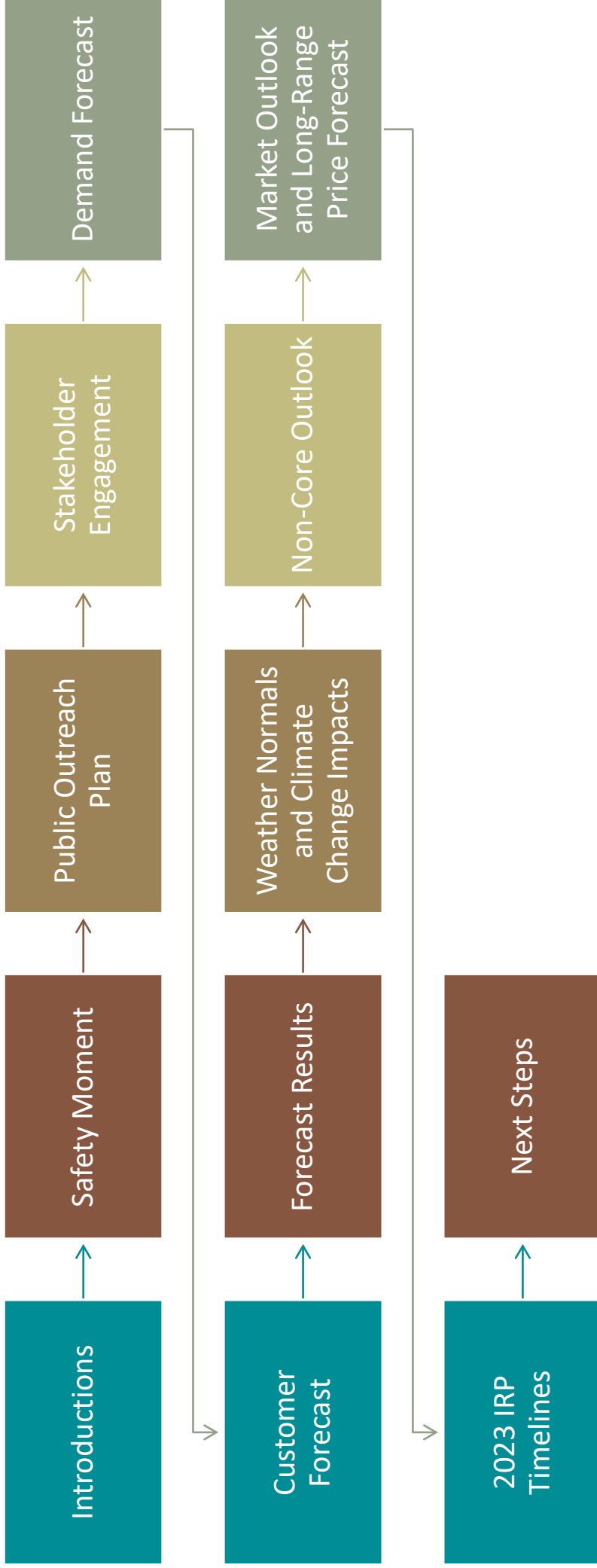

Enjoying the Great Outdoors Safely



While hunting, fishing, camping, and enjoying all of the activities the great outdoors has to offer following the tips below are some ways to stay safe:

- Obey applicable hunting laws and make yourself visible to other hunters.
- Watch your footing while traversing through rough terrain and wilderness to avoid sprains and strains.
- Make sure camp fires are fully extinguished before leaving camp sites.
- Wear sunscreen to protect your skin from sunburns.
- Protect yourself from insect bites and stings by using insect repellent methods.
- Drive safely on the road and off-the-road if you plan to use UTV's, ATV's, etc.

Safety Moment

Public Outreach Plan

- The Company identifies five general segments of stakeholders
 - Commission Staffs
 - Customer representatives
 - Community-based organizations
 - Expert Public
 - General Public
- Cascade notifies these segments in several ways, perhaps bill inserts, media releases to broadcast and print outlets, social media (Facebook and Twitter), meetings throughout service territory, web page, Commission web page.
- Cascade has a dedicated Internet webpage where customers and interested parties can view the IRP timeline, TAG presentations and minutes, as well as current and past IRPs.
- The Company believes that customers and interested parties were made aware of Cascade's IRP meetings, opportunity to participate, as well as availability of CNGC personnel to address any related issues. Additionally, Cascade hosts the Conservation Advisory Group (CAG) to receive regular input on energy efficiency issues.

Stakeholder Engagement

- For attendance at meetings, in an effort to further clarify roles and responsibilities for the Company as well as stakeholders, Cascade follows a Stakeholder Engagement Design Document, presented in TAG1.
- In the past decades, “rules of the road” for participation in Pacific Northwest utility advisory groups and collaboratives have ranged from full informality to specific charters. The latter has taken significant time for crafting and agreement by all parties. Cascade’s Stakeholder Design Document attempts to capture the best from each approach.
- Cascade’s meetings are informal so either unmuting or raising your hand, or even typing questions into chat is fine with Cascade.

Demand Forecast

A Little Fun with Spurious Correlations...

Per capita consumption of chicken
correlates with

Total US crude oil imports

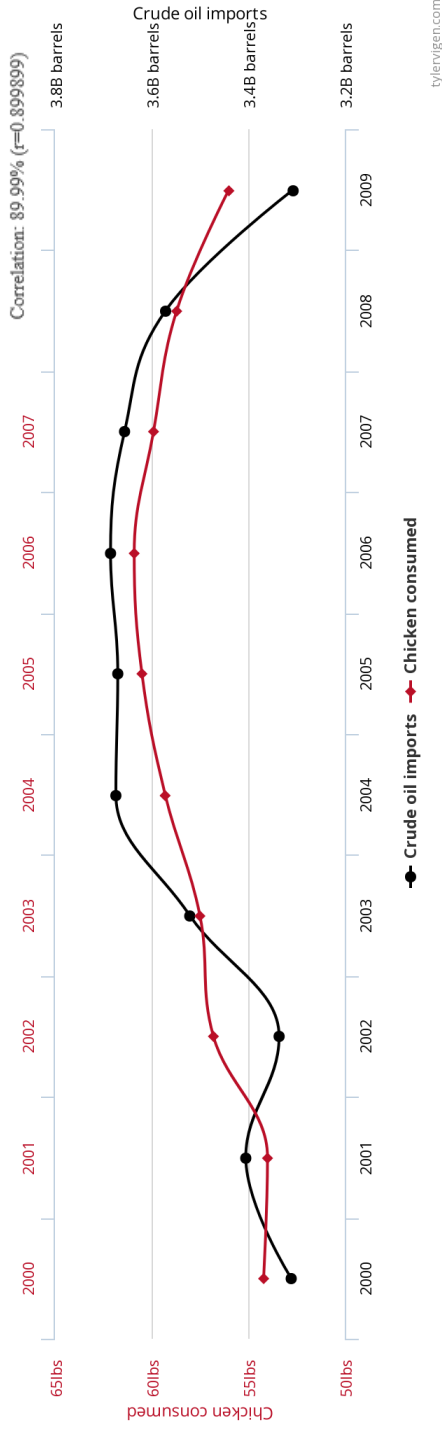

Demand Forecast

- The Cascade demand forecast developed for the IRP is a forecast of core customers and their usage, including peak demand, for the next 20+ years.
- Demand is forecasted at:
 - the citygate and citygate loop level;
 - the rate schedule level;
 - the daily level; and
 - forecasted out to 2050 for decarbonization planning.

Key Definitions

- **AIC:** The Akaike information criterion (AIC)
 - A measure of the relative quality of statistical models for a given set of data. Given a collection of models for the data, AIC estimates the quality of each model, relative to each of the other models. Hence, AIC provides a means for model selection.
- **ARIMA:** Auto-Regressive Integrated Moving Average
 - Type of model that is fitted to time series data.
 - When doing regressions using time series variables, it is common for the errors (or residuals) to have a time series structure. This could mean there is a predictable structure to the errors, meaning they can also be modeled. This is where the ARIMA term comes in.
- **Fourier Terms**
 - The decomposition of a time series into a set of sine-waves (or cosine-waves) with differing amplitudes, frequencies, and phase angles. Essentially, these terms help find seasonalities within a time series that wasn't accounted for by regressors.
- Weather in terms of HDDs (Heating Degree Day), referencing 60 degrees.
- Wind is average daily wind speed.
- Citygate loops are a group of citygates that service a similar area that are forecasted together due to pipeline operations.

Weather Stations



- The seven weather stations are shown on the map.
- Cascade’s service territory is shaded in aqua.
- Each citygate and loop is assigned to a weather station.

Core Customers/Load Breakdown - 2021

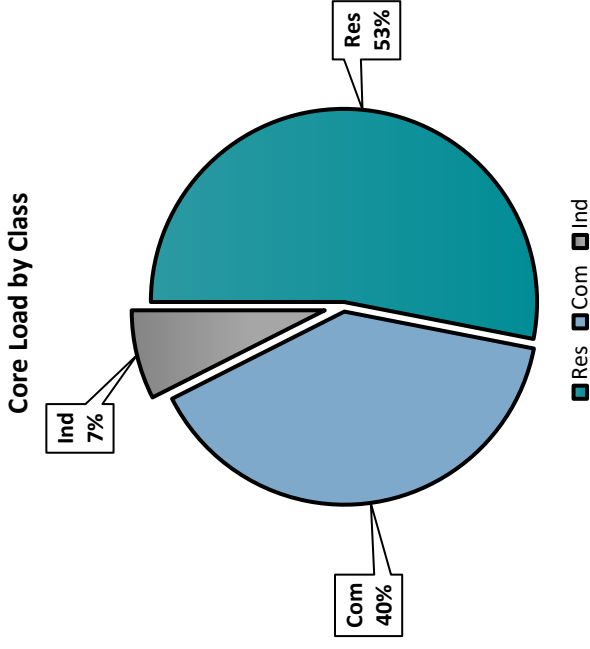
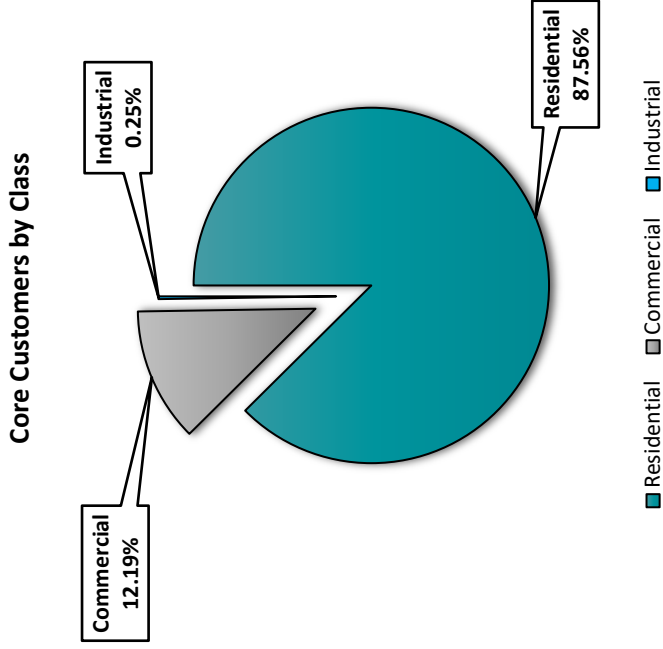
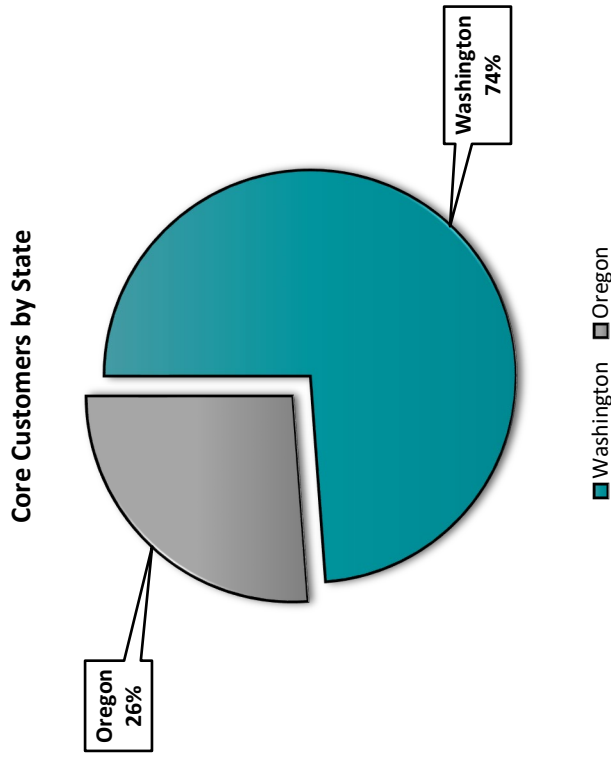

Process

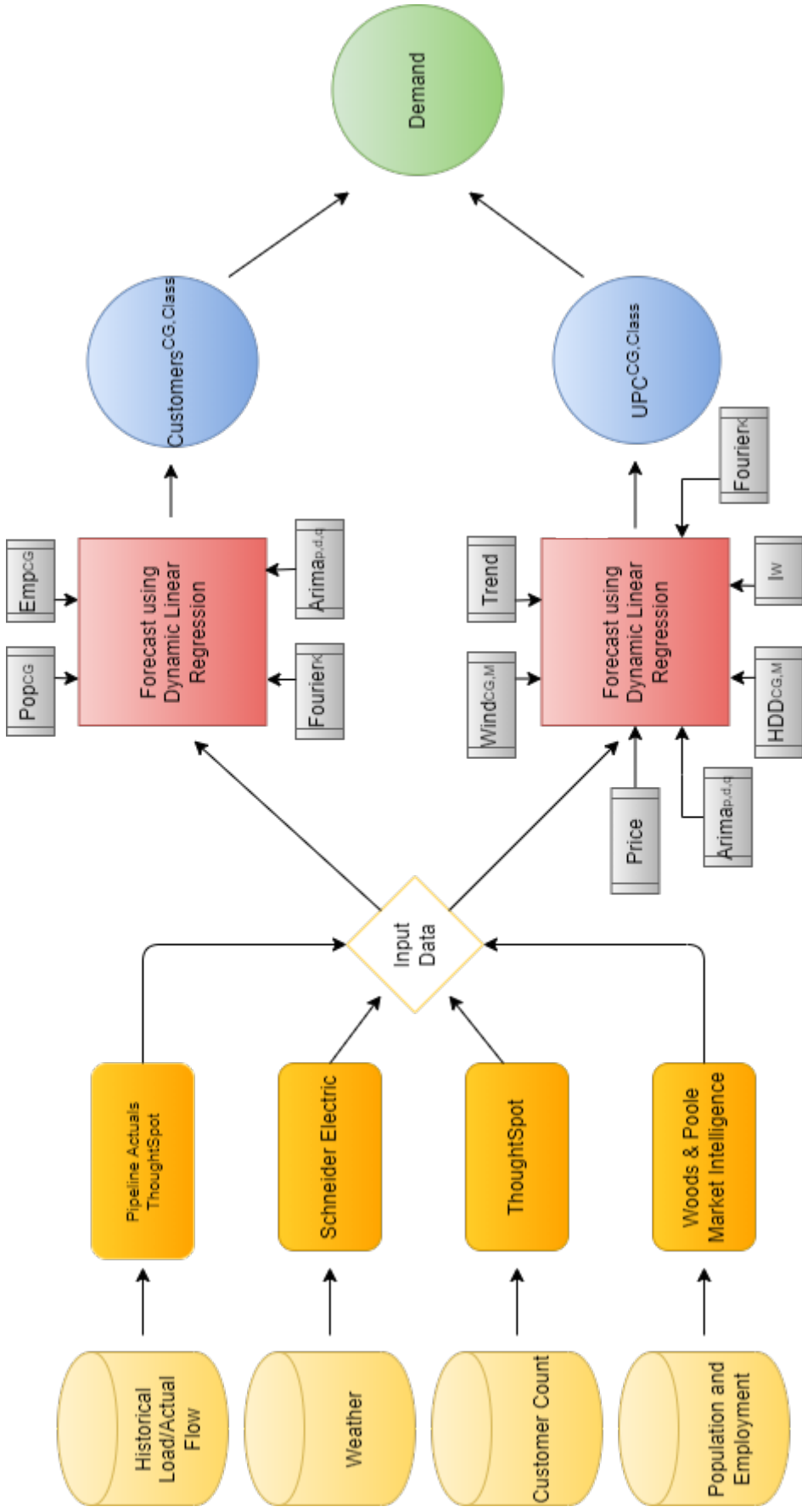

Inputs

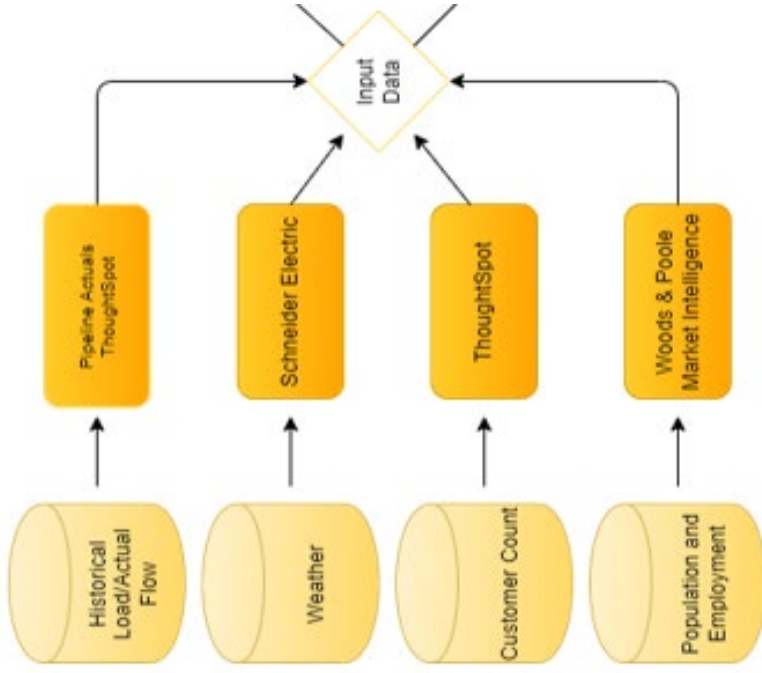

- Cascade uses data from various sources:
 - Pipeline actuals at daily/Citygate level.
 - Woods & Poole at county level.
 - ThoughtSpot citygate/monthly allocations
- Market intelligence monthly.
- Unifying inputs is an important part of the forecasting process.

Customer Forecast

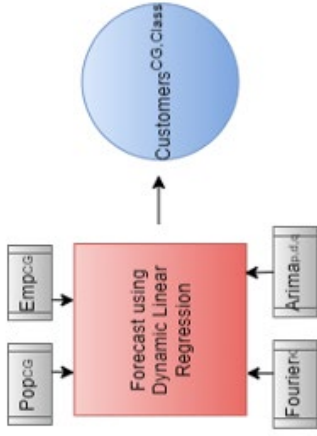

Customer Forecast

$$C_{CG,Class} = \alpha_0 + \alpha_1 Pop^{CG} + \alpha_2 Emp^{CG} + Fourier(k) + ARIMA \in (p,d,q)$$

Model Notes:

- C = Customers; CG = Citygate; Class = Residential, Commercial, Industrial, or Interruptible; ARIMA ∈ (p,d,q) = Indicates that the model has p autoregressive terms, d difference terms, and q moving average terms; Pop = Population; Emp = Employment; Fourier(k) = Captures seasonality of k number of seasons.

Start with Linear Model

Some are Naïve models

Tests for any collinearity

Customer Forecast Inputs

2023 CNGC IRP

County	Populatic	Employe
ALBANY-LEBANON	70,221	29,329
ASTORIA	27,905	12,293
BAKER	15,219	6,517
BEND	29,726	12,947
BEND-PRINEVILLE	39,554	17,551
BENTON	51,491	19,344
BROOKINGS	13,18	4,988
CLACKAMAS	156,015	47,703

Woods & Poole Data

ThoughtSpot Data

3	Acctg Year	Acctg Month	Gate (Loop)	Shutdown Area	Rate	MR Cycle	SP Type	Total Therms	Number of Prem ID
4	2020	1	Umatilla	56-H011	CNGO11LV	CA00	CNGG-IND	0	1
5	2021	1	Umatilla	56-H011	CNGO11LV	CA00	CNGG-IND	0	1
6	2022	1	Umatilla	56-H011	CNGO11LV	CA00	CNGG-IND	0	1
7	2015	1	Athens	56-H008	CNGOR101	CA06	CNGG-RES	708	3
8	2015	1	Athens	56-I033	CNGOR101	CA06	CNGG-RES	31331	316
9	2015	1	Athens	56-I038	CNGOR101	CA06	CNGG-RES	16611	171
10	2016	1	Athens	56-I033	CNGOR101	CA06	CNGG-RES	27992	321
11	2016	1	Athens	56-H008	CNGOR101	CA06	CNGG-RES	599	3
12	2016	1	Athens	56-I038	CNGOR101	CA06	CNGG-RES	14858	171
13	2017	1	Athens	56-H008	CNGOR101	CA06	CNGG-RES	947	3
14	2017	1	Athens	56-I038	CNGOR101	CA06	CNGG-RES	22870	173

Appendix A
IRP Process

A	B	C	D	E	F	G	H	I	J	K	
Aggregated Locations	Loop	Year	Month	Day	Year	Month	Day	Date	Actual Dth	None Core	Core
1	Aggregated Locations	2015	1	1	2015	1	1	1/1/2015 Thursday	6,315	2,819	3,496
38	ABERDEEN/HOOQUIAM/MCCLEARY	2015	2	1	2015	2	1	2/1/2015 Sunday	3,243	1,083	2,160
39	ABERDEEN/HOOQUIAM/MCCLEARY	2015	3	1	2015	3	1	3/1/2015 Sunday	4,424	2,335	2,089
40	ABERDEEN/HOOQUIAM/MCCLEARY	2015	4	1	2015	4	1	4/1/2015 Wednesday	5,725	3,560	2,165
41	ABERDEEN/HOOQUIAM/MCCLEARY	2015	5	1	2015	5	1	5/1/2015 Friday	3,721	2,472	1,250
42	ABERDEEN/HOOQUIAM/MCCLEARY	2015	6	1	2015	6	1	6/1/2015 Monday	4,827	3,748	1,079
43	ABERDEEN/HOOQUIAM/MCCLEARY	2015	7	1	2015	7	1	7/1/2015 Wednesday	4,076	3,500	576.3
44	ABERDEEN/HOOQUIAM/MCCLEARY	2015	8	1	2015	8	1	8/1/2015 Saturday	3,106	2,589	517
45	ABERDEEN/HOOQUIAM/MCCLEARY	2015	9	1	2015	9	1	9/1/2015 Tuesday	4,067	3,393	674.3
46	ABERDEEN/HOOQUIAM/MCCLEARY	2015	10	1	2015	10	1	10/1/2015 Thursday	4,598	3,705	893.2
47	ABERDEEN/HOOQUIAM/MCCLEARY	2015	11	1	2015	11	1	11/1/2015 Sunday	4,074	2,752	1,322
48	ABERDEEN/HOOQUIAM/MCCLEARY	2015	12	1	2015	12	1	12/1/2015 Tuesday	3,444	2,078	1,366
49	ABERDEEN/HOOQUIAM/MCCLEARY	2015	1	1	2015	1	1	1/1/2015 Thursday	51	0	51
50	ACME	2015	2	1	2015	2	1	2/1/2015 Sunday	29	0	29
51	ACME	2015	3	1	2015	3	1	3/1/2015 Sunday	31	0	31
52	ACME	2015	4	1	2015	4	1	4/1/2015 Wednesday	28	0	28
53	ACME	2015	5	1	2015	5	1	5/1/2015 Friday	12	0	12
54	ACME	2015	6	1	2015	6	1	6/1/2015 Monday	6	0	6
55	ACME	2015	7	1	2015	7	1	7/1/2015 Wednesday	5	0	5
56	ACME	2015	8	1	2015	8	1	8/1/2015 Saturday	6	0	6
57	ACME	2015	9	1	2015	9	1	9/1/2015 Tuesday	12	0	12
58	ACME	2015	10	1	2015	10	1	10/1/2015 Thursday	14	0	14

Page 67

Pipeline Data

Customer Forecast

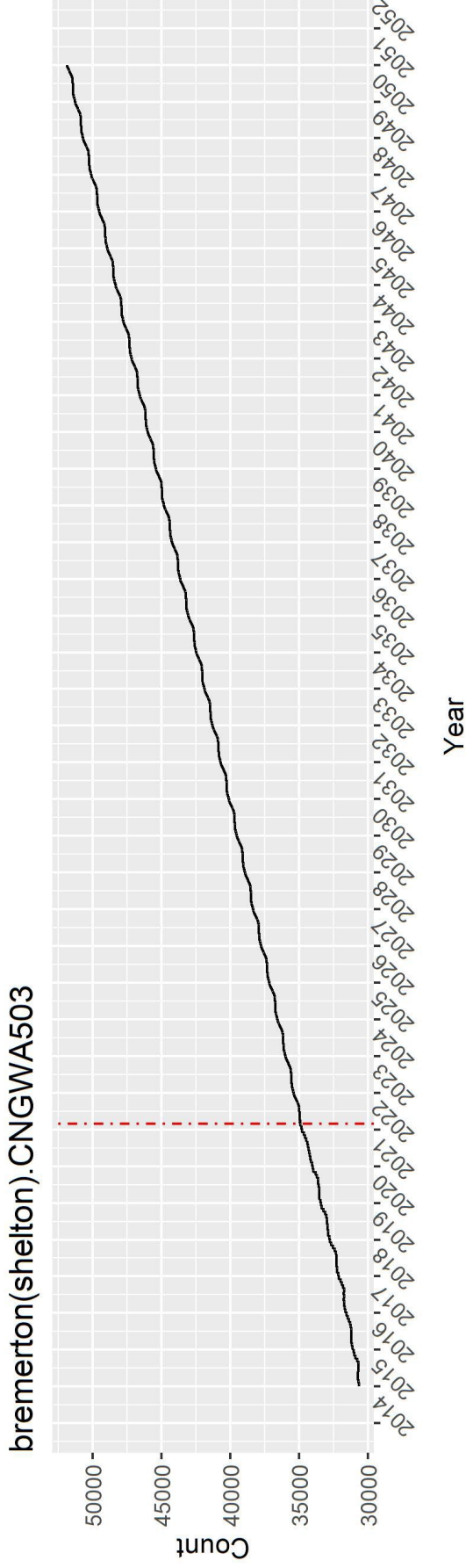

Model Selection

Xregs	AICc
Fourier	1505.389
Population + Fourier	1506.871
Employment + Fourier	1507.519
Employment	1562.932
Population	1566.24
Employment + Population + Fourier	1568.108
Arima Only	1597.354

Customer Forecast - High and Low Growth

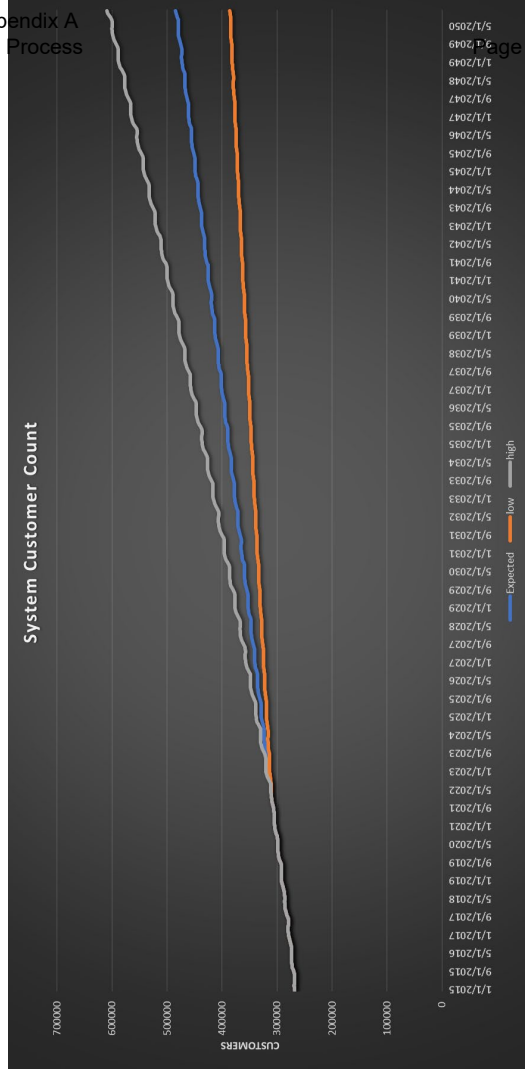
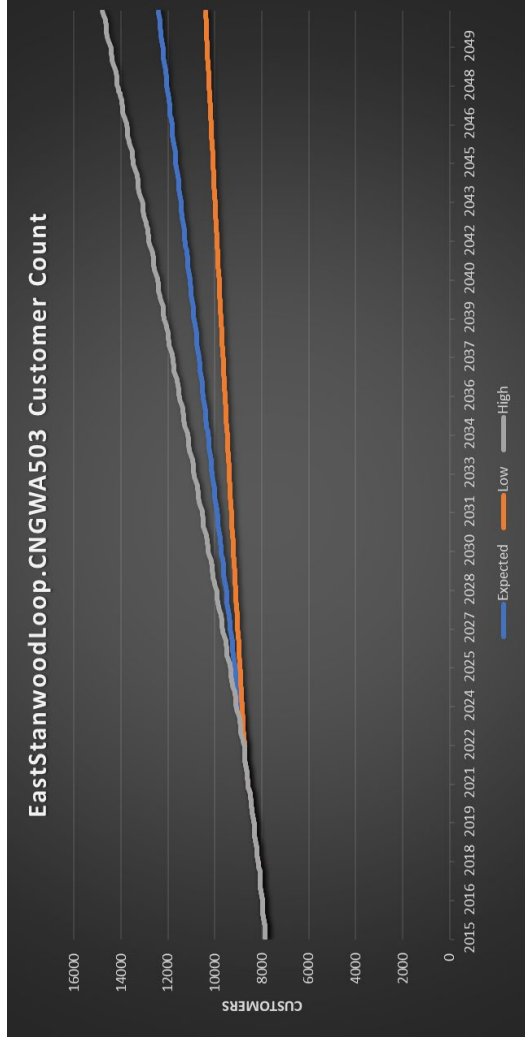
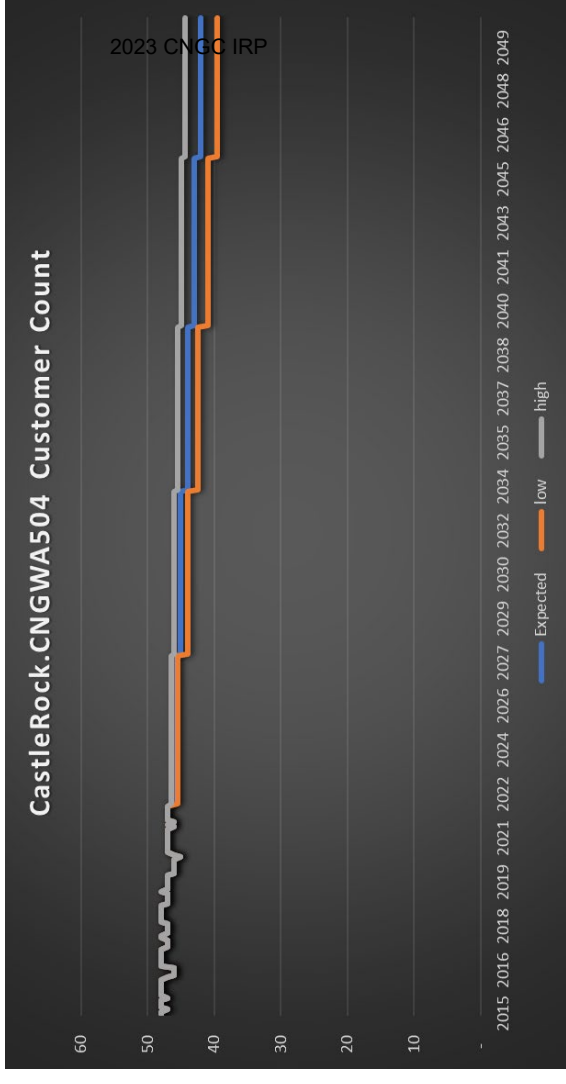

Appendix A
IRP Process

Customer Growth Rates

System	High	Base-Case	Low
Residential	2.33%	1.56%	0.75%
Commercial	1.90%	1.28%	0.62%
Industrial	2.22%	1.47%	0.66%
Total	2.28%	1.52%	0.74%

WA	High	Base-Case	Low
Residential	2.12%	1.42%	0.69%
Commercial	1.95%	1.31%	0.64%
Industrial	1.87%	1.27%	0.58%
Total	2.10%	1.41%	0.68%

OR	High	Base-Case	Low
Residential	1.78%	1.19%	0.58%
Commercial	1.78%	1.19%	0.58%
Industrial	3.08%	2.02%	0.91%
Total	2.73%	1.83%	0.88%

Use Per Customer Forecast

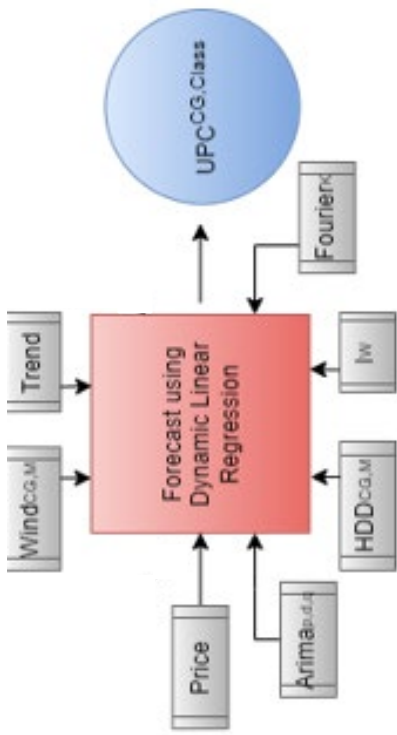

$$\text{Therms}/C^{CG,Class} = \alpha_0 + \alpha_1 \text{HDD}^{CG,M} + \alpha_2 I_w + \alpha_4 \text{WIND}^{CG,M} + \text{Price} + \text{Trend} + \text{Fourier}(k) + \text{ARIMA} \in (p,d,q)$$

Model Notes:

- Therms/C = Therms per customer; CG = Citygate; Class = Residential, Commercial, Industrial, or Interruptible; HDD = Heating Degree Days; M= Month; I_w = Indicator Variable set to 1 if it is a weekend; T = Trend Variable increasing by 1 for each day forecasted; WIND = Daily average wind speed; Price is FOM pricing.

Start with linear model

Use Per Customer Forecast Inputs

$$\text{Therms}/C^{\text{CG,Class}} = \alpha_0 + \alpha_1 \text{HDD}^{\text{CG, M}} + \alpha_2 I_w + \alpha_4 \text{WIND}^{\text{CG, M}} + \text{Price} + \text{Trend} + \text{Fourier}(k) + \text{ARIMA} \in (p,d,q)$$

Aggregated.Locations	CNGOR101	weekend	jan.hdd	feb.hdd	mar.hdd	apr.hdd	may.hdd	jun.hdd	jul.hdd	aug.hdd	sep.hdd	oct.hdd	nov.hdd	dec.hdd	jan.wind	feb.wind	mar.wind	apr.wind	may.wind	jun.wind	jul.wind	aug.wind	sep.wind	oct.wind	nov.wind	dec.wind	price	
south hermiston	137	0	29	0	0	0	0	0	0	0	0	0	0	0	3	0	0	0	0	0	0	0	0	0	0	0	0	3.09550005

UPC Forecast Results

2023 CNGC IR

ar1	ar2	ar3	ma1	ma2	ma3	ma4	intercept	weekend	jan.hdd	feb.hdd	mar.hdd	apr.hdd	may.hdd	jun.hdd	jul.hdd	aug.hdd	sep.hdd	oct.hdd	nov.hdd
0.072517433	0.202667228	0.564950142	0.178551246	-0.067482619	-0.513945530	0.047368441	0.084391666	-0.008088873	0.011839269	0.011870203	0.010491619	0.009235327	0.006505575	0.005502497	0.005191624	0.0043315505	0.005899139	0.009113726	0.010875138

dec.hdd	jan.wind	feb.wind	mar.wind	apr.wind	may.wind	jun.wind	jul.wind	aug.wind	sep.wind	oct.wind	nov.wind	dec.wind	price	S1-365	C1-365	S2-365	C2-365	S3-365	C3-365
0.011958002	0.004857669	0.004504779	0.004358709	0.002700278	0.000552336	-0.000246139	-0.000274343	0.00029844	0.001779977	0.003644867	0.004009029	0.004188376	-0.002184843	0.0163337025	0.009787113	0.006171567	0.001279059	0.000465429	0.001946981

sumas_spe_loop.CNGWA503.upc: Dynamic Linear Regression Model

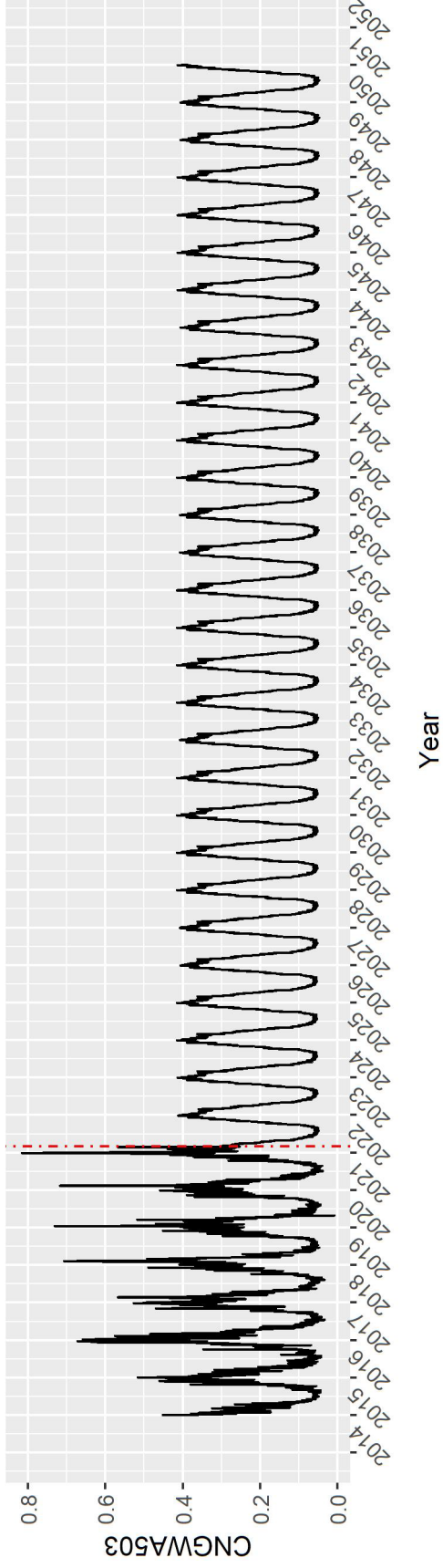

acme.CNGWA503.upc: Dynamic Linear Regression Model

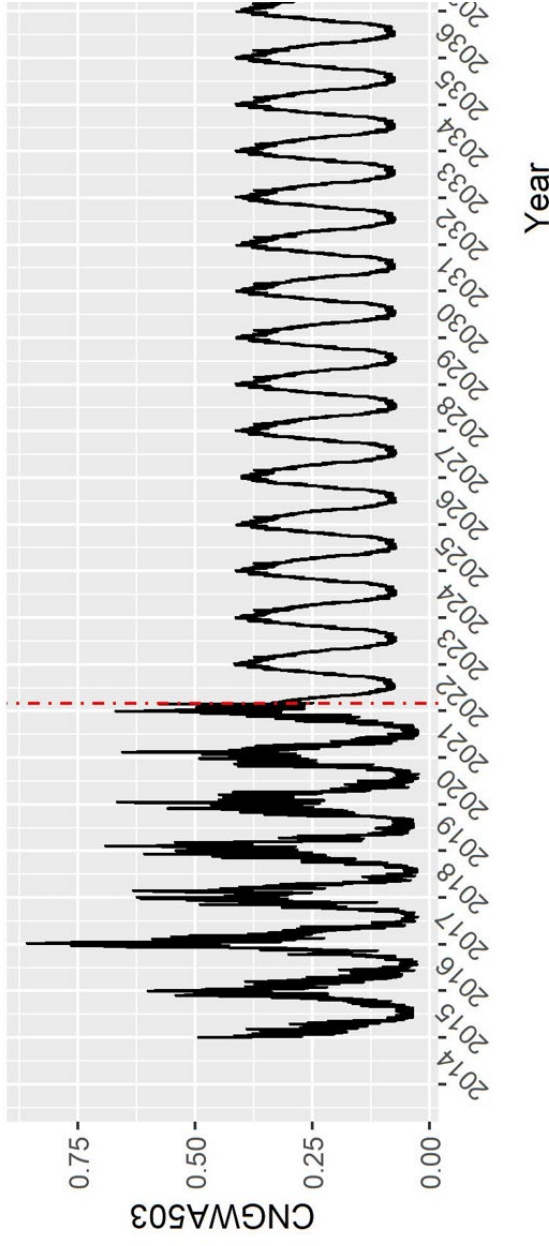

Fourier terms

What do they do exactly?

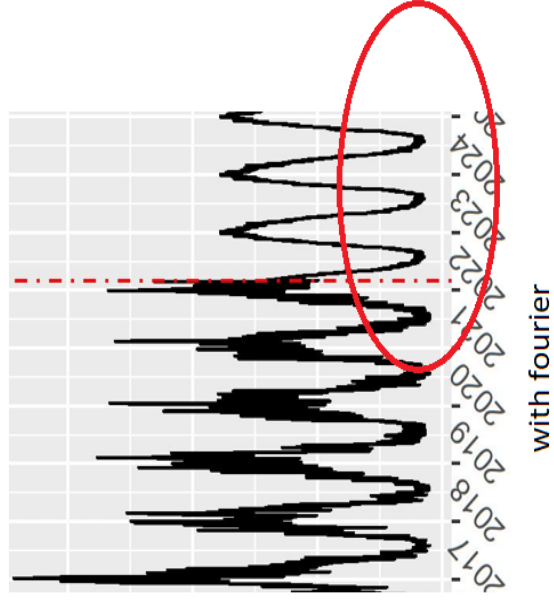
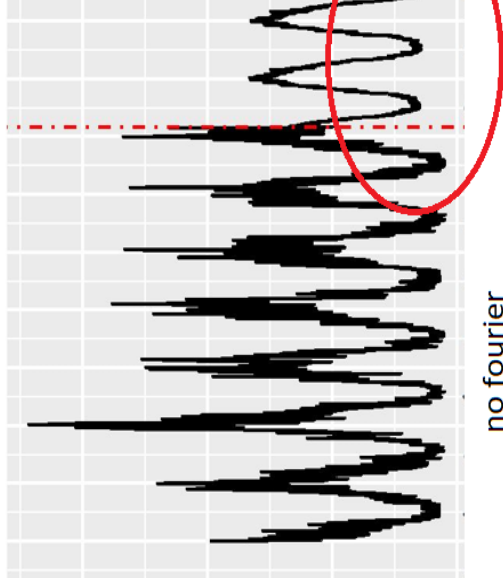

Peak Day Use-Per-Customer

10,000 simulations ran on each of Cascade's seven weather zones along with a system-wide weighted simulation.

Found 95th, 99th, and 100th percentile of each weather location.

99th percentile lined up with previous peak day values.

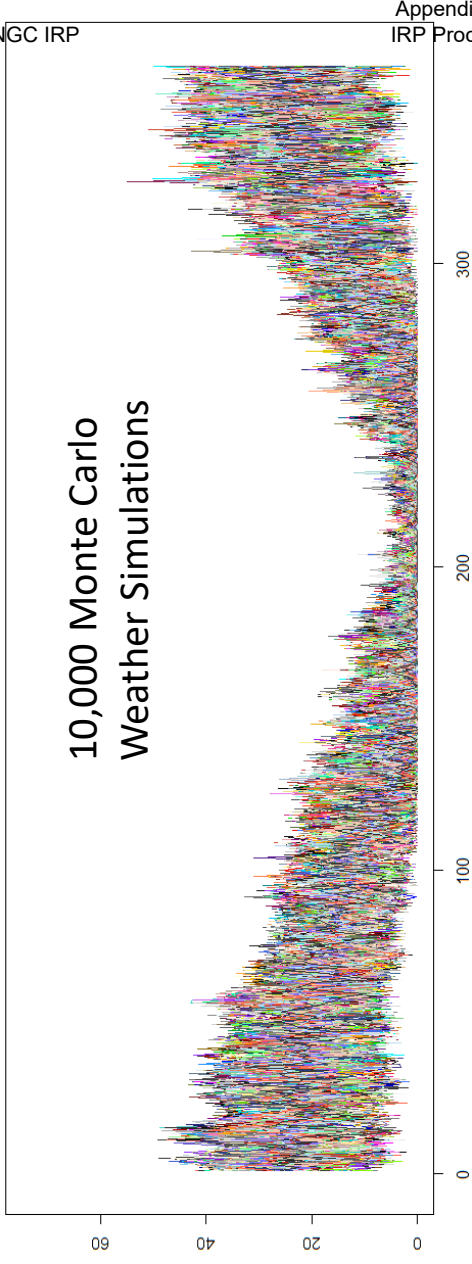

baker.CNGOR101 - Peak Forecast

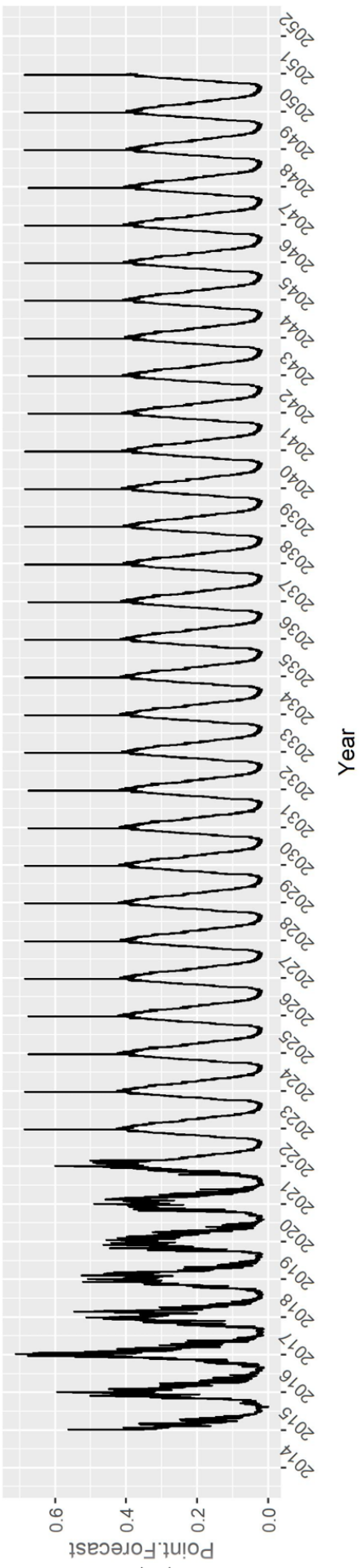

Methodology Changes

- Added price as a regressor
- Shifted customer class:

3	Acctg Year	Acctg Month	Gate (Loop)	Shutdown Area	Rate	MR Cycle	SP Type	Total Therms	Number of Prem ID
4	2020	1	Umatilla	56-H011	CNGO11LV	CA00	CNGG-IND	0	1
5	2021	1	Umatilla	56-H011	CNGO11LV	CA00	CNGG-IND	0	1
6	2022	1	Umatilla	56-H011	CNGO11LV	CA00	CNGG-IND	0	1
7	2015	1	Athens	56-H008	CNGOR101	CA06	CNGG-RES	708	3
8	2015	1	Athens	56-I033	CNGOR101	CA06	CNGG-RES	31331	316
9	2015	1	Athens	56-I038	CNGOR101	CA06	CNGG-RES	16611	171
10	2016	1	Athens	56-I033	CNGOR101	CA06	CNGG-RES	27992	321
11	2016	1	Athens	56-H008	CNGOR10	CA06	CNGG-RES	599	3
12	2016	1	Athens	56-I038	CNGOR101	CA06	CNGG-RES	14858	171
13	2017	1	Athens	56-H008	CNGOR101	CA06	CNGG-RES	947	3
14	2017	1	Athens	56-I038	CNGOR101	CA06	CNGG-RES	22870	173

- Compared to pipeline data, CA01-CA14 need to be shifted back 1 month
- Peak day: Coldest in 30 years to Monte Carlo simulations

Non-Weather Dependent Demand

- Demand that is not influenced by weather.
- Typically caused by a customer who ramps up production based on the time of season.
- Cascade's models can accurately capture this type of demand.

Moxee

Moxee - Industrial

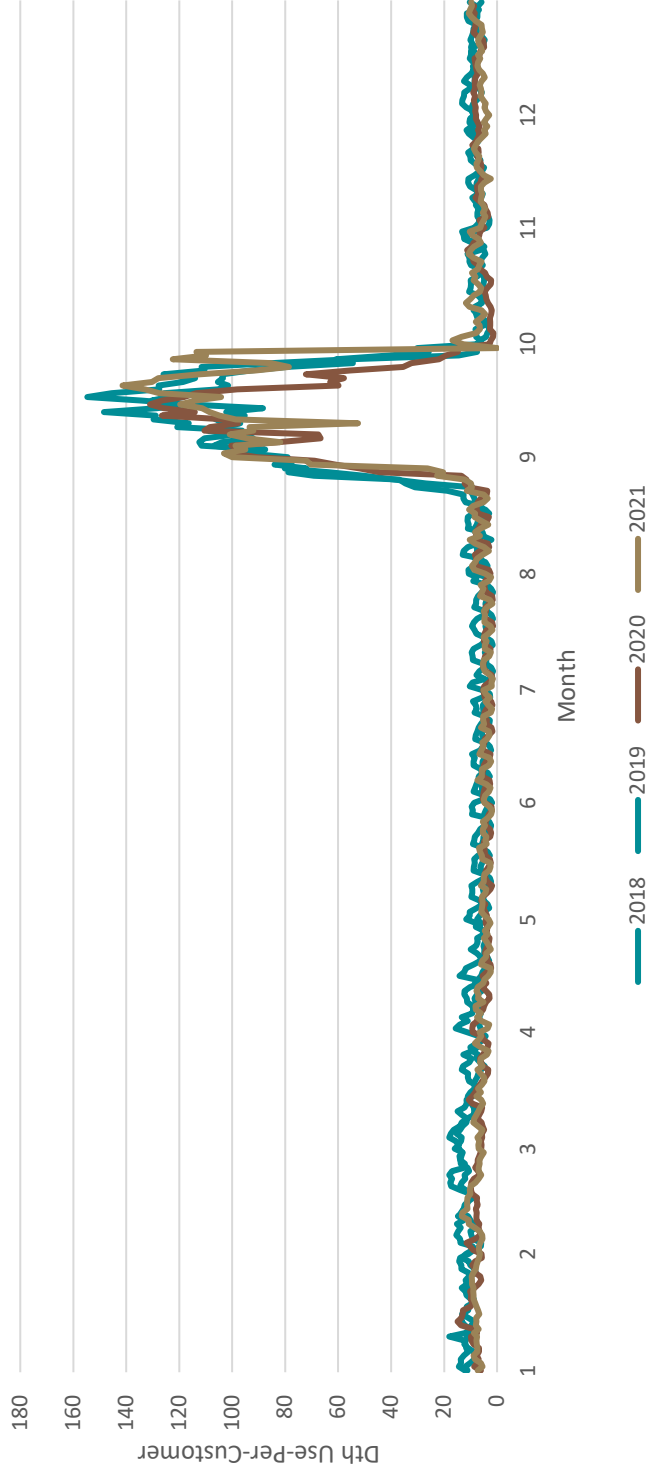

Forecast Results

Final Demand Calculation

eaststanwoodloop.CNGWA503

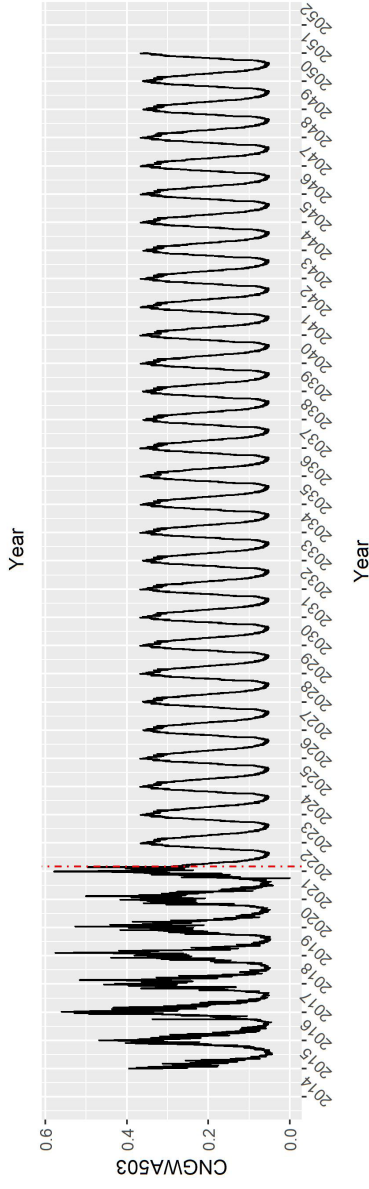
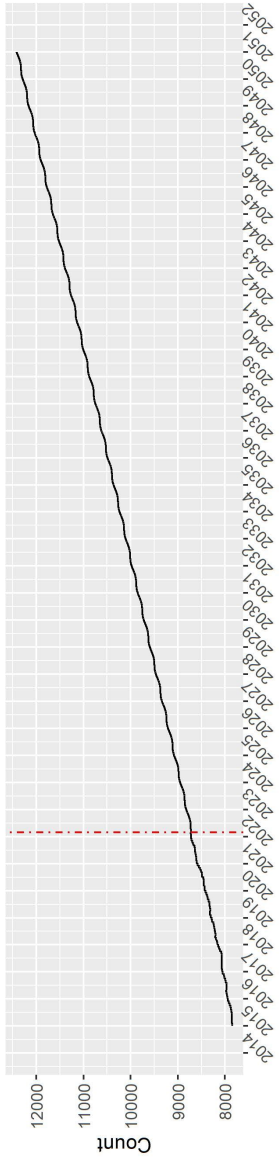

eaststanwoodloop.CNGWA503.csv.demand.Demand

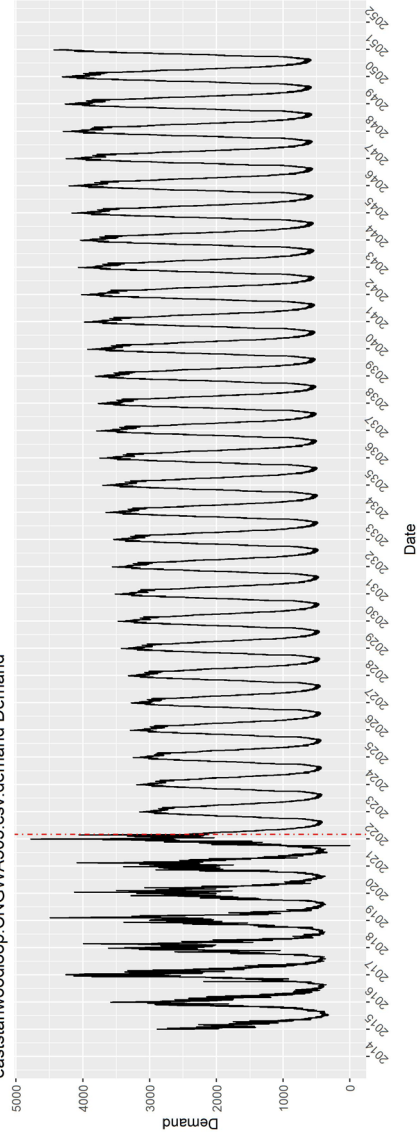

Oregon Demand

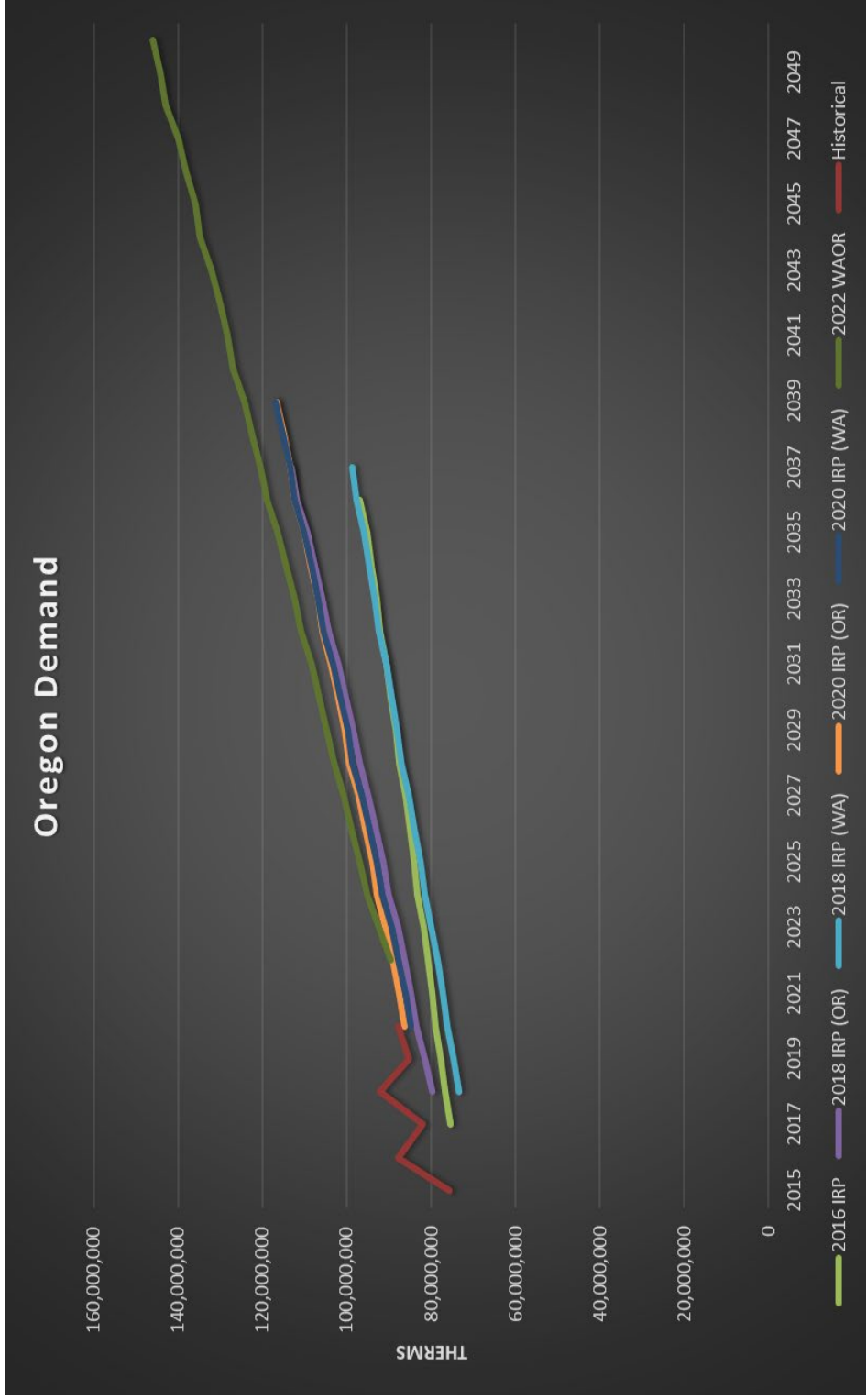

Washington Demand

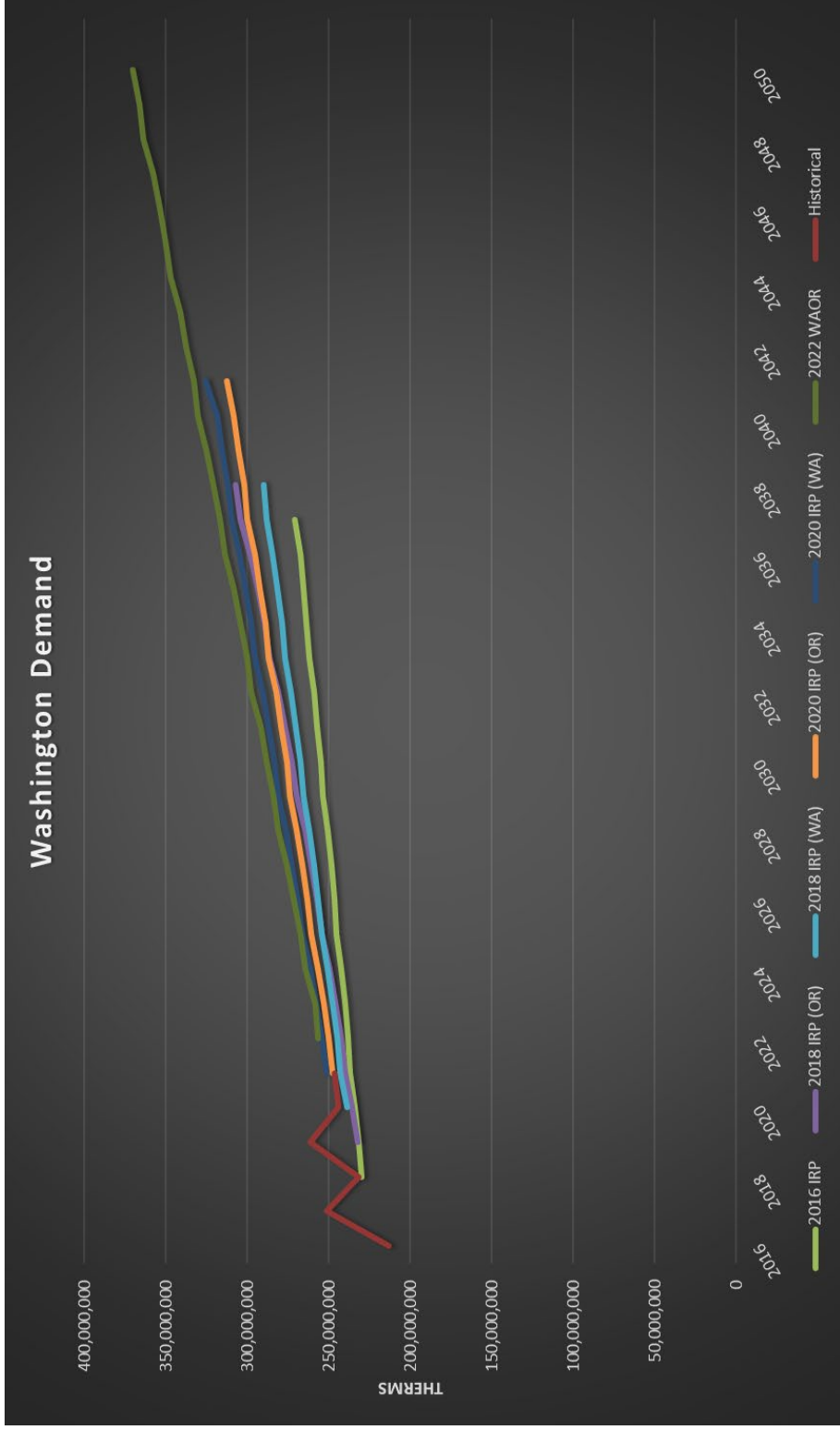

Total System Demand

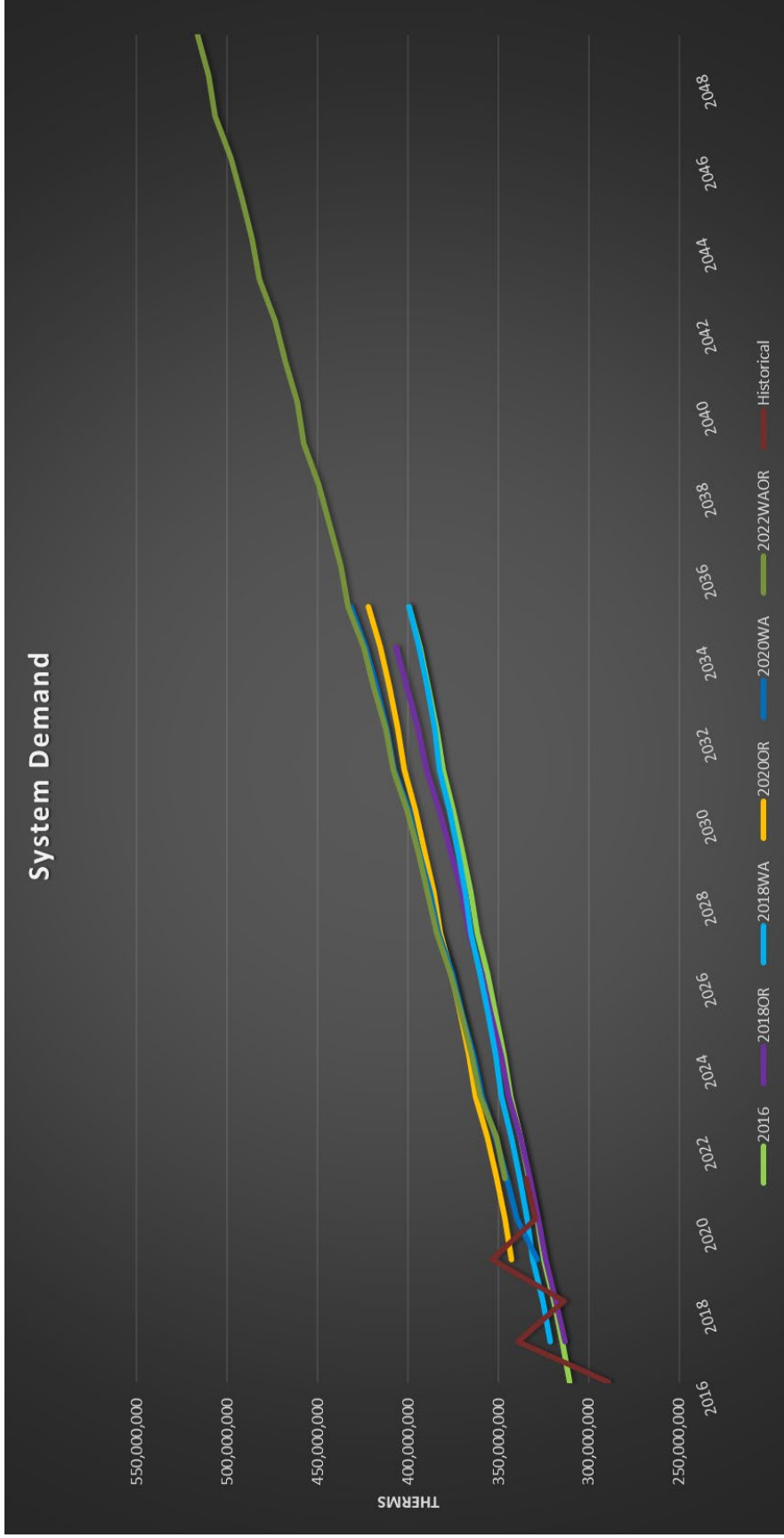

Weather Normals and Climate Change Impacts

Weather Normals

Historically, Cascade has used the average weather from the past 30 years for weather normals.

As Cascade is looking at Climate Change impacts, the Company has provided several different ranges of weather normals.

Scenario	Historical Range	Peak HDD	Avg Annual
Previous IRP	1990-2019	55.7	4012
30-year	1992-2021	49.9	4025
20-year	2002-2021	49.9	4037
15-year	2007-2021	46.7	4038
10-year	2012-2021	46.7	3872

Climate Change Impacts

- Cascade utilized Climate Change data from the Intergovernmental Panel on Climate Change.¹
- Cascade used the Coupled Model Intercomparison Project Phase 4 (CMIP5) with the RCP 4.5 scenario which included 36 different models.
- Cascade chose this scenario as it best represents the Western North America emission goals and was labeled as the most probable baseline scenario.²
- Cascade also modeled using the 18 most conservative models as well as the Environmental Protection Agency’s noted historical temperature change (.54°F per decade since 1979).³

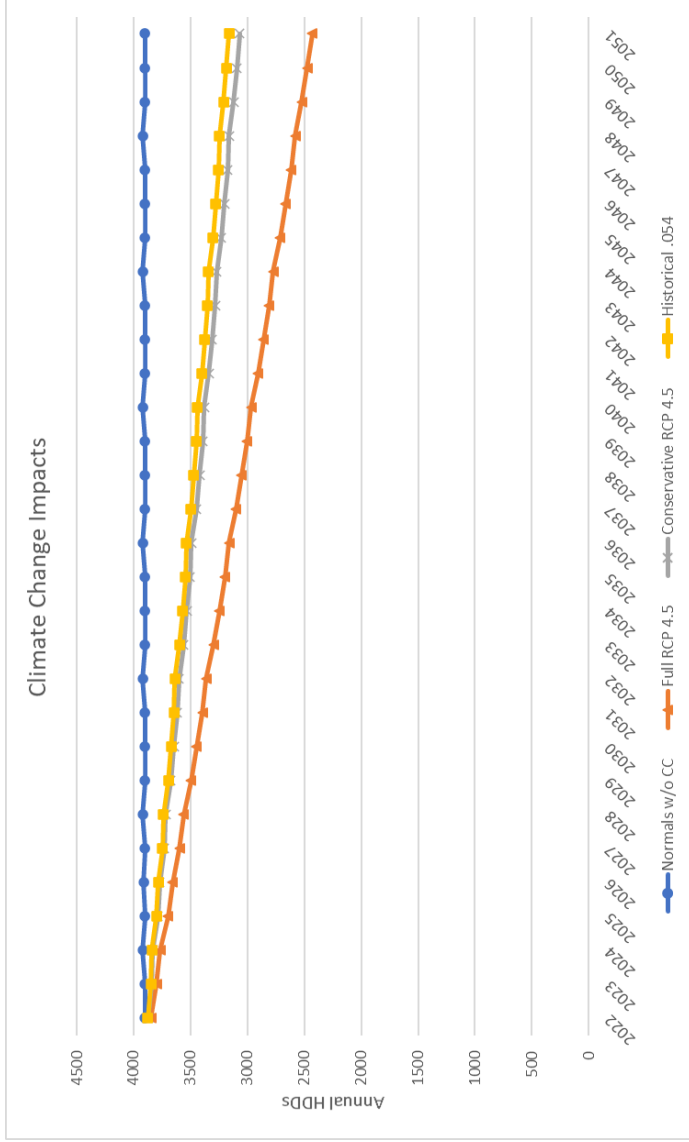

1 [HTTPS://IPCC-BROWSER.IPCC-DATA.ORG/BROWSER/SEARCH?FORMAT](https://ipcc-browser.ipcc-data.org/browser/search?format)

2 REPRESENTATIVE CONCENTRATION PATHWAY – WIKIPEDIA

3 CLIMATE CHANGE INDICATORS: U.S. AND GLOBAL TEMPERATURE | US EPA

Climate Change Impacts

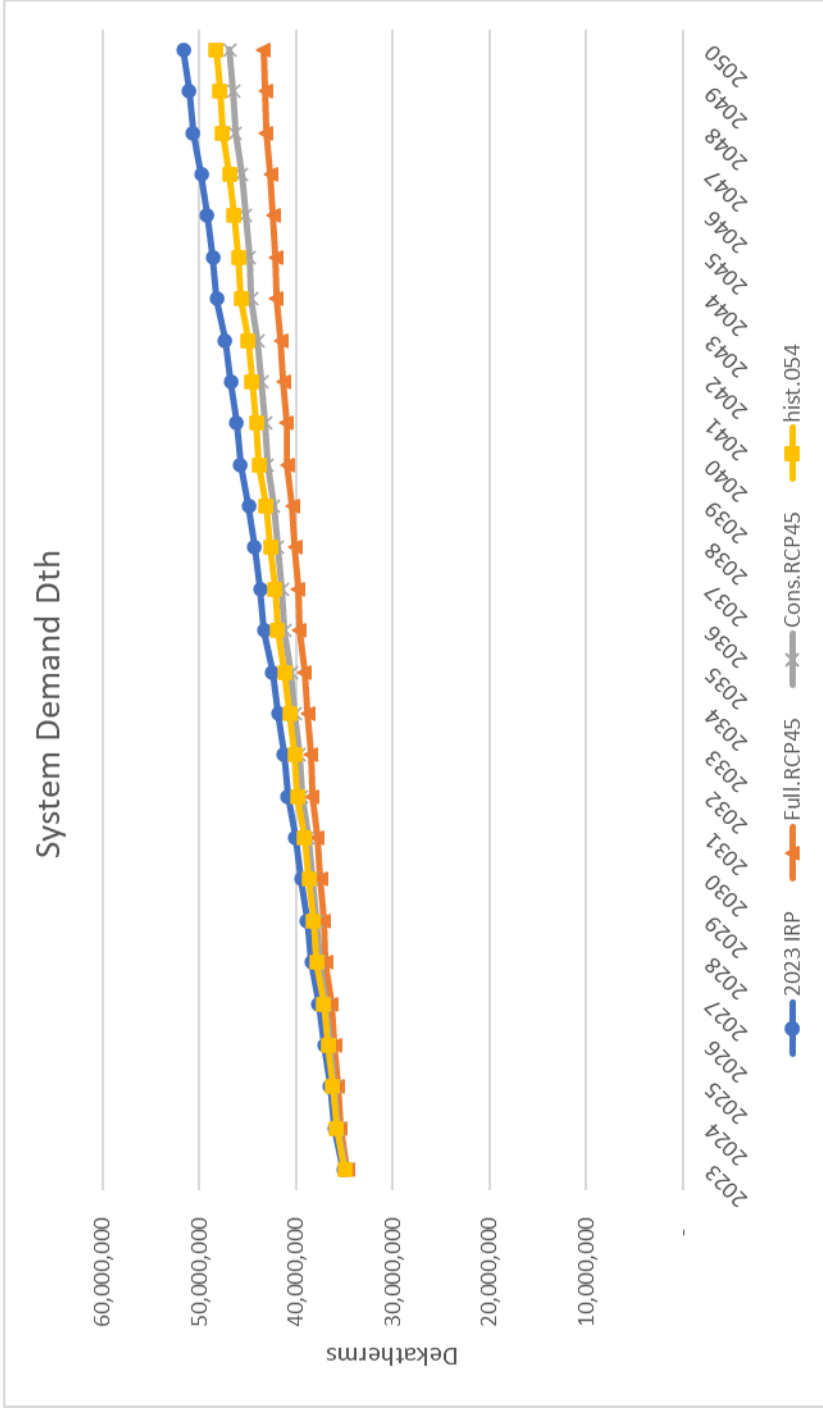

Non-Core Outlook

Non-Core Outlook

- Cascade forecasts the non-core out to 2050.
- Unlike the core, non-core (or transportation) customers are customers who schedule and purchase their own gas, generally through a marketer, to get gas to the citygate. The customer then uses Cascade's distribution system to receive the gas.
- Cascade's transportation customers include all types of industrial customers. It includes farms that may not use any gas during the winter to food manufacturers that average 800,000 therms per month throughout the year.
- Cascade also serves five electric generation customers in Washington and one in Oregon. Those six customers project to use approximately 419,000,000 therms in 2023.

Transportation Customers

- Cascade's transportation customer forecast increased from the previous forecast. The current forecast projects the customer count to be 245 in 2023, up from 234 customers from the previous forecast, with plans to bring on several new customers over the next five years. Cascade's industrial managers are working closely with potential industrial customers.
- Cascade's projection increased by 12 million therms from the previous forecast. The increase is mainly a direct result from the new customers the Company added.
- Cascade projects the transportation customers in Washington and Oregon to consume approximately 598 million therms in 2023.

Non-Core Forecast Results

Transportation customers in Washington forecast to use 537 million therms in 2023.

Transportation customers in Oregon forecast to use 61 million therms in 2023.

Electric Generation customers forecast to use 419 million therms in 2023.

Non-Core total forecast for 2023 is approximately 1.017 billion therms.

Market Outlook and Long-Range Price Forecast

Long Range Market Outlook

Despite LNG export growth and increased domestic demand for natural gas, EIA projects that the Henry Hub price will remain below \$4/MMBtu throughout the projection period in most cases. Amid growth in LNG exports, the natural gas spot price at the Henry Hub faces upward pressure from the mid-2020s through the early 2040s across all cases except the High Oil and Gas Supply case.

Steady growth in natural gas demand in the industrial sector and growing electric power sector demand for natural gas after 2035 also put upward pressure on the Henry Hub price during this time.¹

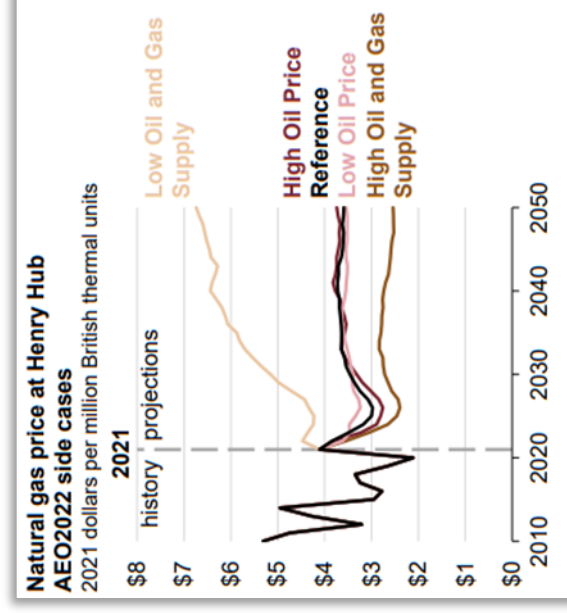

Coronavirus, the Economy, and Natural Gas

Declining Demand

- EIA's April *Short-Term Energy Outlook* (STEO) forecasts decreased total U.S. natural gas consumption in 2021 and 2022 following a decline in 2020. Consumption in 2020 was 1.9 billion cubic feet per day (Bcf/d) lower than the all-time high of 85.1 Bcf/d set in 2019. Total consumption declined as a result of the economic slowdown associated with the COVID-19 pandemic and lower heating demand amid milder temperatures.¹
- Both Cascade's FERC form 2 and MDUR's 2021 Annual Report imply there was no material impact to operations or revenues from Covid-19.

Price Volatility Impacting Demand

- The impact of high and volatile prices is leading to much bigger reductions for gas and LNG. Last week, Wood Mackenzie cut forecast gas demand in Europe by 4% for 2022 and 5% for 2023 compared with July 2021 (the outlook before the winter rise in gas prices)
- Asian LNG demand to come in at around 270 mmtpa, flat versus 2021, and down 4.5% on Wood Mackenzie's prior forecasts of 283 mmtpa. As global LNG prices moderate next year, Wood Mackenzie expects demand to rise to 280 mmtpa in 2023.)²

¹ EIA April 2021 STEO

² The Edge: How the war is choking energy demand

Price Forecast Calculation Process

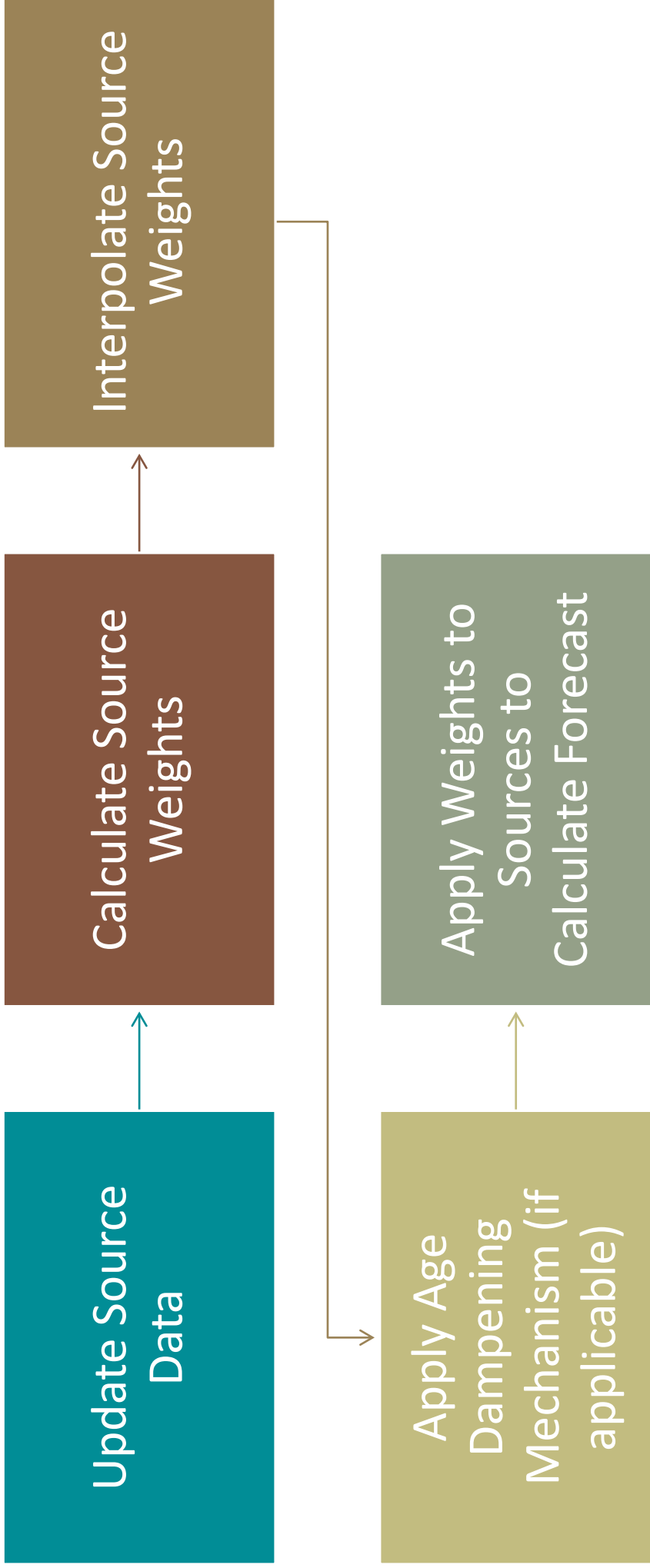

Long Range Price Forecast - Sources

Cascade's long-term planning price forecast is based on a blend of current market pricing along with long-term fundamental price forecasts.

The fundamental forecasts consider sources such as Wood Mackenzie, EIA, the Northwest Power and Conservation Council (NWPCC), S&P Global, the Intercontinental Exchange (ICE), and various third-party long-term price forecasts.

While not a guarantee of where the market will ultimately finish, Henry Hub NYMEX is the most current information that provides some direction as to future market prices.

Wood Mackenzie's long-term forecast is at a monthly level by basin. Cascade uses this to help shape the forecast's monthly basis pricing.

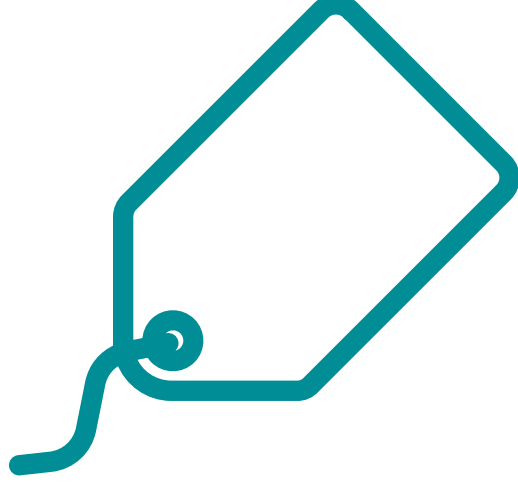

Sources Continued



THE COMPANY ALSO RELIES ON EIA'S FORECAST; HOWEVER, IT HAS ITS LIMITATIONS SINCE IT IS NOT ALWAYS AS CURRENT AS THE MOST RECENT MARKET ACTIVITY. FURTHER, THE EIA FORECAST PROVIDES MONTHLY BREAKDOWNS IN THE SHORT-TERM, BUT LONGER-TERM FORECASTS ARE ONLY BY YEAR.



CNGC ASSIGNS A WEIGHT TO EACH SOURCE TO DEVELOP THE MONTHLY HENRY HUB PRICE FORECAST FOR THE 20-YEAR PLANNING HORIZON.



ALTHOUGH IT IS IMPOSSIBLE TO ACCURATELY ESTIMATE THE FUTURE, FOR TRADING PURPOSES THE MOST RECENT PERIOD HAS BEEN THE BEST INDICATOR OF THE DIRECTION OF THE MARKET. HOWEVER, CASCADE ALSO CONSIDERS OTHER FACTORS (HISTORICAL CONSTRAINTS) WHICH CAN LEAD TO MINOR ADJUSTMENTS TO THE FINAL LONG-RANGE FORECAST.

Price Forecast Weights

Considerations in weight assignments:

- Cascade produces a weighting system based on an analysis of the symmetric mean absolute percentage error (SMAPE) of its sources since 2010;
- Some sources produce forecasts daily, while others are far less frequent.
 - Cascade uses an age dampening mechanism to account for this in its price forecast, reducing the impact of forecasts that do not account for more current market information.

SMAPE to Weights

$$SMAPE = |(\text{Actual} - \text{Forecast}) / ((\text{Actual} + \text{Forecast}) / 2)|$$

Cascade calculates the weight of the inverse of the SMAPEs of each source, which are then smoothed using Holt-Winters smoothing.

Rank (order of severity)	Weight		Interval
	Source 1	Source 2	
MSE	0.605111033	0.394888967	0.210222067
MAE	0.563119545	0.436880455	0.12623909
MAPE	0.562986465	0.437013535	0.12597293
RMSE	0.553149363	0.446850637	0.106298727
MAAPE	0.546818641	0.453181359	0.093637282
SMAPE	0.546045931	0.453954069	0.092091861

Example of Unsmoothed Weight Calculations by Source

	Source 1	Source 2	Source 3	Source 4
T+8	0.237316542	0.224109939	0.317405756	0.221167763
T+9	0.165516016	0.204743885	0.463881136	0.165858963
T+10	0.2092634	0.178375551	0.407479269	0.20488178
T+11	0.190493321	0.256691958	0.30400596	0.248808761
T+12	0.125623842	0.498275448	0.216825417	0.159275292
T+13	0.174170781	0.331083637	0.289279079	0.205466503
T+14	0.107674741	0.578677045	0.194447694	0.11920052
T+15	0.168128627	0.39434101	0.257778228	0.179752135
T+16	0.137570017	0.490453841	0.236754446	0.135221696
T+17	0.16124735	0.398220835	0.301492422	0.139039393
T+18	0.167346294	0.36071593	0.331817645	0.140120131

Unsmoothed Weights by Source

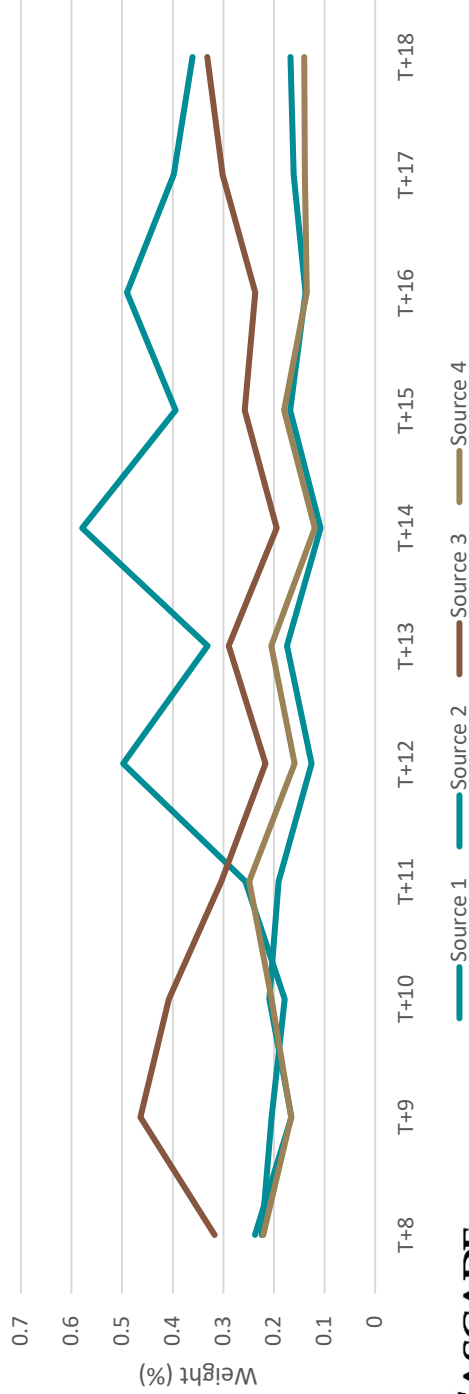

Example of Smoothed Weight Calculations by Source

	Source 1	Source 2	Source 3	Source 4
T+8	0.210945514	0.273340067	0.316566729	0.199147689
T+9	0.203808917	0.284713928	0.316745954	0.194731201
T+10	0.197699412	0.294028366	0.317166229	0.191105994
T+11	0.192517021	0.301522286	0.317766021	0.188194672
T+12	0.188161769	0.307434596	0.318483797	0.185919839
T+13	0.184533679	0.312004199	0.319258024	0.184204098
T+14	0.181532775	0.315470003	0.320027169	0.182970053
T+15	0.179059082	0.318070912	0.320729698	0.182140308
T+16	0.177871605	0.318363025	0.321577606	0.182187764
T+17	0.178493366	0.315293759	0.322759839	0.183453036
T+18	0.18047041	0.309688996	0.324180298	0.185660296

Smoothed Weights by Source

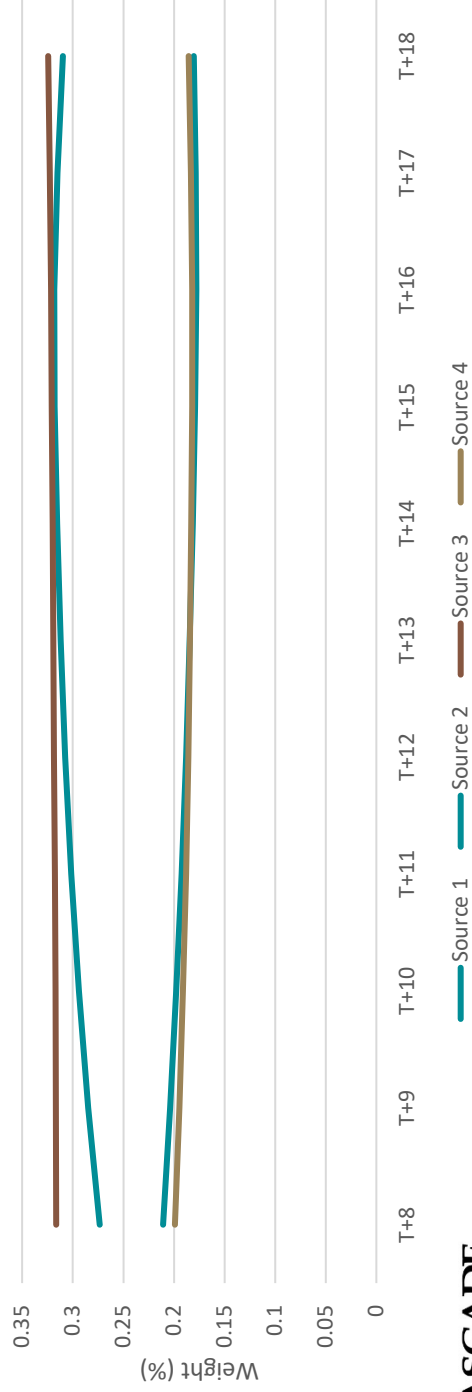

Price Forecast Weight Adjustments

In Months T+1 to T+12, Cascade uses NYMEX Forward pricing for all locations exclusively;

- For short term forecasting, the marketplace is ideal because forward prices should reflect all current events that impact the forecast (weather, storage, etc.)
- Long term forecasting is more concerned about the fundamental market intelligence, which is reflected in the analysis of Cascade's sources.

Months T+13 to T+48 are used to interpolate the weights from exclusively NYMEX to the weights calculated from each source's SMAPE.

Months T+49 onward use the age dampened (if applicable) weights of each source.

Example Weights Price Forecast For 2023 IRP (Not Interpolated)

	Source 1	Source 2	Source 3	Source 4
May-23	100.000%	0.000%	0.000%	0.000%
Jun-23	18.453%	31.200%	31.926%	18.420%
Jul-23	18.153%	31.547%	32.003%	18.297%
Aug-23	17.906%	31.807%	32.073%	18.214%
Sep-23	17.787%	31.836%	32.158%	18.219%
Oct-23	17.849%	31.529%	32.276%	18.345%
Nov-23	18.047%	30.969%	32.418%	18.566%
Dec-23	18.335%	30.237%	32.574%	18.853%
Jan-24	18.667%	29.418%	32.735%	19.180%
Feb-24	18.999%	28.592%	32.891%	19.518%
Mar-24	19.285%	27.843%	33.032%	19.839%
Apr-24	19.622%	26.890%	33.243%	20.245%

Example Weights Price Forecast For 2023 IRP (Interpolated)

	Source 1	Source 2	Source 3	Source 4
May-23	100.000%	0.000%	0.000%	0.000%
Jun-23	97.917%	0.797%	0.816%	0.471%
Jul-23	95.833%	1.606%	1.629%	0.931%
Aug-23	93.750%	2.422%	2.442%	1.387%
Sep-23	91.667%	3.227%	3.260%	1.847%
Oct-23	89.583%	3.998%	4.093%	2.326%
Nov-23	87.500%	4.724%	4.945%	2.832%
Dec-23	85.417%	5.400%	5.817%	3.367%
Jan-24	83.333%	6.028%	6.708%	3.930%
Feb-24	81.250%	6.618%	7.614%	4.518%
Mar-24	79.167%	7.187%	8.526%	5.121%
Apr-24	77.083%	7.667%	9.478%	5.772%

With gas markets as volatile as they are, it has never been more important to ensure that data is as current as possible for forecasting.

- Stale data may be missing key factors that impact the price forecast.
- Long term forecasting is somewhat more insulated against this, so we don't want to discount older sources too heavily or exclude them entirely.

If any source is more than eleven months old, all outdated sources are decremented by the ratio of how many months old they are to the aggregate number of stale months.

Decrementing weights are then added back to the sources proportionate to how current their data is.

Price Forecast Age Dampening Mechanism

Example Weights Price Forecast For 2023 IRP

No Age Dampening			
Age (Months)			
0	16	5	2
Source 1	Source 2	Source 3	Source 4
0.000%	37.212%	35.045%	27.743%

Age Dampened			
Age (Months)			
0	16	5	2
Source 1	Source 2	Source 3	Source 4
0.000%	17.673%	42.799%	39.528%

2023 IRP Remaining Schedule

Process Items	Process Elements	Date
TAG 3 (WA)	Distribution System Planning, Alternative Resources, Price Forecast, Avoided Costs, Current Supply Resources, Transport Issues.	6/29/2022
TAG 3 (OR)	Distribution System Planning, Alternative Resources, Price Forecast, Avoided Costs, Current Supply Resources, Transport Issues.	7/14/2022
TAG 4 (WA)	Carbon Impacts, Energy Efficiency, Bio-Natural Gas, Preliminary Resource Integration Results.	8/10/2022
TAG 4 (OR)	Carbon Impacts, Energy Efficiency (ETO), Bio-Natural Gas, Preliminary Resource Integration Results.	9/20/2022
TAG 5 (WA)	Final Integration Results, finalization of plan components, Proposed new 2- to 4-year Action Plan.	9/28/2022
TAG 5 (OR)	Final Integration Results, finalization of plan components, Proposed new 4-year Action Plan.	11/9/2022
Draft of 2022 IRP distributed (WA)	Filing of Draft IRP	11/24/2022
Draft of 2022 IRP distributed (OR)	Filing of Draft IRP	1/5/2023
Comments due on draft from all stakeholders (WA)	Comments due from Stakeholders	1/13/2023
Comments due on draft from all stakeholders (OR)	Comments due from Stakeholders	2/24/2023
TAG 6, if needed (WA)	An additional TAG if needed based on comments from Stakeholders	2/1/2023
TAG 6, if needed (OR)	An additional TAG if needed based on comments from Stakeholders	3/15/2023
IRP filing (WA)	IRP Final Filing	2/24/2023
IRP filing (OR)	IRP Final Filing	4/14/2023



Questions/Next Steps



Review Plans for TAG 3 Discussion

- Distribution System Planning
- Alternative Resources
- Price Forecast
- Avoided Cost
- Current Supply Resources
- Transport Issues
- Next WA TAG is Wednesday, June 29
- Next OR TAG is Thursday, July 14

Contact Information

Mark Sellers-Vaughn – Manager, Supply Resource Planning: (509) 734-4589
mark.sellers-vaughn@cngc.com

Brian Robertson – Supervisor, Resource Planning: (509) 221-9808
brian.robertson@cngc.com

Devin McGreal – Senior Resource Planning Economist: (509) 734-4681
devin.mcgreal@cngc.com

Ashton Davis – Resource Planning Economist II: (509) 734-4520
ashton.davis@cngc.com

Cascade IRP email – irp@cngc.com



In the Community to Serve®

Integrated Resource Plan Technical Advisory Group Meeting #2

MAY 18, 2022

MICROSOFT TEAMS/TELECONFERENCE



In the Community to Serve®



In the Community to Serve®

TAG #2 – TAG Meeting

Date & time: 05/11/2022, 9:00 AM to 12:40 PM

Location: Microsoft Teams Meeting

Presenters: Brian Robertson, Devin McGreal, & Ashton Davis

In attendance: Abe Abdallah, Andrew Rector, Becky Hodges, Brian Cunnington, Brian Hoyle, Bruce Folsom, Byron Harmon, Caleb Reimer, Carolyn Stone, Chris Robbins, Corey Dahl, Eric Wood, Haixiao Huang, Isaac Myhrum, Jocelyne Moore, Jon Storvick, Kary Burin, Kathleen Campbell, Kathy Moyd, Kim Herb, Mark Sellers-Vaughn, Marty Saldivar, Matt Steele, Michael Parvinen, Monica Cowlshaw, Pamela Archer, Patrick Darras, Sudeshna Pal, Taylor Mead, & Tom Pardee

Brian Robertson, Supervisor of Resource Planning, opened the meeting by welcoming and thanking stakeholders for participating in Cascade's IRP Process. Brian then proceeded with introductions.

Presentation #1 – Safety Moment (Brian Robertson)

- Brian Robertson gave a quick safety moment on outdoor safety.

Presentation #2 – Public Outreach Plan and Stakeholder Engagement (Brian Robertson)

- Brian presented Cascade's plan to reach out to external stakeholders for future IRP meetings. Cascade has suggested several ideas such as media releases, social media, meetings throughout service territory, web page, Commission web page, and perhaps bill inserts.

Presentation #3 – Demand Forecast (Ashton Davis)

- Throughout the presentation, Ashton presented the methodology and results behind the customers, annual demand, and peak day demand forecasts.
- Ashton began with details and key definitions for the models.
- R software was discussed in brief details along with sharing how Cascade's weather stations are broken out and how citygates are assigned to the weather stations.
- Ashton shared a breakdown of the Company's customers by rate class.
- Each input for these forecasts were discussed on slide 15, and then further discussed in detail throughout slides 16-26.

Question: Kathy Moyd asked about gas bans due to legislation and how that impacts the forecast?

Answer: Ashton mentioned the ban in Bellingham to new commercial buildings within city limits. Cascade's subject matter experts doesn't think there will be much of an impact because if a commercial Company wants to build in Bellingham, they'll do it outside of city limits. This ban, however, will give Cascade an opportunity to monitor any impacts future bans may have on a city.

- Ashton then covered methodology changes and non-weather dependent demand.

- Ashton then shared how the customer forecast and the use per customer (upc) forecast come together to create the final demand. Details of the final results for Washington, Oregon, and System was provided. The data provided included no climate change (CC), where climate change was described in presentation #4.

Presentation #4 – Weather Normals and Climate Change Impacts (Brian Robertson)

- Past weather normals and peak day was provided with a few other scenarios of grabbing weather data by different historical ranges.
- Brian went into detail about the different climate change data that was reviewed and ultimately chosen to include in Cascade's modeling. Cascade included no CC, a full RCP 4.5 CC, a conservative CC, and a historical .054°F CC. Each of these models would decrement the normal HDDs Cascade uses to forecast annual demand.
- The results in usage that each of these climate change impacts had were provided on slide 38.
- Brian mentioned Cascade's preference would be to use a more conservative approach than the full RCP 4.5. Brian asked external stakeholders for feedback. OPUC mentioned running the others as scenarios along with the more conservative approach. WUTC wanted to look into the analysis more before responding.

Presentation #5 – Non-Core Outlook (Brian Robertson)

- Brian provided an outlook on Cascade's transportation and electric generation customers usage out to 2050.

Presentation #6 – Market Outlook and Long-Range Price Forecast (Devin McGreal)

- Devin provided a quick look into the future of Natural Gas markets and then touched on COVID impacts and the economy. Cascade noted that in the Company's FERC form 2 and MDUR's 2021 Annual Report, Cascade implies there was no material impact to operations or revenues from COVID-19.
- Devin then discussed Cascade's price forecast calculation process and then went into detail on each topic;
 - Updated Source Data;
 - Calculated Source Weights;
 - Interpolated Source Weights;
 - Apply Age Dampening Mechanism (if applicable); and
 - Apply Weights to Sources to Calculate Forecast.

Presentation #9 – 2023 IRP Schedule (Brian Robertson)

- Brian went through the WA TAG schedule as well as the OR TAG schedule.
- Brian noted that the next TAG meeting will be Washington focused and take place on June 29th.

Post Presentations – Byron Harmon asked for a technical Q&A session. Cascade remained on the call to answer those questions. Below are a few of the Q&A's that Cascade would like to highlight:

Q: Is the α_0 variable an intercept or a garbage term.

A: Intercept. Cascade looked into the and determined the α_0 variable is needed.

Q: What is the purpose of Population/Employment in the customer forecast?

A: Cascade utilizes Population/Employment as an explanatory variable to help explain what Cascade's customers may do in the future.

Q: Can you discuss the approach to using several models for the customer forecast and were there any discussions or ramification around using different models?

A: Cascade has a very diverse service territory, which means there are different ways to forecast customers. In some areas, there may be a high correlation between customer counts and population, therefore a model using population as an explanatory variable is stronger than others. There are other areas where population may not be a significant explanatory variable, so using another model may be better.

Q: It appears Cascade's upc forecast is pretty flat. Can you expand on that?

A: There are a few that are declining, but this is likely due to the fact that DSM hasn't been applied yet. When DSM is applied, the upc for each location will show a decline.

Q: Is it possible the fourier terms are covering up a gap in the data that our models are missing? For example, are HDDs different in the Fall compared to Spring.

A: We have noticed a difference in UPC per HDD based on time of the year. Generally, the UPC per HDD is higher in the colder months and smaller in the warmer months.

The Meeting was Adjourned

Per Cascade Commitment #8 (Stakeholder Engagement Design Document, 2/22,2022: "Provide TAG minutes that include the action items from bullet #7 as well as any upcoming deadlines for feedback on the IRP"), here are additional action items to track, coming out of the TAG2 meeting:

1. Brian will look into any analytics regarding Cascade's IRP website and will meet with Byron Harmon on comments about the Stakeholder Engagement Document.
2. Cascade will look at other demographics such as income levels as well as end use forecasting to account for building code changes for future IRPs.
3. Cascade will include high/low bands in the forecast charts in Appendix B of the IRP.



In the Community to Serve®

Integrated Resource Plan Technical Advisory Group Meeting #3

JUNE 29, 2022

MICROSOFT TEAMS/TELECONFERENCE

Agenda

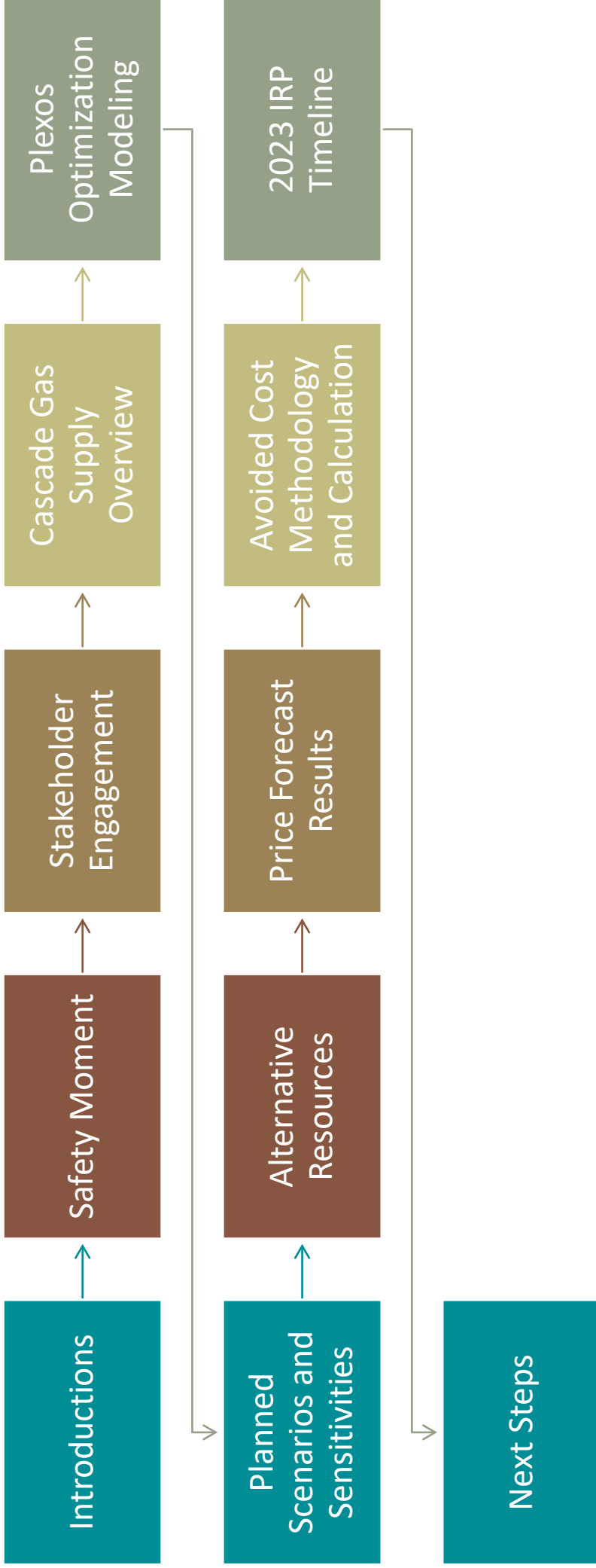

Hot Weather Safety Tips:

- ❖ **Stay hydrated** – Drink plenty of fluids. Drink at least 15 ounces before starting work outside, and then 5-7 ounces more every 15-20 minutes.
- ❖ **Avoid dehydrating liquids** – Drinks such as alcohol, coffee, tea, and caffeinated beverages can cause dehydration.
- ❖ **Wear protective clothing** – Clothing that is lightweight, light-colored, and loose-fitting help protect against the heat.
- ❖ **Pace yourself** – Work at a slower even pace and know your limits and abilities, especially when working outdoors.
- ❖ **Schedule frequent breaks** – Take time to drink water and rest in a cool, shaded location, preferably with air conditioning.
- ❖ **Avoid getting sunburn** – Wear sunscreen and a hat.
- ❖ **Be alert to signs of heat-related illness** – Know what to look for and check on other workers for signs of heat stress.
- ❖ **Avoid direct sun** – Find shade or block out the sun if possible.
- ❖ **Eat smaller meals** – Eat fruits high in fiber and natural juices. Avoid eating meals that are high in protein.

The More You Know		
Heat Stroke	Heat Exhaustion	Heat Cramps
Lack of Sweating, Dry, reddish, hot skin High Body Temperature Rapid pulse Chills Slurred speech	Excessive Sweating Weakness or tiredness Clammy skin Muscle Cramps Dizziness and/or confusion	Pain in legs, arms, or abdomen Muscle spasms in legs, arms, or abdomen

Article Reference: <https://blog.societyinsurance.com/10-safety-tips-for-working-in-hot-weather/>

Safety Moment

Stakeholder Engagement¹

CASCADE COMMITMENTS

Allowing for open, inclusive, and balanced participation and information sharing.

Recognizing that some parties may not have the industry knowledge or the resources to devote to analyzing all aspects of the IRP and that their interest may be one of breadth.

Understanding TAG members can and should speak up if they need more information or if the time for discussion is too short and merits further discussion.

REQUESTS OF STAKEHOLDERS

Ask questions of the Company on technical and methodological aspects.

Recognize relative informality of the meetings and ability to interject for clarification and understanding.

When possible, provide feedback to meeting materials in advance of the meeting, to give Company representatives time to prepare information for an informed discussion

Cascade Gas Supply Overview

PORTFOLIO PROCUREMENT DESIGN BASED ON A DECLINING PERCENTAGE EACH YEAR, ACCORDINGLY: Year 1:

Approximately 80% of annual requirements; Year 2: 60%, Year 3: 25%.

- 80% allows more flexibility operationally.
- Allows us to be in the market monthly through First of Month (FOM) purchase or Day Gas purchases.

Hedged Percentages (fixed-price physical) Currently 50% of annual requirements. Second year max is set at 40%, and 25% hedged volumes for year three.

- Cascade’s hedging program is flexible and can be adjusted in response to changes in market conditions.

CNGC’s Gas Supply Oversight Committee (GSOC) would consider a modification of this plan if the outer year 3 year forward price is 20% higher/lower than the front month over a reasonably sustained period.

Annual load expectation (Nov-Oct) is approximately 35,000,000 dths, consistent with recent load history.

HIGHLIGHTS FOR THE 2022 PORTFOLIO DESIGN



In the Community to Serve

TRANSPORTATION

Cascade holds transport on 6 Pipelines

- Enbridge
- Williams Northwest Pipeline
- GTN Pipeline
- Nova
- Foothills
- Ruby

End delivery is on 3 pipelines

- Enbridge
- Williams Northwest Pipeline
- GTN Pipeline

Portfolio is arranged around available transport and system demands.

Pipeline transport flow

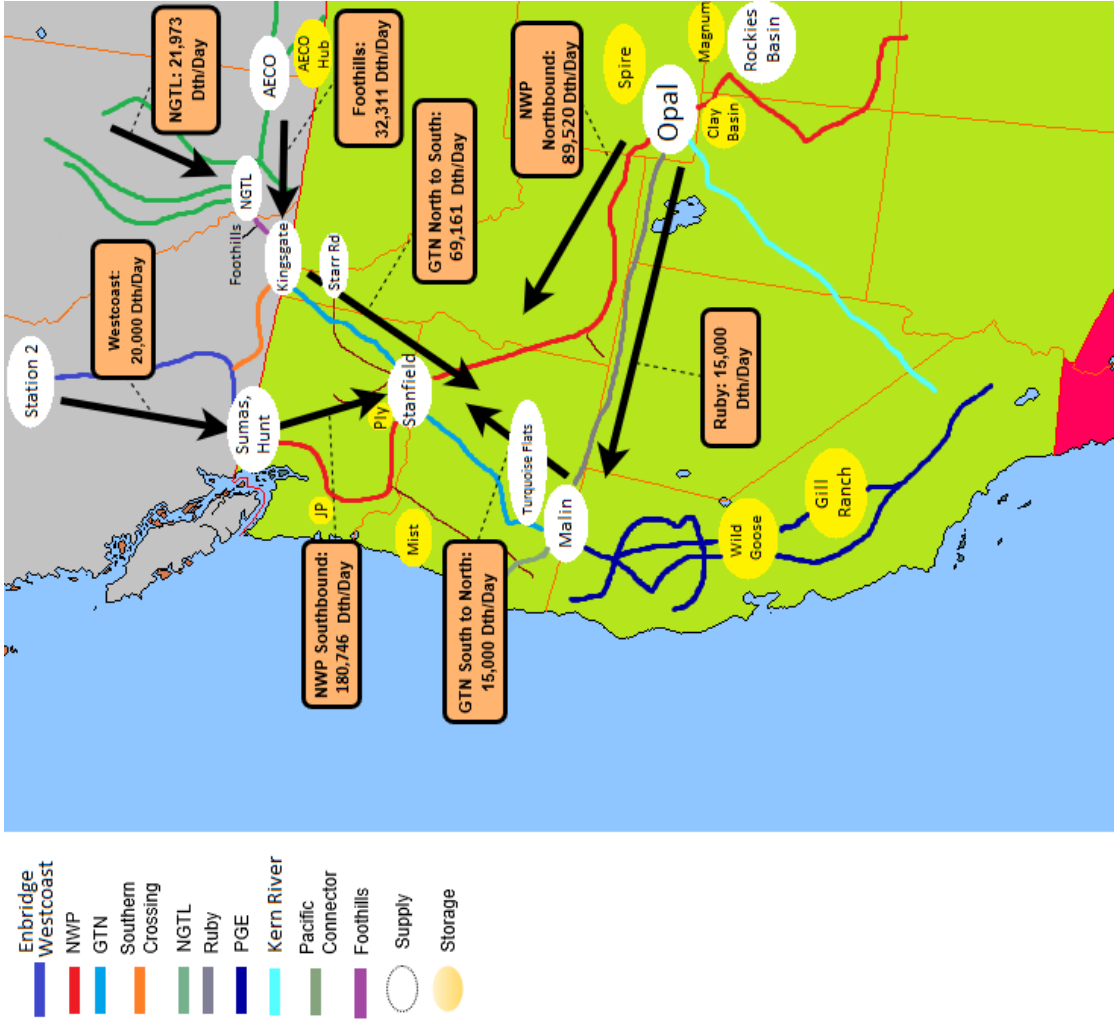

Winter Usage 21/22

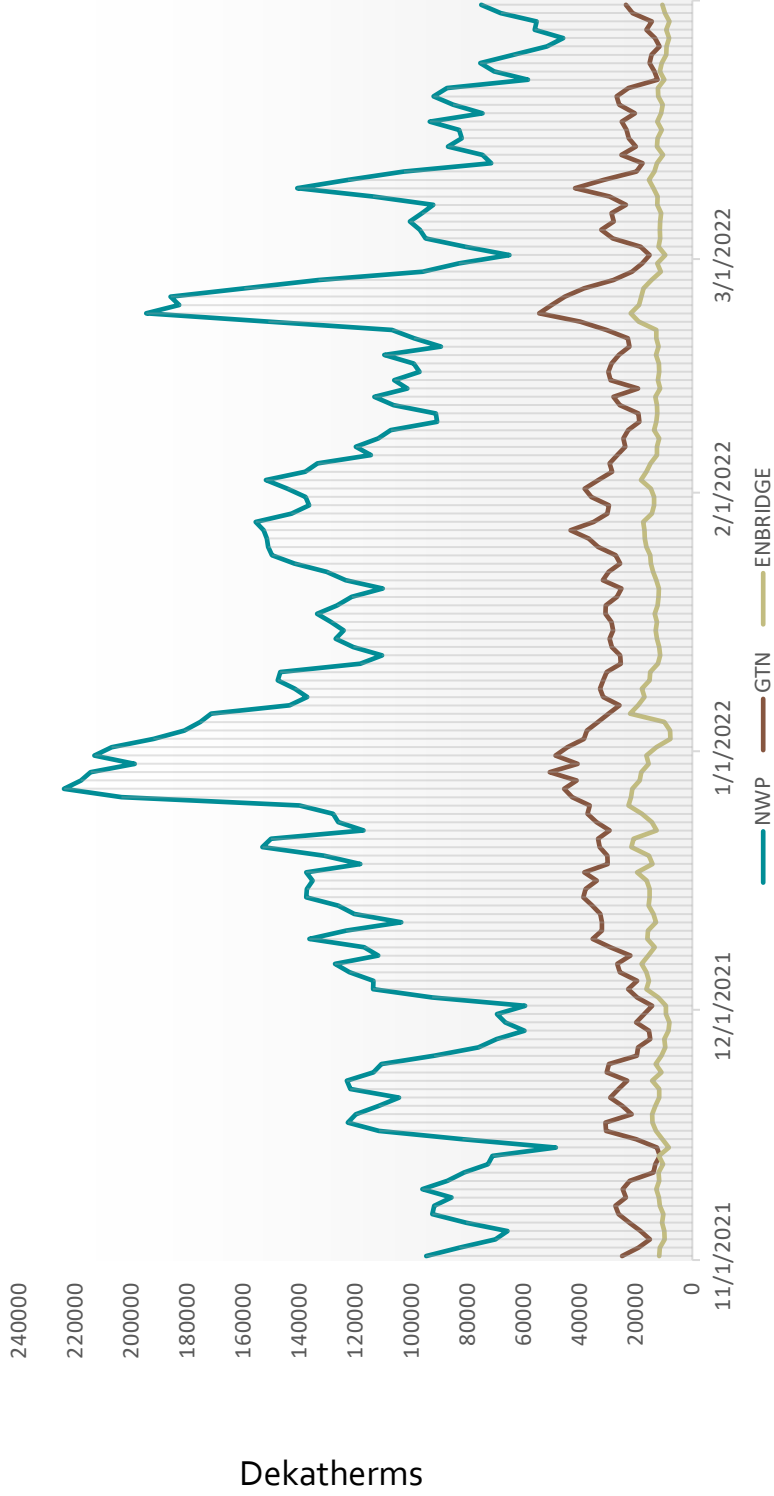

Dekatherms

Transport Summary

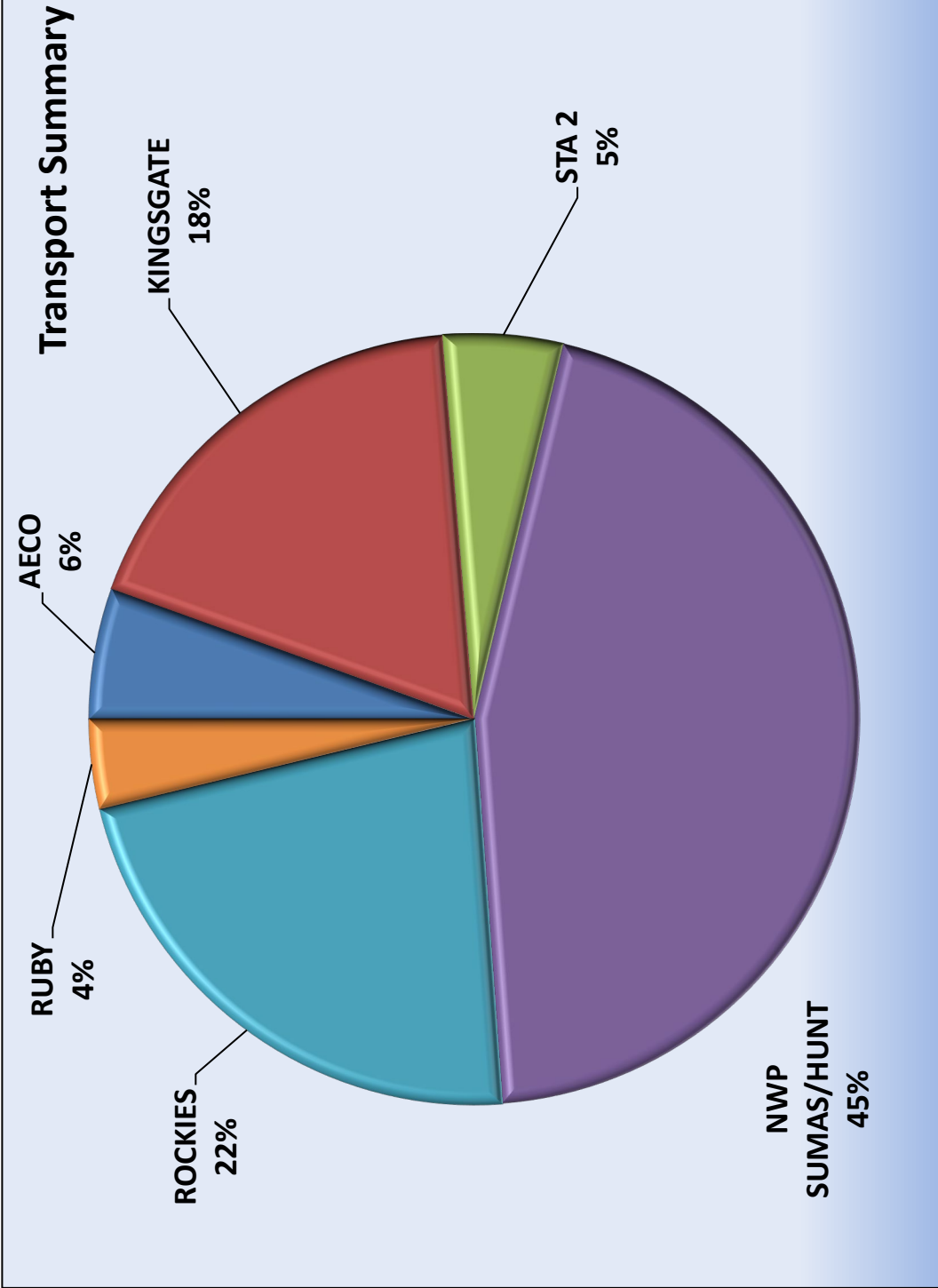

Supply Summary By Location 21/22 Season

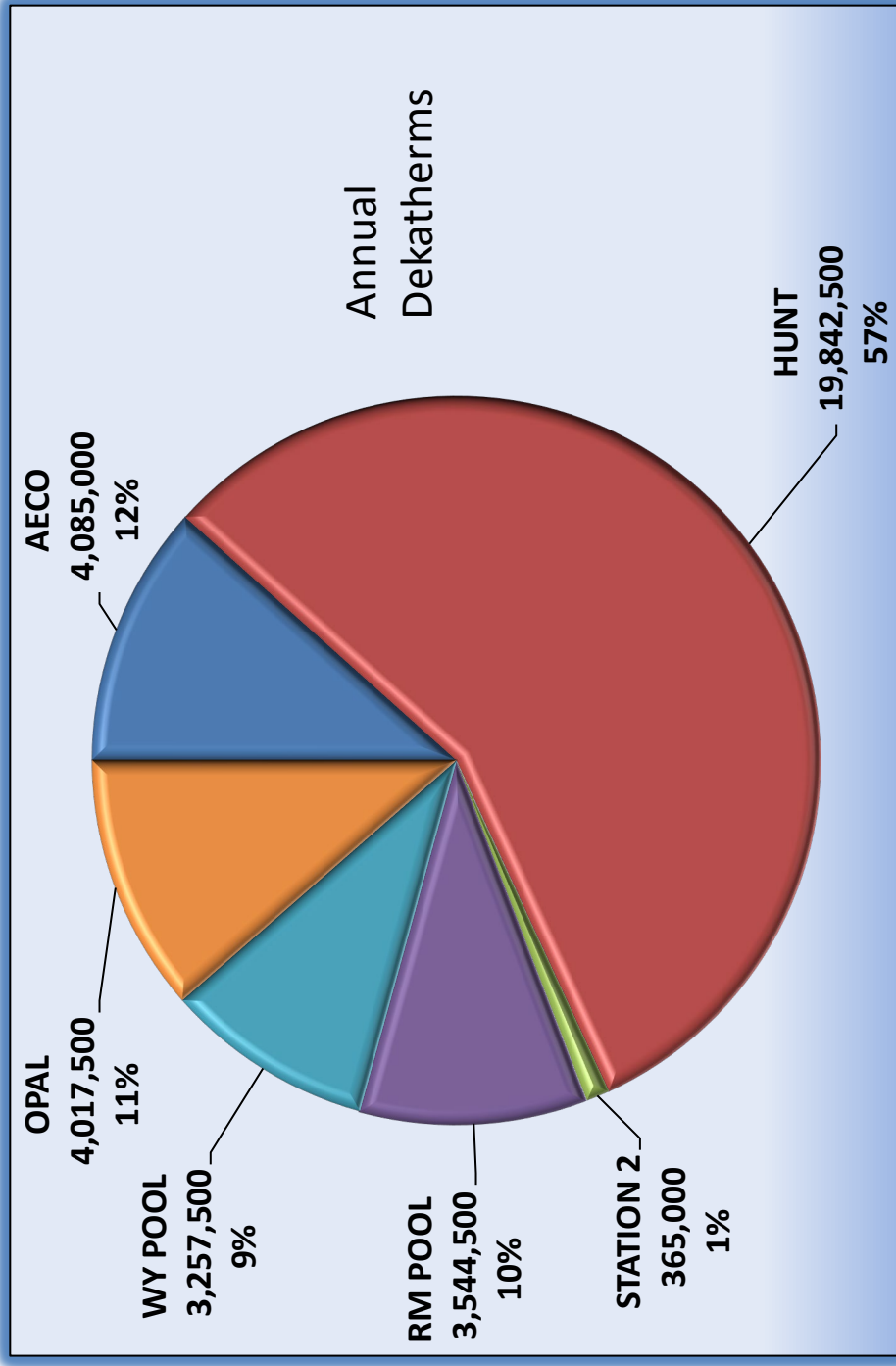

Jackson Prairie

- 4 accounts with 1,235,593 dth capacity, 56,366 dth of withdrawal rights
- CNGC cycled approximately 99.48% of Jackson Prairie storage over the past winter season
- CNGC targets cycling Jackson Prairie, with pricing and other market and operating conditions considered

Plymouth

- 2 accounts with 662,200 dths capacity, 78,125 dth of demand
- In addition to above we have TF-2 (Firm Redelivery Transportation) of 10,675 dths
- CNGC remains committed to using Plymouth as a peaking resource

MIST

- Added in the spring of 2019, addition capacity and demand added in fall of 2021.
- The added Demand and capacity is a valuable operating resource in winter
- 1,640,000 dth of capacity, 50,000 dth of demand
- CNGC targets cycling Mist, with pricing and other market and operating conditions considered
- At 100% of demand, Cascade can meet approximately 67% of Peak Day needs.
- Total Storage Capacity accounts for approximately 14.75% of Winter demand
- Winter Demand is approximately 68% of Annual Demand

Storage Resources



In the Community to Serve®

JACKSON PRAIRIE STORAGE USAGE FOR 21/22

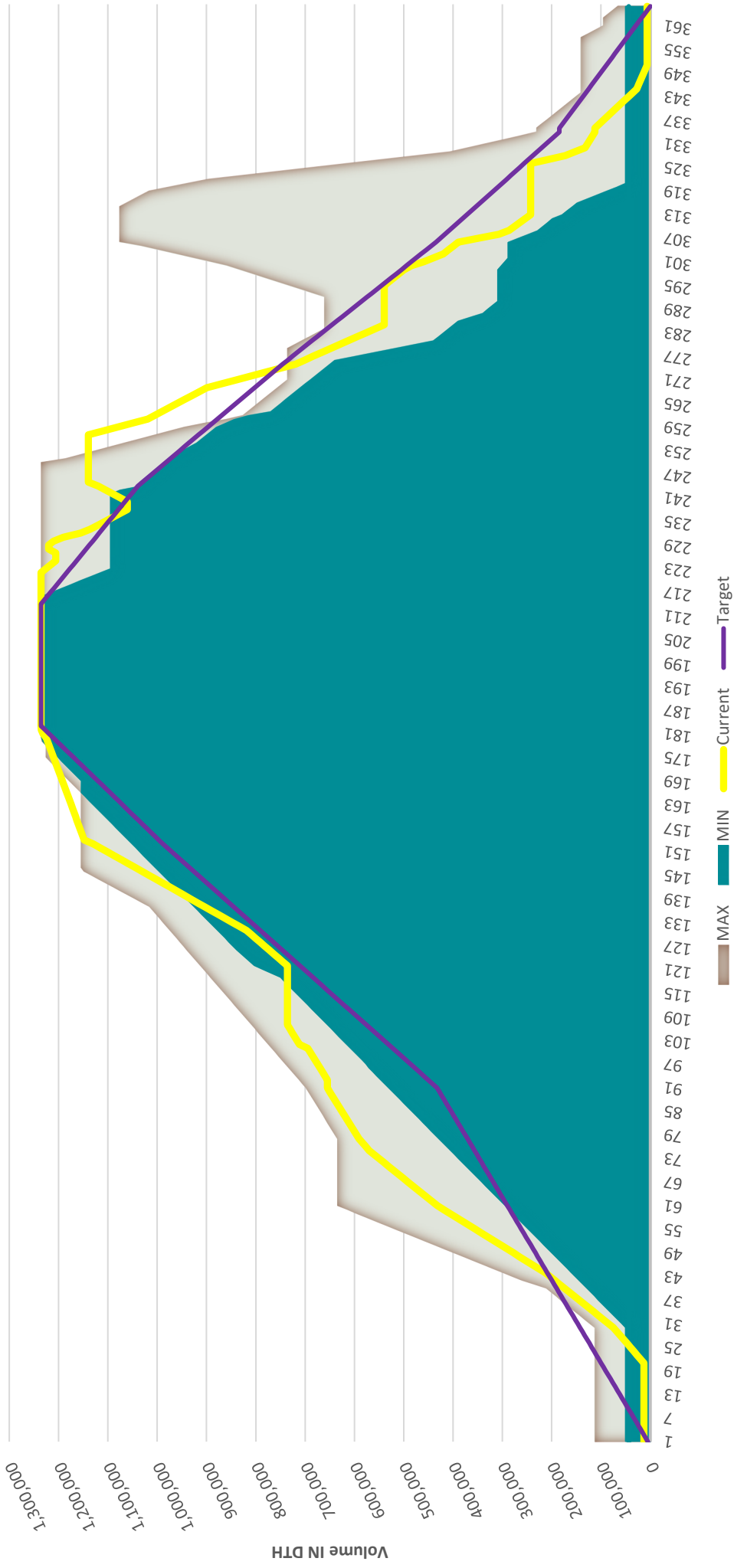

MIST STORAGE USAGE FOR 21/22

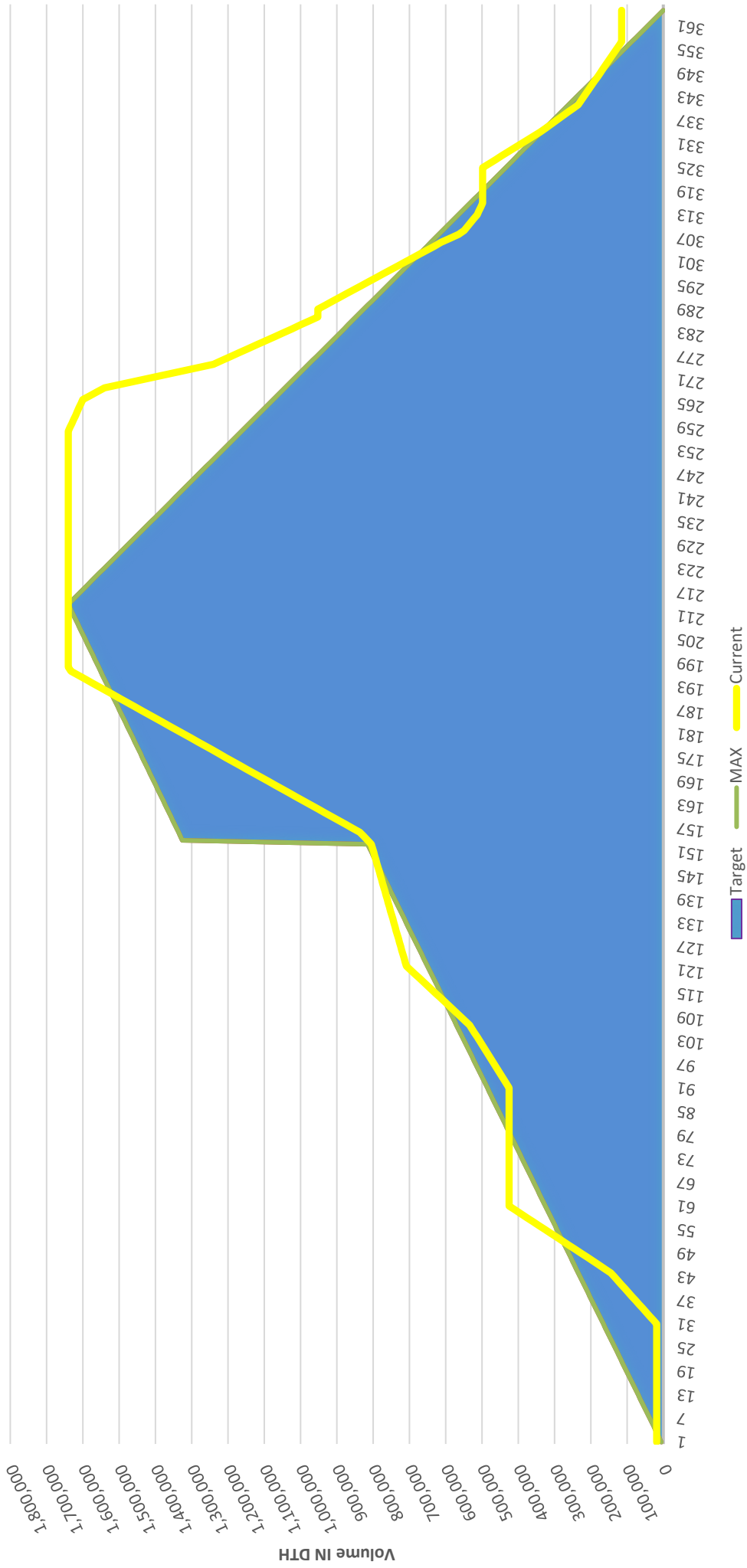

Storage map runs from April 1 to March 31

PLYMOUTH STORAGE USAGE FOR 21/22

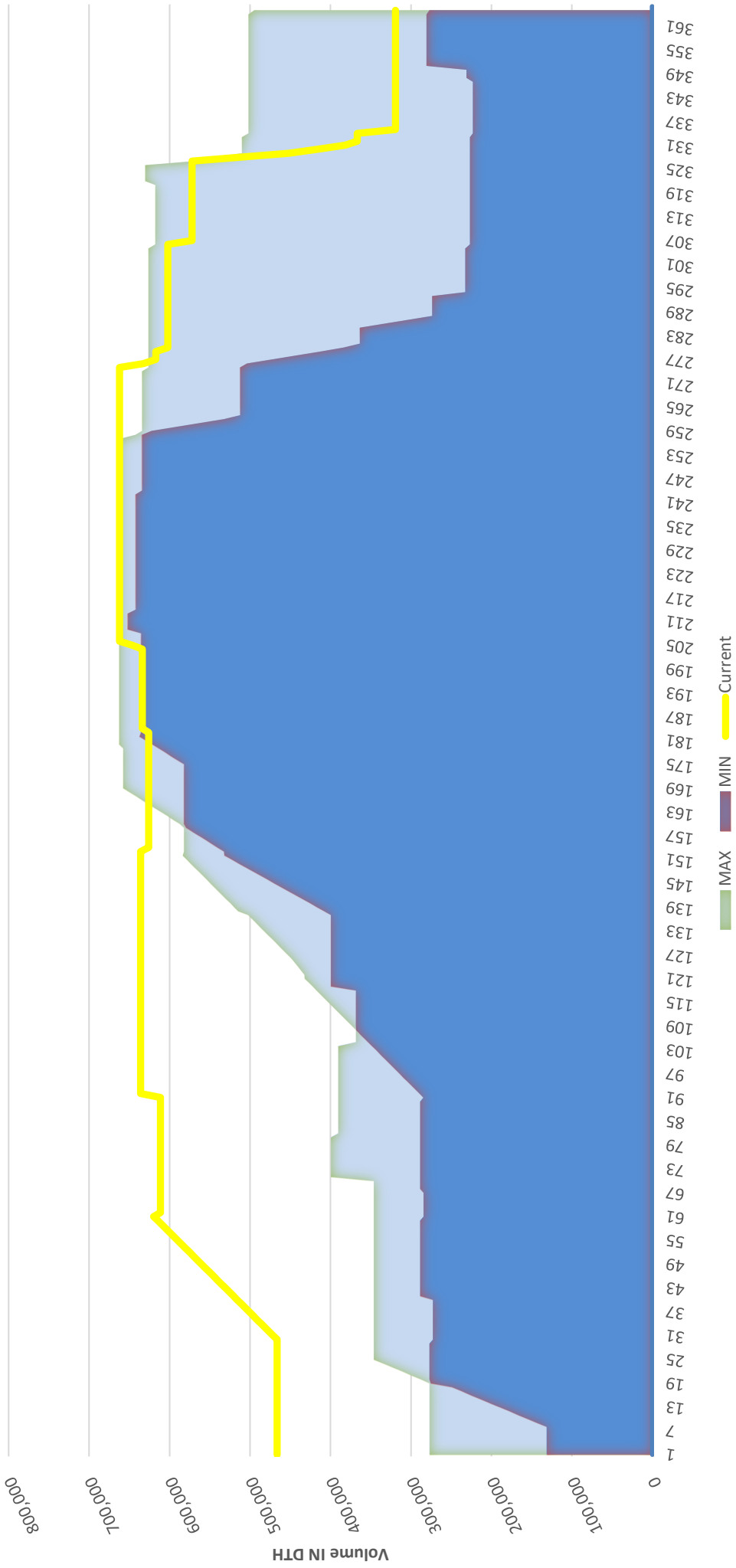

Storage map runs from April 1 to March 31

Hedge Calculation Table			
	Year 1	Year 2	Year 3
Contracted Base Supply Target	80%	60%	25%
Hedge Target	50%	40%	25%
Forecast Annual Usage	36,142,302	36,759,083	37,114,597
Needed Base Supply to Contract	28,913,842	22,055,450	9,278,649
Hedge Target	18,071,151	14,703,633	9,278,649
Current Hedged	14,292,000	7,094,000	-
Current Indexed	4,771,500	-	-
Remaining to Hedge	3,599,821	7,609,633	9,278,649
Remaining Indexed Supply Needed	5,963,593	7,351,817	-

***Forecast**

The Forecast is based on the IRP 20 year forecast

***Contracted Base Supply**

Base Supply is the overall amount of the contracted supply whether indexed or hedged. CNG uses 80% of the forecast to allow for storage usage and operational flexibility. The outward years use a ladder scale down to obtain a portion of the portfolio annually.

***hedge Target**

A percentage of the forecasted amount

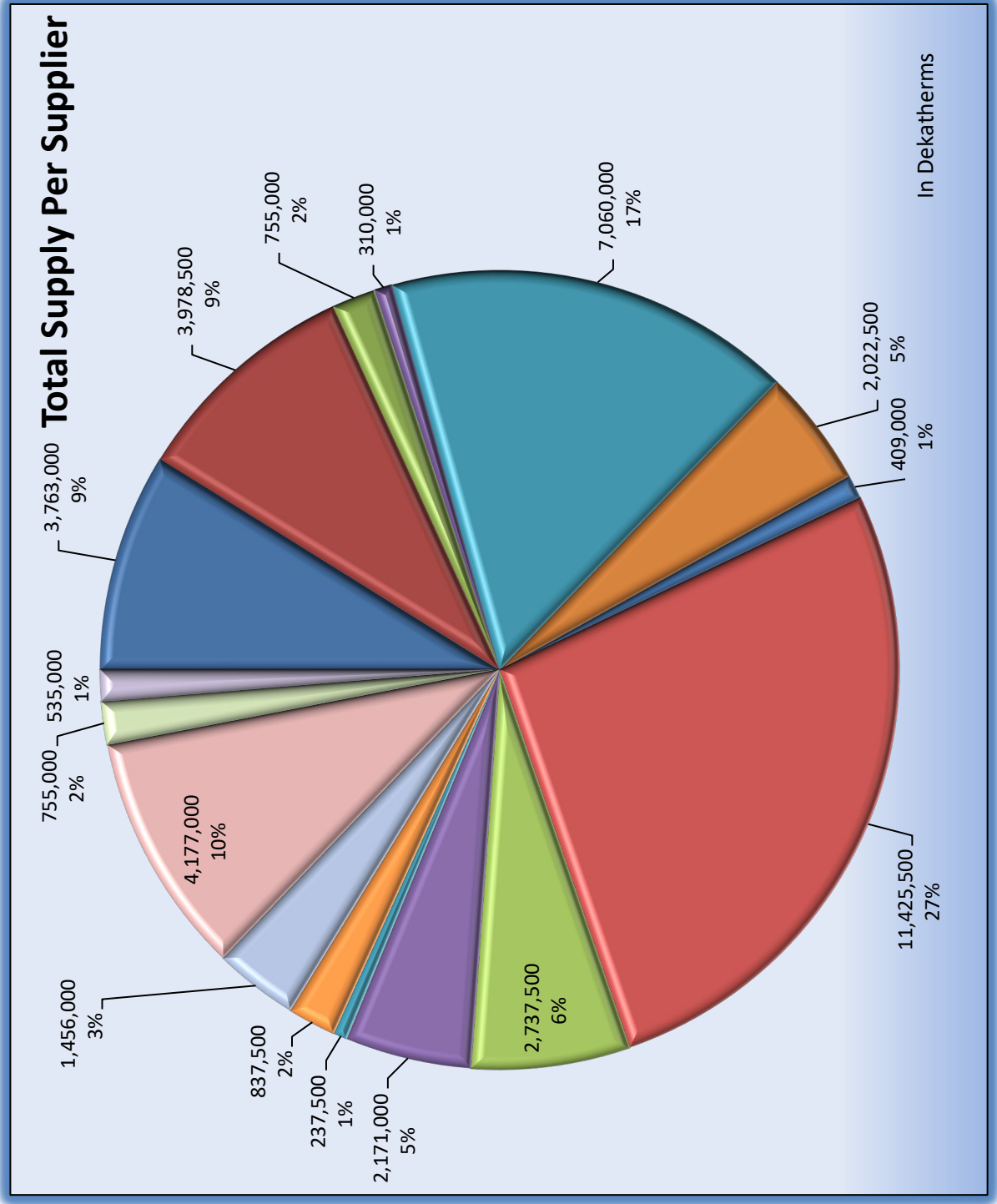

Cascade strives for supplier diversity

Cascade has over 25 active NAESB's
16 currently have active agreements for gas purchases



Renewable Natural Gas

Cascade is the successful bidder in response to a Deschutes County RFP issued to make beneficial use of the landfill gas produced at the Knott Landfill located in Bend, OR. Cascade does not yet have a contract in place with Deschutes County, but our intent is to develop a landfill gas conversion facility, improve the gas to pipeline quality RNG specifications, and inject the RNG into Cascade's distribution system pending successful contract negotiations.

Cascade's business development department is continuously looking at new RNG opportunities.

More information on RNG opportunities will be provided in TAG 4.

Winter Supply Stack

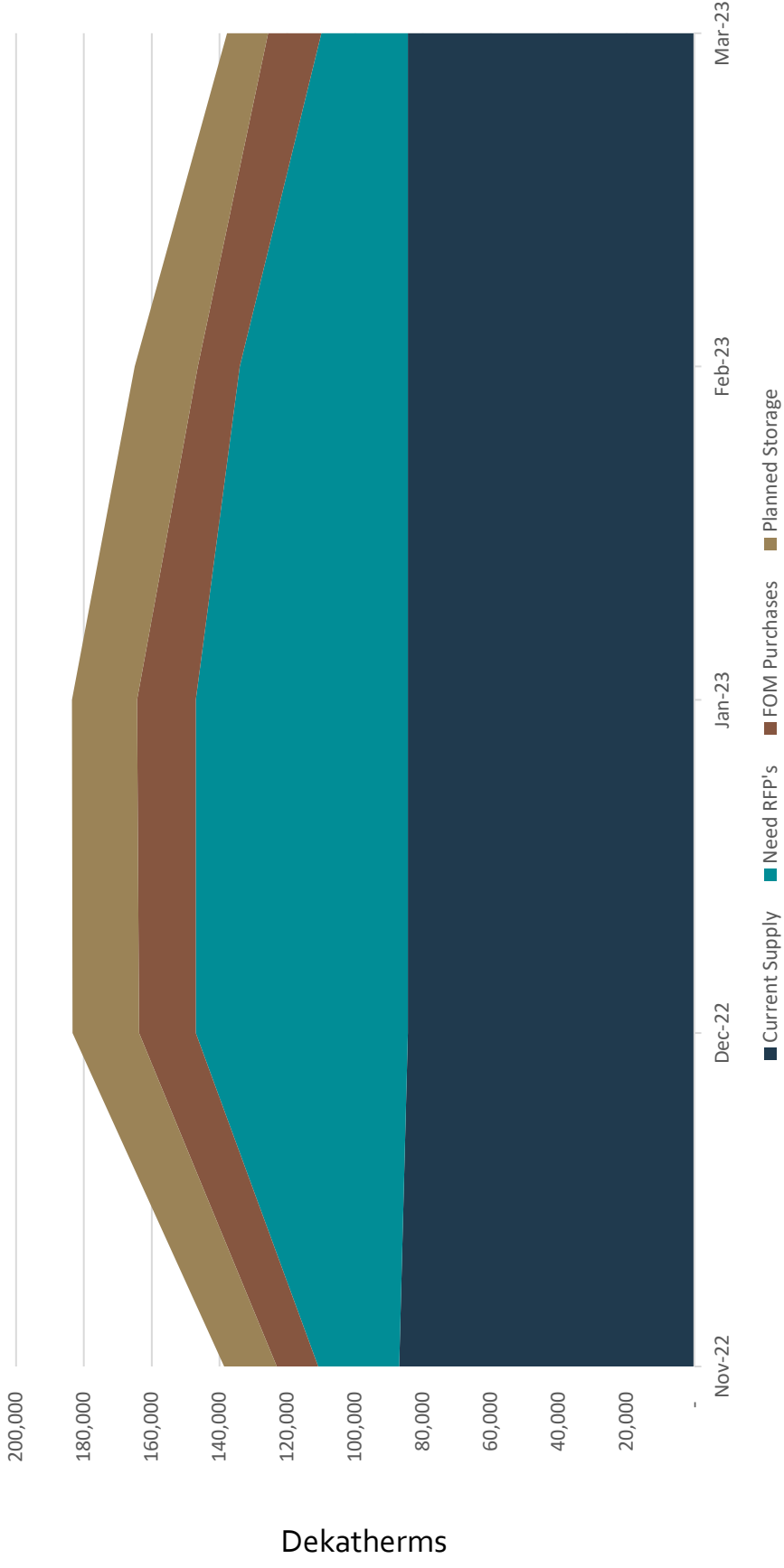

Peak Day Stack Example

Peak Day- 275,000 Dth
Total Resources- 353,491 Dth

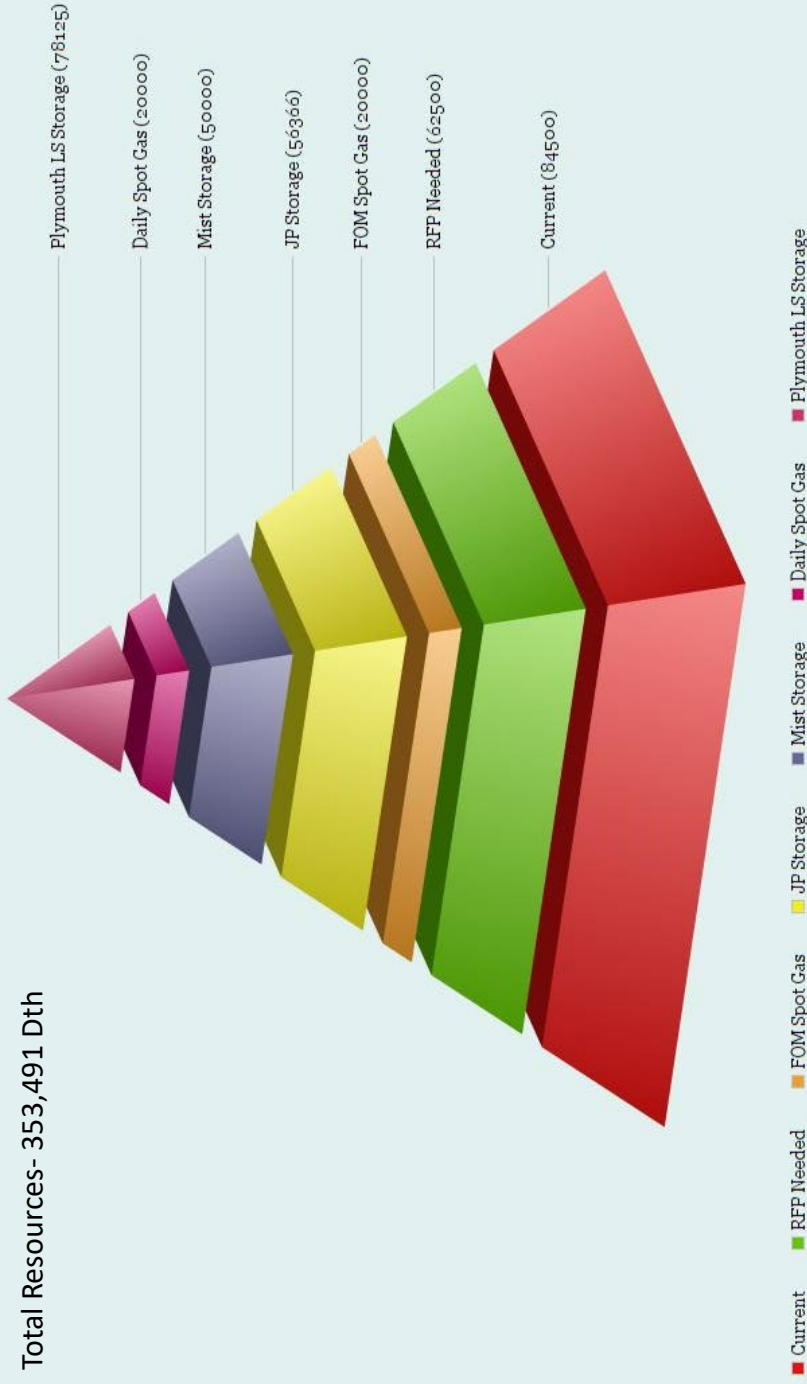

Plexos Optimization Modeling

Plexos Model

Cascade utilizes Plexos for resource optimization.

This model permits the Company to develop and analyze a variety of resource portfolios to help determine the type, size, and timing of resources best matched to forecast requirements.

Plexos is very powerful and complex. It operates by combining a series of existing and potential demand side and supply side resources and optimizes their utilization at the lowest net present cost over the entire planning period for a given demand forecast and emissions constraints.

Plexos is a unified energy modeling and forecasting software platform. Its powerful simulation engine analyzes zonal and nodal energy models ranging from long-term investment planning to medium-term operational planning and down to short-term, hourly, and intra-hourly market simulations.¹

It is important to recognize that Plexos provides helpful but not perfect information to guide decisions.

Supply needs to get gas to the citygate.

Many of Cascade's transport agreements were entered into decades ago, based on demand projections at that point in time.

Sum of receipt quantity and aggregated delivery quantity can help identify resource deficiency depending on how rights are allocated.

The aggregated look can mask individual citygate issues for looped sections, and the disaggregated look can create deficiencies where they don't exist.

In many cases operational capacity is greater than contracted.

Supply, storage, and upstream transportation focuses on the core, but non-core must be included for emissions modeling.

Plexos has perfect knowledge.

Modeling Challenges



In the Community to Serve®

Base Case Plexos Inputs

- Demand
- Supply
- Price Forecast
- Storage
- Transportation
- Constraints
- Emissions

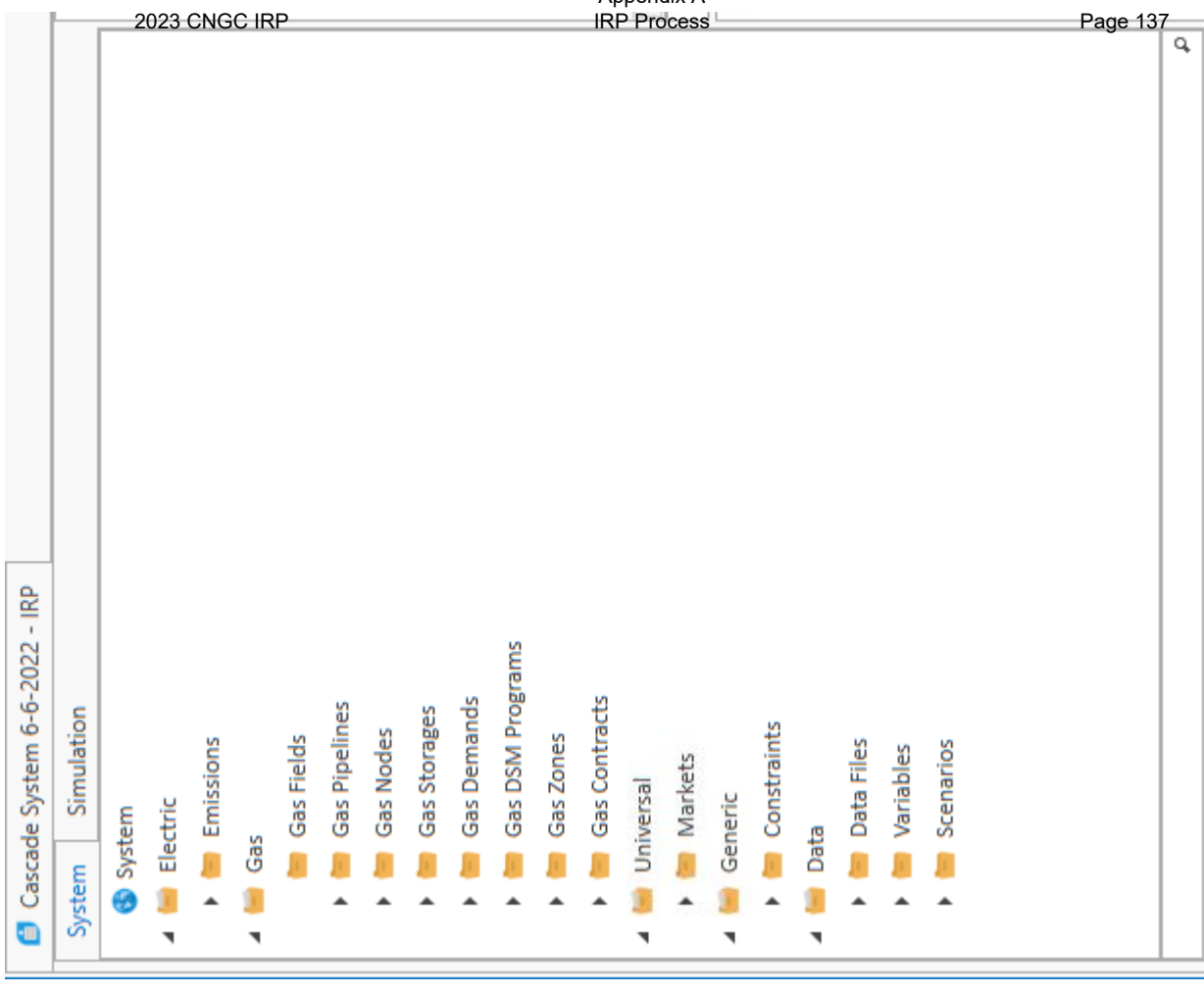

Demand Behind the Gate

Cascade has strived over the last several years to enhance the IRP forecast and resource analysis to get to as granular a level as possible using the available data.

Attempts to forecast demand behind the gate using existing forecasting methodology has been challenging.

Customer billing data does not have daily meter reads for core customers making regression analysis on use per HDD per customer difficult.

Some towns can be served by multiple pipelines and the mix can change over time.

For more information on the customer and demand forecast, please visit Cascade's webpage¹ for TAG 2 information or reach out to Cascade's Resource Planning team.

Demand

Demand is forecasted at the citygate level by rate schedule.

For NWP, each citygate demand is associated with the zone.

For GTN, each citygate demand is associated with its respective citygate interconnect.

Demand Inputs

- Forecast type is the daily amount as an input.
- Daily projected usage from 2023-2050.
- DSM is not an input in the base case. DSM is added once the projected therm savings when modeled against competing resources is finalized. DSM is modeled as a decrement to demand in Plexos.

Demand Example

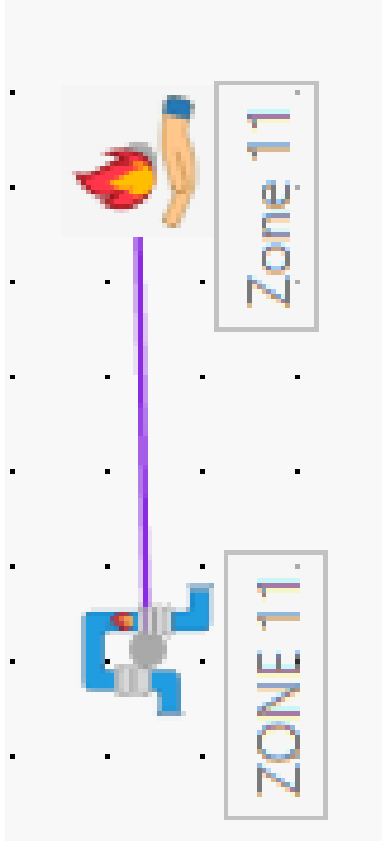
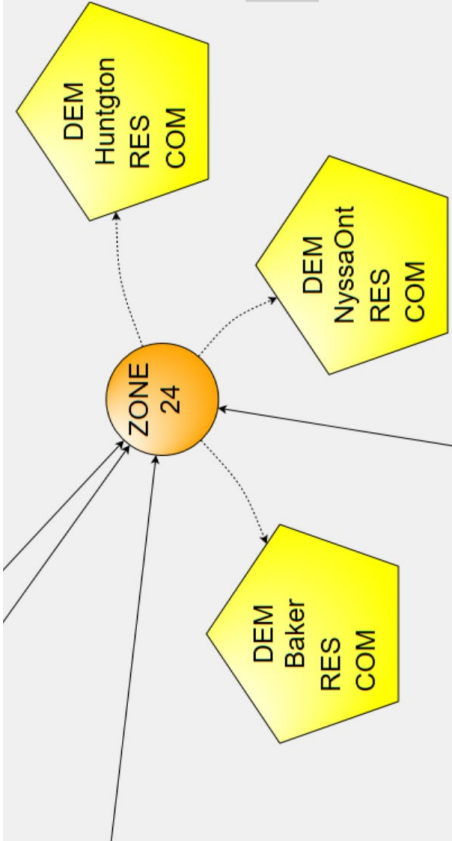

- Gas DSM Programs
- Zone 11.DSM

- Zone 11
 - Gas Demands
 - Settings
 - Demand Type
 - Production
 - Demand

Parent Object	Gas Dema...	Property	Value	Data File	Units	Band	Date From
System	Zone 11	Demand Type	Input		-	1	
System	Zone 11	Demand		ConsRCP	MMBtu	1	
System	Zone 11	Shortage Price	10000		\$/MMBtu	1	
System	Zone 11	Excess Price	-100		\$/MMBtu	1	

Demand Example 2

Supply

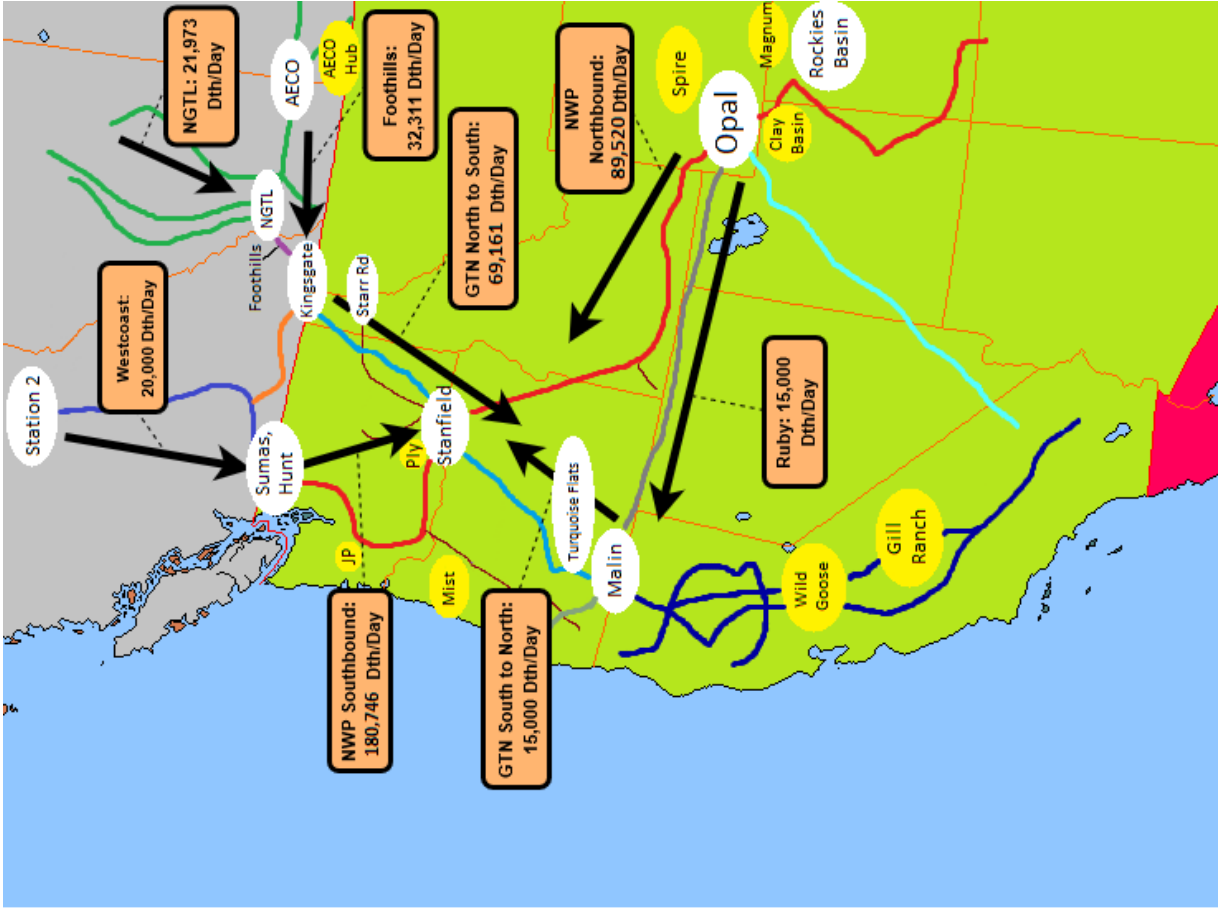

- Enbridge
- Westcoast
- NWP
- GTN
- Southern Crossing
- NGTL
- Ruby
- PGE
- Kern River
- Pacific Connector
- Foothills
- Supply
- Storage

Supply

Cascade can purchase gas at four markets; AECCO, SUMAS, KINGSGATE and OPAL. At each market Cascade can purchase gas at different locations along the pipeline. For the first year, Cascade uses all current contracts for Supply inputs. For years 2 -28 (2023-2050), Cascade uses Base, Fixed, Winter base, Summer and Winter day gas, and Peak day incremental supplies as inputs. Over the planning horizon, the contracts are renewed in November and April.

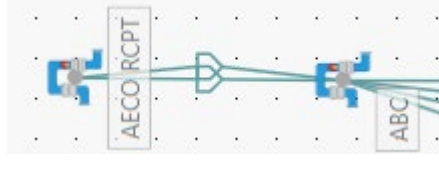

Supply Base and Fixed

Supply Base and Fixed are the baseline supply contracts that are entered into every 12 months.

A base contract has a basis rate. This is defined as the price of gas at a given market (i.e., AECO base is the expected cost of gas at NYMEX plus the basis for AECO, for a given month).

A fixed contract has a fixed rate.

A penalty is applied to each contract when the gas is not taken for a day. This type of penalty forces these types of contracts to only take the optimal amount of gas to serve the base demand.

Supply Example

Objects Memberships Properties

Category	Template	Gas Fields	Gas Pipelines
-			

Collection	Parent Object	Child Object	Property	Value	Data File	Units	Band	Date From	Date To	Timeslice	Action	Expression
Gas Contracts	System	AECO INDEX	Contract Type	Base		-	1				=	
Gas Contracts	System	AECO INDEX	Quantity Day		Supply MDQ	MMBtu	1				=	
Gas Contracts	System	AECO INDEX	Price	0		\$/MMBtu	1				+	AECO
Gas Contracts	System	AECO INDEX	Renomination Start Period	Is a Start Period		-	1			M11,D1	=	

- ▲ AECO INDEX
- ▶ Template
- ▶ Gas Fields
- ▶ Gas Pipelines
- ▶ Gas Nodes
- ▶ AECO RCPT
- ▶ Constraints
- ▶ Emissions
- ▶ Linked Gas Demands
- ▶ Inheritors
- ▶ Lists

- ▲ AECO INDEX
- ▶ Gas Contracts
- ▶ Settings
 - ▶ Contract Type
 - ▶ Expansion Optimality
- ▶ Constraints
 - ▶ Quantity Day
 - ▶ Quantity Year
 - ▶ Min Quantity Day
- ▶ Production
 - ▶ Is Available
 - ▶ Price
 - ▶ Price Collar Min

Base Supply (Cont'd)

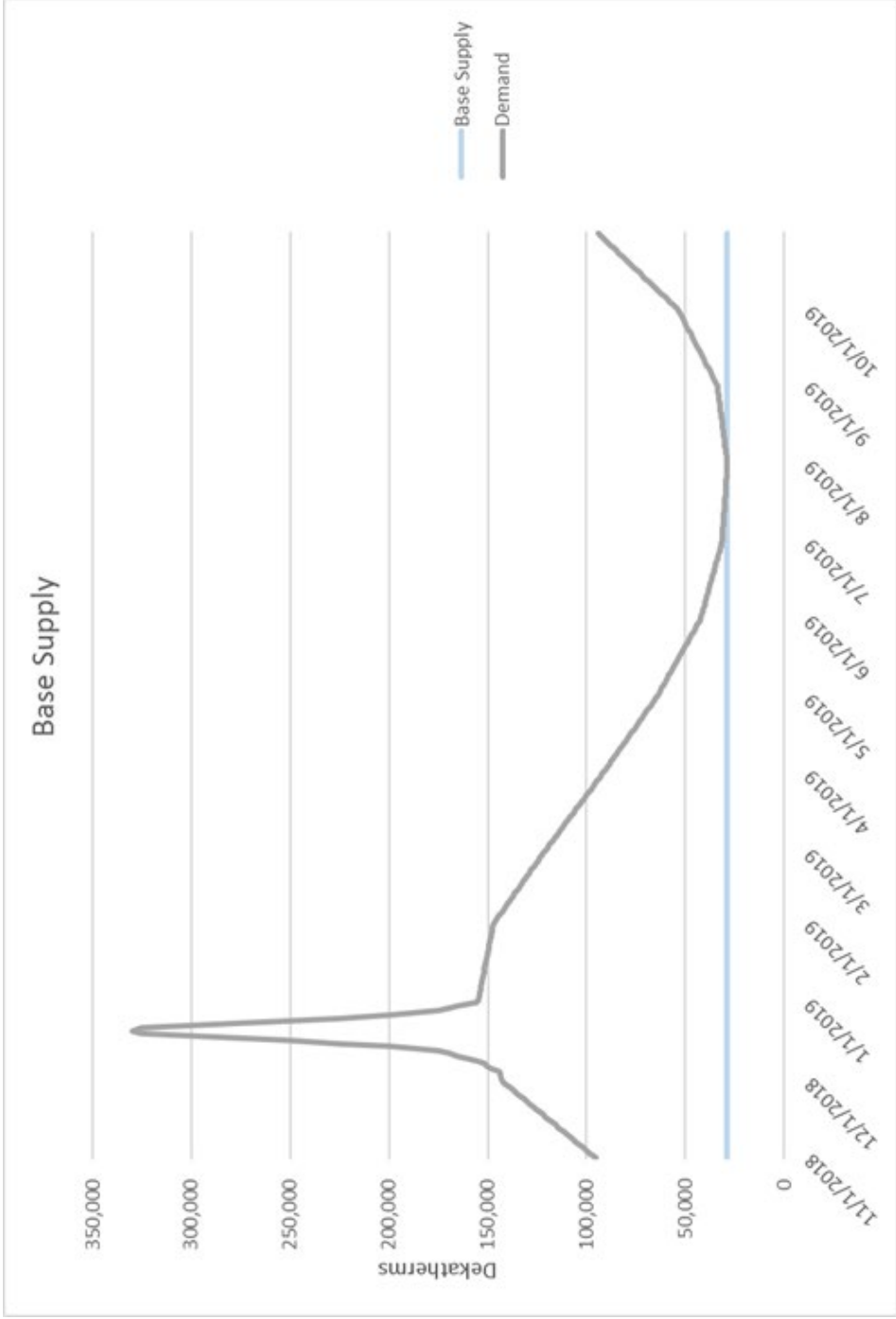

Winter Base Supply

Winter base supply is contracted supply with a premium charge that is slightly higher than base gas.

The Maximum Daily Quantity (MDQ) is optimally set by Plexos.

Winter supply is renewed every November and completes at the end of March.

Winter Supply is additional baseline supply on top of the base or fixed supplies for the winter months.

There is a penalty associated to this contract to force Plexos to take the optimal amount of additional winter base gas.

Winter Base Supply (Cont'd)

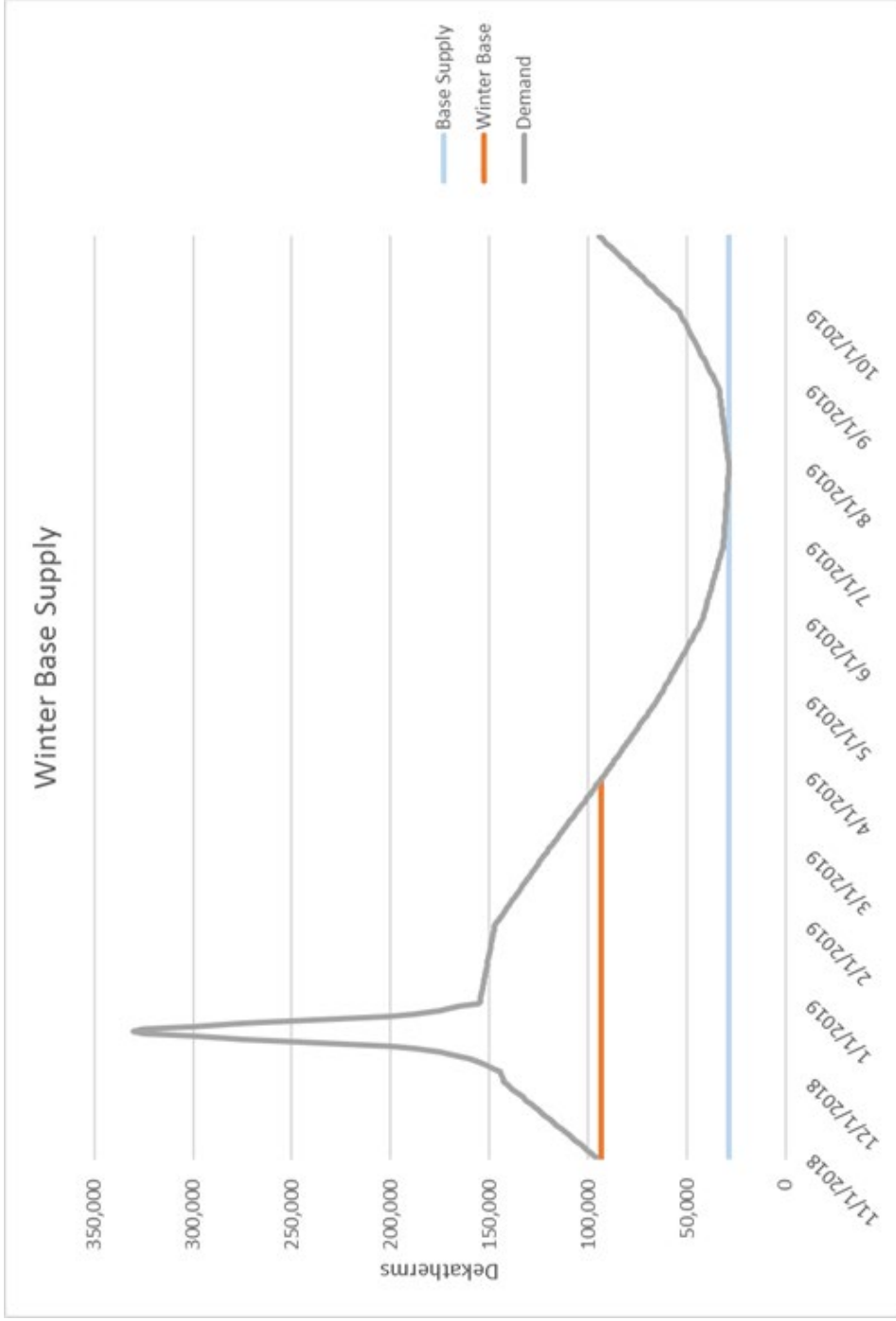

Day Supply (Winter)

Winter Day supply is gas that is Renominated at the beginning of November each year.

The Renomination function takes into account the fixed and variable costs of a resource to determine the proper amount to take in a given period.

Winter day gas has an MDQ cap but is not a must take supply.

If a winter day supply has an MDQ of 10,000 dth then it can take anywhere from 0 to 10,000 dth of gas on any given day in the winter.

Winter day supply has a slightly higher premium than winter base supply and it can be contracted from November to April.

Winter Day Supply (Cont'd)

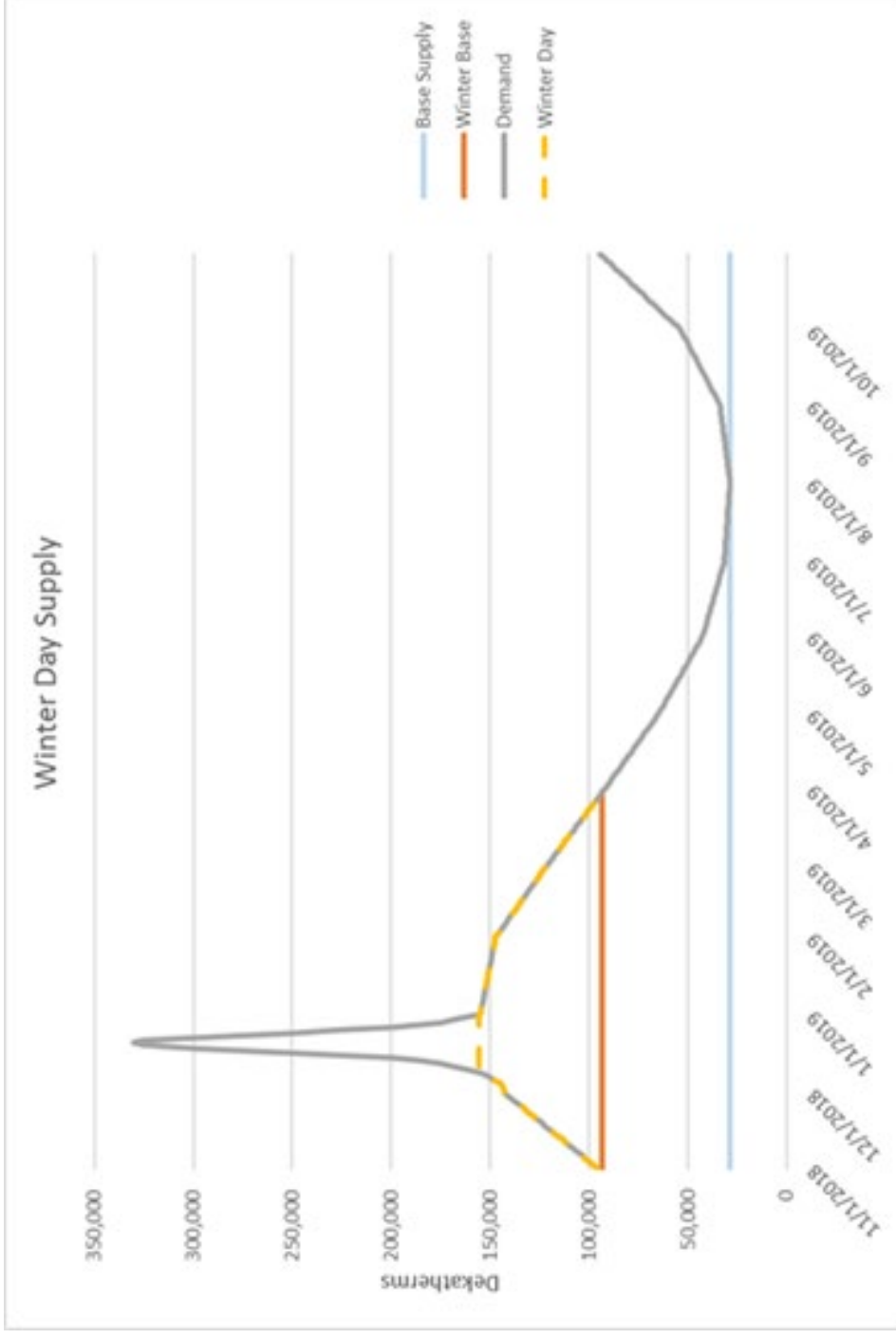

Day Supply (Summer)

Summer day supply is gas that is Renominated at the beginning of April each year.

Summer day gas has an MDQ cap but is not a must take supply.

If a summer day supply has an MDQ of 10,000 dth then it can take anywhere from 0 to 10,000 dth of gas on any given day in the summer.

Summer day supply has a slightly higher cost than base supply and it can be contracted from April to November.

Day Supply (Summer)

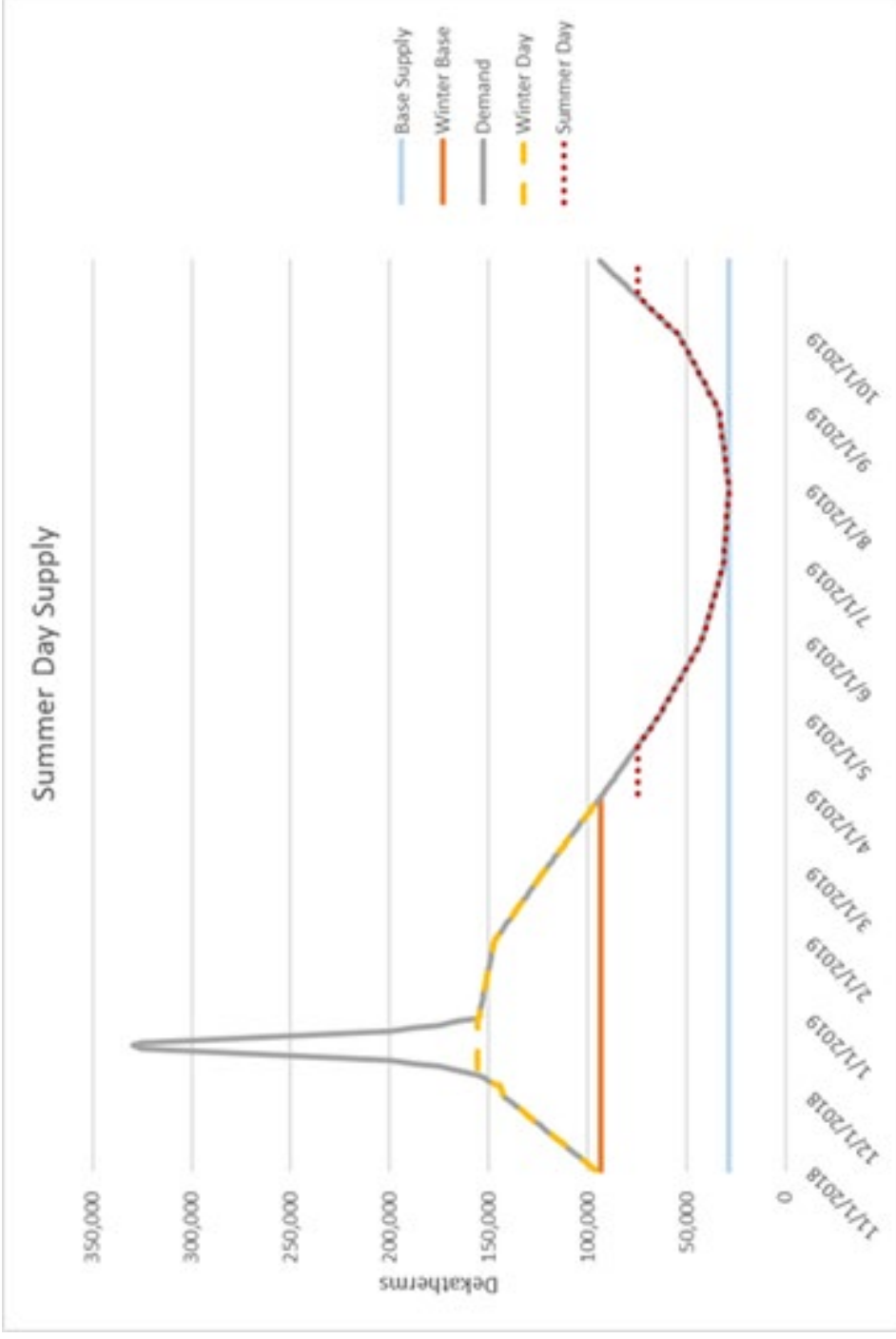

Peak Supply

Peak supply is gas purchased on high demand days where base, index, winter base, or day supply cannot accommodate.

Peak supply has a slightly higher premium to buy than day supply.

As long as Cascade has the transport capacity or can utilize a third party's transport capacity, we can purchase as much peak supply as needed to meet peak demand.

Total Supply

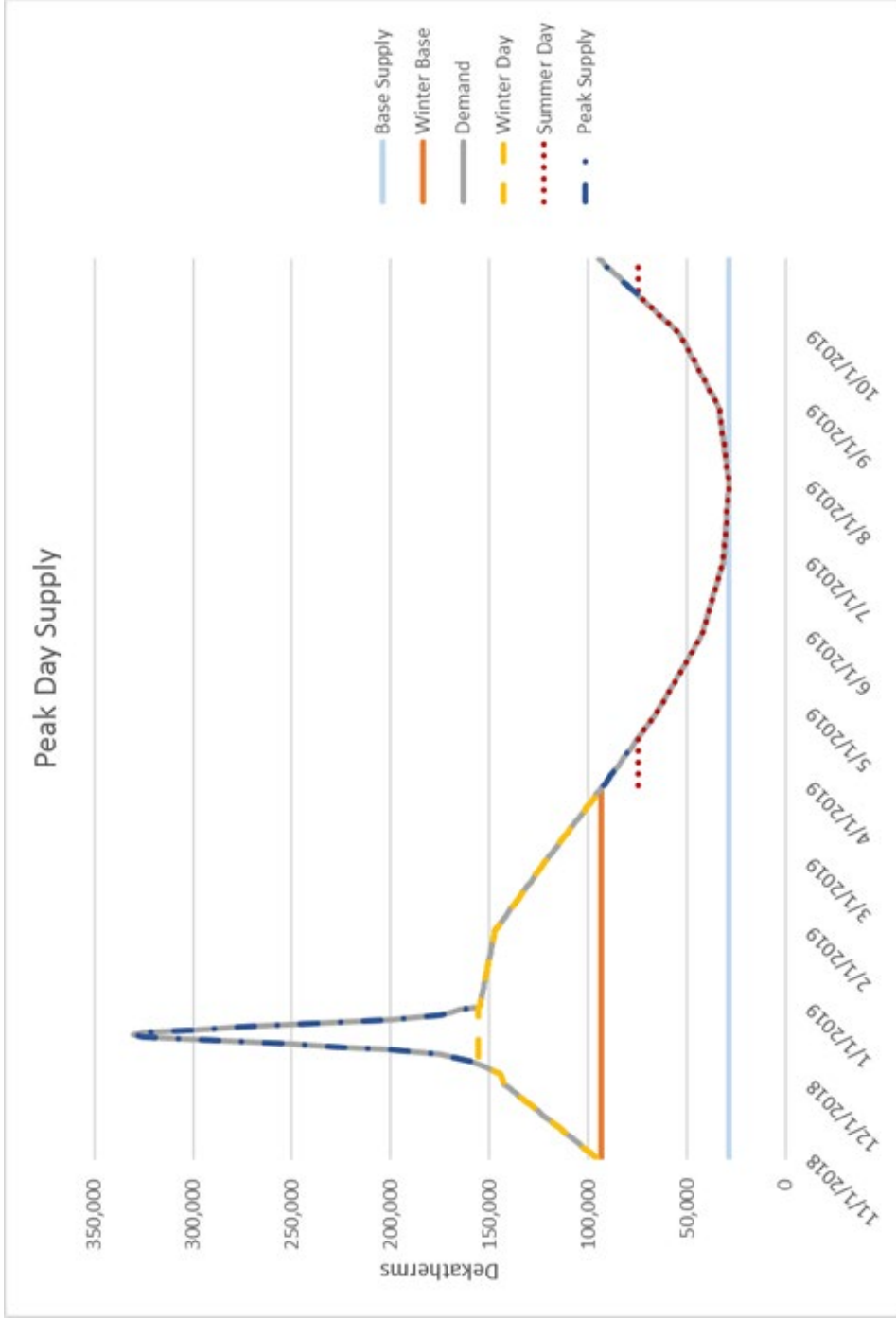

Storage

Cascade leases storage at 3 locations: Jackson Prairie (JP), Plymouth (Ply), and Mist.

Cascade has 4 storage contracts with JP, 2 contracts with Plymouth, and 2 with Mist (will go to 1 combined contract in 2024).

Storage injections targets for JP are set at 35% by the end of June, 80% by the end of August, and 100% by the end of September.

These targets are set by upstream pipelines' tariffs.

Cascade can withdrawal approximately 56,000 dth per day from JP, 78,000 dth per day from Plymouth, and 50,000 Dth per day from Mist for a total of approximately 184,000 dth per day.

Storage Example

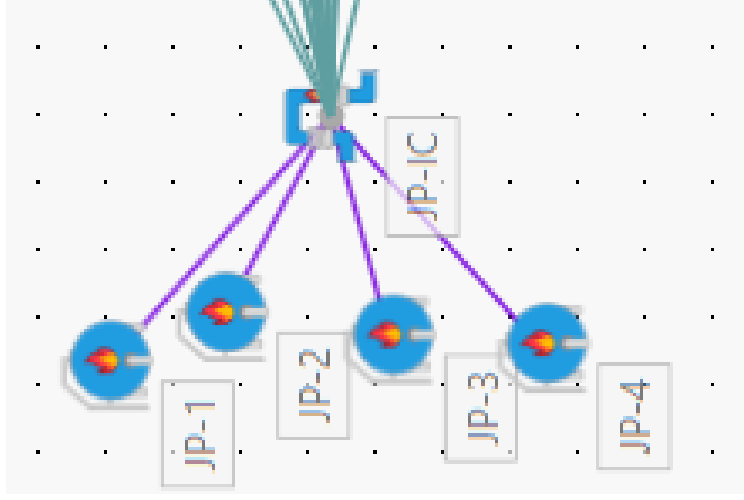
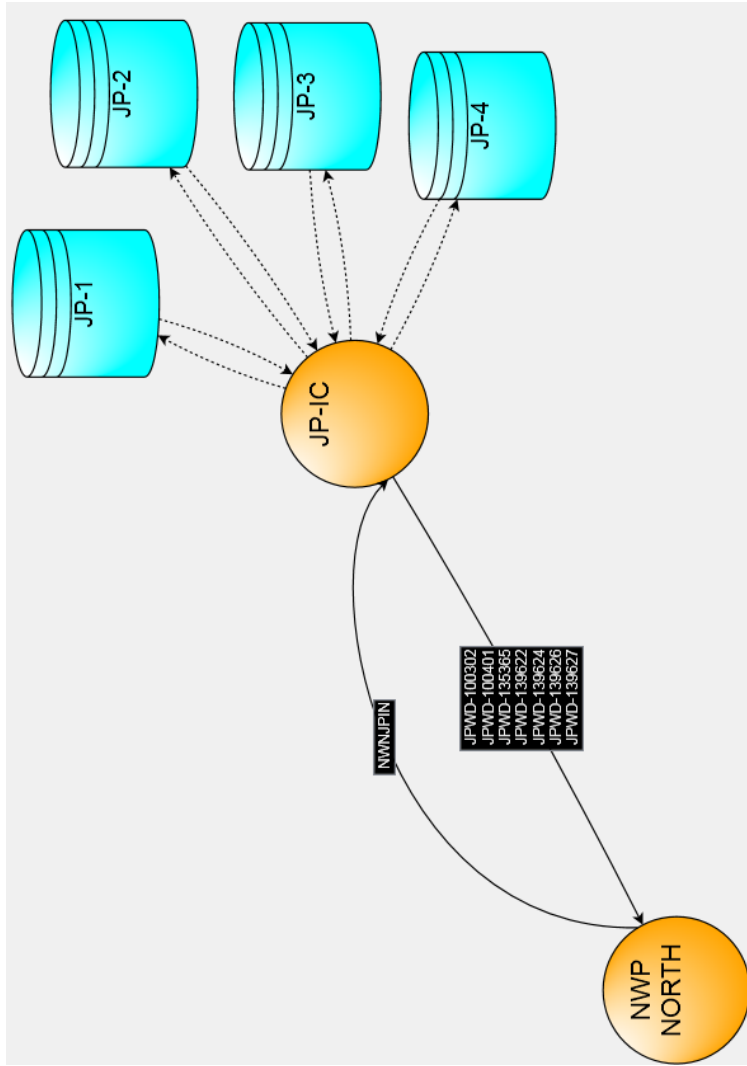

Storage Example 2

Objects Memberships Properties

Category Template

-

Collection	Parent Object	Child Object	Property	Value	Data File	Units	Band	Date From	Date To	Timeslice	Action
Gas Storages	System	PLY-1	Max Volume	100000		MMBtu	1				=
Gas Storages	System	PLY-1	Withdrawal Charge			\$/MMBtu	1				=
Gas Storages	System	PLY-1	Injection Charge			\$/MMBtu	1				=
Gas Storages	System	PLY-1	Reservation Charge			\$/MMBtu/month	1				=
Gas Storages	System	PLY-1	Reservation Volume			MMBtu	1				=
Gas Storages	System	PLY-1	Injection Fuel Rate			%	1				=
Gas Storages	System	PLY-1	Withdrawal Fuel Rate			%	1				=
Gas Storages	System	PLY-1	FO&M Charge			\$000	1				=
Gas Storages	System	PLY-1	Max Withdrawal Day	60000		MMBtu	1			M1-3,11-12	=
Gas Storages	System	PLY-1	Max Withdrawal Day	0		MMBtu	1			M4-10	=
Gas Storages	System	PLY-1	Max Injection Day	0		MMBtu	1			M1-3,11-12	=
Gas Storages	System	PLY-1	Max Injection Day	60000		MMBtu	1			M4-10	=

- PLY-1
- Template
- Gas Nodes
- Ply-IC
- Constraints
- Inheritors
- Lists

- PLY-1
 - Gas Storages
 - Settings
 - Expansion Optimality
 - Production
 - Is Available
 - Max Volume
 - Initial Volume
 - Withdrawal Charge
 - Dispatch Withdrawal Charge
 - Injection Charge
 - Injection Ratchet
 - Withdrawal Ratchet

Transportation

Transportation contracts are the means of how Cascade gets the gas from the supplier to the end user.

Cascade has multiple types of transportation:

- A single delivery point.
- Multiple delivery points.

The multiple delivery point contracts gives Cascade the flexibility to move the gas where it's most needed.

On NWP, transportation goes to the zonal level because MDDO's can be reallocated within a zone to the citygate. Additionally, NWP typically issues constraint concerns at the zonal level.

On GTN, transportation goes to the citygate level as MDDO's cannot be reallocated within the GTN zone.

Transportation (Cont'd)

Transportation has an MDQ, a D1 rate, a transportation rate, and a fuel loss percentage.

A maximum delivery quantity (MDQ) which is the maximum amount of gas Cascade can move on the pipeline on a single day.

A D1 rate which is the reservation rate to have the ability to move the MDQ amount on the pipeline.

A transportation rate which is the rate per dekatherm that is actually moved on the pipeline.

The fuel loss percentage is the statutory percent of gas based on the tariff from the pipeline that is lost and unaccounted for from the point of where the gas was purchased to the citygate.

Transport Example

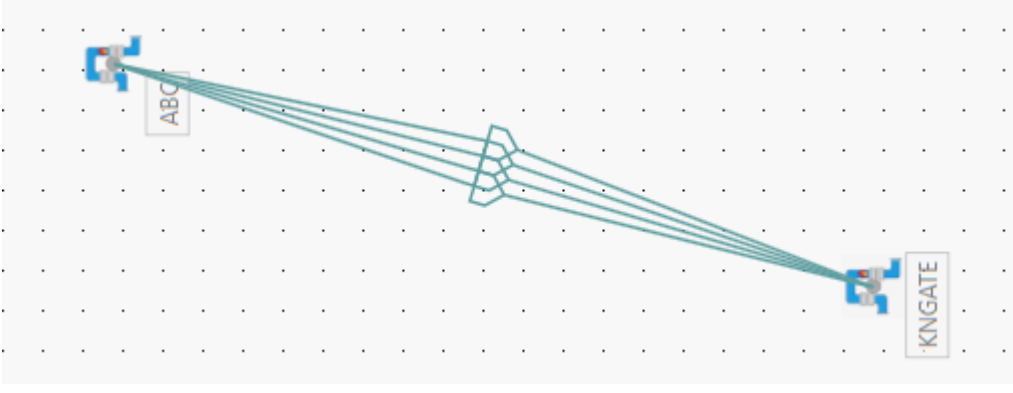
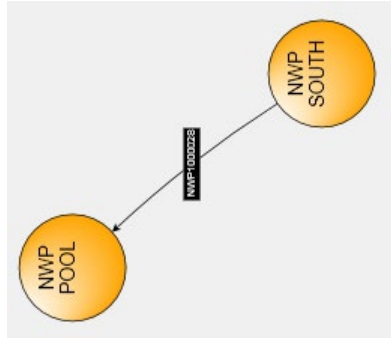

Transport Example

Objects Memberships Properties

Category	Template	Gas Node From	Gas Node To
-		ABC	KINGATE

Collection	Parent Object	Child Object	Property	Value	Data File	Units	Band	Date From	Date To	Timeslice	Action
Gas Pipelines	System	FTHLSFS1	Max Flow Day	125000	MDQ	MMBtu	1				=
Gas Pipelines	System	FTHLSFS1	Flow Charge		Flow Charge	\$/MMBtu	1				=
Gas Pipelines	System	FTHLSFS1	Reservation Charge		Reservation Charge	\$/MMBtu/month	1				=
Gas Pipelines	System	FTHLSFS1	Reservation Volume		Reservation Volume	MMBtu	1				=
Gas Pipelines	System	FTHLSFS1	Loss Rate		Loss Rate	%	1				=

FTHLSFS1

- Template
- Gas Node From
 - ABC
- Gas Node To
 - KINGATE
- Constraints
- Conditions
- Inheritors
- Lists
- Gas Contracts

FTHLSFS1

- Gas Pipelines
 - Settings
- Expansion Optimality
- Constraints
 - Max Flow Day
- Production
 - Is Available
 - Is Bidirectional
 - Flow Charge
 - Dispatch Flow Charge
 - Flow Charge Level
 - Initial Volume

Delivery Rights vs Receipt Rights

Cascade has more Delivery Rights than Receipt Rights.

Approximately 457,000 Dth of Delivery Rights.

Approximately 360,000 Dth of Receipt Rights.

The excess Delivery Rights allow Cascade to be flexible with the 360,000 Dth of Receipt Rights.

Example of delivery right flexibility



All of the following must be true

$$X1 \leq 4\text{MDTs}$$

$$X2 \leq 4\text{MDTs}$$

$$X3 \leq 4\text{MDTs}$$

$$X1 + X2 + X3 \leq 4\text{MDTs}$$

Example of delivery right inflexibility

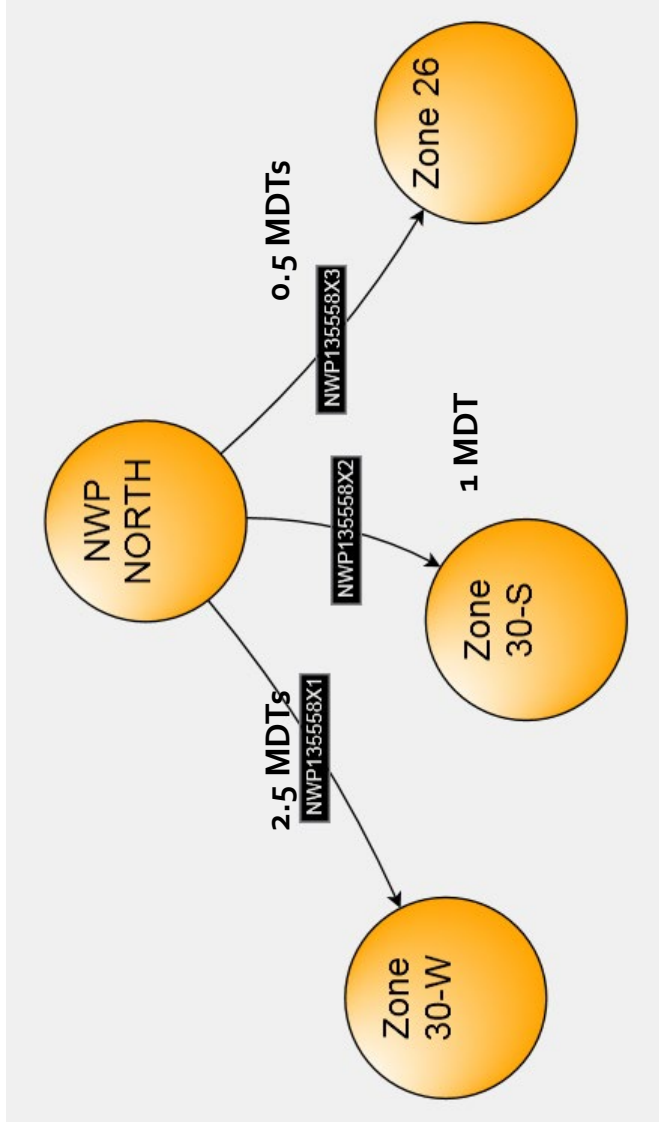

Transport Constraints

To simplify modeling in Plexos the software allows the user to group multiple paths of one contract into a constraint group.

This tells Plexos to allow each path to take up to X Dekatherms, but not to exceed X Dekatherms for all paths of the contract.

The analyst identifies which contracts should be in the group and assigns an MDQ for the constraint group.

Transport Constraints Example

Collection	Parent Object	Child Object	Property	Value	Data File	Units	Band
Constraints	System	100302STN	Sense	<=		-	1
Constraints	System	100302STN	RHS Day		Constraint RHS Day	-	1
Gas Pipeline.Constraints	NWP10030226B	100302STN	Flow Coefficient	1		MMBtu	1
Gas Pipeline.Constraints	NWP100302MEORB	100302STN	Flow Coefficient	1		MMBtu	1
Gas Pipeline.Constraints	NWP100302STN	100302STN	Flow Coefficient	1		MMBtu	1

Location of Zones (Source: NWP)

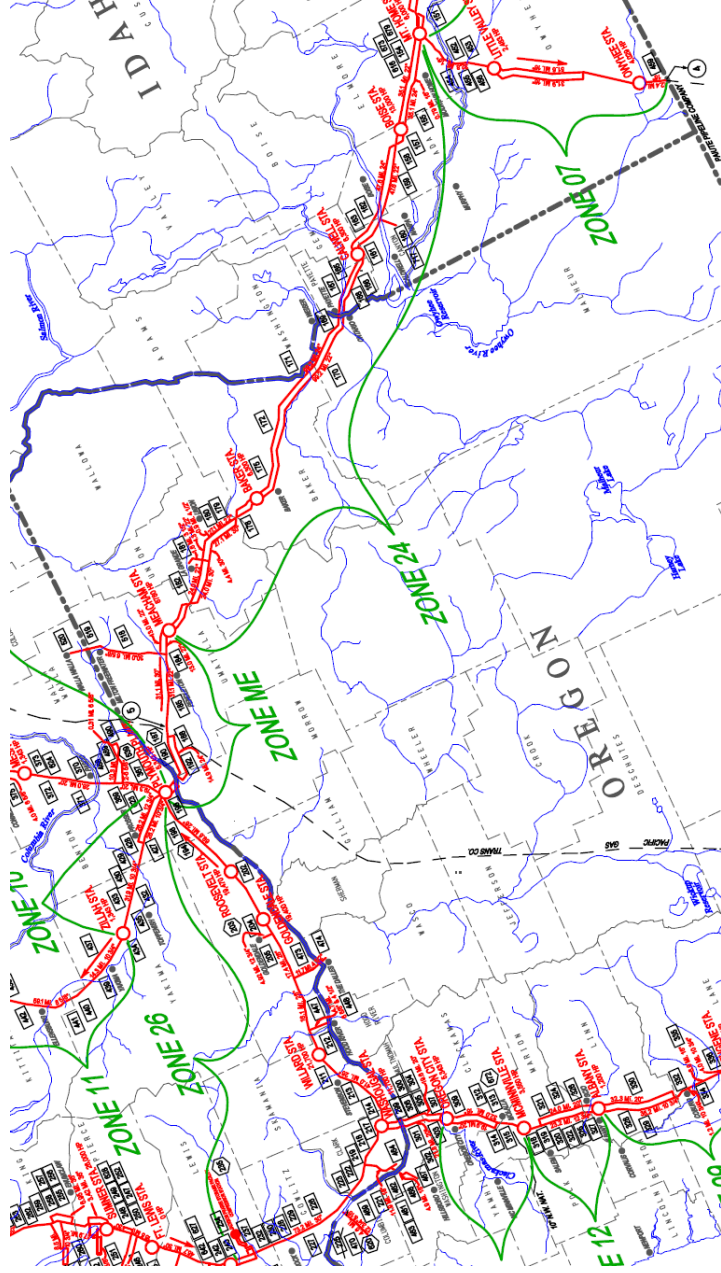

Emissions

Cascade is modeling emissions as a constraint.

Emissions constraints are based on the Climate Commitment Act (CCA) for Washington and the Climate Protection Plan for Oregon.

Plexos must balance traditional gas along with carbon offsets and renewable natural gas to meet demand while hitting emission reduction targets.

Cascade will discuss decarbonization planning further at TAG 4.

Emissions Example

WA CO2

- Template
- Gas Fields
- Gas Nodes
 - Non-Core Traditional Gas WA
 - POOL SMSPLP Traditional
 - WA CCIs
 - ZONE 10 Traditional
 - ZONE 11 Traditional
 - ZONE 20 Traditional
 - ZONE 26 Traditional
 - ZONE 30-S Traditional
 - ZONE 30-W Traditional

WA CO2

- Emissions
- Constraints
 - Max Production Year
 - Max Production Penalty
- Emission.Gas Nodes
 - Production Rate

Collection	Parent Object	Child Object	Property	Value	Data File	Units
Emissions	System	WA CO2	Max Production Year	1E+30		ton
Emissions	System	WA CO2	Max Production Year	1E+30	CO2e Limits	ton
Emission.Gas Nodes	WA CO2	Non-Core Traditional Gas WA	Production Rate	106.12		lb/MMBtu
Emission.Gas Nodes	WA CO2	POOL SMSPLP Traditional	Production Rate	106.12		lb/MMBtu
Emission.Gas Nodes	WA CO2	WA CCIs	Production Rate	-2000		lb/MMBtu
Emission.Gas Nodes	WA CO2	ZONE 10 Traditional	Production Rate	106.12		lb/MMBtu

Planned Scenarios and Sensitivities

Supply Resource Optimization Process Flow Chart

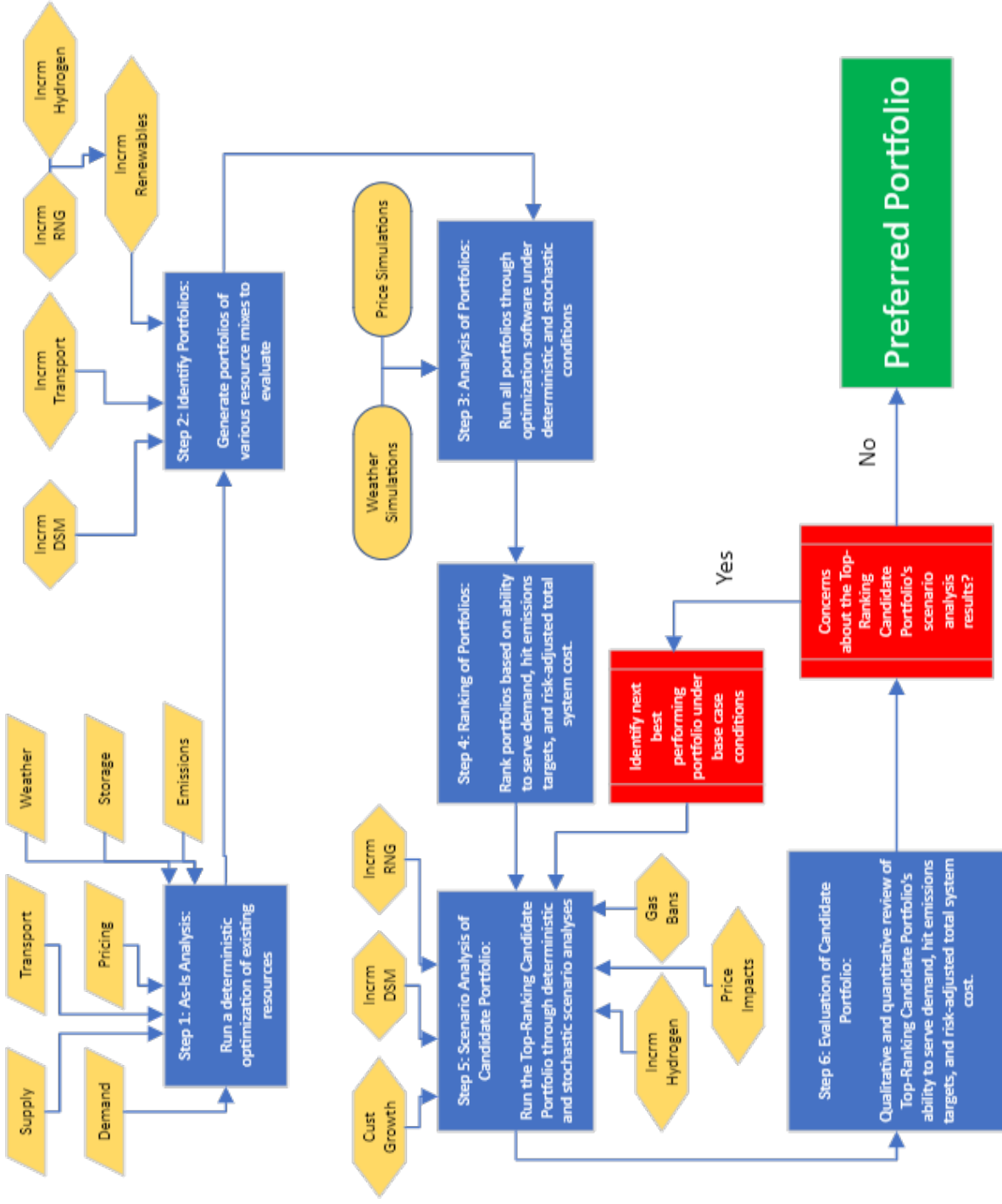

Supply Resource Optimization Process

Step 1: As-Is Analysis

- Run a deterministic optimization of existing resources to uncover timing and quantity of resource deficiencies.

Step 2: Identify Portfolios

- Cascade will be evaluating six different portfolios of incremental resources for the 2023 IRP. Each will be a mix of various incremental resources, including transportation capacity, RNG, Hydrogen, and DSM.

Step 3: Analysis of Portfolios

- Each portfolio will be run through the Plexos optimizer under expected conditions (see Base Case scenario.) The portfolios will be evaluated under deterministic and stochastic weather/pricing, and the timing/quantity if applicable of unserved demand and emissions reductions shortfalls will be recorded. Cascade will also record the risk-adjusted total system cost of each portfolio.

Supply Resource Optimization Process Cont.

Step 4: Ranking of Portfolios

- The Top Ranking Candidate Portfolio will be the portfolio that is able to serve all forecasted demand over the planning horizon while hitting all emissions reductions goals. In the case of multiple portfolios accomplishing this, the portfolio that does it with the lowest risk-adjusted total system cost will be the Top-Ranking Candidate Portfolio.

Step 5: Scenario Analysis of Candidate Portfolio

- The Top Ranking Candidate Portfolio is re-run through the Plexos optimizer under five scenarios. These scenarios will provide sensitivity testing of customer growth, energy efficiency, RNG, hydrogen, Natural Gas bans, and Natural Gas pricing. The portfolio will be evaluated under deterministic and stochastic weather/pricing, and the timing/quantity if applicable of unserved demand and emissions reductions shortfalls will be recorded. Cascade will also record the risk-adjusted total system cost of each portfolio.

Step 6: Evaluation of Candidate Portfolio

- Cascade performs a qualitative and quantitative review of Top-Ranking Candidate Portfolio's ability to serve demand, hit emissions targets, and the risk-adjusted total system cost of the portfolio under the scenarios evaluated. If there are concerns about the portfolio's ability to hit these metrics, or the cost of hitting these metrics, the Company may loop back to Step 5 with a new portfolio that might be more insulated against identified risks. Otherwise, the portfolio is named Cascade's Preferred Portfolio.

Additional Preferred Portfolio Considerations

- Does it get supply to the citygate?
- Is it reliable?
- Does it have a long lead time?
- How much does it cost?
- New build vs. depreciated cost
- The rate pancake
- Is it a base load or peaking resource?
- How many dekatherms are needed?
- What is the “shape” of resource?
- Is it tried and true technology, new technology, or yet to be discovered?
- Who else will be competing for the resource?

2023 IRP Proposed Scenarios	Scenario						High Price - Interrupted Supply	Other?	
	Base Case - OR-CPP and WA-CCA	Carbon Neutral by 2050	Limited RNG availability	Electrification	High Customer Case	High Price - Interrupted Supply			
Customer Growth	Current Expectations						Current Expectations		
Energy Efficiency	CPA Projections	Scenario 2 CPA Projections						CPA Projections	
Renewable Natural Gas	Expected Availability	Expected - High Avail.	Low Availability	Expected - High Avail.		Expected Availability			
Hydrogen	Expected Availability	Expected - High Avail.	Low Availability	Expected - High Avail.		Expected Availability			
Natural Gas Bans	Current Bans						Current Bans		
Natural Gas Price	Expected Price	Adjusted Price?	Expected Price	Adjusted Price?		High Price			

Resource Integration

Scenario 1 – Base Case

- Main Element: Expected values for all sensitivities
- Customer Growth: Based on 2023 IRP Load Forecast
- Energy Efficiency: Based on 2023 CPAs from Cascade (WA) and ETO (OR)
- RNG Availability: Cascade weighted share high/technical blend of AGF/ICF Study
- Hydrogen Availability: Maximum blend of 20% supply by volume
- Natural Gas Bans: Consideration of all expected bans in load forecast
- Natural Gas Price: Based on 2023 IRP Price Forecast

Scenario 2 – Carbon Neutral by 2050

- Main Element: Zero CO₂e emissions by 2050 as per CCA/CPP guidelines
- Customer Growth: Based on 2023 IRP Load Forecast
- Energy Efficiency: Based on adjusted 2023 CPAs from Cascade (WA) and ETO (OR) using higher commodity cost as input into avoided cost
- RNG Availability: Cascade weighted share of technical potential of AGF/ICF Study
- Hydrogen Availability: Maximum blend of 30% supply by volume
- Natural Gas Bans: Consideration of all expected bans in load forecast
- Natural Gas Price: 10% downward adjustment to 2023 IRP Price Forecast, higher price of RNG volumes above and beyond base case, capped at \$26/dth

Scenario 3 – Limited RNG Availability

- Main Element: Competition and stagnating technology leads to lower than expected RNG availability, conservative approach to hydrogen blending
- Customer Growth: Based on 2023 IRP Load Forecast
- Energy Efficiency: Based on adjusted 2023 CPAs from Cascade (WA) and ETO (OR) using higher commodity cost as input into avoided cost
- RNG Availability: Cascade weighted share of low potential of AGF/ICF Study
- Hydrogen Availability: Maximum blend of 5% supply by volume
- Natural Gas Bans: Consideration of all expected bans in load forecast
- Natural Gas Price: Geologic gas based 2023 IRP Price Forecast. Consideration of higher price for RNG

Scenario 4 – Increased Electrification

- Main Element: Lower than expected load projections due to both discretionary electrification and increased regulatory bans on natural gas.
- Customer Growth: customer growth in Cascade’s residential and commercial rate classes gradually slows to zero growth in 2025 and afterwards, residential and commercial customer count reduced to 10% by 2050
- Energy Efficiency: Based on adjusted 2023 CPAs from Cascade (WA) and ETO (OR) using higher commodity cost as input into avoided cost
- RNG Availability: Cascade weighted share high/technical blend of AGF/ICF Study
- Hydrogen Availability: Maximum blend of 20% supply by volume
- Natural Gas Bans: Consideration of all expected and proposed bans in load forecast
- Natural Gas Price: 10% downward adjustment to 2023 IRP Price Forecast

Scenario 5 – High Customer Growth

- Main Element: Higher than expected customer growth, with the same emissions reduction requirements in the CPP/CCA
- Customer Growth: Based on high growth projections of the 2023 IRP Load Forecast
- Energy Efficiency: Based on adjusted 2023 CPAs from Cascade (WA) and ETO (OR) using higher commodity cost as input into avoided cost
- RNG Availability: Cascade weighted share of the technical potential in the AGF/ICF Study
- Hydrogen Availability: Maximum blend of 30% supply by volume
- Natural Gas Bans: Consideration of all expected bans in load forecast
- Natural Gas Price: 10% upward adjustment to 2023 IRP Price Forecast, higher price of RNG volumes above and beyond base case, capped at \$26/dth

Scenario 6 – High Price – Interrupted Supply

- Main Element: Indiscriminate, stochastically derived incidents cause disruptions in availability of geologic gas at specific basins
- Customer Growth: Based on expected growth projections of the 2023 IRP Load Forecast
- Energy Efficiency: Based on 2023 CPAs from Cascade (WA) and ETO (OR)
- RNG Availability: Cascade weighted share high/technical blend of AGF/ICF Study
- Hydrogen Availability: Maximum blend of 20% supply by volume
- Natural Gas Bans: Consideration of all expected bans in load forecast
- Natural Gas Price: During incidents, price at other basins spike to 99th percentile stochastic pricing

Alternative Resources

Once a deficiency is identified, Cascade must analyze potential solutions to ensure service over the planning horizon.

Conversations with partners at various pipelines, storage facilities, new supply sources.

Emissions reduction planning has added another level of planning that could create modeling shortfalls.

Plexos is used to ultimately derive the optimal mix of resources, referred to as the “preferred portfolio.”

Major resource issues on the horizon



In the Community to Serve®

Location of Current & Alternative Resources

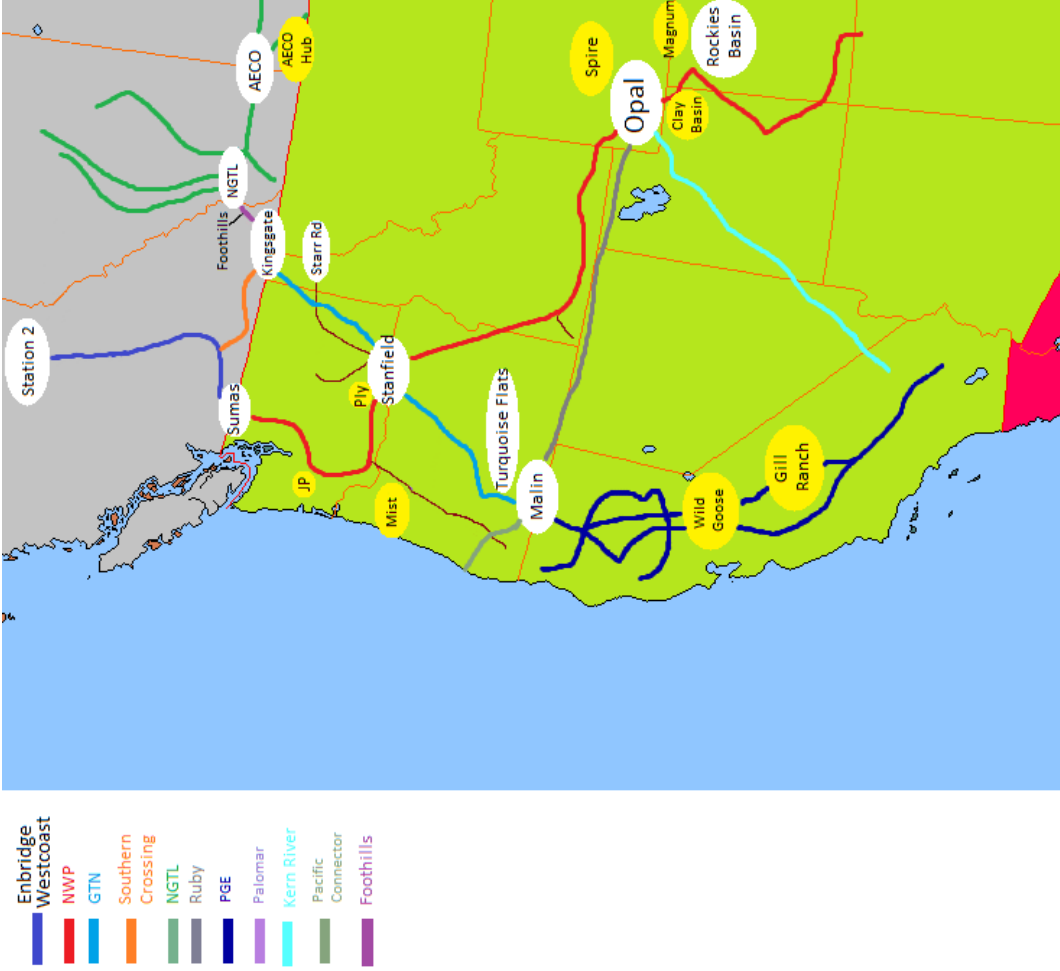

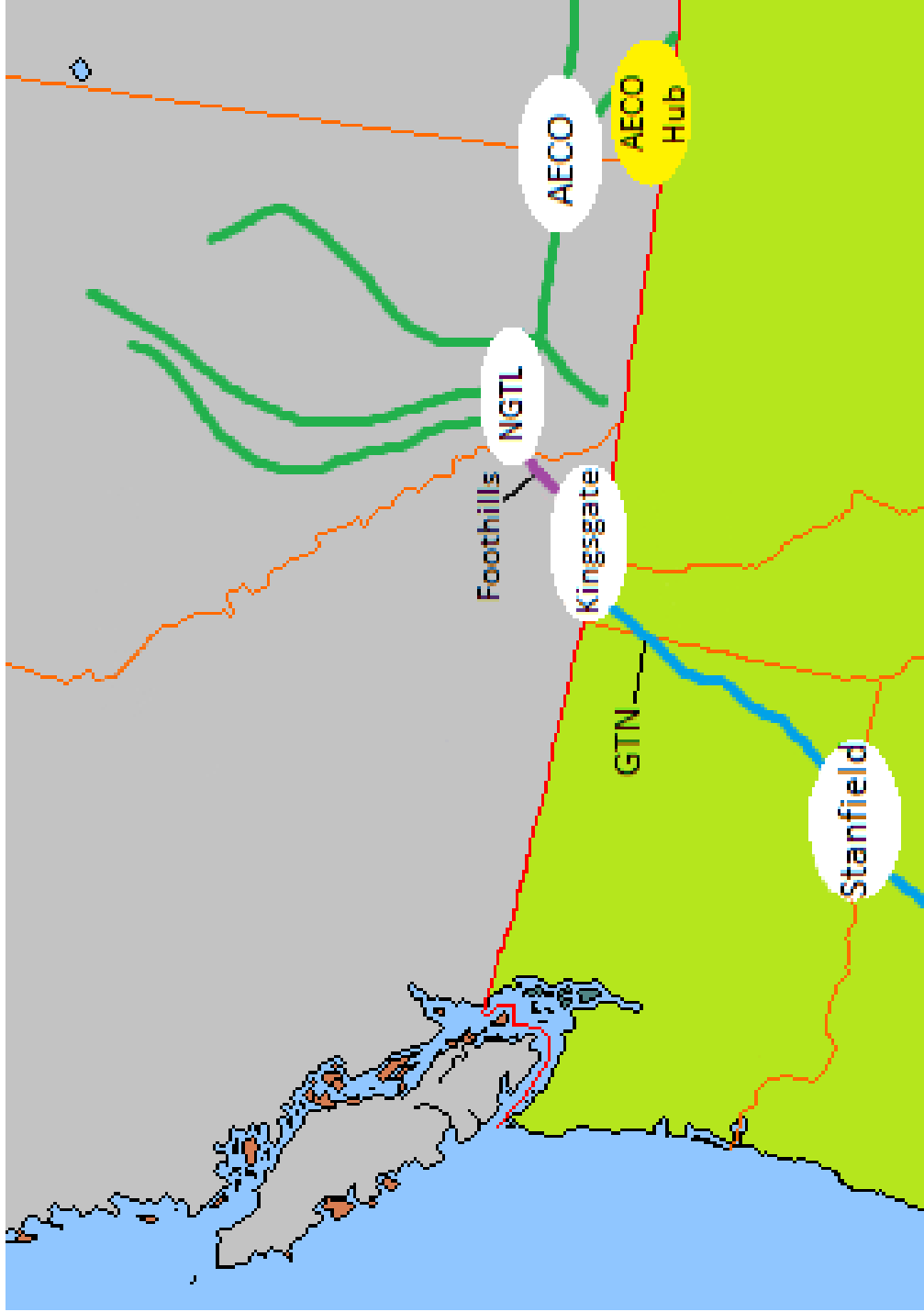

Incremental Transport – North to South

- Incremental NGTL – Additional capacity to move gas from AECO basin to Alberta/BC border
- Incremental Foothills – Additional capacity to move gas from Alberta/BC border to Kingsgate
- Incremental GTN N/S – Additional capacity to move gas from Kingsgate to various citygates along GTN



In the Community to Serve®

Incremental Transport – Northwest Pipeline

- I-5 Mainline Expansion – Additional capacity to move gas along I-5 corridor in western Washington
- Wenatchee Lateral Expansion – Additional capacity to move gas along Wenatchee Lateral to central Washington
- Spokane Lateral Expansion – Additional capacity to move gas along Spokane Lateral to eastern Washington
- Eastern Oregon Mainline Expansion – Additional capacity to move gas along Eastern Oregon Lateral to Oregon citygates

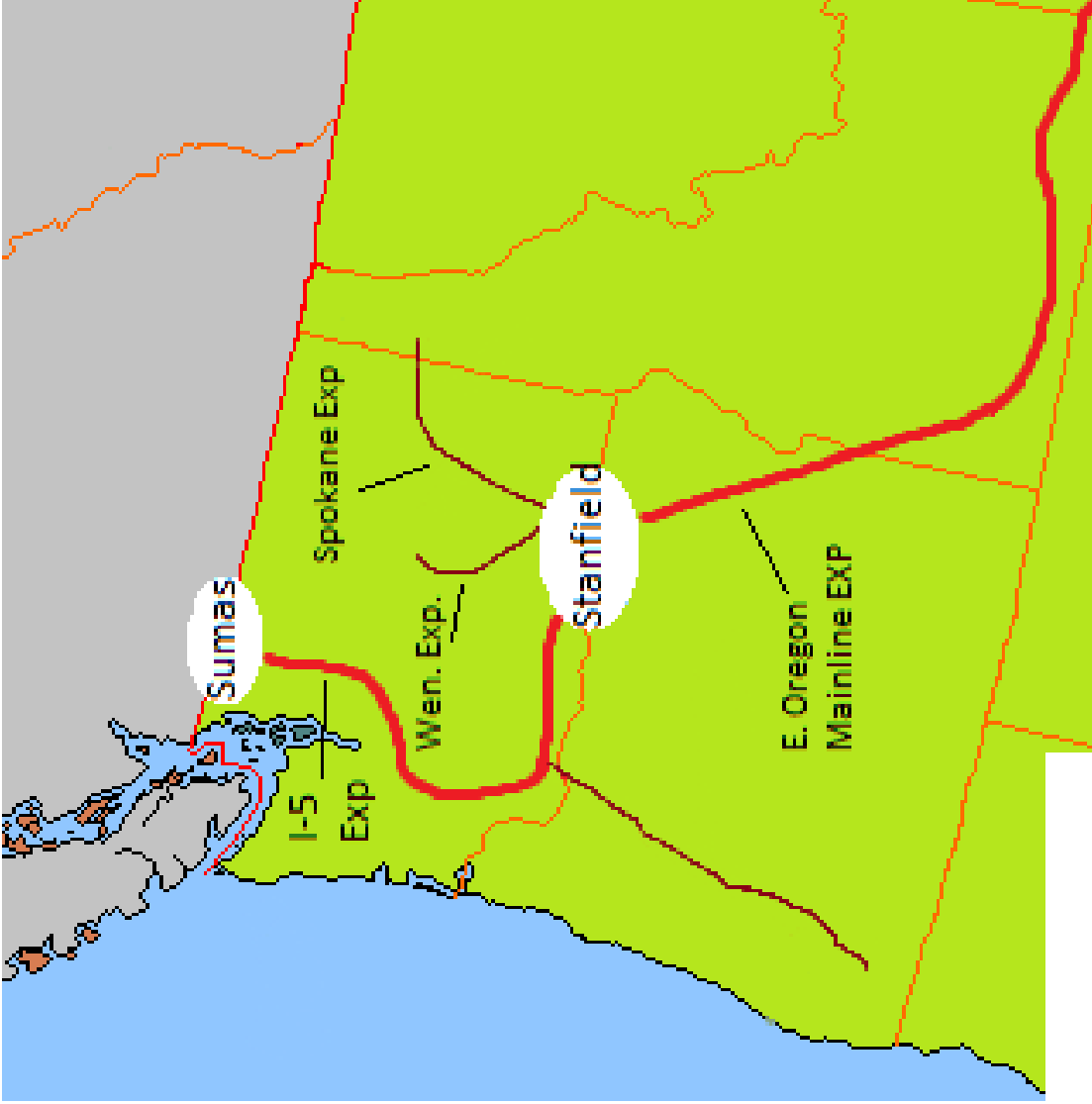

Incremental Transport – South to North

Incremental Opal– Additional capacity to move gas from Utah to Opal

Incremental GTN S/N – Additional capacity to move gas from Turquoise Flats to various citygates along GTN

Incremental Ruby – Additional capacity to move gas from Rockies Basin to Turquoise Flats



Incremental Transport – Bilateral

- T-South Southern Crossing – Price arbitrage opportunity to move gas between Sumas and AECCO basins bilaterally
- Pacific Connector – Pipeline that will feed LNG facility on Oregon coast, increasing liquidity at Malin

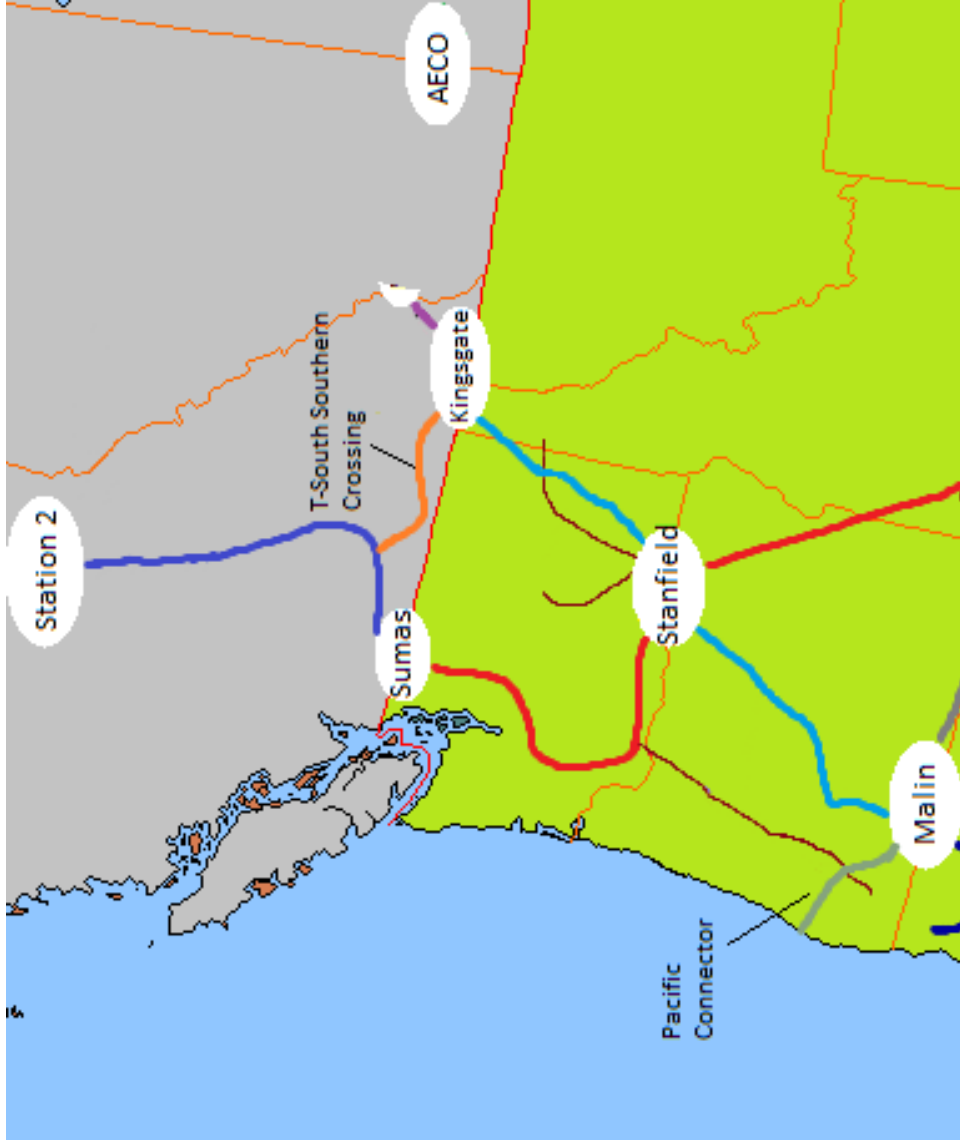

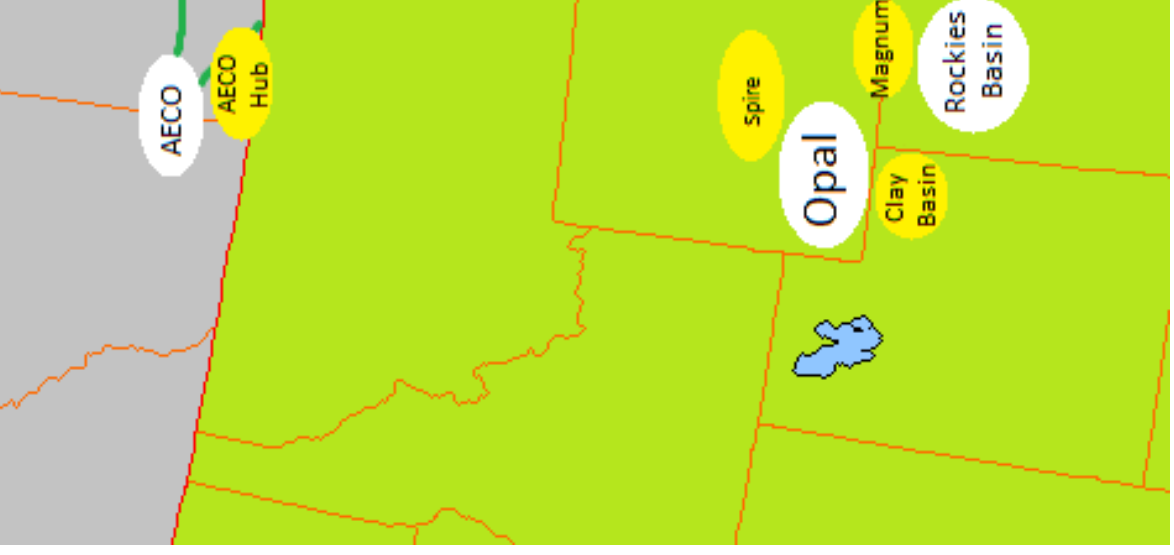

Incremental Storage - North and East

Spire Storage – Additional storage in southwest Wyoming serving the system, primarily Oregon

Magnum Storage – Additional storage near Rocky Mountains, serving the system, primarily Oregon

AECO Hub Storage – Additional storage near AECO Hub, serving the system

Clay Basin Storage – Additional storage near Opal



In the Community to Serve®

Incremental Storage - South and West

- Gill Ranch Storage – Additional storage in central California, serving the system, primarily Oregon
- Mist Storage – Additional storage in northern Oregon, serving the system, primarily Washington
- Wild Goose Storage – Additional storage in northern California, serving the system, primarily Oregon

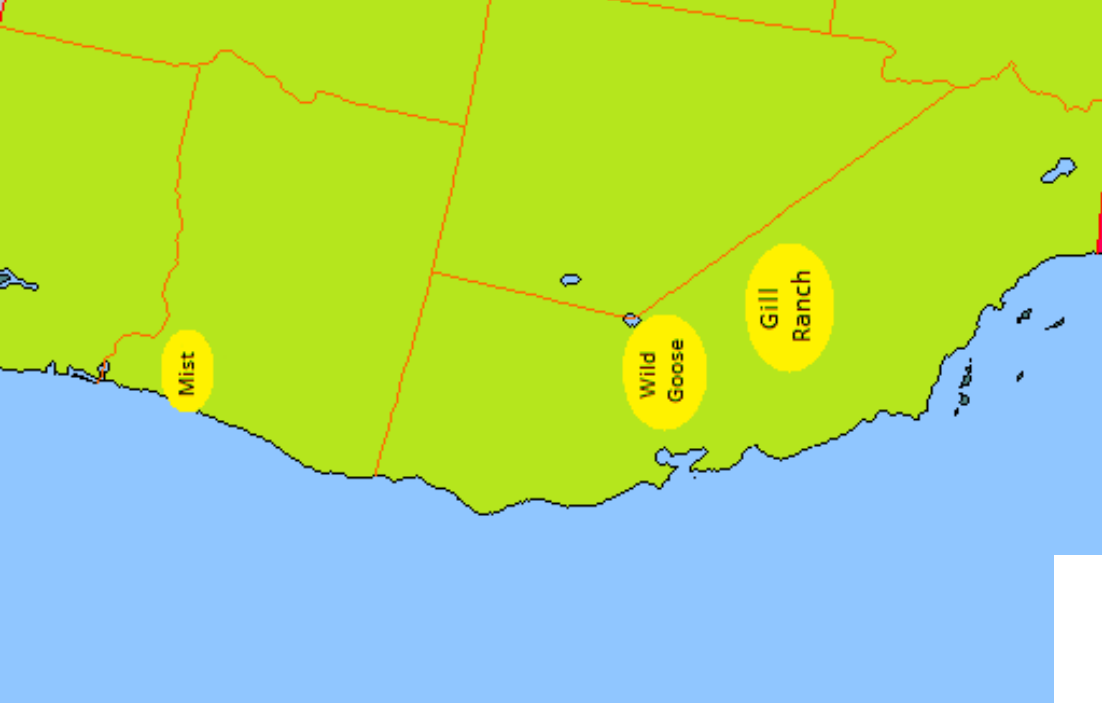

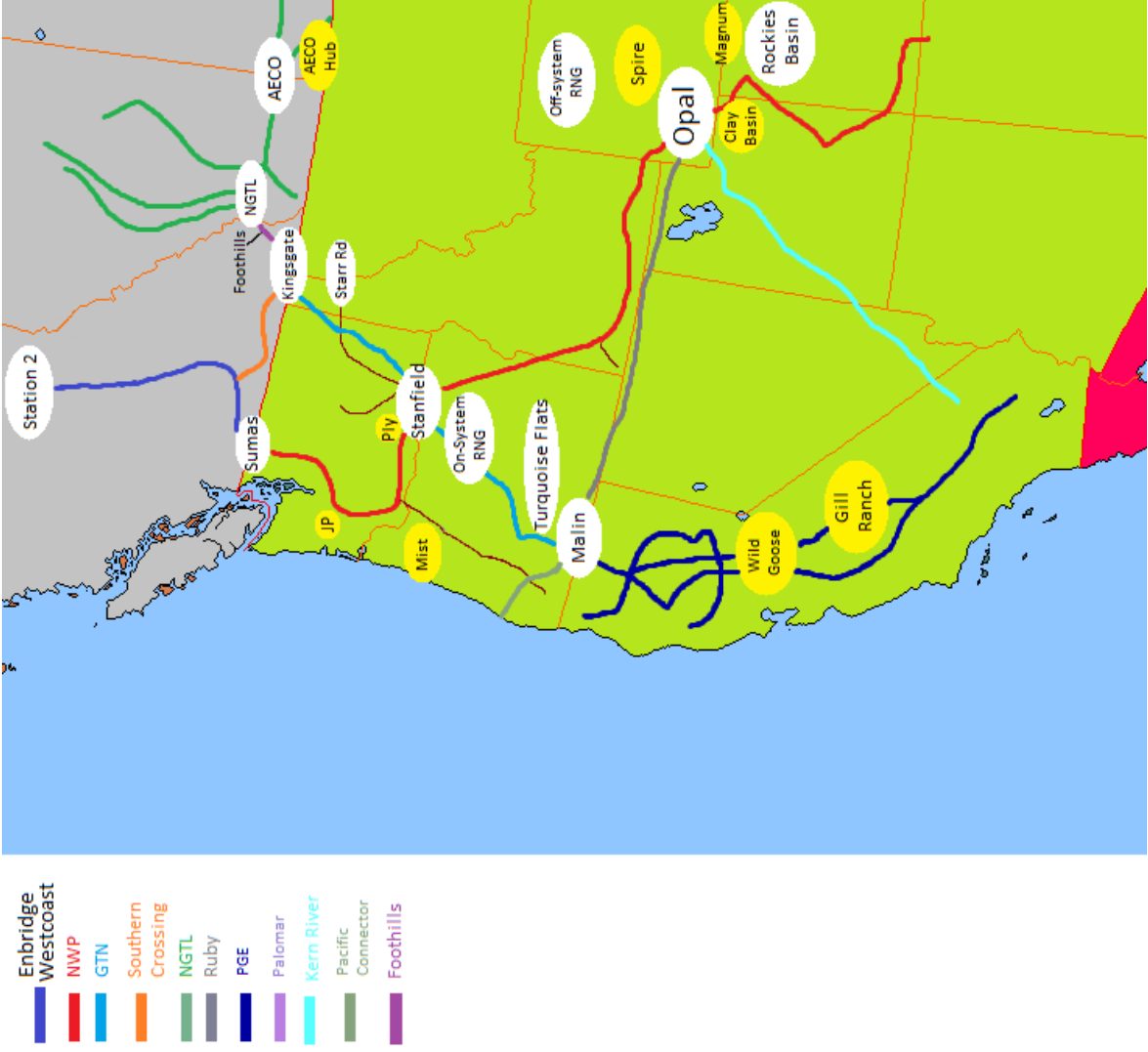

Incremental Supplies

Incremental Opal Supply – Additional supply around the Rockies Basin

Renewable Natural Gas – Incremental biogas supply directly to distribution system

Hydrogen – Incremental Hydrogen supply directly to distribution system



In the Community to Serve®

Price Forecast Results

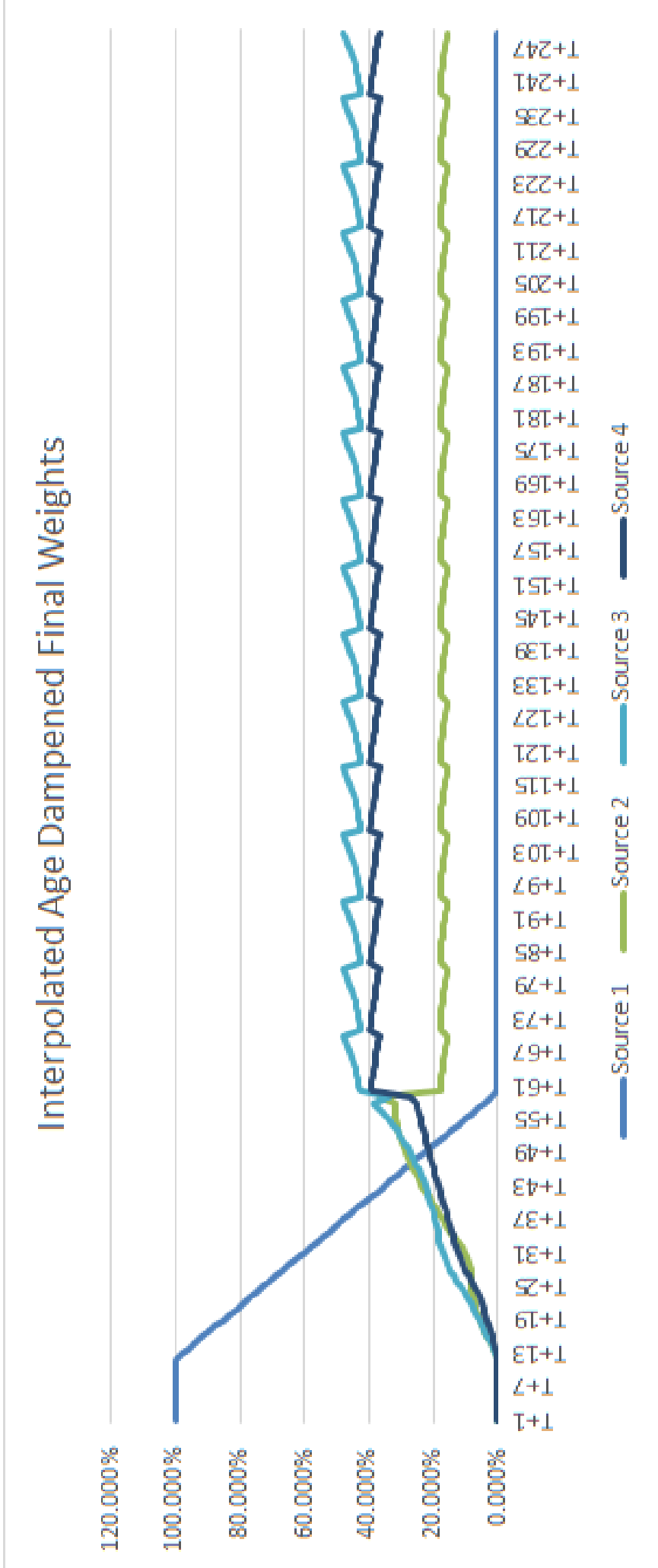

CNGC Price Forecast as of 5/23/2022

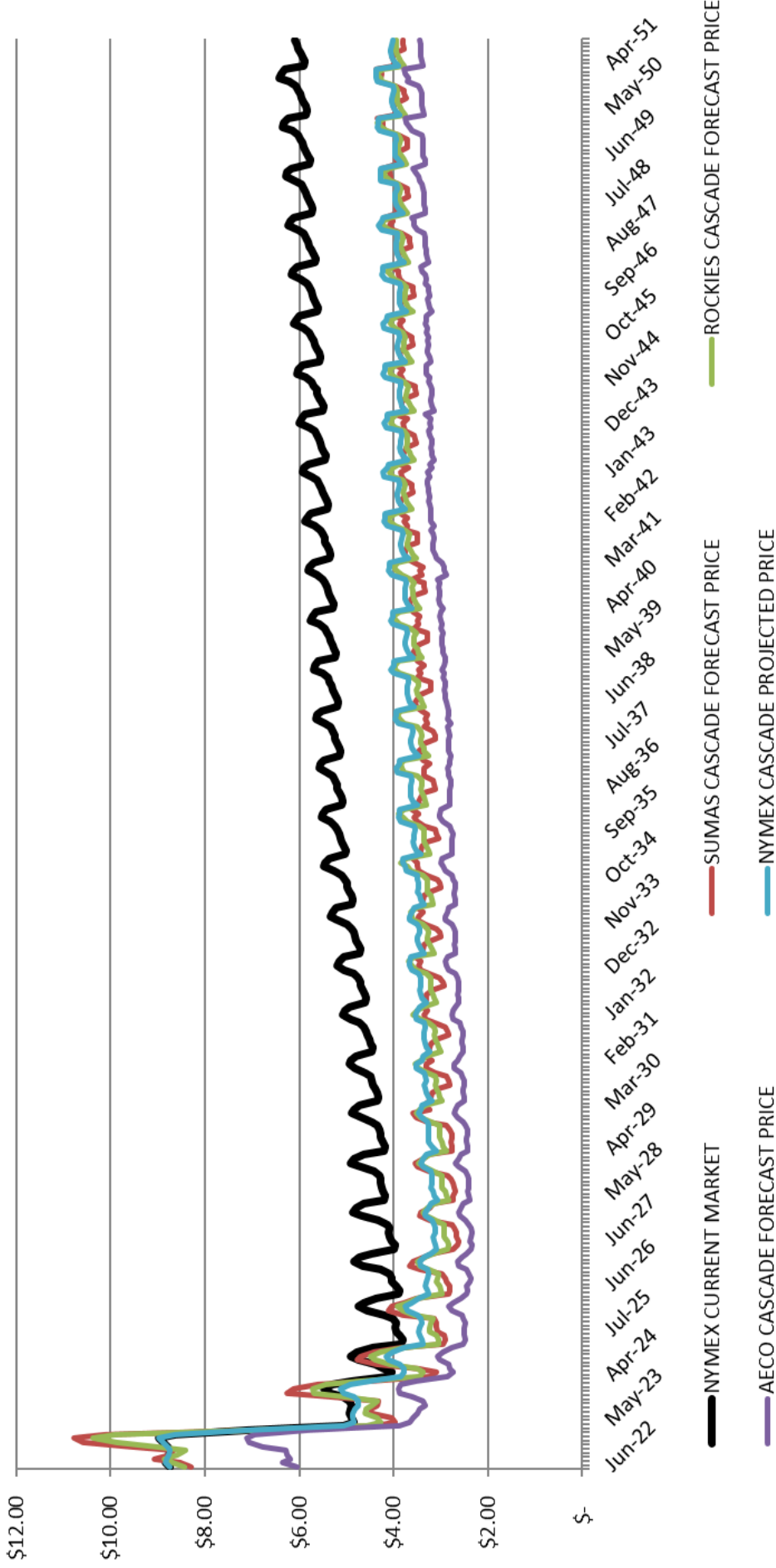

Avoided Cost Methodology and Calculation

Avoided Cost Overview

As part of the IRP process, Cascade produces a 28-year price forecast and 45 years of avoided costs.

The avoided cost is an estimated cost to serve the next unit of demand with a supply side resource option at a point in time. This incremental cost to serve represents the cost that could be avoided through energy conservation.

The avoided cost forecast can be used as a guideline for comparing energy conservation with the cost of acquiring and transporting natural gas to meet demand.

For the 2023 IRP, Cascade has continued to evolve its avoided cost formula to create a more transparent and intuitive final number.

- Methodologies for calculating Distribution System Costs and Risk Premium have been revised from the 2020 IRP.

The various elements of the avoided cost will need to be reconsidered with regards to emissions reductions goals.

The Company produces an expected avoided cost case based on peak day and, in the case of distribution system costs, peak hour.

Avoided Cost Overview

The components that go into Cascade's avoided cost calculation are as follows:

$$AC_{nominal} = (TC_v + TCF + SC_v + CC + E_{Comp} + DSC + RP) * E_{adder}$$

Where:

$AC_{nominal}$ = The nominal avoided cost for a given year. To put this into real dollars you must apply the following: $\text{Avoided Cost}/(1+\text{Discount Rate})^{\text{Years}}$ from the reference year.

TC_v = Variable Transportation Costs

TC_f = Fixed Transportation Costs (When Avoidable)

SC_v = Variable Storage Costs

CC = Commodity Costs

E_{Comp} = Environmental Compliance Costs

DSC = Distribution System Costs

RP = Risk Premium

E_{adder} = Environmental Adder, as recommended by the Northwest Power and Conservation Council

Avoided Cost Formula



In the Community to Serve®

Methodology – Unchanged from 2020 IRP

Variable Transportation costs are pulled directly from the major pipelines that Cascade utilizes (NWP, GTN, Enbridge, Ruby, Nova Gas Transmission (NGTL) and Foothills).

Fixed Transportation are only included when avoidable (i.e.. potential to offset upstream capacity acquisition)

Storage costs are only captured if there is an avoidable future storage cost (i.e.. On system storage).

Commodity Costs are taken from Cascade's 28-year price forecast.

Environmental Compliance costs are derived from social cost of carbon with 2.5% discount rate, scaled up to real \$2021

Environmental adder now applied to all elements of the avoided cost, still 10% as per NWPCC guidance

- For the 2023 IRP, Cascade has moved away from deriving distribution system costs from margin.
- The Company's new distribution system cost calculation looks at forecasted capital expenses related ONLY to growth, and uses the company's load growth forecast to translate these costs to a per therm basis.
- Additionally, it's important to recognize that while energy efficiency may not be able to fully eliminate the need for a distribution system enhancement, it can defer the need for these enhancements to a later year. Because of the economic principle of the time value of money, this deferral has value, and that value is the avoided distribution system cost
- Since Avoided Cost is based on peak day, this deferral value is then multiplied by the ratio of peak day demand to an average day's demand to get the impact on peak day.
- Distribution system analysis is concerned with the pressure during peak hour, so the daily number must then be multiplied by the ratio of peak hour demand to that day's total demand.

Methodology – Distribution System Costs

Capacity Modeling

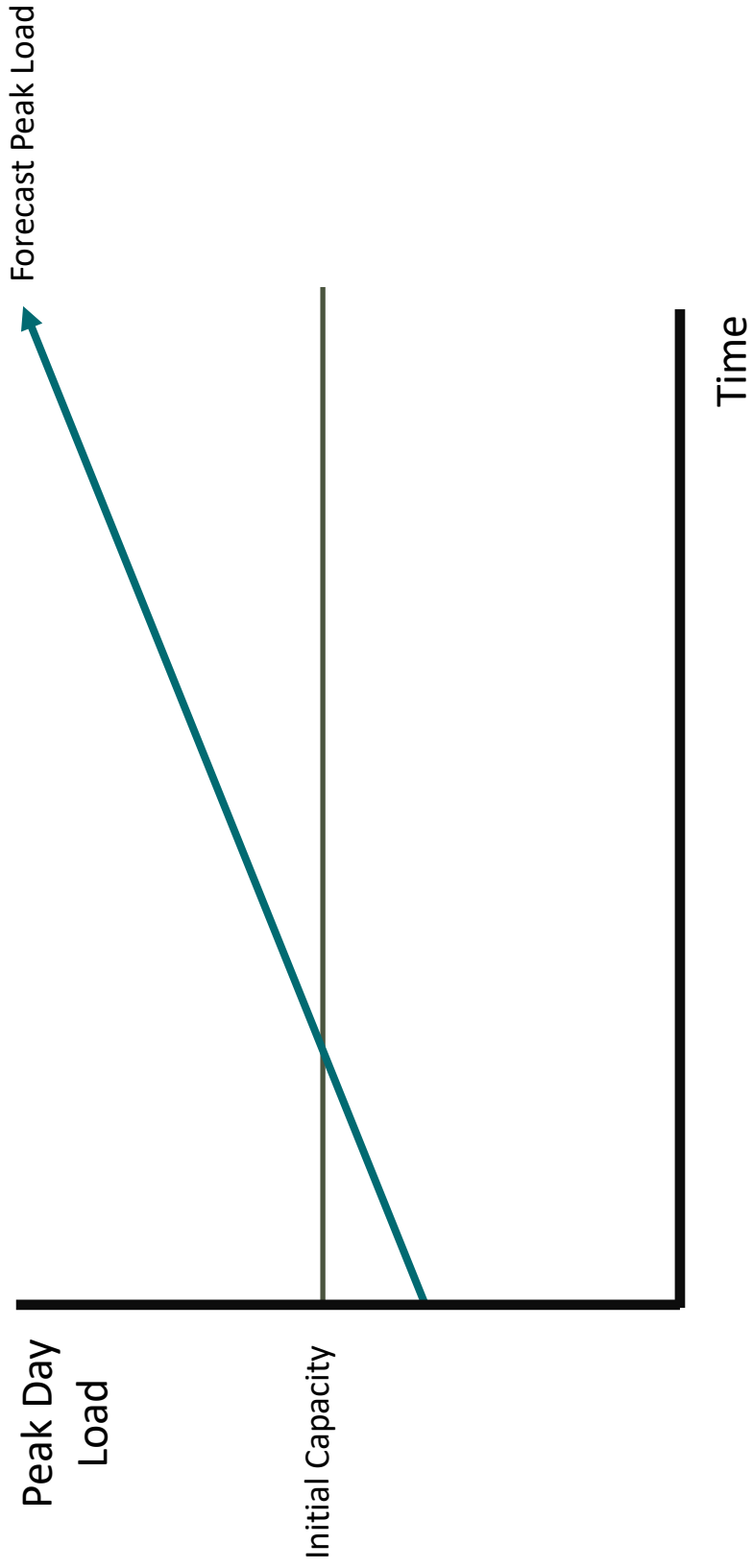

Capacity Modeling

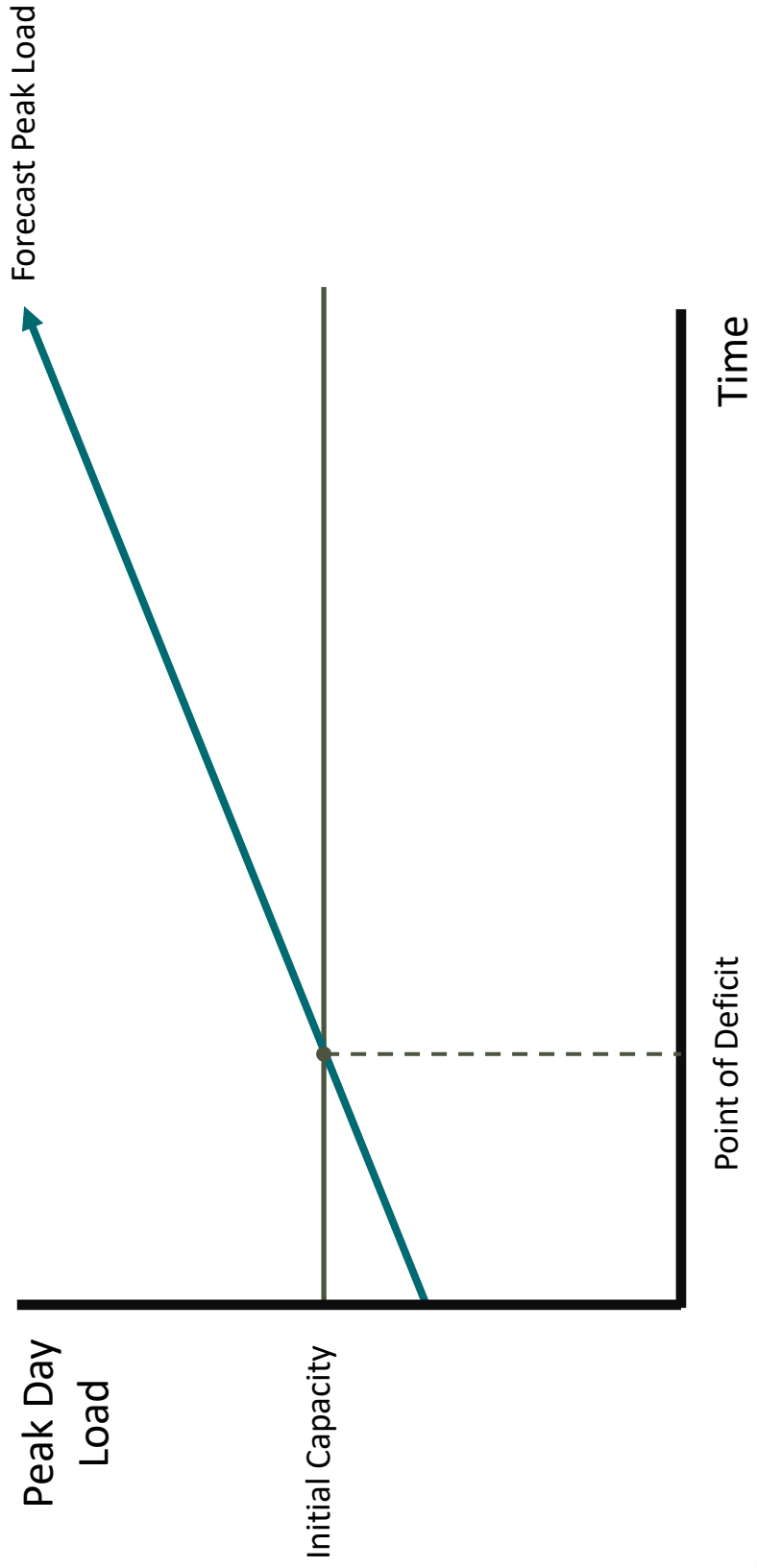

Capacity Modeling

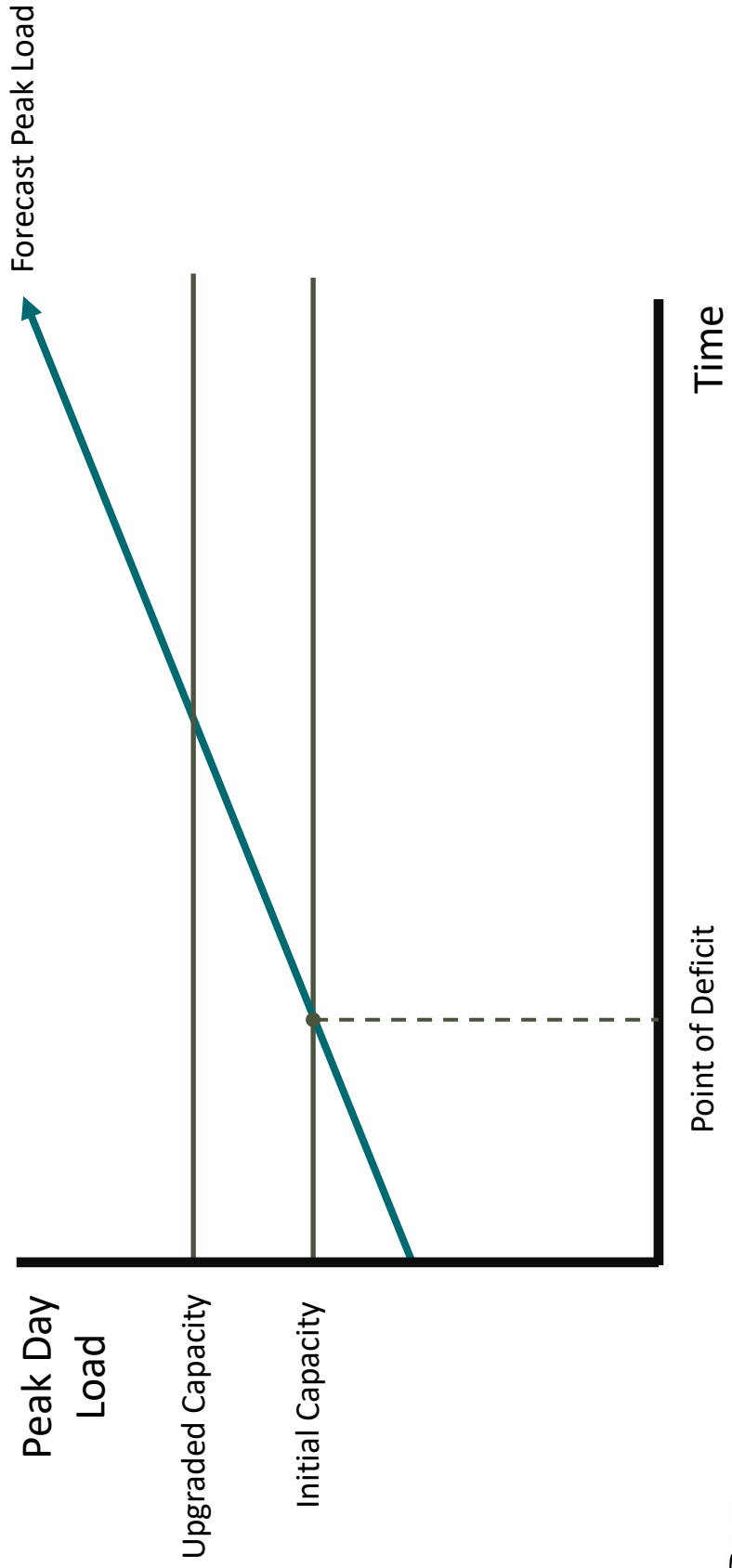

Capacity Modeling

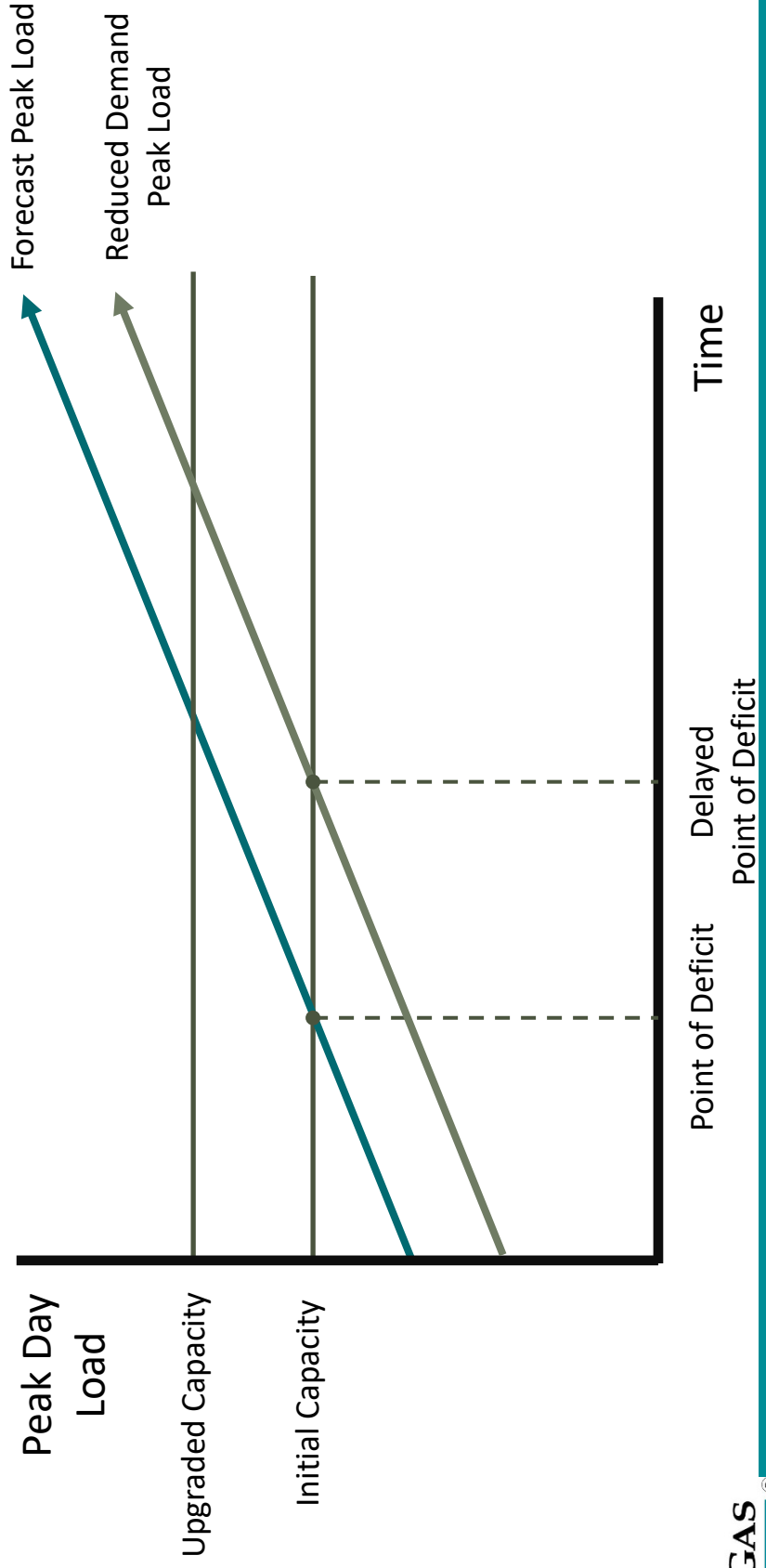

Capacity Modeling

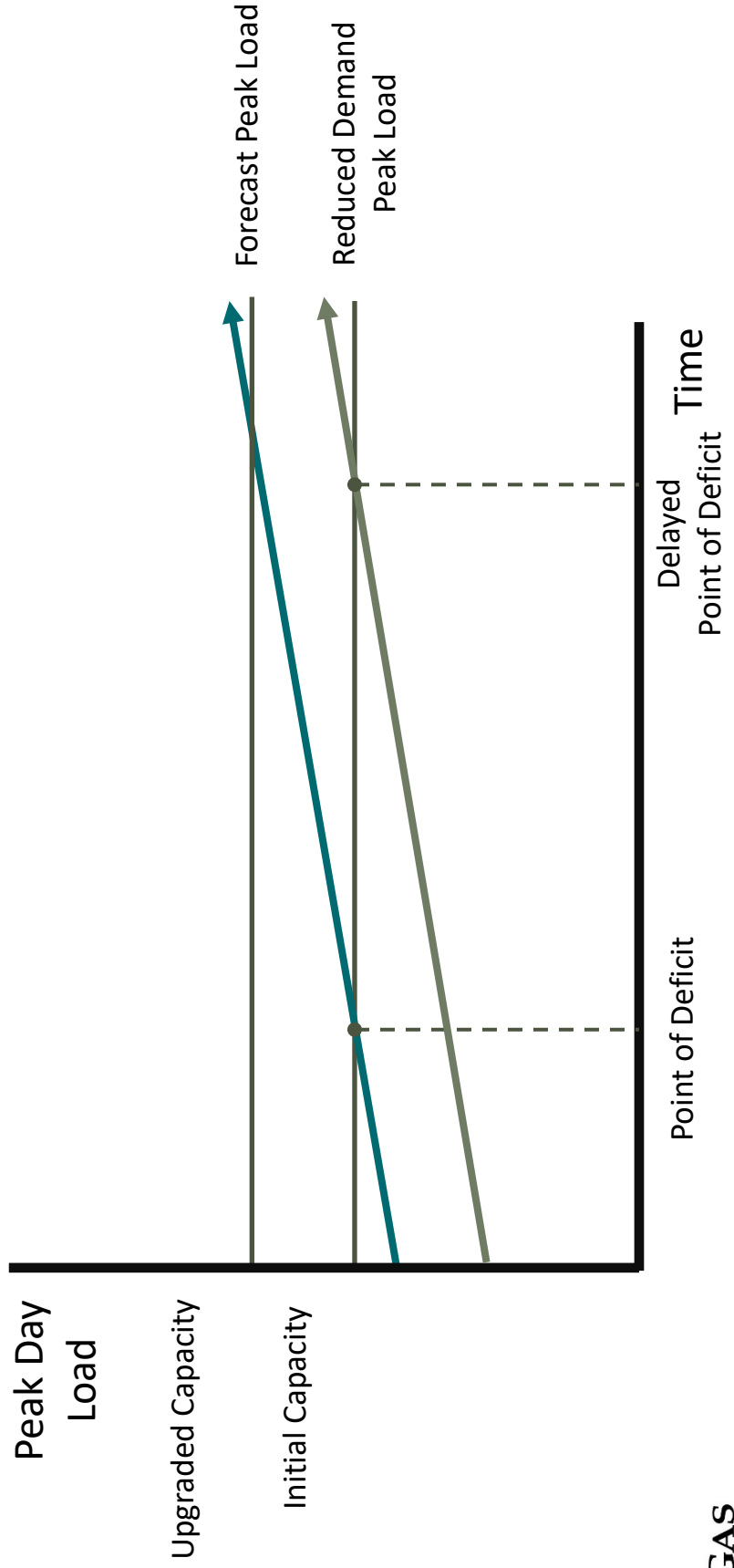

Cost of Capacity Enhancement

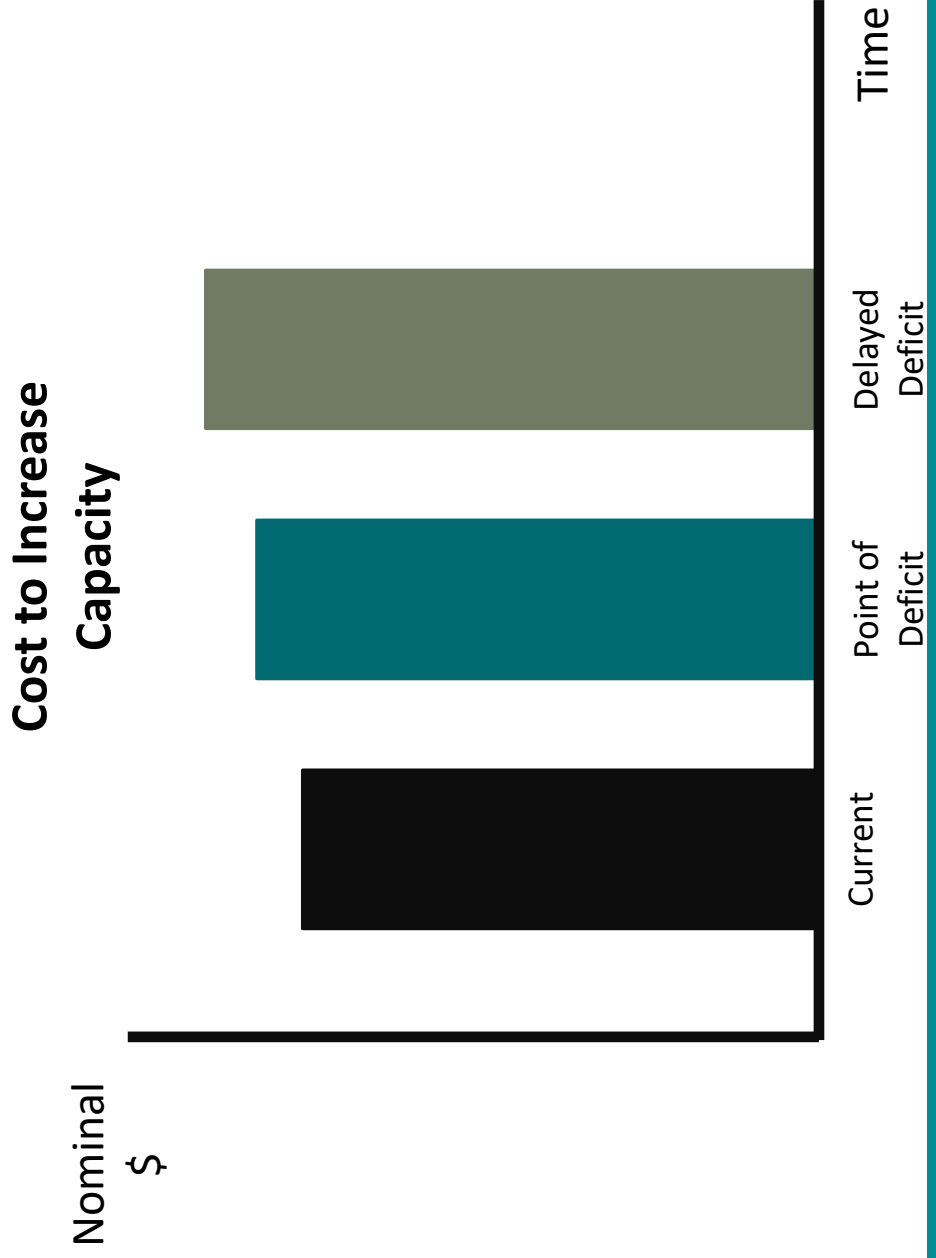

Deferral Valuation

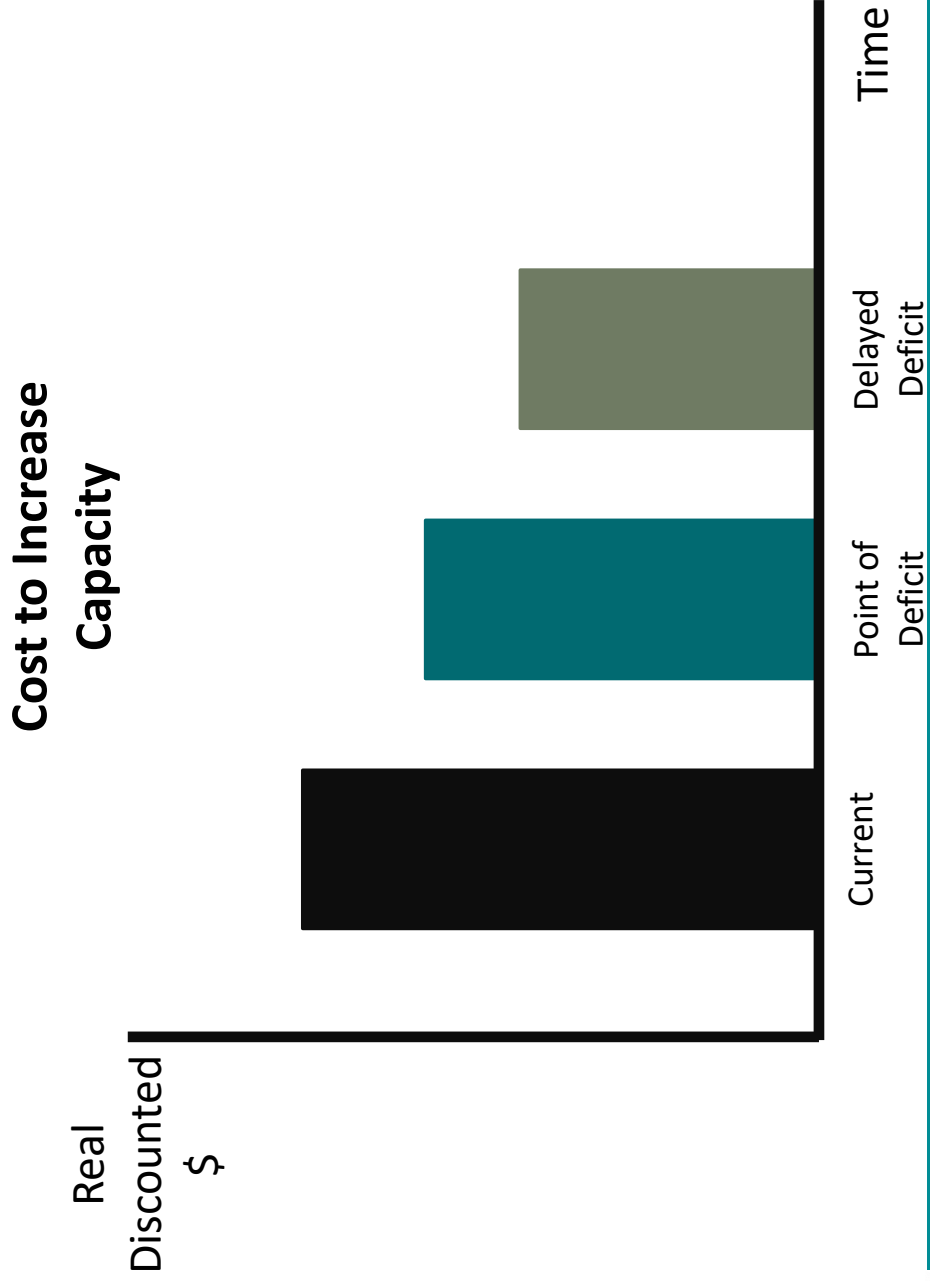

Deferral Valuation

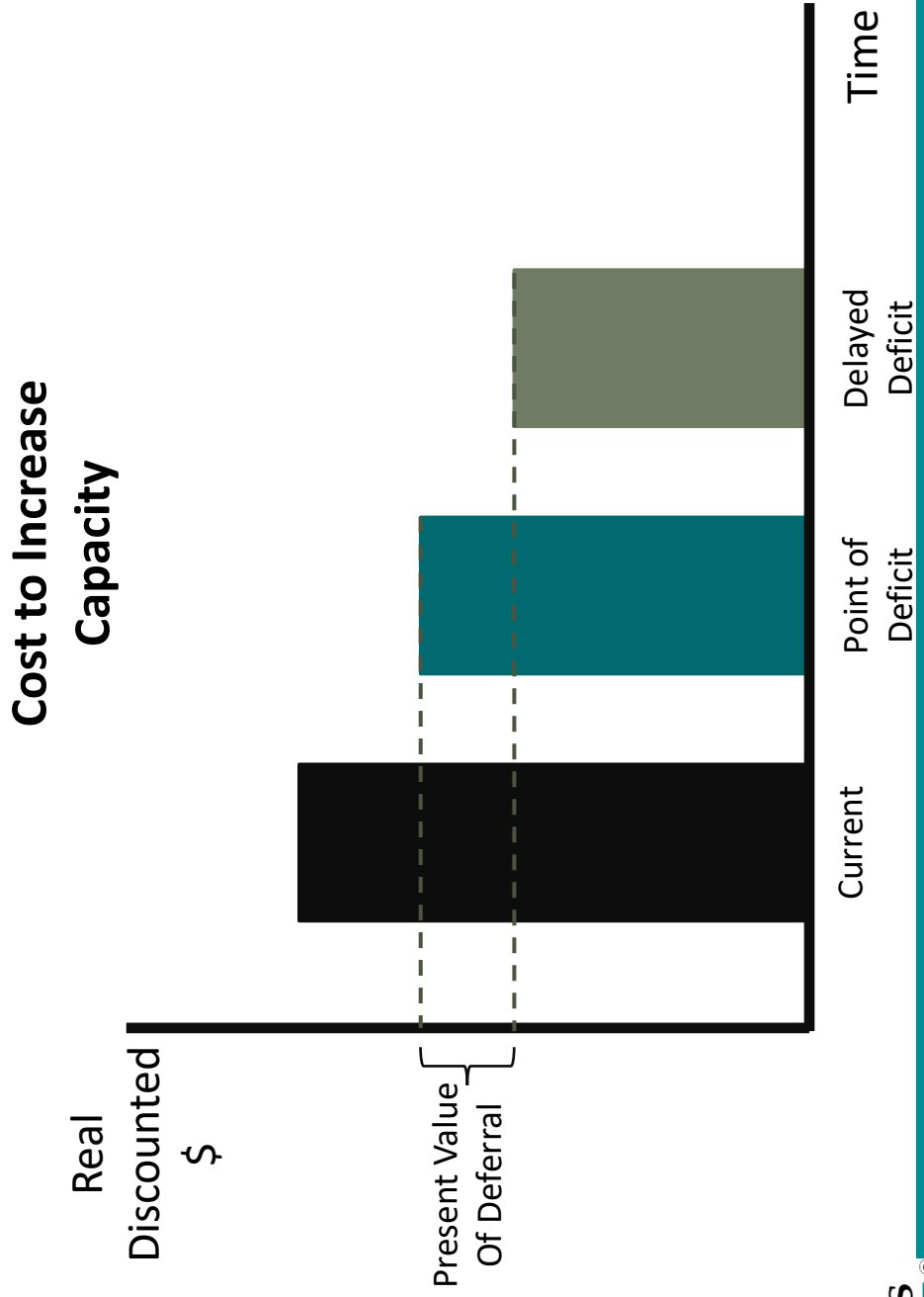

Cascade defines risk premium as the difference between the impacts of a potential extreme upward price movement versus that of an extreme downward price movement.

Due to the lognormal nature of stochastic gas prices, the risk presented from rising prices will typically exceed that of falling prices.

This analysis is used in a risk-adjusted price calculation, where the stochastic risk premium is compared to an annualized deterministic price to calculate the final risk premium.

Methodology – Risk Premium

A Quick Visual: Normal vs. Lognormal Distributions

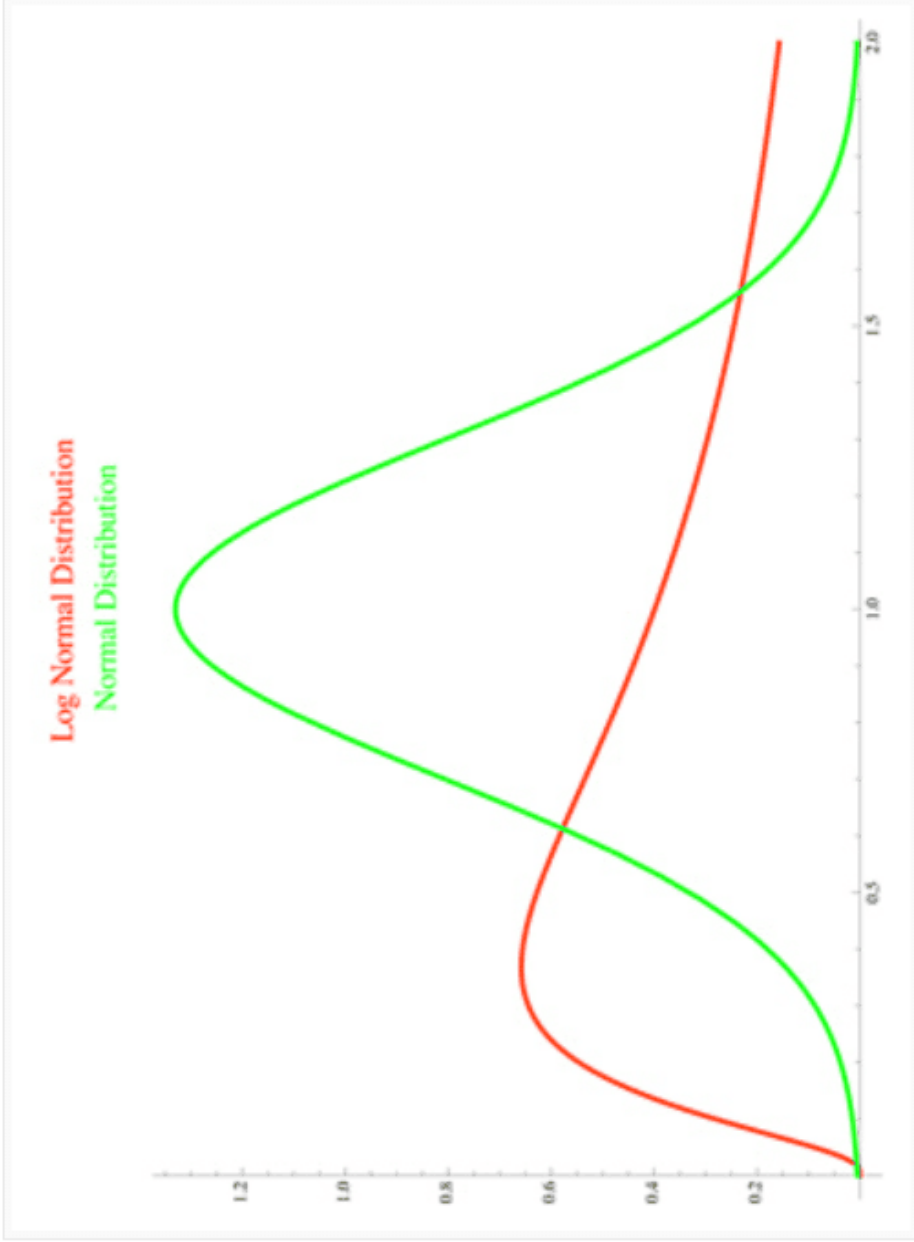

Stochastic Sumas Pricing - 11/1/2023

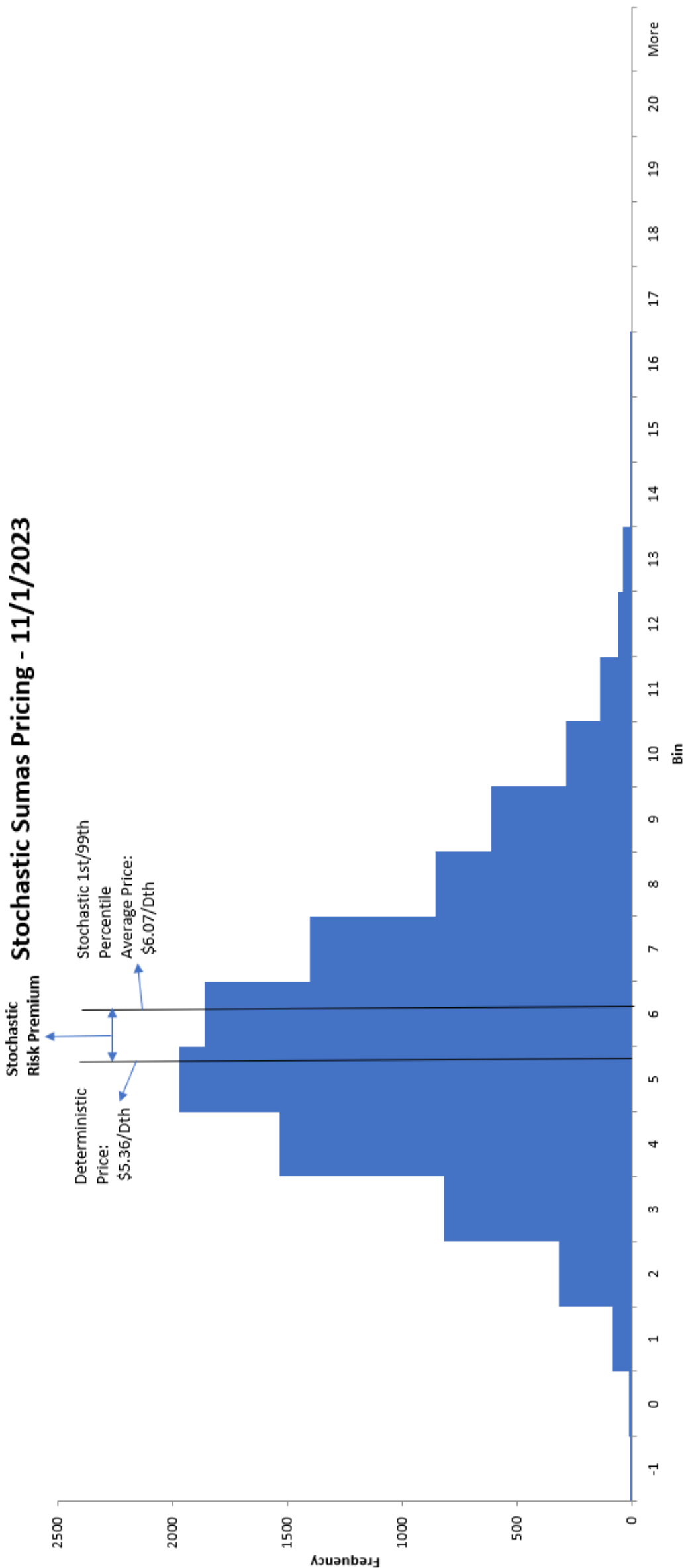

Risk-Adjusted Risk Premium Final Calculation

(Deterministic Price * .75 + (((99th Percentile Stochastic Price + 1st Percentile Stochastic Price) / 2) * .25)) - Deterministic Price

- Captures the difference between expected pricing and a blend of deterministic and stochastic pricing
- This methodology is consistent with other risk-adjusted processes in Cascade's IRP, and informed by the calculations performed by other regional LDCs
- Accurately captures the increasing uncertainty around pricing, as nominal risk premium generally increases over time

2023 IRP Avoided Cost Risk Premium

Year #	Calendar Year	Risk Reduction Value (\$/Dth)
1	2023	-\$0.010
2	2024	-\$0.011
3	2025	-\$0.018
4	2026	-\$0.013
5	2027	\$0.001
6	2028	\$0.014
7	2029	\$0.046
8	2030	\$0.077
9	2031	\$0.175
10	2032	\$0.239
11	2033	\$0.204
12	2034	\$0.146
13	2035	\$0.125
14	2036	\$0.256
15	2037	\$0.235
16	2038	\$0.168
17	2039	\$0.225
18	2040	\$0.263
19	2041	\$0.296
20	2042	\$0.296

Avoided Cost - Conclusion

Cascade is continuing to improve its avoided cost calculation with enhancements to its distribution system and risk premium cost calculations

Cascade's resource planning team has provided its avoided cost figures to the Company's energy efficiency team, who will be sending back a conservation potential assessment based on these inputs.

2023 IRP Remaining Schedule

Process Items	Process Elements	Date
TAG 3 (OR)	Alternative Resources, Price Forecast, Avoided Costs, Current Supply Resources, Transport Issues.	7/14/2022
TAG 4 (WA)	Distribution System Planning, Carbon Impacts, Energy Efficiency, Bio-Natural Gas, Preliminary Resource Integration Results.	8/10/2022
TAG 4 (OR)	Distribution System Planning, Carbon Impacts, Energy Efficiency (ETO), Bio-Natural Gas, Preliminary Resource Integration Results.	9/20/2022
TAG 5 (WA)	Final Integration Results, finalization of plan components, Proposed new 2- to 4-year Action Plan.	9/28/2022
TAG 5 (OR)	Final Integration Results, finalization of plan components, Proposed new 4-year Action Plan.	11/9/2022
Draft of 2022 IRP distributed (WA)	Filing of Draft IRP	11/24/2022
Draft of 2022 IRP distributed (OR)	Filing of Draft IRP	1/5/2023
Comments due on draft from all stakeholders (WA)	Comments due from Stakeholders	1/13/2023
Comments due on draft from all stakeholders (OR)	Comments due from Stakeholders	2/24/2023
TAG 6, if needed (WA)	An additional TAG if needed based on comments from Stakeholders	2/1/2023
TAG 6, if needed (OR)	An additional TAG if needed based on comments from Stakeholders	3/15/2023
IRP filing (WA)	IRP Final Filing	2/24/2023
IRP filing (OR)	IRP Final Filing	4/14/2023



Questions/Next Steps



Review Plans for TAG 4 Discussion

- Distribution System Planning
 - Carbon Impacts
 - Energy Efficiency
 - Renewable Natural Gas
 - Preliminary Resource Integration Results
- Next OR TAG (TAG 3) is Thursday, July 14
 - Next WA TAG is Wednesday, August 10

Contact Information

Mark Sellers-Vaughn – Manager, Supply Resource Planning: (509) 734-4589
mark.sellers-vaughn@cngc.com

Brian Robertson – Supervisor, Resource Planning: (509) 221-9808
brian.robertson@cngc.com

Devin McGreal – Senior Resource Planning Economist: (509) 734-4681
devin.mcgreal@cngc.com

Ashton Davis – Resource Planning Economist II: (509) 734-4520
ashton.davis@cngc.com

Cascade IRP email – irp@cngc.com



In the Community to Serve®

Integrated Resource Plan Technical Advisory Group Meeting #3

JUNE 29, 2022

MICROSOFT TEAMS/TELECONFERENCE



In the Community to Serve®



In the Community to Serve®

TAG #3 WA – TAG Meeting

Date & time: 06/29/2022, 9:00 AM to 12:15 PM

Location: Microsoft Teams Meeting

Presenters: Eric Wood, Brian Robertson, Devin McGreal, & Ashton Davis

In attendance: Abe Abdallah, Ashton Davis, Brian Cunnington, Brian Hoyle, Brian Robertson, Bruce Folsom, Byron Harmon, Caleb Reimer, Carolyn Stone, Corey Dahl, Devin McGreal, Eric Wood, Garret Senger, Jon Storvick, Kary Burin, Kathleen Campbell, Kevin Connell, Kim Herb, Mark Chiles, Mark Sellers-Vaughn, Michael Brutocao, Michael Parvinen, Monica Cowlshaw, Pamela Archer, Stokes Chad, Tom Pardee, & Vincent Morales

Brian Robertson, Supervisor of Resource Planning, opened the meeting by welcoming and thanking stakeholders for participating in Cascade's IRP Process. Brian then proceeded with introductions, the agenda, a safety moment, and a reminder of the stakeholder engagement commitments.

Presentation #1 – Cascade Gas Supply Overview (Eric Wood)

- Eric Wood presented Cascade's current portfolio design along with charts and maps that outline how Cascade currently purchases gas and utilizes storage.
- Eric also provided information on Cascade's current hedge plans.
- Eric gave an update on the RNG project in Bend that Cascade was a successful bidder on.

Question: Byron Harmon asked about the size of the contract.

Answer: Cascade is still working through those details and will share once a contract is finalized.

Question: Kim Herb asked if Cascade would be owning this or purchasing from it.

Answer: At this time, Cascade is looking at owning and operating the facility but that has yet to be finalized.

- Eric then wrapped up his presentation with information on Cascade's winter and peak day supply stacks.

Presentation #2 – Base Case Plexos Modeling (Brian Robertson)

- Brian discussed the change Cascade made from SENDOUT to Plexos as well as the modeling challenges the Company must consider and work through.
- Brian then went into depth about the inputs to Cascade's base model which included: Demand, Supply, Price Forecast, Storage, Transportation, Constraints, and Emissions.

Question: Byron asked if base supply is the cheapest, would it be possible to have an annual sinusoidal base supply that more closely matches the demand curve? Would that be too complicated to contract?

Answer: Cascade explained that it would be difficult to contract but it also may not make sense to contract. The demand curve shown in the TAG slides was smoothed based on normal weather. In reality, the curve is very dependent on weather and varies quite a bit. Contracting at the sinusoidal level may put us in a position where we're oversupplied with warmer than normal weather. Day gas gives the Company flexibility to purchase gas on an as-needed basis.

Presentation #3 – Planned Scenarios and Sensitivities (Brian Robertson and Devin McGreal)

- Brian went through the step-by-step process of Cascade's Supply Resource Optimization Process Flow Chart. This process allows the Company to fully vet multiple portfolios and stress test them with scenarios and sensitivities to come up with a preferred portfolio.
- Devin then went through Cascade's six scenarios and the different aspects of each scenario.

Question: Kim asked about new technologies and if there will be any leveraging any kind of standardization around determining readiness level.

Answer: Devin discussed our scenario modeling where we'll test multiple ranges around the availability of new technologies. These will essentially stress test the readiness levels of new technologies and will allow Cascade do provide qualitative and quantitative analysis on both the assumptions and the potential impacts of these scenarios.

Question: Kim asked about conversations with Energy Trust of Oregon and how anticipated costs with the Climate Protection Program may impact avoided cost.

Answer: Devin mentioned that we follow the guidelines of UM-1893 and does think that it would be a good topic to discuss within that docket. At the moment, Cascade is utilizing the social cost of carbon which is essentially capturing compliance as part of the regulation.

Presentation #4 – Alternative Resources (Ashton Davis)

- Ashton provided insight on alternative resources as well as reasons for needing alternative resources.
- Cascade's alternative resources included incremental transportation, incremental storage, and incremental supply.

Presentation #5 – Price Forecast Results (Devin McGreal)

- Devin provided Cascade price forecast results and touched on recent movement on prices as well as the importance of locking down the price forecast.

Presentation #6 – Avoided Cost (Devin McGreal)

- Devin gave a brief introduction to the purpose of the avoided cost calculation.
- Devin discussed the different aspects of the avoided cost formula.
- He then provided a reminder on the parts of the avoided cost formula that remain unchanged from the previous IRP.
- Devin then dove into the two items that saw significant changes to the avoided cost formula; the distribution system cost and the risk premium.

Presentation #7 – 2023 IRP Schedule (Brian Robertson)

- Brian went through the remaining TAG schedules for both WA and OR.
- Brian noted that the next TAG meeting will be Oregon focused and take place on July 14.

The Meeting was Adjourned

Per Cascade Commitment #8 (Stakeholder Engagement Design Document, 2/22,2022: “Provide TAG minutes that include the action items from bullet #7 as well as any upcoming deadlines for feedback on the IRP”), here are additional action items to track, coming out of the TAG 3 meeting:

1. For the Oregon TAG 3 meeting, Cascade will provide information on gas bans related to the Oregon service territory. More specifically, the Bend Community Climate Action Plan.



In the Community to Serve[®]

Integrated Resource Plan (WA) Technical Advisory Group Meeting #4

AUGUST 10, 2022

MICROSOFT TEAMS/TELECONFERENCE



In the Community to Serve[®]

Agenda

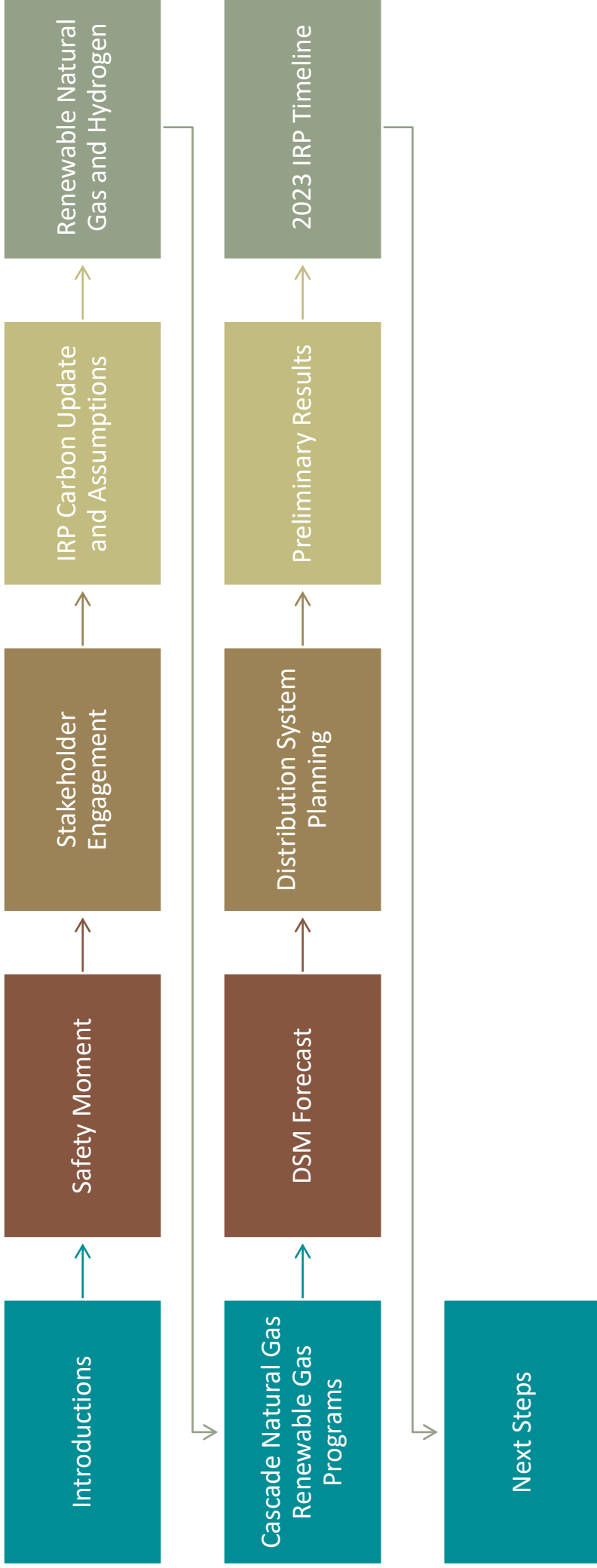

Safety Moment

Preventing Eyestrain

The National Safety Council provided several tips to take to avoid strained and tired eyes.

- Keep your screen at arm's length.
- Don't forget to blink.
- Take a break every 20 minutes by looking away at something at least 20-feet away for at least 20 seconds.
- Be mindful of lighting and glare.
- Make sure your screen isn't too bright.
- Adjust computer monitor properly.
- Increase your computer's type size.

https://www.nsc.org/Portals/0/Documents/Membership%20Site%20Document%20Library/2018_Materials/Digital%20Signage/Prevent-Eyestrain.pdf?ver=2019-06-17-171635-500

<https://www.nsc.org/LinkClick.aspx?fileticket=FTZXV6bFDp%3d&portalId=0>



Stakeholder Engagement¹

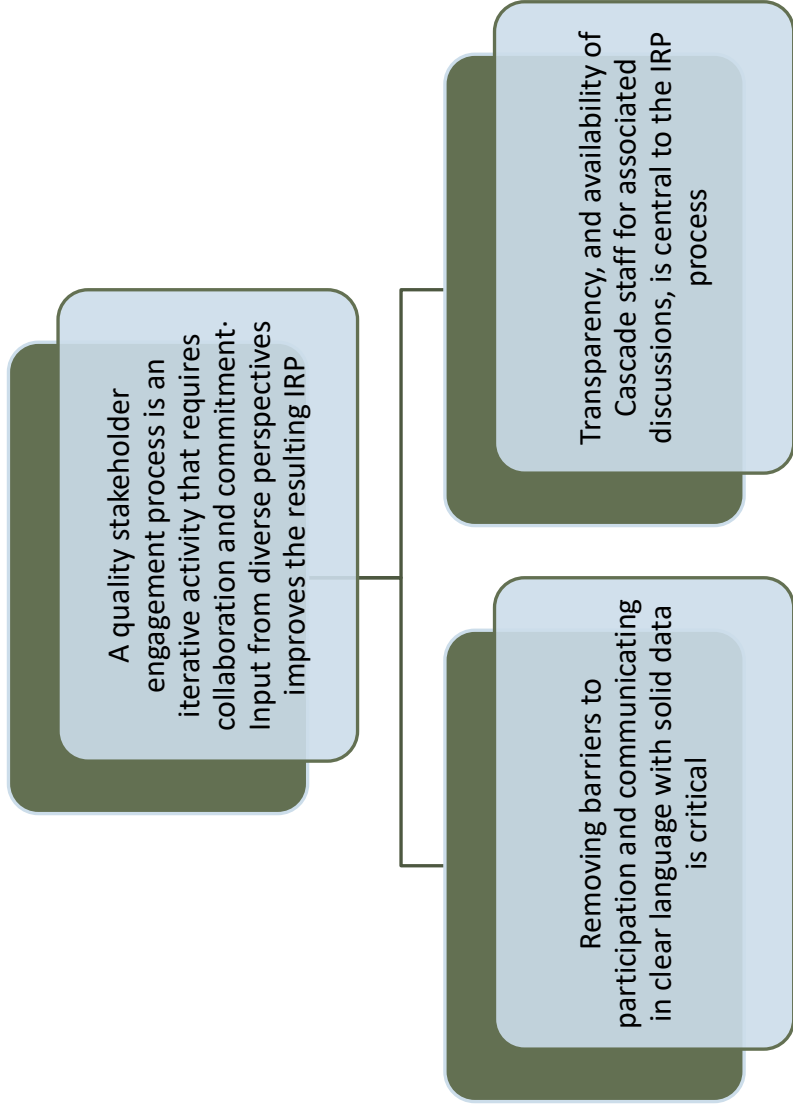

What is a Stakeholder?

Customers and the general public participating in the IRP process are called Stakeholders. Stakeholders also include the professional analytical staffs of the state utility commissions and groups representing residential and industrial customers. Further, community-based organizations and independent experts attending the series of meetings.

IRP Carbon Update and Assumptions



In the Community to Serve®

Topics to Cover

Cascade's commitment to reducing emissions

- Current Baseline Customer Emissions
- Emissions Reductions

GHG Policy

- Climate Commitment Act
 - Ways to offset emissions
- The local focus
 - Bellingham
 - Whatcom County
 - Bend
- National focus

Different policies between WA and OR

Cascade's Washington Compliance Plan

Upstream Methane Emissions Factor

Next Steps and Conclusion



Cascade's commitment to reducing emissions

As an energy provider proudly serving Washington and Oregon, Cascade Natural Gas has an important role to play in securing a lower carbon future for the Pacific Northwest. Natural gas remains the cleanest option to meeting the region's peak energy demand. This means keeping Cascade's system reliable and affordable for customers while helping communities meet their GHG emission reduction targets.

Communities and agency programs focused on emissions reductions for Cascade include: Bellingham, Bend, Whatcom County, Washington Climate Commitment Act and Oregon Climate Protection Program

Environmental Policy:

The Company will operate efficiently to meet the needs of the present without compromising the ability of future generations to meet their own needs. Our environmental goals are:

- *To minimize waste and maximize resources;*
- *To be a good steward of the environment while providing high quality and reasonably priced products and services; and*
- *To comply with or surpass all applicable environmental laws, regulations and permit requirements*

Projected Baseline Emissions

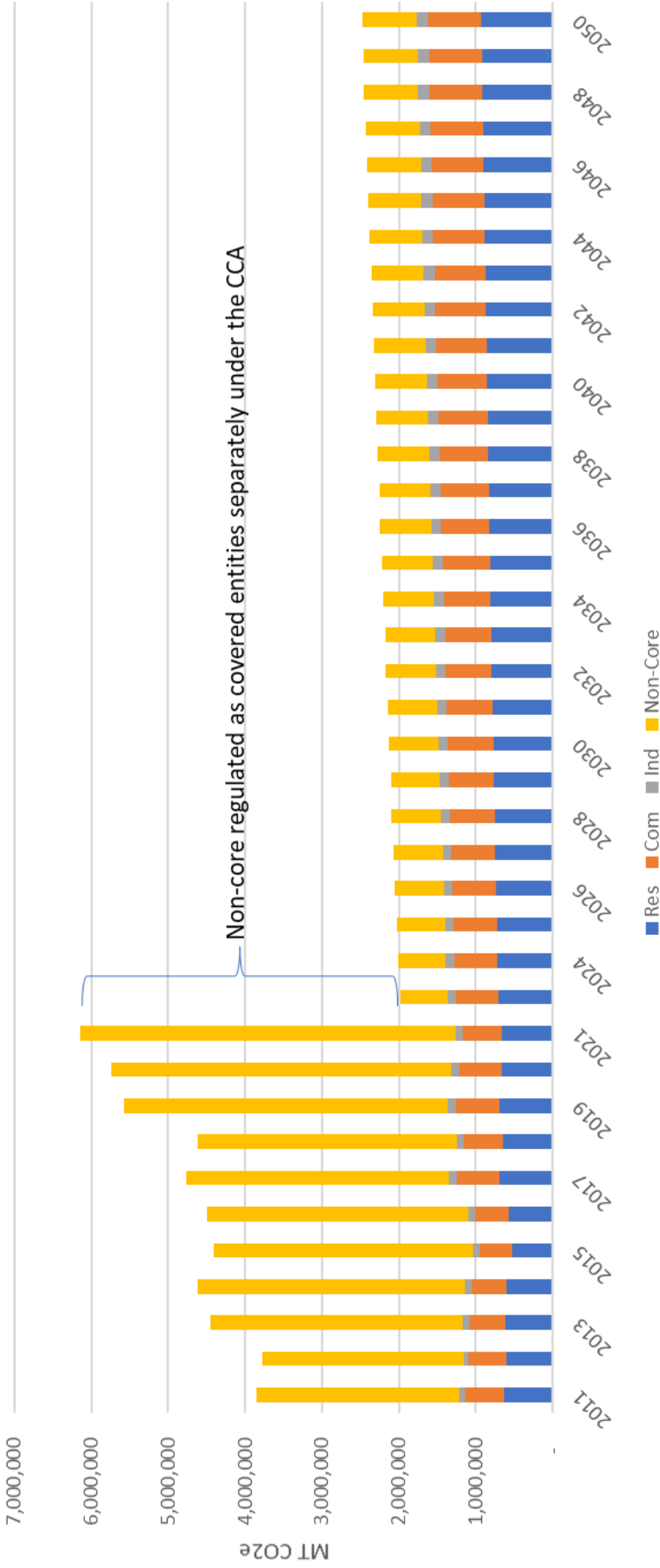

Projected Emissions for CCA Compliance for Cascade's IRP Baseline

Reducing Customer Emissions

Energy Efficiency and Conservation/DSM

- Increasing focus on energy efficiency and benchmarking (HB-1257)
- Commercial program adaptation to meet increased goals

Renewable Natural Gas

- Cascade is engaged in discussions with developers on several projects.
- RNG deliveries could start by mid to late 2024.

Annual EE and Conservation/ DSM Savings	WA		OR	
	therms	MT CO2e	therms	MT CO2e
2019	760,956	4,038	499,135	2,648
2020	659,176	3,498	427,060	2,266
2021	1,243,223	6,597	525,372	2,788

Emissions from Natural Gas Distribution Operations

Cascade’s methane emissions from pipeline infrastructure and GHG emissions from combustion equipment

- Distribution system methane emissions and compressor station emissions reported to the Dept of Ecology equals about 24,000 to 25,000 metric tons of CO₂e.
- EPA recently announced amendments to Subpart W reporting, proposing emission factor updates and reporting of “other large release events” starting in reporting year 2023. EPA defines the release events as releases of ≥250 MT CO₂e (~500,000 scf of pipeline quality natural gas).
- With other operational emissions added to our inventory, we expect total annual emissions between 35,000 to 48,000 metric tons of CO₂e.
- Cascade’s methane emissions rate is in the range of 0.06% and 0.10% (% of volume of methane emitted per total methane throughput volume).

Reducing Operations Emissions

Cascade is committed to methane emissions reductions

- Cascade became a founding member of EPA's Natural Gas Star Methane Challenge Program in March 2016 participating in Excavation Damages Prevention category
 - Created Public Awareness Coordinator position and implemented a Damage Prevention Program
 - Actively participating in 811, Common Ground Alliance, local underground utility coordinating councils, and damage complaint programs in Washington and Oregon.
 - Analyze excavation damages and report data to EPA
- Created a more robust inventory of GHG emissions in all operational areas for 2022 and ongoing
 - Example is expansion of internal reporting of gas losses to include much smaller non-hazardous releases
- Cascade mitigates methane leaks, and has adopted a program to quickly address even small leaks that are not considered a public safety concern
- Exploring more ways to reduce emissions in normal operations, including the use of methane capture technology for pipeline blowdowns

Reducing Operations Emissions

System Integrity Projects

- Since 2012, Cascade has replaced over 98 miles of early vintage steel pipe with new steel or polyethylene pipe in Washington and over 45 miles in Oregon.
- Cascade is better positioned than most US utilities as it has no unprotected steel pipeline and no cast iron pipe

Climate Commitment Act

Program establishing a declining cap on GHG emissions from covered entities consistent with the limits established in RCW 70A.45.020, and a program to track, verify, and enforce compliance with the cap through the use of compliance instruments.

Anthropogenic GHG Emissions Reductions:

- Achieve 1990 levels (90.5 million metric tons) by 2020
- 45% below 1990 levels (50 million MT) by 2030
- 70% below 1990 levels (27 million metric tons) by 2040
- 95% below 1990 levels (5 million metric tons) by 2050

Covered Entities:

- Fuel suppliers, natural gas distribution, electric utilities, and large facilities.
- Landfills and certain emissions intensive and trade exposed (EITE) entities are added in during 2nd and 3rd compliance periods.

Climate Commitment Act

Cascade's regulated emissions:

- Customer Emissions – about 2,000,000 metric tons CO₂e in 2023
 - All core customers
 - Non-core customers that are not covered entities under the CCA (= / > 25,000), and excludes customers that may "opt-in" to program individually or that may petition to be emissions-intensive and trade exposed (EITE).
- Operations Emissions – about 24,000 to 25,000 metric tons CO₂e
 - Methane leakage
 - Fuel combustion from >5 mmbtu sources (e.g. compressor stations)

Climate Commitment Act

Baseline

- 2015-2019 average

No Cost Allowances for Natural Gas Suppliers

- See chart

Allocation of No Cost Allowances

- 2023 – proposed allocation by September 1, 2023
- 2024 and thereafter, allocations made in October of prior year

Cascade's Projected Trajectory of No Cost Allowance Allocations (Metric Tons)

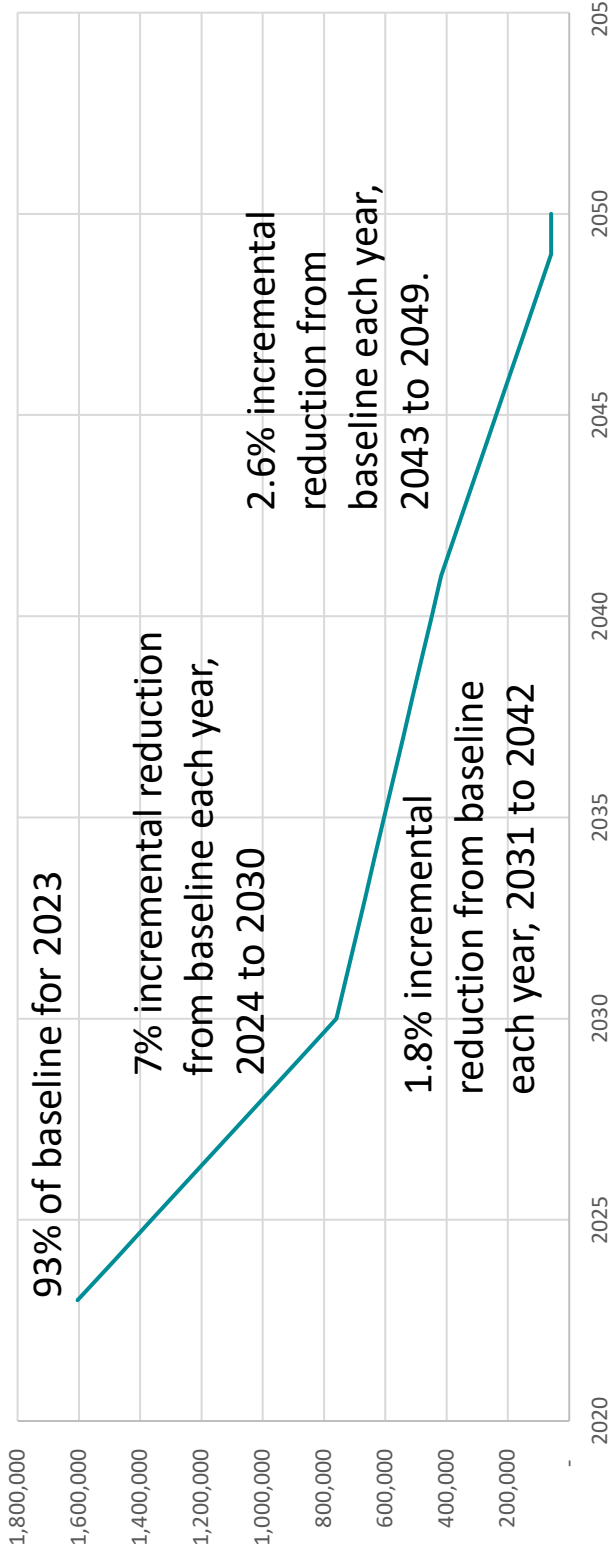

Climate Commitment Act

Rule Requirements Commence on January 1, 2023

4 Year Compliance Periods

- 2023-2026, 2027-2030, 2031-2034, ...

Compliance Demonstrations

- Full compliance demonstrations required by Nov 1 of the year following the end of a 4-year compliance period
- Interim compliance period demonstrations by Nov 1 annually of 30% of prior year's emissions.

Quarterly Auctions Commence 2023

Climate Commitment Act - 2023 Example Auction Schedule

- Update registration 40 days prior to auction.
- Submit auction registration 30 days prior to auction.
- Consultants make disclosures 15 days prior to auction.
- Ensure compliance 12 days prior; Ecology sends approval.
- Issue payment within 7 days of Ecology Notice

Same process for each qtrly auction

Ecology distributes 2023 no-cost allowances - September 1, 2023

Ecology distributes next years' no-cost allowances by October 24 annually

Ecology announces next years' allowance prices 1st bus. day in Dec.

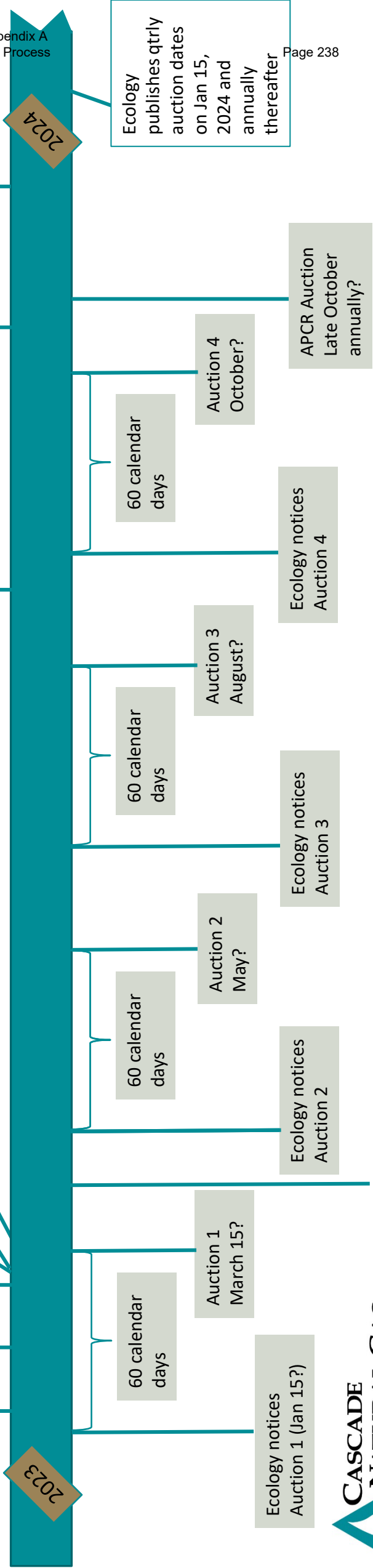

Ecology publishes qtrly auction dates on Jan 15, 2024 and annually thereafter

APCR Auction Late October annually?

45 days after each auction, Ecology provides auction summary.

CCA Compliance Options

Renewable Natural Gas

- One for one replacement of fossil gas.

Allowances

- Bid for allowances in quarterly auction

Offsets

- Limit use to 8% of compliance obligation in first compliance period, 6% thereafter.

Energy Efficiency and Conservation/Demand-side Management

Hydrogen

- Future option

CCA Compliance Options

RNG limits in Cascade’s modeling are based on the Company’s potential share of RNG projected values in 2019 AGF/ICF Study.

- The 2019 AGF study provides RNG potential by 2040 by RNG type, and adoption curves for the various types of RNG are then used to generate acquisition curves for each resource

Cascade’s position is that the constraining factor for maximum hydrogen acquisition will be the amount that can be safely blended with geologic gas

- According to a technical report by the Gas Technology Institute, “If less than 20% hydrogen is introduced into distribution system the overall risk is not significant for both distribution mains and service lines.” Also, the National Renewable Energy Laboratory’s research findings indicate adding hydrogen blends at 20% or less to existing natural gas pipeline systems would result in only minor increases in safety risk
- This is a volumetric quantity. Hydrogen burns at a lower heating volume, and all modeling is done in therms (energy) vs. volume. The adjusted safe blending quantity of hydrogen energy is approximately 7.4%

CCA Resource Projections

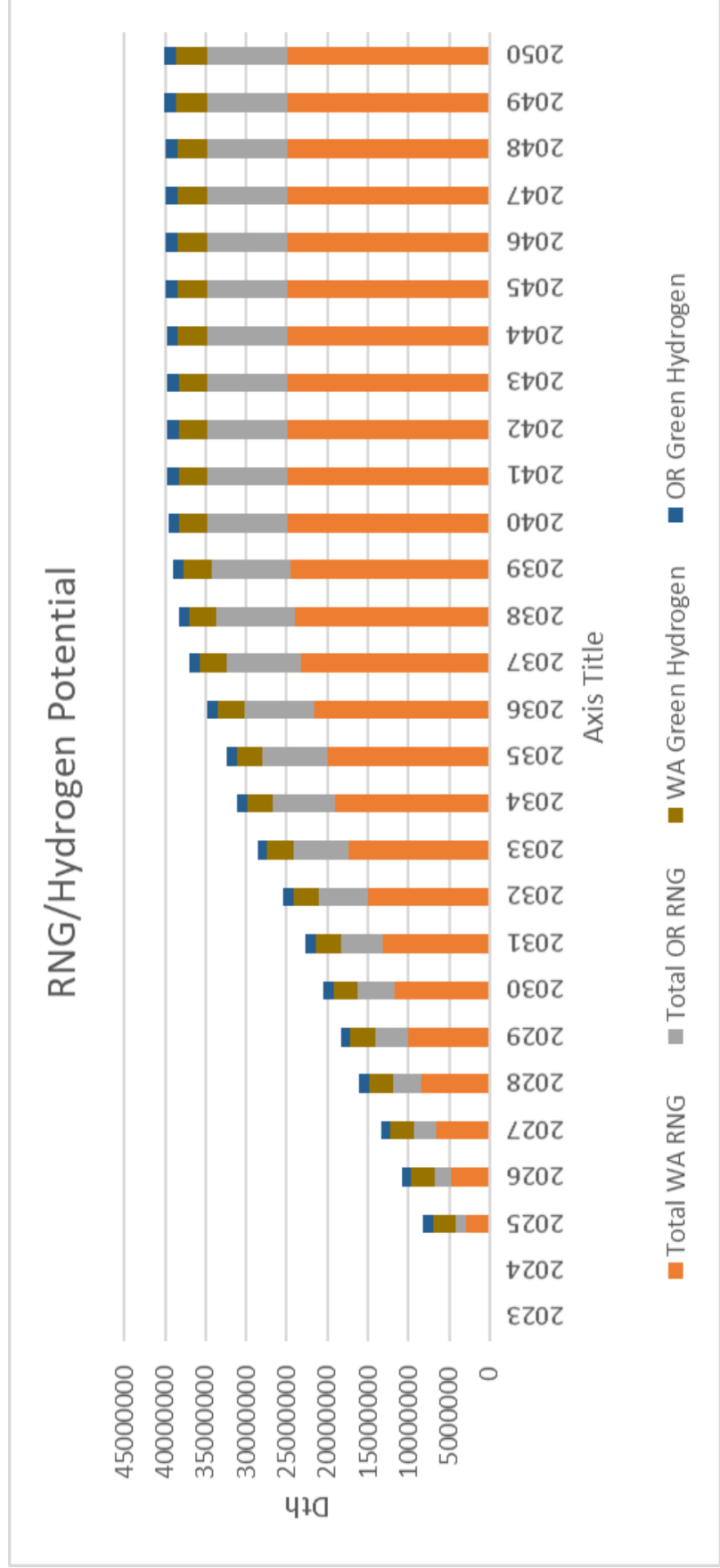

City of Bellingham

Bellingham City Council passed an ordinance on Feb 7, 2022, which requires electric space and water heating equipment for new commercial and large (4+ story multifamily buildings) buildings. It also requires incremental improvements in EE (building envelope, lighting, insulation) and solar installation or readiness in new buildings.

The electric-only mandate for space and water heating does not apply to single family construction, detached houses, duplexes, townhomes or row houses.

The ordinance takes effect August 7, 2022.

Cascade is running sensitivity analyses based on the new limitations to the use of natural gas in new buildings. Cascade pulled historical data from the 2017-2021 to see which customers would have been affected if this ban took place earlier. The result was approximately 50 customers per year. Cascade decremented customer counts by 50, cumulatively, each year for the forecast.

City of Bellingham

The City of Bellingham continues to work on the design of a Climate Action Fund. Preliminary drafts indicate that this would be treated as a property tax and would direct funds towards electrification, among other efforts. Following the City Council and Mayor expressing reservations about the design and timing of the plan it was announced they will delay putting the measure on the November ballot.

Whatcom County

On July 27th, 2021, Whatcom County voted to ban the construction of new refineries, coal-fired power plants and other fossil fuel-related infrastructure

This does not constitute a gas ban but may have impacts on distribution system enhance projects if needed in Whatcom County.

City of Bend

Aspirational goal to reduce GHG by 40% by 2030 based on 4 areas of focus:

- Energy Supply
- Transportation
- Energy in Buildings
- Waste and Materials

There isn't a specific carve-out for what Cascade is required to do for this action plan. However, Cascade's representative on the original Climate Action Steering Committee (CASC) helped identify pathways for gas to support the City goals through development of an offset program and a biodigester plant. Regulatory is working on offset programs and Cascade was awarded Bend landfill RFP.

The City's current Environment and Climate Committee is having preliminary discussions about the role of gaseous fuels as part of a decarbonized future. Cascade intends to share information on its emerging RNG efforts and overall renewable gas potential as appropriate.

National Focus

US Dept of Energy is in process of holding a proposed rulemaking for energy conservation standards for commercial water heating equipment. This rulemaking may result in impacts to baseline equipment used to determine the Company's Energy Efficiency portfolio.

The US Dept of Energy has also launched a notice of intent for funding opportunities for Clean Hydrogen Programs associated with the Bipartisan Infrastructure Law. Cascade is monitoring opportunities for partnerships in this sector across the states we serve.

EPA recently announced amendments to Subpart W (O&G segment) operational GHG emissions reporting, proposing emission factor updates and additional reporting of "other large release events". These changes are proposed to be effective starting in reporting year 2023. Comments are due this fall with final rule by end of year.

US Supreme Court issued its decision July 1st on *West Virginia v. the EPA*, ruling on the extent of EPA's ability to regulate carbon emissions from power plants. EPA is expected to propose new GHG regulation on existing electric generating units in 2023 considering the court's decision. Future rulemaking could result in additional low carbon fuel requirements for new and existing electric generation.

US Senate Bill - Inflation Reduction Act of 2022 was released in late July, which includes climate change investments to promote decarbonizing the economy. A Methane Emissions Reduction Program is included in the bill and would require fees or investments in reducing methane leaks from production and distribution of natural gas.

Differing Policy Between WA and OR

Emissions Compliance Option Differences	WA CCA	OR CPP
RNG - Environmental Attributes	?	X
RNG – Biogas with Associated Environmental Attributes	X	X
No Cost Allowance Allocations	X	X
Auctions for Additional Allowance Purchases	X	
Allowance trades between covered entities		?
Environmental Offsets	X	
Community Climate Investment Credits (CCI Credits)		X
Energy Efficiency and Conservation	X	X
Hydrogen	X	X

Differences with compliance options across the states we serve are anticipated to create some challenges with compliance planning.

Limiting RNG to demonstrating contractual delivery is misaligned with other states’ determinations and overlooks recognition of how electric RECs are considered and other state agency recognition of RNG compliance use.

New Cascade Calculation Methodology - 2023 IRP

Equation: $Emission Rate_{Total} = Upstream Emission Rate_{CO_2e} + Customer Emission Rate_{CO_2e}$

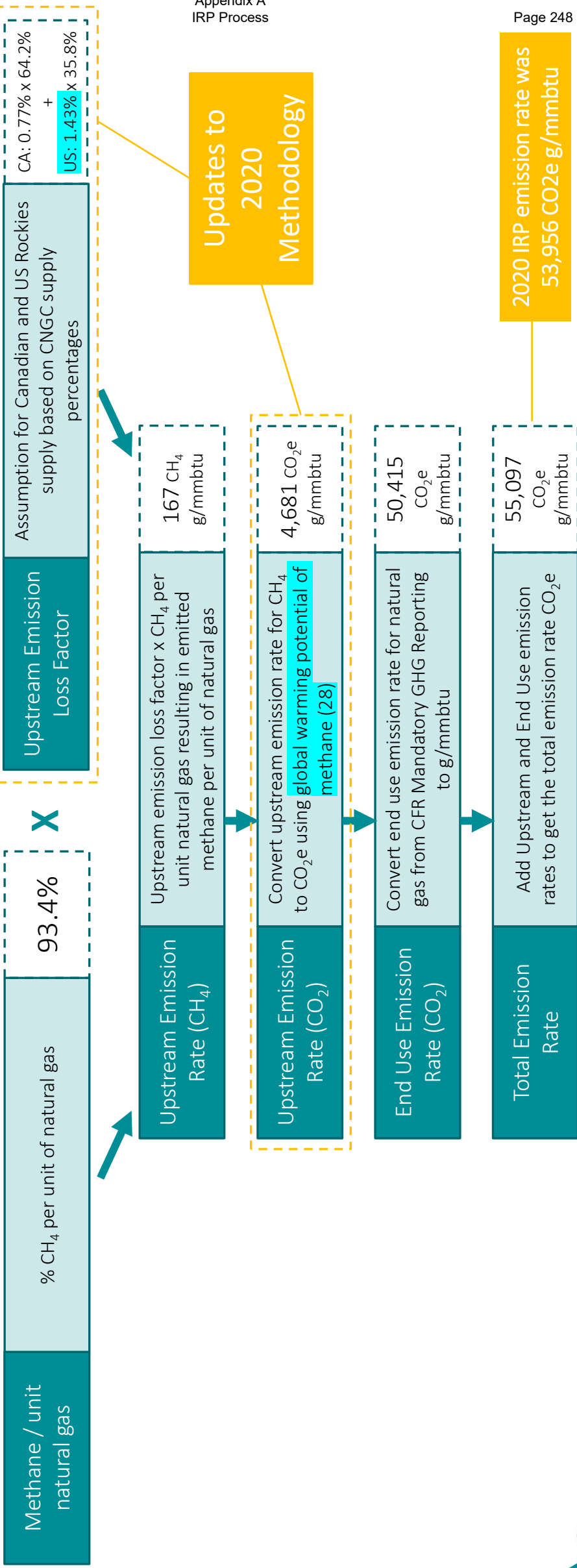

Calculation Updates

- 1. Update Upstream Emissions Rate to 1.43% based on EPA 2017 Emission Year (gas system only)**
 - Our current 1.00% upstream emission rate has remained the lowest reported in studies (EDF, IEA, NETL, and EPA GHG Inventory 2017 Emission Year) according to methodology applied by the NW Power & Conservation Council. **Re-evaluation of the studies appears to support a recommended increase in the upstream emissions rate to at least the 2017 EPA GHG Inventory Estimate of 1.43%.** This is within the range of the NETL Life Cycle Model Study and 0.08% below the IEA 2019 rate estimate.
 - A highlight of these studies was identifying the challenge of tracking methane emissions in the gas supply chain. **One potential option for Cascade to account for difficulties in emissions tracking through all of the studies is to integrate a *scenario modeling* approach, which could include the 2.47% rate as a *high emissions* scenario.**
- 2. Update the GWP of Methane to 28**
 - While international reporting standard under the United Nations Framework Convention on Climate Change currently requires the use of the GWP values from IPCC's AR4 (25), **the GWP estimates presented by the most recent IPCC scientific assessment reflect the current state of science.** In the IPCC AR5 Synthesis Report, this value is 28.
- 3. Maintain value for % Methane in Natural Gas**
 - The 93.4% methane in natural gas is in line with EPA estimates of 95-98% and therefore, can be maintained. We will periodically review and update this if our sourced natural gas would indicate differently.

Reasoning Behind Calculation Updates

While Cascade recognizes upward pressure on upstream emission rates as new evaluation methods arise, we do not believe it is appropriate to move forward with the results of a single study when several other recent studies from reputable sources have not corroborated that result.

- EDF Methodology
 - **Claim:** Current inventory methods miss emissions that occur during abnormal operating conditions, and improvement of these methods could improve and verify international inventories
 - **Response:** Accurately measuring methane remains challenging and requires more frequent, regular sampling, and potentially more satellite-based methane tracking. Cascade will continue to track new methane monitoring approaches and monitoring standards as they are developed but will currently defer to a stronger consensus of upstream emissions documentation using multiple reputable sources.

Upstream Emission Rate Comparison¹

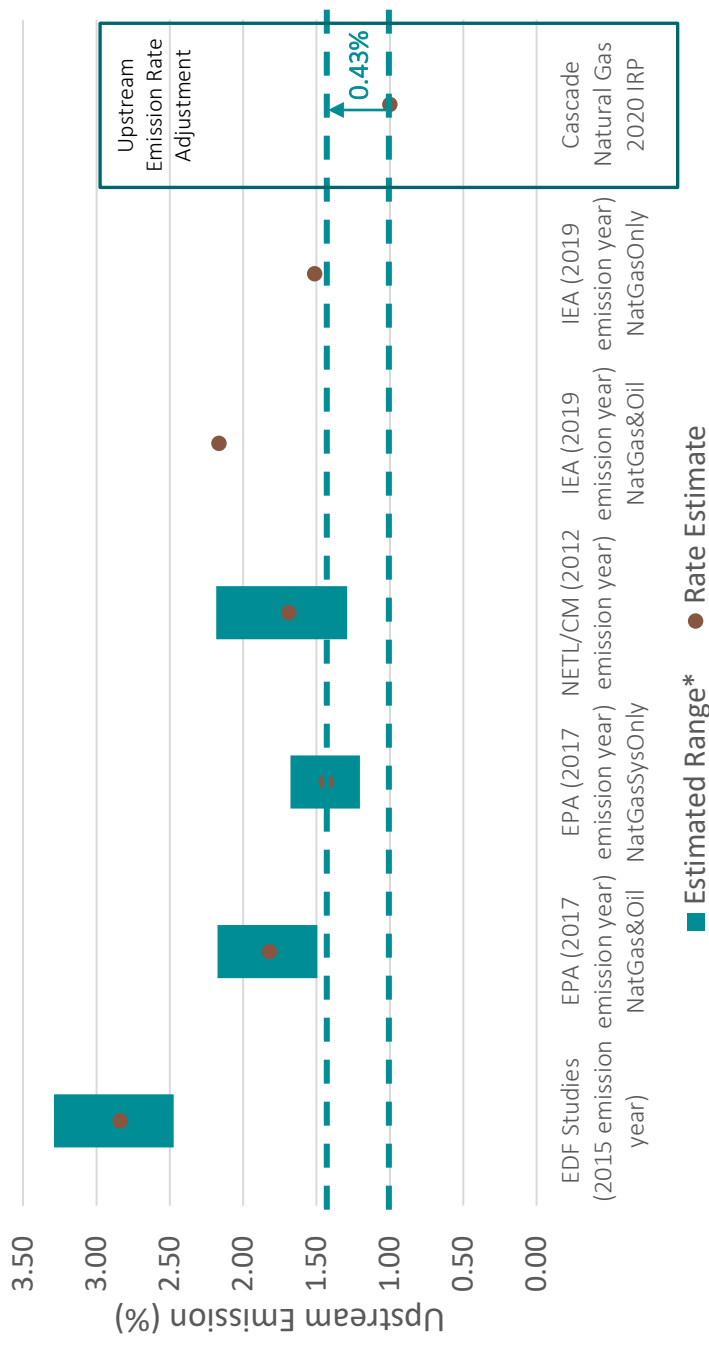

Next Steps

Compliance planning and demonstrations for the WA CCA

- Working UTC and other LDCs on auction revenue distributions for compliance

Cascade continues to pay close attention to National, Regional, and Local policies related to Carbon

Will provide a brief update of the modeling impacts at TAG 5

Renewable Natural Gas

What is Renewable Natural Gas (RNG)?

RNG is pipeline quality natural gas produced from various biomass sources through biochemical processes such as anaerobic digestion or gasification.¹

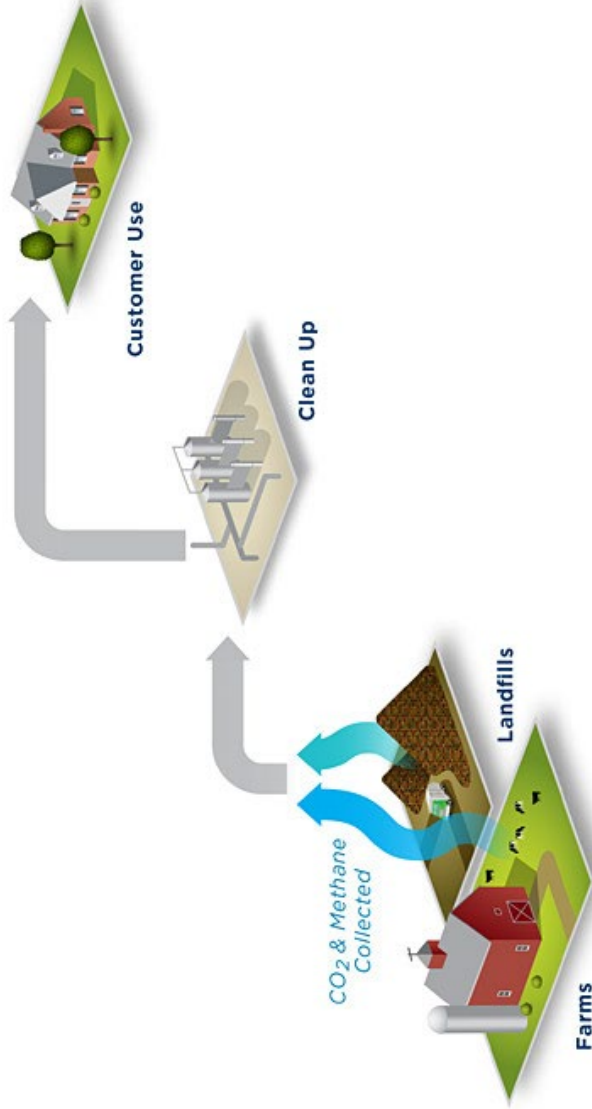

¹ U.S. Department of Energy, Alternative Fuels Data Center, Renewable Natural Gas

Renewable Natural Gas

Examples:

- Biogas from Landfills
 - Collect waste from residential, industrial, and commercial entities.
 - Digestion process takes place in the ground, rather than in a digester.
- Biogas from Livestock Operations
 - Collects animal manure and delivers to anaerobic digester.
- Biogas from Wastewater Treatment
 - Produced during digestion of solids that are removed during the wastewater treatment process.
- Other sources include organic waste from food manufacturers and wholesalers, supermarkets, restaurants, hospitals, and more.¹

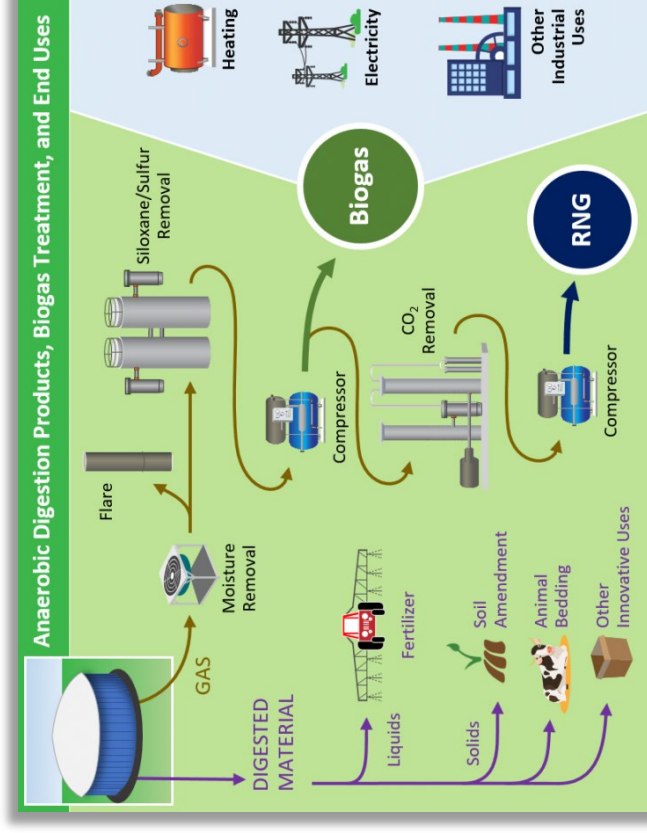

¹ U.S. Department of Energy, Alternative Fuels Data Center, Renewable Natural Gas

Benefits

Fuel diversity benefits – Use of RNG increases and diversifies domestic energy production. RNG can be used as a baseload fuel source with high availability rates. It leverages existing infrastructure such as pipelines and heavy-duty vehicles. Biogas feedstocks for RNG are generated continuously from a variety of sources.

Economic benefits – The development of RNG projects can benefit the local economy through the construction of RNG processing and fueling station infrastructure and sale of natural gas-powered vehicles. National, state and local incentives may be available depending on the end use, such as credits for production of RNG used for vehicle fuel. These financial incentives can provide additional economic drivers for project development.

Benefits

Local air quality benefits – Replacing traditional diesel or gasoline with RNG can significantly reduce emissions of nitrogen oxides and particulate matter, resulting in local air quality benefits. RNG is comprised primarily of methane; compared to fossil natural gas, RNG contains zero to very low levels of constituents, such as ethane, propane, butane, pentane or other trace hydrocarbons.

Greenhouse gas emission reductions – RNG projects capture and recover methane produced at a landfill or anaerobic digestion (AD) facility. Methane has a global warming potential more than 25 times greater than CO₂ and a relatively short (12-year) atmospheric life, so reducing these emissions can achieve near-term beneficial impacts in mitigating global climate change. For facilities that are not already required to mitigate such emissions, an RNG project can reduce methane emissions significantly.

Renewable Natural Gas



Principles of RNG Cost-Effectiveness Evaluation

On the surface, RNG appears to not be cost effective when compared to traditional natural gas, but a number of factors can level the playing field

- Potential hedge value of RNG
- Value of environmental attributes
- Cost savings related to building vs. buying

RNG is a critical resource in Cascade’s projected compliance resource stack related to the CPP and CCA, but must be acquired prudently

When not deemed cost effective, RNG acquisition may still be desired under certain regulatory exceptions (Oregon SB 98)

Cascade’s Cost Effectiveness Formula

$$C_{RNG} = I_{RNG} - AC_U - AC_D + \sum_{T=1}^{365} (P_{RNG} + VC - CIF) * Q$$

$$C_{Conventional} = \sum_{T=1}^{365} (P_{Conventional} + VC) * Q$$

Where

- C_{RNG} = The all-inclusive annual cost of a proposed RNG project
- I_{RNG} = The annual required investment to procure a proposed RNG resource. If Cascade is simply buying the gas and/or environmental attributes, this value is zero.
- AC_U = Avoided upstream costs
- AC_D = Avoided distribution system costs
- P = Daily price of gas being evaluated
- Q = Daily quantity of gas being evaluated
- VC = Variable cost to move one dekatherm of gas to Cascade’s distribution system. This value can be zero if a project connects directly to the Company’s system.
- CIF = Carbon Intensity Factor. This is calculated by multiplying the Company’s expected carbon compliance cost by 1 minus the ratio of a proposed projects carbon intensity to conventional gas’ carbon intensity.
- $C_{Conventional}$ = The all-inclusive annual cost of conventional natural gas.

If $C_{Conventional} \geq C_{RNG}$, a project can be considered cost effective, and should be acquired. If not, the project may still be considered under the regulatory exceptions

Key Inputs

Case/RIN Selector
 State Jurisdiction
 Project Terms (yrs)
 Project Output Volumes (dth)
 Project Output Percentage (Obligated)
 Supply Price (annualized)
 Project Investment Percentage
 Project Investment
 Carbon Treatment
 RINs Risk Rating
 Inflation Escalator?
 RNG Revenue Increase / (Decrease)
 RNG Percentage Change
 Voluntary RNG Price Adder (\$/therm)
 Potential Market Value (Enterprise Value)

D5
 WA
 15
 200,000
 100.0%
 \$1.45
 100.0%
 \$3,000,000
 Landfill CNG
 Avg
 CPI

\$1,471,938
 0.51%
 \$0.91107
 -\$21,432,726

Purchase Vs. Build?

Cascade utilizes different models based on whether the Company is evaluating the purchase of RNG or the building and ownership of an RNG generating facility

While philosophically the same, build model provides a more detailed breakdown of items related to ownership

Purchase model considers revenue that the Company would earn from transportation agreements of volumes of RNG that Cascade would not own

Future Considerations

Include Risk Reduction value from avoided cost as RNG benefit?

Stochastic analysis of key inputs

Modification of CIF factor to use IRP marginal carbon compliance cost?

Voluntary RNG/Offset Program

Internal re-organization planning to staff the program

Work in process to secure RNG resources and/or attributes

Next steps:

- IT systems/ billing systems in place
- Stakeholder meetings
- Program/tariff filing

The State of Hydrogen

RNG and Hydrogen will be critical in meeting the dual goals of decarbonizing energy pipelines while maintaining the benefits of reliability and resiliency provided by our distribution system

Hydrogen Shot [Hydrogen Shot](#) | [Department of Energy](#)

- 111 Goal: reduce the cost of clean hydrogen by 80% to \$1 per 1 Kg in 1 decade

H2Hubs

- Release of NOI to fund Bipartisan Infrastructure Law's \$8 billion program
- Develop regional hubs across the country
- Hubs will include production, processing, delivery, storage, and end-use of hydrogen
- FOA in Sept/Oct 2022

Hydrogen Research

Sister company investment in GTI and LCRI

LCRI [Low-Carbon Resources Initiative \(epri.com\)](https://www.epri.com)

- 5-year collaborative supported by electric and gas utilities
- Advance the technologies needed for deep decarbonization within the next decade so they can be deployed in the 2030 to 2050 timeframe

GTI Hydrogen Technology Center [Hydrogen Technology Center • GTI Energy](#)

- Cross-cutting research, product development, and demonstration projects, focused on clean hydrogen production, storage, delivery, and use

Hydrogen Research – examples

H2@SCALE IN TEXAS AND BEYOND

ASSESSING H2 COMPATIBILITY IN NATURAL GAS INFRASTRUCTURE

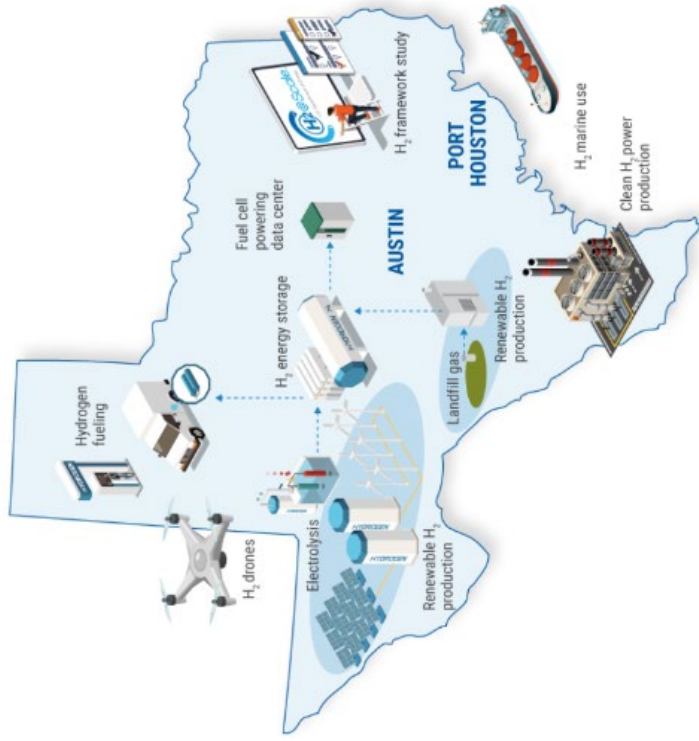

Cascade Natural Gas Renewable Gas Programs

RNG DEVELOPMENT STATUS

KENT CROUSE – INDUSTRIAL SERVICES MGR. – RENEWABLE NATURAL GAS & H₂

WUTC TAG4 – 8/10/22

Overview

Priority 1 – On System RNG Development with Attribute Purchase

- 4 projects in active contract negotiations
- 1 project in early development

Priority 2 – On System RNG Development, Transportation Only

- Where Environmental Attributes cannot be purchased, these projects displace geological gas on Cascade's system
- 1 project under contract
- 1 project in active contract negotiation
- 5 projects in early development

Deschutes County Landfill, Bend OR

- Cascade/Jacobs Engineering Team was successful candidate chosen through RFP process to own and operate processing facilities to convert landfill gas to RNG.
- RNG to be injected into local distribution system.
- Currently working through landfill operation & contractual details with Deschutes County
- Volumes/Term - 2,500,000 therm/yr, 20 Years - TBD

Combined Landfill/Food Waste Project– Benton, County

- 3rd part developer has rights to raw biogas from two sources in close proximity to each other - a Landfill and a Food Processing Plant.
- Currently in contract negotiations with developer to purchase RNG from both locations.
- RNG to be injected into local distribution system.
- Volumes/Term - 1,250,000 therm/yr, 15 years

Municipal Industrial Food Wastewater Project— Franklin, County

- Wastewater from 6 food producers/manufacturers aggregated in municipal processing facility
- Purchase and Interconnect contract negotiations in progress
- RNG to be injected into local distribution system.
- Volume/Terms - 3,400,000 therm/yr, 15-20 years

Industrial Food Waste Project— Yakima, County

- Food Waste from Industrial Food Processor
- Purchase and Interconnect contract negotiations in progress
- RNG to be injected into local distribution system.
- Volume/Terms - 715,000 therm/yr, 10 years

National Food Waste Aggregator – Cowlitz, County

- Food Waste aggregated from ~100 grocery stores in Washington & Oregon
- Interconnect Agreement executed for RNG transportation service
- RNG to be injected into local distribution system.
- Volumes - 1,800,000 therm/yr, operation start planned Q4/23

Dairy RNG Project– Snohomish, County

- 3,500 Head Dairy Operation
- Interconnect Agreement in negotiation for RNG transportation service
- RNG to be injected into local distribution system.
- Volumes - 815,000 therm/yr, operational start late Q4/23

Single RNG Projects can provide significant local impacts

Projects listed for Franklin County, Yakima County, Snohomish County, and Deschutes County, OR are sufficiently significant to offset near 100% of geological gas during times of lowest system demand

DSM Forecast, 2023 IRP

Monica Cowlishaw & Caleb Reimer

August 10th, 2022

DSM Topics

Overview

- Program Performance
- LoadMAP Modeling Tool

LoadMAP Scenarios – Changes in Avoided Costs

- Original 2021 CPA
- Updated Reference Case Avoided Costs
- RNG Future
- RNG Future + Municipal Gas Bans

Energy Efficiency Forecast

Energy Efficiency Programs

- Commercial and Industrial
- Residential
- Portfolio

DSM Action Items / Next Steps

Overview

Incremental Portfolio Annual Accomplishments

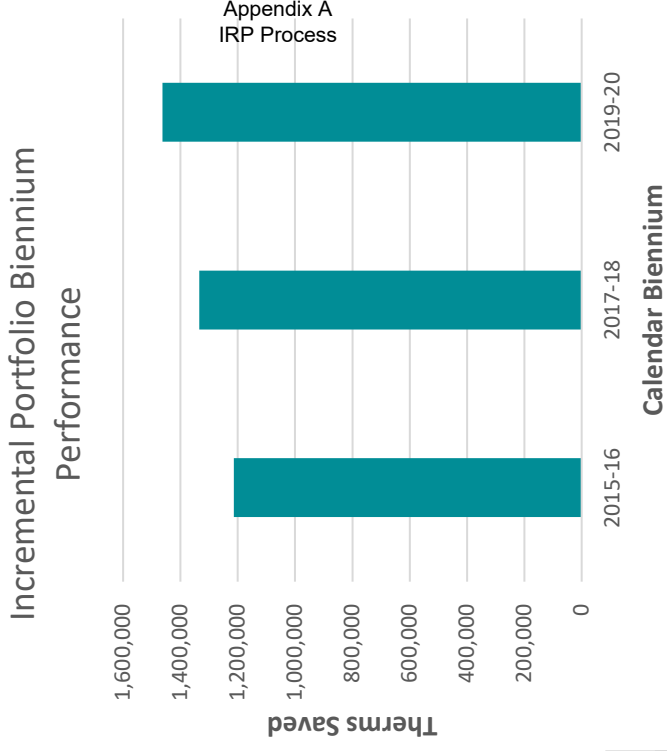
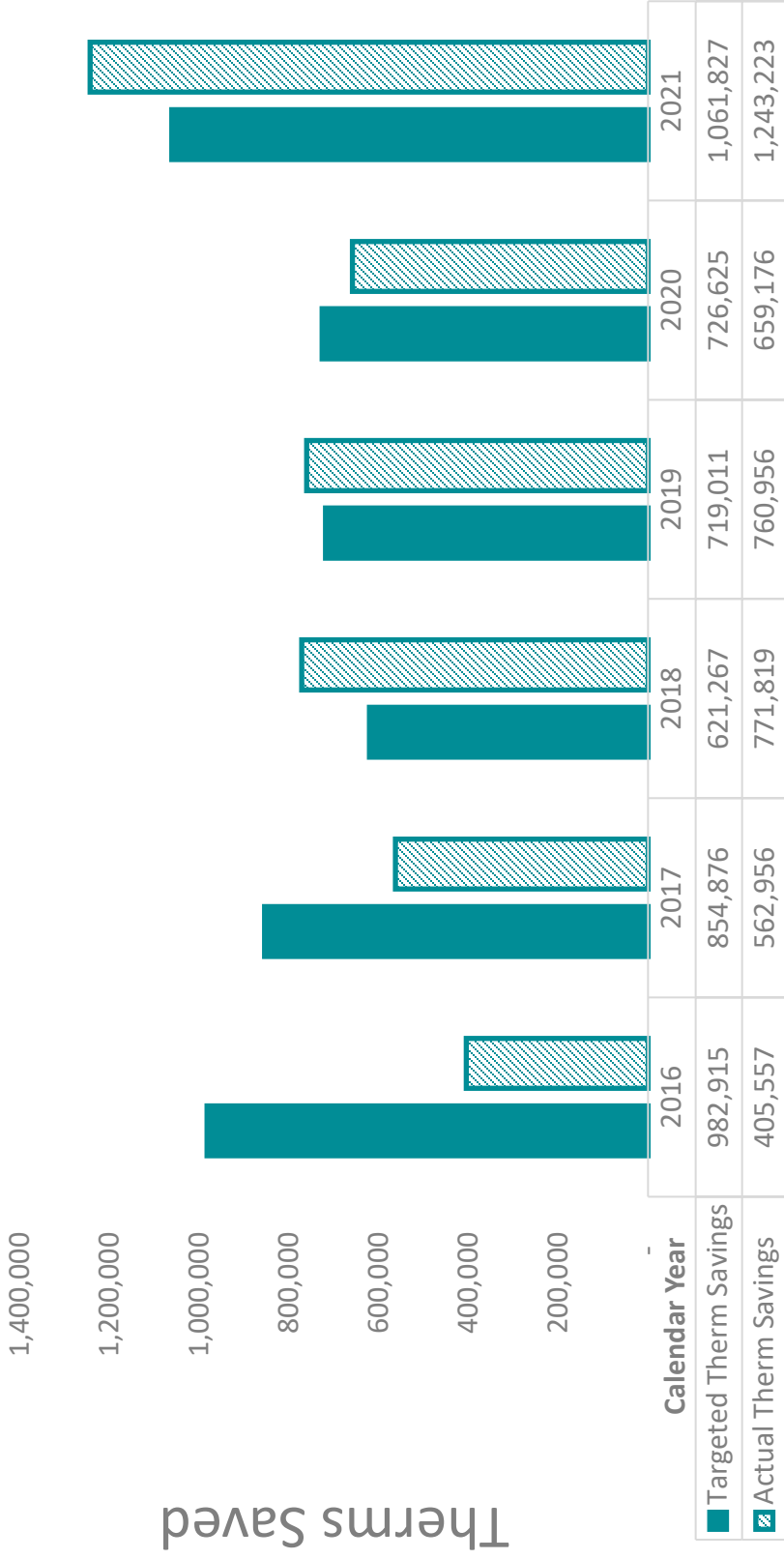

LoadMAP Analysis Framework

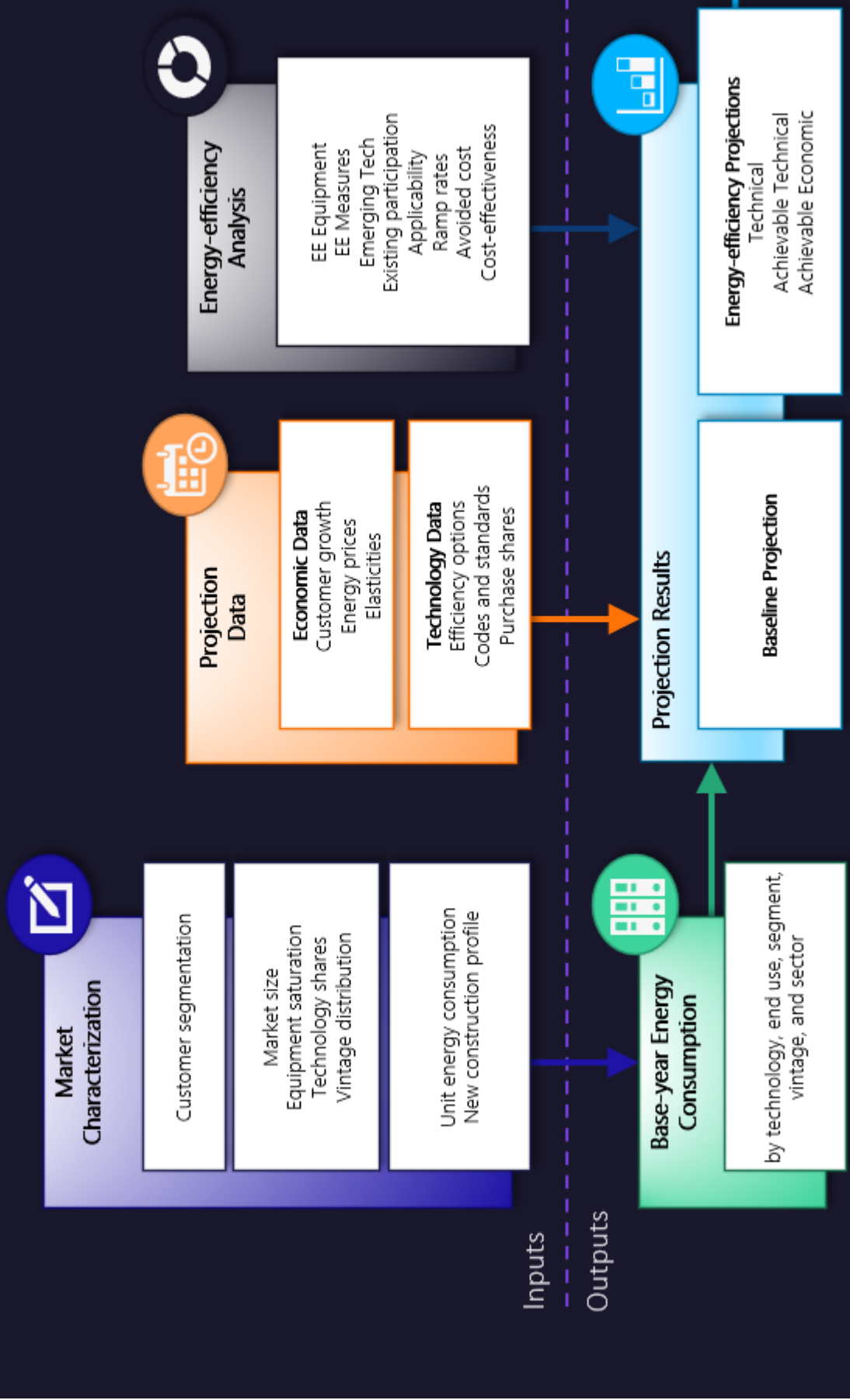

LoadMAP Analysis Framework

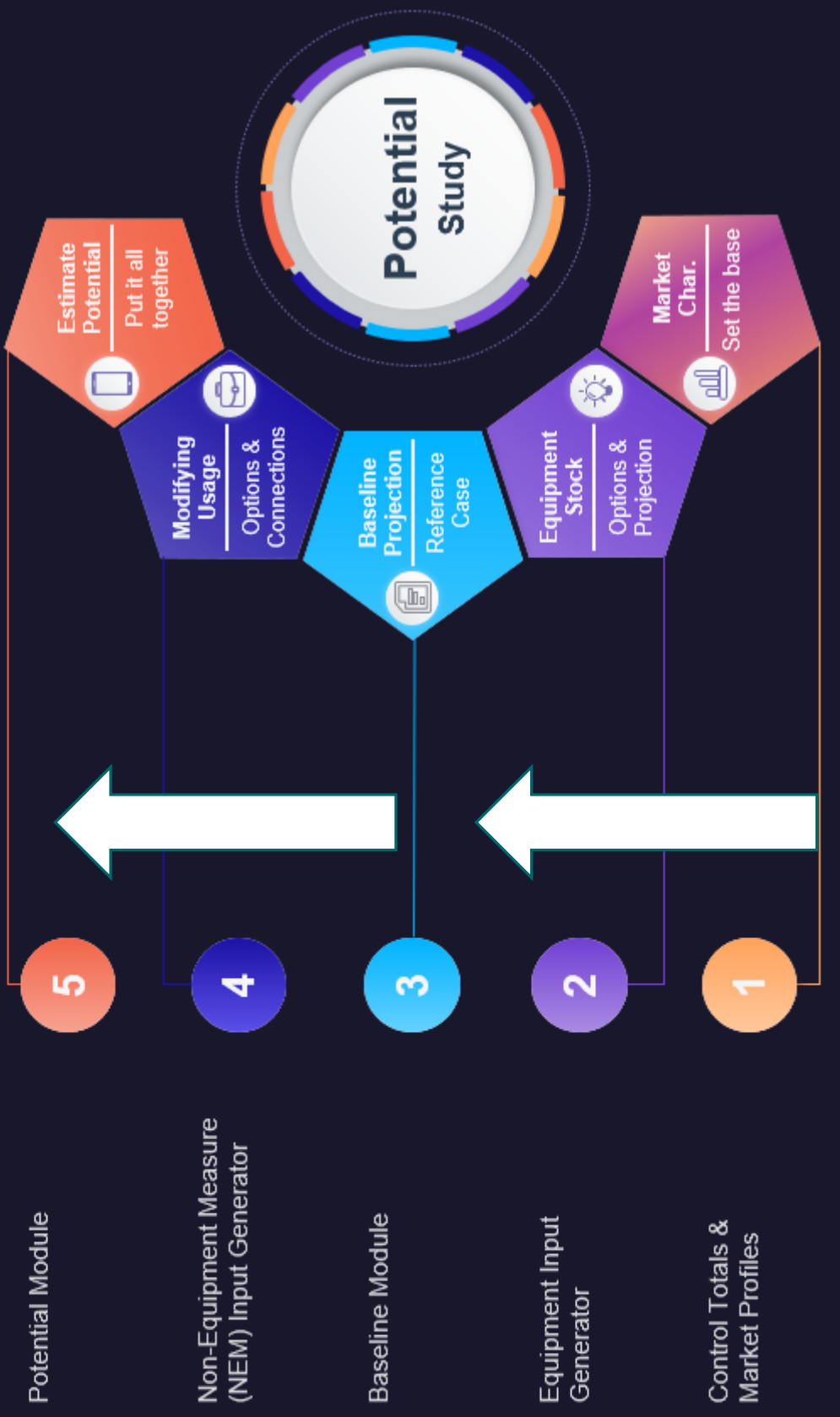

3 New LoadMAP Scenarios

- Original 2021 Discount Rate = 3.40%
- Updated Discount Rate = 5.06%
- Time Horizon of 2050
- Declining HDD

Scenario Comparison - Cumulative Achievable UCT Potential

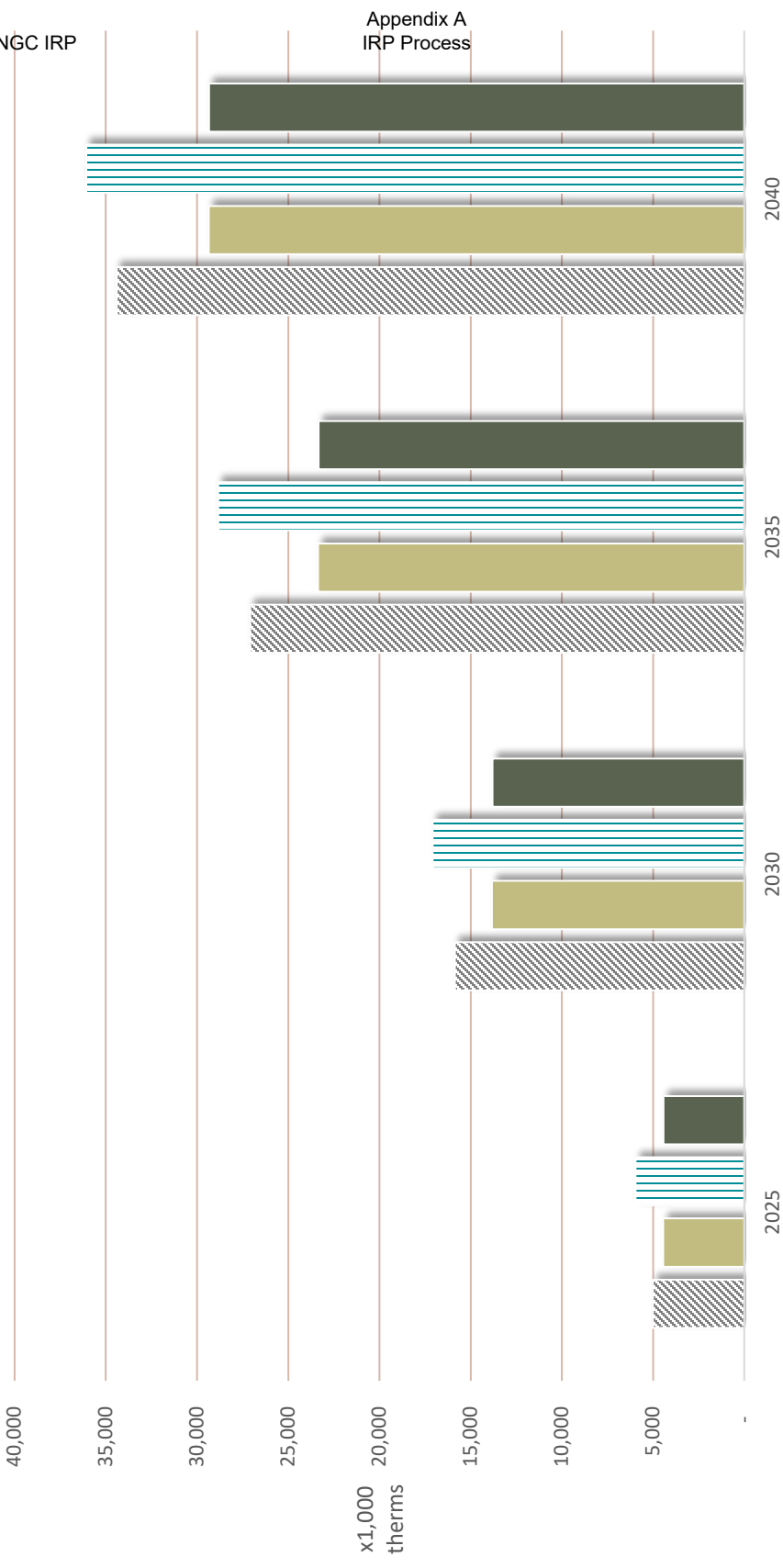

- ▨ Original 2021 CPA
- A - 2023 IRP Reference Case
- ▨ B - RNG Future Avoided Costs
- C - RNG Future + Muni Bans

Scenario Comparison

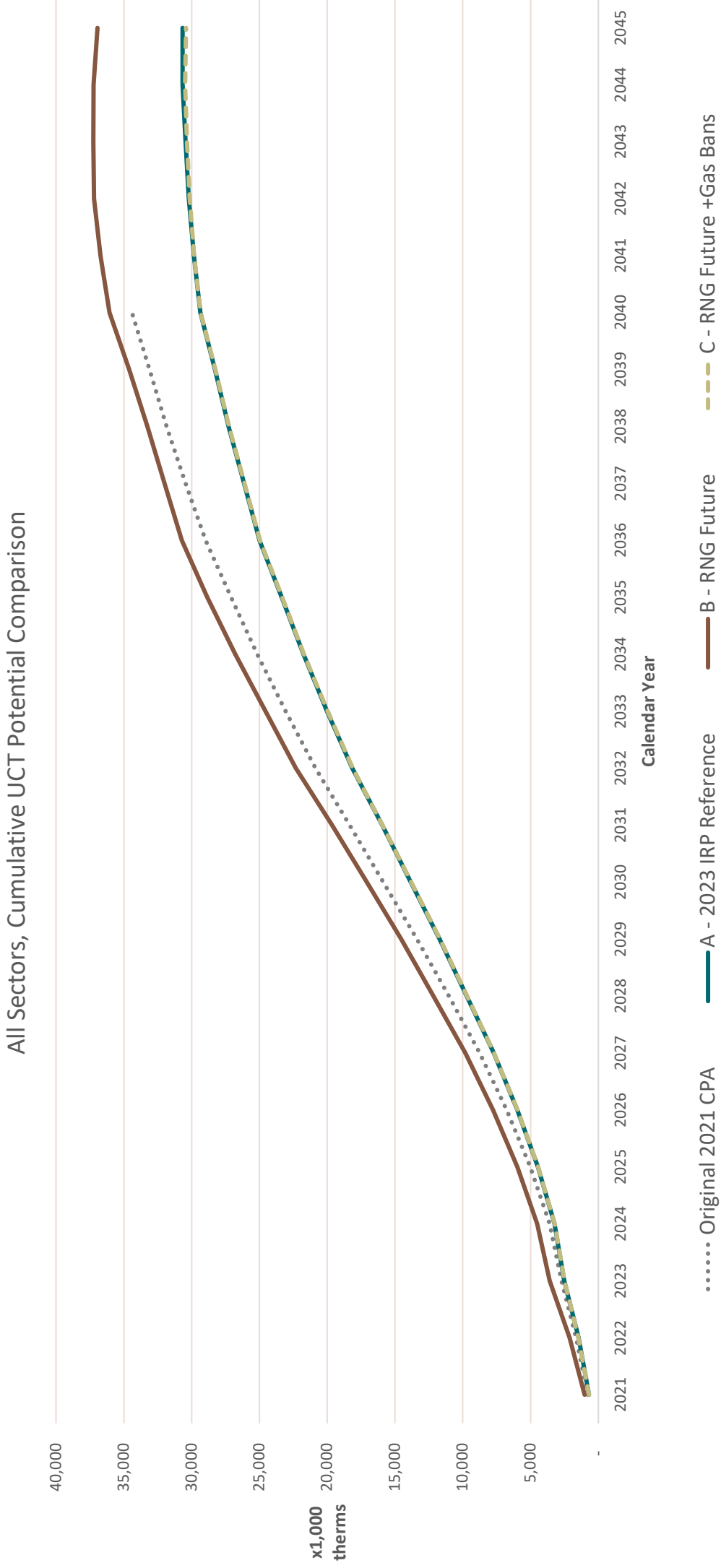

Energy Efficiency Present - 2045 Cumulative Potential Forecast

2023 IRP Reference Case – Portfolio Potential Savings

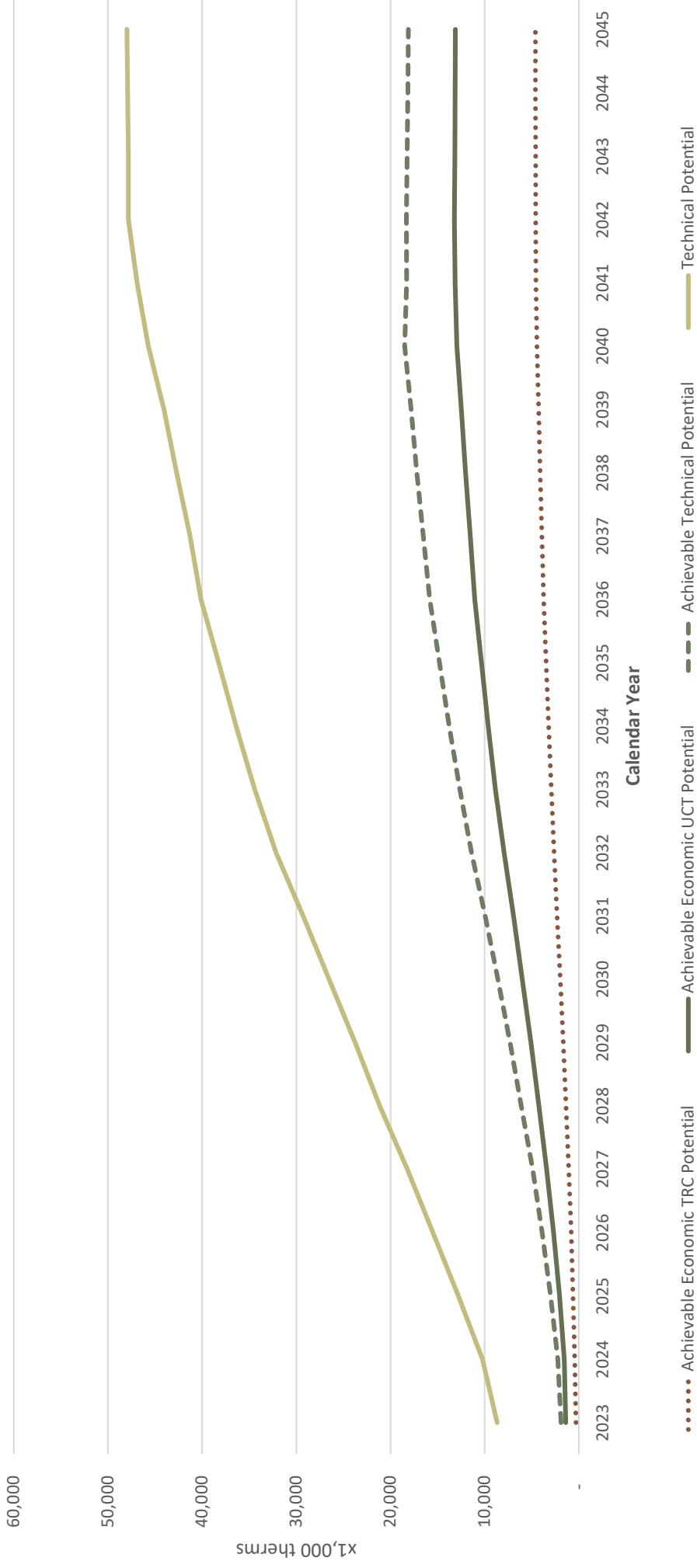

COMMERCIAL & INDUSTRIAL

COMMERCIAL FORECAST SUMMARY

Summary of Energy Savings (thousand therms), Selected Years	2023	2024	2025	2030	2035	2040	2045
Reference Baseline	243,965	247,595	247,199	253,812	259,582	266,336	272,292
Cumulative Savings (thousand therms)							
Achievable Economic TRC Potential	363	836	1,441	6,453	11,253	14,155	15,144
Achievable Economic UCT Potential	378	873	1,492	6,497	11,294	14,426	15,585
Achievable Technical Potential	1,157	2,475	3,874	11,760	17,586	20,586	21,070
Technical Potential	2,338	4,661	6,943	18,372	25,225	28,582	29,740
Energy Savings (% of Baseline)							
Achievable Economic TRC Potential	0.1%	0.3%	0.6%	2.5%	4.3%	5.3%	5.6%
Achievable Economic UCT Potential	0.2%	0.4%	0.6%	2.6%	4.4%	5.4%	5.7%
Achievable Technical Potential	0.5%	1.0%	1.6%	4.6%	6.8%	7.7%	7.7%
Technical Potential	1.0%	1.9%	2.8%	7.2%	9.7%	10.7%	10.9%
Incremental Savings (thousand therms)							
Achievable Economic TRC Potential	361	466	624	1,264	1,142	1,040	1,295
Achievable Economic UCT Potential	377	485	638	1,241	1,153	1,068	1,204
Achievable Technical Potential	1,386	1,493	1,667	1,966	1,599	1,401	1,765
Technical Potential	2,332	2,280	2,425	2,550	2,011	1,777	2,384

Commercial Top Ten Measures

Rank	Measure / Technology (Ranked by 1st year potential)	Achievable Economic UCT Potential (therms) Incremental (Annual) Potential					% of 2045 Total
		2023	2024	2025	2035	2045	
		1	Commercial - Insulation - Roof/Ceiling	53,388	92,767	139,502	
2	Commercial - Water Heater	32,064	34,862	42,111	208,234	202,618	16.8%
3	Commercial - Gas Boiler - Insulate Hot Water Lines	26,824	48,090	72,526	61,649	1,592	0.1%
4	Commercial - Insulation - Wall Cavity	25,027	29,326	46,540	175,988	367,074	30.5%
5	Commercial - Fryer	20,018	28,260	38,956	73,257	85,244	7.1%
6	Commercial - Boiler	19,899	19,746	19,100	14,450	0	0.0%
7	Commercial - Hydronic Heating Radiator Replacement	19,784	22,456	27,855	39,368	48,567	4.0%
8	Commercial - Water Heater - Ozone Laundry	18,807	22,322	25,359	1,647	0	0.0%
9	Commercial - Furnace	16,887	20,497	29,491	200,564	207,175	17.2%
10	Commercial - Gas Boiler - Hot Water Reset	15,082	17,364	19,149	925	0	0.0%

INDUSTRIAL FORECAST SUMMARY

	2023	2024	2025	2030	2035	2040	2045
Summary of Energy Savings (thousand therms), Selected Years							
Reference Baseline	243,965	247,595	247,199	253,812	259,582	266,336	272,292
Cumulative Savings (thousand therms)							
Achievable Economic TRC Potential	94	204	321	927	1,326	1,534	1,518
Achievable Economic UCT Potential	81	168	256	697	1,082	1,322	1,333
Achievable Technical Potential	121	258	405	1,130	1,595	1,818	1,792
Technical Potential	158	334	515	1,391	1,927	2,172	2,155
Energy Savings (% of Baseline)							
Achievable Economic TRC Potential	0.0%	0.1%	0.1%	0.4%	0.5%	0.6%	0.6%
Achievable Economic UCT Potential	0.0%	0.1%	0.1%	0.3%	0.4%	0.5%	0.5%
Achievable Technical Potential	0.0%	0.1%	0.2%	0.4%	0.6%	0.7%	0.7%
Technical Potential	0.1%	0.1%	0.2%	0.5%	0.7%	0.8%	0.8%
Incremental Savings (thousand therms)							
Achievable Economic TRC Potential	95	110	121	123	86	68	60
Achievable Economic UCT Potential	81	87	89	93	83	71	63
Achievable Technical Potential	125	143	154	149	102	82	72
Technical Potential	160	179	187	176	119	97	86

Industrial Top Ten Measures

Rank	Measure / Technology (Ranked by 1st year potential)	Achievable Economic UCT Potential (therms) Incremental (Annual) Potential					% of 2045 Total
		2023	2024	2025	2035	2045	
1	Industrial - Strategic Energy Management	20,542	21,046	21,191	23,494	23,502	37%
2	Industrial - Process - Insulate Heated Process Fluids	10,778	11,058	11,161	1,523	2,064	3.3%
3	Industrial - Gas Boiler - Insulate Hot Water Lines	9,703	9,750	9,711	9,614	982	1.6%
4	Industrial - Gas Boiler - Stack Economizer	9,556	9,785	9,854	1,323	1,165	1.9%
5	Industrial - Process Heat Recovery	5,148	6,128	7,047	508	2,535	4.0%
6	Industrial - Gas Boiler - Insulate Steam Lines/Condensate Tank	4,744	4,656	4,570	460	0	0.0%
7	Industrial - Gas Boiler - Hot Water Reset	4,563	4,674	4,709	5,243	865	1.4%
8	Industrial - Gas Boiler - High Turndown	3,759	3,847	3,872	518	457	0.7%
9	Industrial - Gas Boiler - Maintenance	3,091	4,801	4,388	17,794	17,508	27.8%
10	Industrial - Unit Heater	2,431	2,872	2,282	2,125	744	1.2%

RESIDENTIAL

Energy Efficiency 2045 Cumulative Potential Forecast: Residential (RES)

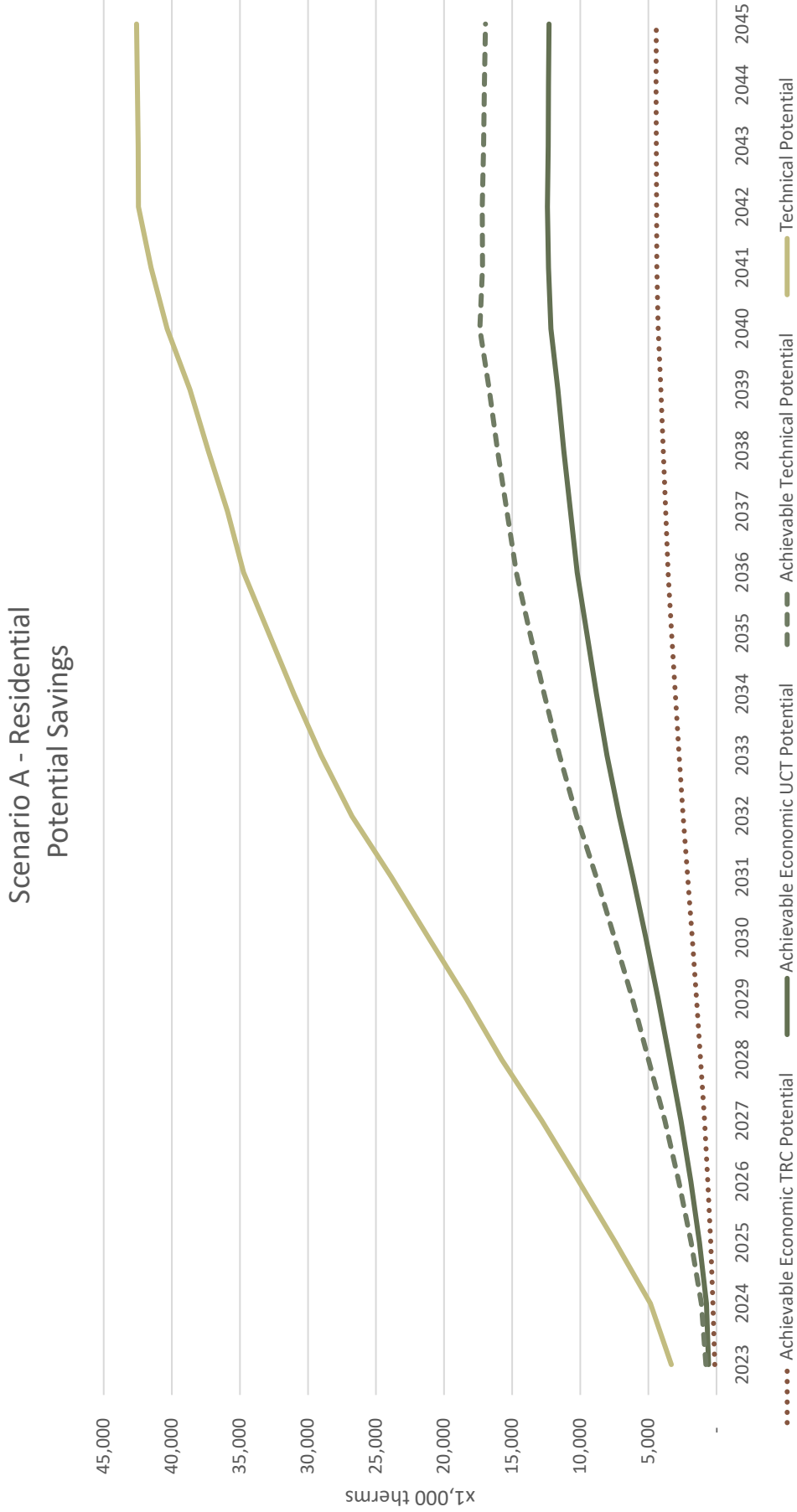

RESIDENTIAL FORECAST SUMMARY

Summary of Energy Savings (thousand therms), Selected Years	2023	2024	2025	2030	2035	2040	2045
Reference Baseline	243,965	247,595	247,199	253,812	259,582	266,336	272,292
Cumulative Savings (thousand therms)							
Achievable Economic TRC Potential	125	255	424	1,784	3,285	4,270	4,416
Achievable Economic UCT Potential	584	723	1,246	5,183	9,526	12,153	12,290
Achievable Technical Potential	767	1,115	1,865	7,480	13,687	17,372	16,968
Technical Potential	3,303	4,846	7,404	21,146	32,873	40,339	42,598
Energy Savings (% of Baseline)							
Achievable Economic TRC Potential	0.1%	0.1%	0.2%	0.7%	1.3%	1.6%	1.6%
Achievable Economic UCT Potential	0.2%	0.3%	0.5%	2.0%	3.7%	4.6%	4.5%
Achievable Technical Potential	0.3%	0.5%	0.8%	2.9%	5.3%	6.5%	6.2%
Technical Potential	1.4%	2.0%	3.0%	8.3%	12.7%	15.1%	15.6%
Incremental Savings (thousand therms)							
Achievable Economic TRC Potential	128	144	176	339	285	194	6
Achievable Economic UCT Potential	596	466	548	970	889	667	103
Achievable Technical Potential	786	680	795	1,411	1,291	903	105
Technical Potential	3,383	2,654	2,722	3,061	2,161	1,862	373

Residential Top Ten Measures

Rank	Measure / Technology (Ranked by 1st year potential)	Achievable Economic UCT Potential (therms) Incremental (Annual) Potential					% of 2045 Total
		2023	2024	2025	2035	2045	
1	Residential - Furnace - Direct Fuel	224,866	46,915	51,094	78,871	17,013	16%
2	Residential - Water Heater <= 55 gal.	95,501	95,478	102,000	129,025	56,865	55.1%
3	Residential - ENERGY STAR™ Connected Thermostat	79,577	88,382	96,342	171,431	0	0.0%
4	Residential - Insulation - Ceiling, Installation	43,181	45,054	46,154	57,517	0	0.0%
5	Residential - ENERGY STAR Clothes Washers	26,259	23,351	29,544	72,556	25,005	24.2%
6	Residential - Fireplace	26,073	26,046	25,884	24,706	0	0.0%
7	Residential - Insulation - Basement Sidewall	13,741	22,273	33,146	106,689	0	0.0%
8	Residential - Ducting - Repair and Sealing	13,311	23,226	35,459	27,481	0	0.0%
9	Residential - Gas Boiler - Pipe Insulation	8,093	4,387	5,339	8,416	0	0.0%
10	Residential - Thermostat - Programmable	7,909	13,837	21,415	17,955	0	0.0%

Top Measures - Alternate Scenarios B - RNG Future

Rank	Measure / Technology (Ranked by 1st year potential)	Achievable Economic UCT Potential (therms) Incremental (Annual) Potential				% of 2045 Total	
		2023	2024	2025	2045		
1	Residential - Furnace - Direct Fuel	497,823	48,474	52,809	81,232	9,913	6.4%
2	Residential - Water Heater <= 55 gal.	157,310	168,259	194,025	333,759	112,159	72.2%
3	Residential - Insulation - Wall Cavity, Installation	80,537	90,234	98,374	174,805	0	0.0%
4	Residential - ENERGY STAR Connected Thermostat	76,250	79,488	81,342	99,135	0	0.0%
5	Residential - Insulation - Ceiling, Installation	45,271	47,226	48,373	60,020	0	0.0%
6	Residential - ENERGY STAR Clothes Washers	27,177	24,182	30,603	75,153	26,528	17.1%

C - RNG Future + Gas Bans

Rank	Measure / Technology (Ranked by 1st year potential)	Achievable Economic UCT Potential (therms) Incremental (Annual) Potential				% of 2045 Total	
		2023	2024	2025	2045		
1	Residential - Furnace - Direct Fuel	231,677	48,474	52,809	81,232	17,013	16.8%
2	Residential - ENERGY STAR Connected Thermostat	87,597	90,494	100,657	136,991	55,018	54.3%
3	Residential - Water Heater <= 55 gal.	80,424	90,106	98,231	174,657	0	0.0%
4	Residential - Insulation - Ceiling, Installation	43,479	45,364	46,472	57,916	0	0.0%
5	Residential - ENERGY STAR Clothes Washers	26,573	26,548	26,385	25,188	0	0.0%
6	Residential - Fireplace	26,290	23,326	29,521	72,544	25,005	24.7%



Portfolio

Portfolio Top Twenty Measures

Rank	Measure / Technology (Ranked by 1st year potential)	Achievable Economic UCT Potential (therms)					% of 2045 Total
		2023	2024	2025	2035	2045	
1	Residential - Furnace - Direct Fuel	224,866	46,915	51,094	78,871	17,013	1%
2	Residential - Water Heater <= 55 gal.	95,501	95,478	102,000	129,025	56865	4.2%
3	Residential - ENERGY STAR Connected Thermostat	79,577	88,382	96,342	171,431	0	0.0%
4	Residential - Insulation - Ceiling, Installation	53,388	92,767	139,502	99,986	17548	1.3%
5	Commercial - Insulation - Roof/Ceiling	43,181	45,054	46,154	57,517	0	0.0%
6	Residential - ENERGY STAR Clothes Washers	32,064	34,862	42,111	208,234	202618	14.8%
7	Commercial - Water Heater	26,824	48,090	72,526	61,649	1592	0.1%
8	Commercial - Gas Boiler - Insulate Hot Water Lines	26,259	23,351	29,544	72,556	25005	1.8%
9	Industrial - Strategic Energy Management	26,073	26,046	25,884	24,706	0	0.0%
10	Commercial - Insulation - Wall Cavity	25,027	29,326	46,540	175,988	367074	26.8%
11	Commercial - Fryer	20,542	21,046	21,191	23,494	23502	1.7%
12	Commercial - Boiler	20,018	28,260	38,956	73,257	85244	6.2%
13	Commercial - Hydronic Heating Radiator Replacement	19,899	19,746	19,100	14,450	0	0.0%
14	Residential - Fireplace	19,784	22,456	27,855	39,368	48567	3.5%
15	Commercial - Water Heater - Ozone Laundry	18,807	22,322	25,359	1,647	0	0.0%
16	Commercial - Furnace	16,887	20,497	29,491	200,564	207175	15.1%
17	Commercial - Gas Boiler - Hot Water Reset	15,082	17,364	19,149	925	0	0.0%
18	Industrial - Process - Insulate Heated Process Fluids	13,827	14,170	14,218	4,348	3190	0.2%
19	Commercial - Kitchen Hood - DCV/MUA	13,741	22,273	33,146	106,689	0	0.0%
20	Commercial - Unit Heater	13,311	23,226	35,459	27,481	0	0.0%

DSM Action Items /Next Steps

- EM&V: Operating under Biennial Conservation Plan
- New CPA: Completing in 2023
- Municipal Gas Bans: Impact on future assumption i.e., scenario B & C
- Code changes
- Low income
- Adaptive management
- IRP DSM Chapter: September 2022

Questions?

Preliminary Results

Preliminary upstream pipeline transportation results

	First year shortfall w/o DSM	Max Shortfall	First year shortfall w/ DSM	Max Shortfall
Zone 11	2034	7,570	2046	1,430
Zone ME-WA and GTN	2038	20,390	2049	3,600

- Preliminary results show shortfalls on transportation side.
- DSM delays about 11-12 years.
- Remaining shortfall could be solved by targeted DSM, pipeline expansion, on-system RNG/Hydrogen if deemed peak day reliable, etc.

Base Case Modeling for Climate Commitment Act

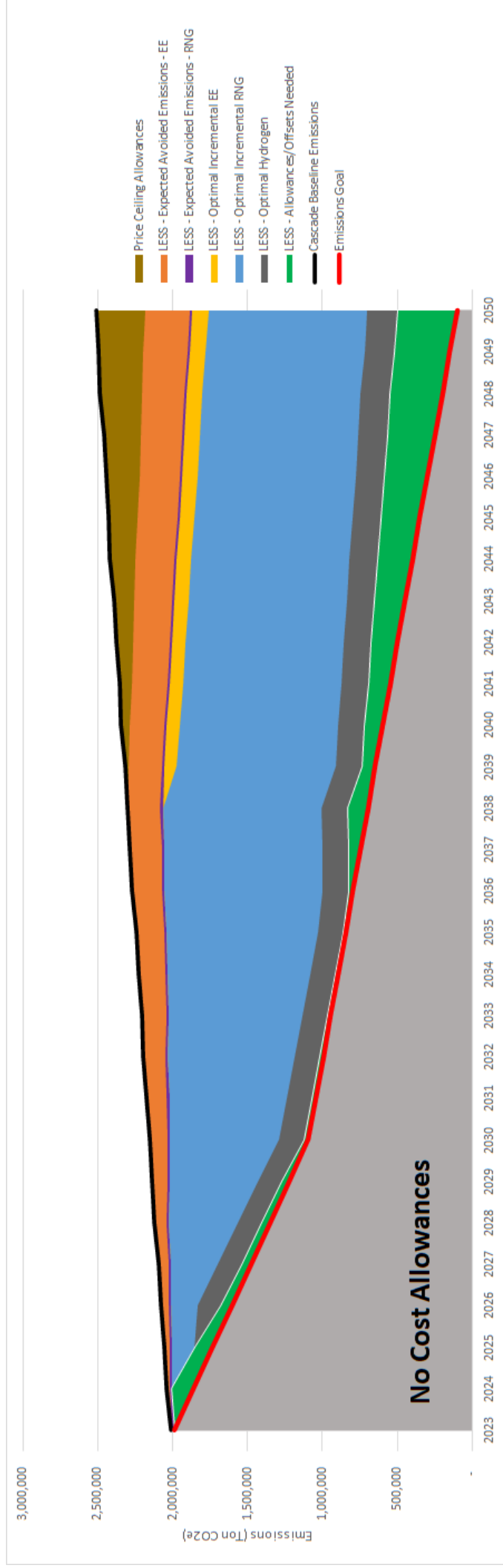

Distribution System Planning

KATHLEEN CAMPBELL, PE – SENIOR ENGINEER

WASHINGTON

AUGUST 10TH, 2022



Presentation will cover:

1. Distribution system modeling process
2. Identification of system deficits/constraints
3. Distribution enhancements/reinforcements options to address deficits
4. Enhancement review and selection process to capital budget
5. Enhancement/reinforcements identified in 2023-2027 capital budget
6. Iterative process of IRP

Distribution System Modeling

System Dynamics:

Piping:

- Diameter – ½” to 20”
- Material – Polyethylene and Steel
- Operating Pressure – 20 psi to 900 psi
- Washington – approx. 4,893 miles of distribution & 170 miles of transmission
- Oregon – approx. 1,710 miles of distribution & 107 miles of transmission

System Dynamic's Cont.

Facilities:

- Regulator stations – Over 700
- Valves – Over 1,600
- Other equipment such as heaters, odorizer and compressors



System Design

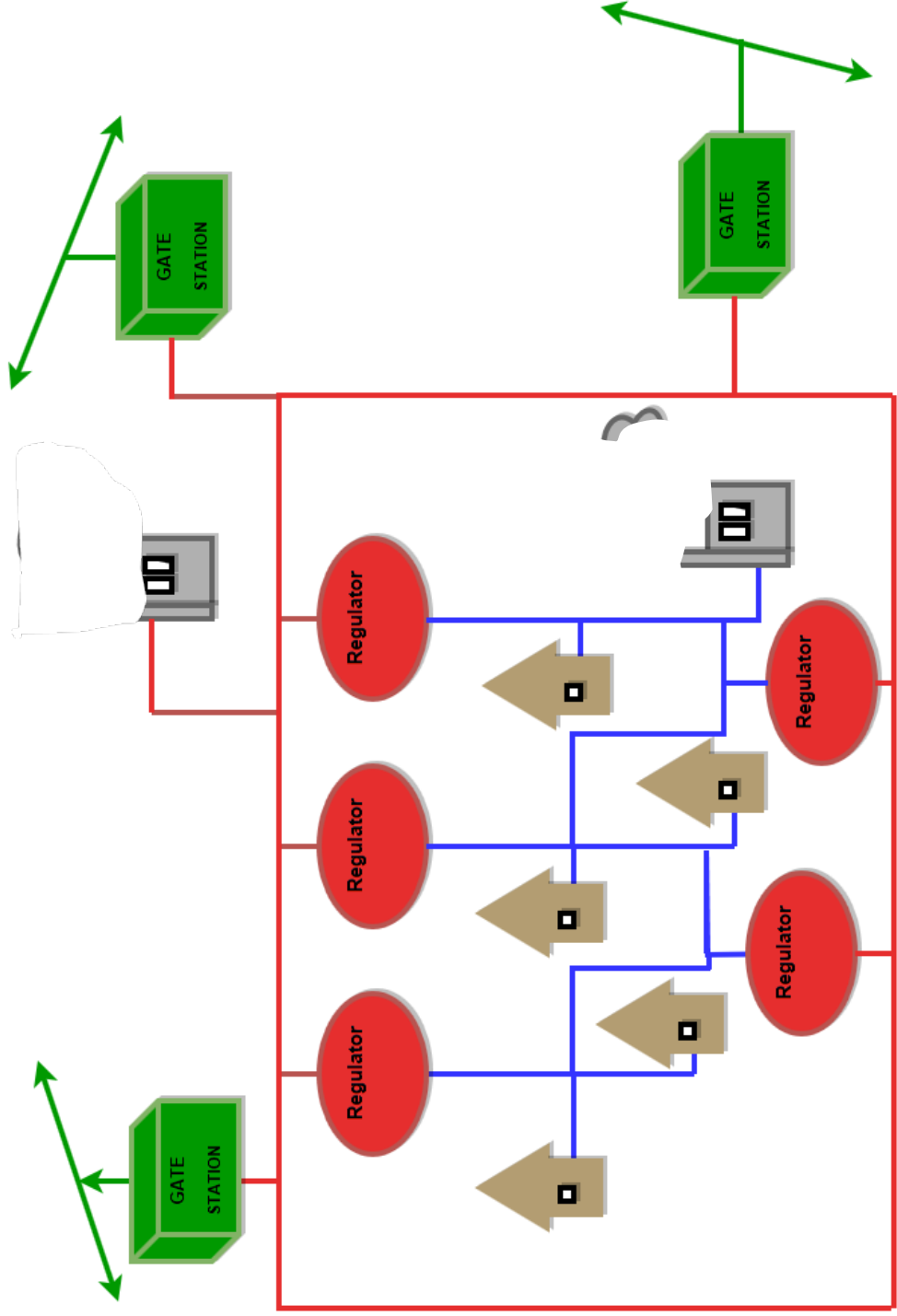

Synergi Gas Modeling

- To evaluate our systems for growth and potential future deficits we use our gas modeling software, Synergi Gas
- Synergi gas is distributed and supported by DNV GL
- Synergi Gas models incorporates:
 - Total customer loads
 - Existing pipe and system configurations
- Synergi gas is a hydraulic modeling software that allows us to predict flows and pressures on our system based on gas demands predicted during a peak weather event.
- Synergi models are updated every three years and maintained between rebuilds

Synergi Model Example

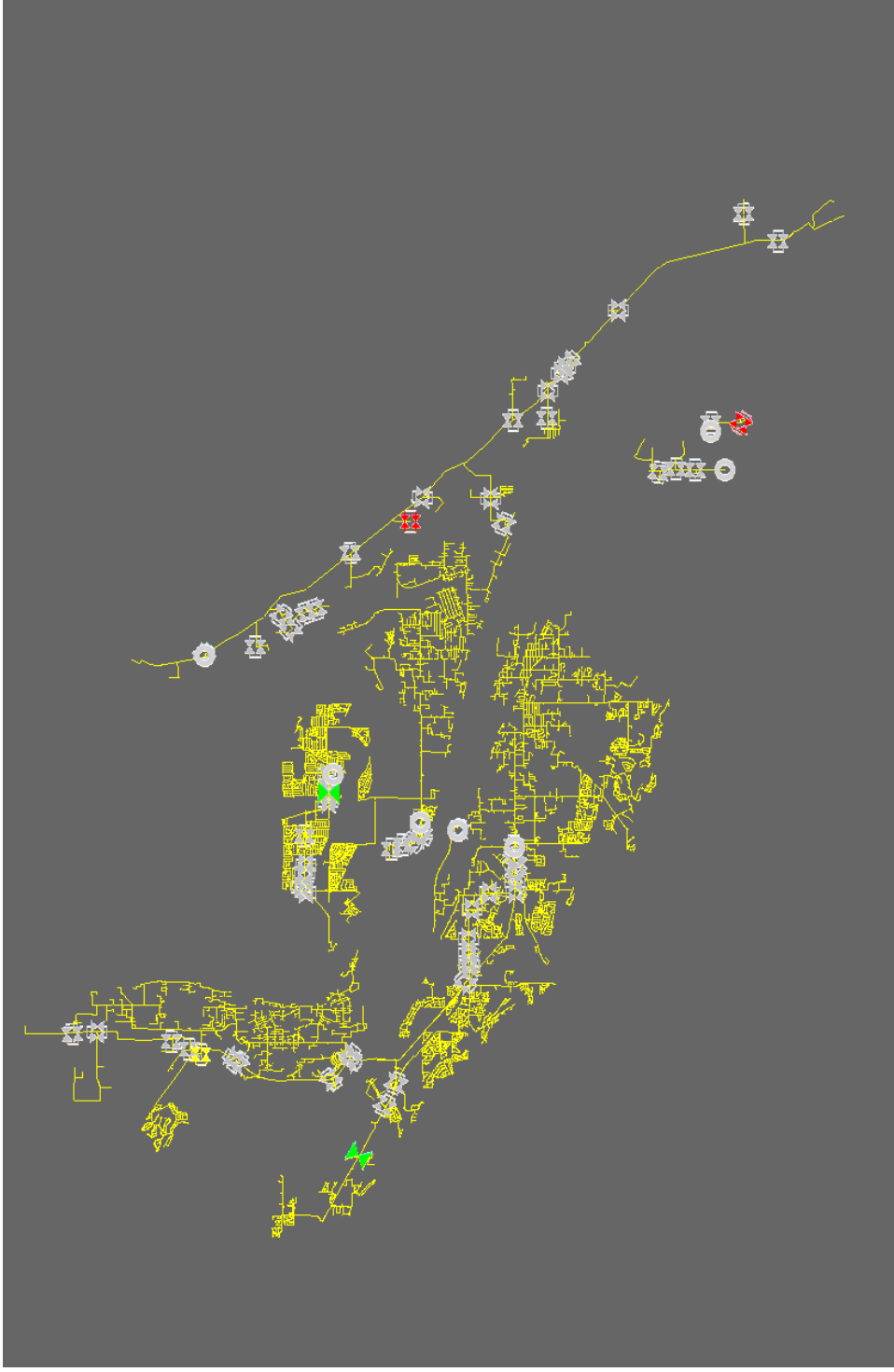

Model Building Process

Synergi models are completely rebuilt every three years and maintained/updated between rebuilds

When models are rebuilt

- We export current GIS data to build spatial model
- We export current CC&B billing data to CMM to create an updated demands file
- We validation and calibrate each district model to a recent low-pressure event using existing data (ERXs/pressure charts/SCADA/metertek/LV usage)
- We create a design day model based on the updated heating degree day determined by gas supply (determined by trending historical weather events)

CNG models were rebuilt in 2021

Data Gathering

CC&B (Customer Billing Data)

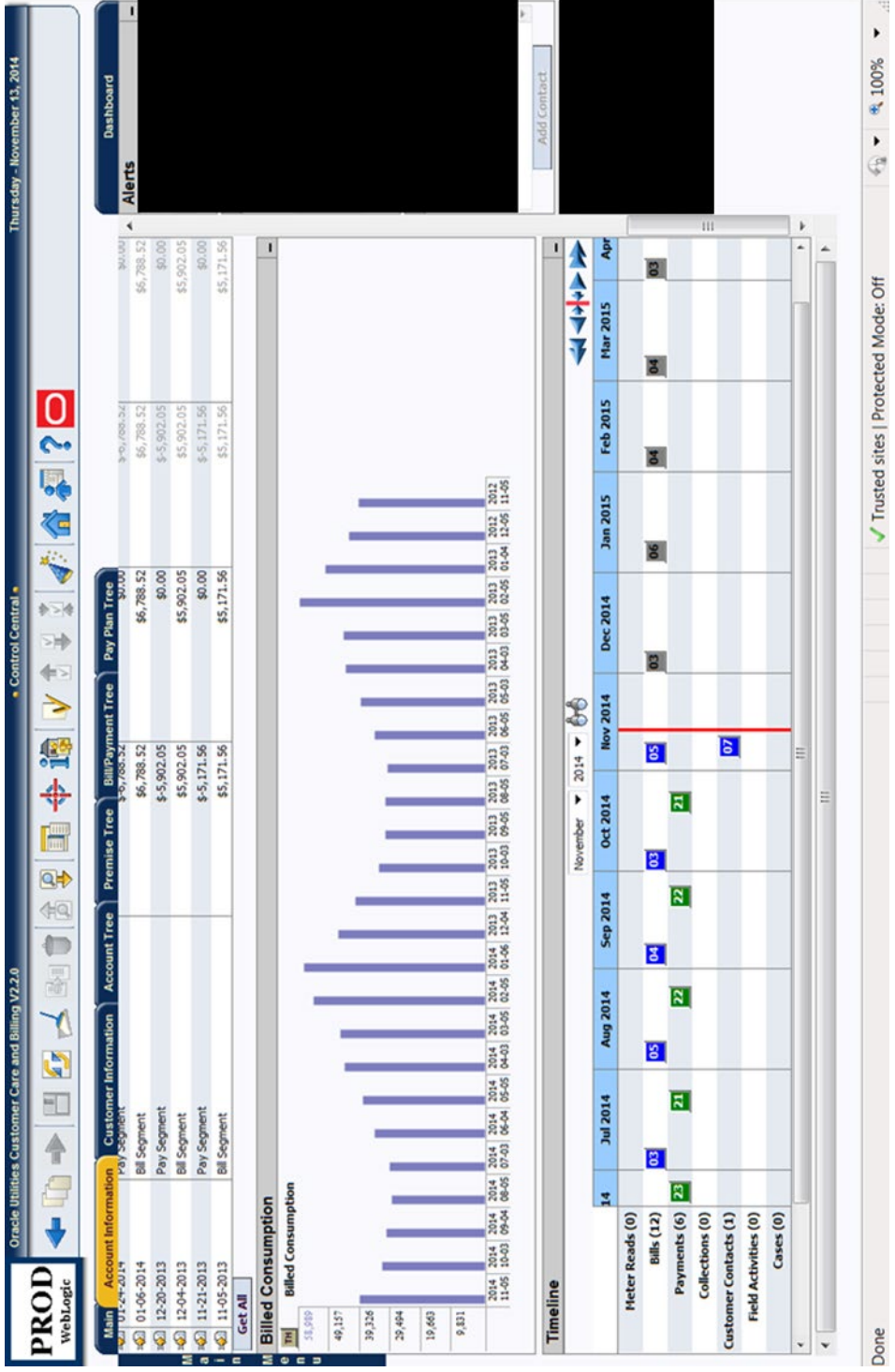

Data Gathering

MDU SCADA View
Pressures
Usage
Odorizers
Other Systems

- IGC
- CNGC
- Northwest Washington
- Central Washington
- Southwest Washington
- Oregon

- MDU

Data Legend

CNGC Southwest Washington Usage

The data on this page is automatically refreshed every 5 minutes. Reloading the page before the timer expires will not necessarily result in newer data.

Generated: 09/01/2016 04:41:40 PM PDT
Refreshed: 09/01/2016 03:48:06 PM PDT
Next Refresh: 00:04:57

Data View Mode

List
#
Grid
A-Z

SCADA Data

Real time and historical flow characteristics at specific locations in the system

Monitored Area	Flow Rate (MCF/HR)	Previous Hour (DekaTherms)	Current Gas Day (DekaTherms)	Previous Gas Day (DekaTherms)
Puget Sound NS Run1	56.5	61	538	1652
Bremerton Gate Run1	90.5	99	906	2454
Shelton Gate Total	232.1	259	2399	5829
Mc Cleary Gate Run1	207.7	216	1837	4884
South Longview Gate Total	1620.9	1569	11624	21984
Kelso Gate Total	787.1	816	6508	15172
Kalama Gate Total	199.8	225	1914	5435
Co Gen Run1	0.0	0	0	0
Fibre Mill Run1	448.4	475	4271	7952
Mint Farm Run1	1912.2	1923	13754	28647

Data Gathering

Peak Heating Degree Day (HDD) modeled by CNG based on historical weather data
 Peak HDD = 60 – Average Daily Temp

District	HDD	Avg Daily Temperature (°F)
Aberdeen	46	14
Bellingham	47	13
Bend	71	-11
Bremerton	46	14
Eastern Oregon	73	-13
Kennewick	65	-5
Longview	46	14
Mt Vernon	47	13
Pendleton	67	-7
Walla Walla	66	-6
Wenatchee	65	-5
Yakima	65	-5



Customer Management Module (CMM)

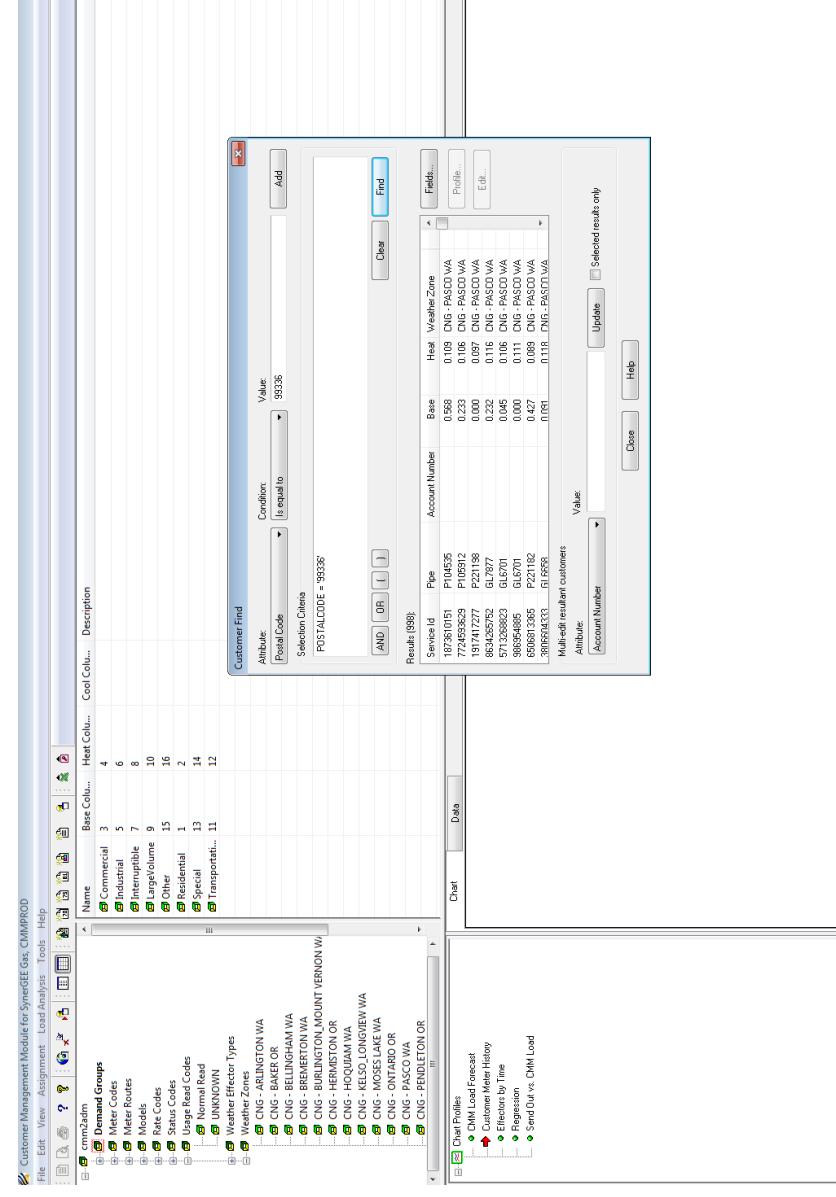

Brings CC&B customer data into Synergi as demands file

Demand file applies load spatially in the model.

Calibrated vs Peak Degree Day

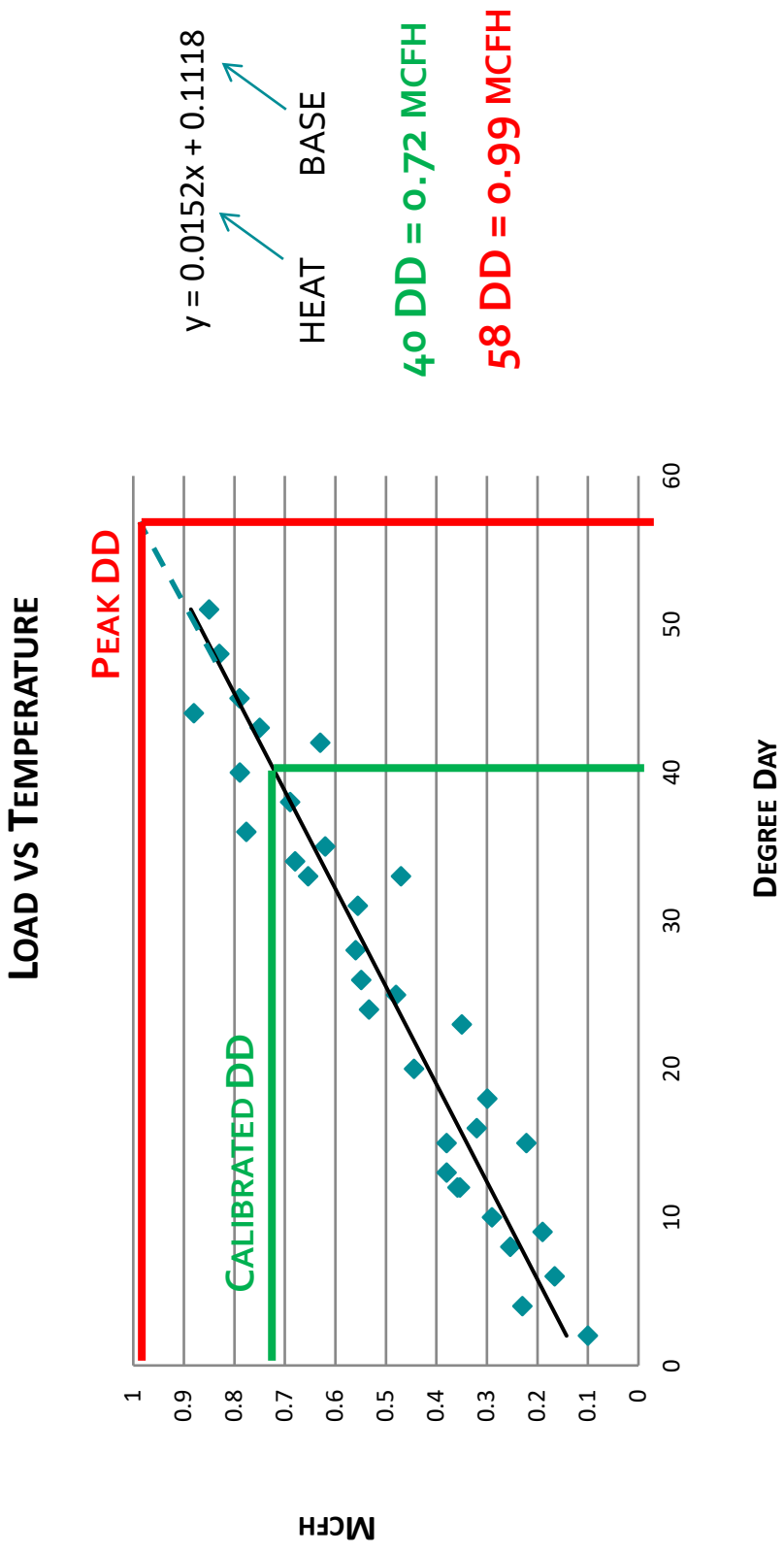

Identification of system deficits/constraints

Synergi Modeling Capabilities:

- Review Large Volume Customer requests
- Model RNG
- Supports design/sizing of pipe and pipeline components (regulator stations, compressors)
- Future planning
- Model IRP predicted growth
- Identify deficiencies
- Determine system reliability
- Optimize distribution enhancement options

What is a capacity deficit?

A deficit is defined as a critical system that is at or limiting capacity.

Critical system examples include:

- Pipeline bottlenecks
- Minimum inlet pressure to a regulator station or HP system
- Not meeting a required customer delivery pressure
- Component limiting capacity

Distribution System Modeling Process to ensure we can meet IRP growth predictions

As part of the IRP process, we complete a comprehensive review of all of our distribution system models every two years to ensure that we can maintain reliable service to our customers during peak low temperature events.

With our capital budget cycle, we also complete system reviews on an annual basis.

If a deficit is predicted the system is evaluated and a reinforcement/enhancement is proposed and selected based on alternative analysis considerations and placed into the capital budget based on timing needs of the predicted deficit.

Distribution Enhancement/Reinforcement Options to address deficits

Enhancement Options

Pipeline:

- Replacements
- Reinforcements
- Loops & Back feeds
- Pressure Increases
- Uprates

Facility Upgrades

Additional Regulator Stations feeding the distribution system

New Strategically placed Gate Stations

Compressor Stations

Distribution Enhancement Example

Theoretical low-pressure scenario

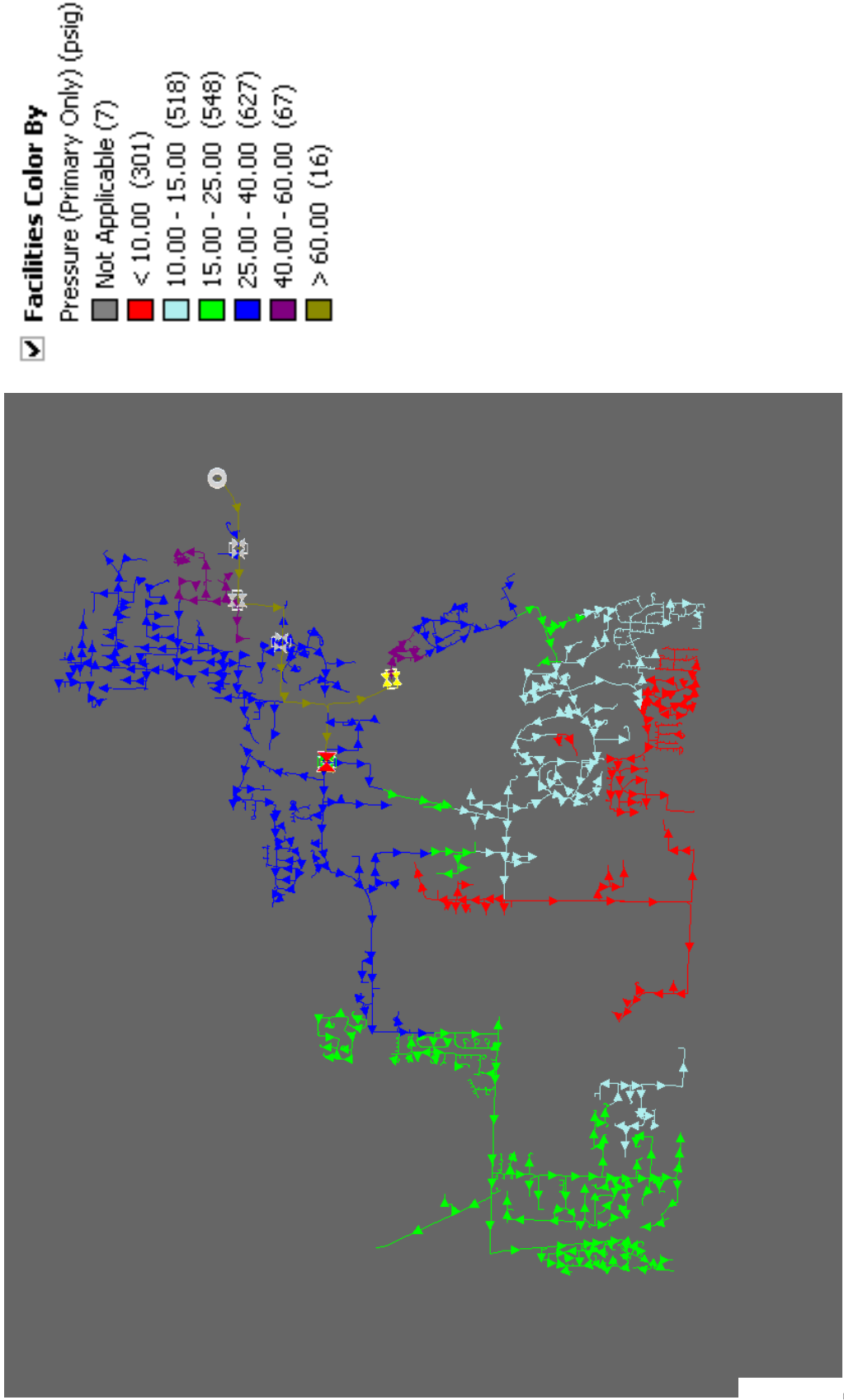

Distribution Enhancement Options

Low pressure scenario

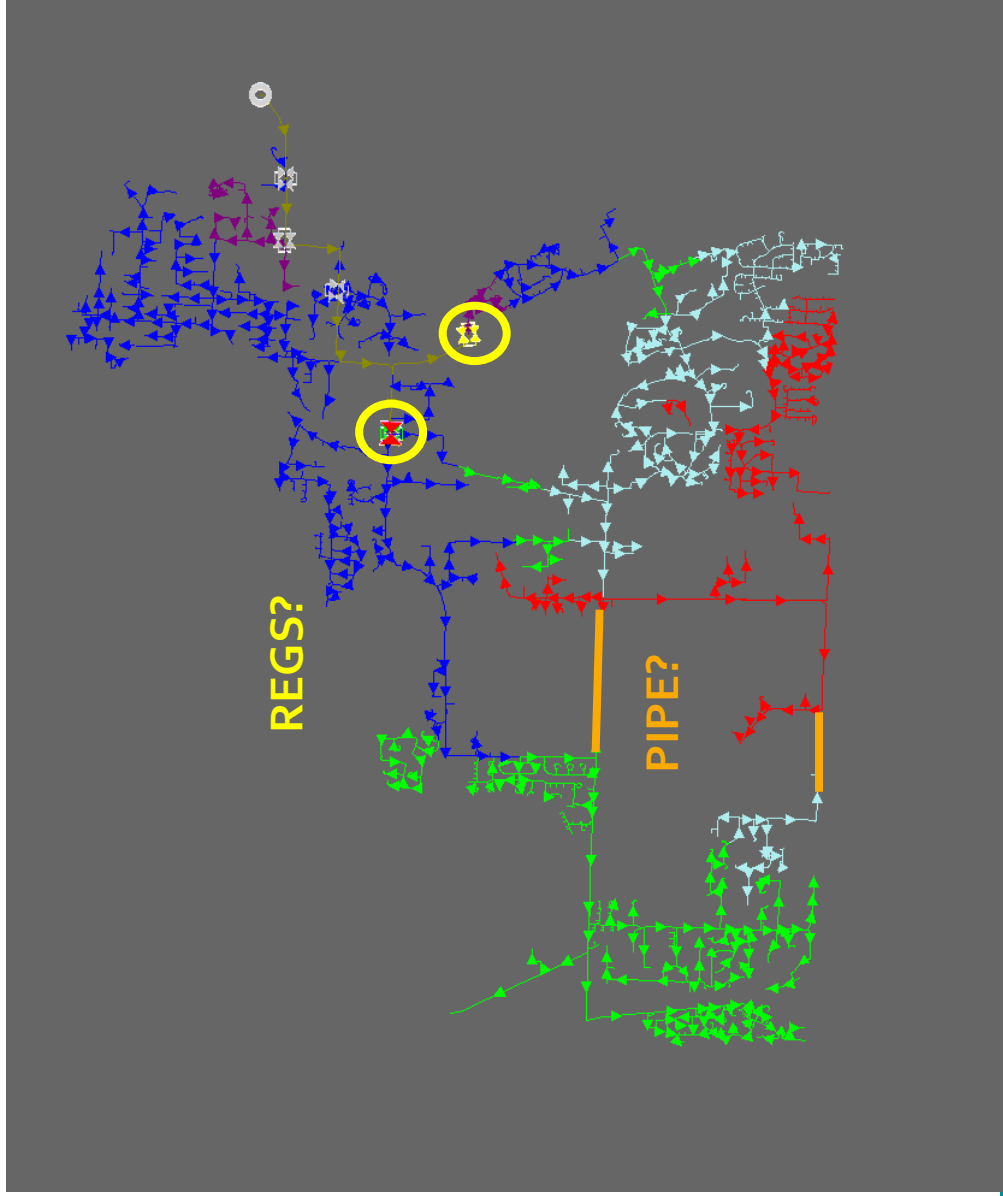

- Compressor station infeasible
- Other Solutions?

Distribution Enhancement Options

Reinforcement option #1

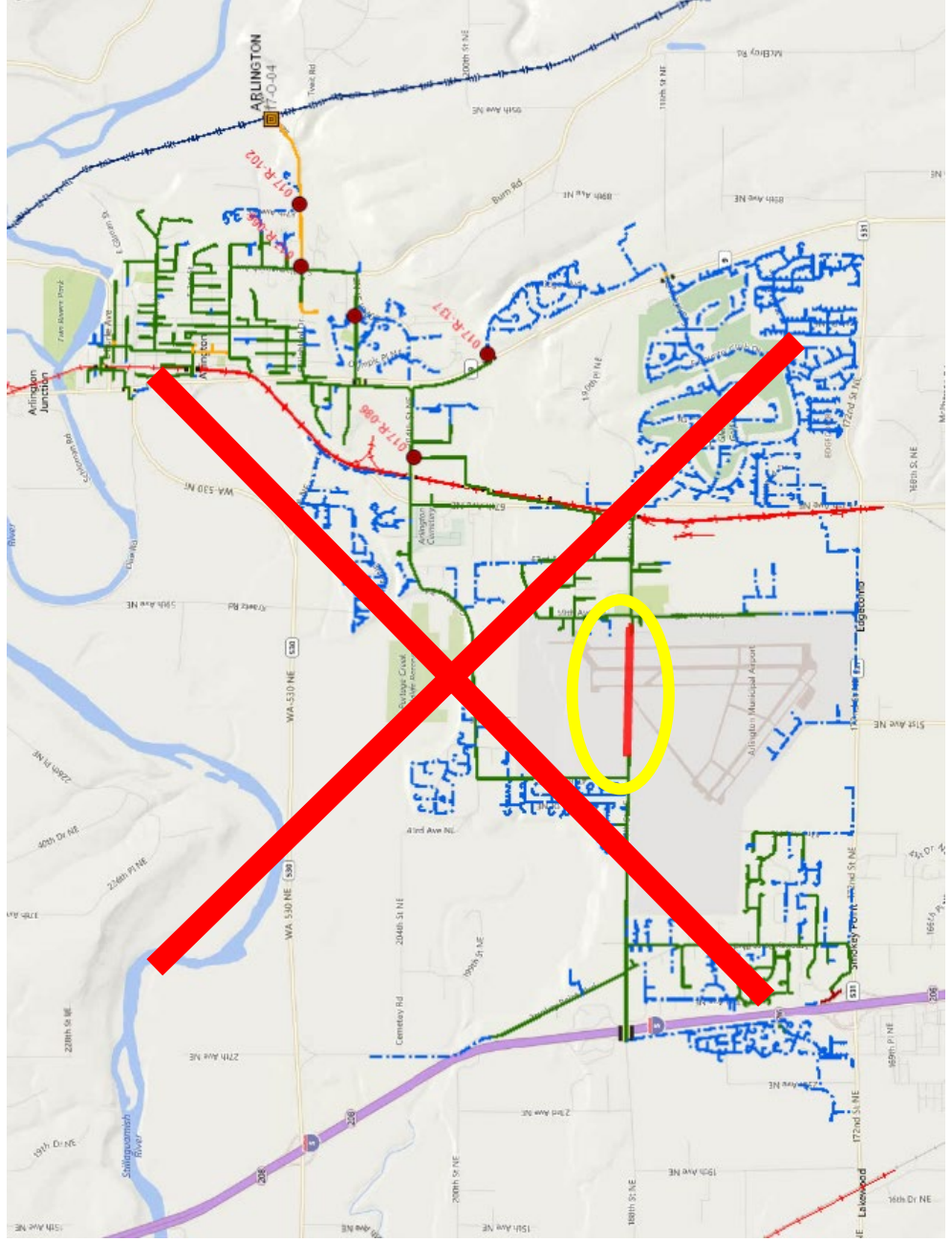

Distribution Enhancement Options

Reinforcement option #2

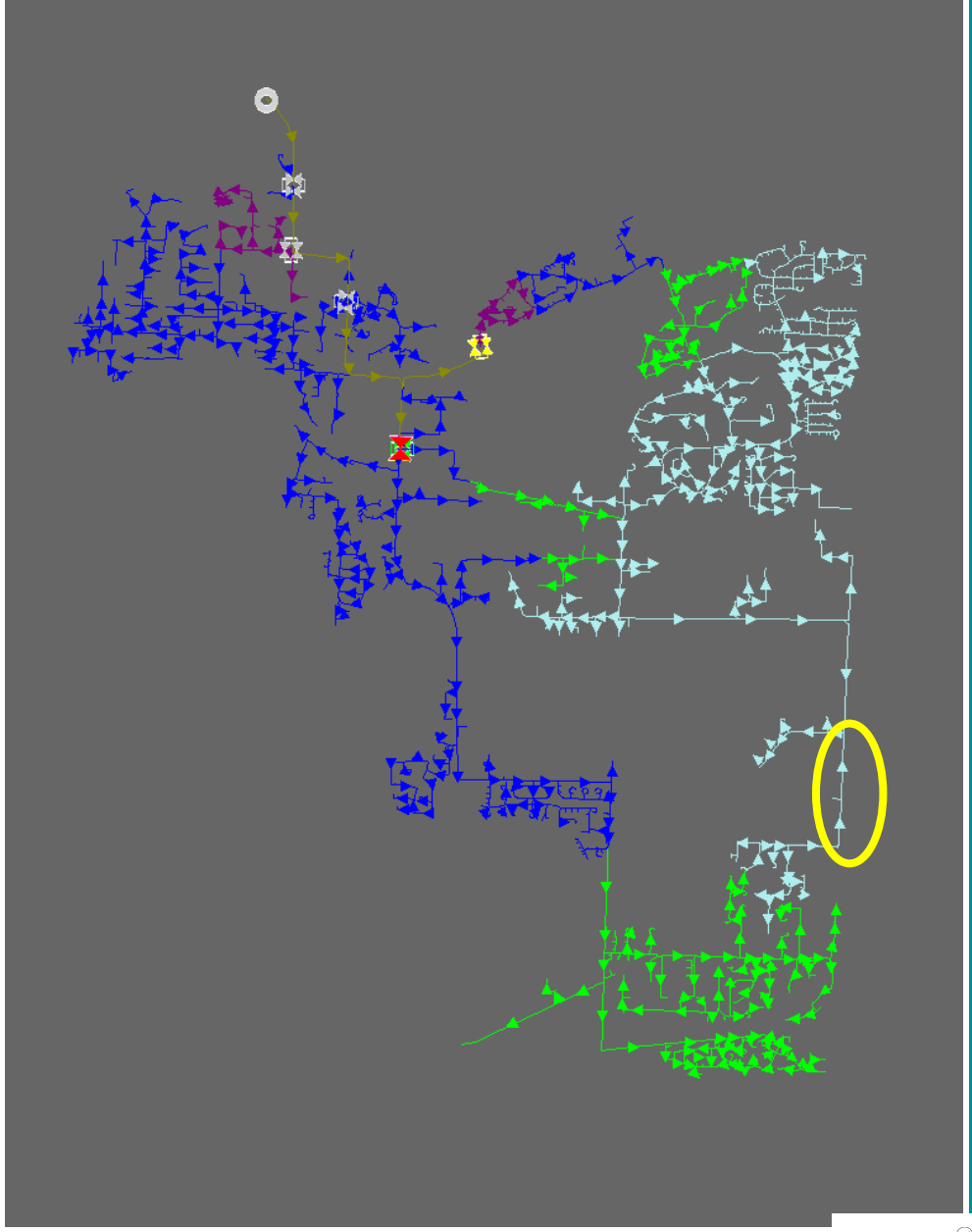

Facilities Color By

Pressure (Primary Only) (psig)

Not Applicable (8)
< 10.00 (0)
10.00 - 15.00 (780)
15.00 - 25.00 (367)
25.00 - 40.00 (844)
40.00 - 60.00 (71)
> 60.00 (16)

Enhancements Considerations

Scope

Cost

Capacity Increase

Timing

System Benefits

Alternative Analysis

Enhancement Review and Selection Process to Capital Budget

Enhancement Selection Guidelines:

- Shortest segment of pipe that addresses deficiency
- Segment of pipe with the most favorable construction conditions
- Segment of pipe that minimizes environmental concerns and impacts to the community
- Segment of pipe that provides opportunity to add additional customers
- Total construction cost including restoration

Enhancement Selection Process:

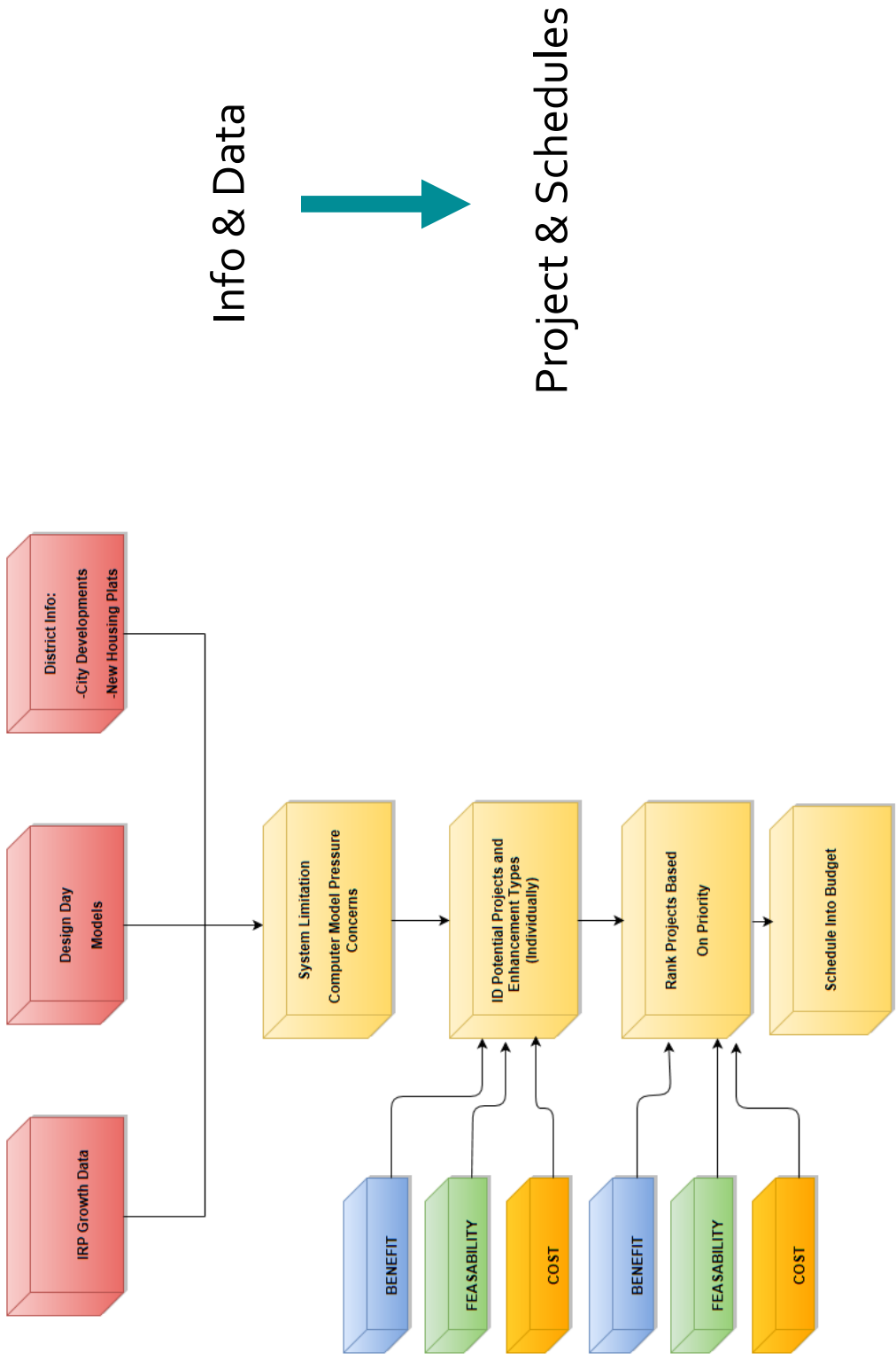

Enhancements/Reinforcements Identified in 2023-2027 Capital Budget

2023-2027 WA Distribution Enhancements:

- Kitsap Phase V Pipeline Reinforcement
- Aberdeen HP Reinforcements
- Bellingham 6-inch HP Reinforcement – Meador Ave
- Richland HP Reinforcements
- South Kennewick Reinforcements
- Pasco 6-inch HP Reinforcement
- Burlington South Feed Reinforcement
- Wapato 4-inch HP Replacement

Kitsap Phase V Pipeline Reinforcement

Scope: 4 miles of 12-inch HP

Cost: \$530k in 2023 and \$4.5M in 2024

Timing:

- 2023 Design and Permitting
- 2024 Construction

Benefits: Completes 12-inch Loop from Shelton to Bremerton on 8-inch Kitsap Transmission Line (installed in 1963)

Alternative Considered: Supports long term system planning, ties into Phase IV and Phase III

8-inch HP reinforcement on Basich Blvd

Scope: 12,500 ft of 8-inch HP and regulator station

Cost: \$950k in 2022 & \$3.233M in 2023

Timing: 2022 Design/Permitting & 2023 Construction

Benefits: Provides redundant feed into Aberdeen DP

Alternatives Considered: Would need to complete significant DP system reinforcements as an alternative

Elma/Satsop Gate Station

Scope: Second supply source to the Greys Harbor Lateral

Cost:

- CNG
- \$129k in 2024 & \$1.57M in 2025
- NWP
- \$514k in 2024 & \$2.6M in 2025

Timing: 2024 Design/Permitting & 2025 Construction

Benefits: Addresses high pressure issues in Aberdeen and provides redundancy to McCleary Gate

Alternatives Considered: Reinforce and or replace Greys Harbor Lateral

Bellingham 6-inch HP Reinforcement – Meador Ave

Scope: 2500 ft of 6-inch HP

Cost: \$262k in 2022 and \$964k in 2023

Timing:

- 2022 Design and Permitting
- 2023 Construction

Benefits: Eliminates pipe hanging on above ground bridge crossing

Alternatives Considered: None, no alternative route with comparable cost

Richland HP Reinforcements

RICHLAND 12-INCH HP PHASE 2

Scope: 3.75 miles of 12-inch HP

Cost: \$5.79M in 2023

Timing: 2023 Construction

RICHLAND Y GATE UPGRADE

Scope: Gate Upgrade

Cost:

- CNG
- \$11.5k in 2022 & \$1.79M in 2023
- NWP
- \$503k in 2022 & \$4.53M in 2023

Timing: 2022 Design/Permitting & 2023 Construction

Benefits: Solves capacity deficit in Richland and provides a back feed to Richland HP

Alternatives Considered: Upgrading the Kennewick gate and replacing the 6-inch Richland HP lateral on Clearwater and Columbia Center

South Kennewick Reinforcements

SOUTH KENNEWICK GATE

Scope: New Gate Station

Cost:

- o CNG
- o \$302k in 2023 & \$1.125M in 2024
- o NWP
- o \$503k in 2022 & \$2.52M in 2024

Timing:

- o 2023 Design and Permitting
- o 2024 Construction

KENNEWICK 8-INCH PE REINFORCEMENT

Scope: 2500 ft of 8-inch PE

Cost: \$557k in 2024

Timing: 2024 Construction

Benefits: Solves low pressure issue in Kennewick and supports growth
Alternatives Considered: Alternative reinforcements and loops to distribution system

Pasco 6-inch HP Reinforcement

Scope: 5 miles of 6-inch HP

Cost: \$203k in 2024 & \$4.9M in 2025

Timing:

- 2024 Design and Permitting
- 2025 Construction

Benefits: Addresses high pressure capacity deficit in Pasco

Alternatives Considered: Upgrade North Pasco gate and reinforce HP out of gate

Burlington South Feed Reinforcement

Scope: 15,000 ft of 6-inch PE and Reg Station

Cost: \$40k in 2022 & \$1.69M in 2023

Timing:

- 2022 Design and Permitting
- 2023 Construction

Benefits: Addresses low pressure issues in Burlington, loops system

Alternatives Considered: HP extension with a new reg station, no equivalent DP loops

Wapato 4-inch HP Replacement/Reinforcement

Scope: Replace 31,000 ft of 4-inch HP with 6-inch HP

Cost: \$400k in 2022 & \$6M in 2023

Timing:

- 2022 Design and Permitting
- 2023 Construction

Benefits: Addresses MAOP concerns on 4-inch HP, provides additional capacity to Wapato

Alternatives Considered: New gate near Donald with HP back feed to Wapato, challenging route with significantly higher costs

Iterative Process of IRP

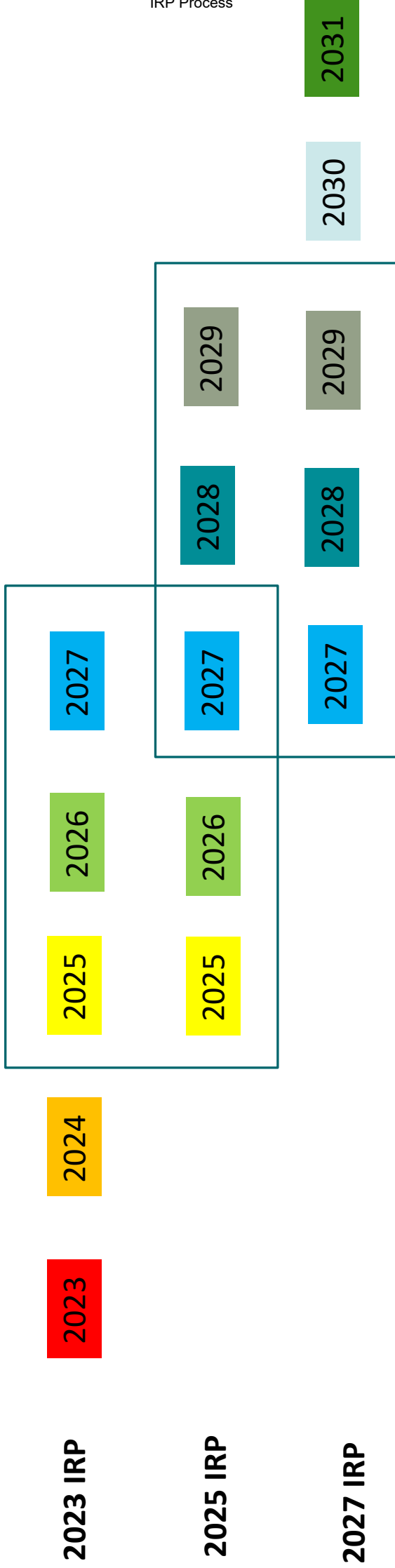

Questions?

2023 IRP Remaining Schedule

Process Items	Process Elements	Date
TAG 4 (OR)	Carbon Impacts, Energy Efficiency (ETO), Bio-Natural Gas, Preliminary Resource Integration Results.	9/20/2022
TAG 5 (WA)	Final Integration Results, finalization of plan components, Proposed new 2- to 4-year Action Plan.	9/28/2022
TAG 5 (OR)	Final Integration Results, finalization of plan components, Proposed new 4-year Action Plan.	11/9/2022
Draft of 2022 IRP distributed (WA)	Filing of Draft IRP	11/24/2022
Draft of 2022 IRP distributed (OR)	Filing of Draft IRP	1/5/2023
Comments due on draft from all stakeholders (WA)	Comments due from Stakeholders	1/13/2023
Comments due on draft from all stakeholders (OR)	Comments due from Stakeholders	2/24/2023
TAG 6, if needed (WA)	An additional TAG if needed based on comments from Stakeholders	2/1/2023
TAG 6, if needed (OR)	An additional TAG if needed based on comments from Stakeholders	3/15/2023
IRP filing (WA)	IRP Final Filing	2/24/2023
IRP filing (OR)	IRP Final Filing	4/14/2023



Questions/Next Steps



Review Plans for TAG 5 Discussion

- Final Integration Results • Next WA TAG is
- Finalization of Plan components • Next OR TAG (TAG 4) is
- Proposed new Action Plan • Tuesday, September 20

Contact Information

Mark Sellers-Vaughn – Manager, Supply Resource Planning: (509) 734-4589
mark.sellers-vaughn@cngc.com

Brian Robertson – Supervisor, Resource Planning: (509) 221-9808
brian.robertson@cngc.com

Devin McGreal – Senior Resource Planning Economist: (509) 734-4681
devin.mcgreal@cngc.com

Ashton Davis – Resource Planning Economist II: (509) 734-4520
ashton.davis@cngc.com

Cascade IRP email – irp@cngc.com



In the Community to Serve[®]

Integrated Resource Plan (WA) Technical Advisory Group Meeting #4

AUGUST 10, 2022

MICROSOFT TEAMS/TELECONFERENCE



In the Community to Serve[®]



In the Community to Serve®

TAG #4 WA – TAG Meeting

Date & time:	08/10/2022, 9:00 AM to 3:00 PM
Location:	Microsoft Teams Meeting
Presenters:	Abbie Krebsbach, Brian Robertson, Devin McGreal, Kent Crouse, Lori Blattner, Monica Cowlshaw, Caleb Reimer, & Kathleen Campbell
In attendance:	Abbie Krebsbach, Abe Abdallah, Becky Hodges, Brian Cunnington, Brian Robertson, Bruce Folsom, Byron Harmon, Caleb Reimer, Carolyn Stone, Carra Sahler, Chanda Marek, Chris Robbins, Dan Kirschner, Devin McGreal, Eric Wood, Haixiao Huang, Heide Caswell, James Fraser, Jon Storvick, JP Batmale, Kathleen Campbell, Kent Crouse, Kevin Connell, Lori Blattner, Mark Sellers-Vaughn, Matt Steele, Michael Parvinen, Monica Cowlshaw, Pamela Archer, & Robert Slowinski

Brian Robertson, Supervisor of Resource Planning, opened the meeting by welcoming and thanking stakeholders for participating in Cascade's IRP Process. Brian then proceeded with introductions, the agenda, a safety moment, and a reminder of the stakeholder engagement principles.

Presentation #1 – IRP Carbon Update and Assumptions (Abbie Krebsbach & Brian Robertson)

- Abbie began by discussing Cascade's commitment to reduce emissions with a predominant amount of time spent on discussing the Climate Commitment Act (CCA).
- Abbie shared the Company's baseline emissions and described the non-core regulated as covered entities separately under the CCA.
- Abbie also covered customer and operation emissions.
- As part of the CCA discussion, Abbie shared the options Cascade has to comply with the CCA rules and what our RNG/Hydrogen projections look like.

Question: Byron asked if there were any entities that fell through emission requirement cracks since Cascade is only responsible for certain transport customers.

Answer: Abbie responded that there are certain rules that may make entities exempt from emission reduction requirements, but Cascade didn't have any specific customers or examples during the meeting.

Question: JP asked if the current pipe Cascade was putting into the ground was safe for Hydrogen.

Answer: Kathleen informed the group that the more modern pipe is safe when it comes to Hydrogen blending and the vintage pipe is where there could be concerns.

- Brian then discussed the local GHG reduction focus and how Cascade planned to model those.
- Abbie touched on the national GHG reduction focus and then described the differences between Washington and Oregon policies.
- Abbie then discussed the upstream emissions calculation and described in detail the changes from the previous IRP.

Presentation #2 – Renewable Natural Gas (Brian Robertson, Devin McGreal, Lori Blattner, & Kent Crouse)

- Brian gave a high-level overview of what Renewable Natural Gas (RNG) is, some examples of RNG, and the benefits of RNG. Brian also described the main issue with RNG is the high cost.

Question: Byron asked if his understanding that RNG is a constant supply that supplies the same amount of gas each day throughout the year was correct.

Answer: Kathleen explained that Byron's understanding is correct and there are multiple reasons as to why an RNG project generally supplies the same amount of gas for each day of the year.

Question: Abe asked a clarifying question after Cascade mentioned the high price of RNG. Abe's question was how RNG prices compare to other green gas production costs.

Answer: Devin explained that we utilize an AGF ICF study for long term RNG and Hydrogen pricing and in that study, it shows that RNG starts out cheaper and then prices increase, where Hydrogen is the exact opposite.

- Devin McGreal discussed how Cascade does RNG Cost-Effectiveness analysis. Devin also covered the differences between purchase vs build when it comes to RNG.
- Lori gave an update on Cascade's voluntary RNG program and gave some information on Hydrogen.

Question: Byron asked if there would be a more concrete timeline for the voluntary RNG program in the IRP narrative.

Answer: Lori said that Cascade plans to have something in place by the end of the year, so including more narrative on the voluntary RNG program shouldn't be an issue.

Question: Abe asked if Cascade has looked at existing H2 blending projects operation in Europe and Australia.

Answer: Lori mentioned that Cascade has been monitoring the GTI study that has discussed H2 blending projects from across the world in great detail. Brian also mentioned that a member of Cascade recently went to Denmark to tour RNG/Hydrogen facilities.

- Kent described in detail several projects that Cascade is working on to get on-system RNG onto Cascade's system.

Presentation #3 – Demand Side Management (DSM) Forecast (Monica Cowlshaw & Caleb Reimer)

- Monica shared an overview of Cascade's energy efficiency program performance and then passed it off to Caleb to discuss the LoadMAP modeling tool and analysis framework.
- Monica then described the different scenarios that were run and discussed that the 2023 IRP values are different than the original 2021 CPA. Cascade also modeled a higher avoided cost using RNG pricing as well as a combination of that and natural gas bans. Each scenario provided varying amounts of DSM.
- Caleb then discussed forecast summaries and the top measures for Commercial, Industrial, and Residential customers.
- Caleb then went through the top twenty overall measures, which results in the final portfolio. Monica then described the DSM action items and next steps.

Presentation #4 – Preliminary Results (Brian Robertson)

- Brian shared the preliminary results for Cascade’s upstream transportation and showed how future DSM could delay upstream transportation needs approximately 11-12 years.
- Brian also showed what Cascade’s base case modeling could look like for the final results. Cascade is still working through CCA modeling to ensure the accuracy of all inputs.

Presentation #5 – Distribution System Planning (Kathleen Campbell)

- Kathleen covered the overall distribution system modeling process and the data gathering process for Synergi.

Question: Heide asked about the time granularity of the billing data that goes into the CMM model.

Answer: Kathleen mentioned that the data comes from Cascade’s customer care and billing system which comes in at a monthly level.

- Kathleen shared how Cascade identifies system deficits/constraints and discussed options to address these system deficits/constraints.

Question: Heide asked if Cascade has ever done any transient modeling.

Answer: Kathleen mentioned that engineering is familiar with the transient modeling and mentioned that Cascade is developing those models for the Company’s distribution system.

- Kathleen went through the Company’s capacity enhancement review and selection process and how projects are placed in the capital budget.
- Kathleen then discussed the distribution system projects Cascade has planned for 2023-2027 in great detail. Then there was a brief discussion on the iterative process of an IRP where projects in the 3-5 year range will be included in future IRPs since those are completed every two years.

Presentation #6 – 2023 IRP Schedule (Brian Robertson)

- Brian went through the remaining TAG schedules for both WA and OR.
- Brian noted that the next TAG meeting will be Oregon focused and take place on September 20th while the next WA TAG meeting will take place on September 28th.

The Meeting was Adjourned

Per Cascade Commitment #8 (Stakeholder Engagement Design Document, 2/22/2022: “Provide TAG minutes that include the action items from bullet #7 as well as any upcoming deadlines for feedback on the IRP”), here are additional action items to track, coming out of the TAG 4 meeting:

1. Cascade will provide an update and details on the voluntary RNG program in the IRP narrative.



In the Community to Serve[®]

Integrated Resource Plan (WA) Technical Advisory Group Meeting #5

OCTOBER 20, 2022

MICROSOFT TEAMS/TELECONFERENCE



In the Community to Serve[®]

Agenda

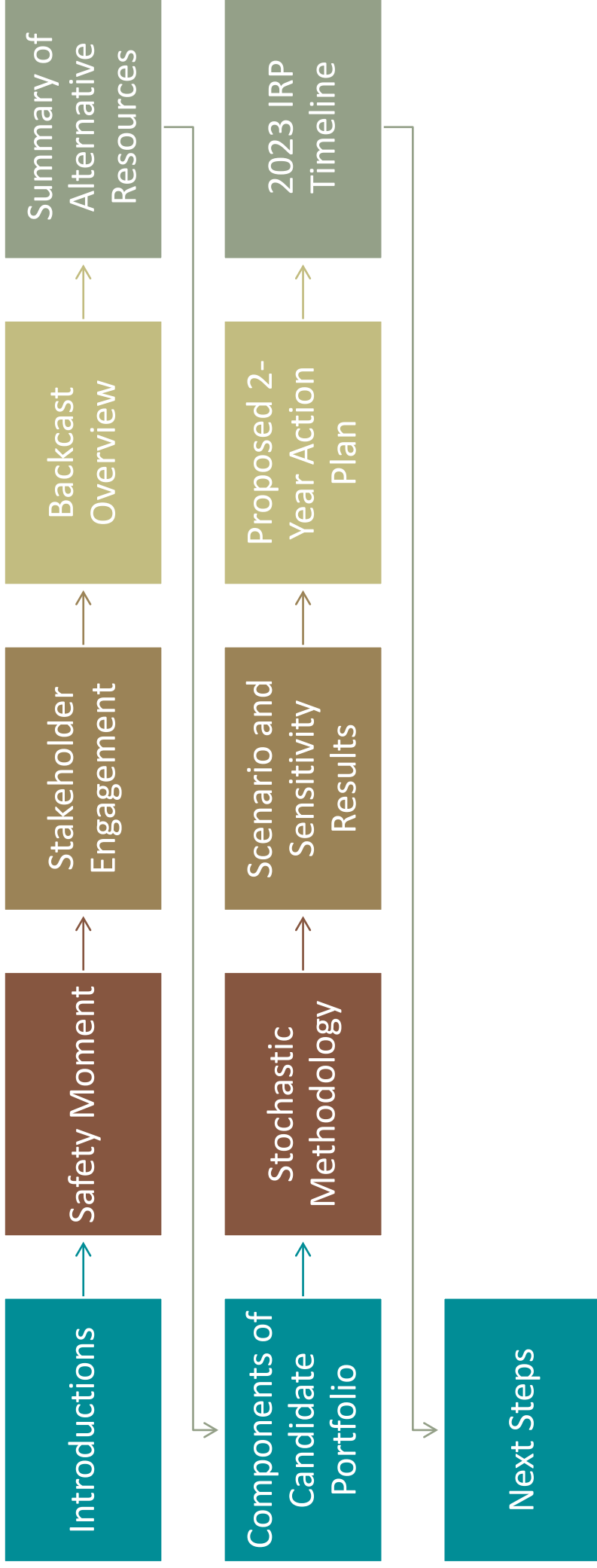

How to Relieve Stress

Stress can have a negative impact on bodies and overall health. Here are some tips to relieve it:

- **Listen to Music** – Playing calm, meditative, relaxing music can help lower blood pressure. This can include listening to ocean waves or nature sounds.
- **Talk to Someone** – Take a break and talk to a friend or a counselor. When you are under a lot of stress a reassuring voice can help put everything into a better perspective.
- **Healthy Eating** – Try to avoid sugary and fatty snack foods. Eating fruits, vegetables, and fish with high Omega-3 fatty acids are a better alternative and have been shown to reduce stress symptoms.
- **Laugh** – Laughter they say is the best medicine and when it comes to stress, this is true. Laughing releases endorphins that decrease the levels of stress hormones. Laughing tricks your brain into making you happy.
- **Drink Tea** – Avoid coffee and caffeinated drinks; these beverages cause a short-term spike in blood pressure. Green tea has less caffeine and contains amino acids that have a calming effect.
- **Exercise** – Exercising, even for a short walk around the office or simply standing up and stretching will get your blood moving and release endorphins to immediately provide some relief to a stressful moment.
- **Breathe** – Taking deliberate, slow, deep breaths helps to center your body, clear your mind, and slow your heart rate. Understanding stress and how it effects your body can help you understand the right steps you need to take to help relieve it.

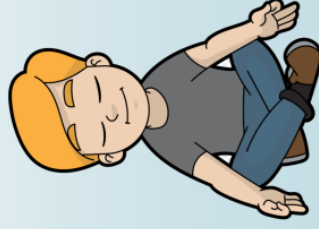

Safety Moment

Stakeholder Engagement¹

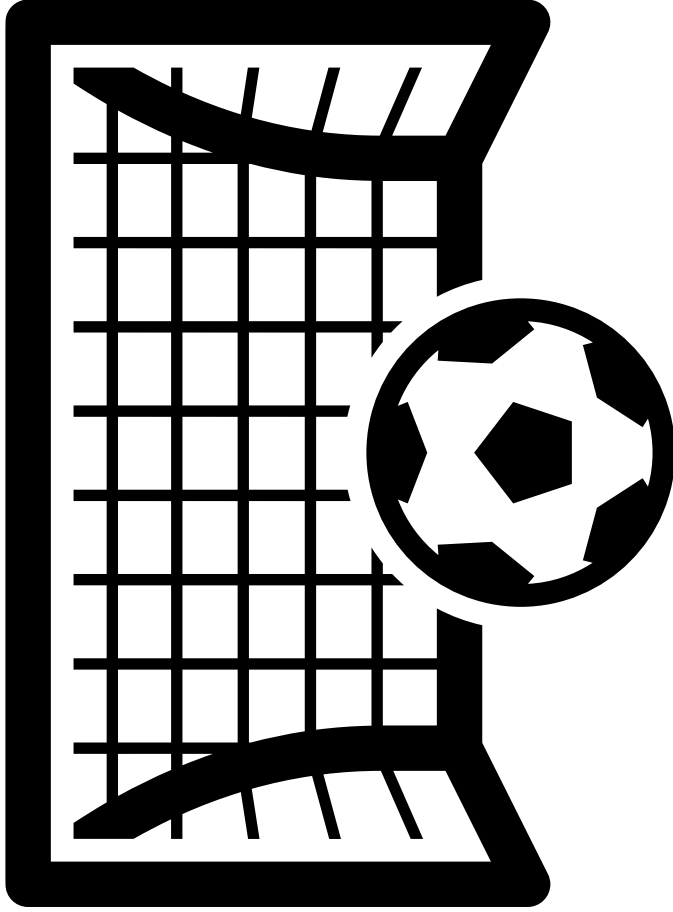

While Cascade owns and is responsible for the IRP, the Company desires to have involvement from stakeholders to provide a diversity of perspectives.

A best practices IRP is informed by perspectives, analyses and access to concerns and approaches that the Company may not have considered.

Some stakeholders participate in multiple IRP processes and have a line-of-sight that may not be available to Cascade, despite the Company monitoring other utilities' IRPs and associated processes.

Backcast Overview

Backcasting (Cross-validation)

Cross-validation:

- Estimates the skill of a model on unseen data.
- Flags problems like overfitting, sampling bias...

Hold out cross validation:

- Data is split into “training” and “test” sets
- Model is fit to “training” set
- Model’s forecast is compared to “test” set for accuracy

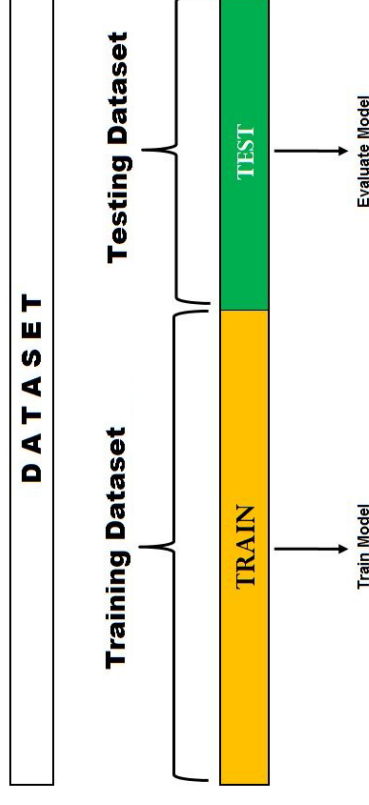

Breakdown of a forecast analysis

In-sample Forecast

Out-of-sample Forecast

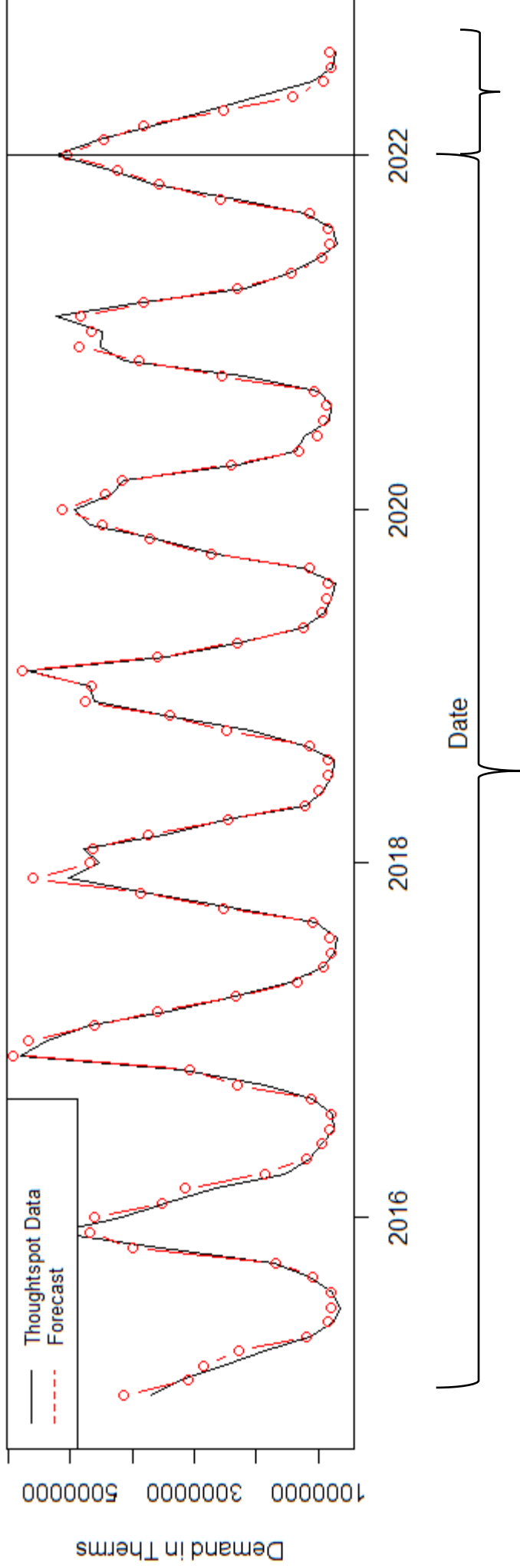

Training Set

Test Set

Sumas SPE Loop: 503 (Residential)

Last cross-validation:

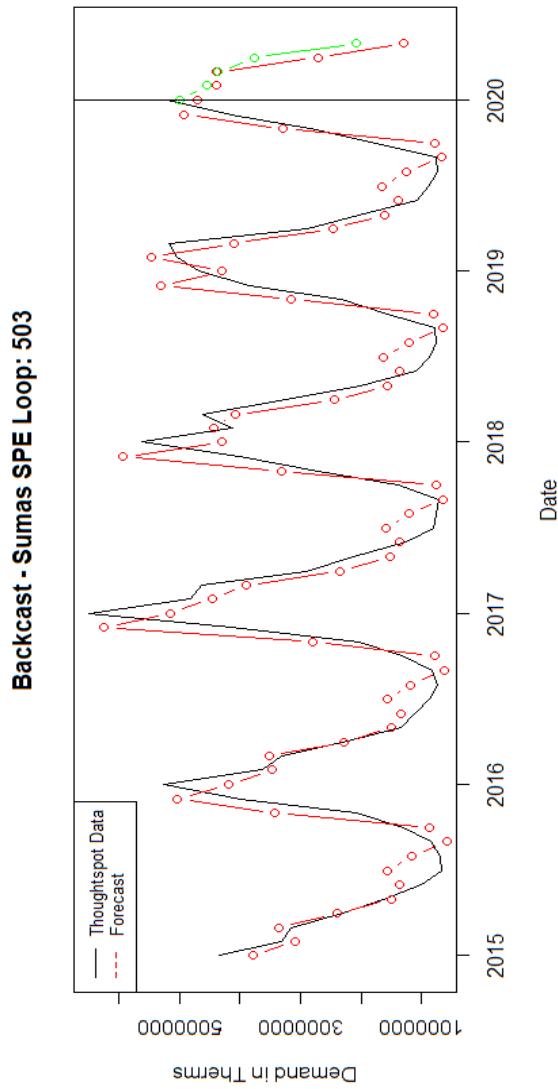

Current cross-validation:

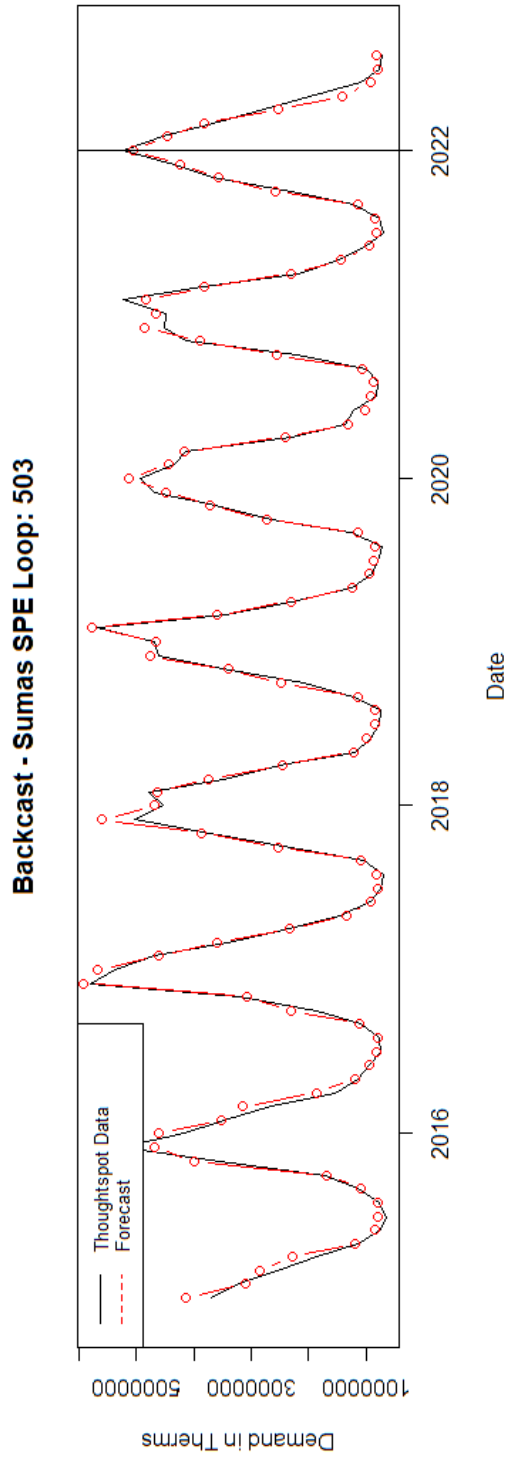

Sumas SPE Loop – 504 (Commercial)

Last cross-validation:

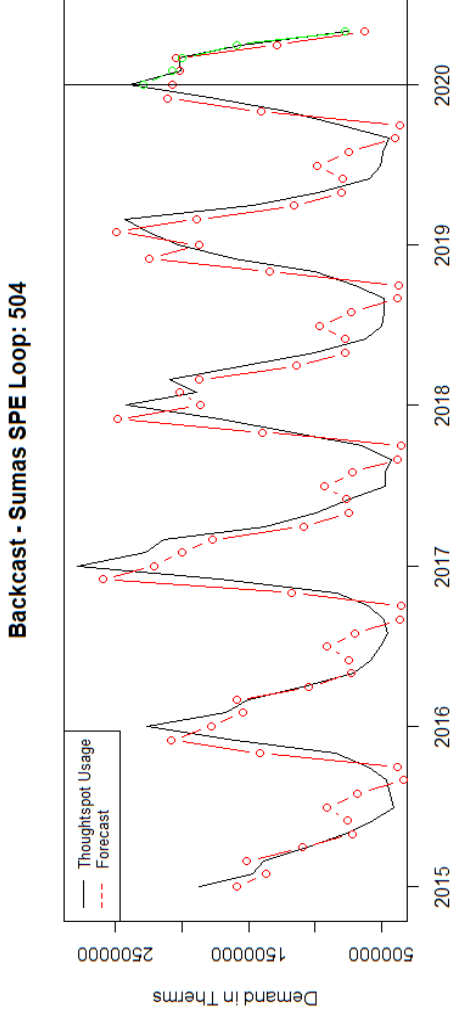

Current cross-validation:

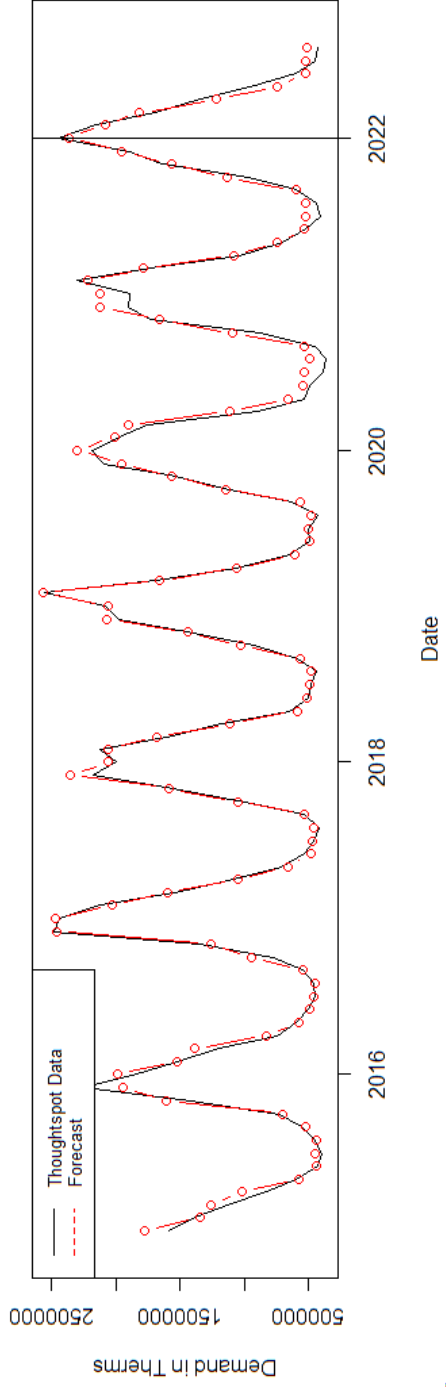

Sumas SPE Loop – 505 (Industrial)

Last cross-validation:

Backcast - Sumas SPE Loop: 505

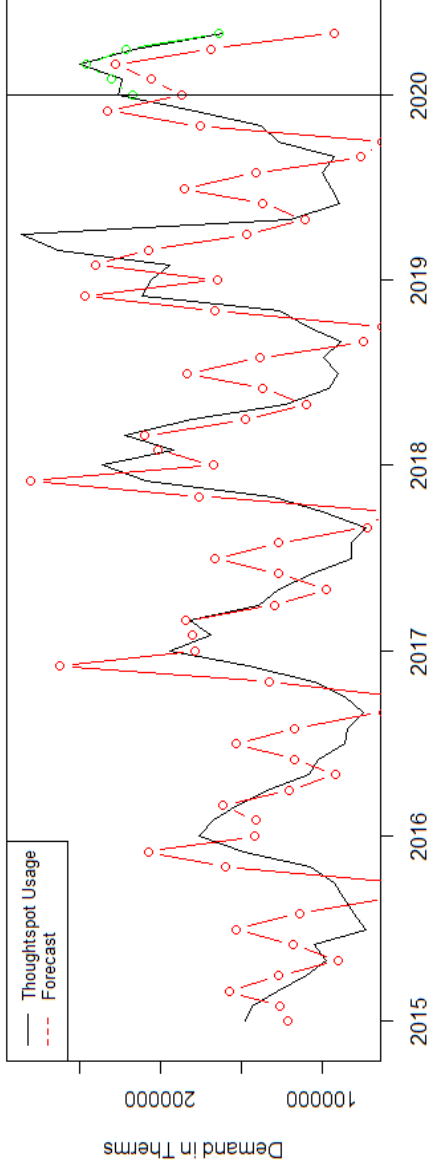

Current cross-validation:

Backcast - Sumas SPE Loop: 505

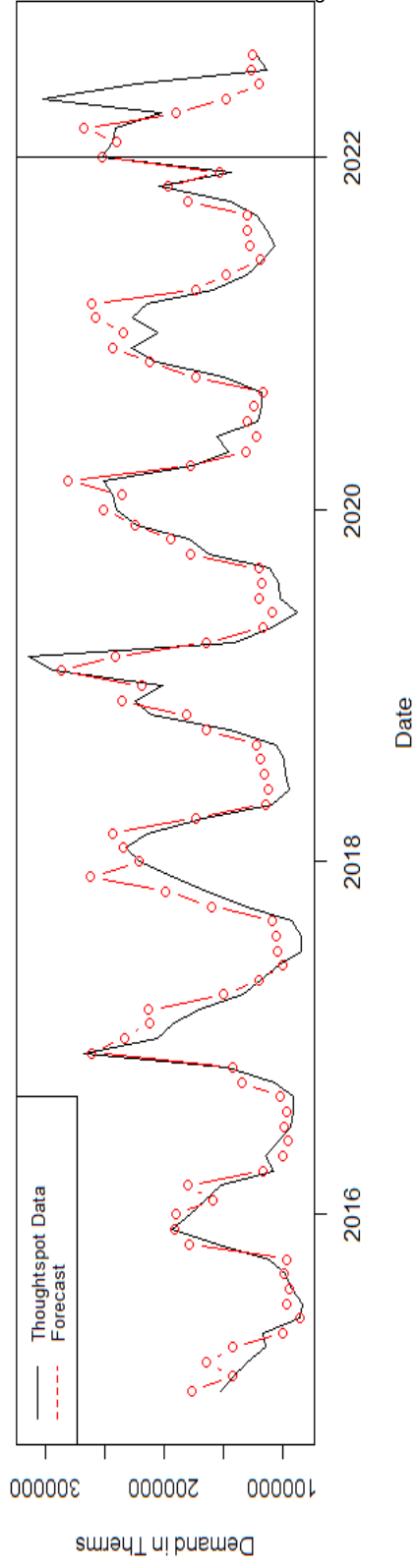

Yakima 503

Last cross-validation:

Backcast - Yakima: 503

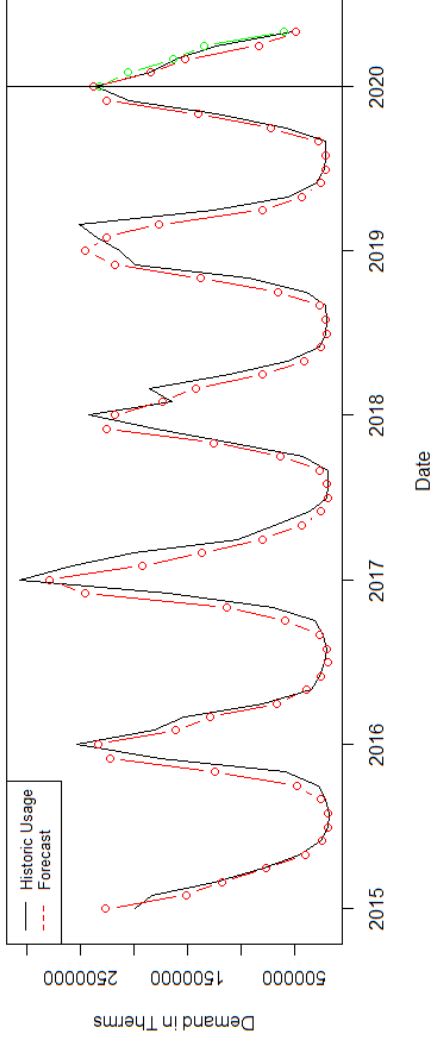

Backcast - Yakima Loop: 503

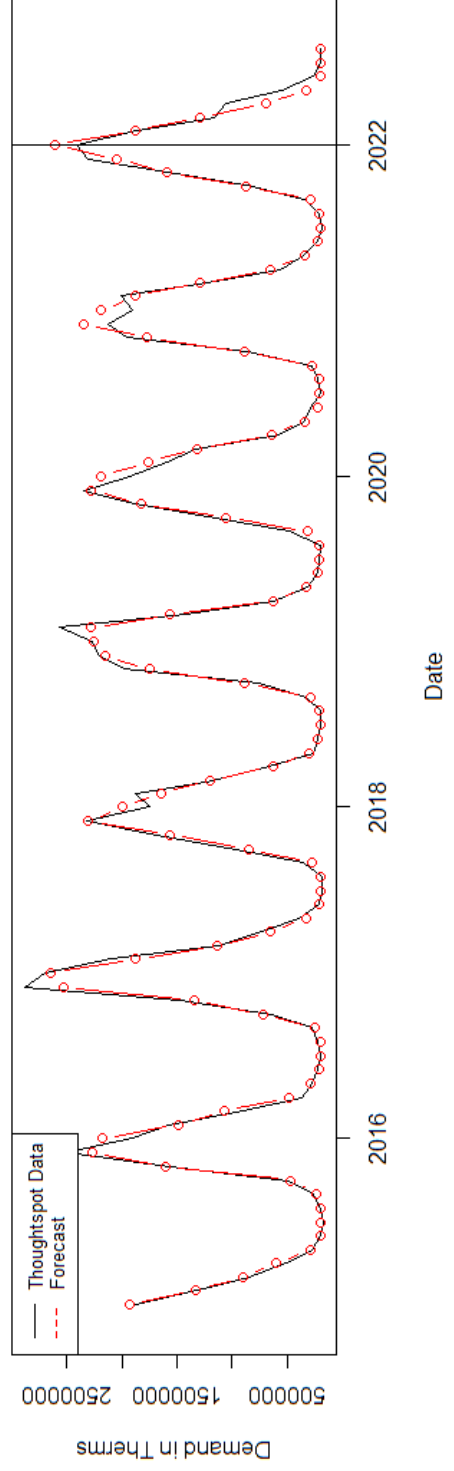

Current cross-validation:

Yakima 504

Last cross-validation:

Backcast - Yakima: 504

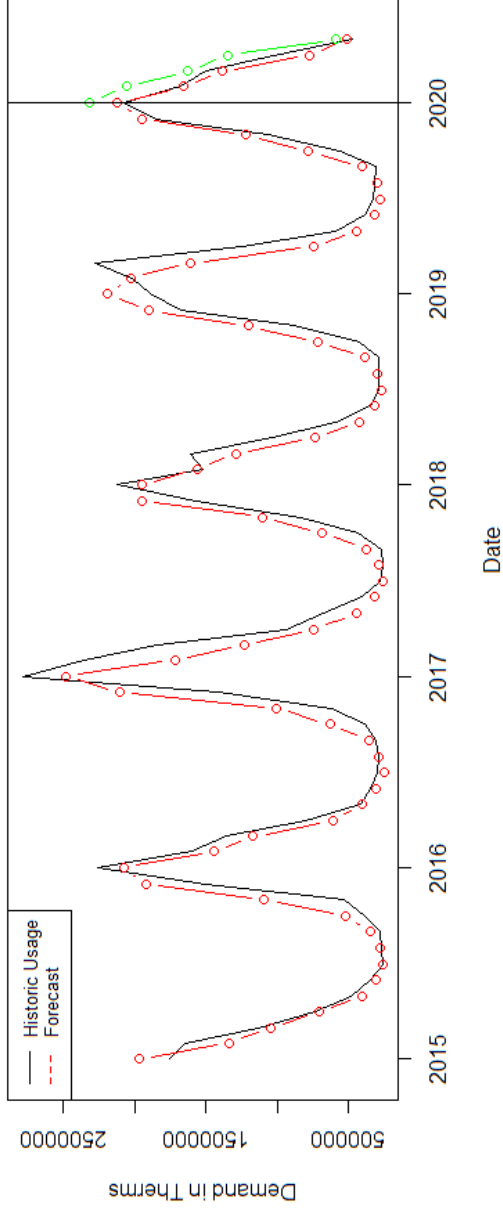

Backcast - Yakima Loop: 504

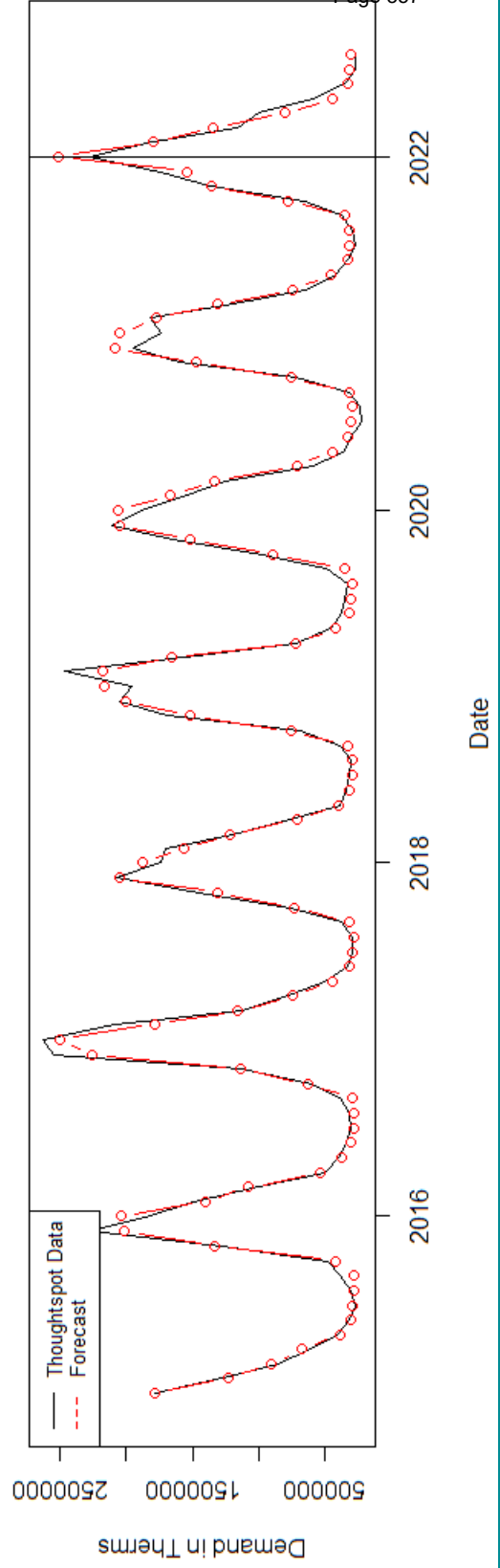

Current cross-validation:

Yakima 505

Last cross-validation:

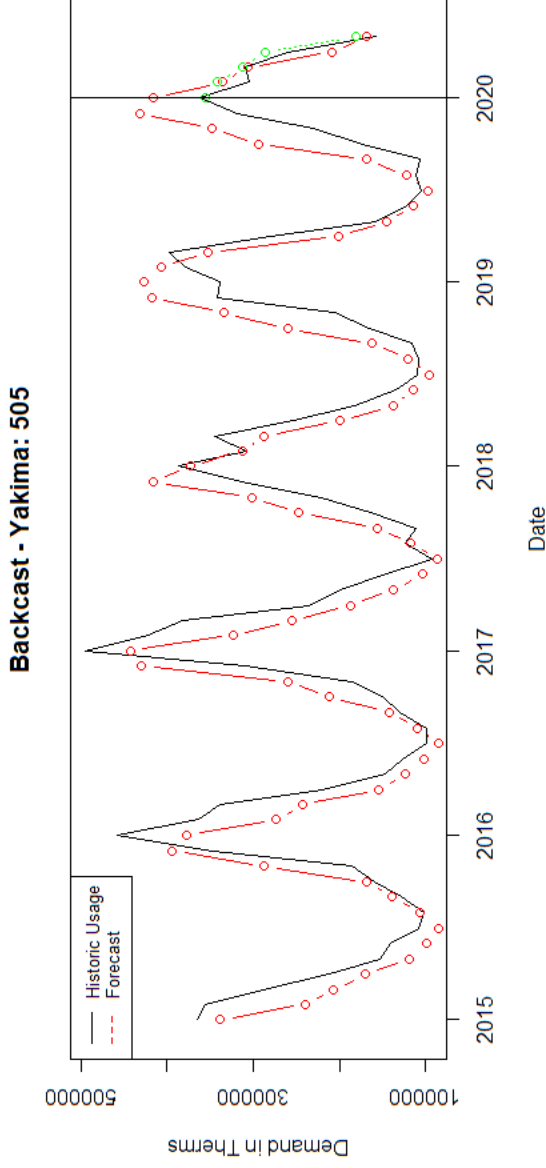

Current cross-validation:

Backcast - Yakima Loop: 505

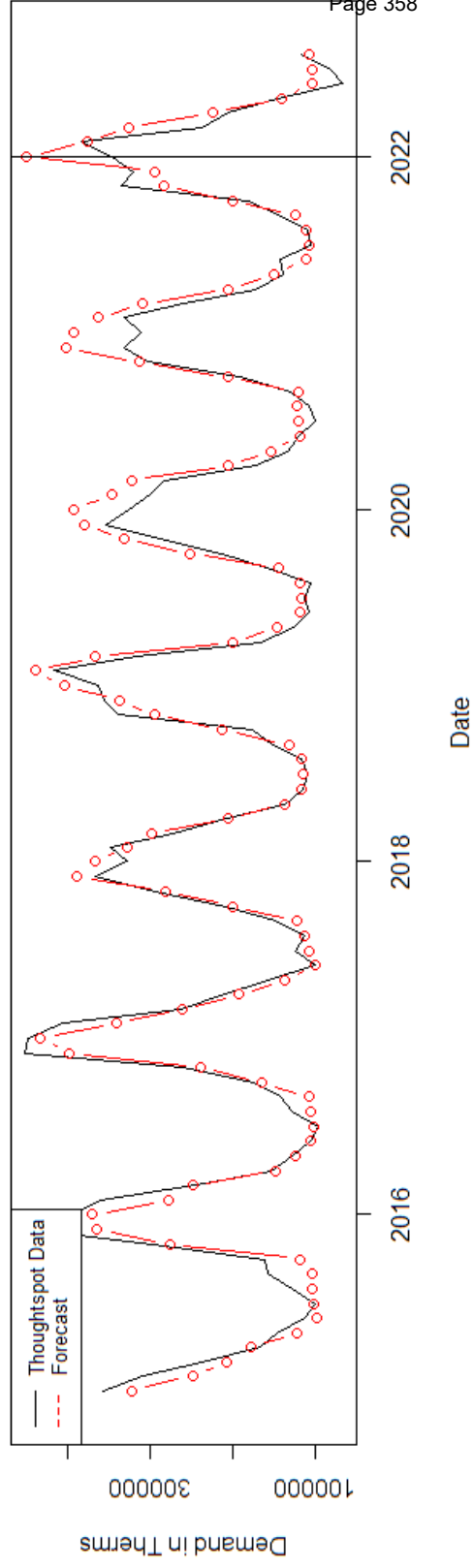

Next Steps:

- Investigate industrial regressors to improve forecasts
- Build script for faster cross-validation

Summary of Alternative Resources

Incremental Transport

- Incremental Transport – Northwest Pipeline Bilateral
- Incremental Transport – North to South GTN
- Incremental Transport – South to North GTN
- Incremental Transport – T-South/Pacific Connector

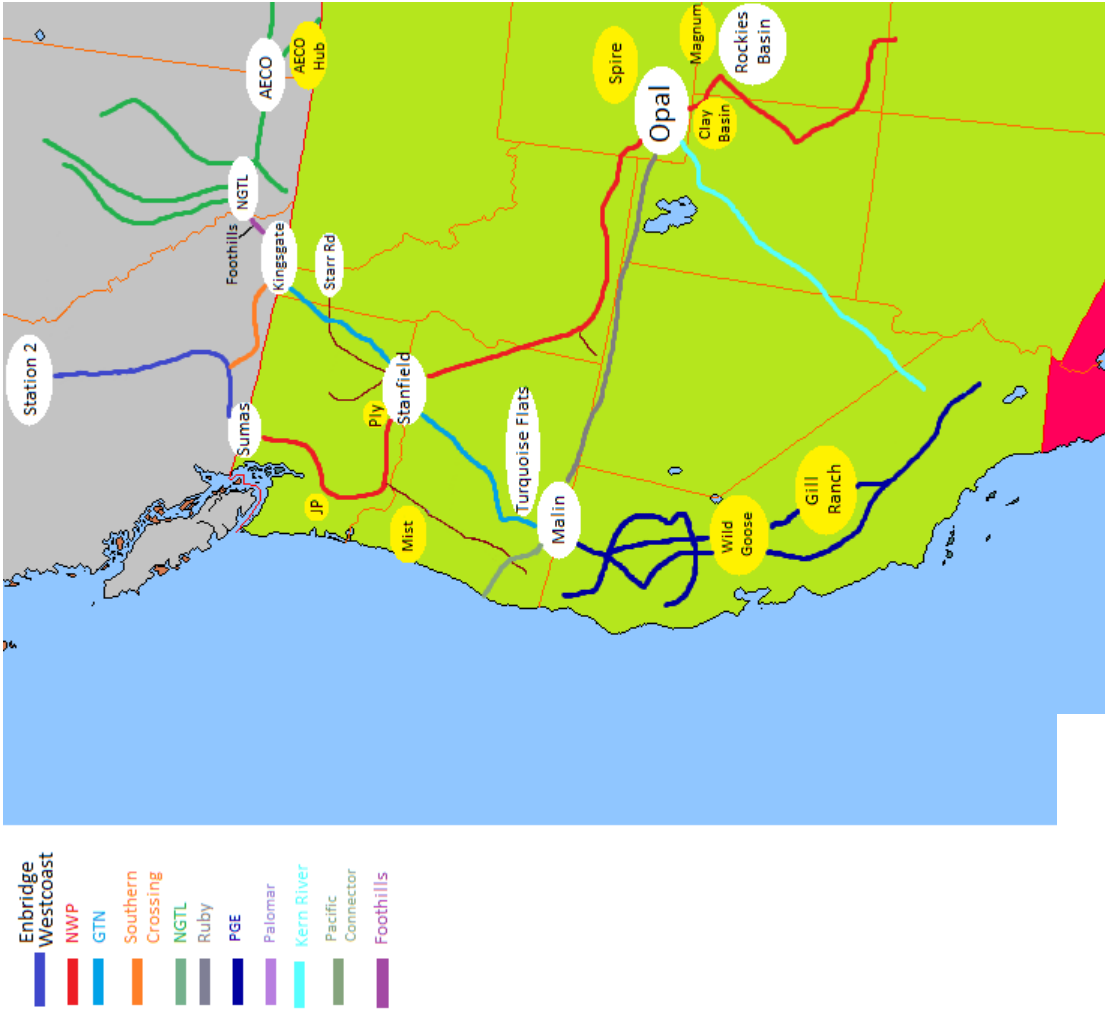

Incremental Storage

- Incremental Storage - North and East
- Incremental Storage - South and West



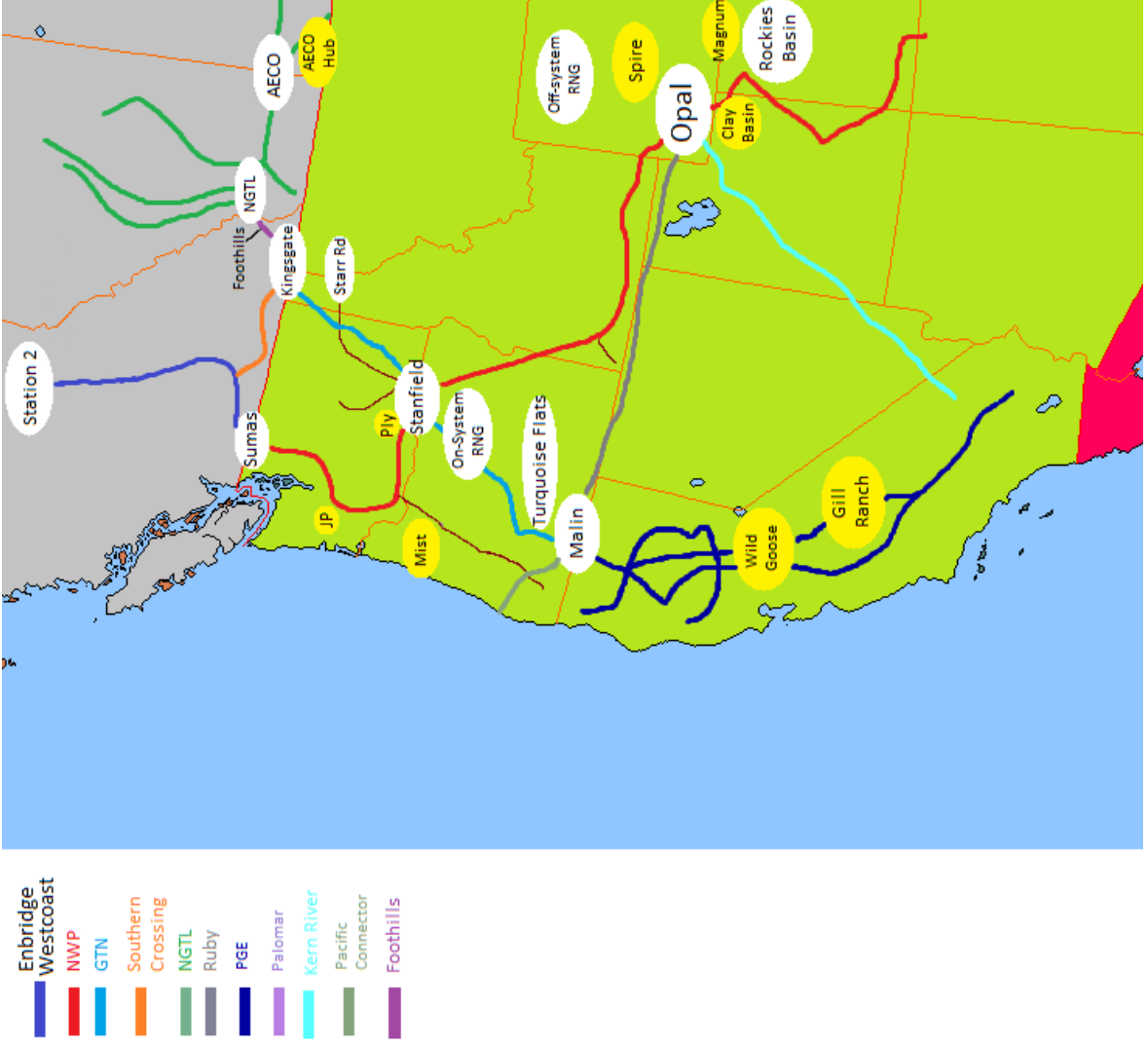

Incremental Supplies

Incremental Opal Supply – Additional supply around the Rockies Basin

Renewable Natural Gas – Incremental biogas supply directly to distribution system

Hydrogen – Incremental Hydrogen supply directly to distribution system



Components of Candidate Portfolios

Supply Resource Optimization Process Flow Chart

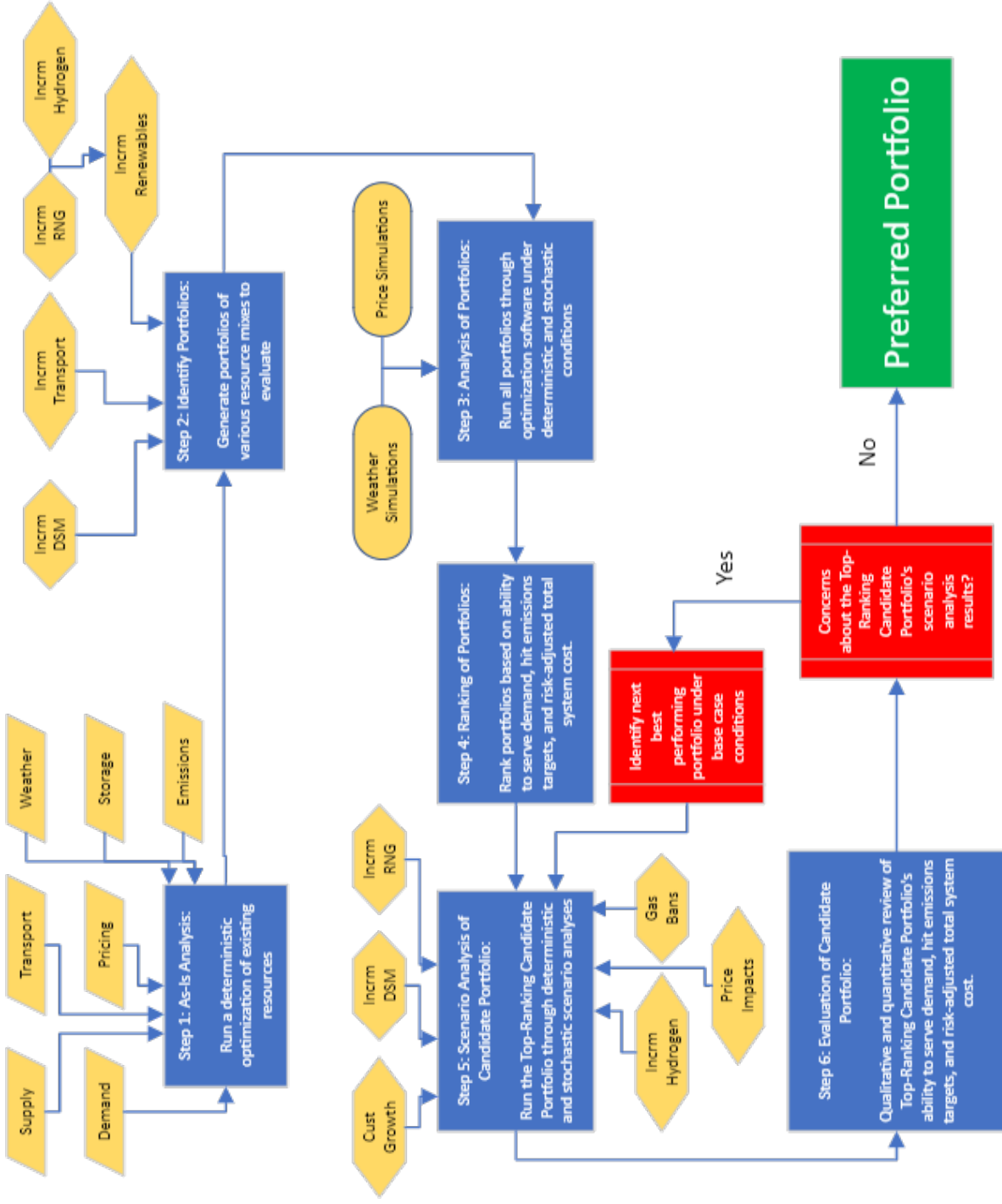

Supply Resource Optimization Process

Step 1: As-Is Analysis

- Run a deterministic optimization of existing resources to uncover timing and quantity of resource deficiencies.

Step 2: Identify Portfolios

- Cascade will be evaluating six different portfolios of incremental resources for the 2023 IRP. Each will be a mix of various incremental resources, including transportation capacity, RNG, Hydrogen, and DSM.

Step 3: Analysis of Portfolios

- Each portfolio will be run through the Plexos optimizer under expected conditions (see Base Case scenario.) The portfolios will be evaluated under deterministic and stochastic weather/pricing, and the timing/quantity if applicable of unserved demand and emissions reductions shortfalls will be recorded. Cascade will also record the risk-adjusted total system cost of each portfolio.

Supply Resource Optimization Process Cont.

Step 4: Ranking of Portfolios

- The Top Ranking Candidate Portfolio will be the portfolio that is able to serve all forecasted demand over the planning horizon while hitting all emissions reductions goals. In the case of multiple portfolios accomplishing this, the portfolio that does it with the lowest risk-adjusted total system cost will be the Top-Ranking Candidate Portfolio.

Step 5: Scenario Analysis of Candidate Portfolio

- The Top Ranking Candidate Portfolio is re-run through the Plexos optimizer under five scenarios. These scenarios will provide sensitivity testing of customer growth, energy efficiency, RNG, hydrogen, Natural Gas bans, and Natural Gas pricing. The portfolio will be evaluated under deterministic and stochastic weather/pricing, and the timing/quantity if applicable of unserved demand and emissions reductions shortfalls will be recorded. Cascade will also record the risk-adjusted total system cost of each portfolio.

Step 6: Evaluation of Candidate Portfolio

- Cascade performs a qualitative and quantitative review of Top-Ranking Candidate Portfolio's ability to serve demand, hit emissions targets, and the risk-adjusted total system cost of the portfolio under the scenarios evaluated. If there are concerns about the portfolio's ability to hit these metrics, or the cost of hitting these metrics, the Company may loop back to Step 5 with a new portfolio that might be more insulated against identified risks. Otherwise, the portfolio is named Cascade's Preferred Portfolio.

Recap – As-Is Analysis

Cascade has finalized its load forecast for the 2023 WA IRP.

All of Cascade’s existing resources have been run through PLEXOS® to complete the Company’s As-Is analysis as discussed in Step 1 of the Supply Resource Optimization Process.

- Assuming contracts evergreen.
- Assuming emissions reduction requirements as outlined in the CCA and CPP, but no usage of compliance instruments.
- These preliminary results do not include the impacts of incremental DSM beyond existing installed measures.

Recap – As-Is Shortfalls

Transport (Dth)		
	First Year Shortfall	Max Shortfall
Zone 11	2034	7,570
Zone ME-WA and GTN	2038	20,390

Emissions (Dth)		
	First Year Shortfall	Max Shortfall
Washington	2024	40,047,090
Oregon	2023	17,114,540

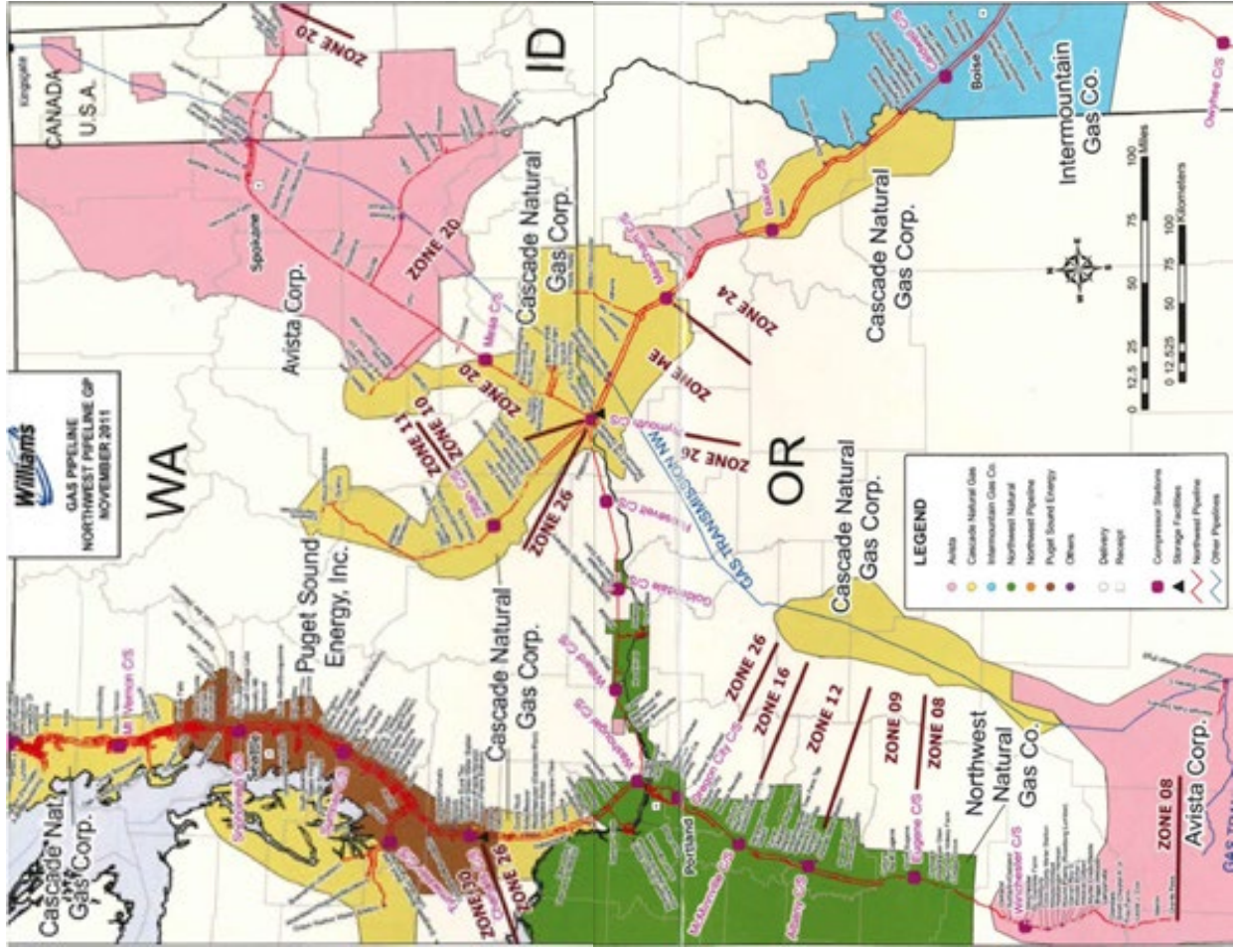

List of Candidate Portfolios

All-In Portfolio

All-In Portfolio Less DSM

Transportation Only Portfolio

Offsets Only Portfolio

RNG Only Portfolio

Hydrogen Only Portfolio

RNG and Hydrogen (Renewables) Only Portfolio

All-In Portfolio

Best deterministic mix of all alternative resources considered:

- Incremental Transport Resources
- Incremental Storage Resources
- Cost Effective DSM from CPA
- Incremental RNG
- Incremental Hydrogen
- Compliance Instruments

All-In Portfolio – PLEXOS® Suggested Resource Mix

All Cost-Effective DSM

Incremental RNG – Utilized mostly in Oregon, 154,210 Dth starting in 2023, up to 15,635,780 Dth by 2050

Incremental Hydrogen – 90,970 Dth starting in 2029, up to 524,700 Dth by 2050

Compliance Instruments – Utilized as needed, exact number discussed under confidential treatment in IRP

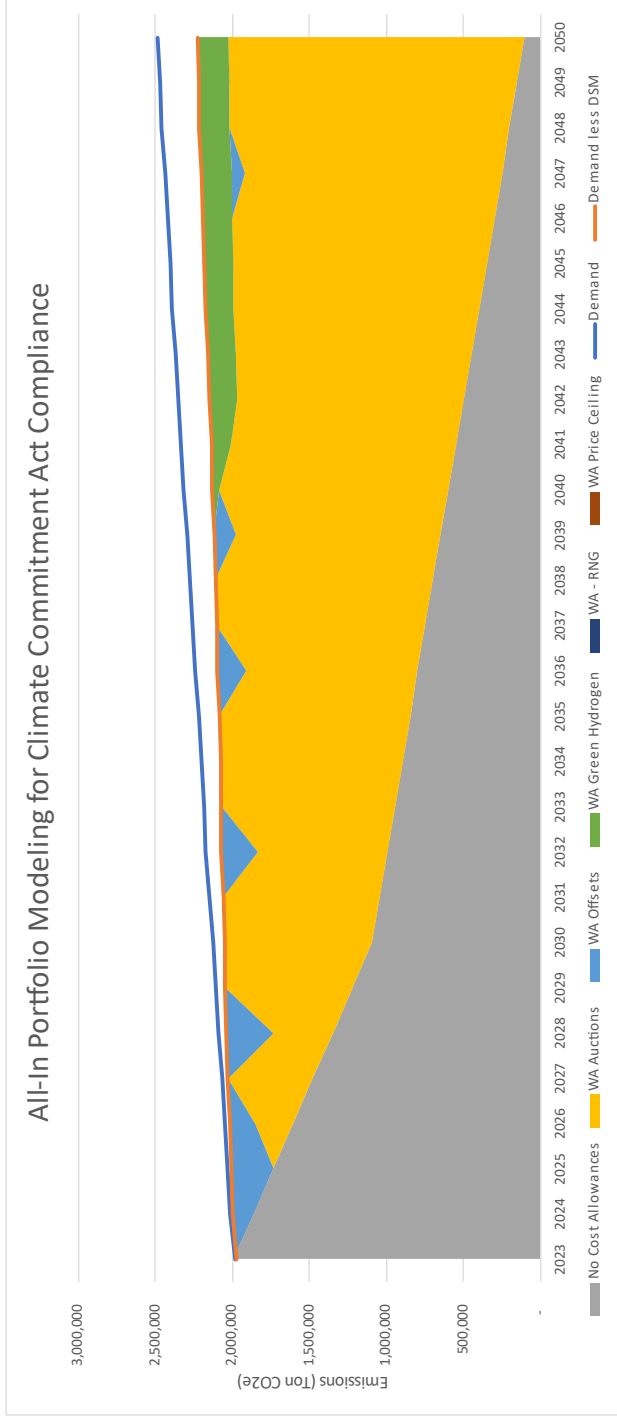

In the Community to Serve®

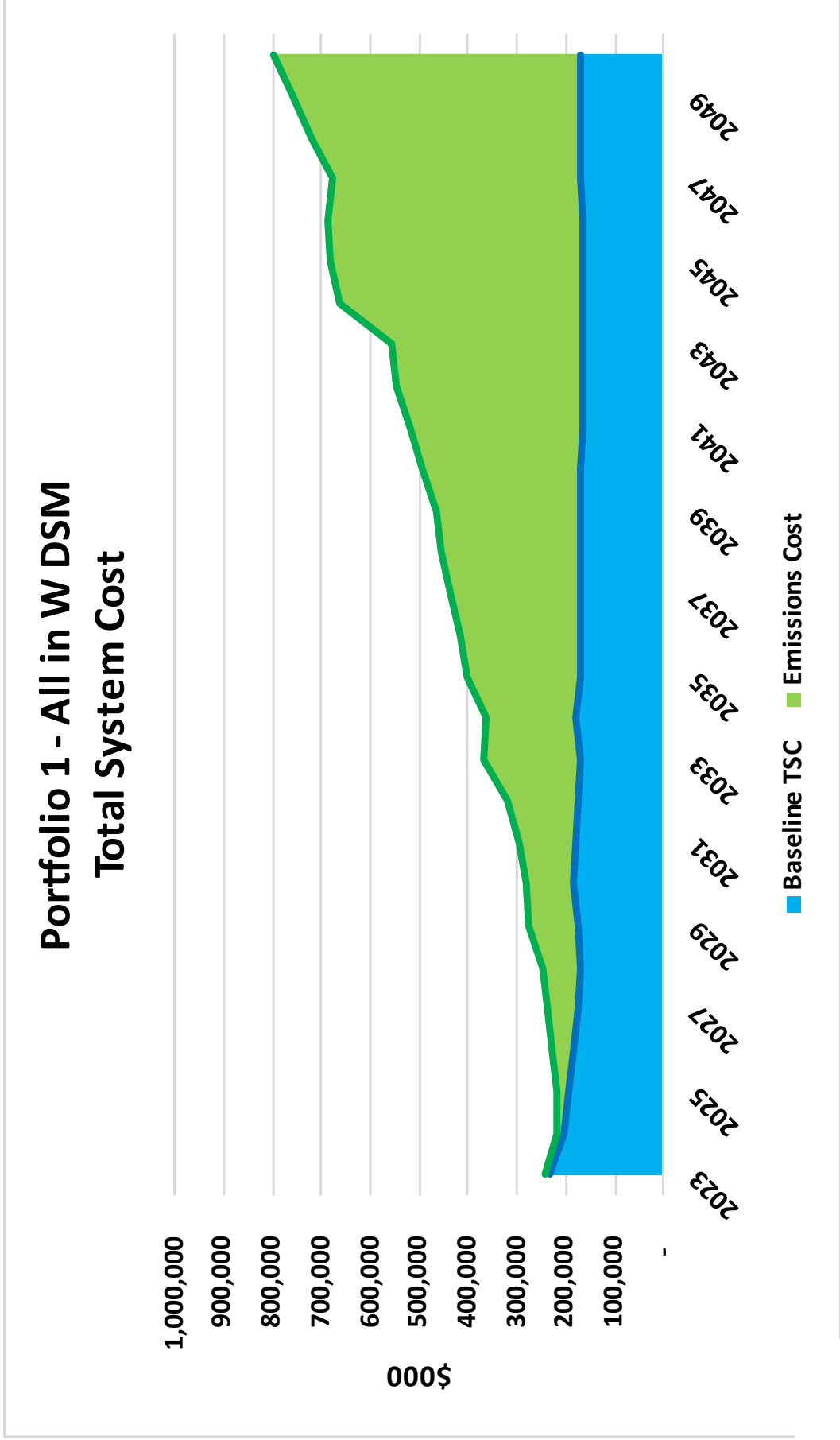

All-In Less DSM Portfolio

Best deterministic mix of all alternative resources considered:

- Incremental Transport Resources
- Incremental Storage Resources
- Incremental RNG
- Incremental Hydrogen
- Compliance Instruments

All-In Less DSM Portfolio – PLEXOS® Suggested Resource Mix

Incremental RNG – Utilized mostly in Oregon, 298,180 Dth starting in 2023, up to 17,591,130 Dth by 2050

Incremental Hydrogen – 90,970 Dth starting in 2029, up to 524,700 Dth by 2050

Compliance Instruments – Utilized as needed, exact number discussed under confidential treatment in IRP



In the Community to Serve®

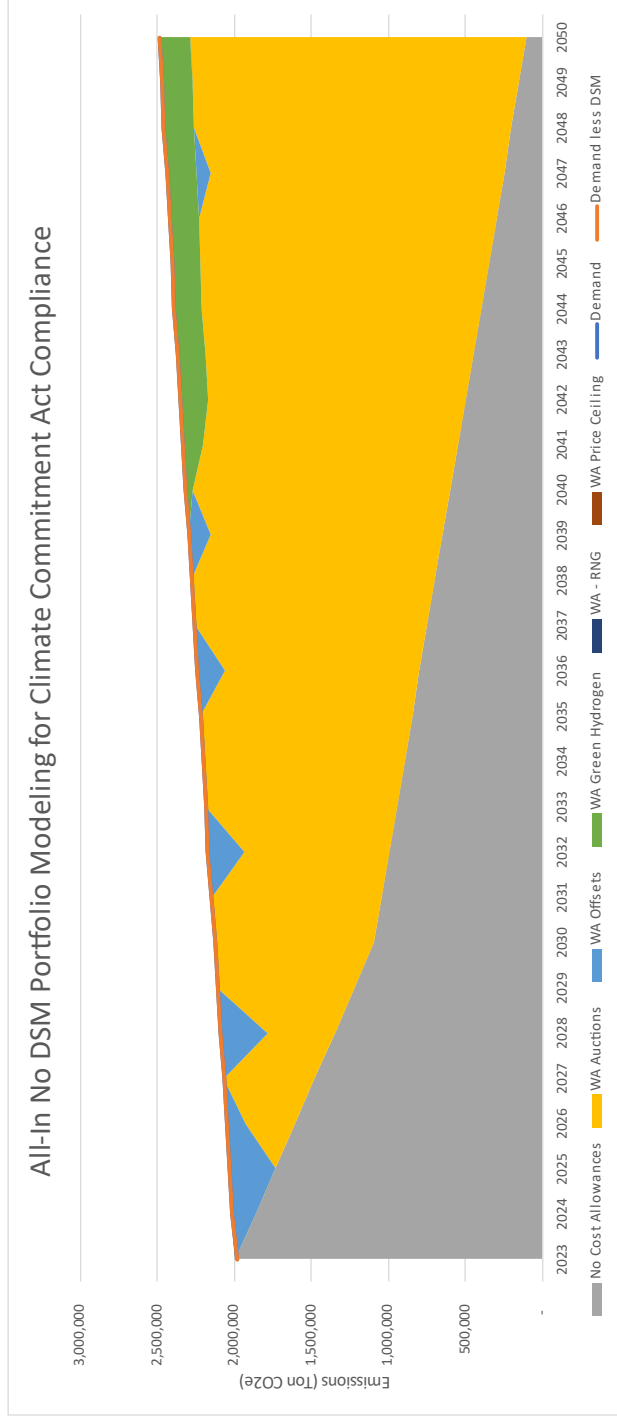

Portfolio 2 - All in W No DSM Total System Cost

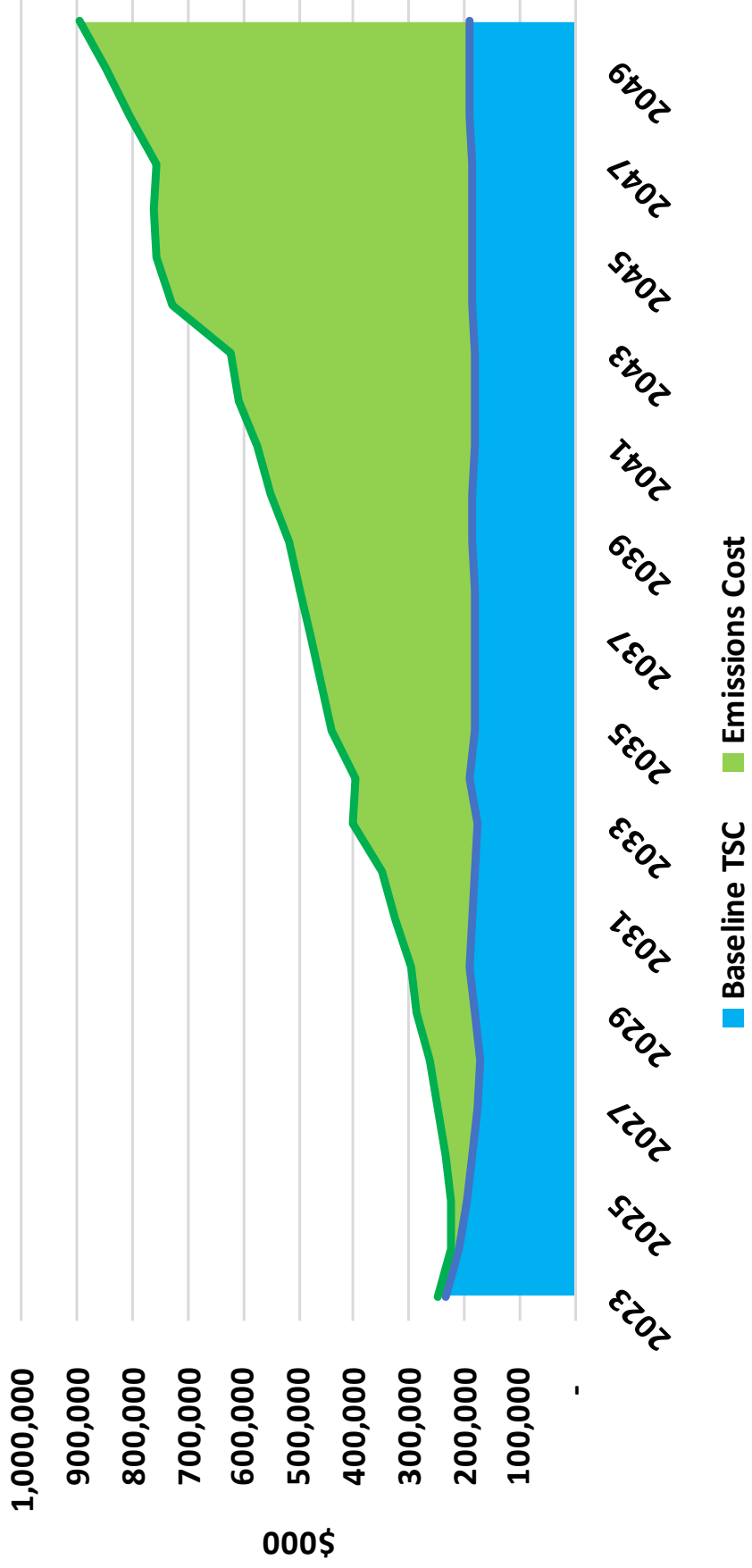

Incremental Transportation Only Portfolio

Cost Effective DSM from CPA

Best deterministic mix of all Transportation Resources:

- Incremental Transport – North to South
- Incremental Transport – Northwest Pipeline
- Incremental Transport – South to North
- Incremental Transport – Bilateral

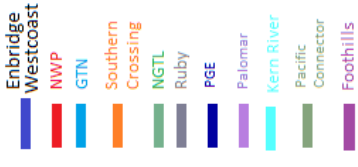

Incremental Transportation Only Portfolio – PLEXOS® Suggested Resource Mix

All Cost-Effective DSM

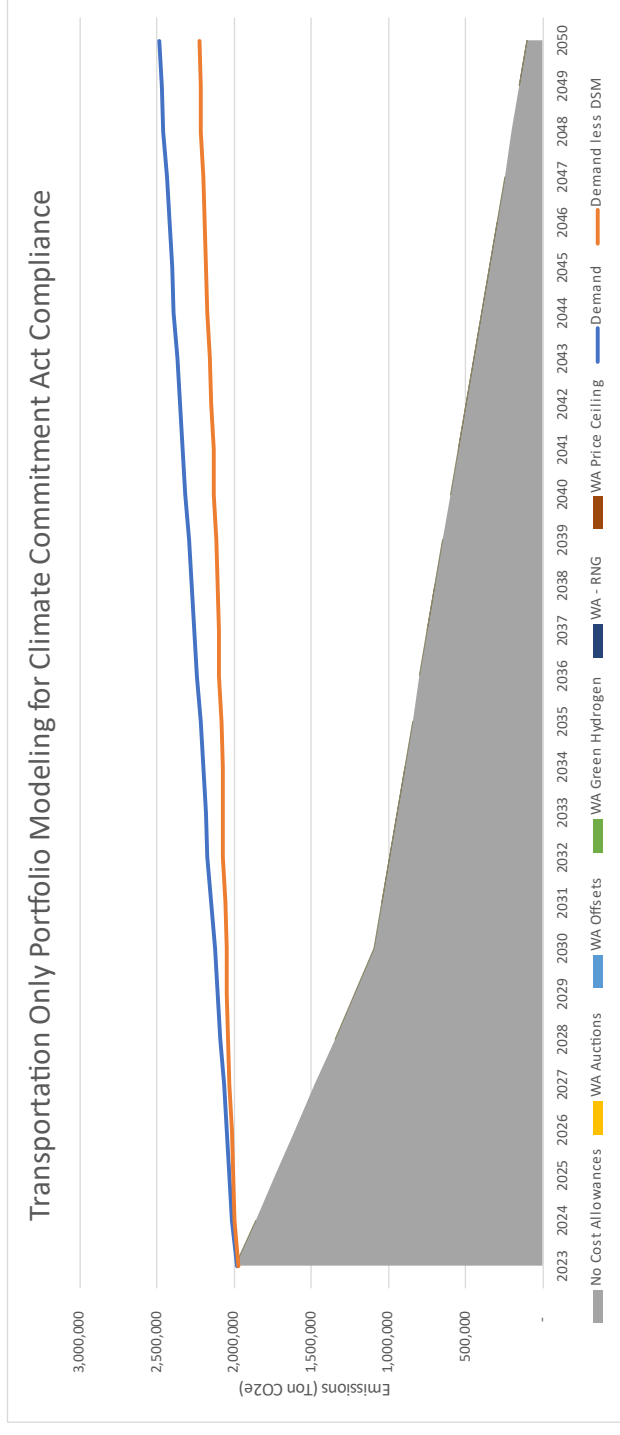

***Not Considered as a Candidate Portfolio due to emissions reductions shortfalls**

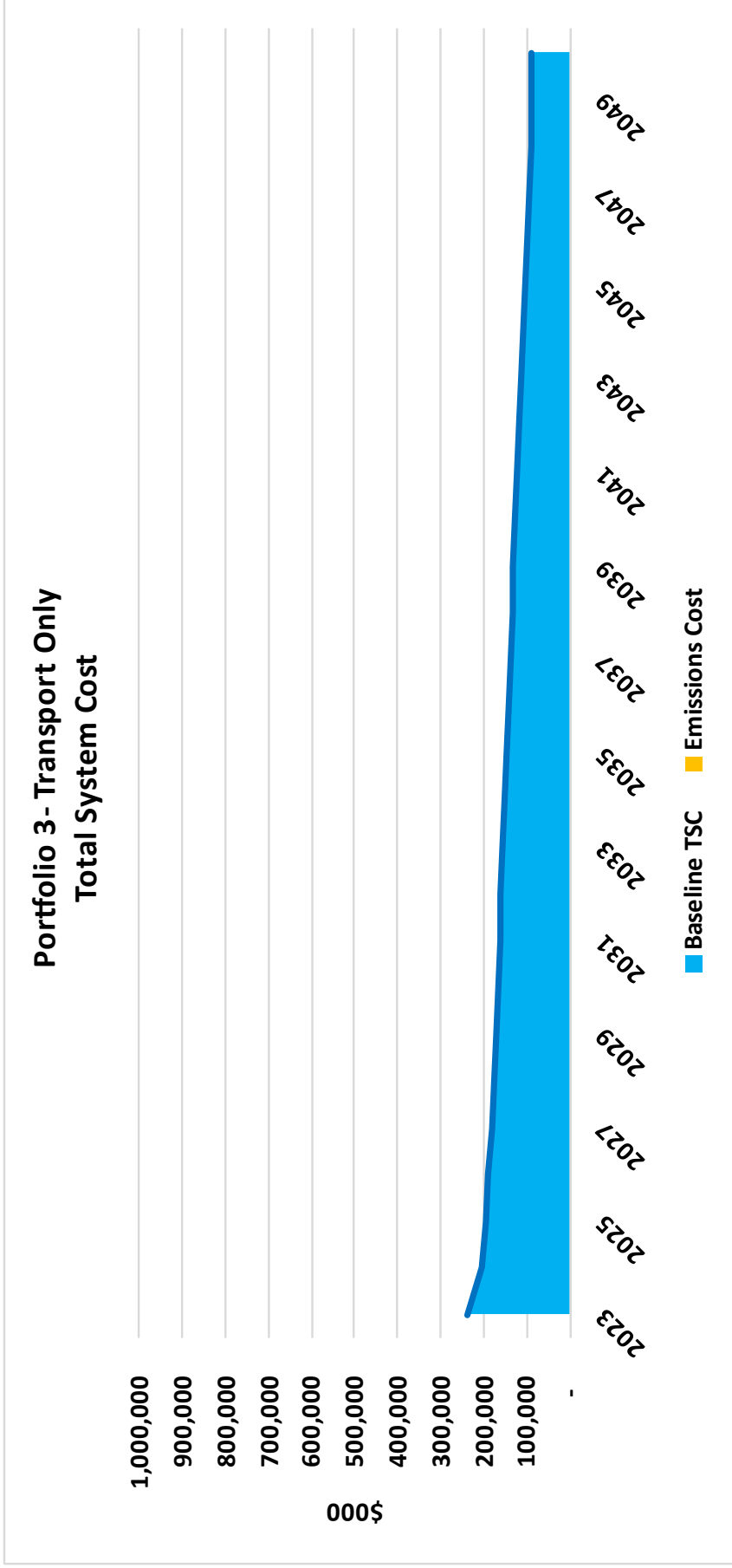

*Not Considered as a Candidate Portfolio due to emissions reductions shortfalls

Offsets Only Portfolio

Cost Effective Demand Side Management from Conservation Potential Assessment
Best deterministic mix of Auction Allowances and Offsets in Washington, and Community
Climate Investments (CCI) in Oregon

Offsets Only Portfolio – PLEXOS® Suggested Resource Mix

All Cost-Effective DSM

Compliance Instruments – Maximum possible utilization with no other emissions reduction resource

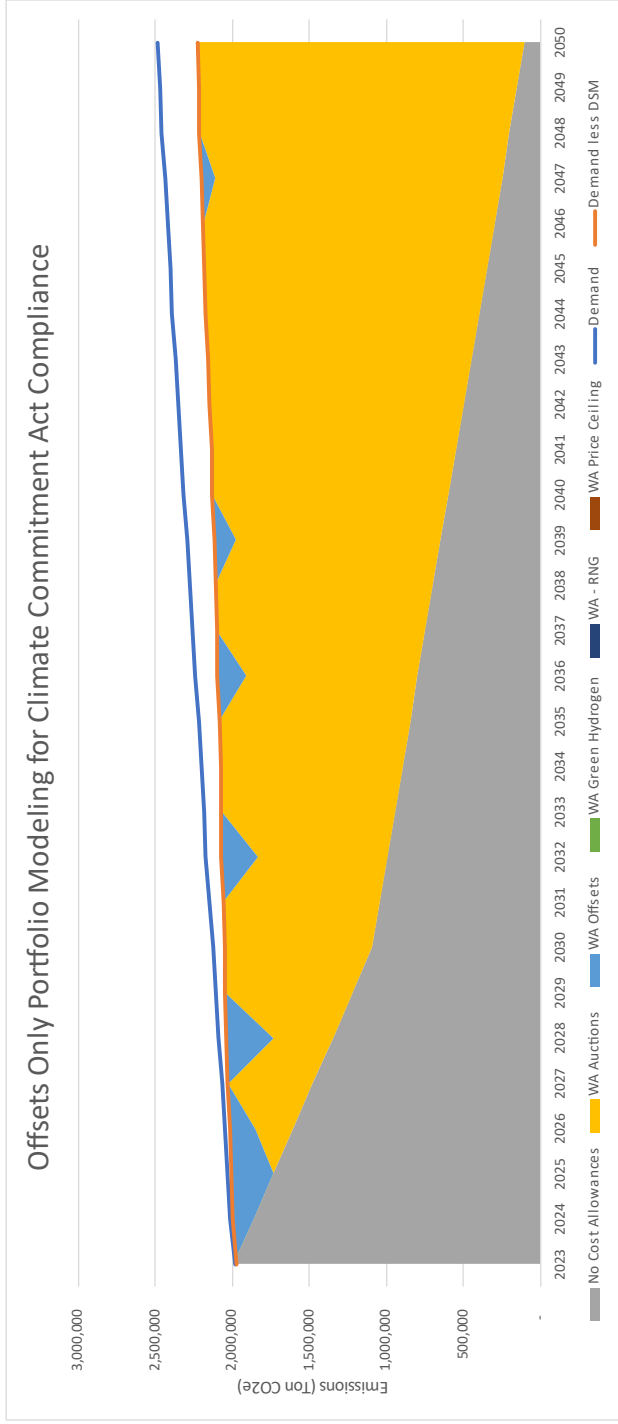

***Not Considered as a Candidate Portfolio due to emissions reductions shortfalls in Oregon**



In the Community to Serve®

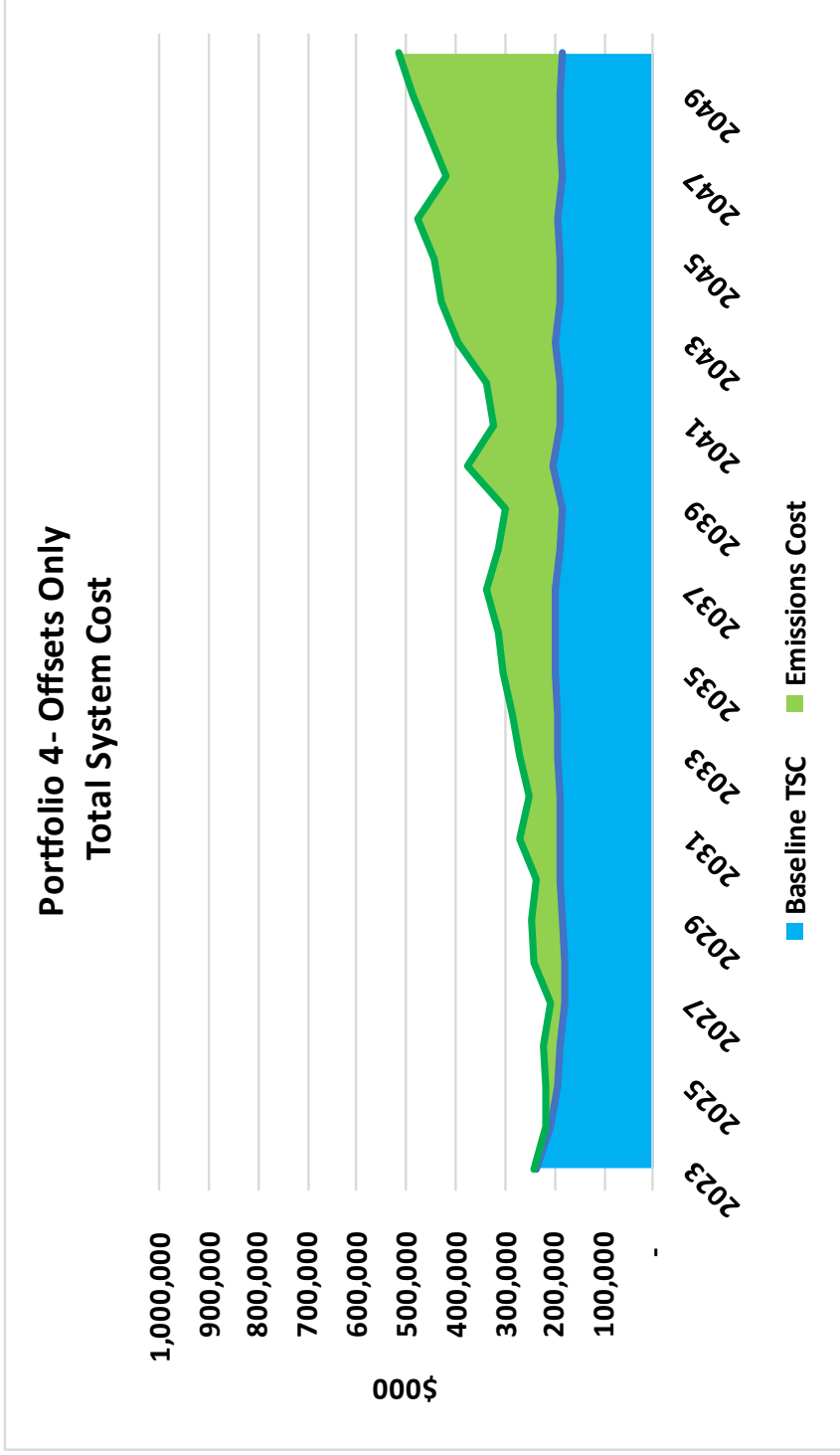

*Not Considered as a Candidate Portfolio due to emissions reductions shortfalls

RNG Only Portfolio

Cost Effective DSM from CPA

Incremental RNG

RNG Only Portfolio – PLEXOS® Suggested Resource Mix

All Cost-Effective DSM

Incremental RNG – Utilized mostly in Oregon, 1,218,140 Dth starting in 2023, up to 17,264,820 Dth by 2050

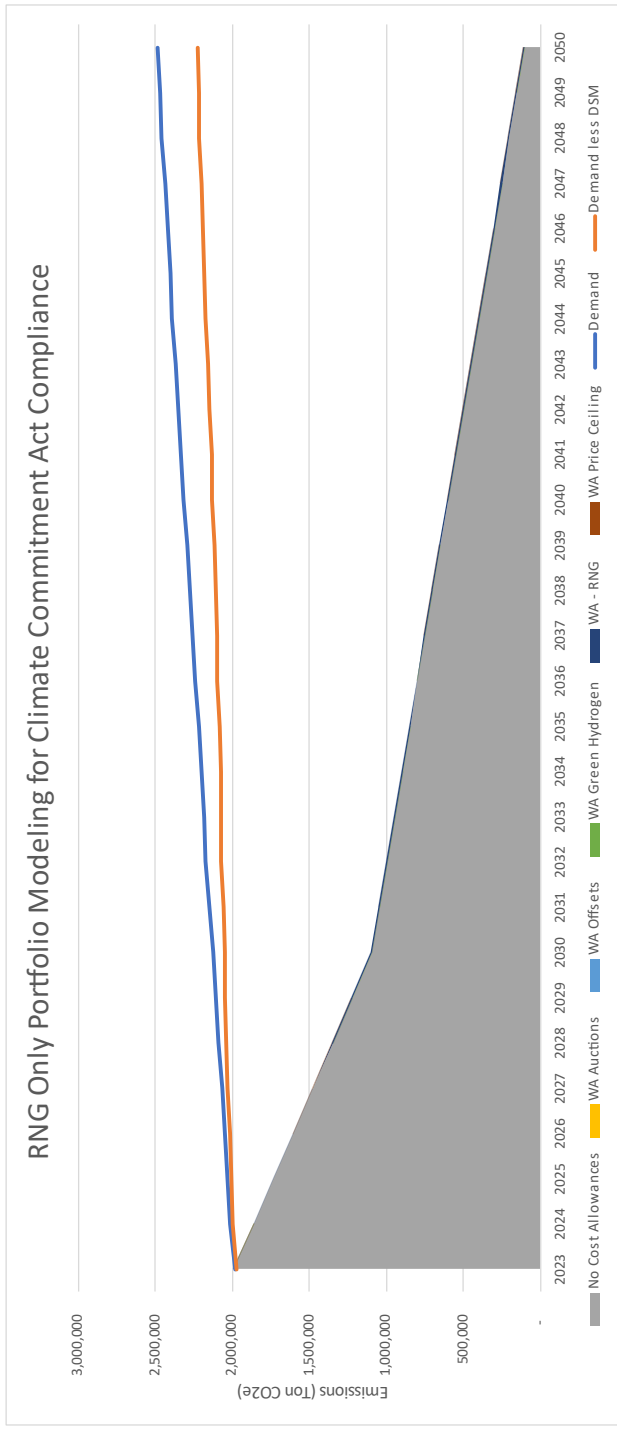

*Not Considered as a Candidate Portfolio due to emissions reductions shortfalls



In the Community to Serve®

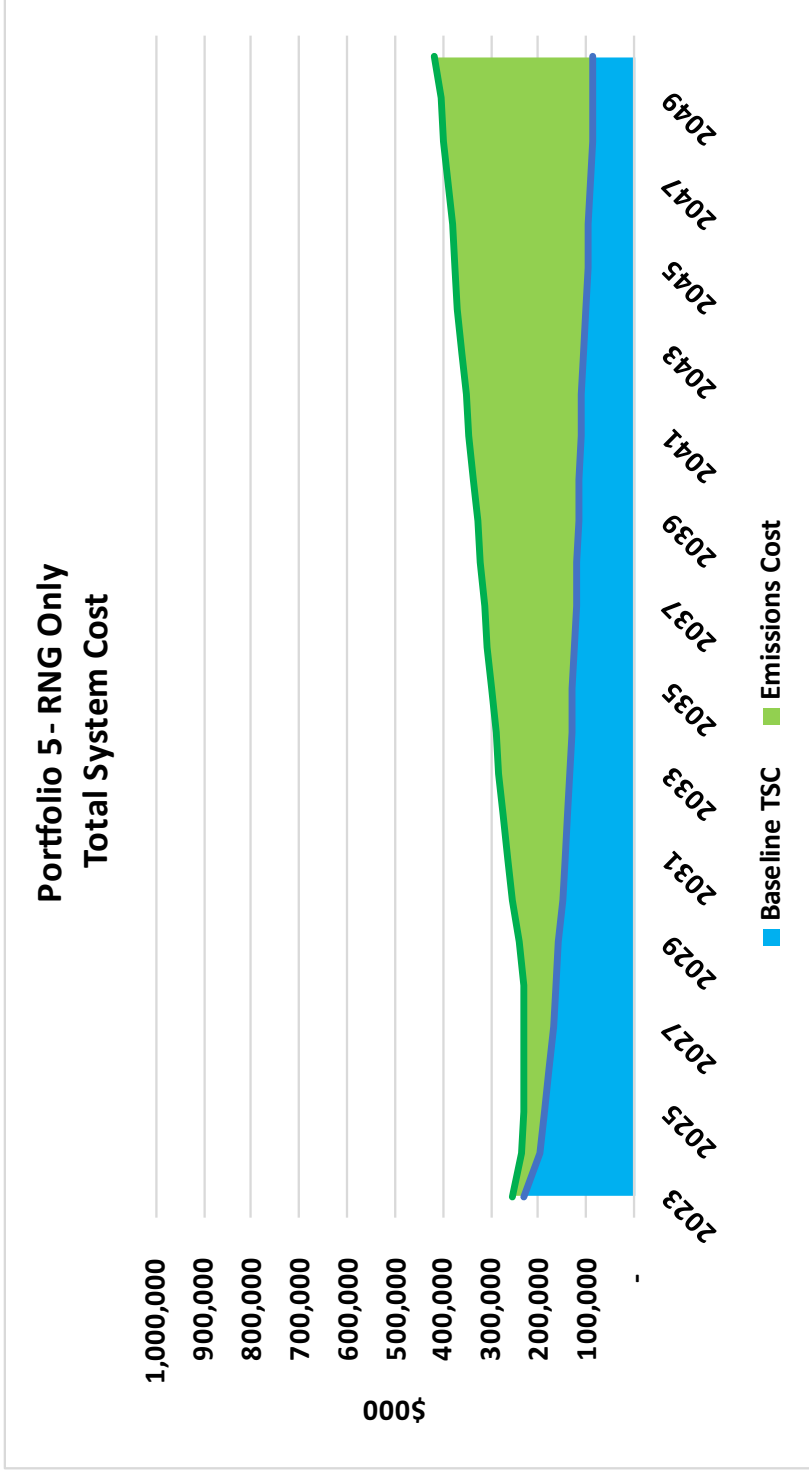

*Not Considered as a Candidate Portfolio due to emissions reductions shortfalls

Hydrogen Only Portfolio

Cost Effective DSM from CPA

Incremental Hydrogen

Hydrogen Only Portfolio – PLEXOS® Suggested Resource Mix

All Cost-Effective DSM

Incremental Hydrogen – 3,029,770
Dth starting in 2023, up to 5,260,150
Dth by 2050



In the Community to Serve

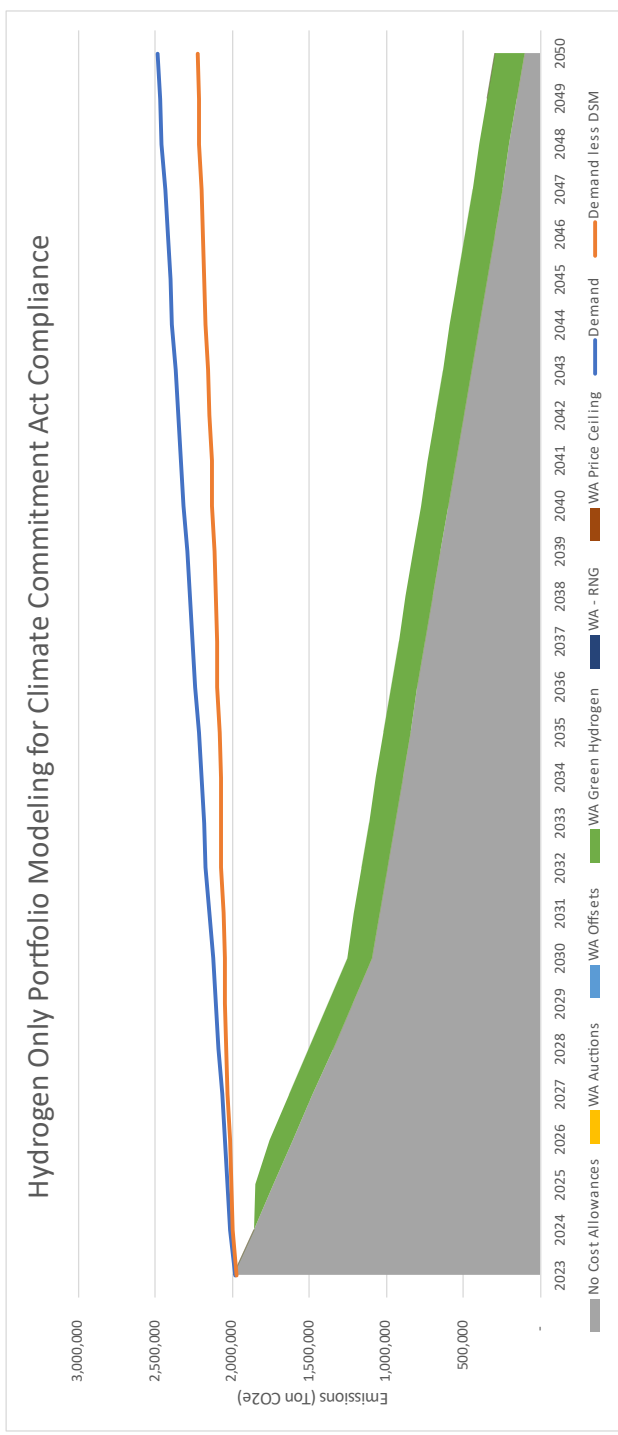

*Not Considered as a Candidate Portfolio due to emissions reductions shortfalls

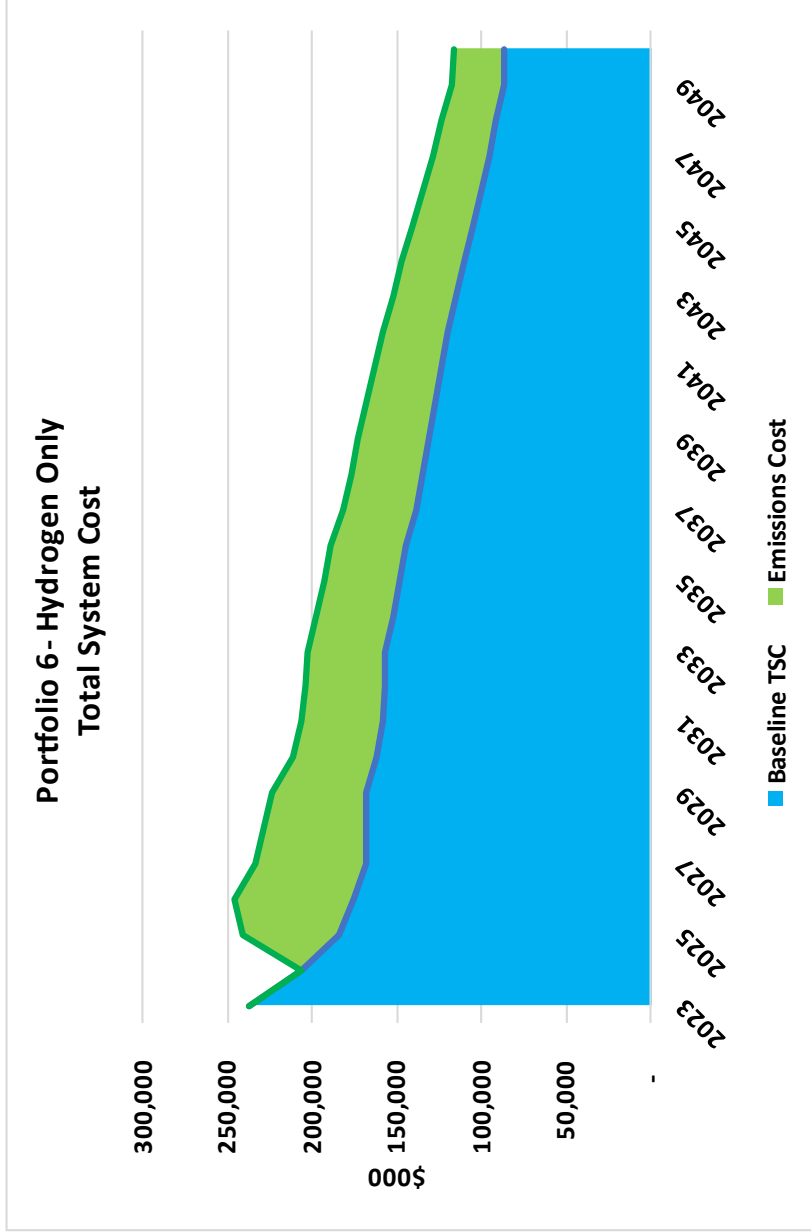

*Not Considered as a Candidate Portfolio due to emissions reductions shortfalls

Renewables Only Portfolio

Cost Effective DSM from CPA

Incremental RNG

Incremental Hydrogen

Renewables Only Portfolio – PLEXOS® Suggested Resource Mix

All Cost-Effective DSM

Incremental RNG – Utilized mostly in Oregon, 1,218,400 Dth starting in 2023, up to 15,768,420 Dth by 2050

Incremental Hydrogen – 2,167,550 Dth starting in 2023, up to 5,427,200 Dth by 2050

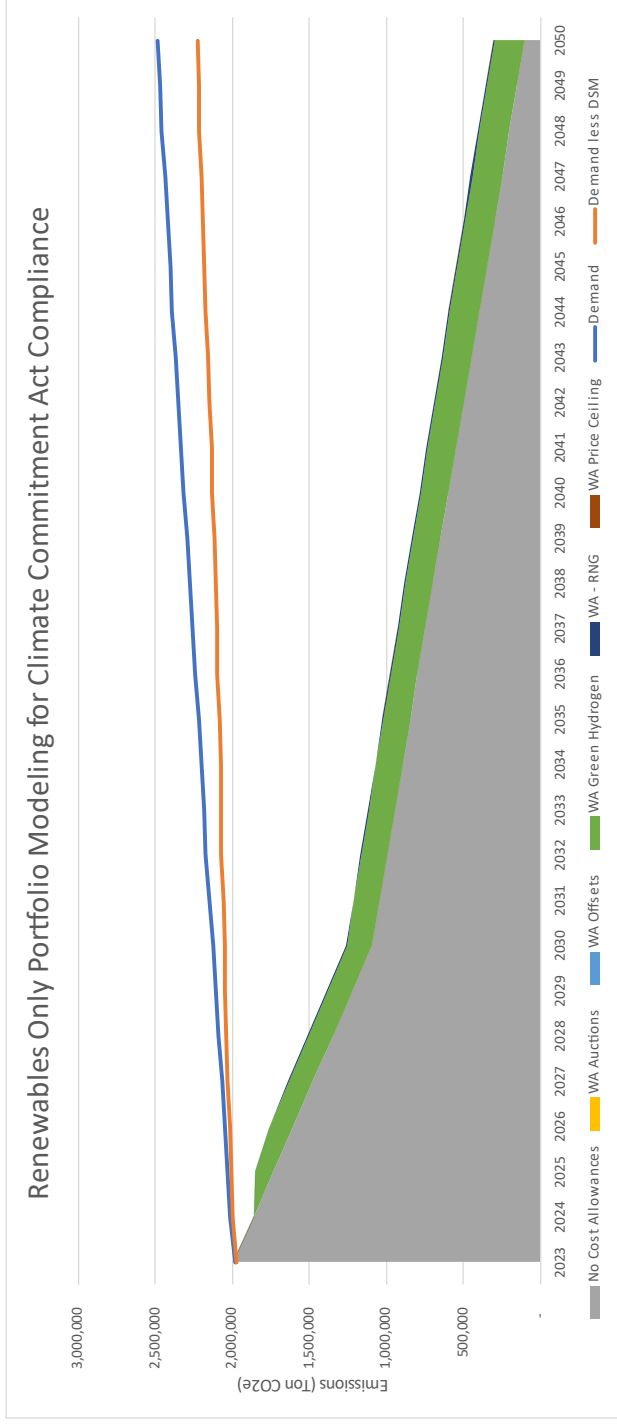

*Not Considered as a Candidate Portfolio due to emissions reductions shortfalls



In the Community to Serve®

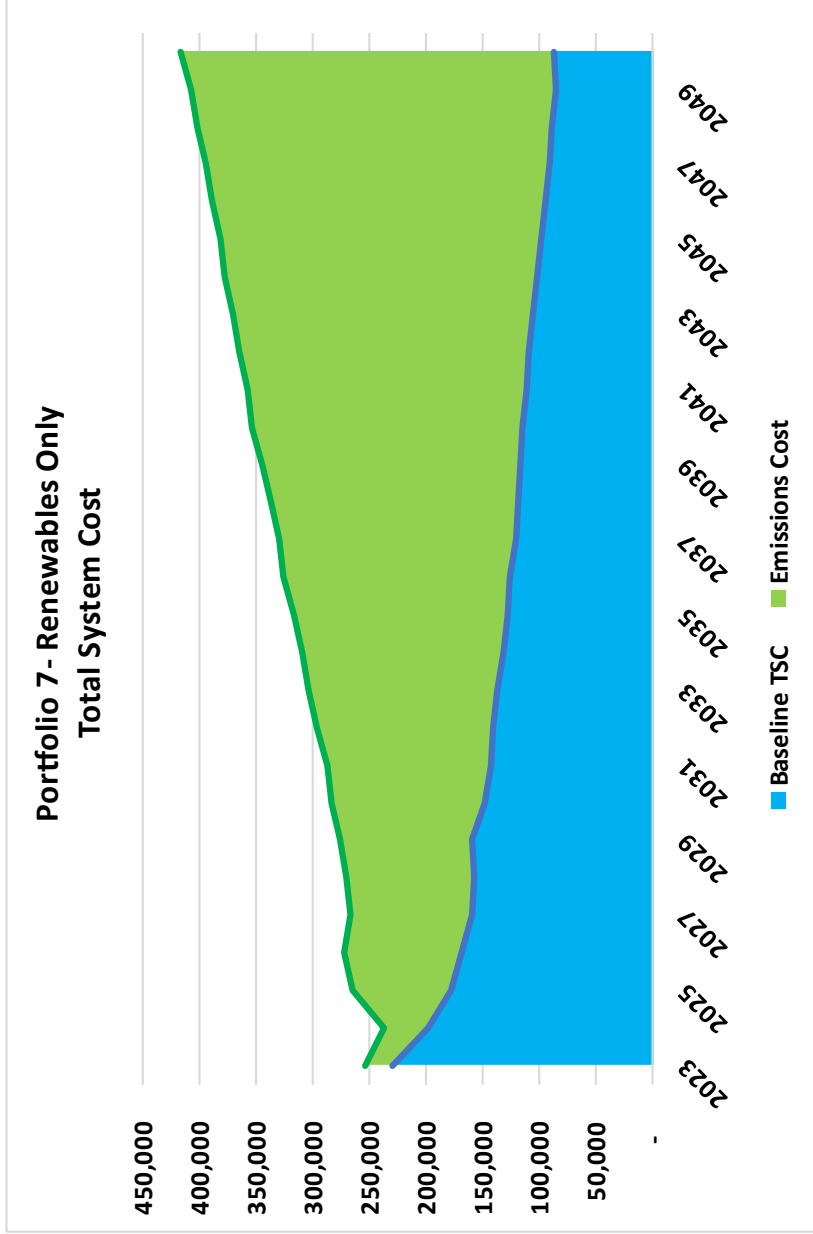

*Not Considered as a Candidate Portfolio due to emissions reductions shortfalls

Methodology Behind Ranking of Portfolios

Cascade uses deterministic results to identify the intrinsic value of a portfolio, and Value at Risk (VaR) analysis to capture the extrinsic value.

Additionally, portfolios are ranked primarily on their peak day unserved demand, and secondarily on their total system costs.

Deterministic results are given 75% weight, and stochastic results 25% weight. The concluding values are Cascade's Risk-Adjusted Results.

2023-2050 Total System Cost + Emissions

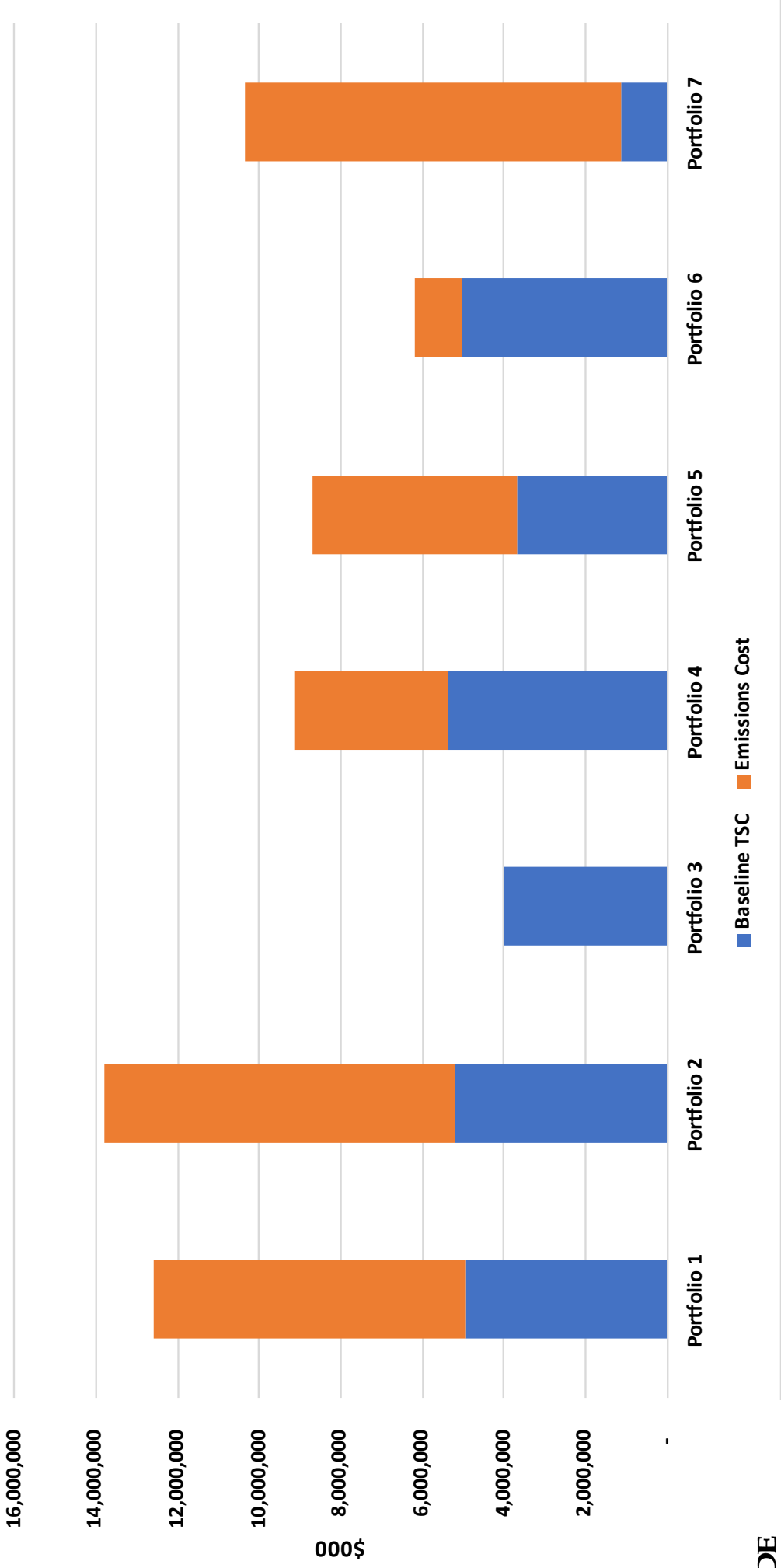

Final Ranking of Portfolios

Portfolios with deterministic Emissions Reduction Shortfalls will not be considered for Preferred Portfolio

Portfolio	Total System Cost (\$000)	Emissions Reduction Shortfalls?
All-In	12,597,464	No
All-In Less DSM	13,801,375	No
Transportation Only	4,006,652	Yes
Offsets Only	9,143,372	Yes
RNG Only	8,708,882	Yes
Hydrogen Only	6,172,433	Yes
Renewables Only	10,340,747	Yes



A Subsidiary of MDU Resources Group, Inc.

In the Community to Serve®

Top Ranked Candidate Portfolio Components

All Cost-Effective DSM

Incremental RNG – Utilized mostly in Oregon, 154,210 Dth starting in 2023, up to 15,635,780 Dth by 2050

Incremental Hydrogen – 90,970 Dth starting in 2029, up to 524,700 Dth by 2050

Compliance Instruments – Utilized as needed, exact number discussed under confidential treatment in IRP



In the Community to Serve®

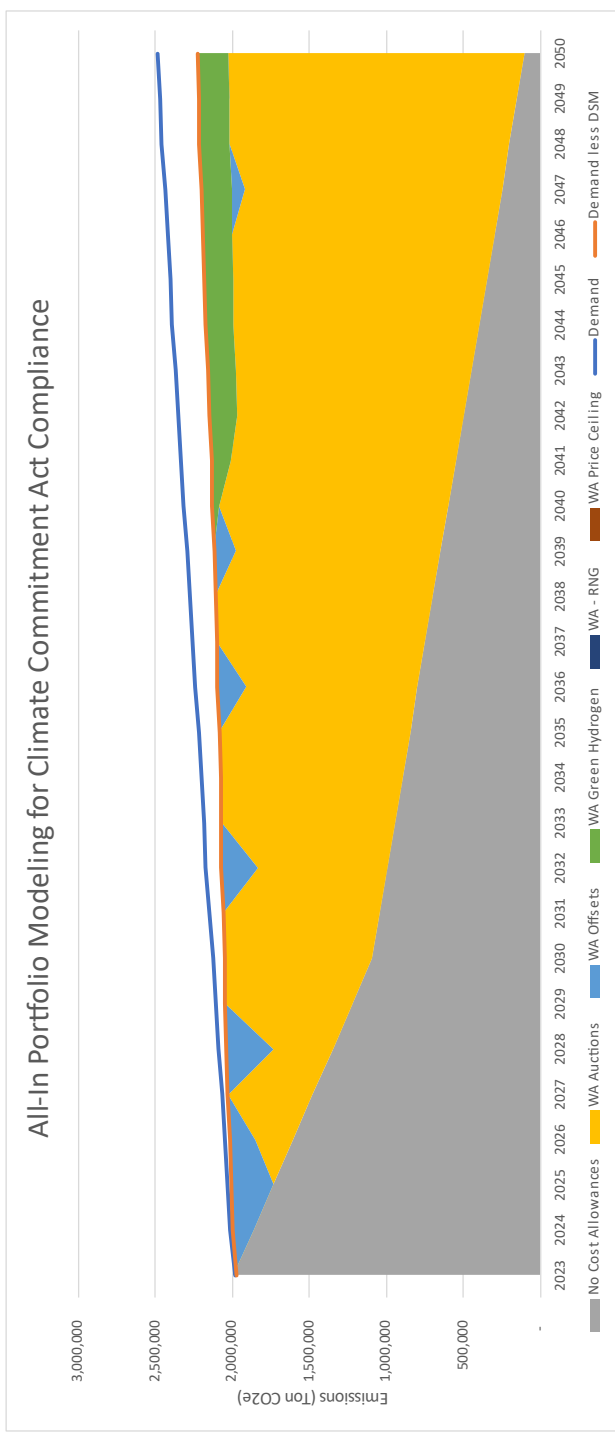

Stochastic Methodology

Stochastic Model Methodology

Prior to the 2018 IRP, Cascade used the Monte Carlo functionality within SENDOUT® to run its stochastic analyses.

- SENDOUT® has computational limitations related to the number of draws it can perform, and the time it takes to complete those draws.

For the 2018 IRP, Cascade enhanced its methodology to allow for a more robust Monte Carlo simulation on weather and price.

For the 2020 IRP, Cascade has further enhanced the Monte Carlo simulation's basin correlations regarding price and weather is correlated between weather stations.

For the 2023 IRP, Cascade has kept the same Monte Carlo simulation process. Prices are correlated between basins and weather is correlated between weather stations.

Cascade's Methodology (Cont'd)

Cascade will continue to perform a 10,000 draw Monte Carlo Simulation of weather and price using R.

For each weather location Cascade records daily mean temperatures, standard deviations, correlations, and the largest 1 day jump to have historically occurred in that month.

For each basins' pricing, Cascade records historic averages, lows, highs, standard deviations, and correlations.

This data is all loaded into R where R can perform 10,000 28-year (2023-2050) unique weather patterns and price paths.

Cascade's Methodology

First, Cascade runs 1 draw of its Monte Carlo simulation for its first weather location.

The remaining weather locations are then run for draw 1 but correlated to the first weather location's results using a mathematical process called Cholesky Decomposition. This process helps create a more realistic simulation for each draw.

This process is repeated 10,000 times, with the calculated HDDs from each draw stored in a separate matrix.

A similar process is followed for price.

Cascade's Methodology (Cont'd)

Historical Correlated Weather							
City	Baker City	Bellingham	Bremerton	Pendleton	Redmond	Walla Walla	Yakima
Baker City	1.00000						
Bellingham	0.63383	1.00000					
Bremerton	0.65848	0.86889	1.00000				
Pendleton	0.70245	0.73001	0.69979	1.00000			
Redmond	0.71736	0.76293	0.76183	0.79743	1.00000		
Walla Walla	0.71051	0.72579	0.69180	0.95952	0.78995	1.00000	
Yakima	0.66974	0.69391	0.68315	0.79445	0.70062	0.81950	1.00000

Cholesky Adjusted Correlations from Cholesky Adjusted Monte Carlo Variables							
City	Baker City	Bellingham	Bremerton	Pendleton	Redmond	Walla Walla	Yakima
Baker City	1.00000						
Bellingham	0.58003	1.00000					
Bremerton	0.59590	0.87959	1.00000				
Pendleton	0.67497	0.64893	0.62268	1.00000			
Redmond	0.68570	0.76602	0.77980	0.72101	1.00000		
Walla Walla	0.68806	0.60883	0.60391	0.95098	0.70710	1.00000	
Yakima	0.67272	0.60801	0.62417	0.76391	0.63660	0.79252	1.00000

Non-Adjusted Correlations from Random Monte Carlo Variables							
City	Baker City	Bellingham	Bremerton	Pendleton	Redmond	Walla Walla	Yakima
Baker City	1.00000						
Bellingham	-0.02544	1.00000					
Bremerton	0.06280	0.17484	1.00000				
Pendleton	0.00031	-0.13384	-0.05538	1.00000			
Redmond	0.03081	0.09014	0.10164	-0.02054	1.00000		
Walla Walla	-0.00535	-0.18812	0.07940	0.06387	0.03300	1.00000	
Yakima	-0.00832	-0.09987	-0.01647	-0.03853	0.17427	0.12550	1.00000

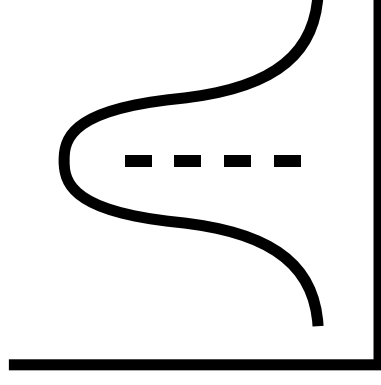

Cascade's Methodology

In the previous IRP, Cascade calculated a system weighted HDD for each draw, identifying the draw that results in the 99th percentile of stochastic weather. The daily HDDs of each weather location in this draw are then loaded into SENDOUT[®], which allows the Company to capture the costs and unserved demand of a given portfolio under extreme conditions.

A similar process is undertaken for Monte Carlo simulations on price.

In the current IRP, Cascade loaded in 200 random draws into PLEXOS[®] so Cascade's integrated model can optimize around 200 different weather and price paths.

Monte Carlo Demand Results

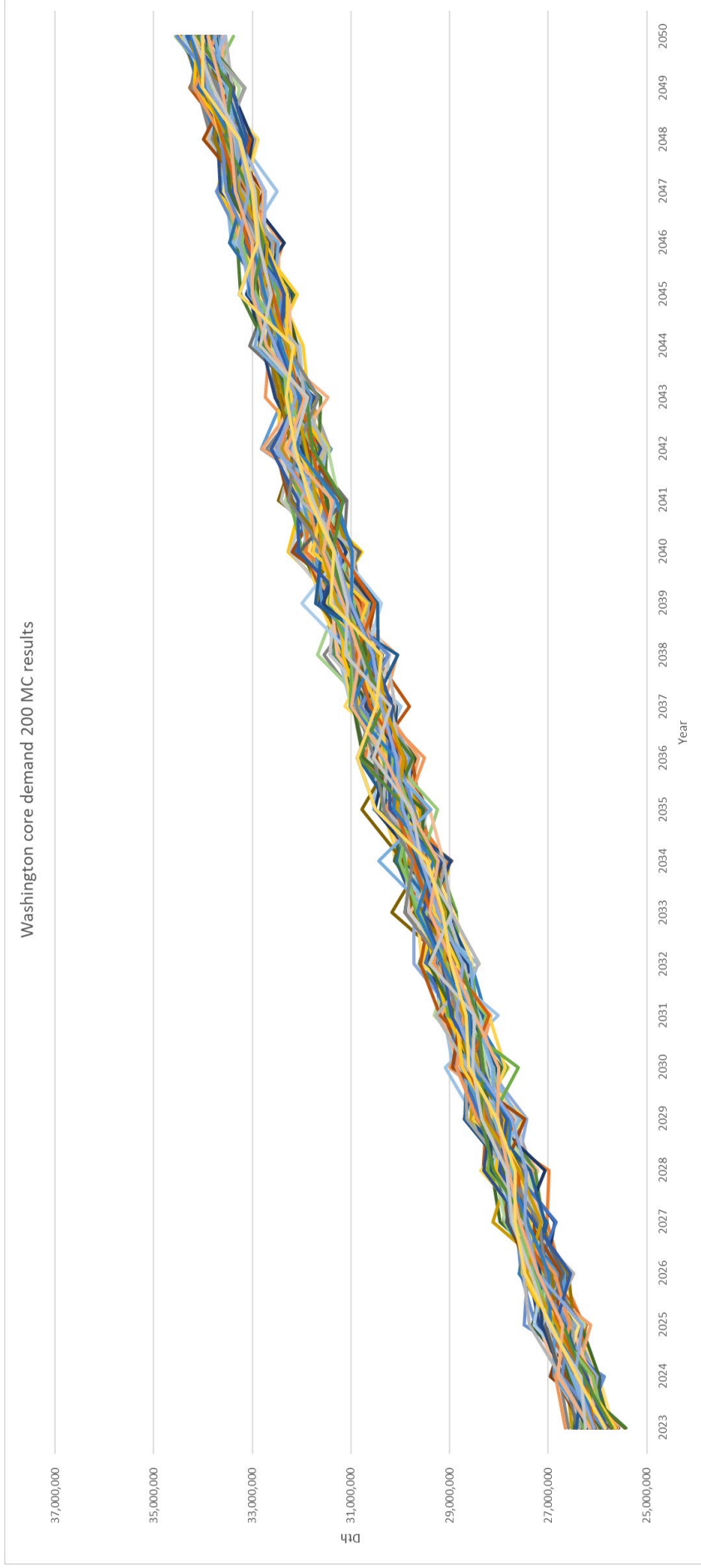

WA first compliance period demand

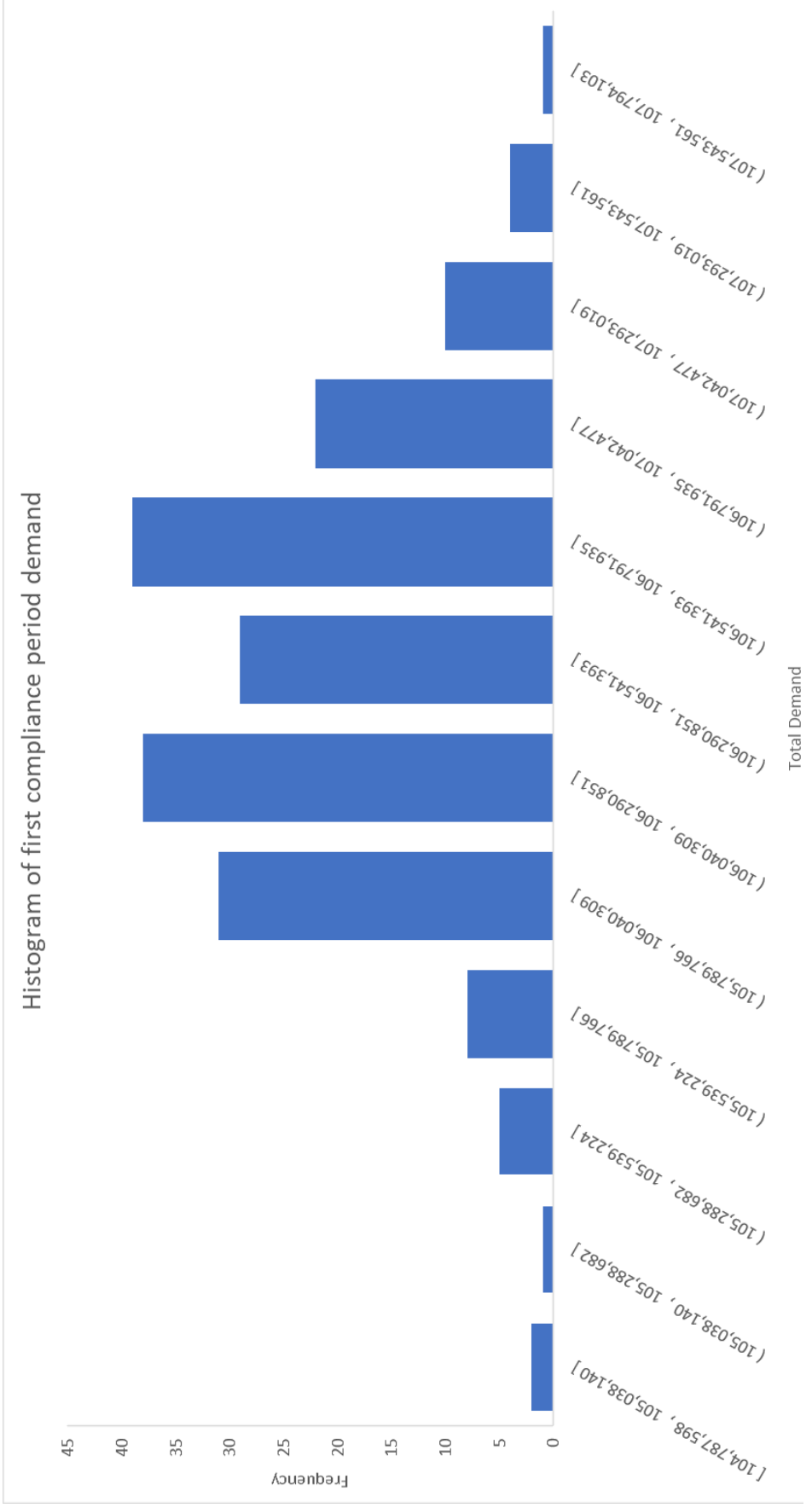

Total System Cost (2023-2050)

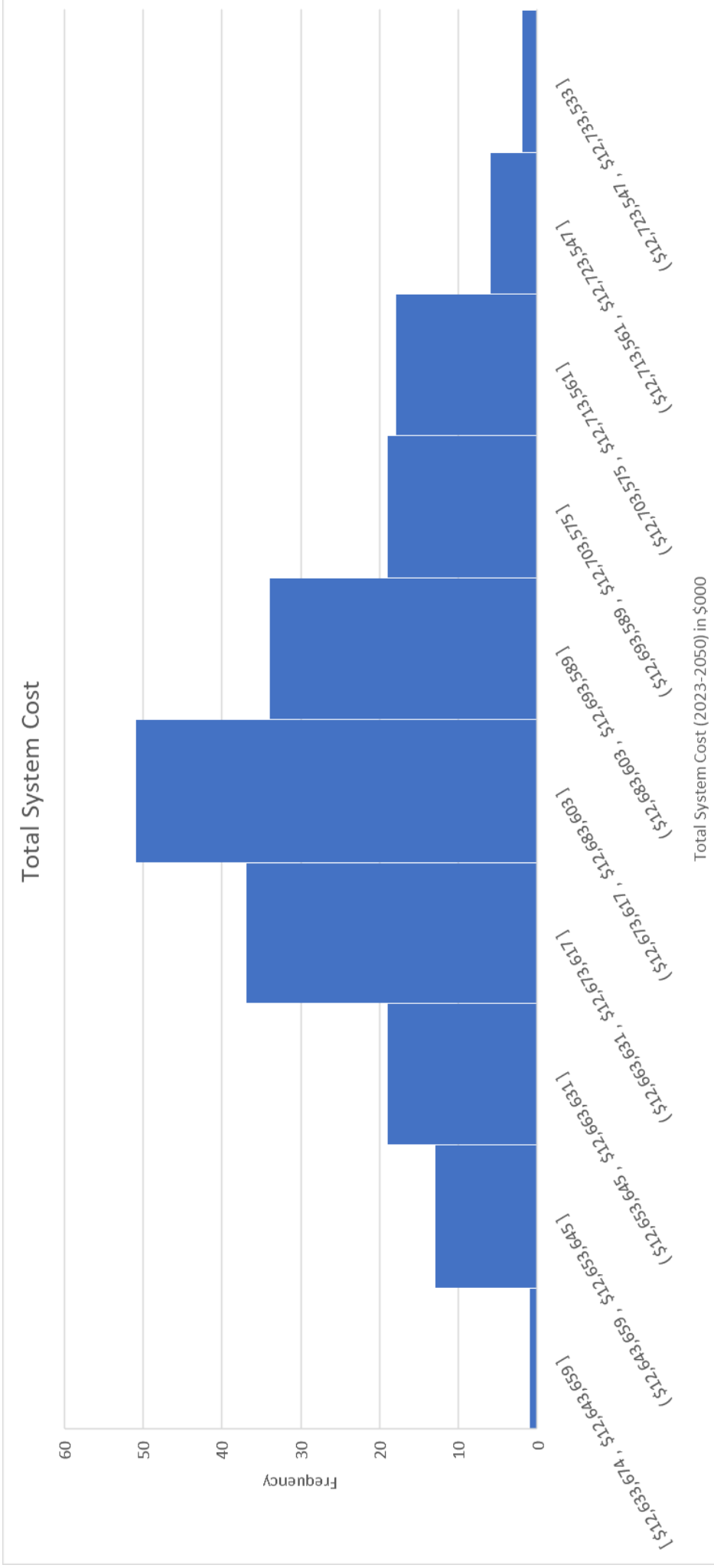

AECO Price Simulations

10,000 Simulations

AECO (n=10000)

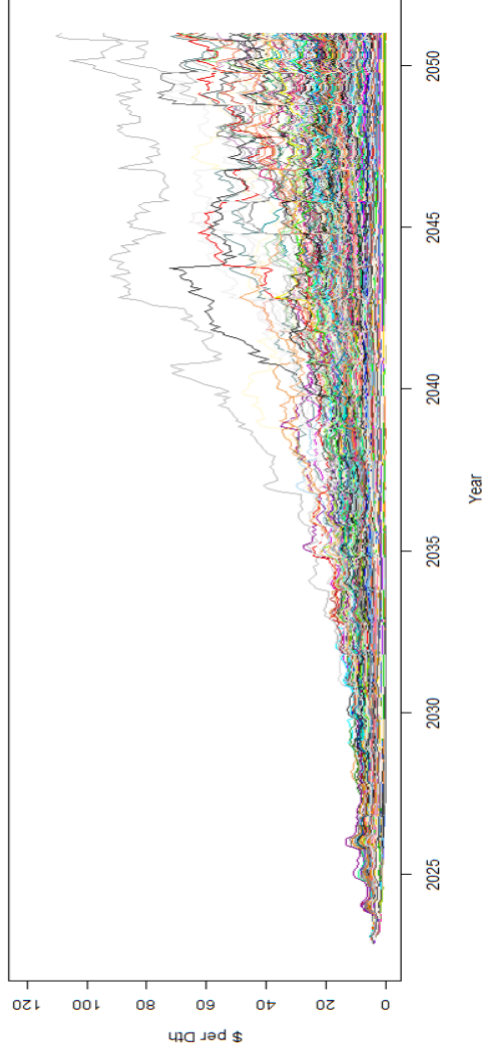

99th Percentile

AECO 99% Confidence Scaled

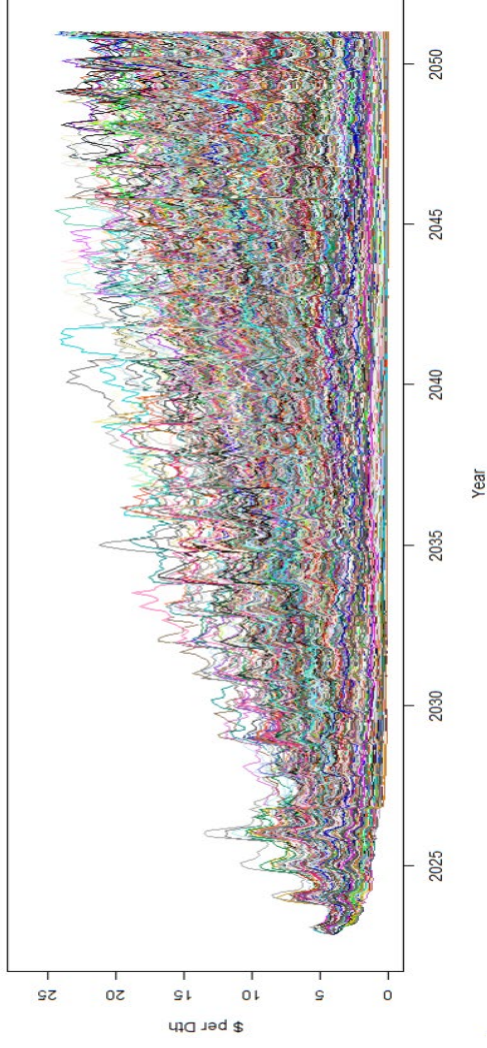

Rockies Price Simulations

10,000 Simulations

Rockies (n=10000)

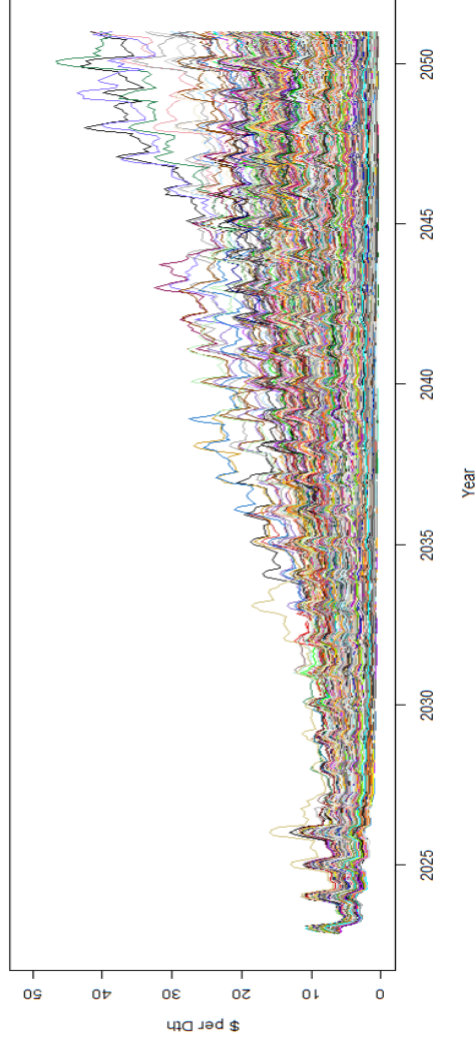

99th Percentile

Rockies 99% Confidence Scaled

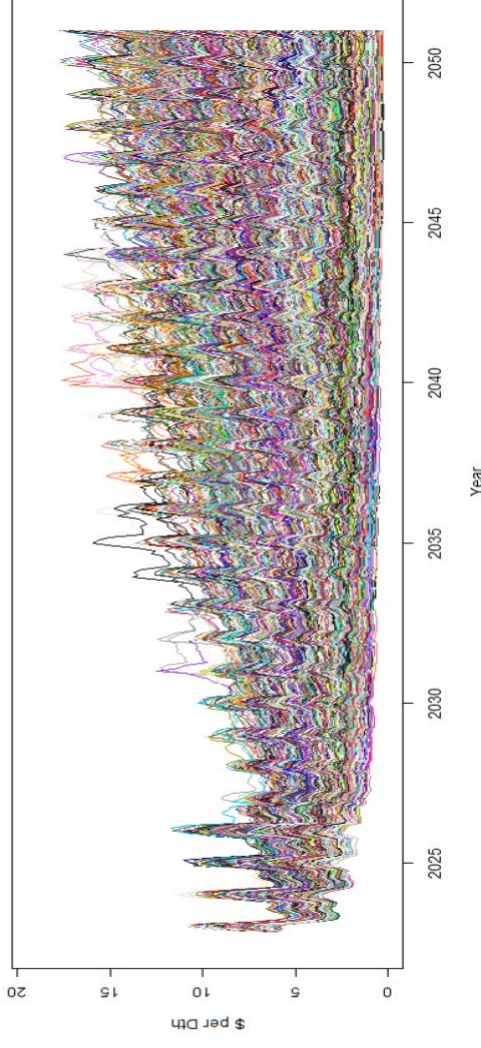

Sumas Price Simulations

10,000 Simulations

Sumas (n=10000)

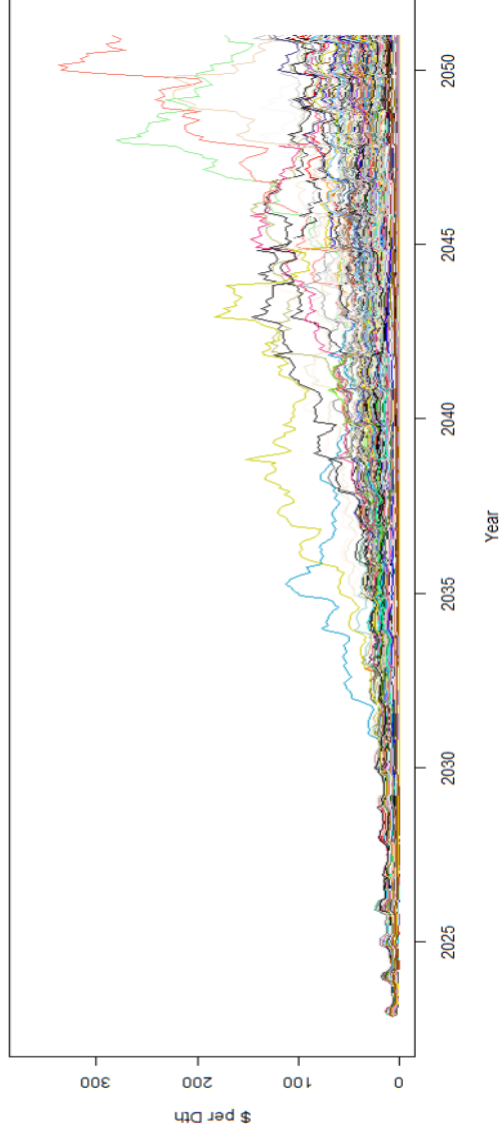

99th Percentile

Sumas 99% Confidence Scaled

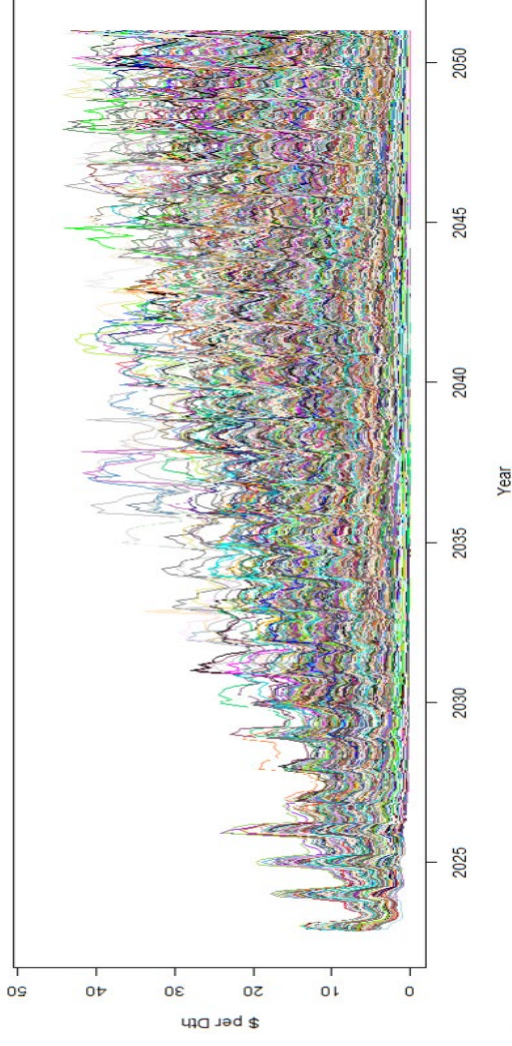

Scenario and Sensitivity Results

New Philosophy Behind Scenario/Sensitivity Modeling

In previous IRPs, Cascade modeled a wide breadth of scenarios and sensitivities that, according to some stakeholder feedback, may have been too expansive for the IRP

- Pro – Allowed the Company to analyze the impact of a wide number of externalities
- Con – Time constraints do not allow for a deep analysis of the results of scenario modeling

For the 2023 IRP, Cascade had reduced the number of scenarios run to five, but each scenario will include a robust quantitative and qualitative analysis of the expected changes to costs and ability to meet emissions reduction requirements under the scenario.

Scenario – A series of assumptions (sensitivities) that differ from the Company’s base case modeling

Sensitivity – A variable within a given scenario that may be modified to reflect the assumptions of that scenario

2023 IRP Proposed Scenarios	Scenario						High Price - Interrupted Supply	Other?
	Base Case - OR-CPP and WA-CCA	Carbon Neutral by 2050	Limited RNG availability	Electrification	High Customer Case	High Price - Interrupted Supply		
Customer Growth		Current Expectations		No new customers after 2030	High Customer Counts	Current Expectations		
Energy Efficiency	CPA Projections		Scenario 2 CPA Projections			CPA Projections		
Renewable Natural Gas	Expected Availability	Expected - High Avail.	Low Availability	Expected - High Avail.		Expected Availability		
Hydrogen	Expected Availability	Expected - High Avail.	Low Availability	Expected - High Avail.		Expected Availability		
Natural Gas Bans		Current Bans		Additional Bans	Current Bans	Current Bans		
Natural Gas Price	Expected Price	Adjusted Price?	Expected Price	Adjusted Price?	Adjusted Price?	High Price		

Scenario 2 – Carbon Neutral by 2050

- Main Element: Zero CO₂e emissions by 2050 as per CCA/CPP guidelines
- Customer Growth: Based on 2023 IRP Load Forecast
- Energy Efficiency: Based on adjusted 2023 CPAs from Cascade (WA) and ETO (OR) using higher commodity cost as input into avoided cost
- RNG Availability: Cascade weighted share of technical potential of American Gas Foundation/ICF Study
- Hydrogen Availability: Maximum blend of 30% supply by volume
- Natural Gas Bans: Consideration of all expected bans in load forecast
- Natural Gas Price: 10% downward adjustment to 2023 IRP Price Forecast, higher price of RNG volumes above and beyond base case, capped at \$26/dth

Scenario 2 – Carbon Neutral by 2050 Cost Comparison

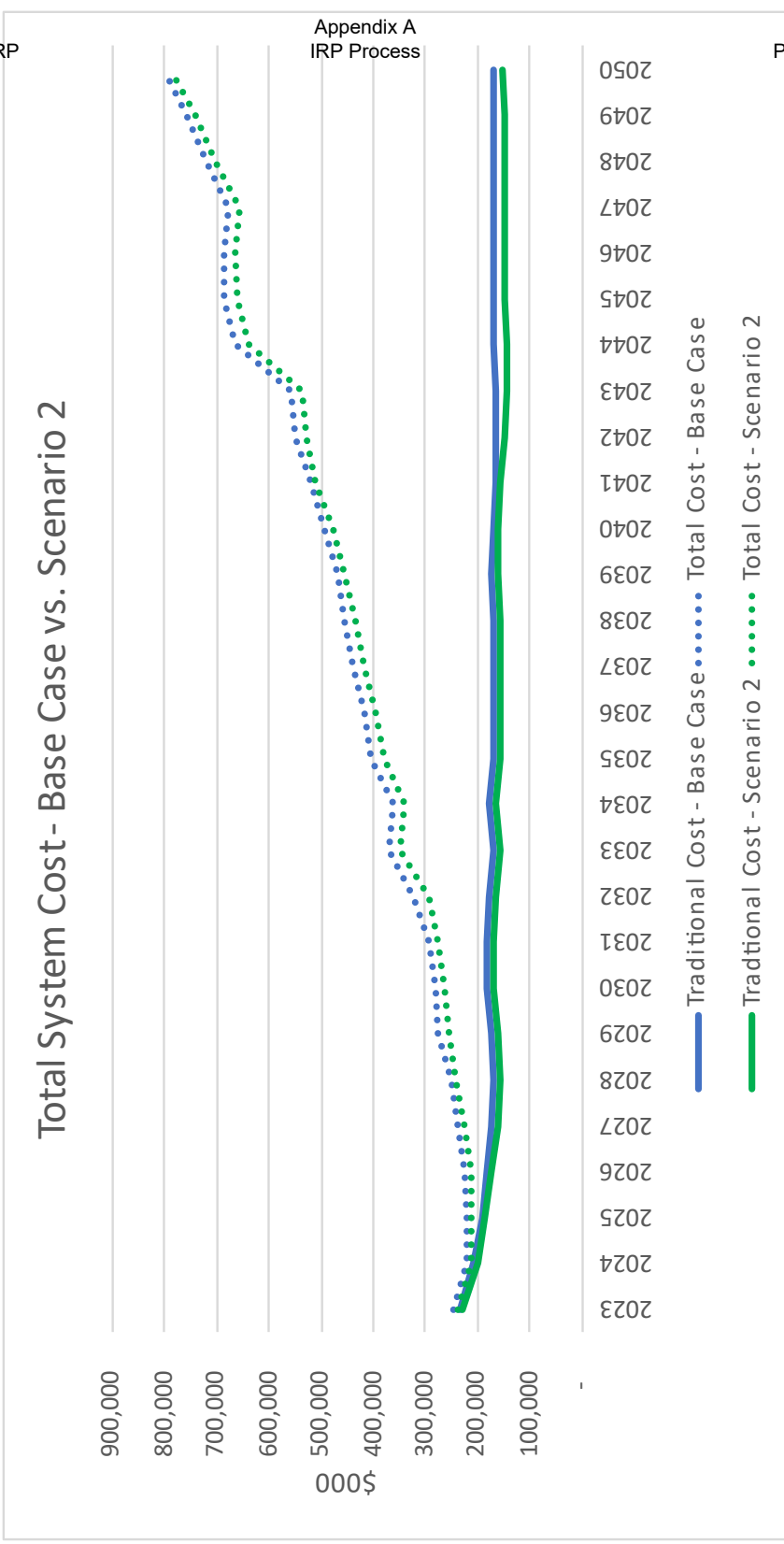

Scenario 2 – Carbon Neutral by 2050 Resource Stack

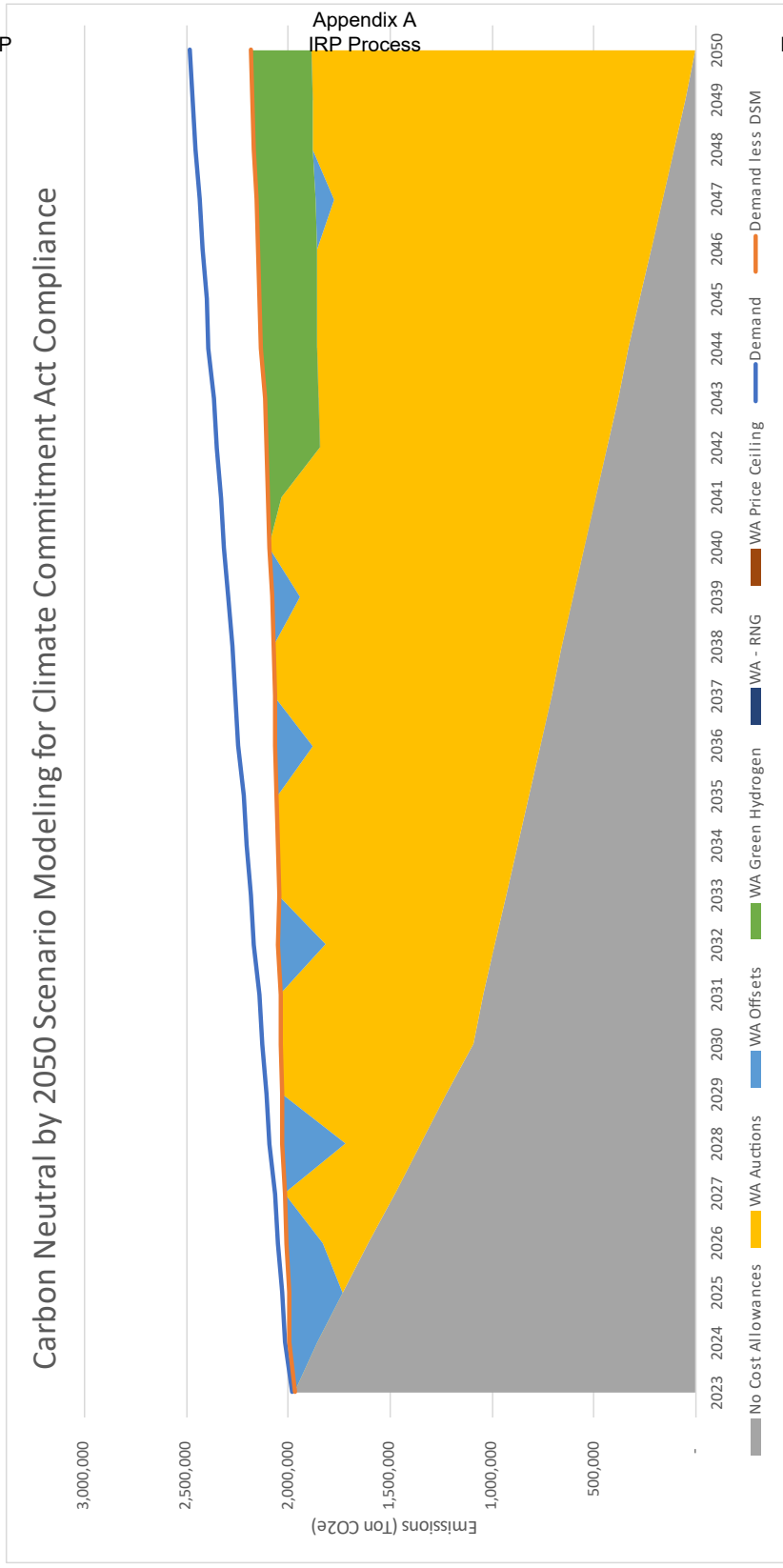

In the Community to Serve®

Scenario 2 – Key Takeaways

- Cascade does believe it would be able to hit emissions reduction goals even in a Carbon Neutral by 2050 scenario.
- Aggressive utilization of green Hydrogen in later years is key to the Company’s success in this scenario.
- If market conditions were to manifest as modeled (lower price of traditional natural gas due to presumed regional effort at carbon neutrality, declining pricing of hydrogen) cost would not be a barrier to accomplishing this goal.

Scenario 3 – Limited RNG Availability

- Main Element: Competition and stagnating technology leads to lower than expected RNG availability, conservative approach to hydrogen blending
- Customer Growth: Based on 2023 IRP Load Forecast
- Energy Efficiency: Based on adjusted 2023 CPAs from Cascade (WA) and ETO (OR) using higher commodity cost as input into avoided cost
- RNG Availability: Cascade weighted share of low potential of AGF/ICF Study
- Hydrogen Availability: Maximum blend of 5% supply by volume
- Natural Gas Bans: Consideration of all expected bans in load forecast
- Natural Gas Price: Geologic gas based 2023 IRP Price Forecast. Consideration of higher price for RNG

Scenario 3 – Limited RNG Availability Cost Comparison



In the Community to Serve

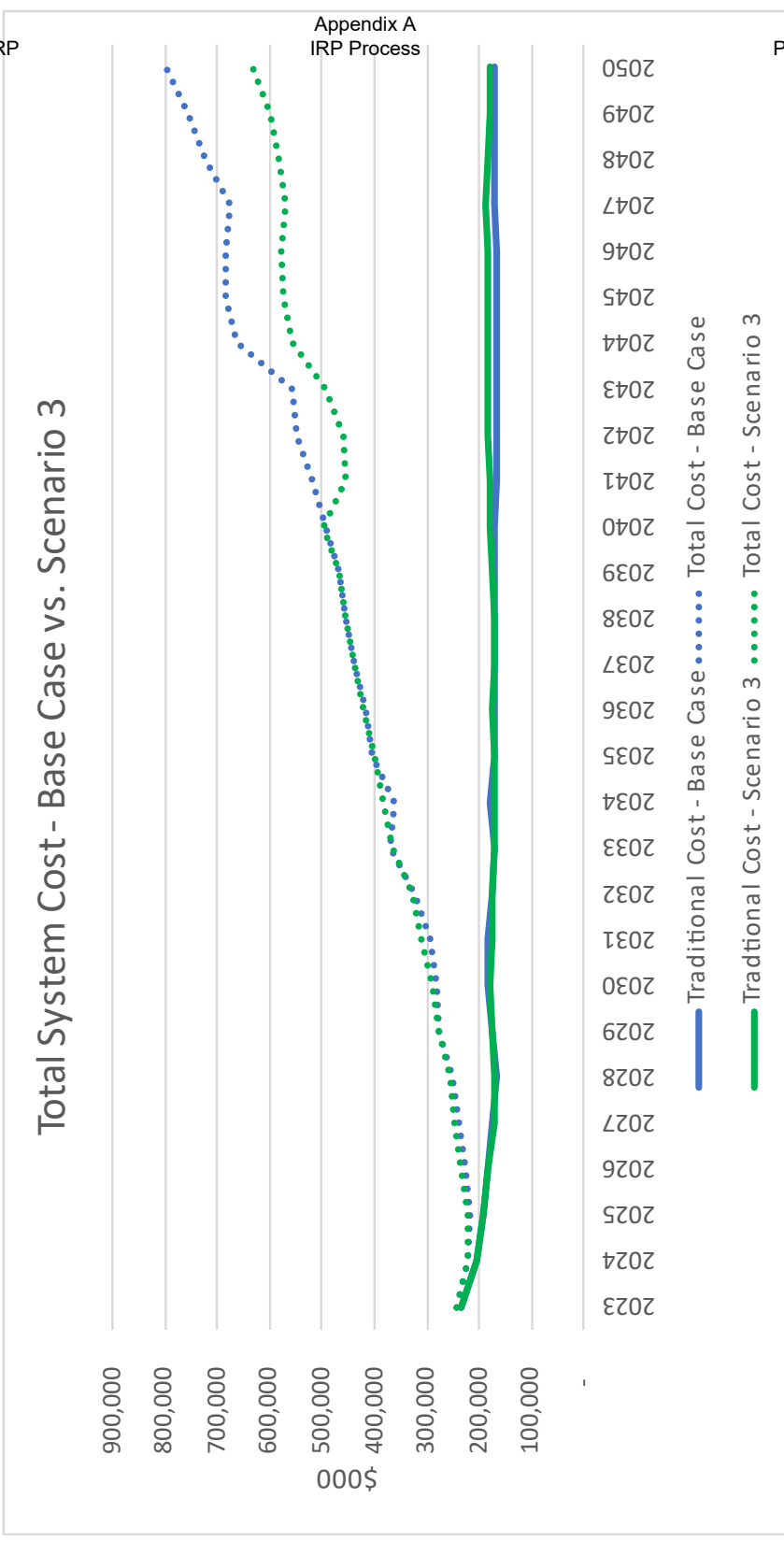

Scenario 3 – Limited RNG Availability Resource Stack – Washington

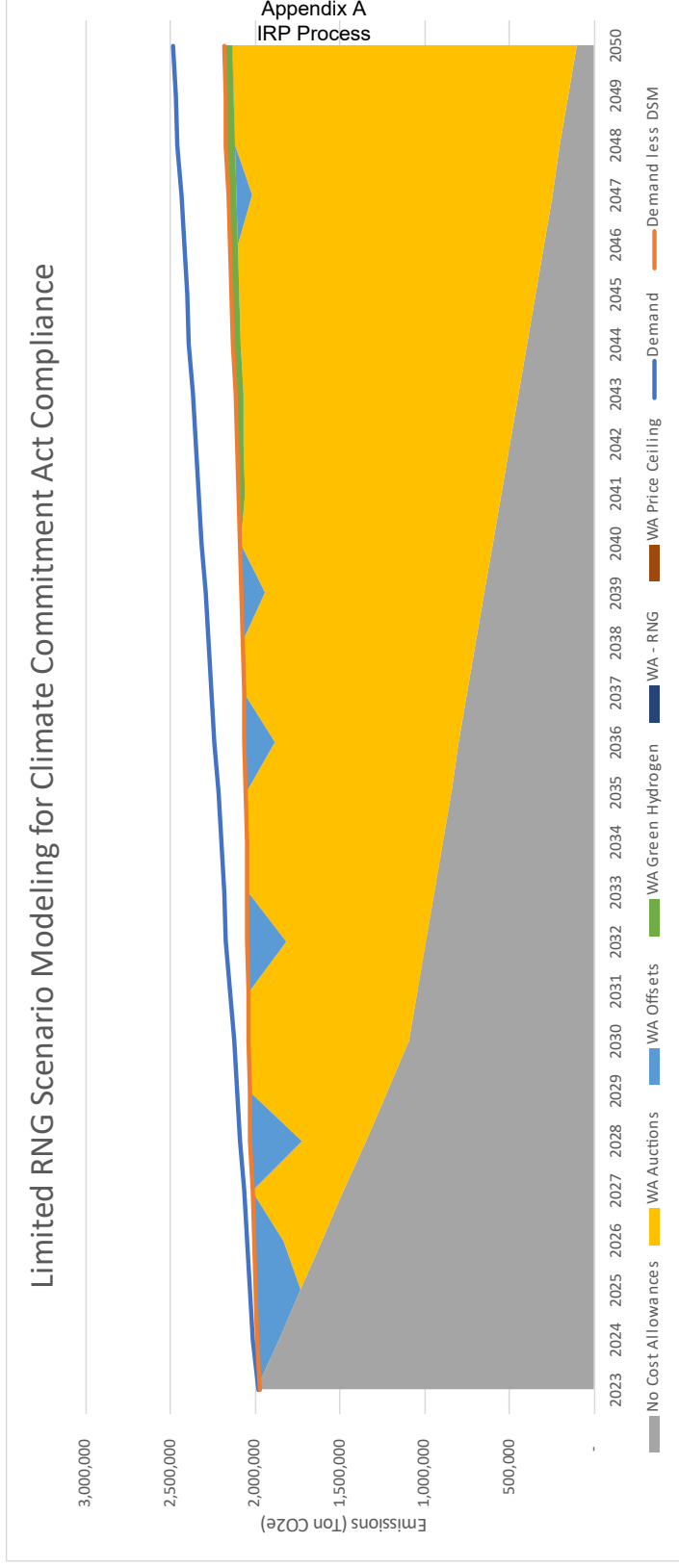

In the Community to Serve®

Scenario 3 – Limited RNG Availability Resource Stack – Oregon



In the Community to Serve

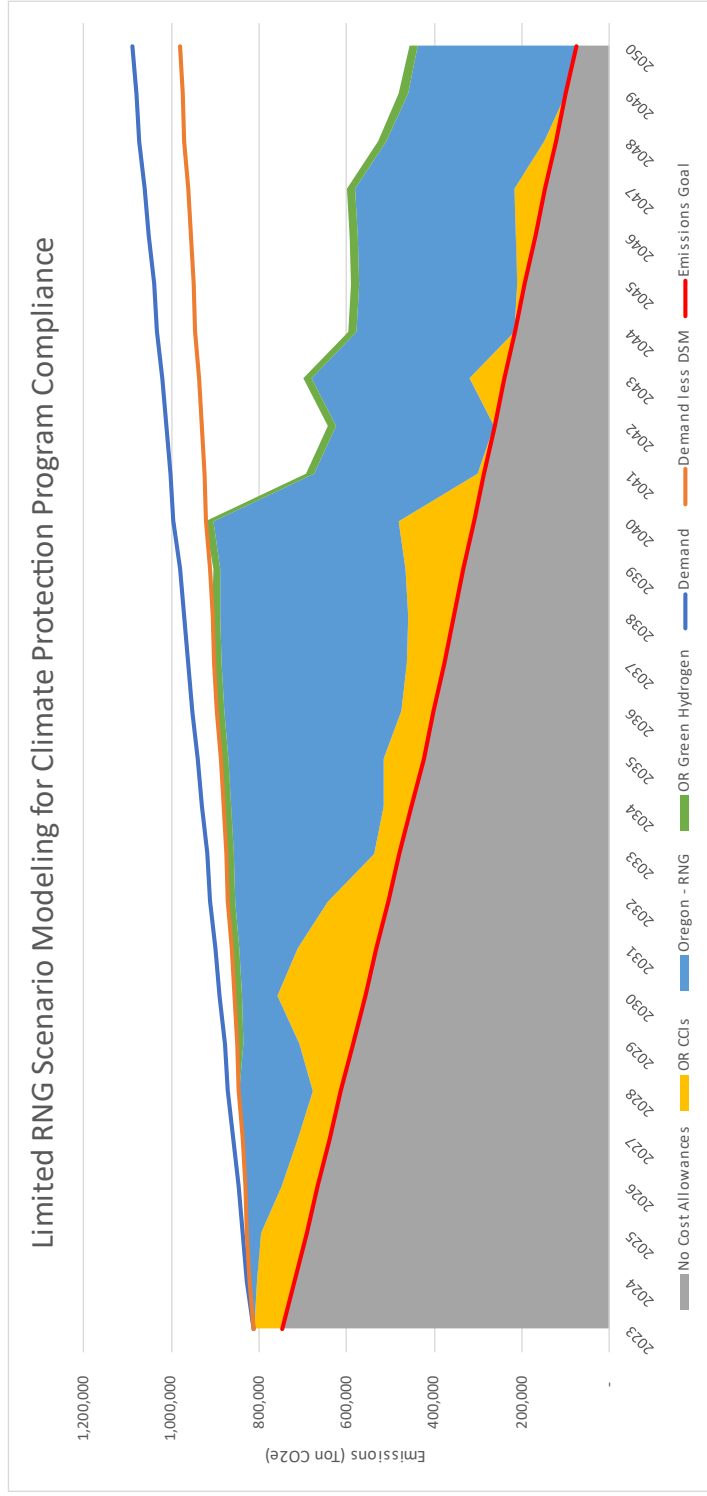

Scenario 3 – Key Takeaways

- Cascade does believe it would be able to hit emissions reduction goals in a low RNG environment in Washington, but will be challenged to be successful in meeting its goals in Oregon
- Aggressive pursuit of RNG will be vital to the Company’s success
- While in compliance, costs were typically higher in a limited RNG scenario, but not prohibitively so.

Scenario 4 – Increased Electrification

- Main Element: Lower than expected load projections due to both discretionary electrification and increased regulatory bans on natural gas.
- Customer Growth: customer growth in Cascade’s residential and commercial rate classes gradually slows to zero growth in 2025 and afterwards, residential and commercial customer count reduced to 10% by 2050.
- Energy Efficiency: Based on adjusted 2023 CPAs from Cascade (WA) and ETO (OR) using higher commodity cost as input into avoided cost.
- RNG Availability: Cascade weighted share high/technical blend of AGF/ICF Study.
- Hydrogen Availability: Maximum blend of 20% supply by volume.
- Natural Gas Bans: Consideration of all expected and proposed bans in load forecast.
- Natural Gas Price: 10% downward adjustment to 2023 IRP Price Forecast.

Scenario 4 – Increased Electrification Cost Comparison

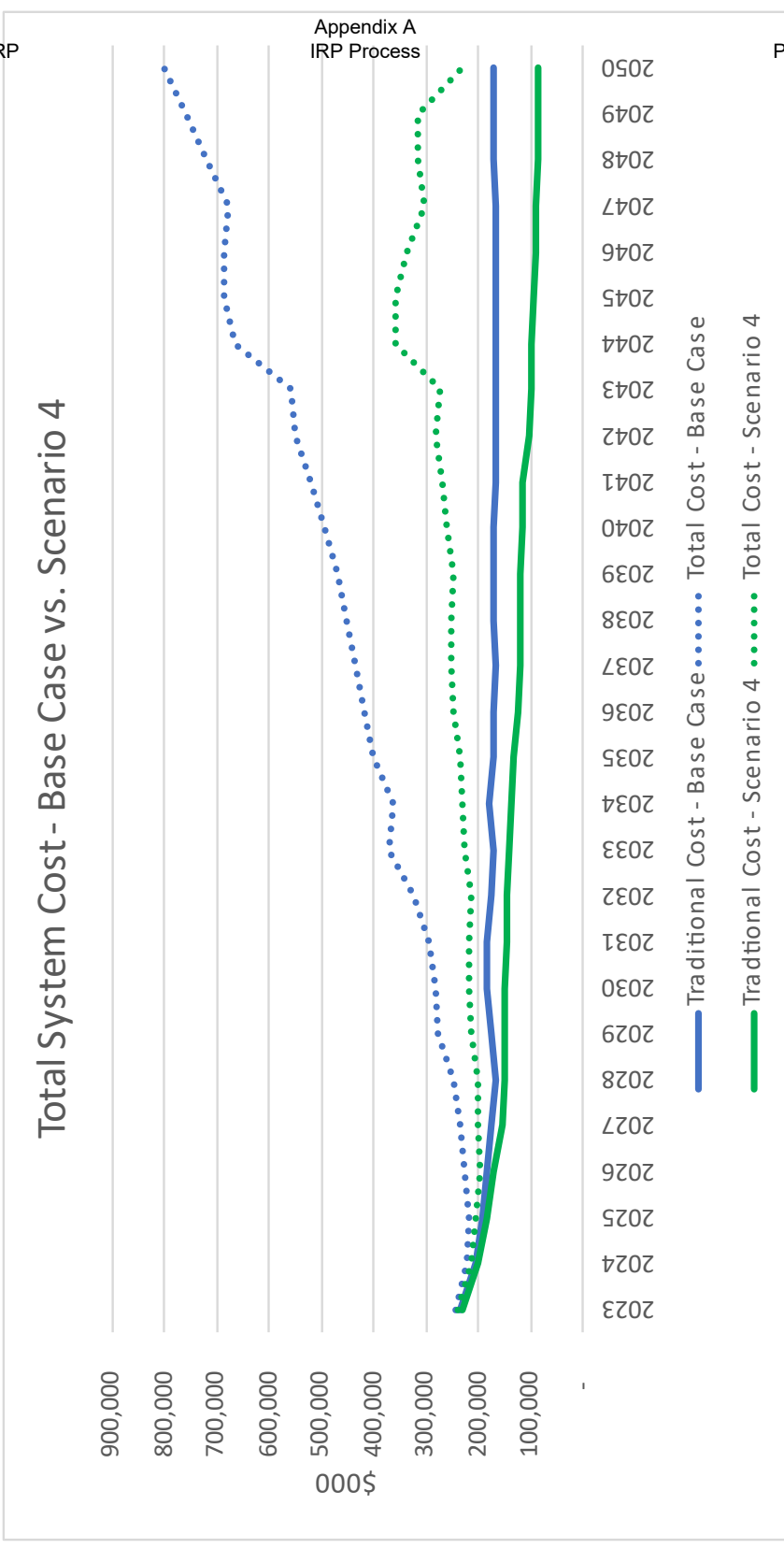

Scenario 4 – Increased Electrification Resource Stack

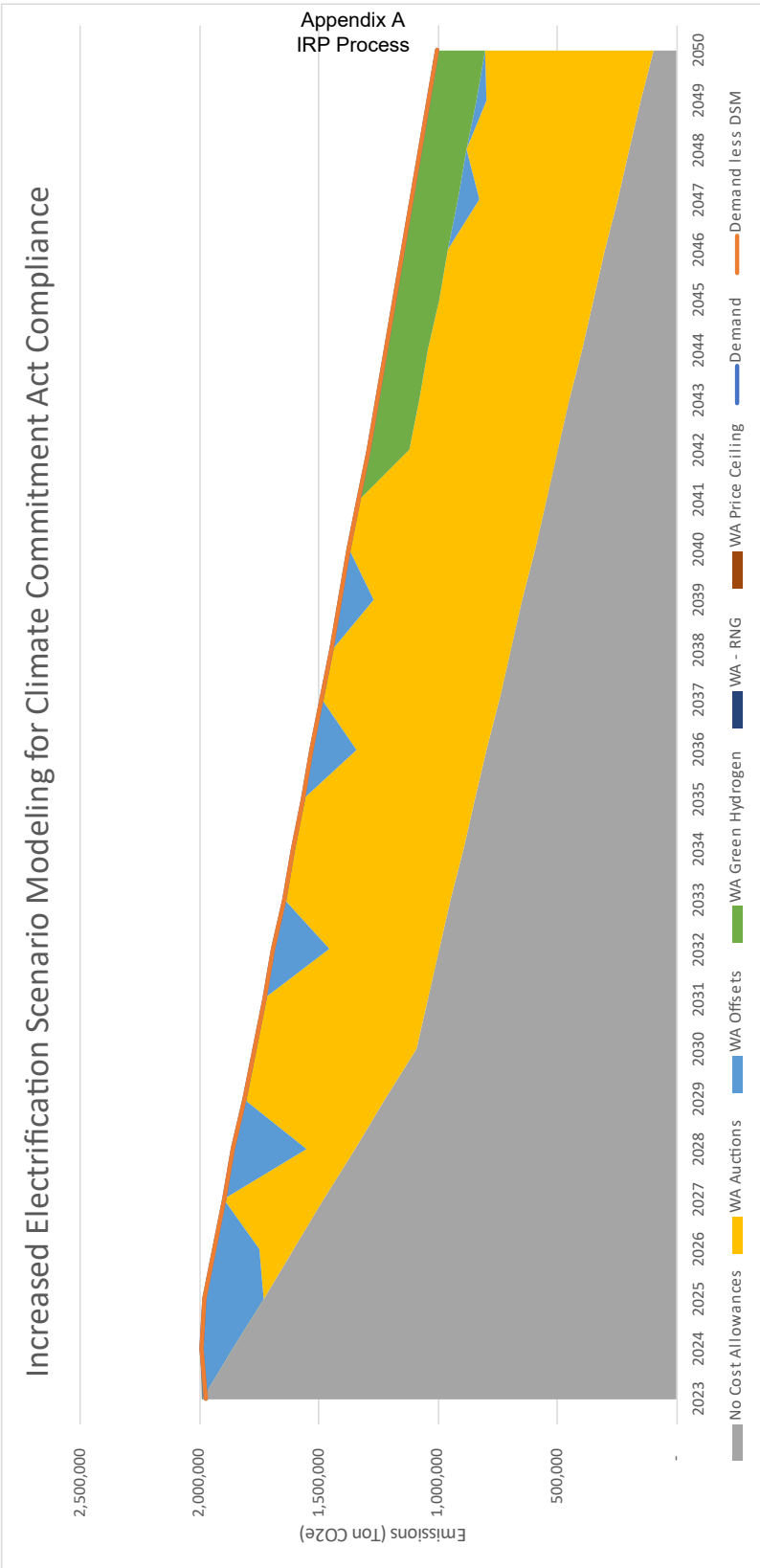

In the Community to Serve®

Scenario 4 – Key Takeaways

- Increased electrification would make compliance with emissions reduction requirements far easier.
- Costs under electrification are significantly lower to Cascade, but this is a result of those costs being shifted elsewhere. Before any policy decisions can be made based on this, an apples to apples comparison of what the resulting cost increases to customers would be must be performed.
- Lower costs do not necessarily reflect lower rates to customers, as lower customer counts may lead to higher costs per customer. Cascade will be performing rate impact analysis to be included in the final IRP.

Scenario 5 – High Customer Growth

- Main Element: Higher than expected customer growth, with the same emissions reduction requirements in the CPP/CCA
- Customer Growth: Based on high growth projections of the 2023 IRP Load Forecast
- Energy Efficiency: Based on adjusted 2023 CPAs from Cascade (WA) and ETO (OR) using higher commodity cost as input into avoided cost
- RNG Availability: Cascade weighted share of the technical potential in the AGF/ICF Study
- Hydrogen Availability: Maximum blend of 30% supply by volume
- Natural Gas Bans: Consideration of all expected bans in load forecast
- Natural Gas Price: 10% upward adjustment to 2023 IRP Price Forecast, higher price of RNG volumes above and beyond base case, capped at \$26/dth

Scenario 5 – High Customer Growth Cost Comparison

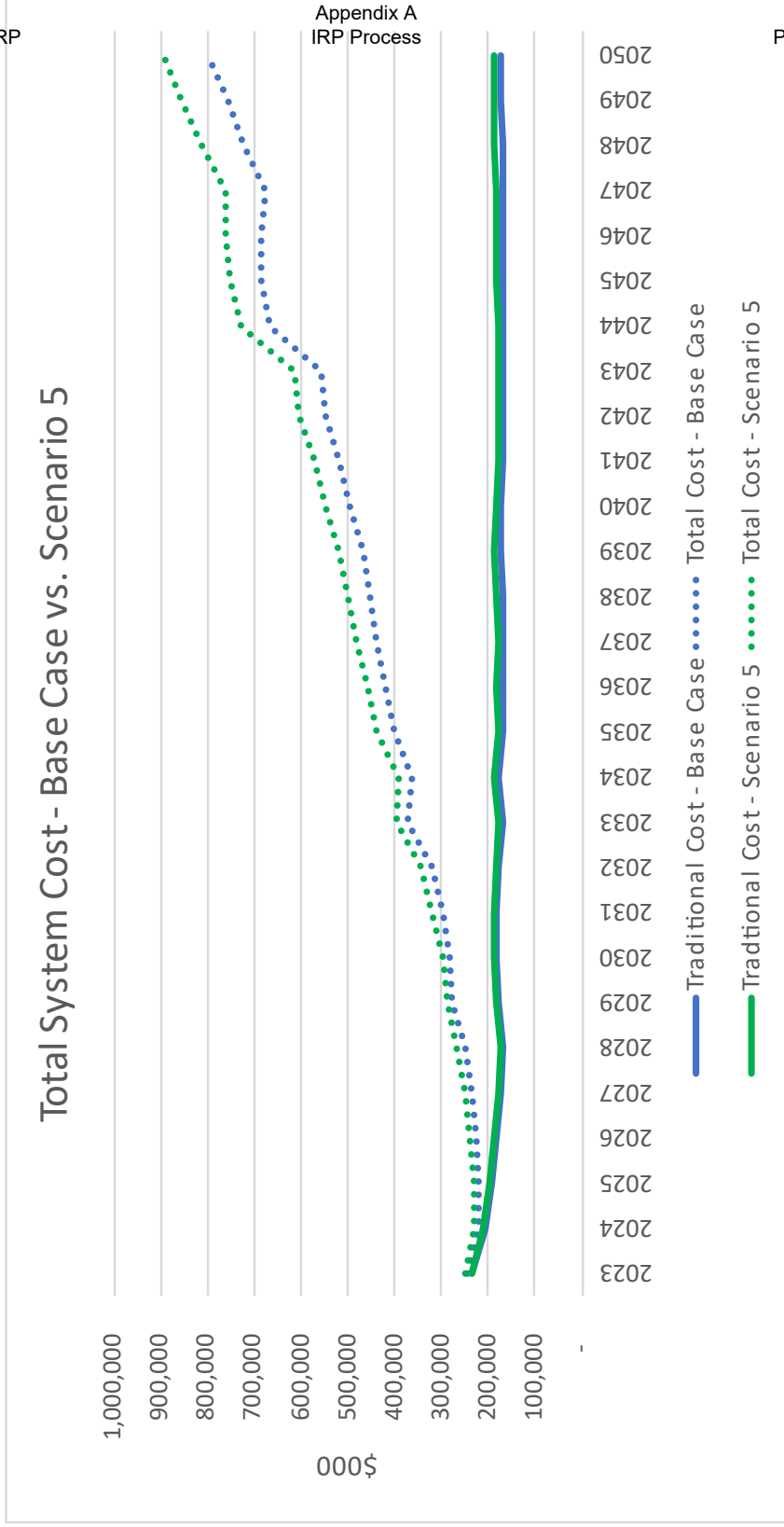

Scenario 5 – High Customer Growth Customer Growth Resource Stack

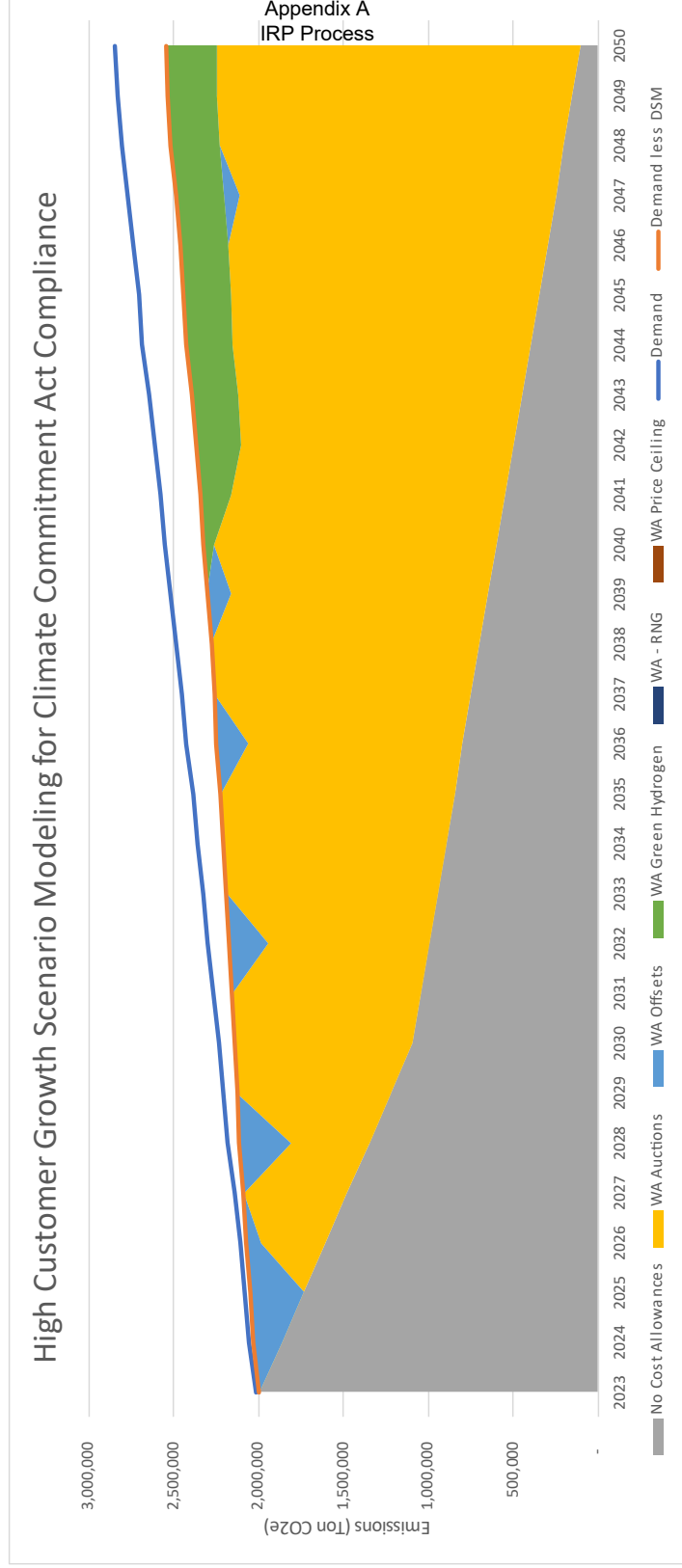

Scenario 5 – Key Takeaways

- Cascade is pleased to see that Company expects to be able to meet customer demand and reach emissions reductions goals in a high growth scenario.
- Aggressive participation in WA allowance auction, including the use of price ceiling allowances when needed, will be vital to the Company’s success, along with aggressive RNG acquisition in Oregon.
- As expected, costs will be higher under a high growth scenario, mostly driven by increased costs related to emissions reduction requirements. These costs do not appear to be cost prohibitive under deterministic modeling.

Scenario 6 – High Price – Interrupted Supply

- Main Element: Indiscriminate, stochastically derived incidents cause disruptions in availability of geologic gas at specific basins
- Customer Growth: Based on high growth projections of the 2023 IRP Load Forecast
- Energy Efficiency: Based on 2023 CPAs from Cascade (WA) and ETO (OR)
- RNG Availability: Cascade weighted share high/technical blend of AGF/ICF Study
- Hydrogen Availability: Maximum blend of 20% supply by volume
- Natural Gas Bans: Consideration of all expected bans in load forecast
- Natural Gas Price: During incidents, price at other basins spike to 99th percentile stochastic pricing

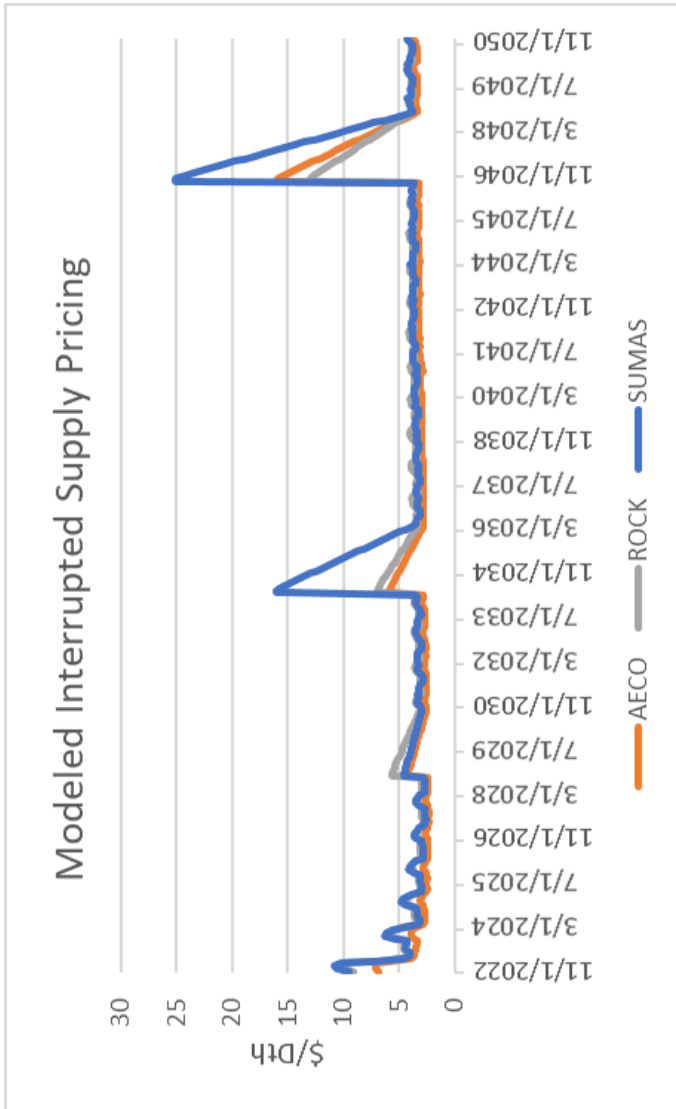
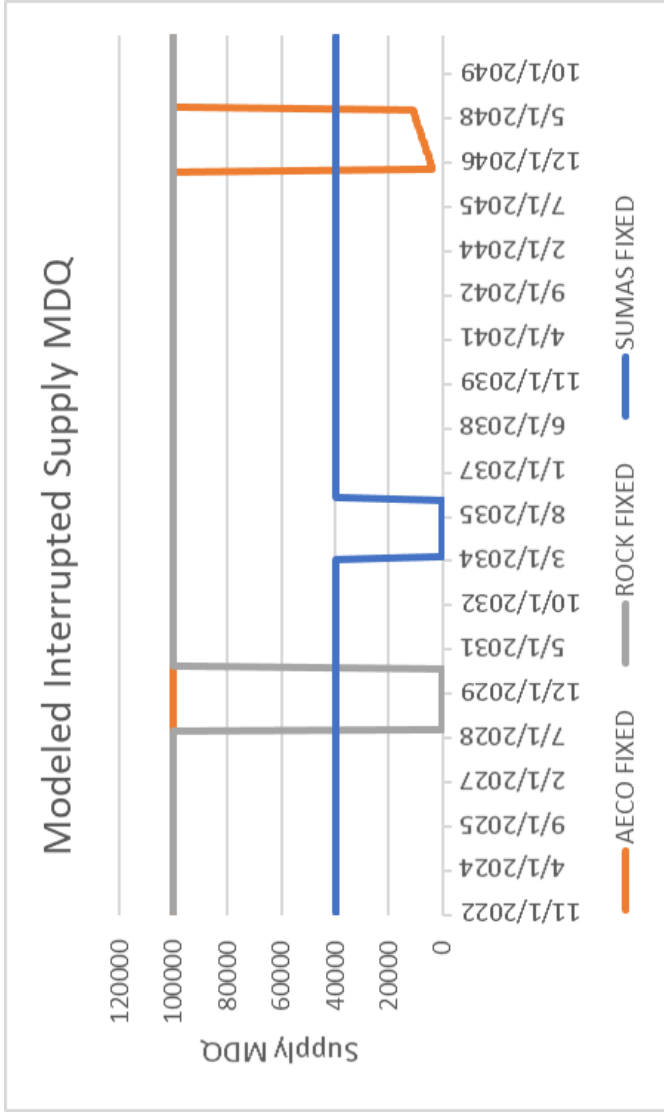

Scenario 6 – High Price/Interrupted Supply Cost Comparison

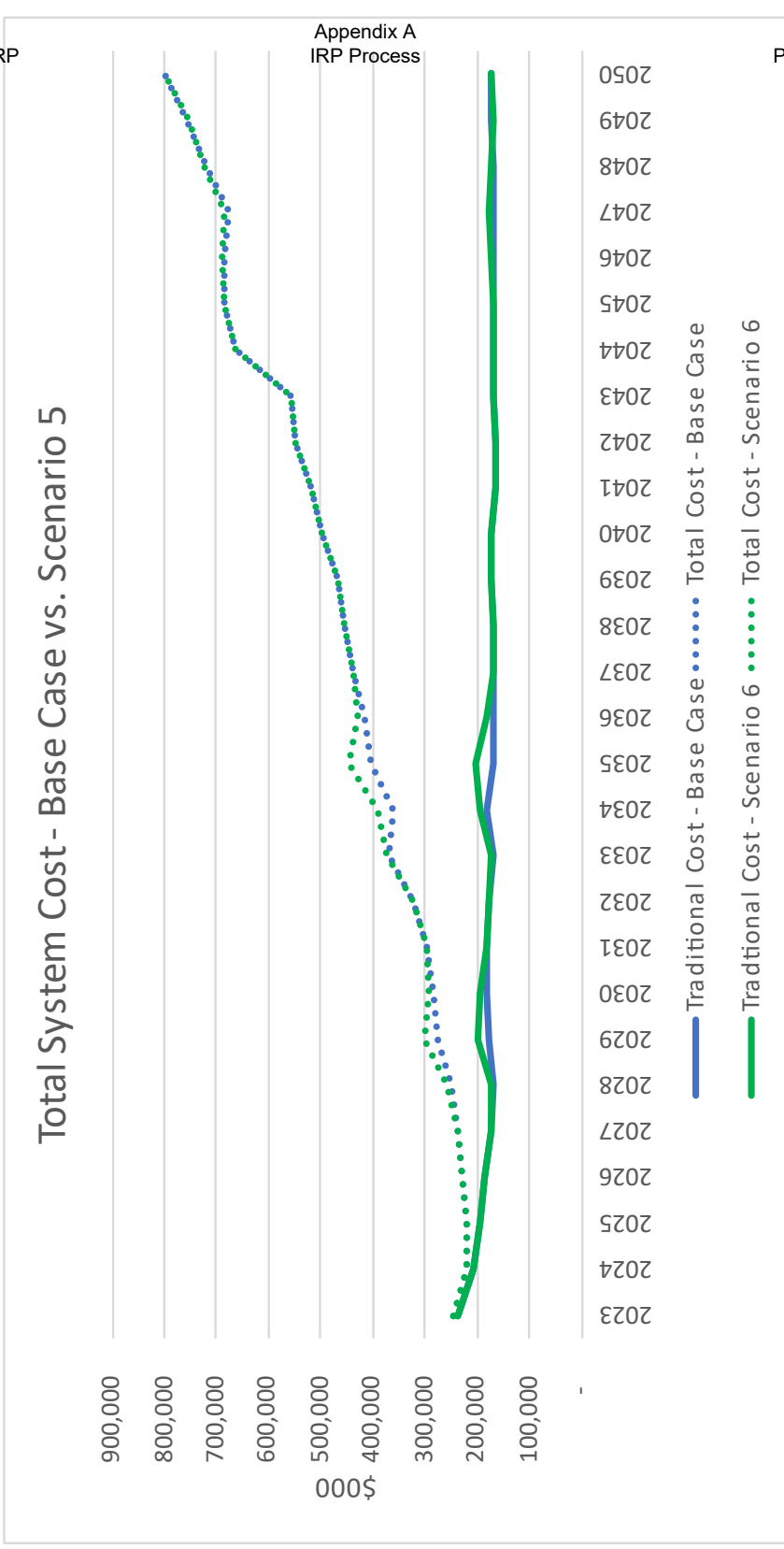

Scenario 6 – High Price/Interrupted Supply Resource Stack

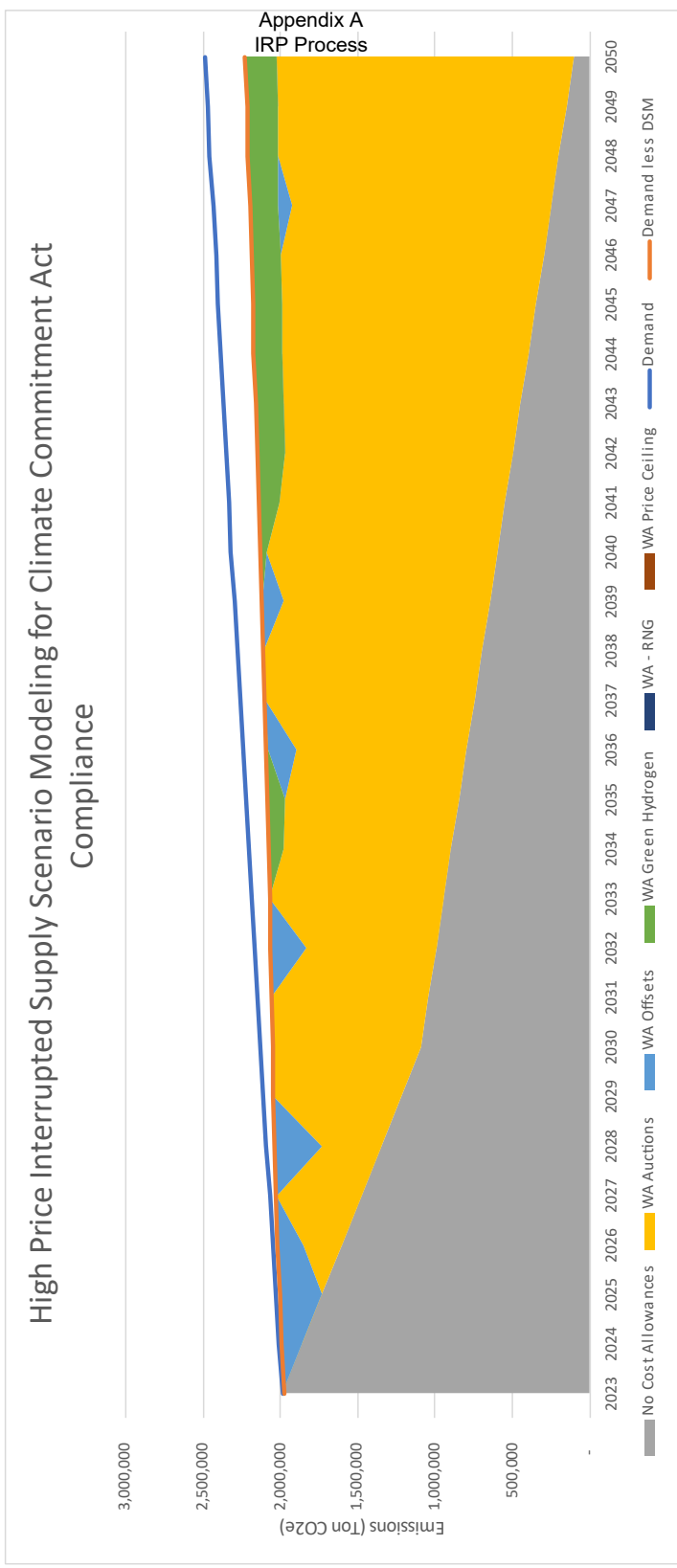

In the Community to Serve®

Scenario 6 – Key Takeaways

- Cascade is able to meet emissions reductions targets, but has identified a potential shortfall in serving load in 2034 during the modeled Sumas incident
 - Cascade will include discussion in the narrative about how an incident like this would be handled, including lessons learned from prior instances.
- Cascade’s participation in hydrogen markets is largely dependent on when pricing becomes attractive. Interrupted supply modeling indicates that price shocks from incidents could accelerate Cascade’s entry into these markets as short term hedges/protection against these price movements.
- As expected, costs will be higher during price shock incidents, but not as significantly as the Company initially expected.

Proposed Two-Year Action Plan

Two-Year Action Plan

- Demand:
 - Incorporate end use forecasting in the load forecast model
- Avoided Cost:
 - Investigate incorporating a separate avoided cost for transportation (non-core) customers
 - Explore how environmental compliance costs from the CCA/CPP impact the avoided cost
- Demand Side Management:
 - EM&V: Operating under Biennial Conservation Plan
 - New CPA: Completing in 2023
 - Municipal Gas Bans: Impact on future assumption i.e., scenario B & C
 - Code changes
 - Low income
 - Adaptive management

Two-Year Action Plan (Cont'd)

- Compliance:
 - Acquire the number of offsets and allowances needed to meet compliance under the Climate Commitment Act.
 - Acquire on-system RNG (System resource that will be utilized in OR and WA as needed).
 - Continue to participate in the local climate community action plans around Cascade's service territory.
- Distribution System Planning:
 - Kitsap Phase V Pipeline Reinforcement
 - Aberdeen HP Reinforcements
 - Bellingham 6-inch HP Reinforcement –Meador Ave
 - Richland HP Reinforcements
 - South Kennewick Reinforcements
 - Pasco 6-inch HP Reinforcement
 - Burlington South Feed Reinforcement
 - Wapato 4-inch HP Replacement

2023 IRP Remaining Schedule

Process Items	Process Elements	Date
TAG 5 (OR)	Final Integration Results, finalization of plan components, Proposed new 4-year Action Plan.	11/9/2022
Draft of 2022 IRP distributed (WA)	Filing of Draft IRP	11/23/2022
Draft of 2022 IRP distributed (OR)	Filing of Draft IRP	1/5/2023
Comments due on draft from all stakeholders (WA)	Comments due from Stakeholders	1/13/2023
Comments due on draft from all stakeholders (OR)	Comments due from Stakeholders	2/24/2023
TAG 6, if needed (WA)	An additional TAG if needed based on comments from Stakeholders	2/1/2023
TAG 6, if needed (OR)	An additional TAG if needed based on comments from Stakeholders	3/15/2023
IRP filing (WA)	IRP Final Filing	2/24/2023
IRP filing (OR)	IRP Final Filing	4/14/2023



Questions/Next Steps



Review Plans for Draft IRP and TAG 5 Discussion

- Draft IRP will be filed Wednesday, November 23
- Next OR TAG (TAG 5) is Wednesday, November 9
 - Final Integration Results
 - Finalization of Plan components
 - Proposed new Action Plan

Contact Information

Mark Sellers-Vaughn – Manager, Supply Resource Planning: (509) 734-4589 mark.sellers-vaughn@cngc.com

Brian Robertson – Supervisor, Resource Planning: (509) 221-9808 brian.robertson@cngc.com

Devin McGreal – Senior Resource Planning Economist: (509) 734-4681 devin.mcgreal@cngc.com

Ashton Davis – Resource Planning Economist II: (509) 734-4520 ashton.davis@cngc.com

Cascade IRP email – irp@cngc.com



In the Community to Serve[®]

Integrated Resource Plan (WA) Technical Advisory Group Meeting #5

OCTOBER 20, 2022

MICROSOFT TEAMS/TELECONFERENCE



In the Community to Serve[®]



In the Community to Serve®

TAG #4 WA – TAG Meeting

Date & time: 10/20/2022, 9:00 AM to 12:00 PM

Location: Microsoft Teams Meeting

Presenters: Brian Robertson, Devin McGreal, & Ashton Davis

In attendance: Ashton Davis, Brian Cunnington, Brian Robertson, Bruce Folsom, Byron Harmon, Caleb Reimer, Carolyn Stone, Chris Robbins, Corey Dahl, Devin McGreal, Eric Wood, Gabe Forrester, Garret Senger, Haixiao Huang, Jon Storvick, JP Batmale, Kary Burin, Kim Herb, Mark Sellers-Vaughn, Michael Parvinen, Monica Cowlshaw, Pamela Archer, Sebastian Weber, Zachary Sowards

Brian Robertson, Supervisor of Resource Planning, opened the meeting by welcoming and thanking stakeholders for participating in Cascade’s IRP Process. Brian then proceeded with introductions, the agenda, a safety moment, and a reminder of the stakeholder engagement goals.

Presentation #1 – Backcast Overview (Ashton Michael Davis)

- Ashton opened by sharing what cross-validation, or backcast, is and how it’s used to test the accuracy of a model.
- Ashton then provided a breakdown of how the cross-validation modeling works.
- Ashton shared the results of the model, as well as an explanation of what the results of the cross-validation tells Cascade. In summary, the “fit” of Cascade’s models have been relatively good and provide useful feedback on where improvements can be made.

Question: Byron asked if the Sumas SPE Loop industrial rate schedule results are representative of industrial customers in general.

Answer: Ashton responded with “in general, yes.” Industrial customers in general are more difficult to forecast than Residential and Commercial customers, but not all Industrial customers were as difficult to forecast than the Sumas SPE Loop.

Presentation #2 – Summary of Alternative Resources (Ashton Davis)

- Ashton provided a high-level summary of Cascade’s alternative upstream resources. Alternative upstream resources include transportation, storage, traditional natural gas, renewable natural gas, and hydrogen.

Question: Byron asked a clarification question about incremental RNG and hydrogen.

Answer: Brian explained that incremental is referring to anything above and beyond what Cascade currently is contracted for.

Question: Byron asked if the renewable fuels are incremental to our supply or if it would replace what Cascade is currently using?

Answer: Devin explained that it would absolutely replace traditional natural gas in an effort to reduce emissions.

Presentation #3 – Components of Candidate Portfolios (Brian Robertson)

- Brian covered Cascade's six steps to running the Company's Supply Resource Optimization Process. This process explains how Cascade analyzes portfolios through a deterministic and stochastic analysis and then runs sensitivity and scenario analysis on the top ranked portfolio.

Question: Byron asked a question about the portfolio generation process, if all portfolios go through the full Supply Resource Optimization Process, as well as why Cascade goes through the process of evaluating different portfolios.

Answer: Devin responded that there is a UTC rule that comes from the electric world where utilities have to evaluate multiple portfolios, so while the electric world that can be different resources like hydro, solar, coal wind, etc. a gas utility has less options. Cascade comes up with 5 or 6 portfolios that are a mix of environmental compliance options mostly, which for time efficiency reasons are only run under expected conditions. Even though the resulting optimized mix of resources is what we expect will end up ultimately being the preferred portfolio, it is important to test it under stochastic conditions like extreme price or extreme weather and to see what we can learn about it from scenario analyses. Additionally, if the portfolio that is optimized for deterministic conditions fails significantly under stochastic conditions, such as the Company not coming close to hitting emissions targets, the portfolio could still be rejected and require modifications.

- Brian recapped the As-Is Analysis, which shows how Cascade's current supply resources would meet future needs. Transportation shortfalls would begin mid- to late-2030's and emission shortfalls would begin right away.
- Brian then listed the portfolios and provided information about each portfolio. This included what the portfolio entails, how it does or does not meet emission reduction targets, as well as costs.

Question: Byron asked Cascade to explain the dynamics between offset and allowance purchasing and what would cause the blips on slide 27.

Answer: Brian explained the number of offsets/allowances and the prices of each, as well as having an understanding that decisions are made every four years for compliance periods which is an important factor of when carbon compliance options are selected. Brian also mentioned that Plexos has perfect knowledge, so it will optimize the least-cost options by compliance period.

- The final rankings of the portfolios were provided, with the All-in including DSM portfolio being the least cost, least risk option that met supply and emission targets. The All-in Portfolio includes a small amount of on-system RNG, offsets, allowance purchasing, and hydrogen to meet customer demand while meeting carbon compliance targets.

Presentation #4 – Stochastic Methodology (Brian Robertson)

- Brian provided background information on Cascade's stochastic methodology throughout the previous IRPs. Cascade was limited with the amount of Monte Carlo simulations in previous IRPs, but Cascade has continued to improve this process by utilizing R, a free statistical analysis software.
- Brian then gave details on how the process of weather and price Monte Carlo's work as well as some results from the stochastic analysis.

Presentation #5 – Scenario and Sensitivity (Devin McGreal)

- Devin described the new philosophy behind scenario and sensitivity modeling, which is reducing the number of scenarios to allow for more in-depth and robust analysis. In the past, Cascade modeled a wide breadth of scenarios and sensitivities, but time constraints did not allow for a deep analysis of the results.
- Devin went into detail regarding each scenario and sensitivity, describing what is included.
- Total system costs, carbon emission resource stacks, and key takeaways were provided for every scenario

Question: Kim asked if the carbon neutral scenario was linked to the E3 study that was done for Northwest Natural.

Answer: Devin responded that the carbon neutral scenario came from the UM 2178 docket, and the assumptions in the E3 report may not be the same assumptions in Cascade's carbon neutral scenario, although there may be some similarities.

Presentation #6 – Proposed Two-Year Action Plan (Brian Robertson)

- Brian described Cascade's current Two-Year Action Plan that Cascade will undertake over the next two years.

Presentation #7 – 2023 IRP Schedule (Brian Robertson)

- Brian went through the remaining TAG schedules for both WA and OR.
- Brian noted that the next TAG meeting will be Oregon-focused and take place on November 9th while the next WA step is that the draft will be filed November 23rd.

The Meeting was Adjourned

Per Cascade Commitment #8 (Stakeholder Engagement Design Document, 2/22/2022: "Provide TAG minutes that include the action items from bullet #7 as well as any upcoming deadlines for feedback on the IRP"), here are additional action items to track, coming out of the TAG 4 meeting:

1. Cascade will include narrative on scenarios that show emission shortfalls.
2. Cascade will provide bill impact analysis in the IRP.



In the Community to Serve[®]

Integrated Resource Plan (WA) Technical Advisory Group Meeting #6

FEBRUARY 1, 2023

MICROSOFT TEAMS/TELECONFERENCE



In the Community to Serve[®]

Agenda

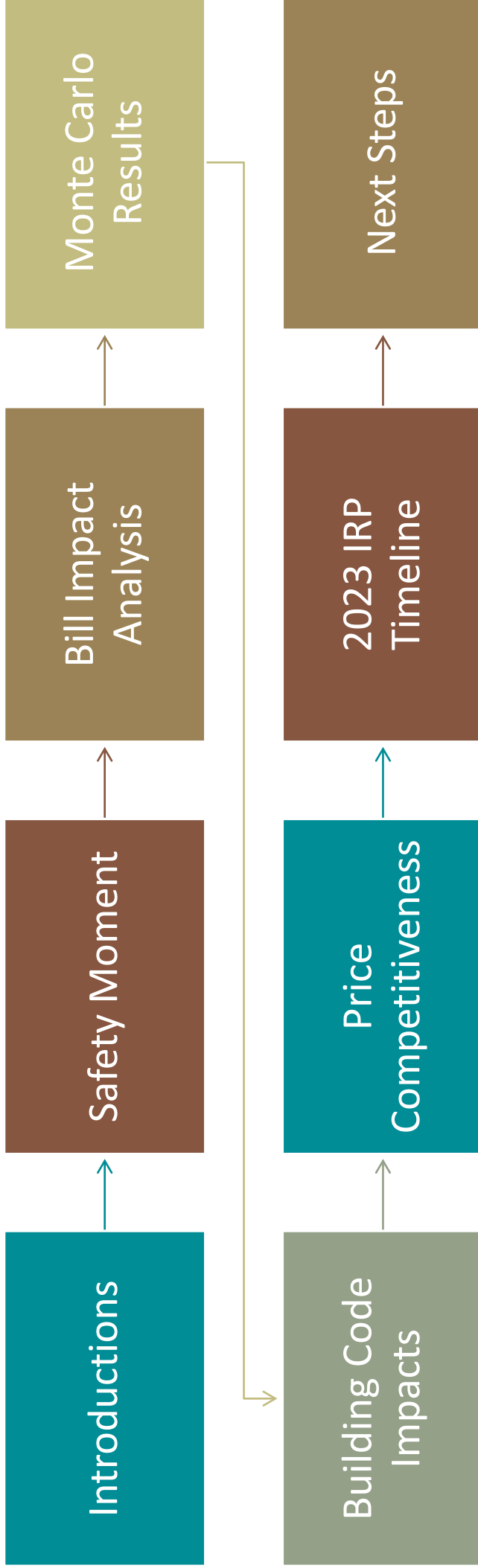

FIRE PREVENTION

Following the tips below will help reduce the risk of fire and help protect you, your family, and home.

- **Smoke Alarms** – Have smoke alarms installed on every level of your home, inside bedrooms, and outside sleeping areas. Test monthly and change the batteries yearly.
- **Candles** – Keep lit candles away from combustible materials such as curtains, newspapers, furniture, etc.
- **Heating** – Maintain a three-foot zone around the heater to keep kids and pets safe and to prevent combustible materials from catching fire. Have heating equipment and chimneys cleaned yearly by a qualified professional. Keep a fire extinguisher nearby.
- **Electrical** – Prevent electrical fires by not overloading circuits or extension cords. Unplug appliances when not in use. Inspect outlets if plugs fit loosely, loose fittings can cause an outlet to overheat.
- **Clothes Dryers** – Clean the lint filter every time you start a load of clothes in the dryer. Clean dryer vent and exhaust duct with good quality vent brush and check for lint buildup behind the dryer at least twice a year.

Safety Moment

Bill Impact Analysis

- For the As-Is scenario, Cascade assumed a business-as-usual approach with no carbon emission targets. This is done primarily to allow the Company to identify any upstream capacity shortfalls independent of emissions reduction requirements.
- Cascade then estimated bill impacts for each of the scenarios;
 - All-In w DSM, meet CPP and CCA compliance targets (Base Case)
 - Carbon Neutral by 2050
 - Limited RNG
 - Increased Electrification
 - High Customer Growth
 - High Price Interrupted Supply

All-In w DSM, meet CPP and CCA compliance targets (Base Case)

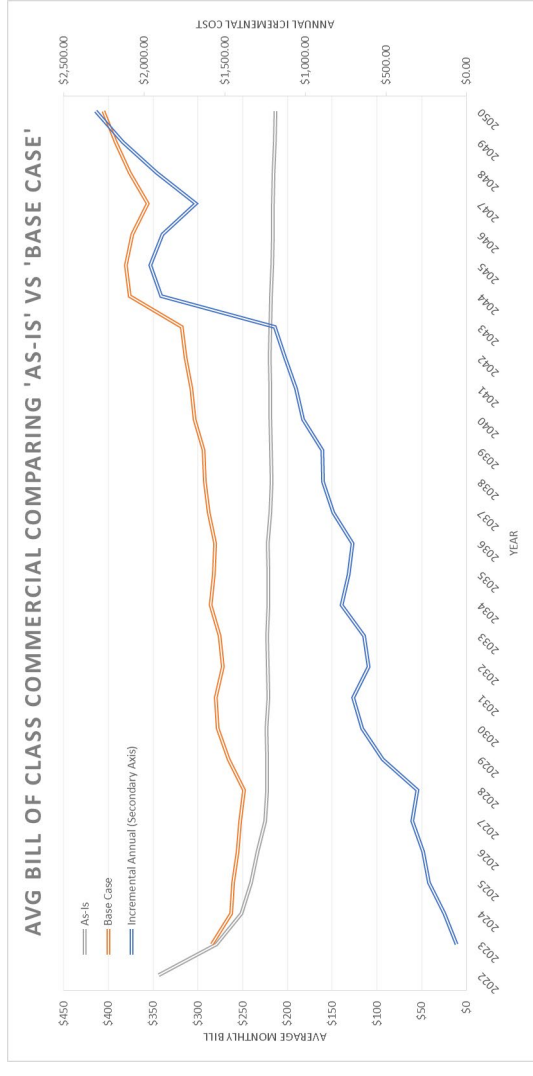
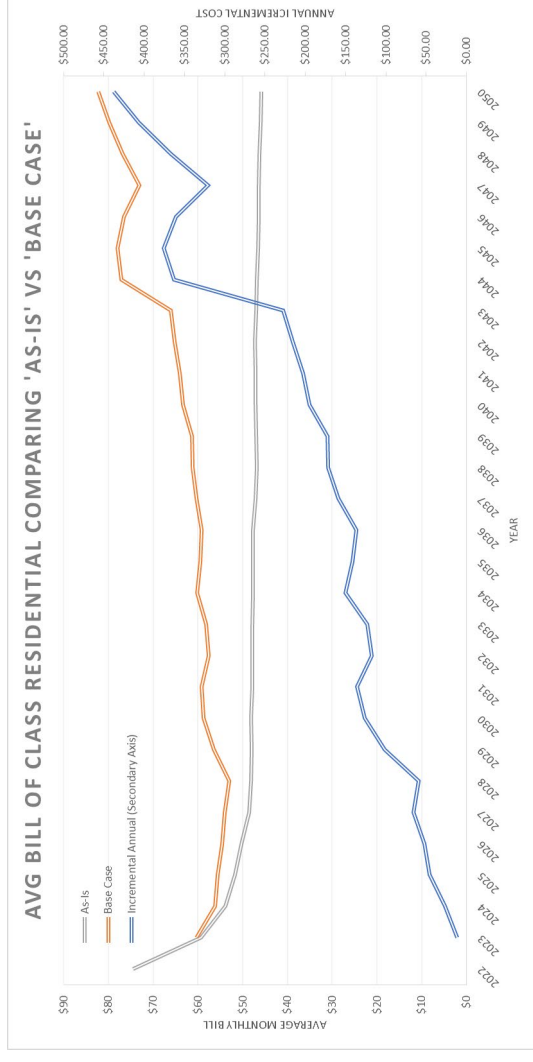

Takeaways:

- Preferred Portfolio could increase Residential Bills 20% by 2035 and 44% by 2050 over business-as-usual bills estimates. Commercial bills could increase by 22% and 47% by 2035 and 2050, respectively.

Carbon Neutral by 2050

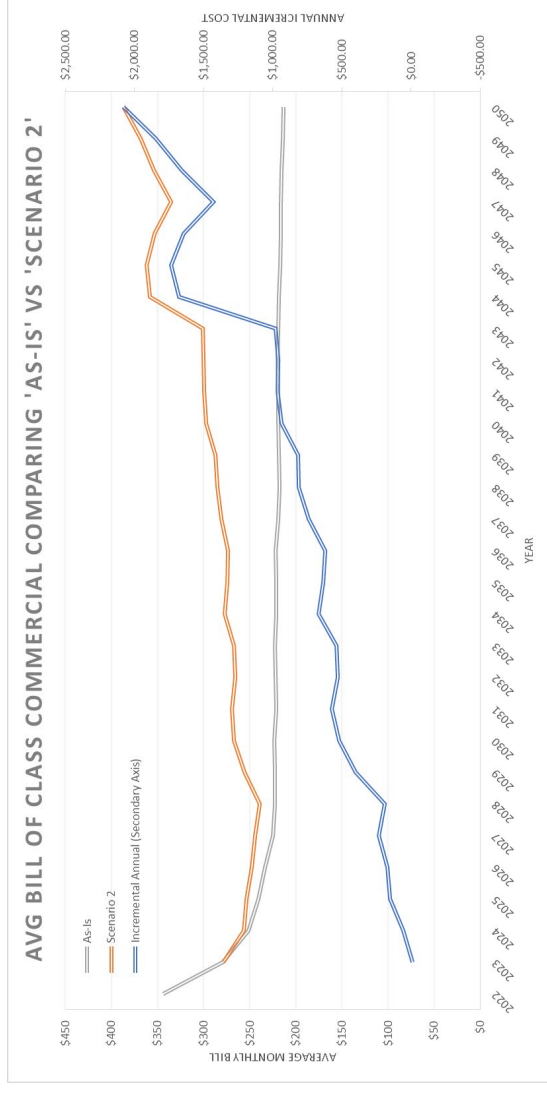
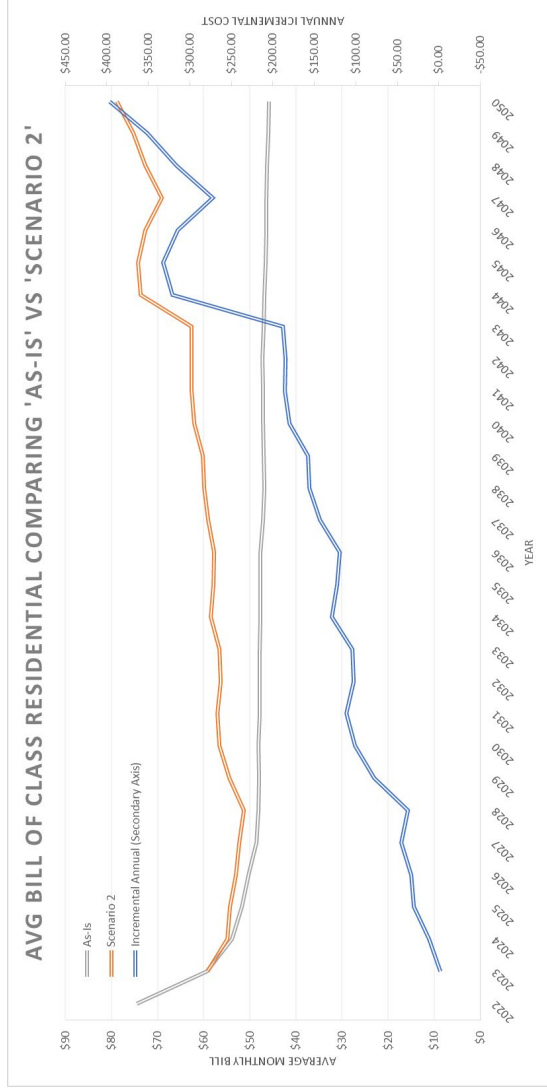

Takeaways:

- Carbon Neutral Scenario could increase Residential Bills 17% by 2035 and 41% by 2050 over business-as-usual bills estimates. Commercial bills could increase by 19% and 44% by 2035 and 2050, respectively.
- Leading cause as to why the bills don't rise as high as the preferred portfolio is due to a lower projected traditional supply pricing.

Limited RNG

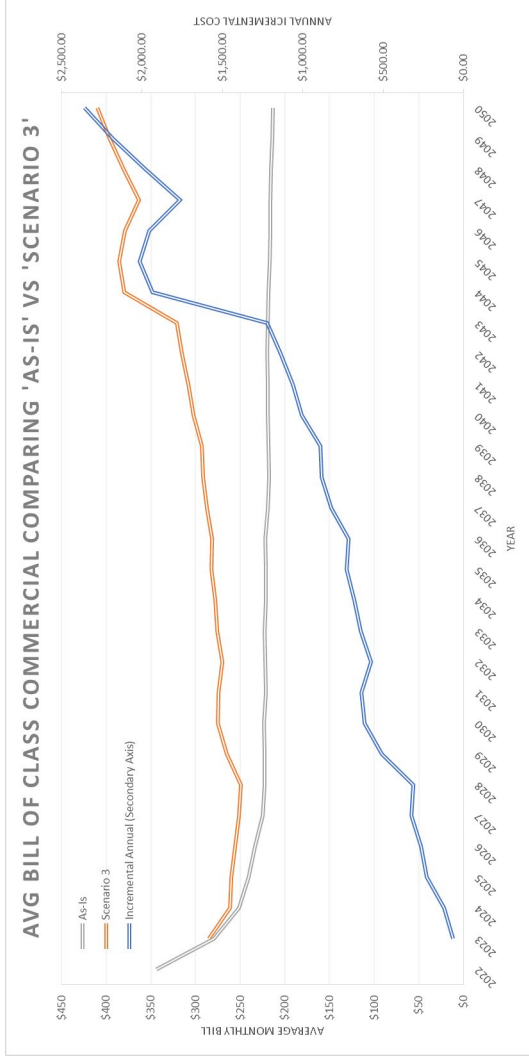
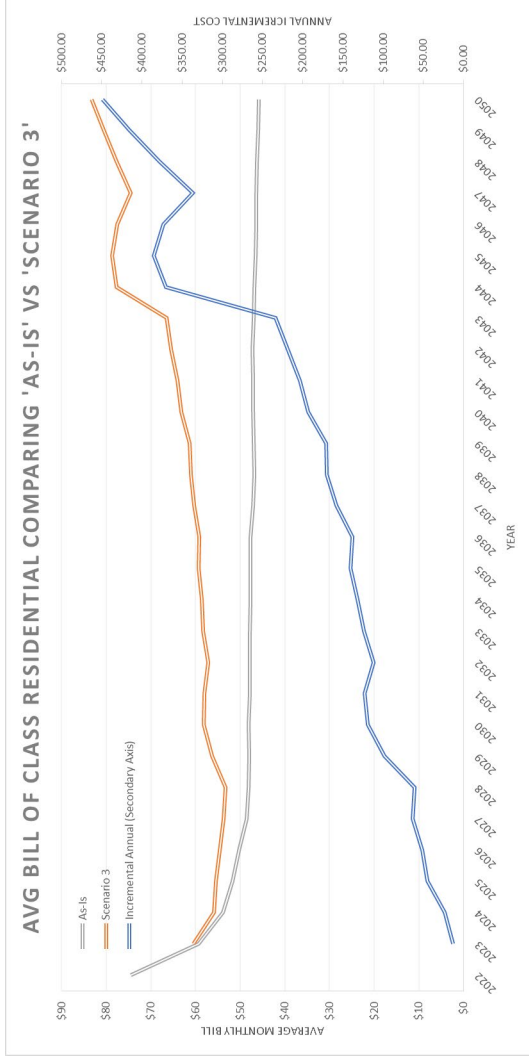

Takeaways:

- Limited RNG Scenario could increase Residential Bills 20% by 2035 and 45% by 2050 over business-as-usual bills estimates. Commercial bills could increase by 21% and 48% by 2035 and 2050, respectively.
- Limiting the amount of RNG and Hydrogen in the later years would force the company to seek more expensive compliance options. Limited RNG/Hydrogen has a greater impact on Oregon than Washington.

Increased Electrification

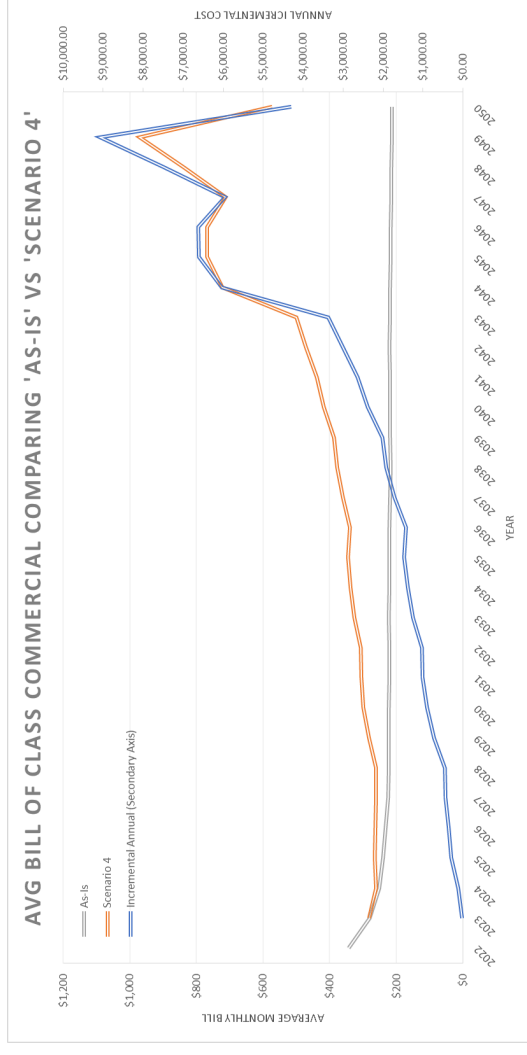
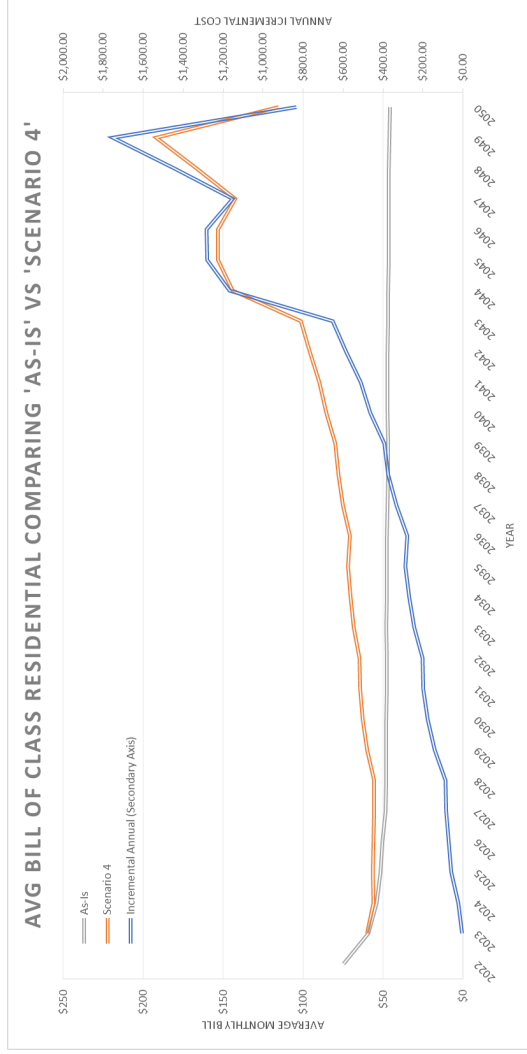

Takeaways:

- Increased Electrification Scenario could increase Residential Bills 33% by 2035 and 60% by 2050 over business-as-usual bills estimates. Commercial bills could increase by 36% and 60% by 2035 and 2050, respectively.
- Electrification comes at the consequence of a significant cost and load increase to regional electric utilities, with all of the risks associated with the ability to serve such a dramatic influx of customers.

High Customer Growth

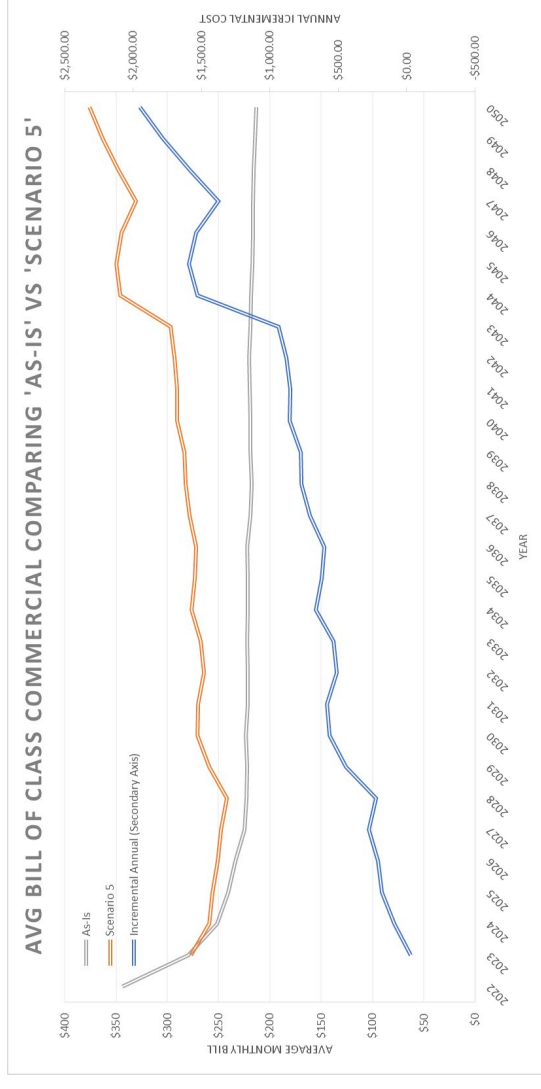
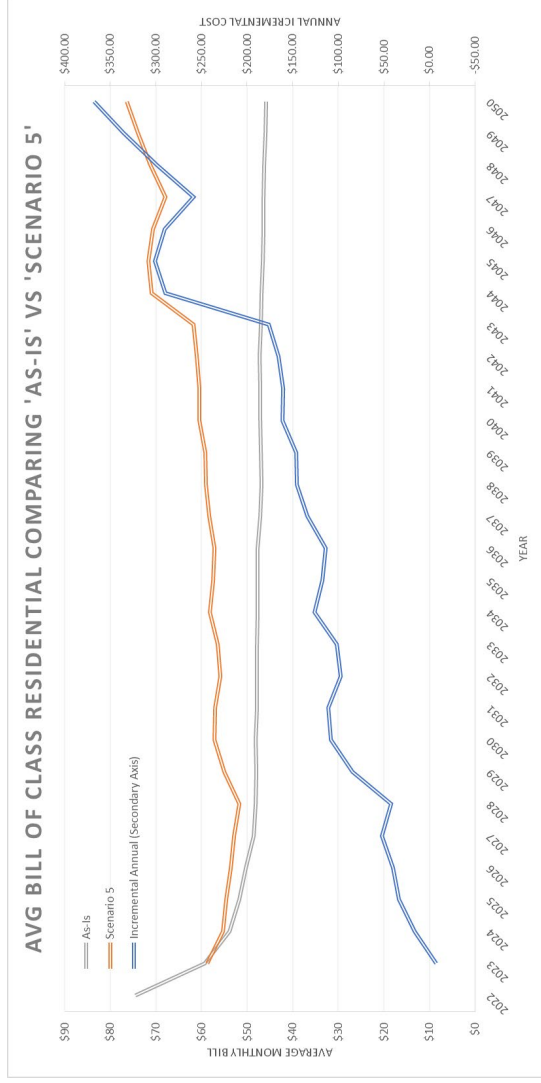

Takeaways:

- High Customer Growth Scenario could increase Residential Bills 17% by 2035 and 40% by 2050 over business-as-usual bills estimates. Commercial bills could increase by 19% and 43% by 2035 and 2050, respectively.
- Although revenue requirement is higher than the preferred portfolio, the costs are spread out between a larger customer base, decreasing the impact to customers.

High Price Interrupted Supply

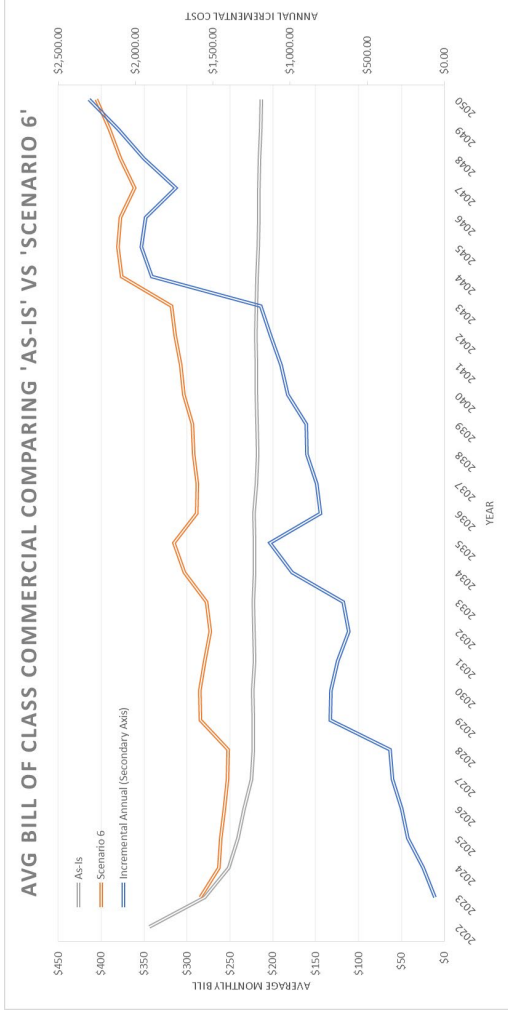
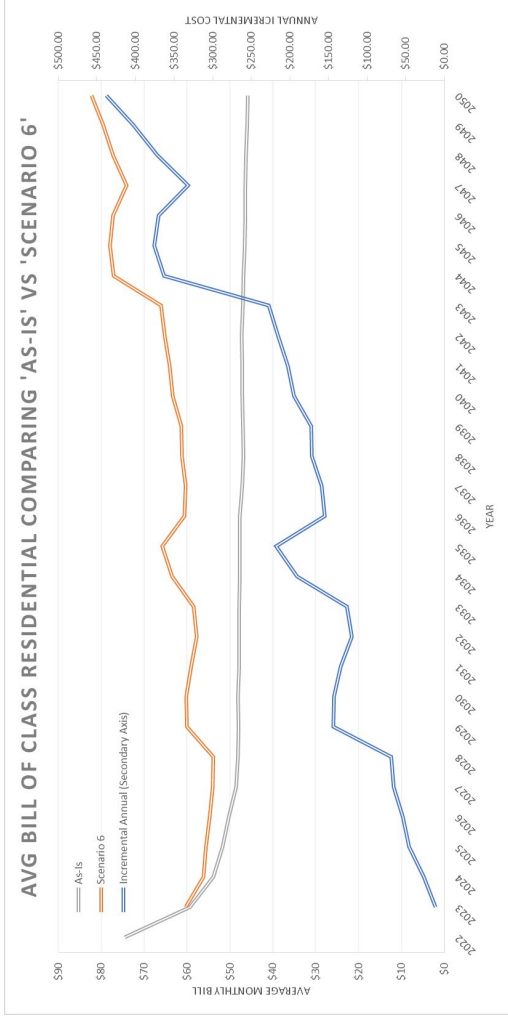

Takeaways:

- High Customer Growth Scenario could increase Residential Bills 27% by 2035 and 44% by 2050 over business-as-usual bills estimates. Commercial bills could increase by 30% and 47% by 2035 and 2050, respectively.
- Cascade has a hedge program intended to reduce the customer risk to price volatility, however, certain unforeseen circumstances could have impacts to customer bills.

Monte Carlo Demand Results

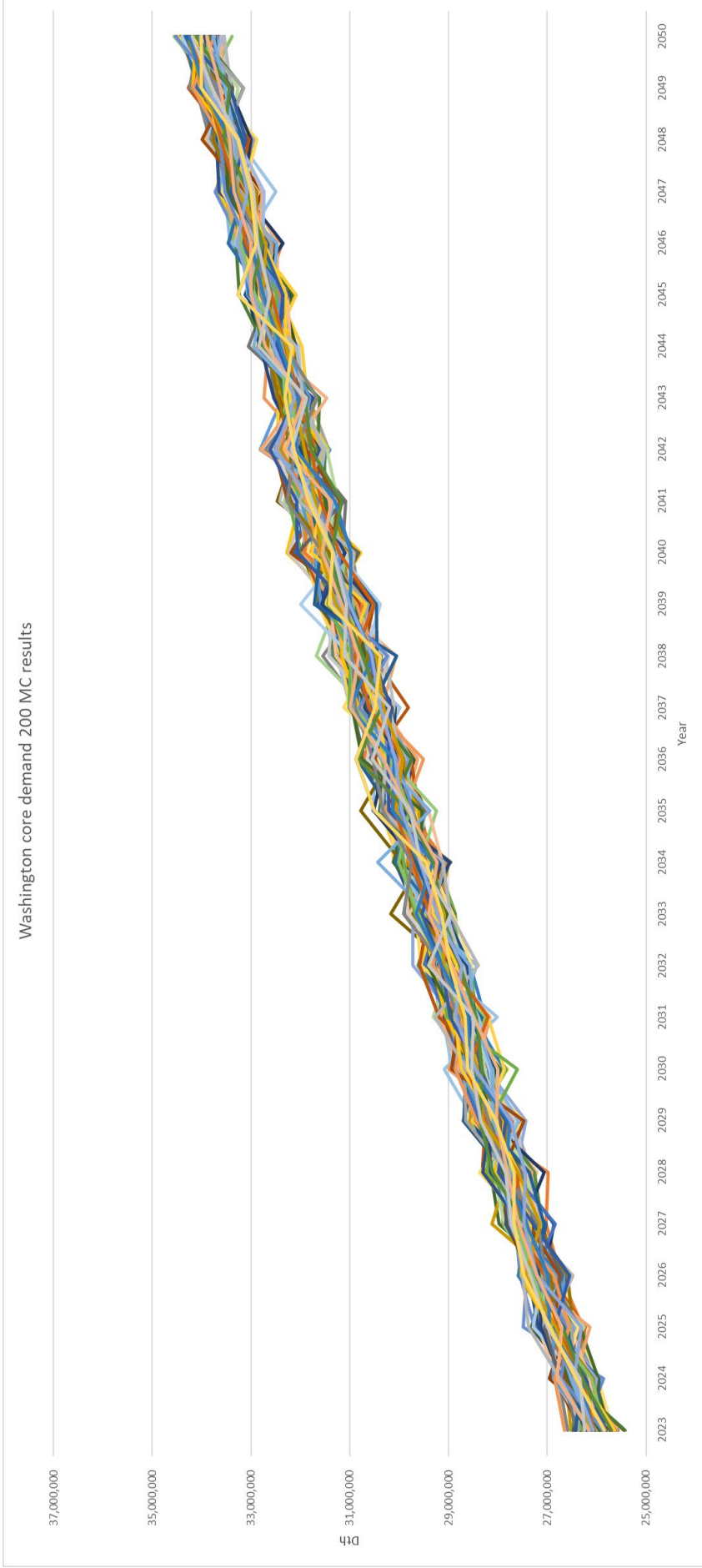

AECO Price Simulations

10,000 Simulations

AECO (n=10000)

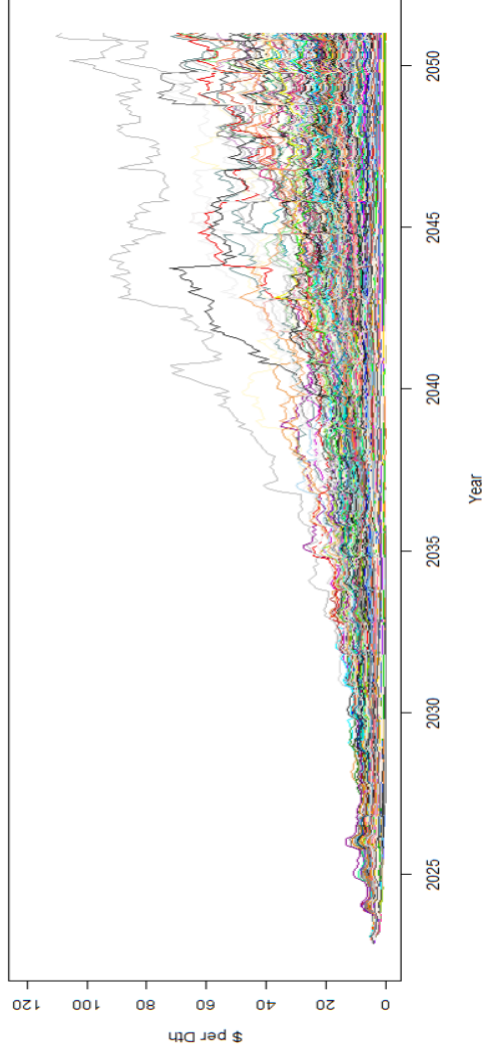

99th Percentile

AECO 99% Confidence Scaled

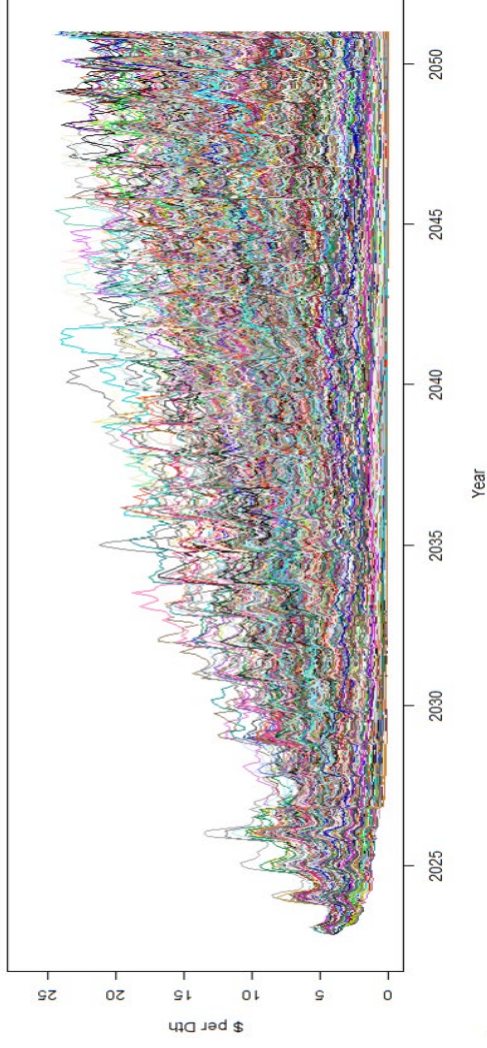

Rockies Price Simulations

10,000 Simulations

Rockies (n=10000)

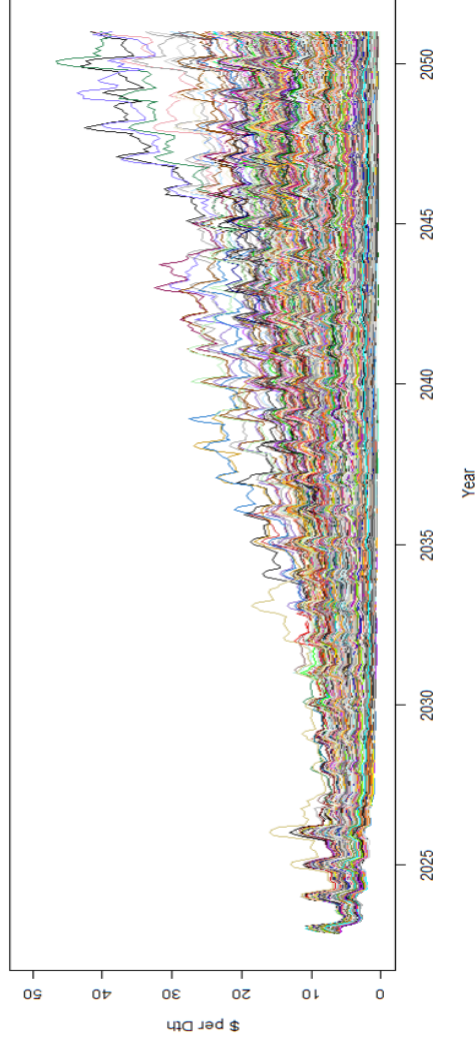

99th Percentile

Rockies 99% Confidence Scaled

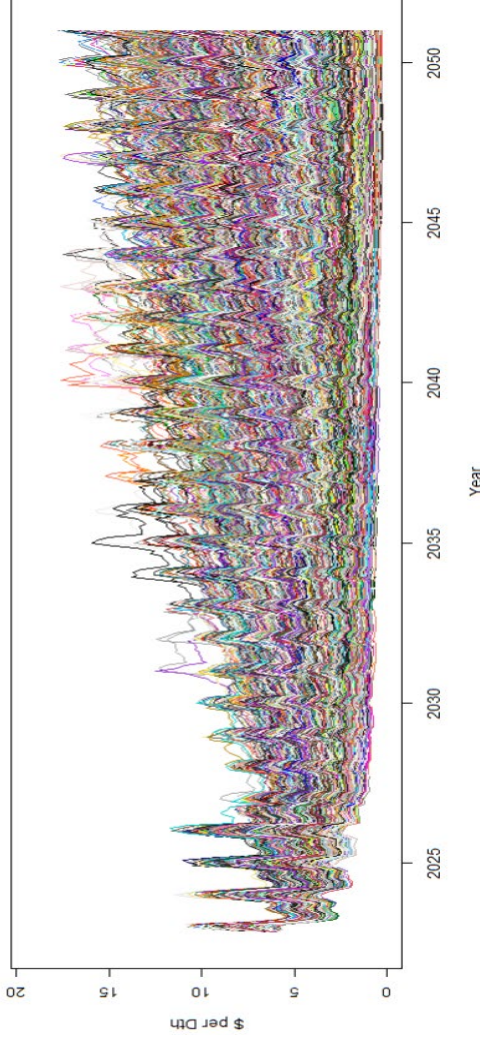

Sumas Price Simulations

10,000 Simulations

Sumas (n=10000)

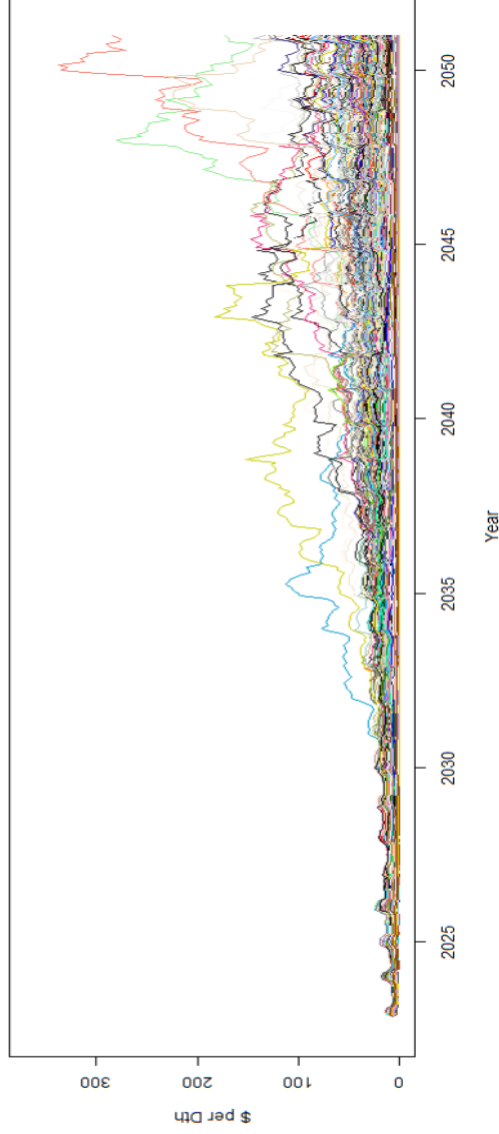

99th Percentile

Sumas 99% Confidence Scaled

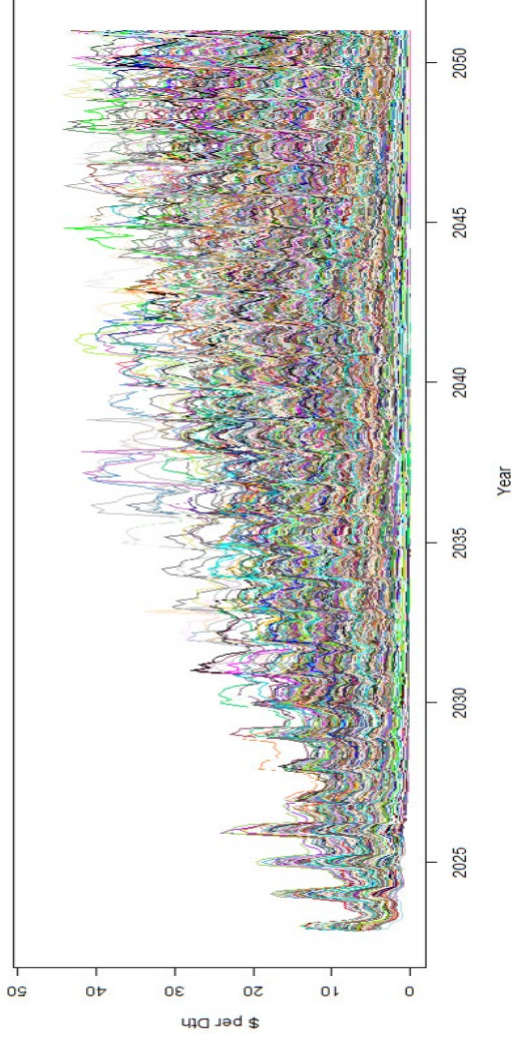

Emission ranges for first three compliance periods

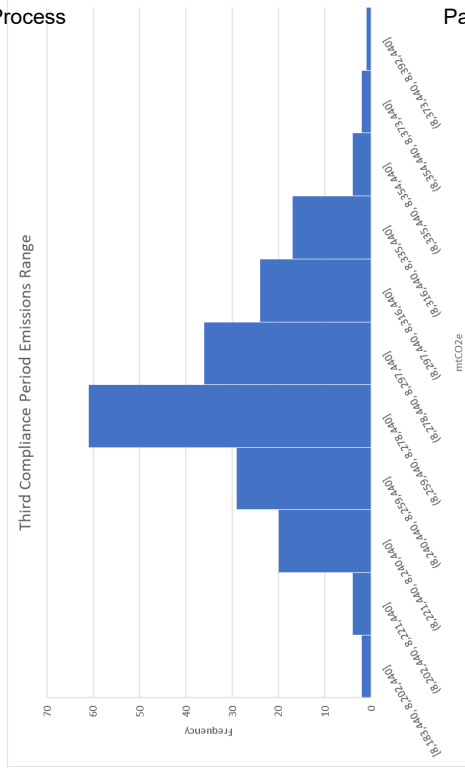
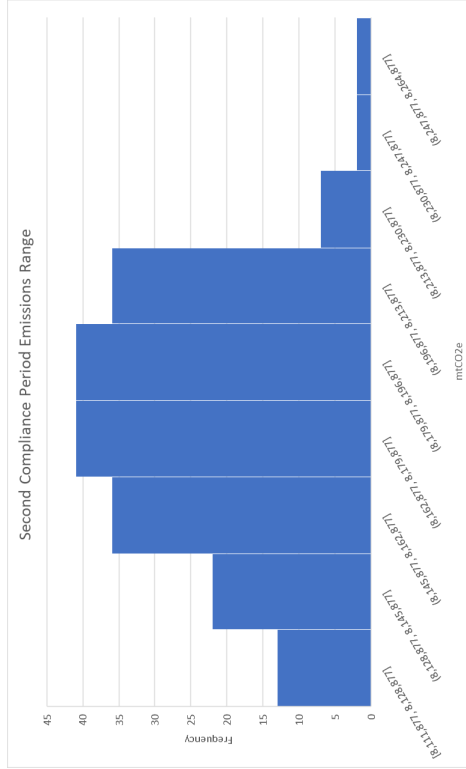
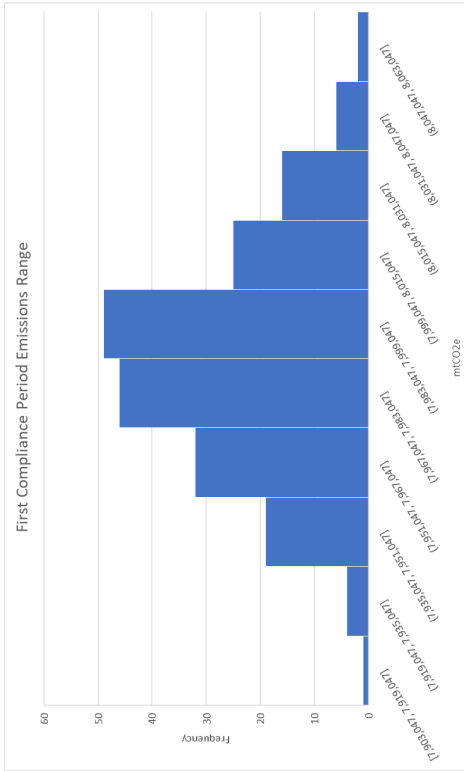

Green Hydrogen Take (Entire Planning Period)

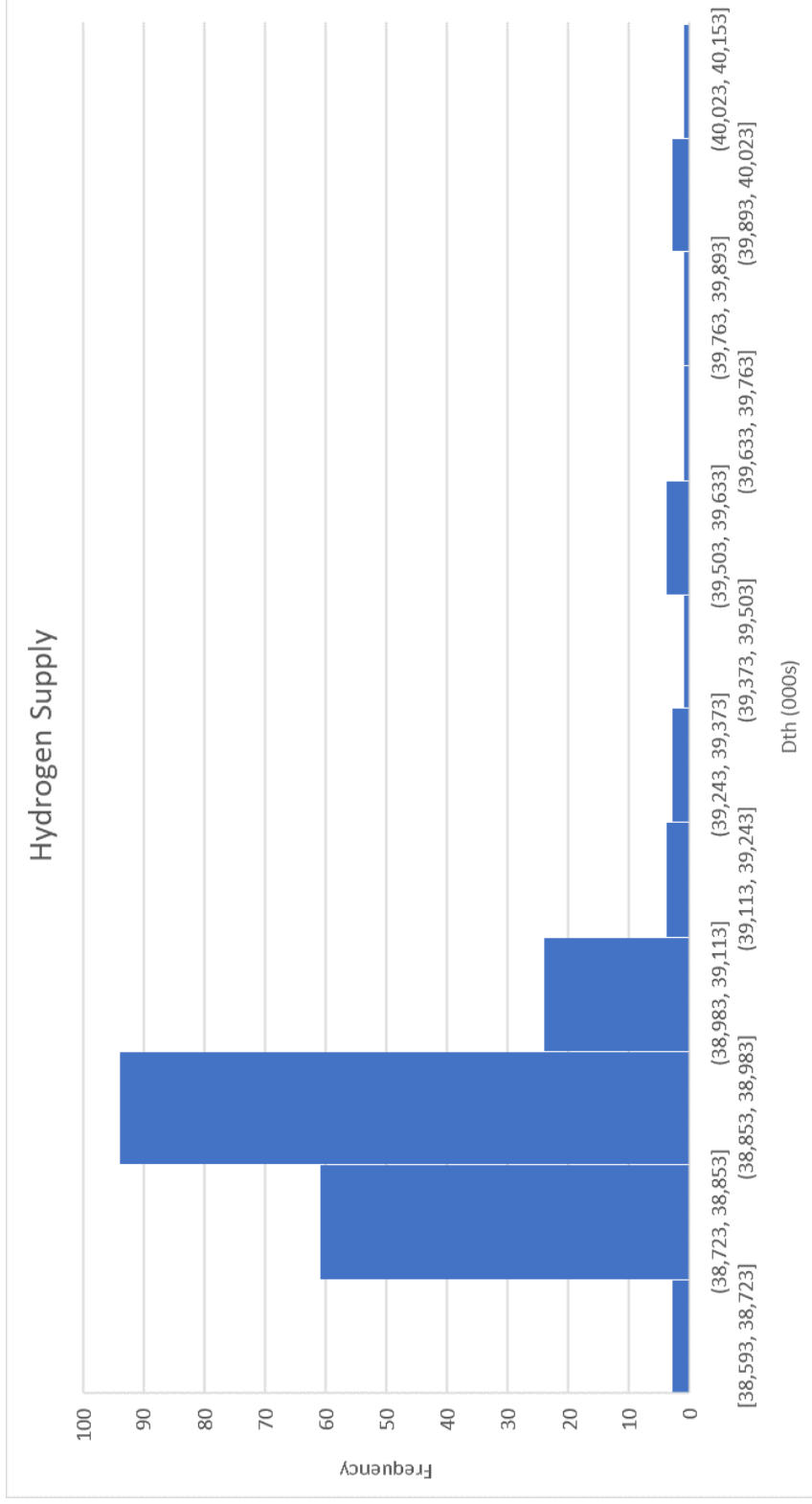

Allowance Purchases (Entire Planning Period)

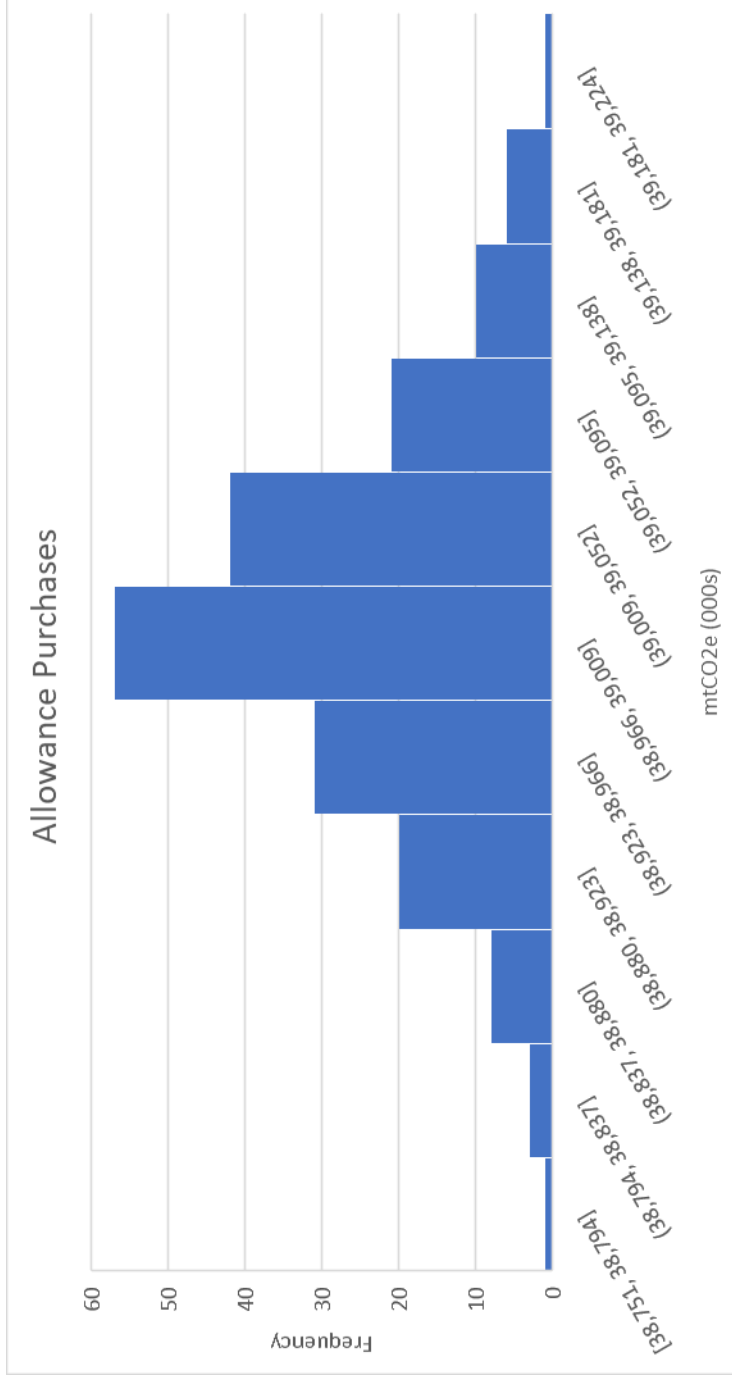

Off System RNG Cost results for MC on Traditional Supply Pricing

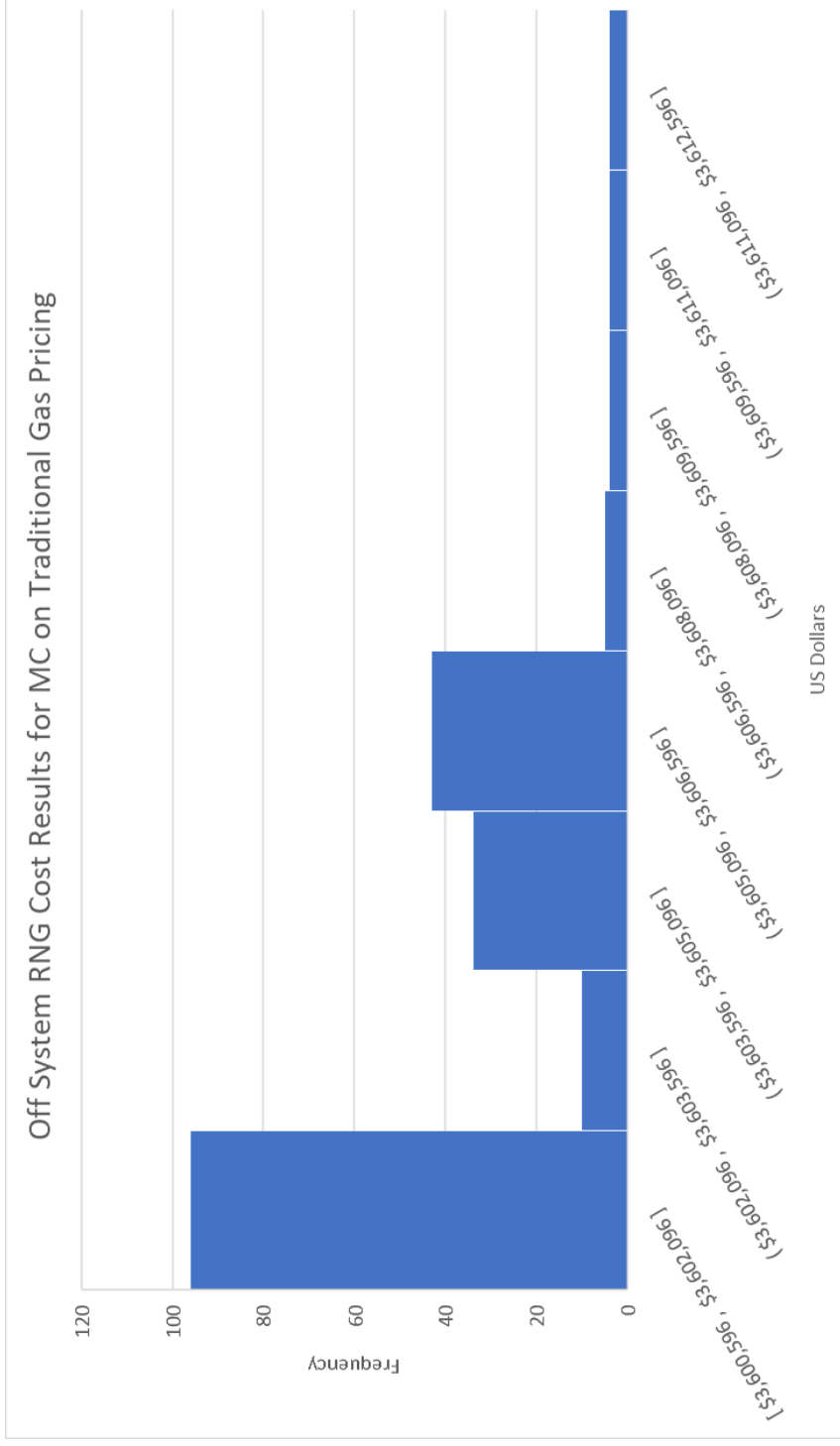

Compliance Success Rate

Portfolio	CCA Compliance Success Rate
As-Is Model	0%
All In W DSM	100%
All In No DSM	100%
Offsets Only	99%
Hydrogen Only	0%
Renewables Only	0%
RNG Only	0%
Transport Only	0%

Building Code Impacts

- Staff asked about RCW 19.27A.020(2)(a) and questioned if Cascade has adequately anticipated further reductions from building codes.
- Cascade Response:
 - RCW 19.27A.020(2)(a) is a broad goal that provides direction to the SBCC to adopt amendments to the WSEC that progressively moves the needle for new construction homes and buildings to be non-emitting by 2031. To achieve this goal, it is important to consider that a non-emitting (zero fossil-fuel greenhouse gas emission) home/building is typically considered based upon the net emissions; however, the legislative direction does not specify “net” in this circumstance. Consideration of net emissions is important, as it allows for a broader and more reliable energy portfolio. To achieve net-zero, emitting energy uses can be offset by renewable energy production (i.e. wind or solar) or energy that has a negative carbon intensity (i.e. RNG); thus, allowing for emitting (i.e. NG) energy use during severe weather events, while still having a home/building that has net-zero emissions.
 - Under RCW 19.27A.020(2)(a), the SBCC is directed to “...help achieve the broader goal...” of zero emission homes/buildings. Note that this is a goal, not a mandate. Conversely, RCW 19.27A.160 is an explicit direction to the SBCC to move towards a 70% reduction in annual net energy consumption by 2031. This is a mandate, and is clear that the goal is a “net” energy.

Building Code Impacts (Cont'd)

• Since RCW 19.27A.020(2)(a), the enacting legislation resulted from 2009 SB 5854. Therefore, the 2012, 2015, 2018, and 2021 code cycles were all likely impacted by the legislation. This chart provides an explanation of how the SBCC has addressed the more explicit legislative direction of RCW 19.27A.160.

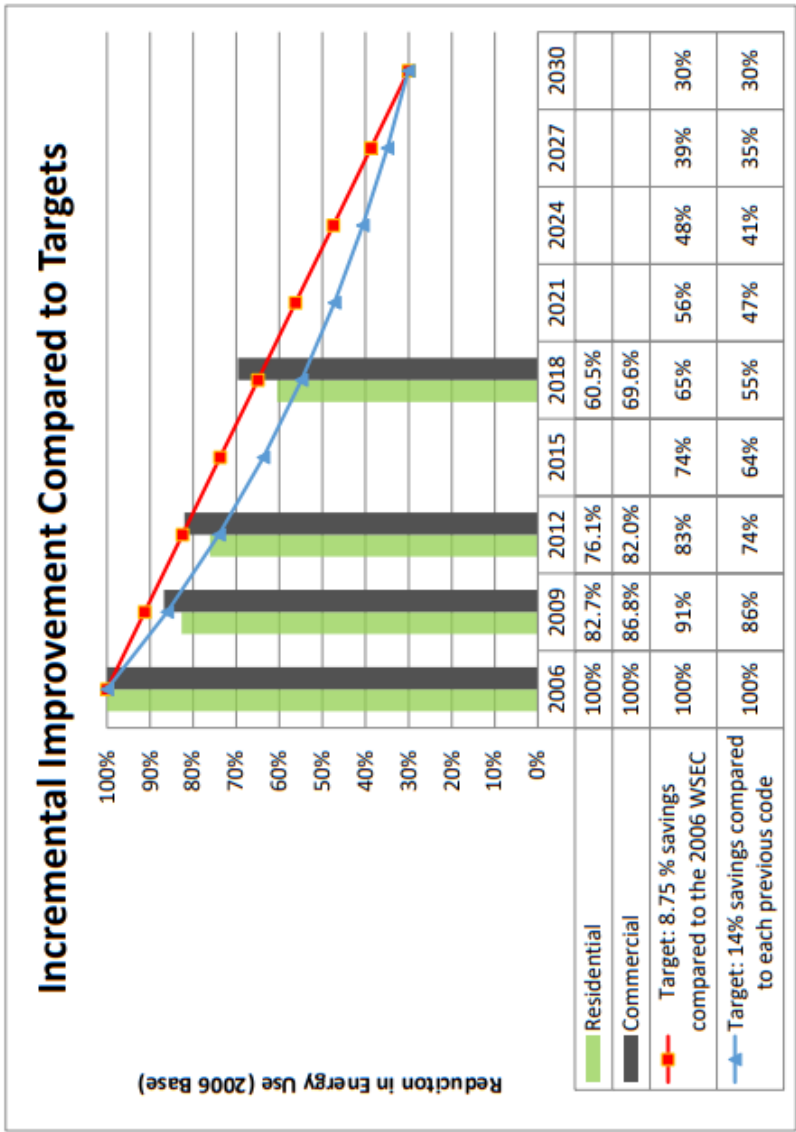

Chart Source: Final Cost Benefit Analysis for the 2021 WSEC-R

Building Code Impacts (Cont'd)

- Some of the most impactful measures were found in the 2018 and 2021 WSEC. For example, NEEA, in their [WA Residential Post Code Adoption Market Research Final Report](#), found that “...builder practices have significantly changed under the 2018 WSEC compared to the 2015 WSEC. This includes a shift towards electric space heating and water heating...” “...the incidence of electric primary space heating is 88% in this study of the 2018 WSEC; the 2015 WSEC study (CLEAResult 2020) recorded a 20% incidence of electric primary space heating for comparison. Water heating fuel is also showing significant changes. This study of the 2018 WSEC shows 87% electric water heating, while the 2015 WSEC study (CLEAResult 2020) recorded 44% electric water heating.” (Note that this NEEA report was focused solely on residential; NEEA’s [2018 WSEC Energy Savings Analysis for Nonresidential Buildings](#) may provide some additional insight for commercial projects).
- With the forthcoming 2021 WSEC (effective July 1, 2023), the use of natural gas for space and water heating is generally prohibited for commercial buildings, and may only be used for supplementary (backup) heating or within gas heat pumps in residential buildings. Given the shift towards electric appliances already found from the 2018 WSEC, the 2021 WSEC will only further this trend.

Building Code Impacts (Cont'd)

- Pre-2018 building code impacts were mainly to energy efficiency programs.
- 2018 and 2021 building code impacts have had a larger role on end use appliances which impact use per customer.
- When customers replace end use appliances, they are not required to report that to the Company, which results in end use data that may or may not be accurate.
- Cascade utilizes an ARIMA model that captures trends in use per customer (upc), and then uses that trend when forecasting future upc.

Price Competitiveness

- Staff questions if Cascade’s customer count estimates incorporate Cascade’s price-competitiveness? For example, vis-à-vis other utility options in the future.
- Cascade included price as a variable in Cascade’s load forecast model in an attempt to capture price elasticity. Cascade believes this could be improved to capture customer count elasticity when it comes to fuel switching, and has been working with Guidehouse to develop a methodology for future IRPs.
- Cascade does include an electrification scenario. This scenario encompasses customers fuel switching from natural gas to electric, which gives the Company reasonable expectations for a decreasing customer count.
- Cascade is interested to hear from other parties on other ideas the Company can implement.

2023 IRP Remaining Schedule

- File Final IRP on February 24, 2023

Contact Information

Mark Sellers-Vaughn – Manager, Supply Resource Planning: (509) 734-4589 mark.sellers-vaughn@cngc.com

Brian Robertson – Supervisor, Resource Planning: (509) 221-9808 brian.robertson@cngc.com

Devin McGreal – Senior Resource Planning Economist: (509) 734-4681 devin.mcgreal@cngc.com

Ashton Davis – Resource Planning Economist II: (509) 734-4520 ashton.davis@cngc.com

Jenny De Boer – Resource Planning Economist I: (208) 871-8331 Jennifer.DeBoer@cngc.com

Cascade IRP email – irp@cngc.com



In the Community to Serve®

Integrated Resource Plan (WA) Technical Advisory Group Meeting #6

FEBRUARY 1, 2023

MICROSOFT TEAMS/TELECONFERENCE



In the Community to Serve®



In the Community to Serve®

TAG #6 WA – TAG Meeting

Date & time: 2/1/2023, 1:00 PM to 2:30 PM

Location: Microsoft Teams Meeting

Presenters: Brian Robertson, Devin McGreal, & Ashton Davis

In attendance: Abbie Krebsbach, Abe Abdallah, Ashton Davis, Brian Robertson, Bruce Folsom, Byron Harmon, Caleb Reimer, Carolyn Stone, Carra Sahler, Chris Robbins, Corey Dahl, Devin McGreal, Eric Wood, Garret Senger, Jennifer De Boer, Jon Storvick, JP Batmale, Kary Burin, Kevin Connell, Kim Herb, Lori Blattner, Mark Sellers-Vaughn, Michael Freels, Monica Cowlshaw, Kathy Moyd, Patrick Darras, Patrick Shaughnessy, Rachel Preece, Russ Nishikawa, Sebastian Weber, Tammy Nygard, Ty Jennings, Zachary Sowards,

Brian Robertson, Supervisor of Resource Planning, opened the meeting by welcoming and thanking stakeholders for participating in Cascade's IRP Process. Brian then proceeded with introductions, the agenda, and a safety moment.

Presentation #1 – Bill Impact Analysis (Devin McGreal)

- Devin opened the meeting by stating that the Bill Impact analysis is a preliminary analysis that is run through a much simpler calculation than when bills are actually adjusted in regulatory filings.
- Devin discussed the different scenarios and how they compared to a business-as-usual case.
- While discussing the different scenarios, Devin also described reasons as to why bills were impacted more in some scenarios than others.

Question: Byron asked if Cascade considered behavioral like end uses of hydrogen in our modeling.

Answer: Devin responded that Cascade does consider that. When the Company modeled Hydrogen, a 20% volume was chosen as the blend, which is an equivalent of 7% by energy.

Question: Byron asked about the Plexos model and about path dependency. For example, Hydrogen has a projection in the future, and as time goes on while the Plexos model is running can the projection change?

Answer: Devin responded that the Plexos model doesn't quite have that functionality. It is something that the Company will need to discuss with Plexos to see if this is a possible functionality. Devin did mention that Cascade runs scenario modeling that encompasses some of these path changes that Byron referred to. Cascade would also like to add that changes to resources over time are the main reason IRPs are reproduced every two years.

Presentation #2 – Monte Carlo Results (Ashton Davis)

- Ashton provided a reminder to everyone that Cascade performed Monte Carlo simulations on weather as well as price. In future IRPs, Cascade will investigate performing Monte Carlo simulations on customer count as well.
- Ashton then shared some of the results the Monte Carlo simulations provided when analyzed in Plexos. For example, Cascade is able to analyze the range of carbon compliance obligations for each compliance period. Cascade can also analyze the range for each carbon compliance supply side option.

Question: Byron asked how the 1st percentile was being defined when those prices were removed from the first graph to the graph that only provided the 99th percentile.

Answer: Ashton responded that we'll need to look into it and confirm. Cascade has confirmed that the percentiles were based on the highest peak event.

Presentation #3 – Building Code Impacts (Brian Robertson)

- Brian discussed the RCW19.27A.020(2)(a) rule in depth, explaining that it is more of a goal, and how it may impact Cascade. Brian then shared RCW 19.27A.160 and discussed how that RCW is more of a mandate than a goal.
- Brian then discussed how pre-2018 a lot of the building code changes had a bigger impact on energy efficiency programs. Post-2018, the building code changes had a major impact on which end use appliances are allowed, resulting in a big impact to customer count and use per customer.
- Cascade is still gathering as much data as possible on the impacts that building code changes will have on the customer and load forecast model. This IRP locked in the forecast in early-2022, so there are building code changes implemented in the data from the 2018 WSEC, but the 2021 WSEC changes won't come into effect until after the IRP is filed. Cascade will continue to gather data and update the forecast in future IRPs to reflect these building code changes.

Presentation #4 – 2023 IRP Schedule (Brian Robertson)

- Brian noted that the final step is that Cascade will file the final IRP on February 24th, 2023.

The Meeting was Adjourned

Per Cascade Commitment #8 (Stakeholder Engagement Design Document, 2/22/2022: "Provide TAG minutes that include the action items from bullet #7 as well as any upcoming deadlines for feedback on the IRP"), here are additional action items to track, coming out of the TAG 6 meeting:

1. Cascade will look into ways to model path dependency issues in PLEXOS.
2. Cascade will investigate Monte Carlo simulations on customer counts.

Cascade Natural Gas Integrated Resource Planning Feedback Report

Item #	Date	TAG Meeting	Name/Company	Comment/Question	Cascade Response
1	4/4/2022	TAG 1	WUTC	Will Cascade consider more frequent breaks throughout the TAG meetings?	Cascade would be open to ideas on how often the Company should break during TAG meetings. Cascade suggests we shouldn't break more often than once per hour, with a 5-minute maximum for each break, unless we need a longer lunch break.
2	4/4/2022	TAG 1	WUTC	Will Cascade consider adding in at least 15-minutes of unscheduled time during meetings, perhaps at the end, for the sole purpose of encouraging questions?	Cascade intended for the penultimate TAG 1 slide to be that unscheduled time as you indicated. Key Cascade members will remain in the meeting as long as needed to respond to questions.
3	4/4/2022	TAG 1	WUTC	During the virtual presentation, is hand raising encouraged or unmuting? Any guidance in future meetings on how to participate would be beneficial for stakeholders. Perhaps laying this groundwork at the beginning of TAG meetings would be useful.	Cascade's meetings are very informal so either unmuting or raising your hand, or even typing questions into chat is fine with Cascade. Cascade will clarify this in future TAG meetings as well as include this information in the Stakeholder Engagement Design Document.
4	4/4/2022	TAG 1	WUTC	Does Cascade plan on sending out minutes/summaries of each meeting? Staff's hope is that such summaries would include any comments or questions from TAG members and Cascade's initial response to those items, in addition to including such as an appendix in the final IRP.	Yes, Cascade will provide minutes that include questions, stakeholder comments, and Cascade's responses.
5	4/4/2022	TAG 1	WUTC	On slide 17, Cascade staff noted natural gas volatility of 179.1%. Staff is not familiar with volatility as a metric. It would be helpful to have a bit more explanation of what it is, how it is measured, and what it signifies. Could this volatility result in supply risk/interruption, rather than simply pricing risks? What do volatility projections look like for the future? Does this spike in volatility have greater meaning to Cascade beyond hedging and prices?	Volatility is a statistical measure of the magnitude of changes for a particular value, regardless of direction. Volatility is often measured with terms such as variance or standard deviation. A low variance/standard deviation would mean low volatility. The EIA defines their measure of volatility as the magnitude of daily changes in the closing price for natural gas in a 30-day window, based on rolling front-month contracts. For example, the EIA would measure what future contracts are for February 2022 each day in January 2022. A high volatility might show low February priced contracts earlier in January, but as time goes on, the market begins showing very high February contracts, resulting in a high volatility measure. This could be due to a number of market conditions, supply issues, production issues, unexpected weather; even related to pricing hubs in Europe and Asia where Henry Hub price volatility has historically corresponded. Volatility is key metric in Cascade's Value at Risk analysis. A high volatility environment presents high risk to the both the hedged and unhedged portion of the Company's portfolio. Short term, the Company is projecting that high volatility will continue into the upcoming heating season, as there is still great uncertainty surrounding the variables discussed above. Long-term, however, Cascade does expect the market to stabilize, leading to lower volatility in the outer years of Cascade's hedging horizon and beyond. Cascade does not see any significant relationship between volatility and supply/interruption risk.
6	4/4/2022	TAG 1	WUTC	Since the UTC has new staff assigned to this IRP, it would be helpful to staff to schedule a walkthrough of the load forecast, avoided cost methodology, upstream emissions methodology, stochastic analysis, and resource integration. Additionally, if Cascade does indeed intend to use Plexos rather than SENDOUT as its resource integration software for this IRP, it will be helpful to schedule a demonstration of the software and how Cascade uses it.	Cascade's next four TAG meetings are intended to dig into these models and much of the TAG meetings will be a walkthrough of these models. Cascade's recommendation would be that after each TAG meeting, if there is still a request for a walkthrough, Cascade would gladly set up a meeting to further dive into a model/methodology.
7	4/4/2022	TAG 1	WUTC	UTC staff commend Cascade for starting a conversation around stakeholder engagement and their demonstrated openness to amendments to the IRP stakeholder engagement document.	We appreciate this comment. Cascade is committed to implementing best practices for stakeholder engagement while recognizing stakeholders have a full workload.
8	4/4/2022	TAG 1	WUTC	During the meeting Cascade Staff noted previous engagement strategies (e.g. Facebook posts regarding the Bend TAG and consideration of a mailer), for the sake of clarity, would it be possible to have anticipated outreach strategies outlined in the IRP stakeholder engagement document during a future update? Clearly outlining Cascades outreach plans/efforts may make it easier to have future discussions about improving outreach strategies. For example, "Cascade staff plans to publish TAG meeting notices on their Twitter account 2 weeks prior to each meeting" – this example would clearly communicate one step Cascade plans to take.	Cascade appreciates this comment and perspective. The Company understands the importance of stakeholder engagement and wants to ensure customers and interested parties know how and when to participate in Cascade's IRP efforts. Cascade will include on the TAG 2 meeting agenda a discussion of Cascade's engagement strategies. The Company looks forward to this discussion.
9	4/6/2022	TAG 1	OPUC	OPUC checked in on the plan to not hold separate DSM-related workshops noted in Order 21-127 and in Slide 14 of Cascade's TAG presentation and just addressing through the TAG meetings. OPUC is fine with that plan as long as the Company will be addressing all the issues that were raised in the Order on that topic.	Cascade agrees with this and is amenable to any follow up workshops if those topics are not discussed in detail to OPUCs satisfaction during Cascade's TAG meetings.
10	5/26/2022	TAG 2	WUTC	Has Cascade considered using the RCP8.5 emissions pathway for its climate modeling? This is the modeling pathway used by the Northwest Power and Conservation Council in their 2021 Northwest Power Plan. Avista has chosen to follow suit and also uses the RCP8.5 pathway.	Yes, Cascade considered RCP2.6, RCP4.5, RCP6.0, and RCP8.5. RCP 8.5 is the most extreme scenario and described as "to be very unlikely, but still possible as feedbacks are not well understood." Cascade also believes taking a more conservative approach to ensure the Company doesn't underplan other decarbonization strategies is the best approach. In the two- to four-year action plan, Cascade will continue to research and gain a better understanding on the potential impacts of climate change.
11	5/26/2022	TAG 2	WUTC	Staff recommends that Cascade update their Consumer Forecast in light of the recent changes by the State Building Code Council.	Due to recent changes to the State Building Code, Cascade will be making changes to the load forecast models. However, given the timing of the changes, Cascade will not be able to make this change for this IRP. Revamping the load forecast model to account for end use changes will be a 6 month to year long project, which falls outside of the IRP Planning timeline. Cascade will include this in the two- to four-year action plan.

Cascade Natural Gas Integrated Resource Planning Feedback Report

Item #	Date	TAG Meeting	Name/Company	Comment/Question	Cascade Response																																	
12	5/26/2022	TAG 2	WUTC	Staff would like to commend Cascade for their responsiveness to previous comments. Cascade outlining their strategies for outreach provided more clarity regarding their outreach process. Cascade made it clear how participants could interact during the TAG; this improved the accessibility of the meeting.	Cascade appreciates this comment and perspective. The Company understands the importance of stakeholder engagement and wants to ensure those attending our meetings have the ability to interject and ask questions or make comments.																																	
13	5/26/2022	TAG 2	WUTC	Why doesn't the pricing forecast include cap and trade, renewable natural gas, green hydrogen, the social cost of carbon or other environmental risks?	The price forecast presented in TAG 2 is intended to be the Company's projected forecast for the price of geologic natural gas. Cascade does believe that exogenous factors as listed by Staff are incorporated into the various basin forecasts that the Company references as appropriate regarding their potential impact to regional traditional natural gas processes. This forecast is ultimately one input, of many, to the Company's processes that utilize the price forecast. In Cascade's resource optimization process, the Company models the costs and availability of geologic natural gas, renewable natural gas, green hydrogen, and offset credits (typically priced as a function of the Social Cost of Carbon). The resulting projected cost of gas is an optimized blend of all of these factors. Cascade will present the price of RNG, green hydrogen, and offset credits in future TAG meetings.																																	
14	5/26/2022	TAG 2	WUTC	On slide 4, of the TAG 2 presentation, it states "The Company believes that customers and interested parties were made aware of Cascade's IRP meetings" – what is this belief based on?	Cascade has a designated web page that informs customers and interested parties of the IRP process and how to participate. Cascade also reached out via email to dockets where the Company felt those intervenors would be interested in Cascade's IRP. With that said, Cascade does have a plan to continue and better bolster our communication for future IRP processes.																																	
15	7/13/2022	TAG 3	WUTC	1. On slide 19, the Winter Supply Stack graph features two datasets in the same color. Would it be possible to get new draft of that graph with each element in a different color?	Cascade has updated this slide, along with an updated slide 9 due to coloring issues, in the TAG 3 presentation that is on Cascade's Washington IRP website.																																	
16	7/13/2022	TAG 3	WUTC	On slides 82-101, Cascade discusses new methodology for determining Avoided Costs. This analysis, in part, focuses on Distribution System Costs. a. For slides 87-95, what is the net outcome of these changes on avoided costs? b. As shown in slides 87-95, does this result in a kind of double counting of what is already considered in avoided costs? Does the "time value of money" apply to most components of Cascade's avoided cost calculation such as Commodity Costs, Variable Storage Costs, or even Fixed Transportation Costs?? c. For slides 93 and 94, what are Cascade's assumptions of the "time value of money"? How does it plan to value the delay shown in the charts? d. Slides 93 and 94 suggest that it is a sort of timed cost savings between present real costs and lower presumed future real costs for upgrades as opposed to traditional "time value of money" that relies upon a default ROI assumption. Is this a correct interpretation?	a. In appendix A at the bottom of the feedback report Figure 1 and 2 show distribution costs for the 2023 IRP as well as the avoided distribution system costs in the filed 2020 WA IRP. b. It is important here to recognize that distribution system costs are a unique element of the avoided cost mix because they represent a variable that is not avoidable, but rather deferrable. For an element such as commodity cost, for instance, for every therm that is not consumed by an end use customer but instead is conserved, that is one therm that Cascade will never need to purchase. Regarding distribution system costs, however, assuming that the Company is continuing to grow, reducing demand peak load does not remove the need for a distribution system enhancement, but rather delays when the forecasted point of deficit will occur (see slide 91 for a visual example.) One exception to this could be fixed transportation costs, where energy efficiency may not be able to remove the need for incremental upstream capacity but rather defer it to a later year, but Cascade has not identified a need for any incremental upstream capacity and thus has no avoidable fixed transportation costs in the 2023 IRP. c. It is important to note that slides 93 and 94 are illustrative examples and not representative of actual numbers. The assumption of the time value of money is the standard valuation formula, where $PV = FV / (1+i)^t$ where i = Cascade's weighted average cost of capital (WACC) and t = number of years. In slide 93, the assumption is that costs rise by inflation over time. In slide 94, ceteris paribus, Cascade's WACC exceeds inflation, leading to lower future valuations over time. d. Slides 93 and 94 suggest that it is a sort of timed cost savings between present real costs and lower presumed future real costs for upgrades as opposed to traditional "time value of money" that relies upon a default ROI assumption. Is this a correct interpretation? – As discussed in Cascade's answer to 2c. the cost savings shown between slides 93 and 94 are a function of default ROI assumptions. Any money that does not need to be immediately spent on distribution system projects should generate an ROI for the Company equal to its WACC. That fundamental principle supports the calculation of the Present Value of Deferral illustrated on slide 95.																																	
17	7/13/2022	TAG 3	WUTC	For slides 85 and 86, what is the difference between the previous "carbon compliance costs" from the 2020 IRP and the new "Environmental Compliance Costs"?	This value is, for the most part, relatively unchanged. The name has been updated to reflect the fact that these compliance costs do not just reflect carbon but all emissions under the banner of CO2e. The SCC was also updated to be expressed in Real \$2021. A comparison of the values can be found with Figure 3 and 4 in appendix A.																																	
18	8/17/2022	TAG 4	WUTC	On slide 8, does this graph include Cascade's methane emissions discussed in slide 10?	No. The emissions on this graph are emissions from natural gas combustion from customer use.																																	
19	8/17/2022	TAG 4	WUTC	The bar graph on slide 8 is very useful. It does a good job communicating the scope of baseline emissions growth. Staff would like to request a similar graphic showing Cascade's combined portfolio of fuels and CCA compliance options over time to meet that demand while complying with its various legal and regulatory requirements?	Cascade will be providing graphics with this information at TAG 5.																																	
20	8/17/2022	TAG 4	WUTC	On slide 27, Cascade notes that their gas is 93.4% methane. What is the other 6.6%?	Natural gas is composed mostly of methane and small amounts of other constituents. Literature ¹ provides a typical composition in the table displayed below. <table border="1"> <thead> <tr> <th colspan="3">Typical Composition of Natural Gas</th> </tr> <tr> <th>Name</th> <th>Formula</th> <th>Volume (%)</th> </tr> </thead> <tbody> <tr> <td>Methane</td> <td>CH₄</td> <td>~85</td> </tr> <tr> <td>Ethane</td> <td>C₂H₆</td> <td>3-8</td> </tr> <tr> <td>Propane</td> <td>C₃H₈</td> <td>1-2</td> </tr> <tr> <td>Butane</td> <td>C₄H₁₀</td> <td><1</td> </tr> <tr> <td>Pentane</td> <td>C₅H₁₂</td> <td><1</td> </tr> <tr> <td>Carbon dioxide</td> <td>CO₂</td> <td>1-2</td> </tr> <tr> <td>Hydrogen sulfide</td> <td>H₂S</td> <td><1</td> </tr> <tr> <td>Nitrogen</td> <td>N₂</td> <td>1-5</td> </tr> <tr> <td>Helium</td> <td>He</td> <td><0.5</td> </tr> </tbody> </table> <p>The US Energy Information Administration (EIA) notes on their webpage on Natural gas explained², "The largest component of natural gas is methane, a compound with one carbon atom and four hydrogen atoms (CH₄). Natural gas also contains smaller amounts of natural gas liquids (NGLs, which are also hydrocarbon gas liquids), and nonhydrocarbon gases, such as carbon dioxide and water vapor." Cascade notes there is some variability in gas quality on pipelines and between pipelines, but gas quality typically falls in the ranges indicated above.</p>	Typical Composition of Natural Gas			Name	Formula	Volume (%)	Methane	CH ₄	~85	Ethane	C ₂ H ₆	3-8	Propane	C ₃ H ₈	1-2	Butane	C ₄ H ₁₀	<1	Pentane	C ₅ H ₁₂	<1	Carbon dioxide	CO ₂	1-2	Hydrogen sulfide	H ₂ S	<1	Nitrogen	N ₂	1-5	Helium	He	<0.5
Typical Composition of Natural Gas																																						
Name	Formula	Volume (%)																																				
Methane	CH ₄	~85																																				
Ethane	C ₂ H ₆	3-8																																				
Propane	C ₃ H ₈	1-2																																				
Butane	C ₄ H ₁₀	<1																																				
Pentane	C ₅ H ₁₂	<1																																				
Carbon dioxide	CO ₂	1-2																																				
Hydrogen sulfide	H ₂ S	<1																																				
Nitrogen	N ₂	1-5																																				
Helium	He	<0.5																																				
21	8/17/2022	TAG 4	WUTC	On slide 27, Cascade notes that their gas is 93.4% methane. Does the End of Use Emission rate include the combustion of these non-methane gasses in Cascade's natural gas?	The End of Use Emission rate used is published in EPA rulemaking. Cascade is confirming with EPA that this emission rate includes combustion of the non-methane gasses and will provide an update when we receive EPA's feedback.																																	

Cascade Natural Gas Integrated Resource Planning Feedback Report

Item #	Date	TAG Meeting	Name/Company	Comment/Question	Cascade Response
22	8/17/2022	TAG 4	WUTC	On slide 28, Cascade notes "The 93.4% methane in natural gas is in line with EPA estimates of 95-98% and therefore, can be maintained." What percent would be out of line with EPA estimates? What is the basis for this in vs out of line assessment?	Cascade determined to maintain the previous IRP's assumption of 93.4% methane in natural gas for this IRP. This value represents an average percentage of methane in natural gas from past EPA GHG inventory data. In comparison, there are several sources listing the methane composition of commercial natural gas: Yale Climate Communication lists the range as 70-90%, Britannica lists it at 85-90%, and the EPA Pipeline Quality Estimate lists 95-98%. Cascade believes the 93.4% is in line with the EPA estimates of 95-98%. Cascade also recently reviewed methane content data available from GTN/Williams at citygates representing natural gas delivered from the US Rockies and confirmed natural gas received is about 93.7% methane.
23	8/17/2022	TAG 4	WUTC	On slide 10, staff would appreciate data presented on "other operational emissions". Have the number of these other operational emissions changed over time?	<p>Emissions estimated from distribution mains and services, meter/regulating station equipment, and larger combustion equipment, such as compressor engines, total approximately 24,000 to 25,000 metric tons of CO₂e per year. These emissions have been quantified since 2010 and have remained about the same over time as default emissions factors are required to quantify most of the emissions.</p> <p>Emissions which include excavation damage, natural force damage and other outside force damage, corrosion, and equipment/weld issues were approximately 6,154 metric tons of CO₂e in 2021 and were similar in 2020. These emissions could have a greater potential for annual variability due to the types of causes. Cascade has been collecting and reporting this data to the UTC for a couple years and the Company will use this data for evaluating emissions trends ongoing.</p> <p>Other operational emissions (blowdowns, pressure relief/venting and routine maintenance, meters, and smaller combustion equipment) are being added to Cascade's inventory this year and are preliminarily estimated to be about 10,000 to 15,000 metric tons of CO₂e. Cascade is exploring the use of company specific data to more accurately estimate these emissions. The Company's approach to quantifying these emissions may also change in future with EPA's proposed emission factor changes in the agency's 40 CFR Part 98 Subpart W rule amendments.</p> <p>Cascade is committed to reducing operational emissions. As a comparison, when considering customer emissions of approximately 2 million metric tons CO₂e, Cascade's total operational emissions are a very small percentage. Total operational emissions are currently projected to be in the range of 1-2% of total Cascade emissions regulated under the WA Climate Commitment Act.</p>
24	8/17/2022	TAG 4	WUTC	On slide 11, Cascade discussed their active efforts to track and decrease operational emissions. Does Cascade have data reporting these efforts?	Data demonstrating reductions is limited at this time. However, UTC does receive leak mitigation data reports from Cascade annually in March. Also, internal data tracked by the Company's operations shows few open leaks on the system and those are scheduled for repair according to Cascade's expedited leak management program. Expediting leak mitigation on the system shows that the Company's efforts have reduced leak emissions since implementing the program. Also, a more robust emissions inventory will be available in 2023 for 2022 emissions. Cascade plans to use this comprehensive emissions inventory to evaluate emissions and trends, identify additional emissions reduction opportunities, and better quantify emissions reductions.
25	8/17/2022	TAG 4	WUTC	On slide 21, Cascade assessed "The result was approximately 50 customers per year. Cascade decremented customer counts by 50, cumulatively, each year for the forecast." Does this mean that total customers from this city is anticipated to decrease by 50 customers per year or that, relative to the anticipated trend in customers, future values are 50 customers per year smaller? Are these losses entirely residential customers or are they randomly distributed among commercial, residential, and industrial customers?	This means that relative to the anticipated forecast in customers, future values are smaller. Cascade applied this cumulatively, so a 50 customer decrement to the forecast in the first year, 100 customers the second year, and so on and so forth through the 28-year planning horizon. Cascade believes this gas ban will have a bigger impact to the commercial customers than the residential and industrial customers so the decrement was applied to the commercial customers. Cascade will be monitoring the actual effects of this ban and will reassess this analysis in future IRPs.
26	8/17/2022	TAG 4	WUTC	On slides 21 through 24, Cascade discusses the impacts of various local natural gas policies. However, the April 2022 revision of the Washington State Building Code was not discussed. What impacts will that revision have?	Cascade discussed the Washington State Building Code changes during TAG 2. Cascade indicated at that meeting that due to the timing of the building code votes, and the fact that Cascade does not do end use forecasting, implementing these changes would require Cascade to delay the IRP six months to a year to change the load demand forecast methodology. Cascade will be monitoring the effects of these building code changes as well as adjusting the load forecast methodology to account for these building code changes with end use forecasting in future IRPs.
27	10/26/2022	TAG 5	WUTC	On slide 27, the slide notes the amount of incremental RNG. Are these levels consistent with anticipated requirements of RCW 80.28.390?	The RNG amounts on slide 27 include the amounts needed for Washington and Oregon. RCW 80.28.390 only requires gas utilities to offer RNG as an offset to traditional gas. There are no statutory amount Cascade needs to require or supply under the voluntary program. Once the voluntary RNG program, Cascade will be able to monitor the amount of interest and enabling the Company to update the models with accurate voluntary RNG information.
28	10/26/2022	TAG 5	WUTC	On slide 28, the graph shows that emissions costs will result in total costs more than quadrupling. How much is this expected to impact ratepayer bills? How will these bill impacts shift demand?	Cascade is currently analyzing the ratepayer bill impacts and will provide that information in the draft filing of the IRP narrative.
29	10/26/2022	TAG 5	WUTC	On slide 79, Cascade describes the attributes of scenario 5. What impact does limiting Hydrogen to 20% have on the portfolio?	If Cascade were to constrict the model to only hydrogen to comprise 20% of supply by volume, the Company would need to acquire additional allowances through the auction mechanism. The Company still projects that it would be able to comply with emissions reduction requirements through this, but costs would increase, particularly in later years as the cost of hydrogen is forecasted to decline over time while the cost of allowances will rise. Cascade has modeled this, and in Figure 5 shows that total system costs rise when only allowing a 20% hydrogen blend.
30	10/26/2022	TAG 5	WUTC	On slide 65, there is a chart with a row labeled "Natural gas bans" with some columns filled "current bans." However, later slides, such as 70, refer to this scenario assumption as "Consideration of all expected bans in load forecast." Are these the same assumption?	Yes, those are the same assumption. Cascade will clarify that language in the IRP Narrative.

Cascade Natural Gas Integrated Resource Planning Feedback Report

Item #	Date	TAG Meeting	Name/Company	Comment/Question	Cascade Response
31	10/26/2022	TAG 5	WUTC	On slide 65, there is a chart with a row labeled "Natural gas bans" with the electrification column filled "Additional Bans." However, the electrification scenario on slide 75 refers to this assumption as "Consideration of all expected and proposed bans in load forecast." Are these the same assumption?	Yes, those are the same assumption. Cascade will clarify that language in the IRP Narrative.
32	11/3/2022	Additional Q's	WUTC	On slide 101 of TAG 4, Cascade lists "Enhancement Selection Guidelines", the 3rd line notes "Segment of pipe that minimizes environmental concerns and impacts to the community" Could Cascade please expand on this?	Every system deficit will have a unique enhancement to address the deficit.
33	11/3/2022	Additional Q's	WUTC	What environmental concerns are analyzed?	Environmental concerns will depend on the enhancement considered. An example of environmental concerns would be minimizing water crossing. Pipeline routes could be modified to avoid stream, river crossing or wetlands.
34	11/3/2022	Additional Q's	WUTC	What types of community impacts does Cascade assess?	Community impacts will depend on the enhancement considered. An example of a community impact would be modifying pipeline routes to avoid road moratoriums (roads that have recently been improved) or high consequence areas.
35	11/3/2022	Additional Q's	WUTC	Does this include an equity assessment of the impacts?	Equity assessments are not currently directly involved in enhancement selection but could be a future consideration.
36	11/3/2022	Additional Q's	WUTC	What type(s) of methodology and data does Cascade use here?	Not currently being considered.
37	11/3/2022	Additional Q's	WUTC	How are these criteria weighted against the other listed points?	Not currently being considered.
38	1/20/2023	Draft IRP Comments	WUTC	At page 3-2, to ensure adequate policy analysis, Staff questions if Cascade could extend the assumptions for the customer count forecast out to 2050 to line up with the imperatives of the CCA?	Cascade has extended all forecasting assumptions out to 2050 for both the customer forecast and the use-per-customer forecast. Cascade will make this detail clearer on page 3-2.
39	1/20/2023	Draft IRP Comments	WUTC	At page 3-5, Staff questions how Cascade chose its climate models and how those choices compare to the models relied upon by the NWPCC?	See Response to item 40.
40	1/20/2023	Draft IRP Comments	WUTC	At Page 3-6, Staff questions Cascade's citation of Wikipedia for the proposition that Cascade's climate model portfolio is the most probable? Staff further questions why RCP 4.5, representing Western North American emission goals, is preferable to climate modelling that represents global emissions goals?	a. According to the IPCC, the RCP 4.5 scenario is their intermediate scenario. There are scenarios with more aggressive assumptions and some with worst case climate results. RCP 1.9 or 2.6 are very stringent pathways, with requirements like CO2 emissions starting to decline in 2020, going to zero by 2100. RCP 7 would represent a baseline outcome instead of an emissions target, and RCP 8.5 represents a worst-case climate scenario with emissions continuing to rise. Cascade discovered multiple research specialists' papers regarding the most probable scenario, as noted in the Wikipedia references. Cascade believes the RCP4.5 scenario to be a reasonable scenario with assumptions balanced between aspirational mitigation targets with plausible ones. This decision was further backed up by the research previously stated. Cascade is open to a discussion around providing demand scenarios with different climate assumptions in future IRPs. b. Cascade's approach to selecting a climate scenario was not based on global emissions goals versus Western North American emissions goals. Instead, Cascade analyzed each of the RCP scenarios from the IPCC. RCP 1.9 actually represents global emissions goals, similar to the Paris Agreement. Cascade believes this could be a useful scenario to model, but ultimately wanted a more intermediate scenario to use as a forecast baseline going forward.
41	1/20/2023	Draft IRP Comments	WUTC	At page 3-9, Staff questions if Cascade's customer count estimates incorporate Cascade's price-competitiveness? For example, vis-à-vis other utility options in the future.	Cascade's forecast models are sensitive to trends happening in historical data, such as an uptick in industrial fuel switching for example, but Cascade does not include any alterations to its baseline forecast. Cascade does include an electrification scenario to model the impacts on Cascade's system. This analysis can be found in Cascade's scenario modeling which includes assumptions like increased electrification or low growth (in Chapter 9, specifically Figure 9-3 on page 9-5.) Cascade is also investigating a price/customer elasticity factor that can be applied to the customer or load forecast model for future IRPs.
42	1/20/2023	Draft IRP Comments	WUTC	At page 3-9, Staff questions if Cascade has considered the attrition rate of the existing building stock with natural gas fixtures, and whether the Company has accounted for the likely change in attrition rate of furnaces due to the adoption of hydrogen-blended fuel.	Cascade is very interested in the demand results of customers adopting hydrogen-blended fuel strategies, but with little to no information on how this will effect Cascade's demand, no changes were made to the baseline forecast. Further analysis that this topic is covered under would be Cascade's scenario modeling in Chapter 9, specifically Figure 9-3 on page 9-5.
43	1/20/2023	Draft IRP Comments	WUTC	At Page 3-13, Staff questions why figure 3-6 has 4-year cycles and requests more information.	This is a result of leap years; the extra day of load is showing as growth. Cascade will investigate a better way to visualize this without confusion.
44	1/20/2023	Draft IRP Comments	WUTC	At Page 3-20, figure 3-18, Staff questions why the peak day growth increases faster than Washington Base load minus DSM in figure 3-15? Additional narrative would be helpful to include in the final IRP.	Despite using a baseline climate scenario showing decreasing HDDs, peak days are remaining volatile and are not declining over time like the normal annual HDDs do. Therefore, the current growth of annual load is declining at a higher rate than peak day.
45	1/20/2023	Draft IRP Comments	WUTC	At Page 3-21, regarding non-core outlook, Staff questions whether the Company has assessed the impact, if any, the environmental policy discussed in Chapter 6 will have on this customer count? Additional narrative and analysis would be helpful to include in the final IRP.	Cascade has assessed the impact the environmental policies in both Washington and Oregon have on the non-core outlook. When a non-core customer wants to connect to Cascade's system, Cascade must determine if the customer could put the Company in a position where meeting carbon compliance is at risk. Cascade is also analyzing whether non-core customers will seek other sources of fuel, naturally reducing Cascade's customer count.
46	1/20/2023	Draft IRP Comments	WUTC	At Page 3-26, Staff would like further explanation for the bullet that reads "An understanding that an increased cost of improved precision sometimes has decreasing customer benefits;"	This is a general concept comparing the added effort put into a task versus the actual benefit received. As a quick example, it might not make sense for an analyst to spend an inordinate amount of time trying to increase a forecast's accuracy metric of 99.1% to 99.2% when this time could be better spent analyzing more climate scenarios or challenging the robustness of a baseline forecast assumption. This bullet point was not referring to any particular case, but simply conveying transparency in Cascade's forecasting assumptions and the philosophy behind forecast decision making.
47	1/20/2023	Draft IRP Comments	WUTC	At Page 4-2, Staff notes the last bullet in the cyan box appears incomplete; it is not clear to what the "lowest" refers.	Thank you for this comment. This should read "Modeling of Cascade's available resources results in the lowest reasonably priced optimum portfolio." This will be edited for the final version.

Cascade Natural Gas Integrated Resource Planning Feedback Report

Item #	Date	TAG Meeting	Name/Company	Comment/Question	Cascade Response
48	1/20/2023	Draft IRP Comments	WUTC	At Page 4-8, Staff questions how many customers participate in the voluntary tariff for renewable natural gas service? For example, how has this participation changed over time?	Cascade does not currently have any customers participating in a voluntary RNG program. Cascade is still in the process of procuring RNG as a supply side resource. Without having RNG to offer, Cascade is unable to offer the supply in a voluntary program. Cascade anticipates a tariff will be filed in May or June allowing customers several months in advance to sign up before the service is actually available.
49	1/20/2023	Draft IRP Comments	WUTC	At Page 4-11, Staff questions what role transporting RNG without owning environmental attributes plays in Cascade's portfolio and CCA compliance?	As a point of clarification, Cascade does not claim that it will be able to use environmental attributes that the Company does not own towards CCA compliance. Cascade views the role of these transactions similar to that of its transportation customers, where the Company enters into an agreement with the third party to transport that customer's RNG, with the customer paying a designated rate for this service. Cascade believes the Company plays an important role in decarbonization and is open and willing to connect RNG suppliers as a good neighbor, even when we are not receiving the environmental attribute.
50	1/20/2023	Draft IRP Comments	WUTC	At Page 4-14, Staff requests additional narrative and explanation regarding the following assertion: "For both the CCA in Washington and the CPP in Oregon, hydrogen is considered a one-for-one offset to traditional natural gas."	Cascade has added language starting on Page 4-14 explaining its rationale behind the proposed utilization of hydrogen.
51	1/20/2023	Draft IRP Comments	WUTC	At Page 4-16, Staff questions if Cascade considered the impacts of competing uses for hydrogen such as industrial applications, vehicle fuels, and energy storage for electricity generation? Staff recommends additional narrative and explanation regarding the company's impact assumptions.	In Figure 9-3 on Page 9-5 of the Resource Integration chapter of the 2023 IRP, the Company details a number of sensitivities related to hydrogen (expected availability, high availability, low availability.) These sensitivities are explained quantitatively in the subsequent glossary, and qualitatively in the scenario descriptions themselves. In scenario 3, for instance, the Company evaluates a low RNG scenario on page 9-27, where "This scenario models a world where higher than expected competition for RNG, coupled with stagnation in technological developments related to RNG and Hydrogen, leads to a constraint of a limited amount of RNG and Hydrogen available for acquisition." Cascade will add some language to chapter 4 to inform the reader that analyses of externalities that can impact hydrogen, and how those factors impact resource acquisition decisions.
52	1/20/2023	Draft IRP Comments	WUTC	At Page 4-15, Staff questions if Cascade has assessed green hydrogen fuel prices. For example, are they likely to be less expensive than compared to electricity while produced at sufficient scale to meet Cascade's portfolio needs?	Regarding pricing, Cascade has had challenges finding current pricing projections for green hydrogen beyond the 2020 source documented in the 2023 IRP. The Company reached out to its consultant Guidehouse, who agreed that its assumptions for hydrogen pricing were valid. This consultant also concurred with Cascade's position that the primary constraint regarding hydrogen volumes will be the ability to integrate hydrogen into the Company's system as opposed to availability for Cascade to acquire its portfolio needs. That being said, the Company acknowledges this is a very nascent market and will update these assumptions in future IRPs as more information becomes available.
53	1/20/2023	Draft IRP Comments	WUTC	At Page 4-16, figure 4-4, Staff questions why the RNG/hydrogen potential stops growing around 2040? Staff requests additional narrative and explanation.	Cascade based its assumption around the availability of RNG on the 2019 ACF/ICF study cited on page 4-15. In this study, it can be seen in Figure 8-23 that RNG level off at or before 2040. While this is the end of the study period, a common theme from these figures is that growth does not appear to be significant leading up to 2040, leading to Cascade's assumption that these resources will mature at or before this point. This is substantiated by the statement on page 27 of the study, where the ICF says F54 Hydrogen growth potential does not stop around 2040, although it does slow as it is constrained as a function of by volume of traditional natural gas in Cascade's system (20% by volume in the base case.) The Company will add narrative to the final draft with regards to this.
54	1/20/2023	Draft IRP Comments	WUTC	At Page 4-17, figure 4-5, Staff questions if green hydrogen costs are projected to go below RNG by 2029; for example, why is RNG a large portfolio item in figure 4-4?	It is important to note that figure 4-4 is not meant to signify the portion of RNG in the Company's Preferred Portfolio, but rather the potential volume of RNG and Hydrogen resources that the Company forecasts to be available to acquire. This is identified on page 4-16 "Figure 4-4 shows the potential RNG volumes available to Cascade." Staff is correct that Company projects Green Hydrogen cost to fall below that of RNG by 2029 as per figure 4-5.
55	1/20/2023	Draft IRP Comments	WUTC	At page 4-23, Figure 4-8 regarding volatility, did Cascade consider any long-term uncertainty or probability relating to the price forecast? Further, does Cascade consider any volatility in the price forecast, and how might these impact the performance of portfolios? Finally, has Cascade compared its forecast to the volatility and stability of historical gas prices?	Cascade has many approaches to dealing with uncertainty and probability in the price forecast. The first approach is by creating scenarios for low and high pricing environments. The second approach is to take several different price forecasts from multiple consultants and publicly available sources like the EIA and blend the forecasts together. Each source is weighted by its historic performance and accuracy. Each source is also dampened if its original release date is older than others. The details of this process are described on pages 4-22 through 4-24. Lastly, Cascade performs Monte Carlo simulations on price to include in scenario analysis found in Chapter 9 – Resource Integration. For example, scenario 6 is a high price and interrupted supply scenario. Page 9-35 explains that "the price of traditional natural gas is modeled to be follow the Company's base case modeling until an incident occurs, at which point prices spike to the 99th percentile of stochastic pricing of the basin where the incident occurs, with other basins experiencing correlated increases." Figure 6 in Appendix A was presented at Tag 5 on October 20th, 2022 via Microsoft Teams. It shows one example of a Monte Carlo simulation on price, in this instance, on the Sumas basin. As the graph on the right shows, Cascade's 99th percentile hit the \$40-\$50 range, where January 2023 Sumas pricing reached. Finally, regarding comparing to historical gas prices, Cascade's price forecast methodology involves comparing all forecast sources' historical accuracy in predicting futures. If a forecast is particularly bad at predicting, it is dampened, and the other sources are relied on more heavily. Lastly, the first 15 months of Cascade's price forecast are 100% futures pricing as analysis has shown that this is historically the most accurate.
56	1/20/2023	Draft IRP Comments	WUTC	At Page 4-26, GTN capacity Acquisition, Cascade states, "which was shown in the 2018 and 2020 IRPs as needed resources to meet central Oregon capacity." Staff questions whether Cascade can demonstrate that this added capacity is needed? Staff questions whether this is in line with future long-term projections?	The contract for this capacity was signed to a binding agreement, utilizing the analyses in the acknowledged 2018 and 2020 IRPs as the rationale for the prudent acquisition of this resource. This decision is further reinforced by the Company's As-Is analysis, which identifies shortfalls in Oregon by 2028 even including the additional GTN capacity. This shortfall would only be exacerbated without the upstream GTN capacity

Cascade Natural Gas Integrated Resource Planning Feedback Report

Item #	Date	TAG Meeting	Name/Company	Comment/Question	Cascade Response
57	1/20/2023	Draft IRP Comments	WUTC	At Pages 4-26 and 4-27, Staff questions if Cascade has demonstrated the need for these additional pipeline capacity resources elsewhere in the IRP? Staff requests additional narrative.	As a point of clarification, these resources are part of a section labeled "Incremental Supply Side Resource Options." With the exception of the additional GTN capacity that has already been justified, the Company is not claiming it needs these resources, but rather that they are options that are modeled in the 2023 IRP. With the exception of the already agreed upon GTN capacity, none of the other options are selected as part of the Preferred Portfolio.
58	1/20/2023	Draft IRP Comments	WUTC	At page 6-17, the IRP states "The Climate Commitment Act requirements are modeled in this IRP and have some representation of natural gas system decarbonization. Cascade will consider the published study in the next IRP." Staff requests additional information regarding what stage of decarbonization planning Cascade is in, if any?	Cascade is in the early stages of exploring decarbonization and has utilized the Washington Climate Commitment Act compliance modeling from the IRP to inform on decarbonization strategies. In addition to purchasing and retiring emissions allowances at auction, Cascade is expecting to accomplish some decarbonization through carbon offsets, renewable natural gas and renewable thermal credits, hydrogen, and through implementing energy efficiency and conservation programs.
59	1/20/2023	Draft IRP Comments	WUTC	At page 9-30, figure 9-27, Staff questions what impact increasing annual customer costs consistent with the figure would have on customer counts? Staff recommends the Company include more analysis on this outcome as well as any risks posed to customers that might result from this scenario such as energy burden as well as the likelihood of overinvestment, and stranded assets.	Cascade does include price as a variable in Cascade's load forecast model in an attempt to capture price elasticity. Cascade believes this could be improved to capture customer count elasticity when it comes to fuel switching and has been working with its consultant Guidehouse to develop a methodology for future IRPs. Additionally, the Company did already include adjustments to customer counts in the scenario referenced in figure 9-27. As per the explanation of the scenario: "This scenario models lower than expected load growth projections due to both discretionary electrification and increased regional bans on natural gas. In this scenario, customer growth in Cascade's residential, and commercial rate classes gradually slows to zero growth in 2025 and afterwards, residential and commercial customer count reduced to 10% by 2050."
60	1/20/2023	Draft IRP Comments	WUTC	At page 9-30, figure 9-27, Staff requests additional information regarding the primary driver for bill increases. For example, is it the higher ratio of fixed costs per customer or increasing fuel and compliance costs?	The primary purpose of this scenario is to analyze the relationship between electrification and bill impacts. The reduction of customer counts is described in the scenario explanation, and this reduction of customer count leads to the higher ratio of fixed costs per customer that produces the rate impacts shown in figure 9-27.
61	1/20/2023	Draft IRP Comments	WUTC	Regarding equity considerations in the IRP analysis: a. At page 7-16, figure 7-5, Staff notes the low-income budget is about 1/20th the budget for Residential. Staff questions how this aligns with "progress towards equitable distribution of nonenergy benefits" (pg 7-6) or "the triple bottom line of economics, equity, and sustainability." (pg 6-5, emphasis added)? b. Page 7-24, section titled "Importance of Outreach and Cohesive Messaging", Staff asks if Cascade can demonstrate, and provide additional narrative explaining, how equity is incorporated into each of the bullet points, and also address the efficacy of each strategy as it relates to advancing equity? c. 8-9,8-10, section title "Distribution System Enhancement Selection Guidelines" Staff asks if Cascade can provide examples of how equity is incorporated into each of the bullet points? d. At page 9-30, figure 9-27, Staff questions what the equity impacts of increasing bills are and whether Cascade has considered these impacts?	Cascade has added language to the Company Overview chapter that discusses the Company's Equity Considerations.
62	1/20/2023	Draft IRP Comments	WUTC	State building code: a. At page 3-9, Staff questions whether Cascade's customer count estimates adequately anticipate further reductions from building codes. Staff would like to highlight RCW 19.27A.020(2)(a), which states that the Washington state energy code shall be designed to construct increasingly energy efficient homes and buildings that help achieve the broader goal of building zero fossil-fuel greenhouse gas emission homes and buildings by the year 2031. Staff recommends the Company include more information and narrative regarding building code assumptions. b. At page 3-17, has the Company quantified the DSM impact in figure 3-13, if the scenario customer counts were to match the expectations of RCW 19.27A.020(2)(a)? Staff questions how large the DSM impact would be in figure 3-13. c. At page 6-16, Staff would like to highlight RCW 19.27A.020(2)(a). d. At page 9-5, figure 9-3, Staff questions how Cascade modeled customer growth assumptions – "Current expectations," and whether they should align closer with RCW 19.27A.020(2)(a).	Cascade has included narrative in Chapter 3 regarding the building code impacts.
63	1/20/2023	Draft IRP Comments	WUTC	Appendix K, Staff requests that Cascade label each customer class in layperson terms. It is not clear which types of customers are affected in each chart.	Cascade has updated the labels for each customer class in Appendix K.
64	1/20/2023	Draft IRP Comments	WUTC	Staff would like to highlight the decarbonization plan in connection to the next IRP in (1) Final Order for Avista in Docket UE-210854 contained in the Settlement Stipulation, and (2) Final Order for PSE in Docket UE-220066. Staff looks forward to more discussion on this topic.	Cascade appreciates Staff highlighting these two decarbonization plans. Cascade looks forward to discussing this topic further.

Cascade Natural Gas Integrated Resource Planning Feedback Report

Item #	Date	TAG Meeting	Name/Company	Comment/Question	Cascade Response
65	1/20/2023	Draft IRP Comments	WUTC	Staff questions whether PLEXOS's optimized portfolio choices might change in light of path-dependent and knowledge-limited decision making. Staff looks forward to more discussion regarding modeling and how the company uses it to develop compliance resource portfolios.	Cascade appreciates Staff's question on path-dependency and knowledge-limited decision making. Cascade would like to highlight that due to uncertainty around some of the projections is the main reason for scenario modeling. The scenario's are supposed to simulate likely paths that Cascade may see in the future. Cascade also runs monte carlo simulations to show the different load and price scenarios the Company could experience. This is also a big reason why IRPs are run every 2 years as the information in the IRP either becomes solidified or adjusted as more knowns are determined.
66	1/20/2023	Draft IRP Comments	WUTC	Staff questions whether Cascade has considered incorporating electrification strategy into its next IRP?	Cascade included an electrification scenario in the current IRP process. Cascade does not serve electricity to customers, so analyzing the impact on the electric side will require a region wide analysis on the impacts to natural gas and electric customers under and electrification strategy. Cascade looks forward to further discussions on electrification in future IRPs.
67	1/30/2023	Draft IRP Comments	Public Counsel	In Figure 4-5, What is the reason for the sudden forecasted price increase?	On page 4-16, Cascade explains "To model the pricing of RNG, the Company followed the example of another regional LDC in using a forecast that does not employ a traditional supply curve because of the "lumpy" nature of RNG projects coming online. To that end, prices are split into two tranches. The first tranche, covering the first 1/3rd of projected supply, is priced at \$13/dth, while the second tranche, covering the remaining 2/3rd of supply, is priced at \$19/dth. "
68	1/30/2023	Draft IRP Comments	Public Counsel	How does futures pricing play into recent price instability in the Western U.S.?	Cascade's usage of future's market pricing was vital in producing an accurate short term forecast during recent price instability. Most long term forecasts did not project the extreme pricing that the Company saw, but the utilization of futures pricing ensured that Cascade's price forecast was accurate in the short term each week. As prices have recently regressed back to normal levels, the Company is still confident in its long term forecasts from sources beyond futures market pricing.
69	1/30/2023	Draft IRP Comments	Public Counsel	How does current price instability play out in the High Price sensitivity on Page 9-6? Put another way, does this approach account for the magnitude of instability we have witnessed?	Cascade does believe that recent price instability does validate the philosophy behind this approach, but provides insights as to how this process could be improved. As discussed during the TAG process, during a stochastic incident in Cascade's modeling, prices at Sumas spiked between approximately 10 and 25 dollars per dekatherm. During the 2022-2023 heating season, prices ranged between approximately 15 and 45 dollars per dekatherm. Cascade took a somewhat conservative approach in modeling price volatility as a result of feedback from the 2020 IRP process, where stakeholders informed the Company that they believed Cascade's stochastic modeling may have resulted in prices that were too extreme. In future IRPs the Company will look at higher volatility inputs in stochastic modeling to allow for modeled extreme events to reflect recently observed pricing.
70	1/30/2023	Draft IRP Comments	Public Counsel	Was the current price instability in the Western U.S. anticipated in Cascade's stochastic price modeling?	The objective of stochastic analysis is to model extreme pricing events such as the events that occurred during the 2022-2023 heating season. While the Company didn't necessarily anticipate this specific event, the impacts of such extreme pricing to PVRP can be anticipated to some extent as a result of stochastic modeling.
71	1/30/2023	Draft IRP Comments	Public Counsel	As I'm sure your team has witnessed, there has been tremendous instability in western gas prices at AECO, Sumas, and Rockies/Opal since December 2022. Although prices have moderated somewhat since December of last year, they remain elevated over Henry Hub prices and remain volatile from day to day. Generally speaking, how has the IRP team responded to this recent instability? I have some additional questions (items 67-70) relating to specific content in the IRP related to the recent price instability, so this is detailed context for what exactly I'm referencing in those comments/questions.	Please see response to items 67-70. Cascade would also like to highlight that the Company does have a Hedge Plan, which is provided in Appendix H. In the Hedge Plan, Cascade indicates on page 17 that the Company's Hedge Plan saved customers approximately \$41.5 million of gas costs compared to the market. Cascade will continue to monitor and update the Hedge Plan as well as the Company's stochastic modeling as more information around price instability becomes known.
72	1/30/2023	Draft IRP Comments	Public Counsel	Public Counsel is aware that Oregon CUB has raised concerns about continued load growth projected in Oregon, despite state policy moving away from GHG emitting resources. Washington policy moves in a similar direction. We're aware that this draft IRP accounts for changes in state policy, but I'm curious how Cascade has responded to CUB's concerns in Oregon.	Cascade appreciates Public Counsel's question around customer growth and current state policies. Cascade has included more narrative around the GTN Express expansion in Chapter 4 of the IRP. Cascade will also add that the 2023 IRP includes Cascade's plan to meet the decarbonization compliance obligations from both the CCA and the CPP while continuing to grow the customer base. In future IRPs, Cascade will continue to monitor customer growth as more policy changes come in effect and bill impacts become realized.

Figure 1: Draft 2023 Avoided Distribution System Costs

\$/dth	Zone 1	Zone 2	Zone 3	Zone 4	Oregon	Washington	System
2023	0.91321002	3.12080498	2.05795516	2.01678461	2.01678461	1.81227098	1.91356241
2024	0.00000000	2.71203016	1.87062160	6.17641314	6.17641314	2.69564406	4.41959799
2025	0.93970316	2.08661663	1.12964956	1.40916221	1.40916221	1.27706815	1.34249164
2026	1.22866014	2.98390713	1.68604792	1.96593125	1.96593125	1.81934573	1.89194655
2027	1.01349731	1.86768539	0.93345949	1.36296144	1.36296144	1.14668822	1.25380393
2028	0.90999050	1.39810979	0.72419499	0.98422414	0.98422414	0.91079405	0.94716247
2029	0.62831183	1.33064563	0.61367536	0.8813022	0.8813022	0.75568008	0.81789815
2030	0.00000000	1.39641684	0.52416385	1.00885332	1.00885332	0.89291870	0.95033876
2031	1.04367617	1.89042661	0.91988573	1.26611812	1.26611812	1.14754440	1.20627155
2032	0.87249321	1.85008927	0.98867865	1.15504381	1.15504381	1.13856069	1.14672444
2033	0.51298999	1.26099274	0.56181444	0.73441624	0.73441624	0.67646187	0.70516549
2034	0.51232936	0.88941043	0.37767526	0.5199821	0.5199821	0.50248425	0.51115058
2035	0.42294758	0.75986421	0.36707085	0.46771964	0.46771964	0.46015886	0.46390356
2036	0.00000000	0.88996281	0.32556048	0.54462577	0.54462577	0.55768123	0.55121512
2037	0.40591469	1.04080725	0.55803519	0.71059515	0.71059515	0.60827385	0.65895150
2038	0.40627074	0.68822626	0.33395934	0.43826705	0.43826705	0.42313867	0.43063145
2039	0.39775740	0.65586520	0.30556349	0.39816944	0.39816944	0.39587271	0.39701023
2040	0.35987509	0.45787451	0.22382584	0.27444211	0.27444211	0.29829774	0.28648253
2041	0.00000000	0.00000000	0.15058588	0.3252165	0.3252165	0.32781245	0.32652673
2042	0.47435308	0.70444011	0.32166149	0.44283477	0.44283477	0.42851170	0.43560563

Figure 2: Filed 2020 WA IRP Avoided Distribution System Costs

\$/dth	Zone 1	Zone 2	Zone 3	Zone 4	Oregon	Washington	System
2021	0.17435758	0.17140622	0.17201064	0.18054241	0.18054241	0.17276028	0.17499891
2022	0.184021695	0.180921018	0.181531687	0.19079733	0.19079733	0.18232985	0.184778914
2023	0.188933316	0.185818523	0.186390201	0.19614467	0.19614467	0.187204523	0.189804404
2024	0.171094367	0.168304602	0.168936266	0.17794185	0.17794185	0.169605082	0.172060762
2025	0.20503093	0.201738289	0.202504462	0.21348958	0.21348958	0.2032673	0.206288953
2026	0.184611244	0.181679137	0.182180908	0.19234188	0.19234188	0.182957391	0.18572383
2027	0.184601138	0.18173303	0.182148696	0.19255561	0.19255561	0.182951579	0.185801045
2028	0.184269064	0.181431862	0.18181788	0.19240622	0.19240622	0.182631676	0.185539723
2029	0.184255467	0.181457928	0.181837777	0.19259725	0.19259725	0.182646487	0.185626518
2030	0.185133729	0.182381187	0.182880775	0.1938037	0.1938037	0.183591233	0.186686648
2031	0.18246011	0.179785675	0.180309637	0.19119067	0.19119067	0.180965571	0.184071226
2032	0.182086652	0.179438936	0.179699186	0.19085196	0.19085196	0.180501383	0.18364219
2033	0.184826789	0.182161249	0.182413949	0.19390931	0.19390931	0.183233204	0.186486497
2034	0.185716139	0.183100254	0.183313172	0.19501154	0.19501154	0.184136506	0.187464527
2035	0.185858798	0.183253198	0.183453781	0.1953277	0.1953277	0.184287017	0.187679667
2036	0.185496781	0.182960943	0.183378919	0.19520604	0.19520604	0.184046863	0.187506907
2037	0.182587532	0.180091432	0.180271681	0.19217151	0.19217151	0.181064002	0.18449511
2038	0.186232782	0.183747613	0.183901224	0.196162	0.196162	0.18470451	0.188262644
2039	0.186358129	0.183884086	0.184047586	0.19644579	0.19644579	0.184840619	0.188453087
2040	0.186004908	0.183568945	0.183639798	0.19620377	0.19620377	0.184482658	0.188156182

Figure 3: Draft 2023 Environmental Compliance Costs

\$/dth	System
2023	4.48879
2024	4.557849
2025	4.695965
2026	4.765024
2027	4.834082
2028	4.90314
2029	4.972199
2030	5.041257
2031	5.110315
2032	5.179374
2033	5.248432
2034	5.31749
2035	5.386549
2036	5.455607
2037	5.593723
2038	5.662782
2039	5.73184
2040	5.800898
2041	5.869957
2042	5.939015

Figure 4: Filed 2020 WA IRP Environmental Compliance Costs

\$/dth	System
2021	4.02043
2022	4.084246
2023	4.148063
2024	4.211879
2025	4.339512
2026	4.403328
2027	4.467145
2028	4.530961
2029	4.594777
2030	4.658594
2031	4.72241
2032	4.786226
2033	4.850043
2034	4.913859
2035	4.977675
2036	5.041492
2037	5.169124
2038	5.232941
2039	5.296757
2040	5.360573

Figure 5: Hydrogen Blending impact to Scenario 5

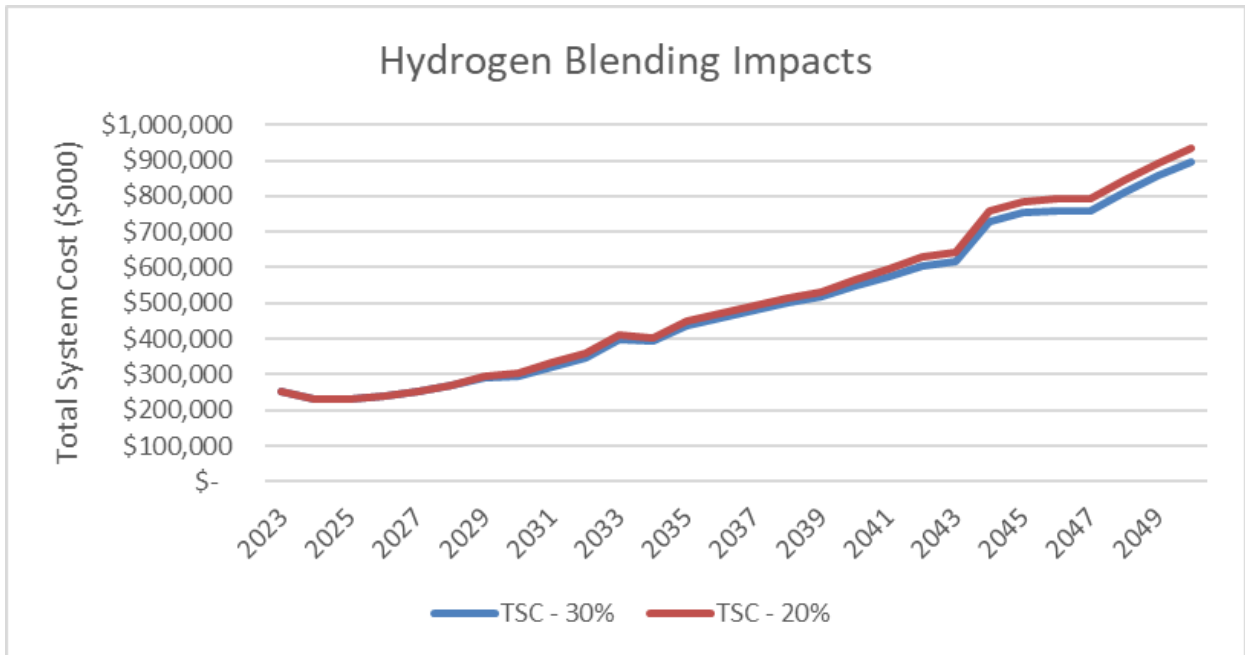
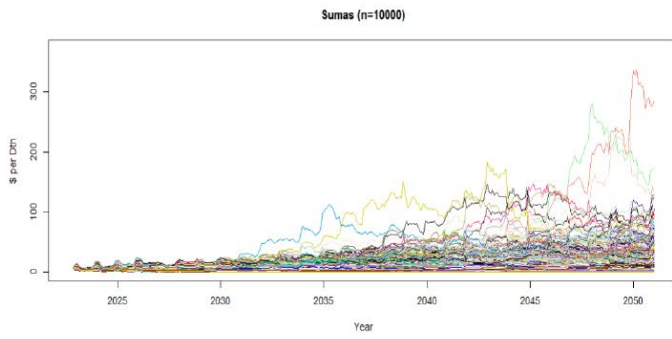

Figure 6: Monte Carlo Price Results

10,000 Simulations



99th Percentile

