

**BEFORE THE WASHINGTON  
UTILITIES & TRANSPORTATION COMMISSION**

WASHINGTON UTILITIES AND TRANSPORTATION COMMISSION,

Complainant,

v.

AVISTA CORPORATION d/b/a AVISTA UTILITIES,

Respondent.

---

DOCKET NOS. UE-190334 and UG-190335, UE-190222 (*Consolidated*)

**DAVID J. GARRETT**

**ON BEHALF OF PUBLIC COUNSEL**

---

**EXHIBIT DJG-20**

*William Sharpe: A Simplified Model for Portfolio Analysis*

October 3, 2019



---

A Simplified Model for Portfolio Analysis

Author(s): William F. Sharpe

Source: *Management Science*, Vol. 9, No. 2 (Jan., 1963), pp. 277-293

Published by: [INFORMS](#)

Stable URL: <http://www.jstor.org/stable/2627407>

Accessed: 01/03/2011 03:24

---

Your use of the JSTOR archive indicates your acceptance of JSTOR's Terms and Conditions of Use, available at <http://www.jstor.org/page/info/about/policies/terms.jsp>. JSTOR's Terms and Conditions of Use provides, in part, that unless you have obtained prior permission, you may not download an entire issue of a journal or multiple copies of articles, and you may use content in the JSTOR archive only for your personal, non-commercial use.

Please contact the publisher regarding any further use of this work. Publisher contact information may be obtained at <http://www.jstor.org/action/showPublisher?publisherCode=informs>.

Each copy of any part of a JSTOR transmission must contain the same copyright notice that appears on the screen or printed page of such transmission.

JSTOR is a not-for-profit service that helps scholars, researchers, and students discover, use, and build upon a wide range of content in a trusted digital archive. We use information technology and tools to increase productivity and facilitate new forms of scholarship. For more information about JSTOR, please contact [support@jstor.org](mailto:support@jstor.org).



INFORMS is collaborating with JSTOR to digitize, preserve and extend access to *Management Science*.

<http://www.jstor.org>

# A SIMPLIFIED MODEL FOR PORTFOLIO ANALYSIS\*

WILLIAM F. SHARPE†

*University of Washington*

This paper describes the advantages of using a particular model of the relationships among securities for practical applications of the Markowitz portfolio analysis technique. A computer program has been developed to take full advantage of the model: 2,000 securities can be analyzed at an extremely low cost—as little as 2% of that associated with standard quadratic programming codes. Moreover, preliminary evidence suggests that the relatively few parameters used by the model can lead to very nearly the same results obtained with much larger sets of relationships among securities. The possibility of low-cost analysis, coupled with a likelihood that a relatively small amount of information need be sacrificed make the model an attractive candidate for initial practical applications of the Markowitz technique.

## 1. Introduction

Markowitz has suggested that the process of portfolio selection be approached by (1) making probabilistic estimates of the future performances of securities, (2) analyzing those estimates to determine an *efficient set* of portfolios and (3) selecting from that set the portfolios best suited to the investor's preferences [1, 2, 3]. This paper extends Markowitz' work on the second of these three stages—*portfolio analysis*. The preliminary sections state the problem in its general form and describe Markowitz' solution technique. The remainder of the paper presents a simplified model of the relationships among securities, indicates the manner in which it allows the portfolio analysis problem to be simplified, and provides evidence on the costs as well as the desirability of using the model for practical applications of the Markowitz technique.

## 2. The Portfolio Analysis Problem

A security analyst has provided the following predictions concerning the future returns from each of  $N$  securities:

$E_i$   $\equiv$  the expected value of  $R_i$  (the return from security  $i$ )  
 $C_{i1}$  through  $C_{in}$ ;  $C_{ij}$  represents the covariance between  $R_i$  and  $R_j$  (as usual, when  $i = j$  the figure is the variance of  $R_i$ )

\* Received December 1961.

† The author wishes to express his appreciation for the cooperation of the staffs of both the Western Data Processing Center at UCLA and the Pacific Northwest Research Computer Laboratory at the University of Washington where the program was tested. His greatest debt, however, is to Dr. Harry M. Markowitz of the RAND Corporation, with whom he was privileged to have a number of stimulating conversations during the past year. It is no longer possible to segregate the ideas in this paper into those which were his, those which were the author's, and those which were developed jointly. Suffice it to say that the only accomplishments which are unquestionably the property of the author are those of authorship—first of the computer program and then of this article.

The portfolio analysis problem is as follows. Given such a set of predictions, determine the set of *efficient portfolios*; a portfolio is efficient if none other gives either (a) a higher expected return and the same variance of return or (b) a lower variance of return and the same expected return.

Let  $X_i$  represent the proportion of a portfolio invested in security  $i$ . Then the expected return ( $E$ ) and variance of return ( $V$ ) of any portfolio can be expressed in terms of (a) the basic data ( $E_i$ -values and  $C_{ij}$ -values) and (b) the amounts invested in various securities:

$$E = \sum_i X_i E_i$$

$$V = \sum_i \sum_j X_i X_j C_{ij}.$$

Consider an objective function of the form:

$$\begin{aligned} \phi &= \lambda E - V \\ &= \lambda \sum_i X_i E_i - \sum_i \sum_j X_i X_j C_{ij}. \end{aligned}$$

Given a set of values for the parameters ( $\lambda$ ,  $E_i$ 's and  $C_{ij}$ 's), the value of  $\phi$  can be changed by varying the  $X_i$  values as desired, as long as two basic restrictions are observed:

1. The entire portfolio must be invested:<sup>1</sup>

$$\sum_i X_i = 1$$

and 2. no security may be held in negative quantities:<sup>2</sup>

$$X_i \geq 0 \quad \text{for all } i.$$

A portfolio is described by the proportions invested in various securities—in our notation by the values of  $X_i$ . For each set of admissible values of the  $X_i$  variables there is a corresponding predicted combination of  $E$  and  $V$  and thus of  $\phi$ . Figure 1 illustrates this relationship for a particular value of  $\lambda$ . The line  $\phi_1$  shows the combinations of  $E$  and  $V$  which give  $\phi = \phi_1$ , where  $\phi = \lambda E - V$ ; the other lines refer to larger values of  $\phi$  ( $\phi_3 > \phi_2 > \phi_1$ ). Of all possible portfolios, one will maximize the value of  $\phi$ ;<sup>3</sup> in figure 1 it is portfolio  $C$ . The relationship between this solution and the portfolio analysis problem is obvious. The  $E$ ,  $V$  combination obtained will be on the boundary of the set of attainable combinations; moreover, the objective function will be tangent to the set at that point. Since this function is of the form

$$\phi = \lambda E - V$$

<sup>1</sup> Since cash can be included as one of the securities (explicitly or implicitly) this assumption need cause no lack of realism.

<sup>2</sup> This is the standard formulation. Cases in which short sales are allowed require a different approach.

<sup>3</sup> This fact is crucial to the critical line computing procedure described in the next section.

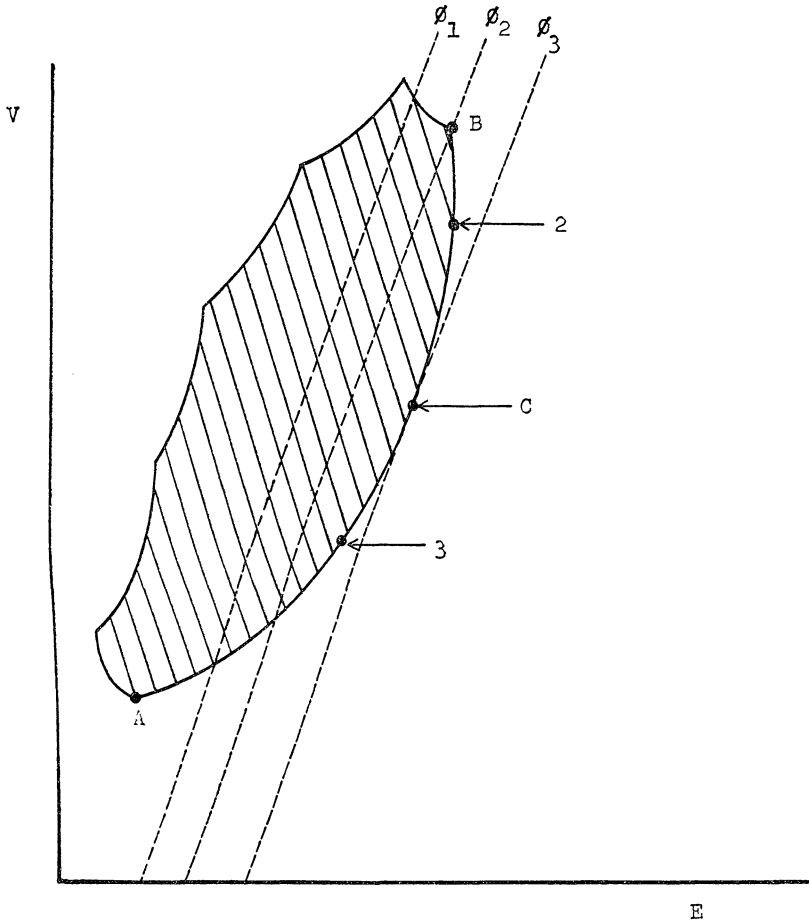

FIGURE 1

the slope of the boundary at the point must be  $\lambda$ ; thus, by varying  $\lambda$  from  $+\infty$  to 0, every solution of the portfolio analysis problem can be obtained.

For any given value of  $\lambda$  the problem described in this section requires the maximization of a quadratic function,  $\phi$  (which is a function of  $X_i, X_i^2$ , and  $X_i X_j$  terms) subject to a linear constraint ( $\sum_i X_i = 1$ ), with the variables restricted to non-negative values. A number of techniques have been developed to solve such *quadratic programming problems*. The critical line method, developed by Markowitz in conjunction with his work on portfolio analysis, is particularly suited to this problem and was used in the program described in this paper.

### 3. The Critical Line Method

Two important characteristics of the set of efficient portfolios make systematic solution of the portfolio analysis problem relatively straightforward. The first concerns the relationships among portfolios. Any set of efficient portfolios can be

described in terms of a smaller set of *corner portfolios*. Any point on the  $E, V$  curve (other than the points associated with corner portfolios) can be obtained with a portfolio constructed by dividing the total investment between the two adjacent corner portfolios. For example, the portfolio which gives  $E, V$  combination  $C$  in Figure 1 might be some linear combination of the two corner portfolios with  $E, V$  combinations shown by points 2 and 3. This characteristic allows the analyst to restrict his attention to corner portfolios rather than the complete set of efficient portfolios; the latter can be readily derived from the former.

The second characteristic of the solution concerns the relationships among corner portfolios. Two corner portfolios which are adjacent on the  $E, V$  curve are related in the following manner: one portfolio will contain either (1) all the securities which appear in the other, plus one additional security or (2) all but one of the securities which appear in the other. Thus in moving down the  $E, V$  curve from one corner portfolio to the next, the quantities of the securities in efficient portfolios will vary until either one drops out of the portfolio or another enters. The point at which a change takes place marks a new corner portfolio.

The major steps in the critical line method for solving the portfolio analysis problem are:

1. The corner portfolio with  $\lambda = \infty$  is determined. It is composed entirely of the one security with the highest expected return.<sup>4</sup>
2. Relationships between (a) the amounts of the various securities contained in efficient portfolios and (b) the value of  $\lambda$  are computed. It is possible to derive such relationships for any section of the  $E, V$  curve between adjacent corner portfolios. The relationships which apply to one section of the curve will not, however, apply to any other section.
3. Using the relationships computed in (2), each security is examined to determine the value of  $\lambda$  at which a change in the securities included in the portfolio would come about:
  - a. securities presently in the portfolio are examined to determine the value of  $\lambda$  at which they would drop out, and
  - b. securities not presently in the portfolio are examined to determine the value of  $\lambda$  at which they would enter the portfolio.
4. The next largest value of  $\lambda$  at which a security either enters or drops out of the portfolio is determined. This indicates the location of the next corner portfolio.
5. The composition of the new corner portfolio is computed, using the relationships derived in (2). However, since these relationships held only for the section of the curve between this corner portfolio and the preceding one, the solution process can only continue if new relationships are derived. The method thus returns to step (2) unless  $\lambda = 0$ , in which case the analysis is complete.

The amount of computation required to complete a portfolio analysis using

<sup>4</sup> In the event that two or more of the securities have the same (highest) expected return, the first efficient portfolio is the combination of such securities with the lowest variance.

this method is related to the following factors:

1. The number of securities analyzed  
This will affect the extent of the computation in step (2) and the number of computations in step (3).
2. The number of corner portfolios  
Steps (2) through (5) must be repeated once to find each corner portfolio.
3. The complexity of the variance-covariance matrix  
Step (2) requires a matrix be inverted and must be repeated once for each corner portfolio.

The amount of computer memory space required to perform a portfolio analysis will depend primarily on the size of the variance-covariance matrix. In the standard case, if  $N$  securities are analyzed this matrix will have  $\frac{1}{2}(N^2 + N)$  elements.

#### 4. The Diagonal Model

Portfolio analysis requires a large number of comparisons; obviously the practical application of the technique can be greatly facilitated by a set of assumptions which reduces the computational task involved in such comparisons. One such set of assumptions (to be called the diagonal model) is described in this article. This model has two virtues: it is one of the simplest which can be constructed without assuming away the existence of interrelationships among securities and there is considerable evidence that it can capture a large part of such interrelationships.

The major characteristic of the diagonal model is the assumption that the returns of various securities are related only through common relationships with some basic underlying factor. The return from any security is determined solely by random factors and this single outside element; more explicitly:

$$R_i = A_i + B_i I + C_i$$

where  $A_i$  and  $B_i$  are parameters,  $C_i$  is a random variable with an expected value of zero and variance  $Q_i$ , and  $I$  is the level of some index. The index,  $I$ , may be the level of the stock market as a whole, the Gross National Product, some price index or any other factor thought to be the most important single influence on the returns from securities. The future level of  $I$  is determined in part by random factors:

$$I = A_{n+1} + C_{n+1}$$

where  $A_{n+1}$  is a parameter and  $C_{n+1}$  is a random variable with an expected value of zero and a variance of  $Q_{n+1}$ . It is assumed that the covariance between  $C_i$  and  $C_j$  is zero for all values of  $i$  and  $j$  ( $i \neq j$ ).

Figure 2 provides a graphical representation of the model.  $A_i$  and  $B_i$  serve to locate the line which relates the expected value of  $R_i$  to the level of  $I$ .  $Q_i$  indicates the variance of  $R_i$  around the expected relationship (this variance is assumed to

be the same at each point along the line). Finally,  $A_{n+1}$  indicates the expected value of  $I$  and  $Q_{n+1}$  the variance around that expected value.

The diagonal model requires the following predictions from a security analyst:

- 1) values of  $A_i$ ,  $B_i$  and  $Q_i$  for each of  $N$  securities
- 2) values of  $A_{n+1}$  and  $Q_{n+1}$  for the index  $I$ .

The number of estimates required from the analyst is thus greatly reduced: from 5,150 to 302 for an analysis of 100 securities and from 2,003,000 to 6,002 for an analysis of 2,000 securities.

Once the parameters of the diagonal model have been specified all the inputs required for the standard portfolio analysis problem can be derived. The relationships are:

$$\begin{aligned}
 E_i &= A_i + B_i(A_{n+1}) \\
 V_i &= (B_i)^2(Q_{n+1}) + Q_i \\
 C &= (B_i)(B_j)(Q_{n+1})
 \end{aligned}$$

A portfolio analysis could be performed by obtaining the values required by the diagonal model, calculating from them the full set of data required for the standard portfolio analysis problem and then performing the analysis with the derived values. However, additional advantages can be obtained if the portfolio analysis problem is restated directly in terms of the parameters of the diagonal model. The following section describes the manner in which such a restatement can be performed.

### 5. The Analogue

The return from a portfolio is the weighted average of the returns from its component securities:

$$R_p = \sum_{i=1}^N X_i R_i$$

The contribution of each security to the total return of a portfolio is simply  $X_i R_i$  or, under the assumptions of the diagonal model:

$$X_i(A_i + B_i I + C_i).$$

The total contribution of a security to the return of the portfolio can be broken into two components: (1) an investment in the "basic characteristics" of the security in question and (2) an "investment" in the index:

- (1)  $X_i(A_i + B_i I + C_i) = X_i(A_i + C_i)$
- (2)  $+ X_i B_i I$

The return of a portfolio can be considered to be the result of (1) a series of investments in  $N$  "basic securities" and (2) an investment in the index:

$$R_p = \sum_{i=1}^N X_i(A_i + C_i) + \left[ \sum_{i=1}^N X_i B_i \right] I$$



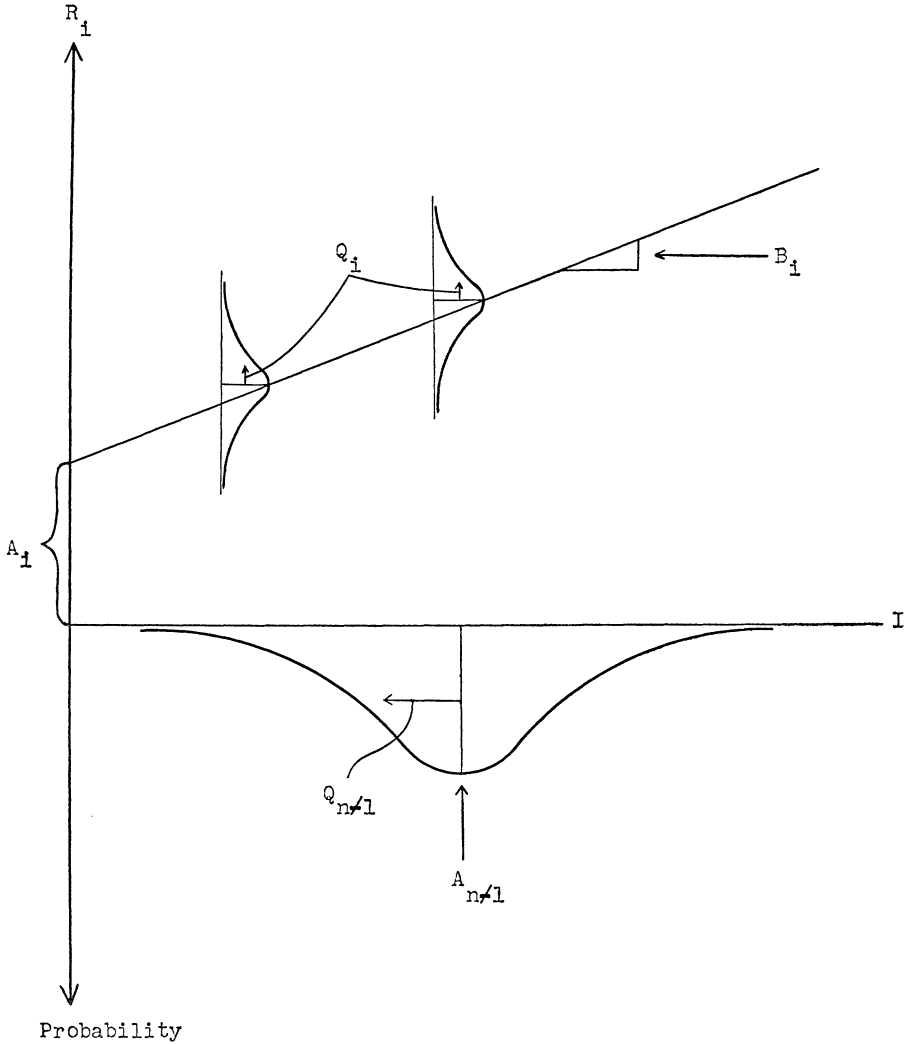

FIGURE 2

Defining  $X_{n+1}$  as the weighted average responsiveness of  $R_p$  to the level of  $I$ :

$$X_{n+1} \equiv \sum_{i=1}^N X_i B_i$$

and substituting this variable and the formula for the determinants of  $I$ , we obtain:

$$\begin{aligned} R_p &= \sum_{i=1}^N X_i (A_i + C_i) + X_{n+1} (A_{n+1} + C_{n+1}) \\ &= \sum_{i=1}^{N+1} X_i (A_i + C_i). \end{aligned}$$

The expected return of a portfolio is thus:

$$E = \sum_{i=1}^{N+1} X_i A_i$$

while the variance is:<sup>5</sup>

$$V = \sum_{i=1}^{N+1} X_i^2 Q_i$$

This formulation indicates the reason for the use of the parameters  $A_{n+1}$  and  $Q_{n+1}$  to describe the expected value and variance of the future value of  $I$ . It also indicates the reason for calling this the “diagonal model”. The variance-covariance matrix, which is full when  $N$  securities are considered, can be expressed as a matrix with non-zero elements only along the diagonal by including an  $(n + 1)$ st security defined as indicated. This vastly reduces the number of computations required to solve the portfolio analysis problem (primarily in step 2 of the critical line method, when the variance-covariance matrix must be inverted) and allows the problem to be stated directly in terms of the basic parameters of the diagonal model:

$$\text{Maximize: } \lambda E - V$$

$$\text{Where: } E = \sum_{i=1}^{N+1} X_i A_i$$

$$V = \sum_{i=1}^{N+1} X_i^2 Q_i$$

Subject to:  $X_i \geq 0$  for all  $i$  from 1 to  $N$

$$\sum_{i=1}^N X_i = 1$$

$$\sum_{i=1}^N X_i B_i = X_{n+1}.$$

## 6. The Diagonal Model Portfolio Analysis Code

As indicated in the previous section, if the portfolio analysis problem is expressed in terms of the basic parameters of the diagonal model, computing time and memory space required for solution can be greatly reduced. This section describes a machine code, written in the FORTRAN language, which takes full advantage of the characteristics of the diagonal model. It uses the critical line method to solve the problem stated in the previous section.

The computing time required by the diagonal code is considerably smaller than that required by standard quadratic programming codes. The RAND QP

<sup>5</sup> Recall that the diagonal model assumes  $\text{cov}(C_i, C_j) = 0$  for all  $i$  and  $j$  ( $i \neq j$ ).

code<sup>6</sup> required 33 minutes to solve a 100-security example on an IBM 7090 computer; the same problem was solved in 30 seconds with the diagonal code. Moreover, the reduced storage requirements allow many more securities to be analyzed: with the IBM 709 or 7090 the RAND QP code can be used for no more than 249 securities, while the diagonal code can analyze up to 2,000 securities.

Although the diagonal code allows the total computing time to be greatly reduced, the cost of a large analysis is still far from insignificant. Thus there is every incentive to limit the computations to those essential for the final selection of a portfolio. By taking into account the possibilities of borrowing and lending money, the diagonal code restricts the computations to those absolutely necessary for determination of the final set of efficient portfolios. The importance of these alternatives, their effect on the portfolio analysis problem and the manner in which they are taken into account in the diagonal code are described in the remainder of this section.

#### A. The "lending portfolio"

There is some interest rate ( $r_l$ ) at which money can be lent with virtual assurance that both principal and interest will be returned; at the least, money can be buried in the ground ( $r_l = 0$ ). Such an alternative could be included as one possible security ( $A_i = 1 + r_l$ ,  $B_i = 0$ ,  $Q_i = 0$ ) but this would necessitate some needless computation.<sup>7</sup> In order to minimize computing time, lending at some pure interest rate is taken into account explicitly in the diagonal code.

The relationship between lending and efficient portfolios can best be seen in terms of an  $E, \sigma$  curve showing the combinations of expected return and standard deviation of return ( $= \sqrt{V}$ ) associated with efficient portfolios. Such a curve is shown in Figure 3 (FBCG); point  $A$  indicates the  $E, \sigma$  combination attained if all funds are lent. The relationship between lending money and purchasing portfolios can be illustrated with the portfolio which has the  $E, \sigma$  combination shown by point  $Z$ . Consider a portfolio with  $X_z$  invested in portfolio  $Z$  and the remainder ( $1 - X_z$ ) lent at the rate  $r_l$ . The expected return from such a portfolio would be:

$$E = X_z E_z + (1 - X_z)(1 + r_l)$$

and the variance of return would be:

$$V = X_z^2 V_z + (1 - X_z)^2 V_l + 2X_z(1 - X_z)(\text{cov}_{zl})$$

<sup>6</sup> The program is described in [4]. Several alternative quadratic programming codes are available. A recent code, developed by IBM, which uses the critical line method is likely to prove considerably more efficient for the portfolio analysis problem. The RAND code is used for comparison since it is the only standard program with which the author has had experience.

<sup>7</sup> Actually, the diagonal code cannot accept non-positive values of  $Q_i$ ; thus if the lending alternative is to be included as simply another security, it must be assigned a very small value of  $Q_i$ . This procedure will give virtually the correct solution but is inefficient.

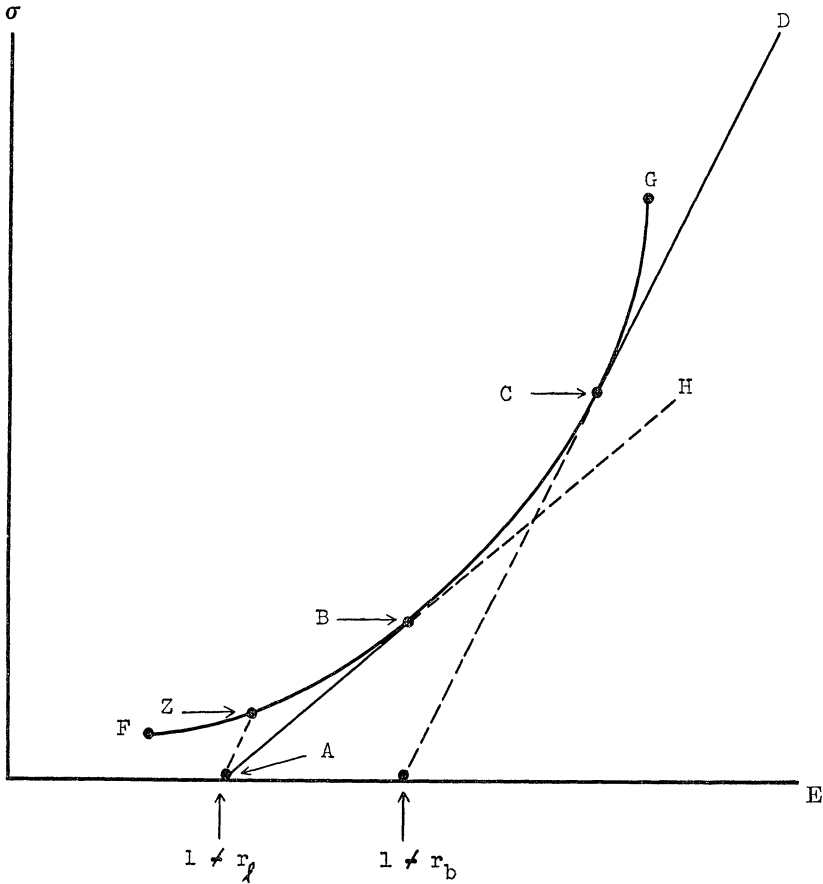

FIGURE 3

But, since  $V_l$  and  $cov_{zl}$  are both zero:

$$V = X_z^2 V_z$$

and the standard deviation of return is:

$$\sigma = X_z \sigma_z .$$

Since both  $E$  and  $\sigma$  are linear functions of  $X_z$ , the  $E, \sigma$  combinations of all portfolios made up of portfolio  $Z$  plus lending must lie on a straight line connecting points  $Z$  and  $A$ . In general, by splitting his investment between a portfolio and lending, an investor can attain any  $E, \sigma$  combination on the line connecting the  $E, \sigma$  combinations of the two components.

Many portfolios which are efficient in the absence of the lending alternative becomes inefficient when it is introduced. In Figure 3, for example, the possibility of attaining  $E, \sigma$  combinations along the line  $AB$  makes all portfolios along the original  $E, \sigma$  curve from point  $F$  to point  $B$  inefficient. For any desired level of

$E$  below that associated with portfolio  $B$ , the most efficient portfolio will be some combination of portfolio  $B$  and lending. Portfolio  $B$  can be termed the "lending portfolio" since it is the appropriate portfolio whenever some of the investor's funds are to be lent at the rate  $r_l$ . This portfolio can be found readily once the  $E, \sigma$  curve is known. It lies at the point on the curve at which a ray from  $(E = 1 + r_l, \sigma = 0)$  is tangent to the curve. If the  $E, \sigma$  curve is not known in its entirety it is still possible to determine whether or not a particular portfolio is the lending portfolio by computing the rate of interest which *would* make the portfolio in question the lending portfolio. For example, the rate of interest associated in this manner with portfolio  $C$  is  $r_b$ , found by extending a tangent to the curve down to the  $E$ -axis. The diagonal code computes such a rate of interest for each corner portfolio as the analysis proceeds; when it falls below the previously stated lending rate the code computes the composition of the lending portfolio and terminates the analysis.

### *B. The "borrowing portfolio"*

In some cases an investor may be able to borrow funds in order to purchase even greater amounts of a portfolio than his own funds will allow. If the appropriate rate for such borrowing were  $r_b$ , illustrated in figure 3, the  $E, \sigma$  combinations attainable by purchasing portfolio  $C$  with both the investor's funds and with borrowed funds would lie along the line  $CD$ , depending on the amount borrowed. Inclusion of the borrowing alternative makes certain portfolios inefficient which are efficient in the absence of the alternative; in this case the affected portfolios are those with  $E, \sigma$  combinations along the segment of the original  $E, \sigma$  curve from  $C$  to  $G$ . Just as there is a single appropriate portfolio if any lending is contemplated, there is a single appropriate portfolio if borrowing is contemplated. This "borrowing portfolio" is related to the rate of interest at which funds can be borrowed in exactly the same manner as the "lending portfolio" is related to the rate at which funds can be lent.

The diagonal code does not take account of the borrowing alternative in the manner used for the lending alternative since it is necessary to compute all previous corner portfolios in order to derive the portion of the  $E, \sigma$  curve below the borrowing portfolio. For this reason all computations required to derive the full  $E, \sigma$  curve above the lending portfolio must be made. However, the code does allow the user to specify the rate of interest at which funds can be borrowed. If this alternative is chosen, none of the corner portfolios which will be inefficient when borrowing is considered will be printed. Since as much as 65% of the total computer time can be spent recording (on tape) the results of the analysis this is not an insignificant saving.

## **7. The Cost of Portfolio Analysis with the Diagonal Code**

The total time (and thus cost) required to perform a portfolio analysis with the diagonal code will depend upon the number of securities analyzed, the number of corner portfolios and, to some extent, the composition of the corner portfolios. A formula which gives quite an accurate estimate of the time required

to perform an analysis on an IBM 709 computer was obtained by analyzing a series of runs during which the time required to complete each major segment of the program was recorded. The approximate time required for the analysis will be:<sup>8</sup>

$$\begin{aligned} \text{Number of seconds} &= .6 \\ &+ .114 \times \text{number of securities analyzed} \\ &+ .54 \times \text{number of corner portfolios} \\ &+ .0024 \times \text{number of securities analyzed} \times \text{number of} \\ &\quad \text{corner portfolios.} \end{aligned}$$

Unfortunately only the number of securities analyzed is known before the analysis is begun. In order to estimate the cost of portfolio analysis before it is performed, some relationship between the number of corner portfolios and the number of securities analyzed must be assumed. Since no theoretical relationship can be derived and since the total number of corner portfolios could be several times the number of securities analysed, it seemed desirable to obtain some crude notion of the typical relationship when "reasonable" inputs are used. To accomplish this, a series of portfolio analyses was performed using inputs generated by a Monte Carlo model.

Data were gathered on the annual returns during the period 1940–1951 for 96 industrial common stocks chosen randomly from the New York Stock Exchange. The returns of each security were then related to the level of a stock market index and estimates of the parameters of the diagonal model obtained. These parameters were assumed to be samples from a population of  $A_i$ ,  $B_i$  and  $Q_i$  triplets related as follows:

$$\begin{aligned} A_i &= \bar{A} + r_1 \\ B_i &= \bar{B} + \psi A_i + r_2 \\ Q_i &= \bar{Q} + \theta A_i + \gamma B_i + r_3 \end{aligned}$$

where  $r_1$ ,  $r_2$  and  $r_3$  are random variables with zero means. Estimates for the parameters of these three equations were obtained by regression analysis and estimates of the variances of the random variables determined.<sup>9</sup> With this information the characteristics of any desired number of securities could be generated. A random number generator was used to select a value for  $A_i$ ; this value, together with an additional random number determined the value of  $B_i$ ; the value of  $Q_i$  was then determined with a third random number and the previously obtained values of  $A_i$  and  $B_i$ .

Figure 4 shows the relationship between the number of securities analyzed

<sup>8</sup> The computations in this section are based on the assumption that no corner portfolios prior to the lending portfolio are printed. If the analyst chooses to print all preceding portfolios, the estimates given in this section should be multiplied by 2.9; intermediate cases can be estimated by interpolation.

<sup>9</sup> The random variables were considered normally distributed; in one case, to better approximate the data, two variances were used for the distribution—one for the portion above the mean and another for the portion below the mean.

Number of corner portfolios with an interest rate  $\geq 3\%$

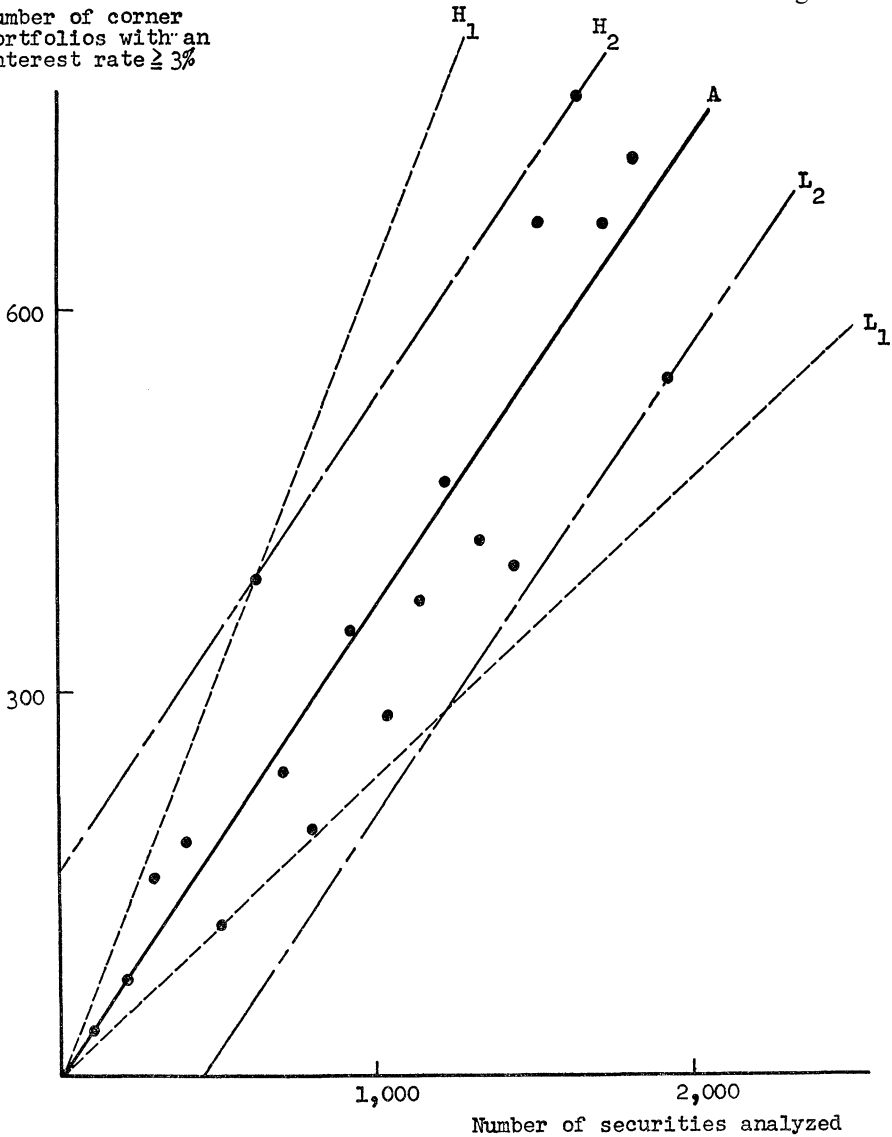

FIGURE 4

and the number of corner portfolios with interest rates greater than 3% (an approximation to the "lending rate"). Rather than perform a sophisticated analysis of these data, several lines have been used to bracket the results in various ways. These will be used subsequently as extreme cases, on the presumption that most practical cases will lie within these extremes (but with no presumption that these limits will never be exceeded). Curve A indicates the average relationship between the number of portfolios and the number of securities:

average  $(N_p/N_s) = .37$ . Curve  $H_1$  indicates the highest such relationship: maximum  $(N_p/N_s) = .63$ ; the line  $L_1$  indicates the lowest: minimum  $(N_p/N_s) = .24$ . The other two curves,  $H_2$  and  $L_2$ , indicate respectively the maximum deviation above (155) and below (173) the number of corner portfolios indicated by the average relationship  $N_p = .37 N_s$ .

In Figure 5 the total time required for a portfolio analysis is related to the number of securities analyzed under various assumptions about the relationship

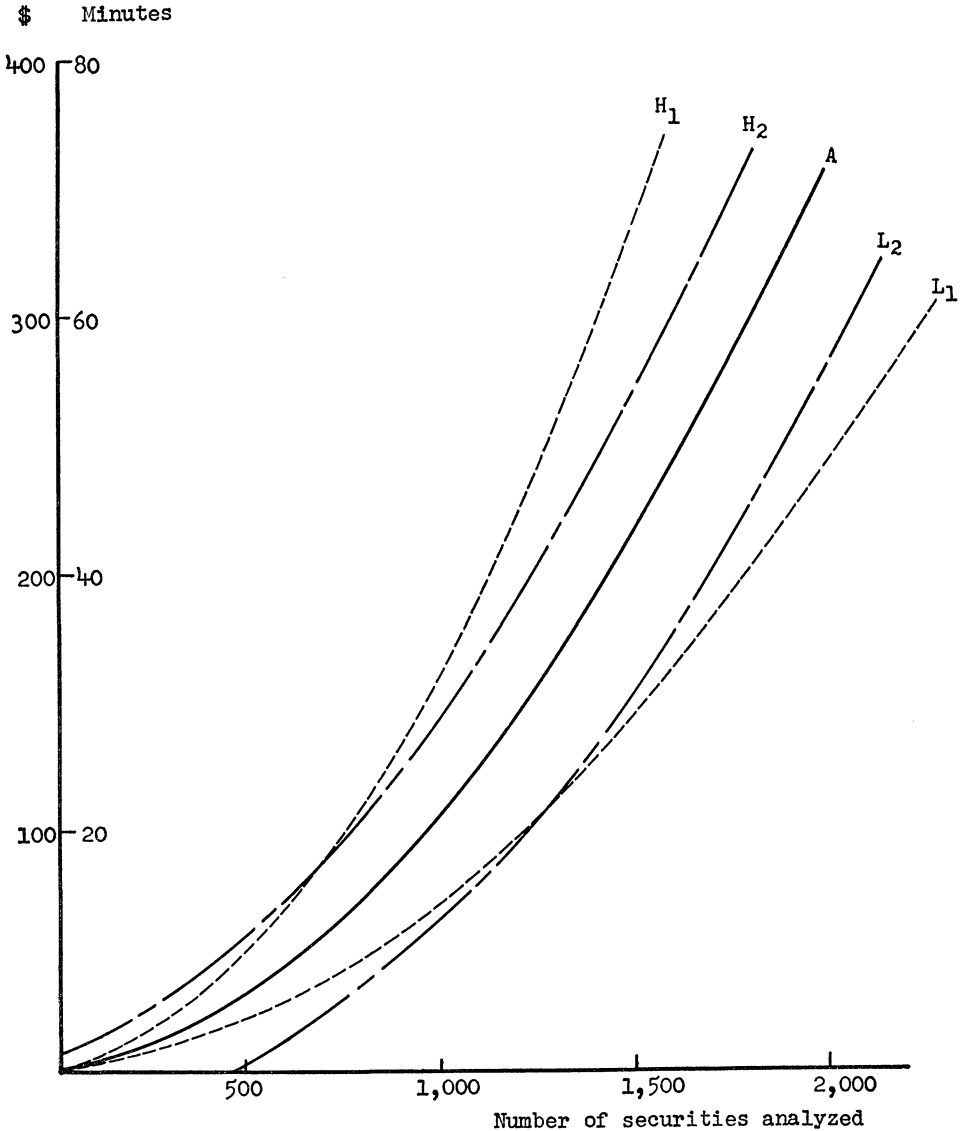

FIGURE 5



between the number of corner portfolios and the number of securities analyzed. Each of the curves shown in Figure 5 is based on the corresponding curve in Figure 4; for example, curve A in Figure 5 indicates the relationship between total time and number of securities analyzed on the assumption that the relationship between the number of corner portfolios and the number of securities is that shown by curve A in Figure 4. For convenience a second scale has been provided in Figure 5, showing the total cost of the analysis on the assumption that an IBM 709 computer can be obtained at a cost of \$300 per hour.

### 8. The Value of Portfolio Analysis Based on the Diagonal Model

The assumptions of the diagonal model lie near one end of the spectrum of possible assumptions about the relationships among securities. The model's extreme simplicity enables the investigator to perform a portfolio analysis at a very small cost, as we have shown. However, it is entirely possible that this simplicity so restricts the security analyst in making his predictions that the value of the resulting portfolio analysis is also very small.

In order to estimate the ability of the diagonal model to summarize information concerning the performance of securities a simple test was performed. Twenty securities were chosen randomly from the New York Stock Exchange and their performance during the period 1940-1951 used to obtain two sets of

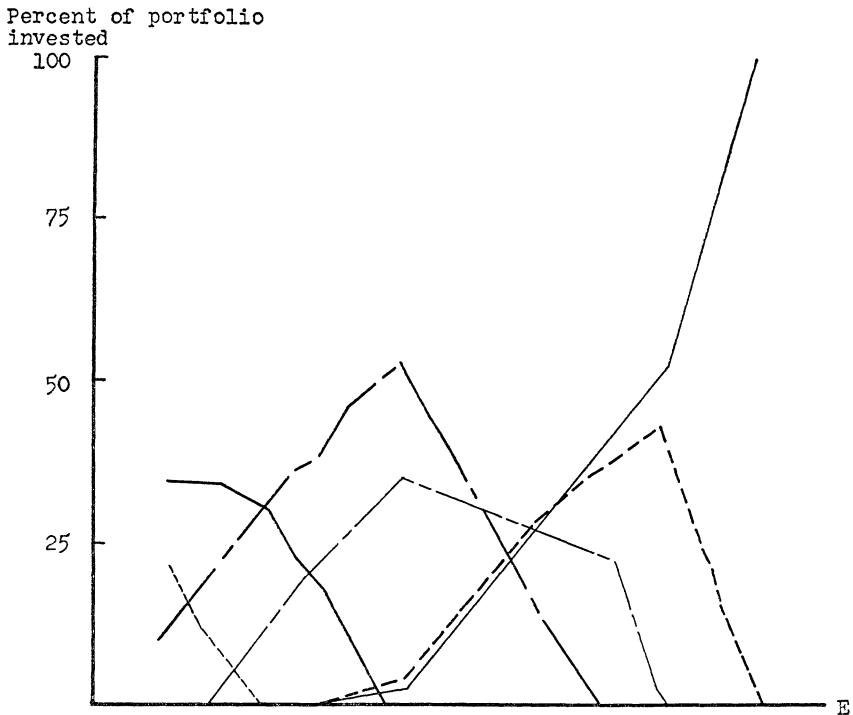

FIG. 6a. Composition of efficient portfolios derived from the analysis of the parameters of the diagonal model.

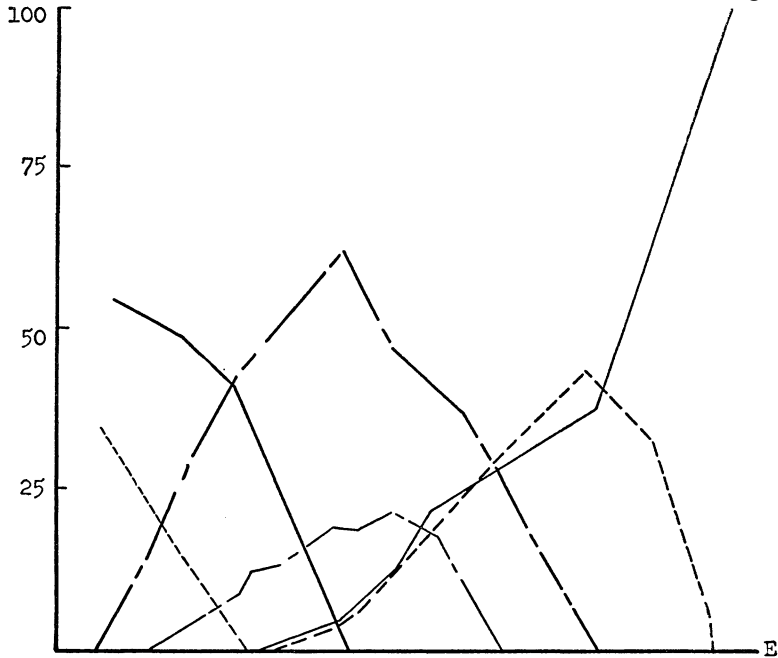

FIG. 6b. Composition of efficient portfolios derived from the analysis of historical data

data: (1) the actual mean returns, variances of returns and covariances of returns during the period and (2) the parameters of the diagonal model, estimated by regression techniques from the performance of the securities during the period. A portfolio analysis was then performed on each set of data. The results are summarized in Figures 6a and 6b. Each security which entered any of the efficient portfolios in significant amounts is represented by a particular type of line; the height of each line above any given value of  $E$  indicates the percentage of the efficient portfolio with that particular  $E$  composed of the security in question. The two figures thus indicate the compositions of all the efficient portfolios chosen from the analysis of the historical data (Figure 6b) and the compositions of all the portfolios chosen from the analysis of the parameters of the diagonal model (Figure 6a). The similarity of the two figures indicates that the 62 parameters of the diagonal model were able to capture a great deal of the information contained in the complete set of 230 historical relationships. An additional test, using a second set of 20 securities, gave similar results.

These results are, of course, far too fragmentary to be considered conclusive but they do suggest that the diagonal model may be able to represent the relationships among securities rather well and thus that the value of portfolio analyses based on the model will exceed their rather nominal cost. For these reasons it appears to be an excellent choice for the initial practical applications of the Markowitz technique.

**References**

1. MARKOWITZ, HARRY M., *Portfolio Selection, Efficient Diversification of Investments*, New York, John Wiley and Sons, Inc., 1959.
2. MARKOWITZ, HARRY M., "Portfolio Selection", *The Journal of Finance*, Vol. 12, (March 1952), 77-91.
3. MARKOWITZ, HARRY M., "The Optimization of a Quadratic Function Subject to Linear Constraints," *Naval Research Logistics Quarterly*, Vol. 3, (March and June, 1956), 111-133.
4. WOLFE, PHILIP, "The Simplex Method for Quadratic Programming," *Econometrica*, Vol. 27, (July, 1959), 382-398.