

BEFORE THE WASHINGTON UTILITIES AND TRANSPORTATION COMMISSION

DOCKET NO. UE-14_____

EXHIBIT NO._____(SJK-2)

SCOTT J. KINNEY

REPRESENTING AVISTA CORPORATION



2013 Electric Integrated Resource Plan

August 31, 2013



Safe Harbor Statement

This document contains forward-looking statements. Such statements are subject to a variety of risks, uncertainties and other factors, most of which are beyond the Company's control, and many of which could have a significant impact on the Company's operations, results of operations and financial condition, and could cause actual results to differ materially from those anticipated.

For a further discussion of these factors and other important factors, please refer to the Company's reports filed with the Securities and Exchange Commission. The forward-looking statements contained in this document speak only as of the date hereof. The Company undertakes no obligation to update any forward-looking statement or statements to reflect events or circumstances that occur after the date on which such statement is made or to reflect the occurrence of unanticipated events. New factors emerge from time to time, and it is not possible for management to predict all of such factors, nor can it assess the impact of each such factor on the Company's business or the extent to which any such factor, or combination of factors, may cause actual results to differ materially from those contained in any forward-looking statement.

Acronym List

AC: Alternating Current

aMW: Average Megawatt

AFUDC: Allowance for Funds Used During Construction

ARIMA: Auto Regressive Integrated Moving Average

BART: Best Available Retrofit Technology

BPA: Bonneville Power Administration

Btu: British Thermal Unit

CAA: Clean Air Act

CDD: Cooling Degree Days

CFL: Compact Fluorescent Light

CPA: Conservation Potential Assessment

CO₂: Carbon Dioxide

COB: California Oregon Border

CT: Combustion Turbine

CCCT: Combined-Cycle Combustion Turbine

CPU: Central Processing Unit

DC: Direct Current

DLC: Direct Load Control

EIA: Energy Independence Act

EPA: Environmental Protection Agency

FERC: Federal Energy Regulatory Commission

FIPs: Federal Implementation Plans

GDP: Gross Domestic Product

HAPs: Hazardous Air Pollutants

HDD: Heating Degree Days

HRSG: Heat Recovery Steam Generator

HVAC: Heating, Ventilation, and Air Conditioning

IGCC: Integrated Gasification Combined-Cycle

IMHR: Implied Market Heat Rate

IPPs: Independent Power Producers

IPUC: Idaho Public Utilities Commission

IRP: Integrated Resource Plan

ITC: Investment Tax Credit

kV: Kilovolt

LGIR: Large Generator Interconnection Request

LNG: Liquid Natural Gas

LOLE: Loss of Load Expectation

LOLH: Loss of Load Hours

LOLP: Loss of Load Probability

LRC: Least Resource Cost

MATS: Mercury Air Toxic Standards

MSA: Metropolitan Statistical Area

MW: Megawatt

MWh: Megawatt Hours

NEEA: Northwest Energy Efficiency Alliance

NERC: North American Reliability Corporation

NO_x: Nitrous Oxides

NPCC: Northwest Power and Conservation Council

NREL: National Renewable Energy Laboratory

NTTG: Northern Tier Transmission Group

NWPP: Northwest Power Pool

O&M: Operations and Maintenance

OATT: Open Access Transmission Tariff

OTC: Once Through Cooling

PNCA: Pacific Northwest Coordination Agreement

PRISM: Preferred Resource Strategy Linear Programming Model

PRS: Preferred Resource Strategy

PSD: Prevention of Significant Deterioration

PM: Planning Margin

PTC: Production Tax Credit

PUDs: Public Utility Districts

RPS: Renewable Portfolio Standard

SCCT: Simple Cycle Combustion Turbine

SGDP: Smart Grid Demonstration Project

TAC: Technical Advisory Committee

TPC: Transmission Planning Committee

TRC: Total Resource Cost

UPC: Use-per-customer

UTC: Washington Utilities and Transportation Commission

WAC: Washington Administrative Code

WCI: Western Climate Initiative

WECC: Western Electricity Coordinating Council

WNP-3: Washington Nuclear Plant No. 3

WNU: Weather Normalized Usage

WSU: Washington State University

Table of Contents

Executive Summary	i
Resource Needs.....	i
Modeling and Results.....	iii
Electricity and Natural Gas Market Forecasts.....	iii
Energy Efficiency Acquisition.....	iv
Preferred Resource Strategy.....	v
Greenhouse Gas Emissions.....	viii
Action Items.....	x
1. Introduction and Stakeholder Involvement	1-1
IRP Process.....	1-1
2013 IRP Outline.....	1-4
Regulatory Requirements.....	1-5
2. Loads & Resources	2-1
Introduction & Highlights.....	2-1
Economic Characteristics of Avista's Service Territory.....	2-1
Customer and Load Forecast Assumptions.....	2-5
Native Load Forecast.....	2-15
Peak Demand Forecast.....	2-16
High and Low Load Growth Cases.....	2-18
Voluntary Renewable Energy Program (Buck-A-Block).....	2-19
Customer-Owned Generation.....	2-20
Avista Resources and Contracts.....	2-22
Spokane River Hydroelectric Developments.....	2-23
Clark Fork River Hydroelectric Developments.....	2-24
Total Hydroelectric Generation.....	2-24
Thermal Resources.....	2-25
Power Purchase and Sale Contracts.....	2-27
Reserve Margins.....	2-30
Avista's Loss of Load Analysis.....	2-32
Balancing Loads and Resources.....	2-34
Washington State Renewable Portfolio Standard.....	2-36
Resource Requirements.....	2-37
3. Energy Efficiency	3-1
Introduction.....	3-1
Conservation Potential Assessment Approach.....	3-2
Overview of Energy Efficiency Potentials.....	3-5
Conservation Targets.....	3-8
Comparison with the Sixth Power Plan Methodology.....	3-9
Avoided Cost Sensitivities.....	3-10
Energy Efficiency-Related Financial Impacts.....	3-12
Integrating Results into Business Planning and Operations.....	3-13
Demand Response.....	3-16
4. Policy Considerations	4-1
Environmental Issues.....	4-1
Avista's Climate Change Policy Efforts.....	4-3
State and Federal Environmental Policy Considerations.....	4-4
EPA Regulations.....	4-5
5. Transmission & Distribution	5-1
Introduction.....	5-1
FERC Planning Requirements and Processes.....	5-2
Regional Transmission System.....	5-4
Avista's Transmission System.....	5-4
Transmission System Information for the 2013 IRP.....	5-5

Table of Contents

Distribution System Efficiencies	5-8
6. Generation Resource Options.....	6-1
Introduction.....	6-1
Assumptions.....	6-1
Gas-Fired Combined Cycle Combustion Turbine	6-3
Hydroelectric Project Upgrades and Options	6-15
Thermal Resource Upgrade Options	6-18
7. Market Analysis	7-1
Introduction.....	7-1
Marketplace.....	7-2
Fuel Prices and Conditions	7-7
Greenhouse Gas Emissions	7-12
Risk Analysis	7-12
Market Price Forecast	7-19
Scenario Analysis.....	7-24
High and Low Natural Gas Price Scenarios.....	7-28
8. Preferred Resource Strategy.....	8-1
Introduction.....	8-1
Supply-Side Resource Acquisitions	8-1
Resource Deficiencies.....	8-5
Preferred Resource Strategy	8-8
Efficient Frontier Analysis.....	8-16
Determining the Avoided Costs of Energy Efficiency.....	8-19
Determining the Avoided Cost of New Generation Options.....	8-20
Efficient Frontier Comparison of Greenhouse Gas Policies.....	8-21
Energy Efficiency Scenarios	8-23
Colstrip	8-26
Other Portfolio Scenarios	8-31
9. Action Items	9-1
Summary of the 2011 IRP Action Plan.....	9-1
2013 IRP Action Plan	9-5
Production Credits.....	9-7

Table of Figures

Figure 1: Load-Resource Balance—Winter 18 Hour Capacity.....	i
Figure 2: Load-Resource Balance—Summer 18 Hour Capacity	ii
Figure 3: Load-Resource Balance—Energy.....	ii
Figure 4: Average Mid-Columbia Electricity Price Forecast.....	iii
Figure 5: Stanfield Natural Gas Price Forecast.....	iv
Figure 6: Cumulative Energy Efficiency Acquisitions	v
Figure 7: Efficient Frontier	vi
Figure 8: Avista’s Qualifying Renewables for Washington State’s EIA.....	viii
Figure 8: Avista Owned and Controlled Resource’s Greenhouse Gas Emissions	ix
Figure 9: U.S. Western Interconnect Greenhouse Gas Emissions	ix
Figure 2.1: Avista’s Service Territory.....	2-2
Figure 2.2: Population Levels 1970 – 2011.....	2-2
Figure 2.3: Population Growth and U.S. Recessions, 1971-2011.....	2-3
Figure 2.4: Employment Breakdown by Major Sector, 2011.....	2-4
Figure 2.5: Post Recession Employment Growth, June 2009-December 2012.....	2-4
Figure 2.6: Personal Income Breakdown by Major Source, 2011.....	2-5
Figure 2.7: Population Forecast, 2013-2035.....	2-7
Figure 2.8: House Start History and Forecast (2000-2035).....	2-8
Figure 2.9: Annual Growth in Use per Customer 2006 - 2012.....	2-10
Figure 2.10: Area Average Household Size, Historical and Forecast 1990-2035.....	2-12
Figure 2.11: Residential Use per Customer, 2006-2035.....	2-14
Figure 2.12: Avista’s Customer Growth, 1997-2033.....	2-15
Figure 2.13: Native Load History and Forecast, 1997-2035.....	2-16
Figure 2.14: Winter and Summer Peak Demand, 1997-2035.....	2-18
Figure 2.15: Load Growth Scenarios, 2014-2035.....	2-19
Figure 2.16: 15 kW Photovoltaic Installation in Rathdrum, ID.....	2-20
Figure 2.17: Buck-A-Block Customer and Demand Growth.....	2-20
Figure 2.18: Net Metering Customers	2-21
Figure 2.19: Solar Energy Transfer Payments	2-22
Figure 2.20: 2020 Market Reliance & Capacity Cost Tradeoffs to Achieve 5 Percent LOLP ...	2-33
Figure 2.21: Winter 1 Hour Capacity Load and Resources.....	2-34
Figure 2.22: Summer 18-Hour Capacity Load and Resources	2-35
Figure 2.23: Annual Average Energy Load and Resources.....	2-36
Figure 3.1: Historical and Forecast Conservation Acquisition (system).....	3-2
Figure 3.2: Analysis Approach Overview	3-4
Figure 3.3: Cumulative Conservation Potentials, Selected Years.....	3-7
Figure 5.1: Avista Transmission Map	5-5
Figure 5.2: Spokane’s 9 th and Central Feeder (9CE12F4) Outage History.....	5-10
Figure 6.1: Solar’s Effect on California Load.....	6-7
Figure 6.2: New Resource Levelized Costs (first 20 Years)	6-14
Figure 6.3: Historical and Planned Hydro Upgrades	6-16
Figure 7.1: NERC Interconnection Map	7-2
Figure 7.2: 20-Year Annual Average Western Interconnect Energy	7-3
Figure 7.3: Resource Retirements (Nameplate Capacity)	7-5
Figure 7.4: Cumulative Generation Resource Additions (Nameplate Capacity).....	7-6
Figure 7.5: Henry Hub Natural Gas Price Forecast.....	7-8
Figure 7.6: Northwest Expected Energy.....	7-11
Figure 7.7: Regional Wind Expected Capacity Factors.....	7-12
Figure 7.8: Historical Stanfield Natural Gas Prices (2004-2012)	7-13
Figure 7.9: Stanfield Annual Average Natural Gas Price Distribution	7-14
Figure 7.10: Stanfield Natural Gas Distributions	7-14
Figure 7.11: Wind Model Output for the Northwest Region	7-18
Figure 7.12: 2012 Actual Wind Output BPA Balancing Authority.....	7-19

Table of Contents

Figure 7.13: Mid-Columbia Electric Price Forecast Range	7-21
Figure 7.14: Western States Greenhouse Gas Emissions.....	7-23
Figure 7.15: Base Case Western Interconnect Resource Mix	7-24
Figure 7.16: Mid-Columbia Prices Comparison with and without Coal Plant Retirements	7-25
Figure 7.17: Western U.S. Carbon Emissions Comparison	7-26
Figure 7.18: Greenhouse Gas Pricing Scenarios.....	7-27
Figure 7.19: Nominal Mid-Columbia Prices for Alternative Greenhouse Gas Policies	7-27
Figure 7.20: Annual Greenhouse Gas Emissions for Alternative Greenhouse Gas Policies.....	7-28
Figure 7.21: Annual Natural Gas Price Forecast Scenarios	7-29
Figure 7.22: Natural Gas Price Scenario's Mid-Columbia Price Forecasts.....	7-29
Figure 7.23: Implied Market Heat Rate Changes	7-30
Figure 7.24: Changes to Mid-Columbia Prices and Western US Greenhouse Gas Levels	7-31
Figure 8.1: Resource Acquisition History	8-2
Figure 8.2: Conceptual Efficient Frontier Curve	8-4
Figure 8.3: Physical Resource Positions (Includes Energy Efficiency).....	8-6
Figure 8.4: REC Requirements vs. Qualifying RECs for Washington State EIA	8-7
Figure 8.5: Energy Efficiency Annual Expected Acquisition.....	8-10
Figure 8.6: Load Forecast with/without Energy Efficiency.....	8-10
Figure 8.7: Avista Owned and Controlled Resource's Greenhouse Gas Emissions	8-12
Figure 8.8: Power Supply Expense Range	8-14
Figure 8.9: Real Power Supply Expected Rate Growth Index \$/MWh (2012 = 100)	8-15
Figure 8.10: Expected Case Efficient Frontier.....	8-18
Figure 8.11: Efficient Frontier Comparison.....	8-23
Figure 8.12: Efficient Frontier Comparison.....	8-25
Figure 8.13: 2018-33 Power Supply Costs with and without Colstrip Units 3 and 4	8-27
Figure 8.14: Greenhouse Gas Emissions without Colstrip Units 3 and 4	8-28
Figure 8.15: Change to Power Supply Cost without Colstrip	8-28
Figure 8.16: Change to Power Supply Cost without Colstrip	8-29
Figure 8.17: Annual Levelized Cost (2027-33) of Colstrip Scenarios	8-31
Figure 8.18: Load Growth Scenario's Cost/Risk Comparison	8-35
Figure 8.19: Resource Specific Scenarios	8-37

Table of Tables

Table 1: The 2013 Preferred Resource Strategy	v
Table 2: The 2011 Preferred Resource Strategy	vii
Table 1.1: TAC Meeting Dates and Agenda Items	1-2
Table 1.2: External Technical Advisory Committee Participating Organizations	1-3
Table 1.3 Idaho IRP Requirements	1-6
Table 1.4 Washington IRP Rules and Requirements	1-6
Table 2.1: U.S. Long-run Baseline Forecast Assumptions, 2013-2035	2-6
Table 2.2: Avista WA-ID MSAs Baseline Forecast Assumptions, 2013-2035	2-6
Table 2.3: Customer Growth Correlations, January 2006-December 2012	2-14
Table 2.4: Average Day Spokane Temperatures 1890-2012 (Degrees Fahrenheit)	2-17
Table 2.5: Avista-Owned Hydro Resources	2-25
Table 2.6: Avista-Owned Thermal Resources	2-27
Table 2.7: Mid-Columbia Capacity and Energy Contracts	2-28
Table 2.8: PURPA Agreements	2-29
Table 2.9: Other Contractual Rights and Obligations	2-30
Table 2.10: Regional Load & Resource Balance	2-32
Table 2.11: Washington State RPS Detail (aMW)	2-38
Table 2.12: Winter 18-Hour Capacity Position (MW)	2-39
Table 2.13: Summer 18-Hour Capacity Position (MW)	2-40
Table 2.14: Average Annual Energy Position (aMW)	2-41
Table 3.1: Cumulative Potential Savings (Across All Sectors for Selected Years)	3-7
Table 3.2: Annual Achievable Potential Energy Efficiency (aMW)	3-8
Table 5.1: IRP Requested Transmission Upgrade Studies	5-7
Table 5.2: Third-Party Large Generation Interconnection Requests	5-8
Table 5.3: Completed Feeder Rebuilds	5-9
Table 5.4: Planned Feeder Rebuilds	5-10
Table 6.1: Natural Gas Fired Plant Cost and Operational Characteristics	6-5
Table 6.2: Natural Gas-Fired Plant Levelized Costs per MWh	6-5
Table 6.4: Northwest Wind Project Levelized Costs per MWh	6-6
Table 6.4: Solar Nominal Levelized Cost (\$/MWh)	6-8
Table 6.5: Coal Capital Costs	6-9
Table 6.6: Coal Project Levelized Cost per MWh	6-9
Table 6.7: Other Resource Options Levelized Costs (\$/MWh)	6-13
Table 6.8: New Resource Levelized Costs Considered in PRS Analysis	6-15
Table 6.9: New Resource Levelized Costs Not Considered in PRS Analysis	6-15
Table 6.10: Hydro Upgrade Option Costs and Benefits	6-18
Table 7.1: AURORA ^{XMP} Zones	7-2
Table 7.2: Western Interconnect Transmission Upgrades Included in Analysis	7-4
Table 7.3: Natural Gas Price Basin Differentials from Henry Hub	7-9
Table 7.4: Monthly Price Differentials for Stanfield from Henry Hub	7-9
Table 7.5: January through June Load Area Correlations	7-15
Table 7.6: July through December Load Area Correlations	7-16
Table 7.7: Area Load Coefficient of Determination (Standard Deviation/Mean)	7-16
Table 7.8: Area Load Coefficient of Determination (Standard Deviation/Mean)	7-16
Table 7.9: Expected Capacity factor by Region	7-18
Table 7.10: Annual Average Mid-Columbia Electric Prices (\$/MWh)	7-22
Table 8.1: Qualifying Washington EIA Resources	8-7
Table 8.2: 2013 Preferred Resource Strategy	8-8
Table 8.3: 2011 Preferred Resource Strategy	8-9
Table 8.4: PRS Rate Base Additions from Capital Expenditures	8-13
Table 8.5: Avista Medium-Term Winter Peak Hour Capacity Tabulation	8-16
Table 8.6: Avista Medium-Term Summer 18-Hour Sustained Peak Capacity Tabulation	8-16
Table 8.7: Efficient Frontier Sample Resource Mixes	8-18

Table of Contents

Table 8.8: Nominal Levelized Avoided Costs of the PRS (\$/MWh)	8-20
Table 8.9: Updated Annual Avoided Costs (\$/MWh).....	8-21
Table 8.10: Alternative PRS with National Climate Change Legislation	8-22
Table 8.11: Preferred Portfolio Cost and Risk Comparison (Millions \$).....	8-23
Table 8.12: Preferred Portfolio Cost and Risk Comparison for Avoided Cost Studies	8-25
Table 8.13: No Colstrip Resource Strategy Scenario.....	8-26
Table 8.14: Policy Portfolio Scenarios.....	8-33
Table 8.15: Load Growth Sensitivities	8-35
Table 8.16: Winter 1 Hour Capacity Position (MW) with New Resources.....	8-38
Table 8.16: Summer 18-Hour Capacity Position (MW) with New Resources	8-39
Table 8.17: Average Annual Energy Position (aMW) With New Resources	8-40

2013 Electric IRP Introduction

Avista has a long tradition of innovation as a provider of a safe, reliable, low-cost, and clean, mix of generation resources. The 2013 Integrated Resource Plan (IRP) continues this legacy by looking into the future energy needs of our customers. The IRP analyzes and outlines a strategy to meet projected demand and renewable portfolio standards through energy efficiency and a careful mix of new renewable and traditional energy resources.

Avista currently projects having adequate resources, between owned and contractually controlled generation, to meet our customers' needs until 2020. Plant upgrades, energy efficiency measures and in the longer term additional natural gas-fired generation are integral parts of Avista's 2013 IRP resource strategy.

Two significant changes from the 2011 IRP should be noted:

- The 2011 IRP recommendations for new renewable resources have been met with a 30-year purchased power agreement with Palouse Wind, and the Kettle Falls Generating Station being qualified as a renewable energy resource under Washington state's Energy Independence Act; and
- Load growth is expected to be at just over 1 percent, a decline from the growth of 1.6 percent forecast in 2011. This delays the need for a new natural gas-fired resource by one year.

Each IRP is a thoroughly researched and data-driven document to guide responsible resource planning for the company. The IRP is updated every two years and looks 20 years into the future. This plan is developed by Avista's professional energy analysts using sophisticated modeling tools and with input from interested community, educational and state utility commission stakeholders.

The plan's Preferred Resource Strategy (PRS) section covers Avista's projected resource acquisitions over the next 20 years.

Some highlights of the 2013 PRS include:

- Demand response (temporarily reducing the demand for energy) is included in the PRS for the first time and could provide 19 MW of peak energy reduction in the 2022 – 2027 timeframe.
- Energy efficiency (using less energy to perform activities) reduces load growth by 42 percent over the next 20 years.
- 486 MW of additional clean-burning natural gas-fired generation facilities are required between 2020 and 2033.
- Transmission upgrades will be needed to carry the output from new generation. Avista will continue to participate in regional efforts to expand the region's transmission system.

This document is mostly technical in nature. The IRP has an Executive Summary and chapter highlights at the beginning of each section to help guide the reader. Avista expects to begin developing the 2015 IRP in early 2014. Stakeholder involvement is encouraged and interested parties may contact John Lyons at 509-495-8515 or john.lyons@avistacorp.com for more information on participating in the IRP process.

Executive Summary

Avista Corporation’s 2013 Electric Integrated Resource Plan (IRP) guides its resource strategy over the next two years and directs resource procurements over the 20-year plan. It provides a snapshot of Avista’s resources and loads and guides future resource acquisitions over a range of expected and possible future conditions. The 2013 Preferred Resource Strategy (PRS) includes energy efficiency, upgrades at existing generation and distribution facilities, demand response and new gas-fired generation.

The PRS balances cost, reliability, rate volatility, and renewable resource requirements. Avista’s management and the Technical Advisory Committee (TAC) guide the development of the PRS and the IRP by providing significant input on modeling and planning assumptions. TAC members include customers, commission staff, the Northwest Power and Conservation Council, consumer advocates, academics, utility peers, government agencies, and interested internal parties.

Resource Needs

Avista’s peak planning methodology includes operating reserves, regulation, load following, wind integration and a planning margin. Avista currently projects having adequate resources between owned and contractually controlled generation to meet annual physical energy and capacity needs until 2020. Chapter 2 explains the peak planning methodology. See Figures 1 – 3 for Avista’s physical resource positions for winter capacity, summer capacity, and annual energy load and resource balances.

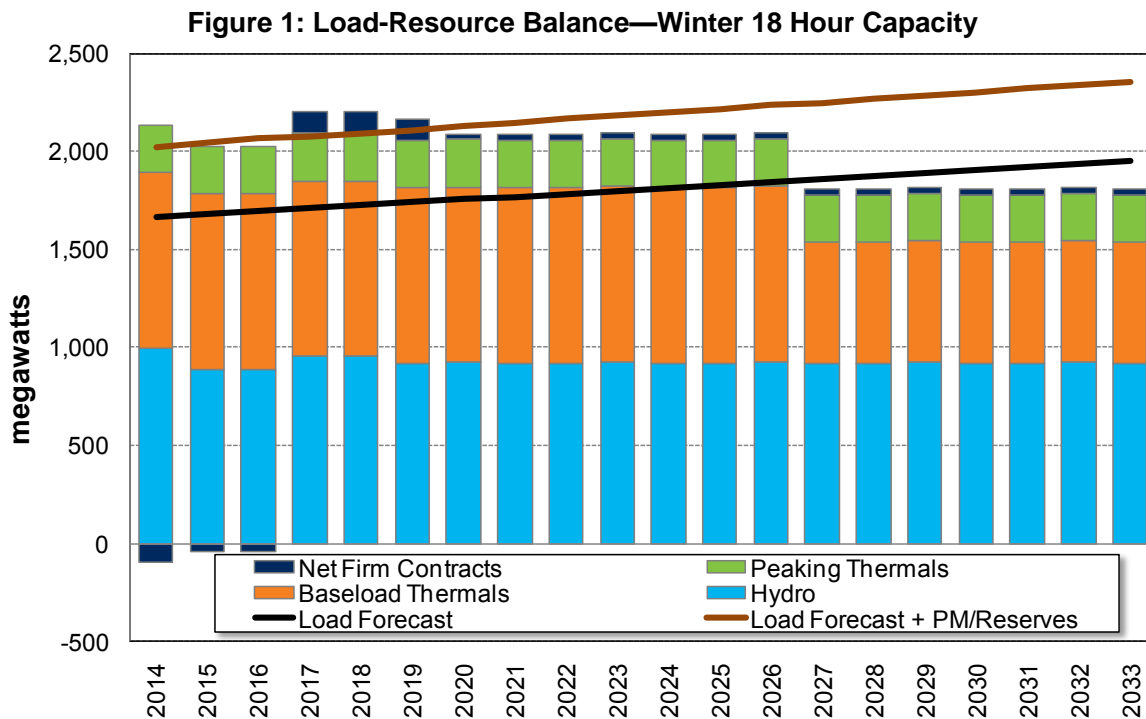

Figure 2: Load-Resource Balance—Summer 18 Hour Capacity

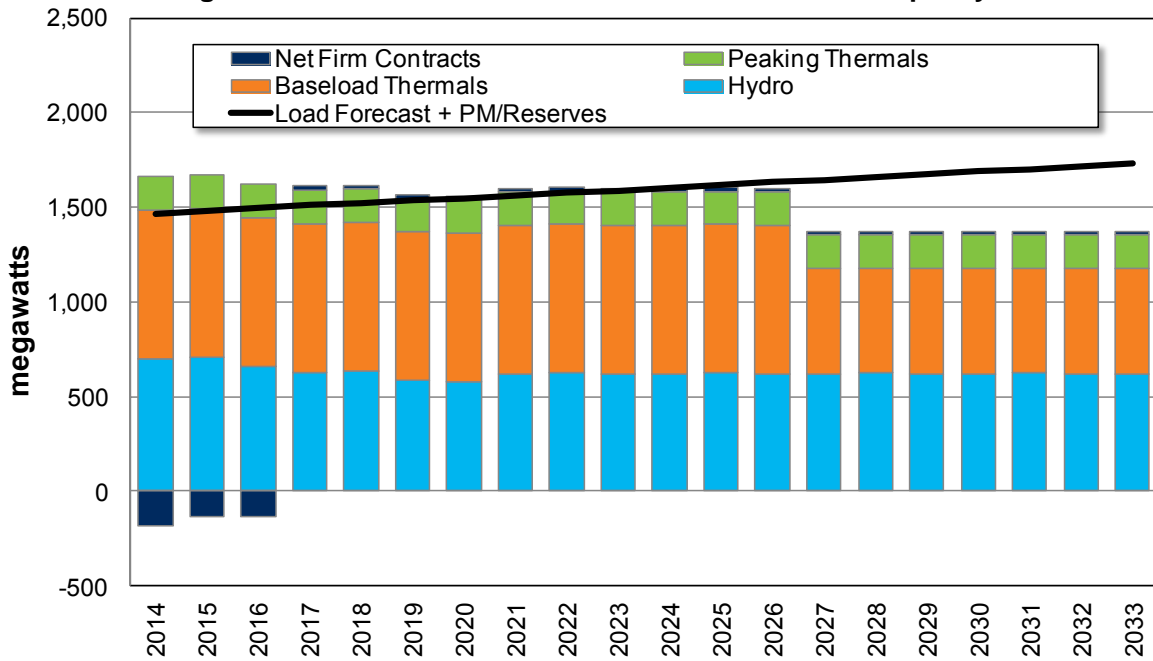
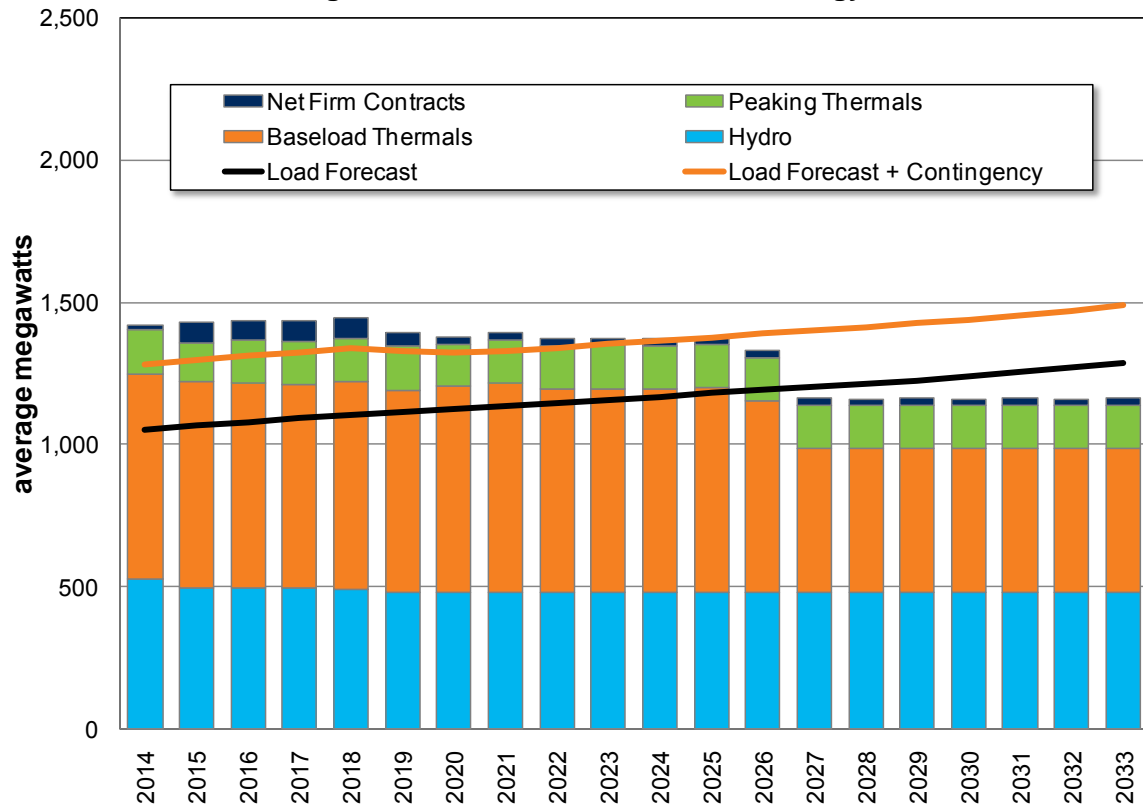

Figure 3: Load-Resource Balance—Energy



Figures 1 – 3 include the effects of new energy efficiency programs on the load forecast. Absent energy efficiency, Avista would be resource deficient earlier. The region has a significant summer capacity surplus; Avista plans to meet all summer capacity needs with term purchases. A short-term capacity need exists in the winters of 2014/15 and 2015/16. This capacity need is short-lived because a 150 MW capacity sale contract ends in 2016. Avista expects to address these short-term deficits with market purchases; therefore, the first long-term capacity deficit begins in 2020.

Modeling and Results

Avista uses a multiple-step approach to develop its PRS. It begins by identifying and quantifying potential new generation resources to serve projected electricity demand across the West. A Western Interconnect-wide study explains the impact of regional markets on the Northwest electricity marketplace. Avista then maps its existing resources to the present transmission grid configuration in a model simulating hourly operations for the Western Interconnect from 2014 to 2033. The model adds cost-effective new resources and transmission across the Western Interconnect to meet overall projected loads. Monte Carlo-style analysis varies hydroelectric and wind generation, loads, forced outages and natural gas price data over 500 iterations of potential future market conditions. The simulation estimates Mid-Columbia electricity market prices by iteration and the results of the 500 iterations form the Expected Case.

Electricity and Natural Gas Market Forecasts

Figure 4 shows the 2013 IRP electricity price forecast for the Expected Case, including the price range over the 500 Monte Carlo iterations. The forecasted levelized average Mid-Columbia market price is \$44.08 per MWh in nominal dollars over 20 years.

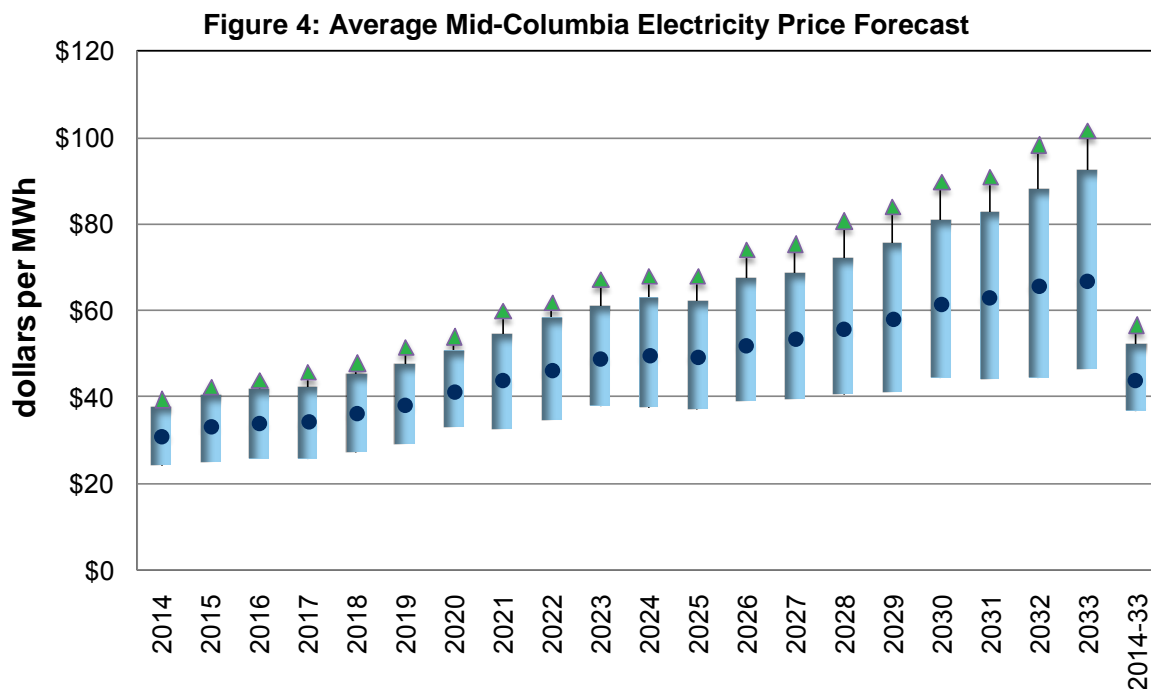

Electricity and natural gas prices are highly correlated because natural gas fuels marginal generation in the Northwest during most of the year. Figure 5 presents nominal levelized Expected Case natural gas prices at the Stanfield trading hub, located in northeastern Oregon, as well as the forecast range from the 500 Monte Carlo iterations performed for the case. The average is \$5.40 per dekatherm over the next 20 years. See Chapter 7 for details on the company's natural gas price forecast.

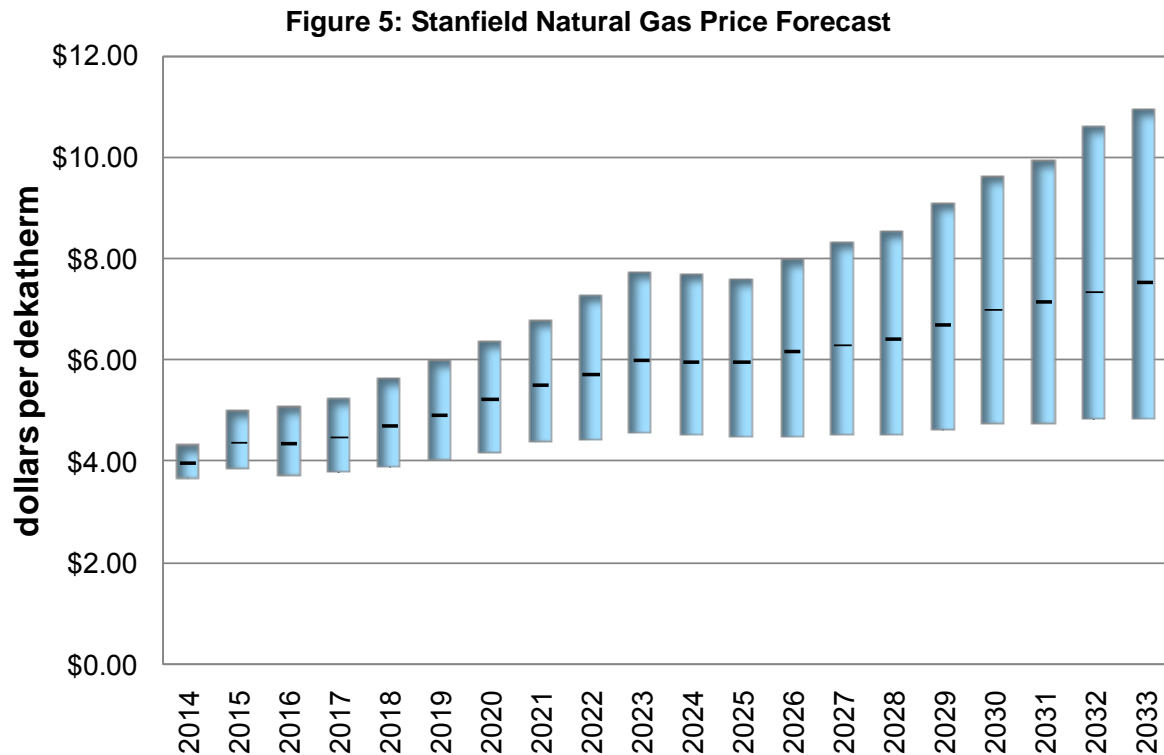

Energy Efficiency Acquisition

Avista commissioned a 20-year Conservation Potential Assessment in 2013. The study analyzed over 4,300 energy efficiency equipment and measure options for residential, commercial, and industrial applications. Data from this study formed the basis of the IRP conservation potential evaluations. Figure 6 shows how historical efforts in energy efficiency decrease Avista's energy requirements by 125 aMW, or approximately ten percent. By 2033, energy efficiency reduces load by 164 aMW. More detail about Avista's energy efficiency programs is contained in Chapter 3.

Figure 6: Cumulative Energy Efficiency Acquisitions

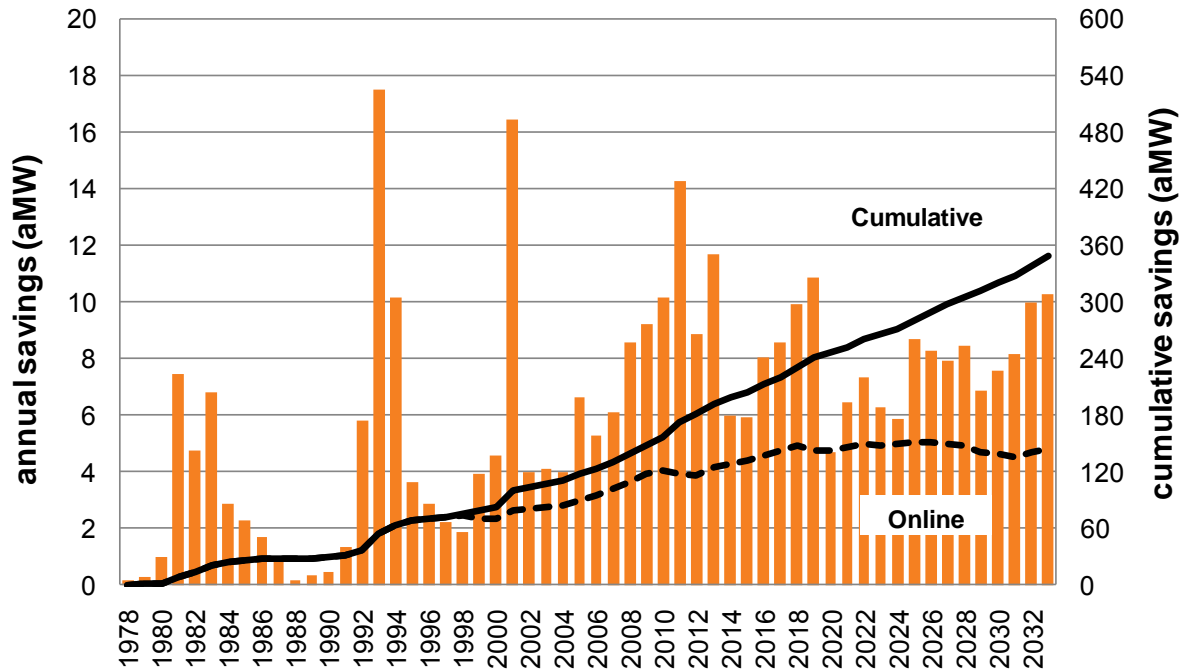

Preferred Resource Strategy

The PRS includes careful consideration by Avista’s management and the TAC of the information gathered and analyzed in the IRP process. It meets future load growth with efficiency upgrades at existing generation and distribution facilities, conservation, wind, and natural gas-fired technologies as shown in Table 1.

Table 1: The 2013 Preferred Resource Strategy

Resource	By the End of Year	Nameplate (MW)	Energy (aMW)
Simple Cycle CT	2019	83	76
Simple Cycle CT	2023	83	76
Combined Cycle CT	2026	270	248
Rathdrum CT Upgrade	2028	6	5
Simple Cycle CT	2032	50	46
Total		492	451
Efficiency Improvements	Acquisition Range	Peak Reduction	Energy (aMW)
Energy Efficiency	2014-2033	221	164
Demand Response	2022-2027	19	0
Distribution Efficiencies	2014-2017	<1	<1
Total		240	164

The 2013 PRS describes a reasonable low-cost plan along the efficient frontier of potential resource portfolios accounting for fuel supply risk and price risk. Major changes from the 2011 PRS include reduced contributions from conservation, wind, and

natural gas-fired resources. For the first time the PRS includes a modest contribution from demand response.

Each new resource and energy efficiency option is valued against the Expected Case Mid-Columbia electricity market to identify its future value to Avista, as well as its inherent risk measured by year-to-year portfolio cost volatility. These values, and their associated capital and fixed operation and maintenance (O&M) costs, form the input into Avista’s Preferred Resource Strategy Linear Programming Model (PRiSM). PRiSM assists Avista by developing optimal mixes of new resources along an efficient frontier. Chapter 8 provides a detailed discussion of the efficient frontier concept.

The PRS provides a “least reasonable cost” portfolio that minimizes future costs and risks given actual or expected environmental constraints. An efficient frontier helps determine the tradeoffs between risk and cost. The approach is similar to finding an optimal mix of risk and return in an investment portfolio. As expected returns increase, so do risks. Reducing risk reduces overall returns. There is a trade-off between power supply costs and power supply cost variability. Figure 7 presents the change in cost and risk from the PRS on the Efficient Frontier. Lower power cost variability comes from investments in more expensive, but less risky, resources. The PRS selection is the location on the efficient frontier where reduced risk justifies the increased cost.

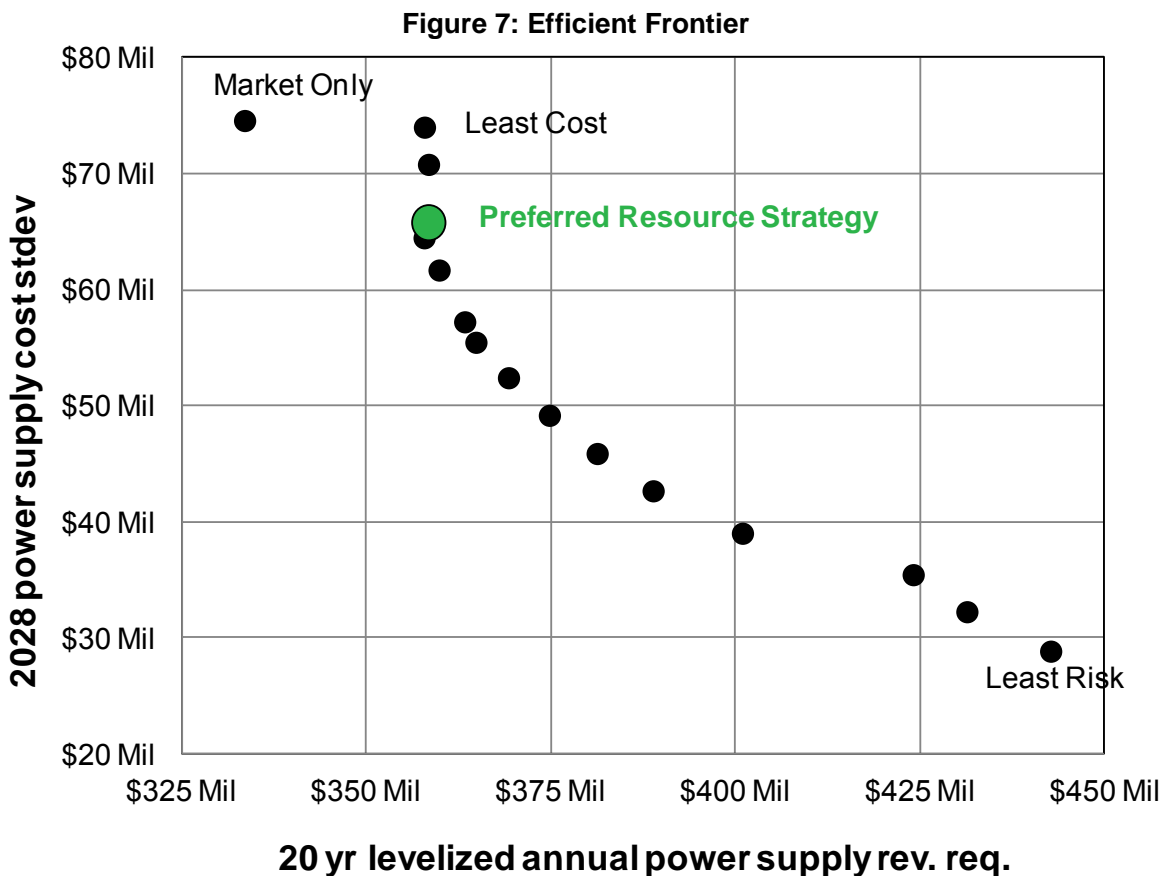

The IRP includes several scenarios to identify tipping points where the PRS could change under conditions alternative to the Expected Case. Chapter 8 includes scenarios for load growth, capital costs, higher energy efficiency acquisitions, and greenhouse gas policies.

The 2013 PRS is significantly different from the 2011 IRP resource strategy; the 2011 PRS is in Table 2. Since the prior plan, Avista's renewable and capacity needs have changed. Adding Palouse Wind to Avista's resource mix in December 2012 satisfied the 2012 Northwest Wind component of the 2011 PRS. Changes in the Washington State Energy Independence Act (EIA) eliminated the need for a 2019/2020 wind resource. The amendment under SB 5575 adds the Kettle Falls Generating Station, and other legacy biomass plants, as EIA qualifying resources beginning in 2016. The 2011 IRP forecast 1.6 percent annual load growth, while this IRP forecasts just over 1 percent growth (see Chapter 2). Lower expected load growth delays the first natural gas-fired resource need by one year and eliminates the need for a combined cycle combustion turbine in 2023.

Table 2: The 2011 Preferred Resource Strategy

Resource	By the End of Year	Nameplate (MW)	Energy (aMW)
Northwest Wind	2012	120	35
Simple Cycle CT	2018	83	75
Existing Thermal Resource Upgrades	2019	4	3
Northwest Wind	2019-2020	120	35
Simple Cycle CT	2020	83	75
Combined Cycle CT	2023	270	237
Combined Cycle CT	2026	270	237
Simple Cycle CT	2029	46	42
Total		996	739
Efficiency Improvements	Acquisition Range	Peak Reduction (MW)	Energy (aMW)
Distribution Efficiencies	2012-2031	28	13
Energy Efficiency	2012-2031	419	310
Total		447	323

Washington voters approved the EIA through Initiative 937 in the November 2006 general election. The EIA requires utilities with over 25,000 customers to meet 3 percent of retail load from qualified renewable resources by 2012, 9 percent by 2016, and 15 percent by 2020. The initiative also requires utilities to acquire all cost-effective conservation and energy efficiency measures.

Avista expects to meet or exceed its renewable energy requirements through the 20-year plan with a combination of qualifying hydroelectric upgrades, the Palouse Wind project, the Kettle Falls Generating Station and selective renewable energy certificate (REC) purchases. A list of the qualifying generation projects and the associated

expected output is in Table 8 below. The flexibility of I-937 to use RECs from the current year, from the previous year, or from the following year for compliance helps Avista mitigate year-to-year variability in the output of qualifying renewable resources.

Figure 8: Avista's Qualifying Renewables for Washington State's EIA

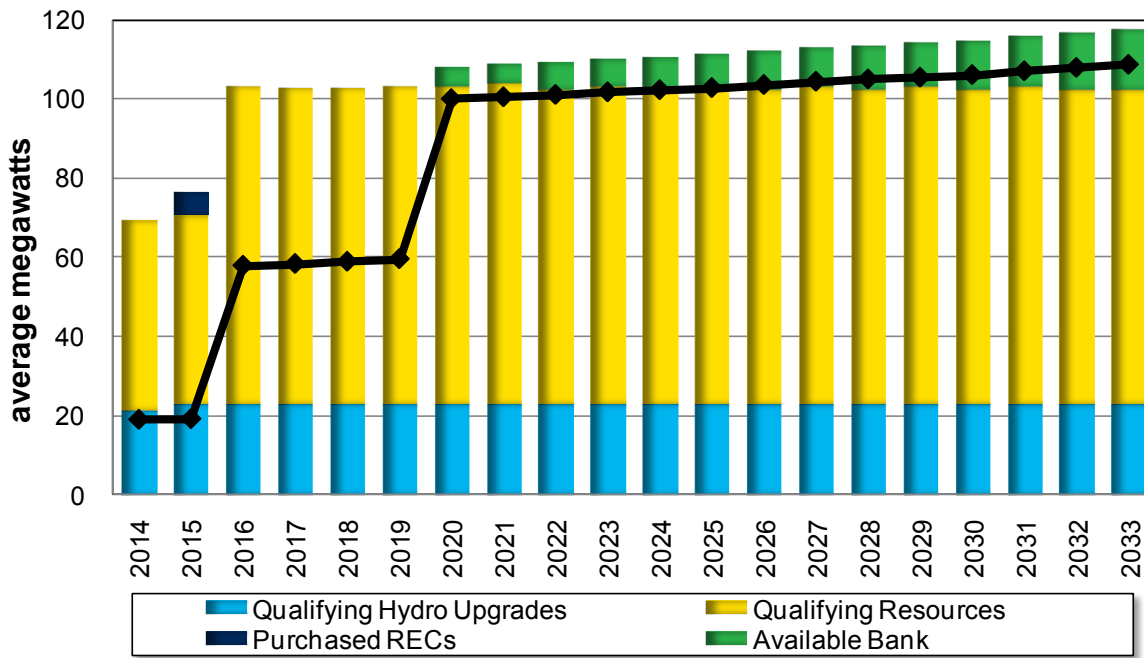

Greenhouse Gas Emissions

Forecasts of greenhouse gas emissions costs have been included as part of Avista's Expected Case since the 2007 IRP. Based on current legislative priorities and the President's Climate Action Plan, a national greenhouse gas cap-and-trade system or tax is no longer likely. Therefore, the Expected Case does not include a market or tax solution to reduce emissions. Instead, because the states and the EPA are implementing regulatory models limiting emissions for new facilities, and requiring current facilities to either implement best available control technologies or shut down, this IRP forecasts significant numbers of plant retirements to meet these environmental rules. Figure 9 shows projected greenhouse gas emissions for existing and new Avista generation assets, but it does not account for emissions from market purchases or sales. While Avista's emissions increase modestly, western region emissions fall from historic levels as less-cost-effective coal and older natural gas-fired plants retire (see Figure 10). Avista does not follow this overall trajectory because the carbon intensity of its portfolio already is relatively low. More details about state and federal greenhouse gas policies are in chapter 4.

Figure 9: Avista Owned and Controlled Resource's Greenhouse Gas Emissions

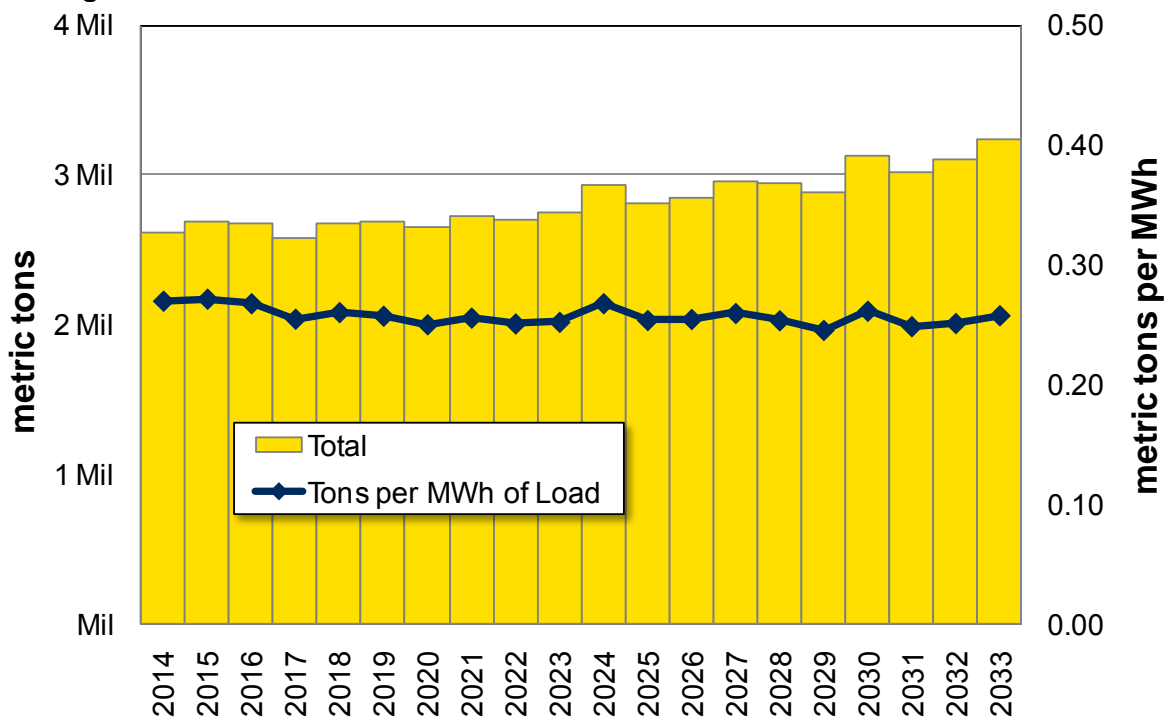
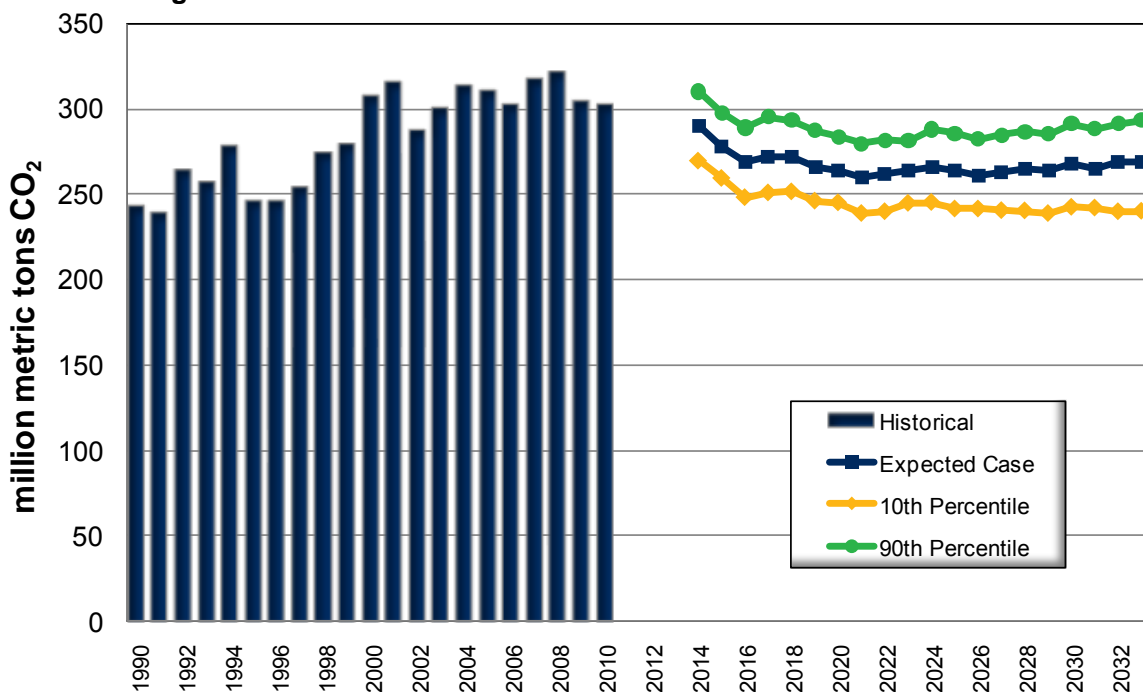

Figure 10: U.S. Western Interconnect Greenhouse Gas Emissions



Action Items

The 2013 Action Plan updates progress on the 2011 Action Items and outlines activities Avista intends to perform for the 2015 IRP. It includes input from Commission Staff, Avista's management team, and the TAC. Action Item categories include resource additions and analysis, demand side management, environmental policy, modeling and forecasting enhancements, and transmission planning. Chapter 9 and discusses the new Action Items.

1. Introduction and Stakeholder Involvement

Avista submits an IRP to the Idaho and Washington public utility commissions biennially.¹ The 2013 IRP is Avista's thirteenth plan. It identifies and describes a PRS for meeting load growth while balancing cost and risk measures with environmental mandates.

Avista is statutorily obligated to provide reliable electricity service to its customers at rates, terms, and conditions that are fair, just, reasonable, and sufficient. Avista assesses different resource acquisition strategies and business plans to acquire resources to meet resource adequacy requirements and optimize the value of its current resource portfolio. The IRP is a resource evaluation tool rather than a plan for acquiring a particular set of assets. The 2013 IRP continues refining Avista's resource acquisition efforts.

IRP Process

The 2013 IRP is developed and written with the aid of a public process. Avista actively seeks input for its IRPs from a variety of constituents through the TAC. The TAC is 75 participants including Commission Staff from Idaho and Washington, customers, academics, government agencies, consultants, utilities, and other interested parties who accepted an invitation to join, or had asked to be involved in, the planning process.

Avista sponsored six TAC meetings for the 2013 IRP. The first meeting was on May 23, 2012, and the last was on June 19, 2013. TAC meetings cover different aspects of the 2013 IRP planning activities and solicited contributions to, and assessments of, modeling assumptions, modeling processes, and results. Table 1.1 contains a list of TAC meeting dates and the agenda items covered in each meeting.

Agendas and presentations from the TAC meetings are in Appendix A and on Avista's website at <http://www.avistautilities.com/inside/resources/irp/electric>. Past IRPs and TAC presentations are also here.

¹ Washington IRP requirements are contained in WAC 480-100-238 Integrated Resource Planning. Idaho IRP requirements are in Case No. U-1500-165 Order No. 22299, Case No. GNR-E-93-1, Order No. 24729, and Case No. GNR-E-93-3, Order No. 25260.

Chapter 1- Introduction and Stakeholder Involvement

Table 1.1: TAC Meeting Dates and Agenda Items

Meeting Date	Agenda Items
TAC 1 – May 23, 2012	<ul style="list-style-type: none"> • Powering our Future Game • 2011 Renewable RFP • Palouse Wind Project Update • 2011 IRP Acknowledgement • Energy Independence Act Compliance and Forecast • Work Plan
TAC 2 – September 4 and 5, 2012	<ul style="list-style-type: none"> • Palouse Wind Project Tour • Avista REC Planning Methods • Energy and Economic Forecast • Shared Value Report • Generation Options • Spokane River Assessment
TAC 3 – November 7, 2012	<ul style="list-style-type: none"> • Electricity Market Modeling • Colstrip Discussion • Energy Efficiency • Peak Load Forecast • Reliability Planning • Energy Storage
TAC 4 – February 6, 2013	<ul style="list-style-type: none"> • Natural Gas Price Forecast • Electric Price Forecast • Transmission Planning • Resource Needs Assessment • Market & Portfolio Scenario Development
TAC 5 – March 20, 2013	<ul style="list-style-type: none"> • Market Forecast Scenario Results • Conservation Avoided Costs • Demand Response • Draft 2013 IRP Preferred Resource Strategy • Portfolio Scenarios
TAC 6 – June 19, 2013	<ul style="list-style-type: none"> • 2013 Final Preferred Resource Strategy • Portfolio Scenario Analysis • Net Metering and Buck-A-Block • Action Plan • 2013 IRP Document Introduction

Avista wishes to acknowledge and thank all of the organizations identified in Table 1.2 who participated in the TAC process.

Table 1.2: External Technical Advisory Committee Participating Organizations

Organization
AES Corporation
Alexander Boats, LLC
Ameresco Quantum
City of Spokane
Clearwater Paper
Eastern Washington University
EnerNOC Utility Solutions
Eugene Water & Electric Board
First Wind
GE Energy
Gonzaga University
Grant PUD
Greater Spokane Incorporated
Idaho Power
Idaho Public Utilities Commission
Inland Power & Light
Puget Sound Energy
Residential and Small Commercial Customers
Sierra Club
TransAlta
Washington Department of Enterprise Services
Washington State Legislature
Washington Utilities and Transportation Commission
Winfiniti

Issue Specific Public Involvement Activities

In addition to the TAC meetings, Avista sponsors and participates in several other collaborative processes involving a range of public interests.

External Energy Efficiency (“Triple E”) Board

The Triple E Board, formed in 1995, provides stakeholders and public groups biannual opportunities to discuss Avista’s energy efficiency efforts. The Triple E Board grew out of the DSM Issues group.

FERC Hydro Relicensing – Clark Fork and Spokane River Projects

Over 50 stakeholder groups participated in the Clark Fork hydro-relicensing process beginning in 1993. This led to the first all-party settlement filed with a FERC relicensing application, and eventual issuance of a 45-year FERC operating license in February 2003. This collaborative process continues in the implementation of the license and Clark Fork Settlement Agreement, with stakeholders participating in various protection, mitigation, and enhancement efforts. More recently, Avista received a 50-year license for the Spokane River Project following a multi-year collaborative process involving

Chapter 1- Introduction and Stakeholder Involvement

several hundred stakeholders. Implementation began in 2009 with a variety of collaborating parties.

Low Income Rate Assistance Program

This program is coordinated with four community action agencies in Avista's Washington service territory. The program began in 2001 and reviews administrative issues and needs on a quarterly basis.

Regional Planning

The Pacific Northwest's generation and transmission system operates in a coordinated fashion. Avista participates in the efforts of many organization's planning processes. Information from this participation supplements Avista's IRP process. Some of the organizations that Avista participates in are:

- Western Electricity Coordinating Council
- Northwest Power and Conservation Council
- Northwest Power Pool
- Pacific Northwest Utilities Conference Committee
- ColumbiaGrid
- Northwest Transmission Assessment Committee
- North American Electric Reliability Council

Future Public Involvement

As previously explained, Avista actively solicits input from interested parties to enhance its IRP process. We continue to expand TAC membership and diversity, and maintain the TAC meetings as an open public process.

2013 IRP Outline

The 2013 IRP consists of nine chapters plus an executive summary and this introduction. A series of technical appendices supplement this report.

Executive Summary

This chapter summarizes the overall results and highlights of the 2013 IRP.

Chapter 1: Introduction and Stakeholder Involvement

This chapter introduces the IRP and details public participation and involvement in the integrated resource planning process.

Chapter 2: Loads and Resources

The first half of this chapter covers Avista's load forecast and related local economic forecasts. The last half describes Avista's owned generating resources, major contractual rights and obligations, capacity, energy and renewable energy credit tabulations, and reserve obligations.

Chapter 1- Introduction and Stakeholder Involvement

Chapter 3: Energy Efficiency

This chapter discusses Avista's energy efficiency programs. It provides an overview of the conservation potential assessment and summarizes the energy efficiency modeling results for the 2013 IRP.

Chapter 4: Policy Considerations

This chapter focuses on some of the major policy issues for resource planning, including state and federal greenhouse gas policies and environmental regulations.

Chapter 5: Transmission & Distribution

This chapter discusses Avista's distribution and transmission systems, as well as regional transmission planning issues. It includes detail on transmission cost studies used in the IRP modeling and a summary of the 10-year Transmission Plan. The chapter finishes with a discussion of Avista's distribution efficiency and grid modernization projects.

Chapter 6: Generation Resource Options

This chapter covers the costs and operating characteristics of the generation resource options modeled for the 2013 IRP.

Chapter 7: Market Analysis

This chapter details Avista's IRP modeling and analysis of the various wholesale markets applicable to the 2013 IRP.

Chapter 8: Preferred Resource Strategy

This chapter details Avista's 2013 Preferred Resource Strategy (PRS) and explains how the PRS could change in response to scenarios differing from the Expected Case.

Chapter 9: Action Items

This chapter discusses progress made on Action Items from the 2011 IRP. It details new Action Items for the 2015 IRP.

Regulatory Requirements

The IRP process for Idaho has several requirements documented in IPUC Orders Nos. 22299 and 24729. Table 1.3 summarizes the applicable IRP requirements.

Chapter 1- Introduction and Stakeholder Involvement

Table 1.3 Idaho IRP Requirements

Requirement	Plan Citation
Identify and list relevant operating characteristics of existing resources by categories including: hydroelectric, coal-fired, oil or gas-fired, PURPA (by type), exchanges, contracts, transmission resources, and others.	Chapter 2- Loads & Resources
Identify and discuss the 20-year load forecast plus scenarios for the different customer classes. Identify the assumptions and models used to develop the load forecast.	Chapter 2- Loads & Resources Chapter 8- Preferred Resource Strategy
Identify the utility's plan to meet load over the 20-year planning horizon. Include costs and risks of the plan under a range of plausible scenarios.	Chapter 8- Preferred Resource Strategy
Identify energy efficiency resources and costs.	Chapter 3- Energy Efficiency
Provide opportunities for public participation and involvement.	Chapter 1- Introduction and Stakeholder Involvement

The IRP process for Washington has several requirements documented in Washington Administrative Code (WAC). Table 1.4 summarizes where within the IRP the applicable WACs are addressed.

Table 1.4 Washington IRP Rules and Requirements

Rule and Requirement	Plan Citation
WAC 480-100-238(4) – Work plan filed no later than 12 months before next IRP due date. Work plan outlines content of IRP. Work plan outlines method for assessing potential resources.	Work plan submitted to the UTC on August 31, 2012; see Appendix B for a copy of the Work Plan.
WAC 480-100-238(5) – Work plan outlines timing and extent of public participation.	Appendix B
WAC 480-100-238(2)(a) – Plan describes mix of energy supply resources.	Chapter 6- Generation Resource Options
WAC 480-100-238(2)(a) – Plan describes conservation supply.	Chapter 3- Energy Efficiency
WAC 480-100-238(2)(a) – Plan addresses supply in terms of current and future needs of utility ratepayers.	Chapter 2- Loads & Resources
WAC 480-100-238(2)(b) – Plan uses lowest reasonable cost (LRC) analysis to select mix of resources.	Chapter 8- Preferred Resource Strategy
WAC 480-100-238(2)(b) – LRC analysis considers resource costs.	Chapter 8- Preferred Resource Strategy
WAC 480-100-238(2)(b) – LRC analysis considers market-volatility risks.	Chapter 4- Policy Considerations Chapter 7- Market Analysis Chapter 8- Preferred Resource Strategy
WAC 480-100-238 (2)(b) – LRC analysis considers demand side uncertainties.	Chapter 3- Energy Efficiency Chapter 8- Preferred Resource Strategy
WAC 480-100-238(2)(b) – LRC analysis considers resource dispatchability.	Chapter 6- Generation Resource Options Chapter 7- Market Analysis

Chapter 1- Introduction and Stakeholder Involvement

WAC 480-100-238(2)(b) – LRC analysis considers resource effect on system operation.	Chapter 7- Market Analysis Chapter 8- Preferred Resource Strategy
WAC 480-100-238(2)(b) – LRC analysis considers risks imposed on ratepayers.	Chapter 4- Policy Considerations Chapter 6- Generation Resource Options Chapter 7- Market Analysis Chapter 8- Preferred Resource Strategy
WAC 480-100-238(2)(b) – LRC analysis considers public policies regarding resource preference adopted by Washington state or federal government.	Chapter 2- Loads & Resources Chapter 4- Policy Considerations Chapter 8- Preferred Resource Strategy
WAC 480-100-238(2)(b) – LRC analysis considers cost of risks associated with environmental effects including emissions of carbon dioxide.	Chapter 4- Policy Considerations Chapter 8- Preferred Resource Strategy
WAC 480-100-238(2)(c) – Plan defines conservation as any reduction in electric power consumption that results from increases in the efficiency of energy use, production, or distribution.	Chapter 3- Energy Efficiency Chapter 8- Preferred Resource Strategy
WAC 480-100-238(3)(a) – Plan includes a range of forecasts of future demand.	Chapter 2- Loads & Resources Chapter 8- Preferred Resource Strategy
WAC 480-100-238(3)(a) – Plan develops forecasts using methods that examine the effect of economic forces on the consumption of electricity.	Chapter 2- Loads & Resources Chapter 5- Transmission & Distribution Chapter 8- Preferred Resource Strategy
WAC 480-100-238-(3)(a) – Plan develops forecasts using methods that address changes in the number, type and efficiency of end-uses.	Chapter 2- Loads & Resources Chapter 3- Energy Efficiency Chapter 5- Transmission & Distribution
WAC 480-100-238(3)(b) – Plan includes an assessment of commercially available conservation, including load management.	Chapter 3- Energy Efficiency Chapter 5- Transmission & Distribution
WAC 480-100-238(3)(b) – Plan includes an assessment of currently employed and new policies and programs needed to obtain the conservation improvements.	Chapter 3- Energy Efficiency Chapter 5- Transmission & Distribution
WAC 480-100-238(3)(c) – Plan includes an assessment of a wide range of conventional and commercially available nonconventional generating technologies.	Chapter 6- Generator Resource Options Chapter 8- Preferred Resource Strategy
WAC 480-100-238(3)(d) – Plan includes an assessment of transmission system capability and reliability (as allowed by current law).	Chapter 5- Transmission & Distribution
WAC 480-100-238(3)(e) – Plan includes a comparative evaluation of energy supply resources (including transmission and distribution) and improvements in conservation using LRC.	Chapter 3- Energy Efficiency Chapter 5- Transmission & Distribution
WAC-480-100-238(3)(f) – Demand forecasts and resource evaluations are integrated into the long range plan for resource acquisition.	Chapter 3- Energy Efficiency Chapter 5- Transmission & Distribution Chapter 6- Generator Resource Options Chapter 8- Preferred Resource Strategy

Chapter 1- Introduction and Stakeholder Involvement

WAC 480-100-238(3)(g) – Plan includes a two-year action plan that implements the long range plan.	Chapter 9- Action Items
WAC 480-100-238(3)(h) – Plan includes a progress report on the implementation of the previously filed plan.	Chapter 9- Action Items
WAC 480-100-238(5) – Plan includes description of consultation with commission staff. (Description not required)	Chapter 1- Introduction and Stakeholder Involvement
WAC 480-100-238(5) – Plan includes description of work plan. (Description not required)	Appendix B
WAC 480-107-015(3) – Proposed request for proposals for new capacity needed within three years of the IRP.	Chapter 8- Preferred Resource Strategy

2. Loads & Resources

Introduction & Highlights

An explanation and quantification of Avista's loads and resources are integral to the IRP. The load section of this chapter summarizes customer and load forecasts, load growth scenarios, and enhancements to forecasting models and processes. The resource section of the chapter covers Avista's current resource mix, including descriptions of owned and operated generation, as well as long-term power purchase contracts. The combination of the load forecast and current generation mix show the future resource need to meet energy, peak demand, and renewable energy requirements.

Section Highlights

- The 2013 IRP energy forecast grows 1.0 percent per year, replacing the 1.4 percent annual growth rate in the 2011 IRP.
- Peak load growth is slower than energy growth, at 0.84 percent in the winter and 0.90 percent in the summer.
- Avista's first long-term capacity deficit is in 2020; the first energy deficit is in 2026.
- Palouse Wind became operational December 13, 2012.
- Kettle Falls qualifies for the Washington State Energy Independence Act (EIA) beginning in 2016.
- This IRP meets all EIA mandates over the next 20 years with a combination of qualifying hydro upgrades, Palouse Wind, and Kettle Falls.

Economic Characteristics of Avista's Service Territory

Avista serves electricity customers in most of the urban and suburban areas of 24 counties of eastern Washington and northern Idaho. Figure 2.1 shows Avista's electricity and natural gas service territories. Over 80 percent of Avista's customers are located in three Metropolitan Statistical Areas (MSAs): Spokane MSA (Spokane County, WA), Coeur d'Alene MSA (Kootenai County, ID), and Lewiston, ID-WA MSA (Nez Perce County, ID and Asotin County, WA). The load portion of this chapter focuses on population, employment and personal income for the three MSAs combined.

Figure 2.1: Avista's Service Territory

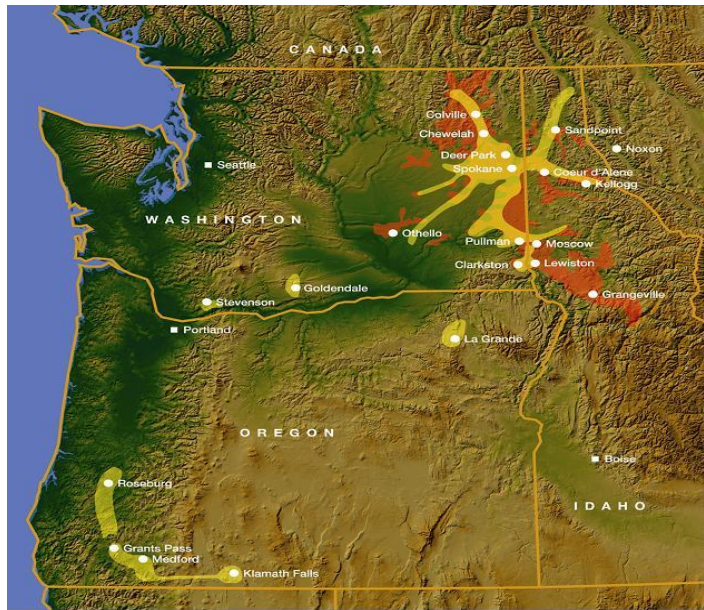

Population across the three MSAs is approximately 680,000. Since 1970, average annual population growth is about 1 percent. Figure 2.2 shows population in the three main MSAs. The Coeur d'Alene MSA has enjoyed the most rapid population growth since the early 1990s, increasing its share of service area population from 15 percent in 1990 to over 20 percent today.

Figure 2.2: Population Levels 1970 – 2011

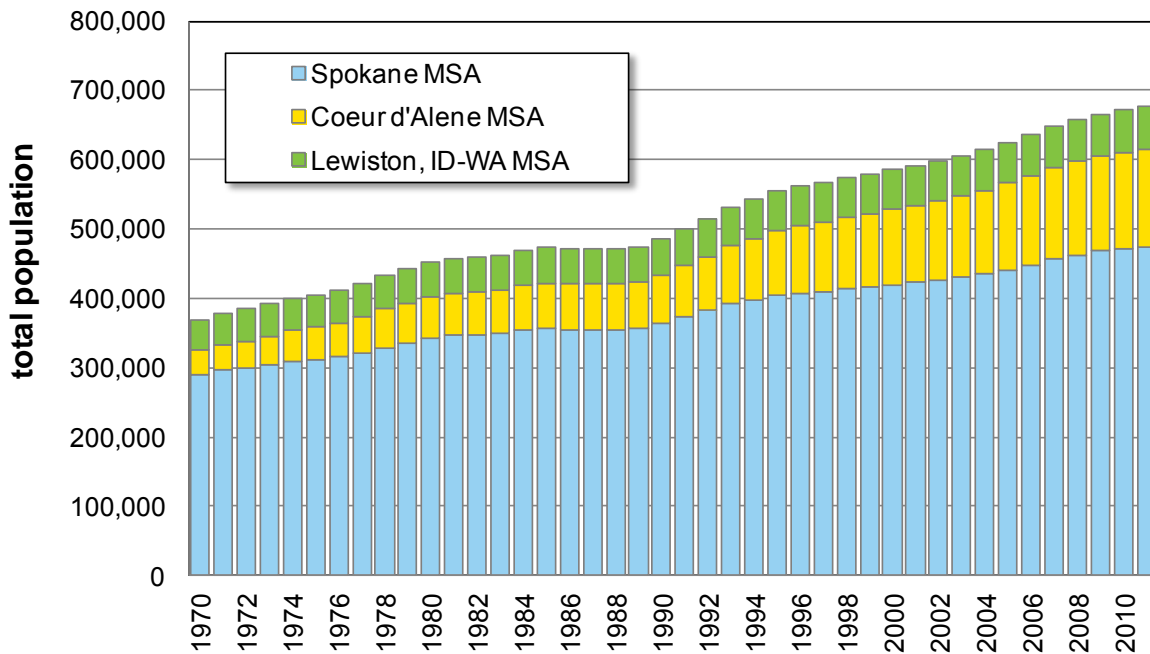

Population growth is a function of both regional and national employment growth. The regional business cycle follows the U.S. business cycle, meaning regional economic expansions or contractions follow national trends. A study done by Eastern Washington University's Institute for Public Policy and Economic Analysis documents this correlation between the regional and national business cycles.¹ Econometric analysis shows that when regional employment growth is stronger than U.S. growth (see Equation 2.2) over expansionary periods; regional population growth tends to accelerate. The reverse also holds true. Figure 2.3 shows annual population growth since 1971. In the deep economic downturns of the mid-1970s, early 1980s and the recent Great Recession, reduced population growth rates in Avista's service territory led to lower load growth. The Great Recession reduced population growth from nearly 2 percent in 2007 to less than 1 percent from 2010-2012.

Figure 2.3: Population Growth and U.S. Recessions, 1971-2011

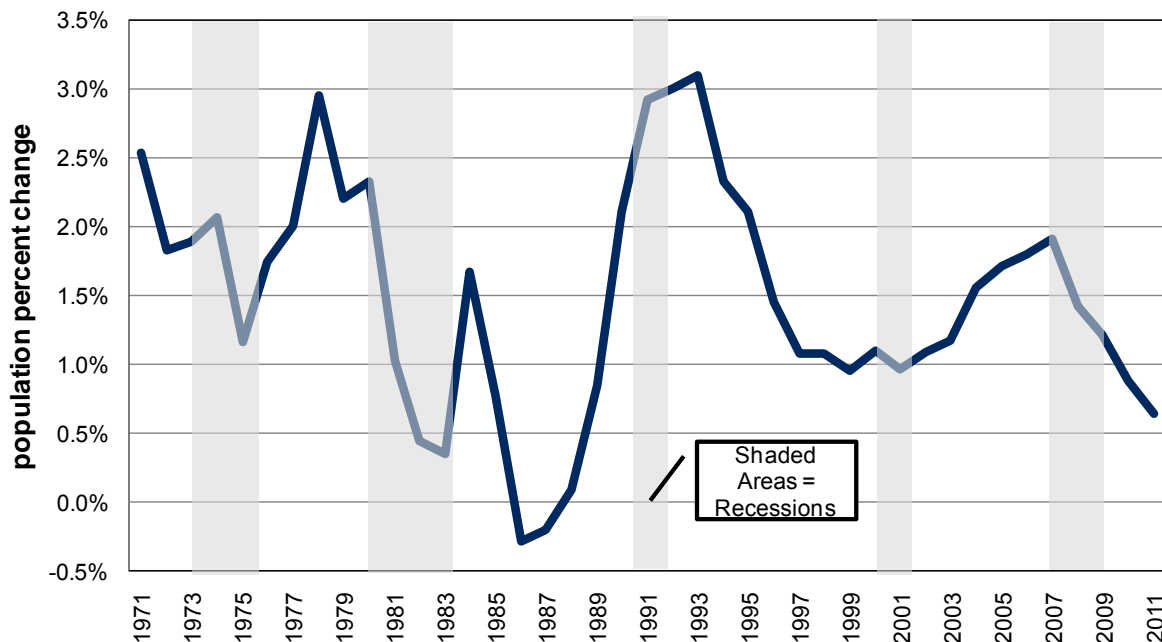

The Inland Northwest has transitioned from a natural resources-based manufacturing economy to a services-based economy. Figure 2.4 shows the breakdown of employment for all three MSAs. Just over 70 percent of employment is in private services, followed by government (15 percent) and private goods-producing sectors (13 percent). Government employment in the three MSAs is notably higher than in the Portland and Puget Sound MSAs. Farming now accounts for one percent of employment.

¹ *An Exploration of Similarities between National and Regional Economic Activity in the Inland Northwest*, Monograph No. 11, May 2006. <http://www.ewu.edu/cbpa/centers-and-institutes/ippea/monograph-series.xml>.

Figure 2.4: Employment Breakdown by Major Sector, 2011

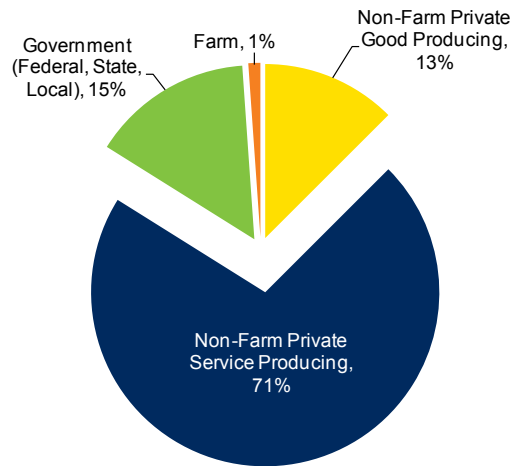

Between 1990 and 2007, non-farm employment growth averaged 2.5 percent per year. However, Figure 2.5 shows that since the end of the Great Recession in 2009, there has been no regional economic growth, and a significant regional lag relative to national employment recovery over the same period. Regional employment growth did not materialize until the second half of 2012, when services employment started to grow. Prior to this, reductions in federal, state, and local government offset employment gains in the goods producing sector.

Figure 2.5: Post Recession Employment Growth, June 2009-December 2012

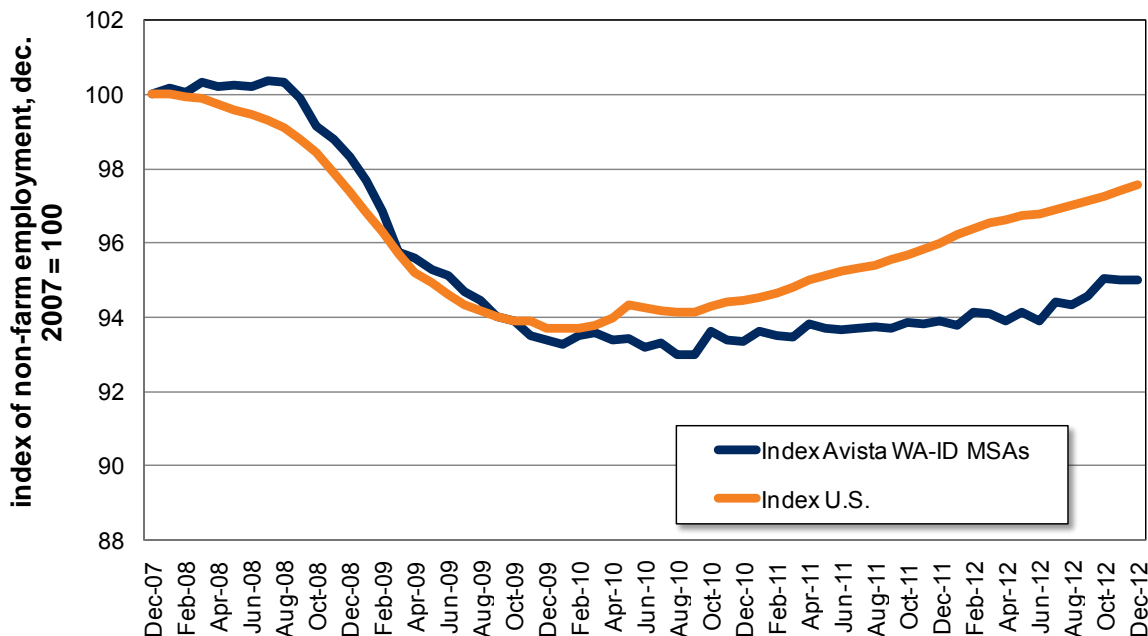

On a brighter economic note, the Spokane and Coeur d’Alene MSAs have emerged as major providers of health and higher education services to the Inland Northwest. A

recent addition to these sectors is a new University of Washington medical school branch located in the City of Spokane. Public and private universities and the regional medical system will support the new medical school.

Finally, Figure 2.6 shows the distribution of personal income, a broad measure of both earned income and transfer payments, for Avista's Washington-Idaho MSAs. Regular income consists of net earnings from employment and investment income in the form of dividends interest and rent. Personal current transfer payments include money income and in-kind transfers received through unemployment benefits, low-income food assistance, Social Security, Medicare and Medicaid.

Figure 2.6: Personal Income Breakdown by Major Source, 2011

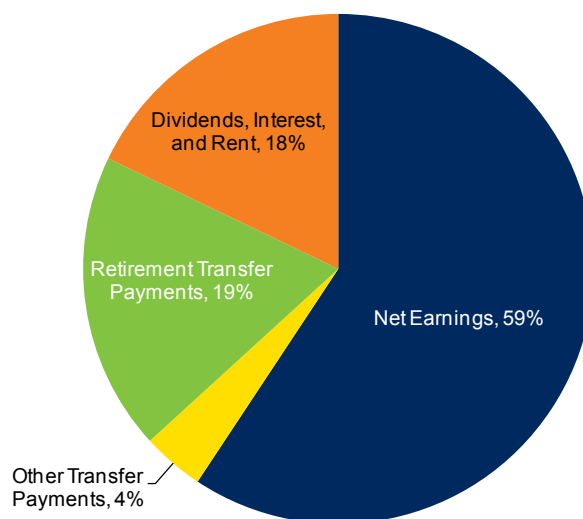

Although roughly 60 percent of personal income is from net earnings, transfer payments account for 23 percent, or more than one in every five dollars of personal income. Transfer payments have been the fastest growing component of personal income in the region. This reflects an aging regional population, a surge of military veterans, and the Great Recession, which significantly increased payments from unemployment insurance and other low-income assistance programs. In 1970, the share of net earnings and transfer payments in WA-ID MSAs accounted for 64 percent and 12 percent, respectively. The income share of transfer payments has nearly doubled over the last 40 years. The relatively high regional dependence on government employment and transfer payments means continued fiscal consolidation at the federal level would be an economic drag on future growth.

Customer and Load Forecast Assumptions

The customer and load forecasts use: (1) forecasts of U.S. and county-level economic growth; (2) forecasts of heating and cooling degree-days; and (3) forecasts of use-per-customer trends. Topics discussed below provide background to the final customer and load forecasts.

Avista's load forecasting methodology is undergoing significant restructuring. The restructuring involves using an Auto Regressive Integrated Moving Average (ARIMA) technique. ARIMA improves the modeling of economic drivers involving population, industrial production, income levels and energy prices to predict long-term energy demand. This new methodology will improve forecasts used in the 2015 IRP.

Assumptions for U.S. and County-level Economic Growth

The forecast used for this IRP, finalized July 2012, relies on national and county-level forecasts from multiple sources. However, forecasts developed "in-house" and from Global Insight are the principle forecast sources. Avista purchases forecasts from Global Insight, an internationally recognized economic forecasting consulting firm. Table 2.1 presents key U.S. forecast assumptions.

Table 2.1: U.S. Long-run Baseline Forecast Assumptions, 2013-2035

Assumption	Average (%)	Source
Gross Domestic Product	2.5	Global Insight, Federal Reserve, Bloomberg Consensus Forecasts, Energy Information Administration, and Avista Forecasts
Consumer Inflation	2.0	Federal Reserve
Worker Productivity	2.0	Global Insight
Employment Growth	0.9	Global Insight
Industrial Production	2.3	Global Insight
Population Growth	0.9	Global Insight

Long-run gross domestic product (GDP) growth reflects an average of multiple forecast sources, including Avista's own in-house forecasts. In theory, long-run GDP growth should be the sum of productivity growth plus population growth—2.9 percent using the numbers above. However, the forecast sources above generally assume fiscal consolidation (reducing the size of government deficits and debt accumulation) in the U.S. and other developing countries. Fiscal consolidation, along with less consumer credit, will keep U.S. GDP growth under 2.9 percent over the next 20-years. Prior to the Great Recession, U.S. long-run GDP growth was around 3 percent. Consumer inflation reflects the U.S. Federal Reserve's implied anchor for long-run inflation.

Table 2.2 presents key assumptions for the Spokane, Coeur d'Alene and Lewiston, ID-WA MSAs. These three areas comprise more than 80 percent of Avista's service area economy.

Table 2.2: Avista WA-ID MSAs Baseline Forecast Assumptions, 2013-2035

Assumption	Average	Source
Employment Growth	0.8%	Global Insight and Avista Forecasts
Housing Starts	4,200 per yr.	Global Insight
Population Growth	1.1%	Global Insight and Avista Forecasts

Employment growth and housing starts are key predictors of customer and population growth. Modest forecasts in these areas translate into modest customer growth forecasts. Long-run population growth in Avista's service area is nearly identical to long-run growth rates of total customers over the same period. Therefore, population growth forecasts are a proxy for long-run customer growth, especially for the residential and commercial customer classes.

In addition to Global Insight's population forecasts for the major MSAs, Avista uses two other in-house methods for generating customer growth forecasts. Both methods provide a baseline reasonableness test of Global Insight's population forecasts, which forms the basis of Avista's long-run customer forecasts. Figure 2.7 shows Global Insight's population forecasts.

Figure 2.7: Population Forecast, 2013-2035

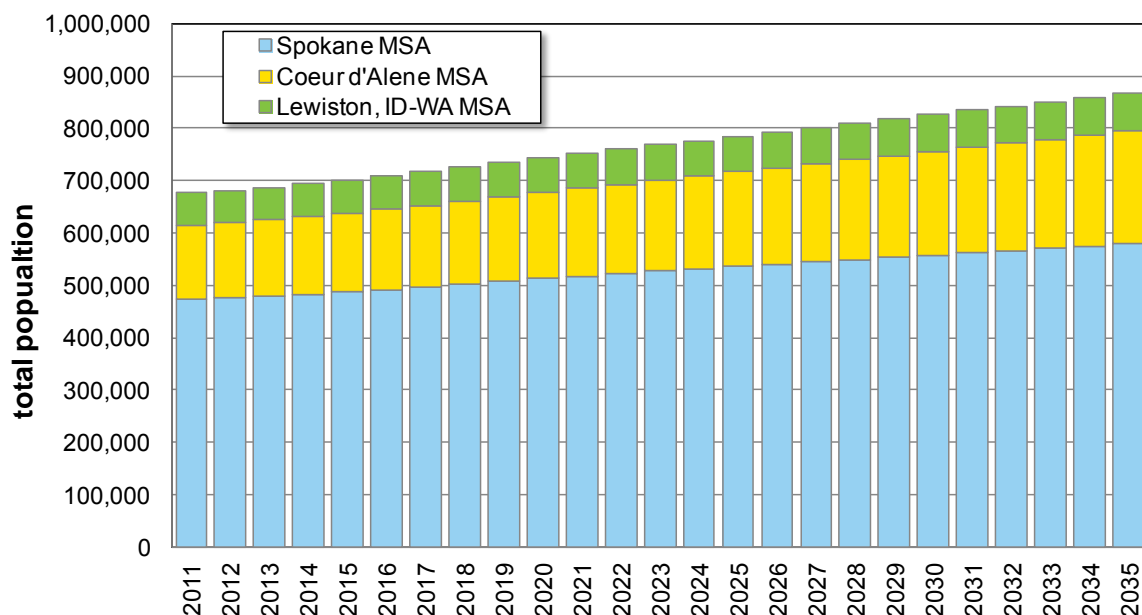

While one method uses Global Insight's annual housing forecasts to project annual changes in residential and commercial customers in the MSAs, the second forecast method uses the following simple time-series regression estimated from historical data:

Equation 2.1: Conservation Avoided Costs

$$\Delta C_t = \alpha_0 + \alpha_1 M_{t-1} + \epsilon_t$$

Where:

α_0 = Intercept value of the estimated equation.

ΔC_t = Change in Avista's total residential electric customers from year t to year t-1 (annual numbers are 12 month averages).

M_{t-1} = The number of housing starts (single family homes and multi-family units) reported at time t-1 for Avista’s three combined WA-ID MSAs.

ϵ_t = Random error term.

Figure 2.8 shows housing start forecasts to the end of the IRP period using the Global Insight forecasts.

Figure 2.8: House Start History and Forecast (2000-2035)

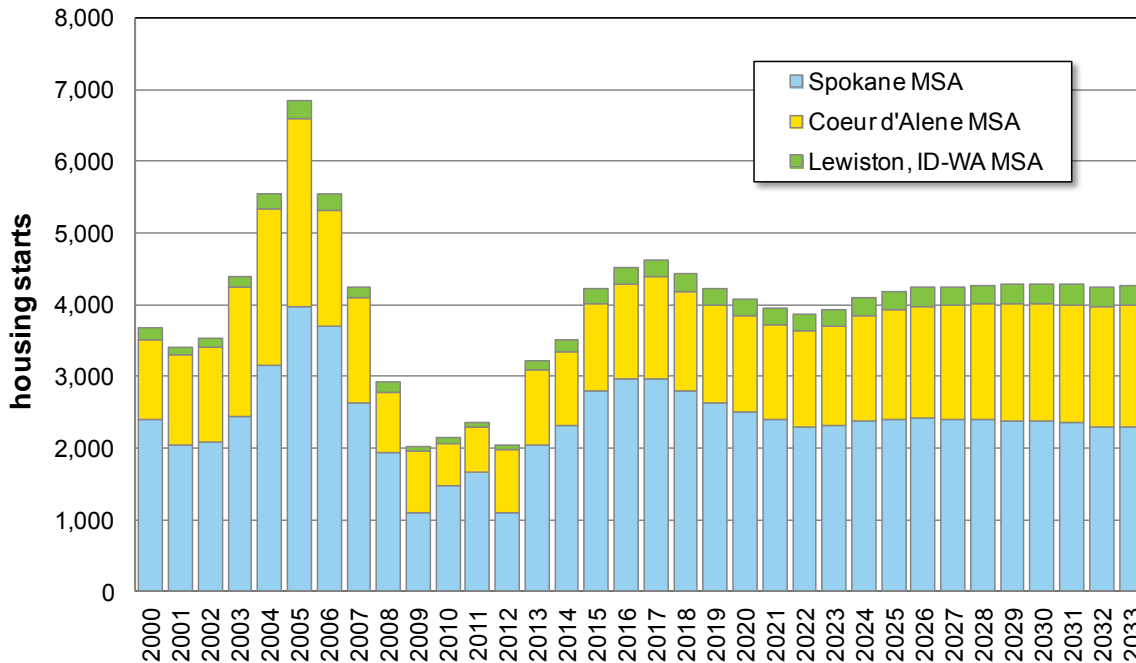

Annual regional and U.S. employment growth is used to forecast annual population growth in the MSAs. The population forecast uses the simple time-series regression model estimated from historical data in Equation 2.2.

Equation 2.2: Population Forecast

$$P_t = \alpha_0 + \alpha_1 E_{t-1,MSA} + \alpha_2 E_{t-1,US} + \alpha_3 D_{2002} + \epsilon_t$$

Where:

- α_0 = Intercept value of the estimated equation.
- P_t = Population growth rate in year t in Avista’s WA-ID MSAs.
- $E_{t-1,MSA}$ = Growth rate in non-farm employment in year t-1 in Avista’s WA-ID MSAs.
- $E_{t-1,US}$ = U.S. growth in non-farm employment in year t-1.
- D_{2002} = Dummy for 2002 outlier.
- ϵ_t = Random error term.

Avista’s forecast uses Global Insight’s forecasts for U.S. employment growth and in-house forecasts for local employment growth. This approach reflects the statistically

significant one-year lag between regional and U.S. employment and local population growth rates. Higher or lower employment growth in Avista's service area relative to the U.S. in time t-1 is associated with higher or lower population growth in time t.

The in-house employment forecasts developed using Equation 2.2 are generated through a time-series model linking regional employment growth (the dependent variable) to national GDP growth (the independent variable). As discussed below, this modeling approach can generate high- and low-growth cases for load by altering assumptions about future local employment growth.

Weather Forecasts

The load forecast uses 30-year monthly temperature averages recorded at the Spokane International Airport weather station through 2012. Several other weather stations are located in Avista's service territory, but their data is available for much shorter durations and they are highly correlated with the Spokane International Airport data.

Avista uses heating degree-days (HDD) to measure cold-weather load sensitivity and cooling degree-days (CDD) to measure hot-weather load sensitivity. The weather normalization process uses regressions of the following form:

Equation 2.3: Weather Normalization

$$\text{kWh/C}_{t,y,s} = \alpha_0 + \alpha_1 \text{HDD}_{t,y,s} + \alpha_2 \text{QHDD}_{t,y,s} + \alpha_3 \text{CDD}_{t,y,s} + \epsilon_{t,y,s} \text{ for month } t, \text{ year } y, \text{ schedule } s$$

Where:

$\text{kWh/C}_{t,y,s}$ = Weather normalization.

α = Marginal effect of each degree-day type.

$\text{HDD}_{t,y,s}$ = The HDDs for month t, year y and schedule s.

$\text{QHDD}_{t,y,s}$ = The coldest HDD months, December through March.

$\text{CDD}_{t,y,s}$ = The CDDs for month t, year y and schedule s.

$\epsilon_{t,y,s}$ = Random error term.

The estimated regressions are used to produce two predicted values of $\text{kWh/C}_{t,y,s}$. One estimate uses the actual data to produce $\text{kWh/C}_{t,y,s}$, measuring usage driven by weather conditions in month "t". This represents the weather-predicted value of usage per customer for month t in year y. The second estimate, $\text{kWh/C}_{t,y,s}$, reflects the predicted usage per customer for month t in year y, based on the 30-year National Oceanic and Atmospheric Administration average. The difference between the two estimates reflects the deviation of month t weather-driven usage from the usage predicted by long-run degree-days:

Equation 2.4: Weather Normalization Adjustment Factor

$$T_{t,y,s} = \text{Usage predicted by normal weather} - \text{Usage predicted by actual weather}$$

The deviation $T_{t,y,s}$ is then added to the actual value of $\text{kWh/C}_{t,y,s}$ to obtain weather normalized usage (WNU).

Equation 2.5: Weather Normalized Amount

$$(kWh/C_{t,y,s})^{WNU} = kWh/C_{t,y,s} + T_{t,y,s}$$

Where:

$(kWh/C_{t,y,s})^{WNU}$ = Weather normalized usage in kWh.

$kWh/C_{t,y,s}$ = Actual usage that was observed.

$T_{t,y,s}$ = Weather normalization adjustment factor.

If weather conditions in month t are hotter than average (more CDD than average), then the adjustment factor will be negative. When added to $kWh/C_{t,y,s}$, WNU will be lower, reflecting an adjustment back to what usage should have been with “average” weather.

Use per Customer Projections

A database of monthly electricity sales and customer numbers by rate schedule forms the basis of use-per-customer (UPC) forecasts by rate schedule, customer class and state. Historical data is weather-normalized to remove the impact of HDD and CDD deviations from expected normal values, as discussed above. Weather normalized UPC forecasts multiplied by tariff schedule customer forecasts result in a total load forecast.

Historical data for Avista’s service area shows that weather normalized UPC in the service area is declining. Figure 2.9 shows annual growth in UPC since 2006. Over this period, the average annual rate of decline in UPC was about 0.5 percent and largely reflected a declining trend in the residential sector. The key factors influencing long-run UPC are: (1) own-price and cross-price elasticity; (2) income elasticity as related to consumer purchases of energy-related goods; (3) conservation programs; and (4) changes in household size.

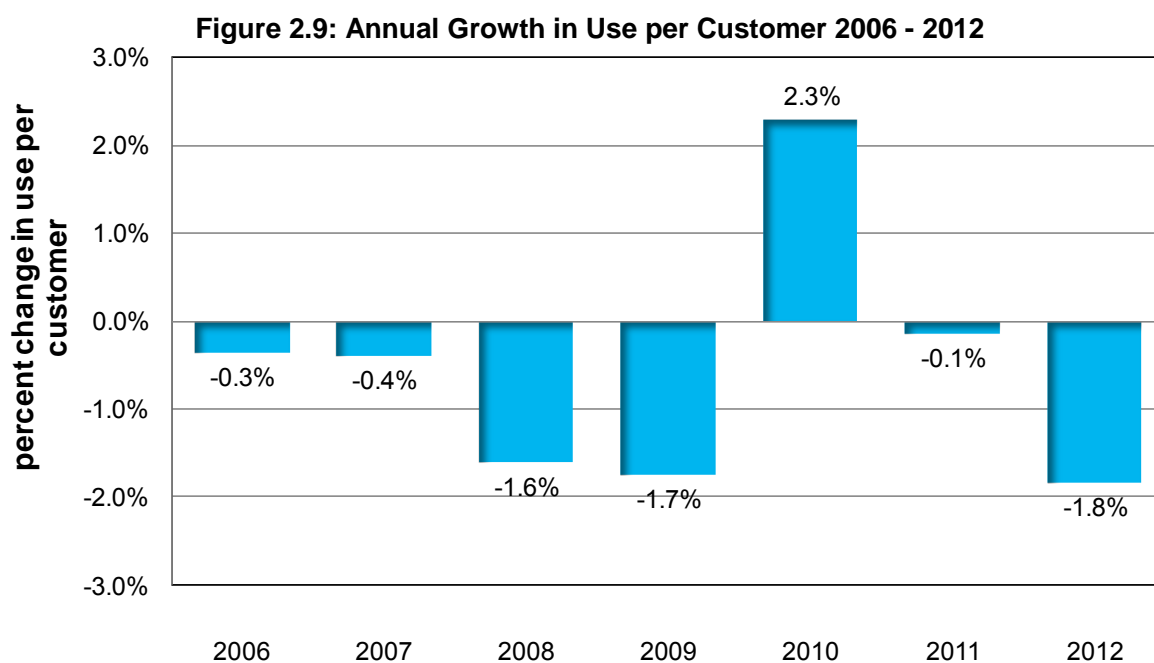

Chapter 2: Loads & Resources

Retail electricity price increases reduce electricity UPC. Own-price elasticity is an important consideration in any electricity demand forecast because it measures the sensitivity of quantity demanded for a given change in price. A consumer who is sensitive to a price change has a relatively elastic demand profile. A customer who is unresponsive to price changes has a relatively inelastic demand profile. During the 2000-01 Energy Crisis customers displayed increasing price sensitivity and subsequently reduced electricity usage in response to relatively large price changes. Recent research shows that the more in-home information consumers have about electricity usage and costs, the more price sensitive they become.²

Cross-price elasticity measures the relationship between the quantity of electricity demanded and the quantity of potential substitutes (e.g., propane or natural gas for heat) when the price of electricity increases relative to the price of the substitute. A positive cross elasticity coefficient indicates cross-price elasticity between electricity and the substitute. A negative coefficient indicates the absence of cross-price elasticity, and that considered product is not a substitute for electricity, but is instead complementary to it. An increase in the price of electricity increases the use of the complementary good, and a decrease in the price of electricity decreases the use of the complementary good.

The principal application of cross elasticity impact in the IRP is its substitutability by natural gas in some applications, including water and space heating. The correlation between retail electricity prices and the commodity cost of natural gas has increased as the industry relies on more natural gas-fired generation to meet loads. This increased positive correlation has reduced the net effect of cross price elasticity between retail natural gas and electricity prices.

Income elasticity measures the relationship between a change in consumer income and the change in consumer demand for electricity. As incomes rise, the ability of a consumer to pay for more electricity increases. The ability to afford electricity-related products also increases. As incomes rise, consumers are more likely to purchase more electricity-consuming products that increase UPC, such as larger dwellings, mobile electronic devices, high definition televisions and electric vehicles. However, it also enables them to buy more energy efficient products reducing UPC, including more energy efficient windows and appliances, in addition to rooftop solar photovoltaic cells.

Although elasticity plays a key role in customer behavior, estimating elasticity is problematic. Currently Avista lacks sufficient data to estimate elasticity values for its service area. National estimates of elasticity exist; however, for a variety of reasons, there is no guarantee they reflect regional consumer behavior.

Elasticity comes in two forms: short-run and long-run. In terms of own-price elasticity, quantity responses are less sensitive to price increases in the short-run because consumers lack sufficient time to implement efficiency programs or find lower cost

² Jessoe and Rapson (2012), *The Short-run and Long-run Effects of Behavioral Interventions: Experimental Evidence from Energy Conservation*, NBER working paper 18492. Allcott and Rogers (2012), *Knowledge is (Less) Power: Experimental Evidence from Residential Energy Use*, NBER work paper 18344.

substitutes. This is not the case in the long-run, so elasticity should increase as the time for adjustment increases. For example, the Energy Information Administration currently uses a value of -0.3 for short-run own-price elasticity for residential electricity, accounting for the "...successful deployment of smart grid projects funded under the American Recovery and Reinvestment Act of 2009."³ However, the Energy Information Administration estimates long-run elasticity ranges from -0.04 to -1.45.⁴

Recent research (Arimura, Li, Newell, and Palmer, 2011) indicates that conservation programs reduce long-run residential usage.⁵ However, empirical problems arise when estimating the impact of energy efficiency on load. These programs affect historical data; therefore, the forecast already contains the impacts of existing conservation levels. However, Avista is currently working with the EnerNOC consulting group to estimate energy efficiency savings. Future IRPs will address a more concrete empirical estimate on the impact of energy efficiency programs to avoid double counting.

Figure 2.10 shows average household size in Avista's electric service area since 1990. The size has fallen to 2.5 people per household or about 2 percent smaller than in 1990. The forecast is for average household size to stay below the current level through 2035.

Figure 2.10: Area Average Household Size, Historical and Forecast 1990-2035

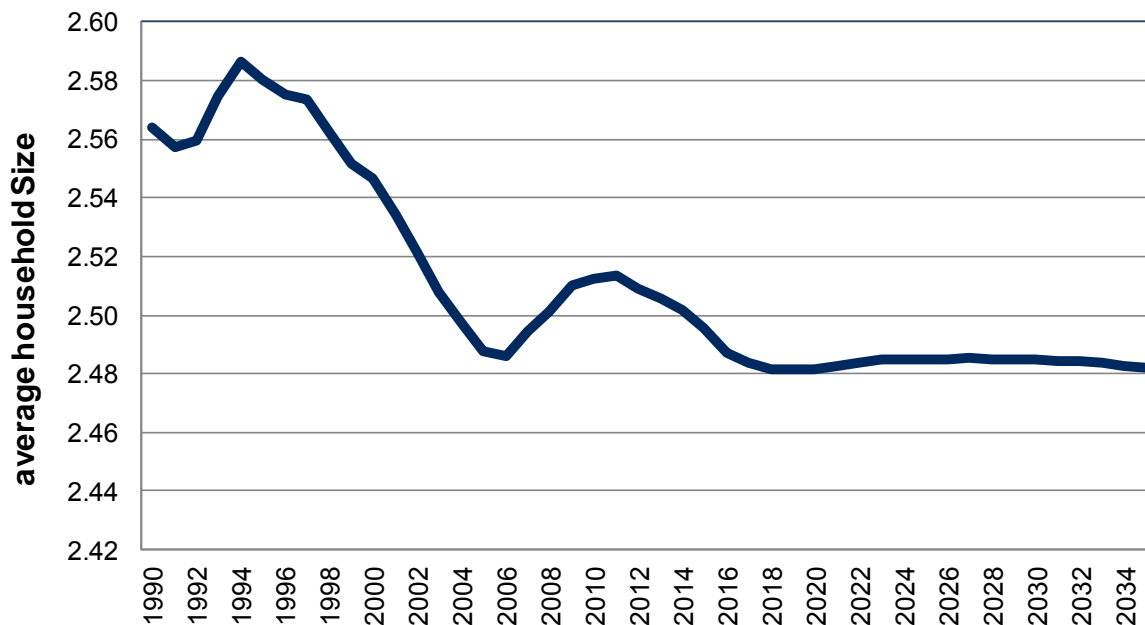

³ See U.S. Energy Information Administration, *Assumptions to the Annual Energy Outlook 2012*, Residential Demand Module, p. 32.

⁴ See U.S. Energy Information Administration, Working Memorandum from George Lady, *NEMS Price Elasticities of Demand for Residential and Commercial Energy Use*, Table 2, p. 4.

⁵ Arimura, Li, Newell, and Palmer (2011), *Cost-effectiveness of Electricity Energy Efficiency Programs*, NBER working paper 17556.

Residential use accounts for 88 percent of customers and 40 percent of load, the factors discussed above impact the long-run trend UPC as follows:

Equation 2.6: Use per Customer

UPC Trend = f (long- and short-run price and income elasticity, conservation programs, household size, long-run weather factors)

Rather than modeling each piece on the right side of Equation 2.6, the forecast attempts to model the long-run UPC trend as a whole using historical UPC data. An analysis of data since 2005 shows the UPC can be modeled using a linear trend in the residential forecast. This trend is alongside other explanatory variables related to heating and cooling degree-days. Future forecast models will explicitly include variables that influence UPC trends, such as household size, price and consumer income. Besides long-run potential climate change, the only individual component related in Equation 2.6 explicitly considered is the adoption of electric vehicles in Avista's service area.

The 2013 IRP electric vehicle adoption scenario is half of the 2011 IRP forecast. This revision reflects evidence indicating the adoption of electric vehicles is occurring at a slower pace than previously expected. The electric vehicle fleet is a combination of plug-in hybrids and electric-only passenger vehicles. The 2011 IRP forecast of electric vehicles utilized the Northwest Power and Conservation Council's (NPCCs) forecast from the Sixth Northwest Conservation and Power Plan.⁶ The slow rate of electric vehicle adoption in Avista's service area likely coincides to the service area's post-recession employment recovery (discussed above), including a 10 percent decline in inflation-adjusted median household income since 2007, and the continued high price of electric vehicles relative to traditional alternatives.

One forecast shown in Figure 2.11 assumes the long-run UPC will continue to decline until 2028 when it could slowly increase due to electric vehicle adoption. The other forecast is the no-electric vehicle case where they are not widely adopted. Here, UPC continues to decline, but more slowly after 2028. Given current electric vehicle adoption rates, the no-electric vehicle case seems more likely.

⁶ <http://www.nwcouncil.org/energy/powerplan/6/plan/>

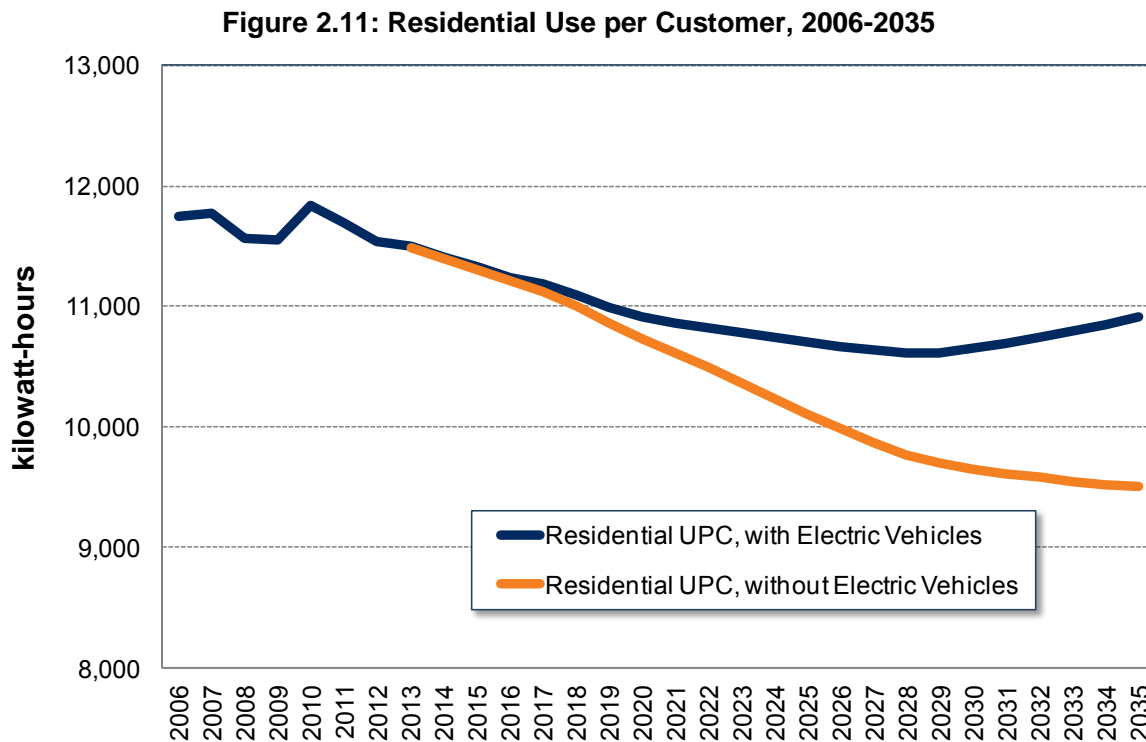

Customer Forecast

Table 2.3 shows the historical correlation of year-over-year customer growth across the four main customer groups: residential, commercial, industrial and streetlights. The correlation between residential and commercial is high, meaning forecasted growth rates should behave similarly. As a result, both the residential and commercial groups correlate to population growth. Industrial and streetlights change very slowly; so these forecasts use simple trending and smoothing methods.

Table 2.3: Customer Growth Correlations, January 2006-December 2012

Customer Class (Year-over-Year)	Residential, Year-over- Year	Commercial, Year-over- Year	Industrial, Year-over- Year	Streetlights, Year-over- Year
Residential	1			
Commercial	0.899	1		
Industrial	-0.320	-0.169	1	
Streetlights	-0.246	-0.205	0.280	1

To reproduce the high correlation between residential and commercial customers in the forecast, the residential customer forecast is used as a driver for the commercial forecast. This is done by regressing past commercial customer changes against past residential customer changes, as shown in Equation 2.7. Using the estimated equation,

forecasted customer changes are inserted to generate the forecasted change in commercial customers.

Equation 2.7: Customer Forecast

$$\Delta C_{t,commercial} = \alpha_0 + \alpha_1 \Delta C_{t,residential} + \epsilon_t,$$

Where:

- α_0 = Intercept value of the estimated equation.
- $\Delta C_{t,commercial}$ = Change in Avista’s total commercial electric customers from year t to year t-1 (annual numbers are 12-month averages).
- $\Delta C_{t,residential}$ = Change in Avista’s total residential electric customers from year t to year t-1 (annual numbers are 12-month averages).
- ϵ_t = Random error term.

In aggregate, average annual customer growth is 1.1 percent out to 2035, with residential and commercial driving most of the growth at 1.1 percent annually. Industrial growth is 0.3 percent annually. The aggregate growth forecast is considerably below the pre-Great Recession growth rate of 1.6 percent. See Figure 2.12.

Figure 2.12: Avista’s Customer Growth, 1997-2033

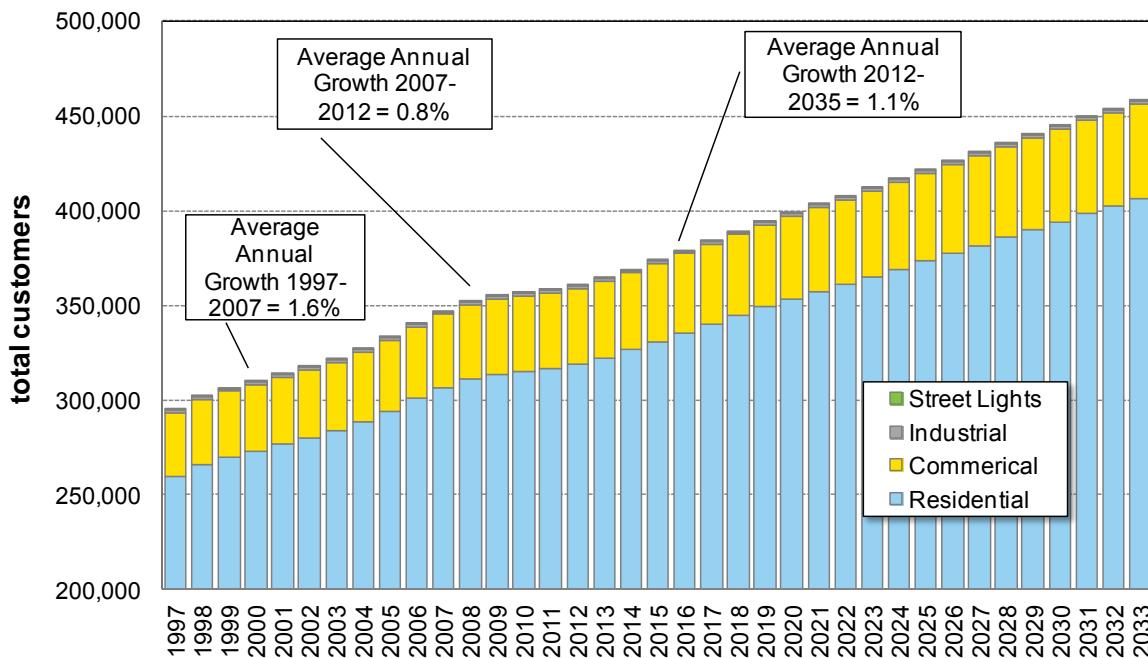

Native Load Forecast

Retail sales provide the data used to project future loads. Retail sales translate into average megawatt hours (aMW) using a regression model ensuring monthly load shapes conform to history. The load forecast is a retail sales forecast combined with line

losses incurred in the delivery of electricity across Avista's transmission and distribution systems.

Figure 2.13 presents annual net native load growth. Note the significant drop in the 2000-01 Western Energy Crisis and smaller declines in the Great Recession. Annual growth averages 1 percent through 2035.

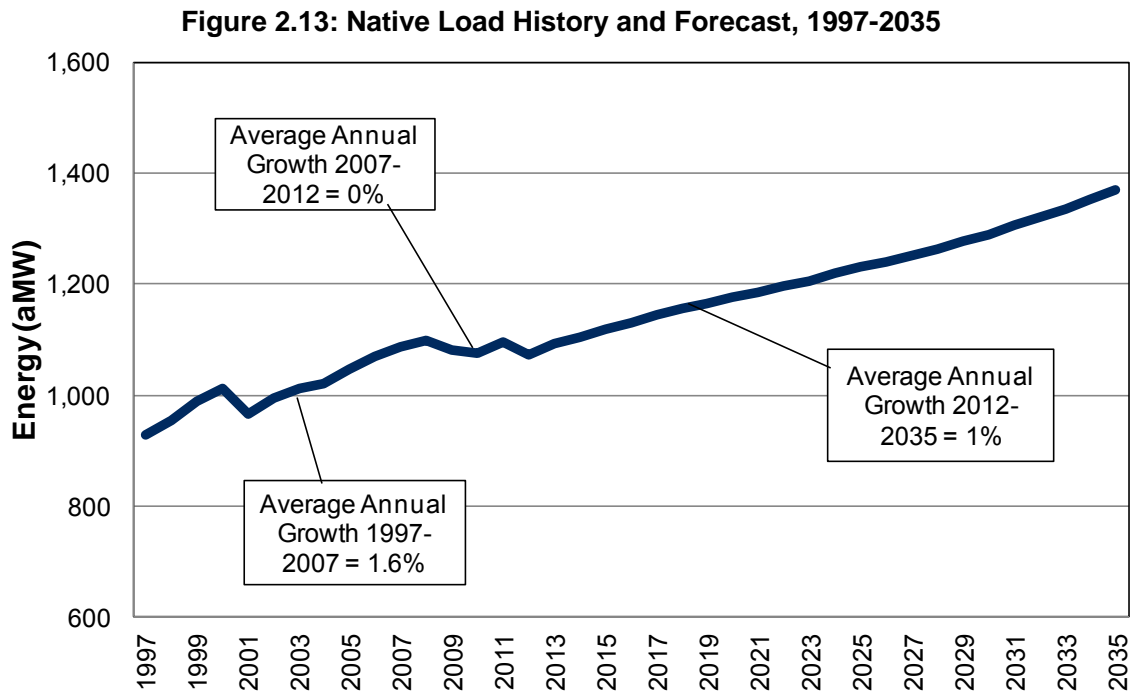

Peak Demand Forecast

The energy or load forecast is important to the development of the IRP because retail sales growth drives many future system costs. When planning to meet the needs of all of Avista's customers, a forecast of peak demand is also crucial to determine the need for new capacity. In other words, Avista must not only meet the energy needs of its customers, but also have enough capacity to meet demands in its highest load hour.

Avista's typical peak hour is in the winter months, between November and early February. Recent warm winters, hot summers and added air conditioning load have created some summer months where loads were higher than the winter. This phenomenon has transformed Avista into a dual peaking utility. Even though summer peaks may be higher than winter, Avista still expects to have its highest electricity load in the winter.

Avista's peak load forecast began by normalizing historical data to set a base peak level adjusted for temperatures. After the adjustment, peak loads trend with economic factors similar to the energy forecast. Normalizing base peak loads begins with adjusting the 2012 peak for temperature variation from normal. Using daily peak load data for 24 months an econometric model isolates the relationship between load and temperatures,

Chapter 2: Loads & Resources

day of the week, holidays, school days, season and other factors. These relationships are normalized using a 123-year average of historical Spokane temperatures. For the winter forecast, the coldest day of each year is averaged to determine the base planning temperature.⁷ For the summer, the same process is used but for the hottest day. In the winter the average coldest day is 3.9 degrees Fahrenheit, the coldest temperature on record was -17 degrees on December 30, 1968. Avista last saw an extreme winter peak temperature in 2004 with a -9 degrees day average. For summer peak planning, the average hottest day (average of daily high and low temperature) is 82.3 degrees. The hottest average day on record is 90 degrees on July 27, 1928. Avista's last extreme summer temperature was 86 degrees in 2008. See Table 2.4 for details. One caution using the average of extreme annual temperatures is the extreme temperature may land on a Friday, weekend, or on a holiday, the extreme temperature is not going to have a large impact on peak load these days. This base forecast weights the days of the week to reflect the average temperature given extreme temperatures can happen on any given day.

Table 2.4: Average Day Spokane Temperatures 1890-2012 (Degrees Fahrenheit)

Customer Class	Coldest Day	Hottest Day
Extreme	-17.0	90.0
Average	3.9	82.3
Standard Deviation	8.9	2.8
90th Percentile	-8.8	86.0
Recent Extreme Temperatures	2004: -9.0	2008: 86.0

Using the normalized base peak levels from 2012, the peak load forecast uses an econometric model relying on GDP growth as its primary driver, similar to the energy forecast. With this regression relationship, peak load growth is simulated using assumptions about future GDP growth. GDP growth out to 2017 was set at the average of multiple forecast sources.⁸ Using this average shapes the near term impacts of the business cycle on peak load growth. From 2018-35 the long-run GDP growth was 2.5 percent.

This analysis resulted in a 20-year peak growth rate of 0.84 percent in the winter and a 0.90 percent growth rate in the summer. Figure 2.14 illustrates these growth levels compared to historical peaks for both summer and winter (other monthly peaks are developed but not shown). Avista's all-time native load peak was in 2009 with peak loads at 1,821 MW, on this day the average temperature reached -7 degrees. The historical summer peak occurred in July 2006 when average temperatures reached 87 degrees. The historical winter and summer annual average growth rates between 1997 and 2012 were 0.85 and 1.0 percent, respectively. The forecast peaks represent an

⁷ The coldest day based on the average of daily high and low temperatures.

⁸ The forecast sources are the U.S. Federal Reserve, Bloomberg's survey of forecasters, Reuter's survey of forecasters, The Economist's survey of forecasters, Global Insight, Economy.com, Blue Chip consensus forecast. Averaging these sources reduces the systematic forecast error that can arise from using a single source forecast.

expected peak level given average extreme temperatures; actual peak loads are expected to deviate from this forecast. Avista resources meet the deviated peak loads first, and market purchases meet the remaining peak loads.⁹

Figure 2.14: Winter and Summer Peak Demand, 1997-2035

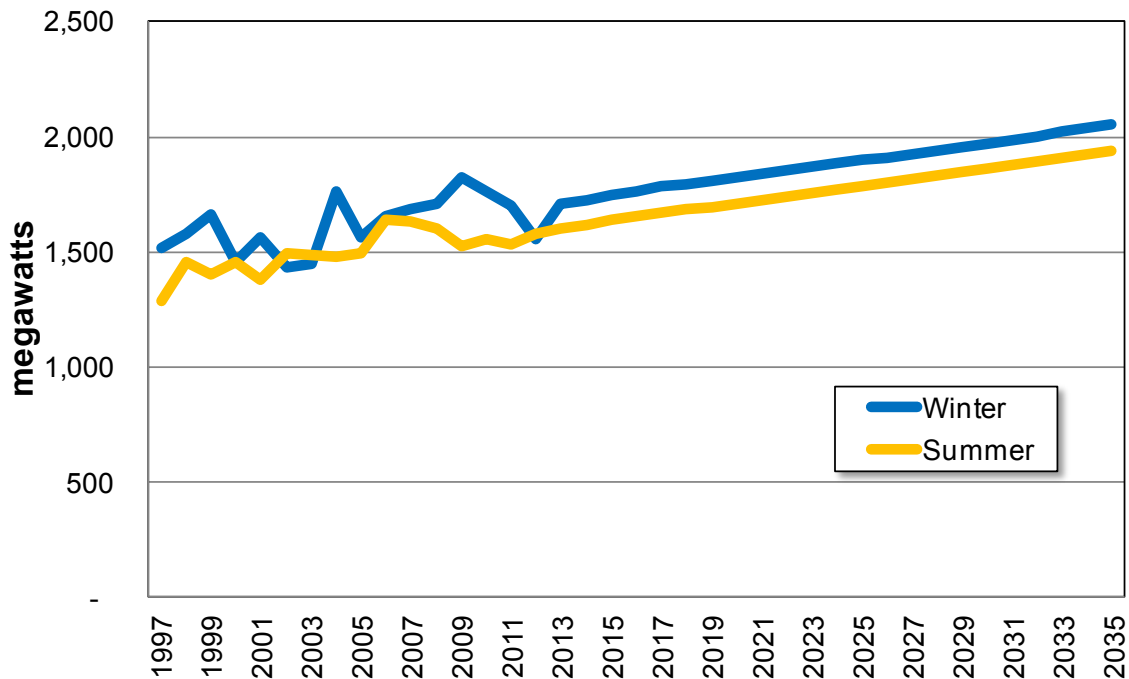

High and Low Load Growth Cases

Avista produces high and low load forecasts to test the PRS. These forecasts are very difficult to create because many factors influence the outcome. In past IRPs, Avista used ranges from the NPCC's Sixth Power Plan as a guide. This IRP relies on this basic relationship to derive the high and low load growth rates:

Equation 2.8: Long Run Load to Customer Relationship

$$\% \text{ change in load} \approx \% \text{ change in customers} + \% \text{ change in UPC.}^{10}$$

Recalling the discussion above, population growth approximates long-run customer growth, and population growth approximates employment growth. Therefore using Equation 2.2 to simulate population growth should be under differing assumptions of regional employment growth, holding U.S. employment and UPC growth rates constant. Avista uses this method to forecast alternative load growth cases. The low case

⁹ Avista maintains a 14 percent planning margin above these peak levels, and operating reserves.

¹⁰ Since $UPC = \text{load}/\text{customers}$, calculus shows that the annual percentage change $UPC \approx$ percentage change in load - percentage change in customers. Rearranging terms, we have, the annual percentage change in load \approx percentage change in customers + percentage change in UPC.

assumes regional employment growth averages 0.5 percent out to 2035; the high-growth case assumes 2.5 percent. Figure 2.15 shows the results of these assumptions. Figure 2.15 also shows the U.S. baseline forecast from the Energy Information Administration and a low-medium forecast uses Global Insight's base-line forecasts for employment growth to forecast population growth.

Figure 2.15: Load Growth Scenarios, 2014-2035

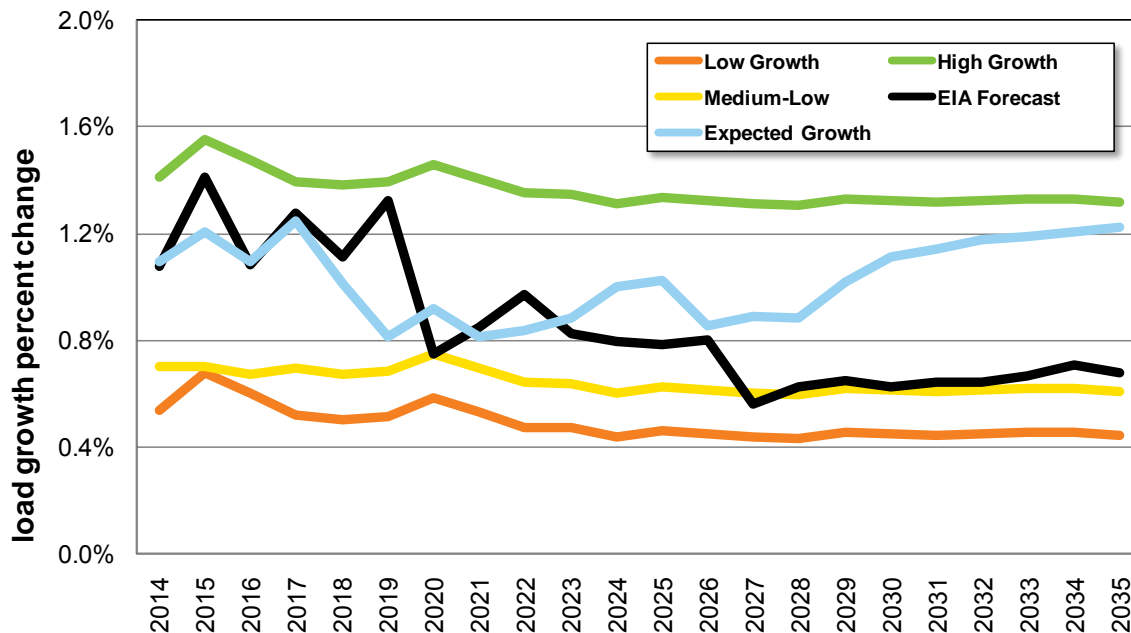

Voluntary Renewable Energy Program (Buck-A-Block)

Since 2002, Avista has offered customers the opportunity to purchase renewable energy voluntarily as part of their utility billing process. Customers currently can purchase 300 kWh blocks for \$1.00 to meet their personal renewable energy goals. This program is rate neutral and funded by participating customers. Avista's 35 MW share of the Stateline Wind project supplies most of the program through March 2014. Along with the wind energy, the purchase agreement includes renewable energy credits. The current mix of renewable credits used by Buck-A-Block customers is 85 percent from wind, 14.8 percent from biomass and the remaining 0.2 percent from the 15 kW Rathdrum Solar project (see Figure 2.16).

Since inception, participants purchased an average of 8.1 aMW of renewable energy through the Buck-A-Block program. Figure 2.17 shows the growth of customers and purchased energy in the program. After initial growth in the program, purchases leveled off in 2008 at just over 8.0 aMW per year.

Figure 2.16: 15 kW Photovoltaic Installation in Rathdrum, ID



Figure 2.17: Buck-A-Block Customer and Demand Growth

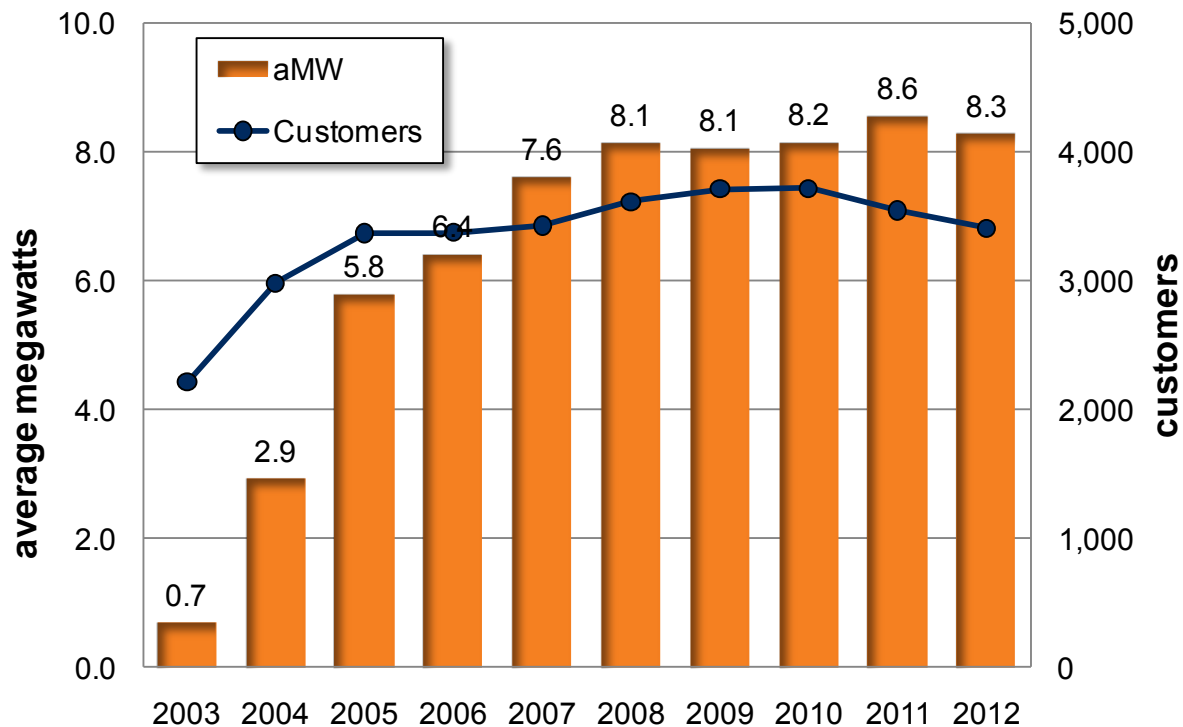

Customer-Owned Generation

A small but growing number of customers continue to install their own generation at an increasing pace. In 2007 and 2008, the average new net-metering customers were 10, and between 2009 and 2012, the average increased to 38 per year, likely in response to generous federal and state tax incentives. These projects qualify for the federal government’s 30 percent tax credit and in the state of Washington, customer-owned projects can qualify for additional tax incentives of up to \$5,000 per year. The quantity of generation each year through 2020 determines the amount of incentives paid. The Washington state utility taxes credit finances the incentives. Solar projects can qualify for total incentives worth up to \$0.54 per kWh with solar panels and inverters manufactured in Washington. All other customer-owned generation receives a minimum

payment of \$0.12 per kWh, increasing depending upon the manufacturing location of the installed equipment.

At this time, 190 customers have installed net-metered generation equipment for a total of 1.1 MW of capacity. This level equals approximately 0.5 percent of Avista's generation capacity. Eighty percent of the installations are in Washington, with most in Spokane County. Figure 2.18 shows annual net metering customer additions. Solar is 83 percent of net metered technology; the remaining is a mix of wind, combined solar and wind systems, and biogas. The average annual capacity factor of the solar facilities is 13 percent. Small wind turbines typically produce less than a 10 percent capacity factor depending on location. At current tax incentive levels, the number of new net-metered systems will continue at their current pace or may even increase. Where tax subsidies end without a significant reduction in technology cost, the interest in net metering likely will return to pre-tax incentive levels. If the number of net-metering customers continues to increase, Avista may need to adjust rate structures for customers who rely on the utility's infrastructure but do not contribute financially for infrastructure costs.

Figure 2.18: Net Metering Customers

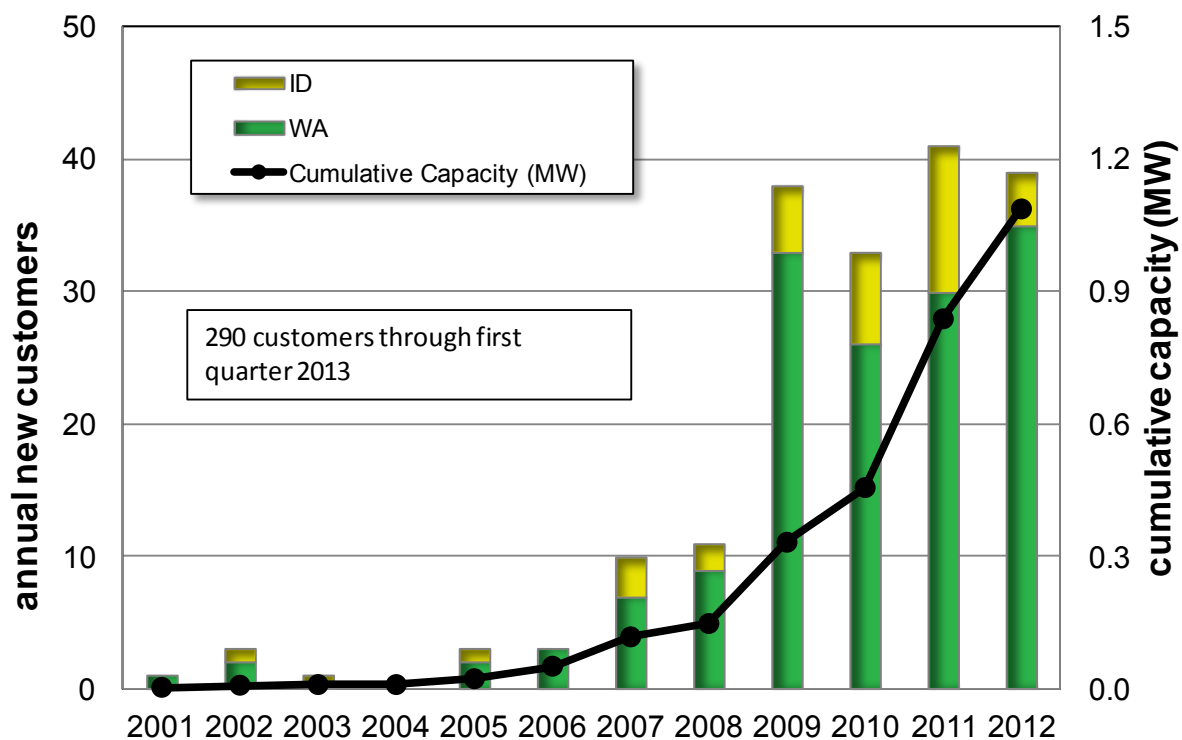

The reason for increased interest in customer-owned generation may have more to do with economics than environmental benefits. Figure 2.19 shows how current government subsidies make solar energy attractive to customers. This example uses a

5 kW system at \$7,000 per kW, or a \$35,000 total installation cost.¹¹ The cost without government assistance is 80 cents per kWh, roughly ten times Avista’s retail electricity rate. The federal tax Investment Tax Credit (ITC) and favorable federal depreciation rules transfers up to 42 cents per kWh from the system owner to taxpayers. Washington state picks up an additional 12 to 54 cents per kWh. With combined federal and state subsidies, a customer has the potential to install “made in Washington” panels and inverters and have not only its entire costs paid for, but also make a profit and receive free energy. Given these generous incentives, the potential exists for additional net metering customers on Avista’s system, especially where present funding is limited under RCW 82.16.130 to the lesser of 0.5 percent of taxable power sales or \$100,000.

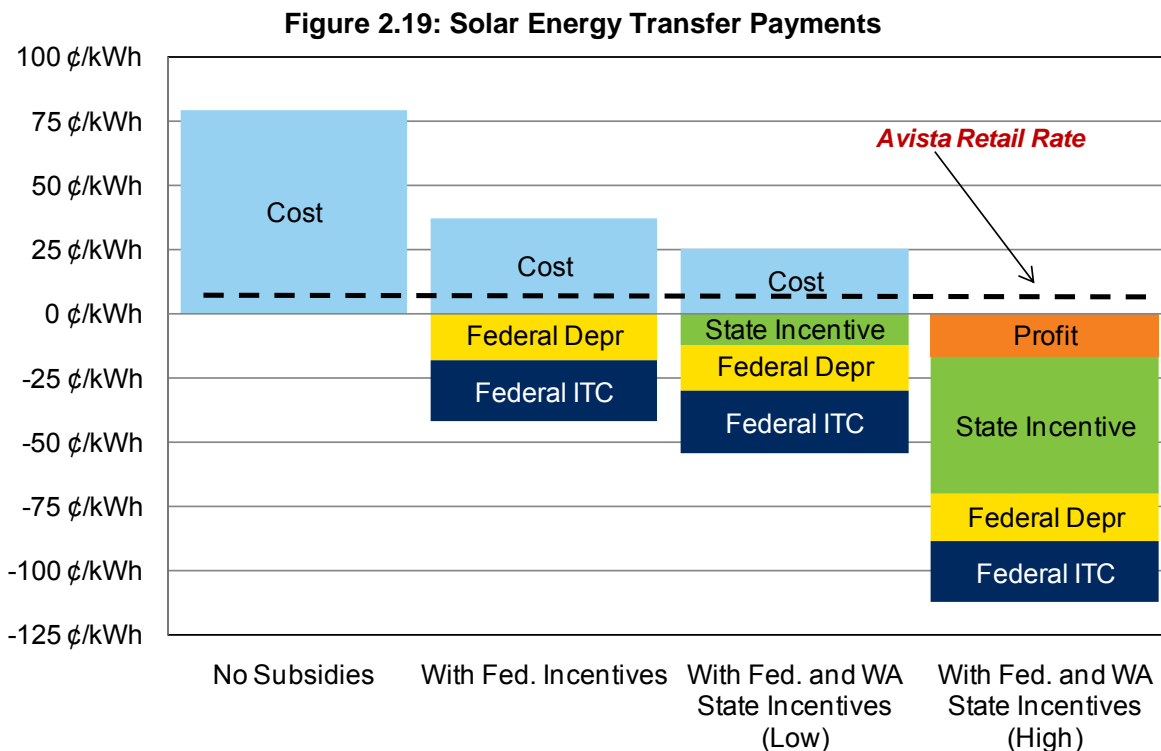

Avista Resources and Contracts

Avista relies on a diverse portfolio of generating assets to meet customer loads, including owning and operating eight hydroelectric developments located on the Spokane and Clark Fork rivers. Avista’s thermal assets include partial ownership of two coal-fired units in Montana, five natural gas-fired projects, and a biomass plant located near Kettle Falls, Washington.

¹¹ A higher cost of solar is used to represent the costs of panels and inverters manufactured in Washington with typically higher installation costs to illustrate the costs/benefits of the “made in Washington” Renewable Energy Systems Cost Recovery Incentive Payments.

Spokane River Hydroelectric Developments

Avista owns and operates six hydroelectric developments on the Spokane River. Five of these developments received a new 50-year FERC operating license in June 2009. The following section describes the Spokane River developments and provides the maximum on-peak capacity and nameplate capacity ratings for each plant. The maximum on-peak capacity of a generating unit is the total amount of electricity a plant can safely generate. This is often higher than the nameplate rating for hydroelectric developments. The nameplate, or installed capacity, is the capacity of a plant as rated by the manufacturer. All six of the hydroelectric developments on the Spokane River connect to Avista's transmission system.

Post Falls

Post Falls is the most upstream hydroelectricity facility on the Spokane River. It is located several miles east of the Washington/Idaho border. The development began operating in 1906, and during summer months maintains the elevation of Lake Coeur d'Alene. The development has six units, with the last unit added in 1980. Post Falls has a 14.75 MW nameplate rating and is capable of producing 18.0 MW.

Upper Falls

The Upper Falls development began generating in 1922 in downtown Spokane, and now is within the boundaries of Riverfront Park. This project is comprised of a single 10.0 MW nameplate unit with a 10.26 MW maximum capacity rating.

Monroe Street

Monroe Street was Avista's first generation development. It began serving customers in 1890 near what is now Riverfront Park. Rebuilt in 1992, the single generating unit has a 14.8 MW nameplate rating and a 15.0 MW maximum capacity rating.

Nine Mile

A private developer built the Nine Mile development in 1908 near Nine Mile Falls, Washington, nine miles northwest of Spokane. Avista (then Washington Water Power) purchased the project in 1925 from the Spokane & Inland Empire Railroad Company. Its four units have a 26.4 MW nameplate rating and 17.6 MW maximum capacity rating.¹² A new hydraulic control system was installed in 2010, replacing the original flashboard system that maintained full pool conditions seasonally.

Nine Mile is currently undergoing substantial multi-year upgrades. Nine Mile Units 1 and 2 upgrades to two 8 MW generators/turbines, replace both existing 3 MW units. Once operational in 2016, the new units will add 1.4 aMW of energy beyond the original configuration and 6.4 MW of capacity above current generation levels. In addition to these capacity upgrades, the facility will receive upgrades to the hydraulic governors, static excitation system, switchgear, station service, control and protection packages, ventilation upgrades, rehabilitation of intake gates and sediment bypass system, and

¹² This is the de-rated capacity considering the outage of Nine Mile Unit 1 and de-rate of Unit 2.

other investments. The fall 2013 Unit 4 overhaul includes new turbine runners, thrust bearings, and operating system. Avista plans to overhaul Unit 3 in 2018-19.

Long Lake

The Long Lake development is located northwest of Spokane and maintains the Lake Spokane reservoir, also known as Long Lake. The plant received new runners in the 1990s, adding 2.2 aMW of additional energy. The project's four units have an 81.6 MW nameplate rating and provide 88.0 MW of combined capacity.

Little Falls

The Little Falls development, completed in 1910 near Ford, Washington, is the furthest downstream hydro facility on the Spokane River. A new runner upgrade in 2001 generates 0.6 aMW more energy. The facility's four units generate 35.2 MW of on-peak capacity and have a 32.0 MW nameplate rating. Avista is carrying out a series of upgrades to the Little Falls development. Much of the new electrical equipment and the installation of a new generator excitation system are complete. Current projects include replacing station service equipment, updating the powerhouse crane, and developing new control schemes and panels. After the preliminary work is completed, replacing generators, turbines, and unit protection and control systems on the four units will start.

Clark Fork River Hydroelectric Developments

The Clark Fork River Developments includes hydroelectric projects located near Clark Fork, Idaho, and Noxon, Montana, 70 miles south of the Canadian border. The plants operate under a FERC license through 2046. Both hydroelectric projects on the Clark Fork River connect to Avista's transmission system.

Cabinet Gorge

The Cabinet Gorge development started generating power in 1952 with two units. The plant added two additional generators the following year. The current maximum on-peak capacity of the plant is 270.5 MW; it has a nameplate rating of 265.2 MW. Upgrades at this project began with the replacement of the Unit 1 turbine in 1994. Unit 3 received an upgrade in 2001. Unit 2 received an upgrade in 2004. Unit 4 received a turbine runner upgrade in 2007.

Noxon Rapids

The Noxon Rapids development includes four generators installed between 1959 and 1960, and a fifth unit added in 1977. Avista recently completed a major turbine upgrade, with Units 1 through 4 receiving new runners between 2009 and 2012. The upgrades increased the capacity of each unit from 105 MW to 112.5 MW and added a total of 6.6 aMW of EIA qualified energy.

Total Hydroelectric Generation

In total, Avista's hydroelectric plants have 1,065.4 MW of on-peak capacity. Table 2.5 summarizes the location and operational capacities of Avista's hydroelectric projects. This table includes the expected energy output of each facility based on the 70-year hydrologic record for the year ending 2012.

Table 2.5: Avista-Owned Hydro Resources

Project Name	River System	Location	Nameplate Capacity (MW)	Maximum Capability (MW)	Expected Energy (aMW)
Monroe Street	Spokane	Spokane, WA	14.8	15.0	11.6
Post Falls	Spokane	Post Falls, ID	14.8	18.0	10.0
Nine Mile	Spokane	Nine Mile Falls, WA	26.0	17.5	12.5
Little Falls	Spokane	Ford, WA	32.0	35.2	22.1
Long Lake	Spokane	Ford, WA	81.6	89.0	53.4
Upper Falls	Spokane	Spokane, WA	10.0	10.2	7.5
Cabinet Gorge	Clark Fork	Clark Fork, ID	265.2	270.5	124.8
Noxon Rapids	Clark Fork	Noxon, MT	518.0	610.0	198.3
Total			962.4	1,065.4	440.2

Thermal Resources

Avista owns seven thermal generation assets located across the Northwest. Based on IRP analysis, Avista expects each plant to continue operation through the 20-year IRP planning horizon. The resources provide dependable energy and capacity to serve base loads and provide peak load-serving capabilities. A summary of Avista thermal resources is in Table 2.6.

Colstrip Units 3 and 4

The Colstrip plant, located in Eastern Montana, consists of four coal-fired steam plants connected to the double circuit 500 kV BPA transmission line under a long-term wheeling agreement. PPL Global operates the facilities on behalf of the six owners. Avista owns 15 percent of Units 3 and 4. Unit 3 began operating in 1984 and Unit 4 was finished in 1986. Avista's share of Colstrip Units 3 and 4 has a maximum net capacity of 111.0 MW, and a nameplate rating of 123.5 MW per unit. Avista has no ownership interests in Colstrip Unites 1 and 2.

Rathdrum

Rathdrum consists of two simple-cycle combustion turbine units. This natural gas-fired plant is located near Rathdrum, Idaho and connects to Avista's transmission system. It entered service in 1995 and has a maximum capacity of 178.0 MW in the winter and 126.0 MW in the summer. The nameplate rating is 166.5 MW.

Northeast

The Northeast plant, located in Spokane, is two aero-derivative simple-cycle units completed in 1978 and connects to Avista's transmission system. The plant is capable of burning natural gas or fuel oil, but current air permits preclude the use of fuel oil. The combined maximum capacity of the units is 68.0 MW in the winter and 42.0 MW in the summer, with a nameplate rating of 61.2 MW. The plant is currently limited to run no more than approximately 550 hours per year.

Boulder Park

The Boulder Park project entered service in Spokane Valley in 2002 and connects to Avista's transmission system. The site uses six natural gas-fired internal combustion reciprocating engines to produce a combined maximum capacity and nameplate rating of 24.6 MW.

Coyote Springs 2

Coyote Springs 2 is a natural gas-fired combined cycle combustion turbine located near Boardman, Oregon. This plant connects to BPA's 500 kV transmission system under a long-term transmission agreement. The plant began service in 2003. Its maximum capacity is 274 MW in the winter and 221 MW in the summer with a duct burner providing additional capacity of up to 28 MW. The plant's nameplate rating is 287.3 MW.

Avista is in the process of upgrading Coyote Springs 2. Upgrades include cooling optimization and cold day controls. The 2011 IRP process studied both of these updates. The cold day controls remove firing temperature suppression that occurs when ambient temperatures are below 60 degrees. The upgrade improves the heat rate by 0.5 percent and output by approximately 2.0 MW during cold temperature operations. The cooling optimization package improves compressor and natural gas turbine efficiency, resulting in an overall increase in plant output of 2.0 MW. In addition to these upgrades, Coyote Springs 2 now has a Mark VIe control upgrade, a new digital front end on the EX2100 gas turbine exciter, and model-based control with enhanced transient capability. Each of these projects allows Avista to maintain high reliability, reduce future O&M costs, improve our ability to maintain compliance with WECC reliability standards, and help prevent damage that might occur to the machine when electrical system disturbances occur.

Kettle Falls Generation Station and Kettle Falls Combustion Turbine

The Kettle Falls Generating Station, a biomass facility, entered service in 1983 near Kettle Falls, Washington. It is among the largest biomass plants in North America and connects to Avista's 115 kV transmission system. The open-loop biomass steam plant uses waste wood products from area mills and forest slash, but can also burn natural gas. A combustion turbine (CT), added to the facility in 2002, burns natural gas and increases overall plant efficiency by sending exhaust heat to the wood boiler.

The wood-fired portion of the plant has a maximum capacity of approximately 50.0 MW, and its nameplate rating is 50.7 MW. The plant typically operates between 45 and 47 MW because of fuel conditions. The plant's capacity increases to 57.0 MW when operated in combined-cycle mode with the CT. The CT produces 8 MW of peaking capability in the summer and 11 MW in the winter. The CT resource is limited in winter when the natural gas pipeline is capacity constrained; for IRP modeling, the CT does not run when temperatures fall below zero and natural gas pipeline capacity is assumed to serve local natural gas distribution demand.

Table 2.6: Avista-Owned Thermal Resources

Project Name	Location	Fuel Type	Start Date	Winter Maximum Capacity (MW)	Summer Maximum Capacity (MW)	Nameplate Capacity (MW)
Colstrip 3 (15%)	Colstrip, MT	Coal	1984	111.0	111.0	123.5
Colstrip 4 (15%)	Colstrip, MT	Coal	1986	111.0	111.0	123.5
Rathdrum	Rathdrum, ID	Gas	1995	178.0	126.0	166.5
Northeast	Spokane, WA	Gas	1978	68.0	42.0	61.2
Boulder Park	Spokane, WA	Gas	2002	24.6	24.6	24.6
Coyote Springs 2	Boardman, OR	Gas	2003	312.0	251.0	290.0
Kettle Falls	Kettle Falls, WA	Wood	1983	47.0	47.0	50.7
Kettle Falls CT ¹³	Kettle Falls, WA	Gas	2002	11.0	8.0	7.5
Total				862.6	720.6	847.5

Power Purchase and Sale Contracts

Avista utilizes power supply purchase and sale arrangements of varying lengths to meet a portion of its load requirements. This chapter describes the contracts in effect during the scope of the 2013 IRP. Contracts provide many benefits, including environmentally low-impact and low-cost hydro and wind power. A 2012 annual summary of Avista's large contracts is in Table 2.7.

Mid-Columbia Hydroelectric Contracts

During the 1950s and 1960s, Public Utility Districts (PUDs) in central Washington developed hydroelectric projects on the Columbia River. Each plant was large when compared to loads then served by the PUDs. Long-term contracts with public, municipal, and investor-owned utilities throughout the Northwest assisted with project financing, and ensured a market for the surplus power. The contract terms obligate the PUDs to deliver power to Avista points of interconnection.

Avista entered into long-term contracts for the output of four of these projects "at cost." Later, Avista competed in capacity auctions in 2009 through 2013 to purchase new short-term contracts at market-based prices. The Mid-Columbia contracts in Table 2.7 provide energy, capacity, and reserve capabilities; in 2014, the contracts provide approximately 127 MW of capacity and 76 aMW of energy. Over the next 20 years the Douglas PUD (2018) and Chelan PUD (2014) contracts will expire. Avista may extend these contracts or even gain additional capacity in auctions; however, we have no assurance that we will successfully extend our contract rights. Due to this uncertainty around future availability and cost, the IRP does not include these contracts in the resource mix beyond their expiration dates.

The timing of the power received from the Mid-Columbia projects is also a result of agreements including the Columbia River Treaty signed in 1961 and the Pacific

¹³ The Kettle Falls CT numbers include output of the gas turbine plus the benefit of its steam to the main unit's boiler.

Chapter 2: Loads & Resources

Northwest Coordination Agreement (PNCA) signed in 1964. Both agreements optimize hydro project operations in the Northwest United States and Canada. In return for these benefits, Canada receives return energy (Canadian Entitlement). The Columbia River Treaty and the PNCA call for storage water in upstream reservoirs for coordinated flood control and power generation optimization. On September 16, 2024, given a minimum of 10 years written advance notice, the Columbia River Treaty may end. Studies are underway by U.S. and Canadian entities to determine possible post-2024 Columbia River operations. Federal agencies are soliciting feedback from stakeholders and soon negotiations will begin in earnest to decide whether the current treaty will continue, should be ended, or if a new agreement will be struck. This IRP does not model potential alternative outcomes regarding the treaty negotiation, as it is not expected to impact long-term resource acquisition and we cannot speculate on future wholesale electricity market impacts of the treaty.

Table 2.7: Mid-Columbia Capacity and Energy Contracts

Counter Party	Project(s)	Percent Share (%)	Start Date	End Date	Estimated On-Peak Capability (MW)	Annual Energy (aMW)
Grant PUD	Priest Rapids	3.7	Dec-01	Dec-52	28.2	16.7
Grant PUD	Wanapum	3.7	Dec-01	Dec-52	31.0	17.9
Chelan PUD	Rocky Reach	3.0	Jul-11	Dec-14	34.5	21.0
Chelan PUD	Rock Island	3.0	Jul-11	Dec-14	13.9	10.7
Douglas PUD	Wells	3.3	Feb-65	Aug-18	27.9	14.7
Canadian Entitlement					-8.1	-4.6
2014 Total Net Contracted Capacity and Energy					127.4	76.4
2015 Total Net Contracted Capacity and Energy					81.9	46.3

Lancaster Power Purchase Agreement

Avista acquired the output rights to the Lancaster combined-cycle generating station, located in Rathdrum, Idaho, as part of the sale of Avista Energy in 2007. Lancaster presently connects to the BPA transmission system under a long-term wheeling agreement, but Avista is working with the federal agency to interconnect the plant directly with Avista's transmission system at the BPA Lancaster substation. Avista has the sole right to dispatch the plant, and is responsible for providing fuel and energy and capacity payments, under a tolling contract expiring in October 2026.

Public Utility Regulatory Policies Act (PURPA)

In 1978, Congress passed PURPA requiring utilities to purchase power from Independent Power Producers (IPPs) meeting certain criteria depending on their size and fuel source. Over the years, Avista has entered into many such contracts. Current PURPA contracts are in Table 2.8. Avista will renegotiate many of these contracts after the term of the current contract has ended.

Table 2.8: PURPA Agreements

Contract	Owner	Fuel Source	Location	End Date	Size (MW)	Annual Energy (aMW)
Meyers Falls	Hydro Technology Systems Inc	Hydro	Kettle Falls, WA	12/2013	1.30	1.05
Fighting Creek Landfill Gas to Energy Station	Kootenai Electric Cooperative	Municipal Waste	Coeur d'Alene, ID	12/2013	3.20	1.31
Spokane Waste to Energy	City of Spokane	Municipal Waste	Spokane, WA	11/2014	18.00	16.00
Spokane County Digester	Spokane County	Municipal Waste	Spokane, WA	8/2016	0.26	0.14
Plummer Saw Mill	Stimson Lumber	Wood Waste	Plummer, ID	11/2016	5.80	4.00
Deep Creek	Deep Creek Energy	Hydro	Northpoint, WA	12/2016	0.41	0.23
Clark Fork Hydro	James White	Hydro	Clark Fork, ID	12/2017	0.22	0.12
Upriver Dam ¹⁴	City of Spokane	Hydro	Spokane, WA	12/2019	17.60	6.17
Sheep Creek Hydro	Sheep Creek Hydro Inc	Hydro	Northpoint, WA	6/2021	1.40	0.79
Ford Hydro LP	Ford Hydro Ltd Partnership	Hydro	Weippe, ID	6/2022	1.41	0.39
John Day Hydro	David Cereghino	Hydro	Lucille, ID	9/2022	0.90	0.25
Phillips Ranch	Glenn Phillips	Hydro	Northpoint, WA	n/a	0.02	0.01
Total					50.52	30.45

Bonneville Power Administration – WNP-3 Settlement

Avista signed settlement agreements with BPA and Energy Northwest on September 17, 1985, ending construction delay claims against both parties. The settlement provides an energy exchange through June 30, 2019, with an agreement to reimburse Avista for WPPSS – Washington Nuclear Plant No. 3 (WNP-3) preservation costs and an irrevocable offer of WNP-3 capability under the Regional Power Act.

The energy exchange portion of the settlement contains two basic provisions. The first provision provides approximately 42 aMW of energy to Avista from BPA through 2019, subject to a contract minimum of 5.8 million megawatt-hours. Avista is obligated to pay BPA operating and maintenance costs associated with the energy exchange as determined by a formula that ranges from \$16 to \$29 per megawatt-hour in 1987-year constant dollars.

¹⁴ Energy estimate is net of pumping load.

The second provision provides BPA approximately 32 aMW of return energy at a cost equal to the actual operating cost of Avista's highest-cost resource. A further discussion of this obligation, and how Avista plans to account for it, is under the Energy Planning section.

Palouse Wind – Power Purchase Agreement

Avista signed a 30-year power purchase agreement in 2011 with Palouse Wind for the entire output of the 105 MW project. Avista has the option to purchase the project after year 10 of the contract. Commercial operation began in December 2012. The project is EIA qualified and directly connected to Avista's transmission system.

Table 2.9: Other Contractual Rights and Obligations

Contract	Type	Fuel Source	End Date	Winter Capacity (MW)	Summer Capacity (MW)	Annual Energy (aMW)
Stateline	Purchase	Wind	3/2014	0	0	9
Sacramento Municipal Utility District	Sale	System	12/2014	-50	-50	-50
PGE Capacity Exchange	Exchange	System	12/2016	-150	-150	0
Douglas Settlement	Purchase	Hydro	9/2018	2	2	3
WNP-3	Purchase	System	6/2019	82	0	42
Lancaster	Purchase	Natural Gas	10/2026	290	249	222
Palouse Wind	Purchase	Wind	12/2042	0	0	40
Nichols Pumping	Sale	System	n/a	-1	-1	-1
Total				173	50	265

Reserve Margins

Planning reserves accommodate situations when loads exceed and/or resource outputs are below expectations due to adverse weather, forced outages, poor water conditions, or other contingencies. There are disagreements within the industry on reserve margin levels utilities should carry. Many disagreements stem from system differences, such as resource mix, system size, and transmission interconnections.

Reserve margins, on average, increase customer rates when compared to resource portfolios without reserves because of the additional cost of carrying additional generating capacity that is rarely used. Reserve resources have the physical capability to generate electricity, but high operating costs limit their economic dispatch and revenues.

Avista Planning Margin

Avista retains two planning margin targets—capacity and energy. Capacity planning is the traditional metric ensuring utilities can meet peak loads at times of system strain, and cover variability inherent in their generation resources with unpredictable fuel supplies, such as wind and hydro, and varying loads.

Capacity Planning

Utility capacity planning begins with regional planning. Resource and load positions of the region as a whole affect individual utility resource acquisition decisions. The Pacific Northwest has a history of being capacity surplus and energy deficit. The 2000-01 energy crisis led to the rapid development of 3,425 MW of natural gas-fired generation in the Northwest. Over the following 10 years, the Northwest added 2,000 MW of natural gas-fired generation. During this same time, Oregon and Washington added 6,000 MW of wind. With recent wind additions, and their lack of capacity contribution, the region is approaching a capacity balance with loads; but the region remains long on energy due to the quantity of wind generation added to the system.

In recognition of these regional changes, the NPCC has done a considerable amount of analytical work to understand and develop methodologies to identify capacity needs in the region. Based on their work, the Northwest begins to fail a five percent Loss of Load Probability (LOLP) test in the winter of 2017-18.¹⁵ Five percent LOLP means utilities meet all customer demand in 19 of 20 years, or one loss of load event permitted on a planning basis in 20 years due to insufficient generation. The NPCC identifies a need of 350 MW of new capacity, or 300 aMW of peak load reduction, to eliminate potential 2017-18 resource shortfall. The identified regional problem months are in the winter, with a small change of problems in the summer months. The NPCC also studied load growth and market availability scenarios. In the event of higher loads or reduced market availability, the NPCC study indicated that the region should add 2,850 MW of new capacity by 2017.

Because Avista often relies on the Northwest market to serve a portion of its peak load needs, it requested additional data from the NPCC to develop regional load and resource balance reports to understand the regional load and resource system balance. With the NPCC data, Avista developed the information shown in Table 2.10. This table illustrates the region's substantial summer surplus and dwindling winter supplies. The table also illustrates the resource capability based on the length of the peak event. The table shows one, four, and ten-hour peaks, illustrating the unique impact that hydro has on the Northwest's ability to meet peak loads. These regional balances do not include wind capacity.

In January 2018, the one hour implied planning margin is 24.3 percent, but with regional IPPs included, the margin improves to 34.3 percent. During a one-hour event the system has 8,050 excess MW or 11,374 with the IPPs. The real problem lies in a ten-hour event, where only a 4.3 percent planning margin exists absent the IPPs, and a 15 percent margin with them. This translates into modest surpluses of 1,334 MW and 4,658 MW, respectively.

The region is long by more than 11,000 MW without, and over 14,000 MW with, the IPPs in the summer. The main concern during a summer peak load event is that excess power may be scheduled outside of the region on a pre-schedule basis, leaving limited

¹⁵ John Fazio, NPCC, "Adequacy Assessment of the 2017 Pacific Northwest Power Supply", NW Resource Adequacy Forum Steering Committee Meeting, October 26, 2012 in Portland, OR.

resource available for the Northwest. The maximum regional export to California is estimated to be up to 7,980 MW absent any transmission derates. Power could also be exported east through Idaho, but the limit east is 2,250 MW.¹⁶ The Northwest region has options to import power from British Columbia and Montana. The NPCC believes the region has sufficient capacity in the summer, but lacks capacity beginning in 2017 in the winter.

Table 2.10: Regional Load & Resource Balance

	January 2018			August 2018		
	1 Hour	4 Hour	10 Hour	1 Hour	4 Hour	10 Hour
Implied Planning Margin (PM)	24.3%	11.7%	4.3%	44.7%	46.4%	49.3%
w/ IPP Implied PM	34.3%	21.9%	15.0%	56.6%	58.6%	62.0%
Length (MW)	8,050	3,789	1,334	11,687	11,894	12,113
w/ IPP Length (MW)	11,374	7,112	4,658	14,804	15,010	15,229
	January 2025			August 2025		
	1 Hour	4 Hour	10 Hour	1 Hour	4 Hour	10 Hour
Implied Planning Margin (PM)	12.5%	-1.5%	-12.0%	30.7%	29.3%	28.7%
w/ IPP Implied PM	19.1%	5.2%	-5.0%	38.4%	37.1%	36.8%
Length (MW)	4,489	-533	-4,042	8,706	8,141	7,631
w/ IPP Length (MW)	6,853	1,831	-1,679	10,862	10,297	9,788

Avista's Loss of Load Analysis

In the Northwest, reliability matrices can help address the issue of how much planning margin is required. Typical results of these models are LOLP, Loss of Load Hours (LOLH), and Loss of Load Expectation (LOLE) measures. A reliable system is typically defined as having no more than one interruption event in twenty years, or a five percent LOLP. These analyses can be helpful, but usually have an inherent flaw due to the need to assume how much out-of-area imported generation is available for the study.

Avista developed its LOLP model to simulate reliability events caused by to poor hydro runoff, forced outages, and extreme weather conditions on its system, finding that forced outages are the main driver of reliability events and/or the need for imported power. Avista is well positioned to import power. It has adequate transmission capabilities to import power from the wholesale energy markets, but the amount of generation actually available for purchase from third parties at times of system peak is difficult to estimate. To address this concern, a sophisticated regional model must estimate required regional planning margins. As discussed above, the NPCC has performed this regional assessment. The challenge, even at the regional level, is modeling market imports into or exports from the region. To address this shortfall the NPCC and Avista use scenario analyses.¹⁷

The results of Avista's LOLP study are in Figure 2.20. The results use scenario analyses to illustrate potential planning margins using a test year of 2020. The scenarios change the amount of market reliance compared with new resource

¹⁶ Ibid.

¹⁷ Ibid.

acquisitions by Avista. This chart indicates that with a 12 percent planning margin Avista would rely on 275 MW from the market to meet a 5 percent LOLP metric. To eliminate market reliance, Avista would require a 31 percent planning margin at an additional power supply cost of \$40 million per year.

Figure 2.20: 2020 Market Reliance & Capacity Cost Tradeoffs to Achieve 5 Percent LOLP

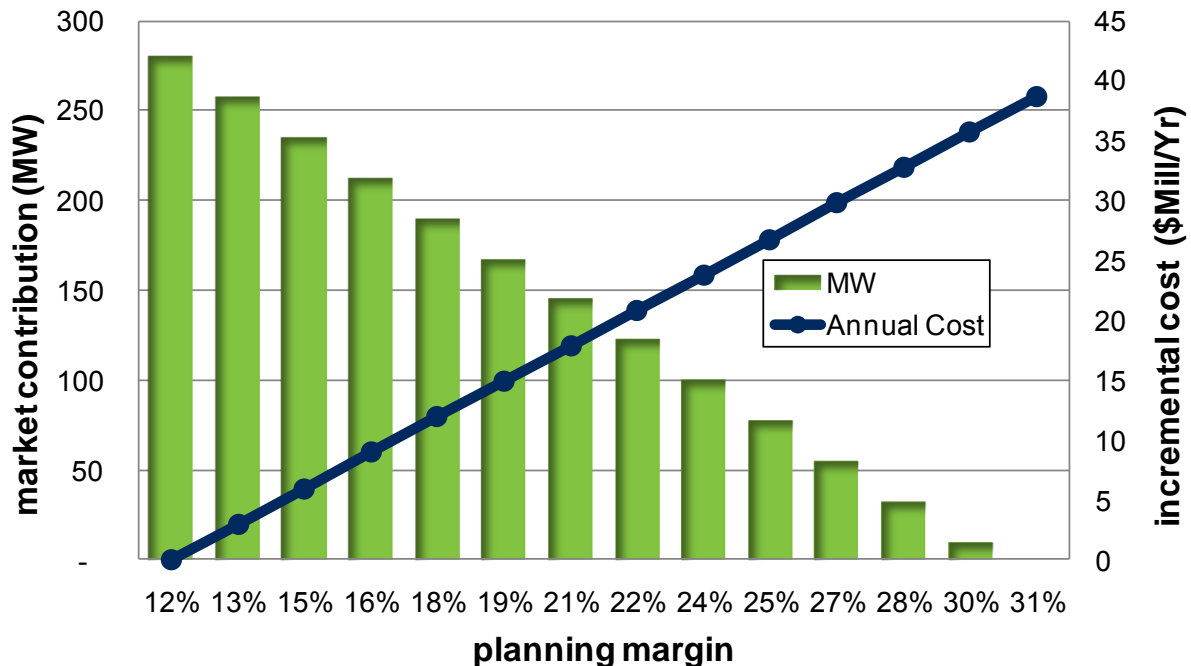

While scenario analysis helps management understand the tradeoffs between imports and new plant construction, it does not help identify the actual planning margin. For this IRP, Avista chose a 14 percent basic planning margin. The addition of operating reserves and other ancillary services results in a total planning margin of 22 percent. This level is similar to the planning margin used in the 2011 IRP and is similar to other utilities. Further, the planning margin is similar to NPCC's 23 percent recommendation for the region.¹⁸ The 14 percent planning margin implies Avista will rely on 240 MW of market power in some peak events.

In addition to understanding the level of imports Avista will depend on during extreme peak events, it considers the regional resource position before deciding to procure new resources. Based on the current regional surplus shown in Table 2.10, Avista does not believe it is necessary procure new resources for future summer deficits. During summer months, the regional resource position is longer than the winter position. As a dual-peaking utility, Avista is concerned with summer reliability, but with the regional resource length described above, the addition of new resources likely is unnecessary.

¹⁸ The NPCC does not consider operating reserves and ancillary services separately from the planning margin, but instead combines them together into one figure.

Where the region shows signs of becoming resource deficient in the future, Avista will re-evaluate its positions.

Balancing Loads and Resources

Both the single-hour and sustained-peak requirements compare future projections of utility loads and resources. The single peak hour is more of a concern in the winter than the three-day sustained 18-hour peak. During winter months, the hydro system is able to sustain generation levels for longer periods than in the summer months due to higher inflows. Figure 2.21 illustrates the winter balance of loads and resources; the first year Avista identifies a significant winter capacity deficit is January 2020. Avista has small deficits in 2015 and 2016, but regional surplus and the expiration of the 150 MW capacity contract with Portland General Electric at the end of 2016 suggests the utility should rely on the short-term marketplace to meet these deficits. A detailed table of Avista’s annual loads and resources is at the end of this chapter in Tables 2.12 through 2.14.

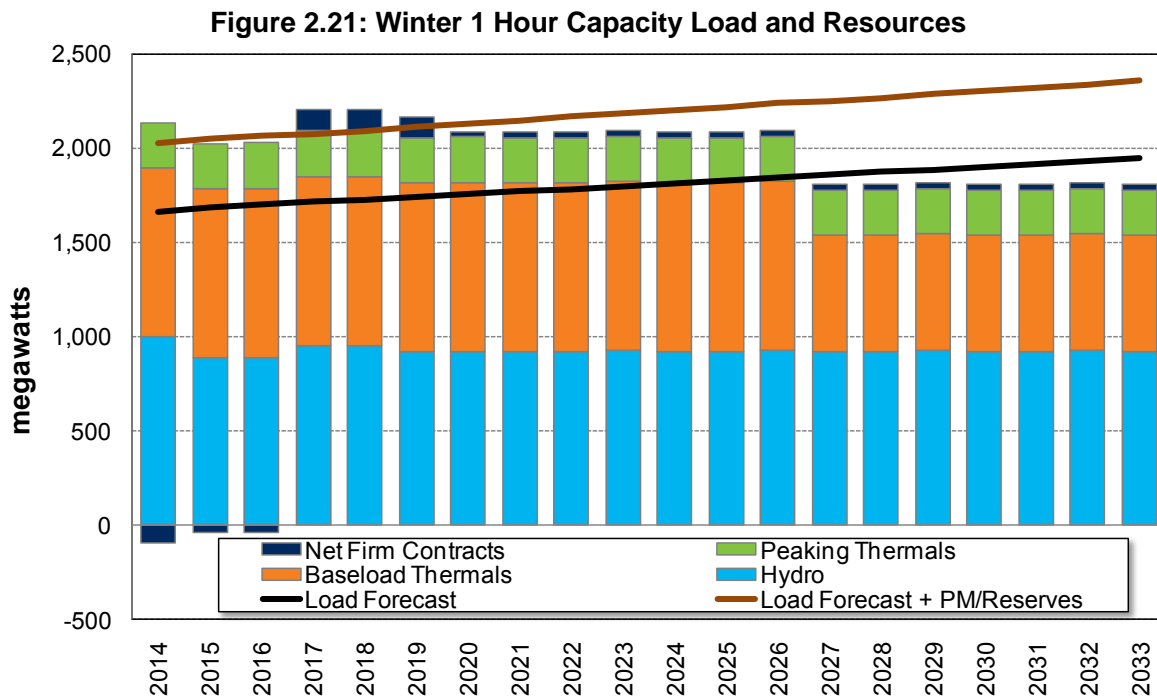

The 2013 IRP does not anticipate meeting summer capacity deficits with new resources, because of the significant regional surplus in the summer. Similar to the region, Avista’s generation additions to meet winter peaks will substantially eliminate summer deficits.

Avista’s summer resource balance is in Figure 2.22. This chart differs from the winter load and resource balance by using an 18-hour sustained peak rather than the single hour peak. The sustained peak is more constraining in the summer months due to reservoir restrictions and lower river flows reducing the amount of continuous hydro

generation available to meet load. This chart also differs from the winter because Avista is not adding a planning margin to the summer due to expected regional surpluses. See Table 2.13 for more details.

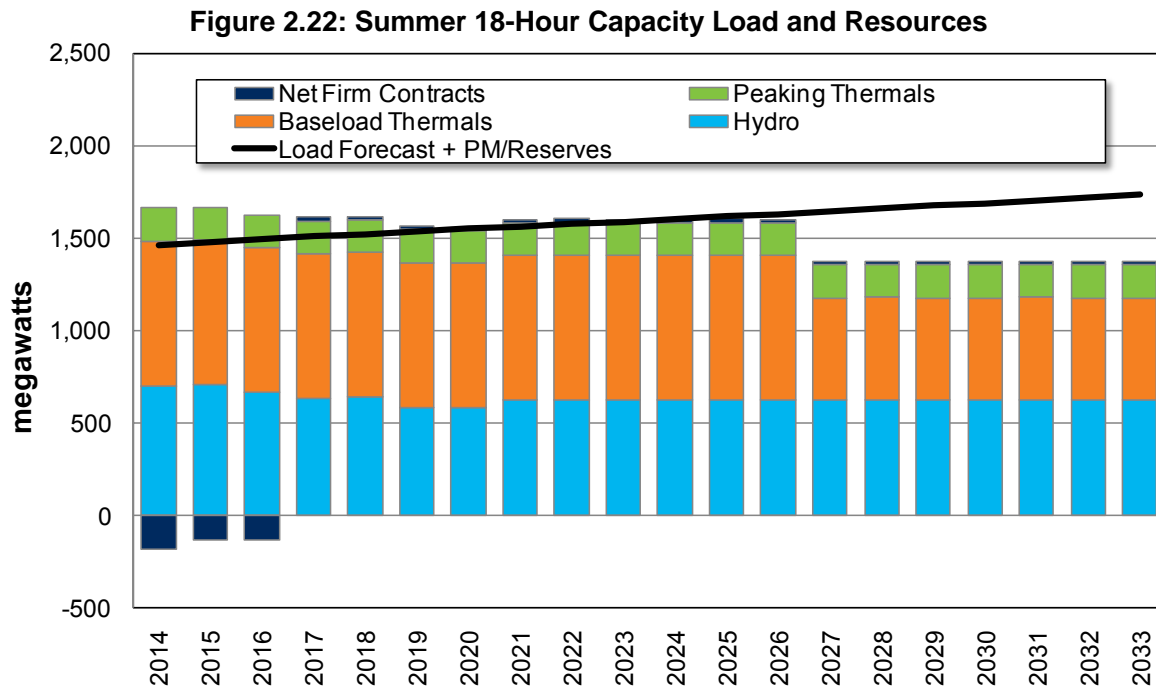

Energy Planning

For energy planning, resources must be adequate to meet customer requirements even when loads are high for extended periods or an outage limits the output of a resource. Where generation capability is not adequate to meet these variations, customers and the utility must rely on the volatile short-term electricity market. In addition to load variability, planning margins accounts for variations in hydroelectric generation.

As with capacity planning, there are differences in regional opinion on the proper method for establishing energy-planning margins. Many utilities in the Northwest base their planning on the amount of energy available during the critical water period of 1936/37.¹⁹ The critical water year of 1936/37 was low on an annual basis, but it was not necessarily low in every month. The IRP could target resource development to reach a 99 percent confidence level on being able to deliver energy to its customers, and it would significantly decrease the frequency of its market purchases. However, this strategy requires investments in approximately 200 MW of generation in addition to the margins included in Expected Case of the IRP. Expenditures to support this high level of reliability would put upward pressure on retail rates for a modest benefit. Avista instead plans to the 90th percentile for hydro. There is a 10 percent chance of needing to purchase energy from the market in any given month over the IRP timeframe, but in

¹⁹ The critical water year represents the lowest historical generation level in the streamflow record.

nine of ten years, Avista would meet all of its energy requirements and sell surplus electricity into the marketplace.

Beyond load and hydroelectricity variability, Avista's WNP-3 contract with BPA contains supply risk. The contract includes a return energy provision in favor of BPA that can equal 32 aMW annually. Under adverse market conditions, BPA almost certainly would exercise this right, as it did during the 2001 Energy Crisis. To account for contract risk, the energy contingency is increased by 32 aMW until the contract expires in 2019. With the addition of WNP-3 to load and hydroelectricity variability, the total energy contingency equals 228 aMW in 2014. See Figure 2.23 for the summary of the annual average energy load and resource net position.

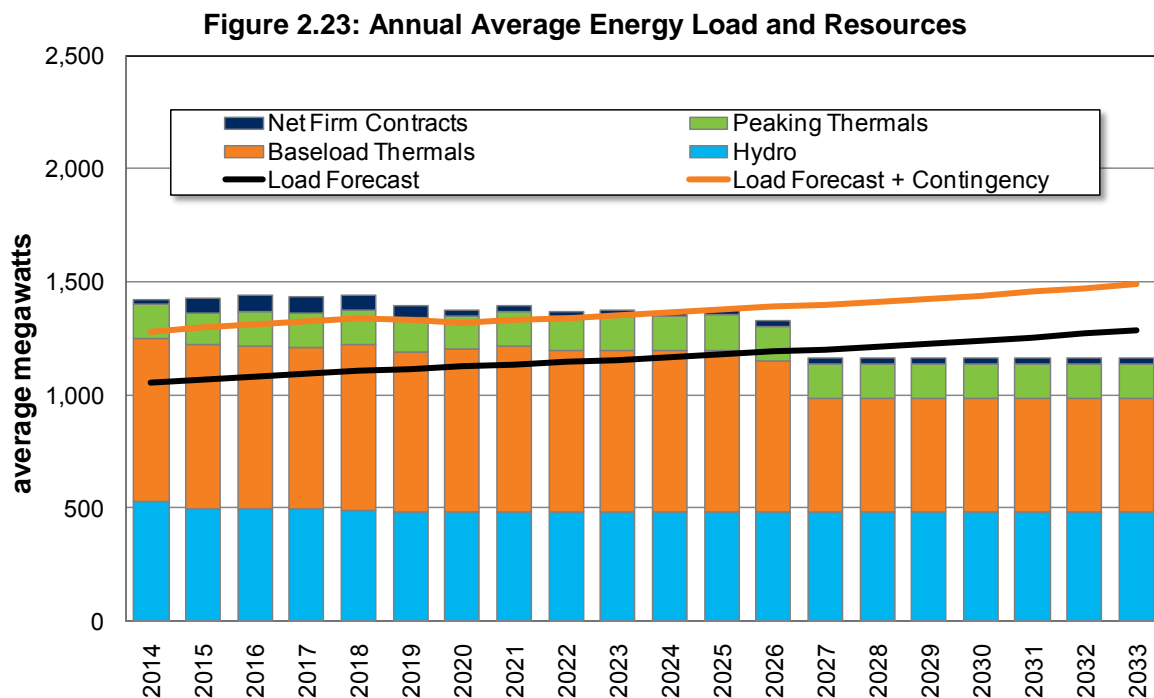

Washington State Renewable Portfolio Standard

In the November 2006 general election, Washington voters approved the EIA. The EIA requires utilities with more than 25,000 customers to source 3 percent of their energy from qualified non-hydroelectric renewables by 2012, 9 percent by 2016, and 15 percent by 2020. Utilities also must acquire all cost effective conservation and energy efficiency measures. In 2011, Avista acquired the Palouse Wind project through a 30-year power purchase agreement to help meet the renewable goal. In 2012, an amendment to the EIA allowed biomass facilities built prior to 1999 to qualify under the law beginning in 2016. This amendment allows Avista's 50 MW Kettle Falls project to qualify and further help the company meet EIA requirements. Table 2.11 shows the forecast amount of RECs required to meet Washington state law, and the amount of qualifying resources already in Avista's generation portfolio. The sales forecast uses the Washington portion of the current load forecast. It illustrates how Avista will maintain a modest surplus of

approximately 10 aMW in 2016 to account for annual generation variability at its EIA-qualifying plants.

Resource Requirements

The resource requirements discussed in this section do not include energy efficiency acquisitions beyond what is contained in the load forecast. The PRS chapter discusses conservation beyond assumptions contained in the load forecast. The following tables present loads and resources to illustrate future resource requirements.

During winter peak periods (Table 2.12), surplus capacity exists through 2019 after taking into account market purchases.²⁰ Without these purchases, a capacity deficit would exist in 2012. Avista believes that the present market can meet these minor winter capacity shortfalls and therefore will optimize its portfolio to postpone new resource investments for winter capacity until 2020.

The summer peak projection in Table 2.13 shows lower loads than in winter, but resource capabilities are also lower due to lower hydroelectricity output and reduced capacity at natural gas-fired resources. The IRP shows persistent summer deficits throughout the 20-year timeframe, but regional surpluses are adequate to fill in these gaps. Many near-term deficits are from decreased hydroelectricity capacity during periods of planned maintenance and upgrades. Taking into account regional surpluses, the load and resource balance is 54 MW short only in 2016. After 2016, when the Portland General Electricity capacity sale contract expires, the next capacity need is in 2019 at 98 MW.

The traditional measure of resource need in the region is the annual average energy position. Table 2.14 shows the energy position. There is enough energy on an annual average basis to meet customer requirements until 2020, when the utility is short 49 aMW. Avista will require 112 aMW of new energy by 2025, and 475 aMW in 2031.

²⁰ Avista relied on work by the NPCC in its Resource Adequacy Forum exercises to determine the level of surplus summer energy and capacity. Reliance is limited to Avista's prorated share of regional load.

Chapter 2: Loads & Resources

Table 2.11: Washington State RPS Detail (aMW)

	On-line Year	Apprentice Labor Credit	Energy	2012	2013	2014	2015	2016	2017	2018	2019	2020	2021	2022	2023	2024	2025	2026	2027	2028	2029	2030	2031	2032	2033		
				3%	3%	3%	3%	3%	9%	9%	9%	9%	9%	15%	15%	15%	15%	15%	15%	15%	15%	15%	15%	15%	15%	15%	15%
WA State Retail Sales Forecast				628	633	640	646	650	658	665	668	671	676	680	684	687	694	698	702	704	711	716	722	726	735		
RPS %				3%	3%	3%	3%	3%	9%	9%	9%	15%	15%	15%	15%	15%	15%	15%	15%	15%	15%	15%	15%	15%	15%		
REQUIRED RENEWABLE ENERGY				19.0	19.0	18.9	19.1	57.9	58.3	58.9	59.5	100.0	100.5	101.0	101.7	102.2	102.8	103.6	104.4	105.0	105.4	106.1	107.0	107.9	108.6		
Incremental Hydro																											
Long Lake 3	1999	1.0	1.6	1.6	1.6	1.6	1.6	1.6	1.6	1.6	1.6	1.6	1.6	1.6	1.6	1.6	1.6	1.6	1.6	1.6	1.6	1.6	1.6	1.6	1.6		
Little Falls 4	2001	1.0	0.6	0.6	0.6	0.6	0.6	0.6	0.6	0.6	0.6	0.6	0.6	0.6	0.6	0.6	0.6	0.6	0.6	0.6	0.6	0.6	0.6	0.6	0.6		
Cabinet 2	2004	1.0	3.3	3.3	3.3	3.3	3.3	3.3	3.3	3.3	3.3	3.3	3.3	3.3	3.3	3.3	3.3	3.3	3.3	3.3	3.3	3.3	3.3	3.3	3.3		
Cabinet 3	2001	1.0	5.2	5.2	5.2	5.2	5.2	5.2	5.2	5.2	5.2	5.2	5.2	5.2	5.2	5.2	5.2	5.2	5.2	5.2	5.2	5.2	5.2	5.2	5.2		
Cabinet 4	2007	1.0	2.3	2.3	2.3	2.3	2.3	2.3	2.3	2.3	2.3	2.3	2.3	2.3	2.3	2.3	2.3	2.3	2.3	2.3	2.3	2.3	2.3	2.3	2.3		
Noxon 1	2009	1.0	2.4	2.4	2.4	2.4	2.4	2.4	2.4	2.4	2.4	2.4	2.4	2.4	2.4	2.4	2.4	2.4	2.4	2.4	2.4	2.4	2.4	2.4	2.4		
Noxon 3	2010	1.0	1.7	1.7	1.7	1.7	1.7	1.7	1.7	1.7	1.7	1.7	1.7	1.7	1.7	1.7	1.7	1.7	1.7	1.7	1.7	1.7	1.7	1.7	1.7		
Noxon 2	2011	1.0	0.9	0.9	0.9	0.9	0.9	0.9	0.9	0.9	0.9	0.9	0.9	0.9	0.9	0.9	0.9	0.9	0.9	0.9	0.9	0.9	0.9	0.9	0.9		
Noxon 4	2012	1.0	1.4	1.4	1.4	1.4	1.4	1.4	1.4	1.4	1.4	1.4	1.4	1.4	1.4	1.4	1.4	1.4	1.4	1.4	1.4	1.4	1.4	1.4	1.4		
Nine Mile	2015	1.0	0.0	1.4	1.4	1.4	1.4	1.4	1.4	1.4	1.4	1.4	1.4	1.4	1.4	1.4	1.4	1.4	1.4	1.4	1.4	1.4	1.4	1.4	1.4		
Wanapum Fish Bypass	2008	1.0	2.5	2.5	2.4	2.4	2.4	2.4	2.4	2.4	2.4	2.4	2.4	2.4	2.4	2.4	2.4	2.4	2.4	2.4	2.4	2.4	2.4	2.4	2.4		
Total Qualifying Resources				21.3	23.3	23.2	23.2	23.2	23.2	23.2	23.2	23.2	23.2	23.2	23.2	23.2	23.2	23.2	23.2	23.2	23.2	23.2	23.2	23.2	23.2		
REC POSITION NET OF INCREMENTAL HYDRO																											
				0.0	0.0	0.0	0.0	-34.7	-35.2	-35.7	-36.4	-76.8	-77.3	-77.9	-78.5	-79.1	-79.6	-80.4	-81.2	-81.8	-82.2	-82.9	-83.8	-84.7	-85.5		
Qualifying Renewable Resources/RECS																											
Purchased RECS				0.0	0.0	0.0	5.7	0.0	0.0	0.0	0.0	0.0	0.0	0.0	0.0	0.0	0.0	0.0	0.0	0.0	0.0	0.0	0.0	0.0	0.0		
Kettle Falls	1983	1.0	0.0	0.0	0.0	0.0	32.5	32.1	31.9	32.5	32.4	33.2	31.8	32.5	31.8	32.5	31.8	32.5	31.8	32.5	31.8	32.5	31.8	32.5	31.8		
Palouse Wind	2012	1.2	39.9	0.0	47.9	47.9	47.9	47.9	47.9	47.9	47.9	47.9	47.9	47.9	47.9	47.9	47.9	47.9	47.9	47.9	47.9	47.9	47.9	47.9	47.9		
Total Qualifying Resources				0.0	47.9	47.9	53.6	80.4	80.0	79.9	80.4	80.3	81.2	79.7	80.4	79.7	80.4	79.7	80.4	79.7	80.4	79.7	80.4	79.7	79.7		
NET REC POSITION BEFORE BANKING & RESERVES																											
				0.0	47.9	47.9	53.6	45.7	44.8	44.2	44.1	3.5	3.9	1.8	1.9	0.6	0.8	-0.7	-0.8	-2.1	-1.8	-3.2	-3.4	-5.0	-5.8		

Chapter 2: Loads & Resources

Table 2.12: Winter 18-Hour Capacity Position (MW)

	2014	2015	2016	2017	2018	2019	2020	2021	2022	2023	2024	2025	2026	2027	2028	2029	2030	2031	2032	2033	
REQUIREMENTS																					
Native Load	-1,665	-1,683	-1,700	-1,713	-1,727	-1,741	-1,755	-1,769	-1,783	-1,798	-1,812	-1,827	-1,842	-1,856	-1,871	-1,887	-1,902	-1,917	-1,933	-1,948	
Firm Power Sales	-211	-158	-158	-8	-8	-6	-6	-6	-6	-6	-6	-6	-6	-6	-6	-6	-6	-6	-6	-6	
Total Requirements	-1,875	-1,841	-1,857	-1,721	-1,735	-1,747	-1,761	-1,775	-1,789	-1,804	-1,818	-1,833	-1,848	-1,863	-1,878	-1,893	-1,908	-1,923	-1,939	-1,954	
RESOURCES																					
Firm Power Purchases	117	117	117	117	117	116	34	34	33	33	33	33	33	33	33	33	33	33	33	33	
Hydro Resources	998	888	889	955	955	919	924	920	920	928	920	920	928	920	920	928	920	920	928	920	
Base Load Thermals	895	895	895	895	895	895	895	895	895	895	895	895	895	895	895	895	895	895	895	895	
Wind Resources	0	0	0	0	0	0	0	0	0	0	0	0	0	0	0	0	0	0	0	0	
Peaking Units	242	242	242	242	242	242	242	242	242	242	242	242	242	242	242	242	242	242	242	242	
Total Resources	2,252	2,143	2,143	2,210	2,210	2,172	2,095	2,091	2,091	2,098	2,090	2,090	2,098	1,811	1,811	1,819	1,811	1,811	1,819	1,811	
Peak Position Before Reserve Plan	377	302	286	489	475	425	334	316	301	294	272	257	250	-51	-66	-74	-97	-112	-120	-143	
RESERVE PLANNING																					
Planning Margin	-233	-236	-238	-240	-242	-244	-246	-248	-250	-252	-254	-256	-258	-260	-262	-264	-266	-268	-271	-273	
Total Ancillary Services Required	-139	-136	-137	-128	-129	-131	-136	-137	-138	-139	-141	-142	-143	-139	-139	-140	-140	-140	-140	-140	
Reserve & Contingency Availability	13	6	6	6	6	6	6	6	6	6	6	6	6	6	6	6	6	6	6	6	
Demand Response	0	0	0	0	0	0	0	0	0	0	0	0	0	0	0	0	0	0	0	0	
Total Reserve Planning	-359	-366	-369	-362	-366	-369	-376	-379	-382	-386	-389	-392	-395	-393	-396	-398	-400	-403	-406	-408	
Peak Position w/ Reserve Planning	17	-64	-84	126	110	56	-42	-64	-81	-92	-117	-135	-145	-445	-462	-472	-497	-515	-525	-551	
Implied Planning Margin	21%	17%	16%	29%	28%	25%	19%	18%	17%	17%	15%	14%	14%	-2%	-3%	-4%	-5%	-6%	-6%	-7%	

Chapter 2: Loads & Resources

Table 2.13: Summer 18-Hour Capacity Position (MW)

	2014	2015	2016	2017	2018	2019	2020	2021	2022	2023	2024	2025	2026	2027	2028	2029	2030	2031	2032	2033
REQUIREMENTS																				
Native Load	-1,465	-1,482	-1,498	-1,510	-1,523	-1,536	-1,550	-1,563	-1,576	-1,590	-1,604	-1,618	-1,631	-1,646	-1,660	-1,674	-1,689	-1,703	-1,718	-1,733
Firm Power Sales	-212	-159	-159	-9	-9	-8	-8	-7	-7	-7	-7	-7	-7	-7	-7	-7	-7	-7	-7	-7
Total Requirements	-1,677	-1,641	-1,657	-1,519	-1,532	-1,544	-1,557	-1,570	-1,584	-1,597	-1,611	-1,625	-1,639	-1,653	-1,667	-1,681	-1,696	-1,710	-1,725	-1,740
RESOURCES																				
Firm Power Purchases	29	29	29	29	29	26	26	26	26	25	25	25	25	25	25	25	25	25	25	25
Hydro Resources	701	707	663	631	638	583	580	622	624	622	622	624	622	622	624	622	622	624	624	622
Base Load Thermals	785	785	785	785	785	785	785	785	785	785	785	785	785	785	556	556	556	556	556	556
Wind Resources	0	0	0	0	0	0	0	0	0	0	0	0	0	0	0	0	0	0	0	0
Peaking Units	176	176	176	176	176	176	176	176	176	176	176	176	176	176	176	176	176	176	176	176
Total Resources	1,691	1,698	1,653	1,621	1,628	1,571	1,568	1,609	1,611	1,609	1,609	1,611	1,609	1,379	1,381	1,379	1,379	1,381	1,379	1,379
Peak Position Before Reserve Plan	14	57	-3	102	96	27	11	39	27	11	-2	-14	-30	-274	-286	-302	-317	-330	-346	-361
RESERVE PLANNING																				
Planning Margin	0	0	0	0	0	0	0	0	0	0	0	0	0	0	0	0	0	0	0	0
Total Ancillary Services Required	-177	-176	-177	-170	-172	-173	-175	-176	-177	-179	-180	-181	-182	-166	-167	-167	-168	-169	-169	-170
Reserve & Contingency Availability	177	176	177	170	172	173	175	176	177	179	180	181	182	166	167	167	168	169	169	170
Demand Response	0	0	0	0	0	0	0	0	0	0	0	0	0	0	0	0	0	0	0	0
Total Reserve Planning	0	0	0	0	0	0	0	0	0	0	0	0	0	0	0	0	0	0	0	0
Peak Position w/ Reserve Planning	14	57	-3	102	96	27	11	39	27	11	-2	-14	-30	-274	-286	-302	-317	-330	-346	-361
Implied Planning Margin	11%	14%	10%	18%	17%	13%	12%	14%	13%	12%	11%	10%	9%	-7%	-7%	-8%	-9%	-9%	-10%	-11%

Chapter 2: Loads & Resources

Table 2.14: Average Annual Energy Position (aMW)

	2014	2015	2016	2017	2018	2019	2020	2021	2022	2023	2024	2025	2026	2027	2028	2029	2030	2031	2032	2033
REQUIREMENTS																				
Native Load	-1,054	-1,067	-1,079	-1,093	-1,105	-1,114	-1,125	-1,135	-1,145	-1,155	-1,167	-1,180	-1,190	-1,201	-1,212	-1,225	-1,239	-1,254	-1,270	-1,285
Firm Power Sales	-109	-58	-58	-6	-6	-5	-5	-5	-5	-5	-5	-5	-5	-5	-5	-5	-5	-5	-5	-5
Total Requirements	-1,163	-1,125	-1,137	-1,099	-1,111	-1,119	-1,130	-1,140	-1,150	-1,160	-1,172	-1,185	-1,195	-1,206	-1,217	-1,230	-1,244	-1,259	-1,274	-1,290
RESOURCES																				
Firm Power Purchases	128	129	128	76	76	56	31	30	30	29	29	29	29	29	29	29	29	29	29	29
Hydro Resources	527	495	495	495	490	481	481	481	481	481	481	481	481	481	481	481	481	481	481	481
Base Load Thermals	723	725	718	715	732	711	724	736	713	717	714	719	673	506	504	506	504	506	504	506
Wind Resources	42	40	40	40	40	40	40	40	40	40	40	40	40	40	40	40	40	40	40	40
Peaking Units	153	139	154	153	153	153	147	151	152	153	152	153	152	153	152	153	152	153	152	153
Total Resources	1,573	1,528	1,535	1,479	1,490	1,440	1,422	1,438	1,416	1,420	1,415	1,421	1,374	1,208	1,206	1,208	1,206	1,208	1,206	1,208
Peak Position Before Reserve Plan	410	404	398	380	379	321	292	299	266	259	243	237	179	2	-12	-22	-39	-51	-69	-82
RESERVE PLANNING																				
Contingency	-228	-231	-231	-232	-232	-214	-195	-196	-196	-197	-197	-198	-198	-199	-199	-200	-200	-201	-202	-202
Peak Position w/ Reserve Planning	182	173	167	148	147	106	96	103	70	63	46	39	-19	-197	-211	-221	-239	-252	-270	-284

3. Energy Efficiency

Introduction

Avista began offering energy efficiency programs to customers in 1978. Notable efficiency achievements include the Energy Exchanger program (1992 to 1994) converting approximately 20,000 homes from electricity to natural gas space and/or water heat. Avista pioneered the country's first system benefit charge for energy efficiency in 1995. In response to the 2001 Western Energy Crisis, Avista acquired over three times the annual acquisition at only double the cost over a six-month period. During the summer of 2011, Avista distributed 2.3 million compact fluorescent lights (CFLs) to residential and commercial customers for an estimated energy savings of 39,005 MWh. Conservation programs regularly meet or exceed regional shares of energy efficiency gains as outlined by the NPCC.

Section Highlights

- This IRP includes a Conservation Potential Assessment of Avista's Idaho and Washington service territories.
- Current Avista-sponsored conservation reduces retail loads by nearly 10 percent, or 115 aMW.
- Avista evaluated over 3,000 equipment options, and over 1,700 measure options covering all major end use equipment, as well as devices and actions to reduce energy consumption for this IRP.

Figure 3.1 illustrates Avista's historical electricity conservation acquisitions. Avista has acquired 168 aMW of energy efficiency since 1978; however, the 18-year average life of the conservation portfolio means some measures have reached the end of their useful lives and are no longer reducing loads. The 18-year assumed measure life accounts for the difference between the Cumulative and Online lines in Figure 3.1.

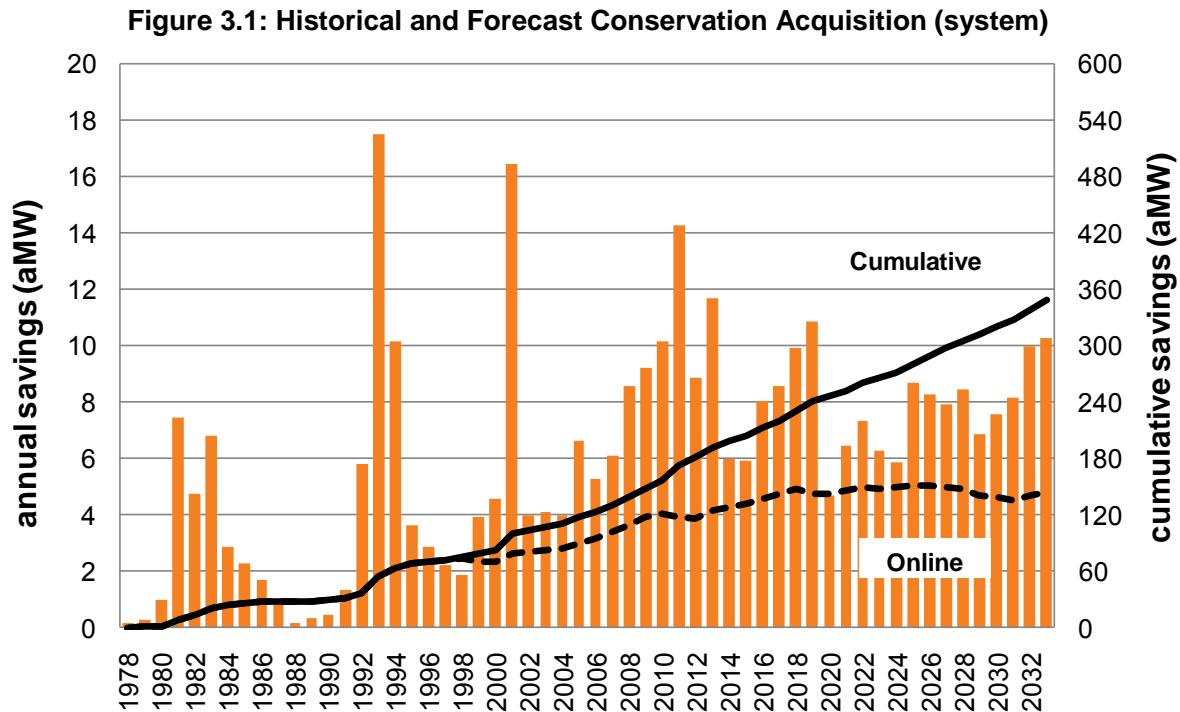

Avista’s energy efficiency programs provide a range of conservation and education options to residential, low income, commercial, and industrial customer segments. The programs are either prescriptive or site-specific. Prescriptive programs, or standard offerings, provide cash incentives for standardized products such as the installation of specified high-efficiency heating equipment. Prescriptive programs are suitable in situations where uniform products or offerings are applicable for large groups of homogeneous customers and primarily offered to residential and small commercial customers. Site-specific programs, or customized offerings, provide cash incentives for any cost-effective energy saving measure or equipment with an economic payback greater than one year and less than eight years for non-LED lighting projects, or less than 13 years for all other end uses and technologies.

Efficiency programs with economic paybacks of less than one year are ineligible for incentives, although Avista assists in educating and informing customers about these types of efficiency measures. Site-specific programs require customized services for commercial and industrial customers because of the unique characteristics of each of their premises and processes. In some cases, Avista uses a prescriptive approach where similar applications of energy efficiency measures result in reasonably consistent savings estimates in conjunction with a high achievable savings potential. An example is prescriptive lighting for commercial and industrial applications.

Conservation Potential Assessment Approach

The EIA obligates Avista to complete an independent Conservation Potential Assessment (CPA) biennially.¹ This study forms the basis for the conservation portion of

¹ See WAC 480-109 and RCW 19.285

this IRP. In 2010, Avista retained Global Energy Partners to conduct this study for its Idaho and Washington electric service territories. EnerNOC acquired the company in 2011 and updated the previous study for this IRP. The CPA identifies the 20-year potential for energy efficiency and provides data on resources specific to Avista’s service territory for use in the 2013 IRP, in accordance with the EIA energy efficiency goals. The energy efficiency potential considers the impacts of existing programs, the influence of known building codes and standards, technology developments and innovations, changes to the economic influences, and energy prices.

EnerNOC took the following steps to assess and analyze energy efficiency and potential within Avista’s service territory. Figure 3.2 illustrates the steps of the analysis.

1. **Market Assessment:** Categorizes energy consumption in the residential (including low-income customers), commercial, and industrial sectors. This assessment uses utility and secondary data to characterize customers’ electric usage behavior in Avista’s service territory. EnerNOC uses this assessment to develop energy market profiles describing energy consumption by market segment, vintage (existing or new construction), end use, and technology.
2. **Demand Forecast:** Develops a demand forecast absent the effects of future conservation program by sector and by end use for the entire study period.
3. **Program Assessment:** Identifies energy-efficiency measures appropriate for Avista’s service territory, including regional savings from energy efficiency measures acquired through Northwest Energy Efficiency Alliance (NEEA) efforts.
4. **Potential:** Analyzes programs to identify the technical, economic and achievable potential. Technical potential chooses the most efficient measure, regardless of cost. Economic potential chooses the most efficient cost-effective measure. Achievable potential adjusts economic potential to account for factors other than pure economics, such as consumer behavior or market penetration rates.

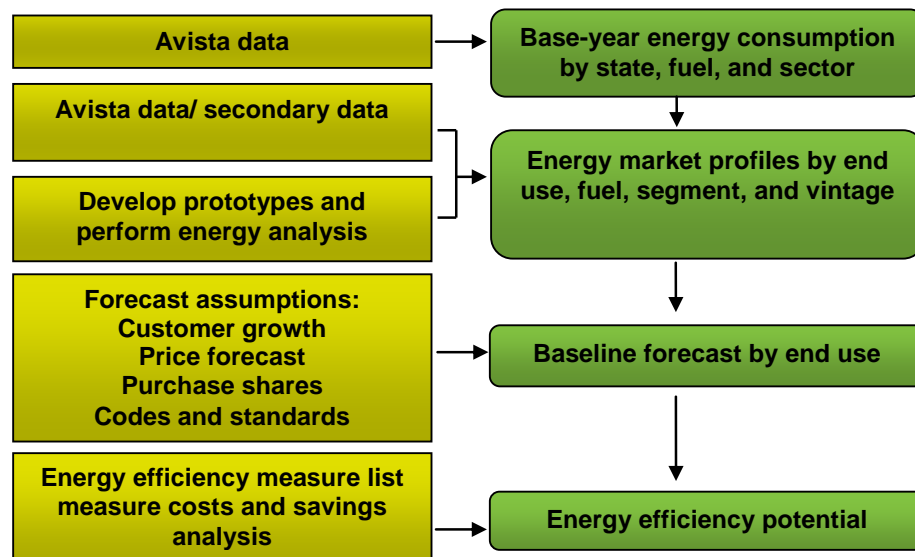
Figure 3.2: Analysis Approach Overview

Market Segmentation

The CPA segments Avista customers by state and rate schedule, translating to residential, commercial and industrial general, commercial and industrial large general, extra large commercial, and extra large industrial services. The residential class segments include single family, multi-family, manufactured home and low-income customers. The low-income threshold for this study is 200 percent of the federal poverty level².

Pumping represents only about 2 percent of total utility loads; the energy savings projected for the pumping customer classification by the NPCC calculator is approximately 4 percent of total savings potential. Within each segment, energy use is characterized by end use, such as space heating, cooling, lighting, water heat or motors and by technology including heat pump, resistance heating and furnace for space heating.

The baseline projection is the “business as usual” metric without future utility conservation programs. It indicates annual electricity consumption and peak demand by customer segment and end use absent future efficiency programs. The baseline projection includes projected impacts of known building codes and energy efficiency standards as of 2012 when the study began. Codes and standards have direct bearing on the amount of energy efficiency potential that exists beyond the impact of these efforts. The baseline projection accounts for market changes including:

- customer and market growth;
- income growth;
- retail rates forecasts;

² Available from census data and the American Community Survey data.

- trends in end use and technology saturations;
- equipment purchase decisions;
- consumer price elasticity;
- income; and
- persons per household.

For each customer segment, a robust list of electrical energy efficiency measures and equipment is compiled, drawing upon the NPCC’s Sixth Power Plan, the Regional Technical Forum, and other measures applicable to Avista. This list of energy efficiency equipment and measures includes 3,076 equipment and 1,774 measure options, representing a wide variety of end use applications, as well as devices and actions able to reduce customer energy consumption. A comprehensive list of equipment and measure options is available in Appendix C. Measure cost, savings, estimated useful life, and other performance factors identified for the list of measures and economic screening performed on each measure for every year of the study to develop the economic potential. Many measures initially do not pass the economic screen using current avoided costs, but some measures may become part of the energy efficiency program as contributing factors evolve during the 20-year planning horizon.

Avista supplements its energy efficiency activities by including potentials for distribution efficiency measures for consistency with the EIA conservation targets and the NPCC Sixth Power Plan. Details about the distribution efficiency projects are in the Transmission and Distribution chapter of this IRP.

Overview of Energy Efficiency Potentials

EnerNOC utilized an approach adhering to the conventions outlined in the National Action Plan for Energy Efficiency Guide for Conducting Potential Studies.³ The guide represents the most credible and comprehensive national industry standard practice for specifying energy efficiency potential. Specifically, three types of potentials are in this study, as discussed below.

Technical Potential

Technical conservation potential uses the most efficient option commercially available to each purchase decision, regardless of cost. This theoretical case provides the broadest and highest definition of savings potentials because it quantifies savings that would result if all current equipment, processes, and practices in all market sectors were replaced by the most efficient and feasible technology. Technical potential does not take into account the cost-effectiveness of the measures. Technical potential is defined as “phase-in technical potential” assuming only that the portion of the current equipment stock that has reached the end of its useful life and is due for turnover is changed out by the most efficient measures available. Non-equipment measures, such as controls and other devices (e.g., programmable thermostats) phase-in over time, just like the equipment measures.

³ National Action Plan for Energy Efficiency (2007). *National Action Plan for Energy Efficiency Vision for 2025: Developing a Framework for Change*. www.epa.gov/eeactionplan.

Economic Potential

Economic potential conservation includes the purchase of the most efficient cost-effective option available for each given equipment or non-equipment measure.⁴ Cost effectiveness is determined by applying the Total Resource Cost (TRC) test using all quantifiable costs and benefits regardless of who accrues them and inclusive of non-energy benefits as identified by the NPCC.⁵ Measures that pass the economic screen represent aggregate economic potential. As with technical potential, economic potential calculations use a phased-in approach. Economic potential is a hypothetical upper-boundary of savings potential representing only economic measures; it does not consider customer acceptance and other factors.

Achievable Potential

Achievable potential refines economic potential by taking into account expected program participation, customer preferences, and budget constraints. This level of potential estimates the achievable savings that could be attained through Avista’s energy efficiency programs when considering market maturity and barriers, customer willingness to adopt new technologies, incentive levels, as well as whether the program is mature or represents the addition of a new program. During this stage, EnerNOC applied market acceptance rates based upon NPCC-defined ramp rates from the Sixth Power Plan taking into account market barriers and measure lives. However, EnerNOC adjusted the ramp rates for the measures and equipment to reflect Avista’s market-specific conditions and program history. In some cases, Avista’s ramp rates exceed the Council’s, illustrating a mature energy efficiency program reaching a greater percentage of the market than estimated by the NPCC’s Sixth Power Plan. In other cases, where a program does not currently exist, a ramp rate could be less than the NPCC’s ramp rate, acknowledging additional design and implementation time is necessary to launch a new program. Other examples of changes to ramp rates include measures or equipment where the regional market shows lower adoption rates than estimated by the NPCC, such as heat pump water heaters.

The CPA forecasts incremental annual achievable potential for all sectors at 6.0 aMW (52,657 MWh) in 2014, increasing to cumulative savings of 156.1 aMW (1,367,490 MWh) by 2033. Table 3.1 and Figure 3.3 show the CPA results for technical, economic, and achievable potentials. The projected baseline electricity consumption forecast increases 44 percent during the 20-year planning horizon. Figure 3.3 compares the technical, economic, achievable potentials, and cumulative first-year savings, for selected years.

⁴ The Industry definition of economic potential and the definition of economic potential referred to in this document are consistent with the definition of “realizable potential for all realistically achievable units”.

⁵ There are other tests to represent economic potential from the perspective of stakeholders (e.g., Participant or Utility Cost), but the TRC is generally accepted as the most appropriate representation of economic potential because it tends to represent the net benefits of energy efficiency to society. The economic screen uses the TRC as a proxy for moving forward and representing achievable energy efficiency savings potential for measures that are most cost-effective.

Table 3.1: Cumulative Potential Savings (Across All Sectors for Selected Years⁶)

	2014	2015	2018	2023	2028	2033
Cumulative Annual Savings (MWh)						
Achievable Potential	52,657	104,806	337,150	648,778	991,979	1,367,490
Economic Potential	316,722	480,967	1,091,669	1,670,165	2,274,053	2,667,367
Technical Potential	1,163,373	1,372,283	2,251,749	3,188,349	3,899,655	4,355,152
Cumulative Annual Savings (aMW)						
Achievable Potential	6.0	12.0	38.5	74.1	113.2	156.1
Economic Potential	36.2	54.9	124.6	190.7	259.6	304.5
Technical Potential	132.8	156.7	257.0	364.0	445.2	497.2

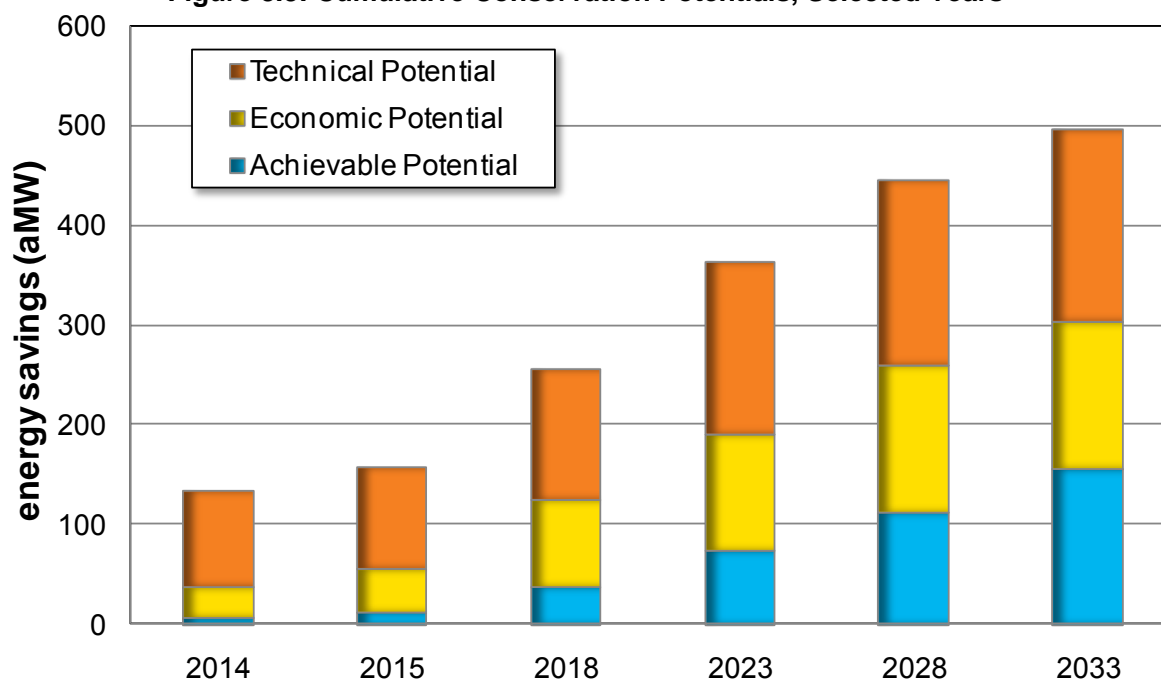
Figure 3.3: Cumulative Conservation Potentials, Selected Years

⁶ Projections include pumping as derived from the Sixth Power Plan's calculator as well as Schedule 25P being modeled separately based on that customer's historical program participation. The decision to model Schedule 25P separately was due to this rate schedule being one large industrial customer and this method seemed more accurate than treating and modeling this customer as a generic industrial customer.

Conservation Targets

This IRP process provides a biennial conservation target for the EIA Biennial Conservation Plan. Other components, such as conservation from distribution and transmission efficiency improvements, combined with the energy efficiency target to arrive at the full Biennial Conservation Plan target for Washington comparable to what is included in the NPCC Sixth Power Plan target.

Based on first year incremental savings, Table 3.2 illustrates Avista’s achievable potential for 2014-2015, as well as a comparison with the Sixth Power Plan’s calculator option 1. The Sixth Power Plan includes components other than conservation such as distribution system efficiencies. Table 3.2 compares the CPA results with the calculator’s energy efficiency portion, excluding distribution efficiency.

Table 3.2: Annual Achievable Potential Energy Efficiency (aMW)

	2014	2015
NPCC Sixth Power Plan Target		
Idaho	5.92	6.13
Washington	9.47	9.81
Total	15.39	15.94
Less Distribution Efficiency from the Sixth Power Plan		
Idaho	(0.33)	(0.45)
Washington	(0.69)	(0.96)
Total	(1.02)	(1.42)
Sixth Power Plan Conservation Target		
Idaho	5.59	5.68
Washington	8.78	8.84
Total	14.37	14.52
Achievable Potential (i.e. Target), net of conversions		
Idaho	1.75	1.57
Washington	3.80	3.87
Total	5.55	5.44

The 2014-15 Biennial Conservation Plan compliance period targets are below those from the Sixth Power Plan for several reasons. First, the calculator provides an approximation of the level of conservation utilities should pursue using regional assumptions; these assumptions may differ from the specifics of a utility’s service territory. Avista’s CPA study employs a methodology consistent with the NPCC while incorporating Avista-specific assumptions to develop an estimate of savings potential for acquisition through energy efficiency programs. Second, the Sixth Power Plan is relatively dated and was developed prior to the Great Recession. It thus contains assumptions of higher growth than observed in recent years. Lower growth reduces potential savings. The Sixth Power Plan does not incorporate the effects of various residential appliance equipment standards promulgated after the Sixth Power Plan. Further, the higher than projected 2010-11 conservation acquisition results decreased

baseline use, thereby diminishing future conservation potential since Avista had already captured those savings. Finally, avoided costs are significantly lower than projected when the Sixth Power Plan was developed.

Electricity to Natural Gas Fuel Switching

While fuel efficiency is not included in the NPCC Sixth Power Plan, Avista has a history of fuel switching from electricity to natural gas, and continues to target natural gas direct use as the most efficient resource option when available. Incremental to the targets listed above are energy savings potential attributable to space and water heat electric to natural gas conversions. Table 3.3 illustrates energy savings potentials from converting electric furnaces and water heaters to natural gas. Nearly all savings are in the residential sector. Conversions ramp up slowly, but because it removes most of the electricity use from two of the largest residential end uses (water and space heating). Space and water heating conversions account for approximately 19 percent of the residential savings during the 20-year IRP period.

Table 3.3: Cumulative Achievable Savings from Conversion to Natural Gas (MWh)

Washington Conversion Potential	2014	2015	2018	2023	2033
Water heater - convert to gas potential	825	1,586	4,112	9,924	20,221
Furnace - convert to gas potential	2,322	5,047	12,715	25,105	55,787
Total Washington conversion potential	3,147	6,633	16,827	35,028	76,009
Idaho Conversion Potential	2014	2015	2018	2023	2033
Water heater - convert to gas potential	47	121	602	4,264	16,451
Furnace - convert to gas potential	837	1,792	4,460	8,698	19,598
Total Idaho conversion potential	884	1,913	5,062	12,961	36,049
Total Service Territory Savings	4,031	1,920	21,889	47,989	112,058

Comparison with the Sixth Power Plan Methodology

As required by Washington Administrative Code (WAC) Chapter 480-109-010 (3)(c), this section describes the technologies, data collection, processes, procedures and assumptions used to develop its biennial targets, along with changes in assumptions or methodologies used in Avista's IRP or the NPCC Sixth Power Plan. WAC Chapter 480-109-010 (4)(c) requires the Washington Utilities and Transportation Commission's (UTC) approval, approval with modifications, or rejection of the targets.

EnerNOC worked with the NPCC staff to compare methodologies and approaches to ensure methodological consistency. The CPA methodology is consistent with the Sixth Power Plan in several key ways. Both the Sixth Power Plan and EnerNOC's approaches utilized end use models employing a bottom-up approach. The models draw on appliance stock, saturation levels and efficiencies information to construct future load requirements. EnerNOC conducted a thorough review of baseline and measure assumptions used by the NPCC and developed a baseline energy- use projection absent any additional energy efficiency measures while including the impact of known codes and standards currently approved at the time of this study. The study reviewed and incorporated NPCC assumptions when Avista-specific or more updated data was not available.

The CPA study developed a comprehensive list of energy-efficiency technologies and end use measures, including those in the Sixth Power Plan. Since the efficiency measures, equipment, and other data used in the Sixth Power Plan are somewhat dated, information from the latest Regional Technical Forum workbooks were used, as well as additional information on measures and equipment specific to Avista. EnerNOC developed equipment saturations, measure costs, savings, estimated useful lives and other parameters based on data from the Sixth Power Plan Conservation Supply Curve workbook databases, the Regional Technical Forum, Avista's Technical Reference Manual, NEEA reports, and other data sources. Similar to the Sixth Power Plan, the study accounts for the difference between lost and non-lost opportunities, and how this affects the rate at which energy efficiency measures penetrate the market. The study used the TRC test as the measure for judging cost-effectiveness. For a more detailed discussion of measures and equipment evaluated within the potential study, please refer to the CPA report prepared by EnerNOC in Appendix C.

After screening measures for cost-effectiveness, the CPA applied a series of factors to evaluate realistic market acceptance rates and program implementation considerations. The resulting achievable potential reflects the realistic deployment rates of energy efficiency measures in Avista's service territory. These factors account for market barriers, customer acceptance, and the time required to implement programs. To develop these factors, EnerNOC reviewed the ramp rates used in the Sixth Power Plan Conservation Supply Curve workbooks and considered Avista's experience.

The Sixth Power Plan assessed a 20-year period beginning in 2010, while this CPA study begins in 2014. Where the Sixth Power Plan relied on average regional data, the CPA utilized data from Avista's service territory, as well as current economic data. Therefore, an allocation of regional potential based on sales, as applied in the Sixth Power Plan, would not necessarily account for Avista's unique service territory characteristics such as customer mix, use per customer, end use saturations, fuel shares, current measure saturations, and expected customer and economic growth. In addition, some industries included in the Sixth Power Plan may not exist in Avista's service territory. While the Sixth Power Plan incorporates distribution system efficiencies, the Avista CPA includes only energy efficiency from energy conservation while distribution system efficiencies and thermal system efficiencies are part of Avista's targets from other sources. A detailed discussion of Avista's distribution feeder program is in Chapter 5, Transmission & Distribution.

Avoided Cost Sensitivities

EnerNOC modeled several scenarios with varying avoided costs assumptions in addition to the Expected Case used for the 2013 IRP to test sensitivity to changes in avoided costs. The scenarios included 150 percent, 125 percent, 100 percent, and 75 percent of the avoided costs relative to the 110 percent level used in the Expected Case. Figure 3.4 illustrates the avoided cost scenarios. Overall, energy efficiency proved to be sensitive to avoided cost assumptions. In particular, acquiring incremental energy efficiency becomes increasingly expensive, so increases in avoided costs do not provide equivalent percentage increases in achievable potential. The Expected Case achievable potential is approximately 154 aMW by 2033, excluding savings from

distribution line losses. With the 150 percent avoided cost case, cumulative achievable potential increases by 23 percent compared with the Expected Case reference scenario, while the 125 percent, 100 percent, and the 75 percent avoided cost cases yielded achievable potential equal to 85 percent, 94 percent and 113 percent of the reference scenario, respectively. Table 3.4 shows achievable potential under the five avoided cost scenarios and the cost impact over the IRP timeframe.

Table 3.4: Achievable Potential with Varying Avoided Costs

	75% AC	100% AC	Expected Case	125% AC	150% AC
Cumulative energy savings (aMW)	131	145	154	174	189
Savings percentage change compared to Expected Case	-15%	-6%	0%	13%	23%
20-Year Nominal Spending (millions)	\$459	\$560	\$711	\$949	\$1,150
Cost percentage change compared to Expected Case	-35%	-21%	0%	34%	62%

In 2014, 41 percent of the projected achievable potential is from residential class measures. This roughly 40/60 allocation between residential and nonresidential savings is consistent with a finding from the previous CPA that the nonresidential sector is becoming the source of a larger share of savings potential. This shift is occurring because many low-cost residential measures are implemented and residential equipment codes and standards are capturing savings previously incented through utility programs.

Approximately 48 percent of residential projected savings come from lighting in 2018, followed by water and space heating. In subsequent years, the percentage of residential savings from lighting decreases as lighting codes and standards are enacted. As a result, space and water heating measures provide greater relative savings potential in the later years of the study.

In the commercial and industrial sectors, lighting accounts for approximately 64 percent of savings potential in 2018 followed by office equipment, heating, ventilation and air conditioning (HVAC), refrigeration, and machine drives. Similar to the residential sector, the savings potential from lighting decreases to about one-third of cumulative potential in 2033, with HVAC, water heating and industrial measures gaining an increasing share of long-term potential.

Heat pump water heater measures in the Sixth Power Plan were projected to replace the CFLs contribution (i.e. significant savings at relatively low costs) in earlier plans. The CPA found heat pump water heaters begin to pass the cost-effectiveness screen in 2014. However, because they are unsuitable for installation in conditioned spaces, the CPA assumes they are not applicable in multifamily and mobile homes. The market for this technology remains immature, limiting the number of near-term installations.

Figure 3.4 shows supply curves composed of the stacked measures and equipment for the IRP time horizon in ascending order of avoided cost. Since there is a gap in the cost of the energy efficiency measures moving up the supply curve, the measures with a very high cost cause a rapid sloping of the curve. The shift of the supply curve toward the right as avoided costs increase is a consequence of increasing amounts of cost-effective potential, but the average cost of acquiring that potential is increasing.

Figure 3.4: Conservation Supply Curve (2033- No Fuel Switching, Pumping and Losses)

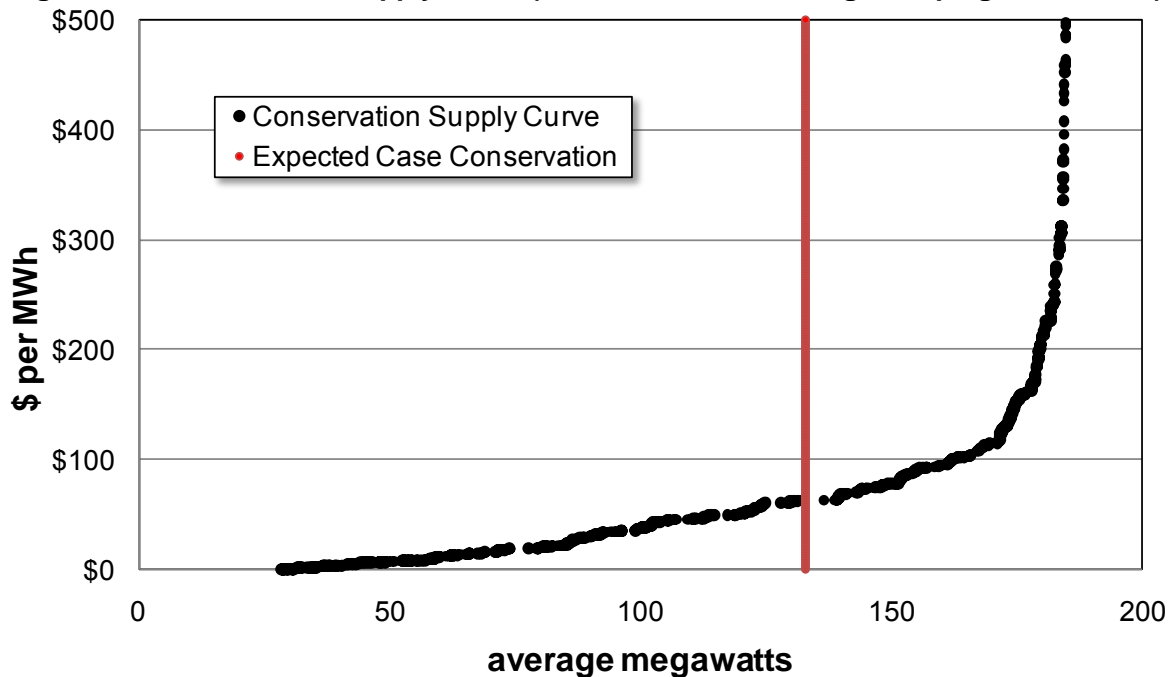

Energy Efficiency-Related Financial Impacts

The EIA requires utilities with over 25,000 customers to obtain a fixed percentage of their electricity from qualifying renewable resources and to acquire all cost-effective and achievable energy conservation.⁷ For the first 24-month period under the law (2010-11), this equaled a ramped-in share of the regional 10-year target identified in the Sixth Power Plan. Penalties of at least \$50 per MWh exist for utilities not achieving Washington targets for conservation resource acquisition.

Regional discussions were under way regarding the definition of “pro-rata” during the 2009 IRP. Avista proposed ramping the 10-year targets identified in the Sixth Power Plan instead of acquiring 20 percent of the first 10-year target identified in the Sixth Power Plan. The “pro-rata” amount would have created drastic ramping challenges, especially in the early years. Due to inconsistencies between the 2009 IRP and the Council’s methodology, Avista elected to use Option 1 of the Sixth Power Plan to establish its conservation acquisition target, adjusted to include electric-to-natural gas space and water heating fuel conversions. The acquisition target was 11 percent

⁷ The EIA defines cost effective as 10 percent higher than the cost a utility would otherwise spend on energy acquisition.

greater than Avista's IRP energy efficiency target for the same period. In April 2010, the UTC approved Avista's 10-year Achievable Potential and Biennial Conservation Target Report in Docket UE-100176.

The EIA requirement to acquire all cost-effective and achievable conservation may pose significant financial implications for Washington customers. Based on the CPA results, the projected 2014 cost to electric customers is \$12.6 million (1.7 percent of total electric revenue requirement) with approximately \$9 million of that projected to be for Washington. This annual amount grows to \$22.2 million by the tenth year, representing a total of \$215.8 million over this 10-year period for electric customers. Figure 3.5 shows the annual cost (in millions of nominal dollars) for the utility to acquire the projected electric achievable potential.

Figure 3.5: Existing & Future Energy Efficiency Costs and Energy Savings

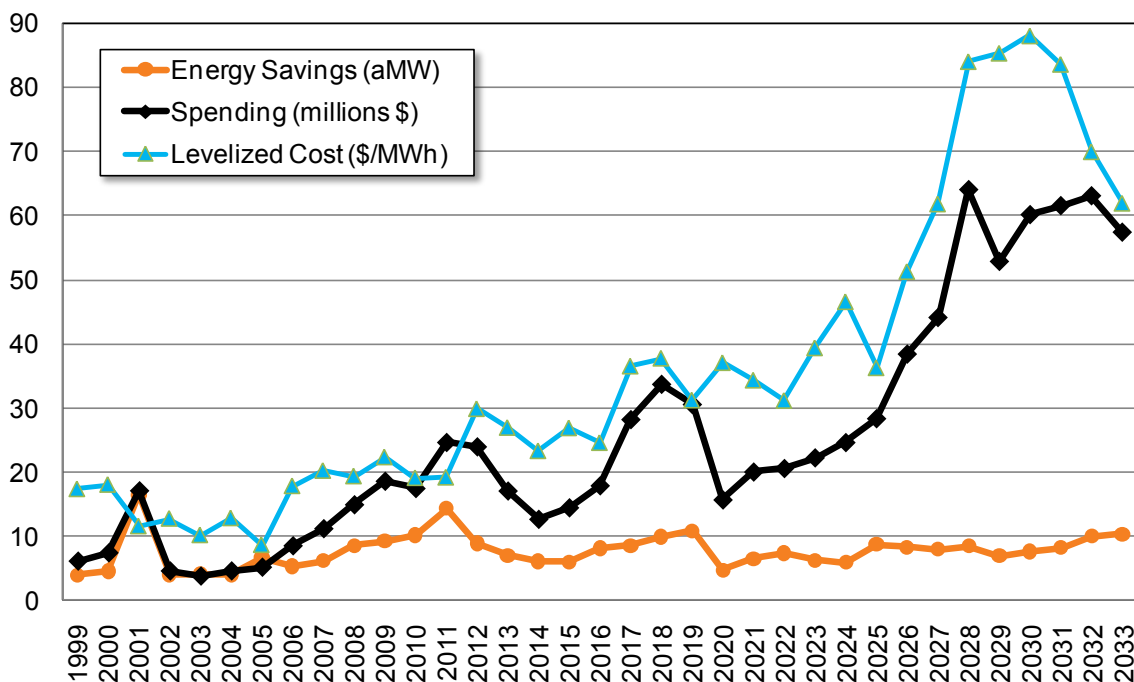

Integrating Results into Business Planning and Operations

The CPA and IRP energy efficiency evaluation processes provide high-level estimates of cost-effective conservation acquisition opportunities. While results of the IRP analyses establish baseline goals for continued development and enhancement of energy efficiency programs, the results are not detailed enough to form an acquisition plan. Avista uses both CPA and IRP evaluation results to establish a budget for energy efficiency measures, to help determine the size and skill sets necessary for future operations, and for identifying general target markets for energy efficiency programs. This section provides an overview of recent operations of the individual sectors as well as energy efficiency business planning.

Chapter 3–Energy Efficiency

Avista retained EnerNOC to develop an independent conservation potential assessment study for its Washington and Idaho electric service territory. This study is useful for the implementation of energy efficiency programs in the following ways.

- Identify conservation resource potential by sector, segment, end use and measure of where energy savings may come from. The energy efficiency implementation staff can use CPA results to determine the segments and end uses/measures to target.
- Identify the measures with the highest TRC benefit-cost ratios, resulting in the lowest cost resources with the greatest benefit.
- Identify measures with great adoption barriers based on the economic versus achievable results by measure. With this information, staff can develop effective programs for measures with slow adoption or significant barriers.
- Improve the design of current program offerings. Staff can review the measure level results by sector and compare the savings with the largest-saving measures currently offered. This analysis may lead to the addition or elimination of programs. Consideration for lost opportunities, and whether to target one particular measure over another measure, are made. One possibility may be to offer higher incentives on measures with higher benefits and lower incentives on measures with lower benefits.

The CPA study illustrates potential markets and provides a list of cost-effective measures to analyze through the on-going energy efficiency business planning process. This review of residential and non-residential program concepts and their sensitivity to more detailed assumptions will feed into program plans for target markets. Potential measures not currently considered at the time of the CPA may develop in the future will be evaluated for possible inclusion in Avista’s Business Plan.

Residential Sector Overview

Avista offers most residential energy efficiency programs through prescriptive or standard offer programs targeting a range of end uses. Programs offered through this prescriptive approach during 2012 included space and water heating conversions, ENERGY STAR[®] appliances, ENERGY STAR[®] homes, space and water equipment upgrades and home weatherization. The ENERGY STAR[®] appliance program phases out in 2013 due to results of a Cadmus net-to-gross study indicating market transformation to a point that incentives are no longer required.

Avista offers its remaining residential energy efficiency programs through other channels. For example, a third-party administer, JACO, operates the refrigerator/freezer recycling program. UCONS administers a manufactured home duct-sealing program. CFL and specialty CFL buy-downs at the manufacturer level provide customers access to lower-priced lamps. Home energy audits, subsidized by a grant from the American Recovery and Reinvestment Act (ARRA), ended in 2012. This program offered home inspections including numerous diagnostic tests and provided a leave-behind kit containing CFLs and weatherization materials. Avista provides educational tips and CFLs at various rural and urban events in an effort to reach all areas within its service

Chapter 3—Energy Efficiency

territory. Avista processed 14,300 energy efficiency rebates in 2012, benefiting approximately 14,000 households. Over \$2.3 million of rebates offset the cost of implementing energy efficiency upgrades for our customers. Third-party contractors implemented a second appliance-recycling program and a manufactured home duct-sealing program. Avista participated in a regional upstream buy-down program called Simple Steps Smart Savings where lighting and showerheads were provided through participating retailers at a reduced amount for customers. Finally, Avista distributed over 26,000 CFLs at various community events throughout the service territory. Residential programs contributed 17,744 MWh and 341,187 therms of energy savings.

Low Income Sector Overview

Six Community Action Agencies administer low-income programs. During 2012 these programs targeted a range of end uses including space and water heating conversions, ENERGY STAR® refrigerators, space and water heating equipment upgrades, and weatherization offered site-specifically through individualized home audits. Avista also funds health and human safety investments considered necessary to ensure habitability of homes and protect investments in energy efficiency, as well as administrative fees enabling Community Action Agencies to continue to deliver these programs.

The Community Action Agencies had 2012 budgets of \$2.0 million for Washington and \$940,000 for Idaho as well as an additional \$50,000 for conservation education in Idaho. Avista processed approximately 1,400 rebates, benefiting 400 households. During 2012, Avista paid \$2.6 million in rebates to the Community Action Agencies to provide fully-subsidized energy efficiency upgrades, health and human safety, and administrative costs for the agencies to administer these programs. The agencies spent nearly \$394,000 on health and human safety or 13 percent of their total expenditures and within their 15 percent allowance for this spending category. Low-income energy efficiency programs contributed 1,111 MWh of electricity savings and 33,029 therms of natural gas savings.

Non-Residential Sector Overview

For the non-residential sectors (commercial, industrial and multi-family applications), energy efficiency programs are offered on a site-specific or custom basis. Avista offers a more prescriptive approach when treatments result in similar savings and the technical potential is high. An example is the prescriptive lighting program. The applications are not purely prescriptive in the traditional sense, such as with residential applications where homogenous programs are provided for all residential customers; however, a more prescriptive approach can be applied for these similar applications.

Non-residential prescriptive programs offered by Avista include, but are not limited to, space and water heating conversions, space and water heating equipment upgrades, appliance upgrades, cooking equipment upgrades, personal computer network controls, commercial clothes washers, lighting, motors, refrigerated warehouses, traffic signals, and vending controls. Also included are residential program offerings such as multi-family and multi-family market transformation since these projects are implemented site-specifically unlike other residential programs.

During 2012, Avista processed 4,167 energy efficiency projects resulting in the payment of over \$13.5 million in rebates paid directly to customers to offset the cost of their energy efficiency projects. These projects contributed 58,756 MWh of electricity and 399,733 therms of natural gas savings.

Energy Smart Grocer is a regional, turnkey program administrated through PECl. This program has been operating for several years. This program will approach saturation levels during the early part of this 20-year planning horizon.

The programs highlighted by the recently completed CPA study will be reviewed for the development of target marketing and the creation of new energy efficiency programs. All electric-efficiency measures with a simple payback exceeding one year and less than eight years for lighting measures or thirteen years for other measures automatically qualify for the non-residential portfolio. The IRP provides account executives, program managers/coordinators and energy efficiency engineers with valuable information regarding potentially cost-effective target markets. However, the unique and specific characteristics of a customer's facility override any high-level program prioritization for non-residential customers.

Demand Response

Over the past decade, demand response has gained attention in the industry as an alternative method to meet peak load growth instead of constructing new generation. Demand response cuts load to specific customers during peak demand use. Typically, customers enroll in programs allowing the utility to change its usage in exchange for discounts. National attention focuses on residential programs to control water heaters, space heating and air conditioners.

Past and Current Programs

Avista's experience with demand response or load management dates back to the 2001 Energy Crisis. Avista responded with an All-Customer Buy-Back program, an Irrigation Buy-Back program and bi-lateral agreements with large industrial customers. These methods along with commercial and residential enhanced energy efficiency programs were effective and enabled Avista to reduce its need for purchases in a very high cost Western energy market. Experience was gained in July 2006 when a multi-day heat wave required Avista to invoke immediate demand response through a media request for customers to conserve and a large customer reduction, Avista was able to reduce same day load by an estimated 50 MW.

Avista conducted a two-year residential load control pilot between 2007 and 2009 to study specific technologies, examine cost-effectiveness and customer acceptance. The intent of this pilot was to be scalable with Direct Load Control (DLC) devices installed in approximately 100 volunteer households in Sandpoint and Moscow, Idaho. This small sample allowed Avista to test the product and systems with the same benefits as if this were a larger scale project, but in a controlled and customer-friendly manner. DLC devices were installed on heat pumps, water heaters, electric forced-air furnaces and air conditioners to control operation during 10 scheduled events at peak times ranging from two hours to four hours. A separate group within those communities participated in an

Chapter 3–Energy Efficiency

In-Home-Display device study as part of this pilot. The program intended to gain customer experience with “near-real time” energy usage feedback equipment. Information gained from the pilot is detailed in the report filed with the Idaho Public Utilities Commission (IPUC).

Avista is engaged in a new demand response program as part of the Northwest Regional Smart Grid Demonstration Project (SGDP) with Washington State University (WSU) and approximately 70 residential customers in the Pullman and Albion, Washington communities. Residential customer assets include a forced-air electric furnace, heat pump, and central air-conditioning with enabling control technology of a Smart Communicating Thermostat provided and installed by Avista. The control approach is non-traditional in several ways. First, the demand response “events” are not prescheduled, but assets are directly controlled by predefined customer preferences (no more than a 2 degree offset for the residential customers, and an energy management system at WSU with a console operator) at anytime the regional Transactive signal needs the curtailment. More importantly, the technology used in this demand response portion of the SGDP predicts if equipment is available for participation in the control event. Lastly, value quantification extends beyond demand and energy savings and explores bill management options for customers with whole house usage data analyzed in conjunction with smart thermostat data. Inefficient homes identified through this analysis prompt customer engagement.

Experiences from the both residential DLC pilots (North Idaho Pilot and the SGDP) show participating customer engagement is high; however, recruiting participants is challenging. Avista’s service territory has a high penetration of natural gas for both typical DLC appliance types of space heat and water heat. Customers who have interest may not have qualifying equipment making them ineligible for participation in the Program. Secondly, customers initially are not interested enough in DLC programs. Supporting evidence of this second aspect is in recent regional DLC programs conducted by the BPA. Lastly, Avista is unable at this time to offer pricing strategies other than direct incentives to compensate customers for participation in the program, which limits customer interest.

The amount of demand and energy reductions per household is lower than a commercial and/or industrial DLC program. Consequently, many households are required to yield significant peak reduction savings, which is why residential DLC programs are commonly mass-market programs. Mass-market scale is needed for program cost effectiveness. Rather than focusing on residential demand response, Avista will focus its Demand Response studies towards commercial and industrial customers. Fewer but larger loads are anticipated to yield adequate acquisition. For this IRP, Avista assumes a potential of five MW per year for a 20 MW total acquisition, assuming a cost of \$120 per kW-year (2012 dollars). As an Action Item, Avista will need to complete an assessment of potential demand response in its commercial and industrial customers, including, a measure of peak reduction, flexibility capability (i.e. spinning reserves) and costs to implement programs.

4. Policy Considerations

Public policy can significantly affect Avista’s current generation resources and the types of resources Avista pursues. The political and regulatory environments have changed significantly since publication of the last IRP. Prospects for implementing a federal cap and trade program to reduce greenhouse gases have greatly diminished. At the same time, a range of regulatory measures pursued by the Environmental Protection Agency (EPA), coupled with political and legal efforts initiated by environmental groups and others, has increased pressures on thermal generation – specifically coal-fired generation. New regulations have particular implications for coal generation, as they involve regional haze, coal ash disposal, mercury emissions, water quality, and greenhouse gas emissions. This chapter provides an overview and discussion about some of the more pertinent public policy issues relevant to the IRP.

Chapter Highlights

- The 2013 IRP uses regulatory means instead of a federal cap and trade or greenhouse gas emissions tax in its Expected Case to reduce emissions.
- Scenario analyses address the impacts of potential greenhouse gas policies.
- The plan anticipates specific regulatory policies to reduce greenhouse gas emissions.
- Avista’s Climate Policy Council monitors greenhouse gas legislation and environmental regulation issues.

Environmental Issues

Environmental concerns present unique resource planning challenges due to the continuously evolving nature of environmental regulation. If avoiding certain air emissions were the only issue faced by electric utilities, resource planning would only require a determination of the amounts and types of renewable generating technology and energy efficiency to acquire. However, the need to maintain system reliability, acquire resources at least cost, mitigate price volatility, meet renewable generation requirements, manage financial risks, and meet environmental laws complicates utility planning. Each generating resource has distinctive operating characteristics, cost structures, and environmental regulatory challenges.

Traditional thermal generation technologies, like coal-fired and natural gas-fired plants, are reliable and provide capacity along with energy. Coal-fired units have high capital costs, long permitting and construction lead times, and relatively low and stable fuel costs. New coal plants are currently difficult, if not impossible, to site due to state and federal laws and regulations, local opposition, and environmental concerns ranging from the impacts of coal mining to power plant emissions. Remote mine locations increase costs from either the transportation of coal to the plant or the transportation of the generated electricity to load centers. By comparison, natural gas-fired plants have relatively low capital costs compared to coal, can typically be located near load centers, can be constructed in relatively short time frames, emit less than half the greenhouse gases emitted by coal, and are the only utility-scale baseload resource that can be developed in many locations. Higher fuel price volatility has historically affected the

Chapter 4–Policy Considerations

economics of natural gas-fired plants. Their performance also decreases in hot weather conditions, it is increasingly difficult to secure sufficient water rights for their efficient operation, and they emit significant greenhouse gases relative to renewable resources.

Renewable energy technologies such as wind, biomass, and solar generation have different challenges. Renewable resources are attractive because they have low or no fuel costs and few, if any, direct emissions. However, solar- and wind-based renewable generation has limited or no capacity value for the operation of Avista's system, and their variable output presents integration challenges requiring additional non-variable capacity investments.

Renewable projects also draw the attention of environmental groups interested in protecting visual aspects of landscapes and wildlife populations. Similar to coal plants, renewable resource projects are located near their fuel sources rather than load centers. The need to site renewable resources in remote locations often requires significant investments in transmission interconnection and capacity expansion, as well as mitigating possible wildlife and aesthetic issues. Unlike coal or natural gas-fired plants, the fuel for non-biomass renewable resources may not be transportable from one location to another to utilize existing transmission facilities or to minimize opposition to project development. Dependence on the health of the forest products industry and access to biomass materials, often located in publicly owned forests, poses challenges to biomass facilities.

The long-term economic viability of renewable resources is uncertain for at least two important reasons. First, federal investment and production tax credits will begin expiring for projects beginning construction after 2013. The continuation of credits and grants cannot be relied upon in light of the impact such subsidies have on the finances of the federal government, and the relative maturity of wind and solar technology development. Second, many relatively unpredictable factors affect the costs of renewable technologies, such as renewable portfolio standard mandates, material prices and currency exchange rates. Capital costs for wind and solar have decreased since the 2011 IRP, but future costs remain uncertain.

Even though there appears to be very little, if any, chance of a national greenhouse gas cap and trade program, uncertainty still exists about greenhouse gas regulation at this IRP's writing. There are pockets of strong regional and national support to address climate change, but little political will at the national level to implement significant new laws to reduce greenhouse gas emissions. However, since the 2011 IRP publication, changes in the approach to greenhouse gas emissions regulation have occurred, including:

- The EPA has commenced actions to regulate greenhouse gas emissions under the Federal Clean Air Act, although some of these efforts have been delayed and most of these initiatives are being legally challenged; and
- California has established economy-wide cap and trade regulation.

Avista’s Climate Change Policy Efforts

Avista’s Climate Policy Council is an interdisciplinary team of management and non-management employees that:

- Facilitates internal and external communications regarding climate change issues;
- Analyzes policy impacts, anticipates opportunities and evaluates strategies for Avista Corporation; and
- Develops recommendations on climate related policy positions and action plans.

The core team of the Climate Policy Council includes members from Environmental Affairs, Government Relations, External Communications, Engineering, Energy Solutions and Resource Planning groups. Other areas of Avista participate as needed to provide input on certain topics. The monthly meetings for this group include work divided into immediate and long-term concerns. The immediate concerns include reviewing and analyzing proposed or pending state and federal legislation, reviewing corporate climate change policy, and responding to internal and external data requests about climate change issues. Longer-term issues involve emissions tracking and certification, considering the merits of different greenhouse gas policies, actively participating in the development of legislation, and benchmarking climate change policies and activities against other organizations.

Membership in the Edison Electric Institute is Avista’s vehicle to engage in federal-level climate change dialog. Avista participates in discussions about hydroelectric and biomass issues through membership in national hydroelectric and biomass associations.

Greenhouse Gas Emissions Concerns for Resource Planning

Resource planning in the context of greenhouse gas emissions regulation raises concerns about the balance between Avista’s obligations for environmental stewardship, and cost implications for its customers. Resource planning must consider the cost effectiveness of resource decisions, as well as the need to mitigate the financial impact of potential future emissions risks. Although some parties would advocate for the immediate reduction or elimination of certain resource technologies, such as coal or even natural gas-fired plants, there are economic and reliability limitations and other concerns related to pursuing this type of policy. Technologically, it is possible to replace fossil-fueled generation with renewables, but the increased prices to customers and the challenges of obtaining enough renewable generation while maintaining system reliability are daunting.

Complying with greenhouse gas regulations, particularly in the form of a cap and trade mechanism, involves at least two approaches: ensuring Avista maintains sufficient allowances and/or offsets to correspond with its emissions during a compliance period, and undertaking measures to reduce Avista’s future emissions. Enabling emission reductions on a utility-wide basis could entail any or all of the following:

Chapter 4–Policy Considerations

- Increasing the efficiency of existing fossil-fueled generation resources;
- Reducing emissions from existing fossil-fueled generation through fuel displacement including co-firing with biomass or biofuels;
- Permanently decreasing the output from existing fossil-fueled resources and substituting resources with lower greenhouse gas emissions;
- Decommissioning or divesting of a fossil-fueled generation and substituting with lower-emitting resources;
- Reducing exposure to market purchases of fossil-fueled generation, particularly during periods of diminished hydropower production, by establishing larger reserves based on lower-emitting technologies; and
- Increasing investments in energy efficiency measures, thereby displacing future resource needs.

With the exception of Avista's commitment to energy efficiency, the specific costs and risks of the actions listed above cannot be adequately evaluated until greenhouse gas emission regulations are established. After a regulatory regime has been implemented the economic effects can be modeled. A specific reduction strategy in a future IRP may occur when greater regulatory clarity and better modeling parameters exist. In the meantime, greenhouse gas emissions reductions in this IRP rely upon EPA and state regulations, established renewable portfolio policies, and established state level greenhouse gas emissions laws.

State and Federal Environmental Policy Considerations

The direction of federal greenhouse gas emissions policies has changed significantly since the 2011 IRP. In the prior plan, Avista based greenhouse gas emissions costs on a weighted average of four different reduction policies that included various levels of state and federal cap and trade programs and carbon taxes. The state of political discourse during the development of this IRP indicates there is no imminent federal cap and trade or carbon tax. Even though there is no national greenhouse gas emissions cost in the Expected Case, this IRP includes a greenhouse gas reduction scenario, with high and low prices for offset/taxes as a proxy to model the possible impacts of future regulation. Chapter 7, Market Analysis, describes the greenhouse gas scenarios and the modeling results.

The President's Climate Action Plan was released on June 25, 2013, after the modeling for this IRP was completed. The plan outlines the Obama administration's three pillars of executive action regarding climate change, which include the following:

- Reduce U.S. carbon emissions;
- Make infrastructure preparations to mitigate the impacts of climate change; and
- Work on efforts to reduce international greenhouse gas emissions and prepare for the impacts of climate change.

A presidential memo was also sent to the Administrator of the EPA on the same day as the Climate Action Plan with several climate change related policy targets. The memo directed the EPA to do the following:

Chapter 4–Policy Considerations

- Issue new proposed greenhouse gas emissions standards for new electric generation resources by September 30, 2013.
- Issue new proposed standards for existing and modified sources by June 1, 2014, final standards by June 1, 2015, and require State implementation plans by June 30, 2016.

The federal Production Tax Credit (PTC), Investment Tax Credit (ITC), and Treasury grant programs are key federal policy considerations for incenting the development of renewable generation. The current PTC and ITC programs are available for projects that begin construction before the end of 2013. The date is 2016 for solar projects. We did not model an extension of these tax incentives because of the uncertainty of their continuation due to the current federal budget deficit situation. Extension of the PTC may accelerate the development of some regional renewable energy projects. This may affect the development of renewable projects in the Western Interconnect, but not necessarily for Avista, because the current resource mix and low projected load growth do not necessitate the development of new renewables in this IRP.

EPA Regulations

The EPA regulations that directly, or indirectly, affect electricity generation include the Clean Air Act, along with its various components, such as the Acid Rain Program, National Ambient Air Quality Standard, Hazardous Air Pollutant rules and the Regional Haze Programs. The U.S. Supreme Court ruled the EPA has authority under the Clean Air Act to regulate greenhouse gas emissions from new motor vehicles and has issued such regulations. When these regulations became effective, carbon dioxide and other greenhouse gases became regulated pollutants under the Prevention of Significant Deterioration (PSD) preconstruction permit program and the Title V operating permit program. Both of these programs apply to power plants and other commercial and industrial facilities. In 2010, the EPA issued a final rule, known as the Tailoring Rule, governing the application of these programs to stationary sources, such as power plants. Most recently, EPA proposed a rule in early 2012 setting standards of performance for greenhouse gas emissions from new and modified fossil-fuel-fired electric generating units and announced plans to issue greenhouse gas guidelines for existing sources.

Promulgated PSD permit rules may affect Avista's thermal generation facilities in the future. These rules can affect the amount of time it takes to obtain permits for new generation and major modifications to existing generating units and the final limitations contained in permits. The promulgated and proposed greenhouse gas rulemakings mentioned above have been legally challenged in multiple venues so we cannot fully anticipate the outcome or extent our facilities may be impacted, nor the timing of rule finalization.

Clean Air Act

The Clean Air Act (CAA), originally adopted in 1970 and modified significantly since, intends to control covered air pollutants to protect and improve air quality. Avista complies with the requirements under the CAA in operating our thermal generating plants. The CAA currently requires a Title V operating permit for Colstrip Units 3 and 4

(expires in 2017), Coyote Springs 2 (renewal expected in 2013), the Kettle Falls GS (renewal expected in 2013), and the Rathdrum CT (expires in 2016). Boulder Park, Northeast CT, and other small activities only require minor source operating or registration permits based on their limited operation and emissions. Title V operating permits renewals occur every five years and typically update all applicable CAA requirements for each facility. Discussion of some major CAA programs follows.

Acid Rain Program

The Acid Rain Program is an emission-trading program for reducing nitrous dioxide by two million tons and sulfur dioxide by 10 million tons below 1980 levels from electric generation facilities. Avista manages annual emissions under this program for Colstrip Units 3 and 4, Coyote Springs 2, and Rathdrum Generating Stations.

National Ambient Air Quality Standards

EPA sets National Ambient Air Quality Standards for pollutants considered harmful to public health and the environment. The CAA requires regular court-mandated updates to occur in June 2013 for nitrogen dioxide, ozone, and particulate matter. Avista does not anticipate any material impacts on its generation facilities from the revised standards at this time.

Hazardous Air Pollutants (HAPs)

HAPs, often known as toxic air pollutants or air toxics, are those pollutants that may cause cancer or other serious health effects. EPA regulates toxic air pollutants from a published list of industrial sources referred to as "source categories". These pollutants must meet control technology requirements if they emit one or more of the pollutants in significant quantities. EPA recently finalized the Mercury Air Toxic Standards (MATS) for the coal and oil-fired source category. Colstrip Units 3 and 4's existing emission control systems should be sufficient to meet mercury limits. For the remaining portion of the rule that specifically addresses air toxics (including metals and acid gases), the joint owners of Colstrip are currently evaluating what type of new emission control systems will be required to meet MATS compliance in 2015. Avista is unable to determine to what extent, or if there will be any, material impact to Colstrip Units 3 and 4 at this time.

Regional Haze Program

EPA set a national goal to eliminate man-made visibility degradation in Class I areas by the year 2064. Individual states are to take actions to make "reasonable progress" through 10-year plans, including application of Best Available Retrofit Technology (BART) requirements. BART is a retrofit program applied to large emission sources, including electric generating units built between 1962 and 1977. In the absence of state programs, EPA may adopt Federal Implementation Plans (FIPs). On September 18, 2012, EPA finalized the Regional Haze FIP for Montana. The FIP includes both emission limitations and pollution controls for Colstrip Units 1 and 2. Colstrip Units 3 and 4 are not currently affected, although the units will be evaluated for Reasonable Progress at the next review period in September 2017. Avista does not anticipate any material impacts on Colstrip Units 3 and 4 at this time.

EPA Mandatory Reporting Rule

Any facility emitting over 25,000 metric tons of greenhouse gases per year must report its emissions to EPA. Colstrip Units 3 and 4, Coyote Springs 2, and Rathdrum CT are currently reporting under this requirement. The Mandatory Reporting Rule also requires greenhouse gas reporting for natural gas distribution system throughput, fugitive emissions from electric power transmission and distribution systems, fugitive emissions from natural gas distribution systems, and from natural gas storage facilities. Avista reported the applicable greenhouse gas emissions in 2012. The State of Washington requires mandatory greenhouse gas emissions reporting similar to the EPA requirements. Oregon has similar reporting requirements.

State and Regional Level Policy Considerations

The lack of a comprehensive federal greenhouse gas policy encouraged several states, such as California, to develop their own climate change laws and regulations. Climate change legislation can take many forms, including economy-wide regulation in the form of a cap and trade system, tax or emissions performance standards for power plants. Comprehensive climate change policy can have multiple individual components, such as renewable portfolio standards, energy efficiency standards, and emission performance standards. Washington enacted all of these components, but other jurisdictions where Avista operates have not. Individual state actions produce a patchwork of competing rules and regulations for utilities to follow, and may be particularly problematic for multi-jurisdictional utilities such as Avista. There are 29 states, plus the District of Columbia, with active renewable portfolio standards, and eight additional states have adopted voluntary standards.¹

The Western Regional Climate Action Initiative, otherwise known as the Western Climate Initiative (WCI), began with a February 26, 2007, agreement to reduce greenhouse gas emissions through a regional reduction goal and market-based trading system. This agreement included the following signatory jurisdictions: Arizona, British Columbia, California, Manitoba, Montana, New Mexico, Oregon, Utah, Quebec and Washington. In July 2010, the WCI released its Final Design for a regional cap and trade regulatory system to cover 90 percent of the societal greenhouse gas emissions within the region by 2015. Arizona, Montana, New Mexico, Oregon, Utah and Washington formally left WCI in November 2011.² The only remaining WCI members are British Columbia, California, Manitoba, Ontario, and Quebec.

Idaho Policy Considerations

Idaho currently does not regulate greenhouse gases or have a renewable portfolio standard (RPS). There is no indication that Idaho is moving toward the active regulation of greenhouse gas emissions. However, the Idaho Department of Environmental Quality would administer greenhouse gas standards under its CAA delegation from the EPA.

Montana Policy Considerations

Montana has a non-statutory goal to reduce greenhouse gas emissions to 1990 levels by 2020. Montana's RPS law, enacted through Senate Bill 415 in 2005, requires utilities

¹ <http://www.dsireusa.org/rpsdata/index.cfm>

² <http://www.platts.com/RSSFeedDetailedNews/RSSFeed/ElectricPower/6695863>

Chapter 4–Policy Considerations

to meet 10 percent of their load with qualified renewables from 2010 through 2014, and 15 percent beginning in 2015. Avista is exempt from the Montana RPS and its reporting requirements beginning on January 2, 2013, with the passage of SB 164 and its signature by the Governor.

Montana implemented a mercury emission standard under Rule 17.8.771 in 2009. The standard exceeds the most recently adopted federal mercury limit. Avista's generation at Colstrip Units 3 and 4 have emissions controls meeting Montana's mercury emissions goal.

Oregon Policy Considerations

The State of Oregon has a history of considering greenhouse gas emissions and renewable portfolio standards legislation. The Legislature enacted House Bill 3543 in 2007, calling for, but not requiring, reductions of greenhouse gas emissions to 10 percent below 1990 levels by 2020, and 75 percent below 1990 levels by 2050. Compliance is expected through a combination of the RPS and other complementary policies, like low carbon fuel standards and energy efficiency measures. The state has not adopted any comprehensive requirements. These reduction goals are in addition to a 1997 regulation requiring fossil-fueled generation developers to offset carbon dioxide (CO₂) emissions exceeding 83 percent of the emissions of a state-of-the-art gas-fired combined cycle combustion turbine by paying into the Climate Trust of Oregon. Senate Bill 838 created a renewable portfolio standard requiring large electric utilities to generate 25 percent of annual electricity sales with renewable resources by 2025. Intermediate term goals include five percent by 2011, 15 percent by 2015, and 20 percent by 2020. Oregon ceased being an active member in the Western Climate Initiative in November 2011. The Boardman coal plant is the only active coal-fired generation facility in Oregon; by 2020, it will cease burning coal. The decision by Portland General Electric to make near-term investments to control emissions from the facility and to discontinue the use of coal, serves as an example of how regulatory, environmental, political and economic pressures can culminate in an agreement that results in the early closure of a coal-fired power plant.

Washington State Policy Considerations

Similar circumstances leading to the closure of the Boardman facility in Oregon encouraged TransAlta, the owner of the Centralia Coal Plant, to agree to shut down one unit at the facility by December 31, 2020, and the other unit by December 31, 2025. The confluence of regulatory, environmental, political and economic pressures brought about the scheduled closure of the Centralia Plant. The State of Washington enacted several measures concerning fossil-fueled generation emissions and generation resource diversification. A 2004 law requires new fossil-fueled thermal electric generating facilities of more than 25 MW of generation capacity to mitigate CO₂ emissions through third-party mitigation, purchased carbon credits, or cogeneration. Washington's EIA, passed in the November 2006 general election, established a requirement for utilities with more than 25,000 retail customers to use qualified renewable energy or renewable energy credits to serve 3 percent of retail load by 2012, 9 percent by 2016 and 15 percent by 2020. Failure to meet these RPS requirements results in at least a \$50 per MWh fine. The initiative also requires utilities to acquire all cost effective conservation and energy efficiency measures up to 110 percent of

Chapter 4–Policy Considerations

avoided cost. Additional details about the energy efficiency portion of the EIA are in Chapter 3.

A utility can also comply with the renewable energy standard by investing in at least 4 percent of its total annual retail revenue requirement on the incremental costs of renewable energy resources and/or renewable energy credits. In 2012, Senate Bill 5575 amended the EIA to define Kettle Falls Generating Station and other legacy biomass facilities that commenced operation before March 31, 1999, as EIA qualified resources beginning in 2016. A 2013 amendment allows multistate utilities to import RECs from outside the Pacific Northwest to meet renewable goals and allows utilities to acquire output from the Centralia coal plant without jeopardizing alternative compliance methods.

Avista will meet or exceed its renewable requirements in this IRP planning period through a combination of qualified hydroelectric upgrades, wind generation from the Palouse Wind PPA, and output from Kettle Falls beginning in 2016. The 2013 IRP Expected Case ensures that Avista meets all EIA RPS goals.

Former Governor Christine Gregoire signed Executive Order 07-02 in February 2007 establishing the following GHG emissions goals:

- 1990 levels by 2020;
- 25 percent below 1990 levels by 2035;
- 50 percent below 1990 levels by 2050 or 70 percent below Washington's expected emissions in 2050;
- Increase clean energy jobs to 25,000 by 2020; and
- Reduce statewide fuel imports by 20 percent.

Washington state's Department of Ecology has adopted regulations to ensure that its State Implementation Plan comports with the requirements of the EPA's regulation of greenhouse gas emissions. We will continue to monitor actions by the Department as it may proceed to adopt additional regulations under its CAA authorities. In 2007, Senate Bill 6001 prohibited electric utilities from entering into long-term financial commitments beyond five years duration for fossil-fueled generation creating 1,100 pounds per MWh or more of greenhouse gases. Beginning in 2013, the emissions performance standard is lowered every five-years to reflect the emissions profile of the latest commercially available CCCT. The emissions performance standard effectively prevents utilities from developing new coal-fired generation and expanding the generation capacity of existing coal-fired generation unless they can sequester emissions from the facility. The Legislature amended Senate Bill 6001 in 2009 to prohibit contractual long-term financial commitments for electricity deliveries that include more than 12 percent of the total power from unspecified sources. The Department of Commerce (Commerce) has commenced a process expected to result in the adoption of a lower emissions performance standard in 2013; a new standard would not be applicable until at least

Chapter 4–Policy Considerations

2017. Commerce filed a final rule with 970 pounds per MWh for greenhouse gas emissions on March 6, 2013, with rules becoming effective on April 6, 2013.³

Washington Governor Inslee signed the Climate Action bill (Senate Bill 5802) on April 2, 2013. This law established an independent evaluation of the costs and benefits of established greenhouse gas emissions reductions programs. Results of this study are due by October 15, 2013 and will help inform development of a climate strategy to meet Washington's greenhouse gas reduction goals.

³ <http://www.commerce.wa.gov/Programs/Energy/Office/Utilities/Pages/EmissionPerfStandards.aspx>

5. Transmission & Distribution

Introduction

Avista delivers electricity from generators to customer meters through a network of conductors, or links and stations, or nodes. The network system is operated at higher voltages where the energy must travel longer distances to reduce current losses across the system. A common rule to determine efficient energy delivery is one kV per mile. For example, a 115 kV power system commonly transfers energy over a distance of 115 miles, while 13 kV power systems are generally limited to delivering energy within 13 miles.

Avista categorizes its energy delivery systems between transmission and distribution voltages. Avista's transmission system operates at 230 kV and 115 kV nominal voltages; the distribution system operates between 4.16 kV and 34.5 kV, but typically at 13.2 kV in its urban service centers. In addition to voltages, the transmission system operates distinctly from the distribution system. For example, the transmission system is a network linking multiple sources with multiple loads, while the distribution system configuration uses radial feeders to link a single source to multiple loads.

Coordinating transmission system operations and planning activities with regional transmission providers maintains a reliable and economic transmission service for our customers. Transmission providers and interested stakeholders coordinate the region's approach to planning, constructing, and operating the transmission system under Federal Energy Regulatory Commission (FERC) rules and state and local agency guidance. This chapter complies with Avista's FERC Standards of Conduct compliance program governing communications between Avista merchant and transmission functions.

This chapter describes Avista's completed and planned distribution upgrade feeder program, the transmission system, completed and planned upgrades, and estimated costs and issues of new generation resource integration.

Chapter Highlights

- Avista continues to participate in regional transmission planning forums.
- The Spokane Valley Reinforcement Project includes both station update and conductor upgrades.
- A large upgrade project is under construction at the Moscow substation to maintain adequate load service and a Noxon substation rebuild project is in the design phase.
- Five distribution feeder rebuilds are complete since the last IRP, six additional feeders rebuilds are planned for 2014.
- Significant generation interconnection study work around Thornton and Lind substations continues.

FERC Planning Requirements and Processes

FERC provides guidance to both regional and local area transmission planning. This section describes several of its requirements and processes important to Avista transmission planning.

FERC Tariff Attachment K

Avista's Open Access Transmission Tariff (OATT) includes Attachment K, satisfying nine transmission planning principles outlined in FERC Order 890. Avista's Attachment K process ensures open and transparent coordination of local, regional, and sub-regional transmission planning. Avista develops a biannual Local Planning Report (in coordination with Avista's five- and ten-year Transmission Plans). Avista encourages participation by interconnected utilities, transmission customers, and other stakeholders in the Local Planning Process. Avista satisfies its sub-regional and regional FERC transmission planning requirements through its membership in ColumbiaGrid. Avista also participates in the Northern Tier Transmission Group and several Western Electricity Coordinating Council (WECC) processes and groups. Participation in these efforts supports regional coordination of Avista's transmission projects.

Western Electricity Coordinating Council

WECC coordinates and promotes electric system reliability in the Western Interconnection. It supports training in power system operations and scheduling functions, and coordinated transmission planning activities throughout the Western Interconnection. Avista participates in WECC's Planning Coordination, Operations, Transmission Expansion Planning Policy and Market Interface Committees, as well as sub groups and other processes such as the Transmission Coordination Work Group.

Northwest Power Pool

Avista is a member of the Northwest Power Pool (NWPP). Formed in 1942 when the federal government directed utilities to coordinate operations in support of wartime production, NWPP committees include the Operating Committee, the Reserve Sharing Group Committee, the Pacific Northwest Coordination Agreement (PNCA) Coordinating Group, and the Transmission Planning Committee (TPC). The TPC exists as a forum addressing northwest electric planning issues and concerns, including a structured interface with external stakeholders.

The NWPP serves as an electricity reliability forum, helping to coordinate present and future industry restructuring, promoting member cooperation to achieve reliable system operation, coordinating power system planning, and assisting the transmission planning process. NWPP membership is voluntary and includes the major generating utilities serving the Northwestern U.S., British Columbia and Alberta. Smaller, principally non-generating utilities participate in an indirect manner through their member systems, such as the BPA.

ColumbiaGrid

ColumbiaGrid formed on March 31, 2006, and its membership includes Avista, BPA, Chelan County PUD, Grant County PUD, Puget Sound Energy, Seattle City Light, Snohomish County PUD, and Tacoma Power. ColumbiaGrid was formed to enhance and improve the operational efficiency, reliability, and planned expansion of the Pacific Northwest transmission grid. Consistent with FERC requirements issued in Orders 890 and 1000, ColumbiaGrid develops sub-regional transmission plans, assesses transmission alternatives (including non-wires alternatives), and provides a decision-making forum and cost-allocation methodology for new transmission projects.

Northern Tier Transmission Group

The Northern Tier Transmission Group (NTTG) formed on August 10, 2007. NTTG members include Deseret Power Electric Cooperative, Idaho Power, Northwestern Energy, PacifiCorp, Portland General Electric, and Utah Associated Municipal Power Systems. These members rely upon the NTTG committee structure to meet FERC's coordinated transmission planning requirements. Avista's transmission network has a number of strong interconnections with three of the six NTTG member systems. Due to the geographical and electrical positions of Avista's transmission network related to NTTG members, Avista participates in the NTTG planning process to foster collaborative relationships with our interconnected utilities.

Transmission Coordination Work Group

The Transmission Coordination Work Group is a joint effort between Avista, BPA, Idaho Power, Pacific Gas and Electric, PacifiCorp, Portland General Electric, Sea Breeze Pacific-RTS, and TransCanada to coordinate transmission project developments expected to interconnect at or near a proposed Northeast Oregon station near Boardman, Oregon. These projects follow WECC Regional Planning and Project Rating Guidelines. Detailed information on projects presently under consideration is available at www.nwpp.org/tcwg. Many of the projects from this effort are on hold or have been terminated.

Avista Transmission Reliability and Operations

Avista plans and operates its transmission system pursuant to applicable criteria established by the North American Electric Reliability Corporation (NERC), WECC, and NWPP. Through involvement in WECC and NWPP standing committees and sub-committees, Avista participates in developing new and revised criteria while coordinating transmission system planning and operation with neighboring systems. Mandatory reliability standards promulgated through FERC and NERC subject Avista to periodic performance audits through these regional organizations.

Avista's transmission system is constructed for the primary purposes of providing reliable and efficient transmission service from the company's portfolio of power resources to its retail native load customers. Portions of Avista's transmission system are fully subscribed for retail load service. Transmission capacity that is not reserved and scheduled for native load service is made available to third parties pursuant to FERC regulations and the terms and conditions of Avista's OATT. Such surplus transmission capacity that is not sold on a long-term (greater than one year) basis is

marketed on a short-term basis to third parties and used by Avista for short-term resource optimization.

Regional Transmission System

BPA owns and operates over 15,000 miles of transmission-level facilities, and it owns the largest portion of the region's high voltage (230 kV or higher) transmission grid. Avista uses BPA transmission to transfer output from its remote generation sources to Avista's transmission system, including its share in Colstrip Units 3 and 4, Coyote Springs 2, Lancaster, and its WNP-3 settlement contract. Avista also contracts with BPA for Network Integration Transmission Service to transfer power to several delivery points on the BPA system to serve portions of Avista's retail load, and to sell power surplus to its needs to other parties in the region.

Avista participates in BPA transmission rate case processes, and in BPA's Business Practices Technical Forum, to ensure charges remain reasonable and support system reliability and access. Avista also works with BPA and other regional utilities to coordinate major transmission facility outages.

Future electricity grid expansion will likely require new transmission assets by federal and other entities. BPA is developing several transmission projects in the Interstate-5 corridor, as well as projects in southern Washington necessary for integrating wind generation resources located in the Columbia Gorge. Each project has the potential to increase BPA transmission rates and thereby affect Avista's costs.

Avista's Transmission System

Avista owns and operates a system of over 2,200 miles of electric transmission facilities. This includes approximately 685 miles of 230 kV line and 1,527 miles of 115 kV line. Figure 5.1 illustrates Avista's transmission system. Avista owns an 11 percent interest in 495 miles of double circuit 500 kV lines between Colstrip and Townsend, Montana. The transmission system includes switching stations and high-voltage substations with transformers, monitoring and metering devices, and other system operation-related equipment. The system transfers power from Avista's generation resources to its retail load centers. Avista also has network interconnections with the following utilities:

- BPA
- Chelan County PUD
- Grant County PUD
- Idaho Power Company
- NorthWestern Energy
- PacifiCorp
- Pend Oreille County PUD

Figure 5.1: Avista Transmission Map



Transmission System Information for the 2013 IRP

Since the 2011 IRP, Avista completed transmission projects to support new generation, increase reliability, and provide system voltage support including;

- Thornton 230 kV switching station
- Garden Springs to Hallet & White section of South Fairchild 115 kV Tap
- Irvin – Opportunity 115 kV line
- Burke Substation to Montana border section of Burke – Thompson Falls A&B 115 kV lines
- Southern half of Bronx – Cabinet Gorge 115 kV line
- Capacitor bank installed at the Lind 115 kV switching station.

Lancaster Integration

Avista has evaluated and proposed an interconnection with BPA at its Lancaster 230 kV Switching Station. Avista and BPA have determined the preferred alternative is to loop the Avista Boulder-Rathdrum 230 kV line into the BPA Lancaster 230 kV station. This interconnection allows Avista to eliminate or offset BPA wheeling charges for moving the output from Lancaster to Avista's system. Besides reducing transmission payments to BPA by Avista, the interconnection benefits both Avista and the BPA by increasing

system reliability, decreasing losses, and delaying the need for additional transformation at BPA's Bell Substation. Studies indicate this project may allow more transfer capability across the combined transmission interconnections of Avista and BPA. This project, in conjunction with other Avista upgrades, also supports increasing the Montana-to-Northwest path rating by as much as 800 MW. Avista has worked collaboratively with BPA and the Lancaster 230 kV interconnection project is planned for completion by the end of 2013.

South Spokane 230 kV Reinforcement

Transmission studies continue to support the need for an additional 230 kV line to the south and west of Spokane. Avista currently has no 230 kV source in these areas and instead relies on its 115 kV system for load service and bulk power flows through the area. The project scope is under development, and preliminary studies indicate the need for the following (or similar) projects:

- A new 230/115 kV station near Garden Springs. Property acquisition for the Garden Springs station and preliminary geo-technical station design work has commenced;
- Tap of the Benewah-Boulder 230 kV line southwest of the Liberty Lake area and construction of a new 230 kV switching station (for later development of a 230/115 kV substation); alternatively, reconstruction of the 115 kV circuits between Beacon and Ninth & Central, and the installation of a 230/115 kV station at that site could be pursued;
- Connecting the Liberty Lake 230 kV station with the Garden Springs 230 kV station; alternatively, connecting the Ninth & Central station to the Garden Springs station;
- Construction of a new 230 kV line from Garden Springs to Westside; and
- Origination and termination of the 115 kV lines from the new Spokane area 230/115 kV station(s).

The South Spokane 230 kV Reinforcement project was scoped at the end of 2012 with a planned in-service date by the end of 2018. The project is planned to enter service in a staged fashion beginning in 2014.

Avista Station Upgrades

As reported in the 2011 IRP, Avista planned to upgrade its Moscow, Noxon, and Westside 230 kV substations. These upgrades improve reliability, add capacity, and update aging components. The Moscow station upgrades, scheduled for completion in 2014, will result in a new facility with a single 250 MVA 230/115 kV station doubling the current station capacity over the next five to 10 years. Further upgrades or rebuilds are planned at the following substations:

- Irvin 115 kV Switching Station [Spokane Valley Reinforcement] (2016)
- Millwood 115 kV Distribution Substation [Spokane Valley Reinforcement] (2013)
- North Lewiston 115 kV Distribution Substation (2014)
- Moscow 230/115 kV Substation (2011-2014)
- Stratford 115 kV Switching Station (2014)

Chapter 5 – Transmission & Distribution

- Blue Creek 115 kV Distribution Substation (2014)
- Harrington 115 kV Distribution Substation (2014)
- Noxon 230 kV Switching Station (2013-2016)
- 9th & Central 115 kV Distribution Substation (2015)
- Greenacres 115 kV Distribution Substation (2014)
- Beacon 230/115 kV Station Partial Rebuild (2017+)

Avista Transmission Upgrades

Avista plans to complete several 115 kV reconductor projects throughout its transmission system over the next decade. These projects focus on replacing decades-old small conductor with conductor capable of greater load-carrying capability and provide more efficient (i.e., fewer electrical losses) service. The following list gives an example of planned transmission projects:

- Spokane Valley Reinforcement Project (2011-2016)
- Bronx – Cabinet Gorge 115 kV (2011-2015)
- Burke – Pine Creek 115 kV (2012-2014)
- Benton – Othello 115 kV (2014-2016)
- Devils Gap – Lind 115 kV (2014-2016)
- Coeur d'Alene – Pine Creek 115 kV (2014-2017)

Generation Interconnection Requests

Avista's Power Supply Department requested generator interconnection studies in several areas of Avista's transmission system for the 2013 IRP. Developers have also requested studies through Avista's Large Generation Interconnection Request (LGIR) process. Table 5.1 states the projects and cost information for each of the IRP-related studies. The study results for each project, including cost and integration options, may be found in Appendix D. These studies are a high level view of the generation interconnect request similar to what would be performed as a feasibility study for a third party under the LGIR process.

Table 5.1: IRP Requested Transmission Upgrade Studies

Project	Size (MW)	Cost ¹
Nine Mile	60	No cost
Long Lake	68	\$9.9 million
Monroe Street	80	No cost ²
Upper Falls	40	No cost ³
Post Falls	16	No cost
Cabinet Gorge	60	No cost
Thornton	200	\$4 million
Benewah to Boulder	300	\$7-\$15 million
Rathdrum	300	\$7-\$30+ million

¹ Cost estimates are in 2013 dollars and use engineering judgment with a 50 percent margin for error.

² An upgrade to the College & Walnut substation may require upgrades.

³ Ibid.

Large Generation Interconnection Requests

Third-party generation companies or independent power producers may make requests for transmission studies to understand the cost and timelines for integrating potential new generation projects. These types of projects follow a strict FERC process and include three study steps to estimate the feasibility, system impact, and facility requirement costs for project integration. Each of these studies provides the requester with a different level of project costs, and the studies are typically complete over at least a one-year period. After this process is completed a contract can be offered to integrate the project and negotiations can begin to enter into a transmission agreement if necessary. Each of the proposed projects are made public to some degree (customer names remain anonymous). Below Table 5.2 lists the current projects remaining in Avista's transmission queue.

Table 5.2: Third-Party Large Generation Interconnection Requests

Project #	Size (MW)	Type	Interconnection
#33	400	Wind	Lind 115 kV Substation
#35	200	CT	Thornton 230 kV Switching Station
#36	105	Wind	Thornton 230 kV Switching Station

Distribution System Efficiencies

In 2008, an Avista system efficiencies team of operational, engineering, and planning staff developed a plan to evaluate potential energy savings from Transmission and Distribution system upgrades. The first phase summarized potential energy savings from distribution feeder upgrades. The second phase, beginning in the summer of 2009, combined transmission system topologies with “right sizing” distribution feeders to reduce system losses, improve system reliability, and meet future load growth.

The system efficiencies team evaluated several efficiency programs to improve both urban and rural distribution feeders. The programs consisted of the following system enhancements:

- Conductor losses;
- Distribution transformers;
- Secondary districts; and
- Volt-ampere reactive compensation.

The energy losses, capital investments, and reductions in operations and maintenance (O&M) costs resulting from the individual efficiency programs under consideration were combined on a per feeder basis. This approach provided a means to rank and compare the energy savings and net resource costs for each feeder.

Feeder Upgrade Program

Avista's distribution system consists of approximately 330 feeders covering 30,000 square miles, ranging in length from three to 73 miles. For rural distribution, feeder

lengths vary widely to meet the electrical loads resulting from the startup and shutdown business swings of the timber, mining and agriculture industries.

The Feeder Upgrade Program's charter criterion has grown to include a more holistic approach to the way Avista addresses each project. This vital program integrates work performed under various operational initiatives in Avista including the Wood Pole Management Program, the Transformer Change-out Program, the Vegetation Management Program and the Feeder Automation Program. The work of the Feeder Upgrade Program includes the replacement of undersized and deteriorating conductors, replacement of failed and end-of-life infrastructure materials including wood poles, cross arms, fuses and insulators. Inaccessible pole alignment, right-away, undergrounding and clear zone compliance issues are addressed for each feeder section as well as regular maintenance work such as leaning poles, guy anchors, unauthorized attachments and joint-use management. This systematic overview enables Avista to cost-effectively deliver a modernized and robust electric distribution system that is more efficient, easier to maintain and more reliable for our customers.

Figure 5.2 illustrates the reliability advantages and reasons for the program. Prior to the 2009 feeder rebuild pilot program, outages were increasing at up to 13 outages per year. After the project, outages declined significantly. In the past two years, only one outage was recorded. The program is in its second year of regular funding and its intended purpose of capturing energy savings through reduced losses, increased reliability and decreased O&M costs is being realized. The feeders addressed through this program to date are shown in Table 5.3. The total energy savings, from both re-conductor and transformer efficiencies for all of these feeders, is approximately 4,869 MWh annually.

Table 5.3: Completed Feeder Rebuilds

Feeder	Area	Year Complete	Annual Energy Savings (MWh)
9CE12F4	Spokane, WA (9 th & Central)	2009	601
BEA12F1	Spokane, WA (Beacon)	2012	972
F&C12F2	Spokane, WA (Francis & Cedar)	2012	570
BEA12F5	Spokane, WA (Beacon)	2013	885
WIL12F2	Wilbur, WA	2013	1,403
CDA121	Coeur d'Alene, ID	2013	438
Total			4,869

The additional benefits ascertained through the work performed through the Feeder Upgrade Program are just now coming to fruition and will require a multi-year study to verify all of the planned benefits. Table 5.4 includes the working plan for feeder rebuilds over the next several years. The additional energy savings is anticipated to reach 1,626 MWh per year.

Chapter 5 – Transmission & Distribution

Figure 5.2: Spokane's 9th and Central Feeder (9CE12F4) Outage History

Table 5.4: Planned Feeder Rebuilds

Feeder	Area	Planned Year	Annual Energy Savings (MWh)
NE12F3	Spokane, WA	2014	115
RAT231	Rathdrum, ID	2014	91
OTH502	Othello, WA	2014	21
M23621	Moscow, ID	2014	151
DVP12F2	Davenport, WA	2014	35
HAR4F1	Harrington, WA	2014	69
BEA12F3	Spokane, WA	2015	167
FWT12F3	Spokane, WA	2015	121
TEN1255	Lewiston, ID/Clarkston, WA	2015	249
ROS12F1	Spokane, WA	2016	267
SPI12F1	Northport, WA	2016	162
TUR112	Pullman, WA	2016	101
TUR113	Pullman, WA	2017-2018	76
Total			1,626

6. Generation Resource Options

Introduction

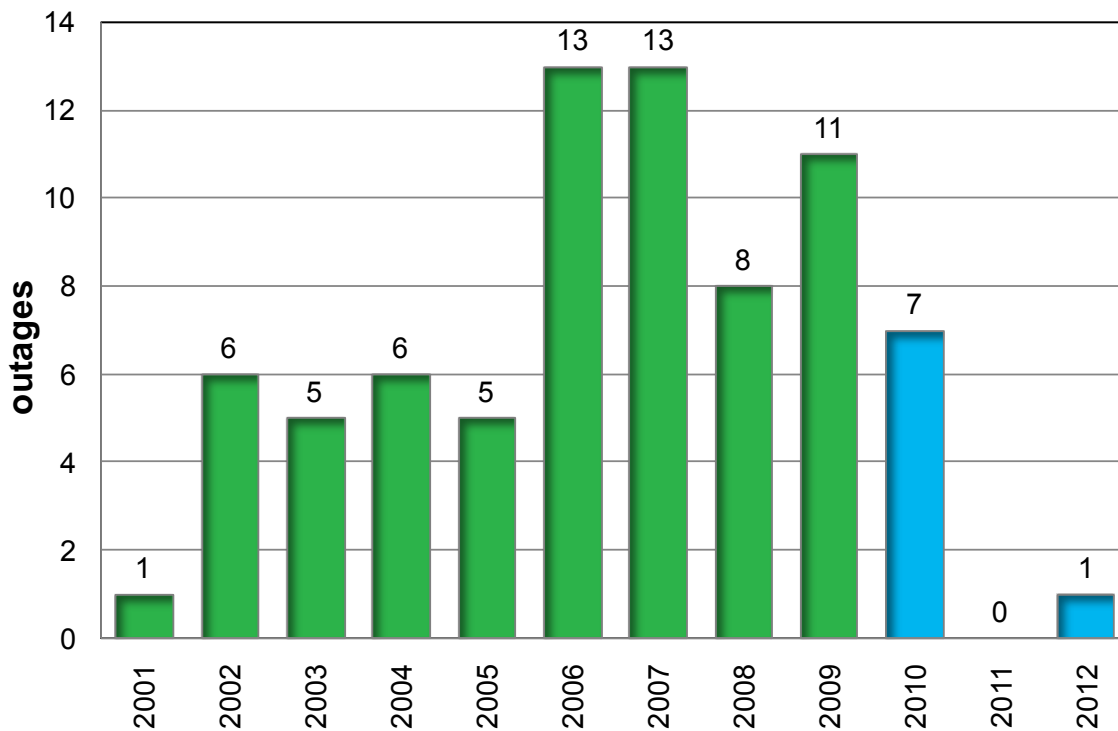
Several generating resource options are available to meet future load growth. Avista can upgrade existing resources, build new facilities, or contract with other energy companies for future delivery. This section describes resources Avista considered in the 2013 IRP to meet future needs. The new resources described in this chapter are mostly generic. Actual resources may differ in size, cost, and operating characteristics due to siting or engineering requirements.

Section Highlights

- Only resources with well-defined costs and operating histories are options to meet future resource needs.
- Wind, solar and hydro upgrades represent renewable options available to Avista; future requests for proposals (RFPs) might identify competing renewable technologies.
- Renewable resource costs assume no extensions of state and federal incentives.
- This IRP models battery storage technology as a resource option for the first time in an Avista IRP.
- Upgrades to Avista's Spokane and Clark Fork River facilities are included as resource options.

Assumptions

For the PRS analyses, Avista only considers commercially available resources with well-known costs, availability and generation profiles. These resources include gas-fired combined cycle combustion turbines (CCCT), simple cycle combustion turbines (SCCT), large-scale wind, storage, hydro upgrades, and certain solar technologies proven on a large-scale commercial basis. Several other resource options described later in the chapter were not included in the PRS analysis, but their costs were estimated for comparative analysis. Potential contractual arrangements with other energy companies are not an option for this plan, but are an option when Avista seeks new resources through a RFP.

Levelized costs referred to throughout this section are at the generation busbar. The nominal discount rate used in the analyses is 6.67 percent based on Avista's weighted average cost of capital approved by the states of Idaho and Washington. Nominal levelized costs result from discounting nominal cash flows at the rate of general inflation. All costs in this section are in 2014 nominal dollars unless otherwise noted.

Chapter 6- Generation Resource Options

Certain renewable resources receive federal and state tax incentives today and into the near future. Solar tax benefits fall by two-thirds after 2016 and all other renewable benefits end in 2013¹. These incentives are included in IRP modeling.

Levelized resource costs presented in this chapter use the maximum available energy for each year, not expected generation. For example, wind generation assumes 34 percent availability, CCCT generation assumes 90 percent availability, and SCCT generation assumes 91 percent availability. Wind resources typically operate at or near assumed availability because the fuel is free, but CCCT or SCCT plants operate at levels well below their availability factors because their output will be displaced when lower-cost wholesale market power is available. Costs are levelized for the first 20 years of the project life using longer useful-life depreciation schedules. The following are definitions for the levelized cost components used in this chapter:

- *Capital Recovery and Taxes*: Depreciation, return of and on capital, federal and state income taxes, property taxes, insurance, and miscellaneous charges such as uncollectible accounts and state taxes for each of these items pertaining to a generation asset investment.
- *Allowance for Funds Used During Construction (AFUDC)*: The cost of money associated with construction payments made on a generation asset during construction.
- *Federal Tax Incentives*: The estimated federal tax incentive (per MWh) in the form of a PTC, a cash grant, or an ITC, attributable to qualified generation options.
- *Fuel Costs*: The average cost of fuel such as natural gas, coal, or wood, per MWh of generation. Additional fuel prices details are included in the Market Analysis section.
- *Fuel Transport*: The cost to transport fuel to the plant, including pipeline capacity charges.
- *Fixed Operations and Maintenance (O&M)*: Costs related to operating the plant such as labor, parts, and other maintenance services that are not based on generation levels.
- *Variable O&M*: Costs per MWh related to incremental generation.
- *Transmission*: Includes depreciation, return on capital, income taxes, property taxes, insurance, and miscellaneous charges such as uncollectible accounts and state taxes for each of these items pertaining to transmission asset investments needed to interconnect the generator and/or third party transmission charges.
- *Other Overheads*: Includes miscellaneous charges for non-capital expenses such as uncollectibles, excise taxes and commission fees.

The tables at the end of this section show incremental capacity, heat rates, generation capital costs, fixed O&M, variable costs, and peak credits for each resource option.²

¹ After completion of the modeling for this IRP, the PTC for wind was expanded to allow any project under construction by the end of 2013 might qualify upon its completion.

Figure 6.2 compares the levelized costs of different resource types. Avista relies on a variety of sources including the NPCC, press releases, regulatory filings, internal analysis, and Avista's experiences with certain technologies for its resource assumptions.

Gas-Fired Combined Cycle Combustion Turbine

Gas-fired CCCT plants provide a reliable source of both capacity and energy for a relatively modest capital investment. The main disadvantage is generation cost volatility due to reliance on natural gas, unless the fuel price is hedged. CCCTs in this IRP are "one-on-one" (1x1) configurations, using air-cooling technology. The 1x1 configuration consists of a single gas turbine, a single heat recovery steam generator (HRSG), and a duct burner to gain more generation from the HRSG. The plants have nameplate ratings between 250 MW and 330 MW each depending on configuration and location. A 2x1 CCCT plant configuration is possible with two turbines and one HRSG, generating up to 600 MW. Avista would need to share the plant with one or more utilities to take advantage of the modest economies of scale and efficiency of a 2x1 plant configuration due to its large size relative to our needs.

Water cooling technology could be an option for CCCT development, depending on the plant location; however, this IRP assumes air-cooled technology because of the difficulties in obtaining new water rights. Where water-cooling technology is available, the plant may require a lower capital investment and have a better heat rate relative to air-cooled technology.

The most likely CCCT configuration for Avista is a 270-300 MW air-cooled plant located in the Idaho portion of Avista's service territory, mainly due to Idaho's lack of an excise tax on natural gas consumed for power generation, a lower sales tax rate relative to Washington, and no fees on carbon dioxide emissions.³ Potential combined cycle plant sites would likely be on the Avista transmission system to avoid third-party wheeling rates. Another advantage of siting a CCCT resource in Avista's service territory in Idaho is access to low-cost natural gas on the GTN pipeline.

Cost and operational estimates for CCCTs modeled in the IRP use data from Avista's internal engineering analyses. The heat rate modeled for an air-cooled CCCT resource is 6,832 Btu/kWh in 2014. The projected CCCT heat rate falls by 0.5 percent annually to reflect anticipated technological improvements. The plants include duct firing for 7 percent of rated capacity at a heat rate of 8,910 Btu/kWh. If Avista were able to site a water-cooled plant, the heat rate would likely be 2 percent lower and net plant output might increase by five MW.

The IRP includes a 6 percent forced outage rate for CCCTs, and 14 days of annual plant maintenance. The plants are capable of backing down to 50 percent of nameplate

² Peak credit is the amount of capacity a resource contributes at the time of system peak load.

³ Washington state applies an excise tax on all fuel consumed for wholesale power generation, the same as it does for retail natural gas service, at approximately 3.875 percent. Washington also has higher sales taxes and has carbon dioxide mitigation fees.

Chapter 6- Generation Resource Options

capacity, and ramping from zero to full load in four hours. Carbon dioxide emissions are 117 pounds per dekatherm of fuel burned. The maximum capability of each plant is highly dependent on ambient temperature and plant elevation.

The anticipated capital cost for an air-cooled CCCT located in Idaho on Avista's transmission system, with AFUDC, is \$1,279 per kW in 2014; \$345 million for a 270 MW plant. Table 6.1 shows the overnight costs for an air-cooled CCCT resource in nominal dollars; Table 6.2 shows levelized costs. The costs include firm natural gas transportation. At this time, excess pipeline capacity exists on the major pipelines near all potential siting locations to supply firm natural gas service.

Natural Gas-Fired Peakers

Natural gas-fired CTs and reciprocating engines, or peaking resources, provide low-cost capacity and are capable of providing energy as needed. Technological advances allow the plants to start and ramp quickly, providing regulation services and reserves for load following and to integrate variable resources such as wind and solar.

The IRP models four peaking resource options: Frame (GE 7EA), hybrid aero-derivative or intercooled (GE LMS 100), reciprocating engines (Wartsila 18V34), and aero-derivative (Pratt FT8). The different peaking technologies range in their abilities to follow load, costs, generating capabilities, and energy-conversion efficiencies. Table 6.1 shows cost and operational estimates based on Avista's internal engineering estimates. All peaking plants assume 0.5 percent annual real dollar cost decrease and forced outage and maintenance rates. The levelized cost for each of the technologies is in Table 6.2.

Firm fuel transportation has become an electric reliability issue with FERC, and is being discussed at several regional and extra-regional forums. For this IRP, Avista continues to assume it will not procure firm natural gas transportation for its peaking resources. Firm transportation could be necessary where pipeline capacity becomes scarce during utility peak hours; however, pipelines near potential sites being modeled by Avista in the IRP are not currently subscribed or expected to be subscribed in the near future to levels high enough to warrant the additional costs of having firm supply. Avista continues to monitor natural gas transportation options for its portfolio. Where non-firm natural gas transportation options become inadequate for system reliability, three options exist: contracting for firm natural gas transportation rights, or on-site oil or natural gas storage.

The lowest-cost peaking resource, as measured by production cost in Table 6.2, is hybrid technology. However, this comparison is misleading, as a peaking resource does not operate at its theoretical maximum operating levels. Peaking resources generally operate only a small number of hours in the year. Therefore, lower capacity-cost resources may be more cost-effective for the portfolio in relation to hybrid technology when considering the number of expected operating hours in the broader IRP modeling process.

Chapter 6- Generation Resource Options

Table 6.1: Natural Gas Fired Plant Cost and Operational Characteristics

Item	Air Cooled CCCT	Frame	Hybrid	Recip. Engines	Aero- Derivative
Capital Cost with AFUDC (\$/kW)	\$1,279	\$910	\$1,199	\$1,141	\$1,185
Fixed O&M (\$/kW- yr)	\$22.70	\$11.48	\$16.07	\$18.78	\$13.56
Heat Rate (Btu/kWh)	6,832	11,286	8,712	8,712	9,802
Variable O&M (\$/MWh)	\$1.77	\$3.13	\$5.22	\$6.26	\$4.17
Units Assumed at Site	1	2	1	6	2
Unit Size (MW)	270	83	92	19	50
Total Project Size (MW)	270	166	92	114	100
Total Cost for Segment Size (millions)	\$345	\$151	\$110	\$128	\$119

Table 6.2: Natural Gas-Fired Plant Levelized Costs per MWh

Item	Air Cooled CCCT	Frame	Hybrid	Recip. Engines	Aero- Derivative
Capital Recovery & Taxes	18.69	13.79	18.17	16.83	17.96
AFUDC	2.02	0.58	0.76	0.70	0.75
Fuel Costs ⁴	41.43	59.68	46.07	46.07	51.83
Fixed O&M	3.72	1.83	2.57	2.92	2.17
Variable O&M	2.25	3.97	6.62	7.94	5.29
Transmission	1.07	0.40	0.72	0.58	0.67
Other Overheads	1.44	1.96	1.67	1.71	1.78
Total Cost	70.62	82.21	76.57	76.75	80.45

Wind Generation

Concerns over the environmental impact of carbon-based generation technologies have increased demand for wind generation. Governments are promoting wind generation with tax credits, renewable portfolio standards, carbon emission restrictions, and stricter controls on existing non-renewable resources. The 2013 “Fiscal Cliff” deal in the U.S. Congress extended the PTC for wind through December 31, 2013, with provisions allowing projects to qualify after 2013 so long as construction begins in 2013. This IRP does not assume the PTC extends beyond this term, but does assume the preferential 5-year tax depreciation remains.

The IRP considers two wind generation resources located both on- and off-system. Both resources assume similar capital costs and wind patterns. On-system projects pay only transmission interconnection costs, whereas off-system projects must pay both interconnection and third-party wheeling costs.

⁴ The Air-Cooled CCCT technologies fuel cost includes a charge for fuel transport to reserve capacity on a major pipeline. The levelized cost of the charge is estimated to be \$5.04 per MWh.

Chapter 6- Generation Resource Options

Wind resources benefit from having no emissions profile or fuel costs, but they are not dispatchable, and have high capital and labor costs on a per-MWh basis when compared to most other resource options. Wind capital costs in 2014, including AFUDC and transmission interconnection, are \$2,340 per kW, with annual fixed O&M costs of \$46 per kW-yr. Fixed O&M includes indirect charges to account for the inherent variation in wind generation, oftentimes referred to as “wind integration.” The cost of wind integration depends on the penetration of wind in Avista’s portfolio, and the market price of power; for this IRP, wind integration is \$4 per kW-year in 2014. These estimates come from Avista’s experience in the wind market at the time of the IRP, and results from Avista’s Wind Integration Study.

The wind capacity factors in the Northwest vary depending on project location, with capacity factors roughly ranging between 25 and 40 percent. This plan assumes Northwest wind has a 33 percent average capacity factor; on-system wind projects have a 34 percent capacity factor. A statistical method, based on regional wind studies, derives a range of annual capacity factors depending on the wind regime in each year (see stochastic modeling assumptions for more details). The expected capacity factor can have a dramatic impact on the levelized cost of a wind project. For example, a 30 percent capacity factor site could be \$30 per MWh higher than a 40 percent capacity factor site holding all other assumptions equal.

Levelized costs, using these expected capacity factors, capital, and operating costs, are in Table 6.4. Actual wind resource costs vary depending on a project’s capacity factor, interconnection point, and the amount of tax related subsidies available. Further, this plan assumes wind resources selected in the PRS include the 20 percent REC apprenticeship adder for Washington state renewable portfolio standard eligible renewable resources. This adder applies only for Washington state compliance with the EIA, requiring 15 percent of the construction labor to be from apprentices through a state-certified apprenticeship program to qualify.

Table 6.3: Northwest Wind Project Levelized Costs per MWh

Item	On-System	Off-System
Capital Recovery & Taxes	80.68	83.12
AFUDC	4.73	4.87
Fuel Costs	0.00	0.00
Fixed O&M	19.81	20.41
Variable O&M	2.65	2.65
Transmission	1.77	9.99
Other Overheads	0.72	0.98
Total Cost	110.36	122.02

Solar Photovoltaic

Solar photovoltaic generation technology costs have fallen substantially in the last several years partly due to low-cost imports, and from renewable portfolio standards and government tax incentives, both inside and outside of the United States. Even with these large cost reductions, Avista’s analysis shows that solar still is uneconomic for

Chapter 6- Generation Resource Options

winter-peaking utilities in the Northwest when compared to other generation resource options, both renewable and non-renewable. This is due to solar's low capacity factor, its lack of on-peak output during cold winter peak periods, and relatively high capital cost. Solar does provide predictable daytime generation complementing the loads of summer-peaking utilities, though fixed panels typically do not produce full output at system peak.

In the Northwest solar provides no wintertime on-peak capability. If a substantial amount of solar is added to a summer peaking utility (e.g., in the desert Southwest), the peak hour recorded prior to the solar installation will be reduced, but the peak will simply be shifted toward sundown when the solar facility witnesses a substantial output reduction. Figure 6.1 presents an example based on California Independent System Operator Daily Renewables output data for August 14, 2012. To better illustrate solar generation's impact, the figure shows a ten-fold increase to actual solar output. Assuming 10,000 MW of alternating current (AC) nameplate solar lowers the peak by 5,662 MW from the actual peak of 45,227, and shifts the overall system peak by two hours.⁵ The example shows a net 56 percent peak credit for solar because solar's output falls off drastically in the later hours of the day.

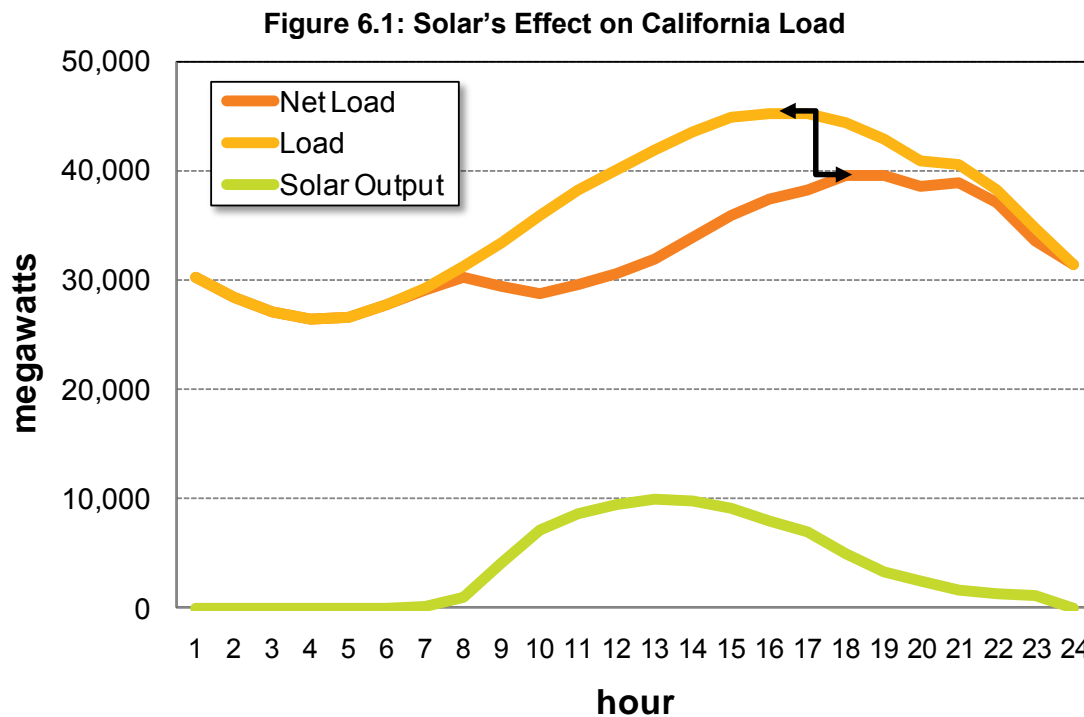

Utility-scale photovoltaic generation can be optimally located for the best solar radiation, albeit at the expense of lower overall generation levels. Solar thermal technologies can

⁵ Solar output generally is quoted on a direct current (DC) basis; however, for an alternating current system output is reduced by approximately 15-23 percent to account for DC-AC conversion and other on-site losses. The actual capacity of the solar generation profile is unknown, it is likely between 1,000 and 1,500 MW.

Chapter 6- Generation Resource Options

produce higher capacity factors than photovoltaic solar projects by as much as 30 percent, and can store energy for several hours for later use in reducing peak loads. Utility-scale solar capital costs in the IRP, including AFUDC, are \$3,403 per kW for photovoltaic and \$6,587 for solar-thermal or concentrating solar projects. A well-placed utility-scale photovoltaic system located in the Pacific Northwest would achieve a capacity factor of less than 18 percent; the IRP uses a 15 percent capacity factor. Only utility-scale photovoltaic was included as an option for the PRS. Avista does not believe solar-thermal is an economically viable option in Avista's service territory given our modest solar resource and the relatively higher capital costs when compared to photovoltaic projects.

Table 6.4 shows the levelized costs of solar resources, including federal incentives. Even with declining prices, solar will continue to struggle as a cost-competitive resource in the Northwest because of its high installation costs and because the technology cannot meet winter peak system requirements. One advantage given to solar in the state of Washington is if the total plant is less than five megawatts it counts as two RECs towards Washington's EIA. Washington state also offers substantial financial incentives for consumer-owned solar. This IRP does not explicitly consider consumer-owned solar, as the overall incentives are not available to utilities and would otherwise be capped at a level that would not affect this plan. Consumer-owned solar continues to be accounted for through reductions in Avista's retail load forecast.

Table 6.4: Solar Nominal Levelized Cost (\$/MWh)

Item	Photovoltaic Solar
Capital Recovery & Taxes	293.32
AFUDC	9.56
Fuel Costs	0.00
Fixed O&M	48.32
Variable O&M	0.00
Transmission	21.61
Other Overheads	2.08
Total Cost (without federal tax incentive)	374.89
Total Cost (with federal tax incentive)	283.58

Coal Generation

The coal generation industry is at a crossroads. In many states, like Washington, new coal-fired plants are unlikely due to emission performance standards. Coal remains a viable option in other parts of the country, but the risks associated with future carbon legislation make investments in this technology challenging. The EPA has proposed a greenhouse gas emission performance standard average of 1,000 lbs per MWh (averaged over a 30-year period). This proposed rule effectively eliminates new coal-fired generation without carbon sequestration, as non-sequestered coal options generate between 1,760 and 1,825 lbs of carbon dioxide per MWh.

Chapter 6- Generation Resource Options

Avista does not plan to build or participate in any new coal-fired generation resources in the future due to the risk of future national carbon mitigation legislation and the effective prohibition contained in Washington state law. Technologies reducing or capturing greenhouse gas emissions in coal-fired resources might enable coal to become a viable technology in the future, but the technology is not commercially available. Though Avista will not pursue coal in this plan, three coal technologies are shown to illustrate their costs: super critical pulverized, integrated gasification combined cycle (IGCC), and IGCC with sequestration. IGCC plants gasify coal, thereby creating a more efficient use of the fuel, lowering carbon emissions and removing other toxic substances before combustion. Sequestration technologies, if they become commercially available, might potentially sequester 90 percent of CO₂ emissions. Table 6.6 shows the costs, heat rates, and CO₂ emissions of the three coal-fired technologies based on estimates from the NPCC's Sixth Power plan and adjusted for Avista's projected inflation rates. Table 6.7 shows the nominal levelized cost per MWh based on the capital costs and plant efficiencies shown in Table 6.6.

Table 6.5: Coal Capital Costs

Item	Super-Critical	IGCC	IGCC w/ Sequestration
Capital Costs (\$/kW includes AFUDC)	\$3,683	\$4,895	\$7,342
Typical Size	600	600	550
Cost per Unit (Millions)	\$2,210	\$2,937	\$4,038
Heat Rate (Btu/kWh)	8,910	8,594	10,652
CO ₂ (lbs per MWh)	1,827	1,762	218

Table 6.6: Coal Project Levelized Cost per MWh

Item	Super-Critical	IGCC	IGCC w/ Sequestration
Capital Recovery & Taxes	54.90	72.26	108.38
AFUDC	8.25	13.35	20.02
Fuel Costs	14.52	14.00	17.36
Fixed O&M	7.24	11.07	11.07
Variable O&M	3.64	8.34	11.25
Transmission	9.47	9.62	4.38
Other Overheads	1.04	1.28	1.31
Total Cost	99.06	129.92	173.77

Energy Storage

Increasing amounts of solar and wind generation on the electric grid makes energy storage technologies attractive from an operational perspective. The technologies could be an ideal way to smooth out renewable generation variability and assist in load following and regulation needs. The technology also could meet peak demand, provide voltage support, relieve transmission congestion, take power during over supply events, and supply other non-energy needs for the system. Over time, storage may become an important part of the nation's grid. Several storage technologies currently exist, including; pumped hydro, traditional and chemical batteries, flywheels, and compressed air.

There are many challenges with storage technology. First, existing technologies consume a significant amount of electricity relative to their output through conversion losses. Second, the cost of storage is high, at near \$4,000 per kW. This cost is nearly four times the initial cost of a natural gas-fired peaking plant that can provide many, but not all, of the same capabilities without the electricity consumption characteristics of storage. Storage costs are forecast to decline over time, and Avista continues to monitor the technologies as part of the IRP process. Third, the current scale of most storage projects is small, limiting their applicability to utility-scale deployment. Fourth, early adoption of technology can be risky, with many industry examples of battery fires and bankruptcy.

The Northwest might be slower in adopting storage technology relative to other regions in the country. The Northwest hydro system already contains a significant amount of storage relative to the rest of the country. However, as more capacity consuming renewables are added to the grid, new storage technologies might play a significant role in meeting the need for additional operational flexibility where upfront capital costs and operational losses fall.

One of the biggest obstacles to energy storage is quantifying and properly valuing its benefits. At a minimum, the value of storage is the spread or difference between the value of energy in on versus off-peak hours (load factoring), minus the losses. Since the technology can meet regulation, load following, and operating reserves, there is value beyond load factoring. Valuing these benefits requires new system modeling tools. Presently there are no adequate tools available in the marketplace. Avista is developing a tool it believes will enable detailed valuations of storage (and other) technologies within our existing mix of flexible hydro and thermal system. The results of these studies are not available for this plan, but should be available in the next IRP.

Other Generation Resource Options

A thorough IRP considers generation resources not readily available in large quantities or commercially or economically ready for utility-scale development. Today a number of emerging technologies, like energy storage, are attractive from an operational or environmental perspective, but are significantly higher-cost than other technologies providing substantially similar capabilities at lower cost. Avista analyzed several of these technologies for the IRP using estimates from the NPCC's Sixth Power Plan,

Chapter 6- Generation Resource Options

publicly available data, and Avista internal engineering analysis. The resources include biomass, geothermal, co-generation, nuclear, landfill gas, and anaerobic digesters. Table 6.7 shows the expected cost of these options. Their costs vary depending on site-specific conditions. All prices shown are utility-scale estimates with no federal tax incentives. However, given the lack of utility-scale development, cost could be substantially higher than shown.

Failure to be included in the PRS is not the last opportunity for technologies to be in Avista's portfolio. The resources will compete with those included in the PRS through Avista's RFP processes. RFP processes identify competitive technologies that might displace resources otherwise included in the IRP strategy. Another possibility is acquisition through federal PURPA law mandates. PURPA provides non-utility developers the ability to sell qualifying power to Avista at guaranteed prices and terms.⁶ Since the 2011 IRP, Avista has acquired three renewable energy projects under PURPA.

Woody Biomass Generation

Woody biomass generation projects use waste wood from lumber or forest restoration process. The generation process is similar to a coal plant: a turbine converts boiler-created steam into electricity. A substantial amount of wood fuel is required for utility-scale generation. Avista's 50 MW Kettle Falls Generation Station consumes over 350,000 tons of wood waste annually, or 48 semi-truck loads of wood chips per day. It typically takes 1.5 tons of wood to make one MWh of electricity; the ratio varies seasonally with the moisture content of the fuel. The viability of another Avista biomass projects depends significantly on the availability and cost of the fuel supply. Many announced biomass projects fail due to lack of a long-term fuel source. If an RFP identifies a potential project, Avista will consider it for a future acquisition. A 25 MW utility scale biomass plant would cost approximately \$111 million in initial capital expenditure (\$4,436 per kW), with fuel and O&M costs increasing the total cost to an amount approaching \$160 per MWh.

Geothermal Generation

Northwest utilities have shown increased interest in geothermal energy over the past several years. It provides predictable electrical capacity and energy with minimal carbon dioxide emissions (zero to 200 pounds per MWh). The technology typically involves injecting water into deep wells; hot earth temperatures heat water and spin turbines for power generation. In recent years, a few projects were built in the Northwest. Due to the geologic conditions of Avista's service territory, no geothermal projects are likely to be developed. For Avista to add this technology to its portfolio, it would require a third-party transmission wheel and be acquired through an RFP process.

Geothermal energy struggles to compete due to high development costs stemming from having to drill several holes thousands of feet below the earth's crust; each hole can cost over \$3 million. Ongoing geothermal costs are low, but the capital required to locate and prove a viable site is significant. Costs shown in this section do not account

⁶ Rates, terms, and conditions are at www.avistautilities.com under Schedule 62.

Chapter 6- Generation Resource Options

for dry-hole risk associated with sites that do not prove to be viable after drilling has taken place. Recent construction estimates for a 15 MW facility are \$71.5 million (\$4,767 per kW). The levelized cost of geothermal power is \$104 per MWh.

Landfill Gas Generation

Landfill gas projects generally use reciprocating engines to burn methane gas collected at landfills. The Northwest has successfully developed many landfill gas resources. The costs of a landfill gas project will depend greatly on the site specifics of a landfill. The Spokane area had a project on one of its landfills, but it was retired after the fuel source depleted to an unsustainable level. The Spokane area no longer landfills its waste and instead uses its Municipal Waste Incinerator. Nearby in Kootenai County, Idaho, the Kootenai Electric Cooperative has developed a 3.2 MW Fighting Creek Project. It is currently under a PURPA contract with Avista. Using publically available costs and the NPCC estimates, landfill gas resources are economically promising, but are limited in their size, quantity, and location. Cost estimates in Table 6.7 assume a 3.2 MW unit with a capital cost of \$8.5 million (\$2,654 per kW including AFUDC). At an 88 percent capacity factor, a landfill gas project could cost up to \$106 per MWh.

Anaerobic Digesters (Manure/Wastewater Treatment)

The number of anaerobic digesters is increasing in the Northwest. These plants typically capture methane from agricultural waste, such as manure or plant residuals, and burn the gas in reciprocating engines to power generators. These facilities tend to be significantly smaller than utility-scale generation projects (less than five MW). Most facilities are located in large dairies or feedlots. A survey of Avista's service territory found no large-scale livestock operations capable of implementing this technology.

Wastewater treatment facilities can also host anaerobic digesting technology. Digesters installed when a facility is initially constructed helps the economics of a project greatly, though costs range greatly depending on the system configuration. Retrofits to existing wastewater treatment facilities are possible, but tend to have higher costs. Many of these projects offset energy needs of the facility, so there may be little, if any, surplus generation capability. Avista currently has a 260 kW waste water system under a PURPA contract with a Spokane County facility.

Typical digester projects are 200 kW to five MW. Current estimates are \$4,775 per kW for utility development, or \$24 million in capital for a five MW project. The actual cost of the technology depends on the fuel source, site specifics, and subsidies available for the project. For example, many digesters qualify for agricultural loans and/or grants. Fuel costs vary based on feedstock prices and transportation costs to move fuel to the digester. The cost of the technology is \$110 per MWh without fuel charges.

Small Cogeneration

Avista has few industrial customers capable of developing cost-effective cogeneration projects. If an interested customer was inclined to develop a small cogeneration project, it could provide benefits including reduced transmission and distribution losses, shared fuel, capital, and emissions costs, and credit toward Washington's EIA targets.

Chapter 6- Generation Resource Options

Another potentially promising option is natural gas pipeline cogeneration. This technology uses waste-heat from large natural gas pipeline compressor stations. In Avista's service territory few compressor stations exist, but the existing compressors in our service territory have potential for this generation technology. Avista has discussed adding cogeneration with pipeline owners.

A big challenge in developing any new cogeneration project is aligning the needs of the cogenerator and the utility's need for power. The optimal time to add cogeneration is when an industrial process is being retrofitted, but oftentimes the utility does not need the new capacity at this time. Another challenge to cogeneration within an IRP is estimating costs when host operations drive costs for a particular project.

Nuclear

Avista does not include nuclear plants as a resource option in the IRP given the uncertainty of their economics, the apparent lack of regional political support for the technology, U.S. nuclear waste handling policies, and Avista's modest needs relative to the size of modern nuclear plants. Nuclear resources could be in Avista's future only if other utilities in the Western Interconnect incorporate nuclear power in their resource mix and offer Avista an ownership share.

The viability of nuclear power could change as national policy priorities focus attention on de-carbonizing the nation's energy supply. The lack of newly completed nuclear facility construction experience in the United States makes estimating construction costs difficult. Cost projections in the IRP are from industry studies, recent nuclear plant license proposals, and a small number of projects currently under development. New smaller, and more modular, nuclear design could increase the potential for nuclear by shortening the permitting and construction phase (lower AFUDC costs), and make these traditionally large projects better fit the needs of smaller utilities.

Table 6.7's nuclear cost estimate is for a 1,100 MW facility. This assumes a capital cost of \$9,125 per kW (including AFUDC). At this cost, a large facility could easily cost \$10 billion to build and cost \$173 per MWh over the first 20 years of project life.

Table 6.7: Other Resource Options Levelized Costs (\$/MWh)

	Landfill Gas	Manure Digester	Wood Biomass	Geothermal	Nuclear
Capital Recovery & Taxes	36.35	65.43	60.09	57.12	114.25
AFUDC	1.01	1.03	4.43	8.78	29.93
Fuel Costs	33.60	33.60	56.40	0.00	10.83
Fixed O&M	4.45	7.70	31.84	29.43	15.41
Variable O&M	25.14	31.75	4.90	5.95	1.98
Transmission	4.67	4.13	1.41	4.08	4.13
Other Overheads	2.02	2.30	2.81	1.17	0.96
Total Cost	107.24	145.95	161.88	106.53	177.50

New Resources Cost Summary

Avista has several resource alternatives for this IRP. Each alternative provides different benefits, costs and risks. The IRP identifies the relevant characteristics and chooses a set of resources that are actionable, meet energy and capacity needs, balance renewable requirements, and minimize costs. Figure 6.2 shows comparative cost per MWh of each new resource alternative over the first 20 years of project life using nominal levelized costs. Tables 6.8 and 6.9 provide detailed assumptions for each type of resource. The ultimate resource selection goes beyond simple levelized cost analyses and considers the capacity contribution of each resource, among other items discussed in the IRP.

Figure 6.2: New Resource Levelized Costs (first 20 Years)

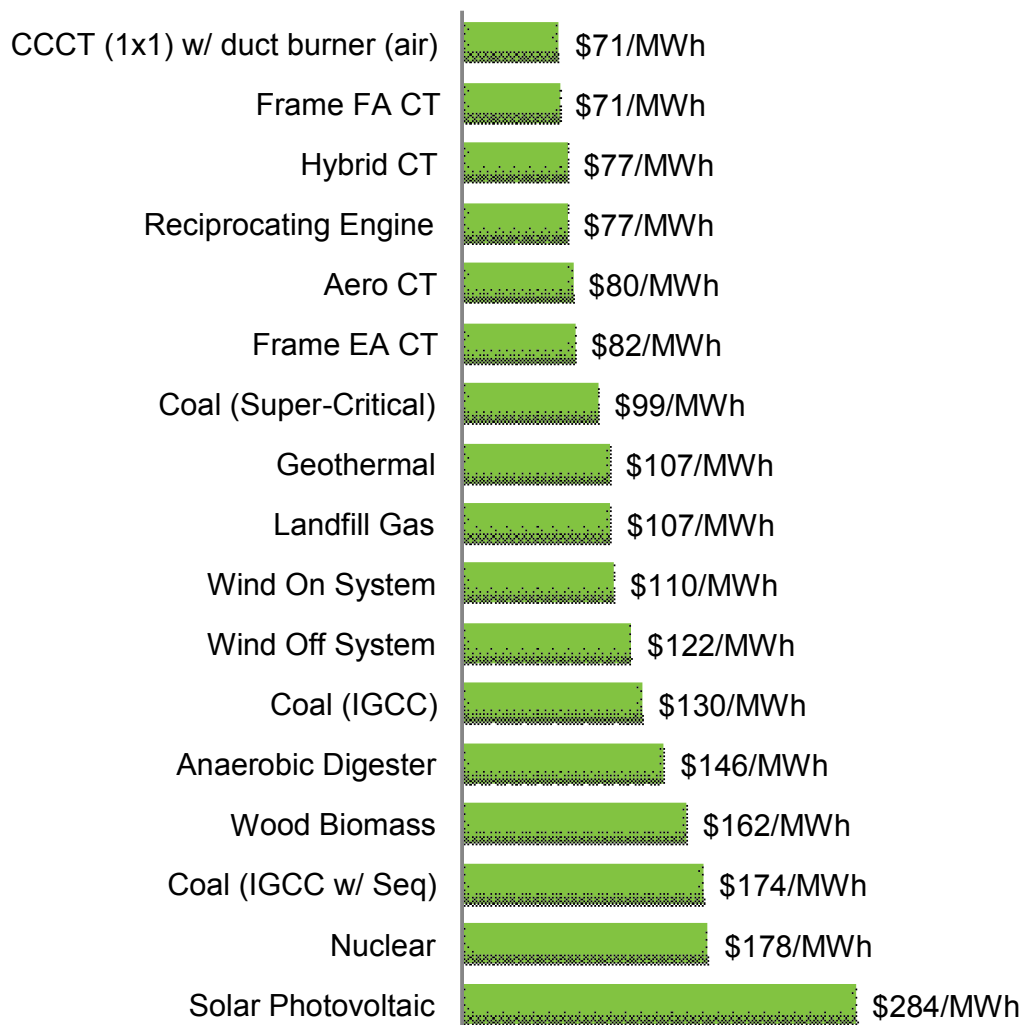

Chapter 6- Generation Resource Options

Table 6.8: New Resource Levelized Costs Considered in PRS Analysis

Resource	Size (MW)	Heat Rate (Btu/kWh)	Capital Cost (\$/kW)	Fixed O&M (\$/kW-yr)	Variable O&M (\$/MWh)	Peak Credit (Winter/Summer)
CCCT (air cooled)	270	6,832	1,279	22.7	1.77	104/94
Frame CT	83	11,286	910	11.5	3.13	104/94
Hybrid CT	92	8,712	1,199	16.1	5.22	104/94
Reciprocating Engines	114	8,712	1,141	18.8	6.26	100/100
Aero CT	100	9,802	1,185	13.6	4.17	104/94
Wind	100	n/a	2,340	53.0	2.09	0/0
Storage	5	n/a	3,889	52.2	0.00	100/100
Solar (photovoltaic)	5	n/a	3,403	53.0	0.00	0/62

Table 6.9: New Resource Levelized Costs Not Considered in PRS Analysis

Resource	Size (MW)	Heat Rate (Btu/kWh)	Capital Cost (\$/kW)	Fixed O&M (\$/kW-yr)	Variable O&M (\$/MWh)	Peak Credit (Winter/Summer)
Pulverized Coal	600	8,910	3,683	41.73	2.87	100/100
IGCC Coal	600	8,594	4,895	62.60	6.57	100/100
IGCC Coal w/ Seq.	550	10,652	7,342	62.60	8.87	100/100
Woody Biomass	25	13,500	4,436	187.80	3.86	100/100
Geothermal	15	n/a	4,767	182.59	4.70	100/100
Landfill Gas	3.2	10,500	2,654	27.13	19.82	100/100
Anaerobic Digester	1	10,500	4,721	46.95	25.04	100/100
Nuclear	1100	10,400	9,125	93.90	1.57	100/100

Hydroelectric Project Upgrades and Options

Avista continues to upgrade many of its hydroelectric facilities. The latest hydroelectric upgrade added nine megawatts to the Noxon Rapids Development in April 2012. Figure 6.3 shows the history of upgrades to Avista's hydroelectric system by year and cumulatively. Avista added 40.1 aMW of incremental hydroelectric energy between 1992 and 2012. Upgrades completed after 1999 qualify for the EIA, thereby reducing the need for additional higher-cost renewable energy options.

Chapter 6- Generation Resource Options

Figure 6.3: Historical and Planned Hydro Upgrades

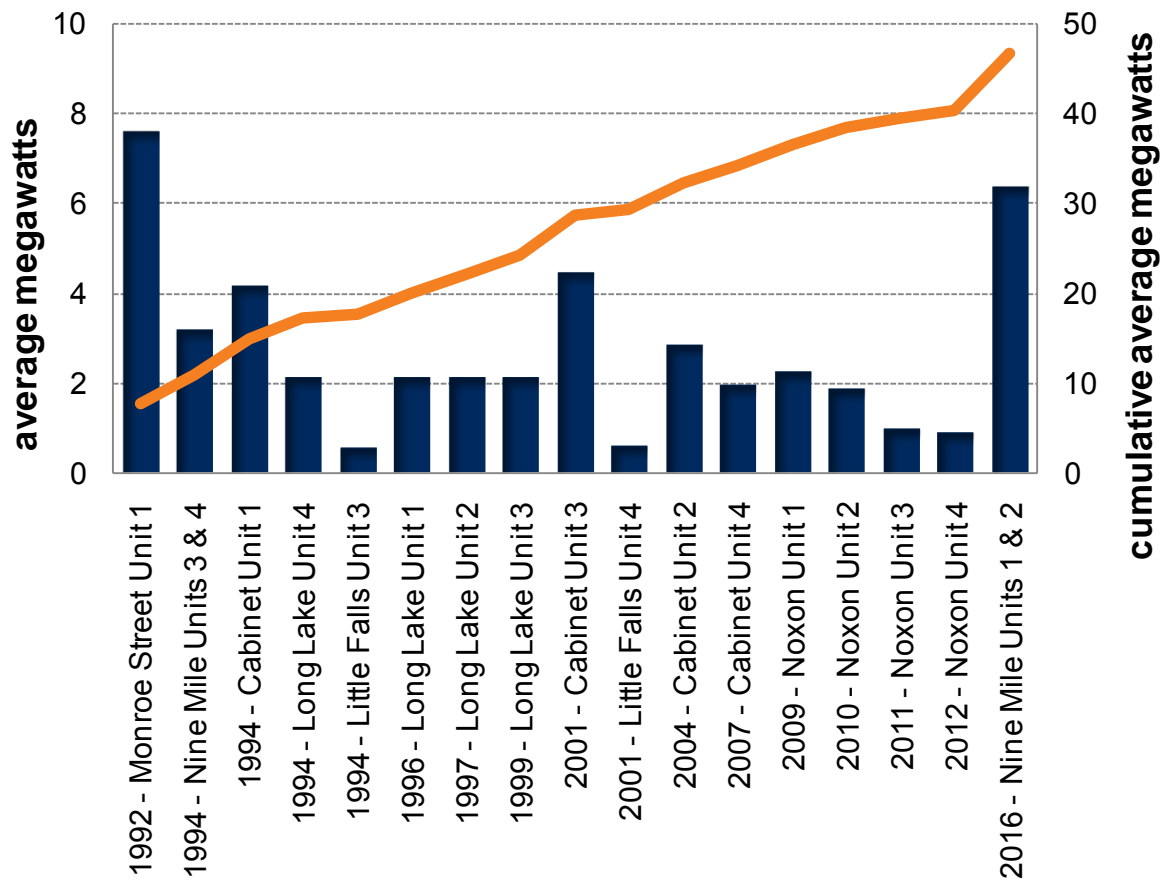

Avista's next upgrade is at Nine Mile, replacing two of the four project units. Avista is currently removing the old equipment on units one and two, and replacing the 105-year old technology with new turbines, runners, generators, and other electrical equipment. The project is scheduled for completion in 2016.

The Spokane River developments were built in the late 1800s and early 1900s, when the priority was to meet then-current loads. They do not to capture a majority of the river flow. In 2012, Avista re-assessed its Spokane River developments. The goal was to develop a long-term strategy and prioritize potential facility upgrades. Avista evaluated five of the six Spokane River developments and estimated costs for generation upgrade options at each. Each upgrade option should qualify for the EIA, meeting the Washington state renewable energy goal. These studies were part of the 2011 IRP Action Plan and are discussed below. Each of these upgrades would be a major engineering project, taking several years to complete, and require major changes to the FERC licenses and project water rights.

Long Lake Second Powerhouse

Avista studied adding a second powerhouse at Long Lake over 20 years ago by using a small arch dam (Saddle Dam) located on the south end of the project site. This project

Chapter 6- Generation Resource Options

would be a major undertaking and require several years to complete, including major changes to the Spokane River license and water rights. In addition to providing customers with a clean energy source, this project could help reduce total dissolved gas concerns by reducing spill at the project and provide incremental capacity to meet peak load growth.

The study focused on three alternatives. The first replaces the existing four-unit powerhouse with four larger units to total 120 MW, increasing capability by 32 MW. The other two alternatives develop a second powerhouse with a penstock beginning from a new intake near the existing saddle dam. One powerhouse option was a single 68 MW turbine project. The second was a two-unit 152 MW project. The best alternative in the study was the single 68 MW option. Table 6.10 shows upgrade costs and characteristics.

Post Falls Refurbishment

The Post Falls hydroelectric development is 108 years old. Three alternatives could increase the existing capacity from 18 MW up to 40 MW. The first option is a new two-unit 40 MW powerhouse on the south channel that removes the existing powerhouse. Alternative 2 retrofits the existing powerhouse with five 8.0 MW units (40 MW total). The last alternative retrofits the existing powerhouse with six 5.6-MW units (33.6 MW total). The cost differences between developing a new powerhouse in the south channel and the smaller plant refurbishment is small. Over the next decade, these alternatives will continue to be studied to address the aging infrastructure of the plant.

Monroe Street/Upper Falls Second Power House

Avista replaced the powerhouse at its Monroe Street project on the Spokane River in 1992. There are three options to increase its capability. Each would be a major undertaking requiring substantial cooperation with the City of Spokane to mitigate disruption in Riverfront Park and downtown Spokane during construction. The upgrade could increase capability by up to 80 MW. To minimize impacts on the downtown area and the park, a tunnel on the east side of Canada Island could be drilled, avoiding most above ground excavation of the south channel. A smaller option would be to add a second 40 MW Upper Falls powerhouse, but this option would require south channel excavation. The least cost option is an 80 MW upgrade adjacent to the existing Upper Falls facility.

Cabinet Gorge Second Powerhouse

Avista is exploring the addition of a second powerhouse at the Cabinet Gorge development site to mitigate total dissolved gas and produce additional electricity. A new powerhouse would benefit from an existing diversion tube around the dam and could range in size between 55 and 110 MW.

Table 6.10: Hydro Upgrade Option Costs and Benefits

Resource	Inc. Capacity (MW)	Inc. Energy (MWh)	Inc. Energy (aMW)	Peak Credit (Winter/Summer)	Capital Cost (\$ Mill)	Levelized Cost (\$/MWh)
Post Falls	22	90,122	10.3	24/0	\$110	158.60
Monroe St/Upper Falls	80	237,352	27.1	31/0	\$153	87.50
Long Lake	68	202,592	23.1	100/100	\$141	97.45
Cabinet Gorge	55	80,963	9.2	0/0	\$116	192.56

Thermal Resource Upgrade Options

The 2011 IRP identified several thermal upgrade options for Avista's fleet. Since then Avista has negotiated with the turbine servicers to have some of the upgrades completed as part of an enhancement package during the 2013 maintenance cycle for Coyote Springs 2. The upgrades include Mark Vie controls, digital front end on the EX2100 gas turbine exciter, and model based controls with enhanced transient capability. These enhancements will improve reliability of the plant, reduce future O&M costs, improve our ability to maintain compliance with WECC reliability standards, and help prevent damage to the machine if electrical system disturbances occur. Installation of cold day controls and cooling optimization will occur after permitting is complete.

In addition to the upgrades at Coyote Springs 2, there are options at the Rathdrum CT site. Other Avista-owned project sites were reviewed, but based on economics none of the options were included for the 2013 IRP.

Rathdrum CT to CCCT Conversion

The Rathdrum CT has two GE 7EA units in simple cycle configuration built in 1995 with an approximate 160 MW of combined output used to serve customers in peak load conditions. It is possible to convert this peaking facility to a combined cycle plant by adding 80 MW of steam-turbine capacity (depending upon temperature), and increasing operating efficiency from a heat rate of 11,612 Btu/kWh, in its existing configuration, to a heat rate of about 8,000 Btu/kWh. A major issue with this conversion, besides overall cost, is noise. Residential development at the site since the plant's construction adds complexity to a project that would shift from occasional use during peak periods to more of a base-load configuration.

Rathdrum CT Water Demineralizer

Another identified upgrade at Rathdrum is the addition of a water demineralizer to allow summertime inlet fogging. Fogging increases peak output during hot summer load periods. The plant utilized a leased demineralizer in the past, but high leasing costs moved Avista to end the program.

7. Market Analysis

Introduction

This section describes the electricity and natural gas market environment developed for the 2013 IRP. It contains pricing risks Avista considers to meet customer demands at the lowest reasonable cost. The analytical foundation for the 2013 IRP is a fundamentals-based electricity model of the entire Western Interconnect. The market analysis evaluates potential resource options on their net value when operated in the wholesale marketplace, rather than on the simple summation of their installation, operation, maintenance, and fuel costs. The PRS analysis uses these net values when selecting future resource portfolios.

Understanding market conditions in the geographic areas of the Western Interconnect is important, because regional markets are highly correlated by large transmission linkages between load centers. This IRP builds on prior analytical work by maintaining the relationships between the various sub-markets within the Western Interconnect, and the changing values of company-owned and contracted-for resources. The backbone of the analysis is AURORA^{XMP}, an electric market model that emulates the dispatch of resources to loads across the Western Interconnect given fuel prices, hydroelectric conditions, and transmission and resource constraints. The model's primary outputs are electricity prices at key market hubs (e.g., Mid-Columbia), resource dispatch costs and values, and greenhouse gas emissions.

Section Highlights

- Natural gas and wind resources dominate new generation additions in the West.
- Shale gas continues to lower natural gas and electricity price forecasts.
- A growing Northwest wind fleet reduces springtime market prices below zero in many hours.
- Federal greenhouse gas policy remains uncertain, but new EPA policies point toward a regulatory model rather than a cap-and-trade system.
- Lower natural gas prices and lower loads have reduced greenhouse gas emissions from the U.S. power industry by 11 percent since 2007.
- The Expected Case forecasts a continuing reduction to Western Interconnect greenhouse gas emissions due to coal plant shut downs brought on by EPA regulations.
- Coal plant shut downs have similar carbon reduction results as a cap-and-trade market scheme, but have the advantage of not causing wholesale market price disruptions.

Marketplace

AURORA^{XMP} is a fundamentals-based modeling tool used by Avista to simulate the Western Interconnect electricity market. The Western Interconnect includes the states west of the Rocky Mountains, the Canadian provinces of British Columbia and Alberta, and the Baja region of Mexico as shown in Figure 7.1. The modeled area has an installed resource base of approximately 240,000 MW.

Figure 7.1: NERC Interconnection Map

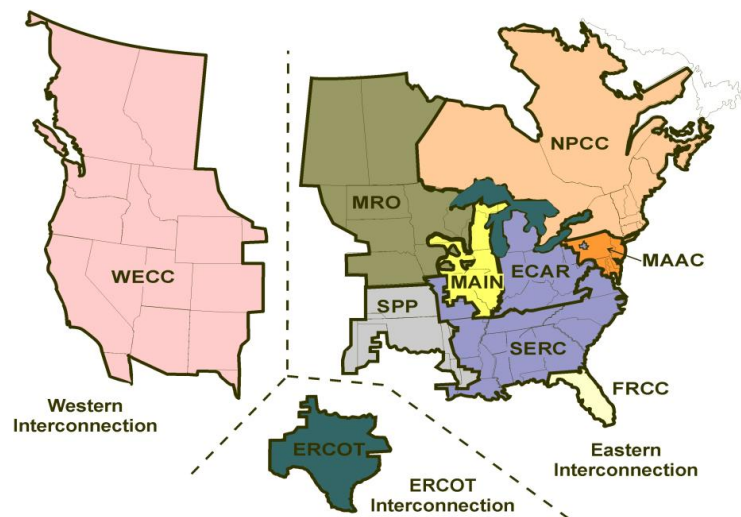

The Western Interconnect is separated from the Eastern and ERCOT interconnects to the east by eight DC inverter stations. It follows operation and reliability guidelines administered by WECC. Avista modeled the electric system as 17 zones based on load concentrations and transmission constraints. After extensive study in prior IRPs, Avista now models the Northwest region as a single zone because this configuration dispatches resources in a manner more reflective of historical operations. Table 7.1 describes the specific zones modeled in this IRP.

Table 7.1: AURORA^{XMP} Zones

Northwest- OR/WA/ID/MT	Southern Idaho
COB- OR/CA Border	Wyoming
Eastern Montana	Southern California
Northern California	Arizona
Central California	New Mexico
Colorado	Alberta
British Columbia	South Nevada
North Nevada	Baja, Mexico
Utah	

Western Interconnect Loads

The 2013 IRP relies on a load forecast for each zone of the Western Interconnect. Avista uses other utilities' resource plans to quantify load growth across the west. These estimates include energy efficiency and demand reduction caused by current and potential emissions legislation, and associated price increases also expected to reduce load growth rates from their present trajectory.

Regional load growth estimates are in Figure 7.2. Avista forecasts overall Western Interconnect loads will rise nearly 1 percent annually over the next 20 years. This is a significant reduction in expected energy growth from the 2011 IRP's 1.65 percent load growth assumption. Between 2008 and 2011, actual Western U.S. electricity demand declined by approximately 1 percent. However, loads did recover from their 2010 low of 2.6 percent below 2008 levels. The reduced energy growth projection is due to lower estimates of economic growth combined with energy efficiency gains that have reducing energy use. On a regional basis, the West Coast and Rocky Mountain states forecasts lower than 1 percent growth, while the desert Southwest region continues to expect growth in the 1 to 2 percent range. The strongest projected growth area in the region comes from Alberta at 2.5 percent.

From a system reliability perspective, Avista expects peak loads to grow at a slower pace than the last IRP. Northwest peak load growth rates average 0.93 percent annually. In California, demand response and high end-use solar penetration should reduce its system peak by 0.26 percent per year. Remaining regions should have growth rates similar to their energy forecast.

Figure 7.2: 20-Year Annual Average Western Interconnect Energy

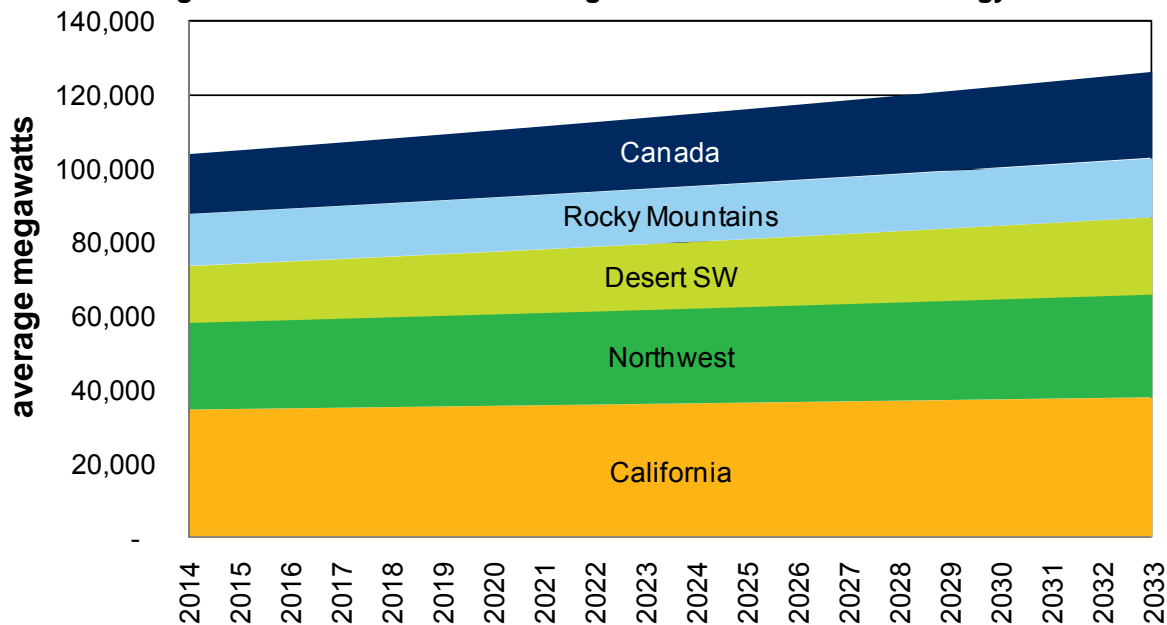

Transmission

In past IRP's, expansion to the region's transmission system was expected to occur in the middle of the 20-year planning horizon. Due to changes in the marketplace, such as lower natural gas prices and the significant reduction in the cost of solar, many transmission projects expected in the 2011 IRP are on hold or cancelled. Remaining transmission projects are smaller or delayed. Table 7.2 shows the regional transmission upgrades included in this IRP. Only upgrades between modeled zones are shown, as transmission upgrades within AURORA^{XMP} zones are not explicitly in the model; they do not affect power transactions between zones.

Table 7.2: Western Interconnect Transmission Upgrades Included in Analysis

Project	From	To	Year Available	Capacity MW
Eastern Nevada Intertie	North Nevada	South Nevada	2016	1,000
Gateway South	Wyoming	Utah	2015	3,000
Gateway Central	Idaho	Utah	2015	1,350
Gateway West	Wyoming	Idaho	2016	1,500
SunZia/Navajo Transmission	Arizona	New Mexico	2017	3,000
Wyoming – Colorado Intertie	Wyoming	Colorado	2014	900
Hemingway to Boardman	Idaho	Northwest	2020	1,400

Resource Retirements

Since filing the 2011 IRP, new attention across western states is being directed to retire aging power plants, specifically plants with larger environmental impacts, such as once-through-cooling (OTC) in California and older coal technology throughout North America. Recently various states, encouraged by environmentally-focused groups, are developing rules to eliminate certain generation technologies. In California, all OTC facilities require retrofitting to eliminate OTC technology, or must retire. Over 14,200 MW of OTC natural gas-fired generators in California are forecast to be retired and replaced in the IRP timeframe. Remaining OTC natural gas-fired and nuclear facilities with more favorable fundamentals are expected to be retrofitted with other cooling technology. Many OTC plants have identified shutdown dates from their utility owners' IRPs, and company news releases. The remaining plants are assumed to shut down between 2017 and 2024; this retirement schedule is similar to WECC studies (see Figure 7.3 for the retirement schedule assumed in the 2013 IRP). Elimination of OTC plants in California will eliminate older technology presently used for reserves and high demand hours. While replacements will be expensive for California customers, they will be served by a more modern generation fleet.

Coal-fired facilities are also under increasing regulatory scrutiny. In the Northwest, the Centralia and Boardman coal plants are scheduled to retire in 2020 and 2025 respectively, a reduction of 1,961 megawatts. Other coal-fired plants throughout the Western Interconnect have announced plant closures, including Four Corners, Carbon,

Arapahoe, San Juan, and Corette. Due to recent EPA standards, the IRP forecasts additional coal-fired facility retrofits or retirements.¹

Plant retirements are based on Avista analyses, considering each plant's location, their unit sizes and fuel costs, and their current emission control technology. Based on these factors, Avista judges whether the plant is likely to face enough regulatory burdens to make the plant uneconomic. It is not the intent of the IRP to include a perfect coal retirement forecast, as this would be impossible. Instead, such analyses help Avista understand the potential effects a reduction in coal output in the West will have on pricing and the benefit of future resource investments by Avista. The analysis found that 12,300 MW of coal generation might shut down over the 20-year planning horizon. A graphical representation of the retirement is in Figure 7.3.

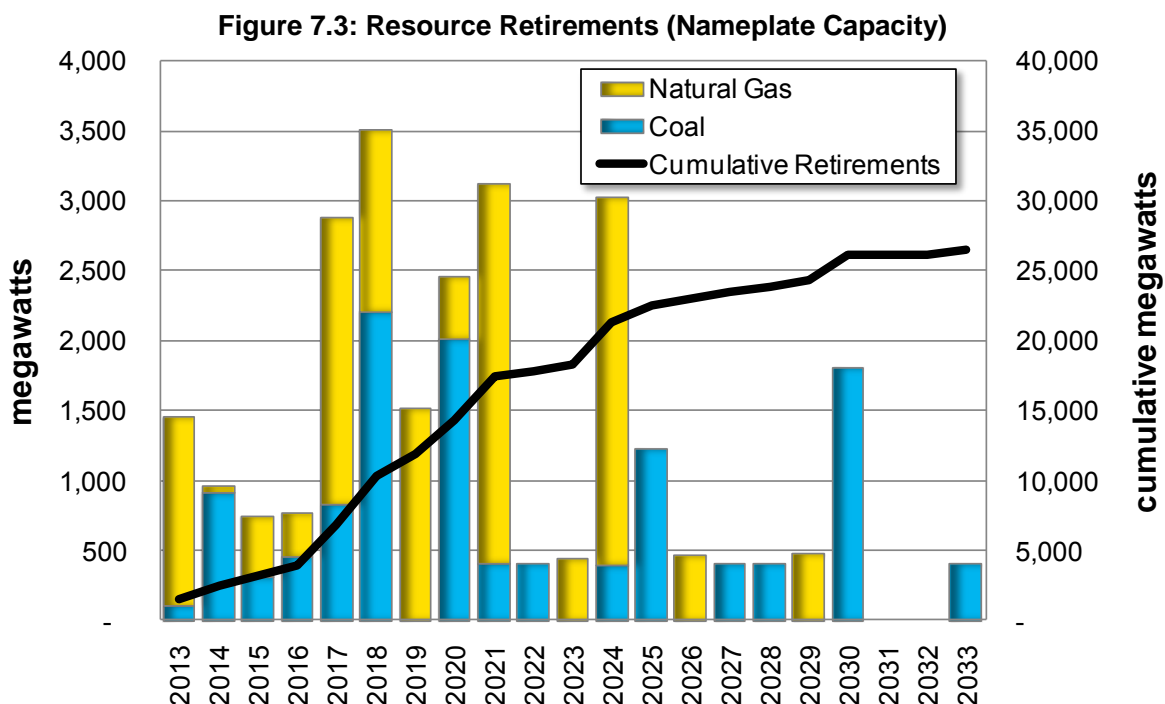

New Resource Additions

New resource capacity is required to meet future load growth and replace retiring power plants over the next 20 years. To fill the gap, resources are added to each region to sustain a 5 percent Loss of Load Probability (LOLP), or in other words, all system demand must be met in 95 percent of simulated forecasts. The generation additions must meet capacity, energy, ancillary services, and renewable portfolio mandates. To meet future requirements, natural gas-fired CCCT or SCCT, solar, wind, coal IGCC with sequestration, and nuclear options were considered.² The IRP does not include new

¹ A recently passed Nevada law allows NV Energy to retire its coal plants.

² Based on analysis in Chapter 6, Generation Resource Options, solar generation in the southern states receives a 56 percent capacity factor, while in the Northwest it would receive no peak credit. Wind

non-sequestered pulverized coal plants over the forecast horizon, consistent with recent EPA new source performance standard issued in late 2012.

Many states have RPS requirements promoting renewable generation to reduce greenhouse gas emissions, provide jobs, and diversify their energy mix. RPS legislation generally requires utilities to meet a portion of their load with qualified renewable resources. No federal RPS mandate exists presently; therefore, each state defines RPS obligations differently. AURORA^{XMP} cannot model RPS levels explicitly. Instead, Avista inputs RPS requirements into the model at levels sufficient to satisfy state laws.

Figure 7.4 illustrates new capacity and RPS additions made in the modeling process. Wind and solar facilities meet most renewable energy requirements. Geothermal, biomass, and hydroelectric resources provide limited RPS contributions. Renewable resource choices differ depending on state laws and the local availability of renewable resources. For example, the Southwest will meet RPS requirements with solar and wind given policy choices by those states. The Northwest will use a combination of wind and hydroelectric upgrades because the costs of these resources are the lowest. Rocky Mountain states will predominately meet RPS requirements with wind.

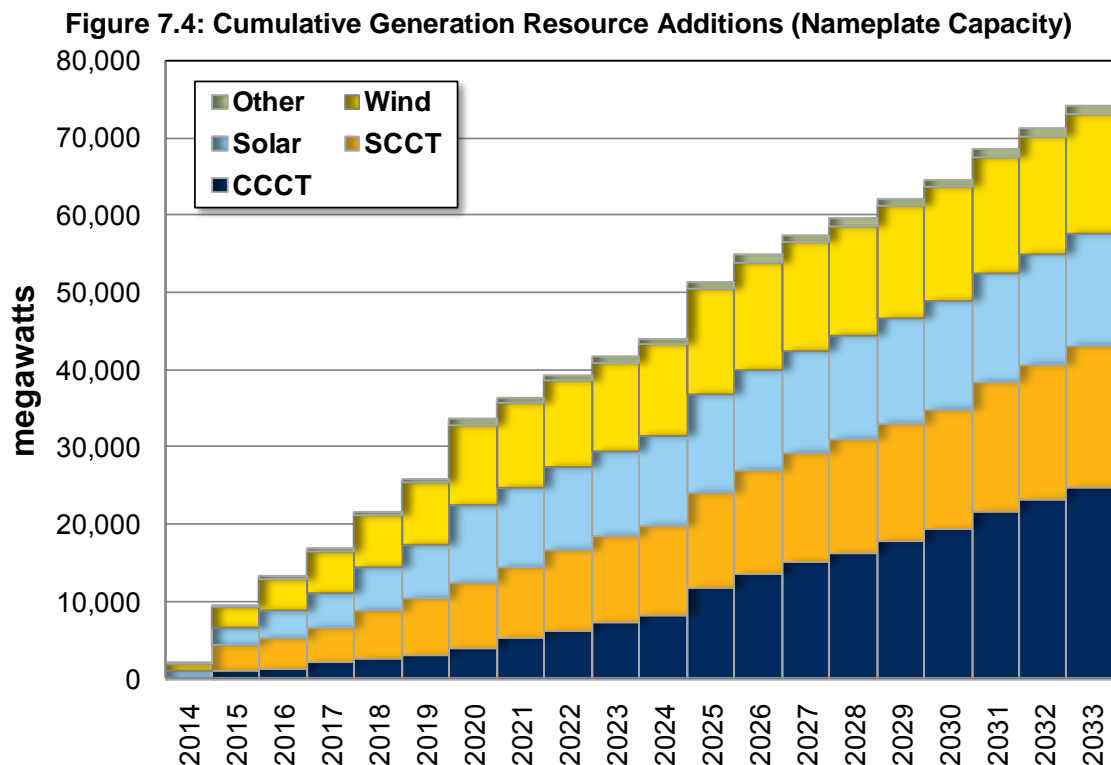

With lower load growth, and even with 26 GW in resource retirements, the forecast for new resource capacity additions is lower than prior IRPs. Compared to the 2011 IRP,

receives a 5 percent capacity credit on a regional basis, but receives no capacity credit for meeting Avista's balancing authority requirements.

future natural gas capacity is down 5 GW, wind is lower by 10 GW, other renewables are slightly lower, and solar maintains similar additions.

The Northwest market will need new capacity beginning in 2017 with the addition of combined- or simple-cycle CTs. Based on market simulation results, a 21 percent regional planning margin (including operating reserves) is necessary. The Northwest likely will continue to develop wind to meet RPS requirements, with small contributions from other renewable resources. Over the 20-year forecast, six gigawatts of new natural gas capacity is projected, along with over seven gigawatts of new wind capacity and one gigawatt of other renewable including solar, biomass, geothermal, and hydro.

Fuel Prices and Conditions

Fuel cost and availability are some of the most important drivers of the overall wholesale marketplace and resource values. Some resources, including geothermal and biomass, have limited fuel options or sources, while coal and natural gas have more potential. Hydro, wind, and solar benefit from free fuel, but are highly dependent on weather and limited siting opportunities.

Natural Gas

The fuel of choice for new base-load and peaking capability continues to be natural gas. Natural gas in past years was subject to significant price volatility. Unconventional sources have since reduced overall price levels and volatility, although it unknown how much volatility will exist in the future market as technology plays out against regulatory pressures and the potential for new demand created by falling prices. Avista uses forward market prices and a combination of two December 2012 forecasts from prominent energy industry consultants to develop its natural gas price forecast for this IRP. The levelized nominal price is \$5.62 per dekatherm at Henry Hub (shown in Figure 7.5 as the gray bars). For the first year of the forecast, forward prices are used. After the first year, a 50/50 average of the consultant forecasts combines with the forward market to transition from a forward pricing methodology to a fundamental price forecast, as follows:

- 2015: 75 percent market, 25 percent consultant average;
- 2016: 50 percent market, 50 percent consultant average; and
- 2017-19: 25 percent market, 75 percent consultant average.

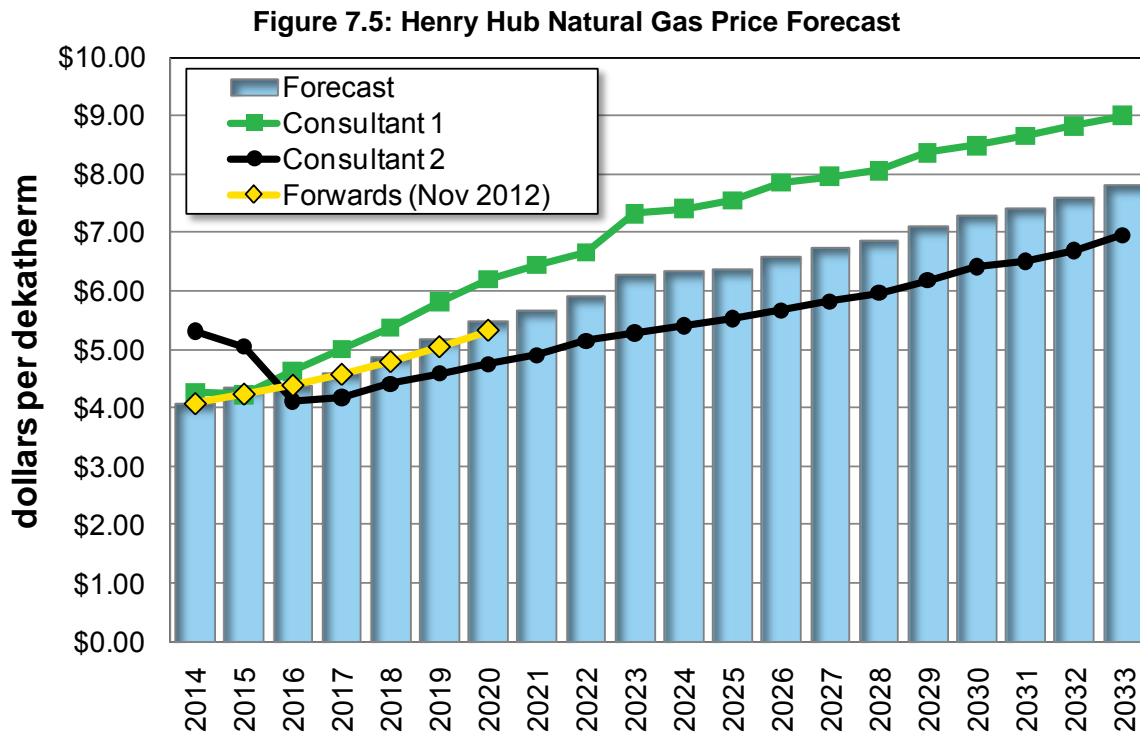

Natural gas market transformation has brought consultant assumptions closer together. In previous forecasts, the Alaskan natural gas pipeline was included in many forecasts, but is no longer included in either forecast. Growth in the residential, commercial, and industrial markets is flat. Carbon legislation used to be included early and robust in both forecasts, but it is now delayed and less robust. The forecast from one consultant has muted demand growth through 2015. As domestic and global GDP growth rates improve, demand growth begins to materialize. This growth is led by natural gas utilized for power generation in support of renewable energy, and by coal plant retirements caused by new EPA regulations. Additionally, widespread adoption of natural gas for transportation and LNG exports increase demand in later years of the forecast. The forecast from one of the consultants has growth driven almost entirely by natural gas generation. LNG exports are also included in this forecast at a very modest level beginning in 2018.

Price differences across North America depend on demand at the trading hubs and the pipeline constraints between them. Many pipeline projects are in the works in the Northwest and the West to access historically cheaper natural gas supplies located in the Rocky Mountains. Table 7.3 presents western natural gas basin differentials from Henry Hub prices. Prices converge over the course of the study as new pipelines and sources of natural gas materialize. To illustrate the seasonality of natural gas prices, monthly Stanfield price shapes in Table 7.4 show selected forecast years.

Table 7.3: Natural Gas Price Basin Differentials from Henry Hub

Basin	2015	2020	2025	2030
Stanfield	101%	95%	94%	96%
Malin	102%	97%	95%	98%
Sumas	96%	94%	93%	95%
AECO	90%	87%	85%	87%
Rockies	100%	92%	86%	85%
Southern CA	106%	102%	103%	106%

Table 7.4: Monthly Price Differentials for Stanfield from Henry Hub

Month	2015	2020	2025	2030
Jan	103.3%	95.3%	93.3%	94.2%
Feb	102.6%	96.1%	93.1%	94.4%
Mar	103.1%	97.8%	96.7%	98.6%
Apr	101.7%	96.8%	93.4%	96.0%
May	98.8%	94.5%	91.9%	93.9%
Jun	98.6%	94.0%	92.0%	92.9%
Jul	98.6%	93.9%	91.8%	94.4%
Aug	98.3%	93.6%	92.9%	95.1%
Sep	97.7%	93.7%	92.7%	95.2%
Oct	99.1%	94.7%	93.6%	95.9%
Nov	103.2%	98.2%	97.3%	99.0%
Dec	102.5%	96.7%	94.6%	98.1%

Unconventional Natural Gas Supplies

Shale natural gas production has game-changing impacts on the natural gas industry, dramatically revising the amount of economical natural gas production. Shale gas can cost less than conventional natural gas production because of economies of scale, near elimination of exploration risks, standardization, and sophisticated production techniques that streamline costs and minimize the time from drilling to market delivery. Shale gas will continue to be a major factor in the natural gas marketplace, holding down both prices and volatility over the long run as production responds to changing market conditions. This in turn leads to numerous ripple effects, including longer-term bilateral hedging transactions, new financing structures including cost index pricing, and/or vertical integration by utilities choosing to limit their exposure to natural gas price increases and volatility.

Shale gas is not without controversy. Concerns about water, air, noise, and seismic impacts arise from unconventional extraction techniques. Water issues include availability, chemical mixing, groundwater contamination, and disposal. Air quality concerns stem from methane leaks during production and processing. Mitigating excessive noise in urban drilling and potential elevated seismic activity near drilling sites are also concerns. State and federal agencies are reviewing the environmental impacts of this production method. As a result, unconventional natural gas production has

stopped in some areas. Increased environmental protections might change costs and environmental uncertainty could precipitate increased price volatility.

Shale gas production influences the U.S. liquid natural gas (LNG) market. It has broken the link between North American natural gas and global LNG prices. Numerous planned re-gasification terminals are on hold or cancelled. Some facilities are seeking approvals to become LNG exporters rather than importers. These changes appear to affect natural gas storage and transportation infrastructure. For example, the Kitimat LNG export terminal in northern British Columbia, if built, will export significant LNG quantities to Asian markets. These exports will affect overall market conditions for natural gas in the United States and the Pacific Northwest, as British Columbia traditionally has provided significant natural gas supplies to the northwest United States.

Coal

This IRP models no new coal plants in the Western Interconnect, so coal price forecasts affect only existing facilities. The average annual price increase over the IRP timeframe is 2.9 percent based on Energy Information Administration estimates for Wyoming Coal Prices. For Colstrip Units 3 and 4, Avista used escalation rates based on expectations from existing contracts.

Hydroelectric

The Northwest U.S., British Columbia, and California have substantial hydroelectric generation capacity. A favorable characteristic of hydroelectric power is its ability to provide near-instantaneous generation up to and potentially beyond its nameplate rating. This characteristic is valuable for meeting peak load, following general intra-day load trends, shaping energy for sale during higher-valued hours, and integrating variable generation resources. The key drawback to hydroelectricity is its variable and limited fuel supply.

This IRP uses an 80-year hydro record from the 2014 BPA rate case. The study provides monthly energy levels for the region over an 80-year hydrological record spanning 1928 to 2009. This IRP also includes BPA hydro estimates for the 80-year record for British Columbia and California. The 80-year record is less than 1 percent lower than the 70-year record used in previous IRPs.

Many IRP analyses use an average of the 80-year hydroelectric record; whereas stochastic studies randomly draw from the 80-year record, as the historical distribution of hydroelectric generation is not normally distributed. Avista does both. Figure 7.6 shows the average hydroelectric energy of 15,706 aMW in Washington, Oregon, Idaho, and western Montana. The chart also shows the range in potential energy used in the stochastic study, with a 10th percentile water year of 12,370 aMW (-21 percent), and a 90th percentile water year of 18,475 aMW (+18 percent).

AURORA^{XMP} maps each hydroelectric plant to a load zone, creating a similar energy shape for all hydro projects in a load zone. For Avista hydroelectric plants, AURORA^{XMP} uses the output from proprietary software with a better representation of operating

characteristics and capabilities. For modeling, AURORA^{XMP} represents hydroelectric plants using annual and monthly capacity factors, minimum and maximum generation levels, and sustained peaking generation capabilities. The model's objective, subject to constraints, is to move hydroelectric generation into peak hours to follow daily load changes; this maximizes the value of the system consistent with actual operations.

Figure 7.6: Northwest Expected Energy

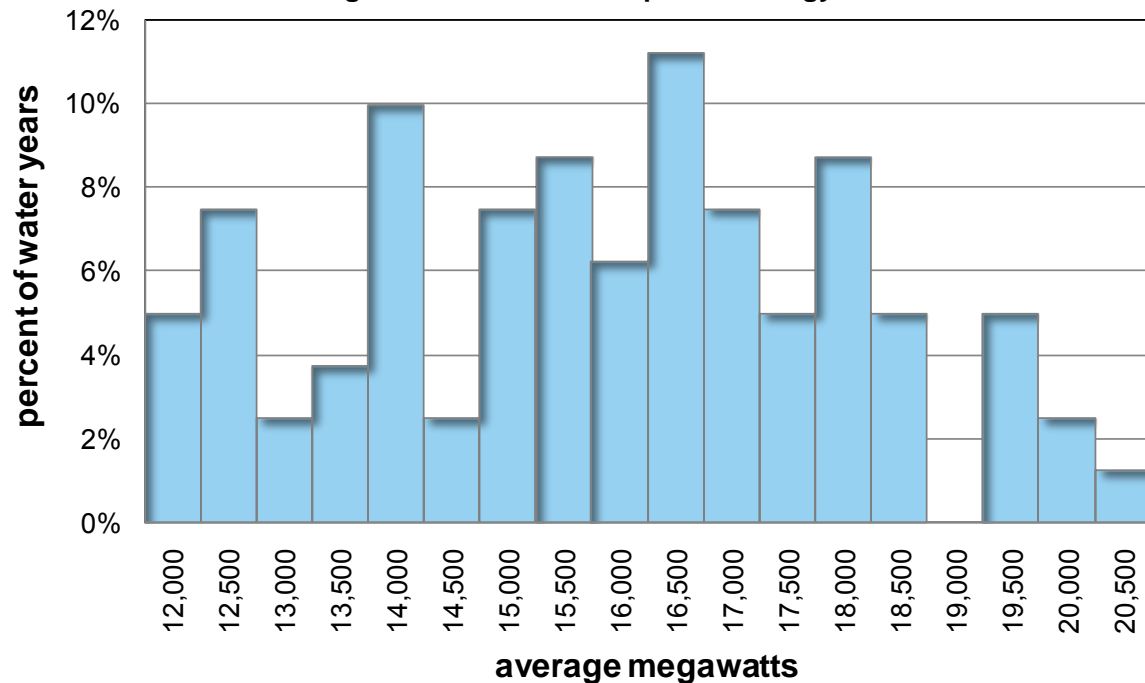

Wind

Additional wind resources are necessary to satisfy renewable portfolio standards. These additions mean significant competition for the remaining higher-quality wind sites. The capacity factors in Figure 7.7 present average generation for the entire area, not for specific projects. The IRP uses capacity factors from a review of the BPA and the National Renewable Energy Laboratory (NREL) wind data.

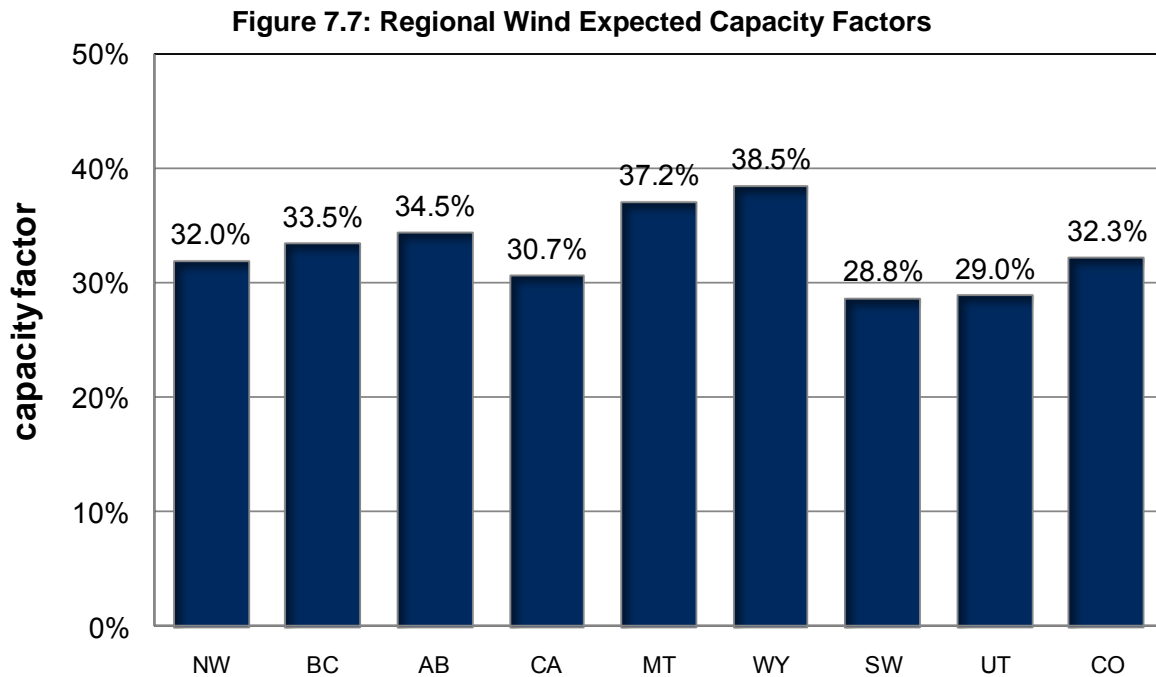

Greenhouse Gas Emissions

Greenhouse gas regulation is a significant risk for the electricity marketplace today because of the industry's heavy reliance on carbon-emitting thermal power generation. Reducing carbon emissions at existing power plants, and the construction of low- and non-carbon-emitting technologies, changes the resource mix over time. Since 2007, carbon emissions from electric generation have fallen from highs by nearly 11 percent due to reduced loads and lower coal generation levels.

Future carbon emissions could continue to fall due to fundamental market changes. To accelerate the reductions, national legislation would be required, but this plan assumes that no federal cap and trade regulations or carbon tax will constrain greenhouse emissions in the IRP timeframe. However, EPA regulations aimed at reducing air pollutants such as NO_x and SO₂ will have some marginal impacts on the generation fleet profile. In the interim, California and some Canadian provinces have greenhouse reduction goals and costs on greenhouse gas emissions. Within the Expected Case's market price forecast of this IRP, only existing greenhouse gas regulations and a forecast of expected plant closures based on current EPA regulations affect the market. No national cap and trade or carbon tax is included with the exception of a carbon-pricing scenario discussed later in this chapter. Environmental regulations decrease or maintain existing greenhouse gas emissions levels, instead of the cap and trade or tax mechanisms used in Avista's earlier IRPs.

Risk Analysis

To account for future electricity price uncertainty, a stochastic study is performed using the variables discussed earlier in this chapter. It is better to represent the electricity

Chapter 7- Market Analysis

price forecast as a range instead of a point estimate, as point estimates are unlikely to forecast underlying assumptions perfectly. Stochastic price forecasts develop a more robust resource strategy by accounting for tail risk. This IRP developed 500 20-year market futures to provide a distribution of the marketplace and illustrate potential tail risk outcomes. The next several pages discuss the input variables driving market prices, and describe the methodology and the range in inputs used in the modeling process.

Natural Gas

Natural gas prices are among the most volatile of any traded commodity. Daily Stanfield prices ranged between \$1.72 and \$13.69 per dekatherm between 2004 and 2012. Average Stanfield monthly prices since January 2004 are in Figure 7.8. Prices retreated from 2008 highs to a monthly price of \$1.87 per dekatherm in April 2012.

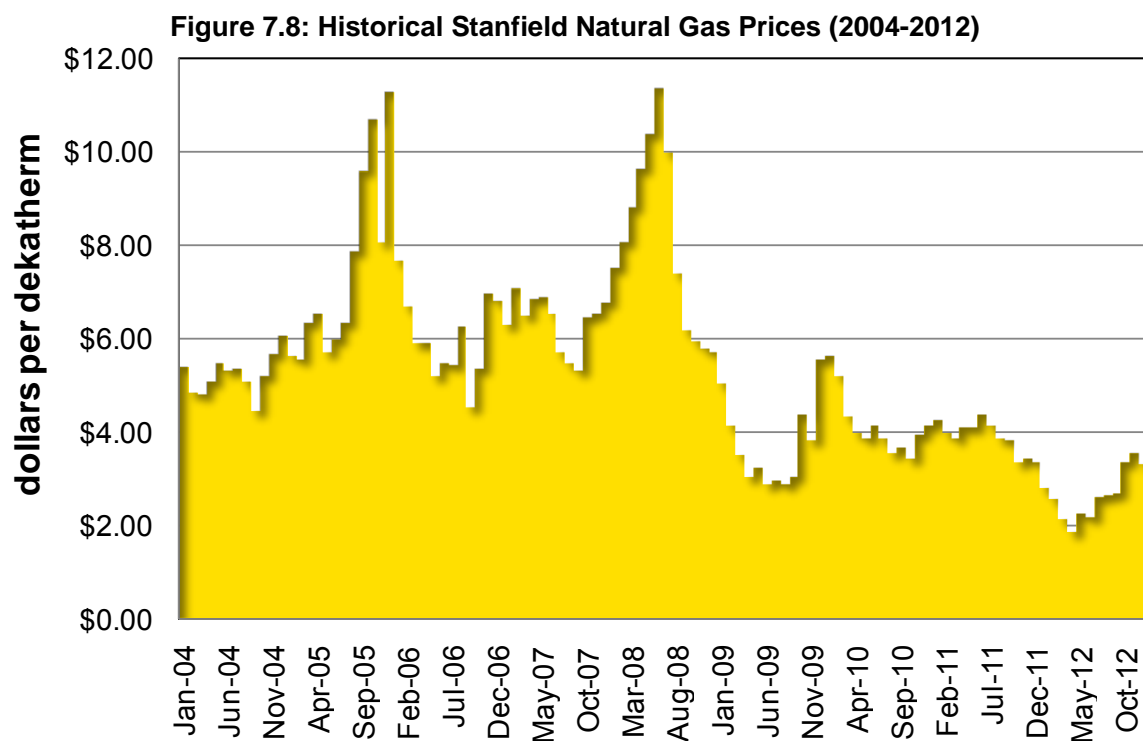

There are several methods to stochastically model natural gas prices. This IRP retains the 2011 IRP method with the mean prices discussed in Figure 7.5 as the starting point. Prices vary using historical month-to-month volatility and a lognormal distribution.

Figure 7.9 shows Stanfield natural gas price duration curves for 2014, 2020, 2026 and 2032. The chart illustrates a larger price range in later years, reflecting a growing distribution. Shorter-term prices are more certain due to additional market information and the quantity of near term natural gas trading. Another view of the forecast is in Figure 7.10. The mean price in 2014 is \$3.95 per dekatherm, represented by the horizontal bar; the median level is \$3.89 per dekatherm. The bottom and top of the bars represent the 10th and 90th percentiles. The bar length indicates price uncertainty.

Figure 7.9: Stanfield Annual Average Natural Gas Price Distribution

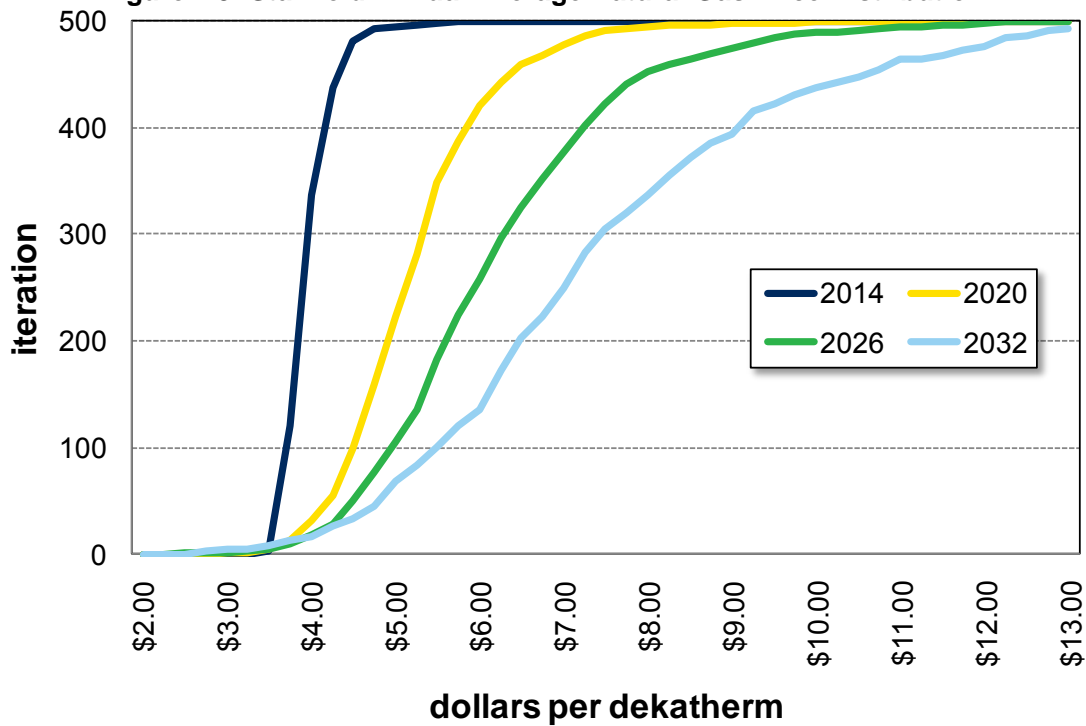
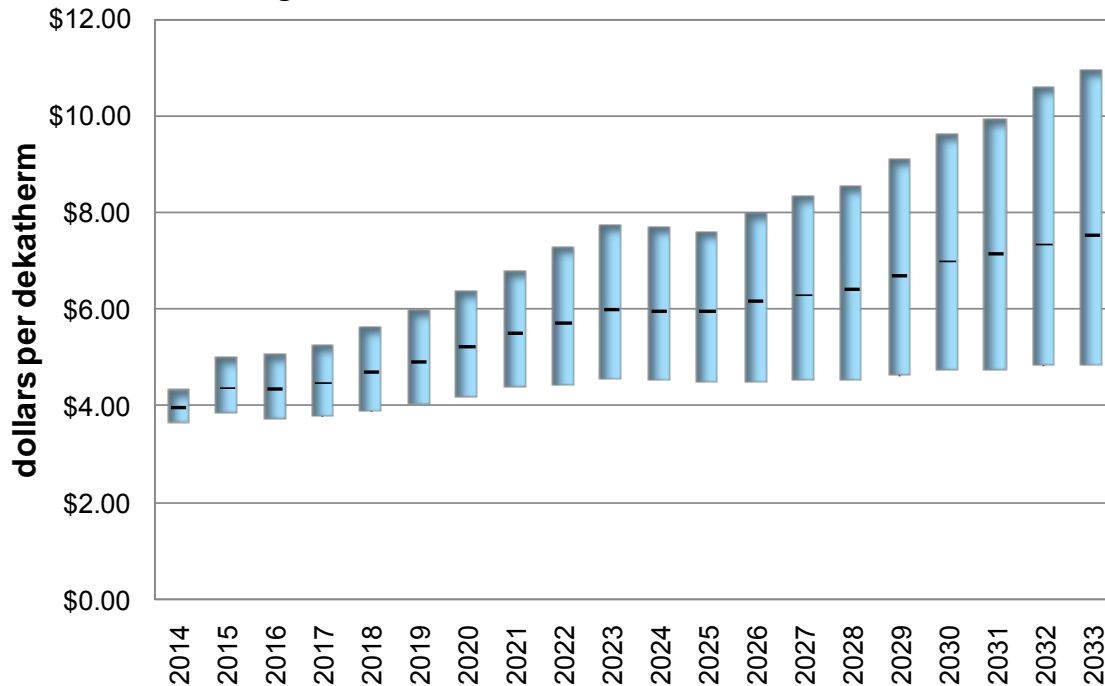

Figure 7.10: Stanfield Natural Gas Distributions



Regional Load Variation

Several factors drive load uncertainty. The largest short-run driver is weather. Over the long-run economic conditions, such as the Great Recession, tend to have a more significant effect on the load forecast. IRP loads increase on average at the levels discussed earlier in this chapter, but risk analyses emulate varying weather conditions and base load impacts.

Avista continues to use a method it first adopted for its 2003 IRP to model weather variation. FERC Form 714 data for the years 2007 through 2011 for the Western Interconnect form the basis for the analysis. Correlations between the Northwest and other Western Interconnect load areas represent how loads change together across the larger system. This method avoids oversimplifying the Western Interconnect load picture. Absent the use of correlation, stochastic models will offset changes in one variable with changes in another, thereby virtually eliminating the possibility of modeling correlated excursions actually experienced by a system. Given the high degree of interdependency across the Western Interconnect created by significant inertia connections, the additional accuracy from modeling loads in this matter is crucial for understanding variation in wholesale electricity market prices. It is also crucial for understanding the value of peaking resources and their use in meeting system variation.

Tables 7.5 and 7.6 present the load correlations used for the 2013 IRP. Statistics are relative to the Northwest load area (Oregon, Washington and Idaho). “NotSig” in the table indicates that no statistically valid correlation exists in the evaluated load data. “Mix” indicates the relationship was not consistent across the 2007 to 2011 period. For regions and periods with NotSig and Mix results, no correlations are modeled. Tables 7.7 and 7.8 provide the coefficient of determination values for each zone.³

Table 7.5: January through June Load Area Correlations

Area	Jan	Feb	Mar	Apr	May	Jun
Alberta	Not Sig	17%	25%	8%	Mix	Mix
Arizona	8%	42%	Mix	Not Sig	Mix	Not Sig
Avista	89%	85%	84%	83%	47%	53%
British Columbia	91%	88%	71%	77%	52%	61%
California	Not Sig	Not Sig	Mix	Mix	17%	32%
CO-UT-WY	-7%	Mix	Mix	-20%	-3%	-17%
Montana	27%	30%	72%	63%	10%	18%
New Mexico	Not Sig	Not Sig	Mix	Not Sig	Mix	Mix
North Nevada	62%	27%	Not Sig	Not Sig	Mix	18%
South Idaho	84%	79%	68%	Not Sig	Not Sig	29%
South Nevada	17%	56%	Mix	Not Sig	Mix	Not Sig

³ The coefficient of determination is the standard deviation divided by the average.

Chapter 7- Market Analysis

Table 7.6: July through December Load Area Correlations

Area	Jul	Aug	Sep	Oct	Nov	Dec
Alberta	Not Sig	Mix	16%	Not Sig	50%	Not Sig
Arizona	Not Sig	Not Sig	Mix	Not Sig	Mix	Not Sig
Avista	66%	77%	68%	77%	93%	91%
British Columbia	70%	38%	19%	79%	90%	81%
California	10%	Not Sig	Not Sig	-11%	Mix	Not Sig
CO-UT-WY	-10%	-2%	-5%	Not Sig	22%	Mix
Montana	Mix	8%	8%	Not Sig	77%	73%
New Mexico	Mix	Mix	Mix	-9%	Not Sig	Not Sig
North Nevada	52%	44%	26%	Not Sig	77%	52%
South Idaho	51%	64%	Not Sig	Mix	86%	89%
South Nevada	Not Sig	25%	Mix	-8%	Mix	56%

Table 7.7: Area Load Coefficient of Determination (Standard Deviation/Mean)

Area	Jan	Feb	Mar	Apr	May	Jun
Alberta	2.9%	2.5%	3.1%	2.6%	2.7%	3.0%
Arizona	5.1%	5.0%	3.5%	5.8%	8.6%	10.3%
Avista	6.9%	5.4%	6.3%	5.9%	5.2%	5.7%
British Columbia	4.8%	4.4%	5.1%	5.3%	5.2%	3.9%
California	5.4%	5.1%	5.3%	5.9%	7.4%	8.1%
CO-UT-WY	4.6%	4.6%	4.4%	3.7%	4.8%	7.9%
Montana	5.5%	4.4%	4.2%	4.3%	3.7%	5.9%
New Mexico	4.5%	5.0%	4.3%	4.6%	6.9%	6.7%
Northern Nevada	2.8%	3.0%	3.2%	3.2%	4.3%	5.5%
Pacific Northwest	6.7%	6.0%	5.6%	5.8%	4.7%	4.3%
South Idaho	6.0%	5.6%	5.1%	6.1%	8.3%	14.7%
South Nevada	5.0%	4.1%	3.5%	6.5%	10.7%	12.7%
Baja Mexico	5.4%	5.1%	5.3%	5.9%	7.4%	8.1%

Table 7.8: Area Load Coefficient of Determination (Standard Deviation/Mean)

Area	Jul	Aug	Sep	Oct	Nov	Dec
Alberta	3.1%	3.2%	2.7%	2.7%	2.9%	3.1%
Arizona	6.5%	6.7%	7.8%	9.2%	4.0%	5.0%
Avista	6.2%	7.2%	5.3%	5.4%	7.0%	6.8%
British Columbia	4.8%	4.4%	4.2%	5.0%	7.0%	5.8%
California	7.0%	7.6%	9.1%	6.7%	5.7%	5.4%
CO-UT-WY	6.7%	5.7%	5.7%	4.1%	4.6%	4.4%
Montana	5.0%	5.0%	3.6%	3.9%	5.1%	5.1%
New Mexico	5.9%	5.4%	6.0%	5.6%	4.6%	4.6%
Northern Nevada	4.7%	4.8%	4.6%	2.8%	3.7%	3.5%
Pacific Northwest	5.5%	5.6%	4.4%	5.1%	7.2%	8.0%
South Idaho	5.1%	7.0%	8.9%	5.7%	7.0%	6.1%
South Nevada	6.6%	7.2%	10.0%	8.7%	3.6%	4.2%
Baja Mexico	7.0%	7.6%	9.1%	6.7%	5.7%	5.4%

Hydroelectric Variation

Hydroelectric generation is the most commonly modeled stochastic variable in the Northwest because it has a large impact on regional electricity prices than other variables. The IRP uses an 80-year hydro record starting with the 1928/29 water year. Every iteration starts with a randomly drawn water year from the historical record, so each water year is selected approximately 125 times in the study (500 scenarios x 20 years / 80 water year records). There is some debate in the Northwest over whether the hydroelectric record has year-to-year correlation. Avista did not model year-to-year correlation after finding a modest 35 percent correlation over the 80-year record.

Wind Variation

Wind has the most volatile short-term generation profile of any large-scale resource presently available to utilities. Storage, apart from some integration with hydroelectric projects, is not a financially viable alternative at this time. This makes it necessary to capture wind volatility in the power supply model to determine its value in the wholesale power market. Accurately modeling wind resources requires hourly and intra-hour generation shapes. For regional market modeling, the representation is similar to how AURORA^{XMP} models hydroelectric resources. A single wind generation shape represents all wind resources in each load area. This shape is smoother than it would be for an individual wind plant, but it closely represents the diversity that a large number of wind farms located across a zone would create.

This simplified wind methodology works well for forecasting electricity prices across a large market, but it does not accurately represent the volatility of specific wind resources Avista might select as part of its Preferred Resource Strategy. Therefore individual wind farm shapes form the basis of wind resource options for Avista.

Ten potential 8,760-hour annual wind shapes represent each geographic region or facility. Each year contains a wind shape drawn from these 10 representations. The IRP relies on two data sources for the wind shapes. The first is BPA balancing area wind data. The second is NREL-modeled data between 2004 and 2006.

Avista believes that an accurate representation of a wind shape across the West requires meeting several conditions:

1. The data is correlated between areas and reflective of history.
2. Data within load areas is auto-correlated.⁴
3. The average and standard deviation of each load area's wind capacity factor is consistent with the expected amount of energy for a particular area in the year and month.
4. The relationship between on- and off-peak wind energy is consistent with historic wind conditions. For example, more energy in off-peak hours than on-peak hours where this has been experienced historically.

⁴ Adjoining hours or groups of hours are correlated to each other.

5. Hourly capacity factors for a diversified wind region are never be greater than about 90 percent due to turbine outages and wind diversity within-area.

Absent meeting these conditions, it is unlikely any wind study provides a level of accuracy adequate for planning efforts. The methodology developed for the 2013 IRP attempts to adhere to the five requirements by first using a regression model based on historic data for each region. The independent variables used in the analysis were month, hour type (night or day), and generation levels from the prior two hours. To reflect correlation between regions, a capacity factor adjustment reflects historic regional correlation using an assumed normal distribution with the historic correlation as the mean. After this adjustment, a capacity factor adjustment takes account of those hours with generation levels exceeding a 90 percent capacity factor. The resulting capacity factors for each region are in Table 7.9. A Northwest region example of an 8,760-hour wind generation profile is in Figure 7.11. This example, shown in blue, has a 33 percent capacity factor. Figure 7.12 shows actual 2012 generation recorded by BPA Transmission; in 2012, the average wind fleet in BPA's balancing authority had a 26.2 percent capacity factor.

Table 7.9: Expected Capacity factor by Region

Region	Capacity Factor	Region	Capacity Factor
Northwest	32.0%	Southwest	28.9%
California	30.9%	Utah	28.8%
Montana	37.2%	Colorado	32.2%
Wyoming	38.5%	British Columbia	33.4%
Eastern Washington	30.7%	Alberta	34.5%

Figure 7.11: Wind Model Output for the Northwest Region

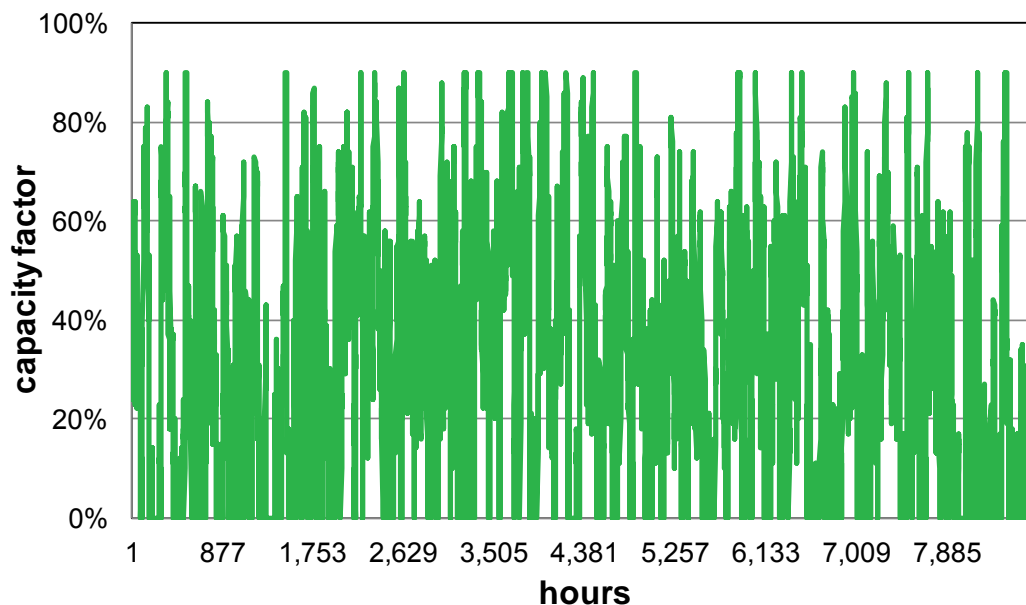
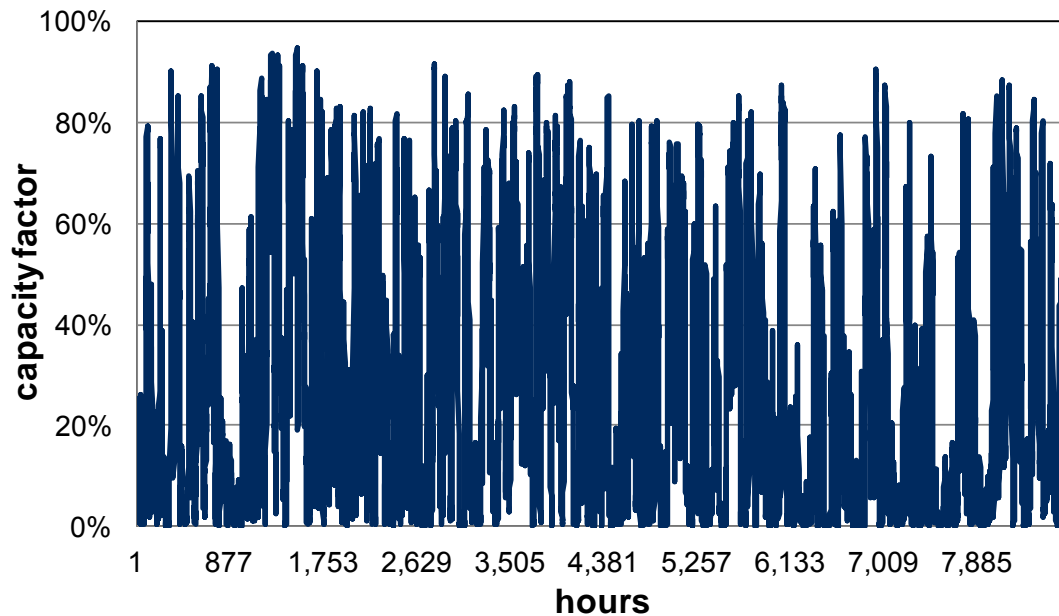

Figure 7.12: 2012 Actual Wind Output BPA Balancing Authority⁵

There is speculation that correlation exists between wind and hydro, especially outside of the winter months where storm events bring both rain to the river system and wind to the wind farms. This IRP does not correlate wind and hydro due to a lack of historical wind data to test this hypothesis. Where correlation exists, it would be optimal to run the model 80 historical wind years with matching historical water years.

Forced Outages

Generator forced outages are represented by a simple average reduction to maximum capability in most deterministic market modeling studies. This over simplification generally represents expected values well; however, it is better to represent the system more accurately in stochastic modeling by randomly placing non-hydro units out of service based on a mean time to repair and an average forced outage rate. Internal studies show that this level of modeling detail is necessary only for natural gas-fired, coal, and nuclear plants with generating capacities in excess of 100 MW. Plants on forced outage smaller than 100 MW do not have a material impact on market prices and therefore are not modeled. Forced outage rates and mean time to repair data for the larger units in the WECC come from analyzing the North American Electric Reliability Corporation's Generating Availability Data System database.

Market Price Forecast

An optimal resource portfolio cannot ignore the extrinsic value inherent in its resource choices. The 2013 IRP simulation compares each resource's expected hourly output using forecasted Mid-Columbia hourly prices over 500 iterations of Monte Carlo-style scenario analysis.

⁵ Chart data is from the BPA at: <http://transmission.bpa.gov/Business/Operations/Wind/default.aspx>.

Hourly zonal electricity prices are equal to either the operating cost of the marginal unit in the modeled zone, or the economic cost to generate and move power from one zone to another. A forecast of available future resources helps create an electricity market price projection. The IRP uses regional planning margins to set minimum capacity requirements rather than simply summing of the capacity needs of individual utilities in the region. This reflects the fact that Western regions can have resource surpluses even where individual utilities are deficit. This imbalance can be due in part to ownership of regional generation by independent power producers, and possible differences in planning methodologies used by utilities in the region.

AURORA^{XMP} assigns market values to each resource alternative available to the PRS, but the model does not itself select PRS resources. Several market price forecasts determine the value and volatility of a resource portfolio. As Avista does not know what will happen in the future, it relies on risk analyses to help determine an optimal resource strategy. Risk analysis uses several market price forecasts with assumptions differing from the expected case, or changes the underlying statistics of a study. The modeling splits alternate cases into stochastic and deterministic studies.

A stochastic study uses Monte Carlo analysis to quantify the variability in future market prices. These analyses include 500 iterations of varying natural gas prices, loads, hydroelectric generation, thermal outages, and wind generation shapes. The IRP includes two stochastic studies—an Expected Case and a case with greenhouse gas emissions pricing. All remaining studies were deterministic; modifying one or more key input assumptions and using average values for the remaining variables.

Mid-Columbia Price Forecast

The Mid-Columbia is Avista's primary electricity trading hub. The Western Interconnect also has trading hubs at the California/Oregon Border (COB), Four Corners (corner of northwestern New Mexico), Palo Verde (central Arizona), SP15 (southern California), NP15 (northern California) and Mead (southern Nevada). The Mid-Columbia market is usually the lowest cost because of the hubs dominant hydroelectric generation assets, though other markets can be less expensive when Rocky Mountain-area natural gas prices are low and natural gas-fired generation is setting marginal power prices.

Fundamentals-based market analysis is critical to understanding the power industry environment. The Expected Case includes two studies. The first is a deterministic market view using expected levels for the key assumptions discussed in the first part of this chapter. The second is a risk or stochastic study with 500 unique scenarios based on different underlining assumptions for natural gas prices, load, wind generation, hydroelectric generation, forced outages, and others. Each study simulates the entire Western Interconnect hourly between 2014 and 2033. The analysis used 25 central processing units (CPUs) linked to a SQL server, creating over 45 GB of data in 3,000 CPU-hours.

The stochastic market average prices are similar to the results from the deterministic model. Figure 7.13 shows the stochastic market price results as horizontal bars

represent the 10th to 90th percentile range for annual prices, the circle shows the average prices, while the triangle represents the 95th percentile. The 20-year nominal levelized price is \$44.08 per MWh. The levelized deterministic price is \$0.10 per MWh higher than the levelized stochastic price presented in Figure 7.14.

Figure 7.13: Mid-Columbia Electric Price Forecast Range

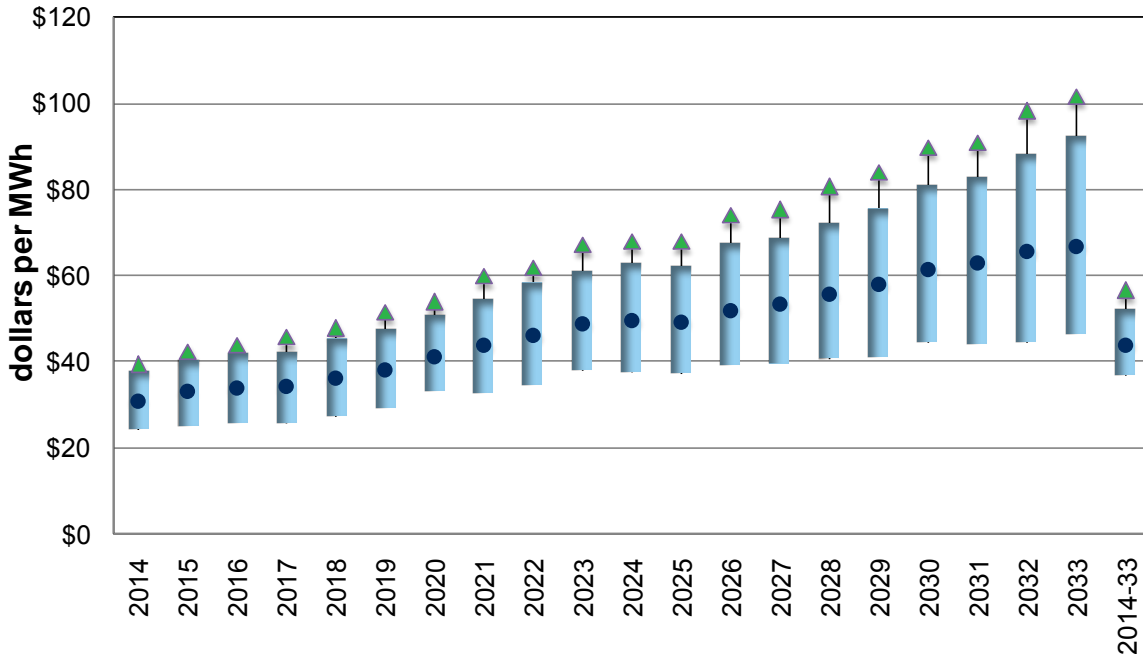

The annual averages of the stochastic case on-peak, off-peak, and levelized prices are in Table 7.10. Spreads between on- and off-peak prices average \$9.76 per MWh over 20 years. The 2011 IRP annual average nominal price was \$70.50 per MWh. The reduction in pricing is a result of lower natural gas prices, lower loads, higher percentages of new low-heat-rate natural gas plants, and the elimination of direct carbon pricing.

Table 7.10: Annual Average Mid-Columbia Electric Prices (\$/MWh)

Year	Flat	Off-Peak	On-Peak
2014	31.02	25.63	35.18
2015	33.06	27.57	37.17
2016	33.91	28.52	37.93
2017	34.14	28.78	38.21
2018	36.18	30.90	40.16
2019	38.29	32.99	42.17
2020	41.34	36.15	45.06
2021	43.72	38.34	47.65
2022	46.06	40.49	50.04
2023	48.85	43.29	52.92
2024	49.52	43.78	53.64
2025	49.35	43.59	53.57
2026	52.04	46.31	56.16
2027	53.37	47.60	57.70
2028	55.65	49.77	59.79
2029	57.94	51.94	62.27
2030	61.39	55.12	66.06
2031	63.06	56.48	67.96
2032	65.65	59.02	70.57
2033	66.97	60.25	71.94
Levelized	44.08	38.46	48.22

Greenhouse Gas Emission Levels

Greenhouse gas levels could increase over the study period absent regulatory policies reversing the trend. This IRP does not include a legislative mandate to reduce greenhouse gases in the Expected Case, such as a cap and trade program or a carbon tax. Rather the forecast includes cap-and-trade pricing in California and power plant shut downs due to EPA and state regulations. This IRP models the California and Canadian carbon laws. Further discussion of carbon policy is in Chapter 4, Policy Considerations.

Figure 7.14 shows historic and expected greenhouse gas emissions for the Western Interconnect. Greenhouse gas emissions from electric generation decrease 10.8 percent between 2010 and 2033. The figure also includes the 10th and 90th percentile statistics from the 500-iteration dataset. The reduction drivers are a lower load forecast when compared to prior IRPs, lower natural gas prices, renewable portfolio standards, and forecasted coal-fired generation retirements.

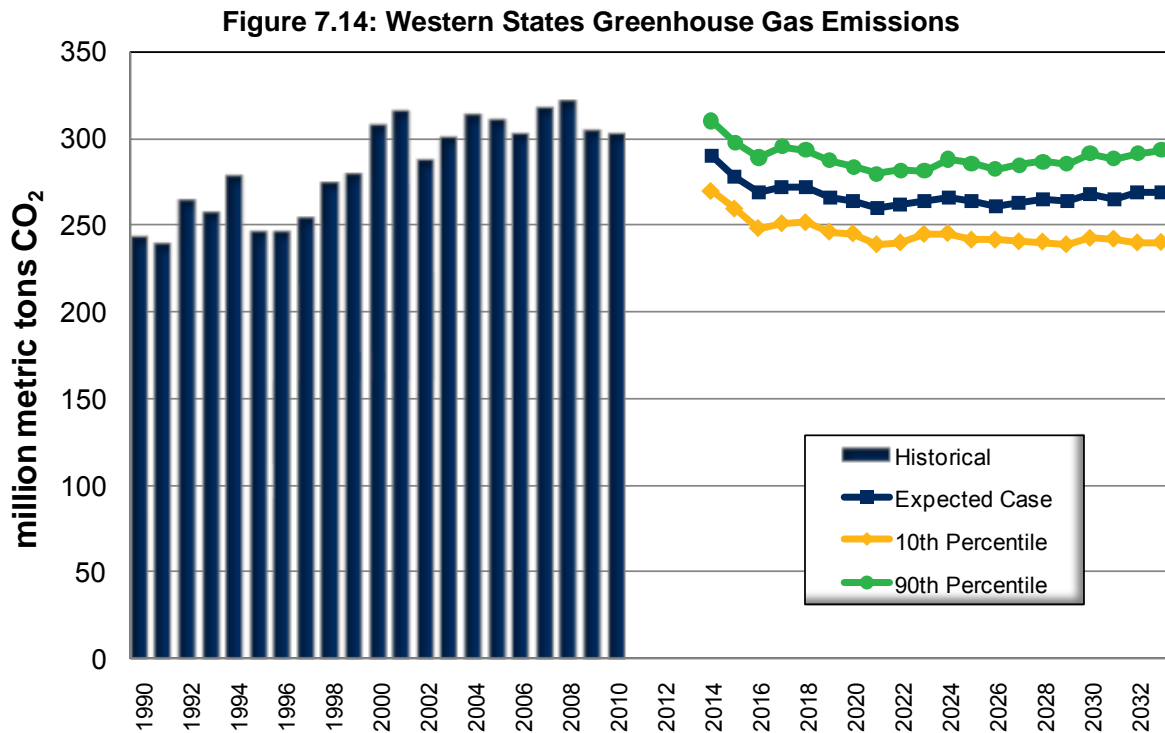

Resource Dispatch

State-level RPS goals and greenhouse gas legislation changes resource dispatch decisions and affect future power prices. The Northwest already is witnessing the market-changing effects of more than an 8,500 MW wind fleet. Figure 7.15 illustrates how natural gas will increase its contribution as a percentage of Western Interconnect generation, from 24 percent in 2014 to 41 percent 2033. The increase offsets coal-fired generation; coal drops from 28 percent in 2014 to 15 percent in 2034. Utility-owned solar and wind increase from 8 percent in 2014 to 11 percent by 2033. New renewable generation sources also reduce coal generation, but natural gas is the primary resource meeting load growth.

Public policy changes encouraging renewable energy development reduce greenhouse gas emissions, but they also change electricity marketplace fundamentals. On the present trajectory, policy changes are likely to move the generation fleet toward natural gas, with its currently low but historically volatile prices. These policies will displace low-cost coal-fired generation with higher-cost renewables and natural gas-fired generation having lower capacity factors (wind) and higher marginal costs (natural gas). If history is our guide, regulated utilities will recover their stranded coal plant investments from customers, requiring customers to pay more. Further, wholesale prices likely will increase with the effects of the changing resource dispatch driven by carbon emission limits and renewable generation integration. New environmental policy driven investments, combined with higher market prices, will necessarily lead to retail rates that are higher than they otherwise would be absent greenhouse gas reduction policies.

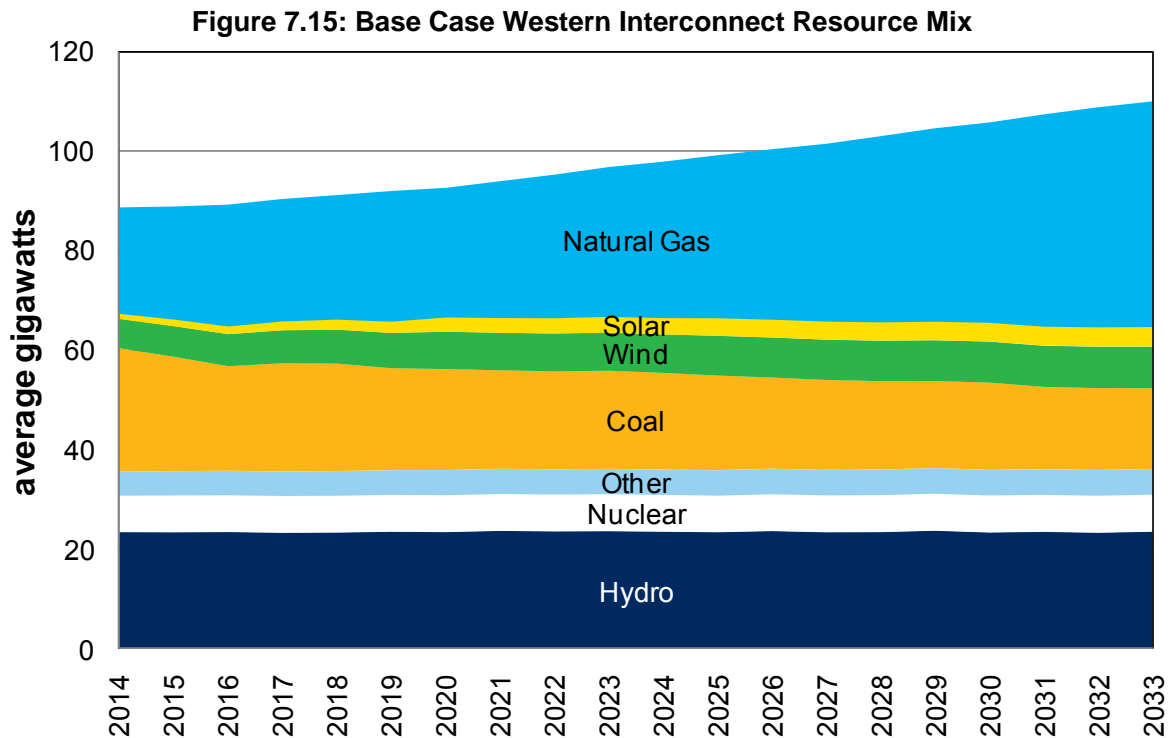

Scenario Analysis

Scenario analysis evaluates the impact of specific changes in underlying assumptions on the market, Avista's generation portfolio, and new generation resource options' values. In addition to the Expected Case, a stochastic greenhouse gas reduction case was studied: the Carbon Pricing Scenario. The case is similar to the 2011 IRP Expected Case. In addition to stochastic market scenarios, deterministic scenarios explain the impacts of lower and higher natural gas prices and higher state RPS. Prior IRPs used market scenarios to stress test the PRS. Since the PRS accounts for a range of possible outcomes in its risk analysis, the market scenario section is more limited in this IRP. Additional scenarios illustrate impacts potential future policies might have on the industry, and how Avista could respond.

No Coal Retirement Scenario

The Expected Case price forecast includes speculative coal plant retirements based on how Avista understands state and federal environmental policies, and the effect on power generation in the Western Interconnect. The No Coal Retirement scenario models the impact coal retirements might have on market prices, greenhouse gas emissions, and the costs to meet customer load growth. In the event coal plants are not retired, the impact on wholesale power prices is minimal. The levelized prices of power over the 20-year period is \$1.25 per MWh lower than the Expected Case (see Figure 7.16), with the largest annual price difference being 4.4 percent.

Figure 7.16: Mid-Columbia Prices Comparison with and without Coal Plant Retirements

Figure 7.17 illustrates the difference between greenhouse gas emissions with and without the coal plant retirements. Based on the model results and assumptions, emissions would be nearly 9 percent higher in 2033 without the assumed coal plant retirements. The coal plant retirements due to regulations has a similar greenhouse gas reduction as a carbon tax or cap and trade scheme, but does not have a substantial impact on market prices. With forced earlier retirement, coal plant owners will face replacement costs up front rather the delayed until carbon prices make coal uneconomic. As regulations continue to force coal plants to improve their environmental footprint, lower compliance costs could take shape as engineers focus on solutions to meet stricter guidelines to reduce air emissions.

The No Coal Retirement scenario allows an estimate of the short-term (20-year) cost of greenhouse gas reduction. This estimate takes into account the changes to the Western Interconnect resources' fuel and variable O&M costs. The analysis also takes into account capital cost changes reflecting investments in new capacity and its associated fixed O&M costs. Based on cost changes and carbon emission reductions, the implied 2019-2033 levelized price paid to reduce carbon emissions is \$95.33 per metric ton (2014\$) for the Western Interconnect.

Figure 7.17: Western U.S. Carbon Emissions Comparison

Carbon Pricing Scenario

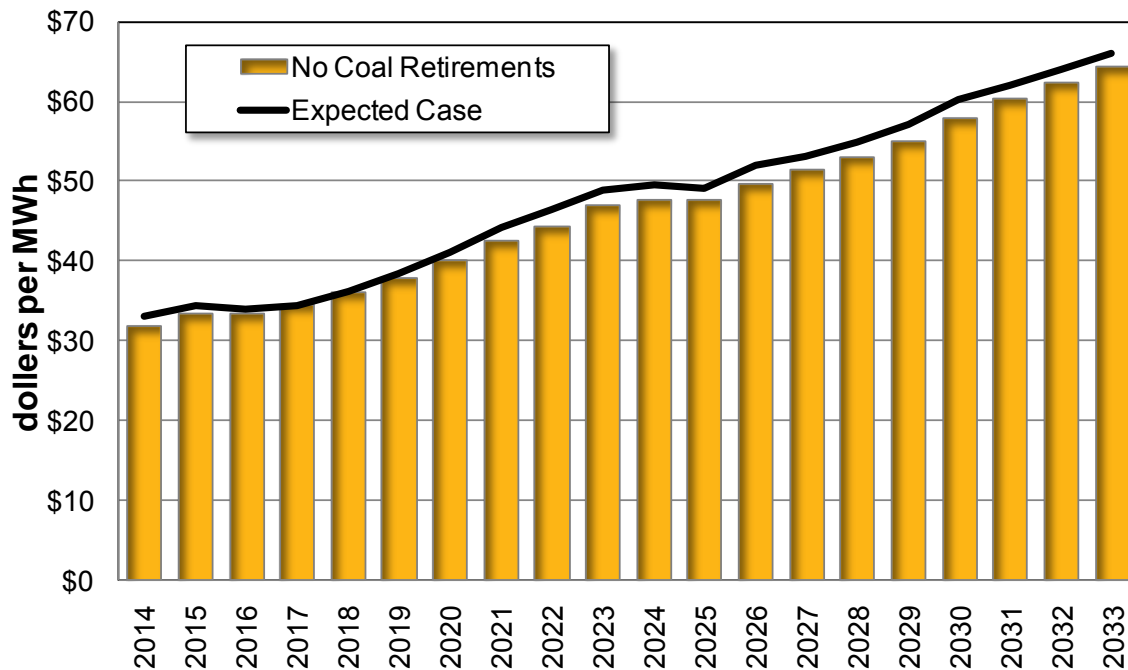
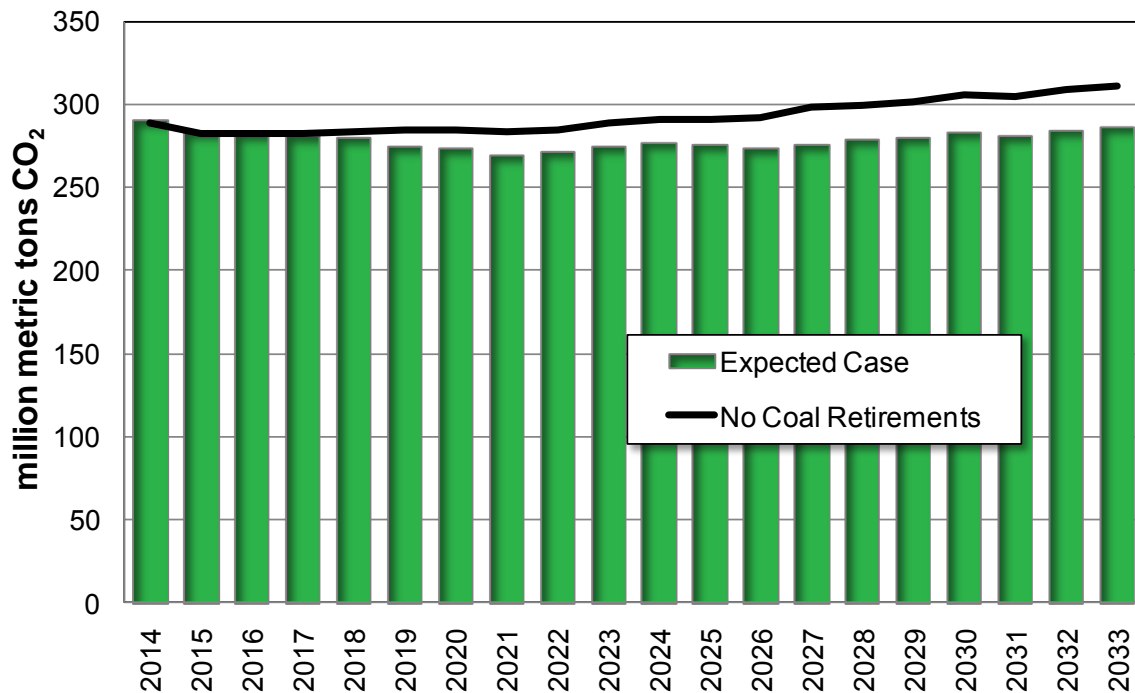
In Avista's recent IRPs, the Expected Case has included explicit costs for greenhouse gas emissions. The Expected Case in this IRP does not include these costs explicitly. The political climate in the last several IRPs was more amenable to national greenhouse gas policies. To understand the costs and ramifications of a national greenhouse gas reduction policy, this scenario quantifies the potential outcomes. It considers four potential carbon mitigation alternatives. Figure 7.18 shows each alternative modeled as a cap and trade mechanism. Figure 7.19 shows the levelized electric market price results of these alternatives compared to the Expected case. The levelized costs are not substantially higher than the Expected Case, as the levelization methodology discounts later periods where carbon policies are expected; therefore, levelization masks future higher market prices for utility customers. Figure 7.20 shows the annual expected greenhouse gas emissions levels for each of the policies. The four potential outcomes represent a range of futures under different forms of greenhouse gas emissions legislation. Over the last nine years of this study the weighted average levelized price is \$22.36 per metric ton, the high case is \$55.06 and the low case is \$19.15 per metric ton.

Chapter 7- Market Analysis

Figure 7.18: Greenhouse Gas Pricing Scenarios

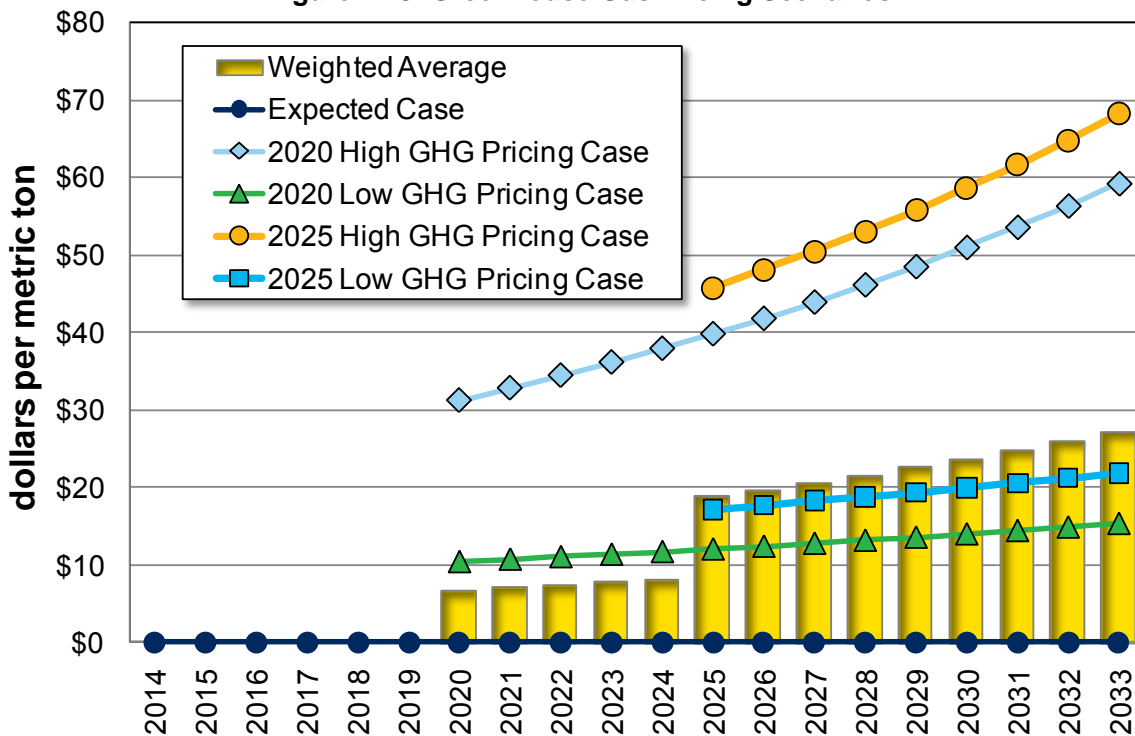

Figure 7.19: Nominal Mid-Columbia Prices for Alternative Greenhouse Gas Policies

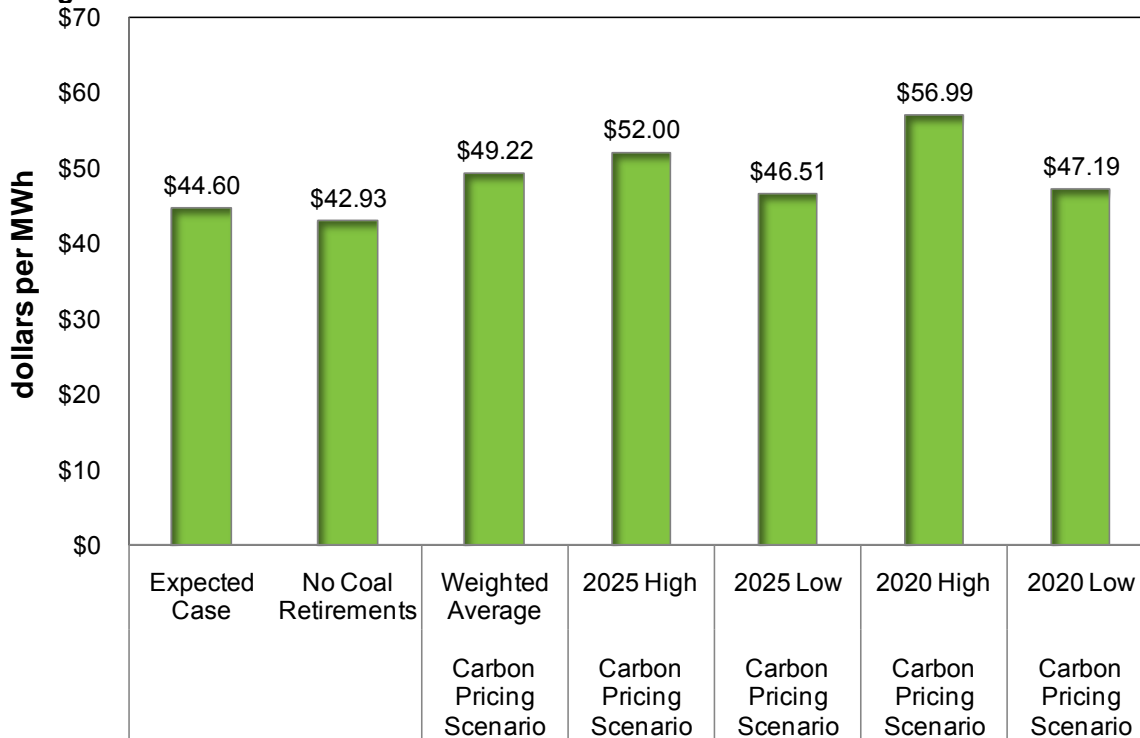
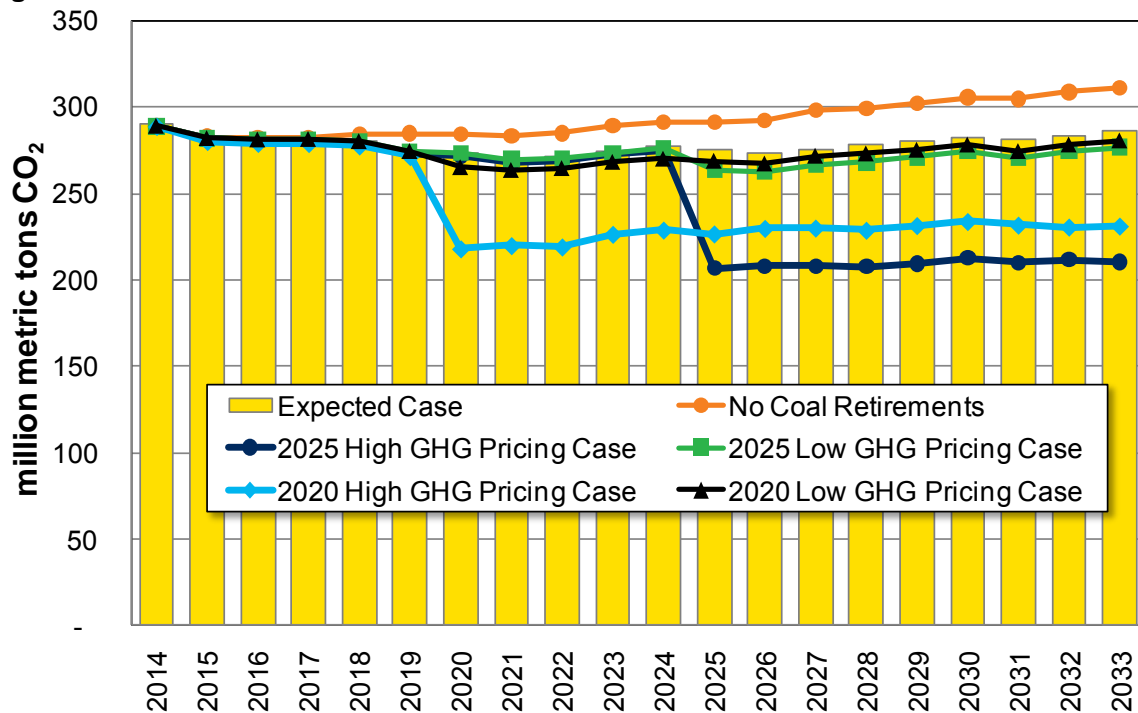

Figure 7.20: Annual Greenhouse Gas Emissions for Alternative Greenhouse Gas Policies

High and Low Natural Gas Price Scenarios

The high and low natural gas price scenarios provide important information about how a potential resource strategy might change if the natural gas prices vary substantially from the Expected Case. They also provide an overview of how the energy market behaves when natural gas prices vary. Over the past several years, as natural gas prices have fallen, certain resources, such as coal, are dispatching differently. For this IRP, Avista completed two natural gas pricing scenarios in addition to the stochastic cases. The stochastic cases' 500 natural gas scenarios are considered a better method to consider the risk of price changes, but these two scenarios are useful in understanding the fundamental market changes.

The high and low price scenarios assume prices either rise or decline up to 35 percent relative to the Expected Case over time. The Expected Case assumes a levelized price of \$5.62 per dekatherm, while the high price scenario is \$7.48. The low price scenario is \$3.97 per dekatherm. Figure 7.21 shows the resultant annual prices. The electricity price forecast follows the general tendencies of the change in natural gas in Figure 7.22. Important to note, the implied market heat rate (IMHR) shown in Figure 7.23 changes significantly with natural gas prices. The IMHR divides natural gas prices by electric prices and is illustrative of the market point in which a heat rate of a natural gas facility is profitable. For example, the approximate heat rate of a CCCT is 7,000 Btu/kWh. Lower natural gas prices make operating gas plants more frequently a better option.

Figure 7.21: Annual Natural Gas Price Forecast Scenarios

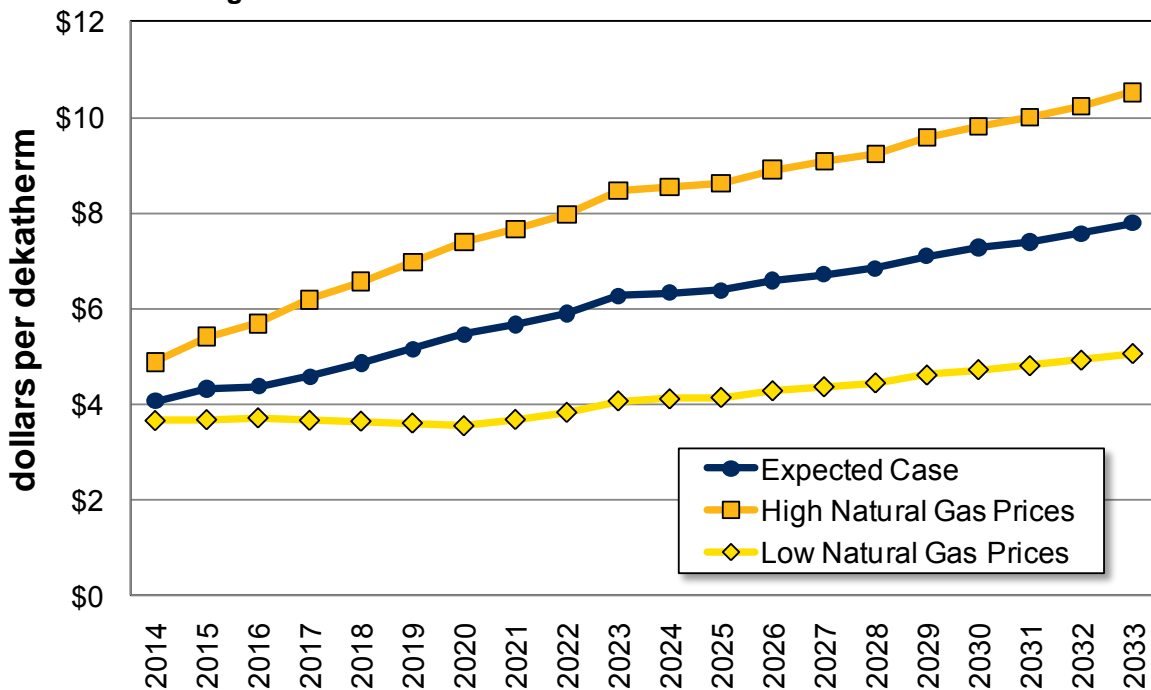
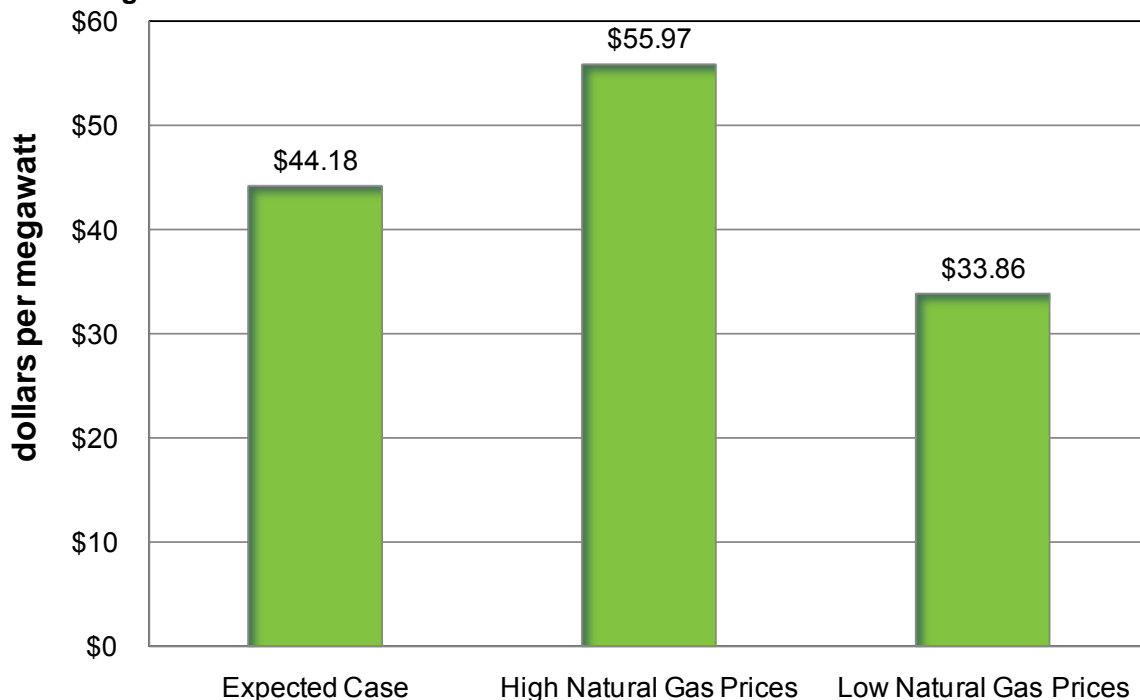
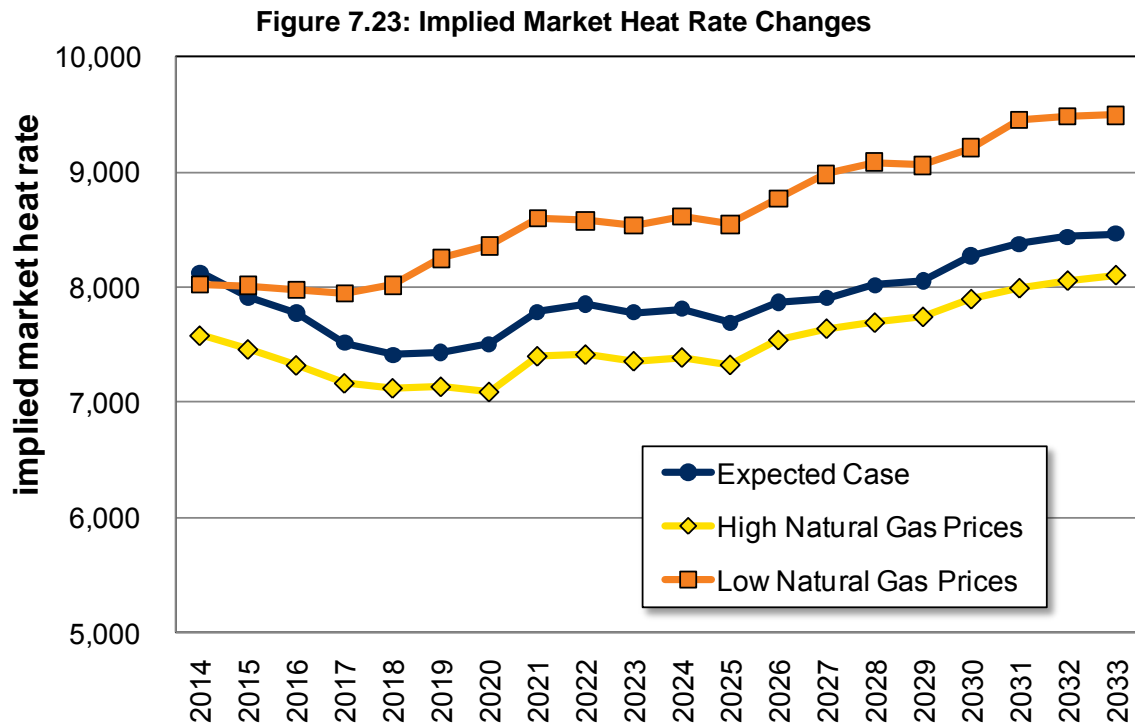

Figure 7.22: Natural Gas Price Scenario's Mid-Columbia Price Forecasts





Increased State Renewable Portfolio Standards

Many western states have RPS requirements. As utilities reach their mandated levels of renewables, some states have increased the goals for reasons of further reducing energy risk, creating green jobs, and lowering carbon emissions. This scenario attempts to address the impact of RPS legislation on the Northwest energy market. If the only goal of the RPS is to lower carbon emissions, this method can be costly. This IRP does not attempt to address these costs for the existing RPS rules, but rather discusses what the costs and benefits are from additional rules.

This scenario is speculative in many ways, such as from which states an increase in RPS levels will come from, and the type of technology used to meet the increased goals. For this analysis, the renewable requirement increases after 2025, and focuses on states where existing standards stop increasing in 2020. For example, this scenario assumes Washington state increases from 15 percent to 25 percent in 2025, and California's increases from 33 percent to 50 percent by 2030. Other states' increases include Colorado, Nevada, New Mexico, and Arizona. Solar will meet much of the need in states with increased requirements that have strong solar potential; additions beyond the current standard could strain existing transmission systems and produce low capacity factors. For this analysis, 7,000 MW of wind, 29,000 MW of solar and 1,000 MW of other renewable technology is added to meet the assumed higher standards of this scenario. The net added cost to the West for these assumed law changes is \$120 billion (2012\$). This compares to the estimated \$17 billion spent on renewable energy investments in the Northwest to date.⁶

⁶This scenario assumes 8,500 MW of Northwest wind using an average cost of \$2,000 per kW.

The market and greenhouse gas reduction benefits of the increased RPS scenario are shown in Figure 7.24 for the years 2025 to 2033. As more solar and wind generation are added to the system wholesale market prices are expected to decline; this scenario shows wholesale price reductions of 3 percent to 4 percent. Overall system costs of the Western Interconnect will not fall due to the large investment levels. The added renewables reduce greenhouse gas emissions from the Expected Case by up to 9 percent toward the end of the study. As with the forced coal plant retirements in the Expected Case, an assumption included in this RPS scenario as well, the higher RPS results in an implied price for carbon. The implied cost of reduced carbon emissions for this increased RPS scenario is \$198 per metric ton. For further information on this calculation, refer to the Expected Case analysis described on page 7.27. While added renewables can reduce fuel costs, the incremental investments in new renewable generation greatly overwhelms the fuel cost savings.

Figure 7.24: Changes to Mid-Columbia Prices and Western US Greenhouse Gas Levels

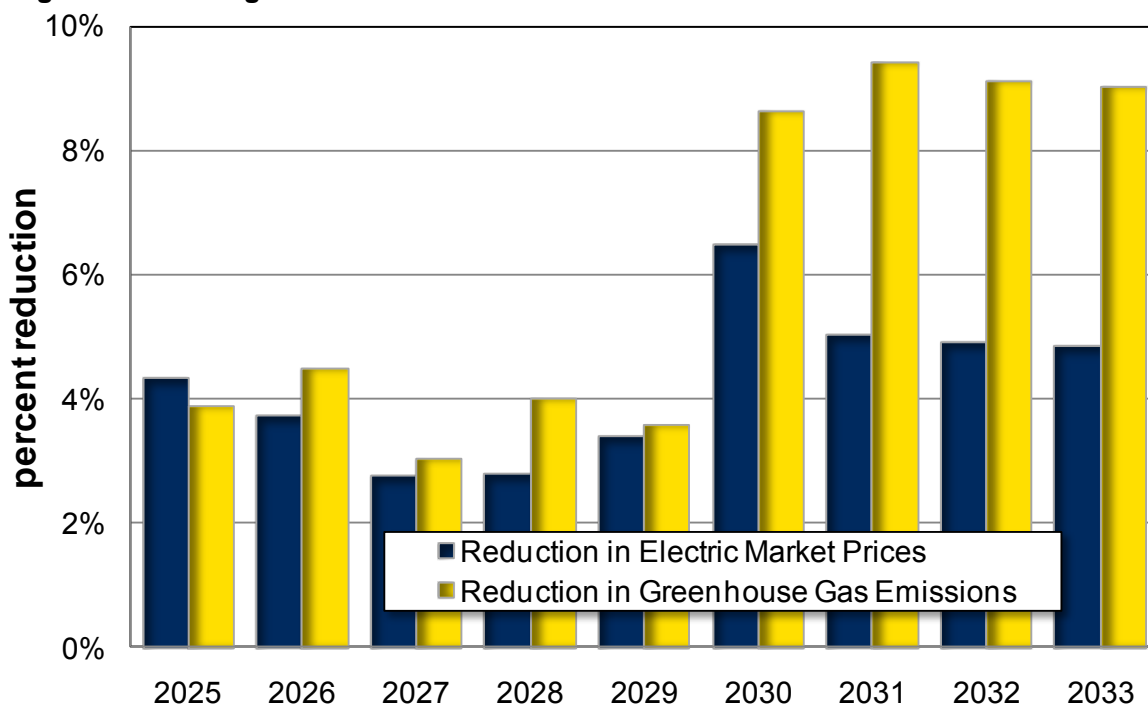

8. Preferred Resource Strategy

Introduction

The PRS chapter describes potential costs and financial risks of various resource acquisition strategies. Further, the chapter details planning and resource decision methods and strategies, the impact of climate change policies, and provides an overview of alternative resource strategies.

The 2013 PRS describes a reasonable low-cost plan along the efficient frontier of potential resource portfolios accounting for fuel supply and price risks. Major changes from the 2011 plan include reduced energy efficiency, wind, and natural gas-fired resources and, for the first time, a modest contribution from demand response. The plan no longer calls for new renewable resources due to the recent acquisition of the 105 MW Palouse Wind Project and the recent law change allowing the Kettle Falls Generation Station to qualify for Washington's EIA beginning in 2016. The strategy's lower energy efficiency level is due to lower avoided costs, increased codes and standards supplanting the need for utility-sponsored acquisition, and rising implementation and verification costs associated with utility-sponsored energy efficiency programs. The reduction in natural gas-fired resources results primarily from a lower retail load forecast. Demand response is included because lower energy prices increase the value of resources providing on-peak capacity.

Section Highlights

- Avista's first anticipated resource acquisition is a natural gas-fired peaker by the end of 2019 to replace expiring contracts and growing loads.
- A combined cycle combustion turbine replaces the Lancaster Facility when its contract ends in 2026.
- The selection of natural gas-fired peaking units is due primarily to their smaller size better fitting Avista's resource deficits.
- The 2013 Preferred Resource Strategy includes demand response programs for the first time.
- Energy efficiency offsets projected load growth by 42 percent through the 20-year IRP timeframe.
- Colstrip Units 3 and 4 remain viable and cost-effective throughout the planning horizon, even under scenarios most adverse to the plant.

Supply-Side Resource Acquisitions

Avista began its shift away from coal-fired resources with the sale of its 210 MW share of the Centralia coal plant in 2000, and its replacement with natural gas-fired generation projects. See Figure 8.1. Since the Centralia sale, Avista has made several generation acquisitions and upgrades, including:

- 25 MW Boulder Park natural gas-fired reciprocating engines (2002);

Chapter 8 – Preferred Resource Strategy

- 7 MW Kettle Falls gas-fired CT (2002);
- 35 MW Stateline wind power purchase agreement (2004);
- 56 MW (total) hydroelectric upgrades (through 2012);
- 270 MW natural gas-fired Lancaster Generation Station power purchase agreement (2010); and
- 105 MW Palouse Wind power purchase agreement (2012).

Figure 8.1: Resource Acquisition History

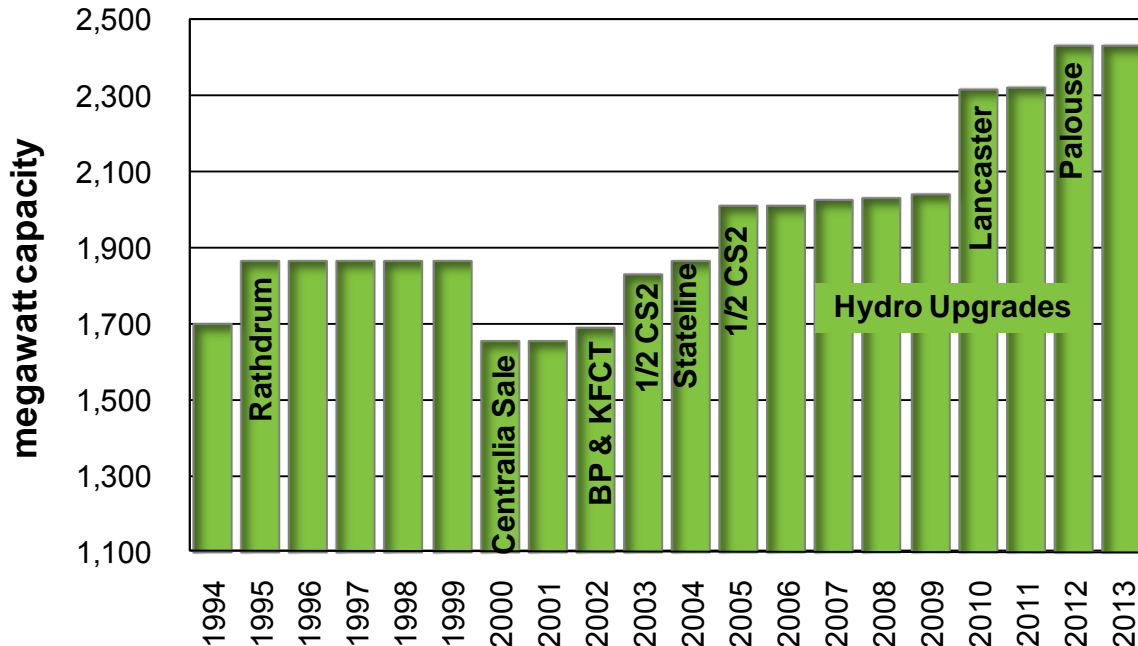

Resource Selection Process

Avista uses several decision support systems to develop its resource strategy, including AURORA^{XMP} and Avista's PRiSM model. The AURORA^{XMP} model, discussed in detail in the Market Analysis chapter, calculates the operating margin (value) of every resource option considered in each of the 500 Monte Carlo simulations of the Expected Case, as well as Avista's existing portfolio of generation assets. The PRiSM model helps make resource decisions. Its objective is to meet resource deficits while accounting for overall cost, risk, capacity, energy, renewable energy requirements, and other constraints. PRiSM evaluates resource values by combining operating margins with capital and fixed operating costs. The model creates an efficient frontier of resources, or the least cost portfolios, given a certain level of risk and constraints. Avista's management selects a resource strategy using this efficient frontier to meet all capacity, energy, RPS, and other requirements.

PRiSM

Avista staff developed the first version of its PRiSM model in 2002 to support resource decision making. PRiSM uses a linear programming routine to support complex decision

Chapter 8 – Preferred Resource Strategy

making with multiple objectives. Linear programming tools provide optimal values for variables, given system constraints.

Overview of the PRiSM model

The PRiSM model requires a number of inputs:

1. Expected future deficiencies
 - Greater of summer 1- or 18-hour capacity
 - Greater of winter 1- or 18-hour capacity
 - Annual energy
 - I-937 RPS requirements
2. Costs to serve future retail loads
3. Existing resource contributions
 - Operating margins
 - Fixed operating costs
4. Resource Options
 - Fixed operating costs
 - Return on capital
 - Interest expense
 - Taxes
 - Generation levels
 - Emission levels
5. Constraints
 - The level of Market reliance (surplus/deficit limits on energy, capacity and RPS)
 - Resources quantities available to meet future deficits

PRiSM uses these inputs to develop an optimal resource mix over time at varying levels of risk. It weights the first twenty years more heavily than the later years to highlight the importance of nearer-term decisions. A simplified view of the PRiSM linear programming objective function is below.

Equation 8.1: PRiSM Objective Function

Minimize: $(X_1 * NPV_{2014-2033}) + (X_2 * NPV_{2014-2063})$

Where: X_1 = Weight of net costs over the first 20 years (95 percent)
 X_2 = Weight of net costs over the next 50 years (5 percent)
 NPV is the net present value of total system cost.¹

An efficient frontier captures the optimal resource mix graphically given varying levels of cost and risk. Figure 8.2 illustrates the efficient frontier concept. As you attempt to lower risk, costs increase. The optimal point on the efficient frontier depends on the level of risk Avista and its customers are willing to accept. The best point on the curve could be

¹ Total system cost is the existing resource marginal costs, all future resource fixed and variable costs, and all future energy efficiency costs and the net short-term market sales/purchases.

where you can make small incremental cost additions for large reductions in risk. Portfolios to the left of the curve would be more optimal, but do not meet the planning requirements or resource constraints. Examples of these constraints are environmental legislation cost, regulation, and the availability of commercially viable technologies greatly limit utility-scale resource options. Further, portfolios to the right of the curve are less efficient as they have higher costs than a portfolio with the same level of risk. The model does not meet deficits with market purchases, or allow the construction of resources in any incremental size.² Instead, it uses market purchases to fill short-term gaps and “constructs” resources in block sizes equal to the project sizes Avista could build.

Figure 8.2: Conceptual Efficient Frontier Curve

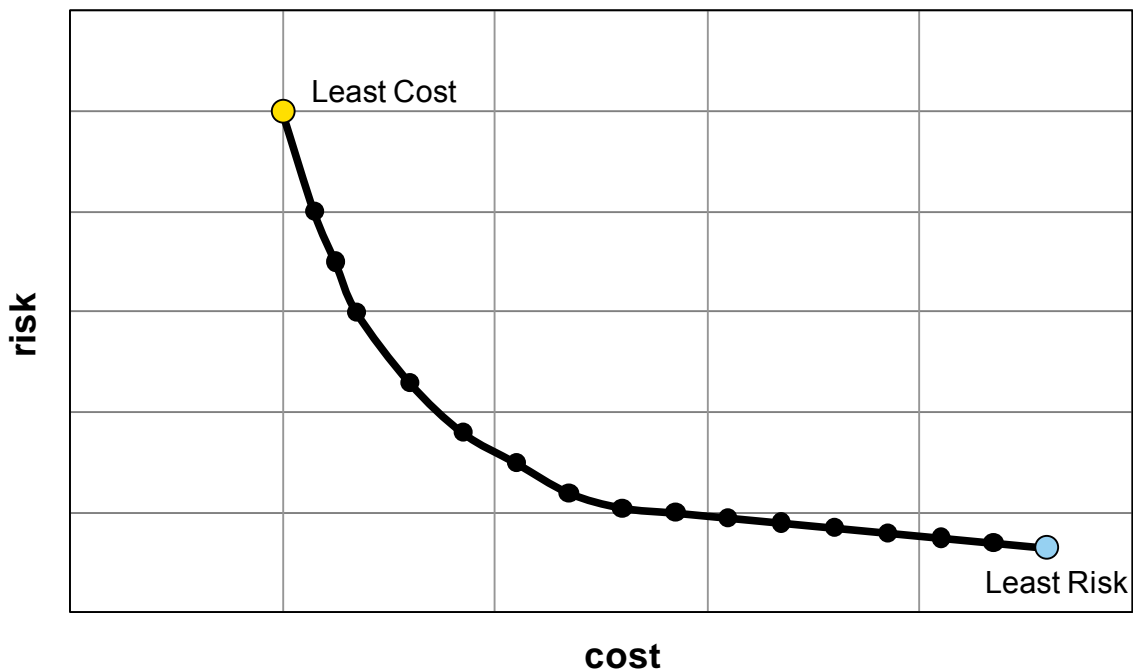

Constraints

As discussed earlier in this chapter, reflecting real-world constraints in the model is necessary to create a more realistic representation of the future. Some constraints are physical and others are societal. The major resource constraints are capacity and energy needs, Washington’s RPS, and greenhouse gas emissions performance standard.

The PRiSM model selects from combined- and simple-cycle natural gas-fired combustion turbines, natural gas-fired reciprocating engines, wind, solar, storage batteries, carbon-sequestered coal, and upgrades to existing thermal and hydro resources. Energy efficiency is a fixed input derived from an iterative process of

² Market reliance, as identified in Section 2, is determined prior to PRiSM’s optimization.
Avista Corp 2013 Electric IRP

Chapter 8 – Preferred Resource Strategy

developing avoided costs using PRiSM. Further, scenarios illustrate energy efficiencies' impact on resource selections. Non-sequestered coal plants are not an option in this IRP because Washington's emissions performance standard bans them.³

Washington's EIA or RPS fundamentally changed how Avista meets future loads. Before the addition of an RPS obligation, the efficient frontier contained a least-cost strategy on one axis, the least-risk strategy on the other axis, and all of the points in between. Management used the efficient frontier to help determine where they wanted to be on the cost-risk continuum. The least cost strategy typically consisted of natural gas-fired peaking resources. Portfolios with less risk generally replaced some of the natural gas-fired peaking resources with wind generation, other renewables, combined cycle natural gas-fired plants, or coal-fired resources. Past IRPs identified resource strategies including all of these risk-reducing resources. Added environmental and legislative constraints reduce the ability of resource choices to positively impact future costs and/or risks, at least in the traditional sense, and the requirement to procure renewable generation resources previously were included only in lower-risk and higher-cost portfolios. Further, these laws increase customer costs by obligating the utility to pay for energy efficiency levels above their direct financial benefit.

Resource Deficiencies

Avista uses a single-hour and a three-day, 18-hour (6 hours each day), peak event methodology to measure resource adequacy. The three-day 18-hour, methodology assures our energy-limited hydro resources can meet a multiday extreme weather event.

Avista considers the regional power surpluses consistent with the NPCC's forecast, and does not plan to acquire long-term generation assets while the region is significantly surplus.

Avista's peak planning methodology includes operating reserves, regulation, load following, wind integration and a planning margin. Even with this planning methodology, Avista currently projects having adequate resources between owned and contractually controlled generation to meet physical energy and capacity needs until 2020.⁴ See Figure 8.3 for Avista's physical resource positions for annual energy, summer capacity, and winter capacity. This figure accounts for the effects of new energy efficiency programs on the load forecast. Absent energy efficiency, Avista would be deficient earlier. Figure 8.3 illustrates short-term capacity needs in the winter of 2014/15 and 2015/16. This period is short-lived because a 150 MW capacity sale contract ends in 2016. Avista expects to address these short-term deficits with market purchases; therefore, the first long-term capacity deficit begins 2020. If Avista uses a similar planning margin in the summer as winter (14 percent plus reserves); Avista would be deficit in the summer of 2025. Given the region has a capacity surplus in the summer;

³ See RCW 80.80.

⁴ See Chapter 2 for further details on this peak planning methodology.

Chapter 8 – Preferred Resource Strategy

Avista will meet its ancillary service needs from its own portfolio, but rely on term purchases to meet other deficits.

PRiSM selects new resources to fill capacity and energy deficits, although the model may over- or under-build where economics support it. Because of acquisitions driven by capacity RPS compliance, large energy surpluses result.

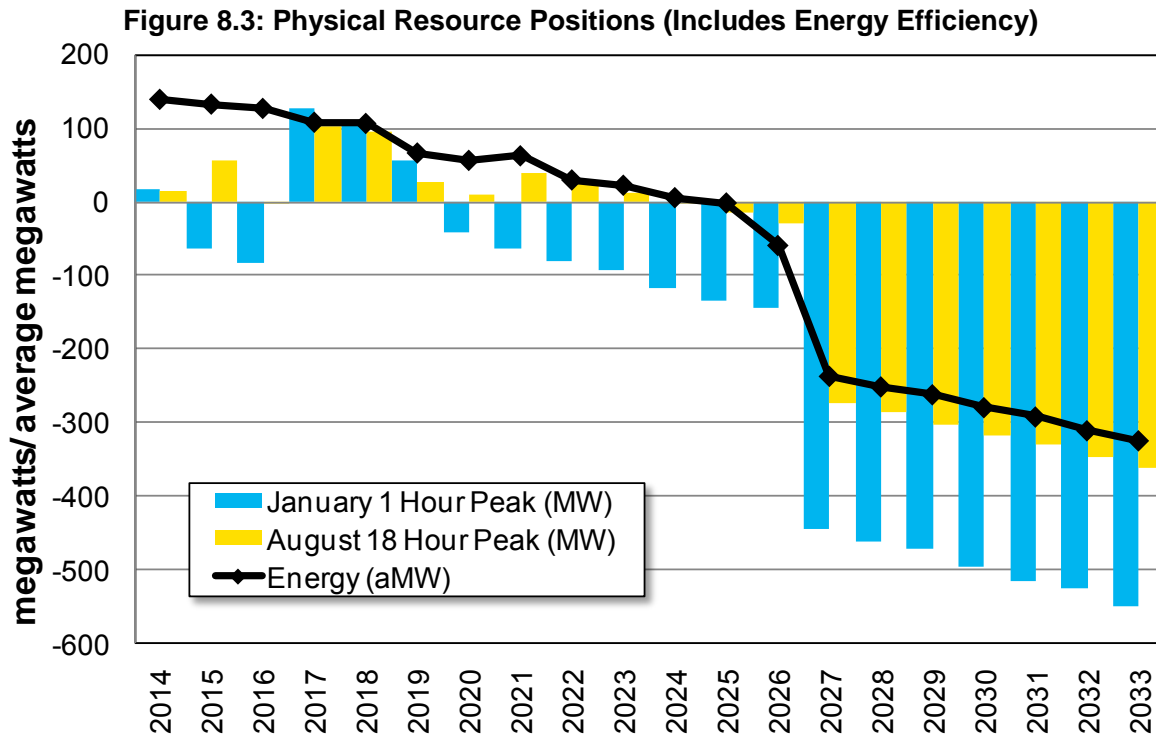

Renewable Portfolio Standards

Washington voters approved the EIA in the November 2006 general election. The EIA requires utilities with over 25,000 customers to meet 3 percent of retail load from qualified renewable resources by 2012, 9 percent by 2016, and 15 percent by 2020. The initiative also requires utilities to acquire all cost-effective energy efficiency and energy efficiency. Avista participates in the UTC’s Renewable Portfolio Standard Workgroup to help interpret application of this law.

Avista expects to meet or exceed its EIA requirements through the 20-year plan with a combination of qualifying hydroelectric upgrades, the Palouse Wind project, the Kettle Falls Generating Station and selective REC purchases. A list of the qualifying generation projects and the associated expected output is in Table 8.1 below. The forecast REC positions are in Figure 8.4. The flexibility included in the EIA to use RECs from the current year, from the previous year, or from the following year for compliance helps mitigate year-to-year variability in the output of qualifying renewable resources.

Chapter 8 – Preferred Resource Strategy

Table 8.1: Qualifying Washington EIA Resources

Resource	Resource Type	On-line Year	Nameplate Capacity	Expected MWh	Expected RECs	Average RECs
Kettle Falls GS ⁵	Biomass	1983	47.0	374,824	281,118	32.1
Long Lake 3	Hydro	1999	4.5	14,197	14,197	1.6
Little Falls 4	Hydro	2001	4.5	4,862	4,862	0.6
Cabinet Gorge 3	Hydro	2001	17.0	45,808	45,808	5.2
Cabinet Gorge 2	Hydro	2004	17.0	29,008	29,008	3.3
Cabinet Gorge 4	Hydro	2007	9.0	20,517	20,517	2.3
Wanapum	Hydro	2008	0.0	22,206	22,206	2.5
Noxon Rapids 1	Hydro	2009	7.0	21,435	21,435	2.4
Noxon Rapids 2	Hydro	2010	7.0	7,709	7,709	0.9
Noxon Rapids 3	Hydro	2011	7.0	14,529	14,529	1.7
Noxon Rapids 4	Hydro	2012	7.0	12,024	12,024	1.4
Palouse Wind	Wind	2012	105.0	349,726	419,671	47.9
Nine Mile 1 & 2	Hydro	2016	4.0	11,826	11,826	1.4
Total			236.0	928,671	904,910	103.3

Figure 8.4: REC Requirements vs. Qualifying RECs for Washington State EIA

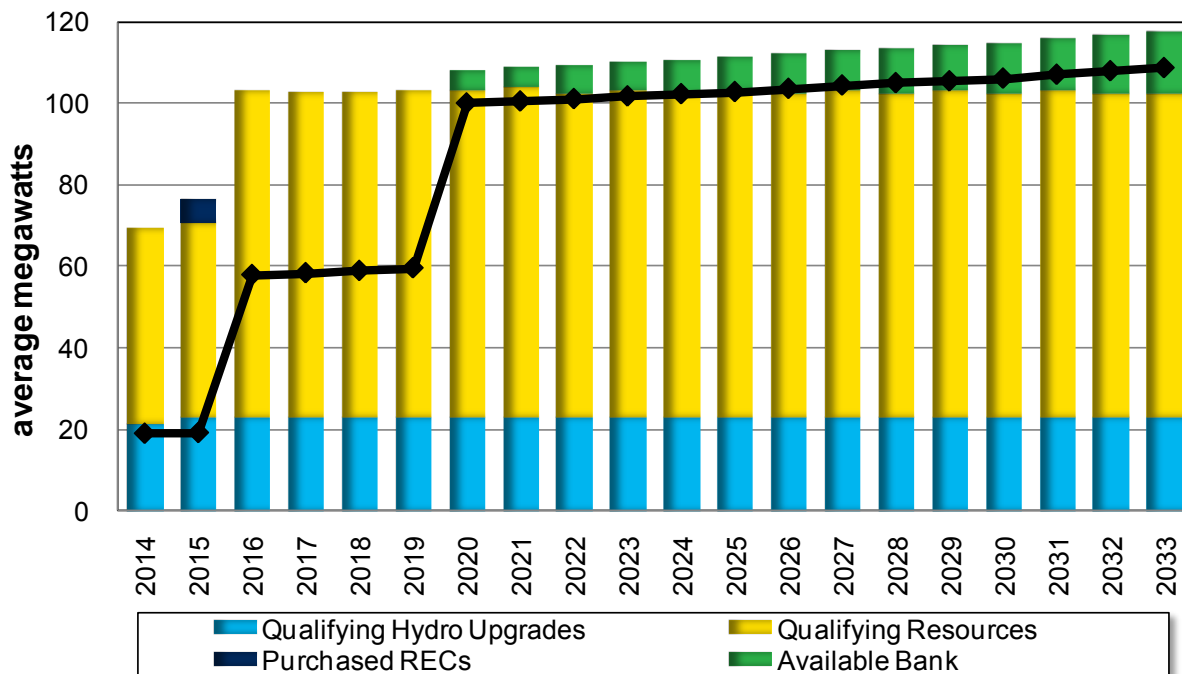

⁵ The Kettle Falls Generation Station becomes EIA qualified beginning in 2016. Clarification is required to determine the amount of energy to qualify for the law (75 percent qualifying is currently assumed).

Preferred Resource Strategy

The 2013 PRS consists of existing thermal resource upgrades, energy efficiency, demand response, and natural gas-fired simple- and combined-cycle gas turbines. A list of forecast acquisitions is in Table 8.2. The first resource acquisition is 83 MW of natural gas-fired peaking technology by the end of 2019. This resource acquisition fills the capacity deficit created by the expiration of the WNP-3 contract with the BPA (82 MW), the expiration of the Douglas County PUD contract for a portion of the Wells hydroelectric facility (28 MW) and load growth. In this IRP evaluation, frame technology SCCTs are preferred. Given the relatively small cost differences between the evaluated natural gas-fired peaker technologies, the ultimate technology selection will be made in a future RFP. Further, technological changes in efficiency and flexibility may mean the Avista will need to revisit this resource choice closer to the actual need. Since the need is six years out, Avista will not release an RFP in the next two years, but will begin a process to evaluate technologies, and potential site locations prior, to a RFP release, likely following the 2015 IRP.

Table 8.2: 2013 Preferred Resource Strategy

Resource	By the End of Year	Nameplate (MW)	Energy (aMW)
Simple Cycle CT	2019	83	76
Simple Cycle CT	2023	83	76
Combined Cycle CT	2026	270	248
Rathdrum CT Upgrade	2028	6	5
Simple Cycle CT	2032	50	46
Total		492	453
Efficiency Improvements	Acquisition Range	Peak Reduction	Energy (aMW)
Energy Efficiency	2014-2033	221	164
Demand Response	2022-2027	19	0
Distribution Efficiencies	2014-2017	<1	<1
Total		240	164

The next resource acquisition is another natural gas-fired peaking technology by the end of 2023. The 2019 acquisition could increase in size to accommodate the 2023 unit, or the 2019 site could be designed to add a second unit later. Given the length in time for this decision, more studies will occur in the next IRP.

The proposed 270 MW CCCT is to replace the Lancaster tolling agreement expiring in October 2026. Avista could renegotiate the current PPA or find other mutual terms to retain the plant for customers. If Avista is not able to retain Lancaster generation, Avista would need to build or procure a similar-sized natural gas-fired unit. The new plant size could meet future load growth needs and could delay or eliminate the need for later two additional resource acquisitions in this plan. Due to the uncertainty surrounding replacing Lancaster, this IRP assumes the replacement is a new facility of similar size. As 2026 approaches, more information and costs will be known and discussed in future IRPs.

Chapter 8 – Preferred Resource Strategy

The 2013 PRS is significantly different from the 2011 IRP resource strategy. The 2011 PRS is in Table 8.3. Since the prior plan, Avista's renewable and capacity needs have changed. First, the 2012 NW Wind need was met with the acquisition of the Palouse Wind PPA and its subsequent commercial operation date of December 2012. Changes in the EIA eliminated the 2019/2020 wind resource acquisition. The amendment under SB 5575 allows the Kettle Falls Generating Station and other legacy biomass resources to be counted as qualifying resources beginning in 2016. Previously, the EIA excluded Kettle Falls due to its age. Another significant change from the 2011 PRS is a lower load growth projection. Loads were expected to grow at 1.6 percent per year in the 2011 IRP. This IRP forecasts 1 percent growth (see Chapter 2, Loads and Resources). This change in load growth delays the first natural gas-fired resource acquisition by one year and eliminates the need for a CCCT in 2023.

Table 8.3: 2011 Preferred Resource Strategy

Resource	By the End of Year	Nameplate (MW)	Energy (aMW)
NW Wind	2012	120	35
Simple Cycle CT	2018	83	75
Existing Thermal Resource Upgrades	2019	4	3
NW Wind	2019-2020	120	35
Simple Cycle CT	2020	83	75
Combined Cycle CT	2023	270	237
Combined Cycle CT	2026	270	237
Simple Cycle CT	2029	46	42
Total		996	739
Efficiency Improvements	Acquisition Range	Peak Reduction (MW)	Energy (aMW)
Distribution Efficiencies	2012-2031	28	13
Energy Efficiency	2012-2031	419	310
Total		447	323

Energy Efficiency

Energy efficiency is an integral part of the IRP analytical process. It also is a critical component of the EIA, where the law requires utilities to obtain all cost effective energy efficiency at below 110 percent of generation alternatives. Avista developed avoided energy costs and compared those figures against a energy efficiency supply curve developed by EnerNOC. The 20-year forecast of energy efficiency acquisitions is in Figure 8.5. Avista plans to acquire 77 aMW of energy efficiency over the next 10 years and 164 aMW over 20 years.⁶ These acquisitions will reduce system peak, shaving 104 MW from peak needs by 2023, and 221 MW by 2033. To illustrate the benefits of energy efficiency, the before and after load forecast is shown in Figure 8.6. Prior to energy efficiency, loads would increase at 1.7 percent per year; with energy efficiency loads growth at 1.07 percent per year. Energy efficiency reduces load growth by 43

⁶ Includes savings with system losses; at the customer's meter savings are 154 aMW.
Avista Corp

Chapter 8 – Preferred Resource Strategy

percent over the 20-year plan. Please refer to Chapter 3 for a more detailed discussion of energy efficiency resources.

Figure 8.5: Energy Efficiency Annual Expected Acquisition

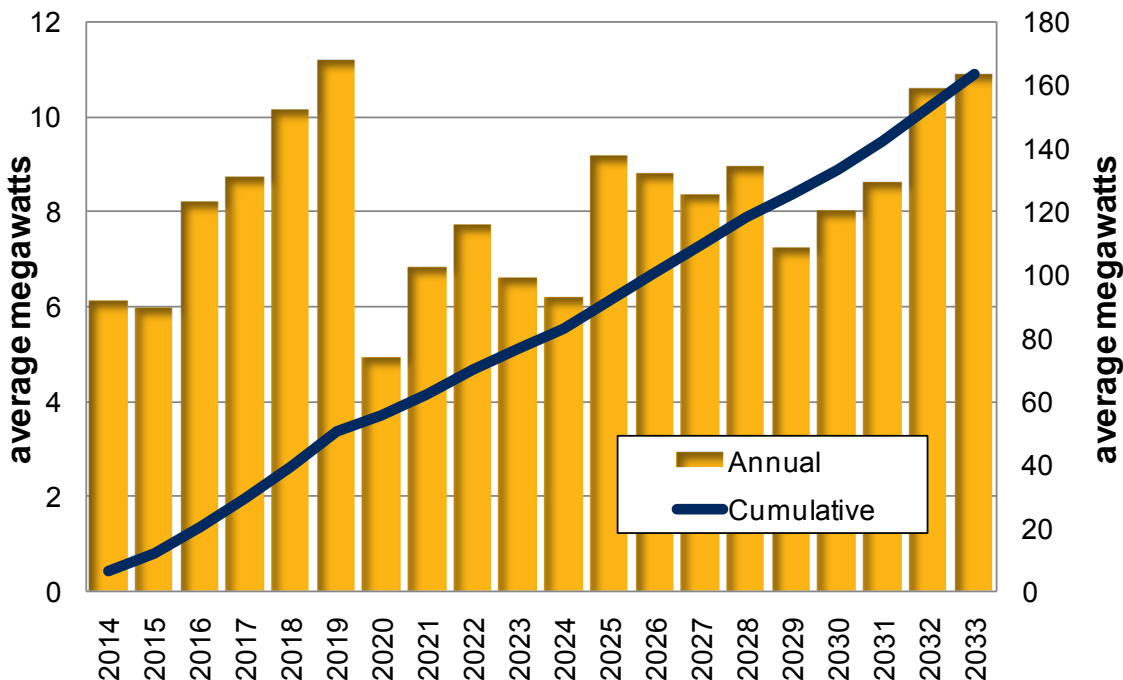
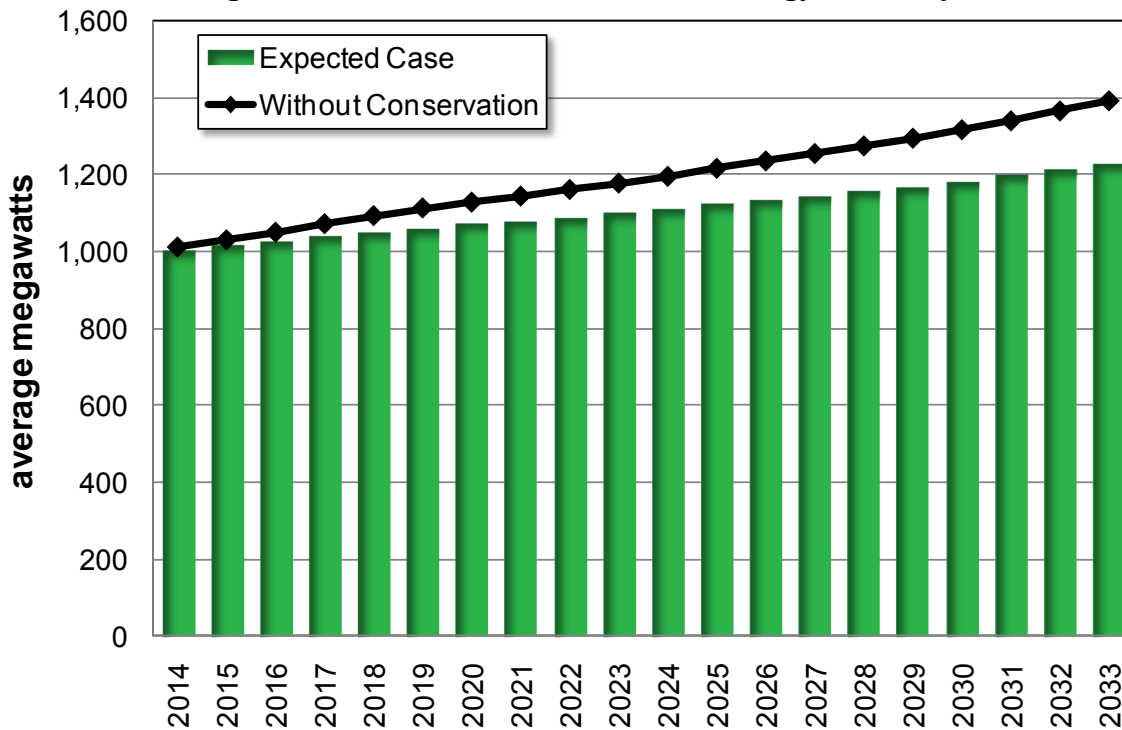

Figure 8.6: Load Forecast with/without Energy Efficiency



Demand Response

For the first time in an Avista IRP, demand response is a selected resource option in the PRS. Demand response is selected beginning in 2022 and continuing through 2027. Demand response could also offset part of the 2019 simple cycle resource, depending on its achievable potential and the actual costs incurred to procure it. Demand response will likely come from industrial and commercial customers with flexible processes; given Avista's limited experience with this resource, demand response research is included as an action item for the IRP.

Distribution Feeder Upgrades

Distribution feeder upgrades entered the PRS for the first time in the 2009 IRP. The upgrade process began with our Ninth and Central Streets feeder in Spokane. The decision to rebuild a feeder considers energy, operation and maintenance savings, the age of existing equipment, reliability indexes, and the number of customers on the feeder. The driver for pursuing a feeder rebuild generally is not energy savings, but rather system reliability. Since the 2011 IRP, several additional feeders were rebuilt. Avista plans to rebuild 13 feeders over the next four years. A broader discussion of our feeder rebuild program is in Chapter 5.

Simple Cycle Combustion Turbines

Avista plans to identify potential sites for new natural gas-fired generation capacity within its service territory ahead of an anticipated need. Avista's service territory has areas with different combinations of benefits and costs. Locations in Washington have higher generation costs because of natural gas fuel taxes and carbon mitigation fees. However, there are other potential benefits of a Washington location, including proximity to natural gas pipelines and Avista's transmission system, lower project elevations providing higher on-peak capacity contributions per investment dollar, and potential for water to cool the facility. In Idaho, lower taxes and fees decrease the cost of a potential facility, but fewer locations exist to site a facility near natural gas pipelines, fewer low cost transmission interconnection points are available, and fewer sites have available cooling water. The identification and procurement of a natural gas project site option will again be an action item for this IRP. Further siting factors for consideration include proximity to neighbors, environmental review, transmission access, pipeline access, elevation, and water availability.

Avista is not specifying a preferred peaking technology until an RFP is completed. Given current assumptions, the resource strategy would select a Frame CT machine. Tradeoffs will occur between capital costs, operating efficiency and flexibility. Frame CT machines are a lower capital cost option, but have higher operating costs and less flexibility, while the hybrid technology has higher capital costs, lower operating costs, and more operational flexibility. Given the hours of operating, the lowest cost option is the less efficient and less flexible Frame CT. Increased flexibility requirements and greenhouse gas emissions costs could make a hybrid machine preferable. If Avista needs regulation or reserve capacity, a hybrid machine may be selected over the Frame CT if no other opportunities were available. If greenhouse gas reductions were identified as the only reason to choose hybrid technology, the emissions reductions would cost

\$147 per reduced metric ton of greenhouse gas emissions. The emissions reductions will not be realized by the owning utility, but rather the power system as a whole. If Avista selected hybrid technology over a Frame CT, the unit would run substantially more hours than the Frame CT causing utility emissions to increase, but regional emissions to slightly decrease because of the higher efficiency of the hybrid machine. Avista plans to study the tradeoffs of peaking technology in the next IRP.

Greenhouse Gas Emissions

Chapter 7, Market Analysis, discusses how greenhouse gas emissions decrease due to coal plant closures because of EPA and state regulations. Avista’s resource mix does not include any retirements due to current or proposed environmental regulations. The only significant lost resource with carbon emissions is the expiration of the Lancaster PPA in 2026, but it will be replaced to maintain system reliability and stabilize rates. Figure 8.7 presents Avista’s expected greenhouse gas emissions (excluding Kettle Falls Generating Station) with the addition of PRS resources. Emissions should not change significantly prior to 2019 other than from year-to-year fluctuations resulting from periodic maintenance outages, market fluctuations, and regional hydroelectric generation levels. Beginning in 2019 additional emissions will occur from new peaking resources, but these resources will not affect overall emissions levels much due to low projected runtime hours. The estimates in Figure 8.6 do not include emissions from purchased power or a reduction in emissions for off-system sales. Avista expects its greenhouse gas emissions intensity from owned and controlled generation to fall from 0.35 short tons per MWh to 0.32 short tons per MWh with the current resource mix and the new generation identified in the PRS.

Figure 8.7: Avista Owned and Controlled Resource’s Greenhouse Gas Emissions

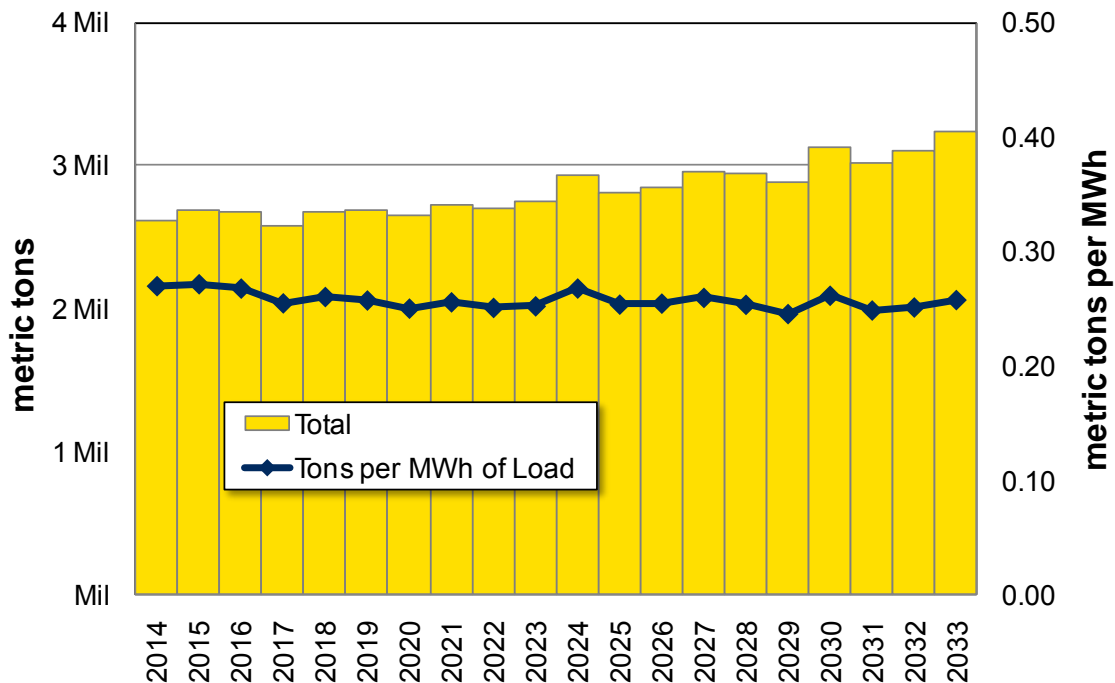

Chapter 8 – Preferred Resource Strategy

Capital Spending Requirements

One of the major assumptions in this IRP is Avista will finance and own all new resources. Using this assumption, and the resources identified in the 2013 PRS, the first capital addition to rate base is in 2020 for the first natural gas-fired peaker. The development is likely to begin multiple years earlier but would likely enter rate base January 1, 2020. Avista may begin making major capital investments for the addition in 2017. The capital cash flows in Table 8.4 include AFUDC, transmission investments for generation, and account for tax incentives, and sales taxes. Over the 20-year IRP timeframe, a total of \$782 million (nominal) in generation and related transmission expenditure is required to support the PRS. The capital investment projection does not include any capital to exercise the Palouse Wind PPA purchase option.

**Table 8.4: PRS Rate Base Additions from Capital Expenditures
(Millions of Dollars)**

Year	Investment	Year	Investment
2014	0.0	2024	91.6
2015	0.0	2025	0.0
2016	0.0	2026	0.0
2017	0.0	2027	421.7
2018	0.0	2028	97.0
2019	0.0	2029	2.4
2020	85.8	2030	0.0
2021	0.0	2031	0.0
2022	0.0	2032	0.0
2023	0.0	2033	83.6
2014-23 Total	85.8	2024-33 Totals	696.2

Annual Power Supply Expenses and Volatility

PRS variance analysis tracks fuel, variable O&M, emissions, and market transaction costs for the existing resource portfolio for each of the 500 Monte Carlo iterations of the Expected Case risk analysis. In addition to existing portfolio costs, new resource capital, fuel, O&M, emissions, and other costs are tracked to provide a range of potential costs to serve future loads. Figure 8.8 shows expected PRS costs through 2033 as the blue bar (nominal dollars). In 2014, costs are expected to be \$24 per MWh. The chart shows costs with a range of two sigma. The lower range is represented by yellow diamonds (\$19 per MWh in 2014) and the upper range is shown with orange dots (\$28 per MWh in 2014). The main driver increasing power supply costs and volatility in future years is natural gas prices and weather (hydro and load variability), Avista increases the volatility assumption of natural gas prices in the future as the commodity price has many unknown future risks and has a history of volatility.

A common IRP question is what will be the change to power supply costs over the time horizon of the plan. Figure 8.9 shows total portfolio costs, but does not account for future load growth that would offset much of the increase as viewed from a customer bill

Chapter 8 – Preferred Resource Strategy

perspective. Figure 8.9 illustrates expected PRS power supply cost changes compared to historical power supply costs, and provides a representation more correlated to future customer bills. Power supply costs, on a per-MWh basis, have increased 2.3 percent per year over inflation between 2002 and 2012. In the next 10 years power supply costs are forecast to fall from 2012 levels if expected energy prices come to fruition along with cost reductions from increased renewable energy credit sales, reduced energy efficiency costs, and consideration of 23 months of increased revenues from a power sale contract with Portland General Electric.⁷

Figure 8.8: Power Supply Expense Range

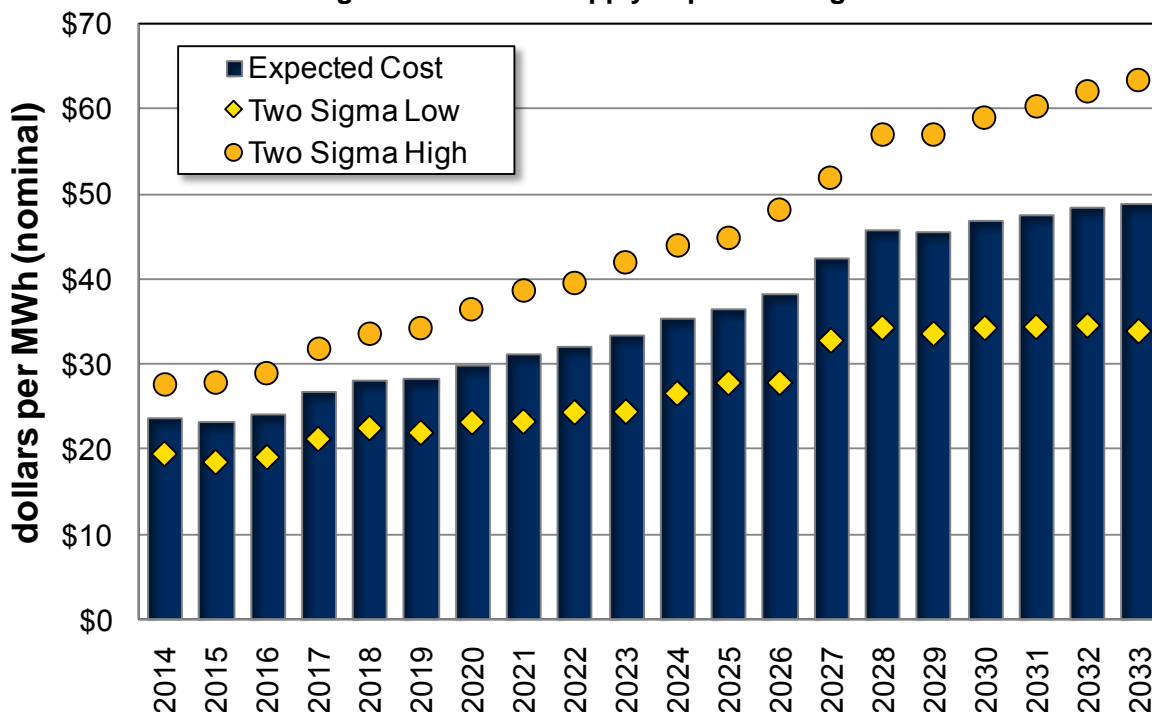

⁷ Since 1998, the capacity payments paid by Portland General Electric to Avista were monetized. Beginning February 2014, the capacity payments will be paid to Avista and reduce power supply costs.
 Avista Corp 2013 Electric IRP 8-14

Chapter 8 – Preferred Resource Strategy

Figure 8.9: Real Power Supply Expected Rate Growth Index \$/MWh (2012 = 100)

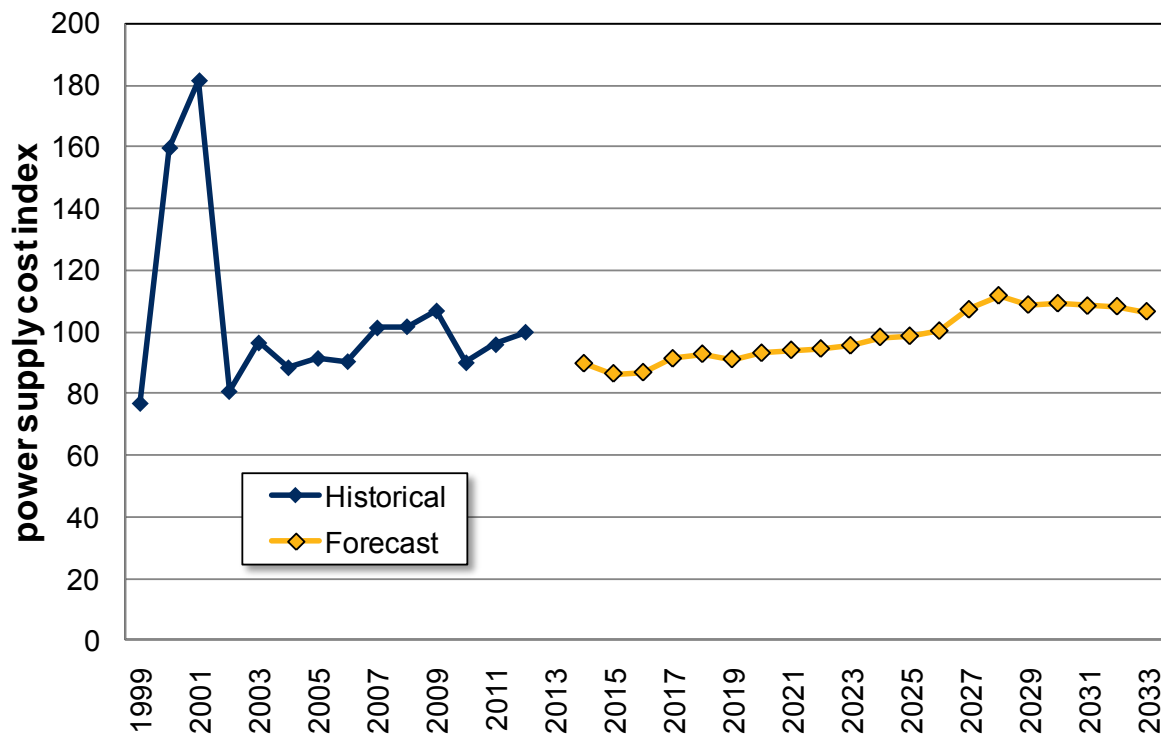

Near Term Load and Resource Balance

Under Washington regulation (WAC 480-107-15), utilities having supply deficits within three years of an IRP filing must file a RFP with the WUTC. The RFP is due to the WUTC no later than 135 days after the IRP filing. After WUTC approval, bids to meet the anticipated capacity shortfall must be solicited within 30 days.

Tables 8.16 and 8.17, shown later in this section, detail Avista's capacity position over the IRP timeframe. With a portion of loads met by Avista's share of the regional capacity surplus, Avista does not require winter capacity until 2019. Simplified summaries for the near-term are displayed below in Tables 8.5 and 8.6. They show short-term capacity deficits met by market transactions in 2015 and 2016. Avista's short positions are short lived as a 150 MW capacity sale to Portland General Electric expires at the end of 2016. As part of the IRP Action Items, Avista will develop a short-term capacity position report to monitor capacity requirements.

Chapter 8 – Preferred Resource Strategy

Table 8.5: Avista Medium-Term Winter Peak Hour Capacity Tabulation

	2014	2015	2016	2017
Load Obligations	1,665	1,683	1,700	1,713
Other Firm Requirements	211	158	158	8
Reserves Planning	359	366	369	362
Total Obligations	2,235	2,206	2,227	2,084
Firm Power Purchases	117	117	117	117
Owned & Contracted Hydro	998	888	889	955
Thermal Resources	1,137	1,137	1,137	1,137
Wind (at Peak)	0	0	0	0
Total Resources	2,252	2,143	2,143	2,210
Net Position	17	-64	-84	126
Short Term Market Purchase	0	75	100	0
Net Position	17	11	16	126

Table 8.6: Avista Medium-Term Summer 18-Hour Sustained Peak Capacity Tabulation

	2014	2015	2016	2017
Load Obligations	1,465	1,482	1,498	1,510
Other Firm Requirements	212	159	159	9
Reserves Planning ⁸	0	0	0	0
Total Obligations	1,677	1,641	1,657	1,519
Firm Power Purchases	29	29	29	29
Owned & Contracted Hydro	701	707	663	631
Thermal Resources	961	961	961	961
Wind (at Peak)	0	0	0	0
Total Resources	1,691	1,698	1,653	1,621
Net Position	14	57	-3	102
Short Term Market Purchase	0	0	25	0
Net Position	14	57	22	102

Efficient Frontier Analysis

Efficient frontier analysis is the backbone of the PRS. The PRiSM model develops the efficient frontier by simulating the costs and risks of resource portfolios using a mixed-integer linear program. PRiSM finds an optimized least cost portfolio for a full range of risk levels. The PRS analyses examined the following portfolios.

⁸ Due to the sustained peak planning methodology, hydroelectric capacity exceeding sustained maximum capability is used for operating and control area reserves.

Chapter 8 – Preferred Resource Strategy

- **Market Only:** Meets all resource deficits with spot market purchases. The portfolio is least cost from a long-term financial perspective, but has the highest level of risk. The strategy fails to meet capacity, energy, and RPS requirements with Avista-controlled assets.
- **Least Cost:** Meets all capacity, energy and RPS requirements with the least-cost resource options. This portfolio ignores power supply expense volatility in favor of lowest-cost resources.
- **Least Risk:** Meets all capacity, energy and RPS requirements with the least-risk mix of resources. This portfolio ignores the overall cost of the selected portfolio in favor of minimizing portfolio volatility (risk).
- **Efficient Frontier:** Meets all capacity, energy and RPS requirements met with sets of intermediate portfolios between the least risk and least cost options. Given the resource assumptions, no resource portfolio can be at a better cost and risk combination than these portfolios.
- **Preferred Resource Strategy:** Meets all capacity, energy and RPS requirements while recognizing both the overall cost and risk inherent in the portfolio. Avista's management chose this portfolio as the most reasonable path to follow given current information.

Figure 8.10 presents the Efficient Frontier. The x-axis is the levelized nominal cost per year for the power supply portfolio, including capital recovery, operating costs, and fuel expense; the y-axis displays the standard deviation of power supply costs in 2028. The year 2028 is far enough out to account for the risk tradeoffs of several resource decisions. If a near term year was selected to measure risk, there would be too few new resource decisions available to distinguish between portfolios. It is necessary to move far enough into the future so load growth provides PRiSM the opportunity to make new resource decisions. By choosing a year later in the planning horizon, relevant resource decisions can be studied.

Avista is not choosing to pursue the least cost strategy, as it relies exclusively on natural gas-fired peaking facilities. This strategy would include more market risk than exists in the portfolio today because the portfolio would trade the Lancaster (CCCT plant) for a SCCT. The PRS instead diversifies Avista's resource mix with peaking and combined-cycle natural gas-fired plants. Further, based on an analysis of the efficient frontier, the additional cost of this strategy is near zero (0.1 percent) on an NPV basis and reduces market risk by 11 percent. Table 8.7 shows a sampling of portfolios along the efficient frontier with the costs, risks, and carbon emissions described.

Chapter 8 – Preferred Resource Strategy

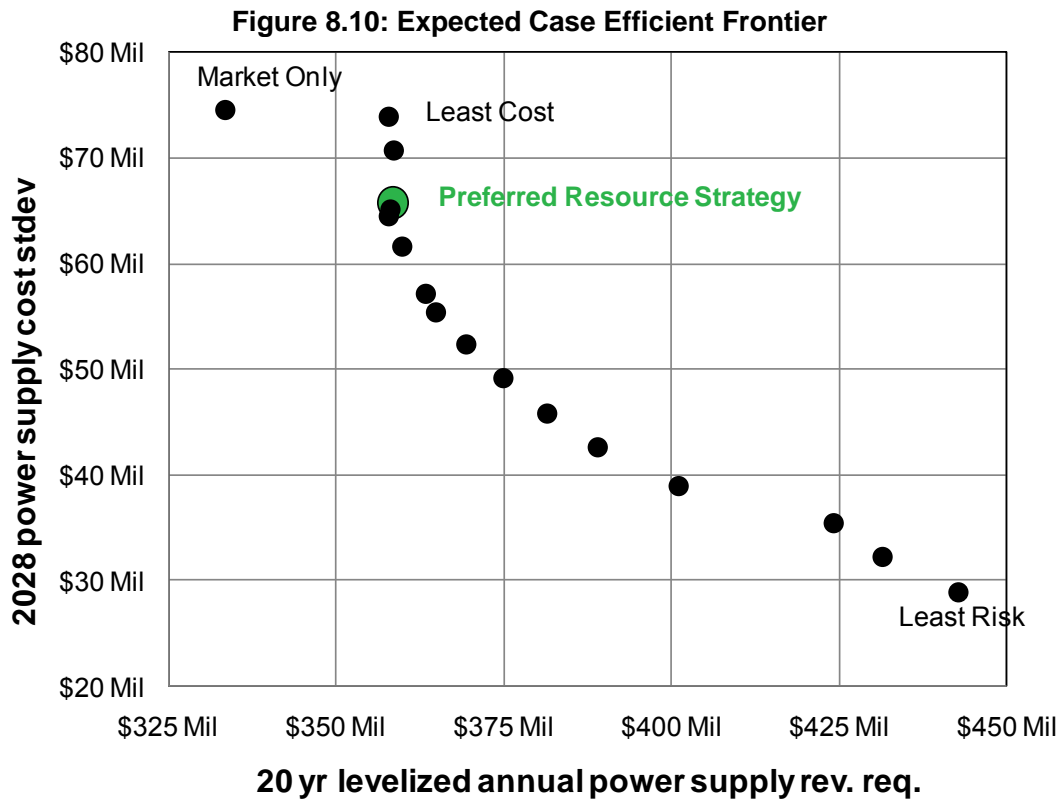

Table 8.7: Efficient Frontier Sample Resource Mixes

Nameplate (MW)	PRS	Low Cost	Medium High Risk	Medium Risk	Medium Low Risk	Low Risk
Combined Cycle CT	270	-	270	270	540	540
Natural Gas-Fired Peaker	299	566	296	216	100	68
Wind	-	-	-	30	50	350
Solar	-	-	-	-	-	-
Biomass	-	-	-	-	-	50
Coal (sequestered)	-	-	-	-	-	-
Hydro Upgrade	-	-	-	-	-	-
Thermal Upgrade	6	6	6	85	85	80
Demand Response	19	20	20	8	12	17
Total (excluded efficiency)	594	592	592	609	788	1,104
Power Supply Revenue Requirement Cost Metrics (Millions)						
20-yr Levelized Cost	\$358.4	\$357.9	\$357.9	\$362.3	\$367.0	\$396.0
2028 Power Supply Std Dev	\$65.7	\$74.0	\$64.4	\$60.5	\$54.1	\$40.2
2033 GHG Emissions (millions of metric tons)	3.2	2.9	3.4	3.4	3.9	3.8

Determining the Avoided Costs of Energy Efficiency

The efficient frontier methodology determines the avoided cost of the new resource additions included in the PRS. There are two avoided cost calculations for this IRP: one for energy efficiency and one for new generation resources. The energy efficiency avoided cost is higher because it includes various benefits beyond generation resource value, as detailed in Table 8.8.

Avoided Cost of Energy Efficiency

Three portfolios are required to derive the supply-side cost components of the avoided cost for energy efficiency calculations. The differences between each portfolio sum to the avoided cost of energy efficiency:

- **Commodity Energy (Market Only):** This resource portfolio includes no new resource additions and the incremental cost of new power supply is the cost to buy power from the short-term market. These prices used are determined from the long-term energy price forecast discussed in Chapter 7.
- **Capacity:** This resource portfolio builds a least-cost strategy to meet peak demand. The difference between the Commodity Energy and Capacity strategies equals the capacity value of the new resources. This estimate typically shows the incremental cost divided by the incremental kilowatts of installed capacity. For this example the \$/kW adder is translated to \$/MWh assuming a flat energy delivery.
- **Pre-Preferred Resource Strategy:** This resource portfolio is similar to the PRS resource mix, but it assumes Avista does no further energy efficiency.

The avoided cost of energy efficiency includes the various components of avoided cost only in those periods where Avista is deficit. For example, the avoided costs of energy efficiency programs only include a capacity value in the years where Avista has capacity needs. Further, the commodity component applies to each energy efficiency program depending on the expected timing of its energy delivery. For example, an air conditioning program receives an energy value based on expected savings in the summer months when actual energy savings occur.

The EIA requires avoided costs used for energy efficiency to be increased by 10 percent to incent energy efficiency acquisition in the IRP. Additionally, reduced transmission and distribution losses, and operations and maintenance are credited in the avoided cost of energy efficiency. The following formula details the avoided cost for energy efficiency measures.

Equation 8.2: Energy Efficiency Avoided Costs

$$\{(E + PC + R) + (E * L) + DC\} * (1 + P)$$

Where:

E = Market energy price. The price calculated with AURORA^{XMP} is \$44.08 per MWh.

Chapter 8 – Preferred Resource Strategy

PC = New resource capacity savings. This value is calculated using PRiSM and is estimated to be \$11.74 per MWh.

R = Risk premium to account for RPS and rate volatility reductions. This PRiSM-calculated value is \$1.89 per MWh.

P = Power Act preference premium. This is the additional 10 percent premium given as a preference towards energy efficiency measures.

L = Transmission and distribution losses. This component is 6.1 percent based on Avista's estimated system average losses.

DC = Distribution capacity savings. This value is approximately \$10/kW-year or \$1.35 per MWh.

Table 8.8 estimates the levelized avoided cost for a theoretical energy efficiency program reducing load by one megawatt each hour of the year:

Table 8.8: Nominal Levelized Avoided Costs of the PRS (\$/MWh)

	2014-2033
Energy Forecast	44.08
Capacity Value	11.74
Risk Premium	1.89
Transmission & Distribution Losses	2.69
Distribution Capacity Savings	1.35
Power Act Premium	6.17
Total	67.92

Determining the Avoided Cost of New Generation Options

Avoided costs change as new information becomes available, including changes to market prices, loads, and resources. Therefore, the estimates in Table 8.9 must be updated at the time a new resource is evaluated. Table 8.9 shows the avoided costs derived from the Preferred Resource Strategy. These prices represent the value of energy from a project making equal deliveries over the year in all hours. In this case, a new resource (such as PURPA qualifying project) would not qualify for capacity payments until 2020, because Avista does not need capacity resources until then.

Chapter 8 – Preferred Resource Strategy

Table 8.9: Updated Annual Avoided Costs (\$/MWh)

Year	Energy	Capacity	Risk	Total
2014	31.02	0.00	0.00	31.02
2015	33.06	0.00	0.00	33.06
2016	33.91	0.00	0.00	33.91
2017	34.14	0.00	0.00	34.14
2018	36.18	0.00	0.00	36.18
2019	38.29	0.00	0.00	38.29
2020	41.34	15.15	0.56	57.06
2021	43.72	15.77	0.59	60.08
2022	46.06	16.41	0.61	63.09
2023	48.85	17.08	0.64	66.57
2024	49.52	17.78	0.66	67.96
2025	49.35	18.50	0.69	68.54
2026	52.04	19.26	0.72	72.01
2027	53.37	20.04	0.75	74.16
2028	55.65	20.86	0.78	77.29
2029	57.94	21.71	0.81	80.46
2030	61.39	22.59	0.84	84.82
2031	63.06	23.51	0.87	87.44
2032	65.65	24.47	0.91	91.03
2033	66.97	25.47	0.95	93.38

Efficient Frontier Comparison of Greenhouse Gas Policies

In addition to the stochastic Expected Case, Avista evaluated a National Climate Change policy scenario. Several hypothetical climate change policies are included in the 500 Monte Carlo market futures to capture the range of policy alternatives (see Chapter 7, Market Analysis for further detail). Given the higher market prices resulting from climate legislation, 20.5 aMW of additional energy efficiency would be acquired over the IRP period, a 12.5 percent increase. The cost of this incremental energy efficiency is 37 percent higher than in the Expected Case.

Except for increased energy efficiency, the PRS under the National Climate Change policy remains similar to the Expected Case's strategy. Somewhat surprisingly, this scenario increases the total resource build, but natural gas-fired frame peaking resources are replaced with hybrid CTs. This change reflects the increasing margin of lower heat rate machines. A detail of the Least Cost strategy, and the likely PRS, under a National Climate Change policy is in Table 8.10.

Chapter 8 – Preferred Resource Strategy

Table 8.10: Alternative PRS with National Climate Change Legislation

Resource	By the End of Year	Nameplate (MW)	Energy (aMW)
Simple Cycle CT	2019	92	85
Simple Cycle CT	2024	92	85
Combined Cycle CT	2026	270	248
Rathdrum CT Upgrade	2024	6	5
Simple Cycle CT	2032	92	85
Total		552	508
Efficiency Improvements	By the End of Year	Peak Reduction	Energy (aMW)
Energy Efficiency	2014-2033	249	185
Demand Response	2022-2027	5	0
Distribution Efficiencies	2014-2017	<1	<1
Total		254	185

Figure 8.11 illustrates the efficient frontier in the Expected Case and a case with National Climate Change legislation. With climate change legislation, the cost curve moves to the right, showing increased customer costs. The curve also shows lower risk, because higher risk resources, such as frame CTs, are no longer the least cost resource. The most cost effective resource shifts from frame CTs to hybrid CTs. A carbon-pricing regime would also increase the amount of energy efficiency pursued by Avista. Figure 8.11 shows this efficient frontier in orange. The higher avoided cost of the national climate change policy increases the amount of energy efficiency, thereby reducing risk through lower loads, but with increased costs.

The lesson learned from this scenario is the utility's cost and financial risk increases. If climate policies were enacted, Avista likely would acquire more energy efficiency. This additional energy efficiency would reduce risk, but at overall higher costs. In reality, if this legislation is passed, a new portfolio would be developed to select resources better suited to a carbon-restricted environment; in this case, Frame CT's are traded for hybrid CTs, lowering risk and lowering cost. Table 8.11 summarizes these cost and risk changes. Since Avista's resource need is at the end of the decade, Avista is able to postpone its technology decision until closer to the time of need.

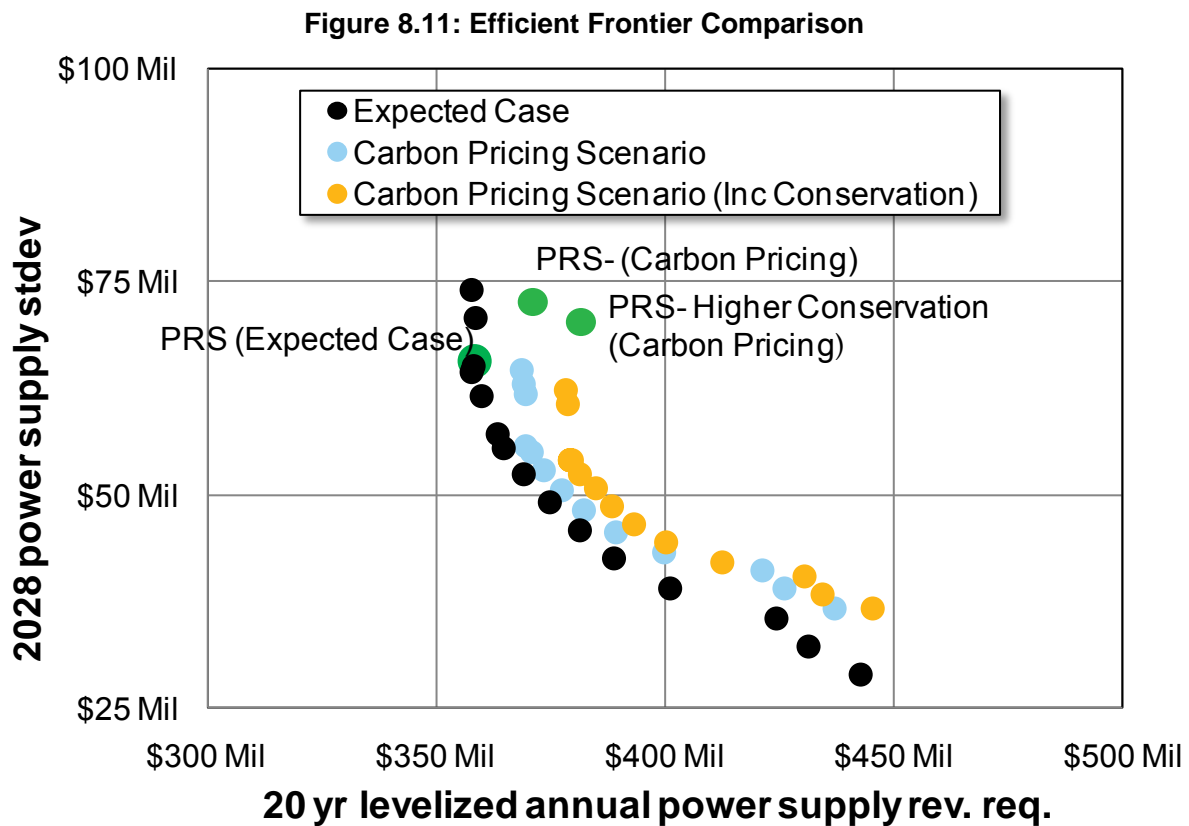

Table 8.11: Preferred Portfolio Cost and Risk Comparison (Millions \$)

Portfolio	20-Yr Power Supply Levelized Cost	
	Expected Case	Carbon Pricing Scenario
PRS	358.4	367.3
PRS w/ Higher Efficiency	365.0	377.8
Climate Scenario- PRS	364.7	374.5
Portfolio	2028 Power Supply Cost Standard Deviation	
	Expected Case	Carbon Pricing Scenario
PRS	65.7	72.6
PRS w/ Higher Efficiency	63.9	70.3
Climate Scenario- PRS	61.0	63.6

Energy Efficiency Scenarios

Due to the complexities introduced by EIA, energy efficiency is not directly modeled in PRISM. Instead, it is separately modeled using the avoided costs discussed above. Avista has found this method of determining energy efficiency investments is robust.

Chapter 8 – Preferred Resource Strategy

Refer to Figure 8.12 for an illustration of this point. This figure demonstrates the changes in risk and cost from the point of view of the PRS and the efficient frontier.

Under current Washington rules, Avista must acquire all cost effective energy efficiency up to 110 percent of the avoided cost. Energy efficiency resources are oversubscribed compared to alternative generating resource options. To illustrate this concept, a portfolio acquiring energy efficiency up to 100 percent of avoided costs is shown as a “light blue dot”. This portfolio adds 154 aMW of energy efficiency (rather than the 168 aMW from the PRS shown as the “green diamond”). This portfolio illustrates power supply costs would be 2.7 percent lower and risk would be 0.3 percent higher if the utility could select this portfolio. This portfolio does not appear on the efficient frontier and is considered more optimal than any portfolio on the efficient frontier as it is to the left of the valid portfolio options, but is an invalid option due to the EIA requirement to over-invest in energy efficiency. A scenario acquiring energy efficiency to a level more consistent with its true contribution to the portfolio likely would lower costs.

If Avista did not acquire any energy efficiency, total power supply costs and risks would increase. This portfolio, shown as a dark orange dot, is 8.6 percent more expensive than the PRS and has 20 percent more risk. This confirms energy efficiency is an effective tool to lower costs and risks, but must be properly balanced to achieve optimal benefits for customers.

Three additional studies illustrating the effect of acquiring energy efficiency beyond 110 percent of cost effectiveness. These portfolios are shown as an orange dot for 125 percent of avoided costs and as a light orange dot for 150 percent of avoided cost in Figure 8.12. These options add 3.6 percent and 8.6 percent to the power supply costs and reduce volatility by 2.9 percent and 5.0 percent respectively. The light blue dot shows the 100 percent of avoided costs case. The efficient frontier illustrates these risk reductions are achievable at lower cost by acquiring generation instead of energy efficiency resources. Further information on the energy efficiency analysis is in Chapter 3, Energy Efficiency. Table 8.12 captures the resource selection of each of these portfolios, the costs, risks and carbon emissions.

Chapter 8 – Preferred Resource Strategy

Figure 8.12: Efficient Frontier Comparison

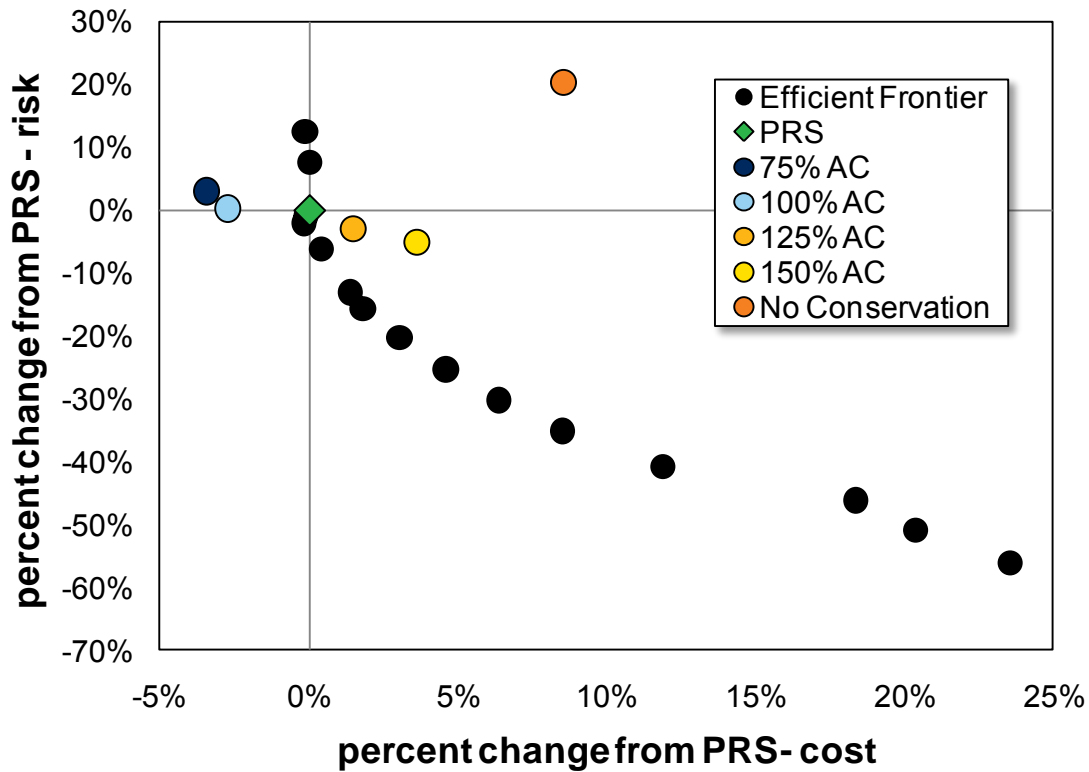

Table 8.12: Preferred Portfolio Cost and Risk Comparison for Avoided Cost Studies

Nameplate (MW)	75%	100%	PRS	125%	150%	0%
Combined Cycle CT	270	270	270	270	270	270
Natural Gas-Fired Peaker	313	316	299	271	228	481
Wind	-	-	-	-	-	-
Solar	-	-	-	-	-	-
Biomass	-	-	-	-	-	-
Coal (sequestered)	-	-	-	-	-	-
Hydro Upgrade	-	-	-	-	-	68
Thermal Upgrade	6	-	6	6	6	-
Energy Efficiency (aMW)	139	154	164	185	201	-
Demand Response	20	19	19	20	20	20
Total	748	748	758	752	725	839
20-year Levelized Cost (millions)	\$346.1	\$349.5	\$354.8	\$363.7	\$371.3	\$389.1
2028 Power Supply Stdev (millions)	\$67.7	\$66.0	\$65.7	\$63.8	\$62.4	\$79.2
2033 Greenhouse Gas Emissions (millions of metric tons)	3.2	3.2	3.3	3.2	3.1	3.2

Colstrip

Coal-fired generation has been the target of increased regulatory and legal attention. Colstrip is a four unit coal-fired plant jointly owned by Avista, NorthWestern Energy, PacifiCorp, PPL- Montana, Portland General Electric, and Puget Sound Energy. Avista's share of the plant is 15 percent of Units 3 and 4, or 222 MW. Units 3 and 4 are newer and larger technology than Units 1 and 2. Avista has no ownership interest in Units 1 or 2 at Colstrip.

As part of the 2011 IRP acknowledgement, the UTC requested that Avista study two Colstrip scenarios. The first scenario is a cost and utility impact if Colstrip is not part of Avista's resource portfolio. The second case examines the costs and utility impacts on Colstrip (Units 3 and 4) from additional environmental controls to meet potential new rules from the EPA. These portfolio scenarios are studied in the Expected Case and the Carbon Pricing scenarios.

No Colstrip Resource Strategy Scenario

In the scenario where Colstrip Units 3 and 4 are no longer resources for Avista customers, Colstrip exits the portfolio at the end of 2017. This case focuses on the costs and risk to replace its capacity and energy, not the revenues from a sale of the asset or the cost of reclamation. Table 8.13 shows an alternative PRS excluding Colstrip Units 3 and 4. The major difference between a portfolio with and without Colstrip is the addition of a CCCT to replace Colstrip Units 3 and 4 in 2017; the remaining portfolio is very similar to the Expected Case PRS.

Table 8.13: No Colstrip Resource Strategy Scenario

Resource	By the End of Year	Nameplate (MW)	Energy (aMW)
Combined Cycle CT	2017	270	248
Simple Cycle CT	2020	50	46
Simple Cycle CT	2023	50	46
Combined Cycle CT	2026	270	248
Simple Cycle CT	2026	51	47
Simple Cycle CT	2029	55	51
Simple Cycle CT	2032	50	46
Total		797	733
Efficiency Improvements	By the End of Year	Peak Reduction (MW)	Energy (aMW)
Energy Efficiency	2014-2033	221	164
Demand Response	2022-2027	20	0
Distribution Efficiencies	2014-2017	<1	<1
Total		241	164

Chapter 8 – Preferred Resource Strategy

Removing Colstrip Units 3 and 4 from Avista’s resource portfolio has a large impact on portfolio costs. Figure 8.13 illustrates the cost impact. In the Expected Case, the present value of added cost is \$505 million or \$52.4 million per year levelized. This is 12.8 percent higher than the PRS (includes Avista’s Colstrip generation). Greenhouse gases decrease by 1.2 million short tons in 2018 and one million tons on average over the 16 years of the study, as shown in Figure 8.14.⁹ The average greenhouse gas reduction cost Avista customers is \$45 per metric ton (levelized).

Using the carbon-pricing scenario, levelized costs increase by \$47.2 million or 10.9 percent per year. In any case evaluated, removing Colstrip Units 3 and 4 from Avista’s resource portfolio creates significantly higher customer costs. To understand the annual impact to power supply expense and risk, Figure 8.15 shows the Expected Case cost difference without Colstrip, and two-sigma tail risk. In the first year, Power Supply Costs are expected to be over \$60 million higher than with the plant, and slowly fall as the substitute plant is depreciated. Another way to look at the increased costs without Colstrip Units 3 and 4 is in Figure 8.16. This figure shows the power supply cost index from earlier in this chapter and includes the no-Colstrip scenario.

Figure 8.13: 2018-33 Power Supply Costs with and without Colstrip Units 3 and 4

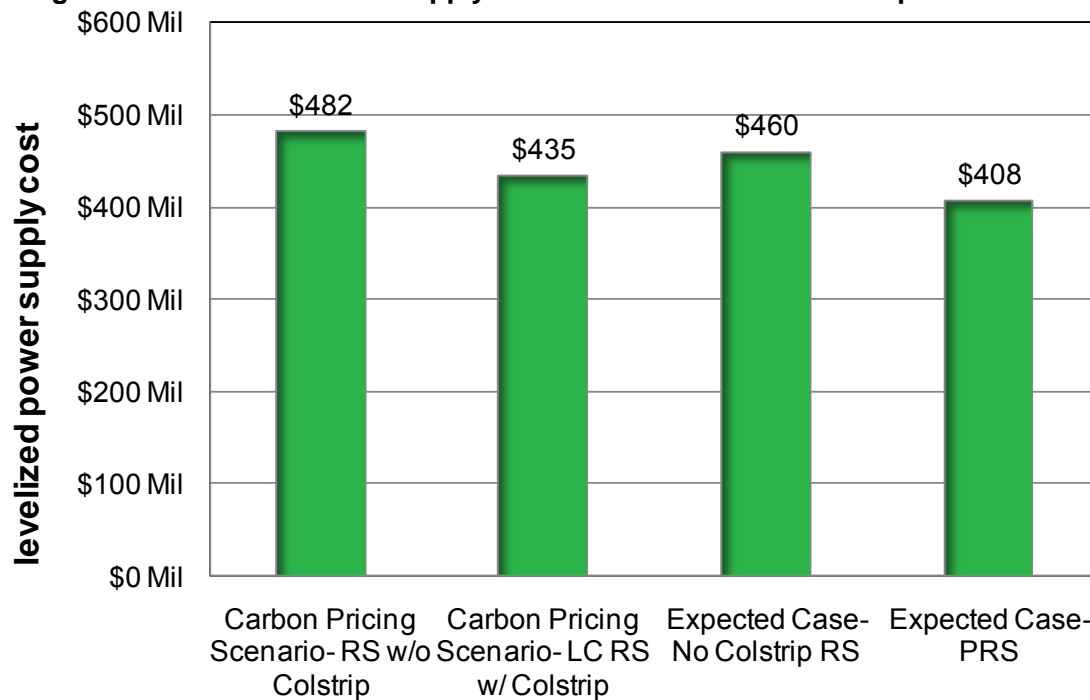

⁹ This figure does not include the carbon neutral emissions from Kettle Falls.
Avista Corp

Chapter 8 – Preferred Resource Strategy

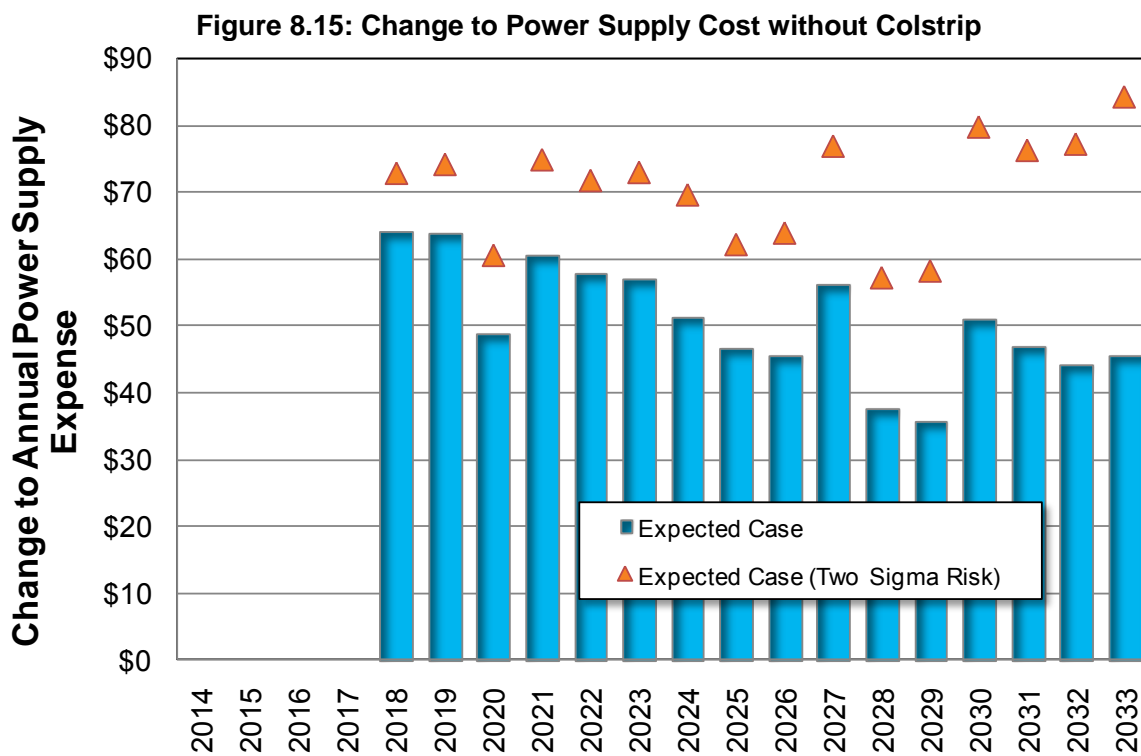
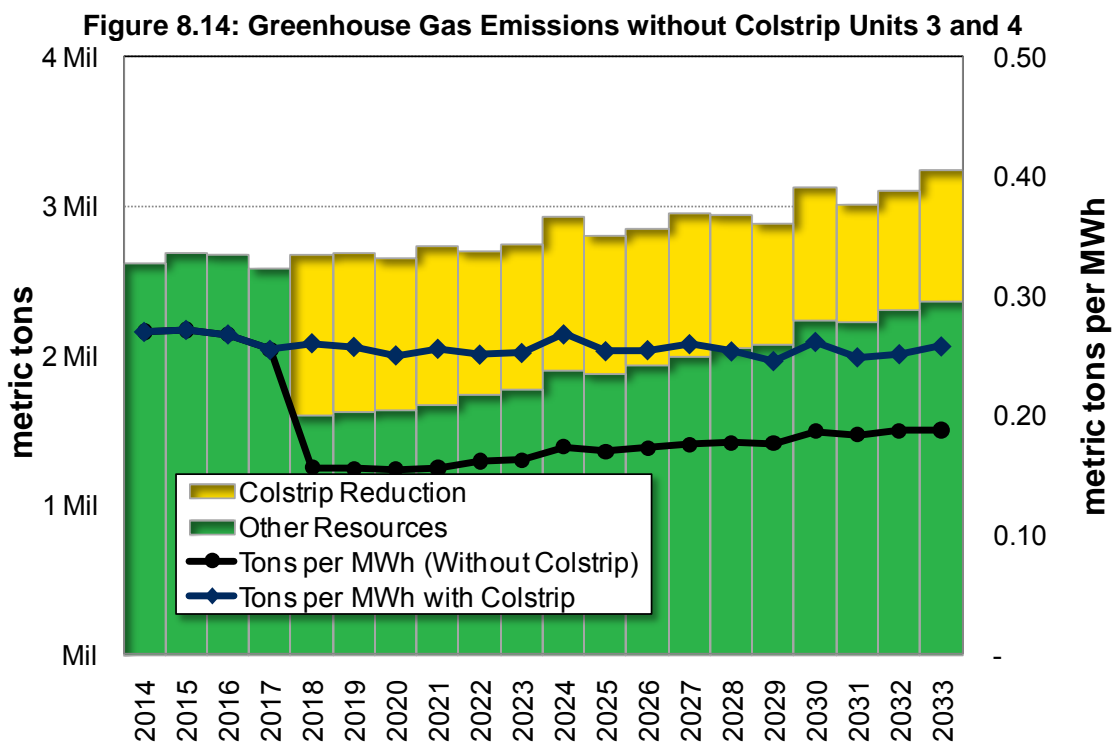

Chapter 8 – Preferred Resource Strategy

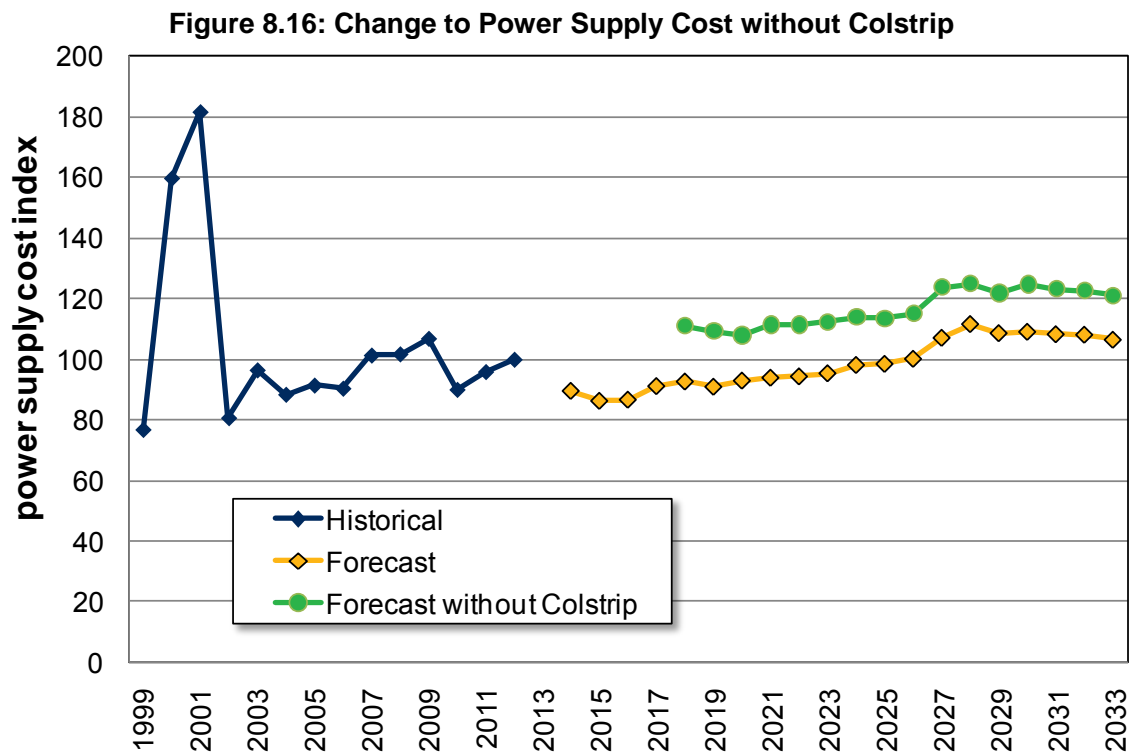

Environmental Control Review

There are potential costly regulations Colstrip Units 3 and 4 could face over the next 20 years of this resource plan if state or federal agencies promulgate new coal-fired generation environmental regulations. This section identifies anticipated regulations the EPA could establish over the time horizon of this plan based on information available during the development of this plan. The President's Climate Action Plan was released after the analysis for this IRP was completed, but details about the plan are in Chapter 4, Policy Considerations. Avista will monitor and review implications of the plan as they develop. This discussion is speculative unless otherwise noted and only pertain to Colstrip Units 3 and 4. The following section discusses four main areas of possible new environmental regulations.

Hazardous Air Pollutants

MATS is for the coal and oil-fired source category. For Colstrip Units 3 and 4, existing emission control systems should be sufficient to meet MATS limitations.

Coal Ash Management/Disposal

Avista does not anticipate a significant change in operation at Colstrip Units 3 and 4 due to coal ash management or disposal issues at this time.

Effluent Discharge Guidelines

Avista does not anticipate a significant change in operation at Colstrip Units 3 and 4 due to coal ash management or disposal issues at this time because it is a zero discharge facility managing wastewater onsite.

Regional Haze Program

Colstrip Units 3 and 4 will be evaluated for reasonable progress on approximately 10-year intervals going forward. Avista anticipates Nitrous Oxides (NO_x) emission controls could be required in 2027. The cost to comply with this potential regulation is unknown due to technology changes potentially on the horizon to reduce NO_x emissions. In order to understand this regulation if imposed on Colstrip Units 3 and 4 using existing technology, a study was completed and submitted to EPA in 2010.

This study evaluates whether or not the cost of installing this existing technology would have an impact on the ongoing operations of the Colstrip Units 3 and 4. The study estimated the cost of a SCR NO_x control to be \$280 million per unit (2011 dollars); Avista chose to increase these estimates by 25 percent to account for potential retrofit costs. Further, Avista believes these control costs are on the high end of the cost range. In this case, Avista's share of this cost for both units would be \$105 million in capital, and about \$560,000 in annual O&M (2014\$). Over the life of this technology, the levelized cost of the controls is \$8.39 per MWh (2014 dollars nominal). Further analysis is in Figure 8.17. This chart illustrates three scenarios for the two market price forecasts (Expected Case and Carbon Pricing Scenario). The results shown in the Expected Case's removal of Colstrip Units 3 and 4 from the portfolio adds \$34 million or (6.1 percent) to power supply costs compared to installing the SCR controls scenario. In the Carbon Pricing Scenario, \$25 million per year is added or 4.3 percent per year without Colstrip Units 3 and 4 compared to installing the SCR. Based on this study using high cost to comply with potential regional haze regulation costs, Colstrip Units 3 and 4 remain a viable and cost-effective resource for Avista's customers.

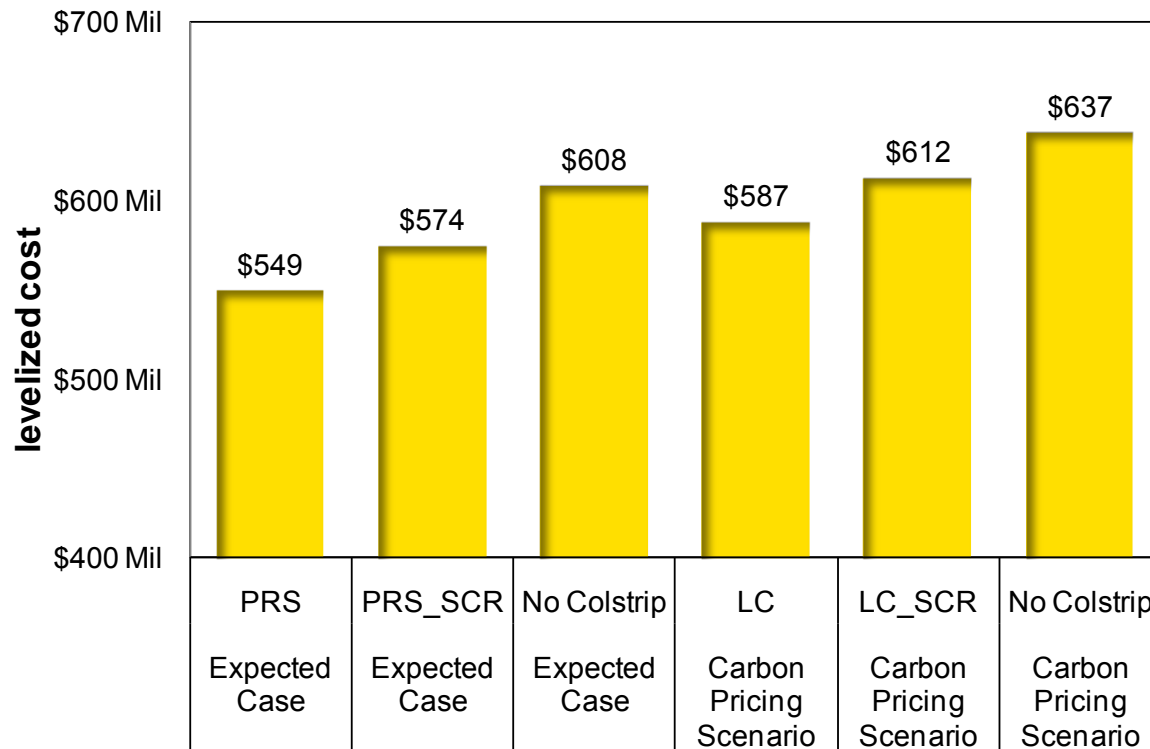
Figure 8.17: Annual Levelized Cost (2027-33) of Colstrip Scenarios

Other Portfolio Scenarios

Avista examined a number of possible policy outcomes affecting future resource selection. These scenarios review how Avista's resource strategy might change in response to new policies

Higher Washington RPS

Avista's current resource mix fully meets the EIA, but it is possible new legislation or a citizen's initiative could increase the renewable goals further. This scenario contemplates this change to understand the resulting cost, risk, and emissions impacts. The scenario assumes an additional step in the renewable goal of 25 percent of Washington retail sales to be from qualified renewables. Such a goal would require Avista to add 77 aMW of qualified renewables beyond the present plan. The PRiSM model found the most cost-effective method to meet this requirement, with a similar risk profile to the PRS would be Spokane River hydroelectric upgrades. Both Long Lake (68 MW) and Monroe Street (55 MW) second powerhouse additions would meet the renewable requirement if they were certified as EIA-qualifying resources. The addition of these upgrades would prevent the final natural gas peaking resource from being required in the PRS. While the 20-year levelized cost is slightly higher than the PRS, the costs between 2025 and 2033 are \$18 million levelized higher, or 3.5 percent.

Chapter 8 – Preferred Resource Strategy

National RPS

Over the past several years, several bills have proposed national RPS legislation. This legislation has not been enacted, but is a potential future scenario to understand. Differences in the proposals have ranged from the type of resources qualifying for the RPS, percentages and timing of renewables required, and hydroelectric netting.¹⁰ For the National RPS scenario, Avista assumes a 20 percent renewable standard with hydroelectric generation (existing or new) netted from load. Given these assumptions, 78 aMW of renewables would be required by the end of this plan. The hydro netting provision would have an impact on how Avista would meet this potential law. As shown in the higher Washington RPS scenario hydro upgrades were selected in the national RPS scenario. If the hydro netting provision counted hydro upgrades as a load reduction rather than a qualifying renewable resource, the hydro upgrades would need to be replaced by new wind generation.

Higher Capacity Planning Margins

This IRP uses a 14 percent planning margin (plus operating reserves) above the winter peak load forecast. Planning margins are not necessarily a precise target and there is no universally accepted standard. To increase reliability, and to protect Avista's customers from the potential of regional power shortages, a higher planning margin standard could be implemented. This scenario increases the planning margin to 20 percent, or an additional 117 MW by the end of plan. In addition to requiring more capacity on the planning horizon, Avista's first-year deficit would occur earlier in 2016.

2011 IRP Preferred Resource Strategy

This scenario illustrates the impacts of changes since the 2011 IRP. Since then, load growth has fallen from 1.6 percent to 1.0 percent per year, reducing Avista's need for new capacity. In addition to load growth changes, the Washington RPS was amended to include Kettle Falls and other legacy biomass projects as a qualifying renewable resource beginning in 2016. These changes eliminate the need for new resources following Avista's recent acquisition of output from the Palouse Wind project.

¹⁰ Hydroelectric netting subtracts a utility's hydroelectric generation from the amount of load that the utility would have their RPS based on. For example, a utility with 1,000,000 MWh of load and 300,000 MWh of hydroelectric generation would only have an RPS requirement based on 700,000 MWh of load.

Table 8.14: Policy Portfolio Scenarios

Nameplate (MW)	PRS	Higher WA St. RPS	National RPS	Higher Capacity Margins	2011 PRS
CCCT	270	270	270	270	540
Natural Gas-Fired Peaker	299	249	296	435	187
Wind	-	-	203	-	120
Solar	-	-	-	-	-
Biomass	-	-	-	-	-
Coal (sequestered)	-	-	-	-	-
Hydro Upgrade	-	148	-	-	-
Thermal Upgrade	6	6	6	6	-
Demand Response	19	10	20	8	-
Total	594	683	795	718	847
20-year Levelized Cost (millions)	\$354.8	\$360.3	\$365.3	\$364.2	\$373.9
2028 Power Supply Stdev (millions)	\$65.7	\$64.8	\$63.6	\$65.8	\$54.0
2033 Greenhouse Gas Emissions (millions of metric tons)	3.2	3.2	3.3	3.4	3.7

Resource Tipping Point Analysis

In many resource plans, a PRS is presented with a comparison to other portfolios to help illustrate cost and risk trade-offs. This IRP extends the portfolio analysis beyond this exercise by focusing on how the portfolio might change if key assumptions changed. This section identifies assumptions that could alter the PRS, such as changes to load growth, varying resource capital costs, the emergence of other non-wind and non-solar renewable options, or an expansion of the region's nuclear generation fleet.

Solar Capital Costs Sensitivity

For the past several years, photovoltaic solar generation costs have decreased and more solar generation installed. Solar has benefited from the federal 30 percent ITC, accelerated depreciation, and lucrative state incentives. Solar price decreases have allowed the technology (with government subsidies) to be cost effective compared with retail utility rates in some parts of the western US. After a review of solar potential in the Northwest, and the needs of our system, solar is not a good fit. As discussed throughout this document, Avista and the Northwest require new capacity for winter peak periods. Avista (and the region) experience winter peaks between 6:00 am and 8:00 am or between 5:00 pm and 6:00 pm. In December and January, the months most likely for a peak to occur, these hours have very little or no sunlight. Adding solar to Avista's resource mix will not delay or remove the need for other resource options. Solar costs would have to fall by a further 88 percent to be cost effective compared to other options.

Nuclear Capital Cost Sensitivity

Nuclear power has made a small resurgence on the U.S. energy-planning horizon, with several large East Coast utilities planning construction of the multi-billion dollar projects. Nuclear's resurgence is driven by a search for low greenhouse gas emitting base-load

Chapter 8 – Preferred Resource Strategy

power. Avista is not large enough, nor does Avista have the load requirements, to construct a large-scale nuclear plant. It is possible that a group of utilities could co-develop a large project, but the failure of the past regional attempt in the 1980s makes that option unlikely. New research has begun on smaller scale nuclear facilities to make the technology more readily available to smaller utilities. This sensitivity study reduces nuclear capital costs until it was picked as a resource in the PRiSM model. Selection by PRiSM indicates lower cost than other options. The model selected nuclear when its capital costs decreased by 70 percent.

IGCC Coal with Sequestration Capital Cost Sensitivity

Like nuclear facilities, much attention has been given to coal gasification along with the sequestration of CO₂ emissions. Also like nuclear power, this technology is expensive, has long lead times, and requires large project scale. The plant is beyond Avista's needs, but a group of utilities could jointly develop a sequestered coal plant. In order to be selected by the PRiSM model, and compete economically with other options, sequestered IGCC capital costs would need to decrease 87 percent from present estimates. Like nuclear plants, the technology has high O&M costs. The O&M costs are nearly as much as the total cost of natural gas CTs including fuel.

Load Forecast Alternatives

An important test in an IRP is to understand how the plan should change with alternative load growth sensitivities. Since Avista's first new resource need is not until the end of 2019, Avista has time to change its resource needs if loads grow faster or slower than predicted. In order to be nimble Avista must have resource options available to quickly add capacity. Three different resource positions based on varying load growth scenarios, along with the Expected Case, are shown below in Figure 8.18. Chapter 2 discusses the economic drivers of these forecasts. The Low Load Growth scenario changes Avista's first deficit year, but the High caseload Growth scenario increases the need from 42 MW to 88 MW. The Low Load Growth and the Medium Load Growth cases push the need to 2024 or 2022 respectively. Toward the end of the plan, the range in resource need is 267 MW between the High and Low Load Growth cases.

Table 8.15 shows the generation resource strategies meeting the load growth alternatives. These strategies are designed to have similar resource portfolios and risk levels as the PRS. Energy efficiency levels also change, reflecting the expected achievable cost effective levels given the changes to new construction assumed in the load forecast scenarios. Energy efficiency levels will differ depending on the amount of existing structures versus new structures, because new structures are built with more efficient building codes. Energy efficiency for existing structures should remain relatively unchanged, but as economic activity changes, the amount of energy efficiency from new construction will vary. Since 87 percent of energy efficiency is from existing structures, the levels of energy efficiency in the Low Load to High Load Growth forecasts do not materially change.

Chapter 8 – Preferred Resource Strategy

Figure 8.18: Load Growth Scenario's Cost/Risk Comparison

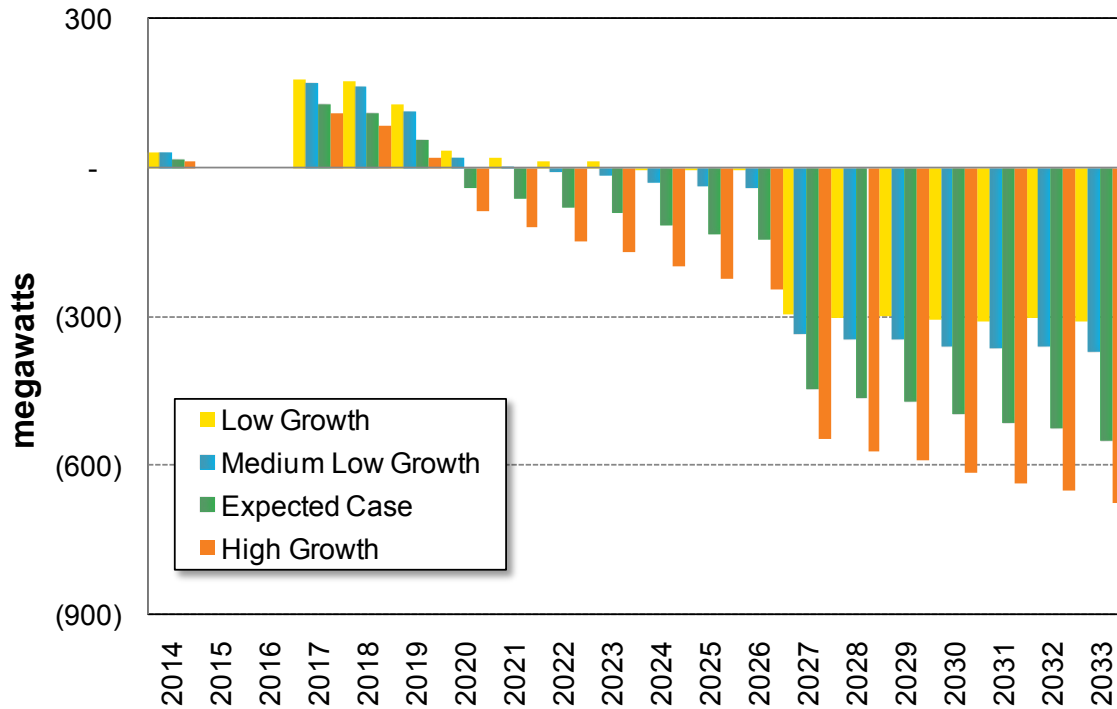

Table 8.15: Load Growth Sensitivities

Year	PRS	Low Load Growth	Medium Low Load Growth	High Load Growth
2019	83 MW SCCT			150 MW SCCT
2020				
2021				
2022			6 MW Upgrade	92 MW SCCT
2023	83 MW SCCT		90 MW SCCT	
2024				
2025				
2026	270 MW CCCT	270 MW CCCT	270 MW CCCT	270 MW CCCT
2027		50 MW SCCT		92 MW SCCT
2028				6 MW Upgrade
2029	6 MW Upgrade			50 MW SCCT
2030				
2031				
2032				
2033	50 MW SCCT			50 MW SCCT
Demand Res. (MW)	19	1	20	20
Efficiency (aMW)	164	142	147	175

Resource-Specific Scenarios

As part of an IRP, resource specific scenarios are helpful to gain understanding of specific resource decisions. This section covers four resource specific scenarios. This exercise illustrates the changes in cost and risk with selective resource decision making. The scenarios evaluate different resource decision such as more renewables, or switching from CTs to CCCTs. Figure 8.19 shows the results of the four scenarios outlined below

- **200 MW Wind and CTs:** 200 MW of new wind is added to the portfolio, 100 MW in 2020 and another 100 MW in 2025. This scenario meets capacity needs with Frame CT's and Demand Response. In the case, costs are 5.5 percent higher and risk 5 percent higher than the PRS. Further, this portfolio lays to the right of the efficient frontier indicating there are more optimal portfolios to meet capacity objectives.
- **200 MW Solar and CTs:** 10 MW of solar is added each year totaling 200 MW over the 20-year planning horizon. Since solar does not provide any capacity benefit to Avista in the winter, Frame CT's are added along with a demand response to meet capacity needs. This scenario results in power supply costs 8 percent higher and risk is 8.5 percent higher
- **Hydro Upgrades and CTs:** The Spokane River hydro upgrades (Post Falls, Monroe Street 2, and Long Lake 2) and Cabinet Gorge upgrades are included in this scenario beginning in 2024 and adding an upgrade each year through 2027. This scenario also fills in remaining capacity needs with CT's, in this portfolio costs and risks are also increased as compared to the PRS. Costs are 5 percent higher and risk is 13 percent higher.
- **Two CCCTs:** The first capacity need in 2019 replaces the SCCT with a CCCT, creating a short-term resource surplus. This scenario then uses another CCCT in 2027 to replace Lancaster (similar to the PRS). The portfolio is on the efficient frontier and reduces power supply volatility. This case lowers risk by 13 percent, but costs increase 2 percent. An RFP would evaluate this portfolio option prior to selecting a new resource in 2020.

The risk is higher in all renewable scenarios, compared to the PRS, because of increased dependence on the energy market. The PRS includes a combination of CCCT and CT plants. CCCT plants reduce market risk as hedges against short-term market shortages. Figure 8.19 shows that the combination of CTs and renewable resources do not outperform the PRS from a risk measure, this illustrates the CCCT plan reduces market risk more than renewables. Renewables help lower risk, this is shown by comparing the portfolio point to the upper most black dot (CT only portfolio). Renewables do not significantly reduce risk because all of the energy is excess to load needs and the energy is sold on the market, where as the CCCT plant is used to meet capacity and energy needs.

Chapter 8 – Preferred Resource Strategy

Figure 8.19: Resource Specific Scenarios

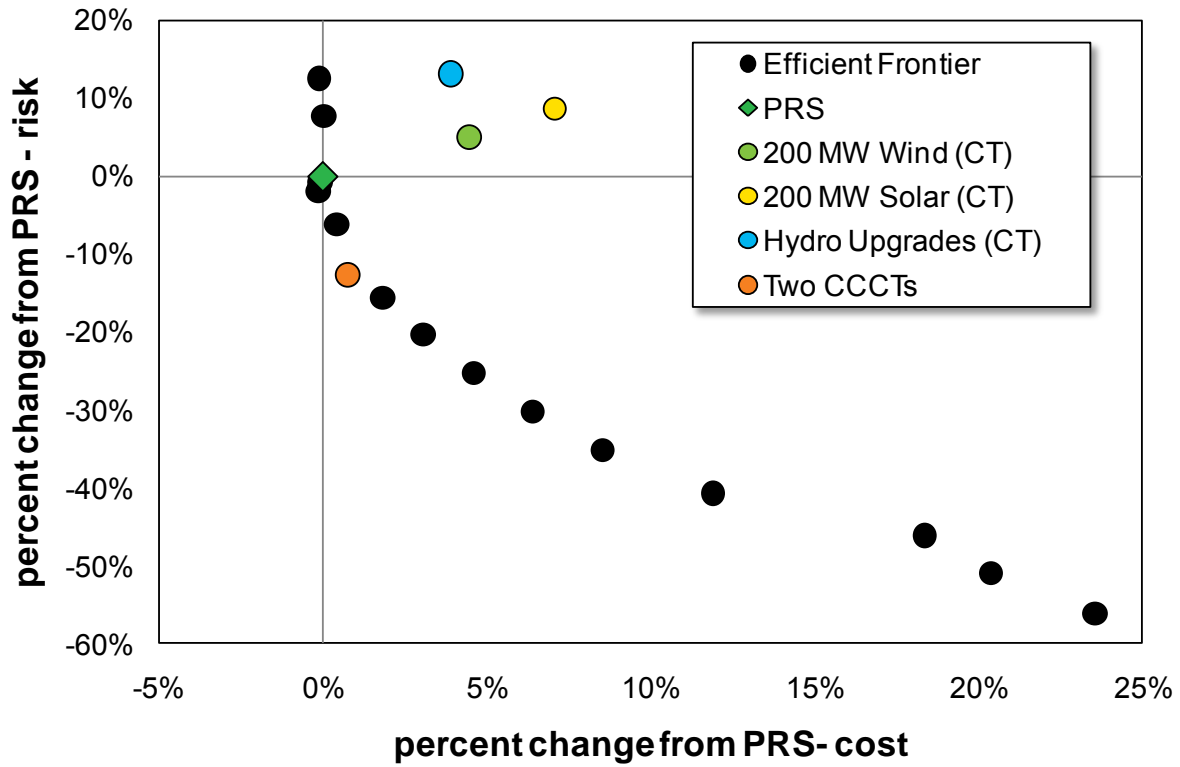

Chapter 8 – Preferred Resource Strategy

Table 8.16: Winter 1 Hour Capacity Position (MW) with New Resources

	2014	2015	2016	2017	2018	2019	2020	2021	2022	2023	2024	2025	2026	2027	2028	2029	2030	2031	2032	2033	
TOTAL LOAD OBLIGATIONS																					
Native Load Forecast	1,673	1,699	1,727	1,753	1,780	1,809	1,830	1,853	1,878	1,901	1,924	1,951	1,978	2,004	2,031	2,056	2,082	2,109	2,139	2,170	
Conservation Forecast	8	16	27	39	53	68	75	84	95	104	112	124	136	148	160	170	180	192	206	221	
Net Native Load Forecast	1,665	1,683	1,700	1,713	1,727	1,741	1,755	1,769	1,783	1,798	1,812	1,827	1,842	1,856	1,871	1,887	1,902	1,917	1,933	1,948	
Firm Power Sales	211	158	158	8	8	6	6	6	6	6	6	6	6	6	6	6	6	6	6	6	
Total Requirements	1,875	1,841	1,857	1,721	1,735	1,747	1,761	1,775	1,789	1,804	1,818	1,833	1,848	1,863	1,878	1,893	1,908	1,923	1,939	1,954	
RESOURCES																					
Firm Power Purchases	117	117	117	117	117	116	34	34	33	33	33	33	33	33	33	33	33	33	33	33	
Hydro Resources	998	888	889	955	955	919	924	920	920	928	920	920	928	920	920	928	920	920	928	920	
Base Load Thermals	895	895	895	895	895	895	895	895	895	895	895	895	895	895	895	895	895	895	895	895	
Wind Resources	0	0	0	0	0	0	0	0	0	0	0	0	0	0	0	0	0	0	0	0	
Peaking Units	242	242	242	242	242	242	242	242	242	242	242	242	242	242	242	242	242	242	242	242	
Total Resources	2,252	2,143	2,143	2,210	2,210	2,172	2,095	2,091	2,091	2,098	2,090	2,090	2,098	1,811	1,811	1,819	1,811	1,811	1,819	1,811	
Peak Position Before Reserve Planning	377	302	286	489	475	425	334	316	301	294	272	257	250	-51	-66	-74	-97	-112	-120	-143	
RESERVE PLANNING																					
Planning Margin	-233	-236	-238	-240	-242	-244	-246	-248	-250	-252	-254	-256	-258	-260	-262	-264	-266	-268	-271	-273	
Total Ancillary Services Required	-139	-136	-137	-128	-129	-131	-136	-137	-138	-139	-141	-142	-143	-139	-139	-140	-140	-140	-140	-140	
Reserve & Contingency Availability met by Hydro	13	6	6	6	6	6	6	6	6	6	6	6	6	6	6	6	6	6	6	6	
Demand Response	0	0	0	0	0	0	0	0	0	0	0	0	0	0	0	0	0	0	0	0	
Total Reserve Planning	-359	-366	-369	-362	-366	-369	-376	-379	-382	-386	-389	-392	-395	-393	-396	-398	-400	-403	-406	-408	
Peak Position w/ Contingency	17	-64	-84	126	110	56	-42	-64	-81	-92	-117	-135	-145	-445	-462	-472	-497	-515	-525	-551	
Planning Margin	20%	16%	15%	28%	27%	24%	19%	18%	17%	16%	15%	14%	14%	-3%	-4%	-4%	-5%	-6%	-6%	-7%	
NEW RESOURCES																					
Short-Term Market Purchase	0	75	100	0	0	0	0	0	0	0	0	0	0	0	0	0	0	0	0	0	
New NG Fired Peakers	0	0	0	0	0	0	80	80	80	80	160	160	160	160	240	240	240	240	240	288	
New Combined Cycle CT	0	0	0	0	0	0	0	0	0	0	0	0	0	260	260	260	260	260	260	260	
Thermal Resource Upgrades	0	0	0	0	0	0	0	0	0	0	0	0	0	0	0	0	0	0	0	0	
Demand Response	0	0	0	0	0	0	0	0	1	6	6	10	15	20	20	20	20	20	20	20	
Total New Resources	0	75	100	0	0	0	80	80	81	86	166	169	175	440	520	522	522	522	522	570	
Peak Position with New Resources	17	11	16	126	110	56	38	16	0	-5	49	34	30	-5	58	50	25	7	-4	19	
Planning Margin with New Resources	20%	20%	21%	28%	27%	24%	23%	22%	21%	21%	24%	23%	23%	21%	24%	24%	24%	22%	21%	21%	22%

Chapter 8 – Preferred Resource Strategy

Table 8.17: Summer 18-Hour Capacity Position (MW) with New Resources

	2014	2015	2016	2017	2018	2019	2020	2021	2022	2023	2024	2025	2026	2027	2028	2029	2030	2031	2032	2033
TOTAL LOAD OBLIGATIONS																				
Native Load Forecast	1,474	1,500	1,527	1,553	1,581	1,611	1,631	1,655	1,679	1,703	1,726	1,753	1,780	1,806	1,834	1,859	1,885	1,912	1,943	1,974
Conservation Forecast	9	18	30	43	58	74	82	92	103	113	122	135	148	161	174	185	196	209	225	241
Net Native Load Forecast	1,465	1,482	1,498	1,510	1,523	1,536	1,550	1,563	1,576	1,590	1,604	1,618	1,631	1,646	1,660	1,674	1,689	1,703	1,718	1,733
Firm Power Sales	212	159	159	9	9	8	8	7	7	7	7	7	7	7	7	7	7	7	7	7
Total Requirements	1,677	1,641	1,657	1,519	1,532	1,544	1,557	1,570	1,584	1,597	1,611	1,625	1,639	1,653	1,667	1,681	1,696	1,710	1,725	1,740
RESOURCES																				
Firm Power Purchases	29	29	29	29	29	26	26	26	26	26	25	25	25	25	25	25	25	25	25	25
Hydro Resources	701	707	663	631	638	583	580	622	624	622	622	624	622	622	624	622	624	622	624	622
Base Load Thermals	785	785	785	785	785	785	785	785	785	785	785	785	785	785	556	556	556	556	556	556
Wind Resources	0	0	0	0	0	0	0	0	0	0	0	0	0	0	0	0	0	0	0	0
Peaking Units	176	176	176	176	176	176	176	176	176	176	176	176	176	176	176	176	176	176	176	176
Total Resources	1,691	1,698	1,653	1,621	1,628	1,571	1,568	1,609	1,611	1,609	1,609	1,611	1,609	1,379	1,381	1,379	1,381	1,379	1,381	1,379
Peak Position Before Reserve Planning	14	57	-3	102	96	27	11	39	27	11	-2	-14	-30	-274	-286	-302	-317	-330	-346	-361
RESERVE PLANNING																				
Planning Margin	0	0	0	0	0	0	0	0	0	0	0	0	0	0	0	0	0	0	0	0
Total Ancillary Services Required	-177	-176	-177	-170	-172	-173	-175	-176	-177	-179	-180	-181	-182	-166	-167	-167	-168	-169	-169	-170
Reserve & Contingency Availability met by Hydro	177	176	177	170	172	173	175	176	177	179	180	181	182	166	167	167	168	169	169	170
Demand Response	0	0	0	0	0	0	0	0	0	0	0	0	0	0	0	0	0	0	0	0
Total Reserve Planning	0	0	0	0	0	0	0	0	0	0	0	0	0	0	0	0	0	0	0	0
Peak Position w/ Contingency	14	57	-3	102	96	27	11	39	27	11	-2	-14	-30	-274	-286	-302	-317	-330	-346	-361
Planning Margin	1%	3%	0%	7%	6%	2%	1%	2%	2%	1%	0%	-1%	-2%	-17%	-17%	-18%	-19%	-19%	-20%	-21%
NEW RESOURCES																				
Short-Term Market Purchase	0	0	25	0	0	0	0	0	0	0	0	0	0	0	0	0	0	0	0	0
New NG Fired Peakers	0	0	0	0	0	0	72	72	72	72	144	144	144	144	217	217	217	217	217	260
New Combined Cycle CT	0	0	0	0	0	0	0	0	0	0	0	0	0	235	235	235	235	235	235	235
Thermal Resource Upgrades	0	0	0	0	0	0	0	0	0	0	0	0	0	0	0	0	5	5	5	5
Demand Response	0	0	0	0	0	0	0	0	0	0	0	0	0	0	0	0	0	0	0	0
Total New Resources	0	0	25	0	0	0	72	72	72	72	144	144	144	379	451	457	457	457	457	500
Peak Position with New Resources	14	57	22	102	96	27	83	111	99	84	142	130	114	105	165	154	140	127	111	139
Planning Margin with New Resources	1%	3%	1%	7%	6%	2%	5%	7%	6%	5%	9%	8%	7%	6%	10%	9%	8%	7%	6%	8%

Chapter 8 – Preferred Resource Strategy

Table 8.18: Average Annual Energy Position (aMW) With New Resources

	2014	2015	2016	2017	2018	2019	2020	2021	2022	2023	2024	2025	2026	2027	2028	2029	2030	2031	2032	2033
TOTAL LOAD OBLIGATIONS																				
Native Load Forecast	1,060	1,079	1,100	1,123	1,144	1,165	1,181	1,197	1,215	1,232	1,250	1,272	1,291	1,311	1,331	1,351	1,373	1,396	1,422	1,449
Conservation Forecast	6	12	20	29	39	51	55	62	70	77	83	92	101	109	118	126	134	142	153	164
Net Native Load Forecast	1,054	1,067	1,079	1,093	1,105	1,114	1,125	1,135	1,145	1,155	1,167	1,180	1,190	1,201	1,212	1,225	1,239	1,254	1,270	1,285
Firm Power Sales	109	58	58	6	6	5	5	5	5	5	5	5	5	5	5	5	5	5	5	5
Total Requirements	1,163	1,125	1,137	1,099	1,111	1,119	1,130	1,140	1,150	1,160	1,172	1,185	1,195	1,206	1,217	1,230	1,244	1,259	1,274	1,290
RESOURCES																				
Firm Power Purchases	128	129	128	76	76	56	31	30	30	29	29	29	29	29	29	29	29	29	29	29
Hydro Resources	527	495	495	495	490	481	481	481	481	481	481	481	481	481	481	481	481	481	481	481
Base Load Thermals	723	725	718	715	732	711	724	736	713	717	714	719	673	506	504	506	504	506	504	506
Wind Resources	42	40	40	40	40	40	40	40	40	40	40	40	40	40	40	40	40	40	40	40
Peaking Units	153	139	154	153	153	153	147	151	152	153	152	153	152	153	152	153	152	153	152	153
Total Resources	1,573	1,528	1,535	1,479	1,490	1,440	1,422	1,438	1,416	1,420	1,415	1,421	1,374	1,208	1,206	1,208	1,206	1,208	1,206	1,208
Energy Position Before Reserve Planning	410	404	398	380	379	321	292	299	266	259	243	237	179	2	-12	-22	-39	-51	-69	-82
RESERVE PLANNING																				
Contingency	-228	-231	-231	-232	-232	-214	-195	-196	-196	-197	-197	-198	-198	-199	-199	-200	-200	-201	-202	-202
Energy Position w/ Contingency	182	173	167	148	147	106	96	103	70	63	46	39	-19	-197	-211	-221	-239	-252	-270	-284
NEW RESOURCES																				
Short-Term Market Purchase	0	0	0	0	0	0	0	0	0	0	0	0	0	0	0	0	0	0	0	0
New NG Fired Peakers	0	0	0	0	0	0	68	68	68	68	135	135	135	135	204	204	204	204	204	249
New Combined Cycle CT	0	0	0	0	0	0	0	0	0	0	0	0	0	245	245	245	245	245	245	245
Thermal Resource Upgrades	0	0	0	0	0	0	0	0	0	0	0	0	0	0	0	0	0	0	0	0
Demand Response	0	0	0	0	0	0	0	0	0	0	0	0	0	0	0	0	0	0	0	0
Total New Resources	0	0	0	0	0	0	68	68	68	68	135	135	135	380	449	454	454	454	454	500
Energy Position with New Resources	182	173	167	148	147	106	164	170	137	130	181	174	116	184	238	233	215	203	184	216

9. Action Items

The IRP is an ongoing and iterative process balancing regular publication timelines with pursuing the best 20-year resource strategies. The biennial publication date provides opportunities to document ongoing improvements to the modeling and forecasting procedures and tools, as well as enhance the process with new research as the planning environment changes. This section provides an overview of the progress made on the 2011 IRP Action Plan and provides the 2013 Action Plan.

Summary of the 2011 IRP Action Plan

The 2011 Action Plan included five separate categories: resource additions and analysis, energy efficiency, environmental policies, modeling and forecasting enhancements, and transmission planning.

2011 Action Plan and Progress Report – Resource Additions and Analysis

- Continue to explore and follow potential new resource opportunities.
 - Over the past two years, Avista began investigating sites for future peaking-capable generation. This process consisted of interconnection feasibility studies, site visits, and permitting and environmental evaluation. Avista will continue this effort over the next several years prior to releasing an RFP for new peaking capacity.
 - Avista is ending studies on wind resource development with the passage of SB 5575 in Washington and the subsequent lack of need for renewables in this IRP. This includes ceasing development at the Reardan Wind site.
- Continue studies on the costs, energy, capacity and environmental benefits of hydro upgrades at both Spokane and Clark Fork River projects.
 - During 2012, Avista studied upgrade options to the Spokane River Project. The assessment included an engineering screening of several upgrade options for the five upper Spokane River developments and concluded with a recommendation to rehabilitate the Nine Mile Falls project rather building or rebuilding the powerhouse. The assessment provided perspectives on the river system’s potential for meeting future load requirements, and options to add renewable energy at a price competitive with other renewables. Details on Spokane River upgrade opportunities are in Chapter 6, Generation Resource Options.
 - Avista completed high-level studies for the Cabinet Gorge hydroelectric development. The review evaluated options to add a fifth unit in the original bypass tunnel for additional capacity and to reduce total dissolved gases. This alternative was uneconomic compared to other utility alternatives.
- Study potential locations for the natural gas-fired resource identified to be online by the end of 2018.

Chapter 9–Action Items

- Avista has begun its efforts to identify a site for a new natural gas-fired peaker. A small cross-function team is investigating potential sites within the service territory. Site selection considers proximity to natural gas pipelines, transmission, and distance away from population centers or locations with potential environmental liabilities. Avista has initiated transmission studies for potential areas discussed in Chapter 5.
- Continue participation in regional IRP processes and, where agreeable, find opportunities to meet resource requirements on a collaborative basis with other utilities.
 - Avista monitors and attends when appropriate other northwest utility's IRP processes. With Avista's needs toward the beginning of the next decade, and for smaller unit sizes, the potential for resource collaboration is unlikely. Collaboration works best on developing large projects where economies of scale benefits smaller off-takers. Given the PRS's first identified resource is for a small peaker, collaborating on a project would be unlikely.
 - Avista's staff continues to participate in regional processes including the development of the Seventh Power Plan, PNUCC studies, and work done by the Western Governors Association.
- Provide an update on the Little Falls and Nine Mile hydroelectric project upgrades.
 - The Nine Mile hydro facility is undergoing rehabilitation. Units 1 and 2 have been removed and engineering work is complete. A status update will be included in the next IRP; the project is scheduled for completion in 2016.
 - At Little Falls, new electrical equipment and generator excitation systems are installed. Avista is replacing station service, updating the powerhouse crane, and developing new control systems on each of the units.
- Study potential for demand response projects with industrial customers.
 - Avista has begun preliminary investigation into demand response from industrial and commercial customers. For this IRP Avista identified 20 MW of commercial demand response. Avista intends to conduct a market assessment study during the next IRP process, and begin preliminary discussion with large industrial customers.
- Continue to monitor regional surplus capacity and Avista's reliance on this surplus for near- and medium-term needs.
 - Avista participates in the NPCC Resource Adequacy Forum. On January 23, 2013, the NPCC released a resource adequacy study. The study found that the Northwest has sufficient resources until a small regional deficit (350 MW) begins in 2017.
 - Avista has short-term winter peaking needs in 2015 and 2016; thereafter a 150 MW return of the PGE capacity sale will provide sufficient capacity through 2019. The Resource Adequacy forum studies provide evidence

that Avista can rely on for market capacity during this period. Further, the report identifies the regional summer peak periods to be surplus into the future, and that Avista can lower its planning margin requirements during summer months.

2011 Action Plan and Progress Report – Energy Efficiency

- Study and quantify transmission and distribution efficiency projects as they apply to the Washington RPS goals.
 - Avista continues to update its transmission and distribution system since the 2011 IRP; it has completed several distribution feeder upgrades and installed smart grid technology in Pullman and Spokane. In the 2010/2011 conservation target report Avista reported 3,512 MWh of savings. In the upcoming 2012/2013 report Avista plans on filing 32,387 MWh of savings.
- Update processes and protocols for conservation, measurement, evaluation and verification.
 - Avista is continuing to work through the process of updating and documenting its processes and procedures for the conservation programs offered through the utility. For evaluation, measurement and verification, Avista is guided by its framework and is committed to revisiting with stakeholders as necessary with the intent of updating and editing it as circumstances warrant.
- Continue to determine the potential impacts and costs of load management options.
 - Avista is participating in the Northwest Regional Smart Grid Demonstration Project to help understand the costs and benefits of load management programs. In the past, Avista has sponsored a pilot in Idaho as a way to understand how these programs could work and understand the costs and benefits. In the future, Avista will focus more on commercial and industrial opportunities by studying the potential and costs of such a programs.

2011 Action Plan and Progress Report – Environmental Policy

- Continue studies of state and federal climate change policies.
 - Avista actively engages in reviewing and participating in state and federal discussions about climate change policies related to electric generation and natural gas distribution. Details about the issues covered are in Chapter 4, Policy Considerations.
- Continue and report on the work of Avista’s Climate Policy Council.
 - Avista’s Climate Policy Council and the Resource Planning team actively analyze state and federal greenhouse gas legislation. This work will continue until final rules are established and laws passed. The focus will then shift to mitigating the costs of meeting the applicable laws and regulations. Avista has quantified its greenhouse gas emissions using the World Resources Initiative–World Business Council for Sustainable

Development inventory protocol in anticipation of state and federal greenhouse gas reporting mandates. Details about Climate Policy Council efforts are in Chapter 4, Policy Considerations.

2011 Action Plan and Progress Report – Modeling and Forecasting

- Continue following regional reliability processes and develop Avista-centric modeling for possible inclusion in the 2013 IRP.
 - Avista has developed, with support from NPCC staff, an Avista view of the northwest load and resource balance (see Chapter 2). Given today's assumptions, the region has enough capacity to meet Northwest winter needs to 2017, and summer capacity needs indefinitely where the larger winter capacity needs are met.
 - Since the 2011, IRP Avista updated and added logic and reporting enhancements to Avista's LOLP model per NPCC staff recommendations. The results of this discussion and analysis led Avista to rely on the mixture of new resources and market purchases to meet a 5 percent LOLP reliability target. See Chapter 2, Loads & Resources, for a discussion of this study.
- Continue studying the impacts of climate change on retail loads.
 - The load forecast includes changes in Spokane temperatures away from the 30-year normal to include fewer heating degree days and more cooling degree days per a 2008 University of Washington study. The study anticipates there will not be a large effect on retail loads from potential climate change activities. Avista investigated studies regarding changing water conditions from climate change and found there is no evidence of changing annual average conditions, but rather higher flows earlier in the year. The higher flows indirectly benefit customers as increased flow periods coincide with higher loads.
- Refine the stochastic model for cost-driver relationships, including further analyzing year-to-year hydro correlation and the correlation between wind, load, and hydro.
 - Quality regional wind output data is available from the BPA website only back to 2007. Given this short term dataset, correlating to load and hydro data will provide statistically insignificant results. The best way to estimate these correlations is to fund a long-term weather consultant study; the NPCC's Seventh Power Plan would benefit from such a study. Avista will be participating in this planning process and will recommend a study based on long-term data.

2011 Action Plan and Progress Report – Transmission and Distribution Planning

- Work to maintain Avista's existing transmission rights, under applicable FERC policies, for transmission service to bundled retail native load.
 - Avista has maintained its existing transmission rights to meet native customer load.

Chapter 9—Action Items

- Continue to participate in BPA transmission processes and rate proceedings to minimize the costs of integrating existing resources outside of Avista’s service area.
 - Avista is actively participating in the BPA transmission rate proceedings.
- Continue to participate in regional and sub-regional efforts to establish new regional transmission structures to facilitate long-term expansion of the regional transmission system.
 - Avista staff participate in and lead many regional transmission efforts including Columbia Grid and the Transmission Coordination Work Group (TCWG).
- Evaluate costs to integrate new resources across Avista’s service territory and from regions outside of the Northwest.
 - Avista’s Transmission group performed seven studies of potential generation upgrades and new facilities, these studies are in Appendix D and Chapter 5.
- Study and implement distribution feeder rebuilds to reduce system losses.
 - Since the 2011 IRP, Avista has completed two feeder rebuilds. These rebuilds reduce losses by 1,542 MWh, improve reliability, and decrease future operation and maintenance costs.
- Continue to study other potential areas to implement Smart Grid projects to other areas of the service territory.
 - With the completion of the Spokane and Pullman Smart Grid projects, Avista put all such future projects on hold. Additional projects will be evaluated on a case-by-case basis for cost effectiveness and increased reliability.
- Study transmission reconfigurations that economically reduce system losses.
 - Avista’s transmission department continues to review potential projects to increase reliability and reduce system losses. Chapter 5, Transmission & distribution, discusses projects meeting this objective.

2013 IRP Action Plan

Avista’s 2013 PRS provides direction and guidance for the type, timing and size of future resource acquisitions. The 2013 IRP Action Plan highlights the activities planned for possible inclusion in the 2015 IRP. Progress and results for the 2013 Action Plan items are reported to the TAC and the results will be included in Avista’s 2015 IRP. The 2013 Action Plan includes input from Commission Staff, Avista’s management team, and the TAC.

Generation Resource Related Analysis

- Consider Spokane and Clark Fork River hydro upgrade options in the next IRP as potential resource options to meet energy, capacity and environmental requirements.

Chapter 9–Action Items

- Continue to evaluate potential locations for the natural gas-fired resource identified to be online by the end of 2019, including environmental reviews, transmission studies, and potential land acquisition.
- Continue participation in regional IRP and regional planning processes and monitor regional surplus capacity and continue to participate in regional capacity planning processes.
- Commission a demand response potential and cost assessment of commercial and industrial customers per its inclusion in the middle of the PRS action plan.
- Continue monitoring state and federal climate change policies and report work from Avista's Climate Change Council.
- Review and update the energy forecast methodology to better integrate economic, regional, and weather drivers of energy use.
- Evaluate the benefits of a short-term (up to 24-months) capacity position report.
- Evaluate options to integrate intermittent resources.

Energy Efficiency

- Work with NPCC, the UTC, and others to resolve adjusted market baseline issues for setting energy efficiency target setting and acquisition claims in Washington.
- Study and quantify transmission and distribution efficiency projects as they apply to EIA goals.
- Update processes and protocols for conservation measurement, evaluation and verification.
- Assess energy efficiency potential on Avista's generation facilities.

Transmission and Distribution Planning

- Work to maintain Avista's existing transmission rights, under applicable FERC policies, for transmission service to bundled retail native load.
- Continue to participate in BPA transmission processes and rate proceedings to minimize costs of integrating existing resources outside of Avista's service area.
- Continue to participate in regional and sub-regional efforts to establish new regional transmission structures to facilitate long-term expansion of the regional transmission system.

Production Credits***Primary Avista 2013 Electric IRP Team***

Individual	Title	Contribution
Clint Kalich	Manager of Resource Planning & Analysis	Project Manager
James Gall	Senior Power Supply Analyst	Analysis/Author
John Lyons	Senior Resource Policy Analyst	Research/Author/Editor
Grant Forsyth	Senior Forecaster & Economist	Load Forecast
Lori Hermanson	Utility Resource Analyst	Energy Efficiency
Richard Maguire	System Planning Engineer	Transmission & Distribution

2013 Electric IRP Contributors

Name	Title
Shawn Bonfield	Regulatory Policy Analyst
Troy Dehnel	Feeder Upgrade Project Coordinator
Thomas Dempsey	Manager, Generation Joint Projects
Leona Doege	DSM Program Manager
Mike Gonnella	Manager of Generation Substation Support
Kelly Irvine	Manager of Natural Gas Planning
Jon Powell	Partnership Solutions Manager
Dave Schwall	Senior Engineer
Darrell Soyars	Manager of Corporate Environmental Compliance
Xin Shane	Power Supply Analyst
Steve Wenke	Chief Generation Engineer
Jessie Wuerst	Senior External Communications Manager

Contact contributors via email by placing their names in this email address format:

first.last@avistacorp.com

2013 Electric Integrated Resource Plan

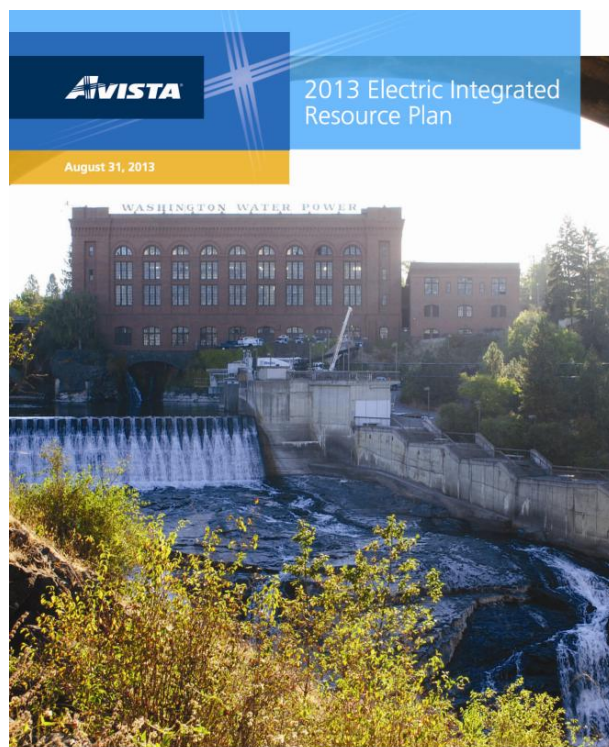

Appendices

Table of Contents

Appendix A – Technical Advisory Committee Presentations (Page 1)

Technical Advisory Committee Meeting 1 (Page 1)

Technical Advisory Committee Meeting 2 (Page 73)

Technical Advisory Committee Meeting 3 (Page 146)

Technical Advisory Committee Meeting 4 (Page 257)

Technical Advisory Committee Meeting 5 (Page 416)

Technical Advisory Committee Meeting 6 (Page 518)

Appendix B – 2013 Work Plan (Page 572)

Appendix C – Conservation Potential Assessment Study (Page 579)

Appendix D – Transmission Studies (Page 872)

Appendix E – New Resource Table for Transmission (Page 910)

2013 Electric Integrated Resource Plan

Appendix A – 2013 Electric IRP Technical Advisory Committee Presentations



Avista's 2013 Electric Integrated Resource Plan
Technical Advisory Committee Meeting No. 1 Agenda
Wednesday, May 23, 2012
Conference Room 130

Topic	Time	Staff
1. Introduction	8:30	Kalich
2. Powering Our Future Game	8:35	Silkworth
3. 2011 Renewable RFP	10:30	Silkworth
4. Palouse Wind Project Update	11:00	First Wind
5. Lunch	12:00	
6. 2011 IRP Acknowledgement	12:45	Kalich
7. Energy Independence Act Compliance & Forecast	1:45	Lyons/Gall
8. Work Plan	2:15	Lyons
9. Adjourn	3:00	



Powering Our Future Game

Steve Silkworth, Manager of Wholesale Marketing & Contracts

Anna Scarlett, Communications Manager

First Technical Advisory Committee Meeting

2013 Electric Integrated Resource Plan

May 23, 2012



Powering Our Future



Tomorrow - 2030

You're the power planner

Meet demand

Meet renewable portfolio standards



Wash. Renewable Portfolio Standards

INITIATIVE MEASURE No. 937

Initiative Measure No. 937 concerns energy resource use by certain electric utilities.

This measure would require certain electric utilities with 25,000 or more customers to meet certain targets for energy conservation and use of renewable energy resources, as defined, including energy credits, or pay penalties. Should this measure be enacted into law?

YES

NO

2012 - 3% of energy delivered to Washington customers
*Dam upgrades, purchased renewable energy

2016 - 9%
*Palouse Wind
*Kettle Falls

2020 (and beyond) - 15%

Today's Energy Generation Capability

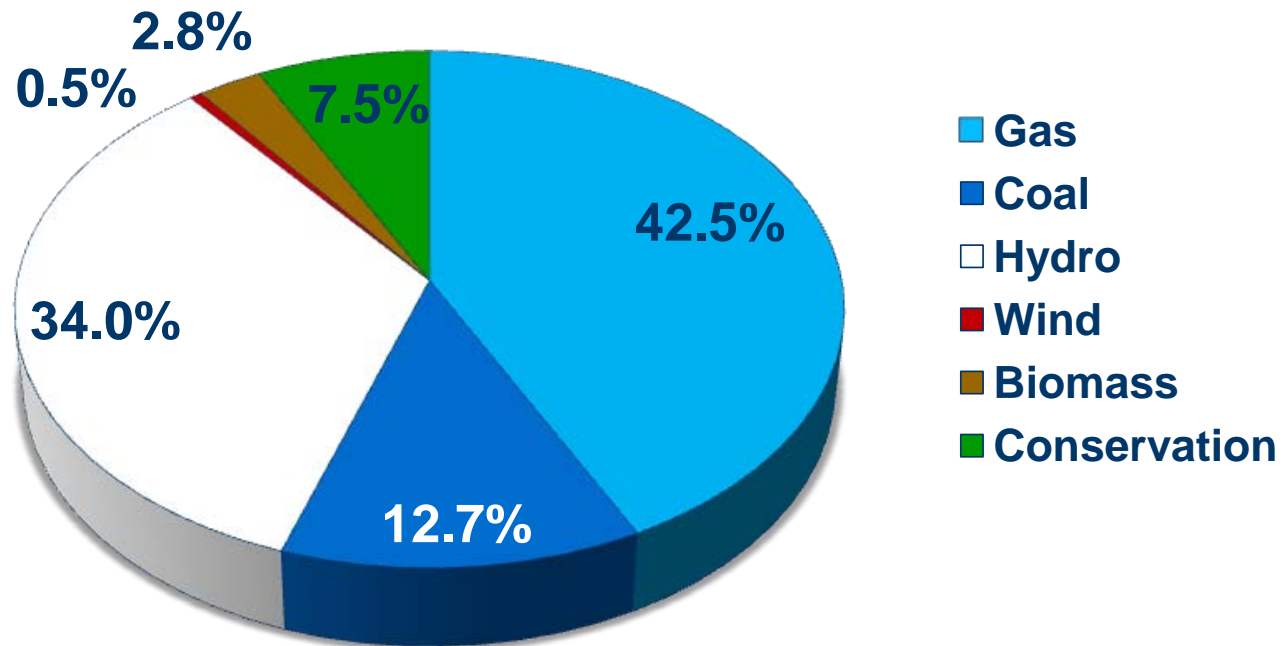

Natural Gas





Powering Our Future

HOW DO WE MEET YOUR ENERGY NEEDS RELIABLY AND RESPONSIBLY, WHILE INTEGRATING RENEWABLE POWER?

Instructions:

Put your resource mix in the colored pie chart or circles

\$ - Lowest Cost
 \$\$\$\$\$ - Highest Cost

Current Energy Generation Capability

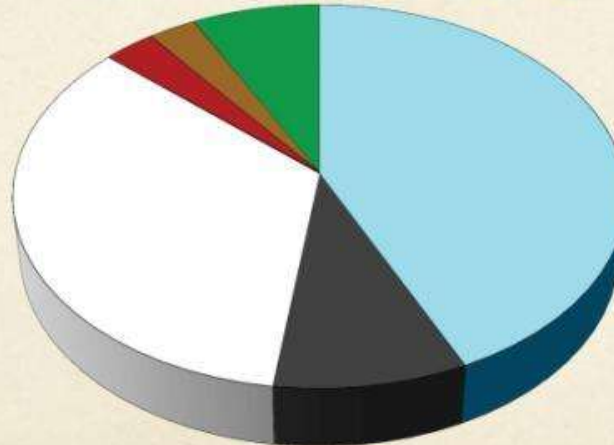

Solar



Nuclear

- Gas
- Coal
- Hydro
- Wind
- Biomass
- Conservation

Solar
 Most Washington State Renewable Portfolio Standards - 95
 Most peak demand - 95
 Cost - \$\$\$\$\$

Nuclear
 Most Washington State Renewable Portfolio Standards - 90
 Most peak demand - 95
 Cost - \$\$\$

Natural gas-fired plants
 Most Washington State Renewable Portfolio Standards - 80
 Most peak demand - 95
 Cost - \$

Biomass
 Most Washington State Renewable Portfolio Standards - 95
 Most peak demand - 95
 Cost - \$\$\$

Wind
 Most Washington State Renewable Portfolio Standards - 95
 Most peak demand - 80
 Cost - \$

Coal
 Most Washington State Renewable Portfolio Standards - 80
 Most peak demand - 95
 Cost - \$\$\$\$

Conservation
 Most Washington State Renewable Portfolio Standards - 80
 Most peak demand - 95, hydroelectric generation
 Cost - \$\$\$\$\$

Hydroelectric
 Most Washington State Renewable Portfolio Standards - 95
 Supply and demand after 1990
 Most peak demand - 95
 Cost - \$





1. Review the materials at your table.
2. Choose a note taker and a spokesperson from your table.
3. Write table # on your worksheet

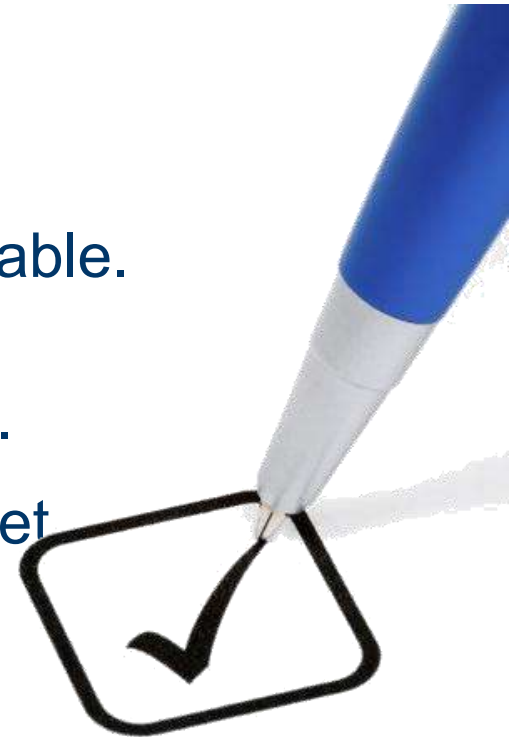

Round 1

Using your blocks, choose any mix you like, placing them on the corresponding spaces on your game board.

Each block signifies 10 percent of your total new resources and you may only use a total of 10 blocks (or 100%).

You can use any combination you like, and you can even use one resource for all your new energy if you like.



Round 1 Conclusion

1. Record your 'resource mix' on the worksheet.
2. Give your worksheet to a facilitator when you are finished.

The image shows a worksheet titled "Powering Our Future" with a table for recording resource mix. The table has columns for "Resource", "Amount", and "Cost per unit". The resources listed are: Natural Gas, Coal, Wind, Solar, Hydro, Nuclear, Biomass, and Other. The table is labeled "Table 1" and has a "Total" row at the bottom.

Resource	Amount	Cost per unit
Natural Gas		
Coal		
Wind		
Solar		
Hydro		
Nuclear		
Biomass		
Other		
Total		

Group discussion



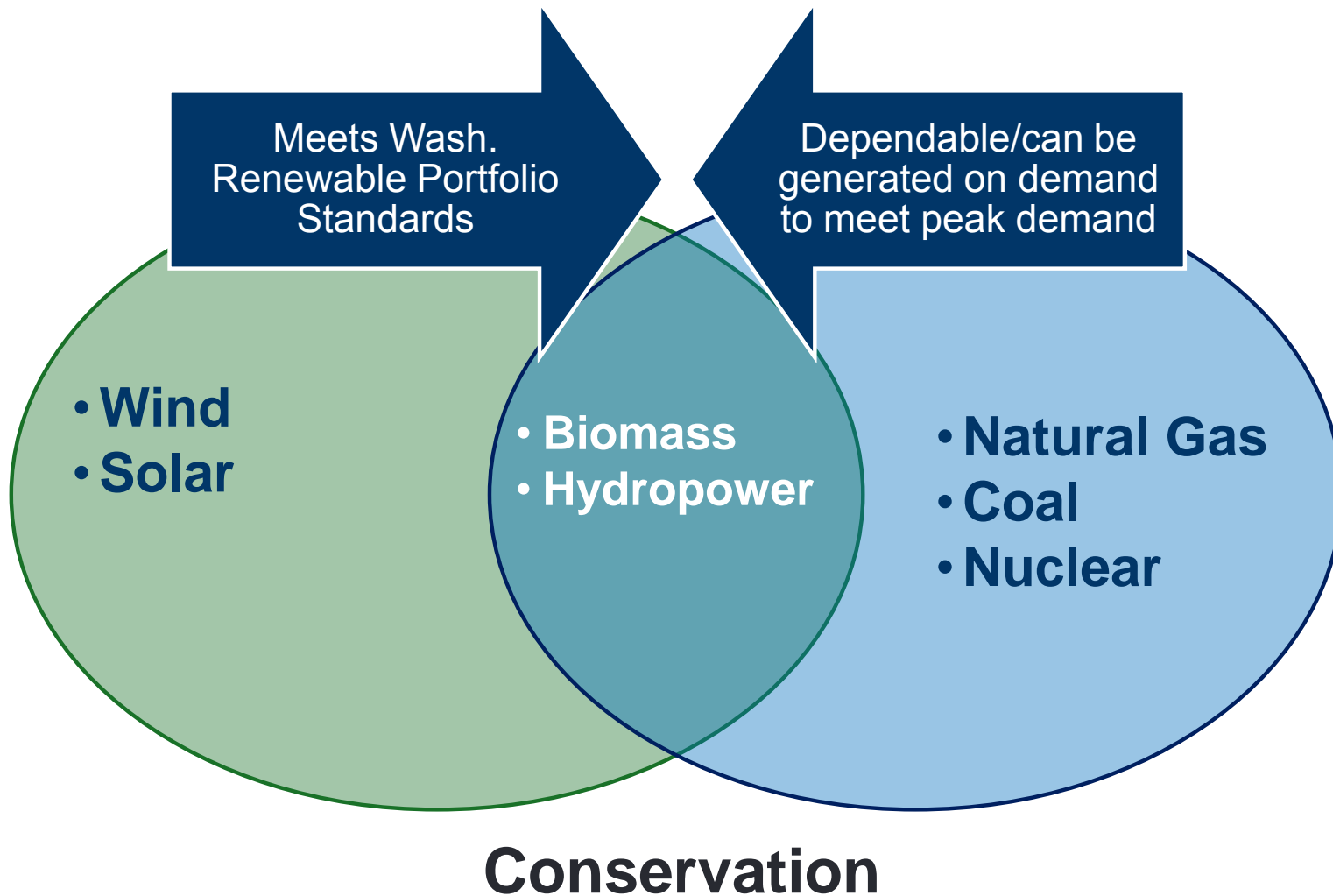

Round 2

Meet electric demand.

Meet renewable portfolio requirements over the next 20 years.

Consider customers' bills, carbon emissions, and your ability to generate enough power to serve all your customers during peak demand times.

	Meets Wash. Renewable Portfolio Mandates	Meets customer needs during peak demand	Relative Cost
Conservation/Energy Efficiency*		✓	\$-\$\$\$
Natural Gas		✓	\$
Wind	✓		\$\$
Hydroelectric**	✓	✓	\$\$
Biomass***	✓	✓	\$\$\$
Coal		✓	\$\$\$
Nuclear		✓	\$\$\$\$
Solar	✓		\$\$\$\$\$

* Energy efficiency programs cost more as the amount of energy that is saved increases.

** Only new hydroelectric plants and the additional energy produced with upgrades performed after 1999 qualify as renewable under Washington State Renewable Portfolio Standards.

***Only biomass plants built after 1999 qualify as renewable under Washington State Renewable Portfolio Standards.



Round 2

Using your blocks, choose any mix you like, placing them on the corresponding spaces on your game board.

Each block signifies 10 percent of your total new resources and you may only use a total of 10 blocks (or 100%).

Use a combination of resources that meet Renewable Portfolio Mandates and resources that are considered dependable and will meet peak demand.



Round 2 Conclusion

1. Record your 'resource mix' on the worksheet.
2. Give your worksheet to a facilitator when you are finished.

The image shows a worksheet titled "Powering Our Future" with a table for recording resource mix data. The table has columns for "Resource", "Amount", and "Cost per unit". The rows are labeled "Natural Gas", "Coal", "Nuclear", "Renewables", and "Total". The worksheet also includes a section for "Name" and "Table #".

Resource	Amount	Cost per unit
Natural Gas		
Coal		
Nuclear		
Renewables		
Total		

Group Discussion

Discussion of impact to emissions, costs, risk

Meet demand at peak times?



Conclusion

Were there any surprises?

What did you learn? What questions do you have?

2011 Renewable RFP

Steve Silkworth, Manager of Wholesale Marketing & Contracts

First Technical Advisory Committee Meeting

2013 Electric Integrated Resource Plan

May 23, 2012



Why Issue a Renewables RFP in 2011?

- 2009 IRP: identified the need for 48 aMW RECs by 2016 to meet the 9% renewable goal in Washington state
- Over supply of turbines. Turbine prices declined to 2004 levels
- ITC/PTC expires in 2012
- Washington state 75% sales tax exemption through June 2013
- Levelized costs were estimated to result in 30% to 40% lower cost than the 2009 RFP of 14 months prior
- REC demand will increase in the next few years as the 2016 tranche approaches

Renewable Resource RFP Overview

- RFP Issued: February 22, 2011
- Quantity: up to 35 aMW of I-937 qualifying renewable power including all renewable energy attributes
- Delivery Start: on or before 12/31/2012
- Term: 20+ years
- Avista requested competitive bids for projects or project output at the most favorable price available. Expected Delivered Price: \$62 per MWh (20 yr) levelized

Renewable Resource RFP Overview

- Received proposals from 11 bidders with 17 options.
- Technologies submitted
 - Wind – Approximately 769 MW
 - Landfill gas – 5 MW
- Pricing was very competitive and reflected the current down-turn in the renewable energy market.
- Comparable projects proposed through the 2009 RFP (approximately 15 months prior) were now up to 30% to 40% less expensive in the 2011 solicitation.

Bid Project Locations

Received bids totaling 774 MW (769 MW wind, 5 MW landfill gas)

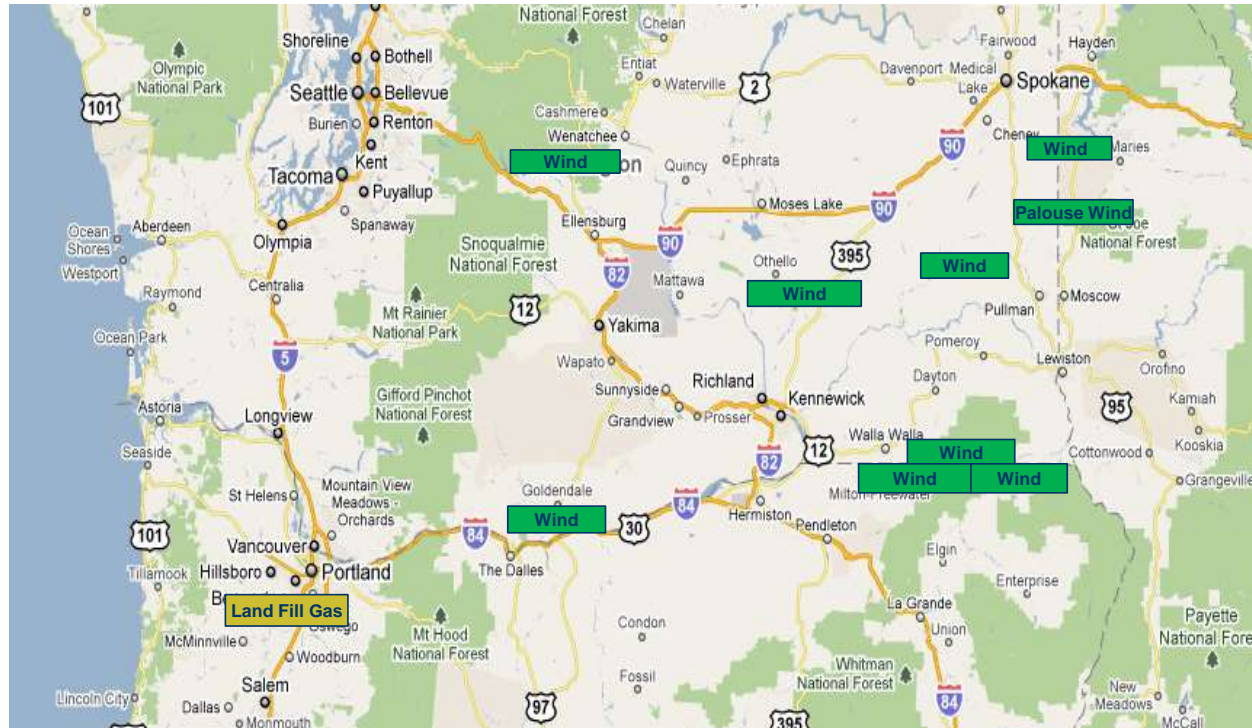

Montana
Wind

Evaluation Criteria

1. Risk Management (30%)
 - Financing ability/experience
2. Net Price (40%)
 - Expected benefit - expected cost
3. Price Risk (10%)
 - Pricing type, O&M, generation quality, and optionality
4. Electric Factors (10%)
 - Transmission, procurement process and equipment
5. Environmental/Community (10%)
 - Permits process and location

Palouse Wind

- Approximately 105 MW
- Near Oakesdale, WA (35 miles south of Spokane)
- Interconnected directly to Avista system
- Developed by First Wind
- Commercial operation by 12/31/2012
- Vestas 1.8 MW turbines – 100M Rotors
- Net capacity factor – expected: 37.5%
- Developer will take advantage of expiring tax incentives



Palouse Wind - 2013 Avista IRP TAC Meeting

Spokane, WA – May 23, 2012



Overview

- Founded in 2002 and headquartered in **Boston** with **200+ employees** at offices and project sites around the U.S.
- Focused on **renewable energy, natural gas, energy storage and transmission development** in core markets, such as the Northeast, West and Hawaii
- Wind projects range from **15 – 205 MW**, situated on private, state and federal lands
- Vertically integrated to develop projects from **conception through operations** bringing stable, long-term contracts to utilities and customers in high-demand markets
- Successfully raised over **\$6 billion** to convert development projects into operating assets



Milford Wind – 306 MW in Utah

First Wind Projects

- **Own and Operate:** 12 projects, 750 MW
- **Operate:** 1 project, 45 MW
- **In Construction:** 4 projects, 230 MW



Cohocton, NY



Mars Hill, ME

Mars Hill 42 MW

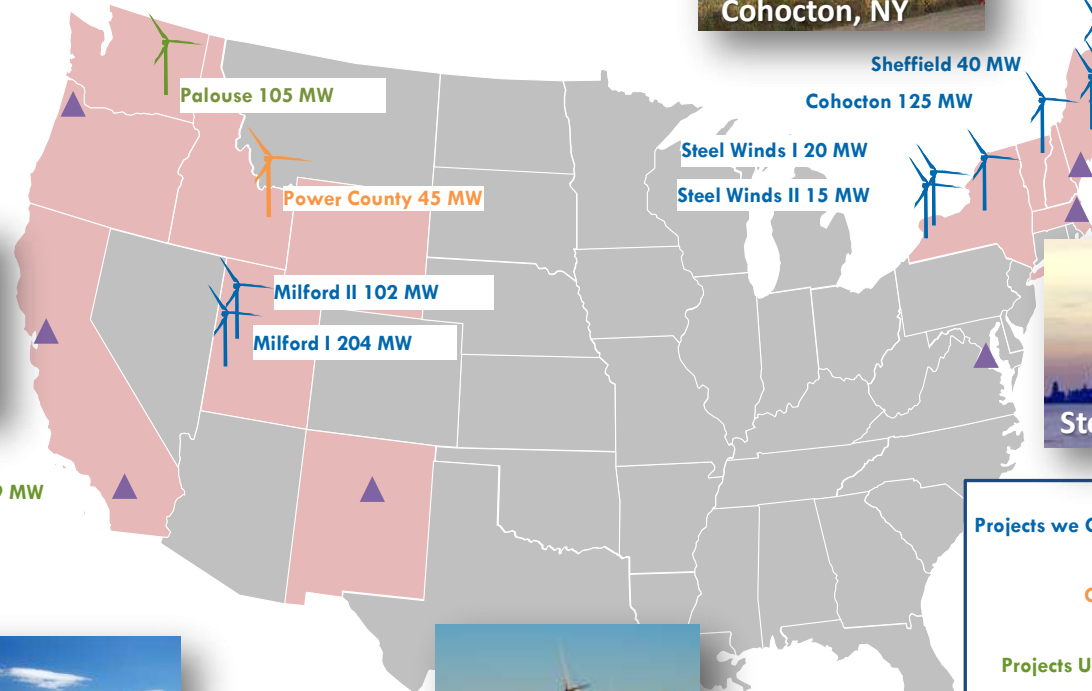

Kahuku, HI

Kahuku 30 MW

Kawaihoa 69 MW

KWP I 30 MW

KWP II 21 MW



KWP, HI



Milford I & II, UT



Steel Winds, NY

Projects we Own and Operate	
Operating Projects	
Projects Under Construction	
Development Areas	
First Wind Office	

A Company of Firsts

Consistently demonstrated leadership in **Innovation, Environmental Stewardship,** and **Community Engagement**

Siting

- **Steel Winds** (20 MW) – Development on EPA Brownfield Site

Environmental

- **KWP** (30 MW) – Development with Habitat Conservation Plan

Power Sales

- **Stetson Phase II** (26 MW) – Unique PPA off-take with Harvard University

Transmission Engineering

- **Milford** (204+ MW) – Developed 88-mile Generator Lead

Technology

- **Kahuku** (30 MW) – Integrated 15 MW Battery Energy Storage System



Our first-in-the-state **Sheffield Wind** project required considerable environmental innovations in Vermont.

Track Record

- **Asset Conversion:** Since its founding, First Wind has raised over **\$6 billion** to convert development projects into operating assets

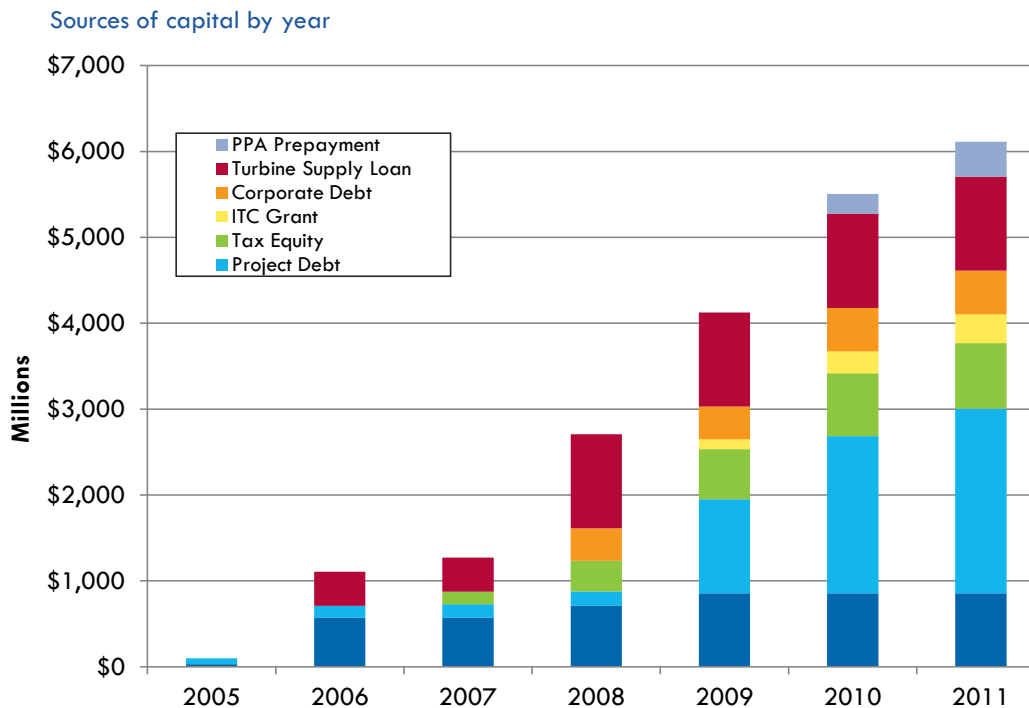

Select Partners





Palouse Wind

Palouse Wind

- Located on ridges between State Route 195 and the town of Oakesdale in Whitman County
- Strong **winter peaking** wind resource, complimentary to regional spring hydro resource
- Utilizing 58 Vestas V100 wind turbines, with total capacity of **105 MW**
- **30-year PPA** with Avista, and interconnection to their new Benawah to Shawnee 230kV line
- **\$210 million capital raise** from private sector
- Will be **largest energy facility in Whitman County**, producing renewable energy for 30,000 homes
- 40 farmers involved

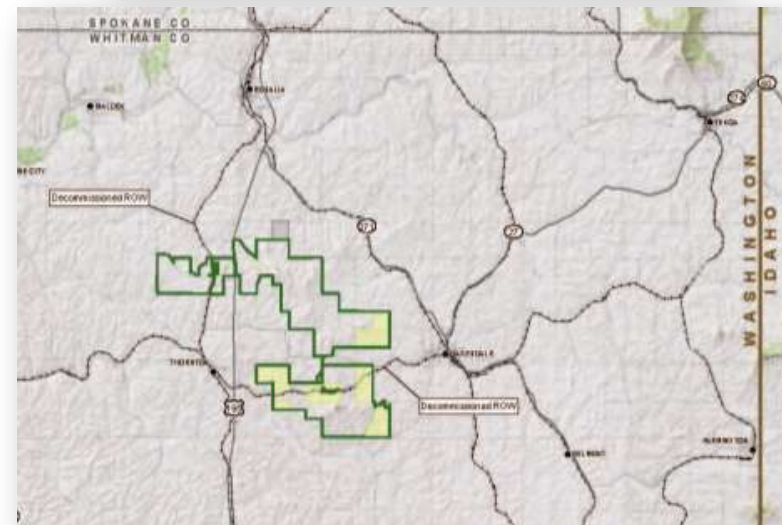

Phases of Developing a Palouse Wind



- 3 years of wind data from 4 tower locations
- Third party wind validation

- Transmission
- Gen-tie routing

- Site design
- Landowner Relations
- Community Involvement

- Envr. Studies
- Public Meetings
- EIS and CUP Hearing

- Avista PPA signed
- Interconnection Agreement
- Financing

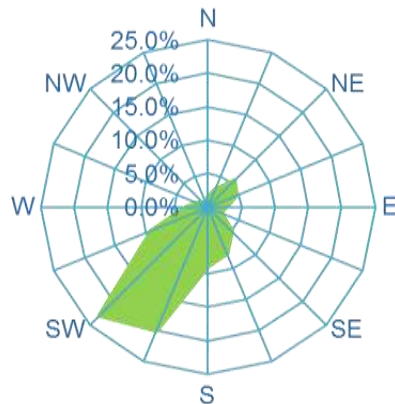

Thorough Environmental Review

- **First** EIS in Whitman County – ever
- All areas of the built and natural environment were evaluated per state law
- Over **250** Comments received during EIS process
- **164** conditions to consider during construction and operations



Important Conditions

1. County CUP Compliance Package. Preconstruction micrositeing surveys
2. Habitat Mitigation. WDFW and Palouse Prairie impacts
3. Avian fatality monitoring
4. Technical Advisory Committee
5. Decommissioning Requirements



Successful Financing

- First Wind has secured **\$210 Million** to finance the Palouse Wind project
- Key Bank-Joint lead arranger and administrative agent
- Norddeutsche Landesbank Girozentrale, CoBank ACB, Banco Santander served as joint lead arrangers

“We applaud First Wind’s dedication that brings significant investment to Eastern Washington. The financing of Palouse Wind **demonstrates the solid fundamentals of the wind project that will provide an excellent source of renewable power for Washington ratepayers.**”

- Andrew Redinger

KeyBanc Director Utility & Renewable Energy



Palouse Wind represents a Major Investment in Whitman County

- Construction will support **150 - 250** jobs
- Approximately **\$30 million** of spending with local businesses in Whitman County and the Inland Northwest
- **15 full-time** operations jobs, and ongoing contracting with local businesses
- Property Tax and Sales Tax Revenue
 - Over **\$700,000** per year generated in tax revenue

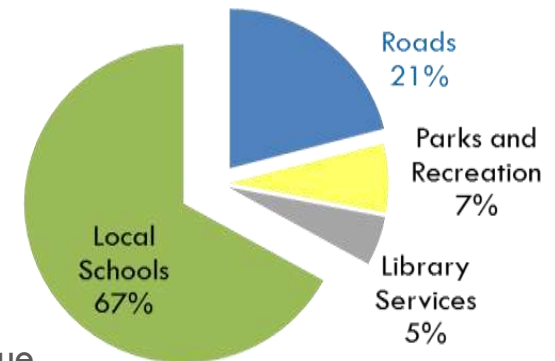

Construction of Palouse Wind

- Construction meets the standards of County CUP conditions
- **40** permanent acres impacted, **5** acres CRP/grassland
- RMT, Inc selected as General Contractor
- Approximately **50** workers on site since October, increasing to **250** this summer
- Civil work on roads and turbine pads
- Avista switchyard construction

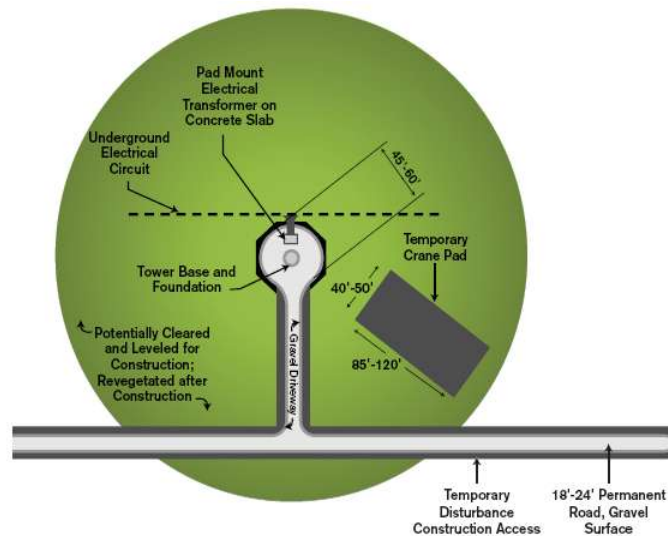

Inland NW Jobs

Contractors to-date include

- Busch Distributors, Oakesdale
- Pearson Fence, Colfax
- Wheatland Inn, Colfax
- Crossets Market, Oakesdale
- Brass Rail, Rosaila
- Plateau Archeology, Pullman
- Stewart Title, Pullman
- Schweitzer Engineering, Pullman
- Memorable Events, Colfax
- Goodfellow Brothers, Wenatchee
- Lydig Construction, Spokane
- Garco Construction, Spokane
- STRATA, Pullman
- Taylor Engineering, Pullman
- Atlas Sand and Gravel, Clarkston
(local gravel pit)
- Landau Associates, Colfax
- Gallatin, Spokane
- Henkles & McCoy, Vancouver
- Ch2MHill, Spokane



Long Term Commitment on the Palouse

- First Wind Scholarship Program
- Palouse Empire Fair, Lentil Fest
- High School boosters
- 4H and FFA Clubs
- Fishing Kids
- Bikes for Books
- Youth sports sponsorship



What to expect in 2012

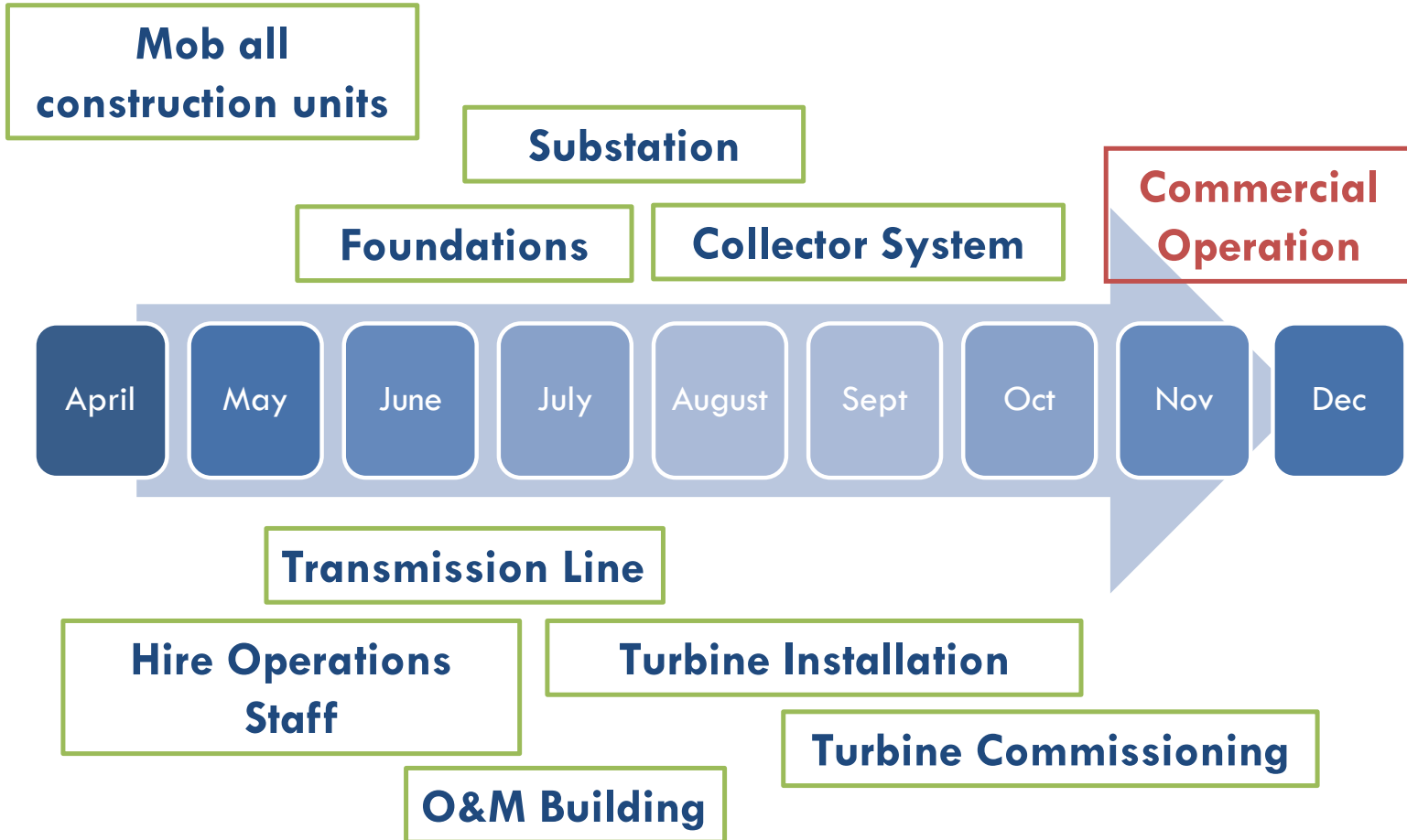

Ben Fairbanks
Director, Business Development
p – 971.998.1411
bfairbanks@firstwind.com





2011 Electric Integrated Resource Plan Acknowledgement Review

Clint Kalich, Manager of Resource Planning and Analysis

First Technical Advisory Committee Meeting

2013 Electric Integrated Resource Plan

May 23, 2012

Acknowledgements

- Idaho Public Utilities Commission (IPUC) Case No. AVU-E-11-04, ORDER NO. 32444 acknowledged Avista's 2011 IRP.
- Washington Utilities and Transportation Commission (UTC) Docket No. UE-101482 acknowledged Avista's IRP on January 12, 2012.
- Acknowledgement is not a pre-approval of the Preferred Resource Strategy or the IRP itself. Future acquisitions obtain a prudence determination in general rate cases.
- IPUC encouraged Avista to make continued efforts to include more public involvement in the TAC.



Public Comments

- No public comments received in Washington jurisdiction.
- Two public comments in Idaho jurisdiction:
 - An individual commenter thought the Company should not receive any public money or rate increases for wind generation.
 - Benewah County, Idaho was concerned that the potential federal greenhouse gas policies in the IRP would lead to increased rates and negatively impact the County, and the policies were not supported by the science. They advocated for Avista to develop alternative policies to benefit the environment and the County.

Resource Needs

- IPUC believes the capacity planning assumptions are reasonable given the Company's access to and the availability of markets if resource deficits are higher than predicted.
- UTC: The 14% summer and 15% winter planning margin above operating reserves are appropriate for planning for peak loads and are consistent with other regional utilities. This is an improvement over the 2009 IRP methodology.
- UTC: Continue involvement in the NPCC Resource Adequacy Forum.
- UTC: Continue to analyze planning margin to determine the most cost-effective way to reliably meet resource adequacy needs.

Load Forecasts

- IPUC supports the inclusion of projected electric vehicle consumption.
- IPUC believes the load forecast assumptions to be reasonable.
- UTC requested a range of load forecasts in the 2009 IRP acknowledgement. 2011 IRP included a high growth case (2.33%) and a low growth case (0.93%). This is expected to continue in future IRPs.
- UTC: the Global Insights forecasts on Table 2.1, p. 2-4. GDP growth (2.7%), unemployment (5%), 1.58 million housing starts per year, and 4.75% federal funds rate may be too optimistic given the current state of the economy. Need to continue to monitor and test models under more conservative growth assumptions.

Energy Efficiency

- IPUC has concerns that the Company “...may not pursue “all” cost-effective conservation if it adheres to certain conservation-potential limitations expressed in the IRP” (maximum versus realistic achievable potential). The 2007 and draft 2012 Idaho State Energy Plans direct the IPUC to encourage utilities to pursue “all cost effective conservation.”
- UTC: Considers the Conservation Potential Assessment (CPA) done for the 2011 IRP to be sound and includes a reasonable range of forecast assumptions.
- UTC: Finds the CPA sensitivity analysis regarding changes to avoided cost “... to be useful in identifying both the potential achievable over this time horizon, but also for identifying higher costs along the supply curves.”



Renewable Portfolio Standard

- IPUC: Early acquisition of wind to meet RPS requirements ahead of need will be will be scrutinized in a future rate case, but the early acquisition allows for the use of tax incentives and lower wind costs.
- UTC: The Company needs to more clearly describe the method used to calculate REC reserve requirements and how the reserves are used for RPS compliance.
- UTC: Need to provide clear analysis of how the Company specifically (new resources, RECs or banking) plans to meet the higher RPS goals from 2016 and beyond.



Transmission & Distribution

- IPUC: Staff is encouraged by efforts to include distribution savings and supports continued involvement with regional transmission groups.
- UTC: Estimated costs for the integration of new resources are useful.
- UTC: Want to see continued cooperation with BPA on the direct interconnection of Lancaster to ensure completion of the project by the end of 2012.
- UTC: Continue to refine the analysis of feeder upgrades as they are completed and track actual loss savings in the 2013 IRP.

Generation Resource Options

- UTC would like to see a discussion and analysis of electric storage technologies for “firming intermittent generation resources or for meeting peaks in load.” This should include cost-effectiveness, commercial availability, and where this resource would fit in relation to other generating resources.
- UTC wants “... an explicit discussion of the future costs and liabilities of operating Colstrip over the 20 year planning horizon” including costs of anticipated EPA regulations because it is a significant resource and the Company’s only coal-fired asset.
- UTC: Model a scenario for the 2013 IRP without Colstrip in the Company’s resource portfolio and show “... estimates of the impact on Net Present Value (cost) of its portfolio and rates”.



Modeling Approach

- UTC: Finds the efficient frontier analysis to be informative in highlighting the tradeoff between risk and cost when choosing resources.
- UTC: Support the continued improvement of modeling for the IRP “... and urge the Company to explore its thinking and strategy with the TAC (technical advisory committee) at an early date.”

Preferred Resource Strategy

- IPUC: Supports increased levels of energy efficiency. Should also include analysis and consideration of cost-effective demand response in the next IRP.
- IPUC: Tipping point analysis is beneficial to test how robust the PRS is and to point out which variables are most important to the PRS.
- UTC: Sensitivity analyses were informative.
 - High and low load growth cases (50% of expected load growth) is too improbable as a tipping point. Want to see this refined.
 - Should include "... load growth variances that result in incremental changes to the PRS, such as the delaying the acquisition of the 2018 SCCT."

Action Plan

- IPUC: The Company made progress on the 2009 IRP Action Items and the 2011 Action Items should enhance the 2013 IRP.
- UTC: 2011 Action Plan is presented well and is well grounded in the modeling and analysis.
- UTC: encourages close monitoring of actual load growth and changes in the market which may require changes to the PRS and the Action Plan.



Energy Independence Act Compliance & Forecast

John Lyons, Power Supply Analyst

James Gall, Senior Power Supply Analyst

First Technical Advisory Committee Meeting

2013 Electric Integrated Resource Plan

May 23, 2012

Energy Independence Act

- RCW 19.285 – The Energy Independence Act is also known as Initiative Measure No. 937 (I-937)
 - Requires utilities with more than 25,000 customers to obtain fifteen percent of their electricity from qualified renewable resources by 2020.
 - Also requires the acquisition of all cost-effective energy conservation.
- I-937 approved by Washington voters on November 6, 2006.

Reporting Requirements

- Annual compliance report, per WAC 480-109-040, is due on or before June 1st beginning in 2012 and must include the following:
 - Utility's annual Washington load for the prior two years,
 - Amount of eligible renewable resources and/or renewable resource credits needed to meet annual goal by January 1 of the target year,
 - Amount and cost of each type of eligible resource used,
 - Amount and cost of any renewable energy credits acquired,
 - Type and cost of the least-cost substitute non-eligible resources available,
 - Incremental cost of eligible renewable resources and renewable energy credits, and
 - The ratio of this investment relative to the utility's total annual retail revenue requirement.

Renewable Energy Requirements



Based on a percentage of Washington state retail sales using two year rolling average

- 3% of sales by January 1, 2012
- 9% of sales by January 1, 2016
- 15% of sales by January 1, 2020



2012 Legislative Modifications

- SB 6414: Review Process for Electric Generation Project or Conservation Review
- SB 5575: Biomass Bill
 - Avista's 50 MW Kettle Falls plant becomes a "qualified renewable resource" beginning January 1, 2016 for the Energy Independence Act



2012 Projected Compliance

	aMW
Required Renewable Energy	18.9
Spokane River	
Long Lake #3	1.6
Little Falls #4	0.6
Clark Fork River	
Cabinet Gorge 2-4	10.8
Noxon Rapids 1-4	5.8
Wanapum Fish Bypass	2.0
Total Hydro Upgrades	20.8
Palouse Wind (2012)	TBD

Long-Term Renewable Energy Requirements & Compliance Forecast

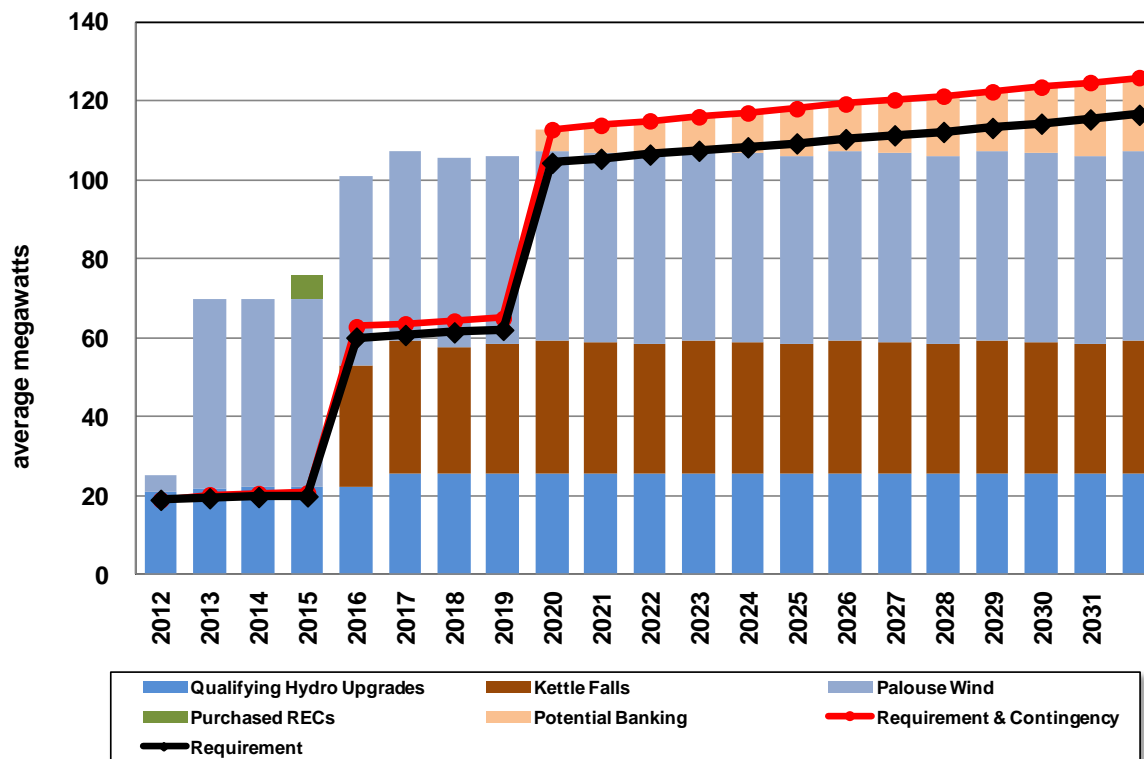



Work Plan

John Lyons, Power Supply Analyst

First Technical Advisory Committee Meeting

2013 Electric Integrated Resource Plan

May 23, 2012

Technical Advisory Committee Meetings

May 23, 2012: Powering Our Future Game, 2011 Renewable RFP, Palouse Wind Project Update, 2011 IRP Acknowledgements, Energy Independence Act Compliance & Forecast, and 2013 Work Plan.

September 2012: Two day TAC meeting. Day 1: Plant tour. Day 2: new resource assumptions, Spokane River assessment, and energy efficiency.

November 2012: Load & resource forecast, reliability planning, stochastic assumptions, and transmission cost studies.

January 2013: Environmental policy update, electric and gas price forecasts, scenario development.

March 2013: Draft Preferred Resource Strategy (PRS), energy efficiency, review of scenarios and futures, and portfolio analysis.

April 2013: Review of the final PRS and action items.

June 2013: Review of the Draft 2013 IRP.

2013 Draft Electric IRP Timeline

Preferred Resource Strategy (PRS) Tasks	Target Date
Finalize load forecast	July 2012
Identify regional resource options for electric market price forecast	September 2012
Identify Avista's supply & conservation resource options	September 2012
Update AURORA ^{xmp} database for electric market price forecast	October 2012
Finalize data sets/statistics variables for risk studies	October 2012
Draft transmission study due	October 2012
Energy efficiency load shapes input into AURORA ^{xmp}	October 2012
Final transmission study due	November 2012
Select natural gas price forecast	December 2012
Finalize deterministic base case	December 2012
Base case stochastic study complete	January 2013
Finalize PRiSM 3.0 model	January 2013
Develop efficient frontier and PRS	January 2013
Simulation of risk studies "futures" complete	February 2013
Simulate market scenarios in AURORA ^{xmp}	February 2013
Evaluate resource strategies against market and future scenarios	March 2013
Present preliminary study and PRS to TAC	March 2013

2013 Draft Electric IRP Timeline

Writing Tasks	Target Date
File 2013 IRP Work Plan	August 2012
Prepare report and appendix outline	September 2012
Prepare text drafts	April 2013
Prepare charts and tables	April 2013
Internal drafts released at Avista	May 2013
External draft released to the TAC	June 2013
Final editing and printing	August 2013
Final IRP submission to Commissions and distribution to TAC	August 31, 2013

2013 Integrated Resource Plan Modeling Process

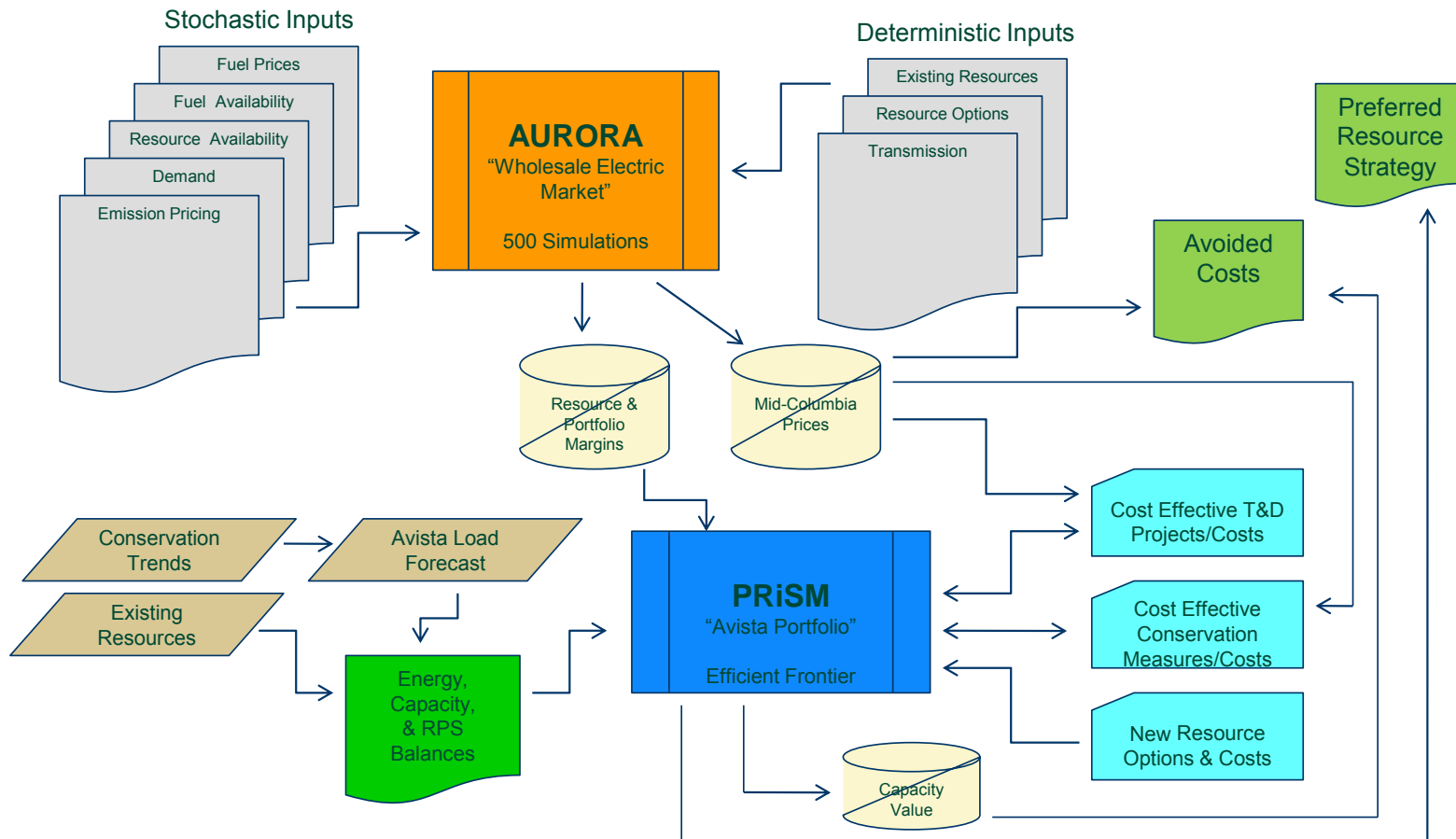

2013 Electric IRP Draft Outline

- Executive Summary
- Introduction and Stakeholder Involvement
- Loads and Resources
 - Economic Conditions
 - Avista Load Forecast
 - Load Forecast Scenarios
 - Avista Resources and Contracts
 - Reserve Margins
 - Resource Requirements

2013 Electric IRP Draft Outline

- Energy Efficiency and Demand Response
 - Conservation Potential Assessment
 - Overview of Energy Efficiency Potentials
 - Sensitivity of Potential to Customer and Economic Growth
 - Avoided Cost Sensitivities
 - Energy Efficiency Related Financial Impacts
 - Integrating Results into Business Planning and Operations
- Policy Considerations
 - Environmental Concerns
 - Greenhouse Gas Issues
 - State and Regional Level Policies

2013 Electric IRP Draft Outline

- Transmission & Distribution
 - Avista's Transmission System
 - Regional Transmission Issues
 - Transmission Construction Costs
 - Integration of Resources on the Avista Transmission System
 - Distribution Efficiencies
- Generation Resource Options
 - Assumptions
 - New Resources
 - Hydroelectric and Thermal Plant Upgrades

2013 Electric IRP Draft Outline

- Market Analysis
 - Assumptions and Fuel Prices
 - Market Price Forecasts
 - Scenario Analysis
- Preferred Resource Strategy
 - Resource Selection Process
 - Preferred Resource Strategy
 - Efficient Frontier Analysis
 - Avoided Costs
 - Portfolio Scenarios
- Action Items

Avista's 2013 Electric Integrated Resource Plan
Technical Advisory Committee Meeting No. 2 Agenda
Wednesday, September 5, 2012
Conference Room 328

Topic	Time	Staff
1. Introduction	8:30	Storro
2. Avista REC Planning Methods	8:35	Gall
3. Energy and Economic Forecasts	9:00	Forsyth
4. Break	10:30	
5. Shared Value Report	10:45	Wuerst
6. Lunch	11:30	
7. Generation Options	12:30	Lyons
8. Break	1:30	
9. Spokane River Assessment	1:45	Schwall
10. Adjourn	3:00	



Avista REC Planning Methods

James Gall, Senior Power Supply Analyst
Second Technical Advisory Committee Meeting
2013 Electric Integrated Resource Plan
September 5, 2012

Energy Independence Act - Refresher

- RCW 19.285 – The Energy Independence Act is also known as Initiative Measure No. 937 (I-937)
 - Requires utilities with more than 25,000 customers to obtain fifteen percent of their electricity from qualified renewable resources by 2020.
 - Also requires the acquisition of all cost-effective energy conservation.
- I-937 approved by Washington voters on November 6, 2006.

Renewable Energy Requirements - Refresher



Based on a percentage of Washington state retail sales using two year rolling average

- 3% of sales by January 1, 2012
- 9% of sales by January 1, 2016
- 15% of sales by January 1, 2020



2011 IRP Planning Margin Requirements

- In past IRP's Avista included a REC planning margin for the variability of load and generation due to weather for compliance of the EIA.
- The 2011 IRP included a planning margin of 7 to 8 aMW between 2012 and 2016 and 23+ aMW after 2016 to account for wind variability
- This planning margin was a threshold for the minimum amount of additional REC's to hold over the expected requirement.

What Has Changed Since 2011 IRP

- Load forecast is lower
- Signed 105 MW PPA for Palouse Wind
- Washington SB 5575 counts Kettle Falls as “renewable” beginning in 2016
- Hydro upgrades may use long-term average incremental energy rather than estimated actual incremental energy for compliance

What Planning Margin Do We Need Now?

- Develop risk model of REC compliance
 - Simulates future loads and qualifying wind, hydro, and biomass output
 - Accounts for actual and potential REC purchases and sales
 - Simulates 100 future outcomes
- Model allows RECs to be “Rolled” over to future years
 - Does not allow bring RECs back from future years
 - Pulling REC’s from future years is allowed but creates a short position that would be needed to be filled
- Tested several REC scenarios and the effects of policy choices

Risk Assumptions

- Load: Expected Forecast with Standard Deviation of 4.2% of Mean with a normal distribution
- Hydro: 1986 to 2011 upgrade estimated energy savings (random draw)
- Palouse: 1990 to 2010 estimates provided by First Wind (random draw)
- Kettle Falls: Expected to run 10 out of 12 months with standard deviation at 5% of mean with a normal distribution. Assumes 75% of fuel counts as renewable

REC Planning Margin Over Time

Scenario	2015 (aMW)			2020 aMW
	Expected REC Position	5th Confidence Level REC Position	Implied Planning Margin	Expected 2020 REC Position (aMW)
2009 Status Higher load forecast, no Palouse or Kettle Falls, Hydro is variable, no EWEB purchase, no Wanapum RECs	-3.1	-9.6	6.5	91.3
2009 with “Hydro Methodology 3”: Same study as above with 10 year historical hydro	-0.9	-1.9	1.0	89.0
Today’s expectations Lower load forecast, Palouse signed, Kettle Falls Counts, Hydro is flat, EWEB sold through 2014.	Long	Long	Zero	Zero

2013 IRP Implications

- REC surplus exceeds potential planning margin requirements
- No REC planning margin will be included for this IRP to meet the EIA
- Planning margins will be taken into account when selling excess RECs
- Without Kettle Falls we would have a 9.9+ aMW Planning Margin for Load/Wind Variation (assumes hydro is fixed)

Commerce REC Filing

Handout:

<http://www.commerce.wa.gov/site/1001/default.aspx>





TAC Economic Outlook

September 5, 2012

Grant D. Forsyth, Ph.D.
Chief Economist
509-495-2765
Grant.Forsyth@avistacorp.com

Goals of Update

- **Highlight national and regional economic conditions that impact customer and usage forecasts.**
- **Highlight long-run issues related long-run growth and fiscal consolidation.**
- **Review most recent electric load forecast.**

National GDP Growth and Inflation: Recent Global Insight (GI) Forecasts

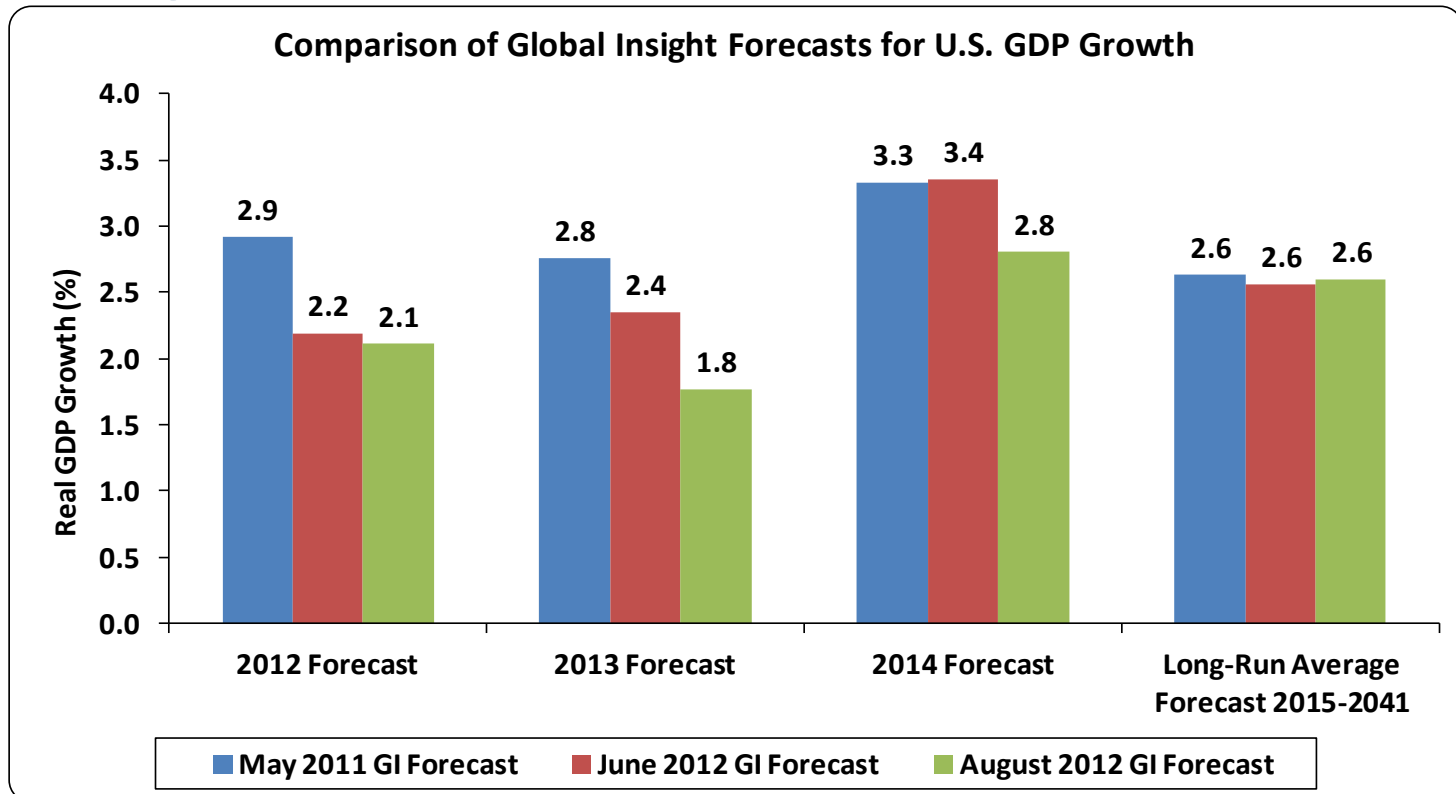

- Modest growth with increasing downside risks to growth in 2012 and 2013: Europe, Asia, and Congress (aka “Fiscal Cliff”).
- Housing market appears to be stabilizing.

Data Source: BEA, Global Insight, and author’s calculations.



SA Employment Index in Key MSAs, June 2009-July 2012

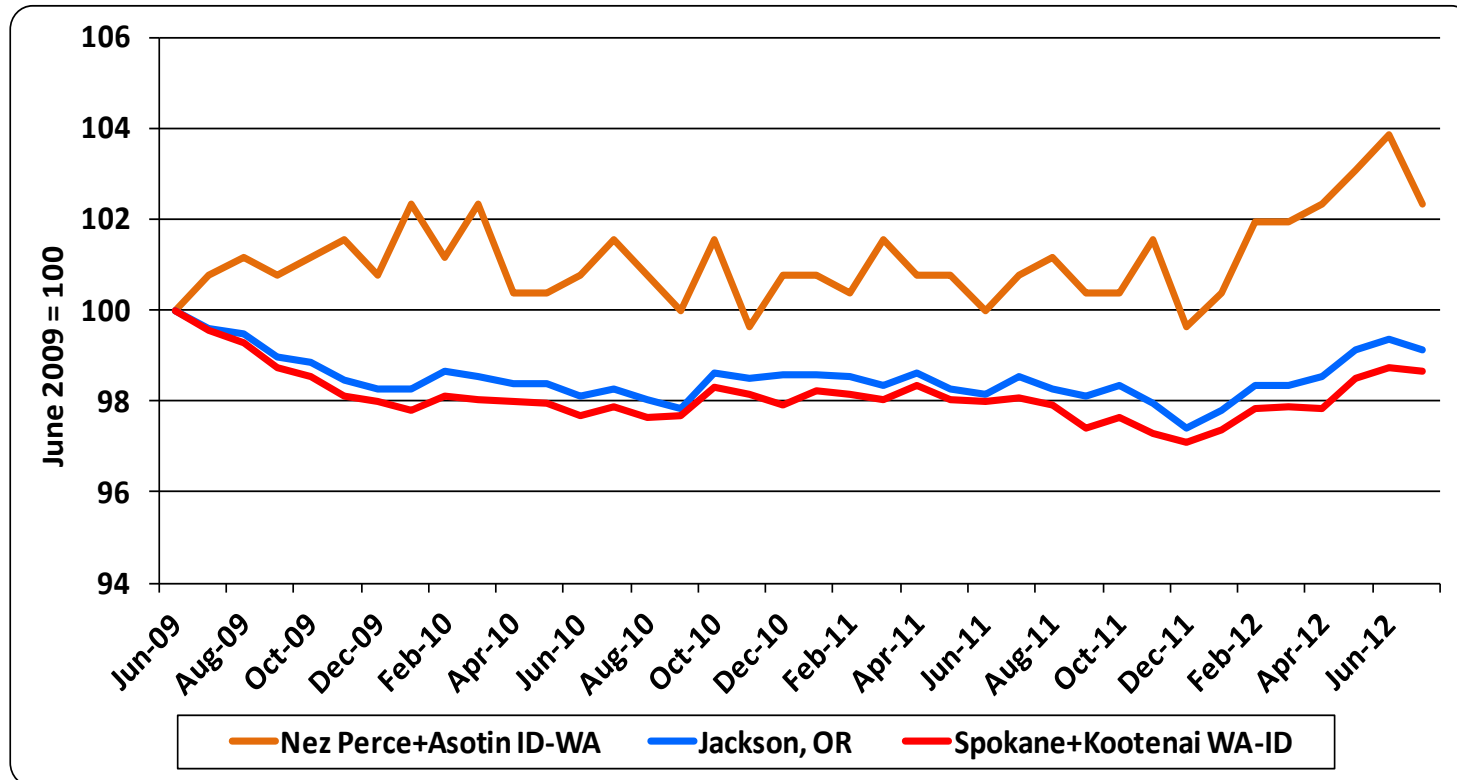

- Employment levels similar to late 2009. Employment is growing in big metro areas.
- Holding down service area population growth and household formation.

Data Source: BLS and author's calculations.



SA Employment Index for Avista's Service Area, June 2009-July 2012

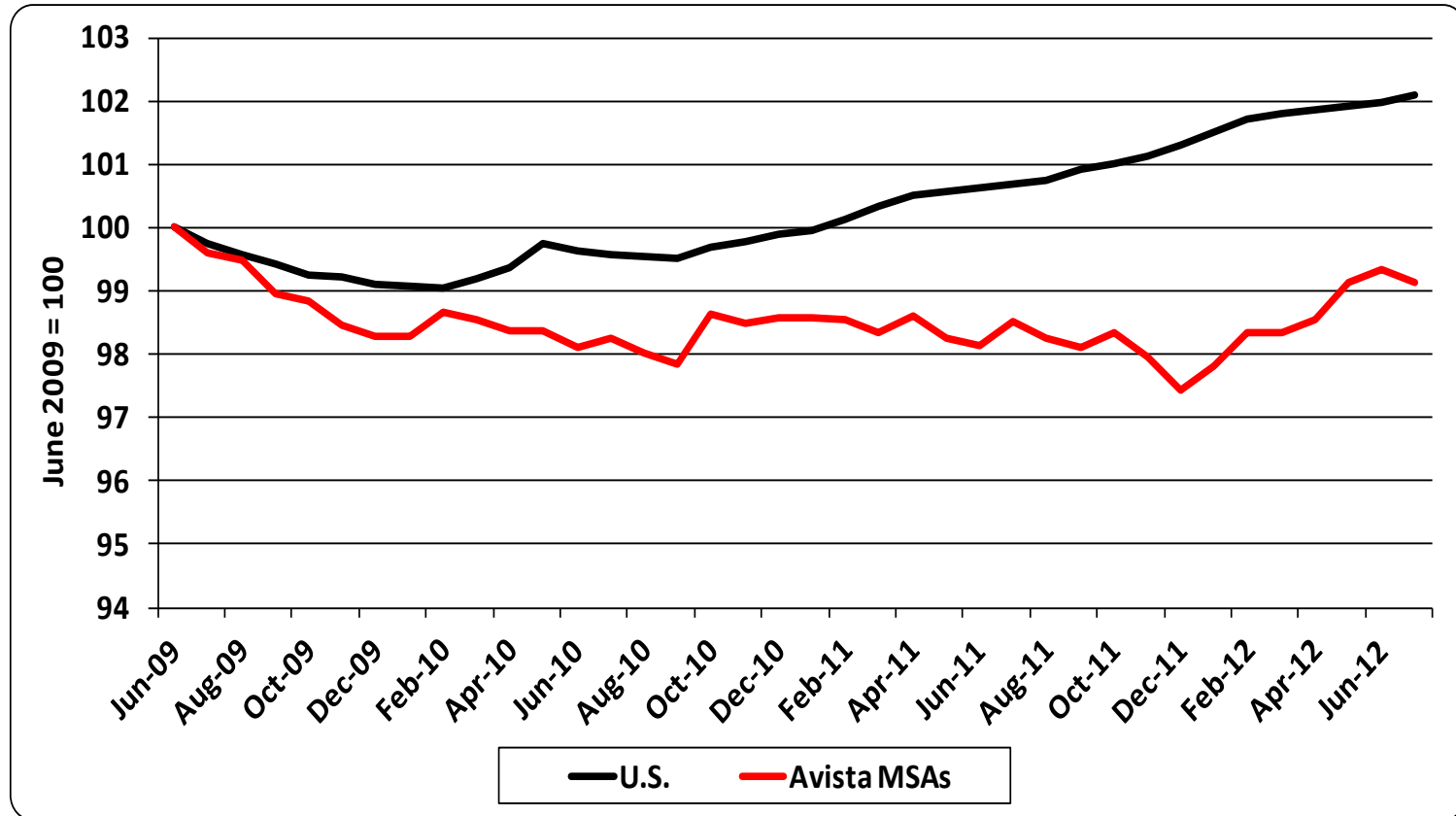

Data Source: BLS and author's calculations.



Unemployment Rate for July, 2009-2012

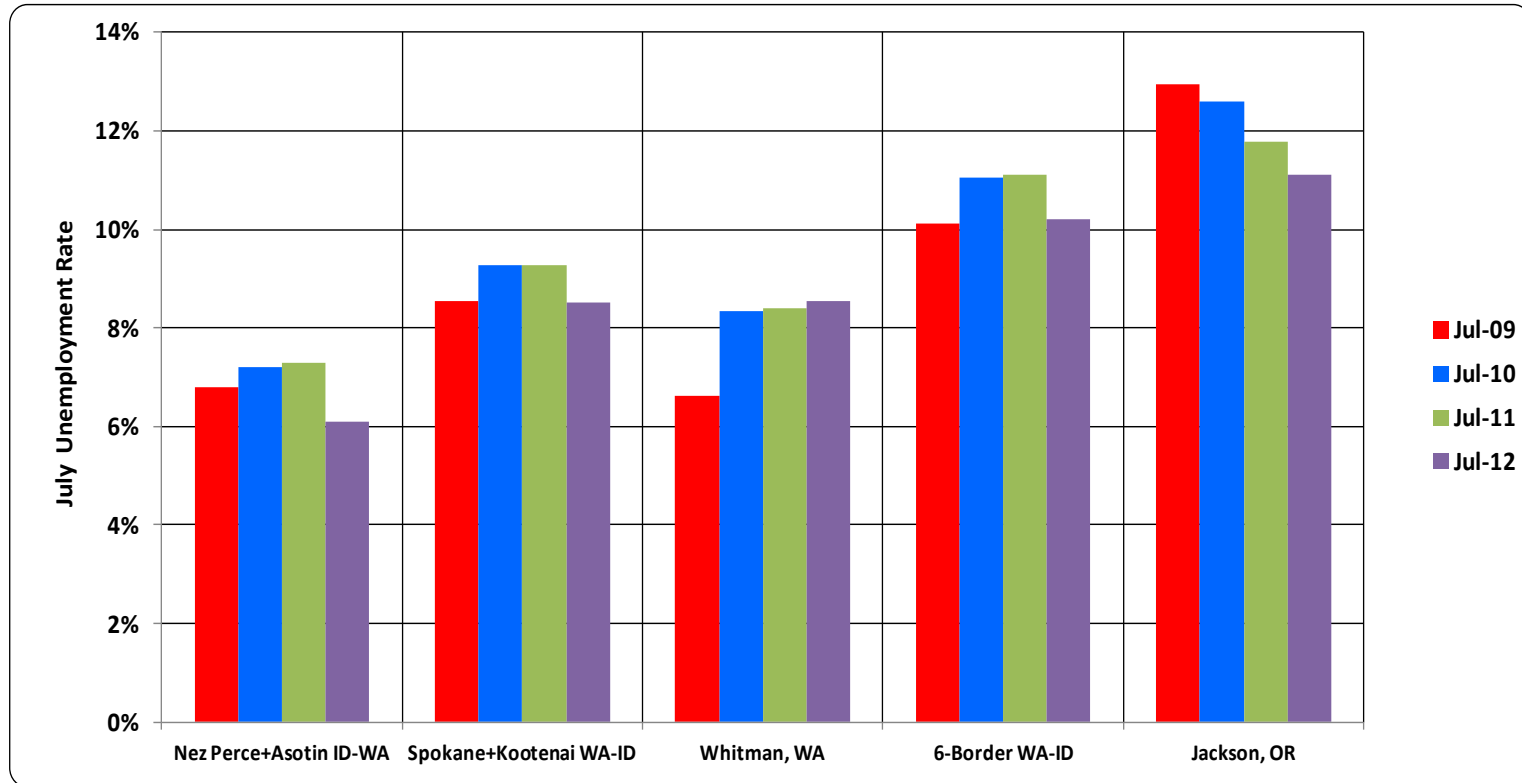

- Jackson, OR (Medford MSA) has fallen the most, rates still high.
- Some of the declines reflect a falling labor force from discourage workers “dropping out.”
- Expect unemployment rates to remain elevated for rest of 2012 and into 2013.

Data Source: BLS and author’s calculations.



Spokane+Kootenai Leading Indicator, 2011-2012

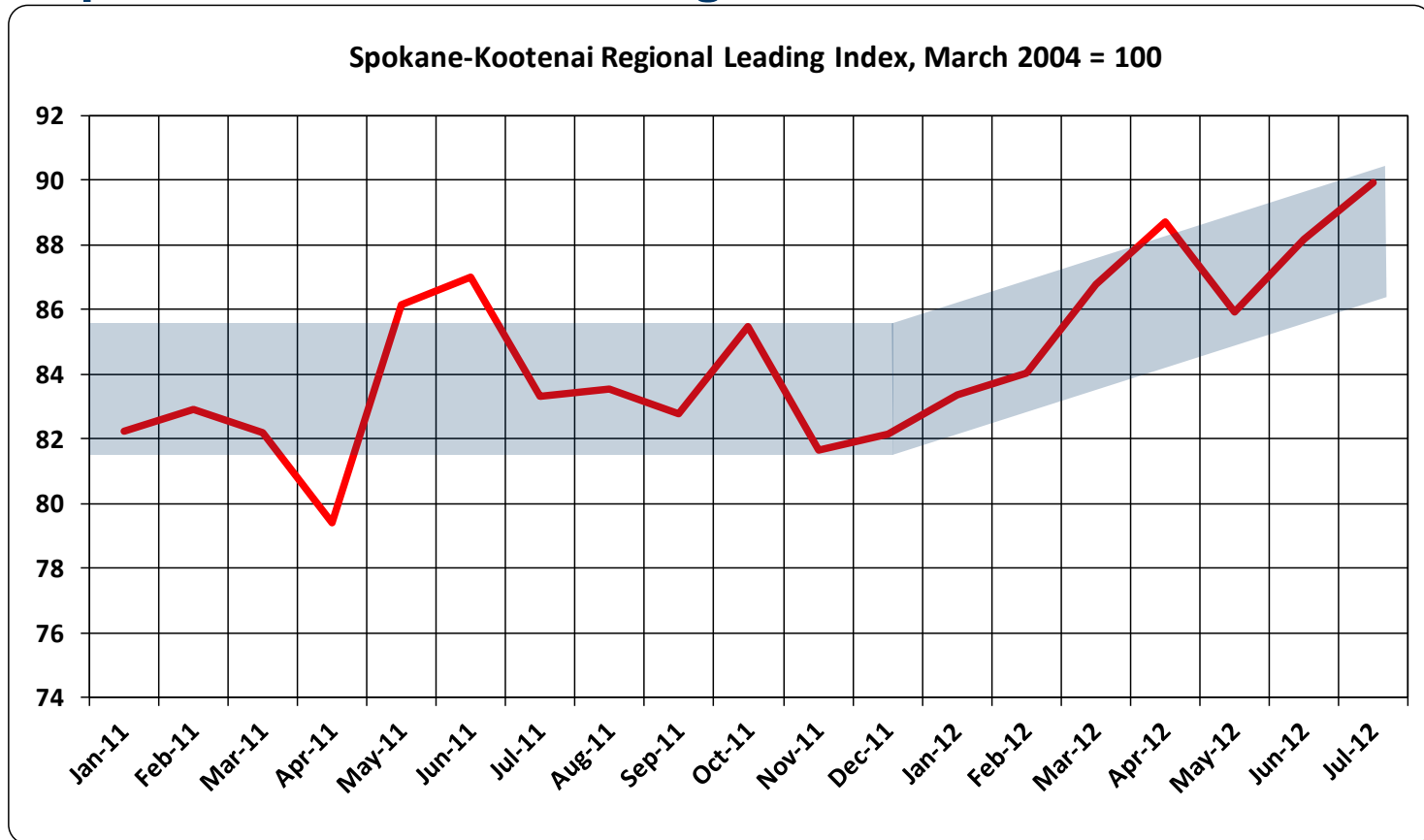

- Highly correlated with employment changes 12 to 15 months in advance.
- Signaling very slow employment growth for the rest of 2012 and through the first half of 2013.

Data Source: Global Insight and author's calculations.



Old vs. New Long-Run: Annualized Employment and Population Growth in Spokane+Kootenai

Employment Growth = $f(\text{U.S. Real GDP Growth})$

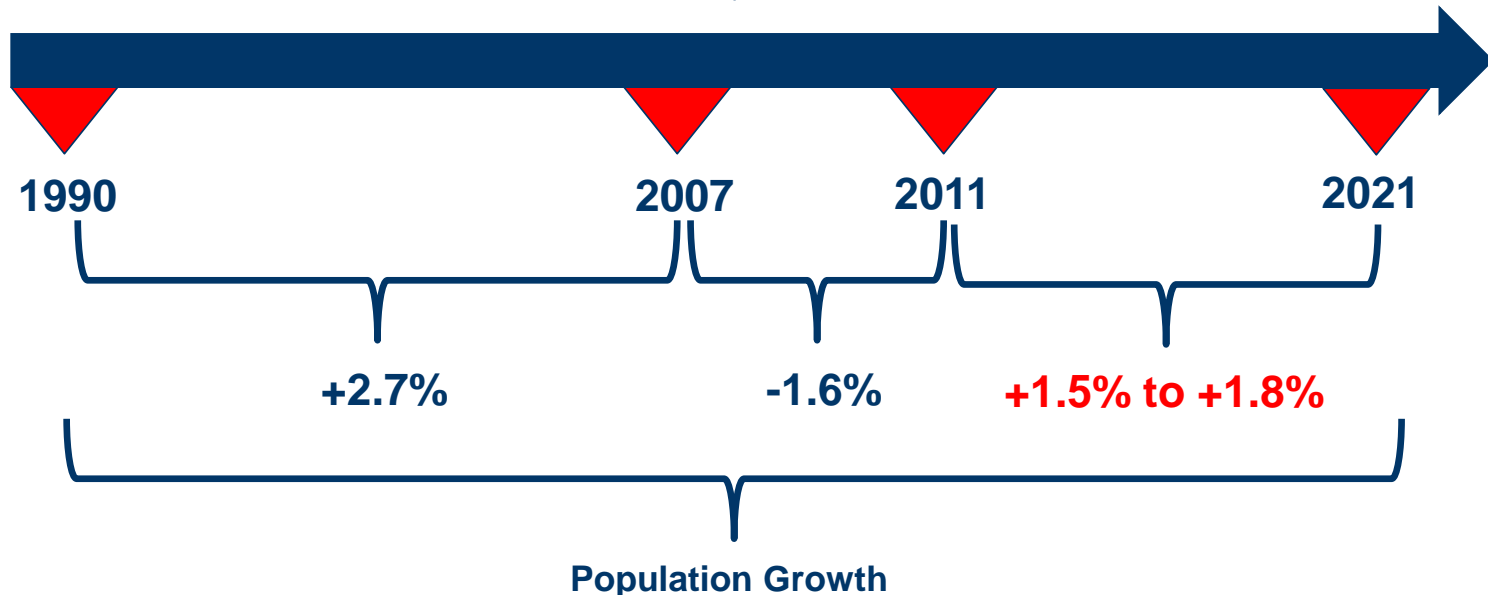

Regional Population Growth = $f(\text{U.S. Employ. Growth, Regional Employ. Growth})$

+1.1% to +1.3%

(-)

(+)

Data Source: BLS and author's calculations.



The Potential Drag of Fiscal Consolidation: Government Transfer Payments to Total Personal Income, 2007 and 2010

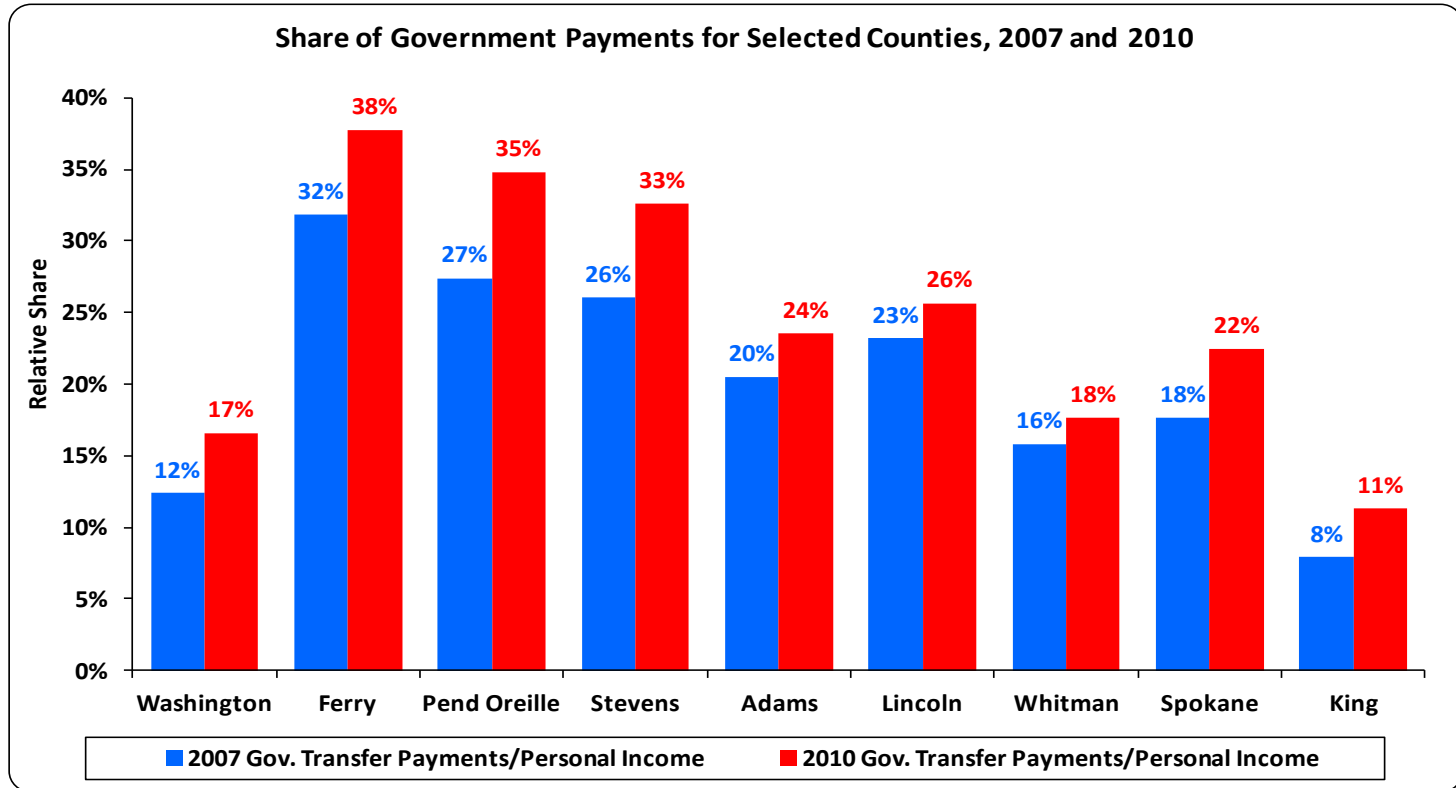

- **Message: Be careful what you ask for in terms of smaller government when government is an important part of your economy.**

Data Source: BEA and author's calculations.



The Potential Drag of Fiscal Consolidation: Government Employment as a Share of Total Employment, 2007 and 2010

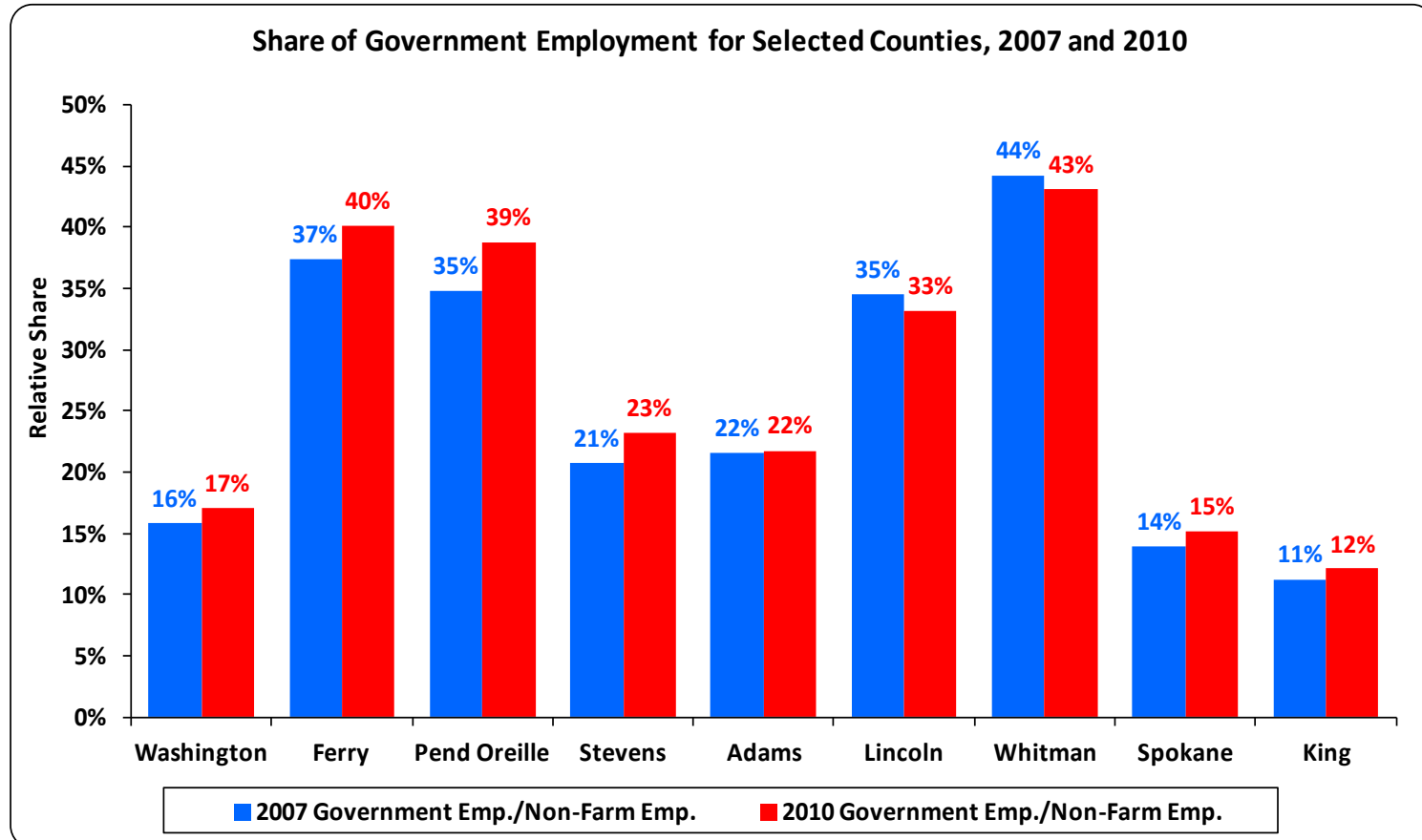

Data Source: BEA and author's calculations.



Looking Forward: Other Issues Potentially Impacting Growth

- **Aerospace firms have shown robust growth. This should continue given Boeing's order book. Potential new 737 plant not in forecast.**
- **Air force is moving ahead with the evaluations of bases for refueling tankers. The 10 finalists will be chosen by late summer 2012. Those chosen for expansion will be announced at year-end.**
- **Changes in the price of natural gas.**

Native Load Forecast Lower

Avista Combined Native Load Washington and Idaho

Forecast Native Load Growth Rates from 2013
5 yr = 1.04% 10 yr = 0.95% 22 yr = 1.01%

Forecast Customer Growth Rates from 2013
5 yr = 1.3% 10 yr = 1.2% 22 yr = 1.1%

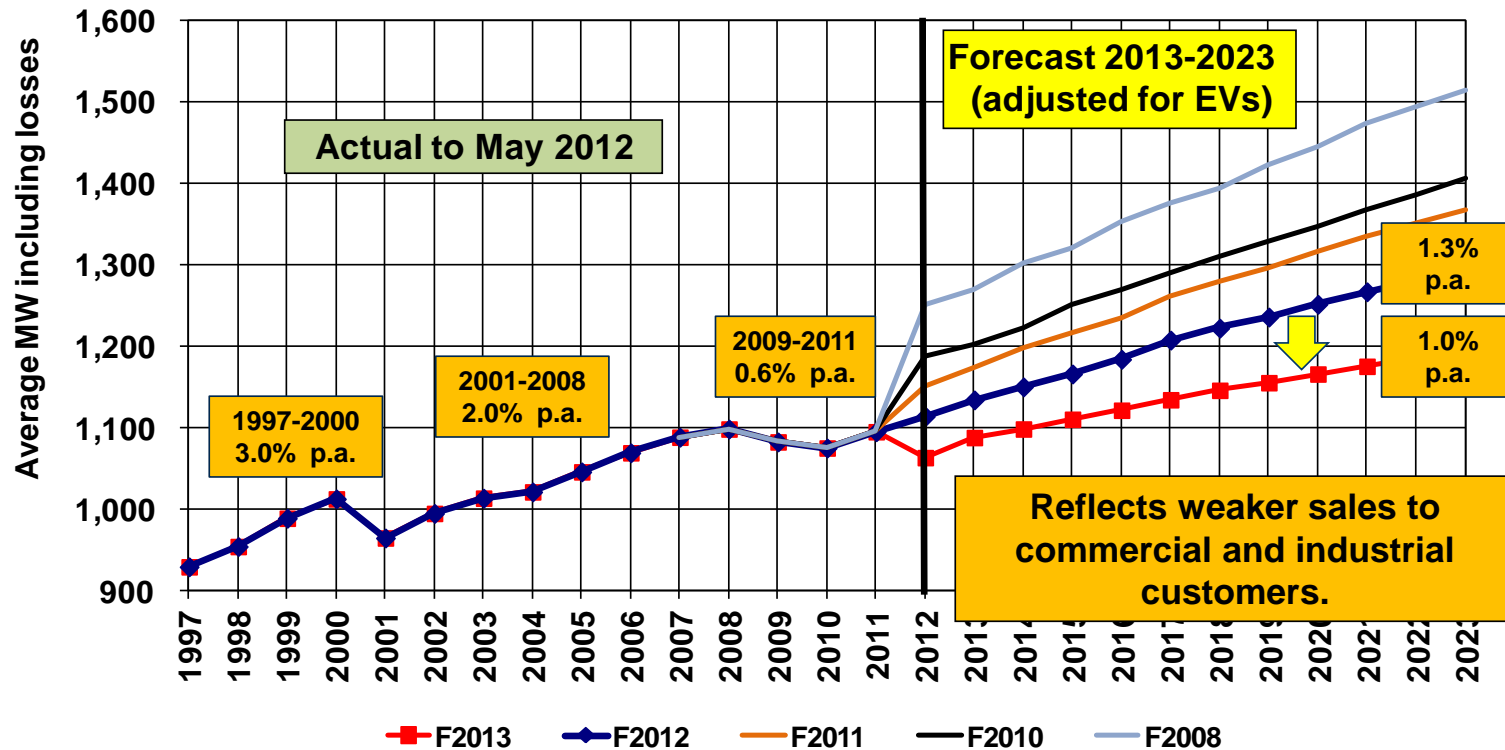

Annual Residential Use Per Customer, 1997-2035

Electric Average Use per Average Customer

Weather Adjusted

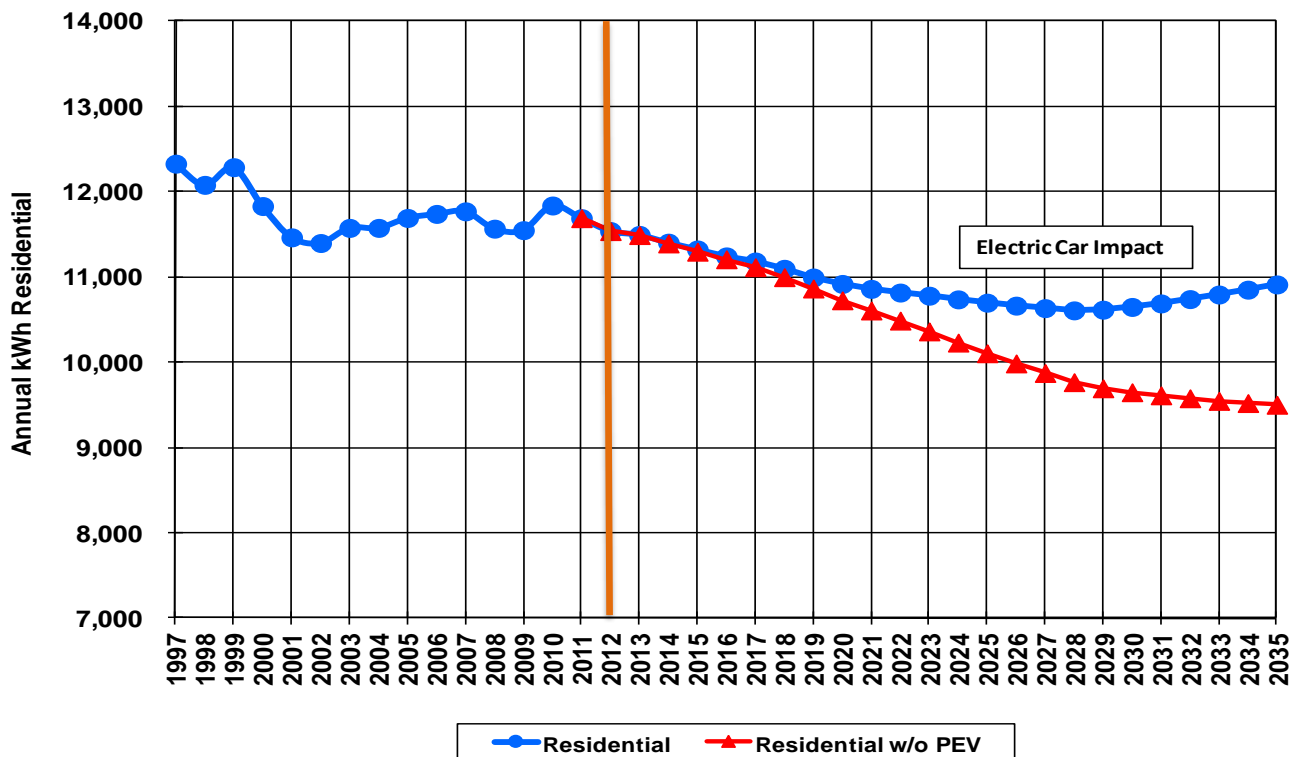



“Together We Will Build Shared Value”

Avista’s 2012 report on our performance

Technical Advisory Committee

Sept. 5, 2012

Jessie Wuerst, Sr. Communications Manager

Cross-Company Shared Value Action Team

Consumer Affairs
Customer Service
Electric Operations
Energy Solutions/DSM
Environmental
Facilities
Gas Operations

Generation & Production
Health & Safety
Human Resources
Rates
Resource Planning
Supply Chain



The business case for reporting

- Increase opportunities to build understanding of Avista's operations for all stakeholders
- Provide information that stakeholder groups want to know about
- Create opportunities for discussing partnerships with stakeholders that bring value to all
- Enhance transparency of Avista as a business to build trust and two-way communication

The “Shared Value” Pyramid



Shared Value – Changing Business Practices

“The principle of shared value...involves creating economic value in a way that *also* creates value for society by addressing its needs and challenges. Businesses must reconnect company success with social progress. Shared value is not social responsibility, philanthropy, or even sustainability, but a new way to achieve economic success.”

Harvard Business Review – Jan. 2011



Shared Value – An Opportunity

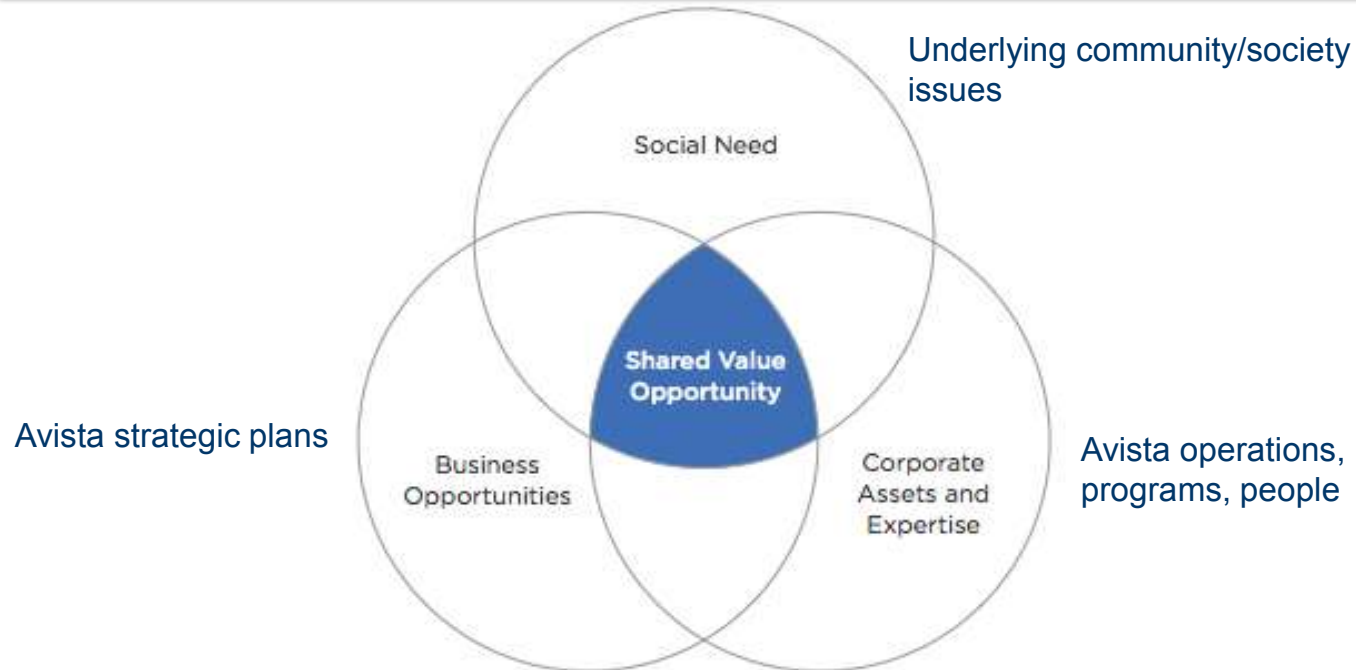

A snapshot in time of what Avista does well that grows our business and at the same time provides “social” value

Shared value opportunities are core to Avista’s vision:

“Delivering reliable energy service and the choices that matter most to you”



Shared Value reporting should focus on:

Linking business strategic priorities and what we know is of interest/concern to customers, media, investors and other stakeholders

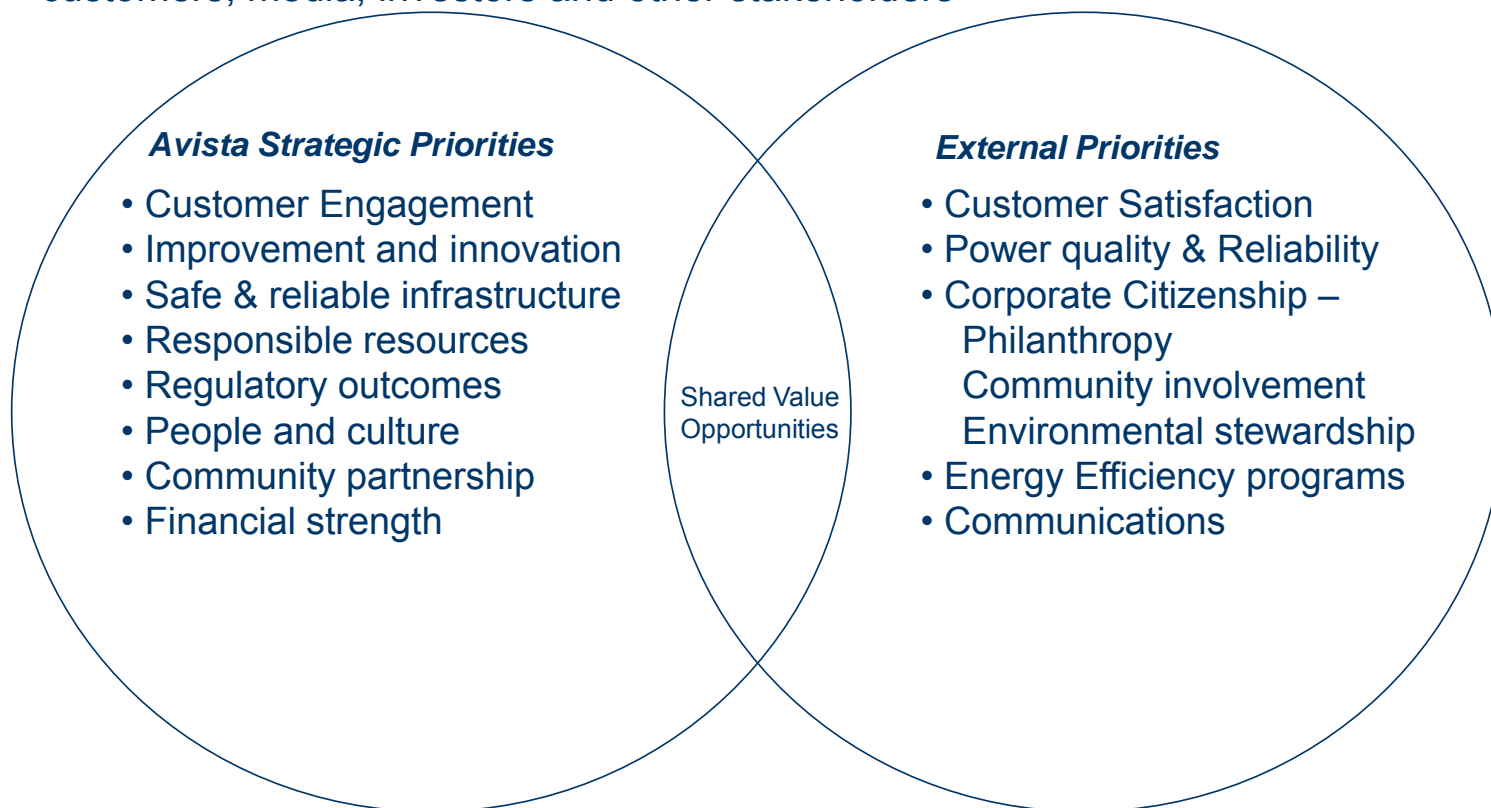

How can we most effectively share this information with stakeholders?

Segment stakeholders, identify current points of contact with each group and insert messaging throughout the year...

Bill insert Newsletter
 Social Media
 Website
 Community presentations (RBMs etc.)
 Employees e.g. account executives
 Employee communications: quarterly meetings, eview, View
 Editorial board meetings
 News releases



AVISTA

An integrated family of reports



Materiality Matters



Questions or Comments?





Generation Options

John Lyons, Senior Resource Policy Analyst
Second Technical Advisory Committee Meeting
2013 Electric Integrated Resource Plan
September 5, 2012

Supply Side Resource Data Sources

- Northwest Power and Conservation Council – 6th Northwest Power Plan
- Internally developed resource lists from:
 - Trade journals
 - Press releases from other companies
 - Engineering studies and other models
 - State commission announcements
 - Proposals from developers
- Consulting firms and reports
- State and federal resource studies and publications
- Data sources are used to check and refine generic resource assumptions

Natural Gas-Fired Resources

Resource Type	First Year	Size (MW)	Levelized Overnight Costs (2012 \$/MWh) *	Capital Cost Excludes AFUDC (2012\$)
SCCT (aero)	2015	100	\$79	\$1,101/kW
SCCT (frame EA)	2015	166	\$81	\$845/kW
SCCT (frame FA)	2015	175	\$70	\$728/kW
Hybrid SCCT	2015	92	\$75	\$1,114/kW
CCCT (air)	2017	270	\$70	\$1,117/kW
Reciprocating Engine	2015	113	\$76	\$1,060 /kW

* Prices are based on a preliminary natural gas price forecast

Other Thermal Resources

Resource Type	First Year	Size (MW)	Levelized Overnight Costs (2012 \$/MWh)	Capital Cost Excludes AFUDC (2012\$)
Coal (Super-critical)	2018	300	\$97	\$3,100/kW
Coal (IGCC)	2014	300	\$127	\$4,000/kW
Coal (IGCC w/sequestration)	2018	250	\$170	\$6,000/kW
Nuclear	2023	100*	\$173	\$7,000/kW
Small Scale Nuclear	2023	25	\$107	\$4,000/kW

* This represents a 100 MW of a 1,100 MW plant.

Renewable and Storage Resources

Resource Type	First Year	Size (MW)	Levelized Overnight Costs (2012 \$/MWh)	Capital Cost Excludes AFUDC (Nominal 2012)
Wind (On System)	2013	100	\$115	\$2,140/kW
Wind (Off System)	2013	100	\$123	\$2,140/kW
Geothermal	2017	15	\$104	\$4,000/kW
Wood Biomass	2015	25	\$160	\$4,000/kW
Landfill Gas	2014	3.2	\$106	\$2,500/kW
Manure Digester	2013	0.85	\$144	\$4,500/kW
Waste Water Treatment	2014	0.85	\$109	\$4,500/kW
Solar Photovoltaic	2014	5	\$312	\$3,500/kW
Solar Thermal	2014	50	\$414	\$6,500/kW
Battery Storage	2015	5	\$126	\$4,000/kW

Avista Upgrade Alternatives

- Avista thermal upgrades
 - Rathdrum CT
 - Coyote Springs 2
- Avista hydroelectric upgrades
 - Spokane River Project
 - Clark Fork River Project

New Resource Options Levelized Costs (\$/MWh)

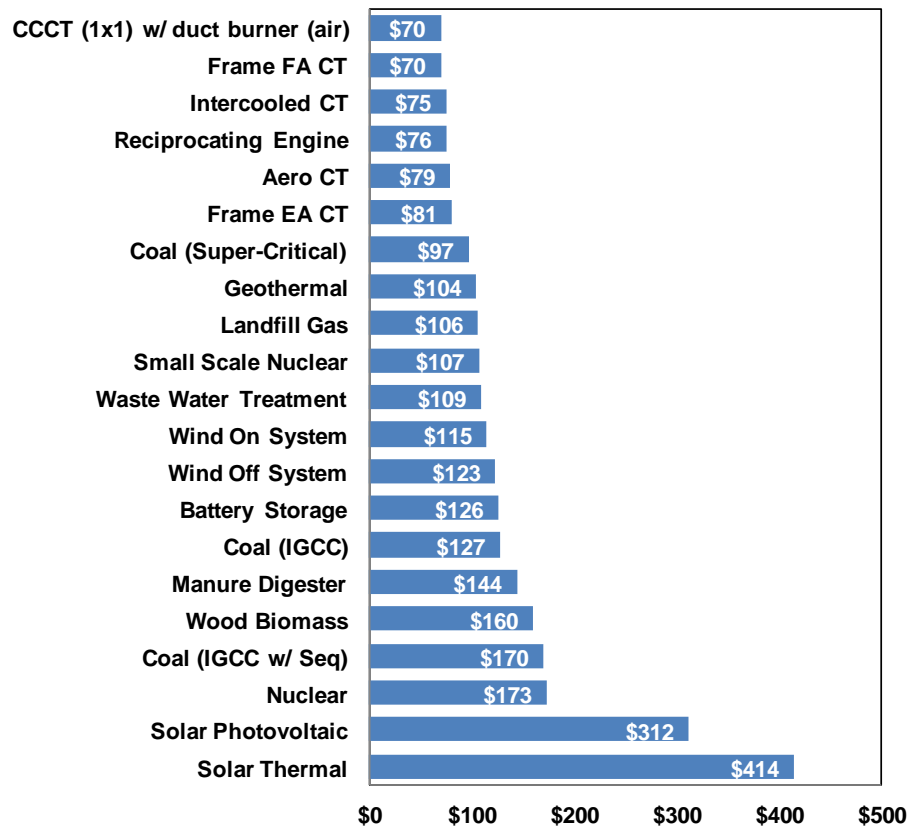

Hydro Modernization Initiative

Modernize Avista's existing fleet of hydro resources to:

- Generate incremental energy to meet load growth
- Produce RECs to meet renewable portfolio standards
- Increase plant efficiency through utilization of new technology
- Reduce risk through improved reliability and environmental mitigation



Develop long-term strategy to assess and prioritize Spokane River plant opportunities, and study Cabinet Gorge modifications to mitigate total dissolved gas issues

*Clean
Resources*

Generation Capability and Service Territory



SERVICE TERRITORY

- Electric and Natural Gas
- Natural Gas

GENERATION SOURCES

- Hydroelectric
- Thermal
- Wind

HYDROELECTRIC		GENERATION CAPABILITY (MW)
1	Noxon Rapids (Noxon, MT)	562.4
2	Cabinet Gorge (Clark Fork, ID)	254.6
3	Long Lake (Spokane, WA)	87.0
4	Little Falls (Spokane, WA)	34.6
5	Post Falls (Post Falls, ID)	18.0
6	Nine Mile (Spokane, WA)	17.6
7	Monroe Street (Spokane, WA)	15.0
8	Upper Falls (Spokane, WA)	10.2
Total Hydroelectric Capability		999.4

THERMAL		GENERATION CAPABILITY (MW)
9	Coyote Springs 2 (Boardman, OR)	278.3
10	Colstrip (Units 3 & 4) (Colstrip, MT)	222.0
11	Rathdrum Combustion Turbines (Rathdrum, ID)	149.0
12	Northeast Combustion Turbines (Spokane, WA)	61.2
13	Kettle Falls Biomass Plant (Kettle Falls, WA)	50.0
14	Boulder Park (Spokane, WA)	24.0
15	Kettle Falls Combustion Turbine (Kettle Falls, WA)	6.9
Total Thermal Capability		791.4

PURCHASED		GENERATION CAPABILITY (MW)
16	Lancaster (Rathdrum, ID) – Contract	275.0
Mid-Columbia Projects		180.0
17	Wells (Douglas PUD)	
18	Rocky Reach (Chelan PUD)	
19	Wanapum (Grant County PUD)	
20	Priest Rapids (Grant County PUD)	
21	Stateline Wind Farm (Touchet, WA)	35.0
Total Purchased Generation Capability		490.0

Value Proposition

- Improve **reliability** by replacing aging equipment
- Improve **performance** (energy and capacity) through technology advancements
- Produce **renewable energy credits** to meet RPS requirements
- Take advantage of **favorable tax treatment**
- Possible resolution of **total dissolved gas** issues



Spokane River Project

- *Spokane River was built out in the late 1800's and early 1900's to meet the growing demands of the Spokane region.*
- *Undersized by today's design standards for hydro development capturing 30% – 60% of available water*



Spokane River Project

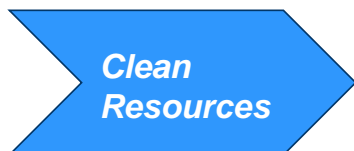

Original Monroe Street Powerhouse

Current Spokane River Project

Facility	Year Built	Generation Capability (MW)	Net Energy Output (MWh)
Post Falls	1906	14.8	90,000
Upper Falls	1922	10.0	71,000
Monroe St	1992	14.8	106,000
Nine Mile	1908	26.4	101,000
Long Lake	1915	78.0	480,000
Little Falls	1910	32.0	201,000
Total		176.0	1049,000



Spokane River Project Flow Duration Curve

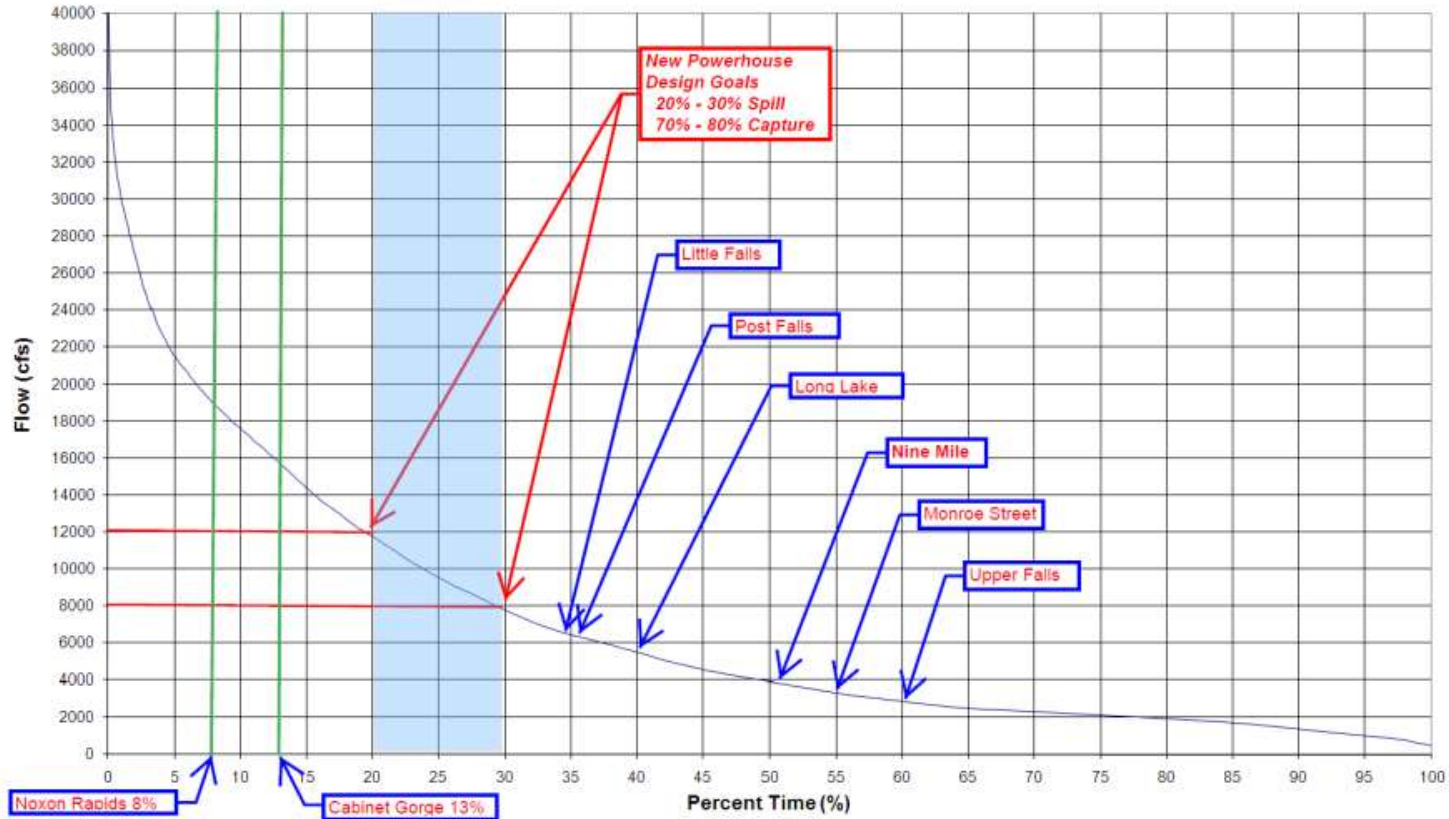

Spokane River Assessment

Goals of the Spokane River Assessment:

- *Fully develop the Spokane River
- Capture 70% - 80%*
- *Provide cost effective generation alternatives
to meet resource needs*
- *Increase plant efficiency and reliability*
- *Address environmental and regulatory
considerations*

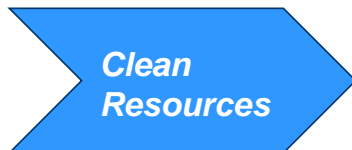

A History of Hydro Upgrades

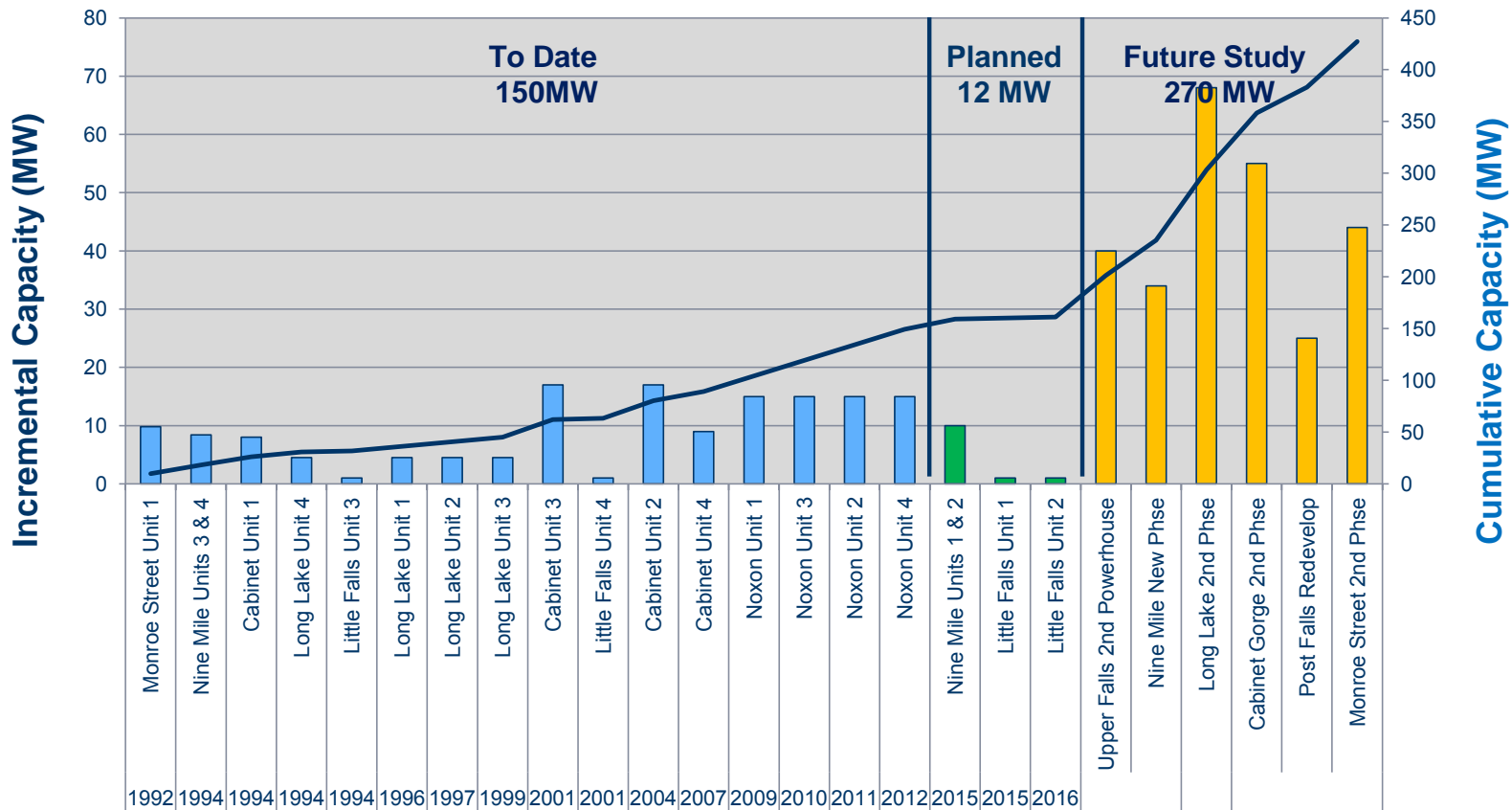

A History of Hydro Upgrades

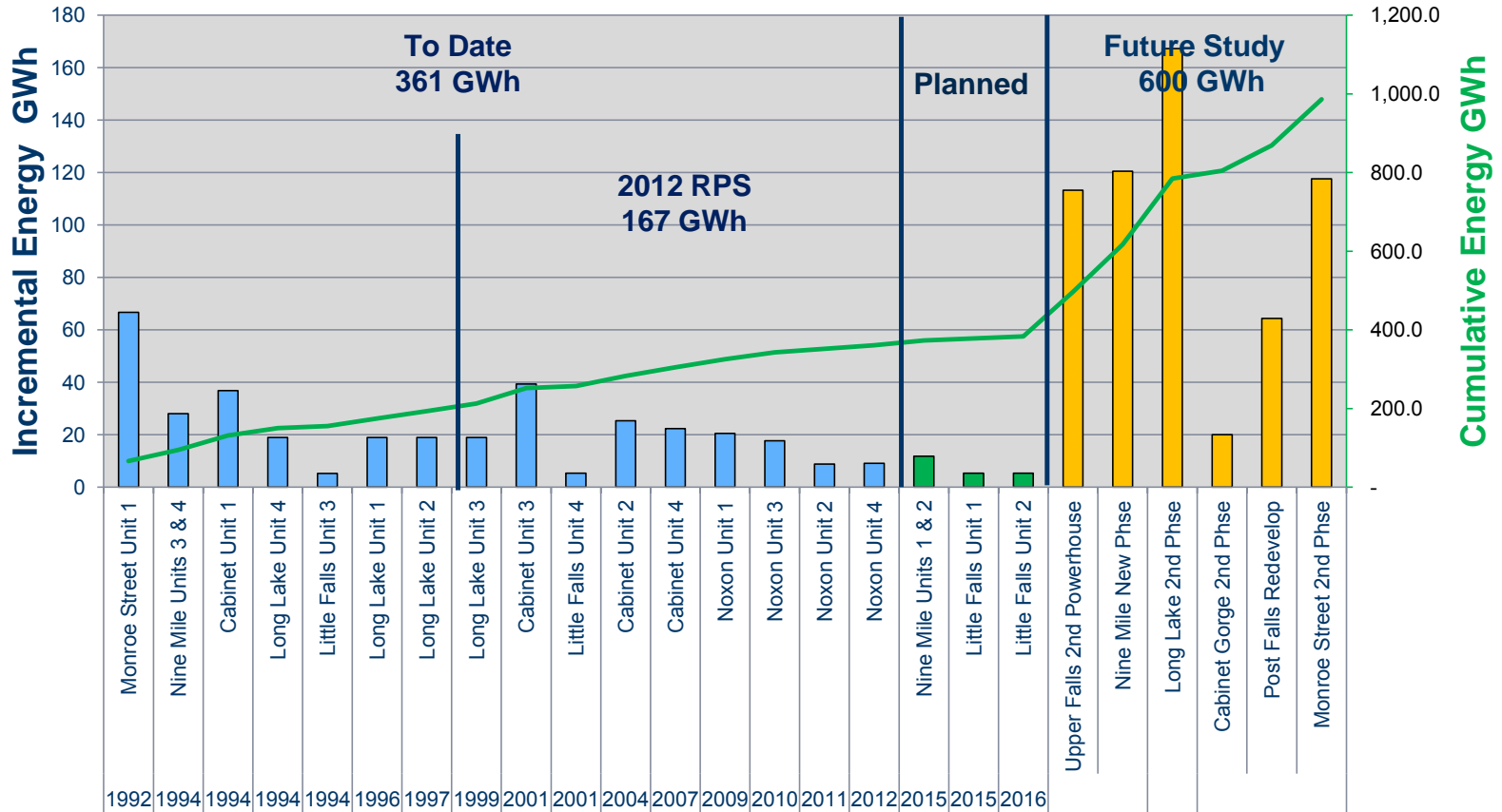

Post Falls Possible Modifications

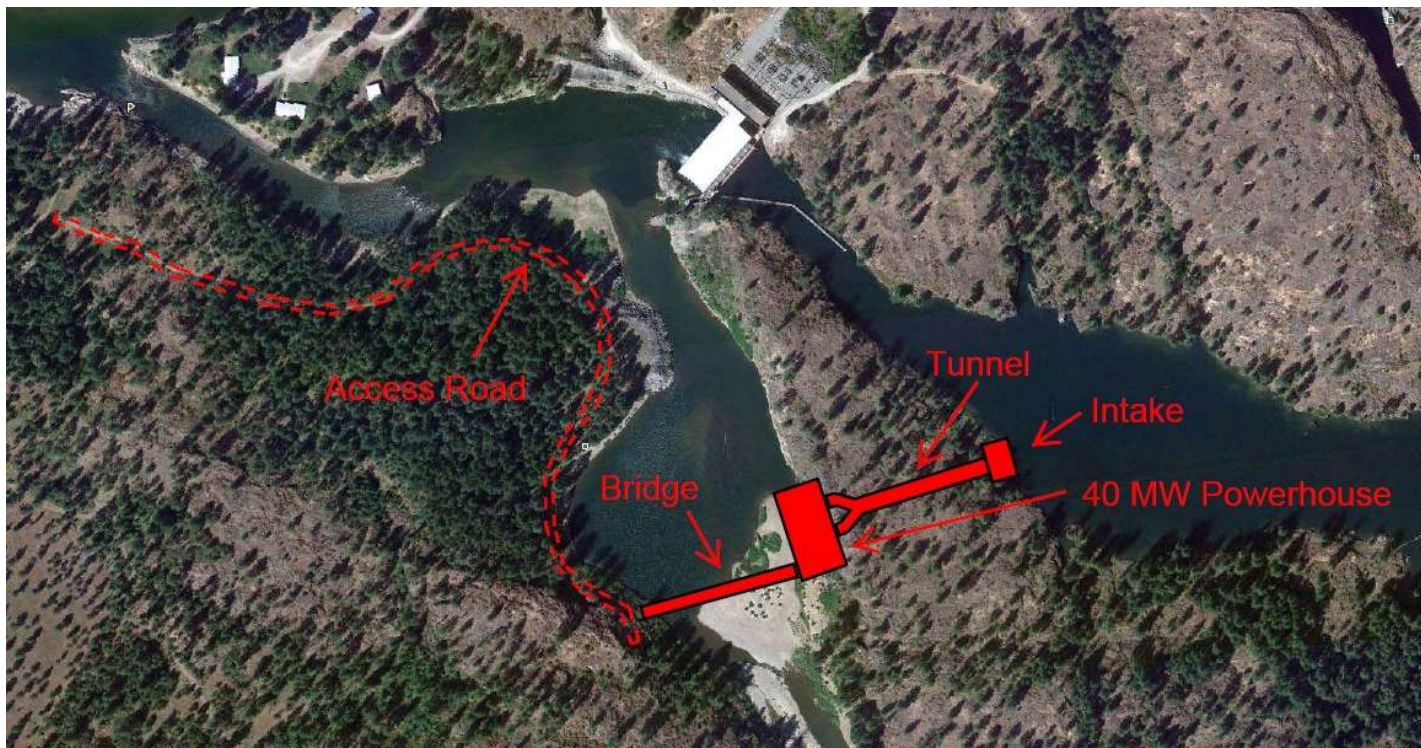

New Powerhouse in the South Channel - 40 MW (2x20)

Post Falls Possible Modifications

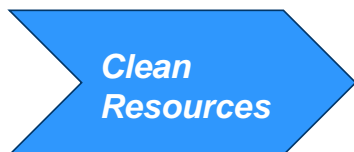

Replace Existing Powerhouse - 40 MW (5x8)

Post Falls Possible Modifications

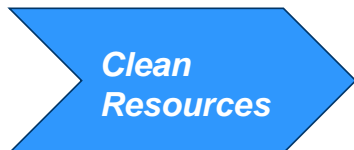

Rebuild Existing Powerhouse Turbine Generators - 33.6 MW (6x5.6)

Upper Falls Possible Modifications

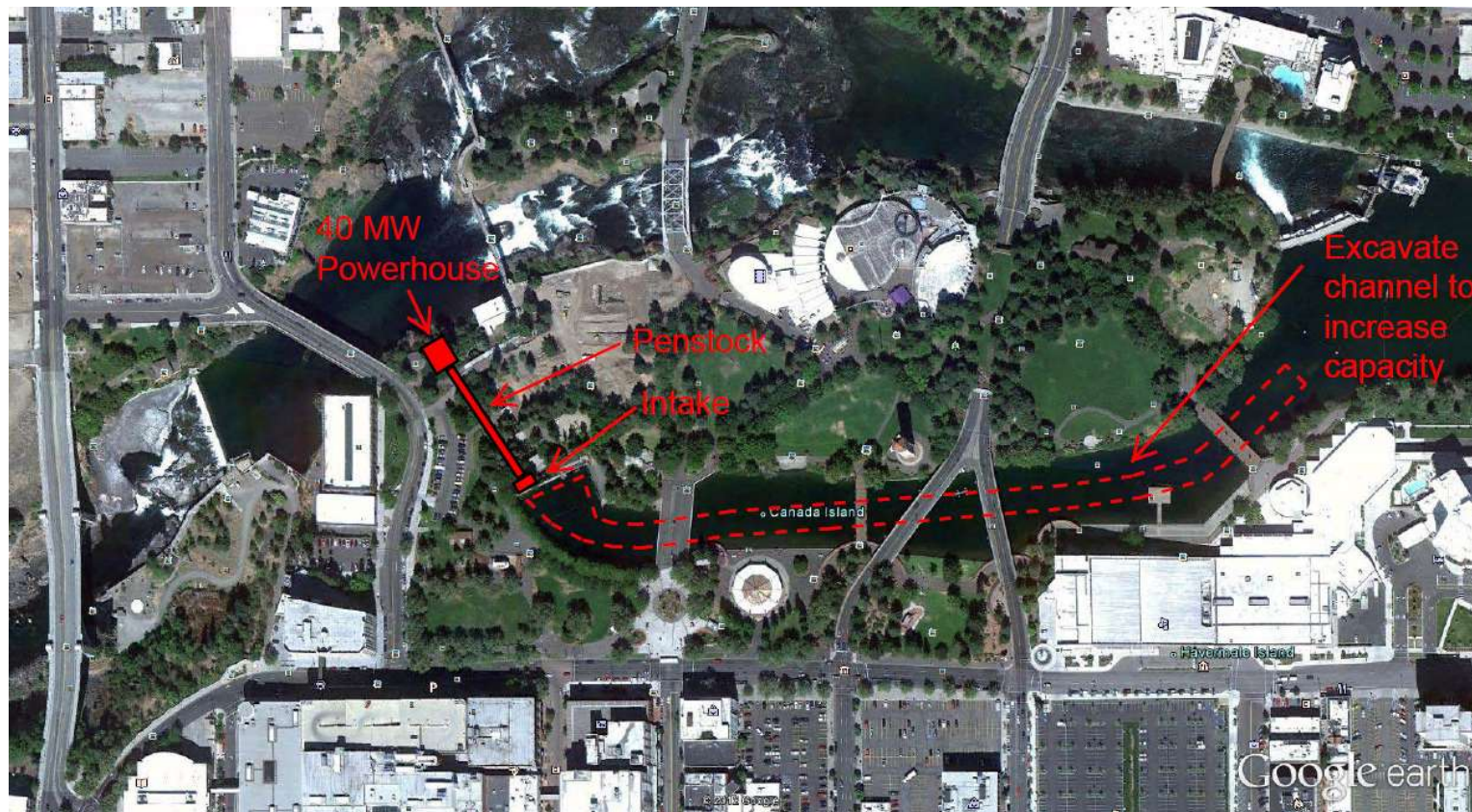

Second Powerhouse with Channel Excavation – 40 MW

Monroe Street Possible Modifications

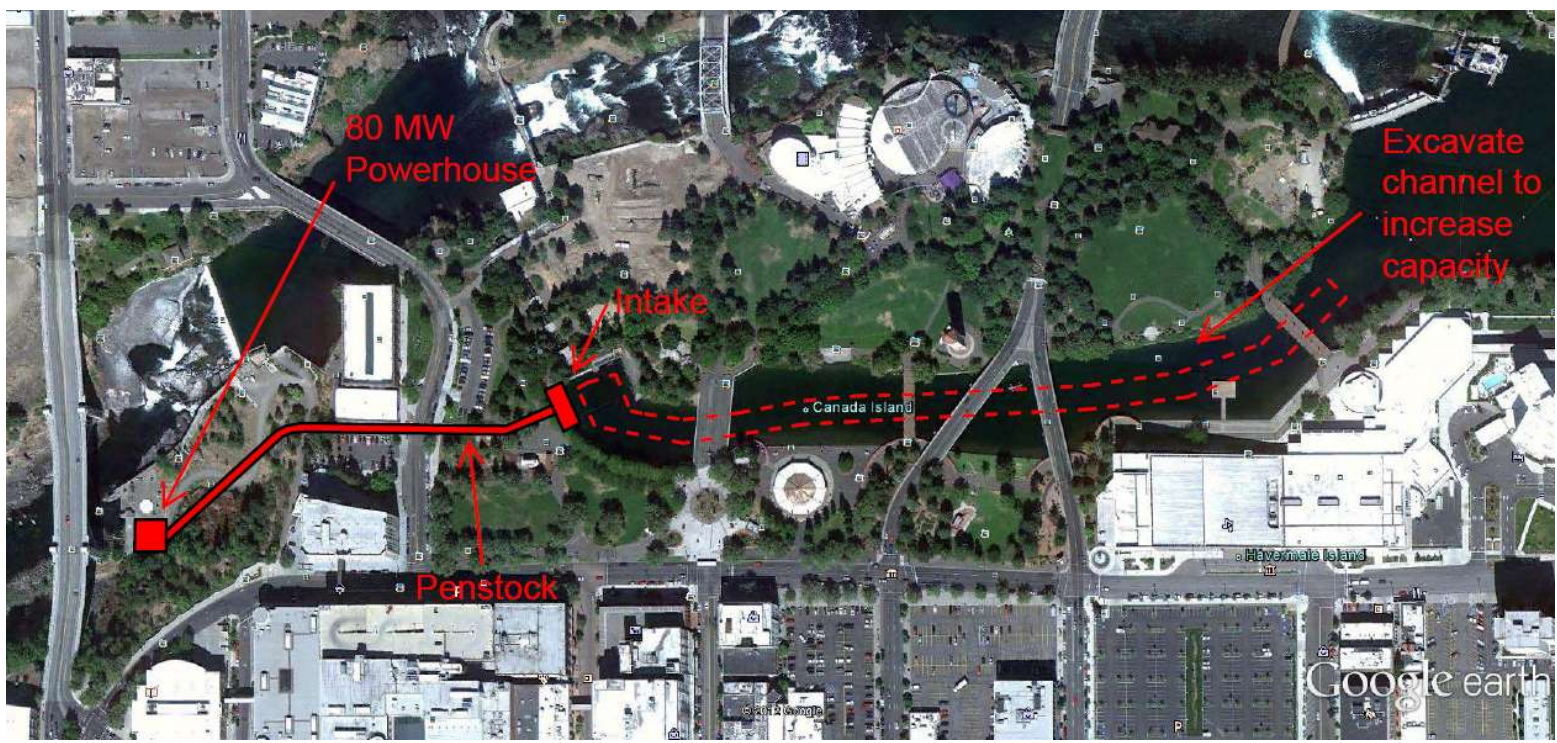

Second Powerhouse – with Channel Excavation 80 MW

Monroe Street Possible Modifications

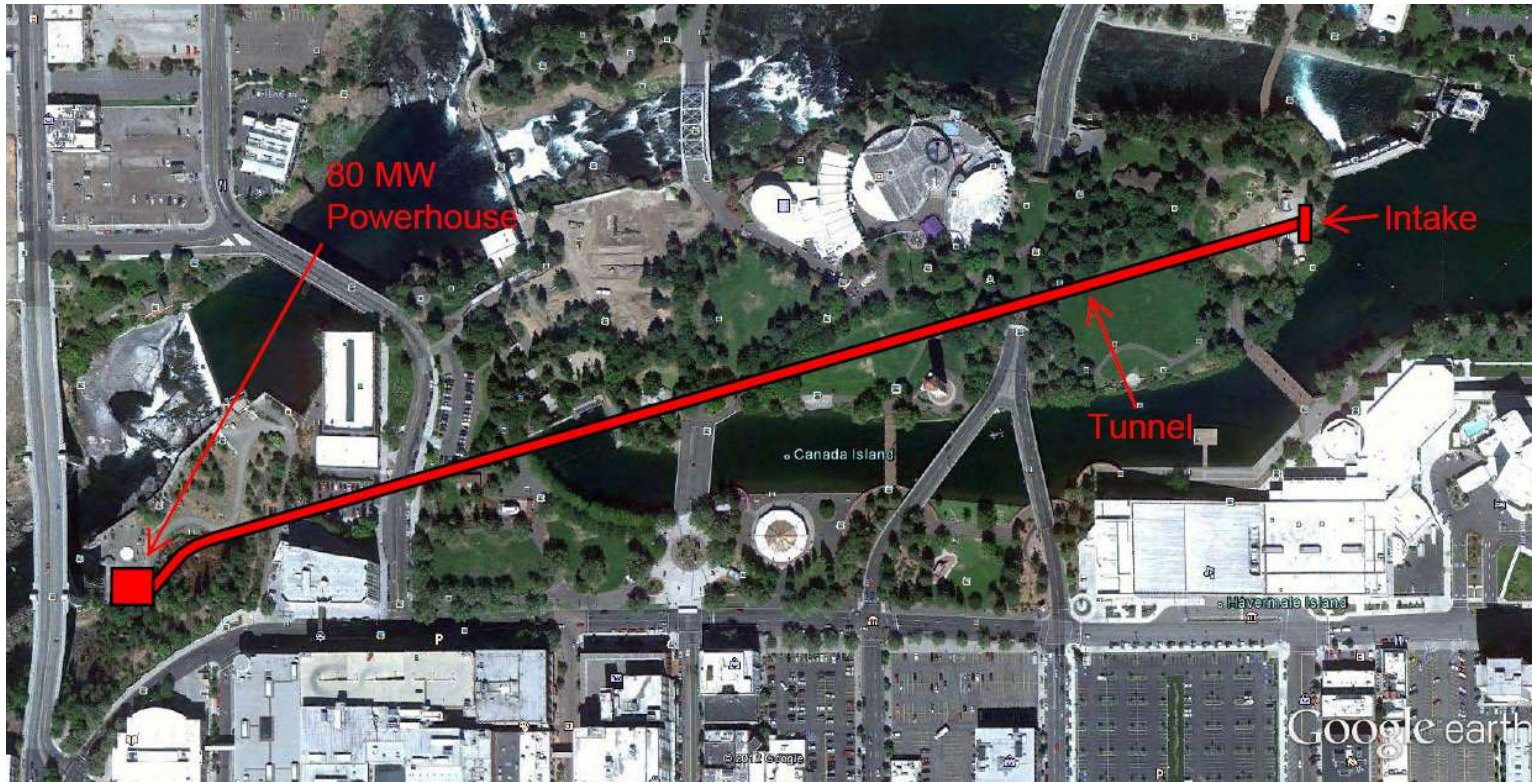

Second Powerhouse – with Tunnel 80 MW

Monroe Street Possible Modifications

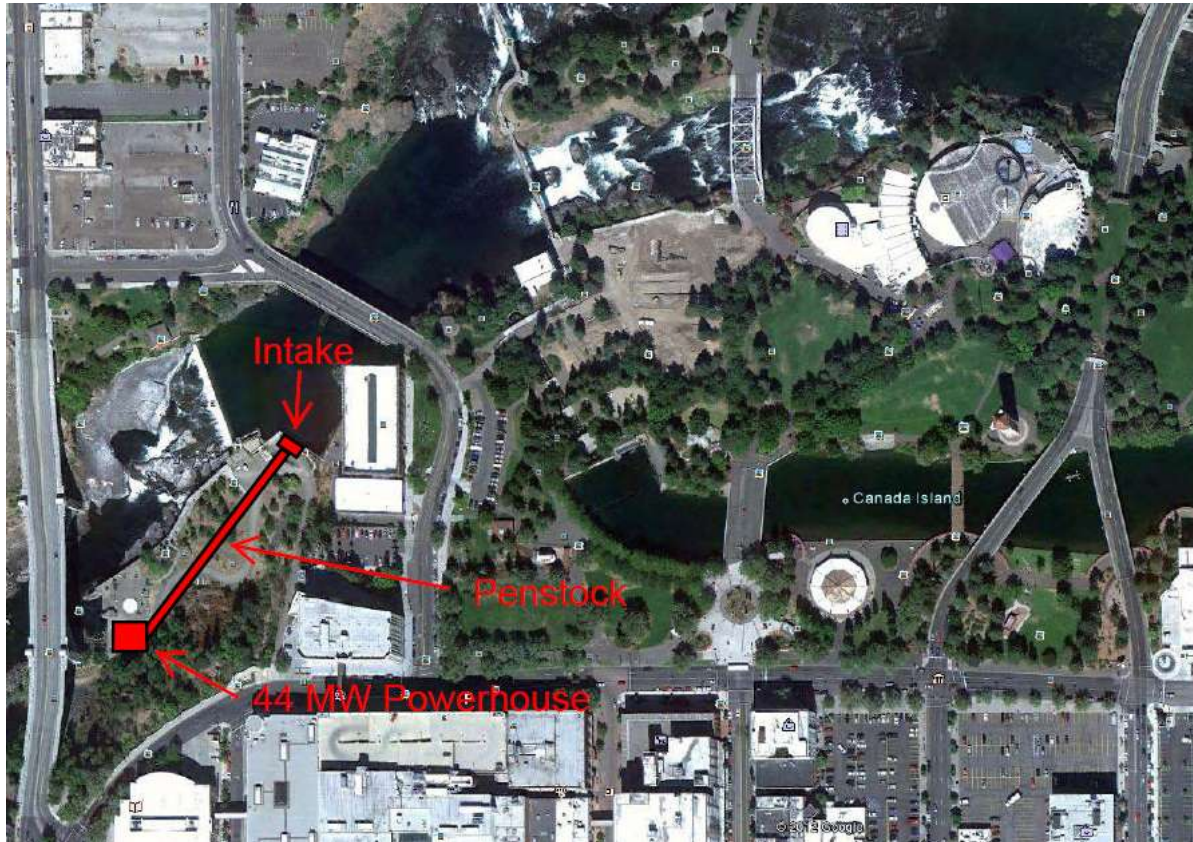

Second Powerhouse – From Monroe Street Dam 44 MW

Nine Mile Possible Modifications

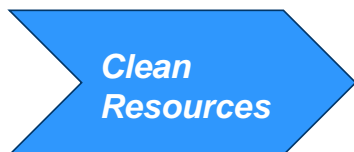

Existing Powerhouse Upgrade Units 1 and 2 – 32MW (4x8)

Nine Mile Possible Modifications

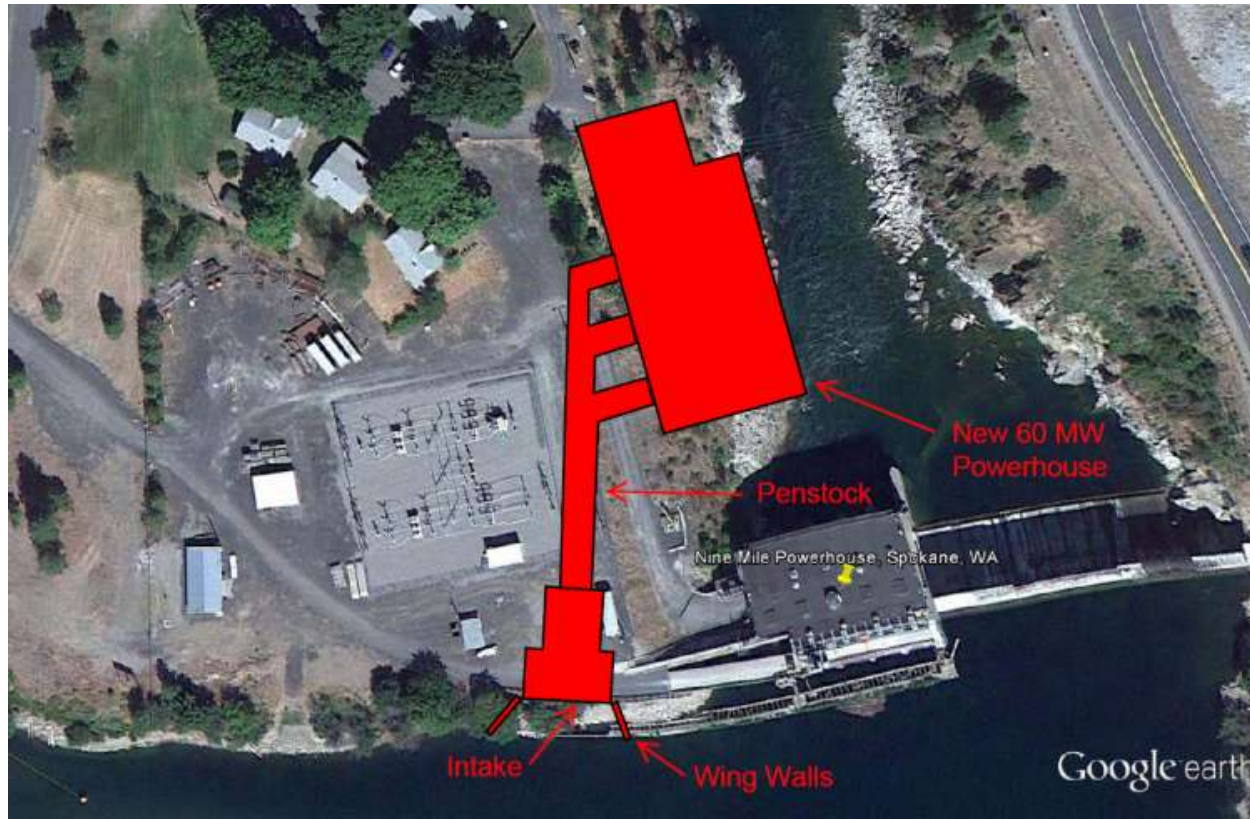

New Powerhouse Downstream Left Bank – 60 MW (3x20)

Nine Mile Possible Modifications



New Powerhouse Downstream Left Bank – 60 MW (5x12)

Nine Mile Possible Modifications

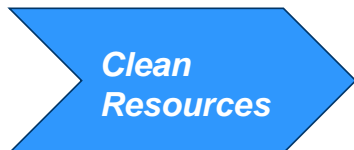

New Powerhouse Existing Location – 60 MW (5x12)

Long Lake Possible Modifications

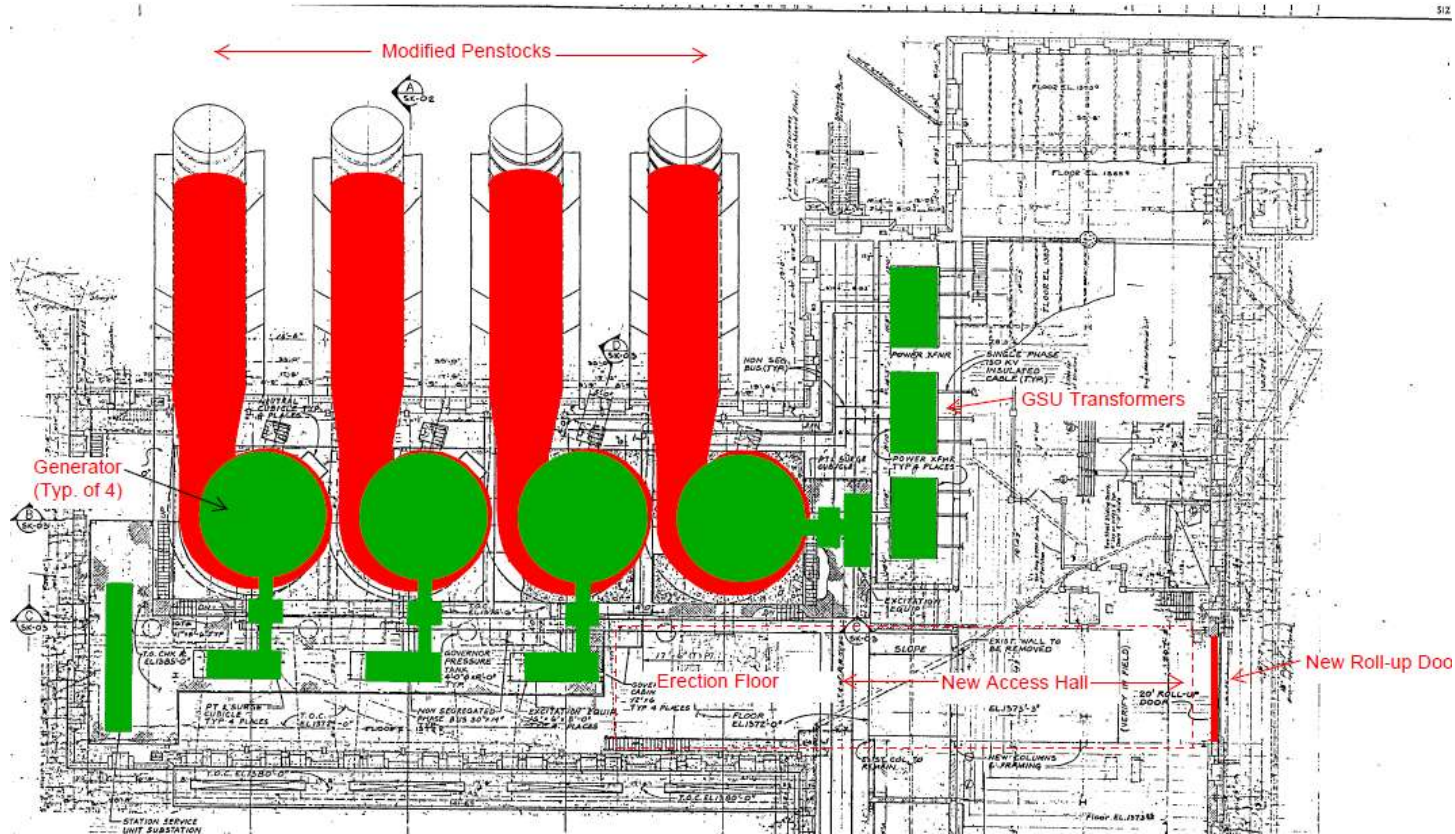

Replace Turbine Generators 120 MW (4x30)

Long Lake Possible Modifications

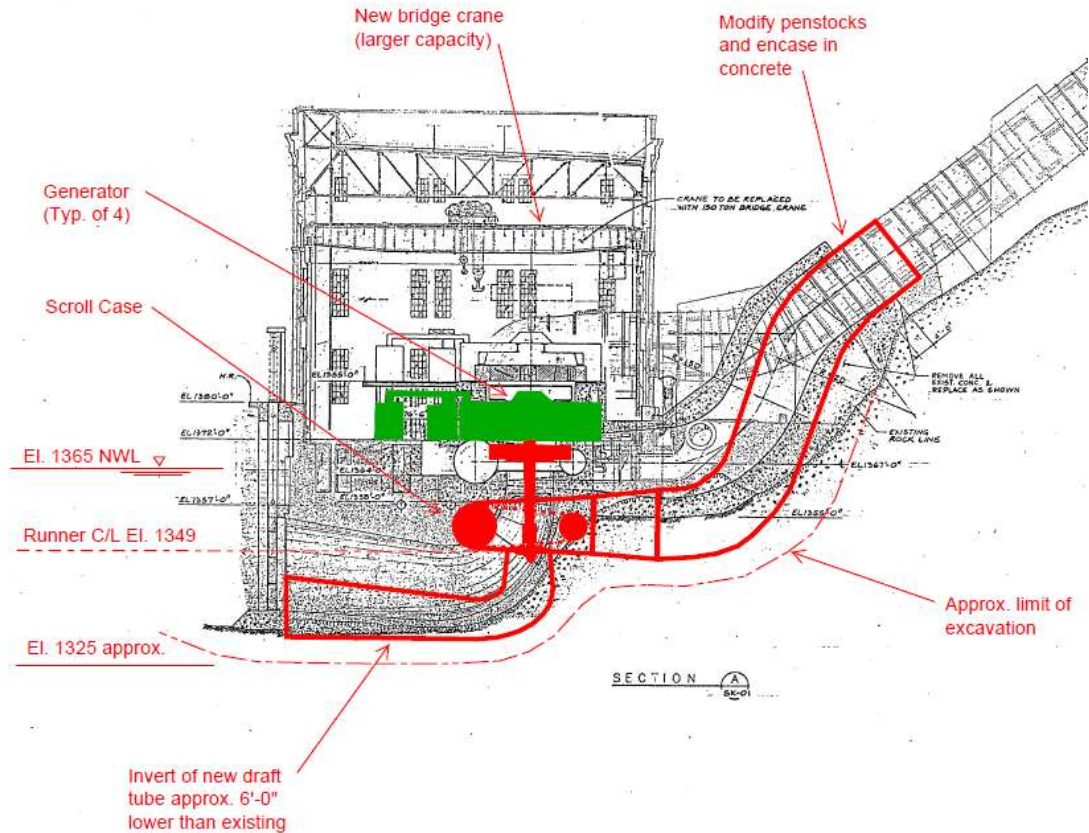

Section View - Replace Turbine Generators 120 MW (4x30)

Long Lake Possible Modifications

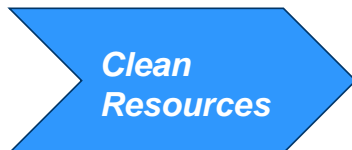

Second Powerhouse from Saddle Dam - 68MW

Little Falls Powerhouse Rebuild

- **Replace Generators**
- **Replace Turbines**
- **Replace Generator Breakers**
- **Replace Excitation Systems**
- **New Modern Control System**
- **New Powerhouse Crane**



Spokane River Project Potential

Facility	Year Built	Generation Capability (MW)	Net Energy Output (MWh)	Upgraded Capability (MW)	Upgraded Energy (MWh)
Post Falls	1906	14.8	90,000	33.6	142,500
Upper Falls	1922	10.0	71,000	50.0	184,200
Monroe St	1992	14.8	106,000	58.8	223,600
Nine Mile	1908	26.4	101,000	60.0	221,500
Long Lake	1915	78.0	480,000	146.0	619,800
Little Falls	1910	32.0	201,000	32.0	201,000
Total		176.0	1049,000	380.4	1,592,600
Percent Increase				116%	52%

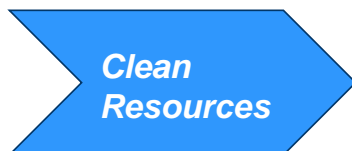

Clark Fork River Project

- *Clark Fork River Project was built in the 1950's and 1960's to meet the growing demands of the Spokane region.*
- *Cabinet Gorge completed in 1952*
- *Noxon Rapids completed in 1960*
 - *5th Unit was added in 1978*
- *Improvements to date include*
 - *New Turbines - efficiency upgrades*
 - *New Generators and rewinds*
 - *New Generator Step-Up Transformers*



Cabinet Gorge HED Refurbishment :

- Replaced 4 turbine runners & rebuilt generators
- Refurbished other turbine generator parts to like new condition
- Upgraded plant from 220 MW to 270 MW
- Environmentally friendly features – greaseless bearings and more efficient turbines
- Upgrade costs \$5 to \$12M, total \$40M
- Complete in 2004

*Clean
Resources*

Noxon Rapids HED Refurbishment

- Replaced Units 1- 4 turbine runners & rebuilt generators
- Replaced Unit 5 generator
- Refurbish other turbine generator parts to like new condition
- Replaced GSU Transformers
- Upgraded plant from 548 MW to 598 MW
- Environmentally friendly features – greaseless bearings and more efficient turbines
- Upgrade costs \$9 to \$17M, total \$77M
- Completed in May 2012

Clean
Resources

Cabinet Gorge Possible Modifications

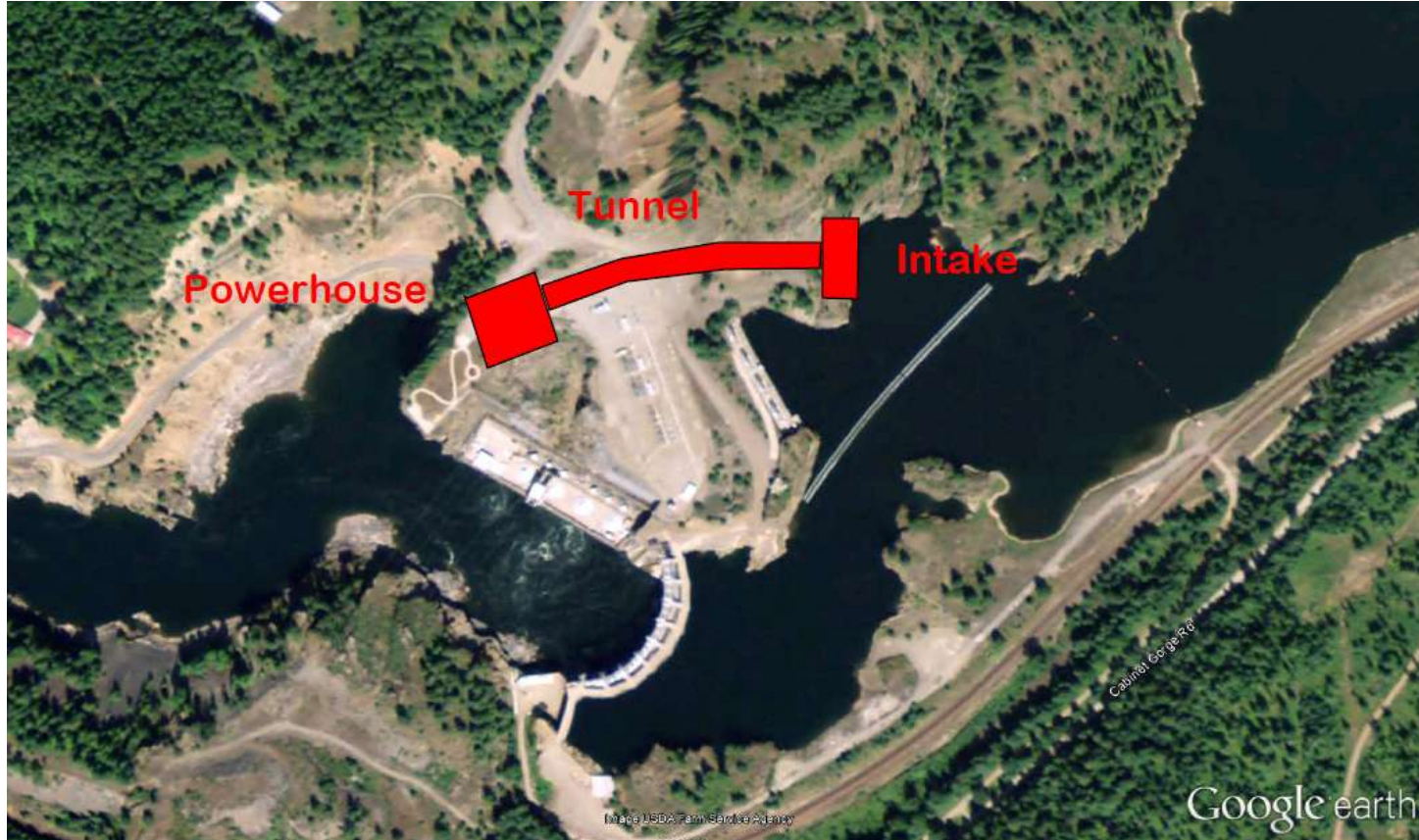

Second Powerhouse in Tunnel

Cabinet Gorge Possible Modifications

- *Increased plant capacity will reduce Spring spillway flows, and thus reduce contributions to total dissolved gas (TDG)*
- *Could increase plant capacity by 55 - 110 MW*
- *Range of plant configurations under study*



Avista's 2013 Electric Integrated Resource Plan
Technical Advisory Committee Meeting No. 3 Agenda
Wednesday, November 7, 2012
Conference Room 328

Topic	Time	Staff
1. Introduction	8:30	Storro
2. Modeling	8:35	Gall
3. Colstrip Discussion	9:15	Lyons
4. Energy Efficiency	10:00	Borstein
5. Lunch	11:30	
6. Peak Load Forecast	12:30	Gall/Forsyth
7. Reliability Planning	1:15	Gall
8. Break	2:00	
9. Energy Storage	2:15	Lyons
Adjourn	3:00	

Materiality Ratings

Avista's 2013 Electric Integrated Resource Plan Technical Advisory Committee

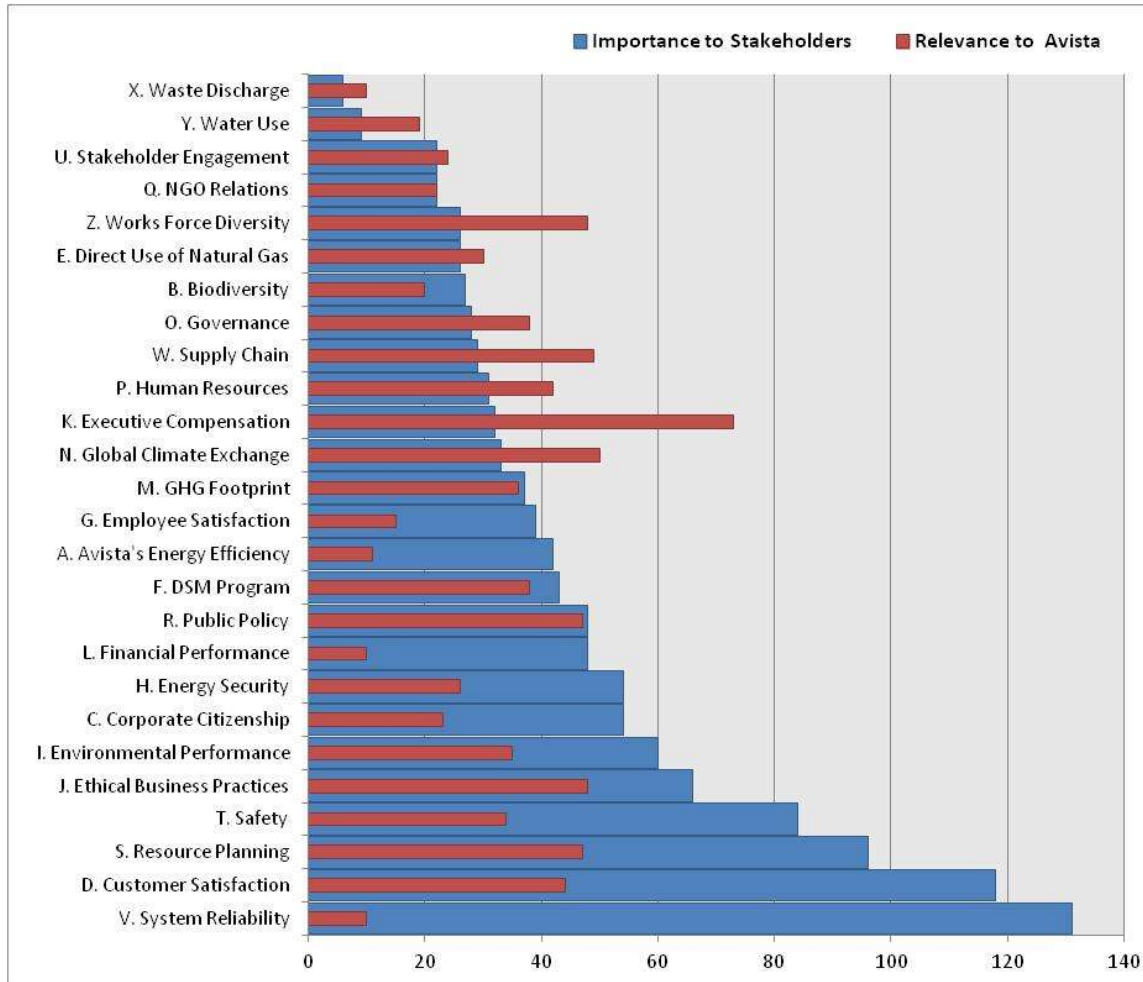

Weighted score – number of responses x rated importance/relevance

September 2012



2013 IRP Modeling Approach

James Gall, Senior Power Supply Analyst

Third Technical Advisory Committee Meeting

2013 Electric Integrated Resource Plan

November 7, 2012

2013 IRP Modeling Process

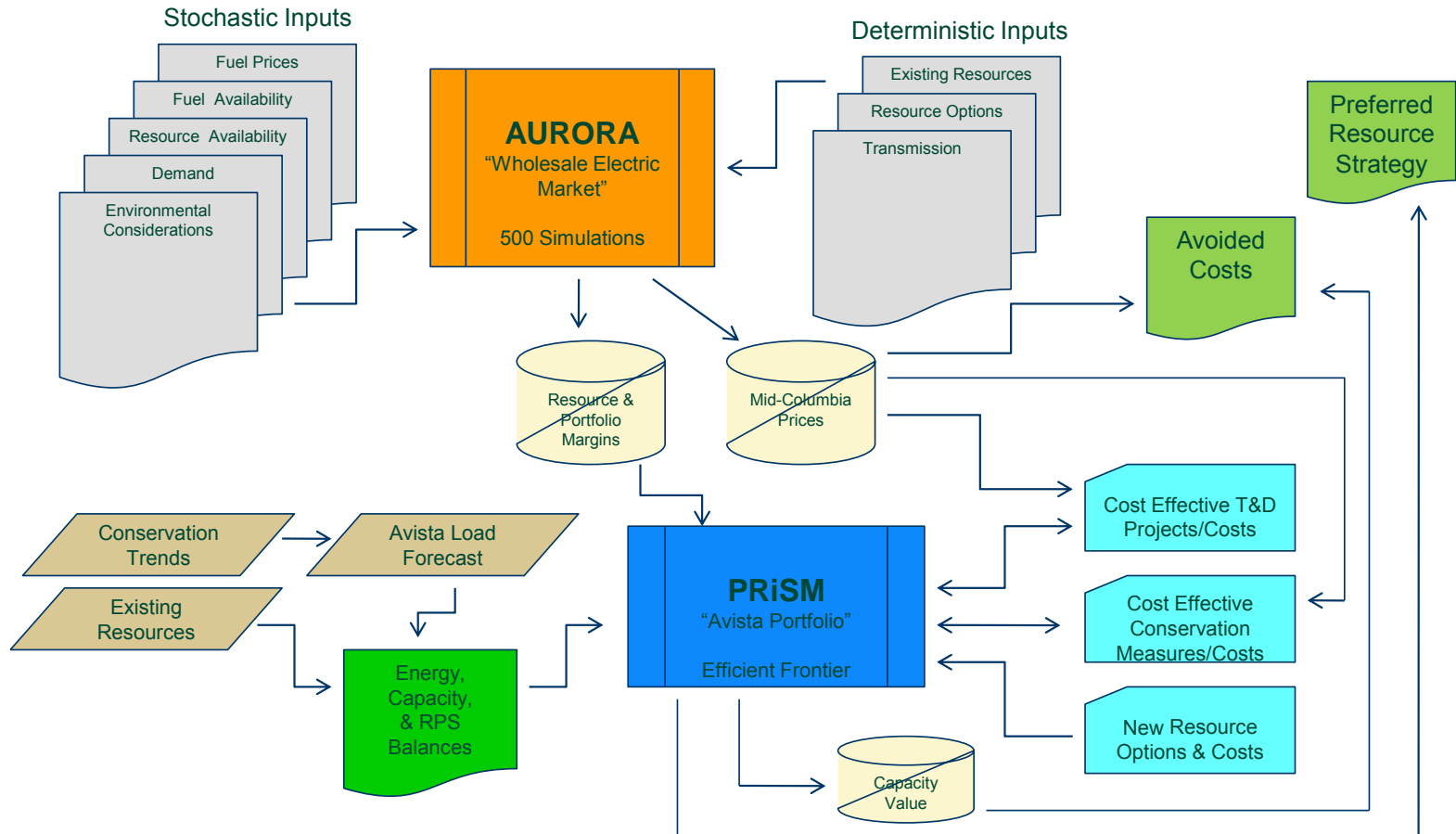

Electric Market Modeling



- 3rd party software- EPIS, Inc.
- Electric market fundamentals- production cost model
- Simulates generation dispatch to meet load
- Outputs:
 - Market prices
 - Regional energy mix
 - Transmission usage
 - Greenhouse gas emissions
 - Power plant margins, generation levels, fuel costs
 - Avista's variable power supply costs



PRiSM- Preferred Resource Strategy Model

- Internally developed using Excel based linear program model (What's Best)
- Selects new resources to meet Avista's capacity, energy, and renewable energy requirements
- Outputs:
 - Power supply costs (variable and fixed)
 - Power supply costs variation
 - New resource selection
 - Emissions
 - Capital requirements



AURORA Inputs

- Regional loads
- Natural gas & coal prices
- Hydro levels
- Wind variation
- Environmental resolutions
- Resource availability
- Transmission

Regional Loads

- Forecast load growth for all regions in the Western Interconnect
- Consider both peak and energy
- Use regional published studies and public IRP's
- Stochastic modeling simulates load changes due to weather and considers regional correlation of weather patterns
- Load changes due to economic reasons are difficult to quantify and are usually picked up as IRP's are published every two years
- Peak load is becoming more difficult to quantify as "Demand Response" programs may cause data integrity issues
- Energy demand forecasts need to be net of conservation

Energy & Peak Forecast (draft)

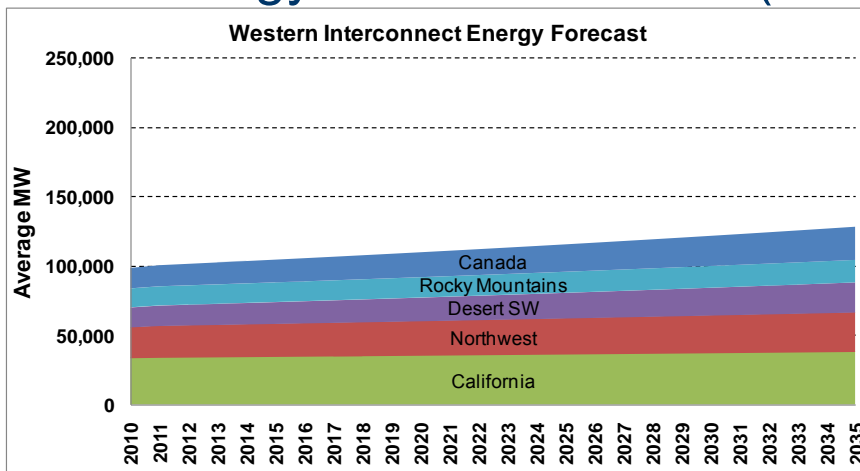

Energy	AAGR
Canada	1.91%
Rocky Mtns.	0.69%
Desert SW	1.64%
California	0.48%
Northwest	0.90%

Peak	AAGR
Canada	1.80%
Rocky Mtns.	0.98%
Desert SW	1.71%
California	-0.26%
Northwest	0.93%

Western Interconnect Peak Load Forecast

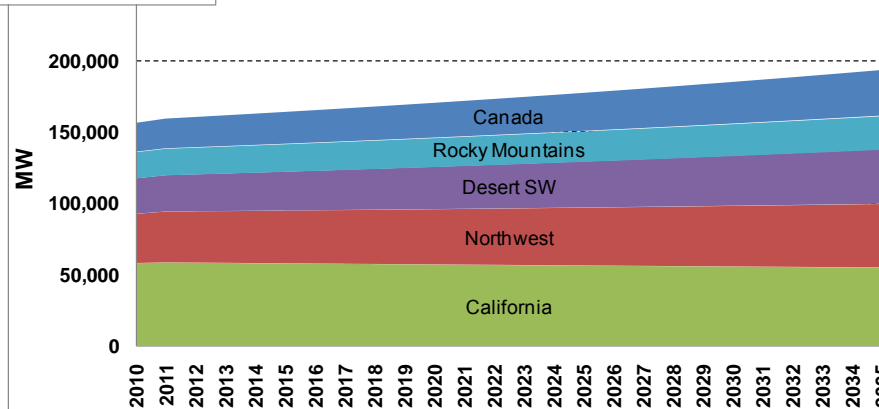

Electric Vehicles (PHEV)

- A potential change in customer load shapes could be a result of PHEV
- To address this- a load adder will be applied to reflect new demand with a majority of load added in off peak hours
- In the 2011 IRP electric vehicle demand was estimated to be 1,370 MW (off-peak) for 2020 (western interconnect)
- The load forecasts from other IRP's typically include PHEV assumptions
- PHEV load will be pullout out of the forecast and modeled as load with an alternative load shape to reflect typical charging patterns

Natural Gas Prices

- Natural gas prices are one of the most difficult inputs to quantify
- A combination of forward prices and consultant studies will be used as the “Base Case” for this IRP. This work should be complete by December 2012
- 500 different prices using an auto regressive technique will be modeled, the mean value of the 500 simulations will be equal to the “Base Case” forecast
- A controversial input for these prices is the amount of variance within the 500 simulation.
 - Historically prices we highly volatile, recent history is more stable
 - Final variance estimates will look at current market volatility and implied variance from options contracts

Natural Gas Prices

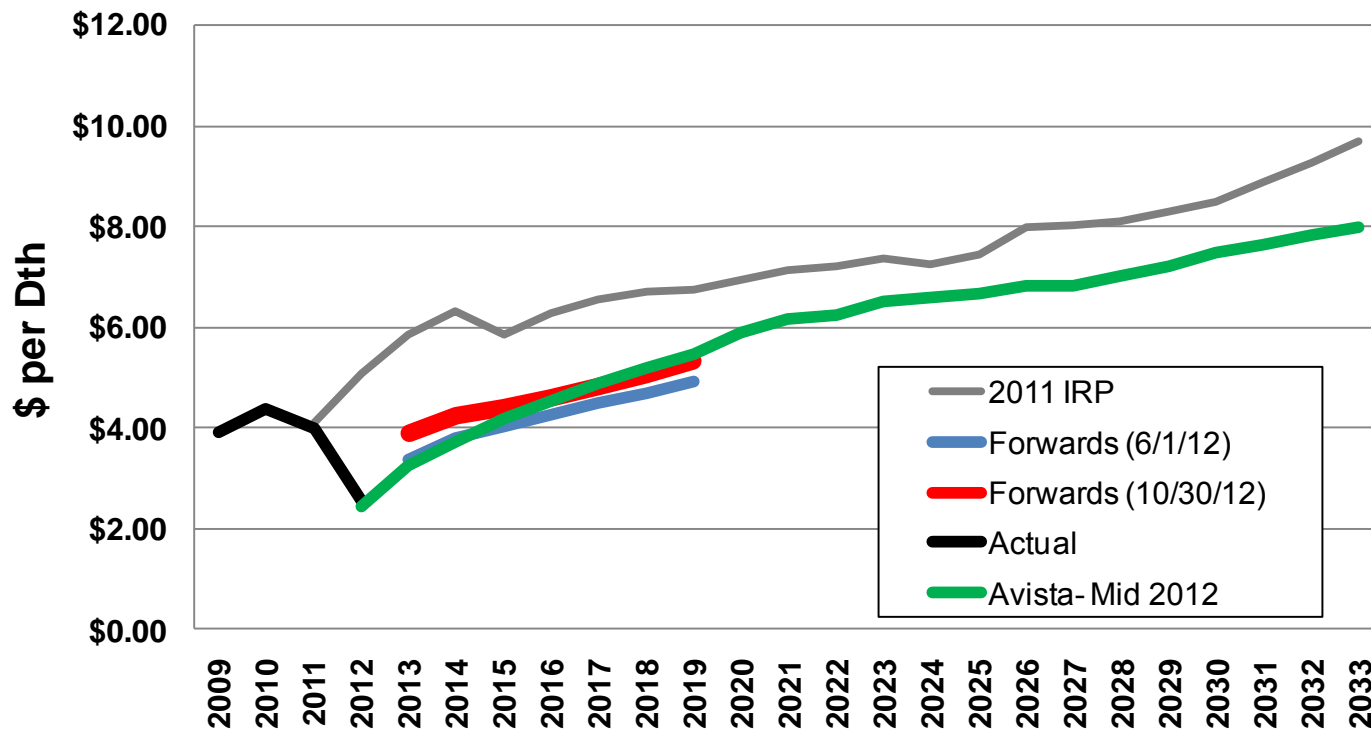

Coal Prices

- With lower natural prices and EPA regulations the demand for US based coal is lower, but potential exports may stabilize the industry
- Western US coal plants typically have long-term contracts and many are mine mouth
- Rail coal projects are subject to diesel price risk
- Prices will be based on review of coal plant publically available prices and EIA mine mouth and rail forecasts

Hydro

- 70 year average hydro conditions are used for the Northwest states, British Columbia and California provided by BPA
 - Hydro levels change monthly
 - AURORA dispatches the monthly hydro based on whether its run-of-river or storage.
- For stochastic studies the hydro levels will be randomly drawn from the 70 year record
- A new Columbia River Treaty could change regional hydro patterns, but until there is resolution, no changes will be considered

Northwest Hydro Variability

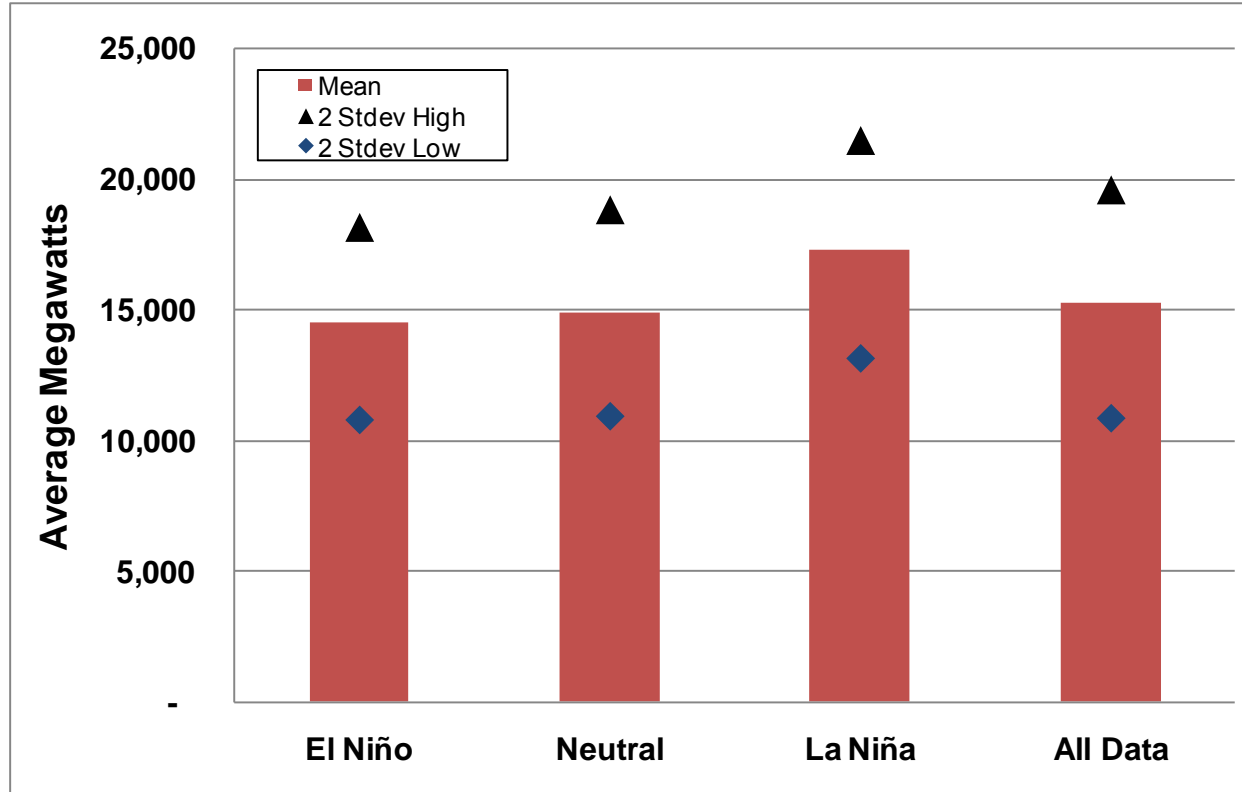

Wind

- Wind generation in the Northwest's is the fastest growing resource type
- RECs and PTC's have caused wind facilities to economically generate in oversupply periods in the Northwest- particularly in the spring months
- Wind is modeled using an autoregressive technique to simulate output in similar to reported data available from BPA, CAISO, and other publically available data sources- also considers correlation between regions
- For stochastic studies several wind curves will be drawn from to simulate variation in wind output each year
- Will pursue temperature/wind correlation for stochastic study

Wind Generation Profile (First week of January 2007-12)

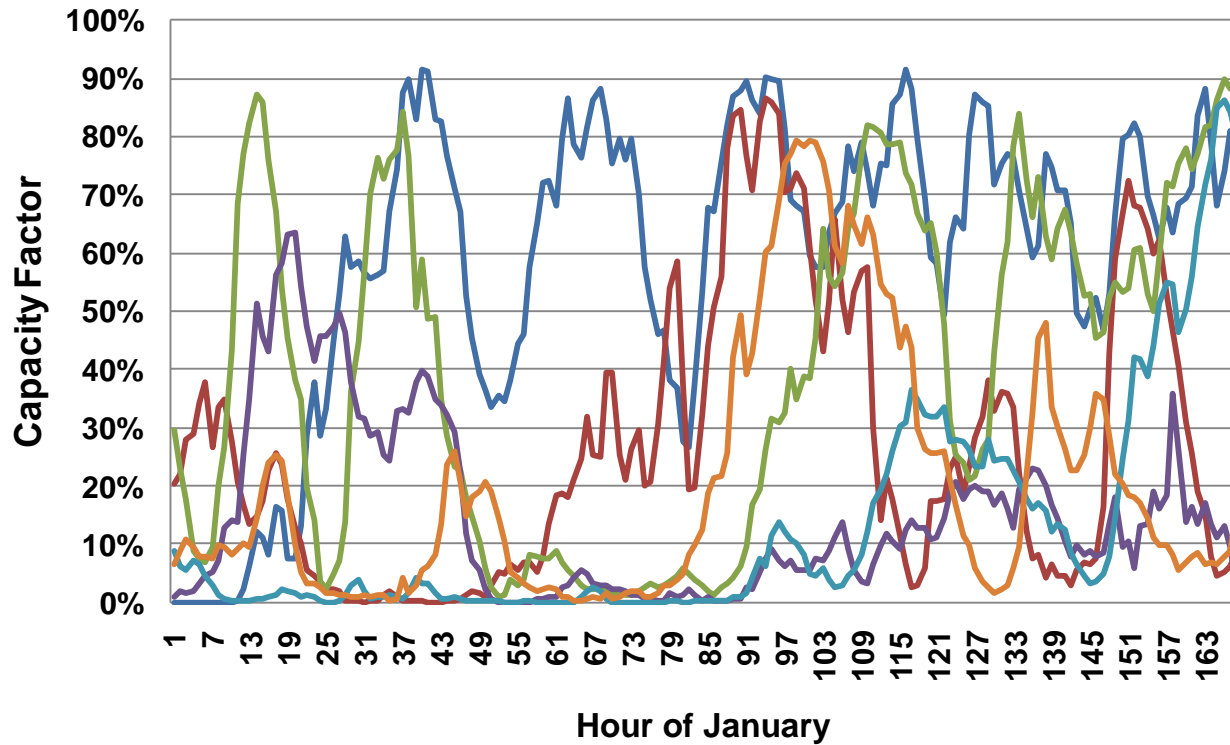

Hours Mid-Columbia Prices Were Less Than \$0/MWh

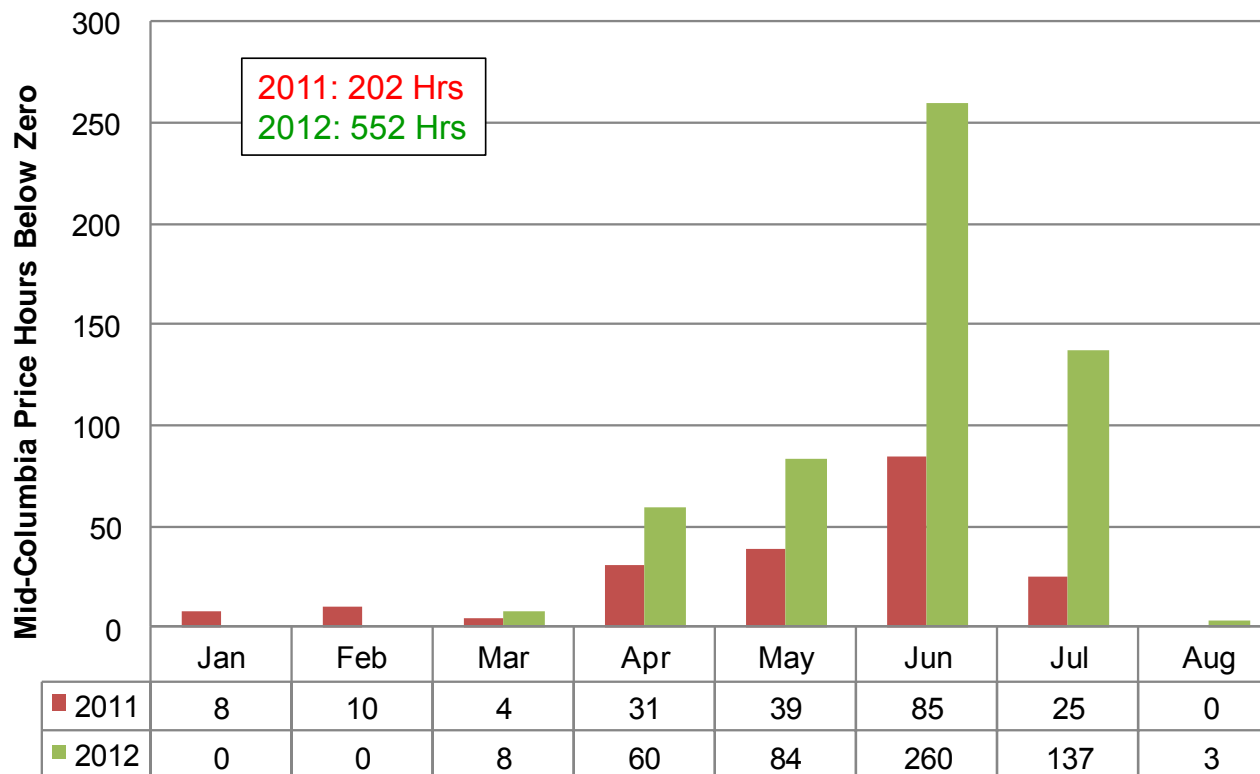

Source: Powerdex daily average prices- substantially more hours had trades with negative pricing



Greenhouse Emission Reduction Scheme

- Currently no eminent national climate change legislation
- Alternative methods for reducing greenhouse gases are more likely than a national cap-and-trade mechanism; such as early retirement of coal plants and regional greenhouse gas limits
- This IRP will model the CO₂ tax in British Columbia and an expected market clearing price for CO₂ in California
- Rather than use a cap & trade or tax method in the IRP base case the model will rather consider all announced coal plants retirements and determine future coal/natural gas plants likely to be retired due to environmental or economic reasons
- This method will show reductions to greenhouse gases in the western US without causing price shocks to the wholesale power markets

Coal Retirements

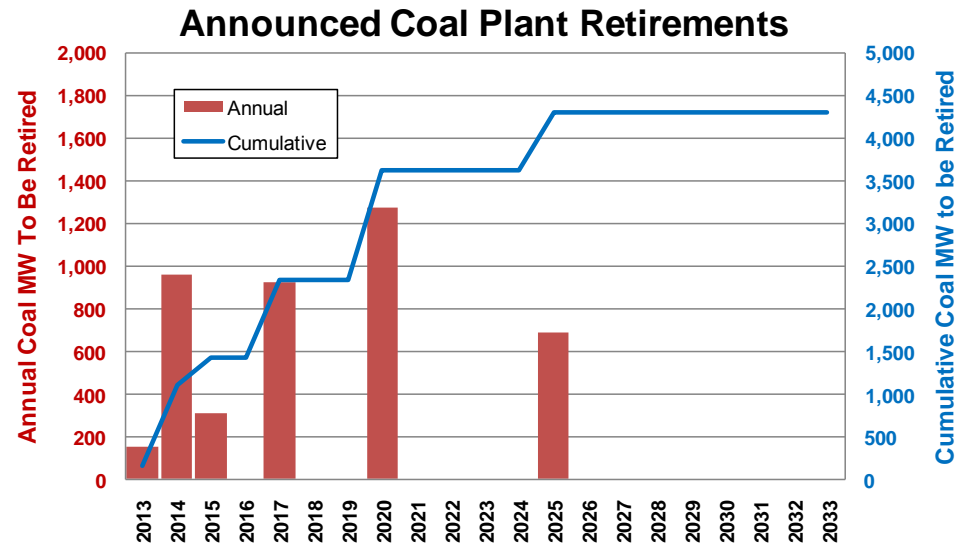

- Announced retirements of 13% of coal plant capacity in the west
- Avista will review all Western Interconnect coal plants and retire plants for modeling purposes. This method is to estimate likely EPA/State related retirements

Water Issues

- Once-through cooling
 - California plants with this cooling technology must be converted to alternative cooling methods or retired
 - For modeling purposes: older natural gas units will be retired and Nuclear plants will be considered retrofitted
 - San Onofre?
- Traditional water cooling
 - New NG resources are finding it more difficult to use water cooling- for new resources air cooling will be assumed

Once-Through Cooling Affect

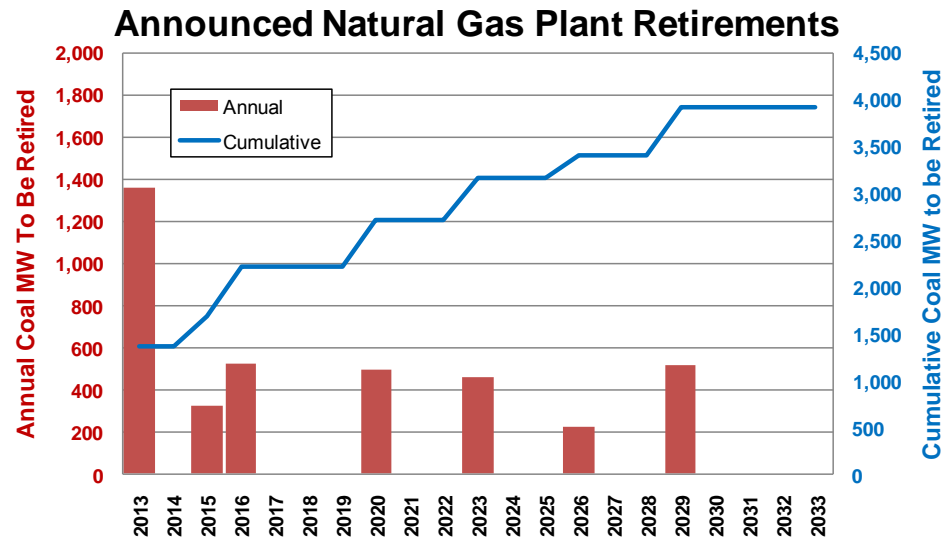

- 13,500 MW of natural gas plants in California could be affected by once-through-cooling rules- nearly 4,000 MW announced retirement
- Represents 27% of California's natural gas fleet

Western State's Renewable Portfolio Standards

- Nine western states have renewable portfolio standards (RPS)
 - A majority of qualifying projects will not be selected in AURORA due to economics, therefore renewable resources are added based likely resource types up to the RPS requirement
- Challenges are with California
 - What renewable quantity will CA allow for import- 25%?
 - How much behind the meter solar will be developed?
- Will state RPS's change- easier or more stringent?
 - Washington recently allowed legacy biomass
 - Colorado increased its requirement from 10% to 30%

Transmission Expansion

- Regional transmission expansion plans have been discussed much of the last decade- with little to show for it!
- For modeling purposes- a review of the expansion opportunities will be discussed and projects that are in advanced stages of development will be included

PRiSM

- Find optimal resource strategy to meet resource deficits over planning horizon
- Model selects its resources to reduce cost, risk, or both.
- Objective Function:
 - Minimize: Total Power Supply Cost on NPV basis (2014-2054)- Focus on first 10 years of the plan
 - Subject to:
 - Risk level
 - Capacity need +/- deviation
 - Energy need +/- deviation
 - Renewable portfolio standards
 - Resource limitations, sizes, and timing

Efficient Frontier

- Demonstrates the trade off of cost and risk
- Avoided Cost Calculation

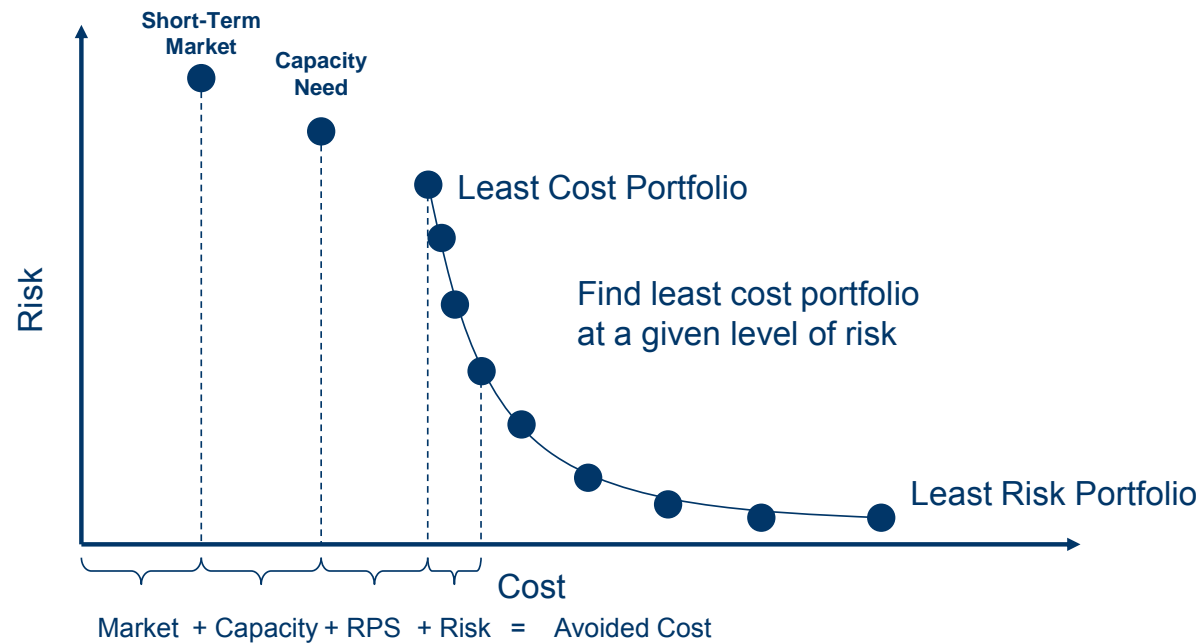



Colstrip Discussion

John Lyons, Senior Resource Policy Analyst

Third Technical Advisory Committee Meeting

2013 Electric Integrated Resource Plan

November 7, 2012

Future of Colstrip – Planning

- Scenarios about the future of Colstrip will be modeled in this IRP
- Washington Commission acknowledgement of the 2011 IRP:
 - “The Company should conduct a broad examination of the cost of continuing the operation of Colstrip over the 20-year planning horizon, including a range of anticipated costs associated with potential U.S. Environmental Protection Agency regulations on coal-fired generation.”
 - “The Company should model a scenario without Colstrip that includes results showing how Avista would choose to meet its load obligations without Colstrip in its portfolio, and estimates of the impact on Net Present Value (cost) of its portfolio and rates.” (Docket UE-101482)

Colstrip Ownership Information

Colstrip Basic Data			Colstrip Ownership Percentages					
Colstrip Unit #	Size (MW)	Year Online	Avista	NorthWestern Energy, LLC	PacifiCorp	Portland General Electric	PPL Montana, LLC	Puget Sound Energy
Unit #1	307	1975	0%	0%	0%	0%	50%	50%
Unit #2	307	1976	0%	0%	0%	0%	50%	50%
Unit #3	740	1984	15%	0%	10%	20%	30%	25%
Unit #4	740	1986	15%	30%	10%	20%	0%	25%
Total	2,094		11%	11%	7%	14%	25%	32%

Colstrip Units #1 – 4 use about one rail car (110 tons) of coal for every five minutes of operation – the whole project uses about 10 million tons of coal per year

Colstrip Economic Benefits

- The plant employs 360 people and the mine has 373 employees
- \$104 million in annual Montana state and local taxes (4.5% of all state revenue collections)
- 3,740 additional jobs and 7,700 more residents in Montana
- \$360 million in additional personal income
- \$638 million more in additional Montana output

Data from *The Economic Contribution of Colstrip Steam Electric Station Units 1-4*, November 2010.

Colstrip – Importance as a Resource

- Colstrip provides 222 MW of capacity for Avista
- 1,416,000 MWh in 2011 (162 aMW)

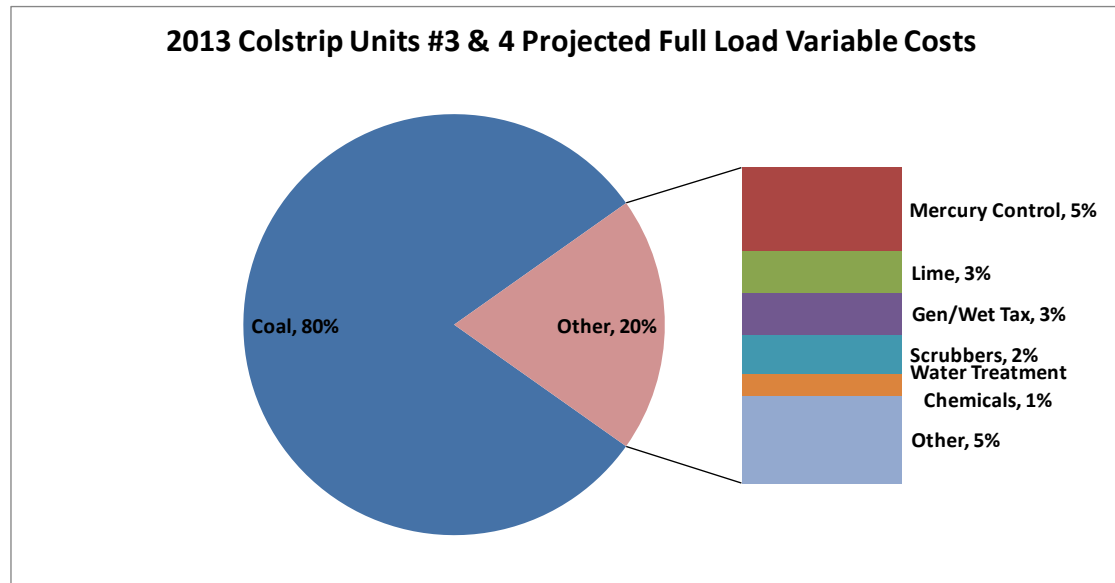

Other includes: full load surge pond variable costs, environmental air pollution taxes, paste plant, coal handling, coal handling dust suppression, bottom ash handling, bottom ash hauling contract and coal conditioning costs.

Colstrip Fuel Supply

- Avista's total annual fuel use at Colstrip is approximately 980,000 tons
- Mine mouth facility
- Current fuel contract expires at the end of 2019
- Currently negotiating a fuel supply extension



Colstrip Modeling in the 2013 IRP

Base Case:

- Colstrip Units #3 – 4 kept in service through IRP modeling period
- Will comply with current and future environmental regulations

Colstrip Scenarios:

- How many scenarios are needed?
- What date or dates should be used to model a shut down of the plant?
- Other assumptions?

Avista Utilities Conservation Potential Assessment Approach for 2013 Update

November 7, 2012

Jan Borstein

Project Manager, Energy Analysis and Planning



Outline

- CPA objectives
- Analysis approach
 - Update 2010 study
 - Changes in approach
- Project schedule

CPA Objectives

CPA objectives

Assess and analyze 20-year cost-effective conservation potential

- Meet Washington I-937 Conservation Potential Assessment requirements
 - Biennium target for 2014-2015
- Support Avista IRP development
- Provide information to support Business Plan development

Analysis Approach

CPA considerations

The CPA approach accounts for the following factors

- Impacts of existing programs
- Impacts of codes and standards
- Technology developments and innovation
- Economic conditions
- Customer growth trends
- Energy prices

Develop three levels of potential

Potential studies identify future opportunities for EE that can be achieved through programs

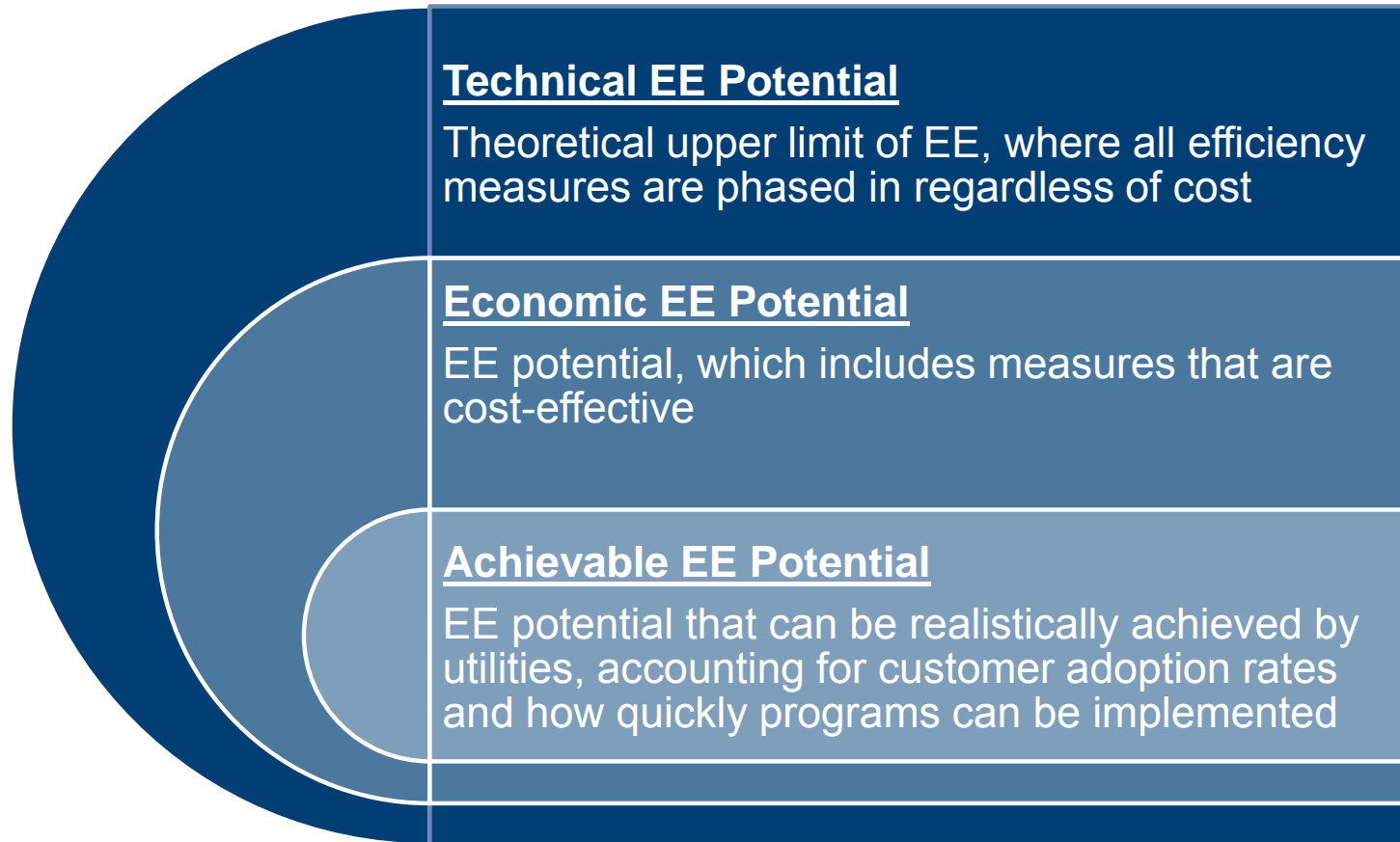

Consistency with Sixth Plan

End-use model — bottom-up

- Building characteristics
- Fuel and equipment saturations
- Measure life
- Stock accounting
- Existing and new vintage
- Lost- and non-lost opportunities
- Measure saturation and applicability
- Measure savings, including contribution to peak
- Codes and standards
- Ramp rates to model market acceptance and program implementation

Consistency with Sixth Plan (cont.)

Measures

- Include nearly all in Sixth Plan
- Others also, e.g., conversion of electric water heaters and furnaces to natural gas
- Sources for measure characterization
 - Avista Technical Reference Manual (TRM)
 - RTF measure workbooks
 - EnerNOC databases, some of same sources used in Sixth Plan

Economic potential, total resource cost (TRC) test

- Considers non-energy benefits

Achievable potential – ramp rates

- Based on Council Sixth Plan ramps rates
- Modified to reflect Avista program history

Avista-specific items

End-use model

- Building characteristics, fuel shares, and equipment saturations are Avista-specific
- Calibrated to Avista 2009 sales by sector
- Update with newly available RBSA data, e.g., information on measure saturation
- Measure savings, including contribution to peak

Building codes and appliance standards updated as of 2012

Avista-specific customer growth forecasts

Avista retail rate and avoided cost forecasts

Ramp rates adjusted to match Avista program history

Potential study analysis framework

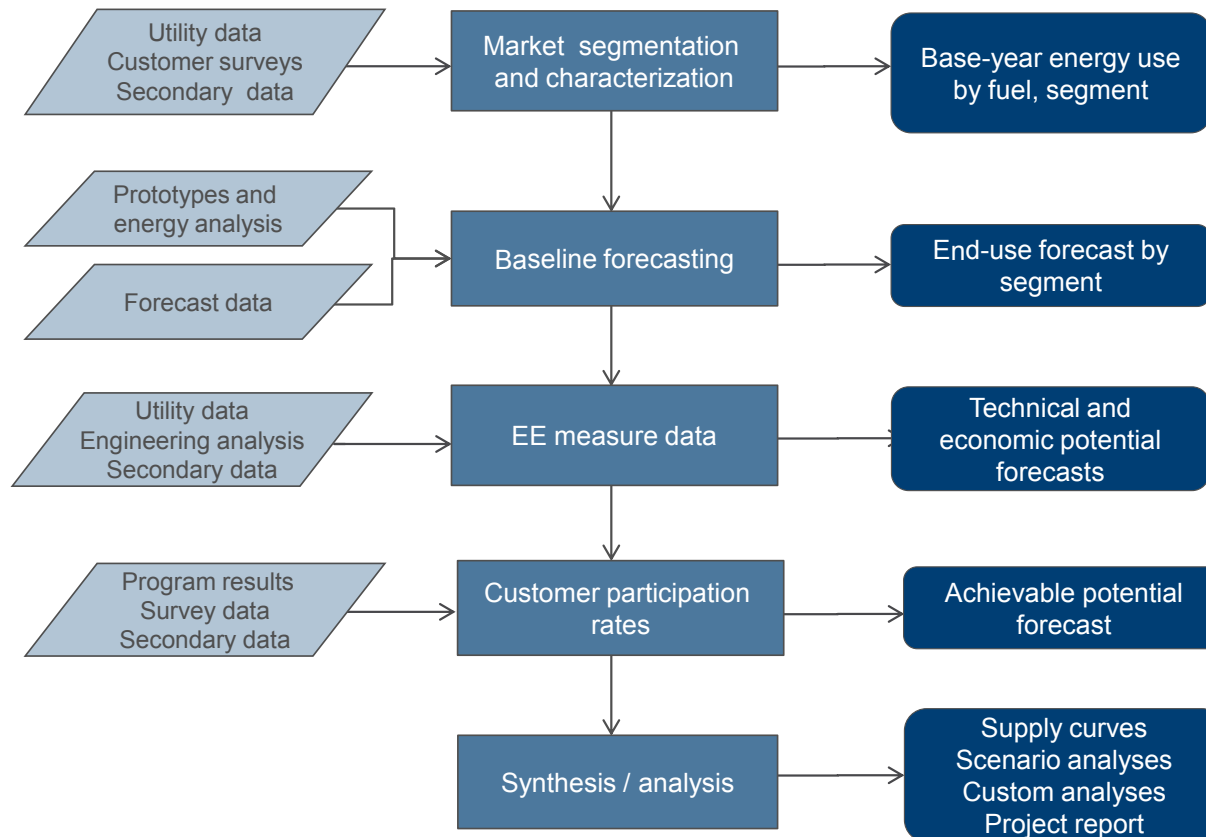

LoadMAP™ analysis tool

The screenshot shows the LoadMAP software interface. The top ribbon includes tabs for LoadMAP, Home, Insert, Page Layout, Formulas, Data, Review, and View. The Home tab is active, showing various toolbars for model controls, base-year data, and forecasting. The spreadsheet below displays a dropdown menu for 'Residential : Single Family : Electric' and a 'Currently Viewing:' section showing 'Residential : Single Family : Electric' and 'Total Households: 2,947,284'. Below this is a table titled 'Average Market Profiles' with columns for End Use, Technology, Saturation, UEC (kWh), and Intensity (kWh/HH).

End Use	Technology	Saturation	UEC (kWh)	Intensity (kWh/HH)
Cooling	Central AC	45.6%	4,877.74	2,222.51
Cooling	Room AC	13.9%	1,777.88	246.54
Combined Heating/Cooling	Air-Source Heat Pump	36.1%	7,140.50	2,578.23
Combined Heating/Cooling	Geothermal Heat Pump	0.8%	6,309.83	47.46
Space Heating	Electric Resistance	1.6%	6,847.50	106.18
Space Heating	Electric Furnace	9.2%	6,162.75	569.82
Water Heating	Water Heater	68.6%	4,200.03	2,881.77
Interior Lighting	Screw-in	100.0%	1,391.63	1,391.63
Interior Lighting	Linear Fluorescent	100.0%	127.98	127.98
Exterior Lighting	Screw-in	100.0%	325.38	325.38
Appliances	Clothes Washer	96.3%	132.76	127.87
Appliances	Clothes Dryer	92.4%	997.15	920.88
Appliances	Dishwasher	73.1%	504.86	369.02
Appliances	Refrigerator	99.9%	950.01	949.27
Appliances	Freezer	55.3%	744.38	411.54
Appliances	Second Refrigerator	31.2%	1,106.58	345.27
Appliances	Stove	85.3%	570.08	486.54
Appliances	Microwave	97.1%	162.46	157.73
Electronics	Personal Computer	134.1%	377.88	440.60

- **LoadMAP stands for Load Management, Analysis and Planning**
- **LoadMAP modeling features:**
 - Embodies principles of rigorous end-use models (like REEPS and COMMEND)
 - Uses stock-accounting
 - Isolates new construction
 - Uses a simple decision logic
 - Models customized by end use
- **From user's perspective:**
 - Excel-based model
 - Easy to update assumptions
 - Enables sensitivity analysis
 - Answers what-if questions

Base-year energy consumption

Base year is 2009

- At start of past study in summer 2010, 2009 was most recent year with complete sales and customer data
- 2009 was also base year for Avista load research study, which provides peak data
- We will calibrate the first few years of the forecast to sales history

Market segmentation by rate class

Used 2009 base year sales data to develop control totals

- Number of customers, annual use, and peak load by sector

Sector	Rate Schedule(s)	Number of meters (customers)	2009 Electricity sales (MWh)	Peak demand (MW)
Residential	001	299,714	3,634,086	993
General Service	011, 012	46,387	738,505	125
Large General Service	021, 022	4,808	2,256,882	347
Extra Large General Service	025, 025P	32	1,145,277	174
Extra Large GS Potlatch	025P	1	892,291	101
Pumping	031, 032	3,673	194,884	14
Total		354,615	8,861,961	1,753

Market characterization

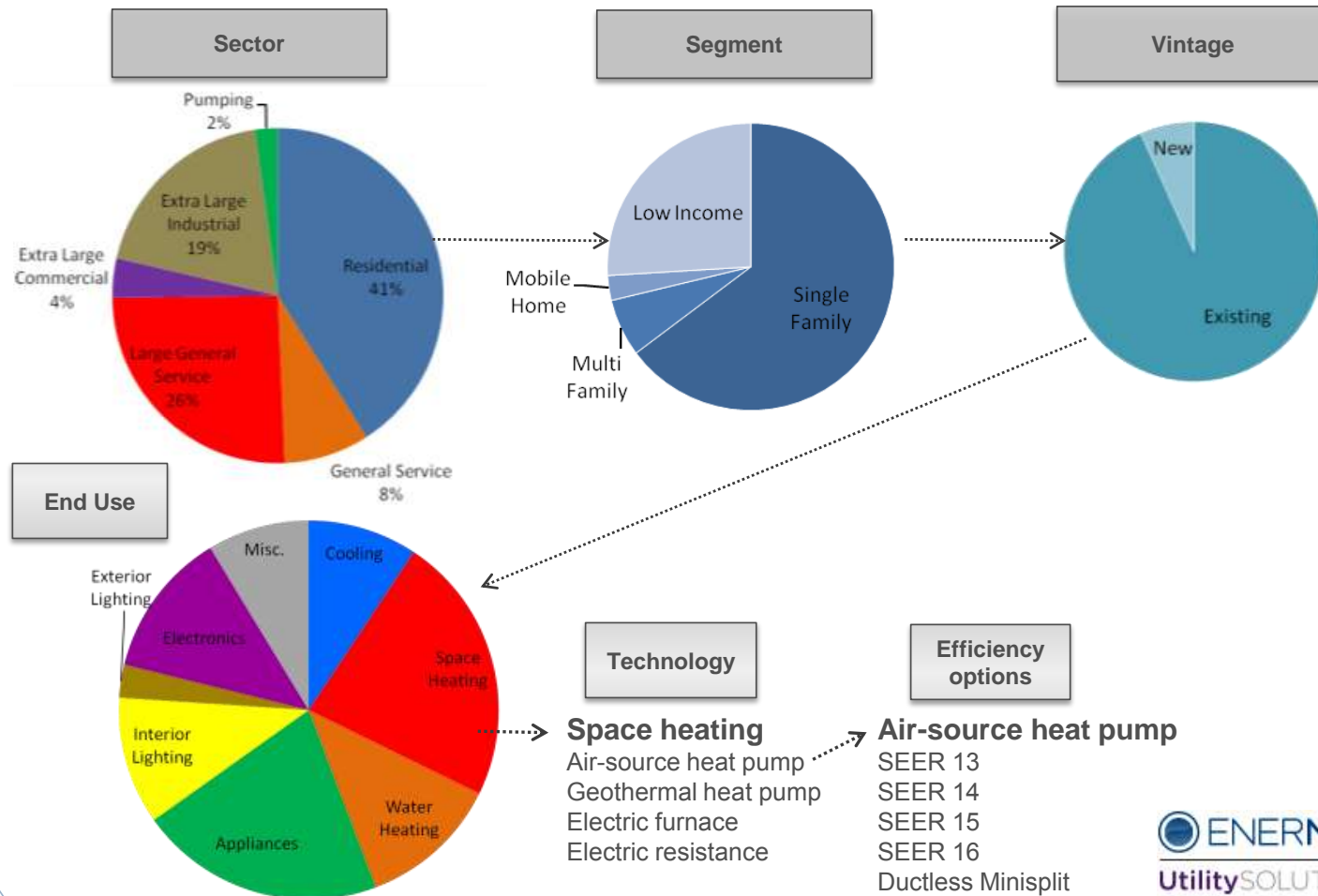

Market characterization by segment

Sector	Customers	2009 Electricity sales (GWh)
Residential	299,714	3,634,086
General Service	46,387	738,505
Large General Service	4,808	2,256,882
Extra Large GS	32	1,145,277
Extra Large GS Potlatch	1	892
Pumping	3,673	194,884
Total	354,615	8,861,961

Residential Segment	Number of Customers	Intensity (kWh/HH)	Electricity Sales (GWh)
Single family	168,339	14,250	2,398,874
Multi family	23,456	8,613	202,032
Mobile/Manufactured	10,022	12,724	127,523
Limited Income	97,896	9,251	905,656
Total	299,714	12,125	3,634,086

Energy Market Profiles

- Market profiles – a snapshot of how customers use energy by end use and technology
 - Number of customers
 - Saturations
 - Unit energy consumption (UEC) or energy use intensity (EUI)
 - Peak factors — fraction of annual electricity use coincident with the system peak
- Existing (average) buildings and new construction

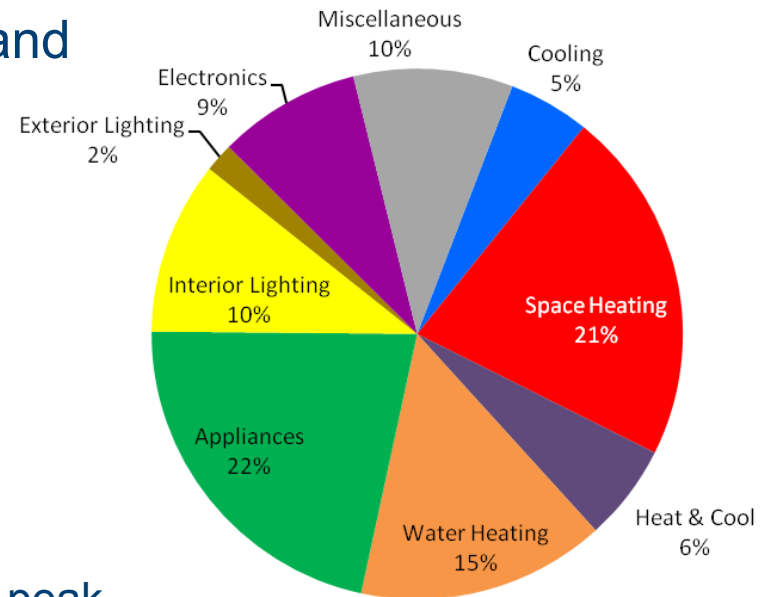

Energy Market Profiles (continued)

*Sample for
residential sector,
all segments*

Average Market Profile - Residential Sector

End Use	Technology	Saturation	UEC (kWh)	Intensity (kWh/HH)	Usage (GWh)
Cooling	Central AC	29%	1,613	470	141
Cooling	Room AC	20%	643	131	39
Combined Heating/Cooling	Air Source Heat Pump	14%	5,051	699	209
Combined Heating/Cooling	Geothermal Heat Pump	0%	3,715	15	4
Space Heating	Electric Resistance	18%	6,114	1,119	335
Space Heating	Electric Furnace	22%	6,779	1,492	447
Space Heating	Supplemental	9%	83	8	2
Water Heating	Water Heater	66%	2,796	1,834	550
Interior Lighting	Screw-in	100%	1,144	1,144	343
Interior Lighting	Linear Fluorescent	66%	121	80	24
Interior Lighting	Pin-based	92%	59	55	16
Exterior Lighting	Screw-in	70%	301	211	63
Exterior Lighting	High Intensity/Flood	2%	116	2	1
Appliances	Clothes Washer	84%	105	88	26
Appliances	Clothes Dryer	80%	621	498	149
Appliances	Dishwasher	86%	185	160	48
Appliances	Refrigerator	100%	746	746	224
Appliances	Freezer	62%	760	474	142
Appliances	Second Refrigerator	35%	787	277	83
Appliances	Stove	86%	299	257	77
Appliances	Microwave	95%	144	137	41
Electronics	Personal Computers	121%	263	317	95
Electronics	TVs	222%	311	688	206
Electronics	Devices and Gadgets	100%	48	48	14
Miscellaneous	Pool Pump	10%	1,328	130	39
Miscellaneous	Furnace Fan	26%	404	107	32
Miscellaneous	Miscellaneous	100%	940	940	282
Total				12,125	3,634

Baseline forecasting

- Model equipment choices for replacement or new construction
- Define equipment efficiency options, up to 10 per technology
- Define baseline purchase shares —begin with Annual Energy Outlook shipments data and modified for Avista service territory or local data
- Building codes and appliance standards

		 Today's Efficiency or Standard Assumption 1st Standard (relative to today's standard) 2nd Standard (relative to today's standard)															
End Use	Technology	2011	2012	2013	2014	2015	2016	2017	2018	2019	2020	2021	2022	2023	2024	2025	
Cooling	Central AC	SEER 13				SEER 14											
	Room AC	EER 9.8			EER 11.0												
	Evaporative Central AC	Conventional															
	Evaporative Room AC	Conventional															
Cooling/Heating	Heat Pump	SEER 13.0/HSPF 7.7				SEER 14.0/HSPF 8.0											
Space Heating	Electric Resistance	Electric Resistance															
Water Heating	Water Heater (<=55 gallons)	EF 0.90				EF 0.95											
	Water Heater (>55 gallons)	EF 0.90				Heat Pump Water Heater											
Lighting	Screw-in/Pin Lamps	Incandescent			Advanced Incandescent - tier 1						Advanced Incandescent - tier 2						
	Linear Fluorescent	T8															
Appliances	Refrigerator/2nd Refrigerator	NAECA Standard				25% more efficient											
	Freezer	NAECA Standard				25% more efficient											
	Dishwasher	Conventional (355 kWh/yr)			14% more efficient (307 kWh/yr)												
	Clothes Washer	Conventional (MEF 1.26 for top loader)				MEF 1.72 for top loader				MEF 2.0 for top loader							
	Clothes Dryer	Conventional (EF 3.01)				5% more efficient (EF 3.17)											

Baseline forecasting

- Air source heat pump example

Efficiency Level	Relative Energy Use	Lifetime	Standards Status	2011 Baseline Purchase Shares	2015 Baseline Purchase Shares
E1 – SEER 13	100.0%	15	Baseline until 2014	78%	0%
E2 – SEER 14 (ENERGY STAR)	91.7%	15	Baseline after 2014	0%	78%
E3 – SEER 15 (CEE Tier 2)	88.6%	15		15%	15%
E4 – SEER 16 (CEE Tier 3)	86.1%	15		7%	7%
E5– Ductless Mini-split System	75.0%	15		0%	0%

Baseline forecasting

- Market size / customer growth
- Income growth
- Avista retail rates forecast
- Trends in end-use/technology saturations
- Equipment purchase decisions
- Cooling and heating degree day values
- Persons/household and physical home size
- Elasticities by end use for each variable (from client or default values based on EPRI REEPS and COMMEND models)

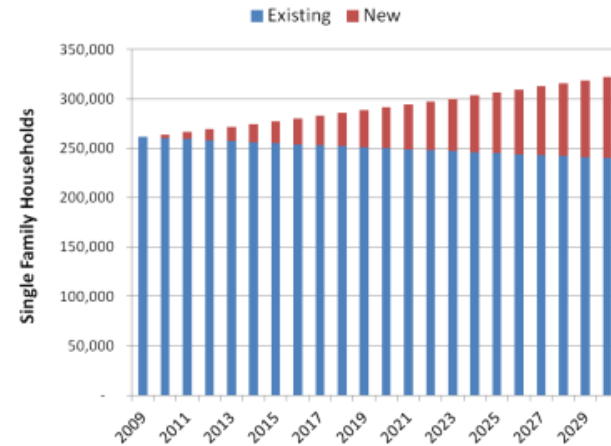

Baseline forecast – Residential

End Use	2009 (MWh)	2012 (MWh)	2017 (MWh)	2022 (MWh)	2027 (MWh)	2032 (MWh)	% Change (‘09–’32)	Avg. growth rate
Cooling	180,022	164,872	197,096	239,735	293,189	357,837	99%	3.0%
Space Heating	784,854	783,258	906,261	1,051,822	1,210,093	1,383,665	76%	2.5%
Heat & Cool	213,860	201,414	229,351	259,524	296,812	343,830	61%	2.1%
Water Heating	549,606	557,026	611,989	675,078	748,532	830,990	51%	1.8%
Appliances	790,377	776,522	796,390	837,724	899,380	996,282	26%	1.0%
Interior Lighting	383,305	375,894	335,220	397,188	465,499	543,171	42%	1.5%
Exterior Lighting	63,864	62,362	61,507	71,895	84,283	98,404	54%	1.9%
Electronics	315,599	336,232	404,126	484,986	570,101	669,577	112%	3.3%
Miscellaneous	352,599	374,582	448,055	540,785	650,016	779,045	121%	3.4%
Total	3,634,086	3,632,162	3,989,994	4,558,738	5,217,905	6,002,803	65%	2.2%

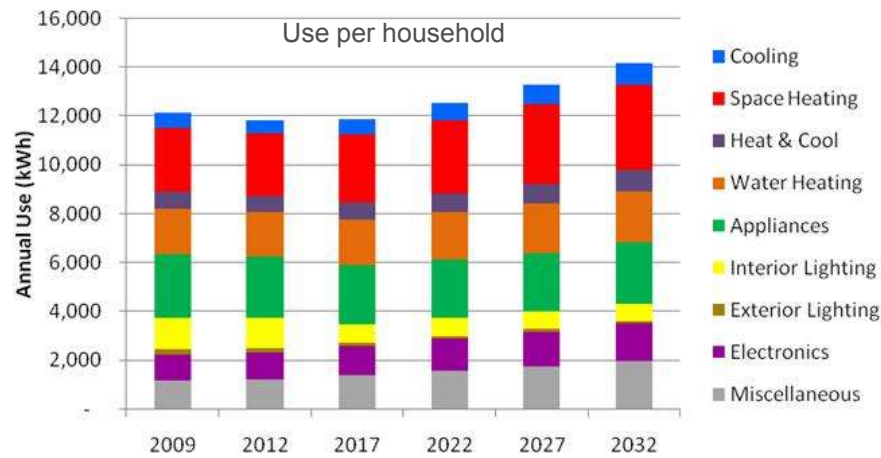

Baseline forecast – Commercial & Industrial

- Total growth of 27.1% over forecast period
- Average annual growth of 1.04%

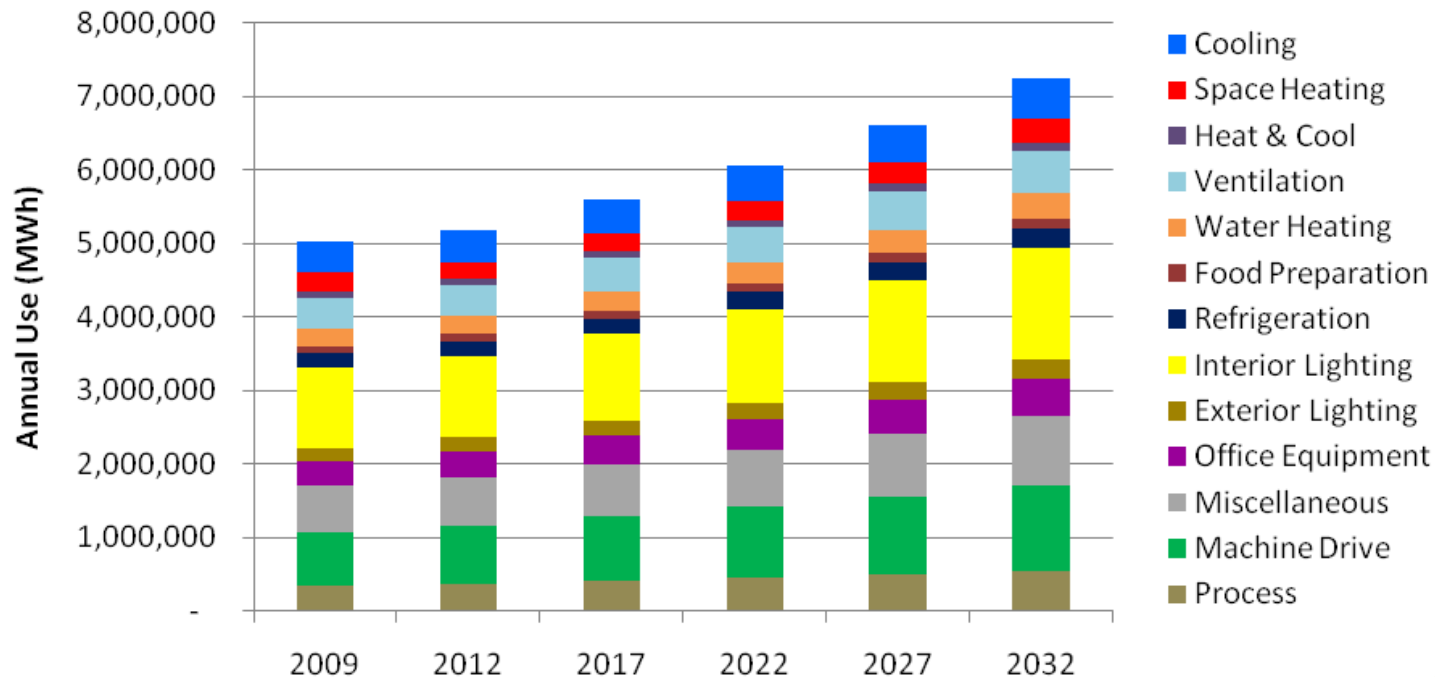

Baseline forecast summary — previous CPA

Overall 48% growth in electricity use

Average annual growth rate of 1.7%



Measure identification & characterization

- Develop measure list using
 - Existing programs
 - RTF data
 - EnerNOC databases
- Characterization
 - Description
 - Costs
 - Savings
 - Applicability
 - Lifetime
- Update measure data
 - Avista TRM
 - RTF measure databases
 - BEST simulations
 - EnerNOC databases

Water heating measures

Conventional (EF 0.95)

Heat pump water heater (EF 2.3)

Solar water heater

Low-flow showerheads

Timer / Thermostat setback

Tank blanket

Drainwater heat recovery

Technical potential

Technical potential

- Hypothetical case
- Most efficient option taken, regardless of cost
- Equipment is replaced at time of failure
- Other devices are phased in over time using a diffusion curve
 - Slope of curve varies according to complexity of measure and cost

Label	Water Heater Technology	Relative Energy Use	Off Market
E1	EF 0.9	100.0%	2014
E2	EF 0.95	94.0%	
E3	EF 2.3 (HPWH)	39.1%	
E4	Solar	38.2%	

Economic potential

Assumptions

- Avoided costs forecasts for energy and capacity
- T&D line losses
- Administrative cost adders

Total Resource Cost test for B/C ratio ≥ 1.0

- Most efficient cost-effective option is selected
- Screening performed for every year

Label	Water Heater Technologies	Relative Energy Use	Off Market	B/C Ratio 2012	B/C Ratio 2017
E1	EF 0.9	100.0%	2014	1.00	-
E2	EF 0.95	94.0%		1.03	1.00
E3	EF 2.3 (HPWH)	39.1%		1.05	1.08
E4	Solar	38.2%		0.68	0.70

Estimate achievable potential

Requires assumptions about customer acceptance, market barriers, and market maturity

Model applies series of factors to economic potential

Savings may be acquired through a variety of means

- Utility incentive programs
- Utility educational programs
- Market transformation, including NEEA

Sample potential results from previous CPA

	2012	2013	2017	2021	2022	2027	2032
Baseline Forecast (MWh)							
	8,805,759	9,000,280	9,600,889	10,425,853	10,646,717	11,876,679	13,310,674
Cumulative Energy Savings (MWh)							
Achievable	52,188	116,482	465,933	917,085	1,069,455	1,765,226	2,493,450
Economic	250,938	520,969	1,627,739	2,454,017	2,632,030	3,259,492	3,813,122
Technical	336,303	702,900	2,224,063	3,411,428	3,664,844	4,590,026	5,311,276
Cumulative Energy Savings (% of Baseline)							
Achievable	0.6%	1.3%	4.9%	8.8%	10.0%	14.9%	18.7%
Economic	2.8%	5.8%	17.0%	23.5%	24.7%	27.4%	28.6%
Technical	3.8%	7.8%	23.2%	32.7%	34.4%	38.6%	39.9%

Sample potential results (continued)

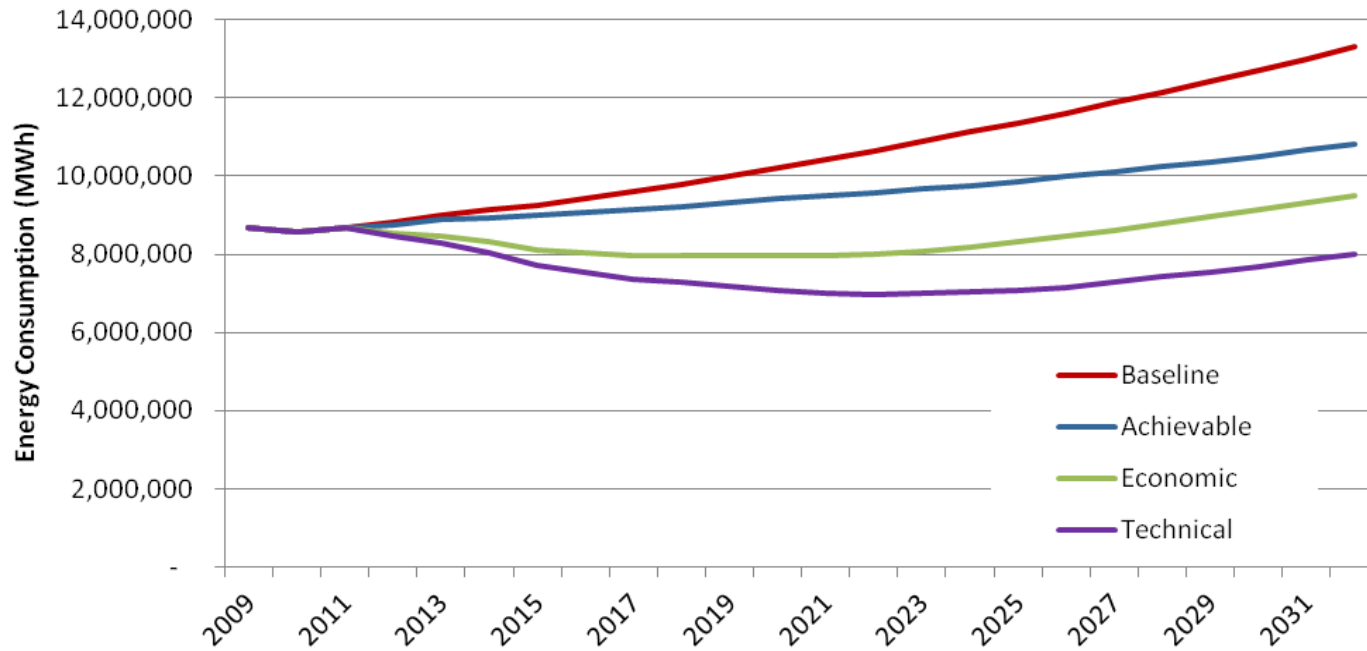

Project Schedule

Project Schedule

- Present project approach to the TAC on November 7, 2012
- Deliver preliminary results in January 2013
- Deliver final results mid-February 2013
- Present final study results to TAC and draft report in March, 2013
- Support the filing in August 2013 with a complete CPA report (including appendices)

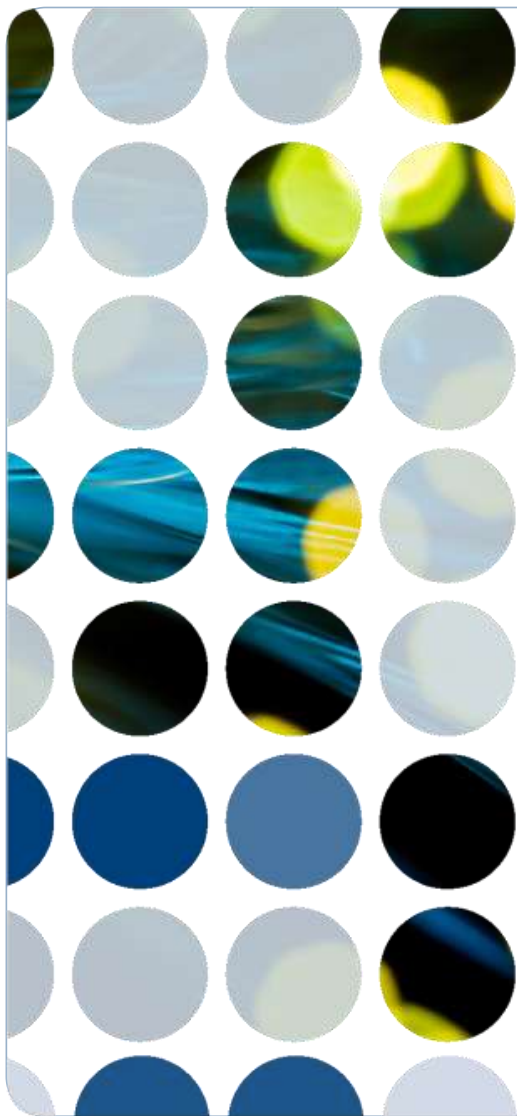

Jan Borstein

jbstein@enernoc.com

303-530-5195

Ingrid Rohmund

irohmund@enernoc.com

760-943-1532



Peak Load Forecast

James Gall, Senior Power Supply Analyst
Grant Forsyth, Senior Forecaster & Economist
Third Technical Advisory Committee Meeting
2013 Electric Integrated Resource Plan
November 7, 2012

Peak Load History

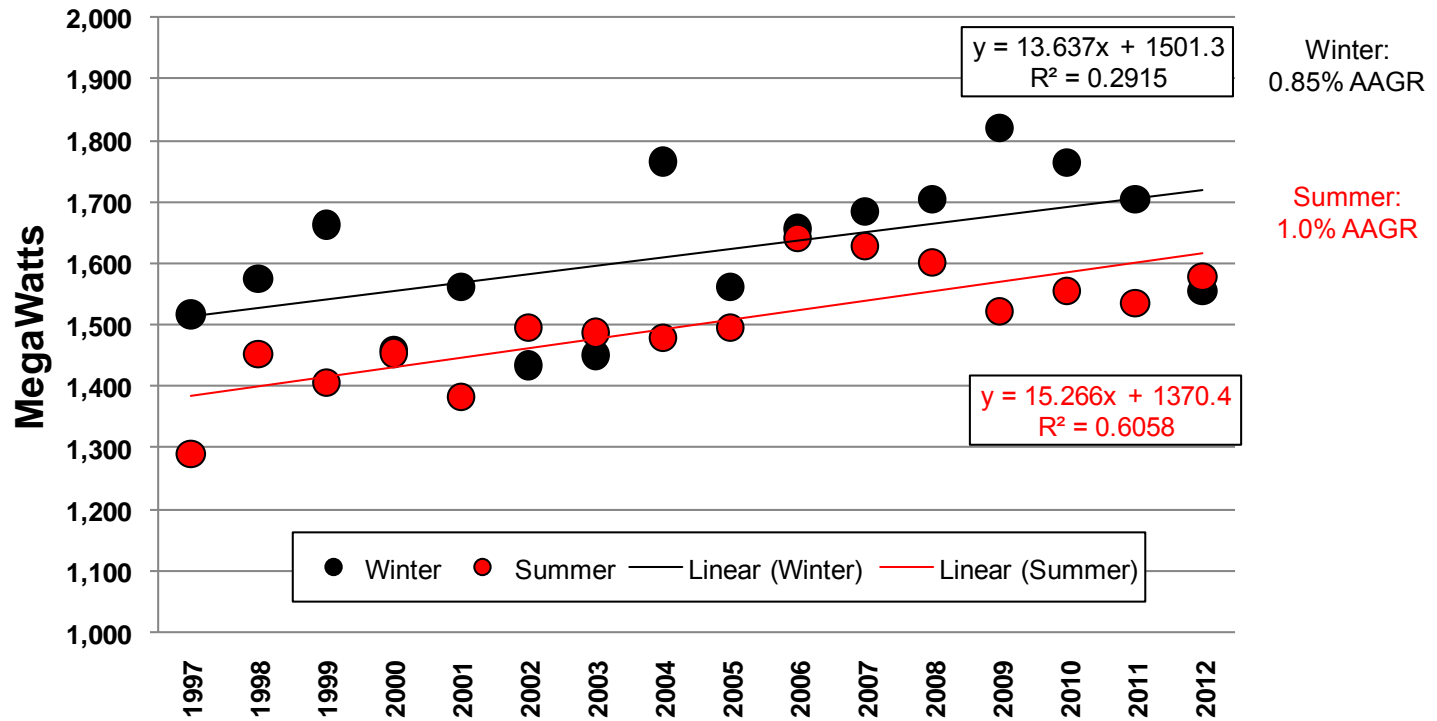

Forecast Methodology

- Use multi-variable regression analysis to identify the 2011/2012 weather adjusted peak load
- Use two years of daily load data as the sample data
- Remove large industrial loads and focus on weather related load
- Variables include:
 - Heating degree days set at 55°, 45°, and 15°
 - Cooling degree days set at 65° and 70°
 - Prior day cooling degree days set at 65° for past two days
 - Summer sunlight percentage
 - NERC and school holidays
 - Number of industrial & residential customers
 - Day of week and month of year

Forecast Methodology (continued)

- Peak load data was adjusted to the natural log to better estimate peak load hours
 - Resulting r^2 : is 0.94
 - Standard error: 36 MW or 3.3%
 - Durbin-Watson: $1.475_{(d-1)}$, $1.973_{(d-2)}$
- Weather adjustment includes 123 years of historical Spokane temperatures and four weekday combinations
- Peak forecast is 1 in 2 peak on a weekday
- LOLP analysis will consider probability of weekend extreme temperatures and will consider it in the planning margin
- L&R will use three day average peak and single hour peak
- Peak forecast includes existing conservation programs- additional programs could further lower the forecast

Historical Average Day Temperatures 1890-2012

	Coldest Day	Hottest Day
Extreme	-17°	90°
Average	3.9°	82.3°
Standard Deviation	8.9°	2.8°
90 th Percentile	-8.8°	86°
Last Tail Event	2004: -9°	2008: 86°

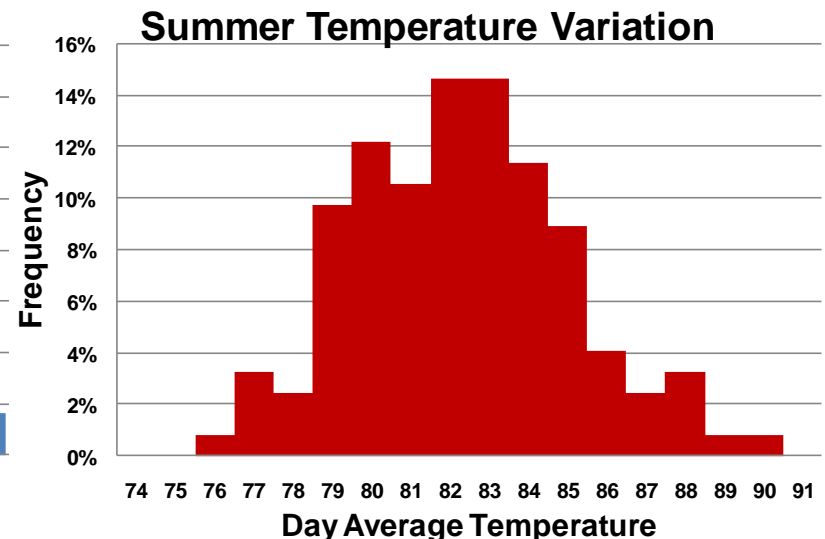
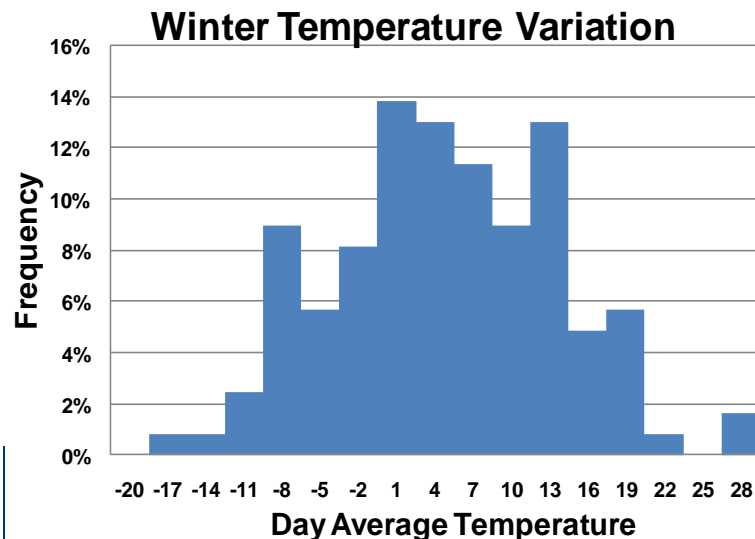

2011/2012 Weather Adjusted Peak Loads

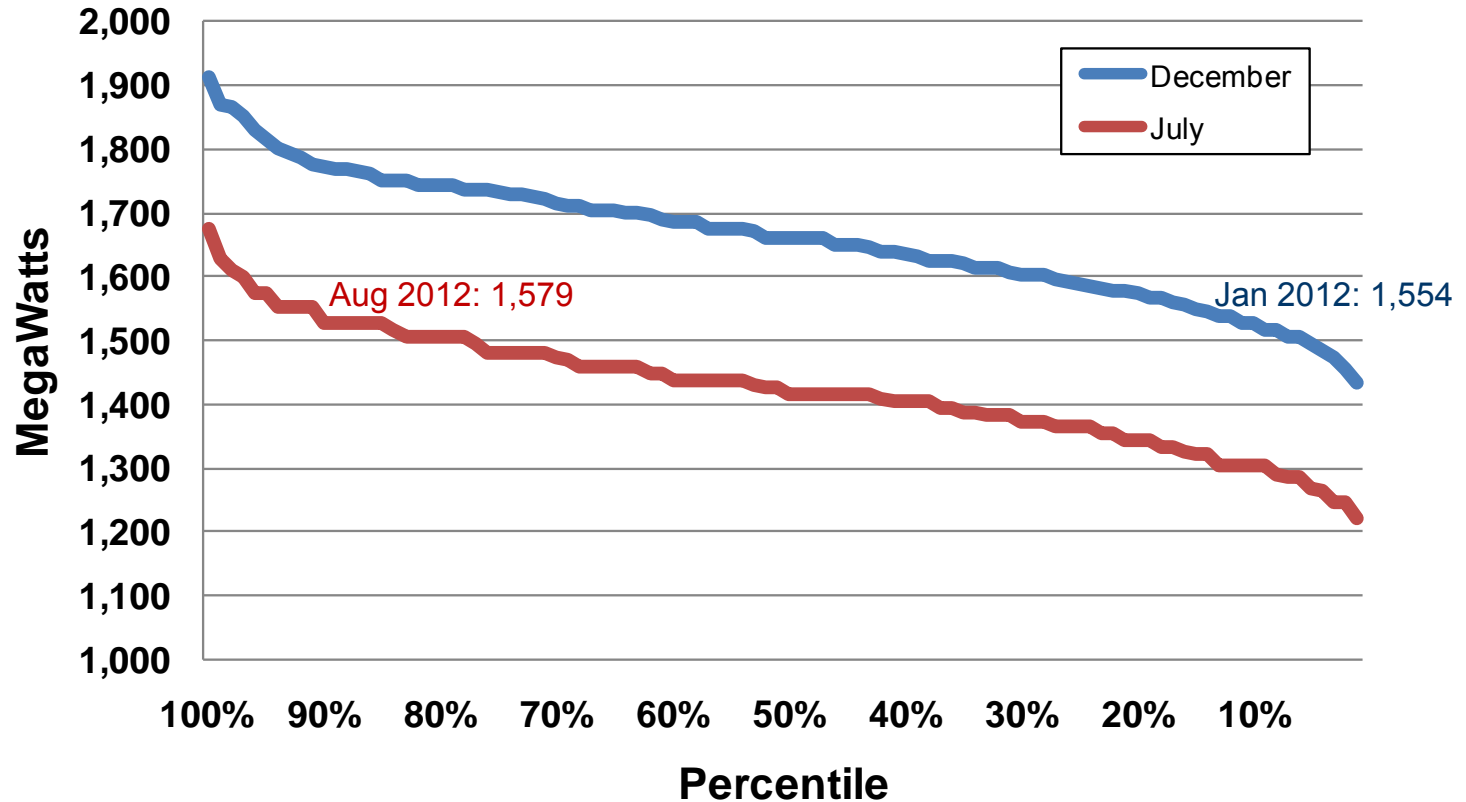

2013 IRP Peak Load Forecast

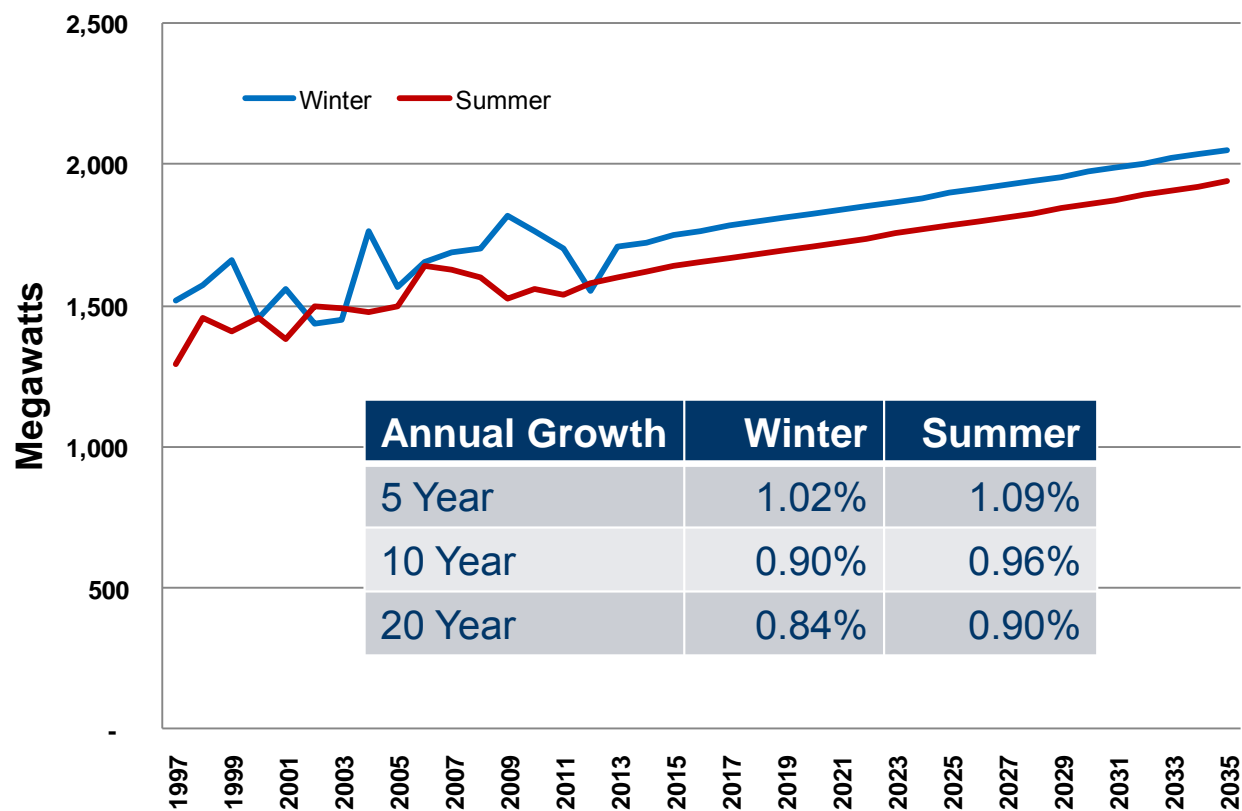

Linking Peak Load Growth to GDP Growth

- Peak loads are not constant over time. Controlling for weather and other seasonal factors, the long-run trend is towards increasing peaks
 - Monthly Peak = f(weather, non-weather seasonal factors, **economic factors**)
 - If we account for weather and non-weather seasonal factors, then changes in the peak load, we assume, are due to economic factors
- Since we cannot easily identify specific economic factors, we use GDP growth as a catch-all proxy
 - Econometric evidence suggests that Avista's load growth, excluding weather and seasonal effects, is significantly, positively correlated with GDP growth.
 - Weather and Seasonal Adjusted Peak Growth = f(GDP Growth) is a relationship estimated with historical data
 - If we have forecasts of GDP growth we can estimate what peak load growth under the assumption that the future GDP/load relationship will not be materially different than what it was in the past

Linking Peak Load Growth to GDP Growth (Cont)

- There is growing evidence that winter peak load growth is slower than summer peak load growth
 - Could be a function of increased use of air conditioning on new and existing homes
 - Weather and Seasonal Adjusted Peak Growth = $f(\text{GDP Growth})$ is estimated for winter peaks and summer peaks. The estimation does produced a slightly higher growth rate for the summer peak
- Where do the forecasts for GDP growth come from?
 - 5-year forecasts are obtained by averaging GDP forecasts across multiple sources: Bloomberg survey of forecasters, The Economist poll of forecasters, WSJ survey of forecasters, Global Insight, Economy.com, and several others
 - From this set of forecasts have an average, a high, and a low forecast out five years. This gives us some sense of how the business cycle will impact peak growth
 - Beyond five years we assume a long-rung GDP growth rate of 2.5%

IRP Peak Forecast Changes

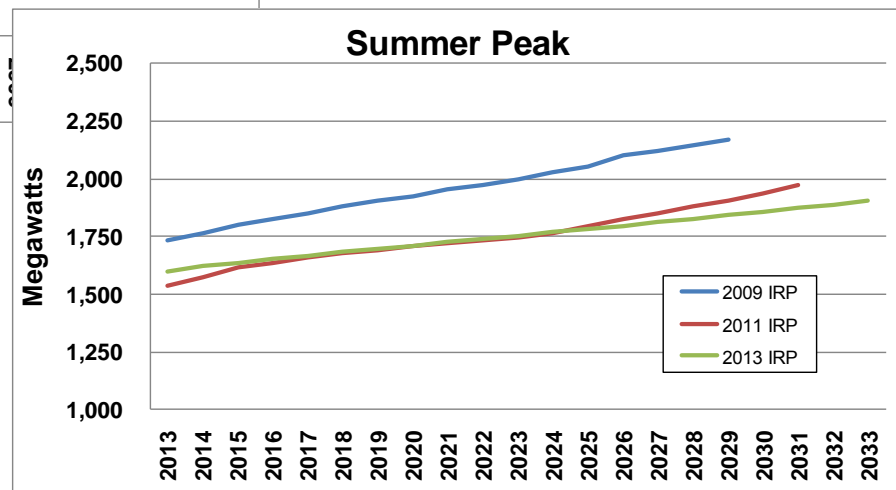
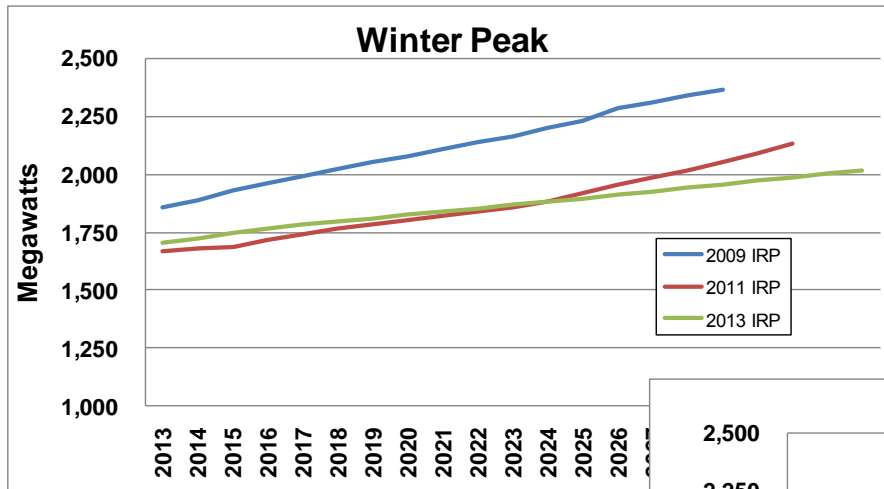

Weather Variation (1 in 20)

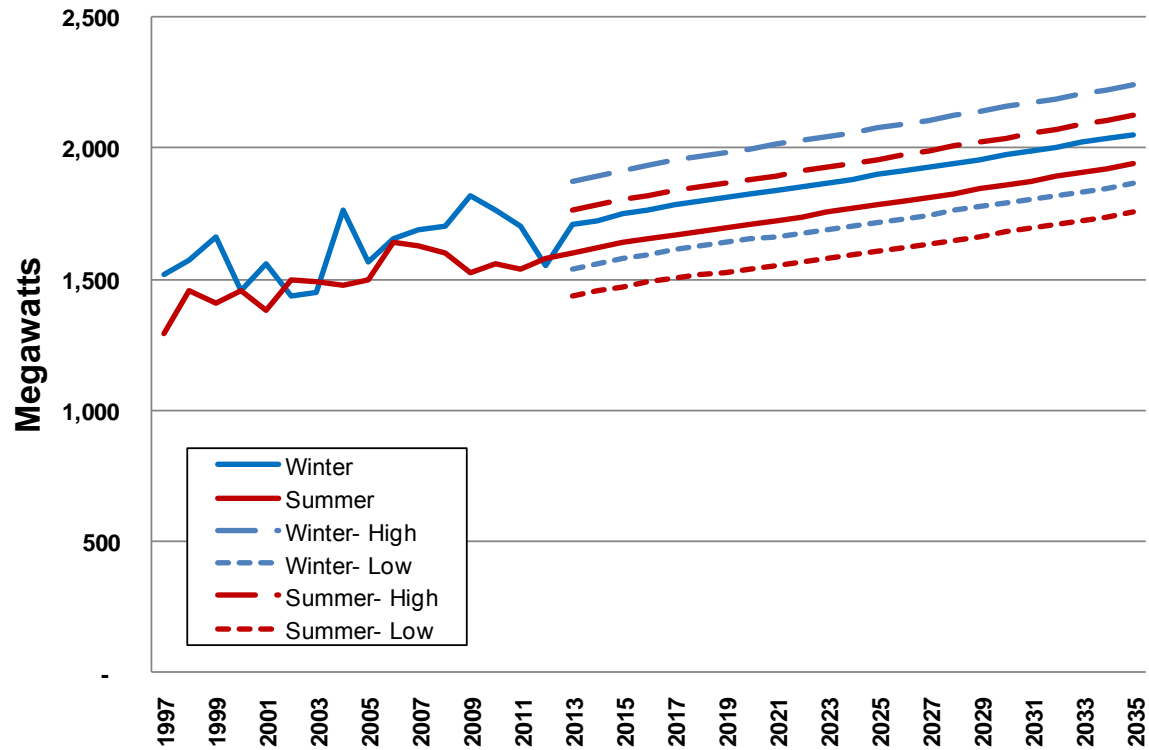



Reliability Planning

James Gall, Senior Power Supply Analyst
Third Technical Advisory Committee Meeting
2013 Electric Integrated Resource Plan
November 7, 2012

What is Reliability Planning?

- Assessment of resource adequacy
- Estimate probability of failing to serve all load
- Used to estimate the planning margin to apply to the peak load forecast

Peak Day Example- August 7, 2012

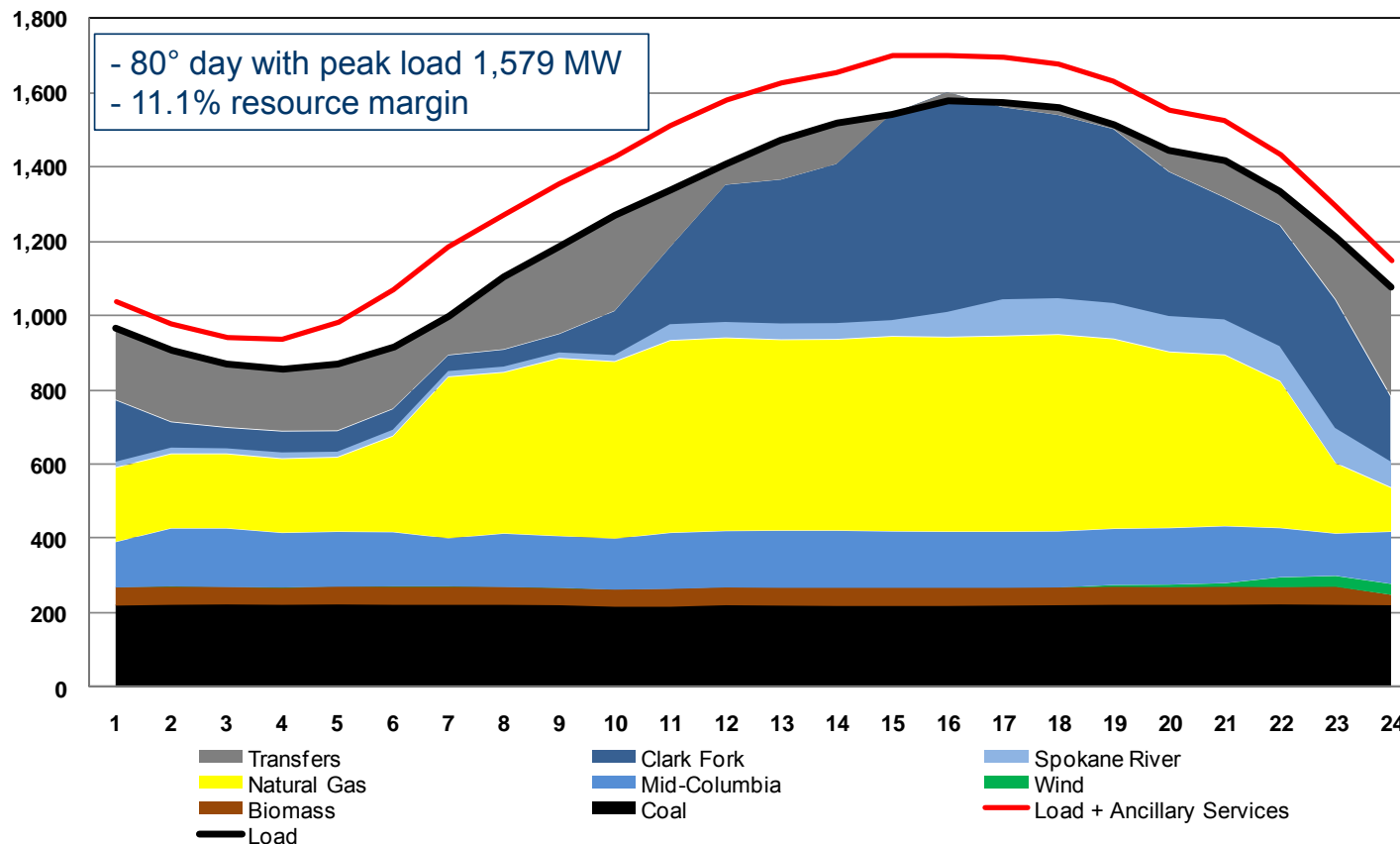

The Tool

- Excel based model with linear program to optimize resource generation to meet load and reserve requires taking into account potential market purchases and sales
- Focus on year 2020
- Simulates 1,000 future scenarios
 - Temperatures, Hydro Availability, Forced Outages, Wind Generation
- Attempts to correlate interaction between variables

Reliability Model Data Work Flow Diagram

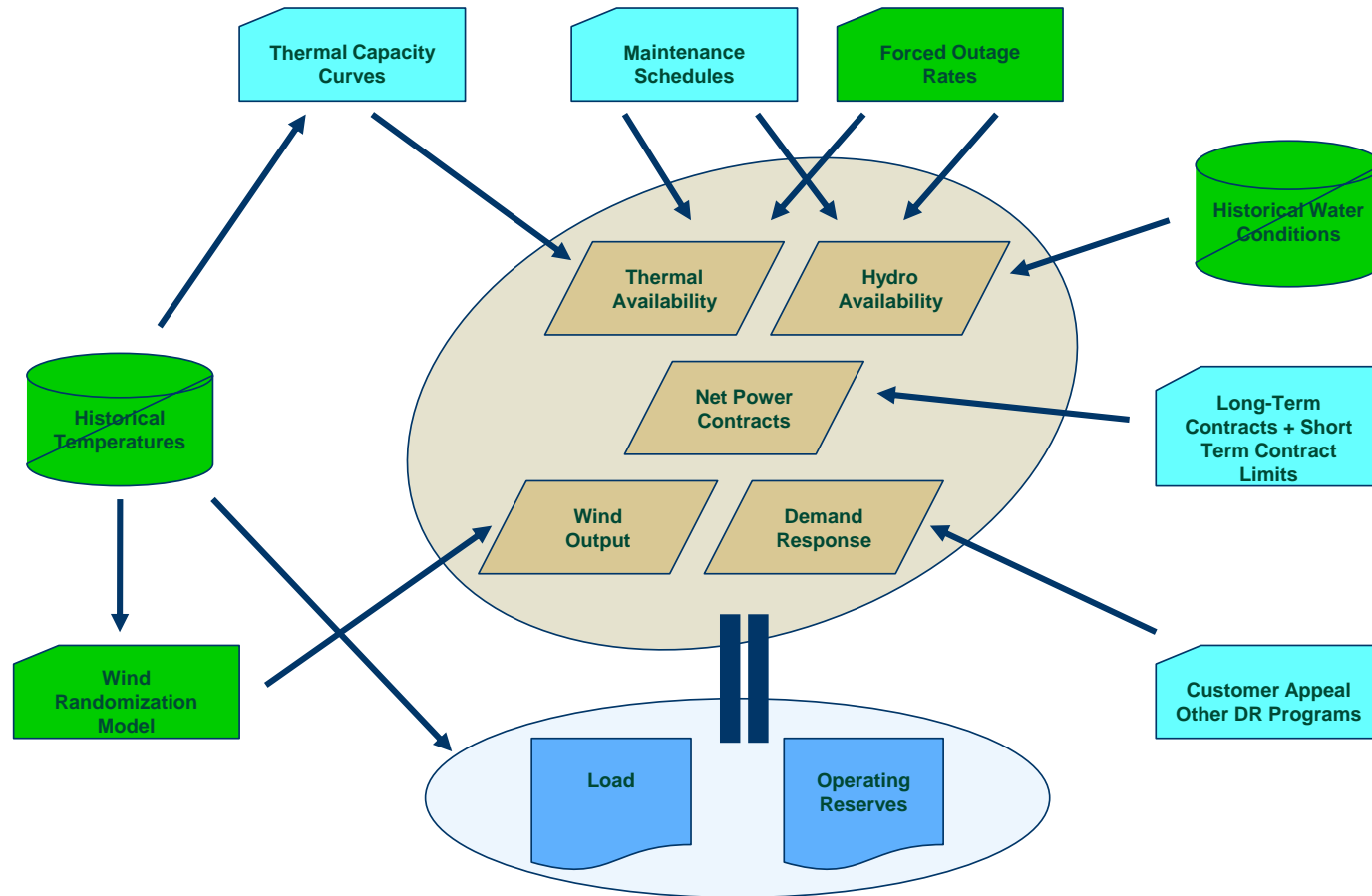

Loads

- Load shapes are derived from historic daily high and low temperatures
- Uses 120+ years of Spokane temperatures
- The average load and the average of the seasonal peak load of the 1,000 scenarios are designed to match the long-term energy & peak forecasts
- Two years of historical hourly loads (netted of large industrials) were used as the dependant variable of a regression analysis
- 303 independent variables were considered including: temperature, holidays, day of week, month, and hour
- Resulted in a 94% R² and 5.3% standard error

Hydro

- Randomly selects a hydro year between 1928 and 1999
- Each hydro year includes monthly energy averages
- Run-of-river facilities
 - Monthly energy average is used for all hours of the month
 - No shaping or reserves are assumed to be available
- Storage facilities
 - Monthly average generation equals the “drawn” hydro level
 - In case of planned/forced outage, water can be spilled
 - Linear program moves energy into hours needed to meet load
 - Reservoir min and max levels, ramping rates, and daily limits are enforced
 - Unused capacity is held as operating reserves

Thermal

- Temperature dependency
 - Gas-fired facilities use capacity based upon location temperatures
 - Temperatures are randomly drawn and are the same as the temperatures used in the load and wind calculation
- Forced outages
 - Input forced outage rate and mean-time-to-repair
 - Outages occur randomly using a frequency and duration method
 - Ramp rates are used following outages
- Maintenance schedules
 - Planned maintenance schedules are assumed
 - Typical outages are in April though June

Wind

- In 2020, only one wind project is expected to be on-line- The 105 MW Palouse Wind Farm
- The project is expected to be on-line by the end of 2012
- Little generation data is available at this time- only a few years of wind speed at a few locations
- To simulate wind generation a regression analysis was used to create a algorithm adjusting generation based on month, temperature, daytime vs nighttime and previous hour(s) generation.
- Method creates realistic generation profile, but due to lack of historical data- scenarios will done to understand the variability of wind during high or low temperatures.

Demand Curtailment

- Customer appeal
 - Public appeal to all customers to conserve energy, radio/TV broadcasts
 - Base case includes 25 MW reductions up to two times per year for hours across the peak
- Industrial process
 - Not included in base case
 - Designed to shift load from peak hours
- Sensitivities studies can help determine value of programs

Reserves

- Operating Reserves:
 - 5% hydro, 7% thermal, 5% wind generation
- Regulating Margin:
 - 1.6% of average hourly load level (based on historical average of max load within hour versus average load)
- Intermediate (Wind) Resource Regulation:
 - Lesser of 10% of nameplate capacity or generation amount
- Reserves are met by excess hydro capacity (for spin & non-spin) and thermal generation not running may be used for non-spin.
- In the event a unit trips- the model will call on regional reserves for 1 hour

Contracts & Market

- Long-term contracts are included as hourly fixed power coming into the system
- Short-term system balancing transaction are allowed with limits:
 - On Peak: 500 MW
 - Off Peak: 1000 MW
 - On Peak Constrained: 0 MW
 - Off Peak Constrained: 500 MW
- Hourly market is modeled dynamically adjusting for regional temperatures and hydro conditions (future enhancement would be to include wind correlation)

Objective Function

Load Serving

- Load [SM]
 - + Thermal commitment [RM]
 - + Hydro commitment [LP]
 - + Wind generation [SM/RM]
 - +/- LT Contracts
 - + Demand curtailment (optional) [LP]
 - +/- Market transactions
-
- ≥ 0 or event triggered

Operating Reserves

- Operating Reserve Requirement
 - Intra-hour load regulation
 - Wind regulation
 - + Available thermal non-spin capability
 - + Unused hydro capability (spin & non-spin)
-
- ≥ 0 or event triggered

What should the penalty be for curtailing load?

SM: Stochastic Model
 RM: Randomization Model
 LP: Linear Program

Metrics

- Monthly and Annual Data
- Loss of Load Probability (LOLP): percent of iterations with a reserve or load loss
 - Calculation: iterations with event / # of iterations
 - Metric: 5% or less
- Loss of Load Hour (LOLH): expected number of hours each year with a load loss
 - Calculation: total hours with event / (# of iterations)
 - Metric: 0.24 (24 hours per 10 years)
- Loss of Load Expectation (LOLE): expected number of days each year with a load loss
 - Calculation: Days with event / # of iterations
 - Metric: 1 day in 10 years or 0.10 or less [or do we want 0.05, 1 in 20?]
- Equivalent Unserved Energy (EUE): average MWh of lost load over a year

Planning Margin Approach

- Simulate system by adding new resources and/or market reliance until the 5% LOLP threshold is met
- Estimate annual power supply costs for each case
- Management must decide on the acceptable level of market reliance given the cost of new generation
- Year 2020 is used to estimate planning margin for other years

2020 Position Forecast (Draft)

3 day x 6 hour Sustained Peak

	Jan	Feb	Mar	Apr	May	Jun	Jul	Aug	Sep	Oct	Nov	Dec
Peak Load	-1,786	-1,639	-1,518	-1,362	-1,238	-1,369	-1,665	-1,636	-1,332	-1,418	-1,651	-1,814
Contracts Sales	-6	-6	-6	-6	-7	-7	-8	-8	-7	-6	-6	-6
Total Peak Obligation	-1,793	-1,646	-1,524	-1,368	-1,245	-1,376	-1,673	-1,644	-1,339	-1,424	-1,657	-1,820
Contract Purchases	92	94	96	96	97	95	88	85	85	87	89	92
Hydro	881	823	749	1,052	1,050	1,045	883	840	763	857	878	890
Thermal	884	881	874	755	450	499	775	780	797	865	873	882
Wind	0	0	0	0	0	0	0	0	0	0	0	0
Peaking	242	236	230	222	182	180	172	176	114	92	232	240
Total Resouraces	2,100	2,034	1,950	2,125	1,778	1,818	1,919	1,881	1,759	1,901	2,072	2,105
Position	307	389	426	757	534	443	246	237	421	477	415	284
Net Reserve Requirement	-40	-61	-153	-140	-130	-139	-30	-31	0	0	-21	-41
Position Net Reserves	267	328	273	617	404	304	216	206	421	477	394	243
Implied Planning Margin	15%	20%	18%	45%	32%	22%	13%	13%	31%	33%	24%	13%

2020 Probabilistic Capacity Requirements

(No Additions or Market Availability)

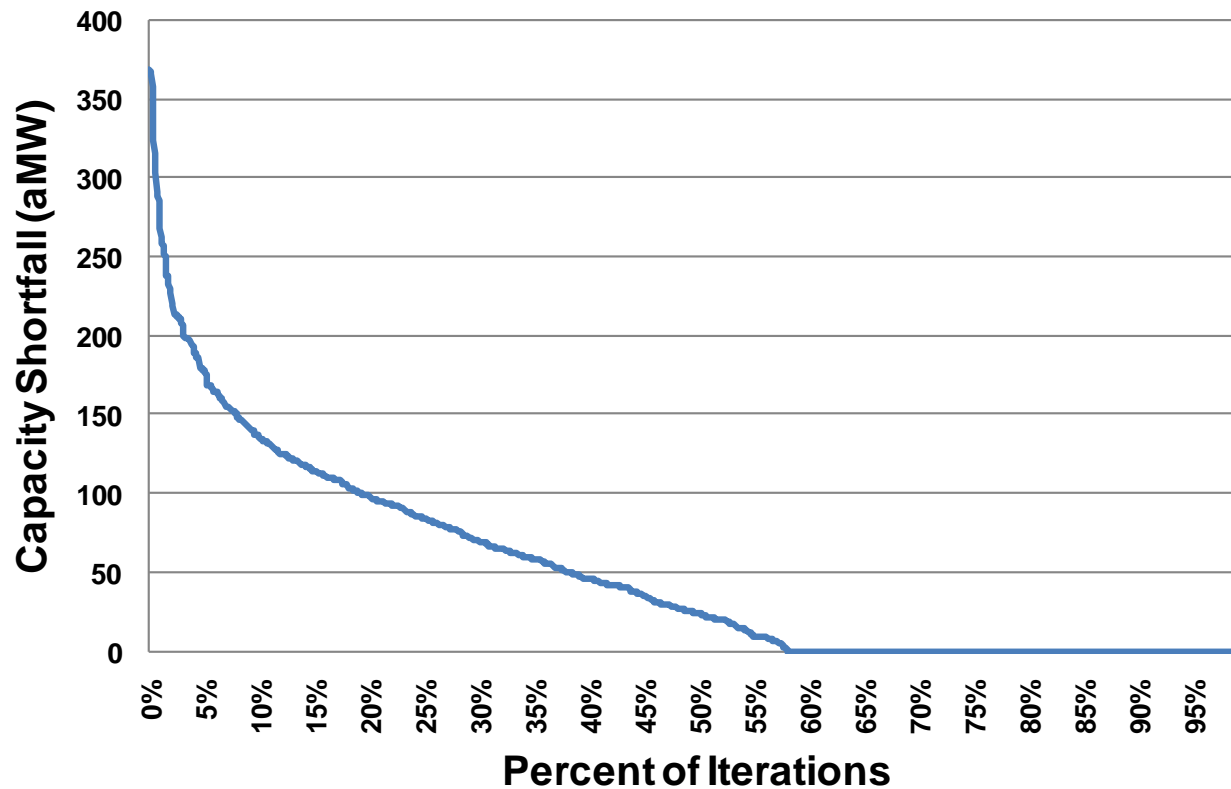

2020 Measure of Hours and Shortfall aMW

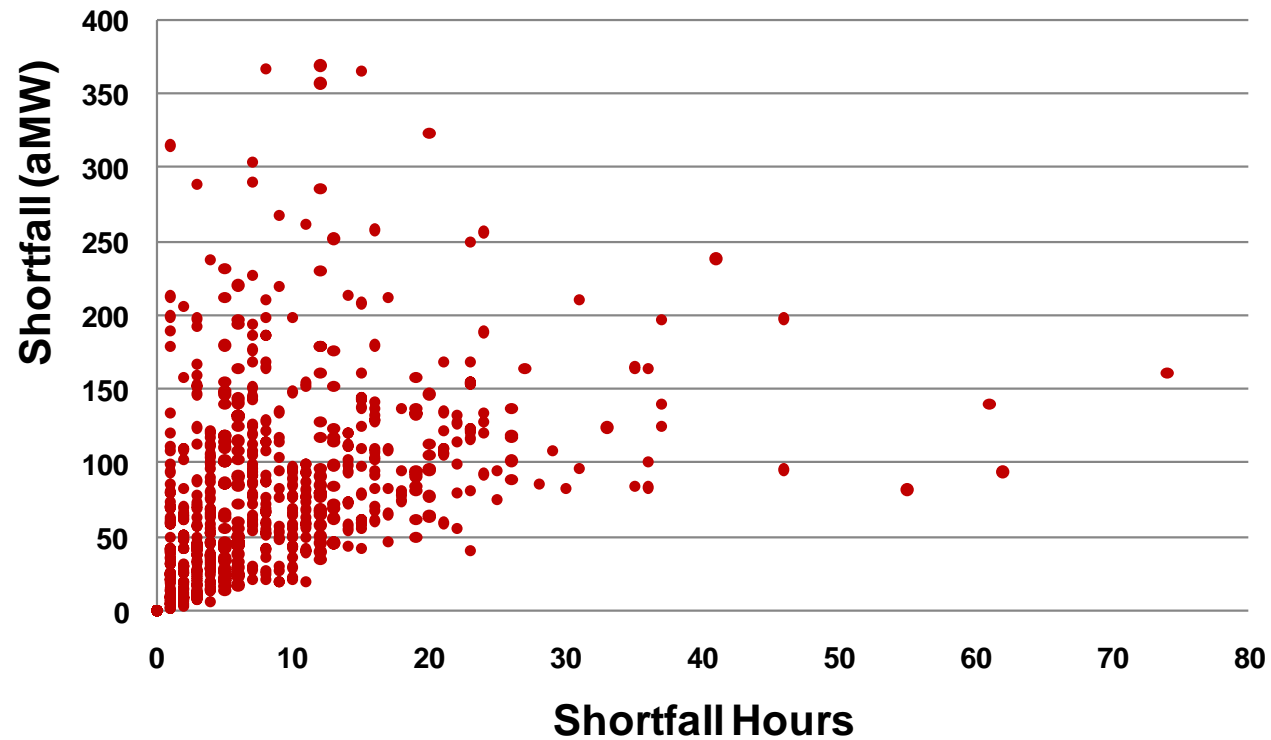

Market Reliance Affect to LOLP in 2020

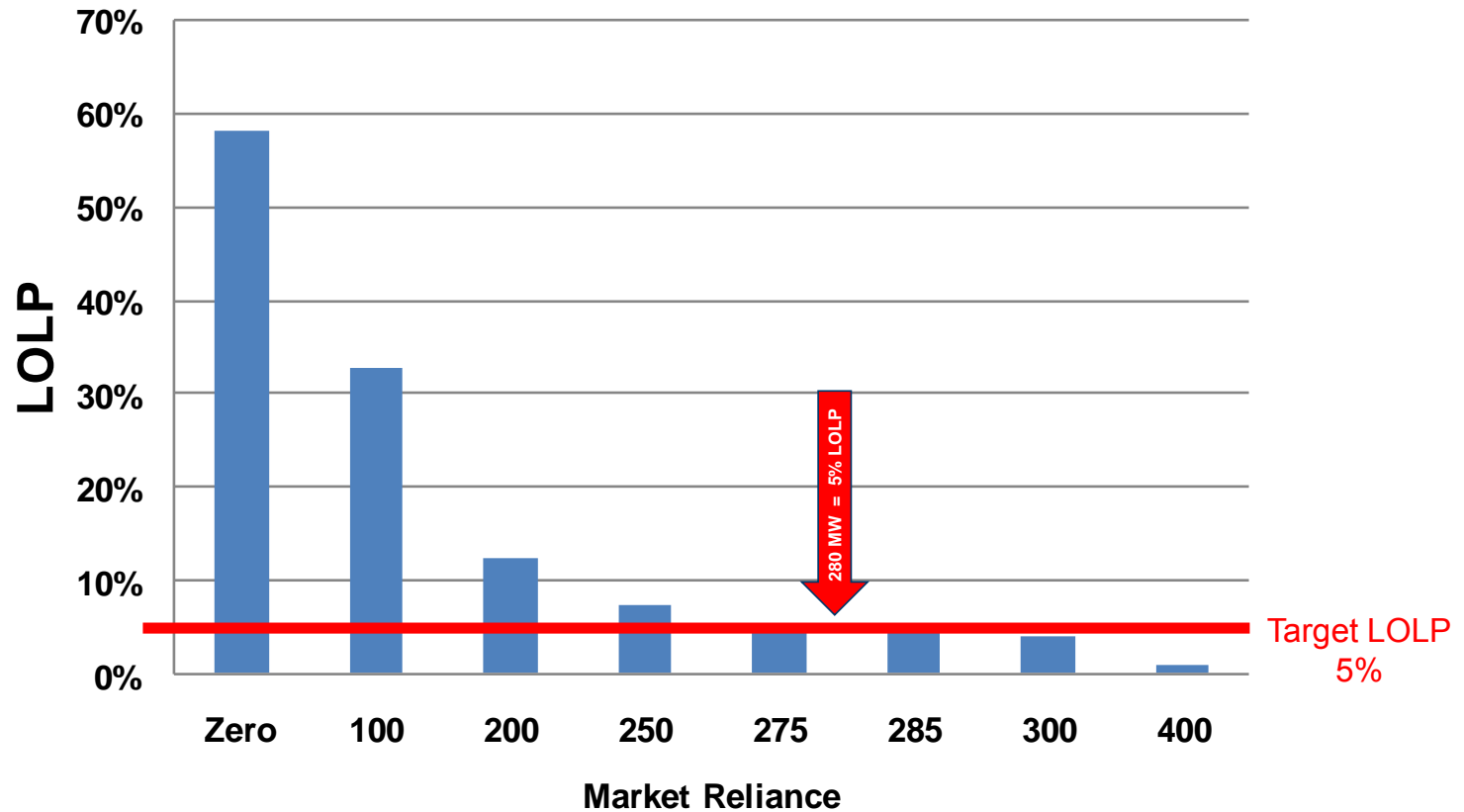

2020 LOLP Monthly Results

Market Reliance	Jan	Feb	Mar	Apr	May	Jun	Jul	Aug	Sep	Oct	Nov	Dec	Annual
Zero	10%	3%	1%	0%	0%	0%	27%	23%	0%	0%	2%	10%	58.2%
100	5%	1%	0%	0%	0%	0%	14%	12%	0%	0%	1%	5%	32.9%
200	2%	0%	0%	0%	0%	0%	6%	4%	0%	0%	0%	1%	12.4%
250	1%	0%	0%	0%	0%	0%	3%	2%	0%	0%	0%	1%	7.3%
275	1%	0%	0%	0%	0%	0%	2%	2%	0%	0%	0%	1%	5.4%
285	0%	0%	0%	0%	0%	0%	2%	2%	0%	0%	0%	0%	4.6%
300	1%	0%	0%	0%	0%	0%	2%	1%	0%	0%	0%	1%	4.1%
400	0%	0%	0%	0%	0%	0%	1%	0%	0%	0%	0%	0%	1.0%

2020 LOLH Monthly Results

Market Reliance	Jan	Feb	Mar	Apr	May	Jun	Jul	Aug	Sep	Oct	Nov	Dec	Annual
Zero	0.86	0.22	0.07	-	-	-	1.94	1.28	0.03	0.01	0.32	0.78	5.50
100	0.46	0.06	0.00	-	-	-	0.82	0.51	0.04	0.00	0.10	0.26	2.26
200	0.08	0.02	0.00	-	-	-	0.28	0.15	0.00	-	0.01	0.08	0.62
250	0.04	0.02	-	-	-	-	0.16	0.09	-	-	0.02	0.02	0.35
275	0.03	0.01	-	-	-	-	0.12	0.06	-	-	0.02	0.01	0.24
285	0.02	0.01	-	-	-	-	0.10	0.06	-	-	0.01	0.01	0.21
300	0.04	-	0.00	-	-	-	0.10	0.03	-	-	0.01	0.03	0.20

0.24 on an annual basis is considered a “reliable” system



Unit Size Affect to LOLP in 2020

Measure	Definition	Goal	300 MW Market	3- 100 MW Units	2- 150 MW Units	1- 300 MW Unit
LOLP	Probability	5%	4.1%	7.5%	8.4%	10.8%
LOLH	Hrs/Yr	0.24	0.20	0.30	0.38	0.45
EUE	aMW	N/A	16	22	30	37

Resource allocation to get to 5% LOLP goal

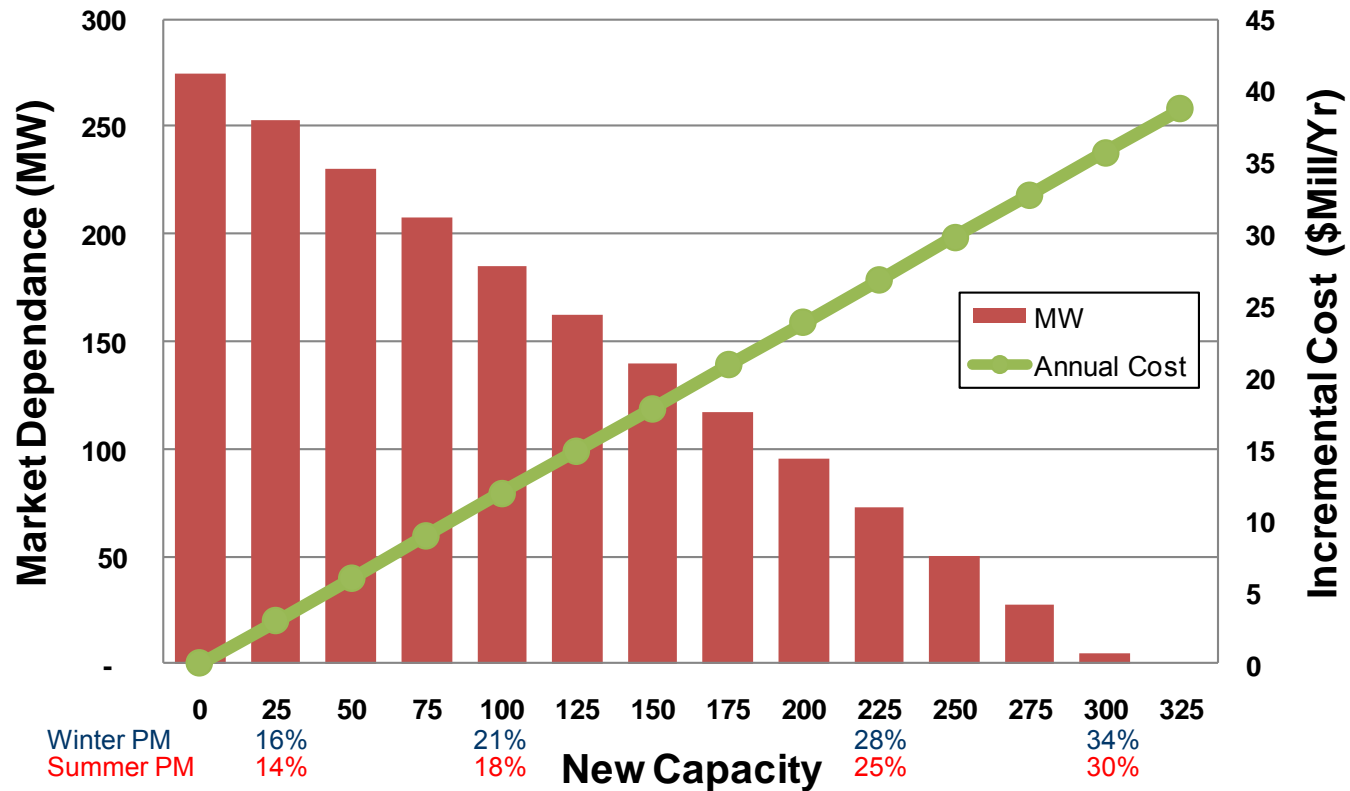



Energy Storage Technologies

John Lyons, Senior Resource Policy Analyst

Third Technical Advisory Committee Meeting

2013 Electric Integrated Resource Plan

November 7, 2012

Types of Energy Storage

- Pumped Hydro
- Batteries
- Flywheel
- Compressed Air

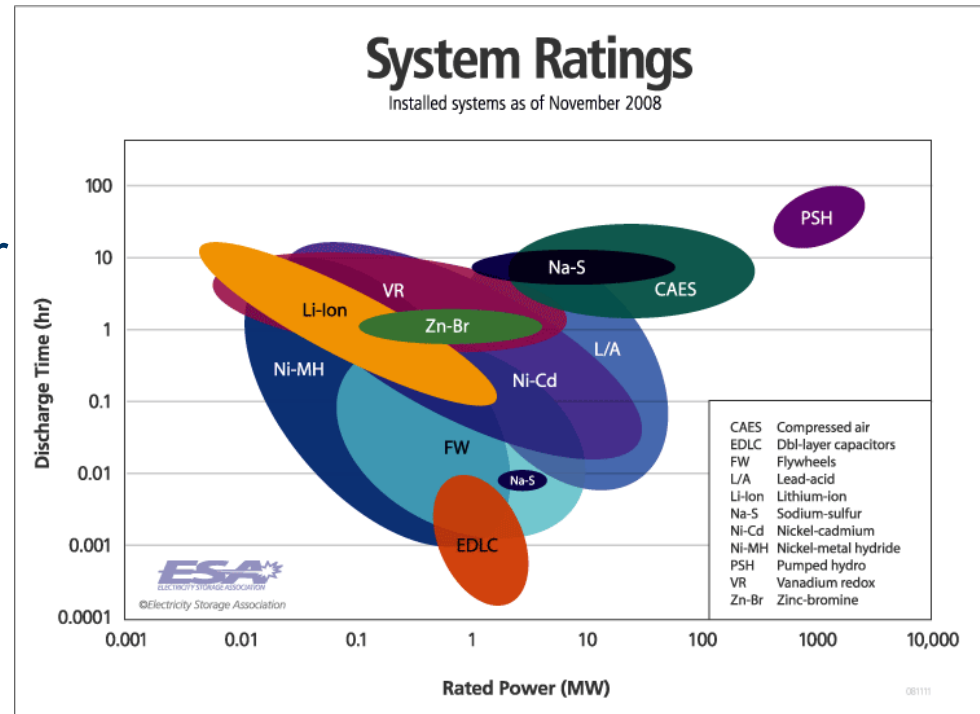

http://www.electricitystorage.org/images/uploads/static_content/technology/technology_resources/ratings_large.gif

Current Worldwide Installed Energy Storage Capacity

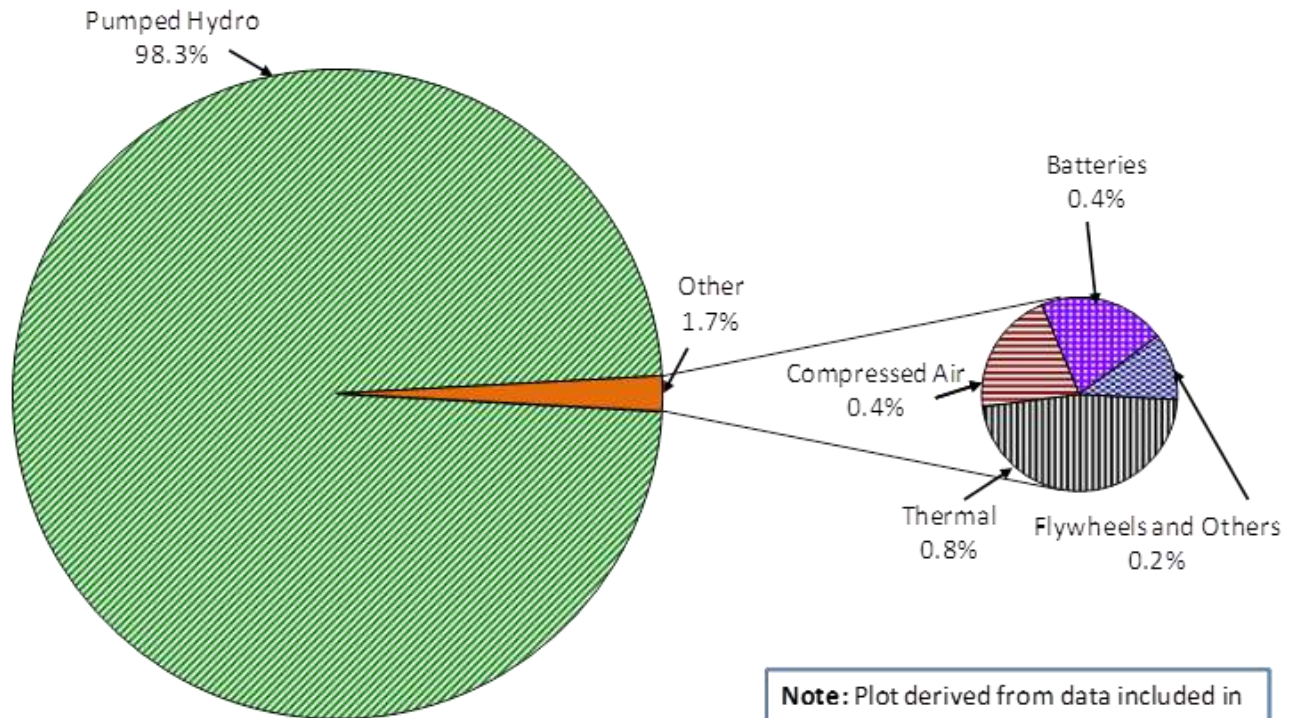

Note: Plot derived from data included in CESA, "Bolstering California's Economy with AB 2514", Page 3.



Energy Storage Applications

Electric Supply

- Electric energy time-shift
- Electric supply capacity

Ancillary Services

- Load following
- Area regulation
- Electric supply reserve capacity
- Voltage support

Grid System

- Transmission support
- Transmission congestion relief
- Transmission and distribution upgrade deferral
- Substation on-site power

Eyer, J. and Corey, G. (2010) Energy Storage for the Electricity Grid: Benefits and Market Potential Assessment Guide. Sandia National Laboratory.

Energy Storage Applications

End User/Utility Customer

- Time-of-use energy cost management
- Demand charge management
- Electric service reliability
- Electric service power quality

Renewables Integration

- Renewables energy time-shift
- Renewables capacity firming
- Wind generation grid integration

Eyer, J. and Corey, G. (2010) Energy Storage for the Electricity Grid: Benefits and Market Potential Assessment Guide. Sandia National Laboratory.

Pumped Hydro Storage

- Works by pumping water between two reservoirs with different elevations during off peak periods
- Largest share of current energy storage in the US – over 20 GW capacity with 31 GW proposed
- Tend to be long lead time resources with unique licensing and siting issues
- Avista has pumped storage potential at Long Lake and Noxon Rapids

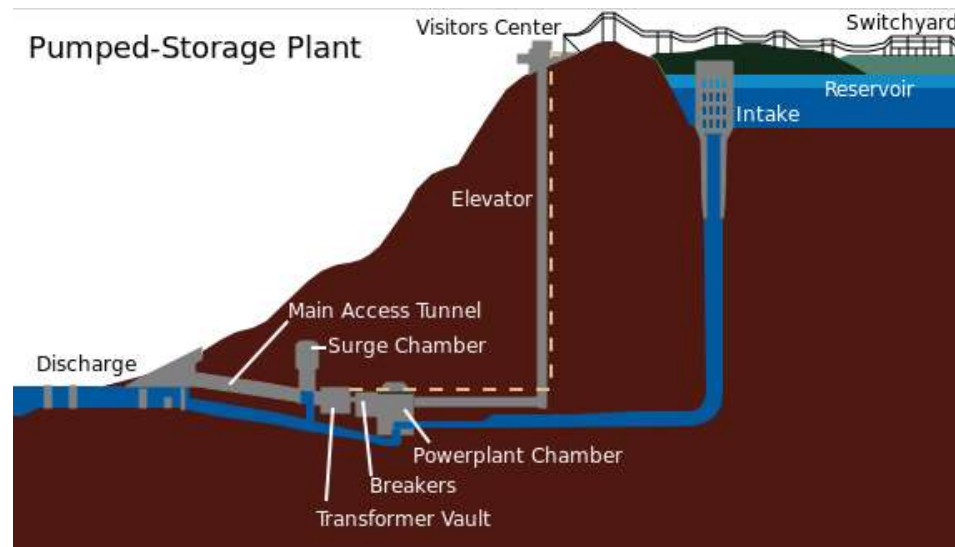

http://en.wikipedia.org/wiki/File:Raccoon_Mountain_Pumped-Storage_Plant.svg

Batteries

- Charge off-peak, or during periods of excess variable generation, for later use
- Several different types available:
 - Lithium-ion
 - Sodium-sulfur
 - Redox flow
 - Zinc bromine

Flywheels

- Converts electric energy into rotational energy, which can be called on quickly to convert back to electricity
- Uses: grid energy storage, short-term storage of excess wind generation and providing regulation services
 - Stephentown, NY – 20 MW (5 MWh over 15 minutes)

Compressed Air

- Technology based on compressing air and pumping it into geological storage in off-peak periods for use in subsequent periods.
- Ongoing projects
 - 1978 – 290 MW Huntorf in Germany (salt dome)
 - 1991 – 110 MW McIntosh, Alabama (salt cavern)
- Scheduled projects
 - 2016 – 300 MW (10 hours) PG&E in Kern County, California
 - 2013 – 200 MW ADELE facility in Germany
 - 2016 – 317 MW Bethel Energy Center in Anderson County, Texas

Energy Storage Federal and State Policies

- No real federal policies requiring the development of energy storage
- Many federal proposals for tax benefits and proposed and actual funding of pilot projects
- Many proposals at the state level, but few implemented

Economic Issues

- High cost of installation
- Low differentials between on and off peak prices
- 2013 IRP = \$4,000/kW for 5 MW in 2015

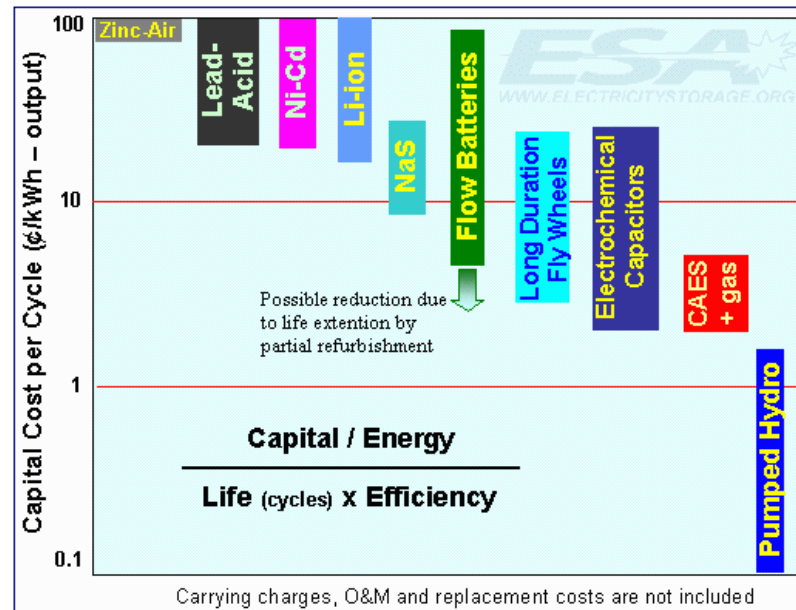

http://www.electricitystorage.org/images/uploads/static_content/technology/technology_resources/cycle_large.gif

Avista's 2013 Electric Integrated Resource Plan
Technical Advisory Committee Meeting No. 4 Agenda
Wednesday, February 6, 2013
Conference Room 428

Topic	Time	Staff
1. Introduction	8:30	
2. Natural Gas Price Forecast	8:35	Irvine
3. Electric Price Forecast	9:45	Gall
4. Break	10:45	
5. Transmission Planning	11:00	Maguire
6. Lunch	12:00	
7. Resource Needs Assessment	1:00	Kalich
8. Break	2:00	
9. Market & Portfolio Scenario Development	2:15	Lyons
10. Adjourn	3:00	



Avista Electric IRP Natural Gas Price Forecast

**Technical Advisory Committee Meeting
February 6, 2013**

Agenda

- Natural Gas 101
- Pacific Northwest Supply and Infrastructure
- Natural Gas Price Fundamentals
 - Short Term
 - Long Term
- Fracking Facts and the Future of Shale

A Brief History ...



The Natural Gas System

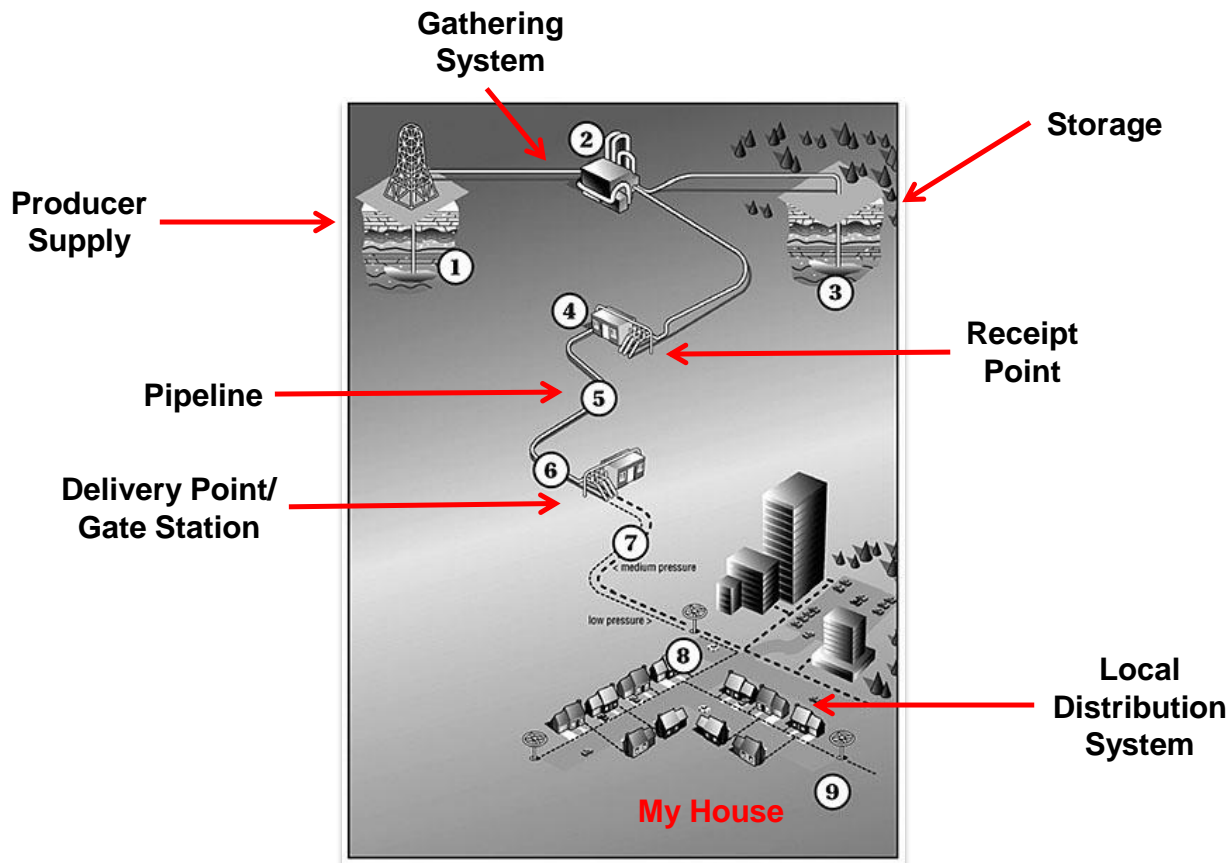

Pipelines Offered a Bundled Service – “One Call, That’s All™”

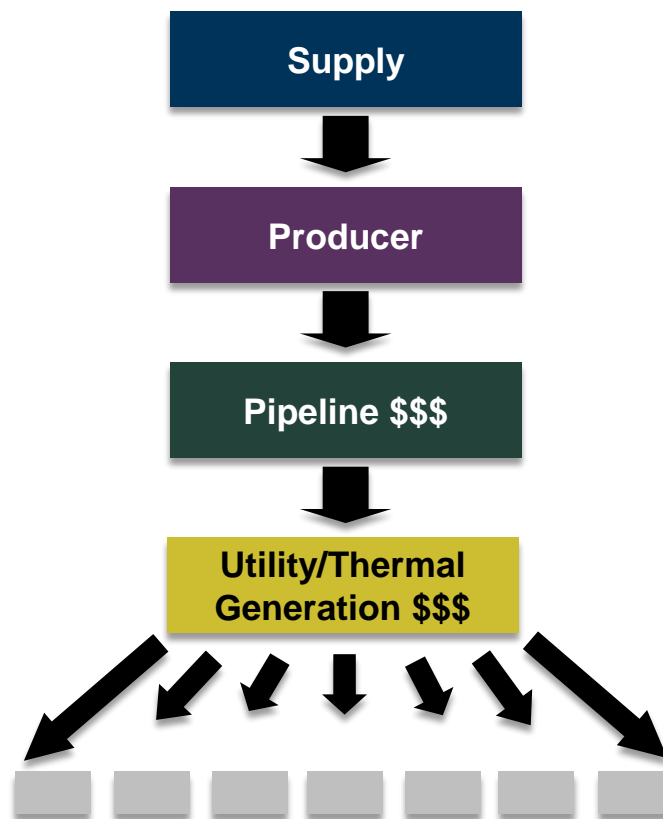

FERC ORDER 436 Pushed the Pipelines Out of the Supply Business

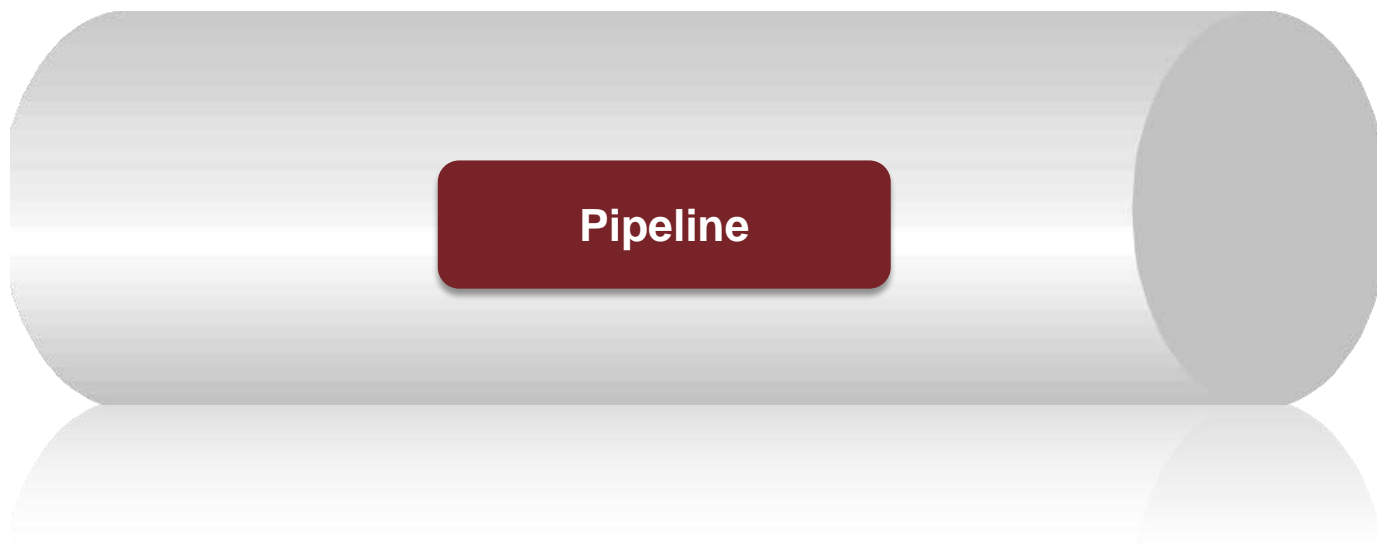

Example of Contracting on a Pipeline

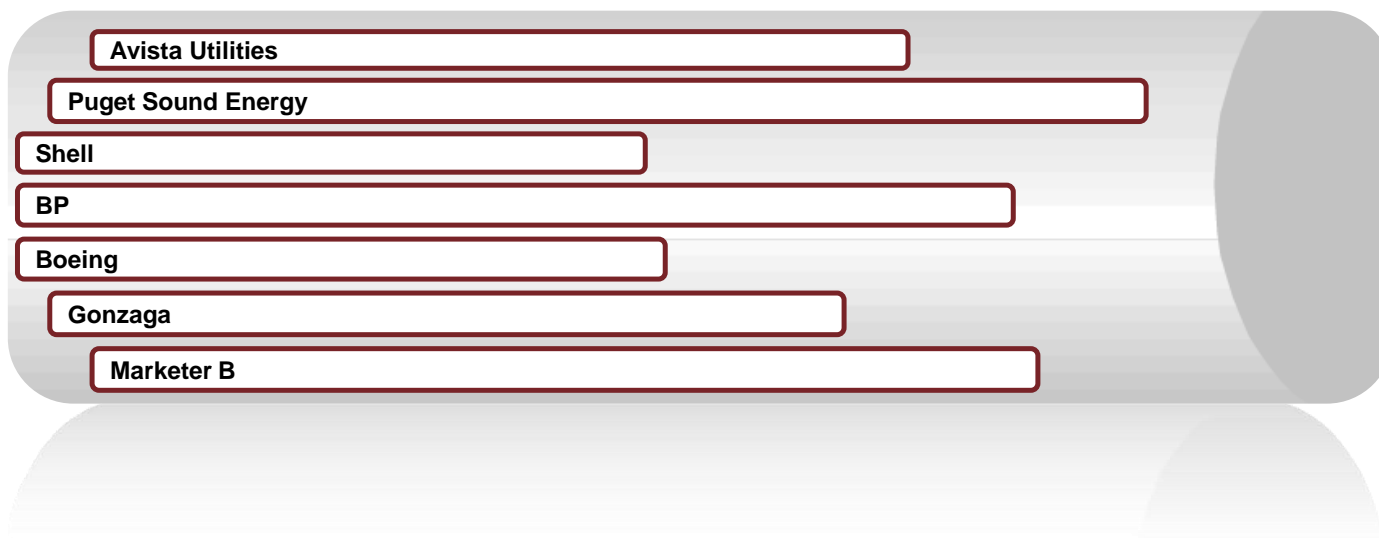

Now Services are Unbundled – You Control the Price for Each Component

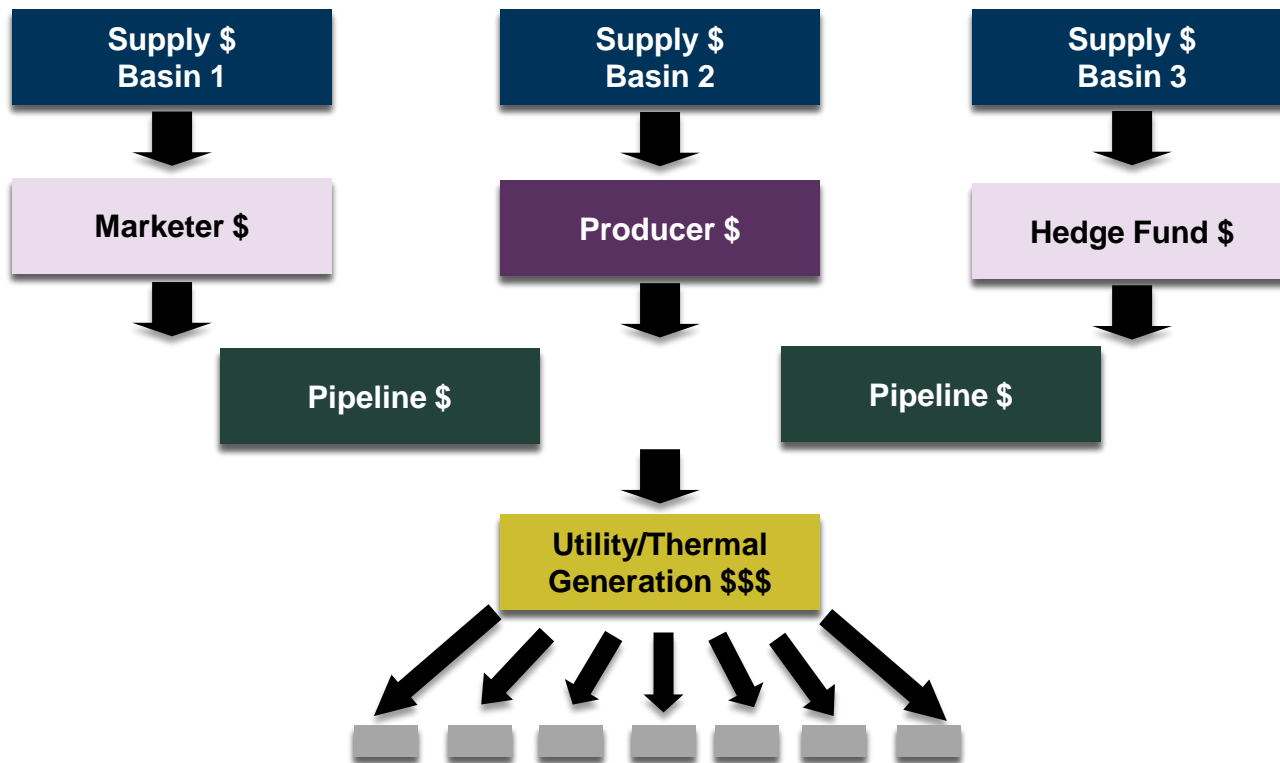

Natural Gas Infrastructure in the Pacific Northwest



Pacific Northwest Supply and Infrastructure

SUPPLY

- ▶ **AECO**
Canadian gas coming out of Alberta, Canada
- ▶ **Rockies**
U.S. domestic gas coming from Wyoming and Colorado
- ▶ **Sumas**
Canadian gas coming out of British Columbia, Canada
- ▶ **Malin**
South central at the Oregon and California border
- ▶ **Stanfield**
Intersection of two major pipelines in North Central Oregon

PIPELINES

- ▶ **Williams Northwest Pipeline**
- ▶ **TransCanada Gas Transmission Northwest**
- ▶ **TransCanada Foothills**
- ▶ **TransCanada Alberta**
- ▶ **Spectra Energy**
- ▶ **Ruby Pipeline**

STORAGE

- ▶ **Jackson Prairie Storage**
- ▶ **Mist Storage**

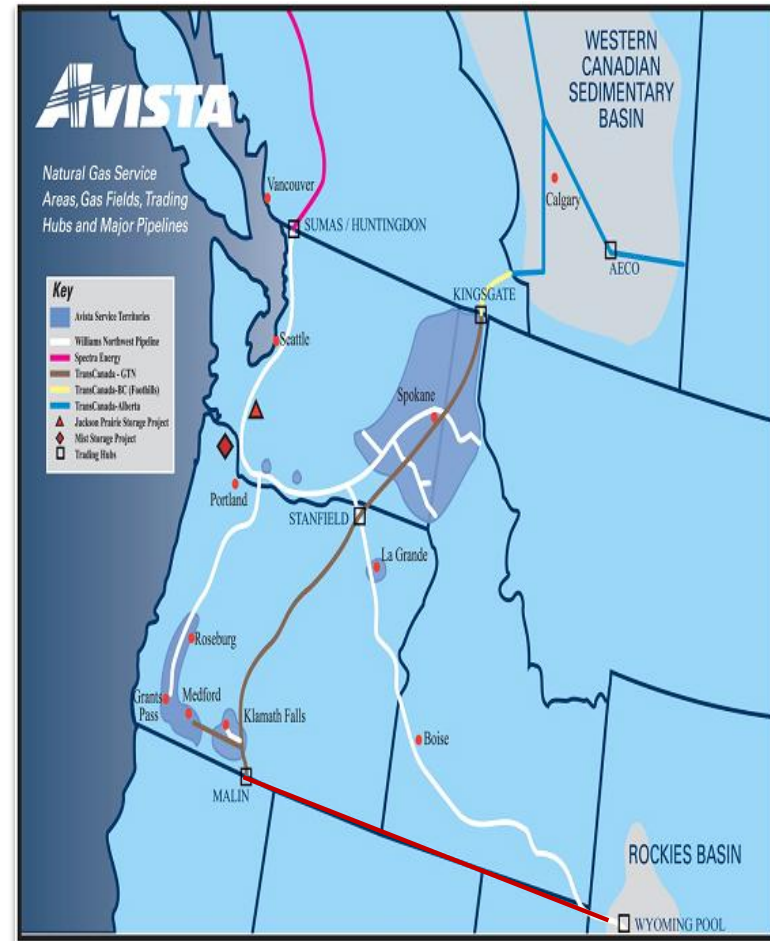

Types of Pipeline Contracts

Firm Transport

- Contractual rights to:
 - Receive
 - Transport
 - Deliver
- From point A to point B

Interruptible Transport

- Contractual rights to:
 - Receive
 - Transport
 - Deliver
- From point A to Point B *AFTER FIRM TRANSPORT HAS BEEN SCHEDULED*

Seasonal Transport

- Firm service available for limited periods (Nov-Mar) or for a limited amount (TF2 on NWP)

Alternate Firm Transport

- The use of firm transport outside of the primary path
- Priority rights below firm
- Priority rights above interruptible

Pipeline Rate Structure

Straight Fixed Variable (SFV)

- Pipeline charges a higher demand charge and a lower variable or commodity charge

Enhanced fixed variable

- Pipeline charges a lower demand charge and a higher variable or commodity charge

Postage Stamp Rate

- Pay the same demand and variable costs regardless of how far the gas is transported

Mileage Based

- Pay a variable and demand charge based on how far the gas is transported

Straight Fixed Variable Costs vs. Enhanced Fixed Variable

- Demand Charge: Paid whether transport is used or not
- Commodity or variable charge: Only paid when gas is actually transported

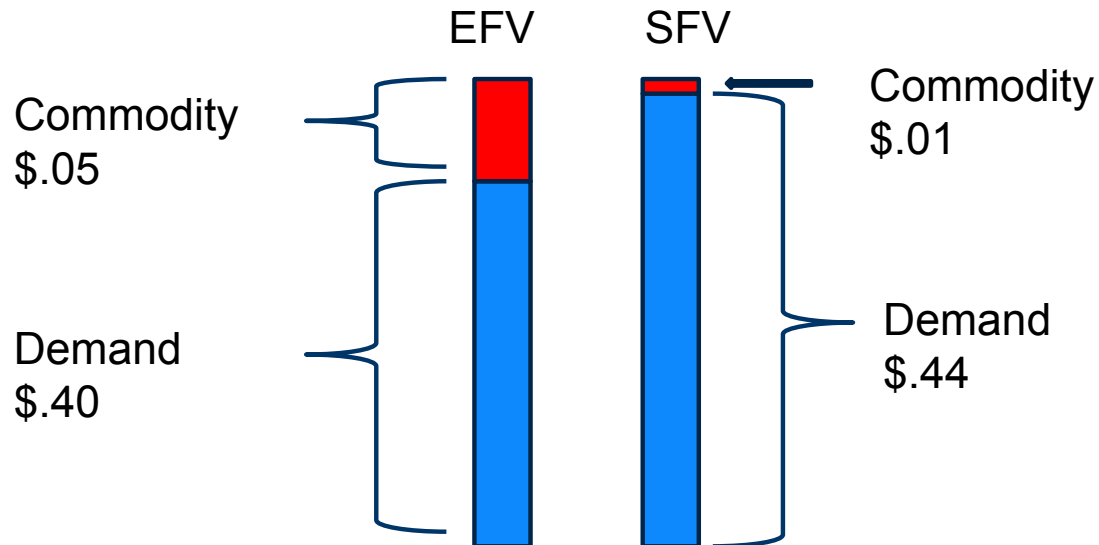

TransCanada Gas Transmission Northwest (GTN)

- Mileage Based
- Point to Point
- Alternate firm allowed in path
- Mostly – demand based with a couple Nomination based points
 - Demand based refers to gas that will be taken off the pipeline based on the demand behind the delivery point.
 - Nomination based refers to the pipeline only delivering what was nominated (requested).
- Usually requires upstream transportation

Natural Gas Transportation

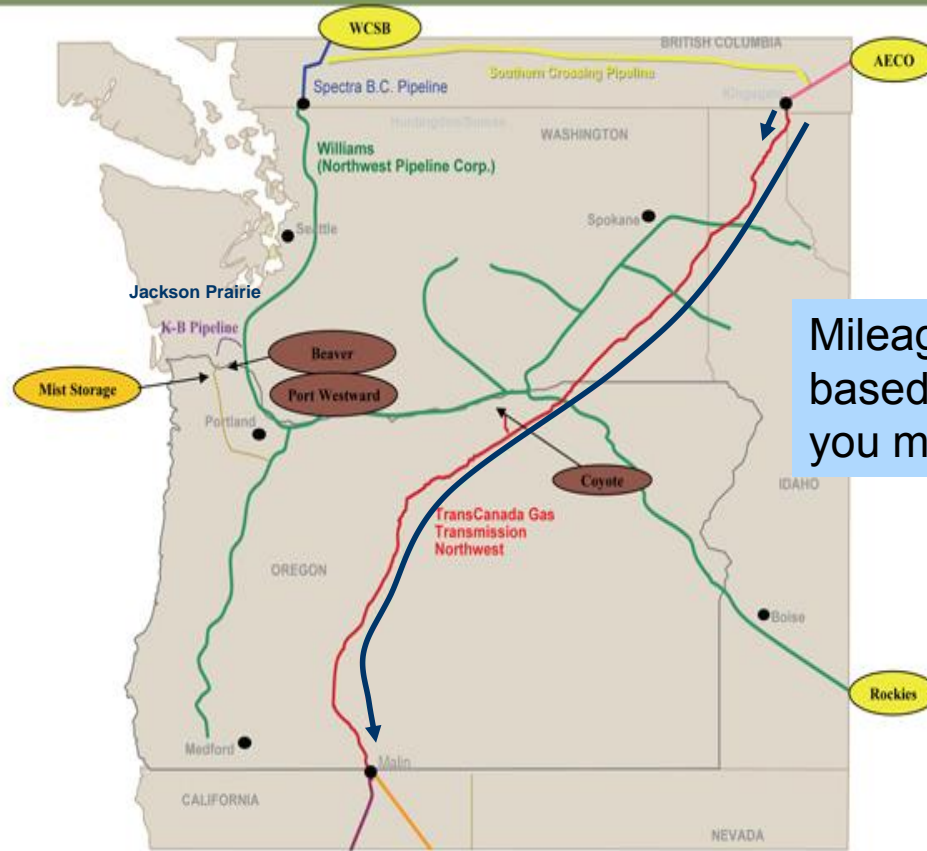

Mileage Base: Pay based on how far you move the gas



Williams Northwest Pipeline (NWP)

- Postage Stamp Based
- Point to Point
 - Delivery to 'zones' allowed
- Alternate firm allowed in and out of path
- Demand based delivery
 - Demand based refers to gas that will be taken off the pipeline based on the demand behind the delivery point.
 - Nomination based refers to the pipeline only delivering what was nominated (requested).
- May or may not require upstream transportation
- Enhanced fixed variable structure

Natural Gas Transportation

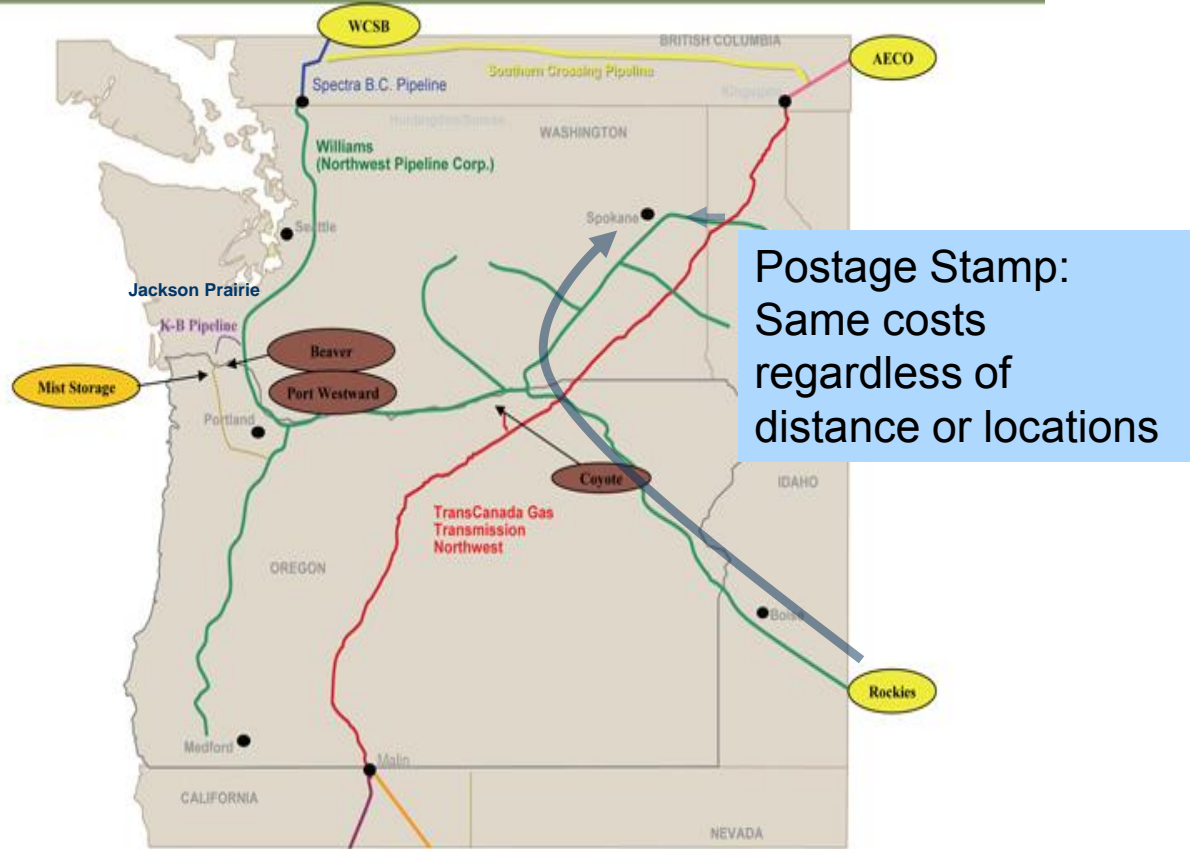

Jackson Prairie Natural Gas Storage Chehalis, Washington

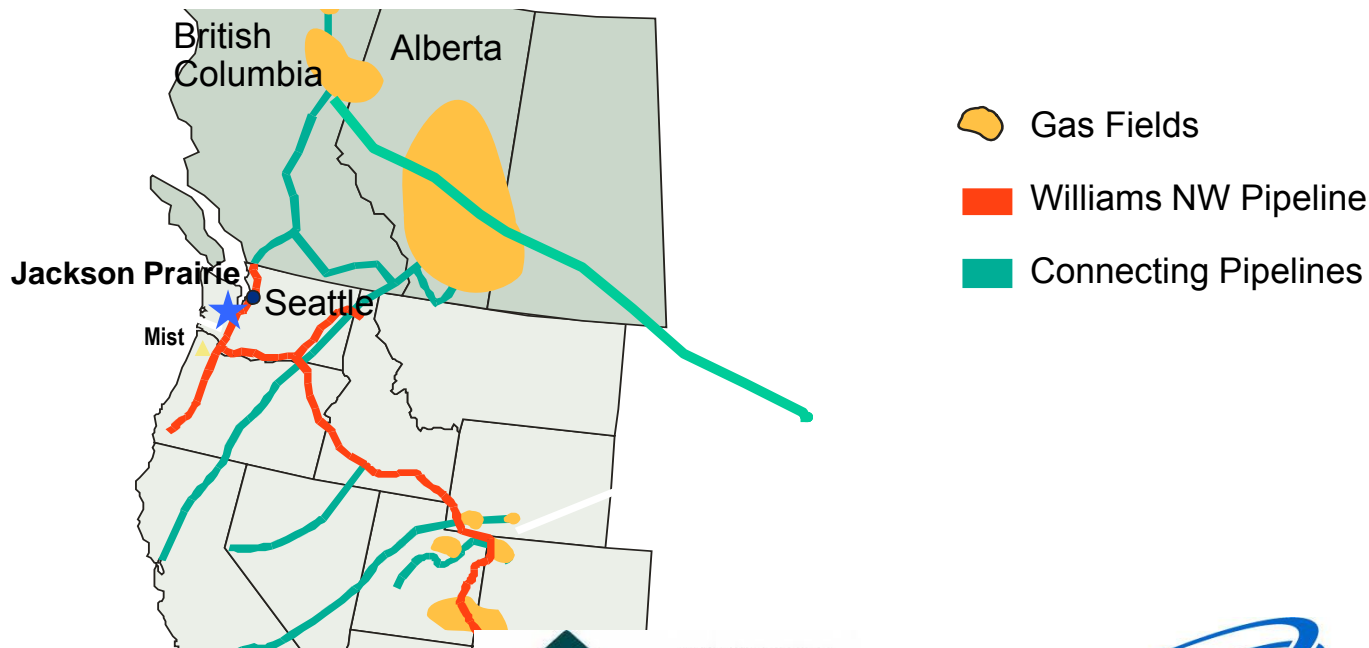

The Facility

- Jackson Prairie is a series of deep, underground reservoirs – basically thick, porous sandstone deposits.
- The sand layers lie approximately 1,000 to 3,000 feet below the ground surface.
- Large compressors and pipelines are employed to both inject and withdraw natural gas at 54 wells spread across the 3,200 acre facility.

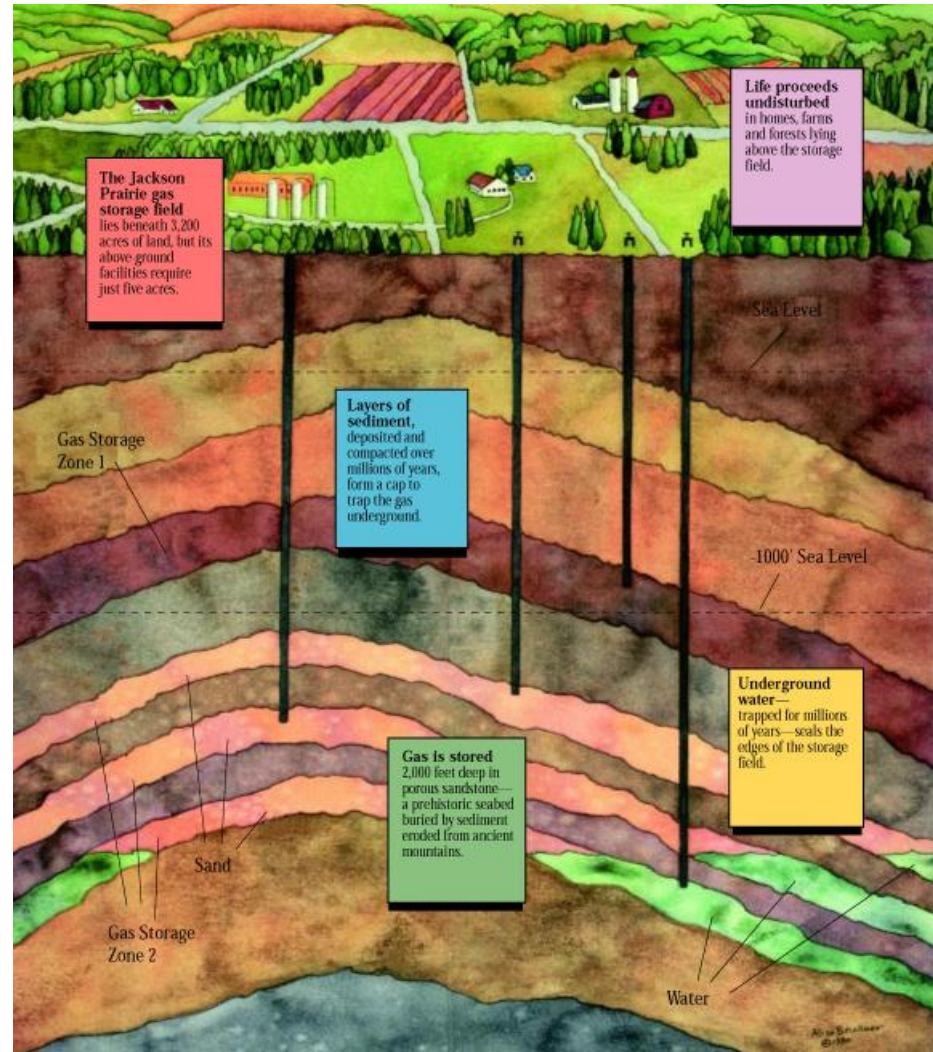

Jackson Prairie Interesting Energy Comparisons

1.2 Bcf per day (energy equivalent)

10 coal trains with 100 - 50 ton cars each

29 - 500 MW gas-fired power plants

13 Hanford-sized nuclear power plants

2 Grand Coulee-sized hydro plants (biggest in US)

46 Bcf of stored gas

12" pipeline 11,000,000 miles long (226,000 miles to the moon)

1,400 Safeco Fields (Baseball Stadiums)

Average flow of the Columbia River for 2 days

Cube - 3,550 feet on a side

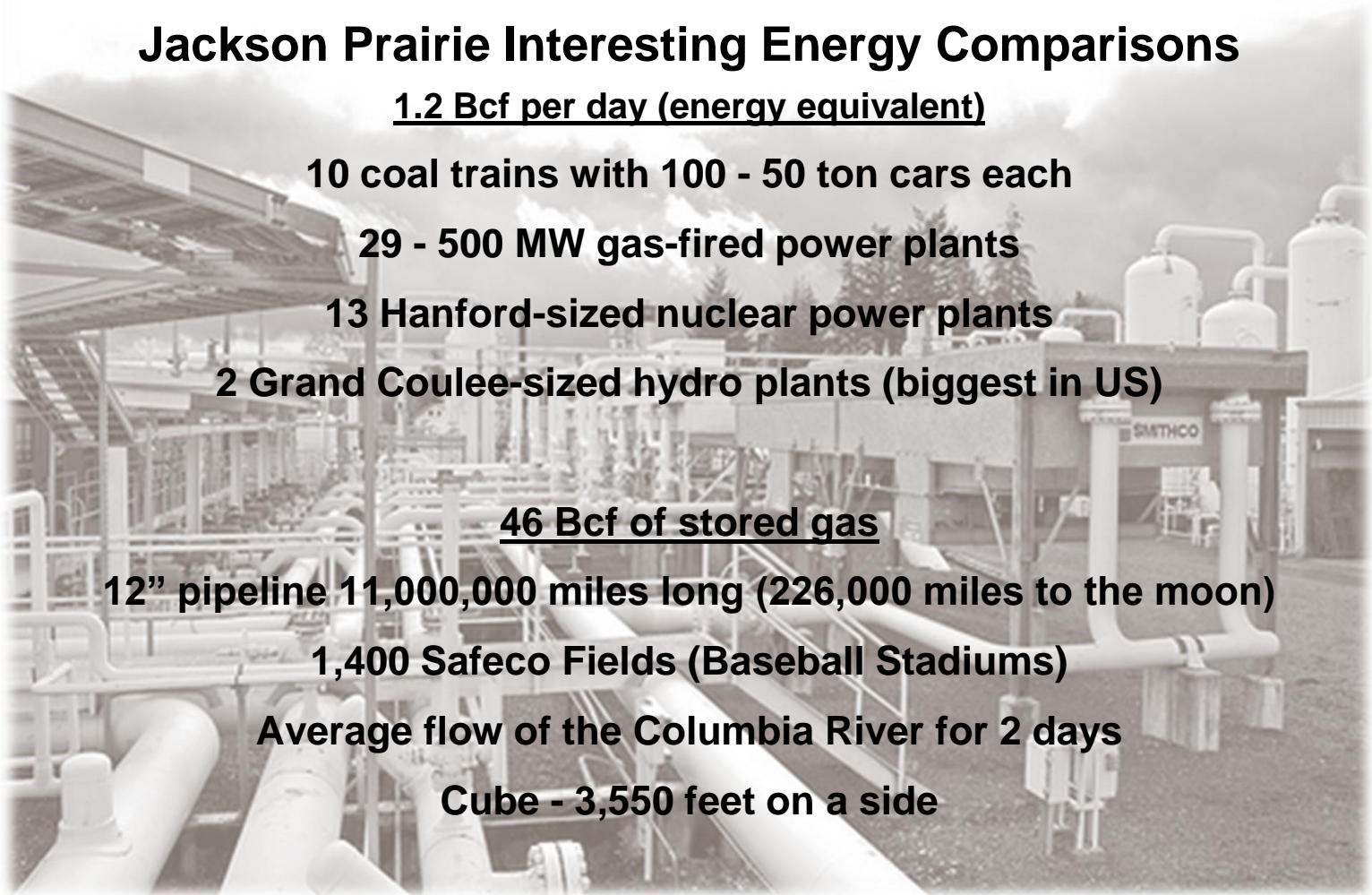

Natural Gas Pricing Fundamentals



What Drives the Natural Gas Market? Natural Gas Spot Prices (Henry Hub)

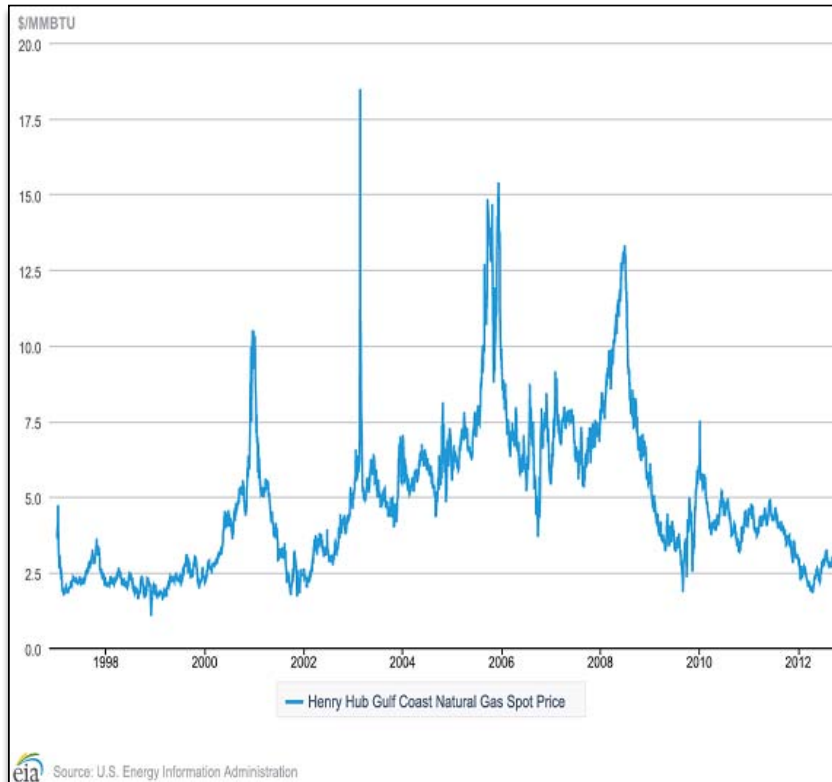

▶ Supply

- Type: Conventional vs. Non-conventional
- Location
- Cost

▶ Demand

- Residential/Commercial/Industrial
- Power Generation
- Natural Gas Vehicles

▶ Legislation

- Environmental

▶ Energy Correlations

- Oil vs. Gas
- Coal vs. Gas
- Natural Gas Liquids

▶ Weather

▶ Storage

The Evolving Trend in Henry Hub Pricing

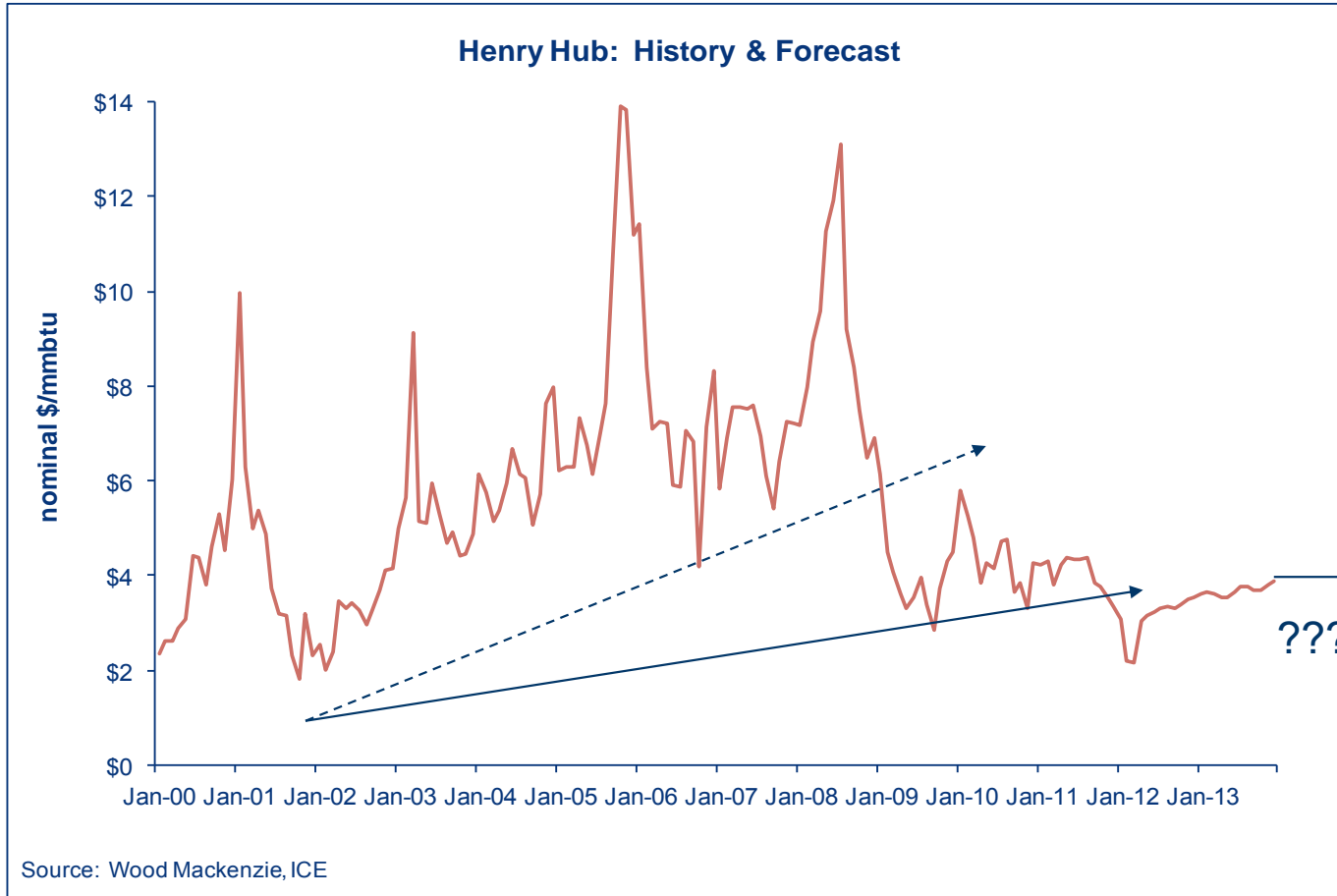

Short Term Market Perspective

Spot Henry Hub Price

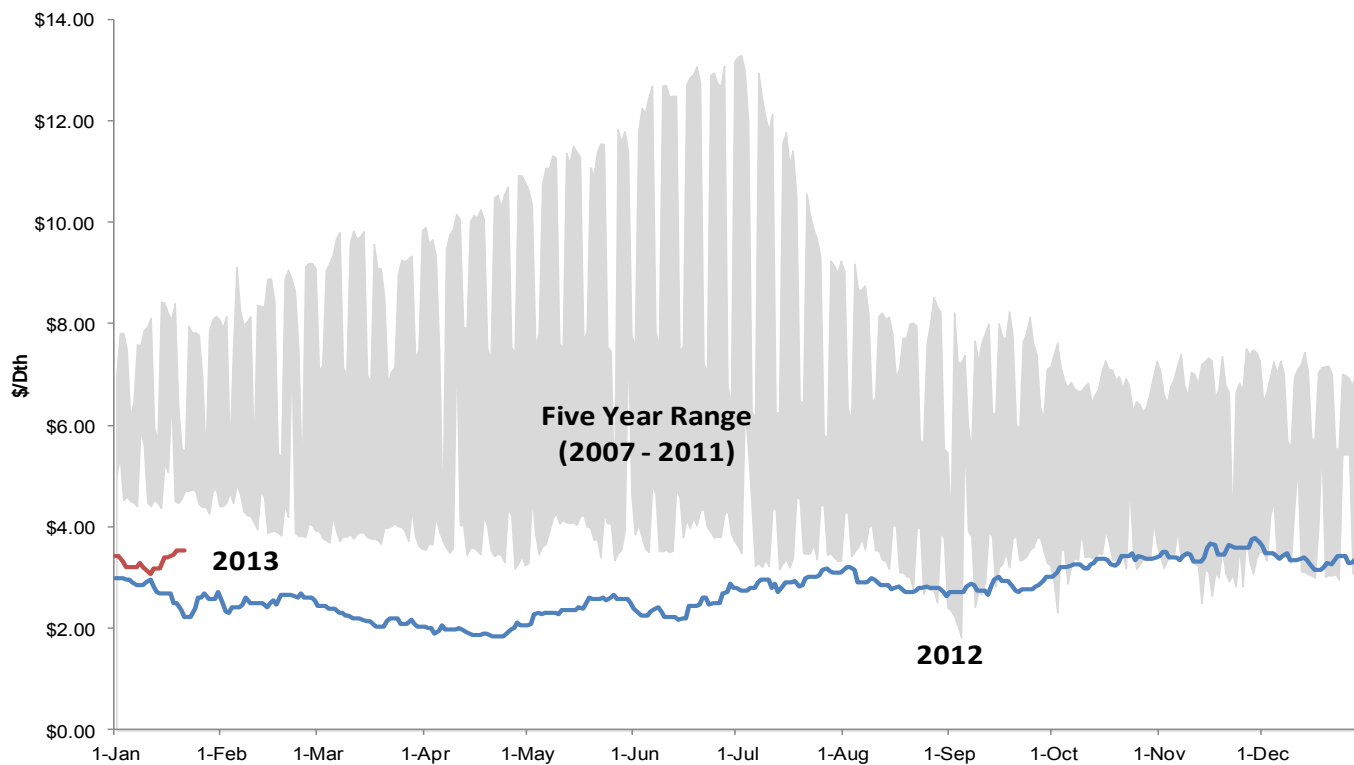

Source: EIA



Short Term Market Perspective

Dry Gas Production

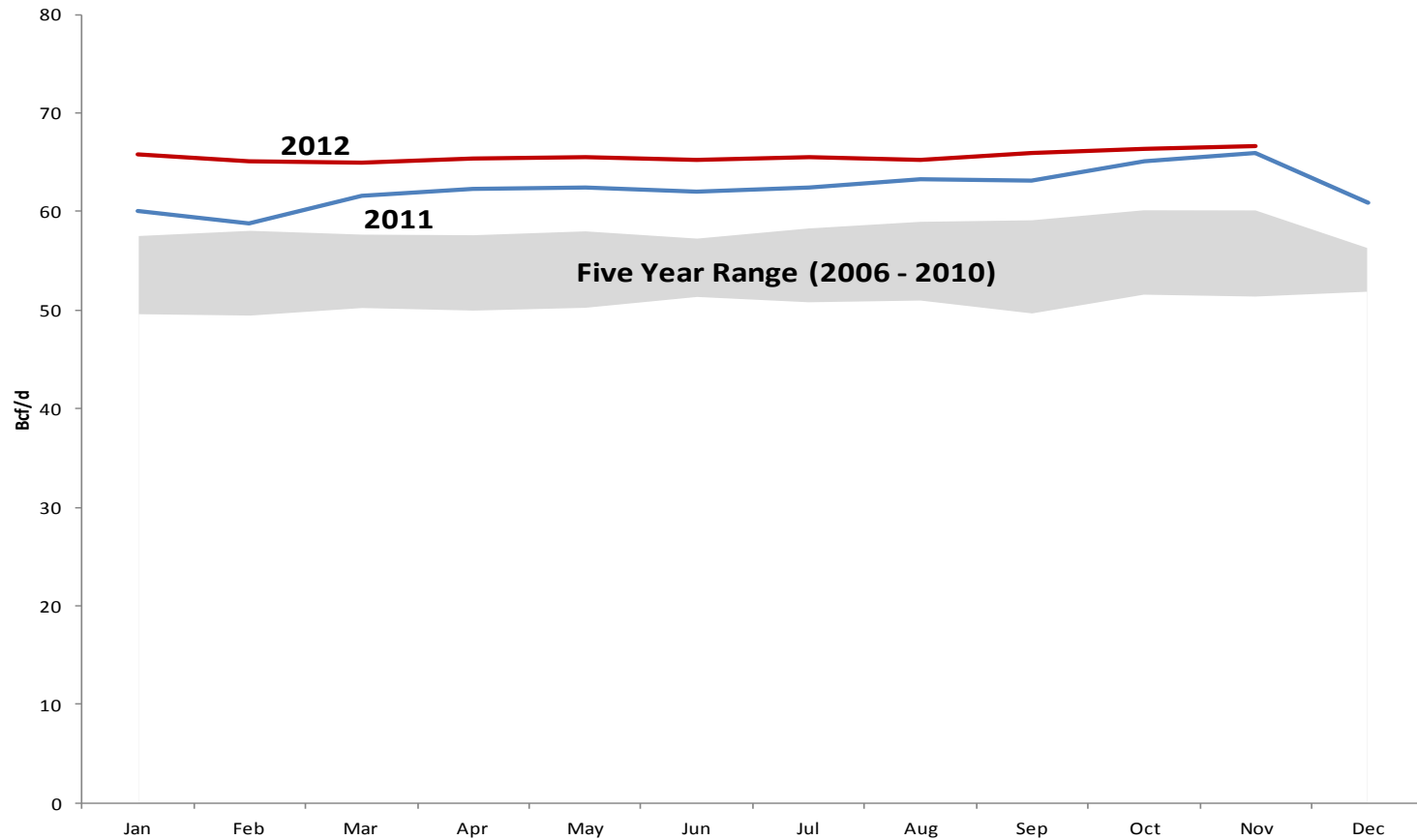

Short Term Market Perspective Storage (as of January 25, 2013)

Region	Total Stockpiles (Bcf)	Week-over-Week Change (Bcf)	Yearly % Change	5-Year Average % Change
Consuming East	1391	(129)	-7.27%	7.90%
Consuming West	398	(18)	-0.25%	14.00%
Producing Region	1013	(47)	-8.33%	17.80%
Total U.S.	2802	(194)	-6.72%	12.20%

Source: U.S. Energy Information Administration, Bloomberg, TD Securities

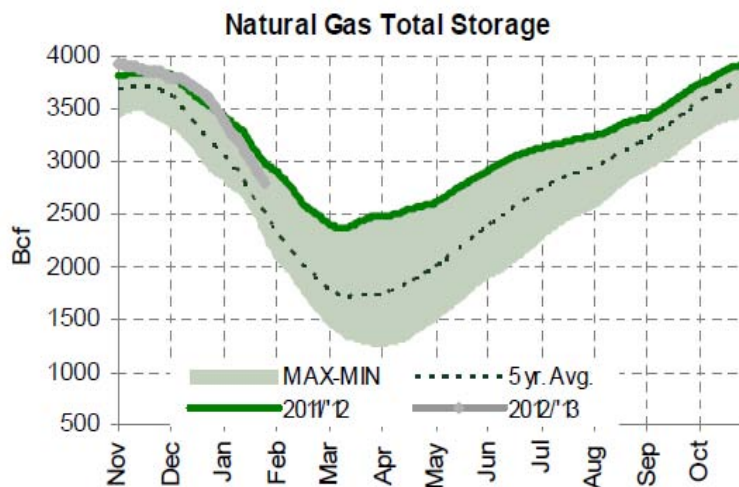

Source: EIA, TD Securities

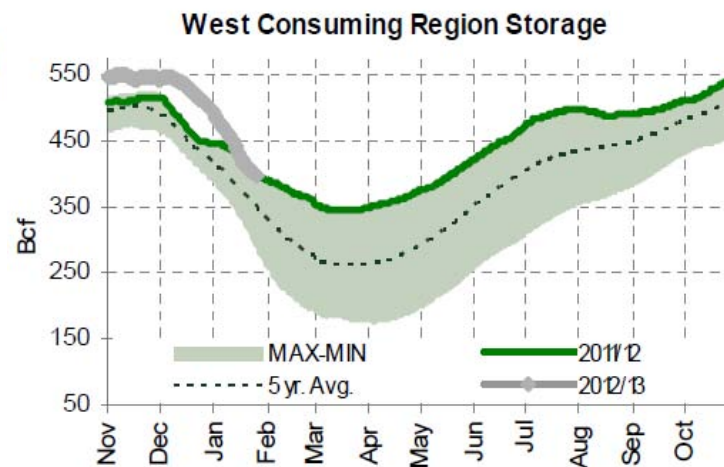

Source: EIA, TD Securities



The Short Term Fundamentals

Bulls

- Weather – Normal is now bullish.
- Dwindling rig counts.
- Economic recovery.
- Coal/Nuke displacement.



Bears

- Production is high.
- Demand is weak.
- Storage is full.
- Oh yeah, production is high.
- Did I mention, production is high.



Fundamental Forecasts vs. Actual Prices Henry Hub

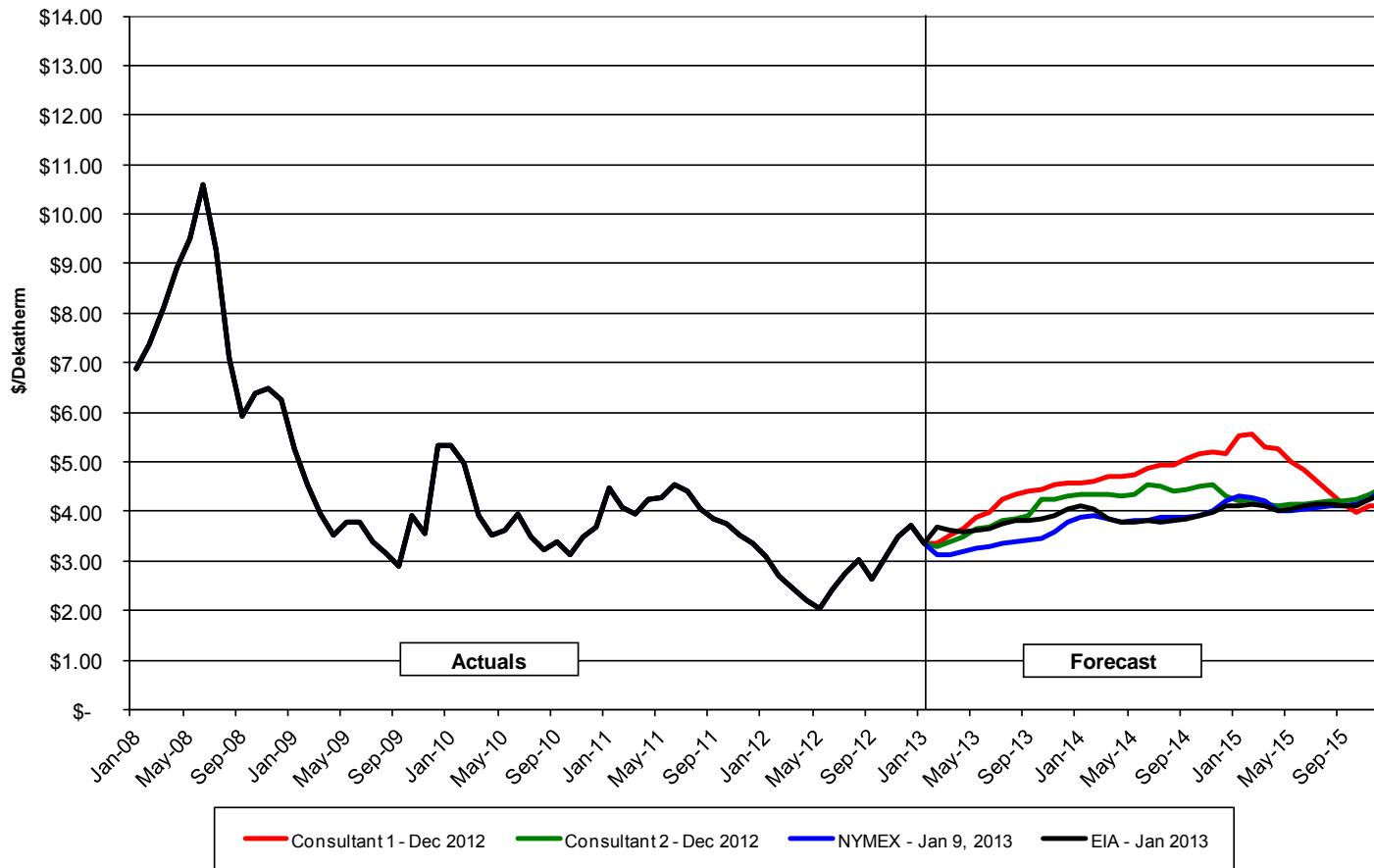

Forecasted Long Term Natural Gas Production

Figure 2. U.S. natural gas production, 1990-2035
(trillion cubic feet)

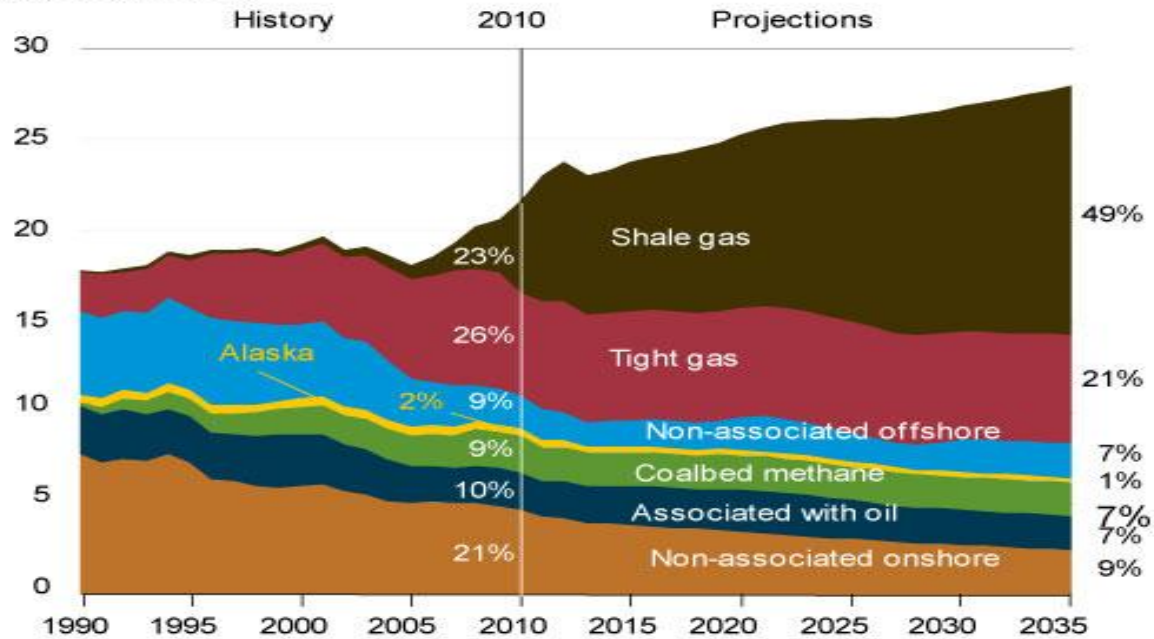

The Link Between Rig Counts and Production

It ain't what it used to be.

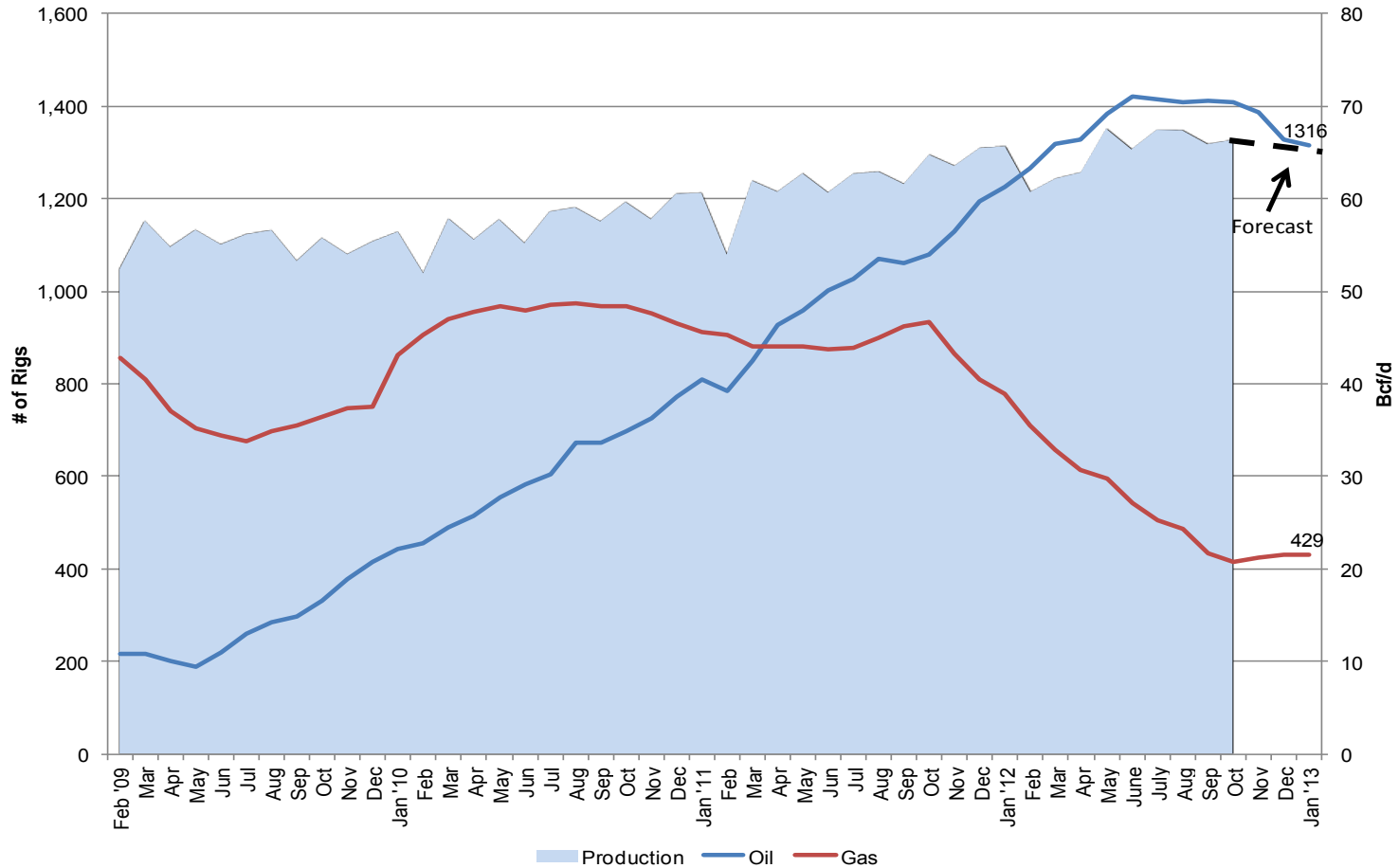

North American Pipeline Infrastructure

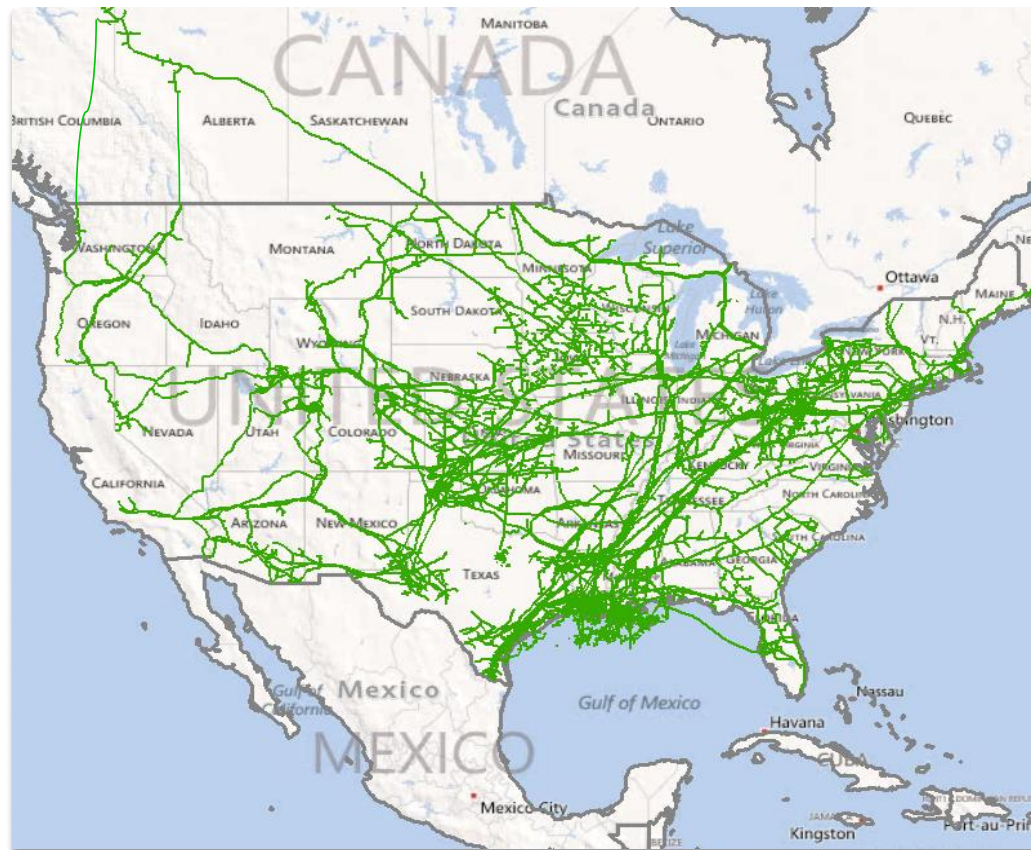

Shale Changed *Everything*

If shale were a country ... it would be the third-largest gas producer!



Source: U.S. Energy Information Administration based on data from various published studies. Canada and Mexico plays from ARI. Updated: May 9, 2011



The Evolving Flow Dynamics

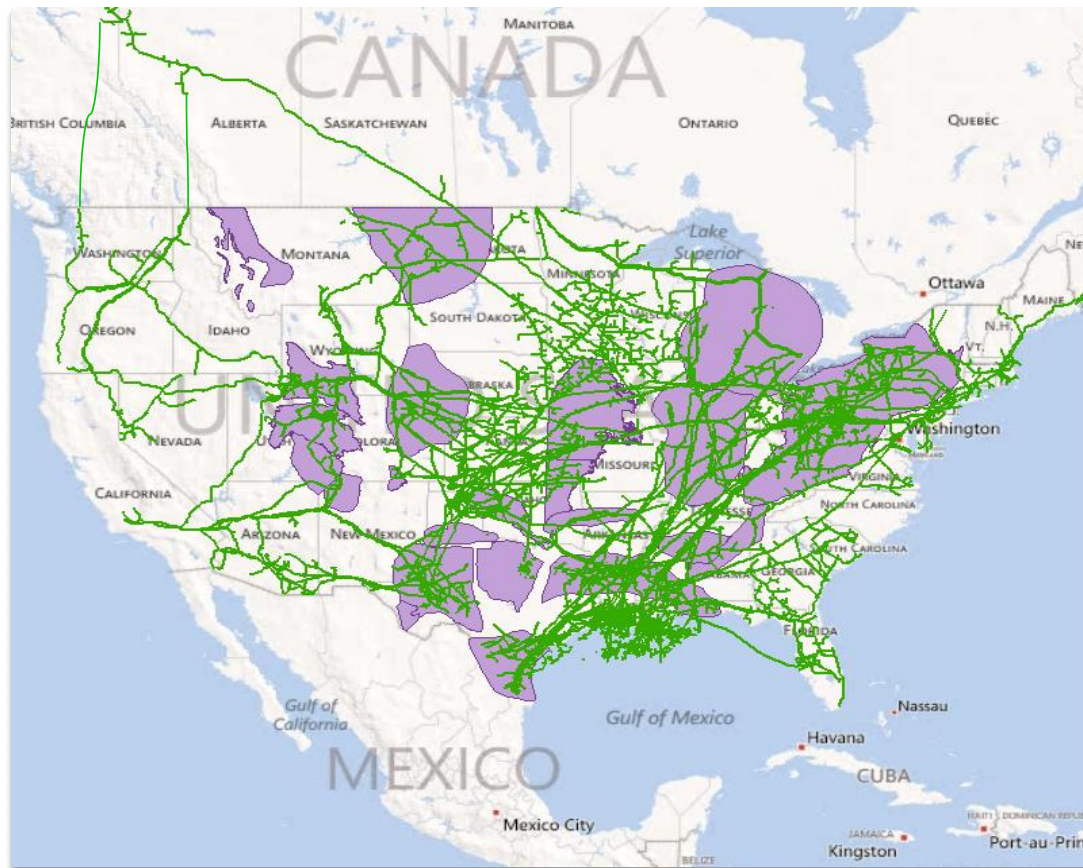

The Decoupling of Crude Oil vs. Natural Gas Prices

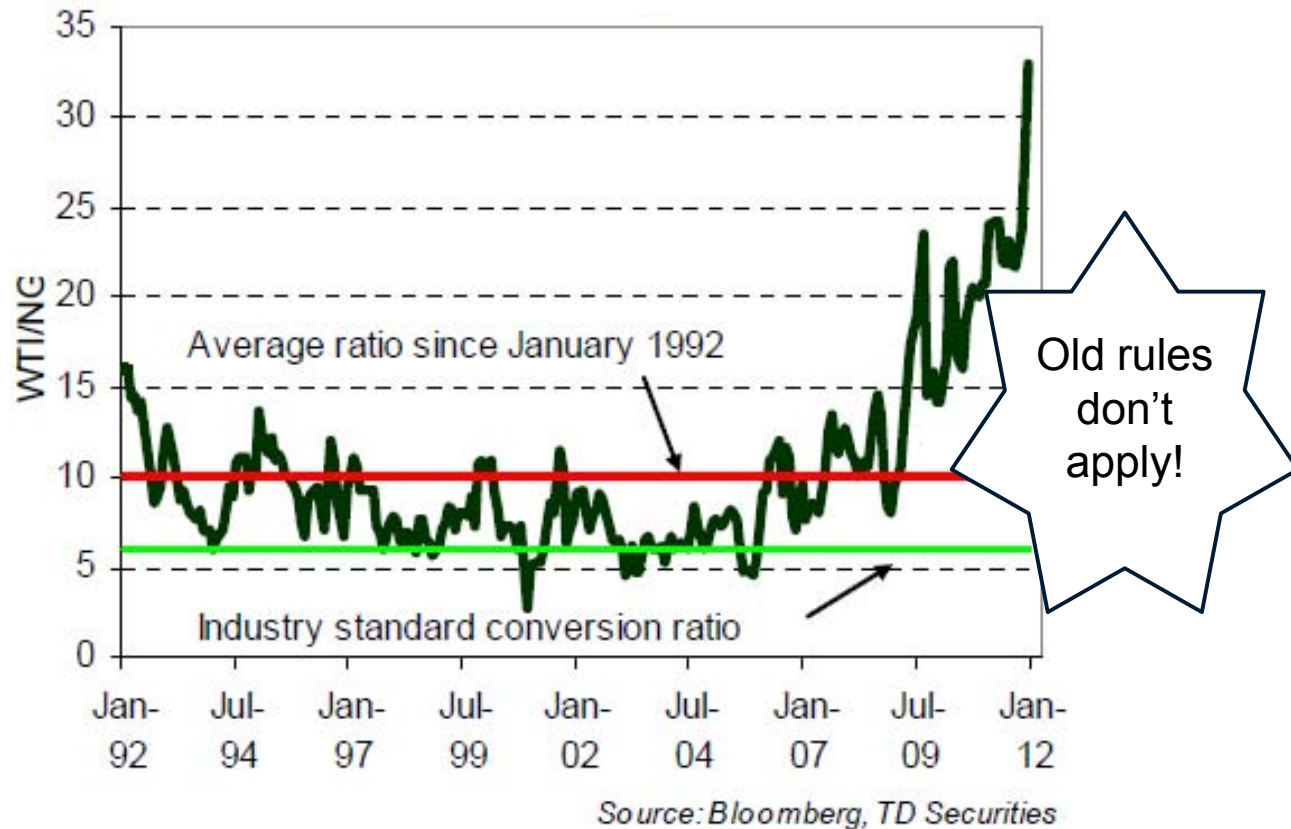

NGL's Impact on the Cost to Produce

Natural Gas Liquids (NGL's) include ethane, propane, normal butane, isobutane, pentane, natural gasoline, and sulphur. They are a bi-product of natural gas production and have many uses and great value.

- Ethane – is used to create ethylene a feedstock in petrochemical production.
- Propane - used as a fuel source. Can be used in cigarette lighters, motor vehicle fuel, portable stoves and lamps, and heating fuel.
- Normal butane and Isobutane – used in refinery alkylation
- Natural gasoline – used in refinery feedstock, crude diluent, and chemical applications.
- Sulphur – used in agricultural fertilizers and industrial feedstock.

NGL's Impact on the Cost to Produce cont.

NGL's enhance the production economics for producers. NGL's are a main contributor to understanding why gas production companies continue to produce even with gas prices at very low levels.

The following table illustrates how the economics can improve with a credit for NGL's.

Shale Play	Cost to Produce without NGL's Credit	Cost to Produce including NGL's Credit
Marcellus	\$4.81	\$2.83
Montney	\$3.85	\$0.57
Barnett	\$5.39	\$2.41

Note: This information is from one of our consultants. These costs are indicative of the impact. The costs can vary from play to play and company to company.



Canada Dry vs. Canada Not Dry

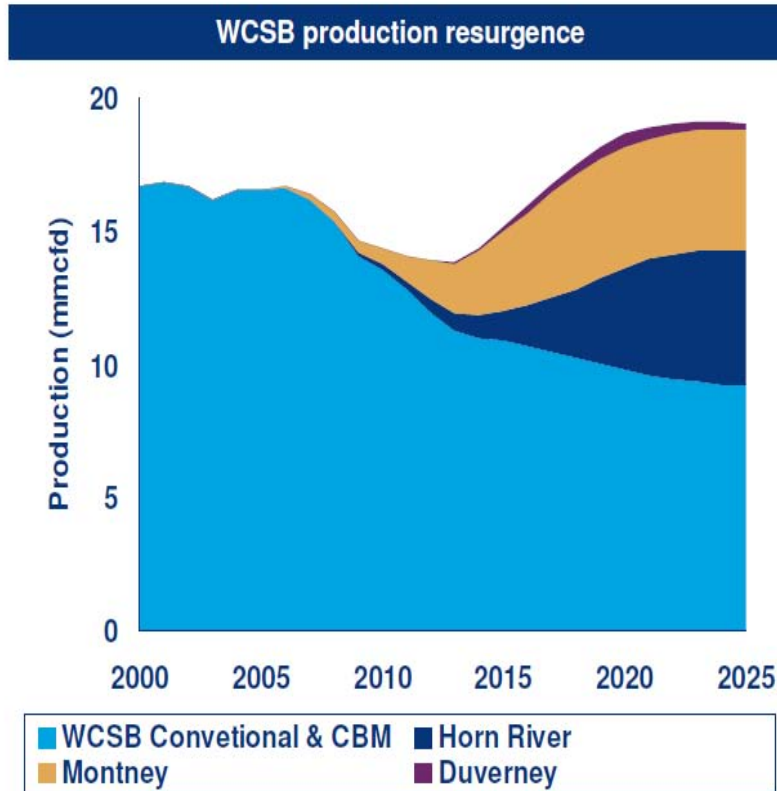

Source: Wood Mackenzie

Why won't Canada be dry?

- Tons of JV money
- IP rates are proving to be better than anticipated.
 - Horn River IP rates have increased 150%
- Economics are pretty good too.
 - Duverney in particular is liquids rich.
- New discoveries = Liard Basin

LNG Export is the New Import

LNG traditionally flows to North America after other higher-priced markets receive their share

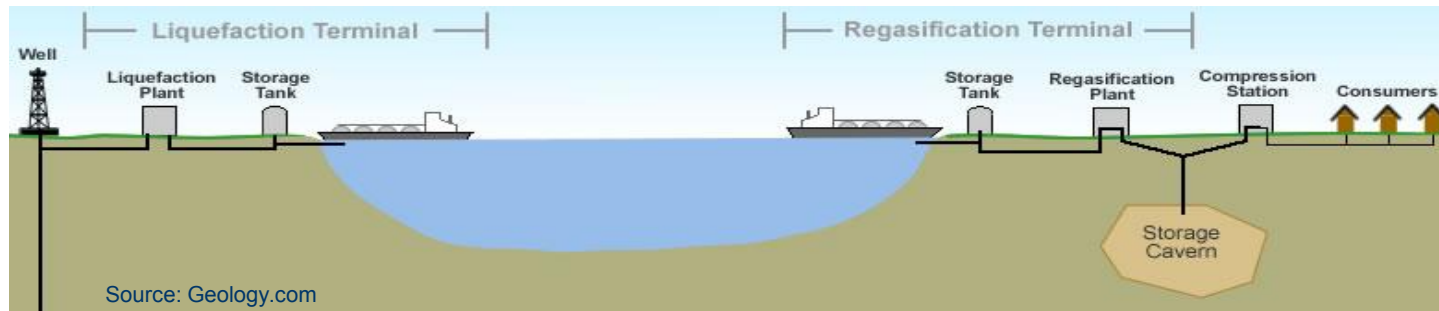

Source: Apache LNG



Source: Federal Energy Regulatory Commission



“The Best Indicator Of Future Behavior Is Past Behavior?”



How low can you go?

- ↓ Production levels continue to remain higher than expected
- ↓ Slow economic recovery
- ↓ Moderation in weather

Seems more upside risk?

- ↑ Declining rig counts
- ↑ “Fracking” bans and/or legislation
- ↑ Any economic recovery
- ↑ Power generation
- ↑ Carbon legislation
- ↑ LNG exports

Long Term Gas Price Drivers

- Economy = Demand
 - Recession, Depression, Inflation, etc.
 - Industrial Demand
 - Demand for Power Generation
- US Natural Gas Production
- LNG Exports/Imports – Global Dynamics
- North American Storage Capacity
- Correlation (or lack thereof) with other energy products
- The Environment
 - Carbon Legislation
 - Renewable Portfolio Standards
 - The “F” Word - FRACKING



IRP Natural Gas Price Forecast Methodology

1. Two fundamental forecasts (Consultant #1 & Consultant #2)
2. Forward prices
3. Carbon legislation adder beginning in 2023 (\$14/ton grows to \$22/ton)
4. Year 1 forward price only
5. Year 2 75% forward price / 25% average consultant forecasts
6. Year 3 50% forward price / 50% average consultant forecasts
7. Year 4 – 6 25% forward price / 75% average consultant forecasts
8. Year 7 50% average consultant without CO2 / 50% average consultant with CO2

2009 IRP Forecasted Prices

Henry Hub Price Forecasts
Nominal \$/Dth

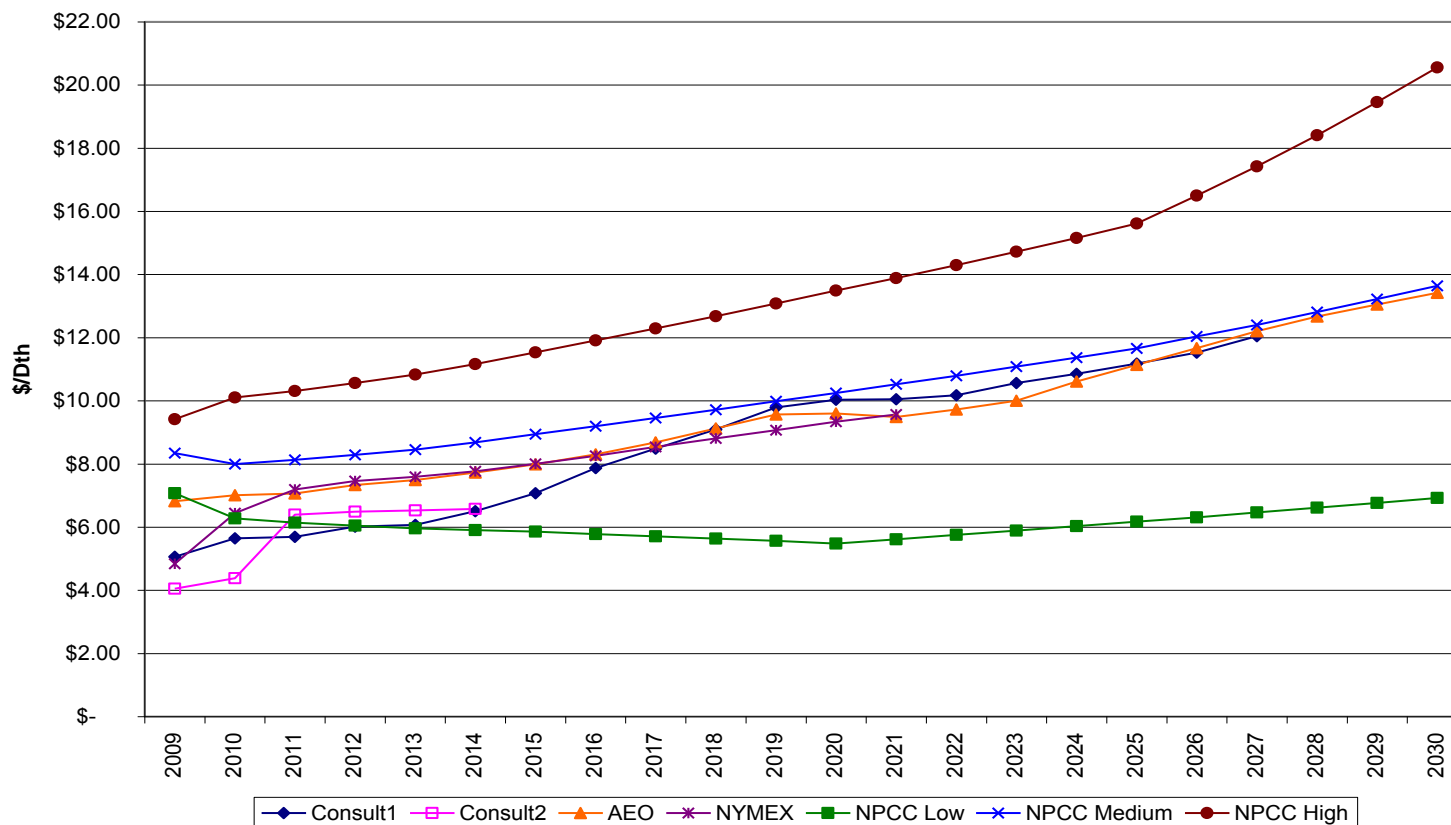

Natural Gas Price Forecasts

Nominal \$/Dth

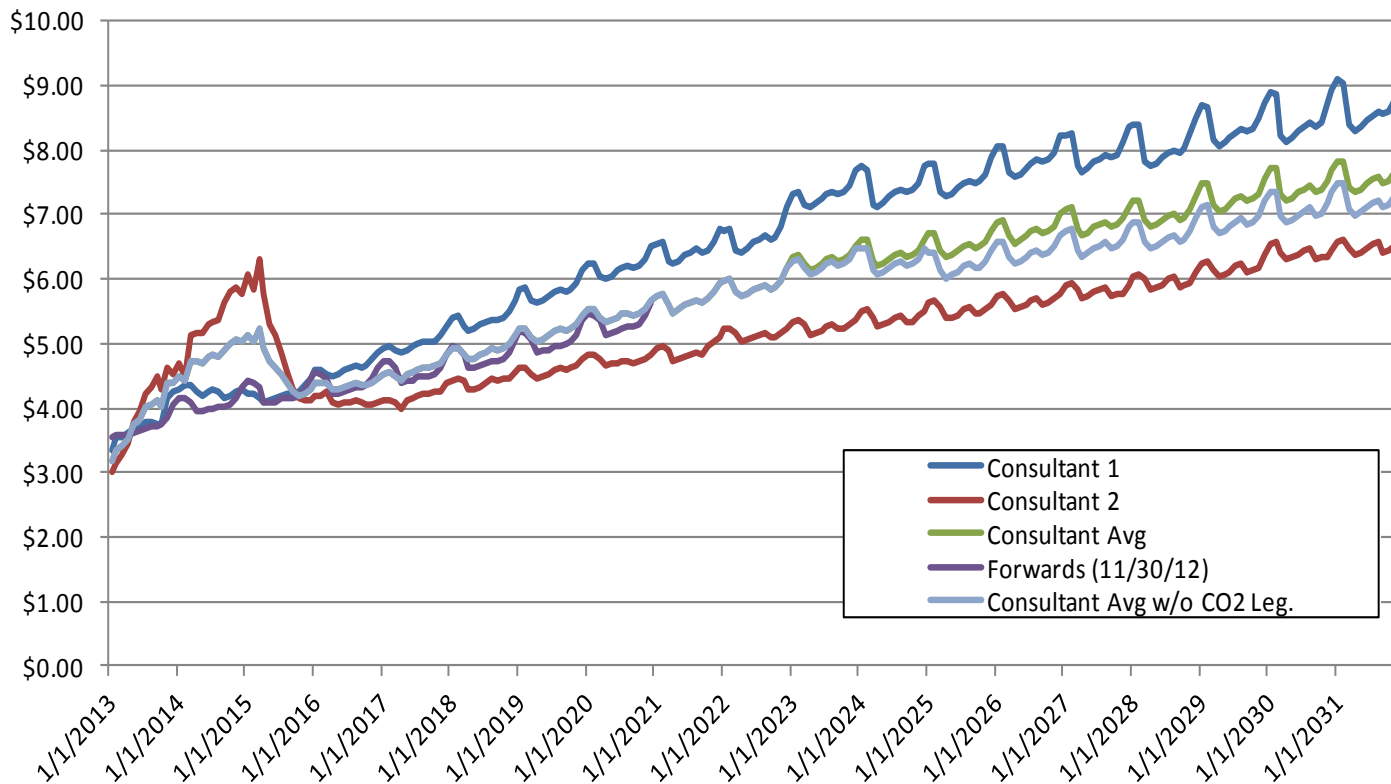

Forecasted Levelized Henry Hub Price (2013 – 2033)

Nominal \$/Dth

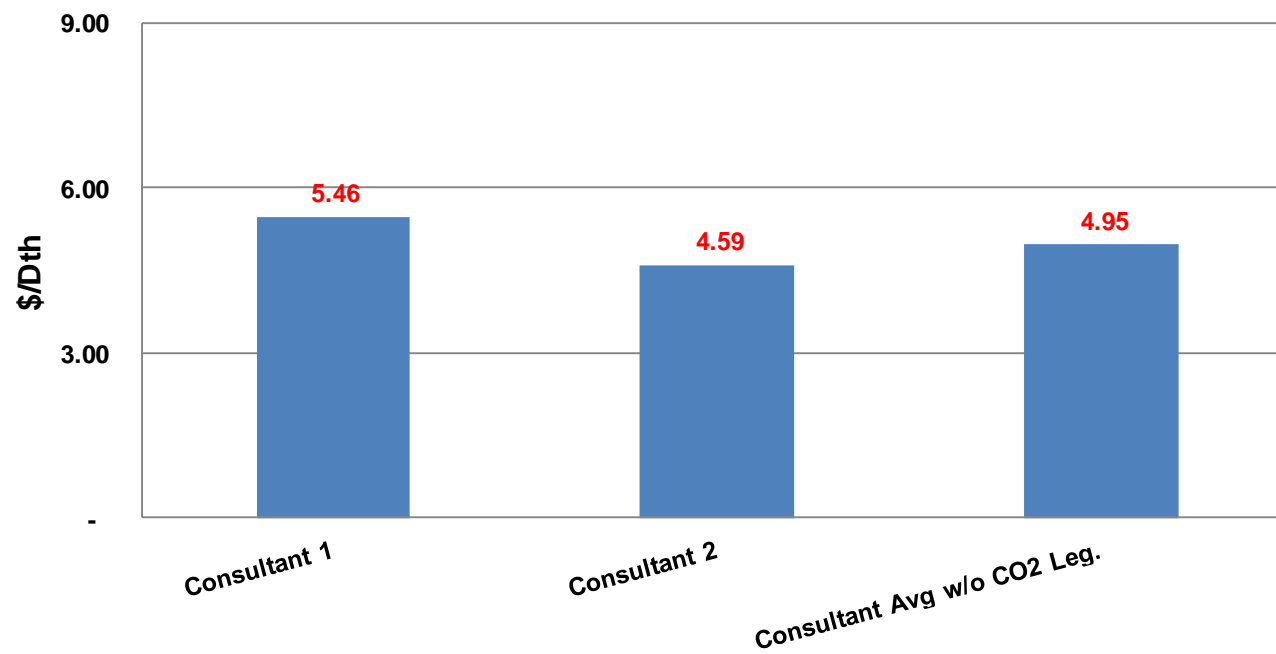

Selected Basin Forecasted Prices

Nominal \$/Dth

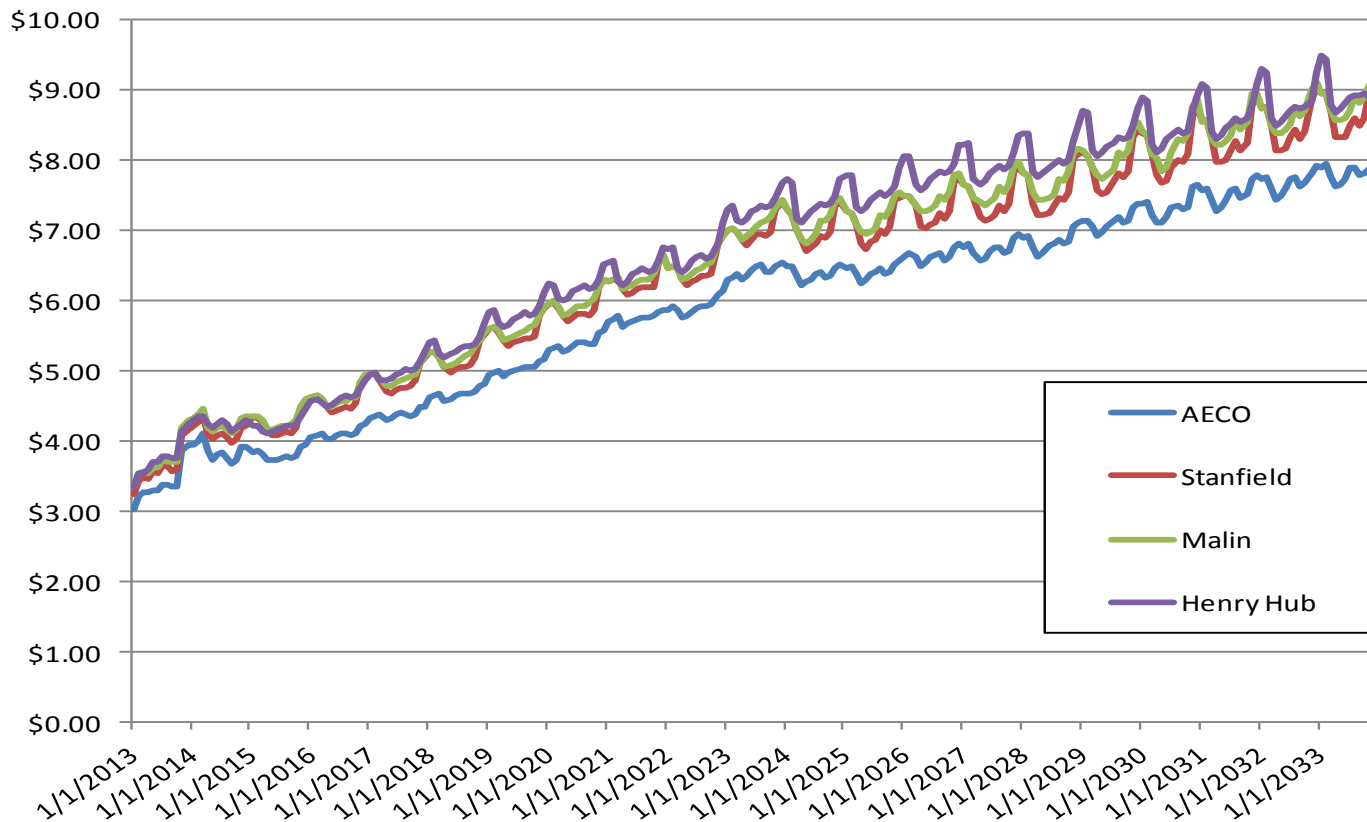

Forecasted Levelized Selected Basin Prices (2013 – 2033)

Nominal \$/Dth

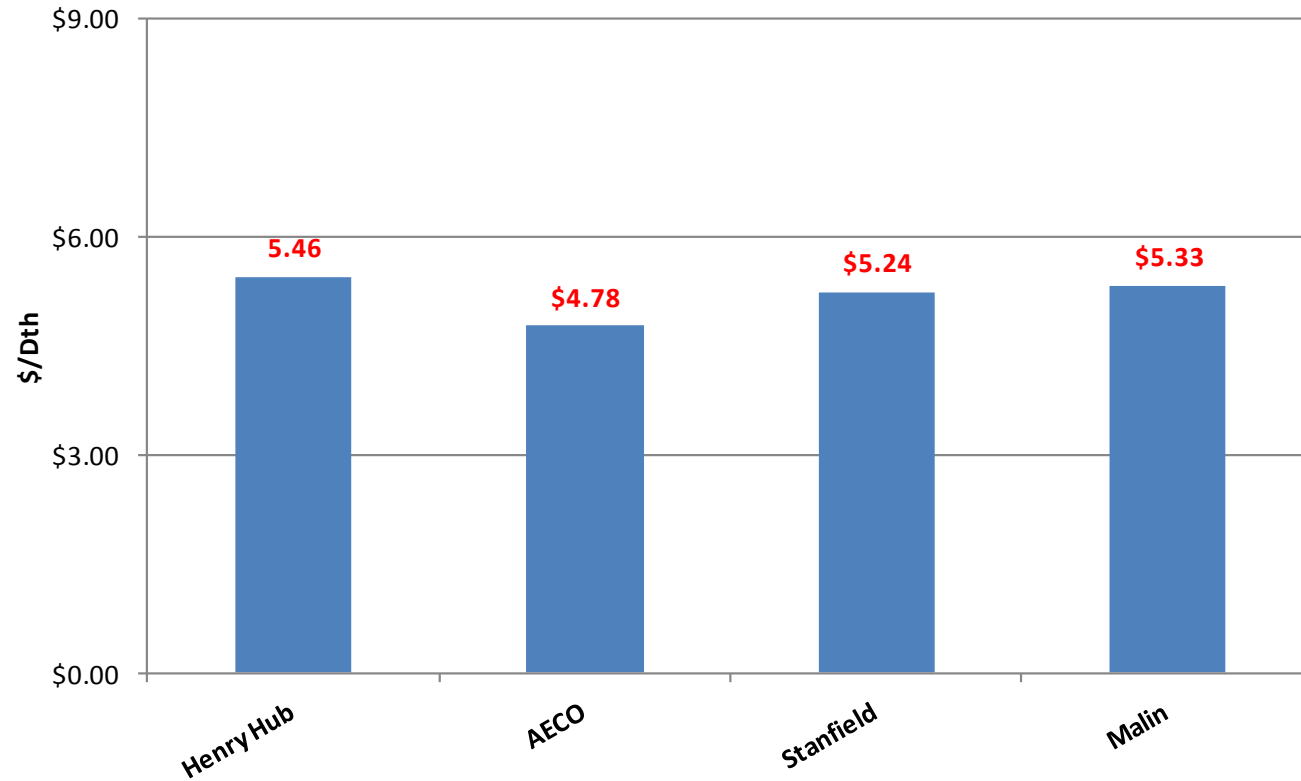

Fracking Facts and the Future of Shale



What is Shale Gas?



Shale gas refers to natural gas that is trapped within shale formations.

Shales are fine-grained sedimentary rocks that can be rich sources of petroleum and natural gas.

Over the past decade, the combination of horizontal drilling and hydraulic fracturing has allowed access to large volumes of shale gas that were previously uneconomical to produce.

Fracking “Facts” Make Headlines

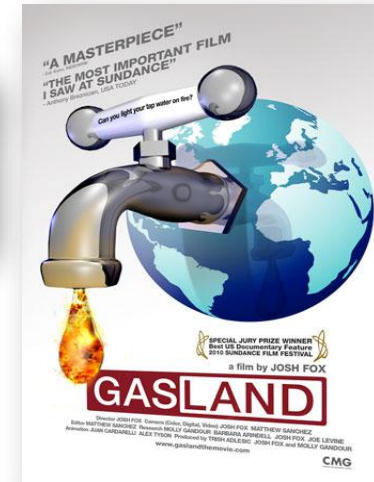

“Insiders Sound an Alarm Amid a Natural Gas Rush”
“Shale plays are just giant Ponzi schemes” – **New York Times**

“Because it’s releasing gases, they’re not able to trap it as much, it’s coming right through the ground.”
” – **John Krasinski “The Late Show with David Letterman”**

“Fracking Shale Gas Emissions Far Worse Than Coal” – **Cornell Chronicle**



The “F” Word

What is “Fracking”?

Hydraulic fracturing (HF or “fracking”) is a process for producing oil and natural gas. A mixture of water, chemicals and a “proppant” (usually sand) is pumped into a well at extremely high pressures to fracture rock and allow natural gas to escape.

An estimated 11,000 new wells are fractured each year; and estimates show another 1,400 existing wells are re-fractured to stimulate production or to produce natural gas from a different production zone.

HF has been around for well over 60 years. This process has been used on over **one million** producing oil and gas wells. Federal, state and other regulatory bodies have had regulations in place for over 50 years.

What Are Some Of The Issues?

Of the many allegations made in the headlines, recent press has focused its attention on the volumes, costs, and environmental impacts of shale gas production.

Issue #1: Shale resources are overestimated.

Issue #2: Shale gas is uneconomic to produce.

Issue #3: Hydraulic fracturing pollutes the air, contaminates water, and causes earthquakes.

What Are The Facts?

Issue #1: Shale resources are overestimated.

Fact: Many independent organizations, companies, and governments have examined and assessed data in order to develop estimated shale gas resource figures. All have concluded that the reserve base is much greater than previously anticipated.

A recently released MIT study states:

“In the US, despite their relative maturity, natural gas resources continue to grow, and the development of low-cost and abundant unconventional gas resources, particularly shale gas has a material impact on future availability and price.” Ernest Moniz, MIT Professor at a hearing before the Senate Energy and Natural Resources Committee.



Who Estimates The Reserve Base?

PGC Resource Assessments, 1990-2010

Total Potential Gas Resources (Mean Values)

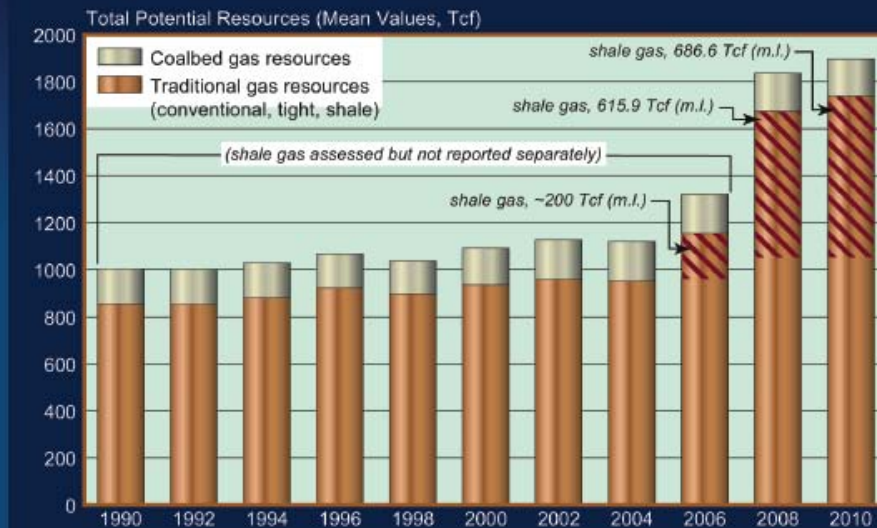

Data source: Potential Gas Committee (2011)

One of the most widely used estimate is from the Potential Gas Committee.

Shale had its first noticeable impact in 2006, nobody questioned it.

In 2008, as more data becomes available another adjustment is made, nobody questioned it.

Now, with even more data a modest increase in shale reserves is made, and now the questioning begins.

Who is the Potential Gas Committee? 100 Volunteer Geoscientists & Petroleum Engineers



What Are The Facts?

Issue #2: Shale gas is uneconomic to produce.

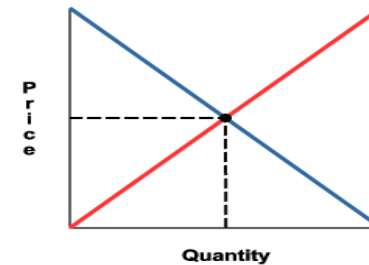

Fact: It is true that current gas prices have fallen to low levels making the economics of some wells challenging. However, there are several factors that are helping to make the economics work.

- Natural Gas Liquids – many of the shale plays are liquids rich. These liquids can be sold at prices which are linked to higher priced oil. The liquids revenue helps to offset costs.
- Drilling effectiveness – producers are showing increases in:
 - Wells per year per rig
 - Lateral length
 - 30 day average production rate.

It's only math: Costs/Volume (Costs↓ / Volumes↑)

What Are The Facts?

Issue #3: “Hydraulic fracturing contaminates ground water, pollutes the air, and causes earthquakes.”

Fact: Water contamination – Contamination of water could occur in a couple of ways, one is by fractures seeping gas and oil into the water table. Secondly, much water is used in the HF process. This water is mixed with other things and could be spilled and be absorbed into the water table.

- * **FracFocus.org** – Public registry created and managed by state regulators
 - * Searchable public database with well-by-well information and glossary of chemicals
 - * More than 10,000 wells and over 100 participating companies; several states using as tool for compliance reporting

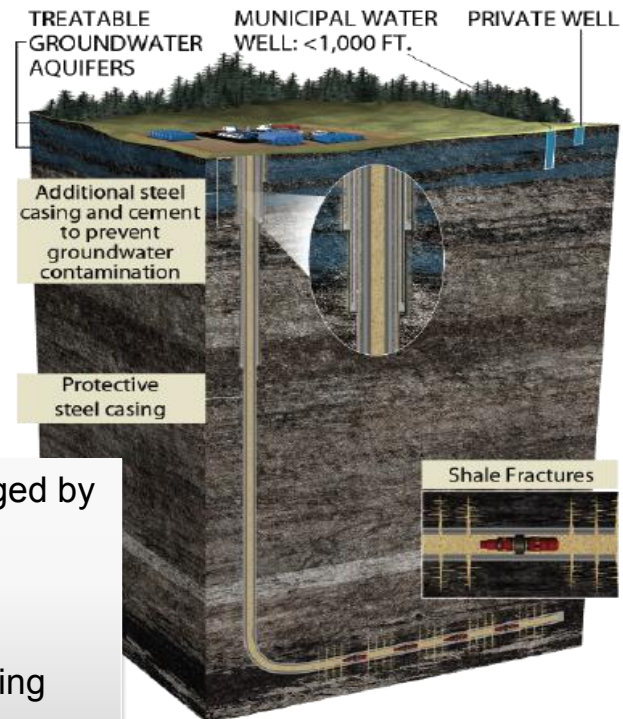

Hydraulic Fracturing and the Water Table

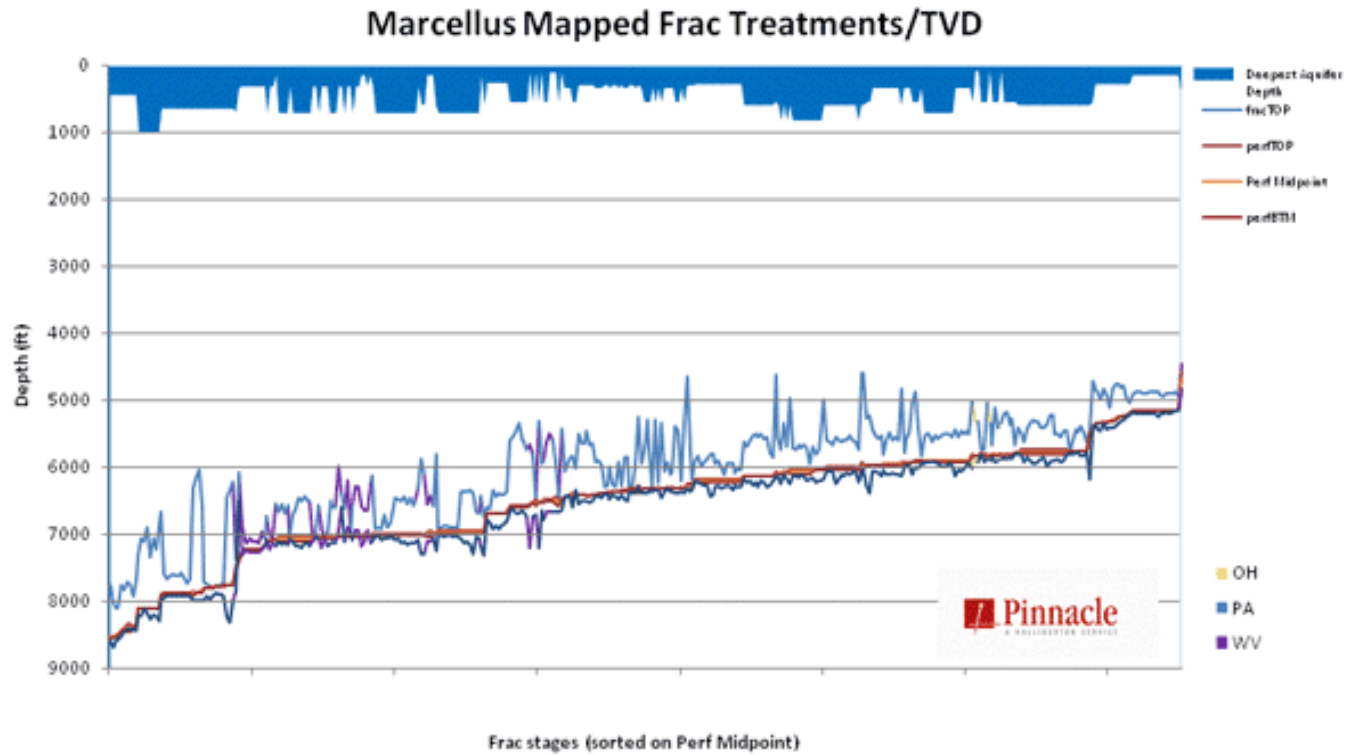

How Much Water Is Used in Hydraulic Fracturing?

Play	Public Supply	Industrial/ Mining	Irrigation	Livestock	Shale Gas	Total Water Use (Bbbls/yr)
Barnett TX	82.7%	3.7%	6.3%	2.3%	0.4%	11.1
Fayetteville AR	2.3%	33.3%	62.9%	0.3%	0.1%	31.9
Haynesville LA/TX	45.9%	13.5%	8.5%	4.0%	0.8%	2.1
Marcellus NY/PA/WV	12.0%	71.7%	0.1%	<0.1%	<0.1%	85.0

How much is 5 Million gallons of water?

It is equivalent to the amount of water consumed by:

- **New York City** in about **seven (7) minutes**
- A 500 megawatt coal-fired **power plant** in **1 day**
- A **golf course** in **25 days**
- **10 acres of cotton** in a season

While these represent continuing consumption, the water used for a gas well is a one-time use.



What Are The Facts?

Issue #3 cont.: “Hydraulic fracturing contaminates ground water, pollutes the air, and causes earthquakes.”

Fact: Pollution – as with most industrial activities there the issue of pollution must be addressed. Most concerning in natural gas processing is the release of volatile organic compounds (VOC) or carcinogens and methane.

Most of the air pollutants at gas sites occurs during the completion phase of processing. The EPA just established rules that will curtail the amount of air pollution caused by gas and oil production. Companies have until 2015 to comply with the new rules, however over half of the companies currently use the required technology.

What Are The Facts?

Issue #3 cont.: “Hydraulic fracturing contaminates ground water, pollutes the air, and causes earthquakes.”

Fact: Earthquakes – It was reported that a recent study conducted by the US Geological Survey appeared to indicate increased seismic activity due to HF.

"USGS's studies do not suggest that hydraulic fracturing, commonly known as 'fracking,' causes the increased rate of earthquakes," Hayes wrote. "USGS's scientists have found, however, that at some locations the increase in seismicity coincides with the injection of wastewater in deep disposal wells." – DOI Deputy Secretary David Hayes



Bottom Line:

Many benefits can be realized:

- Providing jobs
- Rejuvenating the chemical, manufacturing, and steel industry
- Bridge fuel to a renewable energy future
- Reduce dependence on foreign oil

However, there are important environmental issues that will need to continue to be addressed. Industry and regulators should continue to work together to ensure safe development of this vital resource.



Electric Price Forecast

James Gall

Fourth Technical Advisory Committee Meeting

2013 Electric Integrated Resource Plan

February 6, 2013

Historical Mid-Columbia Prices- *What year is it?*

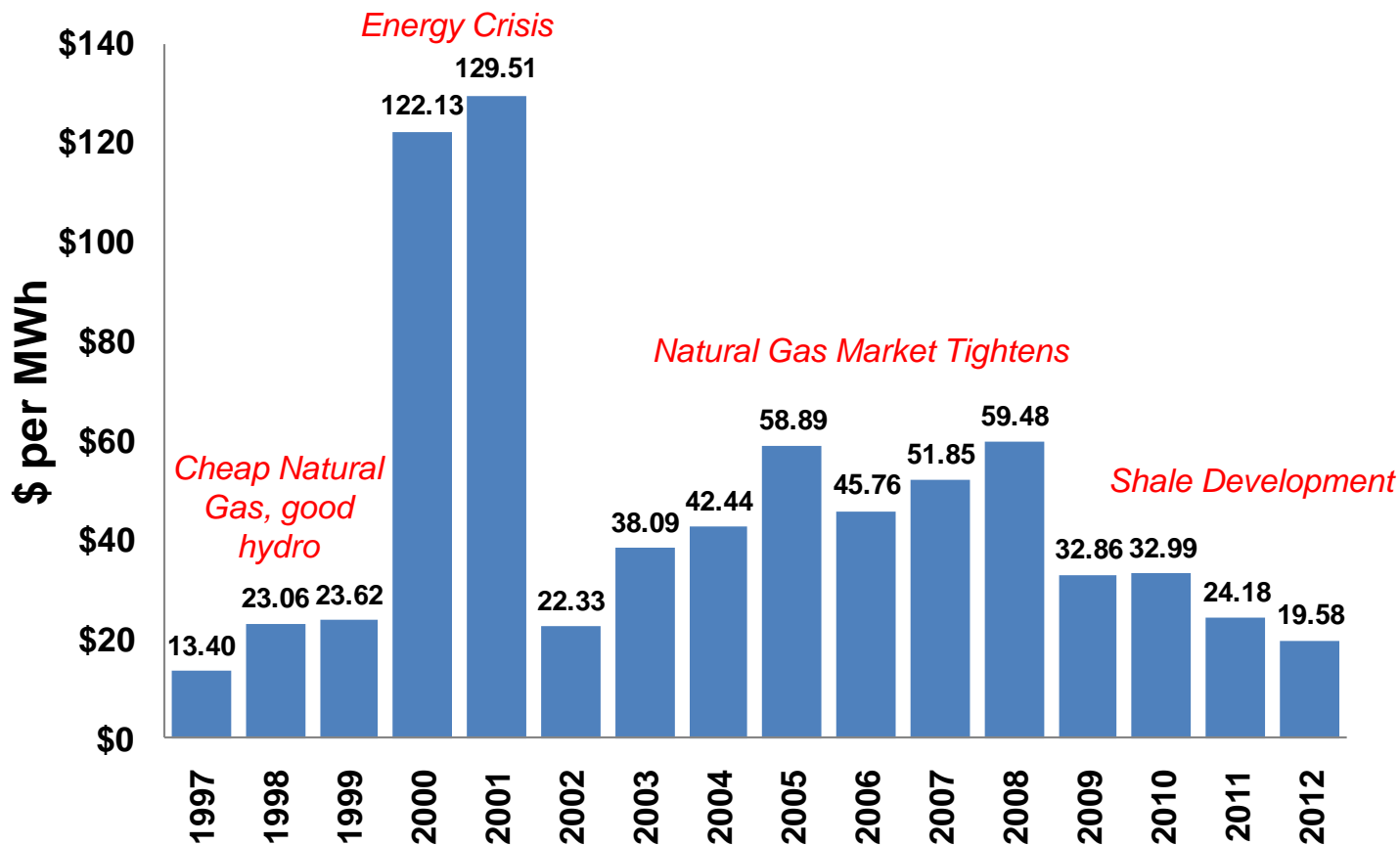

Historic Mid-Columbia and Stanfield Prices

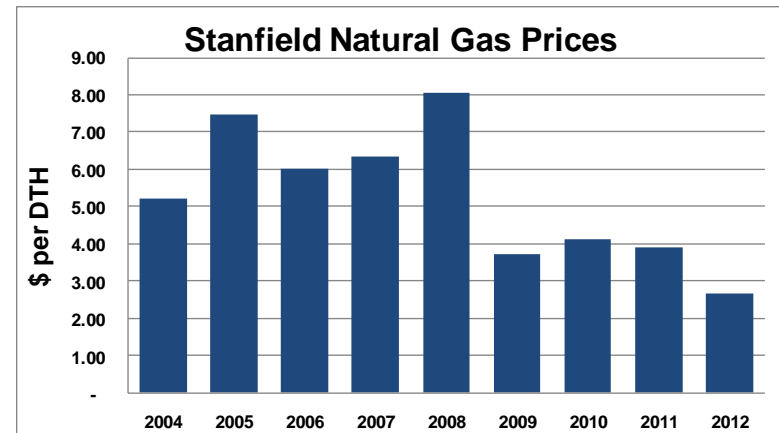
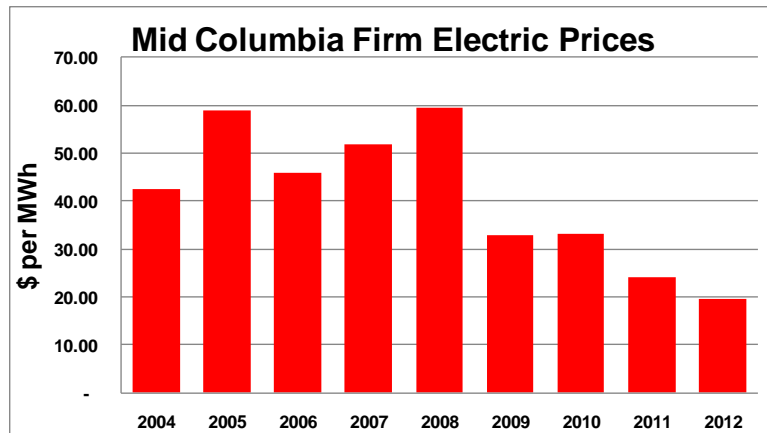

Strong tie between natural gas and electric market

Increased natural gas supply/ lower prices causing price declines at the Mid-Columbia

Are prices now at a new normal?

Pricing Relationships

Implied Market Heat Rate illustrates new wind supply contributing to lowering market prices

Spark Spread shows margin opportunities for Combined Cycle Resources

2011's above average hydro reduced prices further

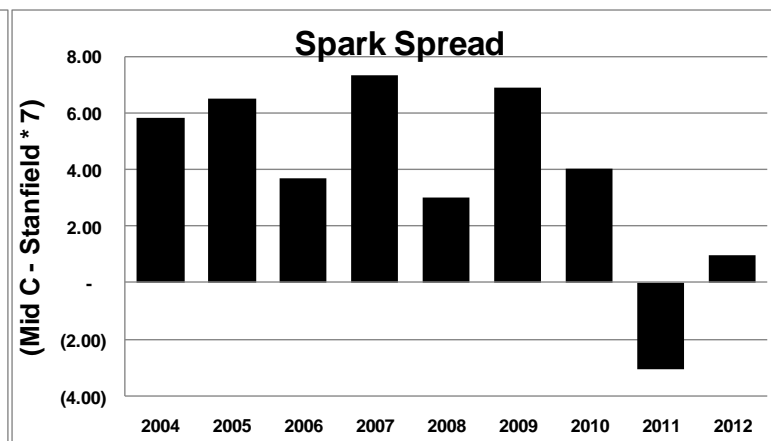
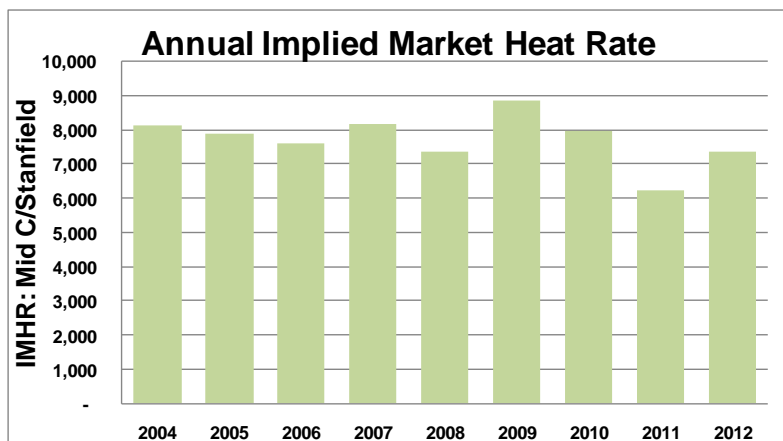

The Ghost of IRP's Past

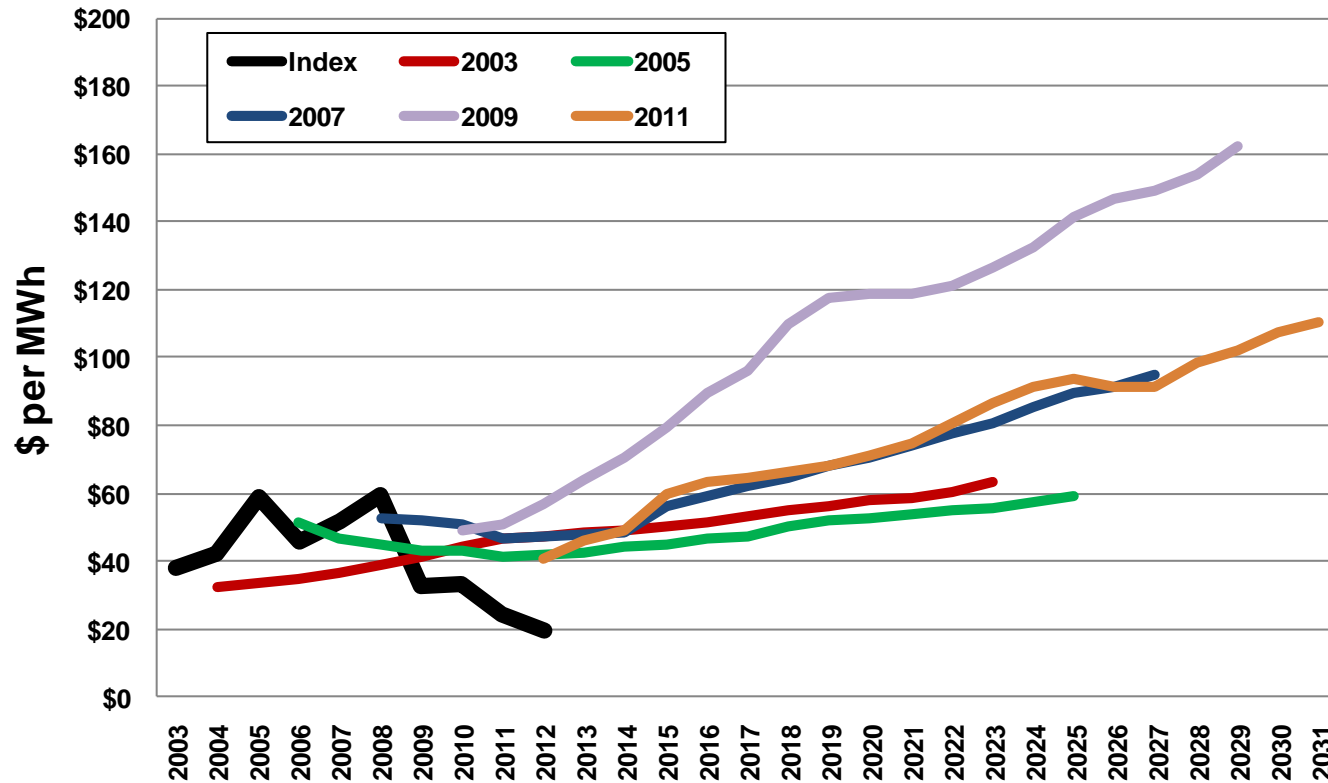

2013 IRP Modeling Process

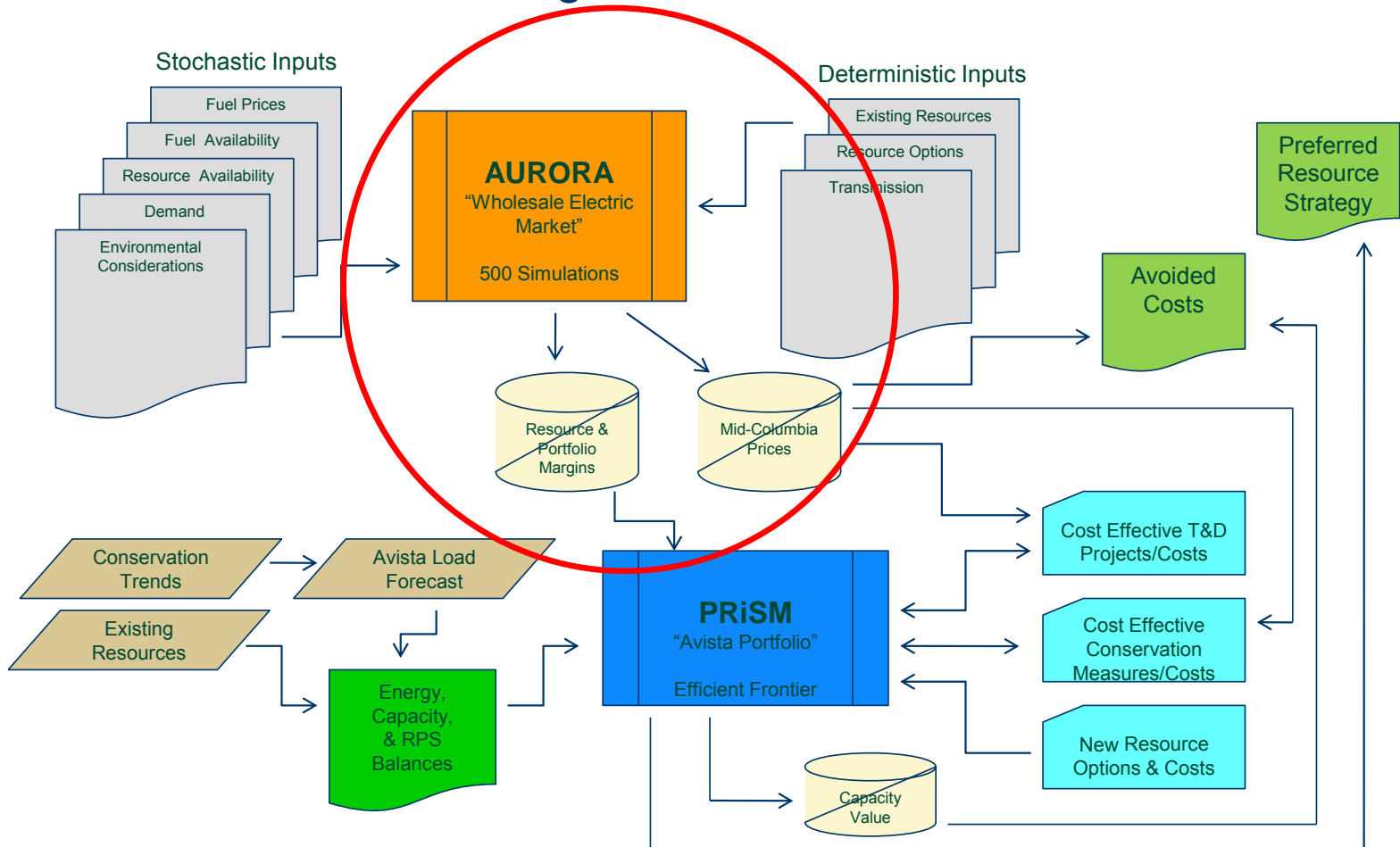

Retail Sales by Western State

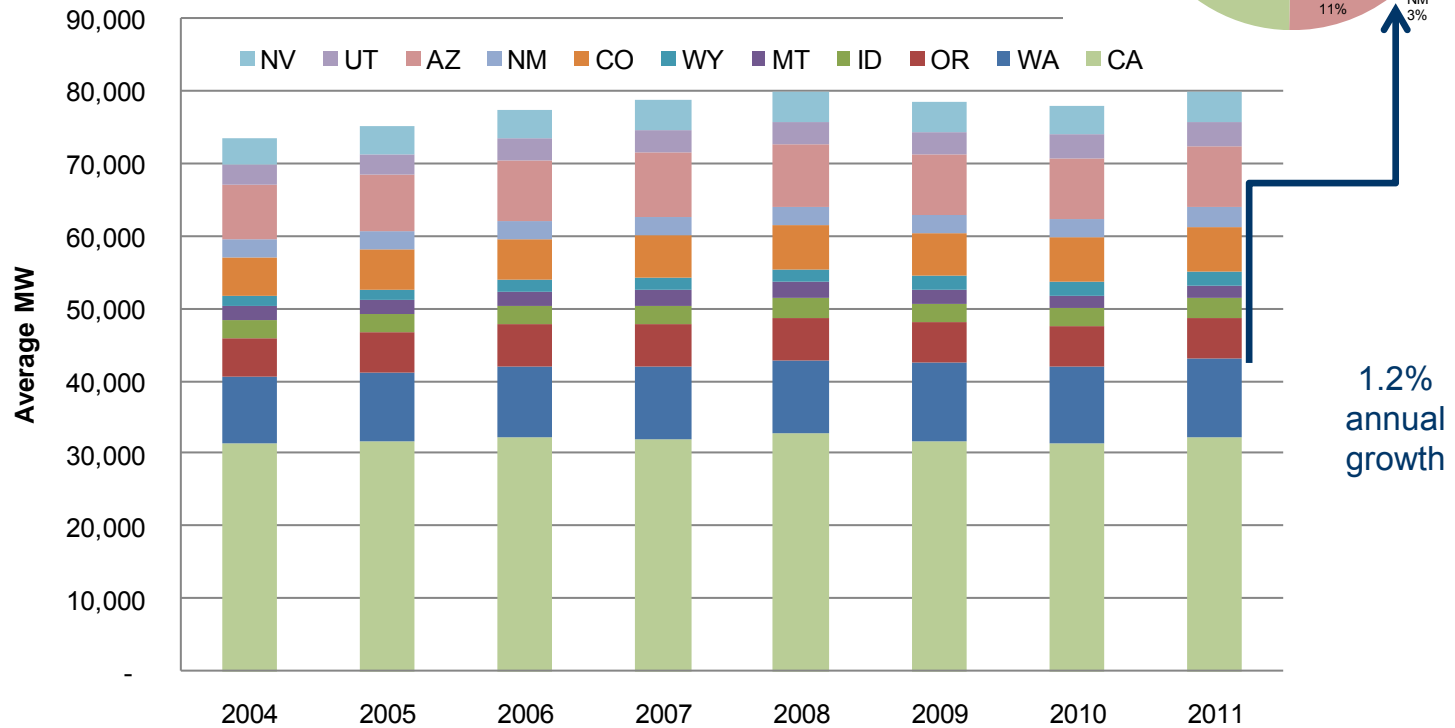

Source: SNL



National Historic Power Generation

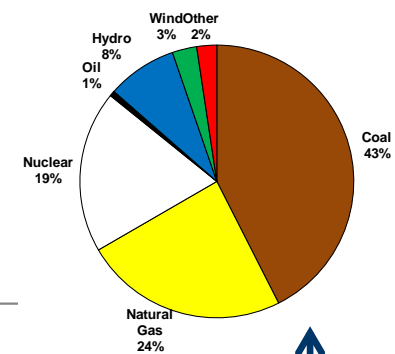
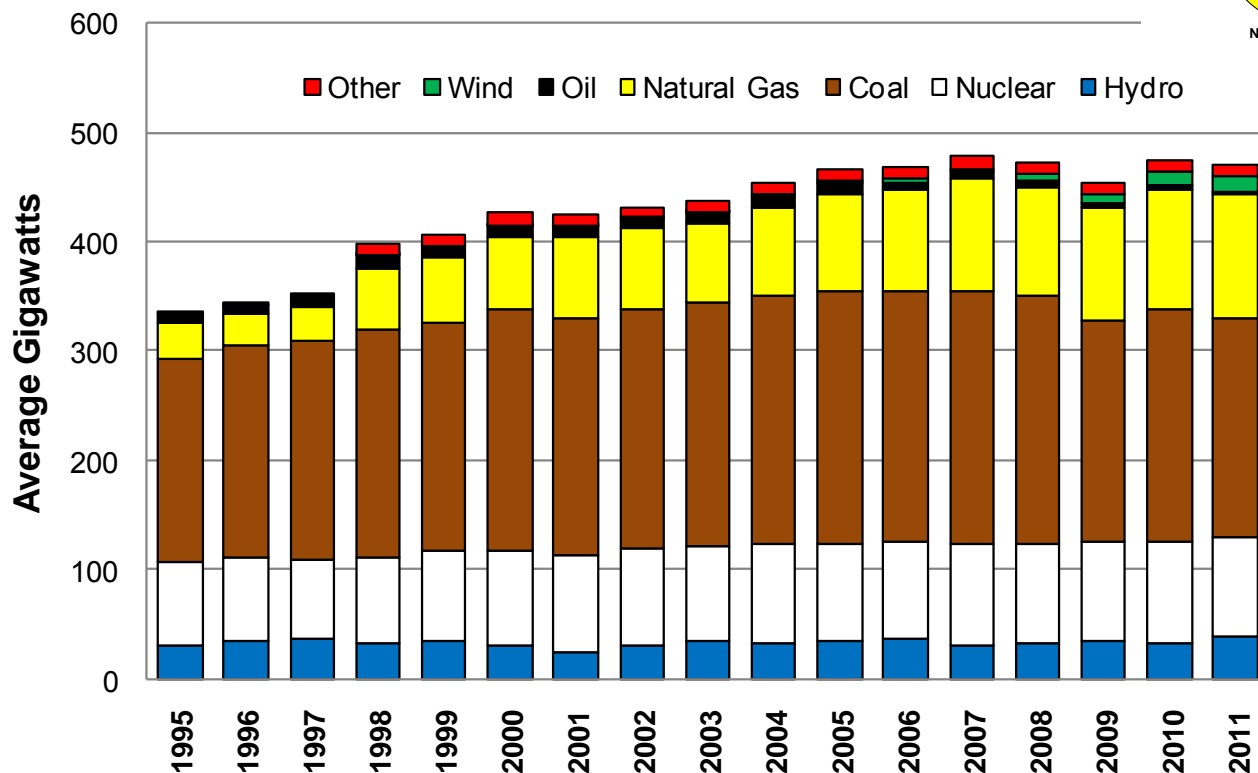

Source: SNL



US Coal Generation Displacement

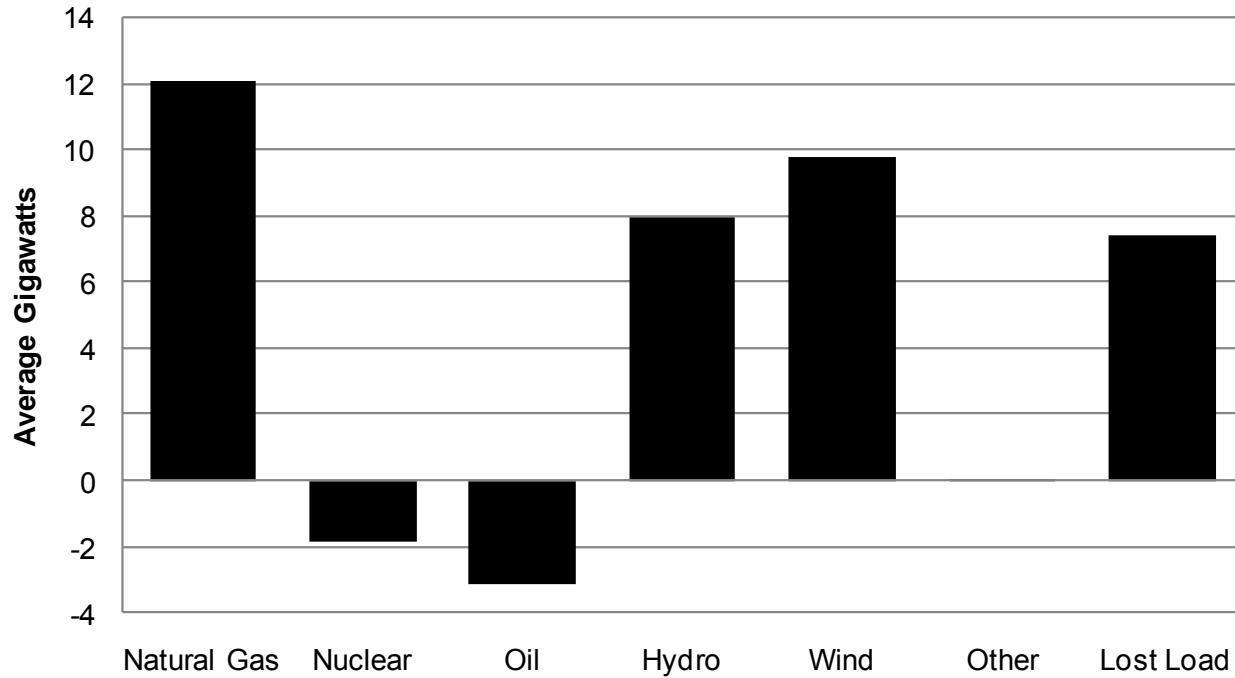

Between 2007 and 2011, Coal Generation decreased 32 aGW

Source: SNL



US Western Interconnect Generation by Fuel Type

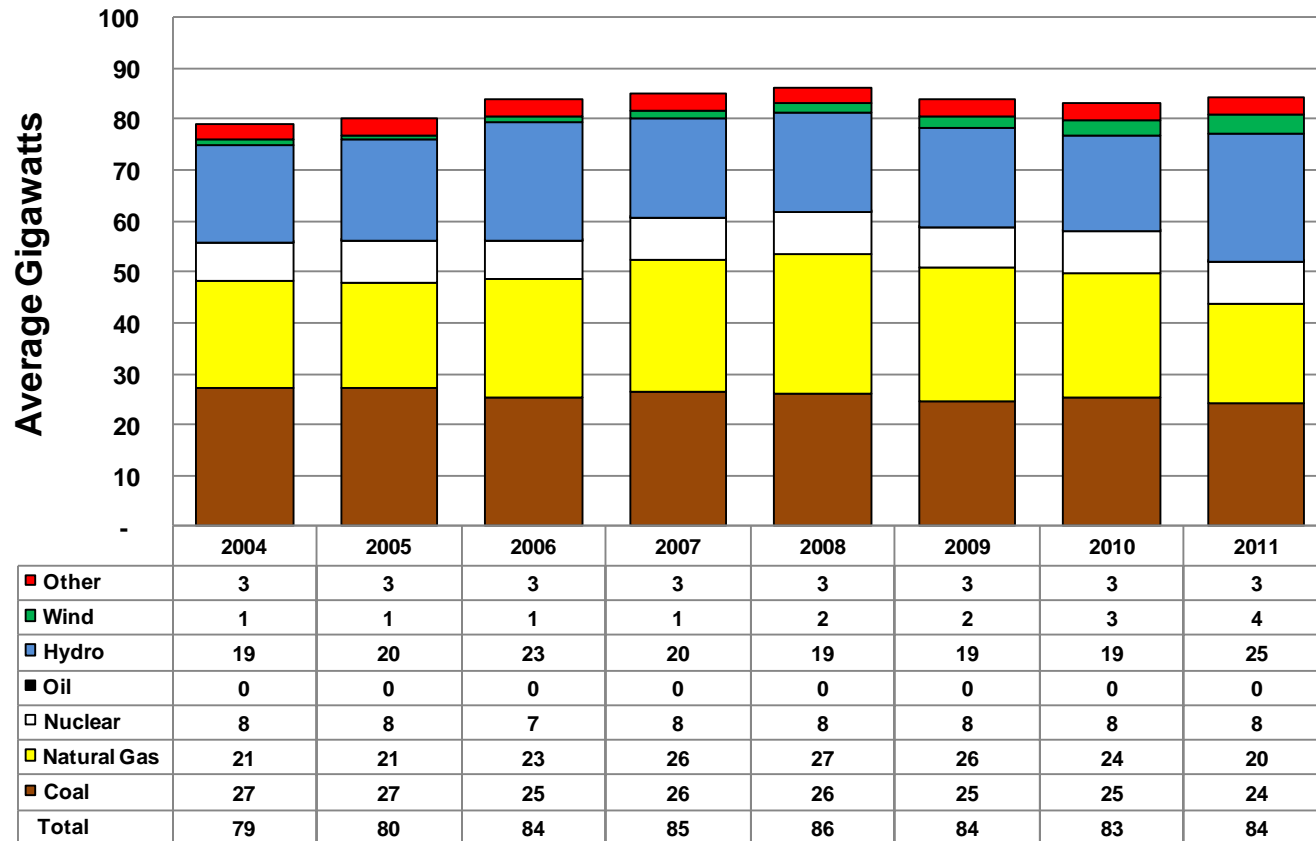

Source: SNL



US Western Interconnect Energy Versus Capacity

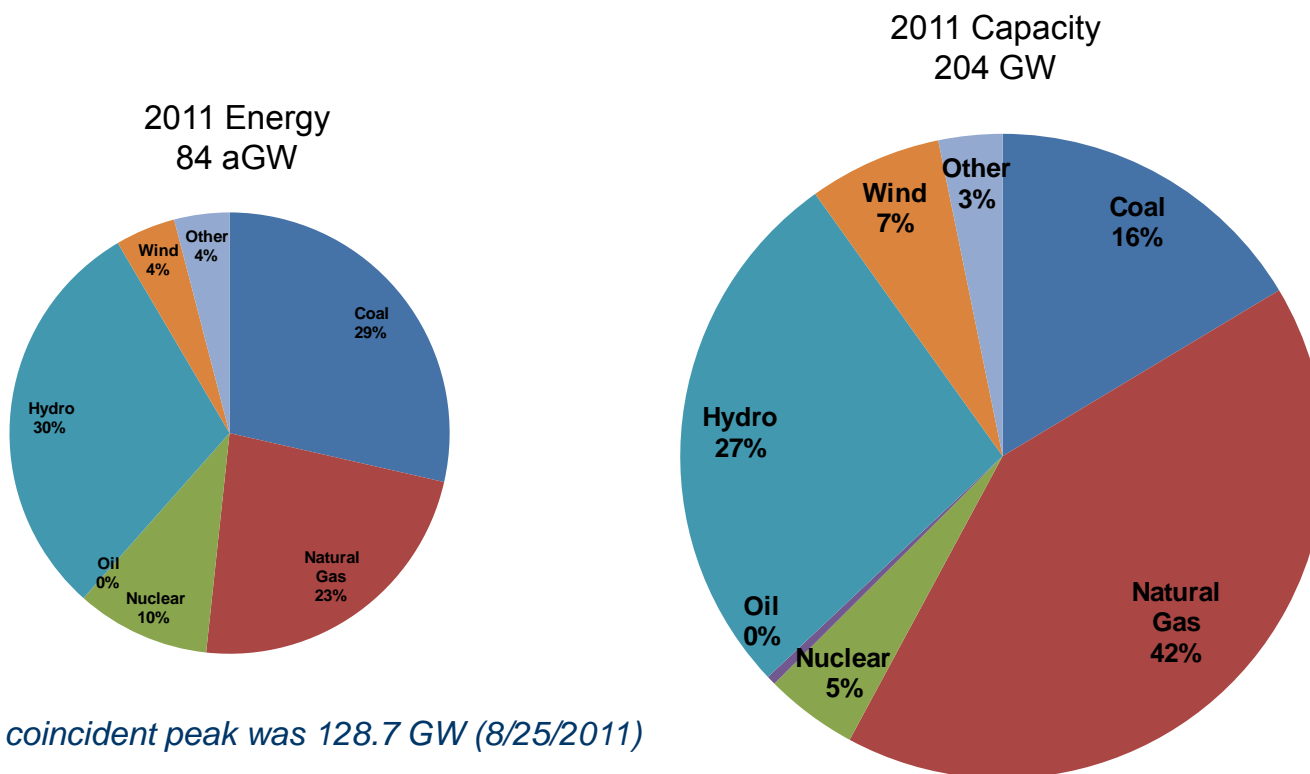

Source: SNL



Electric power in 2011 is 4.6% below 2010, A total of 11% reduction since 2007

Historic US Greenhouse Gas Emissions

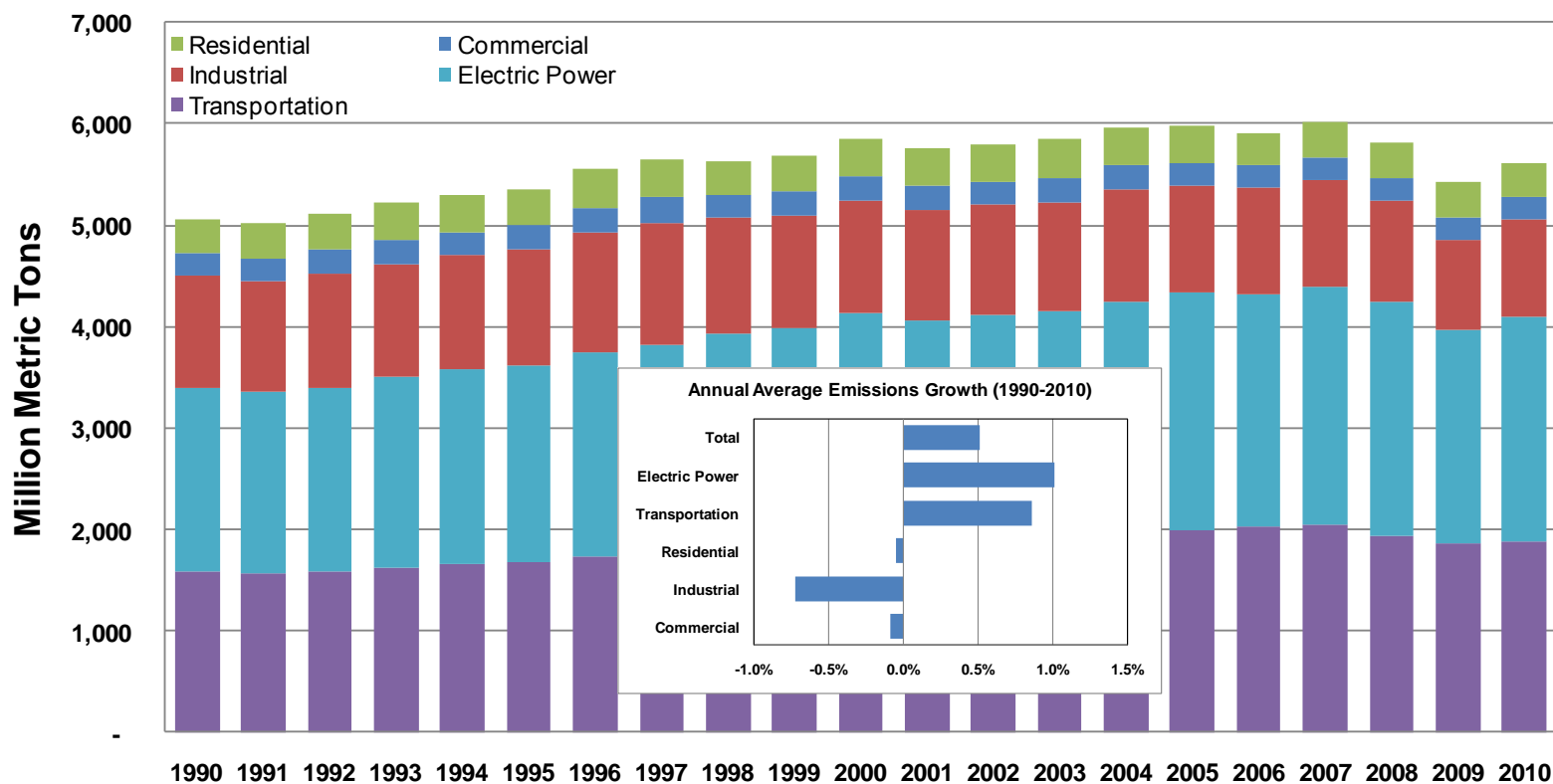

Source: EIA



Western Electric Generation Greenhouse Gas Emissions

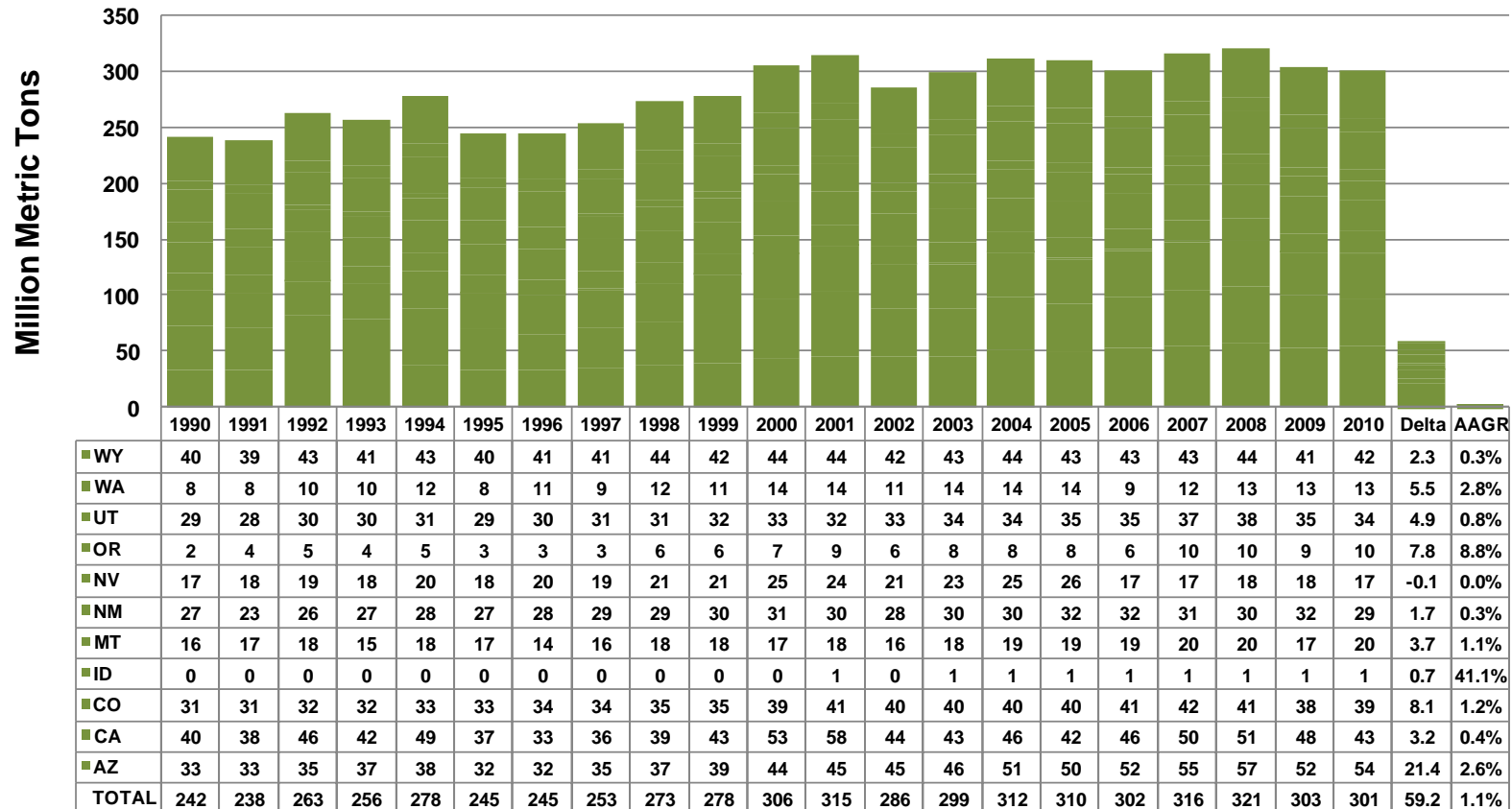

Source: EIA



Electric Market Modeling



- 3rd party software- EPIS, Inc.
- Electric market fundamentals- production cost model
- Simulates generation dispatch to meet load
- Outputs:
 - Market prices
 - Regional energy mix
 - Transmission usage
 - Greenhouse gas emissions
 - Power plant margins, generation levels, fuel costs
 - Avista's variable power supply costs

Stochastic Approach

- Simulate Western Electric market hourly for next 20 years (2014-33)
 - That is 175,248 hours for each study
- Model 500 potential outcomes
 - Variables include fuel prices, loads, wind, hydro, outages, inflation
 - Simulating 87.6 million hours
- Run time is about 5 days on 27 processors
- Why do we do this?
 - Allows for complete financial evaluation of resource alternatives
 - Without stochastic prices we cannot account for tail risk

Aurora Pricing Example- Supply/Demand Curve

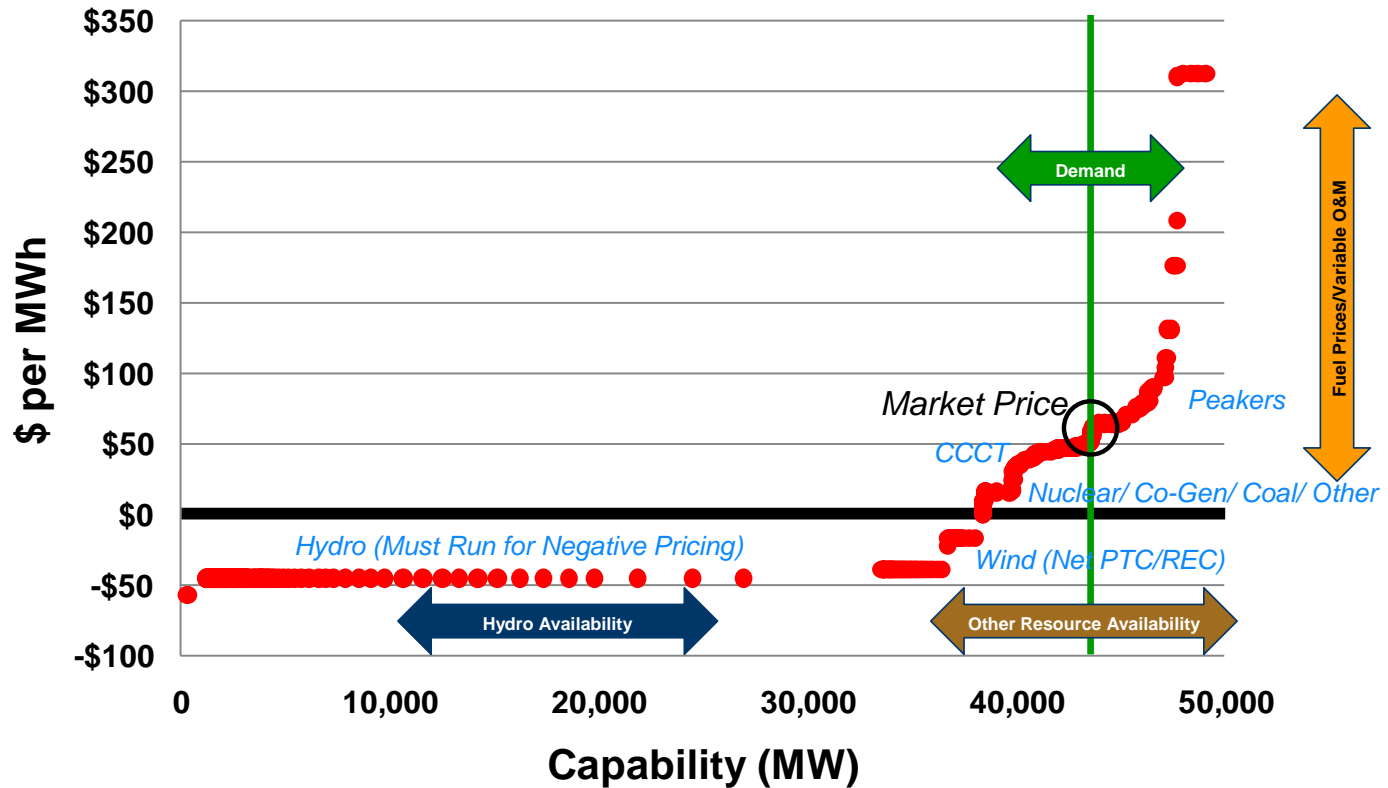

Modeled Western Interconnect Topology

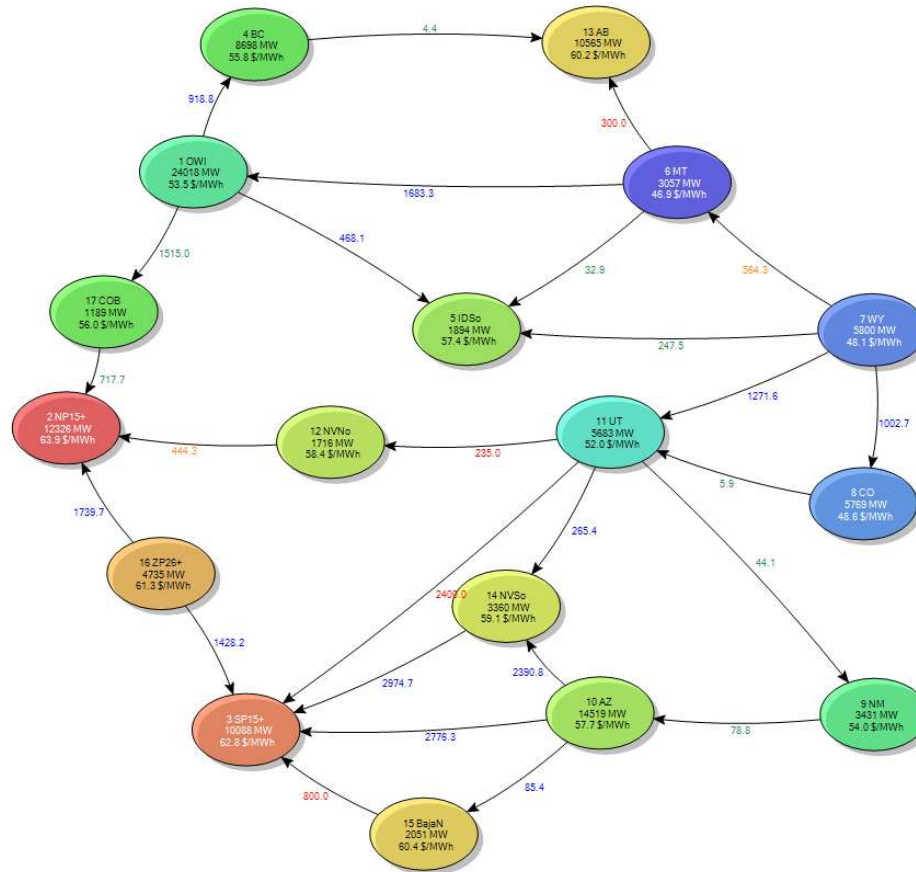

Greenhouse Gas Emissions Modeling

- No national greenhouse gas tax or cap & trade is modeled
- California, Alberta, and British Columbia greenhouse gas reduction schemes are modeled
- Assumes some coal plants will retire due to EPA regulations
 - Plants were selected for retirement based on fuel costs, emission control technology and its location
- Assume certain natural gas once-through-cooling plants in California will be retired over time
- State RPS requirements met mostly by wind & solar

Forecasted Resource Retirements

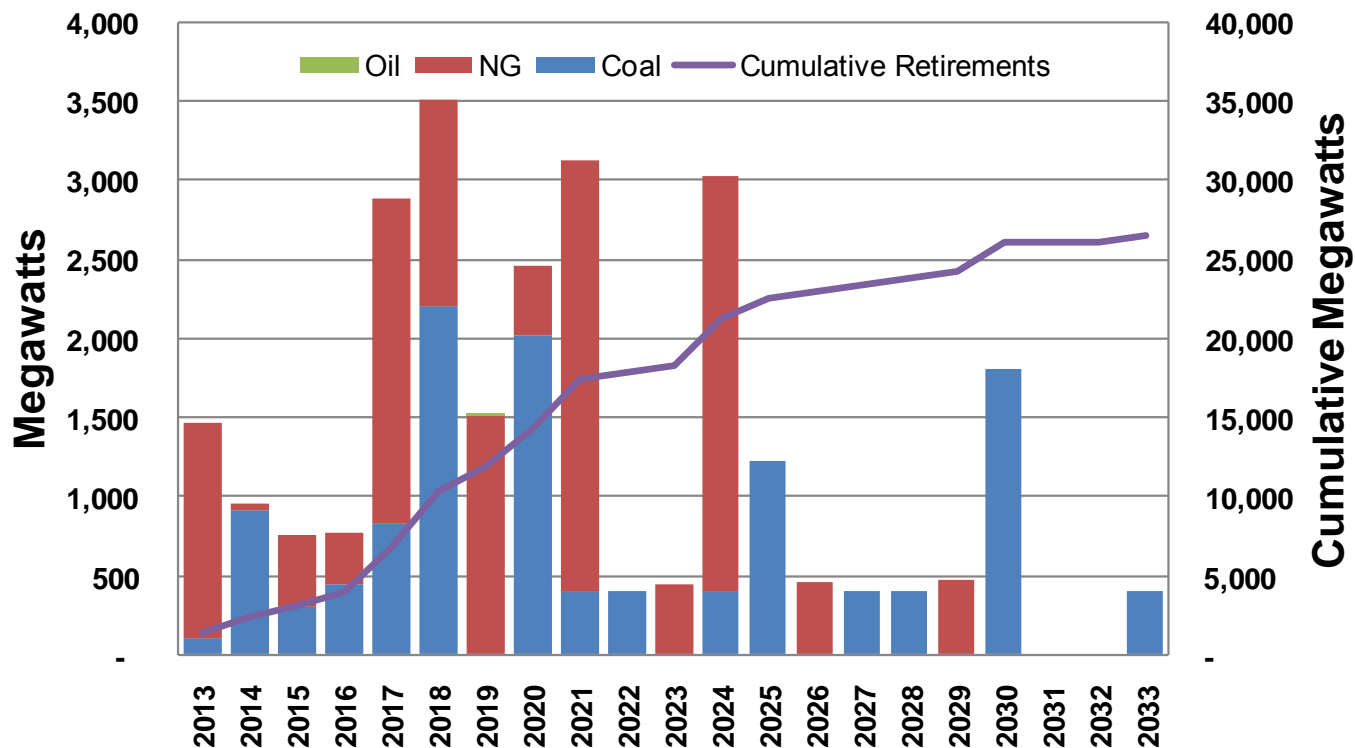

Natural Gas retirements are related to lost generation from once-through-cooling technology phase out in California



New Resource Alternatives

Western Interconnect

Resource alternatives to meet Renewable Portfolio Standards

- Wind
- Solar
- Biomass
- Geothermal
- Hydro Upgrades

Resource alternatives to meet regional capacity requirements

- Combined Cycle
- Simple Cycle (Aero, Frame, Hybrid)
- Solar
- Wind (non RPS states)
- Nuclear
- Coal IGCC with Sequestration
- Energy Storage (not modeled)

Resource Additions (Western Interconnect)

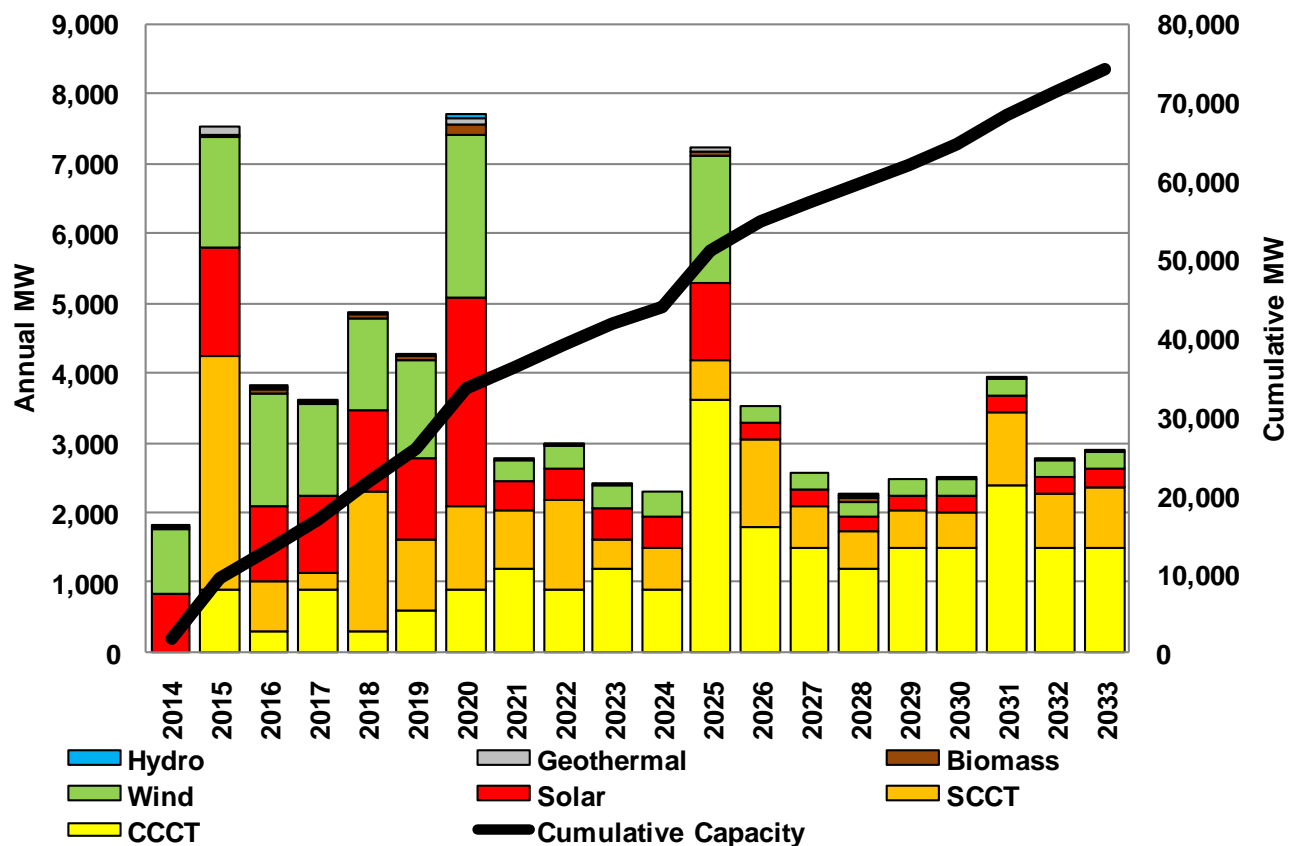

Resource Additions (Northwest)- Maintain 5% LOLP

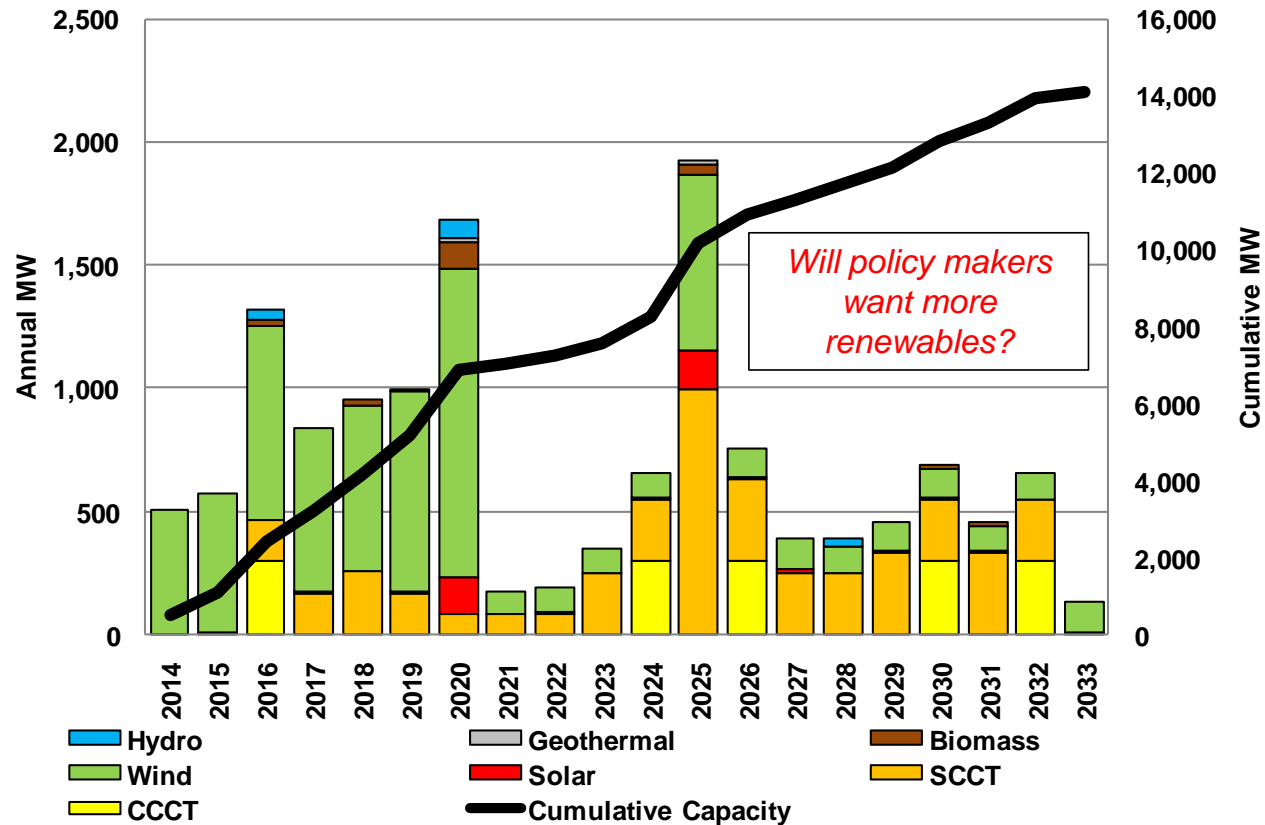

DRAFT

US Western Interconnect Resource Forecasted Output

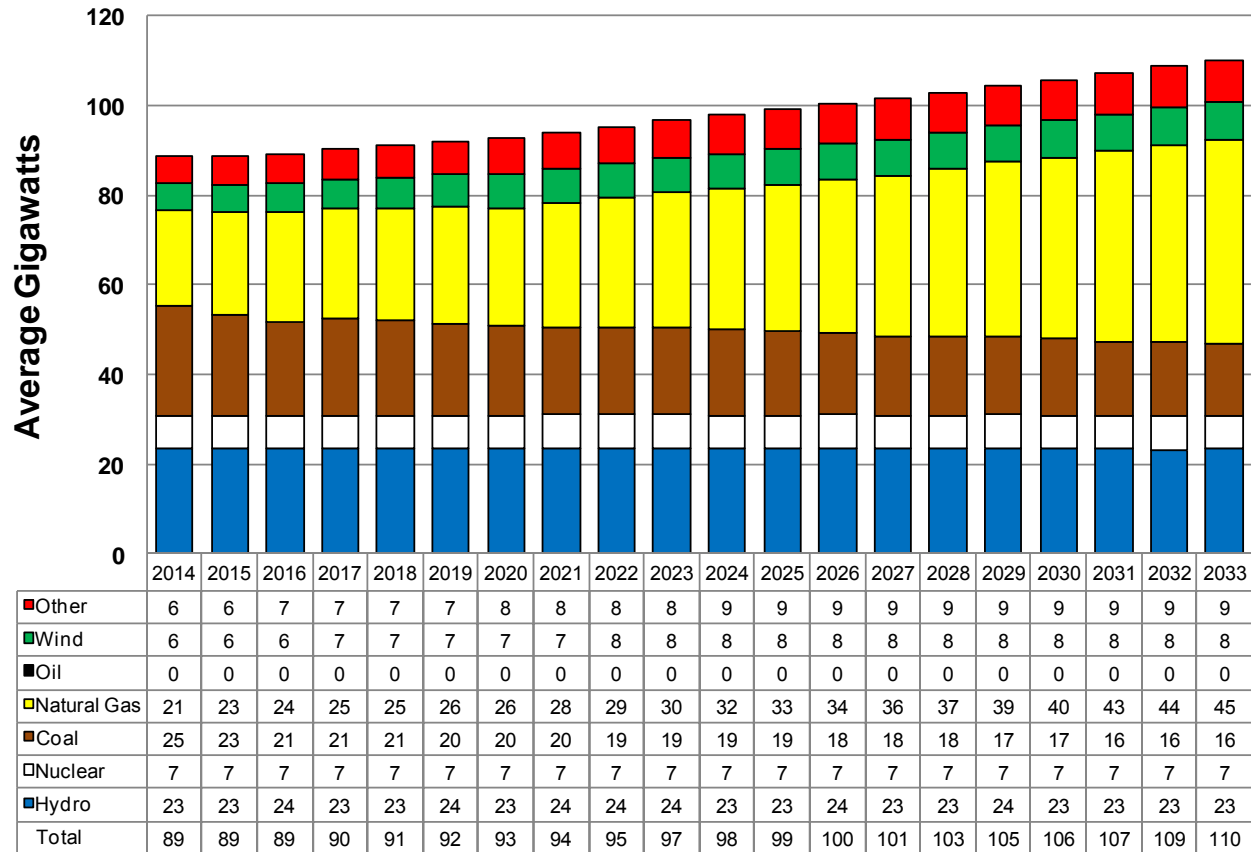

Stanfield Natural Gas Price Forecast

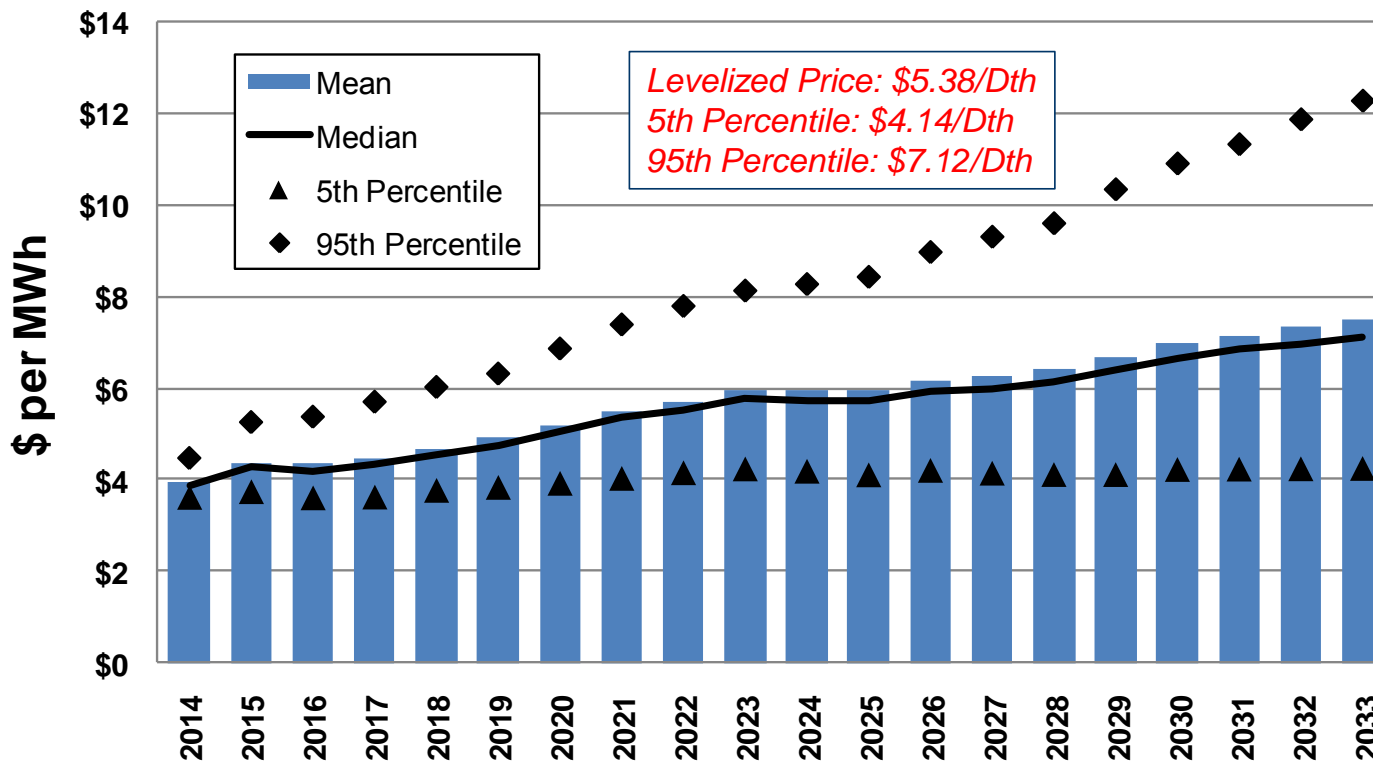

DRAFT

Mid-Columbia Annual Average Forecast

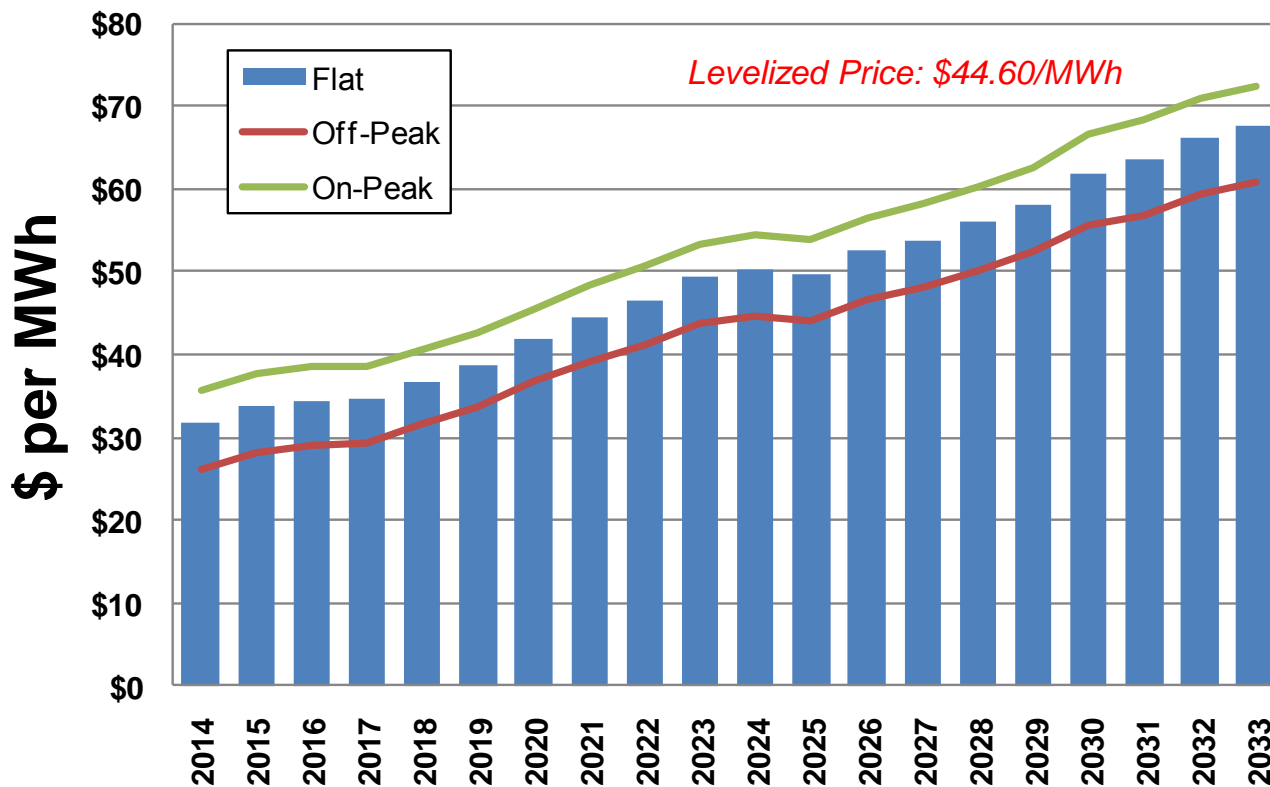

DRAFT

Mid-Columbia Electric Prices: Stochastic Results

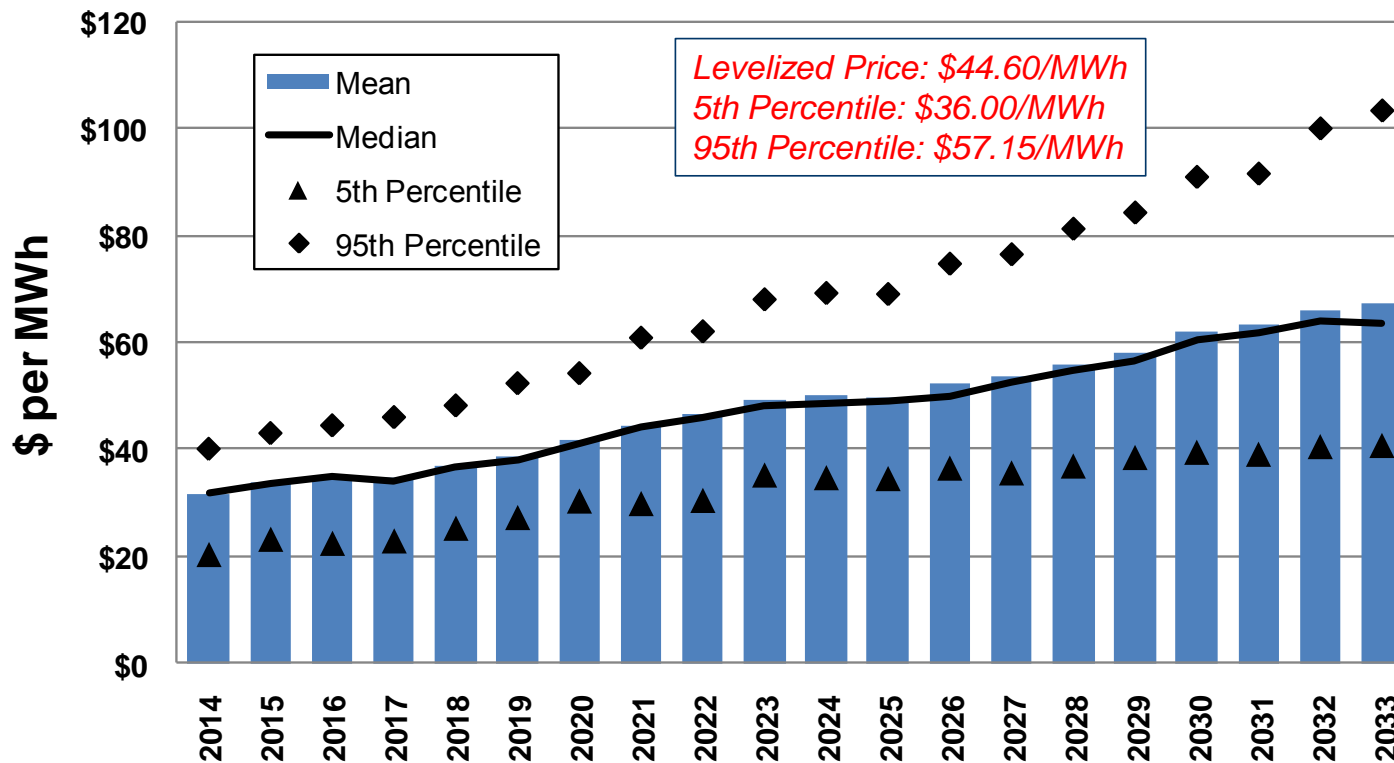

DRAFT

Implied Market Heat Rate (Mid-C / Stanfield x 1,000)

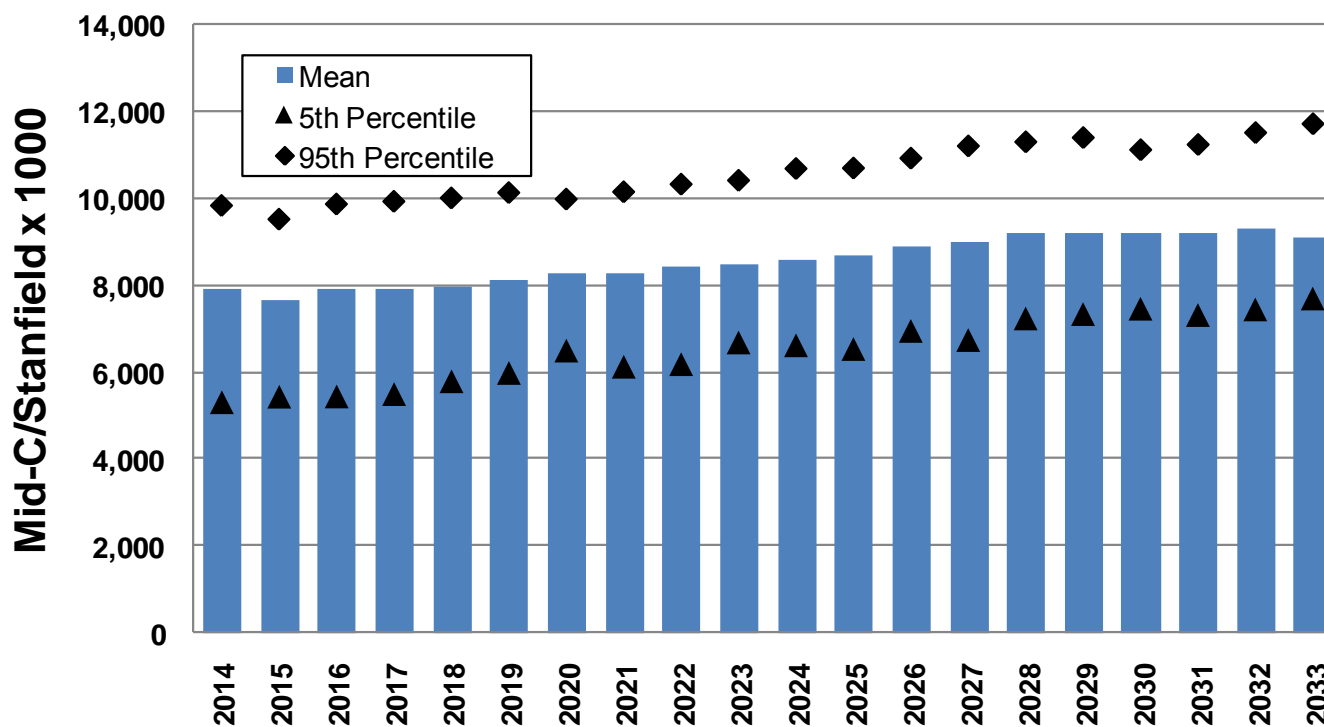

Mid-Columbia Negative Electric Pricing

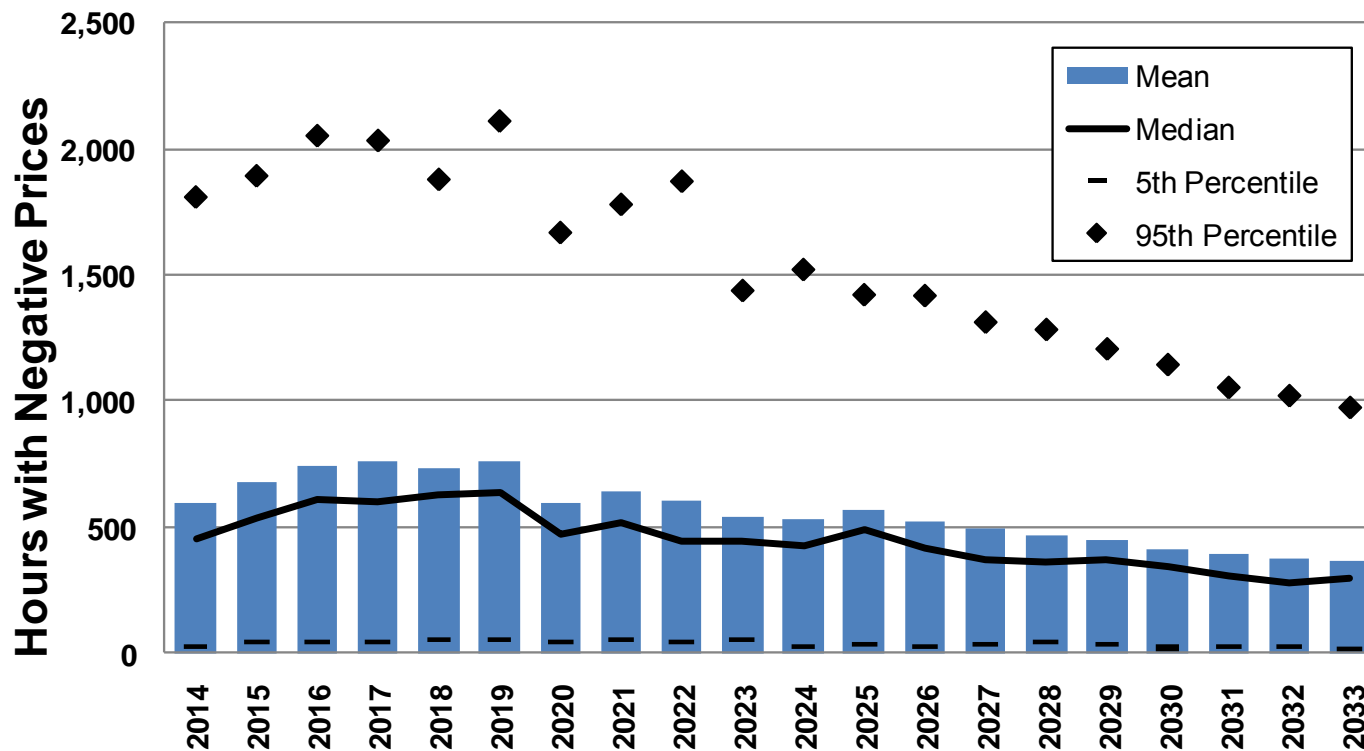

2011 had 202 hours and 2012 had 552 according to Powerdex hourly index



DRAFT

Western US Greenhouse Gas Emissions Forecast

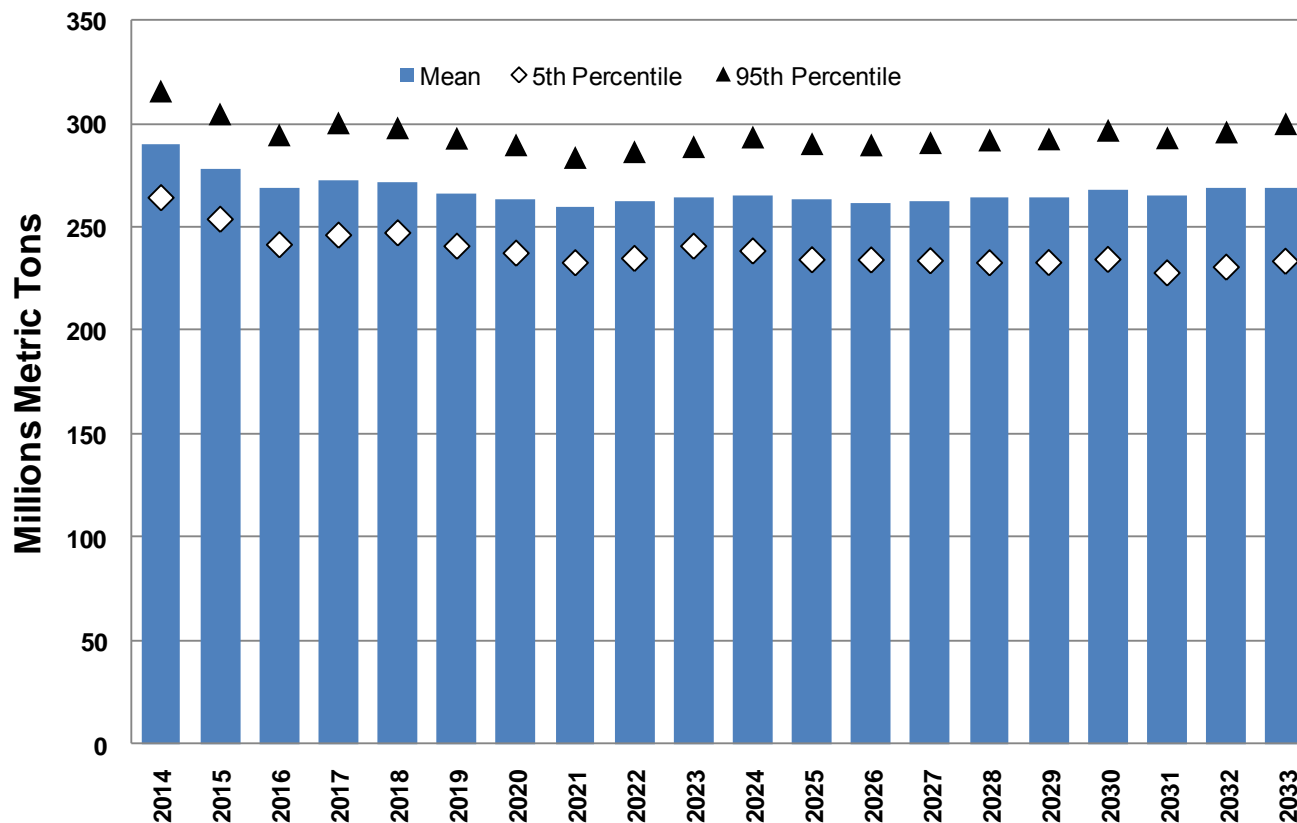

IRP Electric Price Forecast Comparison

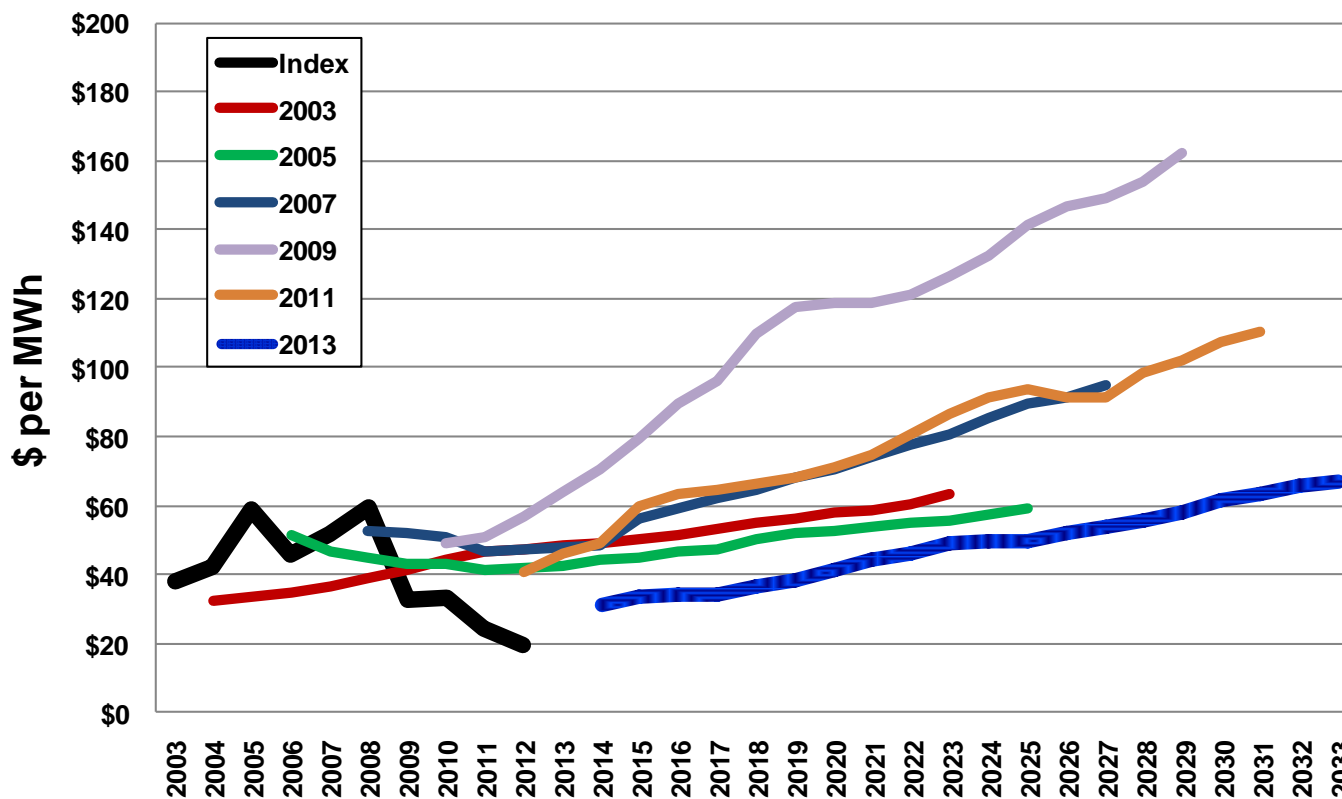

2007-2011 IRP expected case forecasts included carbon reduction schemes increasing market prices



IRP Price Forecast Comparison (No CO₂ Pricing)

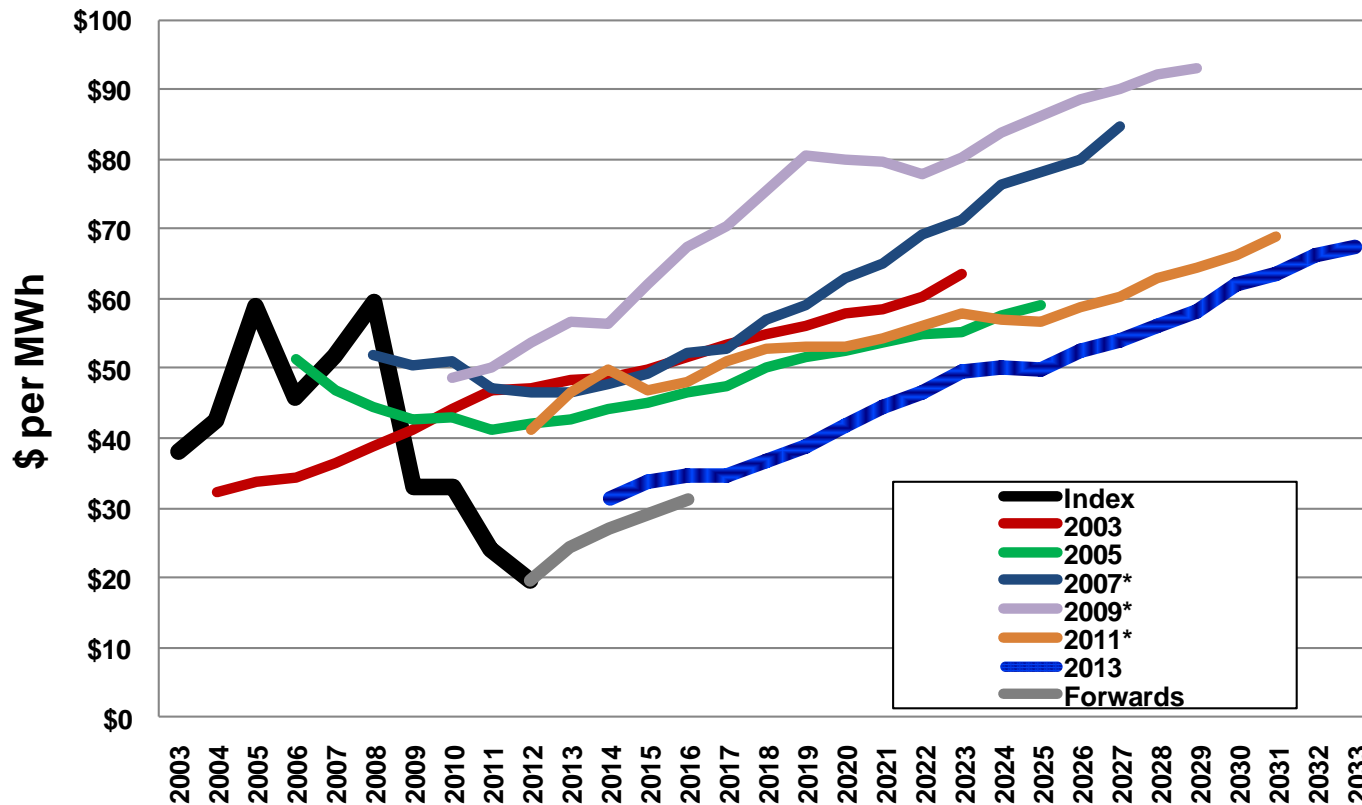



TAC PRESENTATION

New Resource Integration – Transmission

SYSTEM PLANNING

Prepared by Richard Maguire and the Avista System Planning Group

February 6, 2013

Federal Standards of Conduct

1. No non-public transmission information can be shared with the Avista Merchant Function
2. There are Avista Merchant Function personnel in attendance
3. We can't share non-public transmission information today



Agenda

- Introduction to Avista System Planning
- Engineering of Local Generation Requests
- Recent Avista Projects
- Large Generation Interconnection Agreement (LGIA) Queue
- Integrated Resource Plan (IRP) Generation Requests
- Future Transmission Planning Initiatives

Introduction to Avista System Planning

Broad Scope of What We Care About:

- Avista System Performance
- Federal, Regional, and State Compliance
- Regional Transmission System Coordination



Introduction to Avista System Planning

Regional Coordination

WECC

NWPP

CG

NTTG

etc.

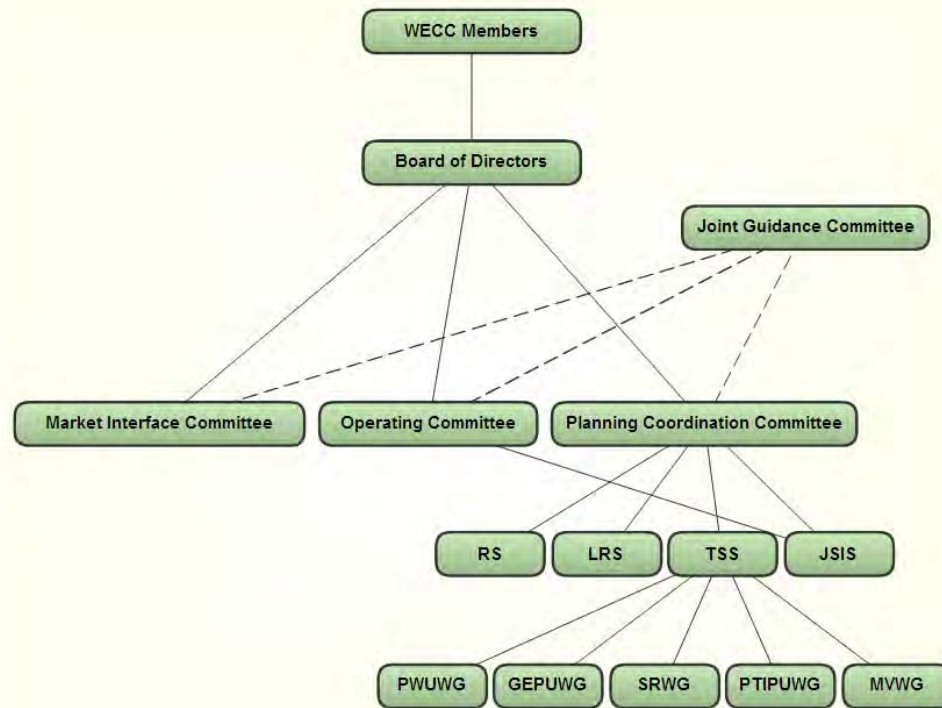

Introduction to Avista System Planning

We also spend our time:

- Developing internal standards and processes
- Engineering the transmission system
- Engineering the distribution system
- Managing Avista assets
- Projecting future loads and resources
- Engineering local generation requests



Agenda

- Introduction to Avista System Planning
- Engineering of Local Generation Requests
- Recent Avista Projects
- Large Generation Interconnection Request (LGIR) Queue
- Integrated Resource Plan (IRP) Generation Requests
- Future Transmission Planning Initiatives

Engineering of Local Generation Requests

Typical Process for Generation Requests

- We generally get requests via two sources:
 - Internal via the IRP requests
 - External *and Internal* via LGIA requests
- We hold a scoping meeting to discuss particulars
- We outline a study plan
- We augment WECC approved cases for our studies
- We analyze the system against the standards
- We publish our findings and recommendations

Engineering of Local Generation Requests

Case Development

	From Number ▲	From Name	To Nur ▲	To Name	Circu ▲	Status	Xfrmr	R	X	B	Lim A MVA
1	40017	ADDY	48007	ADDY AVA	1	Closed	YES	0.03883	0.70558	0.00000	20.0
2	40017	ADDY	48071	CHEWELAH	1	Closed	NO	0.01395	0.05425	0.00778	111.0
3	40017	ADDY	48135	GIFFORD	1	Closed	NO	0.14267	0.13096	0.01488	29.5
4	40017	ADDY	48223	METCHIP	1	Closed	NO	0.00606	0.02316	0.00345	111.0
5	40023	AHSAHKA	48303	OROFINO	1	Closed	NO	0.00500	0.02072	0.00268	111.0
6	40087	BELL BPA	48033	BELL TAP	1	Open	NO	0.00118	0.00369	0.00043	85.9
7	40087	BELL BPA	48449	WAIKIKIT	1	Closed	NO	0.00093	0.00373	0.00051	111.0
8	40149	BR	Western Montana Hydro			625.6 MW	West of Hatwai (Path 6)		117.4 MW		
9	40149	BR	Noxon Rapids (562MW)			137.9 MW	Lolo-Oxbow 230kV		276.8 MW		
			Cabinet Gorge (265MW)			81.7 MW	Dry Creek-Walla Walla 230kV		159.6 MW		
			Libby (605MW)			216.0 MW					
			Hungry Horse (430MW)			190.0 MW	West of Cabinet		1109.1 MW		
							Montana-Northwest (Path 8)		970.0 MW		
			Colstrip Total								
			Colstrip 1 (330MW)			330.0 MW	Idaho-Northwest (Path 14)		-584.6 MW		
			Colstrip 2 (330MW)			330.0 MW	Midpoint-Summer Lake (Path 75)		-75.2 MW		
			Colstrip 3 (823MW)			763.8 MW	Idaho-Montana (Path 18)		-274.5 MW		
			Colstrip 4 (823MW)			775.5 MW					

Engineering of Local Generation Requests

Case Analysis

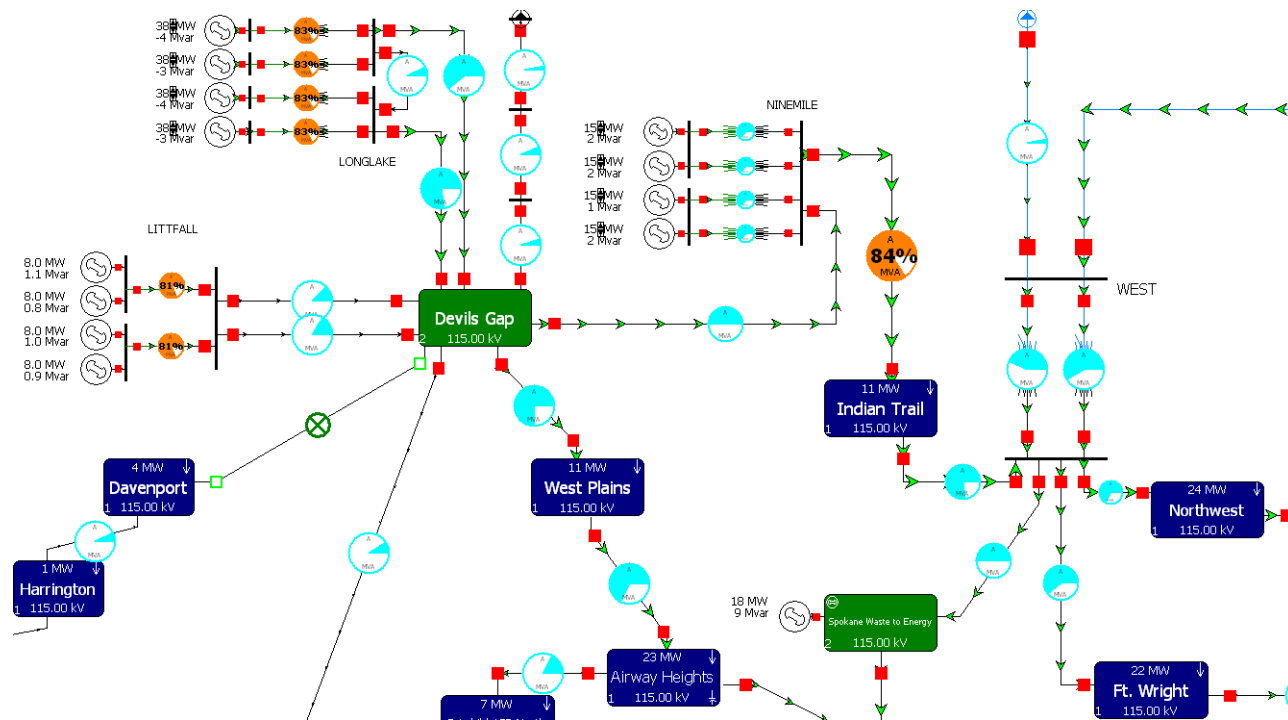

Engineering of Local Generation Requests

➤ Mandatory Federal Standards Include:

- No overloads all lines and equipment in service (N-0)
- No overloads or loss of load for one element out of service (N-1)
- Some relaxation of the above for two elements out (N-2)
- Standards are “Request Agnostic”

➤ Potential Sanctions:

- Up to \$1M Per Day Per Occurrence
- Mitigation Plan must be provided and progress demonstrated

Engineering of Local Generation Requests

Publish Results

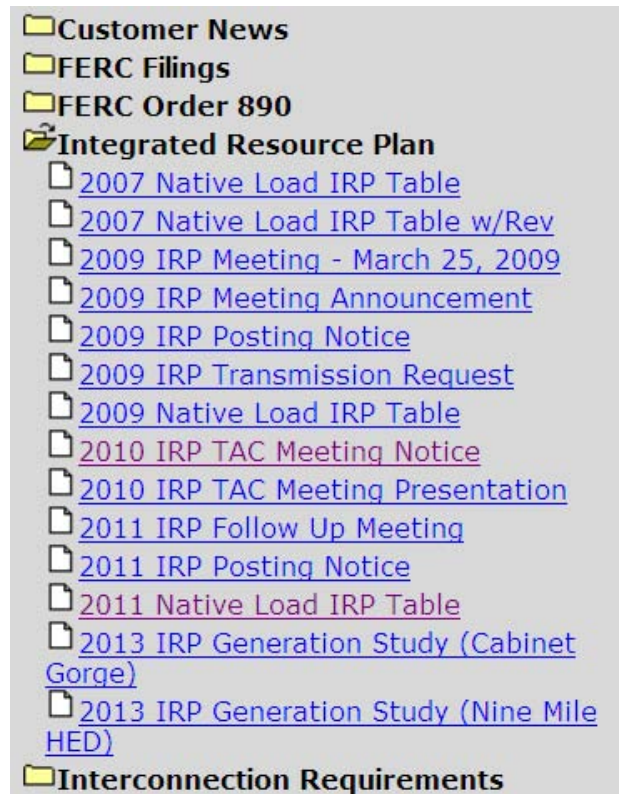

www.oasis.oati.com/avat/index.html



Agenda

- Introduction to Avista System Planning
- Engineering of Local Generation Requests
- **Recent Avista Projects**
- Large Generation Interconnection Request (LGIR) Queue
- Integrated Resource Plan (IRP) Generation Requests
- Future Transmission Planning Initiatives

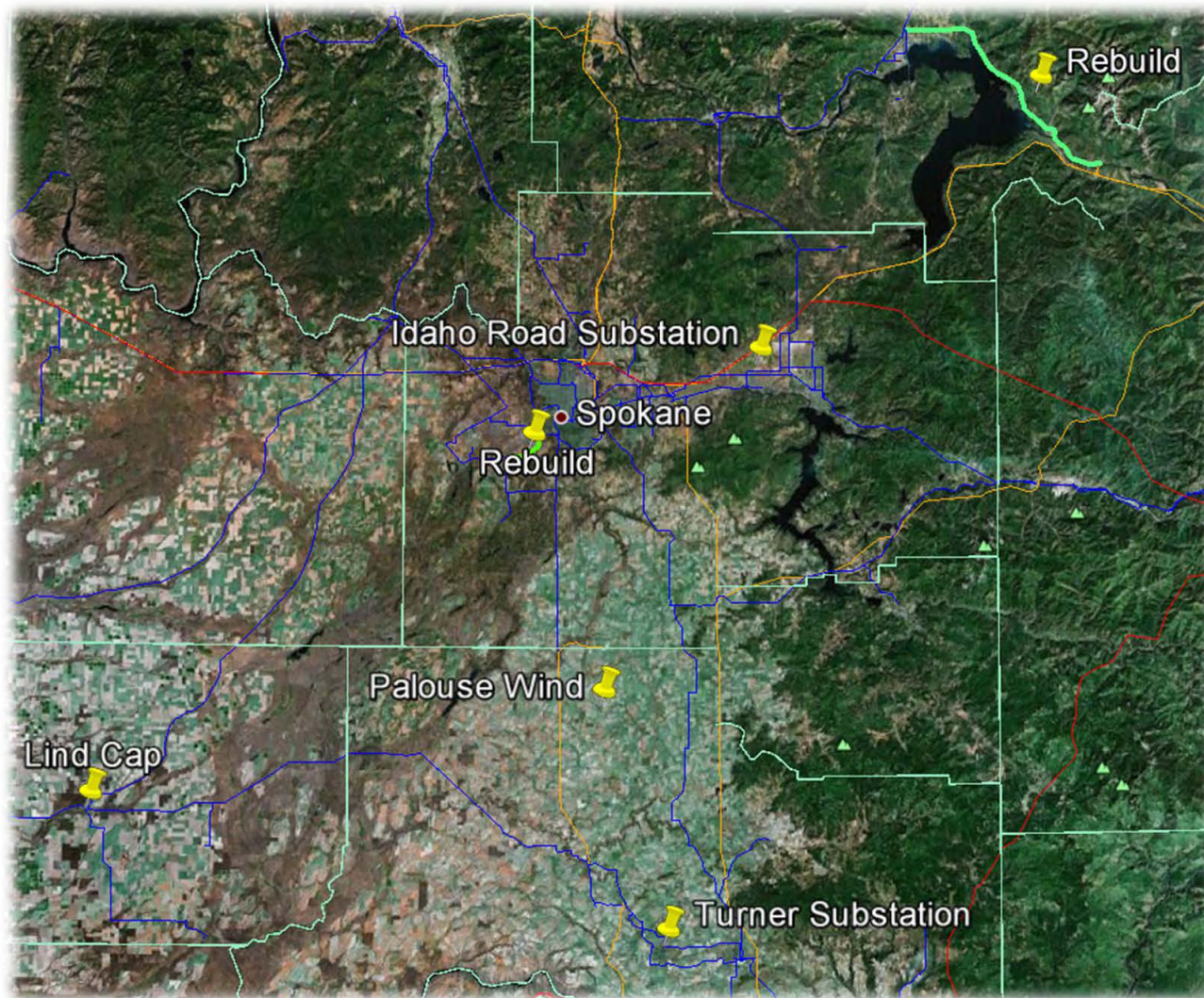

Recent Avista Projects

- Palouse Wind:
 - 58 turbines
 - 105 MW
 - Thornton 230 kV Substation
 - \$4.35M
 - Benewah – Shawnee 230 kV Transmission Line

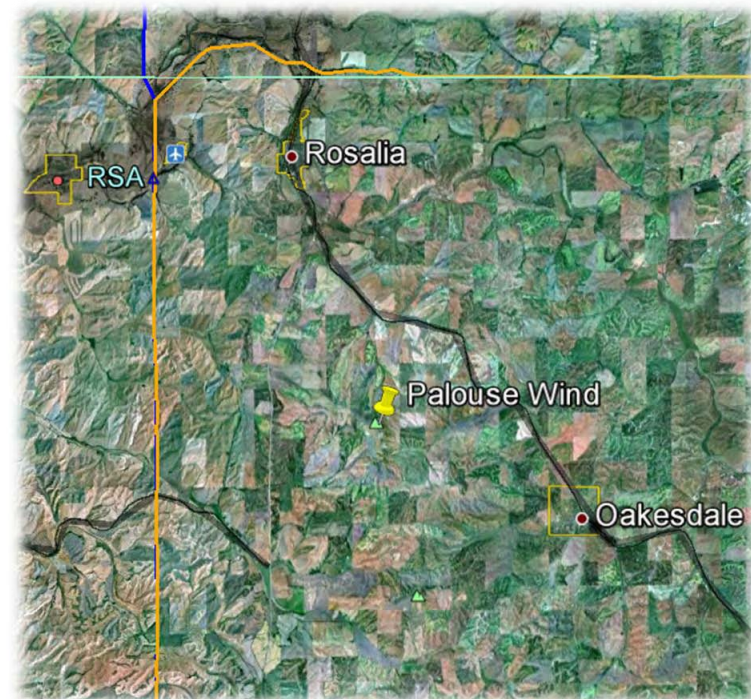









Recent Avista Projects

Lind Capacitor Bank

- ~\$750K



Recent Avista Projects

Idaho Road 115 kV Substation

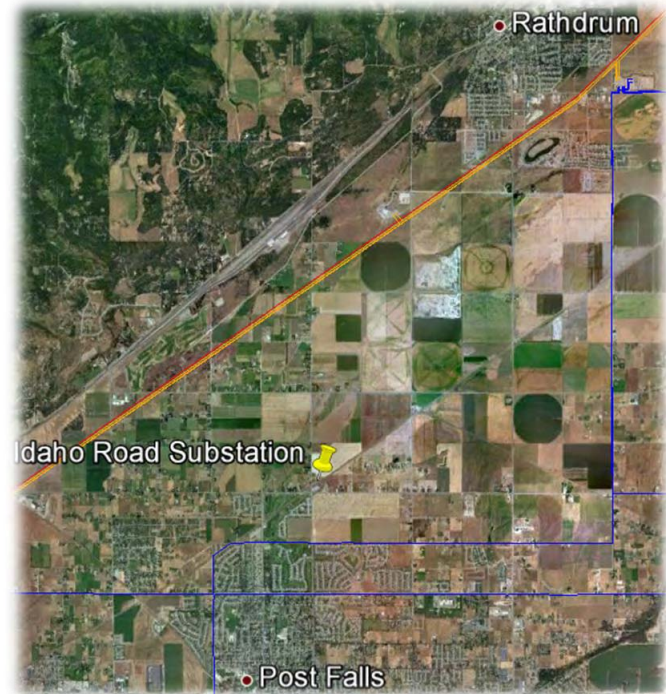

Recent Avista Projects

Turner 115 kV Substation



Recent Avista Projects

115 kV Transmission Lines

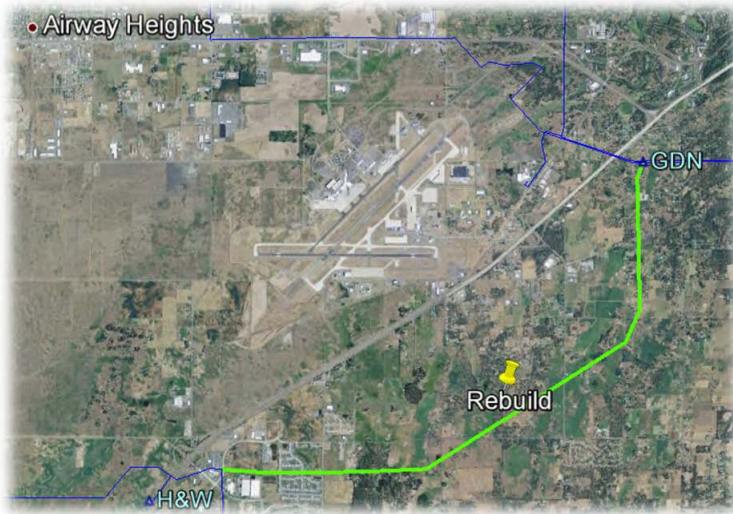

Agenda

- Introduction to Avista System Planning
- Engineering of Local Generation Requests
- Recent Avista Projects
- **Large Generation Interconnection Request (LGIR) Queue**
- Integrated Resource Plan (IRP) Generation Requests
- Future Transmission Planning Initiatives

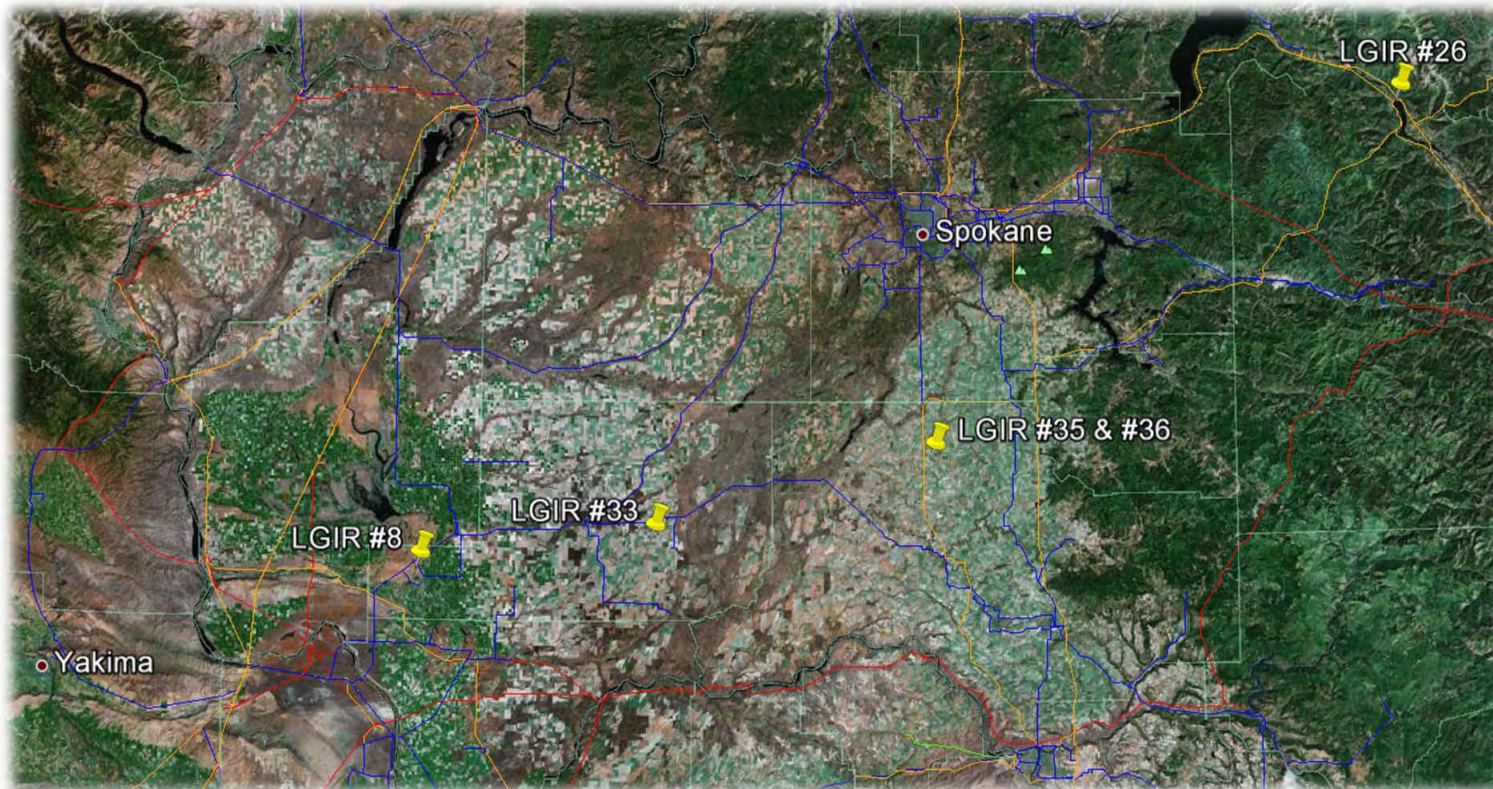

Avista Non-IRP Generation Queue

- **Project # 08**: 75 MW with Facility Study completed
 - \$6.6M 230 kV switching station and tap
 - \$5.6M 115 kV breaker position and reconductor
- **Project # 26**: 42MW with System Impact Study completed
- **Project # 33**: 400 MW in Feasibility Study stage
- **Project # 35**: 200 MW in System Impact Study stage
- **Project # 36**: 105 MW in Feasibility Study stage

<http://www.oasis.oati.com/AVAT>



Agenda

- Introduction to Avista System Planning
- Engineering of Local Generation Requests
- Recent Avista Projects
- Large Generation Interconnection Request (LGIR) Queue
- **Integrated Resource Plan (IRP) Generation Requests**
- Future Transmission Planning Initiatives

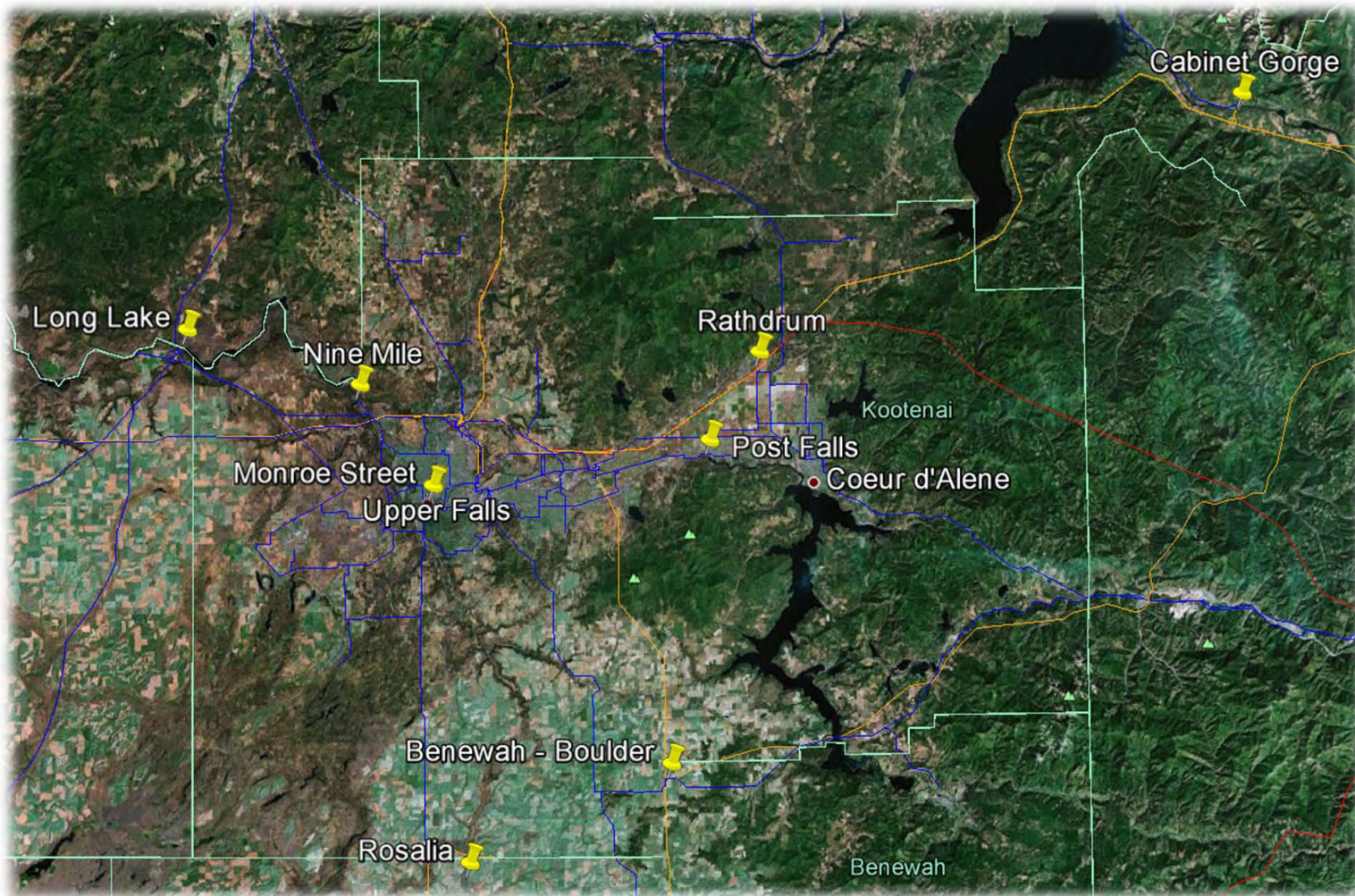

Avista Non-IRP Generation Queue

- **Nine Mile HED**: 60 MW total
- **Long Lake HED**: 68 MW additional (156 MW total)
 - Studied coincident with Nine Mile IRP request
 - \$9.9M for 115 kV Transmission Line reconductoring
- **Monroe Street HED**: 80 MW additional (95 MW total)
- **Upper Falls HED**: 40 MW additional (50.26 MW total)
- **Post Falls HED**: 33.5 MW total



Avista Non-IRP Generation Queue

- **Cabinet Gorge HED:** 60 MW additional (330.5 MW total)
 - No capacity available today during Heavy Summer loading
 - Considering RAS or potential Transmission System upgrades
- **Benewah – Boulder:** 300 MW project currently under study
- **Rathdrum:** 300 MW
 - \$7M for new breaker position at Rathdrum 230 kV Substation
- **Rosalia:** 200 MW
 - \$4M for new breaker position at Thornton 230 kV Substation

Agenda

- Introduction to Avista System Planning
- Engineering of Local Generation Requests
- Recent Avista Projects
- Large Generation Interconnection Request (LGIR) Queue
- Integrated Resource Plan (IRP) Generation Requests
- **Future Transmission Planning Initiatives**

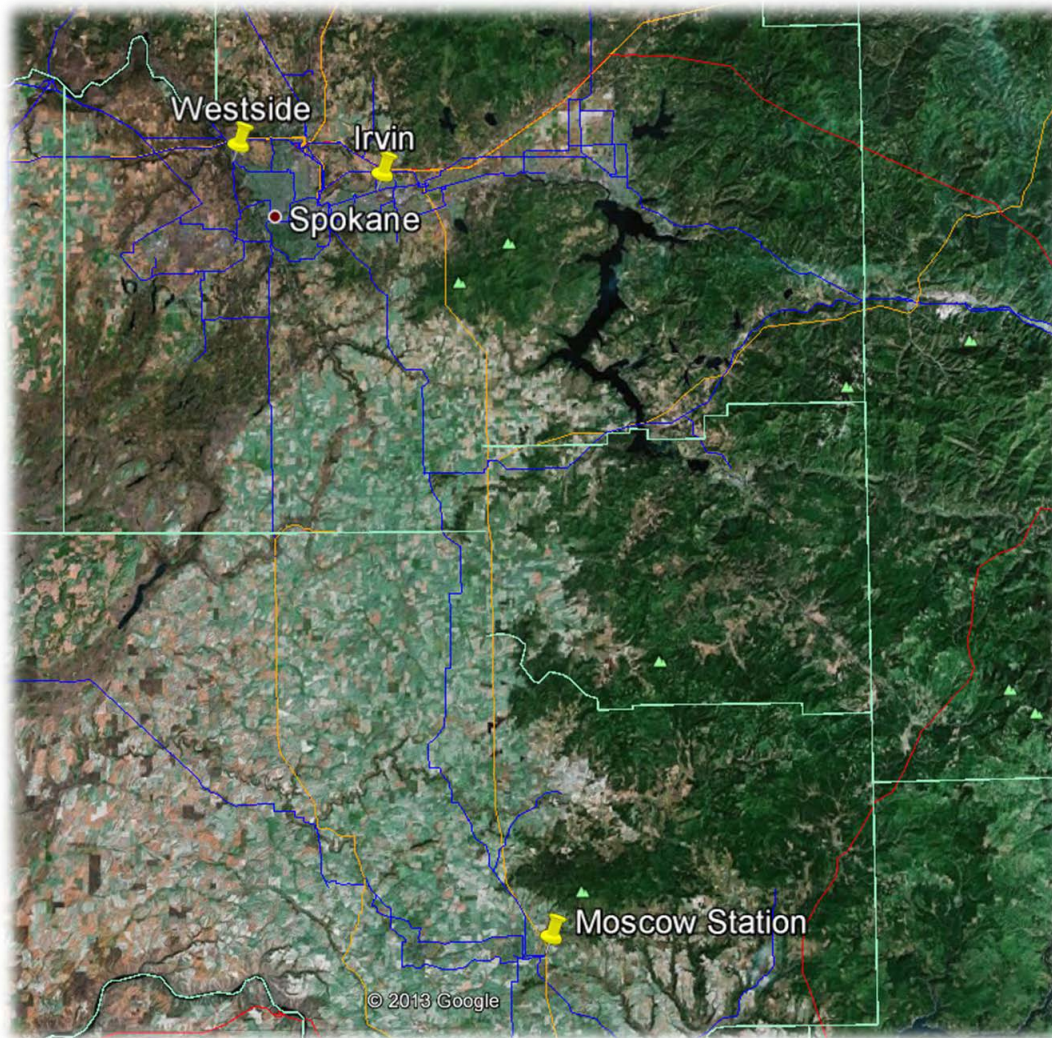

Examples of Future Construction Required to Meet NERC / WECC Reliability Standards

- Moscow Station:
 - 250 MVA transformer
 - Increases capacity to the Moscow / Pullman area and relieves loading on the Shawnee transformer
- Westside Station:
 - Two 250 MVA transformers
 - Increases capacity and security to the West Plains area of Spokane County, and relieves heavy loading on large transformers in the central Spokane area
- Irvin 115 kV and Associated 115 kV Reconductoring:
 - 115 kV Switching Station and other upgrades to meet additional load growth in the Spokane Valley

Recent Avista Projects

Moscow Station Construction



Future Work?

- **Generic Break Point Studies for IRP / 3rd Party Developers:**
 - “How many MW can we integrate where for about what \$\$?”
 - ❖ Main Grid 230 kV Stations.
 - ❖ Select 115 kV Stations.

- **Potential Open Seasons:**
 - “Does anyone want to get to the Mid Columbia?”
 - “Does anyone want to get out of Montana?”
 - “Does anyone want to get to PAC or IPC?”

Questions?





Resource Needs Assessment

Clint Kalich

Fourth Technical Advisory Committee Meeting

2013 Electric Integrated Resource Plan

February 6, 2013

Power Supply Reliability Key Terms

- Peak Demand
 - Winter and Summer single hour view to verify the utility can meet its highest expected load hour in a given year
- Sustained Peak Demand
 - Winter and summer multi-day event (3 day x 6 hour) view to verify the utility can meet its highest expected load hour in a given year
- Energy
 - On an annual basis the utility has enough energy to meet load plus contingencies (e.g., load and hydro variability)
- Operating Reserves
 - System capacity “reserved” to meet unanticipated generation outages; 5% of wind and hydro, and 7% of thermal, plants
 - Regulation to cover moment-to-moment load and generation variability
- Loss of Load Probability (LOLP)
 - Number of modeling exercises where system resources are inadequate to meet needs; 1-in-20 (5%) is deemed adequate

Historical Avista Planning Margin Targets

- 1979: 6% (single hour, hydro only); 15 to 20% with thermal units
- Somewhere in between 1979 and 1986: 13.4% to 18.7%
- 1986 to 2007: 10% + 90 MW (single hour peak)
- 2009: 15%
- 2011: Move to an 18-hour sustained peak per NPCC
 - Winter: 14% + Operating Reserves
 - Summer: 15% + Operating Reserves
 - Equivalent to NPCC 23/24% planning criteria for the Northwest

Adequacy Assessment for the 2017 Pacific Northwest Power Supply



Steering Committee Meeting
October 26, 2012
Portland, Oregon

NW Adequacy Standard

- **Metric:** Loss-of-load probability (LOLP)
- **Threshold:** Maximum of 5 percent
- LOLP is the probability that extraordinary actions would have to be taken in a future year to avoid curtailment of electricity service
- Calculated assuming existing resources only and expected efficiency savings



Major Assumptions

- Existing resources (sited and licensed)
- 6th Power Plan conservation
- Market supplies
 - NW: 3,450 MW winter, 1,000 MW summer
 - SW on-peak: 1,700 MW winter, none summer
 - SW off-peak: 3,000 MW year round
- **Council's medium load forecast**



Major Uncertainties

- Explicitly modeled
 - Water supply
 - Temperature load variation
 - Wind
 - Forced outages
- Not modeled explicitly
 - Economic load growth
 - Uncertainty in SW market



2017 Assessment

- The expected LOLP is 6.6%
- January, February and August most critical months
- **Interpretation:** Relying only on existing resources and expected efficiency savings yields a power supply in 2017 whose likelihood of curtailment exceeds our agreed upon threshold



Actions to Alleviate Inadequacy

- 350 MW of new generating resource capacity drops the expected LOLP to 5%
- Equivalently, 300 average megawatts of additional energy efficiency does the same
- Demand response measures could help
- This is consistent with utility plans and the **Council's resource** strategy



2017 Monthly LOLP

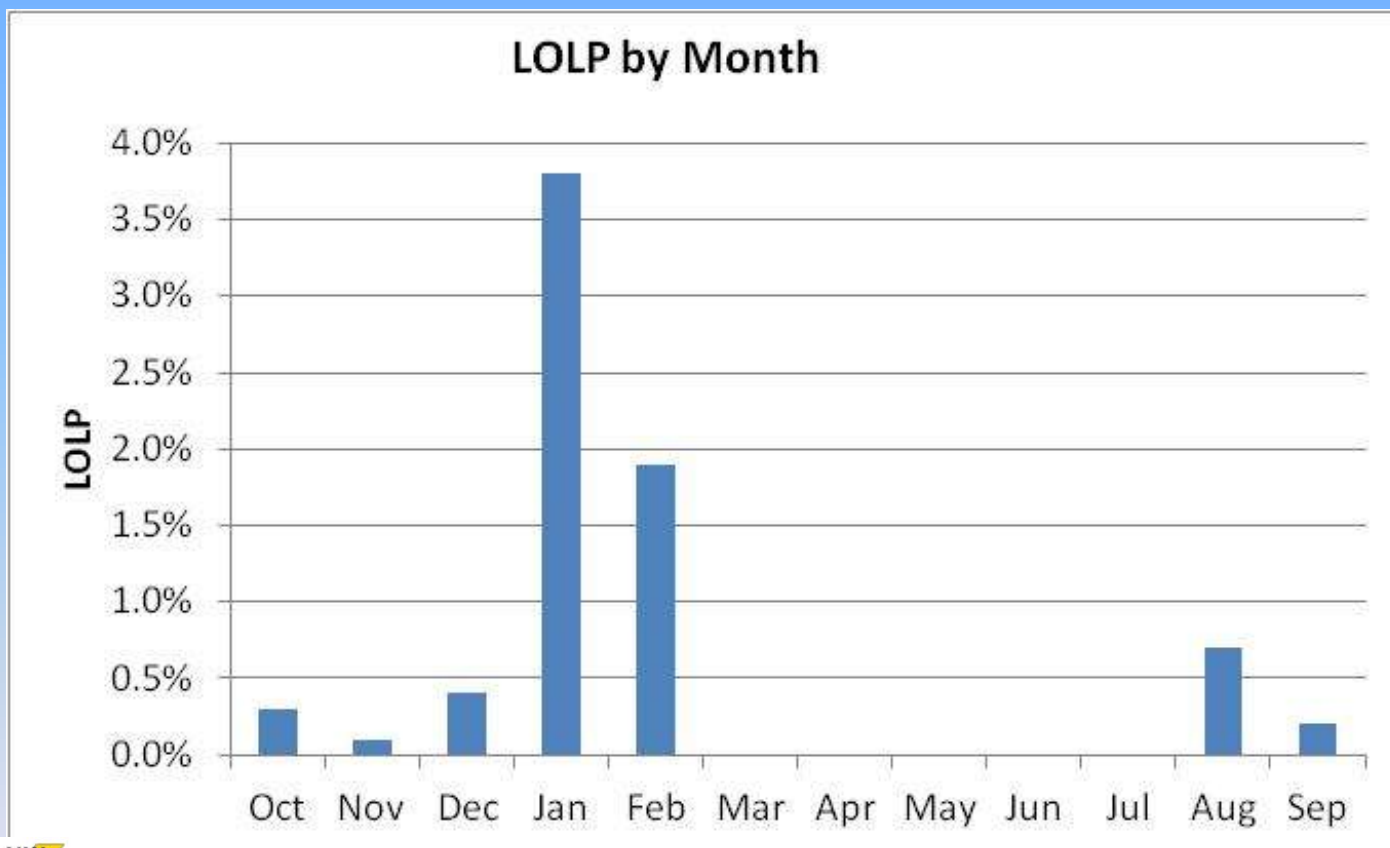

Effects of Uncertainties

Load	SW Winter Market	LOLP
Low	High	2.8%
Low	None	8.4%
High	High	7.8%
High	None	16.8%
Expected	Expected	6.6%

Illustration of LOLP Probability

Likelihood of load deviation and market combinations and associated LOLP

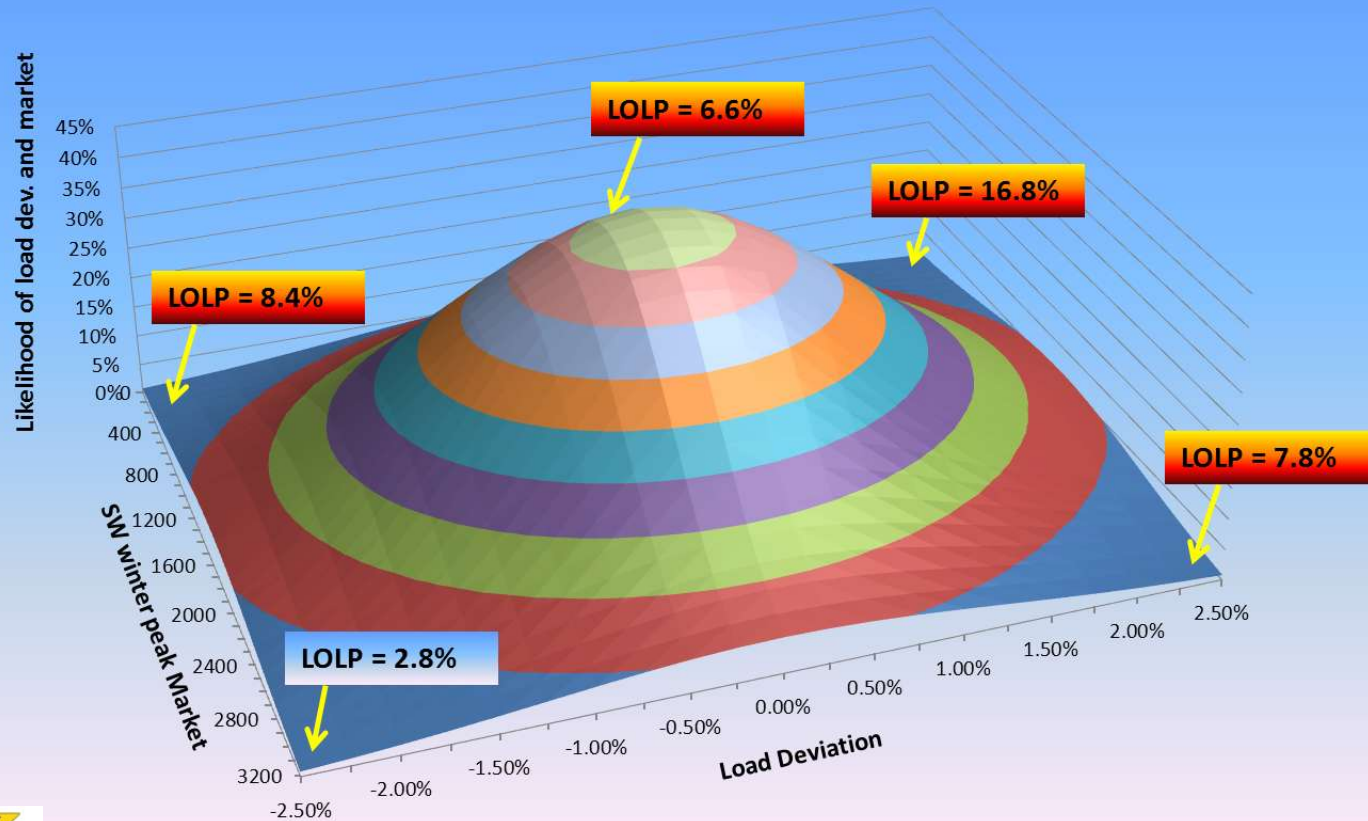

Effects of Adding Resources

- 350 MW of new resource moved the reference case LOLP of 6.6% down to 5.0%
- 2,850 MW of new resource moved a high LOLP of 13.3% down to 5.0%
- Sum of utility planned* resources exceeds 3,000 MW



*In this context “planned” means request for proposals or RFPs.

Variation in LOLP due to Load and Market

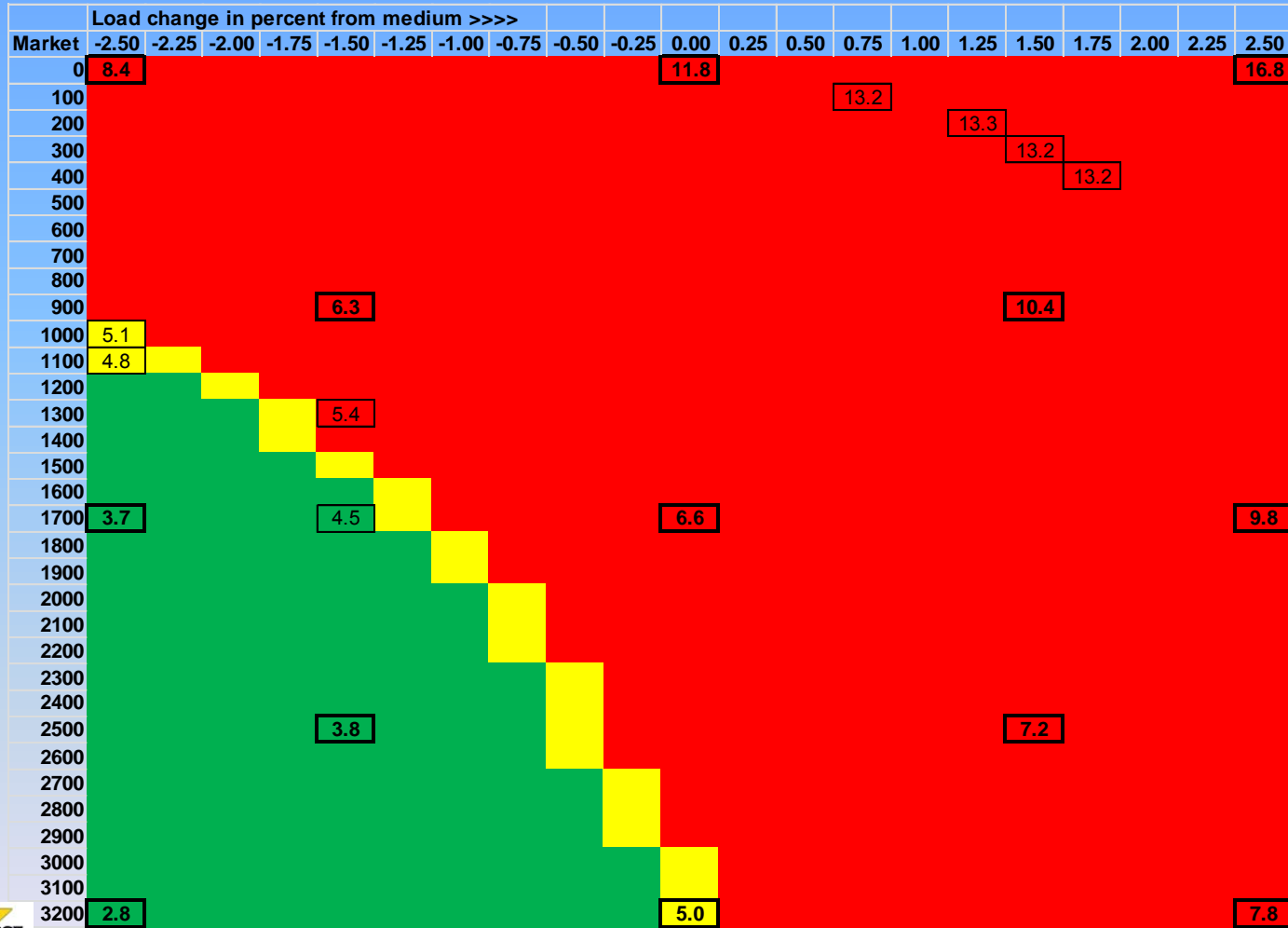

Thermal derate schedules

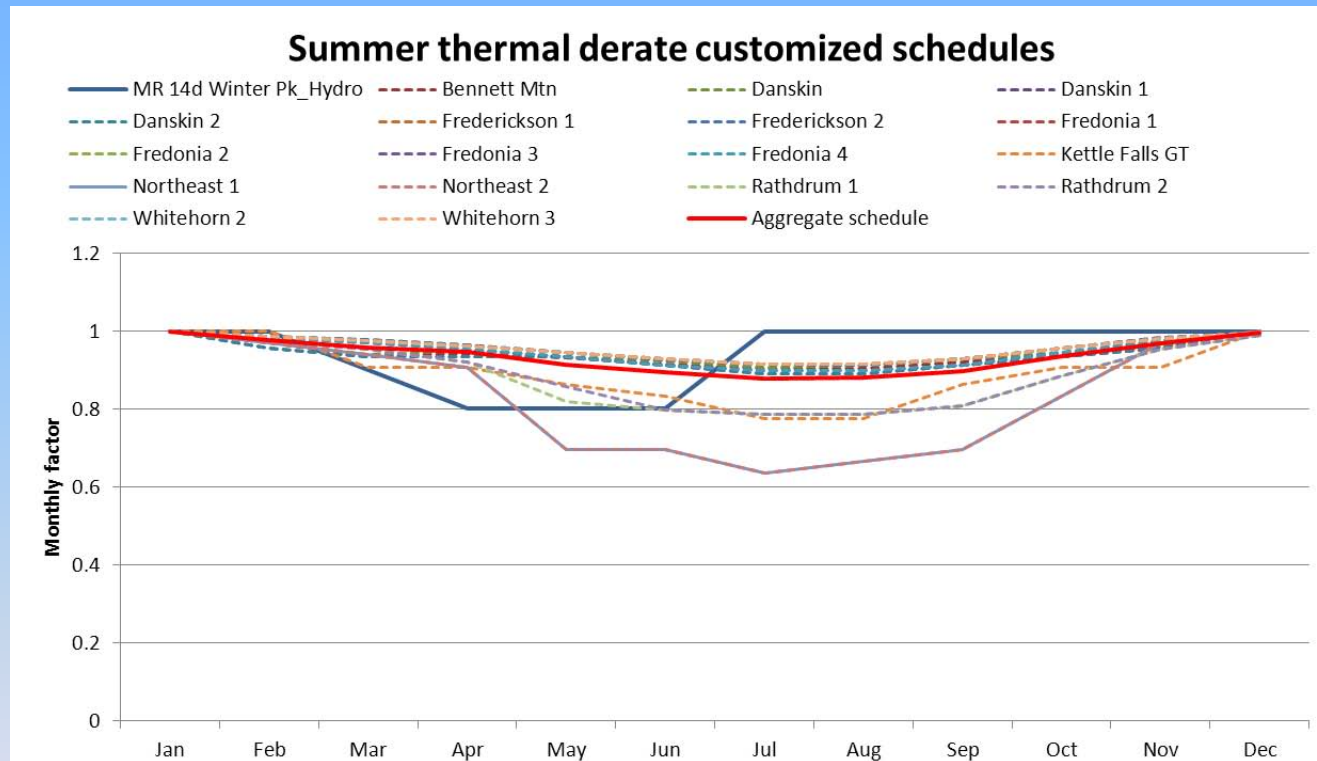

Thermal derate schedules

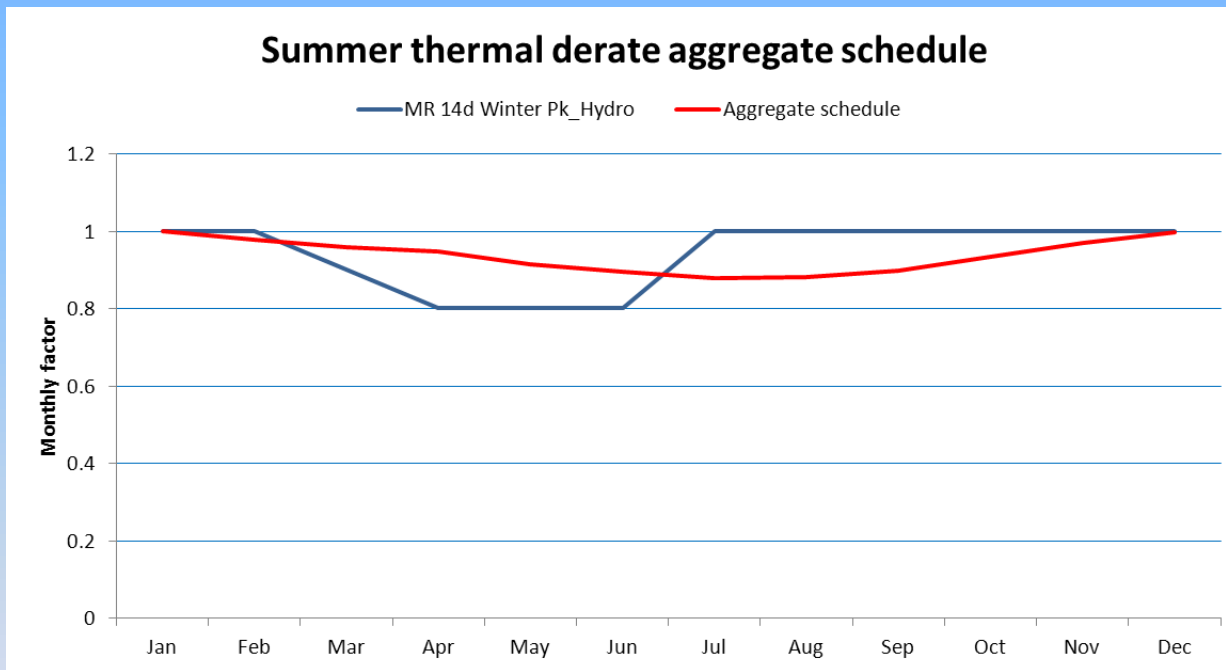

How much CT gets you to 5%

- Add a CT resource that will bring study cases with >5.0% LOLP down to 5.0%

Study Summary				LOLP Pk	LOLP E	LOLP A	EUSR	CVaRE	CVaRPk	EUE	LOLH
Study Case	Load Dev.	Mkt.	Add CT	(%)	(%)	(%)	(%)	(MWh)	(MW)	(MWh)	(Hr/sYr)
Reference Case	0.00%	1700	350	5.0	1.5	5.0	7.3	76466	3410	3851	2.1
High Load, High Market	2.50%	3200	750	5.0	0.9	5.0	7.9	43510	2913	2197	1.4
High Load, Low Market	2.50%	0	4800	5.0	0.8	5.0	6.2	43007	2645	2162	1.4
Low Load, High Market	-2.50%	3200	NA								
Low Load, Low Market	-2.50%	0	1155	5.0	1.5	5.0	6.5	76118	2593	3829	2.4
Med-High Load, Med-High Mkt	1.50%	2500	525	5.0	1.1	5.0	8.0	58041	3165	2923	1.7
Med-High Load, Med-Low Mkt	1.50%	900	1950	5.0	1.3	5.0	6.8	61092	2866	3071	1.9
Med-Low Load, Med-High Mkt	-1.50%	2500	NA								
Med-Low Load, Med-Low Mkt	-1.50%	900	450	5.0	1.5	5.0	6.7	80421	3184	4033	2.3
Reference Load, High Market	0.00%	3200	NA								
Reference Load, Low Market	0.00%	0	2750	5.0	0.8	5.0	6.3	53995	2443	2717	1.9
High Load, Reference Market	2.50%	1700	1200	5.0	1.5	5.0	7.7	75020	3400	3778	2.1
Low Load, Reference Market	-2.50%	1700	NA								
High Case within likely region	1.25%	200	2850	5.0	1.0	5.0	6.6	56369	2587	2836	1.9

Regional Position (2016/17- Peak Hour)

	2016	2016	2016	2017	2017	2017	2017	2017	2017	2017	2017	2017
	10	11	12	1	2	3	4	5	6	7	8	9
	Oct	Nov	Dec	Jan	Feb	Mar	Apr	May	Jun	Jul	Aug	Sep
1-Hr Peak												
Avg Load	24,458	28,593	31,838	33,143	29,949	27,929	25,454	23,596	25,078	26,773	26,151	23,589
Hydro	25,059	25,857	26,675	27,944	26,400	25,773	25,388	25,852	27,271	26,394	25,232	25,198
Hydro Ind.	299	299	299	299	299	299	299	299	299	299	299	299
Total Non-Hydro	25,358	26,155	26,974	28,242	26,699	26,072	25,687	26,151	27,569	26,692	25,531	25,497
Small Renewables	109	109	109	109	109	109	109	109	109	109	109	109
Nuclear	1,130	1,130	1,130	1,130	1,130	1,130	1,130	1,130	1,130	1,130	1,130	1,130
Coal	4,708	4,708	4,708	4,708	4,708	4,708	4,708	4,708	4,708	4,708	4,708	4,708
CCCT	4,868	4,961	5,151	5,151	5,054	4,961	4,868	4,775	4,678	4,678	4,678	4,775
Peakers	1,751	1,784	1,853	1,853	1,817	1,784	1,751	1,717	1,682	1,682	1,682	1,717
Total Non-Hydro	12,566	12,692	12,951	12,951	12,819	12,692	12,566	12,440	12,307	12,307	12,307	12,440
Total Generation	37,924	38,848	39,925	41,194	39,518	38,764	38,253	38,591	39,877	39,000	37,838	37,937
Physical Position	13,466	10,255	8,087	8,050	9,568	10,836	12,799	14,995	14,798	12,227	11,687	14,348
Implied Planning Margin	55%	36%	25%	24%	32%	39%	50%	64%	59%	46%	45%	61%
IPP Generation	3,200	3,240	3,324	3,324	3,281	3,240	3,200	3,159	3,116	3,116	3,116	3,159
Physical Position w/ IPP	16,666	13,495	11,410	11,374	12,849	14,076	15,999	18,154	17,915	15,343	14,804	17,507
W/ IPP Implied Plannin Margin	68%	47%	36%	34%	43%	50%	63%	77%	71%	57%	57%	74%

Data provided by Northwest Power & Conservation Council



Regional Position (2016/17- 10 Hour Peak)

	2016	2016	2016	2017	2017	2017	2017	2017	2017	2017	2017	2017
	10	11	12	1	2	3	4	5	6	7	8	9
	Oct	Nov	Dec	Jan	Feb	Mar	Apr	May	Jun	Jul	Aug	Sep
10-Hr Peak												
Avg Load	22,991	26,878	29,928	31,155	28,152	26,253	23,926	22,181	23,574	25,166	24,582	22,174
Hydro West	3,107	3,656	2,862	2,711	2,597	3,443	3,548	3,736	3,640	3,282	3,366	3,160
Hydro East	21,090	21,564	19,414	16,178	15,722	17,375	19,708	21,239	20,835	19,884	20,723	19,824
Hydro Ind.	299	299	299	299	299	299	299	299	299	299	299	299
Total Hydro	24,496	25,518	22,574	19,188	18,617	21,117	23,554	25,273	24,774	23,464	24,387	23,283
Small Renewables	109	109	109	109	109	109	109	109	109	109	109	109
Nuclear	1,130	1,130	1,130	1,130	1,130	1,130	1,130	1,130	1,130	1,130	1,130	1,130
Coal	4,708	4,708	4,708	4,708	4,708	4,708	4,708	4,708	4,708	4,708	4,708	4,708
CCCT	4,868	4,961	5,151	5,151	5,054	4,961	4,868	4,775	4,678	4,678	4,678	4,775
Peakers	1,751	1,784	1,853	2,203	1,817	1,784	1,751	1,717	1,682	1,682	1,682	1,717
Total Non-Hydro	12,566	12,692	12,951	13,301	12,819	12,692	12,566	12,440	12,307	12,307	12,307	12,440
Total Generation	37,062	38,211	35,525	32,489	31,436	33,809	36,121	37,713	37,081	35,771	36,695	35,723
Physical Position	14,072	11,333	5,598	1,334	3,283	7,556	12,194	15,533	13,507	10,605	12,113	13,549
Implied Planning Margin	61%	42%	19%	4%	12%	29%	51%	70%	57%	42%	49%	61%
IPP Generation	3,200	3,240	3,324	3,324	3,281	3,240	3,200	3,159	3,116	3,116	3,116	3,159
Physical Position w/ IPP	17,271	14,573	8,921	4,658	6,564	10,796	15,394	18,692	16,624	13,721	15,229	16,708
W/ IPP Implied Plannin Margin	75%	54%	30%	15%	23%	41%	64%	84%	71%	55%	62%	75%

Data provided by Northwest Power & Conservation Council



Translating the Regional Position to Avista

- NPCC indicates region will be short capacity in the 2016/7 winter timeframe
 - With region in surplus, utility can rely on market in peak conditions
 - Changes in load growth or out-of-region transfers can change adequacy results
- Summer adequacy is strong for the region
 - With regional summer length- dual peaking utilities can rely on system for summer peaks
 - Future build-outs for winter peaks likely will ensure adequate regional summer capacity

Resource allocation to get Avista to 5% LOLP goal

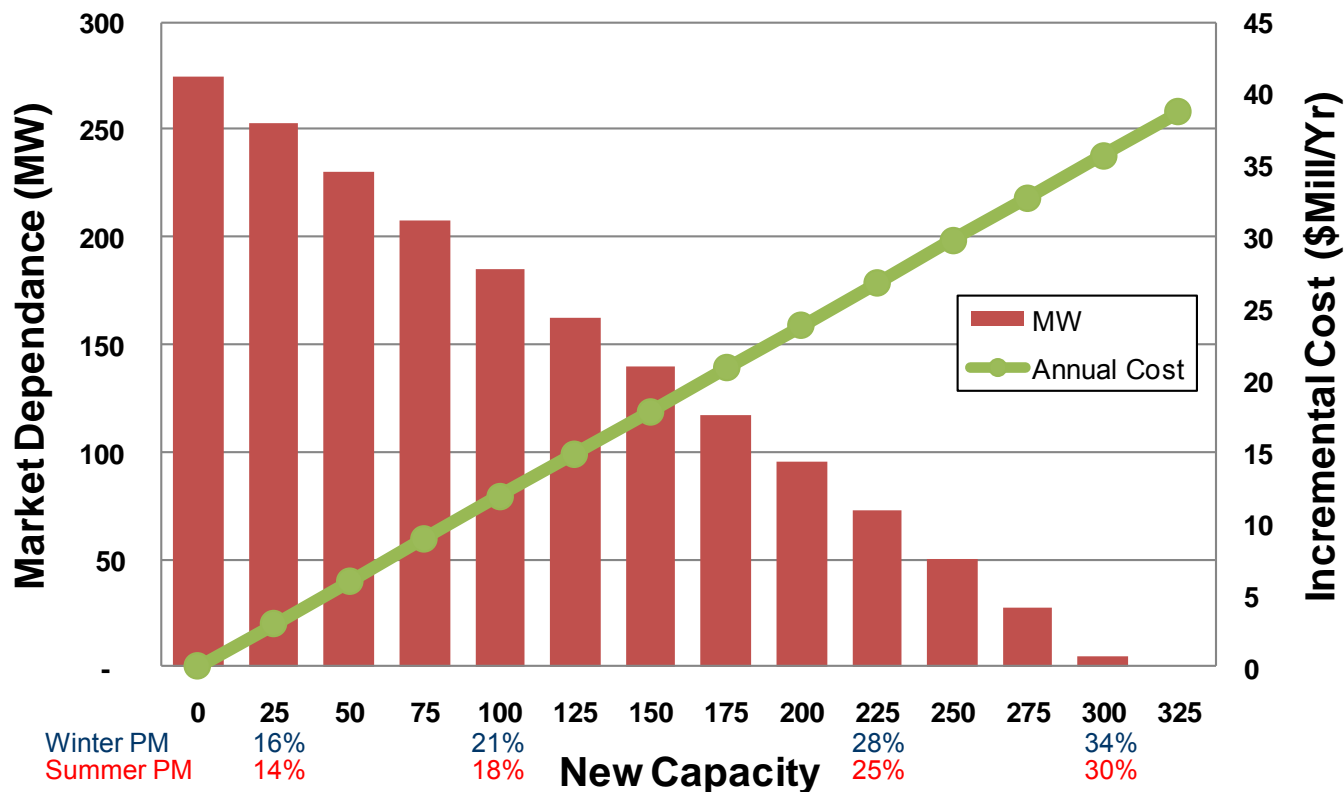

Avista's Peak Planning Criteria

- Winter Peak
 - 14% planning margin above load, plus operating reserves
 - If Avista is deficit prior to 2016/17, and where the NW market has been shown adequately surplus, market purchases will meet deficit needs
- Summer Peak
 - Avista operating reserves are the planning requirement, unless region's "natural" deficit shifts to summer
 - If utility is deficit, market purchases will meet deficit needs
 - However, as with the region, building to meet winter peak generally addresses our summer need
- Both sustained- and single-hour peak positions are considered
- Wind and solar provide no winter peaking capability



January: 18 Hour Peak Position Forecast

	2014	2015	2016	2017	2018	2019	2020	2021	2022	2023	2024	2025	2026	2027	2028	2029	2030	2031	2032	2033	
REQUIREMENTS																					
1 Native Load	-1,596	-1,613	-1,629	-1,643	-1,656	-1,669	-1,683	-1,696	-1,710	-1,724	-1,738	-1,752	-1,766	-1,780	-1,794	-1,809	-1,824	-1,838	-1,853	-1,868	
2 Firm Power Sales	-211	-158	-158	-8	-8	-6	-6	-6	-6	-6	-6	-6	-6	-6	-6	-6	-6	-6	-6	-6	
3 Total Requirements	-1,807	-1,771	-1,787	-1,650	-1,663	-1,675	-1,689	-1,702	-1,716	-1,730	-1,744	-1,758	-1,772	-1,786	-1,801	-1,815	-1,830	-1,844	-1,859	-1,874	
RESOURCES																					
4 Firm Power Purchases	117	117	117	117	117	116	34	34	33	33	33	33	33	33	33	33	33	33	33	33	
5 Hydro Resources	973	866	867	932	932	896	900	896	896	904	896	896	904	896	896	904	896	896	904	896	
6 Base Load Thermals	895	895	895	895	895	895	895	895	895	895	895	895	895	617	617	617	617	617	617	617	
7 Wind Resources	0	0	0	0	0	0	0	0	0	0	0	0	0	0	0	0	0	0	0	0	
8 Peaking Units	242	242	242	242	242	242	242	242	242	242	242	242	242	242	242	242	242	242	242	242	
9 Total Resources	2,227	2,121	2,122	2,187	2,186	2,149	2,071	2,068	2,067	2,074	2,067	2,067	2,074	1,788	1,788	1,796	1,788	1,788	1,796	1,788	
10 PEAK POSITION	421	350	334	536	523	473	383	365	351	345	323	309	303	2	-13	-19	-42	-57	-64	-86	
RESERVE PLANNING																					
11 Planning Margin	-223	-226	-228	-230	-232	-234	-236	-237	-239	-241	-243	-245	-247	-249	-251	-253	-255	-257	-259	-262	
12 Total Ancillary Services Required	-186	-184	-185	-177	-179	-180	-186	-187	-189	-191	-192	-193	-194	-195	-196	-197	-197	-198	-199	-199	
13 Reserve & Contingency Availability	25	9	9	17	17	16	16	16	16	16	16	16	16	16	16	16	16	16	16	16	
14 Demand Response	0	0	0	0	0	0	0	0	0	0	0	0	0	0	0	0	0	0	0	0	
15 Total Reserve Planning	-385	-401	-405	-390	-394	-398	-405	-409	-412	-416	-419	-422	-425	-428	-431	-434	-436	-439	-442	-444	
16 Peak Position w/ Contingency	36	-51	-70	146	129	76	-22	-43	-61	-71	-96	-113	-123	-426	-443	-453	-478	-495	-506	-531	
17 Implied Planning Margin	25%	20%	19%	33%	32%	29%	24%	22%	21%	21%	19%	18%	18%	1%	0%	0%	-1%	-2%	-3%	-4%	
18 NPCC Market Adjustment	0	51	70	0	0	0	0	0	0	0	0	0	0	0	0	0	0	0	0	0	
19 Peak Position Net Market	36	0	0	146	129	76	(22)	(43)	(61)	(71)	(96)	(113)	(123)	(426)	(443)	(453)	(478)	(495)	(506)	(531)	

18 Hour to 1 Hour Comparison

	2014	2015	2016	2017	2018	2019	2020	2021	2022	2023	2024	2025	2026	2027	2028	2029	2030	2031	2032	2033
Winter 1 Hour	17	0	0	126	110	56	(42)	(64)	(81)	(92)	(117)	(135)	(145)	(445)	(462)	(472)	(497)	(515)	(525)	(551)
Winter 18 Hour	36	0	0	146	129	76	(22)	(43)	(61)	(71)	(96)	(113)	(123)	(426)	(443)	(453)	(478)	(495)	(506)	(531)
Delta	19	0	0	19	19	20	20	20	20	21	21	22	22	18	19	19	19	19	20	20



August: 18 Hour Peak Position Forecast

	2014	2015	2016	2017	2018	2019	2020	2021	2022	2023	2024	2025	2026	2027	2028	2029	2030	2031	2032	2033	
REQUIREMENTS																					
1 Native Load	-1,465	-1,482	-1,498	-1,510	-1,523	-1,536	-1,550	-1,563	-1,576	-1,590	-1,604	-1,618	-1,631	-1,646	-1,660	-1,674	-1,689	-1,703	-1,718	-1,733	
2 Firm Power Sales	-212	-159	-159	-9	-9	-8	-8	-7	-7	-7	-7	-7	-7	-7	-7	-7	-7	-7	-7	-7	
3 Total Requirements	-1,677	-1,641	-1,657	-1,519	-1,532	-1,544	-1,557	-1,570	-1,584	-1,597	-1,611	-1,625	-1,639	-1,653	-1,667	-1,681	-1,696	-1,710	-1,725	-1,740	
RESOURCES																					
4 Firm Power Purchases	29	29	29	29	29	26	26	26	26	25	25	25	25	25	25	25	25	25	25	25	
5 Hydro Resources	701	707	663	631	638	583	580	622	624	622	622	624	622	622	624	622	622	624	622	622	
6 Base Load Thermals	785	785	785	785	785	785	785	785	785	785	785	785	785	556	556	556	556	556	556	556	
7 Wind Resources	0	0	0	0	0	0	0	0	0	0	0	0	0	0	0	0	0	0	0	0	
8 Peaking Units	176	176	176	176	176	176	176	176	176	176	176	176	176	176	176	176	176	176	176	176	
9 Total Resources	1,691	1,698	1,653	1,621	1,628	1,571	1,568	1,609	1,611	1,609	1,609	1,611	1,609	1,379	1,381	1,379	1,379	1,381	1,379	1,379	
10 PEAK POSITION	14	57	-3	102	96	27	11	39	27	11	-2	-14	-30	-274	-286	-302	-317	-330	-346	-361	
RESERVE PLANNING																					
11 Planning Margin	0	0	0	0	0	0	0	0	0	0	0	0	0	0	0	0	0	0	0	0	
12 Total Ancillary Services Required	-177	-176	-177	-170	-172	-173	-175	-176	-177	-179	-180	-181	-182	-166	-167	-167	-168	-169	-169	-170	
13 Reserve & Contingency Availability	177	176	177	170	172	173	175	176	177	179	180	181	182	166	167	167	168	169	169	170	
14 Demand Response	0	0	0	0	0	0	0	0	0	0	0	0	0	0	0	0	0	0	0	0	
15 Total Reserve Planning	0	0	0	0	0	0	0	0	0	0	0	0	0	0	0	0	0	0	0	0	
16 Peak Position w/ Contingency	14	57	-3	102	96	27	11	39	27	11	-2	-14	-30	-274	-286	-302	-317	-330	-346	-361	
17 Implied Planning Margin	11%	14%	10%	18%	17%	13%	12%	14%	13%	12%	11%	10%	9%	-7%	-7%	-8%	-9%	-9%	-10%	-11%	
18 NPCC Market Adjustment	0	0	3	0	0	0	0	0	0	0	0	0	0	0	0	0	0	0	0	0	
19 Peak Position Net Market	14	57	0	102	96	27	11	39	27	11	(2)	(14)	(30)	(274)	(286)	(302)	(317)	(330)	(346)	(361)	

18 Hour to 1 Hour Comparison

	2014	2015	2016	2017	2018	2019	2020	2021	2022	2023	2024	2025	2026	2027	2028	2029	2030	2031	2032	2033
Summer 1 Hour	114	159	85	193	185	113	95	125	112	94	79	65	48	(191)	(204)	(221)	(236)	(249)	(267)	(282)
Summer 18 Hour	14	57	0	102	96	27	11	39	27	11	(2)	(14)	(30)	(274)	(286)	(302)	(317)	(330)	(346)	(361)
Delta	(100)	(102)	(85)	(91)	(89)	(86)	(84)	(87)	(85)	(83)	(81)	(80)	(78)	(83)	(83)	(82)	(81)	(80)	(79)	(79)





Market and Portfolio Scenario Development

John Lyons, Senior Resource Policy Analyst

Fourth Technical Advisory Committee Meeting

2013 Electric Integrated Resource Plan

February 6, 2013

Scenarios in the 2013 IRP

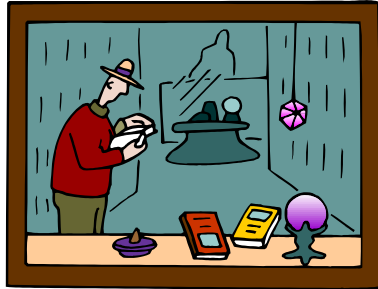

Scenarios provide details about potential impacts of different critical planning assumptions that could have a major impact on resource choices, such as technological, regulatory or environmental changes.

Scenarios will be developed for:

- Avista's current load and resource portfolio
- Preferred Resource Strategy (PRS)
- Wholesale electric market
- Different resource options



2013 IRP Scenario Types

1. Deterministic Market Scenarios: use expected input levels (natural gas prices, hydro, loads, wind, and thermal outages)
2. Stochastic Market Scenarios: use a Monte Carlo analysis
3. Portfolio Scenarios: show alternative portfolios to highlight the cost differences from the PRS

Deterministic Market Scenarios

Deterministic scenarios test the PRS across several fundamentally different futures:

- Low and High Natural Gas Prices
- Carbon Pricing
- No Coal Retirements
- High Storage Technology Penetration
- Increasing RPS

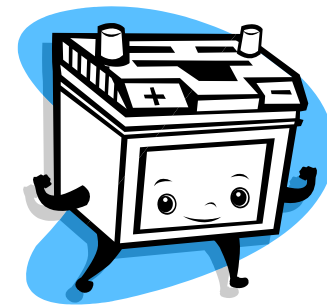

Stochastic Market Scenarios

- Expected Case: assumes average levels of hydro, loads, gas prices, wind, emissions prices and forced outages
- Carbon Pricing Scenario: various pricing trajectories similar to the 2011 IRP expected case



Portfolio Scenarios

- Market reliance only
- CO₂ credit allocations
- 2011 PRS
- Increased Washington RPS – 25% by 2025
- National renewable energy standard – 20% with and without hydro netting
- Alternative Planning Margins
- CT and CCCT tipping points
- Solar cost tipping point
- Nuclear cost tipping point
- Coal sequestration cost tipping point



Colstrip Scenarios

- 2017 Retirement Date
- 2022 Retirement Date
- Incremental Pollution Controls
- Carbon Sequestration
- Railed Coal



Avista's 2013 Electric Integrated Resource Plan
Technical Advisory Committee Meeting No. 5 Agenda
Wednesday, March 20, 2013
Conference Room 428

Topic	Time	Staff
1. Introduction	9:00	
2. Market Forecast Scenario Results and Conservation Avoided Costs	9:05	Gall
3. Conservation Results	9:30	Borstein
4. Break	11:00	
5. Demand Response	11:15	Doege
6. Lunch	12:00	
7. 2013 IRP Preferred Resource Strategy	1:00	Gall
8. Break	2:00	
9. Portfolio Scenarios	2:15	Gall
10. Adjourn	3:00	



Electric Price Forecast Scenario Analysis

James Gall

Fifth Technical Advisory Committee Meeting

2013 Electric Integrated Resource Plan

March 20, 2013

Scenario Planning

This IRP reviews two types of market scenarios to help understand how market forces can impact Avista's resource strategy

1. Deterministic studies- point forecast of future major assumptions
2. Stochastic studies- Monte-Carlo style analysis using 500 iterations for major assumptions

Expected Case Refresher

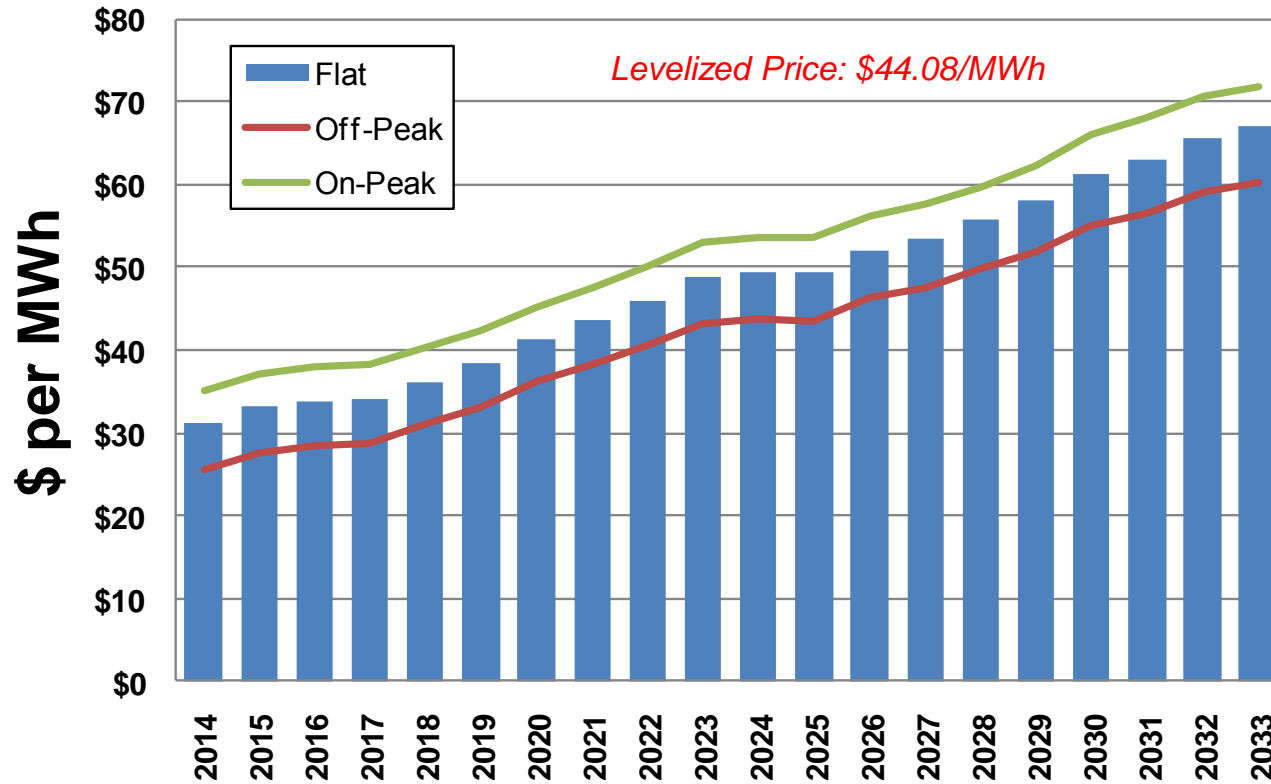

stochastic case

Greenhouse Gas Pricing Scenario

- Developed to understand the ramifications of national greenhouse gas reduction legislation to Avista's resource strategy
- This scenario uses 500 iterations with different potential CO₂ pricing schemes using a cap-and-trade market mechanism
- Five weighted potential pricing structures were developed to create a wide range of potential futures (2014 \$)
 - Expected Case- \$0/ton (33.3%)
 - 2020 High- \$30/ton (16.7%), 2025 High- \$40/ton (16.7%)
 - 2020 Low- \$10/ton (16.7%), 2025 Low- \$15/ton (16.7%)

Greenhouse Gas Pricing Scenario Price Assumptions

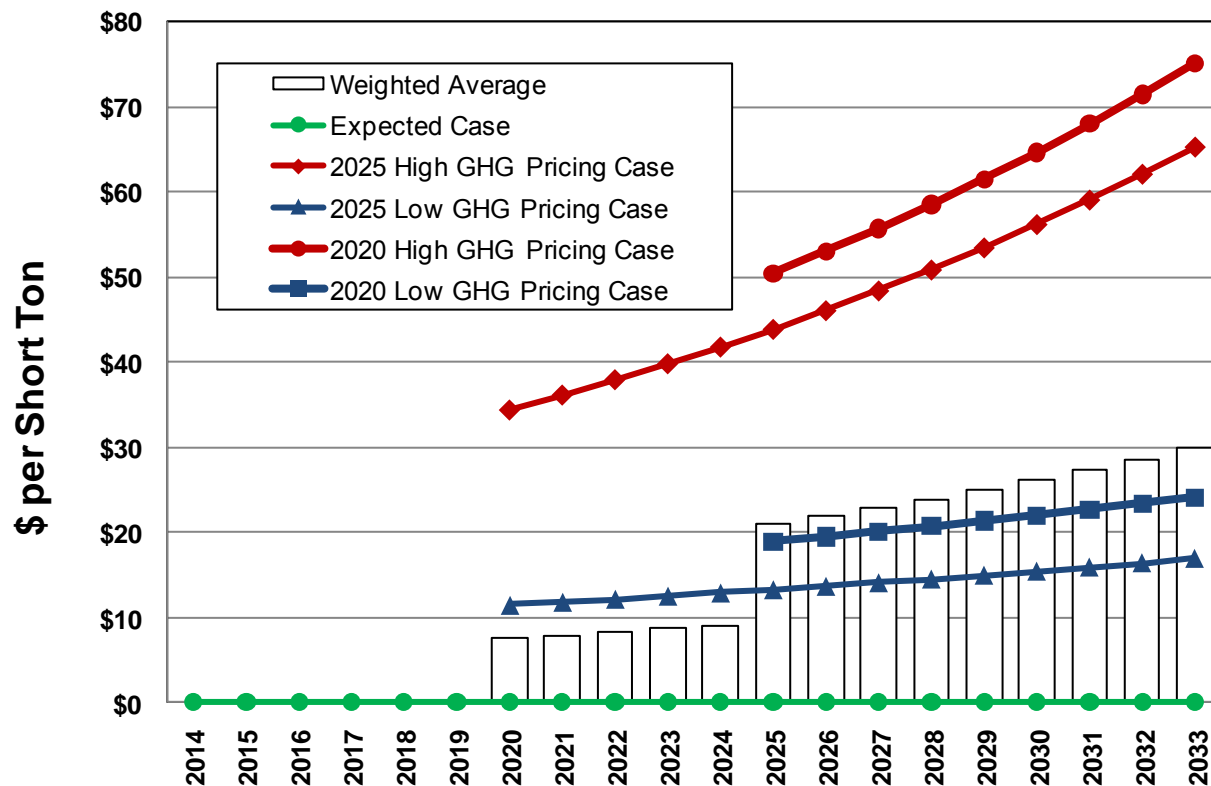

Greenhouse Gas Scenario Market Prices

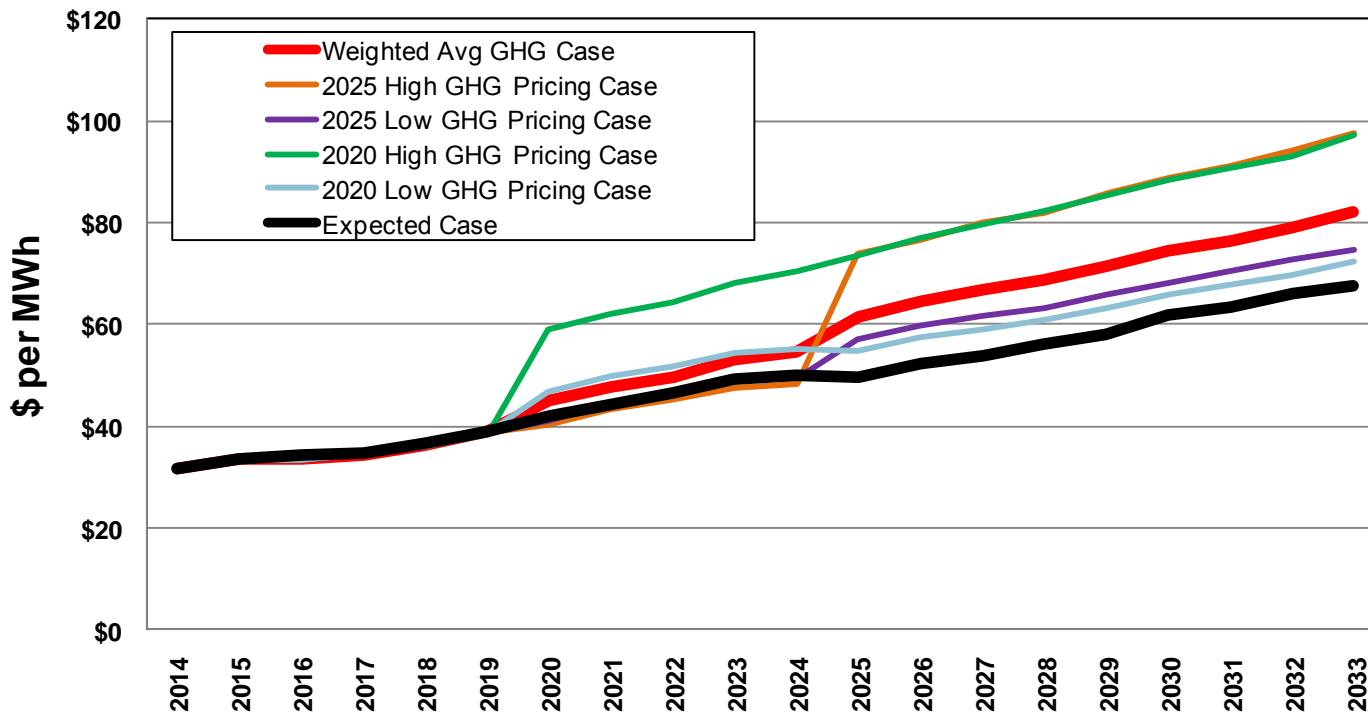

deterministic case

20-Year Levelized Greenhouse Gas Scenario Prices

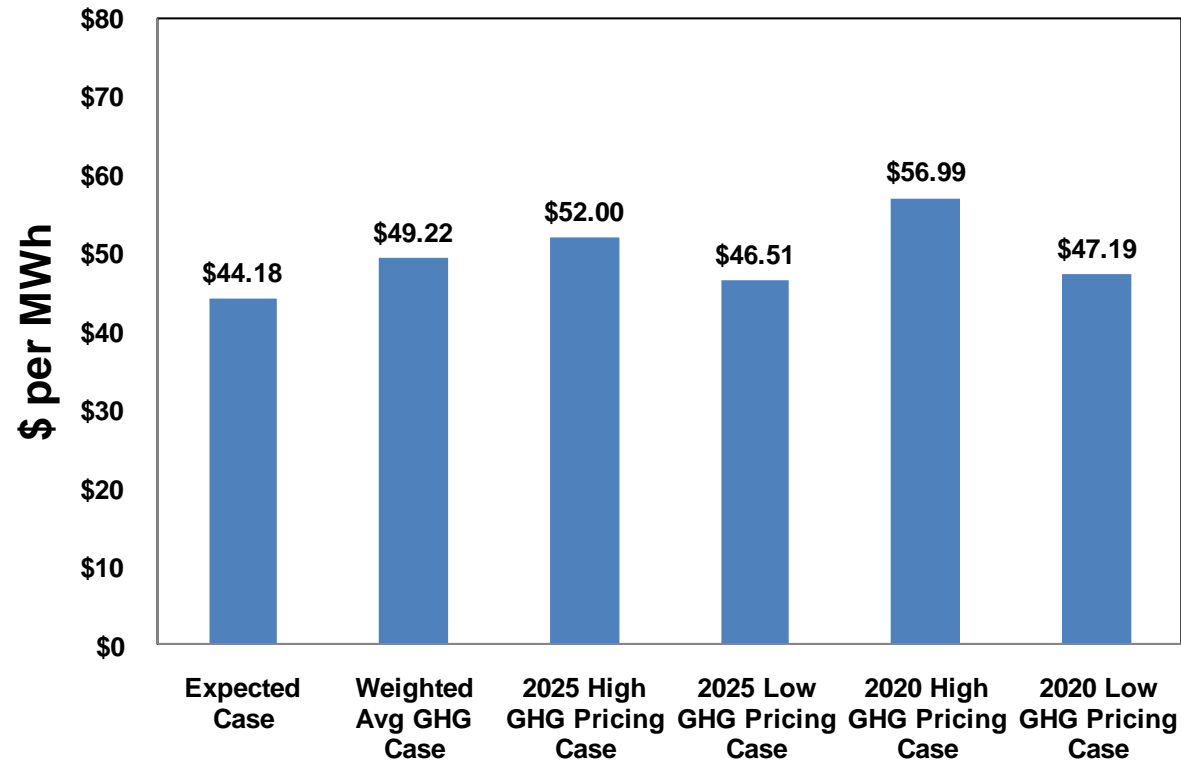

deterministic case

The Real Increase to Electric Market Prices

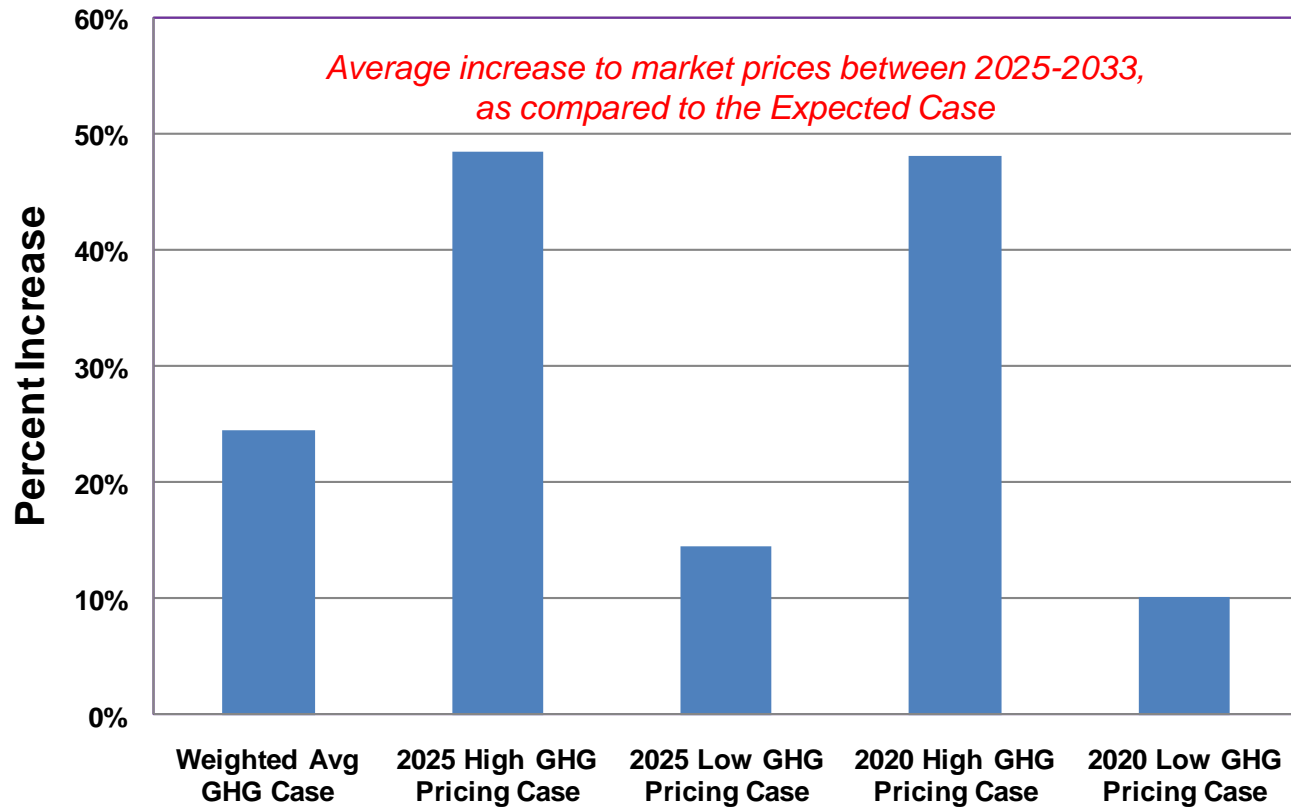

Greenhouse Gas Scenario Reductions

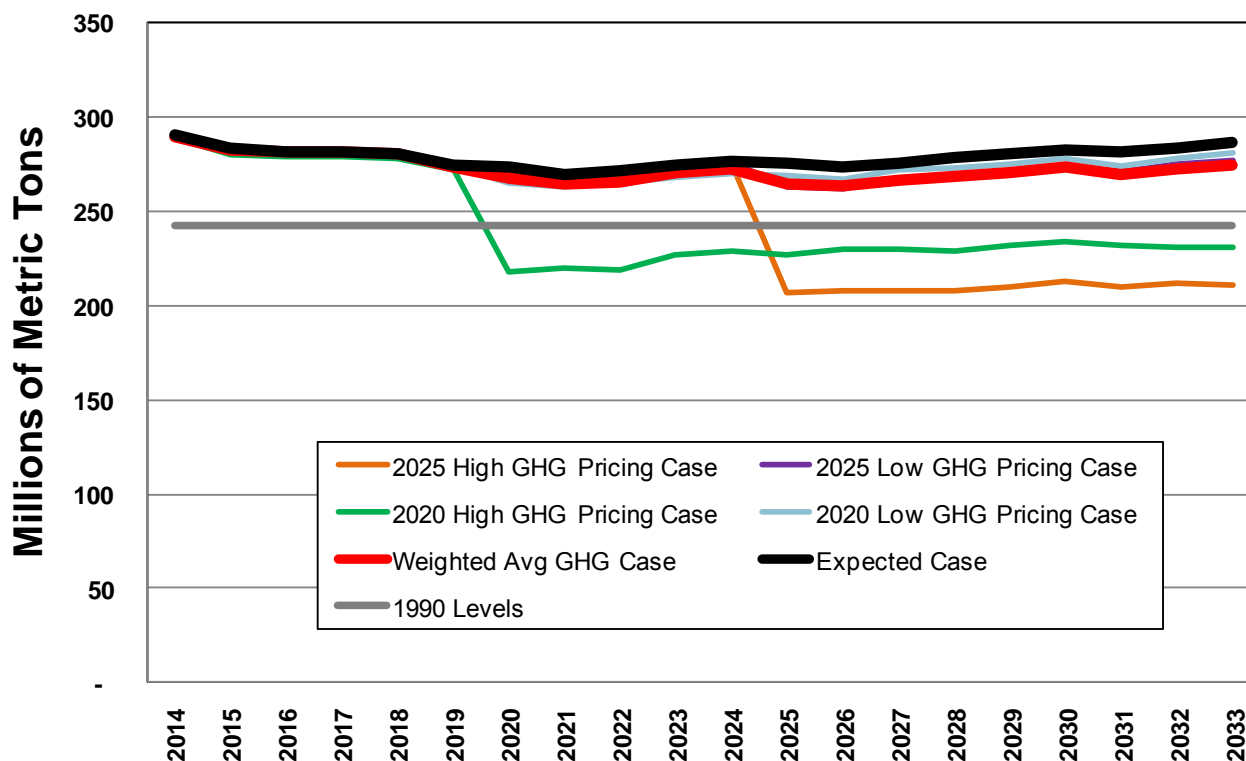

deterministic case

No Coal Plant Retirement Scenario

- Retains 12,000 MW of coal generation for the duration of the forecast

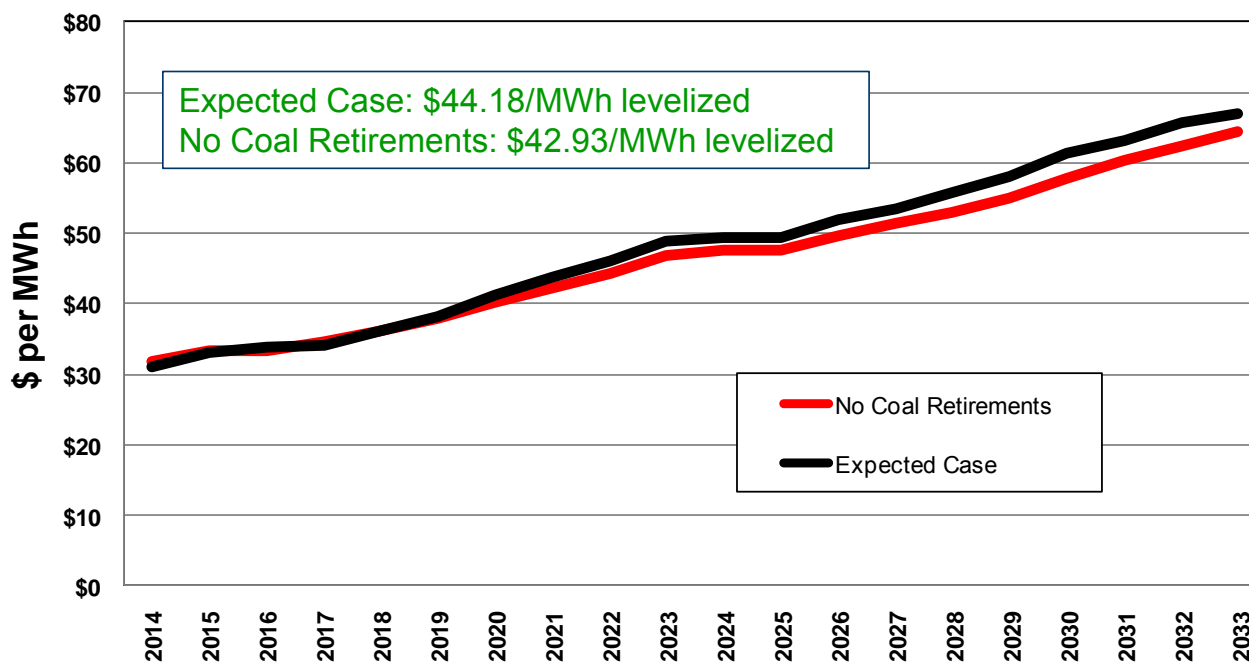

deterministic case

Greenhouse Gas Emissions Increase Without Coal Retirements

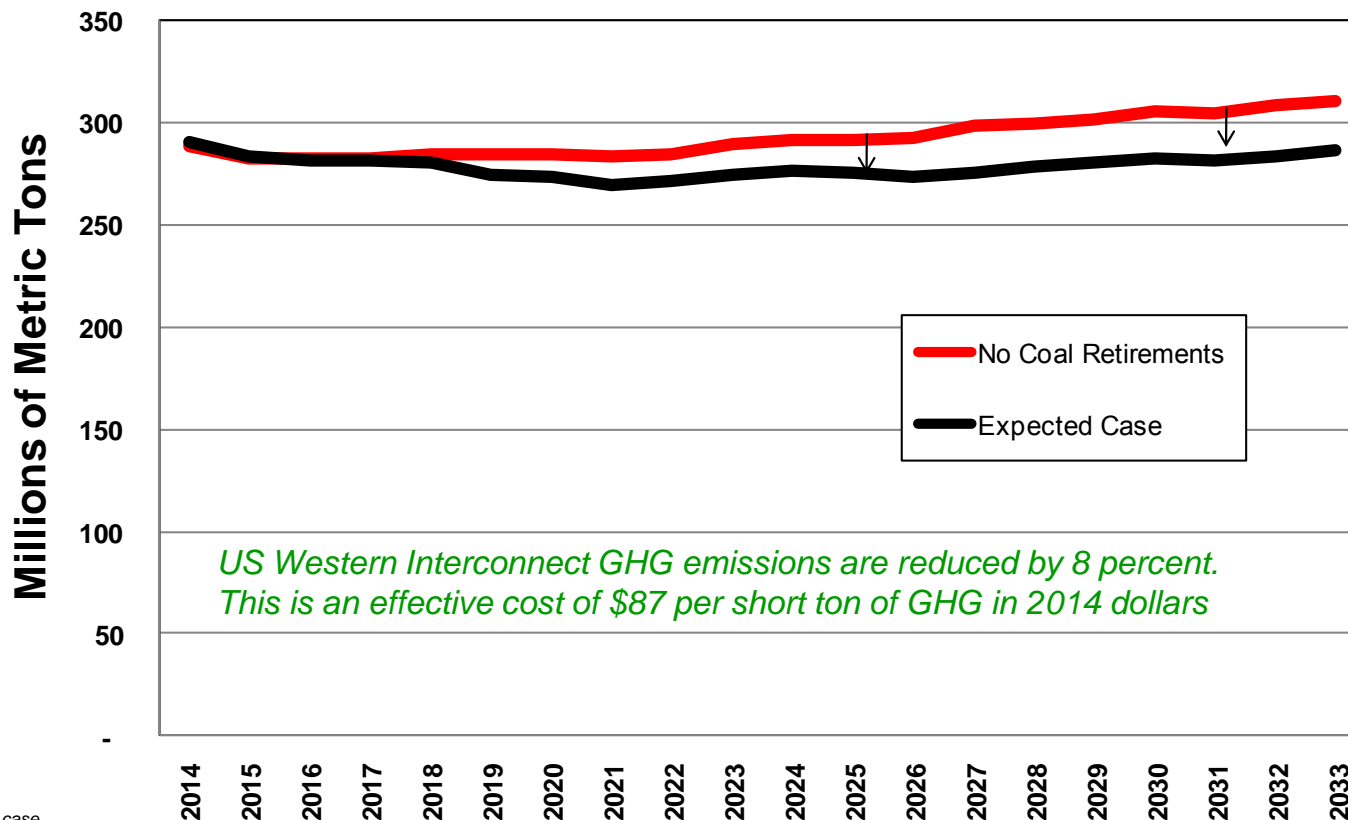

deterministic case

State RPS's Increased Scenario

-Assumes in beginning in 2025, states with lower RPS begin new higher standards

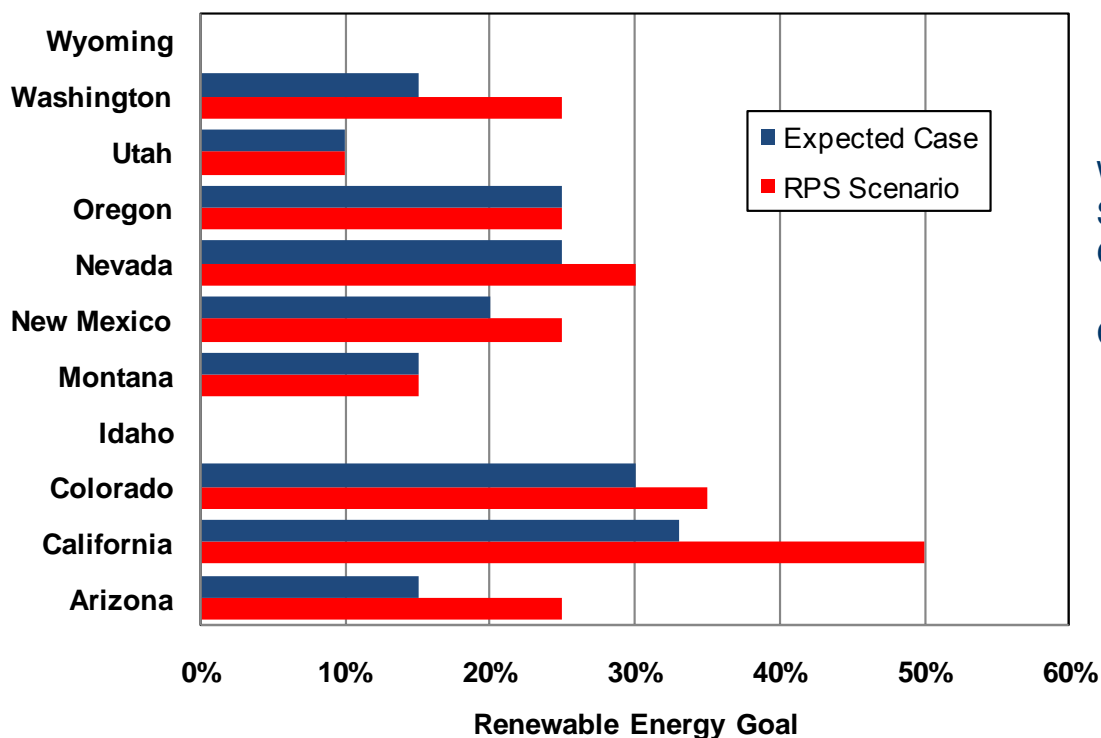

Adds
 Wind: 7,000 MW
 Solar: 29,000 MW
 Other: 1,000 MW

Cost: \$80 billion (2012\$)

Changes to Market Prices and GHG Emissions

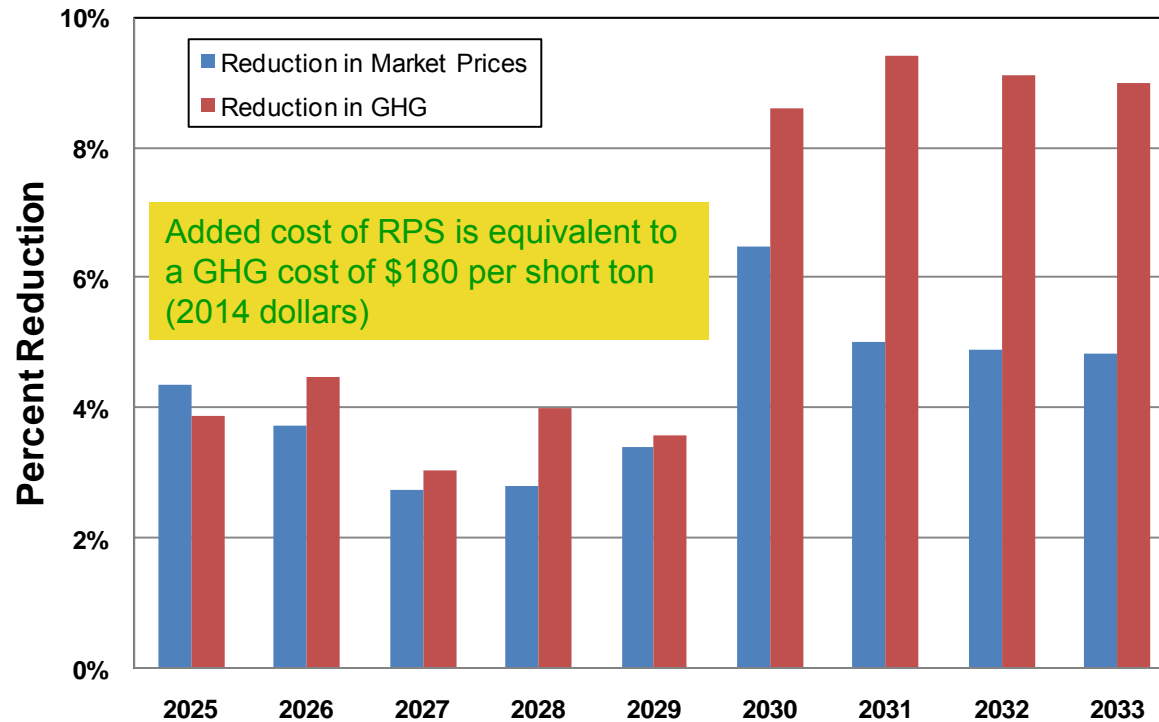



Conservation Avoided Costs

James Gall

Fifth Technical Advisory Committee Meeting

2013 Electric Integrated Resource Plan

March 20, 2013

How to Value Conservation

$$\{(E + PC + R) * (1 + P)\} * (1 + L) + DC * (1 + L)$$

Where:

E = market energy price (calculated by Aurora, including forecasted CO₂ mitigation)

PC = new resource capacity savings (calculated by PRiSM)

R = Risk premium to account for RPS and rate volatility reduction (calculated by PRiSM)

P = Power Act preference premium (10% assumption)

DC = distribution capacity savings (~\$10/kW-year based on Heritage Project calculation)

L = transmission and distribution losses (6.1% assumption based on Avista's system average losses)

Efficient Frontier Approach

Assumes no additional Conservation Resources

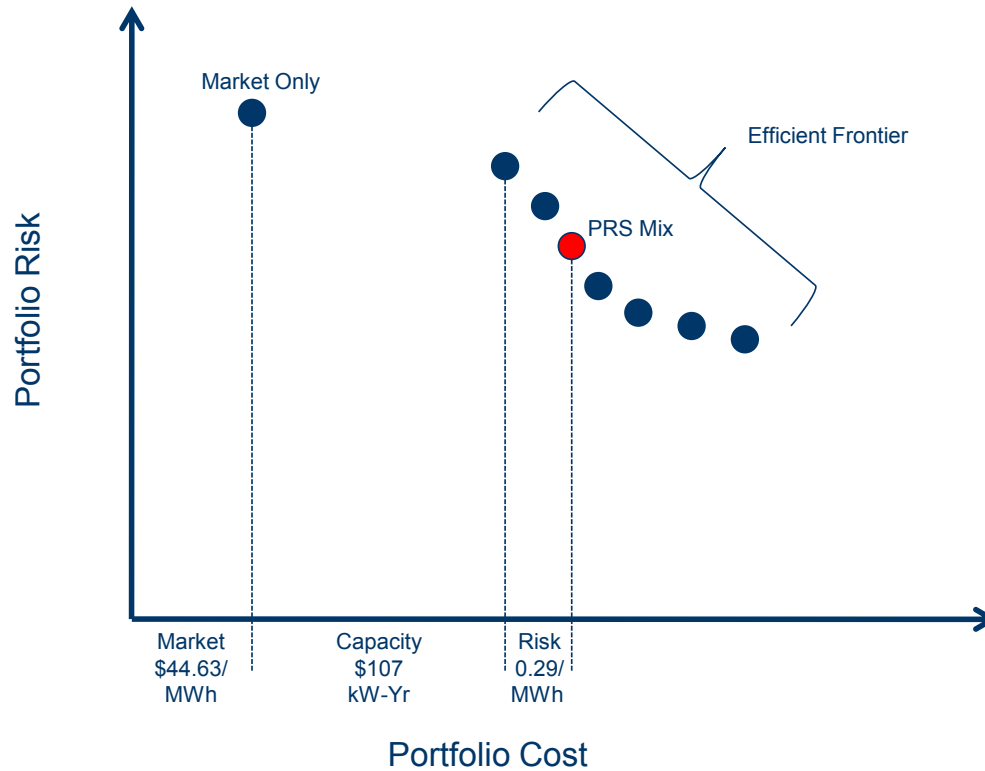

Avoided Cost Calculation

For 1 MW Measure with Flat Delivery

Item	\$/MWh
Energy Price	44.63
Capacity Savings	13.33
Risk Premium	0.29
Subtotal	58.26

← Converts \$107/kW-yr to \$/MWh

Avoided Cost:
\$68.05
 per
 MWh

2011 IRP was \$104.39/MWh

Item	\$/MWh
10% Preference	6.19
Distribution Capacity Savings	0.88
T&D losses	2.72
Subtotal	9.79

Analysis based on earlier draft of Market Prices



Avista Conservation Potential
Assessment – 2013 Update
Overview of Approach and Analysis Results

March 20, 2013



Agenda

- Introductions
- Study objectives
- Analysis approach
- Summary of results
- Consistency with NWPCC Methodology

Introductions

EnerNOC Team

Ingrid Rohmund

Practice Lead,
Energy Analysis
and Planning

Jan Borstein

Project Manager

Various analysts

EnerNOC Utility Solutions Consulting

- Previously Global Energy Partners, and before that a part of EPRI
- Practice areas:
 - Energy Analysis & Planning
 - Program Evaluation and Load Analysis
 - Engineering Services
- 30 full-time consultants
 - Economists/statisticians
 - Engineers

EnerNOC experience with potential studies

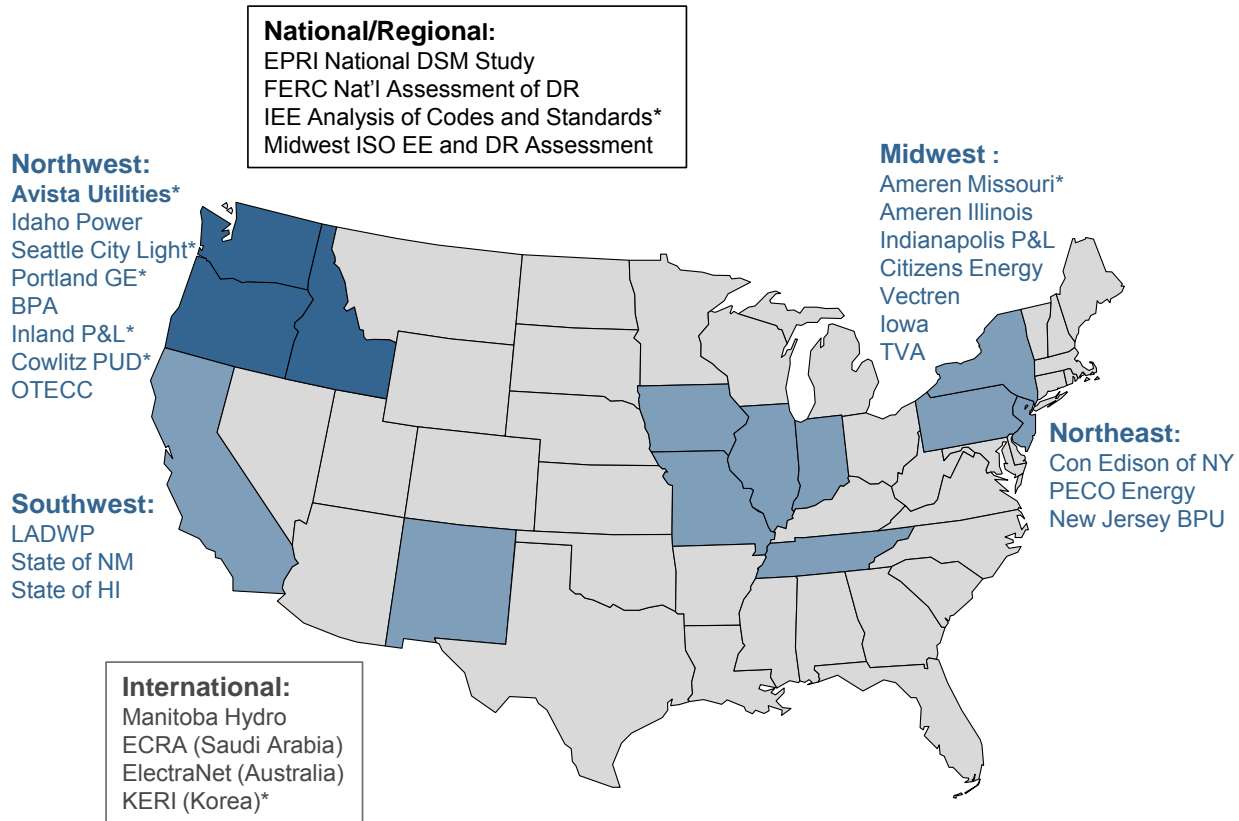

Study objectives

- Study continues Avista's process of updating estimates of conservation potential on a regular basis
- Specific objectives:
 - Provide credible and transparent estimates of conservation potential
 - Assess savings by measure or bundled measure and sector
 - Support Avista's IRP development
 - Establish 2014-2015 biennial target per requirements of Washington I-937



Analysis Approach

Study approach

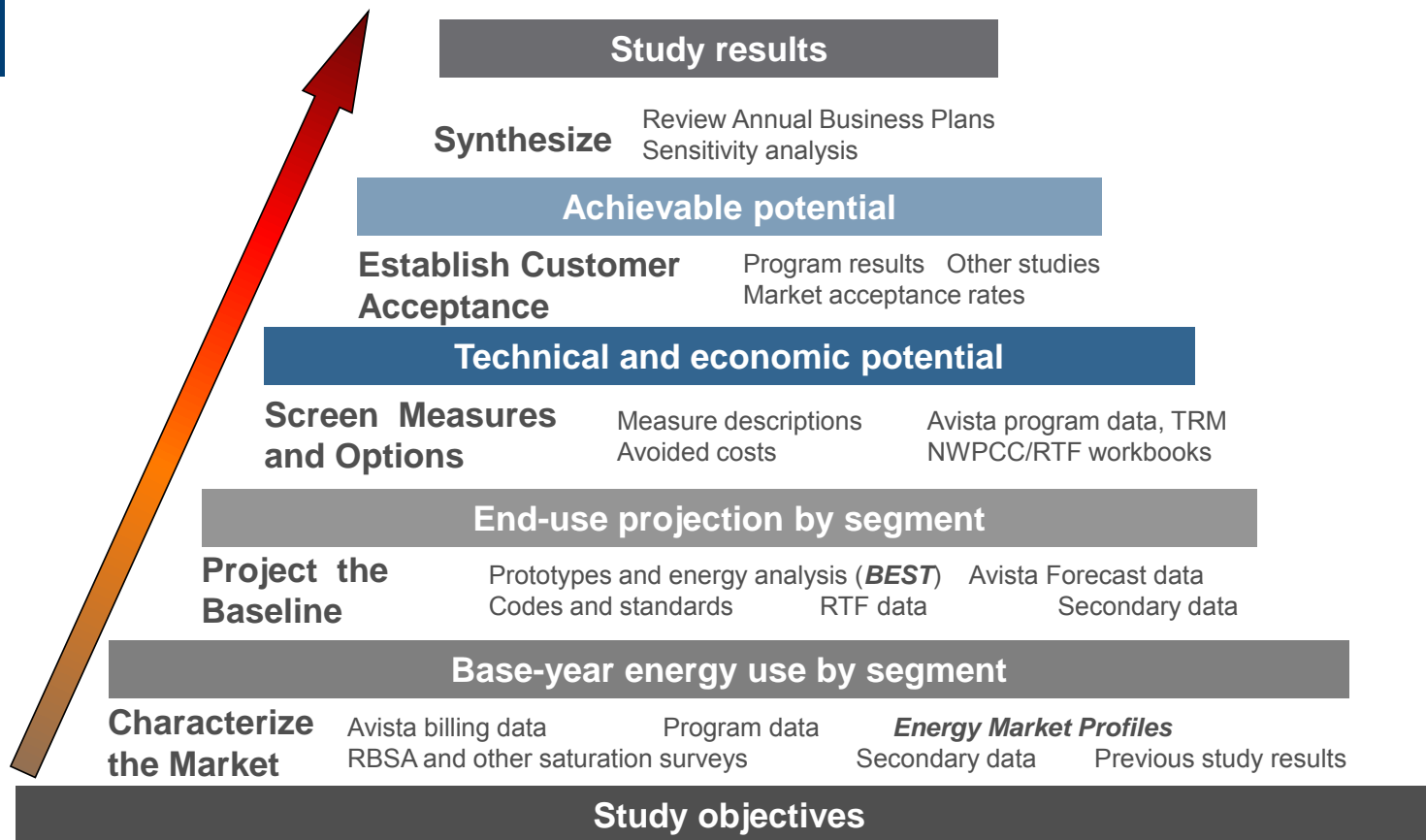

Market segmentation by rate class, 2009

Sector	Rate Schedule(s)	Number of meters (customers)	2009 Electricity sales (MWh)
Residential	001	299,714	3,634,086
General Service	011, 012	46,387	738,505
Large General Service	021, 022	4,808	2,256,882
Extra Large GS – Comm.	025	12	336,047
Extra Large GS – Ind*		19	809,298
Pumping	031, 032	3,673	194,884
Total		354,613	7,969,701

* Idaho 25P was included in previous CPA but for the 2013 study it has been analyzed separately from other large industrial customers.

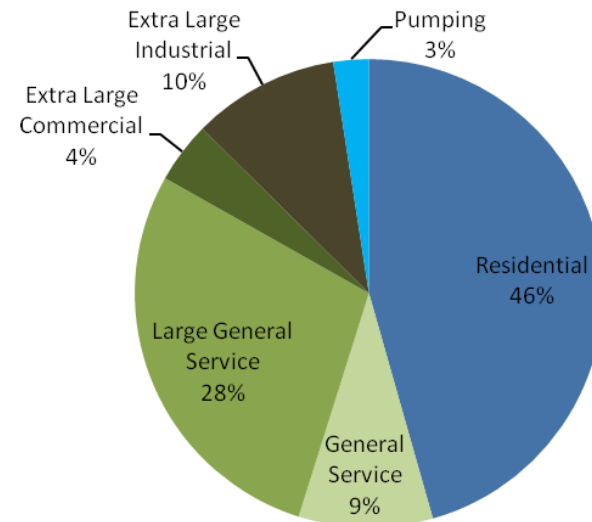

Residential market characterization, 2009

Segment	Annual Use (1000 MWh)	Number of Customers	Intensity (kWh/HH)	% of Total Usage
Single Family	2,399	168,339	14,250	66%
Multi Family	202	23,456	8,613	6%
Mobile Home	128	10,022	12,724	4%
Limited Income	906	97,896	9,251	25%
Total	3,634	299,714	12,125	100%

- Market segmentation developed using U.S. Census American Community Survey data
- Limited Income is defined as customers with annual income approximately two times the poverty level

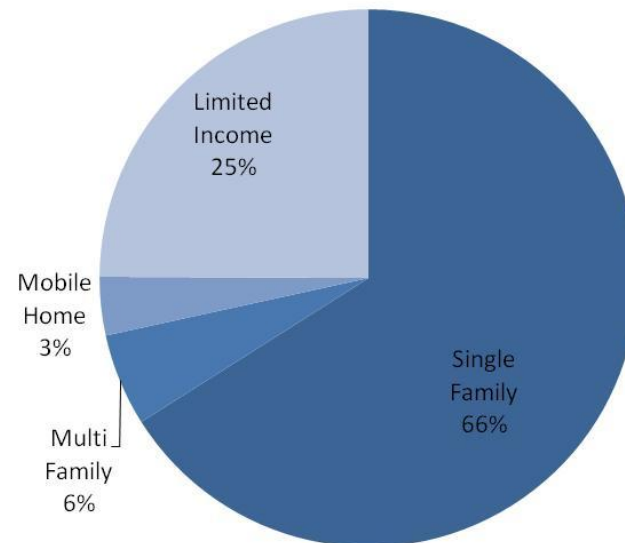

Residential market profile, 2009

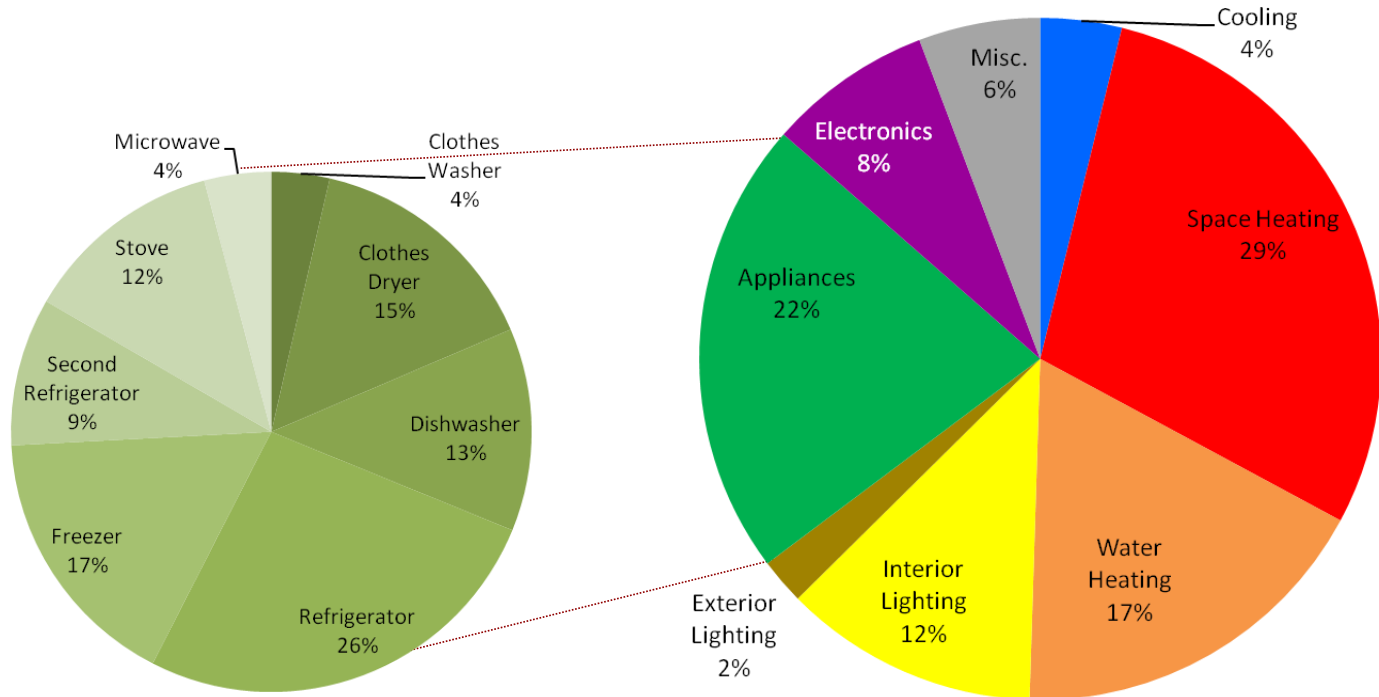

Baseline projection

- Model equipment choices for replacement or new construction
- Define baseline purchase shares —begin with Annual Energy Outlook shipments data and modify for Avista data and program history
- Incorporates building codes and appliance standards currently enacted
- In some cases, this eliminates potential future savings, as higher efficiency option becomes the baseline, least efficient option

Today's Efficiency or Standard Assumption
 1st Standard (relative to today's standard)
 2nd Standard (relative to today's standard)

End Use	Technology	2011	2012	2013	2014	2015	2016	2017	2018	2019	2020	2021	2022	2023	2024	2025
Cooling	Central AC	SEER 13				SEER 14										
	Room AC	EER 9.8			EER 11.0											
Cooling/Heating	Heat Pump	SEER 13.0/HSPF 7.7				SEER 14.0/HSPF 8.0										
Water Heating	Water Heater (<=55)	EF 0.90				EF 0.95										
	Water Heater (>55 gallons)	EF 0.90				Heat Pump Water Heater										
Lighting	Screw-in/Pin Lamps	Incandescent			Advanced Incandescent - tier 1					Advanced Incandescent - tier 2						
	Linear Fluorescent	T8														
Appliances	Refrigerator/2nd	NAECA Standard			25% more efficient											
	Freezer	NAECA Standard			25% more efficient											
	Dishwasher	Conventional (355			14% more efficient (307 kWh/yr)											
	Clothes Washer	Conventional (MEF 1.26 for top loader)				MEF 1.72 for top loader			MEF 2.0 for top loader							
	Clothes Dryer	Conventional (EF 3.01)				5% more efficient (EF 3.17)										

Baseline projection

- Drivers
 - Market size / customer growth
 - Income growth
 - Avista retail rates forecast
 - Trends in end-use/technology saturations
 - Equipment purchase decisions
 - Cooling and heating degree days
 - Persons/household and physical home size
 - Elasticities by end use for each forecast driver
- Calibrated model to align with 2010-2012 sales and conservation program history
 - Began with Sixth Power Plan measure ramp rates and adjusted to program achievements
 - Baseline projection aligns with sales + program achievements



The baseline projection (absent future conservation)

- The metric against which savings are measured. It includes:
 - Current saturations of appliances, equipment, and legacy measures
 - Assumptions about customer and economic growth
 - Trends in fuel shares and appliance/equipment saturations
 - Exogenous variables including electricity prices, income, etc.

Sample Residential Projection
(Use per Household)

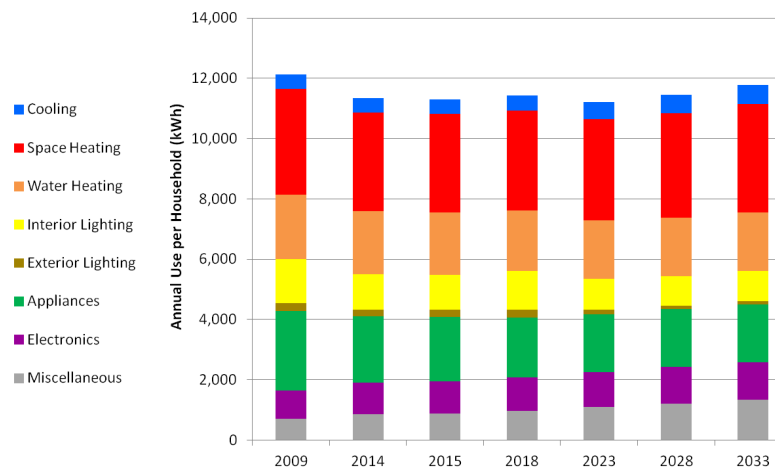

Develop three levels of potential

Potential studies identify future opportunities for EE that can be achieved through programs

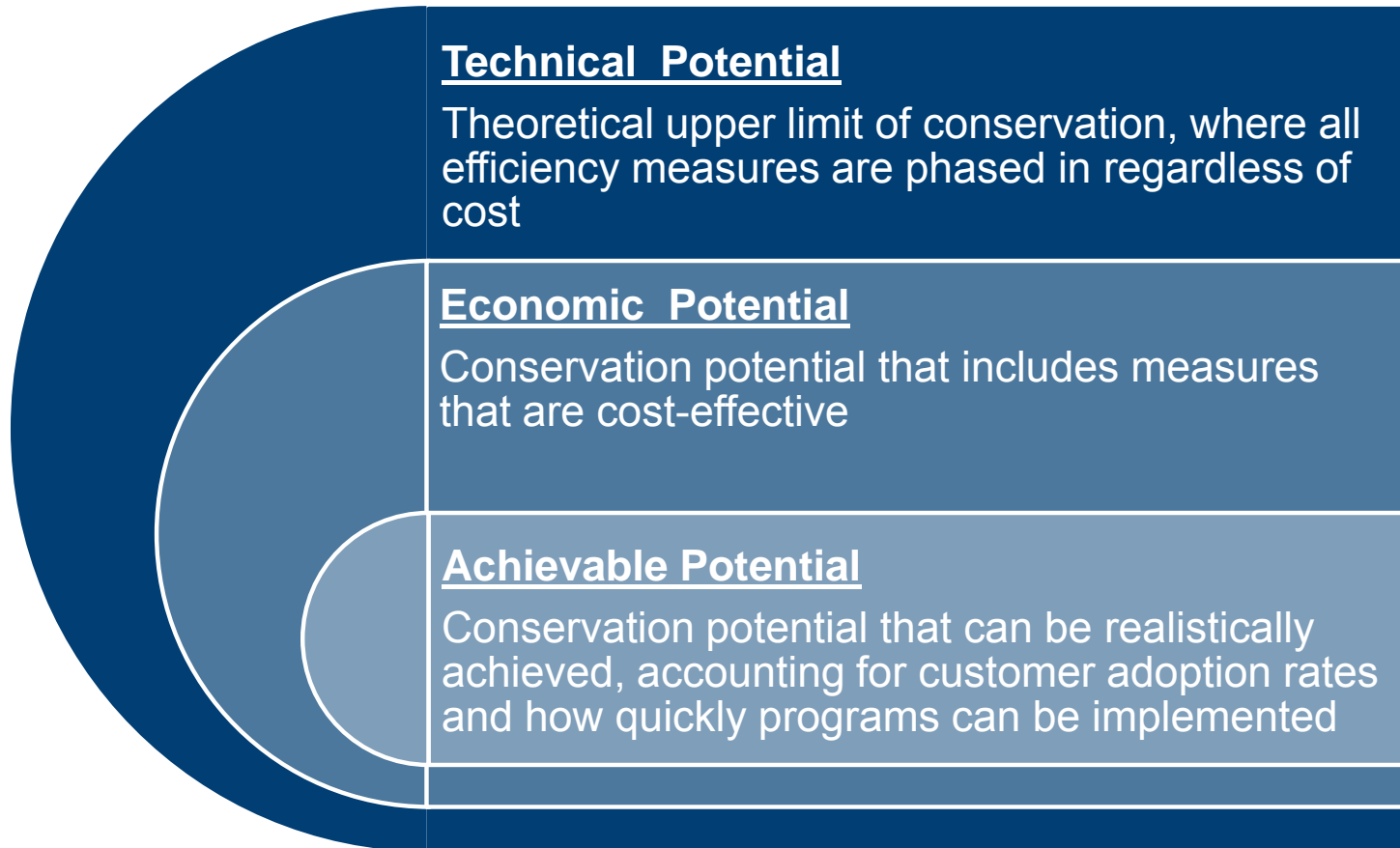

Conservation measure assessment approach

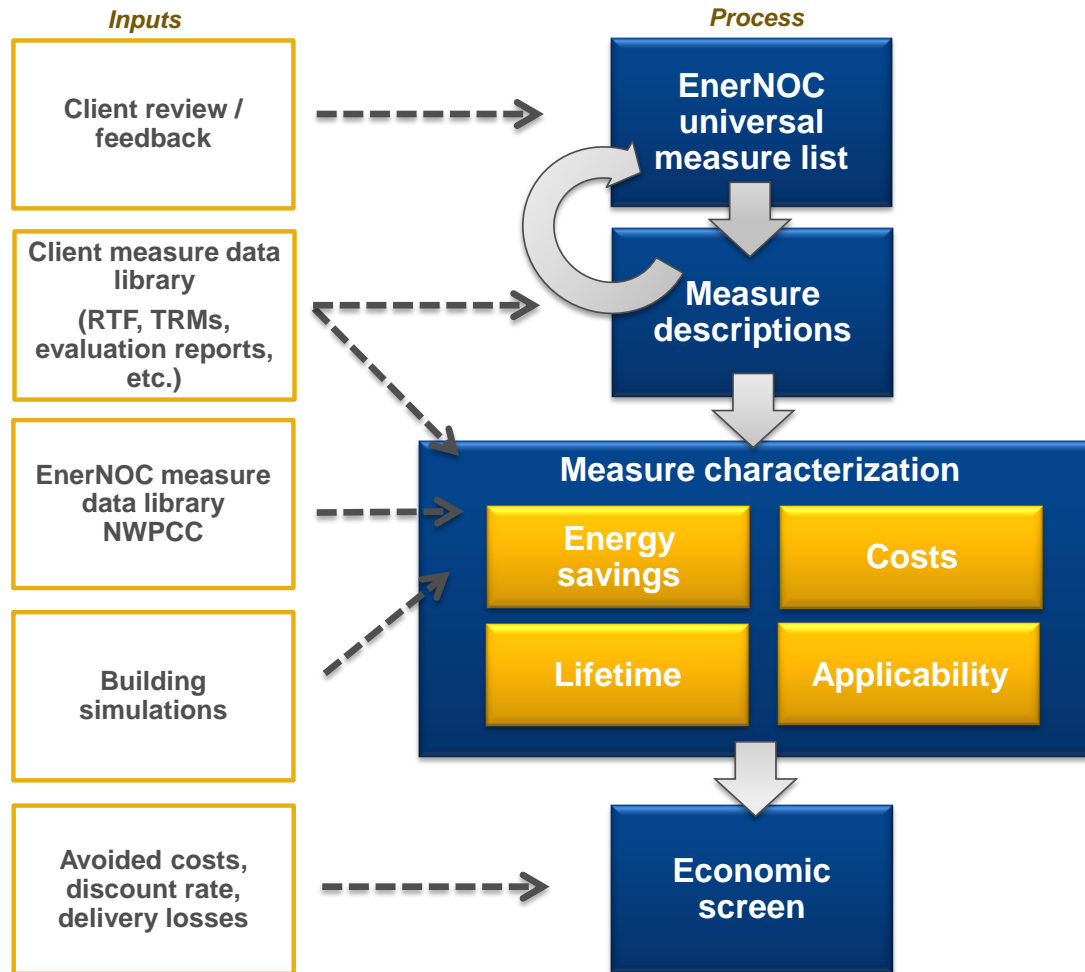



Potential Results

All sectors potential

- Cumulative achievable savings potential in 2014 is 4.4 aMW
- Cumulative achievable savings potential in 2015 is 8.7 aMW

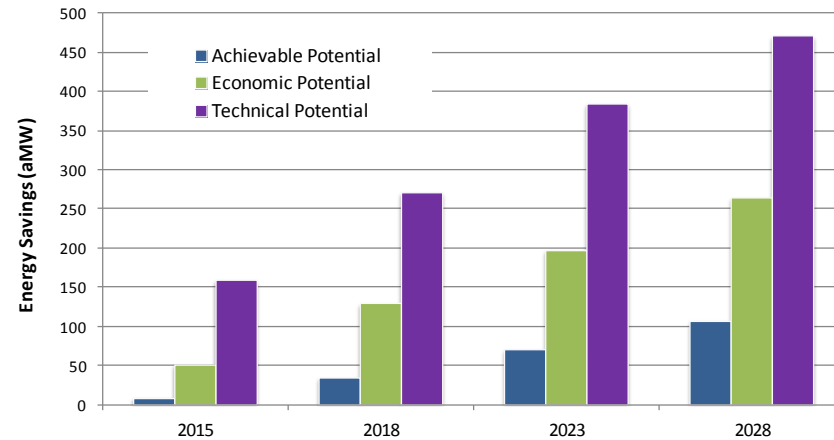

	2014	2015	2018	2023	2028	2033
Cumulative Savings (MWh)						
Achievable Potential	38,726	76,352	300,112	610,600	928,320	1,271,323
Economic Potential	272,830	446,842	1,127,376	1,723,424	2,312,719	2,675,318
Technical Potential	1,173,173	1,392,531	2,374,256	3,366,522	4,122,161	4,604,718
Cumulative Savings (aMW)						
Achievable Potential	4.4	8.7	34.3	69.7	106.0	145.1
Economic Potential	31.1	51.0	128.7	196.7	264.0	305.4
Technical Potential	133.9	159.0	271.0	384.3	470.6	525.7

All sectors potential

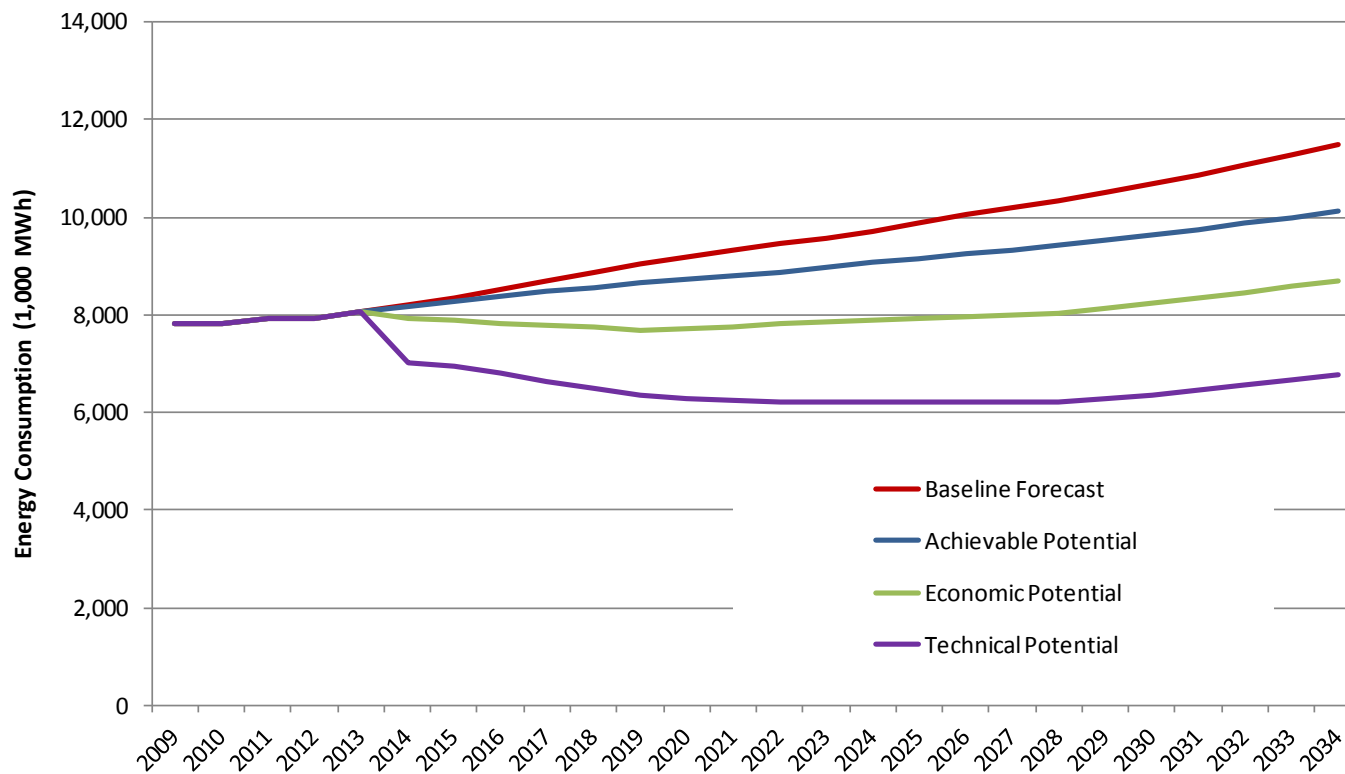

All sectors potential

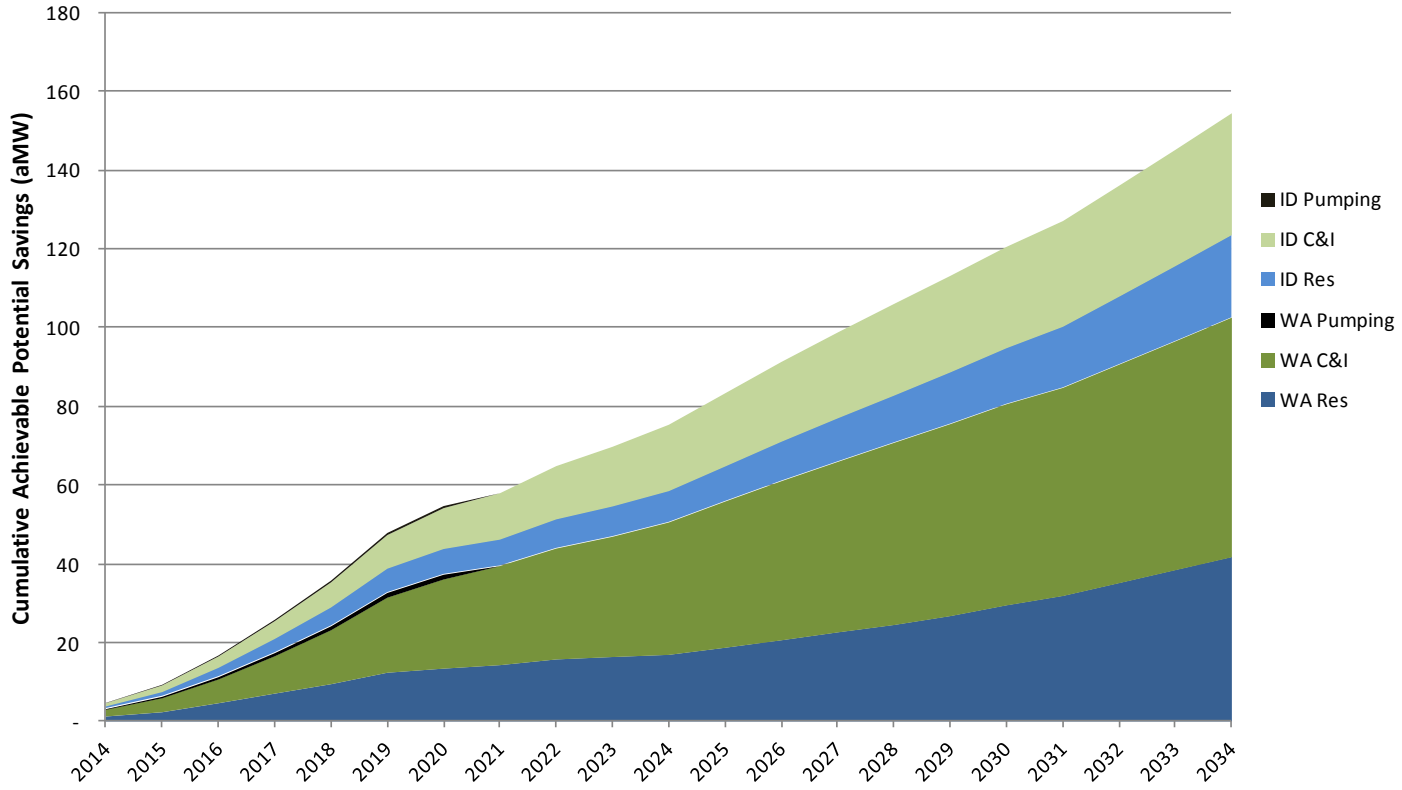

Residential potential

- Cumulative achievable savings potential is 1.9 aMW in 2014
- Grow to 3.4 aMW in 2015

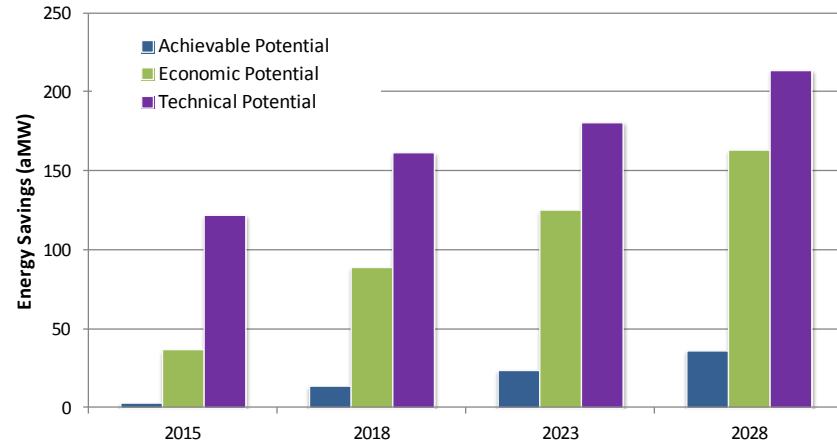

	2014	2015	2018	2023	2028	2033
Cumulative Savings (MWh)						
Achievable Potential	16,247	30,197	124,161	202,569	319,277	503,671
Economic Potential	206,661	322,861	781,184	1,051,855	1,430,505	1,643,220
Technical Potential	987,175	1,070,490	1,415,574	1,557,797	1,870,448	2,071,698
Cumulative Savings (aMW)						
Achievable Potential	1.9	3.4	14.2	23.1	36.4	57.5
Economic Potential	23.6	36.9	89.2	120.1	163.3	187.6
Technical Potential	112.7	122.2	161.6	177.8	213.5	236.5

Residential achievable savings potential – top measures

- Lighting – largely CFLs (including specialty lamps), with LEDs starting to pass the cost-effectiveness test in 2015
- Space heating savings from conversion to gas and ductless heat pumps as well as new programs for duct sealing and shell/infiltration measures
- Water heating savings from conversion to gas; also low-flow fixtures, tank/pipe insulation
- Refrigerator and freezer recycling
- Programmable thermostats
- ENERGY STAR homes and new construction efficiency

Cumulative Achievable Potential in 2018

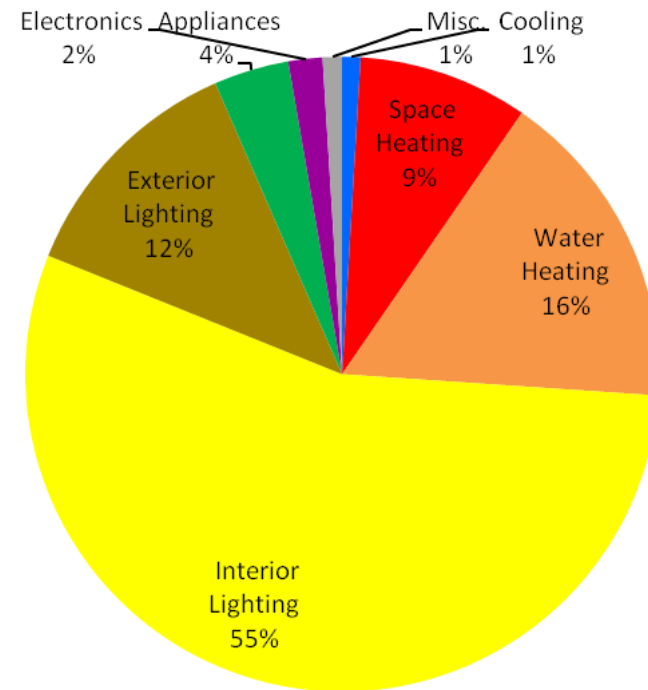

Commercial & Industrial potential

- Cumulative potential in 2015 is 5.3 aMW

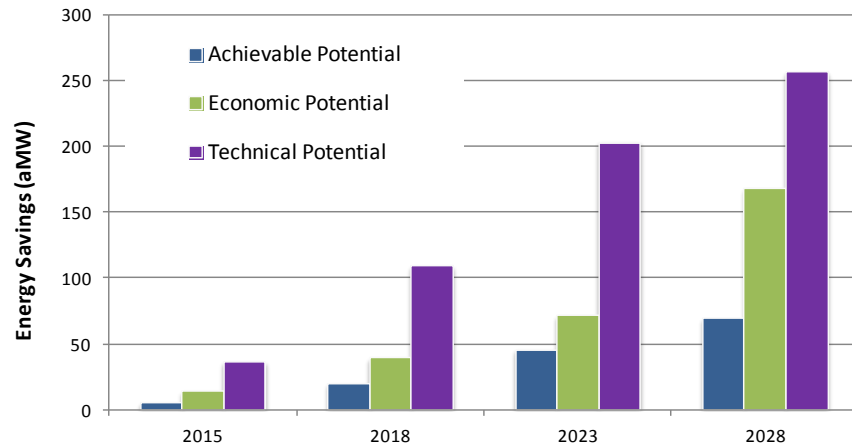

	2014	2015	2018	2023	2028	2033
Cumulative Savings (MWh)						
Achievable Potential	22,478	46,155	175,951	400,188	609,043	767,651
Economic Potential	66,170	123,981	346,193	627,462	1,474,041	1,032,097
Technical Potential	185,998	322,041	958,683	1,782,838	2,251,713	2,533,019
Cumulative Savings (aMW)						
Achievable Potential	2.6	5.3	20.1	45.7	69.5	87.6
Economic Potential	7.6	14.2	39.5	71.6	168.3	117.8
Technical Potential	21.2	36.8	109.4	203.5	257.0	289.2

C&I Conservation potential – top measures

- Lighting – mix of lamps including LEDs, various controls
- HVAC – controls, economizers, variable air volume (VAV) ventilation
- Machine drive and process – 6% from various measures for air compressors, fans, and pumps
- Also low-flow fixtures, tank/pipe insulation
- Office equipment – efficient servers, desktop computers, and printers

Achievable Potential in 2018

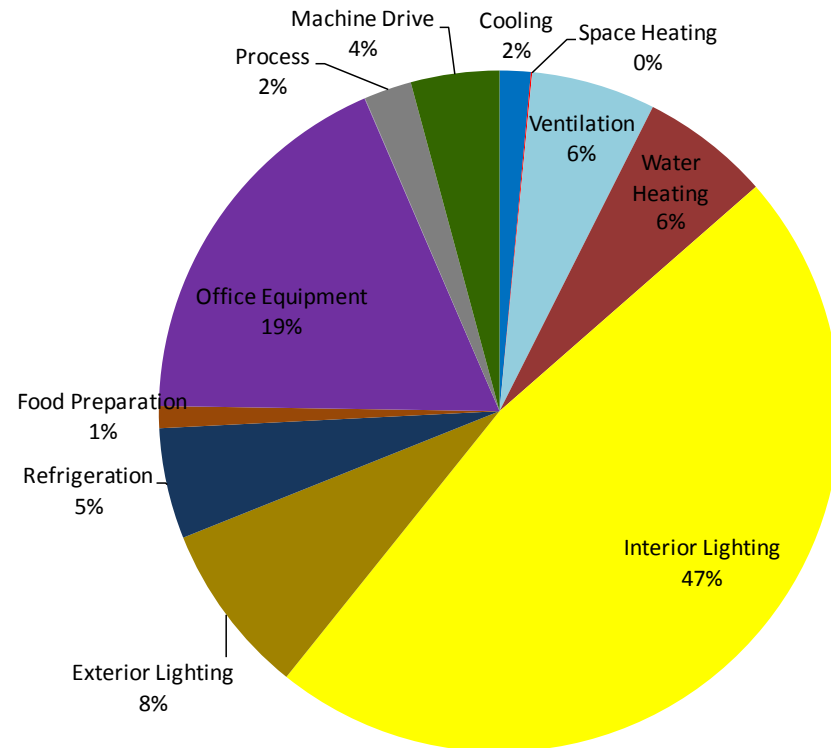

Conservation potential – sensitivity to avoided costs

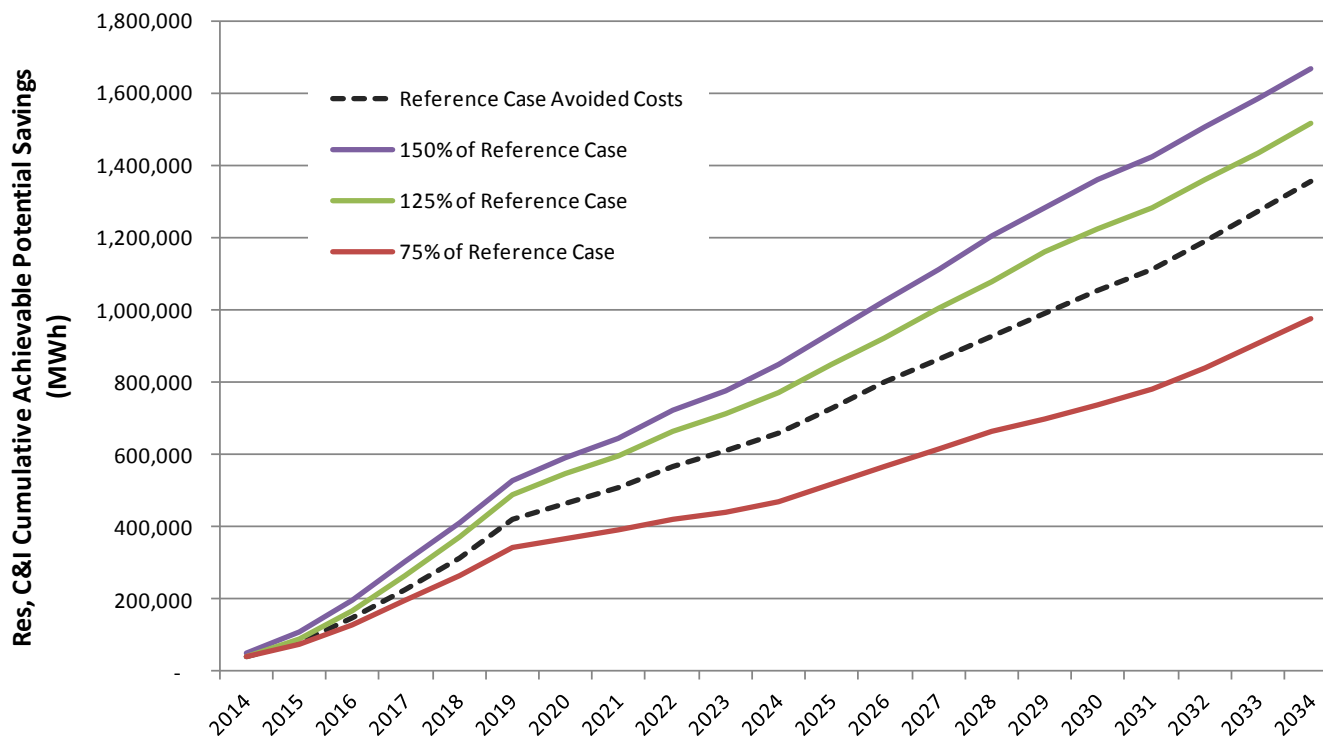

Supply curve for 2015 – cumulative savings

- Nearly 35 GWh of savings are low- or no-cost.

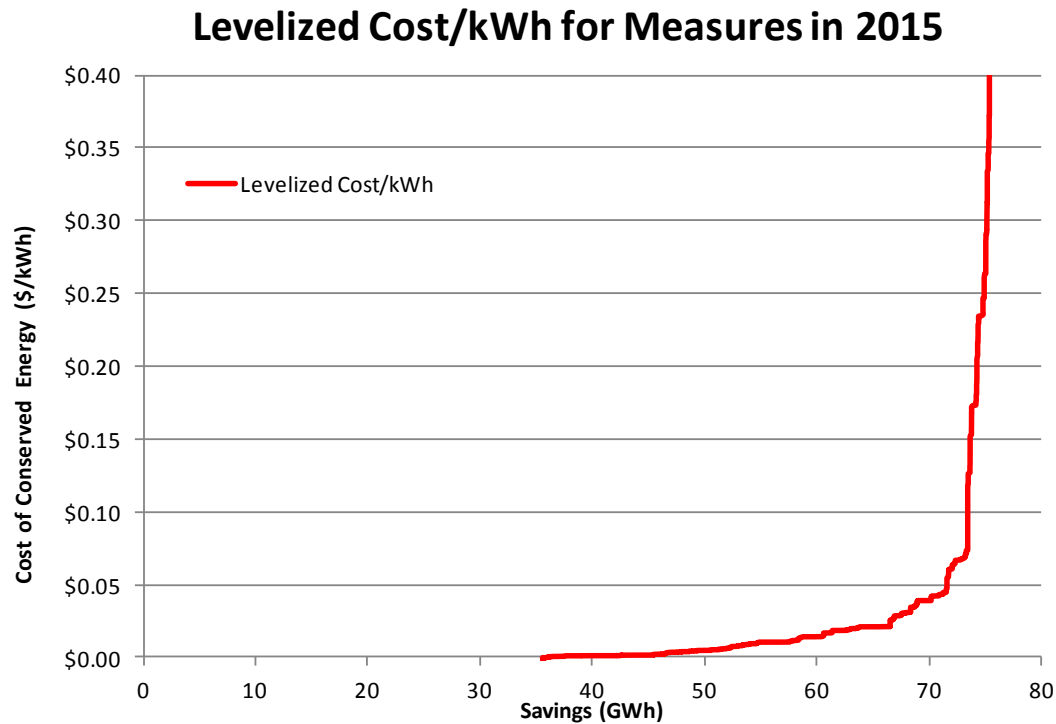

Supply curves for 2020 – avoided costs scenarios

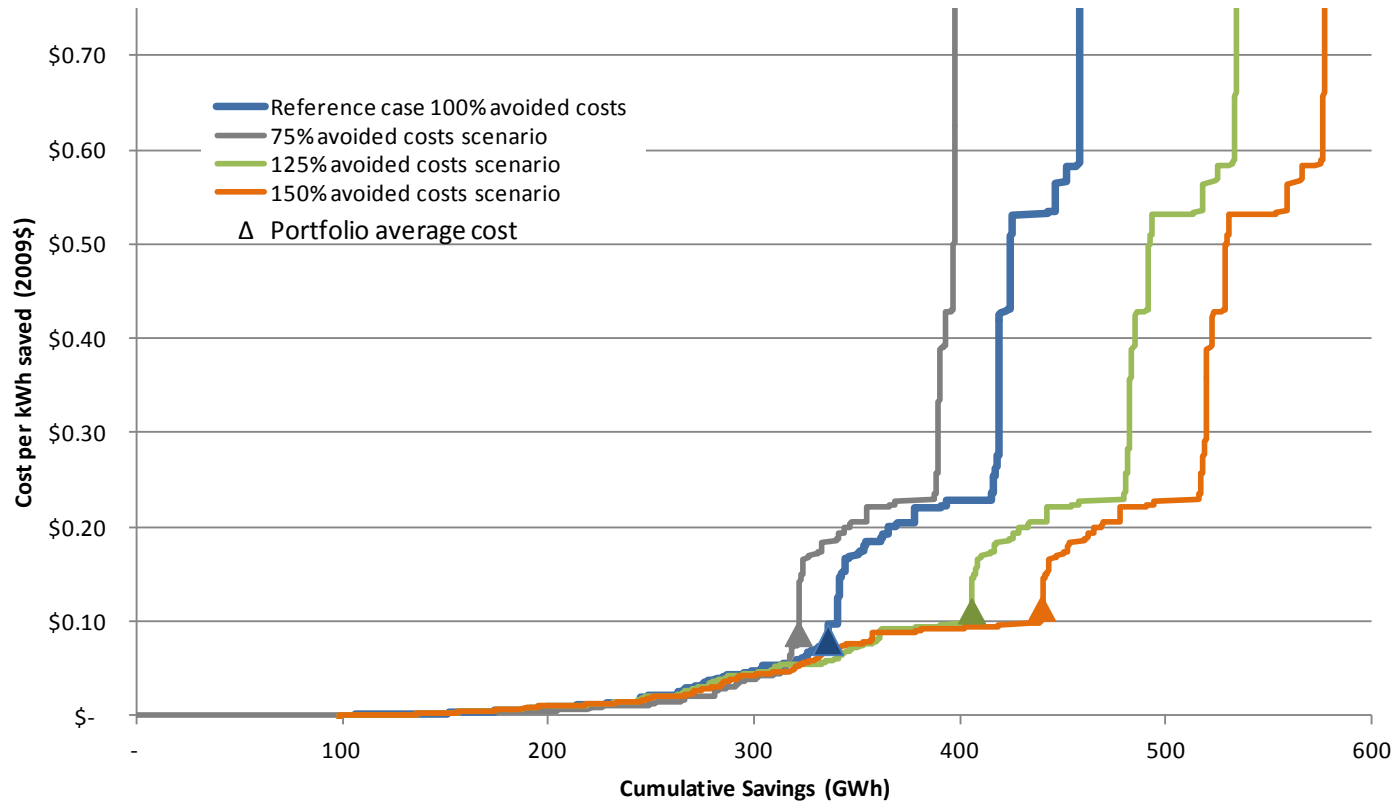

Annual and cumulative savings

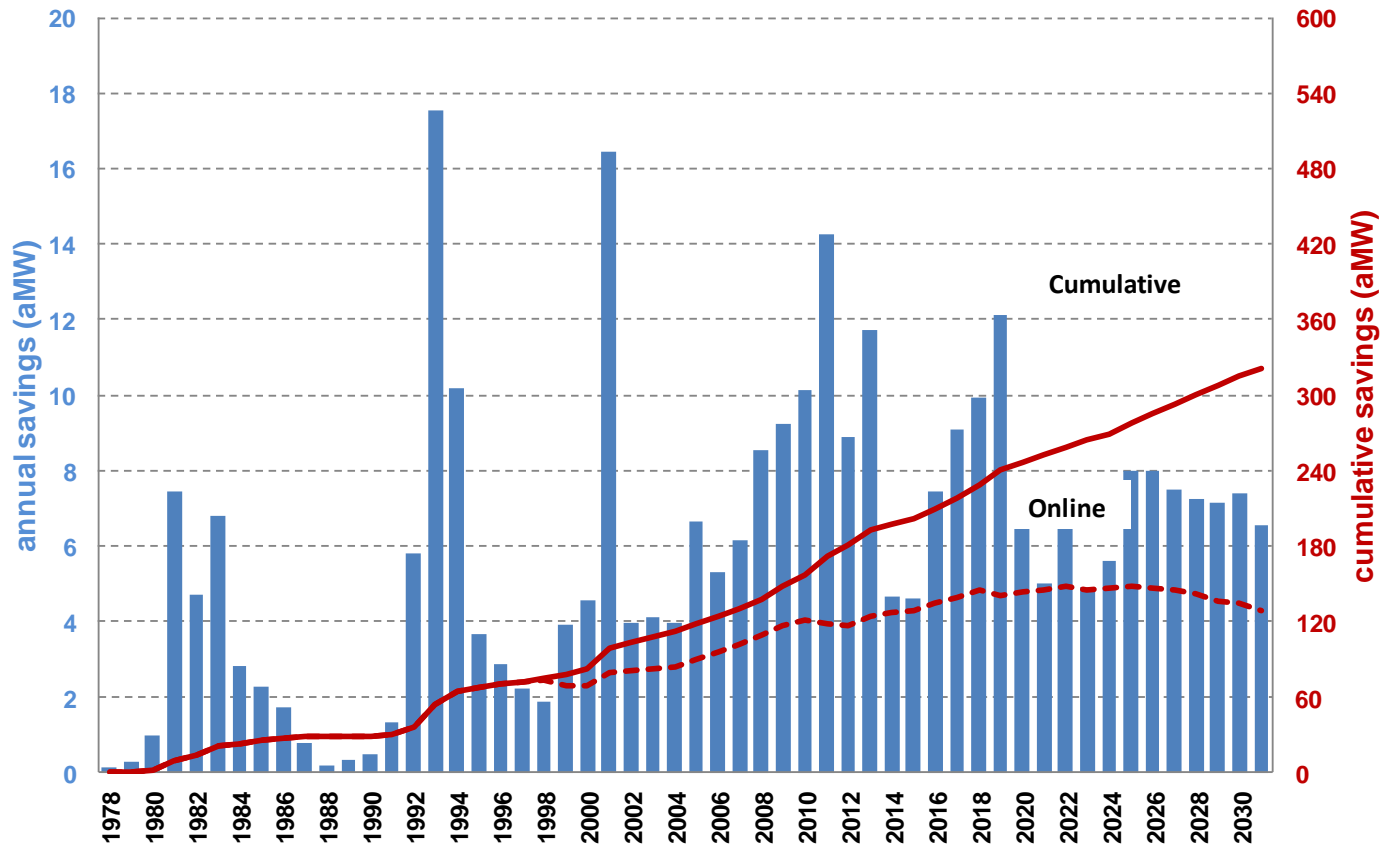



Consistency with the NWPCC Methodology

Initiative 937 Conservation Provisions

- Washington Initiative 937 approved by voters in 2006
- Requires that utilities estimate 10-year potentials
 - Utility Analysis Option must be consistent with the methodology of the Northwest Power and Conservation Council's most recent Power Plan
 - Used to set a two-year biennium conservation target
 - Must be repeated every two years

Consistency with Council Methodology

- End-use model — bottom-up
 - Building characteristics
 - Fuel and equipment saturations
 - Stock accounting based on measure life
 - Codes and standards
 - Existing and new vintage
 - Lost- and non-lost opportunities
 - Measure saturation and applicability
 - Measure savings, including HVAC interactions and contribution to peak
 - Ramp rates to model market acceptance and program implementation

Consistency with Council Methodology (cont.)

- Measures
 - Include nearly all in Sixth Power Plan
 - Plus others. e.g., conversion of electric water heaters / furnaces to gas
 - Sources for measure characterization
 - RTF measure workbooks
 - Avista Technical Reference Manual (TRM)
 - EnerNOC databases, which draw upon same sources used by RTF
- Economic potential, total resource cost (TRC) test
 - Considers non-energy benefits
 - Considers HVAC interactions
 - Include 10% credit based on Conservation Act
- Achievable potential – ramp rates
 - Based on Council Sixth Power Plan ramps rates
 - Modified to reflect Avista program history

Avista-specific items

- Avista customer characteristics
 - Calibrated to Avista 2009 sales by sector
 - Average use per customer based on actual billing data
 - Equipment saturations and unit energy consumption calibrated to match usage
 - Updated with newly available NW Residential Building Stock Assessment data, e.g., information on measure saturation
- Building codes and appliance standards updated as of 2012
- Avista-specific customer growth forecasts
- Avista retail rate and avoided cost forecasts
- Ramp rates adjusted to match Avista program history

Measure reconciliation

- Develop comprehensive measure list using
 - Avista existing programs and business plan
 - RTF Unit Energy Savings workbooks
 - Sixth Power Plan
 - Previous Avista CPA
 - Recent EnerNOC studies

Water heating measures

Conventional (EF 0.95)

Heat pump water heater (EF 2.3)

Solar water heater

Low-flow showerheads

Timer / Thermostat setback

Tank blanket

Drain water heat recovery

Measure reconciliation (cont.)

- Characterization
 - Description
 - Costs
 - Savings
 - Applicability
 - Lifetime
 - Measure data sources
 - RTF UES measure databases
 - Sixth Power Plan Workbooks
 - Avista TRM
 - SEEM data
 - BEST simulations
 - EnerNOC databases
 - Convert to LoadMAP format
 - Savings as % of baseline use
 - Per household, scaled to match Avista calibration
 - Per sq. ft. for C&I
 - Remove non-applicable adjustments such as storage rate
- 

Market adoption rates for achievable potential

- Achievable potential requires assumptions about customer acceptance and market maturity
- Northwest Power & Conservation Council's Sixth Power Plan **Lost Opportunity** ramp rates used to develop market acceptance factors
- *It is most important to focus on near-term ramp rates because studies are updated every two years*

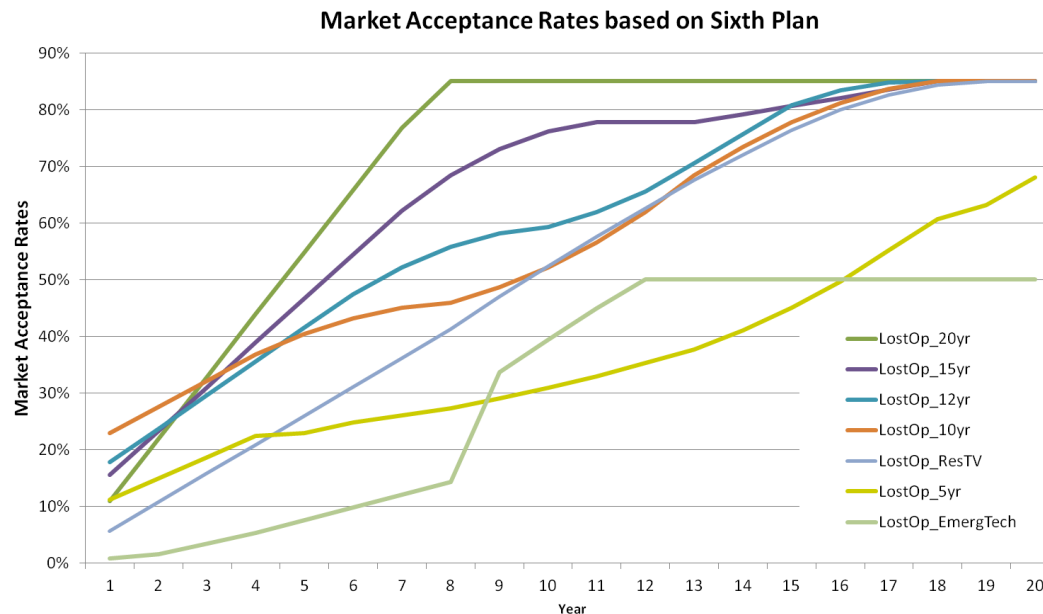

Market adoption rates for achievable potential (cont.)

- Calibrated ramp rates to actual program achievements for Lighting and HVAC measures
- Acceptance different from Sixth Power Plan rates

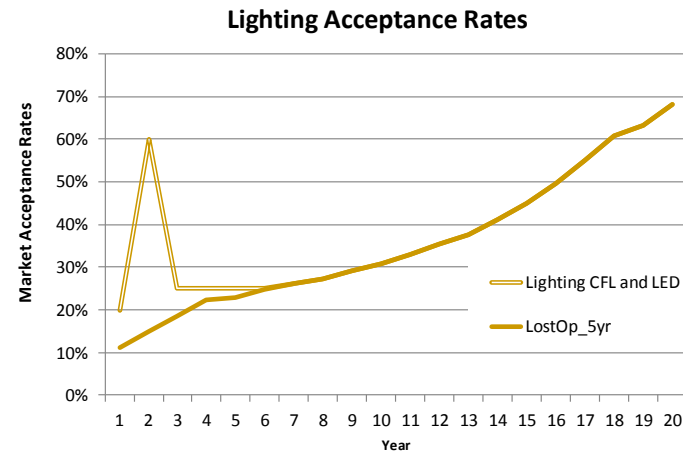
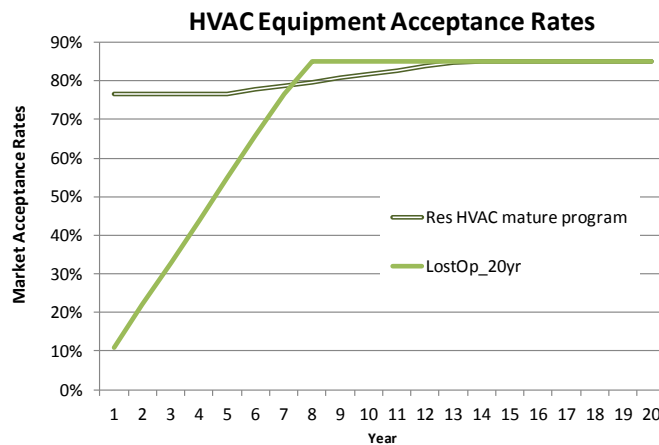



Study schedule

- Presented project approach to the TAC on November 7, 2012
- Delivered preliminary results in late-February 2013
- Present final study results to TAC March 20, 2013
- Fine-tune analysis
- Draft report in April, 2013
- Support the filing in August 2013 with a complete CPA report



Ingrid Rohmund

Practice Lead

760.943.1532

irohmund@enernoc.com

Jan Borstein

Project Manager

303.530.5195

jborstein@enernoc.com

www.enernoc.com



Demand Response

Technical Advisory Committee #5

March 20th, 2013

Leona Doege

What is Demand Response

Passive:

Pricing programs....

Time-of-Use, Critical Peak Pricing, Peak Time Rebate

Active:

Direct Load Control

Combination programs.....

Pricing program with
enabling technology

Purpose: Reduce or shift load at certain times

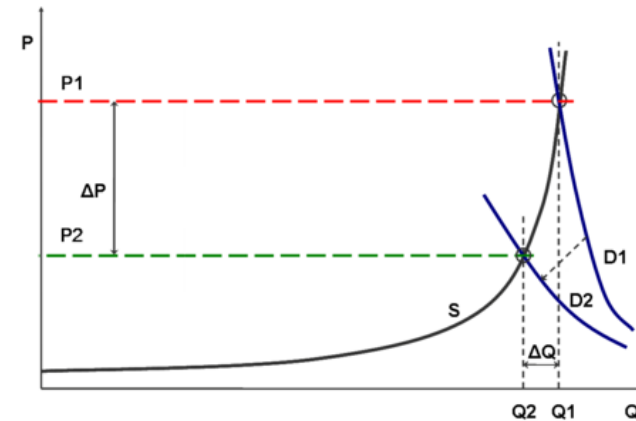

Passive Demand Response

Supporting Dynamic Pricing:

- Avista's Billing System doesn't allow for dynamic rates
- Q3 2014, New Billing System will be capable.
- Metering and its infrastructure would need to be upgraded in many areas.



- Merit to the inverted tail block rate structure currently used.

“Inclining block rates can reduce energy consumption by 6 percent in the near term and more over the long haul” (used in contrast to a flat rate structure, Ahmad Faroqui, “Inclining toward Energy Efficiency,” Public Utilities Fortnightly, August 2008 (http://www.fortnightly.com/exclusive.cfm?o_id=94)

Direct Load Control

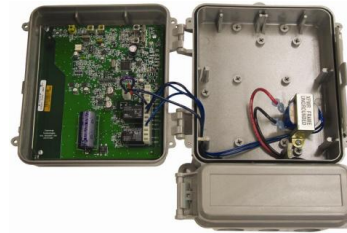

Mass Market:

Residential loads, electric space heat, central air-conditioning, electric water heating, pool pumps.

Commercial Programs:

Irrigation, variety of commercial/industrial processes. Often a 3rd party aggregator is used



(470)



Avista's Direct Load Control Programs

North Idaho Pilot

- 2007-2009:
- 50 DLC Thermostats, 50 DLC Switches
- 10 Events called ranging from 2 to 4 hours each, in both the summer and winter seasons.
- Heat Pumps, Water Heaters, Electric Forced Air Furnaces, Air Conditioning

Smart Grid Demonstration Project

Smart Thermostat Pilot Program

- June 2012 – Dec 31st, 2014
- 69 Thermostats, capable of 1500
- Events are automatic ranging from 10 minutes to 24 hours, temp off-set of 2 degrees.
- Currently in testing mode, ready for real dispatch summer season 2013.
- Heat Pumps, Electric Forced Air Furnaces, Air Conditioning



Other Avista DR Activities

2001 Western Energy Crisis

Nickel Buy Back Program

Operational issues of July 2006

Public Plea

Bi-Lateral Agreement with Industrial Customers



Knowledge Gained

DR Works as Designed

DR Builds Customer Engagement

DLC Value lies in Capacity

High Penetration of Natural Gas in Avista service area

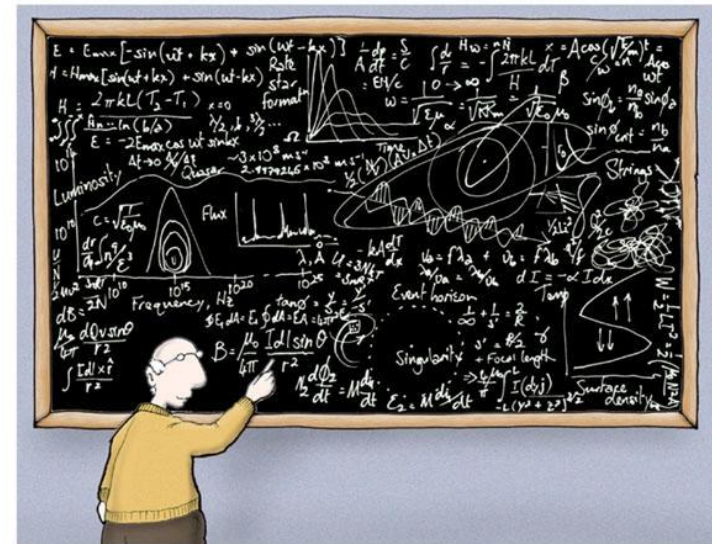

Demand Response Costs (Regional Estimates from NPCC)

Chapter 5: Demand Response

Sixth Power Plan

Table 5-2: Demand Response Assumptions

Program	MW	Fixed Cost	Variable Cost or (hours/year limit)	Season available
Air Conditioning (Direct Control)	200	\$60/kW-year	100 hours/year	Summer
Irrigation	200	\$60/kW-year	100 hours/year	Summer
Space heat/Water heat (Direct Control)	200	\$100/kW-year	50 hours/year	Winter
Aggregators (Commercial)	450	\$70/kW-year	\$150/MWh 80 hours/year	Summer + Winter
Interruptible Contracts	450	\$80/kW-year	40 hours/year	Summer + Winter
Demand Buyback	400	\$10/kW-year	\$150/MWh	All year
Dispatchable Standby Generation	1,000	\$20-\$40/kW-year	\$175-300/MWh	All year



What's Next ?

Discussion of DR Options

Q&A

Thank you for your time!

Leona Doege

DSM Program Manager

(509) 495-4289

leona.doege@avistacorp.com





Draft 2013 Preferred Resource Strategy

James Gall

Fifth Technical Advisory Committee Meeting

2013 Electric Integrated Resource Plan

March 20, 2013

DRAFT

2013 IRP Modeling Process

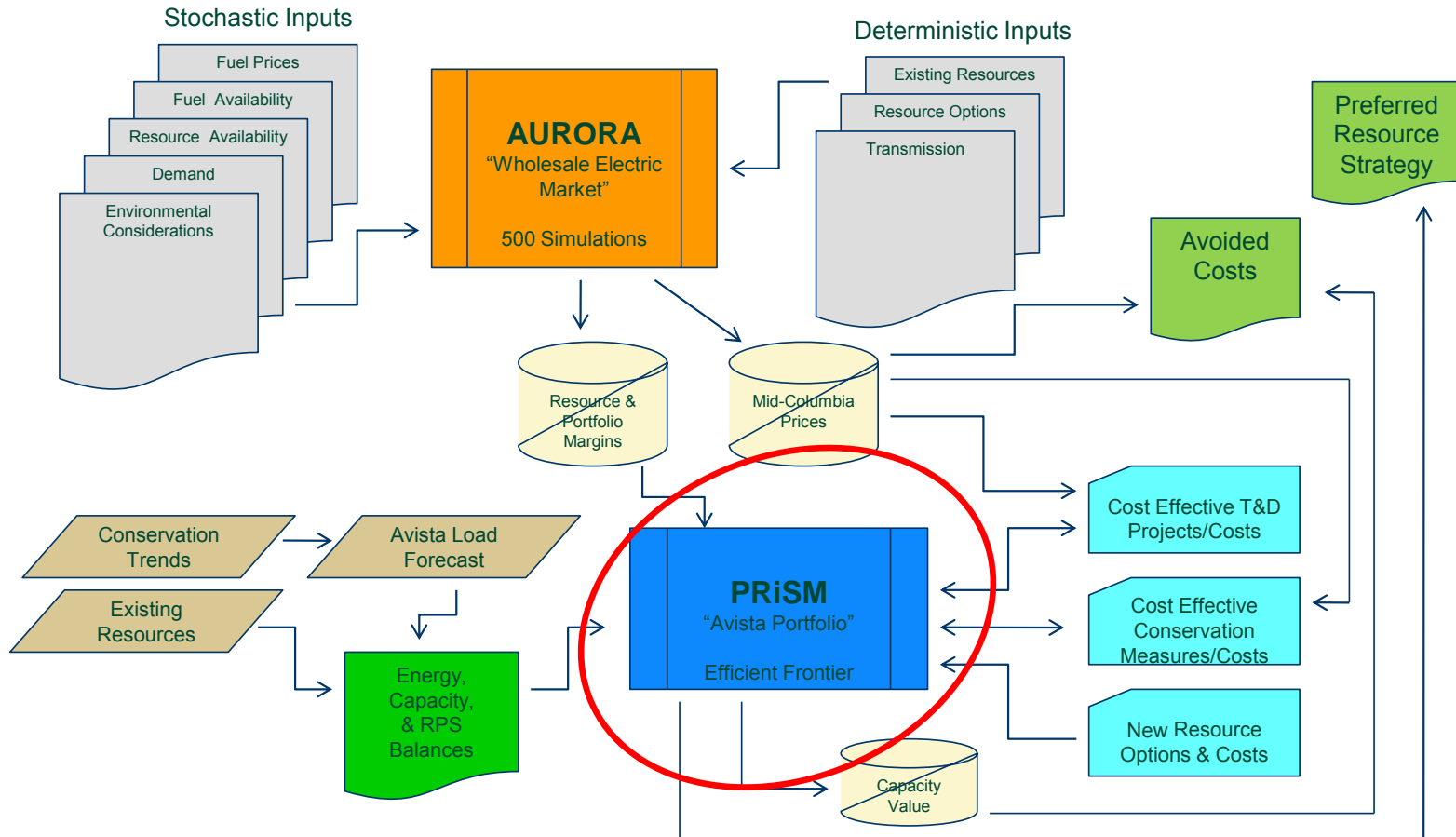

DRAFT

2011 Preferred Resource Strategy

	Year Ending	Resource
Palouse Wind	2012	Wind (~ 42 aMW REC)
	2018	Simple Cycle CT (~ 83 MW)
	2020	Simple Cycle CT (~ 83 MW)
	2018-2019	Thermal Upgrades (~ 7 MW)
	2018-2019	Wind (~ 43 aMW REC)
	2023	Combined Cycle CT (~ 270 MW)
	2026/27	Combined Cycle CT (~ 270 MW)
Smart Grid/Feeder Rebuilds 8.9 aMW in 2012*	2029	Simple Cycle CT (~ 46 MW)
	2012+	Distribution Feeder Upgrades (13 aMW by 2031)
	2012+	Conservation (310 aMW by 2031)

* Early estimate to be verified by third party and does not include regional savings from NEEA

DRAFT

Annual Energy Position

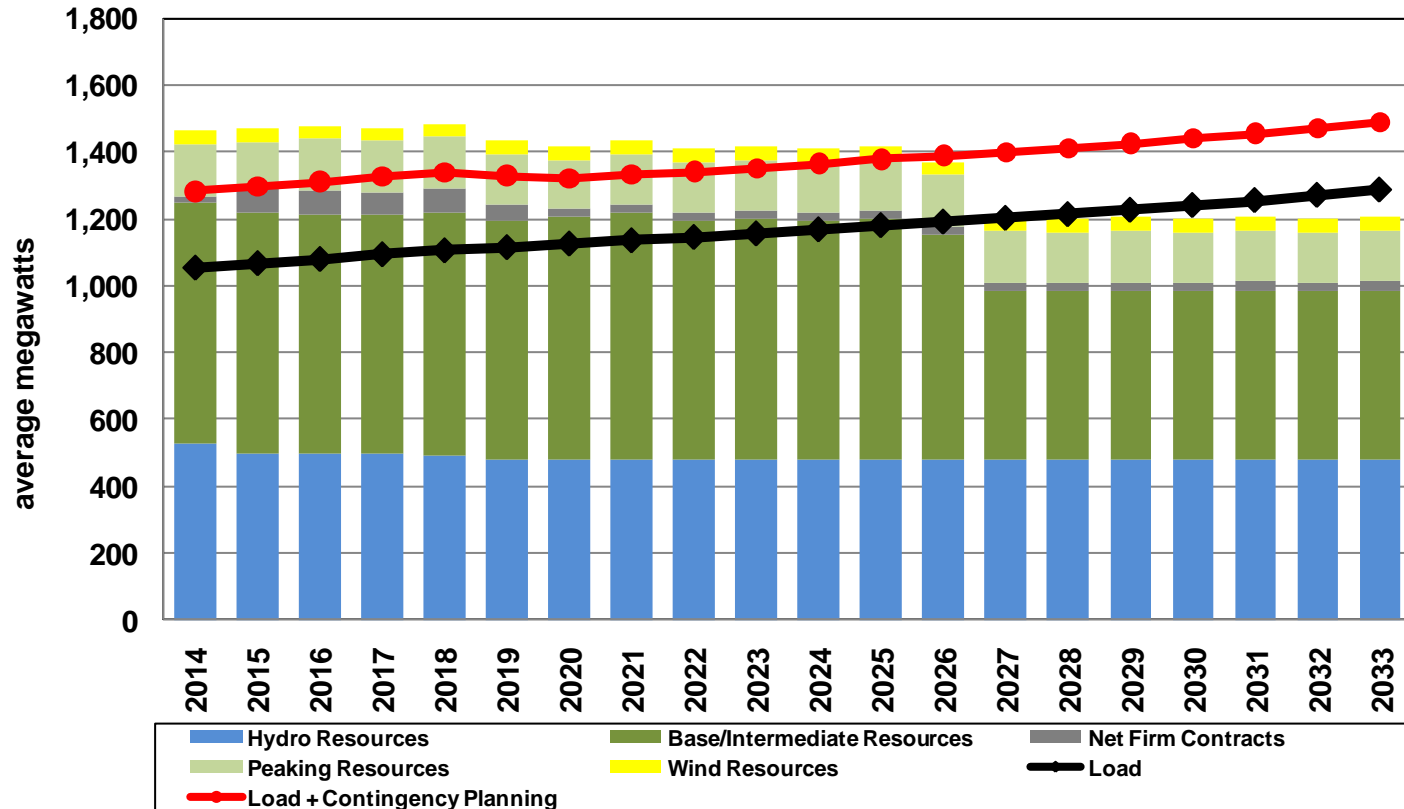

DRAFT

Winter Single Hour Peak Position

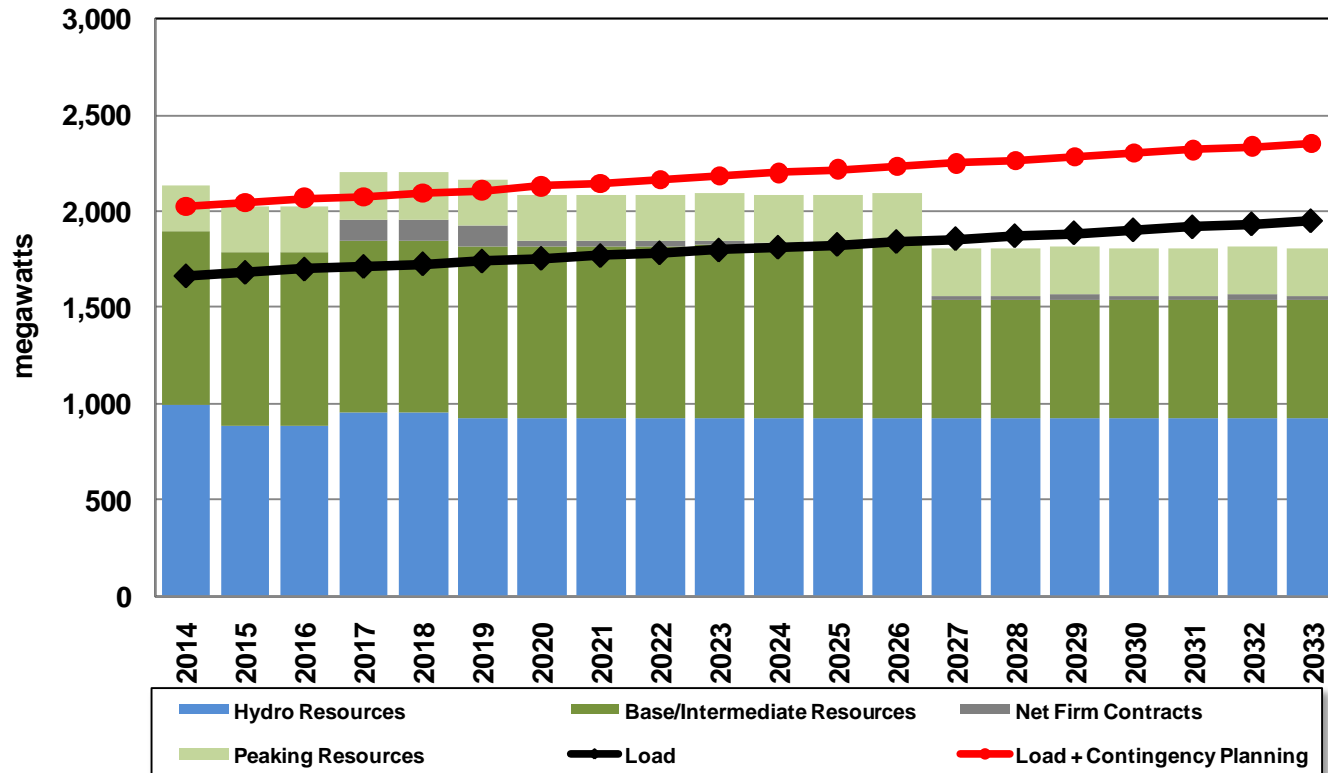

DRAFT

Summer Single Hour Peak Position

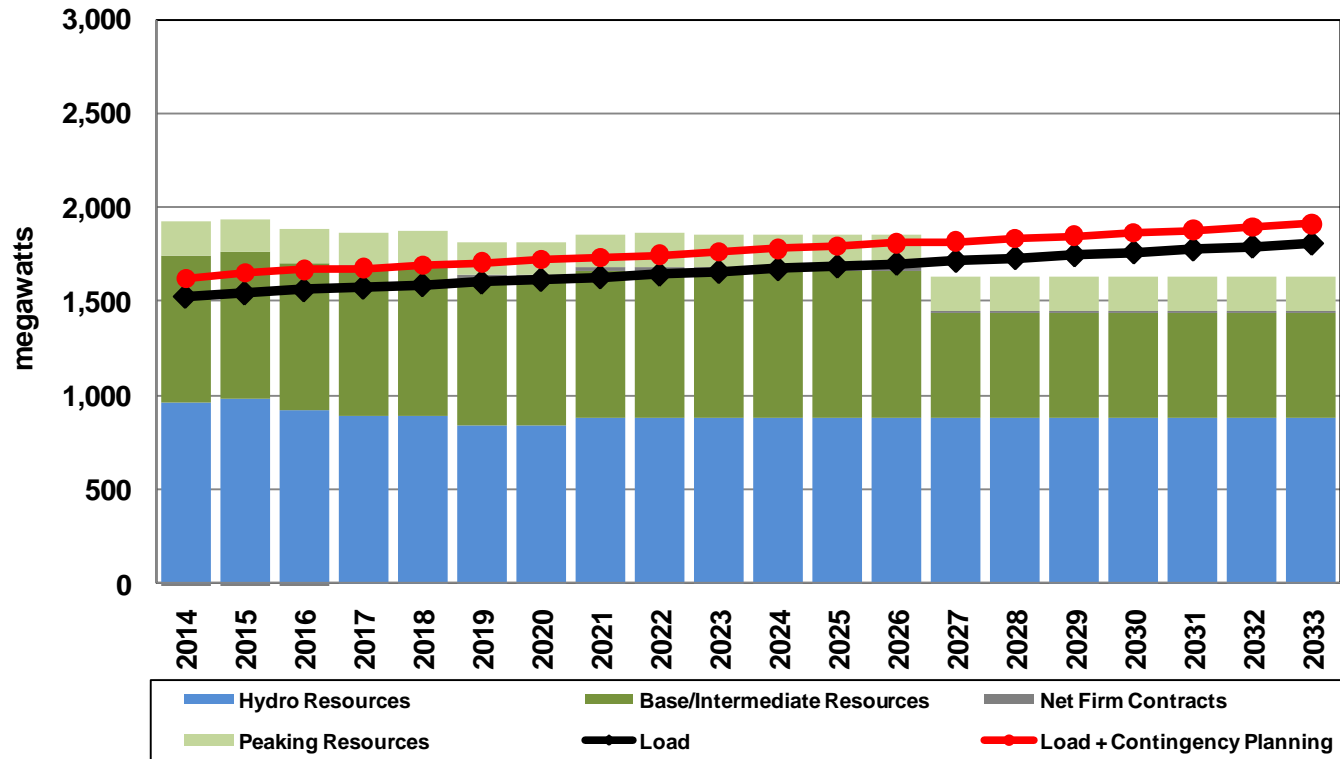

DRAFT

Washington Energy Independence Act Compliance

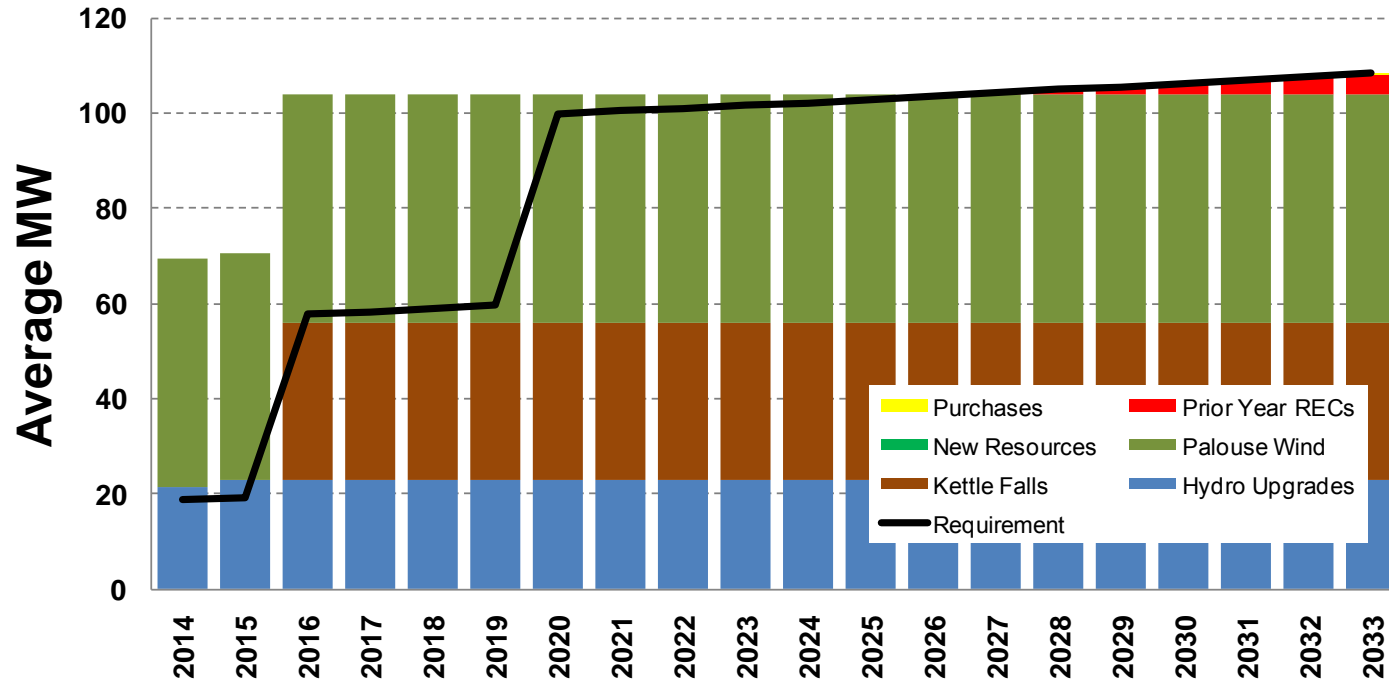

Assumes conservative estimate of Kettle Falls with 75 percent capacity factor

DRAFT

Load Forecast Scenarios

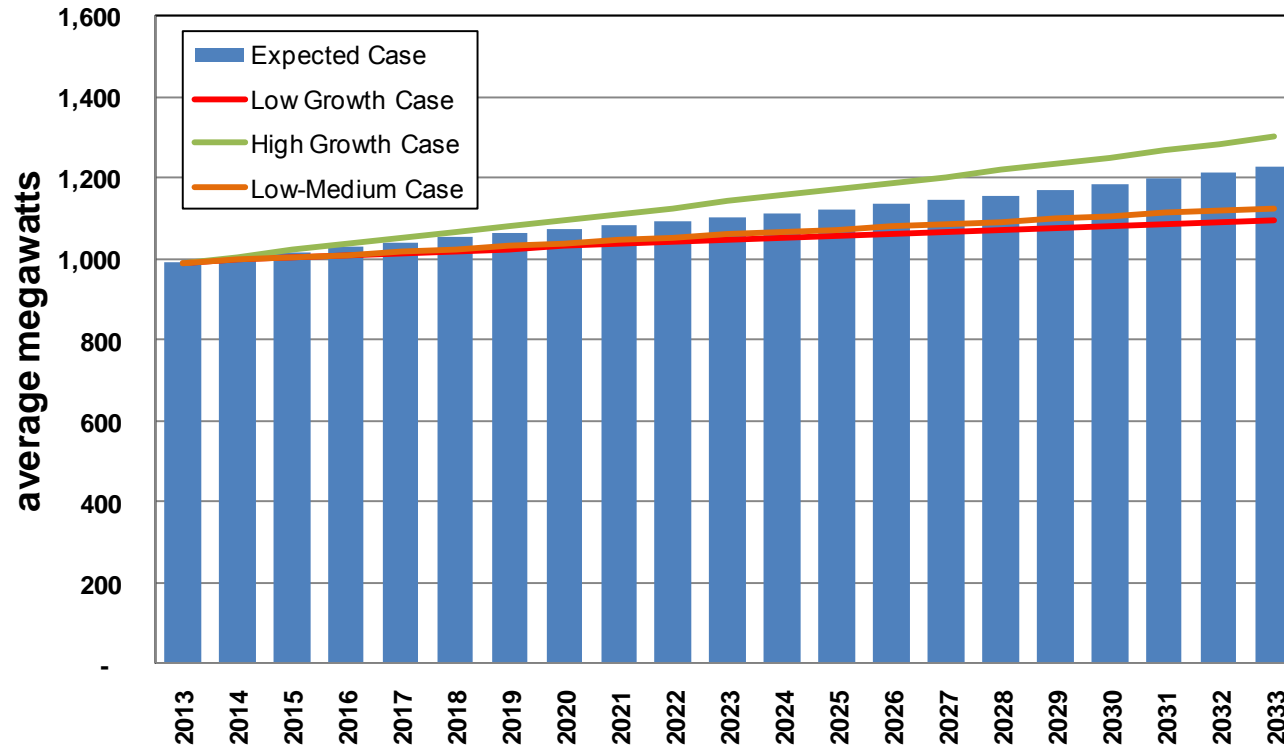

DRAFT

PRiSM Objective Function

- Linear program solving for the optimal resource strategy to meet resource deficits over the planning horizon.
- Model selects its resources to reduce cost, risk, or both.

Minimize: Total Power Supply Cost on NPV basis (2014-2054 with emphasis on the first 14 years of the plan)

Subject to:

- Risk Level
- Capacity Need +/- deviation
- Energy Need +/- deviation
- Renewable Portfolio Standards
- Resource Limitations and Timing

DRAFT

Efficient Frontier

- Demonstrates the trade off between cost and risk
- Avoided Cost Calculation

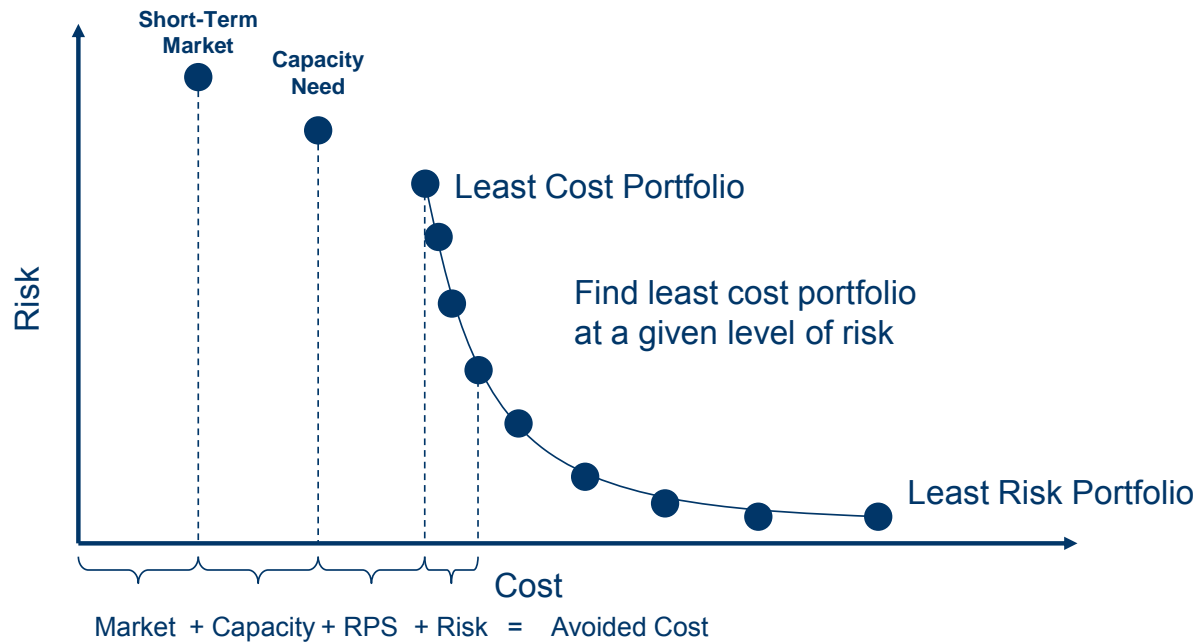

DRAFT

Natural Gas Turbines Cost/Risk Tradeoffs

Ignoring size constraints

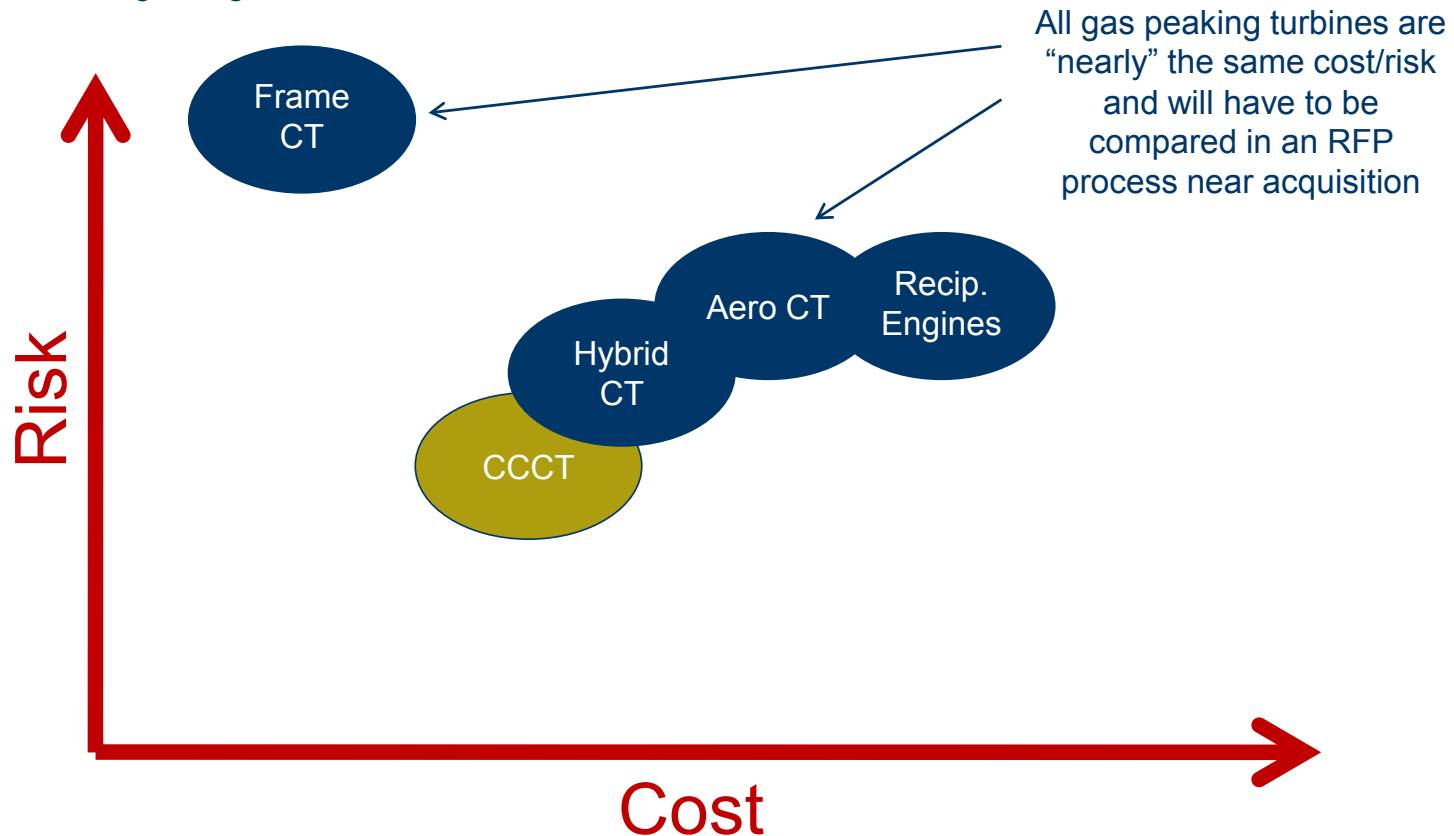

DRAFT

Natural Gas Turbines Cost/Risk Tradeoffs

Includes size constraints

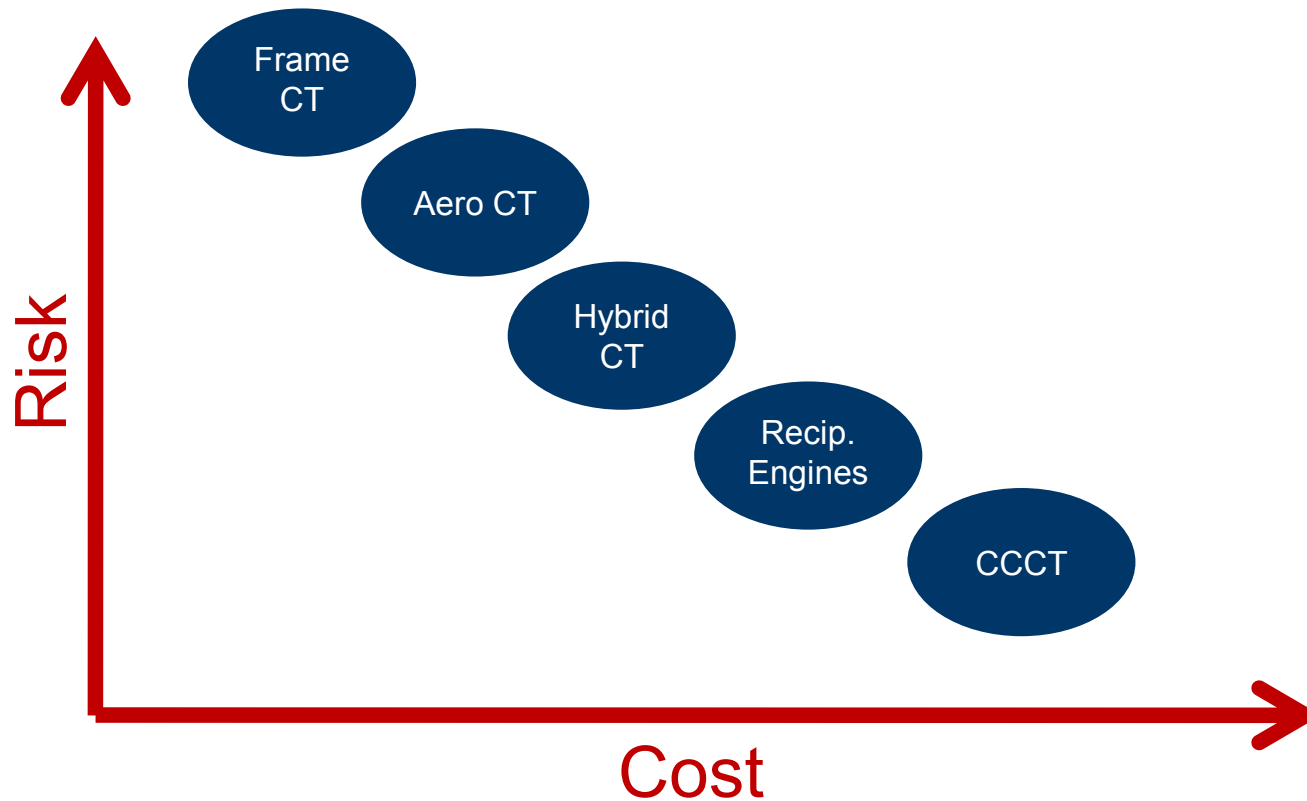

DRAFT

Efficient Frontier (\$millions)

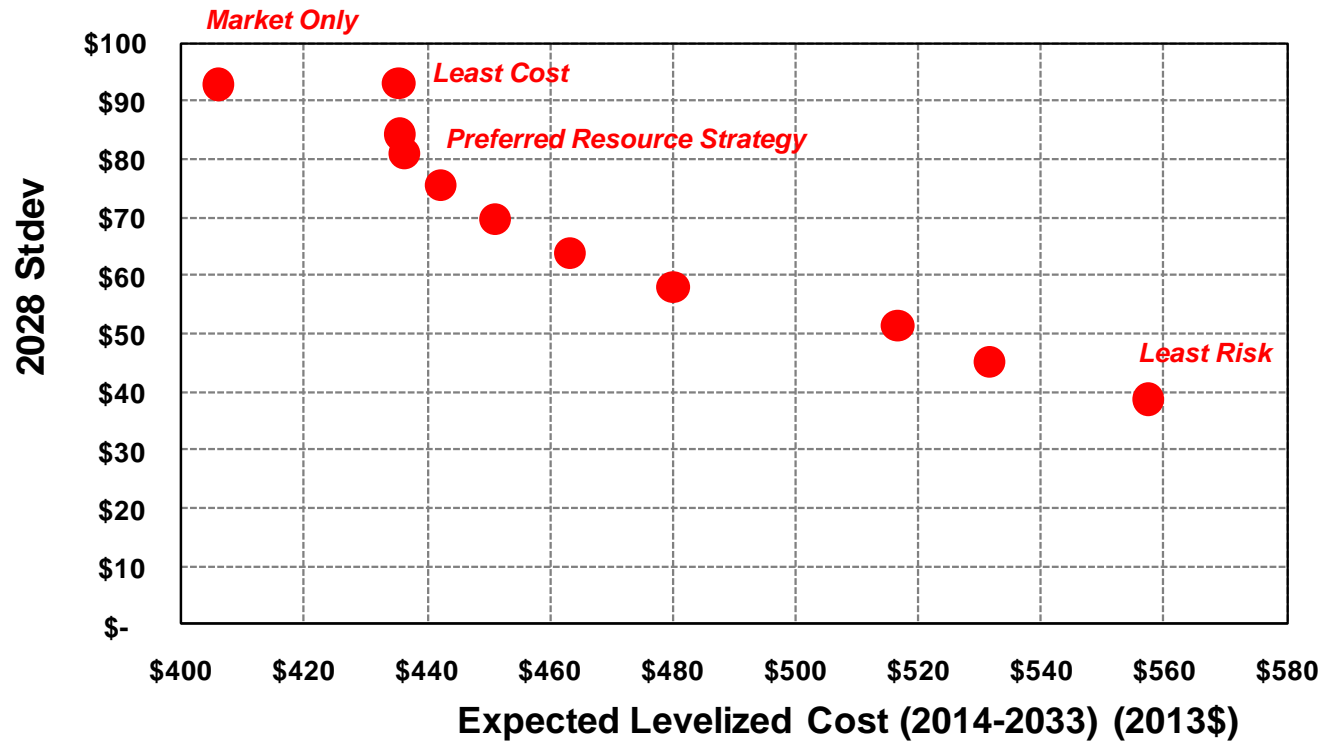

DRAFT

Efficient Frontier- Percent Change

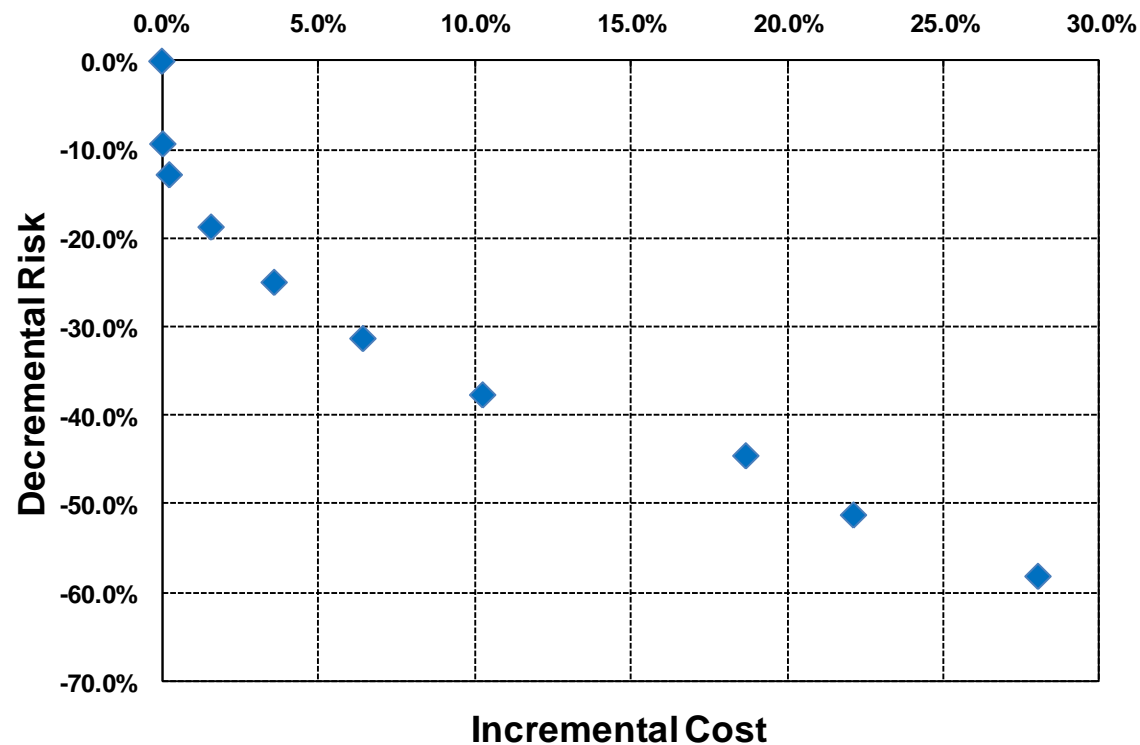

DRAFT

Draft 2013 Preferred Resource Strategy

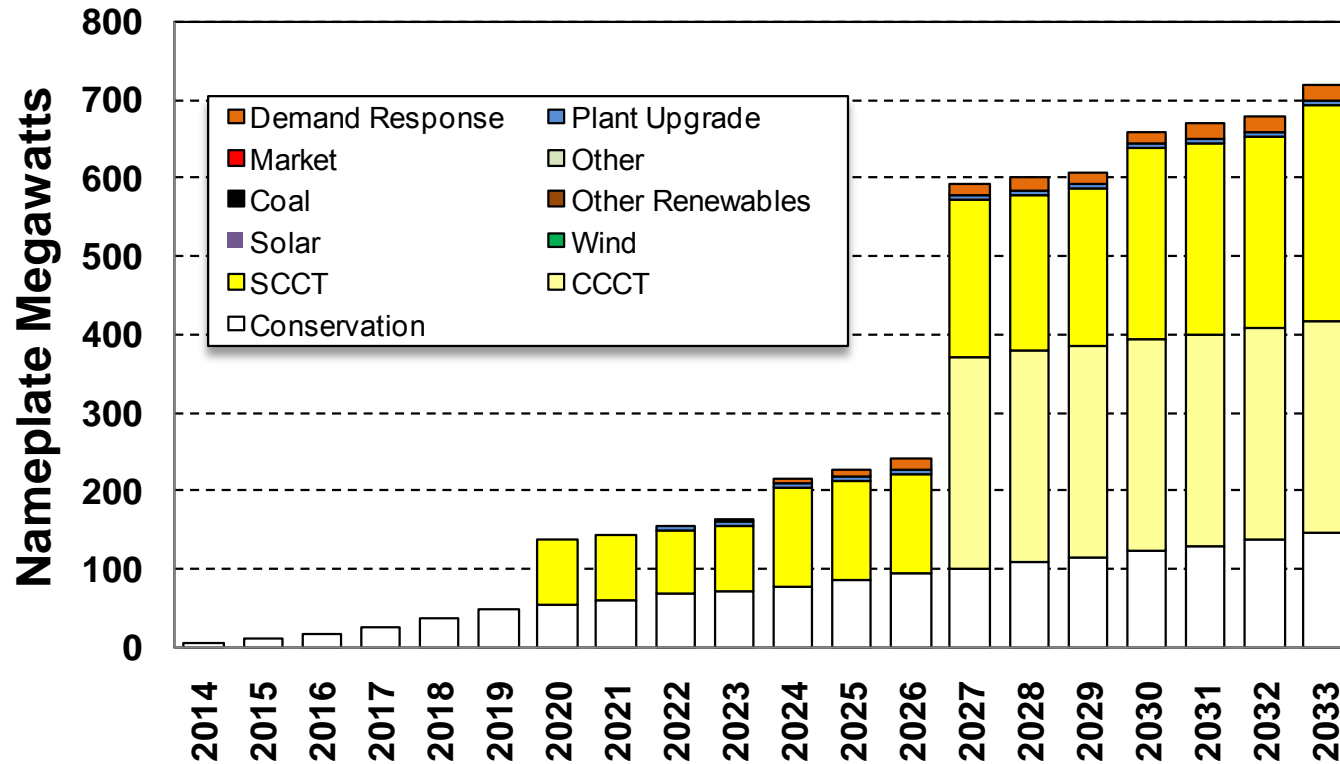

DRAFT

Draft 2013 Preferred Resource Strategy

Resource	By the End of Year	Winter Peak (MW)	Energy Capability (aMW)
SCCT	2019	88	69
Rathdrum CT Upgrade	2021	2	6
SCCT	2023	46	40
SCCT	2026	78	62
CCCT	2026	281	245
SCCT	2029-32	79	69
Generation Total		574	491
Conservation	2014-33	199	147
Demand Response	2022-30	20	0
Distribution Efficiencies	2014-16	<1	<1

DRAFT

Conservation Forecast

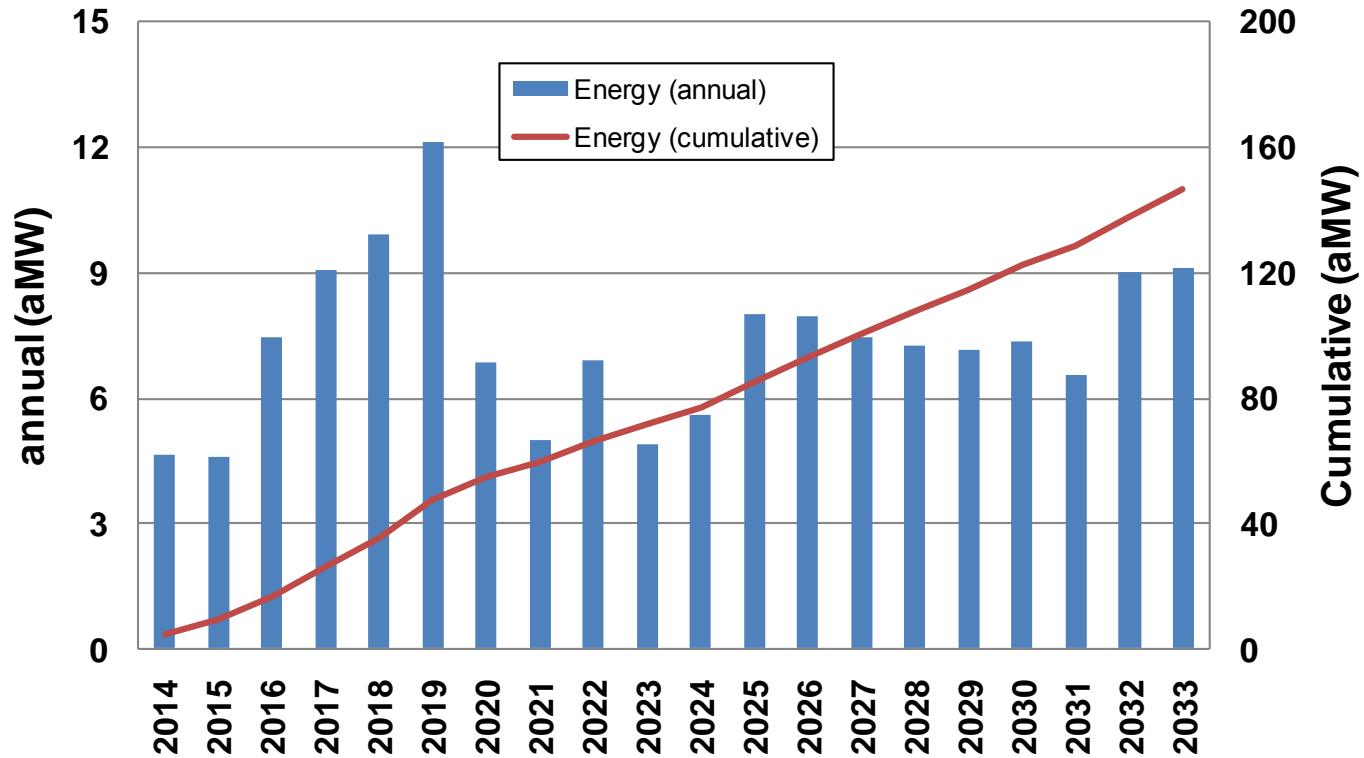

DRAFT

Cost of Conservation

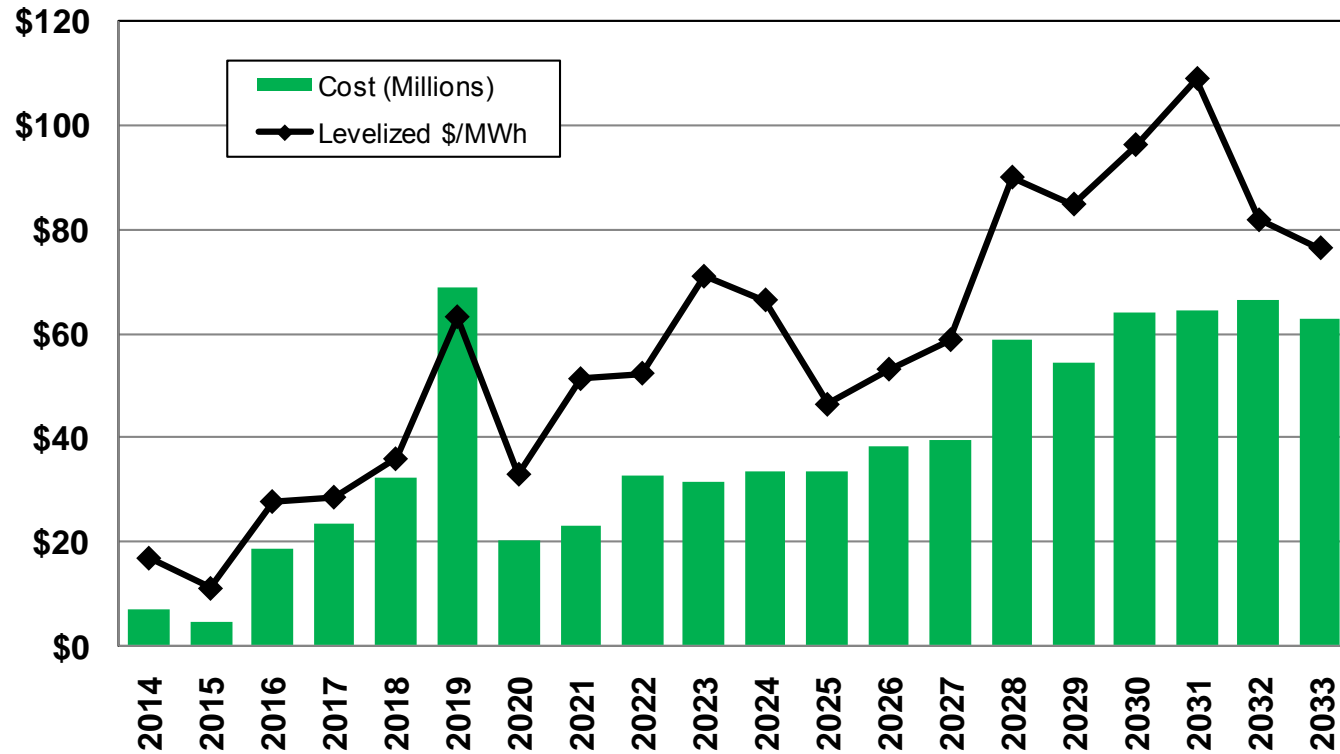

DRAFT

Avista Greenhouse Gas Emissions

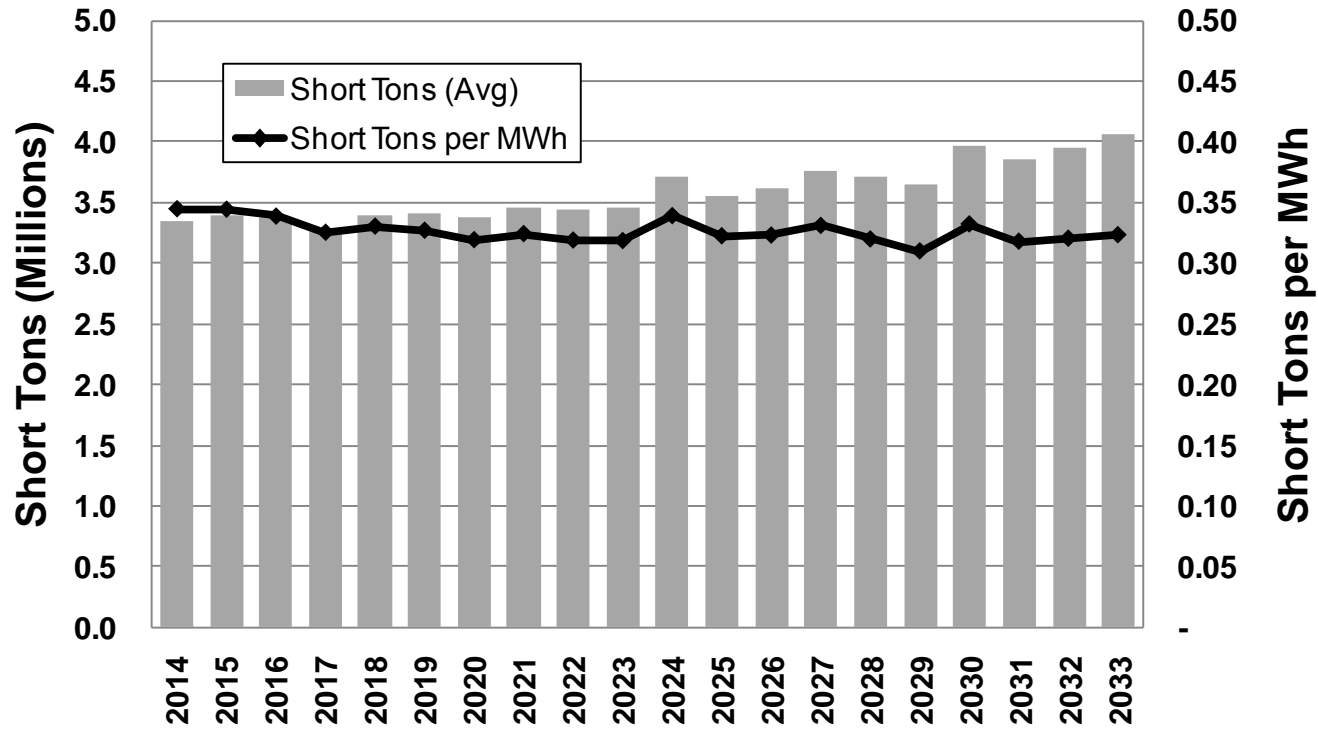

Includes generating resources under Avista control

DRAFT

Draft 2013 PRS Capital Requirements (and Conservation Expense)

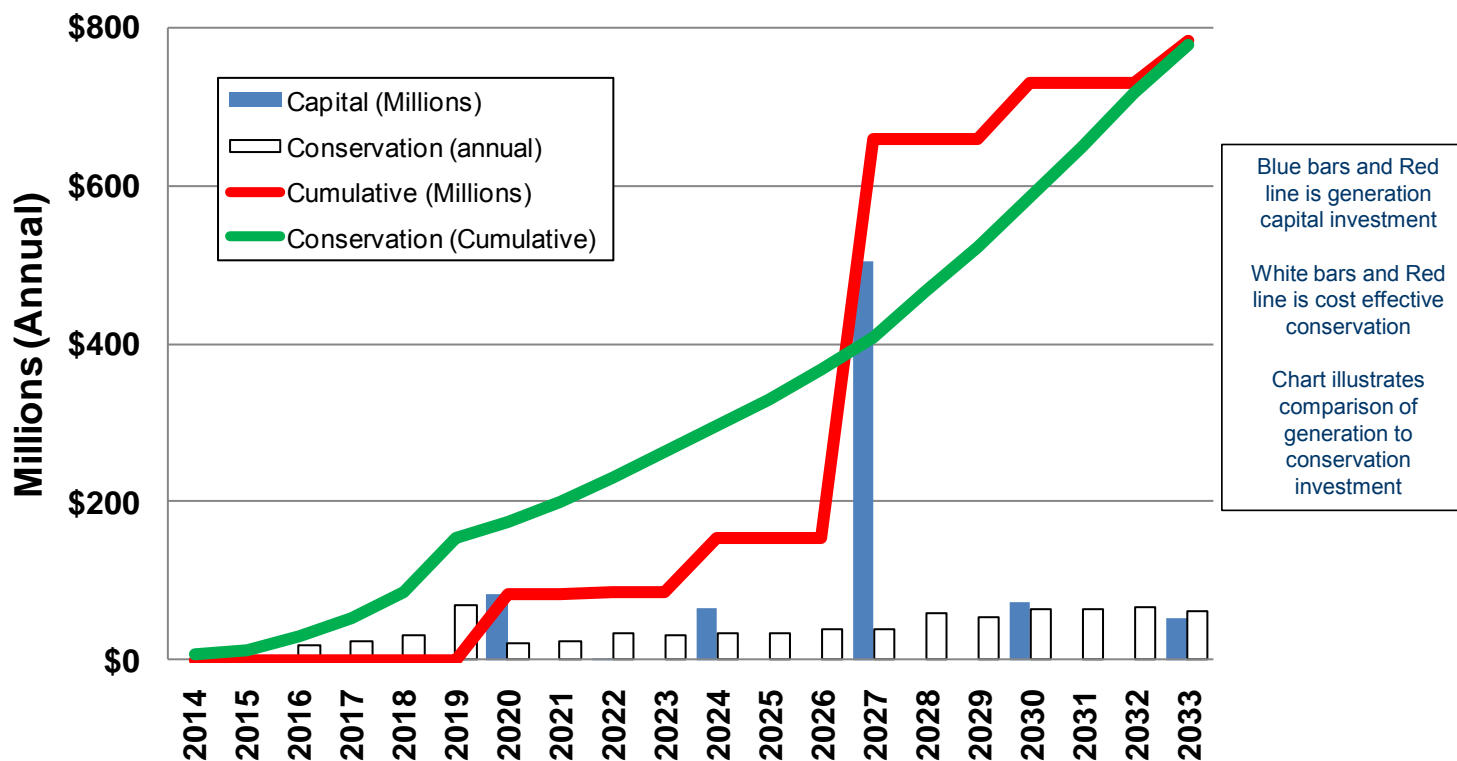

DRAFT

Power Supply Cost Forecast (Range)

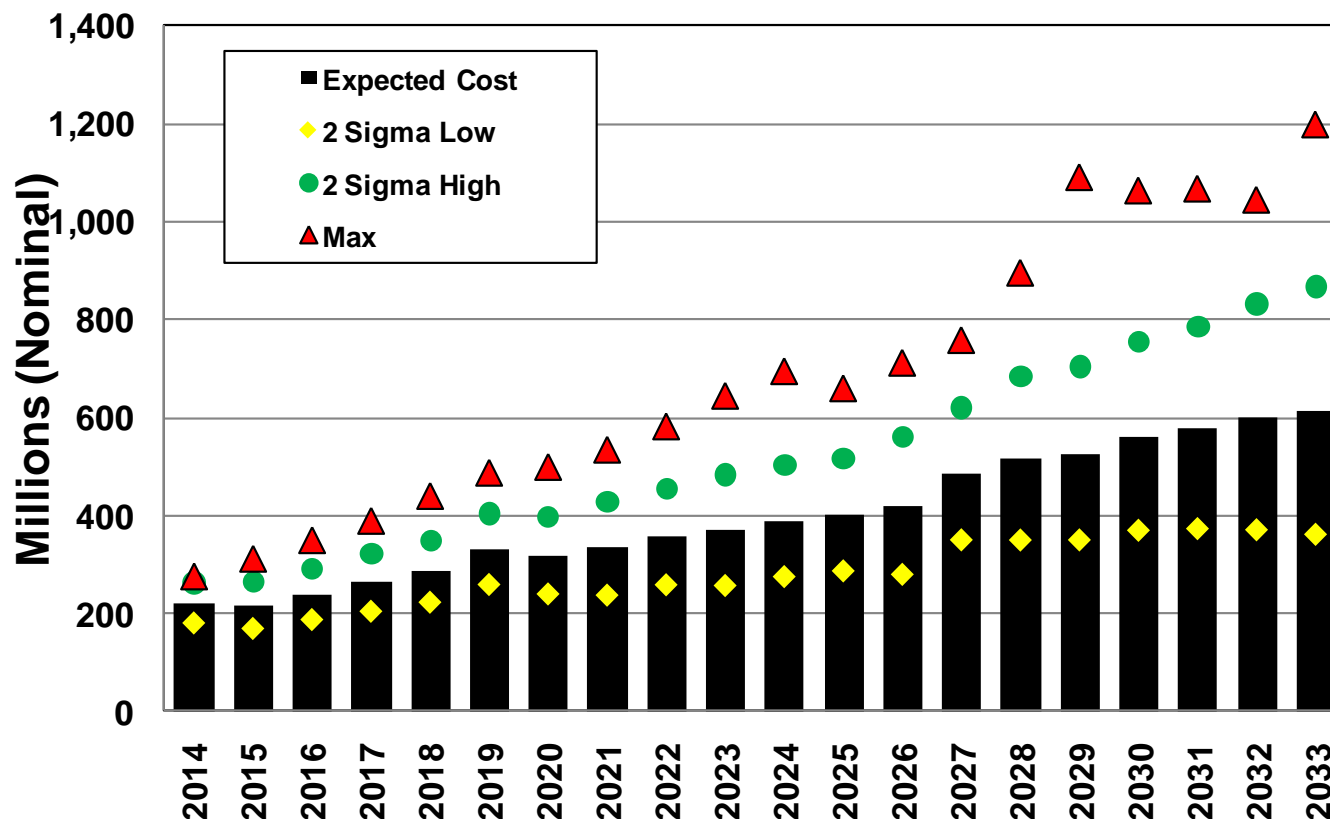

DRAFT

Power Supply Cost Forecast Index (\$/MWh)

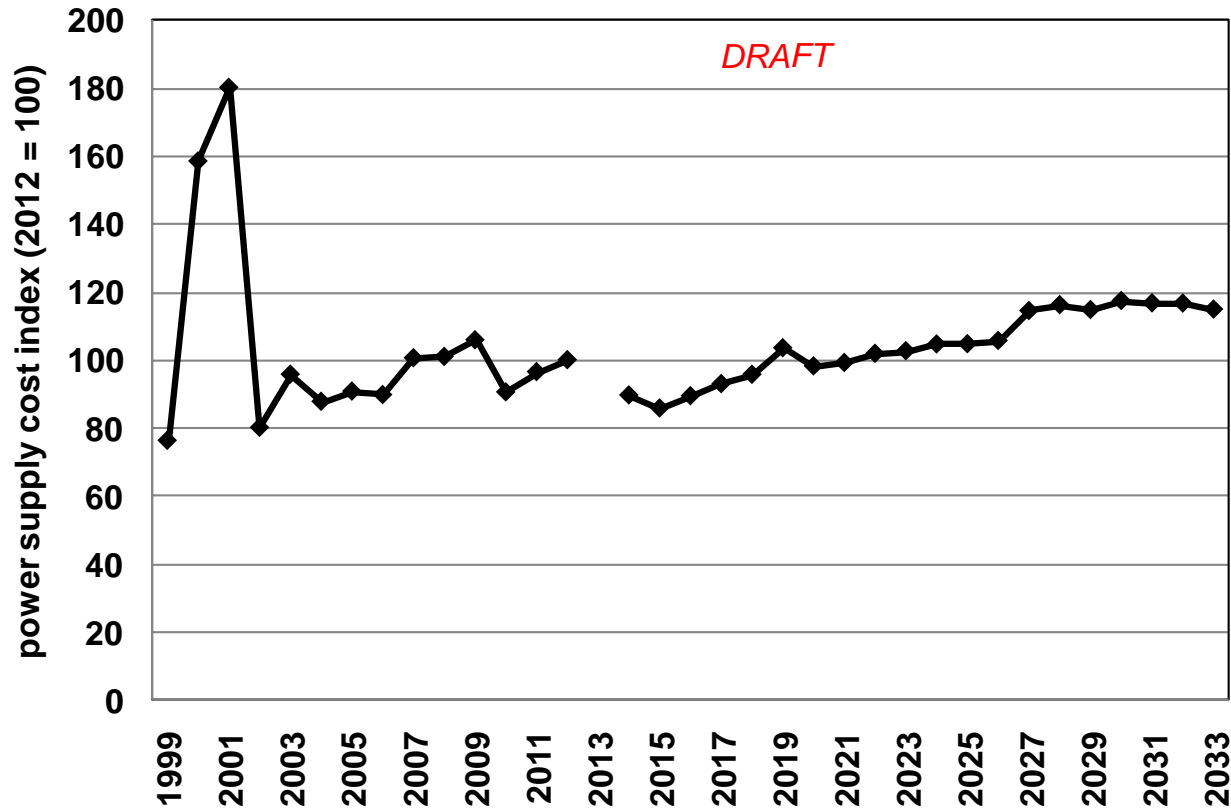



Resource Strategy Scenarios

James Gall

Fifth Technical Advisory Committee Meeting

2013 Electric Integrated Resource Plan

March 20, 2013

DRAFT

Scenario Modeling Status Update

- Scenarios still in progress
 - Conservation
 - Stochastic carbon pricing (and other CO₂ related scenarios)
 - Colstrip scenarios
- These will be presented at the Sixth TAC meeting on June 19, 2013

DRAFT

Efficient Frontier (\$millions)

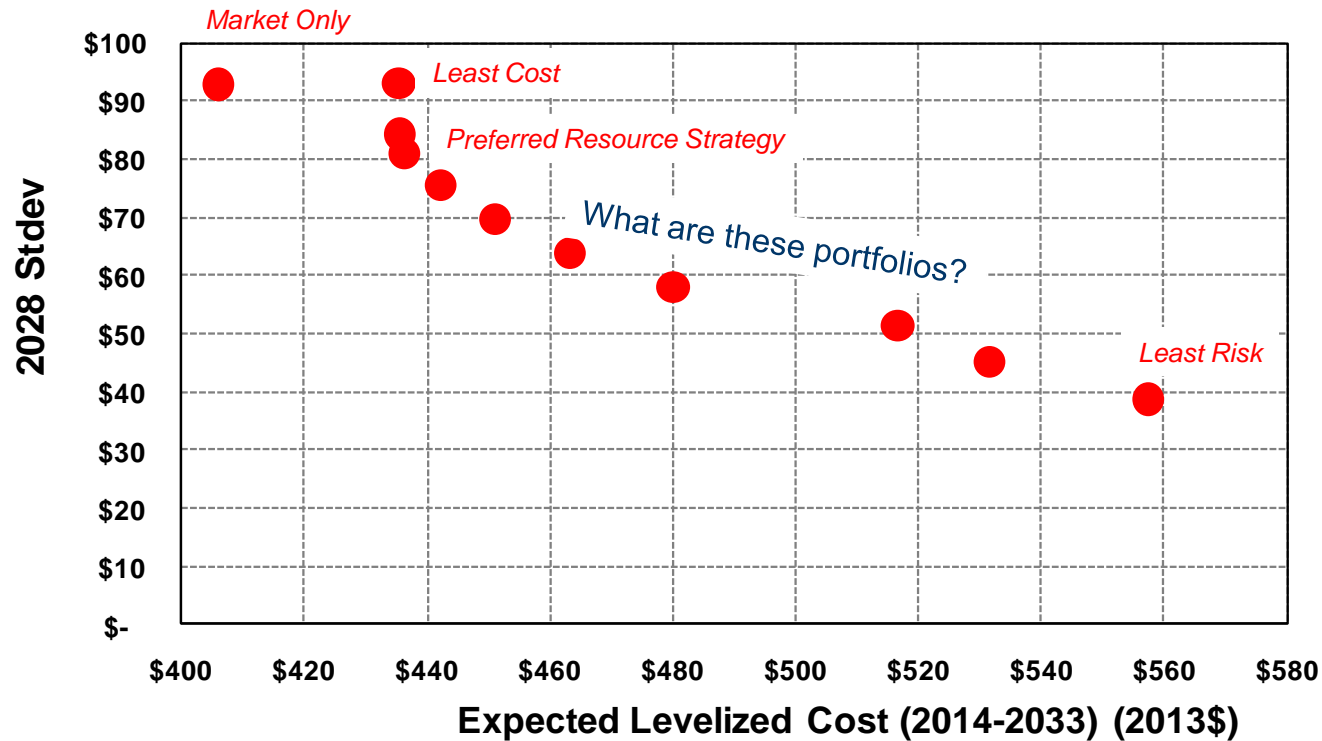

DRAFT

Portfolios Along the Efficient Frontier

Nameplate (MW)	Risk Level					
	PRS	High	Medium High	Medium	Medium Low	Low
CCCT	270	-	270	540	270	270
SCCT	278	549	251	190	149	51
Wind	-	-	-	165	99	350
Solar	-	-	-	-	-	-
Other Renewables	-	-	-	-	-	50
Coal (sequestered)	-	-	-	-	250	295
Other	-	-	-	-	-	-
Market	-	-	-	-	-	-
Plant Upgrade	6	6	85	-	80	80
Demand Response	20	20	20	-	10	15
Total	574	575	626	895	857	1,110
Change in Cost (2028)		-1.0%	1.4%	21.3%	75.8%	109.6%
Change in Risk (2028)		11.0%	-3.5%	-19.4%	-35.9%	-53.1%

DRAFT

2011 PRS Scenario

Year Ending	Resource
2012	Wind (~ 42 aMW REC)
2018	Simple Cycle CT(~ 83 MW)
2020	Simple Cycle CT (~ 83 MW)
2018-2019	Thermal Upgrades (~ 7 MW)
2018-2019	Wind (~ 43 aMW REC)
2023	Combined Cycle CT (~ 270 MW)
2026/27	Combined Cycle CT (~ 270 MW)
2029	Simple Cycle CT (~ 46 MW)
2012+	Distribution Feeder Upgrades (13 aMW by 2031)
2012+	Conservation (310 aMW by 2031)

DRAFT

2011 IRP PRS

- With a lower load forecast and the passage of the biomass bill in Washington, the 2011 PRS overbuilds the needs for the 2013 IRP timeframe
- The adjusted 2011 PRS portfolio is 5.7% higher NPV and lowers power supply risk by 14%- the higher cost is due to overbuilding the expected demand requirements

DRAFT

25% Washington RPS by 2025 Scenario

- The Washington Energy Independence Act (I-937) requires 15% of Washington retail sales to be from renewables by 2020
- This scenario evaluates the costs and benefits if the goal is changed to 25% by 2025

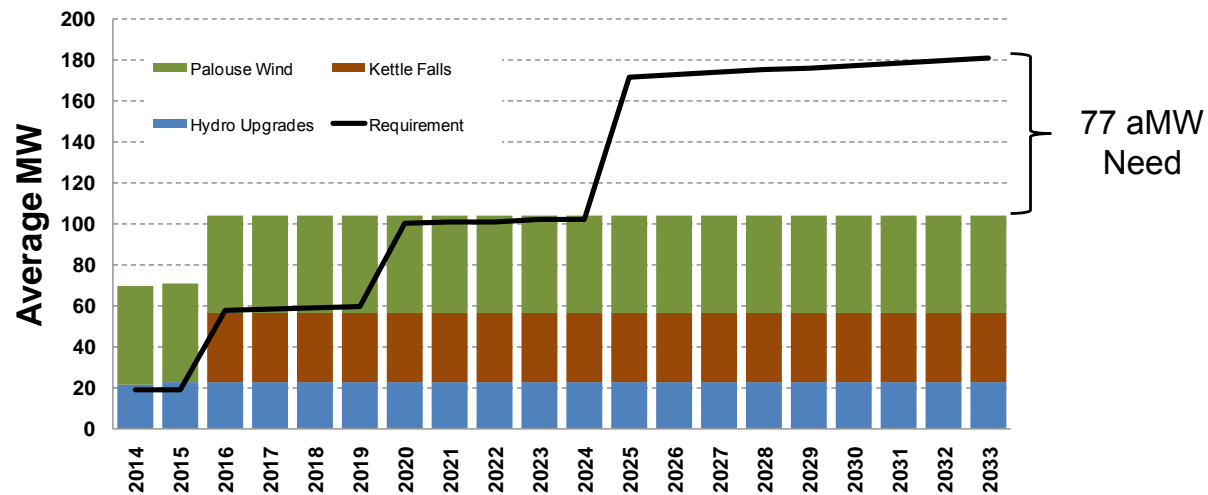

DRAFT

25% Washington RPS in 2025 – Scenario Results

- Hydro upgrades to Long Lake and Monroe Street (148 MW) could meet most of the incremental RPS requirement
- Assuming these resources provide winter capability and summer needs are met by market, this strategy would lower SCCT needs need by 93 MW
- The 2028 cost is 3.7% higher than PRS and risk is 1.8% lower

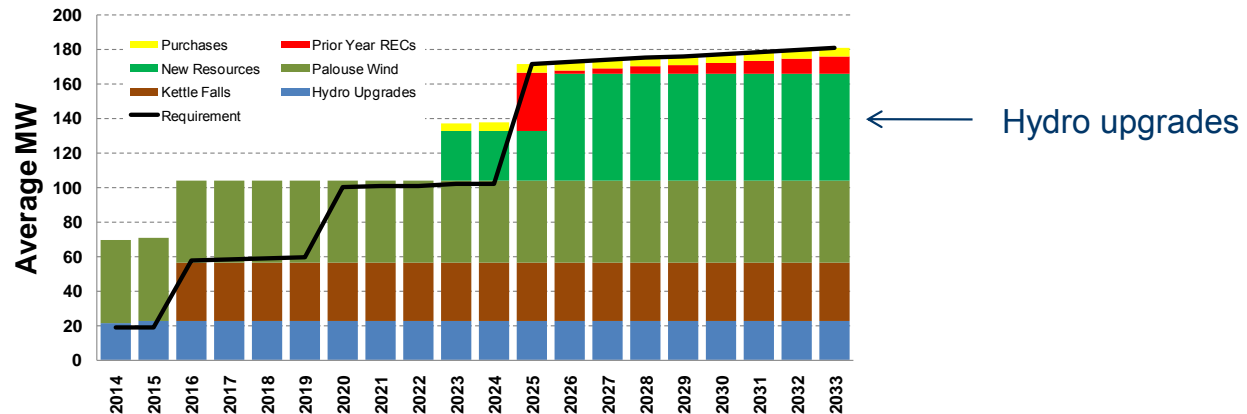

DRAFT

National Renewable Portfolio Standard Scenario

- If the federal government passed legislation requiring renewable generation (i.e. National RPS), this scenario addresses the change in resource strategy and potential costs
- This scenario assumes 10% of load is met by renewables by 2020, then 15% by 2025, and 20% by 2030
- All Avista owned hydro generation would be netted from load to reduce the required quantity of “RECs” – any hydro upgrades would be netted against load rather than receive a REC credit
- For modeling purposes, no banking is assumed and average hydro is used for “hydro netting”

DRAFT

National RPS Scenario Renewable Requirements (aMW)

	2015	2020	2025	2030	2033
Average Load	1,067	1,125	1,180	1,239	1,285
Average Hydro	495	481	481	481	481
Net Load	572	644	699	759	805
RPS %	0%	10%	15%	20%	20%
RPS Required	0	64	105	152	161
Palouse Wind	40	40	40	40	40
Kettle Falls	42	43	43	42	43
Total Existing RECs	82	83	83	82	83
RECs Required	0	0	22	69	78

DRAFT

National RPS Scenario Portfolio Results

- Will require 230 MW of new wind capacity
- Hydro upgrades are not economic without a REC credit
- No other resources change within the Expected Case
- 20 year NPV increases 3.4% over the Expected Case
- 2028 Power Supply Costs are 4% higher and risk is 2.8% lower

DRAFT

Load Forecast Scenarios Impact to Net Position

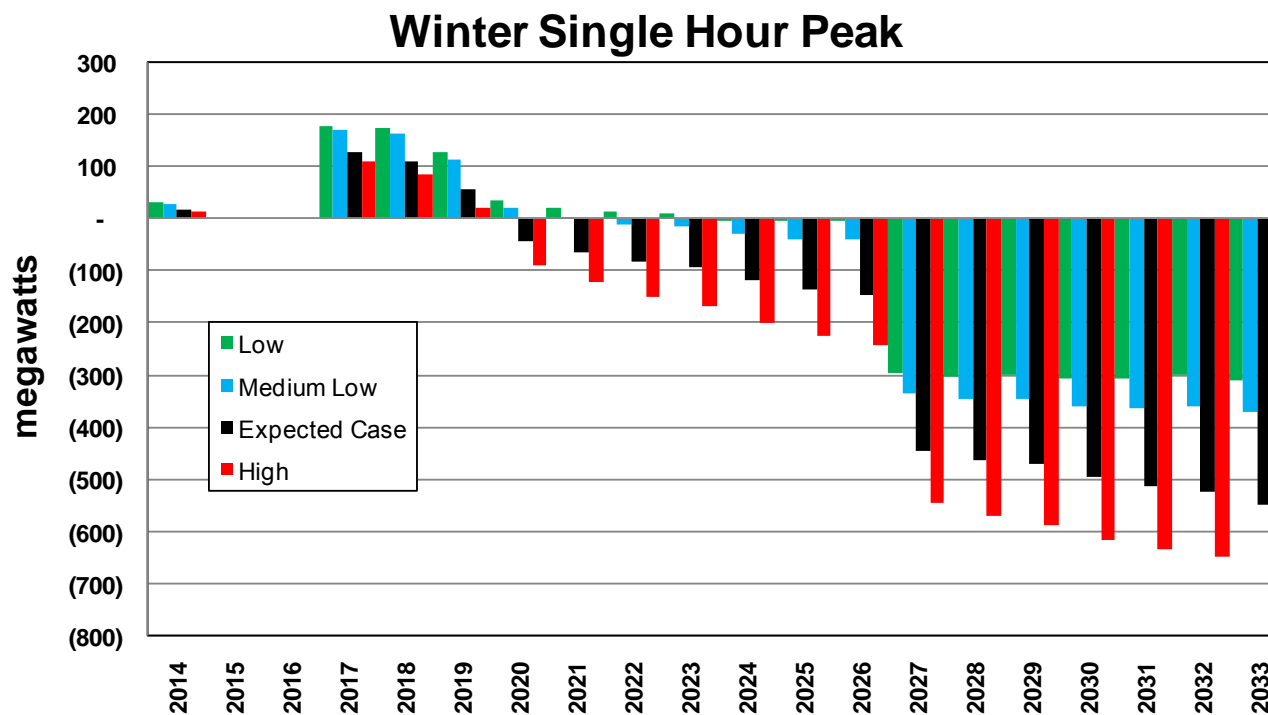

DRAFT

Load Scenario Results

Nameplate (MW)	Load Forecast			
	PRS	Low	Medium Low	High
CCCT	270	270	270	270
SCCT	278	32	91	408
Wind	-	0	0	0
Solar	-	0	0	0
Other Renewables	-	0	0	0
Coal (seq)	-	0	0	0
Other	-	0	0	0
Market	-	0	0	0
Plant Upgrade	6	6	6	6
Demand Response	20	15	20	20
Total	574	323	387	704
Change in Cost (2028)		-5.3%	-3.7%	3.4%
Change in Risk (2028)		-0.1%	-0.5%	-0.4%

DRAFT

High Planning Margin Study (Less Market Dependence)

- This scenario adds more capacity resource need earlier in the study horizon and at a higher quantity, similar to a high load growth scenario
- New resources would be required by the end of 2016 rather than the end of 2019
- Requires 117 MW of additional capacity to be built (assumes met with peaking natural gas resource)
- Result 2.9% higher NPV, 2028 cost is 3.5% higher, risk level is similar to the PRS

DRAFT

Tipping Point Analyses

- Assumes no government incentives
- Find capital cost where resource would join a similar risk portfolio structure as the PRS
- Solar: \$430 per kW (\$3,500 per kW modeled)
 - Solar suffers from providing no winter peak capacity, thus competes on an energy basis only (with little energy)
- IGCC Coal w/ sequestration: \$750 per kW (\$6,000 per kW modeled)
- Nuclear: \$2,150 per kW (\$7,000 per kW modeled)
- Nuclear and Coal has high O&M cost, if those costs were lowered a higher capital cost could be afforded

Avista's 2013 Electric Integrated Resource Plan
Technical Advisory Committee Meeting No. 6 Agenda
Wednesday, June 19, 2013
Conference Room 428

Topic	Time	Staff
1. Introduction	9:30	
2. 2013 Final Preferred Resource Strategy	9:35	Gall
3. Break	10:15	
4. Portfolio Scenario Analysis	10:30	Gall
5. Lunch	12:00	
6. Net Metering and Buck-a-Block	1:00	Kalich
7. Break	1:30	
8. Action Plan	1:45	Lyons
9. 2013 IRP Document Introduction	2:15	Kalich
10. Adjourn	3:00	



2013 Preferred Resource Strategy

James Gall, Senior Power Supply Analyst

Reliability Needs

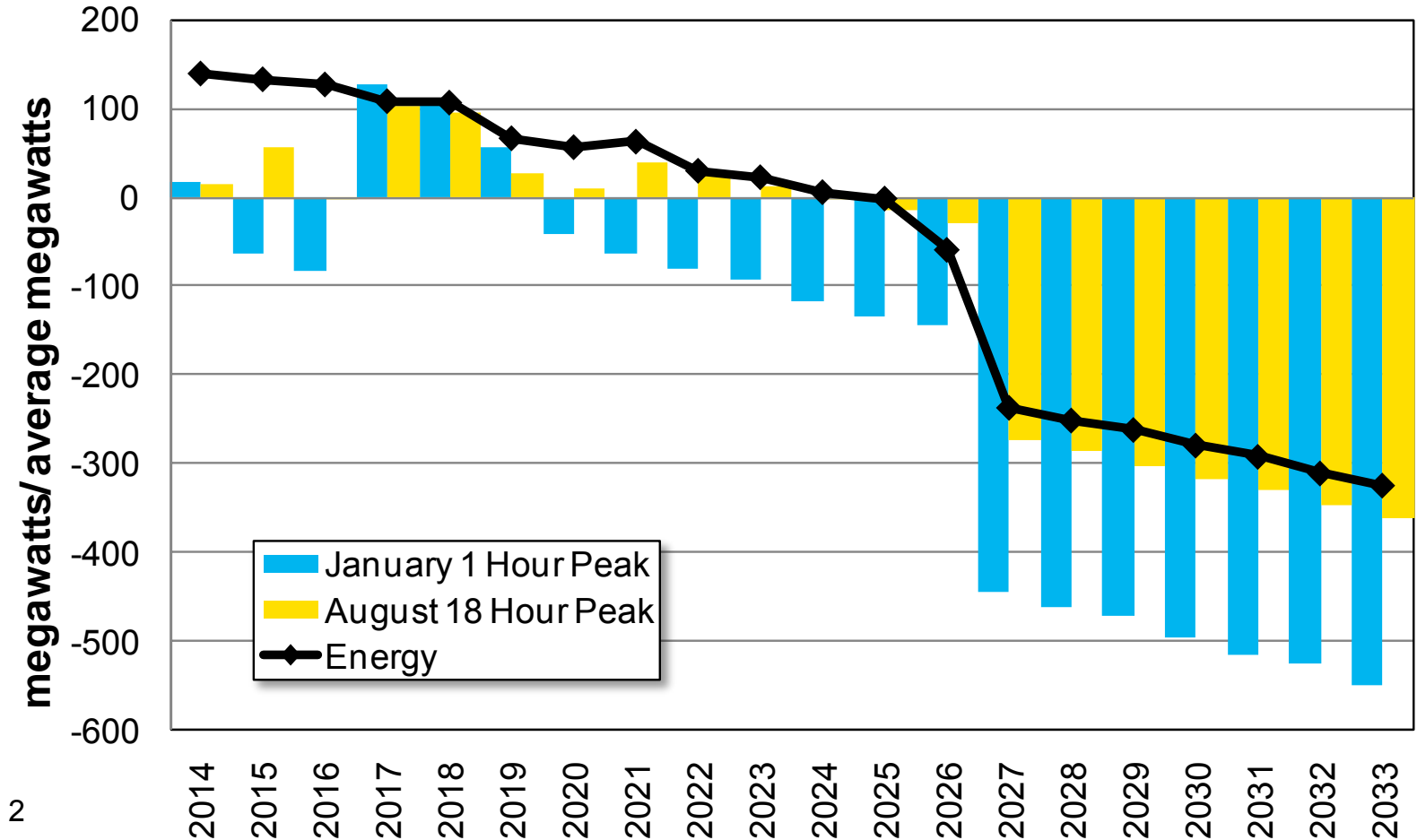

2

Renewable Requirements Met

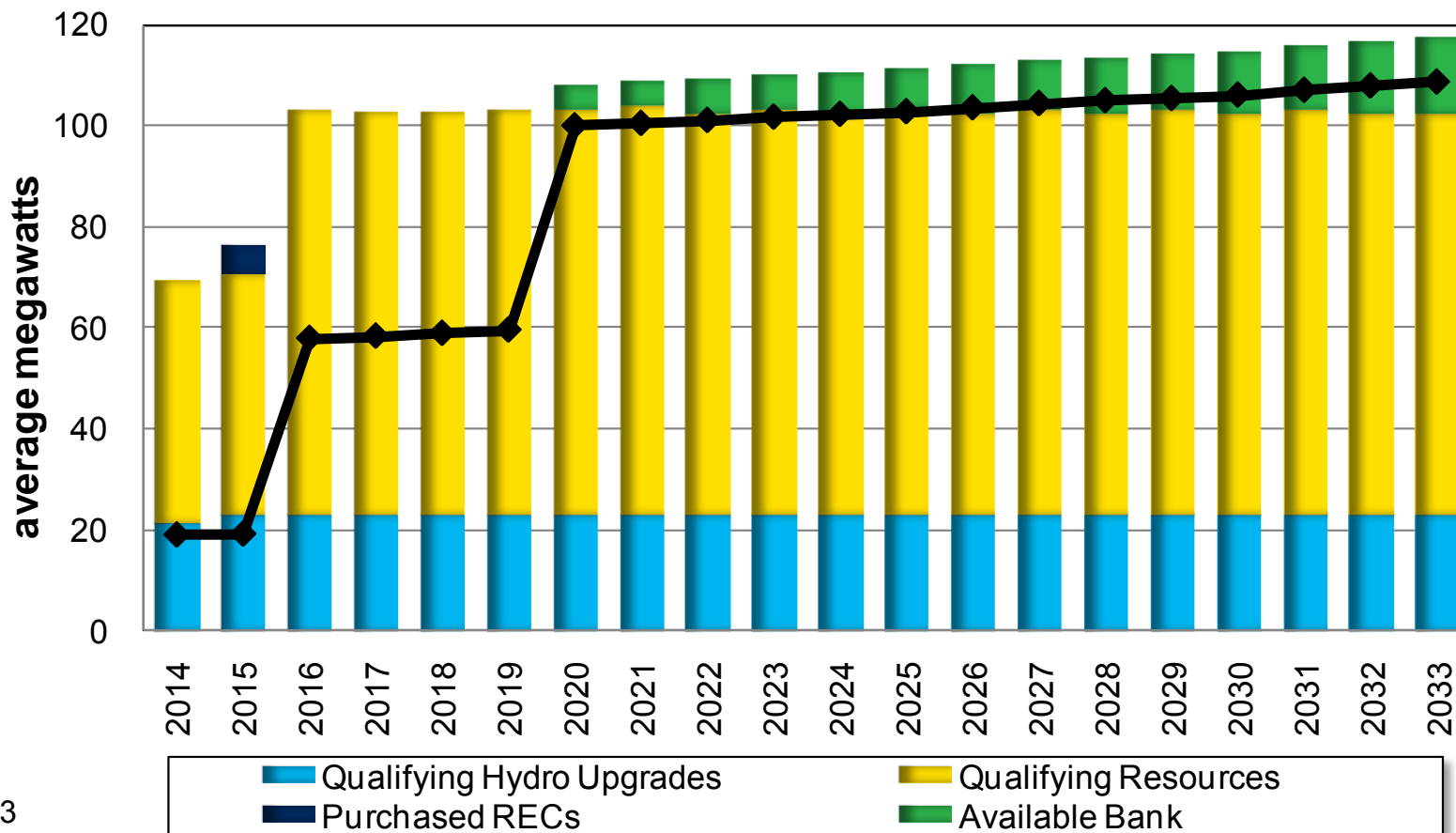

Efficient Frontier Analysis

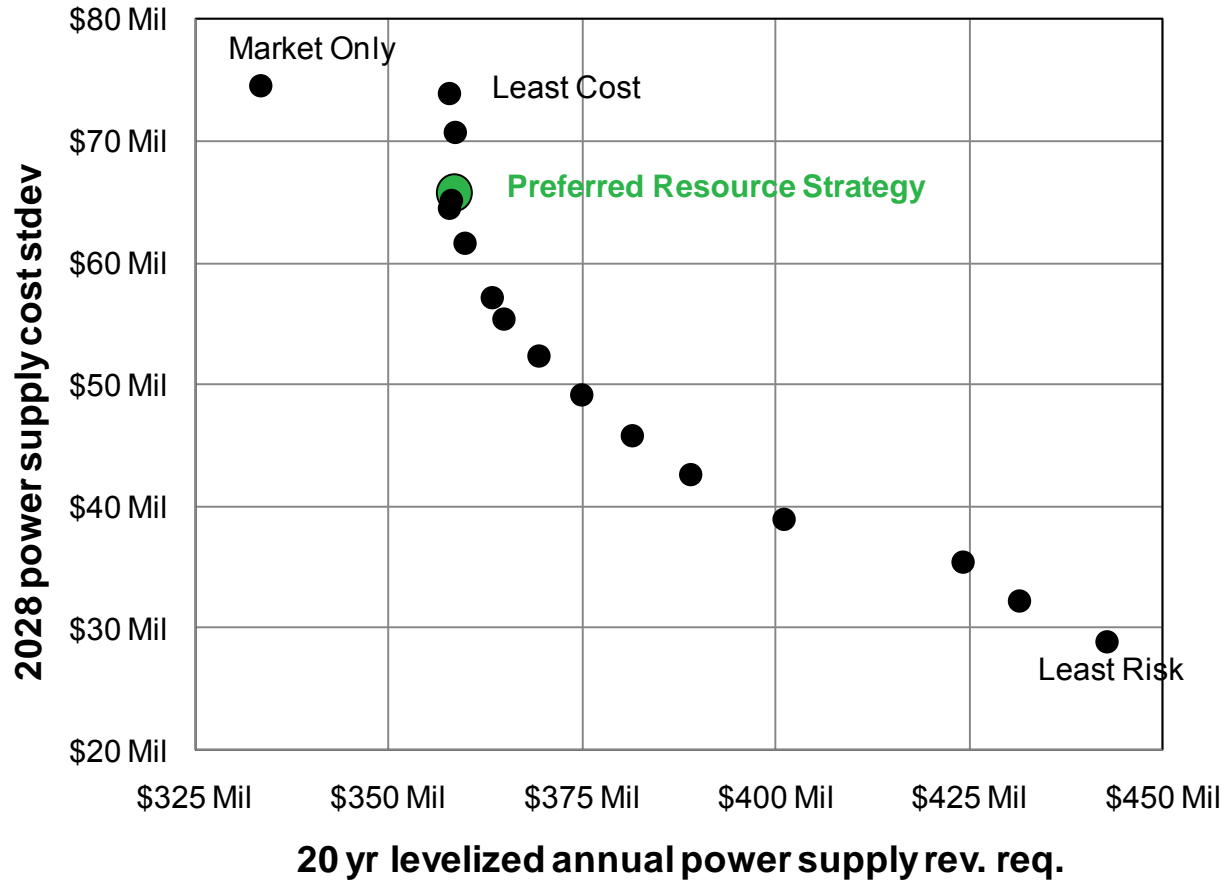

Preferred Resource Strategy

Resource	By the End of Year	Nameplate (MW)	Energy (aMW)
Simple Cycle CT	2019	83	76
Simple Cycle CT	2023	83	76
Combined Cycle CT	2026	270	248
Rathdrum CT Upgrade	2028	6	5
Simple Cycle CT	2032	50	46
Total		492	453
Efficiency Improvements	By the End of Year	Peak Reduction (MW)	Energy (aMW)
Energy Efficiency	2014-2033	221	164
Demand Response	2022-2027	19	0
Distribution Efficiencies	2014-2017	<1	<1
Total		240	164



Resource Capital Requirements

Year	Investment	Year	Investment
2014	0.0	2024	91.6
2015	0.0	2025	0.0
2016	0.0	2026	0.0
2017	0.0	2027	421.7
2018	0.0	2028	97.0
2019	0.0	2029	2.4
2020	85.8	2030	0.0
2021	0.0	2031	0.0
2022	0.0	2032	0.0
2023	0.0	2033	83.6
2014-23 Total	85.8	2024-33 Totals	696.2



Conservation Meets 42% of Load Growth

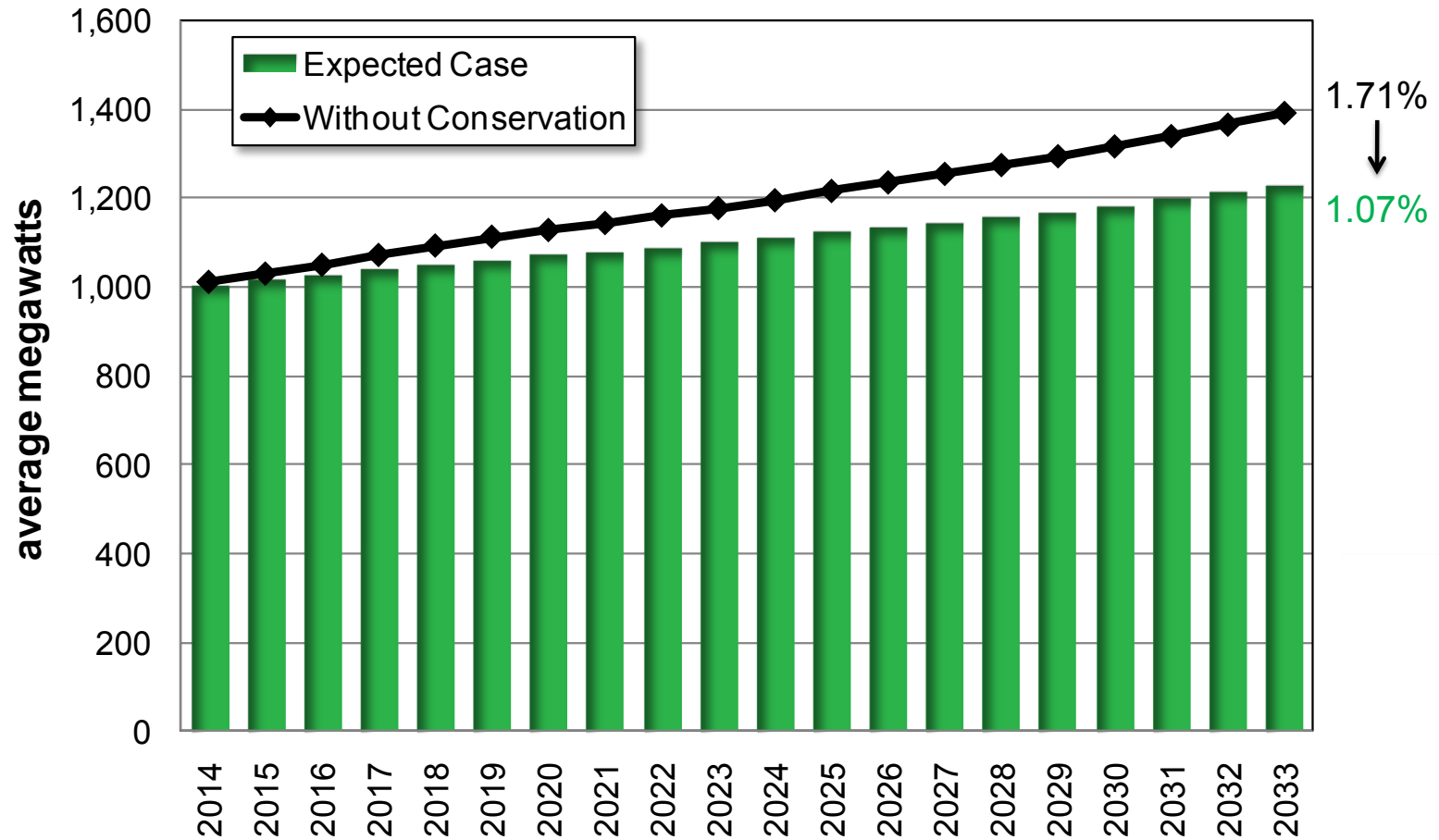

Past and Future Conservation

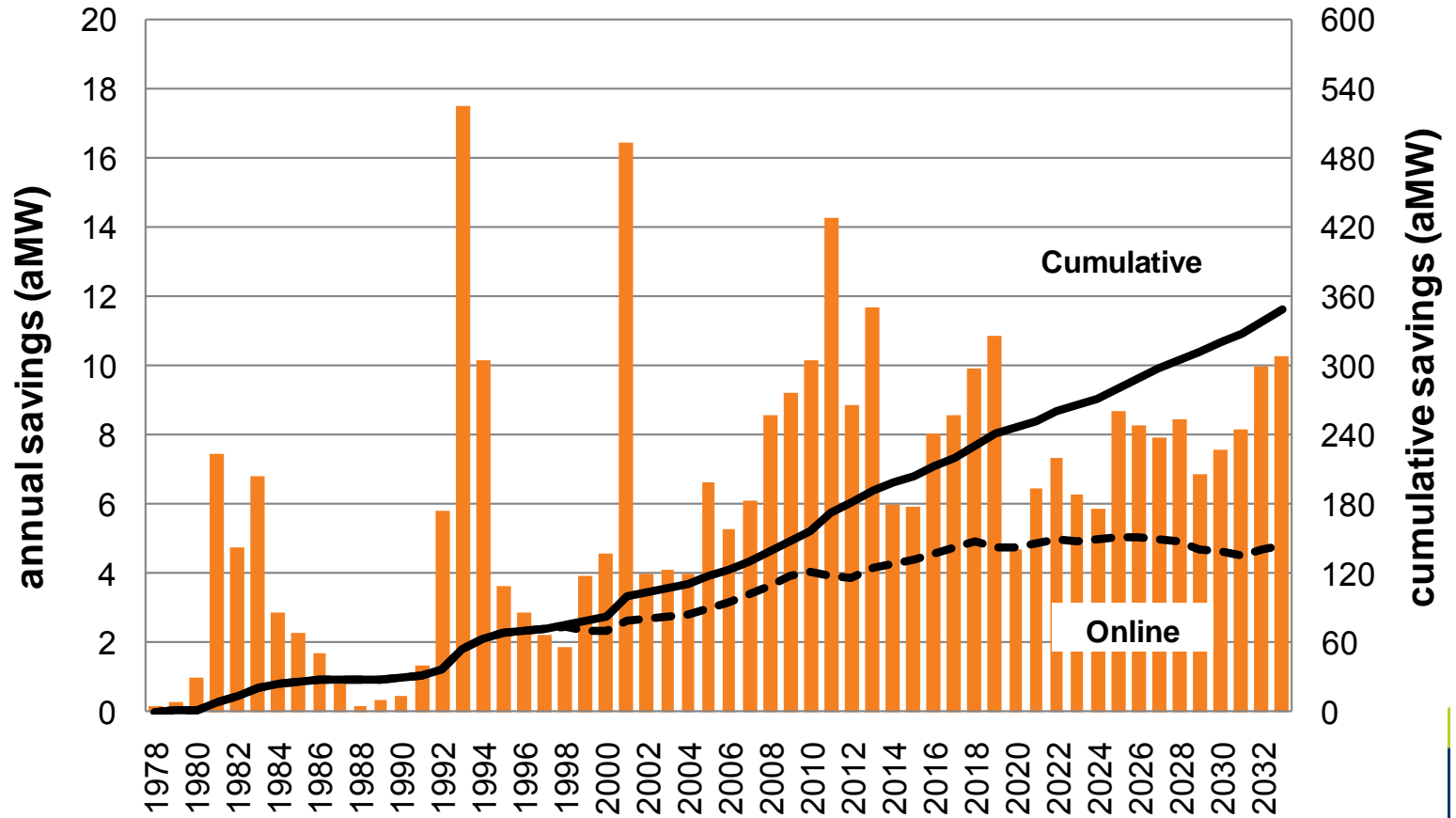

8

Conservation Supply Curve

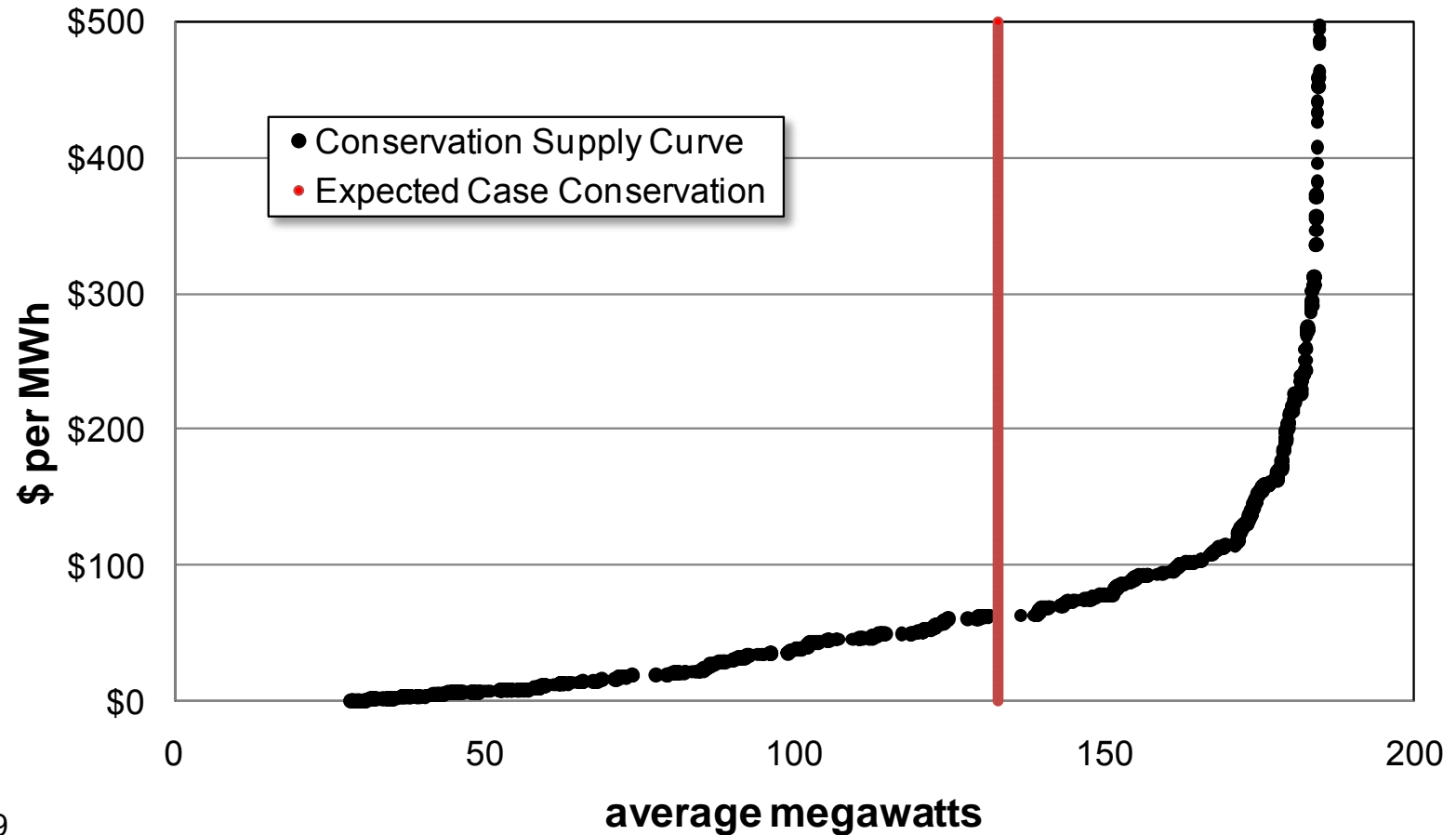

9

Note: excludes fuel switching and pumping programs; not grossed up for line-losses.

Cost of Conservation

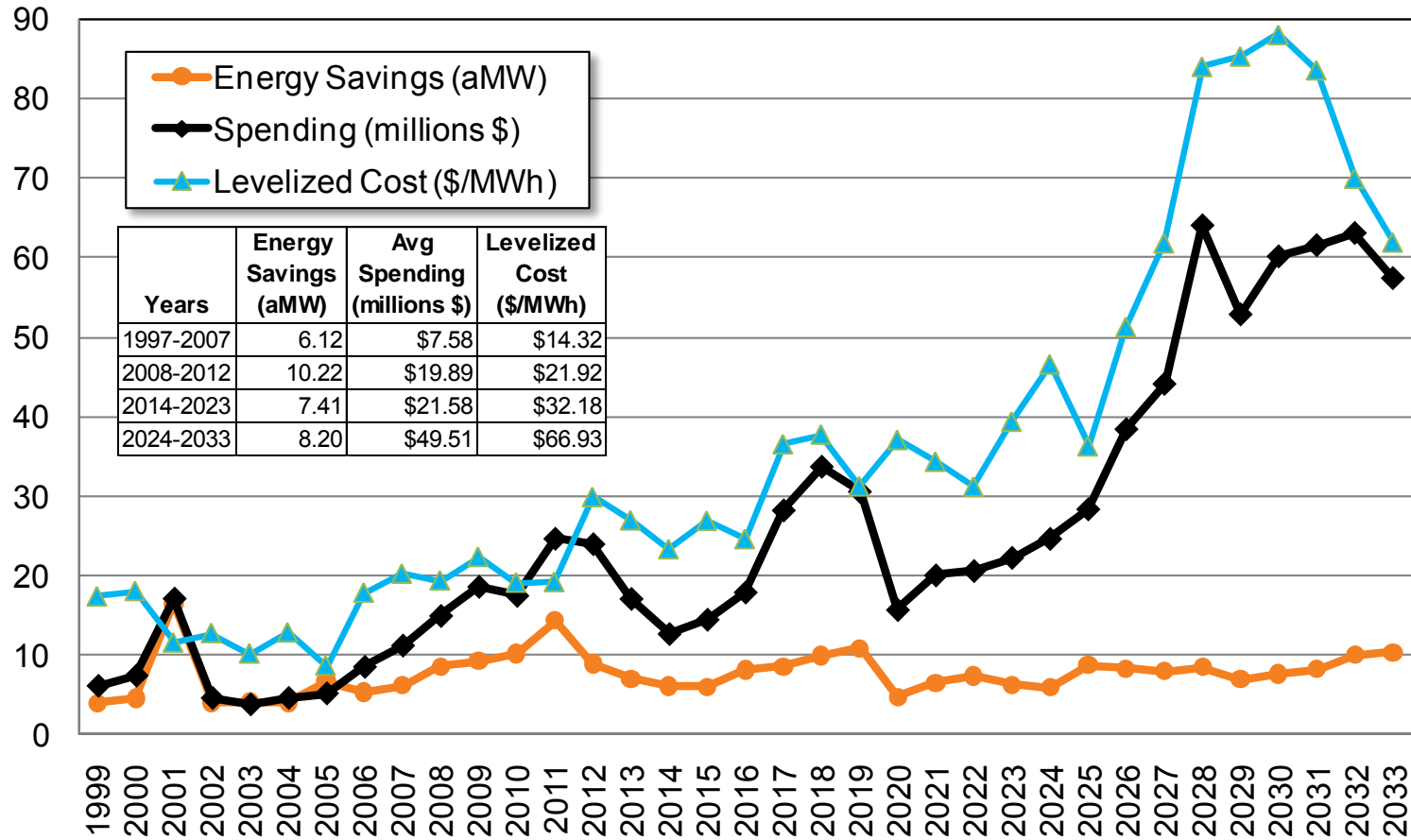

10

Greenhouse Gas Emission Forecast

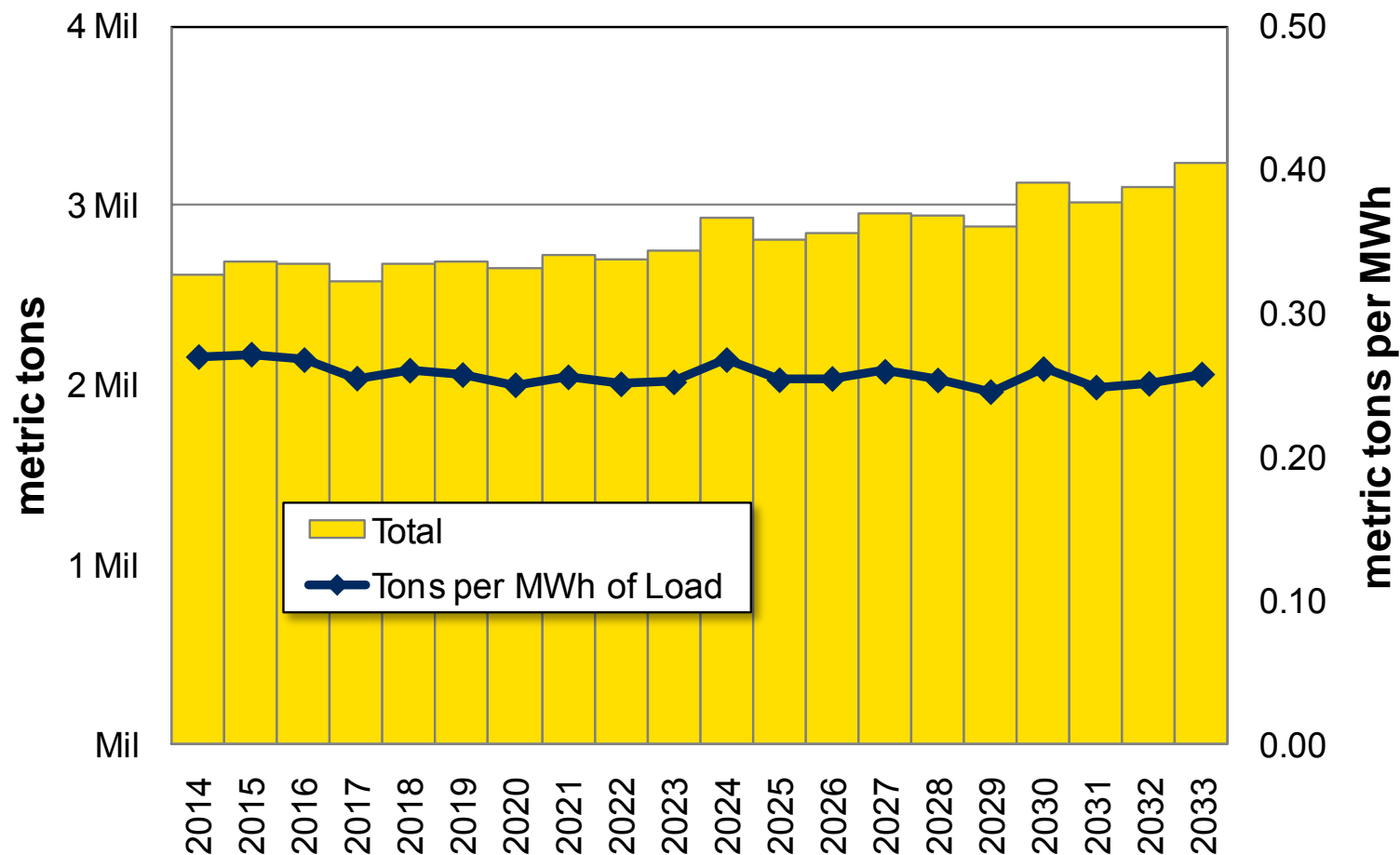

Power Supply Cost Index Forecast (2012\$)

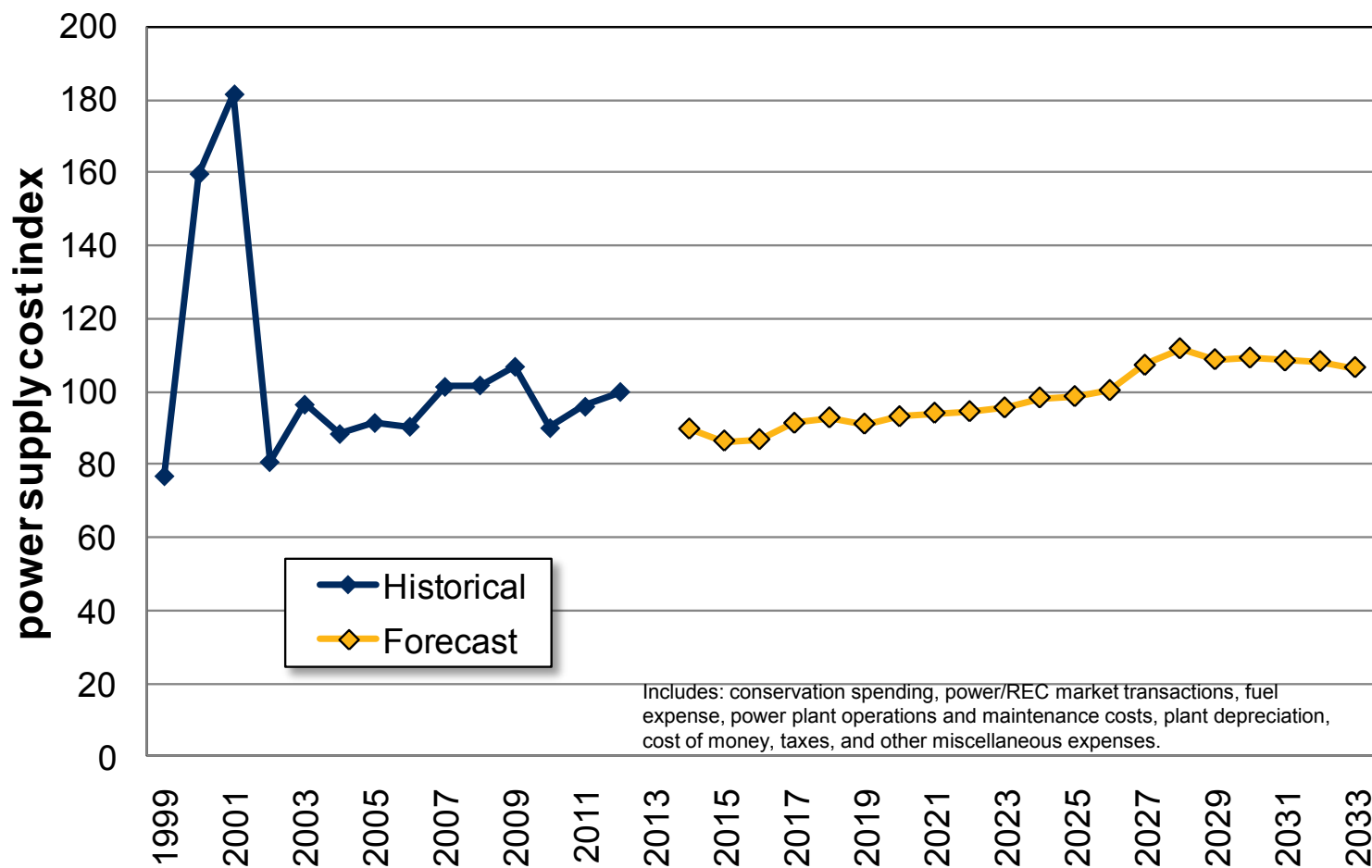



Portfolio Scenario Analysis

James Gall, Senior Power Supply Analyst

Scenarios

- Efficient Frontier Analysis
- Carbon Pricing
- Conservation
- Load Growth
- Resource & Policy Specific Portfolios
- Colstrip



Efficient Frontier

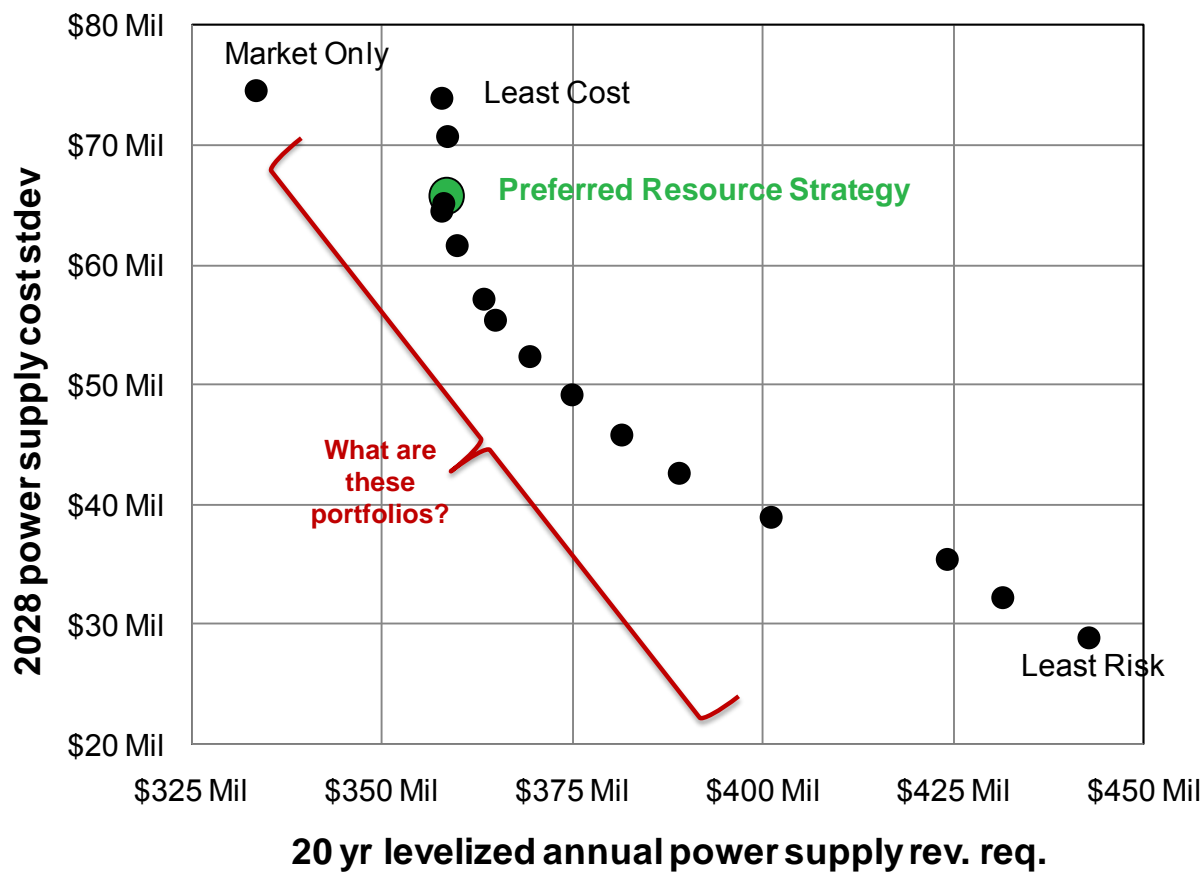

Portfolio Mix at Alternative Risk Levels

Nameplate (MW)	PRS	High Risk	Medium High Risk	Medium Risk	Medium Low Risk	Low Risk
CCCT	270	-	270	270	540	540
SCCT	299	566	296	216	100	68
Wind	-	-	-	30	50	350
Solar	-	-	-	-	-	-
Biomass	-	-	-	-	-	50
Coal (seq)	-	-	-	-	-	-
Hydro Upgrade	-	-	-	-	-	-
Thermal Upgrade	6	6	6	85	85	80
Demand Response	19	20	20	8	12	17
Total (excluded DSM)	594	592	592	609	788	1,104
20-yr Levelized Cost (mill)	\$358.4	\$357.9	\$357.9	\$362.3	\$367.0	\$396.0
2028 Power Supply Stdev (mill)	\$65.7	\$74.0	\$64.4	\$60.5	\$54.1	\$40.2
2033 Greenhouse Gas Emissions (millions of metric tons)	3.2	2.9	3.4	3.4	3.9	3.8



Carbon Pricing Effect to Efficient Frontier

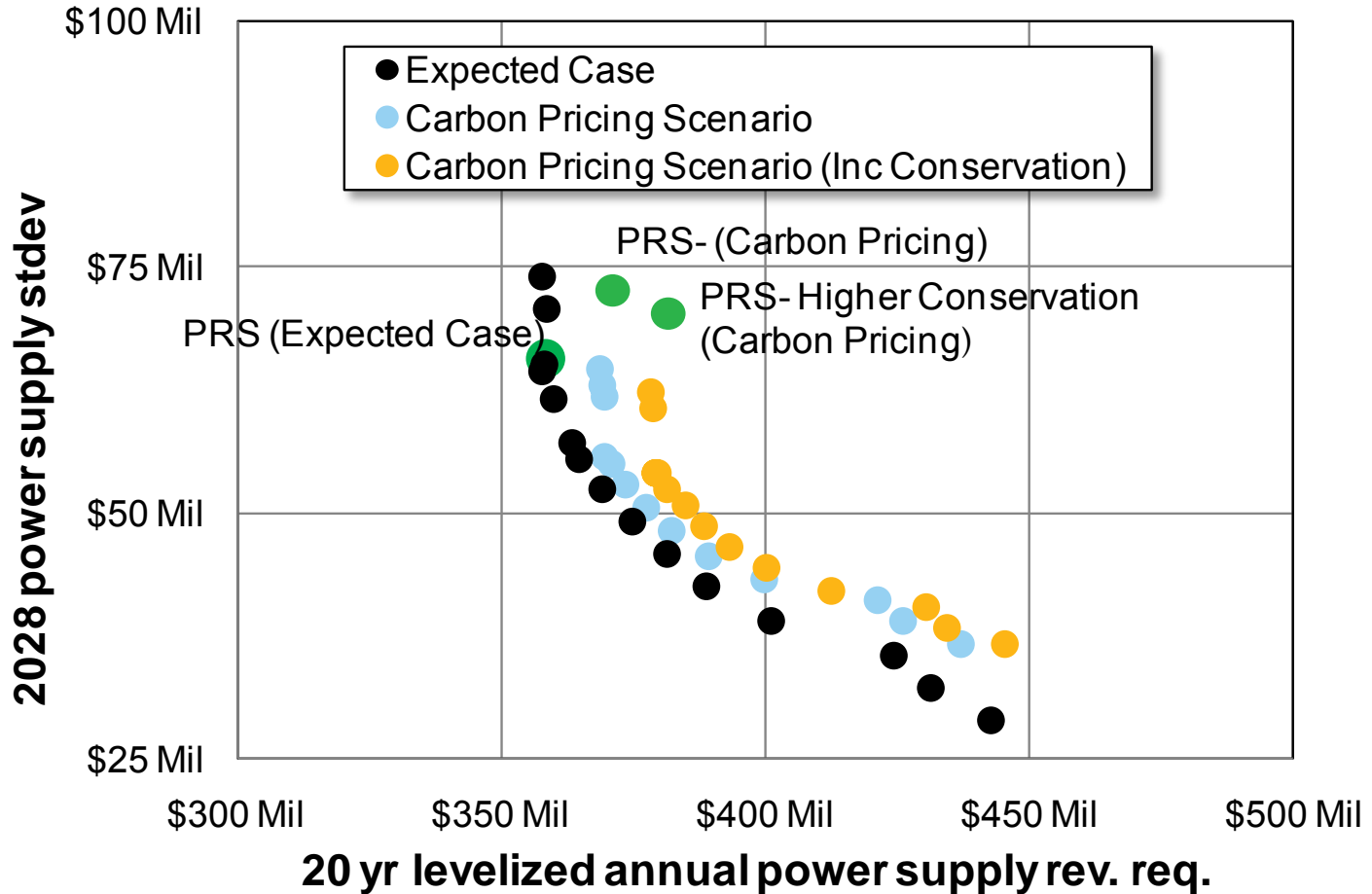

Carbon Pricing Scenario- Least Cost Strategy

Peaking Technology Switches to Higher Efficient Turbines

Portfolio	20-Yr Power Supply Levelized Cost	
	Expected Case	Carbon Pricing Scenario
PRS	\$358.4	\$367.3
PRS w/ Higher Conservation	\$365.0	\$377.8
Carbon Pricing Scenario- LC RS	\$364.7	\$374.5
Portfolio	2028 Power Supply Cost Standard Deviation	
	Expected Case	Carbon Pricing Scenario
PRS	\$65.7	\$72.6
PRS w/ Higher Conservation	\$63.9	\$70.3
Carbon Pricing Scenario- LC RS	\$61.0	\$63.6

Conservation Avoided Cost Scenarios

- Change cost effective point of conservation
- 20 Year Avoided Cost for Conservation is \$67.91/MWh

Avoided Cost Percentage	20 Year aMW	Delta aMW
75%	139	-25
100%	154	-10
Expected Case (110%)	164	0
125%	184	+20
150%	201	+37



Conservation Avoided Cost Scenarios

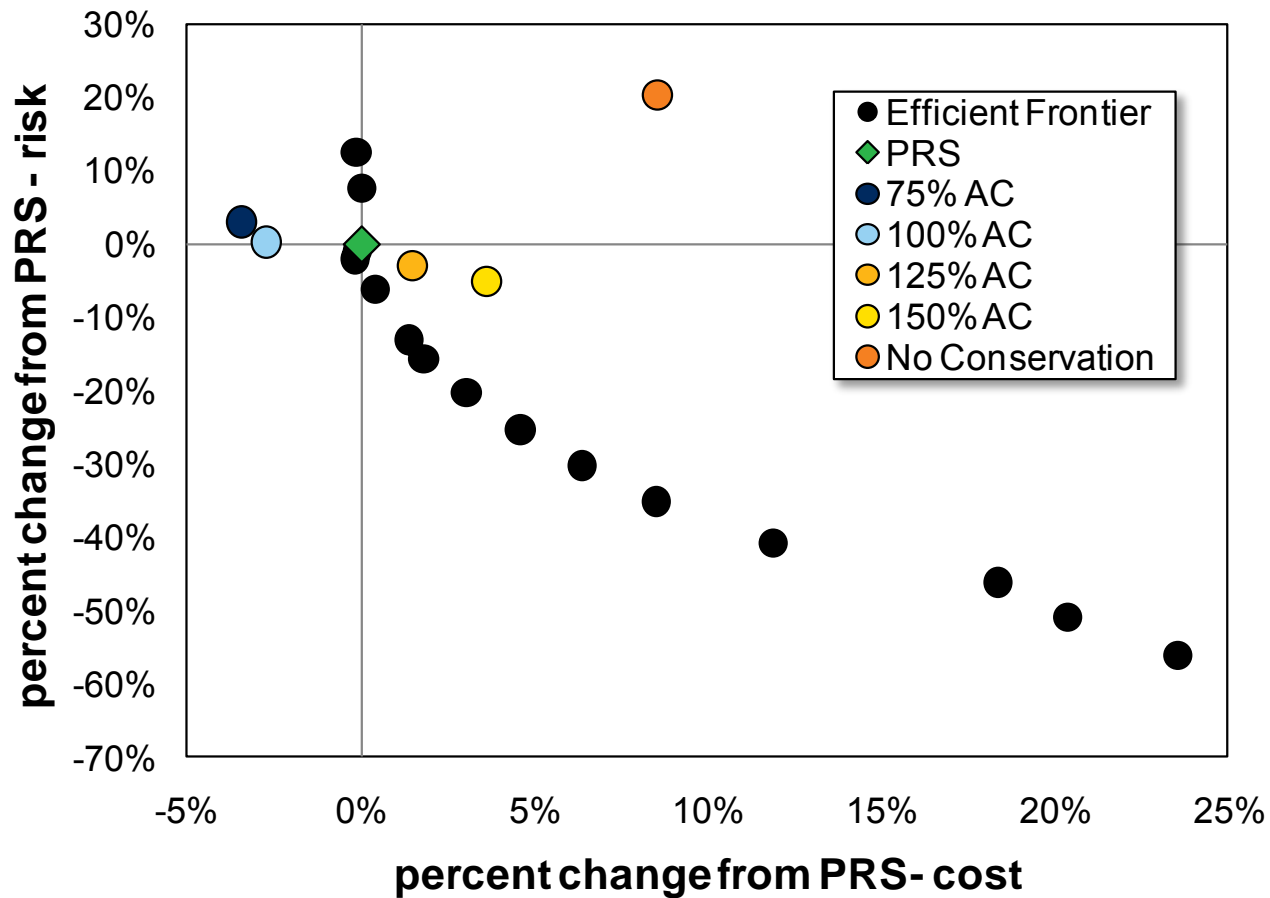

Load Growth Sensitivities

Winter Peak Position

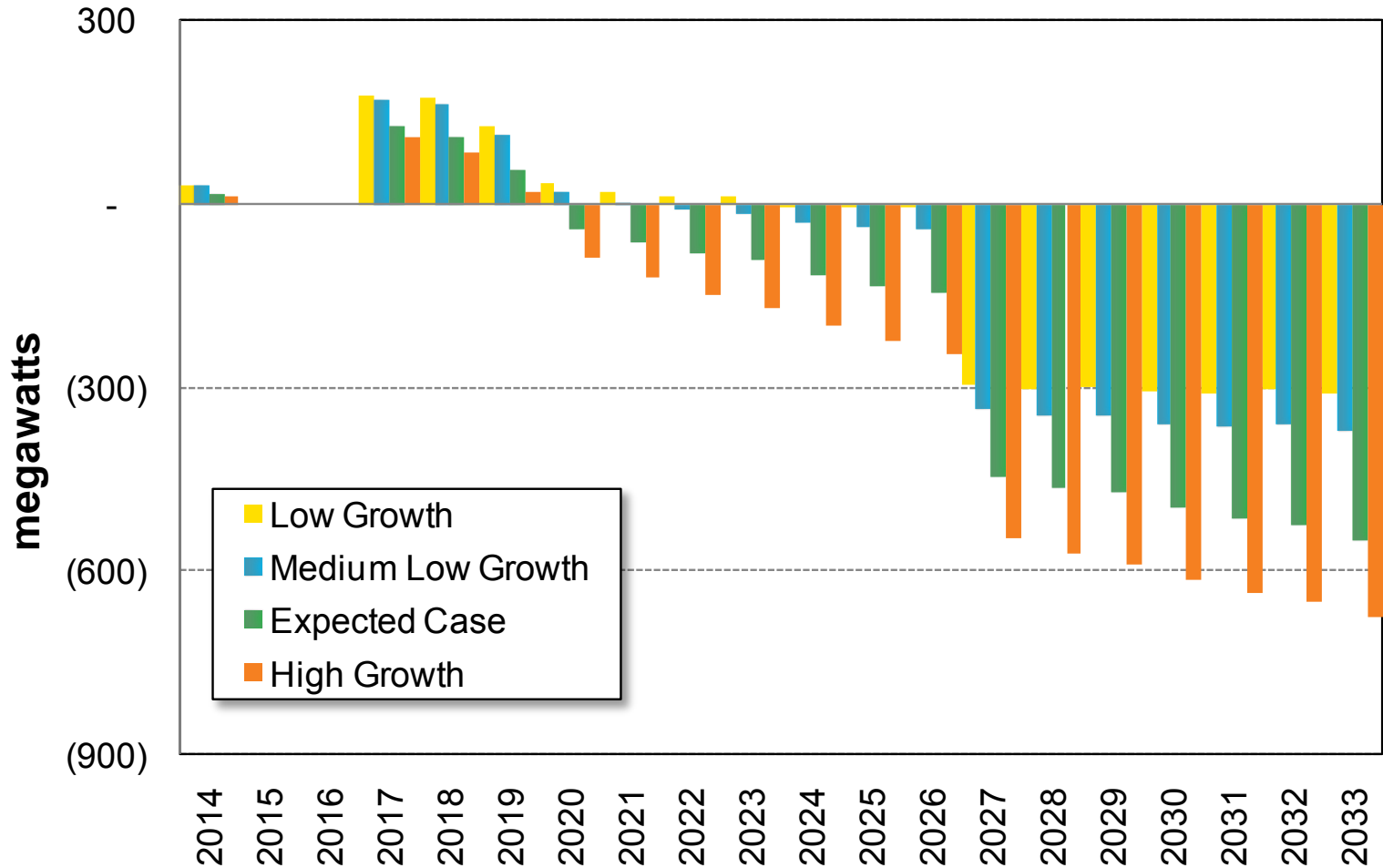

Load Growth Scenarios: Resource Selection

Year	PRS	Low Growth	Medium Low Growth	High Growth
2014				
2015				
2016				
2017				
2018				
2019	83 MW SCCT			150 MW SCCT
2020				
2021				
2022			6 MW Upgrade	92 MW SCCT
2023	83 MW SCCT		90 MW SCCT	
2024				
2025				
2026	270 MW CCCT	270 MW CCCT	270 MW CCCT	270 MW CCCT
2027		50 MW SCCT		92 MW SCCT
2028				6 MW Upgrade
2029	6 MW Upgrade			50 MW SCCT
2030				
2031				
2032				
2033	50 MW SCCT			50 MW SCCT
Demand Response (MW)	19	1	20	20
Conservation (aMW)	164	142	147	175

10

Resource Strategies from Policy Changes

Nameplate (MW)	PRSHigher WA St. RPS	National RPS	Higher Capacity Margins	2011 PRS	
CCCT	270	270	270	540	
NG Peaker	299	249	296	187	
Wind	-	-	203	120	
Solar	-	-	-	-	
Biomass	-	-	-	-	
Coal (seq)	-	-	-	-	
Hydro Upgrade	-	148	-	-	
Thermal Upgrade	6	6	6	-	
Demand Response	19	10	20	-	
Total (Excluding Conservation)	594	683	795	847	
20-yr Levelized Cost (millions)	\$354.8	\$360.3	\$365.3	\$364.2	\$373.9
2028 Power Supply Stdev (millions)	\$65.7	\$64.8	\$63.6	\$65.8	\$54.0
2033 Greenhouse Gas Emissions (millions of metric tons)	3.2	3.2	3.3	3.4	3.7



Resource Specific Portfolios

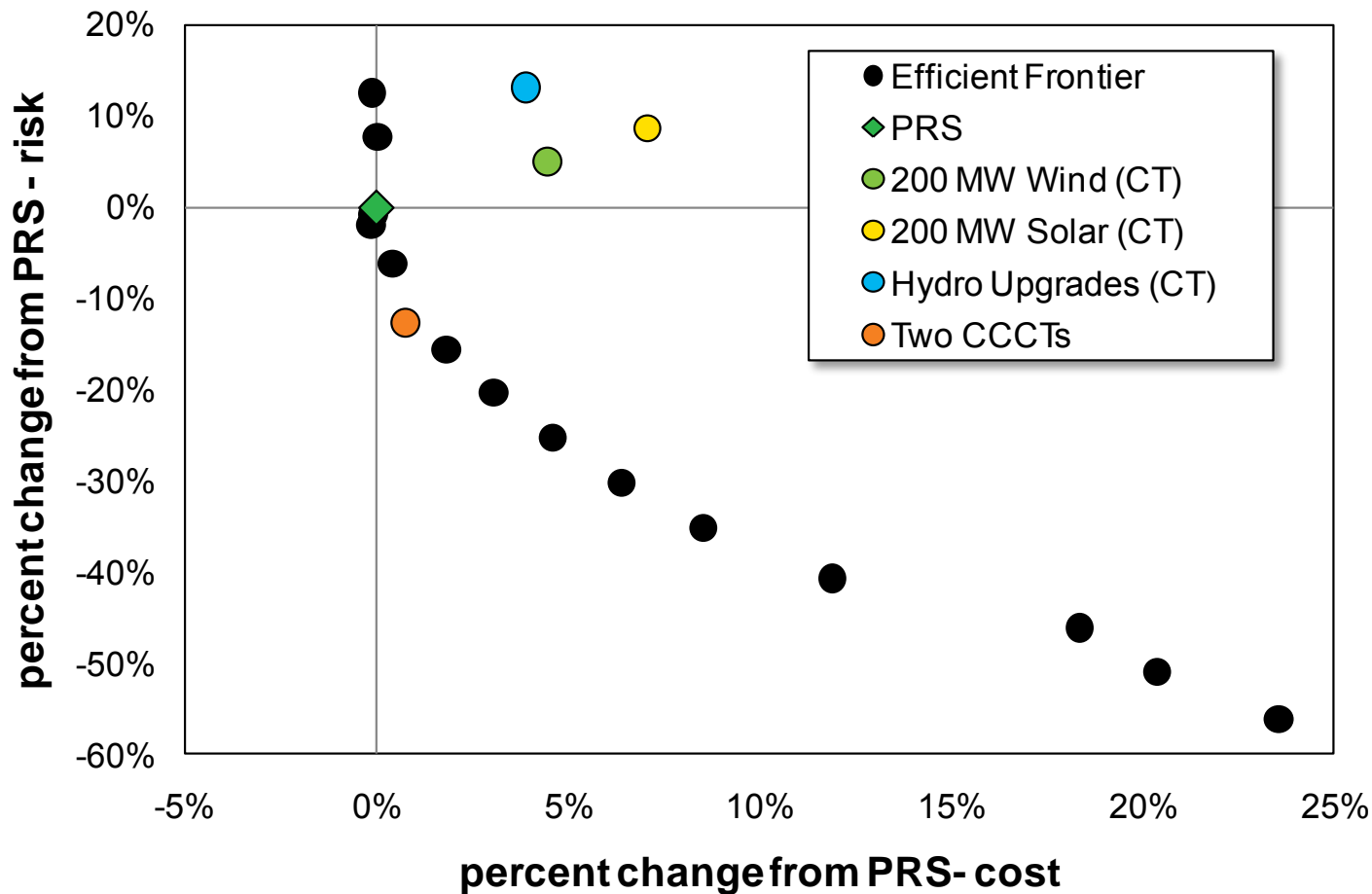

Colstrip Scenarios

- No Colstrip Resource Strategy Scenario
 - Colstrip is removed from portfolio beginning in 2018
 - No costs/benefits included due to its removal
- Regional Haze Program Scenario
 - Assumes Colstrip #3 & #4 must install SCR or shut down in 2027
 - SCR costs are expected to be \$105 million (Avista share) plus \$560k each year in O&M or \$8.39/MWh total cost levelized



Resource Strategy Without Colstrip

Resource	By the End of Year	Nameplate (MW)	Energy (aMW)
Combined Cycle CT	2017	270	248
Simple Cycle CT	2020	50	46
Simple Cycle CT	2023	50	46
Combined Cycle CT	2026	270	248
Simple Cycle CT	2026	51	47
Simple Cycle CT	2029	55	51
Simple Cycle CT	2032	50	46
Total		797	733
Efficiency Improvements	By the End of Year	Peak Reduction (MW)	Energy (aMW)
Energy Efficiency	2014-2033	221	164
Demand Response	2022-2027	20	0
Distribution Efficiencies	2014-2017	<1	<1
Total		241	164

Colstrip Scenarios: Levelized Cost Comparison

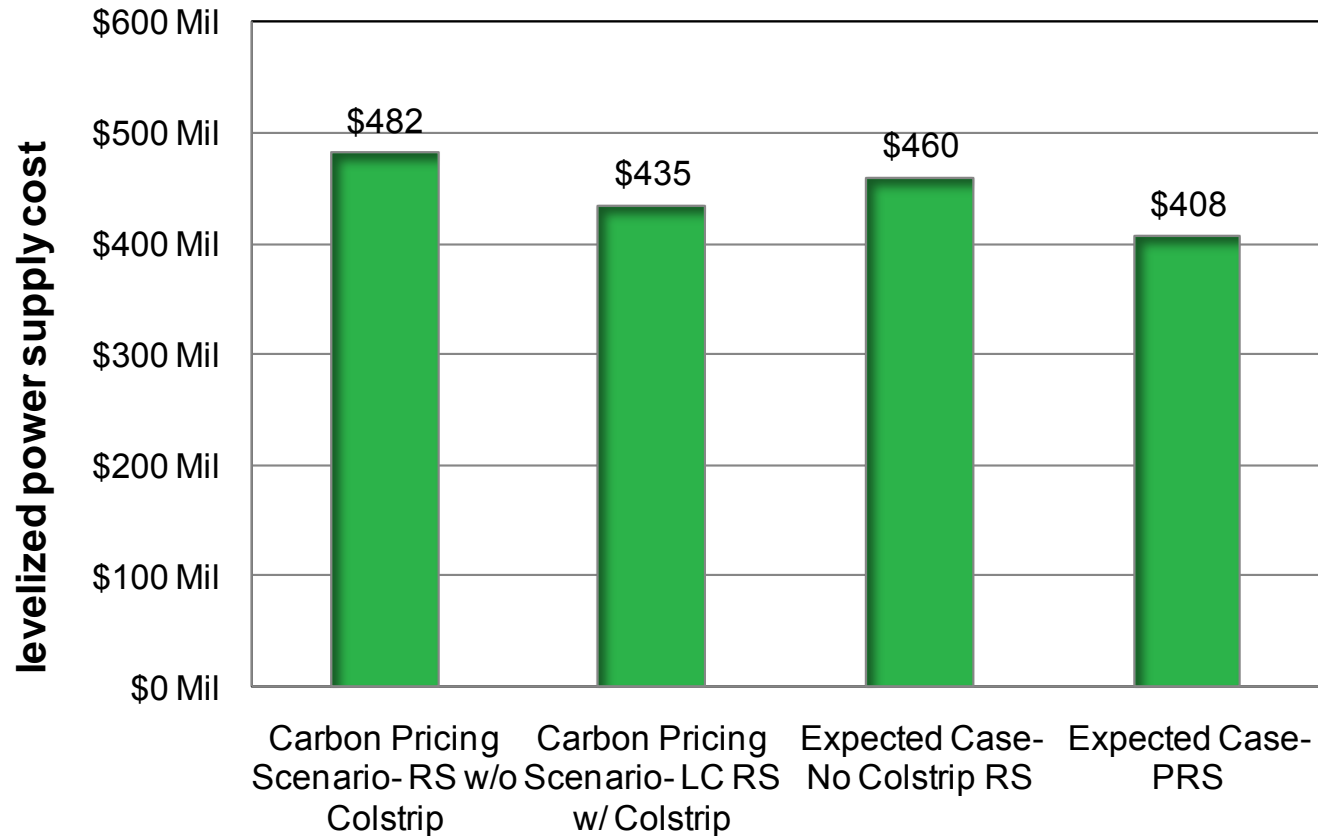

Greenhouse Gas Emissions without Colstrip

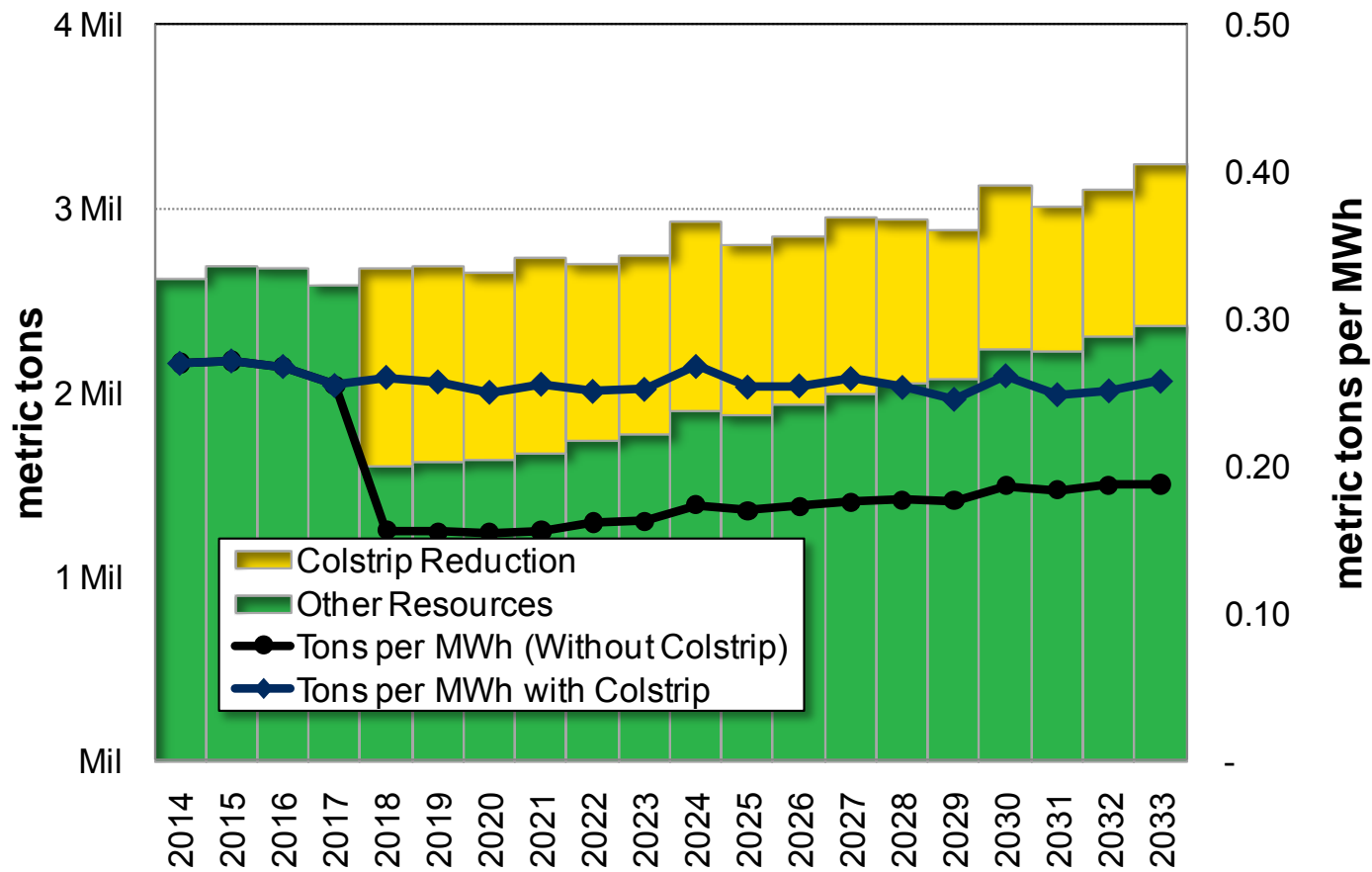

Power Supply Cost Index Comparison

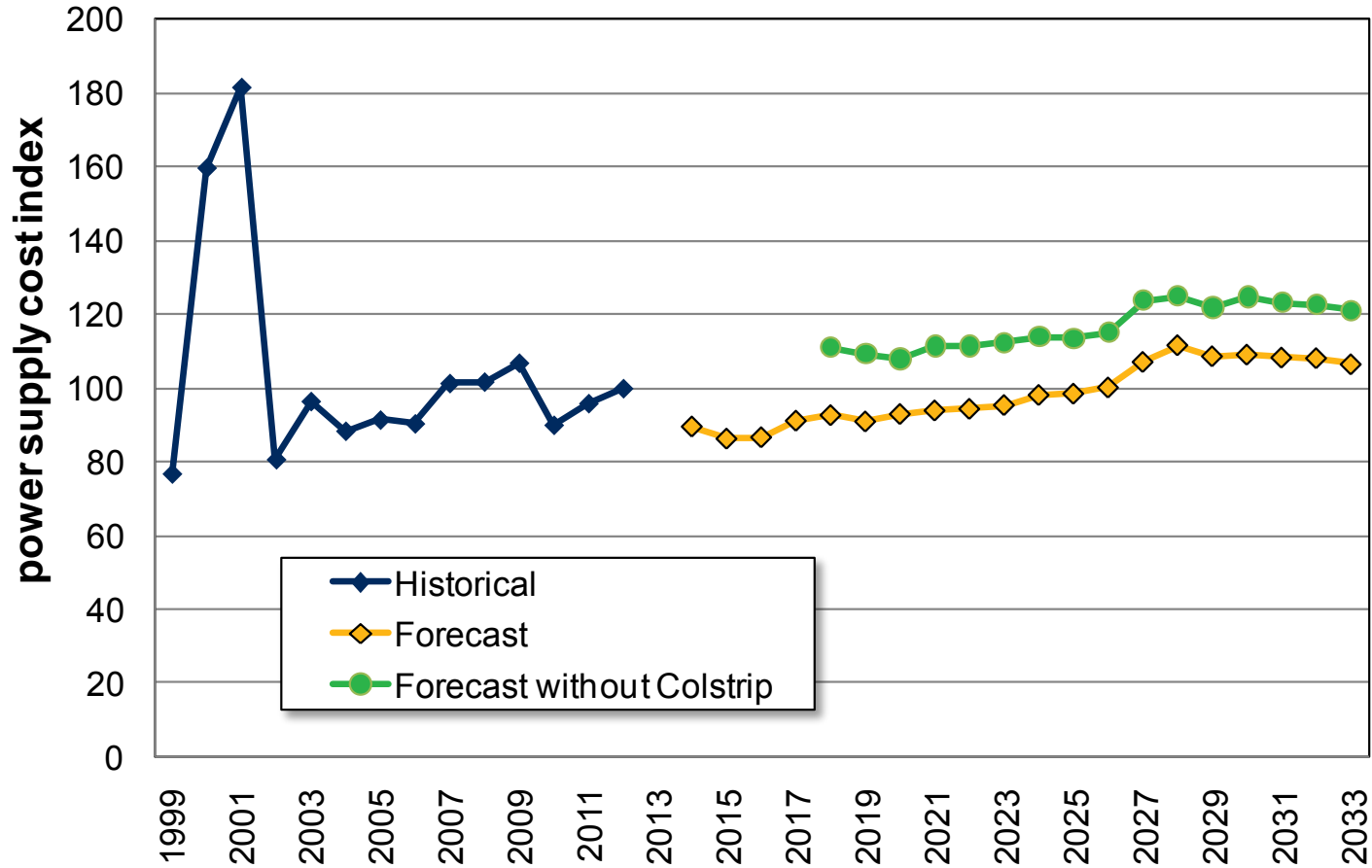

2027-33 Colstrip SCR Analysis

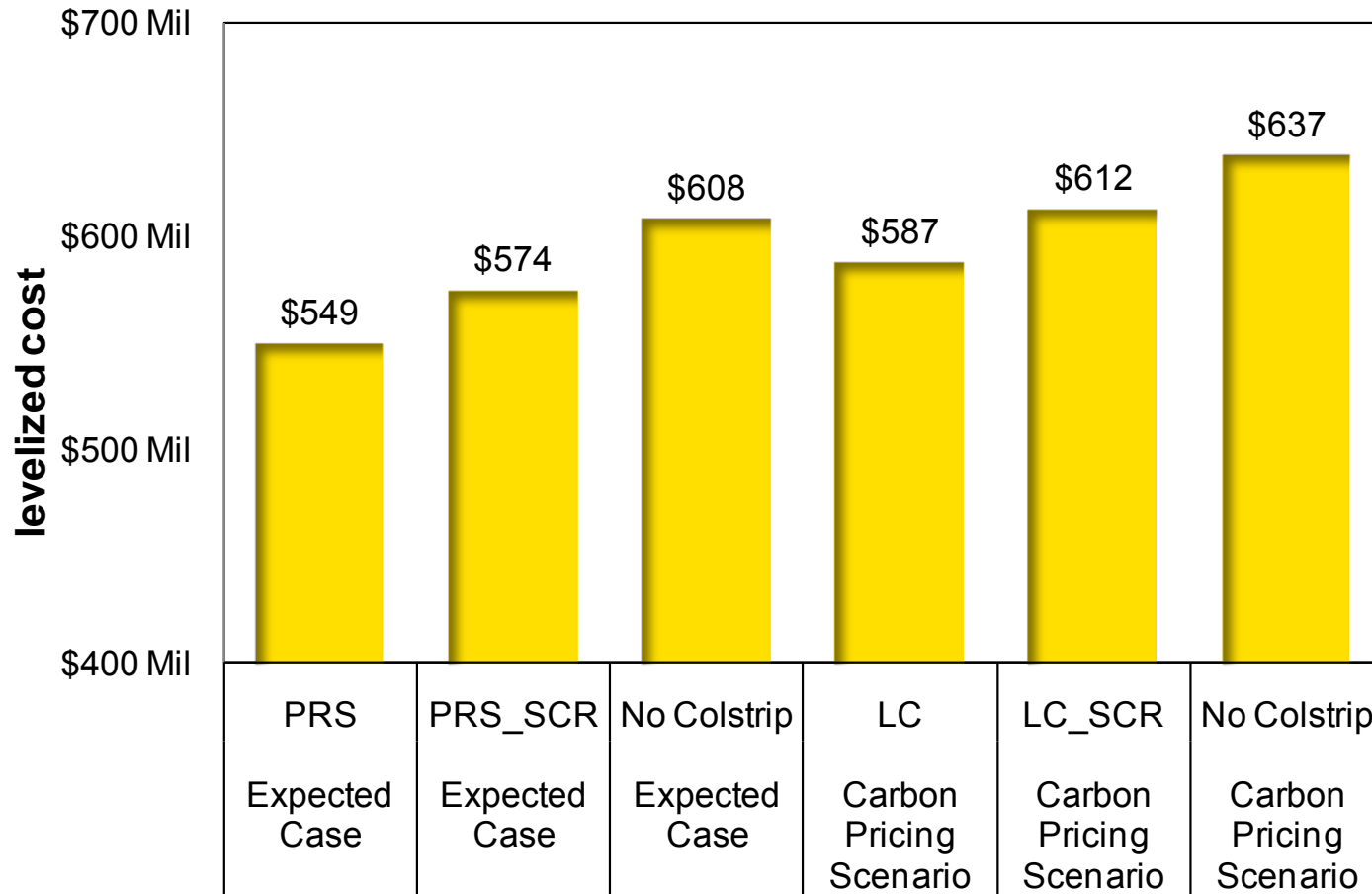



Net Metering and Buck-A-Block

Clint Kalich
Sixth Technical Advisory Committee Meeting
2013 Electric Integrated Resource Plan
June 19, 2013

Avista's Net Metering Customers

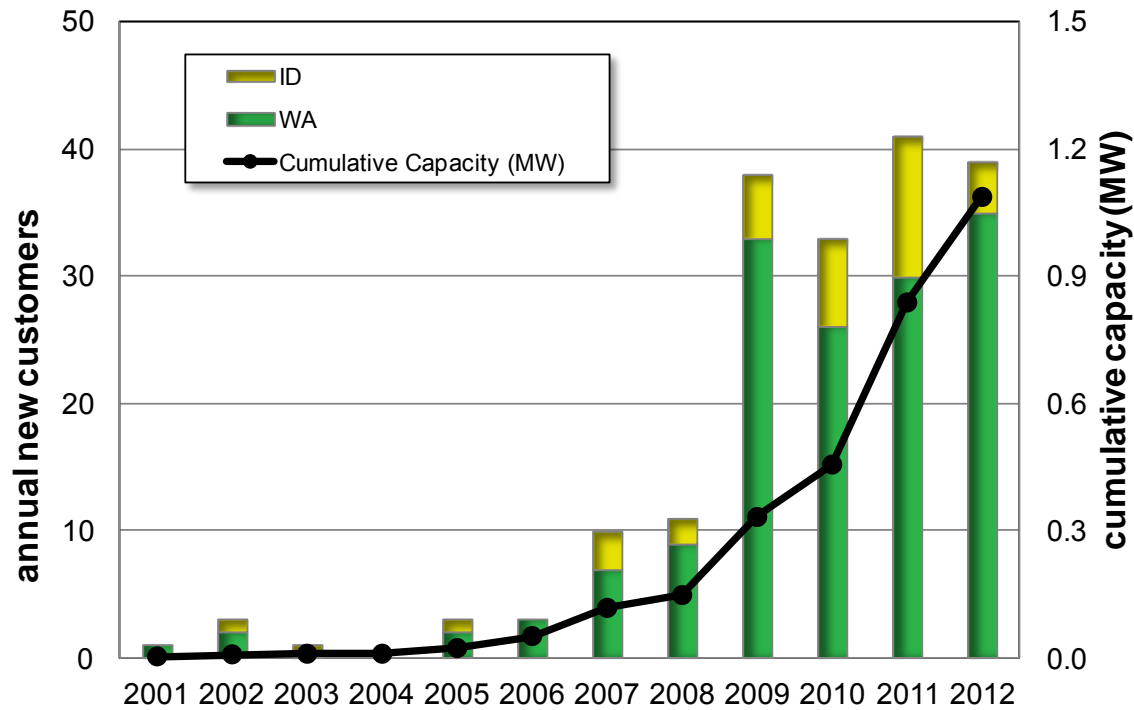

Avista Buck-A-Block Program

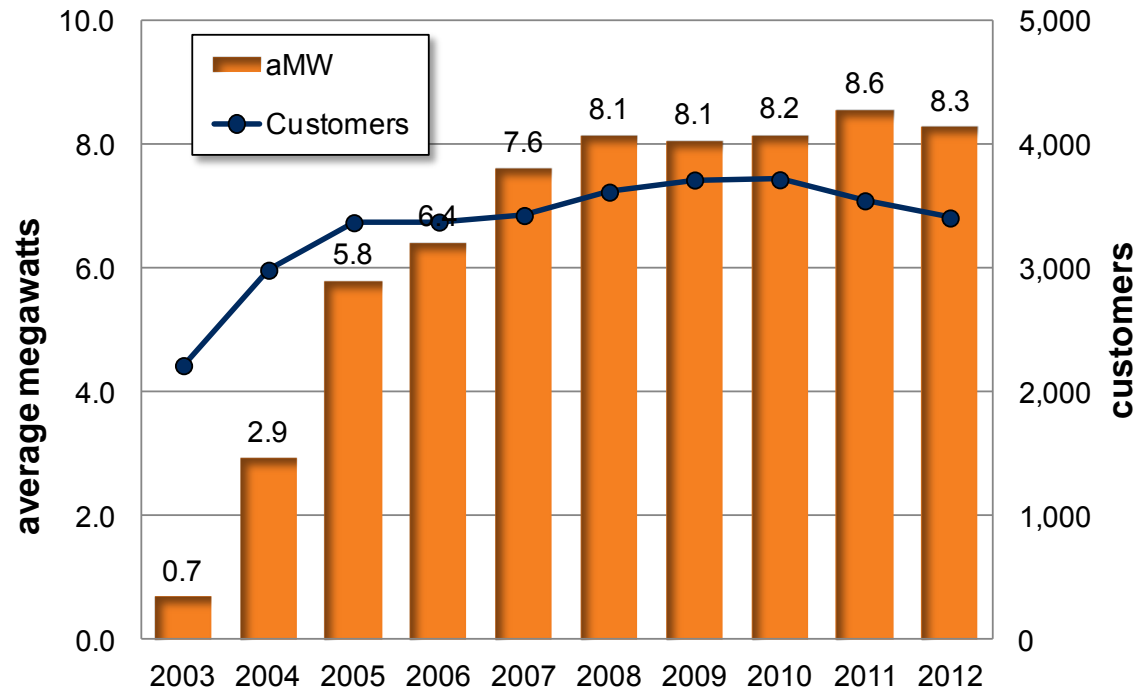

Solar Energy Subsidies

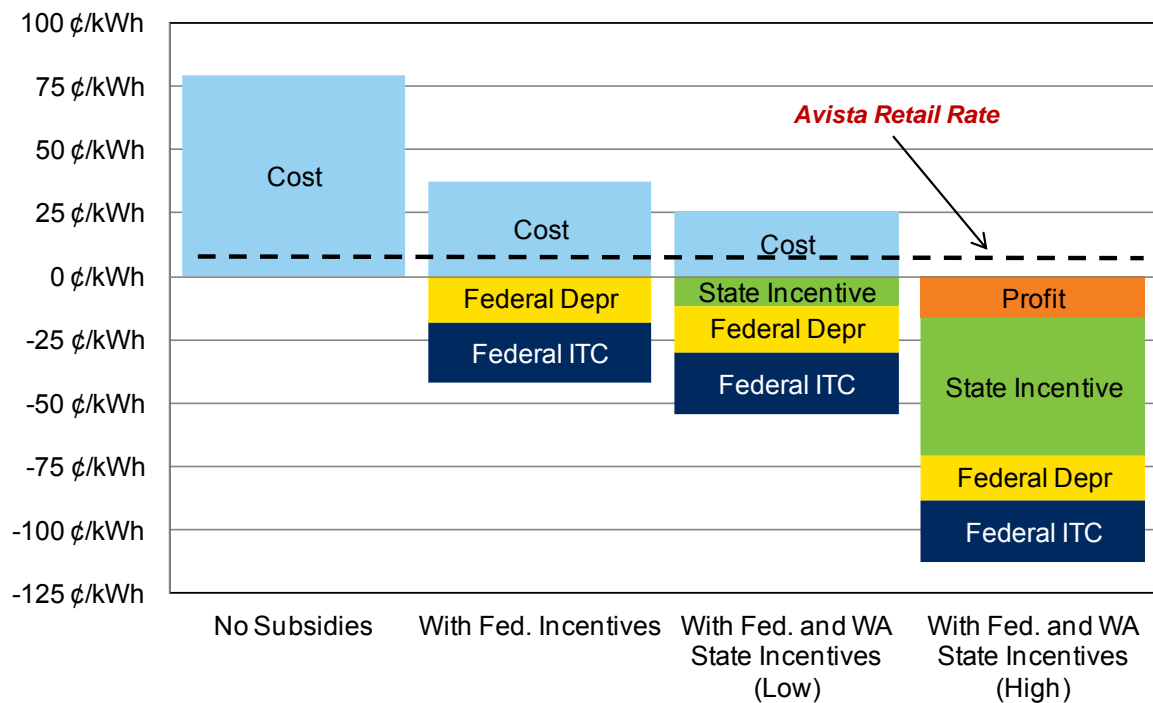

GHG Reduction Option Costs (\$/Ton)

Renewable Portfolio Standards are Least Efficient, by Far

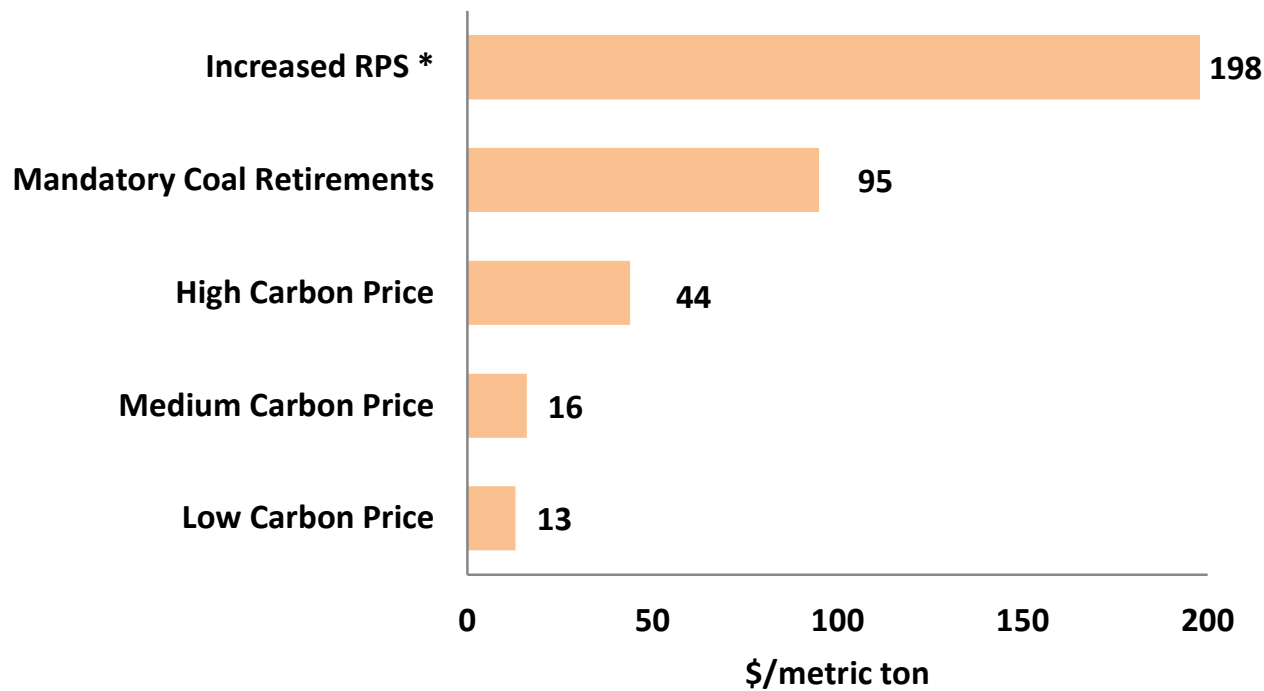



2013 IRP Action Plan

John Lyons
Sixth Technical Advisory Committee Meeting
2013 Electric Integrated Resource Plan
June 19, 2013

Generation Resource Related Analysis

- Spokane and Clark Fork River hydro upgrade options in the 2015 IRP.
- Evaluate potential locations for the natural gas-fired resource for 2019, including environmental reviews, transmission studies, and potential land acquisition.
- Continue participation in regional IRP and regional planning processes and monitor regional surplus capacity and continue to participate in regional capacity planning processes.
- Provide status update on the Little Falls and Nine Mile hydroelectric project upgrade progress.



Generation Resource Related Analysis

- Commission a demand response potential and cost assessment of commercial and industrial customers.
- Continue monitoring state and federal climate change policies and report work from Avista's Climate Change Council.
- Review and update the energy forecast methodology to better integrate economic, regional, and weather drivers of energy use.
- Develop short-term (up to 24-months) capacity position report.



Energy Efficiency

- Work with NPCC, the Washington Utilities and Transportation Commission, and others to resolve adjusted market baseline issues for setting energy efficiency target setting and acquisition claims in Washington.
- Study and quantify transmission and distribution efficiency projects as they apply to I-937 goals.
- Update processes and protocols for conservation measurement, evaluation and verification.



Transmission and Distribution Planning

- Work to maintain the Company's existing transmission rights, under applicable FERC policies, for transmission service to bundled retail native load.
- Continue to participate in BPA transmission processes and rate proceedings to minimize costs of integrating existing resources outside of Avista's service area.
- Continue to participate in regional and sub-regional efforts to establish new regional transmission structures to facilitate long-term expansion of the regional transmission system.





2013 IRP Overview

Clint Kalich
Sixth Technical Advisory Committee Meeting
2013 Electric Integrated Resource Plan
June 19, 2013

Executive Summary

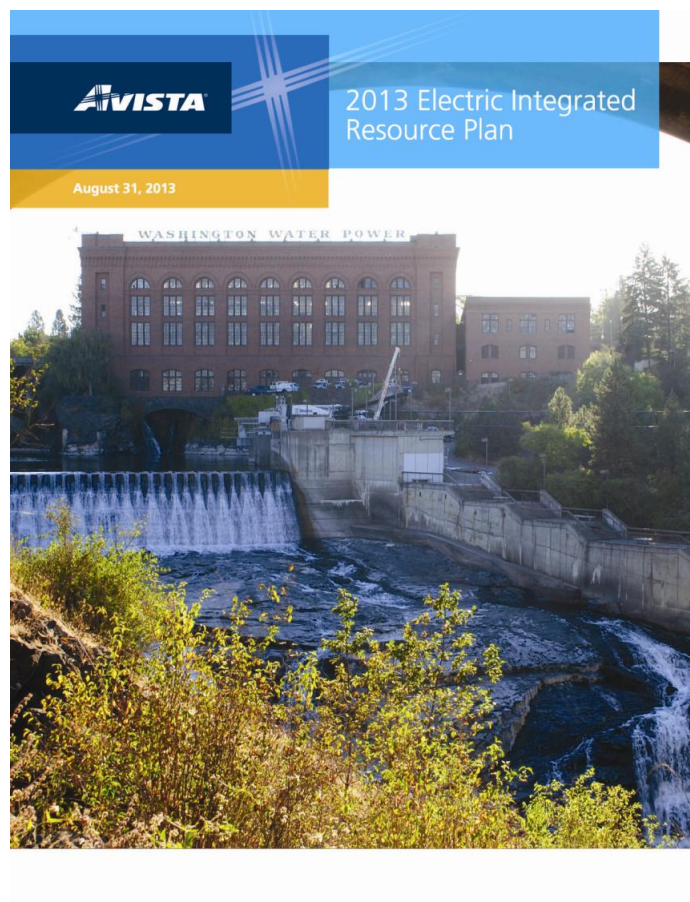

2013 IRP Chapters

- Executive Summary
- Introduction and Stakeholder Involvement
- Loads & Resources
- Energy Efficiency
- Policy Considerations
- Transmission & Distribution
- Generation Resource Options
- Market Analysis
- Preferred Resource Strategy
- Action Items



Loads & Resources

- The 2013 IRP energy forecast grows 1.0 percent per year, replacing the 1.4 percent annual growth rate from the last IRP.
- Peak load growth is slower than energy growth at, at 0.84 percent in the winter and 0.90 percent in the summer.
- Avista's first long-term capacity deficit is in 2020; the first energy deficit is in 2026.
- Palouse Wind became operational December 13, 2012.
- Kettle Falls qualifies for the Washington State Energy Independence Act beginning in 2016.
- This IRP meets all I-937 mandates over the next 20 years with a combination of qualifying hydro upgrades, Palouse Wind and Kettle Falls.



Energy Efficiency

- This IRP includes a Conservation Potential Assessment of the Company's Idaho and Washington service territories.
- Current Company-sponsored conservation reduces retail loads by nearly 10 percent, or 115 aMW.
- Avista evaluated over 3,000 equipment options, and over 1,700 measure options covering all major end use equipment, as well as devices and actions to reduce energy consumption for this IRP.



Policy Considerations

- The 2013 IRP does not include a federal cap and trade or greenhouse gas emissions tax in its Expected Case because there is no policy development underway in a regulatory context.
- The impact of potential greenhouse gas policies are addressed through scenario analyses.
- The plan anticipates specific regulatory policies to reduce greenhouse gas emissions.



Transmission & Distribution

- Avista continues to participate in regional planning forums.
- The Spokane Valley Reinforcement Project includes both station update and conductor upgrades.
- A large upgrade project is under construction at the Moscow substation to maintain adequate load service and a Noxon substation rebuild project is in the design phase.
- Five distribution feeder rebuilds are complete since the last IRP; six additional rebuilds are planned for 2014.
- Significant generation interconnection study work at Thornton and Lind stations continues.



Generation Resource Options

- Only resources with well-defined costs and operating histories are in the PRS analysis.
- Wind, solar, and hydro upgrades represent renewable options available to the Company; future RFPs might identify competing renewable technologies.
- Renewable resource costs assume no extensions of state and federal incentives.
- This IRP models battery storage technology as a resource option for the first time in an Avista IRP.
- Upgrades to Avista's Spokane and Clark Fork River facilities are included as resource options.



Market Analysis

- Gas and wind resources dominate new generation additions in the West.
- Shale gas continues to lower gas and electricity price forecasts.
- A growing Northwest wind fleet reduces springtime market prices below zero in many hours.
- Federal greenhouse gas policy remains uncertain, but new EPA policies point towards a regulatory model rather than a cap-and-trade system.
- Lower natural gas prices and lower loads have reduced greenhouse gas emissions from the US power industry by 11 percent since 2007.



Market Analysis continued

- The Expected Case forecasts a continuing reduction to Western Interconnect greenhouse gas emissions due to coal plant shut downs brought on by EPA regulations.
- Coal plant shut downs have similar carbon reduction results as a cap-and-trade market scheme, but have the advantage of not causing wholesale market price disruptions.

Preferred Resource Strategy

- Avista's first anticipated resource acquisition is a natural gas fired peaker by the end of 2019 to replace expiring contracts and growing loads.
- A combined cycle combustion turbine replaces the Lancaster Facility when its contract ends in 2026.
- The selection of natural gas-fired peaking units is due primarily to their smaller size better fitting Avista's modest resource deficits.
- The Preferred Resource Strategy includes demand response programs for the first time.
- Conservation offsets projected load growth by 42 percent through the 20-year IRP timeframe.



Preferred Resource Strategy continued

- Conservation spending (\$711 million) exceeds new generation resource capital spending (\$696 million) over the 20-year plan.
- The Colstrip coal plant remains a viable and cost-effective resource throughout the planning horizon, even under scenarios most adverse to the plant.



Remaining 2013 IRP Schedule

- June 23 TAC
- May 2013 – internal draft released at Avista
- June 2013 – external draft released to the TAC
- August 2013 – final editing and printing
- August 31, 2013 – final IRP submission to Commissions and distribution to TAC
- June 19, 2013 TAC meeting
- June 21, 2013 Management review of Internal Draft 2013 IRP complete
- June 26, 2013 distribution of Draft 2013 IRP to TAC participants
- July 24, 2013: External review by TAC complete
- August 30, 2013: 2013 IRP documents sent to the Idaho and Washington Commissions
- August 31, 2013: 2013 IRP available to public, including publication on the Company's web site



2013 Electric Integrated Resource Plan

Appendix B – 2013 Electric IRP Work Plan





Work Plan for Avista's 2013 Electric Integrated Resource Plan

**For the
Washington Utilities and Transportation Commission**

August 30, 2012



2013 Integrated Resource Planning Work Plan

This Work Plan is submitted in compliance with the Washington Utilities and Transportation Commission's (UTC) Integrated Resource Planning (IRP) rules (WAC 480-100-238). It outlines the process Avista will follow to develop its 2013 Electric IRP. The Company's 2013 Electric IRP will be filed with Washington and Idaho Commissions by August 31, 2013. Avista uses a public process to solicit technical expertise and feedback throughout the development of the IRP through a series of public Technical Advisory Committee (TAC) meetings. Avista held the first TAC meeting for the 2013 IRP on May 23, 2012.

The 2013 IRP process will be similar to those used to produce the previous four published plans. AURORA^{xmp} will be used for electric market price forecasting, resource valuation, and for conducting Monte-Carlo style risk analyses. AURORA^{xmp} modeling results will be used to select the Preferred Resource Strategy (PRS) using Avista's proprietary PRiSM model. This tool is used to determine how to fill future capacity and energy (physical/renewable) deficits with new resources using an efficient frontier approach to evaluate quantitative portfolio risk versus portfolio cost while accounting for environmental laws and regulations. Qualitative risks will be evaluated in separate analyses. The process timeline is shown in Exhibit 1 and the process to identify the PRS is shown in Exhibit 2.

Avista intends to use both detailed site-specific and generic resource assumptions in its development of the 2013 IRP. The assumptions are based on a combination of Avista's research of similar technologies, engineering studies, and the Northwest Power and Conservation Council's Sixth Power Plan. This plan will study renewable portfolio standards, energy storage, environmental costs, sustained peaking requirements and resource adequacy, energy efficiency programs, and demand response. The IRP will develop a strategy that meets or exceeds both the renewable portfolio standards and greenhouse gas emissions regulations.

Avista intends to test the PRS against several scenarios and potential futures. The TAC meetings will be an important factor to determine the underlying assumptions used in the scenarios and futures. The IRP process is very technical and data intensive; public comments are welcome, however input and participation will be needed in a timely manner for appropriate inclusion into the process so the plan can be submitted according to the tentative schedule outlined in this Work Plan.

Topics and meeting times may change depending on the availability of Company staff and requests for additional topics from the TAC members. The tentative timeline and agenda items for Technical Advisory Committee meetings follows:

- **TAC 1 – May 23, 2012:** Powering Our Future game, 2011 Renewable RFP, Palouse Wind Project update, 2011 IRP acknowledgement, Energy Independence Act compliance and forecast, and 2013 IRP Work Plan discussion.
- **TAC 2 (Day 1) – September 4, 2012:** Palouse Wind Project tour.



- **TAC 2 (Day 2) – September 5, 2012:** Avista renewable energy credit planning methods, energy and economic forecasts, 2012 Shared Value Report, generation options, and Spokane River Assessment.
- **TAC 3 – November 7, 2012:** Peak load forecast, reliability planning, Colstrip discussion, energy storage technologies, modeling, and energy efficiency.
- **TAC 4 – February 6, 2013:** Electric and natural gas price forecasts, transmission planning, resource needs assessment, and market and portfolio scenario development.
- **TAC 5 – March 20, 2013:** Draft PRS, review of scenarios and futures, and portfolio analysis
- **TAC 6 – June 19, 2013:** Review of final PRS and action items.



2013 Electric IRP Draft Outline

This section provides a draft outline of the major sections in the 2013 Electric IRP. This outline will be updated as IRP studies are completed and input from the Technical Advisory Committee has been received.

- 1. Executive Summary**
- 2. Introduction and Stakeholder Involvement**
- 3. Loads and Resources**
 - a. Economic Conditions
 - b. Avista Energy & Peak Load Forecast
 - c. Load Forecast Scenarios
 - d. Avista's Resources and Contracts
 - e. Reliability Planning and Reserve Margins
 - f. Resource Requirements
- 4. Energy Efficiency and Demand Response**
 - a. Conservation Potential Assessment
 - b. Demand Response Opportunities
 - c. Washington State Energy Independence Act
- 5. Policy Considerations**
 - a. Environmental Concerns
 - b. State and Federal Policies
- 6. Transmission Planning**
 - a. Avista's Transmission System
 - b. Future Upgrades and Interconnections
 - c. Transmission Construction Costs and Integration
 - d. Efficiencies
- 7. Generation Resource Options**
 - a. New Resource Options
 - b. Avista Plant Upgrades
- 8. Market Analysis**
 - a. Marketplace
 - b. Fuel Price Forecasts
 - c. Market Price Forecast
 - d. Scenario Analysis
- 9. Preferred Resource Strategy**
 - a. Resource Selection Process
 - b. Preferred Resource Strategy
 - c. Efficient Frontier Analysis
 - d. Avoided Costs
 - e. Portfolio Scenarios
 - f. Tipping Point Analysis
- 10. Action Plan**
 - a. 2011 Action Plan Summary
 - b. 2013 Action Plan

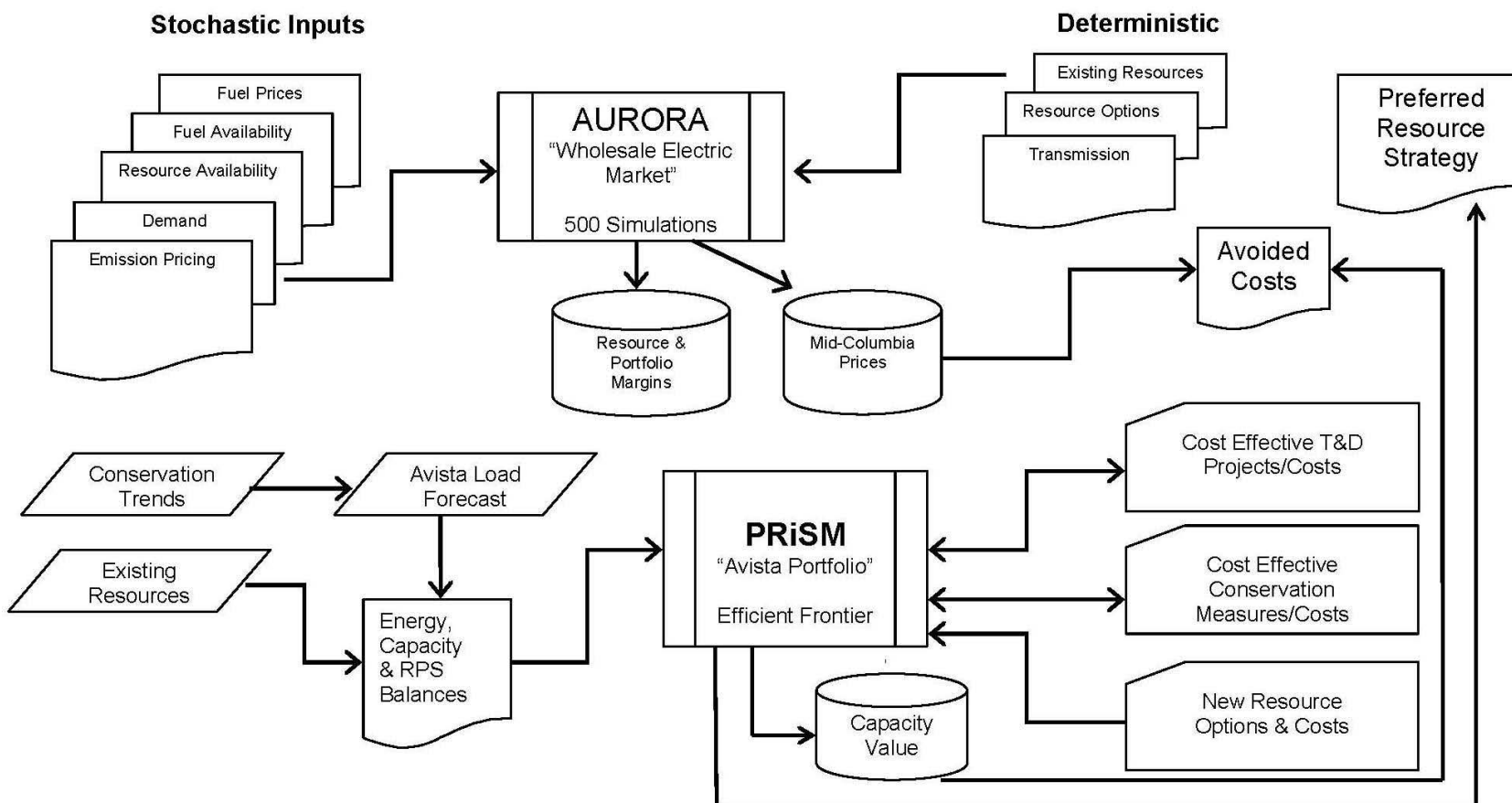

Exhibit 1: 2013 Electric IRP Timeline

<u>Task</u>	<u>Target Date</u>
Preferred Resource Strategy (PRS)	
Finalize energy forecast	July 2012
Identify regional resource options for electric market price forecast	September 2012
Identify Avista's supply & conservation resource options	September 2012
Finalize peak load forecast	September 2012
Update AURORA ^{xmp} database for electric market price forecast	October 2012
Finalize datasets/statistics variables for risk studies	October 2012
Energy efficiency load shapes input into AURORA ^{xmp}	October 2012
Final transmission study due	December 2012
Select natural gas price forecast	December 2012
Finalize deterministic base case	December 2012
Base case stochastic study complete	January 2013
Finalize PRISM model	January 2013
Develop efficient frontier and PRS	January 2013
Simulation of risk studies "futures" complete	February 2013
Simulate market scenarios in AURORA ^{xmp}	February 2013
Evaluate resource strategies against market futures and scenarios	March 2013
Present preliminary study and PRS to TAC	March 2013
Writing Tasks	
File 2013 IRP work plan	August 2012
Prepare report and appendix outline	October 2012
Prepare text drafts	April 2013
Prepare charts and tables	April 2013
Internal draft released at Avista	May 2013
External draft released to the TAC	June 2013
Final editing and printing	August 2013
Final IRP submission to Commissions and distribution to TAC	August 31, 2013



Exhibit 2: 2013 Electric IRP Modeling Process



2013 Electric Integrated Resource Plan

Appendix C – 2013 Electric IRP Avista Electric Conservation Potential Assessment Study



**Avista Electric Conservation Potential
Assessment Study**



Report Number 1341

EnerNOC Utility Solutions Consulting
500 Ygnacio Valley Road
Suite 450
Walnut Creek, CA 94596
Tel: 925.482.2000
www.enernoc.com

Prepared for:
Avista Corporation

Prepared by:
EnerNOC, Inc.

Presented on:
May 30, 2013

This report was prepared by
EnerNOC Utility Solutions
500 Ygnacio Valley Blvd., Suite 450
Walnut Creek, CA 94596
Project Director: I. Rohmund
Project Manager: J. Borstein

EXECUTIVE SUMMARY

Avista Corporation (Avista) engaged EnerNOC Utility Solutions (EnerNOC) to conduct a Conservation Potential Assessment (CPA). The CPA is a 20-year conservation potential study to provide data on conservation resources for developing Avista's 2013 Integrated Resource Plan (IRP), and in accordance with Washington Initiative 937 (I-937). The study updates Avista's last CPA, which EnerNOC performed in 2011. The 2011 CPA used 2009, the first year for which complete billing data was available at the time, as the base year. This update kept 2009 as the base year for the analysis, and calibrated the model used for the assessment to align with actual sales and conservation program achievements for the years 2010–2012.

Study Objectives

The study objectives included:

- Conduct a conservation potential study for electricity for Washington and Idaho. The study accounted for:
 - Impacts of existing Avista conservation programs
 - Impacts of codes and standards
 - Technology developments and innovation
 - The economy and energy prices
- Assess and analyze cost-effective conservation potentials in accordance with the Northwest Power and Conservation Council's (NPPC) Sixth Power Plan methodology and Washington I-937 requirements.
- Obtain supply curves showing the incremental costs associated with achieving higher levels of conservation and stacking efficiency resources by cost of conserved energy.
- Analyze various market penetration rates associated with technical, economic, and achievable potential estimates.

Definitions of Potential

- **Technical potential** is defined as the theoretical upper limit of conservation potential. It assumes that customers adopt all feasible measures regardless of their cost. At the time of existing equipment failure, customers replace their equipment with the most efficient option available. In new construction, customers and developers also choose the most efficient equipment option. Examples of measures that make up technical potential for electricity in the residential sector include:
 - High-efficiency heat pumps for homes with ducts
 - Ductless mini-split heat pumps for homes without ducts
 - Heat pump water heaters
 - LED lighting

Technical potential also assumes the adoption of every other available measure, where applicable. For example, it includes installation of high-efficiency windows in all new construction opportunities and furnace maintenance in all existing buildings with furnace systems. These retrofit measures are phased in over a number of years, which is longer for higher-cost and complex measures.

Executive Summary

- **Economic potential** represents the adoption of all **cost-effective** conservation measures. In this analysis, cost-effectiveness is measured by the total resource cost (TRC) test, which compares lifetime energy and capacity benefits to the incremental cost of the measure. If the benefits outweigh the costs (that is, if the TRC ratio is greater than 1.0), a given measure is considered in the economic potential. Customers are then assumed to purchase the most cost-effective option applicable to them at any decision juncture.
- **Achievable potential** takes into account market maturity, customer preferences for energy-efficient technologies, and expected program participation. Achievable potential establishes a realistic target for the conservation savings that a utility can hope to achieve through its programs. It is determined by applying a series of annual market adoption factors to the economic potential for each conservation measure. These factors represent the ramp rates at which technologies will penetrate the market. To develop these factors, the project team reviewed Avista's **past** conservation program achievements and program history over the last five years, as well as the Northwest Power and Conservation Council (NPCC) ramp rates used in the Sixth Plan. Details regarding the market adoption factors appear in Appendix D.

Study Approach

To execute this project, EnerNOC used a bottom-up analysis approach as shown in Figure ES-1. The analysis involved the following steps.

1. Held a meeting with the client project team to refine the objectives.
2. Performed a market characterization to describe sector-level electricity use for the residential and non-residential (commercial and industrial) sectors for the base year, 2009. This step drew upon the market characterization from the 2011 CPA, but updated the characterization to incorporate new information from the Northwest Energy Efficiency Alliance (NEEA) 2012 Residential Building Stock Assessment (RBSA), **EnerNOC's own databases and tools, and** other secondary data sources such as the American Community Survey (ACS), Northwest Power and Conservation Council (NPCC), and the Energy Information Administration (EIA).
3. Developed a baseline electricity use projection by sector, segment, and end use for 2009 through 2033. **The baseline projection is the "business as usual" metric, without new utility conservation programs, against which energy savings from conservation measures are compared.** The baseline projection includes the impacts of known codes and standards, as of 2012 when the study was conducted, including the Energy Independence and Security Act (EISA) lighting standards, which phase in during 2012–2014, and the 2010 appliance standards. This baseline projection process incorporates the changes in market conditions **such as customer and market growth, income growth, Avista's retail rates forecast, trends in end-use and technology saturations, equipment purchase decisions, consumer price elasticity, and income and persons per household.**
4. Identified and characterized conservation measures. Measures to include and data to characterize them were drawn from the Regional Technical Forum measure workbooks, the Sixth Plan, **Avista's business plan, its technical reference manual, and EnerNOC's own measure database.**
5. Estimated three levels of conservation potential: *Technical, Economic, and Achievable.*

We used EnerNOC's **Load Management Analysis and Planning tool (LoadMAP™)** version 3.0 to develop both the baseline projection and the estimates of conservation potential. EnerNOC developed LoadMAP in 2007 and has enhanced it over time, using it for the EPRI National Potential Study and numerous utility-specific forecasting and potential studies.

Details of the approach as well as the data sources used in the study appear in Chapter 2.

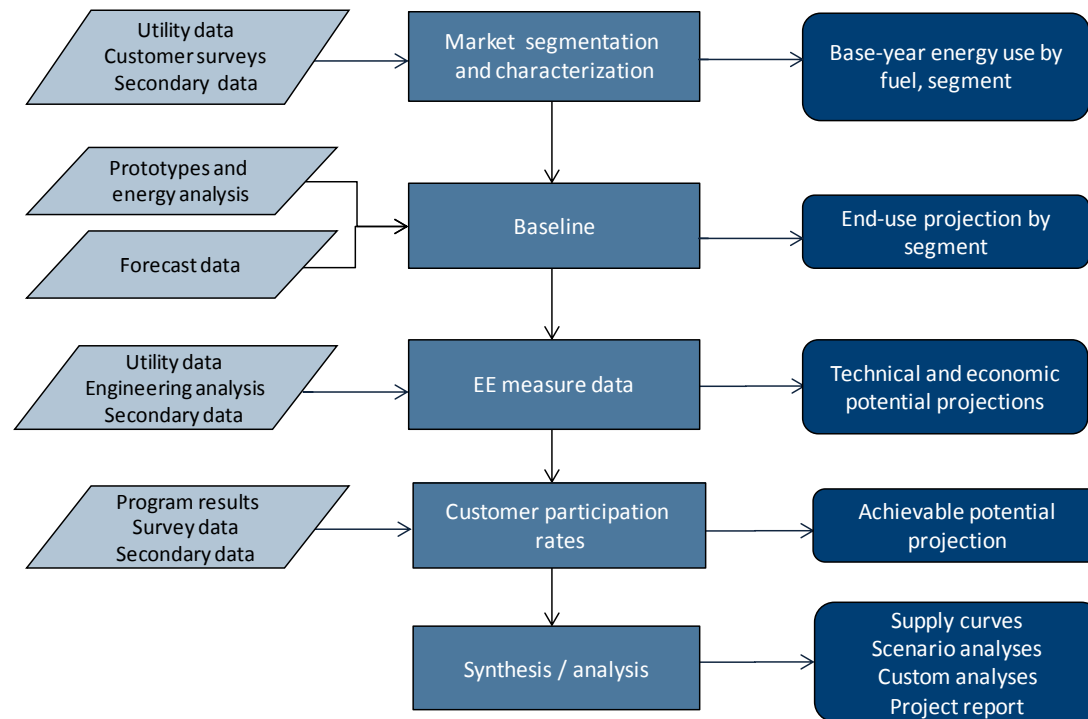
Figure ES-1 Overview of Analysis Approach

Market Characterization

During 2009, Avista served 354,615 residential, commercial, industrial, and pumping customers with a combined electricity use of approximately 8,862 GWh. The study segmented these customers by state and rate class as shown in Table ES-1 and Table ES-2. In addition, the residential class was segmented by housing type and income (single family, multi-family, mobile home, and low income). The low-income threshold for purposes of this study was defined as 200% of the Federal poverty level.

For this study, the project team decided not to explicitly model the conservation potential for pumping customers, which represent 2% of load, but instead to use the NPCC Sixth Plan calculator to estimate pumping potential. Results of that calculation appear in Chapter 4. Potential for rate class 25P was also estimated outside of the LoadMAP framework, and thus 25P sales are not included in Table ES-2.

Table ES-1 Electricity Sales and Peak Demand by Rate Class, Washington 2009

Sector / Rate Class	Rate Schedule(s)	Number of meters (customers)	2009 Electricity Sales (GWh)	2009 Peak Demand (MW)
Residential	001	200,134	2,452	710
General Service	011, 012	27,142	416	64
Large General Service	021, 022	3,352	1,557	232
Extra Large Commercial	025C	9	266	134
Extra Large Industrial	025I	13	614	
Pumping	031, 032	2,361	136	10
Total		233,011	5,440	1,150

Table ES-2 Electricity Sales and Peak Demand by Rate Class, Idaho 2009

Sector / Rate Class	Rate Schedule(s)	Number of meters (customers)	2009 Electricity Sales (MWh)	2009 Peak Demand (MW)
Residential	001	99,580	1,182	283
General Service	011, 012	19,245	323	61
Large General Service	021, 022	1,456	700	115
Extra Large Commercial	025C	3	70	140
Extra Large Industrial	025I	6	196	
Pumping	031, 032	1,312	59	4
Total		121,602	2,530	603

Note: Excludes sales to rate class 25P.

Within each segment, energy use was characterized by end-use (e.g., space heating, cooling, lighting, water heat, motors, etc.) and by technology (e.g., heat pump, resistance heating, furnace for space heating).

Figure ES-2 presents the residential end-use breakout in terms of intensity, kWh/household-year, by segment for Washington and Idaho combined. Space heating is the largest single use in all housing types, accounting for 29% of residential use overall. In three of the four segments, appliances are the second largest energy consumer, followed by water heating and then interior lighting. The exception is multi family housing, where water heating is the second largest end use while appliances are the third largest end use, due to a high saturation of electric water heating compared with the other segments. Across all housing types, interior and exterior lighting combined represents 14% of electricity use in 2009. Electronics, which includes personal computers, televisions, home audio, video game consoles, etc., is 8% of residential electricity usage. The miscellaneous end use includes such devices as furnace fans, pool pumps, and other plug loads (hair dryers, power tools, coffee makers, etc.).

Figure ES-2 Residential Intensity by End Use and Segment (kWh/household, 2009)

Figure 3-6 displays the breakdown of energy use by segment within the C&I sector. Lighting is the largest single energy use across all of the commercial buildings, accounting for 34% of energy use, followed by HVAC with 27% of use. For the extra large industrial customers, machine drive and process loads dominate, together accounting for 64% of energy use.

Figure ES-3 C&I Electricity Consumption by End Use and Segment (2009)

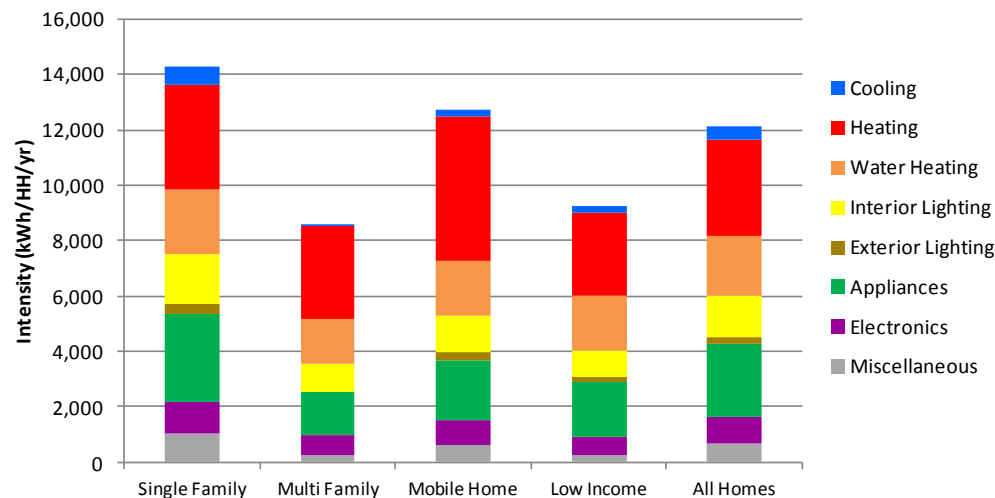
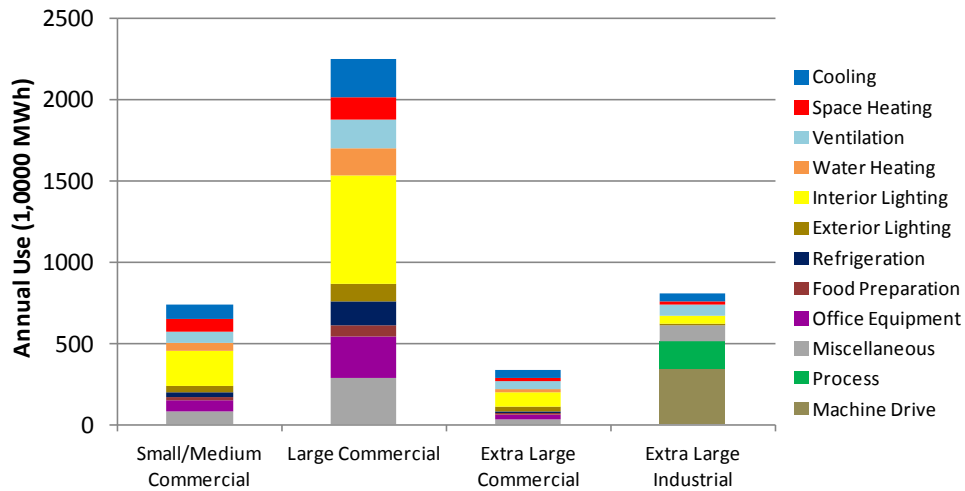

This market characterization is further detailed in Chapter 3.

Conservation Potential Results

All results below show cumulative potential, indicating how a measure installed in one year continues to provide savings in subsequent years through the end of its useful measure life. Incremental annual results appear in Appendix E. Figure ES-4 and Table ES-3 summarize the achievable potential. The C&I sector accounts for the about 55% of the savings initially, and over time its share of savings grows to around 60%.

Figure ES-4 Cumulative Achievable Potential by Sector (MWh)

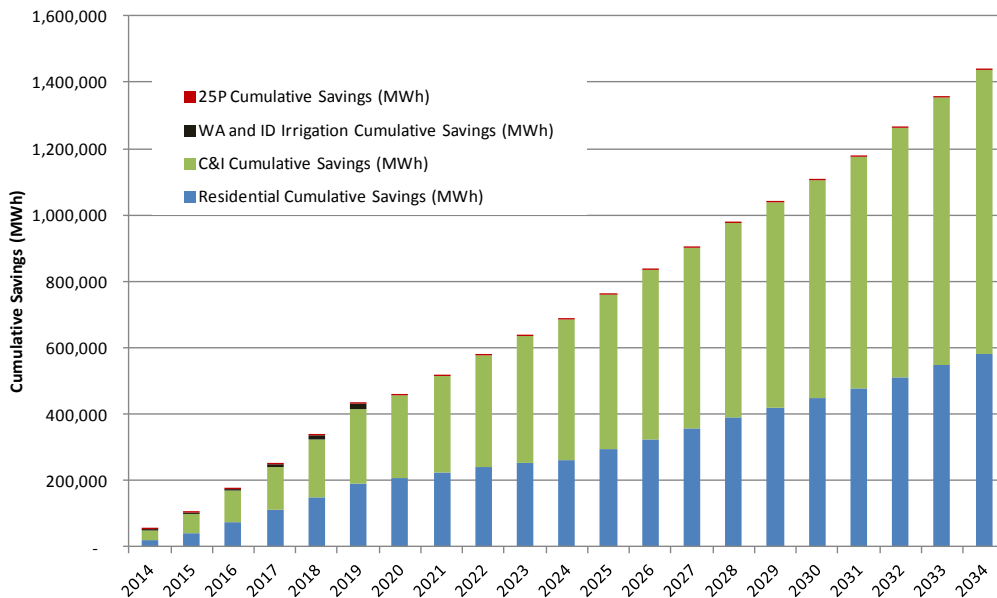

Table ES-3 Cumulative Achievable Potential by State and Sector (MWh)

	2014	2015	2018	2023	2028	2033
Washington Achievable Cumulative Savings (MWh)						
Residential	15,091	29,603	100,792	172,576	266,751	369,293
C&I	19,927	40,930	123,755	256,653	392,186	543,380
Pumping	1,402	3,237	8,742	10,535	10,535	10,535
Total	36,420	73,770	233,289	439,764	669,472	923,208
Washington Achievable Cumulative Savings (aMW)						
Residential	1.7	3.4	11.5	19.7	30.5	42.2
C&I	2.3	4.7	14.1	29.3	44.8	62.0
Pumping	0.2	0.4	1.0	1.2	1.2	1.2
Total	4.2	8.4	26.6	50.2	76.4	105.4
	2014	2015	2018	2023	2028	2033
Idaho Achievable Cumulative Savings (MWh)						
Residential	6,757	13,183	46,795	79,385	125,347	177,826
C&I	8,863	16,427	53,214	124,987	192,518	261,813
Pumping	618	1,426	3,852	4,642	4,642	4,642
Total	16,238	31,036	103,861	209,014	322,507	444,281
Idaho Achievable Cumulative Savings (aMW)						
Residential	0.8	1.5	5.3	9.1	14.3	20.3
C&I	1.0	1.9	6.1	14.3	22.0	29.9
Pumping	0.1	0.2	0.4	0.5	0.5	0.5
Total	1.9	3.5	11.9	23.9	36.8	50.7
	2014	2015	2018	2023	2028	2033
Washington and Idaho Achievable Cumulative Savings (MWh)						
Residential	21,848	42,786	147,588	251,961	392,098	547,119
C&I	28,790	57,357	176,969	381,640	584,703	805,193
Pumping	2,020	4,663	12,593	15,177	15,177	15,177
Total	52,657	104,806	337,150	648,778	991,979	1,367,490
Washington and Idaho Achievable Cumulative Savings (aMW)						
Residential	2.5	4.9	16.8	28.8	44.8	62.5
C&I	3.3	6.5	20.2	43.6	66.7	91.9
Pumping	0.2	0.5	1.4	1.7	1.7	1.7
Total	6.0	12.0	38.5	74.1	113.2	156.1

Figure ES-5 presents the residential cumulative achievable potential in 2018 by end use. We note the following:

- **Lighting**, primarily the conversion of both interior and exterior lamps to compact fluorescent lamps in the first few years, followed by LEDs for exterior lighting starting in 2015 and for interior lighting starting in 2017, represents 70,446 MWh or 47% of savings. Utility programs and other market transformation programs have made customers accepting of new lighting technologies, and thus these technologies are relatively well accepted by consumers.
- **Water heating** is the next highest source of achievable potential. As discussed above, water heating provides the largest economic potential, but the market for heat pump water heaters remains immature, and thus the uptake of this technology is limited in the near term. Although conversion to gas water heating is a mature technology and readily accepted, customers may be unable to convert at the time of replacement due to timing issues or other considerations.
- **Space heating** provides 20% of achievable potential mainly due to electric furnaces being converted to gas units, and resistance heating being displaced by ductless heat pumps.

Figure ES-5 Residential Cumulative Achievable Potential by End Use in 2018

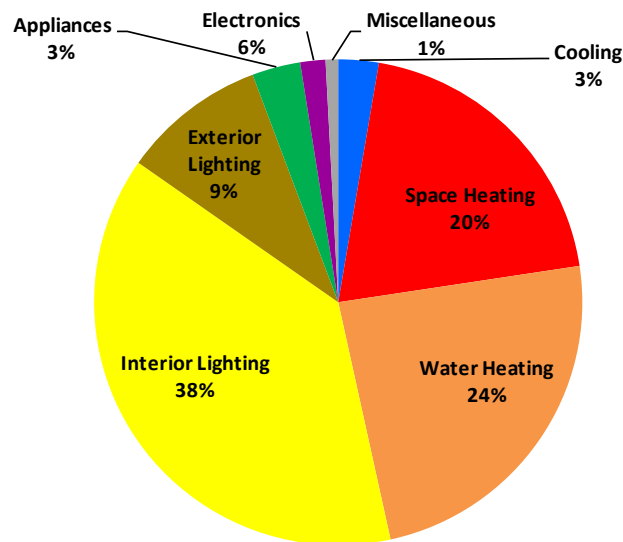

As shown in Figure ES-6, the primary sources of C&I sector achievable savings in 2018 are as follows:

- Interior and exterior lighting, comprising lamps, fixtures, and controls, account for 64% of C&I sector achievable potential. Not only is economic potential high for lighting measures, but they are more readily accepted and implemented in the market than many other, higher cost and more complex measures.
- Office Equipment, which is **the second largest portion of this sector's achievable potential** (11%)
- Water heating and Ventilation each provides 6% of the total savings

Figure ES-6 C&I Cumulative Achievable Potential Cumulative Savings by End Use in 2018 (percentage of total)

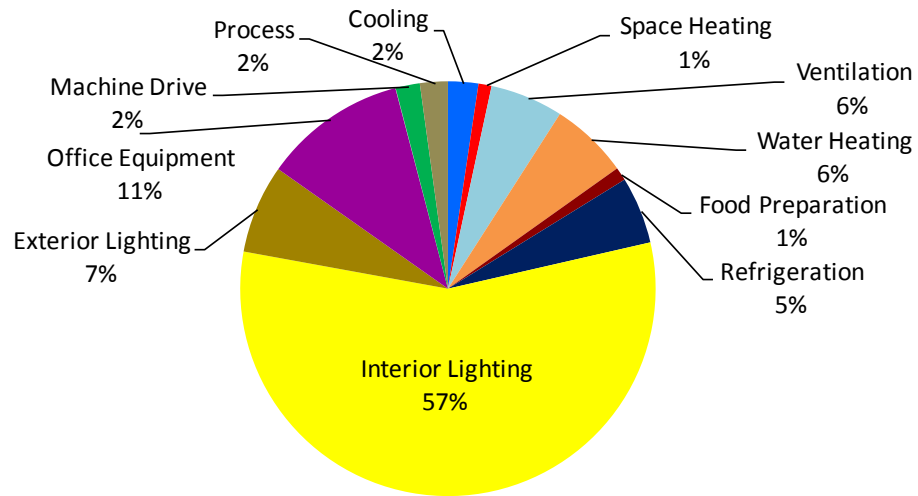

Table ES-4 summarizes the potential, by state and for the overall service territory, for selected years. For pumping and rate class 25P, only achievable potential was calculated. Economic and technical potential for these two relatively small rate classes were assumed to be equal to achievable potential. Figure ES -7 presents this information graphically.

Key findings related to cumulative conservation potentials are as follows.

- **Achievable potential**, for the residential, commercial, and industrial sectors is 100,143 MWh or 11.4 aMW for the 2014–2015 biennium. With the addition of pumping, achievable potential is 12.0 aMW for the 2014-2015 biennium and increases to 156.1 aMW by 2033. Washington provides approximately 70% of the potential in most years. Over the 2014–2033 period, the achievable potential forecast offsets 39% of the overall growth in the residential and C&I combined baseline projections.
- **Economic potential**, which reflects the savings when all cost-effective measures are taken, is 480,967 MWh or 54.9 aMW for 2014–2015. By 2033, economic potential reaches 304.5 aMW.
- **Technical potential**, which reflects the adoption of all conservation measures regardless of cost-effectiveness, is a theoretical upper bound on savings. For 2014–2015, technical potential savings are 1,372,283 MWh or 156.7 aMW. By 2033, technical potential reaches 497.2 aMW.

Table ES-4 Summary of Cumulative Conservation Potential

	2014	2015	2018	2023	2028	2033
Washington Cumulative Savings (MWh)						
Achievable Potential	36,420	73,770	233,289	439,764	669,472	923,208
Economic Potential	214,944	329,262	741,547	1,131,761	1,539,860	1,807,576
Technical Potential	794,447	941,497	1,550,783	2,212,885	2,704,067	3,024,259
Washington Cumulative Savings (aMW)						
Achievable Potential	4.2	8.4	26.6	50.2	76.4	105.4
Economic Potential	24.5	37.6	84.7	129.2	175.8	206.3
Technical Potential	90.7	107.5	177.0	252.6	308.7	345.2
Idaho Cumulative Savings (MWh)						
Achievable Potential	16,238	31,036	103,861	209,014	322,507	444,281
Economic Potential	101,779	151,705	350,121	538,404	734,193	859,791
Technical Potential	368,926	430,787	700,966	975,464	1,195,587	1,330,893
Idaho Cumulative Savings (aMW)						
Achievable Potential	1.9	3.5	11.9	23.9	36.8	50.7
Economic Potential	11.6	17.3	40.0	61.5	83.8	98.1
Technical Potential	42.1	49.2	80.0	111.4	136.5	151.9
Total Washington and Idaho Cumulative Savings (MWh)						
Achievable Potential	52,657	104,806	337,150	648,778	991,979	1,367,490
Economic Potential	316,722	480,967	1,091,669	1,670,165	2,274,053	2,667,367
Technical Potential	1,163,373	1,372,283	2,251,749	3,188,349	3,899,655	4,355,152
Total Washington and Idaho Cumulative Savings (aMW)						
Achievable Potential	6.0	12.0	38.5	74.1	113.2	156.1
Economic Potential	36.2	54.9	124.6	190.7	259.6	304.5
Technical Potential	132.8	156.7	257.0	364.0	445.2	497.2

Note: For pumping and rate class 25P, only achievable potential was calculated and thus economic and technical potential were assumed to be equal to achievable potential for these two rate classes.

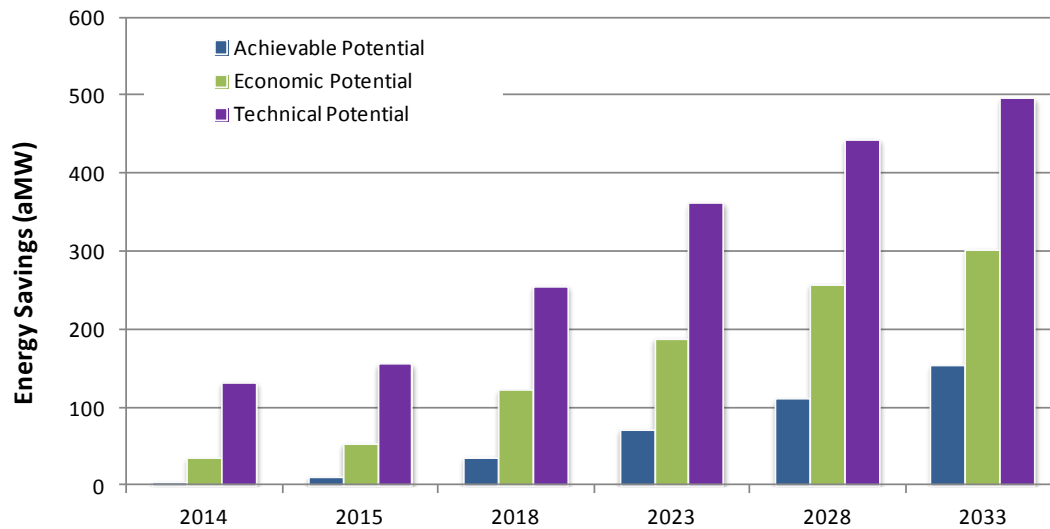
Figure ES -7 Summary of Cumulative Energy Savings, Residential and C&I

Note: Excludes pumping and 25P.

Chapter 4 provides additional detail by sector and segment.

Sensitivity of Potential to Avoided Cost

Similar to the 2011 CPA, EnerNOC modeled several scenarios with varying levels of avoided costs in addition to the reference case. **For this study's purposes, we have included a case where the 10% adder per NW Power and Conservation Act is removed.** The other scenarios included 150%, 125%, and 75% of the avoided costs used in the reference case. Figure ES-8 and Table ES-5 show how achievable potential varies under the four scenarios.

- The reference case achievable potential reaches approximately at 1,352,291 MWh by 2033.
- Removing the 10% adder from the avoided costs decreased this achievable potential to 1,272,206 MWh, 6% reduction.
- With the 150% avoided cost case, achievable potential increased to 1,657,741 MWh (23% increase from reference) while the 125% avoided cost case and the 75% avoided cost case yielded achievable potential equal to 1,521,856 (13% increase) and 1,146,105 MWh (15% decrease) respectively.

While the changes are significant, the relationship between avoided cost and achievable potential is not linear and increases in avoided costs do not provide equivalent percentage increases in achievable potential. Technical potential imposes a limit on the amount of additional conservation and each incremental unit of DSM becomes increasingly expensive.

Figure ES-8 Energy Savings, Cumulative Achievable Potential by Avoided Costs Scenario (MWh)

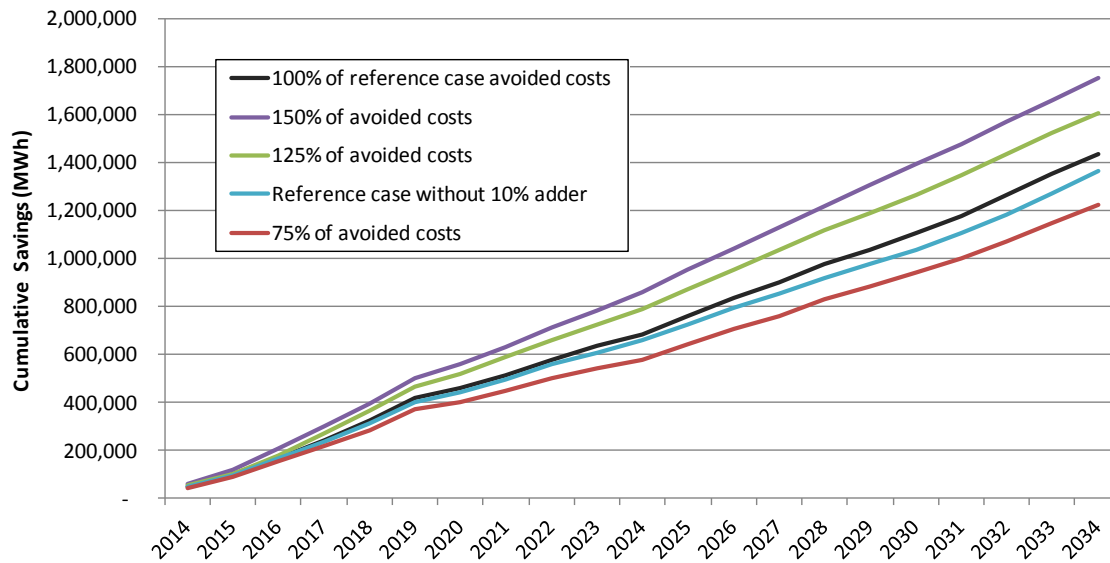

Note: Excludes pumping and 25P.

Table ES-5 Achievable Potential with Varying Avoided Costs

End Use	Reference Scenario	Remove 10% adder	75% of avoided costs	125% of avoided costs	150% of avoided costs
Achievable potential savings 2033 (MWh)	1,352,291	1,272,206	1,146,105	1,521,856	1,657,741
Percentage change in savings vs. 100% avoided cost Scenario		-6%	-15%	13%	23%

Note: Excludes pumping and 25P.

Supply Curves

The project also developed supply curves for each year to support the IRP process. At Avista’s request, the supply curves did not consider economic screening based on Avista’s avoided costs. Instead, all measures were included and the amount of savings from each measure in each year was limited by the ramp rates used for achievable potential. The supply curves do not include the savings from electricity to natural gas fuel switching, discussed above.

A sample supply curve for one year is shown in Figure ES-9. This supply curve is created by stacking measures and equipment over the 20-year planning horizon in ascending order of cost. As expected, this stacking of conservation resources produces a traditional upward-sloping supply curve. Because there is a gap in the cost of the energy efficiency measures as you move up the supply curve, the measures with a very high cost cause a rapid sloping of the supply curve. The supply curve also shows that substantial savings are available at low- or no-cost.

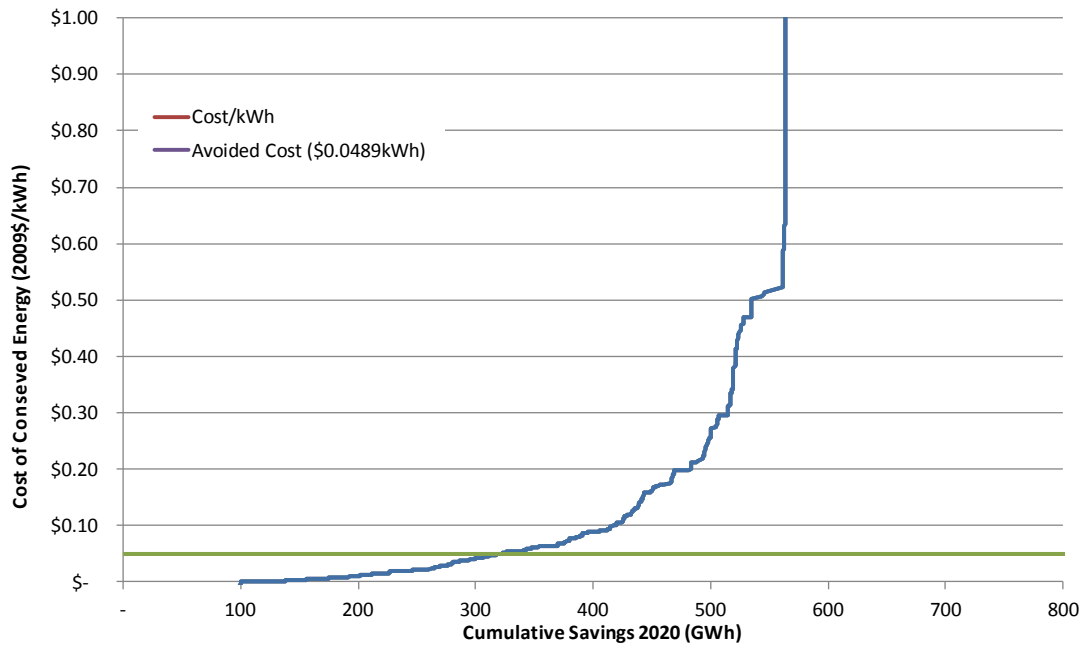
Figure ES-9 Supply Curves for Evaluated EE Measures and Avoided Cost Scenarios

Note: Excludes pumping and 25P.

Washington Potential Excluding Conversions to Natural Gas

Avista has a history of fuel switching from electricity to natural gas and continues to target direct use as the most efficient resource option when available. The conservation potential reported above includes savings potential attributable to conversion of electric space and water heating to natural gas. However, fuel efficiency is not considered in the NPCC Sixth Plan, and thus potential due to fuel conversions **is not included in Avista's conservation target consistent with** Washington I-937. Washington potential consistent with the NPCC Conservation Plan methodology appears in Table ES -6. The energy efficiency target illustrated in Table ES-6, **in addition to Avista's** distribution efficiency target, make up the I-397 target that will be filed in Avista upcoming Biennial Conservation Plan for the 2014–2015 biennium.

Table ES -6 Washington Cumulative Potential Consistent with Conservation Plan Methodology

	2014	2015	2018	2023
Cumulative Savings (MWh)				
Residential	15,091	29,603	100,792	172,576
Commercial and Industrial	19,927	40,930	123,755	256,653
Pumping	1,402	3,237	8,742	0
Conversions to Natural Gas	(3,148)	(6,633)	(16,827)	(35,028)
Total	33,272	67,137	216,462	394,200
Cumulative Savings (aMW)				
Residential	1.72	3.38	11.51	19.70
Commercial and Industrial	2.27	4.67	14.13	29.30
Pumping	0.16	0.37	1.00	0.00
Conversions to Natural Gas	(0.36)	(0.76)	(1.92)	(4.00)
Total	3.80	7.66	24.71	45.00

Executive Summary

Additional details on potential by sector and segment appear in Chapter 4. A second volume provides appendices with supporting information and additional results.

CONTENTS

1	INTRODUCTION	1-1
	Abbreviations and Acronyms	1-2
2	ANALYSIS APPROACH AND DATA DEVELOPMENT	2-1
	Analysis Approach	2-1
	LoadMAP Model	2-2
	Market Characterization	2-3
	Market Profiles	2-6
	Baseline Projection	2-6
	Conservation Measure Analysis	2-6
	Conservation Potential	2-10
	Data Development	2-11
	Data Sources	2-11
	Data Application	2-13
3	MARKET CHARACTERIZATION AND MARKET PROFILES	3-1
	Energy Use Summary	3-1
	Residential Sector	3-3
	C&I Sector	3-8
4	CONSERVATION POTENTIAL	4-1
	Overall Potential	4-1
	Residential Sector	4-4
	Residential Potential by End Use, Technology, and Measure Type	4-6
	Residential Potential by Market Segment	4-10
	C&I Sector Potential	4-12
	C&I Potential by End Use, Technology, and Measure Type	4-14
	C&I Potential by Market Segment	4-19
	Sensitivity of Potential to Avoided Cost	4-20
	Electricity to Natural Gas Fuel Switching	4-21
	Supply Curves	4-22
	Pumping Potential	4-23
	Washington Potential Excluding Conversions to Natural Gas	4-24

LIST OF FIGURES

Figure ES-1	Overview of Analysis Approach	v
Figure ES-2	Residential Intensity by End Use and Segment (kWh/household, 2009).....	vi
Figure ES-3	C&I Electricity Consumption by End Use and Segment (2009)	vii
Figure ES-4	Cumulative Achievable Potential by Sector (MWh).....	vii
Figure ES-5	Residential Cumulative Achievable Potential by End Use in 2018	ix
Figure ES-6	C&I Cumulative Achievable Potential Cumulative Savings by End Use in 2018 (percentage of total)	x
Figure ES -7	Summary of Cumulative Energy Savings, Residential and C&I.....	xii
Figure ES-8	Energy Savings, Cumulative Achievable Potential by Avoided Costs Scenario (MWh) ..	xiii
Figure ES-9	Supply Curves for Evaluated EE Measures and Avoided Cost Scenarios.....	xiv
Figure 2-1	Overview of Analysis Approach	2-1
Figure 2-2	LoadMAP Analysis Framework.....	2-3
Figure 2-3	Approach for Measure Assessment.....	2-7
Figure 2-4	Avoided Costs.....	2-20
Figure 3-1	Electricity Sales by Rate Class, 2009	3-2
Figure 3-2	Electricity Sales by Rate Class, Idaho 2009	3-2
Figure 3-3	Percentage of Residential Electricity Use by End Use and Segment (2009)	3-7
Figure 3-4	Residential Intensity by End Use and Segment (kWh/household, 2009).....	3-8
Figure 3-5	Commercial and Industrial Electricity Consumption by Segment 2009	3-9
Figure 3-6	C&I Electricity Consumption by End Use, 2009	3-11
Figure 3-7	C&I Electricity Consumption by End Use and Segment (2009)	3-12
Figure 4-1	Cumulative Achievable Potential by Sector (MWh).....	4-1
Figure 4-2	Summary of Cumulative Energy Savings, Residential and C&I.....	4-4
Figure 4-4	Residential Cumulative Savings by Potential Case	4-5
Figure 4-5	Residential Cumulative Achievable Potential by End Use in 2018	4-8
Figure 4-6	C&I Cumulative Savings by Potential Case	4-13
Figure 4-7	C&I Cumulative Achievable Potential Cumulative Savings by End Use in 2018 (percentage of total)	4-18
Figure 4-8	C&I Cumulative Achievable Savings in 2018 by End Use and Building Type	4-20
Figure 4-9	Energy Savings, Cumulative Achievable Potential by Avoided Costs Scenario (MWh)	4-21
Figure 4-10	Supply Curves for Evaluated EE Measures and Avoided Cost Scenarios.....	4-23

LIST OF TABLES

Table ES-1	Electricity Sales and Peak Demand by Rate Class, Washington 2009	v
Table ES-2	Electricity Sales and Peak Demand by Rate Class, Idaho 2009	vi
Table ES-3	Cumulative Achievable Potential by State and Sector (MWh)	viii
Table ES-4	Summary of Cumulative Conservation Potential	xi
Table ES-5	Achievable Potential with Varying Avoided Costs	xiii
Table ES -6	Washington Cumulative Potential Consistent with Conservation Plan Methodology	xiv
Table 1-1	Explanation of Abbreviations and Acronyms.....	1-3
Table 2-1	Overview of Segmentation Scheme for Potentials Modeling	2-3
Table 2-2	Residential Electric End Uses and Technologies	2-4
Table 2-3	C&I Electric End Uses and Technologies	2-5
Table 2-4	Number of Measures Evaluated	2-8
Table 2-5	Example Equipment Measures for Air-Source Heat Pump – Single Family Home.....	2-9
Table 2-6	Example Non-Equipment Measures – Single Family Home, Existing.....	2-9
Table 2-7	Economic Screen Results for Selected Single Family Equipment Measures	2-10
Table 2-8	Data Applied for the Market Profiles	2-14
Table 2-9	Data Needs for the Baseline Projection and Potentials Estimation in LoadMAP	2-15
Table 2-10	Residential Electric Equipment Standards Applicable to Avista.....	2-16
Table 2-11	Commercial Electric Equipment Standards Applicable to Avista	2-17
Table 2-12	Industrial Electric Equipment Standards Applicable to Avista.....	2-18
Table 2-13	Data Needs for the Measure Characteristics in LoadMAP	2-19
Table 3-1	Electricity Sales and Peak Demand by Rate Class, Washington 2009	3-1
Table 3-2	Electricity Sales and Peak Demand by Rate Class, Idaho 2009	3-1
Table 3-3	Residential Sector Allocation by Segments, 2009	3-3
Table 3-4	Residential Electricity Usage and Intensity by Segment and State, 2009	3-4
Table 3-5	Average Residential Sector Market Profile, Washington	3-5
Table 3-6	Average Residential Sector Market Profile, Idaho	3-6
Table 3-7	Residential Electricity Use by End Use and Segment (kWh/HH/year, 2009)	3-7
Table 3-8	Commercial and Industrial Sector Market Characterization Results, Washington 2009.....	3-9
Table 3-9	Commercial and Industrial Sector Market Characterization Results, Idaho 2009	3-9
Table 3-10	Large Commercial Segment Market Profile, Washington, 2009	3-10
Table 3-11	C&I Electricity Consumption by End Use and Segment (GWh, 2009)	3-11
Table 4-1	Cumulative Achievable Potential by State and Sector (MWh)	4-2
Table 4-2	Summary of Cumulative Conservation Potential	4-3
Table 4-4	Residential Cumulative Savings by End Use and Potential Type (MWh).....	4-6
Table 4-5	Residential Cumulative Achievable Potential for Equipment Measures (MWh).....	4-9
Table 4-6	Residential Cumulative Achievable Potential by Market Segment.....	4-11
Table 4-7	Residential Cumulative Achievable Potential by End Use and Market Segment, 2018 (MWh)	4-11
Table 4-8	Residential Cumulative Achievable Potential by End Use and Market Segment, 2018 (MWh)	4-12

Table 4-9	Cumulative Conservation Potential for the C&I Sector	4-12
Table 4-10	C&I Cumulative Potential by End Use and Potential Type (MWh)	4-14
Table 4-11	C&I Cumulative Achievable Savings for Equipment Measures (MWh).....	4-16
Table 4-12	C&I Cumulative Achievable Savings for Non-equipment Measures (MWh).....	4-17
Table 4-13	C&I Cumulative Potential by Market Segment, 2018.....	4-19
Table 4-14	C&I Cumulative Achievable Savings in 2018 by End Use and Rate Class(MWh)	4-19
Table 4-15	Achievable Potential with Varying Avoided Costs.....	4-21
Table 4-16	Cumulative Achievable Potential from Conversion to Natural Gas (MWh)	4-22
Table 4-17	Pumping Rate Classes, Electricity Sales and Peak Demand 2009	4-23
Table 4-18	Sixth Plan Calculator Agriculture Incremental Annual Potential, 2014–2019 (MWh) .	4-24
Table 4-19	Washington Cumulative Potential Consistent with Conservation Plan Methodology ..	4-24

INTRODUCTION

Background

Avista Corporation (Avista) engaged EnerNOC Utility Solutions (EnerNOC) to conduct a Conservation Potential Assessment (CPA). The CPA is a 20-year conservation potential study to provide data on conservation resources for developing Avista's 2013 Integrated Resource Plan (IRP), and in accordance with Washington Initiative 937 (I-937). The study updates Avista's last CPA, which EnerNOC performed in 2011. The 2011 CPA used 2009, the first year for which complete billing data was available at the time, as the base year. This update kept 2009 as the base year for the analysis, and calibrated the model used for the assessment to align with actual sales and conservation program achievements for the years 2010–2012.

Report Organization

This remainder of this report is presented in three chapters as outlined below.

- Chapter 2 — Analysis Approach and Data Development
- Chapter 3 — Market Characterization and Market Profiles
- Chapter 4 — Conservation Potential

Definition of Potential

In this study, we estimate the potential for conservation savings. The savings estimates represent gross savings developed into three types of potential: technical potential, economic potential, and achievable potential. Technical and economic potential are both theoretical limits to conservation savings. Achievable potential embodies a set of assumptions about the decisions consumers make regarding the efficiency of the equipment they purchase, the maintenance activities they undertake, the controls they use for energy-consuming equipment, and the elements of building construction. The various levels are described below.

- **Technical potential** is defined as the theoretical upper limit of conservation potential. It assumes that customers adopt all feasible measures regardless of their cost. At the time of existing equipment failure, customers replace their equipment with the most efficient option available. In new construction, customers and developers also choose the most efficient equipment option. Examples of measures that make up technical potential for electricity in the residential sector include:
 - High-efficiency heat pumps for homes with ducts
 - Ductless mini-split heat pumps for homes without ducts
 - Heat pump water heaters
 - LED lighting

Technical potential also assumes the adoption of every other available measure, where applicable. For example, it includes installation of high-efficiency windows in all new construction opportunities and furnace maintenance in all existing buildings with furnace systems. These retrofit measures are phased in over a number of years, which is longer for higher-cost and complex measures.

- **Economic potential** represents the adoption of all *cost-effective* conservation measures. In this analysis, cost-effectiveness is measured by the total resource cost (TRC) test, which compares lifetime energy and capacity benefits to the incremental cost of the measure. If the benefits outweigh the costs (that is, if the TRC ratio is greater than 1.0), a given measure is

Introduction

considered in the economic potential. Customers are then assumed to purchase the most cost-effective option applicable to them at any decision juncture.

- **Achievable potential** takes into account market maturity, customer preferences for energy-efficient technologies, and expected program participation. Achievable potential establishes a realistic target for the conservation savings that a utility can hope to achieve through its programs. It is determined by applying a series of annual market adoption factors to the economic potential for each conservation measure. These factors represent the ramp rates at which technologies will penetrate the market. To develop these factors, the project team reviewed Avista's **past** conservation program achievements and program history over the last five years, as well as the Northwest Power and Conservation Council (NPCC) ramp rates used in the Sixth Plan. Details regarding the market adoption factors appear in Appendix D.

Abbreviations and Acronyms

Throughout the report we use several abbreviations and acronyms. Table 1-1 shows the abbreviation or acronym, along with an explanation.

Table 1-1 Explanation of Abbreviations and Acronyms

Acronym	Explanation
ACS	American Community Survey
AEO	Annual Energy Outlook forecast developed annual by the Energy Information Administration of the DOE
B/C Ratio	Benefit to cost ratio
BEST	EnerNOC's Building Energy Simulation Tool
CAC	Central air conditioning
C&I	Commercial and industrial
CB ECS	Commercial Building Energy Consumption Survey (prepared by EIA)
CBSA	NEAA Commercial Building Stock Assessment
CFL	Compact fluorescent lamp
DEEM	EnerNOC's Database of Energy Efficiency Measures
DEER	State of California Database for Energy-Efficient Resources
DSM	Demand side management
EE	Energy efficiency
EIA	Energy Information Administration
EISA	Energy Efficiency and Security Act of 2007
EPACT	Energy Policy Act of 2005
EPRI	Electric Power Research Institute
EUI	Energy-use index
HH	Household
HID	High intensity discharge lamps
HPWH	Heat pump water heater
IRP	Integrated Resource Plan
LED	Light emitting diode lamp
LoadMAP	EnerNOC's Load Management Analysis and Planning™ tool
MECS	Manufacturing Energy Consumption Survey (prepared by EIA)
NEEA	Northwest Energy Efficiency Alliance
NPCC	Northwest Power and Conservation Council
RTF	Regional Technical Forum
RASS	California Residential Appliance Saturation Survey
CEUS	California Commercial End-Use Survey
REEPS	EPRI Residential End-use Energy Planning System
COMMEND	EPRI COMMERCIAL END-use planning system
RBSA	NEAA Residential Building Stock Assessment
RECS	Residential Energy Consumption Survey (prepared by EIA)
RTU	Roof top unit
Sq. ft.	Square feet
TRM	Technical Reference Manual
TRC	Total resource cost
UEC	Unit energy consumption
UES	Unit energy savings (as defined in RTF measure workbooks)

CHAPTER | 2

ANALYSIS APPROACH AND DATA DEVELOPMENT

This section describes the analysis approach taken for the study and the data sources used to develop the potential estimates.

Analysis Approach

To perform the conservation potential analysis, EnerNOC used a bottom-up analysis approach as shown in Figure 2-1.

Figure 2-1 Overview of Analysis Approach

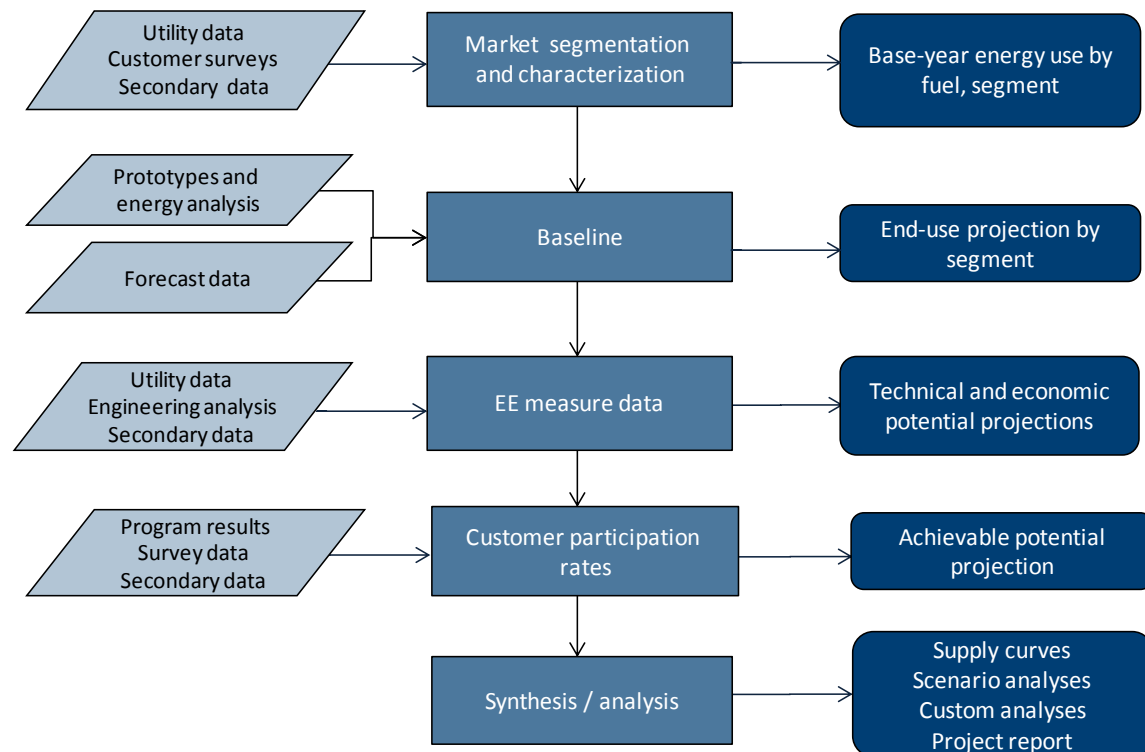

The analysis involved the following steps.

1. Held a meeting with the client project team to refine the objectives of the project in detail. This resulted in a work plan for the study.
2. Performed a market characterization to describe sector-level electricity use for the residential and non-residential (commercial and industrial) sectors for the base year, 2009. This step drew upon the market characterization from the 2011 CPA, but updated the characterization to incorporate new information from the Northwest Energy Efficiency Alliance (NEEA) 2012 Residential Building Stock Assessment (RBSA), **EnerNOC's own databases and tools**, and other secondary data sources such as the American Community Survey (ACS), Northwest Power and Conservation Council (NPCC), and the Energy Information Administration (EIA).
3. Developed a baseline electricity use projection by sector, segment, and end use for 2009 through 2033.

4. Identified and characterized conservation measures.
5. Estimated three levels of conservation potential: measure-level conservation potential: *Technical, Economic, and Achievable*.

The analysis approach for all these steps is described in further detail throughout the remainder of this chapter.

LoadMAP Model

We used EnerNOC's **Load Management Analysis and Planning tool (LoadMAP™)** version 3.0 to develop both the baseline forecast and the estimates of conservation potential. EnerNOC developed LoadMAP in 2007 and has enhanced it over time, using it for the EPRI National Potential Study and numerous utility-specific forecasting and potential studies. Built in Excel, the LoadMAP framework, illustrated in Figure 2-1, is both accessible and transparent and has the following key features.

- Embodies the basic principles of rigorous end-use models (such as EPRI's REEPS and COMMEND) but in a more simplified, accessible form.
- Includes stock-accounting algorithms that treat older, less efficient appliance/equipment stock separately from newer, more efficient equipment. Equipment is replaced according to the measure life and appliance vintage distributions defined by the user.
- Balances the competing needs of simplicity and robustness by incorporating important modeling details related to equipment saturations, efficiencies, vintage, and the like, where market data are available, and treats end uses separately to account for varying importance and availability of data resources.
- Isolates new construction from existing equipment and buildings and treats purchase decisions for new construction and existing buildings separately.
- Uses a simple logic for appliance and equipment decisions. LoadMAP allows the user to drive the appliance and equipment choices year by year directly in the model. This flexible approach allows users to import the results from diffusion models or to input individual assumptions. The framework also facilitates sensitivity analysis.
- Includes appliance and equipment models customized by end use. For example, the logic for lighting is distinct from refrigerators and freezers.
- Can accommodate various levels of segmentation. Analysis can be performed at the sector level (e.g., total residential) or for customized segments within sectors (e.g., housing type or income level).

Consistent with the segmentation scheme and the market profiles we describe below, the LoadMAP model provides projections of baseline energy use by sector, segment, end use, and technology for existing and new buildings. It also provides projections of total energy use and conservation savings associated with the three types of potential.¹

¹ The model computes energy and peak-demand forecasts for each type of potential for each end use as an intermediate calculation. Annual-energy and peak-demand savings are calculated as the difference between the value in the baseline forecast and the value in the potential forecast (e.g., the technical potential forecast).

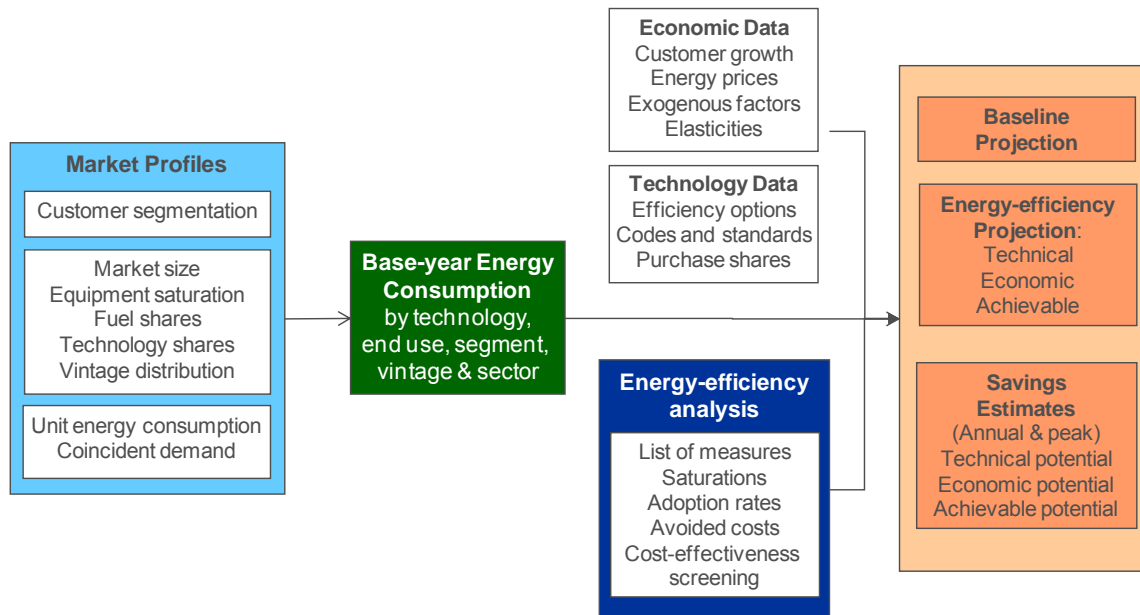
Figure 2-2 LoadMAP Analysis Framework

Market Characterization

In order to estimate the savings potential from conservation measures, it is necessary to understand how much energy is used today and what equipment is currently being used. This characterization begins with a segmentation of Avista's energy footprint to quantify energy use by sector, segment, fuel, end-use application, and the current set of technologies used. We incorporate information from the secondary research sources to advise the market characterization.

Segmentation for Modeling Purposes

The market assessment first defined the market segments (building types, end uses and other dimensions) that are relevant in the Avista service territory. The segmentation scheme for this project is presented in Table 2-1, and is the same as that used in the 2011 CPA.

Table 2-1 Overview of Segmentation Scheme for Potentials Modeling

Market Dimension	Segmentation Variable	Dimension Examples
1	Sector	Residential, commercial and industrial
2	Building type	Residential (single family, multi family, mobile home, low income) Commercial and Industrial (small/medium commercial, large commercial, extra large commercial, extra large industrial)
3	Vintage	Existing and new construction
4	Fuel	Electricity
5	End uses	Cooling, space heating, lighting, water heat, motors, etc. (as appropriate by sector)
6	Appliances/end uses and technologies	Technologies such as lamp type, air conditioning equipment, motors by application, etc.
7	Equipment efficiency levels for new purchases	Baseline and higher-efficiency options as appropriate for each technology

Analysis Approach and Data Development

Following this scheme, the residential sector was segmented as described below, starting with customer segments by building type:

- Single family
- Multi family
- Mobile home
- Low income

In addition to segmentation by housing type, we identified the set of end uses and technologies that are appropriate for Avista's residential sector. These are shown in Table 2-2.

Table 2-2 Residential Electric End Uses and Technologies

End Use	Technology
Cooling	Central Air Conditioning (CAC)
Cooling	Room Air Conditioning (RAC)
Cooling/Space Heating	Air-Source Heat Pump
Cooling/Space Heating	Geothermal Heat Pump
Space Heating	Electric Resistance
Space Heating	Electric Furnace
Space Heating	Supplemental
Water Heating	Water Heater <= 55 gal
Water Heating	Water Heater > 55 gal
Interior Lighting	Screw-in Lamps
Interior Lighting	Linear Fluorescent Lamps
Interior Lighting	Specialty
Exterior Lighting	Screw-in Lamps
Appliances	Clothes Washer
Appliances	Clothes Dryer
Appliances	Dishwasher
Appliances	Refrigerator
Appliances	Freezer
Appliances	Second Refrigerator
Appliances	Stove
Appliances	Microwaves
Electronics	Personal Computers
Electronics	TVs
Electronics	Set-top Boxes/DVR
Electronics	Devices and Gadgets
Miscellaneous	Pool Pump
Miscellaneous	Furnace Fan
Miscellaneous	Miscellaneous

For the commercial and industrial sector (C&I), we segmented the market based on Avista's rate classes, using the following segments.

- Small/medium Commercial
- Large Commercial
- Extra Large Commercial
- Extra Large Industrial

The set of end uses and technologies for the C&I sector appear in Table 2-3.

Table 2-3 C&I Electric End Uses and Technologies

End Use	Technology
Cooling	Central Chiller
Cooling	Roof top AC
Cooling/Heating	Heat Pump
Space Heating	Electric Resistance
Space Heating	Electric Furnace
Ventilation	Ventilation
Water Heating	Water Heater
Interior Lighting	Screw-in
Interior Lighting	High-Bay Fixtures
Interior Lighting	Linear Fluorescent
Exterior Lighting	Exterior Screw-in
Exterior Lighting	HID
Refrigeration	Walk-in Refrigerator
Refrigeration	Reach-in Refrigerator
Refrigeration	Glass Door Display
Refrigeration	Open Display Case
Refrigeration	Icemaker
Refrigeration	Vending Machine
Food Preparation	Oven
Food Preparation	Fryer
Food Preparation	Dishwasher
Food Preparation	Hot Food Container
Office Equipment	Desktop Computer
Office Equipment	Laptop Computer
Office Equipment	Server
Office Equipment	Monitor
Office Equipment	Printer/Copier/Fax
Office Equipment	POS Terminal
Process	Process Cooling/Refrigeration
Process	Process Heating
Process	Electrochemical Process
Machine Drive	Less than 5 HP
Machine Drive	5 - 24 HP
Machine Drive	25 - 99 HP
Machine Drive	100 - 249 HP
Machine Drive	250 – 499 HP
Machine Drive	500 and more HP
Miscellaneous	Non-HVAC Motors
Miscellaneous	Miscellaneous
Miscellaneous	Other Miscellaneous

Analysis Approach and Data Development

For the 2011 study, we performed a high-level market characterization of electricity sales in the 2009 base year to allocate sales to each customer segment. We used Avista billing data by rate class as well as various secondary data sources to identify the annual sales in each customer segment, as well as the market size for each segment. This information provided control totals at a sector level for calibrating the LoadMAP model to known data for the base-year and was used for this CPA update as well.

Market Profiles

The next step was to develop market profiles for each sector, customer segment, end use, and technology. A market profile includes the following elements:

- **Market size** is a representation of the number of customers in the segment. For the residential sector, it is number of households. In the commercial and industrial sector, it is floor space measured in square feet.
- **Saturations** define the fraction of homes or C&I square feet with the various technologies. (e.g., homes with electric space heating).
- **UEC (unit energy consumption) or EUI (energy-use index)** describes the amount of energy consumed in 2009 by a specific technology in buildings that have the technology. UECs are expressed in kWh/household for the residential sector, while EUIs are expressed in kWh/square foot for C&I.
- **Intensity** for the residential sector represents the average energy use for the technology across all homes in 2009. It is computed as the product of the saturation and the UEC and is defined as kWh/household for electricity. For the commercial and industrial sectors, intensity, computed as the product of the saturation and the EUI, represents the average use for the technology across all floor space in 2009.
- **Usage** is the annual energy use by an end use technology in the segment. It is the product of the market size and intensity and is quantified in GWh. The market assessment results and the market profiles are presented in Chapter 3.

Baseline Projection

The next step was to develop the baseline projection of annual electricity usage for 2009 through 2033 by customer segment and end use without new utility programs or naturally occurring efficiency. The end-use projection does include the relatively certain impacts of codes and standards that will unfold over the study timeframe. All such mandates that were defined as of January 2012 are included in the baseline. The baseline projection is the foundation for the analysis of savings from future conservation efforts as well as the metric against which potential savings are measured.

Inputs to the baseline projection include:

- Avista historic sales data and conservation program achievements for 2009 through 2012
- Current economic growth forecasts (i.e., customer growth, income growth)
- Electricity price forecasts
- Trends in fuel shares and equipment saturations
- Existing and approved changes to building codes and equipment standards

Conservation Measure Analysis

This section describes the framework used to assess the savings, costs, and other attributes of conservation measures. These characteristics form the basis for measure-level cost-effectiveness analyses as well as for determining measure-level savings. For all measures, EnerNOC assembled information to reflect equipment performance, incremental costs, and equipment lifetimes. We used this information, along with **Avista's** avoided costs data, in the economic screen to

determine economically feasible measures. Figure 2-3 outlines the framework for measure analysis.

Figure 2-3 Approach for Measure Assessment

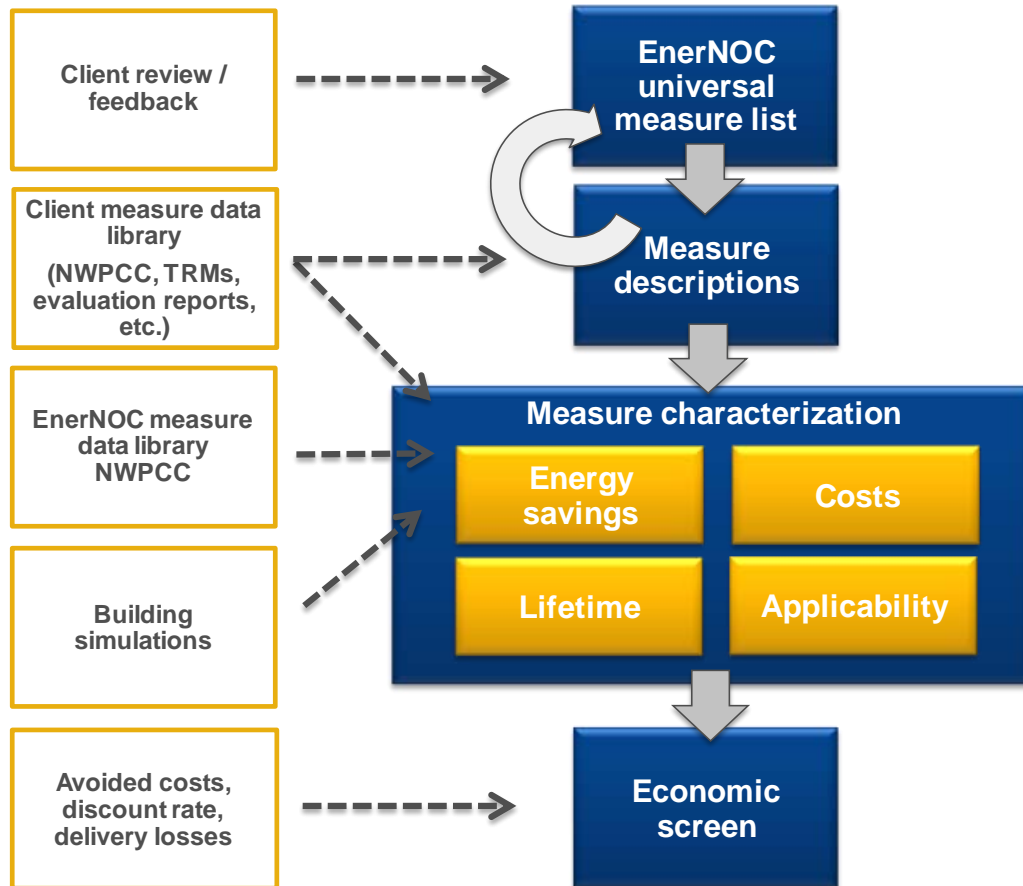

The framework for assessing savings, costs, and other attributes of conservation measures involves identifying the list of conservation measures to include in the analysis, determining their applicability to each market sector and segment, fully characterizing each measure, and performing cost-effectiveness screening.

The first step of the conservation measure analysis was to identify the list of all relevant conservation measures that should be considered for the Avista potential assessment. EnerNOC prepared a preliminary list of measures that compared the list of measures included in Avista's previous CPA with those in its business plan, its technical reference manual, the Sixth Plan, the RTF measure workbooks, and EnerNOC's own measure database in order to reconcile the various measure lists and provide the widest possible list of measures. This universal list of conservation measures covers all major types of end-use equipment, as well as devices and actions to reduce energy consumption. If considered today, some of these measures would not pass the economic screens initially, but may pass in future years as a result of lower projected equipment costs or higher avoided costs. After receiving feedback from Avista, we finalized the measures list.

The selected measures are categorized into two types according to the LoadMAP taxonomy: equipment measures and non-equipment measures.

- **Equipment measures** are efficient energy-consuming pieces of equipment that save energy by providing the same service with a lower energy requirement than a standard unit. An example is an ENERGY STAR refrigerator that replaces a standard efficiency refrigerator. For equipment measures, many efficiency levels may be available for a given technology, ranging

Analysis Approach and Data Development

from the baseline unit (often determined by code or standard) up to the most efficient product commercially available. For instance, in the case of central air conditioners, this list begins with the current federal standard SEER 13 unit and spans a broad spectrum up to a maximum efficiency of a SEER 21 unit.

- **Non-equipment measures** save energy by reducing the need for delivered energy, but do not involve replacement or purchase of major end-use equipment (such as a refrigerator or air conditioner). An example would be a programmable thermostat that is pre-set to run heating and cooling systems only when people are home. Non-equipment measures can apply to more than one end use. For instance, addition of wall insulation will affect the energy use of both space heating and cooling. Non-equipment measures typically fall into one of the following categories:
 - Building shell (windows, insulation, roofing material)
 - Equipment controls (thermostat, energy management system)
 - Equipment maintenance (air conditioning and heat pump maintenance, changing setpoints)
 - Whole-building design (building orientation, passive solar lighting)
 - Lighting retrofits (included as a non-equipment measure because retrofits are performed **prior to the equipment's normal end of life**)
 - Displacement measures (ceiling fan to reduce use of central air conditioners)
 - Commissioning and retrocommissioning

Table 2-4 summarizes the number of equipment and non-equipment measures evaluated for each segment within each sector.

Table 2-4 **Number of Measures Evaluated**

	Residential	C&I	Total Number of Measures
Equipment Measures Evaluated	1,536	1540	3,076
Non-Equipment Measures Evaluated	860	914	1,774
Total Measures Evaluated	2,396	2454	4,850

Once we assembled the list of conservation measures, the project team assessed their energy-saving characteristics. For each measure we also characterized incremental cost, service life, and other performance factors. Following the measure characterization, we performed an economic screening of each measure, which serves as the basis for developing the economic and achievable potential. The residential and C&I measures are listed and described in Appendix B and Appendix C respectively.

Representative Measure Data Inputs

To provide an example of the measure data, Table 2-5 and Table 2-6 present examples of the detailed data inputs behind both equipment and non-equipment measures, respectively, for the case of heat pumps in single-family homes. Table 2-6 displays the various efficiency levels available as equipment measures, as well as the corresponding useful life, energy usage, and cost estimates. The columns labeled On Market and Off Market reflect equipment availability due to codes and standards or the entry of new products to the market.

Table 2-5 Example Equipment Measures for Air-Source Heat Pump – Single Family Home

Efficiency Level	Useful Life	Equipment Cost	Energy Usage(kWh/yr)	On Market	Off Market
SEER 13	15	\$5,700	857	2009	2014
SEER 14 (Energy Star)	15	\$5,767	771	2009	n/a
SEER 15 (CEE Tier 2)	15	\$8,018	760	2009	n/a
SEER 16 (CEE Tier 3)	15	\$9,205	737	2009	n/a

Table 2-6 lists some of the non-equipment measures applicable to space heating in an existing single-family home. All measures are evaluated for cost-effectiveness based on the lifetime benefits relative to the cost of the measure. The total savings and costs are calculated for each year of the study and depend on the base year saturation of the measure, the applicability² of the measure, and the savings as a percentage of the relevant energy end uses.

Table 2-6 Example Non-Equipment Measures – Single Family Home, Existing

End Use	Measure	Saturation in 2009 ³	Applicability	Lifetime (yrs)	Measure Installed Cost	Energy Savings (%)
Space Heating	Insulation - Ducting	15%	59%	18	\$500	5%
Space Heating	Repair and Sealing - Ducting	12%	100%	20	\$571	23%
Space Heating	Thermostat - Clock/Programmable	72%	75%	15	\$249	6%
Space Heating	Doors - Storm and Thermal	38%	100%	12	\$320	1%
Space Heating	Insulation - Infiltration Control	46%	100%	25	\$306	9%
Space Heating	Insulation - Ceiling	76%	75%	25	\$630	10%
Space Heating	Insulation - Radiant Barrier	5%	100%	12	\$923	6%
Space Heating	Windows - High Efficiency/ENERGY STAR	78%	100%	25	\$5,201	30%
Space Heating	Behavioral Measures	20%	50%	1	\$12	1%

Screening Measures for Cost-Effectiveness

Only measures that are cost-effective are included in economic and achievable potential. Therefore, for each individual measure, LoadMAP performs an economic screen. This study uses the TRC test that compares the lifetime energy and peak demand benefits, as well as any non-energy benefits included in the RTF measure database, with the measure's incremental installed cost, including material and labor. The lifetime benefits are calculated by multiplying the annual energy and demand savings for each measure by all appropriate avoided costs for each year, and discounting the dollar savings to the present value equivalent. The analysis uses each measure's values for savings, costs, and lifetimes that were developed as part of the measure

² The applicability factors take into account whether the measure is applicable to a particular building type and whether it is feasible to install the measure. For instance, attic fans are not applicable to homes where there is insufficient space in the attic or there is no attic at all.

³ Note that saturation levels reflected for the base year change over time as more measures are adopted.

Analysis Approach and Data Development

characterization process described above. The analysis also accounts for transmission and distribution losses, and for program administration costs.

The LoadMAP model performs this screening dynamically, taking into account changing savings and cost data over time. Thus, some measures pass the economic screen for some — but not all — of the years in the study period.

It is important to note the following about the economic screen:

- The economic evaluation of every measure in the screen is conducted relative to a baseline condition. For instance, in order to determine the kilowatt-hour (kWh) savings potential of a measure, kWh consumption with the measure applied must be compared to the kWh consumption of a baseline condition.
- The economic screening was conducted only for measures that are applicable to each building type and vintage; thus if a measure is deemed to be irrelevant to a particular building type and vintage, it is excluded from the respective economic screen.

If the measure passes the screen (has a B/C ratio greater than or equal to 1), the measure is included in economic potential. Otherwise, it is screened out for that year. If multiple equipment measures have B/C ratios greater than or equal to 1.0, the most efficient technology is selected by the economic screen. Table 2-7 shows the results of the economic screen for selected measures, indicating how the economic unit for a given technology may vary over time. For example, CFLs are initially the economical unit for interior screw-in lighting, but as the price of LEDs decreases, they become the economical unit for single family homes starting in 2017. For exterior lighting, due to longer hours of operation, LEDs are cost-effective starting in 2015.

Table 2-7 Economic Screen Results for Selected Single Family Equipment Measures

Technology	2014	2015	2016	2017	2018	2019
Interior Screw-in Lighting	CFL	CFL	CFL	LED	LED	LED
Exterior Screw-in Lighting	CFL	LED	LED	LED	LED	LED

Conservation Potential

The approach we used for this study adheres to the approaches and conventions outlined in the National Action Plan for Energy-Efficiency (NAPEE) Guide for Conducting Potential Studies (November 2007).⁴ The NAPEE Guide represents the most credible and comprehensive industry practice for specifying energy-efficiency potential. As described in Chapter 1, three types of potentials were developed as part of this effort: Technical potential, Economic potential, and Achievable potential.

- **Technical potential** is a theoretical construct that assumes the highest efficiency measures that are technically feasible to install are adopted by customers, regardless of cost or customer preferences. Thus, determining the technical potential is relatively straightforward. LoadMAP selects the most efficient equipment options for each technology at the time of equipment replacement. In addition, it installs all relevant non-equipment measures for each technology to calculate savings. For example, for a central heat pump, as shown in Table 2-5, the most efficient option is a SEER 16 system. The multiple non-equipment measures shown in Table 2-6 are then applied to the energy used by the ductless mini-split system to further reduce space conditioning energy use. LoadMAP applies the savings due to the non-equipment measures one-by-one to avoid double counting of savings. The measures are evaluated in order of their B/C ratio, with the measure with the highest B/C ratio applied

⁴ National Action Plan for Energy Efficiency (2007). *National Action Plan for Energy Efficiency Vision for 2025: Developing a Framework for Change*. www.epa.gov/eeactionplan.

first. Each time a measure is applied, the baseline energy use for the end use is reduced and the percentage savings for the next measure is applied to the revised (lower) usage.

- **Economic potential** results from the purchase of the most efficient cost-effective option available for a given equipment or non-equipment measure as determined in the cost-effectiveness screening process described above. As with technical potential, economic potential is a phased-in approach. Economic potential is still a hypothetical upper-boundary of savings potential as it represents only measures that are economic but does not yet consider customer acceptance and other factors.
- **Achievable potential** defines the range of savings that is very likely to occur. It accounts for customers' awareness of efficiency options, any barriers to customer adoption, limits to program design, and other factors that influence the rate at which conservation measures penetrate the market.

The calculation of technical and economic potential is straightforward as described above. To develop estimates for achievable potential, we specify market adoption rates for each measure and each year. For Avista, the project team began with the ramp rates specified in the Sixth Plan conservation workbooks, but modified these to match Avista program history and service territory specifics. For specific measures, we examined historic program results for the four-year period of 2009 through 2012. We then adjusted the 2009–2013 market acceptance rates so that the achievable potential for these measures aligned with the historical results. This provided a starting point for the ramp rates in 2014. For future years, we increased the potential factors to model increasing market acceptance and program improvements. For measures not currently included in Avista programs, we relied upon the Sixth Plan ramp rates and recent EnerNOC potential studies to create market adoption rates. The market adoption rates for each measure appear in Appendix D.

Results of all the potentials analysis are presented in Chapter 4.

Data Development

This section details the data sources used in this study, followed by a discussion of how these sources were applied. In general, data were adapted to local conditions, for example, by using local sources for measure data and local weather for building simulations.

Data Sources

The data sources are organized into the following categories:

- Avista data
- NPCC and RTF data
- EnerNOC's databases and analysis tools
- Other secondary data and reports

Avista Data

Our highest priority data sources for this study were those that were specific to Avista.

- **Avista customer data:** Avista provided number of customers and total electric usage by sector from the customer billing database.
- **Avista Business Plan and program implementation and evaluation data:** Data that outlines the details of conservation programs, program goals, and achievements to date.
- **Avista Technical Resources Manual:** provides collection of UES for prescriptive programs delivered by Avista as informed by its most recent impact evaluation efforts.

Northwest Power and Conservation Council Data

- **Northwest Power and Conservation Council Sixth Plan Conservation Supply Curve Workbooks, 2010.** To develop its Power Plan, the Council used workbooks with detailed information about measures, available at <http://www.nwcouncil.org/energy/powerplan/6/supplycurves/default.htm> .
- **Regional Technical Forum Deemed Measures.** The NWPCC Regional Technical Forum maintains databases of deemed measure savings data, available at <http://www.nwcouncil.org/energy/rtf/measures/Default.asp> .
- **Regional Technical Forum Residential SEEM modeling results**
<http://rtf.nwcouncil.org/measures/support/Default.asp>

EnerNOC Databases, Analysis Tools, and Reports

EnerNOC maintains several databases and modeling tools that we use for forecasting and potential studies.

- **EnerNOC Energy Market Profiles:** For more than 10 years, EnerNOC staff have maintained profiles of end-use consumption for the residential, commercial, and industrial sectors. These profiles include market size, fuel shares, unit consumption estimates, and annual energy use by fuel (electricity and natural gas), customer segment and end use for 10 regions in the U.S. The Energy Information Administration surveys (RECS, CBECS and MECS) as well as state-level statistics and local customer research provide the foundation for these regional profiles.
- **Building Energy Simulation Tool (BEST).** EnerNOC's BEST is a derivative of the DOE 2.2 building simulation model, used to estimate base-year UECs and EUIs, as well as measure savings for the HVAC-related measures.
- **EnerNOC's EnergyShape™:** This database of load shapes includes the following: Residential – electric load shapes for 10 regions, 3 housing types, 13 end uses; Commercial – electric load shapes for 9 regions, 54 building types, 10 end uses; Industrial – electric load shapes, whole facility only, 19 2-digit SIC codes, as well as various 3-digit and 4-digit SIC codes
- **EnerNOC's Database of Energy Efficiency Measures (DEEM):** EnerNOC maintains an extensive database of measure data for our studies. Our database draws upon reliable sources including the California Database for Energy Efficient Resources (DEER), the EIA Technology Forecast Updates – Residential and Commercial Building Technologies – Reference Case, RS Means cost data, and Grainger Catalog Cost data.
- **Recent studies.** EnerNOC has conducted numerous studies of conservation potential in the last five years. We checked our input assumptions and analysis results against the results from these other studies, which include Idaho Power, and Seattle City Light. In addition, we used the information about impacts of building codes and appliance standards from a recent report for the Institute for Energy Efficiency.⁵

Other Secondary Data and Reports

Finally, a variety of secondary data sources and reports were used for this study. The main sources are identified below.

- **Residential Building Stock Assessment:** NEEA's 2011 Residential Building Stock Assessment (RBSA) provides results of a regional study of 1,404 homes, of which 27 are located within Avista's service territory. Due to the relatively low number of customers, 27, within Avista's service territory, we used the results for 113 homes in eastern Washington

⁵ "Assessment of Electricity Savings in the U.S. Achievable through New Appliance/Equipment Efficiency Standards and Building Efficiency Codes (2010 – 2025)." Global Energy Partners, LLC for the Institute for Electric Efficiency, May 2011.
http://www.edisonfoundation.net/iee/reports/IEE_CodesandStandardsAssessment_2010-2025_UPDATE.pdf

and 52 homes in northern Idaho as proxies for Avista's Washington and Idaho service territories respectively. This information allowed us to update the single family home market profiles from the 2011 CPA. At the time of the 2013 CPA, the RBSA results for mobile and multifamily homes had not yet been released.

<http://neea.org/docs/reports/residential-building-stock-assessment-single-family-characteristics-and-energy-use.pdf?sfvrsn=6>

- **Commercial Building Stock Assessment:** NEEA's Commercial Building Stock Assessment (CBSA) provides data on regional commercial buildings. As of the most recent update in 2009, the database contains site-specific information for 2,061 buildings. <http://neea.org/resource-center/regional-data-resources/commercial-building-stock-assessment>
- **American Community Survey:** The US Census American Community Survey is an ongoing survey that provides data every year on household characteristics. <http://www.census.gov/acs/www/>
- **Residential Energy Consumption Survey (RECS).** <http://www.eia.gov/consumption/residential/data/2009/>
- **Annual Energy Outlook.** The Annual Energy Outlook (AEO), conducted each year by the U.S. Energy Information Administration (EIA), presents yearly projections and analysis of energy topics. For this study, we used data from the 2011 AEO.
- **California Statewide Surveys.** The Residential Appliance Saturation Survey (RASS) and the Commercial End Use Survey (CEUS) are comprehensive market research studies conducted by the California Energy Commission. These databases provide a wealth of information on appliance use in homes and businesses. RASS is based on information from almost 25,000 homes and CEUS is based on information from a stratified random sample of almost 3,000 businesses in California.
- **Electric Power Research Institute – Assessment of Achievable Potential from Energy Efficiency and Demand Response Programs in the U.S.,** also known as the EPRI National Potential Study (2009). In 2009, EPRI hired EnerNOC to conduct an assessment of the national potential for energy efficiency, with estimates derived for the four DOE regions.
- **EPRI End-Use Models (REEPS and COMMEND).** These models provide the elasticities we apply to electricity prices, household income, home size and heating and cooling.
- **Database for Energy Efficient Resources (DEER).** The California Energy Commission and California Public Utilities Commission (CPUC) sponsor this database, which is designed to provide well-documented estimates of energy and peak demand savings values, measure costs, and effective useful life (EUL) for the state of California. We used the DEER database to cross check the measure savings we developed using BEST and DEEM.
- **Northwest Power and Conservation Council Sixth Plan workbooks.** To develop its Power Plan, the Council maintains workbooks with detailed information about measures.
- **Other relevant regional sources.** These include reports from the Consortium for Energy Efficiency, the EPA, and the American Council for an Energy-Efficient Economy.

Data Application

We now discuss how the data sources described above were used for each step of the study.

Data Application for Market Characterization

To construct the high-level market characterization of electricity use and households/floor space for the residential, commercial, and industrial sectors, we applied the following data sources:

- Avista internal data, RECS 2009 and the American Community Survey to allocate residential customers by housing type

Data Application for Market Profiles

The specific data elements for the market profiles, together with the key data sources, are shown in Table 2-8. This CPA update began with the market profiles previously developed for the 2011 CPA, but we incorporated new residential sector data from the RBSA as described above. The C&I market profiles were largely unchanged because no significant additional data was available regarding Avista's C&I customers.

To develop the market profiles for each segment, we used the following approach:

1. Developed control totals for each segment. These include market size, segment-level annual electricity use, and annual intensity.
2. Used NEEA reports including the recently released RBSA Single Family report, the Inland Power & Light survey of its residential customers, and RECS to provide information about market size for customer segments, appliance and equipment saturations, appliance and equipment characteristics, UECs, building characteristics, customer behavior, operating characteristics, and energy-efficiency actions already taken.
3. Incorporated secondary data sources to supplement and corroborate the data from items 1 and 2 above.
4. Compared and cross-checked with regional data obtained as part of the EPRI National Potential Study and with the Energy Market Profiles Database.
5. Ensured calibration to control totals for annual electricity sales in each sector and segment.
6. Worked with Avista staff to vet the data against their knowledge and experience.

Table 2-8 Data Applied for the Market Profiles

Model Inputs	Description	Key Sources
Market size	Base-year residential dwellings and C&I floor space	Avista billing data, NEEA Reports, NPCC data
Annual intensity	Residential: Annual energy use (kWh/household) C&I: Annual energy use	Energy Market Profiles , NEEA reports, AEO, Inland Power & Light 2009 Conservation Potential Assessment, previous studies
Appliance/equipment saturations	Fraction of dwellings with an appliance/technology; Percentage of C&I floor space with equipment/technology	NEEA reports, Inland Power & Light residential saturation survey, RECS, and other secondary data
UEC/EUI for each end-use technology	UEC: Annual electricity use for a technology in dwellings that have the technology EUI: Annual electricity use per square foot/employee for a technology in floor space that has the technology	NEEA reports, RASS, CEUS, engineering analysis, prototype simulations, engineering analysis
Appliance/equipment vintage distribution	Age distribution for each technology	NEEA reports, RASS, CEUS, secondary data (DEEM, EIA, EPRI, DEER, etc.)
Efficiency options for each technology	List of available efficiency options and annual energy use for each technology	Prototype simulations, engineering analysis, appliance/equipment standards, secondary data (DEEM, EIA, EPRI, DEER, etc.)
Peak factors	Share of technology energy use that occurs during the peak hour	Avista data; EnerNOC's EnergyShape database

Data Application for Baseline Projection

Table 2-9 summarizes the LoadMAP model inputs requirements. These inputs are required for each segment within each sector, as well as for new construction and existing dwellings/buildings.

Table 2-9 Data Needs for the Baseline Projection and Potentials Estimation in LoadMAP

Model Inputs	Description	Key Sources
Customer growth forecasts	Forecasts of new construction in residential and C&I sectors	AEO 2011 growth forecast US BLS
Equipment purchase shares for baseline projection	For each equipment/technology, purchase shares for each efficiency level; specified separately for existing equipment replacement and new construction	Shipments data from AEO AEO 2011 regional forecast assumptions ⁶ Appliance/efficiency standards analysis Avista program results and evaluation reports
Electricity prices	Forecast of average energy and capacity avoided costs and retail prices	Avista projections AEO 2011
Utilization model parameters	Price elasticities, elasticities for other variables (income, weather)	EPRI's REEPS and COMMEND models AEO 2011 Avista's historical data for normal cooling & heating degree days.

In addition, we implemented assumptions for known future equipment standards as of January, 2012, as shown in the tables below.

⁶ We developed baseline purchase decisions using the Energy Information Agency's *Annual Energy Outlook* report (2011), which utilizes the National Energy Modeling System (NEMS) to produce a self-consistent supply and demand economic model. We calibrated equipment purchase options to match manufacturer shipment data for recent years and then held values constant for the study period. This removes any effects of naturally occurring conservation or effects of future DSM programs that may be embedded in the AEO forecasts.

Table 2-10 Residential Electric Equipment Standards Applicable to Avista

Today's Efficiency or Standard Assumption
 1st Standard (relative to today's standard)
 2nd Standard (relative to today's standard)

End Use	Technology	2011	2012	2013	2014	2015	2016	2017	2018	2019	2020	2021	2022	2023	2024	2025
Cooling	Central AC	SEER 13				SEER 14										
	Room AC	EER 9.8			EER 11.0											
Cooling/Heating	Heat Pump	SEER 13.0/HSPF 7.7				SEER 14.0/HSPF 8.0										
Water Heating	Water Heater (<=55 gallons)	EF 0.90				EF 0.95										
	Water Heater (>55 gallons)	EF 0.90				Heat Pump Water Heater										
Lighting	Screw-in/Pin Lamps	Incandescent			Advanced Incandescent - tier 1					Advanced Incandescent - tier 2						
	Linear Fluorescent	T8														
Appliances	Refrigerator/2nd Refrigerator	NAECA Standard			25% more efficient											
	Freezer	NAECA Standard			25% more efficient											
	Dishwasher	Conventional (355 kWh/yr)			14% more efficient (307 kWh/yr)											
	Clothes Washer	Conventional (MEF 1.26 for top loader)				MEF 1.72 for top loader			MEF 2.0 for top loader							
	Clothes Dryer	Conventional (EF 3.01)				5% more efficient (EF 3.17)										
	Range/Oven	Conventional														
	Microwave	Conventional														

Table 2-11 Commercial Electric Equipment Standards Applicable to Avista

Today's Efficiency or Standard Assumption
 1st Standard (relative to today's standard)
 2nd Standard (relative to today's standard)

End Use	Technology	2011	2012	2013	2014	2015	2016	2017	2018	2019	2020	2021	2022	2023	2024	2025
Cooling	Chillers	2007 ASHRAE 90.1														
	Roof Top Units	EER 11.0/11.2														
	Packaged Terminal AC/HP	EER 9.8	EER 11.0													
Lighting	Screw-in/Pin Lamps	Incandescent			Advanced Incandescent - tier 1						Advanced Incandescent - tier 2					
	Linear Fluorescent	T12	T8													
	High Intensity Discharge	Metal Halide														
Refrigeration	Walk-in Refrigerator/Freezer	EISA 2007 Standard														
	Reach-in Refrigerator	EPACT 2005 Standard														
	Glass Door Display	EPACT 2005 Standard	42% more efficient													
	Open Display Case	EPACT 2005 Standard	18% more efficient													
	Vending Machines	EPACT 2005 Standard	33% more efficient													
	Icemaker	2010 Standard														
Miscellaneous	Non-HVAC Motors	62.3% Efficiency					70% Efficiency									
	Commercial Laundry	MEF 1.26			MEF 1.6											

Table 2-12 Industrial Electric Equipment Standards Applicable to Avista

Today's Efficiency or Standard Assumption
 1st Standard (relative to today's standard)
 2nd Standard (relative to today's standard)

End Use	Technology	2011	2012	2013	2014	2015	2016	2017	2018	2019	2020	2021	2022	2023	2024	2025	
Cooling	Chillers	2007 ASHRAE 90.1															
	Roof Top Units	EER 11.0/11.2															
	Packaged Terminal AC/HP	EER 9.8	EER 11.0														
Lighting	Screw-in/Pin Lamps	Incandescent			Advanced Incandescent - tier 1					Advanced Incandescent - tier 2							
	Linear Fluorescent	T12	T8														
	High Intensity Discharge	Metal Halide															
Machine Drive	Less than 5 HP	62.3% Efficiency				70% Efficiency											
	5-24 HP	EISA 2007 Standards															
	25-99 HP	EISA 2007 Standards															
	100-249 HP	EISA 2007 Standards															
	250-499 HP	EISA 2007 Standards															
	500 or more HP	EISA 2007 Standards															

Conservation Measure Data Application

Table 2-13 details the data sources used for measure characterization.

Table 2-13 Data Needs for the Measure Characteristics in LoadMAP

Model Inputs	Description	Key Sources
Energy Impacts	The annual reduction in consumption attributable to each specific measure. Savings were developed as a percentage of the energy end use that the measure affects.	Avista program results and evaluation reports BEST DEEM DEER NPCC workbooks Other secondary sources
Peak Demand Impacts	Savings during the peak demand periods are specified for each electric measure. These impacts relate to the energy savings and depend on the extent to which each measure is coincident with the system peak.	Avista program results and evaluation reports BEST EnergyShape
Costs	Equipment Measures: Includes the full cost of purchasing and installing the equipment on a per-household, per-square-foot, or per employee basis for the residential, commercial, and industrial sectors, respectively. Non-equipment measures: Existing buildings – full installed cost. New Construction - the costs may be either the full cost of the measure, or as appropriate, it may be the incremental cost of upgrading from a standard level to a higher efficiency level.	Avista program results and evaluation reports DEEM DEER NPCC workbooks RS Means Other secondary sources
Measure Lifetimes	Estimates derived from the technical data and secondary data sources that support the measure demand and energy savings analysis.	Avista program results and evaluation reports DEEM DEER NPCC workbooks Other secondary sources
Applicability	Estimate of the percentage of either dwellings in the residential sector or square feet/employment in the C&I sector where the measure is applicable and where it is technically feasible to implement.	DEEM DEER NPCC workbooks Other secondary sources
On Market and Off Market Availability	Expressed as years for equipment measures to reflect when the equipment technology is available or no longer available in the market.	EnerNOC appliance standards and building codes analysis

Data Application for Cost-effectiveness Screening

To perform the cost-effectiveness screening, the following information was needed:

- Preliminary avoided cost of energy and capacity provided by Avista and based on 2013 IRP planning assumptions, shown in Figure 2-4; note that Avista does not expect to incur any avoided cost for capacity until 2019.
- Line losses of 6.12%, provided by Avista
- Discount rate of 4%, provided by Avista (real)

Analysis Approach and Data Development

- Program administration costs. Program administration costs can typically vary between 5–50% of total program costs. For this study, we used values of 30% that were provided by Avista, based on its program history.

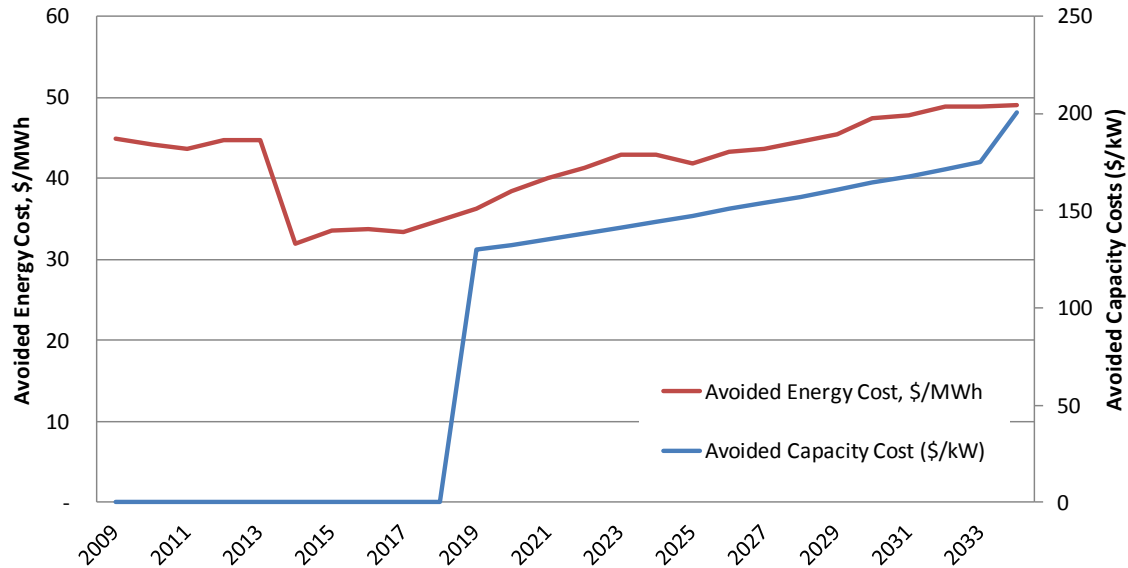
Figure 2-4 *Avoided Costs***Achievable Potential Estimation**

To estimate potentials, two sets of parameters were required.

- **Adoption rates for non-equipment measures.** Equipment is assumed to be replaced at the end of its useful life, but for non-equipment measures, a set of factors is required to model the gradual implementation over time. Rather than installing all non-equipment measures in the first year of the forecast (instantaneous potential), they are phased in according to adoption schedules that vary based on equipment cost and measure complexity. The adoption rates for the Avista study were based on ramp rate curves specified in the NPCC Sixth Power Plan, but modified to reflect **Avista's** program history. These adoption rates are used within LoadMAP to generate the technical and economic potentials.
- **Market acceptance rates (MARs).** These factors are applied to Economic potential to estimate Achievable potential. These rates were developed by beginning with the Northwest Power and Conservation Council ramp rates but then adjusting those rates to reflect **Avista's** DSM program history.

Ramp rates and MARs are discussed in Appendix D.

MARKET CHARACTERIZATION AND MARKET PROFILES

Avista Utilities, headquartered in Spokane, Washington, is an investor-owned utility with annual revenues of more than \$1.6 billion. Avista provides electric and natural gas service to about 680,000 customers in a service territory of more than 30,000 square miles. Avista uses a mix of hydro, natural gas, coal and biomass generation. Avista currently operates a portfolio of electric and natural gas conservation programs in Washington, Idaho, and Oregon for residential, low income, and non-residential customers that is funded by a non-bypassable systems benefits charge. This study addresses electricity conservation potential in Washington and Idaho only. This chapter characterizes the electricity use patterns of Avista's customers.

Energy Use Summary

Table 3-1 and Table 3-2 provide 2009 customer counts and weather-normalized electricity use by sector for Washington and Idaho, respectively. For this study, the NPCC Sixth Plan calculator to estimate conservation potential for pumping. Results of that calculation appear in Chapter 4. Potential for rate class 25P was also estimated outside of the LoadMAP framework, and thus 25P sales are not included in Table 3-2.

Table 3-1 Electricity Sales and Peak Demand by Rate Class, Washington 2009

Sector / Rate Class	Rate Schedule(s)	Number of meters (customers)	2009 Electricity Sales (GWh)	2009 Peak Demand (MW)
Residential	001	200,134	2,452	710
General Service	011, 012	27,142	416	64
Large General Service	021, 022	3,352	1,557	232
Extra Large Commercial	025C	9	266	134
Extra Large Industrial	025I	13	614	
Pumping	031, 032	2,361	136	10
Total		233,011	5,440	1,150

Table 3-2 Electricity Sales and Peak Demand by Rate Class, Idaho 2009

Sector / Rate Class	Rate Schedule(s)	Number of meters (customers)	2009 Electricity Sales (MWh)	2009 Peak Demand (MW)
Residential	001	99,580	1,182	283
General Service	011, 012	19,245	323	61
Large General Service	021, 022	1,456	700	115
Extra Large Commercial	025C	3	70	140
Extra Large Industrial	025I	6	196	
Pumping	031, 032	1,312	59	4
Total		121,602	2,530	603

Note: Excludes sales to rate class 25P.

After excluding pumping and 25 P, the distribution among the sectors in Washington and Idaho is similar, with the largest sector, residential, accounting for 46% of Washington sales and 48% of Idaho sales as shown in Figure 3-1 and Figure 3-2.

Figure 3-1 Electricity Sales by Rate Class, 2009

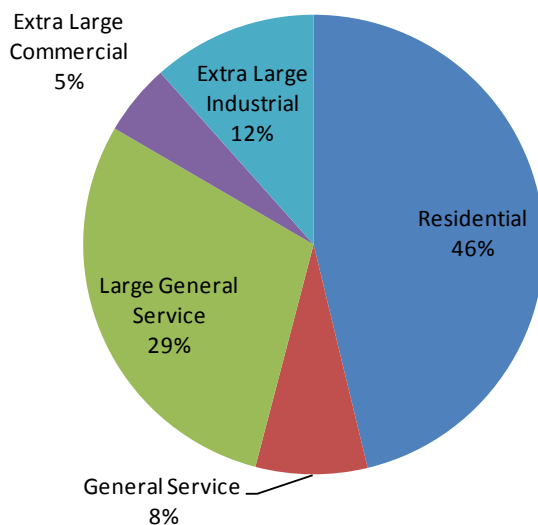
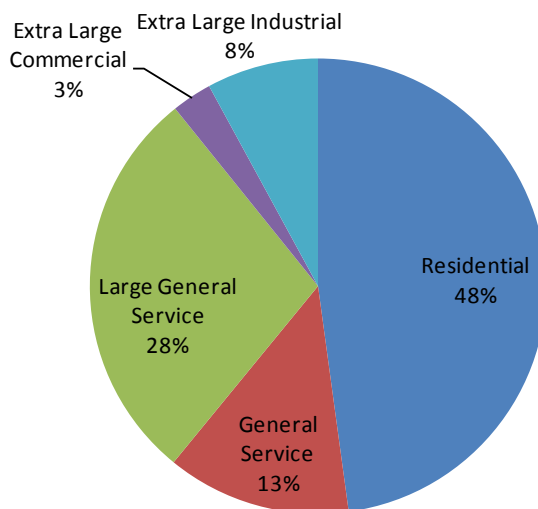

Figure 3-2 Electricity Sales by Rate Class, Idaho 2009



Note: Excludes sales to rate class 25P.

Residential Sector

The total number of households and electric sales for the service territory were obtained from Avista's financial reporting database. In 2009, there were 200,134 households in Washington and 99,580 in Idaho. We allocated these totals into the four residential segments for each segment based on housing type and level of income: Single family, multi family, mobile home, and low income. The single family segment includes single-family detached homes, townhouses, and duplexes or row houses. The multi family segment includes apartments or condos in buildings with more than two units. The mobile homes segment includes mobile homes and other manufactured housing. The low income segment is composed of all three of the housing types: single-family homes, multi-family homes, and mobile homes.

Table 3-3 shows how customers were allocated to segments. Because Avista does not maintain information on housing type or income level, we relied on a variety of survey and demographic sources for segmenting the residential market, including the U.S. Census American Community Survey 2006-2008, and a 2009 Inland Power customer survey. Avista defines the low-income category as those customers with annual income less than or equal to two times the poverty level. For an average household size of 2.5 persons, two times the poverty level is \$32,880. For the purpose of our analysis, we used a slightly higher income level cutoff of \$35,000 to define this segment, which allowed us to take advantage of the data sources listed above.

Table 3-3 Residential Sector Allocation by Segments, 2009

Segment	Washington		Idaho	
	Allocation of Customers	% of Total	Allocation of Customers	% of Total
Single Family	109,134	54%	59,205	59%
Multi Family	18,219	9%	5,237	5%
Mobile Home	5,248	3%	4,774	5%
Low Income	67,533	34%	30,363	31%
Total	200,134	100%	99,580	100%

Next, to determine the residential whole building energy intensity (kWh/household) by segment, we drew upon data from the Energy Information Agency, the NEEA 2012 RBSA, previous NEEA residential reports, and the Inland Power & Light 2009 Conservation Potential Assessment. Based on these sources, we developed the segment level energy intensities shown in Table 3-4. The selected energy intensity values multiplied by the number of households equal the annual sales for each segment. These values sum to the total annual energy use for the residential sector in each state. The single-family segment used roughly two-thirds of the total 2009 residential sector electricity sales.

Table 3-4 Residential Electricity Usage and Intensity by Segment and State, 2009

Washington Segment	No. of Households	Intensity (kWh/HH)	% of Customers	2009 Electricity Use (GWh)	% of Sales
Single Family	109,134	14,547	54%	1,588	65%
Multi Family	18,219	8,728	9%	159	6%
Mobile Home	5,248	13,092	3%	69	3%
Low Income	67,533	9,424	34%	636	26%
Total	200,134	12,250	100%	2,452	100%
Idaho Segment	No. of Households	Intensity (kWh/HH)	% of Customers	2009 Electricity Use (GWh)	% of Sales
Single Family	59,205	13,703	59%	811	69%
Multi Family	5,237	8,213	5%	43	4%
Mobile Home	4,774	12,320	5%	59	5%
Low Income	30,363	8,868	31%	269	23%
Total	99,580	11,874	100%	1,182	100%

As we describe in the previous chapter, the market profiles provide the foundation upon which we develop the baseline projection. For each segment, we created a market profile, which includes the following elements:

- **Market size** represents the number of customers in the segment
- **Saturations** embody the fraction of homes with the electric technologies. (e.g., homes with electric space heating). We developed these using a combination of data from sources including Avista TRM and Business Plan data, NEEA's RBSA and other NEEA reports, Inland Power & Light, NPCC, and AEO data.
- **UEC** (unit energy consumption) describes the amount of electricity consumed in 2009 by a specific technology in homes that have the technology (in kWh/household). As above, we used data from Avista, NEEA, Inland Power & Light, NPCC, and AEO. We also used data from various utility potential studies that EnerNOC has recently completed. As needed, minor adjustments were made to calibrate to whole-building intensities.
- **Intensity** represents the average use for the technology across all homes in 2009. It is computed as the product of the saturation and the UEC and is defined as kWh/household.
- **Usage** is the annual electricity use by a technology/end use in the segment. It is the product of the number of households and intensity and is quantified in GWh.

Table 3-5 and Table 3-6 present the average existing home market profile for all residential segments in Washington and Idaho combined. The existing-home profile represents all the housing stock in 2009. Market profiles for each of the residential segments in Washington and Idaho appear in Appendix A.

Table 3-5 Average Residential Sector Market Profile, Washington**Average Market Profiles - Washington**

End Use	Technology	Saturation	UEC (kWh)	Intensity (kWh/HH)	Usage (GWh)
Cooling	Central AC	28.6%	1,150	330	66
Cooling	Room AC	20.7%	360	75	15
Cooling	Air Source Heat Pump	16.3%	735	120	24
Cooling	Geothermal Heat Pump	0.2%	730	2	0
Space Heating	Electric Resistance	20.4%	6,624	1,350	270
Space Heating	Electric Furnace	10.7%	9,173	980	196
Space Heating	Air Source Heat Pump	16.3%	7,498	1,222	245
Space Heating	Geothermal Heat Pump	0.2%	4,833	11	2
Space Heating	Supplemental	7.8%	260	20	4
Water Heating	Water Heater <= 55 Gal	66.3%	3,074	2,038	408
Water Heating	Water Heater > 55 Gal	3.1%	4,552	140	28
Interior Lighting	Screw-in	100.0%	1,060	1,060	212
Interior Lighting	Linear Fluorescent	100.0%	107	107	21
Interior Lighting	Specialty	100.0%	275	275	55
Exterior Lighting	Screw-in	100.0%	254	254	51
Appliances	Clothes Washer	82.7%	114	94	19
Appliances	Clothes Dryer	78.8%	493	389	78
Appliances	Dishwasher	85.6%	386	330	66
Appliances	Refrigerator	100.0%	694	694	139
Appliances	Freezer	56.1%	774	434	87
Appliances	Second Refrigerator	25.9%	977	253	51
Appliances	Stove	87.7%	386	338	68
Appliances	Microwave	95.6%	114	109	22
Electronics	Personal Computers	119.0%	205	244	49
Electronics	TVs	204.4%	221	452	90
Electronics	Set-top Boxes/DVR	155.2%	128	198	40
Electronics	Devices and Gadgets	100.0%	55	55	11
Miscellaneous	Pool Pump	3.6%	1,415	52	10
Miscellaneous	Furnace Fan	43.7%	577	252	50
Miscellaneous	Miscellaneous	100.0%	373	373	75
Total				12,250	2,452

Table 3-6 Average Residential Sector Market Profile, Idaho

Average Market Profiles - Idaho					
End Use	Technology	Saturation	UEC (kWh)	Intensity (kWh/HH)	Usage (GWh)
Cooling	Central AC	22.0%	945	207	21
Cooling	Room AC	19.7%	297	58	6
Cooling	Air Source Heat Pump	12.9%	609	79	8
Cooling	Geothermal Heat Pump	0.7%	657	5	0
Space Heating	Electric Resistance	20.8%	7,481	1,556	155
Space Heating	Electric Furnace	9.7%	8,401	815	81
Space Heating	Air Source Heat Pump	12.9%	7,415	959	95
Space Heating	Geothermal Heat Pump	0.7%	5,075	35	3
Space Heating	Supplemental	7.5%	258	19	2
Water Heating	Water Heater <= 55 Gal	60.8%	3,127	1,901	189
Water Heating	Water Heater > 55 Gal	3.4%	4,779	160	16
Interior Lighting	Screw-in	100.0%	1,109	1,109	110
Interior Lighting	Linear Fluorescent	100.0%	111	111	11
Interior Lighting	Specialty	100.0%	293	293	29
Exterior Lighting	Screw-in	100.0%	280	280	28
Appliances	Clothes Washer	85.8%	113	97	10
Appliances	Clothes Dryer	81.9%	490	402	40
Appliances	Dishwasher	87.0%	384	334	33
Appliances	Refrigerator	100.0%	690	690	69
Appliances	Freezer	57.8%	768	444	44
Appliances	Second Refrigerator	23.0%	954	219	22
Appliances	Stove	80.9%	379	306	31
Appliances	Microwave	96.0%	114	109	11
Electronics	Personal Computers	122.5%	204	250	25
Electronics	TVs	207.5%	219	454	45
Electronics	Set-top Boxes/DVR	146.1%	125	182	18
Electronics	Devices and Gadgets	100.0%	54	54	5
Miscellaneous	Pool Pump	5.1%	1,422	73	7
Miscellaneous	Furnace Fan	44.0%	593	261	26
Miscellaneous	Miscellaneous	100.0%	410	410	41
Total				11,874	1,182

Table 3-7 and Figure 3-3 present the end-use shares of electricity use by housing type. Space heating is the largest single use in all housing types, accounting for 29% of residential use overall. In the single family, mobile home, and low income segments, appliances are the second largest energy consumer, followed by water heating and then interior lighting. In the case of multi-family housing, water heating is the second largest end use while appliances are the third largest end use, due to a high saturation of electric water heating compared with the other segments. Across all housing types, interior and exterior lighting combined represents 14% of electricity use in 2009. The electronics end use, which includes personal computers, televisions, home audio, video game consoles, etc., is 8% of residential electricity usage across all housing types. The miscellaneous end use includes such devices as furnace fans, pool pumps, and other plug loads (hair dryers, power tools, coffee makers, etc.).

Table 3-7 Residential Electricity Use by End Use and Segment (kWh/HH/year, 2009)

End Use	Single Family	Multi Family	Mobile Home	Low Income	Total Residential
Cooling	652	112	259	256	467
Space Heating	3,739	3,312	5,224	3,009	3,517
Water Heating	2,341	1,628	1,928	1,937	2,139
Interior Lighting	1,810	1,002	1,351	998	1,466
Exterior Lighting	370	21	276	135	263
Appliances	3,163	1,540	2,197	2,013	2,628
Electronics	1,163	726	887	630	945
Miscellaneous	1,013	271	602	272	699
Total	14,250	8,613	12,724	9,251	12,125

Figure 3-3 Percentage of Residential Electricity Use by End Use and Segment (2009)

Figure 3-4 presents the end-use breakout in terms of intensity, kWh/household-year, by segment for both states combined.

Figure 3-4 Residential Intensity by End Use and Segment (kWh/household, 2009)

C&I Sector

The approach we used for the C&I sectors is analogous to the residential sector. It begins with segmentation, then defines market size and annual electricity use, and concludes with market profiles.

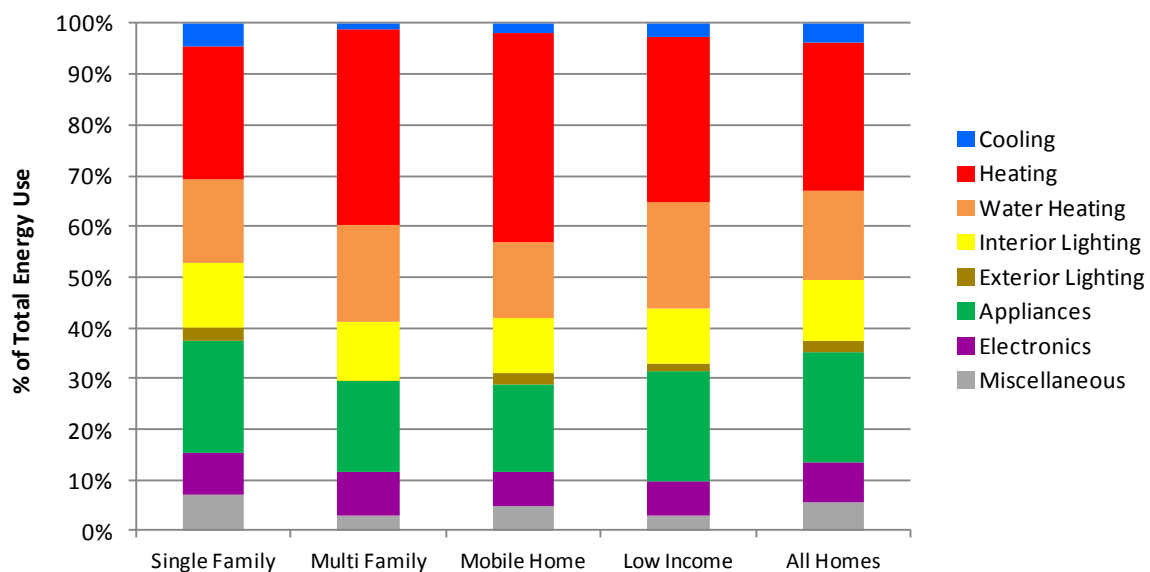
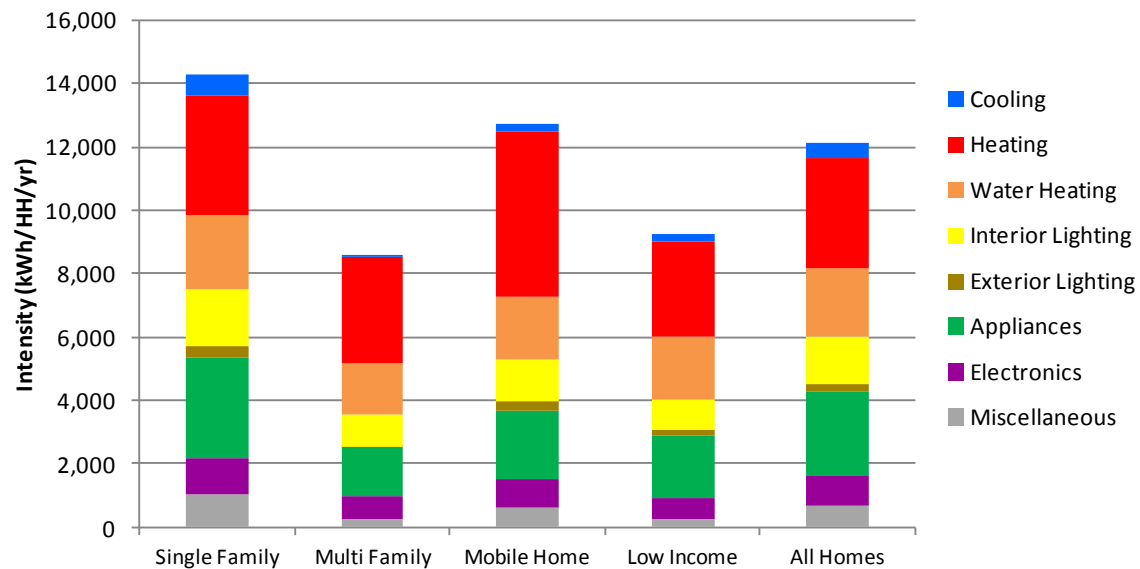
We developed the nonresidential energy use by segment using Avista 2009 billing data by rate class. Table 3-7 and Table 3-8 present the results for the market characterization for Washington and Idaho respectively. Although the General Service 011 and Large General Service 021 rate classes include a small percentage of industrial customers, we chose to model these as primarily commercial building types. For the General Service segment, we assumed facilities were small to medium buildings, dominated by retail facilities. For the Large General Service segment, we assumed the typical facility was an office building. When developing the market profiles, as further described below, we began with these assumed prototypical building types, but adjusted them to account for the diversity in each segment. For the Extra Large General Service rate class 025, we divided customers into separate commercial and industrial segments. This grouping enabled better modeling of the industrial customers. Note that potential for Idaho rate class 025P was determined outside of the LoadMAP modeling framework because it was more appropriate to treat this one large customer separately as opposed to modeling it as a generic C&I customer.

Figure 3-5 shows the relative energy use of each segment as a percentage of C&I sector energy sales.

Table 3-8 Commercial and Industrial Sector Market Characterization Results, Washington 2009

Segment	Electricity Use (GWh)	Intensity (kWh/SqFt)	Floor Space (million SqFt)
Small/Medium Commercial	416	18	24
Large Commercial	1,557	17	93
Extra Large Commercial	266	14	19
Extra Large Industrial	614	40	15
Total	2,852	19	151

Table 3-9 Commercial and Industrial Sector Market Characterization Results, Idaho 2009

Segment	Electricity Use (GWh)	Intensity (kWh/SqFt)	Floor Space (million SqFt)
Small/Medium Commercial	323	18	18
Large Commercial	700	17	42
Extra Large Commercial	70	14	5
Extra Large Industrial	196	40	5
Total	1,289	18	70

Note: Excludes sales to rate class 25P.

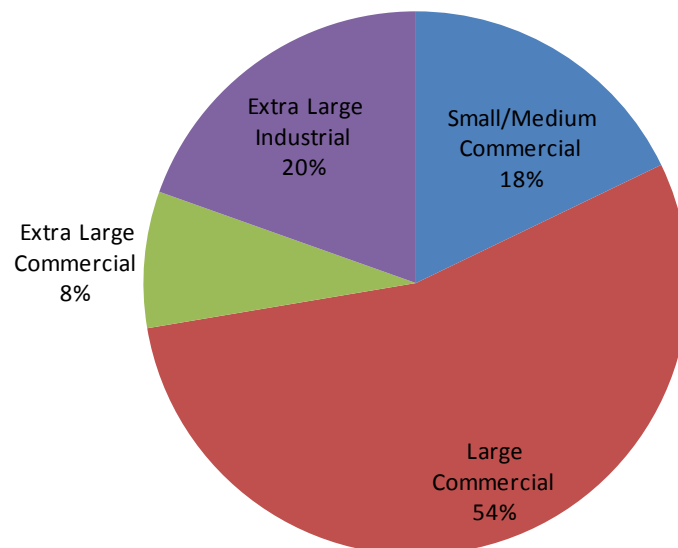
Figure 3-5 Commercial and Industrial Electricity Consumption by Segment 2009

We used data from NEEA reports including the 2009 CBSA, the California Commercial End Use Study (CEUS), and recently completed EnerNOC studies to estimate floor space and annual intensities (in kWh/square foot) for each segment. Because of the heterogeneous nature of the

Market Characterization and Market Profiles

C&I sectors and the wide variation in customer size (compared to residential homes), floor space is used as the unit of measure to quantify energy use and equipment inventories on a per-square-foot basis. Note that we are not concerned with absolute square footage, as the purpose of this study is not to estimate C&I floor space, but with the relative size of each segment and its growth over time.

We then developed market profiles for each non-residential segment in each state. Table 3-10 shows an example commercial average base year market profile, in this case for the Washington Small/Medium Commercial Segment. The market profiles for each of the Washington and Idaho C&I segments are shown in Appendix A.

Table 3-10 Large Commercial Segment Market Profile, Washington, 2009

Average Market Profiles					
End Use	Technology	Saturation	EUI (kWh)	Intensity (kWh/Saft.)	Usage (GWh)
Cooling	Central Chiller	24.7%	2.1	0.5	49
Cooling	RTU	37.8%	2.5	1.0	89
Cooling	Heat Pump	9.1%	3.5	0.3	30
Space Heating	Heat Pump	9.1%	2.3	0.2	20
Space Heating	Electric Resistance	5.9%	3.6	0.2	20
Space Heating	Furnace	12.7%	4.7	0.6	55
Ventilation	Ventilation	75.1%	1.7	1.2	116
Interior Lighting	Interior Screw-in	100.0%	0.9	0.9	88
Interior Lighting	High Bay Fixtures	100.0%	0.7	0.7	66
Interior Lighting	Linear Fluorescent	100.0%	3.3	3.3	307
Exterior Lighting	Exterior Screw-in	100.0%	0.1	0.1	9
Exterior Lighting	HID	100.0%	0.7	0.7	65
Water Heating	Water Heater	54.2%	2.3	1.3	117
Food Preparation	Fryer	18.4%	0.4	0.1	6
Food Preparation	Oven	18.4%	1.9	0.3	32
Food Preparation	Dishwasher	18.4%	0.2	0.0	3
Food Preparation	Hot Food Container	18.4%	0.3	0.1	5
Food Preparation	Food Prep	18.4%	0.0	0.0	0
Refrigeration	Walk in Refrigeration	39.1%	0.5	0.2	17
Refrigeration	Glass Door Display	39.1%	0.4	0.1	13
Refrigeration	Reach-in Refrigerator	39.1%	0.8	0.3	28
Refrigeration	Open Display Case	39.1%	0.3	0.1	10
Refrigeration	Vending Machine	39.1%	0.4	0.1	13
Refrigeration	Icemaker	39.1%	0.7	0.3	24
Office Equipment	Desktop Computer	98.4%	0.9	0.9	82
Office Equipment	Laptop Computer	98.4%	0.1	0.1	6
Office Equipment	Server	98.4%	0.4	0.4	38
Office Equipment	Monitor	98.4%	0.2	0.2	19
Office Equipment	Printer/copier/fax	98.4%	0.2	0.2	19
Office Equipment	POS Terminal	98.4%	0.1	0.1	6
Miscellaneous	Non-HVAC Motor	57.7%	1.4	0.8	75
Miscellaneous	Other Miscellaneous	100.0%	1.4	1.4	127
Total				16.7	1,557

Figure 3-6 displays the breakdown of energy use by end use for all C&I segments combined. This information is further detailed in Table 3-11 and Figure 3-7, which present the end-use shares of electricity use by segment.

Figure 3-6 C&I Electricity Consumption by End Use, 2009

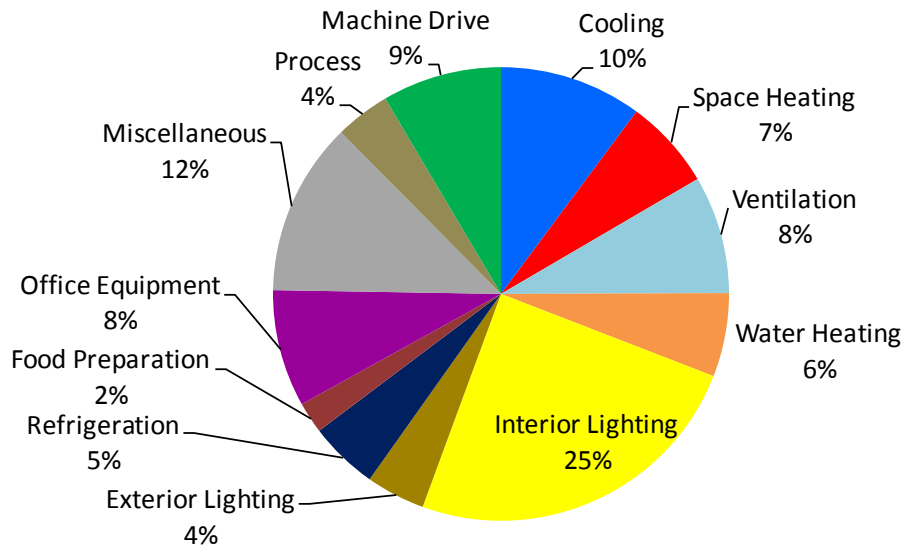
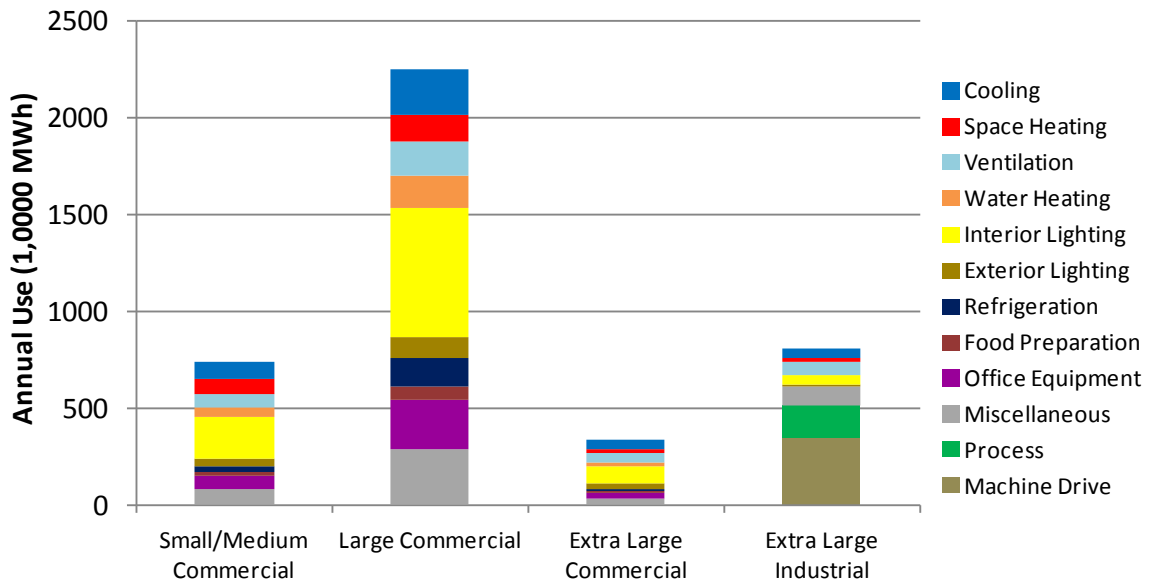

Table 3-11 C&I Electricity Consumption by End Use and Segment (GWh, 2009)

End Use	Small/Medium Commercial	Large Commercial	Extra Large Commercial	Extra Large Industrial	Total C&I
Cooling	87	244	43	48	421
Space Heating	68	168	42	68	347
Ventilation	53	169	24	-	246
Water Heating	213	668	93	50	1,024
Interior Lighting	39	108	22	5	174
Exterior Lighting	36	153	14	-	204
Refrigeration	16	68	8	-	92
Food Preparation	70	248	26	-	344
Office Equipment	81	293	37	99	510
Miscellaneous	75	138	28	25	266
Process	-	-	-	162	162
Machine Drive	-	-	-	352	352
Total	739	2,257	336	809	4,141

Figure 3-7 C&I Electricity Consumption by End Use and Segment (2009)

Observations include the following:

- Commercial buildings, including Small/Medium, Large, and Extra Large
 - Lighting is the largest single energy use across all of the commercial buildings, accounting for 34% of energy use.
 - Space conditioning, including space heating, cooling, and ventilation, is close behind with 27% of energy use.
 - Miscellaneous, which includes non-HVAC motors, vertical transport (e.g. elevators, escalators), medical equipment, telecommunications equipment, and various other loads, is the next largest energy use at 12%.
 - Office equipment, with 10% of use, is the fourth largest end use.
 - Water heating, refrigeration, and food preparation are only a small portion of energy use in the commercial sector overall, though they are more significant in specific building types (supermarkets, restaurants, hospitals, lodging).
- Extra Large Industrial facilities
 - Machine drive and process loads dominate in this segment, together accounting for 64% of energy use.
 - HVAC and interior lighting consume 17% and 7% of energy respectively.

CONSERVATION POTENTIAL

This chapter presents the results of the potential analysis, beginning with overall potential, followed by details for each sector. All results show cumulative potential, indicating how a measure installed in one year continues to provide savings in subsequent years through the end of its useful measure life. Incremental annual results appear in Appendix E.

Overall Potential

Figure 4-1 and Table 4-1 summarize the achievable potential across all sectors. The C&I sector accounts for the about 55% of the savings initially, and over time its share of savings grows to around 60%.

Figure 4-1 Cumulative Achievable Potential by Sector (MWh)

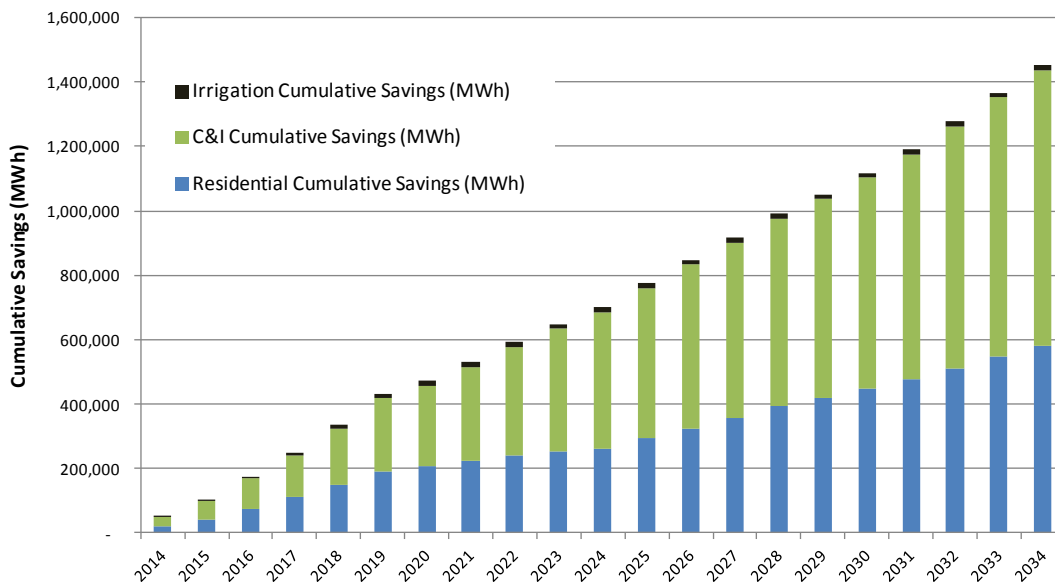

Conservation Potential

Table 4-1 Cumulative Achievable Potential by State and Sector (MWh)

	2014	2015	2018	2023	2028	2033
Washington Achievable Cumulative Savings (MWh)						
Residential	15,091	29,603	100,792	172,576	266,751	369,293
C&I	19,927	40,930	123,755	256,653	392,186	543,380
Pumping	1,402	3,237	8,742	10,535	10,535	10,535
Total	36,420	73,770	233,289	439,764	669,472	923,208
Washington Achievable Cumulative Savings (aMW)						
Residential	1.7	3.4	11.5	19.7	30.5	42.2
C&I	2.3	4.7	14.1	29.3	44.8	62.0
Pumping	0.2	0.4	1.0	1.2	1.2	1.2
Total	4.2	8.4	26.6	50.2	76.4	105.4
	2014	2015	2018	2023	2028	2033
Idaho Achievable Cumulative Savings (MWh)						
Residential	6,757	13,183	46,795	79,385	125,347	177,826
C&I	8,863	16,427	53,214	124,987	192,518	261,813
Pumping	618	1,426	3,852	4,642	4,642	4,642
Total	16,238	31,036	103,861	209,014	322,507	444,281
Idaho Achievable Cumulative Savings (aMW)						
Residential	0.8	1.5	5.3	9.1	14.3	20.3
C&I	1.0	1.9	6.1	14.3	22.0	29.9
Pumping	0.1	0.2	0.4	0.5	0.5	0.5
Total	1.9	3.5	11.9	23.9	36.8	50.7
	2014	2015	2018	2023	2028	2033
Washington and Idaho Achievable Cumulative Savings (MWh)						
Residential	21,848	42,786	147,588	251,961	392,098	547,119
C&I	28,790	57,357	176,969	381,640	584,703	805,193
Pumping	2,020	4,663	12,593	15,177	15,177	15,177
Total	52,657	104,806	337,150	648,778	991,979	1,367,490
Washington and Idaho Achievable Cumulative Savings (aMW)						
Residential	2.5	4.9	16.8	28.8	44.8	62.5
C&I	3.3	6.5	20.2	43.6	66.7	91.9
Pumping	0.2	0.5	1.4	1.7	1.7	1.7
Total	6.0	12.0	38.5	74.1	113.2	156.1

Table 4-2 summarizes the three levels of conservation potential, by state and for the overall service territory, for selected years. For rate class 25P and pumping customers, only achievable potential was assessed; economic and technical potential for these two small rate classes are assumed to be equal to achievable potential.

Table 4-2 Summary of Cumulative Conservation Potential

	2014	2015	2018	2023	2028	2033
Washington Cumulative Savings (MWh)						
Achievable Potential	36,420	73,770	233,289	439,764	669,472	923,208
Economic Potential	214,944	329,262	741,547	1,131,761	1,539,860	1,807,576
Technical Potential	794,447	941,497	1,550,783	2,212,885	2,704,067	3,024,259
Washington Cumulative Savings (aMW)						
Achievable Potential	4.2	8.4	26.6	50.2	76.4	105.4
Economic Potential	24.5	37.6	84.7	129.2	175.8	206.3
Technical Potential	90.7	107.5	177.0	252.6	308.7	345.2
Idaho Cumulative Savings (MWh)						
Achievable Potential	16,238	31,036	103,861	209,014	322,507	444,281
Economic Potential	101,779	151,705	350,121	538,404	734,193	859,791
Technical Potential	368,926	430,787	700,966	975,464	1,195,587	1,330,893
Idaho Cumulative Savings (aMW)						
Achievable Potential	1.9	3.5	11.9	23.9	36.8	50.7
Economic Potential	11.6	17.3	40.0	61.5	83.8	98.1
Technical Potential	42.1	49.2	80.0	111.4	136.5	151.9
Total Washington and Idaho Cumulative Savings (MWh)						
Achievable Potential	52,657	104,806	337,150	648,778	991,979	1,367,490
Economic Potential	316,722	480,967	1,091,669	1,670,165	2,274,053	2,667,367
Technical Potential	1,163,373	1,372,283	2,251,749	3,188,349	3,899,655	4,355,152
Total Washington and Idaho Cumulative Savings (aMW)						
Achievable Potential	6.0	12.0	38.5	74.1	113.2	156.1
Economic Potential	36.2	54.9	124.6	190.7	259.6	304.5
Technical Potential	132.8	156.7	257.0	364.0	445.2	497.2

Note: For pumping and rate class 25P, only achievable potential was calculated and thus economic and technical potential were assumed to be equal to achievable potential for these two rate classes.

Key findings related to cumulative conservation potentials are as follows.

- **Achievable potential**, for the residential, commercial, and industrial sectors is 100,143 MWh or 11.4 aMW for the 2014–2015 biennium. With the addition of pumping, achievable potential is 12.0 aMW for the 2014-2015 biennium and increases to 156.1 aMW by 2033. Washington provides approximately 70% of the potential in most years. Washington provides approximately 70% of the potential in most years. Over the 2014–2033 period, the achievable potential forecast offsets 39% of the overall growth in the residential and C&I combined baseline projections.
- **Economic potential**, which reflects the savings when all cost-effective measures are taken, is 480,967 MWh or 54.9 aMW for 2014-2015. By 2033, economic potential reaches 304.5 aMW.
- **Technical potential**, which reflects the adoption of all conservation measures regardless of cost-effectiveness, is a theoretical upper bound on savings. For 2014–2015, technical potential savings are 1,372,283 MWh or 156.7 aMW. By 2033, technical potential reaches 497.2 aMW.

Error! Not a valid bookmark self-reference. presents the three levels of potential for Residential and C&I graphically.

Figure 4-2 Summary of Cumulative Energy Savings, Residential and C&I

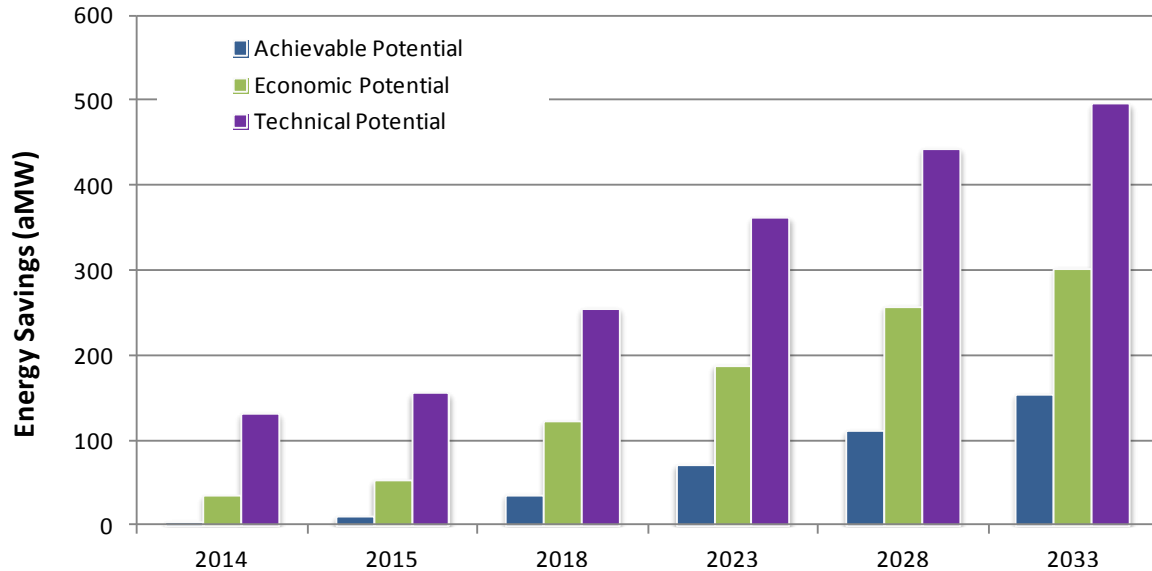

Note: Excludes pumping and rate class 25P.

Residential Sector

Table 4-3 presents estimates for the three types of potential for the residential sector.

Table 4-3 Conservation Potential for the Residential Sector

	2014	2015	2018	2023	2028	2033
Cumulative Savings (MWh)						
Achievable Potential	21,848	42,786	147,588	251,961	392,098	547,119
Economic Potential	231,078	335,111	744,684	1,041,719	1,390,377	1,549,252
Technical Potential	963,411	1,037,905	1,338,457	1,473,324	1,727,383	1,911,746
Energy Savings (aMW)						
Achievable Potential	2.5	4.9	16.8	28.8	44.8	62.5
Economic Potential	26.4	38.3	85.0	118.9	158.7	176.9
Technical Potential	110.0	118.5	152.8	168.2	197.2	218.2

We note the following:

- **Achievable potential** for the 2014-2015 biennium is 42,786 MWh, or approximately 4.9 aMW. By 2033, the cumulative achievable projection savings are 62.5 aMW.
- **Economic potential**, which reflects the savings when all cost-effective measures are taken, is 335,111 MWh for 2014-2015. By 2033, economic potential reaches 176.9 aMW.

- Technical potential** in the residential sector is substantial, because measures such as LED lamps, heat pump water heaters, and solar water heating could cut energy use dramatically. The 2014–2015 technical potential is 1,037,905 MWh. By 2033, technical potential reaches 218.2 aMW. The relatively wide gap between technical and economic potential reflects the **fact that Avista’s long-running residential conservation programs have already achieved much of the conservation that is cost-effective.** In addition, avoided costs are lower than in the past CPA. As a result, additional conservation measures are becoming relatively more costly, and many do not pass the cost-effectiveness screen based on **Avista’s current avoided costs.**

Figure 4-3 depicts the potential energy savings estimates graphically.

Figure 4-3 Residential Cumulative Savings by Potential Case

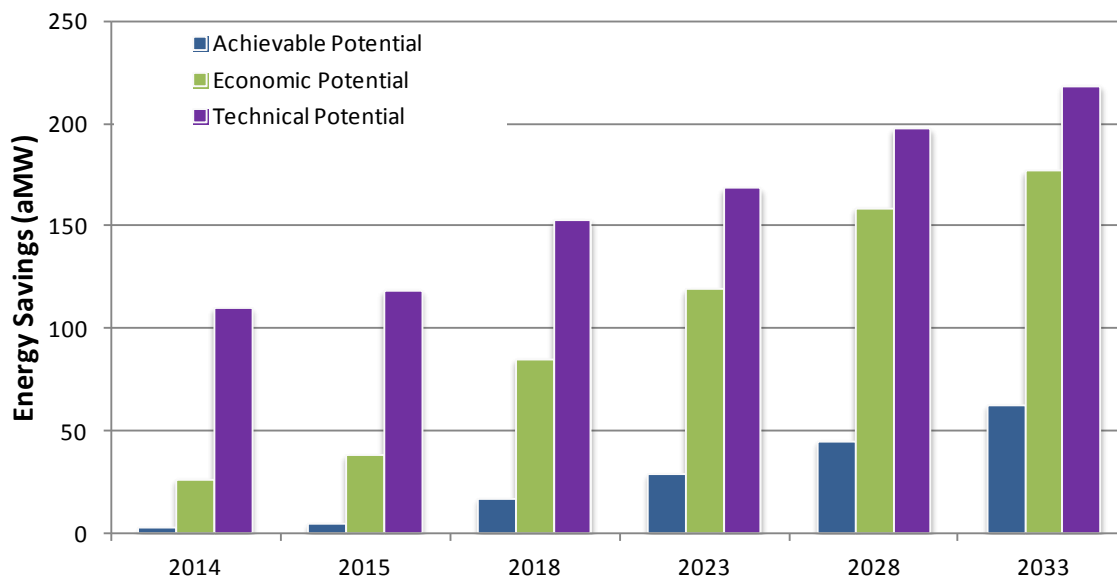

Residential Potential by End Use, Technology, and Measure Type

Table 4-4 provides estimates of savings for each end use and type of potential.

Table 4-4 Residential Cumulative Savings by End Use and Potential Type (MWh)

End Use	Potential Case	2014	2015	2018	2023	2028	2033
Cooling	Achievable	620	1,206	3,955	8,711	13,826	16,615
	Economic	1,968	2,742	8,812	14,724	19,958	23,154
	Technical	80,951	84,487	96,347	115,936	138,315	155,998
Space Heating	Achievable	3,984	8,769	29,422	72,188	126,808	178,884
	Economic	33,250	59,904	165,564	317,802	479,738	572,297
	Technical	426,183	437,898	485,931	568,938	690,804	784,960
Water Heating	Achievable	3,409	9,111	35,322	88,903	146,861	201,703
	Economic	139,048	174,837	285,037	498,268	694,979	750,037
	Technical	205,283	224,051	279,694	387,782	492,126	528,826
Interior Lighting	Achievable	9,112	15,439	56,325	50,856	61,722	77,434
	Economic	36,447	61,757	193,632	121,765	101,412	89,845
	Technical	69,443	97,468	237,734	172,522	159,744	176,303
Exterior Lighting	Achievable	3,121	5,340	14,121	7,568	1,767	4,771
	Economic	12,486	21,361	56,554	18,869	4,680	5,178
	Technical	29,639	37,425	63,855	27,506	18,316	19,975
Appliances	Achievable	1,210	1,979	4,746	11,476	15,137	22,253
	Economic	2,171	3,494	7,934	23,758	26,088	31,776
	Technical	110,903	106,754	97,381	96,098	99,364	99,247
Electronics	Achievable	269	635	2,466	8,038	16,469	27,134
	Economic	4,242	8,047	19,593	31,158	39,062	44,050
	Technical	38,001	44,875	66,641	83,650	96,504	106,895
Misc.	Achievable	122	307	1,232	4,220	9,509	18,325
	Economic	1,465	2,969	7,558	15,375	24,460	32,915
	Technical	3,009	4,947	10,872	20,892	32,212	39,542
5Total	Achievable	21,848	42,786	147,588	251,961	392,098	547,119
	Economic	231,078	335,111	744,684	1,041,719	1,390,377	1,549,252
	Technical	963,411	1,037,905	1,338,457	1,473,324	1,727,383	1,911,746

Focusing first on technical and economic potential, there are significant savings that are both possible and economic in numerous end uses:

- **Space heating** offers the highest technical potential, which would be achieved if all electric furnaces were replaced with SEER 16 air-source heat pumps (either when furnaces fail or by installing a heat pump in lieu of a furnace during new construction) and all electric resistance heat was converted to ductless mini-split systems. Note that conversion to gas is not included in the technical potential because it does not result in the least energy use at the site level.⁷ On the other hand, conversion to gas furnaces is cost-effective and is thus included in the economic potential. In addition, replacing electric resistance heat with

⁷ Based on multiplying site-level electricity use in kWh by 3.412 to convert to equivalent kBTU for comparison with natural gas use.

ductless heat pumps, selected shell measures, and thermostats also contribute to economic potential. By 2018, space heating is the third highest contributor to economic potential.

- **Water heating** offers the second-highest technical potential savings in 2014, which reflects the across-the-board installation of heat pump water heaters and solar water heating. Although solar water heating does not pass the TRC B/C screening, HPWH are found to be cost-effective for water heaters in single family homes.⁸ As with furnaces, conversion to gas is not included in technical potential, but does feature in economic potential. Consequently, economic potential actually grows more rapidly than technical potential. By 2018, water heating is projected to be the largest contributor to economic potential.
- **Appliances** offer the third-highest technical potential in the near term. This reflects both the replacement of failed white-goods appliances with the highest-efficiency option and removal of second refrigerators in appliance recycling programs. However, once the new appliance standards take effect in 2015, relative savings in this category diminish and therefore many technologies no longer pass the economic screen, yielding economic potential that is relatively small.
- **Interior and Exterior Lighting** combine to provide the fourth largest source of technical potential. Initially, economic potential is substantial as well, due to CFLs and high-efficiency linear fluorescent options. By 2018, LEDs have become the cost-effective option in many segments, and thus economic potential grows substantially, making lighting the second highest source of economic potential, behind only water heating.
- **Cooling** also offer substantial technical potential savings opportunities which would be achieved if all air conditioning systems were converted to the highest efficiency units. However, standards again diminish savings relative to the base case and lower cost-effectiveness such that cooling measures are eliminated from economic potential.
- **Electronics** provides substantial technical potential as well, but most alternatives for higher efficiency are not cost effective, largely because the baseline case already incorporates relatively high efficiency equipment, as a result of successful market transformation efforts to date.

Figure 4-4 presents the residential cumulative achievable potential in 2018. This reflects the application of market acceptance rate factor to economic potential, to model how factors including market barriers, customer acceptance, and program maturity affect how quickly measures are implemented. As discussed in Chapter 2, market acceptance rates were developed based on the Sixth Plan ramp rates with adjustments to match Avista program history. We note the following:

- **Lighting**, primarily the conversion of both interior and exterior lamps to compact fluorescent lamps in the first few years, followed by LEDs starting in 2017, represents 70,446 MWh or 47% of savings. Utility programs and other market transformation programs have made customers accepting of new lighting technologies, and thus these technologies are relatively well accepted by consumers.
- **Water heating** is the next highest source of achievable potential. As discussed above, water heating provides the largest economic potential, but the market for heat pump water heaters remains immature, and thus the uptake of this technology is limited in the near term. Although conversion to gas water heating is a mature technology and readily accepted, customers may be unable to convert at the time of replacement due to timing issues or other considerations.
- **Space heating** provides 20% of achievable potential mainly due to electric furnaces being converted to gas units, and resistance heating being displaced by ductless heat pumps.

⁸ HPWH become the baseline technology for water heaters ≥ 55 gallons beginning in 2016 due to a standards change, and thus the larger water heaters do not contribute to potential after 2016.

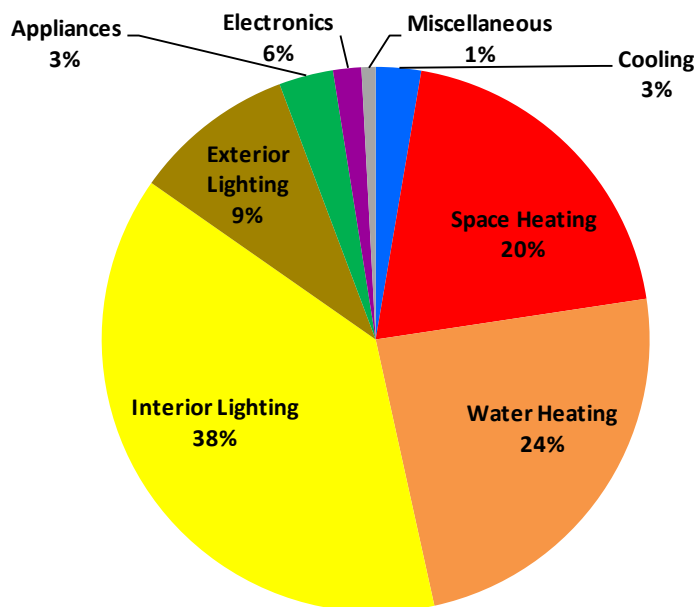
Figure 4-4 Residential Cumulative Achievable Potential by End Use in 2018

As described in Chapter 2, using our LoadMAP model, we develop separate estimates of potential for equipment and non-equipment measures. Table 4-5 presents results for equipment achievable potential at the technology level and Table 4-6 presents non-equipment measures for those measures that passed the cost-effectiveness screening. Initially, the majority of the savings come from the equipment measures, with lighting leading the way. Water heating, space heating, appliances and electronics, mainly televisions, provide savings as well. Over time, non-equipment measures, which are phased into the market more slowly but produce long-lasting savings (e.g., controls, water-saving fixtures, shell measures), produce a greater share of savings. In the non-equipment category, tank blanket installation, pipe insulation and thermostat setbacks for water heaters provide the greatest savings.

Table 4-5 Residential Cumulative Achievable Potential for Equipment Measures (MWh)

End Use	Technology	2014	2015	2018	2023	2028	2033
Cooling	Central AC	500	1,014	2,687	5,462	8,714	10,055
	Room AC	-	-	-	-	-	-
	Air Source Heat Pump	93	94	95	96	97	205
	Geothermal Heat Pump	-	-	-	-	-	-
Space Heating	Electric Resistance	348	837	3,738	13,323	31,336	52,036
	Electric Furnace	3,159	6,839	17,175	33,802	56,037	75,385
	Air Source Heat Pump	256	257	261	264	267	3,561
	Geothermal Heat Pump	-	-	-	-	-	-
Water Heating	Water Heater <= 55 Gal	1,604	3,654	11,129	38,369	82,577	136,249
	Water Heater > 55 Gal	119	166	331	810	1,387	1,944
Interior Lighting	Screw-in	6,268	9,722	39,805	18,279	7,524	15
	Linear Fluorescent	5	10	36	8	-	21
	Specialty	2,838	5,707	16,484	32,296	53,577	76,495
Exterior Lighting	Screw-in	3,121	5,340	14,121	7,568	1,767	4,771
Appliances	Clothes Washer	548	546	542	533	53	12
	Clothes Dryer	-	-	-	-	-	-
	Dishwasher	-	-	-	80	288	601
	Refrigerator	383	775	2,187	4,655	5,854	9,371
	Freezer	34	172	789	1,527	2,647	4,219
	Second Refrigerator	131	259	668	1,413	1,851	3,151
	Stove	114	227	560	1,296	2,109	2,470
Microwave	-	-	-	-	-	-	
Electronics	Personal Computers	106	260	1,111	3,079	5,678	9,692
	TVs	74	187	745	2,543	5,118	7,419
	Set-top boxes/DVR	89	188	610	2,417	5,673	10,023
	Devices and Gadgets	-	-	-	-	-	-
Miscellaneous	Pool Pump	6	15	62	241	968	2,961
	Furnace Fan	116	291	1,170	3,979	8,541	15,364
	Miscellaneous	-	-	-	-	-	-
Grand Total		19,915	36,560	114,306	172,041	282,064	426,022

Conservation Potential

Table 4-6 Residential Cumulative Achievable Savings for Non-equipment Measures (MWh), continued

Measure	2014	2015	2018	2023	2028	2033
Insulation - Ceiling	-	-	53	174	308	606
Insulation - Foundation	-	-	791	2,225	4,753	7,090
Insulation - Infiltration Control	-	-	1,692	9,543	16,408	20,226
Insulation - Wall Cavity	5	18	101	399	1,025	2,887
Refrigerator - Remove Second Unit	-	-	-	1,973	2,335	2,429
Thermostat - Clock/Programmable	243	917	6,783	14,483	18,457	18,619
Water Heater - Faucet Aerators	238	807	3,244	6,411	7,897	7,706
Water Heater - Pipe Insulation	335	1,129	4,790	9,307	11,296	10,828
Water Heater - Low Flow Showerheads	203	606	5,885	14,759	17,448	17,087
Water Heater - Tank Blanket/Insulation	575	1,909	7,317	13,150	14,736	12,937
Water Heater - Thermostat Setback	334	841	2,626	6,097	11,519	14,951
Advanced New Construction Designs	-	-	-	-	1,079	1,801
Behavioral Measures	-	-	-	1,400	2,773	3,930
Total	1,933	6,226	33,281	79,920	110,034	121,098

Residential Potential by Market Segment

Single-family homes were slightly more than half of Avista's residential customers and represented 66% of the sector's energy use in 2009. Furthermore, potential savings are generally higher in single family homes, which have larger saturations of equipment beyond the basics of space heating, water heating, and appliances. Thus, single-family homes account for the largest share of potential savings by segment, representing approximately 73% of achievable potential across the study period as indicated in Table 4-6. Table 4-7 shows the three potential cases by housing type in 2018.

Table 4-6 Residential Cumulative Achievable Potential by Market Segment

	2014	2015	2018	2023	2028	2033
Achievable Savings (MWh)						
Single Family	15,922	30,820	102,461	174,454	268,519	370,353
Multi Family	765	1,551	6,307	11,114	17,841	26,271
Mobile Home	619	1,259	4,131	6,589	10,014	13,837
Low Income	4,541	9,156	34,688	59,803	95,724	136,659
Total	21,848	42,786	147,588	251,961	392,098	547,119
Achievable - % of Savings						
Single Family	73%	72%	69%	69%	68%	68%
Multi Family	4%	4%	4%	4%	5%	5%
Mobile Home	3%	3%	3%	3%	3%	3%
Low Income	21%	21%	24%	24%	24%	25%
Total	100%	100%	100%	100%	100%	100%

Table 4-7 Residential Cumulative Achievable Potential by End Use and Market Segment, 2018 (MWh)

	Single Family	Multi Family	Mobile Home	Low Income
Energy Savings (MWh)				
Achievable Potential	102,461	6,307	4,131	34,688
Economic Potential	464,782	37,980	31,907	210,015
Technical Potential	1,434,368	173,515	131,221	909,267
Energy Savings (aMW)				
Achievable Potential	4%	3%	3%	4%
Economic Potential	20%	20%	26%	24%
Technical Potential	61%	90%	106%	105%

Table 4-8 shows the savings by end use and market segment in 2018. Across all housing types, as discussed previous, lighting is the single largest opportunity, followed by water heating, and space heating. In mobile homes and low income, however, the potential for space heating is higher than for water heating, due to the higher saturation of electric heat, as well as less efficient building shells.

Conservation Potential

Table 4-8 Residential Cumulative Achievable Potential by End Use and Market Segment, 2018 (MWh)

End Use	Single Family	Multi Family	Mobile Home	Low Income	All Homes
Cooling	3,029	31	57	838	3,955
Space Heating	17,689	982	1,117	9,634	29,422
Water Heating	25,266	1,761	490	7,805	35,322
Interior Lighting	39,315	3,053	1,728	12,228	56,325
Exterior Lighting	11,190	87	488	2,355	14,121
Appliances	3,276	228	131	1,112	4,746
Electronics	1,698	142	75	550	2,466
Miscellaneous	998	23	45	167	1,232
Total	102,461	6,307	4,131	34,688	147,588

C&I Sector Potential

The baseline projection for the commercial sector grows steadily during the projection period as the region emerges from the economic downturn. As a result, opportunities for energy-efficiency savings are significant for the C&I sector.

- **Achievable potential** for the 2014-2015 biennium is 57,354 MWh, or approximately 6.5 aMW. By 2033, the cumulative achievable projection savings are 91.9 aMW. Potential for rate class 25P was separately assessed, outside the LoadMAP model, at approximately 1 MWh annually.
- **Economic potential** is 141,191 MWh for 2014-2015. By 2033, economic potential reaches 125.9 aMW.
- **Technical potential** for 2014–2015 potential is 329,713 MWh. By 2033, technical potential reaches 277.2 aMW.

Table 4-9 and Note: Excludes rate class 25P.

Figure 4-5 present the savings associated with each level of potential.

Table 4-9 Cumulative Conservation Potential for the C&I Sector

	2014	2015	2018	2023	2028	2033
Cumulative Savings (MWh)						
Achievable Potential	28,789	57,354	176,964	381,630	584,687	805,172
Economic Potential	83,624	141,191	334,386	613,258	868,483	1,102,916
Technical Potential	197,941	329,713	900,694	1,699,836	2,157,078	2,428,207
Cumulative Savings (aMW)						
Achievable Potential	3.3	6.5	20.2	43.6	66.7	91.9
Economic Potential	9.5	16.1	38.2	70.0	165.7	125.9
Technical Potential	22.6	37.6	102.8	194.0	246.2	277.2

Note: Excludes rate class 25P.

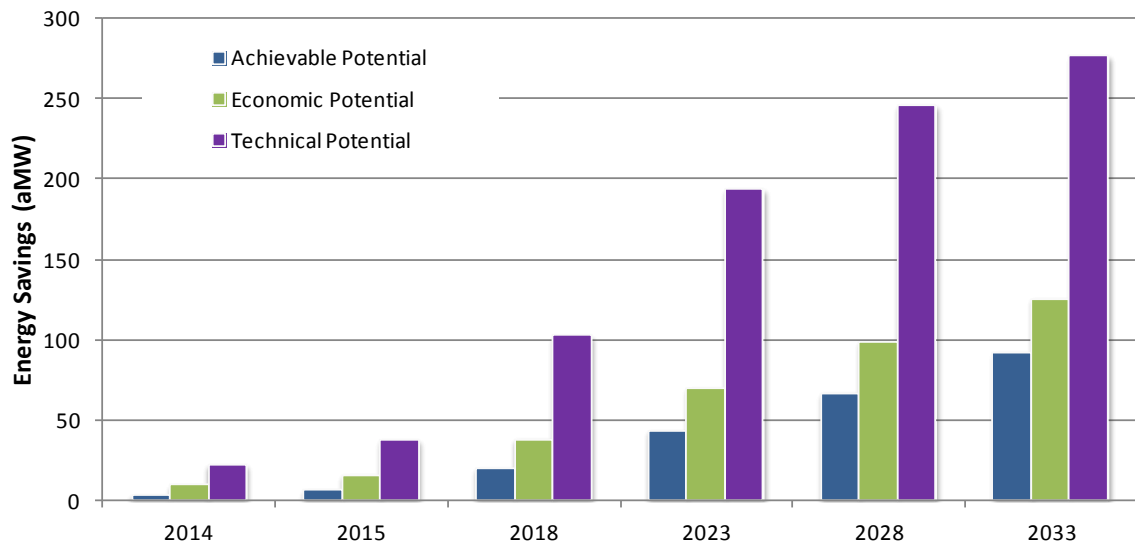
Figure 4-5 C&I Cumulative Savings by Potential Case

Note: Excludes rate class 25P.

C&I Potential by End Use, Technology, and Measure Type

Table 4-10 presents the commercial and industrial sector savings by end use and potential type.

Table 4-10 C&I Cumulative Potential by End Use and Potential Type (MWh)

End Use	Potential	2014	2015	2018	2023	2028	2033
Cooling	Achievable Potential	868	1,376	4,173	16,795	34,853	49,278
	Economic Potential	1,691	2,488	7,079	27,350	53,462	72,875
	Technical Potential	19,454	29,736	97,875	196,371	253,620	294,929
Space Heating	Achievable Potential	519	715	1,803	6,917	15,359	23,827
	Economic Potential	1,288	1,733	4,283	14,806	29,018	41,719
	Technical Potential	11,159	16,184	44,222	108,389	148,257	173,675
Ventilation	Achievable Potential	963	2,239	10,061	31,438	55,099	77,805
	Economic Potential	1,133	2,739	12,553	38,972	66,375	92,514
	Technical Potential	12,706	22,200	83,691	184,710	226,874	241,650
Water Heating	Achievable Potential	1,597	3,270	10,777	32,637	78,331	126,429
	Economic Potential	11,899	22,573	57,844	122,614	211,538	238,809
	Technical Potential	15,102	29,004	80,484	159,912	266,475	297,971
Interior Lighting	Achievable Potential	17,099	34,790	99,910	159,448	196,299	274,184
	Economic Potential	44,373	71,064	145,394	208,161	247,368	342,873
	Technical Potential	77,989	127,519	332,806	565,237	668,438	745,387
Exterior Lighting	Achievable Potential	1,891	3,353	12,231	33,437	48,284	52,775
	Economic Potential	7,402	11,324	33,083	53,407	58,412	60,364
	Technical Potential	12,582	17,733	42,800	75,475	84,874	93,215
Food Preparation	Achievable Potential	1,658	3,354	9,246	20,001	28,341	35,406
	Economic Potential	2,127	4,265	11,312	24,224	34,077	42,363
	Technical Potential	3,928	7,015	17,911	40,248	58,963	73,609
Refrigeration	Achievable Potential	93	343	1,833	4,922	12,431	28,158
	Economic Potential	186	603	2,490	6,123	14,718	33,143
	Technical Potential	3,663	7,396	19,377	40,458	56,695	65,200
Office Equipment	Achievable Potential	3,000	5,894	19,718	46,832	67,723	76,351
	Economic Potential	11,327	20,590	48,337	73,793	83,277	91,979
	Technical Potential	29,051	51,981	104,158	128,436	143,820	158,781
Machine Drive	Achievable Potential	4	8	40	165	300	439
	Economic Potential	8	15	73	295	512	713
	Technical Potential	188	695	2,625	6,418	10,018	11,764
Process	Achievable Potential	426	766	3,337	13,761	26,438	35,254
	Economic Potential	862	1,501	6,179	23,952	43,702	54,818
	Technical Potential	10,272	17,192	66,674	169,003	205,886	233,266
Miscellaneous	Achievable Potential	670	1,248	3,835	15,277	21,229	25,265
	Economic Potential	1,329	2,295	5,758	19,561	26,024	30,744
	Technical Potential	1,848	3,057	8,070	25,178	33,157	38,761
Total	Achievable Potential	28,789	57,354	176,964	381,630	584,687	805,172
	Economic Potential	83,624	141,191	334,386	613,258	868,483	1,102,916
	Technical Potential	197,941	329,713	900,694	1,699,836	2,157,078	2,428,207

Note: Excludes rate class 25P.

The end uses with the highest technical and economic potential are:

- **Interior lighting**, as a result of LED lighting that is now commercially available, has the highest technical potential at 332,806 MWh in 2018. LEDs are found to be cost-effective in all applications beginning in either 2014 or 2015, as a result of longer hours of operation in commercial buildings. In addition, super T8s for linear fluorescent systems, T5s for high-bay fixtures, and control systems also contribute to lighting economic potential. Therefore, economic potential is highest for lighting as well, at 145,394 MWh in 2018, which is roughly 44% of the lighting technical potential and 43% of total economic potential in 2018.
- **HVAC end uses** collectively comprise 25% of technical potential or 225,778 MWh. However, relatively few measures pass the economic screen, so that economic potential is only 23,915 MWh, or about one tenth of the technical potential.
- **Office equipment** has significant technical potential of 101,158 MWh in 2018, and economic potential of 48,337 MWh
- **Water heating** technical potential comes next, with 80,484 MWh, and because measures such as HPWH and water saving devices are cost-effective, economic potential is 57,844 MWh.

Table 4-11 and Table 4-12 present achievable potential savings for equipment measures and non-equipment measures, respectively. Table 4-12 presents only measures that passed the cost-effectiveness test.

Conservation Potential

Table 4-11 C&I Cumulative Achievable Savings for Equipment Measures (MWh)

End Use	Technology	2014	2015	2018	2023	2028	2033
Cooling	Central Chiller	350	670	2,231	6,803	12,639	17,307
	RTU	-	-	-	-	-	-
	Heat Pump	-	-	-	-	-	-
Space Heating	Heat Pump	-	-	-	-	-	-
	Electric Resistance	-	-	-	-	-	-
	Furnace	-	-	-	-	-	-
Ventilation	Ventilation	963	2,072	8,768	26,596	49,646	72,087
Water Heating	Water Heater	1,311	2,844	9,464	26,736	64,973	107,400
Interior Lighting	Linear Fluorescent	93	141	5,268	29,001	44,645	68,240
	Interior Screw-in	10,160	19,861	42,656	29,637	12,498	42,051
	High Bay Fixtures	6,482	14,295	48,666	77,212	85,244	94,133
Exterior Lighting	HID	1,140	2,519	8,105	27,952	41,884	47,529
	Exterior Screw-in	678	708	3,507	2,823	2,075	-
Refrigeration	Reach-in Refrigerator	409	839	2,364	5,026	7,600	10,224
	Glass Door Display	462	946	2,614	5,502	8,266	10,964
	Open Display Case	-	-	-	-	-	-
	Icemaker	291	589	1,595	3,648	4,865	5,399
	Vending Machine	452	921	2,520	5,382	6,822	7,744
	Walk in Refrigerator	-	-	-	-	-	-
Food Preparation	Oven	-	137	944	2,673	8,844	23,982
	Fryer	93	207	670	1,532	2,303	2,660
	Dishwasher	-	-	-	-	-	-
	Hot Food Container	-	-	220	717	1,284	1,516
	Other Food Prep	-	-	-	-	-	-
Office Equipment	Desktop Computers	1,381	2,607	6,968	13,526	20,092	22,514
	Server	1,095	2,340	7,192	16,419	23,871	26,404
	Monitor	121	229	1,979	4,709	6,994	7,837
	Printer/copier/fax	-	-	395	3,452	5,311	6,242
	POS Terminal	-	-	381	956	1,425	1,613
	Laptop Computer	96	182	487	945	1,403	1,573
Miscellaneous	Non-HVAC Motor	-	-	-	-	-	-
	Other Miscellaneous	-	-	-	-	-	-
Process	Process Cooling/Refrigeration	301	574	1,810	8,290	11,076	12,927
	Process Heating	-	-	-	-	-	-
	Electrochemical Process	293	558	1,614	5,791	8,190	9,645
Machine Drive	Less than 5 HP	3	27	122	241	640	851
	5-24 HP	7	14	41	160	212	247
	25-99 HP	19	36	104	405	537	623
	100-249 HP	11	20	59	230	305	353
	250-499 HP	3	6	32	287	343	392
	500 and more HP	6	12	60	543	649	742
Grand Total		26,202	53,316	160,683	306,133	433,342	601,609

Note: Excludes rate class 25P.

Table 4-12 C&I Cumulative Achievable Savings for Non-equipment Measures (MWh)

Measure	2014	2015	2018	2023	2028	2033
Energy Management System	1,142	1,525	3,673	15,912	39,422	63,759
Exterior Lighting - Daylighting Controls	0	0	5	58	271	482
Interior Lighting - Occupancy Sensors	0	0	9	58	113	160
Thermostat - Clock/Programmable	213	296	754	2,471	4,822	6,948
Heat Pump - Maintenance	41	69	277	918	1,387	1,634
Water Heater - Faucet Aerators/Low Flow Nozzles	-	-	-	-	-	411
Water Heater - High Efficiency Circulation Pump	285	425	1,313	5,900	13,358	18,617
Retrocommissioning - Lighting	-	-	1,689	17,461	38,207	43,900
Air-Cooled Chiller - Cond. Water Temperature Reset	0	0	87	761	1,218	1,689
Chiller - Chilled Water Reset	-	-	-	-	17	63
Chiller - Chilled Water Variable-Flow System	0	0	3	16	40	64
Chiller - High Efficiency Cooling Tower Fans	0	0	6	37	69	103
Cooling - Economizer Installation	-	-	168	1,916	4,085	4,999
Fans - Energy Efficient Motors	-	161	720	2,249	2,533	2,293
Interior Lighting - Time Clocks and Timers	-	-	-	21	92	140
Refrigeration - Strip Curtain	43	59	149	415	710	920
LED Exit Lighting	4	20	483	599	771	748
Refrigeration - High Efficiency Case Lighting	-	1	5	29	78	153
Exterior Lighting - Cold Cathode Lighting	72	125	507	1,442	1,703	1,989
Laundry - High Efficiency Clothes Washer	4	7	35	115	157	192
Interior Lighting - Skylights	-	-	7	108	279	469
Office Equipment - Smart Power Strips	305	536	2,316	6,826	8,626	10,168
Ventilation - Demand Control Ventilation	0	5	571	2,576	2,875	3,349
Strategic Energy Management	5	7	62	434	1,163	1,968
Refrigeration - System Controls	28	38	85	192	297	350
Refrigeration - System Maintenance	28	44	169	482	665	829
Refrigeration - System Optimization	17	29	116	252	285	298
Motors - Variable Frequency Drive	6	13	197	1,167	2,159	3,207
Motors - Magnetic Adjustable Speed Drives	222	380	1,489	3,821	4,690	5,921
Compressed Air - System Optimization and Improvements	7	14	196	2,992	9,116	11,744
Compressed Air - Compressor Replacement	100	172	655	2,485	5,571	8,169

Conservation Potential

Measure	2014	2015	2018	2023	2028	2033
Fan System - Controls	3	6	27	89	126	160
Fan System - Optimization	17	29	113	291	350	382
Fan System - Maintenance	0	0	1	8	14	20
Pumping System - Controls	21	37	228	975	1,610	2,275
Pumping System - Maintenance	0	1	13	67	117	169
Total	2,566	4,001	16,130	74,436	150,049	202,076

Note: Excludes rate class 25P.

As shown in Figure 4-6, the primary sources of C&I sector achievable savings in 2018 are as follows:

- Interior and exterior lighting, comprising lamps, fixtures, and controls, account for 64% of C&I sector achievable potential. Not only is economic potential high for lighting measures, but they are more readily accepted and implemented in the market than many other, higher cost and more complex measures.
- Office Equipment, which is the second largest portion of this sector's achievable potential (11%)
- Water heating and Ventilation each provides 6% of the total savings

Figure 4-6 C&I Cumulative Achievable Potential Cumulative Savings by End Use in 2018 (percentage of total)

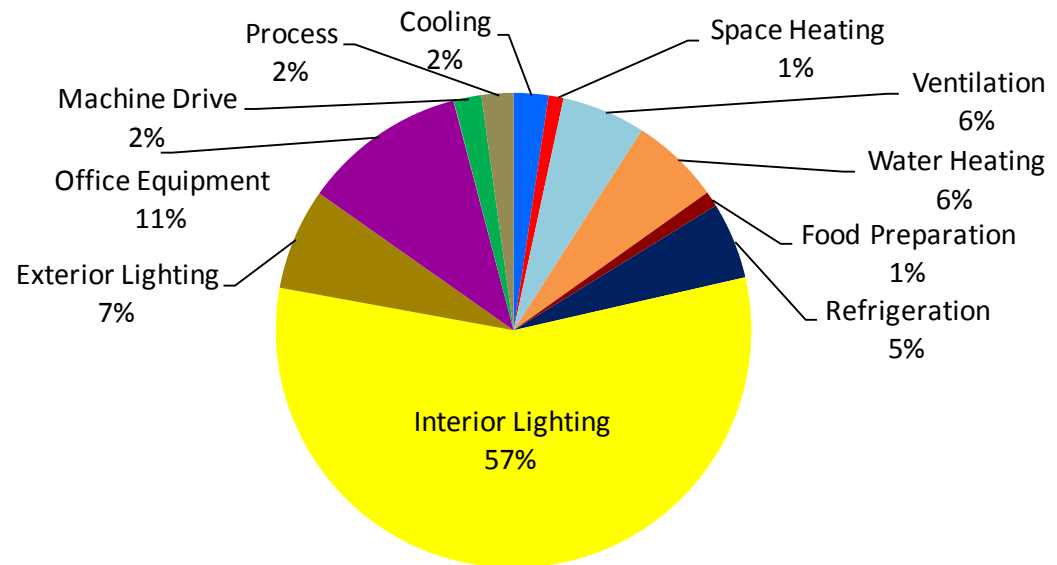

Note: Excludes rate class 25P.

C&I Potential by Market Segment

Table 4-13 shows potential estimates by segment in 2018. The large commercial segment has the largest achievable conservation potential of 201,247 MWh, roughly 58% of the overall commercial achievable potential. The small/medium segment follows with a large gap at 64,655 MWh.

Table 4-13 C&I Cumulative Potential by Market Segment, 2018

	Energy Savings (MWh)		
	Achievable Potential	Economic Potential	Technical Potential
Small/Med. Commercial	34,044	64,655	174,575
Large Commercial	101,745	201,247	529,133
Extra Large Commercial	16,950	31,634	79,582
Extra Large Industrial	24,224	36,850	117,403
Total	176,964	334,386	900,694

Note: Excludes rate class 25P.

Figure 4-7 presents the achievable potential in 2018 by end use and building type. Lighting measures are key measure across all buildings.

Table 4-14 C&I Cumulative Achievable Savings in 2018 by End Use and Rate Class(MWh)

End Use	Small/Medium Commercial	Large Commercial	Extra Large Commercial	Extra Large Industrial	Total
Cooling	835	1,305	665	1,368	4,173
Space Heating	717	163	296	627	1,803
Ventilation	1,740	1,124	1,165	6,031	10,061
Water Heating	1,990	7,772	1,016	-	10,777
Interior Lighting	20,429	61,213	9,566	8,702	99,910
Exterior Lighting	2,967	7,669	1,276	318	12,231
Refrigeration	2,211	6,457	578	-	9,246
Food Preparation	220	639	975	-	1,833
Office Equipment	2,928	15,379	1,411	-	19,718
Miscellaneous	8	24	2	5	40
Process	-	-	-	3,835	3,835
Machine Drive	-	-	-	3,337	3,337
Total	34,044	101,745	16,950	24,224	176,964

Note: Excludes rate class 25P.

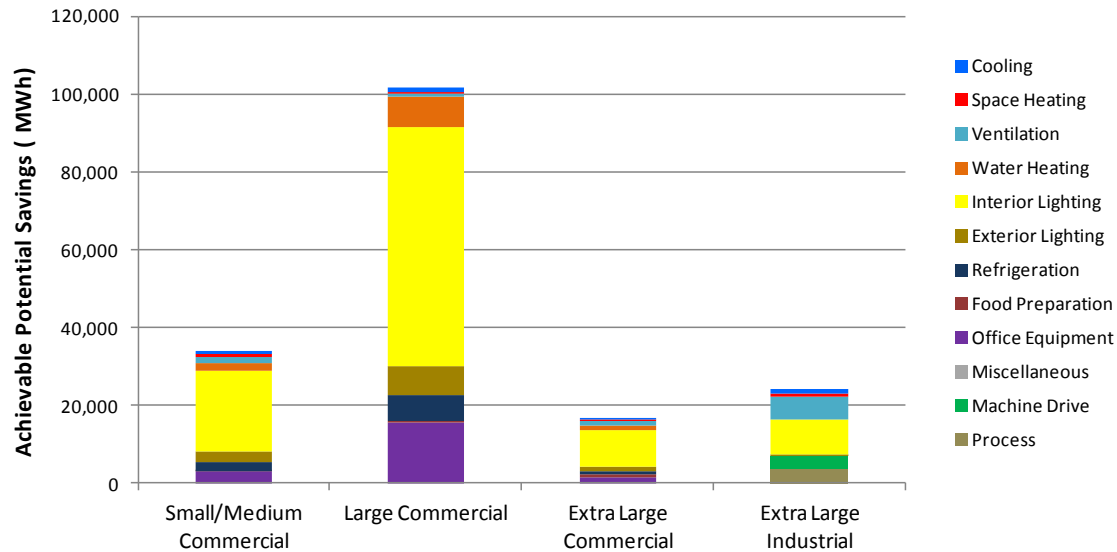
Figure 4-7 C&I Cumulative Achievable Savings in 2018 by End Use and Building Type

Note: Excludes rate class 25P.

Sensitivity of Potential to Avoided Cost

Similar to the 2011 CPA, EnerNOC modeled several scenarios with varying levels of avoided costs in addition to the reference case. **For this study's purposes, we have included a case where the 10% adder per NW Power and Conservation Act is removed.** The other scenarios included 150%, 125%, and 75% of the avoided costs used in the reference case. Figure 4-8 and Table 4-15 show how achievable potential varies under the four scenarios.

- The reference case achievable potential reaches approximately at 1,352,291 MWh by 2033.
- Removing the 10% adder from the avoided costs decreased this achievable potential to 1,272,206 MWh, 6% reduction.
- With the 150% avoided cost case, achievable potential increased to 1,657,741 MWh while the 125% avoided cost case and the 75% avoided cost case yielded achievable potential equal to 1,521,856 and 1,146,105 MWh respectively.

While the changes are significant, the relationship between avoided cost and achievable potential is not linear and increases in avoided costs do not provide equivalent percentage increases in achievable potential. Technical potential imposes a limit on the amount of additional conservation and each incremental unit of DSM becomes increasingly expensive.

Figure 4-8 Energy Savings, Cumulative Achievable Potential by Avoided Costs Scenario (MWh)

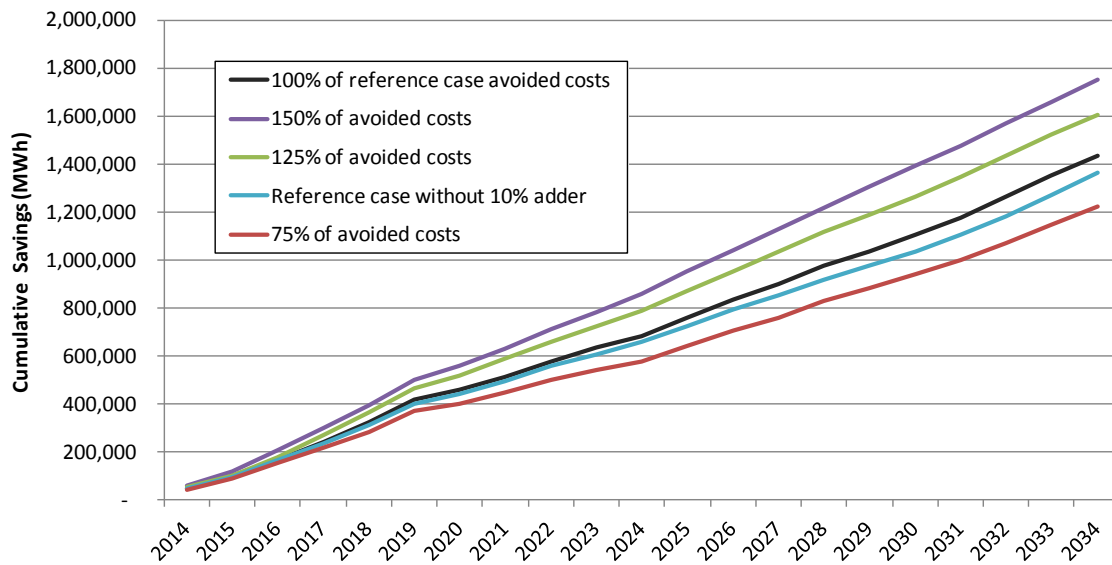

Note: Excludes pumping and rate class 25P.

Table 4-15 Achievable Potential with Varying Avoided Costs

End Use	Reference Scenario	Remove 10% adder	75% of avoided costs	125% of avoided costs	150% of avoided costs
Achievable potential savings 2033 (MWh)	1,352,291	1,272,206	1,146,105	1,521,856	1,657,741
Percentage change in savings vs. 100% avoided cost Scenario		-6%	-15%	13%	23%

Note: Excludes pumping and rate class 25P.

Electricity to Natural Gas Fuel Switching

While fuel efficiency is not considered in the NPCC Sixth Plan, Avista has a history of fuel switching from electricity to natural gas and continues to target direct use as the most efficient resource option when available. The conservation potential modeled above includes savings potential attributable to conversion of electric space and water heating to natural gas. Table 4-16 displays savings potential from converting electric furnaces and water heaters to natural gas.

Within LoadMAP, we modeled savings for these measures in the residential sector only, but because we calibrated the **level of expected conversions to Avista's recent program history that** includes small commercial building conversions as well, this potential may reflect a small percentage of commercial section conversions. Because conversions remove most of the electricity use from two of the largest residential end uses (water and space heating), it accounts for 8.3% of combined residential, commercial and industrial savings by 2033. For water heating, about one-fifth of the savings from gas conversions occurs in new construction. For furnaces, new construction accounts for roughly 27% of the total.

Table 4-16 Cumulative Achievable Potential from Conversion to Natural Gas (MWh)

	2014	2015	2018	2023	2028	2033
Washington Cumulative Savings (MWh)						
Furnace Conversions	2,322	5,047	12,715	25,105	41,493	55,787
Water Heating Conversions	825	1,586	4,112	9,924	14,362	20,221
Total Conversions	3,148	6,633	16,827	35,028	55,855	76,009
Idaho Cumulative Savings (MWh)						
Furnace Conversions	837	1,792	4,460	8,698	14,544	19,598
Water Heating Conversions	47	121	602	4,264	10,085	16,451
Total Conversions	884	1,913	5,062	12,961	24,629	36,049
Total Washington and Idaho Cumulative Savings (MWh)						
Furnace Conversions	3,159	6,839	17,175	33,802	56,037	75,385
Water Heating Conversions	873	1,707	4,714	14,187	24,447	36,673
Total Conversions	4,032	8,546	21,889	47,990	80,484	112,058

Supply Curves

The project also developed supply curves for each year to support the IRP process. At Avista's request, the supply curves did not consider economic screening based on Avista's avoided costs. Instead, all measures were included and the amount of savings from each measure in each year was limited by the ramp rates used for achievable potential. The supply curves do not include the savings from electricity to natural gas fuel switching, discussed above.

A sample supply curve for one year is shown in Figure 4-9. This supply curve is created by stacking measures and equipment over the 20-year planning horizon in ascending order of cost. As expected, this stacking of conservation resources produces a traditional upward-sloping supply curve. Because there is a gap in the cost of the energy efficiency measures as you move up the supply curve, the measures with a very high cost cause a rapid sloping of the supply curve. The supply curve also shows that substantial savings are available at low- or no-cost.

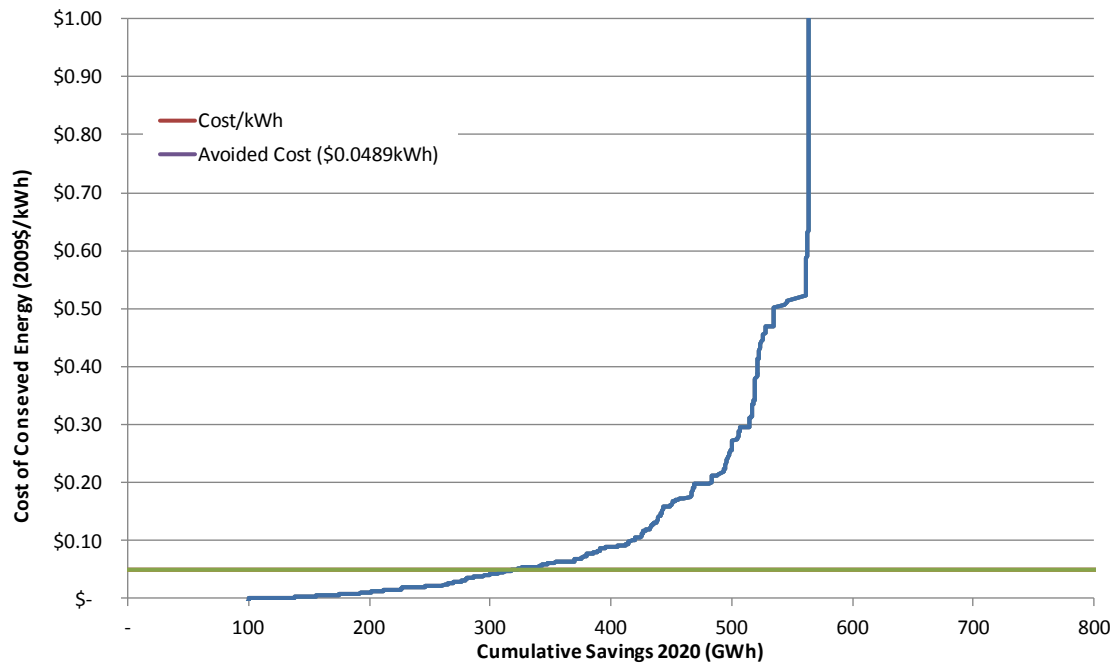
Figure 4-9 Supply Curves for Evaluated EE Measures and Avoided Cost Scenarios

Note: Excludes pumping and rate class 25P.

Pumping Potential

Table 4-18 displays the 2009 electricity sales and peak demand of Avista's pumping customers. These customers include mostly municipal water systems and some irrigation customers. The pumping accounts represent 2.4% of total electricity sales and 0.8% of peak demand (see Table 3-1 and Table 3-2). Because pumping represents a relatively small percentage of Avista's total sales, the project team decided to estimate achievable potential for pumping based on the Sixth Plan calculator agriculture sector, option 3.⁹

Table 4-17 Pumping Rate Classes, Electricity Sales and Peak Demand 2009

Sector	Rate Schedule (s)	Number of meters (customers)	2009 Electricity Sales (MWh)	Peak demand (MW)
Pumping, Washington	031, 032	2,361	135,999	10
Pumping, Idaho	031, 032	1,312	58,885	4
Pumping, Total		3,673	194,884	14
Percentage of System Total			2.4%	0.8%

The Sixth Plan Calculator estimates agricultural conservation targets based on 2007 sales. It provides annual conservation targets through 2019. Table 4-18 displays incremental annual savings potential for 2014–2019.

⁹ Available on the NWPC website at <http://www.nwcouncil.org/energy/powerplan/6/assessmentmethodology/>.

Conservation Potential

Table 4-18 Sixth Plan Calculator Agriculture Incremental Annual Potential, 2014–2019 (MWh)

Segment	2014	2015	2016	2017	2018	2019
Pumping, Washington	1,402	1,835	1,856	1,835	1,814	1,794
Pumping, Idaho	618	809	818	809	799	790
Pumping, Total	2,020	2,643	2,673	2,643	2,614	2,584

Washington Potential Excluding Conversions to Natural Gas

Based on the modeling described above, Washington potential consistent with the NPPC Conservation Plan methodology is as shown in Table 4-19.

Table 4-19 Washington Cumulative Potential Consistent with Conservation Plan Methodology

	2014	2015	2018	2023
Cumulative Savings (MWh)				
Residential	15,091	29,603	100,792	172,576
Commercial and Industrial	19,927	40,930	123,755	256,653
Pumping	1,402	3,237	8,742	0
Conversions to Natural Gas	(3,148)	(6,633)	(16,827)	(35,028)
Total	33,272	67,137	216,462	394,200
Cumulative Savings (aMW)				
Residential	1.72	3.38	11.51	19.70
Commercial and Industrial	2.27	4.67	14.13	29.30
Pumping	0.16	0.37	1.00	0.00
Conversions to Natural Gas	(0.36)	(0.76)	(1.92)	(4.00)
Total	3.80	7.66	24.71	45.00

About EnerNOC

EnerNOC's Utility Solutions Consulting team is part of EnerNOC's Utility Solutions, which provides a comprehensive suite of demand-side management (DSM) services to utilities and grid operators worldwide. Hundreds of utilities have leveraged our technology, our people, and our proven processes to make their energy efficiency (EE) and demand response (DR) initiatives a success. Utilities trust EnerNOC to work with them at every stage of the DSM program lifecycle – assessing market potential, designing effective programs, implementing those programs, and measuring program results.

EnerNOC's Utility Solutions deliver value to our utility clients through two separate practice areas – Implementation and Consulting.

- **Our Implementation team leverages EnerNOC's deep "behind-the-meter expertise" and world-class technology platform** to help utilities create and manage DR and EE programs that deliver reliable and cost-effective energy savings. We focus exclusively on the commercial and industrial (C&I) customer segments, with a track record of successful partnerships that spans more than a decade. Through a focus on high quality, measurable savings, EnerNOC has successfully delivered hundreds of thousands of MWh of energy efficiency for our utility clients, and we have thousands of MW of demand response capacity under management.
- The Consulting team provides expertise and analysis to support a broad range of utility DSM activities, including: potential assessments; end-use forecasts; integrated resource planning; EE, DR, and smart grid pilot and program design and administration; load research; technology assessments and demonstrations; evaluation, measurement and verification; and regulatory support.

The team has decades of combined experience in the utility DSM industry. The staff is comprised of professional electrical, mechanical, chemical, civil, industrial, and environmental engineers as well as economists, business planners, project managers, market researchers, load research professionals, and statisticians. **Utilities view EnerNOC's experts as trusted advisors, and we work together collaboratively to make any DSM initiative a success.**



**Avista Electric Conservation Potential
Assessment Study**

Appendices

Report Number 1341

EnerNOC Utility Solutions Consulting
500 Ygnacio Valley Road
Suite 450
Walnut Creek, CA 94596
Tel: 925.482.2000
www.enernoc.com

Prepared for:
Avista Corporation

Prepared by:
EnerNOC, Inc.

Presented on:
May 30, 2013

This report was prepared by
EnerNOC Utility Solutions Consulting
500 Ygnacio Valley Blvd., Suite 450
Walnut Creek, CA 94596

Project Director: I. Rohmund
Project Manager: J. Borstein

CONTENTS

A	MARKET PROFILES	A-1
B	RESIDENTIAL ENERGY EFFICIENCY EQUIPMENT AND MEASURE DATA	B-1
C	C&I ENERGY EFFICIENCY EQUIPMENT AND MEASURE DATA	C-1
D	MARKET ADOPTION FACTORS	D-1
E	ANNUAL SAVINGS	E-1

LIST OF TABLES

Table A-1	Single Family Electric Market Profile, Washington 2009	A-2
Table A-2	Multi Family Electric Market Profile, Washington 2009	A-3
Table A-3	Mobile Home Electric Market Profile, Washington 2009	A-4
Table A-4	Low Income Electric Market Profile, Washington 2009	A-5
Table A-5	Single Family Electric Market Profile, Idaho 2009	A-6
Table A-6	Multi Family Electric Market Profile, Idaho 2009	A-7
Table A-7	Mobile Home Electric Market Profile, Idaho 2009	A-8
Table A-8	Low income Electric Market Profile, Idaho 2009	A-9
Table A-9	Small/Medium Commercial Electric Market Profile, Washington 2009	A-10
Table A-10	Large Commercial Electric Market Profile, Washington 2009	A-11
Table A-11	Extra Large Commercial Electric Market Profile, Washington 2009	A-12
Table A-12	Extra Large Industrial Electric Market Profile, Washington 2009	A-13
Table A-13	Small/Medium Commercial Electric Market Profile, Idaho 2009	A-14
Table A-14	Large Commercial Electric Market Profile, Idaho 2009	A-15
Table A-15	Extra Large Commercial Electric Market Profile, Idaho 2009	A-16
Table A-16	Extra Large Industrial Electric Market Profile, Idaho 2009	A-17
Table B-1	Residential Energy Efficiency Equipment Measure Descriptions	B-2
Table B-2	Residential Energy Efficiency Non-Equipment Measure Descriptions	B-6
Table B-3	Energy Efficiency Equipment Data, Electric—Single Family, Existing Vintage, Washington	B-10
Table B-4	Energy Efficiency Equipment Data, Electric—Single Family, New Vintage, Washington	B-13
Table B-5	Energy Efficiency Equipment Data, Electric—Single Family, Existing Vintage, Idaho	B-16
Table B-6	Energy Efficiency Equipment Data, Electric—Single Family, New Vintage, Idaho	B-19
Table B-7	Energy Efficiency Equipment Data, Electric—Multi Family, Existing Vintage, Washington	B-22
Table B-8	Energy Efficiency Equipment Data, Electric—Multi Family, New Vintage, Washington	B-25
Table B-9	Energy Efficiency Equipment Data, Electric—Multi Family, Existing Vintage, Idaho	B-28
Table B-10	Energy Efficiency Equipment Data, Electric—Multi Family, New Vintage, Idaho	B-31
Table B-11	Energy Efficiency Equipment Data, Electric—Mobile Home, Existing Vintage, Washington	B-34
Table B-12	Energy Efficiency Equipment Data, Electric—Mobile Home, New Vintage, Washington	B-37
Table B-13	Energy Efficiency Equipment Data, Electric—Mobile Home, Existing Vintage, Idaho	B-40
Table B-14	Energy Efficiency Equipment Data, Electric—Mobile Home, New Vintage, Idaho	B-43
Table B-15	Energy Efficiency Equipment Data, Electric—Low income, Existing Vintage, Washington	B-46
Table B-16	Energy Efficiency Equipment Data, Electric—Low Income, New Vintage, Washington	B-49
Table B-17	Energy Efficiency Equipment Data, Electric—Low Income, Existing Vintage, Idaho	B-52
Table B-18	Energy Efficiency Equipment Data, Electric—Low income, New Vintage, Idaho	B-55
Table B-19	Energy Efficiency Non-Equipment Data, Electric—Single Family, Existing Vintage, Washington	B-58

Table B-20	Energy Efficiency Non-Equipment Data, Electric—Single Family, New Vintage, Washington	B-59
Table B-21	Energy Efficiency Non-Equipment Data, Electric—Single Family, Existing Vintage, Idaho	B-60
Table B-22	Energy Efficiency Non-Equipment Data, Electric—Single Family, New Vintage, Idaho	B-61
Table B-23	Energy Efficiency Non-Equipment Data, Electric—Multi Family, Existing Vintage, Washington	B-62
Table B-24	Energy Efficiency Non-Equipment Data, Electric—Multi Family, New Vintage, Washington	B-63
Table B-25	Energy Efficiency Non-Equipment Data, Electric—Multi Family, Existing Vintage, Idaho	B-64
Table B-26	Energy Efficiency Non-Equipment Data, Electric—Multi Family, New Vintage, Idaho	B-65
Table B-27	Energy Efficiency Non-Equipment Data, Electric—Mobile Home, Existing Vintage, Washington	B-66
Table B-28	Energy Efficiency Non-Equipment Data, Electric—Mobile Home, New Vintage, Washington	B-67
Table B-29	Energy Efficiency Non-Equipment Data, Electric—Mobile Home, Existing Vintage, Idaho	B-68
Table B-30	Energy Efficiency Non-Equipment Data, Electric—Mobile Home, New Vintage, Idaho	B-69
Table B-31	Energy Efficiency Non-Equipment Data, Electric—Low income, Existing Vintage, Washington	B-70
Table B-32	Energy Efficiency Non-Equipment Data, Electric—Low income, New Vintage, Washington	B-71
Table B-33	Energy Efficiency Non-Equipment Data, Electric—Low income, Existing Vintage, Idaho	B-72
Table B-34	Energy Efficiency Non-Equipment Data, Electric—Low income, New Vintage, Idaho	B-73
Table C-1	C&I Energy Efficiency Equipment Measure Descriptions	C-2
Table C-2	Commercial and Industrial Energy Efficiency Non-Equipment Measure Descriptions .	C-5
Table C-3	Energy Efficiency Equipment Data, Electric—Small/Medium Commercial, Existing Vintage, Washington	C-11
Table C-4	Energy Efficiency Equipment Data, Electric—Small/Medium Commercial, New Vintage, Washington	C-14
Table C-5	Energy Efficiency Equipment Data, Small/Medium Commercial, Existing Vintage, Idaho	C-17
Table C-6	Energy Efficiency Equipment Data, Electric— Small/Medium Commercial, New Vintage, Idaho	C-20
Table C-7	Energy Efficiency Equipment Data, Electric—Large Commercial, Existing Vintage, Washington	C-23
Table C-8	Energy Efficiency Equipment Data, Electric— Large Commercial, New Vintage, Washington	C-26
Table C-9	Energy Efficiency Equipment Data, Electric—Large Commercial, Existing Vintage, Idaho	C-29
Table C-10	Energy Efficiency Equipment Data, Electric— Large Commercial, New Vintage, Idaho	C-32
Table C-11	Energy Efficiency Equipment Data, Electric—Extra Large Commercial, Existing Vintage, Washington	C-35
Table C-12	Energy Efficiency Equipment Data, Electric— Extra Large Commercial, New Vintage, Washington	C-38
Table C-13	Energy Efficiency Equipment Data, Electric—Extra Large Commercial, Existing Vintage, Idaho	C-41
Table C-14	Energy Efficiency Equipment Data, Electric— Extra Large Commercial, New Vintage, Idaho	C-44
Table C-15	Energy Efficiency Equipment Data, Electric—Extra Large Industrial, Existing Vintage, Washington	C-47

Table C-16	Energy Efficiency Equipment Data, Electric— Extra Large Industrial, New Vintage, Washington	C-50
Table C-17	Energy Efficiency Equipment Data, Electric—Extra Large Industrial, Existing Vintage, Idaho.....	C-53
Table C-18	Energy Efficiency Equipment Data, Electric— Extra Large Industrial, New Vintage, Idaho.....	C-56
Table C-19	Energy Efficiency Non-Equipment Data—Small/Medium Commercial, Existing Vintage, Washington	C-59
Table C-20	Energy Efficiency Non-Equipment Data— Small/ Medium Commercial, New Vintage, Washington	C-61
Table C-21	Energy Efficiency Non-Equipment Data— Small/Medium Commercial, Existing Vintage, Idaho.....	C-63
Table C-22	Energy Efficiency Non-Equipment Data— Small/ Medium Commercial, New Vintage, Idaho.....	C-65
Table C-23	Energy Efficiency Non-Equipment Data— Large Commercial, Existing Vintage, Washington	C-67
Table C-24	Energy Efficiency Non-Equipment Data— Large Commercial, New Vintage, Washington.....	C-69
Table C-25	Energy Efficiency Non-Equipment Data— Large Commercial, Existing Vintage, Idaho.....	C-71
Table C-26	Energy Efficiency Non-Equipment Data— Large Commercial, New Vintage, Idaho.....	C-73
Table C-27	Energy Efficiency Non-Equipment Data— Extra Large Commercial, Existing Vintage, Washington	C-75
Table C-28	Energy Efficiency Non-Equipment Data— Extra Large Commercial, New Vintage, Washington	C-77
Table C-29	Energy Efficiency Non-Equipment Data— Extra Large Commercial, Existing Vintage, Idaho.....	C-79
Table C-30	Energy Efficiency Non-Equipment Data— Extra Large Commercial, New Vintage, Idaho.....	C-81
Table C-31	Energy Efficiency Non-Equipment Data— Extra Large Industrial, Existing Vintage, Washington	C-83
Table C-32	Energy Efficiency Non-Equipment Data— Extra Large Industrial, New Vintage, Washington	C-85
Table C-33	Energy Efficiency Non-Equipment Data— Extra Large Industrial, Existing Vintage, Idaho.....	C-87
Table C-34	Energy Efficiency Non-Equipment Data— Extra Large Industrial, New Vintage, Idaho.....	C-89
Table D-1	Residential Equipment Measures—Achievable Potential Market Adoption Factors	D-2
Table D-2	Residential Non-Equipment Measures— Achievable Potential Market Adoption Factors.....	D-3
Table D-3	C/I Equipment Measures — Achievable Potential Market Adoption Factors.....	D-4
Table D-4	C/I Non-Equipment Measures — Achievable Potential Market Adoption Factors.....	D-6
Table E-1	Annual Electric Energy Savings, All Sectors (1,000 MWh)	E-1
Table E-2	Annual Electric Energy Savings, All Sectors (1,000 MWh) (continued)	E-2
Table E-3	Annual Electric Energy Savings, Residential (1,000 MWh)	E-3
Table E-4	Annual Electric Energy Savings, Residential (1,000 MWh) (continued)	E-4
Table E-5	Annual Electric Energy Savings, C/I (1,000 MWh)	E-5
Table E-6	Annual Electric Energy Savings, C/I (1,000 MWh) (continued)	E-6

MARKET PROFILES

Market profiles describe electricity use by sector, segment, end use and technology in the base year of the study (2009). The market profiles are given for average buildings and new vintages.

As explained in Chapter 2 of the Avista Conservation Potential Assessment (CPA) report , a market profile includes the following elements:

- **Market size** is a representation of the number of customers in the segment. For the residential sector, it is number of households. In the commercial and industrial sector, it is floor space measured in square feet.
- **Saturations** define the fraction of buildings with the specific technologies. (e.g., homes with electric space heating).
- **UEC (unit energy consumption) or EUI (energy-use index)** describes the amount of energy consumed in the base year by a specific technology in buildings that have the technology. We use UECs expressed in kWh/household for the residential sector, and EUIs expressed in kWh/square foot for the commercial and industrial sectors.
- **Intensity** for the residential sector represents the average energy use for the technology across all households in the base year. It is computed as the product of the saturation and the UEC and is defined as kWh/household for electricity. For the commercial and industrial sector, intensity, computed as the product of the saturation and the EUI, represents the average use for the technology across all floor space.
- **Usage** is the annual energy use by a technology/end use in the segment. It is the product of the market size and intensity and is quantified in GWh for electricity.

This appendix presents the following market profiles:

- Residential market profiles by housing type and state (Table A-1 through Table A-8)
- C&I by rate class and state (Table A-9 through Table A-16)

Market Profiles

Table A-1 Single Family Electric Market Profile, Washington 2009

Average Market Profile						New Units			
End Use	Technology	Saturation	UEC (kWh)	Intensity (kWh/HH)	Usage (GWh)	Saturation	UEC (kWh)	Intensity (kWh/HH)	Compared to Average
Cooling	Central AC	36.8%	1,393	513	56	66.1%	1,601	1,058	15.0%
Cooling	Room AC	10.8%	512	55	6	8.7%	589	51	15.0%
Cooling	Air Source Heat Pump	22.2%	833	185	20	23.3%	958	223	15.0%
Cooling	Geothermal Heat Pump	0.4%	730	3	0	0.4%	840	4	15.0%
Cooling	Ductless HP	0.0%	456	-	-	0.0%	524	-	15.0%
Space Heating	Electric Resistance	7.7%	10,302	792	86	3.8%	11,847	455	15.0%
Space Heating	Electric Furnace	9.8%	11,757	1,157	126	8.9%	13,521	1,198	15.0%
Space Heating	Supplemental	3.3%	117	4	0	3.3%	134	4	15.0%
Space Heating	Air Source Heat Pump	22.2%	8,561	1,903	208	22.2%	9,845	2,188	15.0%
Space Heating	Geothermal Heat Pump	0.4%	4,833	20	2	0.4%	5,558	23	15.0%
Space Heating	Ductless HP	0.0%	4,000	-	-	0.0%	4,600	-	15.0%
Water Heating	Water Heater <= 55 Gal	53.2%	4,031	2,143	234	48.6%	3,684	1,790	-8.6%
Water Heating	Water Heater > 55 Gal	5.6%	4,552	257	28	5.2%	4,157	214	-8.7%
Interior Lighting	Screw-in	100.0%	1,295	1,295	141	100.0%	1,425	1,425	10.0%
Interior Lighting	Linear Fluorescent	100.0%	128	128	14	100.0%	141	141	10.0%
Interior Lighting	Specialty	100.0%	356	356	39	100.0%	409	409	15.0%
Exterior Lighting	Screw-in	100.0%	363	363	40	100.0%	400	400	10.0%
Appliances	Clothes Washer	98.0%	126	124	13	99.8%	95	94	-25.0%
Appliances	Clothes Dryer	92.8%	549	509	56	97.4%	466	454	-15.0%
Appliances	Dishwasher	93.9%	434	407	44	98.6%	369	364	-15.0%
Appliances	Refrigerator	100.0%	793	793	87	100.0%	539	539	-32.0%
Appliances	Freezer	59.9%	881	528	58	69.4%	554	384	-37.1%
Appliances	Second Refrigerator	31.3%	1,083	339	37	31.3%	693	217	-36.0%
Appliances	Stove	85.1%	443	377	41	82.1%	443	364	0.0%
Appliances	Microwave	98.5%	130	128	14	98.5%	134	132	3.0%
Electronics	Personal Computers	140.0%	227	317	35	154.0%	227	349	0.0%
Electronics	TVs	234.0%	240	562	61	245.7%	240	590	0.0%
Electronics	Set-top boxes/DVR	171.7%	136	234	26	188.8%	136	257	0.0%
Electronics	Devices and Gadgets	100.0%	60	60	7	105.0%	67	70	10.0%
Miscellaneous	Pool Pump	5.0%	1,500	75	8	5.3%	1,526	80	1.7%
Miscellaneous	Furnace Fan	59.4%	622	370	40	62.4%	622	388	0.0%
Miscellaneous	Miscellaneous	100.0%	549	549	60	100.0%	604	604	10.0%
Total				14,547	1,588			14,471	-0.5%

Table A-2 Multi Family Electric Market Profile, Washington 2009

Average Market Profile						New Units			
End Use	Technology	Saturation	UEC (kWh)	Intensity (kWh/HH)	Usage (GWh)	Saturation	UEC (kWh)	Intensity (kWh/HH)	Compared to Average
Cooling	Central AC	5.0%	464	23	0	15.0%	534	80	15.0%
Cooling	Room AC	25.0%	355	89	2	18.9%	409	77	15.0%
Cooling	Air Source Heat Pump	1.0%	429	4	0	1.1%	493	5	15.0%
Cooling	Geothermal Heat Pump	0.0%	444	-	-	0.2%	511	1	15.0%
Cooling	Ductless HP	0.0%	229	-	-	0.0%	263	-	15.0%
Space Heating	Electric Resistance	59.0%	5,180	3,056	56	47.2%	5,957	2,812	15.0%
Space Heating	Electric Furnace	5.0%	5,162	258	5	6.0%	5,936	356	15.0%
Space Heating	Supplemental	18.0%	61	11	0	18.0%	70	13	15.0%
Space Heating	Air Source Heat Pump	1.0%	3,220	32	1	1.0%	3,703	37	15.0%
Space Heating	Geothermal Heat Pump	0.0%	2,898	-	-	0.0%	3,333	-	15.0%
Space Heating	Ductless HP	0.0%	2,011	-	-	0.0%	2,313	-	15.0%
Water Heating	Water Heater <= 55 Gal	77.0%	2,142	1,650	30	75.0%	1,958	1,469	-8.6%
Water Heating	Water Heater > 55 Gal	0.0%	3,142	-	-	0.0%	2,870	-	-8.7%
Interior Lighting	Screw-in	100.0%	784	784	14	100.0%	863	863	10.0%
Interior Lighting	Linear Fluorescent	100.0%	89	89	2	100.0%	98	98	10.0%
Interior Lighting	Specialty	100.0%	143	143	3	100.0%	164	164	15.0%
Exterior Lighting	Screw-in	100.0%	21	21	0	100.0%	23	23	10.0%
Appliances	Clothes Washer	32.0%	101	32	1	48.0%	76	36	-25.0%
Appliances	Clothes Dryer	30.7%	439	135	2	46.1%	373	172	-15.0%
Appliances	Dishwasher	64.0%	347	222	4	96.0%	295	283	-15.0%
Appliances	Refrigerator	100.0%	634	634	12	100.0%	431	431	-32.0%
Appliances	Freezer	8.4%	705	59	1	8.9%	443	39	-37.1%
Appliances	Second Refrigerator	5.0%	866	43	1	5.0%	554	28	-36.0%
Appliances	Stove	96.4%	354	342	6	96.4%	354	342	0.0%
Appliances	Microwave	90.0%	104	94	2	90.0%	107	96	3.0%
Electronics	Personal Computers	63.0%	181	114	2	69.3%	181	126	0.0%
Electronics	TVs	165.0%	216	357	7	173.3%	216	375	0.0%
Electronics	Set-top boxes/DVR	154.5%	136	211	4	170.0%	136	232	0.0%
Electronics	Devices and Gadgets	100.0%	54	54	1	105.0%	60	63	10.0%
Miscellaneous	Pool Pump	0.0%	1,500	-	-	0.0%	1,526	-	1.7%
Miscellaneous	Furnace Fan	13.0%	498	65	1	13.7%	498	68	0.0%
Miscellaneous	Miscellaneous	100.0%	206	206	4	100.0%	226	226	10.0%
Total				8,728	159			8,514	-2.5%

Market Profiles

Table A-3 Mobile Home Electric Market Profile, Washington 2009

Average Market Profile						New Units			
End Use	Technology	Saturation	UEC (kWh)	Intensity (kWh/HH)	Usage (GWh)	Saturation	UEC (kWh)	Intensity (kWh/HH)	Compared to Average
Cooling	Central AC	23.2%	553	128	1	39.4%	594	234	7.5%
Cooling	Room AC	23.2%	305	71	0	22.0%	328	72	7.5%
Cooling	Air Source Heat Pump	21.7%	361	79	0	22.8%	388	89	7.5%
Cooling	Geothermal Heat Pump	0.0%	325	-	-	0.0%	349	-	7.5%
Cooling	Ductless HP	0.0%	302	-	-	0.0%	324	-	7.5%
Space Heating	Electric Resistance	1.2%	6,823	81	0	1.1%	7,335	83	7.5%
Space Heating	Electric Furnace	57.6%	7,321	4,214	22	57.6%	7,870	4,530	7.5%
Space Heating	Supplemental	1.4%	3,780	54	0	1.5%	4,064	61	7.5%
Space Heating	Air Source Heat Pump	21.7%	4,667	1,015	5	22.8%	5,017	1,146	7.5%
Space Heating	Geothermal Heat Pump	0.0%	4,200	-	-	0.2%	4,515	9	7.5%
Space Heating	Ductless HP	0.0%	2,649	-	-	0.0%	2,848	-	7.5%
Water Heating	Water Heater <= 55 Gal	75.6%	2,620	1,980	10	75.6%	2,508	1,895	-4.3%
Water Heating	Water Heater > 55 Gal	0.0%	2,959	-	-	0.0%	2,831	-	-4.3%
Interior Lighting	Screw-in	100.0%	1,010	1,010	5	100.0%	1,061	1,061	5.0%
Interior Lighting	Linear Fluorescent	100.0%	100	100	1	100.0%	105	105	5.0%
Interior Lighting	Specialty	100.0%	278	278	1	100.0%	298	298	7.5%
Exterior Lighting	Screw-in	100.0%	283	283	1	100.0%	298	298	5.0%
Appliances	Clothes Washer	86.7%	98	85	0	86.7%	86	75	-12.5%
Appliances	Clothes Dryer	88.9%	428	380	2	88.9%	396	352	-7.5%
Appliances	Dishwasher	80.1%	338	271	1	84.1%	313	263	-7.5%
Appliances	Refrigerator	100.0%	618	618	3	100.0%	520	520	-16.0%
Appliances	Freezer	53.3%	687	366	2	53.3%	559	298	-18.6%
Appliances	Second Refrigerator	17.6%	845	148	1	17.6%	693	122	-18.0%
Appliances	Stove	84.5%	345	292	2	84.5%	345	292	0.0%
Appliances	Microwave	93.6%	101	95	0	93.6%	103	96	1.5%
Electronics	Personal Computers	104.8%	193	202	1	110.1%	193	212	0.0%
Electronics	TVs	234.0%	204	478	3	234.0%	204	478	0.0%
Electronics	Set-top boxes/DVR	154.5%	116	179	1	170.0%	116	197	0.0%
Electronics	Devices and Gadgets	100.0%	51	51	0	100.0%	54	54	5.0%
Miscellaneous	Pool Pump	5.6%	1,125	63	0	5.8%	1,135	66	0.8%
Miscellaneous	Furnace Fan	63.3%	467	296	2	63.3%	467	296	0.0%
Miscellaneous	Miscellaneous	100.0%	274	274	1	100.0%	288	288	5.0%
Total				13,092	69			13,488	3.0%

Table A-4 Low Income Electric Market Profile, Washington 2009

Average Market Profile						New Units			
End Use	Technology	Saturation	UEC (kWh)	Intensity (kWh/HH)	Usage (GWh)	Saturation	UEC (kWh)	Intensity (kWh/HH)	Compared to Average
Cooling	Central AC	22.2%	591	131	9	28.7%	635	182	7.5%
Cooling	Room AC	35.4%	289	102	7	18.0%	311	56	7.5%
Cooling	Air Source Heat Pump	10.4%	467	49	3	10.4%	502	52	7.5%
Cooling	Geothermal Heat Pump	0.0%	437	-	-	0.5%	470	2	7.5%
Cooling	Ductless HP	0.0%	262	-	-	0.0%	281	-	7.5%
Space Heating	Electric Resistance	32.0%	5,914	1,891	128	28.8%	6,358	1,830	7.5%
Space Heating	Electric Furnace	9.9%	6,413	637	43	8.9%	6,894	614	7.5%
Space Heating	Supplemental	12.7%	364	46	3	13.4%	392	52	7.5%
Space Heating	Air Source Heat Pump	10.4%	4,401	459	31	10.4%	4,731	493	7.5%
Space Heating	Geothermal Heat Pump	0.0%	3,042	-	-	0.0%	3,270	-	7.5%
Space Heating	Ductless HP	0.0%	2,296	-	-	0.0%	2,468	-	7.5%
Water Heating	Water Heater <= 55 Gal	83.9%	2,357	1,977	133	83.9%	2,255	1,892	-4.3%
Water Heating	Water Heater > 55 Gal	0.0%	2,950	-	-	0.0%	2,822	-	-4.3%
Interior Lighting	Screw-in	100.0%	758	758	51	100.0%	796	796	5.0%
Interior Lighting	Linear Fluorescent	100.0%	79	79	5	100.0%	83	83	5.0%
Interior Lighting	Specialty	100.0%	181	181	12	100.0%	195	195	7.5%
Exterior Lighting	Screw-in	100.0%	138	138	9	100.0%	145	145	5.0%
Appliances	Clothes Washer	71.3%	89	63	4	78.4%	78	61	-12.5%
Appliances	Clothes Dryer	68.6%	385	264	18	75.4%	356	269	-7.5%
Appliances	Dishwasher	78.5%	305	239	16	86.3%	282	243	-7.5%
Appliances	Refrigerator	100.0%	557	557	38	100.0%	468	468	-16.0%
Appliances	Freezer	63.0%	619	390	26	63.0%	504	317	-18.6%
Appliances	Second Refrigerator	23.4%	761	178	12	23.4%	624	146	-18.0%
Appliances	Stove	89.7%	311	279	19	89.7%	311	279	0.0%
Appliances	Microwave	92.6%	91	85	6	92.6%	93	86	1.5%
Electronics	Personal Computers	101.4%	160	163	11	106.5%	160	171	0.0%
Electronics	TVs	165.0%	180	297	20	165.0%	180	297	0.0%
Electronics	Set-top boxes/DVR	128.8%	107	138	9	141.6%	107	152	0.0%
Electronics	Devices and Gadgets	100.0%	45	45	3	105.0%	48	50	5.0%
Miscellaneous	Pool Pump	2.3%	1,170	27	2	2.3%	1,180	27	0.8%
Miscellaneous	Furnace Fan	25.2%	436	110	7	25.2%	436	110	0.0%
Miscellaneous	Miscellaneous	100.0%	140	140	9	100.0%	147	147	5.0%
Total					9,424	636	9,215		-2.2%

Market Profiles

Table A-5 Single Family Electric Market Profile, Idaho 2009

Average Market Profile						New Units			
End Use	Technology	Saturation	UEC (kWh)	Intensity (kWh/HH)	Usage (GWh)	Saturation	UEC (kWh)	Intensity (kWh/HH)	Compared to Average
Cooling	Central AC	23.2%	1,253	291	17	66.1%	1,441	952	15.0%
Cooling	Room AC	10.8%	461	50	3	8.7%	530	46	15.0%
Cooling	Air Source Heat Pump	14.6%	750	109	6	15.3%	862	132	15.0%
Cooling	Geothermal Heat Pump	1.2%	657	8	0	0.8%	756	6	15.0%
Cooling	Ductless HP	0.0%	478	-	-	0.0%	550	-	15.0%
Space Heating	Electric Resistance	13.3%	10,817	1,436	85	6.6%	12,440	825	15.0%
Space Heating	Electric Furnace	5.5%	12,345	679	40	4.9%	14,197	702	15.0%
Space Heating	Supplemental	4.4%	111	5	0	4.4%	128	6	15.0%
Space Heating	Air Source Heat Pump	14.6%	8,989	1,310	78	14.6%	10,338	1,506	15.0%
Space Heating	Geothermal Heat Pump	1.2%	5,075	58	3	1.2%	5,836	67	15.0%
Space Heating	Ductless HP	0.0%	4,200	-	-	0.0%	4,830	-	15.0%
Water Heating	Water Heater <= 55 Gal	46.4%	4,233	1,962	116	42.4%	3,869	1,639	-8.6%
Water Heating	Water Heater > 55 Gal	5.6%	4,779	270	16	5.2%	4,365	225	-8.7%
Interior Lighting	Screw-in	100.0%	1,360	1,360	81	100.0%	1,496	1,496	10.0%
Interior Lighting	Linear Fluorescent	100.0%	134	134	8	100.0%	148	148	10.0%
Interior Lighting	Specialty	100.0%	374	374	22	100.0%	430	430	15.0%
Exterior Lighting	Screw-in	100.0%	381	381	23	100.0%	420	420	10.0%
Appliances	Clothes Washer	98.0%	126	124	7	99.8%	95	94	-25.0%
Appliances	Clothes Dryer	92.8%	549	509	30	97.4%	466	454	-15.0%
Appliances	Dishwasher	93.9%	434	407	24	98.6%	369	364	-15.0%
Appliances	Refrigerator	100.0%	793	793	47	100.0%	539	539	-32.0%
Appliances	Freezer	59.8%	881	527	31	69.4%	554	384	-37.1%
Appliances	Second Refrigerator	24.8%	1,083	269	16	24.8%	693	172	-36.0%
Appliances	Stove	74.8%	443	331	20	82.1%	487	400	10.0%
Appliances	Microwave	98.5%	130	128	8	98.5%	134	132	3.0%
Electronics	Personal Computers	140.0%	227	317	19	154.0%	227	349	0.0%
Electronics	TVs	231.0%	240	555	33	242.6%	240	583	0.0%
Electronics	Set-top boxes/DVR	153.5%	136	209	12	168.9%	136	230	0.0%
Electronics	Devices and Gadgets	100.0%	60	60	4	105.0%	67	70	10.0%
Miscellaneous	Pool Pump	7.0%	1,500	105	6	7.4%	1,526	112	1.7%
Miscellaneous	Furnace Fan	54.9%	654	359	21	57.7%	654	377	0.0%
Miscellaneous	Miscellaneous	100.0%	584	584	35	100.0%	642	642	10.0%
Total			1,253	13,703	811			13,502	-1.5%

Table A-6 Multi Family Electric Market Profile, Idaho 2009

Average Market Profile						New Units			
End Use	Technology	Saturation	UEC (kWh)	Intensity (kWh/HH)	Usage (GWh)	Saturation	UEC (kWh)	Intensity (kWh/HH)	Compared to Average
Cooling	Central AC	5.0%	395	20	0	15.0%	454	68	15.0%
Cooling	Room AC	25.0%	302	75	0	18.9%	347	66	15.0%
Cooling	Air Source Heat Pump	1.0%	365	4	0	1.1%	419	4	15.0%
Cooling	Geothermal Heat Pump	0.0%	377	-	-	0.2%	434	1	15.0%
Cooling	Ductless HP	0.0%	215	-	-	0.0%	248	-	15.0%
Space Heating	Electric Resistance	59.0%	4,869	2,873	15	47.2%	5,599	2,643	15.0%
Space Heating	Electric Furnace	5.0%	4,852	243	1	6.0%	5,580	335	15.0%
Space Heating	Supplemental	18.0%	58	10	0	18.0%	66	12	15.0%
Space Heating	Air Source Heat Pump	1.0%	3,027	30	0	1.0%	3,481	35	15.0%
Space Heating	Geothermal Heat Pump	0.0%	2,724	-	-	0.0%	3,133	-	15.0%
Space Heating	Ductless HP	0.0%	1,890	-	-	0.0%	2,174	-	15.0%
Water Heating	Water Heater <= 55 Gal	77.0%	2,014	1,551	8	75.0%	1,841	1,380	-8.6%
Water Heating	Water Heater > 55 Gal	0.0%	2,954	-	-	0.0%	2,698	-	-8.7%
Interior Lighting	Screw-in	100.0%	737	737	4	100.0%	811	811	10.0%
Interior Lighting	Linear Fluorescent	100.0%	84	84	0	100.0%	92	92	10.0%
Interior Lighting	Specialty	100.0%	134	134	1	100.0%	154	154	15.0%
Exterior Lighting	Screw-in	100.0%	20	20	0	100.0%	22	22	10.0%
Appliances	Clothes Washer	32.0%	95	30	0	48.0%	71	34	-25.0%
Appliances	Clothes Dryer	30.7%	412	127	1	46.1%	351	161	-15.0%
Appliances	Dishwasher	64.0%	326	209	1	96.0%	277	266	-15.0%
Appliances	Refrigerator	100.0%	596	596	3	100.0%	405	405	-32.0%
Appliances	Freezer	8.4%	662	56	0	8.9%	416	37	-37.1%
Appliances	Second Refrigerator	5.0%	814	41	0	5.0%	521	26	-36.0%
Appliances	Stove	96.4%	333	321	2	96.4%	333	321	0.0%
Appliances	Microwave	90.0%	98	88	0	90.0%	101	91	3.0%
Electronics	Personal Computers	63.0%	170	107	1	69.3%	170	118	0.0%
Electronics	TVs	165.0%	203	335	2	173.3%	203	352	0.0%
Electronics	Set-top boxes/DVR	154.5%	128	198	1	170.0%	128	218	0.0%
Electronics	Devices and Gadgets	100.0%	51	51	0	105.0%	56	59	10.0%
Miscellaneous	Pool Pump	0.0%	1,410	-	-	0.0%	1,434	-	1.7%
Miscellaneous	Furnace Fan	13.0%	468	61	0	13.7%	468	64	0.0%
Miscellaneous	Miscellaneous	100.0%	213	213	1	100.0%	234	234	10.0%
Total					8,213	43	8,010		-2.5%

Market Profiles

Table A-7 Mobile Home Electric Market Profile, Idaho 2009

Average Market Profile						New Units			
End Use	Technology	Saturation	UEC (kWh)	Intensity (kWh/HH)	Usage (GWh)	Saturation	UEC (kWh)	Intensity (kWh/HH)	Compared to Average
Cooling	Central AC	23.2%	475	110	1	39.4%	511	201	7.5%
Cooling	Room AC	23.2%	262	61	0	22.0%	282	62	7.5%
Cooling	Air Source Heat Pump	21.7%	311	68	0	22.8%	334	76	7.5%
Cooling	Geothermal Heat Pump	0.0%	280	-	-	0.0%	300	-	7.5%
Cooling	Ductless HP	0.0%	285	-	-	0.0%	307	-	7.5%
Space Heating	Electric Resistance	1.2%	6,448	77	0	1.1%	6,931	78	7.5%
Space Heating	Electric Furnace	57.6%	6,918	3,982	19	57.6%	7,437	4,281	7.5%
Space Heating	Supplemental	1.4%	3,572	51	0	1.5%	3,840	58	7.5%
Space Heating	Air Source Heat Pump	21.7%	4,410	959	5	22.8%	4,741	1,083	7.5%
Space Heating	Geothermal Heat Pump	0.0%	3,969	-	-	0.0%	4,267	-	7.5%
Space Heating	Ductless HP	0.0%	2,503	-	-	0.0%	2,691	-	7.5%
Water Heating	Water Heater <= 55 Gal	75.6%	2,476	1,871	9	75.6%	2,370	1,791	-4.3%
Water Heating	Water Heater > 55 Gal	0.0%	2,796	-	-	0.0%	2,675	-	-4.3%
Interior Lighting	Screw-in	100.0%	955	955	5	100.0%	1,003	1,003	5.0%
Interior Lighting	Linear Fluorescent	100.0%	94	94	0	100.0%	99	99	5.0%
Interior Lighting	Specialty	100.0%	262	262	1	100.0%	282	282	7.5%
Exterior Lighting	Screw-in	100.0%	268	268	1	100.0%	281	281	5.0%
Appliances	Clothes Washer	86.7%	93	81	0	86.7%	81	71	-12.5%
Appliances	Clothes Dryer	88.9%	404	359	2	88.9%	374	332	-7.5%
Appliances	Dishwasher	80.1%	320	256	1	84.1%	296	249	-7.5%
Appliances	Refrigerator	100.0%	584	584	3	100.0%	491	491	-16.0%
Appliances	Freezer	53.3%	649	346	2	53.3%	529	282	-18.6%
Appliances	Second Refrigerator	17.6%	798	140	1	17.6%	655	115	-18.0%
Appliances	Stove	84.5%	326	276	1	84.5%	326	276	0.0%
Appliances	Microwave	93.6%	96	90	0	93.6%	97	91	1.5%
Electronics	Personal Computers	104.8%	182	191	1	110.1%	182	200	0.0%
Electronics	TVs	234.0%	193	452	2	234.0%	193	452	0.0%
Electronics	Set-top boxes/DVR	154.5%	110	169	1	170.0%	110	186	0.0%
Electronics	Devices and Gadgets	100.0%	49	49	0	100.0%	51	51	5.0%
Miscellaneous	Pool Pump	5.6%	1,063	59	0	5.8%	1,072	63	0.8%
Miscellaneous	Furnace Fan	63.3%	441	279	1	63.3%	441	279	0.0%
Miscellaneous	Miscellaneous	100.0%	230	230	1	100.0%	242	242	5.0%
Total				12,320	59			12,674	2.9%

Table A-8 Low income Electric Market Profile, Idaho 2009

Average Market Profile						New Units			
End Use	Technology	Saturation	UEC (kWh)	Intensity (kWh/HH)	Usage (GWh)	Saturation	UEC (kWh)	Intensity (kWh/HH)	Compared to Average
Cooling	Central AC	22.2%	414	92	3	28.7%	445	128	7.5%
Cooling	Room AC	35.4%	202	72	2	18.0%	218	39	7.5%
Cooling	Air Source Heat Pump	10.4%	327	34	1	10.4%	351	37	7.5%
Cooling	Geothermal Heat Pump	0.0%	306	-	-	0.5%	329	2	7.5%
Cooling	Ductless HP	0.0%	249	-	-	0.0%	267	-	7.5%
Space Heating	Electric Resistance	32.0%	5,619	1,797	55	28.8%	6,040	1,738	7.5%
Space Heating	Electric Furnace	11.2%	6,092	680	21	10.0%	6,549	655	7.5%
Space Heating	Supplemental	12.7%	346	44	1	13.4%	372	50	7.5%
Space Heating	Air Source Heat Pump	10.4%	4,181	436	13	10.4%	4,494	468	7.5%
Space Heating	Geothermal Heat Pump	0.0%	2,890	-	-	0.0%	3,107	-	7.5%
Space Heating	Ductless HP	0.0%	2,181	-	-	0.0%	2,345	-	7.5%
Water Heating	Water Heater <= 55 Gal	83.9%	2,203	1,848	56	83.9%	2,109	1,769	-4.3%
Water Heating	Water Heater > 55 Gal	0.0%	2,758	-	-	0.0%	2,639	-	-4.3%
Interior Lighting	Screw-in	100.0%	709	709	22	100.0%	745	745	5.0%
Interior Lighting	Linear Fluorescent	100.0%	74	74	2	100.0%	78	78	5.0%
Interior Lighting	Specialty	100.0%	169	169	5	100.0%	182	182	7.5%
Exterior Lighting	Screw-in	100.0%	129	129	4	100.0%	136	136	5.0%
Appliances	Clothes Washer	71.3%	83	59	2	78.4%	72	57	-12.5%
Appliances	Clothes Dryer	68.6%	360	247	7	75.4%	333	251	-7.5%
Appliances	Dishwasher	78.5%	285	224	7	86.3%	263	227	-7.5%
Appliances	Refrigerator	100.0%	521	521	16	100.0%	437	437	-16.0%
Appliances	Freezer	63.0%	578	364	11	63.0%	471	297	-18.6%
Appliances	Second Refrigerator	23.4%	711	167	5	23.4%	583	137	-18.0%
Appliances	Stove	89.7%	291	261	8	89.7%	291	261	0.0%
Appliances	Microwave	92.6%	85	79	2	92.6%	87	80	1.5%
Electronics	Personal Computers	101.4%	150	152	5	106.5%	150	160	0.0%
Electronics	TVs	165.0%	168	277	8	165.0%	168	277	0.0%
Electronics	Set-top boxes/DVR	128.8%	100	129	4	141.6%	100	142	0.0%
Electronics	Devices and Gadgets	100.0%	42	42	1	105.0%	44	47	5.0%
Miscellaneous	Pool Pump	2.3%	1,094	25	1	2.3%	1,103	25	0.8%
Miscellaneous	Furnace Fan	25.2%	407	103	3	25.2%	407	103	0.0%
Miscellaneous	Miscellaneous	100.0%	133	133	4	100.0%	140	140	5.0%
Total					8,868	269	8,666		-2.3%

Market Profiles

Table A-9 Small/Medium Commercial Electric Market Profile, Washington 2009

Average Market Profile						New Units			
End Use	Technology	Saturation	UEC (kWh)	Intensity (kWh/HH)	Usage (GWh)	Saturation	UEC (kWh)	Intensity (kWh/HH)	Compared to Average
Cooling	Central Chiller	13.8%	2	0	8	13.8%	2	0	-13.6%
Cooling	RTU	63.1%	2	2	37	63.1%	2	1	-15.9%
Cooling	Heat Pump	3.6%	5	0	4	3.6%	4	0	-15.9%
Space Heating	Electric Resistance	5.9%	7	0	9	5.9%	6	0	-5.0%
Space Heating	Furnace	17.7%	7	1	30	17.7%	7	1	-5.0%
Space Heating	Heat Pump	3.6%	4	0	3	3.6%	3	0	-6.8%
Ventilation	Ventilation	76.9%	2	2	38	76.9%	2	1	-14.8%
Interior Lighting	Interior Screw-in	100.0%	1	1	24	100.0%	1	1	-1.2%
Interior Lighting	High Bay Fixtures	100.0%	1	1	16	100.0%	1	1	-20.0%
Interior Lighting	Linear Fluorescent	100.0%	3	3	80	100.0%	3	3	-12.7%
Exterior Lighting	Exterior Screw-in	100.0%	0	0	4	100.0%	0	0	-26.0%
Exterior Lighting	HID	100.0%	1	1	18	100.0%	1	1	-26.4%
Water Heating	Water Heater	63.0%	2	1	30	63.0%	2	1	-6.0%
Food Preparation	Fryer	25.8%	0	0	1	30.8%	0	0	-0.6%
Food Preparation	Oven	25.8%	1	0	6	35.8%	1	0	-1.2%
Food Preparation	Dishwasher	25.8%	0	0	0	35.8%	0	0	-24.1%
Food Preparation	Hot Food Container	25.8%	0	0	2	35.8%	0	0	-20.0%
Food Preparation	Food Prep	25.8%	0	0	0	35.8%	0	0	-20.0%
Refrigeration	Walk in Refrigeration	52.4%	-	-	-	62.4%	-	-	0.0%
Refrigeration	Glass Door Display	52.4%	0	0	6	57.4%	0	0	-8.8%
Refrigeration	Reach-in Refrigerator	52.4%	1	0	6	57.4%	0	0	-30.0%
Refrigeration	Open Display Case	52.4%	0	0	1	57.4%	0	0	-8.4%
Refrigeration	Vending Machine	52.4%	0	0	4	57.4%	0	0	-12.8%
Refrigeration	Icemaker	52.4%	0	0	4	57.4%	0	0	-11.9%
Office Equipment	Desktop Computer	99.9%	0	0	11	104.9%	0	1	-0.7%
Office Equipment	Laptop Computer	99.9%	0	0	1	104.9%	0	0	-0.7%
Office Equipment	Server	99.9%	0	0	9	104.9%	0	0	-4.7%
Office Equipment	Monitor	99.9%	0	0	6	104.9%	0	0	-2.8%
Office Equipment	Printer/copier/fax	99.9%	0	0	6	104.9%	0	0	-6.1%
Office Equipment	POS Terminal	99.9%	0	0	7	104.9%	0	0	-15.6%
Miscellaneous	Non-HVAC Motor	40.2%	1	0	12	40.2%	1	1	5.1%
Miscellaneous	Other Miscellaneous	100.0%	1	1	34	100.0%	2	2	20.0%
Total					18			16	-6.9%

Table A-10 Large Commercial Electric Market Profile, Washington 2009

Average Market Profile						New Units			
End Use	Technology	Saturation	UEC (kWh)	Intensity (kWh/HH)	Usage (GWh)	Saturation	UEC (kWh)	Intensity (kWh/HH)	Compared to Average
Cooling	Central Chiller	24.7%	2	1	49	24.7%	2	0	-16.9%
Cooling	RTU	37.8%	3	1	89	37.8%	2	1	-17.4%
Cooling	Heat Pump	9.1%	4	0	30	9.1%	3	0	-16.9%
Space Heating	Electric Resistance	5.9%	4	0	20	5.9%	3	0	-12.6%
Space Heating	Furnace	12.7%	5	1	55	12.7%	4	1	-12.6%
Space Heating	Heat Pump	9.1%	2	0	20	9.1%	2	0	-3.5%
Ventilation	Ventilation	75.1%	2	1	116	75.1%	1	1	-14.8%
Interior Lighting	Interior Screw-in	100.0%	1	1	88	100.0%	1	1	-1.4%
Interior Lighting	High Bay Fixtures	100.0%	1	1	66	100.0%	1	1	-20.0%
Interior Lighting	Linear Fluorescent	100.0%	3	3	307	100.0%	3	3	-13.6%
Exterior Lighting	Exterior Screw-in	100.0%	0	0	9	100.0%	0	0	-18.1%
Exterior Lighting	HID	100.0%	1	1	65	100.0%	1	1	-26.4%
Water Heating	Water Heater	54.2%	2	1	117	54.2%	2	1	-4.0%
Food Preparation	Fryer	18.4%	0	0	6	23.4%	0	0	-0.6%
Food Preparation	Oven	18.4%	2	0	32	28.4%	2	1	-1.2%
Food Preparation	Dishwasher	18.4%	0	0	3	28.4%	0	0	-24.1%
Food Preparation	Hot Food Container	18.4%	0	0	5	28.4%	0	0	-39.9%
Food Preparation	Food Prep	18.4%	0	0	0	28.4%	0	0	-20.0%
Refrigeration	Walk in Refrigeration	39.1%	0	0	17	49.1%	0	0	-30.0%
Refrigeration	Glass Door Display	39.1%	0	0	13	44.1%	0	0	-9.7%
Refrigeration	Reach-in Refrigerator	39.1%	1	0	28	44.1%	1	0	-30.0%
Refrigeration	Open Display Case	39.1%	0	0	10	44.1%	0	0	-9.3%
Refrigeration	Vending Machine	39.1%	0	0	13	44.1%	0	0	-12.8%
Refrigeration	Icemaker	39.1%	1	0	24	44.1%	1	0	-12.2%
Office Equipment	Desktop Computer	98.4%	1	1	82	103.4%	1	1	-0.7%
Office Equipment	Laptop Computer	98.4%	0	0	6	103.4%	0	0	-0.7%
Office Equipment	Server	98.4%	0	0	38	103.4%	0	0	-4.7%
Office Equipment	Monitor	98.4%	0	0	19	103.4%	0	0	-2.8%
Office Equipment	Printer/copier/fax	98.4%	0	0	19	103.4%	0	0	-6.1%
Office Equipment	POS Terminal	98.4%	0	0	6	103.4%	0	0	-15.6%
Miscellaneous	Non-HVAC Motor	57.7%	1	1	75	57.7%	1	1	5.1%
Miscellaneous	Other Miscellaneous	100.0%	1	1	127	100.0%	2	2	10.0%
Total					17	1,557		16	-6.8%

Market Profiles

Table A-11 Extra Large Commercial Electric Market Profile, Washington 2009

Average Market Profile						New Units			
End Use	Technology	Saturation	UEC (kWh)	Intensity (kWh/HH)	Usage (GWh)	Saturation	UEC (kWh)	Intensity (kWh/HH)	Compared to Average
Cooling	Central Chiller	52.2%	2	1	21	52.2%	2	1	-14.7%
Cooling	RTU	24.7%	2	1	10	24.7%	2	0	-16.7%
Cooling	Heat Pump	4.4%	2	0	2	4.4%	2	0	-26.2%
Space Heating	Electric Resistance	15.8%	4	1	13	15.8%	4	1	-13.1%
Space Heating	Furnace	5.6%	6	0	6	5.6%	5	0	-13.1%
Space Heating	Heat Pump	90.2%	2	2	33	90.2%	2	2	-12.1%
Ventilation	Ventilation	100.0%	1	1	26	100.0%	1	1	-2.7%
Interior Lighting	Interior Screw-in	100.0%	0	0	6	100.0%	0	0	-20.0%
Interior Lighting	High Bay Fixtures	100.0%	2	2	42	100.0%	2	2	-8.3%
Interior Lighting	Linear Fluorescent	100.0%	0	0	1	100.0%	0	0	-51.9%
Exterior Lighting	Exterior Screw-in	100.0%	1	1	17	100.0%	1	1	-26.4%
Exterior Lighting	HID	26.3%	4	1	19	26.3%	4	1	-2.0%
Water Heating	Water Heater	13.8%	0	0	0	18.8%	0	0	-0.6%
Food Preparation	Fryer	13.8%	2	0	6	23.8%	2	0	-1.2%
Food Preparation	Oven	13.8%	0	0	0	23.8%	0	0	-24.1%
Food Preparation	Dishwasher	13.8%	0	0	0	23.8%	0	0	-39.9%
Food Preparation	Hot Food Container	13.8%	0	0	0	23.8%	0	0	0.0%
Food Preparation	Food Prep	26.6%	0	0	1	36.6%	0	0	-30.0%
Refrigeration	Walk in Refrigeration	26.6%	0	0	1	31.6%	0	0	-9.7%
Refrigeration	Glass Door Display	26.6%	1	0	4	31.6%	0	0	-30.0%
Refrigeration	Reach-in Refrigerator	26.6%	0	0	3	31.6%	0	0	-9.3%
Refrigeration	Open Display Case	26.6%	0	0	2	31.6%	0	0	-27.9%
Refrigeration	Vending Machine	26.6%	0	0	2	31.6%	0	0	-11.4%
Refrigeration	Icemaker	100.0%	1	1	12	105.0%	1	1	-0.7%
Office Equipment	Desktop Computer	100.0%	0	0	1	105.0%	0	0	-0.7%
Office Equipment	Laptop Computer	100.0%	0	0	3	105.0%	0	0	-4.7%
Office Equipment	Server	100.0%	0	0	2	105.0%	0	0	-2.8%
Office Equipment	Monitor	100.0%	0	0	1	105.0%	0	0	-6.1%
Office Equipment	Printer/copier/fax	100.0%	0	0	0	105.0%	0	0	-15.6%
Office Equipment	POS Terminal	88.8%	1	1	14	88.8%	1	1	5.1%
Miscellaneous	Non-HVAC Motor	100.0%	1	1	15	100.0%	1	1	10.0%
Miscellaneous	Other Miscellaneous	4.4%	3	0	3	4.4%	3	0	-3.1%
Total					14	266		13	-6.0%

Table A-12 Extra Large Industrial Electric Market Profile, Washington 2009

Average Market Profile						New Units			
End Use	Technology	Saturation	UEC (kWh)	Intensity (kWh/HH)	Usage (GWh)	Saturation	UEC (kWh)	Intensity (kWh/HH)	Compared to Average
Cooling	Central Chiller	14.4%	8	1	18	14.4%	7	1	-11.7%
Cooling	RTU	17.1%	6	1	17	17.1%	6	1	-12.3%
Cooling	Heat Pump	2.7%	5	0	2	2.7%	4	0	-20.9%
Space Heating	Electric Resistance	10.8%	9	1	14	10.8%	8	1	-5.0%
Space Heating	Furnace	2.0%	9	0	3	2.0%	9	0	0.0%
Space Heating	Heat Pump	2.7%	4	0	2	2.7%	4	0	-4.9%
Ventilation	Ventilation	27.4%	12	3	52	27.4%	10	3	-15.0%
Interior Lighting	Interior Screw-in	100.0%	0	0	5	100.0%	0	0	-5.0%
Interior Lighting	High Bay Fixtures	100.0%	1	1	16	100.0%	1	1	-12.7%
Interior Lighting	Linear Fluorescent	100.0%	1	1	17	100.0%	1	1	-26.0%
Exterior Lighting	Exterior Screw-in	100.0%	0	0	0	100.0%	0	0	-26.4%
Exterior Lighting	HID	100.0%	0	0	4	100.0%	0	0	-26.4%
Process	Process Cooling/Refrigeration	2.4%	100	2	37	2.5%	100	3	0.0%
Process	Process Heating	26.2%	14	4	55	27.5%	14	4	0.0%
Process	Electrochemical Process	2.6%	77	2	31	2.7%	77	2	0.0%
Machine Drive	Less than 5 HP	90.5%	1	1	13	95.0%	1	1	0.0%
Machine Drive	5-24 HP	80.1%	2	2	28	84.1%	2	2	0.0%
Machine Drive	25-99 HP	72.4%	6	4	68	76.0%	6	5	0.0%
Machine Drive	100-249 HP	65.3%	4	3	38	68.6%	4	3	0.0%
Machine Drive	250-499 HP	23.7%	12	3	42	24.9%	12	3	0.0%
Machine Drive	500 and more HP	26.1%	20	5	78	27.4%	20	5	0.0%
Miscellaneous	Miscellaneous	100.0%	5	5	75	103.0%	5	5	0.0%
Total				40	614			40	0.2%

Market Profiles

Table A-13 Small/Medium Commercial Electric Market Profile, Idaho 2009

Average Market Profile						New Units			
End Use	Technology	Saturation	UEC (kWh)	Intensity (kWh/HH)	Usage (GWh)	Saturation	UEC (kWh)	Intensity (kWh/HH)	Compared to Average
Cooling	Central Chiller	13.8%	2	0	6	13.8%	2	0	-13.6%
Cooling	RTU	63.1%	2	2	29	63.1%	2	1	-15.9%
Cooling	Heat Pump	3.6%	5	0	3	3.6%	4	0	-15.9%
Space Heating	Electric Resistance	5.9%	7	0	7	5.9%	6	0	-5.0%
Space Heating	Furnace	17.7%	7	1	23	17.7%	7	1	-5.0%
Space Heating	Heat Pump	3.6%	4	0	2	3.6%	3	0	-6.8%
Ventilation	Ventilation	76.9%	2	2	30	76.9%	2	1	-14.8%
Interior Lighting	Interior Screw-in	100.0%	1	1	18	100.0%	1	1	-1.2%
Interior Lighting	High Bay Fixtures	100.0%	1	1	13	100.0%	1	1	-20.0%
Interior Lighting	Linear Fluorescent	100.0%	3	3	62	100.0%	3	3	-12.7%
Exterior Lighting	Exterior Screw-in	100.0%	0	0	4	100.0%	0	0	-26.0%
Exterior Lighting	HID	100.0%	1	1	13	100.0%	1	1	-26.4%
Water Heating	Water Heater	63.0%	2	1	23	63.0%	2	1	-6.0%
Food Preparation	Fryer	25.8%	0	0	1	30.8%	0	0	-0.6%
Food Preparation	Oven	25.8%	1	0	5	35.8%	1	0	-1.2%
Food Preparation	Dishwasher	25.8%	0	0	0	35.8%	0	0	-24.1%
Food Preparation	Hot Food Container	25.8%	0	0	1	35.8%	0	0	-20.0%
Food Preparation	Food Prep	25.8%	0	0	0	35.8%	0	0	-20.0%
Refrigeration	Walk in Refrigeration	52.4%	-	-	-	62.4%	-	-	0.0%
Refrigeration	Glass Door Display	52.4%	0	0	4	57.4%	0	0	-8.8%
Refrigeration	Reach-in Refrigerator	52.4%	1	0	5	57.4%	0	0	-30.0%
Refrigeration	Open Display Case	52.4%	0	0	0	57.4%	0	0	-8.4%
Refrigeration	Vending Machine	52.4%	0	0	3	57.4%	0	0	-12.8%
Refrigeration	Icemaker	52.4%	0	0	3	57.4%	0	0	-11.9%
Office Equipment	Desktop Computer	99.9%	0	0	9	104.9%	0	1	-0.7%
Office Equipment	Laptop Computer	99.9%	0	0	1	104.9%	0	0	-0.7%
Office Equipment	Server	99.9%	0	0	7	104.9%	0	0	-4.7%
Office Equipment	Monitor	99.9%	0	0	5	104.9%	0	0	-2.8%
Office Equipment	Printer/copier/fax	99.9%	0	0	4	104.9%	0	0	-6.1%
Office Equipment	POS Terminal	99.9%	0	0	5	104.9%	0	0	-15.6%
Miscellaneous	Non-HVAC Motor	40.2%	1	0	9	40.2%	1	1	5.1%
Miscellaneous	Other Miscellaneous	100.0%	1	1	26	100.0%	2	2	20.0%
Total				18	323			16	-6.9%

Table A-14 Large Commercial Electric Market Profile, Idaho 2009

Average Market Profile						New Units			
End Use	Technology	Saturation	UEC (kWh)	Intensity (kWh/HH)	Usage (GWh)	Saturation	UEC (kWh)	Intensity (kWh/HH)	Compared to Average
Cooling	Central Chiller	24.7%	2	1	22	24.7%	2	0	-16.9%
Cooling	RTU	37.8%	3	1	40	37.8%	2	1	-17.4%
Cooling	Heat Pump	9.1%	4	0	14	9.1%	3	0	-16.9%
Space Heating	Electric Resistance	5.9%	4	0	9	5.9%	3	0	-12.6%
Space Heating	Furnace	12.7%	5	1	25	12.7%	4	1	-12.6%
Space Heating	Heat Pump	9.1%	2	0	9	9.1%	2	0	-3.5%
Ventilation	Ventilation	75.1%	2	1	52	75.1%	1	1	-14.8%
Interior Lighting	Interior Screw-in	100.0%	1	1	39	100.0%	1	1	-1.4%
Interior Lighting	High Bay Fixtures	100.0%	1	1	30	100.0%	1	1	-20.0%
Interior Lighting	Linear Fluorescent	100.0%	3	3	138	100.0%	3	3	-13.6%
Exterior Lighting	Exterior Screw-in	100.0%	0	0	4	100.0%	0	0	-18.1%
Exterior Lighting	HID	100.0%	1	1	29	100.0%	1	1	-26.4%
Water Heating	Water Heater	54.2%	2	1	53	54.2%	2	1	-4.0%
Food Preparation	Fryer	18.4%	0	0	3	23.4%	0	0	-0.6%
Food Preparation	Oven	18.4%	2	0	14	28.4%	2	1	-1.2%
Food Preparation	Dishwasher	18.4%	0	0	1	28.4%	0	0	-24.1%
Food Preparation	Hot Food Container	18.4%	0	0	2	28.4%	0	0	-39.9%
Food Preparation	Food Prep	18.4%	0	0	0	28.4%	0	0	-20.0%
Refrigeration	Walk in Refrigeration	39.1%	0	0	8	49.1%	0	0	-30.0%
Refrigeration	Glass Door Display	39.1%	0	0	6	44.1%	0	0	-9.7%
Refrigeration	Reach-in Refrigerator	39.1%	1	0	13	44.1%	1	0	-30.0%
Refrigeration	Open Display Case	39.1%	0	0	4	44.1%	0	0	-9.3%
Refrigeration	Vending Machine	39.1%	0	0	6	44.1%	0	0	-12.8%
Refrigeration	Icemaker	39.1%	1	0	11	44.1%	1	0	-12.2%
Office Equipment	Desktop Computer	98.4%	1	1	37	103.4%	1	1	-0.7%
Office Equipment	Laptop Computer	98.4%	0	0	3	103.4%	0	0	-0.7%
Office Equipment	Server	98.4%	0	0	17	103.4%	0	0	-4.7%
Office Equipment	Monitor	98.4%	0	0	9	103.4%	0	0	-2.8%
Office Equipment	Printer/copier/fax	98.4%	0	0	9	103.4%	0	0	-6.1%
Office Equipment	POS Terminal	98.4%	0	0	3	103.4%	0	0	-15.6%
Miscellaneous	Non-HVAC Motor	57.7%	1	1	34	57.7%	1	1	5.1%
Miscellaneous	Other Miscellaneous	100.0%	1	1	57	100.0%	2	2	10.0%
Total				17	700			16	-6.8%

Market Profiles

Table A-15 Extra Large Commercial Electric Market Profile, Idaho 2009

Average Market Profile						New Units			
End Use	Technology	Saturation	UEC (kWh)	Intensity (kWh/HH)	Usage (GWh)	Saturation	UEC (kWh)	Intensity (kWh/HH)	Compared to Average
Cooling	Central Chiller	52.2%	2	1	6	52.2%	2	1	-14.7%
Cooling	RTU	24.7%	2	1	3	24.7%	2	0	-16.7%
Cooling	Heat Pump	4.4%	2	0	0	4.4%	2	0	-26.2%
Space Heating	Electric Resistance	15.8%	4	1	4	15.8%	4	1	-13.1%
Space Heating	Furnace	5.6%	6	0	2	5.6%	5	0	-13.1%
Space Heating	Heat Pump	90.2%	2	2	9	90.2%	2	2	-12.1%
Ventilation	Ventilation	100.0%	1	1	7	100.0%	1	1	-2.7%
Interior Lighting	Interior Screw-in	100.0%	0	0	1	100.0%	0	0	-20.0%
Interior Lighting	High Bay Fixtures	100.0%	2	2	11	100.0%	2	2	-8.3%
Interior Lighting	Linear Fluorescent	100.0%	0	0	0	100.0%	0	0	-51.9%
Exterior Lighting	Exterior Screw-in	100.0%	1	1	4	100.0%	1	1	-26.4%
Exterior Lighting	HID	26.3%	4	1	5	26.3%	4	1	-2.0%
Water Heating	Water Heater	13.8%	0	0	0	23.8%	0	0	-0.6%
Food Preparation	Fryer	13.8%	2	0	1	23.8%	2	0	-1.2%
Food Preparation	Oven	13.8%	0	0	0	23.8%	0	0	-24.1%
Food Preparation	Dishwasher	13.8%	0	0	0	23.8%	0	0	-39.9%
Food Preparation	Hot Food Container	13.8%	0	0	0	23.8%	0	0	0.0%
Food Preparation	Food Prep	26.6%	0	0	0	31.6%	0	0	-30.0%
Refrigeration	Walk in Refrigeration	26.6%	0	0	0	31.6%	0	0	-9.7%
Refrigeration	Glass Door Display	26.6%	1	0	1	31.6%	0	0	-30.0%
Refrigeration	Reach-in Refrigerator	26.6%	0	0	1	31.6%	0	0	-9.3%
Refrigeration	Open Display Case	26.6%	0	0	1	31.6%	0	0	-27.9%
Refrigeration	Vending Machine	26.6%	0	0	0	31.6%	0	0	-11.4%
Refrigeration	Icemaker	100.0%	1	1	3	105.0%	1	1	-0.7%
Office Equipment	Desktop Computer	100.0%	0	0	0	105.0%	0	0	-0.7%
Office Equipment	Laptop Computer	100.0%	0	0	1	105.0%	0	0	-4.7%
Office Equipment	Server	100.0%	0	0	1	105.0%	0	0	-2.8%
Office Equipment	Monitor	100.0%	0	0	0	105.0%	0	0	-6.1%
Office Equipment	Printer/copier/fax	100.0%	0	0	0	100.0%	0	0	-15.6%
Office Equipment	POS Terminal	88.8%	1	1	4	88.8%	1	1	5.1%
Miscellaneous	Non-HVAC Motor	100.0%	1	1	4	100.0%	1	1	10.0%
Miscellaneous	Other Miscellaneous	4.4%	3	0	1	4.4%	3	0	-3.1%
Total					14			13	-6.0%

Table A-16 Extra Large Industrial Electric Market Profile, Idaho 2009

Average Market Profile						New Units			
End Use	Technology	Saturation	UEC (kWh)	Intensity (kWh/HH)	Usage (GWh)	Saturation	UEC (kWh)	Intensity (kWh/HH)	Compared to Average
Cooling	Central Chiller	14.4%	8	1	6	14.4%	7	1	-11.7%
Cooling	RTU	17.1%	6	1	5	17.1%	6	1	-12.3%
Cooling	Heat Pump	2.7%	4	0	0	2.7%	3	0	-20.9%
Space Heating	Electric Resistance	10.8%	9	1	5	10.8%	8	1	-5.0%
Space Heating	Furnace	2.0%	9	0	1	2.0%	9	0	0.0%
Space Heating	Heat Pump	27.4%	12	3	17	27.4%	10	3	-15.0%
Ventilation	Ventilation	100.0%	0	0	2	100.0%	0	0	-5.0%
Interior Lighting	Interior Screw-in	100.0%	1	1	5	100.0%	1	1	-12.7%
Interior Lighting	High Bay Fixtures	100.0%	1	1	5	100.0%	1	1	-26.0%
Interior Lighting	Linear Fluorescent	100.0%	0	0	0	100.0%	0	0	-26.4%
Exterior Lighting	Exterior Screw-in	100.0%	0	0	1	100.0%	0	0	-26.4%
Exterior Lighting	HID	2.4%	100	2	12	2.5%	100	3	0.0%
Process	Process Cooling/Refrigeration	26.2%	14	4	18	27.5%	14	4	0.0%
Process	Process Heating	2.6%	77	2	10	2.7%	77	2	0.0%
Process	Electrochemical Process	90.5%	1	1	4	95.0%	1	1	0.0%
Machine Drive	Less than 5 HP	80.1%	2	2	9	84.1%	2	2	0.0%
Machine Drive	5-24 HP	72.4%	6	4	22	76.0%	6	5	0.0%
Machine Drive	25-99 HP	65.3%	4	3	12	68.6%	4	3	0.0%
Machine Drive	100-249 HP	23.7%	12	3	13	24.9%	12	3	0.0%
Machine Drive	250-499 HP	26.1%	20	5	25	27.4%	20	5	0.0%
Machine Drive	500 and more HP	100.0%	5	5	24	103.0%	5	5	0.0%
Miscellaneous	Miscellaneous	2.7%	5	0	1	2.7%	5	0	-4.9%
Total				40	196			40	0.2%

APPENDIX | B

RESIDENTIAL ENERGY EFFICIENCY EQUIPMENT AND MEASURE DATA

This appendix presents detailed information for all energy-efficiency measures (*equipment* and *non-equipment* measures per the LoadMAP taxonomy) that were evaluated as part of this study. Several sets of tables are provided.

Measure Descriptions

Table B-1 and Table B-2 provide brief descriptions for all equipment and non-equipment measures that were assessed for potential.

Equipment Measure Data

Table B-3 through Table B-18 list the detailed unit-level data of Washington and Idaho for the equipment measures for each of the housing type segments — Single Family, Multi Family, Mobile Home, and Low income for existing and new construction, respectively. Savings are in annual kWh per household, and incremental costs are in \$/household (\$/HH), unless noted otherwise. The BC ratio shown in the tables are for the first year of the potential analysis (2014), although the B/C ratio is calculated within LoadMAP for each year of the forecast. The B/C ratio in the tables is 1.00 if the measure represents the baseline technology, and zero if the technology is not available in 2014. The final data item in these tables is the levelized cost of conserved energy, which is defined as the cost of the measure divided by the cumulative amount of energy savings accrued over the measure's lifetime (\$/kWh).

Non-Equipment Measure Data

Table B-19 through Table B-34 list the detailed unit-level data of Washington and Idaho for the non-equipment energy efficiency measures for each of the housing type segments and for existing and new construction, respectively. Because these measures can produce energy-use savings for multiple end-use loads (e.g., insulation affects heating and cooling energy use) savings are expressed as a net percentage of all the relevant, combined end-use loads. Base saturation indicates the percentage of homes in which the measure is already installed. Applicability is a factor that account for whether the measure is applicable to the building. Cost is expressed in \$/household. The detailed measure-level tables present the results of the benefit/cost (B/C) analysis for the first year of the potential analysis (2014) although the B/C ratio is calculated within LoadMAP for each year of the forecast. These tables also contain the levelized cost of conserved energy, which is defined as the cost of the measure divided by the **cumulative amount of energy savings accrued over the measure's lifetime**, given in terms of \$/kWh.

Table B-1 Residential Energy Efficiency Equipment Measure Descriptions

End Use	Technology	Measure Description
Cooling	Central AC	Central air conditioners consist of a refrigeration system using a direct expansion cycle. Equipment includes a compressor, an air-cooled condenser (located outdoors), an expansion valve, and an evaporator coil. A supply fan near the evaporator coil distributes supply air through air ducts to the building. Cooling efficiencies vary based on materials used, equipment size, condenser type, and system configuration. CACs may be unitary (all components housed in a factory-built assembly) or split system (an outdoor condenser section and an indoor evaporator section connected by refrigerant lines and with the compressor either indoors or outdoors). Energy efficiency is rated according to the size of the unit using the Seasonal Energy Efficiency Rating (SEER). Ductless systems with Variable Refrigerant Flow further improve the operating efficiency.
Cooling	Room AC	Room air conditioners are designed to cool a single room or space. They incorporate a complete air-cooled refrigeration and air-handling system in an individual package. Room air conditioners come in several forms, including window, split-type, and packaged terminal units. Energy efficiency is rated according to the size of the unit using the Energy Efficiency Rating (EER).
Cooling/ Space Heating	Ductless Heat Pump	Ductless heat pumps systems are similar to conventional air-source heat pumps in that they use electricity to transfer heat between outdoor and indoor air via a vapor compression cycle. They can thus provide both heating and cooling. However, they are mounted through a wall and thus can be retrofitted in homes that use electric zonal baseboard, wall, or ceiling units and as a result do not have ducts. They may also be suitable in new construction, where one or more systems can be installed.
Cooling/ Space Heating	Air-Source Heat Pump	A central heat pump consists of components similar to a CAC system, but is usually designed to function both as a heat pump and an air conditioner. It consists of a refrigeration system using a direct expansion (DX) cycle. Equipment includes a compressor, an air-cooled condenser (located outdoors), an expansion valve, and an evaporator coil (located in the supply air duct near the supply fan) and a reversing valve to change the DX cycle from cooling to heating when required. The cooling and heating efficiencies vary based on the materials used, equipment size, condenser type, and system configuration. Heat pumps may be unitary (all components housed in a factory-built assembly) or a split system (an outdoor condenser section and an indoor evaporator section connected by refrigerant lines, with either outdoors or indoors). A high-efficiency option for a ductless mini-split system is also analyzed.
Cooling/ Space Heating	Geothermal Heat Pump	Geothermal heat pumps are similar to air-source heat pumps, but use the ground or groundwater instead of outside air to provide a heat source/sink. A geothermal heat pump system generally consists of three major subsystems or parts: a geothermal heat pump to move heat between the building and the fluid in the earth connection, an earth connection for transferring heat between the fluid and the earth, and a distribution subsystem for delivering heating or cooling to the building. The system may also have a desuperheater to supplement the building's water heater, or a full-demand water heater to meet all of the building's hot water needs.

Residential Energy Efficiency Equipment and Measure Data

End Use	Technology	Measure Description
Space Heating	Electric Resistance	Resistive heating elements are used to convert electricity directly to heat. Conductive fins surrounding the element or another mechanism is used to deliver the heat directly to the surrounding room or area. These are typically either baseboard or wall-mounted units.
Space Heating	Electric Furnace	Furnaces heat air and distribute the heated air through the building using ducts. Efficiency improvements can include: exhaust fan controls, electronic ignition (no pilot light), compact size and lighter weight to reduce cycling losses, smaller-diameter flue pipe, and sealed combustion. Very high efficiency units, or condensing units, condense the water vapor produced in the combustion process and also use the heat from this condensation.
Water Heating	Water Heater	<p>For electric hot water heating, the most common type is a storage heater, which incorporates an electric heating element, storage tank, outer jacket, insulation, and controls in a single unit. Efficient units are characterized by a high recovery or thermal efficiency and low standby losses (the ratio of heat lost per hour to the content of the stored water). A further efficiency gain is available through a heat pump water heater (HPWH), which uses a vapor-compression thermodynamic cycle similar to that found in an air-conditioner or refrigerator to extract heat from an available source (e.g., air) and reject that heat to a higher temperature sink, in this case, the water in the water heater. Electric instantaneous water heaters are available, but are excluded from this study due to potentially high instantaneous demand concerns.</p> <p>For natural gas hot water heating, the most common type is a storage heater, which incorporates a burner, storage tank, outer jacket, insulation, and controls in a single unit. Efficient units are characterized by a high recovery or thermal efficiency and low standby losses (the ratio of heat lost per hour to the content of the stored water). A further efficiency gain is available in condensing units, which condense the water vapor produced in the combustion process and also use the heat from this condensation.</p>
Interior Lighting	Screw-in	Infrared halogen lamps are designed to be a replacement for standard incandescent lamps. Also referred to as advanced incandescent lamps, these products meet the Energy Independence and Security Act (EISA) lighting standards and are phased in as the baseline technology screw-in lamp technology to reflect the timeline over which the EISA lighting standards take effect. Compact fluorescent lamps are designed to be a replacement for standard incandescent lamps and use about 25% of the energy used by standard incandescent lamps to produce the same lumen output. They can use either electronic or magnetic ballasts. Integral compact fluorescent lamps have the ballast integrated into the base of the lamp and have a standard screw-in base that permits installation into existing incandescent fixtures. Light-emitting diode (LED) lighting has seen recent penetration in specific applications such as traffic lights and exit signs. With the potential for extremely high efficiency, LEDs show promise to provide general-use lighting for interior spaces. Current models commercially available have efficacies comparable to CFLs. However, theoretical efficiencies are significantly higher. LED models under development are expected to provide improved efficacies.
Interior Lighting	Linear Fluorescent	T8 fluorescent lamps are smaller in diameter than standard T12 lamps, resulting in greater light output per watt. T8 lamps also operate at a lower current and wattage, which increases the efficiency of the ballast

Residential Energy Efficiency Equipment and Measure Data

End Use	Technology	Measure Description
		but requires the lamps to be compatible with the ballast. Fluorescent lamp fixtures can include a reflector that increases the light output from the fixture, and thus make it possible to use a fewer number of lamps in each fixture. T5 lamps further increase efficiency by reducing the lamp diameter to 5/8". Light-emitting diode (LED) lighting has seen recent penetration in specific applications such as traffic lights and exit signs. With the potential for extremely high efficiency, LEDs show promise to provide general-use lighting for interior spaces. Current models commercially available have efficacies comparable to CFLs. However, theoretical efficiencies are significantly higher. LED models under development are expected to provide improved efficacies.
Interior Lighting	Specialty Lighting	Bulbs that the DOE does not consider conventional and are not covered by federal efficiency standards. These include: appliance bulbs, heavy-duty bulbs, dimmable bulbs, three-way bulbs, G shape (globe) lamps, candelabra base, and others.
Exterior Lighting	Screw-in	Infrared halogen lamps are designed to be a replacement for standard incandescent lamps. Also referred to as advanced incandescent lamps, these products meet the Energy Independence and Security Act (EISA) lighting standards and are phased in as the baseline technology screw-in lamp technology to reflect the timeline over which the EISA lighting standards take effect. Compact fluorescent lamps are designed to be a replacement for standard incandescent lamps and use about 25% of the energy used by standard incandescent lamps to produce the same lumen output. They can use either electronic or magnetic ballasts. Integral compact fluorescent lamps have the ballast integrated into the base of the lamp and have a standard screw-in base that permits installation into existing incandescent fixtures. Light-emitting diode (LED) lighting has seen recent penetration in specific applications such as traffic lights and exit signs. With the potential for extremely high efficiency, LEDs show promise to provide general-use lighting for interior spaces. Current models commercially available have efficacies comparable to CFLs. However, theoretical efficiencies are significantly higher. LED models under development are expected to provide improved efficacies.
Appliances	Refrigerator	Energy-efficient refrigerators/freezers incorporate features such as improved cabinet insulation, more efficient compressors and evaporator fans, defrost controls, mullion heaters, oversized condenser coils, and improved door seals. Further efficiency increases can be obtained by reducing the volume of refrigerated space, or adding multiple compartments to reduce losses from opening doors.
Appliances	Second Refrigerator	Energy-efficient refrigerators/freezers incorporate features such as improved cabinet insulation, more efficient compressors and evaporator fans, defrost controls, mullion heaters, oversized condenser coils, and improved door seals. Further efficiency increases can be obtained by reducing the volume of refrigerated space, or adding multiple compartments to reduce losses from opening doors.
Appliances	Freezer	Energy-efficient refrigerators/freezers incorporate features such as improved cabinet insulation, more efficient compressors and evaporator fans, defrost controls, mullion heaters, oversized condenser coils, and improved door seals. Further efficiency increases can be obtained by reducing the volume of refrigerated space, or adding multiple compartments to reduce losses from opening doors.

Residential Energy Efficiency Equipment and Measure Data

End Use	Technology	Measure Description
Appliances	Clothes Washer	High efficiency clothes washers use superior designs that require less water. Sensors match the hot water needs to the size and soil level of the load, preventing energy waste. Further energy and water savings can be achieved through advanced technologies such as inverter-drive or combination washer-dryer units. MEF is the official energy efficiency metric used to compare relative efficiencies of different clothes washers. MEF considers the energy used to run the washer, heat the water, and run the dryer. The higher the MEF, the more efficient the clothes washer.
Appliances	Clothes Dryer	An energy-efficient clothes dryer has a moisture-sensing device to terminate the drying cycle rather than using a timer and an energy-efficient motor is used for spinning the dryer tub. Application of a heat pump cycle for extracting the moisture from clothes leads to additional energy savings.
Appliances	Dishwasher	High efficiency dishwashers save by using both improved technology for the primary wash cycle, and by using less hot water. Construction includes more effective washing action, energy-efficient motors, and other advanced technology such as sensors that determine the length of the wash cycle and the temperature of the water necessary to clean the dishes.
Appliances	Stove	These products have additional insulation in the oven compartment and tighter-fitting oven door gaskets and hinges to save energy. Conventional ovens must first heat up about 35 pounds of steel and a large amount of air before they heat up the food. Higher efficiency options include convection ovens, halogen burners, and induction burners.
Appliances	Microwave	No high efficiency option is modeled.
Electronics	Personal Computers	Improved power management can significantly reduce the annual energy consumption of PCs and monitors in both standby and normal operation. ENERGY STAR and Climate Savers labeled products provide increasing level of energy efficiency.
Electronics	TVs	In the average home, TVs consume significant energy, even when they are turned off, to maintain features like clocks, remote control, and channel/station memory. ENERGY STAR labeled consumer electronics can drastically reduce consumption during standby mode, in addition to saving energy through advanced power management during normal use.
Electronics	Devices and Gadgets	High efficiency electronics can use efficient components and employ sleep/powersave modes.
Electronics	Set-top Boxes/DVR	High efficiency electronics can use efficient components and employ sleep/powersave modes.
Miscellaneous	Pool Pump	High-efficiency motors and two-speed pumps provide improved energy efficiency for this load.
Miscellaneous	Furnace Fan	In homes heated by a furnace, there is still substantial energy use by the fan responsible for moving the hot air throughout the ductwork. Application of an Electronically Commutating Motor (ECM) ensures that motor speed matches the heating requirements of the system and saves energy when compared to a continuously operating standard motor.
Miscellaneous	Miscellaneous	Improvement of miscellaneous electricity uses.

Table B-2 Residential Energy Efficiency Non-Equipment Measure Descriptions

End Use	Measure	Description
HVAC (All)	Insulation - Ceiling	Thermal insulation is material or combinations of materials that are used to inhibit the flow of heat energy by conductive, convective, and radiative transfer modes. Thus, thermal insulation above ceilings can conserve energy by reducing the heat loss or gain into attics and/or through roofs. The type of building construction defines insulating possibilities. Typical insulating materials include: loose-fill (blown) cellulose, loose-fill (blown) fiberglass, and rigid polystyrene.
Cooling	Insulation - Ducting	Air distribution ducts can be insulated to reduce heating or cooling losses. Best results can be achieved by covering the entire surface area with insulation. Several types of ducts and duct insulation are available, including flexible duct, pre-insulated duct, duct board, duct wrap, tacked, or glued rigid insulation, and waterproof hard shell materials for exterior ducts. This analysis assumes that installing duct insulation can reduce the temperature drop/gain in ducts by 50%.
HVAC (All)	Insulation - Foundation	Thermal insulation is material or combinations of materials that are used to inhibit the flow of heat energy by conductive, convective, and radiative transfer modes. Thus, thermal insulation can conserve energy by reducing heat loss or gain from a building. The type of building construction defines insulating possibilities. Typical insulating materials include: loose-fill (blown) cellulose, loose-fill (blown) fiberglass, and rigid polystyrene. Foundation insulation is modeled for new construction / major retrofits only.
HVAC (All)	Insulation - Infiltration Control	Lowering the air infiltration rate by caulking small leaks and weather-stripping around window frames, doorframes, power outlets, plumbing, and wall corners can provide significant energy savings. Weather-stripping doors and windows will create a tight seal and further reduce air infiltration.
HVAC (All)	Insulation - Radiant Barrier	Radiant barriers are materials installed to reduce the heat gain in buildings. Radiant barriers are made from materials that are highly reflective and have low emissivity like aluminum. The closer the emissivity is to 0 the better they will perform. Radiant barriers can be placed above the insulation or on the roof rafters.
HVAC (All)	Insulation - Wall Cavity	Thermal insulation is material or combinations of materials that are used to inhibit the flow of heat energy by conductive, convective, and radiative transfer modes. Thus, thermal insulation can conserve energy by reducing heat loss or gain from a building. The type of building construction defines insulating possibilities. Typical insulating materials include: loose-fill (blown) cellulose, loose-fill (blown) fiberglass, and rigid polystyrene. Wall insulation is modeled for new construction / major retrofits only.
HVAC (All)	Insulation - Wall Sheathing	Thermal insulation is material or combinations of materials that are used to inhibit the flow of heat energy by conductive, convective, and radiative transfer modes. Thus, thermal insulation can conserve energy by reducing heat loss or gain from a building. The type of building construction defines insulating possibilities. Typical insulating materials include: loose-fill (blown) cellulose, loose-fill (blown) fiberglass, and rigid polystyrene. Wall sheathing is modeled for new construction / major retrofits only.
Cooling	Ducting - Repair and Sealing	Leakage in unsealed ducts varies considerably because of the differences in fabricating machinery used, the methods for assembly, installation workmanship, and age of the ductwork. Air leaks from the system to the outdoors result in a direct loss proportional to the amount of leakage and the difference in enthalpy between the outdoor air and the conditioned air. To seal ducts, a wide variety of sealing methods and products exist. Each has a relatively short shelf life, and no documented research has identified the aging characteristics of sealant applications.
HVAC (All)	Windows - High Efficiency/ENERGY STAR	High-efficiency windows, such as those labeled under the ENERGY STAR Program, are designed to reduce energy use and increase occupant comfort. High-efficiency windows reduce the amount of heat transfer through the

Residential Energy Efficiency Equipment and Measure Data

End Use	Measure	Description
		glazing surface. For example, some windows have a low-E coating, a thin film of metallic oxide coating on the glass surface that allows passage of short-wave solar energy through glass and prevents long-wave energy from escaping. Another example is double-pane glass that reduces conductive and convective heat transfer. Some double-pane windows are gas-filled (usually argon) to further increase the insulating properties of the window.
HVAC (All)	Windows - Install Reflective Film	Reflective films applied to the window interior help reduce solar gain into the space and thus lower cooling energy use.
HVAC (All)	Doors - Storm and Thermal	Like other components of the shell, doors are subject to several types of heat loss: conduction, infiltration, and radiant losses. Similar to a storm window, a storm door creates an insulating air space between the storm and primary doors. A tight fitting storm door can also help reduce air leakage or infiltration. Thermal doors have exceptional thermal insulation properties and also are provided with weather-stripping on the doorframe to reduce air leakage.
HVAC (All)	Roofs - High Reflectivity	The color and material of a building structure surface will determine the amount of solar radiation absorbed by that surface and subsequently transferred into a building. This is called solar absorptance. By using a living roof or a roofing material with a light color (and a lower solar absorptance), the roof will absorb less solar radiation and consequently reduce the cooling load. Living roofs also reduce stormwater runoff.
HVAC (All)	Attic Fan - Installation	Attic fans can reduce the need for AC by reducing heat transfer from the attic through the ceiling of the house. A well-ventilated attic can be several degrees cooler than a comparable, unventilated attic. An option for an attic fan equipped with a small solar photovoltaic generator is also modeled.
HVAC (All)	Attic Fan - Photovoltaic - Installation	Attic fans can reduce the need for AC by reducing heat transfer from the attic through the ceiling of the house. A well-ventilated attic can be several degrees cooler than a comparable, unventilated attic. An option for an attic fan equipped with a small solar photovoltaic generator is also modeled.
HVAC (All)	Whole-House Fan - Installation	Whole-house fans can reduce the need for AC on moderate-weather days or on cool evenings. The fan facilitates a quick air change throughout the entire house. Several windows must be open to achieve the best results. The fan is mounted on the top floor of the house, usually in a hallway ceiling.
HVAC (All)	Ceiling Fan - Installation	Ceiling fans can reduce the need for air conditioning. However, the house occupants must also select a ceiling fan with a high-efficiency motor and either shutoff the AC system or setup the thermostat temperature of the air conditioning system to realize the potential energy savings. Some ceiling fans also come with lamps. In this analysis, it is assumed that there are no lamps, and installing a ceiling fan will allow occupants to increase the thermostat cooling setpoint up by 2°F.
HVAC (All)	Thermostat - Clock/Programmable	A programmable thermostat can be added to most heating/cooling systems. They are typically used during winter to lower temperatures at night and in summer to increase temperatures during the afternoon. The energy savings from this type of thermostat are identical to those of a "setback" strategy with standard thermostats, but the convenience of a programmable thermostat makes it a much more attractive option. In this analysis, the baseline is assumed to have no thermostat setback.
HVAC (All)	Home Energy Management System	A centralized home energy management system can be used to control and schedule cooling, space heating, lighting, and possibly appliances as well. Some designs also allow the homeowner to remotely control loads via the Internet.
Cooling	Central AC - Early Replacement	CAC systems currently on the market are significantly more efficient than older units, due to technology improvement and stricter appliance standards. This measure incents homeowners to replace an aging but still working unit with a new, higher-efficiency one.
Cooling	Central AC - Maintenance and Tune-Up	An air conditioner's filters, coils, and fins require regular cleaning and maintenance for the unit to function effectively and efficiently throughout its life. Neglecting necessary maintenance leads to a steady decline in

Residential Energy Efficiency Equipment and Measure Data

End Use	Measure	Description
		performance, requiring the AC unit to use more energy for the same cooling load.
Cooling / Space Heating	Central Heat Pump - Maintenance	A heat pump's filters, coils, and fins require regular cleaning and maintenance for the unit to function effectively and efficiently throughout its life. Neglecting necessary maintenance ensures a steady decline in performance while energy use steadily increases.
Cooling	Room AC - Removal of Second Unit	Homeowners may have a second room AC unit that is extremely inefficient. This measure incents homeowners to recycle the second unit and thus also eliminates associated electricity use.
Water Heating	Water Heater - Drainwater Heat Recovery	Drainwater Heat Recovery is a system in which drain water is used to preheat cold water entering the water heater. While these systems themselves are relatively inexpensive, upgrading an existing system could be unreasonable because of demolition costs. Thus they are modeled for new vintage only.
Water Heating	Water Heater - Faucet Aerators	Water faucet aerators are threaded screens that attach to existing faucets. They reduce the volume of water coming out of faucets while introducing air into the water stream. This measure provides energy saving by reducing hot water use, as well as water conservation for both hot and cold water.
Water Heating	Water Heater - Low-Flow Showerheads	Similar to faucet aerators, low-flow showerheads reduce the consumption of hot water, which in turn decreases water heating energy use.
Water Heating	Water Heater - Pipe Insulation	Insulating hot water pipes decreases energy losses from piping that distributes hot water throughout the building. It also results in quicker delivery of hot water and may allow the lowering of the hot water set point, which saves energy. The most common insulation materials for this purpose are polyethylene and neoprene.
Water Heating	Water Heater - Timer	These measures use either a programmable thermostat or a timer to adjust the water heater setpoint at times of low usage, typically when a home is unoccupied.
Water Heating	Water Heater - Desuperheater	A desuperheater can be added to an existing geothermal heat pump system (typically installed with the primary function of space heating and cooling) in order to draw off a portion of the geothermal heat for water heating purposes. The system can either supplement the building's water heater, or be a full-demand water heater that meets all of the building's hot water needs.
Water Heating	Water Heater - Solar System	Solar water heating systems can be used in residential buildings that have an appropriate near-south-facing roof or nearby unshaded grounds for installing a collector. Although system types vary, in general these systems use a solar absorber surface within a solar collector or an actual storage tank. Either a heat-transfer fluid or the actual potable water flows through tubes attached to the absorber and transfers heat from it. (Systems with a separate heat-transfer-fluid loop include a heat exchanger that then heats the potable water.) The heated water is stored in a separate preheat tank or a conventional water heater tank. If additional heat is needed, it is provided by a conventional water-heating system.
Water Heating	Tank Blanket Insulation	Many water heaters have a high factory-set temperature, at 140 degrees F or higher, but most users operate comfortably with the thermostat at 120 degrees F. Reducing the water heater temperature by as little as 10 degrees can save between 3-5% in energy costs.
Water Heating	Thermostat Setback	Many water heaters have a high factory-set temperature, at 140 degrees F or higher, but most users operate comfortably with the thermostat at 125 degrees F. Reducing the water heater temperature by as little as 10 degrees can save between 3-5% in energy costs.
Interior Lighting	Interior Lighting - Occupancy Sensors	Occupancy sensors turn lights off when a space is unoccupied. They are appropriate for areas with intermittent use, such as bathrooms or storage areas.
Exterior Lighting	Exterior Lighting - Photosensor Control	Photosensor controls turn exterior lighting on or off based on ambient lighting levels. Compared with manual operation, this can reduce the operation of

Residential Energy Efficiency Equipment and Measure Data

End Use	Measure	Description
		exterior lighting during daylight hours.
Exterior Lighting	Exterior Lighting - Photovoltaic Installation	Solar photovoltaic generation may be used to power exterior lighting and thus eliminate all or part of the electrical energy use.
Exterior Lighting	Exterior Lighting - Timeclock Installation	Lighting timers turn exterior lighting on or off based on a preset schedule. Compared with manual operation, this can reduce the operation of exterior lighting during daylight hours.
Appliances	Refrigerator - Early Replacement	Refrigerators/freezers currently on the market are significantly more efficient than older units, due to technology improvement and stricter appliance standards. This measure incents homeowners to replace an aging but still working unit with a new, higher-efficiency one.
Appliances	Refrigerator - Remove Second Unit	Homeowners may have a second refrigerator or freezer that is not used to full capacity and that, because of its age, is extremely inefficient. This measure incents homeowners to recycle the second unit and thus also eliminates associated electricity use.
Appliances	Freezer - Remove Second Unit	Homeowners may have a second refrigerator or freezer that is not used to full capacity and that, because of its age, is extremely inefficient. This measure incents homeowners to recycle the second unit and thus also eliminates associated electricity use.
Appliances	Freezer - Early Replacement	Refrigerators/freezers currently on the market are significantly more efficient than older units, due to technology improvement and stricter appliance standards. This measure incents homeowners to replace an aging but still working unit with a new, higher-efficiency one.
Electronics	Reduce Standby Wattage - Smart Power Strips	Representing a growing portion of home electricity consumption, plug-in electronics such as set-top boxes, DVD players, gaming systems, digital video recorders, and even battery chargers for mobile phones and laptop computers are often designed to supply a set voltage. When the units are not in use, this voltage could be dropped significantly (~1 W) and thereby generate a significant energy savings, assumed for this analysis to be between 4-5% on average. These savings are in excess of the measures already discussed for computers and televisions.
Miscellaneous	Pool Pump - Timer	A pool pump timer allows the pump to turn off automatically, eliminating the wasted energy associated with unnecessary pumping.
Miscellaneous	Behavioral Measures	The behavioral measure models the wide range of options for providing homeowners with ongoing information on their energy use, for example via a web portal. These tools are based on the premise that homeowners will reduce energy use if they better understand how they use energy and the associated costs. The level of assumed savings is based on isolated behavioral effects and excludes the technology effects of all other measures listed here.

Residential Energy Efficiency Equipment and Measure Data

Table B-3 Energy Efficiency Equipment Data, Electric—Single Family, Existing Vintage, Washington

End Use	Technology	Eff. Definition	Savings (kWh/HH/yr)	Incremental Cost (\$/HH)	Lifetime (Years)	BC Ratio (2015)	Levelized Cost of Energy (\$/kWh)
Cooling	Central AC	SEER 13	-	\$0.00	15	-	\$0.00
Cooling	Central AC	SEER 14 (Energy Star)	116.70	\$277.86	15	1.40	\$0.21
Cooling	Central AC	SEER 15 (CEE Tier 2)	160.13	\$555.71	15	0.95	\$0.30
Cooling	Central AC	SEER 16 (CEE Tier 3)	196.50	\$833.57	15	0.90	\$0.37
Cooling	Central AC	Ductless Mini-Split System	352.42	\$4,399.48	20	0.64	\$0.88
Cooling	Room AC	EER 9.8	-	\$0.00	10	1.00	\$0.00
Cooling	Room AC	EER 10.8 (Energy Star)	46.56	\$104.04	10	0.84	\$0.26
Cooling	Room AC	EER 11	54.94	\$282.26	10	0.64	\$0.61
Cooling	Room AC	EER 11.5	74.37	\$625.50	10	0.44	\$1.00
Cooling	Air Source Heat Pump	SEER 13	-	\$0.00	15	-	\$0.00
Cooling	Air Source Heat Pump	SEER 14 (Energy Star)	85.84	\$0.00	15	1.30	\$0.00
Cooling	Air Source Heat Pump	SEER 15 (CEE Tier 2)	97.34	\$0.00	15	0.89	\$0.00
Cooling	Air Source Heat Pump	SEER 16 (CEE Tier 3)	119.45	\$0.00	15	0.83	\$0.00
Cooling	Air Source Heat Pump	Ductless Mini-Split System	214.24	\$0.00	20	0.83	\$0.00
Cooling	Geothermal Heat Pump	Standard	-	\$0.00	15	1.00	\$0.00
Cooling	Geothermal Heat Pump	High Efficiency	104.84	\$0.00	15	0.91	\$0.00
Cooling	Ductless HP	Ductless Mini-Split System	-	\$0.00	20	1.00	\$0.00
Space Heating	Electric Resistance	Electric Resistance	-	\$0.00	20	1.00	\$0.00
Space Heating	Electric Resistance	Ductless Mini-Split System	3,605.70	\$156.87	20	1.34	\$0.00
Space Heating	Electric Furnace	3400 BTU/KW	-	\$0.00	15	1.00	\$0.00
Space Heating	Supplemental	Supplemental	-	\$0.00	5	1.00	\$0.00
Space Heating	Air Source Heat Pump	SEER 13	-	\$0.00	15	-	\$0.00
Space Heating	Air Source Heat Pump	SEER 14 (Energy Star)	126.61	\$67.05	15	1.30	\$0.05
Space Heating	Air Source Heat Pump	SEER 15 (CEE Tier 2)	998.92	\$2,318.20	15	0.89	\$0.20
Space Heating	Air Source Heat Pump	SEER 16 (CEE Tier 3)	1,225.79	\$3,504.51	15	0.83	\$0.25
Space Heating	Air Source Heat Pump	Ductless Mini-Split System	2,198.46	\$5,655.04	20	0.83	\$0.18
Space Heating	Geothermal Heat Pump	Standard	-	\$0.00	15	1.00	\$0.00
Space Heating	Geothermal Heat Pump	High Efficiency	693.85	\$1,500.00	15	0.91	\$0.19
Space Heating	Ductless HP	Ductless Mini-Split System	-	\$0.00	20	1.00	\$0.00
Water Heating	Water Heater <= 55 Gal	Baseline (EF=0.90)	-	\$0.00	15	1.00	\$0.00
Water Heating	Water Heater <= 55 Gal	High Efficiency (EF=0.95)	207.44	\$77.11	15	1.03	\$0.03
Water Heating	Water Heater <= 55 Gal	EF 2.3 (HP)	1,999.65	\$1,761.86	15	0.91	\$0.08
Water Heating	Water Heater <= 55 Gal	Solar	2,791.58	\$6,214.86	15	0.47	\$0.19
Water Heating	Water Heater > 55 Gal	Baseline (EF=0.90)	-	\$0.00	15	1.00	\$0.00
Water Heating	Water Heater >	High Efficiency	264.15	\$97.23	15	1.03	\$0.03

Residential Energy Efficiency Equipment and Measure Data

End Use	Technology	Eff. Definition	Savings (kWh/HH/yr)	Incremental Cost (\$/HH)	Lifetime (Years)	BC Ratio (2015)	Levelized Cost of Energy (\$/kWh)
	55 Gal	(EF=0.95)					
Water Heating	Water Heater > 55 Gal	EF 2.3 (HP)	2,000.81	\$1,691.15	15	0.93	\$0.07
Water Heating	Water Heater > 55 Gal	Solar	3,154.00	\$6,144.15	15	0.52	\$0.17
Interior Lighting	Screw-in	Incandescent	-	\$0.00	4	-	\$0.00
Interior Lighting	Screw-in	Infrared Halogen	269.42	\$188.19	5	1.00	\$0.15
Interior Lighting	Screw-in	CFL	855.57	\$33.82	6	2.54	\$0.01
Interior Lighting	Screw-in	LED	1,169.35	\$1,937.55	12	-	\$0.17
Interior Lighting	Screw-in	LED	1,169.35	\$1,937.55	12	-	\$0.17
Interior Lighting	Linear Fluorescent	T12	-	\$0.00	6	1.00	\$0.00
Interior Lighting	Linear Fluorescent	T8	11.21	-\$3.65	6	1.14	-\$0.06
Interior Lighting	Linear Fluorescent	Super T8	33.57	\$29.17	6	0.70	\$0.16
Interior Lighting	Linear Fluorescent	T5	34.89	\$49.41	6	0.55	\$0.26
Interior Lighting	Linear Fluorescent	LED	36.60	\$433.68	10	0.19	\$1.40
Interior Lighting	Specialty	Halogen	-	\$0.00	4	1.00	\$0.00
Interior Lighting	Specialty	CFL	263.66	\$1.92	7	1.91	\$0.00
Interior Lighting	Specialty	LED	277.40	\$522.52	12	0.29	\$0.19
Exterior Lighting	Screw-in	Incandescent	-	\$0.00	4	-	\$0.00
Exterior Lighting	Screw-in	Infrared Halogen	92.90	\$51.30	5	1.00	\$0.12
Exterior Lighting	Screw-in	CFL	315.29	-\$1.24	3	4.38	\$0.00
Exterior Lighting	Screw-in	LED	365.98	\$757.28	12	-	\$0.21
Exterior Lighting	Screw-in	LED	365.98	\$757.28	12	-	\$0.21
Appliances	Clothes Washer	Baseline	-	\$0.00	14	-	\$0.00
Appliances	Clothes Washer	Energy Star (MEF > 1.8)	51.92	\$69.81	14	-	\$0.12
Appliances	Clothes Washer	Horizontal Axis	71.68	\$150.80	14	1.00	\$0.19
Appliances	Clothes Dryer	Baseline	-	\$0.00	13	-	\$0.00
Appliances	Clothes Dryer	Moisture Detection	76.97	\$48.40	13	1.00	\$0.06
Appliances	Dishwasher	Baseline	-	\$0.00	15	1.00	\$0.00
Appliances	Dishwasher	Energy Star	64.27	\$460.95	9	-	\$0.93
Appliances	Dishwasher	Energy Star (2011)	8.42	\$5.61	15	1.00	\$0.06
Appliances	Refrigerator	Baseline	-	\$0.00	20	-	\$0.00
Appliances	Refrigerator	Energy Star	55.03	\$20.67	20	-	\$0.03
Appliances	Refrigerator	Baseline (2014)	100.80	\$0.00	13	1.00	\$0.00
Appliances	Refrigerator	Energy Star (2014)	161.28	\$88.71	13	1.02	\$0.05
Appliances	Freezer	Baseline	-	\$0.00	22	-	\$0.00
Appliances	Freezer	Energy Star	44.98	\$3.98	22	-	\$0.01
Appliances	Freezer	Baseline (2014)	104.39	-\$145.00	11	1.00	-\$0.15
Appliances	Freezer	Energy Star (2014)	167.03	-\$112.83	11	1.00	-\$0.07
Appliances	Second Refrigerator	Baseline	-	\$0.00	20	-	\$0.00
Appliances	Second Refrigerator	Energy Star	75.16	\$20.67	20	-	\$0.02
Appliances	Second Refrigerator	Baseline (2014)	137.68	\$0.00	13	1.00	\$0.00

Residential Energy Efficiency Equipment and Measure Data

End Use	Technology	Eff. Definition	Savings (kWh/HH/yr)	Incremental Cost (\$/HH)	Lifetime (Years)	BC Ratio (2015)	Levelized Cost of Energy (\$/kWh)
Appliances	Second Refrigerator	Energy Star (2014)	220.29	\$88.71	13	1.01	\$0.04
Appliances	Stove	Baseline	-	\$0.00	13	1.00	\$0.00
Appliances	Stove	Convection Oven	10.67	\$1.86	13	1.00	\$0.02
Appliances	Stove	Induction (High Efficiency)	53.33	\$1,432.20	13	0.39	\$2.59
Appliances	Microwave	Baseline	-	\$0.00	9	1.00	\$0.00
Electronics	Personal Computers	Baseline	-	\$0.00	5	1.00	\$0.00
Electronics	Personal Computers	Energy Star	89.47	\$1.20	5	1.01	\$0.00
Electronics	Personal Computers	Climate Savers	127.82	\$175.49	5	0.85	\$0.30
Electronics	TVs	Baseline	-	\$0.00	11	1.00	\$0.00
Electronics	TVs	Energy Star	52.12	\$0.56	10	0.95	\$0.00
Electronics	Set-top boxes/DVR	Baseline	-	\$0.00	11	1.00	\$0.00
Electronics	Set-top boxes/DVR	Energy Star	31.55	\$0.56	11	1.01	\$0.00
Electronics	Devices and Gadgets	Devices and Gadgets	-	\$0.00	5	1.00	\$0.00
Miscellaneous	Pool Pump	Baseline Pump	-	\$0.00	15	1.00	\$0.00
Miscellaneous	Pool Pump	High Efficiency Pump	137.76	\$85.00	15	1.00	\$0.05
Miscellaneous	Pool Pump	Two-Speed Pump	551.02	\$579.00	15	0.83	\$0.09
Miscellaneous	Furnace Fan	Baseline	-	\$0.00	18	1.00	\$0.00
Miscellaneous	Furnace Fan	Furnace Fan with ECM	157.58	\$0.64	18	1.28	\$0.00
Miscellaneous	Miscellaneous	Miscellaneous	-	\$0.00	5	1.00	\$0.00

Residential Energy Efficiency Equipment and Measure Data

Table B-4 Energy Efficiency Equipment Data, Electric—Single Family, New Vintage, Washington

End Use	Technology	Eff. Definition	Savings (kWh/HH/yr)	Incremental Cost (\$/HH)	Lifetime (Years)	BC Ratio (2015)	Levelized Cost of Energy (\$/kWh)
Cooling	Central AC	SEER 13	-	\$0.00	15	-	\$0.00
Cooling	Central AC	SEER 14 (Energy Star)	148.36	\$277.86	15	1.40	\$0.16
Cooling	Central AC	SEER 15 (CEE Tier 2)	197.61	\$555.71	15	0.95	\$0.24
Cooling	Central AC	SEER 16 (CEE Tier 3)	238.95	\$833.57	15	0.90	\$0.30
Cooling	Central AC	Ductless Mini-Split System	448.12	\$4,399.48	20	0.65	\$0.69
Cooling	Room AC	EER 9.8	-	\$0.00	10	1.00	\$0.00
Cooling	Room AC	EER 10.8 (Energy Star)	57.89	\$104.04	10	0.85	\$0.21
Cooling	Room AC	EER 11	68.22	\$282.26	10	0.65	\$0.49
Cooling	Room AC	EER 11.5	92.51	\$625.50	10	0.45	\$0.80
Cooling	Air Source Heat Pump	SEER 13	-	\$0.00	15	-	\$0.00
Cooling	Air Source Heat Pump	SEER 14 (Energy Star)	109.44	\$67.05	15	1.30	\$0.05
Cooling	Air Source Heat Pump	SEER 15 (CEE Tier 2)	120.45	\$2,318.20	15	0.91	\$1.66
Cooling	Air Source Heat Pump	SEER 16 (CEE Tier 3)	145.65	\$3,504.51	15	0.85	\$2.08
Cooling	Air Source Heat Pump	Ductless Mini-Split System	273.14	\$5,655.04	20	0.87	\$1.46
Cooling	Geothermal Heat Pump	Standard	-	\$0.00	15	1.00	\$0.00
Cooling	Geothermal Heat Pump	High Efficiency	124.81	\$1,500.00	15	0.92	\$1.04
Cooling	Ductless HP	Ductless Mini-Split System	-	\$0.00	20	1.00	\$0.00
Space Heating	Electric Resistance	Electric Resistance	-	\$0.00	20	1.00	\$0.00
Space Heating	Electric Resistance	Ductless Mini-Split System	4,146.56	\$156.87	20	1.35	\$0.00
Space Heating	Electric Furnace	3400 BTU/KW	-	\$0.00	15	1.00	\$0.00
Space Heating	Supplemental	Supplemental	-	\$0.00	5	1.00	\$0.00
Space Heating	Air Source Heat Pump	SEER 13	-	\$0.00	15	-	\$0.00
Space Heating	Air Source Heat Pump	SEER 14 (Energy Star)	161.42	\$67.05	15	1.30	\$0.04
Space Heating	Air Source Heat Pump	SEER 15 (CEE Tier 2)	1,236.03	\$2,318.20	15	0.91	\$0.16
Space Heating	Air Source Heat Pump	SEER 16 (CEE Tier 3)	1,494.65	\$3,504.51	15	0.85	\$0.20
Space Heating	Air Source Heat Pump	Ductless Mini-Split System	2,802.94	\$5,655.04	20	0.87	\$0.14
Space Heating	Geothermal Heat Pump	Standard	-	\$0.00	15	1.00	\$0.00
Space Heating	Geothermal Heat Pump	High Efficiency	826.07	\$1,500.00	15	0.92	\$0.16
Space Heating	Ductless HP	Ductless Mini-Split System	-	\$0.00	20	1.00	\$0.00
Water Heating	Water Heater <= 55 Gal	Baseline (EF=0.90)	-	\$0.00	15	1.00	\$0.00
Water Heating	Water Heater <= 55 Gal	High Efficiency (EF=0.95)	207.44	\$77.11	15	1.03	\$0.03
Water Heating	Water Heater <= 55 Gal	EF 2.3 (HP)	1,999.65	\$1,761.86	15	0.91	\$0.08
Water Heating	Water Heater <= 55 Gal	Solar	2,791.58	\$6,214.86	15	0.47	\$0.19
Water Heating	Water Heater > 55 Gal	Baseline (EF=0.90)	-	\$0.00	15	1.00	\$0.00
Water Heating	Water Heater >	High Efficiency	264.15	\$97.23	15	1.03	\$0.03

Residential Energy Efficiency Equipment and Measure Data

End Use	Technology	Eff. Definition	Savings (kWh/HH/yr)	Incremental Cost (\$/HH)	Lifetime (Years)	BC Ratio (2015)	Levelized Cost of Energy (\$/kWh)
	55 Gal	(EF=0.95)					
Water Heating	Water Heater > 55 Gal	EF 2.3 (HP)	2,000.81	\$1,691.15	15	0.93	\$0.07
Water Heating	Water Heater > 55 Gal	Solar	3,154.00	\$6,144.15	15	0.52	\$0.17
Interior Lighting	Screw-in	Incandescent	-	\$0.00	4	-	\$0.00
Interior Lighting	Screw-in	Infrared Halogen	307.59	\$188.19	5	1.00	\$0.13
Interior Lighting	Screw-in	CFL	976.77	\$33.82	6	2.46	\$0.01
Interior Lighting	Screw-in	LED	1,334.99	\$1,937.55	12	-	\$0.15
Interior Lighting	Screw-in	LED	1,334.99	\$1,937.55	12	-	\$0.15
Interior Lighting	Linear Fluorescent	T12	-	\$0.00	6	1.00	\$0.00
Interior Lighting	Linear Fluorescent	T8	13.19	-\$3.65	6	1.13	-\$0.05
Interior Lighting	Linear Fluorescent	Super T8	39.53	\$29.17	6	0.73	\$0.14
Interior Lighting	Linear Fluorescent	T5	41.09	\$49.41	6	0.58	\$0.22
Interior Lighting	Linear Fluorescent	LED	43.10	\$433.68	10	0.21	\$1.19
Interior Lighting	Specialty	Halogen	-	\$0.00	4	1.00	\$0.00
Interior Lighting	Specialty	CFL	303.20	-\$6.90	7	2.33	\$0.00
Interior Lighting	Specialty	LED	319.01	\$163.55	12	0.76	\$0.05
Exterior Lighting	Screw-in	Incandescent	-	\$0.00	4	-	\$0.00
Exterior Lighting	Screw-in	Infrared Halogen	168.10	\$20.17	5	1.00	\$0.03
Exterior Lighting	Screw-in	CFL	473.06	\$0.00	3	4.21	\$0.00
Exterior Lighting	Screw-in	LED	599.29	\$88.71	12	-	\$0.02
Exterior Lighting	Screw-in	LED	599.29	\$88.71	12	-	\$0.02
Appliances	Clothes Washer	Baseline	-	\$0.00	14	-	\$0.00
Appliances	Clothes Washer	Energy Star (MEF > 1.8)	100.07	\$3.98	14	-	\$0.00
Appliances	Clothes Washer	Horizontal Axis	183.40	-\$145.00	14	1.00	-\$0.07
Appliances	Clothes Dryer	Baseline	-	\$0.00	13	-	\$0.00
Appliances	Clothes Dryer	Moisture Detection	76.97	\$48.40	13	1.00	\$0.06
Appliances	Dishwasher	Baseline	-	\$0.00	15	1.00	\$0.00
Appliances	Dishwasher	Energy Star	64.52	\$460.95	9	-	\$0.92
Appliances	Dishwasher	Energy Star (2011)	8.45	\$5.61	15	1.00	\$0.06
Appliances	Refrigerator	Baseline	-	\$0.00	20	-	\$0.00
Appliances	Refrigerator	Energy Star	62.37	\$20.17	20	-	\$0.02
Appliances	Refrigerator	Baseline (2014)	114.24	\$0.00	13	1.00	\$0.00
Appliances	Refrigerator	Energy Star (2014)	182.79	\$88.71	13	1.02	\$0.05
Appliances	Freezer	Baseline	-	\$0.00	22	-	\$0.00
Appliances	Freezer	Energy Star	48.14	\$3.98	22	-	\$0.01
Appliances	Freezer	Baseline (2014)	111.72	-\$145.00	11	1.00	-\$0.14
Appliances	Freezer	Energy Star (2014)	178.76	-\$112.83	11	1.01	-\$0.07
Appliances	Second Refrigerator	Baseline	-	\$0.00	20	-	\$0.00
Appliances	Second Refrigerator	Energy Star	80.17	\$20.67	20	-	\$0.02
Appliances	Second Refrigerator	Baseline (2014)	146.86	\$0.00	13	1.00	\$0.00

Residential Energy Efficiency Equipment and Measure Data

End Use	Technology	Eff. Definition	Savings (kWh/HH/yr)	Incremental Cost (\$/HH)	Lifetime (Years)	BC Ratio (2015)	Levelized Cost of Energy (\$/kWh)
Appliances	Second Refrigerator	Energy Star (2014)	234.98	\$88.71	13	1.01	\$0.04
Appliances	Stove	Baseline	-	\$0.00	13	1.00	\$0.00
Appliances	Stove	Convection Oven	10.66	\$1.86	13	1.00	\$0.02
Appliances	Stove	Induction (High Efficiency)	53.32	\$1,432.20	13	0.39	\$2.59
Appliances	Microwave	Baseline	-	\$0.00	9	1.00	\$0.00
Electronics	Personal Computers	Baseline	-	\$0.00	5	1.00	\$0.00
Electronics	Personal Computers	Energy Star	87.57	\$1.20	5	1.01	\$0.00
Electronics	Personal Computers	Climate Savers	125.09	\$175.49	5	0.85	\$0.30
Electronics	TVs	Baseline	-	\$0.00	11	1.00	\$0.00
Electronics	TVs	Energy Star	57.91	\$0.56	11	1.02	\$0.00
Electronics	Set-top boxes/DVR	Baseline	-	\$0.00	11	1.00	\$0.00
Electronics	Set-top boxes/DVR	Energy Star	31.55	\$0.56	11	1.01	\$0.00
Electronics	Devices and Gadgets	Devices and Gadgets	-	\$0.00	5	1.00	\$0.00
Miscellaneous	Pool Pump	Baseline Pump	-	\$0.00	15	1.00	\$0.00
Miscellaneous	Pool Pump	High Efficiency Pump	155.66	\$85.00	15	1.01	\$0.05
Miscellaneous	Pool Pump	Two-Speed Pump	622.65	\$579.00	15	0.88	\$0.08
Miscellaneous	Furnace Fan	Baseline	-	\$0.00	18	1.00	\$0.00
Miscellaneous	Furnace Fan	Furnace Fan with ECM	157.58	\$0.64	18	1.28	\$0.00
Miscellaneous	Miscellaneous	Miscellaneous	-	\$0.00	5	1.00	\$0.00

Residential Energy Efficiency Equipment and Measure Data

Table B-5 Energy Efficiency Equipment Data, Electric—Single Family, Existing Vintage, Idaho

End Use	Technology	Eff. Definition	Savings (kWh/HH/yr)	Incremental Cost (\$/HH)	Lifetime (Years)	BC Ratio (2015)	Levelized Cost of Energy (\$/kWh)
Cooling	Central AC	SEER 13	-	\$0.00	15	-	\$0.00
Cooling	Central AC	SEER 14 (Energy Star)	105.03	\$277.86	15	1.40	\$0.23
Cooling	Central AC	SEER 15 (CEE Tier 2)	144.12	\$555.71	15	0.94	\$0.33
Cooling	Central AC	SEER 16 (CEE Tier 3)	176.85	\$833.57	15	0.89	\$0.41
Cooling	Central AC	Ductless Mini-Split System	317.18	\$4,399.48	20	0.64	\$0.98
Cooling	Room AC	EER 9.8	-	\$0.00	10	1.00	\$0.00
Cooling	Room AC	EER 10.8 (Energy Star)	41.90	\$104.04	10	0.83	\$0.29
Cooling	Room AC	EER 11	49.45	\$282.26	10	0.63	\$0.68
Cooling	Room AC	EER 11.5	66.94	\$625.50	10	0.43	\$1.11
Cooling	Air Source Heat Pump	SEER 13	-	\$0.00	15	-	\$0.00
Cooling	Air Source Heat Pump	SEER 14 (Energy Star)	77.25	\$0.00	15	1.30	\$0.00
Cooling	Air Source Heat Pump	SEER 15 (CEE Tier 2)	87.61	\$0.00	15	0.89	\$0.00
Cooling	Air Source Heat Pump	SEER 16 (CEE Tier 3)	107.51	\$0.00	15	0.84	\$0.00
Cooling	Air Source Heat Pump	Ductless Mini-Split System	192.81	\$0.00	20	0.85	\$0.00
Cooling	Geothermal Heat Pump	Standard	-	\$0.00	15	1.00	\$0.00
Cooling	Geothermal Heat Pump	High Efficiency	94.35	\$0.00	15	0.91	\$0.00
Cooling	Ductless HP	Ductless Mini-Split System	-	\$0.00	20	1.00	\$0.00
Space Heating	Electric Resistance	Electric Resistance	-	\$0.00	20	1.00	\$0.00
Space Heating	Electric Resistance	Ductless Mini-Split System	3,785.99	\$156.87	20	1.35	\$0.00
Space Heating	Electric Furnace	3400 BTU/KW	-	\$0.00	15	1.00	\$0.00
Space Heating	Supplemental	Supplemental	-	\$0.00	5	1.00	\$0.00
Space Heating	Air Source Heat Pump	SEER 13	-	\$0.00	15	-	\$0.00
Space Heating	Air Source Heat Pump	SEER 14 (Energy Star)	132.94	\$67.05	15	1.30	\$0.04
Space Heating	Air Source Heat Pump	SEER 15 (CEE Tier 2)	1,048.86	\$2,318.20	15	0.89	\$0.19
Space Heating	Air Source Heat Pump	SEER 16 (CEE Tier 3)	1,287.08	\$3,504.51	15	0.84	\$0.24
Space Heating	Air Source Heat Pump	Ductless Mini-Split System	2,308.39	\$5,655.04	20	0.85	\$0.17
Space Heating	Geothermal Heat Pump	Standard	-	\$0.00	15	1.00	\$0.00
Space Heating	Geothermal Heat Pump	High Efficiency	728.55	\$1,500.00	15	0.91	\$0.18
Space Heating	Ductless HP	Ductless Mini-Split System	-	\$0.00	20	1.00	\$0.00
Water Heating	Water Heater <= 55 Gal	Baseline (EF=0.90)	-	\$0.00	15	1.00	\$0.00
Water Heating	Water Heater <= 55 Gal	High Efficiency (EF=0.95)	217.82	\$77.11	15	1.03	\$0.03
Water Heating	Water Heater <= 55 Gal	EF 2.3 (HP)	2,099.63	\$1,761.86	15	0.87	\$0.07
Water Heating	Water Heater <= 55 Gal	Solar	2,931.16	\$6,214.86	15	0.44	\$0.18
Water Heating	Water Heater > 55 Gal	Baseline (EF=0.90)	-	\$0.00	15	1.00	\$0.00
Water Heating	Water Heater > 55 Gal	High Efficiency (EF=0.95)	277.36	\$97.23	15	1.03	\$0.03
Water Heating	Water Heater > 55 Gal	EF 2.3 (HP)	2,100.85	\$1,691.15	15	0.90	\$0.07

Residential Energy Efficiency Equipment and Measure Data

End Use	Technology	Eff. Definition	Savings (kWh/HH/yr)	Incremental Cost (\$/HH)	Lifetime (Years)	BC Ratio (2015)	Levelized Cost of Energy (\$/kWh)
	55 Gal						
Water Heating	Water Heater > 55 Gal	Solar	1,877.26	\$6,144.15	15	0.43	\$0.28
Interior Lighting	Screw-in	Incandescent	-	\$0.00	4	-	\$0.00
Interior Lighting	Screw-in	Infrared Halogen	282.89	\$188.19	5	1.00	\$0.14
Interior Lighting	Screw-in	CFL	898.35	\$33.82	6	2.59	\$0.01
Interior Lighting	Screw-in	LED	1,227.82	\$1,937.55	12	-	\$0.16
Interior Lighting	Screw-in	LED	1,227.82	\$1,937.55	12	-	\$0.16
Interior Lighting	Linear Fluorescent	T12	-	\$0.00	6	1.00	\$0.00
Interior Lighting	Linear Fluorescent	T8	11.77	-\$3.50	6	1.14	-\$0.05
Interior Lighting	Linear Fluorescent	Super T8	35.25	\$28.01	6	0.71	\$0.15
Interior Lighting	Linear Fluorescent	T5	36.64	\$47.43	6	0.56	\$0.24
Interior Lighting	Linear Fluorescent	LED	38.43	\$416.33	10	0.20	\$1.28
Interior Lighting	Specialty	Halogen	-	\$0.00	4	1.00	\$0.00
Interior Lighting	Specialty	CFL	276.84	\$1.92	7	1.93	\$0.00
Interior Lighting	Specialty	LED	291.27	\$522.52	12	0.30	\$0.18
Exterior Lighting	Screw-in	Incandescent	-	\$0.00	4	-	\$0.00
Exterior Lighting	Screw-in	Infrared Halogen	97.55	\$49.25	5	1.00	\$0.11
Exterior Lighting	Screw-in	CFL	331.06	-\$1.19	3	4.38	\$0.00
Exterior Lighting	Screw-in	LED	384.28	\$726.99	12	-	\$0.19
Exterior Lighting	Screw-in	LED	384.28	\$726.99	12	-	\$0.19
Appliances	Clothes Washer	Baseline	-	\$0.00	14	-	\$0.00
Appliances	Clothes Washer	Energy Star (MEF > 1.8)	51.92	\$69.81	14	-	\$0.12
Appliances	Clothes Washer	Horizontal Axis	71.68	\$150.80	14	1.00	\$0.19
Appliances	Clothes Dryer	Baseline	-	\$0.00	13	-	\$0.00
Appliances	Clothes Dryer	Moisture Detection	76.97	\$48.40	13	1.00	\$0.06
Appliances	Dishwasher	Baseline	-	\$0.00	15	1.00	\$0.00
Appliances	Dishwasher	Energy Star	64.27	\$460.95	9	-	\$0.93
Appliances	Dishwasher	Energy Star (2011)	8.42	\$5.61	15	1.00	\$0.06
Appliances	Refrigerator	Baseline	-	\$0.00	20	-	\$0.00
Appliances	Refrigerator	Energy Star	55.03	\$20.17	20	-	\$0.03
Appliances	Refrigerator	Baseline (2014)	100.80	\$0.00	13	1.00	\$0.00
Appliances	Refrigerator	Energy Star (2014)	161.28	\$88.71	13	1.01	\$0.05
Appliances	Freezer	Baseline	-	\$0.00	22	-	\$0.00
Appliances	Freezer	Energy Star	44.98	\$3.98	22	-	\$0.01
Appliances	Freezer	Baseline (2014)	104.39	-\$145.00	11	1.00	-\$0.15
Appliances	Freezer	Energy Star (2014)	167.03	-\$112.83	11	1.00	-\$0.07
Appliances	Second Refrigerator	Baseline	-	\$0.00	20	-	\$0.00
Appliances	Second Refrigerator	Energy Star	75.16	\$20.67	20	-	\$0.02
Appliances	Second Refrigerator	Baseline (2014)	137.68	\$0.00	13	1.00	\$0.00
Appliances	Second Refrigerator	Energy Star (2014)	220.29	\$88.71	13	1.01	\$0.04

Residential Energy Efficiency Equipment and Measure Data

End Use	Technology	Eff. Definition	Savings (kWh/HH/yr)	Incremental Cost (\$/HH)	Lifetime (Years)	BC Ratio (2015)	Levelized Cost of Energy (\$/kWh)
Appliances	Stove	Baseline	-	\$0.00	13	1.00	\$0.00
Appliances	Stove	Convection Oven	10.67	\$1.86	13	1.00	\$0.02
Appliances	Stove	Induction (High Efficiency)	53.33	\$1,432.20	13	0.38	\$2.59
Appliances	Microwave	Baseline	-	\$0.00	9	1.00	\$0.00
Electronics	Personal Computers	Baseline	-	\$0.00	5	1.00	\$0.00
Electronics	Personal Computers	Energy Star	89.47	\$1.20	5	1.01	\$0.00
Electronics	Personal Computers	Climate Savers	127.82	\$175.49	5	0.85	\$0.30
Electronics	TVs	Baseline	-	\$0.00	11	1.00	\$0.00
Electronics	TVs	Energy Star	52.12	\$0.56	11	1.02	\$0.00
Electronics	Set-top boxes/DVR	Baseline	-	\$0.00	11	1.00	\$0.00
Electronics	Set-top boxes/DVR	Energy Star	31.55	\$0.56	11	1.01	\$0.00
Electronics	Devices and Gadgets	Devices and Gadgets	-	\$0.00	5	1.00	\$0.00
Miscellaneous	Pool Pump	Baseline Pump	-	\$0.00	15	1.00	\$0.00
Miscellaneous	Pool Pump	High Efficiency Pump	137.76	\$85.00	15	1.00	\$0.05
Miscellaneous	Pool Pump	Two-Speed Pump	551.02	\$579.00	15	0.83	\$0.09
Miscellaneous	Furnace Fan	Baseline	-	\$0.00	18	1.00	\$0.00
Miscellaneous	Furnace Fan	Furnace Fan with ECM	165.46	\$0.64	18	1.29	\$0.00
Miscellaneous	Miscellaneous	Miscellaneous	-	\$0.00	5	1.00	\$0.00

Residential Energy Efficiency Equipment and Measure Data

Table B-6 Energy Efficiency Equipment Data, Electric—Single Family, New Vintage, Idaho

End Use	Technology	Eff. Definition	Savings (kWh/HH/yr)	Incremental Cost (\$/HH)	Lifetime (Years)	BC Ratio (2015)	Levelized Cost of Energy (\$/kWh)
Cooling	Central AC	SEER 13	-	\$0.00	15	-	\$0.00
Cooling	Central AC	SEER 14 (Energy Star)	133.52	\$277.86	15	1.40	\$0.18
Cooling	Central AC	SEER 15 (CEE Tier 2)	177.85	\$555.71	15	0.95	\$0.27
Cooling	Central AC	SEER 16 (CEE Tier 3)	215.06	\$833.57	15	0.90	\$0.34
Cooling	Central AC	Ductless Mini-Split System	403.30	\$4,399.48	20	0.64	\$0.77
Cooling	Room AC	EER 9.8	-	\$0.00	10	1.00	\$0.00
Cooling	Room AC	EER 10.8 (Energy Star)	52.10	\$104.04	10	0.84	\$0.24
Cooling	Room AC	EER 11	61.40	\$282.26	10	0.64	\$0.55
Cooling	Room AC	EER 11.5	83.26	\$625.50	10	0.44	\$0.89
Cooling	Air Source Heat Pump	SEER 13	-	\$0.00	15	-	\$0.00
Cooling	Air Source Heat Pump	SEER 14 (Energy Star)	98.49	\$67.05	15	1.30	\$0.06
Cooling	Air Source Heat Pump	SEER 15 (CEE Tier 2)	108.40	\$2,318.20	15	0.92	\$1.85
Cooling	Air Source Heat Pump	SEER 16 (CEE Tier 3)	131.09	\$3,504.51	15	0.87	\$2.31
Cooling	Air Source Heat Pump	Ductless Mini-Split System	245.83	\$5,655.04	20	0.88	\$1.63
Cooling	Geothermal Heat Pump	Standard	-	\$0.00	15	1.00	\$0.00
Cooling	Geothermal Heat Pump	High Efficiency	112.33	\$1,500.00	15	0.92	\$1.15
Cooling	Ductless HP	Ductless Mini-Split System	-	\$0.00	20	1.00	\$0.00
Space Heating	Electric Resistance	Electric Resistance	-	\$0.00	20	1.00	\$0.00
Space Heating	Electric Resistance	Ductless Mini-Split System	4,353.88	\$156.87	20	1.37	\$0.00
Space Heating	Electric Furnace	3400 BTU/kW	-	\$0.00	15	1.00	\$0.00
Space Heating	Supplemental	Supplemental	-	\$0.00	5	1.00	\$0.00
Space Heating	Air Source Heat Pump	SEER 13	-	\$0.00	15	-	\$0.00
Space Heating	Air Source Heat Pump	SEER 14 (Energy Star)	169.49	\$67.05	15	1.30	\$0.03
Space Heating	Air Source Heat Pump	SEER 15 (CEE Tier 2)	1,297.83	\$2,318.20	15	0.92	\$0.15
Space Heating	Air Source Heat Pump	SEER 16 (CEE Tier 3)	1,569.38	\$3,504.51	15	0.87	\$0.19
Space Heating	Air Source Heat Pump	Ductless Mini-Split System	2,943.09	\$5,655.04	20	0.88	\$0.14
Space Heating	Geothermal Heat Pump	Standard	-	\$0.00	15	1.00	\$0.00
Space Heating	Geothermal Heat Pump	High Efficiency	867.38	\$1,500.00	15	0.92	\$0.15
Space Heating	Ductless HP	Ductless Mini-Split System	-	\$0.00	20	1.00	\$0.00
Water Heating	Water Heater <= 55 Gal	Baseline (EF=0.90)	-	\$0.00	15	1.00	\$0.00
Water Heating	Water Heater <= 55 Gal	High Efficiency (EF=0.95)	217.82	\$77.11	15	1.03	\$0.03
Water Heating	Water Heater <= 55 Gal	EF 2.3 (HP)	2,099.63	\$1,761.86	15	0.87	\$0.07
Water Heating	Water Heater <= 55 Gal	Solar	2,931.16	\$6,214.86	15	0.44	\$0.18
Water Heating	Water Heater > 55 Gal	Baseline (EF=0.90)	-	\$0.00	15	1.00	\$0.00
Water Heating	Water Heater > 55 Gal	High Efficiency (EF=0.95)	277.36	\$97.23	15	1.03	\$0.03
Water Heating	Water Heater > 55 Gal	EF 2.3 (HP)	2,100.85	\$1,691.15	15	0.90	\$0.07

Residential Energy Efficiency Equipment and Measure Data

End Use	Technology	Eff. Definition	Savings (kWh/HH/yr)	Incremental Cost (\$/HH)	Lifetime (Years)	BC Ratio (2015)	Levelized Cost of Energy (\$/kWh)
	55 Gal						
Water Heating	Water Heater > 55 Gal	Solar	1,877.26	\$6,144.15	15	0.43	\$0.28
Interior Lighting	Screw-in	Incandescent	-	\$0.00	4	-	\$0.00
Interior Lighting	Screw-in	Infrared Halogen	322.96	\$188.19	5	1.00	\$0.13
Interior Lighting	Screw-in	CFL	1,025.61	\$33.82	6	2.51	\$0.01
Interior Lighting	Screw-in	LED	1,401.74	\$1,937.55	12	-	\$0.14
Interior Lighting	Screw-in	LED	1,401.74	\$1,937.55	12	-	\$0.14
Interior Lighting	Linear Fluorescent	T12	-	\$0.00	6	1.00	\$0.00
Interior Lighting	Linear Fluorescent	T8	13.85	-\$3.50	6	1.13	-\$0.05
Interior Lighting	Linear Fluorescent	Super T8	41.50	\$28.01	6	0.74	\$0.12
Interior Lighting	Linear Fluorescent	T5	43.14	\$47.43	6	0.59	\$0.20
Interior Lighting	Linear Fluorescent	LED	45.26	\$416.33	10	0.21	\$1.09
Interior Lighting	Specialty	Halogen	-	\$0.00	4	1.00	\$0.00
Interior Lighting	Specialty	CFL	318.36	-\$6.40	7	2.32	\$0.00
Interior Lighting	Specialty	LED	334.96	\$164.04	12	0.77	\$0.05
Exterior Lighting	Screw-in	Incandescent	-	\$0.00	4	-	\$0.00
Exterior Lighting	Screw-in	Infrared Halogen	173.38	\$20.17	5	1.00	\$0.03
Exterior Lighting	Screw-in	CFL	491.00	\$0.00	3	4.30	\$0.00
Exterior Lighting	Screw-in	LED	620.11	\$88.71	12	-	\$0.01
Exterior Lighting	Screw-in	LED	620.11	\$88.71	12	-	\$0.01
Appliances	Clothes Washer	Baseline	-	\$0.00	14	-	\$0.00
Appliances	Clothes Washer	Energy Star (MEF > 1.8)	100.07	\$3.98	14	-	\$0.00
Appliances	Clothes Washer	Horizontal Axis	183.40	-\$145.00	14	1.00	-\$0.07
Appliances	Clothes Dryer	Baseline	-	\$0.00	13	-	\$0.00
Appliances	Clothes Dryer	Moisture Detection	76.97	\$48.40	13	1.00	\$0.06
Appliances	Dishwasher	Baseline	-	\$0.00	15	1.00	\$0.00
Appliances	Dishwasher	Energy Star	64.52	\$460.95	9	-	\$0.92
Appliances	Dishwasher	Energy Star (2011)	8.45	\$5.61	15	1.00	\$0.06
Appliances	Refrigerator	Baseline	-	\$0.00	20	-	\$0.00
Appliances	Refrigerator	Energy Star	62.37	\$20.17	20	-	\$0.02
Appliances	Refrigerator	Baseline (2014)	114.24	\$0.00	13	1.00	\$0.00
Appliances	Refrigerator	Energy Star (2014)	182.79	\$88.71	13	1.02	\$0.05
Appliances	Freezer	Baseline	-	\$0.00	22	-	\$0.00
Appliances	Freezer	Energy Star	48.14	\$3.98	22	-	\$0.01
Appliances	Freezer	Baseline (2014)	111.72	-\$145.00	11	1.00	-\$0.14
Appliances	Freezer	Energy Star (2014)	178.76	-\$112.83	11	1.00	-\$0.07
Appliances	Second Refrigerator	Baseline	-	\$0.00	20	-	\$0.00
Appliances	Second Refrigerator	Energy Star	80.17	\$20.67	20	-	\$0.02
Appliances	Second Refrigerator	Baseline (2014)	146.86	\$0.00	13	1.00	\$0.00
Appliances	Second Refrigerator	Energy Star (2014)	234.98	\$88.71	13	1.01	\$0.04

Residential Energy Efficiency Equipment and Measure Data

End Use	Technology	Eff. Definition	Savings (kWh/HH/yr)	Incremental Cost (\$/HH)	Lifetime (Years)	BC Ratio (2015)	Levelized Cost of Energy (\$/kWh)
Appliances	Stove	Baseline	-	\$0.00	13	1.00	\$0.00
Appliances	Stove	Convection Oven	11.73	\$1.86	13	1.00	\$0.02
Appliances	Stove	Induction (High Efficiency)	58.65	\$1,432.20	13	0.38	\$2.35
Appliances	Microwave	Baseline	-	\$0.00	9	1.00	\$0.00
Electronics	Personal Computers	Baseline	-	\$0.00	5	1.00	\$0.00
Electronics	Personal Computers	Energy Star	87.57	\$1.20	5	1.01	\$0.00
Electronics	Personal Computers	Climate Savers	125.09	\$175.49	5	0.85	\$0.30
Electronics	TVs	Baseline	-	\$0.00	11	1.00	\$0.00
Electronics	TVs	Energy Star	57.91	\$0.56	11	1.02	\$0.00
Electronics	Set-top boxes/DVR	Baseline	-	\$0.00	11	1.00	\$0.00
Electronics	Set-top boxes/DVR	Energy Star	31.55	\$0.56	11	1.01	\$0.00
Electronics	Devices and Gadgets	Devices and Gadgets	-	\$0.00	5	1.00	\$0.00
Miscellaneous	Pool Pump	Baseline Pump	-	\$0.00	15	1.00	\$0.00
Miscellaneous	Pool Pump	High Efficiency Pump	155.66	\$85.00	15	1.01	\$0.05
Miscellaneous	Pool Pump	Two-Speed Pump	622.65	\$579.00	15	0.87	\$0.08
Miscellaneous	Furnace Fan	Baseline	-	\$0.00	18	1.00	\$0.00
Miscellaneous	Furnace Fan	Furnace Fan with ECM	165.46	\$0.64	18	1.29	\$0.00
Miscellaneous	Miscellaneous	Miscellaneous	-	\$0.00	5	1.00	\$0.00

Residential Energy Efficiency Equipment and Measure Data

Table B-7 Energy Efficiency Equipment Data, Electric—Multi Family, Existing Vintage, Washington

End Use	Technology	Eff. Definition	Savings (kWh/HH/yr)	Incremental Cost (\$/HH)	Lifetime (Years)	BC Ratio (2015)	Levelized Cost of Energy (\$/kWh)
Cooling	Central AC	SEER 13	-	\$0.00	15	-	\$0.00
Cooling	Central AC	SEER 14 (Energy Star)	41.57	\$92.62	15	1.40	\$0.19
Cooling	Central AC	SEER 15 (CEE Tier 2)	81.72	\$185.24	15	0.96	\$0.20
Cooling	Central AC	SEER 16 (CEE Tier 3)	115.28	\$277.86	15	0.93	\$0.21
Cooling	Central AC	Ductless Mini-Split System	150.88	\$2,012.28	20	0.62	\$0.94
Cooling	Room AC	EER 9.8	-	\$0.00	10	1.00	\$0.00
Cooling	Room AC	EER 10.8 (Energy Star)	32.61	\$52.02	10	0.86	\$0.19
Cooling	Room AC	EER 11	38.42	\$141.13	10	0.66	\$0.44
Cooling	Room AC	EER 11.5	52.05	\$312.75	10	0.46	\$0.71
Cooling	Air Source Heat Pump	SEER 13	-	\$0.00	15	-	\$0.00
Cooling	Air Source Heat Pump	SEER 14 (Energy Star)	44.14	\$1,245.78	15	1.30	\$2.44
Cooling	Air Source Heat Pump	SEER 15 (CEE Tier 2)	71.87	\$2,315.13	15	0.92	\$2.79
Cooling	Air Source Heat Pump	SEER 16 (CEE Tier 3)	101.38	\$3,277.48	15	0.85	\$2.80
Cooling	Air Source Heat Pump	Ductless Mini-Split System	132.69	\$5,022.03	20	0.85	\$2.68
Cooling	Geothermal Heat Pump	Standard	-	\$0.00	15	1.00	\$0.00
Cooling	Geothermal Heat Pump	High Efficiency	63.75	\$1,500.00	15	0.89	\$2.03
Cooling	Ductless HP	Ductless Mini-Split System	-	\$0.00	20	1.00	\$0.00
Space Heating	Electric Resistance	Electric Resistance	-	\$0.00	20	1.00	\$0.00
Space Heating	Electric Resistance	Ductless Mini-Split System	1,812.94	\$156.87	20	1.27	\$0.01
Space Heating	Electric Furnace	3400 BTU/KW	-	\$0.00	15	1.00	\$0.00
Space Heating	Supplemental	Supplemental	-	\$0.00	5	1.00	\$0.00
Space Heating	Air Source Heat Pump	SEER 13	-	\$0.00	15	-	\$0.00
Space Heating	Air Source Heat Pump	SEER 14 (Energy Star)	172.19	\$1,245.78	15	1.30	\$0.63
Space Heating	Air Source Heat Pump	SEER 15 (CEE Tier 2)	538.74	\$2,315.13	15	0.92	\$0.37
Space Heating	Air Source Heat Pump	SEER 16 (CEE Tier 3)	760.01	\$3,277.48	15	0.85	\$0.37
Space Heating	Air Source Heat Pump	Ductless Mini-Split System	994.66	\$5,022.03	20	0.85	\$0.36
Space Heating	Geothermal Heat Pump	Standard	-	\$0.00	15	1.00	\$0.00
Space Heating	Geothermal Heat Pump	High Efficiency	416.01	\$1,500.00	15	0.89	\$0.31
Space Heating	Ductless HP	Ductless Mini-Split System	-	\$0.00	20	1.00	\$0.00
Water Heating	Water Heater <= 55 Gal	Baseline (EF=0.90)	-	\$0.00	15	1.00	\$0.00
Water Heating	Water Heater <= 55 Gal	High Efficiency (EF=0.95)	110.09	\$77.11	15	1.01	\$0.06
Water Heating	Water Heater <= 55 Gal	EF 2.3 (HP)	1,061.19	\$1,761.86	15	0.64	\$0.14
Water Heating	Water Heater <= 55 Gal	Solar	1,202.35	\$6,214.86	15	0.27	\$0.45
Water Heating	Water Heater > 55 Gal	Baseline (EF=0.90)	-	\$0.00	15	1.00	\$0.00
Water Heating	Water Heater >	High Efficiency	182.05	\$97.23	15	1.02	\$0.05

Residential Energy Efficiency Equipment and Measure Data

End Use	Technology	Eff. Definition	Savings (kWh/HH/yr)	Incremental Cost (\$/HH)	Lifetime (Years)	BC Ratio (2015)	Levelized Cost of Energy (\$/kWh)
	55 Gal	(EF=0.95)					
Water Heating	Water Heater > 55 Gal	EF 2.3 (HP)	1,378.92	\$1,691.15	15	0.78	\$0.11
Water Heating	Water Heater > 55 Gal	Solar	1,231.85	\$6,144.15	15	0.35	\$0.43
Interior Lighting	Screw-in	Incandescent	-	\$0.00	4	-	\$0.00
Interior Lighting	Screw-in	Infrared Halogen	163.13	\$134.14	5	1.00	\$0.18
Interior Lighting	Screw-in	CFL	518.03	\$12.45	6	2.94	\$0.00
Interior Lighting	Screw-in	LED	708.02	\$1,161.45	12	-	\$0.17
Interior Lighting	Screw-in	LED	708.02	\$1,161.45	12	-	\$0.17
Interior Lighting	Linear Fluorescent	T12	-	\$0.00	6	1.00	\$0.00
Interior Lighting	Linear Fluorescent	T8	7.79	-\$1.83	6	1.13	-\$0.04
Interior Lighting	Linear Fluorescent	Super T8	23.35	\$14.59	6	0.76	\$0.11
Interior Lighting	Linear Fluorescent	T5	24.27	\$24.70	6	0.61	\$0.19
Interior Lighting	Linear Fluorescent	LED	25.46	\$216.84	10	0.23	\$1.01
Interior Lighting	Specialty	Halogen	-	\$0.00	4	1.00	\$0.00
Interior Lighting	Specialty	CFL	105.71	\$0.77	7	1.91	\$0.00
Interior Lighting	Specialty	LED	111.22	\$209.01	12	0.29	\$0.19
Exterior Lighting	Screw-in	Incandescent	-	\$0.00	4	-	\$0.00
Exterior Lighting	Screw-in	Infrared Halogen	5.39	\$5.08	5	1.00	\$0.20
Exterior Lighting	Screw-in	CFL	18.28	-\$0.32	3	5.74	-\$0.01
Exterior Lighting	Screw-in	LED	21.22	\$1,167.57	12	-	\$5.64
Exterior Lighting	Screw-in	LED	21.22	\$1,167.57	12	-	\$5.64
Appliances	Clothes Washer	Baseline	-	\$0.00	14	-	\$0.00
Appliances	Clothes Washer	Energy Star (MEF > 1.8)	41.54	\$69.81	14	-	\$0.15
Appliances	Clothes Washer	Horizontal Axis	57.34	\$150.80	14	1.00	\$0.24
Appliances	Clothes Dryer	Baseline	-	\$0.00	13	-	\$0.00
Appliances	Clothes Dryer	Moisture Detection	61.35	\$48.40	13	1.00	\$0.08
Appliances	Dishwasher	Baseline	-	\$0.00	15	1.00	\$0.00
Appliances	Dishwasher	Energy Star	51.42	\$460.95	15	-	\$0.78
Appliances	Dishwasher	Energy Star (2011)	6.74	\$5.61	15	1.00	\$0.07
Appliances	Refrigerator	Baseline	-	\$0.00	20	-	\$0.00
Appliances	Refrigerator	Energy Star	44.02	\$20.17	20	-	\$0.03
Appliances	Refrigerator	Baseline (2014)	80.64	\$0.00	13	1.00	\$0.00
Appliances	Refrigerator	Energy Star (2014)	129.03	\$88.71	13	1.01	\$0.07
Appliances	Freezer	Baseline	-	\$0.00	22	-	\$0.00
Appliances	Freezer	Energy Star	35.99	\$3.98	22	-	\$0.01
Appliances	Freezer	Baseline (2014)	83.52	-\$145.00	11	1.00	-\$0.19
Appliances	Freezer	Energy Star (2014)	133.62	-\$112.83	11	0.99	-\$0.09
Appliances	Second Refrigerator	Baseline	-	\$0.00	20	-	\$0.00
Appliances	Second Refrigerator	Energy Star	60.13	\$20.67	20	-	\$0.02
Appliances	Second Refrigerator	Baseline (2014)	110.14	\$0.00	13	1.00	\$0.00

Residential Energy Efficiency Equipment and Measure Data

End Use	Technology	Eff. Definition	Savings (kWh/HH/yr)	Incremental Cost (\$/HH)	Lifetime (Years)	BC Ratio (2015)	Levelized Cost of Energy (\$/kWh)
Appliances	Second Refrigerator	Energy Star (2014)	176.23	\$88.71	13	1.01	\$0.05
Appliances	Stove	Baseline	-	\$0.00	13	1.00	\$0.00
Appliances	Stove	Convection Oven	8.53	\$1.86	13	1.00	\$0.02
Appliances	Stove	Induction (High Efficiency)	42.66	\$1,432.20	13	0.38	\$3.23
Appliances	Microwave	Baseline	-	\$0.00	9	1.00	\$0.00
Electronics	Personal Computers	Baseline	-	\$0.00	5	1.00	\$0.00
Electronics	Personal Computers	Energy Star	71.58	\$1.20	5	1.01	\$0.00
Electronics	Personal Computers	Climate Savers	102.26	\$175.49	5	0.85	\$0.37
Electronics	TVs	Baseline	-	\$0.00	11	1.00	\$0.00
Electronics	TVs	Energy Star	46.91	\$0.56	11	1.02	\$0.00
Electronics	Set-top boxes/DVR	Baseline	-	\$0.00	11	1.00	\$0.00
Electronics	Set-top boxes/DVR	Energy Star	31.55	\$0.56	11	1.01	\$0.00
Electronics	Devices and Gadgets	Devices and Gadgets	-	\$0.00	5	1.00	\$0.00
Miscellaneous	Pool Pump	Baseline Pump	-	\$0.00	15	1.00	\$0.00
Miscellaneous	Pool Pump	High Efficiency Pump	137.76	\$85.00	15	1.00	\$0.05
Miscellaneous	Pool Pump	Two-Speed Pump	551.02	\$579.00	15	0.83	\$0.09
Miscellaneous	Furnace Fan	Baseline	-	\$0.00	18	1.00	\$0.00
Miscellaneous	Furnace Fan	Furnace Fan with ECM	126.06	\$0.00	18	1.27	\$0.00
Miscellaneous	Miscellaneous	Miscellaneous	-	\$0.00	5	1.00	\$0.00

Residential Energy Efficiency Equipment and Measure Data

Table B-8 Energy Efficiency Equipment Data, Electric—Multi Family, New Vintage, Washington

End Use	Technology	Eff. Definition	Savings (kWh/HH/yr)	Incremental Cost (\$/HH)	Lifetime (Years)	BC Ratio (2015)	Levelized Cost of Energy (\$/kWh)
Cooling	Central AC	SEER 13	-	\$0.00	15	-	\$0.00
Cooling	Central AC	SEER 14 (Energy Star)	53.20	\$92.62	15	1.40	\$0.15
Cooling	Central AC	SEER 15 (CEE Tier 2)	103.85	\$185.24	15	0.97	\$0.15
Cooling	Central AC	SEER 16 (CEE Tier 3)	146.35	\$277.86	15	0.93	\$0.16
Cooling	Central AC	Ductless Mini-Split System	192.62	\$2,012.28	20	0.63	\$0.74
Cooling	Room AC	EER 9.8	-	\$0.00	10	1.00	\$0.00
Cooling	Room AC	EER 10.8 (Energy Star)	40.50	\$52.02	10	0.87	\$0.15
Cooling	Room AC	EER 11	47.72	\$141.13	10	0.69	\$0.35
Cooling	Room AC	EER 11.5	64.71	\$312.75	10	0.49	\$0.57
Cooling	Air Source Heat Pump	SEER 13	-	\$0.00	15	-	\$0.00
Cooling	Air Source Heat Pump	SEER 14 (Energy Star)	56.37	\$1,245.78	15	1.30	\$1.91
Cooling	Air Source Heat Pump	SEER 15 (CEE Tier 2)	91.36	\$2,315.13	15	0.94	\$2.19
Cooling	Air Source Heat Pump	SEER 16 (CEE Tier 3)	128.74	\$3,277.48	15	0.88	\$2.20
Cooling	Air Source Heat Pump	Ductless Mini-Split System	169.45	\$5,022.03	20	0.87	\$2.10
Cooling	Geothermal Heat Pump	Standard	-	\$0.00	15	1.00	\$0.00
Cooling	Geothermal Heat Pump	High Efficiency	75.90	\$1,500.00	15	0.90	\$1.71
Cooling	Ductless HP	Ductless Mini-Split System	-	\$0.00	20	1.00	\$0.00
Space Heating	Electric Resistance	Electric Resistance	-	\$0.00	20	1.00	\$0.00
Space Heating	Electric Resistance	Ductless Mini-Split System	2,084.88	\$156.87	20	1.29	\$0.01
Space Heating	Electric Furnace	3400 BTU/KW	-	\$0.00	15	1.00	\$0.00
Space Heating	Supplemental	Supplemental	-	\$0.00	5	1.00	\$0.00
Space Heating	Air Source Heat Pump	SEER 13	-	\$0.00	15	-	\$0.00
Space Heating	Air Source Heat Pump	SEER 14 (Energy Star)	219.90	\$1,245.78	15	1.30	\$0.49
Space Heating	Air Source Heat Pump	SEER 15 (CEE Tier 2)	684.88	\$2,315.13	15	0.94	\$0.29
Space Heating	Air Source Heat Pump	SEER 16 (CEE Tier 3)	965.10	\$3,277.48	15	0.88	\$0.29
Space Heating	Air Source Heat Pump	Ductless Mini-Split System	1,270.27	\$5,022.03	20	0.87	\$0.28
Space Heating	Geothermal Heat Pump	Standard	-	\$0.00	15	1.00	\$0.00
Space Heating	Geothermal Heat Pump	High Efficiency	495.28	\$1,500.00	15	0.90	\$0.26
Space Heating	Ductless HP	Ductless Mini-Split System	-	\$0.00	20	1.00	\$0.00
Water Heating	Water Heater <= 55 Gal	Baseline (EF=0.90)	-	\$0.00	15	1.00	\$0.00
Water Heating	Water Heater <= 55 Gal	High Efficiency (EF=0.95)	110.09	\$77.11	15	1.01	\$0.06
Water Heating	Water Heater <= 55 Gal	EF 2.3 (HP)	1,061.19	\$1,761.86	15	0.64	\$0.14
Water Heating	Water Heater <= 55 Gal	Solar	1,202.35	\$6,214.86	15	0.27	\$0.45
Water Heating	Water Heater > 55 Gal	Baseline (EF=0.90)	-	\$0.00	15	1.00	\$0.00
Water Heating	Water Heater > 55 Gal	High Efficiency (EF=0.95)	182.05	\$97.23	15	1.02	\$0.05
Water Heating	Water Heater > 55 Gal	EF 2.3 (HP)	1,378.92	\$1,691.15	15	0.78	\$0.11

Residential Energy Efficiency Equipment and Measure Data

End Use	Technology	Eff. Definition	Savings (kWh/HH/yr)	Incremental Cost (\$/HH)	Lifetime (Years)	BC Ratio (2015)	Levelized Cost of Energy (\$/kWh)
	55 Gal						
Water Heating	Water Heater > 55 Gal	Solar	1,231.85	\$6,144.15	15	0.35	\$0.43
Interior Lighting	Screw-in	Incandescent	-	\$0.00	4	-	\$0.00
Interior Lighting	Screw-in	Infrared Halogen	186.22	\$134.14	5	1.00	\$0.16
Interior Lighting	Screw-in	CFL	591.38	\$12.45	6	2.81	\$0.00
Interior Lighting	Screw-in	LED	808.26	\$1,381.00	12	-	\$0.18
Interior Lighting	Screw-in	LED	808.26	\$1,381.00	12	-	\$0.18
Interior Lighting	Linear Fluorescent	T12	-	\$0.00	6	1.00	\$0.00
Interior Lighting	Linear Fluorescent	T8	9.18	-\$1.83	6	1.13	-\$0.04
Interior Lighting	Linear Fluorescent	Super T8	27.49	\$14.59	6	0.80	\$0.10
Interior Lighting	Linear Fluorescent	T5	28.58	\$24.70	6	0.65	\$0.16
Interior Lighting	Linear Fluorescent	LED	29.98	\$216.84	10	0.24	\$0.86
Interior Lighting	Specialty	Halogen	-	\$0.00	4	1.00	\$0.00
Interior Lighting	Specialty	CFL	121.57	-\$13.05	7	3.30	-\$0.02
Interior Lighting	Specialty	LED	127.91	\$62.12	12	1.02	\$0.05
Exterior Lighting	Screw-in	Incandescent	-	\$0.00	4	-	\$0.00
Exterior Lighting	Screw-in	Infrared Halogen	6.13	\$5.08	5	1.00	\$0.18
Exterior Lighting	Screw-in	CFL	20.80	-\$0.32	3	5.55	-\$0.01
Exterior Lighting	Screw-in	LED	24.14	\$75.05	12	-	\$0.32
Exterior Lighting	Screw-in	LED	24.14	\$75.05	12	-	\$0.32
Appliances	Clothes Washer	Baseline	-	\$0.00	14	-	\$0.00
Appliances	Clothes Washer	Energy Star (MEF > 1.8)	41.54	\$69.81	14	-	\$0.15
Appliances	Clothes Washer	Horizontal Axis	57.34	\$150.80	14	1.00	\$0.24
Appliances	Clothes Dryer	Baseline	-	\$0.00	13	-	\$0.00
Appliances	Clothes Dryer	Moisture Detection	61.35	\$48.40	13	1.00	\$0.08
Appliances	Dishwasher	Baseline	-	\$0.00	15	1.00	\$0.00
Appliances	Dishwasher	Energy Star	51.61	\$460.95	9	-	\$1.15
Appliances	Dishwasher	Energy Star (2011)	6.76	\$5.61	15	1.00	\$0.07
Appliances	Refrigerator	Baseline	-	\$0.00	20	-	\$0.00
Appliances	Refrigerator	Energy Star	49.89	\$20.17	20	-	\$0.03
Appliances	Refrigerator	Baseline (2014)	91.39	\$0.00	13	1.00	\$0.00
Appliances	Refrigerator	Energy Star (2014)	146.23	\$88.71	13	1.01	\$0.06
Appliances	Freezer	Baseline	-	\$0.00	22	-	\$0.00
Appliances	Freezer	Energy Star	38.51	\$3.98	22	-	\$0.01
Appliances	Freezer	Baseline (2014)	89.38	-\$145.00	11	1.00	-\$0.18
Appliances	Freezer	Energy Star (2014)	143.01	-\$112.83	11	1.00	-\$0.09
Appliances	Second Refrigerator	Baseline	-	\$0.00	13	-	\$0.00
Appliances	Second Refrigerator	Energy Star	64.14	\$20.67	20	-	\$0.02
Appliances	Second Refrigerator	Baseline (2014)	117.49	\$0.00	13	1.00	\$0.00
Appliances	Second Refrigerator	Energy Star (2014)	187.98	\$88.71	13	1.01	\$0.05

Residential Energy Efficiency Equipment and Measure Data

End Use	Technology	Eff. Definition	Savings (kWh/HH/yr)	Incremental Cost (\$/HH)	Lifetime (Years)	BC Ratio (2015)	Levelized Cost of Energy (\$/kWh)
Appliances	Stove	Baseline	-	\$0.00	13	1.00	\$0.00
Appliances	Stove	Convection Oven	8.53	\$1.86	13	1.00	\$0.02
Appliances	Stove	Induction (High Efficiency)	42.66	\$1,432.20	13	0.38	\$3.23
Appliances	Microwave	Baseline	-	\$0.00	9	1.00	\$0.00
Electronics	Personal Computers	Baseline	-	\$0.00	5	1.00	\$0.00
Electronics	Personal Computers	Energy Star	70.05	\$1.20	5	1.01	\$0.00
Electronics	Personal Computers	Climate Savers	100.08	\$175.49	5	0.85	\$0.38
Electronics	TVs	Baseline	-	\$0.00	11	1.00	\$0.00
Electronics	TVs	Energy Star	52.12	\$0.56	11	1.02	\$0.00
Electronics	Set-top boxes/DVR	Baseline	-	\$0.00	11	1.00	\$0.00
Electronics	Set-top boxes/DVR	Energy Star	31.55	\$0.56	11	1.01	\$0.00
Electronics	Devices and Gadgets	Devices and Gadgets	-	\$0.00	5	1.00	\$0.00
Miscellaneous	Pool Pump	Baseline Pump	-	\$0.00	15	1.00	\$0.00
Miscellaneous	Pool Pump	High Efficiency Pump	155.66	\$85.00	15	1.01	\$0.05
Miscellaneous	Pool Pump	Two-Speed Pump	622.65	\$579.00	15	0.88	\$0.08
Miscellaneous	Furnace Fan	Baseline	-	\$0.00	18	1.00	\$0.00
Miscellaneous	Furnace Fan	Furnace Fan with ECM	126.06	\$0.64	18	1.27	\$0.00
Miscellaneous	Miscellaneous	Miscellaneous	-	\$0.00	5	1.00	\$0.00

Residential Energy Efficiency Equipment and Measure Data

Table B-9 Energy Efficiency Equipment Data, Electric—Multi Family, Existing Vintage, Idaho

End Use	Technology	Eff. Definition	Savings (kWh/HH/yr)	Incremental Cost (\$/HH)	Lifetime (Years)	BC Ratio (2015)	Levelized Cost of Energy (\$/kWh)
Cooling	Central AC	SEER 13	-	\$0.00	15	-	\$0.00
Cooling	Central AC	SEER 14 (Energy Star)	35.49	\$92.62	15	1.40	\$0.23
Cooling	Central AC	SEER 15 (CEE Tier 2)	69.76	\$185.24	15	0.96	\$0.23
Cooling	Central AC	SEER 16 (CEE Tier 3)	98.42	\$277.86	15	0.92	\$0.24
Cooling	Central AC	Ductless Mini-Split System	128.81	\$2,012.28	20	0.62	\$1.11
Cooling	Room AC	EER 9.8	-	\$0.00	10	1.00	\$0.00
Cooling	Room AC	EER 10.8 (Energy Star)	27.73	\$52.02	10	0.84	\$0.22
Cooling	Room AC	EER 11	32.67	\$141.13	10	0.65	\$0.51
Cooling	Room AC	EER 11.5	44.26	\$312.75	10	0.45	\$0.84
Cooling	Air Source Heat Pump	SEER 13	-	\$0.00	15	-	\$0.00
Cooling	Air Source Heat Pump	SEER 14 (Energy Star)	37.52	\$1,245.78	15	1.30	\$2.87
Cooling	Air Source Heat Pump	SEER 15 (CEE Tier 2)	61.09	\$2,315.13	15	0.92	\$3.28
Cooling	Air Source Heat Pump	SEER 16 (CEE Tier 3)	86.18	\$3,277.48	15	0.85	\$3.29
Cooling	Air Source Heat Pump	Ductless Mini-Split System	112.78	\$5,022.03	20	0.84	\$3.15
Cooling	Geothermal Heat Pump	Standard	-	\$0.00	15	1.00	\$0.00
Cooling	Geothermal Heat Pump	High Efficiency	54.19	\$1,500.00	15	0.87	\$2.39
Cooling	Ductless HP	Ductless Mini-Split System	-	\$0.00	20	1.00	\$0.00
Space Heating	Electric Resistance	Electric Resistance	-	\$0.00	20	1.00	\$0.00
Space Heating	Electric Resistance	Ductless Mini-Split System	1,704.17	\$156.87	20	1.27	\$0.01
Space Heating	Electric Furnace	3400 BTU/KW	-	\$0.00	15	1.00	\$0.00
Space Heating	Supplemental	Supplemental	-	\$0.00	5	1.00	\$0.00
Space Heating	Air Source Heat Pump	SEER 13	-	\$0.00	15	-	\$0.00
Space Heating	Air Source Heat Pump	SEER 14 (Energy Star)	161.86	\$1,245.78	15	1.30	\$0.67
Space Heating	Air Source Heat Pump	SEER 15 (CEE Tier 2)	506.41	\$2,315.13	15	0.92	\$0.40
Space Heating	Air Source Heat Pump	SEER 16 (CEE Tier 3)	714.41	\$3,277.48	15	0.85	\$0.40
Space Heating	Air Source Heat Pump	Ductless Mini-Split System	934.98	\$5,022.03	20	0.84	\$0.38
Space Heating	Geothermal Heat Pump	Standard	-	\$0.00	15	1.00	\$0.00
Space Heating	Geothermal Heat Pump	High Efficiency	391.05	\$1,500.00	15	0.87	\$0.33
Space Heating	Ductless HP	Ductless Mini-Split System	-	\$0.00	20	1.00	\$0.00
Water Heating	Water Heater <= 55 Gal	Baseline (EF=0.90)	-	\$0.00	15	1.00	\$0.00
Water Heating	Water Heater <= 55 Gal	High Efficiency (EF=0.95)	103.48	\$77.11	15	1.00	\$0.06
Water Heating	Water Heater <= 55 Gal	EF 2.3 (HP)	997.52	\$1,761.86	15	0.57	\$0.15
Water Heating	Water Heater <= 55 Gal	Solar	1,130.20	\$6,214.86	15	0.24	\$0.48
Water Heating	Water Heater > 55 Gal	Baseline (EF=0.90)	-	\$0.00	15	1.00	\$0.00
Water Heating	Water Heater > 55 Gal	High Efficiency (EF=0.95)	171.13	\$97.23	15	1.01	\$0.05
Water Heating	Water Heater > 55 Gal	EF 2.3 (HP)	1,296.19	\$1,691.15	15	0.71	\$0.11

Residential Energy Efficiency Equipment and Measure Data

End Use	Technology	Eff. Definition	Savings (kWh/HH/yr)	Incremental Cost (\$/HH)	Lifetime (Years)	BC Ratio (2015)	Levelized Cost of Energy (\$/kWh)
	55 Gal						
Water Heating	Water Heater > 55 Gal	Solar	1,158.24	\$6,144.15	15	0.31	\$0.46
Interior Lighting	Screw-in	Incandescent	-	\$0.00	4	-	\$0.00
Interior Lighting	Screw-in	Infrared Halogen	153.34	\$134.14	5	1.00	\$0.19
Interior Lighting	Screw-in	CFL	486.95	\$12.45	6	3.12	\$0.00
Interior Lighting	Screw-in	LED	665.53	\$1,161.45	12	-	\$0.18
Interior Lighting	Screw-in	LED	665.53	\$1,161.45	12	-	\$0.18
Interior Lighting	Linear Fluorescent	T12	-	\$0.00	6	1.00	\$0.00
Interior Lighting	Linear Fluorescent	T8	7.33	-\$1.83	6	1.13	-\$0.05
Interior Lighting	Linear Fluorescent	Super T8	21.95	\$14.59	6	0.75	\$0.12
Interior Lighting	Linear Fluorescent	T5	22.81	\$24.70	6	0.60	\$0.20
Interior Lighting	Linear Fluorescent	LED	23.93	\$216.84	10	0.22	\$1.07
Interior Lighting	Specialty	Halogen	-	\$0.00	4	1.00	\$0.00
Interior Lighting	Specialty	CFL	99.37	\$0.77	7	1.91	\$0.00
Interior Lighting	Specialty	LED	104.55	\$209.01	12	0.28	\$0.20
Exterior Lighting	Screw-in	Incandescent	-	\$0.00	4	-	\$0.00
Exterior Lighting	Screw-in	Infrared Halogen	5.06	\$5.08	5	1.00	\$0.22
Exterior Lighting	Screw-in	CFL	17.18	-\$0.32	3	5.89	-\$0.01
Exterior Lighting	Screw-in	LED	19.94	\$1,167.57	12	-	\$6.00
Exterior Lighting	Screw-in	LED	19.94	\$1,167.57	12	-	\$6.00
Appliances	Clothes Washer	Baseline	-	\$0.00	14	-	\$0.00
Appliances	Clothes Washer	Energy Star (MEF > 1.8)	39.05	\$69.81	14	-	\$0.16
Appliances	Clothes Washer	Horizontal Axis	53.90	\$150.80	14	1.00	\$0.25
Appliances	Clothes Dryer	Baseline	-	\$0.00	13	-	\$0.00
Appliances	Clothes Dryer	Moisture Detection	57.67	\$48.40	13	1.00	\$0.08
Appliances	Dishwasher	Baseline	-	\$0.00	15	1.00	\$0.00
Appliances	Dishwasher	Energy Star	48.33	\$460.95	9	-	\$1.23
Appliances	Dishwasher	Energy Star (2011)	6.33	\$5.61	15	0.99	\$0.08
Appliances	Refrigerator	Baseline	-	\$0.00	20	-	\$0.00
Appliances	Refrigerator	Energy Star	41.38	\$20.17	20	-	\$0.03
Appliances	Refrigerator	Baseline (2014)	75.80	\$0.00	13	1.00	\$0.00
Appliances	Refrigerator	Energy Star (2014)	121.28	\$88.71	13	1.01	\$0.07
Appliances	Freezer	Baseline	-	\$0.00	22	-	\$0.00
Appliances	Freezer	Energy Star	33.83	\$3.98	22	-	\$0.01
Appliances	Freezer	Baseline (2014)	78.50	-\$145.00	11	1.00	-\$0.20
Appliances	Freezer	Energy Star (2014)	125.61	-\$112.83	11	0.99	-\$0.10
Appliances	Second Refrigerator	Baseline	-	\$0.00	20	-	\$0.00
Appliances	Second Refrigerator	Energy Star	56.52	\$20.67	20	-	\$0.03
Appliances	Second Refrigerator	Baseline (2014)	103.54	\$0.00	13	1.00	\$0.00
Appliances	Second Refrigerator	Energy Star (2014)	165.66	\$88.71	13	1.00	\$0.05

Residential Energy Efficiency Equipment and Measure Data

End Use	Technology	Eff. Definition	Savings (kWh/HH/yr)	Incremental Cost (\$/HH)	Lifetime (Years)	BC Ratio (2015)	Levelized Cost of Energy (\$/kWh)
Appliances	Stove	Baseline	-	\$0.00	13	1.00	\$0.00
Appliances	Stove	Convection Oven	8.02	\$1.86	13	1.00	\$0.02
Appliances	Stove	Induction (High Efficiency)	40.10	\$1,432.20	13	0.37	\$3.44
Appliances	Microwave	Baseline	-	\$0.00	9	1.00	\$0.00
Electronics	Personal Computers	Baseline	-	\$0.00	5	1.00	\$0.00
Electronics	Personal Computers	Energy Star	67.28	\$1.20	5	1.01	\$0.00
Electronics	Personal Computers	Climate Savers	96.12	\$175.49	5	0.85	\$0.39
Electronics	TVs	Baseline	-	\$0.00	11	1.00	\$0.00
Electronics	TVs	Energy Star	44.09	\$0.56	11	1.02	\$0.00
Electronics	Set-top boxes/DVR	Baseline	-	\$0.00	11	1.00	\$0.00
Electronics	Set-top boxes/DVR	Energy Star	29.65	\$0.56	11	1.01	\$0.00
Electronics	Devices and Gadgets	Devices and Gadgets	-	\$0.00	5	1.00	\$0.00
Miscellaneous	Pool Pump	Baseline Pump	-	\$0.00	15	1.00	\$0.00
Miscellaneous	Pool Pump	High Efficiency Pump	129.49	\$85.00	15	1.00	\$0.06
Miscellaneous	Pool Pump	Two-Speed Pump	517.96	\$579.00	15	0.81	\$0.10
Miscellaneous	Furnace Fan	Baseline	-	\$0.00	18	1.00	\$0.00
Miscellaneous	Furnace Fan	Furnace Fan with ECM	118.50	\$0.00	18	1.27	\$0.00
Miscellaneous	Miscellaneous	Miscellaneous	-	\$0.00	5	1.00	\$0.00

Residential Energy Efficiency Equipment and Measure Data

Table B-10 Energy Efficiency Equipment Data, Electric—Multi Family, New Vintage, Idaho

End Use	Technology	Eff. Definition	Savings (kWh/HH/yr)	Incremental Cost (\$/HH)	Lifetime (Years)	BC Ratio (2015)	Levelized Cost of Energy (\$/kWh)
Cooling	Central AC	SEER 13	-	\$0.00	15	-	\$0.00
Cooling	Central AC	SEER 14 (Energy Star)	45.42	\$92.62	15	1.40	\$0.18
Cooling	Central AC	SEER 15 (CEE Tier 2)	88.66	\$185.24	15	0.96	\$0.18
Cooling	Central AC	SEER 16 (CEE Tier 3)	124.94	\$277.86	15	0.93	\$0.19
Cooling	Central AC	Ductless Mini-Split System	164.44	\$2,012.28	20	0.63	\$0.87
Cooling	Room AC	EER 9.8	-	\$0.00	10	1.00	\$0.00
Cooling	Room AC	EER 10.8 (Energy Star)	34.44	\$52.02	10	0.86	\$0.18
Cooling	Room AC	EER 11	40.58	\$141.13	10	0.67	\$0.41
Cooling	Room AC	EER 11.5	55.03	\$312.75	10	0.47	\$0.67
Cooling	Air Source Heat Pump	SEER 13	-	\$0.00	15	-	\$0.00
Cooling	Air Source Heat Pump	SEER 14 (Energy Star)	47.92	\$1,245.78	15	1.30	\$2.25
Cooling	Air Source Heat Pump	SEER 15 (CEE Tier 2)	77.66	\$2,315.13	15	0.93	\$2.58
Cooling	Air Source Heat Pump	SEER 16 (CEE Tier 3)	109.43	\$3,277.48	15	0.87	\$2.59
Cooling	Air Source Heat Pump	Ductless Mini-Split System	144.03	\$5,022.03	20	0.86	\$2.47
Cooling	Geothermal Heat Pump	Standard	-	\$0.00	15	1.00	\$0.00
Cooling	Geothermal Heat Pump	High Efficiency	64.51	\$1,500.00	15	0.87	\$2.01
Cooling	Ductless HP	Ductless Mini-Split System	-	\$0.00	20	1.00	\$0.00
Space Heating	Electric Resistance	Electric Resistance	-	\$0.00	20	1.00	\$0.00
Space Heating	Electric Resistance	Ductless Mini-Split System	1,959.79	\$156.87	20	1.29	\$0.01
Space Heating	Electric Furnace	3400 BTU/kW	-	\$0.00	15	1.00	\$0.00
Space Heating	Supplemental	Supplemental	-	\$0.00	5	1.00	\$0.00
Space Heating	Air Source Heat Pump	SEER 13	-	\$0.00	15	-	\$0.00
Space Heating	Air Source Heat Pump	SEER 14 (Energy Star)	206.71	\$1,245.78	15	1.30	\$0.52
Space Heating	Air Source Heat Pump	SEER 15 (CEE Tier 2)	643.79	\$2,315.13	15	0.93	\$0.31
Space Heating	Air Source Heat Pump	SEER 16 (CEE Tier 3)	907.19	\$3,277.48	15	0.87	\$0.31
Space Heating	Air Source Heat Pump	Ductless Mini-Split System	1,194.05	\$5,022.03	20	0.86	\$0.30
Space Heating	Geothermal Heat Pump	Standard	-	\$0.00	15	1.00	\$0.00
Space Heating	Geothermal Heat Pump	High Efficiency	465.56	\$1,500.00	15	0.87	\$0.28
Space Heating	Ductless HP	Ductless Mini-Split System	-	\$0.00	20	1.00	\$0.00
Water Heating	Water Heater <= 55 Gal	Baseline (EF=0.90)	-	\$0.00	15	1.00	\$0.00
Water Heating	Water Heater <= 55 Gal	High Efficiency (EF=0.95)	103.48	\$77.11	15	1.00	\$0.06
Water Heating	Water Heater <= 55 Gal	EF 2.3 (HP)	997.52	\$1,761.86	15	0.57	\$0.15
Water Heating	Water Heater <= 55 Gal	Solar	1,130.20	\$6,214.86	15	0.24	\$0.48
Water Heating	Water Heater > 55 Gal	Baseline (EF=0.90)	-	\$0.00	15	1.00	\$0.00
Water Heating	Water Heater > 55 Gal	High Efficiency (EF=0.95)	171.13	\$97.23	15	1.01	\$0.05
Water Heating	Water Heater > 55 Gal	EF 2.3 (HP)	1,296.19	\$1,691.15	15	0.71	\$0.11

Residential Energy Efficiency Equipment and Measure Data

End Use	Technology	Eff. Definition	Savings (kWh/HH/yr)	Incremental Cost (\$/HH)	Lifetime (Years)	BC Ratio (2015)	Levelized Cost of Energy (\$/kWh)
	55 Gal						
Water Heating	Water Heater > 55 Gal	Solar	1,158.24	\$6,144.15	15	0.31	\$0.46
Interior Lighting	Screw-in	Incandescent	-	\$0.00	4	-	\$0.00
Interior Lighting	Screw-in	Infrared Halogen	175.05	\$134.14	5	1.00	\$0.17
Interior Lighting	Screw-in	CFL	555.89	\$12.45	6	2.98	\$0.00
Interior Lighting	Screw-in	LED	759.76	\$1,381.00	12	-	\$0.19
Interior Lighting	Screw-in	LED	759.76	\$1,381.00	12	-	\$0.19
Interior Lighting	Linear Fluorescent	T12	-	\$0.00	6	1.00	\$0.00
Interior Lighting	Linear Fluorescent	T8	8.63	-\$1.83	6	1.13	-\$0.04
Interior Lighting	Linear Fluorescent	Super T8	25.84	\$14.59	6	0.78	\$0.10
Interior Lighting	Linear Fluorescent	T5	26.86	\$24.70	6	0.63	\$0.17
Interior Lighting	Linear Fluorescent	LED	28.18	\$216.84	10	0.23	\$0.91
Interior Lighting	Specialty	Halogen	-	\$0.00	4	1.00	\$0.00
Interior Lighting	Specialty	CFL	114.28	-\$13.07	7	3.40	-\$0.02
Interior Lighting	Specialty	LED	120.23	\$61.68	12	1.01	\$0.05
Exterior Lighting	Screw-in	Incandescent	-	\$0.00	4	-	\$0.00
Exterior Lighting	Screw-in	Infrared Halogen	5.76	\$5.08	5	1.00	\$0.19
Exterior Lighting	Screw-in	CFL	19.55	-\$0.34	3	5.79	-\$0.01
Exterior Lighting	Screw-in	LED	22.70	\$75.05	12	-	\$0.34
Exterior Lighting	Screw-in	LED	22.70	\$75.05	12	-	\$0.34
Appliances	Clothes Washer	Baseline	-	\$0.00	14	-	\$0.00
Appliances	Clothes Washer	Energy Star (MEF > 1.8)	39.05	\$69.81	14	-	\$0.16
Appliances	Clothes Washer	Horizontal Axis	53.90	\$150.80	14	1.00	\$0.25
Appliances	Clothes Dryer	Baseline	-	\$0.00	13	-	\$0.00
Appliances	Clothes Dryer	Moisture Detection	57.67	\$48.40	13	1.00	\$0.08
Appliances	Dishwasher	Baseline	-	\$0.00	15	1.00	\$0.00
Appliances	Dishwasher	Energy Star	48.52	\$460.95	9	-	\$1.23
Appliances	Dishwasher	Energy Star (2011)	6.36	\$5.61	15	0.99	\$0.08
Appliances	Refrigerator	Baseline	-	\$0.00	20	-	\$0.00
Appliances	Refrigerator	Energy Star	46.90	\$20.17	20	-	\$0.03
Appliances	Refrigerator	Baseline (2014)	85.91	\$0.00	13	1.00	\$0.00
Appliances	Refrigerator	Energy Star (2014)	137.46	\$88.71	13	1.01	\$0.06
Appliances	Freezer	Baseline	-	\$0.00	22	-	\$0.00
Appliances	Freezer	Energy Star	36.20	\$3.98	22	-	\$0.01
Appliances	Freezer	Baseline (2014)	84.02	-\$145.00	11	1.00	-\$0.19
Appliances	Freezer	Energy Star (2014)	134.43	-\$112.83	11	0.99	-\$0.09
Appliances	Second Refrigerator	Baseline	-	\$0.00	20	-	\$0.00
Appliances	Second Refrigerator	Energy Star	60.29	\$20.67	20	-	\$0.02
Appliances	Second Refrigerator	Baseline (2014)	110.44	\$0.00	13	1.00	\$0.00
Appliances	Second Refrigerator	Energy Star (2014)	176.70	\$88.71	13	1.00	\$0.05

Residential Energy Efficiency Equipment and Measure Data

End Use	Technology	Eff. Definition	Savings (kWh/HH/yr)	Incremental Cost (\$/HH)	Lifetime (Years)	BC Ratio (2015)	Levelized Cost of Energy (\$/kWh)
Appliances	Stove	Baseline	-	\$0.00	13	1.00	\$0.00
Appliances	Stove	Convection Oven	8.02	\$1.86	13	1.00	\$0.02
Appliances	Stove	Induction (High Efficiency)	40.10	\$1,432.20	13	0.37	\$3.44
Appliances	Microwave	Baseline	-	\$0.00	9	1.00	\$0.00
Electronics	Personal Computers	Baseline	-	\$0.00	5	1.00	\$0.00
Electronics	Personal Computers	Energy Star	65.85	\$1.20	5	1.01	\$0.00
Electronics	Personal Computers	Climate Savers	94.07	\$175.49	5	0.85	\$0.40
Electronics	TVs	Baseline	-	\$0.00	11	1.00	\$0.00
Electronics	TVs	Energy Star	48.99	\$0.56	11	1.02	\$0.00
Electronics	Set-top boxes/DVR	Baseline	-	\$0.00	11	1.00	\$0.00
Electronics	Set-top boxes/DVR	Energy Star	29.65	\$0.56	11	1.01	\$0.00
Electronics	Devices and Gadgets	Devices and Gadgets	-	\$0.00	5	1.00	\$0.00
Miscellaneous	Pool Pump	Baseline Pump	-	\$0.00	15	1.00	\$0.00
Miscellaneous	Pool Pump	High Efficiency Pump	146.32	\$85.00	15	1.01	\$0.05
Miscellaneous	Pool Pump	Two-Speed Pump	585.29	\$579.00	15	0.85	\$0.09
Miscellaneous	Furnace Fan	Baseline	-	\$0.00	18	1.00	\$0.00
Miscellaneous	Furnace Fan	Furnace Fan with ECM	118.50	\$0.64	18	1.27	\$0.00
Miscellaneous	Miscellaneous	Miscellaneous	-	\$0.00	5	1.00	\$0.00

Residential Energy Efficiency Equipment and Measure Data

Table B-11 Energy Efficiency Equipment Data, Electric—Mobile Home, Existing Vintage, Washington

End Use	Technology	Eff. Definition	Savings (kWh/HH/yr)	Incremental Cost (\$/HH)	Lifetime (Years)	BC Ratio (2015)	Levelized Cost of Energy (\$/kWh)
Cooling	Central AC	SEER 13	-	\$0.00	15	-	\$0.00
Cooling	Central AC	SEER 14 (Energy Star)	46.32	\$277.86	20	1.40	\$0.42
Cooling	Central AC	SEER 15 (CEE Tier 2)	63.55	\$555.71	15	0.78	\$0.76
Cooling	Central AC	SEER 16 (CEE Tier 3)	77.99	\$833.57	15	0.73	\$0.92
Cooling	Central AC	Ductless Mini-Split System	139.87	\$4,399.48	20	0.51	\$2.23
Cooling	Room AC	EER 9.8	-	\$0.00	10	1.00	\$0.00
Cooling	Room AC	EER 10.8 (Energy Star)	27.99	\$52.02	10	0.85	\$0.22
Cooling	Room AC	EER 11	33.03	\$141.13	10	0.65	\$0.51
Cooling	Room AC	EER 11.5	44.72	\$312.75	10	0.45	\$0.83
Cooling	Air Source Heat Pump	SEER 13	-	\$0.00	15	-	\$0.00
Cooling	Air Source Heat Pump	SEER 14 (Energy Star)	43.49	\$1,720.87	15	1.30	\$3.42
Cooling	Air Source Heat Pump	SEER 15 (CEE Tier 2)	40.94	\$2,315.13	15	0.96	\$4.89
Cooling	Air Source Heat Pump	SEER 16 (CEE Tier 3)	50.24	\$3,277.48	15	0.88	\$5.64
Cooling	Air Source Heat Pump	Ductless Mini-Split System	90.11	\$5,022.03	20	0.89	\$3.94
Cooling	Geothermal Heat Pump	Standard	-	\$0.00	15	1.00	\$0.00
Cooling	Geothermal Heat Pump	High Efficiency	46.66	\$1,500.00	15	0.90	\$2.78
Cooling	Ductless HP	Ductless Mini-Split System	-	\$0.00	20	1.00	\$0.00
Space Heating	Electric Resistance	Electric Resistance	-	\$0.00	20	1.00	\$0.00
Space Heating	Electric Resistance	Ductless Mini-Split System	2,388.11	\$156.87	20	1.28	\$0.00
Space Heating	Electric Furnace	3400 BTU/KW	-	\$0.00	15	1.00	\$0.00
Space Heating	Supplemental	Supplemental	-	\$0.00	5	1.00	\$0.00
Space Heating	Air Source Heat Pump	SEER 13	-	\$0.00	15	-	\$0.00
Space Heating	Air Source Heat Pump	SEER 14 (Energy Star)	239.45	\$1,720.87	15	1.30	\$0.62
Space Heating	Air Source Heat Pump	SEER 15 (CEE Tier 2)	528.37	\$2,315.13	15	0.96	\$0.38
Space Heating	Air Source Heat Pump	SEER 16 (CEE Tier 3)	648.37	\$3,277.48	15	0.88	\$0.44
Space Heating	Air Source Heat Pump	Ductless Mini-Split System	1,162.86	\$5,022.03	20	0.89	\$0.31
Space Heating	Geothermal Heat Pump	Standard	-	\$0.00	15	1.00	\$0.00
Space Heating	Geothermal Heat Pump	High Efficiency	813.13	\$188.19	15	0.90	\$0.02
Space Heating	Ductless HP	Ductless Mini-Split System	-	\$0.00	20	1.00	\$0.00
Water Heating	Water Heater <= 55 Gal	Baseline (EF=0.90)	-	\$0.00	15	1.00	\$0.00
Water Heating	Water Heater <= 55 Gal	High Efficiency (EF=0.95)	134.84	\$77.11	15	1.01	\$0.05
Water Heating	Water Heater <= 55 Gal	EF 2.3 (HP)	1,299.77	\$1,761.86	15	0.72	\$0.12
Water Heating	Water Heater <= 55 Gal	Solar	1,472.84	\$6,214.86	15	0.32	\$0.36
Water Heating	Water Heater > 55 Gal	Baseline (EF=0.90)	-	\$0.00	15	1.00	\$0.00
Water Heating	Water Heater >	High Efficiency	171.70	\$97.23	15	1.02	\$0.05

Residential Energy Efficiency Equipment and Measure Data

End Use	Technology	Eff. Definition	Savings (kWh/HH/yr)	Incremental Cost (\$/HH)	Lifetime (Years)	BC Ratio (2015)	Levelized Cost of Energy (\$/kWh)
	55 Gal	(EF=0.95)					
Water Heating	Water Heater > 55 Gal	EF 2.3 (HP)	1,300.53	\$1,691.15	15	0.76	\$0.11
Water Heating	Water Heater > 55 Gal	Solar	1,162.12	\$6,144.15	15	0.34	\$0.46
Interior Lighting	Screw-in	Incandescent	-	\$0.00	4	-	\$0.00
Interior Lighting	Screw-in	Infrared Halogen	210.16	\$188.19	5	1.00	\$0.19
Interior Lighting	Screw-in	CFL	667.39	\$28.57	6	2.81	\$0.01
Interior Lighting	Screw-in	LED	912.15	\$1,353.42	12	-	\$0.15
Interior Lighting	Screw-in	LED	912.15	\$1,353.42	12	-	\$0.15
Interior Lighting	Linear Fluorescent	T12	-	\$0.00	6	1.00	\$0.00
Interior Lighting	Linear Fluorescent	T8	8.74	-\$3.65	6	1.14	-\$0.08
Interior Lighting	Linear Fluorescent	Super T8	26.18	\$29.17	6	0.65	\$0.20
Interior Lighting	Linear Fluorescent	T5	27.22	\$49.41	6	0.51	\$0.33
Interior Lighting	Linear Fluorescent	LED	28.55	\$433.68	10	0.17	\$1.80
Interior Lighting	Specialty	Halogen	-	\$0.00	4	1.00	\$0.00
Interior Lighting	Specialty	CFL	205.65	\$1.34	7	1.92	\$0.00
Interior Lighting	Specialty	LED	216.37	\$365.76	12	0.31	\$0.17
Exterior Lighting	Screw-in	Incandescent	-	\$0.00	4	-	\$0.00
Exterior Lighting	Screw-in	Infrared Halogen	72.47	\$51.30	5	1.00	\$0.15
Exterior Lighting	Screw-in	CFL	245.95	-\$1.81	3	4.75	\$0.00
Exterior Lighting	Screw-in	LED	285.49	\$1,356.06	12	-	\$0.49
Exterior Lighting	Screw-in	LED	285.49	\$1,356.06	12	-	\$0.49
Appliances	Clothes Washer	Baseline	-	\$0.00	14	-	\$0.00
Appliances	Clothes Washer	Energy Star (MEF > 1.8)	40.50	\$69.81	14	-	\$0.16
Appliances	Clothes Washer	Horizontal Axis	55.91	\$150.80	14	1.00	\$0.25
Appliances	Clothes Dryer	Baseline	-	\$0.00	13	-	\$0.00
Appliances	Clothes Dryer	Moisture Detection	60.29	\$48.40	13	1.00	\$0.08
Appliances	Dishwasher	Baseline	-	\$0.00	15	1.00	\$0.00
Appliances	Dishwasher	Energy Star	50.13	\$460.95	9	-	\$1.19
Appliances	Dishwasher	Energy Star (2011)	6.57	\$5.61	15	1.00	\$0.07
Appliances	Refrigerator	Baseline	-	\$0.00	20	-	\$0.00
Appliances	Refrigerator	Energy Star	42.92	\$20.17	20	-	\$0.03
Appliances	Refrigerator	Baseline (2014)	78.63	\$0.00	13	1.00	\$0.00
Appliances	Refrigerator	Energy Star (2014)	125.80	\$88.71	13	1.01	\$0.07
Appliances	Freezer	Baseline	-	\$0.00	22	-	\$0.00
Appliances	Freezer	Energy Star	35.09	\$3.98	22	-	\$0.01
Appliances	Freezer	Baseline (2014)	81.43	-\$145.00	11	1.00	-\$0.20
Appliances	Freezer	Energy Star (2014)	130.28	-\$112.83	11	0.99	-\$0.10
Appliances	Second Refrigerator	Baseline	-	\$0.00	20	-	\$0.00
Appliances	Second Refrigerator	Energy Star	58.63	\$20.67	20	-	\$0.02
Appliances	Second Refrigerator	Baseline (2014)	107.39	\$0.00	13	1.00	\$0.00

Residential Energy Efficiency Equipment and Measure Data

End Use	Technology	Eff. Definition	Savings (kWh/HH/yr)	Incremental Cost (\$/HH)	Lifetime (Years)	BC Ratio (2015)	Levelized Cost of Energy (\$/kWh)
Appliances	Second Refrigerator	Energy Star (2014)	171.83	\$88.71	13	1.01	\$0.05
Appliances	Stove	Baseline	-	\$0.00	13	1.00	\$0.00
Appliances	Stove	Convection Oven	8.32	\$1.86	13	1.00	\$0.02
Appliances	Stove	Induction (High Efficiency)	41.60	\$1,432.20	13	0.37	\$3.32
Appliances	Microwave	Baseline	-	\$0.00	9	1.00	\$0.00
Electronics	Personal Computers	Baseline	-	\$0.00	5	1.00	\$0.00
Electronics	Personal Computers	Energy Star	76.05	\$1.20	5	1.01	\$0.00
Electronics	Personal Computers	Climate Savers	108.65	\$175.49	5	0.85	\$0.35
Electronics	TVs	Baseline	-	\$0.00	11	1.00	\$0.00
Electronics	TVs	Energy Star	44.30	\$0.56	11	1.02	\$0.00
Electronics	Set-top boxes/DVR	Baseline	-	\$0.00	11	1.00	\$0.00
Electronics	Set-top boxes/DVR	Energy Star	26.81	\$0.56	11	1.01	\$0.00
Electronics	Devices and Gadgets	Devices and Gadgets	-	\$0.00	5	1.00	\$0.00
Miscellaneous	Pool Pump	Baseline Pump	-	\$0.00	15	1.00	\$0.00
Miscellaneous	Pool Pump	High Efficiency Pump	103.32	\$85.00	15	0.98	\$0.07
Miscellaneous	Pool Pump	Two-Speed Pump	413.27	\$579.00	15	0.74	\$0.12
Miscellaneous	Furnace Fan	Baseline	-	\$0.00	18	1.00	\$0.00
Miscellaneous	Furnace Fan	Furnace Fan with ECM	118.18	\$0.64	18	1.27	\$0.00
Miscellaneous	Miscellaneous	Miscellaneous	-	\$0.00	5	1.00	\$0.00

Residential Energy Efficiency Equipment and Measure Data

Table B-12 Energy Efficiency Equipment Data, Electric—Mobile Home, New Vintage, Washington

End Use	Technology	Eff. Definition	Savings (kWh/HH/yr)	Incremental Cost (\$/HH)	Lifetime (Years)	BC Ratio (2015)	Levelized Cost of Energy (\$/kWh)
Cooling	Central AC	SEER 13	-	\$0.00	15	-	\$0.00
Cooling	Central AC	SEER 14 (Energy Star)	55.05	\$277.86	15	1.40	\$0.44
Cooling	Central AC	SEER 15 (CEE Tier 2)	73.33	\$555.71	15	0.94	\$0.66
Cooling	Central AC	SEER 16 (CEE Tier 3)	88.67	\$833.57	15	0.89	\$0.81
Cooling	Central AC	Ductless Mini-Split System	166.28	\$4,399.48	20	0.62	\$1.87
Cooling	Room AC	EER 9.8	-	\$0.00	10	1.00	\$0.00
Cooling	Room AC	EER 10.8 (Energy Star)	32.54	\$52.02	10	0.86	\$0.19
Cooling	Room AC	EER 11	38.34	\$141.13	10	0.66	\$0.44
Cooling	Room AC	EER 11.5	51.99	\$312.75	10	0.46	\$0.71
Cooling	Air Source Heat Pump	SEER 13	-	\$0.00	15	-	\$0.00
Cooling	Air Source Heat Pump	SEER 14 (Energy Star)	51.74	\$1,720.87	15	1.30	\$2.88
Cooling	Air Source Heat Pump	SEER 15 (CEE Tier 2)	47.26	\$2,315.13	15	0.97	\$4.24
Cooling	Air Source Heat Pump	SEER 16 (CEE Tier 3)	57.15	\$3,277.48	15	0.89	\$4.96
Cooling	Air Source Heat Pump	Ductless Mini-Split System	107.18	\$5,022.03	20	0.90	\$3.32
Cooling	Geothermal Heat Pump	Standard	-	\$0.00	15	1.00	\$0.00
Cooling	Geothermal Heat Pump	High Efficiency	51.93	\$1,500.00	15	0.91	\$2.50
Cooling	Ductless HP	Ductless Mini-Split System	-	\$0.00	20	1.00	\$0.00
Space Heating	Electric Resistance	Electric Resistance	-	\$0.00	20	1.00	\$0.00
Space Heating	Electric Resistance	Ductless Mini-Split System	2,567.22	\$156.87	20	1.29	\$0.00
Space Heating	Electric Furnace	3400 BTU/KW	-	\$0.00	15	1.00	\$0.00
Space Heating	Supplemental	Supplemental	-	\$0.00	5	1.00	\$0.00
Space Heating	Air Source Heat Pump	SEER 13	-	\$0.00	15	-	\$0.00
Space Heating	Air Source Heat Pump	SEER 14 (Energy Star)	284.83	\$1,720.87	15	1.30	\$0.52
Space Heating	Air Source Heat Pump	SEER 15 (CEE Tier 2)	609.96	\$2,315.13	15	0.97	\$0.33
Space Heating	Air Source Heat Pump	SEER 16 (CEE Tier 3)	737.59	\$3,277.48	15	0.89	\$0.38
Space Heating	Air Source Heat Pump	Ductless Mini-Split System	1,383.21	\$5,022.03	20	0.90	\$0.26
Space Heating	Geothermal Heat Pump	Standard	-	\$0.00	15	1.00	\$0.00
Space Heating	Geothermal Heat Pump	High Efficiency	671.05	\$1,500.00	15	0.91	\$0.19
Space Heating	Ductless HP	Ductless Mini-Split System	-	\$0.00	20	1.00	\$0.00
Water Heating	Water Heater <= 55 Gal	Baseline (EF=0.90)	-	\$0.00	15	1.00	\$0.00
Water Heating	Water Heater <= 55 Gal	High Efficiency (EF=0.95)	141.18	\$77.11	15	1.02	\$0.05
Water Heating	Water Heater <= 55 Gal	EF 2.3 (HP)	1,360.93	\$1,761.86	15	0.73	\$0.11
Water Heating	Water Heater <= 55 Gal	Solar	1,542.14	\$6,214.86	15	0.33	\$0.35
Water Heating	Water Heater > 55 Gal	Baseline (EF=0.90)	-	\$0.00	15	1.00	\$0.00
Water Heating	Water Heater >	High Efficiency	179.84	\$97.23	15	1.02	\$0.05

Residential Energy Efficiency Equipment and Measure Data

End Use	Technology	Eff. Definition	Savings (kWh/HH/yr)	Incremental Cost (\$/HH)	Lifetime (Years)	BC Ratio (2015)	Levelized Cost of Energy (\$/kWh)
	55 Gal	(EF=0.95)					
Water Heating	Water Heater > 55 Gal	EF 2.3 (HP)	1,362.23	\$1,691.15	15	0.77	\$0.11
Water Heating	Water Heater > 55 Gal	Solar	1,217.25	\$6,144.15	15	0.35	\$0.44
Interior Lighting	Screw-in	Incandescent	-	\$0.00	4	-	\$0.00
Interior Lighting	Screw-in	Infrared Halogen	229.01	\$188.19	5	1.00	\$0.18
Interior Lighting	Screw-in	CFL	727.25	\$28.57	6	2.74	\$0.01
Interior Lighting	Screw-in	LED	993.96	\$1,937.55	12	-	\$0.20
Interior Lighting	Screw-in	LED	993.96	\$1,937.55	12	-	\$0.20
Interior Lighting	Linear Fluorescent	T12	-	\$0.00	6	1.00	\$0.00
Interior Lighting	Linear Fluorescent	T8	9.82	-\$3.65	6	1.14	-\$0.07
Interior Lighting	Linear Fluorescent	Super T8	29.43	\$29.17	6	0.67	\$0.18
Interior Lighting	Linear Fluorescent	T5	30.59	\$49.41	6	0.53	\$0.30
Interior Lighting	Linear Fluorescent	LED	32.09	\$433.68	10	0.18	\$1.60
Interior Lighting	Specialty	Halogen	-	\$0.00	4	1.00	\$0.00
Interior Lighting	Specialty	CFL	221.07	-\$7.66	7	2.45	-\$0.01
Interior Lighting	Specialty	LED	232.60	\$134.50	12	0.74	\$0.06
Exterior Lighting	Screw-in	Incandescent	-	\$0.00	4	-	\$0.00
Exterior Lighting	Screw-in	Infrared Halogen	78.72	\$51.30	5	1.00	\$0.14
Exterior Lighting	Screw-in	CFL	267.15	-\$2.04	3	4.76	\$0.00
Exterior Lighting	Screw-in	LED	310.10	\$757.28	12	-	\$0.25
Exterior Lighting	Screw-in	LED	310.10	\$757.28	12	-	\$0.25
Appliances	Clothes Washer	Baseline	-	\$0.00	14	-	\$0.00
Appliances	Clothes Washer	Energy Star (MEF > 1.8)	47.25	\$69.81	14	-	\$0.13
Appliances	Clothes Washer	Horizontal Axis	65.23	\$150.80	14	1.00	\$0.21
Appliances	Clothes Dryer	Baseline	-	\$0.00	13	-	\$0.00
Appliances	Clothes Dryer	Moisture Detection	65.61	\$48.40	13	1.00	\$0.07
Appliances	Dishwasher	Baseline	-	\$0.00	15	1.00	\$0.00
Appliances	Dishwasher	Energy Star	54.76	\$460.95	9	-	\$1.09
Appliances	Dishwasher	Energy Star (2011)	7.17	\$5.61	15	1.00	\$0.07
Appliances	Refrigerator	Baseline	-	\$0.00	20	-	\$0.00
Appliances	Refrigerator	Energy Star	60.09	\$20.17	20	-	\$0.02
Appliances	Refrigerator	Baseline (2014)	110.08	\$0.00	13	1.00	\$0.00
Appliances	Refrigerator	Energy Star (2014)	176.12	\$88.71	13	1.02	\$0.05
Appliances	Freezer	Baseline	-	\$0.00	22	-	\$0.00
Appliances	Freezer	Energy Star	48.64	\$3.98	22	-	\$0.01
Appliances	Freezer	Baseline (2014)	112.87	-\$145.00	11	1.00	-\$0.14
Appliances	Freezer	Energy Star (2014)	180.59	-\$112.83	11	1.01	-\$0.07
Appliances	Second Refrigerator	Baseline	-	\$0.00	20	-	\$0.00
Appliances	Second Refrigerator	Energy Star	80.12	\$20.67	20	-	\$0.02
Appliances	Second Refrigerator	Baseline (2014)	146.77	\$0.00	13	1.00	\$0.00

Residential Energy Efficiency Equipment and Measure Data

End Use	Technology	Eff. Definition	Savings (kWh/HH/yr)	Incremental Cost (\$/HH)	Lifetime (Years)	BC Ratio (2015)	Levelized Cost of Energy (\$/kWh)
Appliances	Second Refrigerator	Energy Star (2014)	234.83	\$88.71	13	1.01	\$0.04
Appliances	Stove	Baseline	-	\$0.00	13	1.00	\$0.00
Appliances	Stove	Convection Oven	35.13	\$0.56	13	1.00	\$0.00
Appliances	Stove	Induction (High Efficiency)	41.59	\$0.00	13	0.37	\$0.00
Appliances	Microwave	Baseline	-	\$0.00	9	1.00	\$0.00
Electronics	Personal Computers	Baseline	-	\$0.00	5	1.00	\$0.00
Electronics	Personal Computers	Energy Star	74.43	\$1.20	5	1.01	\$0.00
Electronics	Personal Computers	Climate Savers	106.33	\$175.49	5	0.85	\$0.36
Electronics	TVs	Baseline	-	\$0.00	11	1.00	\$0.00
Electronics	TVs	Energy Star	49.22	\$0.56	11	1.02	\$0.00
Electronics	Set-top boxes/DVR	Baseline	-	\$0.00	11	1.00	\$0.00
Electronics	Set-top boxes/DVR	Energy Star	26.81	\$0.56	11	1.01	\$0.00
Electronics	Devices and Gadgets	Devices and Gadgets	-	\$0.00	5	1.00	\$0.00
Miscellaneous	Pool Pump	Baseline Pump	-	\$0.00	15	1.00	\$0.00
Miscellaneous	Pool Pump	High Efficiency Pump	115.77	\$85.00	15	0.99	\$0.06
Miscellaneous	Pool Pump	Two-Speed Pump	463.09	\$579.00	15	0.78	\$0.11
Miscellaneous	Furnace Fan	Baseline	-	\$0.00	18	1.00	\$0.00
Miscellaneous	Furnace Fan	Furnace Fan with ECM	118.18	\$0.64	18	1.27	\$0.00
Miscellaneous	Miscellaneous	Miscellaneous	-	\$0.00	5	1.00	\$0.00

Residential Energy Efficiency Equipment and Measure Data

Table B-13 Energy Efficiency Equipment Data, Electric—Mobile Home, Existing Vintage, Idaho

End Use	Technology	Eff. Definition	Savings (kWh/HH/yr)	Incremental Cost (\$/HH)	Lifetime (Years)	BC Ratio (2015)	Levelized Cost of Energy (\$/kWh)
Cooling	Central AC	SEER 13	-	\$0.00	15	-	\$0.00
Cooling	Central AC	SEER 14 (Energy Star)	39.83	\$277.86	15	1.40	\$0.60
Cooling	Central AC	SEER 15 (CEE Tier 2)	54.66	\$555.71	15	0.94	\$0.88
Cooling	Central AC	SEER 16 (CEE Tier 3)	67.07	\$833.57	15	0.89	\$1.07
Cooling	Central AC	Ductless Mini-Split System	120.29	\$4,399.48	20	0.62	\$2.59
Cooling	Room AC	EER 9.8	-	\$0.00	10	1.00	\$0.00
Cooling	Room AC	EER 10.8 (Energy Star)	24.07	\$52.02	10	0.84	\$0.26
Cooling	Room AC	EER 11	28.41	\$141.13	10	0.64	\$0.59
Cooling	Room AC	EER 11.5	38.46	\$312.75	10	0.44	\$0.96
Cooling	Air Source Heat Pump	SEER 13	-	\$0.00	15	-	\$0.00
Cooling	Air Source Heat Pump	SEER 14 (Energy Star)	37.41	\$1,720.87	15	1.30	\$3.98
Cooling	Air Source Heat Pump	SEER 15 (CEE Tier 2)	35.21	\$2,315.13	15	0.96	\$5.69
Cooling	Air Source Heat Pump	SEER 16 (CEE Tier 3)	43.21	\$3,277.48	15	0.88	\$6.56
Cooling	Air Source Heat Pump	Ductless Mini-Split System	77.49	\$5,022.03	20	0.88	\$4.59
Cooling	Geothermal Heat Pump	Standard	-	\$0.00	15	1.00	\$0.00
Cooling	Geothermal Heat Pump	High Efficiency	40.13	\$1,500.00	15	0.89	\$3.23
Cooling	Ductless HP	Ductless Mini-Split System	-	\$0.00	20	1.00	\$0.00
Space Heating	Electric Resistance	Electric Resistance	-	\$0.00	20	1.00	\$0.00
Space Heating	Electric Resistance	Ductless Mini-Split System	2,256.76	\$156.87	20	1.27	\$0.00
Space Heating	Electric Furnace	3400 BTU/KW	-	\$0.00	15	1.00	\$0.00
Space Heating	Supplemental	Supplemental	-	\$0.00	5	1.00	\$0.00
Space Heating	Air Source Heat Pump	SEER 13	-	\$0.00	15	-	\$0.00
Space Heating	Air Source Heat Pump	SEER 14 (Energy Star)	226.28	\$1,720.87	15	1.30	\$0.66
Space Heating	Air Source Heat Pump	SEER 15 (CEE Tier 2)	499.31	\$2,315.13	15	0.96	\$0.40
Space Heating	Air Source Heat Pump	SEER 16 (CEE Tier 3)	612.71	\$3,277.48	15	0.88	\$0.46
Space Heating	Air Source Heat Pump	Ductless Mini-Split System	1,098.90	\$5,022.03	20	0.88	\$0.32
Space Heating	Geothermal Heat Pump	Standard	-	\$0.00	15	1.00	\$0.00
Space Heating	Geothermal Heat Pump	High Efficiency	768.40	\$188.19	15	0.89	\$0.02
Space Heating	Ductless HP	Ductless Mini-Split System	-	\$0.00	20	1.00	\$0.00
Water Heating	Water Heater <= 55 Gal	Baseline (EF=0.90)	-	\$0.00	15	1.00	\$0.00
Water Heating	Water Heater <= 55 Gal	High Efficiency (EF=0.95)	127.42	\$77.11	15	1.01	\$0.05
Water Heating	Water Heater <= 55 Gal	EF 2.3 (HP)	1,228.29	\$1,761.86	15	0.64	\$0.12
Water Heating	Water Heater <= 55 Gal	Solar	1,391.83	\$6,214.86	15	0.27	\$0.39
Water Heating	Water Heater > 55 Gal	Baseline (EF=0.90)	-	\$0.00	15	1.00	\$0.00
Water Heating	Water Heater > 55 Gal	High Efficiency (EF=0.95)	162.25	\$97.23	15	1.01	\$0.05
Water Heating	Water Heater > 55 Gal	EF 2.3 (HP)	1,229.00	\$1,691.15	15	0.68	\$0.12

Residential Energy Efficiency Equipment and Measure Data

End Use	Technology	Eff. Definition	Savings (kWh/HH/yr)	Incremental Cost (\$/HH)	Lifetime (Years)	BC Ratio (2015)	Levelized Cost of Energy (\$/kWh)
	55 Gal						
Water Heating	Water Heater > 55 Gal	Solar	1,098.20	\$6,144.15	15	0.30	\$0.48
Interior Lighting	Screw-in	Incandescent	-	\$0.00	4	-	\$0.00
Interior Lighting	Screw-in	Infrared Halogen	198.60	\$188.19	5	1.00	\$0.20
Interior Lighting	Screw-in	CFL	630.68	\$28.57	6	2.95	\$0.01
Interior Lighting	Screw-in	LED	861.98	\$1,353.42	12	-	\$0.16
Interior Lighting	Screw-in	LED	861.98	\$1,353.42	12	-	\$0.16
Interior Lighting	Linear Fluorescent	T12	-	\$0.00	6	1.00	\$0.00
Interior Lighting	Linear Fluorescent	T8	8.26	-\$3.50	6	1.14	-\$0.08
Interior Lighting	Linear Fluorescent	Super T8	24.74	\$28.01	6	0.65	\$0.21
Interior Lighting	Linear Fluorescent	T5	25.72	\$47.43	6	0.50	\$0.34
Interior Lighting	Linear Fluorescent	LED	26.98	\$416.33	10	0.17	\$1.83
Interior Lighting	Specialty	Halogen	-	\$0.00	4	1.00	\$0.00
Interior Lighting	Specialty	CFL	194.34	\$1.34	7	1.93	\$0.00
Interior Lighting	Specialty	LED	204.47	\$365.76	12	0.30	\$0.18
Exterior Lighting	Screw-in	Incandescent	-	\$0.00	4	-	\$0.00
Exterior Lighting	Screw-in	Infrared Halogen	68.48	\$49.25	5	1.00	\$0.16
Exterior Lighting	Screw-in	CFL	232.42	-\$1.53	3	4.76	\$0.00
Exterior Lighting	Screw-in	LED	269.78	\$1,356.33	12	-	\$0.52
Exterior Lighting	Screw-in	LED	269.78	\$1,356.33	12	-	\$0.52
Appliances	Clothes Washer	Baseline	-	\$0.00	14	-	\$0.00
Appliances	Clothes Washer	Energy Star (MEF > 1.8)	38.27	\$69.81	14	-	\$0.17
Appliances	Clothes Washer	Horizontal Axis	52.83	\$150.80	14	1.00	\$0.26
Appliances	Clothes Dryer	Baseline	-	\$0.00	13	-	\$0.00
Appliances	Clothes Dryer	Moisture Detection	56.98	\$48.40	13	1.00	\$0.08
Appliances	Dishwasher	Baseline	-	\$0.00	15	1.00	\$0.00
Appliances	Dishwasher	Energy Star	47.38	\$460.95	9	-	\$1.26
Appliances	Dishwasher	Energy Star (2011)	6.21	\$5.61	15	0.99	\$0.08
Appliances	Refrigerator	Baseline	-	\$0.00	20	-	\$0.00
Appliances	Refrigerator	Energy Star	40.56	\$20.17	20	-	\$0.04
Appliances	Refrigerator	Baseline (2014)	74.30	\$0.00	13	1.00	\$0.00
Appliances	Refrigerator	Energy Star (2014)	118.88	\$88.71	13	1.01	\$0.07
Appliances	Freezer	Baseline	-	\$0.00	22	-	\$0.00
Appliances	Freezer	Energy Star	33.16	\$3.98	22	-	\$0.01
Appliances	Freezer	Baseline (2014)	76.95	-\$145.00	11	1.00	-\$0.21
Appliances	Freezer	Energy Star (2014)	123.12	-\$112.83	11	0.99	-\$0.10
Appliances	Second Refrigerator	Baseline	-	\$0.00	20	-	\$0.00
Appliances	Second Refrigerator	Energy Star	55.40	\$20.67	20	-	\$0.03
Appliances	Second Refrigerator	Baseline (2014)	101.48	\$0.00	13	1.00	\$0.00
Appliances	Second Refrigerator	Energy Star (2014)	162.38	\$88.71	13	1.00	\$0.05

Residential Energy Efficiency Equipment and Measure Data

End Use	Technology	Eff. Definition	Savings (kWh/HH/yr)	Incremental Cost (\$/HH)	Lifetime (Years)	BC Ratio (2015)	Levelized Cost of Energy (\$/kWh)
Appliances	Stove	Baseline	-	\$0.00	13	1.00	\$0.00
Appliances	Stove	Convection Oven	7.86	\$1.86	13	1.00	\$0.02
Appliances	Stove	Induction (High Efficiency)	39.31	\$1,432.20	13	0.37	\$3.51
Appliances	Microwave	Baseline	-	\$0.00	9	1.00	\$0.00
Electronics	Personal Computers	Baseline	-	\$0.00	5	1.00	\$0.00
Electronics	Personal Computers	Energy Star	71.87	\$1.20	5	1.01	\$0.00
Electronics	Personal Computers	Climate Savers	102.67	\$175.49	5	0.85	\$0.37
Electronics	TVs	Baseline	-	\$0.00	11	1.00	\$0.00
Electronics	TVs	Energy Star	41.87	\$0.56	11	1.02	\$0.00
Electronics	Set-top boxes/DVR	Baseline	-	\$0.00	11	1.00	\$0.00
Electronics	Set-top boxes/DVR	Energy Star	25.34	\$0.56	11	1.01	\$0.00
Electronics	Devices and Gadgets	Devices and Gadgets	-	\$0.00	5	1.00	\$0.00
Miscellaneous	Pool Pump	Baseline Pump	-	\$0.00	15	1.00	\$0.00
Miscellaneous	Pool Pump	High Efficiency Pump	97.63	\$85.00	15	0.97	\$0.08
Miscellaneous	Pool Pump	Two-Speed Pump	390.54	\$579.00	15	0.71	\$0.13
Miscellaneous	Furnace Fan	Baseline	-	\$0.00	18	1.00	\$0.00
Miscellaneous	Furnace Fan	Furnace Fan with ECM	111.68	\$0.64	18	1.26	\$0.00
Miscellaneous	Miscellaneous	Miscellaneous	-	\$0.00	5	1.00	\$0.00

Residential Energy Efficiency Equipment and Measure Data

Table B-14 Energy Efficiency Equipment Data, Electric—Mobile Home, New Vintage, Idaho

End Use	Technology	Eff. Definition	Savings (kWh/HH/yr)	Incremental Cost (\$/HH)	Lifetime (Years)	BC Ratio (2015)	Levelized Cost of Energy (\$/kWh)
Cooling	Central AC	SEER 13	-	\$0.00	15	-	\$0.00
Cooling	Central AC	SEER 14 (Energy Star)	47.34	\$277.86	15	1.40	\$0.51
Cooling	Central AC	SEER 15 (CEE Tier 2)	63.06	\$555.71	15	0.94	\$0.76
Cooling	Central AC	SEER 16 (CEE Tier 3)	76.25	\$833.57	15	0.89	\$0.95
Cooling	Central AC	Ductless Mini-Split System	143.00	\$4,399.48	20	0.62	\$2.18
Cooling	Room AC	EER 9.8	-	\$0.00	10	1.00	\$0.00
Cooling	Room AC	EER 10.8 (Energy Star)	27.98	\$52.02	10	0.85	\$0.22
Cooling	Room AC	EER 11	32.97	\$141.13	10	0.65	\$0.51
Cooling	Room AC	EER 11.5	44.72	\$312.75	10	0.45	\$0.83
Cooling	Air Source Heat Pump	SEER 13	-	\$0.00	15	-	\$0.00
Cooling	Air Source Heat Pump	SEER 14 (Energy Star)	44.49	\$1,720.87	15	1.30	\$3.34
Cooling	Air Source Heat Pump	SEER 15 (CEE Tier 2)	40.65	\$2,315.13	15	0.97	\$4.93
Cooling	Air Source Heat Pump	SEER 16 (CEE Tier 3)	49.15	\$3,277.48	15	0.89	\$5.77
Cooling	Air Source Heat Pump	Ductless Mini-Split System	92.17	\$5,022.03	20	0.90	\$3.85
Cooling	Geothermal Heat Pump	Standard	-	\$0.00	15	1.00	\$0.00
Cooling	Geothermal Heat Pump	High Efficiency	44.66	\$1,500.00	15	0.90	\$2.90
Cooling	Ductless HP	Ductless Mini-Split System	-	\$0.00	20	1.00	\$0.00
Space Heating	Electric Resistance	Electric Resistance	-	\$0.00	20	1.00	\$0.00
Space Heating	Electric Resistance	Ductless Mini-Split System	2,426.02	\$156.87	20	1.29	\$0.00
Space Heating	Electric Furnace	3400 BTU/kW	-	\$0.00	15	1.00	\$0.00
Space Heating	Supplemental	Supplemental	-	\$0.00	5	1.00	\$0.00
Space Heating	Air Source Heat Pump	SEER 13	-	\$0.00	15	-	\$0.00
Space Heating	Air Source Heat Pump	SEER 14 (Energy Star)	269.16	\$1,720.87	15	1.30	\$0.55
Space Heating	Air Source Heat Pump	SEER 15 (CEE Tier 2)	576.42	\$2,315.13	15	0.97	\$0.35
Space Heating	Air Source Heat Pump	SEER 16 (CEE Tier 3)	697.02	\$3,277.48	15	0.89	\$0.41
Space Heating	Air Source Heat Pump	Ductless Mini-Split System	1,307.13	\$5,022.03	20	0.90	\$0.27
Space Heating	Geothermal Heat Pump	Standard	-	\$0.00	15	1.00	\$0.00
Space Heating	Geothermal Heat Pump	High Efficiency	634.14	\$1,500.00	15	0.90	\$0.20
Space Heating	Ductless HP	Ductless Mini-Split System	-	\$0.00	20	1.00	\$0.00
Water Heating	Water Heater <= 55 Gal	Baseline (EF=0.90)	-	\$0.00	15	1.00	\$0.00
Water Heating	Water Heater <= 55 Gal	High Efficiency (EF=0.95)	133.42	\$77.11	15	1.01	\$0.05
Water Heating	Water Heater <= 55 Gal	EF 2.3 (HP)	1,286.08	\$1,761.86	15	0.66	\$0.12
Water Heating	Water Heater <= 55 Gal	Solar	1,457.32	\$6,214.86	15	0.29	\$0.37
Water Heating	Water Heater > 55 Gal	Baseline (EF=0.90)	-	\$0.00	15	1.00	\$0.00
Water Heating	Water Heater > 55 Gal	High Efficiency (EF=0.95)	169.95	\$97.23	15	1.01	\$0.05
Water Heating	Water Heater > 55 Gal	EF 2.3 (HP)	1,287.31	\$1,691.15	15	0.71	\$0.11

Residential Energy Efficiency Equipment and Measure Data

End Use	Technology	Eff. Definition	Savings (kWh/HH/yr)	Incremental Cost (\$/HH)	Lifetime (Years)	BC Ratio (2015)	Levelized Cost of Energy (\$/kWh)
	55 Gal						
Water Heating	Water Heater > 55 Gal	Solar	1,150.30	\$6,144.15	15	0.31	\$0.46
Interior Lighting	Screw-in	Incandescent	-	\$0.00	4	-	\$0.00
Interior Lighting	Screw-in	Infrared Halogen	216.42	\$188.19	5	1.00	\$0.19
Interior Lighting	Screw-in	CFL	687.25	\$28.57	6	2.88	\$0.01
Interior Lighting	Screw-in	LED	939.30	\$1,937.55	12	-	\$0.21
Interior Lighting	Screw-in	LED	939.30	\$1,937.55	12	-	\$0.21
Interior Lighting	Linear Fluorescent	T12	-	\$0.00	6	1.00	\$0.00
Interior Lighting	Linear Fluorescent	T8	9.28	-\$3.50	6	1.14	-\$0.07
Interior Lighting	Linear Fluorescent	Super T8	27.81	\$28.01	6	0.67	\$0.18
Interior Lighting	Linear Fluorescent	T5	28.91	\$47.43	6	0.52	\$0.30
Interior Lighting	Linear Fluorescent	LED	30.33	\$416.33	10	0.18	\$1.63
Interior Lighting	Specialty	Halogen	-	\$0.00	4	1.00	\$0.00
Interior Lighting	Specialty	CFL	208.91	-\$7.12	7	2.46	-\$0.01
Interior Lighting	Specialty	LED	219.80	\$140.97	12	0.70	\$0.07
Exterior Lighting	Screw-in	Incandescent	-	\$0.00	4	-	\$0.00
Exterior Lighting	Screw-in	Infrared Halogen	74.39	\$49.25	5	1.00	\$0.14
Exterior Lighting	Screw-in	CFL	252.46	-\$1.76	3	4.76	\$0.00
Exterior Lighting	Screw-in	LED	293.05	\$726.99	12	-	\$0.25
Exterior Lighting	Screw-in	LED	293.05	\$726.99	12	-	\$0.25
Appliances	Clothes Washer	Baseline	-	\$0.00	14	-	\$0.00
Appliances	Clothes Washer	Energy Star (MEF > 1.8)	44.65	\$69.81	14	-	\$0.14
Appliances	Clothes Washer	Horizontal Axis	61.64	\$150.80	14	1.00	\$0.22
Appliances	Clothes Dryer	Baseline	-	\$0.00	13	-	\$0.00
Appliances	Clothes Dryer	Moisture Detection	62.00	\$48.40	13	1.00	\$0.08
Appliances	Dishwasher	Baseline	-	\$0.00	15	1.00	\$0.00
Appliances	Dishwasher	Energy Star	51.75	\$460.95	9	-	\$1.15
Appliances	Dishwasher	Energy Star (2011)	6.78	\$5.61	15	0.99	\$0.07
Appliances	Refrigerator	Baseline	-	\$0.00	20	-	\$0.00
Appliances	Refrigerator	Energy Star	56.79	\$20.17	20	-	\$0.03
Appliances	Refrigerator	Baseline (2014)	104.02	\$0.00	13	1.00	\$0.00
Appliances	Refrigerator	Energy Star (2014)	166.43	\$88.71	13	1.02	\$0.05
Appliances	Freezer	Baseline	-	\$0.00	22	-	\$0.00
Appliances	Freezer	Energy Star	45.96	\$3.98	22	-	\$0.01
Appliances	Freezer	Baseline (2014)	106.66	-\$145.00	11	1.00	-\$0.15
Appliances	Freezer	Energy Star (2014)	170.66	-\$112.83	11	1.00	-\$0.07
Appliances	Second Refrigerator	Baseline	-	\$0.00	20	-	\$0.00
Appliances	Second Refrigerator	Energy Star	75.71	\$20.67	20	-	\$0.02
Appliances	Second Refrigerator	Baseline (2014)	138.70	\$0.00	13	1.00	\$0.00
Appliances	Second Refrigerator	Energy Star (2014)	221.91	\$88.71	13	1.01	\$0.04

Residential Energy Efficiency Equipment and Measure Data

End Use	Technology	Eff. Definition	Savings (kWh/HH/yr)	Incremental Cost (\$/HH)	Lifetime (Years)	BC Ratio (2015)	Levelized Cost of Energy (\$/kWh)
Appliances	Stove	Baseline	-	\$0.00	13	1.00	\$0.00
Appliances	Stove	Convection Oven	33.20	\$0.56	13	1.00	\$0.00
Appliances	Stove	Induction (High Efficiency)	39.30	\$0.00	13	0.36	\$0.00
Appliances	Microwave	Baseline	-	\$0.00	9	1.00	\$0.00
Electronics	Personal Computers	Baseline	-	\$0.00	5	1.00	\$0.00
Electronics	Personal Computers	Energy Star	70.34	\$1.20	5	1.01	\$0.00
Electronics	Personal Computers	Climate Savers	100.48	\$175.49	5	0.85	\$0.38
Electronics	TVs	Baseline	-	\$0.00	11	1.00	\$0.00
Electronics	TVs	Energy Star	46.52	\$0.56	11	1.02	\$0.00
Electronics	Set-top boxes/DVR	Baseline	-	\$0.00	11	1.00	\$0.00
Electronics	Set-top boxes/DVR	Energy Star	25.34	\$0.56	11	1.01	\$0.00
Electronics	Devices and Gadgets	Devices and Gadgets	-	\$0.00	5	1.00	\$0.00
Miscellaneous	Pool Pump	Baseline Pump	-	\$0.00	15	1.00	\$0.00
Miscellaneous	Pool Pump	High Efficiency Pump	109.40	\$85.00	15	0.99	\$0.07
Miscellaneous	Pool Pump	Two-Speed Pump	437.62	\$579.00	15	0.76	\$0.11
Miscellaneous	Furnace Fan	Baseline	-	\$0.00	18	1.00	\$0.00
Miscellaneous	Furnace Fan	Furnace Fan with ECM	111.68	\$0.64	18	1.27	\$0.00
Miscellaneous	Miscellaneous	Miscellaneous	-	\$0.00	5	1.00	\$0.00

Residential Energy Efficiency Equipment and Measure Data

Table B-15 Energy Efficiency Equipment Data, Electric—Low income, Existing Vintage, Washington

End Use	Technology	Eff. Definition	Savings (kWh/HH/yr)	Incremental Cost (\$/HH)	Lifetime (Years)	BC Ratio (2015)	Levelized Cost of Energy (\$/kWh)
Cooling	Central AC	SEER 13	-	\$0.00	15	-	\$0.00
Cooling	Central AC	SEER 14 (Energy Star)	49.41	\$185.24	15	1.40	\$0.32
Cooling	Central AC	SEER 15 (CEE Tier 2)	67.79	\$370.47	15	0.93	\$0.47
Cooling	Central AC	SEER 16 (CEE Tier 3)	83.19	\$555.71	15	0.87	\$0.58
Cooling	Central AC	Ductless Mini-Split System	149.20	\$2,394.23	20	0.64	\$1.14
Cooling	Room AC	EER 9.8	-	\$0.00	10	1.00	\$0.00
Cooling	Room AC	EER 10.8 (Energy Star)	26.53	\$104.04	10	0.81	\$0.46
Cooling	Room AC	EER 11	31.30	\$282.26	10	0.60	\$1.07
Cooling	Room AC	EER 11.5	42.38	\$625.50	10	0.40	\$1.75
Cooling	Air Source Heat Pump	SEER 13	-	\$0.00	15	-	\$0.00
Cooling	Air Source Heat Pump	SEER 14 (Energy Star)	37.76	\$1,245.78	15	1.30	\$2.85
Cooling	Air Source Heat Pump	SEER 15 (CEE Tier 2)	51.80	\$2,315.13	15	0.91	\$3.86
Cooling	Air Source Heat Pump	SEER 16 (CEE Tier 3)	63.57	\$3,277.48	15	0.84	\$4.46
Cooling	Air Source Heat Pump	Ductless Mini-Split System	114.01	\$5,022.03	20	0.84	\$3.12
Cooling	Geothermal Heat Pump	Standard	-	\$0.00	15	1.00	\$0.00
Cooling	Geothermal Heat Pump	High Efficiency	62.78	\$1,500.00	15	0.89	\$2.07
Cooling	Ductless HP	Ductless Mini-Split System	-	\$0.00	20	1.00	\$0.00
Space Heating	Electric Resistance	Electric Resistance	-	\$0.00	20	1.00	\$0.00
Space Heating	Electric Resistance	Ductless Mini-Split System	2,070.05	\$156.87	20	1.29	\$0.01
Space Heating	Electric Furnace	3400 BTU/KW	-	\$0.00	15	1.00	\$0.00
Space Heating	Supplemental	Supplemental	-	\$0.00	5	1.00	\$0.00
Space Heating	Air Source Heat Pump	SEER 13	-	\$0.00	15	-	\$0.00
Space Heating	Air Source Heat Pump	SEER 14 (Energy Star)	355.79	\$1,245.78	15	1.30	\$0.30
Space Heating	Air Source Heat Pump	SEER 15 (CEE Tier 2)	488.18	\$2,315.13	15	0.91	\$0.41
Space Heating	Air Source Heat Pump	SEER 16 (CEE Tier 3)	599.06	\$3,277.48	15	0.84	\$0.47
Space Heating	Air Source Heat Pump	Ductless Mini-Split System	1,074.41	\$5,022.03	20	0.84	\$0.33
Space Heating	Geothermal Heat Pump	Standard	-	\$0.00	15	1.00	\$0.00
Space Heating	Geothermal Heat Pump	High Efficiency	436.67	\$1,500.00	15	0.89	\$0.30
Space Heating	Ductless HP	Ductless Mini-Split System	-	\$0.00	20	1.00	\$0.00
Water Heating	Water Heater <= 55 Gal	Baseline (EF=0.90)	-	\$0.00	15	1.00	\$0.00
Water Heating	Water Heater <= 55 Gal	High Efficiency (EF=0.95)	121.27	\$77.11	15	1.01	\$0.05
Water Heating	Water Heater <= 55 Gal	EF 2.3 (HP)	1,168.96	\$1,761.86	15	0.67	\$0.13
Water Heating	Water Heater <= 55 Gal	Solar	1,324.61	\$6,214.86	15	0.29	\$0.41
Water Heating	Water Heater > 55 Gal	Baseline (EF=0.90)	-	\$0.00	15	1.00	\$0.00
Water Heating	Water Heater >	High Efficiency	171.20	\$97.23	15	1.02	\$0.05

Residential Energy Efficiency Equipment and Measure Data

End Use	Technology	Eff. Definition	Savings (kWh/HH/yr)	Incremental Cost (\$/HH)	Lifetime (Years)	BC Ratio (2015)	Levelized Cost of Energy (\$/kWh)
	55 Gal	(EF=0.95)					
Water Heating	Water Heater > 55 Gal	EF 2.3 (HP)	1,296.77	\$1,691.15	15	0.76	\$0.11
Water Heating	Water Heater > 55 Gal	Solar	1,158.76	\$6,144.15	15	0.34	\$0.46
Interior Lighting	Screw-in	Incandescent	-	\$0.00	4	-	\$0.00
Interior Lighting	Screw-in	Infrared Halogen	157.77	\$98.38	5	1.00	\$0.13
Interior Lighting	Screw-in	CFL	501.00	\$17.84	6	2.46	\$0.01
Interior Lighting	Screw-in	LED	684.74	\$1,012.85	12	-	\$0.15
Interior Lighting	Screw-in	LED	684.74	\$1,012.85	12	-	\$0.15
Interior Lighting	Linear Fluorescent	T12	-	\$0.00	6	1.00	\$0.00
Interior Lighting	Linear Fluorescent	T8	6.94	-\$1.79	6	1.13	-\$0.05
Interior Lighting	Linear Fluorescent	Super T8	20.79	\$14.30	6	0.74	\$0.13
Interior Lighting	Linear Fluorescent	T5	21.61	\$24.22	6	0.59	\$0.21
Interior Lighting	Linear Fluorescent	LED	22.67	\$212.60	10	0.21	\$1.11
Interior Lighting	Specialty	Halogen	-	\$0.00	4	1.00	\$0.00
Interior Lighting	Specialty	CFL	134.16	\$0.96	7	1.91	\$0.00
Interior Lighting	Specialty	LED	141.16	\$261.26	12	0.29	\$0.19
Exterior Lighting	Screw-in	Incandescent	-	\$0.00	4	-	\$0.00
Exterior Lighting	Screw-in	Infrared Halogen	35.33	\$9.82	5	1.00	\$0.06
Exterior Lighting	Screw-in	CFL	119.89	-\$0.47	3	4.15	\$0.00
Exterior Lighting	Screw-in	LED	139.17	\$1,016.52	12	-	\$0.75
Exterior Lighting	Screw-in	LED	139.17	\$1,016.52	12	-	\$0.75
Appliances	Clothes Washer	Baseline	-	\$0.00	14	-	\$0.00
Appliances	Clothes Washer	Energy Star (MEF > 1.8)	36.47	\$69.81	14	-	\$0.17
Appliances	Clothes Washer	Horizontal Axis	50.35	\$150.80	14	1.00	\$0.27
Appliances	Clothes Dryer	Baseline	-	\$0.00	13	-	\$0.00
Appliances	Clothes Dryer	Moisture Detection	53.87	\$48.40	13	1.00	\$0.09
Appliances	Dishwasher	Baseline	-	\$0.00	15	1.00	\$0.00
Appliances	Dishwasher	Energy Star	45.15	\$460.95	9	-	\$1.32
Appliances	Dishwasher	Energy Star (2011)	5.91	\$5.61	15	0.99	\$0.08
Appliances	Refrigerator	Baseline	-	\$0.00	20	-	\$0.00
Appliances	Refrigerator	Energy Star	38.65	\$20.17	20	-	\$0.04
Appliances	Refrigerator	Baseline (2014)	70.80	\$0.00	13	1.00	\$0.00
Appliances	Refrigerator	Energy Star (2014)	113.29	\$88.71	13	1.01	\$0.08
Appliances	Freezer	Baseline	-	\$0.00	22	-	\$0.00
Appliances	Freezer	Energy Star	31.60	\$3.98	22	-	\$0.01
Appliances	Freezer	Baseline (2014)	73.33	-\$145.00	11	1.00	-\$0.22
Appliances	Freezer	Energy Star (2014)	117.32	-\$112.83	11	0.99	-\$0.11
Appliances	Second Refrigerator	Baseline	-	\$0.00	13	-	\$0.00
Appliances	Second Refrigerator	Energy Star	52.79	\$20.67	20	-	\$0.03
Appliances	Second Refrigerator	Baseline (2014)	96.71	\$0.00	13	1.00	\$0.00

Residential Energy Efficiency Equipment and Measure Data

End Use	Technology	Eff. Definition	Savings (kWh/HH/yr)	Incremental Cost (\$/HH)	Lifetime (Years)	BC Ratio (2015)	Levelized Cost of Energy (\$/kWh)
Appliances	Second Refrigerator	Energy Star (2014)	154.73	\$88.71	13	1.00	\$0.06
Appliances	Stove	Baseline	-	\$0.00	13	1.00	\$0.00
Appliances	Stove	Convection Oven	7.49	\$1.86	13	1.00	\$0.02
Appliances	Stove	Induction (High Efficiency)	37.46	\$1,432.20	13	0.37	\$3.68
Appliances	Microwave	Baseline	-	\$0.00	9	1.00	\$0.00
Electronics	Personal Computers	Baseline	-	\$0.00	5	1.00	\$0.00
Electronics	Personal Computers	Energy Star	63.35	\$1.20	5	1.01	\$0.00
Electronics	Personal Computers	Climate Savers	90.50	\$175.49	5	0.85	\$0.42
Electronics	TVs	Baseline	-	\$0.00	11	1.00	\$0.00
Electronics	TVs	Energy Star	38.99	\$0.56	11	1.02	\$0.00
Electronics	Set-top boxes/DVR	Baseline	-	\$0.00	11	1.00	\$0.00
Electronics	Set-top boxes/DVR	Energy Star	24.86	\$0.56	11	1.01	\$0.00
Electronics	Devices and Gadgets	Devices and Gadgets	-	\$0.00	5	1.00	\$0.00
Miscellaneous	Pool Pump	Baseline Pump	-	\$0.00	15	1.00	\$0.00
Miscellaneous	Pool Pump	High Efficiency Pump	107.45	\$85.00	15	0.99	\$0.07
Miscellaneous	Pool Pump	Two-Speed Pump	429.80	\$579.00	15	0.75	\$0.12
Miscellaneous	Furnace Fan	Baseline	-	\$0.00	18	1.00	\$0.00
Miscellaneous	Furnace Fan	Furnace Fan with ECM	110.30	\$0.64	18	1.27	\$0.00
Miscellaneous	Miscellaneous	Miscellaneous	-	\$0.00	5	1.00	\$0.00

Residential Energy Efficiency Equipment and Measure Data

Table B-16 Energy Efficiency Equipment Data, Electric—Low Income, New Vintage, Washington

End Use	Technology	Eff. Definition	Savings (kWh/HH/yr)	Incremental Cost (\$/HH)	Lifetime (Years)	BC Ratio (2015)	Levelized Cost of Energy (\$/kWh)
Cooling	Central AC	SEER 13	-	\$0.00	15	-	\$0.00
Cooling	Central AC	SEER 14 (Energy Star)	58.73	\$185.24	15	1.40	\$0.27
Cooling	Central AC	SEER 15 (CEE Tier 2)	78.22	\$370.47	15	0.93	\$0.41
Cooling	Central AC	SEER 16 (CEE Tier 3)	94.59	\$555.71	15	0.87	\$0.51
Cooling	Central AC	Ductless Mini-Split System	177.38	\$2,394.23	20	0.65	\$0.95
Cooling	Room AC	EER 9.8	-	\$0.00	10	1.00	\$0.00
Cooling	Room AC	EER 10.8 (Energy Star)	30.83	\$104.04	10	0.82	\$0.40
Cooling	Room AC	EER 11	36.33	\$282.26	10	0.61	\$0.92
Cooling	Room AC	EER 11.5	49.27	\$625.50	10	0.41	\$1.50
Cooling	Air Source Heat Pump	SEER 13	-	\$0.00	15	-	\$0.00
Cooling	Air Source Heat Pump	SEER 14 (Energy Star)	44.94	\$0.00	15	1.30	\$0.00
Cooling	Air Source Heat Pump	SEER 15 (CEE Tier 2)	59.86	\$0.00	15	0.91	\$0.00
Cooling	Air Source Heat Pump	SEER 16 (CEE Tier 3)	72.38	\$0.00	15	0.85	\$0.00
Cooling	Air Source Heat Pump	Ductless Mini-Split System	135.74	\$0.00	20	0.86	\$0.00
Cooling	Geothermal Heat Pump	Standard	-	\$0.00	15	1.00	\$0.00
Cooling	Geothermal Heat Pump	High Efficiency	69.87	\$0.00	15	0.89	\$0.00
Cooling	Ductless HP	Ductless Mini-Split System	-	\$0.00	20	1.00	\$0.00
Space Heating	Electric Resistance	Electric Resistance	-	\$0.00	20	1.00	\$0.00
Space Heating	Electric Resistance	Ductless Mini-Split System	2,225.30	\$156.87	20	1.30	\$0.00
Space Heating	Electric Furnace	3400 BTU/KW	-	\$0.00	15	1.00	\$0.00
Space Heating	Supplemental	Supplemental	-	\$0.00	5	1.00	\$0.00
Space Heating	Air Source Heat Pump	SEER 13	-	\$0.00	15	-	\$0.00
Space Heating	Air Source Heat Pump	SEER 14 (Energy Star)	423.49	\$1,245.78	15	1.30	\$0.25
Space Heating	Air Source Heat Pump	SEER 15 (CEE Tier 2)	564.08	\$2,315.13	15	0.91	\$0.35
Space Heating	Air Source Heat Pump	SEER 16 (CEE Tier 3)	682.10	\$3,277.48	15	0.85	\$0.42
Space Heating	Air Source Heat Pump	Ductless Mini-Split System	1,279.15	\$5,022.03	20	0.86	\$0.28
Space Heating	Geothermal Heat Pump	Standard	-	\$0.00	15	1.00	\$0.00
Space Heating	Geothermal Heat Pump	High Efficiency	485.98	\$1,500.00	15	0.89	\$0.27
Space Heating	Ductless HP	Ductless Mini-Split System	-	\$0.00	20	1.00	\$0.00
Water Heating	Water Heater <= 55 Gal	Baseline (EF=0.90)	-	\$0.00	15	1.00	\$0.00
Water Heating	Water Heater <= 55 Gal	High Efficiency (EF=0.95)	126.97	\$77.11	15	1.01	\$0.05
Water Heating	Water Heater <= 55 Gal	EF 2.3 (HP)	1,223.96	\$1,761.86	15	0.69	\$0.12
Water Heating	Water Heater <= 55 Gal	Solar	1,386.93	\$6,214.86	15	0.30	\$0.39
Water Heating	Water Heater > 55 Gal	Baseline (EF=0.90)	-	\$0.00	15	1.00	\$0.00
Water Heating	Water Heater >	High Efficiency	179.32	\$97.23	15	1.02	\$0.05

Residential Energy Efficiency Equipment and Measure Data

End Use	Technology	Eff. Definition	Savings (kWh/HH/yr)	Incremental Cost (\$/HH)	Lifetime (Years)	BC Ratio (2015)	Levelized Cost of Energy (\$/kWh)
	55 Gal	(EF=0.95)					
Water Heating	Water Heater > 55 Gal	EF 2.3 (HP)	1,358.29	\$1,691.15	15	0.77	\$0.11
Water Heating	Water Heater > 55 Gal	Solar	1,213.73	\$6,144.15	15	0.35	\$0.44
Interior Lighting	Screw-in	Incandescent	-	\$0.00	4	-	\$0.00
Interior Lighting	Screw-in	Infrared Halogen	171.92	\$98.38	5	1.00	\$0.12
Interior Lighting	Screw-in	CFL	545.94	\$17.84	6	2.41	\$0.01
Interior Lighting	Screw-in	LED	746.16	\$1,012.85	12	-	\$0.14
Interior Lighting	Screw-in	LED	746.16	\$1,012.85	12	-	\$0.14
Interior Lighting	Linear Fluorescent	T12	-	\$0.00	6	1.00	\$0.00
Interior Lighting	Linear Fluorescent	T8	7.80	-\$1.79	6	1.13	-\$0.04
Interior Lighting	Linear Fluorescent	Super T8	23.37	\$14.30	6	0.77	\$0.11
Interior Lighting	Linear Fluorescent	T5	24.29	\$24.22	6	0.62	\$0.18
Interior Lighting	Linear Fluorescent	LED	25.48	\$212.60	10	0.23	\$0.99
Interior Lighting	Specialty	Halogen	-	\$0.00	4	1.00	\$0.00
Interior Lighting	Specialty	CFL	144.22	-\$9.74	7	2.86	-\$0.01
Interior Lighting	Specialty	LED	151.74	\$67.71	12	0.95	\$0.05
Exterior Lighting	Screw-in	Incandescent	-	\$0.00	4	-	\$0.00
Exterior Lighting	Screw-in	Infrared Halogen	38.38	\$9.82	5	1.00	\$0.06
Exterior Lighting	Screw-in	CFL	130.23	-\$0.51	3	4.13	\$0.00
Exterior Lighting	Screw-in	LED	151.17	\$144.92	12	-	\$0.10
Exterior Lighting	Screw-in	LED	151.17	\$144.92	12	-	\$0.10
Appliances	Clothes Washer	Baseline	-	\$0.00	14	-	\$0.00
Appliances	Clothes Washer	Energy Star (MEF > 1.8)	42.55	\$69.81	14	-	\$0.15
Appliances	Clothes Washer	Horizontal Axis	58.74	\$150.80	14	1.00	\$0.23
Appliances	Clothes Dryer	Baseline	-	\$0.00	13	-	\$0.00
Appliances	Clothes Dryer	Moisture Detection	58.62	\$48.40	13	1.00	\$0.08
Appliances	Dishwasher	Baseline	-	\$0.00	15	1.00	\$0.00
Appliances	Dishwasher	Energy Star	49.31	\$460.95	9	-	\$1.21
Appliances	Dishwasher	Energy Star (2011)	6.46	\$5.61	15	0.99	\$0.08
Appliances	Refrigerator	Baseline	-	\$0.00	20	-	\$0.00
Appliances	Refrigerator	Energy Star	54.11	\$20.17	20	-	\$0.03
Appliances	Refrigerator	Baseline (2014)	99.12	\$0.00	13	1.00	\$0.00
Appliances	Refrigerator	Energy Star (2014)	158.60	\$88.71	13	1.02	\$0.05
Appliances	Freezer	Baseline	-	\$0.00	22	-	\$0.00
Appliances	Freezer	Energy Star	43.80	\$3.98	22	-	\$0.01
Appliances	Freezer	Baseline (2014)	101.64	-\$145.00	11	1.00	-\$0.16
Appliances	Freezer	Energy Star (2014)	162.63	-\$112.83	11	1.00	-\$0.08
Appliances	Second Refrigerator	Baseline	-	\$0.00	20	-	\$0.00
Appliances	Second Refrigerator	Energy Star	72.15	\$20.67	20	-	\$0.02
Appliances	Second Refrigerator	Baseline (2014)	132.17	\$0.00	13	1.00	\$0.00

Residential Energy Efficiency Equipment and Measure Data

End Use	Technology	Eff. Definition	Savings (kWh/HH/yr)	Incremental Cost (\$/HH)	Lifetime (Years)	BC Ratio (2015)	Levelized Cost of Energy (\$/kWh)
Appliances	Second Refrigerator	Energy Star (2014)	211.47	\$88.71	13	1.01	\$0.04
Appliances	Stove	Baseline	-	\$0.00	13	1.00	\$0.00
Appliances	Stove	Convection Oven	7.49	\$1.86	13	1.00	\$0.02
Appliances	Stove	Induction (High Efficiency)	37.45	\$1,432.20	13	0.37	\$3.68
Appliances	Microwave	Baseline	-	\$0.00	9	1.00	\$0.00
Electronics	Personal Computers	Baseline	-	\$0.00	5	1.00	\$0.00
Electronics	Personal Computers	Energy Star	62.00	\$1.20	5	1.01	\$0.00
Electronics	Personal Computers	Climate Savers	88.57	\$175.49	5	0.85	\$0.43
Electronics	TVs	Baseline	-	\$0.00	11	1.00	\$0.00
Electronics	TVs	Energy Star	43.32	\$0.56	11	1.02	\$0.00
Electronics	Set-top boxes/DVR	Baseline	-	\$0.00	11	1.00	\$0.00
Electronics	Set-top boxes/DVR	Energy Star	24.86	\$0.56	11	1.01	\$0.00
Electronics	Devices and Gadgets	Devices and Gadgets	-	\$0.00	5	1.00	\$0.00
Miscellaneous	Pool Pump	Baseline Pump	-	\$0.00	15	1.00	\$0.00
Miscellaneous	Pool Pump	High Efficiency Pump	120.40	\$85.00	15	0.99	\$0.06
Miscellaneous	Pool Pump	Two-Speed Pump	481.61	\$579.00	15	0.79	\$0.10
Miscellaneous	Furnace Fan	Baseline	-	\$0.00	18	1.00	\$0.00
Miscellaneous	Furnace Fan	Furnace Fan with ECM	110.30	\$0.64	18	1.27	\$0.00
Miscellaneous	Miscellaneous	Miscellaneous	-	\$0.00	5	1.00	\$0.00

Residential Energy Efficiency Equipment and Measure Data

Table B-17 Energy Efficiency Equipment Data, Electric—Low Income, Existing Vintage, Idaho

End Use	Technology	Eff. Definition	Savings (kWh/HH/yr)	Incremental Cost (\$/HH)	Lifetime (Years)	BC Ratio (2015)	Levelized Cost of Energy (\$/kWh)
Cooling	Central AC	SEER 13	-	\$0.00	15	-	\$0.00
Cooling	Central AC	SEER 14 (Energy Star)	34.58	\$185.24	15	1.40	\$0.46
Cooling	Central AC	SEER 15 (CEE Tier 2)	47.45	\$370.47	15	0.93	\$0.68
Cooling	Central AC	SEER 16 (CEE Tier 3)	58.23	\$555.71	15	0.87	\$0.83
Cooling	Central AC	Ductless Mini-Split System	104.44	\$2,394.23	20	0.63	\$1.62
Cooling	Room AC	EER 9.8	-	\$0.00	10	1.00	\$0.00
Cooling	Room AC	EER 10.8 (Energy Star)	18.57	\$104.04	10	0.80	\$0.66
Cooling	Room AC	EER 11	21.91	\$282.26	10	0.59	\$1.53
Cooling	Room AC	EER 11.5	29.66	\$625.50	10	0.39	\$2.50
Cooling	Air Source Heat Pump	SEER 13	-	\$0.00	15	-	\$0.00
Cooling	Air Source Heat Pump	SEER 14 (Energy Star)	26.43	\$1,245.78	15	1.30	\$4.08
Cooling	Air Source Heat Pump	SEER 15 (CEE Tier 2)	36.26	\$2,315.13	15	0.91	\$5.52
Cooling	Air Source Heat Pump	SEER 16 (CEE Tier 3)	44.50	\$3,277.48	15	0.83	\$6.37
Cooling	Air Source Heat Pump	Ductless Mini-Split System	79.81	\$5,022.03	20	0.84	\$4.45
Cooling	Geothermal Heat Pump	Standard	-	\$0.00	15	1.00	\$0.00
Cooling	Geothermal Heat Pump	High Efficiency	43.95	\$1,500.00	15	0.87	\$2.95
Cooling	Ductless HP	Ductless Mini-Split System	-	\$0.00	20	1.00	\$0.00
Space Heating	Electric Resistance	Electric Resistance	-	\$0.00	20	1.00	\$0.00
Space Heating	Electric Resistance	Ductless Mini-Split System	1,966.55	\$156.87	20	1.29	\$0.01
Space Heating	Electric Furnace	3400 BTU/KW	-	\$0.00	15	1.00	\$0.00
Space Heating	Supplemental	Supplemental	-	\$0.00	5	1.00	\$0.00
Space Heating	Air Source Heat Pump	SEER 13	-	\$0.00	15	-	\$0.00
Space Heating	Air Source Heat Pump	SEER 14 (Energy Star)	338.00	\$1,245.78	15	1.30	\$0.32
Space Heating	Air Source Heat Pump	SEER 15 (CEE Tier 2)	463.77	\$2,315.13	15	0.91	\$0.43
Space Heating	Air Source Heat Pump	SEER 16 (CEE Tier 3)	569.10	\$3,277.48	15	0.83	\$0.50
Space Heating	Air Source Heat Pump	Ductless Mini-Split System	1,020.69	\$5,022.03	20	0.84	\$0.35
Space Heating	Geothermal Heat Pump	Standard	-	\$0.00	15	1.00	\$0.00
Space Heating	Geothermal Heat Pump	High Efficiency	414.84	\$1,500.00	15	0.87	\$0.31
Space Heating	Ductless HP	Ductless Mini-Split System	-	\$0.00	20	1.00	\$0.00
Water Heating	Water Heater <= 55 Gal	Baseline (EF=0.90)	-	\$0.00	15	1.00	\$0.00
Water Heating	Water Heater <= 55 Gal	High Efficiency (EF=0.95)	113.39	\$77.11	15	1.00	\$0.06
Water Heating	Water Heater <= 55 Gal	EF 2.3 (HP)	1,092.98	\$1,761.86	15	0.60	\$0.14
Water Heating	Water Heater <= 55 Gal	Solar	1,238.51	\$6,214.86	15	0.26	\$0.43
Water Heating	Water Heater > 55 Gal	Baseline (EF=0.90)	-	\$0.00	15	1.00	\$0.00
Water Heating	Water Heater > 55 Gal	High Efficiency (EF=0.95)	160.07	\$97.23	15	1.01	\$0.05
Water Heating	Water Heater > 55 Gal	EF 2.3 (HP)	1,212.48	\$1,691.15	15	0.68	\$0.12

Residential Energy Efficiency Equipment and Measure Data

End Use	Technology	Eff. Definition	Savings (kWh/HH/yr)	Incremental Cost (\$/HH)	Lifetime (Years)	BC Ratio (2015)	Levelized Cost of Energy (\$/kWh)
	55 Gal						
Water Heating	Water Heater > 55 Gal	Solar	1,083.44	\$6,144.15	15	0.30	\$0.49
Interior Lighting	Screw-in	Incandescent	-	\$0.00	4	-	\$0.00
Interior Lighting	Screw-in	Infrared Halogen	147.51	\$98.38	5	1.00	\$0.14
Interior Lighting	Screw-in	CFL	468.44	\$17.84	6	2.59	\$0.01
Interior Lighting	Screw-in	LED	640.24	\$1,012.85	12	-	\$0.16
Interior Lighting	Screw-in	LED	640.24	\$1,012.85	12	-	\$0.16
Interior Lighting	Linear Fluorescent	T12	-	\$0.00	6	1.00	\$0.00
Interior Lighting	Linear Fluorescent	T8	6.49	-\$1.79	6	1.13	-\$0.05
Interior Lighting	Linear Fluorescent	Super T8	19.44	\$14.30	6	0.73	\$0.13
Interior Lighting	Linear Fluorescent	T5	20.21	\$24.22	6	0.57	\$0.22
Interior Lighting	Linear Fluorescent	LED	21.20	\$212.60	10	0.21	\$1.19
Interior Lighting	Specialty	Halogen	-	\$0.00	4	1.00	\$0.00
Interior Lighting	Specialty	CFL	125.44	\$0.96	7	1.91	\$0.00
Interior Lighting	Specialty	LED	131.98	\$261.26	12	0.28	\$0.20
Exterior Lighting	Screw-in	Incandescent	-	\$0.00	4	-	\$0.00
Exterior Lighting	Screw-in	Infrared Halogen	33.03	\$9.82	5	1.00	\$0.06
Exterior Lighting	Screw-in	CFL	112.10	-\$0.47	3	4.28	\$0.00
Exterior Lighting	Screw-in	LED	130.12	\$1,016.52	12	-	\$0.80
Exterior Lighting	Screw-in	LED	130.12	\$1,016.52	12	-	\$0.80
Appliances	Clothes Washer	Baseline	-	\$0.00	14	-	\$0.00
Appliances	Clothes Washer	Energy Star (MEF > 1.8)	34.10	\$69.81	14	-	\$0.19
Appliances	Clothes Washer	Horizontal Axis	47.07	\$150.80	14	1.00	\$0.29
Appliances	Clothes Dryer	Baseline	-	\$0.00	13	-	\$0.00
Appliances	Clothes Dryer	Moisture Detection	50.36	\$48.40	13	1.00	\$0.09
Appliances	Dishwasher	Baseline	-	\$0.00	15	1.00	\$0.00
Appliances	Dishwasher	Energy Star	42.21	\$460.95	9	-	\$1.41
Appliances	Dishwasher	Energy Star (2011)	5.53	\$5.61	15	0.99	\$0.09
Appliances	Refrigerator	Baseline	-	\$0.00	20	-	\$0.00
Appliances	Refrigerator	Energy Star	36.14	\$20.17	20	-	\$0.04
Appliances	Refrigerator	Baseline (2014)	66.20	\$0.00	13	1.00	\$0.00
Appliances	Refrigerator	Energy Star (2014)	105.92	\$88.71	13	1.00	\$0.08
Appliances	Freezer	Baseline	-	\$0.00	22	-	\$0.00
Appliances	Freezer	Energy Star	29.54	\$3.98	22	-	\$0.01
Appliances	Freezer	Baseline (2014)	68.56	-\$145.00	11	1.00	-\$0.23
Appliances	Freezer	Energy Star (2014)	109.70	-\$112.83	11	0.98	-\$0.11
Appliances	Second Refrigerator	Baseline	-	\$0.00	20	-	\$0.00
Appliances	Second Refrigerator	Energy Star	49.36	\$20.67	20	-	\$0.03
Appliances	Second Refrigerator	Baseline (2014)	90.42	\$0.00	13	1.00	\$0.00
Appliances	Second Refrigerator	Energy Star (2014)	144.67	\$88.71	13	1.00	\$0.06

Residential Energy Efficiency Equipment and Measure Data

End Use	Technology	Eff. Definition	Savings (kWh/HH/yr)	Incremental Cost (\$/HH)	Lifetime (Years)	BC Ratio (2015)	Levelized Cost of Energy (\$/kWh)
Appliances	Stove	Baseline	-	\$0.00	13	1.00	\$0.00
Appliances	Stove	Convection Oven	7.00	\$1.86	13	1.00	\$0.03
Appliances	Stove	Induction (High Efficiency)	35.02	\$1,432.20	13	0.36	\$3.94
Appliances	Microwave	Baseline	-	\$0.00	9	1.00	\$0.00
Electronics	Personal Computers	Baseline	-	\$0.00	5	1.00	\$0.00
Electronics	Personal Computers	Energy Star	59.23	\$1.20	5	1.01	\$0.00
Electronics	Personal Computers	Climate Savers	84.61	\$175.49	5	0.85	\$0.45
Electronics	TVs	Baseline	-	\$0.00	11	1.00	\$0.00
Electronics	TVs	Energy Star	36.45	\$0.56	11	1.01	\$0.00
Electronics	Set-top boxes/DVR	Baseline	-	\$0.00	11	1.00	\$0.00
Electronics	Set-top boxes/DVR	Energy Star	23.24	\$0.56	11	1.01	\$0.00
Electronics	Devices and Gadgets	Devices and Gadgets	-	\$0.00	5	1.00	\$0.00
Miscellaneous	Pool Pump	Baseline Pump	-	\$0.00	15	1.00	\$0.00
Miscellaneous	Pool Pump	High Efficiency Pump	100.46	\$85.00	15	0.98	\$0.07
Miscellaneous	Pool Pump	Two-Speed Pump	401.86	\$579.00	15	0.73	\$0.12
Miscellaneous	Furnace Fan	Baseline	-	\$0.00	18	1.00	\$0.00
Miscellaneous	Furnace Fan	Furnace Fan with ECM	103.13	\$0.64	18	1.26	\$0.00
Miscellaneous	Miscellaneous	Miscellaneous	-	\$0.00	5	1.00	\$0.00

Residential Energy Efficiency Equipment and Measure Data

Table B-18 Energy Efficiency Equipment Data, Electric—Low income, New Vintage, Idaho

End Use	Technology	Eff. Definition	Savings (kWh/HH/yr)	Incremental Cost (\$/HH)	Lifetime (Years)	BC Ratio (2015)	Levelized Cost of Energy (\$/kWh)
Cooling	Central AC	SEER 13	-	\$0.00	15	-	\$0.00
Cooling	Central AC	SEER 14 (Energy Star)	41.11	\$185.24	15	1.40	\$0.39
Cooling	Central AC	SEER 15 (CEE Tier 2)	54.76	\$370.47	15	0.93	\$0.59
Cooling	Central AC	SEER 16 (CEE Tier 3)	66.21	\$555.71	15	0.87	\$0.73
Cooling	Central AC	Ductless Mini-Split System	124.17	\$2,394.23	20	0.64	\$1.36
Cooling	Room AC	EER 9.8	-	\$0.00	10	1.00	\$0.00
Cooling	Room AC	EER 10.8 (Energy Star)	21.58	\$104.04	10	0.80	\$0.57
Cooling	Room AC	EER 11	25.43	\$282.26	10	0.59	\$1.32
Cooling	Room AC	EER 11.5	34.49	\$625.50	10	0.39	\$2.15
Cooling	Air Source Heat Pump	SEER 13	-	\$0.00	15	-	\$0.00
Cooling	Air Source Heat Pump	SEER 14 (Energy Star)	31.46	\$0.00	15	1.30	\$0.00
Cooling	Air Source Heat Pump	SEER 15 (CEE Tier 2)	41.90	\$0.00	15	0.91	\$0.00
Cooling	Air Source Heat Pump	SEER 16 (CEE Tier 3)	50.67	\$0.00	15	0.85	\$0.00
Cooling	Air Source Heat Pump	Ductless Mini-Split System	95.02	\$0.00	20	0.85	\$0.00
Cooling	Geothermal Heat Pump	Standard	-	\$0.00	15	1.00	\$0.00
Cooling	Geothermal Heat Pump	High Efficiency	48.91	\$0.00	15	0.87	\$0.00
Cooling	Ductless HP	Ductless Mini-Split System	-	\$0.00	20	1.00	\$0.00
Space Heating	Electric Resistance	Electric Resistance	-	\$0.00	20	1.00	\$0.00
Space Heating	Electric Resistance	Ductless Mini-Split System	2,114.04	\$156.87	20	1.30	\$0.01
Space Heating	Electric Furnace	3400 BTU/KW	-	\$0.00	15	1.00	\$0.00
Space Heating	Supplemental	Supplemental	-	\$0.00	5	1.00	\$0.00
Space Heating	Air Source Heat Pump	SEER 13	-	\$0.00	15	-	\$0.00
Space Heating	Air Source Heat Pump	SEER 14 (Energy Star)	402.32	\$1,245.78	15	1.30	\$0.27
Space Heating	Air Source Heat Pump	SEER 15 (CEE Tier 2)	535.87	\$2,315.13	15	0.91	\$0.37
Space Heating	Air Source Heat Pump	SEER 16 (CEE Tier 3)	647.99	\$3,277.48	15	0.85	\$0.44
Space Heating	Air Source Heat Pump	Ductless Mini-Split System	1,215.19	\$5,022.03	20	0.85	\$0.29
Space Heating	Geothermal Heat Pump	Standard	-	\$0.00	15	1.00	\$0.00
Space Heating	Geothermal Heat Pump	High Efficiency	461.68	\$1,500.00	15	0.87	\$0.28
Space Heating	Ductless HP	Ductless Mini-Split System	-	\$0.00	20	1.00	\$0.00
Water Heating	Water Heater <= 55 Gal	Baseline (EF=0.90)	-	\$0.00	15	1.00	\$0.00
Water Heating	Water Heater <= 55 Gal	High Efficiency (EF=0.95)	118.72	\$77.11	15	1.00	\$0.06
Water Heating	Water Heater <= 55 Gal	EF 2.3 (HP)	1,144.40	\$1,761.86	15	0.62	\$0.13
Water Heating	Water Heater <= 55 Gal	Solar	1,296.78	\$6,214.86	15	0.26	\$0.41
Water Heating	Water Heater > 55 Gal	Baseline (EF=0.90)	-	\$0.00	15	1.00	\$0.00
Water Heating	Water Heater > 55 Gal	High Efficiency (EF=0.95)	167.67	\$97.23	15	1.01	\$0.05

Residential Energy Efficiency Equipment and Measure Data

End Use	Technology	Eff. Definition	Savings (kWh/HH/yr)	Incremental Cost (\$/HH)	Lifetime (Years)	BC Ratio (2015)	Levelized Cost of Energy (\$/kWh)
Water Heating	Water Heater > 55 Gal	EF 2.3 (HP)	1,270.00	\$1,691.15	15	0.70	\$0.12
Water Heating	Water Heater > 55 Gal	Solar	1,134.84	\$6,144.15	15	0.31	\$0.47
Interior Lighting	Screw-in	Incandescent	-	\$0.00	4	-	\$0.00
Interior Lighting	Screw-in	Infrared Halogen	160.74	\$98.38	5	1.00	\$0.13
Interior Lighting	Screw-in	CFL	510.45	\$17.84	6	2.54	\$0.01
Interior Lighting	Screw-in	LED	697.66	\$1,012.85	12	-	\$0.15
Interior Lighting	Screw-in	LED	697.66	\$1,012.85	12	-	\$0.15
Interior Lighting	Linear Fluorescent	T12	-	\$0.00	6	1.00	\$0.00
Interior Lighting	Linear Fluorescent	T8	7.29	-\$1.79	6	1.13	-\$0.05
Interior Lighting	Linear Fluorescent	Super T8	21.85	\$14.30	6	0.75	\$0.12
Interior Lighting	Linear Fluorescent	T5	22.71	\$24.22	6	0.60	\$0.20
Interior Lighting	Linear Fluorescent	LED	23.82	\$212.60	10	0.22	\$1.06
Interior Lighting	Specialty	Halogen	-	\$0.00	4	1.00	\$0.00
Interior Lighting	Specialty	CFL	134.85	-\$9.64	7	2.92	-\$0.01
Interior Lighting	Specialty	LED	141.88	\$71.04	12	0.91	\$0.05
Exterior Lighting	Screw-in	Incandescent	-	\$0.00	4	-	\$0.00
Exterior Lighting	Screw-in	Infrared Halogen	35.88	\$9.82	5	1.00	\$0.06
Exterior Lighting	Screw-in	CFL	121.77	-\$0.51	3	4.25	\$0.00
Exterior Lighting	Screw-in	LED	141.35	\$144.92	12	-	\$0.11
Exterior Lighting	Screw-in	LED	141.35	\$144.92	12	-	\$0.11
Appliances	Clothes Washer	Baseline	-	\$0.00	14	-	\$0.00
Appliances	Clothes Washer	Energy Star (MEF > 1.8)	39.78	\$69.81	14	-	\$0.16
Appliances	Clothes Washer	Horizontal Axis	54.92	\$150.80	14	1.00	\$0.25
Appliances	Clothes Dryer	Baseline	-	\$0.00	13	-	\$0.00
Appliances	Clothes Dryer	Moisture Detection	54.81	\$48.40	13	1.00	\$0.09
Appliances	Dishwasher	Baseline	-	\$0.00	15	1.00	\$0.00
Appliances	Dishwasher	Energy Star	46.11	\$460.95	9	-	\$1.29
Appliances	Dishwasher	Energy Star (2011)	6.04	\$5.61	15	0.99	\$0.08
Appliances	Refrigerator	Baseline	-	\$0.00	20	-	\$0.00
Appliances	Refrigerator	Energy Star	50.60	\$20.17	20	-	\$0.03
Appliances	Refrigerator	Baseline (2014)	92.68	\$0.00	13	1.00	\$0.00
Appliances	Refrigerator	Energy Star (2014)	148.29	\$88.71	13	1.01	\$0.06
Appliances	Freezer	Baseline	-	\$0.00	22	-	\$0.00
Appliances	Freezer	Energy Star	40.95	\$3.98	22	-	\$0.01
Appliances	Freezer	Baseline (2014)	95.04	-\$145.00	11	1.00	-\$0.17
Appliances	Freezer	Energy Star (2014)	152.06	-\$112.83	11	1.00	-\$0.08
Appliances	Second Refrigerator	Baseline	-	\$0.00	20	-	\$0.00
Appliances	Second Refrigerator	Energy Star	67.46	\$20.67	20	-	\$0.02
Appliances	Second Refrigerator	Baseline (2014)	123.58	\$0.00	13	1.00	\$0.00
Appliances	Second	Energy Star (2014)	197.72	\$88.71	13	1.01	\$0.04

Residential Energy Efficiency Equipment and Measure Data

End Use	Technology	Eff. Definition	Savings (kWh/HH/yr)	Incremental Cost (\$/HH)	Lifetime (Years)	BC Ratio (2015)	Levelized Cost of Energy (\$/kWh)
	Refrigerator						
Appliances	Stove	Baseline	-	\$0.00	13	1.00	\$0.00
Appliances	Stove	Convection Oven	7.00	\$1.86	13	1.00	\$0.03
Appliances	Stove	Induction (High Efficiency)	35.02	\$1,432.20	13	0.36	\$3.94
Appliances	Microwave	Baseline	-	\$0.00	9	1.00	\$0.00
Electronics	Personal Computers	Baseline	-	\$0.00	5	1.00	\$0.00
Electronics	Personal Computers	Energy Star	57.97	\$1.20	5	1.01	\$0.00
Electronics	Personal Computers	Climate Savers	82.81	\$175.49	5	0.85	\$0.46
Electronics	TVs	Baseline	-	\$0.00	11	1.00	\$0.00
Electronics	TVs	Energy Star	40.50	\$0.56	11	1.02	\$0.00
Electronics	Set-top boxes/DVR	Baseline	-	\$0.00	11	1.00	\$0.00
Electronics	Set-top boxes/DVR	Energy Star	23.24	\$0.56	11	1.01	\$0.00
Electronics	Devices and Gadgets	Devices and Gadgets	-	\$0.00	5	1.00	\$0.00
Miscellaneous	Pool Pump	Baseline Pump	-	\$0.00	15	1.00	\$0.00
Miscellaneous	Pool Pump	High Efficiency Pump	112.58	\$85.00	15	0.99	\$0.07
Miscellaneous	Pool Pump	Two-Speed Pump	450.31	\$579.00	15	0.77	\$0.11
Miscellaneous	Furnace Fan	Baseline	-	\$0.00	18	1.00	\$0.00
Miscellaneous	Furnace Fan	Furnace Fan with ECM	103.13	\$0.64	18	1.26	\$0.00
Miscellaneous	Miscellaneous	Miscellaneous	-	\$0.00	5	1.00	\$0.00

Residential Energy Efficiency Equipment and Measure Data

Table B-19 Energy Efficiency Non-Equipment Data, Electric—Single Family, Existing Vintage, Washington

Measure	Base Saturation	Applicability	Lifetime (Years)	Cost (\$/HH)	Savings (kWh)	BC Ratio	Levelized Cost (\$/kWh)
Central AC - Early Replacement	0.0%	80.0%	15	\$2,895.00	139.3	0.00	\$2.133
Central AC - Maintenance and Tune-Up	41.0%	100.0%	4	\$125.00	137.4	0.06	\$0.251
Room AC - Removal of Second Unit	0.0%	100.0%	5	\$75.00	512.4	0.42	\$0.033
Attic Fan - Installation	12.0%	50.0%	18	\$115.80	6.2	0.00	\$1.736
Attic Fan - Photovoltaic - Installation	13.0%	100.0%	19	\$350.00	6.2	0.00	\$5.107
Ceiling Fan - Installation	51.0%	100.0%	15	\$160.00	108.8	0.06	\$0.151
Whole-House Fan - Installation	6.9%	25.0%	18	\$200.00	174.6	0.08	\$0.106
Air Source Heat Pump - Maintenance	37.8%	100.0%	4	\$125.00	926.7	0.42	\$0.037
Insulation - Ducting	15.0%	59.4%	18	\$500.00	483.1	0.09	\$0.096
Repair and Sealing - Ducting	12.3%	100.0%	20	\$571.38	2,111.0	0.35	\$0.024
Thermostat - Clock/Programmable	71.8%	75.0%	15	\$249.47	587.7	0.49	\$0.044
Doors - Storm and Thermal	38.0%	100.0%	12	\$320.00	116.9	0.05	\$0.322
Insulation - Infiltration Control	46.0%	100.0%	25	\$306.11	876.6	0.48	\$0.028
Insulation - Ceiling	76.4%	75.0%	25	\$630.45	991.9	0.18	\$0.051
Insulation - Radiant Barrier	5.0%	100.0%	12	\$922.68	571.9	0.09	\$0.190
Roofs - High Reflectivity	5.0%	100.0%	15	\$1,549.61	82.7	0.00	\$1.923
Windows - Reflective Film	5.0%	50.0%	10	\$266.67	369.6	0.12	\$0.096
Windows - High Efficiency/Energy Star	77.6%	100.0%	25	\$5,200.97	4,270.5	0.11	\$0.098
Interior Lighting - Occupancy Sensor	23.5%	50.0%	15	\$750.00	444.7	0.05	\$0.173
Exterior Lighting - Photovoltaic Installation	10.0%	100.0%	15	\$2,975.00	53.8	0.00	\$5.679
Exterior Lighting - Photosensor Control	23.5%	100.0%	8	\$90.00	36.3	0.03	\$0.388
Exterior Lighting - Timeclock Installation	10.0%	100.0%	8	\$72.00	36.3	0.04	\$0.310
Water Heater - Faucet Aerators	53.2%	100.0%	25	\$24.00	275.8	1.23	\$0.007
Water Heater - Pipe Insulation	17.0%	100.0%	13	\$15.00	242.9	1.94	\$0.007
Water Heater - Low Flow Showerheads	75.5%	100.0%	10	\$25.48	354.0	1.87	\$0.010
Water Heater - Tank Blanket/Insulation	54.0%	100.0%	10	\$15.00	781.1	4.19	\$0.003
Water Heater - Thermostat Setback	17.0%	100.0%	5	\$40.00	781.1	1.23	\$0.012
Electronics - Reduce Standby Wattage	5.0%	100.0%	8	\$20.00	117.4	0.47	\$0.027
Refrigerator - Early Replacement	10.0%	85.0%	7	\$109.00	319.9	0.16	\$0.059
Refrigerator - Remove Second Unit	17.3%	85.0%	7	\$109.00	437.0	0.83	\$0.043
Freezer - Early Replacement	10.0%	85.0%	5	\$109.00	355.4	0.14	\$0.070
Freezer - Remove Second Unit	17.3%	85.0%	5	\$109.00	384.9	0.75	\$0.065
Behavioral Measures	20.0%	50.0%	1	\$12.00	125.0	0.20	\$0.096
Pool - Pump Timer	58.8%	100.0%	15	\$160.00	194.3	0.12	\$0.085
Insulation - Foundation	25.9%	39.0%	25	\$750.53	521.1	0.19	\$0.116
Insulation - Wall Cavity	88.4%	100.0%	25	\$1,415.87	2,186.1	0.17	\$0.052
Insulation - Wall Sheathing	64.4%	100.0%	20	\$300.00	276.9	0.14	\$0.096
Water Heater - Solar System	5.0%	25.0%	20	\$6,500.00	6,437.3	0.11	\$0.089

Residential Energy Efficiency Equipment and Measure Data

Table B-20 Energy Efficiency Non-Equipment Data, Electric—Single Family, New Vintage, Washington

Measure	Base Saturation	Applicability	Lifetime (Years)	Cost (\$/HH)	Savings (kWh)	BC Ratio	Levelized Cost (\$/kWh)
Central AC - Maintenance and Tune-Up	41.0%	100.0%	4	\$125.00	158.0	0.07	\$0.218
Attic Fan - Installation	12.6%	50.0%	18	\$96.50	8.7	0.01	\$1.027
Attic Fan - Photovoltaic - Installation	4.0%	25.0%	19	\$200.00	8.7	0.00	\$2.072
Ceiling Fan - Installation	52.6%	100.0%	15	\$160.00	174.2	0.10	\$0.094
Whole-House Fan - Installation	4.0%	25.0%	18	\$200.00	239.6	0.12	\$0.078
Air Source Heat Pump - Maintenance	37.8%	100.0%	4	\$125.00	1,065.7	0.53	\$0.032
Insulation - Ducting	50.0%	59.4%	18	\$250.00	553.3	0.22	\$0.042
Thermostat - Clock/Programmable	90.6%	95.0%	15	\$249.47	608.2	0.41	\$0.042
Doors - Storm and Thermal	13.0%	100.0%	12	\$180.00	203.5	0.16	\$0.104
Insulation - Ceiling	81.8%	75.0%	20	\$634.00	549.5	0.13	\$0.102
Insulation - Radiant Barrier	25.0%	100.0%	12	\$922.68	193.4	0.03	\$0.561
Roofs - High Reflectivity	5.0%	100.0%	15	\$516.54	129.8	0.02	\$0.408
Windows - Reflective Film	2.0%	50.0%	10	\$266.67	338.0	0.11	\$0.105
Windows - High Efficiency/Energy Star	95.5%	100.0%	25	\$2,200.00	3,037.6	0.22	\$0.058
Interior Lighting - Occupancy Sensor	23.5%	30.0%	15	\$500.00	493.6	0.10	\$0.104
Exterior Lighting - Photovoltaic Installation	10.0%	100.0%	15	\$2,975.00	60.1	0.00	\$5.076
Exterior Lighting - Photosensor Control	13.2%	100.0%	8	\$90.00	40.0	0.05	\$0.352
Exterior Lighting - Timeclock Installation	16.0%	100.0%	8	\$72.00	40.0	0.06	\$0.282
Water Heater - Faucet Aerators	38.3%	100.0%	25	\$24.00	251.6	1.13	\$0.008
Water Heater - Pipe Insulation	8.0%	100.0%	13	\$15.00	221.9	1.78	\$0.008
Water Heater - Low Flow Showerheads	89.8%	100.0%	10	\$25.48	354.0	1.81	\$0.010
Water Heater - Tank Blanket/Insulation	0.0%	0.0%	10	\$15.00	713.6	3.82	\$0.003
Water Heater - Thermostat Setback	5.0%	100.0%	5	\$40.00	713.6	1.13	\$0.013
Electronics - Reduce Standby Wattage	5.0%	100.0%	8	\$20.00	126.7	0.53	\$0.025
Behavioral Measures	20.0%	75.0%	1	\$12.00	142.7	0.24	\$0.084
Pool - Pump Timer	55.0%	100.0%	15	\$160.00	200.1	0.14	\$0.082
Insulation - Foundation	54.8%	63.6%	20	\$358.00	744.7	0.49	\$0.042
Insulation - Wall Cavity	91.1%	100.0%	25	\$236.00	558.7	0.38	\$0.034
Insulation - Wall Sheathing	64.4%	100.0%	20	\$300.00	315.7	0.17	\$0.084
Water Heater - Drainwater Heat Recovery	1.0%	100.0%	25	\$899.00	1,176.3	0.14	\$0.061

Residential Energy Efficiency Equipment and Measure Data

Table B-21 Energy Efficiency Non-Equipment Data, Electric—Single Family, Existing Vintage, Idaho

Measure	Base Saturation	Applicability	Lifetime (Years)	Cost (\$/HH)	Savings (kWh)	BC Ratio	Levelized Cost (\$/kWh)
Central AC - Early Replacement	0.0%	80.0%	15	\$2,895.00	139.3	0.00	\$2.133
Central AC - Maintenance and Tune-Up	41.0%	100.0%	4	\$125.00	137.4	0.06	\$0.251
Room AC - Removal of Second Unit	0.0%	100.0%	5	\$75.00	512.4	0.42	\$0.033
Attic Fan - Installation	12.0%	50.0%	18	\$115.80	6.2	0.00	\$1.736
Attic Fan - Photovoltaic - Installation	13.0%	100.0%	19	\$350.00	6.2	0.00	\$5.107
Ceiling Fan - Installation	51.0%	100.0%	15	\$160.00	108.8	0.06	\$0.151
Whole-House Fan - Installation	6.9%	25.0%	18	\$200.00	174.6	0.08	\$0.106
Air Source Heat Pump - Maintenance	37.8%	100.0%	4	\$125.00	926.7	0.42	\$0.037
Insulation - Ducting	15.0%	59.4%	18	\$500.00	483.1	0.09	\$0.096
Repair and Sealing - Ducting	12.3%	100.0%	20	\$571.38	2,111.0	0.35	\$0.024
Thermostat - Clock/Programmable	71.8%	75.0%	15	\$249.47	587.7	0.49	\$0.044
Doors - Storm and Thermal	38.0%	100.0%	12	\$320.00	116.9	0.05	\$0.322
Insulation - Infiltration Control	46.0%	100.0%	25	\$306.11	876.6	0.48	\$0.028
Insulation - Ceiling	76.4%	75.0%	25	\$630.45	991.9	0.18	\$0.051
Insulation - Radiant Barrier	5.0%	100.0%	12	\$922.68	571.9	0.09	\$0.190
Roofs - High Reflectivity	5.0%	100.0%	15	\$1,549.61	82.7	0.00	\$1.923
Windows - Reflective Film	5.0%	50.0%	10	\$266.67	369.6	0.12	\$0.096
Windows - High Efficiency/Energy Star	77.6%	100.0%	25	\$5,200.97	4,270.5	0.11	\$0.098
Interior Lighting - Occupancy Sensor	23.5%	50.0%	15	\$750.00	444.7	0.05	\$0.173
Exterior Lighting - Photovoltaic Installation	10.0%	100.0%	15	\$2,975.00	53.8	0.00	\$5.679
Exterior Lighting - Photosensor Control	23.5%	100.0%	8	\$90.00	36.3	0.03	\$0.388
Exterior Lighting - Timeclock Installation	10.0%	100.0%	8	\$72.00	36.3	0.04	\$0.310
Water Heater - Faucet Aerators	53.2%	100.0%	25	\$24.00	275.8	1.23	\$0.007
Water Heater - Pipe Insulation	17.0%	100.0%	13	\$15.00	242.9	1.94	\$0.007
Water Heater - Low Flow Showerheads	75.5%	100.0%	10	\$25.48	354.0	1.87	\$0.010
Water Heater - Tank Blanket/Insulation	54.0%	100.0%	10	\$15.00	781.1	4.19	\$0.003
Water Heater - Thermostat Setback	17.0%	100.0%	5	\$40.00	781.1	1.23	\$0.012
Electronics - Reduce Standby Wattage	5.0%	100.0%	8	\$20.00	117.4	0.47	\$0.027
Refrigerator - Early Replacement	10.0%	85.0%	7	\$109.00	319.9	0.16	\$0.059
Refrigerator - Remove Second Unit	17.3%	85.0%	7	\$109.00	437.0	0.83	\$0.043
Freezer - Early Replacement	10.0%	85.0%	5	\$109.00	355.4	0.14	\$0.070
Freezer - Remove Second Unit	17.3%	85.0%	5	\$109.00	384.9	0.75	\$0.065
Behavioral Measures	20.0%	50.0%	1	\$12.00	125.0	0.20	\$0.096
Pool - Pump Timer	58.8%	100.0%	15	\$160.00	194.3	0.12	\$0.085
Insulation - Foundation	25.9%	39.0%	25	\$750.53	521.1	0.19	\$0.116
Insulation - Wall Cavity	88.4%	100.0%	25	\$1,415.87	2,186.1	0.17	\$0.052
Insulation - Wall Sheathing	64.4%	100.0%	20	\$300.00	276.9	0.14	\$0.096
Water Heater - Solar System	5.0%	25.0%	20	\$6,500.00	6,437.3	0.11	\$0.089

Residential Energy Efficiency Equipment and Measure Data

Table B-22 Energy Efficiency Non-Equipment Data, Electric—Single Family, New Vintage, Idaho

Measure	Base Saturation	Applicability	Lifetime (Years)	Cost (\$/HH)	Savings (kWh)	BC Ratio	Levelized Cost (\$/kWh)
Central AC - Maintenance and Tune-Up	41.0%	100.0%	4	\$125.00	158.0	0.07	\$0.218
Attic Fan - Installation	12.6%	50.0%	18	\$96.50	8.7	0.01	\$1.027
Attic Fan - Photovoltaic - Installation	4.0%	25.0%	19	\$200.00	8.7	0.00	\$2.072
Ceiling Fan - Installation	52.6%	100.0%	15	\$160.00	174.2	0.10	\$0.094
Whole-House Fan - Installation	4.0%	25.0%	18	\$200.00	239.6	0.12	\$0.078
Air Source Heat Pump - Maintenance	37.8%	100.0%	4	\$125.00	1,065.7	0.53	\$0.032
Insulation - Ducting	50.0%	59.4%	18	\$250.00	553.3	0.22	\$0.042
Thermostat - Clock/Programmable	90.6%	95.0%	15	\$249.47	608.2	0.41	\$0.042
Doors - Storm and Thermal	13.0%	100.0%	12	\$180.00	203.5	0.16	\$0.104
Insulation - Ceiling	81.8%	75.0%	20	\$634.00	549.5	0.13	\$0.102
Insulation - Radiant Barrier	25.0%	100.0%	12	\$922.68	193.4	0.03	\$0.561
Roofs - High Reflectivity	5.0%	100.0%	15	\$516.54	129.8	0.02	\$0.408
Windows - Reflective Film	2.0%	50.0%	10	\$266.67	338.0	0.11	\$0.105
Windows - High Efficiency/Energy Star	95.5%	100.0%	25	\$2,200.00	3,037.6	0.22	\$0.058
Interior Lighting - Occupancy Sensor	23.5%	30.0%	15	\$500.00	493.6	0.10	\$0.104
Exterior Lighting - Photovoltaic Installation	10.0%	100.0%	15	\$2,975.00	60.1	0.00	\$5.076
Exterior Lighting - Photosensor Control	13.2%	100.0%	8	\$90.00	40.0	0.05	\$0.352
Exterior Lighting - Timeclock Installation	16.0%	100.0%	8	\$72.00	40.0	0.06	\$0.282
Water Heater - Faucet Aerators	38.3%	100.0%	25	\$24.00	251.6	1.13	\$0.008
Water Heater - Pipe Insulation	8.0%	100.0%	13	\$15.00	221.9	1.78	\$0.008
Water Heater - Low Flow Showerheads	89.8%	100.0%	10	\$25.48	354.0	1.81	\$0.010
Water Heater - Tank Blanket/Insulation	0.0%	0.0%	10	\$15.00	713.6	3.82	\$0.003
Water Heater - Thermostat Setback	5.0%	100.0%	5	\$40.00	713.6	1.13	\$0.013
Electronics - Reduce Standby Wattage	5.0%	100.0%	8	\$20.00	126.7	0.53	\$0.025
Behavioral Measures	20.0%	75.0%	1	\$12.00	142.7	0.24	\$0.084
Pool - Pump Timer	55.0%	100.0%	15	\$160.00	200.1	0.14	\$0.082
Insulation - Foundation	54.8%	63.6%	20	\$358.00	744.7	0.49	\$0.042
Insulation - Wall Cavity	91.1%	100.0%	25	\$236.00	558.7	0.38	\$0.034
Insulation - Wall Sheathing	64.4%	100.0%	20	\$300.00	315.7	0.17	\$0.084
Water Heater - Drainwater Heat Recovery	1.0%	100.0%	25	\$899.00	1,176.3	0.14	\$0.061

Residential Energy Efficiency Equipment and Measure Data

Table B-23 Energy Efficiency Non-Equipment Data, Electric—Multi Family, Existing Vintage, Washington

Measure	Base Saturation	Applicability	Lifetime (Years)	Cost (\$/HH)	Savings (kWh)	BC Ratio	Levelized Cost (\$/kWh)
Central AC - Early Replacement	0.0%	80.0%	15	\$2,895.00	46.4	0.00	\$6.400
Central AC - Maintenance and Tune-Up	32.8%	100.0%	4	\$100.00	45.8	0.03	\$0.602
Room AC - Removal of Second Unit	0.0%	100.0%	5	\$75.00	355.3	0.29	\$0.048
Ceiling Fan - Installation	32.4%	100.0%	15	\$80.00	37.9	0.04	\$0.216
Air Source Heat Pump - Maintenance	25.0%	100.0%	4	\$100.00	360.1	0.21	\$0.077
Insulation - Ducting	13.0%	13.0%	18	\$375.00	7.0	0.00	\$4.945
Repair and Sealing - Ducting	11.8%	100.0%	18	\$500.00	720.5	0.13	\$0.064
Thermostat - Clock/Programmable	27.0%	75.0%	15	\$114.42	315.1	0.35	\$0.037
Doors - Storm and Thermal	17.0%	100.0%	12	\$320.00	-	-	\$0.000
Insulation - Infiltration Control	19.0%	100.0%	12	\$266.00	283.6	0.17	\$0.110
Insulation - Ceiling	30.0%	40.0%	20	\$215.00	277.6	0.17	\$0.068
Insulation - Radiant Barrier	5.0%	100.0%	12	\$922.68	433.3	0.06	\$0.251
Roofs - High Reflectivity	3.0%	100.0%	15	\$1,549.61	39.3	0.00	\$4.045
Windows - Reflective Film	5.0%	50.0%	10	\$166.67	112.4	0.06	\$0.197
Windows - High Efficiency/Energy Star	70.4%	100.0%	25	\$2,500.00	1,020.7	0.05	\$0.196
Interior Lighting - Occupancy Sensor	5.6%	20.0%	15	\$256.00	253.9	0.08	\$0.103
Exterior Lighting - Photovoltaic Installation	10.0%	100.0%	15	\$2,975.00	5.5	0.00	\$55.926
Exterior Lighting - Photosensor Control	7.1%	100.0%	8	\$90.00	2.1	0.00	\$6.688
Exterior Lighting - Timeclock Installation	6.0%	100.0%	8	\$72.00	2.1	0.00	\$5.350
Water Heater - Faucet Aerators	43.2%	100.0%	25	\$24.00	237.5	1.05	\$0.008
Water Heater - Pipe Insulation	6.0%	100.0%	13	\$15.00	149.6	0.90	\$0.011
Water Heater - Low Flow Showerheads	71.6%	100.0%	10	\$25.48	282.0	1.11	\$0.012
Water Heater - Tank Blanket/Insulation	54.0%	100.0%	10	\$15.00	480.9	2.25	\$0.004
Water Heater - Thermostat Setback	17.0%	100.0%	5	\$40.00	480.9	0.67	\$0.019
Electronics - Reduce Standby Wattage	5.0%	100.0%	8	\$20.00	73.6	0.31	\$0.043
Refrigerator - Early Replacement	10.0%	85.0%	7	\$109.00	255.9	0.13	\$0.074
Refrigerator - Remove Second Unit	17.3%	85.0%	7	\$109.00	437.0	0.83	\$0.043
Freezer - Early Replacement	10.0%	85.0%	5	\$109.00	307.9	0.12	\$0.081
Freezer - Remove Second Unit	17.3%	85.0%	5	\$109.00	384.9	0.75	\$0.065
Behavioral Measures	5.0%	25.0%	1	\$12.00	65.5	0.10	\$0.183
Insulation - Wall Cavity	80.0%	100.0%	25	\$707.94	522.3	0.09	\$0.109
Insulation - Wall Sheathing	55.1%	100.0%	20	\$210.00	356.6	0.22	\$0.052

Residential Energy Efficiency Equipment and Measure Data

Table B-24 Energy Efficiency Non-Equipment Data, Electric—Multi Family, New Vintage, Washington

Measure	Base Saturation	Applicability	Lifetime (Years)	Cost (\$/HH)	Savings (kWh)	BC Ratio	Levelized Cost (\$/kWh)
Central AC - Maintenance and Tune-Up	32.8%	100.0%	4	\$100.00	52.7	0.03	\$0.524
Ceiling Fan - Installation	17.6%	100.0%	15	\$80.00	59.7	0.07	\$0.138
Air Source Heat Pump - Maintenance	25.0%	100.0%	4	\$100.00	414.1	0.27	\$0.067
Insulation - Ducting	13.0%	13.0%	18	\$200.00	7.3	0.00	\$2.531
Thermostat - Clock/Programmable	77.0%	80.0%	15	\$114.42	364.1	0.36	\$0.032
Doors - Storm and Thermal	19.0%	100.0%	12	\$180.00	-	-	\$0.000
Insulation - Ceiling	30.7%	50.0%	20	\$152.00	430.5	0.37	\$0.031
Insulation - Radiant Barrier	5.0%	100.0%	12	\$922.68	160.5	0.02	\$0.677
Roofs - High Reflectivity	0.0%	100.0%	15	\$516.54	35.4	0.01	\$1.498
Windows - Reflective Film	2.0%	50.0%	10	\$166.67	129.5	0.07	\$0.171
Windows - High Efficiency/Energy Star	89.2%	100.0%	25	\$2,200.00	2,298.8	0.14	\$0.077
Interior Lighting - Occupancy Sensor	5.6%	10.0%	15	\$256.00	281.1	0.11	\$0.093
Exterior Lighting - Photovoltaic Installation	10.0%	100.0%	15	\$2,975.00	6.3	0.00	\$48.646
Exterior Lighting - Photosensor Control	0.7%	100.0%	8	\$90.00	2.3	0.00	\$6.080
Exterior Lighting - Timeclock Installation	11.0%	100.0%	8	\$72.00	2.3	0.01	\$4.864
Water Heater - Faucet Aerators	11.0%	100.0%	25	\$24.00	217.0	1.04	\$0.009
Water Heater - Pipe Insulation	0.0%	100.0%	13	\$15.00	136.6	1.11	\$0.012
Water Heater - Low Flow Showerheads	66.2%	100.0%	10	\$25.48	282.0	1.42	\$0.012
Water Heater - Tank Blanket/Insulation	0.0%	0.0%	10	\$15.00	439.3	2.67	\$0.005
Water Heater - Thermostat Setback	5.0%	100.0%	5	\$40.00	439.3	0.76	\$0.021
Electronics - Reduce Standby Wattage	5.0%	100.0%	8	\$20.00	79.5	0.35	\$0.039
Behavioral Measures	5.0%	75.0%	1	\$12.00	75.1	0.13	\$0.160
Insulation - Wall Cavity	91.1%	100.0%	25	\$62.50	478.4	1.03	\$0.010
Insulation - Wall Sheathing	55.1%	100.0%	20	\$210.00	410.2	0.26	\$0.045
Water Heater - Drainwater Heat Recovery	1.0%	100.0%	25	\$899.00	724.2	0.09	\$0.100

Residential Energy Efficiency Equipment and Measure Data

Table B-25 Energy Efficiency Non-Equipment Data, Electric—Multi Family, Existing Vintage, Idaho

Measure	Base Saturation	Applicability	Lifetime (Years)	Cost (\$/HH)	Savings (kWh)	BC Ratio	Levelized Cost (\$/kWh)
Central AC - Early Replacement	0.0%	80.0%	15	\$2,895.00	46.4	0.00	\$6.400
Central AC - Maintenance and Tune-Up	32.8%	100.0%	4	\$100.00	45.8	0.03	\$0.602
Room AC - Removal of Second Unit	0.0%	100.0%	5	\$75.00	355.3	0.29	\$0.048
Ceiling Fan - Installation	32.4%	100.0%	15	\$80.00	37.9	0.04	\$0.216
Air Source Heat Pump - Maintenance	25.0%	100.0%	4	\$100.00	360.1	0.21	\$0.077
Insulation - Ducting	13.0%	13.0%	18	\$375.00	7.0	0.00	\$4.945
Repair and Sealing - Ducting	11.8%	100.0%	18	\$500.00	720.5	0.13	\$0.064
Thermostat - Clock/Programmable	27.0%	75.0%	15	\$114.42	315.1	0.35	\$0.037
Doors - Storm and Thermal	17.0%	100.0%	12	\$320.00	-	-	\$0.000
Insulation - Infiltration Control	19.0%	100.0%	12	\$266.00	283.6	0.17	\$0.110
Insulation - Ceiling	30.0%	40.0%	20	\$215.00	277.6	0.17	\$0.068
Insulation - Radiant Barrier	5.0%	100.0%	12	\$922.68	433.3	0.06	\$0.251
Roofs - High Reflectivity	3.0%	100.0%	15	\$1,549.61	39.3	0.00	\$4.045
Windows - Reflective Film	5.0%	50.0%	10	\$166.67	112.4	0.06	\$0.197
Windows - High Efficiency/Energy Star	70.4%	100.0%	25	\$2,500.00	1,020.7	0.05	\$0.196
Interior Lighting - Occupancy Sensor	5.6%	20.0%	15	\$256.00	253.9	0.08	\$0.103
Exterior Lighting - Photovoltaic Installation	10.0%	100.0%	15	\$2,975.00	5.5	0.00	\$55.926
Exterior Lighting - Photosensor Control	7.1%	100.0%	8	\$90.00	2.1	0.00	\$6.688
Exterior Lighting - Timeclock Installation	6.0%	100.0%	8	\$72.00	2.1	0.00	\$5.350
Water Heater - Faucet Aerators	43.2%	100.0%	25	\$24.00	237.5	1.05	\$0.008
Water Heater - Pipe Insulation	6.0%	100.0%	13	\$15.00	149.6	0.90	\$0.011
Water Heater - Low Flow Showerheads	71.6%	100.0%	10	\$25.48	282.0	1.11	\$0.012
Water Heater - Tank Blanket/Insulation	54.0%	100.0%	10	\$15.00	480.9	2.25	\$0.004
Water Heater - Thermostat Setback	17.0%	100.0%	5	\$40.00	480.9	0.67	\$0.019
Electronics - Reduce Standby Wattage	5.0%	100.0%	8	\$20.00	73.6	0.31	\$0.043
Refrigerator - Early Replacement	10.0%	85.0%	7	\$109.00	255.9	0.13	\$0.074
Refrigerator - Remove Second Unit	17.3%	85.0%	7	\$109.00	437.0	0.83	\$0.043
Freezer - Early Replacement	10.0%	85.0%	5	\$109.00	307.9	0.12	\$0.081
Freezer - Remove Second Unit	17.3%	85.0%	5	\$109.00	384.9	0.75	\$0.065
Behavioral Measures	5.0%	25.0%	1	\$12.00	65.5	0.10	\$0.183
Insulation - Wall Cavity	80.0%	100.0%	25	\$707.94	522.3	0.09	\$0.109
Insulation - Wall Sheathing	55.1%	100.0%	20	\$210.00	356.6	0.22	\$0.052

Residential Energy Efficiency Equipment and Measure Data

Table B-26 Energy Efficiency Non-Equipment Data, Electric—Multi Family, New Vintage, Idaho

Measure	Base Saturation	Applicability	Lifetime (Years)	Cost (\$/HH)	Savings (kWh)	BC Ratio	Levelized Cost (\$/kWh)
Central AC - Maintenance and Tune-Up	32.8%	100.0%	4	\$100.00	52.7	0.03	\$0.524
Ceiling Fan - Installation	17.6%	100.0%	15	\$80.00	59.7	0.07	\$0.138
Air Source Heat Pump - Maintenance	25.0%	100.0%	4	\$100.00	414.1	0.27	\$0.067
Insulation - Ducting	13.0%	13.0%	18	\$200.00	7.3	0.00	\$2.531
Thermostat - Clock/Programmable	77.0%	80.0%	15	\$114.42	364.1	0.36	\$0.032
Doors - Storm and Thermal	19.0%	100.0%	12	\$180.00	-	-	\$0.000
Insulation - Ceiling	30.7%	50.0%	20	\$152.00	430.5	0.37	\$0.031
Insulation - Radiant Barrier	5.0%	100.0%	12	\$922.68	160.5	0.02	\$0.677
Roofs - High Reflectivity	0.0%	100.0%	15	\$516.54	35.4	0.01	\$1.498
Windows - Reflective Film	2.0%	50.0%	10	\$166.67	129.5	0.07	\$0.171
Windows - High Efficiency/Energy Star	89.2%	100.0%	25	\$2,200.00	2,298.8	0.14	\$0.077
Interior Lighting - Occupancy Sensor	5.6%	10.0%	15	\$256.00	281.1	0.11	\$0.093
Exterior Lighting - Photovoltaic Installation	10.0%	100.0%	15	\$2,975.00	6.3	0.00	\$48.646
Exterior Lighting - Photosensor Control	0.7%	100.0%	8	\$90.00	2.3	0.00	\$6.080
Exterior Lighting - Timeclock Installation	11.0%	100.0%	8	\$72.00	2.3	0.01	\$4.864
Water Heater - Faucet Aerators	11.0%	100.0%	25	\$24.00	217.0	1.04	\$0.009
Water Heater - Pipe Insulation	0.0%	100.0%	13	\$15.00	136.6	1.11	\$0.012
Water Heater - Low Flow Showerheads	66.2%	100.0%	10	\$25.48	282.0	1.42	\$0.012
Water Heater - Tank Blanket/Insulation	0.0%	0.0%	10	\$15.00	439.3	2.67	\$0.005
Water Heater - Thermostat Setback	5.0%	100.0%	5	\$40.00	439.3	0.76	\$0.021
Electronics - Reduce Standby Wattage	5.0%	100.0%	8	\$20.00	79.5	0.35	\$0.039
Behavioral Measures	5.0%	75.0%	1	\$12.00	75.1	0.13	\$0.160
Insulation - Wall Cavity	91.1%	100.0%	25	\$62.50	478.4	1.03	\$0.010
Insulation - Wall Sheathing	55.1%	100.0%	20	\$210.00	410.2	0.26	\$0.045
Water Heater - Drainwater Heat Recovery	1.0%	100.0%	25	\$899.00	724.2	0.09	\$0.100

Residential Energy Efficiency Equipment and Measure Data

Table B-27 Energy Efficiency Non-Equipment Data, Electric—Mobile Home, Existing Vintage, Washington

Measure	Base Saturation	Applicability	Lifetime (Years)	Cost (\$/HH)	Savings (kWh)	BC Ratio	Levelized Cost (\$/kWh)
Central AC - Early Replacement	0.0%	80.0%	15	\$2,895.00	55.3	0.00	\$5.373
Central AC - Maintenance and Tune-Up	58.9%	100.0%	4	\$100.00	54.5	0.03	\$0.506
Room AC - Removal of Second Unit	0.0%	100.0%	5	\$75.00	305.2	0.25	\$0.056
Ceiling Fan - Installation	60.0%	100.0%	15	\$80.00	41.2	0.05	\$0.199
Whole-House Fan - Installation	5.2%	25.0%	18	\$150.00	66.1	0.04	\$0.211
Air Source Heat Pump - Maintenance	25.0%	100.0%	4	\$125.00	496.0	0.22	\$0.070
Insulation - Ducting	15.0%	65.0%	18	\$375.00	320.3	0.08	\$0.109
Repair and Sealing - Ducting	12.3%	100.0%	18	\$398.09	2,477.4	0.59	\$0.015
Thermostat - Clock/Programmable	51.0%	75.0%	15	\$114.42	513.2	0.94	\$0.023
Doors - Storm and Thermal	38.0%	100.0%	12	\$320.00	79.1	0.04	\$0.476
Insulation - Infiltration Control	46.0%	100.0%	25	\$208.70	364.9	0.42	\$0.046
Insulation - Ceiling	46.2%	85.0%	25	\$276.18	355.8	0.18	\$0.062
Insulation - Radiant Barrier	5.0%	100.0%	12	\$922.68	387.5	0.07	\$0.280
Roofs - High Reflectivity	5.0%	100.0%	15	\$1,549.61	31.3	0.00	\$5.080
Windows - Reflective Film	5.0%	50.0%	10	\$166.67	139.9	0.07	\$0.159
Windows - High Efficiency/Energy Star	52.4%	100.0%	25	\$3,171.89	4,053.4	0.16	\$0.063
Interior Lighting - Occupancy Sensor	66.6%	80.0%	15	\$750.00	346.9	0.04	\$0.222
Exterior Lighting - Photovoltaic Installation	10.0%	100.0%	15	\$2,975.00	41.9	0.00	\$7.281
Exterior Lighting - Photosensor Control	23.4%	100.0%	8	\$90.00	28.3	0.02	\$0.497
Exterior Lighting - Timeclock Installation	10.0%	100.0%	8	\$72.00	28.3	0.03	\$0.398
Water Heater - Faucet Aerators	78.9%	100.0%	25	\$24.00	179.3	1.02	\$0.011
Water Heater - Pipe Insulation	17.0%	100.0%	13	\$15.00	157.9	1.14	\$0.011
Water Heater - Low Flow Showerheads	92.1%	100.0%	10	\$25.48	816.8	2.74	\$0.004
Water Heater - Tank Blanket/Insulation	54.0%	100.0%	10	\$15.00	507.7	2.43	\$0.004
Water Heater - Thermostat Setback	17.0%	100.0%	5	\$40.00	507.7	0.72	\$0.018
Electronics - Reduce Standby Wattage	5.0%	100.0%	8	\$20.00	91.0	0.37	\$0.034
Refrigerator - Early Replacement	10.0%	85.0%	7	\$109.00	249.5	0.12	\$0.076
Refrigerator - Remove Second Unit	17.3%	85.0%	7	\$109.00	437.0	0.83	\$0.043
Freezer - Early Replacement	10.0%	85.0%	5	\$109.00	300.2	0.12	\$0.083
Freezer - Remove Second Unit	17.3%	85.0%	5	\$109.00	384.9	0.75	\$0.065
Behavioral Measures	20.0%	50.0%	1	\$12.00	84.5	0.14	\$0.142
Pool - Pump Timer	50.0%	100.0%	15	\$160.00	145.7	0.09	\$0.113
Insulation - Wall Cavity	81.8%	100.0%	25	\$707.94	1,004.5	0.17	\$0.057
Insulation - Wall Sheathing	64.4%	100.0%	20	\$300.00	187.2	0.11	\$0.141

Residential Energy Efficiency Equipment and Measure Data

Table B-28 Energy Efficiency Non-Equipment Data, Electric—Mobile Home, New Vintage, Washington

Measure	Base Saturation	Applicability	Lifetime (Years)	Cost (\$/HH)	Savings (kWh)	BC Ratio	Levelized Cost (\$/kWh)
Central AC - Maintenance and Tune-Up	58.9%	100.0%	4	\$100.00	58.6	0.03	\$0.471
Ceiling Fan - Installation	57.0%	100.0%	15	\$80.00	60.2	0.07	\$0.136
Whole-House Fan - Installation	4.0%	25.0%	18	\$150.00	82.8	0.05	\$0.168
Air Source Heat Pump - Maintenance	25.0%	100.0%	4	\$125.00	533.2	0.26	\$0.065
Insulation - Ducting	55.0%	65.0%	18	\$200.00	344.0	0.17	\$0.054
Thermostat - Clock/Programmable	57.0%	75.0%	15	\$114.42	552.4	0.77	\$0.021
Doors - Storm and Thermal	13.0%	100.0%	12	\$180.00	126.6	0.11	\$0.167
Insulation - Ceiling	46.2%	85.0%	20	\$176.00	341.1	0.32	\$0.046
Insulation - Radiant Barrier	25.0%	100.0%	12	\$922.68	115.6	0.02	\$0.939
Roofs - High Reflectivity	5.0%	100.0%	15	\$516.54	44.8	0.01	\$1.183
Windows - Reflective Film	2.0%	50.0%	10	\$166.67	116.7	0.06	\$0.190
Windows - High Efficiency/Energy Star	95.5%	100.0%	25	\$2,200.00	1,916.5	0.15	\$0.092
Interior Lighting - Occupancy Sensor	66.6%	80.0%	15	\$500.00	366.0	0.08	\$0.140
Exterior Lighting - Photovoltaic Installation	10.0%	100.0%	15	\$2,975.00	44.8	0.00	\$6.818
Exterior Lighting - Photosensor Control	13.2%	100.0%	8	\$90.00	29.8	0.04	\$0.473
Exterior Lighting - Timeclock Installation	16.0%	100.0%	8	\$72.00	29.8	0.05	\$0.379
Water Heater - Faucet Aerators	56.6%	100.0%	25	\$24.00	171.3	1.01	\$0.011
Water Heater - Pipe Insulation	8.0%	100.0%	13	\$15.00	151.1	1.43	\$0.011
Water Heater - Low Flow Showerheads	92.1%	100.0%	10	\$25.48	781.8	3.37	\$0.004
Water Heater - Tank Blanket/Insulation	0.0%	0.0%	10	\$15.00	485.8	2.95	\$0.004
Water Heater - Thermostat Setback	5.0%	100.0%	5	\$40.00	485.8	0.84	\$0.019
Electronics - Reduce Standby Wattage	5.0%	100.0%	8	\$20.00	94.1	0.40	\$0.033
Behavioral Measures	20.0%	75.0%	1	\$12.00	90.5	0.15	\$0.133
Pool - Pump Timer	35.0%	100.0%	15	\$160.00	148.8	0.10	\$0.110
Insulation - Wall Cavity	64.5%	100.0%	25	\$197.06	356.6	0.31	\$0.044
Insulation - Wall Sheathing	64.4%	100.0%	20	\$300.00	200.7	0.11	\$0.132
Water Heater - Drainwater Heat Recovery	1.0%	100.0%	25	\$899.00	800.7	0.11	\$0.090

Residential Energy Efficiency Equipment and Measure Data

Table B-29 Energy Efficiency Non-Equipment Data, Electric—Mobile Home, Existing Vintage, Idaho

Measure	Base Saturation	Applicability	Lifetime (Years)	Cost (\$/HH)	Savings (kWh)	BC Ratio	Levelized Cost (\$/kWh)
Central AC - Early Replacement	0.0%	80.0%	15	\$2,895.00	55.3	0.00	\$5.373
Central AC - Maintenance and Tune-Up	58.9%	100.0%	4	\$100.00	54.5	0.03	\$0.506
Room AC - Removal of Second Unit	0.0%	100.0%	5	\$75.00	305.2	0.25	\$0.056
Ceiling Fan - Installation	60.0%	100.0%	15	\$80.00	41.2	0.05	\$0.199
Whole-House Fan - Installation	5.2%	25.0%	18	\$150.00	66.1	0.04	\$0.211
Air Source Heat Pump - Maintenance	25.0%	100.0%	4	\$125.00	496.0	0.22	\$0.070
Insulation - Ducting	15.0%	65.0%	18	\$375.00	320.3	0.08	\$0.109
Repair and Sealing - Ducting	12.3%	100.0%	18	\$398.09	2,477.4	0.59	\$0.015
Thermostat - Clock/Programmable	51.0%	75.0%	15	\$114.42	513.2	0.94	\$0.023
Doors - Storm and Thermal	38.0%	100.0%	12	\$320.00	79.1	0.04	\$0.476
Insulation - Infiltration Control	46.0%	100.0%	25	\$208.70	364.9	0.42	\$0.046
Insulation - Ceiling	46.2%	85.0%	25	\$276.18	355.8	0.18	\$0.062
Insulation - Radiant Barrier	5.0%	100.0%	12	\$922.68	387.5	0.07	\$0.280
Roofs - High Reflectivity	5.0%	100.0%	15	\$1,549.61	31.3	0.00	\$5.080
Windows - Reflective Film	5.0%	50.0%	10	\$166.67	139.9	0.07	\$0.159
Windows - High Efficiency/Energy Star	52.4%	100.0%	25	\$3,171.89	4,053.4	0.16	\$0.063
Interior Lighting - Occupancy Sensor	66.6%	80.0%	15	\$750.00	346.9	0.04	\$0.222
Exterior Lighting - Photovoltaic Installation	10.0%	100.0%	15	\$2,975.00	41.9	0.00	\$7.281
Exterior Lighting - Photosensor Control	23.4%	100.0%	8	\$90.00	28.3	0.02	\$0.497
Exterior Lighting - Timeclock Installation	10.0%	100.0%	8	\$72.00	28.3	0.03	\$0.398
Water Heater - Faucet Aerators	78.9%	100.0%	25	\$24.00	179.3	1.02	\$0.011
Water Heater - Pipe Insulation	17.0%	100.0%	13	\$15.00	157.9	1.14	\$0.011
Water Heater - Low Flow Showerheads	92.1%	100.0%	10	\$25.48	816.8	2.74	\$0.004
Water Heater - Tank Blanket/Insulation	54.0%	100.0%	10	\$15.00	507.7	2.43	\$0.004
Water Heater - Thermostat Setback	17.0%	100.0%	5	\$40.00	507.7	0.72	\$0.018
Electronics - Reduce Standby Wattage	5.0%	100.0%	8	\$20.00	91.0	0.37	\$0.034
Refrigerator - Early Replacement	10.0%	85.0%	7	\$109.00	249.5	0.12	\$0.076
Refrigerator - Remove Second Unit	17.3%	85.0%	7	\$109.00	437.0	0.83	\$0.043
Freezer - Early Replacement	10.0%	85.0%	5	\$109.00	300.2	0.12	\$0.083
Freezer - Remove Second Unit	17.3%	85.0%	5	\$109.00	384.9	0.75	\$0.065
Behavioral Measures	20.0%	50.0%	1	\$12.00	84.5	0.14	\$0.142
Pool - Pump Timer	50.0%	100.0%	15	\$160.00	145.7	0.09	\$0.113
Insulation - Wall Cavity	81.8%	100.0%	25	\$707.94	1,004.5	0.17	\$0.057
Insulation - Wall Sheathing	64.4%	100.0%	20	\$300.00	187.2	0.11	\$0.141

Residential Energy Efficiency Equipment and Measure Data

Table B-30 Energy Efficiency Non-Equipment Data, Electric—Mobile Home, New Vintage, Idaho

Measure	Base Saturation	Applicability	Lifetime (Years)	Cost (\$/HH)	Savings (kWh)	BC Ratio	Levelized Cost (\$/kWh)
Central AC - Maintenance and Tune-Up	58.9%	100.0%	4	\$100.00	58.6	0.03	\$0.471
Ceiling Fan - Installation	57.0%	100.0%	15	\$80.00	60.2	0.07	\$0.136
Whole-House Fan - Installation	4.0%	25.0%	18	\$150.00	82.8	0.05	\$0.168
Air Source Heat Pump - Maintenance	25.0%	100.0%	4	\$125.00	533.2	0.26	\$0.065
Insulation - Ducting	55.0%	65.0%	18	\$200.00	344.0	0.17	\$0.054
Thermostat - Clock/Programmable	57.0%	75.0%	15	\$114.42	552.4	0.77	\$0.021
Doors - Storm and Thermal	13.0%	100.0%	12	\$180.00	126.6	0.11	\$0.167
Insulation - Ceiling	46.2%	85.0%	20	\$176.00	341.1	0.32	\$0.046
Insulation - Radiant Barrier	25.0%	100.0%	12	\$922.68	115.6	0.02	\$0.939
Roofs - High Reflectivity	5.0%	100.0%	15	\$516.54	44.8	0.01	\$1.183
Windows - Reflective Film	2.0%	50.0%	10	\$166.67	116.7	0.06	\$0.190
Windows - High Efficiency/Energy Star	95.5%	100.0%	25	\$2,200.00	1,916.5	0.15	\$0.092
Interior Lighting - Occupancy Sensor	66.6%	80.0%	15	\$500.00	366.0	0.08	\$0.140
Exterior Lighting - Photovoltaic Installation	10.0%	100.0%	15	\$2,975.00	44.8	0.00	\$6.818
Exterior Lighting - Photosensor Control	13.2%	100.0%	8	\$90.00	29.8	0.04	\$0.473
Exterior Lighting - Timeclock Installation	16.0%	100.0%	8	\$72.00	29.8	0.05	\$0.379
Water Heater - Faucet Aerators	56.6%	100.0%	25	\$24.00	171.3	1.01	\$0.011
Water Heater - Pipe Insulation	8.0%	100.0%	13	\$15.00	151.1	1.43	\$0.011
Water Heater - Low Flow Showerheads	92.1%	100.0%	10	\$25.48	781.8	3.37	\$0.004
Water Heater - Tank Blanket/Insulation	0.0%	0.0%	10	\$15.00	485.8	2.95	\$0.004
Water Heater - Thermostat Setback	5.0%	100.0%	5	\$40.00	485.8	0.84	\$0.019
Electronics - Reduce Standby Wattage	5.0%	100.0%	8	\$20.00	94.1	0.40	\$0.033
Behavioral Measures	20.0%	75.0%	1	\$12.00	90.5	0.15	\$0.133
Pool - Pump Timer	35.0%	100.0%	15	\$160.00	148.8	0.10	\$0.110
Insulation - Wall Cavity	64.5%	100.0%	25	\$197.06	356.6	0.31	\$0.044
Insulation - Wall Sheathing	64.4%	100.0%	20	\$300.00	200.7	0.11	\$0.132
Water Heater - Drainwater Heat Recovery	1.0%	100.0%	25	\$899.00	800.7	0.11	\$0.090

Residential Energy Efficiency Equipment and Measure Data

Table B-31 Energy Efficiency Non-Equipment Data, Electric—Low income, Existing Vintage, Washington

Measure	Base Saturation	Applicability	Lifetime (Years)	Cost (\$/HH)	Savings (kWh)	BC Ratio	Levelized Cost (\$/kWh)
Central AC - Early Replacement	0.0%	80.0%	15	\$2,895.00	59.1	0.00	\$5.026
Central AC - Maintenance and Tune-Up	24.6%	100.0%	4	\$100.00	58.3	0.43	\$0.473
Room AC - Removal of Second Unit	0.0%	100.0%	5	\$75.00	289.2	0.24	\$0.059
Attic Fan - Installation	2.9%	50.0%	18	\$115.80	2.4	0.00	\$4.502
Attic Fan - Photovoltaic - Installation	2.0%	25.0%	19	\$350.00	2.4	0.00	\$13.244
Ceiling Fan - Installation	40.8%	100.0%	15	\$80.00	42.0	0.05	\$0.196
Whole-House Fan - Installation	5.3%	25.0%	18	\$150.00	67.3	0.04	\$0.207
Air Source Heat Pump - Maintenance	25.0%	100.0%	4	\$125.00	480.2	0.62	\$0.072
Insulation - Ducting	13.0%	25.0%	18	\$395.00	279.5	0.37	\$0.131
Repair and Sealing - Ducting	11.8%	100.0%	18	\$500.00	837.0	0.46	\$0.056
Thermostat - Clock/Programmable	35.9%	75.0%	15	\$114.42	450.0	1.19	\$0.026
Doors - Storm and Thermal	17.0%	100.0%	12	\$320.00	68.7	0.04	\$0.548
Insulation - Infiltration Control	19.0%	100.0%	12	\$266.00	522.9	0.64	\$0.060
Insulation - Ceiling	39.3%	55.0%	20	\$215.00	170.6	0.45	\$0.111
Insulation - Radiant Barrier	5.0%	100.0%	12	\$922.68	336.6	0.36	\$0.323
Roofs - High Reflectivity	3.0%	100.0%	15	\$1,549.61	31.9	0.00	\$4.987
Windows - Reflective Film	5.0%	50.0%	10	\$166.67	142.5	0.07	\$0.156
Windows - High Efficiency/Energy Star	71.3%	100.0%	25	\$2,500.00	1,226.3	0.40	\$0.163
Interior Lighting - Occupancy Sensor	8.2%	20.0%	15	\$256.00	254.7	0.09	\$0.103
Exterior Lighting - Photovoltaic Installation	10.0%	100.0%	15	\$2,975.00	20.4	0.00	\$14.935
Exterior Lighting - Photosensor Control	8.4%	100.0%	8	\$90.00	13.8	0.01	\$1.020
Exterior Lighting - Timeclock Installation	6.0%	100.0%	8	\$72.00	13.8	0.02	\$0.816
Water Heater - Faucet Aerators	45.5%	100.0%	25	\$24.00	170.6	1.00	\$0.011
Water Heater - Pipe Insulation	6.0%	100.0%	13	\$15.00	150.2	1.22	\$0.011
Water Heater - Low Flow Showerheads	73.8%	100.0%	10	\$25.48	777.0	2.77	\$0.004
Water Heater - Tank Blanket/Insulation	54.0%	100.0%	10	\$15.00	482.9	2.29	\$0.004
Water Heater - Thermostat Setback	17.0%	100.0%	5	\$40.00	482.9	0.68	\$0.019
Electronics - Reduce Standby Wattage	5.0%	100.0%	8	\$20.00	64.3	0.27	\$0.049
Refrigerator - Early Replacement	10.0%	85.0%	7	\$109.00	224.7	0.11	\$0.084
Refrigerator - Remove Second Unit	17.3%	85.0%	7	\$109.00	437.0	0.83	\$0.043
Freezer - Early Replacement	10.0%	85.0%	5	\$109.00	270.4	0.10	\$0.092
Freezer - Remove Second Unit	17.3%	85.0%	5	\$109.00	384.9	0.75	\$0.065
Behavioral Measures	5.0%	25.0%	1	\$12.00	71.9	0.11	\$0.167
Pool - Pump Timer	50.0%	100.0%	15	\$160.00	151.5	0.10	\$0.108
Insulation - Foundation	13.0%	40.0%	20	\$358.00	361.5	0.63	\$0.087
Insulation - Wall Cavity	44.2%	100.0%	25	\$1,415.87	870.1	0.38	\$0.130
Insulation - Wall Sheathing	58.8%	100.0%	20	\$210.00	162.6	0.44	\$0.114

Residential Energy Efficiency Equipment and Measure Data

Table B-32 Energy Efficiency Non-Equipment Data, Electric—Low income, New Vintage, Washington

Measure	Base Saturation	Applicability	Lifetime (Years)	Cost (\$/HH)	Savings (kWh)	BC Ratio	Levelized Cost (\$/kWh)
Central AC - Maintenance and Tune-Up	24.6%	100.0%	4	\$100.00	62.7	0.44	\$0.440
Attic Fan - Installation	15.0%	50.0%	18	\$96.50	3.3	0.00	\$2.739
Attic Fan - Photovoltaic - Installation	5.0%	25.0%	19	\$200.00	3.3	0.00	\$5.524
Ceiling Fan - Installation	33.0%	100.0%	15	\$80.00	65.4	0.08	\$0.126
Whole-House Fan - Installation	4.0%	25.0%	18	\$150.00	89.9	0.06	\$0.155
Air Source Heat Pump - Maintenance	37.8%	100.0%	4	\$125.00	516.2	0.65	\$0.067
Insulation - Ducting	25.0%	25.0%	18	\$210.00	303.0	0.44	\$0.064
Thermostat - Clock/Programmable	45.3%	75.0%	15	\$114.42	490.0	1.05	\$0.024
Doors - Storm and Thermal	19.0%	100.0%	12	\$180.00	111.5	0.10	\$0.190
Insulation - Ceiling	39.0%	50.0%	20	\$152.00	300.6	0.67	\$0.045
Insulation - Radiant Barrier	5.0%	100.0%	12	\$922.68	103.0	0.32	\$1.054
Roofs - High Reflectivity	0.0%	100.0%	15	\$516.54	48.7	0.01	\$1.089
Windows - Reflective Film	2.0%	50.0%	10	\$166.67	126.8	0.07	\$0.175
Windows - High Efficiency/Energy Star	80.2%	100.0%	25	\$2,200.00	1,681.0	0.44	\$0.105
Interior Lighting - Occupancy Sensor	8.2%	10.0%	15	\$256.00	268.5	0.12	\$0.098
Exterior Lighting - Photovoltaic Installation	10.0%	100.0%	15	\$2,975.00	21.8	0.00	\$13.986
Exterior Lighting - Photosensor Control	0.0%	100.0%	8	\$90.00	14.5	0.02	\$0.971
Exterior Lighting - Timeclock Installation	11.0%	100.0%	8	\$72.00	14.5	0.02	\$0.777
Water Heater - Faucet Aerators	10.6%	100.0%	25	\$24.00	162.9	1.04	\$0.012
Water Heater - Pipe Insulation	0.0%	100.0%	13	\$15.00	143.7	1.56	\$0.012
Water Heater - Low Flow Showerheads	66.2%	100.0%	10	\$25.48	743.6	3.45	\$0.005
Water Heater - Tank Blanket/Insulation	0.0%	0.0%	10	\$15.00	462.1	2.80	\$0.004
Water Heater - Thermostat Setback	5.0%	100.0%	5	\$40.00	462.1	0.80	\$0.020
Electronics - Reduce Standby Wattage	5.0%	100.0%	8	\$20.00	66.9	0.29	\$0.047
Behavioral Measures	5.0%	75.0%	1	\$12.00	77.7	0.13	\$0.154
Pool - Pump Timer	35.0%	100.0%	15	\$160.00	154.7	0.11	\$0.106
Insulation - Foundation	27.4%	40.0%	20	\$358.00	395.1	0.65	\$0.080
Insulation - Wall Cavity	45.6%	100.0%	25	\$62.50	311.7	1.25	\$0.016
Insulation - Wall Sheathing	58.8%	100.0%	20	\$210.00	175.7	0.46	\$0.105
Water Heater - Drainwater Heat Recovery	1.0%	100.0%	25	\$899.00	761.6	0.12	\$0.095

Residential Energy Efficiency Equipment and Measure Data

Table B-33 Energy Efficiency Non-Equipment Data, Electric—Low income, Existing Vintage, Idaho

Measure	Base Saturation	Applicability	Lifetime (Years)	Cost (\$/HH)	Savings (kWh)	BC Ratio	Levelized Cost (\$/kWh)
Central AC - Early Replacement	0.0%	80.0%	15	\$2,895.00	59.1	0.00	\$5.026
Central AC - Maintenance and Tune-Up	24.6%	100.0%	4	\$100.00	58.3	0.43	\$0.473
Room AC - Removal of Second Unit	0.0%	100.0%	5	\$75.00	289.2	0.24	\$0.059
Attic Fan - Installation	2.9%	50.0%	18	\$115.80	2.4	0.00	\$4.502
Attic Fan - Photovoltaic - Installation	2.0%	25.0%	19	\$350.00	2.4	0.00	\$13.244
Ceiling Fan - Installation	40.8%	100.0%	15	\$80.00	42.0	0.05	\$0.196
Whole-House Fan - Installation	5.3%	25.0%	18	\$150.00	67.3	0.04	\$0.207
Air Source Heat Pump - Maintenance	25.0%	100.0%	4	\$125.00	480.2	0.62	\$0.072
Insulation - Ducting	13.0%	25.0%	18	\$395.00	279.5	0.37	\$0.131
Repair and Sealing - Ducting	11.8%	100.0%	18	\$500.00	837.0	0.46	\$0.056
Thermostat - Clock/Programmable	35.9%	75.0%	15	\$114.42	450.0	1.19	\$0.026
Doors - Storm and Thermal	17.0%	100.0%	12	\$320.00	68.7	0.04	\$0.548
Insulation - Infiltration Control	19.0%	100.0%	12	\$266.00	522.9	0.64	\$0.060
Insulation - Ceiling	39.3%	55.0%	20	\$215.00	170.6	0.45	\$0.111
Insulation - Radiant Barrier	5.0%	100.0%	12	\$922.68	336.6	0.36	\$0.323
Roofs - High Reflectivity	3.0%	100.0%	15	\$1,549.61	31.9	0.00	\$4.987
Windows - Reflective Film	5.0%	50.0%	10	\$166.67	142.5	0.07	\$0.156
Windows - High Efficiency/Energy Star	71.3%	100.0%	25	\$2,500.00	1,226.3	0.40	\$0.163
Interior Lighting - Occupancy Sensor	8.2%	20.0%	15	\$256.00	254.7	0.09	\$0.103
Exterior Lighting - Photovoltaic Installation	10.0%	100.0%	15	\$2,975.00	20.4	0.00	\$14.935
Exterior Lighting - Photosensor Control	8.4%	100.0%	8	\$90.00	13.8	0.01	\$1.020
Exterior Lighting - Timeclock Installation	6.0%	100.0%	8	\$72.00	13.8	0.02	\$0.816
Water Heater - Faucet Aerators	45.5%	100.0%	25	\$24.00	170.6	1.00	\$0.011
Water Heater - Pipe Insulation	6.0%	100.0%	13	\$15.00	150.2	1.22	\$0.011
Water Heater - Low Flow Showerheads	73.8%	100.0%	10	\$25.48	777.0	2.77	\$0.004
Water Heater - Tank Blanket/Insulation	54.0%	100.0%	10	\$15.00	482.9	2.29	\$0.004
Water Heater - Thermostat Setback	17.0%	100.0%	5	\$40.00	482.9	0.68	\$0.019
Electronics - Reduce Standby Wattage	5.0%	100.0%	8	\$20.00	64.3	0.27	\$0.049
Refrigerator - Early Replacement	10.0%	85.0%	7	\$109.00	224.7	0.11	\$0.084
Refrigerator - Remove Second Unit	17.3%	85.0%	7	\$109.00	437.0	0.83	\$0.043

Residential Energy Efficiency Equipment and Measure Data

Table B-34 Energy Efficiency Non-Equipment Data, Electric—Low income, New Vintage, Idaho

Measure	Base Saturation	Applicability	Lifetime (Years)	Cost (\$/HH)	Savings (kWh)	BC Ratio	Levelized Cost (\$/kWh)
Central AC - Maintenance and Tune-Up	24.6%	100.0%	4	\$100.00	62.7	0.44	\$0.440
Attic Fan - Installation	15.0%	50.0%	18	\$96.50	3.3	0.00	\$2.739
Attic Fan - Photovoltaic - Installation	5.0%	25.0%	19	\$200.00	3.3	0.00	\$5.524
Ceiling Fan - Installation	33.0%	100.0%	15	\$80.00	65.4	0.08	\$0.126
Whole-House Fan - Installation	4.0%	25.0%	18	\$150.00	89.9	0.06	\$0.155
Air Source Heat Pump - Maintenance	37.8%	100.0%	4	\$125.00	516.2	0.65	\$0.067
Insulation - Ducting	25.0%	25.0%	18	\$210.00	303.0	0.44	\$0.064
Thermostat - Clock/Programmable	45.3%	75.0%	15	\$114.42	490.0	1.05	\$0.024
Doors - Storm and Thermal	19.0%	100.0%	12	\$180.00	111.5	0.10	\$0.190
Insulation - Ceiling	39.0%	50.0%	20	\$152.00	300.6	0.67	\$0.045
Insulation - Radiant Barrier	5.0%	100.0%	12	\$922.68	103.0	0.32	\$1.054
Roofs - High Reflectivity	0.0%	100.0%	15	\$516.54	48.7	0.01	\$1.089
Windows - Reflective Film	2.0%	50.0%	10	\$166.67	126.8	0.07	\$0.175
Windows - High Efficiency/Energy Star	80.2%	100.0%	25	\$2,200.00	1,681.0	0.44	\$0.105
Interior Lighting - Occupancy Sensor	8.2%	10.0%	15	\$256.00	268.5	0.12	\$0.098
Exterior Lighting - Photovoltaic Installation	10.0%	100.0%	15	\$2,975.00	21.8	0.00	\$13.986
Exterior Lighting - Photosensor Control	0.0%	100.0%	8	\$90.00	14.5	0.02	\$0.971
Exterior Lighting - Timeclock Installation	11.0%	100.0%	8	\$72.00	14.5	0.02	\$0.777
Water Heater - Faucet Aerators	10.6%	100.0%	25	\$24.00	162.9	1.04	\$0.012
Water Heater - Pipe Insulation	0.0%	100.0%	13	\$15.00	143.7	1.56	\$0.012
Water Heater - Low Flow Showerheads	66.2%	100.0%	10	\$25.48	743.6	3.45	\$0.005
Water Heater - Tank Blanket/Insulation	0.0%	0.0%	10	\$15.00	462.1	2.80	\$0.004
Water Heater - Thermostat Setback	5.0%	100.0%	5	\$40.00	462.1	0.80	\$0.020
Electronics - Reduce Standby Wattage	5.0%	100.0%	8	\$20.00	66.9	0.29	\$0.047
Behavioral Measures	5.0%	75.0%	1	\$12.00	77.7	0.13	\$0.154
Pool - Pump Timer	35.0%	100.0%	15	\$160.00	154.7	0.11	\$0.106
Insulation - Foundation	27.4%	40.0%	20	\$358.00	395.1	0.65	\$0.080
Insulation - Wall Cavity	45.6%	100.0%	25	\$62.50	311.7	1.25	\$0.016
Insulation - Wall Sheathing	58.8%	100.0%	20	\$210.00	175.7	0.46	\$0.105
Water Heater - Drainwater Heat Recovery	1.0%	100.0%	25	\$899.00	761.6	0.12	\$0.095

C&I ENERGY EFFICIENCY EQUIPMENT AND MEASURE DATA

This appendix presents detailed information for all commercial energy-efficiency measures (*equipment* and *non-equipment* measures per the LoadMAP taxonomy) that were evaluated in this study.

Table C-1 and Table C-2 provide brief narrative descriptions for all equipment and non-equipment measures that were assessed for potential.

Table C-3 through Table C-18 list the detailed unit-level data (including economic screen results) for commercial equipment measures in existing and new buildings. The column headings and units are the same as described for the corresponding residential sector tables above.

Table C-19 through Table C-34 list the detailed unit-level data (including economic screen results) for commercial non-equipment measures in existing and new construction. The column headings and units are the same as described for the corresponding residential sector tables above.

Table C-1 C&I Energy Efficiency Equipment Measure Descriptions

End Use	Technology	Measure Description
Cooling	Air-Cooled Chiller	A central chiller plant creates chilled water for distribution throughout the facility. Because of the wide variety of system types and sizes, savings and cost values for efficiency improvements represent an average over screw, reciprocating, and centrifugal technologies. Under this simplified approach, each central system is characterized by an aggregate efficiency value (inclusive of chiller, pumps, and motors), in kW/ton with a further efficiency upgrade through the application of variable refrigerant flow technology.
Cooling	Water-Cooled Chiller	A central chiller plant creates chilled water for distribution throughout the facility. Water source chillers include heat rejection via a condenser loop and cooling tower. Because of the wide variety of system types and sizes, savings and cost values for efficiency improvements represent an average over screw, reciprocating, and centrifugal technologies. Under this simplified approach, each central system is characterized by an aggregate efficiency value (inclusive of chiller, pumps, motors, and condenser loop equipment), in kW/ton with a further efficiency upgrade through the application of variable refrigerant flow technology.
Cooling	Roof Top AC	Packaged cooling systems, such as rooftop units (RTUs), are simple to install and maintain, and are commonly used in small and medium-sized commercial buildings. Applications range from a single supply system with air intake filters, supply fan, and cooling coil, or can become more complex with the addition of a return air duct, return air fan, and various controls to optimize performance. For packaged RTUs, varying Energy Efficiency Ratios (EER) are modeled, as well as a ductless mini-split system.
Cooling / Space Heating	Air-Source Heat Pump	For heat pumps, units with increasing EER and COP levels are evaluated, as well as a ductless mini-split system.
Cooling / Space Heating	Geothermal Heat Pump	For heat pumps, units with increasing EER and COP levels are evaluated.
Space Heating	Electric Furnace	Resistive heating elements are used to convert electricity directly to heat. The heat is then delivered by a supply fan and duct system to the regions that require heating.
Space Heating	Electric Resistance	Resistive heating elements are used to convert electricity directly to heat. Conductive fins surrounding the element or another mechanism is used to deliver the heat directly to the surrounding room or area. These are typically either baseboard or wall-mounted units.
Ventilation	Ventilation	A variable air volume ventilation system modulates the air flow rate as needed based on the interior conditions of the building to reduce fan load, improve dehumidification, and reduce energy usage.
Water Heating	Water Heater	Efficient electric water heaters are characterized by a high recovery or thermal efficiency (percentage of delivered electric energy which is transferred to the water) and low standby losses (the ratio of heat lost per hour to the content of the stored water). Included in the savings associated with high-efficiency electric water heaters are timers that allow temperature setpoints to change with hot water demand patterns. For example, the heating element could be shut off throughout the night, increasing the overall energy factor of the unit. In addition, tank and pipe insulation reduces standby losses and therefore reduces the demands on the water heater. This analysis considers conventional electric water heaters and heat pump water heaters.
Interior Lighting	Screw-in	This measure evaluates higher-efficiency alternatives for screw-in interior lamps including halogen, CFL, and LED.
Interior Lighting	High-Bay Fixtures	With the exception of screw-in lighting, commercial and industrial lighting efficiency changes typically require more than the simple purchase and installation of an alternative lamp. Restrictions regarding ballasts, fixtures, and circuitry limit the potential for direct substitution of one lamp type for another. Also, during the buildout for a leased office space, management could decide

C&I Energy Efficiency Equipment and Measure Data

End Use	Technology	Measure Description
		to replace all lamps, ballasts, and fixtures with different configurations. This type of decision-making is modeled on a stock turnover basis because of the time between opportunities for upgrades. For High-Bay fixtures, alternatives include mercury vapor, metal halides, T5 fluorescent high output, and high-pressure sodium.
Interior Lighting	Linear Fluorescent	With the exception of screw-in lighting, commercial and industrial lighting efficiency changes typically require more than the simple purchase and installation of an alternative lamp. Restrictions regarding ballasts, fixtures, and circuitry limit the potential for direct substitution of one lamp type for another. Also, during the buildout for a leased office space, management could decide to replace all lamps, ballasts, and fixtures with different configurations. This type of decision-making is modeled on a stock turnover basis because of the time between opportunities for upgrades. For linear fluorescent fixtures, alternatives include T12, T8, Super T8, T5, and LED.
Exterior Lighting	Screw-in	This measure evaluates higher-efficiency alternatives for screw-in interior lamps including halogen, CFL, and LED.
Exterior Lighting	HID	Alternatives modeled include metal halides, T8 and T5 high output, high pressure sodium, and LEDs
Exterior Lighting	Linear Fluorescent	For linear fluorescent fixtures, alternatives include T12, T8, Super T8, T5, and LED.
Refrigeration	Walk-in Refrigerator	These refrigerators can be designed to perform at higher efficiency through a combination of compressor equipment upgrades, default temperature settings, and defrost patterns. Standard refrigeration compressors typically operate at approximately 65% efficiency. High-efficiency models are available that can improve compressor efficiency by 15%. Analysis assumes unit with: 140 square feet, Cooling capacity of 26,230 BTU/hr.
Refrigeration	Reach-in Refrigerator	A significant amount of energy in the commercial sector can be attributed to "reach-in" units. These stand-alone appliances can range from a residential-style refrigerator/freezer unit in an office kitchen or the breakroom of a retail store, to the larger reach-in units in foodservice applications. As in the case of residential units, these refrigerators can be designed to perform at higher efficiency through a combination of compressor equipment upgrades, default temperature settings, and defrost patterns. Analysis assumes unit with: 48 cubic feet, Cooling capacity of 3000 BTU/hr.
Refrigeration	Glass Door Display, Open Display Case	These refrigerators can be designed to perform at higher efficiency through a combination of compressor equipment upgrades, default temperature settings, and defrost patterns. Standard refrigeration compressors typically operate at approximately 65% efficiency. High-efficiency models are available that can improve compressor efficiency by 15%. Analysis assumes unit with: Cooling capacity of 20,000 BTU/hr
Refrigeration	Icemaker	By optimizing the timing of ice production and the type of output to the specific application, icemakers are assumed to deliver electricity savings.
Refrigeration	Vending Machine	High-efficiency vending machines incorporate more efficient compressors and lighting.
Food Preparation	Ovens,Fryers, Hot Food Containers, Dishwashers	This set of measures includes high-efficiency fryers, ovens, dishwashers, and hot food containers. Less common equipment, such as broilers and steamers, and assumed to be modeled with the other more common equipment types.
Office Equipment	Desktop Computer, Laptop, Monitors	ENERGY STAR labeled computers automatically power down to 15 watts or less when not in use and may actually last longer than conventional products because they spend a large portion of time in a low-power sleep mode. ENERGY STAR labeled computers also generate less heat than conventional models.
Office Equipment	Server	In addition to the "sleep" mode a reductions, servers have additional energy-saving opportunities through "virtualization" and other architecture solutions that involve optimal matching of computation tasks to hardware requirements

C&I Energy Efficiency Equipment and Measure Data

End Use	Technology	Measure Description
Office Equipment	Printer/Copier/Fax	ENERGY STAR labeled office equipment saves energy by powering down and "going to sleep" when not in use. ENERGY STAR labeled copiers are equipped with a feature that allows them to automatically turn off after a period of inactivity.
Office Equipment	POS Terminal	Point-of-sale terminals in retail and supermarket facilities are always on. Efficient models incorporate a high-efficiency power supply to reduce energy use.
Miscellaneous	Non-HVAC Motors	Includes motors for a variety of non-HVAC uses including vertical transportation. Premium efficiency motors can provide savings of 0.5% to 3% over standard motors. The savings results from the fact that energy efficient motors run cooler than their standard counterparts, resulting in an increase in the life of the motor insulation and bearing. In general, an efficient motor is a more reliable motor because there are fewer winding failures, longer periods between needed maintenance, and fewer forced outages. For example, using copper instead of aluminum in the windings, and increasing conductor cross-sectional area, lowers a motor's I ² R losses.
Miscellaneous	Miscellaneous	Improvement of miscellaneous electricity uses

Table C-2 Commercial and Industrial Energy Efficiency Non-Equipment Measure Descriptions

End Use	Measure	Description
HVAC (All)	Insulation - Ceiling	Thermal insulation is material or combinations of materials that are used to inhibit the flow of heat energy by conductive, convective, and radiative transfer modes. Thus, thermal insulation can conserve energy by reducing the heat loss or gain of a building. The type of building construction defines insulating possibilities. Typical insulating materials include: loose-fill (blown) cellulose; loose-fill (blown) fiberglass; and rigid polystyrene.
HVAC (All)	Insulation - Ducting	Air distribution ducts can be insulated to reduce heating or cooling losses. Best results can be achieved by covering the entire surface area with insulation. Insulation material inhibits the transfer of heat through the air-supply duct. Several types of ducts and duct insulation are available, including flexible duct, pre-insulated duct, duct board, duct wrap, tacked, or glued rigid insulation, and waterproof hard shell materials for exterior ducts.
HVAC (All)	Insulation - Radiant Barrier	Radiant barriers are materials installed to reduce the heat gain in buildings. Radiant barriers are made from materials that are highly reflective and have low emissivity like aluminum. The closer the emissivity is to 0 the better they will perform. Radiant barriers can be placed above the insulation or on the roof rafters.
HVAC (All)	Insulation - Wall Cavity	Thermal insulation is material or combinations of materials that are used to inhibit the flow of heat energy by conductive, convective, and radiative transfer modes. Thus, thermal insulation can conserve energy by reducing the heat loss or gain of a building. The type of building construction defines insulating possibilities. Typical insulating materials include: loose-fill (blown) cellulose; loose-fill (blown) fiberglass; and rigid polystyrene.
HVAC (All)	Ducting - Repair and Sealing	Leakage in unsealed ducts varies considerably because of the differences in fabricating machinery used, the methods for assembly, installation workmanship, and age of the ductwork. Air leaks from the system to the outdoors result in a direct loss proportional to the amount of leakage and the difference in enthalpy between the outdoor air and the conditioned air. To seal ducts, a wide variety of sealing methods and products exist. Each has a relatively short shelf life, and no documented research has identified the aging characteristics of sealant applications.
HVAC (All)	Windows - High Efficiency	High-efficiency windows, such as those labeled under the ENERGY STAR Program, are designed to reduce a building's energy bill while increasing comfort for the occupants at the same time. High-efficiency windows have reducing properties that reduce the amount of heat transfer through the glazing surface. For example, some windows have a low-E coating, which is a thin film of metallic oxide coating on the glass surface that allows passage of short-wave solar energy through glass and prevents long-wave energy from escaping. Another example is double-pane glass that reduces conductive and convective heat transfer. There are also double-pane glasses that are gas-filled (usually argon) to further increase the insulating properties of the window.
HVAC (All)	Roof - High Reflectivity	The color and material of a building structure surface will determine the amount of solar radiation absorbed by that surface and subsequently transferred into a building. This is called solar absorptance. By using a living roof or a roofing material with a light color (and a lower solar absorptance), the roof will absorb less solar radiation and consequently reduce the cooling load. Living roofs also reduce stormwater runoff.
HVAC (All)	Roofs - Green	A green roof covers a section or the entire building roof with a waterproof membrane and vegetative material. Like cool roofs, green roofs can reduce solar absorptance and they can also provide insulation. They also provide non-energy benefits by absorbing rainwater and thus reducing storm water run-off, providing wildlife habitat, and reducing so-called urban heat island effects.
Cooling	Chiller - Condenser Water Temperature Reset	Resetting the condenser water temperature to the lowest possible setting allows the cooling tower to generate cooler water whenever possible and decreases the temperature lift between the condenser and the evaporator.

C&I Energy Efficiency Equipment and Measure Data

End Use	Measure	Description
		This will generally increase chiller part-load efficiency, though it may require increased tower fan energy use.
Cooling	Chiller - Economizer	Economizers allow outside air (when it is cool and dry enough) to be brought into the building space to meet cooling loads instead of using mechanically cooled interior air. A dual enthalpy economizer consists of indoor and outdoor temperature and humidity sensors, dampers, motors, and motor controls. Economizers are most applicable to temperate climates and savings will be smaller in extremely hot or humid areas.
Cooling	Chiller - VSD on Fans	Variable speed drives, which reduce chiller energy use under part load, are modeled for both air-cooled and water-cooled chillers.
Cooling	Chiller - Chilled Water Reset	Chilled water reset controls save energy by improving chiller performance through increasing the supply chilled water temperature, which allows increased suction pressure during low load periods. Raising the chilled water temperature also reduces chilled water piping losses. However, the primary savings from the chilled water reset measure results from chiller efficiency improvement. This is due partly to the smaller temperature difference between chilled water and ambient air, and partly due to the sensitivity of chiller performance to suction temperature.
Cooling	Chiller - Chilled Water Variable-Flow System	The part-load efficiency of chilled water loops can be improved substantially by varying the flow speed of the delivered water with the building demand for cooling.
Cooling	Chiller - High Efficiency Cooling Tower Fans	High-efficiency cooling fans utilize efficient components and variable frequency drives that improve fan performance by adjusting fan speed and rotation as conditions change.
Cooling	RTU - Evaporative Precooler	Evaporative precooling can improve the performance of air conditioning systems, most commonly RTUs. These systems typically use indirect evaporative cooling as a first stage to pre-cool outside air. If the evaporative system cannot meet the full cooling load, the air stream is further cooled with conventional refrigerative air conditioning technology.
Cooling	RTU - Maintenance	Regular cleaning and maintenance enables a roof top unit to function effectively and efficiently throughout its years of service. Neglecting necessary maintenance leads to a steady decline in performance while energy use increases. Maintenance can increase the efficiency of poorly performing equipment by as much as 10%.
Cooling / Space Heating	Heat Pump - Maintenance	Regular cleaning and maintenance enables a heat pump to function effectively and efficiently throughout its years of service. Neglecting necessary maintenance leads to a steady decline in performance while energy use increases. Maintenance can increase the efficiency of poorly performing equipment by as much as 10%.
Ventilation	Ventilation - Demand Control Ventilation	Also known as CO2 Controlled, this measure uses carbon dioxide (CO2) levels to indicate the level of occupancy in a space. Sensors monitor CO2 levels so that air handling controls can adjust the amount of outside air intake. Ventilation rates are thereby controlled based on occupancy, rather than a fixed rate, thus saving HVAC energy use.
Ventilation	Fans – Energy Efficient Motors	High-efficiency motors are essentially interchangeable with standard motors, but differences in construction make them more efficient. Energy-efficient motors achieve their improved efficiency by reducing the losses that occur in the conversion of electrical energy to mechanical energy. This analysis assumes that the efficiency of supply fans is increased by 5% due to installing energy-efficient motors.
Water Heating	Water Heater - Faucet Aerators/Low Flow Nozzles	A faucet aerator or low flow nozzle spreads the stream from a faucet helping to reduce water usage. The amount of water passing through the aerator is measured in gallons per minute (GPM) and the lower the GPM the more water the aerator conserves.
Water Heating	Water Heater - High Efficiency Circulation	A high efficiency circulation pump uses an electronically commutated motor (ECM) to improve motor efficiency over a larger range of partial loads. In

C&I Energy Efficiency Equipment and Measure Data

End Use	Measure	Description
	Pump	addition, an ECM allows for improved low RPM performance with greater torque and smaller pump dimensions.
Water Heating	Water Heater - Pipe Insulation	Insulating hot water pipes decreases the amount of energy lost during distribution of hot water throughout the building. Insulating pipes will result in quicker delivery of hot water and allows lowering the water heating set point. There are several different types of insulation, the most common being polyethylene and neoprene.
Water Heating	Water Heater - Tank Blanket/Insulation	Insulation levels on hot water heaters can be increased by installing a fiberglass blanket on the outside of the tank. This increase in insulation reduces standby losses and thus saves energy. Water heater insulation is available either by the blanket or by square foot of fiberglass insulation with R-values ranging from 5 to 14.
Water Heating	Thermostat setback	Installing a setback thermostat on the water heater can lead to significant energy savings during periods when there is no one in the building.
Interior Lighting	Interior Lighting – Central Lighting Controls	Daylighting controls use a photosensor to detect ambient light and adjust or turn off electric lights accordingly.
Interior Lighting	Photocell controlled T8 dimming ballasts	Photocells, in concert with dimming ballasts, can detect when adequate daylighting is available and dim or turn off lights to reduce electricity consumption. Usually one photocell is used to control a group of fixtures, a zone, or a circuit.
Interior Lighting	LED Exit Lighting	The lamps inside exit signs represent a significant energy end-use, since they usually operate 24 hours per day. Many old exit signs use incandescent lamps, which consume approximately 40 watts per sign. The incandescent lamps can be replaced with LED lamps that are specially designed for this specific purpose. In comparison, the LED lamps consume approximately 2-5 watts.
Interior Lighting	Interior Lighting - Occupancy Sensors	The installation of occupancy sensors allows lights to be turned off during periods when a space is unoccupied, virtually eliminating the wasted energy due to lights being left on. There are several types of occupancy sensors in the market.
Interior Lighting	Interior Lighting - Timeclocks and Timers	In many cases lighting remains on at night and during weekends. A simple timer can set a schedule for turning lights off to reduce operating hours.
Interior Lighting	Interior Screw-in - Task Lighting	Individual work areas can use task lighting instead of brightly lighting the entire area. Significant energy savings can be realized by focusing light directly where it is needed and lowering the general lighting level. An example of task lighting is the common desk lamp. A 25W desk lamp can be installed in place of a typical lamp in a fixture.
Interior Lighting	Interior Lighting – Hotel Guestroom Controls	Hotel guestrooms can be fitted with occupancy controls that turn off energy-using equipment when the guest is not using the room. The occupancy controls comes in several forms, but this analysis assumes the simplest kind, which is a simple switch near the room's entry where the guest can deposit their room key or card. If the key or card is present, then lights, TV, and air conditioning can receive power and operate. When the guest leaves and takes the key, all equipment shuts off.
Interior Lighting	Interior Lighting - Skylights	Addition of transparent windows/fixtures in the roof to allow daylight to enter and reduce the need for powered lighting. Applies to new construction only.
Interior Lighting	Interior Fluorescent - Bi-Level Fixture	Bi-level fixtures have the ability to reduce light output to a lower level, given a control strategy that is based on a timer, occupancy sensor, motion sensor, or manual switch.
Interior Lighting	Interior Fluorescent – High Bay Fixtures	Fluorescent fixtures designed for high-bay applications have several advantages over similar HID fixtures: lower energy consumption, lower lumen depreciation rates, better dimming options, faster start-up and restrike, better color rendition, more pupil lumens, and reduced glare.
Exterior	Exterior Lighting -	Daylighting controls use a photosensor to detect ambient light and adjust or

C&I Energy Efficiency Equipment and Measure Data

End Use	Measure	Description
Lighting	Daylighting Controls	turn off electric lights accordingly.
Exterior Lighting	Exterior Lighting - Photovoltaic Installation	Solar photovoltaic generation may be used to power exterior lighting and thus eliminate all or part of the electrical energy use.
Exterior Lighting	Exterior Lighting – Cold Cathode Lighting	Cold cathode lighting does not use an external heat source to provide thermionic emission of electrons. Cold cathode lighting is typically used for exterior signage or where temperatures are likely to drop below freezing.
Food Preparation	Cooking Exhaust hood with sensor control	Improved exhaust hoods involve installing variable-speed controls on commercial kitchen hoods. These controls provide ventilation based on actual cooking loads. When grills, broilers, stoves, fryers or other kitchen appliances are not being used, the controls automatically sense the reduced load and decrease the fan speed accordingly. This results in lower energy consumption because the system is only running as needed rather than at 100% capacity at all times.
Refrigeration	Refrigerator - Anti-Sweat Heater/ Auto Door Closer	Anti-sweat heaters are used in virtually all low-temperature display cases and many medium-temperature cases to control humidity and prevent the condensation of water vapor on the sides and doors and on the products contained in the cases. Typically, these heaters stay on all the time, even though they only need to be on about half the time. Anti-sweat heater controls can come in the form of humidity sensors or time clocks.
Refrigeration	Refrigerator - Door Gasket Replacement	This measure involves replacing aging door gaskets that no longer adequately seal reach-in refrigerators or glass door display cases.
Refrigeration	Refrigerator - Floating Head Pressure	Floating head pressure control allows the pressure in the condenser to "float" with ambient temperatures. This method reduces refrigeration compression ratios, improves system efficiency and extends the compressor life. The greatest savings with a floating head pressure approach occurs when the ambient temperatures are low, such as in the winter season. Floating head pressure control is most practical for new installations. However, retrofits installation can be completed with some existing refrigeration systems. Installing floating head pressure control increases the capacity of the compressor when temperatures are low, which may lead to short cycling.
Refrigeration	Refrigerator - Strip Curtain	Strip curtains at the entrances to large walk-in coolers or freezers, such as those used in supermarkets, reduce air transfer between the refrigerated space and the surrounding space.
Refrigeration (All)	Insulation - Bare suction lines	Suction lines deliver refrigerant fluid from to the inlet or suction side of a compressor. Insulating these lines prevents ambient air from heating the fluid in the line, and thus improves efficiency.
Refrigeration	Refrigerator - High Efficiency Case Lighting	High-efficiency case lighting, usually with LEDs, reduces waste heat from lighting that must be removed from refrigerated display cases.
Refrigeration	Refrigerator – Night Covers	Night covers can be used on open refrigeration cases when a facility is closed or few customers are in the store.
Refrigeration	Vending Machine - Controller	Cold beverage vending machines usually operate 24 hours a day regardless of whether the surrounding area is occupied or not. The result is that the vending machine consumes energy unnecessarily, because it will operate all night to keep the beverage cold even when there would be no customer until the next morning. A vending machine controller can reduce energy consumption without compromising the temperature of the vended product. The controller uses an infrared sensor to monitor the surrounding area's occupancy and will power down the vending machine when the area is unoccupied. It will also monitor the room's temperature and will re-power the machine at one to three hour intervals independent of occupancy to ensure that the product stays cold.
Office Equipment	Office Equipment – Smart Power Strips	These power strips incorporate motion sensing to power down office equipment when not in use.

C&I Energy Efficiency Equipment and Measure Data

End Use	Measure	Description
Micellaneous	Laundry – High Efficiency Clothes Washer	High efficiency clothes washers use designs that require less water. These machines use sensors to match the hot water needs to the load, preventing energy waste. There are two designs: top-loading and front-loading. Further energy and water savings can be achieved through advanced technologies such as inverter-drive or combination washer-dryer units.
Micellaneous	Micellaneous – ENERGY STAR Washer Cooler	An ENERGY STAR water cooler has more insulation and improved chilling mechanisms, resulting in about half the energy use of a standard cooler.
Micellaneous	Pumps - Variable Speed Control	The part-load efficiency of drive systems can be improved by varying the speed of the motor drive. An additional benefit of variable-speed controls is the ability to start and stop the motor and process gradually, thus extending the life of the motor and associated machinery.
Machine Drive	Motors – Variable Frequency Drive	In addition to energy savings, VFDs increase motor and system life and provide a greater degree of control over the motor system. Especially for motor systems handling fluids, VFDs can efficiently respond to changing operating conditions.
Machine Drive	Motors – Magnetic Adjustable Speed Drives	To allow for adjustable speed operation, this technology uses magnetic induction to couple a drive to its load. Varying the magnetic slip within the coupling controls the speed of the output shaft. Magnetic drives perform best at the upper end of the speed range due to the energy consumed by the slip. Unlike traditional ASDs, magnetically coupled ASDs create no power distortion on the electrical system. However, magnetically coupled ASD efficiency is best when power needs are greatest. VFDs may show greater efficiency when the average load speed is below 90% of the motor speed, however this occurs when power demands are reduced.
Machine Drive	Compressed Air – System Controls, Optimization and Improvements, Maintenance	Controls for compressed air systems can shift load from two partially loaded compressors to one compressor in order to maximize compression efficiency and may also involve the addition of VFDs. Improvements include installing high-efficiency motors. Maintenance includes fixing air leaks and replacing air filters.
Machine Drive	Fan Systems – Controls, Optimization and Improvements, Maintenance	Controls for compressed air systems can shift load from two partially loaded compressors to one compressor in order to maximize compression efficiency and may also involve the addition of VFDs. Improvements include installing high-efficiency motors. Maintenance includes fixing air leaks and replacing air filters.
Machine Drive	Pumping Systems – Controls, Optimization and Maintenance	Pumping systems optimization includes installing VFDs, correctly resizing the motors, and installing timers and automated on-off controls. Maintenance includes repairing diaphragms and fixing piping leaks.
Machine Drive	Motors - Synchronous Belts	Synchronous belts offer higher efficiency compared with standard belts due to reduced slipping, as well as less maintenance and retensioning.
Process	Refrigeration – System Controls, Maintenance, and Optimization	Because refrigeration equipment performance degrades over time and control settings are frequently overridden, these measures account for savings that can be achieved through system maintenance and controls optimization.
HVAC (All)	Energy Management System	An energy management system (EMS) allows managers/owners to monitor and control the major energy-consuming systems within a commercial building. At the minimum, the EMS can be used to monitor and record energy consumption of the different end-uses in a building, and can control operation schedules of the HVAC and lighting systems. The monitoring function helps building managers/owners to identify systems that are operating inefficiently so that actions can be taken to correct the problem. The EMS can also provide preventive maintenance scheduling that will reduce the cost of operations and maintenance in the long run. The control functionality of the EMS allows the building manager/owner to operate building systems from one central location. The operation schedules set via the EMS help to prevent building

C&I Energy Efficiency Equipment and Measure Data

End Use	Measure	Description
		systems from operating during unwanted or unoccupied periods. This analysis assumes that this measure is limited to buildings with a central HVAC system.
HVAC (All)	Thermostat - Clock/Programmable	A programmable thermostat can be added to most heating/cooling systems. They are typically used during winter to lower temperatures at night and in summer to increase temperatures during the afternoon. There are two-setting models, and well as models that allow separate programming for each day of the week. The energy savings from this type of thermostat are identical to those of a "setback" strategy with standard thermostats, but the convenience of a programmable thermostat makes it a much more attractive option. In this analysis, the baseline is assumed to have no thermostat setback.
HVAC (All)	Advanced New Construction Designs	Advanced new construction designs use an integrated approach to the design of new buildings to account for the interaction of building systems. Designs may specify the building orientation, building shell, proper sizing of equipment and systems, and controls strategies with the goal of optimizing building energy efficiency and comfort. Options that may be evaluated and incorporated include passive solar strategies, increased thermal mass, natural ventilation, energy recovery ventilation, daylighting strategies, and shading strategies. This measure is modeled for new vintage only.
HVAC, Lighting	Commissioning - HVAC, Lighting, Comprehensive	For new construction and major renovations, commissioning ensures that building systems are properly designed, specified, and installed to meet the design intent and provide high-efficiency performance. As the names suggests, HVAC Commissioning and Lighting Commissioning focus only on HVAC and lighting equipment and controls. Comprehensive commissioning addresses these systems but usually begins earlier in the design process, and may also address domestic hot water, non-HVAC fans, vertical transport, telecommunications, fire protection, and other building systems.
HVAC, Lighting	Retrocommissioning - HVAC, Lighting	In existing buildings, the retrocommissioning process identifies low-cost or no cost measures, including controls adjustments, to improve building performance and reduce operating costs. Retrocommissioning addresses HVAC, lighting, DHW, and other major building systems.
All	Transformer	All electric power passes through one or more transformers on its way to service equipment, lighting, and other loads. Currently available materials and designs can considerably reduce both load and no-load losses. The new NEMA TP-1 standard is used as the reference definition for energy -efficient products. Tier-1 represents TP-1 dry-type transformers while Tier-2 reflects a switch to liquid immersed TP-1 products. More efficient transformers with attractive payback periods are estimated to save 40 to 50 percent of the energy lost by a "typical" transformer, which translates into a one to three percent reduction in electric bills for commercial and industrial customers.
All	Strategic Energy Management	Strategic Energy Management is a systematic approach to integrating energy management into an organization's business practices and creating lasting energy management processes that produce reliable energy savings.

C&I Energy Efficiency Equipment and Measure Data

Table C-3 Energy Efficiency Equipment Data, Electric—Small/Medium Commercial, Existing Vintage, Washington

End Use	Technology	Efficiency Definition	Savings (kWh/SQ FT/yr)	Incremental Cost (\$/SQ FT)	Lifetime (Years)	BC Ratio (2015)	Levelized Cost of Energy (\$/kWh)
Cooling	Central Chiller	1.5 kw/ton, COP 2.3	-	\$0.00	20	-	\$0.00
Cooling	Central Chiller	1.3 kw/ton, COP 2.7	0.31	\$0.39	20	1.10	\$0.09
Cooling	Central Chiller	1.26 kw/ton, COP 2.8	0.38	\$0.50	20	0.96	\$0.09
Cooling	Central Chiller	1.0 kw/ton, COP 3.5	0.79	\$0.62	20	0.99	\$0.06
Cooling	Central Chiller	0.97 kw/ton, COP 3.6	0.83	\$0.74	20	0.95	\$0.06
Cooling	Central Chiller	Variable Refrigerant Flow	1.09	\$11.57	20	0.18	\$0.75
Cooling	RTU	EER 9.2	-	\$0.00	16	-	\$0.00
Cooling	RTU	EER 10.1	0.21	\$0.18	16	-	\$0.07
Cooling	RTU	EER 11.2	0.42	\$0.35	16	1.00	\$0.07
Cooling	RTU	EER 12.0	0.55	\$0.58	16	0.91	\$0.09
Cooling	RTU	Ductless VRF	0.68	\$5.12	16	0.28	\$0.62
Cooling	Heat Pump	EER 9.3, COP 3.1	-	\$0.00	15	-	\$0.00
Cooling	Heat Pump	EER 10.3, COP 3.2	0.42	\$0.39	15	-	\$0.08
Cooling	Heat Pump	EER 11.0, COP 3.3	0.66	\$1.18	15	1.00	\$0.15
Cooling	Heat Pump	EER 11.7, COP 3.4	0.88	\$1.57	15	0.97	\$0.15
Cooling	Heat Pump	EER 12, COP 3.4	0.97	\$1.96	15	0.93	\$0.18
Cooling	Heat Pump	Ductless Mini-Split System	1.07	\$11.50	20	0.52	\$0.76
Space Heating	Electric Resistance	Standard	-	\$0.00	25	1.00	\$0.00
Space Heating	Furnace	Standard	-	\$0.00	18	1.00	\$0.00
Ventilation	Ventilation	Constant Volume	-	\$0.00	15	1.00	\$0.00
Ventilation	Ventilation	Variable Air Volume	1.37	\$1.22	15	0.92	\$0.08
Interior Lighting	Interior Screw-in	Incandescents	-	\$0.00	1	-	\$0.00
Interior Lighting	Interior Screw-in	Infrared Halogen	0.47	\$0.09	1	1.00	\$0.18
Interior Lighting	Interior Screw-in	CFL	1.96	\$0.03	4	5.64	\$0.00
Interior Lighting	Interior Screw-in	LED	2.17	\$1.18	12	-	\$0.06
Interior Lighting	High Bay Fixtures	Metal Halides	-	\$0.00	6	1.00	\$0.00
Interior Lighting	High Bay Fixtures	High Pressure Sodium	0.25	-\$0.07	9	2.04	-\$0.04
Interior Lighting	High Bay Fixtures	T8	0.25	-\$0.15	6	4.03	-\$0.11
Interior Lighting	High Bay Fixtures	T5	0.32	-\$0.15	6	4.81	-\$0.08
Interior Lighting	Linear Fluorescent	T12	-	\$0.00	6	1.00	\$0.00
Interior Lighting	Linear Fluorescent	T8	0.34	-\$0.03	6	1.11	-\$0.02
Interior Lighting	Linear Fluorescent	Super T8	1.03	\$0.25	6	0.94	\$0.04
Interior Lighting	Linear Fluorescent	T5	1.07	\$0.43	6	0.81	\$0.07
Interior Lighting	Linear Fluorescent	LED	1.12	\$3.74	15	-	\$0.29
Exterior Lighting	Exterior Screw-in	Incandescent	-	\$0.00	1	-	\$0.00
Exterior Lighting	Exterior Screw-in	Infrared Halogen	0.09	\$0.05	1	1.00	\$0.50
Exterior Lighting	Exterior Screw-in	CFL	0.38	\$0.02	4	6.92	\$0.01
Exterior Lighting	Exterior Screw-in	Metal Halides	0.39	\$0.05	4	3.30	\$0.04
Exterior Lighting	Exterior Screw-in	LED	0.43	\$0.64	12	-	\$0.15
Exterior	HID	Metal Halides	-	\$0.00	6	1.00	\$0.00

C&I Energy Efficiency Equipment and Measure Data

End Use	Technology	Efficiency Definition	Savings (kWh/SQ FT/yr)	Incremental Cost (\$/SQ FT)	Lifetime (Years)	BC Ratio (2015)	Levelized Cost of Energy (\$/kWh)
Lighting							
Exterior Lighting	HID	High Pressure Sodium	0.17	-\$0.13	9	2.08	-\$0.10
Exterior Lighting	HID	Low Pressure Sodium	0.18	\$0.55	9	0.57	\$0.40
Water Heating	Water Heater	Baseline (EF=0.90)	-	\$0.00	15	1.00	\$0.00
Water Heating	Water Heater	High Efficiency (EF=0.95)	0.11	\$0.02	15	1.02	\$0.02
Water Heating	Water Heater	EF 2.0	1.07	-\$0.48	15	2.84	-\$0.04
Water Heating	Water Heater	EF 2.3	1.20	-\$0.47	15	3.25	-\$0.03
Water Heating	Water Heater	EF 2.4	1.24	-\$0.47	15	3.38	-\$0.03
Water Heating	Water Heater	Geothermal Heat Pump	1.42	\$3.53	15	0.38	\$0.21
Water Heating	Water Heater	Solar	1.56	\$3.03	15	0.44	\$0.17
Food Preparation	Fryer	Standard	-	\$0.00	12	1.00	\$0.00
Food Preparation	Fryer	Efficient	0.03	\$0.04	12	0.87	\$0.12
Food Preparation	Oven	Standard	-	\$0.00	12	1.00	\$0.00
Food Preparation	Oven	Efficient	0.39	\$0.36	12	0.92	\$0.10
Food Preparation	Dishwasher	Standard	-	\$0.00	12	1.00	\$0.00
Food Preparation	Dishwasher	Efficient	0.02	\$0.05	12	0.87	\$0.28
Food Preparation	Hot Food Container	Standard	-	\$0.00	12	1.00	\$0.00
Food Preparation	Hot Food Container	Efficient	0.32	\$0.16	12	0.96	\$0.05
Food Preparation	Food Prep	Standard	-	\$0.00	12	1.00	\$0.00
Food Preparation	Food Prep	Efficient	0.00	\$0.03	12	0.88	\$1.40
Refrigeration	Walk in Refrigeration	Standard	-	\$0.00	18	1.00	\$0.00
Refrigeration	Walk in Refrigeration	Efficient	-	\$0.09	18	0.90	\$0.00
Refrigeration	Glass Door Display	Standard	-	\$0.00	18	1.00	\$0.00
Refrigeration	Glass Door Display	Efficient	0.16	\$0.00	18	1.36	\$0.00
Refrigeration	Reach-in Refrigerator	Standard	-	\$0.00	18	1.00	\$0.00
Refrigeration	Reach-in Refrigerator	Efficient	0.15	\$0.02	18	1.15	\$0.01
Refrigeration	Open Display Case	Standard	-	\$0.00	18	1.00	\$0.00
Refrigeration	Open Display Case	Efficient	0.00	\$0.00	18	0.92	\$0.33
Refrigeration	Vending Machine	Base	-	\$0.00	10	-	\$0.00
Refrigeration	Vending Machine	Base (2012)	0.09	\$0.00	10	1.00	\$0.00
Refrigeration	Vending Machine	High Efficiency	0.11	\$0.00	10	-	\$0.00
Refrigeration	Vending Machine	High Efficiency (2012)	0.17	\$0.00	10	1.18	\$0.00
Refrigeration	Icemaker	Standard	-	\$0.00	12	1.00	\$0.00
Refrigeration	Icemaker	Efficient	0.05	\$0.00	12	1.11	\$0.01
Office Equipment	Desktop Computer	Baseline	-	\$0.00	4	1.00	\$0.00
Office Equipment	Desktop Computer	Energy Star	0.21	\$0.00	4	1.01	\$0.00
Office Equipment	Desktop Computer	Climate Savers	0.30	\$0.36	4	0.85	\$0.32
Office Equipment	Laptop Computer	Baseline	-	\$0.00	4	1.00	\$0.00
Office Equipment	Laptop Computer	Energy Star	0.02	\$0.00	4	1.00	\$0.01
Office Equipment	Laptop Computer	Climate Savers	0.04	\$0.12	4	0.84	\$0.87
Office	Server	Standard	-	\$0.00	3	1.00	\$0.00

C&I Energy Efficiency Equipment and Measure Data

End Use	Technology	Efficiency Definition	Savings (kWh/SQ FT/yr)	Incremental Cost (\$/SQ FT)	Lifetime (Years)	BC Ratio (2015)	Levelized Cost of Energy (\$/kWh)
Equipment							
Office Equipment	Server	Energy Star	0.11	\$0.01	3	0.99	\$0.04
Office Equipment	Monitor	Standard	-	\$0.00	4	1.00	\$0.00
Office Equipment	Monitor	Energy Star	0.06	\$0.00	4	1.03	\$0.01
Office Equipment	Printer/copier/fax	Standard	-	\$0.00	6	1.00	\$0.00
Office Equipment	Printer/copier/fax	Energy Star	0.08	\$0.04	6	0.95	\$0.09
Office Equipment	POS Terminal	Standard	-	\$0.00	4	1.00	\$0.00
Office Equipment	POS Terminal	Energy Star	0.02	\$0.00	4	1.00	\$0.03
Miscellaneous	Non-HVAC Motor	Standard	-	\$0.00	15	-	\$0.00
Miscellaneous	Non-HVAC Motor	Standard (2015)	0.01	\$0.06	15	-	\$0.71
Miscellaneous	Non-HVAC Motor	High Efficiency	0.01	\$0.00	15	1.00	\$0.00
Miscellaneous	Non-HVAC Motor	High Efficiency (2015)	0.06	\$0.06	15	0.98	\$0.08
Miscellaneous	Non-HVAC Motor	Premium	-	\$0.00	0	-	\$0.00
Miscellaneous	Non-HVAC Motor	Premium (2015)	-	\$0.00	0	-	\$0.00
Miscellaneous	Other Miscellaneous	Miscellaneous	-	\$0.00	5	-	\$0.00
Miscellaneous	Other Miscellaneous	Miscellaneous (2013)	0.00	\$0.00	5	1.00	\$0.00

C&I Energy Efficiency Equipment and Measure Data

Table C-4 Energy Efficiency Equipment Data, Electric—Small/Medium Commercial, New Vintage, Washington

End Use	Technology	Efficiency Definition	Savings (kWh/SQ FT/yr)	Incremental Cost (\$/SQ FT)	Lifetime (Years)	BC Ratio (2015)	Levelized Cost of Energy (\$/kWh)
Cooling	Central Chiller	1.5 kw/ton, COP 2.3	-	\$0.00	20	-	\$0.00
Cooling	Central Chiller	1.3 kw/ton, COP 2.7	0.28	\$0.39	20	1.10	\$0.10
Cooling	Central Chiller	1.26 kw/ton, COP 2.8	0.34	\$0.50	20	0.96	\$0.11
Cooling	Central Chiller	1.0 kw/ton, COP 3.5	0.70	\$0.62	20	0.98	\$0.06
Cooling	Central Chiller	0.97 kw/ton, COP 3.6	0.74	\$0.74	20	0.94	\$0.07
Cooling	Central Chiller	Variable Refrigerant Flow	0.97	\$11.57	20	0.18	\$0.84
Cooling	RTU	EER 9.2	-	\$0.00	16	-	\$0.00
Cooling	RTU	EER 10.1	0.20	\$0.18	16	-	\$0.08
Cooling	RTU	EER 11.2	0.41	\$0.35	16	1.00	\$0.07
Cooling	RTU	EER 12.0	0.53	\$0.58	16	0.91	\$0.09
Cooling	RTU	Ductless VRF	0.65	\$5.12	16	0.28	\$0.65
Cooling	Heat Pump	EER 9.3, COP 3.1	-	\$0.00	15	-	\$0.00
Cooling	Heat Pump	EER 10.3, COP 3.2	0.40	\$0.39	15	-	\$0.08
Cooling	Heat Pump	EER 11.0, COP 3.3	0.63	\$1.18	15	1.00	\$0.16
Cooling	Heat Pump	EER 11.7, COP 3.4	0.84	\$1.57	15	0.97	\$0.16
Cooling	Heat Pump	EER 12, COP 3.4	0.93	\$1.96	15	0.93	\$0.18
Cooling	Heat Pump	Ductless Mini-Split System	1.03	\$11.50	20	0.52	\$0.79
Space Heating	Electric Resistance	Standard	-	\$0.00	25	1.00	\$0.00
Space Heating	Furnace	Standard	-	\$0.00	18	1.00	\$0.00
Ventilation	Ventilation	Constant Volume	-	\$0.00	15	1.00	\$0.00
Ventilation	Ventilation	Variable Air Volume	1.89	\$1.22	15	1.01	\$0.06
Interior Lighting	Interior Screw-in	Incandescents	-	\$0.00	1	-	\$0.00
Interior Lighting	Interior Screw-in	Infrared Halogen	0.65	\$0.09	1	1.00	\$0.13
Interior Lighting	Interior Screw-in	CFL	2.67	\$0.03	4	5.27	\$0.00
Interior Lighting	Interior Screw-in	LED	2.96	\$1.18	12	-	\$0.04
Interior Lighting	High Bay Fixtures	Metal Halides	-	\$0.00	6	1.00	\$0.00
Interior Lighting	High Bay Fixtures	High Pressure Sodium	0.24	-\$0.07	9	2.06	-\$0.04
Interior Lighting	High Bay Fixtures	T8	0.24	-\$0.15	6	4.16	-\$0.11
Interior Lighting	High Bay Fixtures	T5	0.30	-\$0.15	6	4.95	-\$0.09
Interior Lighting	Linear Fluorescent	T12	-	\$0.00	6	1.00	\$0.00
Interior Lighting	Linear Fluorescent	T8	0.32	-\$0.03	6	1.11	-\$0.02
Interior Lighting	Linear Fluorescent	Super T8	0.96	\$0.25	6	0.93	\$0.05
Interior Lighting	Linear Fluorescent	T5	1.00	\$0.43	6	0.79	\$0.08
Interior Lighting	Linear Fluorescent	LED	1.05	\$3.74	15	-	\$0.31
Exterior Lighting	Exterior Screw-in	Incandescent	-	\$0.00	1	-	\$0.00
Exterior Lighting	Exterior Screw-in	Infrared Halogen	0.08	\$0.05	1	1.00	\$0.60
Exterior Lighting	Exterior Screw-in	CFL	0.32	\$0.02	4	7.11	\$0.02
Exterior Lighting	Exterior Screw-in	Metal Halides	0.32	\$0.05	4	3.29	\$0.04
Exterior Lighting	Exterior Screw-in	LED	0.36	\$0.64	12	-	\$0.18
Exterior	HID	Metal Halides	-	\$0.00	6	1.00	\$0.00

C&I Energy Efficiency Equipment and Measure Data

End Use	Technology	Efficiency Definition	Savings (kWh/SQ FT/yr)	Incremental Cost (\$/SQ FT)	Lifetime (Years)	BC Ratio (2015)	Levelized Cost of Energy (\$/kWh)
Lighting							
Exterior Lighting	HID	High Pressure Sodium	0.17	-\$0.13	9	2.08	-\$0.10
Exterior Lighting	HID	Low Pressure Sodium	0.18	\$0.55	9	0.57	\$0.40
Water Heating	Water Heater	Baseline (EF=0.90)	-	\$0.00	15	1.00	\$0.00
Water Heating	Water Heater	High Efficiency (EF=0.95)	0.11	\$0.02	15	1.02	\$0.02
Water Heating	Water Heater	EF 2.0	1.05	-\$0.48	15	2.86	-\$0.04
Water Heating	Water Heater	EF 2.3	1.18	-\$0.47	15	3.27	-\$0.03
Water Heating	Water Heater	EF 2.4	1.22	-\$0.47	15	3.40	-\$0.03
Water Heating	Water Heater	Geothermal Heat Pump	1.39	\$3.53	15	0.38	\$0.22
Water Heating	Water Heater	Solar	1.53	\$3.03	15	0.43	\$0.17
Food Preparation	Fryer	Standard	-	\$0.00	12	1.00	\$0.00
Food Preparation	Fryer	Efficient	0.03	\$0.04	12	0.87	\$0.12
Food Preparation	Oven	Standard	-	\$0.00	12	1.00	\$0.00
Food Preparation	Oven	Efficient	0.39	\$0.36	12	0.92	\$0.10
Food Preparation	Dishwasher	Standard	-	\$0.00	12	1.00	\$0.00
Food Preparation	Dishwasher	Efficient	0.02	\$0.05	12	0.87	\$0.28
Food Preparation	Hot Food Container	Standard	-	\$0.00	12	1.00	\$0.00
Food Preparation	Hot Food Container	Efficient	0.32	\$0.16	12	0.96	\$0.05
Food Preparation	Food Prep	Standard	-	\$0.00	12	1.00	\$0.00
Food Preparation	Food Prep	Efficient	0.00	\$0.03	12	0.87	\$1.73
Refrigeration	Walk in Refrigeration	Standard	-	\$0.00	18	1.00	\$0.00
Refrigeration	Walk in Refrigeration	Efficient	-	\$0.09	18	0.90	\$0.00
Refrigeration	Glass Door Display	Standard	-	\$0.00	18	1.00	\$0.00
Refrigeration	Glass Door Display	Efficient	0.16	\$0.00	18	1.36	\$0.00
Refrigeration	Reach-in Refrigerator	Standard	-	\$0.00	18	1.00	\$0.00
Refrigeration	Reach-in Refrigerator	Efficient	0.15	\$0.02	18	1.15	\$0.01
Refrigeration	Open Display Case	Standard	-	\$0.00	18	1.00	\$0.00
Refrigeration	Open Display Case	Efficient	0.00	\$0.00	18	0.91	\$0.35
Refrigeration	Vending Machine	Base	-	\$0.00	10	-	\$0.00
Refrigeration	Vending Machine	Base (2012)	0.09	\$0.00	10	1.00	\$0.00
Refrigeration	Vending Machine	High Efficiency	0.11	\$0.00	10	-	\$0.00
Refrigeration	Vending Machine	High Efficiency (2012)	0.17	\$0.00	10	1.18	\$0.00
Refrigeration	Icemaker	Standard	-	\$0.00	12	1.00	\$0.00
Refrigeration	Icemaker	Efficient	0.05	\$0.00	12	1.11	\$0.01
Office Equipment	Desktop Computer	Baseline	-	\$0.00	4	1.00	\$0.00
Office Equipment	Desktop Computer	Energy Star	0.21	\$0.00	4	1.01	\$0.00
Office Equipment	Desktop Computer	Climate Savers	0.30	\$0.36	4	0.85	\$0.32
Office Equipment	Laptop Computer	Baseline	-	\$0.00	4	1.00	\$0.00
Office Equipment	Laptop Computer	Energy Star	0.02	\$0.00	4	1.00	\$0.01

C&I Energy Efficiency Equipment and Measure Data

End Use	Technology	Efficiency Definition	Savings (kWh/SQ FT/yr)	Incremental Cost (\$/SQ FT)	Lifetime (Years)	BC Ratio (2015)	Levelized Cost of Energy (\$/kWh)
Office Equipment	Laptop Computer	Climate Savers	0.04	\$0.12	4	0.84	\$0.87
Office Equipment	Server	Standard	-	\$0.00	3	1.00	\$0.00
Office Equipment	Server	Energy Star	0.11	\$0.01	3	0.99	\$0.04
Office Equipment	Monitor	Standard	-	\$0.00	4	1.00	\$0.00
Office Equipment	Monitor	Energy Star	0.06	\$0.00	4	1.03	\$0.01
Office Equipment	Printer/copier/fax	Standard	-	\$0.00	6	1.00	\$0.00
Office Equipment	Printer/copier/fax	Energy Star	0.08	\$0.04	6	0.95	\$0.09
Office Equipment	POS Terminal	Standard	-	\$0.00	4	1.00	\$0.00
Office Equipment	POS Terminal	Energy Star	0.02	\$0.00	4	1.00	\$0.03
Miscellaneous	Non-HVAC Motor	Standard	-	\$0.00	15	-	\$0.00
Miscellaneous	Non-HVAC Motor	Standard (2015)	0.01	\$0.06	15	-	\$0.71
Miscellaneous	Non-HVAC Motor	High Efficiency	0.01	\$0.00	15	1.00	\$0.00
Miscellaneous	Non-HVAC Motor	High Efficiency (2015)	0.06	\$0.06	15	0.98	\$0.08
Miscellaneous	Non-HVAC Motor	Premium	-	\$0.00	0	-	\$0.00
Miscellaneous	Non-HVAC Motor	Premium (2015)	-	\$0.00	0	-	\$0.00
Miscellaneous	Other Miscellaneous	Miscellaneous	-	\$0.00	5	-	\$0.00
Miscellaneous	Other Miscellaneous	Miscellaneous (2013)	0.00	\$0.00	5	1.00	\$0.00

C&I Energy Efficiency Equipment and Measure Data

Table C-5 Energy Efficiency Equipment Data, Small/Medium Commercial, Existing Vintage, Idaho

End Use	Technology	Efficiency Definition	Savings (kWh/SQ FT/yr)	Incremental Cost (\$/SQ FT)	Lifetime (Years)	BC Ratio (2015)	Levelized Cost of Energy (\$/kWh)
Cooling	Central Chiller	1.5 kw/ton, COP 2.3	-	\$0.00	20	-	\$0.00
Cooling	Central Chiller	1.3 kw/ton, COP 2.7	0.31	\$0.39	20	1.10	\$0.09
Cooling	Central Chiller	1.26 kw/ton, COP 2.8	0.38	\$0.50	20	0.96	\$0.09
Cooling	Central Chiller	1.0 kw/ton, COP 3.5	0.79	\$0.62	20	0.99	\$0.06
Cooling	Central Chiller	0.97 kw/ton, COP 3.6	0.83	\$0.74	20	0.95	\$0.06
Cooling	Central Chiller	Variable Refrigerant Flow	1.09	\$11.57	20	0.18	\$0.75
Cooling	RTU	EER 9.2	-	\$0.00	16	-	\$0.00
Cooling	RTU	EER 10.1	0.21	\$0.18	16	-	\$0.07
Cooling	RTU	EER 11.2	0.42	\$0.35	16	1.00	\$0.07
Cooling	RTU	EER 12.0	0.55	\$0.58	16	0.91	\$0.09
Cooling	RTU	Ductless VRF	0.68	\$5.12	16	0.28	\$0.62
Cooling	Heat Pump	EER 9.3, COP 3.1	-	\$0.00	15	-	\$0.00
Cooling	Heat Pump	EER 10.3, COP 3.2	0.42	\$0.39	15	-	\$0.08
Cooling	Heat Pump	EER 11.0, COP 3.3	0.66	\$1.18	15	1.00	\$0.15
Cooling	Heat Pump	EER 11.7, COP 3.4	0.88	\$1.57	15	0.97	\$0.15
Cooling	Heat Pump	EER 12, COP 3.4	0.97	\$1.96	15	0.93	\$0.18
Cooling	Heat Pump	Ductless Mini-Split System	1.07	\$11.50	20	0.51	\$0.76
Space Heating	Electric Resistance	Standard	-	\$0.00	25	1.00	\$0.00
Space Heating	Furnace	Standard	-	\$0.00	18	1.00	\$0.00
Ventilation	Ventilation	Constant Volume	-	\$0.00	15	1.00	\$0.00
Ventilation	Ventilation	Variable Air Volume	1.37	\$1.22	15	0.93	\$0.08
Interior Lighting	Interior Screw-in	Incandescents	-	\$0.00	1	-	\$0.00
Interior Lighting	Interior Screw-in	Infrared Halogen	0.47	\$0.09	1	1.00	\$0.18
Interior Lighting	Interior Screw-in	CFL	1.96	\$0.03	4	5.64	\$0.00
Interior Lighting	Interior Screw-in	LED	2.17	\$1.18	12	-	\$0.06
Interior Lighting	High Bay Fixtures	Metal Halides	-	\$0.00	6	1.00	\$0.00
Interior Lighting	High Bay Fixtures	High Pressure Sodium	0.25	-\$0.07	9	2.01	-\$0.04
Interior Lighting	High Bay Fixtures	T8	0.25	-\$0.15	6	3.95	-\$0.11
Interior Lighting	High Bay Fixtures	T5	0.32	-\$0.15	6	4.72	-\$0.08
Interior Lighting	Linear Fluorescent	T12	-	\$0.00	6	1.00	\$0.00
Interior Lighting	Linear Fluorescent	T8	0.34	-\$0.03	6	1.11	-\$0.02
Interior Lighting	Linear Fluorescent	Super T8	1.03	\$0.25	6	0.95	\$0.04
Interior Lighting	Linear Fluorescent	T5	1.07	\$0.43	6	0.82	\$0.07
Interior Lighting	Linear Fluorescent	LED	1.12	\$3.74	15	-	\$0.29
Exterior Lighting	Exterior Screw-in	Incandescent	-	\$0.00	1	-	\$0.00
Exterior Lighting	Exterior Screw-in	Infrared Halogen	0.13	\$0.05	1	1.00	\$0.37
Exterior Lighting	Exterior Screw-in	CFL	0.52	\$0.02	4	6.55	\$0.01
Exterior Lighting	Exterior Screw-in	Metal Halides	0.52	\$0.05	4	3.32	\$0.03
Exterior Lighting	Exterior Screw-in	LED	0.58	\$0.64	12	-	\$0.11
Exterior	HID	Metal Halides	-	\$0.00	6	1.00	\$0.00

C&I Energy Efficiency Equipment and Measure Data

End Use	Technology	Efficiency Definition	Savings (kWh/SQ FT/yr)	Incremental Cost (\$/SQ FT)	Lifetime (Years)	BC Ratio (2015)	Levelized Cost of Energy (\$/kWh)
Lighting							
Exterior Lighting	HID	High Pressure Sodium	0.15	-\$0.13	9	2.09	-\$0.11
Exterior Lighting	HID	Low Pressure Sodium	0.16	\$0.55	9	0.57	\$0.43
Water Heating	Water Heater	Baseline (EF=0.90)	-	\$0.00	15	1.00	\$0.00
Water Heating	Water Heater	High Efficiency (EF=0.95)	0.11	\$0.02	15	1.03	\$0.02
Water Heating	Water Heater	EF 2.0	1.07	-\$0.48	15	2.79	-\$0.04
Water Heating	Water Heater	EF 2.3	1.20	-\$0.47	15	3.19	-\$0.03
Water Heating	Water Heater	EF 2.4	1.24	-\$0.47	15	3.32	-\$0.03
Water Heating	Water Heater	Geothermal Heat Pump	1.42	\$3.53	15	0.40	\$0.21
Water Heating	Water Heater	Solar	1.56	\$3.03	15	0.46	\$0.17
Food Preparation	Fryer	Standard	-	\$0.00	12	1.00	\$0.00
Food Preparation	Fryer	Efficient	0.03	\$0.04	12	0.88	\$0.12
Food Preparation	Oven	Standard	-	\$0.00	12	1.00	\$0.00
Food Preparation	Oven	Efficient	0.39	\$0.36	12	0.93	\$0.10
Food Preparation	Dishwasher	Standard	-	\$0.00	12	1.00	\$0.00
Food Preparation	Dishwasher	Efficient	0.02	\$0.05	12	0.87	\$0.28
Food Preparation	Hot Food Container	Standard	-	\$0.00	12	1.00	\$0.00
Food Preparation	Hot Food Container	Efficient	0.32	\$0.16	12	0.98	\$0.05
Food Preparation	Food Prep	Standard	-	\$0.00	12	1.00	\$0.00
Food Preparation	Food Prep	Efficient	0.00	\$0.03	12	0.87	\$1.73
Refrigeration	Walk in Refrigeration	Standard	-	\$0.00	18	1.00	\$0.00
Refrigeration	Walk in Refrigeration	Efficient	-	\$0.09	18	0.90	\$0.00
Refrigeration	Glass Door Display	Standard	-	\$0.00	18	1.00	\$0.00
Refrigeration	Glass Door Display	Efficient	0.16	\$0.00	18	1.37	\$0.00
Refrigeration	Reach-in Refrigerator	Standard	-	\$0.00	18	1.00	\$0.00
Refrigeration	Reach-in Refrigerator	Efficient	0.15	\$0.02	18	1.16	\$0.01
Refrigeration	Open Display Case	Standard	-	\$0.00	18	1.00	\$0.00
Refrigeration	Open Display Case	Efficient	0.00	\$0.00	18	0.92	\$0.33
Refrigeration	Vending Machine	Base	-	\$0.00	10	-	\$0.00
Refrigeration	Vending Machine	Base (2012)	0.09	\$0.00	10	1.00	\$0.00
Refrigeration	Vending Machine	High Efficiency	0.11	\$0.00	10	-	\$0.00
Refrigeration	Vending Machine	High Efficiency (2012)	0.17	\$0.00	10	1.19	\$0.00
Refrigeration	Icemaker	Standard	-	\$0.00	12	1.00	\$0.00
Refrigeration	Icemaker	Efficient	0.05	\$0.00	12	1.11	\$0.01
Office Equipment	Desktop Computer	Baseline	-	\$0.00	4	1.00	\$0.00
Office Equipment	Desktop Computer	Energy Star	0.21	\$0.00	4	1.01	\$0.00
Office Equipment	Desktop Computer	Climate Savers	0.30	\$0.36	4	0.85	\$0.32
Office Equipment	Laptop Computer	Baseline	-	\$0.00	4	1.00	\$0.00
Office Equipment	Laptop Computer	Energy Star	0.02	\$0.00	4	1.00	\$0.01

C&I Energy Efficiency Equipment and Measure Data

End Use	Technology	Efficiency Definition	Savings (kWh/SQ FT/yr)	Incremental Cost (\$/SQ FT)	Lifetime (Years)	BC Ratio (2015)	Levelized Cost of Energy (\$/kWh)
Office Equipment	Laptop Computer	Climate Savers	0.04	\$0.12	4	0.84	\$0.87
Office Equipment	Server	Standard	-	\$0.00	3	1.00	\$0.00
Office Equipment	Server	Energy Star	0.11	\$0.01	3	0.99	\$0.04
Office Equipment	Monitor	Standard	-	\$0.00	4	1.00	\$0.00
Office Equipment	Monitor	Energy Star	0.06	\$0.00	4	1.03	\$0.01
Office Equipment	Printer/copier/fax	Standard	-	\$0.00	6	1.00	\$0.00
Office Equipment	Printer/copier/fax	Energy Star	0.08	\$0.04	6	0.95	\$0.09
Office Equipment	POS Terminal	Standard	-	\$0.00	4	1.00	\$0.00
Office Equipment	POS Terminal	Energy Star	0.02	\$0.00	4	1.00	\$0.03
Miscellaneous	Non-HVAC Motor	Standard	-	\$0.00	15	-	\$0.00
Miscellaneous	Non-HVAC Motor	Standard (2015)	0.01	\$0.06	15	-	\$0.71
Miscellaneous	Non-HVAC Motor	High Efficiency	0.01	\$0.00	15	1.00	\$0.00
Miscellaneous	Non-HVAC Motor	High Efficiency (2015)	0.06	\$0.06	15	0.98	\$0.08
Miscellaneous	Non-HVAC Motor	Premium	-	\$0.00	0	-	\$0.00
Miscellaneous	Non-HVAC Motor	Premium (2015)	-	\$0.00	0	-	\$0.00
Miscellaneous	Other Miscellaneous	Miscellaneous	-	\$0.00	5	-	\$0.00
Miscellaneous	Other Miscellaneous	Miscellaneous (2013)	0.00	\$0.00	5	1.00	\$0.00

C&I Energy Efficiency Equipment and Measure Data

Table C-6 Energy Efficiency Equipment Data, Electric— Small/Medium Commercial, New Vintage, Idaho

End Use	Technology	Efficiency Definition	Savings (kWh/SQ FT/yr)	Incremental Cost (\$/SQ FT)	Lifetime (Years)	BC Ratio (2015)	Levelized Cost of Energy (\$/kWh)
Cooling	Central Chiller	1.5 kw/ton, COP 2.3	-	\$0.00	20	-	\$0.00
Cooling	Central Chiller	1.3 kw/ton, COP 2.7	0.28	\$0.39	20	1.10	\$0.10
Cooling	Central Chiller	1.26 kw/ton, COP 2.8	0.34	\$0.50	20	0.96	\$0.11
Cooling	Central Chiller	1.0 kw/ton, COP 3.5	0.70	\$0.62	20	0.98	\$0.06
Cooling	Central Chiller	0.97 kw/ton, COP 3.6	0.74	\$0.74	20	0.94	\$0.07
Cooling	Central Chiller	Variable Refrigerant Flow	0.97	\$11.57	20	0.18	\$0.84
Cooling	RTU	EER 9.2	-	\$0.00	16	-	\$0.00
Cooling	RTU	EER 10.1	0.20	\$0.18	16	-	\$0.08
Cooling	RTU	EER 11.2	0.41	\$0.35	16	1.00	\$0.07
Cooling	RTU	EER 12.0	0.53	\$0.58	16	0.91	\$0.09
Cooling	RTU	Ductless VRF	0.65	\$5.12	16	0.28	\$0.65
Cooling	Heat Pump	EER 9.3, COP 3.1	-	\$0.00	15	-	\$0.00
Cooling	Heat Pump	EER 10.3, COP 3.2	0.40	\$0.39	15	-	\$0.08
Cooling	Heat Pump	EER 11.0, COP 3.3	0.63	\$1.18	15	1.00	\$0.16
Cooling	Heat Pump	EER 11.7, COP 3.4	0.84	\$1.57	15	0.97	\$0.16
Cooling	Heat Pump	EER 12, COP 3.4	0.93	\$1.96	15	0.93	\$0.18
Cooling	Heat Pump	Ductless Mini-Split System	1.03	\$11.50	20	0.51	\$0.79
Space Heating	Electric Resistance	Standard	-	\$0.00	25	1.00	\$0.00
Space Heating	Furnace	Standard	-	\$0.00	18	1.00	\$0.00
Ventilation	Ventilation	Constant Volume	-	\$0.00	15	1.00	\$0.00
Ventilation	Ventilation	Variable Air Volume	1.89	\$1.22	15	1.02	\$0.06
Interior Lighting	Interior Screw-in	Incandescents	-	\$0.00	1	-	\$0.00
Interior Lighting	Interior Screw-in	Infrared Halogen	0.65	\$0.09	1	1.00	\$0.13
Interior Lighting	Interior Screw-in	CFL	2.67	\$0.03	4	5.28	\$0.00
Interior Lighting	Interior Screw-in	LED	2.96	\$1.18	12	-	\$0.04
Interior Lighting	High Bay Fixtures	Metal Halides	-	\$0.00	6	1.00	\$0.00
Interior Lighting	High Bay Fixtures	High Pressure Sodium	0.24	-\$0.07	9	2.03	-\$0.04
Interior Lighting	High Bay Fixtures	T8	0.24	-\$0.15	6	4.08	-\$0.11
Interior Lighting	High Bay Fixtures	T5	0.30	-\$0.15	6	4.86	-\$0.09
Interior Lighting	Linear Fluorescent	T12	-	\$0.00	6	1.00	\$0.00
Interior Lighting	Linear Fluorescent	T8	0.32	-\$0.03	6	1.11	-\$0.02
Interior Lighting	Linear Fluorescent	Super T8	0.96	\$0.25	6	0.94	\$0.05
Interior Lighting	Linear Fluorescent	T5	1.00	\$0.43	6	0.80	\$0.08
Interior Lighting	Linear Fluorescent	LED	1.05	\$3.74	15	-	\$0.31
Exterior Lighting	Exterior Screw-in	Incandescent	-	\$0.00	1	-	\$0.00
Exterior Lighting	Exterior Screw-in	Infrared Halogen	0.11	\$0.05	1	1.00	\$0.44
Exterior Lighting	Exterior Screw-in	CFL	0.44	\$0.02	4	6.76	\$0.01
Exterior Lighting	Exterior Screw-in	Metal Halides	0.44	\$0.05	4	3.31	\$0.03
Exterior Lighting	Exterior Screw-in	LED	0.48	\$0.64	12	-	\$0.14
Exterior	HID	Metal Halides	-	\$0.00	6	1.00	\$0.00

C&I Energy Efficiency Equipment and Measure Data

End Use	Technology	Efficiency Definition	Savings (kWh/SQ FT/yr)	Incremental Cost (\$/SQ FT)	Lifetime (Years)	BC Ratio (2015)	Levelized Cost of Energy (\$/kWh)
Lighting							
Exterior Lighting	HID	High Pressure Sodium	0.15	-\$0.13	9	2.09	-\$0.11
Exterior Lighting	HID	Low Pressure Sodium	0.16	\$0.55	9	0.57	\$0.43
Water Heating	Water Heater	Baseline (EF=0.90)	-	\$0.00	15	1.00	\$0.00
Water Heating	Water Heater	High Efficiency (EF=0.95)	0.11	\$0.02	15	1.03	\$0.02
Water Heating	Water Heater	EF 2.0	1.05	-\$0.48	15	2.80	-\$0.04
Water Heating	Water Heater	EF 2.3	1.18	-\$0.47	15	3.20	-\$0.03
Water Heating	Water Heater	EF 2.4	1.22	-\$0.47	15	3.33	-\$0.03
Water Heating	Water Heater	Geothermal Heat Pump	1.39	\$3.53	15	0.39	\$0.22
Water Heating	Water Heater	Solar	1.53	\$3.03	15	0.45	\$0.17
Food Preparation	Fryer	Standard	-	\$0.00	12	1.00	\$0.00
Food Preparation	Fryer	Efficient	0.03	\$0.04	12	0.88	\$0.12
Food Preparation	Oven	Standard	-	\$0.00	12	1.00	\$0.00
Food Preparation	Oven	Efficient	0.39	\$0.36	12	0.93	\$0.10
Food Preparation	Dishwasher	Standard	-	\$0.00	12	1.00	\$0.00
Food Preparation	Dishwasher	Efficient	0.02	\$0.05	12	0.87	\$0.28
Food Preparation	Hot Food Container	Standard	-	\$0.00	12	1.00	\$0.00
Food Preparation	Hot Food Container	Efficient	0.32	\$0.16	12	0.98	\$0.05
Food Preparation	Food Prep	Standard	-	\$0.00	12	1.00	\$0.00
Food Preparation	Food Prep	Efficient	0.00	\$0.03	12	0.87	\$1.73
Refrigeration	Walk in Refrigeration	Standard	-	\$0.00	18	1.00	\$0.00
Refrigeration	Walk in Refrigeration	Efficient	-	\$0.09	18	0.90	\$0.00
Refrigeration	Glass Door Display	Standard	-	\$0.00	18	1.00	\$0.00
Refrigeration	Glass Door Display	Efficient	0.16	\$0.00	18	1.37	\$0.00
Refrigeration	Reach-in Refrigerator	Standard	-	\$0.00	18	1.00	\$0.00
Refrigeration	Reach-in Refrigerator	Efficient	0.15	\$0.02	18	1.16	\$0.01
Refrigeration	Open Display Case	Standard	-	\$0.00	18	1.00	\$0.00
Refrigeration	Open Display Case	Efficient	0.00	\$0.00	18	0.92	\$0.35
Refrigeration	Vending Machine	Base	-	\$0.00	10	-	\$0.00
Refrigeration	Vending Machine	Base (2012)	0.09	\$0.00	10	1.00	\$0.00
Refrigeration	Vending Machine	High Efficiency	0.11	\$0.00	10	-	\$0.00
Refrigeration	Vending Machine	High Efficiency (2012)	0.17	\$0.00	10	1.19	\$0.00
Refrigeration	Icemaker	Standard	-	\$0.00	12	1.00	\$0.00
Refrigeration	Icemaker	Efficient	0.05	\$0.00	12	1.11	\$0.01
Office Equipment	Desktop Computer	Baseline	-	\$0.00	4	1.00	\$0.00
Office Equipment	Desktop Computer	Energy Star	0.21	\$0.00	4	1.01	\$0.00
Office Equipment	Desktop Computer	Climate Savers	0.30	\$0.36	4	0.85	\$0.32
Office Equipment	Laptop Computer	Baseline	-	\$0.00	4	1.00	\$0.00
Office Equipment	Laptop Computer	Energy Star	0.02	\$0.00	4	1.00	\$0.01

C&I Energy Efficiency Equipment and Measure Data

End Use	Technology	Efficiency Definition	Savings (kWh/SQ FT/yr)	Incremental Cost (\$/SQ FT)	Lifetime (Years)	BC Ratio (2015)	Levelized Cost of Energy (\$/kWh)
Office Equipment	Laptop Computer	Climate Savers	0.04	\$0.12	4	0.84	\$0.87
Office Equipment	Server	Standard	-	\$0.00	3	1.00	\$0.00
Office Equipment	Server	Energy Star	0.11	\$0.01	3	0.99	\$0.04
Office Equipment	Monitor	Standard	-	\$0.00	4	1.00	\$0.00
Office Equipment	Monitor	Energy Star	0.06	\$0.00	4	1.03	\$0.01
Office Equipment	Printer/copier/fax	Standard	-	\$0.00	6	1.00	\$0.00
Office Equipment	Printer/copier/fax	Energy Star	0.08	\$0.04	6	0.95	\$0.09
Office Equipment	POS Terminal	Standard	-	\$0.00	4	1.00	\$0.00
Office Equipment	POS Terminal	Energy Star	0.02	\$0.00	4	1.00	\$0.03
Miscellaneous	Non-HVAC Motor	Standard	-	\$0.00	15	-	\$0.00
Miscellaneous	Non-HVAC Motor	Standard (2015)	0.01	\$0.06	15	-	\$0.71
Miscellaneous	Non-HVAC Motor	High Efficiency	0.01	\$0.00	15	1.00	\$0.00
Miscellaneous	Non-HVAC Motor	High Efficiency (2015)	0.06	\$0.06	15	0.98	\$0.08
Miscellaneous	Non-HVAC Motor	Premium	-	\$0.00	0	-	\$0.00
Miscellaneous	Non-HVAC Motor	Premium (2015)	-	\$0.00	0	-	\$0.00
Miscellaneous	Other Miscellaneous	Miscellaneous	-	\$0.00	5	-	\$0.00
Miscellaneous	Other Miscellaneous	Miscellaneous (2013)	0.00	\$0.00	5	1.00	\$0.00

C&I Energy Efficiency Equipment and Measure Data

Table C-7 Energy Efficiency Equipment Data, Electric—Large Commercial, Existing Vintage, Washington

End Use	Technology	Efficiency Definition	Savings (kWh/SQ FT/yr)	Incremental Cost (\$/SQ FT)	Lifetime (Years)	BC Ratio (2015)	Levelized Cost of Energy (\$/kWh)
Cooling	Central Chiller	1.5 kw/ton, COP 2.3	-	\$0.00	20	-	\$0.00
Cooling	Central Chiller	1.3 kw/ton, COP 2.7	0.29	\$0.26	20	1.10	\$0.06
Cooling	Central Chiller	1.26 kw/ton, COP 2.8	0.34	\$0.33	20	0.97	\$0.07
Cooling	Central Chiller	1.0 kw/ton, COP 3.5	0.71	\$0.41	20	1.02	\$0.04
Cooling	Central Chiller	0.97 kw/ton, COP 3.6	0.76	\$0.49	20	0.99	\$0.05
Cooling	Central Chiller	Variable Refrigerant Flow	0.99	\$7.63	20	0.21	\$0.54
Cooling	RTU	EER 9.2	-	\$0.00	16	-	\$0.00
Cooling	RTU	EER 10.1	0.22	\$0.13	16	-	\$0.05
Cooling	RTU	EER 11.2	0.44	\$0.25	16	1.00	\$0.05
Cooling	RTU	EER 12.0	0.57	\$0.41	16	0.93	\$0.06
Cooling	RTU	Ductless VRF	0.70	\$3.67	16	0.32	\$0.43
Cooling	Heat Pump	EER 9.3, COP 3.1	-	\$0.00	15	-	\$0.00
Cooling	Heat Pump	EER 10.3, COP 3.2	0.29	\$0.18	15	-	\$0.06
Cooling	Heat Pump	EER 11.0, COP 3.3	0.45	\$0.55	15	1.00	\$0.10
Cooling	Heat Pump	EER 11.7, COP 3.4	0.61	\$0.73	15	0.98	\$0.10
Cooling	Heat Pump	EER 12, COP 3.4	0.66	\$0.91	15	0.95	\$0.12
Cooling	Heat Pump	Ductless Mini-Split System	0.74	\$5.35	20	0.56	\$0.51
Space Heating	Electric Resistance	Standard	-	\$0.00	25	1.00	\$0.00
Space Heating	Furnace	Standard	-	\$0.00	18	1.00	\$0.00
Ventilation	Ventilation	Constant Volume	-	\$0.00	15	1.00	\$0.00
Ventilation	Ventilation	Variable Air Volume	1.39	\$1.22	15	0.91	\$0.08
Interior Lighting	Interior Screw-in	Incandescents	-	\$0.00	1	-	\$0.00
Interior Lighting	Interior Screw-in	Infrared Halogen	0.49	\$0.08	1	1.00	\$0.16
Interior Lighting	Interior Screw-in	CFL	2.03	\$0.03	4	5.52	\$0.00
Interior Lighting	Interior Screw-in	LED	2.24	\$1.11	12	-	\$0.05
Interior Lighting	High Bay Fixtures	Metal Halides	-	\$0.00	6	1.00	\$0.00
Interior Lighting	High Bay Fixtures	High Pressure Sodium	0.24	-\$0.08	9	2.10	-\$0.04
Interior Lighting	High Bay Fixtures	T8	0.24	-\$0.16	6	4.40	-\$0.12
Interior Lighting	High Bay Fixtures	T5	0.31	-\$0.16	6	5.23	-\$0.10
Interior Lighting	Linear Fluorescent	T12	-	\$0.00	6	1.00	\$0.00
Interior Lighting	Linear Fluorescent	T8	0.34	-\$0.03	6	1.11	-\$0.02
Interior Lighting	Linear Fluorescent	Super T8	1.03	\$0.25	6	0.94	\$0.04
Interior Lighting	Linear Fluorescent	T5	1.07	\$0.42	6	0.81	\$0.07
Interior Lighting	Linear Fluorescent	LED	1.12	\$3.67	15	-	\$0.28
Exterior Lighting	Exterior Screw-in	Incandescent	-	\$0.00	1	-	\$0.00
Exterior Lighting	Exterior Screw-in	Infrared Halogen	0.05	\$0.01	1	1.00	\$0.26
Exterior Lighting	Exterior Screw-in	CFL	0.22	\$0.01	4	6.10	\$0.01
Exterior Lighting	Exterior Screw-in	Metal Halides	0.22	\$0.02	4	3.35	\$0.02
Exterior Lighting	Exterior Screw-in	LED	0.24	\$0.19	12	-	\$0.08
Exterior	HID	Metal Halides	-	\$0.00	6	1.00	\$0.00

C&I Energy Efficiency Equipment and Measure Data

End Use	Technology	Efficiency Definition	Savings (kWh/SQ FT/yr)	Incremental Cost (\$/SQ FT)	Lifetime (Years)	BC Ratio (2015)	Levelized Cost of Energy (\$/kWh)
Lighting							
Exterior Lighting	HID	High Pressure Sodium	0.15	-\$0.11	9	2.03	-\$0.09
Exterior Lighting	HID	Low Pressure Sodium	0.16	\$0.45	9	0.58	\$0.36
Water Heating	Water Heater	Baseline (EF=0.90)	-	\$0.00	15	1.00	\$0.00
Water Heating	Water Heater	High Efficiency (EF=0.95)	0.13	\$0.02	15	1.03	\$0.01
Water Heating	Water Heater	EF 2.0	1.26	-\$0.48	15	2.78	-\$0.03
Water Heating	Water Heater	EF 2.3	1.42	-\$0.47	15	3.18	-\$0.03
Water Heating	Water Heater	EF 2.4	1.46	-\$0.47	15	3.30	-\$0.03
Water Heating	Water Heater	Geothermal Heat Pump	1.67	\$3.53	15	0.40	\$0.18
Water Heating	Water Heater	Solar	1.84	\$3.03	15	0.46	\$0.14
Food Preparation	Fryer	Standard	-	\$0.00	12	1.00	\$0.00
Food Preparation	Fryer	Efficient	0.07	\$0.02	12	1.07	\$0.03
Food Preparation	Oven	Standard	-	\$0.00	12	1.00	\$0.00
Food Preparation	Oven	Efficient	0.74	\$0.46	12	0.95	\$0.06
Food Preparation	Dishwasher	Standard	-	\$0.00	12	1.00	\$0.00
Food Preparation	Dishwasher	Efficient	0.06	\$0.10	12	0.89	\$0.16
Food Preparation	Hot Food Container	Standard	-	\$0.00	12	1.00	\$0.00
Food Preparation	Hot Food Container	Efficient	0.21	\$0.30	12	0.70	\$0.15
Food Preparation	Food Prep	Standard	-	\$0.00	12	1.00	\$0.00
Food Preparation	Food Prep	Efficient	0.01	\$0.03	12	0.88	\$0.46
Refrigeration	Walk in Refrigeration	Standard	-	\$0.00	18	1.00	\$0.00
Refrigeration	Walk in Refrigeration	Efficient	0.11	\$1.26	18	0.88	\$0.87
Refrigeration	Glass Door Display	Standard	-	\$0.00	18	1.00	\$0.00
Refrigeration	Glass Door Display	Efficient	0.13	\$0.01	18	1.25	\$0.00
Refrigeration	Reach-in Refrigerator	Standard	-	\$0.00	18	1.00	\$0.00
Refrigeration	Reach-in Refrigerator	Efficient	0.16	\$0.08	18	1.01	\$0.04
Refrigeration	Open Display Case	Standard	-	\$0.00	18	1.00	\$0.00
Refrigeration	Open Display Case	Efficient	0.00	\$0.04	18	0.88	\$0.55
Refrigeration	Vending Machine	Base	-	\$0.00	10	-	\$0.00
Refrigeration	Vending Machine	Base (2012)	0.11	\$0.00	10	1.00	\$0.00
Refrigeration	Vending Machine	High Efficiency	0.13	\$0.00	10	-	\$0.00
Refrigeration	Vending Machine	High Efficiency (2012)	0.20	\$0.00	10	1.09	\$0.00
Refrigeration	Icemaker	Standard	-	\$0.00	12	1.00	\$0.00
Refrigeration	Icemaker	Efficient	0.10	\$0.02	12	1.06	\$0.02
Office Equipment	Desktop Computer	Baseline	-	\$0.00	4	1.00	\$0.00
Office Equipment	Desktop Computer	Energy Star	0.39	\$0.00	4	1.02	\$0.00
Office Equipment	Desktop Computer	Climate Savers	0.55	\$0.32	4	0.87	\$0.15
Office Equipment	Laptop Computer	Baseline	-	\$0.00	4	1.00	\$0.00
Office Equipment	Laptop Computer	Energy Star	0.02	\$0.00	4	1.01	\$0.00

C&I Energy Efficiency Equipment and Measure Data

End Use	Technology	Efficiency Definition	Savings (kWh/SQ FT/yr)	Incremental Cost (\$/SQ FT)	Lifetime (Years)	BC Ratio (2015)	Levelized Cost of Energy (\$/kWh)
Office Equipment	Laptop Computer	Climate Savers	0.04	\$0.06	4	0.85	\$0.42
Office Equipment	Server	Standard	-	\$0.00	3	1.00	\$0.00
Office Equipment	Server	Energy Star	0.13	\$0.01	3	1.02	\$0.02
Office Equipment	Monitor	Standard	-	\$0.00	4	1.00	\$0.00
Office Equipment	Monitor	Energy Star	0.05	\$0.01	4	1.00	\$0.03
Office Equipment	Printer/copier/fax	Standard	-	\$0.00	6	1.00	\$0.00
Office Equipment	Printer/copier/fax	Energy Star	0.07	\$0.02	6	0.98	\$0.04
Office Equipment	POS Terminal	Standard	-	\$0.00	4	1.00	\$0.00
Office Equipment	POS Terminal	Energy Star	0.01	\$0.00	4	1.00	\$0.03
Miscellaneous	Non-HVAC Motor	Standard	-	\$0.00	15	-	\$0.00
Miscellaneous	Non-HVAC Motor	Standard (2015)	0.01	\$0.06	15	-	\$0.63
Miscellaneous	Non-HVAC Motor	High Efficiency	0.01	\$0.00	15	1.00	\$0.00
Miscellaneous	Non-HVAC Motor	High Efficiency (2015)	0.07	\$0.06	15	0.98	\$0.07
Miscellaneous	Non-HVAC Motor	Premium	-	\$0.00	0	-	\$0.00
Miscellaneous	Non-HVAC Motor	Premium (2015)	-	\$0.00	0	-	\$0.00
Miscellaneous	Other Miscellaneous	Miscellaneous	-	\$0.00	5	-	\$0.00
Miscellaneous	Other Miscellaneous	Miscellaneous (2013)	0.00	\$0.00	5	1.00	\$0.00

C&I Energy Efficiency Equipment and Measure Data

Table C-8 Energy Efficiency Equipment Data, Electric— Large Commercial, New Vintage, Washington

End Use	Technology	Efficiency Definition	Savings (kWh/SQ FT/yr)	Incremental Cost (\$/SQ FT)	Lifetime (Years)	BC Ratio (2015)	Levelized Cost of Energy (\$/kWh)
Cooling	Central Chiller	1.5 kw/ton, COP 2.3	-	\$0.00	20	-	\$0.00
Cooling	Central Chiller	1.3 kw/ton, COP 2.7	0.26	\$0.24	20	1.10	\$0.07
Cooling	Central Chiller	1.26 kw/ton, COP 2.8	0.31	\$0.31	20	0.97	\$0.07
Cooling	Central Chiller	1.0 kw/ton, COP 3.5	0.64	\$0.38	20	1.02	\$0.04
Cooling	Central Chiller	0.97 kw/ton, COP 3.6	0.68	\$0.45	20	0.99	\$0.05
Cooling	Central Chiller	Variable Refrigerant Flow	0.89	\$7.06	20	0.21	\$0.56
Cooling	RTU	EER 9.2	-	\$0.00	16	-	\$0.00
Cooling	RTU	EER 10.1	0.21	\$0.13	16	-	\$0.05
Cooling	RTU	EER 11.2	0.41	\$0.25	16	1.00	\$0.05
Cooling	RTU	EER 12.0	0.54	\$0.41	16	0.93	\$0.06
Cooling	RTU	Ductless VRF	0.66	\$3.67	16	0.32	\$0.46
Cooling	Heat Pump	EER 9.3, COP 3.1	-	\$0.00	15	-	\$0.00
Cooling	Heat Pump	EER 10.3, COP 3.2	0.31	\$0.18	15	-	\$0.05
Cooling	Heat Pump	EER 11.0, COP 3.3	0.50	\$0.55	15	1.00	\$0.10
Cooling	Heat Pump	EER 11.7, COP 3.4	0.66	\$0.73	15	0.98	\$0.10
Cooling	Heat Pump	EER 12, COP 3.4	0.73	\$0.91	15	0.96	\$0.11
Cooling	Heat Pump	Ductless Mini-Split System	0.81	\$5.35	20	0.57	\$0.47
Space Heating	Electric Resistance	Standard	-	\$0.00	25	1.00	\$0.00
Space Heating	Furnace	Standard	-	\$0.00	18	1.00	\$0.00
Ventilation	Ventilation	Constant Volume	-	\$0.00	15	1.00	\$0.00
Ventilation	Ventilation	Variable Air Volume	1.79	\$1.22	15	0.99	\$0.06
Interior Lighting	Interior Screw-in	Incandescents	-	\$0.00	1	-	\$0.00
Interior Lighting	Interior Screw-in	Infrared Halogen	0.61	\$0.08	1	1.00	\$0.13
Interior Lighting	Interior Screw-in	CFL	2.52	\$0.03	4	5.27	\$0.00
Interior Lighting	Interior Screw-in	LED	2.78	\$1.11	12	-	\$0.04
Interior Lighting	High Bay Fixtures	Metal Halides	-	\$0.00	6	1.00	\$0.00
Interior Lighting	High Bay Fixtures	High Pressure Sodium	0.25	-\$0.08	9	2.09	-\$0.04
Interior Lighting	High Bay Fixtures	T8	0.25	-\$0.16	6	4.36	-\$0.12
Interior Lighting	High Bay Fixtures	T5	0.31	-\$0.16	6	5.19	-\$0.09
Interior Lighting	Linear Fluorescent	T12	-	\$0.00	6	1.00	\$0.00
Interior Lighting	Linear Fluorescent	T8	0.31	-\$0.03	6	1.11	-\$0.02
Interior Lighting	Linear Fluorescent	Super T8	0.93	\$0.25	6	0.92	\$0.05
Interior Lighting	Linear Fluorescent	T5	0.97	\$0.42	6	0.78	\$0.08
Interior Lighting	Linear Fluorescent	LED	1.02	\$3.67	15	-	\$0.31
Exterior Lighting	Exterior Screw-in	Incandescent	-	\$0.00	1	-	\$0.00
Exterior Lighting	Exterior Screw-in	Infrared Halogen	0.05	\$0.01	1	1.00	\$0.26
Exterior Lighting	Exterior Screw-in	CFL	0.22	\$0.01	4	6.10	\$0.01
Exterior Lighting	Exterior Screw-in	Metal Halides	0.22	\$0.02	4	3.35	\$0.02
Exterior Lighting	Exterior Screw-in	LED	0.24	\$0.19	12	-	\$0.08
Exterior	HID	Metal Halides	-	\$0.00	6	1.00	\$0.00

C&I Energy Efficiency Equipment and Measure Data

End Use	Technology	Efficiency Definition	Savings (kWh/SQ FT/yr)	Incremental Cost (\$/SQ FT)	Lifetime (Years)	BC Ratio (2015)	Levelized Cost of Energy (\$/kWh)
Lighting							
Exterior Lighting	HID	High Pressure Sodium	0.15	-\$0.11	9	2.03	-\$0.09
Exterior Lighting	HID	Low Pressure Sodium	0.16	\$0.45	9	0.58	\$0.36
Water Heating	Water Heater	Baseline (EF=0.90)	-	\$0.00	15	1.00	\$0.00
Water Heating	Water Heater	High Efficiency (EF=0.95)	0.12	\$0.02	15	1.03	\$0.02
Water Heating	Water Heater	EF 2.0	1.21	-\$0.48	15	2.81	-\$0.03
Water Heating	Water Heater	EF 2.3	1.35	-\$0.47	15	3.21	-\$0.03
Water Heating	Water Heater	EF 2.4	1.39	-\$0.47	15	3.34	-\$0.03
Water Heating	Water Heater	Geothermal Heat Pump	1.60	\$3.53	15	0.39	\$0.19
Water Heating	Water Heater	Solar	1.76	\$3.03	15	0.45	\$0.15
Food Preparation	Fryer	Standard	-	\$0.00	12	1.00	\$0.00
Food Preparation	Fryer	Efficient	0.07	\$0.02	12	1.07	\$0.03
Food Preparation	Oven	Standard	-	\$0.00	12	1.00	\$0.00
Food Preparation	Oven	Efficient	0.74	\$0.46	12	0.95	\$0.06
Food Preparation	Dishwasher	Standard	-	\$0.00	12	1.00	\$0.00
Food Preparation	Dishwasher	Efficient	0.06	\$0.10	12	0.89	\$0.16
Food Preparation	Hot Food Container	Standard	-	\$0.00	12	1.00	\$0.00
Food Preparation	Hot Food Container	Efficient	0.21	\$0.30	12	0.70	\$0.15
Food Preparation	Food Prep	Standard	-	\$0.00	12	1.00	\$0.00
Food Preparation	Food Prep	Efficient	0.01	\$0.03	12	0.88	\$0.46
Refrigeration	Walk in Refrigeration	Standard	-	\$0.00	18	1.00	\$0.00
Refrigeration	Walk in Refrigeration	Efficient	0.11	\$1.26	18	0.88	\$0.88
Refrigeration	Glass Door Display	Standard	-	\$0.00	18	1.00	\$0.00
Refrigeration	Glass Door Display	Efficient	0.13	\$0.01	18	1.25	\$0.00
Refrigeration	Reach-in Refrigerator	Standard	-	\$0.00	18	1.00	\$0.00
Refrigeration	Reach-in Refrigerator	Efficient	0.23	\$0.08	18	1.05	\$0.03
Refrigeration	Open Display Case	Standard	-	\$0.00	18	1.00	\$0.00
Refrigeration	Open Display Case	Efficient	0.00	\$0.04	18	0.88	\$0.55
Refrigeration	Vending Machine	Base	-	\$0.00	10	-	\$0.00
Refrigeration	Vending Machine	Base (2012)	0.11	\$0.00	10	1.00	\$0.00
Refrigeration	Vending Machine	High Efficiency	0.13	\$0.00	10	-	\$0.00
Refrigeration	Vending Machine	High Efficiency (2012)	0.20	\$0.00	10	1.09	\$0.00
Refrigeration	Icemaker	Standard	-	\$0.00	12	1.00	\$0.00
Refrigeration	Icemaker	Efficient	0.09	\$0.02	12	1.06	\$0.02
Office Equipment	Desktop Computer	Baseline	-	\$0.00	4	1.00	\$0.00
Office Equipment	Desktop Computer	Energy Star	0.39	\$0.00	4	1.02	\$0.00
Office Equipment	Desktop Computer	Climate Savers	0.55	\$0.32	4	0.87	\$0.15
Office Equipment	Laptop Computer	Baseline	-	\$0.00	4	1.00	\$0.00
Office Equipment	Laptop Computer	Energy Star	0.02	\$0.00	4	1.01	\$0.00

C&I Energy Efficiency Equipment and Measure Data

End Use	Technology	Efficiency Definition	Savings (kWh/SQ FT/yr)	Incremental Cost (\$/SQ FT)	Lifetime (Years)	BC Ratio (2015)	Levelized Cost of Energy (\$/kWh)
Office Equipment	Laptop Computer	Climate Savers	0.04	\$0.06	4	0.85	\$0.42
Office Equipment	Server	Standard	-	\$0.00	3	1.00	\$0.00
Office Equipment	Server	Energy Star	0.13	\$0.01	3	1.02	\$0.02
Office Equipment	Monitor	Standard	-	\$0.00	4	1.00	\$0.00
Office Equipment	Monitor	Energy Star	0.05	\$0.01	4	1.00	\$0.03
Office Equipment	Printer/copier/fax	Standard	-	\$0.00	6	1.00	\$0.00
Office Equipment	Printer/copier/fax	Energy Star	0.07	\$0.02	6	0.98	\$0.04
Office Equipment	POS Terminal	Standard	-	\$0.00	4	1.00	\$0.00
Office Equipment	POS Terminal	Energy Star	0.01	\$0.00	4	1.00	\$0.03
Miscellaneous	Non-HVAC Motor	Standard	-	\$0.00	15	-	\$0.00
Miscellaneous	Non-HVAC Motor	Standard (2015)	0.01	\$0.06	15	-	\$0.63
Miscellaneous	Non-HVAC Motor	High Efficiency	0.01	\$0.00	15	1.00	\$0.00
Miscellaneous	Non-HVAC Motor	High Efficiency (2015)	0.07	\$0.06	15	0.98	\$0.07
Miscellaneous	Non-HVAC Motor	Premium	-	\$0.00	0	-	\$0.00
Miscellaneous	Non-HVAC Motor	Premium (2015)	-	\$0.00	0	-	\$0.00
Miscellaneous	Other Miscellaneous	Miscellaneous	-	\$0.00	5	-	\$0.00
Miscellaneous	Other Miscellaneous	Miscellaneous (2013)	0.00	\$0.00	5	1.00	\$0.00

Table C-9 Energy Efficiency Equipment Data, Electric—Large Commercial, Existing Vintage, Idaho

End Use	Technology	Efficiency Definition	Savings (kWh/SQ FT/yr)	Incremental Cost (\$/SQ FT)	Lifetime (Years)	BC Ratio (2015)	Levelized Cost of Energy (\$/kWh)
Cooling	Central Chiller	1.5 kw/ton, COP 2.3	-	\$0.00	20	-	\$0.00
Cooling	Central Chiller	1.3 kw/ton, COP 2.7	0.29	\$0.26	20	1.10	\$0.06
Cooling	Central Chiller	1.26 kw/ton, COP 2.8	0.34	\$0.33	20	0.97	\$0.07
Cooling	Central Chiller	1.0 kw/ton, COP 3.5	0.71	\$0.41	20	1.02	\$0.04
Cooling	Central Chiller	0.97 kw/ton, COP 3.6	0.76	\$0.49	20	0.99	\$0.05
Cooling	Central Chiller	Variable Refrigerant Flow	0.99	\$7.63	20	0.21	\$0.54
Cooling	RTU	EER 9.2	-	\$0.00	16	-	\$0.00
Cooling	RTU	EER 10.1	0.22	\$0.13	16	-	\$0.05
Cooling	RTU	EER 11.2	0.44	\$0.25	16	1.00	\$0.05
Cooling	RTU	EER 12.0	0.57	\$0.41	16	0.93	\$0.06
Cooling	RTU	Ductless VRF	0.70	\$3.67	16	0.32	\$0.43
Cooling	Heat Pump	EER 9.3, COP 3.1	-	\$0.00	15	-	\$0.00
Cooling	Heat Pump	EER 10.3, COP 3.2	0.29	\$0.18	15	-	\$0.06
Cooling	Heat Pump	EER 11.0, COP 3.3	0.45	\$0.55	15	1.00	\$0.10
Cooling	Heat Pump	EER 11.7, COP 3.4	0.61	\$0.73	15	0.98	\$0.10
Cooling	Heat Pump	EER 12, COP 3.4	0.66	\$0.91	15	0.95	\$0.12
Cooling	Heat Pump	Ductless Mini-Split System	0.74	\$5.35	20	0.56	\$0.51
Space Heating	Electric Resistance	Standard	-	\$0.00	25	1.00	\$0.00
Space Heating	Furnace	Standard	-	\$0.00	18	1.00	\$0.00
Ventilation	Ventilation	Constant Volume	-	\$0.00	15	1.00	\$0.00
Ventilation	Ventilation	Variable Air Volume	1.39	\$1.22	15	0.92	\$0.08
Interior Lighting	Interior Screw-in	Incandescents	-	\$0.00	1	-	\$0.00
Interior Lighting	Interior Screw-in	Infrared Halogen	0.49	\$0.08	1	1.00	\$0.16
Interior Lighting	Interior Screw-in	CFL	2.03	\$0.03	4	5.53	\$0.00
Interior Lighting	Interior Screw-in	LED	2.24	\$1.11	12	-	\$0.05
Interior Lighting	High Bay Fixtures	Metal Halides	-	\$0.00	6	1.00	\$0.00
Interior Lighting	High Bay Fixtures	High Pressure Sodium	0.24	-\$0.08	9	2.09	-\$0.04
Interior Lighting	High Bay Fixtures	T8	0.24	-\$0.16	6	4.37	-\$0.12
Interior Lighting	High Bay Fixtures	T5	0.31	-\$0.16	6	5.20	-\$0.10
Interior Lighting	Linear Fluorescent	T12	-	\$0.00	6	1.00	\$0.00
Interior Lighting	Linear Fluorescent	T8	0.34	-\$0.03	6	1.11	-\$0.02
Interior Lighting	Linear Fluorescent	Super T8	1.03	\$0.25	6	0.95	\$0.04
Interior Lighting	Linear Fluorescent	T5	1.07	\$0.42	6	0.81	\$0.07
Interior Lighting	Linear Fluorescent	LED	1.12	\$3.67	15	-	\$0.28
Exterior Lighting	Exterior Screw-in	Incandescent	-	\$0.00	1	-	\$0.00
Exterior Lighting	Exterior Screw-in	Infrared Halogen	0.05	\$0.01	1	1.00	\$0.26
Exterior Lighting	Exterior Screw-in	CFL	0.22	\$0.01	4	6.10	\$0.01
Exterior Lighting	Exterior Screw-in	Metal Halides	0.22	\$0.02	4	3.35	\$0.02
Exterior Lighting	Exterior Screw-in	LED	0.24	\$0.19	12	-	\$0.08
Exterior	HID	Metal Halides	-	\$0.00	6	1.00	\$0.00

C&I Energy Efficiency Equipment and Measure Data

End Use	Technology	Efficiency Definition	Savings (kWh/SQ FT/yr)	Incremental Cost (\$/SQ FT)	Lifetime (Years)	BC Ratio (2015)	Levelized Cost of Energy (\$/kWh)
Lighting							
Exterior Lighting	HID	High Pressure Sodium	0.15	-\$0.11	9	2.02	-\$0.09
Exterior Lighting	HID	Low Pressure Sodium	0.16	\$0.45	9	0.58	\$0.36
Water Heating	Water Heater	Baseline (EF=0.90)	-	\$0.00	15	1.00	\$0.00
Water Heating	Water Heater	High Efficiency (EF=0.95)	0.13	\$0.02	15	1.03	\$0.01
Water Heating	Water Heater	EF 2.0	1.26	-\$0.48	15	2.76	-\$0.03
Water Heating	Water Heater	EF 2.3	1.42	-\$0.47	15	3.16	-\$0.03
Water Heating	Water Heater	EF 2.4	1.46	-\$0.47	15	3.29	-\$0.03
Water Heating	Water Heater	Geothermal Heat Pump	1.67	\$3.53	15	0.41	\$0.18
Water Heating	Water Heater	Solar	1.84	\$3.03	15	0.47	\$0.14
Food Preparation	Fryer	Standard	-	\$0.00	12	1.00	\$0.00
Food Preparation	Fryer	Efficient	0.07	\$0.02	12	1.07	\$0.03
Food Preparation	Oven	Standard	-	\$0.00	12	1.00	\$0.00
Food Preparation	Oven	Efficient	0.74	\$0.46	12	0.96	\$0.06
Food Preparation	Dishwasher	Standard	-	\$0.00	12	1.00	\$0.00
Food Preparation	Dishwasher	Efficient	0.06	\$0.10	12	0.89	\$0.16
Food Preparation	Hot Food Container	Standard	-	\$0.00	12	1.00	\$0.00
Food Preparation	Hot Food Container	Efficient	0.21	\$0.30	12	0.70	\$0.15
Food Preparation	Food Prep	Standard	-	\$0.00	12	1.00	\$0.00
Food Preparation	Food Prep	Efficient	0.01	\$0.03	12	0.88	\$0.46
Refrigeration	Walk in Refrigeration	Standard	-	\$0.00	18	1.00	\$0.00
Refrigeration	Walk in Refrigeration	Efficient	0.11	\$1.26	18	0.88	\$0.87
Refrigeration	Glass Door Display	Standard	-	\$0.00	18	1.00	\$0.00
Refrigeration	Glass Door Display	Efficient	0.13	\$0.01	18	1.26	\$0.00
Refrigeration	Reach-in Refrigerator	Standard	-	\$0.00	18	1.00	\$0.00
Refrigeration	Reach-in Refrigerator	Efficient	0.16	\$0.08	18	1.02	\$0.04
Refrigeration	Open Display Case	Standard	-	\$0.00	18	1.00	\$0.00
Refrigeration	Open Display Case	Efficient	0.00	\$0.04	18	0.88	\$0.55
Refrigeration	Vending Machine	Base	-	\$0.00	10	-	\$0.00
Refrigeration	Vending Machine	Base (2012)	0.11	\$0.00	10	1.00	\$0.00
Refrigeration	Vending Machine	High Efficiency	0.13	\$0.00	10	-	\$0.00
Refrigeration	Vending Machine	High Efficiency (2012)	0.20	\$0.00	10	1.09	\$0.00
Refrigeration	Icemaker	Standard	-	\$0.00	12	1.00	\$0.00
Refrigeration	Icemaker	Efficient	0.10	\$0.02	12	1.06	\$0.02
Office Equipment	Desktop Computer	Baseline	-	\$0.00	4	1.00	\$0.00
Office Equipment	Desktop Computer	Energy Star	0.39	\$0.00	4	1.02	\$0.00
Office Equipment	Desktop Computer	Climate Savers	0.55	\$0.32	4	0.87	\$0.15
Office Equipment	Laptop Computer	Baseline	-	\$0.00	4	1.00	\$0.00
Office Equipment	Laptop Computer	Energy Star	0.02	\$0.00	4	1.01	\$0.00

C&I Energy Efficiency Equipment and Measure Data

End Use	Technology	Efficiency Definition	Savings (kWh/SQ FT/yr)	Incremental Cost (\$/SQ FT)	Lifetime (Years)	BC Ratio (2015)	Levelized Cost of Energy (\$/kWh)
Office Equipment	Laptop Computer	Climate Savers	0.04	\$0.06	4	0.85	\$0.42
Office Equipment	Server	Standard	-	\$0.00	3	1.00	\$0.00
Office Equipment	Server	Energy Star	0.13	\$0.01	3	1.01	\$0.02
Office Equipment	Monitor	Standard	-	\$0.00	4	1.00	\$0.00
Office Equipment	Monitor	Energy Star	0.05	\$0.01	4	1.00	\$0.03
Office Equipment	Printer/copier/fax	Standard	-	\$0.00	6	1.00	\$0.00
Office Equipment	Printer/copier/fax	Energy Star	0.07	\$0.02	6	0.98	\$0.04
Office Equipment	POS Terminal	Standard	-	\$0.00	4	1.00	\$0.00
Office Equipment	POS Terminal	Energy Star	0.01	\$0.00	4	1.00	\$0.03
Miscellaneous	Non-HVAC Motor	Standard	-	\$0.00	15	-	\$0.00
Miscellaneous	Non-HVAC Motor	Standard (2015)	0.01	\$0.06	15	-	\$0.63
Miscellaneous	Non-HVAC Motor	High Efficiency	0.01	\$0.00	15	1.00	\$0.00
Miscellaneous	Non-HVAC Motor	High Efficiency (2015)	0.07	\$0.06	15	0.98	\$0.07
Miscellaneous	Non-HVAC Motor	Premium	-	\$0.00	0	-	\$0.00
Miscellaneous	Non-HVAC Motor	Premium (2015)	-	\$0.00	0	-	\$0.00
Miscellaneous	Other Miscellaneous	Miscellaneous	-	\$0.00	5	-	\$0.00
Miscellaneous	Other Miscellaneous	Miscellaneous (2013)	0.00	\$0.00	5	1.00	\$0.00

C&I Energy Efficiency Equipment and Measure Data

Table C-10 Energy Efficiency Equipment Data, Electric— Large Commercial, New Vintage, Idaho

End Use	Technology	Efficiency Definition	Savings (kWh/SQ FT/yr)	Incremental Cost (\$/SQ FT)	Lifetime (Years)	BC Ratio (2015)	Levelized Cost of Energy (\$/kWh)
Cooling	Central Chiller	1.5 kw/ton, COP 2.3	-	\$0.00	20	-	\$0.00
Cooling	Central Chiller	1.3 kw/ton, COP 2.7	0.26	\$0.24	20	1.10	\$0.07
Cooling	Central Chiller	1.26 kw/ton, COP 2.8	0.31	\$0.31	20	0.97	\$0.07
Cooling	Central Chiller	1.0 kw/ton, COP 3.5	0.64	\$0.38	20	1.02	\$0.04
Cooling	Central Chiller	0.97 kw/ton, COP 3.6	0.68	\$0.45	20	0.99	\$0.05
Cooling	Central Chiller	Variable Refrigerant Flow	0.89	\$7.06	20	0.21	\$0.56
Cooling	RTU	EER 9.2	-	\$0.00	16	-	\$0.00
Cooling	RTU	EER 10.1	0.21	\$0.13	16	-	\$0.05
Cooling	RTU	EER 11.2	0.41	\$0.25	16	1.00	\$0.05
Cooling	RTU	EER 12.0	0.54	\$0.41	16	0.93	\$0.06
Cooling	RTU	Ductless VRF	0.66	\$3.67	16	0.32	\$0.46
Cooling	Heat Pump	EER 9.3, COP 3.1	-	\$0.00	15	-	\$0.00
Cooling	Heat Pump	EER 10.3, COP 3.2	0.31	\$0.18	15	-	\$0.05
Cooling	Heat Pump	EER 11.0, COP 3.3	0.50	\$0.55	15	1.00	\$0.10
Cooling	Heat Pump	EER 11.7, COP 3.4	0.66	\$0.73	15	0.98	\$0.10
Cooling	Heat Pump	EER 12, COP 3.4	0.73	\$0.91	15	0.95	\$0.11
Cooling	Heat Pump	Ductless Mini-Split System	0.81	\$5.35	20	0.57	\$0.47
Space Heating	Electric Resistance	Standard	-	\$0.00	25	1.00	\$0.00
Space Heating	Furnace	Standard	-	\$0.00	18	1.00	\$0.00
Ventilation	Ventilation	Constant Volume	-	\$0.00	15	1.00	\$0.00
Ventilation	Ventilation	Variable Air Volume	1.79	\$1.22	15	1.00	\$0.06
Interior Lighting	Interior Screw-in	Incandescents	-	\$0.00	1	-	\$0.00
Interior Lighting	Interior Screw-in	Infrared Halogen	0.61	\$0.08	1	1.00	\$0.13
Interior Lighting	Interior Screw-in	CFL	2.52	\$0.03	4	5.28	\$0.00
Interior Lighting	Interior Screw-in	LED	2.78	\$1.11	12	-	\$0.04
Interior Lighting	High Bay Fixtures	Metal Halides	-	\$0.00	6	1.00	\$0.00
Interior Lighting	High Bay Fixtures	High Pressure Sodium	0.25	-\$0.08	9	2.08	-\$0.04
Interior Lighting	High Bay Fixtures	T8	0.25	-\$0.16	6	4.34	-\$0.12
Interior Lighting	High Bay Fixtures	T5	0.31	-\$0.16	6	5.16	-\$0.09
Interior Lighting	Linear Fluorescent	T12	-	\$0.00	6	1.00	\$0.00
Interior Lighting	Linear Fluorescent	T8	0.31	-\$0.03	6	1.11	-\$0.02
Interior Lighting	Linear Fluorescent	Super T8	0.93	\$0.25	6	0.92	\$0.05
Interior Lighting	Linear Fluorescent	T5	0.97	\$0.42	6	0.79	\$0.08
Interior Lighting	Linear Fluorescent	LED	1.02	\$3.67	15	-	\$0.31
Exterior Lighting	Exterior Screw-in	Incandescent	-	\$0.00	1	-	\$0.00
Exterior Lighting	Exterior Screw-in	Infrared Halogen	0.05	\$0.01	1	1.00	\$0.26
Exterior Lighting	Exterior Screw-in	CFL	0.22	\$0.01	4	6.10	\$0.01
Exterior Lighting	Exterior Screw-in	Metal Halides	0.22	\$0.02	4	3.35	\$0.02
Exterior Lighting	Exterior Screw-in	LED	0.24	\$0.19	12	-	\$0.08
Exterior	HID	Metal Halides	-	\$0.00	6	1.00	\$0.00

C&I Energy Efficiency Equipment and Measure Data

End Use	Technology	Efficiency Definition	Savings (kWh/SQ FT/yr)	Incremental Cost (\$/SQ FT)	Lifetime (Years)	BC Ratio (2015)	Levelized Cost of Energy (\$/kWh)
Lighting							
Exterior Lighting	HID	High Pressure Sodium	0.15	-\$0.11	9	2.02	-\$0.09
Exterior Lighting	HID	Low Pressure Sodium	0.16	\$0.45	9	0.58	\$0.36
Water Heating	Water Heater	Baseline (EF=0.90)	-	\$0.00	15	1.00	\$0.00
Water Heating	Water Heater	High Efficiency (EF=0.95)	0.12	\$0.02	15	1.03	\$0.02
Water Heating	Water Heater	EF 2.0	1.21	-\$0.48	15	2.79	-\$0.03
Water Heating	Water Heater	EF 2.3	1.35	-\$0.47	15	3.19	-\$0.03
Water Heating	Water Heater	EF 2.4	1.39	-\$0.47	15	3.32	-\$0.03
Water Heating	Water Heater	Geothermal Heat Pump	1.60	\$3.53	15	0.40	\$0.19
Water Heating	Water Heater	Solar	1.76	\$3.03	15	0.46	\$0.15
Food Preparation	Fryer	Standard	-	\$0.00	12	1.00	\$0.00
Food Preparation	Fryer	Efficient	0.07	\$0.02	12	1.07	\$0.03
Food Preparation	Oven	Standard	-	\$0.00	12	1.00	\$0.00
Food Preparation	Oven	Efficient	0.74	\$0.46	12	0.96	\$0.06
Food Preparation	Dishwasher	Standard	-	\$0.00	12	1.00	\$0.00
Food Preparation	Dishwasher	Efficient	0.06	\$0.10	12	0.89	\$0.16
Food Preparation	Hot Food Container	Standard	-	\$0.00	12	1.00	\$0.00
Food Preparation	Hot Food Container	Efficient	0.21	\$0.30	12	0.70	\$0.15
Food Preparation	Food Prep	Standard	-	\$0.00	12	1.00	\$0.00
Food Preparation	Food Prep	Efficient	0.01	\$0.03	12	0.88	\$0.46
Refrigeration	Walk in Refrigeration	Standard	-	\$0.00	18	1.00	\$0.00
Refrigeration	Walk in Refrigeration	Efficient	0.11	\$1.26	18	0.88	\$0.88
Refrigeration	Glass Door Display	Standard	-	\$0.00	18	1.00	\$0.00
Refrigeration	Glass Door Display	Efficient	0.13	\$0.01	18	1.26	\$0.00
Refrigeration	Reach-in Refrigerator	Standard	-	\$0.00	18	1.00	\$0.00
Refrigeration	Reach-in Refrigerator	Efficient	0.23	\$0.08	18	1.05	\$0.03
Refrigeration	Open Display Case	Standard	-	\$0.00	18	1.00	\$0.00
Refrigeration	Open Display Case	Efficient	0.00	\$0.04	18	0.88	\$0.55
Refrigeration	Vending Machine	Base	-	\$0.00	10	-	\$0.00
Refrigeration	Vending Machine	Base (2012)	0.11	\$0.00	10	1.00	\$0.00
Refrigeration	Vending Machine	High Efficiency	0.13	\$0.00	10	-	\$0.00
Refrigeration	Vending Machine	High Efficiency (2012)	0.20	\$0.00	10	1.09	\$0.00
Refrigeration	Icemaker	Standard	-	\$0.00	12	1.00	\$0.00
Refrigeration	Icemaker	Efficient	0.09	\$0.02	12	1.06	\$0.02
Office Equipment	Desktop Computer	Baseline	-	\$0.00	4	1.00	\$0.00
Office Equipment	Desktop Computer	Energy Star	0.39	\$0.00	4	1.02	\$0.00
Office Equipment	Desktop Computer	Climate Savers	0.55	\$0.32	4	0.87	\$0.15
Office Equipment	Laptop Computer	Baseline	-	\$0.00	4	1.00	\$0.00
Office Equipment	Laptop Computer	Energy Star	0.02	\$0.00	4	1.01	\$0.00

C&I Energy Efficiency Equipment and Measure Data

End Use	Technology	Efficiency Definition	Savings (kWh/SQ FT/yr)	Incremental Cost (\$/SQ FT)	Lifetime (Years)	BC Ratio (2015)	Levelized Cost of Energy (\$/kWh)
Office Equipment	Laptop Computer	Climate Savers	0.04	\$0.06	4	0.85	\$0.42
Office Equipment	Server	Standard	-	\$0.00	3	1.00	\$0.00
Office Equipment	Server	Energy Star	0.13	\$0.01	3	1.01	\$0.02
Office Equipment	Monitor	Standard	-	\$0.00	4	1.00	\$0.00
Office Equipment	Monitor	Energy Star	0.05	\$0.01	4	1.00	\$0.03
Office Equipment	Printer/copier/fax	Standard	-	\$0.00	6	1.00	\$0.00
Office Equipment	Printer/copier/fax	Energy Star	0.07	\$0.02	6	0.98	\$0.04
Office Equipment	POS Terminal	Standard	-	\$0.00	4	1.00	\$0.00
Office Equipment	POS Terminal	Energy Star	0.01	\$0.00	4	1.00	\$0.03
Miscellaneous	Non-HVAC Motor	Standard	-	\$0.00	15	-	\$0.00
Miscellaneous	Non-HVAC Motor	Standard (2015)	0.01	\$0.06	15	-	\$0.63
Miscellaneous	Non-HVAC Motor	High Efficiency	0.01	\$0.00	15	1.00	\$0.00
Miscellaneous	Non-HVAC Motor	High Efficiency (2015)	0.07	\$0.06	15	0.98	\$0.07
Miscellaneous	Non-HVAC Motor	Premium	-	\$0.00	0	-	\$0.00
Miscellaneous	Non-HVAC Motor	Premium (2015)	-	\$0.00	0	-	\$0.00
Miscellaneous	Other Miscellaneous	Miscellaneous	-	\$0.00	5	-	\$0.00
Miscellaneous	Other Miscellaneous	Miscellaneous (2013)	0.00	\$0.00	5	1.00	\$0.00

Table C-11 Energy Efficiency Equipment Data, Electric—Extra Large Commercial, Existing Vintage, Washington

End Use	Technology	Efficiency Definition	Savings (kWh/SQ FT/yr)	Incremental Cost (\$/SQ FT)	Lifetime (Years)	BC Ratio (2015)	Levelized Cost of Energy (\$/kWh)
Cooling	Central Chiller	Variable Refrigerant Flow	1.08	\$10.92	20	0.15	\$0.71
Cooling	RTU	EER 9.2	-	\$0.00	16	-	\$0.00
Cooling	RTU	EER 10.1	0.20	\$0.24	16	-	\$0.10
Cooling	RTU	EER 11.2	0.40	\$0.45	16	1.00	\$0.09
Cooling	RTU	EER 12.0	0.52	\$0.75	16	0.89	\$0.12
Cooling	RTU	Ductless VRF	0.63	\$6.64	16	0.26	\$0.87
Cooling	Heat Pump	EER 9.3, COP 3.1	-	\$0.00	15	-	\$0.00
Cooling	Heat Pump	EER 10.3, COP 3.2	0.20	\$0.24	15	-	\$0.11
Cooling	Heat Pump	EER 11.0, COP 3.3	0.31	\$0.73	15	1.00	\$0.20
Cooling	Heat Pump	EER 11.7, COP 3.4	0.42	\$0.97	15	0.97	\$0.20
Cooling	Heat Pump	EER 12, COP 3.4	0.46	\$1.21	15	0.94	\$0.23
Cooling	Heat Pump	Ductless Mini-Split System	0.51	\$7.10	20	0.54	\$0.99
Space Heating	Electric Resistance	Standard	-	\$0.00	25	1.00	\$0.00
Space Heating	Furnace	Standard	-	\$0.00	18	1.00	\$0.00
Ventilation	Ventilation	Constant Volume	-	\$0.00	15	1.00	\$0.00
Ventilation	Ventilation	Variable Air Volume	2.10	\$1.22	15	1.04	\$0.05
Interior Lighting	Interior Screw-in	Incandescents	-	\$0.00	1	-	\$0.00
Interior Lighting	Interior Screw-in	Infrared Halogen	0.79	\$0.14	1	1.00	\$0.18
Interior Lighting	Interior Screw-in	CFL	3.25	\$0.06	4	5.60	\$0.00
Interior Lighting	Interior Screw-in	LED	3.59	\$1.90	12	-	\$0.05
Interior Lighting	High Bay Fixtures	Metal Halides	-	\$0.00	6	1.00	\$0.00
Interior Lighting	High Bay Fixtures	High Pressure Sodium	0.10	-\$0.05	9	2.23	-\$0.07
Interior Lighting	High Bay Fixtures	T8	0.10	-\$0.11	6	5.65	-\$0.19
Interior Lighting	High Bay Fixtures	T5	0.13	-\$0.10	6	6.21	-\$0.15
Interior Lighting	Linear Fluorescent	T12	-	\$0.00	6	1.00	\$0.00
Interior Lighting	Linear Fluorescent	T8	0.23	-\$0.03	6	1.12	-\$0.02
Interior Lighting	Linear Fluorescent	Super T8	0.69	\$0.21	6	0.89	\$0.06
Interior Lighting	Linear Fluorescent	T5	0.71	\$0.35	6	0.75	\$0.09
Interior Lighting	Linear Fluorescent	LED	0.75	\$3.08	15	-	\$0.36
Exterior Lighting	Exterior Screw-in	Incandescent	-	\$0.00	1	-	\$0.00
Exterior Lighting	Exterior Screw-in	Infrared Halogen	0.02	\$0.00	1	1.00	\$0.22
Exterior Lighting	Exterior Screw-in	CFL	0.07	\$0.00	4	5.89	\$0.01
Exterior Lighting	Exterior Screw-in	Metal Halides	0.07	\$0.00	4	3.36	\$0.02
Exterior Lighting	Exterior Screw-in	LED	0.07	\$0.05	12	-	\$0.07
Exterior Lighting	HID	Metal Halides	-	\$0.00	6	1.00	\$0.00
Exterior Lighting	HID	High Pressure Sodium	0.19	-\$0.16	9	2.08	-\$0.10
Exterior Lighting	HID	Low Pressure Sodium	0.21	\$0.64	9	0.57	\$0.40

C&I Energy Efficiency Equipment and Measure Data

End Use	Technology	Efficiency Definition	Savings (kWh/SQ FT/yr)	Incremental Cost (\$/SQ FT)	Lifetime (Years)	BC Ratio (2015)	Levelized Cost of Energy (\$/kWh)
Water Heating	Water Heater	Baseline (EF=0.90)	-	\$0.00	15	1.00	\$0.00
Water Heating	Water Heater	High Efficiency (EF=0.95)	0.20	\$0.02	15	1.04	\$0.01
Water Heating	Water Heater	EF 2.0	1.95	-\$0.48	15	2.49	-\$0.02
Water Heating	Water Heater	EF 2.3	2.19	-\$0.47	15	2.86	-\$0.02
Water Heating	Water Heater	EF 2.4	2.26	-\$0.47	15	2.98	-\$0.02
Water Heating	Water Heater	Geothermal Heat Pump	2.59	\$3.53	15	0.56	\$0.12
Water Heating	Water Heater	Solar	2.84	\$3.03	15	0.65	\$0.09
Food Preparation	Fryer	Standard	-	\$0.00	12	1.00	\$0.00
Food Preparation	Fryer	Efficient	0.03	\$0.00	12	1.13	\$0.02
Food Preparation	Oven	Standard	-	\$0.00	12	1.00	\$0.00
Food Preparation	Oven	Efficient	0.84	\$0.38	12	1.00	\$0.05
Food Preparation	Dishwasher	Standard	-	\$0.00	12	1.00	\$0.00
Food Preparation	Dishwasher	Efficient	0.03	\$0.04	12	0.89	\$0.18
Food Preparation	Hot Food Container	Standard	-	\$0.00	12	1.00	\$0.00
Food Preparation	Hot Food Container	Efficient	0.10	\$0.22	12	0.66	\$0.22
Food Preparation	Food Prep	Standard	-	\$0.00	12	1.00	\$0.00
Food Preparation	Food Prep	Efficient	0.00	\$0.03	12	0.88	\$0.77
Refrigeration	Walk in Refrigeration	Standard	-	\$0.00	18	1.00	\$0.00
Refrigeration	Walk in Refrigeration	Efficient	0.04	\$0.05	18	0.95	\$0.08
Refrigeration	Glass Door Display	Standard	-	\$0.00	18	1.00	\$0.00
Refrigeration	Glass Door Display	Efficient	0.04	\$0.00	18	1.39	\$0.00
Refrigeration	Reach-in Refrigerator	Standard	-	\$0.00	18	1.00	\$0.00
Refrigeration	Reach-in Refrigerator	Efficient	0.21	\$0.02	18	1.19	\$0.01
Refrigeration	Open Display Case	Standard	-	\$0.00	18	1.00	\$0.00
Refrigeration	Open Display Case	Efficient	0.01	\$0.03	18	0.93	\$0.25
Refrigeration	Vending Machine	Base	-	\$0.00	10	-	\$0.00
Refrigeration	Vending Machine	Base (2012)	0.12	\$0.00	10	1.00	\$0.00
Refrigeration	Vending Machine	High Efficiency	0.14	\$0.00	10	-	\$0.00
Refrigeration	Vending Machine	High Efficiency (2012)	0.21	\$0.00	10	1.24	\$0.00
Refrigeration	Icemaker	Standard	-	\$0.00	12	1.00	\$0.00
Refrigeration	Icemaker	Efficient	0.04	\$0.00	12	1.12	\$0.01
Office Equipment	Desktop Computer	Baseline	-	\$0.00	4	1.00	\$0.00
Office Equipment	Desktop Computer	Energy Star	0.28	\$0.00	4	1.02	\$0.00
Office Equipment	Desktop Computer	Climate Savers	0.39	\$0.33	4	0.86	\$0.22
Office Equipment	Laptop Computer	Baseline	-	\$0.00	4	1.00	\$0.00
Office Equipment	Laptop Computer	Energy Star	0.03	\$0.00	4	1.00	\$0.01
Office Equipment	Laptop Computer	Climate Savers	0.04	\$0.10	4	0.84	\$0.61
Office Equipment	Server	Standard	-	\$0.00	3	1.00	\$0.00
Office	Server	Energy Star	0.05	\$0.00	3	1.00	\$0.03

C&I Energy Efficiency Equipment and Measure Data

End Use	Technology	Efficiency Definition	Savings (kWh/SQ FT/yr)	Incremental Cost (\$/SQ FT)	Lifetime (Years)	BC Ratio (2015)	Levelized Cost of Energy (\$/kWh)
Equipment							
Office Equipment	Monitor	Standard	-	\$0.00	4	1.00	\$0.00
Office Equipment	Monitor	Energy Star	0.03	\$0.01	4	0.99	\$0.04
Office Equipment	Printer/copier/fax	Standard	-	\$0.00	6	1.00	\$0.00
Office Equipment	Printer/copier/fax	Energy Star	0.02	\$0.01	6	0.96	\$0.06
Office Equipment	POS Terminal	Standard	-	\$0.00	4	1.00	\$0.00
Office Equipment	POS Terminal	Energy Star	0.00	\$0.00	4	0.99	\$0.05
Miscellaneous	Non-HVAC Motor	Standard	-	\$0.00	15	-	\$0.00
Miscellaneous	Non-HVAC Motor	Standard (2015)	0.00	\$0.06	15	-	\$1.06
Miscellaneous	Non-HVAC Motor	High Efficiency	0.01	\$0.00	15	1.00	\$0.00
Miscellaneous	Non-HVAC Motor	High Efficiency (2015)	0.04	\$0.06	15	0.97	\$0.12
Miscellaneous	Non-HVAC Motor	Premium	-	\$0.00	0	-	\$0.00
Miscellaneous	Non-HVAC Motor	Premium (2015)	-	\$0.00	0	-	\$0.00
Miscellaneous	Other Miscellaneous	Miscellaneous	-	\$0.00	5	-	\$0.00
Miscellaneous	Other Miscellaneous	Miscellaneous (2013)	0.00	\$0.00	5	1.00	\$0.00

C&I Energy Efficiency Equipment and Measure Data

Table C-12 Energy Efficiency Equipment Data, Electric— Extra Large Commercial, New Vintage, Washington

End Use	Technology	Efficiency Definition	Savings (kWh/SQ FT/yr)	Incremental Cost (\$/SQ FT)	Lifetime (Years)	BC Ratio (2015)	Levelized Cost of Energy (\$/kWh)
Cooling	Central Chiller	Variable Refrigerant Flow	1.01	\$10.92	20	0.15	\$0.77
Cooling	RTU	EER 9.2	-	\$0.00	16	-	\$0.00
Cooling	RTU	EER 10.1	0.19	\$0.24	16	-	\$0.10
Cooling	RTU	EER 11.2	0.38	\$0.44	16	1.00	\$0.10
Cooling	RTU	EER 12.0	0.49	\$0.73	16	0.89	\$0.12
Cooling	RTU	Ductless VRF	0.60	\$6.51	16	0.26	\$0.90
Cooling	Heat Pump	EER 9.3, COP 3.1	-	\$0.00	15	-	\$0.00
Cooling	Heat Pump	EER 10.3, COP 3.2	0.17	\$0.24	15	-	\$0.12
Cooling	Heat Pump	EER 11.0, COP 3.3	0.28	\$0.73	15	1.00	\$0.23
Cooling	Heat Pump	EER 11.7, COP 3.4	0.37	\$0.97	15	0.97	\$0.23
Cooling	Heat Pump	EER 12, COP 3.4	0.41	\$1.21	15	0.94	\$0.26
Cooling	Heat Pump	Ductless Mini-Split System	0.45	\$7.10	20	0.54	\$1.12
Space Heating	Electric Resistance	Standard	-	\$0.00	25	1.00	\$0.00
Space Heating	Furnace	Standard	-	\$0.00	18	1.00	\$0.00
Ventilation	Ventilation	Constant Volume	-	\$0.00	15	1.00	\$0.00
Ventilation	Ventilation	Variable Air Volume	2.23	\$1.22	15	1.06	\$0.05
Interior Lighting	Interior Screw-in	Incandescents	-	\$0.00	1	-	\$0.00
Interior Lighting	Interior Screw-in	Infrared Halogen	0.87	\$0.14	1	1.00	\$0.16
Interior Lighting	Interior Screw-in	CFL	3.61	\$0.06	4	5.48	\$0.00
Interior Lighting	Interior Screw-in	LED	3.99	\$1.90	12	-	\$0.05
Interior Lighting	High Bay Fixtures	Metal Halides	-	\$0.00	6	1.00	\$0.00
Interior Lighting	High Bay Fixtures	High Pressure Sodium	0.10	-\$0.05	9	2.23	-\$0.07
Interior Lighting	High Bay Fixtures	T8	0.10	-\$0.11	6	5.65	-\$0.19
Interior Lighting	High Bay Fixtures	T5	0.13	-\$0.10	6	6.21	-\$0.15
Interior Lighting	Linear Fluorescent	T12	-	\$0.00	6	1.00	\$0.00
Interior Lighting	Linear Fluorescent	T8	0.22	-\$0.03	6	1.12	-\$0.02
Interior Lighting	Linear Fluorescent	Super T8	0.66	\$0.21	6	0.88	\$0.06
Interior Lighting	Linear Fluorescent	T5	0.68	\$0.35	6	0.74	\$0.09
Interior Lighting	Linear Fluorescent	LED	0.72	\$3.08	15	-	\$0.37
Exterior Lighting	Exterior Screw-in	Incandescent	-	\$0.00	1	-	\$0.00
Exterior Lighting	Exterior Screw-in	Infrared Halogen	0.01	\$0.00	1	1.00	\$0.38
Exterior Lighting	Exterior Screw-in	CFL	0.04	\$0.00	4	6.57	\$0.01
Exterior Lighting	Exterior Screw-in	Metal Halides	0.04	\$0.00	4	3.32	\$0.03
Exterior Lighting	Exterior Screw-in	LED	0.04	\$0.05	12	-	\$0.12
Exterior Lighting	HID	Metal Halides	-	\$0.00	6	1.00	\$0.00
Exterior Lighting	HID	High Pressure Sodium	0.19	-\$0.16	9	2.08	-\$0.10
Exterior Lighting	HID	Low Pressure Sodium	0.21	\$0.64	9	0.57	\$0.40

C&I Energy Efficiency Equipment and Measure Data

End Use	Technology	Efficiency Definition	Savings (kWh/SQ FT/yr)	Incremental Cost (\$/SQ FT)	Lifetime (Years)	BC Ratio (2015)	Levelized Cost of Energy (\$/kWh)
Water Heating	Water Heater	Baseline (EF=0.90)	-	\$0.00	15	1.00	\$0.00
Water Heating	Water Heater	High Efficiency (EF=0.95)	0.20	\$0.02	15	1.04	\$0.01
Water Heating	Water Heater	EF 2.0	1.98	-\$0.48	15	2.49	-\$0.02
Water Heating	Water Heater	EF 2.3	2.22	-\$0.47	15	2.85	-\$0.02
Water Heating	Water Heater	EF 2.4	2.29	-\$0.47	15	2.97	-\$0.02
Water Heating	Water Heater	Geothermal Heat Pump	2.62	\$3.53	15	0.57	\$0.12
Water Heating	Water Heater	Solar	2.88	\$3.03	15	0.66	\$0.09
Food Preparation	Fryer	Standard	-	\$0.00	12	1.00	\$0.00
Food Preparation	Fryer	Efficient	0.03	\$0.00	12	1.13	\$0.02
Food Preparation	Oven	Standard	-	\$0.00	12	1.00	\$0.00
Food Preparation	Oven	Efficient	0.84	\$0.38	12	1.00	\$0.05
Food Preparation	Dishwasher	Standard	-	\$0.00	12	1.00	\$0.00
Food Preparation	Dishwasher	Efficient	0.03	\$0.04	12	0.89	\$0.18
Food Preparation	Hot Food Container	Standard	-	\$0.00	12	1.00	\$0.00
Food Preparation	Hot Food Container	Efficient	0.10	\$0.22	12	0.66	\$0.22
Food Preparation	Food Prep	Standard	-	\$0.00	12	1.00	\$0.00
Food Preparation	Food Prep	Efficient	0.00	\$0.03	12	0.88	\$0.62
Refrigeration	Walk in Refrigeration	Standard	-	\$0.00	18	1.00	\$0.00
Refrigeration	Walk in Refrigeration	Efficient	0.04	\$0.05	18	0.95	\$0.08
Refrigeration	Glass Door Display	Standard	-	\$0.00	18	1.00	\$0.00
Refrigeration	Glass Door Display	Efficient	0.04	\$0.00	18	1.39	\$0.00
Refrigeration	Reach-in Refrigerator	Standard	-	\$0.00	18	1.00	\$0.00
Refrigeration	Reach-in Refrigerator	Efficient	0.21	\$0.02	18	1.20	\$0.01
Refrigeration	Open Display Case	Standard	-	\$0.00	18	1.00	\$0.00
Refrigeration	Open Display Case	Efficient	0.01	\$0.03	18	0.93	\$0.25
Refrigeration	Vending Machine	Base	-	\$0.00	10	-	\$0.00
Refrigeration	Vending Machine	Base (2012)	0.10	\$0.00	10	1.00	\$0.00
Refrigeration	Vending Machine	High Efficiency	0.12	\$0.00	10	-	\$0.00
Refrigeration	Vending Machine	High Efficiency (2012)	0.18	\$0.00	10	1.21	\$0.00
Refrigeration	Icemaker	Standard	-	\$0.00	12	1.00	\$0.00
Refrigeration	Icemaker	Efficient	0.04	\$0.00	12	1.12	\$0.01
Office Equipment	Desktop Computer	Baseline	-	\$0.00	4	1.00	\$0.00
Office Equipment	Desktop Computer	Energy Star	0.28	\$0.00	4	1.02	\$0.00
Office Equipment	Desktop Computer	Climate Savers	0.39	\$0.33	4	0.86	\$0.22
Office Equipment	Laptop Computer	Baseline	-	\$0.00	4	1.00	\$0.00
Office Equipment	Laptop Computer	Energy Star	0.03	\$0.00	4	1.00	\$0.01
Office Equipment	Laptop Computer	Climate Savers	0.04	\$0.10	4	0.84	\$0.61
Office Equipment	Server	Standard	-	\$0.00	3	1.00	\$0.00
Office	Server	Energy Star	0.05	\$0.00	3	1.00	\$0.03

C&I Energy Efficiency Equipment and Measure Data

End Use	Technology	Efficiency Definition	Savings (kWh/SQ FT/yr)	Incremental Cost (\$/SQ FT)	Lifetime (Years)	BC Ratio (2015)	Levelized Cost of Energy (\$/kWh)
Equipment							
Office Equipment	Monitor	Standard	-	\$0.00	4	1.00	\$0.00
Office Equipment	Monitor	Energy Star	0.03	\$0.01	4	0.99	\$0.04
Office Equipment	Printer/copier/fax	Standard	-	\$0.00	6	1.00	\$0.00
Office Equipment	Printer/copier/fax	Energy Star	0.02	\$0.01	6	0.96	\$0.06
Office Equipment	POS Terminal	Standard	-	\$0.00	4	1.00	\$0.00
Office Equipment	POS Terminal	Energy Star	0.00	\$0.00	4	0.99	\$0.05
Miscellaneous	Non-HVAC Motor	Standard	-	\$0.00	15	-	\$0.00
Miscellaneous	Non-HVAC Motor	Standard (2015)	0.00	\$0.06	15	-	\$1.06
Miscellaneous	Non-HVAC Motor	High Efficiency	0.01	\$0.00	15	1.00	\$0.00
Miscellaneous	Non-HVAC Motor	High Efficiency (2015)	0.04	\$0.06	15	0.97	\$0.12
Miscellaneous	Non-HVAC Motor	Premium	-	\$0.00	0	-	\$0.00
Miscellaneous	Non-HVAC Motor	Premium (2015)	-	\$0.00	0	-	\$0.00
Miscellaneous	Other Miscellaneous	Miscellaneous	-	\$0.00	5	-	\$0.00
Miscellaneous	Other Miscellaneous	Miscellaneous (2013)	0.00	\$0.00	5	1.00	\$0.00

C&I Energy Efficiency Equipment and Measure Data

Table C-13 Energy Efficiency Equipment Data, Electric—Extra Large Commercial, Existing Vintage, Idaho

End Use	Technology	Efficiency Definition	Savings (kWh/SQ FT/yr)	Incremental Cost (\$/SQ FT)	Lifetime (Years)	BC Ratio (2015)	Levelized Cost of Energy (\$/kWh)
Cooling	Central Chiller	Variable Refrigerant Flow	1.08	\$10.92	20	0.16	\$0.71
Cooling	RTU	EER 9.2	-	\$0.00	16	-	\$0.00
Cooling	RTU	EER 10.1	0.20	\$0.24	16	-	\$0.10
Cooling	RTU	EER 11.2	0.40	\$0.45	16	1.00	\$0.09
Cooling	RTU	EER 12.0	0.52	\$0.75	16	0.89	\$0.12
Cooling	RTU	Ductless VRF	0.63	\$6.64	16	0.26	\$0.87
Cooling	Heat Pump	EER 9.3, COP 3.1	-	\$0.00	15	-	\$0.00
Cooling	Heat Pump	EER 10.3, COP 3.2	0.20	\$0.24	15	-	\$0.11
Cooling	Heat Pump	EER 11.0, COP 3.3	0.31	\$0.73	15	1.00	\$0.20
Cooling	Heat Pump	EER 11.7, COP 3.4	0.42	\$0.97	15	0.97	\$0.20
Cooling	Heat Pump	EER 12, COP 3.4	0.46	\$1.21	15	0.94	\$0.23
Cooling	Heat Pump	Ductless Mini-Split System	0.51	\$7.10	20	0.53	\$0.99
Space Heating	Electric Resistance	Standard	-	\$0.00	25	1.00	\$0.00
Space Heating	Furnace	Standard	-	\$0.00	18	1.00	\$0.00
Ventilation	Ventilation	Constant Volume	-	\$0.00	15	1.00	\$0.00
Ventilation	Ventilation	Variable Air Volume	2.10	\$1.22	15	1.02	\$0.05
Interior Lighting	Interior Screw-in	Incandescents	-	\$0.00	1	-	\$0.00
Interior Lighting	Interior Screw-in	Infrared Halogen	0.79	\$0.14	1	1.00	\$0.18
Interior Lighting	Interior Screw-in	CFL	3.25	\$0.06	4	5.61	\$0.00
Interior Lighting	Interior Screw-in	LED	3.59	\$1.90	12	-	\$0.05
Interior Lighting	High Bay Fixtures	Metal Halides	-	\$0.00	6	1.00	\$0.00
Interior Lighting	High Bay Fixtures	High Pressure Sodium	0.10	-\$0.05	9	2.26	-\$0.07
Interior Lighting	High Bay Fixtures	T8	0.10	-\$0.11	6	5.77	-\$0.19
Interior Lighting	High Bay Fixtures	T5	0.13	-\$0.10	6	6.31	-\$0.15
Interior Lighting	Linear Fluorescent	T12	-	\$0.00	6	1.00	\$0.00
Interior Lighting	Linear Fluorescent	T8	0.23	-\$0.03	6	1.12	-\$0.02
Interior Lighting	Linear Fluorescent	Super T8	0.69	\$0.21	6	0.88	\$0.06
Interior Lighting	Linear Fluorescent	T5	0.71	\$0.35	6	0.74	\$0.09
Interior Lighting	Linear Fluorescent	LED	0.75	\$3.08	15	-	\$0.36
Exterior Lighting	Exterior Screw-in	Incandescent	-	\$0.00	1	-	\$0.00
Exterior Lighting	Exterior Screw-in	Infrared Halogen	0.02	\$0.00	1	1.00	\$0.22
Exterior Lighting	Exterior Screw-in	CFL	0.07	\$0.00	4	5.90	\$0.01
Exterior Lighting	Exterior Screw-in	Metal Halides	0.07	\$0.00	4	3.36	\$0.02
Exterior Lighting	Exterior Screw-in	LED	0.07	\$0.05	12	-	\$0.07
Exterior Lighting	HID	Metal Halides	-	\$0.00	6	1.00	\$0.00
Exterior Lighting	HID	High Pressure Sodium	0.19	-\$0.16	9	2.09	-\$0.10
Exterior Lighting	HID	Low Pressure Sodium	0.21	\$0.64	9	0.57	\$0.40

C&I Energy Efficiency Equipment and Measure Data

End Use	Technology	Efficiency Definition	Savings (kWh/SQ FT/yr)	Incremental Cost (\$/SQ FT)	Lifetime (Years)	BC Ratio (2015)	Levelized Cost of Energy (\$/kWh)
Water Heating	Water Heater	Baseline (EF=0.90)	-	\$0.00	15	1.00	\$0.00
Water Heating	Water Heater	High Efficiency (EF=0.95)	0.20	\$0.02	15	1.03	\$0.01
Water Heating	Water Heater	EF 2.0	1.95	-\$0.48	15	2.55	-\$0.02
Water Heating	Water Heater	EF 2.3	2.19	-\$0.47	15	2.92	-\$0.02
Water Heating	Water Heater	EF 2.4	2.26	-\$0.47	15	3.04	-\$0.02
Water Heating	Water Heater	Geothermal Heat Pump	2.59	\$3.53	15	0.52	\$0.12
Water Heating	Water Heater	Solar	2.84	\$3.03	15	0.60	\$0.09
Food Preparation	Fryer	Standard	-	\$0.00	12	1.00	\$0.00
Food Preparation	Fryer	Efficient	0.03	\$0.00	12	1.11	\$0.02
Food Preparation	Oven	Standard	-	\$0.00	12	1.00	\$0.00
Food Preparation	Oven	Efficient	0.84	\$0.38	12	0.99	\$0.05
Food Preparation	Dishwasher	Standard	-	\$0.00	12	1.00	\$0.00
Food Preparation	Dishwasher	Efficient	0.03	\$0.04	12	0.88	\$0.18
Food Preparation	Hot Food Container	Standard	-	\$0.00	12	1.00	\$0.00
Food Preparation	Hot Food Container	Efficient	0.10	\$0.22	12	0.65	\$0.22
Food Preparation	Food Prep	Standard	-	\$0.00	12	1.00	\$0.00
Food Preparation	Food Prep	Efficient	0.00	\$0.03	12	0.88	\$0.77
Refrigeration	Walk in Refrigeration	Standard	-	\$0.00	18	1.00	\$0.00
Refrigeration	Walk in Refrigeration	Efficient	0.04	\$0.05	18	0.95	\$0.08
Refrigeration	Glass Door Display	Standard	-	\$0.00	18	1.00	\$0.00
Refrigeration	Glass Door Display	Efficient	0.04	\$0.00	18	1.39	\$0.00
Refrigeration	Reach-in Refrigerator	Standard	-	\$0.00	18	1.00	\$0.00
Refrigeration	Reach-in Refrigerator	Efficient	0.21	\$0.02	18	1.18	\$0.01
Refrigeration	Open Display Case	Standard	-	\$0.00	18	1.00	\$0.00
Refrigeration	Open Display Case	Efficient	0.01	\$0.03	18	0.93	\$0.25
Refrigeration	Vending Machine	Base	-	\$0.00	10	-	\$0.00
Refrigeration	Vending Machine	Base (2012)	0.12	\$0.00	10	1.00	\$0.00
Refrigeration	Vending Machine	High Efficiency	0.14	\$0.00	10	-	\$0.00
Refrigeration	Vending Machine	High Efficiency (2012)	0.21	\$0.00	10	1.23	\$0.00
Refrigeration	Icemaker	Standard	-	\$0.00	12	1.00	\$0.00
Refrigeration	Icemaker	Efficient	0.04	\$0.00	12	1.12	\$0.01
Office Equipment	Desktop Computer	Baseline	-	\$0.00	4	1.00	\$0.00
Office Equipment	Desktop Computer	Energy Star	0.28	\$0.00	4	1.02	\$0.00
Office Equipment	Desktop Computer	Climate Savers	0.39	\$0.33	4	0.86	\$0.22
Office Equipment	Laptop Computer	Baseline	-	\$0.00	4	1.00	\$0.00
Office Equipment	Laptop Computer	Energy Star	0.03	\$0.00	4	1.00	\$0.01
Office Equipment	Laptop Computer	Climate Savers	0.04	\$0.10	4	0.84	\$0.61
Office Equipment	Server	Standard	-	\$0.00	3	1.00	\$0.00
Office	Server	Energy Star	0.05	\$0.00	3	1.00	\$0.03

C&I Energy Efficiency Equipment and Measure Data

End Use	Technology	Efficiency Definition	Savings (kWh/SQ FT/yr)	Incremental Cost (\$/SQ FT)	Lifetime (Years)	BC Ratio (2015)	Levelized Cost of Energy (\$/kWh)
Equipment							
Office Equipment	Monitor	Standard	-	\$0.00	4	1.00	\$0.00
Office Equipment	Monitor	Energy Star	0.03	\$0.01	4	0.99	\$0.04
Office Equipment	Printer/copier/fax	Standard	-	\$0.00	6	1.00	\$0.00
Office Equipment	Printer/copier/fax	Energy Star	0.02	\$0.01	6	0.96	\$0.06
Office Equipment	POS Terminal	Standard	-	\$0.00	4	1.00	\$0.00
Office Equipment	POS Terminal	Energy Star	0.00	\$0.00	4	0.99	\$0.05
Miscellaneous	Non-HVAC Motor	Standard	-	\$0.00	15	-	\$0.00
Miscellaneous	Non-HVAC Motor	Standard (2015)	0.00	\$0.06	15	-	\$1.06
Miscellaneous	Non-HVAC Motor	High Efficiency	0.01	\$0.00	15	1.00	\$0.00
Miscellaneous	Non-HVAC Motor	High Efficiency (2015)	0.04	\$0.06	15	0.97	\$0.12
Miscellaneous	Non-HVAC Motor	Premium	-	\$0.00	0	-	\$0.00
Miscellaneous	Non-HVAC Motor	Premium (2015)	-	\$0.00	0	-	\$0.00
Miscellaneous	Other Miscellaneous	Miscellaneous	-	\$0.00	5	-	\$0.00
Miscellaneous	Other Miscellaneous	Miscellaneous (2013)	0.00	\$0.00	5	1.00	\$0.00

C&I Energy Efficiency Equipment and Measure Data

Table C-14 Energy Efficiency Equipment Data, Electric— Extra Large Commercial, New Vintage, Idaho

End Use	Technology	Efficiency Definition	Savings (kWh/SQ FT/yr)	Incremental Cost (\$/SQ FT)	Lifetime (Years)	BC Ratio (2015)	Levelized Cost of Energy (\$/kWh)
Cooling	Central Chiller	Variable Refrigerant Flow	1.01	\$10.92	20	0.15	\$0.77
Cooling	RTU	EER 9.2	-	\$0.00	16	-	\$0.00
Cooling	RTU	EER 10.1	0.19	\$0.24	16	-	\$0.10
Cooling	RTU	EER 11.2	0.38	\$0.44	16	1.00	\$0.10
Cooling	RTU	EER 12.0	0.49	\$0.73	16	0.89	\$0.12
Cooling	RTU	Ductless VRF	0.60	\$6.51	16	0.26	\$0.90
Cooling	Heat Pump	EER 9.3, COP 3.1	-	\$0.00	15	-	\$0.00
Cooling	Heat Pump	EER 10.3, COP 3.2	0.17	\$0.24	15	-	\$0.12
Cooling	Heat Pump	EER 11.0, COP 3.3	0.28	\$0.73	15	1.00	\$0.23
Cooling	Heat Pump	EER 11.7, COP 3.4	0.37	\$0.97	15	0.97	\$0.23
Cooling	Heat Pump	EER 12, COP 3.4	0.41	\$1.21	15	0.94	\$0.26
Cooling	Heat Pump	Ductless Mini-Split System	0.45	\$7.10	20	0.53	\$1.12
Space Heating	Electric Resistance	Standard	-	\$0.00	25	1.00	\$0.00
Space Heating	Furnace	Standard	-	\$0.00	18	1.00	\$0.00
Ventilation	Ventilation	Constant Volume	-	\$0.00	15	1.00	\$0.00
Ventilation	Ventilation	Variable Air Volume	2.23	\$1.22	15	1.05	\$0.05
Interior Lighting	Interior Screw-in	Incandescents	-	\$0.00	1	-	\$0.00
Interior Lighting	Interior Screw-in	Infrared Halogen	0.87	\$0.14	1	1.00	\$0.16
Interior Lighting	Interior Screw-in	CFL	3.61	\$0.06	4	5.48	\$0.00
Interior Lighting	Interior Screw-in	LED	3.99	\$1.90	12	-	\$0.05
Interior Lighting	High Bay Fixtures	Metal Halides	-	\$0.00	6	1.00	\$0.00
Interior Lighting	High Bay Fixtures	High Pressure Sodium	0.10	-\$0.05	9	2.26	-\$0.07
Interior Lighting	High Bay Fixtures	T8	0.10	-\$0.11	6	5.77	-\$0.19
Interior Lighting	High Bay Fixtures	T5	0.13	-\$0.10	6	6.31	-\$0.15
Interior Lighting	Linear Fluorescent	T12	-	\$0.00	6	1.00	\$0.00
Interior Lighting	Linear Fluorescent	T8	0.22	-\$0.03	6	1.12	-\$0.02
Interior Lighting	Linear Fluorescent	Super T8	0.66	\$0.21	6	0.87	\$0.06
Interior Lighting	Linear Fluorescent	T5	0.68	\$0.35	6	0.73	\$0.09
Interior Lighting	Linear Fluorescent	LED	0.72	\$3.08	15	-	\$0.37
Exterior Lighting	Exterior Screw-in	Incandescent	-	\$0.00	1	-	\$0.00
Exterior Lighting	Exterior Screw-in	Infrared Halogen	0.01	\$0.00	1	1.00	\$0.38
Exterior Lighting	Exterior Screw-in	CFL	0.04	\$0.00	4	6.58	\$0.01
Exterior Lighting	Exterior Screw-in	Metal Halides	0.04	\$0.00	4	3.32	\$0.03
Exterior Lighting	Exterior Screw-in	LED	0.04	\$0.05	12	-	\$0.12
Exterior Lighting	HID	Metal Halides	-	\$0.00	6	1.00	\$0.00
Exterior Lighting	HID	High Pressure Sodium	0.19	-\$0.16	9	2.09	-\$0.10
Exterior Lighting	HID	Low Pressure Sodium	0.21	\$0.64	9	0.57	\$0.40

C&I Energy Efficiency Equipment and Measure Data

End Use	Technology	Efficiency Definition	Savings (kWh/SQ FT/yr)	Incremental Cost (\$/SQ FT)	Lifetime (Years)	BC Ratio (2015)	Levelized Cost of Energy (\$/kWh)
Water Heating	Water Heater	Baseline (EF=0.90)	-	\$0.00	15	1.00	\$0.00
Water Heating	Water Heater	High Efficiency (EF=0.95)	0.20	\$0.02	15	1.03	\$0.01
Water Heating	Water Heater	EF 2.0	1.98	-\$0.48	15	2.54	-\$0.02
Water Heating	Water Heater	EF 2.3	2.22	-\$0.47	15	2.92	-\$0.02
Water Heating	Water Heater	EF 2.4	2.29	-\$0.47	15	3.04	-\$0.02
Water Heating	Water Heater	Geothermal Heat Pump	2.62	\$3.53	15	0.52	\$0.12
Water Heating	Water Heater	Solar	2.88	\$3.03	15	0.60	\$0.09
Food Preparation	Fryer	Standard	-	\$0.00	12	1.00	\$0.00
Food Preparation	Fryer	Efficient	0.03	\$0.00	12	1.11	\$0.02
Food Preparation	Oven	Standard	-	\$0.00	12	1.00	\$0.00
Food Preparation	Oven	Efficient	0.84	\$0.38	12	0.99	\$0.05
Food Preparation	Dishwasher	Standard	-	\$0.00	12	1.00	\$0.00
Food Preparation	Dishwasher	Efficient	0.03	\$0.04	12	0.88	\$0.18
Food Preparation	Hot Food Container	Standard	-	\$0.00	12	1.00	\$0.00
Food Preparation	Hot Food Container	Efficient	0.10	\$0.22	12	0.65	\$0.22
Food Preparation	Food Prep	Standard	-	\$0.00	12	1.00	\$0.00
Food Preparation	Food Prep	Efficient	0.00	\$0.03	12	0.88	\$0.62
Refrigeration	Walk in Refrigeration	Standard	-	\$0.00	18	1.00	\$0.00
Refrigeration	Walk in Refrigeration	Efficient	0.04	\$0.05	18	0.95	\$0.08
Refrigeration	Glass Door Display	Standard	-	\$0.00	18	1.00	\$0.00
Refrigeration	Glass Door Display	Efficient	0.04	\$0.00	18	1.39	\$0.00
Refrigeration	Reach-in Refrigerator	Standard	-	\$0.00	18	1.00	\$0.00
Refrigeration	Reach-in Refrigerator	Efficient	0.21	\$0.02	18	1.19	\$0.01
Refrigeration	Open Display Case	Standard	-	\$0.00	18	1.00	\$0.00
Refrigeration	Open Display Case	Efficient	0.01	\$0.03	18	0.93	\$0.25
Refrigeration	Vending Machine	Base	-	\$0.00	10	-	\$0.00
Refrigeration	Vending Machine	Base (2012)	0.10	\$0.00	10	1.00	\$0.00
Refrigeration	Vending Machine	High Efficiency	0.12	\$0.00	10	-	\$0.00
Refrigeration	Vending Machine	High Efficiency (2012)	0.18	\$0.00	10	1.20	\$0.00
Refrigeration	Icemaker	Standard	-	\$0.00	12	1.00	\$0.00
Refrigeration	Icemaker	Efficient	0.04	\$0.00	12	1.12	\$0.01
Office Equipment	Desktop Computer	Baseline	-	\$0.00	4	1.00	\$0.00
Office Equipment	Desktop Computer	Energy Star	0.28	\$0.00	4	1.02	\$0.00
Office Equipment	Desktop Computer	Climate Savers	0.39	\$0.33	4	0.86	\$0.22
Office Equipment	Laptop Computer	Baseline	-	\$0.00	4	1.00	\$0.00
Office Equipment	Laptop Computer	Energy Star	0.03	\$0.00	4	1.00	\$0.01
Office Equipment	Laptop Computer	Climate Savers	0.04	\$0.10	4	0.84	\$0.61
Office Equipment	Server	Standard	-	\$0.00	3	1.00	\$0.00
Office	Server	Energy Star	0.05	\$0.00	3	1.00	\$0.03

C&I Energy Efficiency Equipment and Measure Data

End Use	Technology	Efficiency Definition	Savings (kWh/SQ FT/yr)	Incremental Cost (\$/SQ FT)	Lifetime (Years)	BC Ratio (2015)	Levelized Cost of Energy (\$/kWh)
Equipment							
Office Equipment	Monitor	Standard	-	\$0.00	4	1.00	\$0.00
Office Equipment	Monitor	Energy Star	0.03	\$0.01	4	0.99	\$0.04
Office Equipment	Printer/copier/fax	Standard	-	\$0.00	6	1.00	\$0.00
Office Equipment	Printer/copier/fax	Energy Star	0.02	\$0.01	6	0.96	\$0.06
Office Equipment	POS Terminal	Standard	-	\$0.00	4	1.00	\$0.00
Office Equipment	POS Terminal	Energy Star	0.00	\$0.00	4	0.99	\$0.05
Miscellaneous	Non-HVAC Motor	Standard	-	\$0.00	15	-	\$0.00
Miscellaneous	Non-HVAC Motor	Standard (2015)	0.00	\$0.06	15	-	\$1.06
Miscellaneous	Non-HVAC Motor	High Efficiency	0.01	\$0.00	15	1.00	\$0.00
Miscellaneous	Non-HVAC Motor	High Efficiency (2015)	0.04	\$0.06	15	0.97	\$0.12
Miscellaneous	Non-HVAC Motor	Premium	-	\$0.00	0	-	\$0.00
Miscellaneous	Non-HVAC Motor	Premium (2015)	-	\$0.00	0	-	\$0.00
Miscellaneous	Other Miscellaneous	Miscellaneous	-	\$0.00	5	-	\$0.00
Miscellaneous	Other Miscellaneous	Miscellaneous (2013)	0.00	\$0.00	5	1.00	\$0.00

C&I Energy Efficiency Equipment and Measure Data

Table C-15 Energy Efficiency Equipment Data, Electric—Extra Large Industrial, Existing Vintage, Washington

End Use	Technology	Efficiency Definition	Savings (kWh/SQ FT/yr)	Incremental Cost (\$/SQ FT)	Lifetime (Years)	BC Ratio (2015)	Levelized Cost of Energy (\$/kWh)
Cooling	Central Chiller	0.75 kw/ton, COP 4.7	-	\$0.00	20	-	\$0.00
Cooling	Central Chiller	0.60 kw/ton, COP 5.9	1.69	\$0.33	20	1.10	\$0.01
Cooling	Central Chiller	0.58 kw/ton, COP 6.1	1.91	\$0.66	20	0.97	\$0.02
Cooling	Central Chiller	0.55 kw/Ton, COP 6.4	2.25	\$0.93	20	0.95	\$0.03
Cooling	Central Chiller	0.51 kw/ton, COP 6.9	2.70	\$1.59	20	0.90	\$0.04
Cooling	Central Chiller	0.50 kw/Ton, COP 7.0	2.81	\$1.92	20	0.87	\$0.05
Cooling	Central Chiller	0.48 kw/ton, COP 7.3	3.04	\$2.25	20	0.84	\$0.05
Cooling	Central Chiller	Variable Refrigerant Flow	3.92	\$39.62	20	0.15	\$0.72
Cooling	RTU	EER 9.2	-	\$0.00	16	-	\$0.00
Cooling	RTU	EER 10.1	0.56	\$0.39	16	-	\$0.06
Cooling	RTU	EER 11.2	1.12	\$0.73	16	1.00	\$0.05
Cooling	RTU	EER 12.0	1.47	\$1.22	16	0.92	\$0.07
Cooling	RTU	Ductless VRF	1.79	\$10.83	16	0.31	\$0.50
Cooling	Heat Pump	EER 9.3, COP 3.1	-	\$0.00	15	-	\$0.00
Cooling	Heat Pump	EER 10.3, COP 3.2	0.41	\$0.92	15	-	\$0.19
Cooling	Heat Pump	EER 11.0, COP 3.3	0.65	\$2.75	15	1.00	\$0.36
Cooling	Heat Pump	EER 11.7, COP 3.4	0.87	\$3.66	15	0.95	\$0.36
Cooling	Heat Pump	EER 12, COP 3.4	0.95	\$4.58	15	0.90	\$0.42
Cooling	Heat Pump	Ductless Mini-Split System	1.06	\$26.86	20	0.45	\$1.80
Space Heating	Electric Resistance	Standard	-	\$0.00	25	1.00	\$0.00
Space Heating	Furnace	Standard	-	\$0.00	18	1.00	\$0.00
Space Heating	Heat Pump	EER 9.3, COP 3.1	-	\$0.00	15	-	\$0.00
Space Heating	Heat Pump	EER 10.3, COP 3.2	0.13	\$0.92	15	-	\$0.61
Space Heating	Heat Pump	EER 11.0, COP 3.3	0.25	\$2.75	15	1.00	\$0.95
Space Heating	Heat Pump	EER 11.7, COP 3.4	0.37	\$3.66	15	0.95	\$0.87
Space Heating	Heat Pump	EER 12, COP 3.4	0.47	\$4.58	15	0.90	\$0.84
Space Heating	Heat Pump	Ductless Mini-Split System	1.04	\$26.86	20	0.45	\$1.83
Space Heating	Heat Pump	EER 9.3, COP 3.1	-	\$0.00	15	-	\$0.00
Space Heating	Heat Pump	EER 10.3, COP 3.2	0.13	\$0.92	15	-	\$0.61
Space Heating	Heat Pump	EER 11.0, COP 3.3	0.25	\$2.75	15	1.00	\$0.95
Space Heating	Heat Pump	EER 11.7, COP 3.4	0.37	\$3.66	15	0.95	\$0.87
Space Heating	Heat Pump	EER 12, COP 3.4	0.47	\$4.58	15	0.90	\$0.84
Space Heating	Heat Pump	Ductless Mini-Split System	1.04	\$26.86	20	0.45	\$1.83
Ventilation	Ventilation	Constant Volume	-	\$0.00	15	1.00	\$0.00
Ventilation	Ventilation	Variable Air Volume	8.88	\$1.22	15	1.46	\$0.01
Interior Lighting	Interior Screw-in	Incandescents	-	\$0.00	1	-	\$0.00
Interior Lighting	Interior Screw-in	Infrared Halogen	0.18	\$0.04	1	1.00	\$0.20
Interior Lighting	Interior Screw-in	CFL	0.76	\$0.02	4	5.79	\$0.01
Interior Lighting	Interior Screw-in	LED	0.84	\$0.52	12	-	\$0.06
Interior Lighting	High Bay Fixtures	Metal Halides	-	\$0.00	6	1.00	\$0.00
Interior Lighting	High Bay Fixtures	High Pressure Sodium	0.40	-\$0.14	9	2.11	-\$0.04
Interior Lighting	High Bay Fixtures	T8	0.40	-\$0.28	6	4.58	-\$0.13
Interior Lighting	High Bay Fixtures	T5	0.51	-\$0.28	6	5.58	-\$0.10
Interior Lighting	Linear Fluorescent	T12	-	\$0.00	6	1.00	\$0.00
Interior Lighting	Linear Fluorescent	T8	0.09	-\$0.01	6	1.12	-\$0.02

C&I Energy Efficiency Equipment and Measure Data

End Use	Technology	Efficiency Definition	Savings (kWh/SQ FT/yr)	Incremental Cost (\$/SQ FT)	Lifetime (Years)	BC Ratio (2015)	Levelized Cost of Energy (\$/kWh)
Interior Lighting	Linear Fluorescent	Super T8	0.26	\$0.08	6	0.88	\$0.06
Interior Lighting	Linear Fluorescent	T5	0.27	\$0.14	6	0.74	\$0.09
Interior Lighting	Linear Fluorescent	LED	0.29	\$1.21	15	-	\$0.37
Exterior Lighting	Exterior Screw-in	Incandescent	-	\$0.00	1	-	\$0.00
Exterior Lighting	Exterior Screw-in	Infrared Halogen	0.01	\$0.00	1	1.00	\$0.24
Exterior Lighting	Exterior Screw-in	CFL	0.04	\$0.00	4	6.00	\$0.01
Exterior Lighting	Exterior Screw-in	Metal Halides	0.04	\$0.00	4	3.36	\$0.02
Exterior Lighting	Exterior Screw-in	LED	0.04	\$0.03	12	-	\$0.07
Exterior Lighting	HID	Metal Halides	-	\$0.00	6	1.00	\$0.00
Exterior Lighting	HID	High Pressure Sodium	0.05	-\$0.04	9	2.10	-\$0.11
Exterior Lighting	HID	Low Pressure Sodium	0.06	\$0.18	9	0.57	\$0.42
Process	Process Cooling/Refrigeration	Standard	-	\$0.00	10	1.00	\$0.00
Process	Process Cooling/Refrigeration	Efficient	18.88	\$5.59	10	1.23	\$0.04
Process	Process Heating	Standard	-	\$0.00	10	1.00	\$0.00
Process	Electrochemical Process	Standard	-	\$0.00	10	1.00	\$0.00
Process	Electrochemical Process	Efficient	13.16	\$2.64	10	1.20	\$0.02
Machine Drive	Less than 5 HP	Standard	-	\$0.00	15	-	\$0.00
Machine Drive	Less than 5 HP	High Efficiency	0.00	\$0.06	15	-	\$0.99
Machine Drive	Less than 5 HP	Standard (2015)	0.01	\$0.00	15	1.00	\$0.00
Machine Drive	Less than 5 HP	Premium	0.04	\$0.06	15	1.04	\$0.11
Machine Drive	Less than 5 HP	High Efficiency (2015)	-	\$0.00	0	-	\$0.00
Machine Drive	Less than 5 HP	Premium (2015)	-	\$0.00	0	-	\$0.00
Machine Drive	5-24 HP	Standard	-	\$0.00	10	1.00	\$0.00
Machine Drive	5-24 HP	High	0.01	\$0.02	10	1.01	\$0.17
Machine Drive	5-24 HP	Premium	-	\$0.00	0	-	\$0.00
Machine Drive	25-99 HP	Standard	-	\$0.00	10	1.00	\$0.00
Machine Drive	25-99 HP	High	0.03	\$0.02	10	1.01	\$0.06
Machine Drive	25-99 HP	Premium	-	\$0.00	0	-	\$0.00
Machine Drive	100-249 HP	Standard	-	\$0.00	10	1.00	\$0.00
Machine Drive	100-249 HP	High	0.02	\$0.02	10	1.01	\$0.10
Machine Drive	100-249 HP	Premium	-	\$0.00	0	-	\$0.00
Machine Drive	250-499 HP	Standard	-	\$0.00	10	1.00	\$0.00

C&I Energy Efficiency Equipment and Measure Data

End Use	Technology	Efficiency Definition	Savings (kWh/SQ FT/yr)	Incremental Cost (\$/SQ FT)	Lifetime (Years)	BC Ratio (2015)	Levelized Cost of Energy (\$/kWh)
Machine Drive	250-499 HP	High	0.06	\$0.02	10	1.01	\$0.03
Machine Drive	250-499 HP	Premium	-	\$0.00	0	-	\$0.00
Machine Drive	500 and more HP	Standard	-	\$0.00	10	1.00	\$0.00
Machine Drive	500 and more HP	High	0.10	\$0.02	10	1.01	\$0.02
Machine Drive	500 and more HP	Premium	-	\$0.00	0	-	\$0.00
Miscellaneous	Miscellaneous	Miscellaneous	-	\$0.00	5	1.00	\$0.00

C&I Energy Efficiency Equipment and Measure Data

Table C-16 Energy Efficiency Equipment Data, Electric— Extra Large Industrial, New Vintage, Washington

End Use	Technology	Efficiency Definition	Savings (kWh/SQ FT/yr)	Incremental Cost (\$/SQ FT)	Lifetime (Years)	BC Ratio (2015)	Levelized Cost of Energy (\$/kWh)
Cooling	Central Chiller	0.75 kw/ton, COP 4.7	-	\$0.00	20	-	\$0.00
Cooling	Central Chiller	0.60 kw/ton, COP 5.9	1.58	\$0.33	20	1.10	\$0.01
Cooling	Central Chiller	0.58 kw/ton, COP 6.1	1.79	\$0.66	20	0.97	\$0.03
Cooling	Central Chiller	0.55 kw/Ton, COP 6.4	2.11	\$0.93	20	0.95	\$0.03
Cooling	Central Chiller	0.51 kw/ton, COP 6.9	2.53	\$1.59	20	0.89	\$0.04
Cooling	Central Chiller	0.50 kw/Ton, COP 7.0	2.63	\$1.92	20	0.86	\$0.05
Cooling	Central Chiller	0.48 kw/ton, COP 7.3	2.84	\$2.25	20	0.83	\$0.06
Cooling	Central Chiller	Variable Refrigerant Flow	3.67	\$39.62	20	0.15	\$0.76
Cooling	RTU	EER 9.2	-	\$0.00	16	-	\$0.00
Cooling	RTU	EER 10.1	0.56	\$0.39	16	-	\$0.06
Cooling	RTU	EER 11.2	1.12	\$0.74	16	1.00	\$0.05
Cooling	RTU	EER 12.0	1.47	\$1.23	16	0.92	\$0.07
Cooling	RTU	Ductless VRF	1.79	\$10.88	16	0.30	\$0.50
Cooling	Heat Pump	EER 9.3, COP 3.1	-	\$0.00	15	-	\$0.00
Cooling	Heat Pump	EER 10.3, COP 3.2	0.39	\$0.92	15	-	\$0.20
Cooling	Heat Pump	EER 11.0, COP 3.3	0.62	\$2.75	15	1.00	\$0.38
Cooling	Heat Pump	EER 11.7, COP 3.4	0.83	\$3.66	15	0.95	\$0.38
Cooling	Heat Pump	EER 12, COP 3.4	0.91	\$4.58	15	0.90	\$0.43
Cooling	Heat Pump	Ductless Mini-Split System	1.01	\$26.86	20	0.45	\$1.88
Space Heating	Electric Resistance	Standard	-	\$0.00	25	1.00	\$0.00
Space Heating	Furnace	Standard	-	\$0.00	18	1.00	\$0.00
Space Heating	Heat Pump	EER 9.3, COP 3.1	-	\$0.00	15	-	\$0.00
Space Heating	Heat Pump	EER 10.3, COP 3.2	0.13	\$0.92	15	-	\$0.62
Space Heating	Heat Pump	EER 11.0, COP 3.3	0.25	\$2.75	15	1.00	\$0.96
Space Heating	Heat Pump	EER 11.7, COP 3.4	0.36	\$3.66	15	0.95	\$0.88
Space Heating	Heat Pump	EER 12, COP 3.4	0.47	\$4.58	15	0.90	\$0.85
Space Heating	Heat Pump	Ductless Mini-Split System	1.02	\$26.86	20	0.45	\$1.86
Space Heating	Heat Pump	EER 9.3, COP 3.1	-	\$0.00	15	-	\$0.00
Space Heating	Heat Pump	EER 10.3, COP 3.2	0.13	\$0.92	15	-	\$0.62
Space Heating	Heat Pump	EER 11.0, COP 3.3	0.25	\$2.75	15	1.00	\$0.96
Space Heating	Heat Pump	EER 11.7, COP 3.4	0.36	\$3.66	15	0.95	\$0.88
Space Heating	Heat Pump	EER 12, COP 3.4	0.47	\$4.58	15	0.90	\$0.85
Space Heating	Heat Pump	Ductless Mini-Split System	1.02	\$26.86	20	0.45	\$1.86
Ventilation	Ventilation	Constant Volume	-	\$0.00	15	1.00	\$0.00
Ventilation	Ventilation	Variable Air Volume	13.69	\$1.22	15	1.63	\$0.01
Interior Lighting	Interior Screw-in	Incandescents	-	\$0.00	1	-	\$0.00
Interior Lighting	Interior Screw-in	Infrared Halogen	0.21	\$0.04	1	1.00	\$0.18
Interior Lighting	Interior Screw-in	CFL	0.85	\$0.02	4	5.65	\$0.00
Interior Lighting	Interior Screw-in	LED	0.94	\$0.52	12	-	\$0.06
Interior Lighting	High Bay Fixtures	Metal Halides	-	\$0.00	6	1.00	\$0.00
Interior Lighting	High Bay Fixtures	High Pressure Sodium	0.40	-\$0.14	9	2.11	-\$0.04
Interior Lighting	High Bay Fixtures	T8	0.40	-\$0.28	6	4.58	-\$0.13
Interior Lighting	High Bay Fixtures	T5	0.51	-\$0.28	6	5.58	-\$0.10
Interior Lighting	Linear Fluorescent	T12	-	\$0.00	6	1.00	\$0.00
Interior Lighting	Linear Fluorescent	T8	0.09	-\$0.01	6	1.12	-\$0.02

C&I Energy Efficiency Equipment and Measure Data

End Use	Technology	Efficiency Definition	Savings (kWh/SQ FT/yr)	Incremental Cost (\$/SQ FT)	Lifetime (Years)	BC Ratio (2015)	Levelized Cost of Energy (\$/kWh)
Interior Lighting	Linear Fluorescent	Super T8	0.27	\$0.08	6	0.89	\$0.06
Interior Lighting	Linear Fluorescent	T5	0.28	\$0.14	6	0.75	\$0.09
Interior Lighting	Linear Fluorescent	LED	0.29	\$1.21	15	-	\$0.36
Exterior Lighting	Exterior Screw-in	Incandescent	-	\$0.00	1	-	\$0.00
Exterior Lighting	Exterior Screw-in	Infrared Halogen	0.01	\$0.00	1	1.00	\$0.24
Exterior Lighting	Exterior Screw-in	CFL	0.04	\$0.00	4	6.00	\$0.01
Exterior Lighting	Exterior Screw-in	Metal Halides	0.04	\$0.00	4	3.36	\$0.02
Exterior Lighting	Exterior Screw-in	LED	0.04	\$0.03	12	-	\$0.07
Exterior Lighting	HID	Metal Halides	-	\$0.00	6	1.00	\$0.00
Exterior Lighting	HID	High Pressure Sodium	0.05	-\$0.04	9	2.10	-\$0.11
Exterior Lighting	HID	Low Pressure Sodium	0.06	\$0.18	9	0.57	\$0.42
Process	Process Cooling/Refrigeration	Standard	-	\$0.00	10	1.00	\$0.00
Process	Process Cooling/Refrigeration	Efficient	18.88	\$5.59	10	1.23	\$0.04
Process	Process Heating	Standard	-	\$0.00	10	1.00	\$0.00
Process	Electrochemical Process	Standard	-	\$0.00	10	1.00	\$0.00
Process	Electrochemical Process	Efficient	13.16	\$2.64	10	1.20	\$0.02
Machine Drive	Less than 5 HP	Standard	-	\$0.00	15	-	\$0.00
Machine Drive	Less than 5 HP	High Efficiency	0.00	\$0.06	15	-	\$0.99
Machine Drive	Less than 5 HP	Standard (2015)	0.01	\$0.00	15	1.00	\$0.00
Machine Drive	Less than 5 HP	Premium	0.04	\$0.06	15	1.04	\$0.11
Machine Drive	Less than 5 HP	High Efficiency (2015)	-	\$0.00	0	-	\$0.00
Machine Drive	Less than 5 HP	Premium (2015)	-	\$0.00	0	-	\$0.00
Machine Drive	5-24 HP	Standard	-	\$0.00	10	1.00	\$0.00
Machine Drive	5-24 HP	High	0.01	\$0.02	10	1.01	\$0.17
Machine Drive	5-24 HP	Premium	-	\$0.00	0	-	\$0.00
Machine Drive	25-99 HP	Standard	-	\$0.00	10	1.00	\$0.00
Machine Drive	25-99 HP	High	0.03	\$0.02	10	1.01	\$0.06
Machine Drive	25-99 HP	Premium	-	\$0.00	0	-	\$0.00
Machine Drive	100-249 HP	Standard	-	\$0.00	10	1.00	\$0.00
Machine Drive	100-249 HP	High	0.02	\$0.02	10	1.01	\$0.10
Machine Drive	100-249 HP	Premium	-	\$0.00	0	-	\$0.00
Machine Drive	250-499 HP	Standard	-	\$0.00	10	1.00	\$0.00

C&I Energy Efficiency Equipment and Measure Data

End Use	Technology	Efficiency Definition	Savings (kWh/SQ FT/yr)	Incremental Cost (\$/SQ FT)	Lifetime (Years)	BC Ratio (2015)	Levelized Cost of Energy (\$/kWh)
Machine Drive	250-499 HP	High	0.06	\$0.02	10	1.01	\$0.03
Machine Drive	250-499 HP	Premium	-	\$0.00	0	-	\$0.00
Machine Drive	500 and more HP	Standard	-	\$0.00	10	1.00	\$0.00
Machine Drive	500 and more HP	High	0.10	\$0.02	10	1.01	\$0.02
Machine Drive	500 and more HP	Premium	-	\$0.00	0	-	\$0.00
Miscellaneous	Miscellaneous	Miscellaneous	-	\$0.00	5	1.00	\$0.00

C&I Energy Efficiency Equipment and Measure Data

Table C-17 Energy Efficiency Equipment Data, Electric—Extra Large Industrial, Existing Vintage, Idaho

End Use	Technology	Efficiency Definition	Savings (kWh/SQ FT/yr)	Incremental Cost (\$/SQ FT)	Lifetime (Years)	BC Ratio (2015)	Levelized Cost of Energy (\$/kWh)
Cooling	Central Chiller	0.75 kw/ton, COP 4.7	-	\$0.00	20	-	\$0.00
Cooling	Central Chiller	0.60 kw/ton, COP 5.9	1.69	\$0.33	20	1.10	\$0.01
Cooling	Central Chiller	0.58 kw/ton, COP 6.1	1.91	\$0.66	20	0.97	\$0.02
Cooling	Central Chiller	0.55 kw/Ton, COP 6.4	2.25	\$0.93	20	0.95	\$0.03
Cooling	Central Chiller	0.51 kw/ton, COP 6.9	2.70	\$1.59	20	0.90	\$0.04
Cooling	Central Chiller	0.50 kw/Ton, COP 7.0	2.81	\$1.92	20	0.87	\$0.05
Cooling	Central Chiller	0.48 kw/ton, COP 7.3	3.04	\$2.25	20	0.84	\$0.05
Cooling	Central Chiller	Variable Refrigerant Flow	3.92	\$39.62	20	0.15	\$0.72
Cooling	RTU	EER 9.2	-	\$0.00	16	-	\$0.00
Cooling	RTU	EER 10.1	0.56	\$0.39	16	-	\$0.06
Cooling	RTU	EER 11.2	1.12	\$0.73	16	1.00	\$0.05
Cooling	RTU	EER 12.0	1.47	\$1.22	16	0.92	\$0.07
Cooling	RTU	Ductless VRF	1.79	\$10.83	16	0.31	\$0.50
Cooling	Heat Pump	EER 9.3, COP 3.1	-	\$0.00	15	-	\$0.00
Cooling	Heat Pump	EER 10.3, COP 3.2	0.41	\$0.92	15	-	\$0.19
Cooling	Heat Pump	EER 11.0, COP 3.3	0.65	\$2.75	15	1.00	\$0.36
Cooling	Heat Pump	EER 11.7, COP 3.4	0.87	\$3.66	15	0.95	\$0.36
Cooling	Heat Pump	EER 12, COP 3.4	0.95	\$4.58	15	0.90	\$0.42
Cooling	Heat Pump	Ductless Mini-Split System	1.06	\$26.86	20	0.45	\$1.80
Space Heating	Electric Resistance	Standard	-	\$0.00	25	1.00	\$0.00
Space Heating	Furnace	Standard	-	\$0.00	18	1.00	\$0.00
Space Heating	Heat Pump	EER 9.3, COP 3.1	-	\$0.00	15	-	\$0.00
Space Heating	Heat Pump	EER 10.3, COP 3.2	0.13	\$0.92	15	-	\$0.61
Space Heating	Heat Pump	EER 11.0, COP 3.3	0.25	\$2.75	15	1.00	\$0.95
Space Heating	Heat Pump	EER 11.7, COP 3.4	0.37	\$3.66	15	0.95	\$0.87
Space Heating	Heat Pump	EER 12, COP 3.4	0.47	\$4.58	15	0.90	\$0.84
Space Heating	Heat Pump	Ductless Mini-Split System	1.04	\$26.86	20	0.45	\$1.83
Space Heating	Heat Pump	EER 9.3, COP 3.1	-	\$0.00	15	-	\$0.00
Space Heating	Heat Pump	EER 10.3, COP 3.2	0.13	\$0.92	15	-	\$0.61
Space Heating	Heat Pump	EER 11.0, COP 3.3	0.25	\$2.75	15	1.00	\$0.95
Space Heating	Heat Pump	EER 11.7, COP 3.4	0.37	\$3.66	15	0.95	\$0.87
Space Heating	Heat Pump	EER 12, COP 3.4	0.47	\$4.58	15	0.90	\$0.84
Space Heating	Heat Pump	Ductless Mini-Split System	1.04	\$26.86	20	0.45	\$1.83
Ventilation	Ventilation	Constant Volume	-	\$0.00	15	1.00	\$0.00
Ventilation	Ventilation	Variable Air Volume	8.88	\$1.22	15	1.46	\$0.01
Interior Lighting	Interior Screw-in	Incandescents	-	\$0.00	1	-	\$0.00
Interior Lighting	Interior Screw-in	Infrared Halogen	0.18	\$0.04	1	1.00	\$0.20
Interior Lighting	Interior Screw-in	CFL	0.76	\$0.02	4	5.79	\$0.01
Interior Lighting	Interior Screw-in	LED	0.84	\$0.52	12	-	\$0.06
Interior Lighting	High Bay Fixtures	Metal Halides	-	\$0.00	6	1.00	\$0.00
Interior Lighting	High Bay Fixtures	High Pressure Sodium	0.40	-\$0.14	9	2.11	-\$0.04
Interior Lighting	High Bay Fixtures	T8	0.40	-\$0.28	6	4.58	-\$0.13
Interior Lighting	High Bay Fixtures	T5	0.51	-\$0.28	6	5.58	-\$0.10
Interior Lighting	Linear Fluorescent	T12	-	\$0.00	6	1.00	\$0.00
Interior Lighting	Linear Fluorescent	T8	0.09	-\$0.01	6	1.12	-\$0.02

C&I Energy Efficiency Equipment and Measure Data

End Use	Technology	Efficiency Definition	Savings (kWh/SQ FT/yr)	Incremental Cost (\$/SQ FT)	Lifetime (Years)	BC Ratio (2015)	Levelized Cost of Energy (\$/kWh)
Interior Lighting	Linear Fluorescent	Super T8	0.26	\$0.08	6	0.88	\$0.06
Interior Lighting	Linear Fluorescent	T5	0.27	\$0.14	6	0.74	\$0.09
Interior Lighting	Linear Fluorescent	LED	0.29	\$1.21	15	-	\$0.37
Exterior Lighting	Exterior Screw-in	Incandescent	-	\$0.00	1	-	\$0.00
Exterior Lighting	Exterior Screw-in	Infrared Halogen	0.01	\$0.00	1	1.00	\$0.24
Exterior Lighting	Exterior Screw-in	CFL	0.04	\$0.00	4	6.00	\$0.01
Exterior Lighting	Exterior Screw-in	Metal Halides	0.04	\$0.00	4	3.36	\$0.02
Exterior Lighting	Exterior Screw-in	LED	0.04	\$0.03	12	-	\$0.07
Exterior Lighting	HID	Metal Halides	-	\$0.00	6	1.00	\$0.00
Exterior Lighting	HID	High Pressure Sodium	0.05	-\$0.04	9	2.10	-\$0.11
Exterior Lighting	HID	Low Pressure Sodium	0.06	\$0.18	9	0.57	\$0.42
Process	Process Cooling/Refrigeration	Standard	-	\$0.00	10	1.00	\$0.00
Process	Process Cooling/Refrigeration	Efficient	18.88	\$5.59	10	1.23	\$0.04
Process	Process Heating	Standard	-	\$0.00	10	1.00	\$0.00
Process	Electrochemical Process	Standard	-	\$0.00	10	1.00	\$0.00
Process	Electrochemical Process	Efficient	13.16	\$2.64	10	1.20	\$0.02
Machine Drive	Less than 5 HP	Standard	-	\$0.00	15	-	\$0.00
Machine Drive	Less than 5 HP	High Efficiency	0.00	\$0.06	15	-	\$0.99
Machine Drive	Less than 5 HP	Standard (2015)	0.01	\$0.00	15	1.00	\$0.00
Machine Drive	Less than 5 HP	Premium	0.04	\$0.06	15	1.04	\$0.11
Machine Drive	Less than 5 HP	High Efficiency (2015)	-	\$0.00	0	-	\$0.00
Machine Drive	Less than 5 HP	Premium (2015)	-	\$0.00	0	-	\$0.00
Machine Drive	5-24 HP	Standard	-	\$0.00	10	1.00	\$0.00
Machine Drive	5-24 HP	High	0.01	\$0.02	10	1.01	\$0.17
Machine Drive	5-24 HP	Premium	-	\$0.00	0	-	\$0.00
Machine Drive	25-99 HP	Standard	-	\$0.00	10	1.00	\$0.00
Machine Drive	25-99 HP	High	0.03	\$0.02	10	1.01	\$0.06
Machine Drive	25-99 HP	Premium	-	\$0.00	0	-	\$0.00
Machine Drive	100-249 HP	Standard	-	\$0.00	10	1.00	\$0.00
Machine Drive	100-249 HP	High	0.02	\$0.02	10	1.01	\$0.10
Machine Drive	100-249 HP	Premium	-	\$0.00	0	-	\$0.00
Machine Drive	250-499 HP	Standard	-	\$0.00	10	1.00	\$0.00

C&I Energy Efficiency Equipment and Measure Data

End Use	Technology	Efficiency Definition	Savings (kWh/SQ FT/yr)	Incremental Cost (\$/SQ FT)	Lifetime (Years)	BC Ratio (2015)	Levelized Cost of Energy (\$/kWh)
Machine Drive	250-499 HP	High	0.06	\$0.02	10	1.01	\$0.03
Machine Drive	250-499 HP	Premium	-	\$0.00	0	-	\$0.00
Machine Drive	500 and more HP	Standard	-	\$0.00	10	1.00	\$0.00
Machine Drive	500 and more HP	High	0.10	\$0.02	10	1.01	\$0.02
Machine Drive	500 and more HP	Premium	-	\$0.00	0	-	\$0.00
Miscellaneous	Miscellaneous	Miscellaneous	-	\$0.00	5	1.00	\$0.00

C&I Energy Efficiency Equipment and Measure Data

Table C-18 Energy Efficiency Equipment Data, Electric— Extra Large Industrial, New Vintage, Idaho

End Use	Technology	Efficiency Definition	Savings (kWh/SQ FT/yr)	Incremental Cost (\$/SQ FT)	Lifetime (Years)	BC Ratio (2015)	Levelized Cost of Energy (\$/kWh)
Cooling	Central Chiller	0.75 kw/ton, COP 4.7	-	\$0.00	20	-	\$0.00
Cooling	Central Chiller	0.60 kw/ton, COP 5.9	1.58	\$0.33	20	1.10	\$0.01
Cooling	Central Chiller	0.58 kw/ton, COP 6.1	1.79	\$0.66	20	0.97	\$0.03
Cooling	Central Chiller	0.55 kw/Ton, COP 6.4	2.11	\$0.93	20	0.95	\$0.03
Cooling	Central Chiller	0.51 kw/ton, COP 6.9	2.53	\$1.59	20	0.89	\$0.04
Cooling	Central Chiller	0.50 kw/Ton, COP 7.0	2.63	\$1.92	20	0.86	\$0.05
Cooling	Central Chiller	0.48 kw/ton, COP 7.3	2.84	\$2.25	20	0.83	\$0.06
Cooling	Central Chiller	Variable Refrigerant Flow	3.67	\$39.62	20	0.15	\$0.76
Cooling	RTU	EER 9.2	-	\$0.00	16	-	\$0.00
Cooling	RTU	EER 10.1	0.56	\$0.39	16	-	\$0.06
Cooling	RTU	EER 11.2	1.12	\$0.74	16	1.00	\$0.05
Cooling	RTU	EER 12.0	1.47	\$1.23	16	0.92	\$0.07
Cooling	RTU	Ductless VRF	1.79	\$10.88	16	0.30	\$0.50
Cooling	Heat Pump	EER 9.3, COP 3.1	-	\$0.00	15	-	\$0.00
Cooling	Heat Pump	EER 10.3, COP 3.2	0.39	\$0.92	15	-	\$0.20
Cooling	Heat Pump	EER 11.0, COP 3.3	0.62	\$2.75	15	1.00	\$0.38
Cooling	Heat Pump	EER 11.7, COP 3.4	0.83	\$3.66	15	0.95	\$0.38
Cooling	Heat Pump	EER 12, COP 3.4	0.91	\$4.58	15	0.90	\$0.43
Cooling	Heat Pump	Ductless Mini-Split System	1.01	\$26.86	20	0.45	\$1.88
Space Heating	Electric Resistance	Standard	-	\$0.00	25	1.00	\$0.00
Space Heating	Furnace	Standard	-	\$0.00	18	1.00	\$0.00
Space Heating	Heat Pump	EER 9.3, COP 3.1	-	\$0.00	15	-	\$0.00
Space Heating	Heat Pump	EER 10.3, COP 3.2	0.13	\$0.92	15	-	\$0.62
Space Heating	Heat Pump	EER 11.0, COP 3.3	0.25	\$2.75	15	1.00	\$0.96
Space Heating	Heat Pump	EER 11.7, COP 3.4	0.36	\$3.66	15	0.95	\$0.88
Space Heating	Heat Pump	EER 12, COP 3.4	0.47	\$4.58	15	0.90	\$0.85
Space Heating	Heat Pump	Ductless Mini-Split System	1.02	\$26.86	20	0.45	\$1.86
Space Heating	Heat Pump	EER 9.3, COP 3.1	-	\$0.00	15	-	\$0.00
Space Heating	Heat Pump	EER 10.3, COP 3.2	0.13	\$0.92	15	-	\$0.62
Space Heating	Heat Pump	EER 11.0, COP 3.3	0.25	\$2.75	15	1.00	\$0.96
Space Heating	Heat Pump	EER 11.7, COP 3.4	0.36	\$3.66	15	0.95	\$0.88
Space Heating	Heat Pump	EER 12, COP 3.4	0.47	\$4.58	15	0.90	\$0.85
Space Heating	Heat Pump	Ductless Mini-Split System	1.02	\$26.86	20	0.45	\$1.86
Ventilation	Ventilation	Constant Volume	-	\$0.00	15	1.00	\$0.00
Ventilation	Ventilation	Variable Air Volume	13.69	\$1.22	15	1.63	\$0.01
Interior Lighting	Interior Screw-in	Incandescents	-	\$0.00	1	-	\$0.00
Interior Lighting	Interior Screw-in	Infrared Halogen	0.21	\$0.04	1	1.00	\$0.18
Interior Lighting	Interior Screw-in	CFL	0.85	\$0.02	4	5.65	\$0.00
Interior Lighting	Interior Screw-in	LED	0.94	\$0.52	12	-	\$0.06
Interior Lighting	High Bay Fixtures	Metal Halides	-	\$0.00	6	1.00	\$0.00
Interior Lighting	High Bay Fixtures	High Pressure Sodium	0.40	-\$0.14	9	2.11	-\$0.04
Interior Lighting	High Bay Fixtures	T8	0.40	-\$0.28	6	4.58	-\$0.13
Interior Lighting	High Bay Fixtures	T5	0.51	-\$0.28	6	5.58	-\$0.10
Interior Lighting	Linear Fluorescent	T12	-	\$0.00	6	1.00	\$0.00
Interior Lighting	Linear Fluorescent	T8	0.09	-\$0.01	6	1.12	-\$0.02

C&I Energy Efficiency Equipment and Measure Data

End Use	Technology	Efficiency Definition	Savings (kWh/SQ FT/yr)	Incremental Cost (\$/SQ FT)	Lifetime (Years)	BC Ratio (2015)	Levelized Cost of Energy (\$/kWh)
Interior Lighting	Linear Fluorescent	Super T8	0.27	\$0.08	6	0.89	\$0.06
Interior Lighting	Linear Fluorescent	T5	0.28	\$0.14	6	0.75	\$0.09
Interior Lighting	Linear Fluorescent	LED	0.29	\$1.21	15	-	\$0.36
Exterior Lighting	Exterior Screw-in	Incandescent	-	\$0.00	1	-	\$0.00
Exterior Lighting	Exterior Screw-in	Infrared Halogen	0.01	\$0.00	1	1.00	\$0.24
Exterior Lighting	Exterior Screw-in	CFL	0.04	\$0.00	4	6.00	\$0.01
Exterior Lighting	Exterior Screw-in	Metal Halides	0.04	\$0.00	4	3.36	\$0.02
Exterior Lighting	Exterior Screw-in	LED	0.04	\$0.03	12	-	\$0.07
Exterior Lighting	HID	Metal Halides	-	\$0.00	6	1.00	\$0.00
Exterior Lighting	HID	High Pressure Sodium	0.05	-\$0.04	9	2.10	-\$0.11
Exterior Lighting	HID	Low Pressure Sodium	0.06	\$0.18	9	0.57	\$0.42
Process	Process Cooling/Refrigeration	Standard	-	\$0.00	10	1.00	\$0.00
Process	Process Cooling/Refrigeration	Efficient	18.88	\$5.59	10	1.23	\$0.04
Process	Process Heating	Standard	-	\$0.00	10	1.00	\$0.00
Process	Electrochemical Process	Standard	-	\$0.00	10	1.00	\$0.00
Process	Electrochemical Process	Efficient	13.16	\$2.64	10	1.20	\$0.02
Machine Drive	Less than 5 HP	Standard	-	\$0.00	15	-	\$0.00
Machine Drive	Less than 5 HP	High Efficiency	0.00	\$0.06	15	-	\$0.99
Machine Drive	Less than 5 HP	Standard (2015)	0.01	\$0.00	15	1.00	\$0.00
Machine Drive	Less than 5 HP	Premium	0.04	\$0.06	15	1.04	\$0.11
Machine Drive	Less than 5 HP	High Efficiency (2015)	-	\$0.00	0	-	\$0.00
Machine Drive	Less than 5 HP	Premium (2015)	-	\$0.00	0	-	\$0.00
Machine Drive	5-24 HP	Standard	-	\$0.00	10	1.00	\$0.00
Machine Drive	5-24 HP	High	0.01	\$0.02	10	1.01	\$0.17
Machine Drive	5-24 HP	Premium	-	\$0.00	0	-	\$0.00
Machine Drive	25-99 HP	Standard	-	\$0.00	10	1.00	\$0.00
Machine Drive	25-99 HP	High	0.03	\$0.02	10	1.01	\$0.06
Machine Drive	25-99 HP	Premium	-	\$0.00	0	-	\$0.00
Machine Drive	100-249 HP	Standard	-	\$0.00	10	1.00	\$0.00
Machine Drive	100-249 HP	High	0.02	\$0.02	10	1.01	\$0.10
Machine Drive	100-249 HP	Premium	-	\$0.00	0	-	\$0.00
Machine Drive	250-499 HP	Standard	-	\$0.00	10	1.00	\$0.00

C&I Energy Efficiency Equipment and Measure Data

End Use	Technology	Efficiency Definition	Savings (kWh/SQ FT/yr)	Incremental Cost (\$/SQ FT)	Lifetime (Years)	BC Ratio (2015)	Levelized Cost of Energy (\$/kWh)
Machine Drive	250-499 HP	High	0.06	\$0.02	10	1.01	\$0.03
Machine Drive	250-499 HP	Premium	-	\$0.00	0	-	\$0.00
Machine Drive	500 and more HP	Standard	-	\$0.00	10	1.00	\$0.00
Machine Drive	500 and more HP	High	0.10	\$0.02	10	1.01	\$0.02
Machine Drive	500 and more HP	Premium	-	\$0.00	0	-	\$0.00
Miscellaneous	Miscellaneous	Miscellaneous	-	\$0.00	5	1.00	\$0.00

Table C-19 Energy Efficiency Non-Equipment Data—Small/Medium Commercial, Existing Vintage, Washington

Measure	Base Saturation	Applicability	Lifetime (Years)	Incremental Cost (\$/SqFt)	Savings (kWh/Sq Ft)	BC Ratio (2015)	Levelized Cost of Energy (\$/kWh)
RTU - Maintenance	14.0%	100.0%	4	\$0.08	0.4	0.22	\$0.060
RTU - Evaporative Precooler	0.0%	0.0%	15	\$0.88	1.2	0.21	\$0.061
Chiller - Chilled Water Reset	0.0%	0.0%	4	\$0.86	0.4	0.03	\$0.529
Chiller - Chilled Water Variable-Flow System	0.0%	0.0%	10	\$0.86	0.1	0.02	\$1.018
Chiller - VSD	0.0%	0.0%	20	\$1.17	0.8	0.11	\$0.105
Chiller - High Efficiency Cooling Tower Fans	0.0%	0.0%	10	\$0.04	0.0	0.00	\$10.961
Chiller - Condenser Water Temperature Reset	0.0%	0.0%	14	\$0.87	0.4	0.07	\$0.206
Cooling - Economizer Installation	51.8%	65.0%	15	\$0.15	0.6	0.64	\$0.020
Heat Pump - Maintenance	28.1%	100.0%	4	\$0.03	0.9	1.42	\$0.009
Insulation - Ducting	9.0%	100.0%	20	\$0.41	0.2	0.36	\$0.136
Repair and Sealing - Ducting	5.0%	50.0%	15	\$0.38	0.7	0.47	\$0.048
Energy Management System	34.8%	100.0%	14	\$0.35	0.8	0.37	\$0.040
Cooking - Exhaust Hoods with Sensor Control	1.0%	20.0%	10	\$0.04	-	-	\$0.000
Fans - Energy Efficient Motors	11.0%	100.0%	10	\$0.05	0.1	0.25	\$0.057
Fans - Variable Speed Control	10.9%	100.0%	10	\$0.20	0.7	0.32	\$0.033
Retrocommissioning - HVAC	15.0%	100.0%	4	\$0.60	0.6	0.35	\$0.280
Pumps - Variable Speed Control	0.0%	45.0%	10	\$0.44	0.0	0.00	\$5.336
Thermostat - Clock/Programmable	38.7%	50.0%	11	\$0.11	0.3	0.32	\$0.044
Insulation - Ceiling	19.0%	90.0%	20	\$0.64	0.7	0.43	\$0.066
Insulation - Radiant Barrier	10.3%	25.0%	20	\$0.26	0.4	0.45	\$0.050
Roofs - High Reflectivity	3.3%	100.0%	15	\$0.18	0.2	0.21	\$0.063
Windows - High Efficiency	66.1%	100.0%	20	\$0.44	1.0	0.52	\$0.032
Interior Lighting - Central Lighting Controls	81.2%	100.0%	8	\$0.65	0.2	0.02	\$0.581
Interior Lighting - Photocell Controlled T8 Dimming Ballasts	0.9%	60.0%	8	\$0.50	0.8	0.14	\$0.085
Exterior Lighting - Daylighting Controls	1.6%	100.0%	8	\$0.11	0.5	0.28	\$0.029
Interior Fluorescent - Bi-Level Fixture w/Occupancy Sensor	10.0%	30.0%	8	\$0.50	0.3	0.06	\$0.212
Interior Fluorescent - High Bay Fixtures	10.0%	30.0%	11	\$0.70	1.7	0.21	\$0.046
Interior Lighting - Occupancy Sensors	7.1%	60.0%	8	\$0.20	0.2	0.14	\$0.179
Exterior Lighting - Photovoltaic Installation	5.0%	25.0%	5	\$0.92	0.6	0.03	\$0.307
Interior Screw-in - Task Lighting	25.0%	100.0%	5	\$0.24	0.1	0.02	\$0.500
Interior Lighting - Time Clocks and Timers	9.1%	75.0%	8	\$0.20	0.1	0.07	\$0.357
Water Heater - Faucet Aerators/Low Flow Nozzles	50.5%	100.0%	9	\$0.01	0.1	0.68	\$0.016
Water Heater - Pipe Insulation	45.6%	100.0%	15	\$0.28	0.1	0.04	\$0.216
Water Heater - High Efficiency Circulation Pump	0.0%	0.0%	10	\$0.11	1.4	1.11	\$0.009
Water Heater - Tank Blanket/Insulation	68.0%	100.0%	10	\$0.02	0.1	0.44	\$0.024
Water Heater - Thermostat Setback	5.0%	100.0%	10	\$0.11	0.1	0.06	\$0.163
Refrigeration - Anti-Sweat Heater/Auto Door Closer	0.0%	100.0%	16	\$0.20	0.1	0.03	\$0.264
Refrigeration - Floating Head Pressure	17.9%	50.0%	16	\$0.35	0.0	0.01	\$1.061
Refrigeration - Door Gasket Replacement	5.0%	100.0%	8	\$0.10	0.0	0.01	\$0.710
Insulation - Bare Suction Lines	5.0%	100.0%	8	\$0.10	0.0	0.02	\$0.525
Refrigeration - Night Covers	5.0%	100.0%	8	\$0.05	0.0	0.02	\$2.859
Refrigeration - Strip Curtain	5.0%	56.3%	4	\$0.00	-	-	\$0.000
Vending Machine - Controller	2.0%	10.0%	10	\$0.27	0.0	0.01	\$0.701
LED Exit Lighting	46.9%	90.0%	10	\$0.00	0.0	4.04	\$0.006
Retrocommissioning - Lighting	5.0%	100.0%	5	\$0.10	0.3	0.15	\$0.081
Refrigeration - High Efficiency Case	12.0%	56.0%	6	\$0.04	0.0	0.01	\$1.656

C&I Energy Efficiency Equipment and Measure Data

Measure	Base Saturation	Applicability	Lifetime (Years)	Incremental Cost (\$/SqFt)	Savings (kWh/Sq Ft)	BC Ratio (2015)	Levelized Cost of Energy (\$/kWh)
Lighting							
Exterior Lighting - Cold Cathode Lighting	14.6%	50.0%	5	\$0.00	0.4	16.94	\$0.001
Laundry - High Efficiency Clothes Washer	6.9%	10.0%	10	\$0.00	0.0	4.82	\$0.002
Interior Lighting - Hotel Guestroom Controls	0.0%	0.0%	8	\$0.14	0.1	0.04	\$0.211
Miscellaneous - Energy Star Water Cooler	5.0%	100.0%	8	\$0.00	0.0	0.27	\$0.044
Interior Lighting - Skylights	0.0%	0.0%	0	\$0.00	0.2	1.00	\$0.000
Ventilation - Demand Control Ventilation	6.4%	20.0%	10	\$0.04	0.1	0.52	\$0.065
Office Equipment - Smart Power Strips	15.4%	30.0%	7	\$0.00	0.4	286.03	\$0.000
Strategic Energy Management	0.0%	0.0%	3	\$0.00	-	6.00	\$0.000
Refrigeration - Multiplex - Floating section Pressure - Air-cooled Cond.	0.0%	0.0%	0	\$0.00	-	1.00	\$0.000
Refrigeration - Multiplex Controls - Floating section Pressure - Evap. Cond.	0.0%	0.0%	0	\$0.00	-	1.00	\$0.000
Refrigeration - Multiplex - Eff. Air-cooled Condenser	0.0%	0.0%	0	\$0.00	-	1.00	\$0.000
Refrigeration - Multiplex - Eff. Water-cooled Condenser	0.0%	0.0%	0	\$0.00	-	1.00	\$0.000
RTU - Maintenance	14.0%	100.0%	4	\$0.08	0.4	0.22	\$0.060
RTU - Evaporative Precooler	0.0%	0.0%	15	\$0.88	1.2	0.21	\$0.061
Chiller - Chilled Water Reset	0.0%	0.0%	4	\$0.86	0.4	0.03	\$0.529
Chiller - Chilled Water Variable-Flow System	0.0%	0.0%	10	\$0.86	0.1	0.02	\$1.018
Chiller - VSD	0.0%	0.0%	20	\$1.17	0.8	0.11	\$0.105
Chiller - High Efficiency Cooling Tower Fans	0.0%	0.0%	10	\$0.04	0.0	0.00	\$10.961
Chiller - Condenser Water Temperature Reset	0.0%	0.0%	14	\$0.87	0.4	0.07	\$0.206
Cooling - Economizer Installation	51.8%	65.0%	15	\$0.15	0.6	0.64	\$0.020
Heat Pump - Maintenance	28.1%	100.0%	4	\$0.03	0.9	1.42	\$0.009
Insulation - Ducting	9.0%	100.0%	20	\$0.41	0.2	0.36	\$0.136
Repair and Sealing - Ducting	5.0%	50.0%	15	\$0.38	0.7	0.47	\$0.048
Energy Management System	34.8%	100.0%	14	\$0.35	0.8	0.37	\$0.040
Cooking - Exhaust Hoods with Sensor Control	1.0%	20.0%	10	\$0.04	-	-	\$0.000
Fans - Energy Efficient Motors	11.0%	100.0%	10	\$0.05	0.1	0.25	\$0.057
Fans - Variable Speed Control	10.9%	100.0%	10	\$0.20	0.7	0.32	\$0.033
Retrocommissioning - HVAC	15.0%	100.0%	4	\$0.60	0.6	0.35	\$0.280
Pumps - Variable Speed Control	0.0%	45.0%	10	\$0.44	0.0	0.00	\$5.336
Thermostat - Clock/Programmable	38.7%	50.0%	11	\$0.11	0.3	0.32	\$0.044
Insulation - Ceiling	19.0%	90.0%	20	\$0.64	0.7	0.43	\$0.066
Insulation - Radiant Barrier	10.3%	25.0%	20	\$0.26	0.4	0.45	\$0.050

C&I Energy Efficiency Equipment and Measure Data

Table C-20 Energy Efficiency Non-Equipment Data— Small/ Medium Commercial, New Vintage, Washington

Measure	Base Saturation	Applicability	Lifetime (Years)	Incremental Cost (\$/SqFt)	Savings (kWh/SqFt)	BC Ratio (2015)	Levelized Cost of Energy (\$/kWh)
RTU - Maintenance	14.0%	100.0%	4	\$0.08	0.2	0.14	\$0.102
RTU - Evaporative Precooler	0.0%	0.0%	15	\$0.88	1.0	0.18	\$0.073
Chiller - Chilled Water Reset	0.0%	0.0%	4	\$0.86	0.4	0.02	\$0.641
Chiller - Chilled Water Variable-Flow System	0.0%	0.0%	10	\$0.86	0.1	0.02	\$0.823
Chiller - VSD	0.0%	0.0%	20	\$1.17	0.7	0.10	\$0.122
Chiller - High Efficiency Cooling Tower Fans	0.0%	0.0%	10	\$0.04	0.0	0.00	\$8.973
Chiller - Condenser Water Temperature Reset	0.0%	0.0%	14	\$0.87	0.3	0.06	\$0.247
Cooling - Economizer Installation	51.8%	65.0%	15	\$0.15	-	0.28	\$0.000
Heat Pump - Maintenance	28.1%	100.0%	4	\$0.03	0.5	0.96	\$0.015
Insulation - Ducting	9.0%	50.0%	20	\$0.41	-	0.32	\$0.000
Energy Management System	27.7%	100.0%	14	\$0.35	1.9	0.63	\$0.017
Cooking - Exhaust Hoods with Sensor Control	1.0%	20.0%	10	\$0.04	-	-	\$0.000
Fans - Energy Efficient Motors	11.0%	100.0%	10	\$0.05	0.1	0.17	\$0.067
Fans - Variable Speed Control	8.0%	100.0%	10	\$0.20	0.5	0.25	\$0.044
Pumps - Variable Speed Control	5.0%	45.0%	10	\$0.44	0.0	0.00	\$5.075
Thermostat - Clock/Programmable	34.0%	50.0%	11	\$0.11	1.0	0.86	\$0.012
Insulation - Ceiling	15.3%	90.0%	20	\$0.16	-	0.38	\$0.000
Insulation - Radiant Barrier	7.0%	25.0%	20	\$0.26	-	0.30	\$0.000
Roofs - High Reflectivity	5.0%	100.0%	15	\$0.09	-	0.07	\$0.000
Windows - High Efficiency	60.5%	100.0%	20	\$0.35	-	0.31	\$0.000
Interior Lighting - Central Lighting Controls	81.2%	100.0%	8	\$0.65	-	-	\$0.000
Interior Lighting - Photocell Controlled T8 Dimming Ballasts	0.9%	60.0%	8	\$0.38	0.7	0.16	\$0.074
Exterior Lighting - Daylighting Controls	10.0%	100.0%	8	\$0.09	-	0.00	\$0.000
Interior Fluorescent - Bi-Level Fixture w/Occupancy Sensor	10.0%	30.0%	8	\$0.50	0.3	0.05	\$0.243
Interior Fluorescent - High Bay Fixtures	10.0%	30.0%	11	\$0.70	1.5	0.20	\$0.052
Interior Lighting - Occupancy Sensors	7.1%	60.0%	8	\$0.20	-	0.07	\$0.000
Exterior Lighting - Photovoltaic Installation	5.0%	25.0%	5	\$0.92	-	-	\$0.000
Interior Screw-in - Task Lighting	25.0%	100.0%	5	\$0.24	0.1	0.03	\$0.507
Interior Lighting - Time Clocks and Timers	9.1%	75.0%	8	\$0.20	-	0.05	\$0.000
Water Heater - Faucet Aerators/Low Flow Nozzles	50.5%	100.0%	9	\$0.01	0.1	0.67	\$0.017
Water Heater - Pipe Insulation	45.6%	100.0%	15	\$0.28	0.1	0.04	\$0.227
Water Heater - High Efficiency Circulation Pump	0.0%	0.0%	10	\$0.11	1.3	1.09	\$0.010
Water Heater - Tank Blanket/Insulation	40.4%	100.0%	10	\$0.02	0.0	0.21	\$0.051
Water Heater - Thermostat Setback	10.0%	100.0%	10	\$0.11	0.1	0.06	\$0.174
Refrigeration - Anti-Sweat Heater/Auto Door Closer	0.0%	100.0%	16	\$0.20	0.1	0.03	\$0.289
Refrigeration - Floating Head Pressure	17.9%	50.0%	16	\$0.35	-	0.00	\$0.000
Refrigeration - Door Gasket Replacement	5.0%	100.0%	8	\$0.10	0.0	0.01	\$1.014
Insulation - Bare Suction Lines	5.0%	100.0%	8	\$0.10	-	-	\$0.000
Refrigeration - Night Covers	5.0%	100.0%	8	\$0.05	0.0	0.02	\$3.122
Refrigeration - Strip Curtain	5.0%	56.3%	4	\$0.00	-	-	\$0.000
Vending Machine - Controller	2.0%	10.0%	10	\$0.27	0.0	0.01	\$0.804
LED Exit Lighting	91.2%	90.0%	10	\$0.00	0.0	5.42	\$0.006
Refrigeration - High Efficiency Case	26.1%	56.0%	6	\$0.02	0.0	0.38	\$0.559

C&I Energy Efficiency Equipment and Measure Data

Measure	Base Saturation	Applicability	Lifetime (Years)	Incremental Cost (\$/SqFt)	Savings (kWh/SqFt)	BC Ratio (2015)	Levelized Cost of Energy (\$/kWh)
Lighting							
Exterior Lighting - Cold Cathode Lighting	14.6%	50.0%	5	\$0.00	0.3	20.03	\$0.001
Laundry - High Efficiency Clothes Washer	6.9%	10.0%	10	\$0.00	0.0	5.78	\$0.002
Interior Lighting - Hotel Guestroom Controls	0.0%	0.0%	8	\$0.14	0.1	0.06	\$0.213
Miscellaneous - Energy Star Water Cooler	5.0%	100.0%	8	\$0.00	0.0	0.33	\$0.037
Interior Lighting - Skylights	0.0%	0.0%	0	\$0.00	-	1.00	\$0.000
Ventilation - Demand Control Ventilation	12.9%	20.0%	10	\$0.04	-	0.38	\$0.000
Office Equipment - Smart Power Strips	15.4%	30.0%	7	\$0.00	0.5	393.51	\$0.000
Strategic Energy Management	0.0%	0.0%	3	\$0.00	-	6.00	\$0.000
Refrigeration - Multiplex - Floating section Pressure - Air-cooled Cond.	0.0%	0.0%	0	\$0.00	-	1.00	\$0.000
Refrigeration - Multiplex Controls - Floating section Pressure - Evap. Cond.	0.0%	0.0%	0	\$0.00	-	1.00	\$0.000
Refrigeration - Multiplex - Eff. Air-cooled Condenser	0.0%	0.0%	0	\$0.00	-	1.00	\$0.000
Refrigeration - Multiplex - Eff. Water-cooled Condenser	0.0%	0.0%	0	\$0.00	-	1.00	\$0.000
RTU - Maintenance	14.0%	100.0%	4	\$0.08	0.2	0.14	\$0.102
RTU - Evaporative Precooler	0.0%	0.0%	15	\$0.88	1.0	0.18	\$0.073
Chiller - Chilled Water Reset	0.0%	0.0%	4	\$0.86	0.4	0.02	\$0.641
Chiller - Chilled Water Variable-Flow System	0.0%	0.0%	10	\$0.86	0.1	0.02	\$0.823
Chiller - VSD	0.0%	0.0%	20	\$1.17	0.7	0.10	\$0.122
Chiller - High Efficiency Cooling Tower Fans	0.0%	0.0%	10	\$0.04	0.0	0.00	\$8.973
Chiller - Condenser Water Temperature Reset	0.0%	0.0%	14	\$0.87	0.3	0.06	\$0.247
Cooling - Economizer Installation	51.8%	65.0%	15	\$0.15	-	0.28	\$0.000
Heat Pump - Maintenance	28.1%	100.0%	4	\$0.03	0.5	0.96	\$0.015
Insulation - Ducting	9.0%	50.0%	20	\$0.41	-	0.32	\$0.000
Energy Management System	27.7%	100.0%	14	\$0.35	1.9	0.63	\$0.017
Cooking - Exhaust Hoods with Sensor Control	1.0%	20.0%	10	\$0.04	-	-	\$0.000
Fans - Energy Efficient Motors	11.0%	100.0%	10	\$0.05	0.1	0.17	\$0.067
Fans - Variable Speed Control	8.0%	100.0%	10	\$0.20	0.5	0.25	\$0.044
Pumps - Variable Speed Control	5.0%	45.0%	10	\$0.44	0.0	0.00	\$5.075
Thermostat - Clock/Programmable	34.0%	50.0%	11	\$0.11	1.0	0.86	\$0.012
Insulation - Ceiling	15.3%	90.0%	20	\$0.16	-	0.38	\$0.000
Insulation - Radiant Barrier	7.0%	25.0%	20	\$0.26	-	0.30	\$0.000
Roofs - High Reflectivity	5.0%	100.0%	15	\$0.09	-	0.07	\$0.000
Windows - High Efficiency	60.5%	100.0%	20	\$0.35	-	0.31	\$0.000
Interior Lighting - Central Lighting Controls	81.2%	100.0%	8	\$0.65	-	-	\$0.000
Interior Lighting - Photocell Controlled T8 Dimming Ballasts	0.9%	60.0%	8	\$0.38	0.7	0.16	\$0.074
Exterior Lighting - Daylighting Controls	10.0%	100.0%	8	\$0.09	-	0.00	\$0.000

C&I Energy Efficiency Equipment and Measure Data

Table C-21 Energy Efficiency Non-Equipment Data— Small/Medium Commercial, Existing Vintage, Idaho

Measure	Base Saturation	Applicability	Lifetime (Years)	Incremental Cost (\$/SqFt)	Savings (kWh/SqFt)	BC Ratio (2015)	Levelized Cost of Energy (\$/kWh)
RTU - Maintenance	31.3%	100.0%	4	\$0.08	0.4	0.22	\$0.060
RTU - Evaporative Precooler	0.0%	0.0%	15	\$0.88	1.2	0.21	\$0.061
Chiller - Chilled Water Reset	0.0%	0.0%	4	\$0.86	0.4	0.03	\$0.529
Chiller - Chilled Water Variable-Flow System	0.0%	0.0%	10	\$0.86	0.1	0.02	\$1.018
Chiller - VSD	0.0%	0.0%	20	\$1.17	0.8	0.11	\$0.105
Chiller - High Efficiency Cooling Tower Fans	0.0%	0.0%	10	\$0.04	0.0	0.00	\$10.961
Chiller - Condenser Water Temperature Reset	0.0%	0.0%	14	\$0.87	0.4	0.07	\$0.206
Cooling - Economizer Installation	51.8%	65.0%	15	\$0.15	0.1	0.36	\$0.140
Heat Pump - Maintenance	28.1%	100.0%	4	\$0.03	0.9	1.41	\$0.009
Insulation - Ducting	9.0%	100.0%	20	\$0.41	0.0	0.31	\$1.480
Repair and Sealing - Ducting	5.0%	50.0%	15	\$0.38	0.1	0.32	\$0.586
Energy Management System	34.8%	100.0%	14	\$0.35	4.4	1.28	\$0.007
Cooking - Exhaust Hoods with Sensor Control	1.0%	20.0%	10	\$0.04	-	-	\$0.000
Fans - Energy Efficient Motors	28.9%	100.0%	10	\$0.05	0.5	0.98	\$0.011
Fans - Variable Speed Control	26.5%	100.0%	10	\$0.20	0.7	0.31	\$0.033
Retrocommissioning - HVAC	15.0%	100.0%	4	\$0.60	0.1	0.31	\$1.917
Pumps - Variable Speed Control	0.0%	45.0%	10	\$0.44	0.0	0.00	\$5.336
Thermostat - Clock/Programmable	38.7%	50.0%	11	\$0.11	2.8	2.30	\$0.004
Insulation - Ceiling	10.0%	90.0%	20	\$0.64	0.1	0.35	\$0.580
Insulation - Radiant Barrier	7.0%	25.0%	20	\$0.26	0.0	0.33	\$0.567
Roofs - High Reflectivity	4.5%	100.0%	15	\$0.18	0.0	0.12	\$0.434
Windows - High Efficiency	60.5%	100.0%	20	\$0.44	0.1	0.33	\$0.392
Interior Lighting - Central Lighting Controls	81.2%	100.0%	8	\$0.65	0.1	0.01	\$1.389
Interior Lighting - Photocell Controlled T8 Dimming Ballasts	0.9%	60.0%	8	\$0.50	0.8	0.14	\$0.085
Exterior Lighting - Daylighting Controls	1.6%	100.0%	8	\$0.11	0.1	0.07	\$0.121
Interior Fluorescent - Bi-Level Fixture w/Occupancy Sensor	10.0%	30.0%	8	\$0.50	0.3	0.06	\$0.212
Interior Fluorescent - High Bay Fixtures	15.4%	30.0%	11	\$0.70	1.7	0.21	\$0.046
Interior Lighting - Occupancy Sensors	18.3%	60.0%	8	\$0.20	0.1	0.10	\$0.427
Exterior Lighting - Photovoltaic Installation	5.0%	25.0%	5	\$0.92	0.2	0.01	\$1.278
Interior Screw-in - Task Lighting	25.0%	100.0%	5	\$0.24	0.1	0.02	\$0.500
Interior Lighting - Time Clocks and Timers	9.1%	75.0%	8	\$0.20	0.0	0.05	\$0.855
Water Heater - Faucet Aerators/Low Flow Nozzles	50.5%	100.0%	9	\$0.01	0.1	0.67	\$0.016
Water Heater - Pipe Insulation	45.6%	100.0%	15	\$0.28	0.1	0.04	\$0.216
Water Heater - High Efficiency Circulation Pump	0.0%	0.0%	10	\$0.11	1.4	1.10	\$0.009
Water Heater - Tank Blanket/Insulation	68.0%	100.0%	10	\$0.02	0.1	0.43	\$0.024
Water Heater - Thermostat Setback	5.0%	100.0%	10	\$0.11	0.1	0.06	\$0.163
Refrigeration - Anti-Sweat Heater/Auto Door Closer	0.0%	100.0%	16	\$0.20	0.1	0.03	\$0.264
Refrigeration - Floating Head Pressure	17.9%	50.0%	16	\$0.35	-	0.00	\$0.000
Refrigeration - Door Gasket Replacement	5.0%	100.0%	8	\$0.10	0.0	0.01	\$0.710
Insulation - Bare Suction Lines	5.0%	100.0%	8	\$0.10	-	-	\$0.000
Refrigeration - Night Covers	5.0%	100.0%	8	\$0.05	0.0	0.02	\$2.859
Refrigeration - Strip Curtain	5.0%	56.3%	4	\$0.00	-	-	\$0.000
Vending Machine - Controller	2.0%	10.0%	10	\$0.27	0.0	0.01	\$0.701

C&I Energy Efficiency Equipment and Measure Data

Measure	Base Saturation	Applicability	Lifetime (Years)	Incremental Cost (\$/SqFt)	Savings (kWh/SqFt)	BC Ratio (2015)	Levelized Cost of Energy (\$/kWh)
LED Exit Lighting	46.9%	90.0%	10	\$0.00	0.0	3.34	\$0.006
Retrocommissioning - Lighting	24.1%	100.0%	5	\$0.10	0.1	0.05	\$0.233
Refrigeration - High Efficiency Case Lighting	12.0%	56.0%	6	\$0.04	0.0	0.01	\$1.909
Exterior Lighting - Cold Cathode Lighting	14.6%	50.0%	5	\$0.00	0.3	15.57	\$0.001
Laundry - High Efficiency Clothes Washer	6.9%	10.0%	10	\$0.00	0.0	4.79	\$0.002
Interior Lighting - Hotel Guestroom Controls	0.0%	0.0%	8	\$0.14	0.1	0.03	\$0.211
Miscellaneous - Energy Star Water Cooler	24.1%	100.0%	8	\$0.00	0.0	0.27	\$0.044
Interior Lighting - Skylights	0.0%	0.0%	0	\$0.00	0.1	1.00	\$0.000
Ventilation - Demand Control Ventilation	10.2%	20.0%	10	\$0.04	0.0	0.42	\$0.134
Office Equipment - Smart Power Strips	15.4%	30.0%	7	\$0.00	0.4	285.77	\$0.000
Strategic Energy Management	0.0%	0.0%	3	\$0.00	-	6.00	\$0.000
Refrigeration - Multiplex - Floating section Pressure - Air-cooled Cond.	0.0%	0.0%	0	\$0.00	-	1.00	\$0.000
Refrigeration - Multiplex Controls - Floating section Pressure - Evap. Cond.	0.0%	0.0%	0	\$0.00	-	1.00	\$0.000
Refrigeration - Multiplex - Eff. Air-cooled Condenser	0.0%	0.0%	0	\$0.00	-	1.00	\$0.000
Refrigeration - Multiplex - Eff. Water-cooled Condenser	0.0%	0.0%	0	\$0.00	-	1.00	\$0.000
RTU - Maintenance	31.3%	100.0%	4	\$0.08	0.4	0.22	\$0.060
RTU - Evaporative Precooler	0.0%	0.0%	15	\$0.88	1.2	0.21	\$0.061
Chiller - Chilled Water Reset	0.0%	0.0%	4	\$0.86	0.4	0.03	\$0.529
Chiller - Chilled Water Variable-Flow System	0.0%	0.0%	10	\$0.86	0.1	0.02	\$1.018
Chiller - VSD	0.0%	0.0%	20	\$1.17	0.8	0.11	\$0.105
Chiller - High Efficiency Cooling Tower Fans	0.0%	0.0%	10	\$0.04	0.0	0.00	\$10.961
Chiller - Condenser Water Temperature Reset	0.0%	0.0%	14	\$0.87	0.4	0.07	\$0.206
Cooling - Economizer Installation	51.8%	65.0%	15	\$0.15	0.1	0.36	\$0.140
Heat Pump - Maintenance	28.1%	100.0%	4	\$0.03	0.9	1.41	\$0.009
Insulation - Ducting	9.0%	100.0%	20	\$0.41	0.0	0.31	\$1.480
Repair and Sealing - Ducting	5.0%	50.0%	15	\$0.38	0.1	0.32	\$0.586
Energy Management System	34.8%	100.0%	14	\$0.35	4.4	1.28	\$0.007
Cooking - Exhaust Hoods with Sensor Control	1.0%	20.0%	10	\$0.04	-	-	\$0.000
Fans - Energy Efficient Motors	28.9%	100.0%	10	\$0.05	0.5	0.98	\$0.011
Fans - Variable Speed Control	26.5%	100.0%	10	\$0.20	0.7	0.31	\$0.033
Retrocommissioning - HVAC	15.0%	100.0%	4	\$0.60	0.1	0.31	\$1.917
Pumps - Variable Speed Control	0.0%	45.0%	10	\$0.44	0.0	0.00	\$5.336
Thermostat - Clock/Programmable	38.7%	50.0%	11	\$0.11	2.8	2.30	\$0.004
Insulation - Ceiling	10.0%	90.0%	20	\$0.64	0.1	0.35	\$0.580
Insulation - Radiant Barrier	7.0%	25.0%	20	\$0.26	0.0	0.33	\$0.567

Table C-22 Energy Efficiency Non-Equipment Data— Small/ Medium Commercial, New Vintage, Idaho

Measure	Base Saturation	Applicability	Lifetime (Years)	Incremental Cost (\$/SqFt)	Savings (kWh/SqFt)	BC Ratio (2015)	Levelized Cost of Energy (\$/kWh)
RTU - Maintenance	21.4%	100.0%	4	\$0.08	0.2	0.14	\$0.102
RTU - Evaporative Precooler	0.0%	0.0%	15	\$0.88	1.0	0.18	\$0.073
Chiller - Chilled Water Reset	0.0%	0.0%	4	\$0.86	0.4	0.02	\$0.641
Chiller - Chilled Water Variable-Flow System	0.0%	0.0%	10	\$0.86	0.1	0.02	\$0.823
Chiller - VSD	0.0%	0.0%	20	\$1.17	0.7	0.09	\$0.122
Chiller - High Efficiency Cooling Tower Fans	0.0%	0.0%	10	\$0.04	0.0	0.00	\$8.973
Chiller - Condenser Water Temperature Reset	0.0%	0.0%	14	\$0.87	0.3	0.06	\$0.247
Cooling - Economizer Installation	51.8%	65.0%	15	\$0.15	-	0.28	\$0.000
Heat Pump - Maintenance	28.1%	100.0%	4	\$0.03	0.5	0.96	\$0.015
Insulation - Ducting	9.0%	50.0%	20	\$0.41	-	0.32	\$0.000
Energy Management System	34.8%	100.0%	14	\$0.35	2.2	0.73	\$0.014
Cooking - Exhaust Hoods with Sensor Control	1.0%	20.0%	10	\$0.04	-	-	\$0.000
Fans - Energy Efficient Motors	28.9%	100.0%	10	\$0.05	0.1	0.21	\$0.067
Fans - Variable Speed Control	50.5%	100.0%	10	\$0.20	0.5	0.25	\$0.044
Pumps - Variable Speed Control	5.0%	45.0%	10	\$0.44	0.0	0.00	\$5.075
Thermostat - Clock/Programmable	34.0%	50.0%	11	\$0.11	1.4	1.19	\$0.009
Insulation - Ceiling	21.5%	90.0%	20	\$0.16	-	0.38	\$0.000
Insulation - Radiant Barrier	7.0%	25.0%	20	\$0.26	-	0.30	\$0.000
Roofs - High Reflectivity	5.0%	100.0%	15	\$0.09	-	0.07	\$0.000
Windows - High Efficiency	60.5%	100.0%	20	\$0.35	-	0.31	\$0.000
Interior Lighting - Central Lighting Controls	81.2%	100.0%	8	\$0.65	-	-	\$0.000
Interior Lighting - Photocell Controlled T8 Dimming Ballasts	0.9%	60.0%	8	\$0.38	0.7	0.16	\$0.074
Exterior Lighting - Daylighting Controls	10.0%	100.0%	8	\$0.09	-	0.00	\$0.000
Interior Fluorescent - Bi-Level Fixture w/Occupancy Sensor	10.0%	30.0%	8	\$0.50	0.3	0.05	\$0.243
Interior Fluorescent - High Bay Fixtures	13.7%	30.0%	11	\$0.70	1.5	0.19	\$0.052
Interior Lighting - Occupancy Sensors	11.9%	60.0%	8	\$0.20	-	0.07	\$0.000
Exterior Lighting - Photovoltaic Installation	5.0%	25.0%	5	\$0.92	-	-	\$0.000
Interior Screw-in - Task Lighting	25.0%	100.0%	5	\$0.24	0.1	0.03	\$0.507
Interior Lighting - Time Clocks and Timers	9.1%	75.0%	8	\$0.20	-	0.05	\$0.000
Water Heater - Faucet Aerators/Low Flow Nozzles	50.5%	100.0%	9	\$0.01	0.1	0.66	\$0.017
Water Heater - Pipe Insulation	45.6%	100.0%	15	\$0.28	0.1	0.04	\$0.227
Water Heater - High Efficiency Circulation Pump	0.0%	0.0%	10	\$0.11	1.3	1.08	\$0.010
Water Heater - Tank Blanket/Insulation	68.0%	100.0%	10	\$0.02	0.0	0.21	\$0.051
Water Heater - Thermostat Setback	10.0%	100.0%	10	\$0.11	0.1	0.06	\$0.174
Refrigeration - Anti-Sweat Heater/Auto Door Closer	0.0%	100.0%	16	\$0.20	0.1	0.03	\$0.289
Refrigeration - Floating Head Pressure	17.9%	50.0%	16	\$0.35	0.1	0.03	\$0.323
Refrigeration - Door Gasket Replacement	5.0%	100.0%	8	\$0.10	0.0	0.01	\$1.014
Insulation - Bare Suction Lines	5.0%	100.0%	8	\$0.10	0.1	0.08	\$0.160
Refrigeration - Night Covers	5.0%	100.0%	8	\$0.05	0.0	0.02	\$3.122
Refrigeration - Strip Curtain	5.0%	56.3%	4	\$0.00	-	-	\$0.000
Vending Machine - Controller	2.0%	10.0%	10	\$0.27	0.0	0.01	\$0.804
LED Exit Lighting	91.2%	90.0%	10	\$0.00	0.0	5.18	\$0.006
Refrigeration - High Efficiency Case	30.0%	56.0%	6	\$0.02	0.0	0.32	\$0.292

C&I Energy Efficiency Equipment and Measure Data

Measure	Base Saturation	Applicability	Lifetime (Years)	Incremental Cost (\$/SqFt)	Savings (kWh/SqFt)	BC Ratio (2015)	Levelized Cost of Energy (\$/kWh)
Lighting							
Exterior Lighting - Cold Cathode Lighting	14.6%	50.0%	5	\$0.00	0.3	18.13	\$0.001
Laundry - High Efficiency Clothes Washer	6.9%	10.0%	10	\$0.00	0.0	5.75	\$0.002
Interior Lighting - Hotel Guestroom Controls	0.0%	0.0%	8	\$0.14	0.1	0.05	\$0.213
Miscellaneous - Energy Star Water Cooler	11.9%	100.0%	8	\$0.00	0.0	0.33	\$0.037
Interior Lighting - Skylights	0.0%	0.0%	0	\$0.00	-	1.00	\$0.000
Ventilation - Demand Control Ventilation	19.7%	20.0%	10	\$0.04	-	0.38	\$0.000
Office Equipment - Smart Power Strips	15.4%	30.0%	7	\$0.00	0.3	215.34	\$0.000
Strategic Energy Management	0.0%	0.0%	3	\$0.00	-	6.00	\$0.000
Refrigeration - Multiplex - Floating section Pressure - Air-cooled Cond.	0.0%	0.0%	0	\$0.00	-	1.00	\$0.000
Refrigeration - Multiplex Controls - Floating section Pressure - Evap. Cond.	0.0%	0.0%	0	\$0.00	-	1.00	\$0.000
Refrigeration - Multiplex - Eff. Air-cooled Condenser	0.0%	0.0%	0	\$0.00	-	1.00	\$0.000
Refrigeration - Multiplex - Eff. Water-cooled Condenser	0.0%	0.0%	0	\$0.00	-	1.00	\$0.000
RTU - Maintenance	21.4%	100.0%	4	\$0.08	0.2	0.14	\$0.102
RTU - Evaporative Precooler	0.0%	0.0%	15	\$0.88	1.0	0.18	\$0.073
Chiller - Chilled Water Reset	0.0%	0.0%	4	\$0.86	0.4	0.02	\$0.641
Chiller - Chilled Water Variable-Flow System	0.0%	0.0%	10	\$0.86	0.1	0.02	\$0.823
Chiller - VSD	0.0%	0.0%	20	\$1.17	0.7	0.09	\$0.122
Chiller - High Efficiency Cooling Tower Fans	0.0%	0.0%	10	\$0.04	0.0	0.00	\$8.973
Chiller - Condenser Water Temperature Reset	0.0%	0.0%	14	\$0.87	0.3	0.06	\$0.247
Cooling - Economizer Installation	51.8%	65.0%	15	\$0.15	-	0.28	\$0.000
Heat Pump - Maintenance	28.1%	100.0%	4	\$0.03	0.5	0.96	\$0.015
Insulation - Ducting	9.0%	50.0%	20	\$0.41	-	0.32	\$0.000
Energy Management System	34.8%	100.0%	14	\$0.35	2.2	0.73	\$0.014
Cooking - Exhaust Hoods with Sensor Control	1.0%	20.0%	10	\$0.04	-	-	\$0.000
Fans - Energy Efficient Motors	28.9%	100.0%	10	\$0.05	0.1	0.21	\$0.067
Fans - Variable Speed Control	50.5%	100.0%	10	\$0.20	0.5	0.25	\$0.044
Pumps - Variable Speed Control	5.0%	45.0%	10	\$0.44	0.0	0.00	\$5.075
Thermostat - Clock/Programmable	34.0%	50.0%	11	\$0.11	1.4	1.19	\$0.009
Insulation - Ceiling	21.5%	90.0%	20	\$0.16	-	0.38	\$0.000
Insulation - Radiant Barrier	7.0%	25.0%	20	\$0.26	-	0.30	\$0.000
Roofs - High Reflectivity	5.0%	100.0%	15	\$0.09	-	0.07	\$0.000
Windows - High Efficiency	60.5%	100.0%	20	\$0.35	-	0.31	\$0.000
Interior Lighting - Central Lighting Controls	81.2%	100.0%	8	\$0.65	-	-	\$0.000
Interior Lighting - Photocell Controlled T8 Dimming Ballasts	0.9%	60.0%	8	\$0.38	0.7	0.16	\$0.074
Exterior Lighting - Daylighting Controls	10.0%	100.0%	8	\$0.09	-	0.00	\$0.000

C&I Energy Efficiency Equipment and Measure Data

Table C-23 Energy Efficiency Non-Equipment Data— Large Commercial, Existing Vintage, Washington

Measure	Base Saturation	Applicability	Lifetime (Years)	Incremental Cost (\$/SqFt)	Savings (kWh/SqFt)	BC Ratio (2015)	Levelized Cost of Energy (\$/kWh)
RTU - Maintenance	27.0%	100.0%	4	\$0.06	0.4	0.30	\$0.044
RTU - Evaporative Precooler	0.0%	0.0%	15	\$0.88	1.3	0.12	\$0.060
Chiller - Chilled Water Reset	15.0%	100.0%	4	\$0.18	0.4	0.11	\$0.120
Chiller - Chilled Water Variable-Flow System	30.0%	45.0%	10	\$0.18	0.1	0.04	\$0.226
Chiller - VSD	15.0%	88.2%	20	\$1.17	0.7	0.05	\$0.117
Chiller - High Efficiency Cooling Tower Fans	15.0%	43.5%	10	\$0.04	0.0	0.00	\$11.820
Chiller - Condenser Water Temperature Reset	5.0%	100.0%	14	\$0.18	0.4	0.17	\$0.046
Cooling - Economizer Installation	51.6%	65.0%	15	\$0.15	0.8	0.47	\$0.015
Heat Pump - Maintenance	28.1%	100.0%	4	\$0.06	0.8	0.61	\$0.021
Insulation - Ducting	8.0%	100.0%	20	\$0.41	0.0	0.31	\$1.046
Repair and Sealing - Ducting	5.0%	50.0%	15	\$0.38	0.1	0.32	\$0.421
Energy Management System	44.0%	100.0%	14	\$0.35	2.5	0.68	\$0.013
Cooking - Exhaust Hoods with Sensor Control	1.0%	15.0%	10	\$0.04	-	-	\$0.000
Fans - Energy Efficient Motors	11.0%	100.0%	10	\$0.05	0.1	0.17	\$0.072
Fans - Variable Speed Control	2.0%	100.0%	10	\$0.20	0.6	0.27	\$0.040
Retrocommissioning - HVAC	15.0%	100.0%	4	\$0.30	0.4	0.37	\$0.216
Pumps - Variable Speed Control	0.0%	45.0%	10	\$0.13	0.0	0.01	\$1.381
Thermostat - Clock/Programmable	33.0%	50.0%	11	\$0.11	0.8	0.65	\$0.015
Insulation - Ceiling	9.0%	40.0%	20	\$0.85	0.4	0.34	\$0.152
Insulation - Radiant Barrier	7.0%	25.0%	20	\$0.26	0.0	0.31	\$0.521
Roofs - High Reflectivity	1.5%	100.0%	15	\$0.08	0.1	0.07	\$0.109
Windows - High Efficiency	71.9%	100.0%	20	\$0.88	0.2	0.32	\$0.385
Interior Lighting - Central Lighting Controls	85.7%	100.0%	8	\$0.65	0.2	0.03	\$0.384
Interior Lighting - Photocell Controlled T8 Dimming Ballasts	0.9%	60.0%	8	\$0.45	0.8	0.15	\$0.078
Exterior Lighting - Daylighting Controls	1.6%	25.0%	8	\$0.29	0.1	0.02	\$0.549
Interior Fluorescent - Bi-Level Fixture w/Occupancy Sensor	10.0%	30.0%	8	\$0.40	0.3	0.07	\$0.173
Interior Fluorescent - High Bay Fixtures	10.0%	30.0%	11	\$0.63	1.6	0.24	\$0.042
Interior Lighting - Occupancy Sensors	12.6%	60.0%	8	\$0.20	0.2	0.16	\$0.118
Exterior Lighting - Photovoltaic Installation	5.0%	25.0%	5	\$0.92	0.1	0.00	\$2.235
Interior Screw-in - Task Lighting	10.0%	100.0%	5	\$0.24	0.1	0.02	\$0.531
Interior Lighting - Time Clocks and Timers	9.3%	75.0%	8	\$0.20	0.1	0.09	\$0.236
Water Heater - Faucet Aerators/Low Flow Nozzles	3.0%	100.0%	9	\$0.03	0.1	0.27	\$0.042
Water Heater - Pipe Insulation	0.0%	0.0%	15	\$0.28	0.1	0.04	\$0.185
Water Heater - High Efficiency Circulation Pump	0.6%	25.0%	10	\$0.11	1.6	1.31	\$0.008
Water Heater - Tank Blanket/Insulation	0.0%	0.0%	10	\$0.04	0.1	0.26	\$0.041
Water Heater - Thermostat Setback	0.0%	0.0%	10	\$0.11	0.1	0.07	\$0.141
Refrigeration - Anti-Sweat Heater/Auto Door Closer	0.0%	100.0%	16	\$0.20	0.1	0.02	\$0.321
Refrigeration - Floating Head Pressure	38.0%	60.0%	16	\$0.35	0.0	0.00	\$1.320
Refrigeration - Door Gasket Replacement	5.0%	100.0%	8	\$0.10	0.0	0.02	\$0.463
Insulation - Bare Suction Lines	5.0%	100.0%	8	\$0.10	0.0	0.02	\$0.653
Refrigeration - Night Covers	5.0%	100.0%	8	\$0.05	0.0	0.04	\$0.449
Refrigeration - Strip Curtain	12.6%	56.3%	4	\$0.00	0.0	19.02	\$0.001
Vending Machine - Controller	2.0%	10.0%	10	\$0.27	0.1	0.01	\$0.596

C&I Energy Efficiency Equipment and Measure Data

Measure	Base Saturation	Applicability	Lifetime (Years)	Incremental Cost (\$/SqFt)	Savings (kWh/SqFt)	BC Ratio (2015)	Levelized Cost of Energy (\$/kWh)
LED Exit Lighting	46.9%	90.0%	10	\$0.00	0.0	3.74	\$0.006
Retrocommissioning - Lighting	5.0%	100.0%	5	\$0.05	0.3	0.31	\$0.042
Refrigeration - High Efficiency Case Lighting	12.0%	56.0%	6	\$0.04	-	-	\$0.000
Exterior Lighting - Cold Cathode Lighting	14.6%	50.0%	5	\$0.00	0.3	15.65	\$0.001
Laundry - High Efficiency Clothes Washer	6.9%	10.0%	10	\$0.00	0.0	4.60	\$0.002
Interior Lighting - Hotel Guestroom Controls	1.0%	2.0%	8	\$0.14	0.1	0.04	\$0.224
Miscellaneous - Energy Star Water Cooler	5.0%	100.0%	8	\$0.00	0.0	0.26	\$0.047
Interior Lighting - Skylights	0.0%	0.0%	0	\$0.00	0.4	1.00	\$0.000
Ventilation - Demand Control Ventilation	7.9%	15.0%	10	\$0.04	0.2	0.88	\$0.029
Office Equipment - Smart Power Strips	15.4%	30.0%	7	\$0.00	0.3	208.80	\$0.000
Strategic Energy Management	0.0%	0.0%	3	\$0.00	-	6.00	\$0.000
Refrigeration - Multiplex - Floating section Pressure - Air-cooled Cond.	0.0%	0.0%	0	\$0.00	-	1.00	\$0.000
Refrigeration - Multiplex Controls - Floating section Pressure - Evap. Cond.	0.0%	0.0%	0	\$0.00	-	1.00	\$0.000
Refrigeration - Multiplex - Eff. Air-cooled Condenser	0.0%	0.0%	0	\$0.00	-	1.00	\$0.000
Refrigeration - Multiplex - Eff. Water-cooled Condenser	0.0%	0.0%	0	\$0.00	-	1.00	\$0.000
RTU - Maintenance	27.0%	100.0%	4	\$0.06	0.4	0.30	\$0.044
RTU - Evaporative Precooler	0.0%	0.0%	15	\$0.88	1.3	0.12	\$0.060
Chiller - Chilled Water Reset	15.0%	100.0%	4	\$0.18	0.4	0.11	\$0.120
Chiller - Chilled Water Variable-Flow System	30.0%	45.0%	10	\$0.18	0.1	0.04	\$0.226
Chiller - VSD	15.0%	88.2%	20	\$1.17	0.7	0.05	\$0.117
Chiller - High Efficiency Cooling Tower Fans	15.0%	43.5%	10	\$0.04	0.0	0.00	\$11.820
Chiller - Condenser Water Temperature Reset	5.0%	100.0%	14	\$0.18	0.4	0.17	\$0.046
Cooling - Economizer Installation	51.6%	65.0%	15	\$0.15	0.8	0.47	\$0.015
Heat Pump - Maintenance	28.1%	100.0%	4	\$0.06	0.8	0.61	\$0.021
Insulation - Ducting	8.0%	100.0%	20	\$0.41	0.0	0.31	\$1.046
Repair and Sealing - Ducting	5.0%	50.0%	15	\$0.38	0.1	0.32	\$0.421
Energy Management System	44.0%	100.0%	14	\$0.35	2.5	0.68	\$0.013
Cooking - Exhaust Hoods with Sensor Control	1.0%	15.0%	10	\$0.04	-	-	\$0.000
Fans - Energy Efficient Motors	11.0%	100.0%	10	\$0.05	0.1	0.17	\$0.072
Fans - Variable Speed Control	2.0%	100.0%	10	\$0.20	0.6	0.27	\$0.040
Retrocommissioning - HVAC	15.0%	100.0%	4	\$0.30	0.4	0.37	\$0.216
Pumps - Variable Speed Control	0.0%	45.0%	10	\$0.13	0.0	0.01	\$1.381
Thermostat - Clock/Programmable	33.0%	50.0%	11	\$0.11	0.8	0.65	\$0.015
Insulation - Ceiling	9.0%	40.0%	20	\$0.85	0.4	0.34	\$0.152
Insulation - Radiant Barrier	7.0%	25.0%	20	\$0.26	0.0	0.31	\$0.521

Table C-24 Energy Efficiency Non-Equipment Data— Large Commercial, New Vintage, Washington

Measure	Base Saturation	Applicability	Lifetime (Years)	Incremental Cost (\$/SqFt)	Savings (kWh/SqFt)	BC Ratio (2015)	Levelized Cost of Energy (\$/kWh)
RTU - Maintenance	27.0%	100.0%	4	\$0.06	0.2	0.19	\$0.076
RTU - Evaporative Precooler	0.0%	0.0%	15	\$0.88	1.0	0.11	\$0.073
Chiller - Chilled Water Reset	30.0%	100.0%	4	\$0.18	0.3	0.09	\$0.151
Chiller - Chilled Water Variable-Flow System	30.0%	45.0%	10	\$0.18	0.1	0.06	\$0.168
Chiller - VSD	15.0%	88.2%	20	\$1.17	0.6	0.05	\$0.141
Chiller - High Efficiency Cooling Tower Fans	15.0%	43.5%	10	\$0.04	0.0	0.00	\$10.716
Chiller - Condenser Water Temperature Reset	25.0%	100.0%	14	\$0.18	0.3	0.14	\$0.058
Cooling - Economizer Installation	44.3%	65.0%	15	\$0.15	0.0	0.04	\$0.517
Heat Pump - Maintenance	14.7%	100.0%	4	\$0.06	0.5	0.44	\$0.034
Insulation - Ducting	8.0%	50.0%	20	\$0.41	0.0	0.30	\$15.903
Energy Management System	48.5%	100.0%	14	\$0.35	2.9	0.81	\$0.011
Cooking - Exhaust Hoods with Sensor Control	1.0%	15.0%	10	\$0.04	-	-	\$0.000
Fans - Energy Efficient Motors	11.0%	100.0%	10	\$0.05	0.1	0.19	\$0.084
Fans - Variable Speed Control	2.0%	100.0%	10	\$0.20	0.5	0.22	\$0.051
Pumps - Variable Speed Control	5.0%	45.0%	10	\$0.13	0.0	0.01	\$1.313
Thermostat - Clock/Programmable	33.0%	50.0%	11	\$0.11	1.4	1.14	\$0.009
Insulation - Ceiling	75.0%	90.0%	20	\$0.35	0.0	0.31	\$2.770
Insulation - Radiant Barrier	7.0%	25.0%	20	\$0.26	0.0	0.30	\$29.882
Roofs - High Reflectivity	5.0%	100.0%	15	\$0.05	0.0	0.01	\$2.520
Windows - High Efficiency	71.9%	100.0%	20	\$0.88	0.0	0.30	\$17.807
Interior Lighting - Central Lighting Controls	85.7%	100.0%	8	\$0.65	-	-	\$0.000
Interior Lighting - Photocell Controlled T8 Dimming Ballasts	0.9%	60.0%	8	\$0.34	0.7	0.18	\$0.068
Exterior Lighting - Daylighting Controls	10.0%	25.0%	8	\$0.19	-	0.00	\$0.000
Interior Fluorescent - Bi-Level Fixture w/Occupancy Sensor	10.0%	30.0%	8	\$0.40	0.3	0.06	\$0.201
Interior Fluorescent - High Bay Fixtures	10.0%	30.0%	11	\$0.63	1.4	0.21	\$0.049
Interior Lighting - Occupancy Sensors	12.6%	60.0%	8	\$0.20	-	0.06	\$0.000
Exterior Lighting - Photovoltaic Installation	5.0%	25.0%	5	\$0.92	-	-	\$0.000
Interior Screw-in - Task Lighting	10.0%	100.0%	5	\$0.24	0.1	0.03	\$0.538
Interior Lighting - Time Clocks and Timers	9.3%	75.0%	8	\$0.20	-	0.05	\$0.000
Water Heater - Faucet Aerators/Low Flow Nozzles	3.0%	100.0%	9	\$0.03	0.1	0.26	\$0.044
Water Heater - Pipe Insulation	0.0%	0.0%	15	\$0.28	0.1	0.03	\$0.295
Water Heater - High Efficiency Circulation Pump	0.6%	25.0%	10	\$0.11	1.6	1.30	\$0.008
Water Heater - Tank Blanket/Insulation	0.0%	0.0%	10	\$0.04	0.1	0.25	\$0.043
Water Heater - Thermostat Setback	0.0%	0.0%	10	\$0.11	0.1	0.07	\$0.147
Refrigeration - Anti-Sweat Heater/Auto Door Closer	0.0%	100.0%	16	\$0.20	0.0	0.03	\$0.355
Refrigeration - Floating Head Pressure	38.0%	60.0%	16	\$0.35	-	0.00	\$0.000
Refrigeration - Door Gasket Replacement	5.0%	100.0%	8	\$0.10	0.0	0.02	\$0.662
Insulation - Bare Suction Lines	5.0%	100.0%	8	\$0.10	-	-	\$0.000
Refrigeration - Night Covers	5.0%	100.0%	8	\$0.05	0.0	0.04	\$0.495
Refrigeration - Strip Curtain	12.6%	56.3%	4	\$0.00	0.0	15.67	\$0.001
Vending Machine - Controller	2.0%	10.0%	10	\$0.27	0.0	0.01	\$0.684
LED Exit Lighting	91.2%	90.0%	10	\$0.00	0.0	4.71	\$0.006
Refrigeration - High Efficiency Case	24.0%	56.0%	6	\$0.02	0.1	0.23	\$0.061

C&I Energy Efficiency Equipment and Measure Data

Measure	Base Saturation	Applicability	Lifetime (Years)	Incremental Cost (\$/SqFt)	Savings (kWh/SqFt)	BC Ratio (2015)	Levelized Cost of Energy (\$/kWh)
Lighting							
Exterior Lighting - Cold Cathode Lighting	14.6%	50.0%	5	\$0.00	0.3	18.50	\$0.001
Laundry - High Efficiency Clothes Washer	6.9%	10.0%	10	\$0.00	0.0	5.06	\$0.002
Interior Lighting - Hotel Guestroom Controls	1.0%	2.0%	8	\$0.14	0.1	0.05	\$0.227
Miscellaneous - Energy Star Water Cooler	5.0%	100.0%	8	\$0.00	0.0	0.29	\$0.042
Interior Lighting - Skylights	0.0%	0.0%	0	\$0.00	-	1.00	\$0.000
Ventilation - Demand Control Ventilation	12.4%	15.0%	10	\$0.04	-	0.53	\$0.000
Office Equipment - Smart Power Strips	15.4%	30.0%	7	\$0.00	0.3	221.56	\$0.000
Strategic Energy Management	0.0%	0.0%	3	\$0.00	-	6.00	\$0.000
Refrigeration - Multiplex - Floating section Pressure - Air-cooled Cond.	0.0%	0.0%	0	\$0.00	-	1.00	\$0.000
Refrigeration - Multiplex Controls - Floating section Pressure - Evap. Cond.	0.0%	0.0%	0	\$0.00	-	1.00	\$0.000
Refrigeration - Multiplex - Eff. Air-cooled Condenser	0.0%	0.0%	0	\$0.00	-	1.00	\$0.000
Refrigeration - Multiplex - Eff. Water-cooled Condenser	0.0%	0.0%	0	\$0.00	-	1.00	\$0.000
RTU - Maintenance	27.0%	100.0%	4	\$0.06	0.2	0.19	\$0.076
RTU - Evaporative Precooler	0.0%	0.0%	15	\$0.88	1.0	0.11	\$0.073
Chiller - Chilled Water Reset	30.0%	100.0%	4	\$0.18	0.3	0.09	\$0.151
Chiller - Chilled Water Variable-Flow System	30.0%	45.0%	10	\$0.18	0.1	0.06	\$0.168
Chiller - VSD	15.0%	88.2%	20	\$1.17	0.6	0.05	\$0.141
Chiller - High Efficiency Cooling Tower Fans	15.0%	43.5%	10	\$0.04	0.0	0.00	\$10.716
Chiller - Condenser Water Temperature Reset	25.0%	100.0%	14	\$0.18	0.3	0.14	\$0.058
Cooling - Economizer Installation	44.3%	65.0%	15	\$0.15	0.0	0.04	\$0.517
Heat Pump - Maintenance	14.7%	100.0%	4	\$0.06	0.5	0.44	\$0.034
Insulation - Ducting	8.0%	50.0%	20	\$0.41	0.0	0.30	\$15.903
Energy Management System	48.5%	100.0%	14	\$0.35	2.9	0.81	\$0.011
Cooking - Exhaust Hoods with Sensor Control	1.0%	15.0%	10	\$0.04	-	-	\$0.000
Fans - Energy Efficient Motors	11.0%	100.0%	10	\$0.05	0.1	0.19	\$0.084
Fans - Variable Speed Control	2.0%	100.0%	10	\$0.20	0.5	0.22	\$0.051
Pumps - Variable Speed Control	5.0%	45.0%	10	\$0.13	0.0	0.01	\$1.313
Thermostat - Clock/Programmable	33.0%	50.0%	11	\$0.11	1.4	1.14	\$0.009
Insulation - Ceiling	75.0%	90.0%	20	\$0.35	0.0	0.31	\$2.770
Insulation - Radiant Barrier	7.0%	25.0%	20	\$0.26	0.0	0.30	\$29.882
Roofs - High Reflectivity	5.0%	100.0%	15	\$0.05	0.0	0.01	\$2.520
Windows - High Efficiency	71.9%	100.0%	20	\$0.88	0.0	0.30	\$17.807
Interior Lighting - Central Lighting Controls	85.7%	100.0%	8	\$0.65	-	-	\$0.000
Interior Lighting - Photocell Controlled T8 Dimming Ballasts	0.9%	60.0%	8	\$0.34	0.7	0.18	\$0.068
Exterior Lighting - Daylighting Controls	10.0%	25.0%	8	\$0.19	-	0.00	\$0.000

Table C-25 Energy Efficiency Non-Equipment Data— Large Commercial, Existing Vintage, Idaho

Measure	Base Saturation	Applicability	Lifetime (Years)	Incremental Cost (\$/SqFt)	Savings (kWh/SqFt)	BC Ratio (2015)	Levelized Cost of Energy (\$/kWh)
RTU - Maintenance	36.9%	100.0%	4	\$0.06	0.4	0.30	\$0.044
RTU - Evaporative Precooler	0.0%	0.0%	15	\$0.88	1.3	0.12	\$0.060
Chiller - Chilled Water Reset	15.0%	100.0%	4	\$0.18	0.4	0.11	\$0.120
Chiller - Chilled Water Variable-Flow System	30.0%	45.0%	10	\$0.18	0.1	0.04	\$0.226
Chiller - VSD	15.0%	88.2%	20	\$1.17	0.7	0.05	\$0.117
Chiller - High Efficiency Cooling Tower Fans	15.0%	43.5%	10	\$0.04	0.0	0.00	\$11.820
Chiller - Condenser Water Temperature Reset	18.5%	100.0%	14	\$0.18	0.4	0.17	\$0.046
Cooling - Economizer Installation	51.6%	65.0%	15	\$0.15	0.2	0.14	\$0.068
Heat Pump - Maintenance	28.1%	100.0%	4	\$0.06	0.8	0.61	\$0.021
Insulation - Ducting	8.0%	100.0%	20	\$0.41	0.0	0.30	\$2.323
Repair and Sealing - Ducting	5.0%	50.0%	15	\$0.38	0.0	0.31	\$0.792
Energy Management System	45.9%	100.0%	14	\$0.35	1.7	0.47	\$0.019
Cooking - Exhaust Hoods with Sensor Control	1.0%	15.0%	10	\$0.04	-	-	\$0.000
Fans - Energy Efficient Motors	11.0%	100.0%	10	\$0.05	0.1	0.14	\$0.072
Fans - Variable Speed Control	21.7%	100.0%	10	\$0.20	0.6	0.27	\$0.040
Retrocommissioning - HVAC	15.0%	100.0%	4	\$0.30	0.1	0.31	\$1.053
Pumps - Variable Speed Control	0.0%	45.0%	10	\$0.13	0.0	0.01	\$1.381
Thermostat - Clock/Programmable	33.0%	50.0%	11	\$0.11	0.6	0.44	\$0.022
Insulation - Ceiling	9.0%	40.0%	20	\$0.85	0.1	0.31	\$0.599
Insulation - Radiant Barrier	7.0%	25.0%	20	\$0.26	0.0	0.30	\$1.652
Roofs - High Reflectivity	1.5%	100.0%	15	\$0.08	0.0	0.02	\$0.482
Windows - High Efficiency	71.9%	100.0%	20	\$0.88	0.1	0.31	\$0.833
Interior Lighting - Central Lighting Controls	85.7%	100.0%	8	\$0.65	0.3	0.03	\$0.328
Interior Lighting - Photocell Controlled T8 Dimming Ballasts	0.9%	60.0%	8	\$0.45	0.8	0.15	\$0.078
Exterior Lighting - Daylighting Controls	1.6%	25.0%	8	\$0.29	-	0.00	\$0.000
Interior Fluorescent - Bi-Level Fixture w/Occupancy Sensor	10.0%	30.0%	8	\$0.40	0.3	0.07	\$0.173
Interior Fluorescent - High Bay Fixtures	15.4%	30.0%	11	\$0.63	1.6	0.23	\$0.042
Interior Lighting - Occupancy Sensors	23.2%	60.0%	8	\$0.20	0.3	0.17	\$0.101
Exterior Lighting - Photovoltaic Installation	5.0%	25.0%	5	\$0.92	-	-	\$0.000
Interior Screw-in - Task Lighting	10.0%	100.0%	5	\$0.24	0.1	0.02	\$0.531
Interior Lighting - Time Clocks and Timers	9.3%	75.0%	8	\$0.20	0.1	0.09	\$0.202
Water Heater - Faucet Aerators/Low Flow Nozzles	47.9%	100.0%	9	\$0.03	0.1	0.26	\$0.042
Water Heater - Pipe Insulation	0.0%	0.0%	15	\$0.28	0.1	0.04	\$0.185
Water Heater - High Efficiency Circulation Pump	0.6%	25.0%	10	\$0.11	1.6	1.30	\$0.008
Water Heater - Tank Blanket/Insulation	0.0%	0.0%	10	\$0.04	0.1	0.26	\$0.041
Water Heater - Thermostat Setback	0.0%	0.0%	10	\$0.11	0.1	0.07	\$0.141
Refrigeration - Anti-Sweat Heater/Auto Door Closer	0.0%	100.0%	16	\$0.20	0.1	0.02	\$0.321
Refrigeration - Floating Head Pressure	38.0%	60.0%	16	\$0.35	-	0.00	\$0.000
Refrigeration - Door Gasket Replacement	5.0%	100.0%	8	\$0.10	0.0	0.02	\$0.463
Insulation - Bare Suction Lines	5.0%	100.0%	8	\$0.10	-	-	\$0.000
Refrigeration - Night Covers	5.0%	100.0%	8	\$0.05	0.0	0.04	\$0.449
Refrigeration - Strip Curtain	12.6%	56.3%	4	\$0.00	0.0	18.97	\$0.001
Vending Machine - Controller	2.0%	10.0%	10	\$0.27	0.1	0.01	\$0.596

C&I Energy Efficiency Equipment and Measure Data

Measure	Base Saturation	Applicability	Lifetime (Years)	Incremental Cost (\$/SqFt)	Savings (kWh/SqFt)	BC Ratio (2015)	Levelized Cost of Energy (\$/kWh)
LED Exit Lighting	46.9%	90.0%	10	\$0.00	0.0	3.00	\$0.006
Retrocommissioning - Lighting	24.1%	100.0%	5	\$0.05	0.3	0.33	\$0.038
Refrigeration - High Efficiency Case Lighting	12.0%	56.0%	6	\$0.04	0.0	0.00	\$5.412
Exterior Lighting - Cold Cathode Lighting	14.6%	50.0%	5	\$0.00	0.3	15.57	\$0.001
Laundry - High Efficiency Clothes Washer	6.9%	10.0%	10	\$0.00	0.0	4.57	\$0.002
Interior Lighting - Hotel Guestroom Controls	1.0%	2.0%	8	\$0.14	0.1	0.03	\$0.224
Miscellaneous - Energy Star Water Cooler	24.1%	100.0%	8	\$0.00	0.0	0.26	\$0.047
Interior Lighting - Skylights	0.0%	0.0%	0	\$0.00	0.4	1.00	\$0.000
Ventilation - Demand Control Ventilation	7.9%	15.0%	10	\$0.04	0.0	0.53	\$0.315
Office Equipment - Smart Power Strips	15.4%	30.0%	7	\$0.00	0.5	353.57	\$0.000
Strategic Energy Management	0.0%	0.0%	3	\$0.00	-	6.00	\$0.000
Refrigeration - Multiplex - Floating section Pressure - Air-cooled Cond.	0.0%	0.0%	0	\$0.00	-	1.00	\$0.000
Refrigeration - Multiplex Controls - Floating section Pressure - Evap. Cond.	0.0%	0.0%	0	\$0.00	-	1.00	\$0.000
Refrigeration - Multiplex - Eff. Air-cooled Condenser	0.0%	0.0%	0	\$0.00	-	1.00	\$0.000
Refrigeration - Multiplex - Eff. Water-cooled Condenser	0.0%	0.0%	0	\$0.00	-	1.00	\$0.000
RTU - Maintenance	36.9%	100.0%	4	\$0.06	0.4	0.30	\$0.044
RTU - Evaporative Precooler	0.0%	0.0%	15	\$0.88	1.3	0.12	\$0.060
Chiller - Chilled Water Reset	15.0%	100.0%	4	\$0.18	0.4	0.11	\$0.120
Chiller - Chilled Water Variable-Flow System	30.0%	45.0%	10	\$0.18	0.1	0.04	\$0.226
Chiller - VSD	15.0%	88.2%	20	\$1.17	0.7	0.05	\$0.117
Chiller - High Efficiency Cooling Tower Fans	15.0%	43.5%	10	\$0.04	0.0	0.00	\$11.820
Chiller - Condenser Water Temperature Reset	18.5%	100.0%	14	\$0.18	0.4	0.17	\$0.046
Cooling - Economizer Installation	51.6%	65.0%	15	\$0.15	0.2	0.14	\$0.068
Heat Pump - Maintenance	28.1%	100.0%	4	\$0.06	0.8	0.61	\$0.021
Insulation - Ducting	8.0%	100.0%	20	\$0.41	0.0	0.30	\$2.323
Repair and Sealing - Ducting	5.0%	50.0%	15	\$0.38	0.0	0.31	\$0.792
Energy Management System	45.9%	100.0%	14	\$0.35	1.7	0.47	\$0.019
Cooking - Exhaust Hoods with Sensor Control	1.0%	15.0%	10	\$0.04	-	-	\$0.000
Fans - Energy Efficient Motors	11.0%	100.0%	10	\$0.05	0.1	0.14	\$0.072
Fans - Variable Speed Control	21.7%	100.0%	10	\$0.20	0.6	0.27	\$0.040
Retrocommissioning - HVAC	15.0%	100.0%	4	\$0.30	0.1	0.31	\$1.053
Pumps - Variable Speed Control	0.0%	45.0%	10	\$0.13	0.0	0.01	\$1.381
Thermostat - Clock/Programmable	33.0%	50.0%	11	\$0.11	0.6	0.44	\$0.022
Insulation - Ceiling	9.0%	40.0%	20	\$0.85	0.1	0.31	\$0.599
Insulation - Radiant Barrier	7.0%	25.0%	20	\$0.26	0.0	0.30	\$1.652

C&I Energy Efficiency Equipment and Measure Data

Table C-26 Energy Efficiency Non-Equipment Data— Large Commercial, New Vintage, Idaho

Measure	Base Saturation	Applicability	Lifetime (Years)	Incremental Cost (\$/SqFt)	Savings (kWh/SqFt)	BC Ratio (2015)	Levelized Cost of Energy (\$/kWh)
RTU - Maintenance	27.0%	100.0%	4	\$0.06	0.2	0.19	\$0.076
RTU - Evaporative Precooler	0.0%	0.0%	15	\$0.88	1.0	0.11	\$0.073
Chiller - Chilled Water Reset	30.0%	100.0%	4	\$0.18	0.3	0.10	\$0.151
Chiller - Chilled Water Variable-Flow System	30.0%	45.0%	10	\$0.18	0.1	0.06	\$0.168
Chiller - VSD	15.0%	88.2%	20	\$1.17	0.6	0.05	\$0.141
Chiller - High Efficiency Cooling Tower Fans	15.0%	43.5%	10	\$0.04	0.0	0.00	\$10.716
Chiller - Condenser Water Temperature Reset	31.4%	100.0%	14	\$0.18	0.3	0.15	\$0.058
Cooling - Economizer Installation	44.3%	65.0%	15	\$0.15	-	0.03	\$0.000
Heat Pump - Maintenance	28.1%	100.0%	4	\$0.06	0.5	0.43	\$0.034
Insulation - Ducting	8.0%	50.0%	20	\$0.41	-	0.30	\$0.000
Energy Management System	55.8%	100.0%	14	\$0.35	1.6	0.47	\$0.020
Cooking - Exhaust Hoods with Sensor Control	1.0%	15.0%	10	\$0.04	-	-	\$0.000
Fans - Energy Efficient Motors	28.9%	100.0%	10	\$0.05	0.1	0.17	\$0.084
Fans - Variable Speed Control	47.3%	100.0%	10	\$0.20	0.5	0.23	\$0.051
Pumps - Variable Speed Control	5.0%	45.0%	10	\$0.13	0.0	0.01	\$1.313
Thermostat - Clock/Programmable	33.0%	50.0%	11	\$0.11	0.4	0.29	\$0.033
Insulation - Ceiling	75.0%	90.0%	20	\$0.35	-	0.30	\$0.000
Insulation - Radiant Barrier	7.0%	25.0%	20	\$0.26	-	0.30	\$0.000
Roofs - High Reflectivity	5.0%	100.0%	15	\$0.05	-	0.01	\$0.000
Windows - High Efficiency	71.9%	100.0%	20	\$0.88	-	0.30	\$0.000
Interior Lighting - Central Lighting Controls	85.7%	100.0%	8	\$0.65	0.4	0.06	\$0.213
Interior Lighting - Photocell Controlled T8 Dimming Ballasts	0.9%	60.0%	8	\$0.34	0.7	0.18	\$0.068
Exterior Lighting - Daylighting Controls	14.5%	25.0%	8	\$0.19	1.7	0.75	\$0.016
Interior Fluorescent - Bi-Level Fixture w/Occupancy Sensor	10.0%	30.0%	8	\$0.40	0.3	0.06	\$0.201
Interior Fluorescent - High Bay Fixtures	15.4%	30.0%	11	\$0.63	1.4	0.21	\$0.049
Interior Lighting - Occupancy Sensors	23.2%	60.0%	8	\$0.20	0.4	0.24	\$0.066
Exterior Lighting - Photovoltaic Installation	5.0%	25.0%	5	\$0.92	2.0	0.15	\$0.100
Interior Screw-in - Task Lighting	10.0%	100.0%	5	\$0.24	0.1	0.02	\$0.538
Interior Lighting - Time Clocks and Timers	15.2%	75.0%	8	\$0.20	0.2	0.14	\$0.131
Water Heater - Faucet Aerators/Low Flow Nozzles	47.9%	100.0%	9	\$0.03	0.1	0.26	\$0.044
Water Heater - Pipe Insulation	0.0%	0.0%	15	\$0.28	0.1	0.03	\$0.295
Water Heater - High Efficiency Circulation Pump	0.6%	25.0%	10	\$0.11	1.6	1.28	\$0.008
Water Heater - Tank Blanket/Insulation	0.0%	0.0%	10	\$0.04	0.1	0.25	\$0.043
Water Heater - Thermostat Setback	0.0%	0.0%	10	\$0.11	0.1	0.07	\$0.147
Refrigeration - Anti-Sweat Heater/Auto Door Closer	0.0%	100.0%	16	\$0.20	0.0	0.03	\$0.355
Refrigeration - Floating Head Pressure	38.0%	60.0%	16	\$0.35	0.1	0.02	\$0.330
Refrigeration - Door Gasket Replacement	5.0%	100.0%	8	\$0.10	0.0	0.02	\$0.662
Insulation - Bare Suction Lines	5.0%	100.0%	8	\$0.10	0.1	0.08	\$0.163
Refrigeration - Night Covers	5.0%	100.0%	8	\$0.05	0.0	0.04	\$0.495
Refrigeration - Strip Curtain	29.7%	56.3%	4	\$0.00	0.0	15.63	\$0.001
Vending Machine - Controller	2.0%	10.0%	10	\$0.27	0.0	0.01	\$0.684
LED Exit Lighting	91.2%	90.0%	10	\$0.00	0.0	4.50	\$0.006
Refrigeration - High Efficiency Case	24.0%	56.0%	6	\$0.02	0.0	0.14	\$0.102

C&I Energy Efficiency Equipment and Measure Data

Measure	Base Saturation	Applicability	Lifetime (Years)	Incremental Cost (\$/SqFt)	Savings (kWh/SqFt)	BC Ratio (2015)	Levelized Cost of Energy (\$/kWh)
Lighting							
Exterior Lighting - Cold Cathode Lighting	14.6%	50.0%	5	\$0.00	0.3	18.13	\$0.001
Laundry - High Efficiency Clothes Washer	6.9%	10.0%	10	\$0.00	0.0	5.03	\$0.002
Interior Lighting - Hotel Guestroom Controls	1.0%	2.0%	8	\$0.14	0.1	0.05	\$0.227
Miscellaneous - Energy Star Water Cooler	11.9%	100.0%	8	\$0.00	0.0	0.29	\$0.042
Interior Lighting - Skylights	0.0%	0.0%	0	\$0.00	0.7	1.00	\$0.000
Ventilation - Demand Control Ventilation	15.0%	15.0%	10	\$0.04	-	0.54	\$0.000
Office Equipment - Smart Power Strips	15.4%	30.0%	7	\$0.00	0.3	219.97	\$0.000
Strategic Energy Management	0.0%	0.0%	3	\$0.00	-	6.00	\$0.000
Refrigeration - Multiplex - Floating section Pressure - Air-cooled Cond.	0.0%	0.0%	0	\$0.00	-	1.00	\$0.000
Refrigeration - Multiplex Controls - Floating section Pressure - Evap. Cond.	0.0%	0.0%	0	\$0.00	-	1.00	\$0.000
Refrigeration - Multiplex - Eff. Air-cooled Condenser	0.0%	0.0%	0	\$0.00	-	1.00	\$0.000
Refrigeration - Multiplex - Eff. Water-cooled Condenser	0.0%	0.0%	0	\$0.00	-	1.00	\$0.000
RTU - Maintenance	27.0%	100.0%	4	\$0.06	0.2	0.19	\$0.076
RTU - Evaporative Precooler	0.0%	0.0%	15	\$0.88	1.0	0.11	\$0.073
Chiller - Chilled Water Reset	30.0%	100.0%	4	\$0.18	0.3	0.10	\$0.151
Chiller - Chilled Water Variable-Flow System	30.0%	45.0%	10	\$0.18	0.1	0.06	\$0.168
Chiller - VSD	15.0%	88.2%	20	\$1.17	0.6	0.05	\$0.141
Chiller - High Efficiency Cooling Tower Fans	15.0%	43.5%	10	\$0.04	0.0	0.00	\$10.716
Chiller - Condenser Water Temperature Reset	31.4%	100.0%	14	\$0.18	0.3	0.15	\$0.058
Cooling - Economizer Installation	44.3%	65.0%	15	\$0.15	-	0.03	\$0.000
Heat Pump - Maintenance	28.1%	100.0%	4	\$0.06	0.5	0.43	\$0.034
Insulation - Ducting	8.0%	50.0%	20	\$0.41	-	0.30	\$0.000
Energy Management System	55.8%	100.0%	14	\$0.35	1.6	0.47	\$0.020
Cooking - Exhaust Hoods with Sensor Control	1.0%	15.0%	10	\$0.04	-	-	\$0.000
Fans - Energy Efficient Motors	28.9%	100.0%	10	\$0.05	0.1	0.17	\$0.084
Fans - Variable Speed Control	47.3%	100.0%	10	\$0.20	0.5	0.23	\$0.051
Pumps - Variable Speed Control	5.0%	45.0%	10	\$0.13	0.0	0.01	\$1.313
Thermostat - Clock/Programmable	33.0%	50.0%	11	\$0.11	0.4	0.29	\$0.033
Insulation - Ceiling	75.0%	90.0%	20	\$0.35	-	0.30	\$0.000
Insulation - Radiant Barrier	7.0%	25.0%	20	\$0.26	-	0.30	\$0.000
Roofs - High Reflectivity	5.0%	100.0%	15	\$0.05	-	0.01	\$0.000
Windows - High Efficiency	71.9%	100.0%	20	\$0.88	-	0.30	\$0.000
Interior Lighting - Central Lighting Controls	85.7%	100.0%	8	\$0.65	0.4	0.06	\$0.213
Interior Lighting - Photocell Controlled T8 Dimming Ballasts	0.9%	60.0%	8	\$0.34	0.7	0.18	\$0.068
Exterior Lighting - Daylighting Controls	14.5%	25.0%	8	\$0.19	1.7	0.75	\$0.016

C&I Energy Efficiency Equipment and Measure Data

Table C-27 Energy Efficiency Non-Equipment Data— Extra Large Commercial, Existing Vintage, Washington

Measure	Base Saturation	Applicability	Lifetime (Years)	Incremental Cost (\$/SqFt)	Savings (kWh/SqFt)	BC Ratio (2015)	Levelized Cost of Energy (\$/kWh)
RTU - Maintenance	47.0%	100.0%	4	\$0.06	0.3	0.27	\$0.050
RTU - Evaporative Precooler	0.0%	0.0%	15	\$0.88	1.1	0.12	\$0.068
Chiller - Chilled Water Reset	30.0%	100.0%	4	\$0.09	0.3	0.19	\$0.072
Chiller - Chilled Water Variable-Flow System	30.0%	45.0%	10	\$0.09	0.1	0.11	\$0.097
Chiller - VSD	3.0%	100.0%	20	\$1.17	0.7	0.07	\$0.118
Chiller - High Efficiency Cooling Tower Fans	25.0%	73.7%	10	\$0.04	0.0	0.00	\$12.451
Chiller - Condenser Water Temperature Reset	31.4%	100.0%	14	\$0.09	0.3	0.32	\$0.024
Cooling - Economizer Installation	73.4%	90.0%	15	\$0.15	0.0	0.03	\$0.577
Heat Pump - Maintenance	5.0%	100.0%	4	\$0.06	0.4	0.30	\$0.043
Insulation - Ducting	2.0%	100.0%	20	\$0.41	0.1	0.33	\$0.274
Repair and Sealing - Ducting	5.0%	50.0%	15	\$0.38	0.3	0.39	\$0.099
Energy Management System	81.3%	100.0%	14	\$0.35	4.1	1.10	\$0.008
Cooking - Exhaust Hoods with Sensor Control	1.0%	10.0%	10	\$0.04	0.0	0.10	\$0.103
Fans - Energy Efficient Motors	11.0%	100.0%	10	\$0.05	0.1	0.17	\$0.061
Fans - Variable Speed Control	2.0%	100.0%	10	\$0.20	0.6	0.29	\$0.037
Retrocommissioning - HVAC	15.0%	100.0%	4	\$0.20	0.2	0.36	\$0.268
Pumps - Variable Speed Control	1.0%	45.0%	10	\$0.44	0.0	0.00	\$7.933
Thermostat - Clock/Programmable	25.0%	50.0%	11	\$0.11	2.1	1.71	\$0.006
Insulation - Ceiling	2.0%	90.0%	20	\$0.85	0.2	0.33	\$0.265
Insulation - Radiant Barrier	2.0%	25.0%	20	\$0.26	0.0	0.32	\$0.426
Roofs - High Reflectivity	0.0%	100.0%	15	\$0.18	0.0	0.02	\$0.687
Windows - High Efficiency	94.6%	100.0%	20	\$2.10	0.1	0.30	\$1.632
Interior Lighting - Central Lighting Controls	78.1%	100.0%	8	\$0.65	0.0	0.00	\$3.005
Interior Lighting - Photocell Controlled T8 Dimming Ballasts	2.5%	60.0%	8	\$0.40	0.5	0.11	\$0.105
Exterior Lighting - Daylighting Controls	1.6%	20.0%	8	\$0.29	0.3	0.06	\$0.135
Interior Fluorescent - Bi-Level Fixture w/Occupancy Sensor	10.0%	30.0%	8	\$0.20	0.2	0.09	\$0.131
Interior Fluorescent - High Bay Fixtures	10.0%	30.0%	11	\$0.56	1.1	0.18	\$0.056
Interior Lighting - Occupancy Sensors	41.7%	60.0%	8	\$0.20	0.0	0.07	\$0.925
Exterior Lighting - Photovoltaic Installation	5.0%	25.0%	5	\$0.92	0.4	0.02	\$0.549
Interior Screw-in - Task Lighting	5.0%	100.0%	5	\$0.24	0.1	0.03	\$0.366
Interior Lighting - Time Clocks and Timers	12.1%	75.0%	8	\$0.20	0.0	0.05	\$1.849
Water Heater - Faucet Aerators/Low Flow Nozzles	47.3%	100.0%	9	\$0.03	0.1	0.43	\$0.026
Water Heater - Pipe Insulation	0.0%	0.0%	15	\$0.28	0.2	0.07	\$0.115
Water Heater - High Efficiency Circulation Pump	0.6%	25.0%	10	\$0.11	2.6	2.11	\$0.005
Water Heater - Tank Blanket/Insulation	0.0%	0.0%	10	\$0.04	0.2	0.41	\$0.026
Water Heater - Thermostat Setback	0.0%	0.0%	10	\$0.11	0.1	0.12	\$0.088
Refrigeration - Anti-Sweat Heater/Auto Door Closer	10.0%	100.0%	16	\$0.20	0.0	0.01	\$1.098
Refrigeration - Floating Head Pressure	10.0%	50.0%	16	\$0.35	0.0	0.00	\$2.158
Refrigeration - Door Gasket Replacement	5.0%	100.0%	8	\$0.10	0.0	0.02	\$0.505
Insulation - Bare Suction Lines	5.0%	100.0%	8	\$0.10	0.0	0.01	\$1.067
Refrigeration - Night Covers	5.0%	100.0%	8	\$0.05	0.0	0.06	\$0.239
Refrigeration - Strip Curtain	12.6%	56.3%	4	\$0.00	0.0	3.75	\$0.004
Vending Machine - Controller	2.0%	10.0%	10	\$0.27	0.1	0.01	\$0.566

C&I Energy Efficiency Equipment and Measure Data

Measure	Base Saturation	Applicability	Lifetime (Years)	Incremental Cost (\$/SqFt)	Savings (kWh/SqFt)	BC Ratio (2015)	Levelized Cost of Energy (\$/kWh)
LED Exit Lighting	46.9%	90.0%	10	\$0.00	0.0	4.54	\$0.004
Retrocommissioning - Lighting	5.0%	100.0%	5	\$0.05	0.1	0.09	\$0.118
Refrigeration - High Efficiency Case Lighting	12.0%	56.0%	6	\$0.04	0.2	0.34	\$0.043
Exterior Lighting - Cold Cathode Lighting	14.6%	50.0%	5	\$0.00	0.4	19.92	\$0.000
Laundry - High Efficiency Clothes Washer	6.9%	10.0%	10	\$0.00	0.0	2.68	\$0.004
Interior Lighting - Hotel Guestroom Controls	0.0%	0.0%	8	\$0.14	0.1	0.06	\$0.154
Miscellaneous - Energy Star Water Cooler	5.0%	100.0%	8	\$0.00	0.0	0.15	\$0.080
Interior Lighting - Skylights	0.0%	0.0%	0	\$0.00	0.0	1.00	\$0.000
Ventilation - Demand Control Ventilation	1.0%	10.0%	10	\$0.04	0.0	0.13	\$0.415
Office Equipment - Smart Power Strips	15.4%	30.0%	7	\$0.00	0.3	207.83	\$0.000
Strategic Energy Management	0.0%	0.0%	3	\$0.00	-	6.00	\$0.000
Refrigeration - Multiplex - Floating section Pressure - Air-cooled Cond.	0.0%	0.0%	0	\$0.00	-	1.00	\$0.000
Refrigeration - Multiplex Controls - Floating section Pressure - Evap. Cond.	0.0%	0.0%	0	\$0.00	-	1.00	\$0.000
Refrigeration - Multiplex - Eff. Air-cooled Condenser	0.0%	0.0%	0	\$0.00	-	1.00	\$0.000
Refrigeration - Multiplex - Eff. Water-cooled Condenser	0.0%	0.0%	0	\$0.00	-	1.00	\$0.000
RTU - Maintenance	47.0%	100.0%	4	\$0.06	0.3	0.27	\$0.050
RTU - Evaporative Precooler	0.0%	0.0%	15	\$0.88	1.1	0.12	\$0.068
Chiller - Chilled Water Reset	30.0%	100.0%	4	\$0.09	0.3	0.19	\$0.072
Chiller - Chilled Water Variable-Flow System	30.0%	45.0%	10	\$0.09	0.1	0.11	\$0.097
Chiller - VSD	3.0%	100.0%	20	\$1.17	0.7	0.07	\$0.118
Chiller - High Efficiency Cooling Tower Fans	25.0%	73.7%	10	\$0.04	0.0	0.00	\$12.451
Chiller - Condenser Water Temperature Reset	31.4%	100.0%	14	\$0.09	0.3	0.32	\$0.024
Cooling - Economizer Installation	73.4%	90.0%	15	\$0.15	0.0	0.03	\$0.577
Heat Pump - Maintenance	5.0%	100.0%	4	\$0.06	0.4	0.30	\$0.043
Insulation - Ducting	2.0%	100.0%	20	\$0.41	0.1	0.33	\$0.274
Repair and Sealing - Ducting	5.0%	50.0%	15	\$0.38	0.3	0.39	\$0.099
Energy Management System	81.3%	100.0%	14	\$0.35	4.1	1.10	\$0.008
Cooking - Exhaust Hoods with Sensor Control	1.0%	10.0%	10	\$0.04	0.0	0.10	\$0.103
Fans - Energy Efficient Motors	11.0%	100.0%	10	\$0.05	0.1	0.17	\$0.061
Fans - Variable Speed Control	2.0%	100.0%	10	\$0.20	0.6	0.29	\$0.037
Retrocommissioning - HVAC	15.0%	100.0%	4	\$0.20	0.2	0.36	\$0.268
Pumps - Variable Speed Control	1.0%	45.0%	10	\$0.44	0.0	0.00	\$7.933
Thermostat - Clock/Programmable	25.0%	50.0%	11	\$0.11	2.1	1.71	\$0.006
Insulation - Ceiling	2.0%	90.0%	20	\$0.85	0.2	0.33	\$0.265
Insulation - Radiant Barrier	2.0%	25.0%	20	\$0.26	0.0	0.32	\$0.426

Table C-28 Energy Efficiency Non-Equipment Data— Extra Large Commercial, New Vintage, Washington

Measure	Base Saturation	Applicability	Lifetime (Years)	Incremental Cost (\$/SqFt)	Savings (kWh/SqFt)	BC Ratio (2015)	Levelized Cost of Energy (\$/kWh)
RTU - Maintenance	47.0%	100.0%	4	\$0.06	0.2	0.17	\$0.086
RTU - Evaporative Precooler	0.0%	0.0%	15	\$0.88	0.9	0.11	\$0.082
Chiller - Chilled Water Reset	60.0%	100.0%	4	\$0.09	0.3	0.16	\$0.091
Chiller - Chilled Water Variable-Flow System	30.0%	45.0%	10	\$0.09	0.1	0.08	\$0.127
Chiller - VSD	3.0%	100.0%	20	\$1.17	0.6	0.06	\$0.138
Chiller - High Efficiency Cooling Tower Fans	25.0%	73.7%	10	\$0.04	0.0	0.00	\$11.601
Chiller - Condenser Water Temperature Reset	57.1%	100.0%	14	\$0.09	0.3	0.34	\$0.030
Cooling - Economizer Installation	73.4%	90.0%	15	\$0.15	-	0.02	\$0.000
Heat Pump - Maintenance	5.0%	100.0%	4	\$0.06	0.2	0.18	\$0.082
Insulation - Ducting	2.0%	50.0%	20	\$0.41	-	0.31	\$0.000
Energy Management System	80.0%	100.0%	14	\$0.35	2.7	0.78	\$0.012
Cooking - Exhaust Hoods with Sensor Control	1.0%	10.0%	10	\$0.04	0.0	0.10	\$0.117
Fans - Energy Efficient Motors	11.0%	100.0%	10	\$0.05	0.1	0.16	\$0.070
Fans - Variable Speed Control	2.0%	100.0%	10	\$0.20	0.6	0.31	\$0.037
Pumps - Variable Speed Control	1.0%	45.0%	10	\$0.44	0.0	0.00	\$7.545
Thermostat - Clock/Programmable	25.0%	50.0%	11	\$0.11	2.0	1.61	\$0.006
Insulation - Ceiling	2.0%	90.0%	20	\$0.35	-	0.31	\$0.000
Insulation - Radiant Barrier	2.0%	25.0%	20	\$0.26	-	0.30	\$0.000
Roofs - High Reflectivity	5.0%	100.0%	15	\$0.18	-	0.01	\$0.000
Windows - High Efficiency	94.6%	100.0%	20	\$1.69	-	0.30	\$0.000
Interior Lighting - Central Lighting Controls	78.1%	100.0%	8	\$0.65	-	-	\$0.000
Interior Lighting - Photocell Controlled T8 Dimming Ballasts	2.5%	60.0%	8	\$0.30	0.5	0.14	\$0.086
Exterior Lighting - Daylighting Controls	10.0%	20.0%	8	\$0.19	-	0.00	\$0.000
Interior Fluorescent - Bi-Level Fixture w/Occupancy Sensor	10.0%	30.0%	8	\$0.20	0.2	0.09	\$0.143
Interior Fluorescent - High Bay Fixtures	10.0%	30.0%	11	\$0.56	1.0	0.17	\$0.061
Interior Lighting - Occupancy Sensors	41.7%	60.0%	8	\$0.20	-	0.06	\$0.000
Exterior Lighting - Photovoltaic Installation	5.0%	25.0%	5	\$0.92	-	-	\$0.000
Interior Screw-in - Task Lighting	25.0%	100.0%	5	\$0.24	0.1	0.04	\$0.376
Interior Lighting - Time Clocks and Timers	12.1%	75.0%	8	\$0.20	-	0.04	\$0.000
Water Heater - Faucet Aerators/Low Flow Nozzles	47.3%	100.0%	9	\$0.03	0.1	0.43	\$0.027
Water Heater - Pipe Insulation	0.0%	0.0%	15	\$0.28	0.1	0.05	\$0.180
Water Heater - High Efficiency Circulation Pump	0.6%	25.0%	10	\$0.11	2.5	2.10	\$0.005
Water Heater - Tank Blanket/Insulation	0.0%	0.0%	10	\$0.04	0.1	0.21	\$0.052
Water Heater - Thermostat Setback	0.0%	0.0%	10	\$0.11	0.1	0.12	\$0.090
Refrigeration - Anti-Sweat Heater/Auto Door Closer	10.0%	100.0%	16	\$0.20	0.0	0.01	\$1.217
Refrigeration - Floating Head Pressure	10.0%	50.0%	16	\$0.35	0.2	0.04	\$0.188
Refrigeration - Door Gasket Replacement	5.0%	100.0%	8	\$0.10	0.0	0.02	\$0.721
Insulation - Bare Suction Lines	5.0%	100.0%	8	\$0.10	0.2	0.13	\$0.093
Refrigeration - Night Covers	5.0%	100.0%	8	\$0.05	0.0	0.06	\$0.263
Refrigeration - Strip Curtain	29.7%	56.3%	4	\$0.00	0.0	3.12	\$0.005
Vending Machine - Controller	2.0%	10.0%	10	\$0.27	0.0	0.01	\$0.784
LED Exit Lighting	91.2%	90.0%	10	\$0.00	0.0	5.08	\$0.004
Refrigeration - High Efficiency Case	26.1%	56.0%	6	\$0.02	0.1	0.87	\$0.041

C&I Energy Efficiency Equipment and Measure Data

Measure	Base Saturation	Applicability	Lifetime (Years)	Incremental Cost (\$/SqFt)	Savings (kWh/SqFt)	BC Ratio (2015)	Levelized Cost of Energy (\$/kWh)
Lighting							
Exterior Lighting - Cold Cathode Lighting	14.6%	50.0%	5	\$0.00	0.3	22.34	\$0.001
Laundry - High Efficiency Clothes Washer	6.9%	10.0%	10	\$0.00	0.0	2.95	\$0.004
Interior Lighting - Hotel Guestroom Controls	0.0%	0.0%	8	\$0.14	0.1	0.07	\$0.158
Miscellaneous - Energy Star Water Cooler	5.0%	100.0%	8	\$0.00	0.0	0.17	\$0.073
Interior Lighting - Skylights	0.0%	0.0%	0	\$0.00	-	1.00	\$0.000
Ventilation - Demand Control Ventilation	5.9%	10.0%	10	\$0.04	-	0.11	\$0.000
Office Equipment - Smart Power Strips	15.4%	30.0%	7	\$0.00	0.3	219.19	\$0.000
Strategic Energy Management	0.0%	0.0%	3	\$0.00	-	6.00	\$0.000
Refrigeration - Multiplex - Floating section Pressure - Air-cooled Cond.	0.0%	0.0%	0	\$0.00	-	1.00	\$0.000
Refrigeration - Multiplex Controls - Floating section Pressure - Evap. Cond.	0.0%	0.0%	0	\$0.00	-	1.00	\$0.000
Refrigeration - Multiplex - Eff. Air-cooled Condenser	0.0%	0.0%	0	\$0.00	-	1.00	\$0.000
Refrigeration - Multiplex - Eff. Water-cooled Condenser	0.0%	0.0%	0	\$0.00	-	1.00	\$0.000
RTU - Maintenance	47.0%	100.0%	4	\$0.06	0.2	0.17	\$0.086
RTU - Evaporative Precooler	0.0%	0.0%	15	\$0.88	0.9	0.11	\$0.082
Chiller - Chilled Water Reset	60.0%	100.0%	4	\$0.09	0.3	0.16	\$0.091
Chiller - Chilled Water Variable-Flow System	30.0%	45.0%	10	\$0.09	0.1	0.08	\$0.127
Chiller - VSD	3.0%	100.0%	20	\$1.17	0.6	0.06	\$0.138
Chiller - High Efficiency Cooling Tower Fans	25.0%	73.7%	10	\$0.04	0.0	0.00	\$11.601
Chiller - Condenser Water Temperature Reset	57.1%	100.0%	14	\$0.09	0.3	0.34	\$0.030
Cooling - Economizer Installation	73.4%	90.0%	15	\$0.15	-	0.02	\$0.000
Heat Pump - Maintenance	5.0%	100.0%	4	\$0.06	0.2	0.18	\$0.082
Insulation - Ducting	2.0%	50.0%	20	\$0.41	-	0.31	\$0.000
Energy Management System	80.0%	100.0%	14	\$0.35	2.7	0.78	\$0.012
Cooking - Exhaust Hoods with Sensor Control	1.0%	10.0%	10	\$0.04	0.0	0.10	\$0.117
Fans - Energy Efficient Motors	11.0%	100.0%	10	\$0.05	0.1	0.16	\$0.070
Fans - Variable Speed Control	2.0%	100.0%	10	\$0.20	0.6	0.31	\$0.037
Pumps - Variable Speed Control	1.0%	45.0%	10	\$0.44	0.0	0.00	\$7.545
Thermostat - Clock/Programmable	25.0%	50.0%	11	\$0.11	2.0	1.61	\$0.006
Insulation - Ceiling	2.0%	90.0%	20	\$0.35	-	0.31	\$0.000
Insulation - Radiant Barrier	2.0%	25.0%	20	\$0.26	-	0.30	\$0.000
Roofs - High Reflectivity	5.0%	100.0%	15	\$0.18	-	0.01	\$0.000
Windows - High Efficiency	94.6%	100.0%	20	\$1.69	-	0.30	\$0.000
Interior Lighting - Central Lighting Controls	78.1%	100.0%	8	\$0.65	-	-	\$0.000
Interior Lighting - Photocell Controlled T8 Dimming Ballasts	2.5%	60.0%	8	\$0.30	0.5	0.14	\$0.086
Exterior Lighting - Daylighting Controls	10.0%	20.0%	8	\$0.19	-	0.00	\$0.000

C&I Energy Efficiency Equipment and Measure Data

Table C-29 Energy Efficiency Non-Equipment Data— Extra Large Commercial, Existing Vintage, Idaho

Measure	Base Saturation	Applicability	Lifetime (Years)	Incremental Cost (\$/SqFt)	Savings (kWh/SqFt)	BC Ratio (2015)	Levelized Cost of Energy (\$/kWh)
RTU - Maintenance	54.2%	100.0%	4	\$0.06	0.3	0.26	\$0.050
RTU - Evaporative Precooler	0.0%	0.0%	15	\$0.88	1.1	0.12	\$0.068
Chiller - Chilled Water Reset	36.0%	100.0%	4	\$0.09	0.3	0.19	\$0.072
Chiller - Chilled Water Variable-Flow System	30.0%	45.0%	10	\$0.09	0.1	0.11	\$0.097
Chiller - VSD	3.0%	100.0%	20	\$1.17	0.7	0.06	\$0.118
Chiller - High Efficiency Cooling Tower Fans	25.0%	73.7%	10	\$0.04	0.0	0.00	\$12.451
Chiller - Condenser Water Temperature Reset	31.4%	100.0%	14	\$0.09	0.3	0.37	\$0.025
Cooling - Economizer Installation	73.4%	90.0%	15	\$0.15	0.0	0.02	\$1.832
Heat Pump - Maintenance	24.1%	100.0%	4	\$0.06	0.8	0.66	\$0.021
Insulation - Ducting	2.0%	100.0%	20	\$0.41	0.0	0.32	\$0.695
Repair and Sealing - Ducting	5.0%	50.0%	15	\$0.38	0.1	0.34	\$0.240
Energy Management System	82.8%	100.0%	14	\$0.35	2.9	0.78	\$0.011
Cooking - Exhaust Hoods with Sensor Control	1.0%	10.0%	10	\$0.04	0.0	0.11	\$0.098
Fans - Energy Efficient Motors	11.0%	100.0%	10	\$0.05	0.1	0.17	\$0.061
Fans - Variable Speed Control	21.7%	100.0%	10	\$0.20	0.6	0.29	\$0.037
Retrocommissioning - HVAC	15.0%	100.0%	4	\$0.20	0.1	0.32	\$0.714
Pumps - Variable Speed Control	1.0%	45.0%	10	\$0.44	0.0	0.00	\$7.933
Thermostat - Clock/Programmable	25.0%	50.0%	11	\$0.11	1.3	1.02	\$0.010
Insulation - Ceiling	2.0%	90.0%	20	\$0.85	0.1	0.32	\$0.687
Insulation - Radiant Barrier	2.0%	25.0%	20	\$0.26	0.0	0.31	\$1.057
Roofs - High Reflectivity	0.0%	100.0%	15	\$0.18	0.0	0.02	\$2.179
Windows - High Efficiency	94.6%	100.0%	20	\$2.10	0.0	0.30	\$3.948
Interior Lighting - Central Lighting Controls	78.1%	100.0%	8	\$0.65	-	-	\$0.000
Interior Lighting - Photocell Controlled T8 Dimming Ballasts	2.5%	60.0%	8	\$0.40	0.5	0.11	\$0.105
Exterior Lighting - Daylighting Controls	1.6%	20.0%	8	\$0.29	-	0.00	\$0.000
Interior Fluorescent - Bi-Level Fixture w/Occupancy Sensor	10.0%	30.0%	8	\$0.20	0.2	0.09	\$0.131
Interior Fluorescent - High Bay Fixtures	11.4%	30.0%	11	\$0.56	1.1	0.17	\$0.056
Interior Lighting - Occupancy Sensors	43.5%	60.0%	8	\$0.20	-	0.06	\$0.000
Exterior Lighting - Photovoltaic Installation	0.0%	0.0%	0	\$0.00	-	-	\$0.000
Interior Screw-in - Task Lighting	0.0%	0.0%	0	\$0.00	-	-	\$0.000
Interior Lighting - Time Clocks and Timers	0.0%	0.0%	0	\$0.00	-	-	\$0.000
Water Heater - Faucet Aerators/Low Flow Nozzles	0.0%	0.0%	0	\$0.00	-	-	\$0.000
Water Heater - Pipe Insulation	0.0%	0.0%	0	\$0.00	-	-	\$0.000
Water Heater - High Efficiency Circulation Pump	0.0%	0.0%	0	\$0.00	-	-	\$0.000
Water Heater - Tank Blanket/Insulation	0.0%	0.0%	0	\$0.00	-	-	\$0.000
Water Heater - Thermostat Setback	0.0%	0.0%	0	\$0.00	-	-	\$0.000
Refrigeration - Anti-Sweat Heater/Auto Door Closer	0.0%	0.0%	0	\$0.00	-	-	\$0.000
Refrigeration - Floating Head Pressure	0.0%	0.0%	0	\$0.00	-	-	\$0.000
Refrigeration - Door Gasket Replacement	0.0%	0.0%	0	\$0.00	-	-	\$0.000
Insulation - Bare Suction Lines	0.0%	0.0%	0	\$0.00	-	-	\$0.000
Refrigeration - Night Covers	0.0%	0.0%	0	\$0.00	-	-	\$0.000
Refrigeration - Strip Curtain	0.0%	0.0%	0	\$0.00	-	-	\$0.000
Vending Machine - Controller	0.0%	0.0%	0	\$0.00	-	-	\$0.000

C&I Energy Efficiency Equipment and Measure Data

Measure	Base Saturation	Applicability	Lifetime (Years)	Incremental Cost (\$/SqFt)	Savings (kWh/SqFt)	BC Ratio (2015)	Levelized Cost of Energy (\$/kWh)
LED Exit Lighting	0.0%	0.0%	0	\$0.00	-	-	\$0.000
Retrocommissioning - Lighting	0.0%	0.0%	0	\$0.00	-	-	\$0.000
Refrigeration - High Efficiency Case Lighting	0.0%	0.0%	0	\$0.00	-	-	\$0.000
Exterior Lighting - Cold Cathode Lighting	0.0%	0.0%	0	\$0.00	-	-	\$0.000
Laundry - High Efficiency Clothes Washer	0.0%	0.0%	0	\$0.00	-	-	\$0.000
Interior Lighting - Hotel Guestroom Controls	0.0%	0.0%	0	\$0.00	-	-	\$0.000
Miscellaneous - Energy Star Water Cooler	0.0%	0.0%	0	\$0.00	-	-	\$0.000
Interior Lighting - Skylights	0.0%	0.0%	0	\$0.00	-	-	\$0.000
Ventilation - Demand Control Ventilation	0.0%	0.0%	0	\$0.00	-	-	\$0.000
Office Equipment - Smart Power Strips	0.0%	0.0%	0	\$0.00	-	-	\$0.000
Strategic Energy Management	0.0%	0.0%	0	\$0.00	-	-	\$0.000
Refrigeration - Multiplex - Floating section Pressure - Air-cooled Cond.	0.0%	0.0%	0	\$0.00	-	-	\$0.000
Refrigeration - Multiplex Controls - Floating section Pressure - Evap. Cond.	0.0%	0.0%	0	\$0.00	-	-	\$0.000
Refrigeration - Multiplex - Eff. Air-cooled Condenser	0.0%	0.0%	0	\$0.00	-	-	\$0.000
Refrigeration - Multiplex - Eff. Water-cooled Condenser	0.0%	0.0%	0	\$0.00	-	-	\$0.000
RTU - Maintenance	54.2%	100.0%	4	\$0.06	0.3	0.26	\$0.050
RTU - Evaporative Precooler	0.0%	0.0%	15	\$0.88	1.1	0.12	\$0.068
Chiller - Chilled Water Reset	36.0%	100.0%	4	\$0.09	0.3	0.19	\$0.072
Chiller - Chilled Water Variable-Flow System	30.0%	45.0%	10	\$0.09	0.1	0.11	\$0.097
Chiller - VSD	3.0%	100.0%	20	\$1.17	0.7	0.06	\$0.118
Chiller - High Efficiency Cooling Tower Fans	25.0%	73.7%	10	\$0.04	0.0	0.00	\$12.451
Chiller - Condenser Water Temperature Reset	31.4%	100.0%	14	\$0.09	0.3	0.37	\$0.025
Cooling - Economizer Installation	73.4%	90.0%	15	\$0.15	0.0	0.02	\$1.832
Heat Pump - Maintenance	24.1%	100.0%	4	\$0.06	0.8	0.66	\$0.021
Insulation - Ducting	2.0%	100.0%	20	\$0.41	0.0	0.32	\$0.695
Repair and Sealing - Ducting	5.0%	50.0%	15	\$0.38	0.1	0.34	\$0.240
Energy Management System	82.8%	100.0%	14	\$0.35	2.9	0.78	\$0.011
Cooking - Exhaust Hoods with Sensor Control	1.0%	10.0%	10	\$0.04	0.0	0.11	\$0.098
Fans - Energy Efficient Motors	11.0%	100.0%	10	\$0.05	0.1	0.17	\$0.061
Fans - Variable Speed Control	21.7%	100.0%	10	\$0.20	0.6	0.29	\$0.037
Retrocommissioning - HVAC	15.0%	100.0%	4	\$0.20	0.1	0.32	\$0.714
Pumps - Variable Speed Control	1.0%	45.0%	10	\$0.44	0.0	0.00	\$7.933
Thermostat - Clock/Programmable	25.0%	50.0%	11	\$0.11	1.3	1.02	\$0.010
Insulation - Ceiling	2.0%	90.0%	20	\$0.85	0.1	0.32	\$0.687
Insulation - Radiant Barrier	2.0%	25.0%	20	\$0.26	0.0	0.31	\$1.057

Table C-30 Energy Efficiency Non-Equipment Data— Extra Large Commercial, New Vintage, Idaho

Measure	Base Saturation	Applicability	Lifetime (Years)	Incremental Cost (\$/SqFt)	Savings (kWh/SqFt)	BC Ratio (2015)	Levelized Cost of Energy (\$/kWh)
RTU - Maintenance	48.7%	100.0%	4	\$0.06	0.2	0.17	\$0.086
RTU - Evaporative Precooler	0.0%	0.0%	15	\$0.88	0.9	0.11	\$0.082
Chiller - Chilled Water Reset	60.0%	100.0%	4	\$0.09	0.3	0.17	\$0.091
Chiller - Chilled Water Variable-Flow System	30.0%	45.0%	10	\$0.09	0.1	0.09	\$0.127
Chiller - VSD	3.0%	100.0%	20	\$1.17	0.6	0.06	\$0.138
Chiller - High Efficiency Cooling Tower Fans	25.0%	73.7%	10	\$0.04	0.0	0.00	\$11.601
Chiller - Condenser Water Temperature Reset	57.1%	100.0%	14	\$0.09	0.3	0.37	\$0.030
Cooling - Economizer Installation	73.4%	90.0%	15	\$0.15	-	0.02	\$0.000
Heat Pump - Maintenance	24.1%	100.0%	4	\$0.06	0.6	0.58	\$0.026
Insulation - Ducting	4.6%	50.0%	20	\$0.41	0.3	0.38	\$0.088
Energy Management System	82.8%	100.0%	14	\$0.35	2.5	0.73	\$0.013
Cooking - Exhaust Hoods with Sensor Control	1.0%	10.0%	10	\$0.04	0.0	0.10	\$0.111
Fans - Energy Efficient Motors	28.9%	100.0%	10	\$0.05	0.1	0.18	\$0.070
Fans - Variable Speed Control	47.3%	100.0%	10	\$0.20	0.6	0.31	\$0.037
Pumps - Variable Speed Control	1.0%	45.0%	10	\$0.44	0.0	0.00	\$7.545
Thermostat - Clock/Programmable	30.3%	50.0%	11	\$0.11	1.6	1.33	\$0.007
Insulation - Ceiling	14.5%	90.0%	20	\$0.35	0.4	0.43	\$0.056
Insulation - Radiant Barrier	5.5%	25.0%	20	\$0.26	0.9	0.62	\$0.021
Roofs - High Reflectivity	5.0%	100.0%	15	\$0.18	-	0.01	\$0.000
Windows - High Efficiency	94.6%	100.0%	20	\$1.69	1.1	0.36	\$0.106
Interior Lighting - Central Lighting Controls	82.5%	100.0%	8	\$0.65	3.0	0.39	\$0.031
Interior Lighting - Photocell Controlled T8 Dimming Ballasts	2.5%	60.0%	8	\$0.30	0.5	0.14	\$0.086
Exterior Lighting - Daylighting Controls	10.0%	20.0%	8	\$0.19	0.3	0.16	\$0.079
Interior Fluorescent - Bi-Level Fixture w/Occupancy Sensor	10.0%	30.0%	8	\$0.20	0.2	0.09	\$0.143
Interior Fluorescent - High Bay Fixtures	10.8%	30.0%	11	\$0.56	1.0	0.17	\$0.061
Interior Lighting - Occupancy Sensors	48.7%	60.0%	8	\$0.20	3.0	1.32	\$0.009
Exterior Lighting - Photovoltaic Installation	5.0%	25.0%	5	\$0.92	0.4	0.03	\$0.481
Interior Screw-in - Task Lighting	25.0%	100.0%	5	\$0.24	0.1	0.04	\$0.376
Interior Lighting - Time Clocks and Timers	25.4%	75.0%	8	\$0.20	1.5	0.67	\$0.019
Water Heater - Faucet Aerators/Low Flow Nozzles	47.3%	100.0%	9	\$0.03	0.1	0.44	\$0.027
Water Heater - Pipe Insulation	0.0%	0.0%	15	\$0.28	0.1	0.05	\$0.180
Water Heater - High Efficiency Circulation Pump	0.6%	25.0%	10	\$0.11	2.5	2.16	\$0.005
Water Heater - Tank Blanket/Insulation	0.0%	0.0%	10	\$0.04	0.1	0.21	\$0.052
Water Heater - Thermostat Setback	0.0%	0.0%	10	\$0.11	0.1	0.12	\$0.090
Refrigeration - Anti-Sweat Heater/Auto Door Closer	0.0%	100.0%	16	\$0.20	0.0	0.01	\$1.217
Refrigeration - Floating Head Pressure	10.0%	50.0%	16	\$0.35	0.5	0.13	\$0.063
Refrigeration - Door Gasket Replacement	5.0%	100.0%	8	\$0.10	0.0	0.02	\$0.721
Insulation - Bare Suction Lines	18.5%	100.0%	8	\$0.10	0.5	0.39	\$0.031
Refrigeration - Night Covers	5.0%	100.0%	8	\$0.05	0.0	0.06	\$0.263
Refrigeration - Strip Curtain	29.7%	56.3%	4	\$0.00	0.0	3.11	\$0.005
Vending Machine - Controller	2.0%	10.0%	10	\$0.27	0.0	0.01	\$0.784
LED Exit Lighting	91.2%	90.0%	10	\$0.00	0.0	5.56	\$0.004
Refrigeration - High Efficiency Case	24.0%	56.0%	6	\$0.02	0.0	0.09	\$0.170

C&I Energy Efficiency Equipment and Measure Data

Measure	Base Saturation	Applicability	Lifetime (Years)	Incremental Cost (\$/SqFt)	Savings (kWh/SqFt)	BC Ratio (2015)	Levelized Cost of Energy (\$/kWh)
Lighting							
Exterior Lighting - Cold Cathode Lighting	14.6%	50.0%	5	\$0.00	0.3	23.65	\$0.001
Laundry - High Efficiency Clothes Washer	6.9%	10.0%	10	\$0.00	0.0	2.93	\$0.004
Interior Lighting - Hotel Guestroom Controls	1.0%	2.0%	8	\$0.14	0.1	0.08	\$0.158
Miscellaneous - Energy Star Water Cooler	5.0%	100.0%	8	\$0.00	0.0	0.17	\$0.073
Interior Lighting - Skylights	0.0%	0.0%	0	\$0.00	4.5	1.00	\$0.000
Ventilation - Demand Control Ventilation	10.2%	10.0%	10	\$0.04	0.6	1.34	\$0.009
Office Equipment - Smart Power Strips	15.4%	30.0%	7	\$0.00	0.3	232.67	\$0.000
Strategic Energy Management	0.0%	0.0%	3	\$0.00	-	6.00	\$0.000
Refrigeration - Multiplex - Floating section Pressure - Air-cooled Cond.	0.0%	0.0%	0	\$0.00	-	1.00	\$0.000
Refrigeration - Multiplex Controls - Floating section Pressure - Evap. Cond.	0.0%	0.0%	0	\$0.00	-	1.00	\$0.000
Refrigeration - Multiplex - Eff. Air-cooled Condenser	0.0%	0.0%	0	\$0.00	-	1.00	\$0.000
Refrigeration - Multiplex - Eff. Water-cooled Condenser	0.0%	0.0%	0	\$0.00	-	1.00	\$0.000
RTU - Maintenance	48.7%	100.0%	4	\$0.06	0.2	0.17	\$0.086
RTU - Evaporative Precooler	0.0%	0.0%	15	\$0.88	0.9	0.11	\$0.082
Chiller - Chilled Water Reset	60.0%	100.0%	4	\$0.09	0.3	0.17	\$0.091
Chiller - Chilled Water Variable-Flow System	30.0%	45.0%	10	\$0.09	0.1	0.09	\$0.127
Chiller - VSD	3.0%	100.0%	20	\$1.17	0.6	0.06	\$0.138
Chiller - High Efficiency Cooling Tower Fans	25.0%	73.7%	10	\$0.04	0.0	0.00	\$11.601
Chiller - Condenser Water Temperature Reset	57.1%	100.0%	14	\$0.09	0.3	0.37	\$0.030
Cooling - Economizer Installation	73.4%	90.0%	15	\$0.15	-	0.02	\$0.000
Heat Pump - Maintenance	24.1%	100.0%	4	\$0.06	0.6	0.58	\$0.026
Insulation - Ducting	4.6%	50.0%	20	\$0.41	0.3	0.38	\$0.088
Energy Management System	82.8%	100.0%	14	\$0.35	2.5	0.73	\$0.013
Cooking - Exhaust Hoods with Sensor Control	1.0%	10.0%	10	\$0.04	0.0	0.10	\$0.111
Fans - Energy Efficient Motors	28.9%	100.0%	10	\$0.05	0.1	0.18	\$0.070
Fans - Variable Speed Control	47.3%	100.0%	10	\$0.20	0.6	0.31	\$0.037
Pumps - Variable Speed Control	1.0%	45.0%	10	\$0.44	0.0	0.00	\$7.545
Thermostat - Clock/Programmable	30.3%	50.0%	11	\$0.11	1.6	1.33	\$0.007
Insulation - Ceiling	14.5%	90.0%	20	\$0.35	0.4	0.43	\$0.056
Insulation - Radiant Barrier	5.5%	25.0%	20	\$0.26	0.9	0.62	\$0.021
Roofs - High Reflectivity	5.0%	100.0%	15	\$0.18	-	0.01	\$0.000
Windows - High Efficiency	94.6%	100.0%	20	\$1.69	1.1	0.36	\$0.106
Interior Lighting - Central Lighting Controls	82.5%	100.0%	8	\$0.65	3.0	0.39	\$0.031
Interior Lighting - Photocell Controlled T8 Dimming Ballasts	2.5%	60.0%	8	\$0.30	0.5	0.14	\$0.086
Exterior Lighting - Daylighting Controls	10.0%	20.0%	8	\$0.19	0.3	0.16	\$0.079

Table C-31 Energy Efficiency Non-Equipment Data— Extra Large Industrial, Existing Vintage, Washington

Measure	Base Saturation	Applicability	Lifetime (Years)	Incremental Cost (\$/SqFt)	Savings (kWh/SqFt)	BC Ratio (2015)	Levelized Cost of Energy (\$/kWh)
Refrigeration - System Controls	5.0%	45.0%	10	\$0.40	0.2	0.06	\$0.198
Refrigeration - System Maintenance	13.6%	45.0%	10	\$0.00	0.1	7.74	\$0.001
Refrigeration - System Optimization	5.0%	45.0%	10	\$0.80	0.2	0.03	\$0.396
Motors - Variable Frequency Drive	25.0%	50.0%	10	\$0.10	-	0.00	\$0.000
Motors - Magnetic Adjustable Speed Drives	20.0%	25.0%	10	\$0.10	-	0.02	\$0.000
Compressed Air - System Controls	0.0%	0.0%	15	\$0.01	-	0.08	\$0.000
Compressed Air - System Optimization and Improvements	35.0%	75.0%	10	\$0.20	-	0.01	\$0.000
Compressed Air - System Maintenance	0.0%	0.0%	3	\$0.03	-	-	\$0.000
Compressed Air - Compressor Replacement	14.6%	17.1%	10	\$0.06	-	0.02	\$0.000
Fan System - Controls	7.8%	8.2%	10	\$0.01	0.0	0.37	\$0.036
Fan System - Optimization	6.6%	8.9%	10	\$0.13	0.2	0.15	\$0.085
Fan System - Maintenance	3.0%	11.3%	3	\$0.01	0.0	0.07	\$0.251
Pumping System - Controls	6.9%	9.3%	10	\$0.01	-	0.02	\$0.000
Pumping System - Optimization	6.7%	9.0%	10	\$0.28	-	0.01	\$0.000
Pumping System - Maintenance	1.5%	10.1%	3	\$0.02	-	-	\$0.000
RTU - Maintenance	21.9%	100.0%	4	\$0.06	0.4	0.29	\$0.045
Chiller - Chilled Water Reset	30.0%	100.0%	4	\$0.09	0.4	0.22	\$0.062
Chiller - Chilled Water Variable-Flow System	30.0%	45.0%	10	\$0.20	0.1	0.04	\$0.236
Chiller - VSD	15.0%	89.0%	20	\$1.17	0.8	0.06	\$0.105
Chiller - High Efficiency Cooling Tower Fans	25.0%	100.0%	10	\$0.04	0.0	0.00	\$9.998
Chiller - Condenser Water Temperature Reset	0.0%	100.0%	14	\$0.20	0.4	0.17	\$0.045
Cooling - Economizer Installation	29.1%	45.0%	15	\$0.15	0.1	0.03	\$0.211
Heat Pump - Maintenance	21.7%	100.0%	4	\$0.03	1.1	1.82	\$0.007
Insulation - Ducting	11.8%	100.0%	20	\$0.41	0.0	0.31	\$4.048
Repair and Sealing - Ducting	5.0%	50.0%	15	\$0.38	0.0	0.31	\$1.794
Energy Management System	11.0%	100.0%	14	\$0.35	4.3	1.10	\$0.007
Fans - Energy Efficient Motors	0.0%	0.0%	10	\$0.14	0.1	0.07	\$0.159
Fans - Variable Speed Control	0.0%	0.0%	10	\$0.20	0.4	0.17	\$0.057
Retrocommissioning - HVAC	1.4%	93.3%	4	\$0.25	0.0	0.31	\$2.167
Pumps - Variable Speed Control	0.1%	0.0%	10	\$0.44	-	0.00	\$0.000
Thermostat - Clock/Programmable	59.0%	70.0%	11	\$0.11	2.0	1.71	\$0.006
Interior Lighting - Central Lighting Controls	83.7%	100.0%	8	\$0.65	0.0	0.00	\$22.297
Exterior Lighting - Daylighting Controls	1.6%	53.6%	8	\$0.08	-	0.00	\$0.000
Interior Fluorescent - High Bay Fixtures	19.1%	50.0%	11	\$0.20	1.7	0.59	\$0.013
LED Exit Lighting	46.9%	90.0%	10	\$0.00	0.0	1.34	\$0.006
Retrocommissioning - Lighting	9.0%	93.0%	5	\$0.05	0.0	0.00	\$2.594
Interior Lighting - Occupancy Sensors	14.7%	60.0%	8	\$0.20	0.0	0.00	\$6.861
Exterior Lighting - Photovoltaic Installation	5.0%	25.0%	5	\$0.92	-	-	\$0.000
Interior Screw-in - Task Lighting	10.0%	100.0%	5	\$0.24	0.1	0.02	\$0.500
Interior Lighting - Time Clocks and Timers	2.4%	75.0%	8	\$0.20	0.0	0.04	\$13.721
Exterior Lighting - Cold Cathode Lighting	14.6%	50.0%	5	\$0.00	0.4	16.94	\$0.001
Interior Lighting - Skylights	1.2%	40.6%	8	\$0.29	0.0	0.00	\$6.518
Ventilation - Demand Control Ventilation	1.0%	10.0%	10	\$0.04	0.0	0.14	\$0.103
Strategic Energy Management	0.0%	20.0%	3	\$0.02	0.0	0.09	\$0.173
Transformers	8.6%	9.4%	10	\$0.13	0.0	0.04	\$0.413

C&I Energy Efficiency Equipment and Measure Data

Measure	Base Saturation	Applicability	Lifetime (Years)	Incremental Cost (\$/SqFt)	Savings (kWh/SqFt)	BC Ratio (2015)	Levelized Cost of Energy (\$/kWh)
Motors - Synchronous belts	17.3%	21.0%	10	\$0.22	-	0.00	\$0.000
Refrigeration - Multiplex - Floating section Pressure - Air-cooled Cond.	0.0%	0.0%	0	\$0.00	-	1.00	\$0.000
Refrigeration - Multiplex Controls - Floating section Pressure - Evap. Cond.	0.0%	0.0%	0	\$0.00	-	1.00	\$0.000
Refrigeration - Multiplex - Eff. Air-cooled Condenser	0.0%	0.0%	0	\$0.00	-	1.00	\$0.000
Refrigeration - Multiplex - Eff. Water-cooled Condenser	0.0%	0.0%	0	\$0.00	-	1.00	\$0.000
Refrigeration - System Controls	5.0%	45.0%	10	\$0.40	0.2	0.06	\$0.198
Refrigeration - System Maintenance	13.6%	45.0%	10	\$0.00	0.1	7.74	\$0.001
Refrigeration - System Optimization	5.0%	45.0%	10	\$0.80	0.2	0.03	\$0.396
Motors - Variable Frequency Drive	25.0%	50.0%	10	\$0.10	-	0.00	\$0.000
Motors - Magnetic Adjustable Speed Drives	20.0%	25.0%	10	\$0.10	-	0.02	\$0.000
Compressed Air - System Controls	0.0%	0.0%	15	\$0.01	-	0.08	\$0.000
Compressed Air - System Optimization and Improvements	35.0%	75.0%	10	\$0.20	-	0.01	\$0.000
Compressed Air - System Maintenance	0.0%	0.0%	3	\$0.03	-	-	\$0.000
Compressed Air - Compressor Replacement	14.6%	17.1%	10	\$0.06	-	0.02	\$0.000
Fan System - Controls	7.8%	8.2%	10	\$0.01	0.0	0.37	\$0.036
Fan System - Optimization	6.6%	8.9%	10	\$0.13	0.2	0.15	\$0.085
Fan System - Maintenance	3.0%	11.3%	3	\$0.01	0.0	0.07	\$0.251
Pumping System - Controls	6.9%	9.3%	10	\$0.01	-	0.02	\$0.000
Pumping System - Optimization	6.7%	9.0%	10	\$0.28	-	0.01	\$0.000
Pumping System - Maintenance	1.5%	10.1%	3	\$0.02	-	-	\$0.000
RTU - Maintenance	21.9%	100.0%	4	\$0.06	0.4	0.29	\$0.045
Chiller - Chilled Water Reset	30.0%	100.0%	4	\$0.09	0.4	0.22	\$0.062
Chiller - Chilled Water Variable-Flow System	30.0%	45.0%	10	\$0.20	0.1	0.04	\$0.236
Chiller - VSD	15.0%	89.0%	20	\$1.17	0.8	0.06	\$0.105
Chiller - High Efficiency Cooling Tower Fans	25.0%	100.0%	10	\$0.04	0.0	0.00	\$9.998
Chiller - Condenser Water Temperature Reset	0.0%	100.0%	14	\$0.20	0.4	0.17	\$0.045
Cooling - Economizer Installation	29.1%	45.0%	15	\$0.15	0.1	0.03	\$0.211
Heat Pump - Maintenance	21.7%	100.0%	4	\$0.03	1.1	1.82	\$0.007
Insulation - Ducting	11.8%	100.0%	20	\$0.41	0.0	0.31	\$4.048
Repair and Sealing - Ducting	5.0%	50.0%	15	\$0.38	0.0	0.31	\$1.794
Energy Management System	11.0%	100.0%	14	\$0.35	4.3	1.10	\$0.007
Fans - Energy Efficient Motors	0.0%	0.0%	10	\$0.14	0.1	0.07	\$0.159
Fans - Variable Speed Control	0.0%	0.0%	10	\$0.20	0.4	0.17	\$0.057

Table C-32 Energy Efficiency Non-Equipment Data— Extra Large Industrial, New Vintage, Washington

Measure	Base Saturation	Applicability	Lifetime (Years)	Incremental Cost (\$/SqFt)	Savings (kWh/SqFt)	BC Ratio (2015)	Levelized Cost of Energy (\$/kWh)
Refrigeration - System Controls	5.0%	45.0%	10	\$0.40	0.2	0.06	\$0.198
Refrigeration - System Maintenance	13.6%	45.0%	10	\$0.00	0.1	7.89	\$0.001
Refrigeration - System Optimization	5.0%	45.0%	10	\$0.80	0.2	0.03	\$0.396
Motors - Variable Frequency Drive	25.0%	50.0%	10	\$0.10	0.2	0.15	\$0.072
Motors - Magnetic Adjustable Speed Drives	24.0%	25.0%	10	\$0.10	0.7	0.65	\$0.017
Compressed Air - System Controls	0.0%	0.0%	15	\$0.01	0.3	2.98	\$0.003
Compressed Air - System Optimization and Improvements	44.8%	75.0%	10	\$0.20	0.8	0.38	\$0.029
Compressed Air - System Maintenance	0.0%	0.0%	3	\$0.03	0.1	0.10	\$0.175
Compressed Air - Compressor Replacement	17.6%	17.1%	10	\$0.06	0.6	0.84	\$0.013
Fan System - Controls	7.8%	8.2%	10	\$0.01	0.0	0.37	\$0.036
Fan System - Optimization	6.6%	8.9%	10	\$0.13	0.2	0.15	\$0.085
Fan System - Maintenance	3.0%	11.3%	3	\$0.01	0.0	0.07	\$0.251
Pumping System - Controls	8.6%	9.3%	10	\$0.01	0.1	1.04	\$0.011
Pumping System - Optimization	6.7%	9.0%	10	\$0.28	0.8	0.28	\$0.040
Pumping System - Maintenance	1.5%	10.1%	3	\$0.02	0.1	0.15	\$0.117
RTU - Maintenance	21.9%	100.0%	4	\$0.06	0.2	0.20	\$0.073
Chiller - Chilled Water Reset	60.0%	100.0%	4	\$0.09	0.3	0.19	\$0.077
Chiller - Chilled Water Variable-Flow System	30.0%	45.0%	10	\$0.20	0.1	0.06	\$0.158
Chiller - VSD	25.0%	89.0%	20	\$1.17	0.7	0.06	\$0.119
Chiller - High Efficiency Cooling Tower Fans	25.0%	100.0%	10	\$0.04	0.0	0.01	\$1.019
Chiller - Condenser Water Temperature Reset	5.0%	100.0%	14	\$0.20	0.4	0.16	\$0.051
Cooling - Economizer Installation	29.1%	45.0%	15	\$0.15	-	-	\$0.000
Heat Pump - Maintenance	21.7%	100.0%	4	\$0.03	0.6	1.07	\$0.014
Insulation - Ducting	11.8%	50.0%	20	\$0.41	-	0.31	\$0.000
Energy Management System	23.6%	100.0%	14	\$0.35	4.9	1.28	\$0.007
Fans - Energy Efficient Motors	0.0%	0.0%	10	\$0.14	0.1	0.06	\$0.187
Fans - Variable Speed Control	0.0%	0.0%	10	\$0.34	0.4	0.10	\$0.114
Pumps - Variable Speed Control	0.1%	0.0%	10	\$0.44	0.2	0.03	\$0.316
Thermostat - Clock/Programmable	59.0%	70.0%	11	\$0.11	1.7	1.41	\$0.007
Interior Lighting - Central Lighting Controls	83.7%	100.0%	8	\$0.65	1.4	0.18	\$0.067
Exterior Lighting - Daylighting Controls	19.7%	53.6%	8	\$0.08	1.4	1.52	\$0.008
Interior Fluorescent - High Bay Fixtures	19.1%	50.0%	11	\$0.20	1.2	0.58	\$0.018
LED Exit Lighting	91.2%	90.0%	10	\$0.00	0.0	1.62	\$0.006
Interior Lighting - Occupancy Sensors	25.0%	60.0%	8	\$0.20	1.4	0.58	\$0.021
Exterior Lighting - Photovoltaic Installation	5.0%	25.0%	5	\$0.92	2.7	0.21	\$0.072
Interior Screw-in - Task Lighting	10.0%	100.0%	5	\$0.24	0.1	0.03	\$0.527
Interior Lighting - Time Clocks and Timers	2.4%	75.0%	8	\$0.20	0.7	0.34	\$0.041
Exterior Lighting - Cold Cathode Lighting	8.4%	50.0%	5	\$0.00	0.3	19.87	\$0.001
Interior Lighting - Skylights	5.3%	40.6%	8	\$0.19	2.1	0.92	\$0.013
Ventilation - Demand Control Ventilation	10.2%	10.0%	10	\$0.04	0.2	0.55	\$0.022
Strategic Energy Management	2.8%	20.0%	3	\$0.02	1.9	4.54	\$0.004
Transformers	8.6%	9.4%	10	\$0.13	0.4	0.28	\$0.040
Motors - Synchronous belts	17.3%	21.0%	10	\$0.22	-	0.00	\$0.000
Refrigeration - Multiplex - Floating section Pressure - Air-cooled Cond.	0.0%	0.0%	0	\$0.00	-	1.00	\$0.000
Refrigeration - Multiplex Controls -	0.0%	0.0%	0	\$0.00	-	1.00	\$0.000

C&I Energy Efficiency Equipment and Measure Data

Measure	Base Saturation	Applicability	Lifetime (Years)	Incremental Cost (\$/SqFt)	Savings (kWh/SqFt)	BC Ratio (2015)	Levelized Cost of Energy (\$/kWh)
Floating section Pressure - Evap. Cond.							
Refrigeration - Multiplex - Eff. Air-cooled Condenser	0.0%	0.0%	0	\$0.00	-	1.00	\$0.000
Refrigeration - Multiplex - Eff. Water-cooled Condenser	0.0%	0.0%	0	\$0.00	-	1.00	\$0.000
Commissioning - HVAC	60.0%	100.0%	25	\$0.70	0.1	0.02	\$0.481
Commissioning - Lighting	78.5%	100.0%	25	\$0.10	2.2	2.28	\$0.003
Advanced New Construction Designs	11.9%	100.0%	35	\$2.00	3.5	0.17	\$0.030
Refrigeration - System Controls	5.0%	45.0%	10	\$0.40	0.2	0.06	\$0.198
Refrigeration - System Maintenance	13.6%	45.0%	10	\$0.00	0.1	7.89	\$0.001
Refrigeration - System Optimization	5.0%	45.0%	10	\$0.80	0.2	0.03	\$0.396
Motors - Variable Frequency Drive	25.0%	50.0%	10	\$0.10	0.2	0.15	\$0.072
Motors - Magnetic Adjustable Speed Drives	24.0%	25.0%	10	\$0.10	0.7	0.65	\$0.017
Compressed Air - System Controls	0.0%	0.0%	15	\$0.01	0.3	2.98	\$0.003
Compressed Air - System Optimization and Improvements	44.8%	75.0%	10	\$0.20	0.8	0.38	\$0.029
Compressed Air - System Maintenance	0.0%	0.0%	3	\$0.03	0.1	0.10	\$0.175
Compressed Air - Compressor Replacement	17.6%	17.1%	10	\$0.06	0.6	0.84	\$0.013
Fan System - Controls	7.8%	8.2%	10	\$0.01	0.0	0.37	\$0.036
Fan System - Optimization	6.6%	8.9%	10	\$0.13	0.2	0.15	\$0.085
Fan System - Maintenance	3.0%	11.3%	3	\$0.01	0.0	0.07	\$0.251
Pumping System - Controls	8.6%	9.3%	10	\$0.01	0.1	1.04	\$0.011
Pumping System - Optimization	6.7%	9.0%	10	\$0.28	0.8	0.28	\$0.040
Pumping System - Maintenance	1.5%	10.1%	3	\$0.02	0.1	0.15	\$0.117
RTU - Maintenance	21.9%	100.0%	4	\$0.06	0.2	0.20	\$0.073
Chiller - Chilled Water Reset	60.0%	100.0%	4	\$0.09	0.3	0.19	\$0.077
Chiller - Chilled Water Variable-Flow System	30.0%	45.0%	10	\$0.20	0.1	0.06	\$0.158
Chiller - VSD	25.0%	89.0%	20	\$1.17	0.7	0.06	\$0.119
Chiller - High Efficiency Cooling Tower Fans	25.0%	100.0%	10	\$0.04	0.0	0.01	\$1.019
Chiller - Condenser Water Temperature Reset	5.0%	100.0%	14	\$0.20	0.4	0.16	\$0.051
Cooling - Economizer Installation	29.1%	45.0%	15	\$0.15	-	-	\$0.000
Heat Pump - Maintenance	21.7%	100.0%	4	\$0.03	0.6	1.07	\$0.014
Insulation - Ducting	11.8%	50.0%	20	\$0.41	-	0.31	\$0.000
Energy Management System	23.6%	100.0%	14	\$0.35	4.9	1.28	\$0.007
Fans - Energy Efficient Motors	0.0%	0.0%	10	\$0.14	0.1	0.06	\$0.187
Fans - Variable Speed Control	0.0%	0.0%	10	\$0.34	0.4	0.10	\$0.114
Pumps - Variable Speed Control	0.1%	0.0%	10	\$0.44	0.2	0.03	\$0.316

Table C-33 Energy Efficiency Non-Equipment Data— Extra Large Industrial, Existing Vintage, Idaho

Measure	Base Saturation	Applicability	Lifetime (Years)	Incremental Cost (\$/SqFt)	Savings (kWh/SqFt)	BC Ratio (2015)	Levelized Cost of Energy (\$/kWh)
Refrigeration - System Controls	11.1%	45.0%	10	\$0.40	12.0	2.67	\$0.004
Refrigeration - System Maintenance	11.1%	45.0%	10	\$0.00	4.0	356.66	\$0.000
Refrigeration - System Optimization	13.6%	45.0%	10	\$0.80	12.0	1.34	\$0.008
Motors - Variable Frequency Drive	32.5%	50.0%	10	\$0.10	0.4	0.33	\$0.033
Motors - Magnetic Adjustable Speed Drives	24.0%	25.0%	10	\$0.10	1.5	1.41	\$0.008
Compressed Air - System Controls	0.0%	0.0%	15	\$0.01	0.7	6.38	\$0.001
Compressed Air - System Optimization and Improvements	44.8%	75.0%	10	\$0.20	1.8	0.82	\$0.013
Compressed Air - System Maintenance	0.0%	0.0%	3	\$0.03	0.1	0.22	\$0.081
Compressed Air - Compressor Replacement	17.6%	17.1%	10	\$0.06	1.3	1.81	\$0.006
Fan System - Controls	7.8%	8.2%	10	\$0.01	0.3	2.66	\$0.004
Fan System - Optimization	8.3%	8.9%	10	\$0.13	1.6	1.12	\$0.010
Fan System - Maintenance	5.2%	11.3%	3	\$0.01	0.1	0.61	\$0.029
Pumping System - Controls	8.6%	9.3%	10	\$0.01	0.3	2.23	\$0.005
Pumping System - Optimization	8.4%	9.0%	10	\$0.28	1.8	0.60	\$0.018
Pumping System - Maintenance	2.9%	10.1%	3	\$0.02	0.1	0.33	\$0.054
RTU - Maintenance	37.6%	100.0%	4	\$0.06	0.9	0.73	\$0.018
Chiller - Chilled Water Reset	39.9%	100.0%	4	\$0.09	1.3	0.74	\$0.019
Chiller - Chilled Water Variable-Flow System	30.0%	45.0%	10	\$0.20	0.3	0.13	\$0.071
Chiller - VSD	50.0%	89.0%	20	\$1.17	2.6	0.19	\$0.032
Chiller - High Efficiency Cooling Tower Fans	25.0%	100.0%	10	\$0.04	0.0	0.00	\$2.995
Chiller - Condenser Water Temperature Reset	14.2%	100.0%	14	\$0.20	1.3	0.55	\$0.014
Cooling - Economizer Installation	29.1%	45.0%	15	\$0.15	-	-	\$0.000
Heat Pump - Maintenance	21.7%	100.0%	4	\$0.03	1.0	1.70	\$0.008
Insulation - Ducting	11.8%	100.0%	20	\$0.41	-	0.30	\$0.000
Repair and Sealing - Ducting	5.0%	50.0%	15	\$0.38	-	0.31	\$0.000
Energy Management System	11.0%	100.0%	14	\$0.35	4.7	1.23	\$0.007
Fans - Energy Efficient Motors	0.0%	0.0%	10	\$0.14	0.6	0.73	\$0.027
Fans - Variable Speed Control	0.0%	0.0%	10	\$0.34	2.5	0.59	\$0.016
Retrocommissioning - HVAC	1.4%	93.3%	4	\$0.25	-	0.30	\$0.000
Pumps - Variable Speed Control	0.1%	0.0%	10	\$0.44	0.4	0.08	\$0.146
Thermostat - Clock/Programmable	59.0%	70.0%	11	\$0.11	2.5	2.04	\$0.005
Interior Lighting - Central Lighting Controls	83.7%	100.0%	8	\$0.65	-	-	\$0.000
Exterior Lighting - Daylighting Controls	1.6%	53.6%	8	\$0.08	-	0.00	\$0.000
Interior Fluorescent - High Bay Fixtures	19.1%	50.0%	11	\$0.20	0.6	0.19	\$0.040
LED Exit Lighting	46.9%	90.0%	10	\$0.00	0.0	0.39	\$0.018
Retrocommissioning - Lighting	9.0%	93.0%	5	\$0.05	-	-	\$0.000
Interior Lighting - Occupancy Sensors	14.7%	60.0%	8	\$0.20	-	0.00	\$0.000
Exterior Lighting - Photovoltaic Installation	5.0%	25.0%	5	\$0.92	-	-	\$0.000
Interior Screw-in - Task Lighting	10.0%	100.0%	5	\$0.24	0.0	0.01	\$1.514
Interior Lighting - Time Clocks and Timers	2.4%	75.0%	8	\$0.20	-	0.00	\$0.000
Exterior Lighting - Cold Cathode Lighting	14.6%	50.0%	5	\$0.00	0.1	5.34	\$0.002
Interior Lighting - Skylights	1.2%	40.6%	8	\$0.29	-	0.00	\$0.000
Ventilation - Demand Control Ventilation	1.0%	10.0%	10	\$0.04	-	-	\$0.000
Strategic Energy Management	2.8%	20.0%	3	\$0.02	0.3	0.64	\$0.026
Transformers	9.8%	9.4%	10	\$0.13	0.3	0.18	\$0.060

C&I Energy Efficiency Equipment and Measure Data

Measure	Base Saturation	Applicability	Lifetime (Years)	Incremental Cost (\$/SqFt)	Savings (kWh/SqFt)	BC Ratio (2015)	Levelized Cost of Energy (\$/kWh)
Motors - Synchronous belts	17.3%	21.0%	10	\$0.22	-	0.01	\$0.000
Refrigeration - Multiplex - Floating section Pressure - Air-cooled Cond.	0.0%	0.0%	0	\$0.00	-	1.00	\$0.000
Refrigeration - Multiplex Controls - Floating section Pressure - Evap. Cond.	0.0%	0.0%	0	\$0.00	-	1.00	\$0.000
Refrigeration - Multiplex - Eff. Air-cooled Condenser	0.0%	0.0%	0	\$0.00	-	1.00	\$0.000
Refrigeration - Multiplex - Eff. Water-cooled Condenser	0.0%	0.0%	0	\$0.00	12.0	1.00	\$0.000
Refrigeration - System Controls	11.1%	45.0%	10	\$0.40	12.0	2.67	\$0.004
Refrigeration - System Maintenance	11.1%	45.0%	10	\$0.00	4.0	356.66	\$0.000
Refrigeration - System Optimization	13.6%	45.0%	10	\$0.80	12.0	1.34	\$0.008
Motors - Variable Frequency Drive	32.5%	50.0%	10	\$0.10	0.4	0.33	\$0.033
Motors - Magnetic Adjustable Speed Drives	24.0%	25.0%	10	\$0.10	1.5	1.41	\$0.008
Compressed Air - System Controls	0.0%	0.0%	15	\$0.01	0.7	6.38	\$0.001
Compressed Air - System Optimization and Improvements	44.8%	75.0%	10	\$0.20	1.8	0.82	\$0.013
Compressed Air - System Maintenance	0.0%	0.0%	3	\$0.03	0.1	0.22	\$0.081
Compressed Air - Compressor Replacement	17.6%	17.1%	10	\$0.06	1.3	1.81	\$0.006
Fan System - Controls	7.8%	8.2%	10	\$0.01	0.3	2.66	\$0.004
Fan System - Optimization	8.3%	8.9%	10	\$0.13	1.6	1.12	\$0.010
Fan System - Maintenance	5.2%	11.3%	3	\$0.01	0.1	0.61	\$0.029
Pumping System - Controls	8.6%	9.3%	10	\$0.01	0.3	2.23	\$0.005
Pumping System - Optimization	8.4%	9.0%	10	\$0.28	1.8	0.60	\$0.018
Pumping System - Maintenance	2.9%	10.1%	3	\$0.02	0.1	0.33	\$0.054
RTU - Maintenance	37.6%	100.0%	4	\$0.06	0.9	0.73	\$0.018
Chiller - Chilled Water Reset	39.9%	100.0%	4	\$0.09	1.3	0.74	\$0.019
Chiller - Chilled Water Variable-Flow System	30.0%	45.0%	10	\$0.20	0.3	0.13	\$0.071
Chiller - VSD	50.0%	89.0%	20	\$1.17	2.6	0.19	\$0.032
Chiller - High Efficiency Cooling Tower Fans	25.0%	100.0%	10	\$0.04	0.0	0.00	\$2.995
Chiller - Condenser Water Temperature Reset	14.2%	100.0%	14	\$0.20	1.3	0.55	\$0.014
Cooling - Economizer Installation	29.1%	45.0%	15	\$0.15	-	-	\$0.000
Heat Pump - Maintenance	21.7%	100.0%	4	\$0.03	1.0	1.70	\$0.008
Insulation - Ducting	11.8%	100.0%	20	\$0.41	-	0.30	\$0.000
Repair and Sealing - Ducting	5.0%	50.0%	15	\$0.38	-	0.31	\$0.000
Energy Management System	11.0%	100.0%	14	\$0.35	4.7	1.23	\$0.007
Fans - Energy Efficient Motors	0.0%	0.0%	10	\$0.14	0.6	0.73	\$0.027
Fans - Variable Speed Control	0.0%	0.0%	10	\$0.34	2.5	0.59	\$0.016

Table C-34 Energy Efficiency Non-Equipment Data— Extra Large Industrial, New Vintage, Idaho

Measure	Base Saturation	Applicability	Lifetime (Years)	Incremental Cost (\$/SqFt)	Savings (kWh/SqFt)	BC Ratio (2015)	Levelized Cost of Energy (\$/kWh)
Refrigeration - System Controls	13.6%	45.0%	10	\$0.40	4.0	0.91	\$0.012
Refrigeration - System Maintenance	13.6%	45.0%	10	\$0.00	12.0	1,086.05	\$0.000
Refrigeration - System Optimization	5.0%	45.0%	10	\$0.80	0.4	0.05	\$0.215
Motors - Variable Frequency Drive	32.5%	50.0%	10	\$0.10	1.9	1.72	\$0.006
Motors - Magnetic Adjustable Speed Drives	24.0%	25.0%	10	\$0.10	0.9	0.81	\$0.013
Compressed Air - System Controls	0.0%	0.0%	15	\$0.01	0.2	1.56	\$0.005
Compressed Air - System Optimization and Improvements	44.8%	75.0%	10	\$0.20	2.2	1.00	\$0.011
Compressed Air - System Maintenance	0.0%	0.0%	3	\$0.03	1.5	2.36	\$0.007
Compressed Air - Compressor Replacement	14.6%	17.1%	10	\$0.06	0.1	0.14	\$0.082
Fan System - Controls	7.8%	8.2%	10	\$0.01	0.7	5.80	\$0.002
Fan System - Optimization	8.3%	8.9%	10	\$0.13	1.2	0.81	\$0.013
Fan System - Maintenance	5.2%	11.3%	3	\$0.01	0.4	2.02	\$0.009
Pumping System - Controls	8.6%	9.3%	10	\$0.01	2.2	18.15	\$0.001
Pumping System - Optimization	6.7%	9.0%	10	\$0.28	0.2	0.06	\$0.185
Pumping System - Maintenance	3.5%	10.1%	3	\$0.02	0.6	1.26	\$0.014
RTU - Maintenance	37.6%	100.0%	4	\$0.06	1.0	0.94	\$0.015
Chiller - Chilled Water Reset	63.4%	100.0%	4	\$0.09	0.5	0.33	\$0.048
Chiller - Chilled Water Variable-Flow System	34.5%	45.0%	10	\$0.20	2.3	1.03	\$0.010
Chiller - VSD	25.0%	89.0%	20	\$1.17	0.0	0.00	\$5.329
Chiller - High Efficiency Cooling Tower Fans	40.1%	100.0%	10	\$0.04	1.2	2.65	\$0.004
Chiller - Condenser Water Temperature Reset	5.0%	100.0%	14	\$0.20	0.2	0.08	\$0.103
Cooling - Economizer Installation	35.5%	45.0%	15	\$0.15	0.5	0.29	\$0.027
Heat Pump - Maintenance	21.7%	100.0%	4	\$0.03	0.5	0.89	\$0.017
Insulation - Ducting	11.8%	50.0%	20	\$0.41	0.3	0.36	\$0.114
Energy Management System	23.6%	100.0%	14	\$0.35	4.7	1.26	\$0.007
Fans - Energy Efficient Motors	0.0%	0.0%	10	\$0.14	2.1	1.36	\$0.008
Fans - Variable Speed Control	0.0%	0.0%	10	\$0.34	0.1	0.03	\$0.361
Pumps - Variable Speed Control	0.1%	0.0%	10	\$0.44	0.1	0.01	\$1.018
Thermostat - Clock/Programmable	63.1%	70.0%	11	\$0.11	3.5	2.86	\$0.003
Interior Lighting - Central Lighting Controls	83.7%	100.0%	8	\$0.65	0.3	0.04	\$0.283
Exterior Lighting - Daylighting Controls	19.7%	53.6%	8	\$0.08	0.4	0.46	\$0.028
Interior Fluorescent - High Bay Fixtures	10.0%	50.0%	11	\$0.20	0.0	0.00	\$3.499
LED Exit Lighting	91.2%	90.0%	10	\$0.00	0.3	25.24	\$0.000
Interior Lighting - Occupancy Sensors	25.0%	60.0%	8	\$0.20	0.7	0.28	\$0.044
Exterior Lighting - Photovoltaic Installation	5.0%	25.0%	5	\$0.92	0.0	0.00	\$6.107
Interior Screw-in - Task Lighting	10.0%	100.0%	5	\$0.24	0.2	0.04	\$0.315
Interior Lighting - Time Clocks and Timers	2.4%	75.0%	8	\$0.20	0.1	0.04	\$0.324
Exterior Lighting - Cold Cathode Lighting	8.4%	50.0%	5	\$0.00	0.5	33.17	\$0.000
Interior Lighting - Skylights	2.4%	40.6%	8	\$0.19	0.1	0.06	\$0.235
Ventilation - Demand Control Ventilation	6.0%	10.0%	10	\$0.04	0.1	0.15	\$0.082
Strategic Energy Management	2.8%	20.0%	3	\$0.02	0.8	1.77	\$0.010
Transformers	9.8%	9.4%	10	\$0.13	0.3	0.23	\$0.049
Motors - Synchronous belts	17.3%	21.0%	10	\$0.22	0.0	0.01	\$1.550
Refrigeration - Multiplex - Floating section Pressure - Air-cooled Cond.	0.0%	0.0%	0	\$0.00	-	1.00	\$0.000
Refrigeration - Multiplex Controls -	0.0%	0.0%	0	\$0.00	-	1.00	\$0.000

C&I Energy Efficiency Equipment and Measure Data

Measure	Base Saturation	Applicability	Lifetime (Years)	Incremental Cost (\$/SqFt)	Savings (kWh/SqFt)	BC Ratio (2015)	Levelized Cost of Energy (\$/kWh)
Floating section Pressure - Evap. Cond.							
Refrigeration - Multiplex - Eff. Air-cooled Condenser	0.0%	0.0%	0	\$0.00	0.3	1.00	\$0.000
Refrigeration - Multiplex - Eff. Water-cooled Condenser	0.0%	0.0%	0	\$0.00	0.2	1.00	\$0.000
Commissioning - HVAC	78.5%	100.0%	25	\$0.70	0.9	0.14	\$0.046
Commissioning - Lighting	78.5%	100.0%	25	\$0.10	0.5	0.57	\$0.011
Advanced New Construction Designs	11.9%	100.0%	35	\$2.00	2.9	0.14	\$0.035
Refrigeration - System Controls	13.6%	45.0%	10	\$0.40	4.0	0.91	\$0.012
Refrigeration - System Maintenance	13.6%	45.0%	10	\$0.00	12.0	1,086.05	\$0.000
Refrigeration - System Optimization	5.0%	45.0%	10	\$0.80	0.4	0.05	\$0.215
Motors - Variable Frequency Drive	32.5%	50.0%	10	\$0.10	1.9	1.72	\$0.006
Motors - Magnetic Adjustable Speed Drives	24.0%	25.0%	10	\$0.10	0.9	0.81	\$0.013
Compressed Air - System Controls	0.0%	0.0%	15	\$0.01	0.2	1.56	\$0.005
Compressed Air - System Optimization and Improvements	44.8%	75.0%	10	\$0.20	2.2	1.00	\$0.011
Compressed Air - System Maintenance	0.0%	0.0%	3	\$0.03	1.5	2.36	\$0.007
Compressed Air - Compressor Replacement	14.6%	17.1%	10	\$0.06	0.1	0.14	\$0.082
Fan System - Controls	7.8%	8.2%	10	\$0.01	0.7	5.80	\$0.002
Fan System - Optimization	8.3%	8.9%	10	\$0.13	1.2	0.81	\$0.013
Fan System - Maintenance	5.2%	11.3%	3	\$0.01	0.4	2.02	\$0.009
Pumping System - Controls	8.6%	9.3%	10	\$0.01	2.2	18.15	\$0.001
Pumping System - Optimization	6.7%	9.0%	10	\$0.28	0.2	0.06	\$0.185
Pumping System - Maintenance	3.5%	10.1%	3	\$0.02	0.6	1.26	\$0.014
RTU - Maintenance	37.6%	100.0%	4	\$0.06	1.0	0.94	\$0.015
Chiller - Chilled Water Reset	63.4%	100.0%	4	\$0.09	0.5	0.33	\$0.048
Chiller - Chilled Water Variable-Flow System	34.5%	45.0%	10	\$0.20	2.3	1.03	\$0.010
Chiller - VSD	25.0%	89.0%	20	\$1.17	0.0	0.00	\$5.329
Chiller - High Efficiency Cooling Tower Fans	40.1%	100.0%	10	\$0.04	1.2	2.65	\$0.004
Chiller - Condenser Water Temperature Reset	5.0%	100.0%	14	\$0.20	0.2	0.08	\$0.103
Cooling - Economizer Installation	35.5%	45.0%	15	\$0.15	0.5	0.29	\$0.027
Heat Pump - Maintenance	21.7%	100.0%	4	\$0.03	0.5	0.89	\$0.017
Insulation - Ducting	11.8%	50.0%	20	\$0.41	0.3	0.36	\$0.114
Energy Management System	23.6%	100.0%	14	\$0.35	4.7	1.26	\$0.007
Fans - Energy Efficient Motors	0.0%	0.0%	10	\$0.14	2.1	1.36	\$0.008
Fans - Variable Speed Control	0.0%	0.0%	10	\$0.34	0.1	0.03	\$0.361
Pumps - Variable Speed Control	0.1%	0.0%	10	\$0.44	0.1	0.01	\$1.018

APPENDIX | D

MARKET ADOPTION FACTORS

A set of market adoption factors are applied to Economic potential to estimate Achievable Potential. These estimate customer adoption of economic measures when delivered through efficiency programs under realistic market and customer preference conditions. They reflect expected program participation given barriers to customer acceptance and program implementation. These adoption rates generally increase over time, reflecting an increasing awareness and willingness to adopt energy-efficient measures. However, in some cases, where a new technology is introduced, the adoption rates drop to reflect that the new technology may not yet be accepted in the market. For mature measures, information channels are assumed to be established for marketing, educating consumers, and coordinating with trade allies and delivery partners. For evolving measures, this is not the case and thus the factors start at a lower level.

The market adoption rates for the Avista study were developed using the ramp rates from the **Northwest Power & Conservation Council's Sixth Plan as a starting point**. The ramp rates were then adjusted based on actual Avista program history and information from program evaluations. These adjustments mainly set the potential in the first years of the study to match with recent program achievements and thus show continuity of results.

Table D-1 through Table D-2 present the Achievable Potential market adoption factors for the residential sector, first for equipment measures and then for non-equipment measures. Table D-3 through Table D-4 present the market adoption factors for the commercial and industrial sector

Table D-1 Residential Equipment Measures—Achievable Potential Market Adoption Factors

End Use	Fuel	Technology	2014	2015	2016	2017	2018	2019	2020	2021	2022	2023	2024	2025	2026
Cooling	Electric	Central AC	77%	78%	79%	80%	81%	82%	83%	84%	85%	85%	85%	85%	85%
Cooling	Electric	Room AC	77%	78%	79%	80%	81%	82%	83%	84%	85%	85%	85%	85%	85%
Cooling	Electric	Air Source Heat Pump	77%	78%	79%	80%	81%	82%	83%	84%	85%	85%	85%	85%	85%
Cooling	Electric	Geothermal Heat Pump	77%	78%	79%	80%	81%	82%	83%	84%	85%	85%	85%	85%	85%
Cooling	Electric	Ductless HP	56%	58%	59%	62%	66%	71%	76%	81%	83%	85%	85%	85%	85%
Space Heating	Electric	Electric Resistance	6%	9%	11%	14%	17%	20%	23%	26%	28%	31%	34%	37%	40%
Space Heating	Electric	Electric Furnace	60%	60%	60%	60%	60%	60%	60%	60%	60%	60%	60%	60%	60%
Space Heating	Electric	Supplemental	11%	17%	23%	28%	34%	40%	45%	51%	57%	62%	68%	74%	79%
Space Heating	Electric	Air Source Heat Pump	77%	78%	79%	80%	81%	82%	83%	84%	85%	85%	85%	85%	85%
Space Heating	Electric	Geothermal Heat Pump	56%	58%	59%	62%	66%	71%	76%	81%	83%	85%	85%	85%	85%
Space Heating	Electric	Ductless HP	28%	32%	37%	40%	43%	45%	46%	49%	52%	57%	62%	68%	73%
Water Heating	Electric	Water Heater <= 55 Gal	5%	7%	9%	10%	12%	15%	20%	25%	30%	35%	40%	45%	50%
Water Heating	Electric	Water Heater > 55 Gal	2%	3%	5%	8%	10%	12%	14%	34%	39%	45%	50%	50%	50%
Interior Lighting	Electric	Screw-in	25%	25%	26%	27%	29%	31%	33%	35%	38%	41%	45%	50%	55%
Interior Lighting	Electric	Linear Fluorescent	25%	25%	26%	27%	29%	31%	33%	35%	38%	41%	45%	50%	55%
Interior Lighting	Electric	Specialty	25%	25%	26%	27%	29%	31%	33%	35%	38%	41%	45%	50%	55%
Exterior Lighting	Electric	Screw-in	25%	25%	26%	27%	29%	31%	33%	35%	38%	41%	45%	50%	55%
Appliances	Electric	Clothes Washer	56%	58%	59%	62%	66%	71%	76%	81%	83%	85%	85%	85%	85%
Appliances	Electric	Clothes Dryer	56%	58%	59%	62%	66%	71%	76%	81%	83%	85%	85%	85%	85%
Appliances	Electric	Dishwasher	56%	58%	59%	62%	66%	71%	76%	81%	83%	85%	85%	85%	85%
Appliances	Electric	Refrigerator	56%	58%	59%	62%	66%	71%	76%	81%	83%	85%	85%	85%	85%
Appliances	Electric	Freezer	56%	58%	59%	62%	66%	71%	76%	81%	83%	85%	85%	85%	85%
Appliances	Electric	Second Refrigerator	56%	58%	59%	62%	66%	71%	76%	81%	83%	85%	85%	85%	85%
Appliances	Electric	Stove	56%	58%	59%	62%	66%	71%	76%	81%	83%	85%	85%	85%	85%
Appliances	Electric	Microwave	56%	58%	59%	62%	66%	71%	76%	81%	83%	85%	85%	85%	85%
Electronics	Electric	Personal Computers	5%	8%	10%	13%	16%	19%	23%	26%	30%	33%	37%	40%	44%
Electronics	Electric	TVs	11%	16%	21%	26%	31%	36%	41%	47%	52%	58%	63%	68%	72%
Electronics	Electric	Set-top boxes/DVR	6%	9%	12%	15%	18%	22%	25%	29%	31%	34%	37%	40%	43%
Electronics	Electric	Devices and Gadgets	6%	9%	12%	15%	18%	22%	25%	29%	31%	34%	37%	40%	43%
Miscellaneous	Electric	Pool Pump	5%	8%	10%	13%	16%	19%	23%	26%	30%	33%	37%	40%	44%
Miscellaneous	Electric	Furnace Fan	9%	13%	17%	21%	25%	29%	34%	39%	45%	49%	54%	57%	60%
Miscellaneous	Electric	Miscellaneous	23%	31%	39%	47%	54%	62%	68%	73%	76%	78%	78%	78%	79%

Table D-2 Residential Non-Equipment Measures— Achievable Potential Market Adoption Factors

Measures	2014	2015	2016	2017	2018	2019	2020	2021	2022	2023	2024	2025	2026
Central AC - Early Replacement	1%	3%	5%	7%	9%	11%	14%	16%	19%	21%	24%	27%	30%
Central AC - Maintenance and Tune-Up	5%	9%	13%	17%	20%	23%	26%	29%	31%	35%	38%	42%	46%
Room AC - Removal of Second Unit	1%	3%	5%	7%	9%	11%	14%	16%	19%	21%	24%	27%	30%
Attic Fan - Installation	5%	7%	9%	11%	14%	16%	18%	20%	23%	25%	27%	29%	32%
Attic Fan - Photovoltaic - Installation	1%	3%	5%	7%	9%	11%	14%	16%	19%	21%	24%	27%	30%
Ceiling Fan - Installation	6%	9%	9%	11%	14%	16%	18%	20%	23%	25%	27%	29%	32%
Whole-House Fan - Installation	2%	8%	15%	22%	31%	39%	48%	57%	59%	62%	64%	67%	69%
Air Source Heat Pump - Maintenance	3%	5%	7%	9%	10%	12%	13%	14%	16%	17%	18%	20%	22%
Insulation - Ducting	1%	3%	5%	7%	9%	11%	14%	16%	19%	21%	24%	27%	30%
Repair and Sealing - Ducting	2%	3%	6%	8%	10%	11%	12%	14%	15%	16%	18%	19%	21%
Thermostat - Clock/Programmable	1%	3%	5%	7%	9%	11%	14%	16%	19%	21%	24%	27%	30%
Doors - Storm and Thermal	5%	7%	9%	11%	14%	16%	18%	20%	23%	25%	27%	29%	32%
Insulation - Infiltration Control	5%	9%	13%	17%	20%	23%	26%	29%	31%	35%	38%	42%	46%
Insulation - Ceiling	12%	13%	14%	14%	15%	16%	17%	18%	19%	20%	21%	22%	23%
Insulation - Radiant Barrier	5%	9%	15%	20%	24%	29%	34%	39%	44%	50%	56%	62%	69%
Roofs - High Reflectivity	1%	3%	5%	7%	9%	11%	14%	16%	19%	21%	24%	27%	30%
Windows - Reflective Film	5%	7%	9%	11%	14%	16%	18%	20%	23%	25%	27%	29%	32%
Windows - High Efficiency/Energy Star	5%	7%	9%	11%	14%	16%	18%	20%	23%	25%	27%	29%	32%
Interior Lighting - Occupancy Sensor	10%	19%	27%	35%	43%	51%	60%	68%	68%	68%	68%	68%	68%
Exterior Lighting - Photovoltaic Installation	2%	8%	15%	22%	31%	39%	48%	57%	59%	62%	64%	67%	69%
Exterior Lighting - Photosensor Control	1%	4%	10%	17%	24%	33%	41%	50%	59%	62%	64%	67%	69%
Exterior Lighting - Timeclock Installation	2%	8%	15%	22%	31%	39%	48%	57%	59%	62%	64%	67%	69%
Water Heater - Faucet Aerators	1%	3%	5%	7%	9%	11%	14%	16%	19%	21%	24%	27%	30%
Water Heater - Pipe Insulation	1%	3%	5%	7%	9%	11%	14%	16%	19%	21%	24%	27%	30%
Water Heater - Low Flow Showerheads	2%	3%	6%	8%	10%	11%	12%	14%	15%	16%	18%	19%	21%
Water Heater - Tank Blanket/Insulation	3%	5%	7%	9%	10%	12%	13%	14%	16%	17%	18%	20%	22%
Water Heater - Thermostat Setback	3%	5%	7%	9%	10%	12%	13%	14%	16%	17%	18%	20%	22%
Electronics - Reduce Standby Wattage	3%	5%	7%	9%	10%	12%	13%	14%	16%	17%	18%	20%	22%
Refrigerator - Early Replacement	3%	4%	6%	8%	11%	13%	16%	19%	23%	25%	27%	29%	32%
Refrigerator - Remove Second Unit	3%	4%	6%	8%	11%	13%	16%	19%	23%	25%	27%	29%	32%
Freezer - Early Replacement	3%	4%	6%	8%	11%	13%	16%	19%	23%	25%	27%	29%	32%
Freezer - Remove Second Unit	3%	4%	6%	8%	11%	13%	16%	19%	23%	25%	27%	29%	32%
Behavioral Measures	1%	3%	5%	7%	9%	11%	14%	16%	19%	21%	24%	27%	30%
Pool - Pump Timer	3%	6%	9%	11%	14%	16%	19%	21%	24%	27%	30%	33%	37%
Insulation - Foundation	3%	6%	9%	11%	14%	16%	19%	21%	24%	27%	30%	33%	37%
Insulation - Wall Cavity	5%	9%	15%	20%	24%	29%	34%	39%	44%	50%	56%	62%	69%
Insulation - Wall Sheathing	1%	3%	5%	7%	9%	11%	14%	16%	19%	21%	24%	27%	30%
Water Heater - Drainwater Heat Recovery	4%	6%	9%	11%	13%	15%	17%	19%	21%	23%	26%	28%	30%
Advanced New Construction Designs	4%	6%	9%	11%	13%	15%	17%	19%	21%	23%	26%	28%	30%
Energy Star Homes	9%	10%	14%	15%	20%	21%	26%	28%	34%	36%	40%	43%	45%

Market Adoption Factors

Table D-3 C/I Equipment Measures — Achievable Potential Market Adoption Factors

End Use	Fuel	Technology	2014	2015	2016	2017	2018	2019	2020	2021	2022	2023	2024	2025	2026
Cooling	Electric	Central Chiller	85%	85%	85%	85%	85%	85%	85%	85%	85%	85%	85%	85%	85%
Cooling	Electric	RTU	85%	85%	85%	85%	85%	85%	85%	85%	85%	85%	85%	85%	85%
Cooling	Electric	PTAC	85%	85%	85%	85%	85%	85%	85%	85%	85%	85%	85%	85%	85%
Cooling	Electric	Heat Pump	85%	85%	85%	85%	85%	85%	85%	85%	85%	85%	85%	85%	85%
Space Heating	Electric	Electric Resistance	25%	30%	35%	40%	45%	50%	55%	60%	65%	70%	75%	80%	85%
Space Heating	Electric	Furnace	85%	85%	85%	85%	85%	85%	85%	85%	85%	85%	85%	85%	85%
Space Heating	Electric	Heat Pump	100%	100%	100%	100%	100%	100%	100%	100%	100%	100%	100%	100%	100%
Ventilation	Electric	Ventilation	85%	85%	85%	85%	85%	85%	85%	85%	85%	85%	85%	85%	85%
Interior Lighting	Electric	Interior Screw-in	33%	45%	54%	61%	66%	70%	73%	76%	78%	80%	81%	82%	82%
Interior Lighting	Electric	High Bay Fixtures	50%	60%	70%	80%	85%	85%	85%	85%	85%	85%	85%	85%	85%
Interior Lighting	Electric	Linear Fluorescent	61%	66%	70%	73%	76%	78%	80%	81%	82%	82%	83%	83%	84%
Exterior Lighting	Electric	Exterior Screw-in	25%	30%	35%	40%	45%	50%	55%	60%	65%	70%	75%	80%	85%
Exterior Lighting	Electric	HID	25%	30%	35%	40%	45%	50%	55%	60%	65%	70%	75%	80%	85%
Water Heating	Electric	Water Heater	13%	15%	18%	20%	23%	25%	28%	30%	33%	35%	38%	40%	45%
Food Preparation	Electric	Fryer	50%	60%	70%	80%	85%	85%	85%	85%	85%	85%	85%	85%	85%
Food Preparation	Electric	Oven	50%	60%	70%	80%	85%	85%	85%	85%	85%	85%	85%	85%	85%
Food Preparation	Electric	Dishwasher	50%	60%	70%	80%	85%	85%	85%	85%	85%	85%	85%	85%	85%
Food Preparation	Electric	Hot Food Container	50%	60%	70%	80%	85%	85%	85%	85%	85%	85%	85%	85%	85%
Food Preparation	Electric	Food Prep	50%	60%	70%	80%	85%	85%	85%	85%	85%	85%	85%	85%	85%
Refrigeration	Electric	Walk in Refrigeration	80%	80%	85%	85%	85%	85%	85%	85%	85%	85%	85%	85%	85%
Refrigeration	Electric	Glass Door Display	80%	80%	85%	85%	85%	85%	85%	85%	85%	85%	85%	85%	85%
Refrigeration	Electric	Reach-in Refrigerator	80%	80%	85%	85%	85%	85%	85%	85%	85%	85%	85%	85%	85%
Refrigeration	Electric	Open Display Case	80%	80%	85%	85%	85%	85%	85%	85%	85%	85%	85%	85%	85%
Refrigeration	Electric	Vending Machine	80%	80%	85%	85%	85%	85%	85%	85%	85%	85%	85%	85%	85%
Refrigeration	Electric	Icemaker	80%	80%	85%	85%	85%	85%	85%	85%	85%	85%	85%	85%	85%
Office Equipment	Electric	Desktop Computer	25%	30%	35%	40%	45%	50%	55%	60%	65%	70%	75%	80%	85%
Office Equipment	Electric	Laptop Computer	25%	30%	35%	40%	45%	50%	55%	60%	65%	70%	75%	80%	85%
Office Equipment	Electric	Server	25%	30%	35%	40%	45%	50%	55%	60%	65%	70%	75%	80%	85%
Office Equipment	Electric	Monitor	25%	30%	35%	40%	45%	50%	55%	60%	65%	70%	75%	80%	85%
Office Equipment	Electric	Printer/copier/fax	25%	30%	35%	40%	45%	50%	55%	60%	65%	70%	75%	80%	85%
Office Equipment	Electric	POS Terminal	25%	30%	35%	40%	45%	50%	55%	60%	65%	70%	75%	80%	85%
Miscellaneous	Electric	Non-HVAC Motor	50%	60%	70%	80%	85%	85%	85%	85%	85%	85%	85%	85%	85%
Miscellaneous	Electric	Other Miscellaneous	50%	60%	70%	80%	85%	85%	85%	85%	85%	85%	85%	85%	85%
Process	Electric	Process Cooling/Refrigeration	50%	60%	70%	80%	85%	85%	85%	85%	85%	85%	85%	85%	85%

Market Adoption Factors

End Use	Fuel	Technology	2014	2015	2016	2017	2018	2019	2020	2021	2022	2023	2024	2025	2026
Process	Electric	Process Heating	25%	30%	35%	40%	45%	50%	55%	60%	65%	70%	75%	80%	85%
Process	Electric	Electrochemical Process	50%	60%	70%	80%	85%	85%	85%	85%	85%	85%	85%	85%	85%
Machine Drive	Electric	Less than 5 HP	50%	60%	70%	80%	85%	85%	85%	85%	85%	85%	85%	85%	85%
Machine Drive	Electric	5-24 HP	50%	60%	70%	80%	85%	85%	85%	85%	85%	85%	85%	85%	85%
Machine Drive	Electric	25-99 HP	50%	60%	70%	80%	85%	85%	85%	85%	85%	85%	85%	85%	85%
Machine Drive	Electric	100-249 HP	43%	51%	60%	68%	72%	72%	72%	72%	72%	72%	72%	72%	72%
Machine Drive	Electric	250-499 HP	43%	51%	60%	68%	72%	72%	72%	72%	72%	72%	72%	72%	72%
Machine Drive	Electric	500 and more HP	43%	51%	60%	68%	72%	72%	72%	72%	72%	72%	72%	72%	72%
Miscellaneous	Electric	Miscellaneous	21%	26%	30%	34%	38%	43%	47%	51%	55%	60%	64%	68%	72%

Market Adoption Factors

Table D-4 C/I Non-Equipment Measures — Achievable Potential Market Adoption Factors

Measures	2014	2015	2016	2017	2018	2019	2020	2021	2022	2023	2024	2025	2026
RTU - Maintenance	8%	16%	24%	34%	43%	51%	60%	68%	68%	68%	68%	68%	68%
RTU - Evaporative Precooler	8%	16%	24%	34%	43%	51%	60%	68%	68%	68%	68%	68%	68%
Chiller - Chilled Water Reset	40%	41%	42%	42%	41%	41%	41%	42%	44%	46%	48%	49%	50%
Chiller - Chilled Water Variable-Flow System	40%	41%	42%	42%	41%	41%	41%	42%	44%	46%	48%	49%	50%
Chiller - VSD	54%	55%	56%	57%	58%	59%	60%	60%	61%	62%	63%	64%	65%
Chiller - High Efficiency Cooling Tower Fans	54%	55%	56%	57%	58%	59%	60%	60%	61%	62%	63%	64%	65%
Chiller - Condenser Water Temperature Reset	40%	41%	42%	42%	41%	41%	41%	42%	44%	46%	48%	49%	50%
Cooling - Economizer Installation	54%	55%	56%	57%	58%	59%	60%	60%	61%	62%	63%	64%	65%
Heat Pump - Maintenance	54%	55%	56%	57%	58%	59%	60%	60%	61%	62%	63%	64%	65%
Insulation - Ducting	54%	55%	56%	57%	58%	59%	60%	60%	61%	62%	63%	64%	65%
Repair and Sealing - Ducting	54%	55%	56%	57%	58%	59%	60%	60%	61%	62%	63%	64%	65%
Energy Management System	40%	41%	42%	42%	41%	41%	41%	42%	44%	46%	48%	49%	50%
Cooking - Exhaust Hoods with Sensor Control	4%	8%	12%	17%	21%	26%	30%	34%	38%	43%	47%	51%	55%
Fans - Energy Efficient Motors	54%	55%	56%	57%	58%	59%	60%	60%	61%	62%	63%	64%	65%
Fans - Variable Speed Control	54%	55%	56%	57%	58%	59%	60%	60%	61%	62%	63%	64%	65%
Retrocommissioning - HVAC	40%	41%	42%	42%	41%	41%	41%	42%	44%	46%	48%	49%	50%
Pumps - Variable Speed Control	54%	55%	56%	57%	58%	59%	60%	60%	61%	62%	63%	64%	65%
Thermostat - Clock/Programmable	40%	41%	42%	42%	41%	41%	41%	42%	44%	46%	48%	49%	50%
Insulation - Ceiling	40%	41%	42%	42%	41%	41%	41%	42%	44%	46%	48%	49%	50%
Insulation - Radiant Barrier	40%	41%	42%	42%	41%	41%	41%	42%	44%	46%	48%	49%	50%
Roofs - High Reflectivity	20%	21%	23%	25%	26%	28%	30%	31%	33%	35%	37%	38%	40%
Windows - High Efficiency	40%	41%	42%	42%	41%	41%	41%	42%	44%	46%	48%	49%	50%
Interior Lighting - Central Lighting Controls	54%	55%	56%	57%	58%	59%	60%	60%	61%	62%	63%	64%	65%
Interior Lighting - Photocell Controlled T8 Dimming Ballasts	54%	55%	56%	57%	58%	59%	60%	60%	61%	62%	63%	64%	65%
Exterior Lighting - Daylighting Controls	54%	55%	56%	57%	58%	59%	60%	60%	61%	62%	63%	64%	65%
Interior Fluorescent - Bi-Level Fixture w/Occupancy Sensor	54%	55%	56%	57%	58%	59%	60%	60%	61%	62%	63%	64%	65%
Interior Fluorescent - High Bay Fixtures	54%	55%	56%	57%	58%	59%	60%	60%	61%	62%	63%	64%	65%
Interior Lighting - Occupancy Sensors	54%	55%	56%	57%	58%	59%	60%	60%	61%	62%	63%	64%	65%
Exterior Lighting - Photovoltaic Installation	54%	55%	56%	57%	58%	59%	60%	60%	61%	62%	63%	64%	65%
Interior Screw-in - Task Lighting	54%	55%	56%	57%	58%	59%	60%	60%	61%	62%	63%	64%	65%
Interior Lighting - Time Clocks and Timers	54%	55%	56%	57%	58%	59%	60%	60%	61%	62%	63%	64%	65%
Water Heater - Faucet Aerators/Low Flow Nozzles	54%	55%	56%	57%	58%	59%	60%	60%	61%	62%	63%	64%	65%
Water Heater - Pipe Insulation	54%	55%	56%	57%	58%	59%	60%	60%	61%	62%	63%	64%	65%
Water Heater - High Efficiency Circulation Pump	20%	21%	23%	25%	26%	28%	30%	31%	33%	35%	37%	38%	40%

Market Adoption Factors

Measures	2014	2015	2016	2017	2018	2019	2020	2021	2022	2023	2024	2025	2026
Water Heater - Tank Blanket/Insulation	54%	55%	56%	57%	58%	59%	60%	60%	61%	62%	63%	64%	65%
Water Heater - Thermostat Setback	20%	21%	23%	25%	26%	28%	30%	31%	33%	35%	37%	38%	40%
Refrigeration - Anti-Sweat Heater/Auto Door Closer	20%	21%	23%	25%	26%	28%	30%	31%	33%	35%	37%	38%	40%
Refrigeration - Floating Head Pressure	40%	41%	42%	42%	41%	41%	41%	42%	44%	46%	48%	49%	50%
Refrigeration - Door Gasket Replacement	40%	41%	42%	42%	41%	41%	41%	42%	44%	46%	48%	49%	50%
Insulation - Bare Suction Lines	40%	41%	42%	42%	41%	41%	41%	42%	44%	46%	48%	49%	50%
Refrigeration - Night Covers	40%	41%	42%	42%	41%	41%	41%	42%	44%	46%	48%	49%	50%
Refrigeration - Strip Curtain	40%	41%	42%	42%	41%	41%	41%	42%	44%	46%	48%	49%	50%
Vending Machine - Controller	54%	55%	56%	57%	58%	59%	60%	60%	61%	62%	63%	64%	65%
LED Exit Lighting	54%	55%	56%	57%	58%	59%	60%	60%	61%	62%	63%	64%	65%
Retrocommissioning - Lighting	54%	55%	56%	57%	58%	59%	60%	60%	61%	62%	63%	64%	65%
Refrigeration - High Efficiency Case Lighting	40%	41%	42%	42%	41%	41%	41%	42%	44%	46%	48%	49%	50%
Exterior Lighting - Cold Cathode Lighting	54%	55%	56%	57%	58%	59%	60%	60%	61%	62%	63%	64%	65%
Laundry - High Efficiency Clothes Washer	54%	55%	56%	57%	58%	59%	60%	60%	61%	62%	63%	64%	65%
Interior Lighting - Hotel Guestroom Controls	54%	55%	56%	57%	58%	59%	60%	60%	61%	62%	63%	64%	65%
Miscellaneous - Energy Star Water Cooler	54%	55%	56%	57%	58%	59%	60%	60%	61%	62%	63%	64%	65%
Commissioning - HVAC	54%	55%	56%	57%	58%	59%	60%	60%	61%	62%	63%	64%	65%
Commissioning - Comprehensive	20%	21%	23%	25%	26%	28%	30%	31%	33%	35%	37%	38%	40%
Commissioning - Lighting	54%	55%	56%	57%	58%	59%	60%	60%	61%	62%	63%	64%	65%
Advanced New Construction Designs	20%	21%	23%	25%	26%	28%	30%	31%	33%	35%	37%	38%	40%
Insulation - Wall Cavity	54%	55%	56%	57%	58%	59%	60%	60%	61%	62%	63%	64%	65%
Roofs - Green	20%	21%	23%	25%	26%	28%	30%	31%	33%	35%	37%	38%	40%
Interior Lighting - Skylights	20%	21%	23%	25%	26%	28%	30%	31%	33%	35%	37%	38%	40%
Ventilation - Demand Control Ventilation	54%	55%	56%	57%	58%	59%	60%	60%	61%	62%	63%	64%	65%
Office Equipment - Smart Power Strips	54%	55%	56%	57%	58%	59%	60%	60%	61%	62%	63%	64%	65%
Strategic Energy Management	40%	41%	42%	42%	41%	41%	41%	42%	44%	46%	48%	49%	50%
Refrigeration - Multiplex - Floating section Pressure - Air-cooled Cond.	40%	41%	42%	42%	41%	41%	41%	42%	44%	46%	48%	49%	50%
Refrigeration - Multiplex Controls - Floating section Pressure - Evap. Cond.	40%	41%	42%	42%	41%	41%	41%	42%	44%	46%	48%	49%	50%
Refrigeration - Multiplex - Eff. Air-cooled Condenser	40%	41%	42%	42%	41%	41%	41%	42%	44%	46%	48%	49%	50%
Refrigeration - Multiplex - Eff. Water-cooled Condenser	40%	41%	42%	42%	41%	41%	41%	42%	44%	46%	48%	49%	50%
Refrigeration - System Controls	54%	55%	56%	57%	58%	59%	60%	60%	61%	62%	63%	64%	65%
Refrigeration - System Maintenance	54%	55%	56%	57%	58%	59%	60%	60%	61%	62%	63%	64%	65%
Refrigeration - System Optimization	54%	55%	56%	57%	58%	59%	60%	60%	61%	62%	63%	64%	65%
Motors - Variable Frequency Drive	54%	55%	56%	57%	58%	59%	60%	60%	61%	62%	63%	64%	65%
Motors - Magnetic Adjustable Speed Drives	54%	55%	56%	57%	58%	59%	60%	60%	61%	62%	63%	64%	65%
Compressed Air - System Controls	40%	41%	42%	42%	41%	41%	41%	42%	44%	46%	48%	49%	50%

Market Adoption Factors

Measures	2014	2015	2016	2017	2018	2019	2020	2021	2022	2023	2024	2025	2026
Compressed Air - System Optimization and Improvements	40%	41%	42%	42%	41%	41%	41%	42%	44%	46%	48%	49%	50%
Compressed Air - System Maintenance	40%	41%	42%	42%	41%	41%	41%	42%	44%	46%	48%	49%	50%
Compressed Air - Compressor Replacement	40%	41%	42%	42%	41%	41%	41%	42%	44%	46%	48%	49%	50%
Fan System - Controls	54%	55%	56%	57%	58%	59%	60%	60%	61%	62%	63%	64%	65%
Fan System - Optimization	54%	55%	56%	57%	58%	59%	60%	60%	61%	62%	63%	64%	65%
Fan System - Maintenance	54%	55%	56%	57%	58%	59%	60%	60%	61%	62%	63%	64%	65%
Pumping System - Controls	54%	55%	56%	57%	58%	59%	60%	60%	61%	62%	63%	64%	65%
Pumping System - Optimization	54%	55%	56%	57%	58%	59%	60%	60%	61%	62%	63%	64%	65%
Pumping System - Maintenance	54%	55%	56%	57%	58%	59%	60%	60%	61%	62%	63%	64%	65%
Transformers	40%	41%	42%	42%	41%	41%	41%	42%	44%	46%	48%	49%	50%
Motors - Synchronous belts	40%	41%	42%	42%	41%	41%	41%	42%	44%	46%	48%	49%	50%

APPENDIX | E

ANNUAL SAVINGS

This section presents the estimates of annual savings. Selected years are shown in Chapter 4 of the CPA report. Table E-1 and Table E-2 show the overall annual savings for all sectors combined. Table E-3 through Table E-6 show the annual savings for the individual sectors.

Table E-1 Annual Electric Energy Savings, All Sectors (1,000 MWh)

	2014	2015	2016	2017	2018	2019	2020	2021	2022	2023
Cumulative Savings (1,000 MWh)										
Achievable Potential	51	100	168	240	325	417	458	515	579	634
Economic Potential	315	476	679	881	1,079	1,284	1,361	1,447	1,552	1,655
Technical Potential	1,161	1,368	1,656	1,966	2,239	2,517	2,695	2,862	3,029	3,173
Incremental Savings (1,000 MWh)										
Achievable Potential	51	50	68	72	84	93	41	57	64	55
Economic Potential	315	162	202	203	198	204	78	86	104	103
Technical Potential	1,161	206	289	310	273	278	178	168	166	144

Annual Savings

Table E-2 Annual Electric Energy Savings, All Sectors (1,000 MWh) (continued)

	2024	2025	2026	2027	2028	2029	2030	2031	2032	2033
Cumulative Savings (1,000 MWh)										
Achievable Potential	685	761	834	903	977	1,037	1,103	1,175	1,262	1,352
Economic Potential	1,751	1,896	2,020	2,138	2,259	2,315	2,388	2,468	2,561	2,652
Technical Potential	3,302	3,472	3,617	3,752	3,884	3,979	4,070	4,163	4,252	4,340
Incremental Savings (1,000 MWh)										
Achievable Potential	51	76	73	69	74	60	66	71	88	90
Economic Potential	96	145	124	118	121	56	74	79	93	91
Technical Potential	129	170	145	135	133	94	91	93	89	88

Table E-3 Annual Electric Energy Savings, Residential (1,000 MWh)

	2014	2015	2016	2017	2018	2019	2020	2021	2022	2023
Cumulative Savings (1,000 MWh)										
Achievable Potential	22	43	75	110	148	189	209	224	241	252
Economic Potential	231	335	469	611	745	879	926	955	998	1,042
Technical Potential	963	1,038	1,154	1,266	1,338	1,409	1,430	1,433	1,454	1,473
Incremental Savings (1,000 MWh)										
Achievable Potential	22	21	32	35	37	42	19	16	16	11
Economic Potential	231	104	134	142	133	135	46	30	43	43
Technical Potential	963	74	116	112	73	70	22	3	20	20

Annual Savings

Table E-4 Annual Electric Energy Savings, Residential (1,000 MWh) (continued)

	2024	2025	2026	2027	2028	2029	2030	2031	2032	2033
Cumulative Savings (1,000 MWh)										
Achievable Potential	263	293	324	357	392	419	447	477	510	547
Economic Potential	1,083	1,164	1,239	1,314	1,390	1,412	1,442	1,474	1,512	1,549
Technical Potential	1,492	1,553	1,611	1,669	1,727	1,765	1,802	1,840	1,876	1,912
Incremental Savings (1,000 MWh)										
Achievable Potential	11	30	31	32	35	27	28	30	34	37
Economic Potential	42	81	75	75	76	21	30	32	38	38
Technical Potential	19	61	58	58	59	37	38	38	36	35

Table E-5 Annual Electric Energy Savings, C/I (1,000 MWh)

	2014	2015	2016	2017	2018	2019	2020	2021	2022	2023
Cumulative Savings (1,000 MWh)										
Achievable Potential	29	57	93	130	177	228	250	291	338	382
Economic Potential	84	141	210	270	334	404	436	492	554	613
Technical Potential	198	330	503	701	901	1,108	1,264	1,429	1,575	1,700
Incremental Savings (1,000 MWh)										
Achievable Potential	29	29	36	37	47	51	22	41	48	43
Economic Potential	84	58	69	60	64	70	31	57	61	60
Technical Potential	198	132	173	198	200	208	156	165	146	125

Annual Savings

Table E-6 Annual Electric Energy Savings, C/I (1,000 MWh) (continued)

	2024	2025	2026	2027	2028	2029	2030	2031	2032	2033
Cumulative Savings (1,000 MWh)										
Achievable Potential	422	468	509	546	585	618	656	698	752	805
Economic Potential	668	732	781	824	868	903	946	994	1,049	1,103
Technical Potential	1,809	1,919	2,006	2,083	2,157	2,214	2,268	2,323	2,376	2,428
Incremental Savings (1,000 MWh)										
Achievable Potential	40	46	42	37	39	34	38	42	54	53
Economic Potential	54	64	49	43	45	34	43	47	56	53
Technical Potential	110	109	87	77	74	57	53	55	53	52

About EnerNOC Utility Solutions Consulting

EnerNOC Utility Solutions Consulting is part of EnerNOC Utility Solutions group, which provides a comprehensive suite of demand-side management (DSM) services to utilities and grid operators worldwide. Hundreds of utilities have leveraged our technology, our people, and our proven processes to make their energy efficiency (EE) and demand response (DR) initiatives a success. Utilities trust EnerNOC to work with them at every stage of the DSM program lifecycle – assessing market potential, designing effective programs, implementing those programs, and measuring program results.

EnerNOC Utility Solutions delivers value to our utility clients through two separate practice areas – Program Implementation and EnerNOC Utility Solutions Consulting.

- Our Program Implementation team leverages EnerNOC's deep **"behind-the-meter expertise" and world-class** technology platform to help utilities create and manage DR and EE programs that deliver reliable and cost-effective energy savings. We focus exclusively on the commercial and industrial (C&I) customer segments, with a track record of successful partnerships that spans more than a decade. Through a focus on high quality, measurable savings, EnerNOC has successfully delivered hundreds of thousands of MWh of energy efficiency for our utility clients, and we have thousands of MW of demand response capacity under management.
- The EnerNOC Utility Solutions Consulting team provides expertise and analysis to support a broad range of utility DSM activities, including: potential assessments; end-use forecasts; integrated resource planning; EE, DR, and smart grid pilot and program design and administration; load research; technology assessments and demonstrations; evaluation, measurement and verification; and regulatory support.

The EnerNOC Utility Solutions Consulting team has decades of combined experience in the utility DSM industry. The staff is comprised of professional electrical, mechanical, chemical, civil, industrial, and environmental engineers as well as economists, business planners, project managers, market researchers, load research professionals, and statisticians. Utilities view our experts as trusted advisors, and we work together collaboratively to make any DSM initiative a success.

2013 Electric Integrated Resource Plan

Appendix D – 2013 Electric IRP Transmission Studies





Interoffice Memorandum System Planning

MEMO: SP-2012-09
DATE: August 14, 2012
TO: Scott Waples
FROM: Richard Maguire
SUBJECT: 2013 IRP Generation Study – Nine Mile HED

Introduction

This study addresses a request from Avista's Power Supply Department for the 2013 IRP regarding increasing the capacity of Nine Mile HED to 60 MW.

The study addresses the following:

- Power flow impact to the transmission system
- Voltage level impact to the transmission system
- Transmission system upgrades necessary to deliver requested generation

History

The Nine Mile project was built by a private developer in 1908 near Nine Mile Falls, Washington, nine miles northwest of Spokane. The Company purchased the project in 1925 from the Spokane & Eastern Railway. Its four units have a 17.6 MW maximum capacity and a 26.4 MW nameplate rating.

Currently Unit 1 provides no generation and Unit 2 is limited to half load and unit 4 failed in the spring of 2011. These units will be replaced, and the desired capacity of the plant upon replacement of the new units is 60 MW. Avista expects the new capacity will add incremental energy towards meeting Washington State Energy Independence Act goals.

Study Methodology and Assumptions

Avista's five year planning horizon planning cases are used and modified with the following projects prior to transmission system analysis:

- Spokane Valley Transmission Reinforcement Project
- Moscow Transformer Replacement Project
- Lancaster Loop-In Project
- Palouse Wind Phase I (LGIP #5)

Study Results

Studies for this request confirm that Avista's transmission system has adequate capacity to integrate the Nine Mile HED at a total plant output of 60 MW under all conditions studied.

The limiting element is the Nine Mile – Indian Trail 115 kV transmission line, and figures showing the base case plus two limiting contingencies follow.

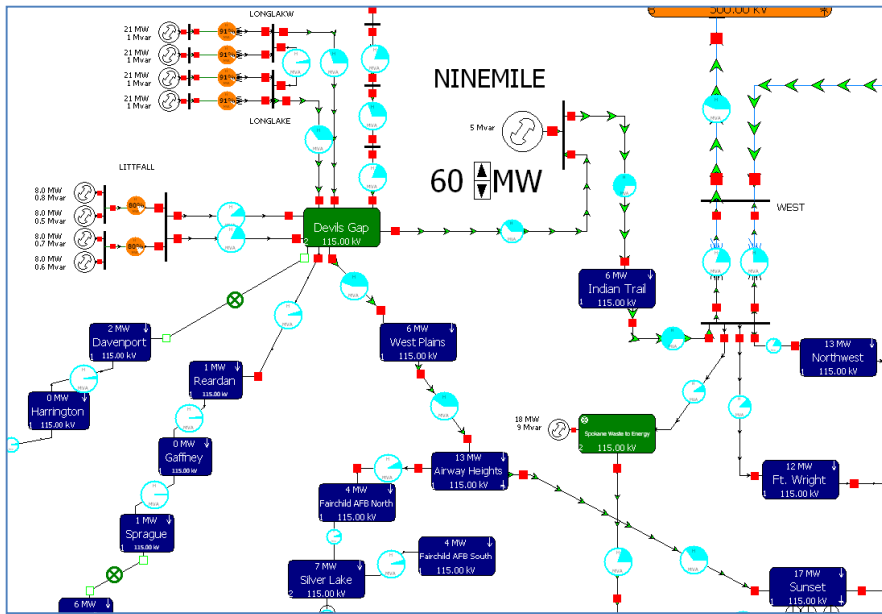

Figure 1. N-0, Avista Spring Case AVA-11Is1ae-16BA1328-WOH4140

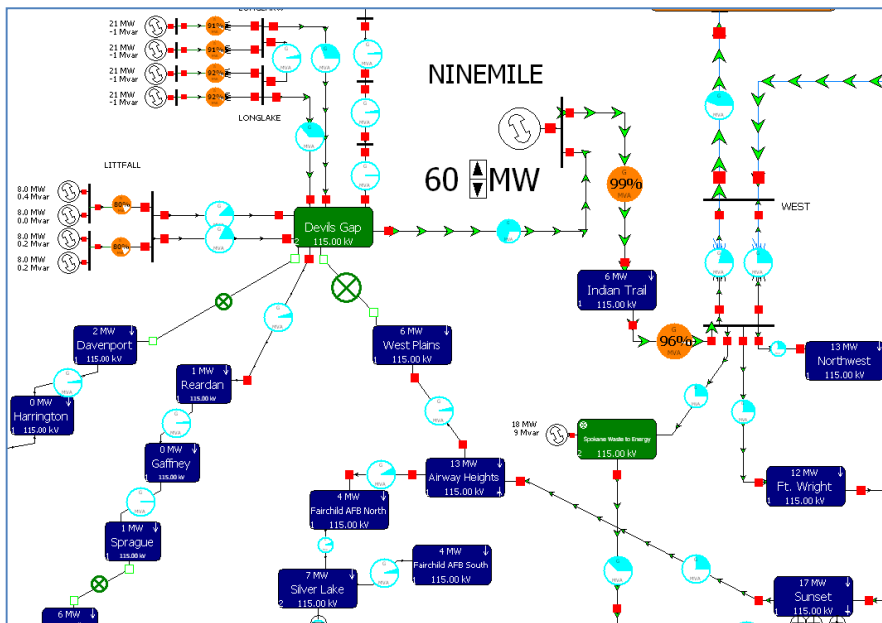

Figure 2. Limiting Contingency: N-1: Airway Heights - Devis Gap 115 kV Open @ DGP

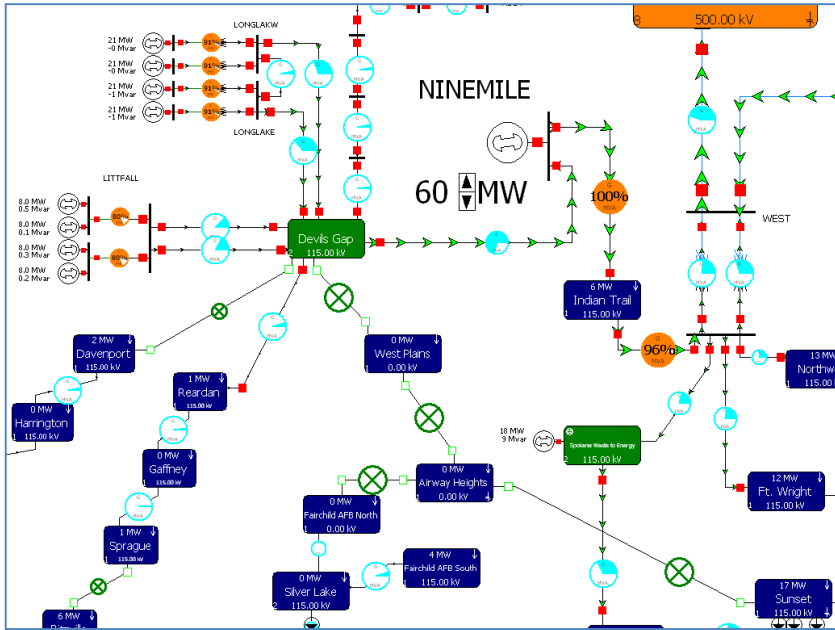

Figure 3. Limiting Contingency: BF A180 Airway Heights 115 kV, Airway Heights - Devils Gap

Distribution:

- S. Waples
- Sharepoint (System Planning)
- OASIS Posting
- Power Supply (J. Gall)



Interoffice Memorandum System Planning

MEMO: SP-2013-04
DATE: January 14, 2013
TO: Scott Waples
FROM: Richard Maguire
SUBJECT: 2013 IRP Generation Study – Long Lake HED

Introduction

This study addresses a request from Avista's Power Supply Department for the 2013 IRP regarding increasing the capacity of Long Lake HED by 68 MW.

This preliminary study addresses the following:

- Power flow impact to the transmission system
- Voltage level impact to the transmission system
- Transmission System upgrades necessary to deliver requested generation

History

The Long Lake project is located northwest of Spokane and maintains the Lake Spokane reservoir, also known as Long Lake. The facility was the highest spillway dam with the largest turbines in the world when it was completed in 1915. The plant was upgraded with new runners in the 1990s, adding 2.2 aMW of additional energy. The project's four units provide 88.0 MW of combined capacity and have an 81.6 MW nameplate rating.

Study Methodology and Assumptions

The five year planning horizon, Avista planning cases, as documented in SP-2011-03 – 2011 Planning Cases Summary Data are modified with the following projects and adjustments before system analysis:

- LGIR #5
- Lind 115 kV Substation Reactive Support
- 2013 IRP Generation Request for Nine Mile HED (60 MW Total)
- Nine Mile HED and Little Falls HED set to maximum generation dispatch
- Increases in Long Lake generation are balanced by decrementing an injection group including all Avista generation with the exception of Long Lake HED, Nine Mile HED, and Little Falls HED.
- *Western Montana Hydro* is limited to 1650 MW
- *West of Hatwai* is limited to 4277 MW

The most limiting case found during this study is the Light Summer with High West of Hatwai Flows (High Transfer Case) numbered AVA-11Is1ae-12BA1251-WOH4277. This is the primary case used in this study.

Figure 1 below presents a high-level view of the Transmission System near Devil's Gap with Long Lake HED generating an additional 68 MW. Note the loading on the Nine Mile – Westside 115 kV Transmission Line. **Table 1** below shows regional power flows with the additional generation.

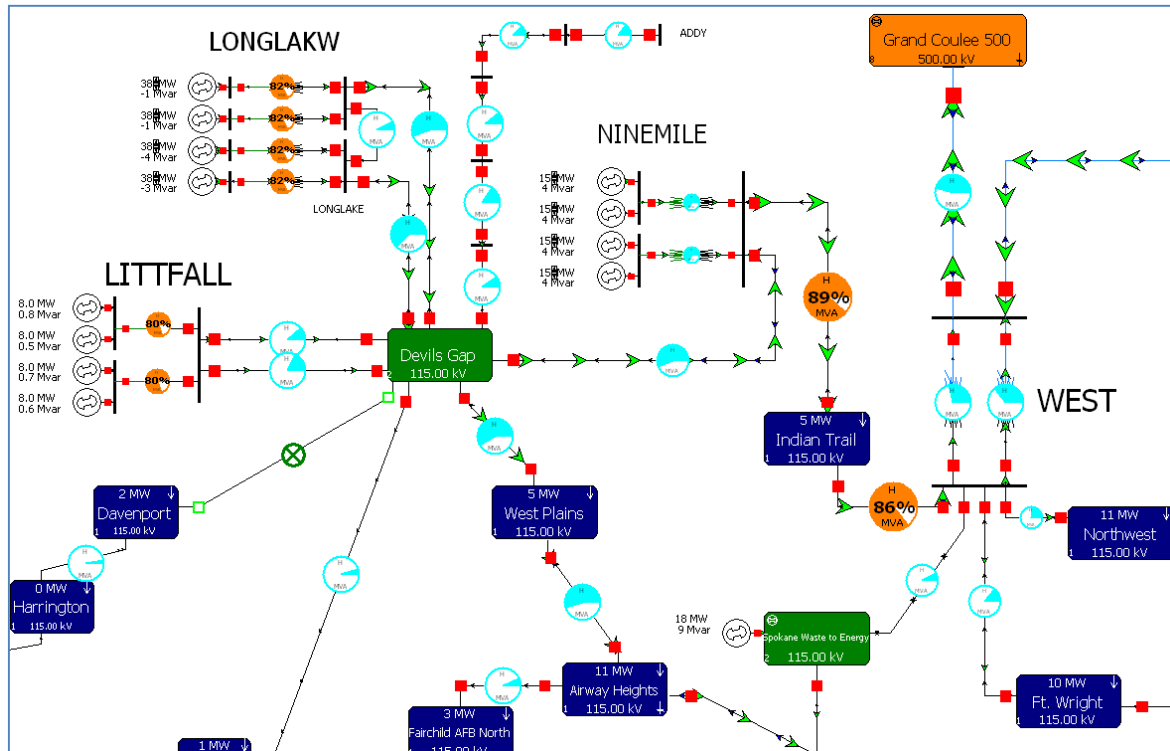

Figure 1: Avista Transmission System near Long Lake HED

Table 1: Regional Power Flows used during system study

Western Montana Hydro	1624.3 MW
Noxon Rapids (562MW)	483.0 MW
Cabinet Gorge (265MW)	221.3 MW
Libby (605MW)	540.0 MW
Hungry Horse (430MW)	380.0 MW

Colstrip Total	
Colstrip 1 (330MW)	330.0 MW
Colstrip 2 (330MW)	330.0 MW
Colstrip 3 (823MW)	787.5 MW
Colstrip 4 (823MW)	792.8 MW

Rathdrum Thermal (175MW)	130.0 MW
Lancaster Thermal (270MW)	249.0 MW
Spokane River Hydro	291.8 MW
Boundary Hydro (1040MW)	975.0 MW

Lower Snake/N.F. Clearwater	
Dworshak (458MW)	344.6 MW
Lower Granite (930MW)	155.0 MW
Little Goose (930MW)	155.0 MW
Lower Monumental (930MW)	273.5 MW

Coulee Generation	
Coulee 500 kV	546.7 MW
Coulee 230 kV	125.0 MW

West of Hatwai (Path 6)	4231.3 MW
Lolo-Oxbow 230kV	129.2 MW
Dry Creek-Walla Walla 230kV	176.8 MW

West of Cabinet	3301.6 MW
Montana-Northwest (Path 8)	2065.1 MW

Idaho-Northwest (Path 14)	751.2 MW
Midpoint-Summer Lake (Path 75)	819.6 MW
Idaho-Montana (Path 18)	-191.9 MW

South of Boundary	963.5 MW
North of John Day (Path 73)	4525.6 MW
TOT 4A (Path 37)	454.4 MW
Miles City DC	200.0 MW

Path C (Path 20)	537.4 MW
Borah West (Path 17)	1578.2 MW
Bridger West (Path 19)	2104.2 MW
Pacific AC Intertie (Path 66)	2855.0 MW
Pacific DC Intertie (Path 65)	1999.9 MW

Northwest Load	17796.4 MW
Idaho Load	2326.0 MW
Montana Load	1339.5 MW
Avista Native Load	-837.0 MW
Avista Balancing Area Load	1179.9 MW
Clearwater Load	63.6 MW

Study Results

Thermal Performance during N-0 conditions

This preliminary study indicates the Avista Transmission System has adequate capacity to integrate an additional 68 MW of generation at Long Lake HED with all lines in service.

Thermal Performance during N-1 conditions

Table 2 shows the results of a study using PowerWorld Simulator's *Available Transfer Capability* tool for Long Lake HED. The table shows limiting transmission segments for contingencies in violation as generation at Long Lake is incremented. In order to incorporate 68 MW of additional generation at Long Lake HED while maintaining Transmission System thermal reliability under N-1 conditions, the following 115 kV Transmission Lines would need upgrades to at least 795 ACSS conductor:

1. Devils Gap – Long Lake #1
2. Devils Gap – Long Lake #2
3. Devils Gap – Ninemile
4. Ninemile – West Side
5. Airway Heights – Devils Gap
6. Airway Heights – Sunset

An approximate cost to reconductor 57.54 miles of 115 kV transmission line would be \$ 9.9M¹.

Table 2: Available Transfer Capability for Long Lake HED

Incremental Generation	Limiting CTG	From Name	To Name
1.86	BF: A413 Westside 115 kV, Ninemile-Westside	AIRWAYHT	SUNSET
1.89	N-1: Airway Heights - Devils Gap 115 kV Open @ DGP	INDTRAIL	WEST
3.32	N-1: Airway Heights - Devils Gap 115 kV	INDTRAIL	WEST
4.05	PSF: Westside 115 kV	AIRWAYHT	SUNSET
4.12	BF: A180 Airway Heights 115 kV, Airway Heights-Devils Gap	INDTRAIL	WEST
4.19	PSF: Airway Heights 115 kV	INDTRAIL	WEST
4.52	N-1: Nine Mile - Westside 115 kV Open @ WES	AIRWAYHT	SUNSET
8.13	N-1: Airway Heights - Devils Gap 115 kV Open @ AIR	INDTRAIL	WEST
11.58	N-1: Nine Mile - Westside 115 kV Open @ NMS	DEVILGPE	W.PLAINS
11.8	N-1: Nine Mile - Westside 115 kV	DEVILGPE	W.PLAINS
15.03	BF: A413 Westside 115 kV, Ninemile-Westside	DEVILGPE	W.PLAINS
17.21	PSF: Westside 115 kV	DEVILGPE	W.PLAINS
17.29	N-1: Nine Mile - Westside 115 kV Open @ WES	DEVILGPE	W.PLAINS
20.54	N-1: Nine Mile - Westside 115 kV Open @ NMS	AIRWAYHT	W.PLAINS
20.75	N-1: Nine Mile - Westside 115 kV	AIRWAYHT	W.PLAINS
24.19	BF: A413 Westside 115 kV, Ninemile-Westside	AIRWAYHT	W.PLAINS
26.27	N-1: Nine Mile - Westside 115 kV Open @ WES	AIRWAYHT	W.PLAINS
26.36	PSF: Westside 115 kV	AIRWAYHT	W.PLAINS
35.57	N-1: Devils Gap - Long Lake #1 115 kV	DEVILGPE	LONGLAKW
45.31	N-1: Devils Gap - Long Lake #2 115 kV	DEVILGPE	LONGLAKE
68.26	N-1: Airway Heights - Devils Gap 115 kV Open @ DGP	DEVILGPE	NINEMILE
69.63	N-1: Airway Heights - Devils Gap 115 kV	DEVILGPE	NINEMILE
70.43	BF: A180 Airway Heights 115 kV, Airway Heights-Devils Gap	DEVILGPE	NINEMILE
70.43	PSF: Airway Heights 115 kV	DEVILGPE	NINEMILE
74.43	N-1: Airway Heights - Devils Gap 115 kV Open @ AIR	DEVILGPE	NINEMILE

¹ All construction costs are in 2013-year dollars and are based on engineering judgment only with +/- 50% error

Voltage Stability

Preliminary voltage studies show that 68 MW of additional generation at Long Lake HED does not introduce any new voltage issues on the Avista Transmission System.

Conclusion

This study indicates the requested new generation at Long Lake HED performs adequately on the local Transmission System with potential updates to several 115 kV Transmission Lines in the West Spokane area.

Potential cost of upgrading Transmission Lines is \$9.9 M, and further costs might be necessary to mitigate issues uncovered in more detailed thermal and transient stability studies.

Distribution:

Scott Waples
SharePoint (System Planning)
Avista OASIS Posting
James Gall - Power Supply & Resource Planning



Interoffice Memorandum System Planning

MEMO: SP-2013-03
DATE: January 22, 2013
TO: Scott Waples
FROM: Richard Maguire
SUBJECT: 2013 IRP Generation Study – Monroe Street HED

Introduction

This study addresses a request from Avista's Power Supply Department for the 2013 IRP regarding adding 80 MW of additional capacity to Monroe Street HED.

This preliminary study addresses the following:

- Thermal impact to the transmission system
- Voltage stability impact to the transmission system
- Transmission System upgrades necessary to deliver requested generation

History

The Monroe Street facility was the Company's first generating unit. It started service in 1890 near what is now Riverfront Park. Rebuilt in 1992, the single generating unit now has a 15.0 MW maximum capacity and a 14.8 MW nameplate rating.

Study Methodology and Assumptions

The five year planning horizon, Avista planning cases, as documented in SP-2011-03 – 2011 Planning Cases Summary Data are modified with the following projects and adjustments before system analysis:

- LGIR #5
- LGIR #35
- Lind 115 kV Substation Reactive Support
- Increases in Monroe Street generation are balanced by decrementing an injection group including all Avista generation with the exception of generation at Monroe Street HED and Upper Falls HED.
- *Western Montana Hydro* is limited to 1650 MW
- *West of Hatwai* is limited to 4277 MW

The most limiting case found during this study is the *Light Summer with High West of Hatwai Flows* (Heavy Summer, High Hydro Case) numbered *AVA-11Is1ae-12BA1251-WOH4277*. This is the primary case used in this study.

Figure 1 below presents a high-level view of the Transmission System near Monroe Street HED with the additional 80 MW of generation supplied by a study generator.

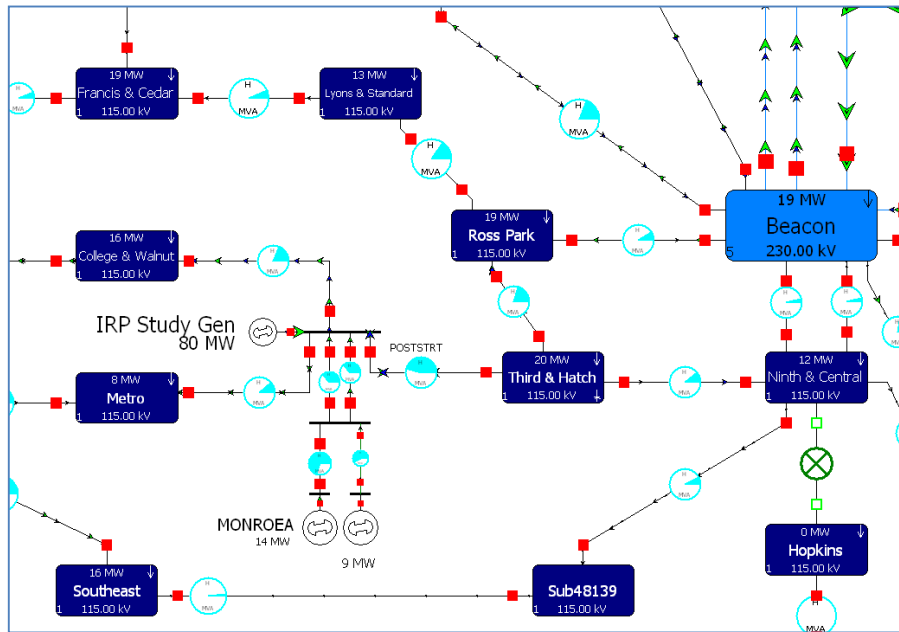

Figure 1: Avista Transmission System near Monroe Street HED

Study Results

Thermal Performance during N-0

This preliminary power flow study indicates the Avista Transmission System has adequate capacity to integrate 80 MW of additional generation at Monroe Street HED with all lines in service.

Thermal Performance during N-1

This preliminary power flow study indicates the Avista Transmission System has adequate capacity to integrate 80 MW of additional generation at Monroe Street HED during N-1 contingency conditions. Table 1 shows the results of a study using PowerWorld Simulator’s *Available Transfer Capability* tool for Monroe Street HED. The study reveals the next closest N-1 contingency violation as an overload of the Post Street – Third and Hatch 115 kV transmission line during the PSF: Westside 115 kV contingency if the additional generation capacity at Monroe Street HED was 122.85 MW.

Table 1: PowerWorld ATC results for Monroe Street HED

Trans Lim	From Name	To Name	Limiting CTG
122.85	POSTSTRT	THIRHACH	PSF: Westside 115 kV
132.47	POSTSTRT	THIRHACH	BF: A470 Westside 115 kV, College & Walnut-Westside
135.41	POSTSTRT	THIRHACH	BF: A410 Westside 115 kV, Sunset-Westside
139.77	POSTSTRT	THIRHACH	BF: A413 Westside 115 kV, Ninemile-Westside
142.54	POSTSTRT	THIRHACH	BUS: Westside 115 kV

Voltage Stability

Preliminary voltage studies show that 80 MW of additional generation at Monroe Street HED does not introduce any new voltage issues on the Avista Transmission System.

Conclusion

This preliminary study indicates the requested generation at Monroe Street HED performs adequately on the local Transmission System pending any conditions revealed through further detailed thermal, voltage, and transient stability studies.

Distribution:

Scott Waples
SharePoint (System Planning)
Avista OASIS Posting
James Gall – Power Supply & Resource Planning



Interoffice Memorandum System Planning

MEMO: SP-2013-05
DATE: January 22, 2013
TO: Scott Waples
FROM: Richard Maguire
SUBJECT: 2013 IRP Generation Study – Upper Falls HED

Introduction

This study addresses a request from Avista's Power Supply Department for the 2013 IRP regarding adding 40 MW of additional capacity to Upper Falls HED. This study will be undertaken as a coincident generation request with the Monroe Street IRP request for three reasons:

- Upper Falls HED and Monroe Street HED connect to the Avista 115 kV Transmission System at the same bus
- The Monroe Street HED IRP request of 80 MW was found to require no transmission system modifications, thereby showing no individual study of the Upper Falls request would be necessary given the lesser requested capacity
- It would be useful to understand the overall impact to the transmission system if both Upper Falls HED and Monroe Street HED IRP requests are pursued

This preliminary study addresses the following:

- Thermal impact to the transmission system
- Voltage stability impact to the transmission system
- Transmission system upgrades necessary to deliver requested generation

History

The Upper Falls project began generating in 1922 in downtown Spokane, and now is within the boundaries of Riverfront Park. This project is comprised of a single 10.0 MW unit with a 10.26 MW maximum capacity rating.

Study Methodology and Assumptions

The five year planning horizon, Avista planning cases, as documented in SP-2011-03 – 2011 Planning Cases Summary Data are modified with the following projects and adjustments before system analysis:

- LGIR #5
- LGIR #35
- 2013 IRP Monroe Street Request
- Lind 115 kV Substation Reactive Support
- Increases in Upper Falls generation are balanced by decrementing an injection group including all Avista generation with the exception of generation at Monroe Street HED and Upper Falls HED.
- *Western Montana Hydro* is limited to 1650 MW
- *West of Hatwai* is limited to 4277 MW

The most limiting case found during this study is the *Light Summer with High West of Hatwai Flows* (Heavy Summer, High Hydro Case) numbered *AVA-11Is1ae-12BA1251-WOH4277*. This is the primary case used in this study.

Figure 1 below presents a high-level view of the Transmission System near Upper Falls HED with the additional 120 MW of coincidental generation supplied by a study generator.

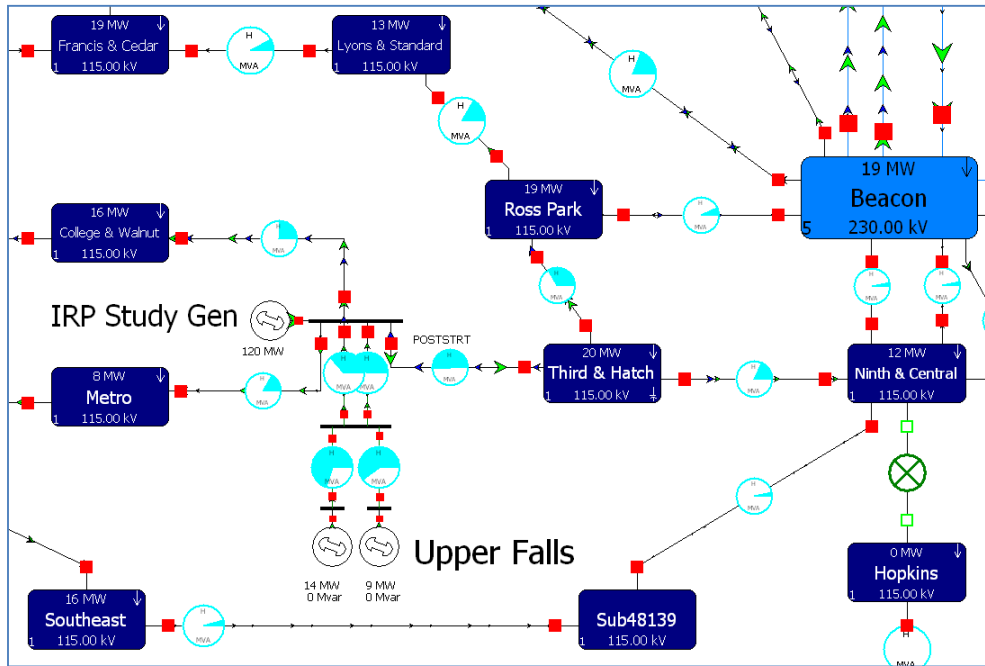

Figure 1: Avista Transmission System near Upper Falls HED

Study Results

Thermal Performance during N-0

This preliminary power flow study indicates the Avista Transmission System has adequate capacity to integrate 40 MW of additional generation at Upper Falls HED with all lines in service. The closest N-0 violation occurs when attempting to integrate 47 MW of generation at Upper Falls which overloads the Post Street-Third & Hatch 115 kV Transmission Line.

Thermal Performance during N-1

This preliminary power flow study indicates the Avista Transmission System has adequate capacity to integrate 40 MW of additional generation at Upper Falls HED during N-1 contingency conditions. Table 1 shows the results of a PowerWorld Simulator *Available Transfer Capability* analysis done for Upper Falls HED. The ATC study reveals the next closest N-1 contingency violation as an overload of the Post Street-Third & Hatch 115 kV Transmission Line during the PSF: Westside 115 kV contingency if the additional generation capacity at Upper Falls HED exceeds 49.49 MW.

Table 1: ATC results for Upper Falls HED

Incremental Generation	Limiting CTG	From Name	To Name
49.49	PSF: Westside 115 kV	POSTSTRT	THIRHACH
58.69	BF: A470 Westside 115 kV, College & Walnut-Westside	POSTSTRT	THIRHACH
62.04	BF: A410 Westside 115 kV, Sunset-Westside	POSTSTRT	THIRHACH
65.93	BF: A413 Westside 115 kV, Ninemile-Westside	POSTSTRT	THIRHACH
68.98	BUS: Westside 115 kV	POSTSTRT	THIRHACH

Voltage Stability

Preliminary voltage studies show that 40 MW of additional generation at Upper Falls HED does not introduce any new voltage issues on the Avista Transmission System.

Conclusion

This preliminary study indicates the requested generation at Upper Falls HED performs adequately on the local Transmission System pending any conditions revealed through further detailed thermal, voltage, and transient stability studies.

Distribution:

Scott Waples
SharePoint (System Planning)
Avista OASIS Posting
James Gall - Power Supply & Resource Planning



Interoffice Memorandum System Planning

MEMO: SP-2013-02
DATE: January 22, 2013
TO: Scott Waples
FROM: Richard Maguire
SUBJECT: 2013 IRP Generation Study – Post Falls HED

Introduction

This study addresses a request from Avista's Power Supply Department for the 2013 IRP regarding increasing the capacity of Post Falls HED to a total output of 33.5 MW.

This preliminary study addresses the following:

- Thermal impact to the transmission system
- Voltage stability impact to the transmission system
- Transmission System upgrades necessary to deliver requested generation

History

Avista's upper most hydroelectric facility on the Spokane River is the Post Falls project, located at its Idaho namesake near the Washington/Idaho border. The project began operation in 1906 and maintains lake elevation during the summer for Lake Coeur d'Alene. The project has six units, with the last unit added in 1980. The project is capable of producing 18.0 MW and has a 14.75 MW nameplate rating.

Study Methodology and Assumptions

The five year planning horizon, Avista planning cases, as documented in SP-2011-03 – 2011 Planning Cases Summary Data are modified with the following projects and adjustments before system analysis:

- LGIP #5
- Lind 115 kV Substation Reactive Support
- Increases in Post Falls generation are balanced by decrementing an injection group including all Avista generation with the exception of Post Falls HED.
- *Western Montana Hydro* is limited to 1650 MW
- *West of Hatwai* is limited to 4277 MW

The most limiting case found during this study is the Heavy Summer with High Local Hydro Generation (Heavy Summer, High Hydro Case) numbered *AVA-11hs2a-12BA2085*. This is the primary case used in this study.

Figure 1 below presents a high-level view of the Transmission System near Post Falls HED. Note the relatively large amount of local load immediately connected to the Post Falls substation when compared to the requested 33.5 MW total plant output.

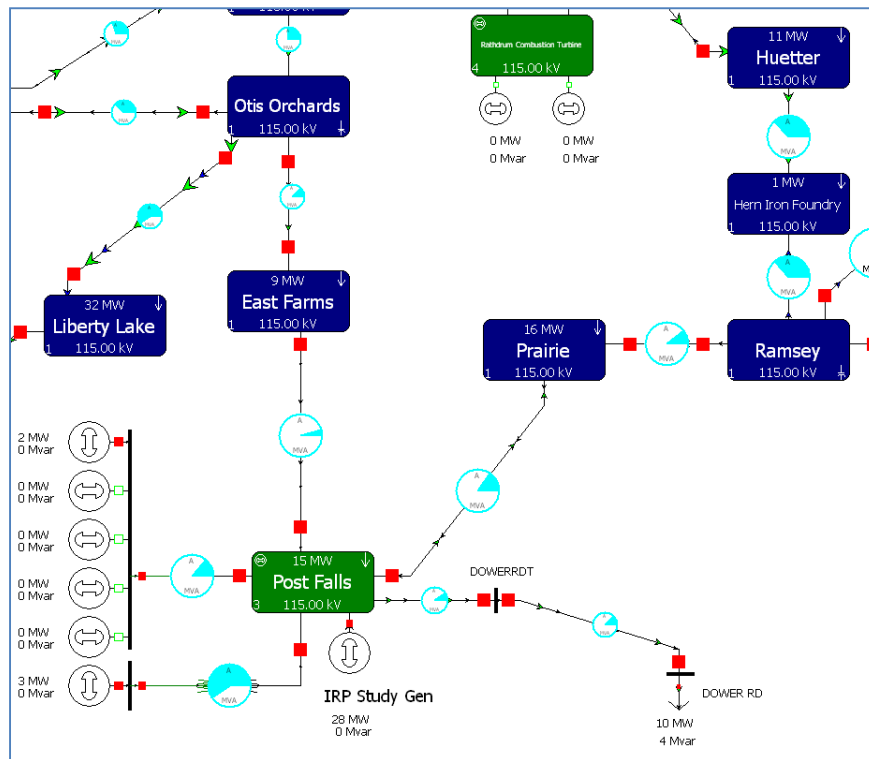

Figure 1: Avista Transmission System near Post Falls HED

Study Results

Thermal Performance during N-0

This preliminary power flow study indicates the Avista Transmission System has adequate capacity to integrate 33.5 MW of total generation at Post Falls HED with all lines in service.

Thermal Performance during N-1

This preliminary power flow study indicates the Avista Transmission System has adequate capacity to integrate 33.5 MW of total generation at Post Falls HED during N-1 contingency conditions. Table 1 shows the results of a PowerWorld Simulator *Available Transfer Capability* analysis done for Post Falls HED. The ATC study reveals the next closest N-1 contingency violation as an overload of the Post Falls – Prairie B 115 kV Transmission Line during the N-1: Otis Orchards – Post Falls 115 kV Open @ PF contingency when the total generation capacity at Post Falls HED is 112.15 MW.

Table 1: ATC study results for Post Falls HED

Trans Lim	From Name	To Name	Limiting CTG
112.15	POST FLS	PRAIRIEB	N-1: Otis Orchards - Post Falls 115 kV Open @ PF
112.16	POST FLS	PRAIRIEB	BF: A642 Otis Orchards 115 kV, Otis Orchards-Post Falls
112.17	POST FLS	PRAIRIEB	N-1: Otis Orchards - Post Falls 115 kV
112.18	POST FLS	PRAIRIEB	PSF: Otis Orchards 115 kV
138.87	EASTFARM	POST FLS	N-1: Post Falls - Ramsey 115 kV Open @ PF
139.68	EASTFARM	POST FLS	N-1: Post Falls - Ramsey 115 kV
139.68	EASTFARM	POST FLS	N-2: Post Falls - Ramsey 115 kV & Ramsey - Rathdrum #1 115 kV
147.42	OTIS	LIBTYLK	SUB: Beacon 230 & 115 (AVA)
173.04	CLEARWTR	N LEWIST	N-2: Dry Creek - North Lewiston 230 kV and Dry Creek - North Lewiston 115 kV and North Lewiston - Tucannon River 115 kV
1638.3	POST FLS	PRAIRIEB	PSF: Post Falls 115 kV

Voltage Stability

Preliminary voltage studies show that 33.5 MW of total generation at Post Falls HED does not introduce any new voltage issues on the Avista Transmission System.

Conclusion

This preliminary study indicates the requested generation at Post Falls HED performs adequately on the local Transmission System pending any conditions revealed through further detailed thermal, voltage, and transient stability studies.

Distribution:

Scott Waples
SharePoint (System Planning)
Avista OASIS Posting
James Gall – Power Supply & Resource Planning



Interoffice Memorandum System Planning

MEMO: SP-2012-14
DATE: October 4, 2012
TO: Scott Waples
FROM: Richard Maguire
SUBJECT: 2013 IRP Generation Study – Cabinet Gorge HED

Introduction

This brief study addresses a request from Avista's Power Supply Department for the 2013 IRP regarding adding up to 110 MW of new generation capacity in the form of two new units to Cabinet Gorge HED.

History

The Cabinet Gorge project started generating power in 1952 with two units. The plant was expanded with two additional generators in the following year. The current maximum capacity of the plant is 270.5 MW; it has a nameplate rating of 265.2 MW. Upgrades at this project began with the replacement of the turbine for Unit 1 in 1994. Unit 3 was upgraded in 2001 and Unit 2 was upgraded in 2004. The final unit, Unit 4, received a \$6 million turbine upgrade in 2007, increasing its generating capacity from 55 MW to 64 MW, and adding 2.1 aMW of additional energy.¹

Study Methodology and Assumptions

Two of Avista's five year planning horizon cases are modified with the following projects prior to analysis:

- Spokane Valley Transmission Reinforcement Project
- Moscow Transformer Replacement Project
- Lancaster Loop-In Project
- Palouse Wind Phase I (LGIP #5)

The two cases used in this study are:

- AVA-16hs2a-16BA2213; Heavy Summer High Hydro (HSHH)
- AVA-11ls1ae-16BS1328-WOH4140; Light Loading High Transfer (HT)

These cases represent two seasonal times when maximum hydro generation is possible.

Table 1 below shows the power flow values with an additional 110 MW of generation at Cabinet Gorge. All changes in generation are coupled with:

- Limiting *Western Montana Hydro* to 1650 MW by reducing outputs of Libby and Hungry Horse
- Limiting *West of Hatwai* to 4277 MW via control of off-system generation

¹ Cabinet Gorge history taken from Avista 2011 Electric Integrated Resource Plan

Heavy Summer High Hydro		Light Spring High Transfer	
West of Hatwai (Path 6)	813.1 MW	West of Hatwai (Path 6)	4275.0 MW
Montana-Northwest (Path 8)	758.7 MW	Montana-Northwest (Path 8)	2101.2 MW
Western Montana Hydro	1650.0 MW	Western Montana Hydro	1650.0 MW
Noxon Rapids (562MW)	570.6 MW	Noxon Rapids (562MW)	570.6 MW
Cabinet Gorge (265MW)	397.0 MW	Cabinet Gorge (265MW)	397.0 MW
Libby (605MW)	395.9 MW	Libby (605MW)	395.9 MW
Hungry Horse (430MW)	286.5 MW	Hungry Horse (430MW)	286.5 MW
Colstrip 1 (330MW)	329.3 MW	Colstrip 1 (330MW)	330.8 MW
Colstrip 2 (330MW)	329.3 MW	Colstrip 2 (330MW)	330.8 MW
Colstrip 3 (823MW)	789.1 MW	Colstrip 3 (823MW)	796.5 MW
Colstrip 4 (823MW)	803.3 MW	Colstrip 4 (823MW)	801.8 MW
Rathdrum Thermal (175MW)	0.0 MW	Rathdrum Thermal (175MW)	140.0 MW
Lancaster Thermal (270MW)	248.4 MW	Lancaster Thermal (270MW)	249.4 MW
Spokane River Hydro	88.2 MW	Spokane River Hydro	183.8 MW
Boundary Hydro (1040MW)	633.6 MW	Boundary Hydro (1040MW)	976.5 MW
Northwest Load	26444.8 MW	Northwest Load	17948.5 MW
Idaho Load	4087.0 MW	Idaho Load	2326.0 MW
Montana Load	1940.3 MW	Montana Load	1339.5 MW
Avista Native Load	-1701.7 MW	Avista Native Load	-959.6 MW
Avista Balancing Area Load	1671.7 MW	Avista Balancing Area Load	911.6 MW
Clearwater Load	58.2 MW	Clearwater Load	58.2 MW

Table 1: Base Case Power Flow Summary

Study Results

Thermal Performance during N-0 conditions

The study indicates that the Avista transmission system has enough capacity to integrate an additional 110 MW of generation at Cabinet Gorge HED with all lines in service during some, but not all, conditions. One example of a limiting condition occurs during hot summer months when the loading is high and full hydro generation is possible. During this heavy summer, high hydro scenario, the present Avista transmission system has just enough transmission capacity for existing generation. Figure 1 below shows the Avista system isolated from neighbor systems for the purpose of determining transmission capacity. This is a unique test for this study, and no other cases are evaluated with the system isolated in this way. The image represents flows in the 2016 heavy summer high hydro case with Cabinet Gorge and Noxon operating at maximum capacity.

Note:

- This study uses existing line ratings. Avista has projects underway raising line ratings in the area, which will result in more transmission capacity once the projects are completed.
- Generation at Cabinet Gorge HED and Noxon Rapids HED could be governed within a nomogram to mitigate thermal overloads during summer conditions when electric loading is high.
- NOTE: these conclusions are contingent upon further detailed studies

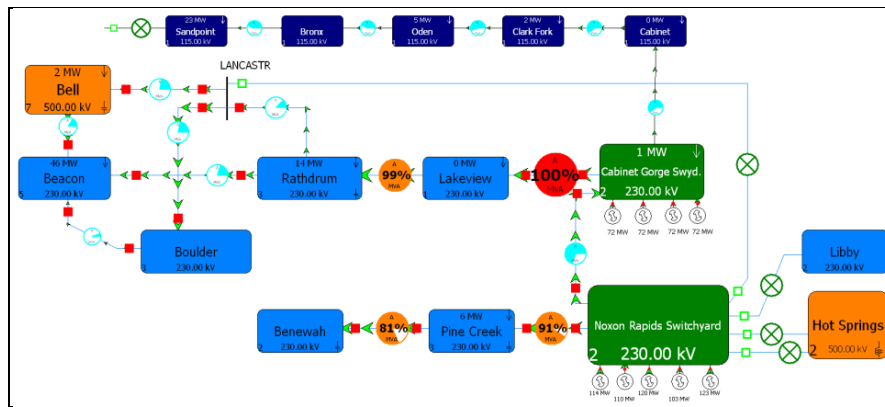

Figure 1: 2016 HSHH, all facilities in service, Cabinet Gorge @287MW

Thermal Performance during N-1 conditions

Given the current study reveals Cabinet Gorge HED must be limited to zero additional capacity when operating under conditions similar to those used in the Heavy Summer, High Hydro case, *only the High Transfer case is used to consider N-1 contingency violations.*

All new N-1 contingency violations found during this study are in the immediate vicinity of the Cabinet Gorge HED. Figure 2 shows the most limiting contingency occurring when the Cabinet to Noxon 230 kV line overloads with a loss of the 230 kV line to Rathdrum for a failure of breaker R404.² As noted in the notes above, Avista has transmission projects underway that lessen the severity of all of the N-1 contingency violations found in this study, and further detailed study will determine what, if any, N-1 violations still exist once the local projects are completed.

Note: Reducing the new generation at Cabinet Gorge to values less than the requested 110 MW directly impacts the new limiting N-1 contingency violations. This behavior likely reduces the steady state nomogram discussed above.

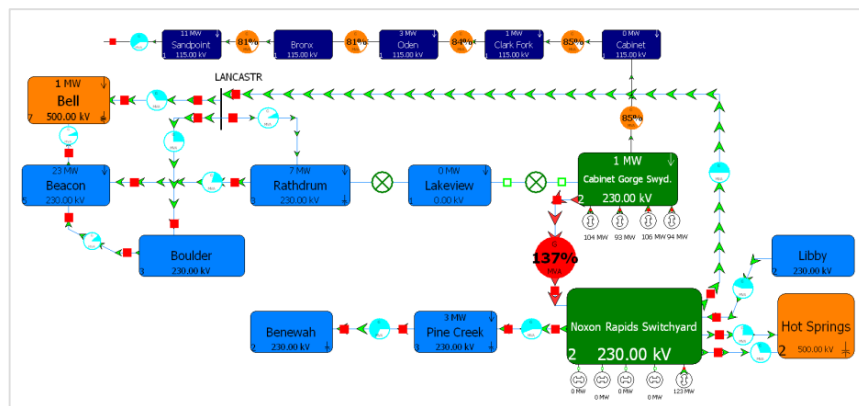

Figure 2: Cabinet-Noxon 230 kV overload during R404 breaker failure

Voltage Stability

With all lines in service, an addition of 110 MW at Cabinet Gorge does not introduce any new voltage violations during N-0 conditions. However, this study indicates several new voltage violations are present during N-1 conditions. The limiting contingency regarding voltage stability occurs at Bus 48057, the Cabinet Gorge 230 kV bus, during the N-1: Cabinet – Noxon 230 kV contingency. The voltage limit used is 1.015 pu, the initial value is 1.045 pu, and the value during contingency is 1.0049 pu. Figure 3 shows the violation.

² BF: R404 Cabinet-Rathdrum, Rathdrum #2 230/115 Transformer

All of the newly created voltage violations can be mitigated by reducing generation at Cabinet Gorge to levels above present values but below the requested 110 MW addition. Additionally, existing and planned projects on the Avista transmission system positively influence these new voltage violations. Further detailed studies are necessary to fully characterize voltage performance.

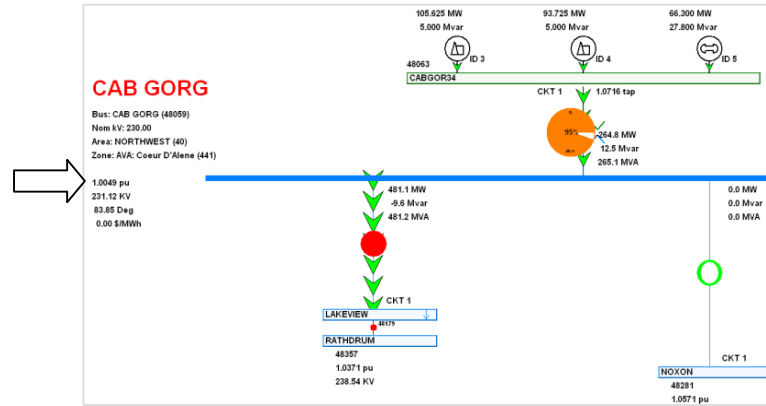

Figure 3: 2016 HT, Voltage Limit Violation, N-1: Cabinet – Noxon 230 kV

Transient Stability

Preliminary studies indicate new generation at Cabinet Gorge adds stability violations during N-1 conditions, and additional generation exacerbates stability issues addressed by the existing Clark Fork remedial action scheme (i.e. RAS). Adding any new generation to the existing RAS scheme clears several of the new N-1 violations, but further studies are necessary to accurately assess solutions for the other violations. Possible solutions could be changes to the existing RAS, a nomogram as discussed above, and/or transmission projects to mitigate violations.

Conclusions

This study indicates the requested new generation at Cabinet Gorge performs adequately on the local transmission system with potential updates to the Clark Fork RAS and limits to Cabinet Gorge and Noxon combined output via a seasonally adjusted nomogram determined by further study.

If operating Cabinet Gorge without limitation is desired, preliminary studies show this is possible via potential projects on one or more of the 230 kV transmission lines carrying power to the load center.

Distribution:

S. Waples
Sharepoint (System Planning)
OASIS Posting
Power Supply (J. Gall)



Interoffice Memorandum System Planning

MEMO: SP-2011-08 Rev A
DATE: August 11, 2011
TO: James Gall, IRP Group
FROM: Reuben Arts
SUBJECT: 500 MW of New Generation in the Rathdrum Area

Introduction

Based on initial 2011 IRP analysis 200 MW of new capacity is required in 2019-2020 and an additional 300 MW of capacity in the 2022-2024 time period. North Idaho is one of several potential locations this capacity could be added, but requires further detail to understand its potential.

Problem Statement

The IRP group is specifically interested in the cost for both the point of integration (POI) station and associated system upgrades, to integrate the new generation with the following options:

1. Cabinet-Rathdrum 230 kV transmission line (assume 5 miles from Rathdrum)
2. Rathdrum-Boulder 230 kV transmission line (assume Lancaster looped in, and assume the generation is half way between Lancaster and Rathdrum)
3. Rathdrum-Beacon 230 kV transmission line (assume 1-2 miles from Rathdrum)
4. Double Tap, Rathdrum-Boulder and Rathdrum-Beacon 230 kV transmission lines (again assume Lancaster is looped in and that the new generation will tap between Lancaster and Rathdrum)
5. Mixed location. 300 MW at the least cost option (between 1 and 4) and an additional 200 MW on the Cabinet-Rathdrum 230 kV transmission line.
6. Other Transmission Alternatives

Power Flow Analysis

The case that was used to highlight the impacts of an additional 500 MW in the Rathdrum area was the WECC approved and Avista modified light summer high flow case (AVA-11Is1ae-12BA1251-WOH4277). The West of Hatwai path typically experiences high flows during light Avista load hours. High West of Hatwai flows tend to coincide with high Western Montana Hydro generation, high Boundary generation, high flows on Montana to Northwest, and light loads in Eastern Washington, North Idaho, and Montana. Existing Clark Fork RAS is in place, and assumed armed, since the Western Montana Hydro (WMH) complex is greater than 1450 MW. Since the New Project would require significant Avista system transmission changes, and RAS changes, the results are listed as though RAS were not armed. This does affect the results of some contingencies, but ultimately does not change the conclusions of this memo.

Option 1

Perhaps one of the worst performing arrangements is option 1. This option immediately requires another line, or a line reconductor, from the 500 MW project back to Rathdrum. In order to stay within N-0 thermal limits the project can only be 175 MW without any system upgrades. In a high flow, N-0 scenario, the line segment from the project back to Rathdrum loads to around 163%, which is roughly 272 MW overloaded. There are a handful of N-1 and N-2 contingencies that cause significant thermal violations, the worst N-1 being the loss of the 230 kV transmission line from the new project to Rathdrum. See Figure 1

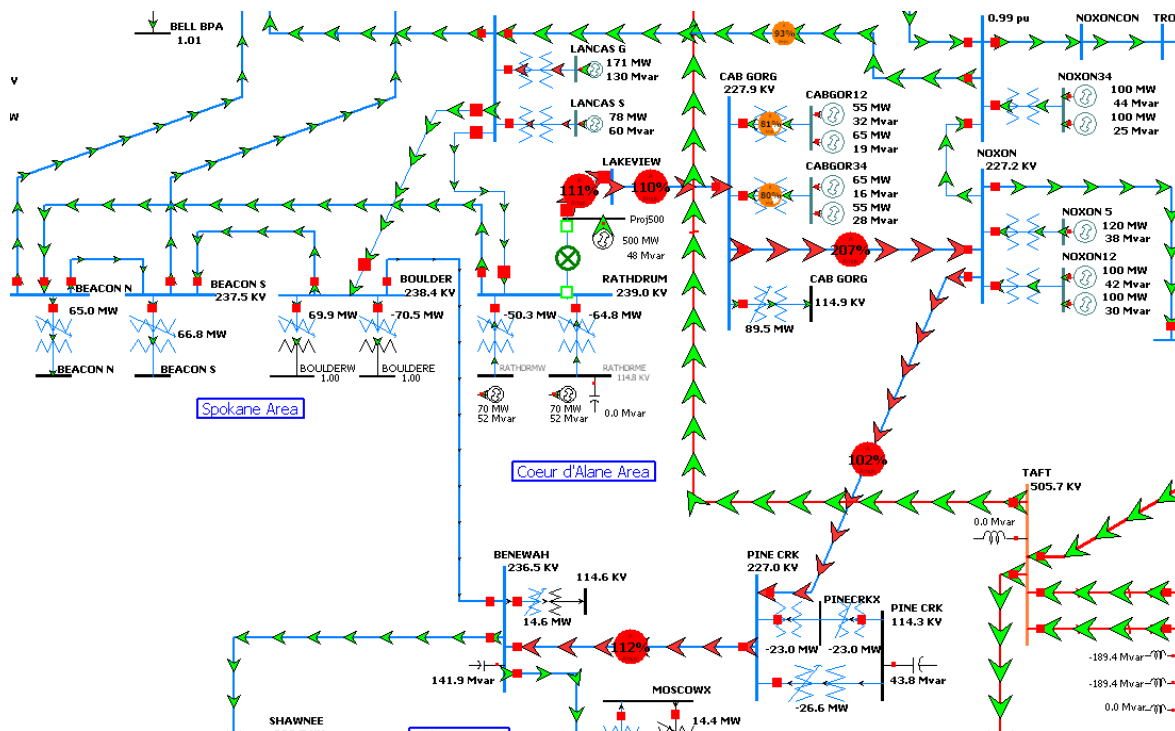

Figure 1 – N-1 Contingency

In addition to this worst case outage there are two N-2 scenarios that cause fairly significant problems as well. The Beacon-Rathdrum and Boulder-Lancaster-Rathdrum 230 kV transmission lines share a common structure for the majority of the line lengths. Losing both lines to the west of Lancaster causes the Bell S3-Lancaster 230 kV transmission line to overload. Losing both lines to the east of Lancaster, causes nearly the same scenario as shown in Figure 1.

To alleviate these overloads three new 230 kV transmission lines, would need to be built. First the Rathdrum-New Project 230 kV transmission line must be reconducted at a cost of roughly \$2.25M. Second, A 230 kV transmission line, with new right-of-way, must be built from the New Project to Lancaster. The estimated distance for this line is roughly 5 miles. The estimated loaded cost for this line, including a new line position at Lancaster and at the New Project, is roughly \$9M. Finally, another 230 kV transmission line, again with new right-of-way, is required from Lancaster to Boulder. This line length is estimate at roughly 15 miles. The estimated loaded cost of the new line, including new line positions, is roughly \$17M. New right-of-way in this area will be difficult to obtain, which would have the potential of more than doubling costs.

RAS may be a viable solution. If at all possible RAS should be a last resort. Unlike improving our transmission system, RAS does not provide operational flexibility and in some cases can compound the impacts of future generation needs. However, it does represent the cheapest solution and is therefore listed as solution 1.

Option 1	N-0 Max. Output	Facility Requirement ¹	Total ² (\$000)
Solution 1	500 MW	Reconductor 230 kV transmission line from new station to Rathdrum, New 230 kV DB-DB Station and RAS ³	13,250
Solution 2	500 MW	Reconductor from Rathdrum-New Project. New line from Lancaster to New Project. New line from Lancaster to Boulder, New 230 kV DB-DB Station	36,250

Option 2

This option would tap the Rathdrum-Boulder, or what soon will be the Rathdrum-Lancaster-Boulder, 230 kV transmission line. This options has no N-0 issues at the full requested 500 MW. There are a handful of N-1 and N-2 contingencies that cause significant thermal violations, the worst being the loss of the Lancaster-Boulder & Rathdrum-Beacon 230 kV transmission lines. These lines share a common structure and therefore represent a credible N-2 scenario. This outage causes the Lancaster-Bell S3 230 kV transmission line to load to 189%, or roughly 450 MW above its thermal limit. See Figure 2.

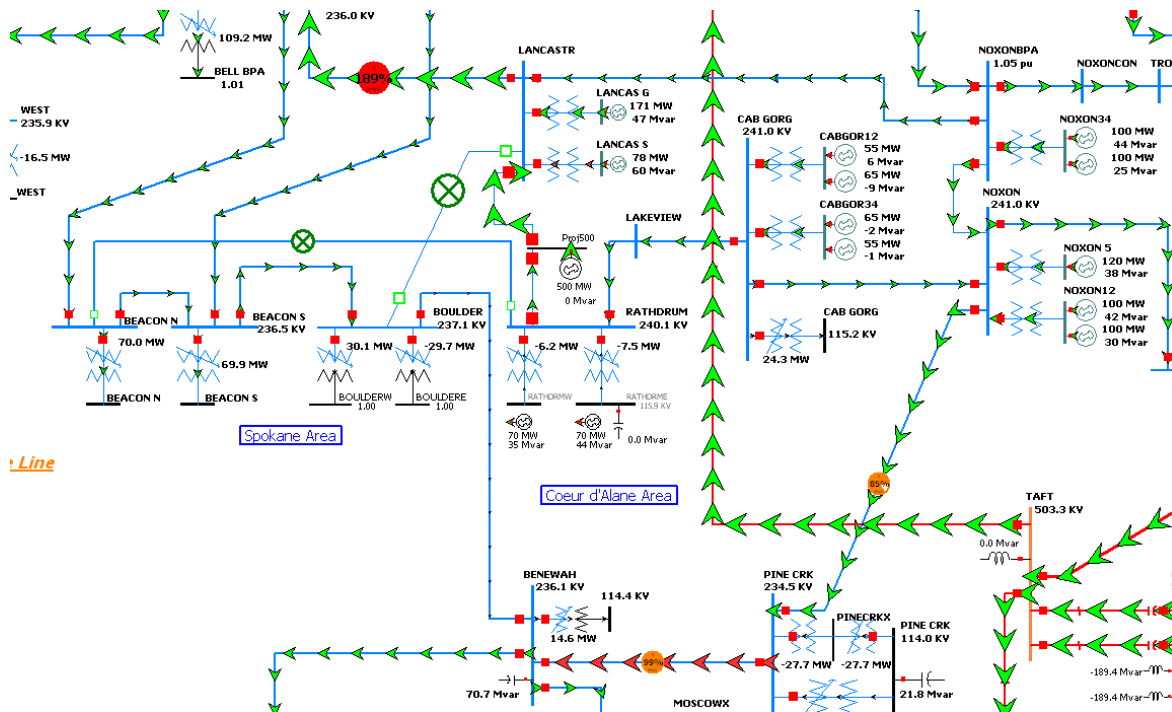

Figure 2 - N-2 Contingency

To alleviate these overloads two new 230 kV transmission lines, would need to be built. A 230 kV transmission line, with new right-of-way, must be built from the New Project to Lancaster. The estimated distance for this line is roughly 3 miles. The estimated loaded cost for this line, including a new line position at Lancaster and at the New Project, is roughly \$8M. Another 230 kV transmission line, again with new right-of-way, is required from Lancaster to Boulder. This line length is estimate at roughly 15 miles. The estimated loaded cost of the new line, including new line positions, is roughly \$17M. New right-of-way in this area will be difficult to obtain, which would have the potential of more than doubling costs.

¹ Cost estimates do not include costs of the radial line to the POI, the generator or generator station if applicable.

² Total is for network and direct assigned costs, are in 2011 dollars, and is +/- 50%.

³ The RAS portion is a worst case scenario where another fiber loop is required. \$3M allocated for RAS.

RAS may be a viable solution. If at all possible RAS should be a last resort. Unlike improving our transmission system, RAS does not provide operational flexibility and in some cases can compound the impacts of future generation needs. However, it does represent the cheapest solution and is therefore listed as solution 1.

Option 2	N-0 Max. Output	Facility Requirement ⁴	Total ⁵ (\$000)
Solution 1	500 MW	New 230 kV DB-DB Station and RAS ⁶	11,000
Solution 2	500 MW	New line from Lancaster to New Project. New line from Lancaster to Boulder, New 230 kV DB-DB Station	33,000

Option 3

This option taps the Rathdrum-Beacon 230 kV transmission line. Again, this option has no N-0 issues at the full requested 500 MW. There are a handful of N-1 and N-2 contingencies that cause significant thermal violations, the worst being the loss of the Beacon-New Project & Rathdrum-Lancaster 230 kV transmission lines. These lines share a common structure and therefore represent a credible N-2 scenario. This outage forces the entire proposed 500 MW toward Cabinet and Noxon. This causes overloads on the Cabinet-Noxon and Pine Creek-Benewah 230 kV transmission lines. See Figure 3.

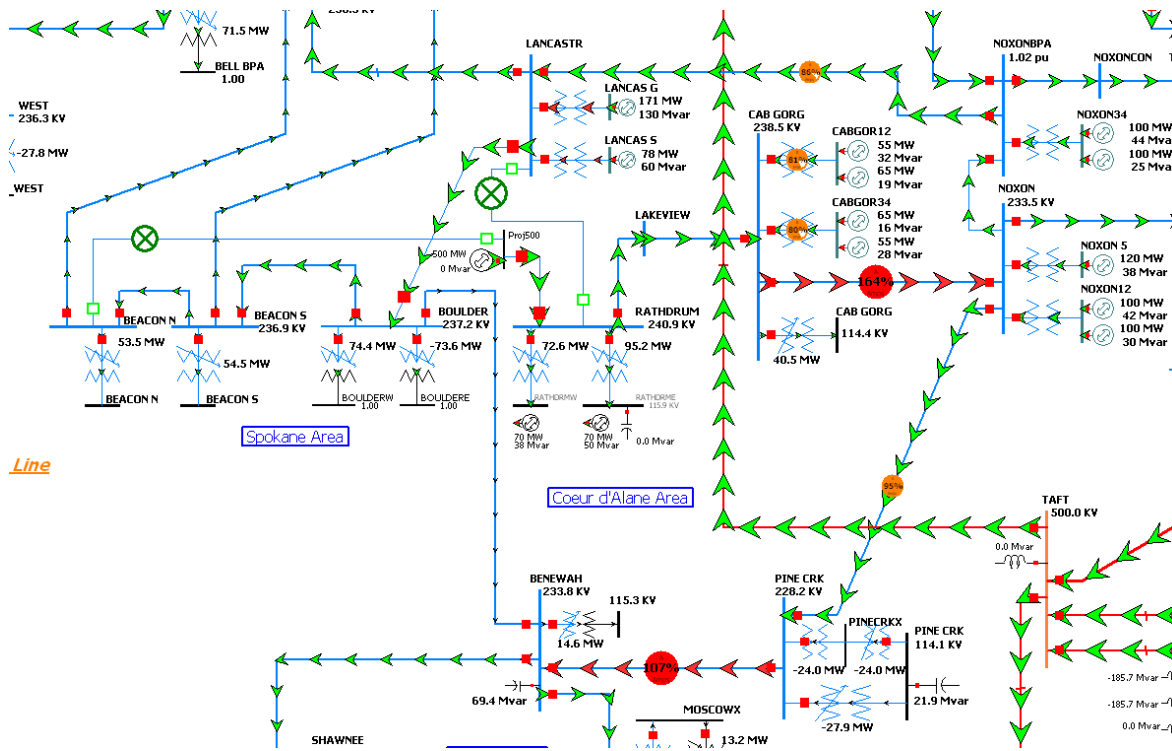

Figure 3 - N-2 Contingency

⁴ Cost estimates do not include costs of the radial line to the POI, the generator or generator station if applicable.

⁵ Total is for network and direct assigned costs, are in 2011 dollars, and is +/- 50%.

⁶ The RAS portion is a worst case scenario where another fiber loop is required. \$3M allocated for RAS.

To alleviate these overloads two new 230 kV transmission lines, would need to be built. A 230 kV transmission line, with new right-of-way, must be built from the New Project to Lancaster. The estimated distance for this line is roughly 3 miles. The estimated loaded cost for this line, including a new line position at Lancaster and at the New Project, is roughly \$8M. Another 230 kV transmission line, again with new right-of-way, is required from Lancaster to Boulder. This line length is estimate at roughly 15 miles. The estimated loaded cost of the new line, including new line positions, is roughly \$17M. New right-of-way in this area will be difficult to obtain, which would have the potential of more than doubling costs.

RAS may be a viable solution. If at all possible RAS should be a last resort. Unlike improving our transmission system, RAS does not provide operational flexibility and in some cases can compound the impacts of future generation needs. However, it does represent the cheapest solution and is therefore listed as solution 1.

Option 3	N-0 Max. Output	Facility Requirement ⁷	Total ⁸ (\$000)
Solution 1	500 MW	New 230 kV DB-DB Station and RAS ⁹	11,000
Solution 2	500 MW	New line from Lancaster to New Project. New line from Lancaster to Boulder, New 230 kV DB-DB Station	33,000

Option 4

This option taps the Rathdrum-Beacon & Rathdrum-Lancaster 230 kV transmission lines. This options has no N-0 issues at the full requested 500 MW. There are a handful of N-1 and N-2 contingencies that cause significant thermal violations, the worst being the loss of the Beacon-New Project & Lancaster-New Project 230 kV transmission lines. These lines share a common structure and therefore represent a credible N-2 scenario. This outage forces the entire proposed 500 MW toward Cabinet and Noxon. This causes overloads on the Cabinet-Noxon and Pine Creek-Benewah 230 kV transmission lines. (Very similar to Figure 3 on the previous page).

To alleviate these overloads two new 230 kV transmission lines, would need to be built. A 230 kV transmission line, with new right-of-way, must be built from the New Project to Lancaster. The estimated distance for this line is roughly 3 miles. The estimated loaded cost for this line, including a new line position at Lancaster and at the New Project, is roughly \$8M. Another 230 kV transmission line, again with new right-of-way, is required from Lancaster to Boulder. This line length is estimate at roughly 15 miles. The estimated loaded cost of the new line, including new line positions, is roughly \$17M. New right-of-way in this area will be difficult to obtain, which would have the potential of more than doubling costs.

RAS may be a viable solution. If at all possible RAS should be a last resort. Unlike improving our transmission system, RAS does not provide operational flexibility and in some cases can compound the impacts of future generation needs. However, it does represent the cheapest solution and is therefore listed as solution 1.

Option 4	N-0 Max. Output	Facility Requirement	Total (\$000)
Solution 1	500 MW	New 230 kV DB-DB Station and RAS	15,000
Solution 2	500 MW	New line from Lancaster to New Project. New line from Lancaster to Boulder, New 230 kV DB-DB Station	37,000

⁷ Cost estimates do not include costs of the radial line to the POI, the generator or generator station if applicable.

⁸ Total is for network and direct assigned costs, are in 2011 dollars, and is +/- 50%.

⁹ The RAS portion is a worst case scenario where another fiber loop is required. \$3M allocated for RAS.

Option 5

This option taps the Rathdrum-Beacon & Rathdrum-Cabinet 230 kV transmission lines. A new switching station is required for each tap. A 300 MW generating station would be on the Beacon-Rathdrum 230 kV transmission line and 200 MW would be on the Rathdrum-Cabinet 230 kV transmission line. This option has no N-0 issues at the full requested 500 MW. There are a handful of N-1 and N-2 contingencies that cause significant thermal violations, the worst being the loss of the Beacon-New Project & Lancaster-Rathdrum 230 kV transmission lines. These lines share a common structure and therefore represent a credible N-2 scenario. This outage forces the entire proposed 500 MW toward Cabinet and Noxon. This causes overloads on the Cabinet-Noxon and Pine Creek-Benewah 230 kV transmission lines. (Very similar to what was shown in Figure 3).

To alleviate these overloads three new 230 kV transmission lines, would need to be built. A 230 kV transmission line, with new right-of-way, must be built from the New Project (300MW piece) to Lancaster. The estimated distance for this line is roughly 5 miles. The estimated loaded cost for this line, including a new line position at Lancaster and at the New Project, is roughly \$9M. Another 230 kV transmission line, again with new right-of-way, is required from Lancaster to Boulder. This line length is estimate at roughly 15 miles. The estimated loaded cost of the new line, including new line positions, is roughly \$17M. Finally, for the loss of the Rathdrum-New Project (200MW piece) 230 kV transmission line, causes the Cabinet-Noxon 230 kV transmission line to load to 117%. To alleviate this overload a new line, with new right-of-way must be built back to Rathdrum. The estimated loaded cost of this 5 mile line, along with associated line positions, is \$9M. New right-of-way in this area will be difficult to obtain, which would have the potential of more than doubling costs.

RAS may be a viable solution. If at all possible RAS should be a last resort. Unlike improving our transmission system, RAS does not provide operational flexibility and in some cases can compound the impacts of future generation needs. However, it does represent the cheapest solution and is therefore listed as solution 1.

Option 5	N-0 Max. Output	Facility Requirement ¹⁰	Total ¹¹ (\$000)
Solution 1	500 MW	Two New 230 kV DB-DB Stations and RAS ¹²	22,000
Solution 2	500 MW	Two New 230 kV DB-DB Stations, New line from Lancaster to New Project (300MW). New line from Lancaster to Boulder, New line from New Project (200MW) to Rathdrum	51,000

Option 6 – Other Transmission Alternatives

In addition to the five options listed, there are a few more options that may seem to be intuitive interconnection points. These integration options are:

- a. Lancaster 230 kV (BPA) switching station
- b. Rathdrum 230/115/13.2 kV substation
- c. Cabinet-Rathdrum & Noxon-Lancaster 230 kV transmission lines
- d. Bell-Taft 500 kV transmission line

Option 6a - Connecting to the Lancaster 230 kV switching station would save Avista the cost of a new switching station. It would also negate the need for a new transmission line, with associated right-of-way, from the new project to Lancaster. The estimated savings, adding the previously quoted loaded costs, less

¹⁰ Cost estimates do not include costs of the radial line to the POI, the generator or generator station if applicable.

¹¹ Total is for network and direct assigned costs, are in 2011 dollars, and is +/- 50%.

¹² The RAS portion is a worst case scenario where another fiber loop is required. \$3M allocated for RAS.

the added cost of connecting to Lancaster, is \$13M¹³. This does not take into account any fees associated with connecting to BPA. This option assumes there is room in the Lancaster substation to accept the new line position. If Lancaster substation cannot accommodate the new line position, the cost savings to interconnect at Lancaster may be negligible or non-existent.

This option would still have all the contingency issues and associated upgrades similar to Option 2.

Option 6b - Connecting to the Rathdrum substation saves the cost of building another switching station. All contingency results are nearly identical to connecting the project to option 2 or option 3. The estimated savings of this option is \$4M¹⁴. This option assumes there is room in the Rathdrum substation to accept the new line position. If Rathdrum substation cannot accommodate the new line position, the cost savings to interconnect at Rathdrum may be negligible or non-existent.

Option 6c – Tapping the Cabinet-Rathdrum & Noxon-Lancaster 230 kV transmission lines does improve the network performance, in comparison to tapping only the Cabinet-Rathdrum 230 kV transmission line. However, this option still requires all the same network upgrades that option 1 requires since it is still possible to have an N-2 situation where the generation of the New Project, Noxon and Cabinet is separated from the Coeur d’Alene/Spokane load. (See Figure 1). This option is listed for completeness.

Option 6d - Connecting solely to the Bell-Taft 500 kV transmission line cannot be done without RAS and possibly some network upgrades on BPA’s system. In addition to the network upgrades that would likely be required on BPA’s system, Avista would also be financially liable to pay wheeling fees from the new project across BPA’s lines to Avista’s load. If the project is connected to both BPA’s Bell-Taft 500 kV transmission line and Avista’s Rathdrum area 230 kV system, effectively avoiding wheeling charges, both RAS and significant network upgrades will be required. Due to the cost of a new 500 kV substation, associated RAS and the potentially large cost of network upgrades on BPA’s 500 kV system, this option is not recommended.

Conclusion

Of the formally identified options, options 2 and 3 represent the least cost and best performing options. Of the other transmission alternatives, the Lancaster switching station, followed by the Rathdrum substation, interconnection options represent the least cost and best performing alternative options. The following favorable options are:

- Option 2: \$11-33M (RAS only vs System Upgrades)¹⁵
- Option 3: \$11-33M (RAS only vs System Upgrades)¹⁵
- Lancaster Alternative Option: \$7-20M (RAS only vs System Upgrades)
- Rathdrum Alternative Option: \$7-33M (RAS only vs System Upgrades)

¹³ Assumes a network upgrade solution would be pursued, instead of a RAS only solution.

¹⁴ This \$4M savings would be for either a RAS only or a network upgrade solution.

¹⁵ If the new project is interconnected to the west of Lancaster, the Lancaster-New Project 230 kV transmission line is not needed. Hence the network upgrade cost would be reduced by \$8M.



Interoffice Memorandum System Planning

MEMO: SP-2013-07
DATE: February 15, 2012
TO: Scott Waples
FROM: Richard Maguire
SUBJECT: IRP Generation Study - Benewah to Boulder 230kV (BB-IRP)

Introduction

This study addresses a request from Avista's Power Supply Department for the 2013 IRP regarding new generation on the Benewah - Boulder 230 kV Transmission Line at one of two capacity levels:

- 150 MW
- 300 MW

The study presents information and discussion on the follow topics:

- Power flow impact to the transmission system
- Transmission system upgrades necessary to deliver requested generation

Study Assumptions and Methodology

The five year planning horizon Avista planning cases, as documented in *SP-2011-03 – 2011 Planning Cases Summary Data*, are modified with the following projects and adjustments prior to system analysis:

- LGIR #35 project (200 MW at Thornton 230 kV Substation)
- LGIR #36 project (105 MW at Thornton 230 kV Substation)
- BB-IRP topology:
 - Benewah – Boulder 230kV Transmission Line tapped 13.1 electrical miles North of Benewah 230 kV Substation
 - Generic generator installed on new BB-IRP 230 kV bus

The following cases are used during this study:

- Avista Heavy Summer High Hydro (“HSHH”) case: AVA-11hs2a-12BA2085
 - Table 1 shows power flows for this case
- Avista Heavy Summer Low Hydro (“HSLH”) case: AVA-11hs2a-12BA2085-LH
 - Table 2 shows power flows for this case
- Avista Light Summer with High West of Hatwai (High Transfers or “HT”)Flows: AVA-11ls1ae-12BA1251-WOH4277
 - Table 3 shows power flows for this case with BB-IRP output = 300 MW



Benewah – Boulder 2013 IRP Study

Table 1: Regional Power Flows for Heavy Summer Case

Western Montana Hydro	1098.1 MW	West of Hatwai (Path 6)	951.8 MW
Noxon Rapids (562MW)	399.4 MW	Lolo-Oxbow 230kV	296.0 MW
Cabinet Gorge (265MW)	184.7 MW	Dry Creek-Walla Walla 230kV	184.1 MW
Libby (605MW)	324.0 MW		
Hungry Horse (430MW)	190.0 MW	West of Cabinet	1581.7 MW
		Montana-Northwest (Path 8)	979.0 MW
Colstrip Total			
Colstrip 1 (330MW)	330.0 MW	Idaho-Northwest (Path 14)	-585.4 MW
Colstrip 2 (330MW)	330.0 MW	Midpoint-Summer Lake (Path 75)	-48.9 MW
Colstrip 3 (823MW)	795.5 MW	Idaho-Montana (Path 18)	-296.3 MW
Colstrip 4 (823MW)	804.9 MW		
		South of Boundary	582.9 MW
Rathdrum Thermal (175MW)	0.0 MW	North of John Day (Path 73)	7034.7 MW
Lancaster Thermal (270MW)	249.0 MW	TOT 4A (Path 37)	407.0 MW
Spokane River Hydro	88.3 MW	Miles City DC	142.0 MW
Boundary Hydro (1040MW)	635.0 MW		
		Path C (Path 20)	118.7 MW
Lower Snake/N.F. Clearwater		Borah West (Path 17)	837.4 MW
Dworshak (458MW)	316.0 MW	Bridger West (Path 19)	2191.6 MW
Lower Granite (930MW)	554.2 MW	Pacific AC Intertie (Path 66)	4430.9 MW
Little Goose (930MW)	555.5 MW	Pacific DC Intertie (Path 65)	2980.0 MW
Lower Monumental (930MW)	531.5 MW		
		Northwest Load	25129.6 MW
Coulee Generation		Idaho Load	3702.5 MW
Coulee 500 kV	2308.5 MW	Montana Load	1836.8 MW
Coulee 230 kV	1292.7 MW	Avista Native Load	-1594.3 MW
		Avista Balancing Area Load	1885.6 MW
		Clearwater Load	58.3 MW

Table 2: Regional Power Flows for Light Summer Case

Western Montana Hydro	627.1 MW	West of Hatwai (Path 6)	120.3 MW
Noxon Rapids (562MW)	138.8 MW	Lolo-Oxbow 230kV	277.0 MW
Cabinet Gorge (265MW)	82.3 MW	Dry Creek-Walla Walla 230kV	159.6 MW
Libby (605MW)	216.0 MW		
Hungry Horse (430MW)	190.0 MW	West of Cabinet	1110.7 MW
		Montana-Northwest (Path 8)	970.1 MW
Colstrip Total			
Colstrip 1 (330MW)	330.0 MW	Idaho-Northwest (Path 14)	-585.9 MW
Colstrip 2 (330MW)	330.0 MW	Midpoint-Summer Lake (Path 75)	-76.0 MW
Colstrip 3 (823MW)	764.2 MW	Idaho-Montana (Path 18)	-274.8 MW
Colstrip 4 (823MW)	776.0 MW		
		South of Boundary	299.4 MW
Rathdrum Thermal (175MW)	0.0 MW	North of John Day (Path 73)	6931.9 MW
Lancaster Thermal (270MW)	249.0 MW	TOT 4A (Path 37)	399.6 MW
Spokane River Hydro	58.1 MW	Miles City DC	142.0 MW
Boundary Hydro (1040MW)	310.0 MW		
		Path C (Path 20)	133.4 MW
Lower Snake/N.F. Clearwater		Borah West (Path 17)	830.6 MW
Dworshak (458MW)	316.0 MW	Bridger West (Path 19)	2188.8 MW
Lower Granite (930MW)	554.2 MW	Pacific AC Intertie (Path 66)	4222.6 MW
Little Goose (930MW)	555.5 MW	Pacific DC Intertie (Path 65)	2980.0 MW
Lower Monumental (930MW)	531.5 MW		
		Northwest Load	25129.6 MW
Coulee Generation		Idaho Load	3702.5 MW
Coulee 500 kV	3066.4 MW	Montana Load	1836.8 MW
Coulee 230 kV	1292.7 MW	Avista Native Load	-1594.3 MW
		Avista Balancing Area Load	1874.1 MW
		Clearwater Load	75.8 MW



Benewah – Boulder 2013 IRP Study

Table 3: Regional Power Flows for High Transfer Case

Western Montana Hydro	1548.0 MW	West of Hatwai (Path 6)	4251.2 MW
Noxon Rapids (562MW)	432.2 MW	Lolo-Oxbow 230kV	140.1 MW
Cabinet Gorge (265MW)	195.8 MW	Dry Creek-Walla Walla 230kV	189.5 MW
Libby (605MW)	540.0 MW		
Hungry Horse (430MW)	380.0 MW	West of Cabinet	3204.5 MW
		Montana-Northwest (Path 8)	2040.8 MW
Colstrip Total			
Colstrip 1 (330MW)	330.0 MW	Idaho-Northwest (Path 14)	741.0 MW
Colstrip 2 (330MW)	330.0 MW	Midpoint-Summer Lake (Path 75)	831.7 MW
Colstrip 3 (823MW)	777.6 MW	Idaho-Montana (Path 18)	-198.3 MW
Colstrip 4 (823MW)	782.9 MW		
		South of Boundary	961.8 MW
Rathdrum Thermal (175MW)	116.4 MW	North of John Day (Path 73)	4775.0 MW
Lancaster Thermal (270MW)	118.1 MW	TOT 4A (Path 37)	448.4 MW
Spokane River Hydro	152.4 MW	Miles City DC	200.0 MW
Boundary Hydro (1040MW)	975.0 MW		
		Path C (Path 20)	528.7 MW
Lower Snake/N.F. Clearwater		Borah West (Path 17)	1570.2 MW
Dworshak (458MW)	168.2 MW	Bridger West (Path 19)	2098.0 MW
Lower Granite (930MW)	0.0 MW	Pacific AC Intertie (Path 66)	3136.7 MW
Little Goose (930MW)	141.8 MW	Pacific DC Intertie (Path 65)	1999.9 MW
Lower Monumental (930MW)	310.0 MW		
		Northwest Load	17796.4 MW
Coulee Generation		Idaho Load	2326.0 MW
Coulee 500 kV	825.7 MW	Montana Load	1339.5 MW
Coulee 230 kV	125.0 MW	Avista Native Load	-837.0 MW
		Avista Balancing Area Load	680.3 MW
		Clearwater Load	71.1 MW



Study Results

Thermal Performance during Category A conditions¹

This preliminary study indicates the Avista Transmission System has adequate capacity to integrate 300 MW at the proposed interconnection point during Category A all lines in service conditions.

Thermal Performance during Category B and Category C conditions

Table 4 shows preliminary results of a study using PowerWorld Simulator's *Available Transfer Capability* (ATC) tool for generation injections at BB-IRP. This tool generates a list of facility thermal violations (From To) that arise under contingency conditions for incremental increases in generation output (BB WM). When the results for each case under study are collected and analyzed together with results from standard contingency analysis studies, this tool provides an idea of what facilities overload for rising levels of generation output.

As the table shows, there are six facilities that come into violation for a requested BB-IRP output of 150 MW, and there are an additional five facilities that come into violation for a requested BB-IRP output of 300 MW.

Table 4: Incremental generation analysis for BB-IRP IRP request²

Case	MW Output	Limiting Contingency	From Name	To Name
HSLH	27.11	BF: A470 Westside 115 kV, College & Walnut-Westside	GLENTAP	NINTHCNT
HSHH	28.2	BUS: Westside 115 kV	POSTSTRT	THIRHACH
HT	84.08	N-1: Hatwai - Moscow 230 230 kV	MOSCOW	MOSCOWX
HSLH	106.34	BUS: Westside 115 kV	ROSSPARK	THIRHACH
HSHH	106.63	BF: A413 Westside 115 kV, Ninemile-Westside	POSTSTRT	THIRHACH
HSHH	112.15	BF: A689 Ninth & Central South 115 kV, Ninth & Central-Otis Orchards	POSTSTRT	THIRHACH
HSLH	116.64	N-2: Bell - Westside 230 kV & Coulee - Westside 230 kV	GLENTAP	NINTHCNT
HSLH	117.24	BUS: Westside 230 kV	GLENTAP	NINTHCNT
HSLH	123.43	BF: A370 Bell S1 & S2 230 kV	BEACON N	BEACON N
HSHH	160.37	N-1: Shawnee - Thornton 230 kV	MOSCOW	MOSCOWX
HSHH	164.3	N-1: North Lewiston - Shawnee 230 kV	TERRVIEW	NPULLMAN
HSHH	173.34	BUS: North Lewiston 230 kV	TERRVIEW	NPULLMAN
HSLH	184.24	BF: A413 Westside 115 kV, Ninemile-Westside	ROSSPARK	THIRHACH
HT	206.31	N-2: Beacon - Boulder 230 kV & Beacon - Rathdrum 230 kV	BOULDERE	IRVIN
HT	215.35	BF: R427 Beacon North & South 230 kV	BOULDERE	IRVIN
HT	215.68	N-2: Beacon - Boulder 230 kV & Beacon - Rathdrum 230 kV	IRVIN	MILLWOOD
HT	223.63	BF: R427 Beacon North & South 230 kV	IRVIN	MILLWOOD
HSHH	253.83	N-2: Shawnee - Thornton 230 kV & Lind - Shawnee 115 kV	MOSCOW	MOSCOWX
HT	269.19	N-2: Beacon - Boulder 230 kV & Beacon - Rathdrum 230 kV	BOULDERW	SPKINDPK
HT	271.24	BUS: Hatwai 230 kV	MOSCOWX	MOSCOW
HSLH	272.76	BUS: Hatwai 230 kV	MOSCOWX	MOSCOW
HSLH	275.44	PSF: Ninth & Central South 115 kV	BEACON S	NINTHCNT
HSHH	275.67	BUS: Westside 230 kV	POSTSTRT	THIRHACH
HSHH	275.84	N-2: Bell - Westside 230 kV & Coulee - Westside 230 kV	POSTSTRT	THIRHACH
HT	280.08	BF: R427 Beacon North & South 230 kV	BOULDERW	SPKINDPK
HSLH	298.33	BUS: North Lewiston 230 kV	HATWAI	LOLO
HT	300.27	N-2: Bell - Taft 500 kV and Bell - Lancaster 230 kV	BOULDER	BB-IRP

¹ Contingency category descriptions can be found at: <http://www.nerc.com/files/TPL-001-0.pdf>

² BF = Breaker Failure; PSF = Protection System Failure; N-X contingencies refer to 'X' transmission element outages



Notes regarding thermal performance:

- Avista has planned projects that mitigate some of the above mentioned facility violations. However, some of the planned projects also result in new facility thermal violations during contingencies. Further study of planned projects and potential options will be necessary.
- Preliminary studies indicate some reduction in the above thermal violations when Projects #35 and #36 are removed from study, but the reduction in thermal violations is confined mainly to limiting facilities south of BB-IRP. Without Projects #35 and #36, significant power continues to flow north through the Boulder 230 kV substation and onto the local 115 kV Transmission System in the Spokane and Spokane Valley areas.

Voltage Performance

Preliminary studies show voltage issues of a nature that can be addressed with properly sited reactive support. Further detailed studies can be used to determine the exact amount and location of any reactive support necessary to mitigate facility voltage violations.



Potential Solutions Options³

230 kV Switching station required for all options mentioned below:

- 4 position double bus double breaker ~ \$4 M

Option 1: Reconductor facilities brought into violation due to the requested generation

- 150 MW option would require:
 - \$3.41 M of 115 kV upgrades
- 300 MW option would require an additional:
 - \$1.9 M of 115 kV upgrades
 - \$5.36 M of 230 kV upgrades

Option 2: Complete currently planned projects and reconductor limiting facilities

- Currently Planned Projects:
 - Lancaster Interconnection
 - Spokane Valley Transmission Reinforcement
 - Moscow Transformer Replacement
 - Westside Transformer Replacement
- 150 MW option would require:
 - \$2.4 M of 115 kV upgrades
- 300 MW option would require an additional:
 - \$932 K of 115 kV upgrades
 - \$5.36 M of 230 kV upgrades

Conclusion

This project is a feasible project based on the preliminary analysis performed. A summary of options and cost estimates is given in Table 3.

Option	Maximum Output	Total Cost (\$000)
1	150 MW	\$7,410
1	300 MW	\$14,670
2	150 MW	\$6,400
3	300 MW	\$12,690

³ All construction costs are in 2013-year dollars and based on engineering judgment alone with +/- 50% accuracy



Interoffice Memorandum System Planning

MEMO: SP-2011-09 Rev B - Final
DATE: January 13, 2012
TO: James Gall, IRP Group
FROM: Reuben Arts
SUBJECT: New Generation, 300 MW in the Rathdrum Area and 200 MW in the Rosalia Area

Introduction

Based on initial 2011 IRP analysis 200 MW of new capacity is required in 2019-2020 and an additional 300 MW of capacity in the 2022-2024 time period. North Idaho is one of several potential locations this capacity could be added, but requires further detail to understand its potential.

Problem Statement

As a follow up to the IRP informational request for 500 MW in N. Idaho, SP-2011-08, the IRP group requests the following additional cost studies.

- 1) Split the 500 MW into ~200 MW connecting at the Thornton substation by the end of 2018, then ~300 MW integrated at Lancaster substation by the end of 2023.
- 2) Split the 500 MW into ~200 MW connecting at the Thornton substation by the end of 2018, then ~300 MW integrated at the Boulder- Lancaster line by the end of 2023.
- 3) Split the 500 MW into ~200 MW connecting at the Thornton substation by the end of 2018, then ~300 MW integrated at the Rathdrum substation by the end of 2023.

Power Flow Analysis

The case that was used to highlight the impacts of an additional 300 MW in the Rathdrum area was the WECC approved and Avista modified light summer high flow case (AVA-11ls1ae-12BA1251-WOH4277). The West of Hatwai path typically experiences high flows during light Avista load hours. High West of Hatwai flows tend to coincide with high Western Montana Hydro generation, high Boundary generation, high flows on Montana to Northwest, and light loads in Eastern Washington, North Idaho, and Montana. Existing Clark Fork RAS is in place, and assumed armed, since the Western Montana Hydro (WMH) complex is greater than 1450 MW. Since the New Project would require significant Avista system transmission changes, and RAS changes, the results are listed as though RAS were not armed. This does affect the results of some contingencies, but ultimately does not change the conclusions of this memo.

Option 1

300 MW of new generation in the Rathdrum area, near the BPA Lancaster substation and 200 MW in the Rosalia area is option 1. The 300 MW portion, assumes a new 230/13 kV Avista generator substation would be required. Several connection possibilities exist for connecting this substation to the 230 kV transmission system in this area. For simplification it will be assumed that the new substation will tap the to-be-constructed Rathdrum – Lancaster 230 kV transmission line. This option has no N-0 issues at the full 300 MW. There are a handful of N-1

and N-2 contingencies that cause significant thermal violations, the worst being the loss of the Lancaster-Boulder & Rathdrum-Beacon 230 kV transmission lines. These lines share a common structure and therefore represent a credible N-2 scenario. This outage causes the Lancaster-Bell S3 230 kV transmission line to load to 164%, or roughly 320 MW above its thermal limit. See Figure 2.

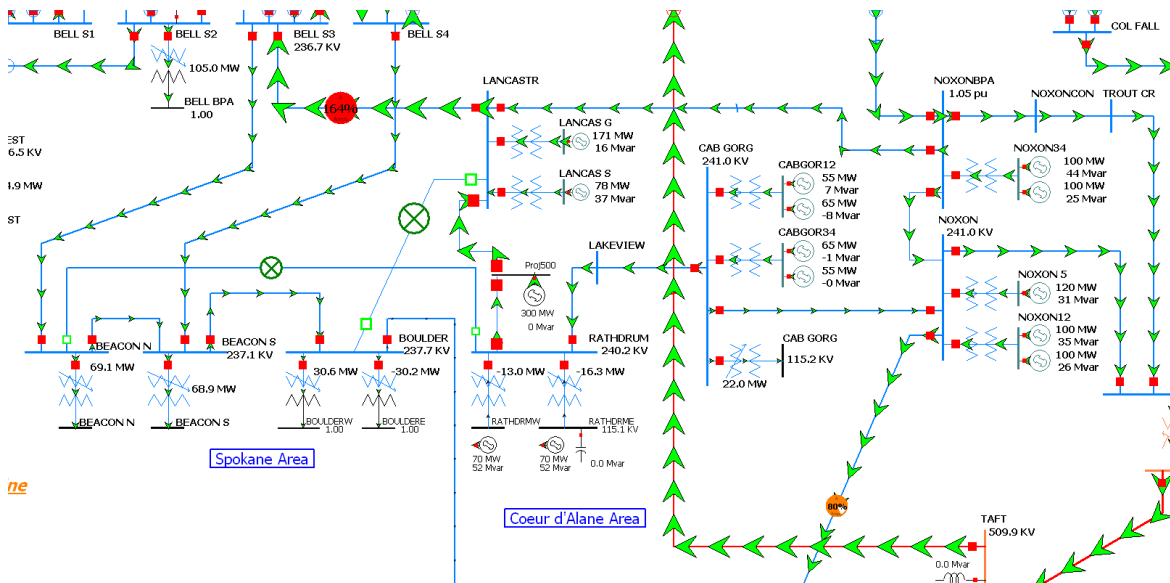

Figure 2 - N-2 Contingency

To alleviate these overloads a new 230 kV transmission line, with new right-of-way, is required from Lancaster to Boulder. This line length is estimate at roughly 15 miles. The estimated loaded cost of the new line, including new line positions, is roughly \$17M. New right-of-way in this area will be difficult to obtain, which would have the potential of more than doubling costs.

RAS may be a viable solution. If at all possible RAS should be a last resort. Unlike improving our transmission system, RAS does not provide operational flexibility and in some cases can compound the impacts of future generation needs. However, it does represent the cheapest solution and is therefore listed as solution 1. A RAS solution would have to integrate with the existing Clark Fork RAS scheme and additionally trip all generation at Lancaster and the proposed new 300 MW facility.

For the 200 MW option, to be located in Rosalia WA, it is assumed that the generation will interconnect at the new Thornton 230 kV switching station (scheduled to be finished in 2012). The steady state impacts from this additional 200 MW would be similar to previously studied LGIR #14 – which sought to connect 220 MW in the Colton WA area. No new transmission system upgrades, with the exception of the interconnection substation, were required. At this time, pending no new queue additions that could be considered senior to this proposed 200 MW, the results are expected to be similar to LGIR #14. Therefore the total cost of integrating 200 MW in the Rosalia area should be \$4M, the cost of another breaker position at Thornton 230 kV switching station.

Option 1	N-0 Max. Output	Facility Requirement ¹	Total ² (\$000)
Solution 1	500 MW	New 230 kV DB-DB Station and RAS. New Breaker Position @ Thornton.	15,000
Solution 2	500 MW	New line from Lancaster to New Project. New 230 kV DB-DB Station. New Breaker Position @ Thornton.	32,000

Option 2

This is essentially the same option as Option 1. Placing the new generation within 1 mile of Lancaster switching station will have roughly the same reliability performance. The major outage of concern is the simultaneous loss of the Rathdrum – Beacon and Rathdrum – Boulder (soon to be Lancaster – Boulder) 230 kV lines. This contingency will cause BPA’s Lancaster – Bell 230 kV transmission line to load to roughly 164% without RAS. There is no room in the Rathdrum area for 300 MW, without RAS or some major transmission upgrades, as outlined in the table below.

Option 2	N-0 Max. Output	Facility Requirement ³	Total ⁴ (\$000)
Solution 1	500 MW	New 230 kV DB-DB Station and RAS. New Breaker Position @ Thornton.	15,000
Solution 2	500 MW	New line from Lancaster to New Project. New 230 kV DB-DB Station. New Breaker Position @ Thornton.	32,000

Option 3

300 MW of new generation in the Rathdrum area, near the BPA Lancaster substation and 200 MW in the Rosalia area is option 1. The 300 MW portion, assumes a new 230/13 kV Avista generator substation would be required. Several connection possibilities exist for connecting this substation to the 230 kV transmission system in this area. For simplification it will be assumed that the new substation will tap the to-be-constructed Rathdrum – Lancaster 230 kV transmission line. This option has no N-0 issues at the full 300 MW. There are a handful of N-1 and N-2 contingencies that cause significant thermal violations, the worst being the loss of the Lancaster-Boulder & Rathdrum-Beacon 230 kV transmission lines. The result is the same as with Option 1. Additionally there with Option 2, there is the opportunity for the Rathdrum-Beacon and the Rathdrum-Boulder (soon to be Rathdrum-Lancaster) 230 kV to be simultaneously lost, as they both share the same structure. This would cause the Cabinet – Noxon 230 kV transmission line to load to 123%.

To alleviate these overloads a new 230 kV transmission line, with new right-of-way, is required from Lancaster to Boulder. This line length is estimate at roughly 15 miles. The estimated loaded cost of the new line, including new line positions, is roughly \$17M. Another 230 kV transmission line, with new right-of-way, from Rathdrum to Lancaster 230 kV switching station, must be built. The loaded cost for this roughly 3 mile line is \$4M. New right-of-way in this area will be difficult to obtain, which would have the potential of more than doubling costs.

¹ Cost estimates do not include costs of the radial line to the POI, the generator or generator station if applicable.

² Total is for network and direct assigned costs, are in 2011 dollars, and is +/- 50%.

³ Cost estimates do not include costs of the radial line to the POI, the generator or generator station if applicable.

⁴ Total is for network and direct assigned costs, are in 2011 dollars, and is +/- 50%.

RAS may be a viable solution. If at all possible RAS should be a last resort. Unlike improving our transmission system, RAS does not provide operational flexibility and in some cases can compound the impacts of future generation needs. However, it does represent the cheapest solution and is therefore listed as solution 1. A RAS solution would have to integrate with the existing Clark Fork RAS scheme and additionally trip all generation at Lancaster and the proposed new 300 MW facility.

For the 200 MW option, to be located in Rosalia WA, it is assumed that the generation will interconnect at the new Thornton 230 kV switching station (scheduled to be finished in 2012). The steady state impacts from this additional 200 MW would be similar to previously studied LGIR #14 – which sought to connect 220 MW in the Colton WA area. No new transmission system upgrades, with the exception of the interconnection substation, were required. At this time, pending no new queue additions that could be considered senior to this proposed 200 MW, the results are expected to be similar to LGIR #14. Therefore the total cost of integrating 200 MW in the Rosalia area should be \$4M, the cost of another breaker position at Thornton 230 kV switching station.

Option 3	N-0 Max. Output	Facility Requirement ⁵	Total ⁶ (\$000)
Solution 1	500 MW	New Breaker Position @ Rathdrum and RAS. New Breaker Position @ Thornton.	11,000
Solution 2	500 MW	New line from Lancaster to Rathdrum. New line from Lancaster to Boulder, New Breaker Position @ Rathdrum. New Breaker Position @ Thornton.	36,000

Conclusion

All options are feasible and vary in cost by roughly \$4M. There are not any great differences in price, reliability or future growth (MW) potential.

Option 3 with RAS represents the cheapest option. There are no substantial reliability gains in putting the project closer to Lancaster. Connecting the project at Rathdrum represents a much cleaner solution that would not require Avista to add yet another substation in the Rathdrum – Lancaster area.

⁵ Cost estimates do not include costs of the radial line to the POI, the generator or generator station if applicable.

⁶ Total is for network and direct assigned costs, are in 2011 dollars, and is +/- 50%.

2013 Electric Integrated Resource Plan

Appendix E – 2013 Electric IRP New Resource Table for Transmission



2013 Avista Electric IRP
New Resource Table For Transmission

	Resource	POR				Capacity	Year
Resource	Location	or Local Area	POD	Start	Stop	MW	Total
Coyote Springs 2	Boardman, OR	Coyote Springs 2	AVA System	1/1/2014	Indefinite	10.0	
Lancaster CCCT	Rathdrum, ID	Bell/Westside	AVA System	1/1/2014	10/31/2026	125.0	
Lancaster CCCT	Rathdrum, ID	Mid-C	AVA System	1/1/2014	10/31/2026	150.0	285.0
Nine Mile	Nine Mile Falls, WA	Nine Mile	AVA System	12/1/2015	Indefinite	7.6	7.6
SCCT	TBD	TBD	AVA System	10/1/2019	Indefinite	83.0	83.0
CCCT	TBD	TBD	AVA System	11/1/2026	Indefinite	270.0	270.0
Rathdrum CT	Rathdrum, ID	Rathdrum	AVA System	5/1/2028	Indefinite	6.0	6.0
SCCT	TBD	TBD	AVA System	10/1/2032	Indefinite	50.0	50.0

Total 702 702

The following table replaces Table 1 “The 2013 Preferred Resource Strategy” in the Executive Summary referenced on page v, and Table 8.2 “Preferred Resource Strategy” in Chapter 8, referenced on page 8-8.

Resource	By the End of Year	Nameplate (MW)	Energy (aMW)
Simple Cycle CT	2019	83	76
Simple Cycle CT	2023	83	76
Combined Cycle CT	2026	270	248
Simple Cycle CT	2027	83	76
Rathdrum CT Upgrade	2028	6	5
Simple Cycle CT	2032	50	46
Total		575	529
Efficiency Improvements	By the End of Year	Peak Reduction	Energy (aMW)
Energy Efficiency	2014-2033	221	164
Demand Response	2022-2027	19	0
Distribution Efficiencies	2014-2017	<1	<1
Total		240	164

The following table replaces Table 8.15 “Load Growth Sensitivities” in Chapter 8 referenced on page 8-35.

Year	PRS	Low Growth	Medium Low Growth	High Growth
2014				
2015				
2016				
2017				
2018				
2019	83 MW SCCT			150 MW SCCT
2020				
2021				
2022			6 MW Upgrade	92 MW SCCT
2023	83 MW SCCT		90 MW SCCT	
2024				
2025				
2026	270 MW CCCT	270 MW CCCT	270 MW CCCT	270 MW CCCT
2027	83 MW SCCT	50 MW SCCT		92 MW SCCT
2028				6 MW Upgrade
2029	6 MW Upgrade			50 MW SCCT
2030				
2031				
2032				
2033	50 MW SCCT			50 MW SCCT
Demand Response (MW)	19	1	20	20
Conservation (aMW)	0	0	0	0