



2 0 2 3

# Electric Integrated Resource Plan Appendices



# 2023 Electric Integrated Resource Plan

## Appendix A – 2023 Technical Advisory Committee Presentations and Meeting Minutes





***2023 Electric Integrated Resource Plan***  
**Technical Advisory Committee Meeting No. 1 Agenda**  
**Wednesday, December 8, 2021**  
**Virtual Meeting**

<b>Topic</b>	<b>Time</b>	<b>Staff</b>
Introductions	9:00	John Lyons
2021 Action Item Review	9:10	John Lyons
Summer 2021 Heat Event Resource Adequacy Feeder Outages	9:45	James Gall David Thompson
NW Power Pool Resource Adequacy Program	10:45	Scott Kinney
Lunch	11:30	
Resource Adequacy Program Impact to IRP	12:30	Michael Brutocao
IRP Resource Adequacy/Resiliency Planning	1:00	James Gall
Break	1:45	
TAC Survey Results & Discussion	2:00	Lori Hermanson
Washington State Customer Benefit Indicators	2:45	Annette Brandon James Gall
2023 Draft IRP Workplan	3:15	John Lyons
Adjourn	3:30	

Microsoft Teams meeting

**Join on your computer or mobile app:** [Click here to join the meeting](#)

**Or call in (audio only):** [+1 509-931-1514,,643047233#](#) United States, Spokane

Phone Conference ID: 643 047 233#



# 2023 IRP Introduction

2023 Avista Electric IRP

TAC 1 – December 8, 2021

John Lyons, Ph.D. Senior Resource Policy Analyst

# Meeting Guidelines

- IRP team is still working remotely and is available by email and phone for questions and comments
- Stakeholder feedback form
  - Responses shared with TAC at meetings, by email and in Appendix
  - Would a form and/or section on the web site be helpful?
- Other IRP data posted to web site – will set up better descriptions and navigation this time due to the amount of data shared
- Virtual IRP meetings on Microsoft Teams until back in the office and able to hold large group meetings again
- TAC presentations and meeting notes posted on IRP page

# Virtual TAC Meeting Reminders

- Please mute mics unless speaking or asking a question
- Raise hand or use the chat box for questions or comments
- Respect the pause
- Please try not to speak over the presenter or a speaker
- Please state your name before commenting for the note taker
- This is a public advisory meeting – presentations and comments will be documented and may be recorded if the tech cooperates

# Integrated Resource Planning

The Integrated Resource Plan (IRP):

- Required by Idaho and Washington\* every other year
  - Washington now requires IRP every four years and update at two years
- Guides resource strategy over the next twenty + years
- Current and projected load & resource position
- Resource strategies under different future policies
  - Generation resource choices
  - Conservation / demand response
  - Transmission and distribution integration
  - Avoided costs
- Market and portfolio scenarios for uncertain future events and issues

# Technical Advisory Committee

- The public process piece of the IRP – input on what to study, how to study, and review of assumptions and results
- Wide range of participants involved in all or parts of the process
  - Ask questions
  - Always looking for help with soliciting new TAC members
- Open forum while balancing need to get through topics
- Welcome requests for studies or different assumptions.
- Available by email or phone for questions or comments between meetings
- Do TAC members want a calendar invite for the meetings?



# Today's TAC Agenda

9:00 – Introductions, Lyons

9:10 – 2021 Action Item Review,  
Lyons

9:45 – Summer 2021 Heat Event,  
Gall and Thompson

10:45 – NW Power Pool Resource  
Adequacy Program, Kinney

11:30 – Lunch

12:30 – Resource Adequacy Program Impact to  
IRP, Brutocao

1:00 – IRP Resource Adequacy/Resiliency  
Planning, Gall

1:45 – Break

2:00 – TAC Survey Results and Discussion,  
Hermanson

2:15 – Washington State Customer Benefit  
Indicators, Brandon and Gall

3:00 – 2023 IRP Draft Work Plan

3:30 – Adjourn



# 2021 IRP Action Item Review

2023 Avista Electric IRP

TAC 1, December 8, 2021 – TAC 1

John Lyons, Ph.D. – Senior Resource Policy Analyst

# 2021 IRP Action Item Review

- Investigate and potentially hire a consultant to develop both a hydro and load forecast to include a shift in climate in the Inland Northwest. This analysis would include a range in new hydro conditions and temperatures so the Company can utilize the new forecast for resource adequacy planning and baseline planning.
  - **Avista is internally studying temperature and precipitation trends at Natural Resources Conservation Service (NRCS) Snow Telemetry (SNOTEL) sites.**
  - **Studying when snowpack peaks, experiences total melt out, and whether the total amount of snow is increasing or decreasing at various locations during specific months.**
  - **Studying Clark Fork and Spokane River flow trends:**
    - **Is the annual flow amount increasing or decreasing?**
    - **Are the flow amounts during specific months increasing or decreasing?**
  - Working through CEATI (Centre for Energy Advancement through Technological Innovation) to examine the effects of Climate Change. The members of CEATI contracted with Artelys Canada Inc. to create the Streamflow Assessment Toolkit for Changing Conditions. Members of CEATI are using this program to look at:
    1. Future Streamflow Scenarios from Available Model Datasets
    2. Historic vs. Future Streamflow Variability
    3. Streamflow correlation with climate indices
    4. Timing of the Spring Freshet
    5. Agreement among Climate Projections
    6. Change in drawdown low-flows

## 2021 IRP Action Item Review

- Investigate streamlining the IRP modeling process to integrate the resource dispatch, resource selection and reliability verification functions.
  - **With the RAP progressing, the need for reliability verification functions may not be necessary.**
  - **Avista is evaluating Plexos to perform this task. We are assessing the dispatch of the system and have not tested the Capacity Expansion logic. Avista does not anticipate using Plexos for the 2023 IRP with the exception of risk assessments.**
- Study options for the Kettle Falls CT regarding potential reductions of the natural gas supply in winter months. The Company will investigate alternatives for this resource including fuel storage, retirement or relocation of the asset.
  - **Avista is still investigating when the plant will be impacted from potential changes and is currently studying alternatives.**

## 2021 IRP Action Item Review

- Determine how to best implement the Washington Commission's strong encouragement under WAC 480-100-620 (3) regarding distribution energy resource planning as a separate process or in conjunction with the 2025 IRP.
  - **This is an area of ongoing work that will be shared with the TAC in 2022.**
  - **Additional staff budgeted for 2022 to help with this effort.**
- Form an Equity Advisory Group to ensure a reduction in burdens to vulnerable populations and highly impacted communities and to ensure benefits are equitably distributed in the transition to clean energy in the state of Washington. This group will provide guidance to the IRP process on ways to achieve these outcomes.
  - **Equity Advisory Group is up and running. They are a major component of the Clean Energy Implementation Plan.**

## 2021 IRP Action Item Review

- Avista will conduct an existing resource market potential to estimate the amount and timing of existing resources available through 2045.
  - **Avista is conducting an all-source RFP in Q1 2022 to identify resources through 2030.**
  - **Avista will study resource opportunities between 2030 and 2045 after the RFP and other regional RFPs are complete.**
- Conduct further peak credit analysis to understand the reliability benefits of all resources including demand response options with different duration and call options of the wide range of DR program options.
  - **Avista plans to use the Resource Adequacy Program Qualifying Capacity Credit (QCC).**
  - **Avista expects the RAP to develop QCC values in Q1 or Q2 of 2022.**

# 2021 IRP Action Item Review

- Avista will partner with a third-party consultant to identify non-energy impacts that have not historically been quantified for both energy efficiency and supply side resources.
  - **DNV was awarded a contract to study these impacts and will present their draft report at the March 2022 TAC meeting.**
  - **TAC participants will be able to provide comments prior to the final draft in April 2022.**
- Formalize the process for public to submit IRP-related comments and questions and for Avista to share responses to those requests.
  - **Realized we need a better system and structure with the sheer amount of data being shared.**
  - **Still deciding if we will set something up and change as needed or provide options for feedback.**
- Develop a transparent methodology to include pricing data and consider available options for new renewable generation and energy storage options.
  - **The 2021 IRP included Avista's spreadsheet for resource cost calculations, due to the complexity of the analysis, Avista seeks input from TAC members on how to best share the information.**



# 2021 Heatwave Loads & Resources

Avista, Electric Technical Advisory Committee

December 8<sup>th</sup>, 2021 – TAC 1

James Gall, Electric IRP Manager



# Regional Temperatures

Annual highest temp, 1948 - 2021

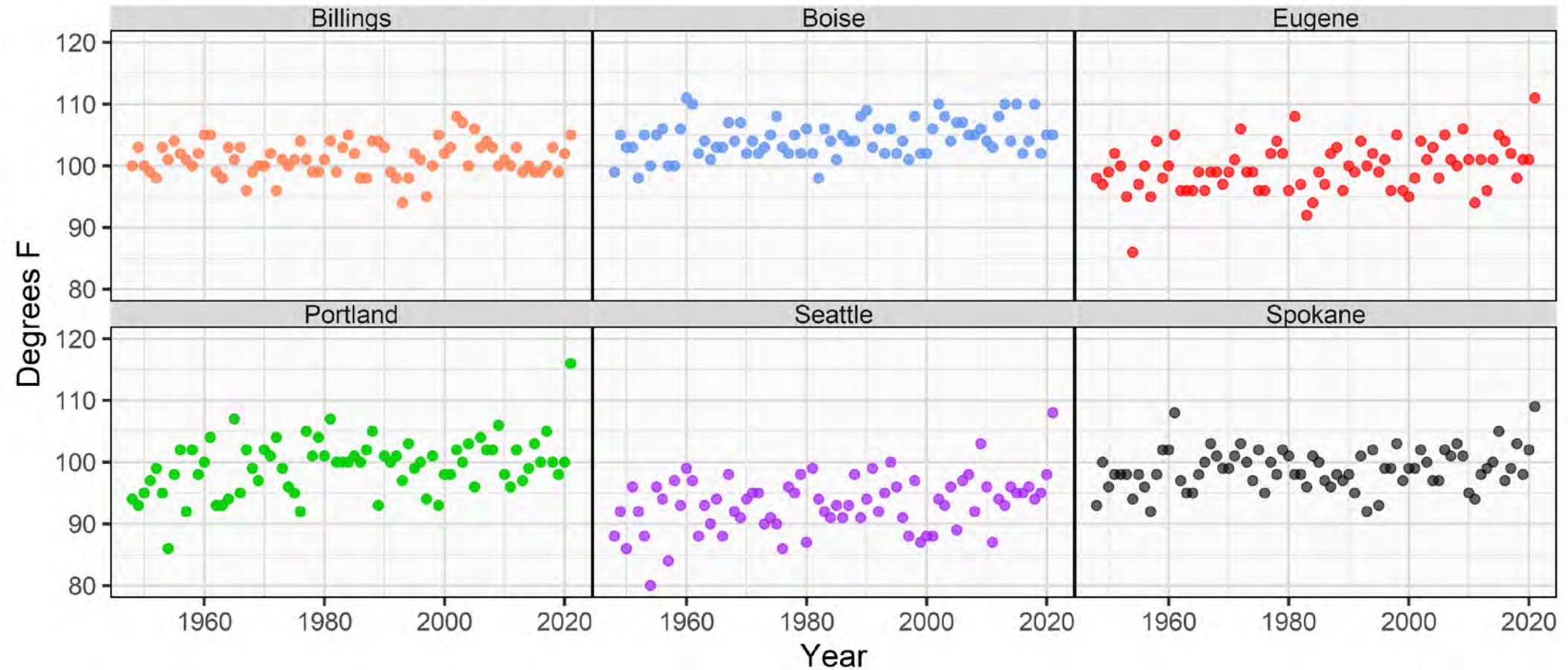

# Pacific Northwest Loads vs Temperature

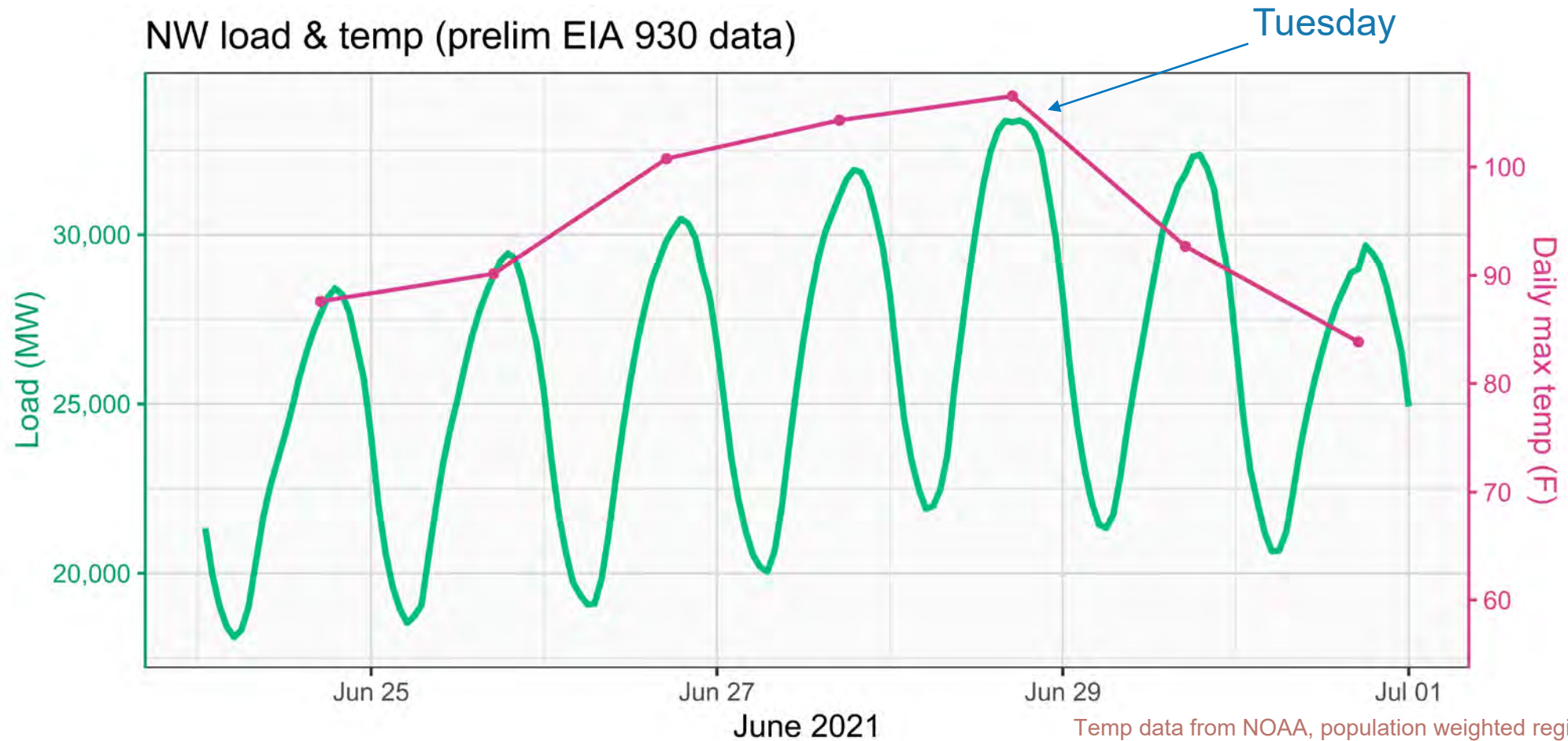

Temp data from NOAA, population weighted regional average (SEA .40; PDX .24; BOI .12; GEG .11, BIL .07, EUG .05)  
 Load data from EIA 930; 12 NW BA coincident loads (AVA, BPA, CHPD, DOPD, GCPD, IPC, NWE, PACW, PGE, PSE, SCL, TWPR)

# NW vs California Loads

Max daily temperatures, July 1998 - early August 2021

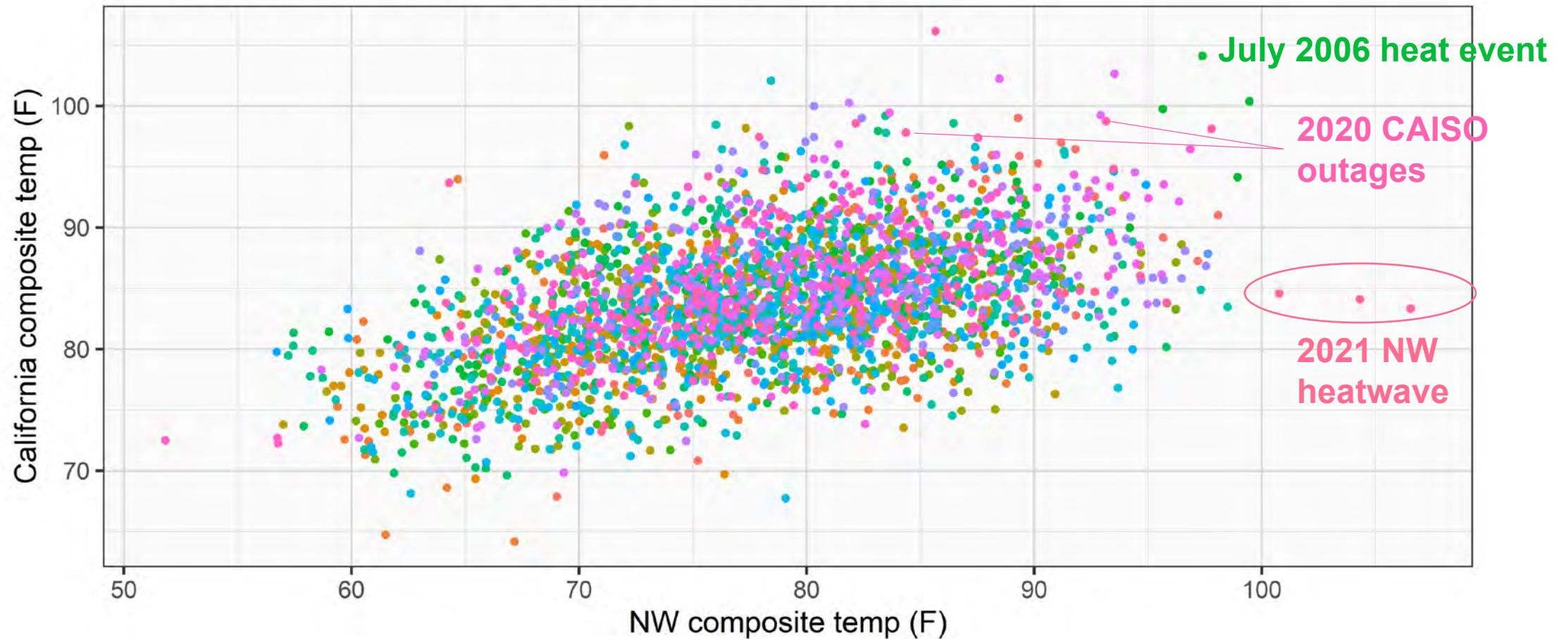

Northwest temp data from NOAA, population weighted regional average (*SEA .40; PDX .24; BOI .12; GEG .11, BIL .07, EUG .05*)  
California temp data from NOAA, roughly weighted average (LA (USC), SAN, SMF, FAT, SJC)

# Spokane Historical Hottest Days

(Avg High & Low Daily Temperature)

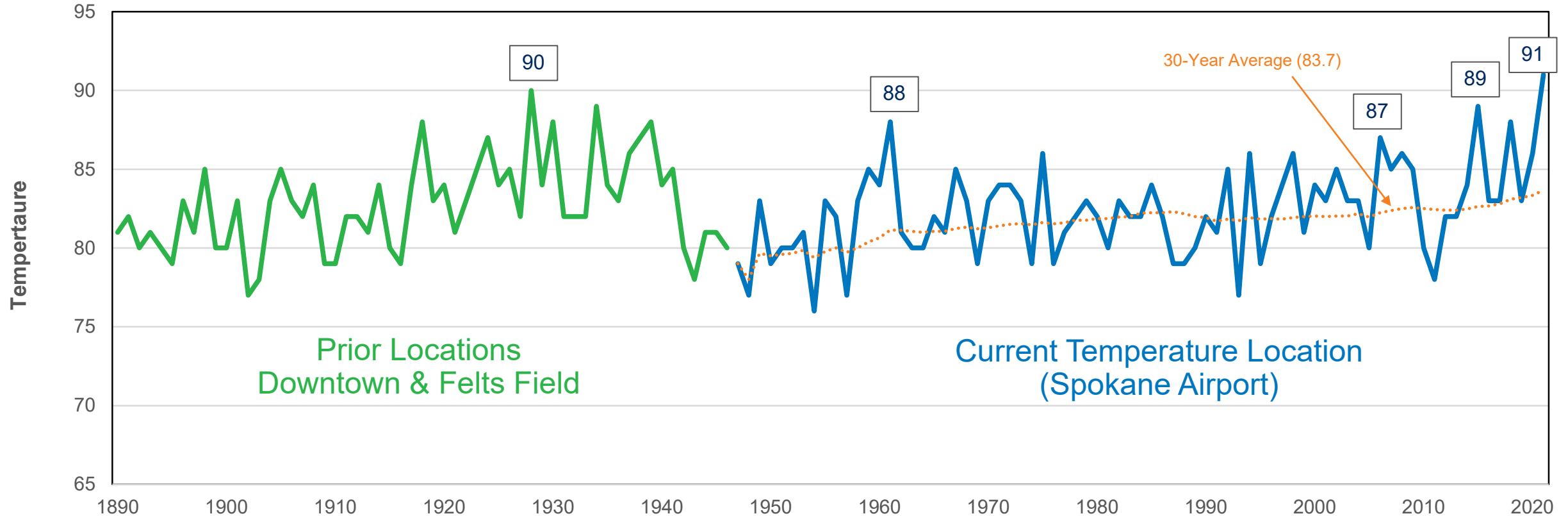

Note: temperatures are not adjusted for locational differences, but summer months

# Avista Peak Loads in Perspective

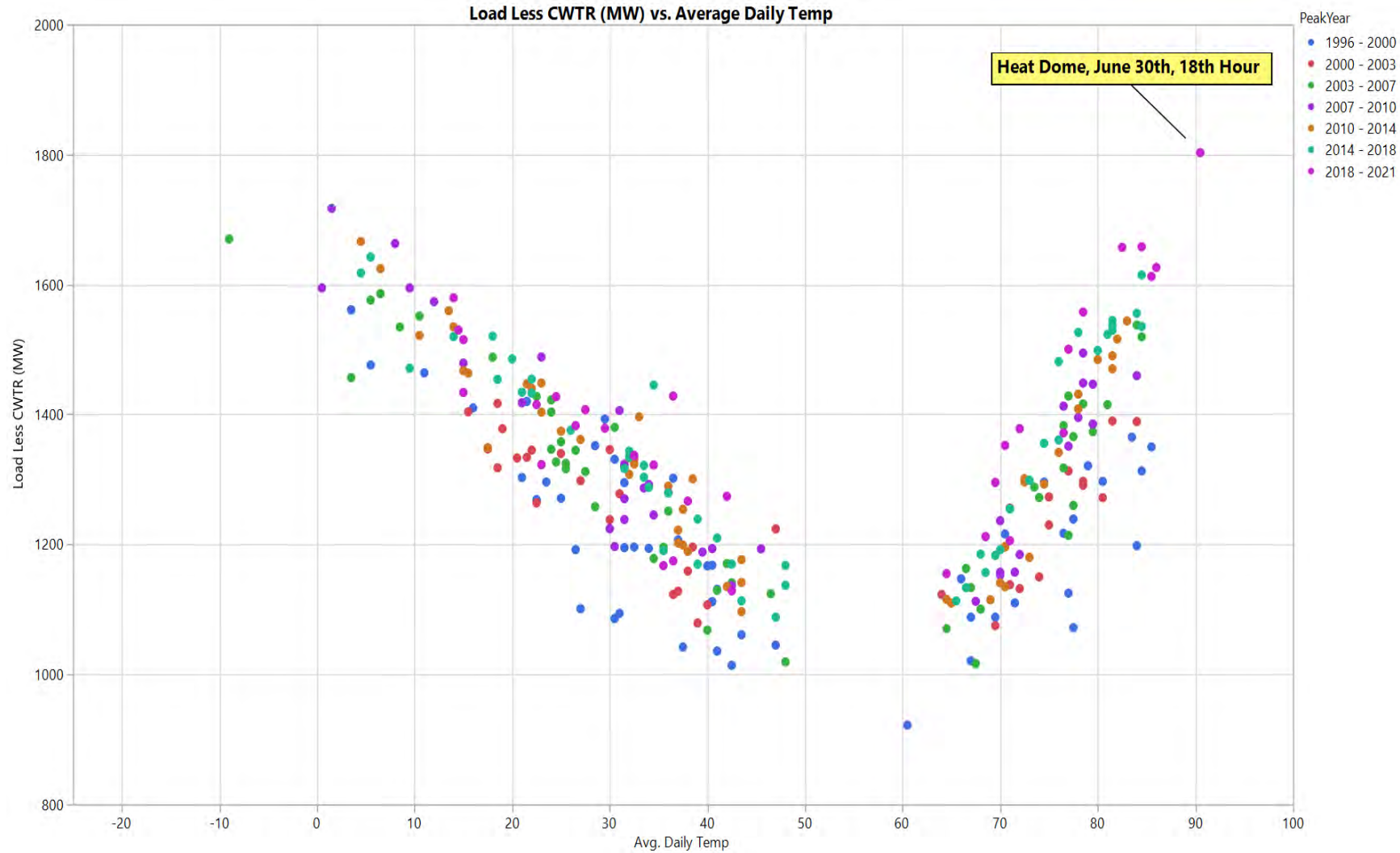

# Avista Hourly Loads

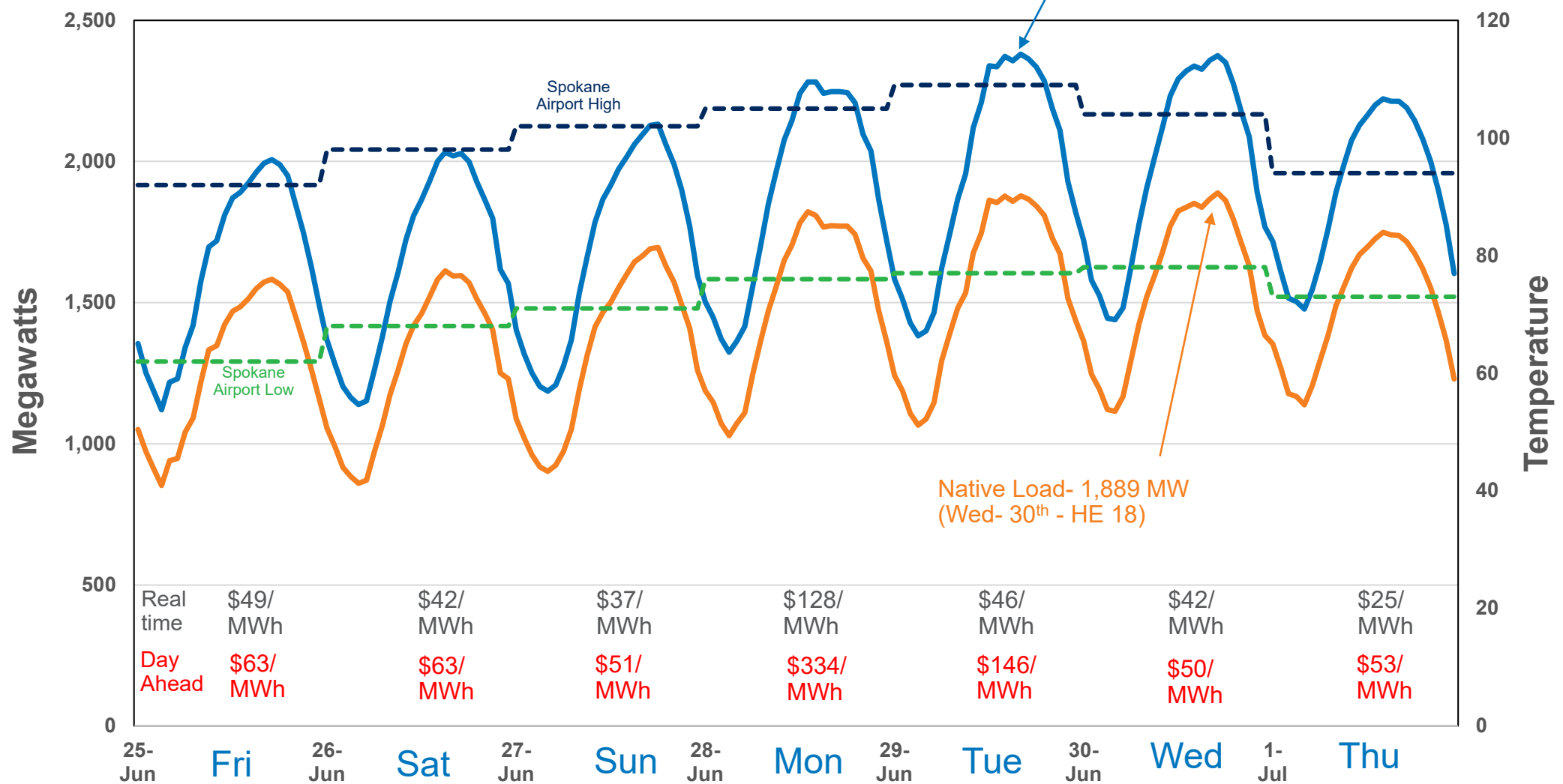

# Load vs Variable Energy Production

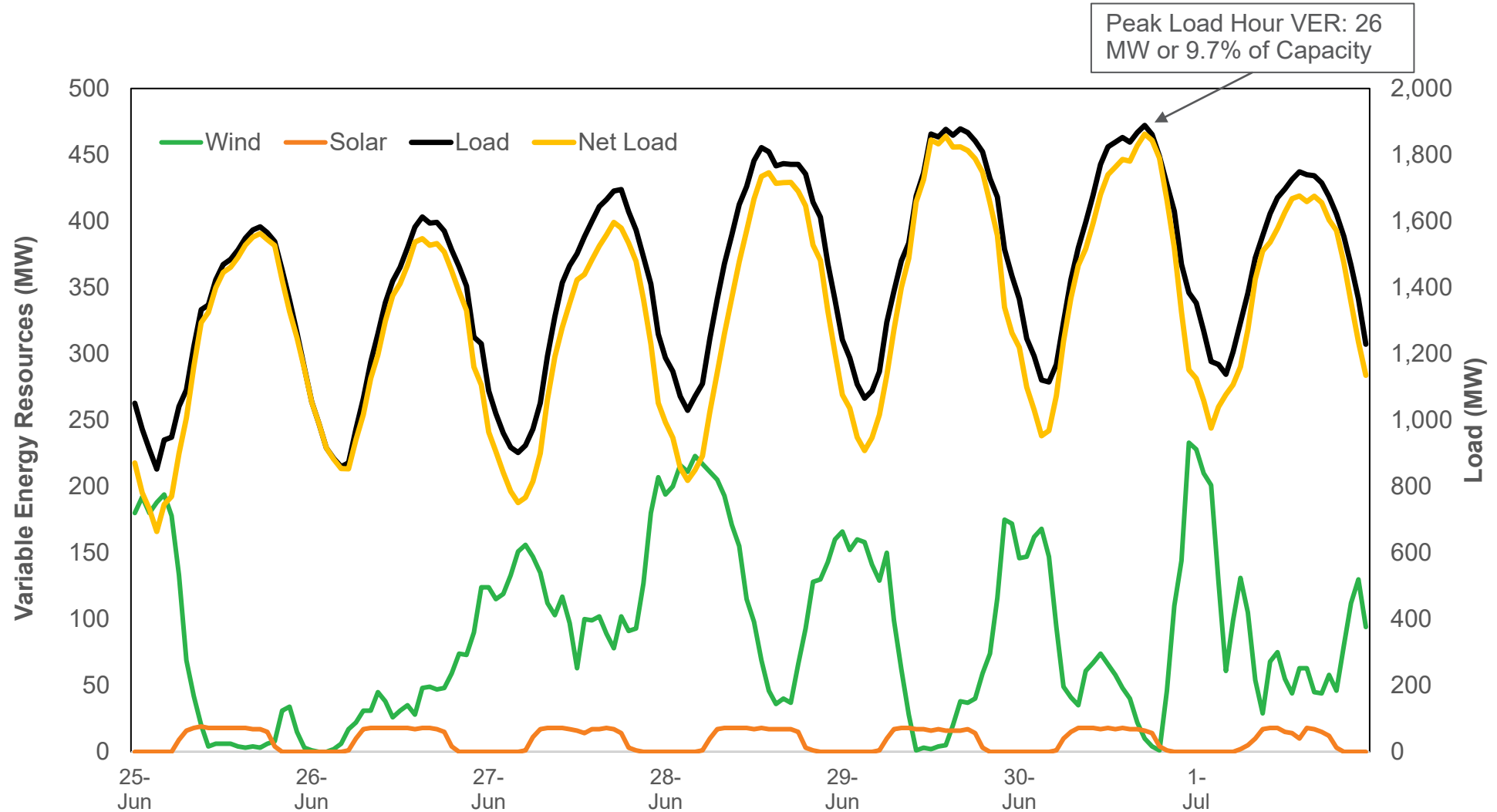

# Summer Peak Load Forecast Implications

- Actual peak load was 92 MW higher (5%) than fundamental forecast given the actual temperature.
- Avista will move to a 30-year average hottest day for summer peak load forecasting.
- Improve peak load forecast techniques.





# Heat Event- Emergency Operating Plan June 28 – July 1, 2021

2023 Electric IRP – TAC 1

December 8, 2021

David Thompson, System Planning Engineer

# EOP Overview June 25 – July 1, 2021

## Event Overview

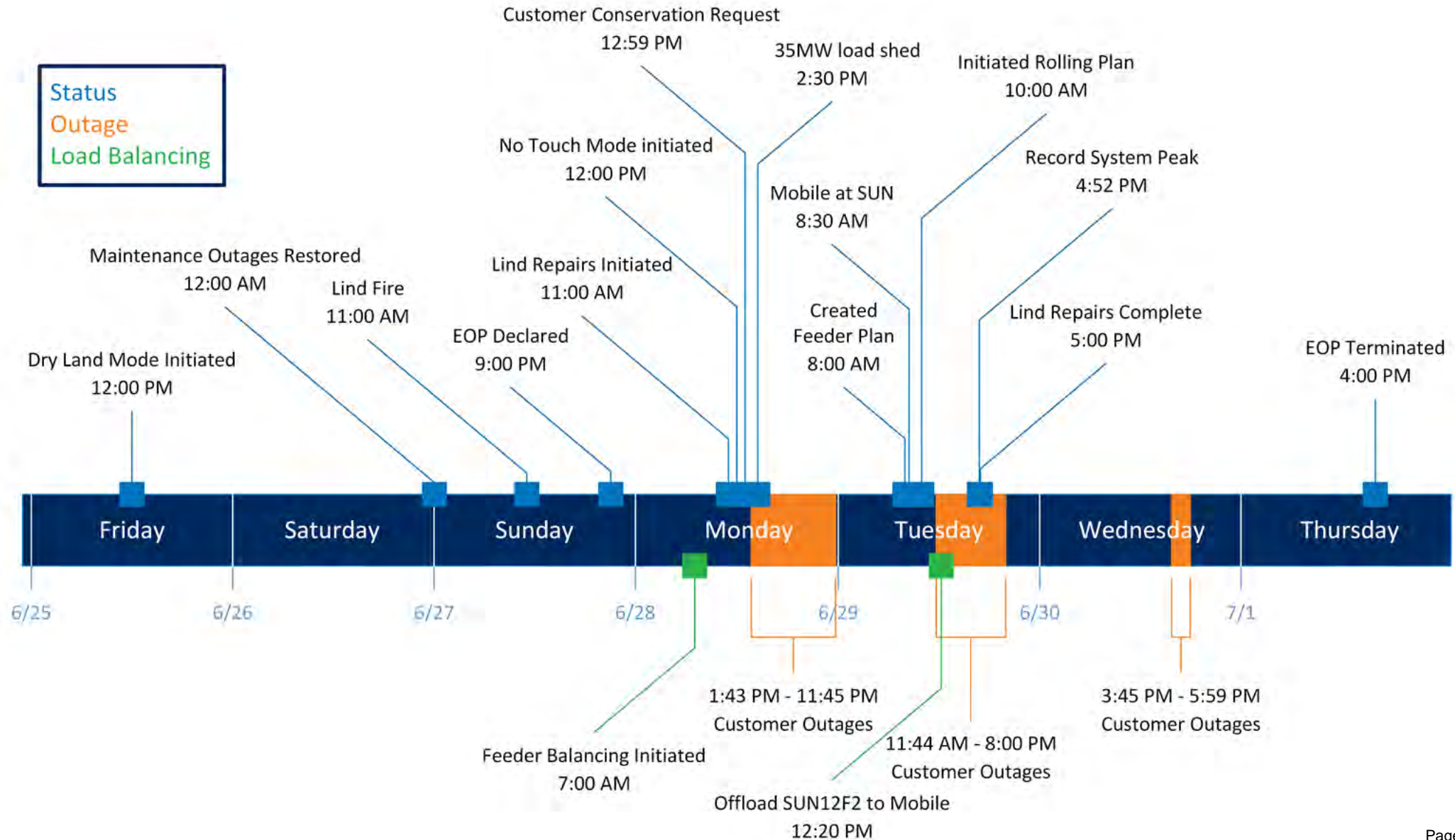

# Temperature Metrics

Date	High Temperature (°F)		Low Temperature (°F)	
	Forecast	Actual	Forecast	Actual
Monday, 6/28	108	105*	73	76
Tuesday, 6/29	110	109*	74	77
Wednesday, 6/30	108	104	74	78
Thursday, 7/1	106	94	73	73

- Record high daily temperatures forecasted by National Weather Service
- Expected significant customer demand for HVAC with indoor activities
- Relatively high “low” temperatures limited equipment cooling

# Balancing Authority Area Peak

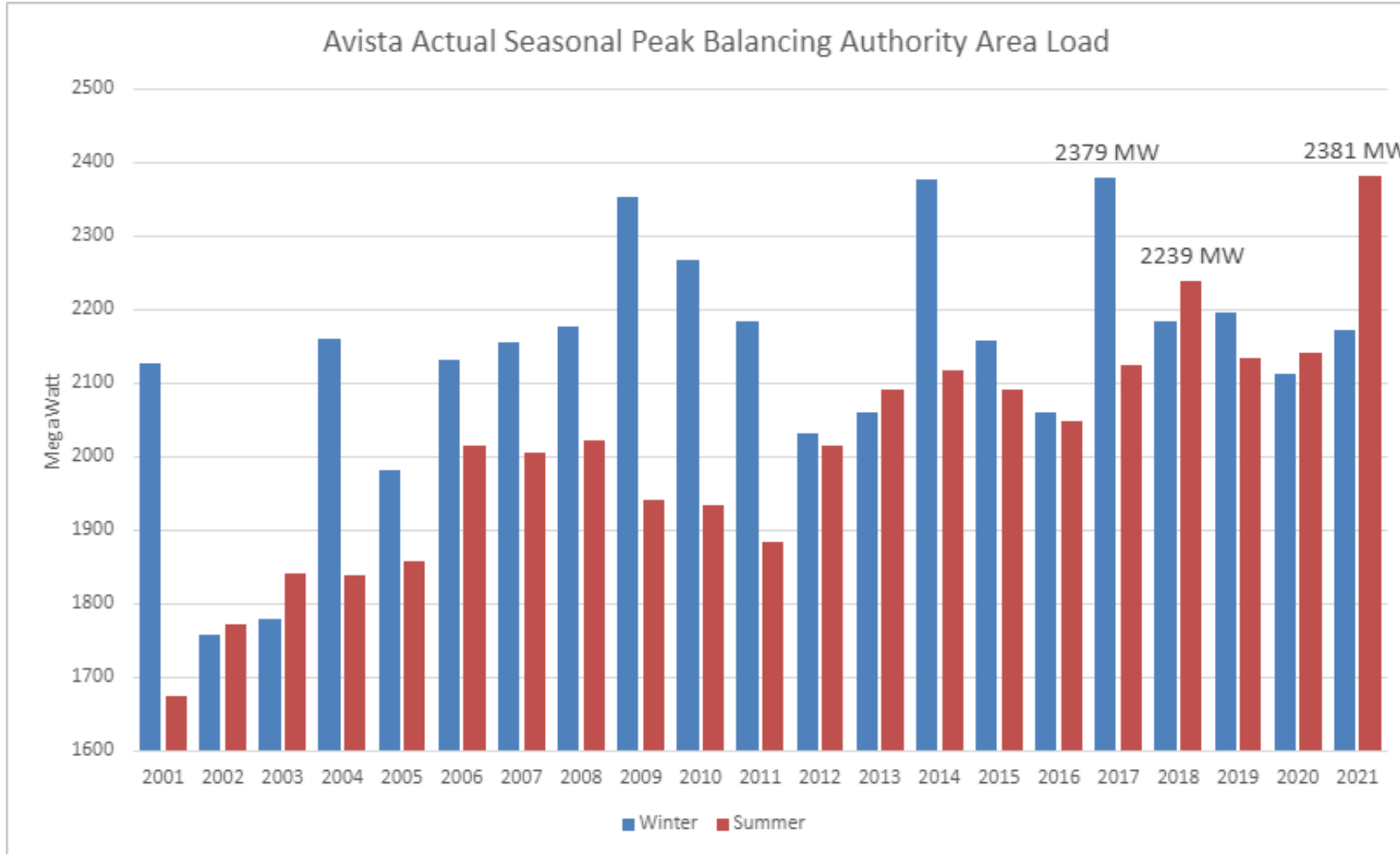

June 28	2,285 MW
June 29	2,381 MW
June 30	2,358 MW

New peak load is 6% increase over prior record.

# Summer Challenges

- Equipment capacity ratings are typically reduced with increasing ambient temperatures
- Cooling systems can adjust capacity ratings

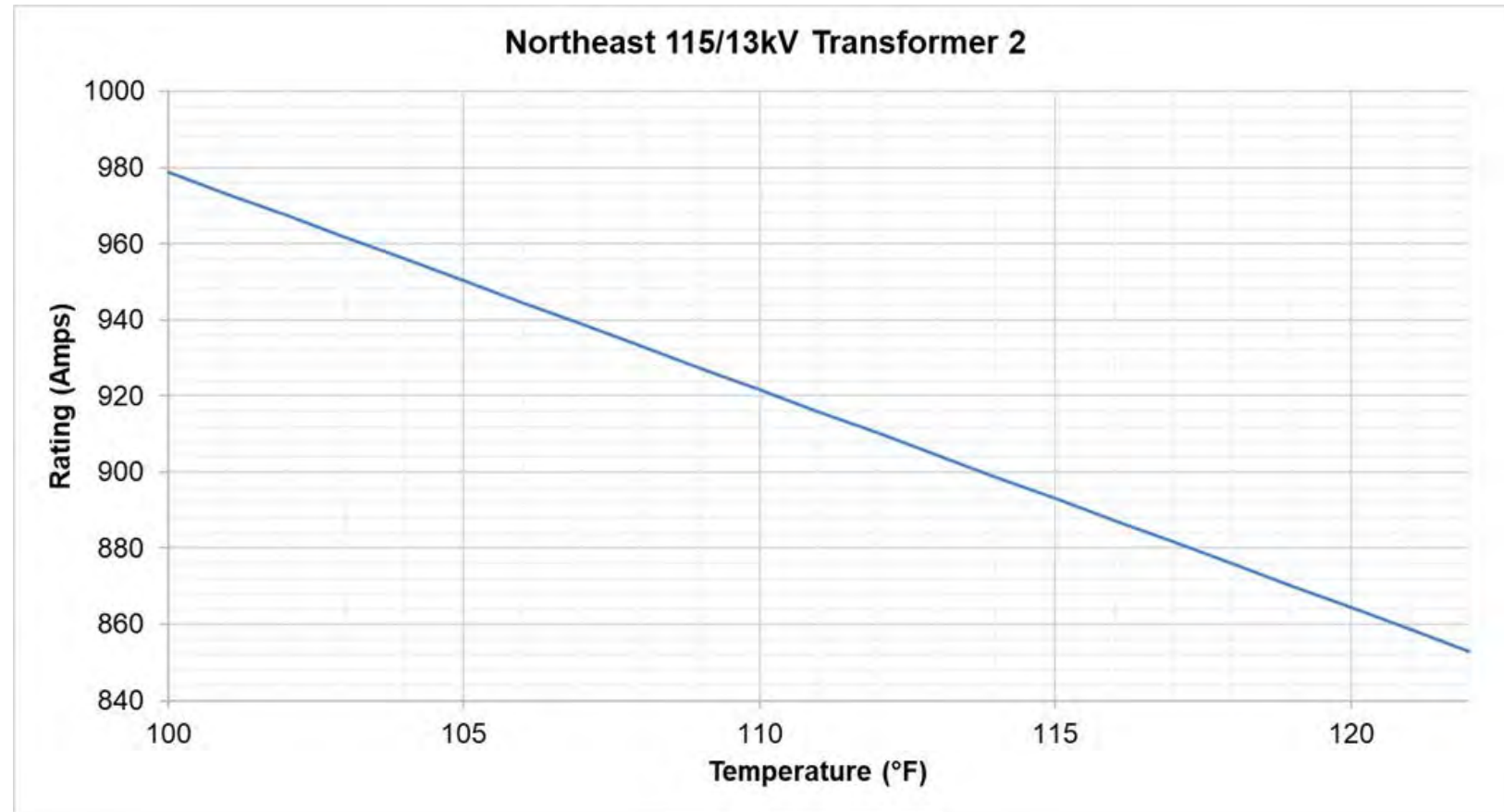

## Heat EOP Performance-Distribution Transformers

- Operating limits are monitored for equipment protection
- 201 transformers in 140 substations throughout Avista's service territory
- Minor alarm at 80°C (176°F), monitored for continued safe operation
- Major alarm at 115°C (239°F), transformer to be taken out of service

Operating Limit	June 28	June 29	June 30
≥80%	19	32	19
≥90%	7	7	1

# Northeast 115/13kV Transformer 2

Monday, June 28

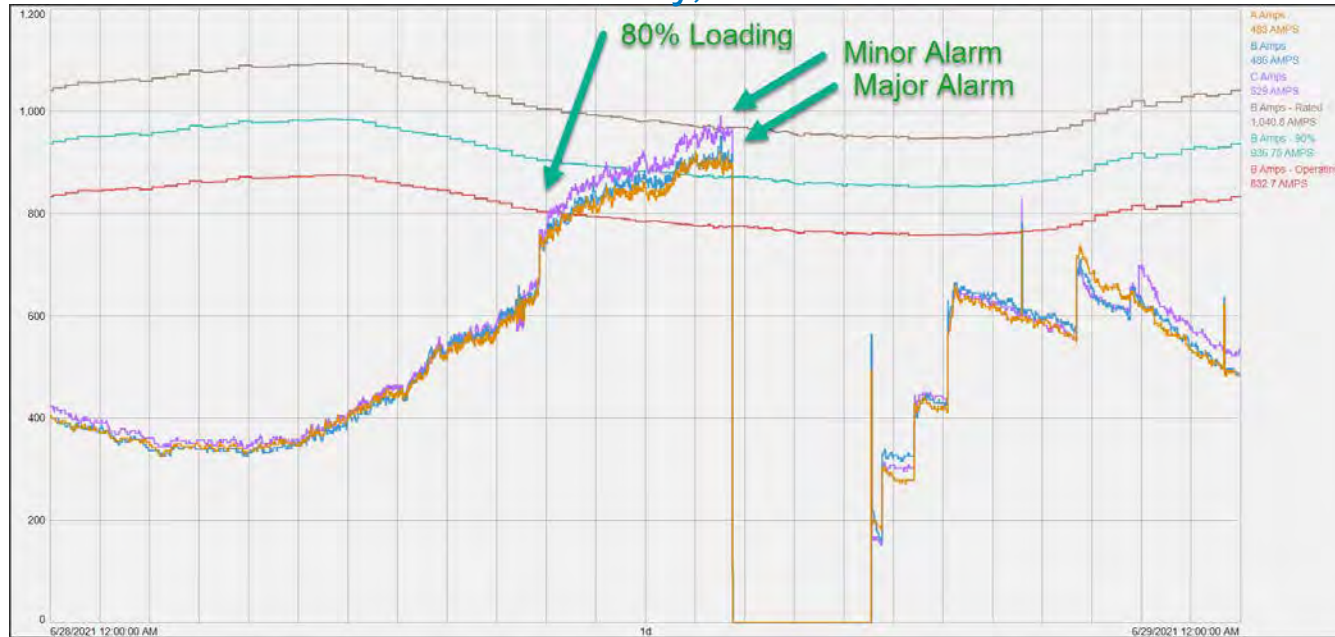

- 9:50 a.m. - Transferred ROS12F1 feeder to Northeast
- 10:18 a.m. – 80% loading
- 1:32 p.m. – minor alarm at 96%
- 1:41 p.m. – major alarm, dropped customers
- Investigation found three cooling fans nonfunctional

# Sunset 115/13kV Transformer 2

- 1:44 p.m. – reached 80%
- 4:12 p.m. – major alarm at 89%, dropped customers on SUN12F2
- 5:30 p.m. – restored SUN12F2
- 7:47 p.m. – major alarm, dropped SUN12F1
- Mobile Substation 4 used to energize SUN12F2, required 4-hour outage

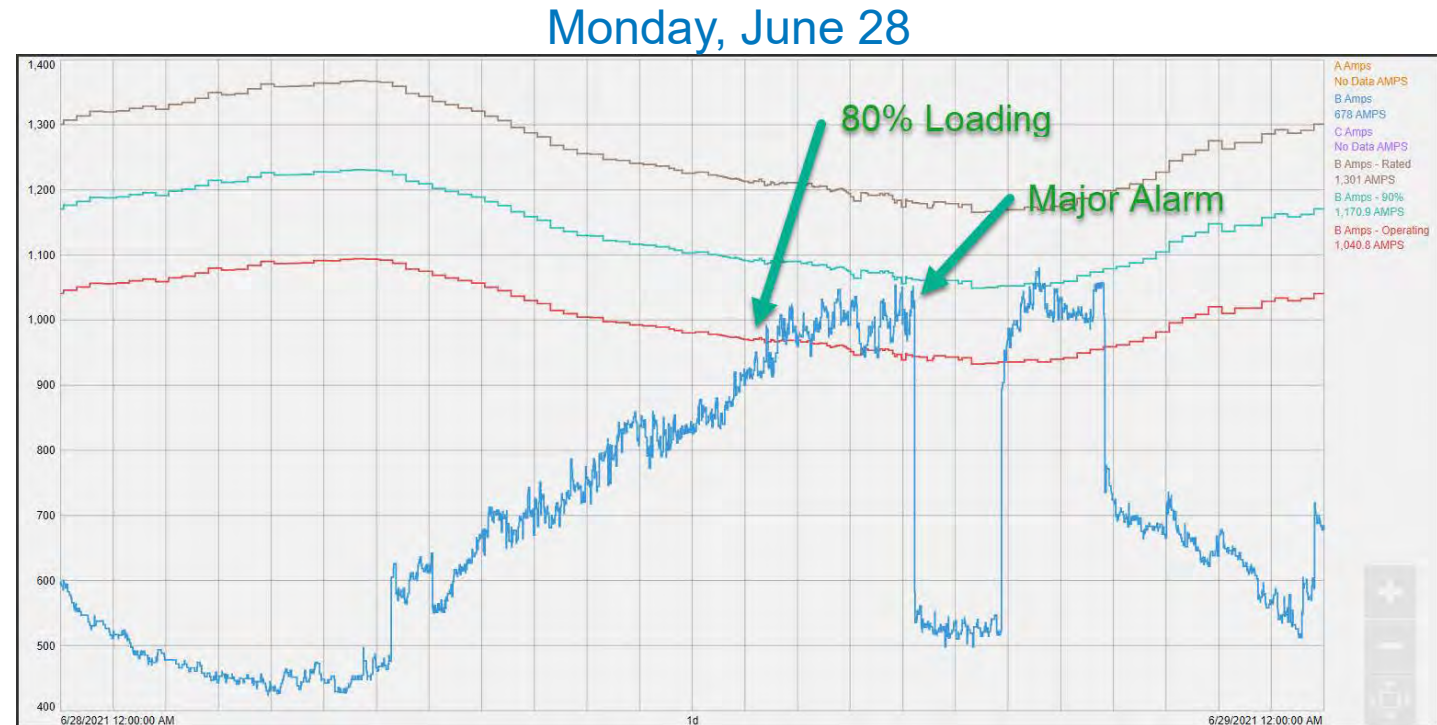



## Heat EOP Performance-Distribution Feeders

- Operating limits are monitored for equipment protection
- 369 distribution feeders connecting substations to customer load
- Operation at 80% of limit initiates notification
- Operation at 100% of limit requires unloading

Operating Limit	June 28	June 29	June 30
≥80%	39	53	32
≥90%	13	16	5

# Transferring Load

- Move load from heavily loaded feeder to adjacent feeder
- Requires surplus capacity on adjacent feeders
- Transfers accomplished remotely or with field crews, depending on feeders

Timestamp	Switching Notice	Load Transfer Action
6/24, 7:18 a.m.	CDA 21-56	HUE142 to HUE141 <sup>1</sup>
6/28, 8:30 a.m.	SPD 21-92	COB12F2 to MEA12F3
6/28, 9:30 a.m.	CDA 21-57	PRA222 to PF212
6/28, 9:50 a.m.	SPD 21-91	ROS12F1 to NE12F1
6/28, 11:30 a.m.	SPD 21-93	GLN12F1 to 3HT12F2
6/28, 11:30 a.m.	SPD 21-94	GLN12F2 to SE12F2
6/28, 3:12 p.m.	CDA 21-58	APW112 to APW115
6/28, 3:44 p.m.	SPD 21-96	WAK12F1 to MEA12F2
6/28, 5:18 p.m.	CDA 21-59	HUE142 to DAL132
6/28, 11:33 p.m.	DO210629	Restore SUN12F1 from C&W12F4 and SUN12F6
6/29, 1:45 a.m.	DD210628	MEA12F2 to WAK12F1
6/29, 8:00 a.m.	CDA 21-60	DAL132 to DAL135
6/29, 9:00 a.m.	PAL 21-18	M15513 to M15514
6/29, 10:41 a.m.	SPD 21-99	NE12F4 to BEA12F2
6/29, 10:45 a.m.	LC 21-20	SLW1358 to LMR1530
6/29, 1:00 p.m.	PAL 21-19	TUR116 to TUR112
6/29, 1:30 p.m.	CDA 21-62	DAL131 to AVD151
6/29, 2:10 p.m.	CDA 21-63	DAL132 to DAL136
6/29, 7:39 p.m.	DO2100629-1	H&W12F2 to H&W12F5 SUN12F2 to H&W12F1
6/30, 9:30 a.m.	CDA 21-64	SPT4521 to SAG742
6/30, 12:01 p.m.	CDA 21-61	PRA221 to PRA222

# Feeder Balancing

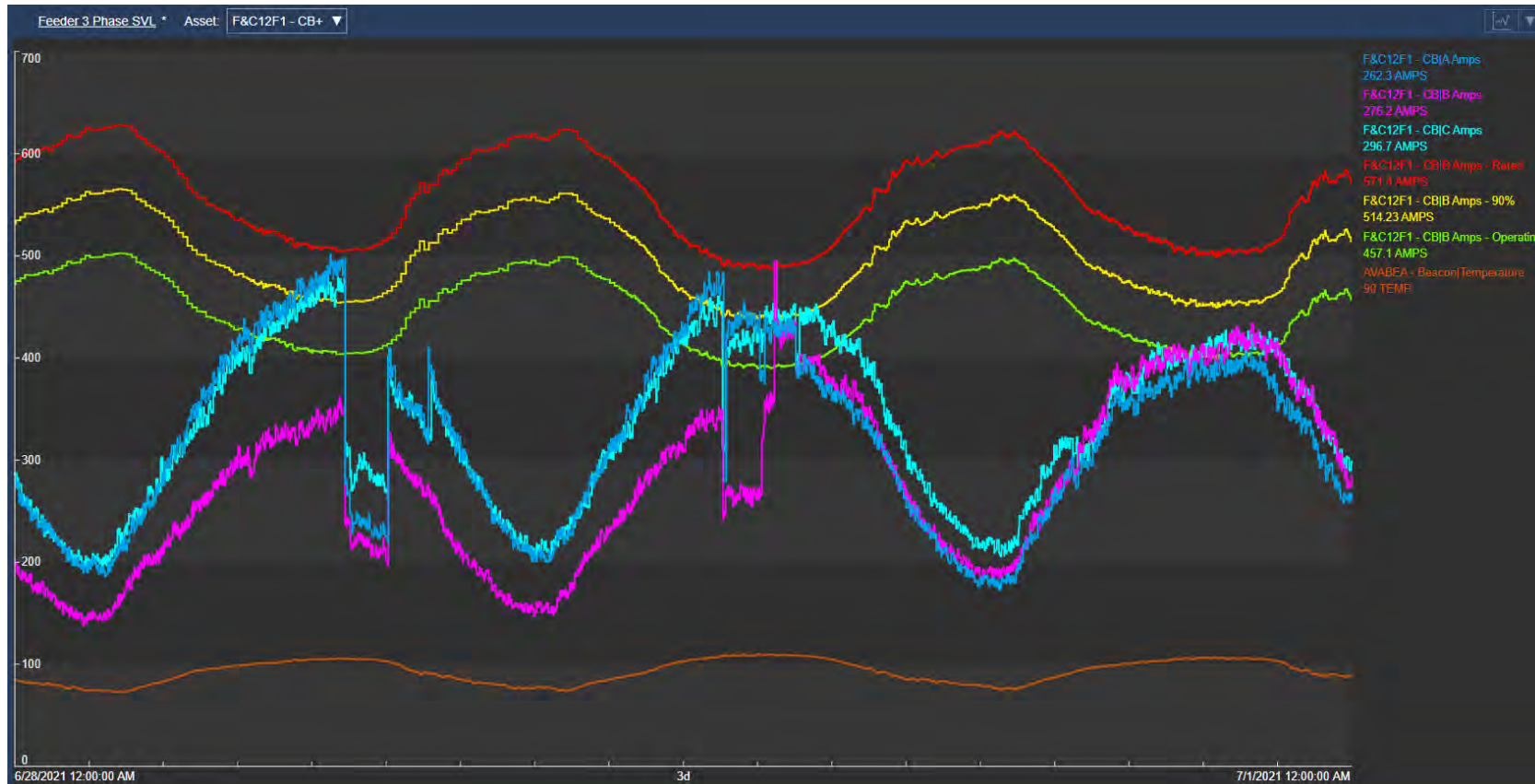

Feeder	June 28	June 29	June 30
3HT12F2	--	4	--
3HT12F4	--	4	--
BEA12F5	--	--	1
BKR12F1	--	1	--
DAL131	3	--	--
F&C12F1	--	1	1
F&C12F2	2	--	--
F&C12F4	--	--	1
IDR253	--	--	1
L&S12F4	--	1	--
LMR1530	--	1	--
NE12F1	--	2	--
PRA221	--	1	--
<b>Total</b>	<b>5</b>	<b>15</b>	<b>4</b>

# Customer Engagement

- Demand response conservation requests
- Commercial customer reduced 35MW on Monday afternoon
- Two high schools
- College campus
- Local water district

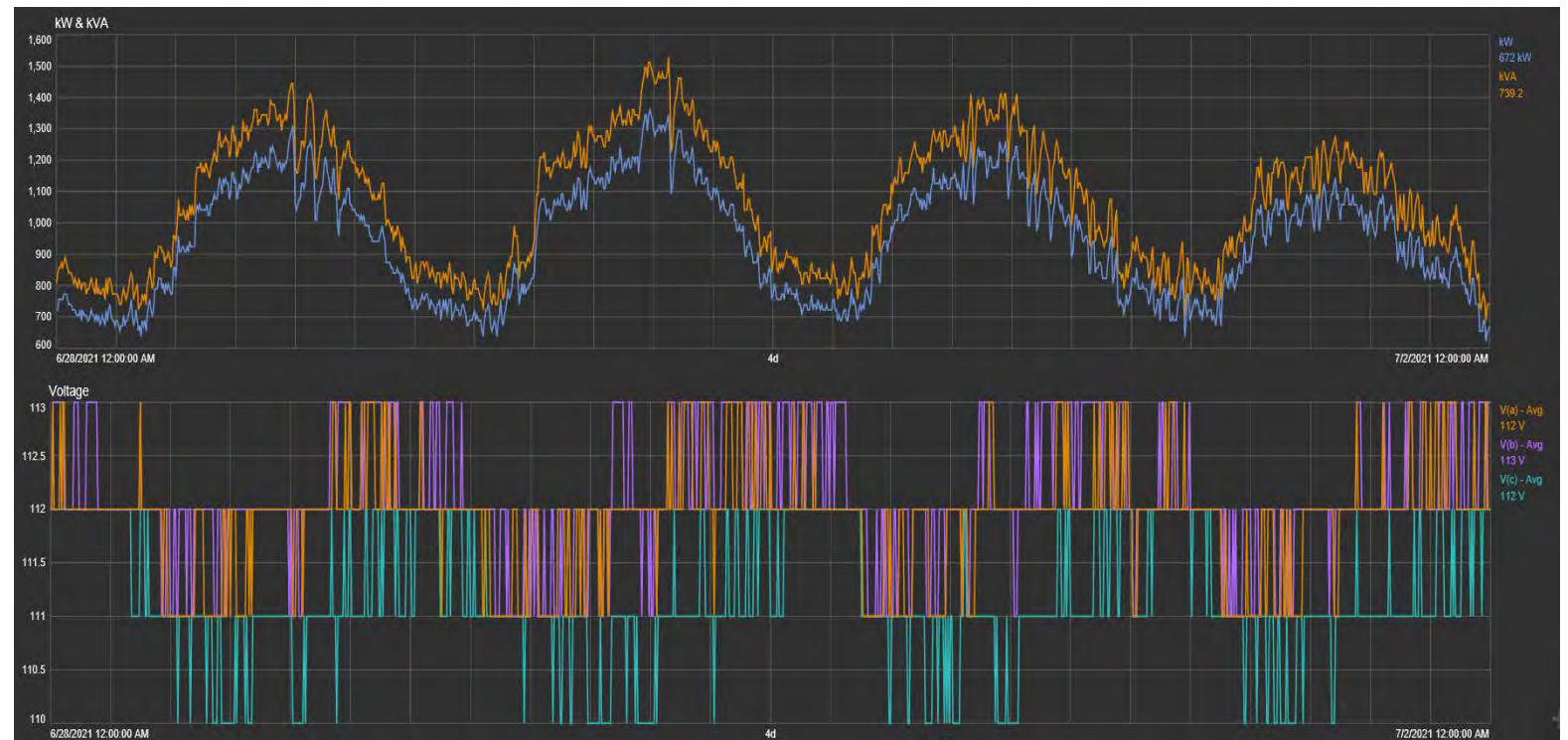

# Heat EOP Performance-Transmission System

- Equipment issues
  - Three 230kV breakers
  - One 230/115kV transformer
  - Next issue would pose significant outage challenges
- No impacts to customers

# Rathdrum Station

- Breaker R-403
  - Cabinet – Rathdrum transmission line
  - Failed bushing
  - Monday 4:47 a.m. until Friday
- Breaker R-400
  - Beacon – Rathdrum transmission line
  - Leaking bushing
  - Wednesday 9:05 a.m. until Thursday
- Additional device failure would likely cause transmission outage

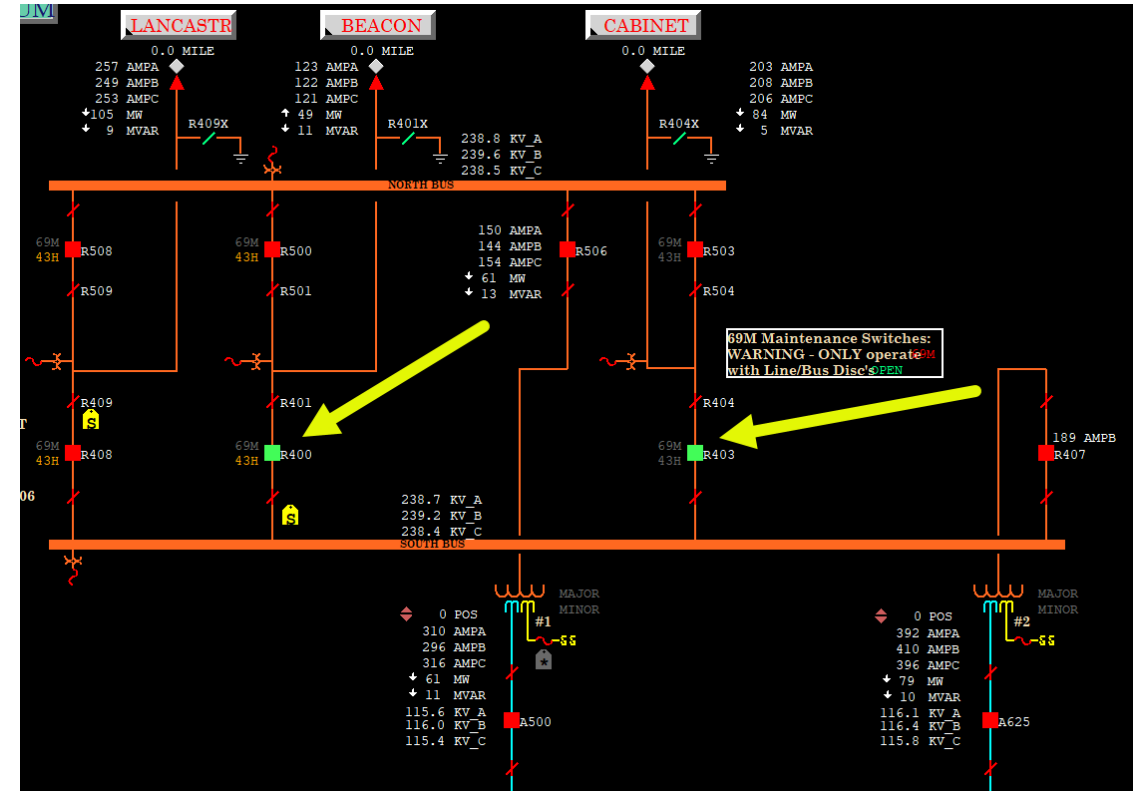

# Beacon Station

- Breaker R-432
  - Beacon – Boulder transmission line
  - Failed bushing
  - Monday 11:39 p.m. until Tuesday 5:13 p.m.
- Beacon 230/115kV Transformer 2
  - Multiple major alarms on Tuesday but operating at 80% of capacity
  - Cooling fan bank loss of power

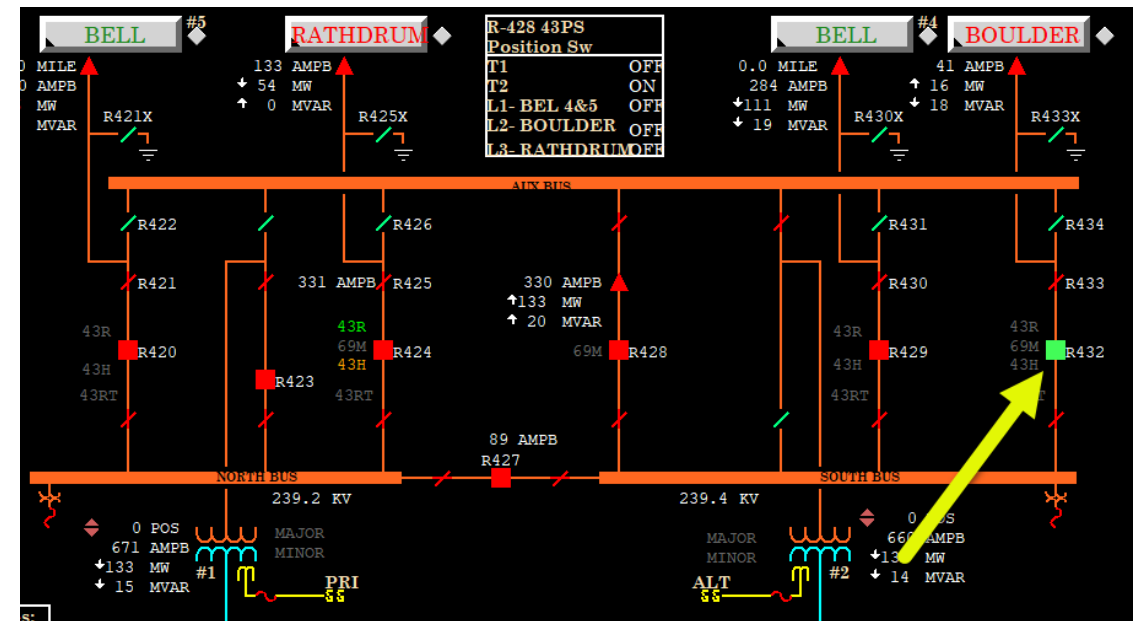

# Heat EOP Summary

- 31 protective events caused customer outages
  - 16,029 customer outages on Monday, June 28
  - 5,523 customers with outages on Tuesday, June 29
  - 603 customers with outages on Wednesday, June 30
- Customer outages regions
  - South Lewiston area
  - Greater Spokane area



# Recommendation Summary

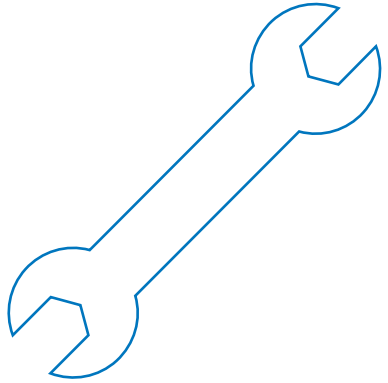

**Capacity Mitigation**

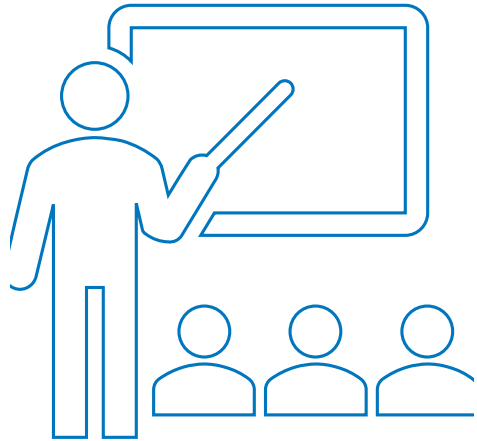

**Distribution System  
Planning  
Assessment**



**Feeder Balancing  
Program**

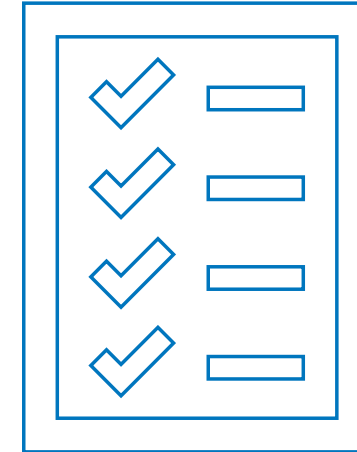

**Operational  
Planning**

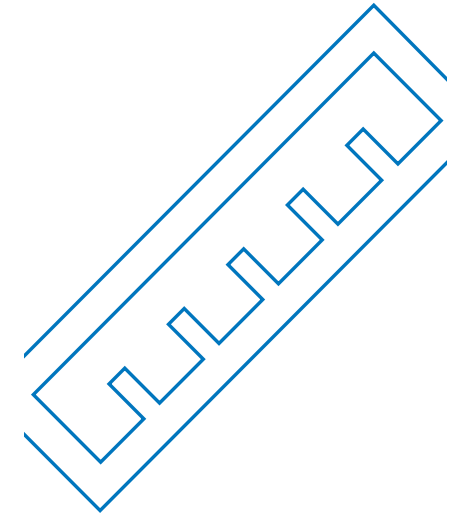

**Major Equipment  
Utilization**

# Q&A

Thank You

# WESTERN RESOURCE ADEQUACY PROGRAM

*AVISTA TAC MEETING*

*DECEMBER 8, 2021*



# AGENDA

- » Overview
- » Timeline
- » Participation
- » Design Framework
- » Governance
- » Costs and Benefits
- » Next Steps

# OVERVIEW

- » The WRAP is a regional capacity program
  - › *Similar programs are available across North America*
  - › *Significant effort to build organizational structure necessary to administer program*
  - › *Capacity will improve reliability in most expedient manner*
  
- » Not building a market – relying on current bilateral structure
  - › *Will not set prices for energy*
  - › *Load Responsible Entity (LRE) remain responsible for determining which resources participate and are potentially deployed*



# BENEFITS

## » RELIABILITY

- › *Ensure sufficient generation and transmission resources are installed and committed to reliably serve demand, during stressed grid and market conditions, with a high degree of confidence*

## » COST SAVINGS

- › *Unlock the benefits of diversity in supply and demand in a safe and equitable way*

## » IMPROVED VISIBILITY & COORDINATION

- › *Enable members to make fully informed RA planning decisions, using common industry planning metrics and methods*



# PROJECT TIMELINE

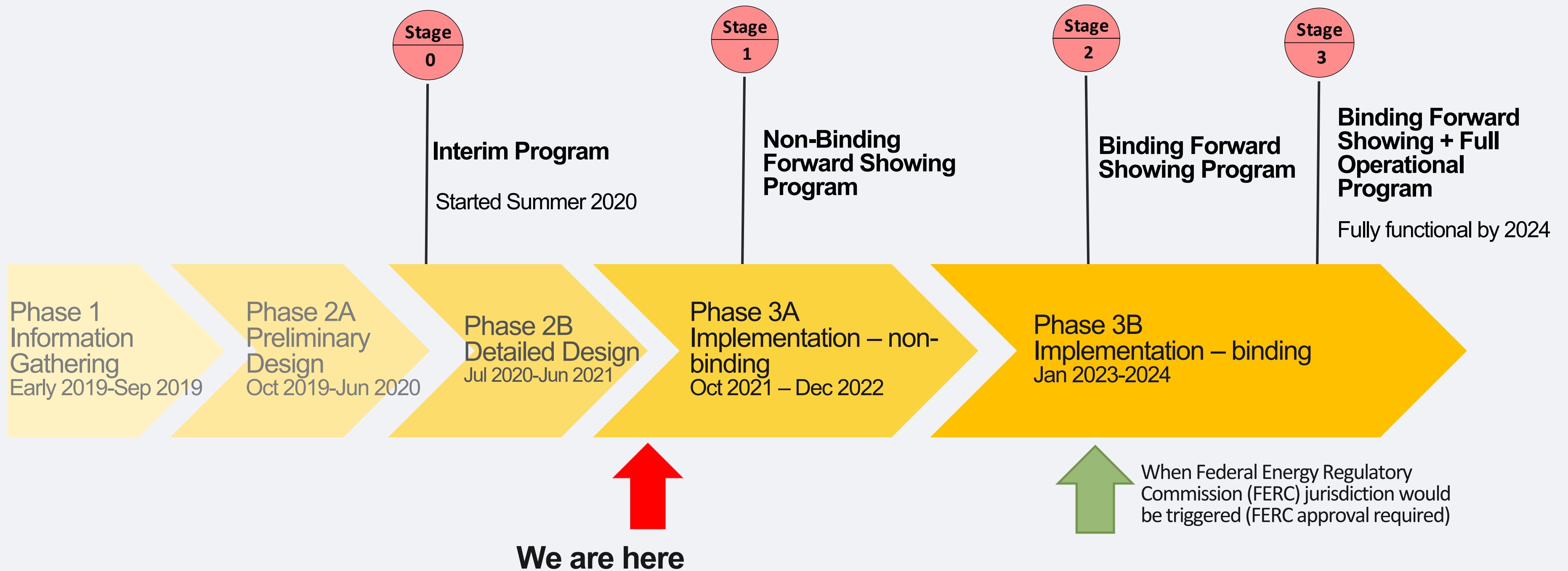

# PROGRAM PARTICIPATION

- Participation open to Load Responsible Entities (LREs) – both in and outside current NWPP footprint
- Voluntary entry (absent any contractual or other regulatory requirements), followed by obligation to comply
- Participants decide how they will meet the program resource requirements – through resource ownership or contracts
- Participants agree to use common resource planning metrics
- IPPs and LREs (program Participants and those not participating) are all eligible to contract with Participants



# INITIAL PHASE 3A PARTICIPANTS

- APS
- AVANGRID
- AVISTA
- BLACK HILLS
- BPA
- CALPINE
- CHELAN PUD
- CLATSKANIE PUD
- DOUGLAS PUD
- EWEB
- GRANT PUD
- IDAHO POWER
- NORTHWESTERN
- NV ENERGY
- PACIFICORP
- PGE
- POWEREX
- PSE
- SRP
- SCL
- SHELL
- SNOHOMISH PUD
- TACOMA POWER
- TEA
- TID

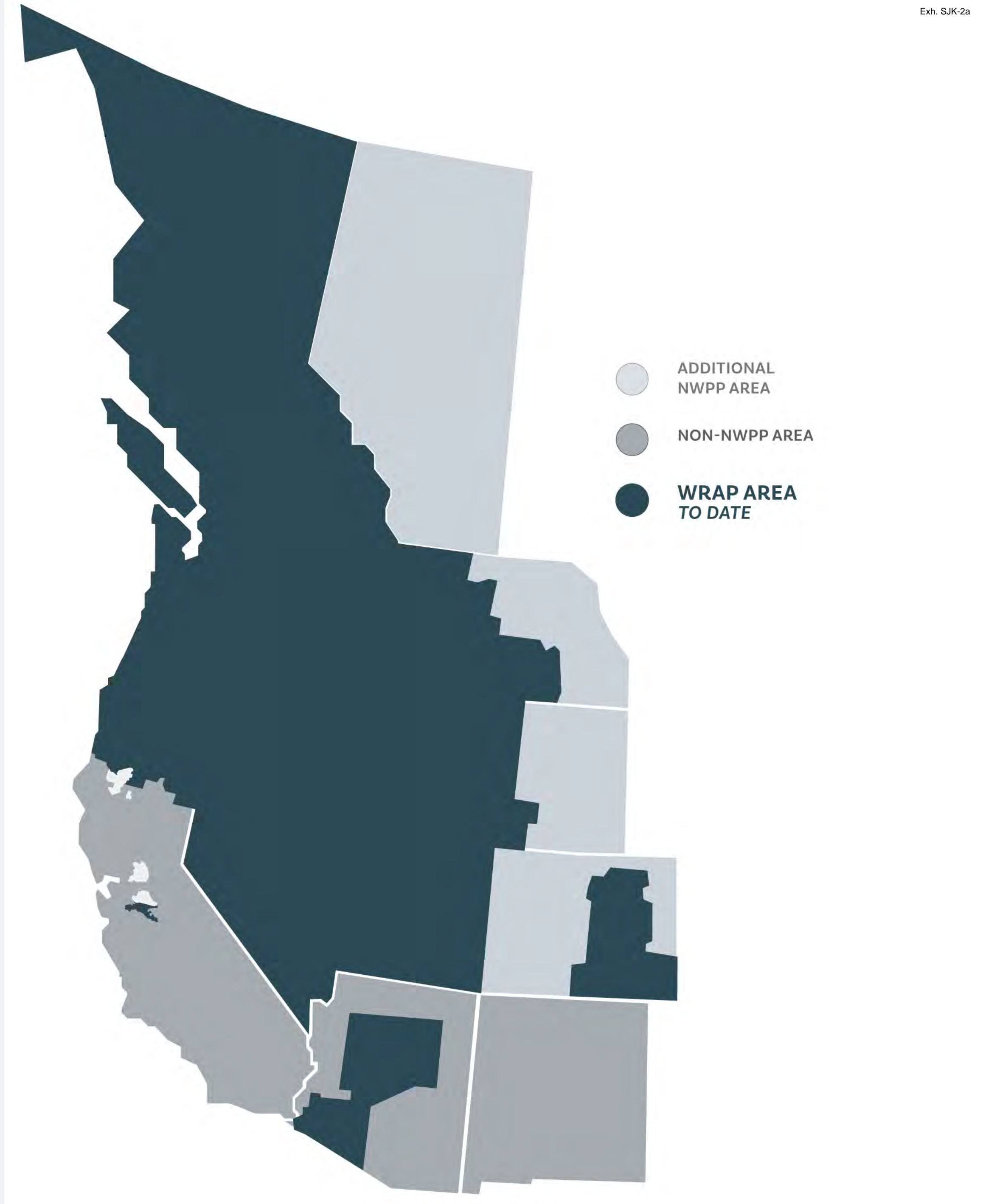

# PHASE 3A – NONBINDING TRIAL

- Phase 3A began Oct 1
- Runs through Dec 2022
- 25 Participants so far
- Approximately 70,000 MWs of peak season load
- Data collected for participating entities on Nov 8
- No penalty for non-compliance
- First forward showing for Winter 2022-2023 on May 15, 2022
- Second forward showing in September 2022 for Summer 2023

# PROGRAM FRAMEWORK

## *Two Time Horizons*

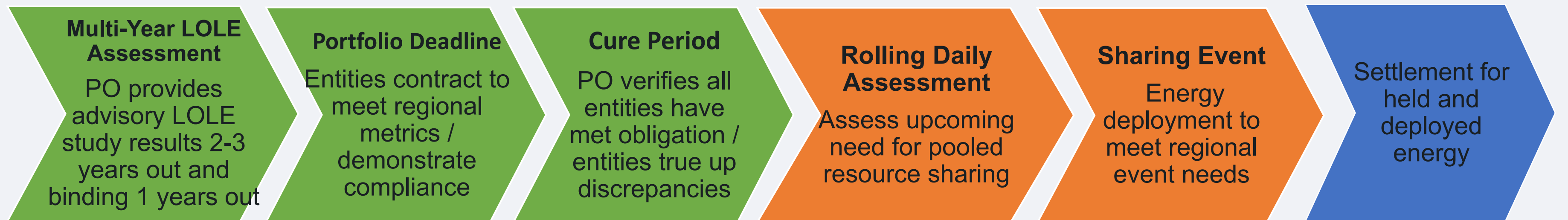
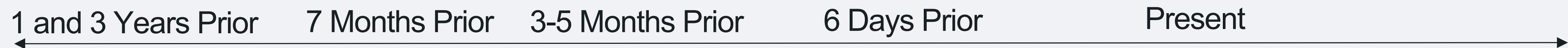
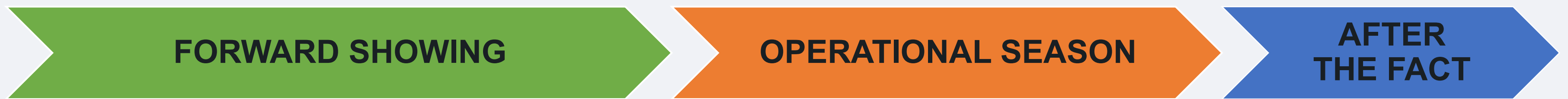

*Note: PO refers to Program Operator*

# FORWARD SHOWING

## BALANCING LOADS AND RESOURCES

### DEMAND SIDE

Calculate: "PURE" CAPACITY NEEDED BASED ON:

- > P50 LOAD FORECAST +
- > Contingency Reserves +
- > PRM needed to meet The RA metric (1 in 10 LOLE)



"PURE" CAPACITY NEEDED <

### SUPPLY SIDE

Calculate: "PURE" CAPACITY AVAILABLE BASED ON:

- > Total Supply, de-rated and qualified as follows:
  - Wind and solar – ELCC*
  - Thermals – UCAP*
  - Run of River Hydro – ELCC*
  - Storage Hydro – UCAP + NWPP developed hydro methodology*
  - Other (Storage, Demand Response, etc.)*

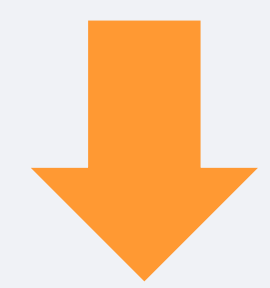

"PURE" SUPPLY AVAILABLE

Show 75% of capacity is backed by firm or conditional firm transmission

# TWO BINDING SEASONS

Season	Binding/ Advisory	Duration	Compliance Showing Date	Cure Period
Winter	Binding	Nov-March 15	March 31	June 1 – July 31
Summer	Binding	June-Sept 15	October 31 (of prior year)	Jan 1 – Feb 28
Spring	Advisory	April-May	N/A	N/A
Fall	Advisory	October	N/A	N/A

Program Operator will provide additional out-year (2-3 years) assessment of RA requirements for planning purposes

# OPERATIONAL PROGRAM

- Need ability to access diversity in real-time
- PO monitors participants needs 5-7 days in advance
- Day ahead assessment
  - › *Participants with unplanned conditions may be eligible for next day assistance*
  - › *Participants with planned extra capacity asked to hold back*
- Operating day assessment
  - › *If a participant meets hour ahead criterion, then they will be provided energy*
  - › *Long participants must deploy energy*
- Transmission
  - › *All transactions scheduled to a hub (Mid-C and ?)*
  - › *Delivering participant must schedule firm transmission to the hub*
  - › *Receiving participant can schedule firm or non-firm transmission from the hub*
- Settlement of both day ahead capacity hold and/or energy deployed

# PROPOSED APPROACH

- » NWPP governing authority – “Public Utility”
- » Independent **Board of Directors (BOD)**
  - › *Once the initial structure of the board and program is established, the board has authority to approve budgets; provide direction and set priorities*
  - › *Proposed governance preserves structures and functions of exiting NWPP program*
- » **Participant Committee (RAPC)** with influence
  - › *Substantive authority to modify amendments to the RA Program*
  - › *Substantive authority to modify RA Program rules*
  - › *Subject to stakeholder right of appeal to independent board*
- » Program Operator – Southwest Power Pool
- » Point of compliance - Load Responsible Entity (LRE)

## GOVERNANCE



# PROPOSED APPROACH

- » **State Officials Committee (SOC)** – meeting through end of year to refine the role of this committee
- » **Nominating Committee (NC)** – the members of the BOD will be selected by a NC comprised of multi-sector representatives.
- » **Program Review Committee (PRC)** – future changes to the program rules will be recommended through a multi-sector committee
- » **Independent Evaluator (IE)** – Reports to BOD for annual review of program

## GOVERNANCE





# NEXT STEPS

## Phase 3A – Non-binding Program

*(October 2021-December 2022)*

### » Non-Binding Forward Showing Program

- › *Determine regional PRM and resource capacity credits in Q1 2022*
- › *Perform two Forward Showings: Winter 2022/23, Summer 2023*

### » Preparation for later phases

- › *Prepare for FERC filing (filing targeted for March 2022)*
- › *Prepare for NWPP independent board (transition in 2023)*
- › *Work through outstanding design considerations for Operations program*

## Phase 3B - Full Binding Program

*(March 2023 showing for winter 2023/24)*

# QUESTIONS

[Northwest Power Pool \(nwppp.org\)](http://nwppp.org)



# Resource Adequacy Program Impact to IRP

Avista, Electric IRP – TAC Meeting 1

December 8<sup>th</sup>, 2021

Michael Brutocao, Natural Gas Analyst

# Planning Reserve Margin

## Summer

- 2021 IRP method: ~14.6%
  - **Planning Margin (7%)** + Operating Reserves + Regulation
- RAP: ~13%
  - **Planning Margin (12%)** + Operating Reserves for Non-Avista Load in Balancing Authority + Regulation

## Winter

- 2021 IRP method: ~24.6%
  - **Planning Margin (16%)** + Operating Reserves + Regulation
- RAP: ~18%
  - **Planning Margin (16%)** + Operating Reserves for Non-Avista Load in Balancing Authority + Regulation

# Obligations – RAP

- Peak Load
- System Sales
- Demand Response (-)
- Regulation
- Operating Reserves for BA Load (only non-native load)
- ~~Avista Operating Reserves~~

# Rights – RAP

- Power Deal Purchases
- Thermal Generation
- Hydro Generation
- Variable Generation
- Small Power (QF, PURPA)
- Storage
- ~~Operating Reserve Credit~~
- ~~Hydro~~

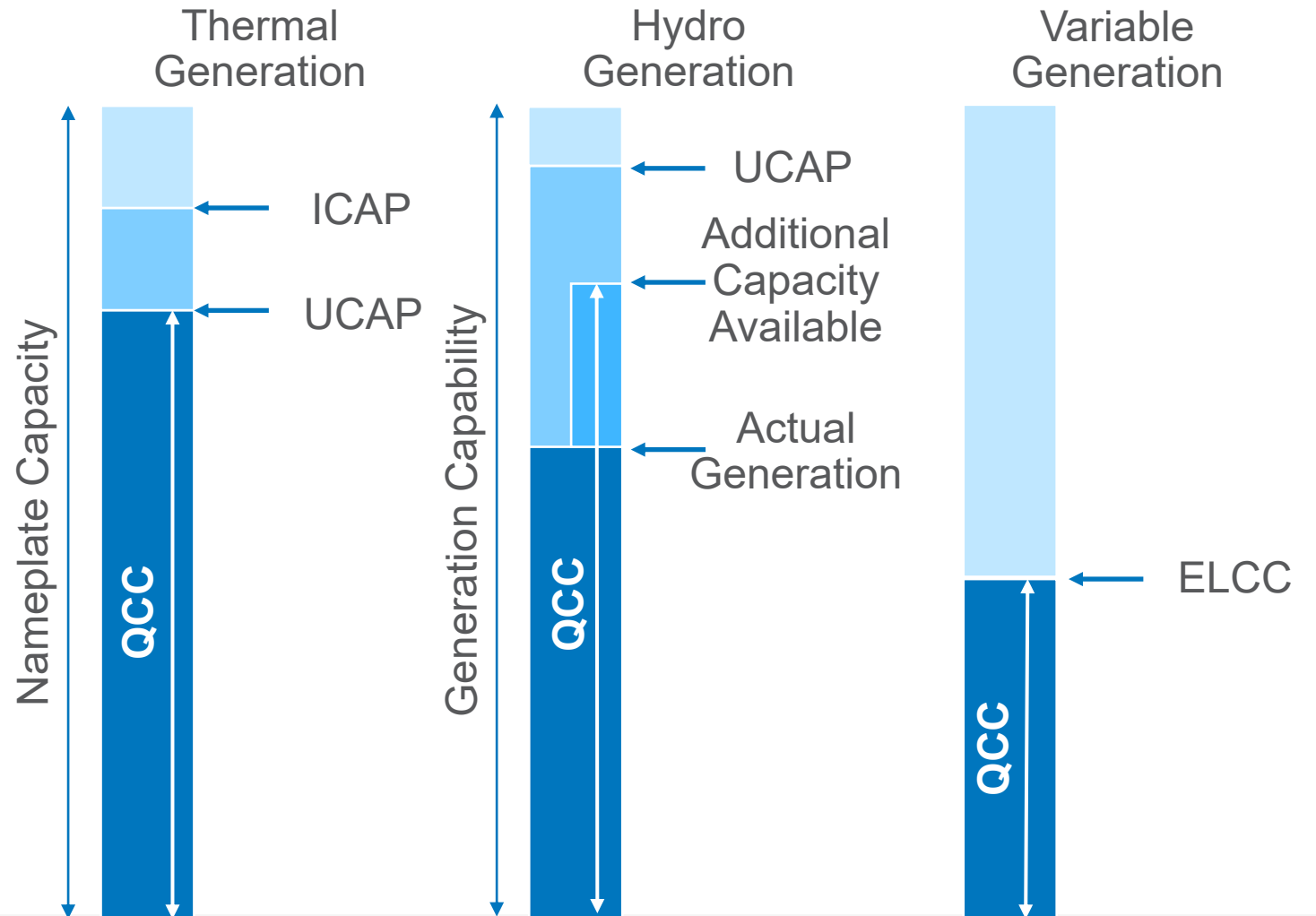

# Calculating Net Position – RAP

Planning Margin

~~Operating Reserves (load)~~

~~Operating Reserves (generation)~~

**Obligations**

Peak Native Load

Power Deal Sales

Capacity Services

Demand Response

Regulation

Operating Reserves for BA Load

~~Operating Reserves~~

**(1) Total Obligation**

**Rights**

Power Deal Purchases

Coal

Wood

Wind

Solar

CCCT

Peaker

Spokane

Clark Fork

Mid-Columbia

Small Power

Storage

~~Oper Reserve Credit hydro~~

**(2) Total Rights**

**(3) Planning Margin**

**Net Position**

**(2) - (1) - (3)**

Resource Capability  
x Qualified Capacity Contribution  

---

Net Capability

Example: Lancaster GS

282.00	
x 98%	
	273.36

# 2021 IRP Net Position with RAP Changes

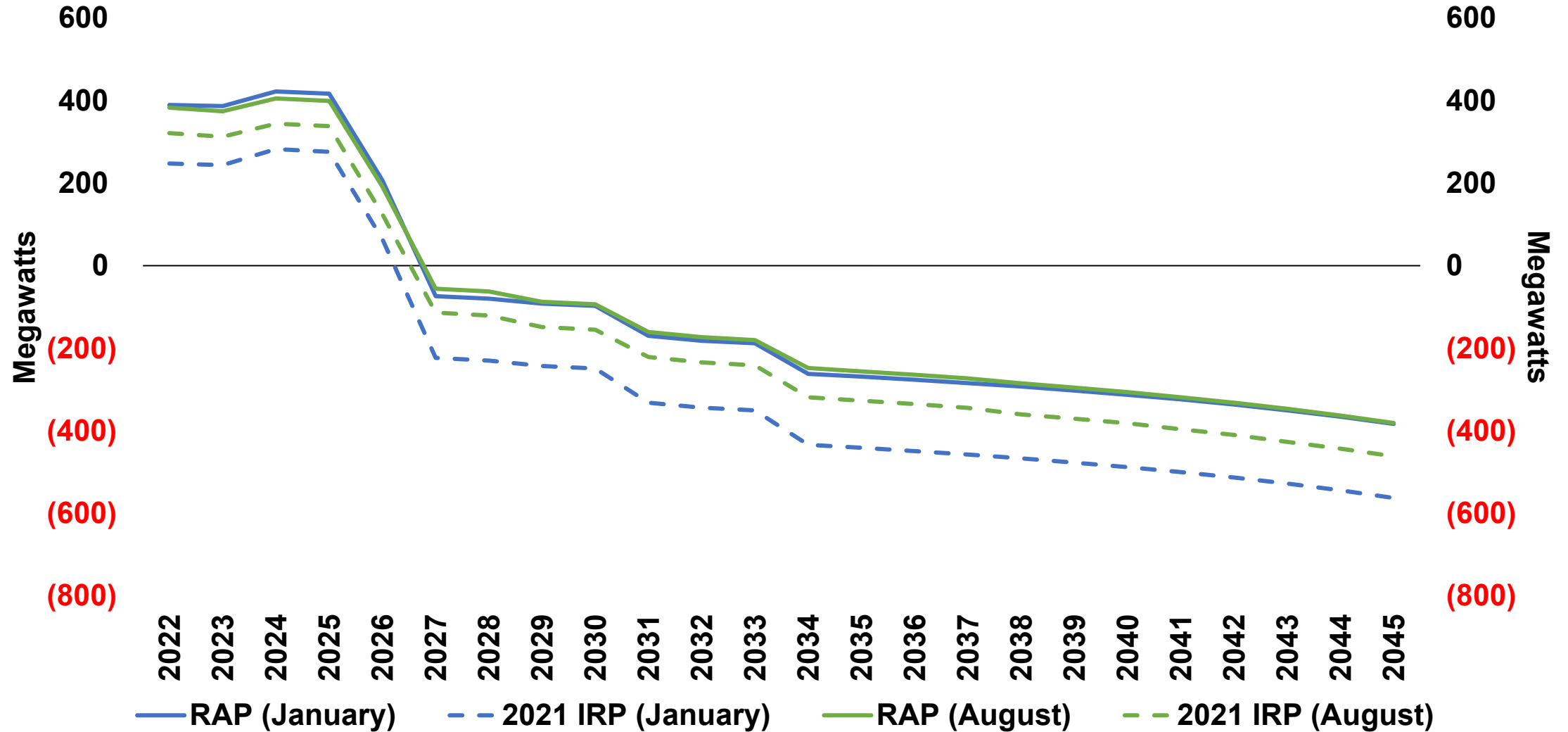

\*Net positions subject to change



# Conclusions

- Participating utilities will use the same methodology for resource adequacy on determination
- Lower capacity requirements using RAP should lower customer cost
- RAP will result in additional market risk due to regional ELCCs for variable resources and storage



# Resource Adequacy & Resiliency

Avista, Electric Technical Advisory Committee

December 8<sup>th</sup>, 2021 – TAC 1

James Gall, Electric IRP Manager

# Resource Adequacy (RA)

- In the simplest terms, RA is just a regulatory construct developed to ensure that there will be sufficient resources available to serve electric demand under all but the most extreme conditions. – Gridworks
  - The result is a utility must plan for a certain “Planning Margin” or “Loss of Load Probability”
- Our utility Commissions have not required a specific RA requirement, but utilities have an obligation to serve (i.e. RCW 80.28.010 (2))
  - ”safe, adequate and efficient, and in all respects just and reasonable”
- Sufficient Resource Adequacy requires either regional coordination or additional resource supply

# NERC Defines Reliability

The NERC defines reliability of the bulk electric system via two main responsibilities – adequacy and security.

**Adequacy** is defined as “the ability of the bulk power system to supply the aggregate electrical demand and energy requirements of the customers at **all times** (e.g., 1 day in 10 years), taking into account scheduled and reasonably expected unscheduled outages of system elements”.

**Security (operating reliability)** is defined as the “ability of the bulk power system to withstand sudden disturbances such as electric short circuits or unanticipated loss of system elements from credible contingencies”

# Past IRP's Resource Adequacy Considerations

- Planning margin requirements
- Loss of load probability studies
- Annual energy acquisition targets
- Resource peak credit estimates
- Largest single contingency

# Resiliency

- Resilience is generally defined as increasing the ability of the power system to prevent or mitigate the impact of unusual or catastrophic events (e.g., storms, fires, earthquakes, cyber and physical attacks).

- Finster, M., Phillips, J., Wallace, K. "Front-Line Resilience Perspectives: the Electric Grid." Prepared for U.S. Department of Energy, Office of Energy Policy and Systems Analysis – Global Security Sciences Division, Argonne National Laboratory (November 2016)

- Washington's CETA calls out energy security and resiliency as benefit from the transition to clean energy
  - This benefit is tracked as a customer benefit indicator"

## Resiliency Area's of Concern

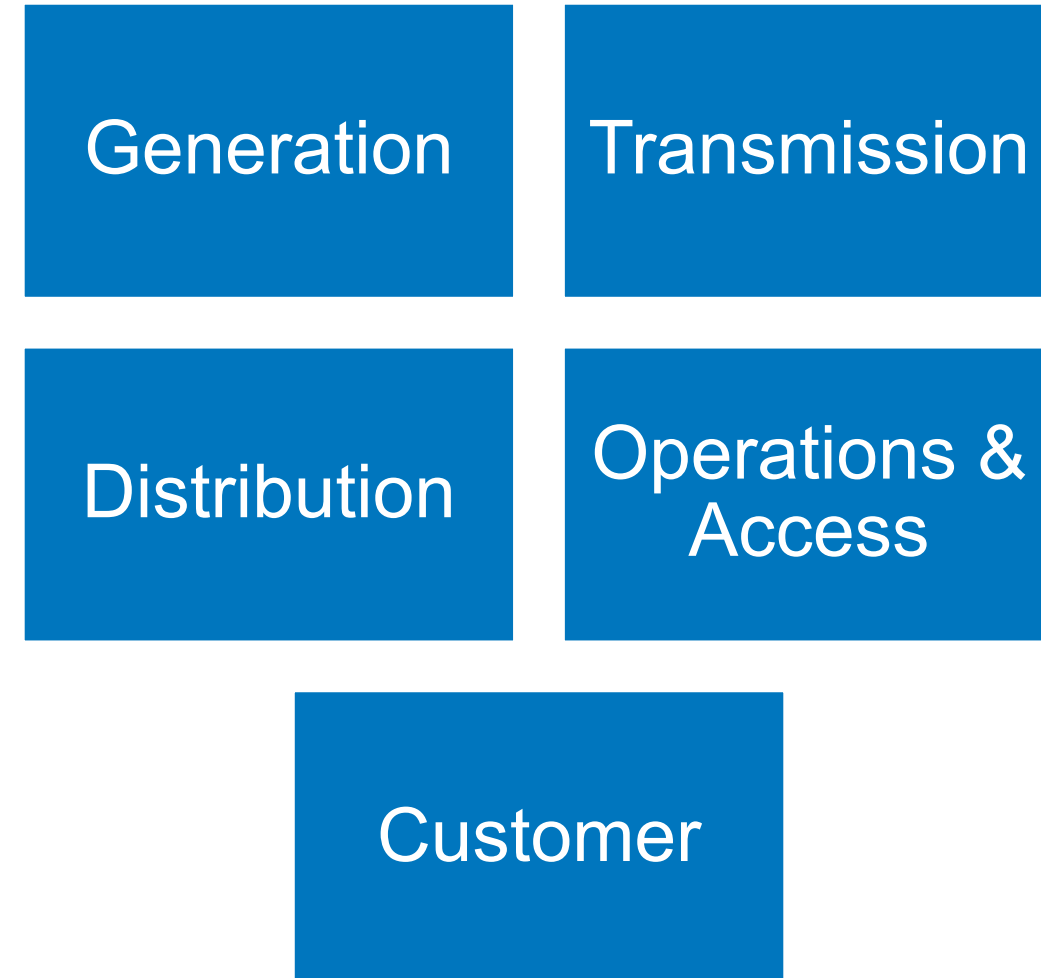

# Resiliency Risks

Flooding

Wind, Snow, and Ice  
Load

Extreme weather  
(drought, heat, rainfall,  
wind, etc.)

Cyber Security, Civil  
Unrest, Terrorism

Wildfires

Permafrost and Land  
Movement

Funding

Organizational Silos

Supply Chain &  
Personnel

# Past IRP's Resiliency Considerations

- Critical water planning (10<sup>th</sup> percentile)
- Fuel supply limitations
- Fuel price risk
- Weather protections included in resource costs
- Modeling weather related generation constraints
- Transmission interconnection requirements
- Non-energy impacts for energy efficiency



# Resource Adequacy & Resiliency Changes for the 2023 IRP

- Resource acquisition will target monthly & seasonal Resource Adequacy Program targets
  - Use RA Qualified Capacity Credits (QCC) for each existing and potential resource
  - Use RA required planning margin
- Ensure Avista has energy resources to meet each month's energy need assuming 10th percentile hydro conditions and 90<sup>th</sup> percentile loads
  - With increasing amounts of wind and solar generation, Avista will need to plan for lower expected generation
  - Should Avista plan for average monthly energy or both On-Peak vs Off-Peak?
  - Draft CETA “use” rules require hourly clean energy delivery “planning”
- Conduct stochastic risk assessment to measure market exposure risk
  - Risk assessment may lead to higher planning margins or need for additional transmission

# Resiliency Group Discussion

- What resiliency topics should be evaluated in the IRP vs other planning forums?
- What level of resiliency should utilities plan for?
  - Spectrum of probability
  - Outage time and service level
  - Utility cost vs societal cost
- How interchangeable is DERs with grid improvements?
- Customer resiliency
  - Self generation, fuel diversity, shell improvements, shelters, critical infrastructure
- Should we conduct resiliency related scenario analysis and what should we change in the plan based on the results?
- Include resiliency credit for local resources
  - May have locational and benefit limitations
  - Additional resources cost are likely for resources to be responsive to distribution outages
  - Require feedback loop between T&D planning
- Integrated Resource and Resiliency Planning
- Resiliency product offerings (i.e., home generators or storage)



# Technical Advisory Committee Participant Survey

2023 Electric IRP

First Technical Advisory Committee Meeting, December 8, 2021

Lori Hermanson, Senior Power Supply Analyst

# Why are you involved in the IRP process?

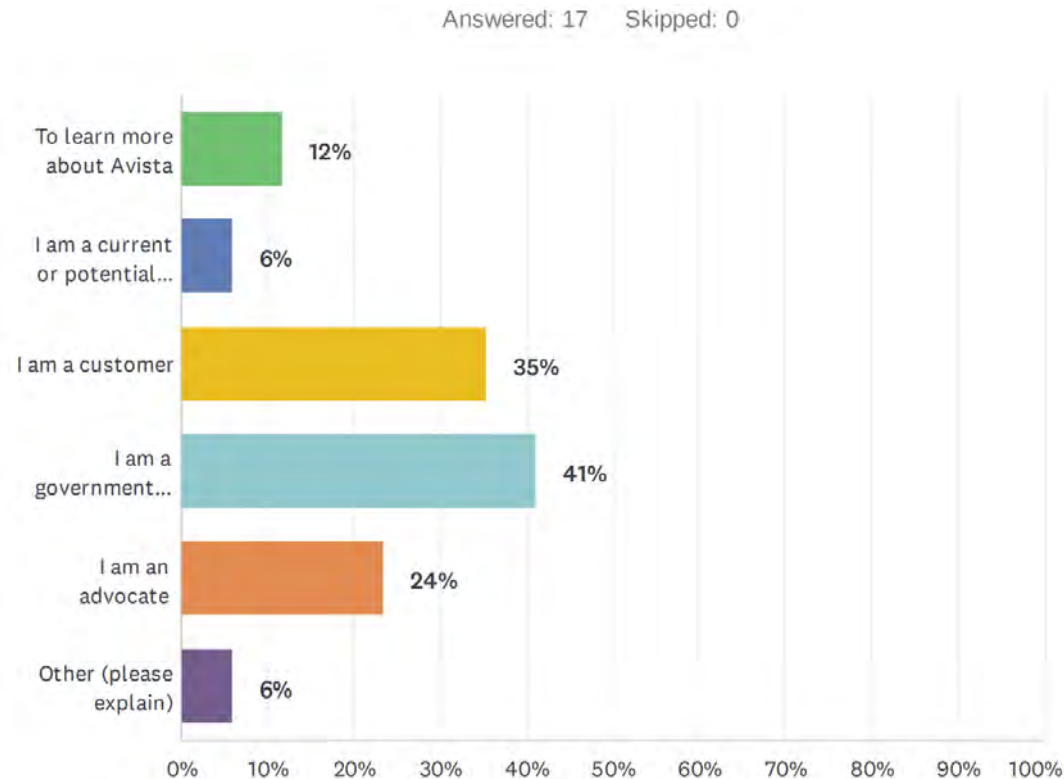

- Majority of participants are non-customers from government entities
- Many are customers
- One wants to drive solar

# Would two IRP tracts (i.e. informative vs. technical) be better?

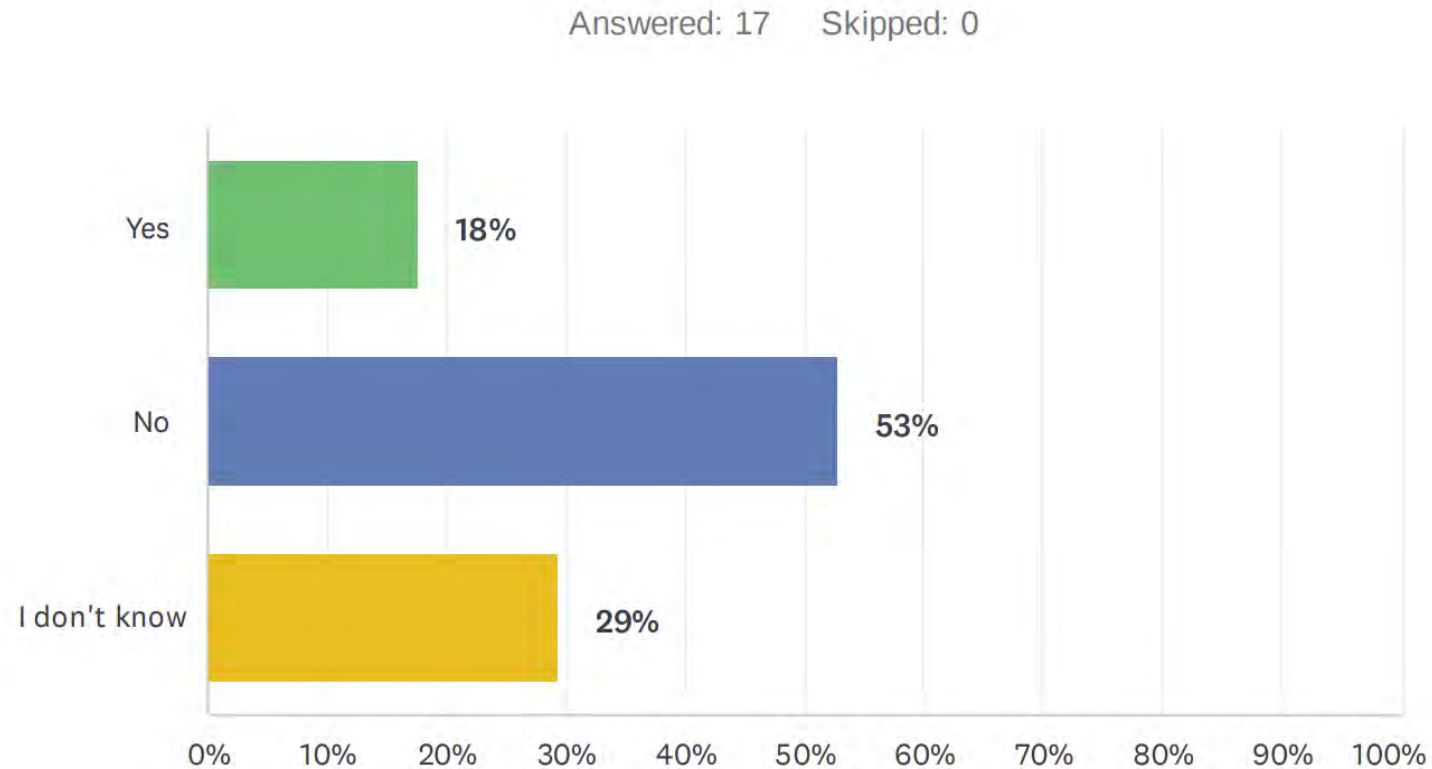

# Which tract would you prefer to participate in?

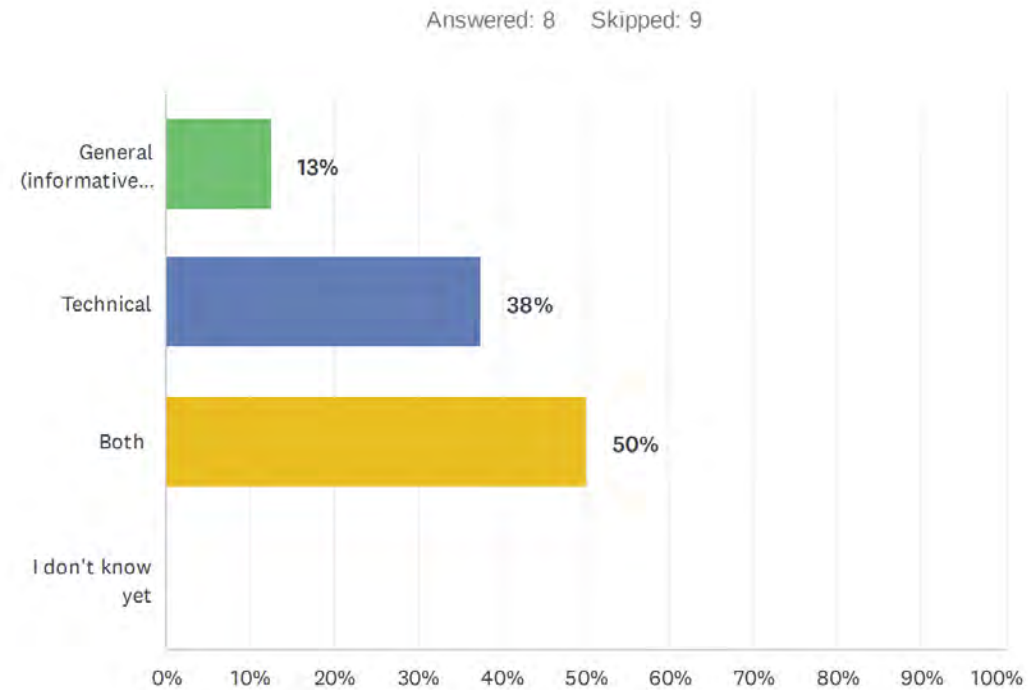

- 88% prefer to participate in technical or both technical and informative

# What is your preference for meeting occurrence and length?

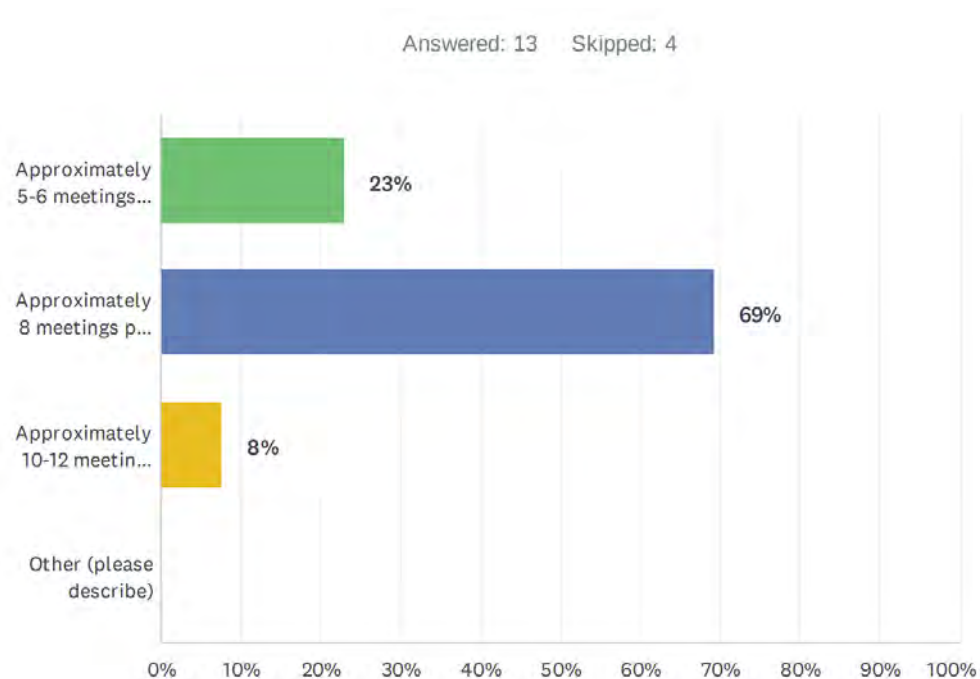

- 69% prefer approximately 8 meetings per IRP with meetings no more than 3-4 hours in length

# What topics would you like to discuss?

- Customer partnerships – local resource options (DR, EE, DER, electrification)
- Resource adequacy\*
- Regional area network vulnerability and Avista's contingency plan to prevent loss of service\*
- Stakeholder review and feedback of Avista's generic resource assumptions\*
- Potential sources of renewable energy realistic for Avista's service territory, DER and energy storage options\*
- Transmission and distribution technologies; T&D capacity limits; improvement needs (both regionally and local)\*
- Regulatory strategy to protect legacy power generating capacity
- Nuclear power to replace coal (long-term, low-cost) instead of wind or solar; use natural gas for peaking not energy
- Impact of customer benefit indicators on IRP process\*
- Resource cost/benefits analysis (new resources vs PPAs)
- Load & resource balance\*
- EV adoption forecast\*
- Action items status\*
- Climate change\*
- Reliability\*
- Jurisdictional allocations



# What additional supporting data would you like to see?

- Balance was right – a strength of the 2021 IRP
- Chart of portfolio with annual operating costs and risk profile of each resource strategy – shows customers' risk exposure
- Updated climate modeling
- Refined resource adequacy considerations that target multiple characteristics including need, duration, probability and size; modeling that allows a suite of storage resources to be selected
- Current plan is to comply with WA law – plan should provide reliable, low-cost power to customers
- Modernize resource modeling with tools like WIS:dom-P (Vibrant Clean Energy) that models load, grid and renewable potential to the neighborhood level and identify where DER + storage deployment is least-cost investment
- Utilize existing biomass energy resource, not wind or solar

# What are your preferences to engage customers?

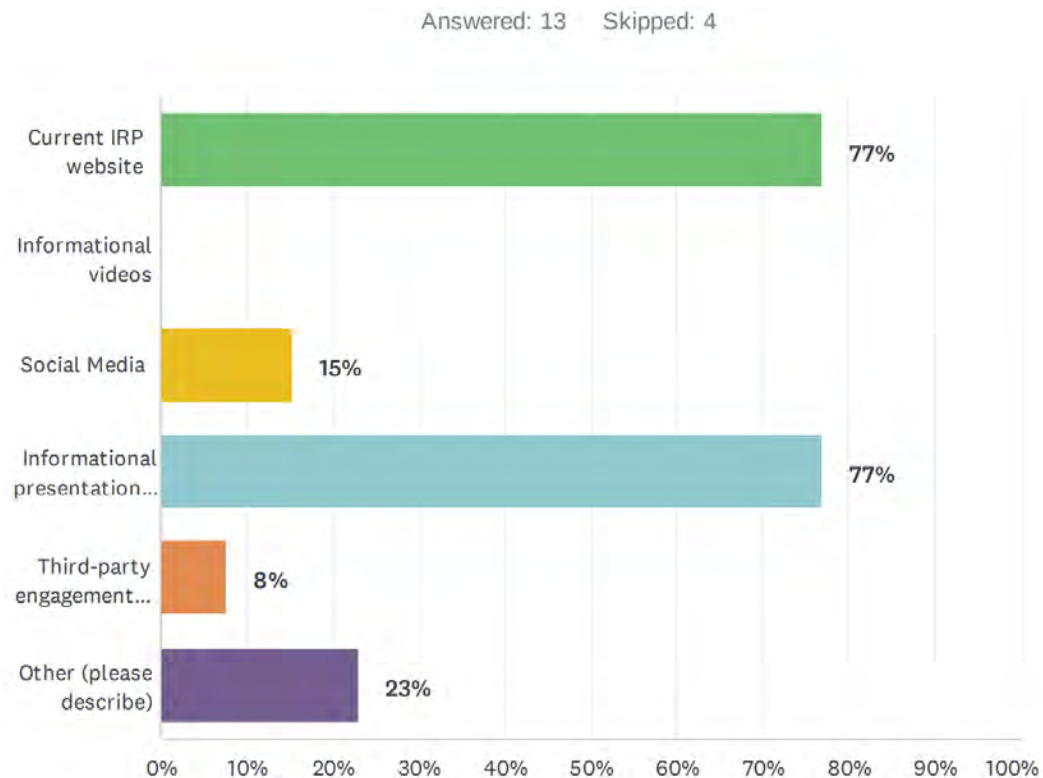

- Majority prefer the website or informational presentations to engage customers
- Improved website that explains the issues and steps instead of text and links
- Newspaper articles
- Input from actual customers not outside environmental groups since customers pay the bills and hold the financial risk

# What did you like about the 2021 IRP Process?

- Process was complete and detailed. Appreciated how Avista endeavored to implement the WA clean energy law and meet Idaho policy expectations (challenging!)
- Increased transparency; amount of data and presentations for varying levels of technical expertise
- Large audience
- Nice job of explaining the data and modeling tools/techniques used so folks understood the outcomes
- Logic was to comply with CETA only – we need a customer-focused IRP!
- Good presentations/presenters
- Remote meetings and format

# What improvements would you like to see?

- Stop assuming Idahoans want methane gas plants. We want reliable, affordable energy.
- Focus on providing low cost, reliable power from sources that have a long-term stable cost outlook. Natural gas costs driven up as its used to firm wind/solar. Should be using nuclear and biomass with limited natural gas for peaking.
- Continue to find ways to make complicated concepts accessible to the general public.
- Online index of what topics were covered during various TAC meetings.
- Promote the process.
- Ensure Avista's modeling tools are able to conduct modern day resource planning (e.g. consider a suite of storage resources to meet capacity shortfalls, multiple characteristics of resource adequacy, modern climate modeling and aligning inputs with a fast-evolving industry)



# Washington State Clean Energy Implementation Plan Customer Benefit Indicators

December 8, 2021 – 2023 Electric IRP TAC 1

Annette Brandon

# Clean Energy Transformation

## IRP to CEIP



### Integrated Resource Plan (IRP)

20+ year resource planning identifying customer future resource needs

- Lowest reasonable cost of resource mix including societal benefits
- Maintain and protect safety, reliable operation and balancing of electric system
- Economic, health and environmental benefits

### Clean Energy Action Plan (CEAP)

Sets 10-Year targets for resources based on the lowest reasonable cost plan including; filed jointly with IRP

- Societal costs;
- Clean energy requirements; and
- Reliability Requirements.

### Clean Energy Implementation Plan (CEIP) 2022-2025

CEIP establishes the actions the utility will take to comply with CETA goals over the next four years. Including:

- Interim Targets
- Specific Targets
- Public Participation Process
- Customer Benefit Indicators

# Public Participation Inputs



## Identify Named Communities

Highly Impacted Communities  
Vulnerable Populations



## Benefits/Barriers “Equity Areas”

Benefits of Clean Energy  
Prioritization  
Barriers to Participation

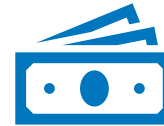

## Customer Benefit Indicators

Measurable  
Accountable



## CEIP

Resource Mix  
Lowest Reasonable Cost  
Resource Adequacy

# Highly Impacted Communities and Vulnerable Populations (“Named Communities”) Who is most Impacted?

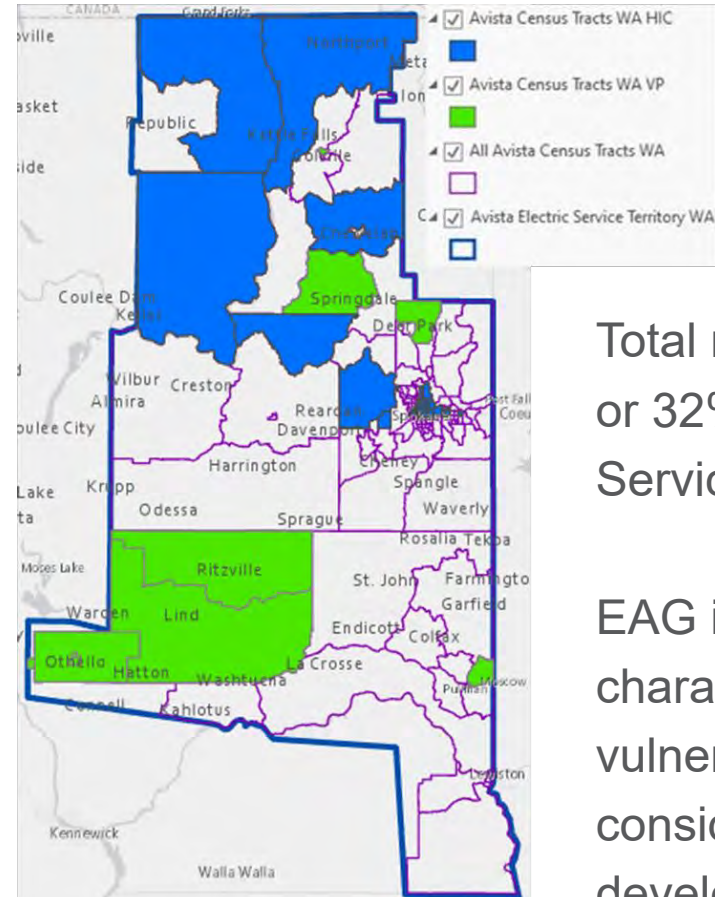
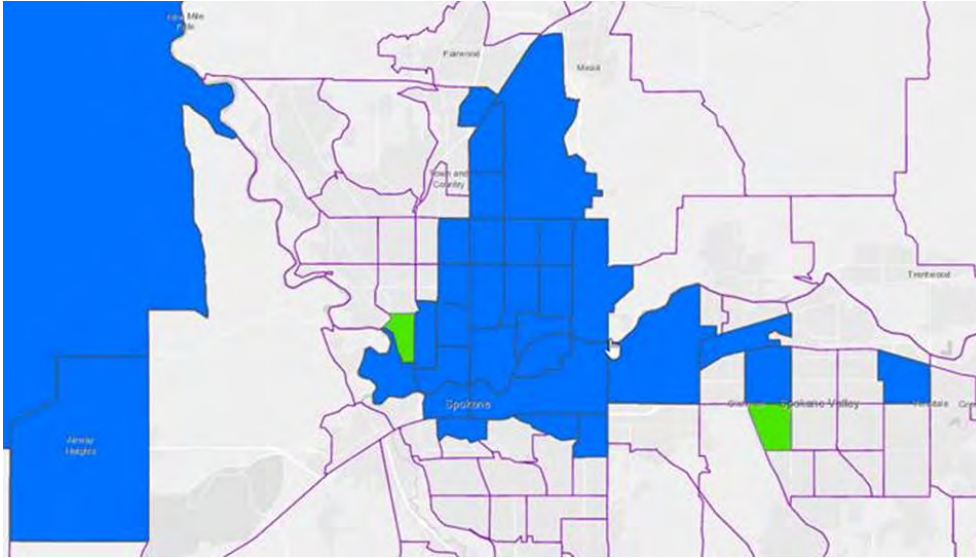

- Highly Impacted Communities

- Designated by DOH
- 34 Census Tracts (25%)

- Vulnerable Populations

- Socioeconomic and sensitive population areas 9 or higher
- 13 Census Tracts (7%)

Total represents 47 areas or 32% of total Washington Service Territory.

EAG identified additional characteristics for vulnerable populations considered as part of CBI development.



# Benefits of Clean Energy Transition

Utilities must consider input from advisory group members (including equity advisory group), and customers to meet requirement that all customers benefit from the transition to clean energy through:

## Equity

- Equitable distribution of energy and nonenergy benefits and reductions of burdens to vulnerable populations and highly impacted communities

## Public Health and Environmental

- Long term and short-term public health and environmental benefits and reductions of costs and risks;
- Such as less air pollution which results in lower asthma rates

## Energy Security and Resiliency

- Energy Security – strategic objective to maintain energy services and protecting against disruption
- Energy Resiliency – ability to adapt to challenging conditions from disruptions

## Meet Planning Standards

- Maintaining and protecting the safety, reliable operation and balancing of the electric system
- Lowest reasonable cost including social costs



# Developing Customer Benefit Indicators – From 86 touchpoints to 12 Final

- How could the transition to clean energy benefit (or unintentionally harm) customers?
  - Affordability
  - Environmental
  - Access to clean energy
  - Energy security, resiliency
  - Community/economic development
  - Health and well-being
- What may be some barriers or burdens?
  - Language
  - Cultural
  - Awareness
  - Transportation Access

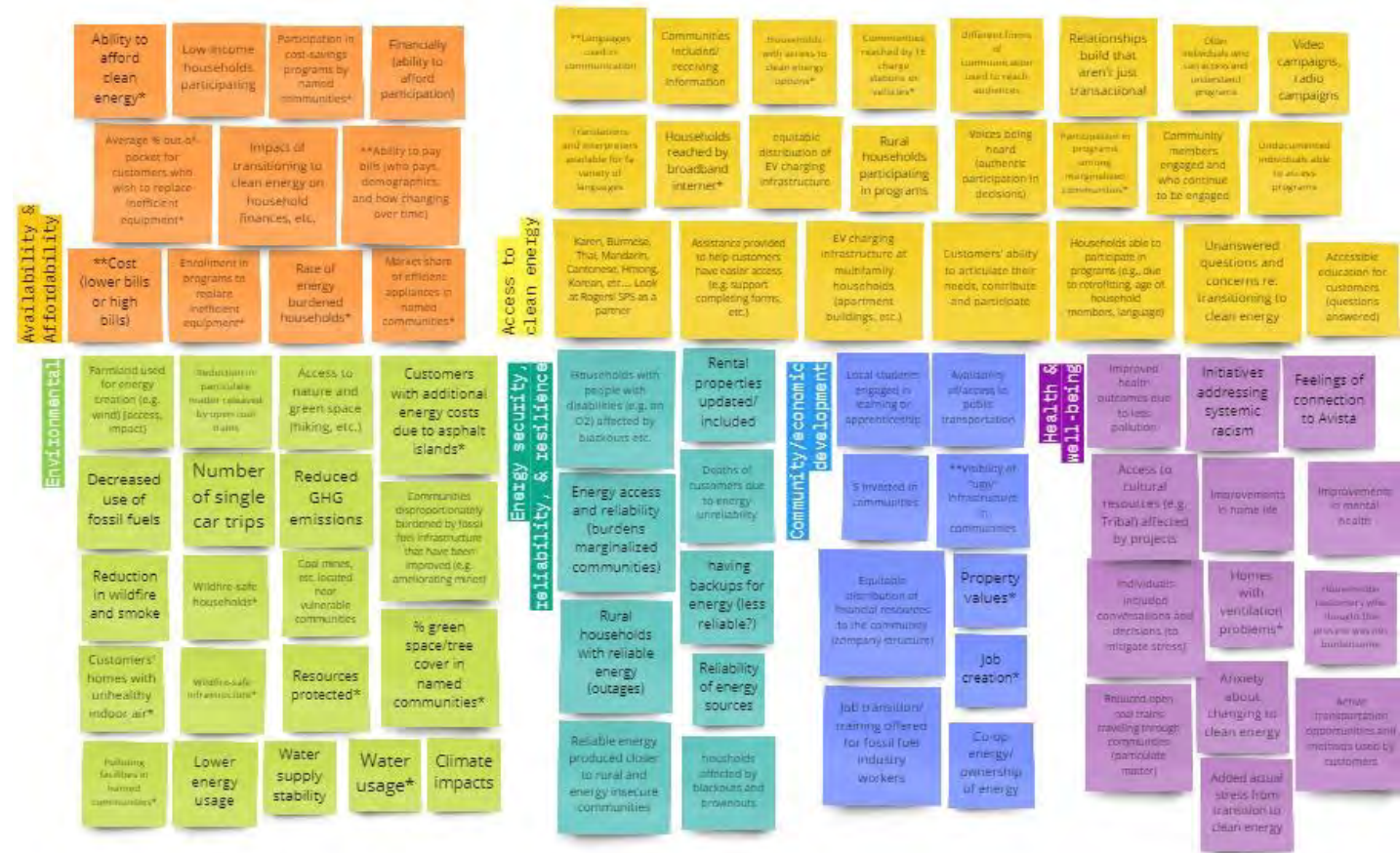

# Prioritizing Customer Benefit Indicators



[This Photo](#) by Unknown Author is licensed under [CC BY-SA](#)

- Communication Power
  - To what extent is the indicator easily understandable by a broad audience?
- Proxy Power
  - Which are critically tied to everyone benefiting equitably from the transition to clean energy? (“Data Herd”)
- Data Power
  - Which are most able to be tracked, measured, and counted?

# Customer Benefit Indicators

**Customer Benefit Indicator (CBI)** – is an attribute, either quantitative or qualitative of a resource or related distribution investment associated with customer benefits

## Customer Benefit Indicators

### Affordability

Participation in Company Programs  
Number of Households with high energy burden (>6%)

### Community Development

Named Community Clean Energy  
Investment in Named Communities

### Access

Outreach and  
Communication  
Transportation  
Electrification

### Energy Resiliency & Security

Energy Availability  
Generation Location

### Environmental

Greenhouse Gas  
Emissions  
Outdoor Air Quality

### Public Health

Employee and  
supplier diversity  
Indoor Air Quality

CBIs are measurement tools for evaluating progress towards ensuring customers are benefitting from the transition to clean energy.

Areas considered:

- ✓ Affordability
- ✓ Access to Clean Energy
- ✓ Environment and Public Health
- ✓ Energy Security and Resiliency
- ✓ Community and Economic Development

# Directly Related IRP CBIs



Number of Households With High Energy Burden

Energy Burden by All Customers and Named Communities



Named Community Clean Energy

Percent of Energy Efficiency, Non-Emitting, Renewable Energy in Named Communities



Energy Availability

Resource Adequacy Planning Margin



Energy Generation Location

Percent of Generation Located in Washington or Connected to Avista T&D system



Outdoor Air Quality

Avista Plant Air Emissions



Greenhouse Gas Emissions

Avista's GHG emissions

# Number of Households with High Energy Burden

The goal is to reduce the number of customers, especially in Named Communities, with an energy burden of six percent or more.

## BASELINE METRIC

County	Households Energy Burdened in Excess of 6% (electric heat)	Energy burdened households as a percent of total households (electric heat)	Average excess burden per household (electric heat)
Adams	802	22%	\$752
Asotin	810	13%	\$669
Ferry	198	18%	\$754
Lincoln	427	18%	\$638
Spokane	14,211	16%	\$533
Stevens	2,355	20%	\$718
Whitman	1,543	11%	\$589
Total	20,346	16%	\$621

Baseline (preliminary) a point-in-time estimate (as of year end 2020) developed by Empower DataWorks.

Named Community detail in progress.

Lowest Reasonable Cost Resource calculation benefits customers in terms of

- ✓ Reduction of Burdens (if located in Named Community)
- ✓ Reduction of Cost (for all Customers)

# Named Community Clean Energy

The Named Community Clean Energy CBI concentrates on the percent of non-emitting or clean energy resources, including distributed generation or energy efficiency in Named Communities.

## Percent of Non-Emitting/Renewable Energy in Named Communities

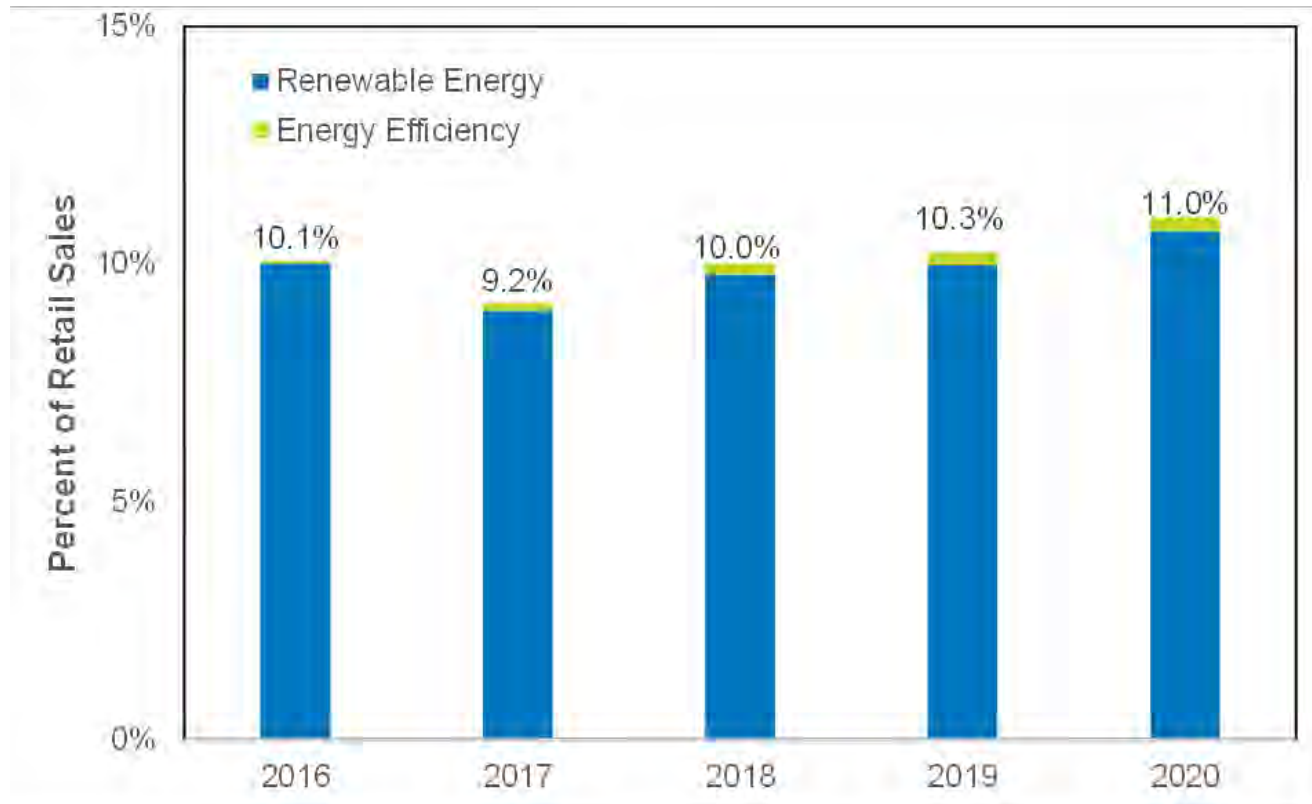

### Power Supply Contribution:

- ✓ Reducing energy burdens and costs.
- ✓ New distributed energy resources may aid in faster recovery from outages.
- ✓ Non-energy benefits such as labor and economic development

# Energy Availability

Avista's resource Planning Margin is a measure of resource adequacy indicating the level of customer exposure to resource outages or market reliance.

## Resource Adequacy Planning Margin

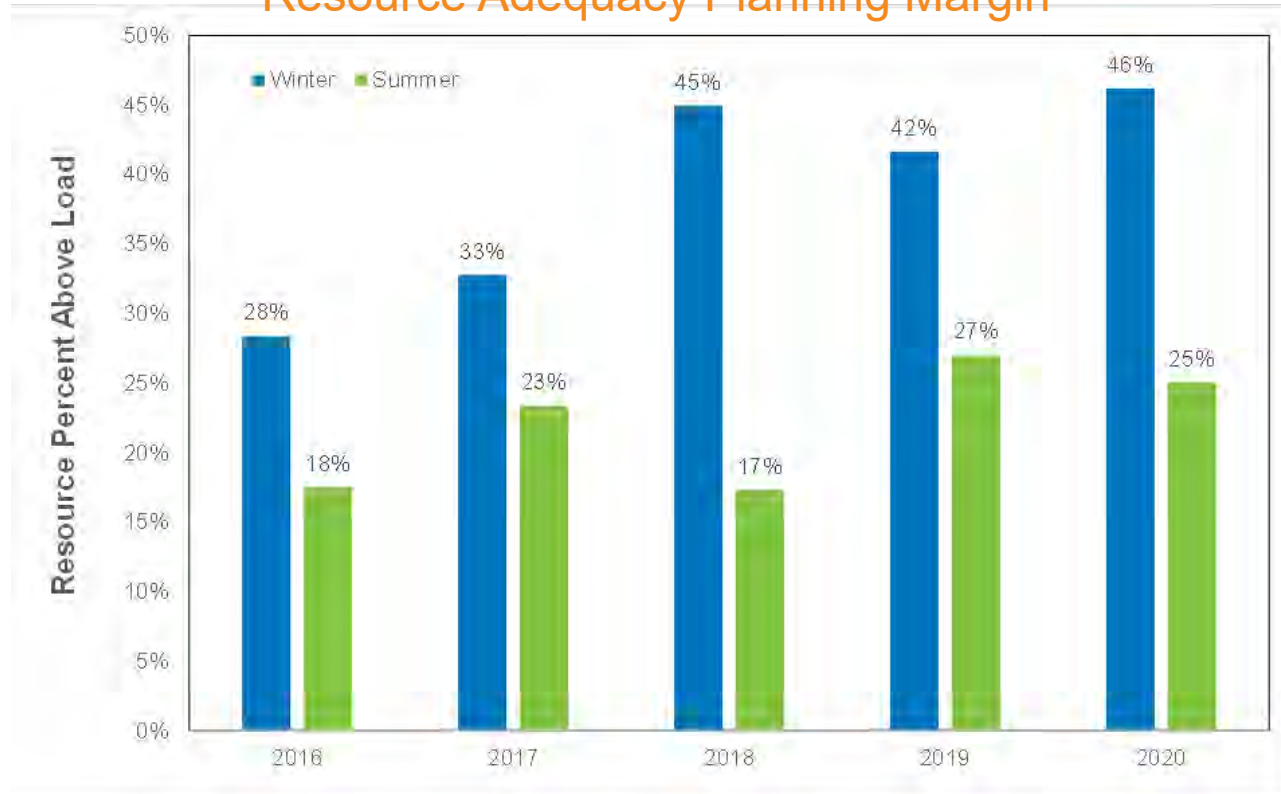



# Energy Generation Location – Energy Security

As part of Named Community development, Avista will track the amount of clean generation and energy efficiency in its annual system resource mix. The benefits associated with this metric will provide economic opportunities to these communities and a more energy secure pathway.

Percent of Generation located in WA or Connected to Avista Transmission system

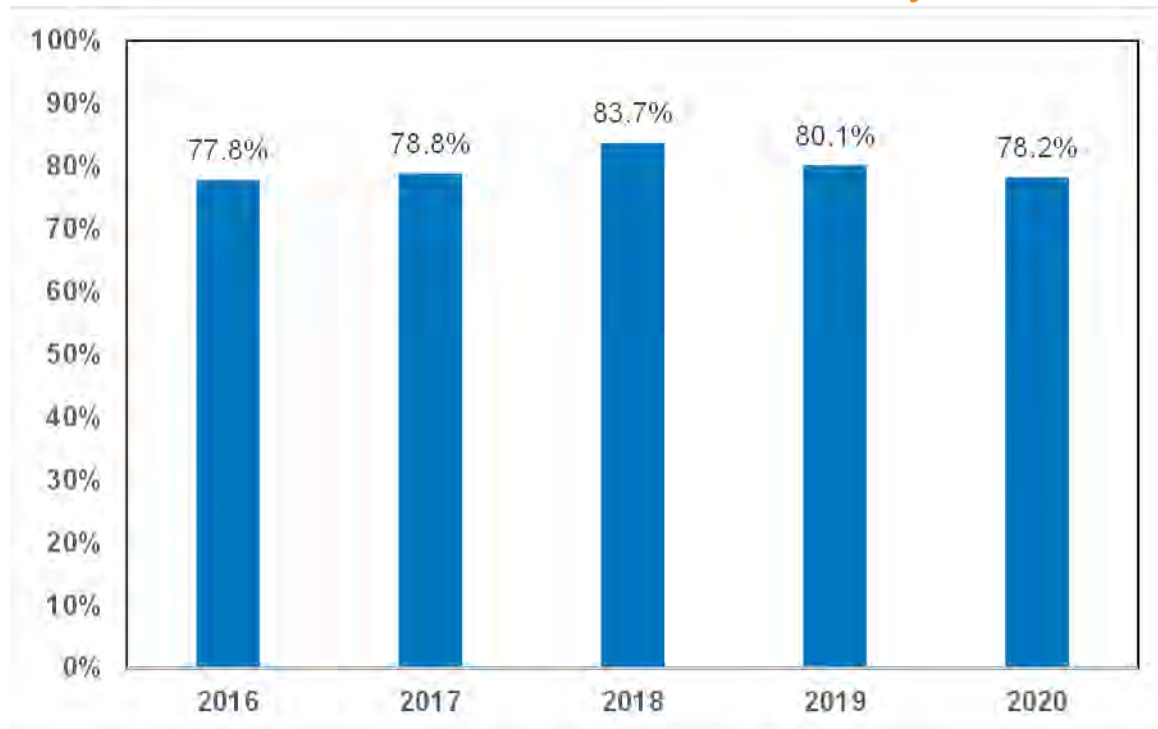

- Locating resources closer to customers will not eliminate disruptions.
- Local generation may create benefits by reducing transmission of power risk and/or policy issues from out-of-state resources.
- There are risks to utilizing local generation such as lack of diversity of weather, for example

# Outdoor Air Quality

Avista will monitor Avista-specific Plant Air Emissions on a locational basis.

## Avista Plant Air Emissions

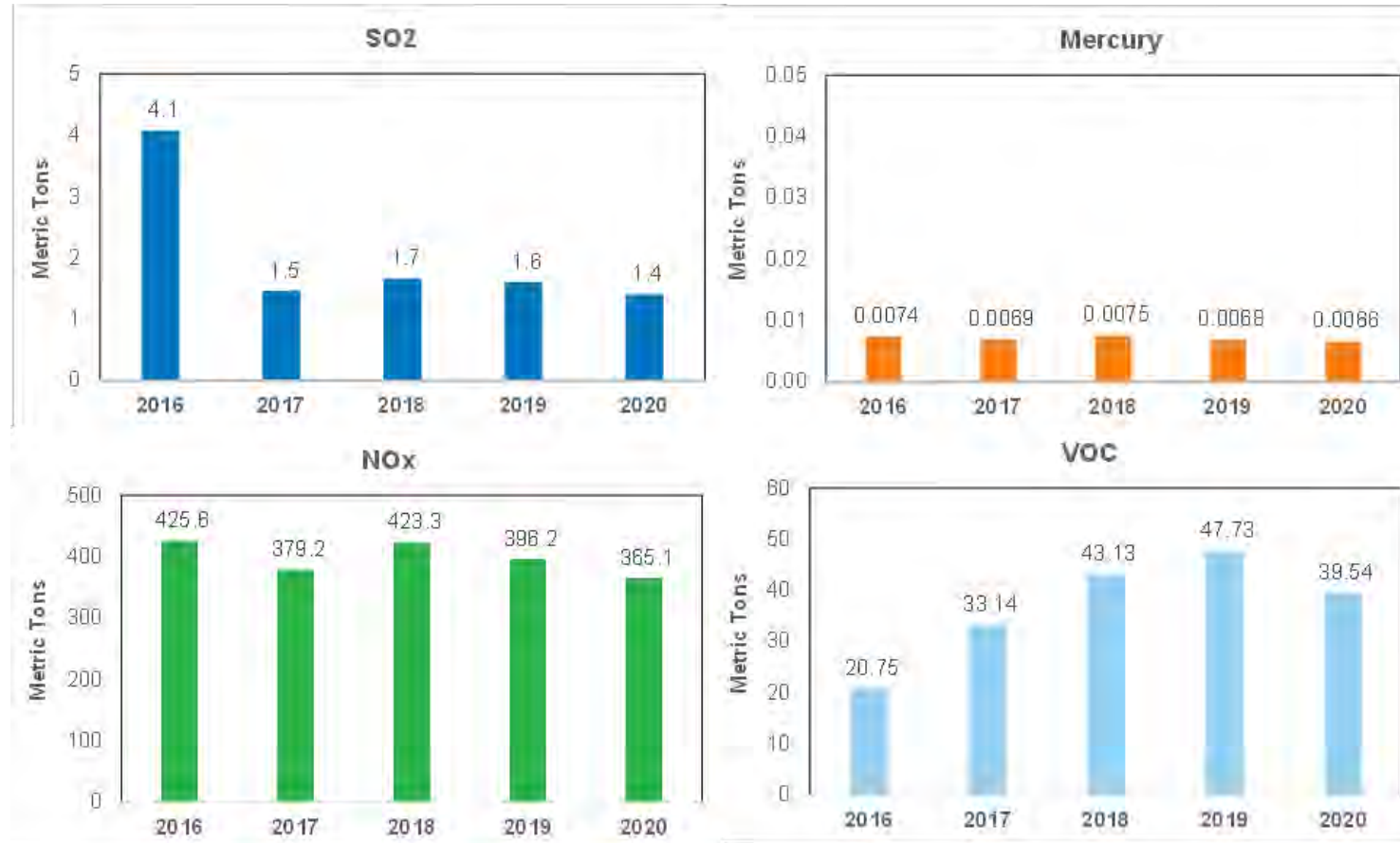

# Greenhouse Gas Emissions

Avista will monitor the greenhouse gas emissions from Avista resources and how it interacts with the wholesale market.

Renewable Energy Projects will contribute to the overall reduction in Regional GHG as we move towards 2030.

## Avista-specific GHG

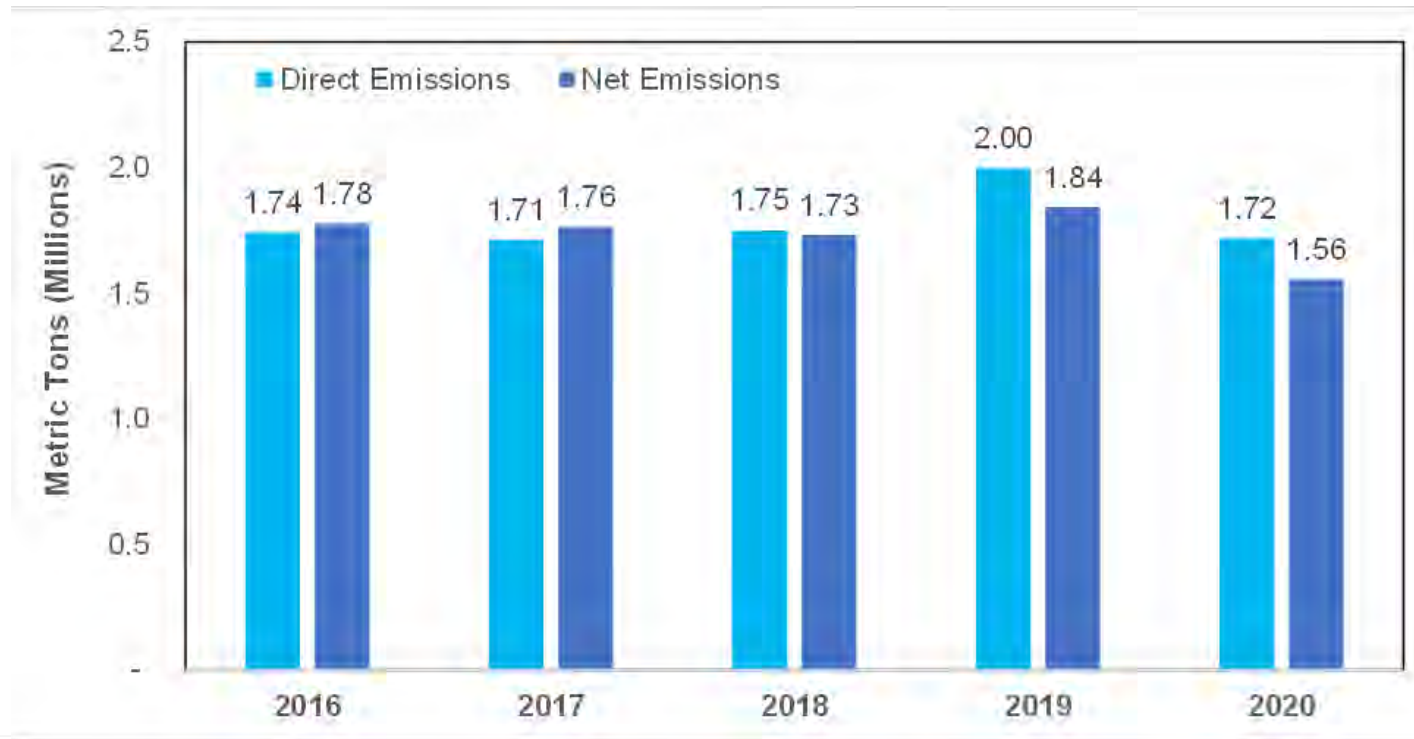

# CBIs and Resource Selection

CBIs must be incorporated into resource selection and program prioritization in order to ensure customers are benefitting from the transition to clean energy.



## Energy Efficiency

Used to prioritize programs  
Focus on impacts to Named Communities



## Demand Response

Will be used in development of Time of Use and Peak Time Rebate pilots



## Renewable Energy Acquisition

Considered in weighting of RFP evaluation

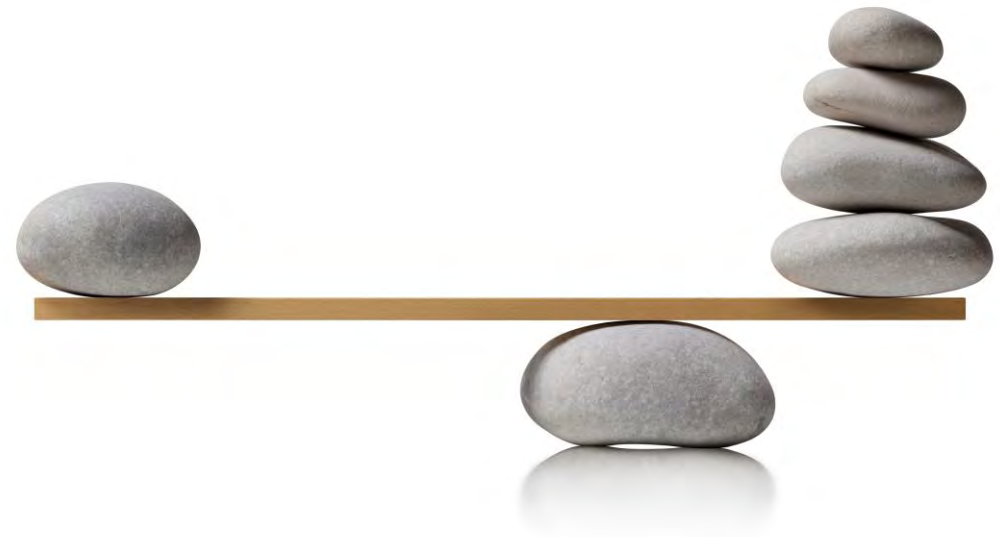

# CBIs and Resource Selection

## IRP Portfolio Analysis and Preferred Portfolio must consider:

- Lowest Reasonable Cost
- Include cost-effective, reliable and feasible conservation and efficiency resources and distributed energy sources
- Consider acquisition of existing renewable resources
- Maintain and Protect safety, reliable operation and balancing of the utility's electric system
- Include long-term strategy and interim steps to equitable distribute benefits or reduce burdens to highly impacted in vulnerable populations
- Assess the environmental health impacts to highly impacted communities



How to incorporate CBIs into this mix?

### Prioritization

- one CBI is not determined to be more important than another on a stand-alone basis.
- Dependent upon resource selection, how much weight should be given?
- What about those that are not able to be quantified
- Weighting of factors?
- Develop standard weighting?

# CBI's Indirectly Related to the IRP

	Participation in Company Programs	Participation in weatherization programs and energy assistance programs (State and Named Community statistic)
	Availability of Methods/Modes of Outreach & Communication	Number of outreach contacts Number of marketing impressions
	Transportation Electrification	Number of trips provided by community-based organizations Number of public charging stations located in Named Communities
	Investments in Named Communities	Incremental spending each year in Named Communities Number of customers/and/or community-based organizations served
	Employee Diversity	Employee diversity equal to communities served by 2035 (goal)
	Outdoor Air Quality	Weighted Average Days Exceeding Healthy Levels
	Energy Availability	Average Outage Duration
	Greenhouse Gas Emissions	Regional GHG Emissions by Sector
	Supplier Diversity	Supplier diversity at 11 percent by 2035 (goal)
	Indoor Air Quality	In development

# How will the IRP address CBI's?

- Directly related IRP CBI's will be quantitatively forecasted in the IRP.
  - including of non-energy impacts and transitioning to 100% clean energy by 2045 may improve these indicators
- Indirectly related IRP CBI's will be qualitatively discussed in the IRP.
- In the event an indicator does not improve
  - Describe why the indicator is not improving
  - Document options for improvement, including impacts to other CBI's
- Other ideas?

# CBI List

✓	Participation in Company Programs	Participation in Energy Efficiency and Weatherization (“other”) Saturation Rate for Energy Assistance Programs
	Number of Households With High Energy Burden	Energy Burden by All Customers and Named Communities
	Availability of Methods/Modes of Outreach / Communication	Number of Outreach Contacts Number of Marketing Impressions
	Transportation Electrification	Number of Annual Trips to CBOs <u>and</u> passenger miles for individuals utilizing electric transportation Number of Public Charging ports available to public in Named Communities
	Named Community Clean Energy	Percent of Non-Emitting/Renewable Energy in Named Communities
	Investment in Named Communities	Incremental annual spending of investments in Named Communities Number of customers and/or CBOs served each year
	Energy Availability	Average Outage Duration Resource Adequacy Planning Margin
	Energy Generation Location	Percent of Generation Located in Washington or Connected to Avista TX system
	Outdoor Air Quality	Weighted Average Days Exceeding Healthy Levels Avista Plant Air Emissions (SO <sub>2</sub> , Mercury, Nox, VOC)
	Greenhouse Gas Emission	Regional GHG Emissions by Sector Avista’s GHG emissions
	Public Health	Employee and Supplier Diversity Indoor Air Quality





# 2023 IRP Draft Work Plan

2023 Electric IRP

TAC 1 – December 8, 2021

John Lyons, Ph.D. – Senior Resource Policy Analyst

# 2023 IRP Work Plan

- IRP regulations require an IRP to be filed in Idaho on April 1, 2023, and a progress report in Washington on January 1, 2023.
- Avista will ask Commissions to extend the filings to June 1, 2023, to allow for the completion of the 2022 All-Source RFP which will fundamentally change the resource strategy.
  - For the progress report in Washington, Avista will have 3 of the 4 requirements for the report by January 2023 but would prefer to hold off on filing a resource strategy until new contracts are signed.
- The IRP will incorporate resource selections from the 2022 All-Source RFP and meet capacity requirements in the Northwest Power Pool's Resource Adequacy Program.

## 2023 IRP Work Plan – Modeling

- Use Aurora for electric market prices, resource valuation and Monte-Carlo style risk analyses of the electric marketplace.
- Aurora modeling results will be used to select the PRS and alternative scenario portfolios using Avista's proprietary PRiSM model.
- Qualitative market risk evaluations involve separate analyses with Avista's ARAM model or Plexos.
- Applied Energy Group (AEG) is conducting energy efficiency and demand response potential studies.
- DNV is conducting non-energy impact study for supply-side resources to improve customer benefit indicators for Washington customers. DNV recently completed a similar study for energy efficiency.

# Tentative 2023 Electric IRP TAC Schedule

- **TAC 1 (Wednesday, December 8, 2021):** 2021 IRP Action Item Review, Summer 2021 Heat Event Review, NWPP Resource Adequacy Program Overview, Resource Adequacy Program Impact to the IRP, IRP Resource Adequacy/Resiliency Planning Discussion, TAC Survey Results and Discussion, Washington State Customer Benefit Indicators, and 2023 IRP workplan.
- **TAC 2 (Tuesday, February 8, 2022):** Process Update, Demand and economic forecast, and Preliminary Load & Resource Balance.
- **TAC 3 (Wednesday, March 9, 2022):** Preliminary natural gas market overview and price forecast, Preliminary wholesale electric price forecast, Non-Energy Impact Study by DNV, and Existing resource overview.

# Tentative 2023 Electric IRP TAC Schedule

- **TAC 4 (Late July 2022):** Conservation Potential Assessment (AEG), Demand Response Potential Assessment (AEG), energy efficiency inclusion of Social Cost of Greenhouse Gas (WA only)
- **TAC 5 (Early August 2022):** IRP transmission planning studies, distribution planning within the IRP, and NWPP Resource Adequacy Program update
- **TAC 6 (August 2022):** Supply side resource cost assumptions including DERs, ancillary services and intermittent generation analysis, update on All-Source RFP, update to energy and peak forecast, and update to Load & Resource balance
- **TAC 7 (September 2022):** Hydro impacts from global climate change studies, load impacts from global climate change studies, DER study scope for 2025 IRP, Clean Energy Implementation Plan update, final wholesale natural gas and electric price forecast, and discuss portfolio and market scenarios options

# Tentative 2023 Electric IRP TAC Schedule

- **Technical Modeling Workshop (October 2022):** PRiSM model overview, risk assessment overview (Plexos or ARAM), and Washington use of electricity modeling
- **TAC 8 (February 2023):** Wholesale market scenario results, RFP update, jurisdictional allocation update, draft Preferred Resource Strategy, Washington 100% clean energy planning standard modeling, and market risk assessment
- ***Virtual Public Meeting- Natural Gas & Electric IRP (February/March 2023)***
- **TAC 9 (March 2023):** Final Preferred Resource Strategy, portfolio scenario analysis, final report overview and comment on plan, and Action Items
- Agendas, presentations & minutes: <https://myavista.com/about-us/integrated-resource-planning>

# Tentative 2023 Draft Electric IRP Timeline

Task	Target Date
Update and finalize energy & peak forecast	May 2022
Transmission & distribution studies complete	June 2022
Identify Avista's supply resource options	July 2022
Finalize demand response options	July 2022
Finalize energy efficiency options	July 2022
Finalize natural gas price forecast	August 2022
Finalize electric price forecast	September 2022
Determine portfolio & market future studies	October 2022
<b>Due date for study requests from TAC members</b>	<b>October 1, 2022</b>
Finalize PRiSM model assumptions	October 2022
Simulate market scenarios in Aurora	November 2022
Portfolio Analysis	February 2022

# Tentative 2023 IRP Writing Tasks

Writing Tasks	Target Date
File 2023 IRP Work Plan	January 1, 2022
Washington Partial Progress Report	January 1, 2023
External draft released to the TAC	March 17, 2023
<b>Public Comments from TAC due</b>	<b>May 12, 2023</b>
Final IRP submission to Commissions and TAC	June 1, 2023



# Tentative 2023 Electric IRP Timeline – Public Data Releases

Task	Targeted Release
Peak & Energy Load Forecast	June 2022
Supply Side Resource Options	July 2022
Energy Efficiency Potential Study	July 2022
Demand Response Potential Study	July 2022
Transmission Interconnect Costs	July 2022
Wholesale Natural Gas Price Forecast	August 2022
Wholesale Electric Price Forecast	September 2022
Climate Change Impact Study Data	October 2022
Load Scenario Data	October 2022
PRiSM Model Available	November 2022
Draft PRiSM Model & Results	February 2023
Final PRiSM Model & Results	March 2023

# 2023 Electric IRP Draft Outline

1. **Executive Summary**
2. **Introduction, Stakeholder Involvement, and Process Changes**
3. **Economic and Load Forecast**
  - Economic Conditions
  - Avista Energy & Peak Load Forecasts
  - Load Forecast Scenarios
4. **Existing Supply Resources**
  - Avista Resources
  - Contractual Resources and Obligations
  - Customer Generation Overview

# 2023 Electric IRP Draft Outline

## 5. Long-Term Position

- Regional Capacity Requirements
- Energy Planning Requirements
- Reserves and Flexibility Assessment

## 6. Transmission Planning & Distribution

- Overview of Avista's Transmission System
- Future Upgrades and Interconnections
- Transmission Construction Costs and Integration
- Merchant Transmission Plan
- Overview of Avista's Distribution System
- Future Upgrades and Interconnections

# 2023 Electric IRP Draft Outline

## 7. Distributed Energy Resources

- Energy efficiency potential
- Demand response potential
- Supply side resource options
- Named Community Actions

## 8. Supply Side Resource Options

- New Resource Options
- Avista Plant Upgrades
- Non-Energy Impacts

# 2023 Electric IRP Draft Outline

## 9. Market Analysis

- Wholesale Natural Gas Market Price Forecast
- Wholesale Electric Market Price Forecast
- Scenario Analysis

## 10. Preferred Resource Strategy

- Preferred Resource Strategy
- Market Exposure Analysis
- Avoided Cost
- Customer Benefit Indicator Impact
- Clean Energy Action Plan Update

# 2023 Electric IRP Draft Outline

## 9. Portfolio Scenarios

- Portfolio Scenarios
- Market Scenario Impacts

## 10. Action Plan

## **Avista 2023 Electric IRP Meeting Notes for TAC 1 on December 8, 2021**

**Participants:** Andres Alvarez, Creative Renewable Solutions; Andrew Artsinger, Tyr Energy; John Barber, Customer; Shay Bauman, PCU; Shawn Bonfield, Avista; Joni Bosh, NWECC; Tamara Bradley, Avista; Annette Brandon, Avista; Michael Brutocao, Avista; Kevin Calhoon, Tyr Energy; Terri Carlock, IPUC; Travis Culbertson, IPUC; Corey Dahl, PCU; Michael Eldred, IPUC; Ryan Finesilver, Avista; Damon Fisher, Avista; Grant Forsyth, Avista; James Gall, Avista; Amanda Ghering, Avista; John Gross, Avista; Josh Haver, IPUC; Lori Hermanson, Avista; Joanna Huang, UTC; Fred Huette, NWECC; Clint Kalich, Avista; Rick Keller, IPUC; Kevin Keyt, IPUC; Scott Kinney, Avista; Mike Louis, IPUC; John Lyons, Avista; Stuart McCausland, Tyr Energy; Jaime Majure, Avista; Heather Moline, UTC; Mike Neher; Elizabeth Osborne, NWPPCC; Tom Pardee, Avista; Jennifer Snyder, UTC; Darrell Soyars, Avista; Dean Spratt, Avista; Art Swannack, Whitman County Commission; Gavin Tenold; David Thompson, Avista; Dave Van Herset, Customer; Katie Ware, Renewable Northwest; Marissa Warren, Idaho Office of Energy; Amy Wheelless, NWECC; Richard Wilson, Tollhouse Energy; Jim Woodward, UTC; Yao Yin, IPUC; and one unidentified caller.

### **Introductions, John Lyons**

**Heather Moline:** Have you considered how to get these meetings out to a larger group?

**John Lyons:** This is a technical group by membership. All that it takes to join is a request to be added but it typically includes folks more deeply involved that have a technical background.

### **2021 Action Item Review, John Lyons**

No notes beyond slide deck.

### **Summer 2021 Heat Event – Resource Adequacy, James Gall**

**Fred Huette:** I'd never heard of CEATI but looks like they've been around for a while. Has Avista been involved with them before?

**Scott Kinney:** Our hydro engineering group has been involved with this group for at least a decade.

**David Thompson:** We've been involved as a member for 15 years for asset management and other areas. It's a research sharing organization (regional). CEATI is similar to EPRI. A lot of the research is done through third party researchers whereas EPRI does a lot of the research/analysis in-house.

**Art Swannack:** My only comment on valley temperatures versus the airport is to remember there wasn't a lot of people in the Spokane Valley until the 1970s. A lot of that area was orchards/fields. Cold air sinks so may not have been warmer in the valley. Would need lots of data to verify.

**Clint Kalich:** Thanks Art for the comment. I believe the point of measurement in the 1960s was the Spokane Airport west of Spokane. But if still the point of measurement was Felts Field, it could be as you suggest. Does anyone know when the Spokane Airport was the point of record? I'm thinking it was pre-60s. [Airport change was 1947].

**Fred Huette:** Was there enough load loss to make enough difference to push the peak load to Wednesday?

**James Gall:** Wednesday very few customers out [context: at the same time]. Not enough out on Tuesday to push the load up. David might be able to add some context in his presentation.

**Scott Kinney:** We made appeals to customers to conserve. I don't think we did this on Wednesday with temperatures declining. And we had a large industrial curtail that helped as well.

**Yao Yin:** In terms of planning for new resources is the net peak or the absolute peak hour that we care about?

**James Gall:** Good question. I see that type of planning in California at least for solar. Plan for peak net of solar. What really should be done for planning is to plan for a peak and then LOLP randomized based on likely production curves. In reality, it nets those peaks off. Both should be done for planning. Customer solar should be netted out as well.

**Yao Yin:** For peak data that we're seeing, the orange line is non-customer solar.

**James Gall:** Correct.

**Yao Yin:** Is it possible that if the peak is met, the net peak is not met?

**James Gall:** I think what can happen is that there's so much solar that the peak gets shifted to another hour and you didn't plan for that. That's something you need to look for. We do a test to make sure the amount of solar from the customer's side doesn't shift our peak. I don't currently see a risk of that on our customer side unless solar penetration is over the 200-300 MW range. In the future, we could see that peak shift, but it should be accounted for in the ELCC calculation if it's done accurately. ELCC would measure each resource's ability to meet sustained peak. We'll talk about this more later today.

**Fred Huette:** What data do you have on residential AC (air conditioning) penetration? There's been a series of heat waves in Portland, and beginning in Seattle, so we're seeing changes in behavior.

**James Gall:** Avista contracted with Bidgely who takes AMI data to estimate several end-uses including AC. Something that we could look at in the future.

**Jennifer Snyder:** NEEA is conducting a multi-family building stock assessment that UTC Staff encourages Avista to participate in.

**Lori Hermanson:** Thanks Jennifer. We have typically participated in these building stock assessments in the past. Our EE group leads these efforts as opposed to our planning group.



**Gavin Tenold:** Why not a 10-year average?

**James Gall:** Regarding the 10-year average, that is definitely an option, as well as using forecasted temperatures. We will continue to monitor. I will defer to Grant Forsyth if he has any other concerns with a short-term view

### **Summer 2021 Heat Event – Feeder Outages, David Thompson**

**Art Swannack:** Any indication of increased business use of AC due to heat safety rules from L&I?

**John Lyons:** Art, that is an area where we don't have good data on – commercial and industrial AC use.

**Fred Huette:** Never heard of a mobile substation, can you describe this?

**David Thompson:** It is a trailer-based transformer, circuit breaker and other components. We have two trailers available for service at the moment. Can be transported in and connected to provide enhancement. Connected overnight. We require a 4-hour outage before dispatch and there may be some staging.

**John Gross:** General rule of thumb is about 24 hours from being notified and mobilized and connected. Even 24 hours would be quick. If feeders have capacity, we'd use those. Typically, in these heat events we don't have feeder capacity and that's why we bring in these mobile options.

**Rick Keller:** When you balance the feeder, is that a manual or automated process?

**David Thompson:** It is a manual process to identify where the imbalance is and to connect that to a different feeder.

**Rick Keller:** On slide 7, can you provide more detail around the cooling non function?

**David Thompson:** The fans have several cooling alarms or levels of alarms. There are 16 fans and they ended up replacing four. The problem was rectified within a short period of time.

**Rick Keller:** If you see a trend where you will experience high temperatures, will you review fans to ensure they're operational.

David Thompson: We cover lessons learned at the end.

**Rick Keller:** Is there a long-term impact to the transformers?

**David Thompson:** Operational concerns of operating in high temperatures and its impacts to the health of the equipment. These steps we're putting in place are to protect the equipment from failure or degradation. Still safe operating conditions based on the manufacturing information, but we still note it for a health index of the assets. The ideas of alarms and dropping of load is to protect the equipment.

**Art Swannack:** Are you looking at higher quality equipment design (bushings, etc.) to decrease future problems?

**David Thompson:** Always looking at best available equipment. This information is captured from asset management equipment health.

**John Gross:** Of the breakers that had bushing issues, newer equipment performed better.

**Fred Huette:** Do you have an estimate of the loss of load for outages mentioned on slide 16?

**David Thompson:** We do not.

**Fred Huette:** The main reason I'm wondering, is there really a significant change in peak load. Realize it's not easy to project.

**David Thompson:** It'd take some projections because this occurred while loads were increasing.

**Fred Huette:** Thank you for making this presentation. We're learning important lessons. Gas plants don't perform well in high heat.

**Gavin Tenold:** What is the average age of your substation transformers?

**David Thompson:** I will look that up and put the answer in the chat.

**Fred Huette:** If you could also give a rough estimate of expected life of that? I think what we're seeing here is that the equipment is generally older than the average life.

**David Thompson:** I'm pretty sure that that is where ours will fall, but I'll get those numbers and post them in the chat.

**David Thompson:** (in chat) Going back to the transformer age question: Typical manufacturer specifications stipulate a 30-year life based on nominal loading. That spec is generally reduced to 20 years if operated at full nameplate capacity 24/7. Avista's approximate population age is 38 years with a range of about 80 years.

### **NW Power Pool Resource Adequacy Program, Scott Kinney**

**Mike Louis:** Please provide an example of conditional firm transmission referenced on slide 9.

**Scott Kinney:** Close to firm but not quite so it allows for curtailment. Firm, you can only curtail due to reliability. A little bit less reliable product that you can buy.

**Joni Bosh:** What documents will be used to create financial settlements – e-tags?

**Scott Kinney:** Will utilize e-tags on a delivery basis. On a day-ahead hold back, the operator will have record on that to determine payment.

**Joni Bosh:** Can the nominating committee nominate non-utility reps to the Board of Directors?

**Scott Kinney:** Yes, it is an independent board so it could. They'll be some structure and requirements.

**Resource Adequacy Program Impact to IRP, Michael Brutocao**

**Yao Yin:** Could you explain why this operating reserve credit is not included?

**James Gall:** The operating reserve credit is hydro capacity capable of delivering reserves that we have not included as firm energy on the resource contribution. Since the new planning margin captures operating reserves and the QCC captures the unit's capability to provide energy, including this additional value would be double counting the available capacity.

**Michael Eldred:** What caused the planning margin difference between the 2021 method to the RAP? The 7% to the 12%.

**James Gall:** When looking at the regional footprint, there's a summer and winter contingency of participating utilities.

**Scott Kinney:** That's exactly right. We're more of a winter peaking, but when looking at the region as a whole, we're more dual peaking.

**James Gall:** I'd argue this is similar in total. The big savings is in the winter and that step change is helped by the diversity of the region and driving the biggest benefit for Avista as far as the amount of capacity we'll have to acquire.

**Michael Eldred:** On the QCC, is that capacity credit for this new RAP service territory?

**James Gall:** It's Avista system specific.

**James Gall:** Peak credit in previous methodology and it was Avista only. In this case, the QCC will be calculated for each resource in the system based on methodology for the various zones/type.

**Michael Brutocao:** These are the values the RAP can count on.

**Scott Kinney:** RAP methodology we've agreed to based on Avista resources.

**James Gall:** Newer resources, such as storage, we're still trying to figure these out.

**Scott Kinney:** The program operator will be monitoring and making those changes on a continuous basis, every other year or maybe annually.

**Joni Bosh:** On the draft, this slide had less detail.

**Michael Brutocao:** It was a poor example of me trying to explain how these values were calculated.

**James Gall:** We updated that it was storage hydro resources and other types of resources. **Scott Kinney:** We do have Mid-C contracts – the PUDs will have their own QCC values and based on our percentages. We'll apply that to these values.

**Mike Louis:** Is that the L&R?

**James Gall:** Yes, from the last IRP adjusted for the RAP. Does not include changes to the load forecast that we provided to the IPUC since the last IRP.

### **IRP Resource Adequacy/Resiliency Planning, James Gall**

**James Gall:** Credit to DER? Should we plan to no more than a 3-hour outage? What belongs in the IRP? Should we pay extra for resources that can provide a certain amount of resiliency?

**Mike Louis:** Special cause variation – response time, can build yourself out of those situations because it's too costly. Common cause – occurs frequently and things you can build for. I think that's helpful in evaluating this.

**Jennifer Snyder:** I'd love to hear from Avista customers on this.

**Annette Brandon:** Jennifer, we have a team set up that is already working with customers on customer resiliency. In the context of the CEIP we also plan on discussing with the EAG again in the context of our CBIs.

**Mike Louis:** Can probably deal with a certain amount of special causes, but I don't think you can build yourself out of these situations.

**Gavin Tenold:** Is the CETA reference to 1 hour planning available? Where is this cited in the statute?

**James Gall:** I don't recall there being a 1-hour reference. The rules don't yet say you have to do 1-hour planning. There was a workshop about what it means to plan the system to meet its load. One option is that we'd have to show from a modeling view that we're capable of providing this on an hourly basis. This is still being refined but one option that the Commission has set out there so far.

**Shawn Bonfield:** The draft rule is not finalized or adopted. Regarding the draft CETA rules discussed, here is a link to the WUTC docket where they are working on the rules: <https://www.utc.wa.gov/casedocket/2021/210183/docsets>. If you scroll down to November 10th, you will see a Notice of Opportunity to Comment along with the proposed draft rules being considered.

**Joni Bosh (in chat):**

Proposed rule: WAC 480-100-650 Reporting and compliance.  
 (1) Resource acquisition and compliance. Using electricity for compliance under RCW 19.405.040(1) and RCW 19.405.050(1) means that a utility:  
 (a) has acquired renewable and nonemitting resources to meet its retail electric load, and  
 (b) can demonstrate compliance as required in subsection (2) of this section.

**Mike Louis:** How do we measure resiliency performance?

**James Gall:** Metric for distribution.

**Scott Kinney:** They monitor some other industry metrics but beyond those IEEE metrics, I'm not sure.

**Heather Moline:** The ability of the bulk power system to meet capacity (resiliency always a response to a very specific event – fire, etc). We're used to thinking of power supply as the average customers versus those having a harder time. I think we should consider resiliency as a local phenomenon.

**Michael Eldred:** Using Plexos for risk assessment - can you explain this further?

**James Gall:** Plexos is a power supply model that dispatches resources to load. We'd run that model stochastically – vary load each hour and generation potential, and randomize inputs impacting generation. The result would be the amount of hours and MWh above load, this would measure the market risk we have in extreme hours even though we would be resource compliant. This test would also validate if we need additional transmission, or if we should acquire additional generation to lessen this market risk.

### **TAC Survey Results and Discussion, Lori Hermanson**

**Lori Hermanson (Slide 3):** 53% no to two TAC tracks.

**Lori Hermanson (Slide 4):** 50% in both tracks and 38% in technical only track, so 85% total. Based on this we will continue the single-track TAC path we have been using.

**Lori Hermanson (Slide 5):** 69% prefer about 8 meetings of no more than 3 to 4 hours. You'll notice that the Work Plan later has 8 meetings of about 4 hours with lunch.

**Lori Hermanson (Slide 6):** More data, document and chapters provided. Are there more topics or areas? Couple: resource adequacy, reliability, climate change, and T&D. These items are included in one agenda item or another so many are already discussed, such as DER today.

**Lori Hermanson (Slide 7):** Additional data about right. One person asked for an additional chart for each strategy, updated climate modeling, hydro area studies and will be included. Regional western effort for resource adequacy will change IRP process to match it. To comply with Washington law – focus on low cost. Modernize with WISDOM-P. We are evaluating more models all the time. Energy Exemplar's Aurora and Plexos enhancements to DER, storage, etc. Draft info in 2022. Utilize existing biomass – upgrade for KFGS and responses to IRP.

**Lori Hermanson (Slide 8):** Last TAC was different with an after-hours TAC meeting geared towards customers. Several hundred RSVPed and over 100 participated. The top two ideas for improvement included better utilizing the IRP web site and informational invitation. Newspaper articles and input from actual customers rather than from outside the service territory.

**Lori Hermanson (Slide 9):** 2021 process – detailed, appreciated the difficulty involved with two states. Increased transparency and breaking down technical/complex issues. Remote meetings and format.

**Lori Hermanson (slide 10):** Improvements. Maybe summarize them. Energy Exemplar's database – whole new section of available storage options with costs.

**Gavin Tenold (chat):** Would we be able to get some data, and details on Exemplar's updates as they relate to how Avista plans to consider DERs?

**Lori Hermanson:** Yes, we'll be presenting on resources that we'll be evaluating. It'll be covered in a future TAC meeting.

**Gavin Tenold (chat):** Thank you, it would be nice to learn in some detail about the tool's updates to DER planning.

### **Washington State Customer Benefit Indicators, Annette Brandon and James Gall**

**Heather Moline:** Of all the renewable energy, about 10% is in those named communities.

**James Gall:** 10% of retail sales was met by non-emitting or renewable resources in named communities. You'll see this percentage grow because we started this in 2016, but didn't include the cumulative impact of energy efficiency already online so this is understated.

**Joni Bosh:** Cumulative number?

**James Gall:** Cumulative for energy efficiency since it's still online, but not for generation – it's the production for that year.

**Joni Bosh:** Drop from 2016 to 2017?

**James Gall:** I think it was hydro conditions. I'll look it up and validate that [Results show it was less generation from Kettle Falls].

**Joni Bosh:** Located in named communities – is it mostly hydro?

**James Gall:** Hydro, biomass, wind in named communities; maybe that's an enhancement we can make. The chart below includes the requested data from the question in the meeting of generation types in named communities.

**Annette Brandon:** Rattlesnake Wind was only online for half of December so this will go up in 2021.

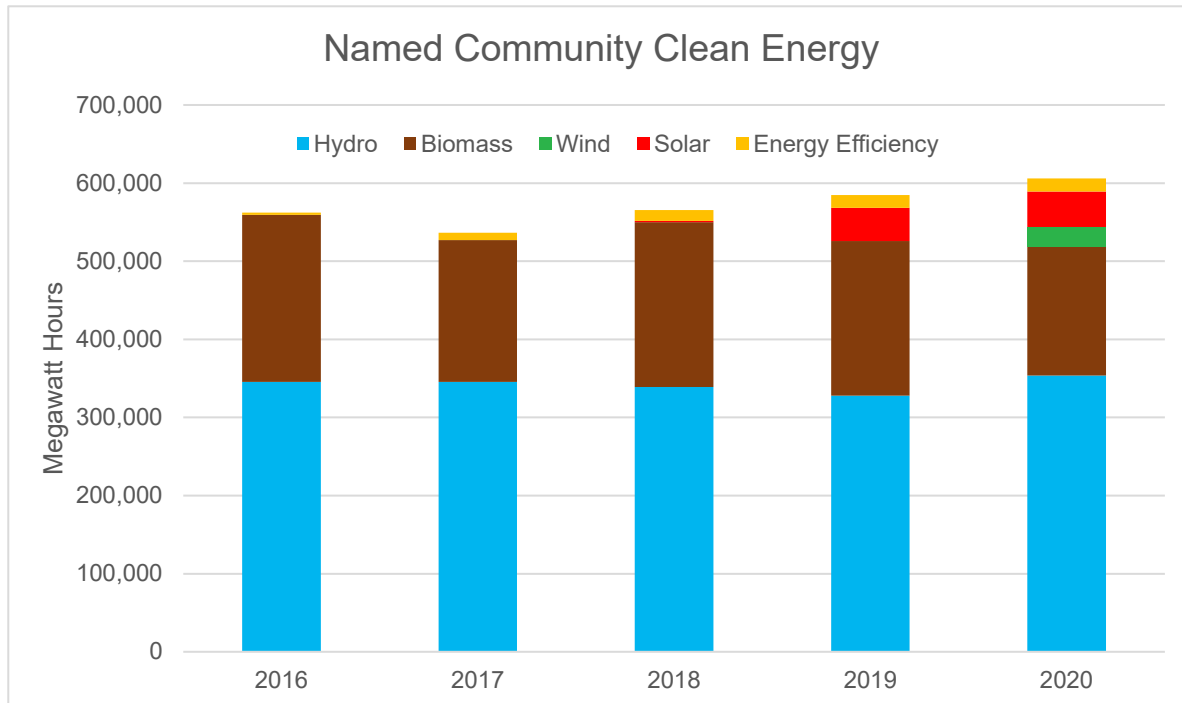

**Joni Bosh:** If these are located in Washington, are they dedicated to Avista customers?

**James Gall:** Yes, we're using them for our load but if there's excess, we sell it. Our system is energy long so a portion will be sold to another entity.

**Annette Brandon:** If it's close to our house, we're more secure based on customer feedback – easy for them to understand and for us to measure improvements

**Joni Bosh:** The rules for your CEIP are CBI values or indications that it wasn't applicable to that resource selection. You may need to include a narrative about how affordability was impacted by this resource selection. I think the "why" is the most important. Narrative on how the CBIs relate to that choice rather than check, check, check. I think this should be applied to all resources not just energy efficiency.

**Heather Moline:** We noticed nothing about DERs (distributed energy resources) beyond energy efficiency.

James Gall: Modeling local solar doesn't do much in our service territory. Implicit opportunity cost conversation could be done if you can't quantify the impact.

### 2023 Draft IRP Workplan, John Lyons

**Michael Eldred:** Portfolio optimization, will it be the same as the last methodology as the last?

**James Gall:** Yes, unless there's a new cost allocation methodology developed first.



***2023 Electric Integrated Resource Plan***  
**Technical Advisory Committee Meeting No. 2 Agenda**  
**Tuesday, February 8, 2022**  
**Virtual Meeting**

<b>Topic</b>	<b>Time</b>	<b>Staff</b>
Introductions	9:00	John Lyons
Process Update	9:10	John Lyons
Demand & Economic Forecast	9:30	Grant Forsyth
Load and Resource Balance Update	11:00	James Gall
Adjourn	11:30	

## Microsoft Teams meeting

**Join on your computer or mobile app**

[Click here to join the meeting](#)

**Or call in (audio only)**

[+1 509-931-1514](tel:+15099311514), [935268410#](tel:+1935268410) United States, Spokane

Phone Conference ID: 935 268 410#

[Find a local number](#) | [Reset PIN](#)

[Learn More](#) | [Meeting options](#)





# 2023 IRP Introduction

2023 Avista Electric IRP

TAC 2 – February 8, 2022

John Lyons, Ph.D. Senior Resource Policy Analyst

# Meeting Guidelines

- IRP team is working remotely and is available for questions and comments
- Stakeholder feedback form
  - Responses shared with TAC at meetings, by email and in Appendix
  - Would a form and/or section on the web site be helpful?
- IRP data posted to web site – updated descriptions and navigation are in development
- Virtual IRP meetings on Microsoft Teams until able to hold large meetings again
- TAC presentations and meeting notes posted on IRP page
- This meeting is being recorded and an automated transcript made

# Virtual TAC Meeting Reminders

- Please mute mics unless speaking or asking a question
- Raise hand or use the chat box for questions or comments
- Respect the pause
- Please try not to speak over the presenter or a speaker
- Please state your name before commenting for the note taker
- This is a public advisory meeting – presentations and comments will be documented and recorded

# Integrated Resource Planning

The Integrated Resource Plan (IRP):

- Required by Idaho and Washington\* every other year
  - Washington requires IRP every four years and update at two years
- Guides resource strategy over the next twenty + years
- Current and projected load & resource position
- Resource strategies under different future policies
  - Generation resource choices
  - Conservation / demand response
  - Transmission and distribution integration
  - Avoided costs
- Market and portfolio scenarios for uncertain future events and issues

# Technical Advisory Committee

- The public process piece of the IRP – input on what to study, how to study, and review of assumptions and results
- Wide range of participants involved in all or parts of the process
  - Please ask questions
  - Always soliciting new TAC members
- Open forum while balancing need to get through topics
- Welcome requests for new studies or different modeling assumptions.
- Available by email or phone for questions or comments between meetings

# 2023 IRP Process Update

- Draft Work Plan sent with today's presentations
  - Are any days of the week better or worse for future meetings?
  - Based on feedback from last TAC – aiming for shorter and more frequent meetings
- Intend to file 2023 IRP on June 1, 2023 – allow time to incorporate results of 2022 All-Source RFP
- Idaho Extension
  - Filed request under Docket No. [AVU-E-22-01](#) to file the next IRP on June 1, 2023, instead of April 1, 2023
  - January 25, 2022: Staff recommendation to set a public comment deadline of February 24, 2022, and Company reply due by March 5, 2022
- Washington IRP update on January 1, 2022, with 3 of the 4 requirements – only Preferred Resource Strategy will not be ready with RFP results

# 2023 IRP TAC Meeting Schedule

- TAC 3: Wednesday, March 9, 2022
  - Preliminary Natural Gas Market Overview and Price Forecast
  - Preliminary Wholesale Electric Price Forecast
  - Non-Energy Impact Study (DNV)
  - Existing Resource Overview
- TAC 4: August 2022
  - Conservation Potential Assessment (AEG)
  - Demand Response Potential Assessment (AEG)
  - Energy Efficiency Inclusion of Social Cost of Greenhouse Gas (WA Only)
- TAC 5: Early September 2022
  - IRP Generation Option Transmission Planning Studies
  - Distribution System Planning with the IRP
  - Western Resource Adequacy Program update

# 2023 IRP TAC Meeting Schedule

- TAC 6: End of September 2022
  - Supply Side Resource Cost Assumptions, including DERs
  - Ancillary Services and Intermittent Generation Analysis
  - All-Source RFP Update
  - Energy and Peak Forecast update
  - Load & Resource Balance update
- TAC 7: October 2022
  - Hydro Impacts from Global Climate Change studies
  - Load Impacts from Global Climate Change studies
  - DER Study Scope for 2025 IRP
  - Clean Energy Implementation Plan update
  - Final Wholesale Natural Gas and Electric Price Forecasts
  - Discuss portfolio and market scenario options



# 2023 IRP TAC Meeting Schedule

- Technical Modeling Workshop October 2022
  - PRiSM model overview
  - Risk Assessment overview
  - Washington use of electricity modeling
- TAC 8: February 2023
  - Wholesale Market Scenario results
  - RFP update
  - Jurisdictional allocation update
  - Draft Preferred Resource Strategy
  - Washington 100% clean energy planning standard modeling
  - Market risk assessment

# 2023 IRP TAC Meeting Schedule

- Virtual Public Meeting – Natural Gas & Electric IRPs (February/March 2023)
  - Recorded presentation
  - Daytime comment and question session
  - Evening comment and question session
- TAC 9: March 2023
  - Final Preferred Resource Strategy
  - Portfolio scenario analysis
  - Final report overview & comment plant
  - Action Items

# Key 2023 IRP Dates

- Finalize 2023 IRP Work Plan – February/March 2022
- Due date for study requests from TAC members – October 1, 2022
- Washington IRP Progress Report – January 1, 2023
- External IRP draft released to the TAC – March 17, 2023
- Public comments from TAC due – May 12, 2023
- Final 2023 IRP submission to Commissions and TAC – June 1, 2023

# Today's Agenda

- 9:00 Introductions, Lyons
- 9:10 Process Update, Lyons
- 9:30 Demand and Economic Forecast, Forsyth
- 11:00 Load and Resource Balance Update
- 11:30 Adjourn



TAC Meeting  
February 8, 2022

# 2023 IRP: Preliminary Economic Conditions and Forecasts

Grant Forsyth, Ph.D.  
Chief Economist  
[Grant.Forsyth@avistacorp.com](mailto:Grant.Forsyth@avistacorp.com)

# Outline

- **Service Area Economy**
- **Long-run Energy Forecast**
- **Peak Load Forecast**

“Models are predicting what’s normal in a world that isn’t normal.”

-Erica Groshen, former head of the BLS and current economic advisor to Cornell University’s Industrial and Labor Relations School.

Quote from: “Here’s another thing the pandemic messed up: economic forecasts,” by David J. Lynch, *The Washington Post*, January 11, 2022

# Service Area Economy: Non-Farm Employment Structure

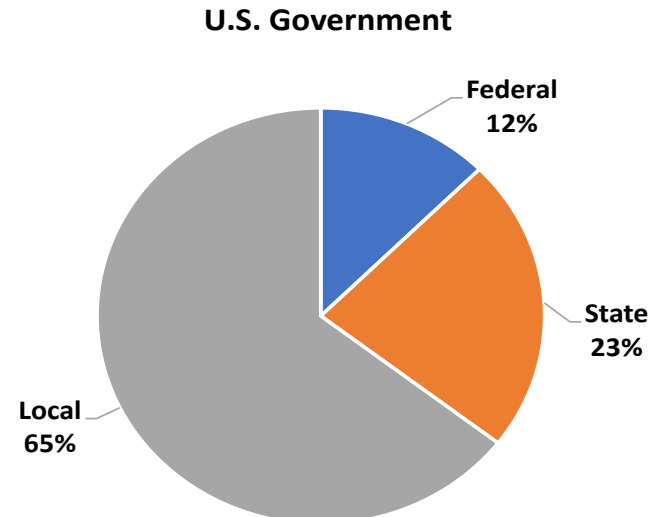
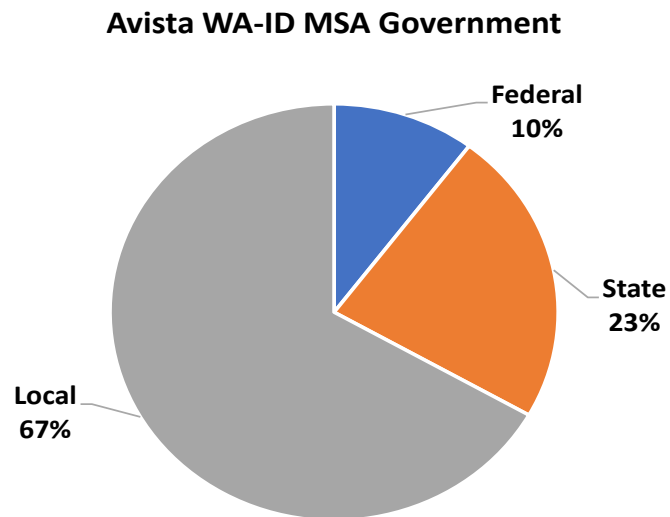
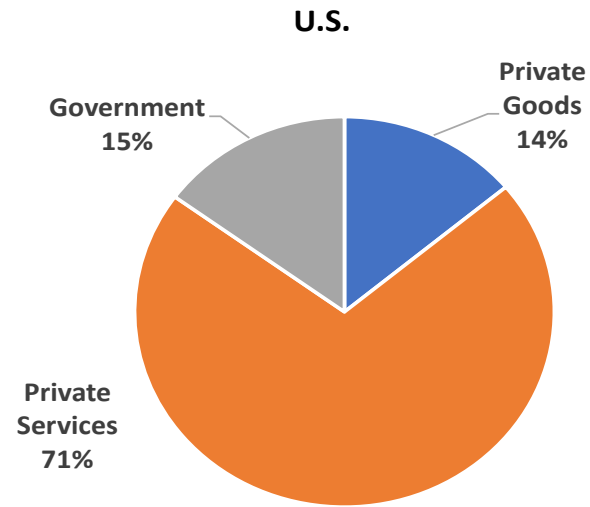
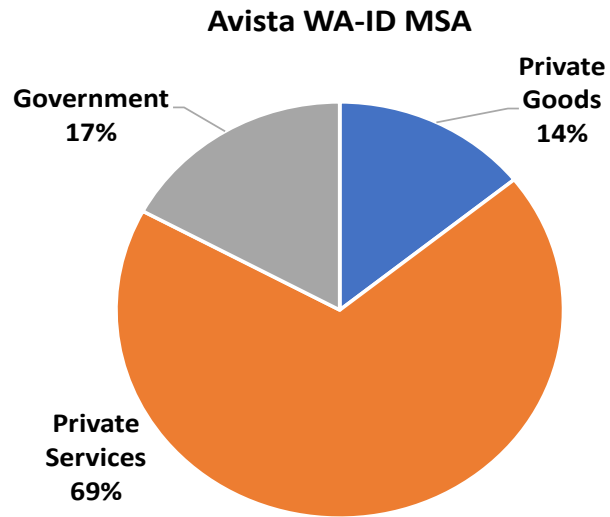

- Comments**
- Employment structure very similar to the U.S.
  - Employment dominated by private services. Without service sector growth, very little employment growth will be generated.
  - Majority of public sector employment is local and related to education.
  - If agriculture is considered, it would account for about 1% to 1.5% of employment.

Source: BLS and author's calculations.



# Service Area Economy: Non-Farm Employment

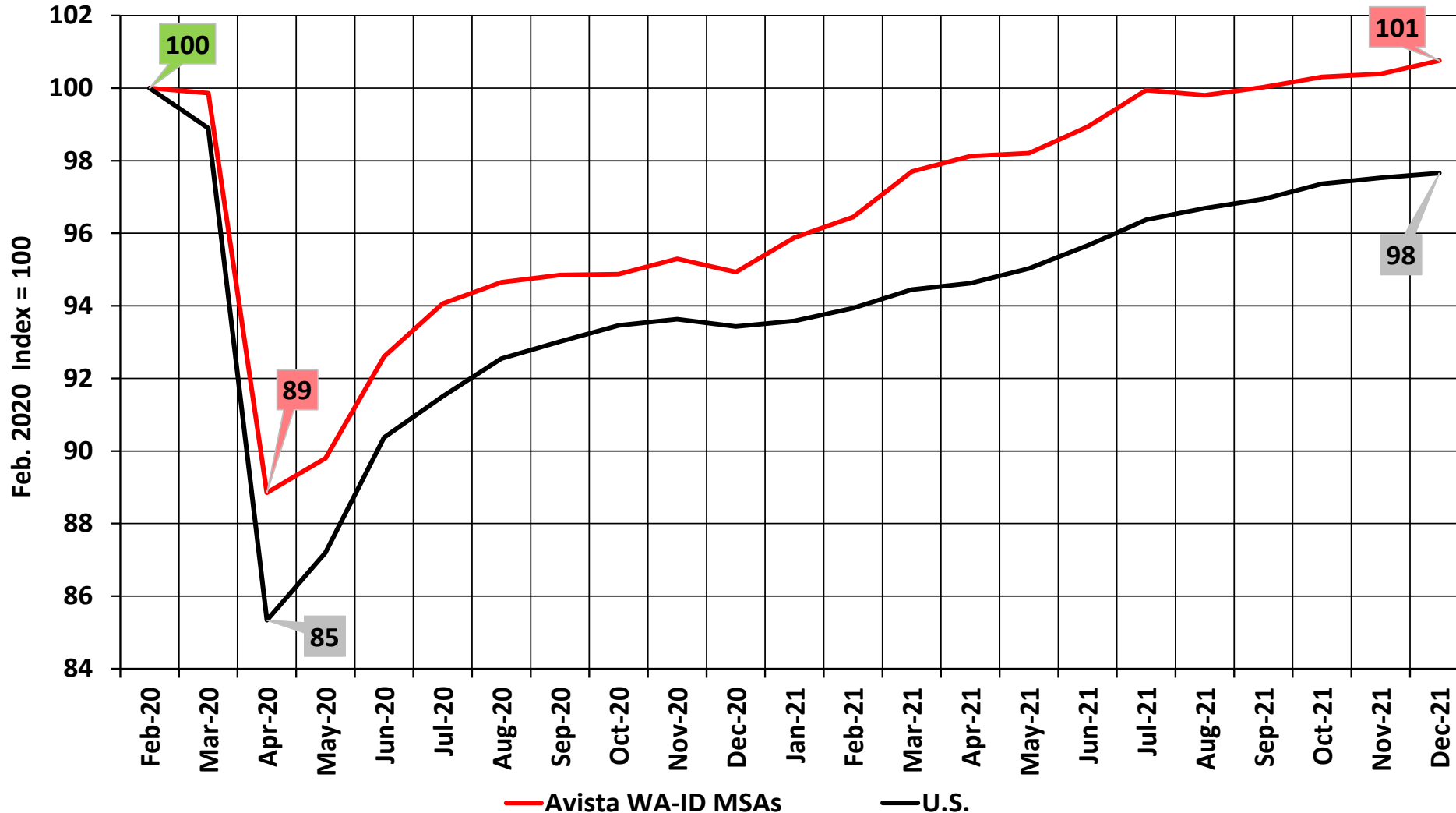

- Comments**
- Region has recovered from the pandemic faster than the U.S.
  - Strong growth in ID and an Amazon expansion in WA were important drivers.
  - However, the region is still suffering many of the same problems seen in the rest of the U.S.: labor shortages, supply disruptions, and inflation. Shelter cost growth has been some of the fastest in the U.S.

Source: BLS, WA ESD, and author's calculations.





# Service Area Economy: WA-ID Metro Population Growth

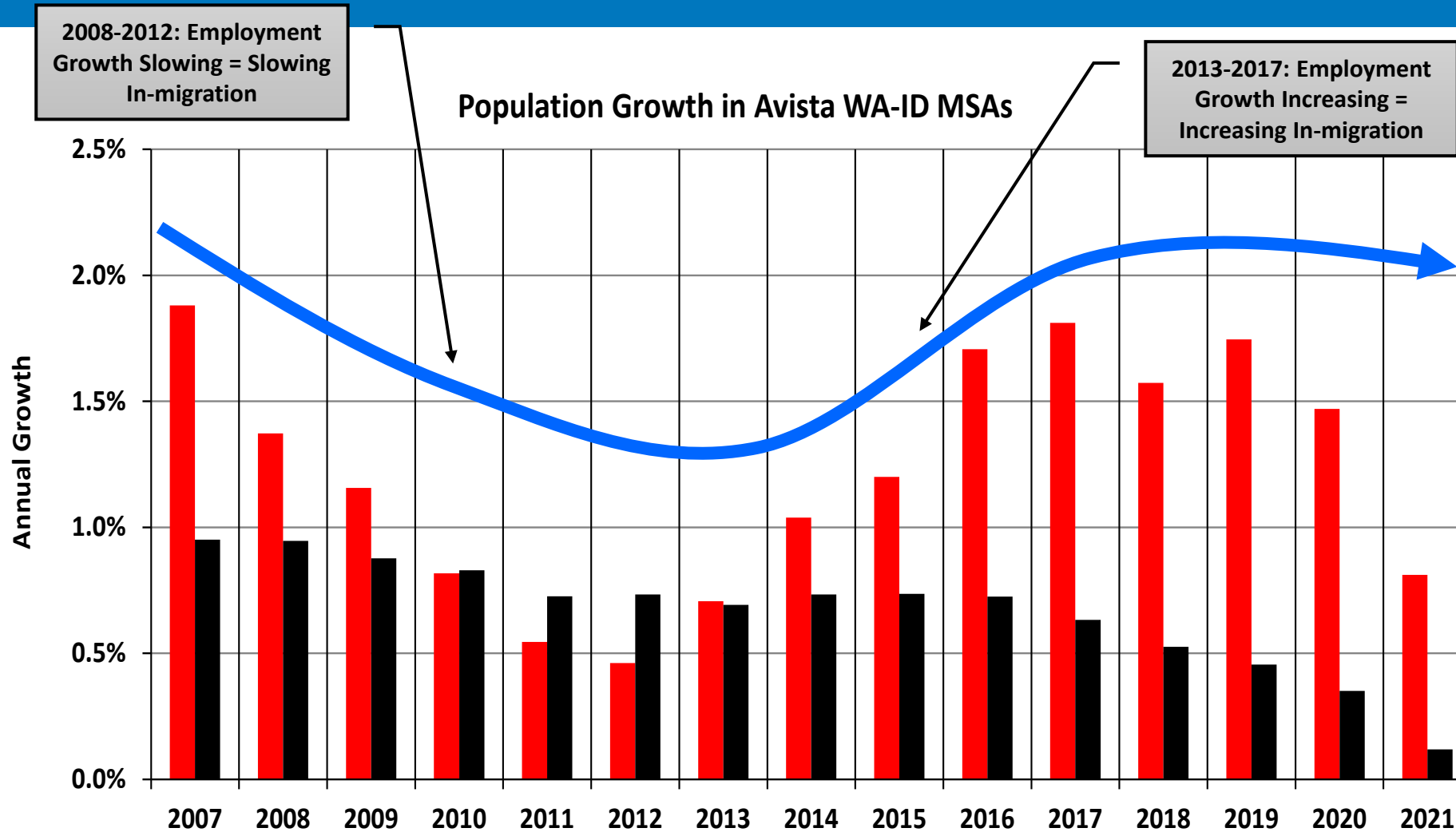

- ### Comments
- Population growth drives most of our customer growth.
  - Significantly higher than U.S. growth because of in-migration. Without in-migration, growth would look like U.S.
  - Pandemic suppressed growth in 2021. We expect a rebound in service area growth after 2021.
  - Growth is highest on the ID side.

Source: BEA, U.S. Census, and author's calculations.



# Service Area Economy: Spokane+Kootenai Residential Units Permitted

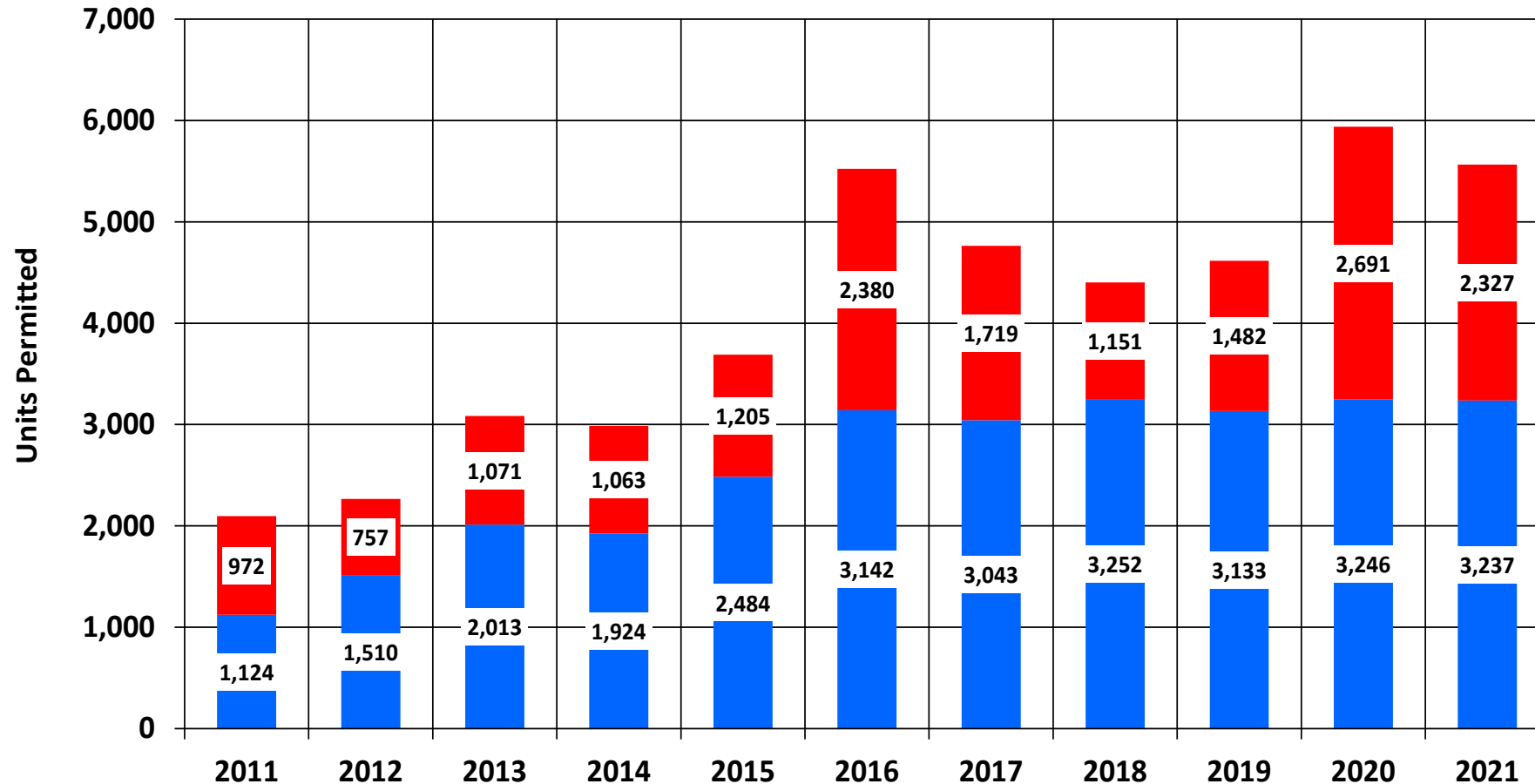

■ Total Spokane+Kootenai Single Family, WA-ID  
■ Total Spokane+Kootenai Apartments, WA-ID

- Comments**
- Strongly connected to population growth.
  - Held up surprisingly well in the pandemic. Recessions would normally push down permitting.
  - Even with strong permitting, demand has outstripped supply of housing. This has pushed price growth to some of the highest in the U.S.
  - Apartments and duplexes have been an important source of new housing in both WA and ID. Duplexes are counted as “single family” in the graph.

Source: Construction Monitor and author’s calculations.



# Service Area Economy: U.S. GDP Growth Assumptions

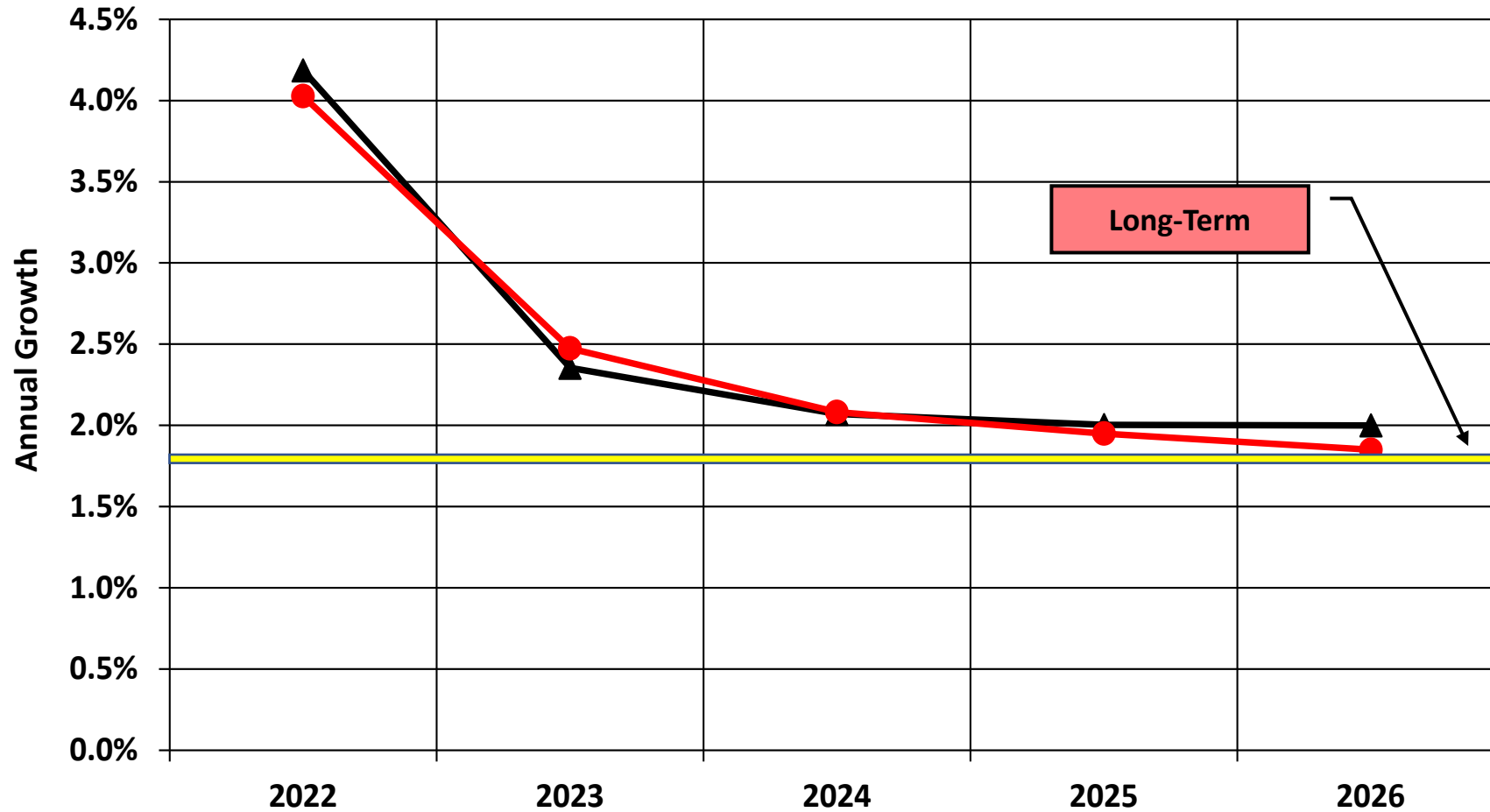

- Comments**
- Long-run growth is a function of population growth and labor productivity growth.
  - U.S. continues to have weak productivity growth and weak population growth.
  - The Fed’s long-run expectation for GDP growth has fallen from 2% to 1.8% (yellow line). This is the growth rate assumed from 2027 to 2045.
  - The assumed long-run GDP forecast is lower compared to previous IRPs. Long-run GDP growth must exceed 2.3% before forecasted industrial load will grow.

Medium-Term → **▲ Average Fall 2021 Forecast**      **● Current Forecast Average**

Source: Various and author’s calculations.



# Long-term Energy Forecast: Basic Approach

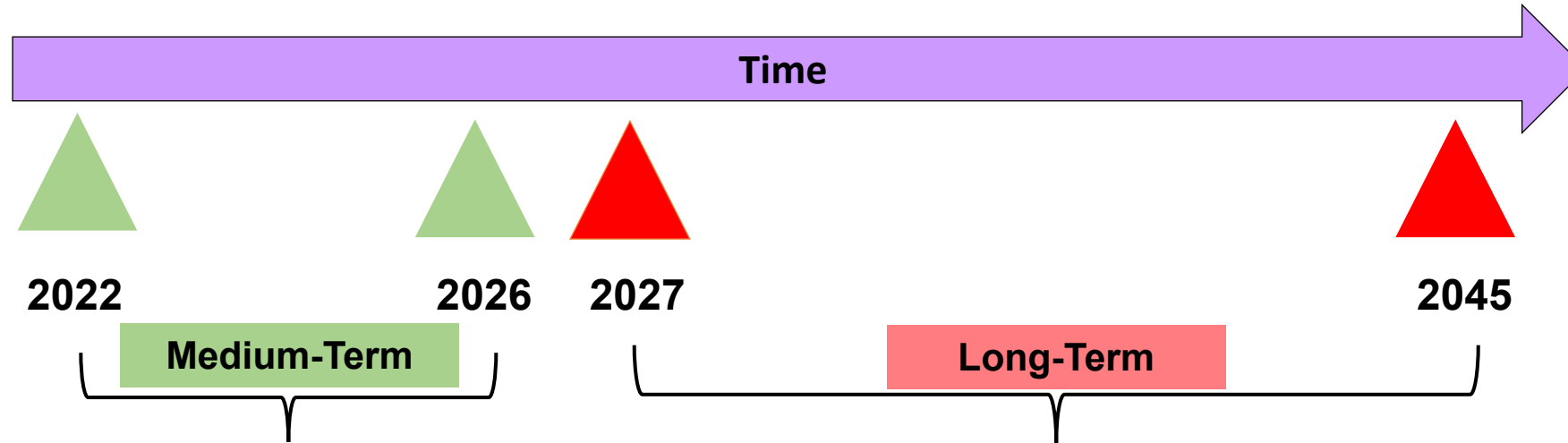

- 1) Monthly econometric model by schedule for each customer class.
- 2) Customer and UPC forecasts.
- 3) 20-year moving average for "normal weather."
- 4) Economic drivers: GDP, industrial production, employment growth, population, price, natural gas penetration, and ARIMA error correction.
- 5) Native load (energy) forecast derived from retail load forecast.
- 6) Current forecast is the Fall 2021 Forecast.

- 1) Boot strap off medium term forecast.
- 2) Apply long-run load growth relationships to develop simulation model for high/low scenarios.
- 3) Include different scenarios for roof top solar penetration with controls for price elasticity, EV/PHEVs, GDP growth, population growth, weather, and natural gas penetration.

# Long-term Energy Forecast: Growth Relationships

Load = Customers x Use Per Customer (UPC)

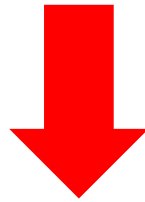

Load Growth  $\approx$  Customer Growth + UPC Growth

Population growth is the primary driver of residential customer growth and residential growth is primary driver of commercial customer growth. Industrial customer growth reflects a long-run trend of declining customers.

Assumed to be a function of multiple factors; the major factors can be altered to see impacts.

# Long-term Energy Forecast: Residential Customer Growth

## Annual Residential Customer Growth Rates

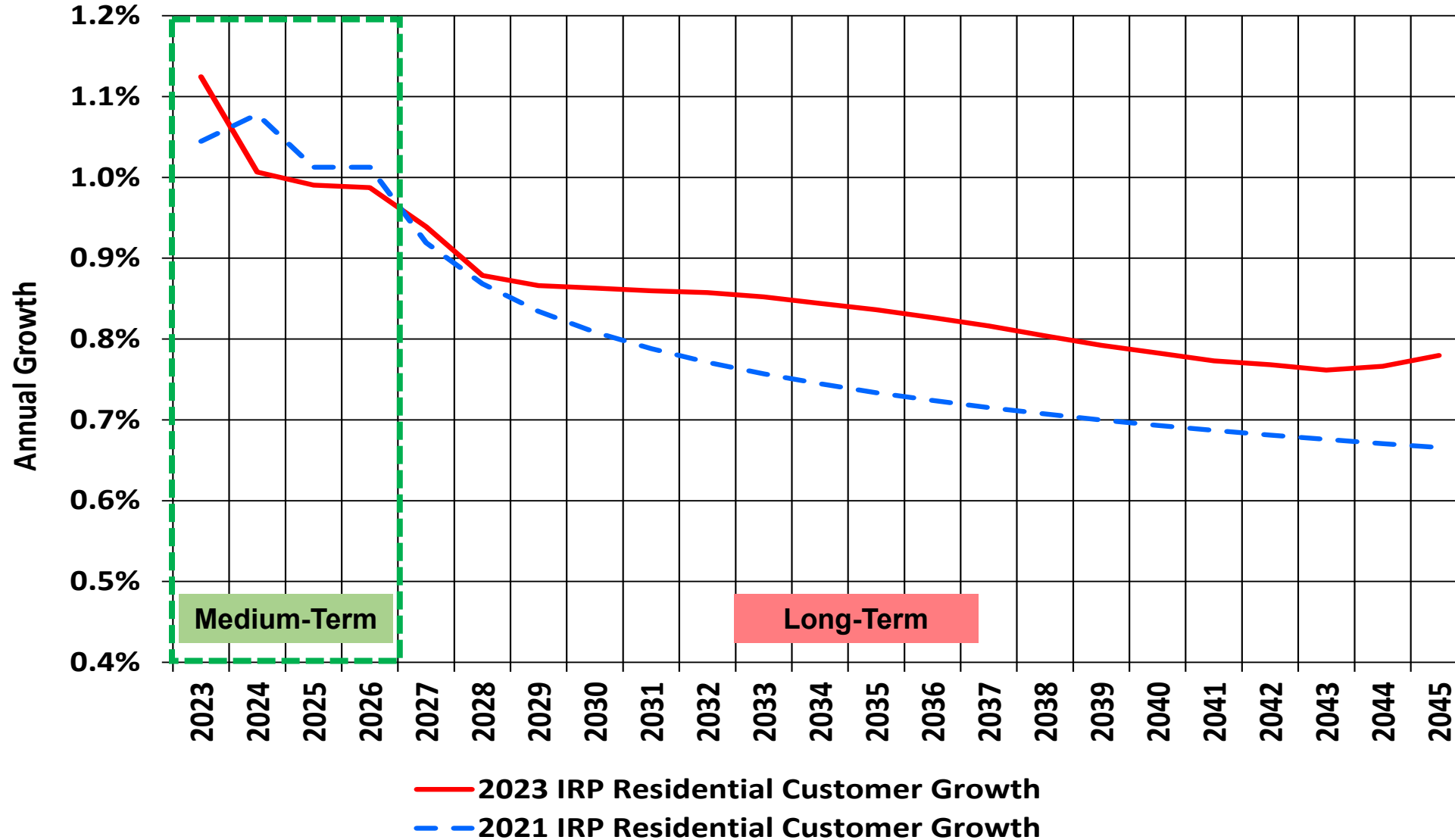

IRP	Avg. Annual Growth
2021 IRP	0.80%
2023 IRP	0.86%
2023 WA	0.69%
2023 ID	1.17%

**Comments**

- From 2027 on, the time-path reflects IHS population forecasts.
- The higher growth rate in this IRP reflects higher forecasted growth in ID.



# Long-term Energy Forecast: Residential Solar Penetration

**Projected Base-Line Residential Solar Customers**

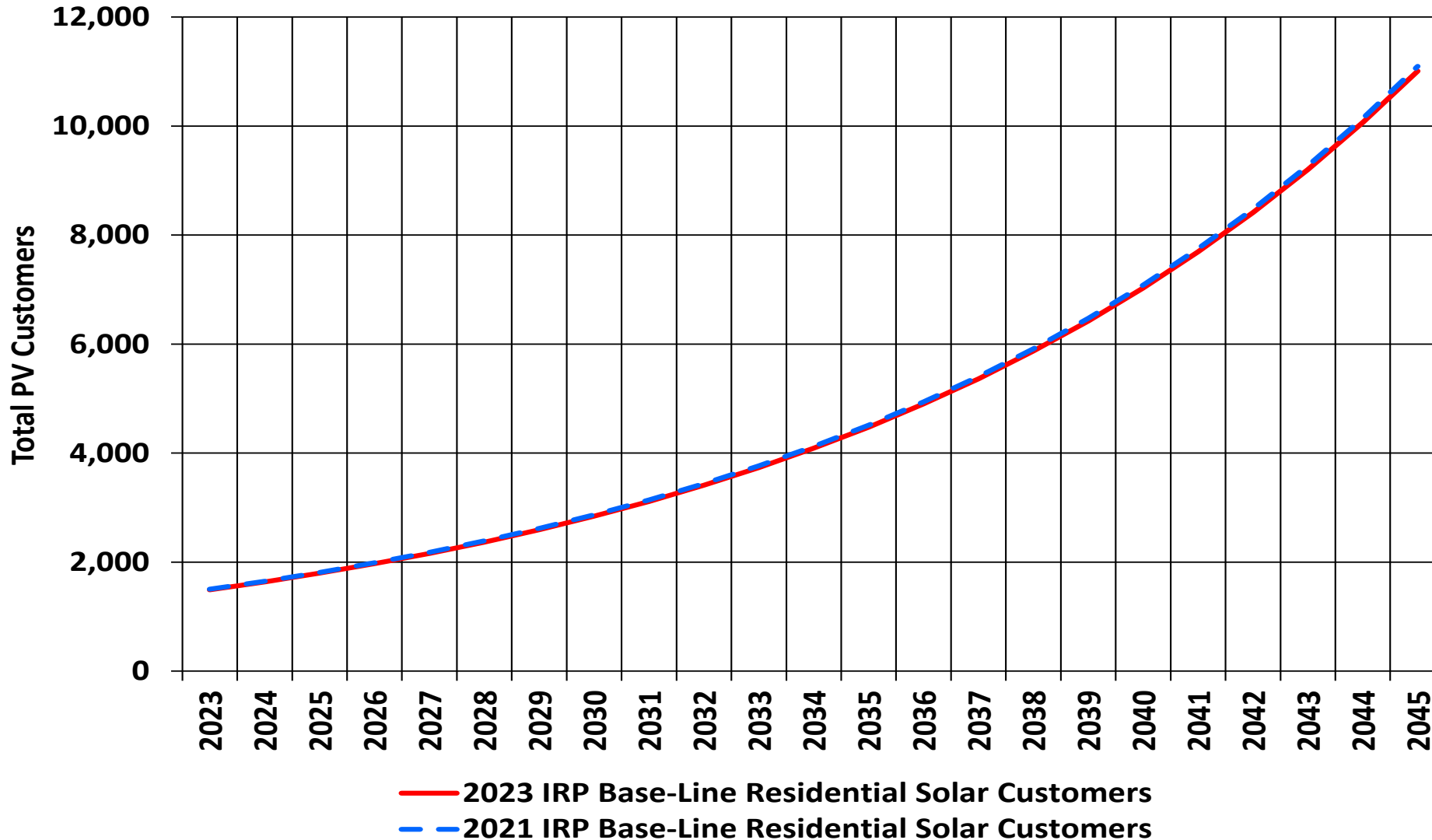

- Comments**
- Solar penetration similar to 2021 IRP.
  - Current penetration is 0.4% of residential customers. This is projected to grow to 2.5% by 2045.
  - Current system size is around 7,000 watts, with the assumption of 8,900 watts by 2045
  - This remains a highly uncertain projection given on-going changes to public policy.



# Long-term Energy Forecast: Light Duty EVs, 2023-2045

### Projected Residential EVs

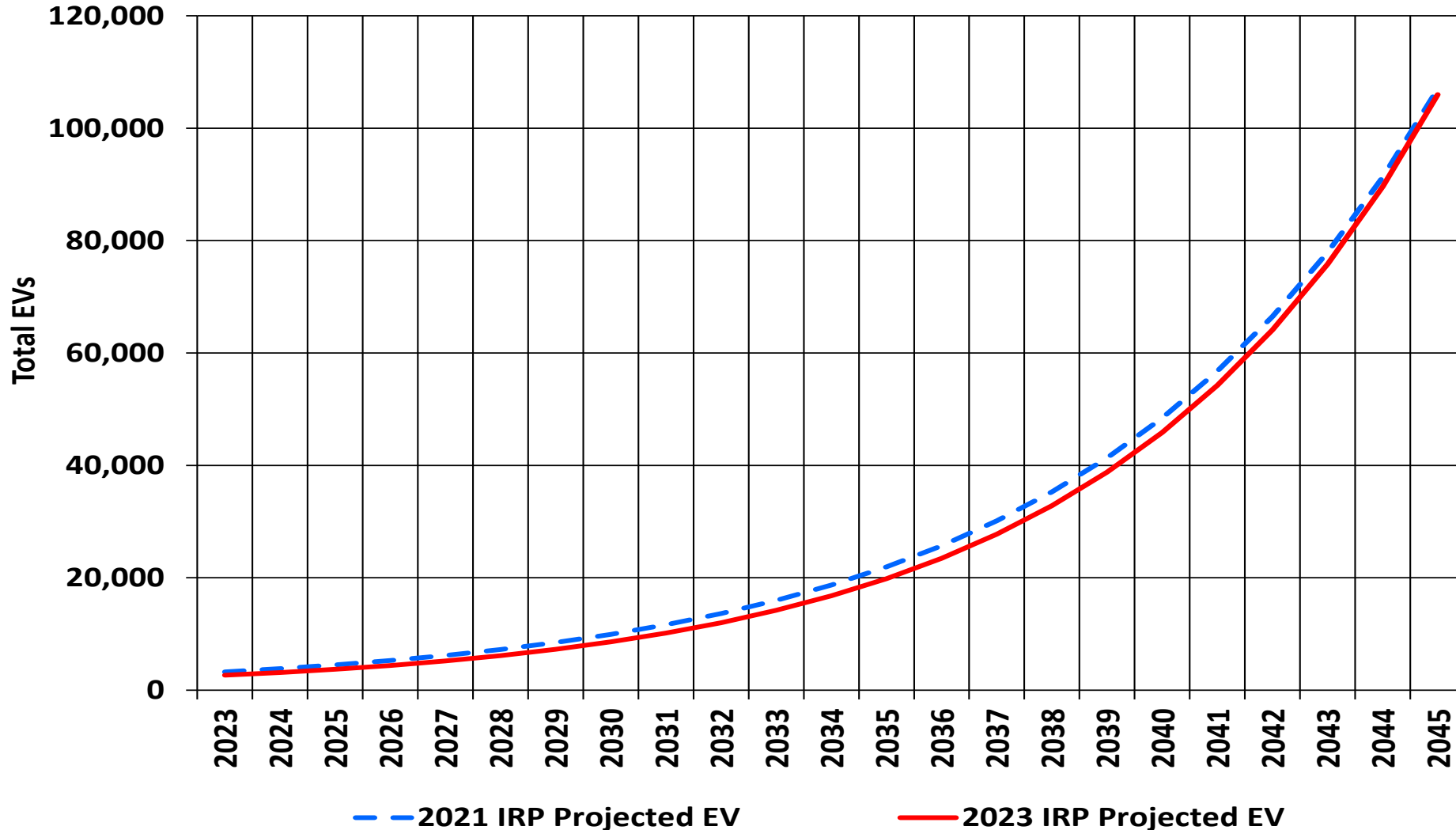

#### Comments

- Similar to 2021 IRP.
- Current light duty EVs are around 2,600. This is projected to grow to 106,000 by 2045.
- Current penetration is 0.3% of household vehicles. This is projected to grow to 13% by 2045.
- This remains a highly uncertain projection given on-going changes in the EV industry and public policy.



# Long-term Energy Forecast: Net Solar and EV Impacts, 2023-2045

### Average Megawatt Impact of Solar and EV/PHEV

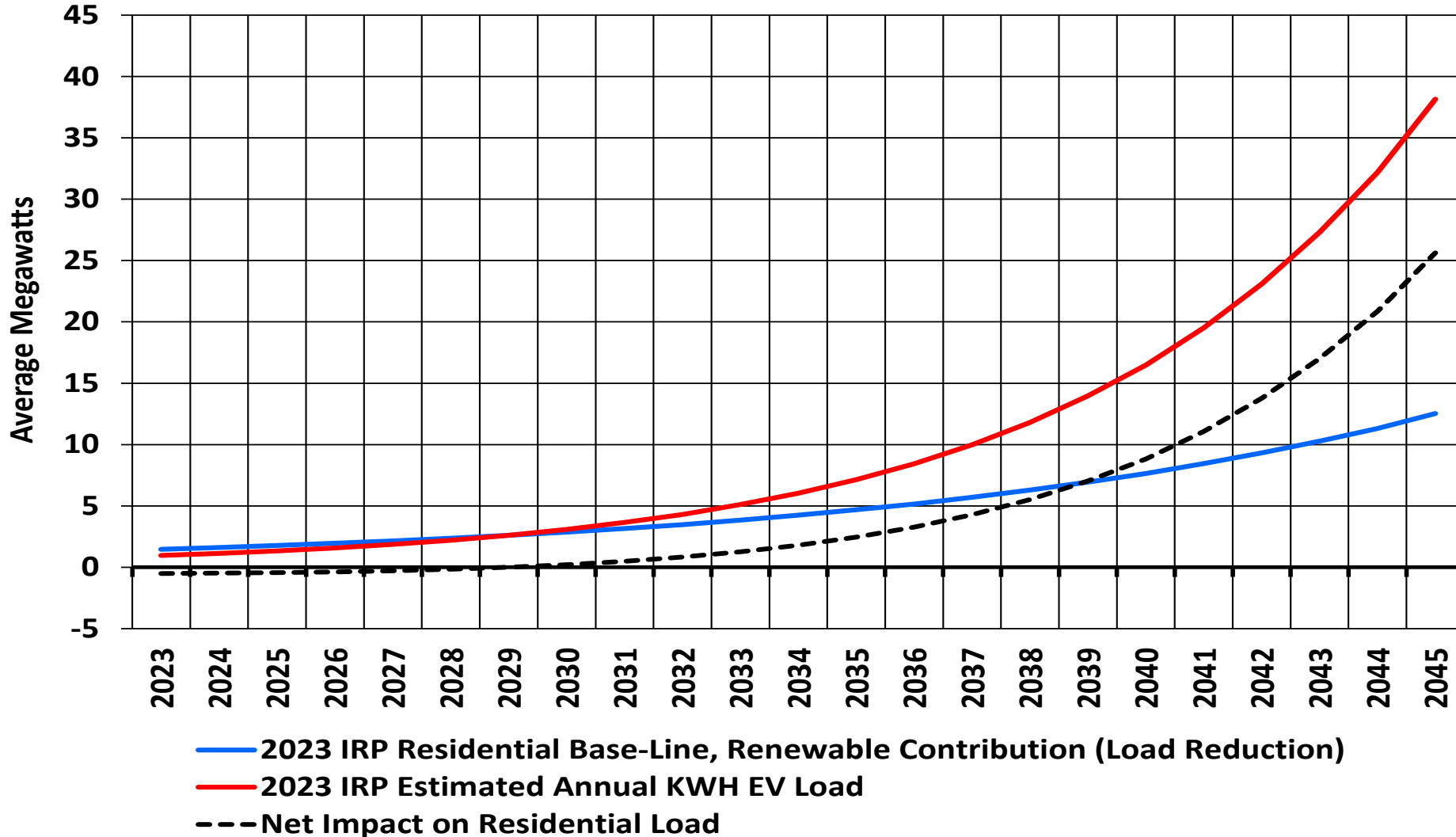

**Comments**

- EVs start to dominate load impacts in late 2030s.



# Long-term Energy Forecast: Native Load

Native Load Forecast, Average Megawatts

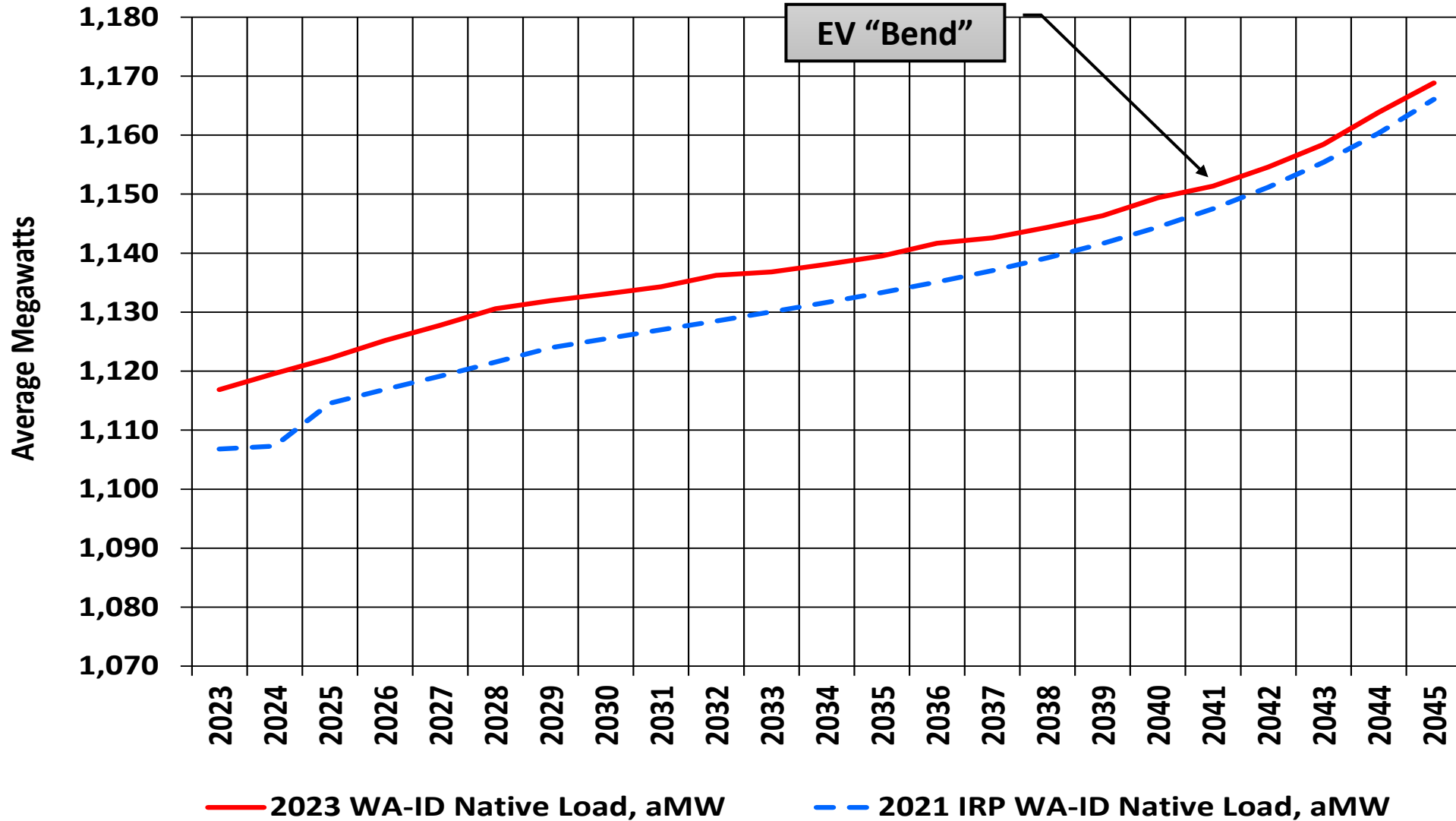

IRP	Avg. Annual Growth
2021 IRP	0.24%
2023 IRP	0.21%
2023 WA	0.15%
2023 ID	0.31%

**Comments**

- The load level is higher because the medium-term forecast in this IRP has stronger economic and population growth assumptions compared with the 2021 IRP.



# Long-term Energy Forecast: State Native Load

State Native Load Forecast, Average Megawatts

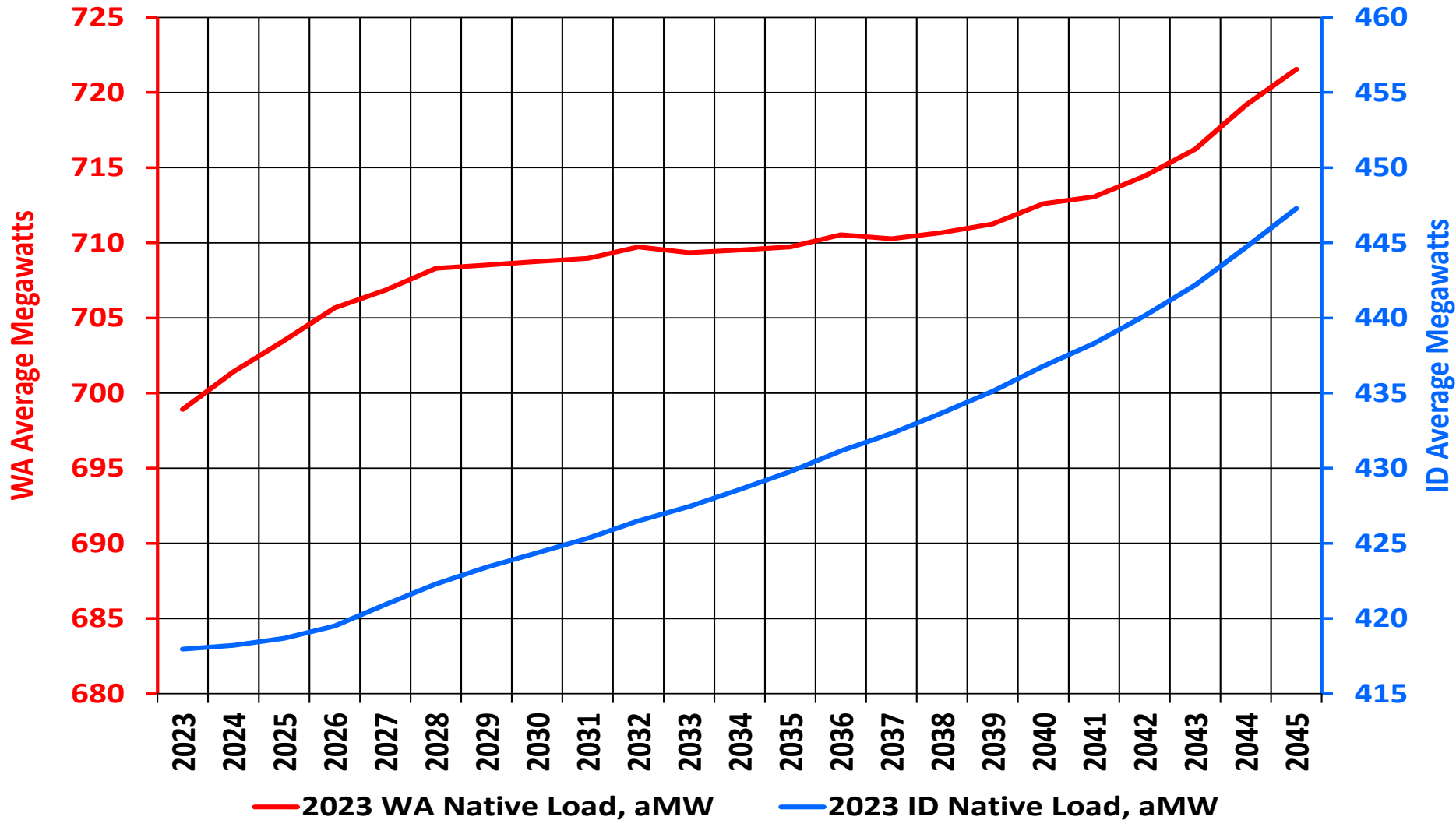

IRP	Avg. Annual Growth
2023 IRP	0.21%
2023 WA	0.15%
2023 ID	0.31%

**Comments**

- ID load growth is higher because (1) its population growth forecast is higher and (2) lower solar penetration compared to WA.
- WA long-term forecast assumes gas penetration (as a share of residential electric customers) is constant. In ID the model assumes a gradual increase.



# Long-term Energy Forecast: Annual Residential UPC Growth

**Base-Line Scenario: Residential UPC Growth Rate**

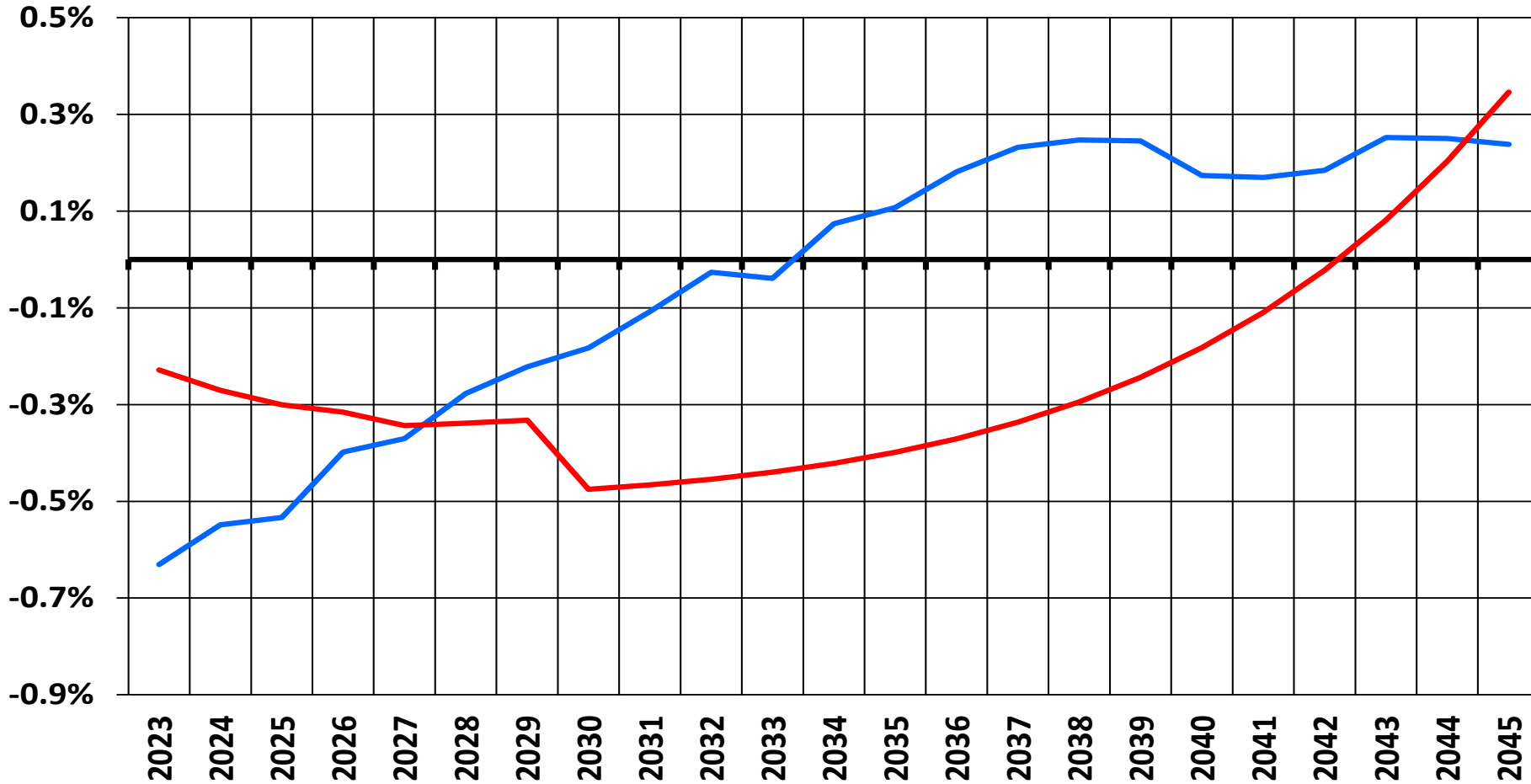

— EIA Reference Case Use Per Household Growth  
 — 2023 IRP Residential Base-Line UPC Growth

**Comments**

- Avista and EIA UPC growth look different because of U.S. population shifts to warmer regions.
- Avista UPC dips in 2030 due to the assumption that the annual growth rate in real residential rate will accelerate from 1% growth from 2027 to 2029 to 1.5% until 2045.
- As noted, it's assumed WA's share of residential customers with gas is constant from 2026 to 2045.



# Long-term Energy Forecast: Residential Own Price Elasticity

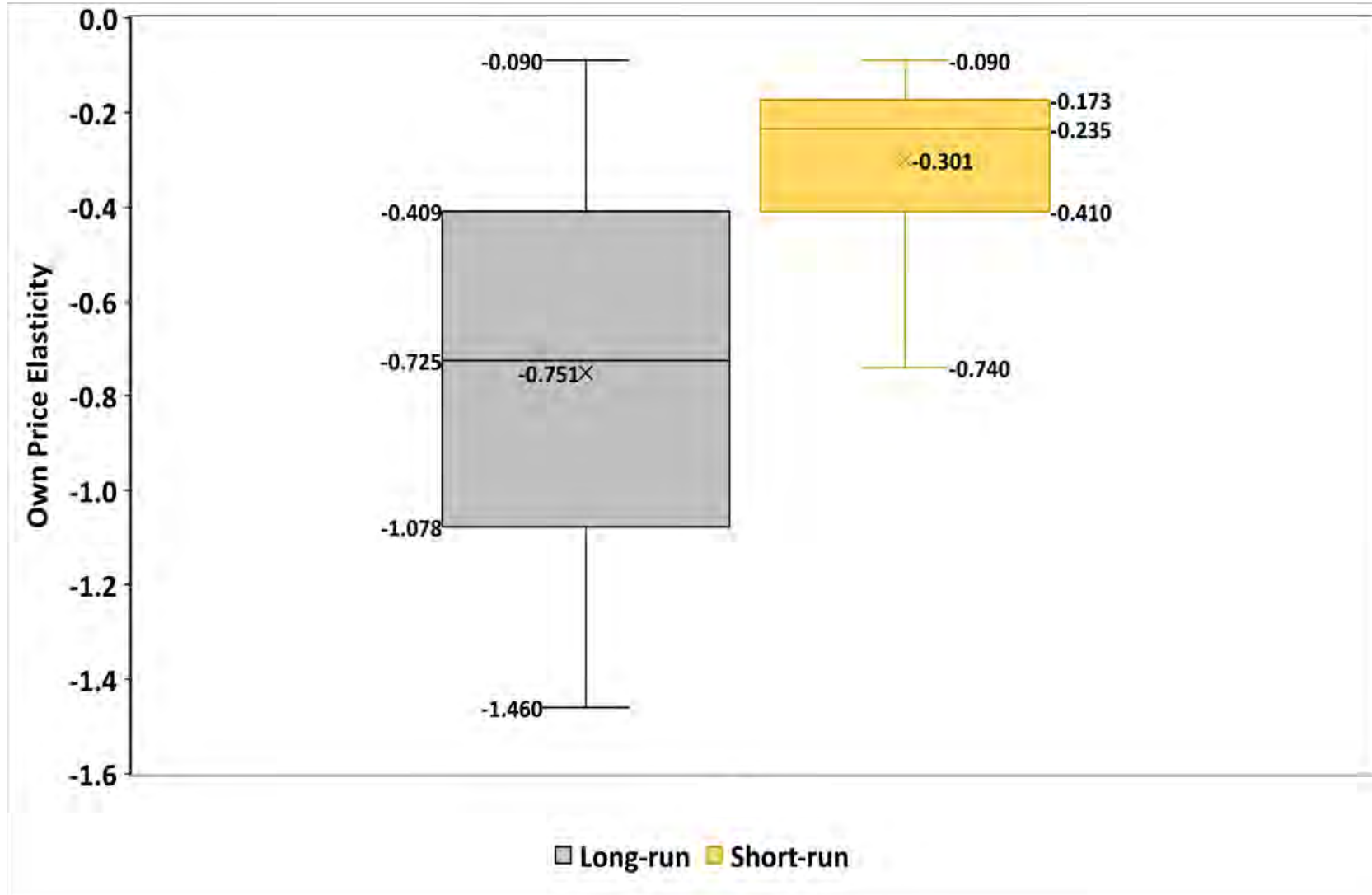

Source: Various sources and author's calculations.

## Comments

- Review of individual studies and surveys of studies to get a range of estimates.
- Long-term forecast assumes a residential elasticity of -0.3.
- Restrictions on natural gas and growth of EVs would likely put downward pressure on elasticity.

# Long-term Energy Forecast: Conservation Impacts

aMW Load Comparison with Conservation Adjustment

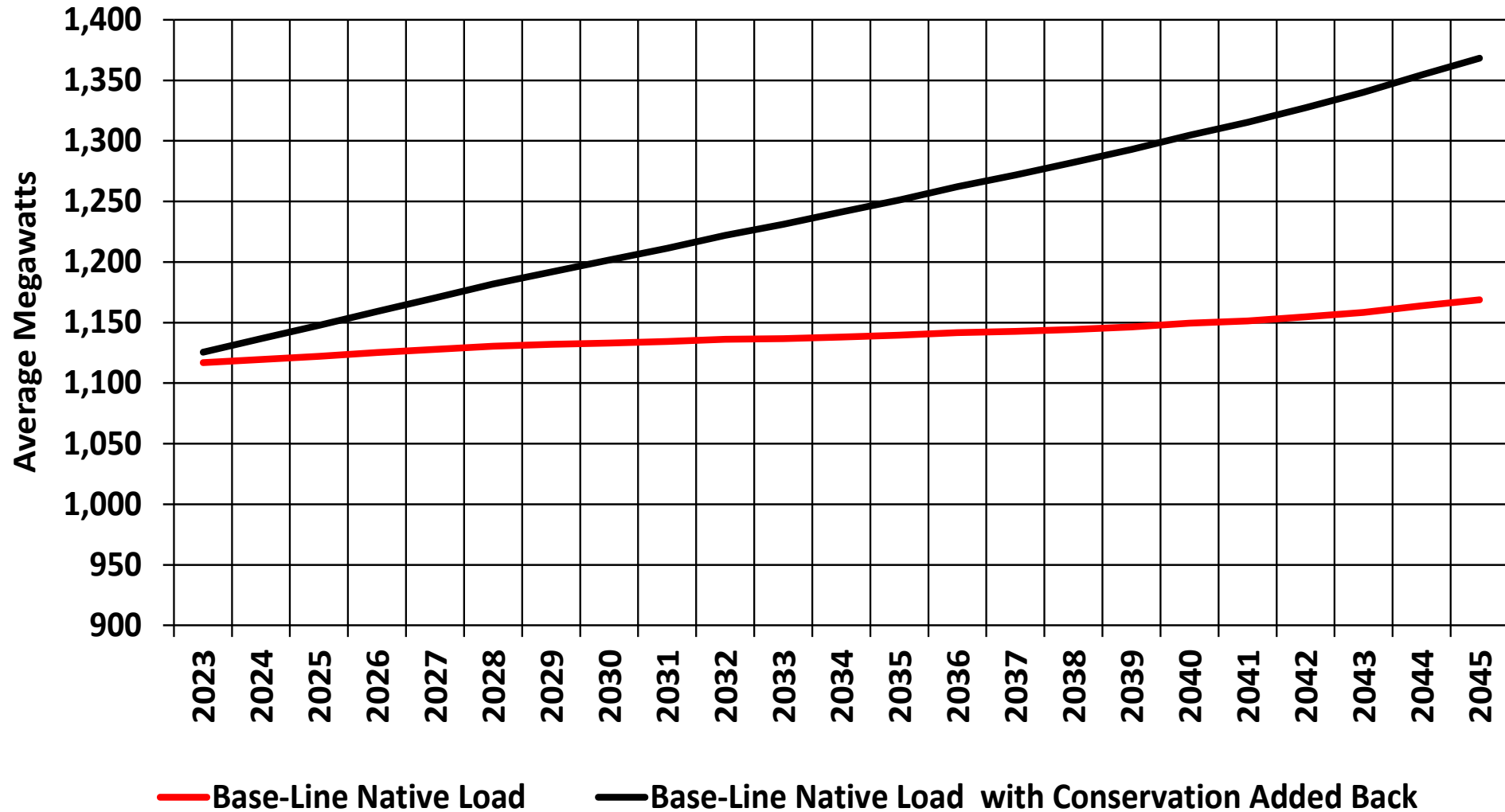

IRP	Avg. Annual Growth
2023 IRP No Conservation	0.89%
2023 IRP	0.21%

**Comments**

- Based on historical conservation behavior.



# Peak Load Forecast: The Basic Model

- Based on monthly peak MW loads since 2004. The peak is pulled from hourly load data for each day for each month. **The model used for this IRP underwent a major revision after the 2021 IRP.**
- Monthly time-series regression model that initially excludes certain industrial loads, EVs, and solar. However, those are added back for the final forecast. **As part of the model revision, the forecasted impact of EVs and solar were improved for this IRP.**
- Explanatory variables include HDD-CDD and monthly and day-of-week dummy variables. The level of real U.S. GDP is the primary economic driver in the model—the higher GDP, the higher peak loads. **The model allows GDP impact to differ between winter and summer. This separation was improved on in the revised model, and it significantly changes the results between winter and summer. The revised model shows Avista is a winter peaking utility until around 2030. This reflects a forecasted summer peak that is expected to grow notably faster than the winter peak.**
- The coefficients of the model are used to generate a distribution of peak loads by month based on historical max/min temperatures since 1890, holding GDP constant. A starting expected peak load is then calculated using the average peak load simulated for that month going back to 1890. **For the 2023 IRP, the starting winter peak average uses data back to 1890; the starting summer peak using a 30-year average.**
- The long-run growth rate of peak loads for summer and winter are calculated using GDP growth under the “*all else constant*” assumption for all other factors in the model.

# Peak Load Forecast: Winter and Summer Forecast

Winter and Summer Peak, Megawatts

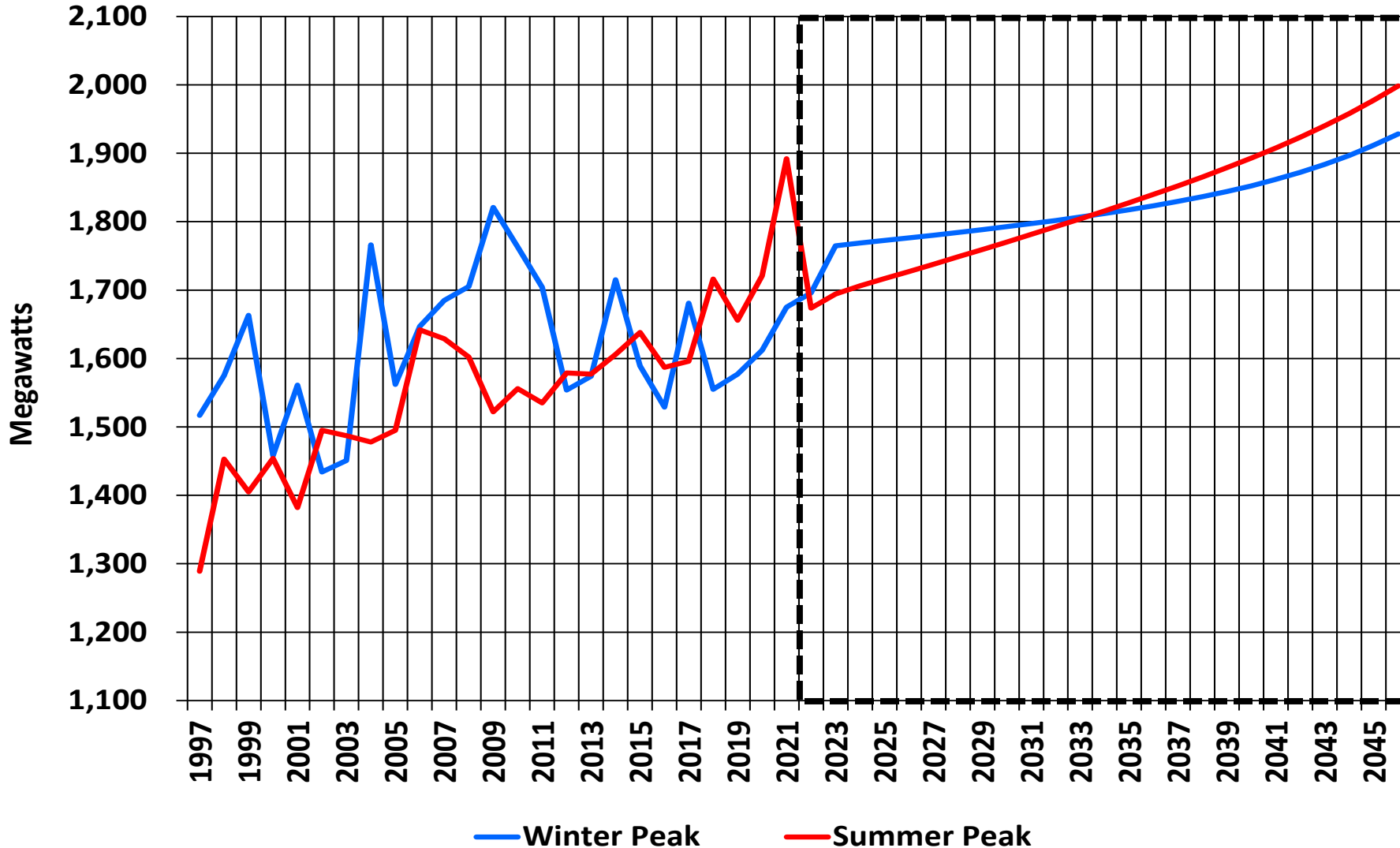

Peak	Avg. Growth 2023-45
Winter	0.37%
Summer	0.73%

- Comments**
- Extreme value of analysis of winter and summer temperatures suggests cold is still a risk.
  - Impacts of electrification policies still being evaluated.
  - There is no trended climate in the current forecast.





# Peak Load Forecast: Change in IRP Summer Peak

Summer Peak: Current and Previous IRP, Megawatts

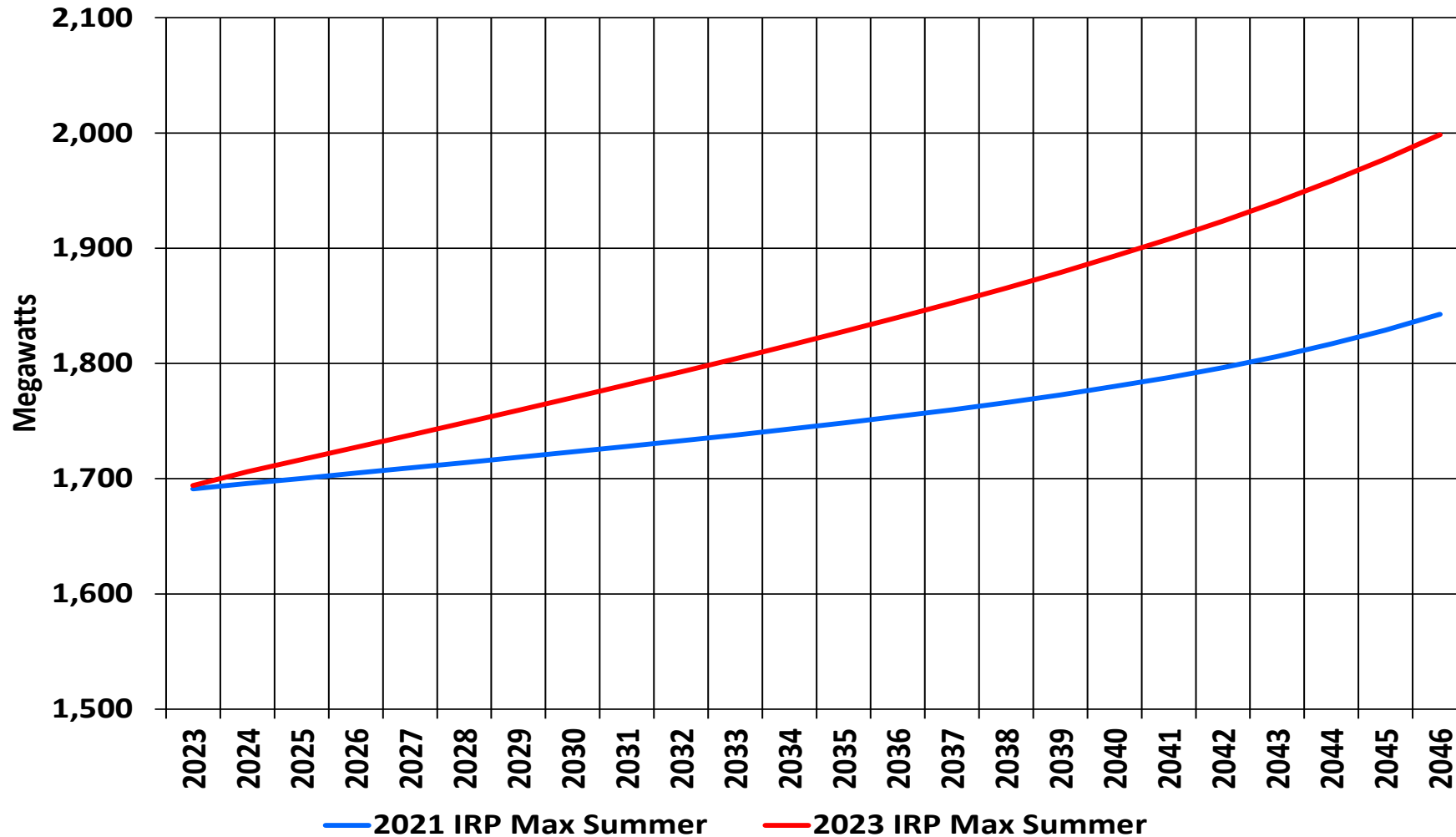

# Peak Load Forecast: Change in IRP Winter Peak

Winter Peak: Current and Previous IRP, Megawatts

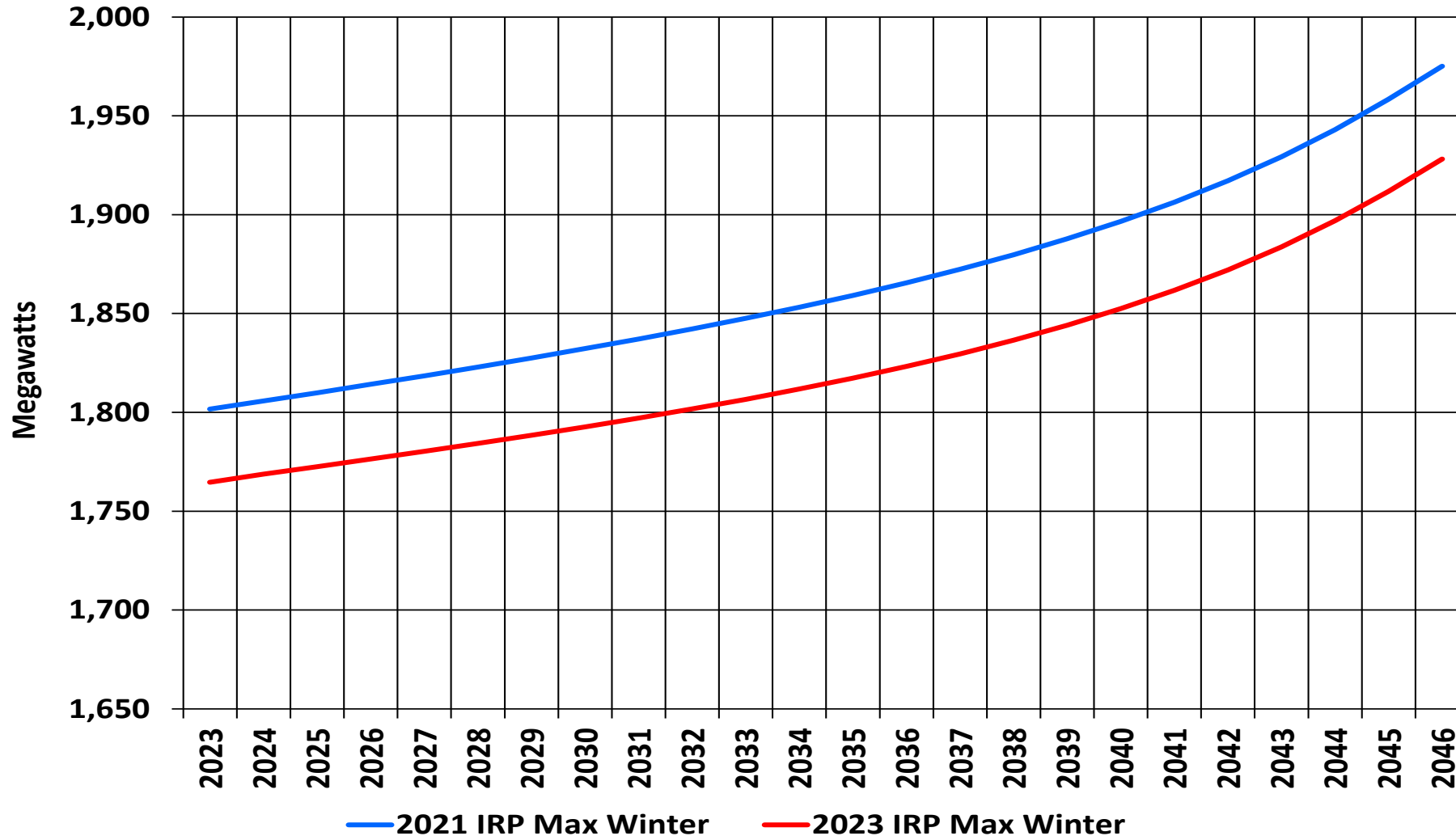

# Questions?



# Load & Resource Balance Update

Avista, Electric Technical Advisory Committee

February 8<sup>th</sup>, 2022 – TAC 2

James Gall, Electric IRP Manager

# Major L&R Changes Since 2021 IRP

- Load forecast
- 30 MW industrial demand response (Washington Rate Case Settlement)
- Chelan County PUD purchase
  - ~88 MW or ~54 aMW equal to 5% of Rocky Reach and Rock Island projects

	2022	2023	2024	2025	2026-2030	2031-2033	2034-2045
Existing Slice	5%	5%	5%	5%	5%		
April 2021 Contract			5%	5%	5%	5%	
December 2021 Contract					5%	10%	10%

# System Capacity Position

Western Resource Adequacy Program not included at this time

## 1 Hour Peak Load & Resource Position

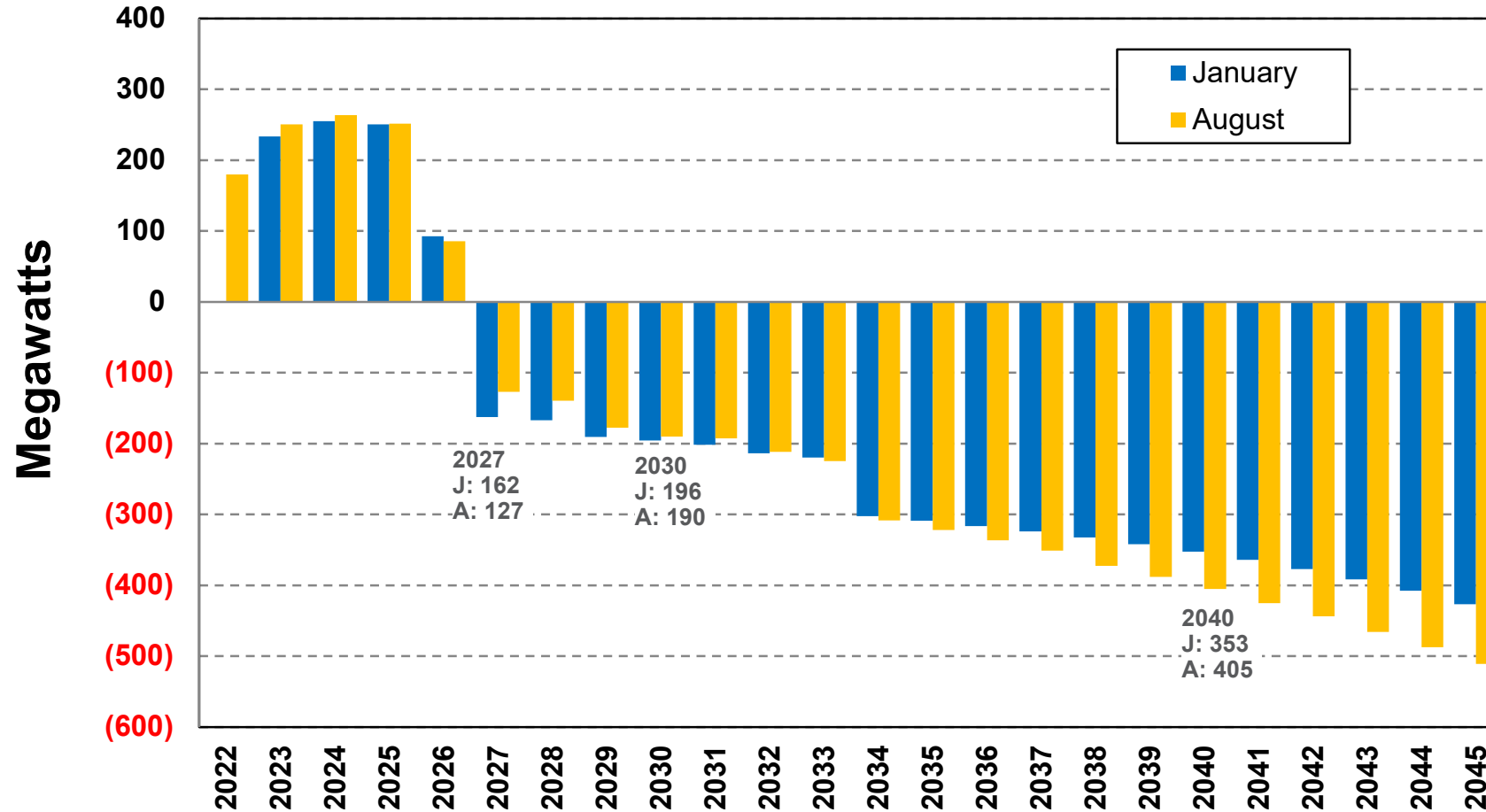

**Peak Planning Criteria**  
 16% winter PRM  
 7% summer PRM  
 Operating reserves (~6%)  
 Regulation (16 MW)

# System Planning Energy Position

## Energy Load & Resource Position

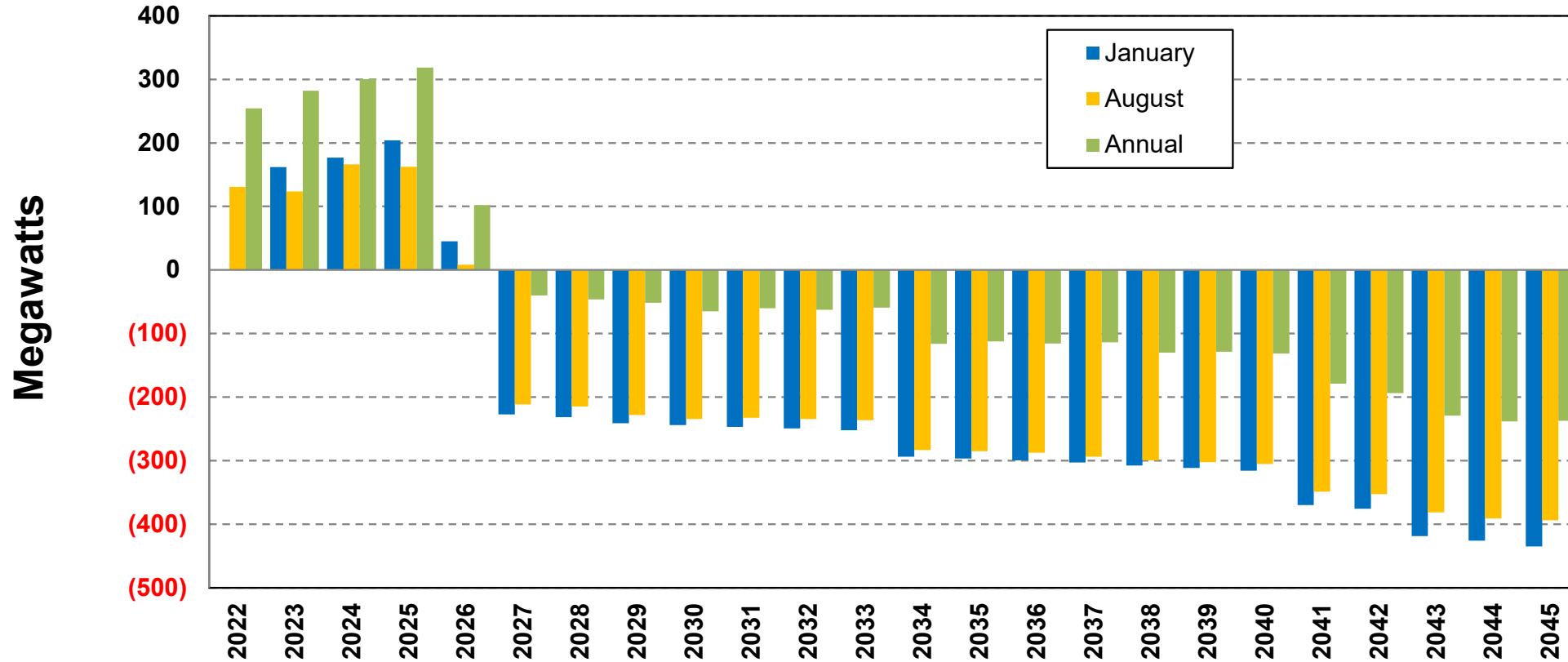

### Energy Contingency Metrics

10<sup>th</sup> percentile hydro  
90<sup>th</sup> percentile load

2023 IRP will update contingency metrics for wind/solar variability (TBD in future TAC meeting)

2023 IRP will energy planning constraint beyond annual

# Monthly Planning Energy Position

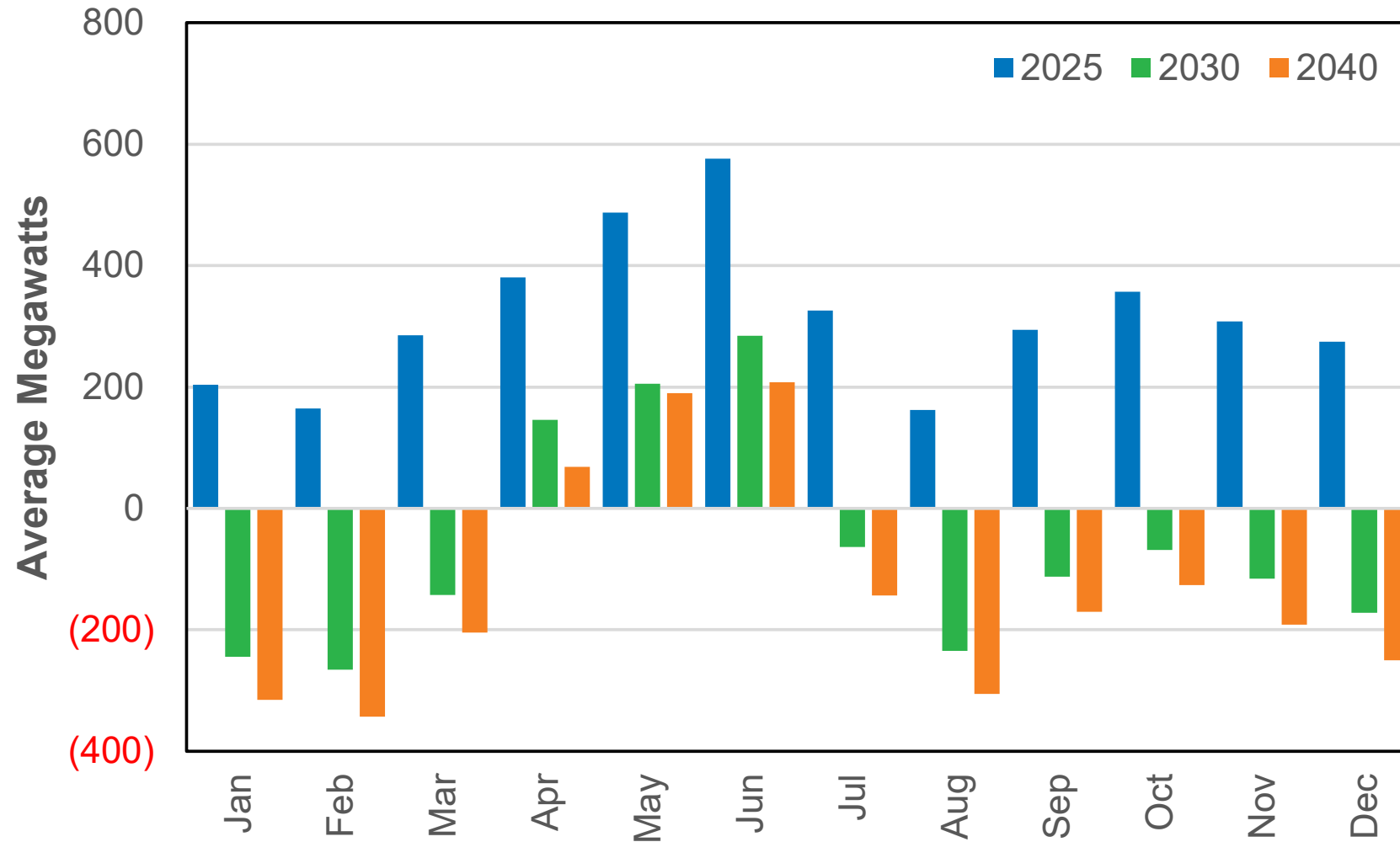



# 2030 Washington CETA Planning

- Draft rules were released January 19<sup>th</sup>, 2022
- Creates a planning standard for renewable energy using two compliance mechanisms
  - Must plan for renewable generation equal to or greater than 80% of retail load to qualify as primary compliance by 2030
  - Remaining retail load must be offset using Alternative Compliance
    - Alternative compliance could be an unbundled REC, energy transformation project, compliance payment
- Planning standard time step and risk level is not defined in the draft rule

# Avista Clean Energy Position for Planning Standard (strawman)

- Monthly retail load vs generation comparison
- Renewable generation exceeding monthly retail load qualifies as alternative compliance
  - On/off peak estimates could be used
- Expected Case Methodology
  - Median Hydro
  - Expected Loads
  - Historical average wind/solar if available
- Resource allocation
  - Existing hydro (PT Ratio)
  - Wind (PT Ratio + WA purchase hourly Idaho share of energy)
  - Solar (allocated to WA)
  - Kettle Falls (PT Ratio + WA purchase hourly Idaho share of energy, 95.4% qualifying)
  - New Chelan PUD contracts (PT Ratio + WA purchase hourly Idaho share of energy)

# 2030 Monthly Accounting Illustration (WA Only)

Illustration Purposes Only

Month	Sales Forecast	WA PURPA	Net Retail Load	Washington Share				Energy Exchange from Idaho	Total Renewable Generation	Primary Compliance	Alternative Compliance
				Hydro	Wind	Solar	Biomass				
Jan	801	21	780	362	62	2	27	84	537	537	-
Feb	822	24	798	333	66	4	26	80	508	508	-
Mar	688	27	661	348	70	5	23	78	524	524	-
Apr	647	28	620	519	66	7	15	81	688	620	68
May	582	25	558	706	55	8	0	78	847	558	289
Jun	600	19	580	730	58	8	10	82	888	580	307
Jul	600	17	583	498	45	9	23	74	650	583	67
Aug	668	15	653	279	46	8	26	70	429	429	-
Sep	664	16	648	252	49	6	28	63	399	399	-
Oct	583	19	564	259	60	4	27	69	419	419	-
Nov	636	19	617	308	68	2	27	79	484	484	-
Dec	752	21	730	377	63	1	29	80	549	549	-
<b>Avg</b>	<b>669</b>	<b>21</b>	<b>649</b>	<b>414</b>	<b>59</b>	<b>5</b>	<b>22</b>	<b>77</b>	<b>577</b>	<b>516</b>	<b>61</b>
										79.6%	9.4%

Note: "Energy Exchange from Idaho" includes wind, biomass, and "new" Chelan PUDs contracts

# Current Annual CETA Energy Position

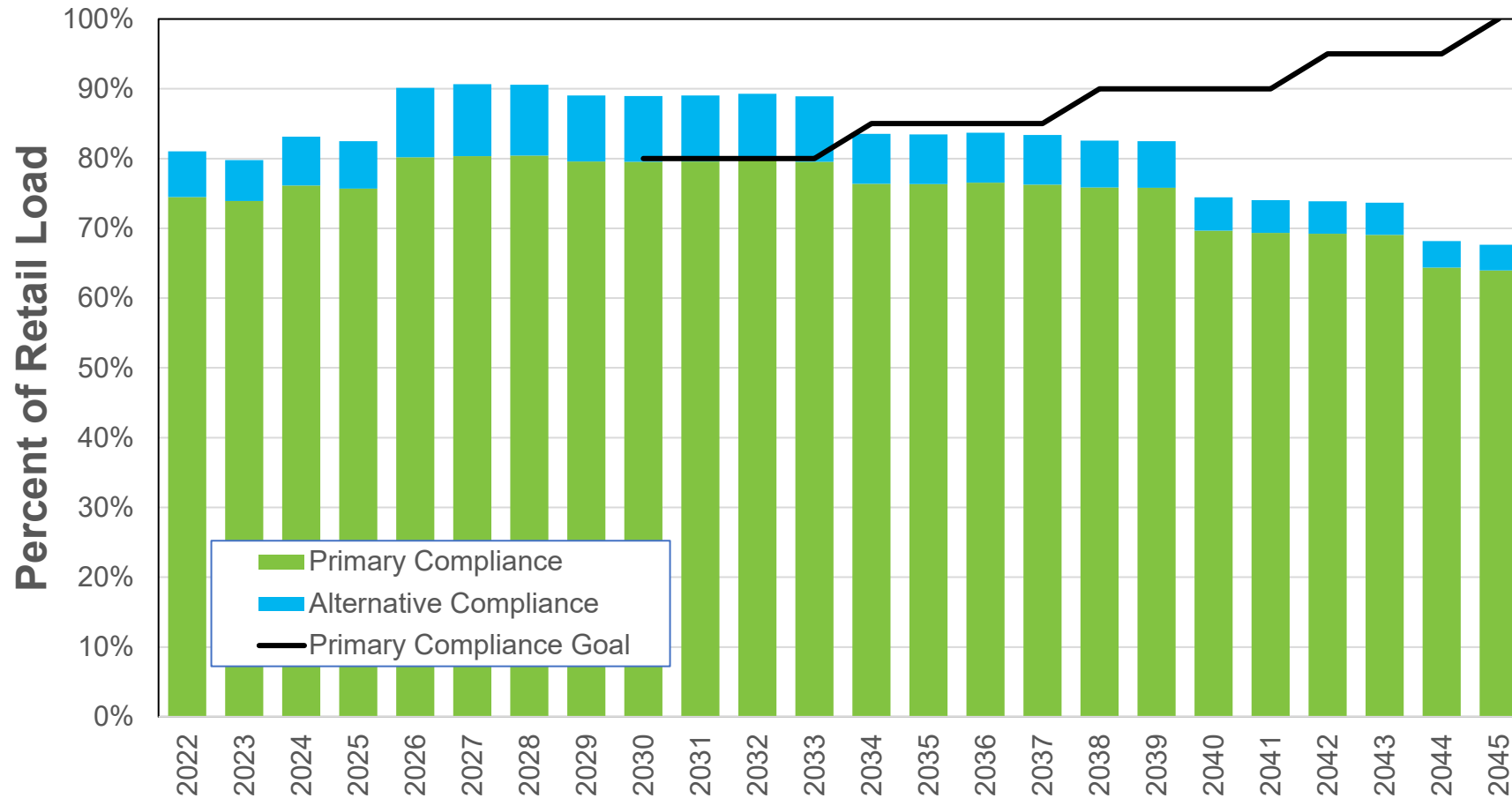

# Compliance Window CETA Energy Position

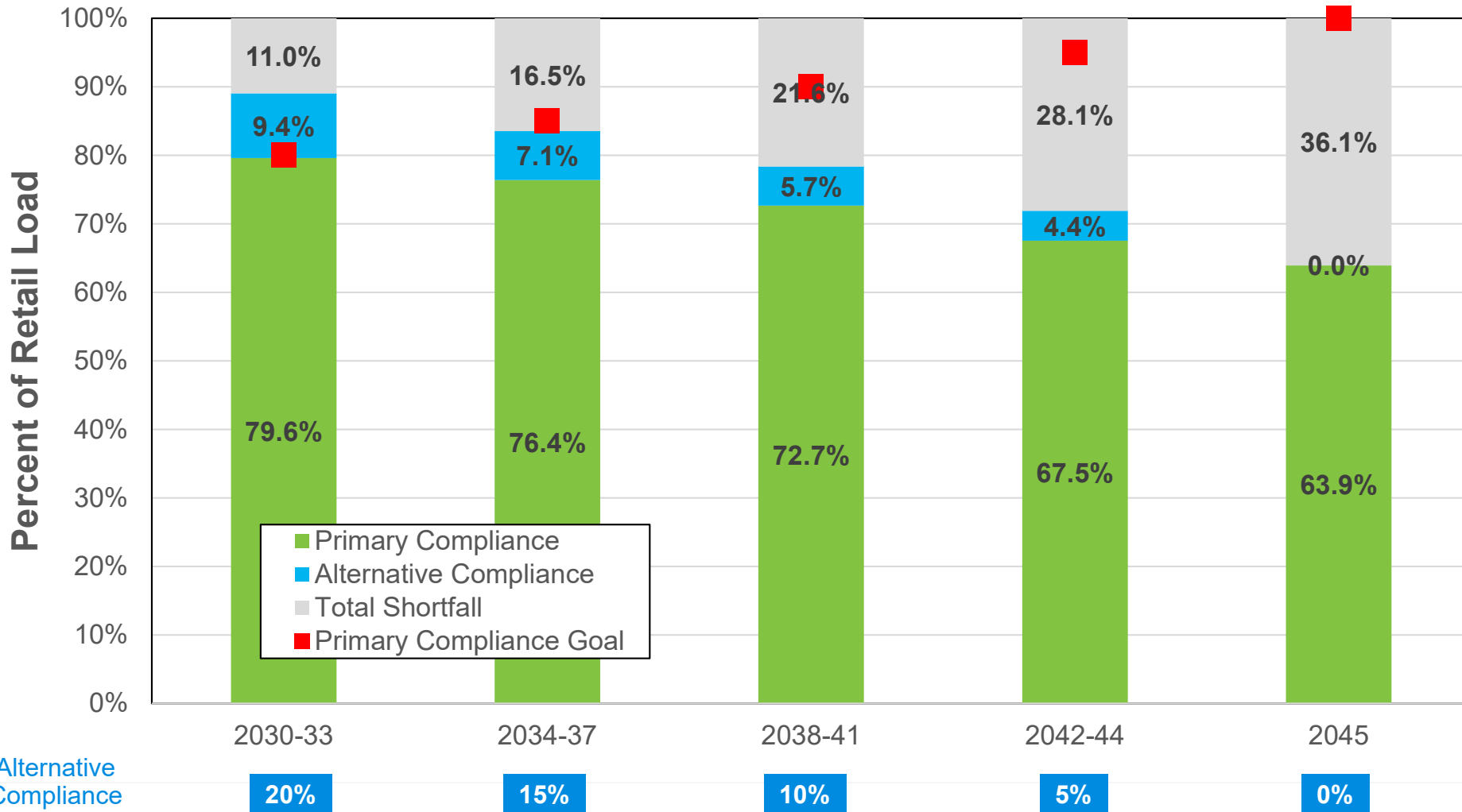

## **Introductions and Process Update, John Lyons**

**Thackston, Jason:** And the insights that you bring to the conversation. We take we take those comments and this interaction seriously. It's not just to check the box kind of thing. We really do spend some time internally after these meetings. Going through the feedback and making adjustments as appropriate to the way that we're approaching our integrated resource plans. Thank you for your commitment to this process and for making the time to be part of it. And I look forward to what we have on the agenda today, so I'll hand it back over to John.

**Lyons, John:** OK, well hopefully you all are seeing the banner that says recording and transcription. If started, we have set that up. We finally got that going for Teams and hopefully that'll give us more robust meeting notes. We will have to go through and edit them because it does bring up some curious versions of what it hears. James, if you want to pull up the slides. I'm John Lyons. I work in the planning team for the integrated resource plan. Pull up the next slide, we'll do brief introductions and go over meeting guidelines. We do have a new person on the team, Mike Hermanson, and we'll see if Mike wants to pop his camera on just for a second there. So there he is. Mike came to us from Spokane County, right?

**Hermanson, Mike:** Correct?

**Lyons, John:** He is going to be doing analytical work particularly with CETA, so you're going to see him a lot on the meetings for the integrated resource plan and the CEIP meetings that will be coming up. I don't know Mike if you want to say hello to everyone.

**Hermanson, Mike:** Oh yeah.

**Lyons, John:** Put you on the spot here so.

**Hermanson, Mike:** Hello, I'm glad to be involved in this work. It's interesting and dynamic works so I'm looking forward to getting involved in it.

**Lyons, John:** Welcome Mike and again it's another person you can reach out to if you have any questions about the IRP. Meeting guidelines – we are still working remotely. We are getting closer to going back into the office which will be nice. This is a stakeholder feedback forum, so we will share all responses at the TAC meetings. If you ask us questions between meetings, or there's something to reach out about, we will bring those back into the TAC and share it. We also will be reporting all of these significant comments in an appendix with the IRP. If it's something like when's the next meeting timing those we don't do, but if it was say more of a technical question, like wind resources in Montana. Those we would share with everyone. We are updating the website on that and we're going to try to formalize a format for submitting questions and comments that might be easier. We have the data that will be posted on the website as it becomes available and we are going to do an updated version of descriptions and navigation because last time was the first time we put a lot of data out there. And it was tough to navigate since we had so much of it. We are going to be virtual on Teams with

recording and the transcripts until we're back to being able to hold large meetings in the office, and we will still be adding the transcription and call in for people that can't travel or just want to make it to a part of the meeting. And we already talked about the recording. If you want to hit the next one, James.

**Lyons, John:** A couple of reminders on this. Remember to mute your mikes unless you're speaking or asking a question, unless you have something really interesting you want to share with us. You can also use the raise your hand function or the chat box for questions or comments if we don't get to him right away. Usually we're waiting for a pause, the Avista team are watching those two. Add those in there and those also get included in the notes. If you can, please state your name before commenting so it shows up on the transcript. I think it usually does a pretty good job of picking up who it is with this transcript function, but it does help for everyone since we aren't live to be able to see each other. It is a public advisory meeting and the comments and presentations are going to be documented and recorded. So just as a reminder of that. Next slide, please. This is just showing what the IRP is for those of you that are new and a refresher for those of you have been with us for a while. It's required every two years. It still is every two years in Idaho, and Washington it's now every four years with an update at two years. That's a change with CETA, the Clean Energy Transformation Act. It guides resource strategy. We traditionally have done 20 years. We've been extending that to 2045 for the last two IRPs to coincide with CETA so we can get those and effects. It's a current projected load and resource position which will be talking about a little bit later. And then we look also at resource strategies under several different future policies, so we have an idea of where things are going. There's a lot of discussion right now about natural gas and where that's going with policy and Washington. We don't ultimately know where it's going to end up, so we end up doing scenarios to be able to figure out if it goes down different paths. What will that mean for our resource selection? We also look at different resource choices. Conservation and demand response get treated as regular resources. Whatever the best resource that's the most cost-effective meets all policy guidelines. We have transmission and distribution integration and will be talking about that more in later meetings. We end up with a series of avoided cost which is important for developers and people with new energy projects, so they know what they're up against. We also do market and portfolio scenarios for those uncertain future events. So, if we have a world that becomes electrification in say 2040 or 2030 What's that going look like differently for the market?

**Lyons, John:** OK James. The TAC, what we're talking about here, it's the public process of the IRP. It's where we get all the input from those participating. Some people participate in the entire TAC, others just in the parts they are familiar with. Maybe it's on renewables or demand response. And then there's those of you that we appreciate that participate in the whole process, but it's where we have different ideas. We give you the information, and then we ask for feedback to make sure what we are doing makes sense. We do have a wide range of participants. Again, there are some people involved in the whole process, some just in parts. If you have a question, just speak up and ask.

Because we're used to this, so we will sling around acronyms and other things rather quickly because we're so used to it. But if you got a question just speak up on that. If you know of other people that would like to participate, we've gotten several here in the last week or so where the people sent an email saying I think this person would like to participate and just let us know. And there's no formal way to get on the TAC, you just send us an email or call us, and we'll add people that want to participate. It is an open forum, but we try to balance the needs of an open forum with getting through our agendas. You'll notice that these this is a shorter meeting than we've traditionally been having, so that was feedback we got at the end of the last IRP. We do welcome requests for additional studies and different modeling assumptions, so we have a way we set things up, but if there's something else you'd like to see or different tweaks to that just let us know. And the teams are available by email or phone. For questions or comments between meeting my name and number are on the website and email address. And you can always start with me and I can get you to the appropriate person. Next slide, please.

**Lyons, John:** A little bit of an update for the 2023 IRP. We sent out the draft work plan with today's presentation. We had talked a bit about that last meeting, but now you have a copy. Think about it and we will be soliciting feedback on if there's some days of the week better or worse for future meetings. You'll notice a lot of the future meetings will just have the month and year so will be able to move that around. Traditionally, it's Tuesday, Wednesday, or Thursday. We try to avoid Monday and Friday meetings, because that's bad form and it's usually tough for getting people on that, but it seems like usually it's either Tuesday or Thursday.

**Lyons, John:** We intend to file a 2023 IRP on June 1<sup>st</sup>, 2023, which is a few months after our initial filing time is, but that's to allow time to incorporate the results of the upcoming all source RFP. We have filed an extension with Idaho, because Washington has an update, so we filed that request and we've got the docket there, AVU-E-22-01. And hopefully I have that hot link set up correctly, and that's to file it on June 1<sup>st</sup>, 2023 instead of April 1<sup>st</sup>. Idaho staff had a recommendation on January 25<sup>th</sup> to set up a public comment deadline of February 24<sup>th</sup> and Company reply comments by March 5<sup>th</sup>. If you have comments, you can go into that docket and it explains how to comment on that. This is just giving us more time so we can get that data in there. For those of you that were participating in the last IRP, we had to do an update a month after it was published because the last RFP contract was finally signed. And in Washington there is an update instead of a full IRP with four requirements. Idaho is every two years after you publish your last one. Washington, it's going to January 1<sup>st</sup> and it'll be every four years. Actually, I do need to change that to 2023, not 2022. And the only thing we wouldn't have ready would be the preferred resource strategy because we won't have that final piece done. Next slide James.

**Lyons, John:** And here's some of the upcoming meetings so you can see the next one. We do have a date scheduled for March 9<sup>th</sup>. We'll have the preliminary natural gas



overview and price forecast, the preliminary wholesale electric price forecast, the early results of the non-energy impact study that we're having done by DNV. So that's something that in the last CEIP and in the last IRP we had talked about measuring those non energy costs and benefits.

**Lyons, John:** Thanks, we're very good at figuring out what costs are for doing things, but when you come to those other issues that are a cost, but it's not one that we can't quantify through a market like say, environmental conditions, human health and comfort, things like that. This is a study that's going to be in there, so that'll be interesting to see some of the results on that. And then we'll also have an existing resource overview. So, looking at our different hydro and thermal and contract facilities. 4<sup>th</sup> TAC meeting will be in August. We've got the conservation and demand response potential assessments by AGE and the energy efficiency inclusion of the social cost of greenhouse gas. That's a Washington only issue. So, you can see these are shorter meetings, so that should be more like this one where it's two and a half, three hours. Fifth one will be in early September. We've got generation resource options for transmission planning, distribution system planning and an update on the Western Resource Adequacy program.

**Lyons, John:** And next slide. So, we are having a few more of these TAC meetings, but hopefully much shorter. End of September, supply side cost assumptions including distributed energy resources, ancillary and intermittent generation analysis, and update to the 2022 all source RFP to show what we've gotten for bids and where we're headed. Energy and peak forecast and balance update to show what we have and what we are projected to need in the future. 7<sup>th</sup> TAC meeting in October. Hydro impacts from global climate change study and the load impacts as well. The study scope for distributed energy resources, that is a fairly large topic to be able to get that data so we're going to be on the scoping on that. I know it may not be as quick as some people would like, but you know, we are trying. We want to do a good job on that and make sure we're getting the right information in the right study that will have an implementation plan for clean energy. That's part of CETA. The finalization of the wholesale gas and electric prices, and then we'll get into the scenario options for portfolios in different markets. Then there will be a technical modeling workshop also in October that'll be the PRiSM model overview. So, every question you wanted to ever ask James about how our model actually picks the different resources, risk assessment overview, and the Washington use of electricity modeling. So that's one where this is more of a highly technical meeting, so we may not have as many people at that, but if you want to listen to it and you're not very technically involved with it, you're still welcome to do that. I don't know James if you had anything else to share about that one.

**Gall, James:** Real quickly, can you hear me?

**Lyons, John:** Yes.

**Gall, James:** OK, just make sure because I can't unmute or mute myself. When we get closer to that that time, we may want to think about having a long meeting? What I mean by long is a 4-hour meeting to go over all the topics. Or do you want to split those up, so it'll be interesting to get some feedback once we get closer to that that time to see how we want to proceed. Because I don't know if everybody is going to have the same interests in those tools.

**Lyons, John:** Those four hours will fly by.

**Gall, James:** But that's what I'm scared about is 4 hours of me talking about models. That could be scary.

**Lyons, John:** Well, last time we actually had a really robust conversation because people were interested because you generally don't get the time to really dig into some of those issues. After that, we'll have the eighth TAC meeting in February. It's a lot more, but most of these presentations will not take that much time. Wholesale market scenario results, the update for the request for proposals for all sources, and jurisdictional allocation updates. As we've had more of a split between Washington and Idaho for their energy policies, we're finding that we may need to allocate resources differently. Traditionally it's pretty much been a 65% Washington and 35% Idaho split, but now we're getting new resources for Washington to meet CETA rather than to meet traditional load. We're going to be we're working to see the best way to set that up with the Commission Staffs. And then we'll have the draft preferred resource strategy, what we think we're going to need over the next 20 years. Resources, size of resources, and timing of them. And the location for some of the resources or rough locations at least. And then we'll have the Washington 100% Clean energy planning standard modeling and how we're going to do that. And the market risk assessment. We'll have a virtual public meeting like we did last time. It'll be either in February or March of 2023, and it'll be both natural gas and electric IRPs, so there will be a recorded presentation, and then we'll have an opportunity for daytime comments and questions and night time, and I imagine we'll do like last time where they'll be a general meeting for everyone and then we'll break out into smaller subgroups so that people can ask questions on those. James, anything else you want to include on that?

**Gall, James:** No, I think we're good on that. More to come. We got to figure out how this is going to work. We learned some lessons from the last time we did our public meeting and hopefully we can apply those to this next round and get better quality feedback and greater participation.

**Lyons, John:** It went out to quite a few people. It was a pretty big meeting for us. Ninth TAC meeting in March of next year will have the final lockdown preferred resource strategy. The results, the portfolio scenarios, and an overview of the final IRP, get comments on the plan and then the action items. Those action items are the things that we want to get to. They're important, but we either ran out of time, or if they're just not quite ripe yet. Things like laws that have been passed but the rules haven't been made

yet. Those we do the best we can getting through them, but we may not. We have to wait till they're finalized. And these are some of the key dates. All of these dates, as well as quite a few others are in the work plan, but these are the important ones for the TAC. Finalization of the work plan will be February or March and then we'll send that to the commissions. It's not a requirement anymore, but we find it is quite useful to keep us on track and to let the TAC and the Commission's know where we're going in this process.

**Lyons, John:** Due date for study requests from the TAC members will be October 1<sup>st</sup>, 2022. If there's something that comes up a little later and it's something we can do quickly or with studies we already had, we would try to do that. But basically October 1<sup>st</sup>. If you have a list of studies, let us know as soon as you can. Because the quicker you set those up, the easier it is for us to be able to work those into the process and have time to think about them. January 1<sup>st</sup> will be the Washington IRP progress report again, will have 3 of the 4 items done except for the PRS and then we would file an update when those are done, the external draft will be released to the TAC on March 17<sup>th</sup>, so a nice Saint Patrick's Day surprise for the TAC, a draft IRP to read. And you'll be able to comment on the entire IRP or sections that are that you're interested in. They'll be due back March 12<sup>th</sup>. We tried to give as much time as we could on that, and then the final IRP submission to the Commissions and TAC will be June 1<sup>st</sup>, 2023.

**Lyons, John:** So for today's agenda you've gotten to listen me drone on for the introductions and the process update, and then we are going to go onto the ever-exciting demand and economic forecast from Grant Forsyth. And then James will be talking about the load and resource balance update and we plan to wrap up by 11:30.

**Gall, James:** Yeah, and we will try to take a break after Grant's presentation and that way we can all rest assured that we're ready for the next topic.

**Lyons, John:** You have to calm down from the excitement of an economic forecast. I know I'm looking forward to it.

**Gall, James:** Yep. I know. Alright Grant, are you ready?

**Lyons, John:** OK.

### **Demand and Economic Forecast, Grant Forsyth**

**Forsyth, Grant:** I am ready. I will share my screen here once if I can. Make that happen just one second. Can you see my slides everybody?

**Kevin Keyt:** Gotcha.

**Hermanson, Lori:** Yep.

**Forsyth, Grant:** OK, and just to confirm this is the full slide, not the presenter settings, correct?

**Hermanson, Lori:** Yes, it looks like it.

**Forsyth, Grant:** OK just want to make sure I'm using two screens and sometimes that happens. So, for those of you don't know, I'm Grant Forsyth the company's economist. I focus on the load forecast. And so this is a presentation I give for essentially every IRP process, and it is essentially going to look at what's the structure of our economy, what's been happening in our economy, and then we move on to what is the current energy forecast for the IRP. And then, what is the current peak load forecast for the higher peak and keep in mind, all of this is preliminary. As we're going to talk about these forecasts are based on my regular biannual forecast that I do for the revenue model. I bootstrap off that for the IRP, and so I'm going to update that forecast in the next month and so. I may integrate that in when that's finished, and so again, these numbers are preliminary, but my suspicion is they won't change that much if and when I update my regular biannual forecast and integrate this in so again. Everything here is preliminary, but I suspect it won't change much. So what we're going to talk about today is really kind of three topic areas. We're going to review the service area economy mostly so we're all on the same page about what it looks like in a big picture sense. I'll spend a little bit of time talking about how we've recovered from the pandemic. Once that's established, will talk about the long run energy forecast. This is, you know, essentially coming up with a native load forecast for the IRP out to 2045. And then we'll move into the peak load forecast, which again is designed to be a long range forecast out to that 2045 period.

**Forsyth, Grant:** Now the thing to keep in mind as I work through this is, it is actually both the long run energy forecast and the peak load forecast have gone through major revisions since we finally got a break from the brutal cycle of back-to-back IRPs. I had some time to go back and review the long run energy forecast and the peak load forecast and was able to make some changes that needed to be made, and in particular on the long run energy forecast. I now have it broke out by jurisdiction, so there's a forecast for Washington. There's a forecast for Idaho. And those are combined to get the aggregate. Forecast on the peak load forecast. Since I've now been at Avista for 10 years, I have more data to work with in terms of peak load than when I first came here and I was able to do a more careful job of evaluating winter and summer and building that into the model. And you do get a noticeably different answer when you remodel that based on the longer historical series I now have available.

**Forsyth, Grant:** Now the one thing I just want to say is this whole process gets judged both internally and externally and I just want to remind everybody that the world is in a state of flux as we all know and this is a quote from Erica Groshen. She's the former head of the Bureau of Labor Statistics and now she's at Cornell and she was quoted in an article in the Washington Post newspaper and the title of the article is: "Here's another thing that the pandemic messed up, economic forecasts". And her quote was "models are predicting what's normal in a world that isn't normal", and I think that's just something to keep in mind as we go through this. Remember, I'm forecasting out to 2045. Literally anything could happen. And it's even harder to know whether you're

going to be in the ballpark when the current period is so in flux. It's just something to keep in mind as you go through this, and you're judging me, which I expect.

**Forsyth, Grant:** Let's talk about the service area economy. A great way to do this is to look at the employment structure. This is a pie chart showing non-farm employment structure for both Avista metro areas we serve in Washington and Idaho because that represents the bulk of our customers. And that's the Spokane area, the Coeur d'Alene area, and the Lewiston - Clarkston area. We compare that against the US. If we look at the top two circles for the Washington and Idaho MSA areas, we have about 70% of employment. Non-farm employment is in services. It's about the same for the US. Government about 17%, it's 15% for the US. Private goods, and this is manufacturing and construction primarily, it's 14% and it's 14% for the US. As a structure, we look a lot like the US and we're really a service-based economy as I like to remind people constantly. When we talk about economic growth if services are not growing it's going to be really hard to generate employment growth, both regionally and nationally.

**Forsyth, Grant:** It's also fun to talk a little bit about government because you know government gets everybody worked up. If you look at that government slice and then break out government and those are the next two pie charts below. If you just look at government, 67% of government in our service territory is local government and it's about the same for the US. And it turns out the vast majority of local government is actually education, that's the biggest driver of local government and if you look at the federal side which everybody gets worked up about, they seem to think half the country works for the federal government. It's not true. Federal employment is only about 10% locally in our service territory, 12% in the US. And this has actually been declining. State employment, about 23% for both the region and the US. And keep in mind, even within state employment, a lot of that is education. When we think about government, really most of it is local and state and most of that is connected to education.

**Forsyth, Grant:** Now if you look at agriculture, so this was non-farm, but if you were to integrate agriculture into this it's probably about 1 to 1 1/2 percent of employment in our service territory. The one thing to keep in mind though, it might be a small share of employment, but it is a really big generator of income in our region. In fact, most of the agricultural products that are grown in our service territory are actually exported overseas because a lot of that is wheat. It's a huge income crop, even though as a share of employment it's relatively small. It's still important to the region's economy.

**Forsyth, Grant:** OK, let me stop there any questions? Hearing none, let's talk about how we've recovered. This is an important discussion, because when we did the 2021 IRP, the pandemic was in full force, there was a lot of uncertainty about how this was going to impact both the economy and load, and actually we've recovered. I think more robustly than what I had expected, and as we'll talk about later, this does impact what the native load forecast is compared to the last IRP. But the good news is, the region that we serve, the Washington and Idaho metro areas – v majority of our customers has fully recovered from those lockdown effects with the pandemic. We're actually doing

better than the US as a whole, at least through December. And what this graph is showing you is the employment level in both in our service territory and the US relative to February 2020, which was the last normal month before the pandemic hit. And what you can see then is all the future employment levels index to February 2020 and where we currently stand, and you can see that we've regionally fully recovered. The US is still about 1 to 2% behind where they were in February 2020, so they have a bit more catchup to do, which is good news and does impact a little bit.

**Forsyth, Grant:** The native load forecast from the last IRP to the current IRP, because we've recovered in a way that is a little bit faster than I had expected. When I did the last IRP, the expectation was for a much more severe, longer term recession than we actually had. Technically the pandemic recession was only two months, which was dramatically shorter than what I had figured in the last IRP. Strong growth in Idaho in particular is one of the reasons we're back above where we were before, slightly above, thanks to Idaho which has really had exceptional growth. It was one of the first states to more than fully recover from the pandemic lockdowns. The region still is suffering some of the problems we see in the rest of the US. We have labor shortages, supply disruptions, issues with inflation and in particular one of my concerns in terms of our overall recovery is inflation pressures and our region are a little bit worse than the US as a whole because shelter costs, housing prices are rising here at a rate that's perhaps some of the fastest in the entire country. And that's exacerbating some of the inflation pressures in the region. But generally speaking, on the employment side, we have recovered. Any questions about that?

**Woodward, Jim (UTC):** Hey there, Grant this is Jim Woodward with the UTC staff. Can you hear me OK?

**Forsyth, Grant:** I can.

**Woodward, Jim (UTC):** Hi thanks, I just had a really quick question. When you say shelter costs, you may have actually said what that is generally. I'm used to seeing like the cost of housing costs. Is that how you are using those two terms.

**Forsyth, Grant:** Yep. Yeah, I'm sorry, that's economist speak and I apologize for that. So, in the index is the price indexes whereas the CPI or the personal consumption Expenditure index which the Fed uses.

**Woodward, Jim (UTC):** It's anonymously.

**Forsyth, Grant:** Shelter refers to housing costs, and it's actually a very broad measure of housing. It's both the cost of housing. It's imputed rent and actual rent on rental housing. And in the broadest sense, it also would include the things that go into a house, and so shelter as I'm using in this case, it's a pretty broad measure. But if you want to narrow it just to housing both rental housing and housing that people can buy, single family homes, there's been a lot of price pressures here in that area. So even

before the pandemic started home prices here were rising quite a bit faster than overall inflation and were some of the highest in the US pre pandemic.

**Woodward, Jim (UTC):** Great.

**Forsyth, Grant:** And it's also been the case for quite some time in the region that rental costs on actual rental housing has been rising quite a bit faster than overall inflation.

**Woodward, Jim (UTC):** Thanks Grant appreciate the clarification.

**Forsyth, Grant:** You bet. One of the reasons why we have some extraordinary home price pressures and rental pressures in the region is that our population growth is actually considerably faster than the US as a whole. And unfortunately, I can see that I left out the legend on this. The red bar is Washington - Idaho MSA population growth. So that's the population growth occurring since 2007 right in our metro service territory. The black line is what's been occurring in the US, so the black bar is the US as a whole. The red is the Avista area. I want to point out that we've been growing much faster than the US. Excluding that period from 2010 to 2013 where the region was trying to recover from the pandemic. I mean the Great Recession from the Great Recession, right. And then as we recover from that, you can see population really accelerates above the US. And what's important to point out is this is due almost entirely to in-migration. It's not that our region is producing more births over deaths than the rest of the US, that's not what's driving our population growth significantly above the US, it is people moving here. That's the primary driver. If in-migration slows or stops, our population growth is going to look more like the US than it does now. This is important because in-migration is driving a lot of our customer growth. It's the primary driver of our customer growth and that's factored into our long run IRP forecast. One of the important or key drivers in that long run energy forecast is the assumption about population growth, because that's a big driver of residential and commercial growth.

**Forsyth, Grant:** Now just a couple things to point out here. You'll notice for the US and 2021 how low that is. In 2021 the US had the lowest population growth rate, probably in recorded history point 1.1%, which is essentially from a statistical point of view zero. What we've observed with the pandemic is that it's suppressed. First, that is organic family formations and accelerated deaths. That had a pretty big suppressing effect on US population growth. But it's important to point out that the US population has been declining pretty steadily since 2016. Even in our region, even though we did much better than the US as a whole in terms of population growth, it does appear to have dropped based on OFM estimates for 2021. That's the office of Financial Management in Washington. Which means we were also affected to some extent by maybe, suppression of the natural rate that is births versus deaths. In other words, births declined, deaths went up, and it may also impact people's ability to migrate as well.

**Forsyth, Grant:** Now, my guess is that things will rebound in 2022 as the pandemic starts to get a bit more under control and people are able to move around a bit more and maybe a bit more comfortable in family formation. That is having children, but

again, in the long run the dominant factor is going to be to what extent in-migration continues in our service territory. If you were to break out the Washington side from the Idaho side, there's no question it's growing much faster in Idaho. And as we're going to talk about later, the forecasts that I'm using in the IRP for population which comes from IHS Connect, it's a national and international forecasting service, they're showing much more population growth for a much longer period on the Idaho side of our service territory than on the Washington side. Any questions about that?

**John Barber (Guest):** Grant this is John Barber, what do you attribute the in-migration to? Is there a simple answer or is it just a complex series of things that are bringing people into the area?

**Forsyth, Grant:** I think its multiple things and that's a reminder for me to make a couple other points about this. I would say part of it is, even though our housing prices have been rising pretty rapidly compared to other regions of the country other larger urban areas, Spokane still looks pretty attractive in terms of home prices here, relative to what the home prices are in some bigger urban areas people are moving from, which means that it still looks pretty affordable to them. They can move to an area that now has world class healthcare both on the Idaho side and on the Washington side. We've got an actually pretty diverse educational system here. Both K through 12 and college. Really, a pretty astonishingly good mixture of public and private. It's an amenity rich area in terms of outdoor activities and I also think we're going to start to pick up people who are capable of now working remotely and would like to live in a smaller urban area. Some of it also is also demographic. I've looked at some data using the IRS statistics on changes of address on tax returns. The IRS actually has a great data set on how people are migrating. They can track people through tax returns. We might also be capturing a lot of older people who maybe don't want to live in an area where there's less health care that it's more advantageous to move to a place like Spokane that isn't super huge but also has closer access to health care. And so, I think it's multiple reasons. What's interesting though, is if you look at this IRS data, everybody assumes that people moving here are coming from California, which is not really true. I mean, California is. You know if you look at where the biggest locations people are coming from. California is one of the largest, but it turns out that regionally in our service territory, we're picking up a lot of people from other places in Washington and other places in Idaho that are moving here. What we're getting is a lot of interest, state migration and so most people moving to Spokane County are actually coming from someplace else in Washington or Idaho. And then the next biggest would be California. Does that answer your question?

**Hermanson, Lori:** Do we have questions? I was going to see if we had any other questions because I think I missed a hand earlier which is no longer out. But anyway, if anybody has any questions, jump in.

**Forsyth, Grant:** OK.

**Hermanson, Lori:** It looks like Joni has questions.



**Joni Bosh (Guest):** Yeah, that was my hand before. Thanks this is Joni Bosh with the Northwest Energy Coalition. I think you've partially answered the question I had which was on the previous slide.

**Forsyth, Grant:** Yeah.

**Joni Bosh (Guest):** If you could break apart the Idaho and Washington components and create similar charts and then on the previous slide it looked like in terms of the index. We dropped and stayed about .45 index points all the way through and I was wondering, is that because of the Amazon expansion? Or what is that main driver for that steady difference?

**Forsyth, Grant:** Yes. Thank you for pointing that out because that's in my comment box and I forgot to mention that. So, if you broke out Idaho and Washington from this, Idaho is about four or five percent above where they were in 2020, February 2020, and that really reflects kind of a different political approach to the pandemic. Fewer lockdowns, fewer restrictions, and so forth. On the Washington side, what's interesting about this is that up until recently, when Washington Employment Security Department revised their employment numbers, Spokane looked like the US that we were about 2% below. But when they revised their numbers for Amazon and this is to make a long story short; Amazon, for reasons of confidentiality, does not report their employment by county. So that meant the Employment Security Department has to estimate it. When they did that estimation and added it into Spokane, it really shifted the numbers around so that Amazon expansion has had a material impact on where we are in terms of recovering from the pandemic and when you get those estimates into the data series, Spokane by itself is back to 100 index, meaning they're back to where we were in February 2020. So, the Amazon thing is material. It really did move the numbers.

**Joni Bosh (Guest):** OK thanks.

**Forsyth, Grant:** You bet. But it's just important to leave you with this idea that you know our customer growth is highly dependent on people moving here that we're not immune to the demographics of the country where people are delaying marriage and having fewer children. That's here as well, so that in-migration component is a primary driver of these red bars. Being above the black bars which are the US.

**Hermanson, Lori:** Grant, it looks like we have another question from Art.

**Forsyth, Grant:** You bet, Art.

**Art Swannack Whitman County Commission (Guest):** Grant, I'm curious if we're seeing a slowdown in that in-migration because my daughter and son in law were looking at moving over here to the Spokane area for an engineering job and the housing costs here for rent was \$1,000 a month more than it was where they're at in the Lacey Olympia area? Sorry.

**Forsyth, Grant:** That's a good point. And yes, I think it's possible. Did the home price growth that we've had; remember, we've received national attention for this region's growth in home prices, it's again some of the highest in the US. I got a call last week from a New York Times reporter working on a story on this issue. It's garnered a lot of attention, but yes, I believe that if the greater growth in home prices don't subside, it will curtail some of the in-migration. Because what's happening is there's been a decline in affordability. And even for people coming from a larger urban area. Maybe a younger couple coming from a larger urban area that housing prices now maybe looked too rich, and so that's entirely possible and the other thing that's an unknown in terms of the housing market is the Fed is switching gears and most central banks around the world are. They're going to start raising rates that really has the potential to slow home price growth, but I don't necessarily think it's going to create that kind of giant correction we saw in the Great Recession. When you saw home prices actually declined substantially. What we may be left with in the region is permanently higher home prices. But maybe hopefully not growing as fast. But yes, that could have an impact on in-migration.

**Art Swannack Whitman County Commission (Guest):** They didn't act on it because the pay wasn't quite as good here and the cost was going to be significantly higher so they stayed on the West side.

**Forsyth, Grant:** No and I'm starting to hear that anecdotally from other people as well, and that is a possibility that in-migration will slow. The other thing affecting this potentially is how growth management is handled. We have a particular type of policy in Washington on growth management that's also potentially affecting what's happening with home prices and buildable lots as the growth management area shrinks. That's been a big topic area on the West side as well, so that's how housing evolves. I absolutely agree. Could it impact the in-migration we've enjoyed in particular? It could cause it to start to slow. Now how I factor that in, it's a tough call. Basically, I'm relying on these long-range forecasts from IHS Connect to give me guidance, but remember those can change from one IRP to the next. Does that answer your question?

**Art Swannack Whitman County Commission (Guest):** Yes, it does, thank you.

**Forsyth, Grant:** OK, so.

**Lyons, John:** Grant, a question on if there's any age breakdown for the in-migration.

**Forsyth, Grant:** No, and that's interesting. I have not been able to get an age breakdown on the in-migration. I will say with the IRS data does you can calculate the number of exemptions, which is essentially people. You can kind of calculate an average adjusted gross income from the data, and so I would say the typical household moving here and the people moving here, it's a household of 2, roughly and their the adjusted gross income on average looks to be pretty similar to what the area median household income is, which is around \$60,000. So that's the other thing I think there's a perception that everybody moving here is from California and they're rich and turns out based on the tax data I've looked at, probably isn't true. But in terms of the age

breakdown, that's harder to get at. But if you look at the demographics of our territory and the fact that it hasn't shifted dramatically. This in-migration suggests to me that you're having migration probably across a broad range of ages. Would be my guess.

**Forsyth, Grant:** If we look at the service area economy, one of the things connected to population growth is permitting and we have seen some interesting permitting activity that's occurred, that really started as a result of the Great Recession was an increasing share of apartments to total permits. Now the blue bar here is single family and duplexes and condos. Single family homes, duplexes, and condominiums, and there's not that many condominiums. It's mostly single-family homes and duplexes. I lump them together. That's in the blue, showing the total amount of permitting of single family and duplexes and the red is the total number of units permitted of apartments.

**Forsyth, Grant:** One of the things you can see in, and this is for the Spokane Kootenai area which is the biggest component of our metro area that we served. What we've seen in this expansion cycle leading up to the pandemic is a pretty good clip of apartment building. And I think what happened is that coming out of the Great Recession, it was easier for builders to get loans to build apartments than it was single family homes. And part of that reflected the ultra-low vacancy rates in apartments in the region, which incidentally are still very low, even though a lot of new apartments have been built. So that's one thing is that we are definitely seeing a lot of, either duplexes or apartments being built. Now the other interesting thing which I did not expect and this is again something that's affecting this IRP forecast compared to the previous IRP, is normally when you have a recession, there's quite a big hit to permitting activity. This did not occur. So, in 2020 I would have expected permitting to fall noticeably. In 2021 I would have also expected it to be weak because of the lingering effects of the pandemic. And you were not seeing that. We've seen really robust permitting activity all through this downturn, which is highly unusual. And you're seeing pretty steady single family and duplex building, but you're definitely seeing a lot of permitting for apartments. And what we've seen in 2020 and 2021 is a lot of that permitting activity has shifted to the Idaho side. In particular, you're seeing a lot of stuff being permitted in the Post Falls area. So, let me let me stop any questions about that?

**Forsyth, Grant:** What's interesting though, even with permitting holding up it, there's not enough building activity to really have an impact either on raising vacancy rates or slowing the home price growth. Some of that also reflects supply disruptions increasing the costs of duplexes and single-family homes. But they held up surprisingly well. And that also because of that, you're going to see a little bit more robust native load forecast than what we saw in the previous IRP because in the previous IRP I assumed this event, the pandemic. The recession would have a depressing effect. And we just didn't see it occur. Questions about that.

**Forsyth, Grant:** OK. Moving more into thinking about the forecast part of this, one of the things I need to think about when I do the forecast, both the five year forecasts that I do twice a year, but I called the medium term forecast, and the longer term forecast,

which is part of the IRP. Which in this case the longer term would be 2026, I mean 2027, to 2045. I have to make some assumptions about long run GDP growth. This graph shows what I'm assuming. Under the current medium-term forecast, which goes out to 2026, which I did in the fall of 2021. That black line is showing what the assumption is of GDP growth that in 2022 it'll be about 4% and it's going to gradually decline down to about 2% as we move out to 2026. The red thing just shows if I was to calculate that current forecast, what would that look like? What hasn't changed much? And incidentally how I calculate this forecast for GDP growth. It's an average across many different forecasters. I like to do that as a consensus forecast, and so what I'm doing is essentially measuring how this consensus forecast is changing over time. And since I did, the forecast in the fall compared to the current average across forecasters, it hasn't changed much. And so that is essentially what I'm doing for that medium-term part of the forecast. But what it's also important is what I assume about the long-term GDP growth, which in this revised long-term forecast model that I've developed, is now an explicit variable. Before it was of an implied variable, now I've made it much more explicit in the model and in the current assumption I used the Fed's projection of long-term GDP growth, which is 1.8%. This is actually lower than the previous IRP, which is, I think, closer to 2%. And so, one of the things to be aware of as we think about long term projections, is people's perception or estimate of long-term growth in the US continues to decline. And that's because long-term GDP growth is a function of two things. Population growth and labor productivity growth. US population growth is at historic lows. Many people think it might recover a bit but will remain very low, probably under half a percent. Productivity growth now is in that 1 to 1 1/2% region, so labor productivity is noticeably lower than what it was prior to the housing bubble bursting prior to the Great Recession. And so, a combination of factors, both demographic and connected to labor productivity is gradually pushing down both the Fed's and other forecasters thinking about what long term growth is in the US. A few years ago it was around 2 1/2%, then it fell to 2%, and now we're below 2% for the long run and I want to point out that's pretty important because it has important implications for the long run. Forecasts of industrial load. And what I estimate right now is for our long run industrial load to really grow in any meaningful way, long run GDP growth would probably have to be above 2.3%. We're below that, and so in the IRP now the projection for the industrial side is no, or slightly negative growth going forward, because we're just not going to have enough growth to support. Industrial production regionally compared to maybe what they need based on historic norms. Any questions about that? It's important to point out that long run assumption matters for what the industrial forecast looks like.

**Woodward, Jim (UTC):** Hey there, Grant this is Jim Woodward again – Washington UTC staff. Per what you just said, and I think your last note in your comment box, I'm assuming that this whole discussion currently is excluding any sector to sector change, namely like building electrification effects, things like that were just. Is that the case? We're just talking about traditional drivers of industrial load, OK?

**Forsyth, Grant:** That's right. Yes, excellent, exactly. And so the purpose of the model that I have is just to establish a baseline look. You can run scenarios so we can say OK, what happens if the long run GDP growth is higher than that. What does that mean? But it is based on sort of more traditional linkages. That's absolutely true.

**Woodward, Jim (UTC):** Great thanks Grant.

**Forsyth, Grant:** You bet. Any other questions about that? OK, so let's talk about the long-term energy forecast and the basic approach here. There's a major revision of this based on feedback from the last IRP. In addition to pressures associated with instructions going their own way from a policy point of view. But just kind of as a big picture though, there's two components to this. There's what I call medium term forecast, which I've already referred to. And again, the medium-term forecast is this forecasted I do on a biannual basis, twice a year for the company's revenue and earnings models. The most recent forecast, that's what I used to bootstrap off of for the long-term forecast, which covers that period 2027 to 2045. The medium term is mostly a set of econometric models. It forecast basically use per customer and customers by schedule, by customer class and so in residential, commercial, industrial and street lighting. Under each one of those classes there's a whole bunch of schedules and I have essentially anything from complicated to a simple econometric or forecasting models that forecast out to 2026. And again, it's customer and UPC (use per customer) forecasts. The idea is once I get the customer forecast and the use per customer forecast, I can multiply them together to get that load number. I assume a 20-year moving average for normal weather. That's built in, but in this new version of the model we do have the ability to change that assumption in the long-term component of the model. The economic drivers that go into the medium term, we've got GDP growth, industrial production which is connected to my assumption of GDP growth, employment growth which is connected to the population forecast. There are variables for price, natural gas penetration, and then there's an ARIMA error correction that goes into most of the models trying to take into account those variables that I can't measure directly. Now I will say on the price side. Price as a variable, it's mostly in the Idaho side, prices falling out as a significant driver at least in the medium term on the Washington side.

**Forsyth, Grant:** Price is difficult to handle. I've talked to a lot of my colleagues at other utilities trying to get an estimate of elasticities specific to your utility. Turns out to be really hard to do and so we're going to talk about how I handle that later. Once I have this forecast for the revenue model, I essentially say based on historic norms, that's a retail forecast. Based on this retail forecast, what would be the equivalent native load based on historic relationships so I can at least get a native load forecast out of that, and then the current forecasts that I'm using for this medium term is fall 2021. I'm going to update this forecast next month and probably with James' permission, will integrate that as the new medium-term component. That's why this current one is called preliminary. Let me stop, any questions about that?

**Art Swannack Whitman County Commission (Guest):** Great. The question that was just asked a minute ago was essentially what factors haven't been put into the model that are coming at us such as this whole clean energy transformation and how that affects. Well, it'll be government, industrial and everybody is building if they're forced out of natural gas.

**Forsyth, Grant:** Right.

**Art Swannack Whitman County Commission (Guest):** And I don't know how you quantify that, but I sure see that there's going to be some difficulty in figuring out what rate you can put those changes into place and make them work.

**Forsyth, Grant:** Yes, and in fact this is quite a long conversation. We've had many conversations with Tom Pardee and James Gall about this, so in the simulation model for the longer-term thing I do have the ability to alter the assumption about natural gas at the residential level. I can make some assumptions about how natural gas may be treated in the future, and it primarily affects directly the residential side, but in the model. I have a correlation variable, or a correlation connection, between residential and commercial because they move very closely over time and I want to make sure that stays the case in the simulation model. By altering the assumption about how much natural gas there is on their resident residential side, it by correlation will also affect the commercial side. Although I can't say it's not a direct effect, it's sort of an assumed indirect effect. So, there is a way to think about that in terms of how natural gas might impact the load side of electricity. The one thing I would oh go ahead, sorry.

**Art Swannack Whitman County Commission (Guest):** I was wondering, does that include the rate with which you can realistically adopt and supply that change? Or is that something way bigger OK?

**Forsyth, Grant:** It's up in the air, so again there's not enough policy clarity at this point. For me to build in an absolute is what we're going to assume. This is the way policy is going to go. It just doesn't seem policy has fully formed enough to build in an absolute with confidence.

**Art Swannack Whitman County Commission (Guest):** Good. Wow.

Forsyth, Grant: Natural gas adjustment. But we can't say within some bounds if it turns out this way, what would it might look like if it turns out this way, what it? What might it look like in terms of electric load?

**Art Swannack Whitman County Commission (Guest):** So I should be able to require. OK, yeah, like you said, it's a big conversation and a lot of logistics just to get it done, let alone if it gets done, thanks.

**Forsyth, Grant:** You bet, and to your point about the industrial side, I don't have a good adjustment process yet for what those restrictions on natural gas would mean for industrial load. It's within the context. The model I'm using is more built into the

residential and commercial side than the industrial side. One of the things we don't know is, as this policy evolves as a matter of economic and industrial policy in the States, will industrial users be treated differently than residential or commercial users?

**Art Swannack Whitman County Commission (Guest):** And there's an in between group. I mean I'm going to pick the government side, but I just thinking about our courthouse that's heated by natural gas. How do you set up a system for that kind of building that will use just electricity to do the heating and cooling?

**Forsyth, Grant:** Right, Yep.

**Art Swannack Whitman County Commission (Guest):** And, I just think of all the supply chain issues we got now, and it just keeps rolling in my head and I'm going to stop before I go too far.

**Forsyth, Grant:** No, I agree, and this is something that, Tom Pardee, who's our gas specialist and James Gall, who's IRP manager, we've talked a lot about this. The problem is one, getting that policy clarity. And the second thing is getting the modeling right and do you have the enough data? They're not just company data, but individual user data. To really model that correctly. Now I'm going to call James out a little bit, James I think you've done some work on what would the aggregate load impacts be if we had to electrify, haven't you done some work on that?

**Gall, James:** Grant, we did a little bit of scenario analysis in the last IRP and one of the challenges we're seeing here now with the Climate Commitment Act in Washington is what is the price signal going to look like for that conversion and trying to estimate? You don't know what customers are going to switch and what customers are not going to switch. Part of that challenge is we need to on a gas IRP look at what that cost forecast is for. One you know allowance purchases, but also renewable natural gas and other clean gas sources, so it's hard to know. So, until we complete the gas IRP, how much electrification is likely given the opportunities and options that the gas side of the business has to lower their emissions we're in a state of flux where we're going to need to rely on the gas IRP to inform the electric IRP as we go along. And right now, how we've situated that is the gas IRP should have a preferred resource strategy and that should inform the electric IRP. He has since the process and electric IRP has been delayed a few months, so we should have some intelligence over the end of summer or early fall on what we think could be that shift in load.

**Forsyth, Grant:** Yeah, and since it did come up last year, let me talk about the assumption of weather. The forecast really assumes a 20-year moving average. So, in other words, each year I update a 20-year moving average with the most recent year of weather data and that gets used as what we call normal weather. So that means in the current simulation that I'm going to show you today the long-term look. I'm assuming the most current 20-year moving average is essentially holding for that whole period. Now the way I've redesigned the simulation model, though for doing the long-term forecast is we can change that. I mean, in other words, we can assume like I did last year, some

sort of trended moving average rather than a static moving average for the whole period. But I know that there's where I think, James I think we're working with some people to figure out what's the best way to handle this so that as we think about weather changes over time, we're all handling it in a uniform way. Is that correct James?

**Gall, James:** Grant, sorry for the delay, can you repeat the question? I have some Teams issues to deal with.

**Forsyth, Grant:** OK so I want to address this. You know I'm assuming in this baseline the 20-year moving average. For that I'm currently using for the medium term that holds over the whole long term, but I would just point out that the new redesigned simulation model allows me to have a trended 20-year moving average rather than a static one.

**Gall, James:** Correct.

**Forsyth, Grant:** But right now, it's just static because we're trying to think about what's the best way to handle this uniformly across all of our work. Is that correct?

**Gall, James:** Correct. And one of the issues we're trying to wrestle with we are going to be studying later in the IRP process. Different climate futures and what we want to do is have this baseline and then when we look at different climate futures, we want to align those with our hydro assumptions. We're conducting a study right now where we're looking at different temperature futures and their impacts on hydro conditions and we want to make sure that the study we use for the hydro condition estimates match the temperatures who want to use in the load forecast scenarios. For right now, it's as Grant described, but we will be doing a scenario later this summer that shows some alternative looks.

**Forsyth, Grant:** Yeah, so I wanted to point it out because this has been a point of controversy in the past. And to let everybody know, the model I'm working with has some ability to change from a static to a more dynamic look at weather, but we're going to keep it static until we get a uniform approach which James just discussed.

**Gall, James:** Yep.

**Forsyth, Grant:** Go ahead, James, if you're going to say something.

**Gall, James:** No, Jim Woodward had a question, his hand is up, go ahead.

**Forsyth, Grant:** Oh, go ahead.

**Woodward, Jim (UTC):** Thanks James. Thanks Grant. I may know the answer to this question. Part of it is encapsulating the exchange I just heard. We went from a discussion of the 20-year weather dataset to getting a little bit into climate change a couple of times, but this is really just preview of coming attractions. For folks, myself and others on the line, who may have more modeling focused questions about scenarios we should probably hold our powder till those TAC sessions. Is that fair to say, versus have that discussion now?



**Forsyth, Grant:** It would be. I mean if you want to be kind to the Economist, you'd probably be better to compile those concerns or questions for where we can talk about it in a more detailed meeting.

**Woodward, Jim (UTC):** Sure, OK. Just wanted to approach it appropriately.

**Forsyth, Grant:** Thanks. This was a big topic of conversation last year, but again, if I think if we could just delay that a little bit until we ourselves have more information about kind of how we're going to go, that'd be great.

**Woodward, Jim (UTC):** Will do, thanks.

**Forsyth, Grant:** OK, so the long-term part, it's a bootstrap off the medium-term forecast. What I'm doing is applying long run load growth relationships, develop a simulation model and that enables me to make certain changes. We can develop high low scenarios, but it also allows us to say OK, what if rooftops solar is higher or lower than we think it's going to be? We can talk about what happens using price elasticity if prices rise a lot faster in real terms than we think, or maybe slower. The impact of ebbs, GDP growth, population growth. And so even though we live in a complicated world and there are thousands of variables impacting the load, we can take a big picture look at key variables and how they might move the load around if we changed those assumptions. The idea is that when we think about load, you can think about load as customers times use per customer. Or alternatively, we can think of load growth as being approximately equal to customer growth plus use per customer growth, and so the style of the model I've developed – that long term component is the ability to change assumptions about customer growth that's in the model. We can change assumptions about what we think about population might be to higher or lower than the IHS Connect forecasts.

**Forsyth, Grant:** The model is also built around what a UPC growth, so we can alter factors that might affect use per customer growth, such as price, elasticity and what's happening to the real price of energy over time. The basic structure of the model is to build around customer growth and use per customer growth for each customer class and then have the ability to make changes in factors that impact UPC or customer growth. So that's another way to think about this long-term part of the model that I'm essentially bootstrapping from the medium-term forecast to get. To show you what the model is currently generating based on inputs, here is residential customer growth. I always start with this. This is what's assumed in the model based on population growth. If I was going to pick one single large driver, it's this assumption that really has a big impact on what loads going to look like in the future is this idea of population growth and how that feeds into customer growth. What you see here is the current assumption for residential customer growth. The 2021 IRP was assumed a few years ago. And the red is what's currently assumed. You can see the outlook for customer growth is higher than in 2021, and this really reflects, I think, primarily an upward revision from IHS Connect about what population growth is going to look like in the future, in particular on the Idaho

side and they've definitely moved upward. There's a bigger than a big upward revision for their population growth in Kootenai County, and you can see this over here. If you look at the 2023 Washington, if we think of the IRP, the average annual growth rate over this time period for the current IRP it's about 0.7% for Washington, but it's about 1.2% for Idaho. That's actually a big difference, so this upward revision in what we're expecting in this IRP reflects what's really happening on the Idaho side.

**Forsyth, Grant:** Now the question I've got on this and it is how much growth can north Idaho take before you begin to have that decline in in-migration. That art was discussing because you simply run into housing price problems and congestion problems that maybe make the area less advantageous for people to move to. These are long term forecasts. There are factors out there that could affect this, but I have to make an assumption. This is the assumption that's currently in there and again driven by those IHS Connect forecasts. Let me know if there are any questions about that.

**Forsyth, Grant:** OK, I will just say that if IHS is right, north Idaho will fundamentally change in the next 20 years. It'll be almost unrecognizable if they're correct. Again, just to keep in mind the medium term, that's from that medium-term forecast that we just discussed. After 2027 on that's longer-term forecast where I'm really relying on those IHS Connect forecasts. To guide what residential customer growth is going to look like and the other thing I would point out, the reason why this residential assumption is so important, because I built into the model a direct correlation between what happens with residential customers and what happens with commercial customers because they're highly correlated over time. If you talk to developers, population growth and household formation is directly tied to commercial growth. Focusing on the residential side, one of the key things here is residential solar penetration. This has generated a tremendous amount of discussion in the past. It's speculative, it's really hard to know how solar is going to go. It depends on a combination of consumer preferences, consumer income, subsidies at the state and federal level. What we see here is the assumption that's built into the model really hasn't changed from one IRP to the next.

**Forsyth, Grant:** Our current penetration rate is about 0.4% of residential customers who have rooftop solar. This is projected to grow to about 2 1/2% by 2045, which incidentally by a lot of regions that's pretty high. The current system size is around 7,000 watts. I assume in the model that system size will grow to almost 9,000 watts by 2045. I'm assuming here that there's going to be some technological innovations that allow maybe more solar to be generated on rooftop installations compared to the past, but again, this is highly uncertain, and subject to all kinds of complex policy factors, pricing factors, and then what we've seen in the pandemic also supply chain issues. OK, let me stop any questions about that?

**Woodward, Jim (UTC):** Hey there Grant, Jim Woodward again, just wondered on this slide. I guess a couple terms I see on the slide residential, solar and you've used rooftop solar a couple times. Just wondering if this forecast, namely those percentages, factor

in. You know additional vehicle or vehicles like community solar and other initiatives like that, if that question makes sense.

**Forsyth, Grant:** Yeah, so this is just customer owned and this is what I would consider traditional solar projects on people's rooftops. Now community solar is interesting and that is on the generation side and James is that correcting?

**Gall, James:** That's exactly right Grant, so we're trying to come up with what is the forecast of our customers demanding energy, so we have to take this into account from a behind the meter point of view, and then on the supply side will evaluate different options to serve those customers from a resource point of view. But you got it right.

**Forsyth, Grant:** OK.

**Woodward, Jim (UTC):** Gotcha, so from an accounting perspective, sounds like you all are tracking that that other item, but it's just not accounted for here.

**Forsyth, Grant:** Correct.

**Woodward, Jim (UTC):** Great thanks.

**Forsyth, Grant:** Yep.

**Hermanson, Lori:** Grant, it looks like we have one more question.

**Forsyth, Grant:** Yep.

**NWR, Gavin Tenold (Guest):** Grant this is Gavin Tenold and we install quite a bit of solar on this this grid. I'm wondering if you've been talking to your renewables division. I'm a little surprised by the system size there of 7,000 watts. A big part of our work now is installing these smaller systems that builders are using to meet the new Energy Code.

**Forsyth, Grant:** OK.

**NWR, Gavin Tenold (Guest):** I'm installing smaller systems. In fact, some large developers are now going to this just as standard on their homes so 3600 kilowatt.

**Forsyth, Grant:** That's really kind of interesting. I didn't know that.

**NWR, Gavin Tenold (Guest):** I'm just kind of curious. I would just encourage you to talk to your renewables division about the quantity of interconnections they've been receiving in the last calendar year since the new code went live on February 1, 2021.

**Forsyth, Grant:** OK.

**NWR, Gavin Tenold (Guest):** I suspect there's a bump. I don't know if it is in your data for 2022.

**Forsyth, Grant:** Yeah, that's a great question.

**Forsyth, Grant:** I'm establishing the baseline based on Avista's own database of customers that have installed systems. 7,000 watts is the median system size, so that's why I'm using. Now the fact that you're having these smaller systems installed, it's interesting, I'd never heard that, so I need to look into that. And because the data that I'm starting with ends in 2020, I would not have yet observed that bump.

**NWR, Gavin Tenold (Guest):** OK, the bump wouldn't have come until Q3 2020.

**Forsyth, Grant:** OK.

**NWR, Gavin Tenold (Guest):** But it's significant. We got a lot of purchase orders for these little 3,600 kW systems and we're out there putting them in a pretty big way.

**Forsyth, Grant:** OK, that's interesting. Let me ask you a question. If people start out with a smaller system, does it increase their probability of expanding the system later?

**NWR, Gavin Tenold (Guest):** I don't have the information for that yet, but it's doable.

**Forsyth, Grant:** OK. Because that's the other thing that's hard to get a handle on is, you start with a small system, but it's technology and prices change. Maybe you could add a lot more. That's a harder thing to get a sense of. And I'm thinking out loud as an economist, if you already are doing something, the probability of expanding that might be higher. If you already have experience with it so, I'm thinking out loud to myself. I will need to talk to some folks about that because the data I have will not have shown that yet. But that's good to know. Anything else? Solar is another tough one that's generated a lot of discussion in the past. Again, not a big change from the 2021 IRP, the focus is on light duty EVs because I just don't have a lot of good information about larger duty vehicles. Now we do have some electric buses and so forth on the system now through the Spokane Transit Authority. But it's still relatively small. Most of them are going to be light duty based on current estimates and I need to talk to our specialist on this, Rendall Farley. Current EVs in our service territory are light duty around 2,600. This is an estimate projected to grow to about 110,000 by 2045. Current penetration is about 0.3% of household vehicles I estimate are some kind of light duty EV and this would be projected to grow to 13% by 2045. Now here's the thing before everybody starts, you know maybe going berserk for some reason. This is a highly uncertain thing, and this is something we've talked about in every IRP.

**Forsyth, Grant:** There's a lot of changes going on in the EV market. You see a lot of the big car companies are expanding models they're going to have available, including pickup trucks. And I don't joke, that's important for our service territory. They're making bigger investments in the ability to produce. How that's going to develop is uncertain, but they're also being constrained by supply constraints. Even pre pandemic there were issues about who's controlling key resources, China versus US versus Russia versus other countries needed to build electric vehicles. The current assumption, just like the previous several IRP's, is that we're not going to start to see a big ramp up occur until we get to mid to later 2020s or 2030s. But again, that's just the assumption I'm making

based on what we're observing currently. There's a lot of uncertainties around this, so let me throw that open for questions.

**Lyons, John:** Wait, we got a question out here Grant.

**Forsyth, Grant:** Fire away.

**Joni Bosh (Guest):** I think it's me. This is Joni again from Northwest Energy Coalition. Is your projection your top estimate? The medium of, the median size of a range of adoption. Do you have a range or an assumption as well on what each EV might use annually? Is that going to be shown in a further slide?

**Forsyth, Grant:** Yes, that's a great question. This was another interesting topic area, and so I'm assuming right now based on my discussions with Rendall Farley something just over 3,000 kilowatts a year per vehicle. And this is light duty mostly household owned. Now, oh go ahead, I'm sorry.

**Joni Bosh (Guest):** One of the questions that I have is how much did you consider that people might put solar on to charge their cars and what that effect would be.

**Forsyth, Grant:** We're going to talk about that in just a second. Just hold on to that, and I think the next slide might help us segue into that discussion.

**Joni Bosh (Guest):** Perfect thank you.

**Hermanson, Lori:** Grant, we have a couple more questions. Phil, do you want to go?

**Forsyth, Grant:** I want to respond to the previous question so just give me a second. They're the National Bureau of Economic Research, which is, some of you probably know about and some of you don't know, it's nonpartisan. It produces a lot of the cutting-edge research for economics in the US. They produced a paper recently that I sent to my colleagues. They did a study of how much energy electric cars use in California. Excuse me, I've lost my professor voice that I used to have so I lose my voice easily now. This study went out and essentially got data from utilities in California and looked at households that had EVs. And what's interesting about it, is that they found that EVs we're actually using a lot less energy than what had been expected. And they think the reason for this is you have a lot of households that have not gone completely EV, and so they're substituting still with gas powered cars. And so, you get into this issue of is that 3,000 kilowatt hours a year? Is that too high? Is that too low? Is that an average over the long run? Because the current estimates from that study, which I thought was quite good, suggests it's lower than that for now, but I went ahead and again based on the expertise inside the company, the number I'm using is 3,000.

**Joni Bosh (Guest):** OK thanks.

**Forsyth, Grant:** So next question, sorry about that. I just want to clarify that.

**Phil Jones:** Can you hear me Grant? This Phil Jones.

**Forsyth, Grant:** Yes, I can. Hi Phil.

**Phil Jones:** Nice to talk with you again. I'm not on the Commissioner bench anymore interrogating you. This is hopefully much more informal on this one. Obviously, I talked with Rendall a lot. You're in the alliance. And just a couple of things. One, I urge you and Rendall, and I go back and forth on EV adoption rates in in your service territory. I'm a little more ambitious. When we look at announcements from GM and Ford and Rivian, to say that 50% of the vehicles will be electric in 2030 maybe 100% in 2035. You know your curves here are a little bit too conservative. I think I see a lot of the adoption, so we have the vehicle side and infrastructure side. I'm going to talk about both. On the vehicle side, I'd urge you to be a little more aggressive both on the light duty side and on the medium-heavy duty side. I think the growth rates are going to be bigger and I think you need to start planning for that both from a load and resources, but just from a flexible load management point of view. That's bigger than what you're doing right here with a long-term energy forecast. I'd be happy to go offline and talk with you and Rendall about this. The evidence is coming in faster than you think. The other thing you need to think about is battery size is getting bigger. Spokane, I grew up there, and I know that people drive light trucks so the Ford F150s, the Silverados, the Rivians are going to come in a big way and probably in Spokane you're going to have more light trucks as a class as a percentage of the registered vehicle fleet than sedans, compacts and even SUVs. So, the battery size Grant on an E Hummer, for example, is it can go up to 185 kilowatt hours. The battery on the Honda Clarity I drive now is only 17. The battery on the new SUVs coming back or 85 kilowatt hours. So, you just have to run the math. You have to make some assumptions on what percent of the fleet in Spokane is going to be trucks as EVs. And I think Rendall in your team are doing this, but I just urge you to be a little mindful. I wouldn't trust that California data. For example, I think there's going to be a lot of kWh consumption at home and in public charging. So that's point number one. Point #2 is on the infrastructure side, on the medium-heavy duty side. This is going to happen a lot faster than you think, and it's really tough for you to model as an economist because there's no data or very little data now. I agree with you on that. But there are firms like Daimler. There's a lot of emerging data right now where you can go and Rendall can talk to GM and Daimler and with the F-150 coming out fleets are electrifying all over the place. We're going to see a lot of fleets in Washington state electrify, so it's important to start modeling that a little bit more. At least get some sensitivities going where you can do a high, medium and low, because I can tell you I'm working on a project now for electrifying the West Coast corridor. Interstate 5, so we're talking about perhaps 60 to 80 sites, probably 8 in the state of Washington that will have 3.5 MW charging hubs, and that's on I-5. So just think about I-90 and with the new Amazon Service center and more service type economies you are going to have some MW level charging sites being sited in your service territory. I would project there's a high likelihood of that happening. If you could start thinking about the medium-heavy duty case a little bit more, both on the Interstate side out on I-90 and 395 as well as the fleets based in Spokane, because you have a lot of warehouses there. I think that would be a good thing, and then the final point is just think about the infrastructure. Maybe this

is more for James or your distribution engineers, but think about what kind of infrastructure and the demands that's going to make on, especially for medium-heavy duty, not so much on light duty. In the beginning, but if you get penetration rates up above what you're talking about, 13% by 45. If let's say you get a 25% penetration rate in the 2030 to 2035 period when your resource adequacy assured, what does that do? Both 2-year RA numbers and then what does that do to? Certain feeders and certain circuits that could be overloaded, so just a few thoughts.

**Forsyth, Grant:** I appreciate that Phil because one of the problems with the EV thing is there is a lot of uncertainty. There's also policy uncertainty and trying to get a sense of how you should model this. But I will definitely. We're keeping notes here. This is being recorded, so we can definitely sit down with the Rendall and talk about how this may need to be altered or how we need to do a scenario here, because I will tell you as we look at the energy forecast, ultimately this ramp up that we see in the later period does have a big impact on what load looks like in the future, and if it comes sooner, I think what you're suggesting is it'll come sooner, it does move things around.

**Forsyth, Grant:** Yep. Any other questions?

**Hermanson, Lori:** Grant you have another question from Art.

**Art Swannack Whitman County Commission (Guest):** I was going to follow on what Phil was saying. I don't necessarily agree on the heavy-duty side. I sit on the state freight board. And what we're hearing there is that Paccar doesn't have anything even on the books for an electric truck, but what they're looking at is a Hydrogen electric, some type of vehicle in that order. But the medium duty local delivery trucks, the guys that are in there in the business are saying that's coming pretty fast. And I think Phil's right on target. I think the infrastructure issue is going to be your biggest issue to do any of this, and it's going to be power generation and it's going to be what size line do you get to the house because if you want a fast charger you need a 50 amp dryer circuit. If you're going into trucks and other stuff, that's going to be a whole other animal.

**Forsyth, Grant:** That's good to know because what we assume about EVs and what we assume about rooftop solar also filters into the peak load forecast. Having some sense of how things are really going to materialize is going to be important for that forecast as well. Anything else?

**Hermanson, Lori:** Jim, do you want to go?

**Woodward, Jim (UTC):** Thanks Lori, thanks Grant, great discussion so far. I have a comment and follow up questions. Good discussion with Phil and Art and others on this forecast and I what I'm hearing is this seems like it's an area of further discussion of more modeling sensitivities. Granted, that's probably not yet right, as we go forward, but you know interested in seeing what scenario options your team might propose. The question I had, Art actually referred to this, briefly on the hydrogen side, and this is more of an accounting question. Any options and scenarios looking into hydrogen and

hydrogen infrastructure. Is that actually on Avista Gas IRP side are those questions better reserved for those channels since I'm kind of new to the Avista fold here?

**Forsyth, Grant:** Right. I will tell you there is nothing in and what I'm doing sort of generating this base for James. There's nothing on the hydrogen side and maybe he wants to talk a little bit about what he's looked at it because I know it's come up in the past, but there's nothing explicit in what I do. James, do you have any comments?

**Gall, James:** I'll add a couple thoughts. Hydrogen is definitely on the table when we start looking at resource options for generation. When he started getting into hydrogen for gas that's going to be talked about on the gas side of the IRP. If we're going to talk about hydrogen for other uses, vehicles for example, that's not necessarily our business. Could it be our business? I don't know but, that's where we're drawing the line we will be talking about. Those fuels for power generation or for gas service, but that's probably where that line is going to get drawn. At least in our IRP process. And for power generation, I believe this summer, we have a TAC meeting on new resource options that will include hydrogen. We're stepping beyond hydrogen and looking at ammonia as a more likely power generation source. We'll have quite a bit of discussion when we get to that topic.

**Woodward, Jim (UTC):** Thanks, James.

**Forsyth, Grant:** Anything else?

**Gall, James:** Grant just one other thing really quick.

**Forsyth, Grant:** Yep.

**Gall, James:** Time check we had the meeting ending at 11:30. We did reserve the meeting until 12 and I don't mind going until 12 since that's what we reserved the meeting for. Even though the agenda we were hoping we could get done by 11:30, it doesn't seem to be the case, so I just wanted to throw that out right now and keep going. And we'll have to catch up on our topics with whatever time we have remaining, this seems to be a good discussion and I don't want to end it. This is the draft and preliminary load forecast and we are going to update it. That's why we wanted to get this out early to everybody to get comments so that when we do our final load forecast later this summer, we know what the issues are ahead of time. Go ahead Grant.

**Forsyth, Grant:** The question came up about net effects. Now I don't think that entirely gets to it, but this is based on current assumptions. The red line is the residential baseline renewable contribution, which is essentially a load reduction, because we're looking at this in terms of traditional rooftop solar and then we have the IRP estimating annual kilowatt hours of EV load. What we're looking at here is the net effect, the difference between the red and blue line. In the mid-2030s, late 2030s you see that EV band really starts to take over in terms of offsetting that solar load. So, there is a certain point where the EV growth is growing much more rapidly than the solar component. And the net effect is that you're having load growth because of that. Now the question came



up about what about people with rooftop solar and charging their cars. That's another interesting question. It's a tough one to model precisely in this aggregate forecast, but again, going back to the National Bureau of Economic Research and looking at some research that they did several years ago about this. There is some evidence that people who get electric cars may also have a slightly higher probability of having rooftop solar. And if that's the case, that will help potentially offset some of that EV band that we're getting in the load we're going to have to generate, so let me just stop and put that back to the question again of whether or not they want to talk about that some more.

**Joni Bosh (Guest):** I'm sorry this is Joni and we don't need to talk about right now. I was just raising the question and I was having trouble finding my mute button. I apologize. That they're in other places where I have worked there's been an impact both on using solar to charge the EV so that the EVs end up having less impact on the grid. In triggering, as you said, more solar installations and back when the first wave of the other very small cars came out, I was talking to the PV manufacturing Arizona. Almost all the people who applied for an EV also went out and had solar installed solar.

**Forsyth, Grant:** Yeah, and that and that's what the research showed is that there's a propensity for those things to be, and if I can speak like an economist, complementary goods. There's some evidence that they maybe will go together over time. There's both. The evidence, some initial empirical evidence as well as theory, suggests that should be the case. I would point out and I hate to throw this out, but it is sort of an interesting thing. I watched an interesting short and I can't remember if it was on the BBC or whatever about cars. Now that have built in solar and so rather than plugging the cars in at night there are car companies now developing solar cars that the roof of the car and the hood of the car is literally solar absorbing and so that's also an interesting piece of technology that as it develops could affect how EV charging at both the commercial and residential level. Let's get to the bigger picture here. This is native load and it's for the system, so I haven't yet broken out Washington from Idaho and you can see that for the current IRP. The native load is somewhat higher, especially out to 2030, then what we saw in 2021 and again that reflects the harsher assumptions I was making about the recovery from the pandemic. During the last IRP, as I said early in the presentation, things just didn't quite materialize in the way that I had initially expected. And so that's helping to push the load up. Also, in particular that residential customer forecast, especially in Idaho is higher, and that's also pushing that up. What you see is an upward revision from the 2021 IRP, especially out to that mid 2030 period. But I also want to point out that this you can see that there's really not a lot of growth until you get to this later period. This bend up that you're seeing, that's the impact of EVs. Maybe this is going to happen sooner and more robustly. And that's again some discussions we need to have, but currently that's what it looks like, but it does, I think, highlight how powerful the impact EVs potentially are. Terms of the growth rate. It's a little bit lower overall to 2023, and actually that should be a 2021. Sorry 2021 IRP. Washington, in particular, is pretty low. Most of the growth is on the Idaho side, which is about twice as high in terms of the forecast. When we think about where our load growth is going to be coming from,

a jurisdictional point of view, under the current assumptions about EVs and solar, it's really on the Idaho side.

**Hermanson, Lori:** Earlier, did anybody have a question that raised their hand? Maybe you've already answered it. Oh wait, there is somebody, John do you want to go ahead?

**John Barber (Guest):** I see, this is John Barber again. My question earlier actually wasn't a question so much as a comment. Putting together EV ownership and rooftop solar, that's fine for people who live in their own homes. For those who live in apartments, they don't have that option. So if you're trying to look at the effect or the connection between owning an EV and having your own solar, we need to be able to somehow factor out those folks that are in apartments and don't have their own roof to put their solar on. And that complicates modeling a little bit further, I suspect Grant.

**Forsyth, Grant:** Yes, thank you for mentioning that. By the way, I meant to talk about this earlier. Avista basically leases me out for various policy work in Olympia. It's not really necessarily always related to energy stuff, but I sit on EIM, the chair of this tax preference Commission and we review tax preference for the legislature working with some nonpartisan staff, and this issue came up because there was a tax preference. It was expiring for solar. And the people who audited the program that nonpartisan staff in Olympia that is state auditor. Legislative auditors found that the preference really didn't do very much to increase solar usage among low income households, and so the recommendation was that they were going to review this and figure out how they want to change it because it didn't really meet that goal of the legislature. And my comment to legislators and anybody who would listen was, if you're going to encourage low income households to adopt solar you have to recognize first off, they don't have money, so they can't. Even if they do own their own home, they probably don't have the resources to get the solar necessarily. But that point that you just raised was an important one is that especially low-income households don't make that decision because they don't own the property. And I would point out that's also the case for a lot of businesses. A lot of businesses do not own the building that they're in, so it's not their decision, and so I completely agree this is a really complicated issue. I haven't figured out how to disaggregate. That is definitely an issue going forward. As we know, your policy makers trying to encourage solar adoption. There's an awful lot of people renting the business building that they're in, and there's an awful lot of people who just don't have the money to do it. It's a good point. Because of the big redesign of the model, this is what it looks like in terms of native load between the two different jurisdictions. And it's pretty noticeable, Idaho load growth is higher because its population growth forecast is higher. And two, it's expected to have lower solar penetration compared to Washington. That's just because of the way it looks right now and projecting it out forward. That could change. Again, that's speculative. The Washington long term forecast assumes, and this was the other big difference between the two, gas penetration at the residential level as a share of residential electric customers. In other words, the share of our customers that are both gas and electric is constant over time. We're basically

assuming for now that gas penetration really starting in 2027 is constant over time, which essentially means that gas customer growth is identical to residential customer growth, whereas in the past, residential gas customer growth has always been slightly higher than residential electric growth because in any given year you have not only new residences, like newly built residences adopting gas. You also have existing residences without gas installing gas and that always gave you a little bit more growth relative to the residential electric slide. Over time, gas penetration was increasing, but for the purposes of getting the conversation started in Washington, we no longer assume that penetration is increasing after 2027, it's constant. In Idaho we do assume that penetration gradually increases over the horizon.

**Hermanson, Lori:** Looks like we have a question from Jim.

**Woodward, Jim (UTC):** Thanks Lori, Grant. I think last slide you commented on that EV bend during the latter 2030s, and this is more of an observation, but slide 27-28. I agree with you. It increases a bit at the end of the period, but these graphs are almost to me, hyperbolic where you have a greater slope in the 2020s in this leveling off in the 2030s for about seven years. With that acceleration late in the period that you commented on, just wondering what those other trends during the 10 to 15 years are largely from.

**Forsyth, Grant:** Right, for Washington, one of the big things affecting this difference we're assuming through here the assumption that population growth, therefore customer growth slows faster in Washington than it does in Idaho. And in fact, the forecast for Idaho really doesn't slow at all. The IHS forecast is that its population growth is pretty constant through this whole time period. A little bit of slowing, but not much. Whereas in this time period, they're predicting a notable slowing on the Washington side, and that's part of the reason it's quite a bit flatter. And so that assumption is having a big impact between the two. That means when you start to get the EV penetration, which I think currently is assumed to be higher in Washington than it is in Idaho, the EV impact is greater. You see a much sharper bend in Washington once those EVs start to impact relative to Idaho, you see a little bit there, but it's mostly here on the Washington side, because right now it appears most EVs are on the Washington side.

**Woodward, Jim (UTC):** Right. So, to recap, more population in-migration driven in Washington for the next 15 or so years. Still sort of that mid 2030s and then the EV effect takes over. Those were sort of broad trend wise what's going on here.

**Forsyth, Grant:** And it's a good point. It's directly connected and again, this goes back to the comment about EVs and solar. It's directly connected to how I'm shaping the accumulation of EVs and solar which again, it's open for discussion. But the way I've shaped it is really determining the way things look the late 2030 - 2040 period.

**Woodward, Jim (UTC):** Great thanks.

**Forsyth, Grant:** You bet. There was a whole bunch of discussion earlier about the gas side. It's possible to run some scenarios about what happens if we allow gas penetration to actually contract. It can contract not because we're losing customers because it just means that gas growth begins to be less than residential customer growth. Or we could potentially talk about what happens if the absolute number of customers declines. These are things I've talked about with both Tom Pardee and James Gall. But there is some potential to change some assumptions. The other thing I'd like to talk a little bit, just because the residential side is so important in terms of how the load forecast ultimately looks, this is use per customer or a growth in residential use per customer, and I've not broken it out. This is for system wide, so it's not broken out by jurisdiction what we see here. The blue line is the EIA current reference case. It's their measure of use per household growth, which is used per customer growth. This is the current scenario outlook for use per customer. It's the red line for our service territory. And again, you can see that this this weird sort of this band is connected to how I'm shaping in the combination of EVs and solar. We're going to see declining use per customer on average, and then we'll get to the period in the early, late mid 2040s where use per customer starts to grow again. Again, that depends on the shaping. We could see that happen sooner. In the EIA reference case, part of the reason they show positive use per customer growth sooner than I do is that part of their modeling assumes ongoing demographic shifts to warmer areas that probably require more air conditioning and so you get a little bit different shape in this case because they're taking into account shifting population within the US.

**Forsyth, Grant:** The other thing I'd point out is that you'll notice there's this weird little step down here. This is because I'm assuming that, and this is something we've assumed in past IRPs, it's really starting in 2030. There will be an acceleration in the real price of electricity. I've assumed an elasticity effect associated with that, and so this dropdown reflects an increase in the rate of growth of rates especially on the residential side and that increase has an elasticity effect and own price elasticity, and so you can see that pushes down use per customer as a step down. Now James and I have talked about this. We could face this. It doesn't have to be a step, but I at least have the ability in the model to alter price. Excuse me, real price growth. Real price growth and real rate growth on the residential side and how that affects usage overtime. This is also going to be affected by what you assume about gas penetration. Any questions about that? I'm going to talk a little bit about the elasticity because this came up a lot last IRP.

**Hermanson, Lori:** Art, do you want to go ahead?

**Art Swannack Whitman County Commission (Guest):** Grant is that a valid assumption anymore that people will actually reduce electricity use with price? I'm thinking with all the gadgets, electric cars and everything else is coming in. I just wonder how elastic they actually are.

**Forsyth, Grant:** That's what I'm going to talk about the next slide, so bear with me. I think I'll answer your question because I think that's a good point. As an economist it's

hard for me to assume that there's no price response ever in the long run. And what I've assumed essentially, it's a pretty conservative long run elasticity number. Meaning it's pretty low, there's not a lot of substitution assumed in the long run. So what I did, and I'm sorry for my voice, is I went out and reviewed a whole bunch of studies on elasticity, especially on the residential side because that seems to be where most studies are and it seems to be where they're able to identify elasticities. Effects may be a little bit more clear than industrial and commercial. They're really even more all over the place than for the residential side. This graph is a boxplot essentially and looking across many different studies and doing a distribution of what those studies find in a box plot. So what box plot is showing is that the average across many different studies, for long run elasticities about minus 0.75 and it's not particularly skewed. The median is about 0.725 and then you have these outliers. Some studies show it as large as minus 1 1/2, which is huge. That's a strong price response in the long run. To something that's low is essentially no price response. You know price quantity response.

**Forsyth, Grant:** You can also look at the short run estimates of elasticity, and not surprising, they're lower than the long run because people have less of a chance to adjust in the short run and here you can see that the average which is the X the average across many different studies is about 0.3. I agree with you Art. I think prescriptions on natural gas growth of EVs would likely put downward pressure on elasticity. I'm not comfortable setting it to zero. I could in the model, it's possible to set it to 0. What I've chosen to do is set a pretty low one that's more consistent with the short run, because I do think you're right, it will be pretty low in the future. But I'm not comfortable setting it to 0. There we go, we can throw that out there for discussion. I'm pretty proud of this. I just want everybody to know. It took me a long time to go through a bunch of different studies to look at this distribution.

**Art Swannack Whitman County Commission (Guest):** Grant this is Art again.

**Forsyth, Grant:** Don't question, don't get hurt.

**Art Swannack Whitman County Commission (Guest):** In the model you've got it as a drop, but it seems to last like eight years or something on that order that you actually have an effect from that price change.

**Forsyth, Grant:** Well, it drops because what happens is I assume the real price, the retail residential rate, instead of growing it 1% a year in inflation adjusted terms, it rises to 1 1/2% a year in inflation adjusted terms. But that drop reflects that. That change in the growth rate, but then it gets melded into a bunch of the other things that are occurring at the same time. This time path that you see after 2030 reflects not only the real residential rate rising faster than it was, but it's also melded in with a bunch of other effects that are impacting use per customer.

**Art Swannack Whitman County Commission (Guest):** So, this is just using gas prices. I've seen people do that for a year or two when fuel prices for vehicles go up, but

then they go back to what they were doing before. For the most part I just wondered if that kick down really is going to last that long and that's just a comment on it.

**Forsyth, Grant:** It's possible that will look differently than that. It's possible to reverse it at some point, so that's entirely possible. Here's the thing that vexes me a little bit, and James can weigh in on this, is that we've got this energy future we're trying to put together. And switching from gas to electric has certain costs imbedded into it and it's sort of unclear to me how you know you're going to be able to switch this future without causing real rate pressure. And so, I want to have the ability to build in rate pressure into the model, even if I'm assuming a relatively low price elasticity because I'm just curious how we're going to make this transition and not see some adjustment in rates occur so the debate becomes what's the appropriate rate of change. And as you point out, what should the time dynamics look like?

**Gall, James:** Grant this James, I'll add a couple thoughts, I think it's appropriate to have this elasticity because it takes into account things that we don't know on some of the uncertainty we talked about. So, if prices go up like we're kind of envisioning.

**Art Swannack Whitman County Commission (Guest):** OK thanks.

**Gall, James:** With the transition to clean energy, we may see more energy efficiency. We may see rooftop. We may see people converting to other fuel sources for heat, for example, wood or potentially propane. You could argue this helps guide some of that uncertainty. We try to be certain on energy efficiency. We tried to be certain on rooftop solar like we've shown earlier, but this can help alleviate some of the uncertainty where customers are going to choose other options, whether it's things that they control or things that we control.

**Art Swannack Whitman County Commission (Guest):** That makes good sense, thanks.

**Forsyth, Grant:** OK, this is the last slide before we get to the peak load and this is something James asks me to do each year and he'll use to help calibrate some of his own work related to conservation. And this red line, and things are a little bit skewed because of the scaling, the red line is the current baseload baseline native load forecast that we've been talking about for the entire system. The black line asked the question of, based on what we think conservation is going to look like in the future, which I estimate based on historic norms of conservation activity. If we essentially add that conservation back. In other words, if we stopped all conservation, what would load look like? And that's the difference, the black line is saying let's assume that we add that conservation back that we don't get it in the future. What does that look like? And it does fundamentally alter the time path. If you have no conservation, load growth per year is about 0.9% versus about 0.2%. But again, it's based on the assumption that conservation is going to go forward in time much in the same way it has in the past. James, do you want comment about that?

**Gall, James:** Sure, couple things on this. Sorry for the delay, but when we get to modeling our resource portfolio this will make a lot more sense later this summer when we start talking about estimating our future energy efficiency we have to start from a point where what if our system our customers didn't have energy efficiency and this helps us with that. That's a starting point and then there will be an iteration process to really figure out energy efficiency savings we project. I think the key message here is that Grant, when he's doing his forecast, it's net of energy efficiency forecast, not one that does not include a future with energy efficiency. I'll leave it at that, and Grant go ahead, keep going.

**Forsyth, Grant:** This is actually the most complicated part. Unfortunately, it comes last and everybody is exhausted here. This is about the peak load forecast, which again going back to one of my first slides talking about the forecast, models of normal forecasts in a world that's not normal. The peak load forecast has been an ongoing evolutionary thing we continue to work on. But because I did get a bit of a break between IRP's this time, I was able to spend a lot of time looking at the model. Looking at the longer series of data I now have compared to when I first came here. So, I used that time to significantly revise the peak load forecast. And in particular, the things that we did this time was we more carefully modeled in how EVs and solar would impact the peak load going forward by trying to more clearly shape those into the peak load. The way it works is the model essentially does a peak load forecast, excluding certain industrial loads, EVs and solar, and then we add those back. And what we've done is really improve the way EVs and solar are added back into the peak load forecast. There's a part of the model revision that forecasted impact the EV and solar were improved for this IRP. I think it's better in that sense, because you do a better job of shaping what peak load should look like in the future. And of course, if we do change assumptions about EVs and solar, that means if we change those assumptions in this simulation model for energy, it will impact peak load and that's the way it should be. The explanatory variables in the model are heating and cooling degree days and we have monthly and day a week dummy variables. There's the level of real GDP. Real GDP is the primary economic driver in the model, so we do have an economic driver. The higher GDP, the higher peak loads. But with the longer data series I now have available to me, I was able to go back and do a better job of analyzing what's been happening statistically between winter and summer and what I did is more finely separate those two in the model and the separation hasn't has improved the model. I think you get better diagnostics out of the model, but what it really also does is it shows that summer is now growing significantly faster than winter. I think the model, because it's doing a better job of separating those two seasons and connected to economic growth, the revised model shows that Avista is a winter peaking utility until around 2030 and then that shifts to summer peaking. And that reflects the fact that summer is growing faster than winter in the new model. The idea is that the coefficients of the model that you know. So, you take this historical data. Do you run a regression? You get these coefficients and what you do is you use those coefficients to generate a distribution of peak loads by month. Based on historical max and min temperatures since 1890,

holding other drivers like GDP constant. You're essentially running a simulation that says look if we get the same kind of temperatures we had back to 1890 with the current regression coefficients of our model, what does that generate in terms of peak load? For the 2023 IRP we changed things a little bit. The starting winter peak we used to project forward that base peak level uses data back to 1890, which is what we've done in the past. But we've shortened the summer average to a 30-year average to take into account that there are some changes going on in the summer.

**Forsyth, Grant:** The other side of the modeling, we can look at the long run growth rate of peak loads for summer and winter by allowing GDP to change holding other things constant and so we can get a growth rate then to generate going forward from those starting peak levels in summer and winter as previously described that came out of that distribution analysis. Now, if you if you do that, this is what the current forecast looks like. Annual winter peak, summer peak. You can see the model predicts we probably should be still winter peaking, but the growth rate in summer is roughly twice what it is in the winter. Peak growth rate is roughly twice of what it is in the winter under the current forecast. But it's important to point out that I've been looking at. I won't bore you with the details, but I've bought a book on extreme value analysis. I've been trying to do a little bit with our temperature data and the thing to realize is even though things are warming, the summers are warmer. We're getting larger peak loads in the summer than we used to. From a distributional point of view, where it's still at risk for really cold winters, and so we're at this interesting crossing point where we actually need to worry about both from a load perspective and a capacity perspective. Impacts of electrification policy still being evaluated. As we change those in the model that will definitely change peak load. And right now, there's no trended climate in the current forecast. Going back to James' early statement we're holding off on that until we have a more comprehensive approach of how to handle that. But with that model revision, we're definitely seeing a crossover point earlier between winter and summer peaking than we saw in the previous IRP.

**Hermanson, Lori:** Grant, we have a question from Fred Heutte.

**Fred Heutte (NWECC) (Guest):** Hi everybody, Fred here at Northwest Energy Coalition. You're already got to part of the question I was going to ask. I had to miss some of the earlier discussion, but I understand you're moving to a 20-year moving forecast for the temperatures and my question was going to be about forward looking, not just historical, but I also think I've been looking at the actual temperature data around the state of Washington for a little project I've been doing to dig into the details. Looking at trends for different parts of the state. And there are some interesting aspects to that, one of which is, it turns out the 70s and 80s were actually pretty cool and a little bit warmer before then, and now it's been warming up since then. And I think you know the about the terminology here, but I think climate change is happening here. But the question is also about the specific variability within both winter and summer. You already answered one question, which was the potential for still having quite cold winter periods that the winter as an average may not be as cold. In fact, winter nighttime temperatures have



been going up pretty consistently, but you might get a period of a week which is really cold, so you have to watch out for that for peak demand.

**Forsyth, Grant:** Exactly.

**Fred Heutte (NVEC) (Guest):** I'm wondering what you're also seeing for this summer period. I mean, we had the heat dome thing last year. Hopefully that doesn't come back for a real long time, but you know, it could.

**Forsyth, Grant:** That's right. When I looked at the longer historical series I have now since coming to Avista and working with the data it's pretty clear, since 2004, it's pretty obvious now that you have the data available this summer is growing faster than winter. That means I have to model that more carefully in the peak load model, which I think I've done. There's no question about it, but there are some other complicating factors and James and I have talked about this. It's also been naturally occurring separate from warmer temperatures is air conditioning penetration, so even if you had held climate constant, let's say you should expect possibly that summer load peak load was growing faster than winter simply because air conditioning is becoming more common. The heat dome, it's probably accelerated the adoption of air conditioning and we're actually seeing air conditioning in apartments. One of the things that's harder to parse out is to separate out these effects of warming temperatures versus air conditioning penetration. We're trying to get better data on that so we can maybe parse that a little more carefully.

**Fred Heutte (NVEC) (Guest):** Yeah, and that's getting to the other point that I'm thinking about it. For one thing, I'm sort of moving away from the idea of the terminology being summer peaking, winter peaking, we're in one mode or another. Both summer and winter are important. You can have a fair bit of difference between them or not very much at all. I live in Portland. PGE is, depending on the year, we're summer peaking or winter peaking we're basically dual peaking. But the real important factor here that I think is really important, is that we're seeing it starting to shift and so right now I think you're saying you're seeing a lot of air conditioning load really showing up, but in the future, if we see a move for transportation and building electrification, well the transportation is a year round thing. Although it adds to peak, you have to manage it. And we've talked about that. I heard about that before, and with building electrification, moving from gas to electric, that will build up winter load quite a lot, and then what does it mean to your summer peaking or winter peaking?

**Forsyth, Grant:** I'm glad you mentioned that, because that's another discussion we've had a lot inside the company, and again especially with James Gall about this issue of electrification, will it shift everything? You know gas covers a lot of heat load. It covers an enormous amount of heat load. And if that goes away, you're changing the calculations substantially on what winter will look like. I agree.

**Fred Heutte (NVEC) (Guest):** The last thing I've got. Basically, daily temperature, high and low data for various stations around the state going back to 1960, and if you look at the charts, they don't seem to move very much. But even a degree or two average shift

can actually make a difference over time. I'm wondering, maybe this is a separate discussion, but how you correlate?

**Forsyth, Grant:** Yes.

**Fred Heutte (NVEC) (Guest):** Alright, temperature and load realizing that you know it's not exactly a tight relationship, in a multiday hot or cold event people will shift their use and use their air conditioners or heating more. For example, it's not exactly like you can lay a rule around the line and say if this is the temperature that's going to be the load and how you're incorporating that into the demand forecast.

**Forsyth, Grant:** We have lagged so we have lag temperature in the heating and cooling degree days in the model. They're what you can actually see. Sometimes peak will come after the hottest day. It might be the next day, for example, and that's because of that buildup and the accumulation of heat, and so there is some lagged heating and cooling degree days. Then the model tries to take into account that more complex dynamic of temperature and usage.

**Fred Heutte (NVEC) (Guest):** OK thanks.

**Hermanson, Lori:** Grant, we have another question from Joni.

**Forsyth, Grant:** OK.

**Joni Bosh (Guest):** Hi I just have a quick follow up with these threads. I'm on the previous slide I think you said you were using GDP as differentiating on the impact and on the slide, we were just looking at it said there's no trend impact yet. So, I was wondering if you could expand on if there's no trended climate in the current forecast if you could expand on how you use the GDP. And maybe James is the one who needs to answer that, but are you going to be looking at various forecasting models on climate going forward?

**Forsyth, Grant:** Think of GDP as the trend variable inside the model so when you have economic growth, I mean, the expectation is with economic growth peak is going to grow over time. Because you have more economic activity occurring in your service territory and that can increase capacity needs. It's like the trend to the base. What I'm finding though, is the association of GDP with summer and winter is now different. Significantly different so that when you separate the GDP sensitivity in the summer from the GDP sensitivity in the winter, and you do that more carefully than what I was doing in the past, that kind of indicator variable GDP clearly is indicating that summer is growing faster than winter.

**Joni Bosh (Guest):** Right.

**Forsyth, Grant:** Right, so on the weather side, in the last IRP, I also did a peak load forecast with not only GDP changing over time but with adjusting the assumption of weather in the peak load so that it was actually changing over time, meaning getting warmer. You can change both of those assumptions. In other words, you can change

different levels of GDP in the future and how that affects growth and so forth. But you can also change what you're assuming about the evolution of weather in the peak load model. In this case I have not done that, so I'm essentially assuming a status quo on the weather side until we get a uniform approach to take. Because when we think about how we want to handle climate change, we want to make sure that we're handling it the same way across modeling. So, if I was to integrate in a trended climate kind of activity, where things are getting warmer, it would definitely shift these lines around some more. Where the summer peak and the winter peak would be pretty close to each other right now, and that's what's in simulation showed last IRP when I allowed that to happen in that peak load model.

**Lyons, John:** Grant, James is having problem unmuting so he had to reboot Teams so he'll be back to add his piece. We did have another question. Is there climate?

**Forsyth, Grant:** Here. OK.

**Joni Bosh (Guest):** OK.

**Forsyth, Grant:** So I just want to make sure Joni doesn't. I'm sorry John. Joni did that answer your question.

**Joni Bosh (Guest):** Yeah, I don't know if James was going to answer part of it too. I mean, we're looking at the work that, for example, PSE is doing. You guys have done work before with the climate team. I think at UW and what? And PSE is looking at the regional models for climate projections. And so I was trying to see.

**Forsyth, Grant:** Or

**Joni Bosh (Guest):** If there is a relationship there that you're incorporating on some of these forecasts or not?

**Forsyth, Grant:** not yet.

**Lyons, John:** Yeah, James is going chime in on that. He just couldn't unmute and I tried to unmute him from my end and it didn't work, so he's rebooting.

**Forsyth, Grant:** OK, alright.

**Joni Bosh (Guest):** Totally sympathetic to that, yeah.

**Lyons, John:** We have a question in the chat. Are climate change models chosen for the temperature assumptions and the peak forecast? Assuming that's like the Power Council took, I think it was three of them.

**Forsyth, Grant:** No, I. Yeah, not yet and again. Um, there's no. So they kind of like with the native load forecast. There's this status quo assumption built in right now. In that and the reason we're kind of building that status quo in at this point. Is because we don't necessarily have a uniform way yet inside the company to treat climate adjustments,

and so I think the goal is to move in that direction and until we get there, I'm sort of holding off on doing any kind of climate adjustments at this point.

**Lyons, John:** I understand it.

**Forsyth, Grant:** A lot of this climate stuff is very complicated. We did. I sat on a webinar with a climatologist from I think it was the UW. And it was extremely good, but what I realized is it's very complicated. There's a lot of stuff going on, a lot of what you read in the press. The popular press isn't exactly what the climate scientists are thinking. It's sometimes more complicated than that, and it also turns out that they're climate scientists, although there there's broad agreement about what's happening, not necessarily in some of the details that we actually need to worry about.

**Lyons, John:** Yeah, it's the modeling details that could be really difficult and very small changes can make huge ramifications.

**Forsyth, Grant:** Right, and it is huge and it's outside my expertise. I mean, that's probably an understatement. Is James back on?

**Lyons, John:** I haven't seen him yet. I did see there was a question. You did good. James?

**Gall, James:** I did make it back just now. I've had a hard day today with the software, but it seems to be working now.

**Forsyth, Grant:** James, Joni was asking about and it's come up a couple times and I actually had two different questions about. Again, you know how we're handling?

**Gall, James:** That was there a question.

**Forsyth, Grant:** Climate in the peak load model and my comment is that like the energy forecast, the native load forecast it's right now. The assumption is status quo until we get a uniform approach to dealing with this across the modeling inside the company.

**Gall, James:** Yeah, that's exactly correct, so this is your 30-year one in two somewhere and your 130 year one in two winter. Once we start to gather the data for the hydro analysis for the different climate change models.

**Gall, James:** What we're going try to do there is look at the temperature changes in those models to have those corresponding hydro conditions match what we want to look at from a forecast scenario point of view and look how those trend together. I can't say at this point in time we're going to be moving our expected case forecast to a specific climate change study, yet we still need to look at the studies that we have available to us on the hydro side.

**Gall, James:** And the challenge in the hydro side is. What we need is granular enough impacts to precipitation and snowpack to be able to forecast what our hydro system is looking like, so we're trying to keep a coordinated effort going on what those different features are. So where we might be limited, and the studies we have available to us.

But we're still working through that right now. We do plan on talking about that this summer at a future TAC meeting, so please be patient with us and we will get to it.

**Forsyth, Grant:** And again, just to emphasize, the scenario energy model I'm using for the native load we talked about earlier, there is the ability to make some assumptions about climate. If people are interested in seeing what might this mean. But again, the ultimate goal is to have something that's being used company wide, so everything can be an integrated appropriately. Anything else Lori, do you see any hands up?

**Hermanson, Lori:** You have a backlog of questions. Joni is your hand still up? I think your questions were all addressed.

**Joni Bosh (Guest):** Yes, sorry.

**Hermanson, Lori:** OK and then Fred, do you still have a question?

**Fred Heutte (NWECC) (Guest):** Just a quick follow up. I really appreciate the discussion the last few minutes. We think it's important to do a climate projected forward baseline, but the question is then how to do that. And I think you're already heading in the direction we're thinking about. You have to be careful about it. The Power Council has done, and I can't say enough for the work they've done, but it's not directly transferable to a situation like Avista that I'll explain in a moment. What they did was they picked out of all the global climate models, they pick three of them, relatively representative. They worked very closely with climate modelers with real experts at Bonneville and other places, the RMJOC study and so forth, and came up with a way to take the global models which have difficulty distinguishing weather in climate between east and west, of the Cascades, and downscaling it to the regional northwest level. If you take that, and I really have very high confidence in what they've done, they've done really good work. They showed a climate signal. It's already in the record back to at least the 1990s, so I think you're right to say go back at least 20 years because you need at least that much to really get a sense of what the natural variation is. But then you know then they're projecting forward. But what they're doing is a regional look and downscaling even further to a relatively compact area like Avista has. I think that requires additional work to get it right. I think our recommendation is work with the climate people at universities and the labs who are readily available. I think in a lot of ways they really haven't begun to fully connect with planning. And I think the two areas that really are the big ones are energy and electric utilities in particular. But energy broadly and agriculture. But I know there's been a lot of work thinking about agriculture about how your project forward. Given this kind of subregional projection what happens? Even your part of Eastern Washington might not be the same as other parts of Eastern Washington. I think these are really live issues, but it's really important also to make the effort and I appreciate the effort. You know the forward progress that you're making on this.

**Forsyth, Grant:** Appreciate that. Any questions. Next in the queue.

**Hermanson, Lori:** Yes Jim Woodward

**Woodward, Jim (UTC):** Thanks, Grant. Appreciated this discussion. Mine's really almost a process or project management question. At least to me personally, it does make sense to have, if possible, a uniform company approach to climate change in modeling. Grant you said earlier in your presentation, you were hoping to essentially finalize this load forecast during the next month. And if we're talking about greater discussion coming in the summer. Do you and your team have the ability to go back and modify based on whatever that final approach ends up being?

**Forsyth, Grant:** What I'm going to update is the medium-term forecast, the five year one. And that's not going to change our ability to make assumption changes in the longer run model. Because the way the model is designed for that medium-term thing, even if you trend in some climates, is not going to have a big impact on that. The real issue is how you handle the 2027 to 2045 assumptions, and that those can be changed, so it's where we're not locking in, in the way that I think you're thinking that strictly.

**Woodward, Jim (UTC):** OK, great, just wanted to make sure there was no apparent timing issue there.

**Forsyth, Grant:** Yeah no. It's really a partial update, not a full update, and it doesn't preclude us from making changes in the longer term component.

**Woodward, Jim (UTC):** Thanks.

**Forsyth, Grant:** Yep.

**Hermanson, Lori:** Grant we also have a question from Art. I can read it or Art did you want to just ask your question?

**Art Swannack Whitman County Commission (Guest):** I guess I can just ask it quick. Is there the real data where you see ups and downs? Is there a max-min variability in this forecast? Because I know from my firefighting stuff that when you get real dry weather your temperatures could swing a lot more than they can when you have wet weather and that affects both winter and summer. So, I just wondered how that's calculated in your peak demands.

**Forsyth, Grant:** There's a high low range that we set up. I'm just not showing that slide, but there is a method that James and I used to set up what we think the range would likely be. And it's based on historical variance.

**Art Swannack Whitman County Commission (Guest):** OK thanks.

**Forsyth, Grant:** Yep.

**Hermanson, Lori:** And Art shared an article. Thanks for that link and I think we have all the questions. And then there's some additional ones where somebody hasn't raised their hand yet. Grant, I think you're ready.

**Forsyth, Grant:** Now in truth in advertising, we did make some calculation changes in the way we're calculating things in the 2023 as part of the revision. I went back to the

2021 IRP. I used the regression model for peak load at that time, but I did make some adjustments to how we are treating solar and EVs to make forecast to forecast comparable. The 2021 IRP summer. This is essentially using the 2021 regression model but updating it with how we're now treating solar and EVs and comparing that against the 2023 IRP. The regression model which does a better job of separating winter from summer in terms of trend activity, and you can see if you do that, you get the out years look quite different. You're definitely seeing higher growth than what you saw in 2021, but again, that growth is more consistent with what we've seen in the past now that we have enough data to parse things more carefully. When you look at the winter side, and again adjusting 2021 slightly but using the same regression coefficients at that time period, you get the same shape, there's about a 20 MW shift down in the winter peak because of the refinements to the model. But notice I always like to point this out in both cases, so let me go back to the previous slide. You know you start to see this curve up over here. That's really that EV effect. And again, as we shift EVs around, if we if we want to change the assumption of how we shape that in, that's going to change the location of this bend. It goes to the same for solar. And I believe that's mercifully the end of the presentation. Do we have any other remaining questions?

**Hermanson, Lori:** I'm not seeing any at the moment. Anybody who wants to jump in.

**Forsyth, Grant:** And people would probably be getting low blood sugar at this point.

**Hermanson, Lori:** No, it's been interesting discussion. It's always so great topic.

**Gall, James:** We've missed our break and we've exceeded our time. I think it's probably appropriate given we were planning on 11:30 is to end now and will cover the L&R effects of this load forecast. We are meeting again in March and I think in just four weeks. There are slides out there and if you have immediate questions, feel free to contact us on that those slide content and we'll cover those at the next meeting, will probably try to schedule that next meeting for an extra hour just to make sure we can cover all those topics as well. I appreciate everybody's attendance. This is probably one of the best interactive TAC meetings we've had in quite a while, so I appreciate that and I just want to open up if there's any other questions or concerns before we call it a day. We will get these presentations, at least this presentation, posted on our TAC website and we'll get the recording and notes available as well. And I believe we're also going to be publishing the data for Grant's forecast. And if you're looking for the quantity of load and peak load by state and the effects of EVs and solar, we will have all those in the spreadsheet on the on the website in the next week or so. So again, thank you everybody and have a great day and we'll see you in March.

**Forsyth, Grant:** Thank you everybody.

**Lyons, John:** Goodbye.

**Woodward, Jim (UTC):** Thanks everyone.



*2023 Electric Integrated Resource Plan*  
**Technical Advisory Committee Meeting No. 3 Agenda**  
 Wednesday, March 9, 2022  
 Virtual Meeting

<b>Topic</b>	<b>Time</b>	<b>Staff</b>
Introductions	8:30	John Lyons
Existing Resource Overview	8:35	Mike Hermanson
Resource Requirements	9:15	James Gall
Break		
Non-Energy Impact Study	10:00	DNV
Lunch	11:30	
Natural Gas Market Overview & Price Forecast	12:30	Tom Pardee
Wholesale Electric Price Forecast	1:15	Lori Hermanson
Adjourn	2:00	





# 2023 IRP Introduction

2023 Avista Electric IRP

TAC 3 – March 9, 2022

John Lyons, Ph.D. Senior Resource Policy Analyst

# Meeting Guidelines

- IRP team is working remotely and is available for questions and comments
- Stakeholder feedback form
  - Responses shared with TAC at meetings, by email and in Appendix
  - Would a form and/or section on the web site be helpful?
- IRP data posted to web site – updated descriptions and navigation are in development
- Virtual IRP meetings on Microsoft Teams until able to hold large meetings again
- TAC presentations and meeting notes posted on IRP page
- This meeting is being recorded and an automated transcript made

# Virtual TAC Meeting Reminders

- Please mute mics unless commenting or asking a question
- Raise hand or use the chat box for questions or comments
- Respect the pause
- Please try not to speak over the presenter or a speaker
- Please state your name before commenting
- Public advisory meeting – comments will be documented and recorded

# Integrated Resource Planning

The Integrated Resource Plan (IRP):

- Required by Idaho and Washington\* every other year
  - Washington requires IRP every four years and update at two years
- Guides resource strategy over the next twenty + years
- Current and projected load & resource position
- Resource strategies under different future policies
  - Generation resource choices
  - Conservation / demand response
  - Transmission and distribution integration
  - Avoided costs
- Market and portfolio scenarios for uncertain future events and issues

# Technical Advisory Committee

- Public process of the IRP – input on what to study, how to study, and review of assumptions and results
- Wide range of participants involved in all or parts of the process
  - Please ask questions
  - Always soliciting new TAC members
- Open forum while balancing need to get through topics
- Welcome requests for new studies or different modeling assumptions.
- Available by email or phone for questions or comments between meetings
- Due date for study requests from TAC members – October 1, 2022
- External IRP draft released to TAC – March 17, 2023, public comments due – May 12, 2023
- Final 2023 IRP submission to Commissions and TAC – June 1, 2023

# 2023 IRP TAC Meeting Schedule

- TAC 4: August 2022
- TAC 5: Early September 2022
- TAC 6: End of September 2022
- TAC 7: October 2022
- Technical Modeling Workshop: October 2022
- TAC 8: February 2023
- Public Meeting Gas & Electric IRPs: February/March 2023
- TAC 9: March 2023

# Today's Agenda

- 8:30 Introductions, John Lyons
- 8:35 Existing Resource Overview, Mike Hermanson
- 9:15 Resource Requirements, James Gall
- Break
- 10:00 Non-Energy Impact Study, DNV
- 11:30 Lunch
- 12:30 Natural Gas Market Overview & Price Forecast, Tom Pardee
- 1:15 Wholesale Electric Price Forecast, Lori Hermanson
- 2:00 Adjourn



# Existing Resource Overview

2023 Avista Electric IRP

TAC 3 – March 9, 2022

Mike Hermanson - Power Supply/CETA Analyst



# Existing Resource Types

## Avista-owned Hydro

## Avista-owned Thermal

- Natural Gas
- Coal
- Biomass

## Contracted Resources

- Mid Columbia Hydro
- Natural Gas
- Wind
- Solar
- PURPA

## Customer-Owned Resources



# Avista Owned Hydro

- Spokane River
  - Post Falls (14.8 MW)
  - Upper Falls (10 MW)
  - Monroe St. (14.8 MW)
  - Nine Mile (36 MW)
  - Long Lake (81.6 MW)
  - Little Falls (32 MW)
  
- Clark Fork River
  - Noxon Rapids (518 MW)
  - Cabinet Gorge (265.2 MW)

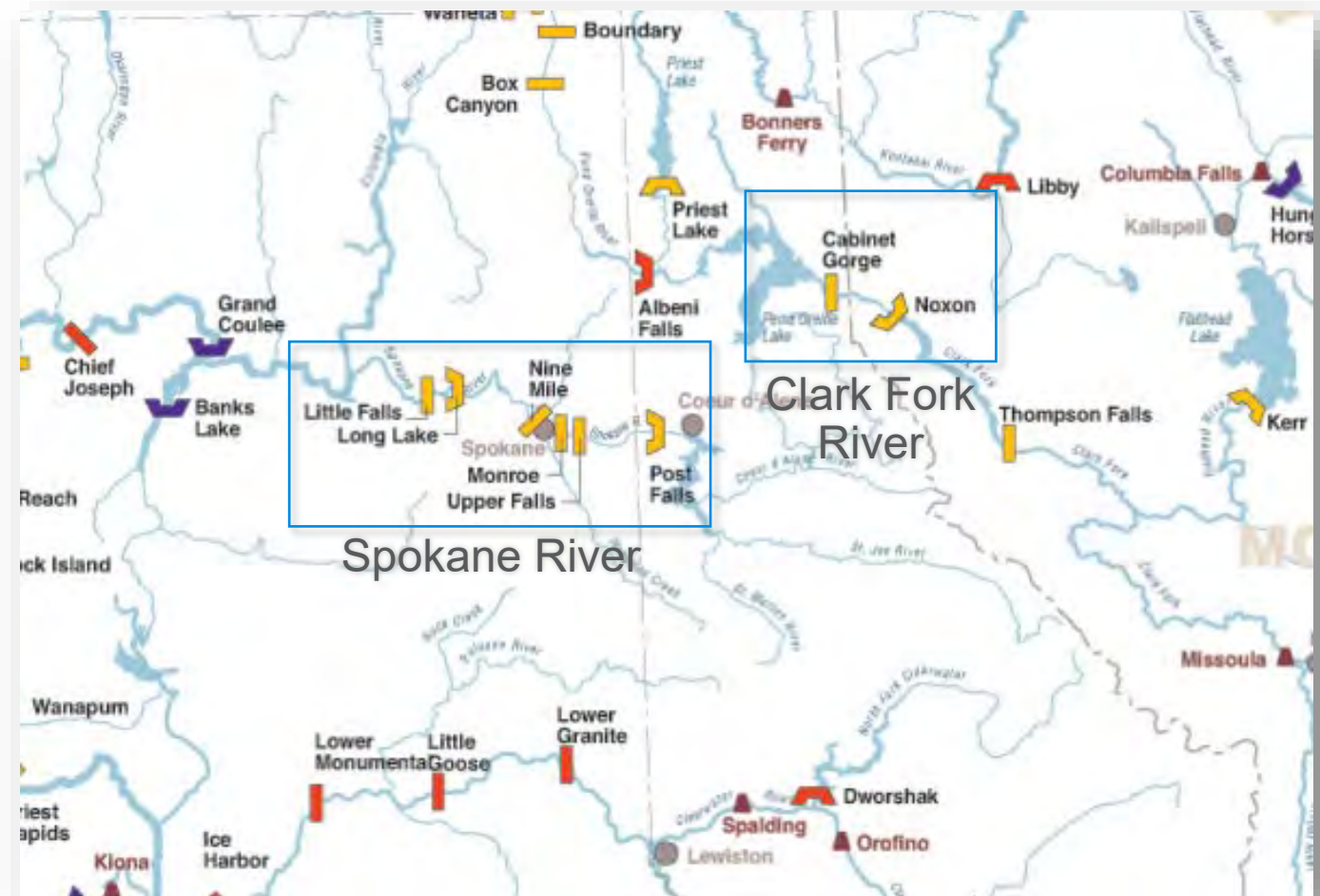

# Spokane River

Project	Nameplate Capacity (MW)	Maximum Capability (MW)	Expected Energy (aMW)*
Post Falls	14.8	18	11.2
Upper Falls	10	10.2	7.3
Monroe Street	14.8	15	11.2
Nine Mile	36	32	22.6
Long Lake	81.6	89	56
Little Falls	32	35.2	11.2
<b>TOTAL</b>	<b>189.2</b>	<b>199.4</b>	<b>119.5</b>



\* based on 80-year hydrologic record

- Post Falls refurbishment – additional 3.8 MW incremental winter capacity and 4 aMW of incremental clean energy.

# Clark Fork River

Project	Nameplate Capacity (MW)	Maximum Capability (MW)	Expected Energy (aMW)*
Cabinet Gorge	265.2	270.5	123.6
Noxon Rapids	518	610	196.5
<b>TOTAL</b>	<b>783.2</b>	<b>880.5</b>	<b>320.1</b>

\* based on 80-year hydrologic record



# Avista Owned Thermal Resources

Project Name	Fuel Type	Winter Maximum Capacity (MW)	Summer Maximum Capacity (MW)	Nameplate Capacity (MW)
Colstrip	Coal	222	222	247
Coyote Springs 2	Gas	317.5	286	306.5
Rathdrum	Gas	176	130	166.2
Northeast	Gas	66	42	61.8
Boulder Park	Gas	24.6	24.6	24.6
Kettle Falls	Wood	47	47	50.7
Kettle Falls CT	Gas	11	8	7.2
<b>Total</b>		<b>864.1</b>	<b>759.6</b>	<b>864.0</b>



# Colstrip Units 3 & 4

- Located in eastern Montana
- Avista owns 15% of units 3 & 4
- After 2025 will not be used to serve Washington customers
- Max net capacity of 222 MW



## Coyote Springs 2

- Natural gas-fired combined cycle combustion turbine (CCCT)
- A combined-cycle power plant **uses both a gas and a steam turbine together to produce up to 50% more electricity from the same fuel than a traditional simple-cycle plant.** The waste heat from the gas turbine is routed to the nearby steam turbine, which generates extra power.
- Max winter capacity of 317.5 MW,  
Max summer capacity of 286 MW



# Rathdrum, Northeast, & Boulder Park

- Rathdrum
  - Simple cycle combustion turbine (CT) units
  - Winter max – 176 MW, Summer Max 126 MW
- Boulder Park
  - Six natural gas internal combustion reciprocating engines
  - Max – 24.6 MW
- Northeast
  - Two aero-derivative simple cycle CT units
  - Winter max 68 MW, Summer max 42 MW
  - Air permit allows 100 run hours per year





# Kettle Falls Generating Station

- Among the largest biomass generation plants in North America
- Open loop steam plant uses waste wood products (hog fuel) from area mills and forest slash.
- Max capacity of 50 MW
- Also has 7.5 MW gas combustion turbine increasing max capacity to 55-58 MW



Kettle Falls

# Power Purchase and Sale Contracts

Contract	Type	Fuel Source	End Date	2021 Annual Energy (aMW)
Mid Columbia Hydro	Purchase	Hydro	varies	132.9
Lancaster	Purchase	Natural Gas	Oct-26	207.8
Palouse Wind	Purchase	Wind	2042	41.2
Rattlesnake Flats	Purchase	Wind	2040	48.3
Adams-Nielson	Purchase	Solar	2038	4.95
Nichols Pumping	Sale	System	2023	-6.4
Morgan Stanley	Sale	Clearwater Paper	2023	-48.4
Douglas PUD	Sale	System	2023	-47

# Mid-Columbia Hydroelectric Contracts

- Douglas PUD
  - Wells – Total Capacity 840 MW
- Chelan PUD
  - Rocky Reach – Total Capacity 1254 MW
  - Rock Island – Total Capacity 503 MW
- Grant PUD
  - Priest Rapids – Total Capacity 953 MW
  - Wanapum – Total Capacity 1,220 MW

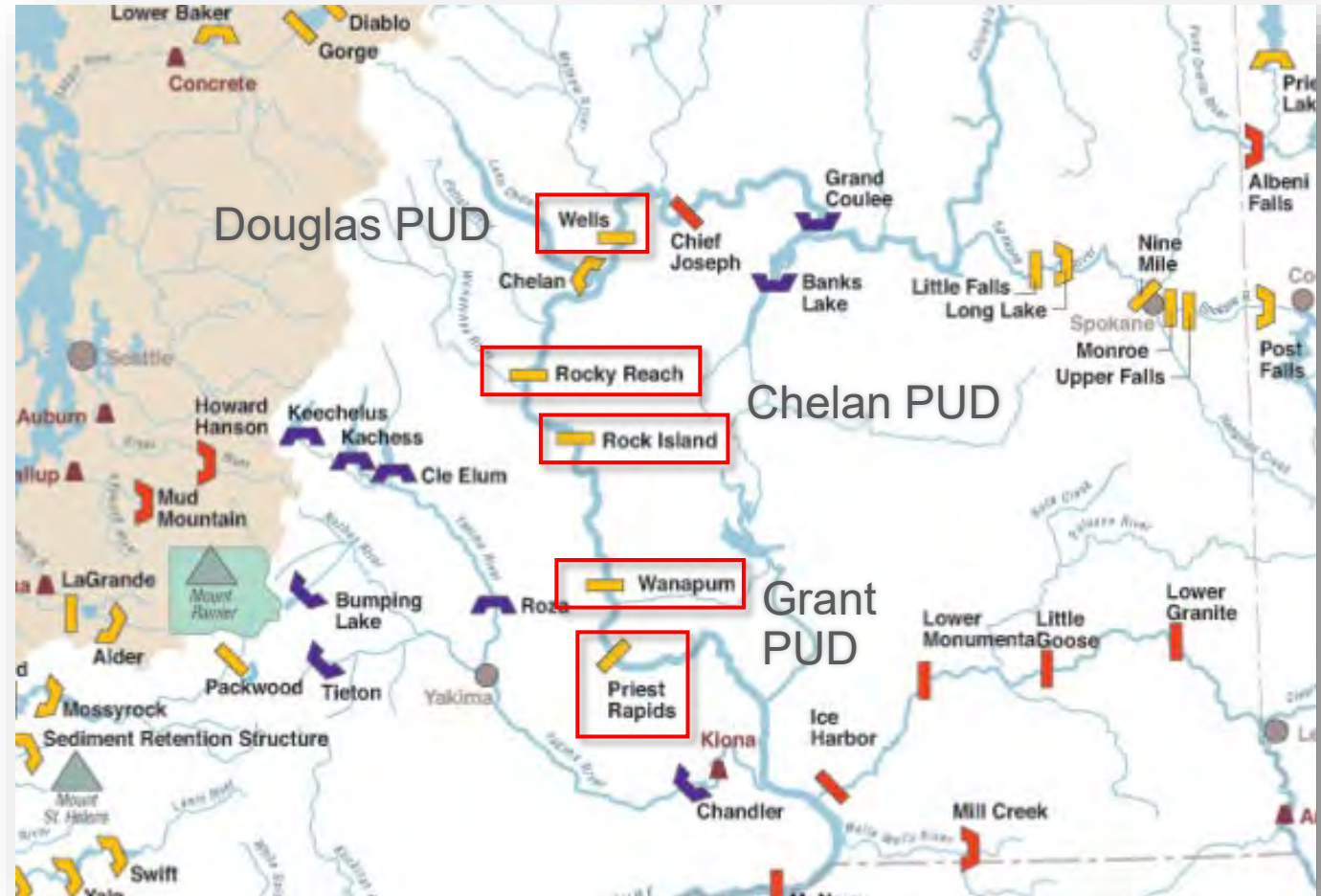

Note: Total capacity represents overall capacity of project, not total capacity of Avista's share.

# Mid-Columbia Hydroelectric Contracts

Counter Party	Project(s)	Percent Share (%)	Start Date	End Date	2020 Estimated On-Peak Capability (MW)	2020 Annual Energy (aMW)
Grant PUD	Priest Rapids	3.79	Dec-2001	Dec-2052	30	19.5
Grant PUD	Wanapum	3.79	Dec-2001	Dec-2052	32	18.7
Chelan PUD	Rocky Reach	5	Jan-2016	Dec-2030	57	35.9
Chelan PUD	Rock Island	5	Jan-2016	Dec-2030	19	18.4
Douglas PUD	Wells	12.76*	Oct-2018	Dec-2028	107	57
Canadian Entitlement					-14	-5.6
2020 Total Net Contracted Capacity and Energy					231	143.90

\* % share varies each year depending on Douglas PUD's load growth

# Mid Columbia Hydroelectric Contracts

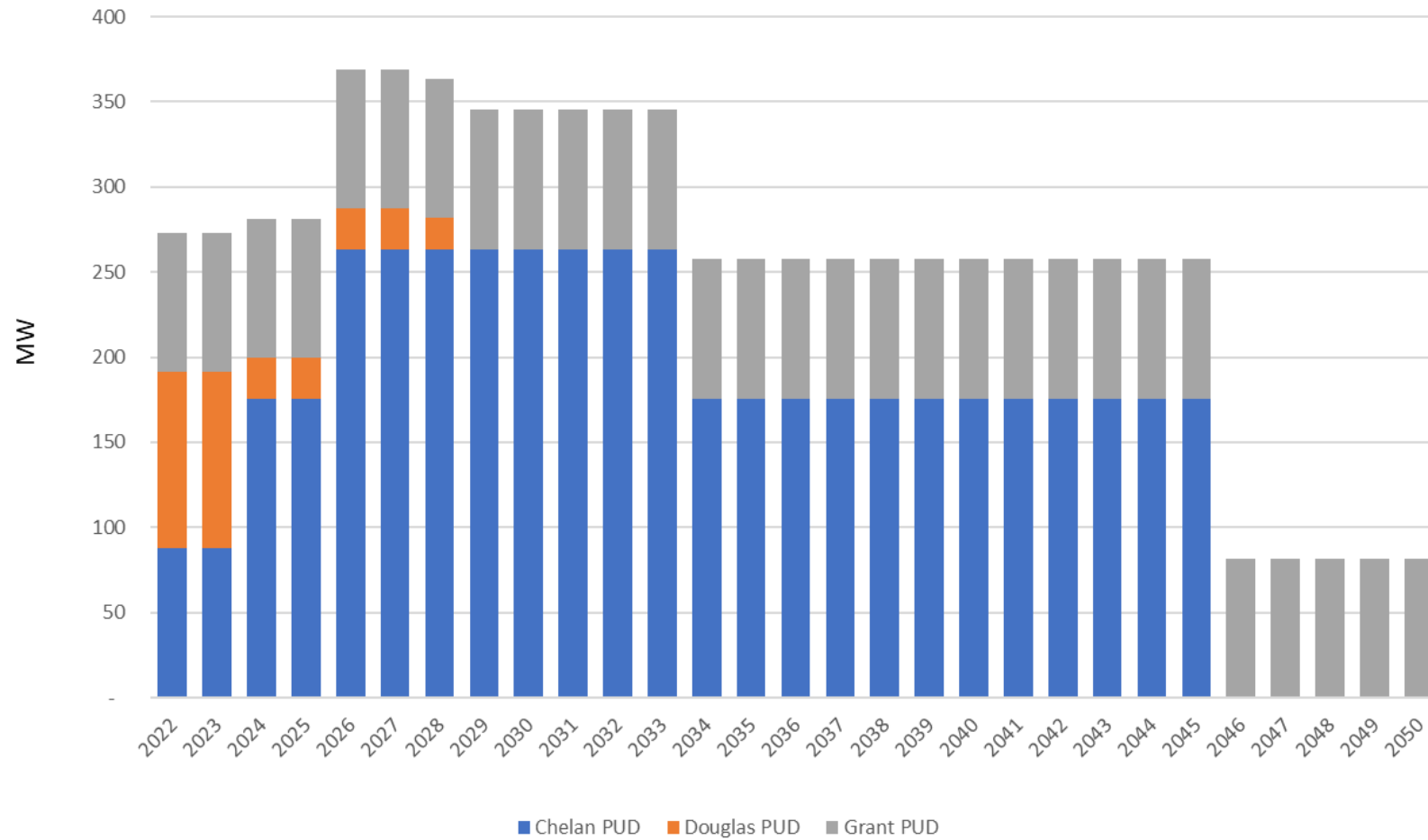

# Wind & Solar Resources

- Palouse PPA
  - Capability – 105 MW
  - 30-year power purchase agreement (PPA)
  - 2021 output – 41.2 aMW
- Rattlesnake Flat PPA
  - Capability - 160.6 MW
  - 20-year PPA
  - 2021 output of 48.3 aMW
- Adams-Nielson Solar PPA
  - Capability – 19.2 MW
  - 80,000 panel facility
  - 2021 output – 4.95 aMW



Palouse Wind

# Public Utility Regulatory Policies Act (PURPA) Contracts

Owner	Fuel Source	Location	Contract End Date	Capability (MW)	Estimated Energy (aMW)
Sheep Creek Hydro Inc	Hydro	Northport, WA	12/31/2025	1.40	0.79
Hydro Technology Systems Inc.	Hydro	Kettle Falls, WA	12/31/2025	1.30	1.05
Deep Creek Energy	Hydro	Northport, WA	12/31/2022	0.41	0.23
Spokane County Water Reclamation*	Biomass	Spokane, WA	8/31/2030	0.26	0.14
Phillips Ranch	Hydro	Northport, WA	N/A	0.02	0.01
City of Spokane Upriver Dam*	Hydro	Spokane, WA	12/31/2024	17.60	6.17
City of Spokane Waste to Energy	Municipal Waste	Spokane, WA	12/30/2022	18.00	16.00
McKinstry*	Solar	Spokane, WA	5/3/2035	0.25	0.05
<b>WA Total</b>				<b>39.24</b>	<b>24.44</b>
University of Idaho*	CHP Steam	Moscow, ID	2/15/2042	0.825	0.74
University of Idaho*	Solar	Moscow, ID	2/15/2042	0.1322	0.033
Ford Hydro LP	Hydro	Weippe, ID	6/30/2022	1.41	0.39
John Day Hydro	Hydro	Lucille, ID	9/21/2022	0.90	0.25
Clark Fork Hydro	Hydro	Clark Fork, ID	12/31/2037	0.22	0.12
Stimson Lumber	Wood Waste	Plummer, ID	12/31/2023	5.80	4.00
Clearwater Paper	Wood Waste	Lewiston, ID	12/31/2023	60.00	43.00
City of Cove	Hydro	Cove, OR	6/30/2038	0.80	0.29
<b>ID Total</b>				<b>70.09</b>	<b>48.82</b>
<b>Total PURPA</b>				<b>109.3</b>	<b>73.3</b>

\*connection is net metered and only contributes when generation exceeds load at facility

# Customer Owned Generation

- 1,798 customer installed systems
- Technology
  - Primarily Solar
  - Some wind, combined solar & wind, and biogas
- Average system is 7.63 kW
- 93% of systems in Washington
- 2021 estimated 1.21 aMW

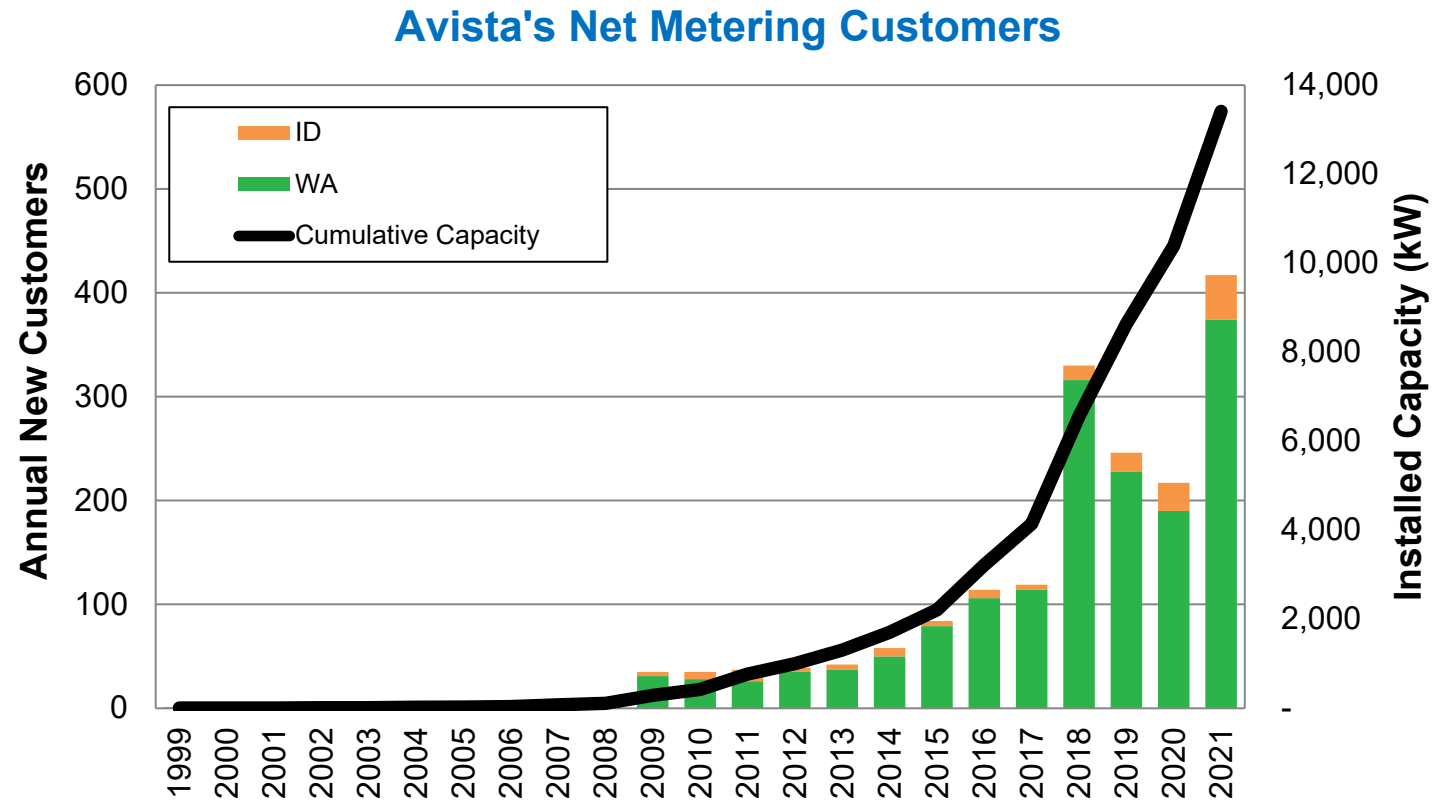



# 2021 System Generation by Resource Type (aMW)

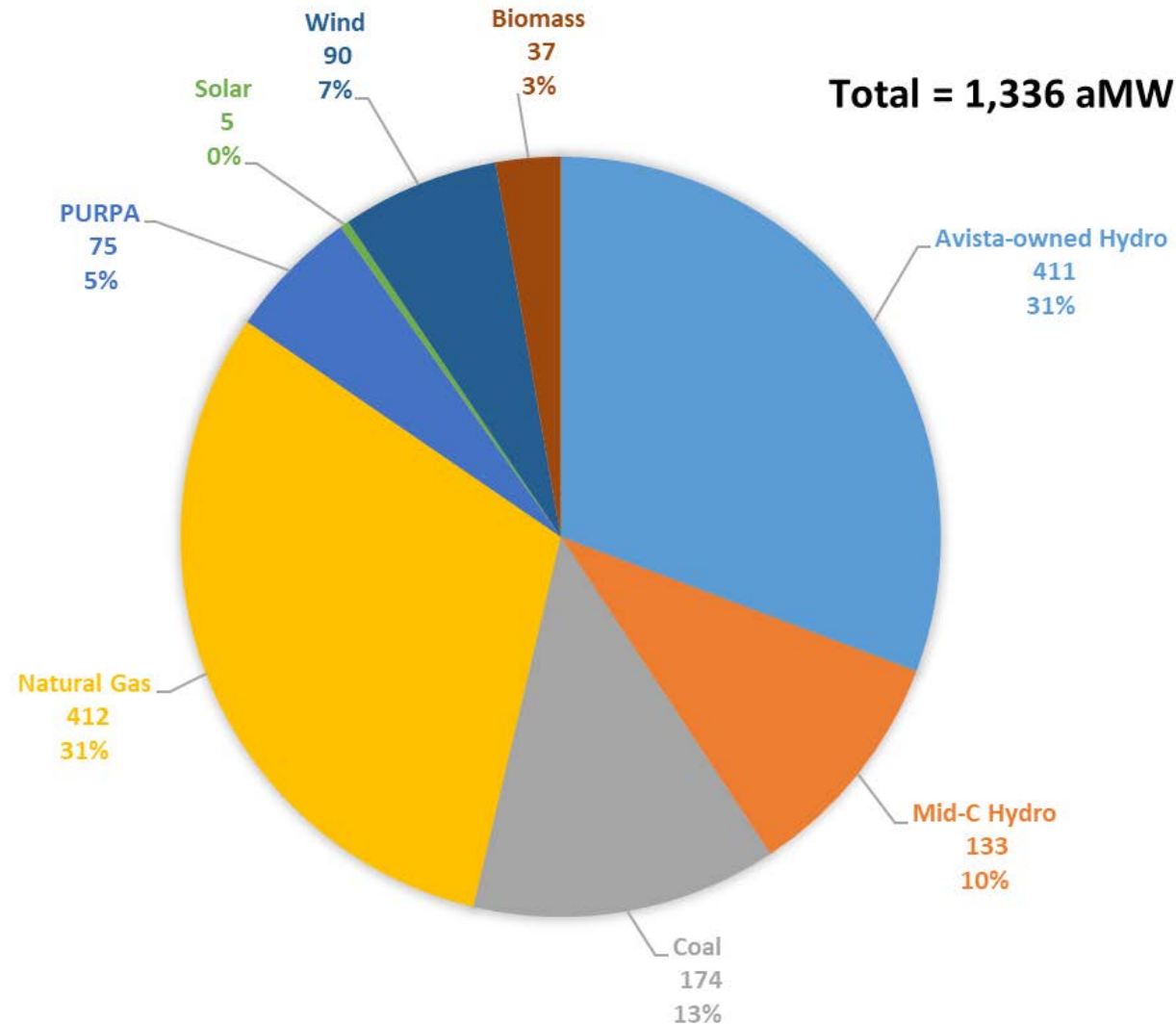

Data is not adjusted for renewable energy credit sales or specified energy sales

# 2021 System Obligations & Energy Sources

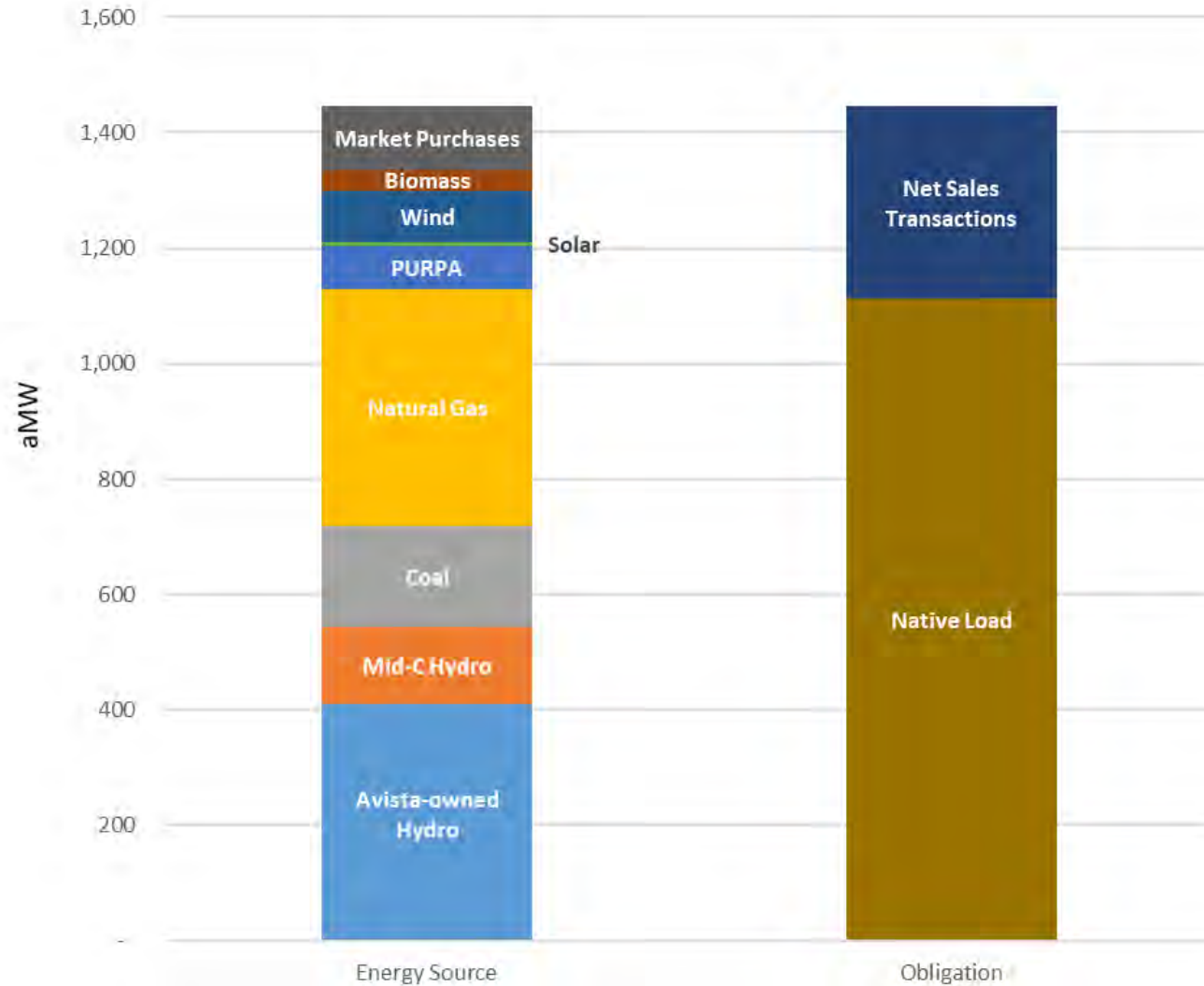



# Load & Resource Balance Update

Avista, Electric Technical Advisory Committee

March 9<sup>th</sup>, 2022 – TAC 3

James Gall, Electric IRP Manager

# Major L&R Changes Since 2021 IRP

- Load forecast
- 30 MW industrial demand response (Washington Rate Case Settlement)
- Chelan County PUD purchase
  - ~88 MW or ~54 aMW equal to 5% of Rocky Reach and Rock Island projects

	2022	2023	2024	2025	2026-2030	2031-2033	2034-2045
Existing Slice	5%	5%	5%	5%	5%		
April 2021 Contract			5%	5%	5%	5%	
December 2021 Contract					5%	10%	10%

# System Capacity Position

Western Resource Adequacy Program not included at this time

## 1 Hour Peak Load & Resource Position

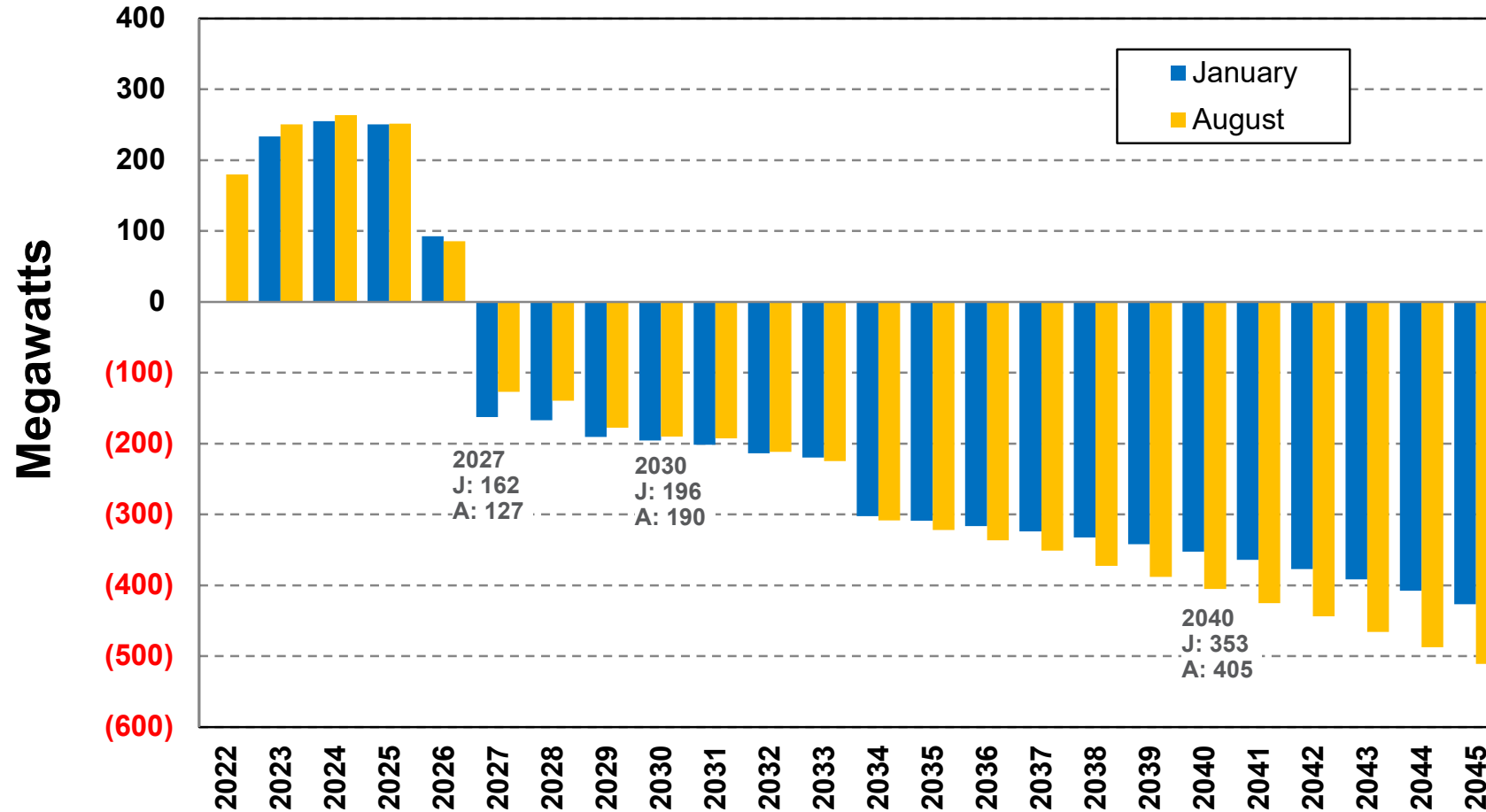

**Peak Planning Criteria**  
 16% winter PRM  
 7% summer PRM  
 Operating reserves (~6%)  
 Regulation (16 MW)

# System Planning Energy Position

## Energy Load & Resource Position

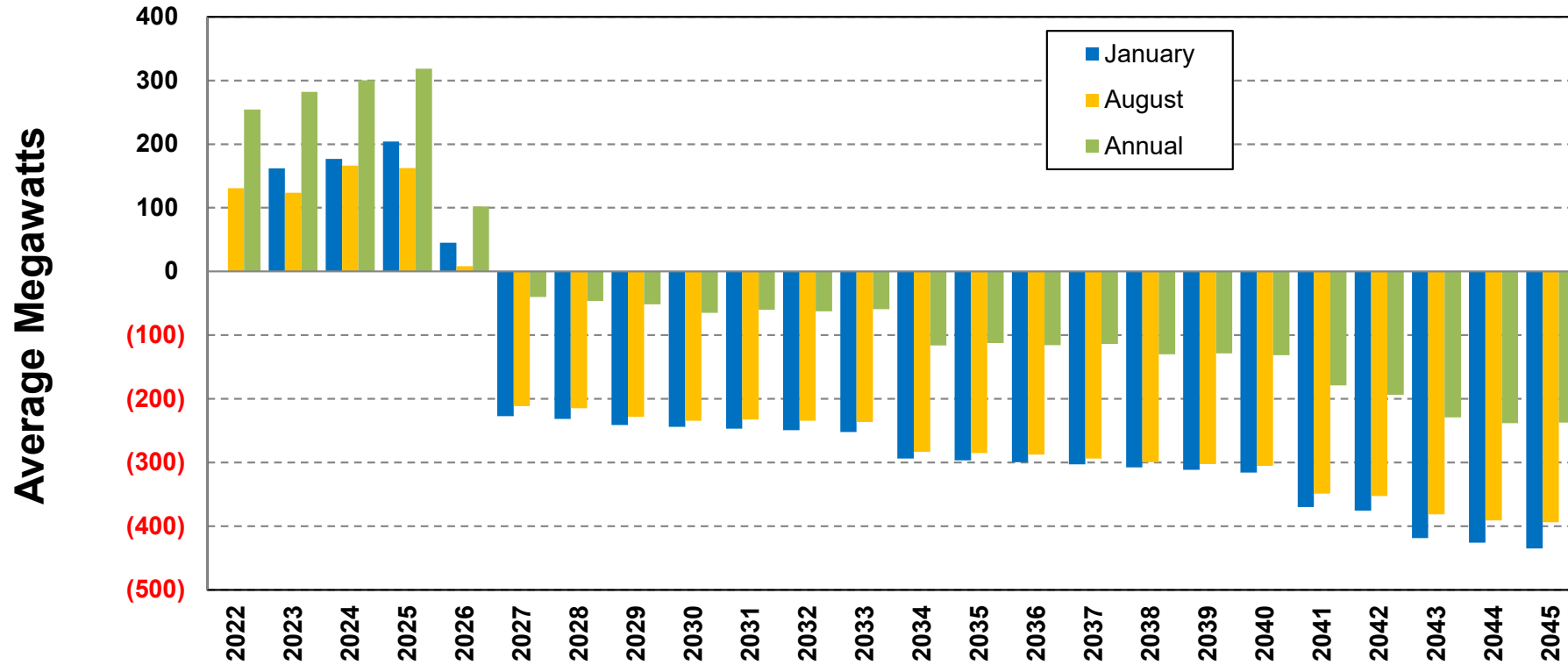

### Energy Contingency Metrics

10<sup>th</sup> percentile hydro  
90<sup>th</sup> percentile load

2023 IRP will update contingency metrics for wind/solar variability (TBD in future TAC meeting)

2023 IRP with energy planning constraint beyond annual

# Monthly Planning Energy Position

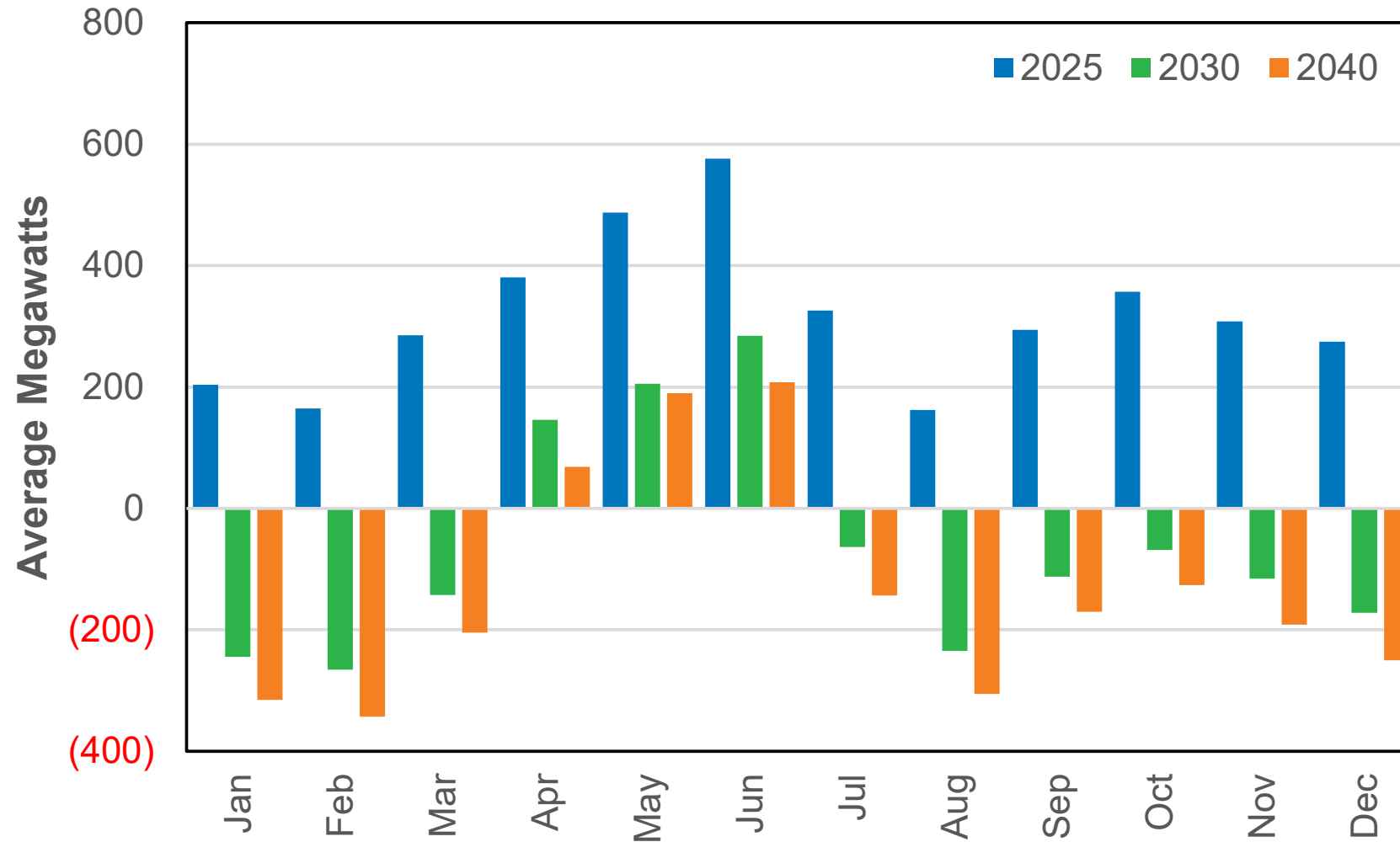

# 2030 Washington CETA Planning

- Draft rules were released January 19<sup>th</sup>, 2022
- Creates a planning requirement and operation requirements
  - **Planning requirement** designs system for renewable energy to deliver to load
  - Operating requirement is creation of renewable energy and retaining nonpower attributes
- The planning standard uses two compliance mechanisms
  - Must plan for renewable generation equal to or greater than 80% of retail load to qualify as primary compliance by 2030
  - Remaining retail load must be offset using Alternative Compliance
    - Alternative compliance could be an unbundled REC, energy transformation project, compliance payment
- Planning standard time step and risk level is not defined in the draft rule



# Avista Clean Energy Position for Planning Standard (strawman- for illustrative purposes)

- Monthly retail load vs generation comparison
- Renewable generation exceeding monthly retail load qualifies as alternative compliance
  - On/off peak estimates could be used
- Expected Case Methodology
  - Median Hydro
  - Expected Loads
  - Historical average wind/solar if available
- Resource allocation
  - Existing hydro (PT Ratio)
  - Wind (PT Ratio + WA purchase hourly Idaho share of energy)
  - Solar (allocated to WA)
  - Kettle Falls (PT Ratio + WA purchase hourly Idaho share of energy, 95.4% qualifying)
  - New Chelan PUD contracts (PT Ratio + WA purchase hourly Idaho share of energy)

# 2030 Monthly Accounting Illustration (WA Only)

## Average Megawatts

Illustration Purposes Only

Month	Sales Forecast	WA PURPA	Net Retail Load	Washington Share				Energy Exchange from Idaho	Total Renewable Generation	Primary Compliance	Alternative Compliance
				Hydro	Wind	Solar	Biomass				
Jan	801	21	780	362	62	2	27	84	537	537	-
Feb	822	24	798	333	66	4	26	80	508	508	-
Mar	688	27	661	348	70	5	23	78	524	524	-
Apr	647	28	620	519	66	7	15	81	688	620	68
May	582	25	558	706	55	8	0	78	847	558	289
Jun	600	19	580	730	58	8	10	82	888	580	307
Jul	600	17	583	498	45	9	23	74	650	583	67
Aug	668	15	653	279	46	8	26	70	429	429	-
Sep	664	16	648	252	49	6	28	63	399	399	-
Oct	583	19	564	259	60	4	27	69	419	419	-
Nov	636	19	617	308	68	2	27	79	484	484	-
Dec	752	21	730	377	63	1	29	80	549	549	-
<b>Avg</b>	<b>669</b>	<b>21</b>	<b>649</b>	<b>414</b>	<b>59</b>	<b>5</b>	<b>22</b>	<b>77</b>	<b>577</b>	<b>516</b>	<b>61</b>
										79.6%	9.4%

Note: "Energy Exchange from Idaho" includes wind, biomass, and "new" Chelan PUDs contracts

# Current Annual CETA Energy Position

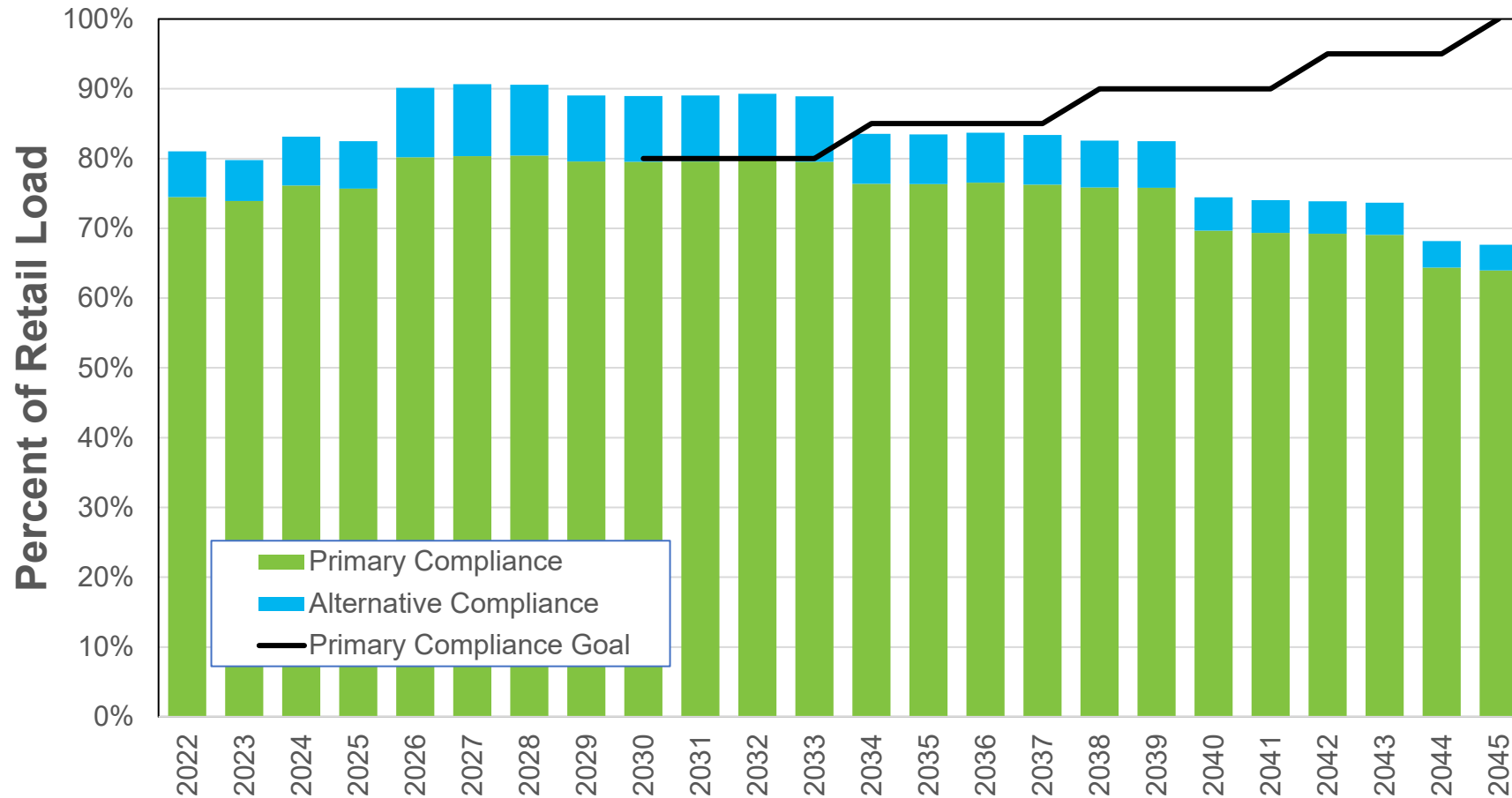

# Compliance Window CETA Energy Position

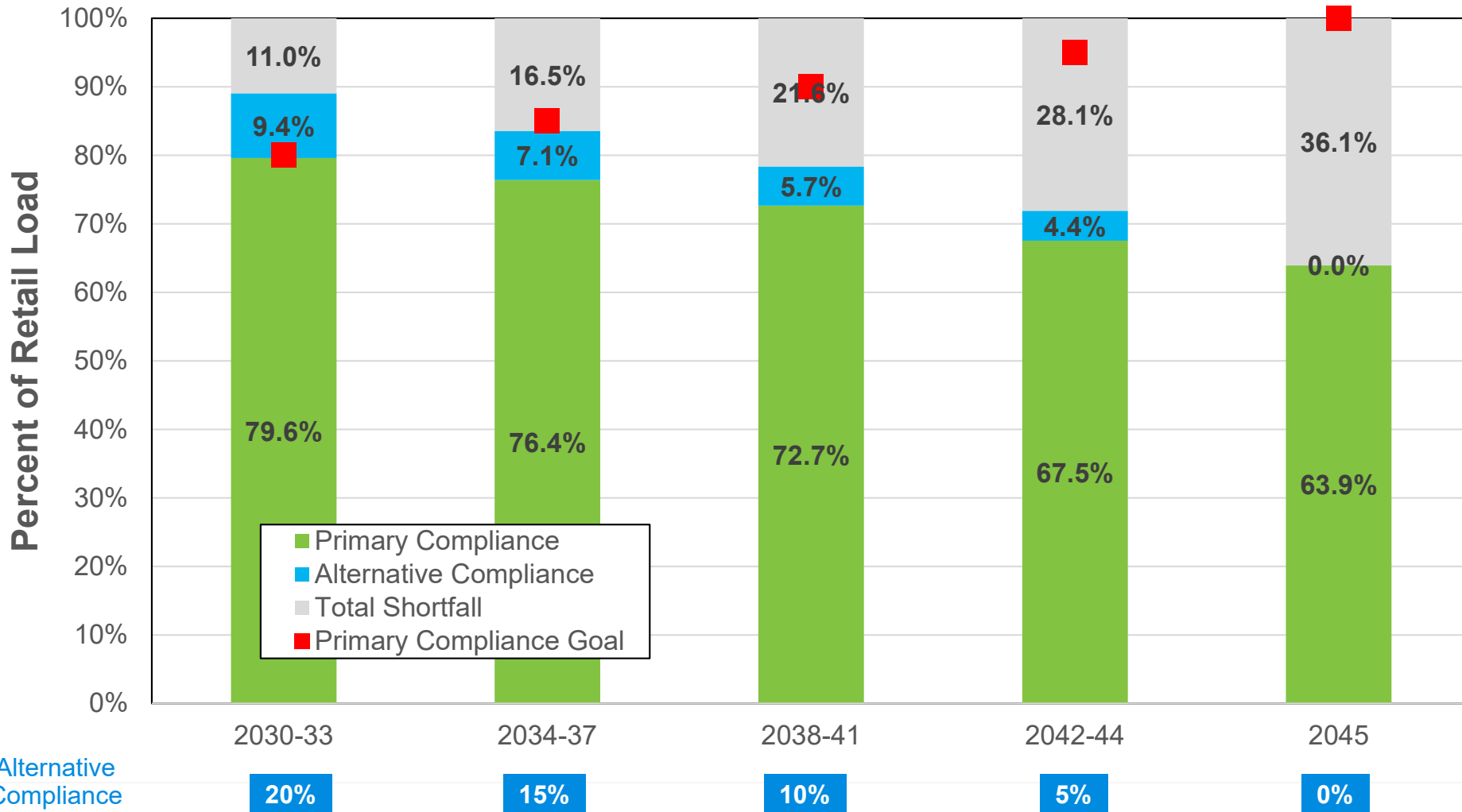



# Supply Side Non-Energy Impacts

09 March 2022

# Agenda

**01** Project Overview

**02** Approach

**03** Results

**04** Gap Analysis

**05** Discussion

# Project Overview

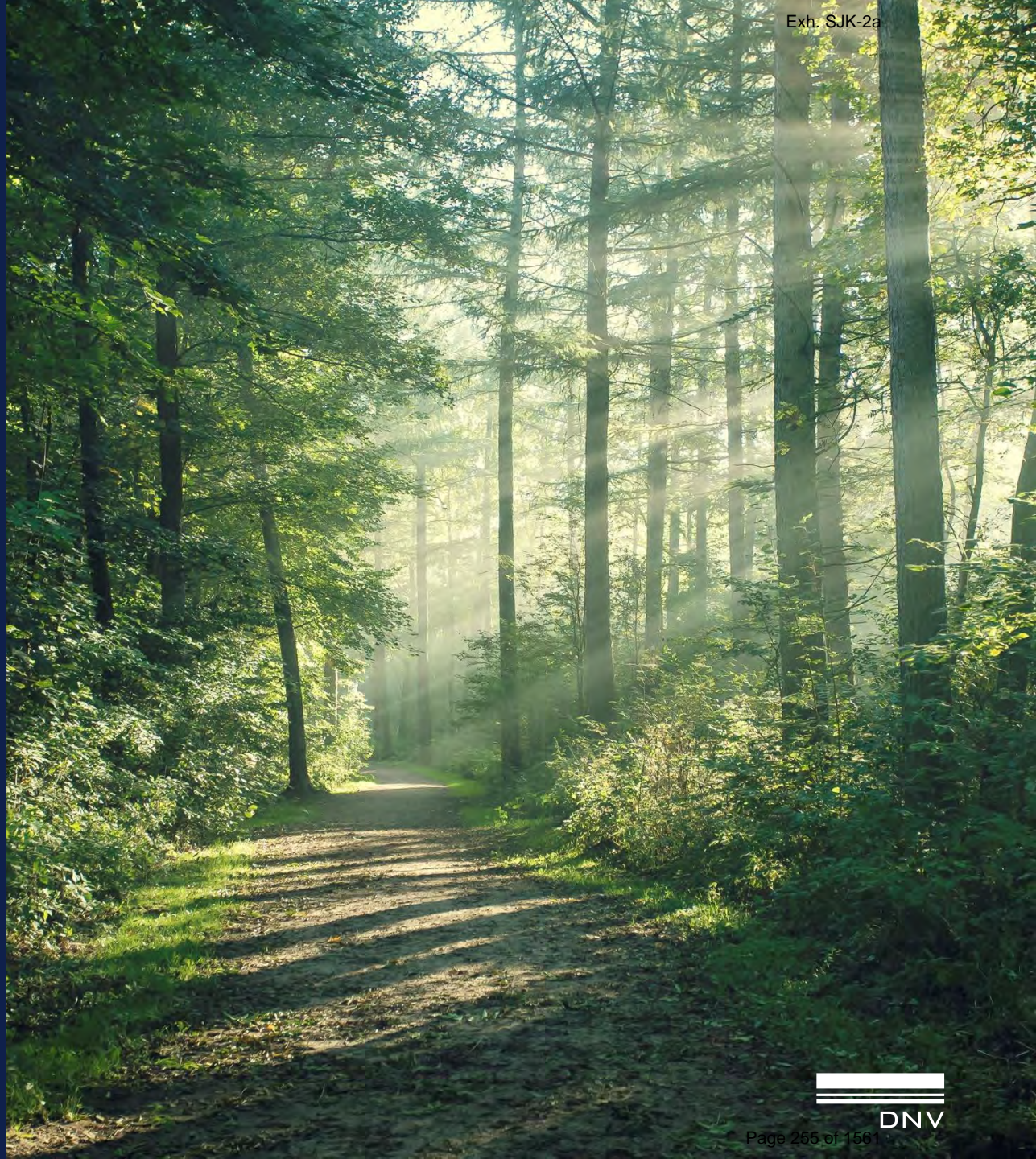

# What is a Supply Side Non-Energy Impact (NEI)?

## Cost of Energy

Impacts included in the cost of energy

Examples:

- Jobs and direct economic impacts
- Fuel costs
- Water use

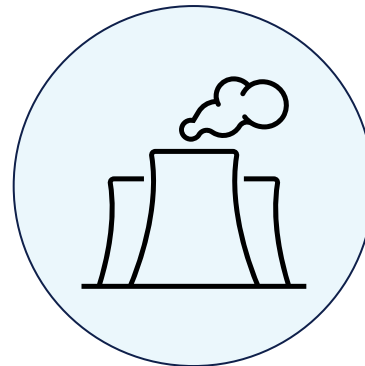

## NEI (Externality)

Impacts **not** accounted for in the cost of energy

Examples:

- Health impacts due to emissions
- Fatalities
- Water use



# Project Overview

Jurisdictional Scan

NEI Database Development

Database Application

Gap Analysis

# Approach



# Potential NEI Approaches

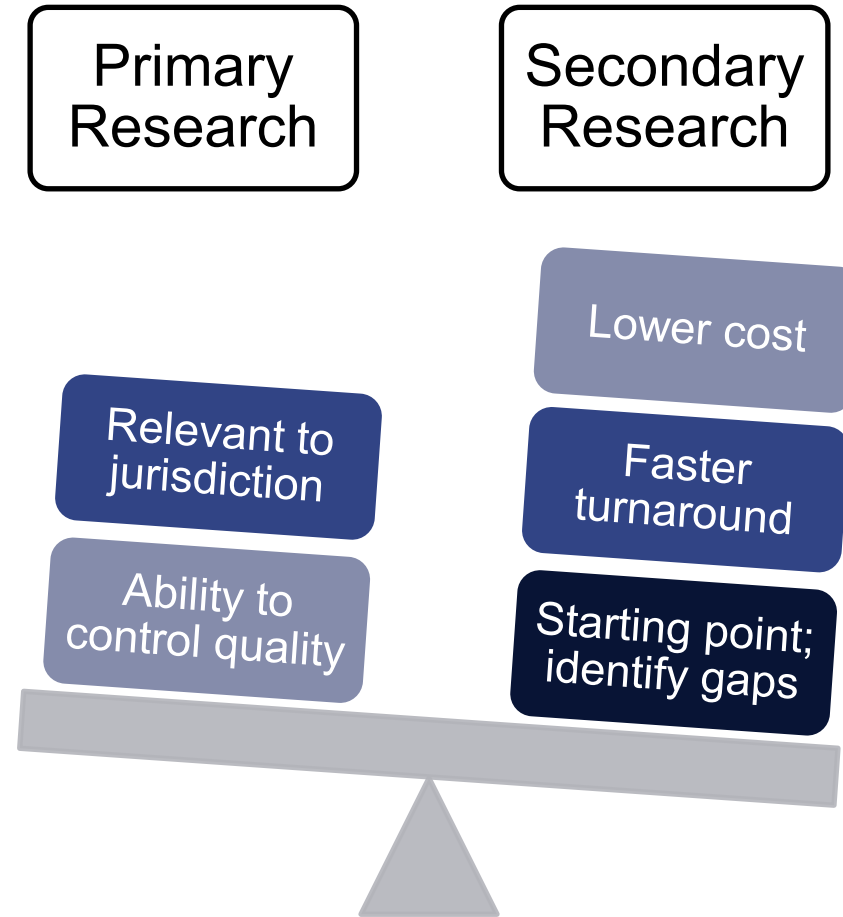

# Database Compilation: Generalized Approach

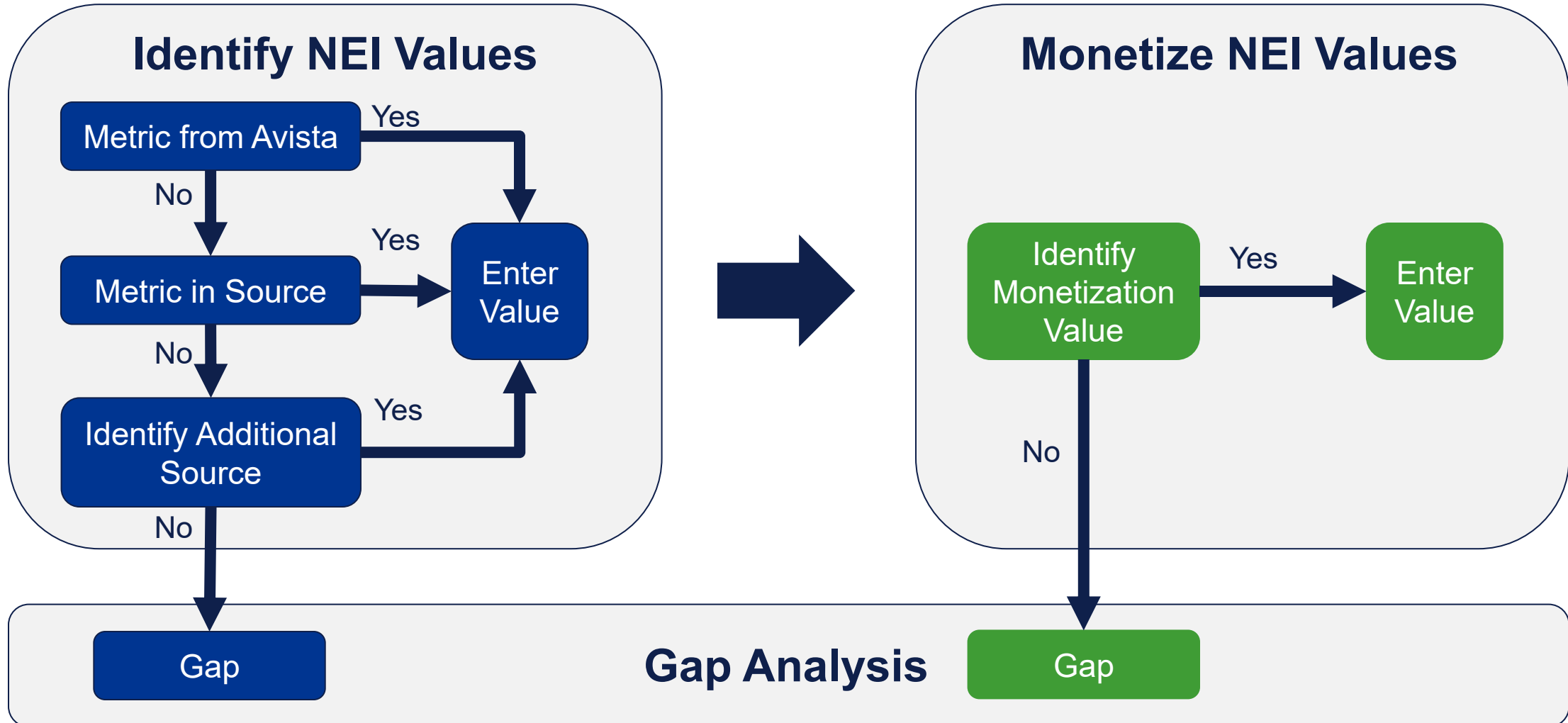

# Approach Limitations

- NEI values are not always comparable across regions
- Potential limitations:
  - Outdated studies
  - Issues with methodology
  - Lack of documentation for some values
- Gaps in secondary research, particularly for monetization

# NEI Metrics

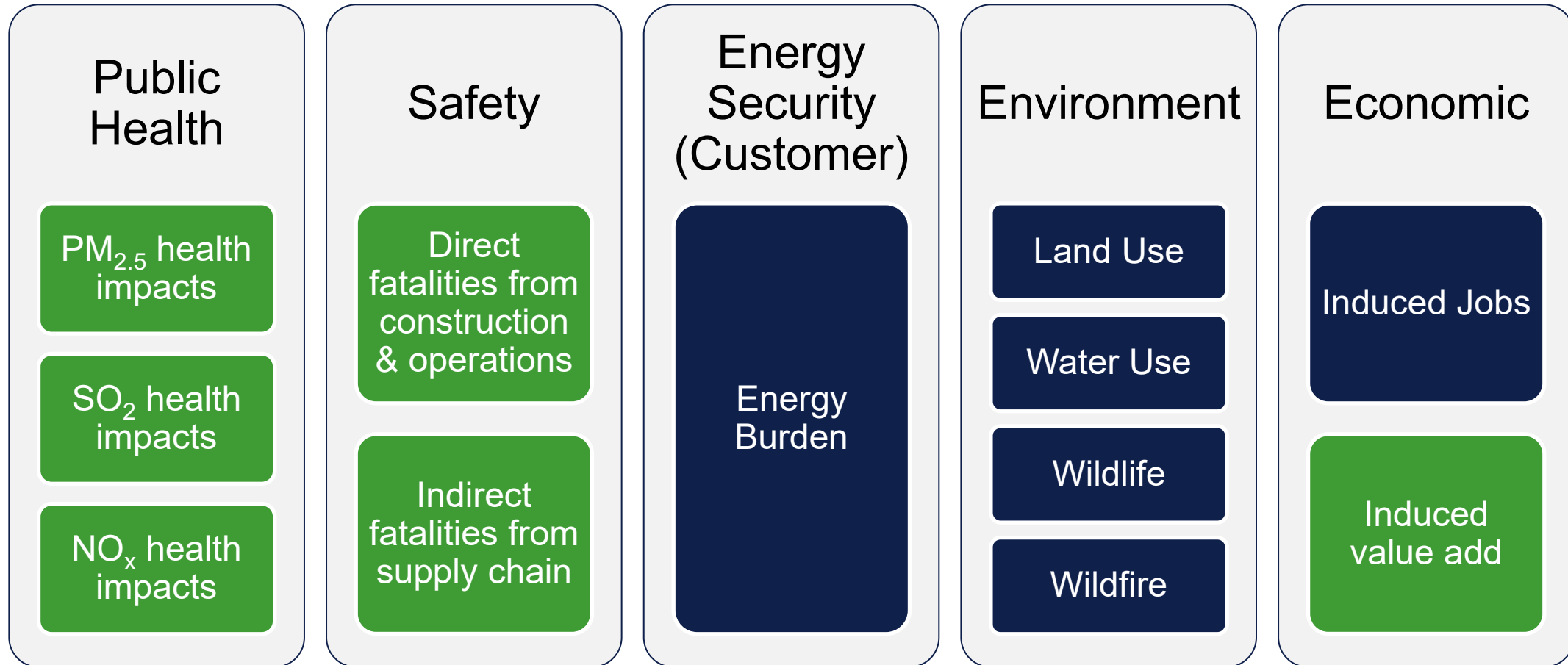

# Summary of Compiled Data

Group	Generator Types	Public Health	Safety	Environment			Economic
				Land Use	Water Use	Wildlife	
<b>Biomass</b>	Biomass	✓	✓	✓	✓		✓
<b>Coal</b>	Coal	✓	✓	✓	✓	✓	✓
	Coal CCS		✓	✓	✓	✓	≈
<b>Hydro</b>	Hydro-PB	✓					✓
	Hydro-GF	✓					✓
	Hydro-Res	✓	✓	✓	✓		✓
	Hydro-RR	✓					✓
	Hydro-RRS	✓					✓
<b>Hydrogen Electrolyzer</b>	HE-LG			✓			
	HE-SM			✓			
<b>Lithium-ion Storage</b>	Batt-LG						
	Batt-SM						
<b>Natural gas</b>	NG-Aero	✓	✓	✓		✓	✓
	NG-CCCT	✓	✓	✓	✓	✓	✓
	NG-CT	✓	✓	✓	✓	✓	✓
	NG-ICE	✓	✓	✓	✓	✓	✓

Group	Generator Types	Public Health	Safety	Environment			Economic
				Land Use	Water Use	Wildlife	
<b>Non-natural gas</b>	NNG-Bio		✓				
	NNG-CF						≈
	NNG-Hyd			✓			
	NNG-LAir						
	NNG-Ren			✓			
<b>Nuclear</b>	Nuclear	✓	✓	✓	✓	✓	
<b>Solar</b>	Solar-Com	✓	✓	✓			≈
	Solar-Rft	✓	✓	✓	✓		≈
	Solar-Utl	✓	✓	✓	✓		≈
<b>Wind</b>	Wind-LG	✓	✓	✓	✓	✓	✓
	Wind-Off	✓	✓	✓	✓		≈
	Wind-SM	✓	✓	✓	✓	✓	✓

# Results





# Public Health: Approach

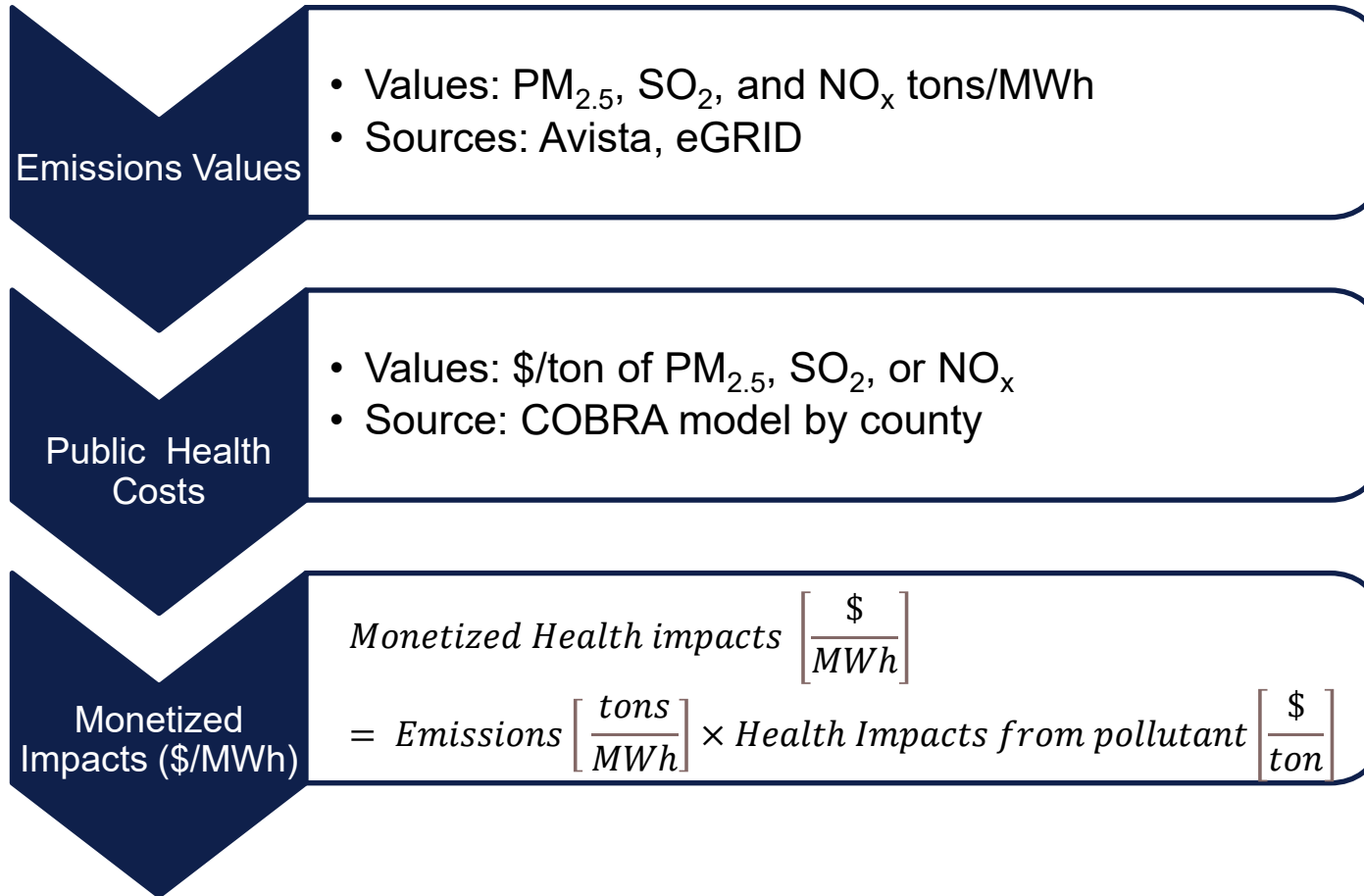

**Results for: All Contiguous U.S. States** [Export: All results](#) | [Current filter](#)

Health Endpoint <sup>1</sup>	Change in Incidence <sup>1</sup> (cases, annual)		Monetary Value <sup>1</sup> (dollars, annual)	
	Low	High	Low	High
Mortality *	0.004	0.010	\$48,754	\$110,385
Nonfatal Heart Attacks *	0.000	0.004	\$76	\$709
Infant Mortality	0.000	0.000	\$298	\$298
Hospital Admits, All Respiratory	0.001	0.001	\$40	\$40
Hospital Admits, Cardiovascular **	0.001	0.001	\$55	\$55
Acute Bronchitis	0.006	0.006	\$4	\$4
Upper Respiratory Symptoms	0.107	0.107	\$5	\$5
Lower Respiratory Symptoms	0.075	0.075	\$2	\$2
Emergency Room Visits, Asthma	0.002	0.002	\$1	\$1
Asthma Exacerbation	0.112	0.112	\$8	\$8
Minor Restricted Activity Days	3.087	3.087	\$271	\$271
Work Loss Days	0.522	0.522	\$105	\$105
<b>🏥 Total Health Effects</b>			<b>\$49,619</b>	<b>\$111,882</b>

\* The Low and High values represent differences in the methods used to estimate some of the health impacts in COBRA. For example, high and low results for avoided premature mortality are based on two different epidemiological studies of the impacts of PM<sub>2.5</sub> on mortality in the United States.  
\*\* Except heart attacks.

# Public Health: PM<sub>2.5</sub>

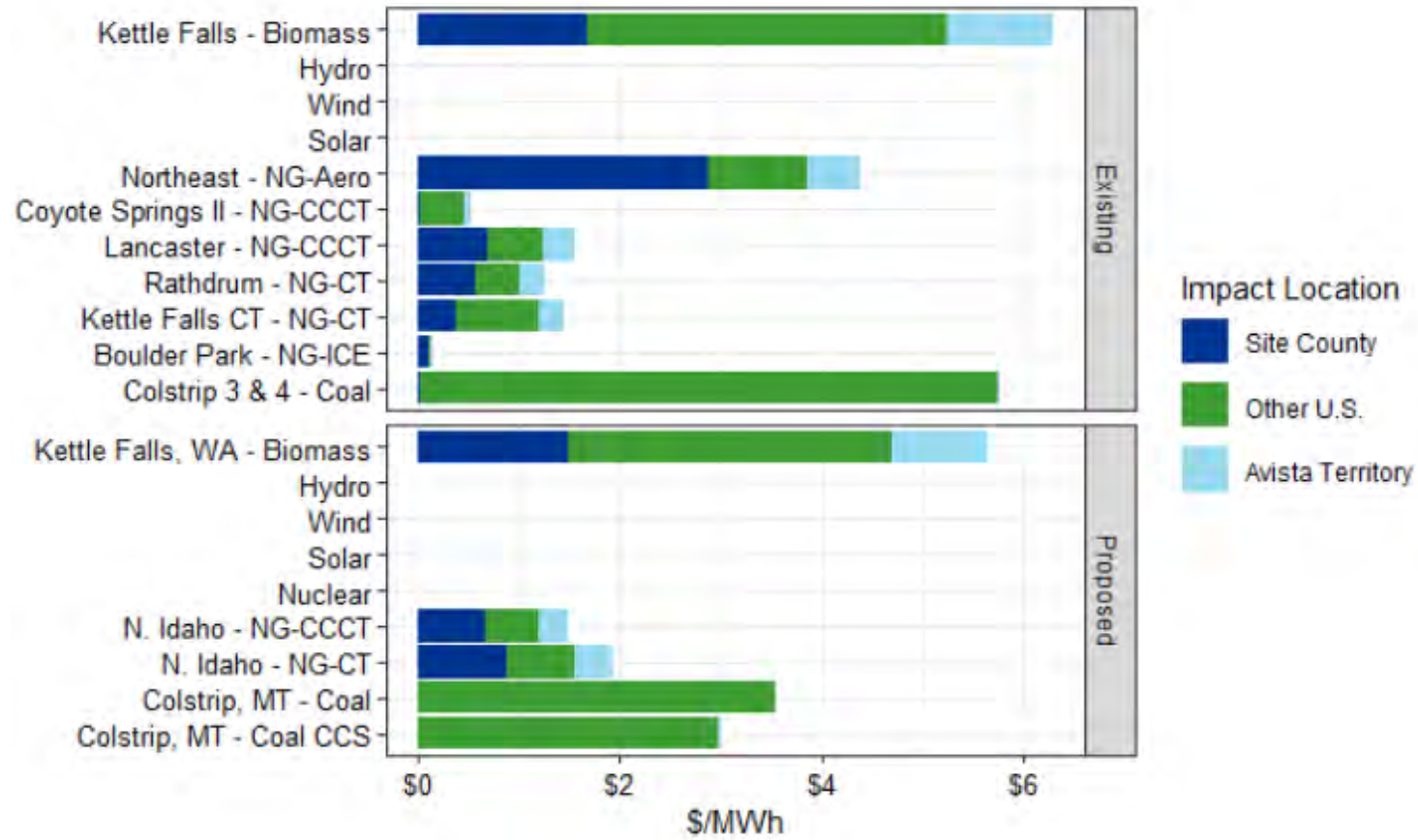

# Public Health: SO<sub>2</sub>

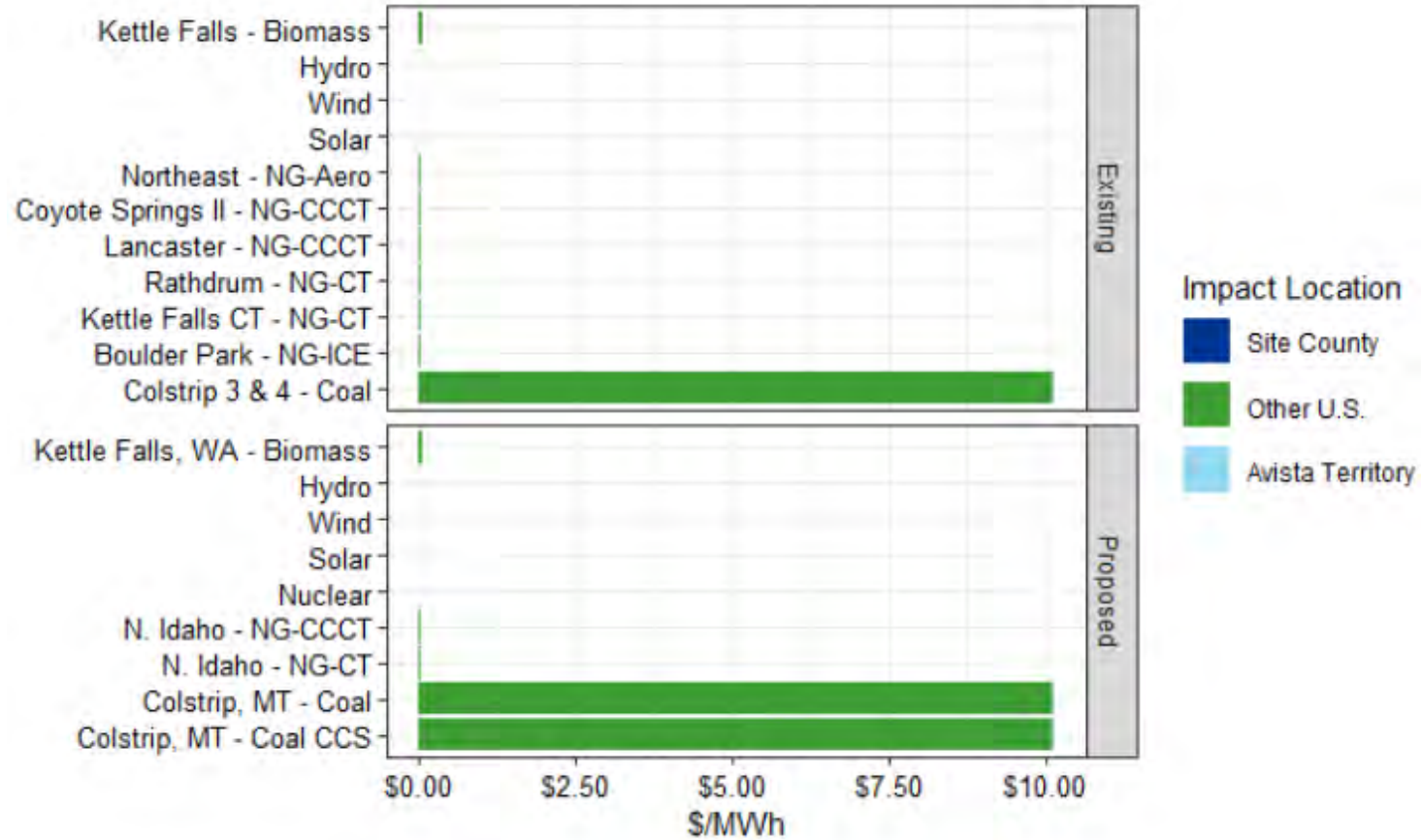

# Public Health: NO<sub>x</sub>

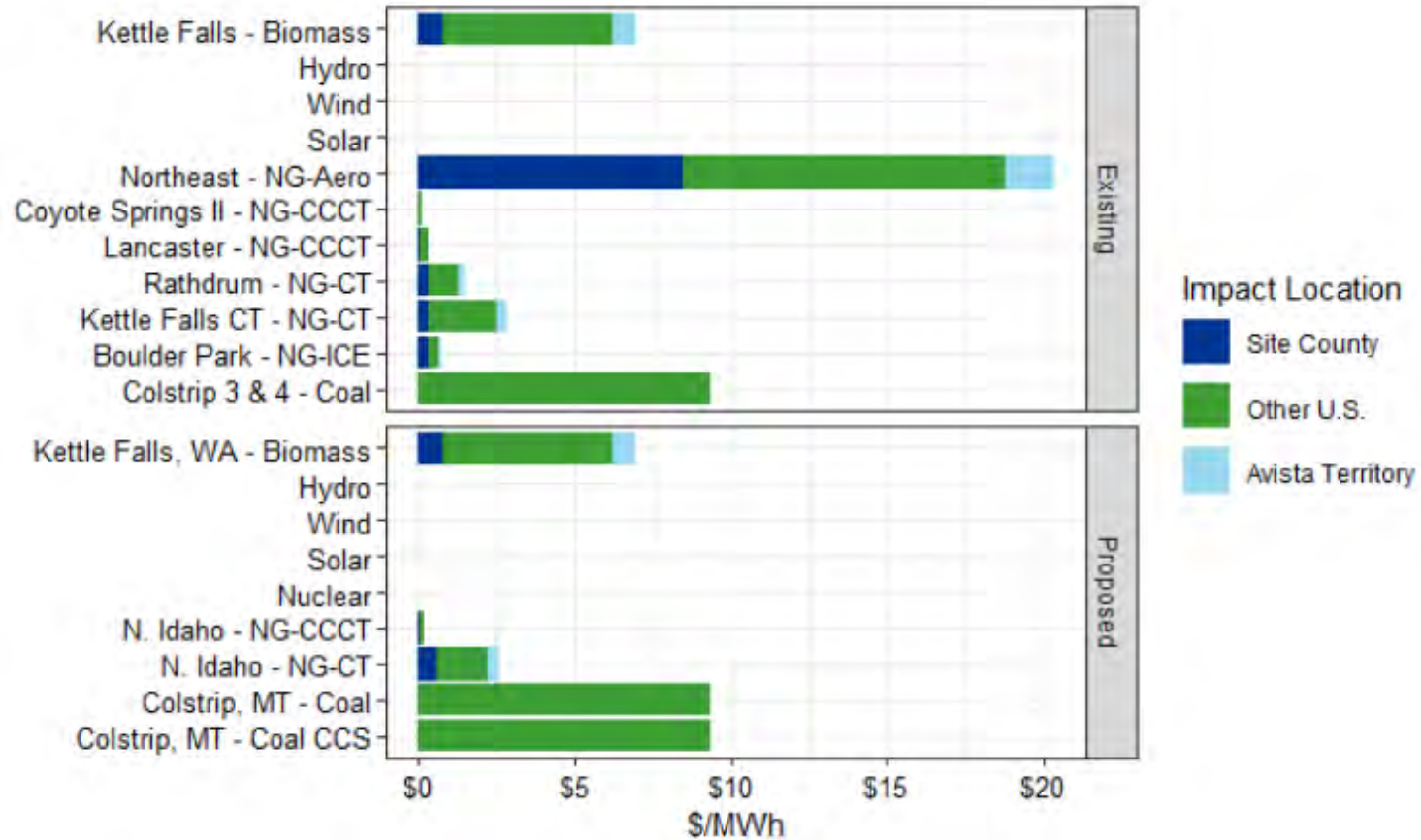

# Safety: Approach

## Fatality Values

- Values: direct fatalities, indirect fatalities
- Sources: BLS, BTS, MSHA, CDC, DOT

## Safety Costs

- Values: value of statistical life, \$/MWh
- Source: EPA

## Monetized Impacts (\$/MWh)

$$\text{Monetized safety} \left[ \frac{\$}{MWh} \right] = \text{Safety} \left[ \frac{\text{Fatalities}}{MWh} \right] \times \text{Value of a Statistical Life} \left[ \frac{\$10,742,916.67}{\text{Fatality}} \right]$$

# Safety: Fatalities

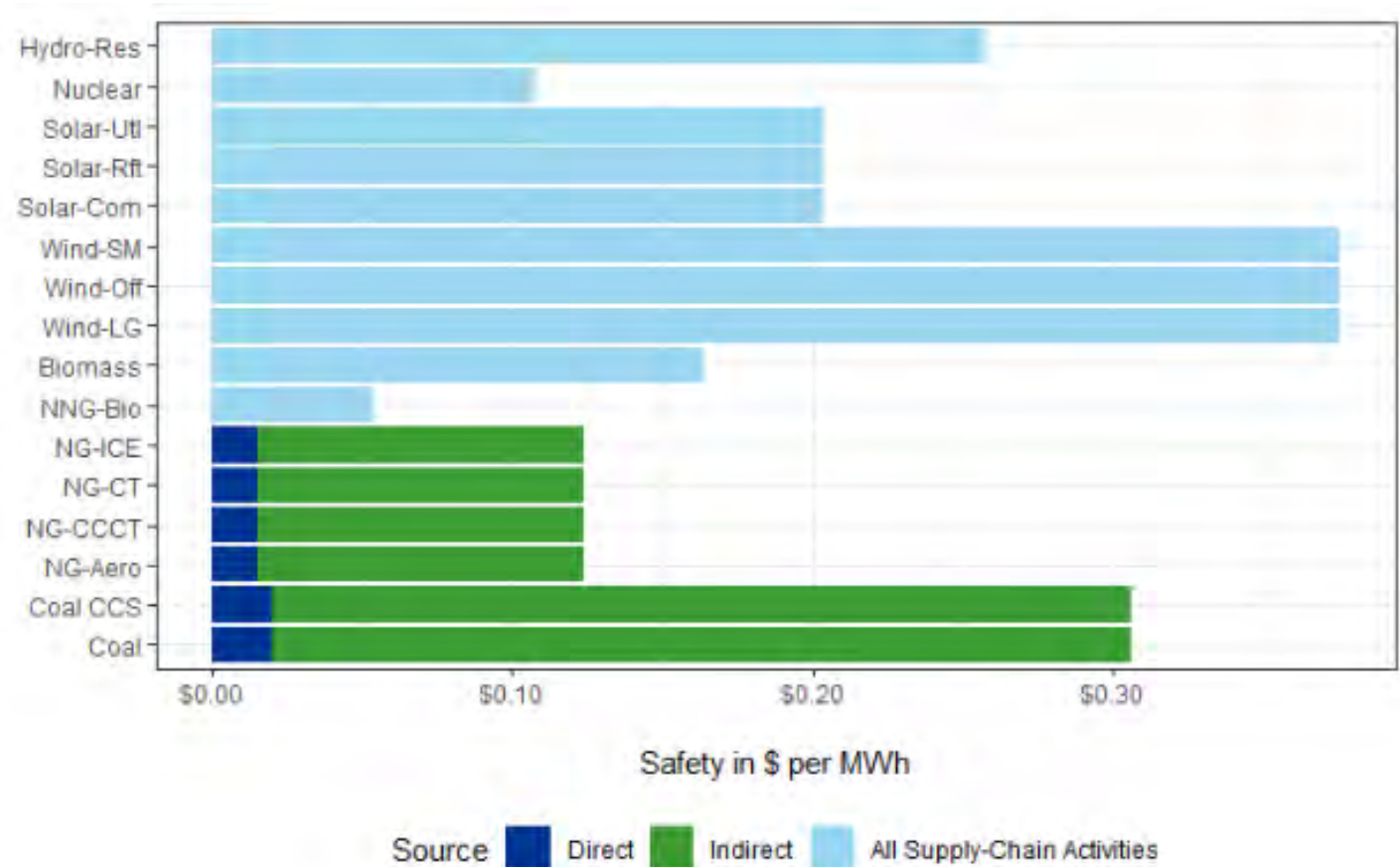

# Economic: Approach

- NREL JEDI models
  - 6 different models
  - Specified location, year of construction, & MW
- Types of impacts:
  - **Direct:** Labor directly related to onsite development, construction, and operations
  - **Indirect:** Supporting industry impacts
  - **Induced:** Impacts due to reinvestment and spending driven by the direct and indirect impacts
- **Value added:** The difference between total gross output and the cost of intermediate inputs. Equivalent to gross domestic product.

Local Economic Impacts - Summary Results				
	Jobs	Earnings	Output	Value Added
During construction period				
Project Development and Onsite Labor Impacts	1,087	\$93.3	\$180.6	\$119.5
Construction and Interconnection Labor	657	\$75.1		
Construction Related Services	431	\$18.2		
Power Generation and Supply Chain Impacts	488	\$22.0	\$69.2	\$35.3
Induced Impacts	364	\$16.0	\$50.1	\$26.7
Total Impacts	1,939	\$131.3	\$299.9	\$181.5
During operating years (annual)				
Onsite Labor Impacts	29	\$2.6	\$2.6	\$2.6
Local Revenue and Supply Chain Impacts	44	\$2.6	\$10.5	\$4.9
Induced Impacts	17	\$0.8	\$2.4	\$1.3
Total Impacts	89	\$5.9	\$15.4	\$8.8

# Economic: Construction Impacts (proposed)

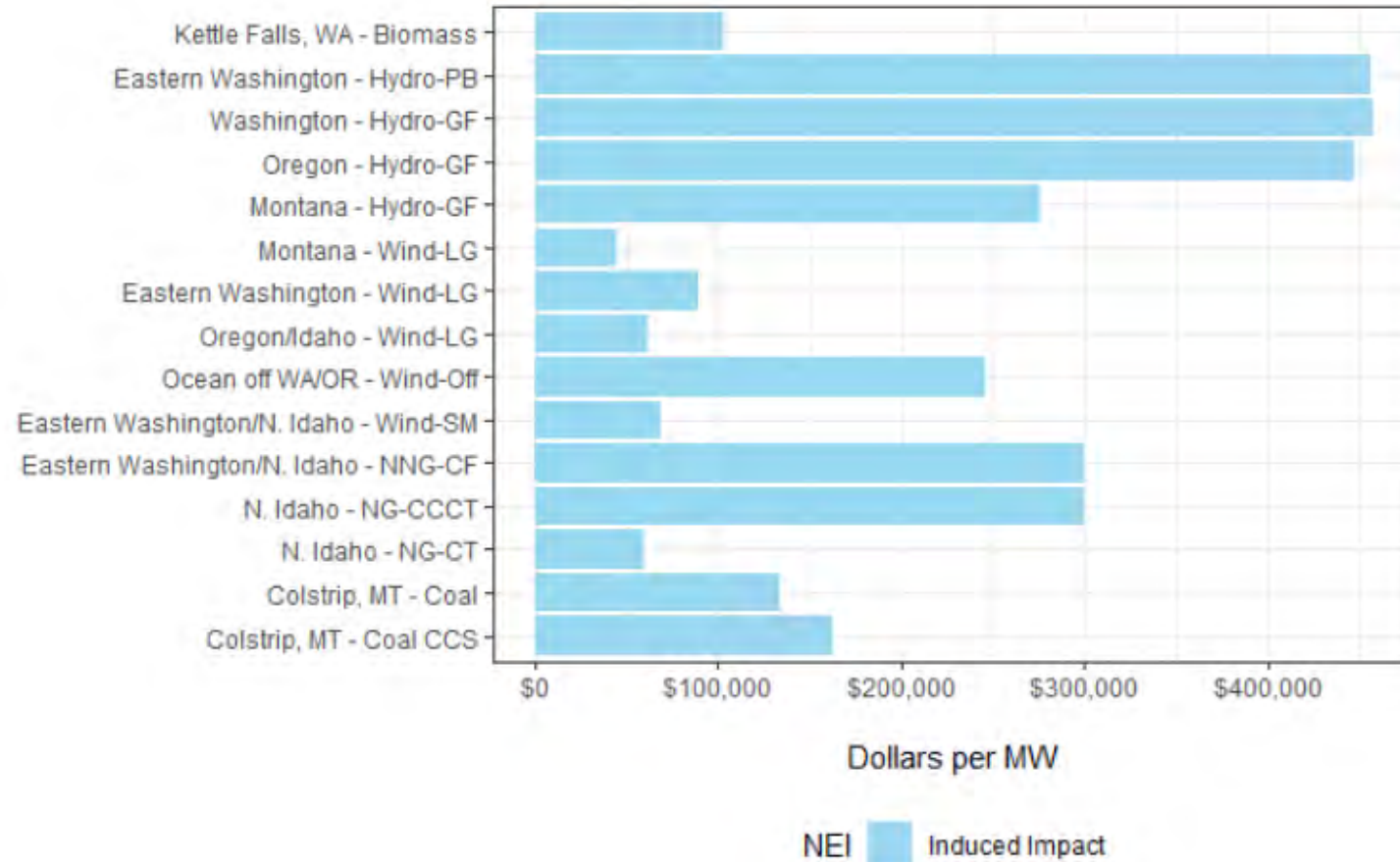



# Economic: Operations Impacts

## Existing

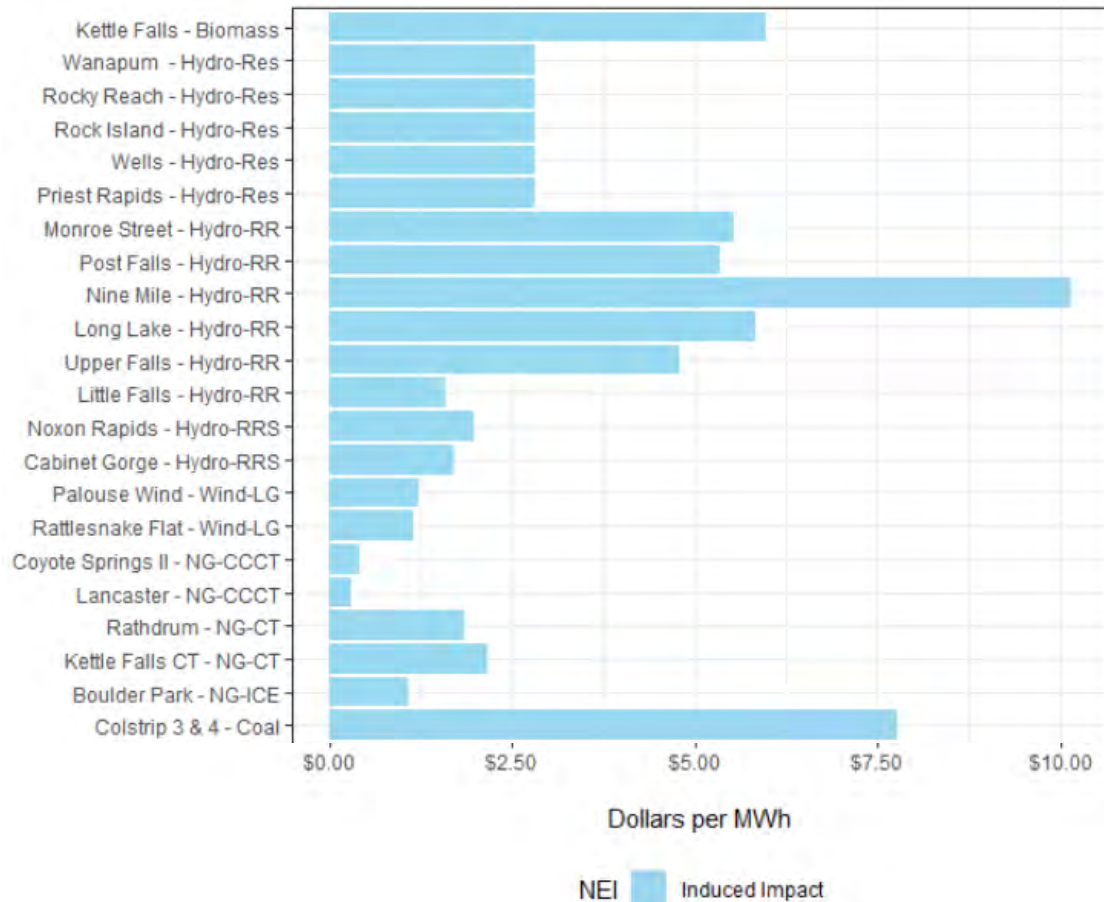

## Proposed

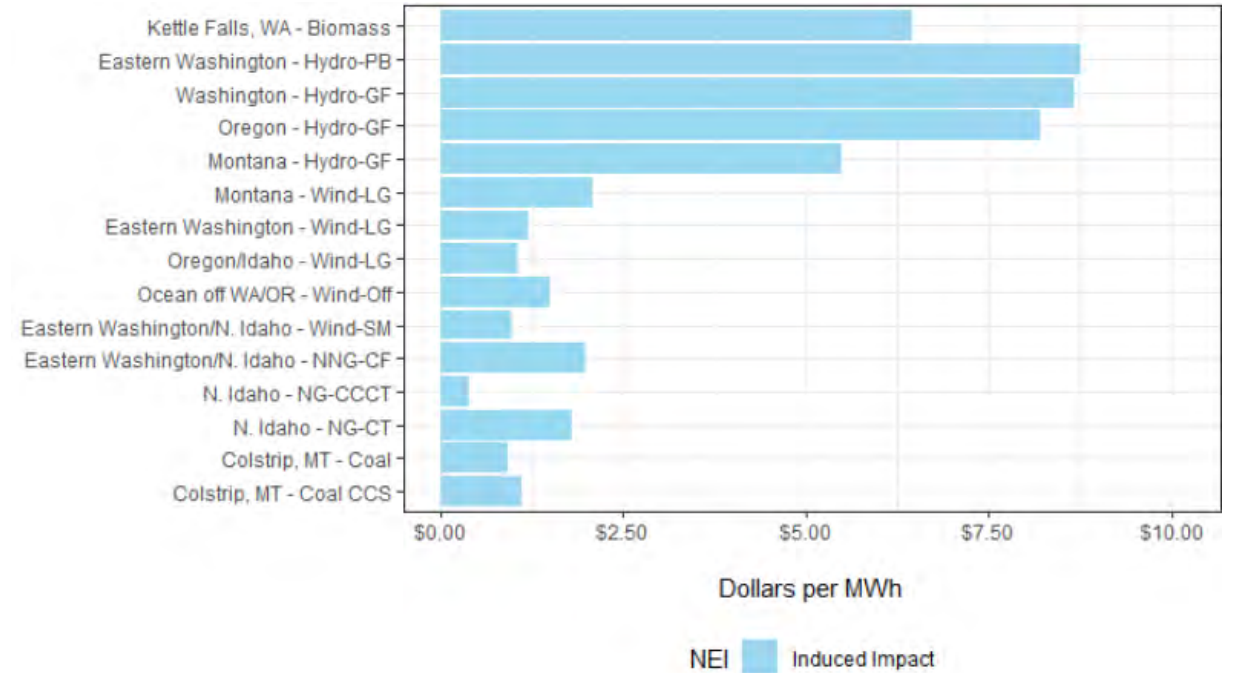

# Database Application Example: Proposed Eastern Washington Large Wind Farm

Impacts per MWh

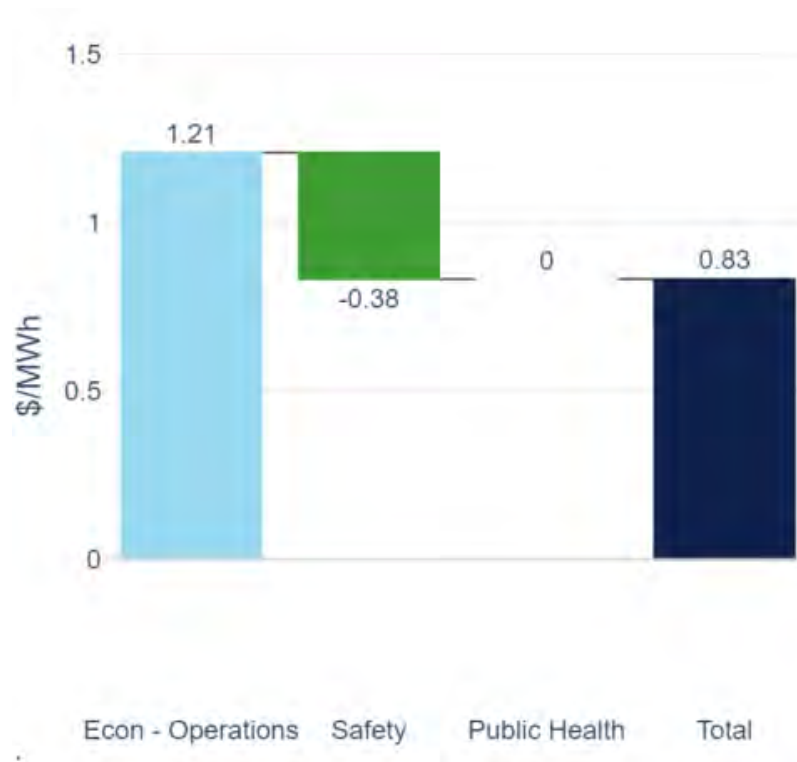

Impacts per MW

NEI	Impact (\$/MW)
Economic - Construction	\$89,600

# Gap Analysis



# Gap analysis

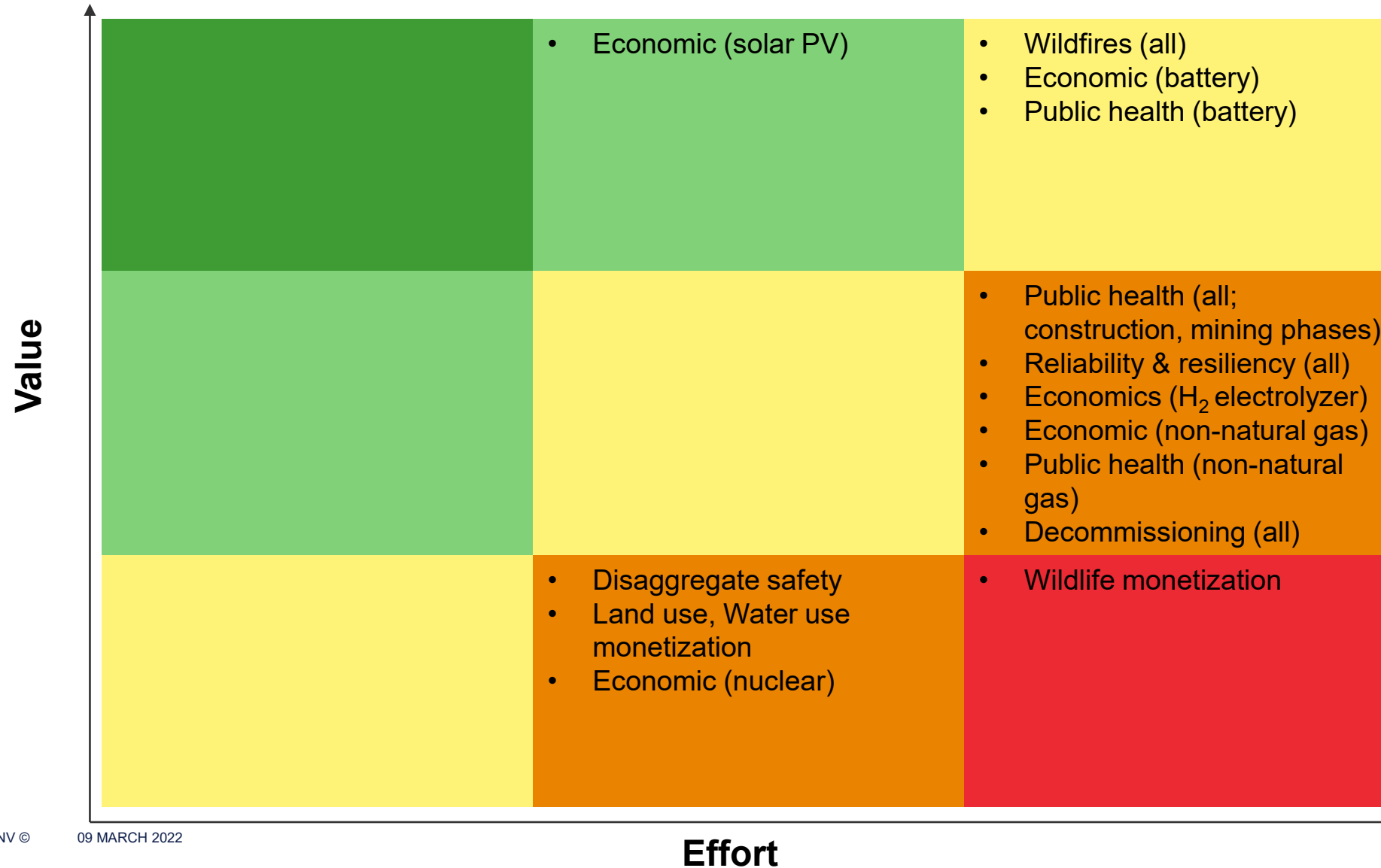

# Discussion



WHEN TRUST MATTERS

[www.dnv.com](http://www.dnv.com)



# Database Compilation: Resource Types

Group	Technology	
	Abbreviation	Generator Types
<b>Biomass</b>	Biomass	Biomass
<b>Coal</b>	Coal	Coal
	Coal CCS	Coal with Carbon Capture
<b>Hydro</b>	Hydro-PB	Pumped hydro - brownfield
	Hydro-GF	Pumped hydro - greenfield
	Hydro-Res	Reservoir hydro
	Hydro-RR	Run-of-river hydro
	Hydro-RRS	Run-of-river hydro with storage
<b>Hydrogen electrolyzer</b>	HE-LG	Hydrogen electrolyzer - large
	HE-SM	Hydrogen electrolyzer - small
<b>Lithium-ion storage</b>	Batt-LG	Lithium-ion Storage - Large
	Batt-SM	Lithium-ion Storage - Small
<b>Natural gas</b>	NG-Aero	Natural gas Aero Turbine
	NG-CCCT	Natural gas CCCT
	NG-CT	Natural gas CT
	NG-ICE	Natural gas internal combustion engine
<b>Non-natural gas</b>	NNG-Bio	Non-natural gas (Bio-fuel)
	NNG-CF	Clean Fuel Turbine
	NNG-Hyd	Non-natural gas (Hydrogen)
	NNG-LAir	Non-natural gas (Liquid air)
	NNG-Ren	Renewable natural gas storage tank
<b>Nuclear</b>	Nuclear	Nuclear
<b>Solar</b>	Solar-Com	Community solar
	Solar-Rft	Rooftop solar
	Solar-Utl	Utility-scale solar
<b>Wind</b>	Wind-LG	Large wind
	Wind-Off	Off-shore wind
	Wind-SM	Small Wind



# Natural Gas Price Forecast

Avista, Electric Technical Advisory Committee  
March 9<sup>th</sup>, 2022 – TAC 3

Tom Pardee, Natural Gas IRP Manager





# U.S. dry natural gas production and consumption

**U.S. dry natural gas production**  
**AEO2021 side cases**  
 trillion cubic feet

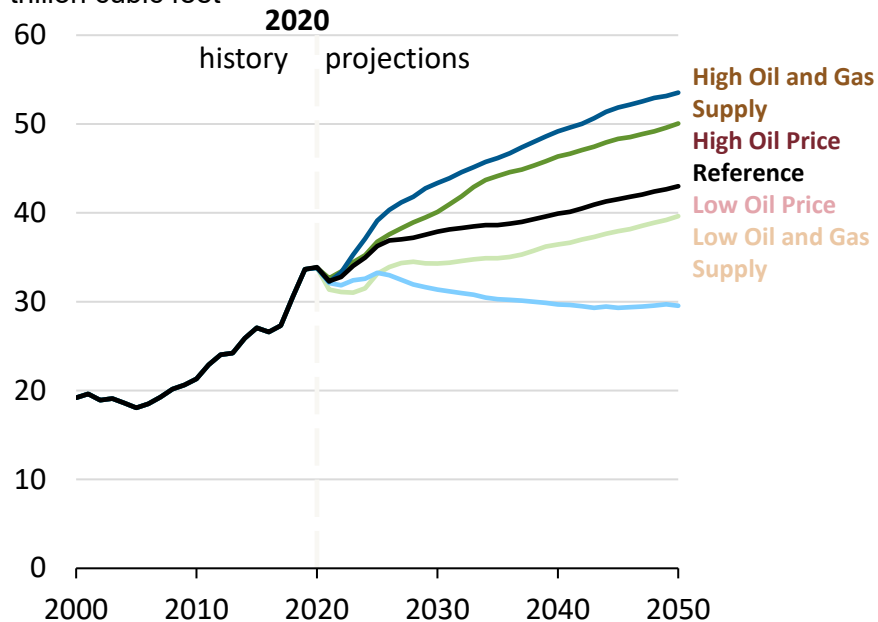

**U.S. natural gas consumption**  
**AEO2021 side cases**  
 trillion cubic feet

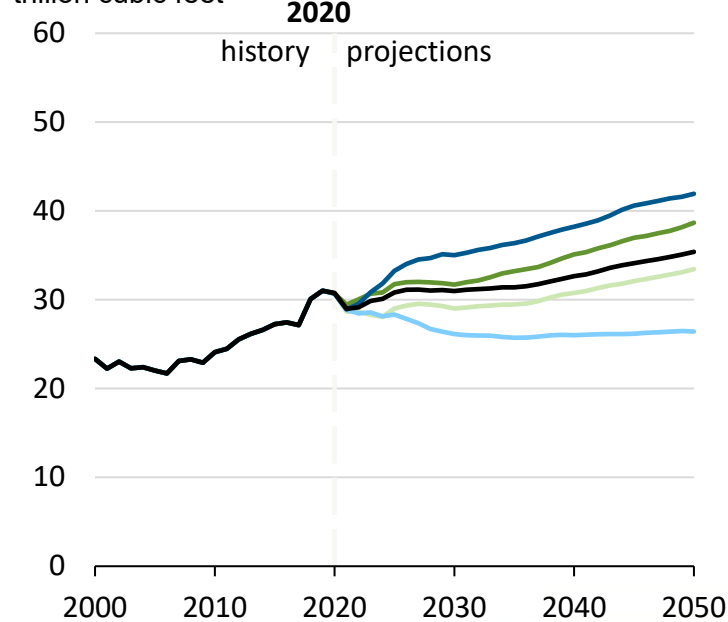

# Natural gas production and prices

**U.S. dry natural gas production**  
**AEO2021 oil and gas supply cases**  
 trillion cubic feet

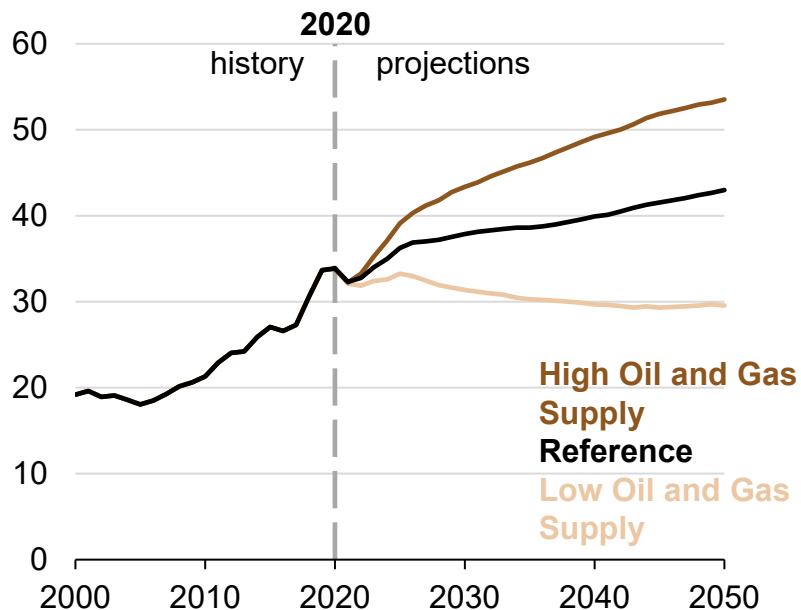

**Natural gas spot price at Henry Hub**  
**AEO2021 oil and gas supply cases**  
 2020 dollars per million British thermal units

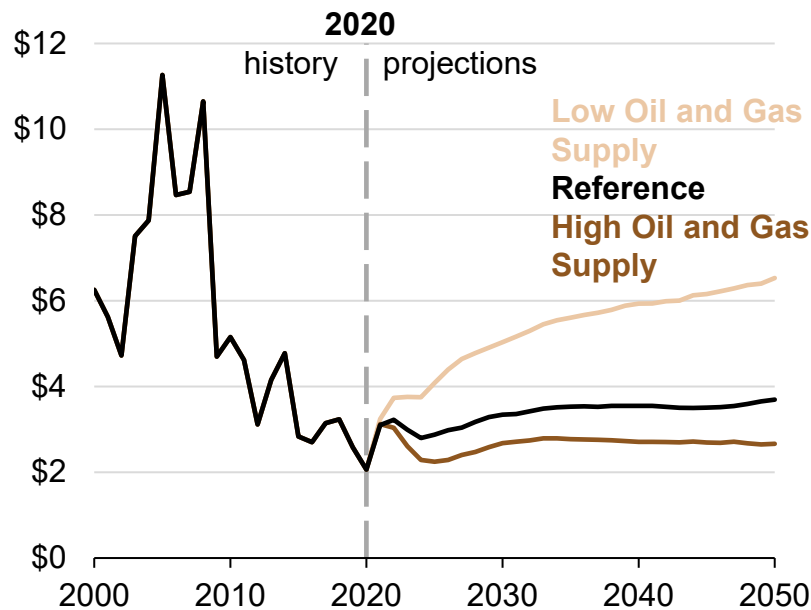

# U.S. production of natural gas from shale resources

U.S. dry natural gas production from shale resources by region, AEO2021 oil and gas supply cases

Reference case  
trillion cubic feet

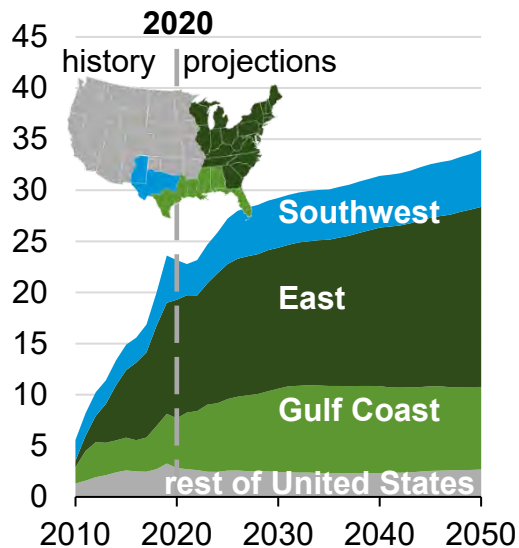

Low Oil and Gas Supply case  
trillion cubic feet

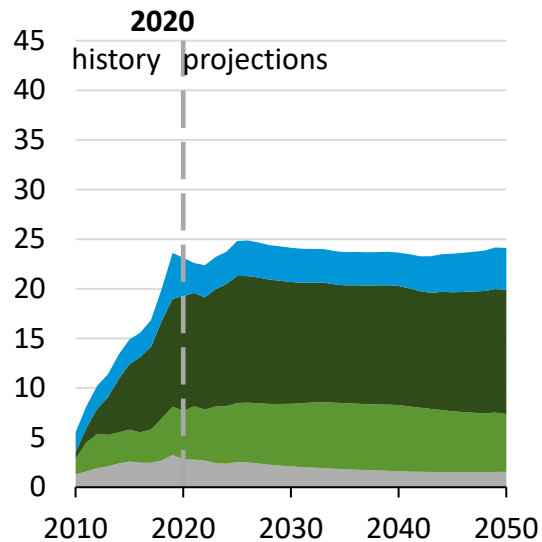

High Oil and Gas Supply case  
trillion cubic feet

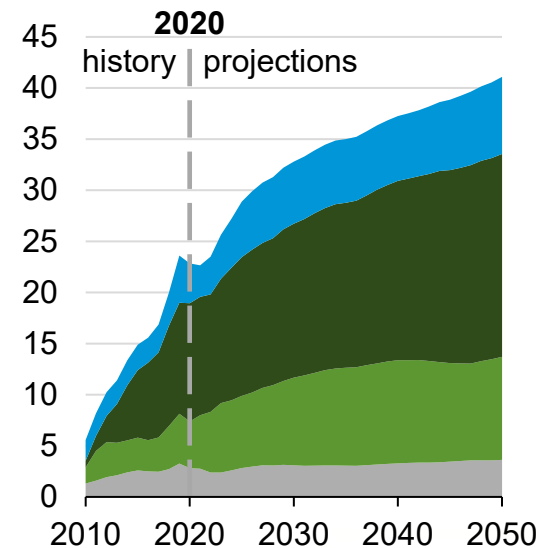

# U.S. production of natural gas from oil formations

U.S. dry natural gas production from oil formations by region, AEO2021 oil and gas supply cases

Reference case  
trillion cubic feet

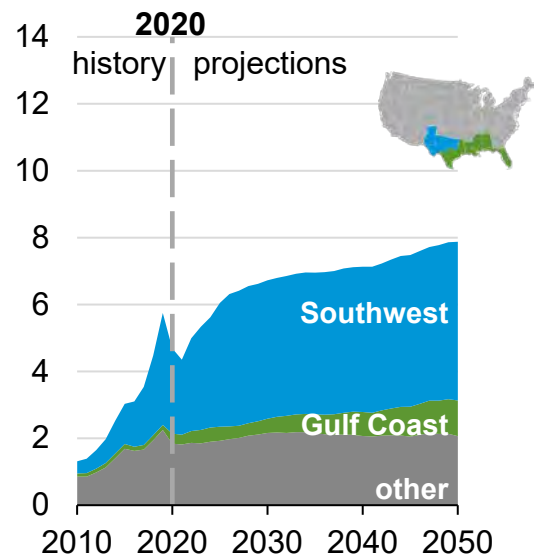

Low Oil and Gas Supply case  
trillion cubic feet

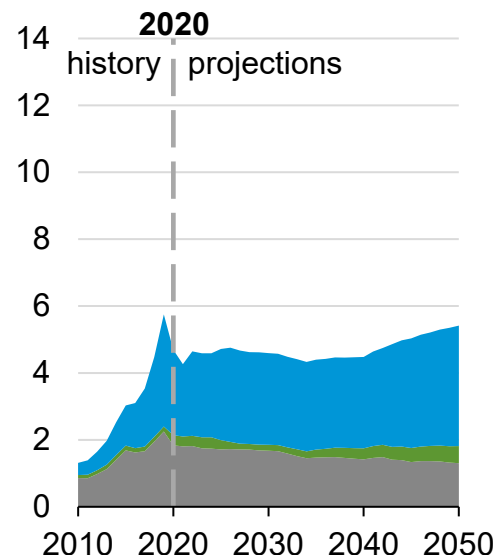

High Oil and Gas Supply case  
trillion cubic feet

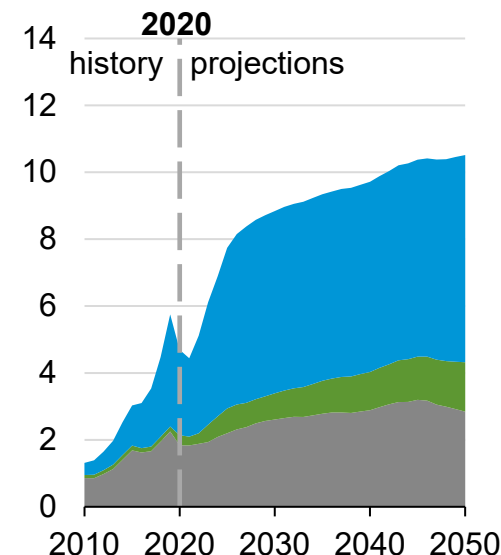

# U.S. natural gas consumption by sector

Natural gas consumption by sector, AEO2021 Reference case

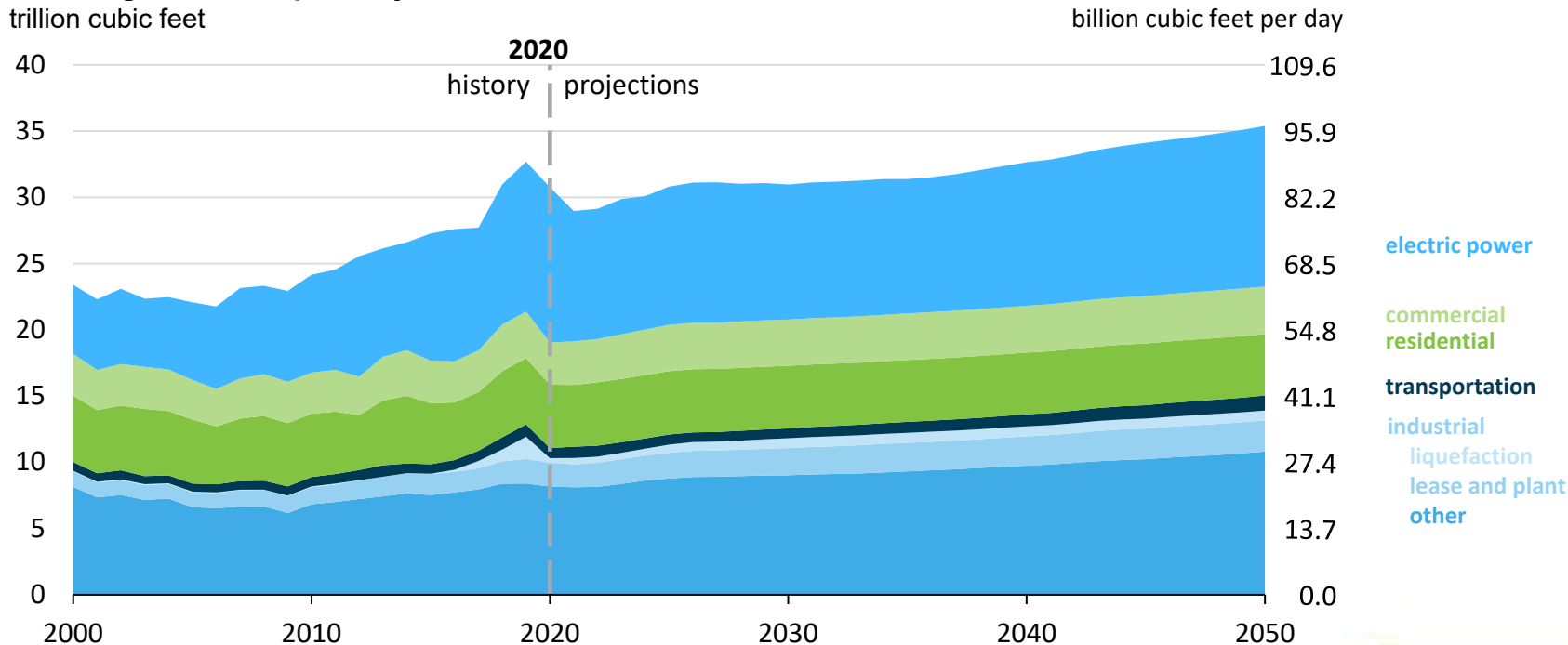

# Change in natural gas disposition by sector and net exports

Natural gas disposition by sector and net exports

AEO2021 Reference case

trillion cubic feet

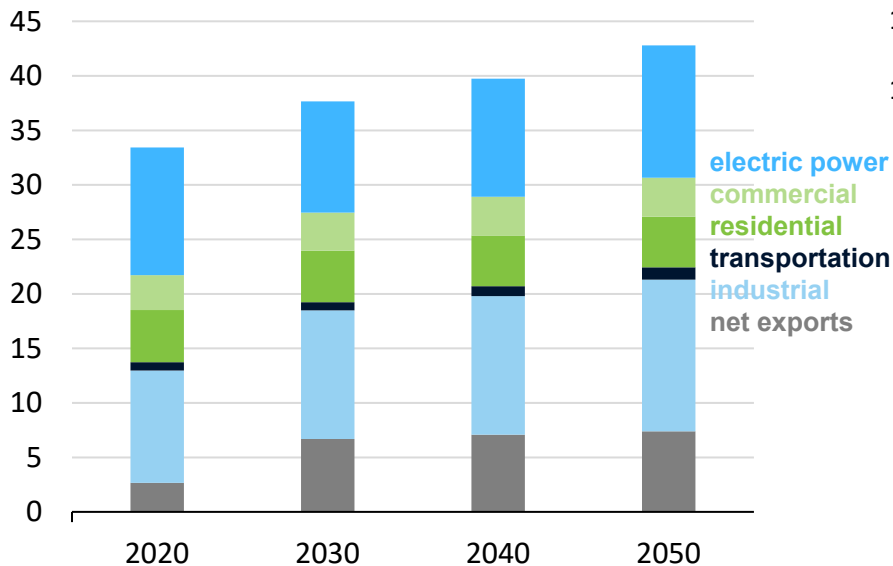

Change in natural gas disposition and net exports

AEO2021 Reference case

relative to 2020 in trillion cubic feet

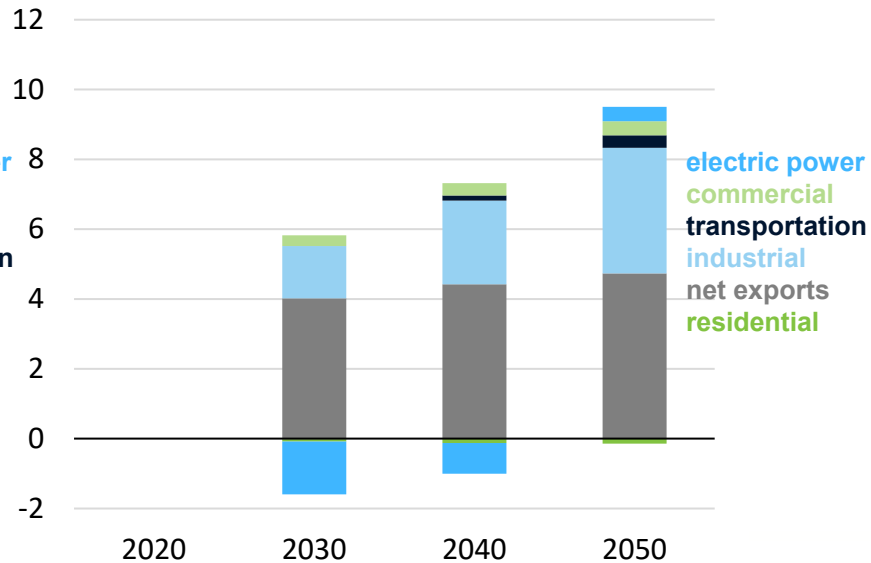

# U.S. natural gas and liquefied natural gas (LNG) trade

U.S. natural gas and LNG trade, AEO2021 oil and gas supply cases

**Reference case**

trillion cubic feet  
(Tcf)

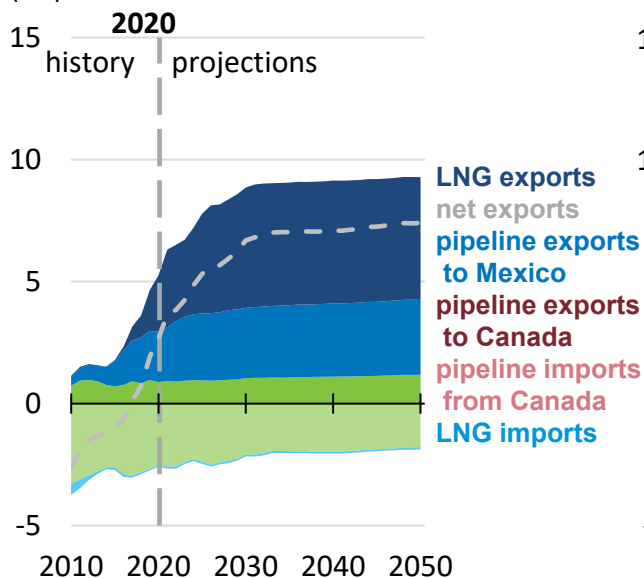

**Low Oil and Gas Supply case**

Tcf

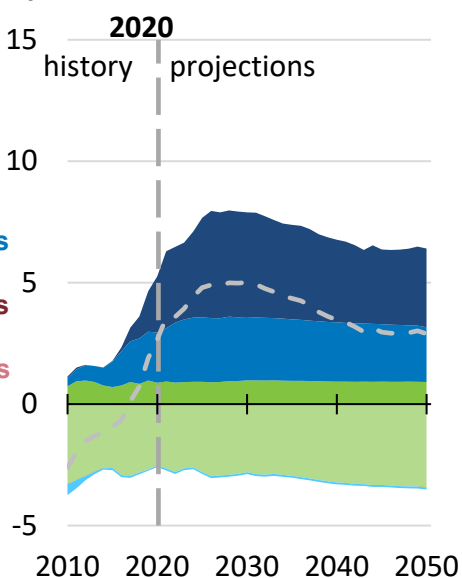

**High Oil and Gas Supply case**

Tcf

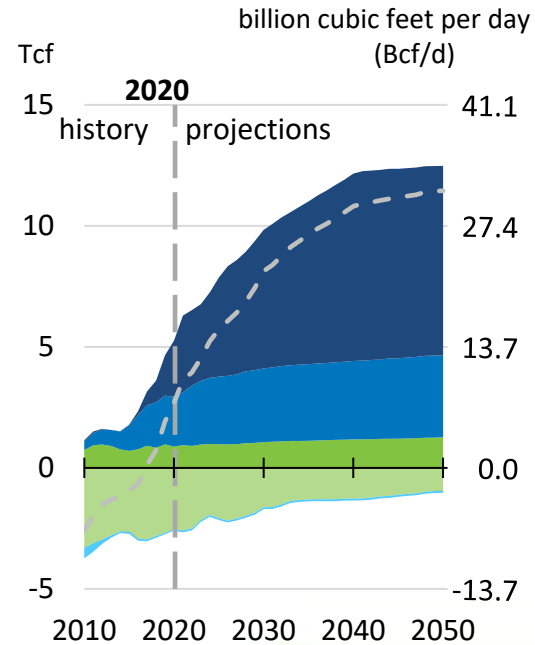

# U.S. liquefied natural gas (LNG) exports and oil and natural gas prices

**U.S. liquefied natural gas exports**  
**AEO2021 supply and price cases**  
 trillion cubic feet

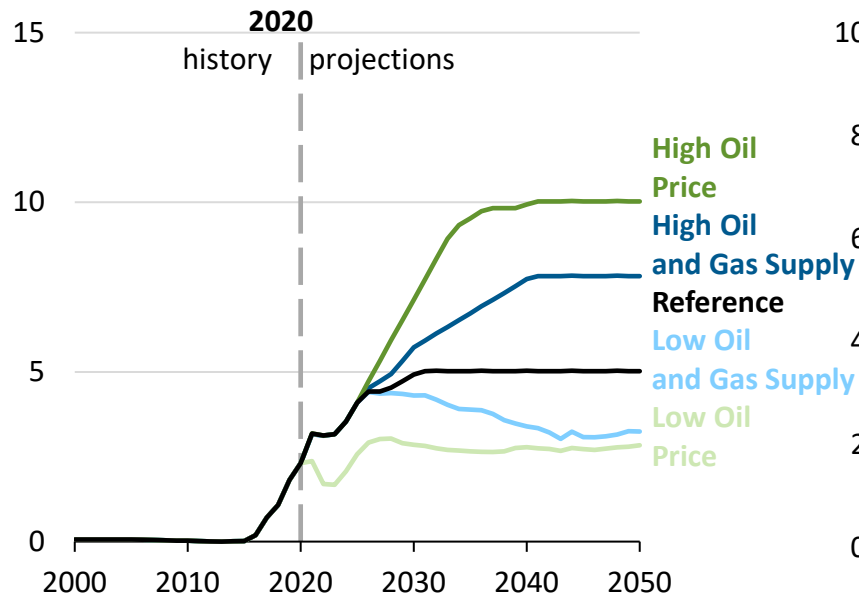

**Ratio of Brent crude oil price to natural gas price**  
**at Henry Hub, AEO2021 supply and price cases**  
 energy-equivalent terms

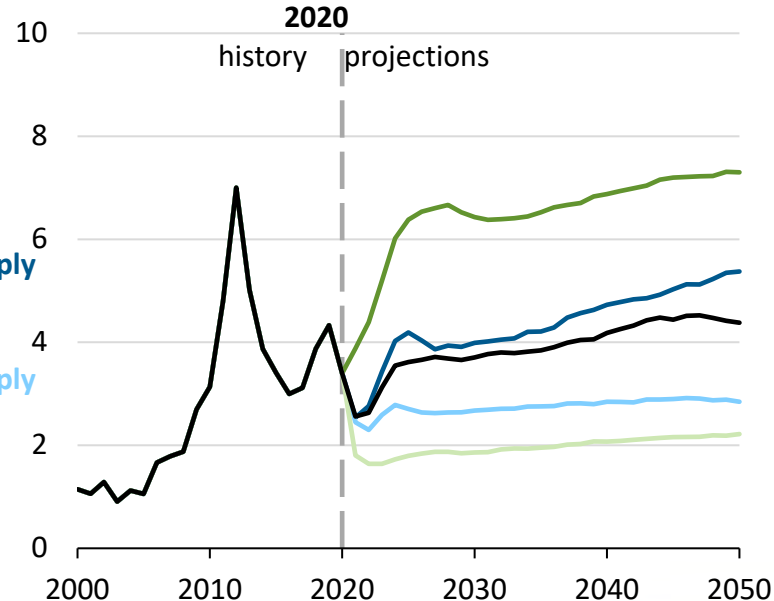



# Rig Count

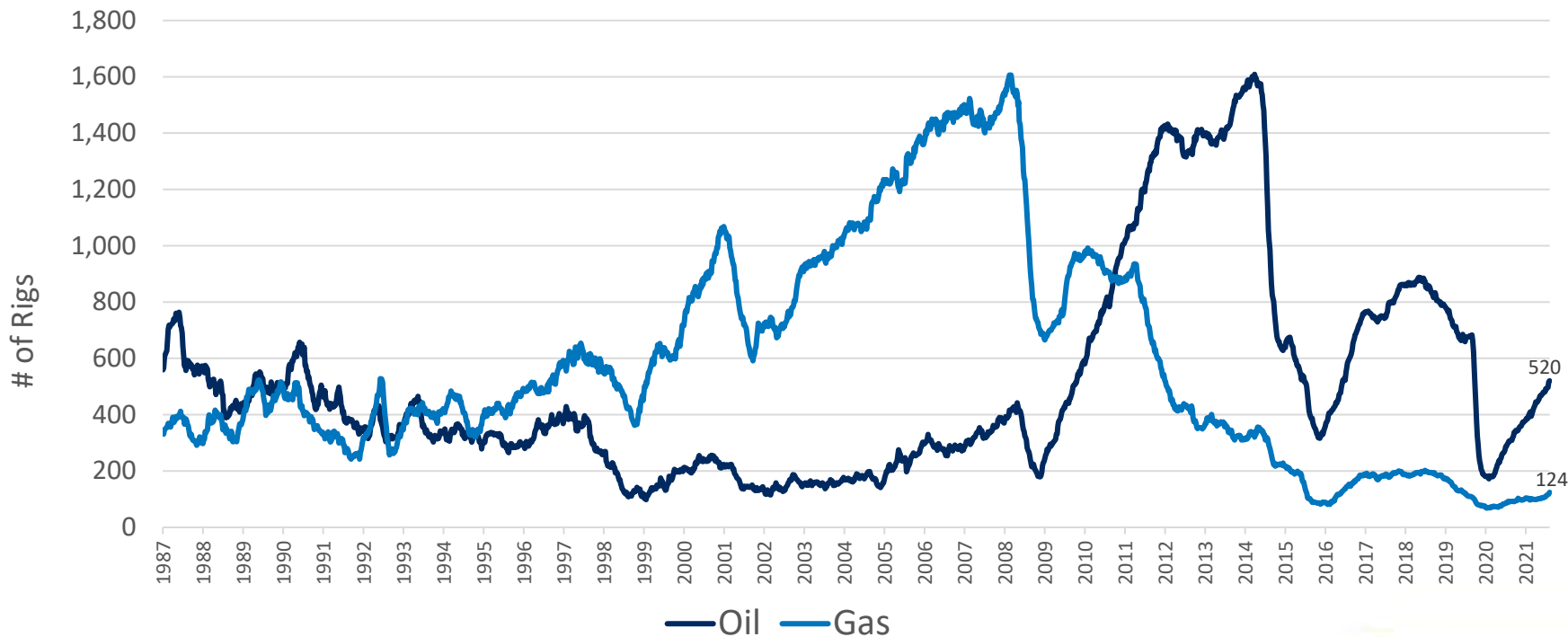

# Production

Seasonal US Production with Forecast



Source: S&P Global, NBC

Seasonal US LNG Export with Forecast

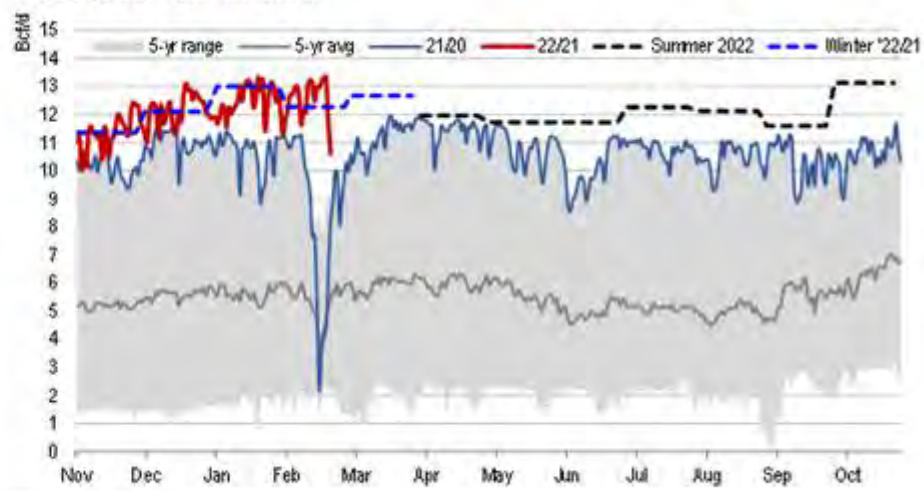

Source: S&P Global, NBC

# Expected Prices

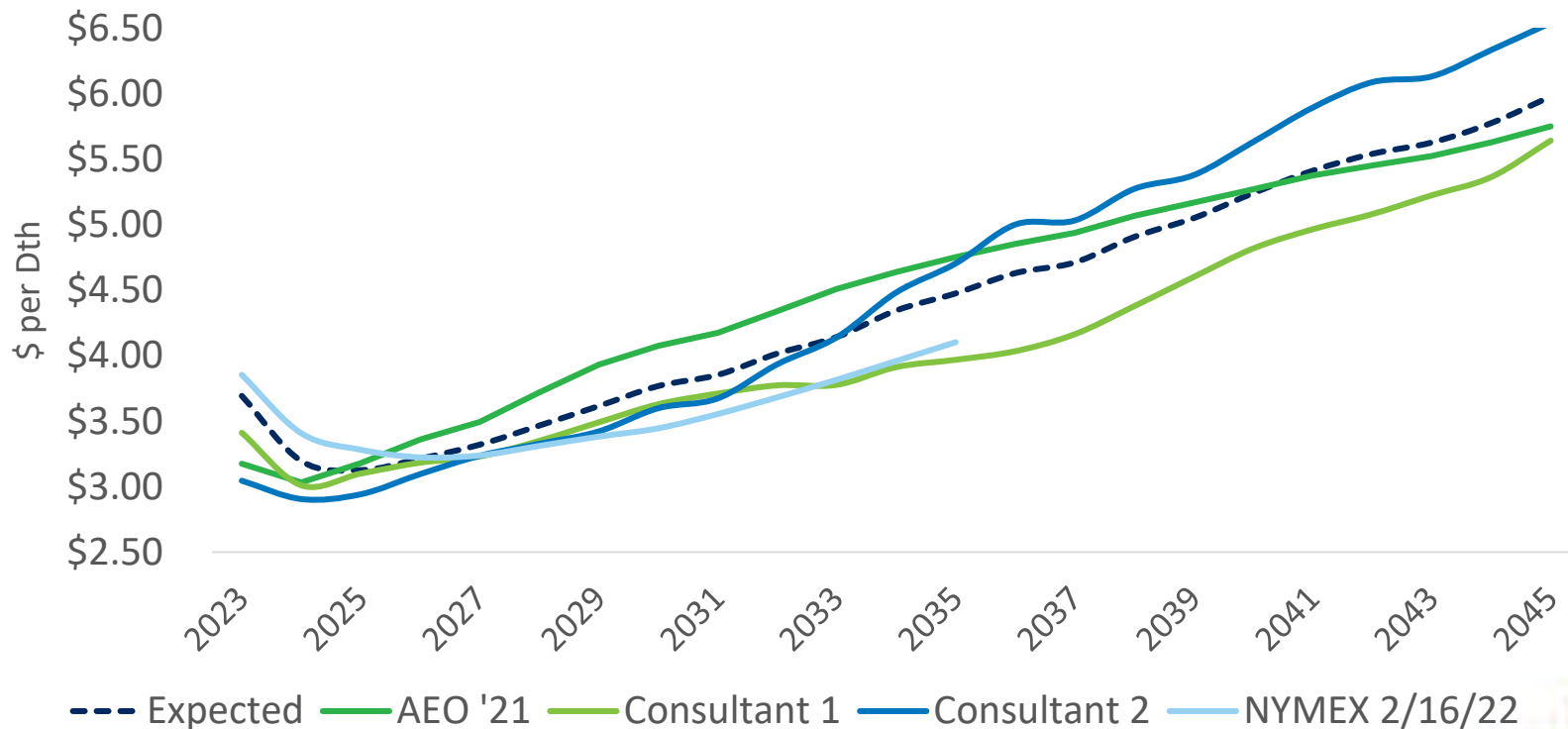

# Expected Prices - Levelized

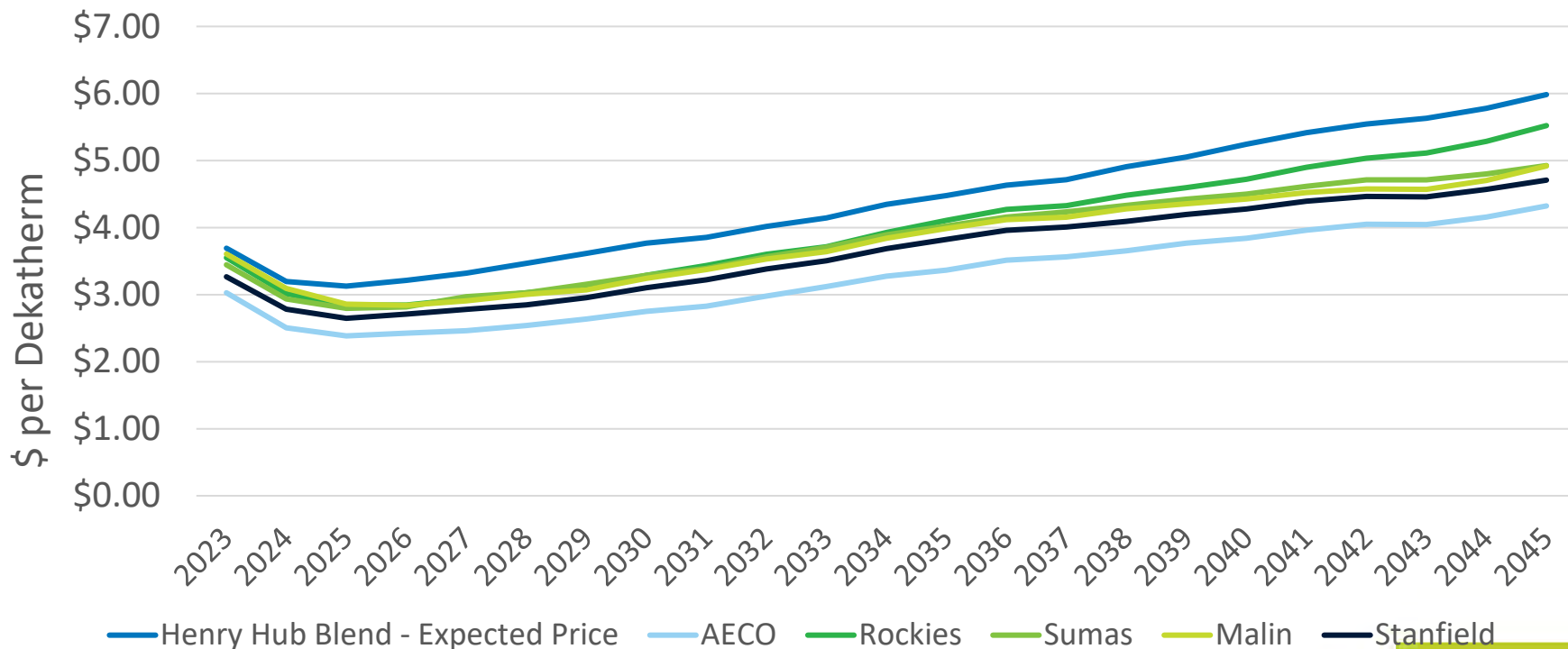

# Levelized Costs (2023 – 2045)

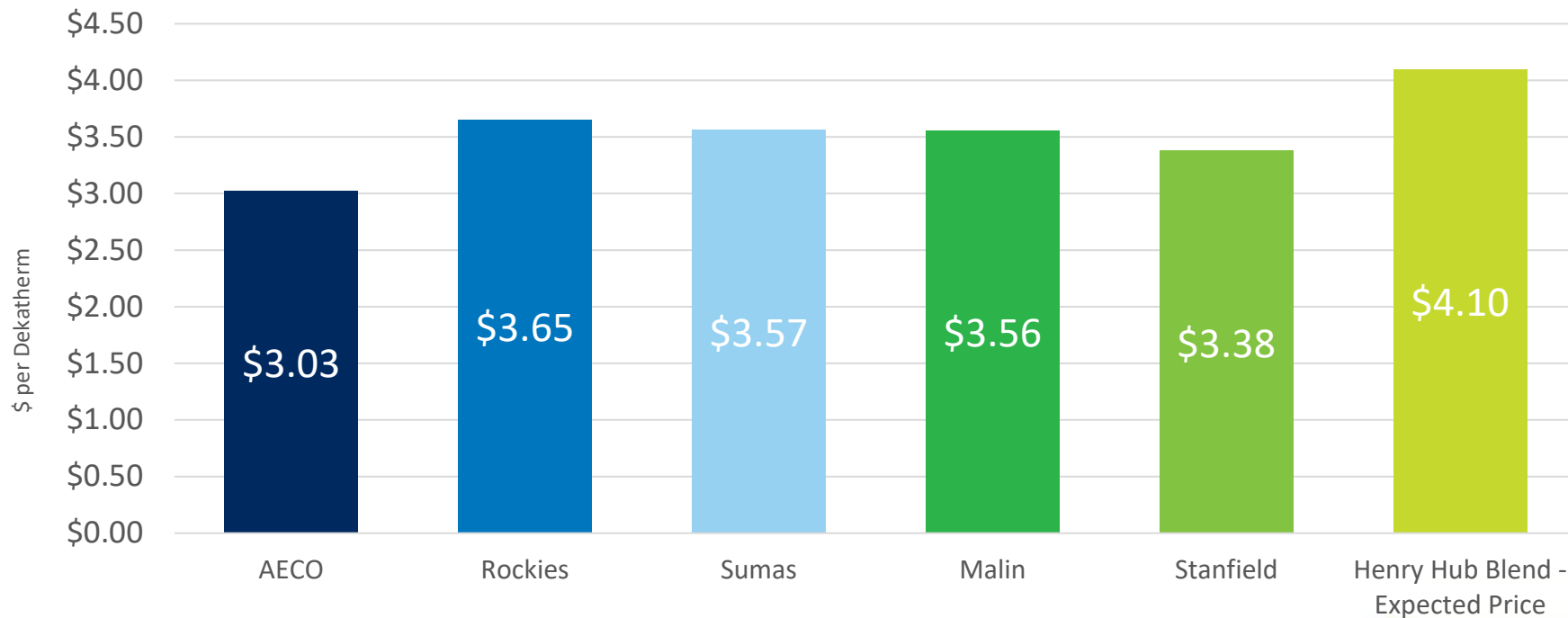

## Basis to Henry Hub - Levelized



# Henry Hub Stochastic Results (500 Draws)

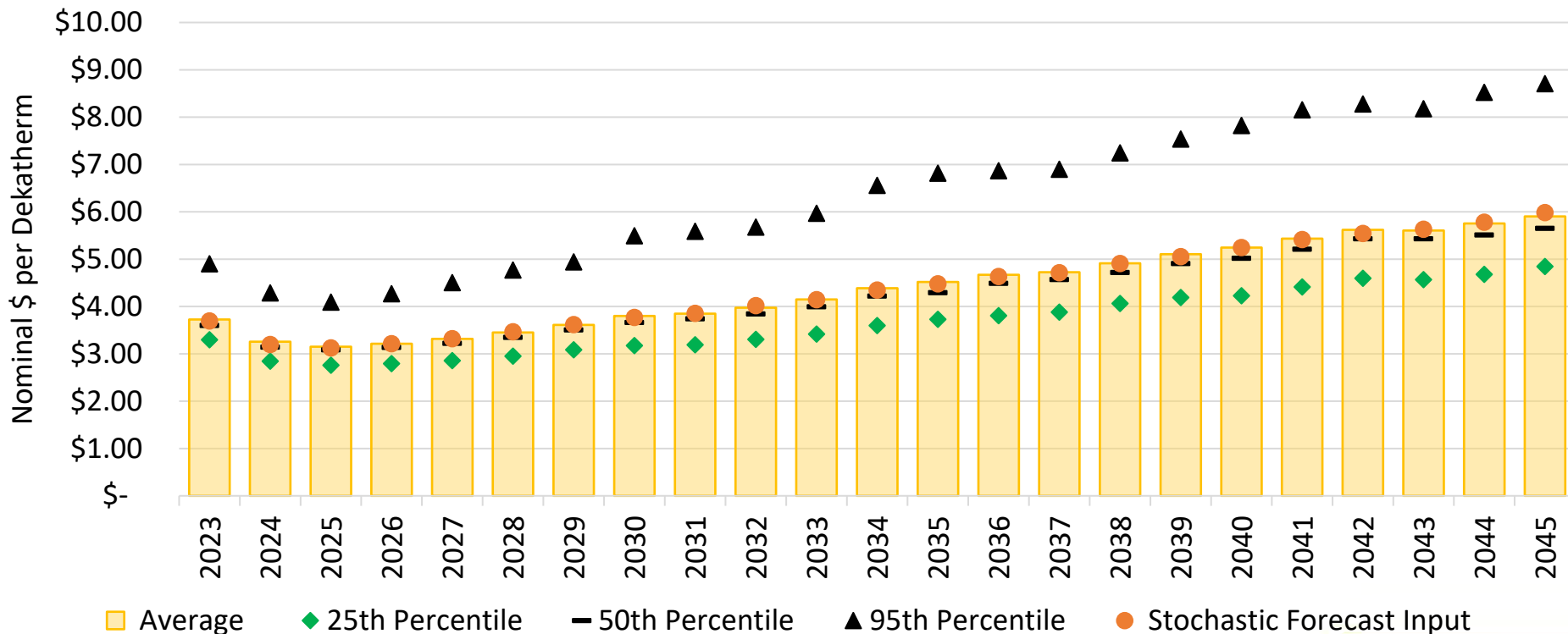

# Henry Hub Stochastic Results (500 Draws)

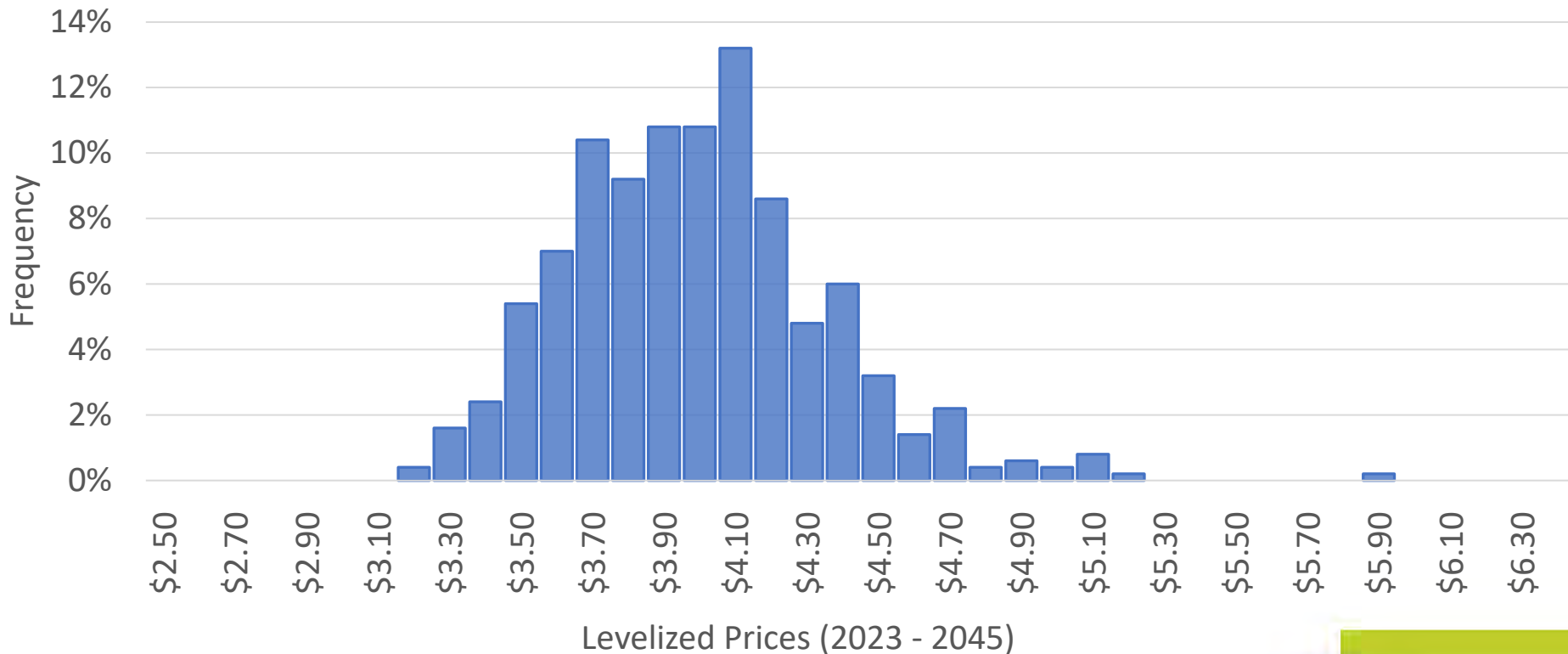





# Electric Wholesale Market Price Forecast

Lori Hermanson, Senior Resource Analyst  
Electric IRP, Third Technical Advisory Committee Meeting  
March 9, 2022

# Overview

- Draft market price forecast based on preliminary analysis
  - To be used for RFP response comparison
- IRP will use this market price forecast with updated natural gas price and other assumptions (late summer)
- Stochastics pricing results will be discussed at a future TAC meeting

# Market Price Forecast – Purpose

- Estimate “market value” of resources options for the IRP
- Estimate dispatch of “dispatchable” resources
- Informs avoided costs
- May change resource selection if resource production is counter to needs of the wholesale market

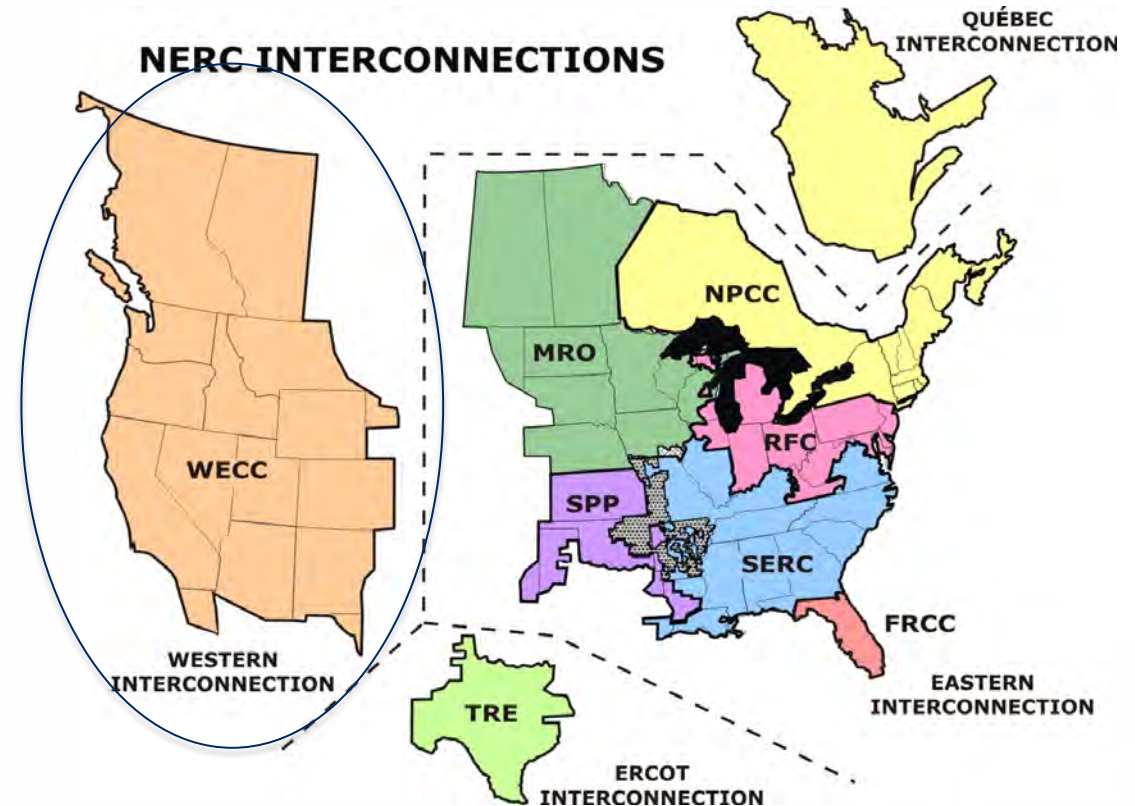

Source: NERC

# Methodology

- 3<sup>rd</sup> party software - Aurora by Energy Exemplar
- Electric market fundamentals - production cost model
- Simulates generation dispatch to meet regional load
- Outputs:
  - Market prices (electric & emission)
  - Regional energy mix
  - Transmission usage
  - Greenhouse gas emissions
  - Power plant margins, generation levels, fuel costs
  - Avista's variable power supply costs

# Wholesale Mid-C Electric Market Price History

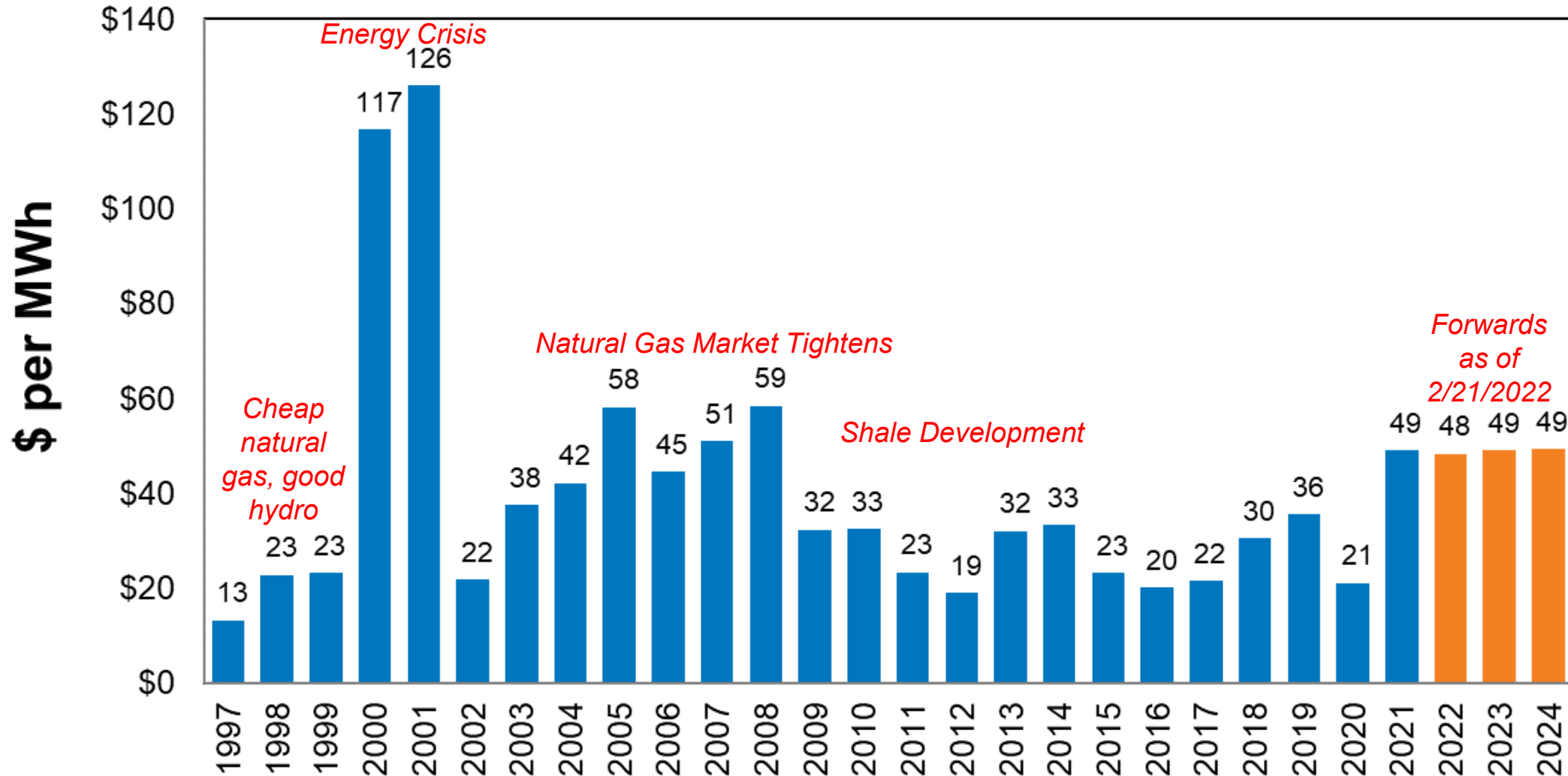

# U.S. Western Interconnect Historical Generation Mix

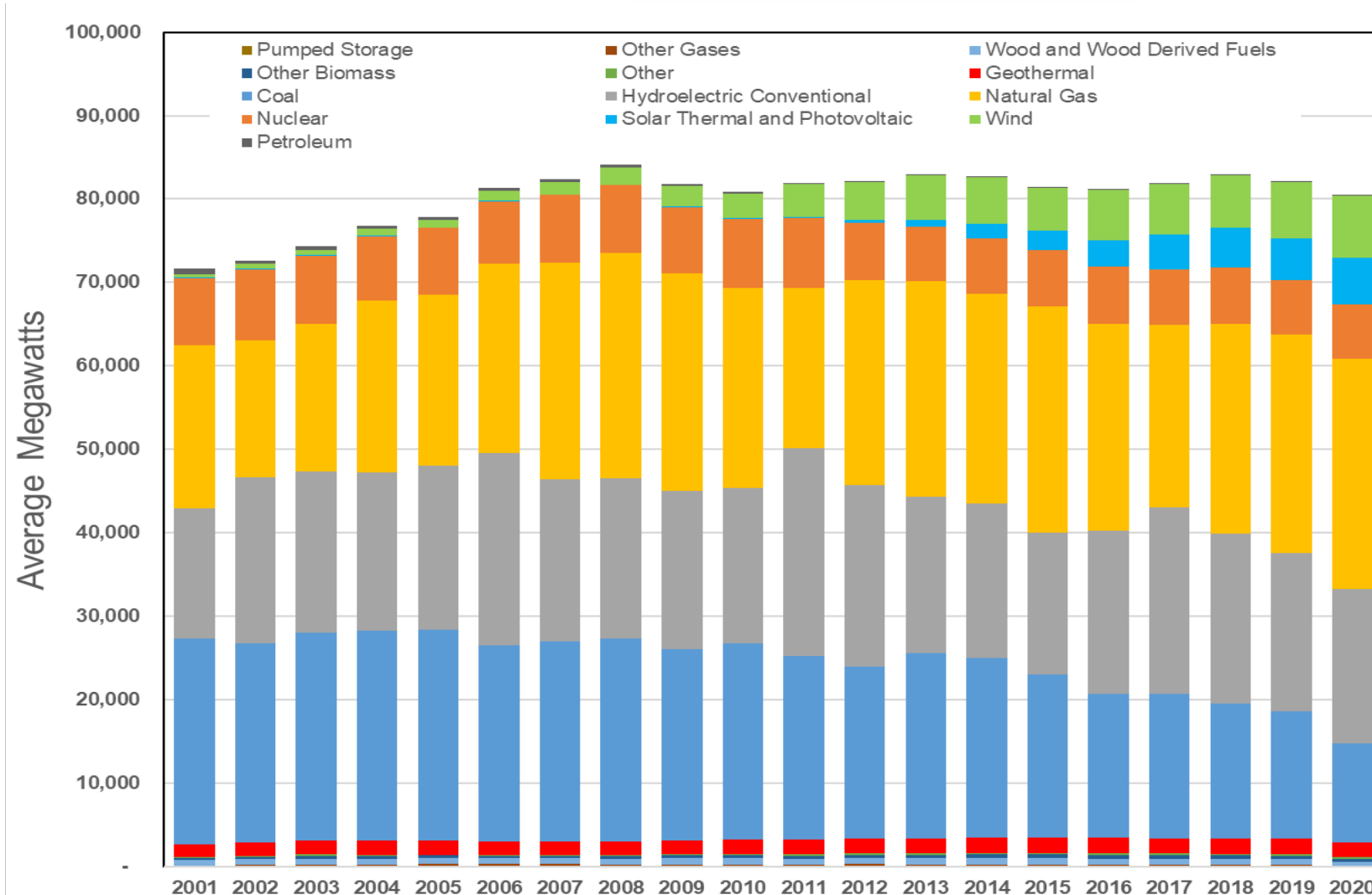

Source: EIA

## Significant changes (aGW)

Solar: + 5.6

Wind: + 7.0

Nat Gas: + 7.9

Coal: - 12.8

Total: + 9.5

Hydro: -4.1 / +5.3

# Northwest Generation Mix (ID, MT, OR and WA)

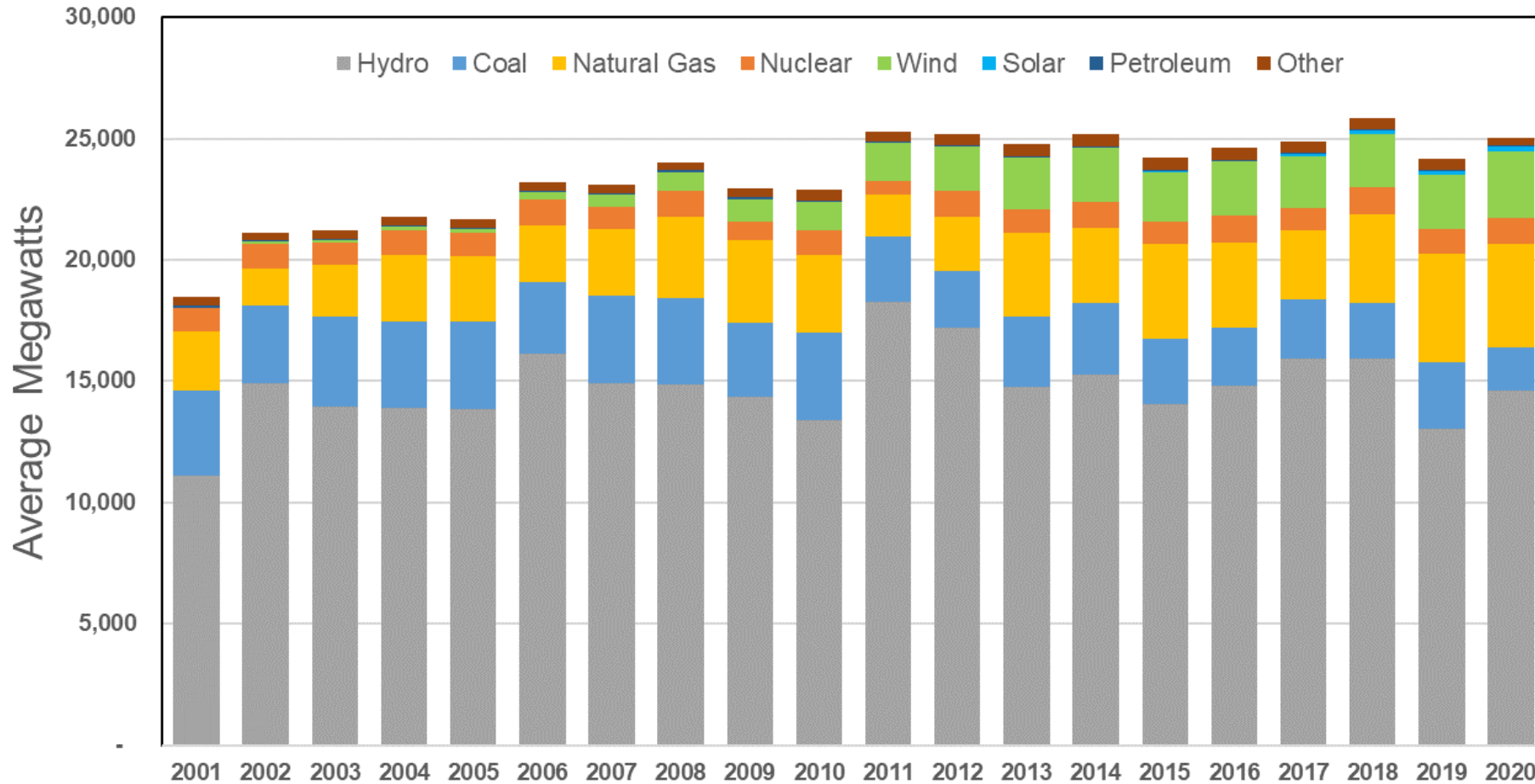

Significant changes (aGW)

Solar: + 0.2

Wind: + 2.7

Nat Gas: + 1.8

Coal: - 1.8

Total: + 6.6

Hydro: -3.5 / +3.7

Source: EIA

# 2020 Fuel Mix

## Northwest

75% GHG Emission Free

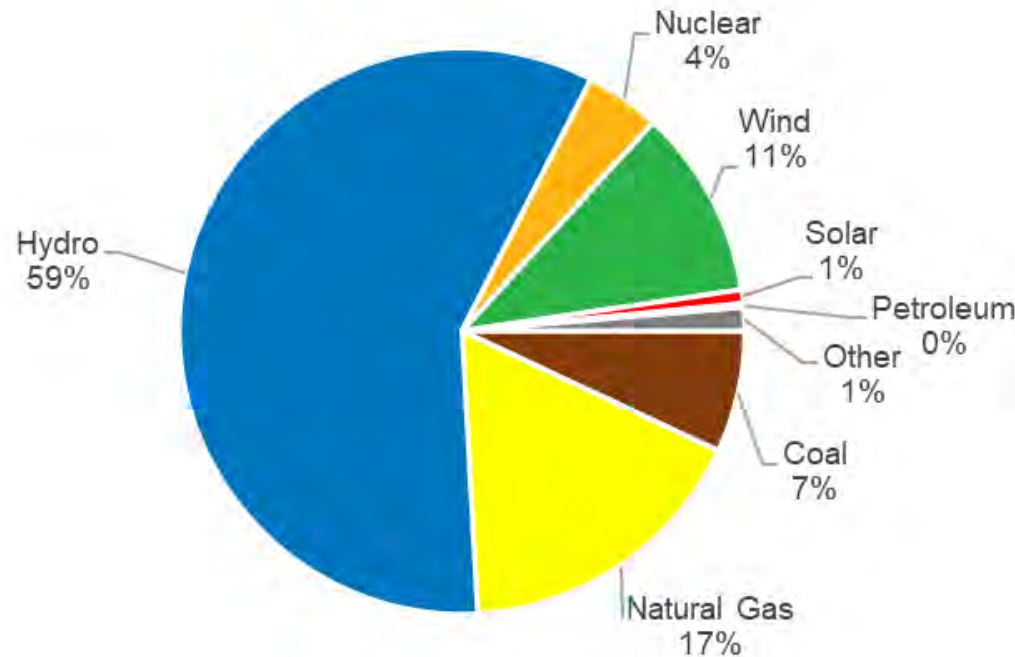

## U.S. Western Interconnect

49% GHG Emission Free

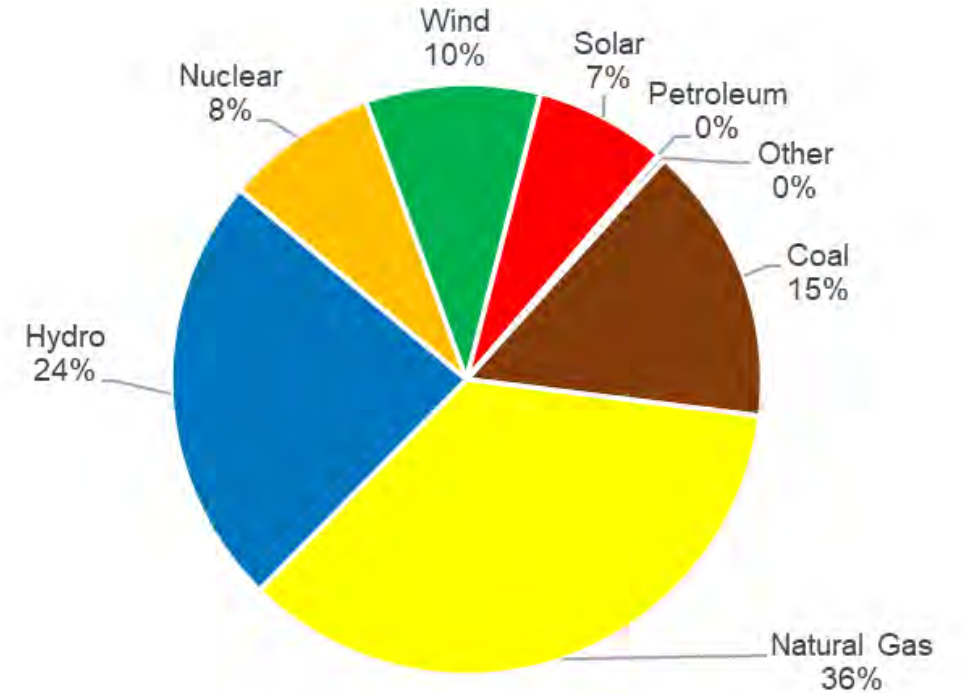

Source: EIA



# Market Indicators- Market is Tightening

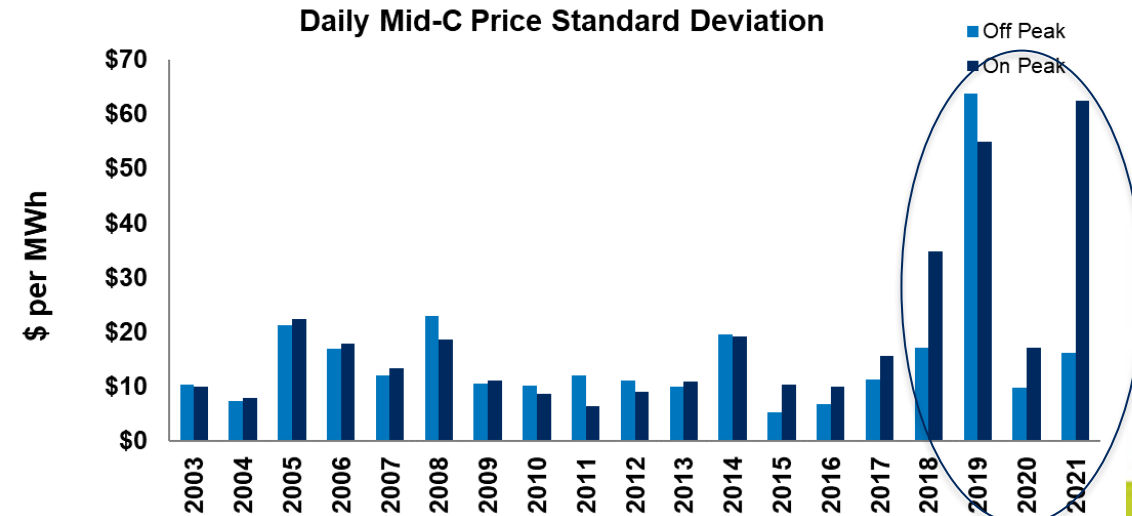
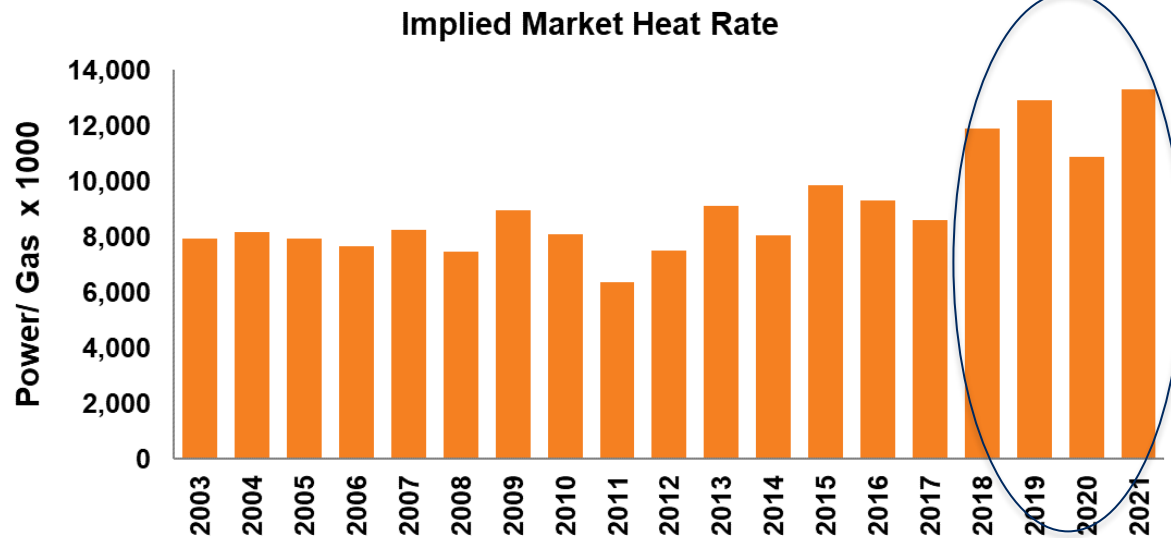
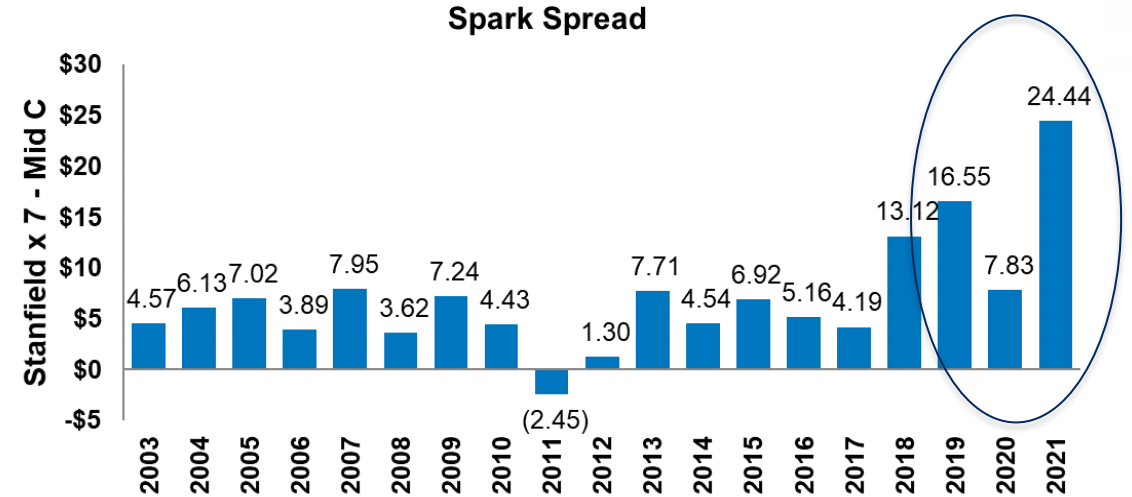
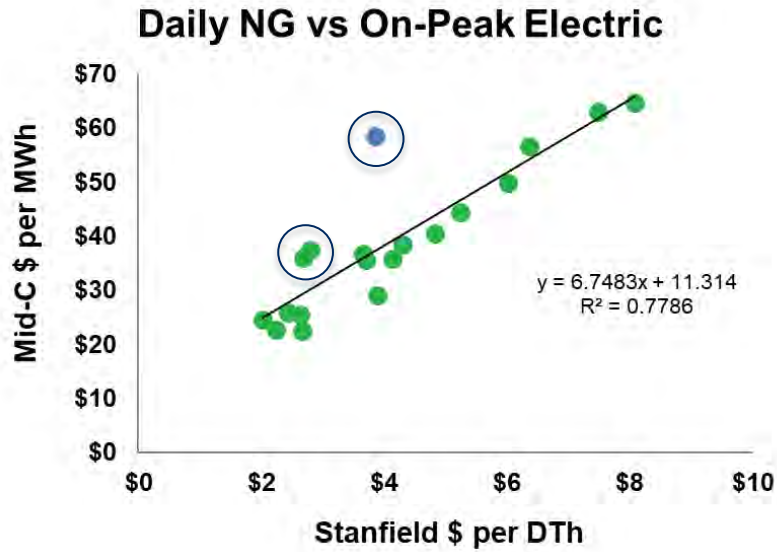

# Monthly Implied Market Heat Rate (2017-2021)

Implied Market Heat Rate

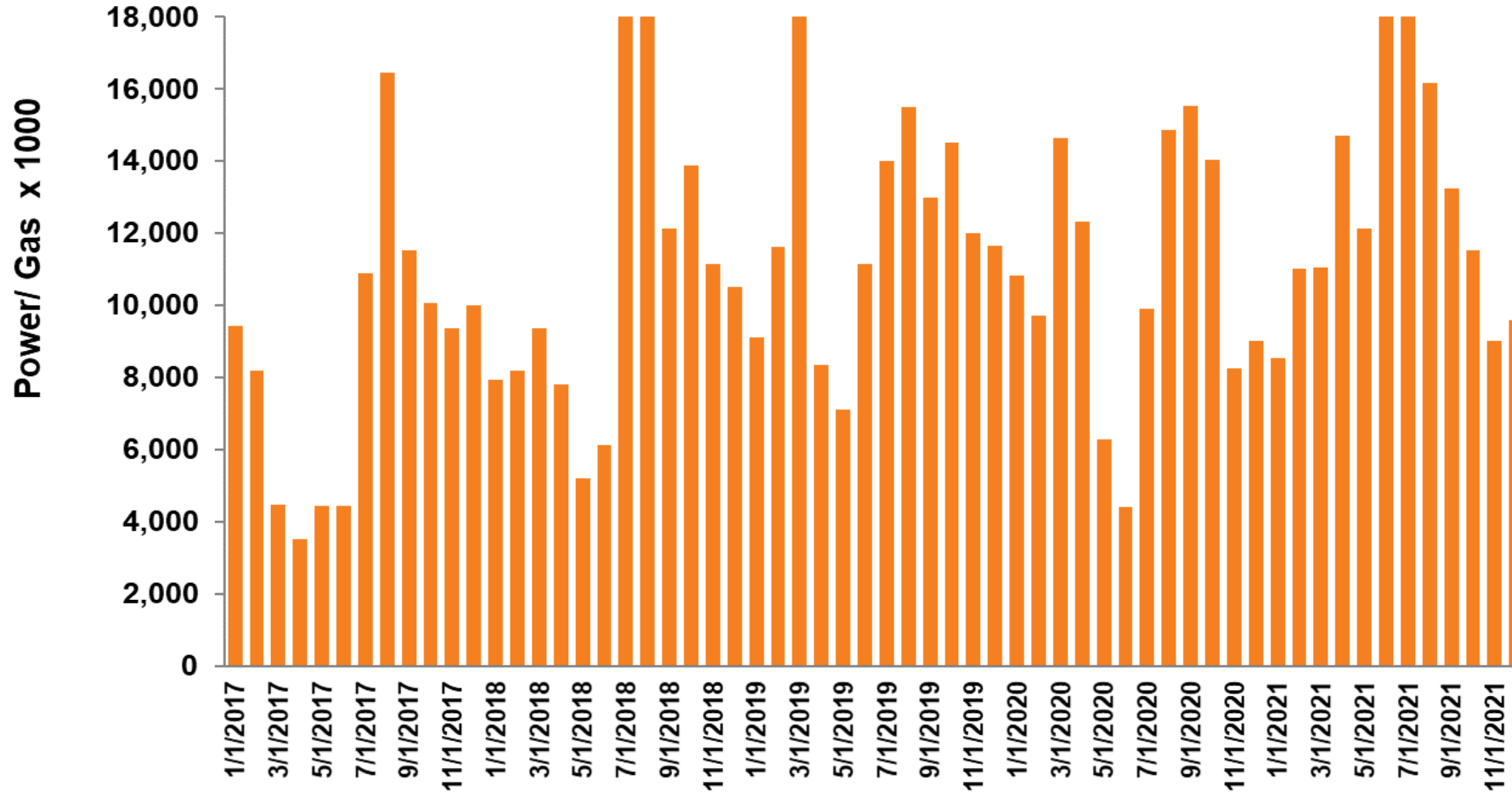

# Electric Greenhouse Gas Emissions U.S. Western Interconnect

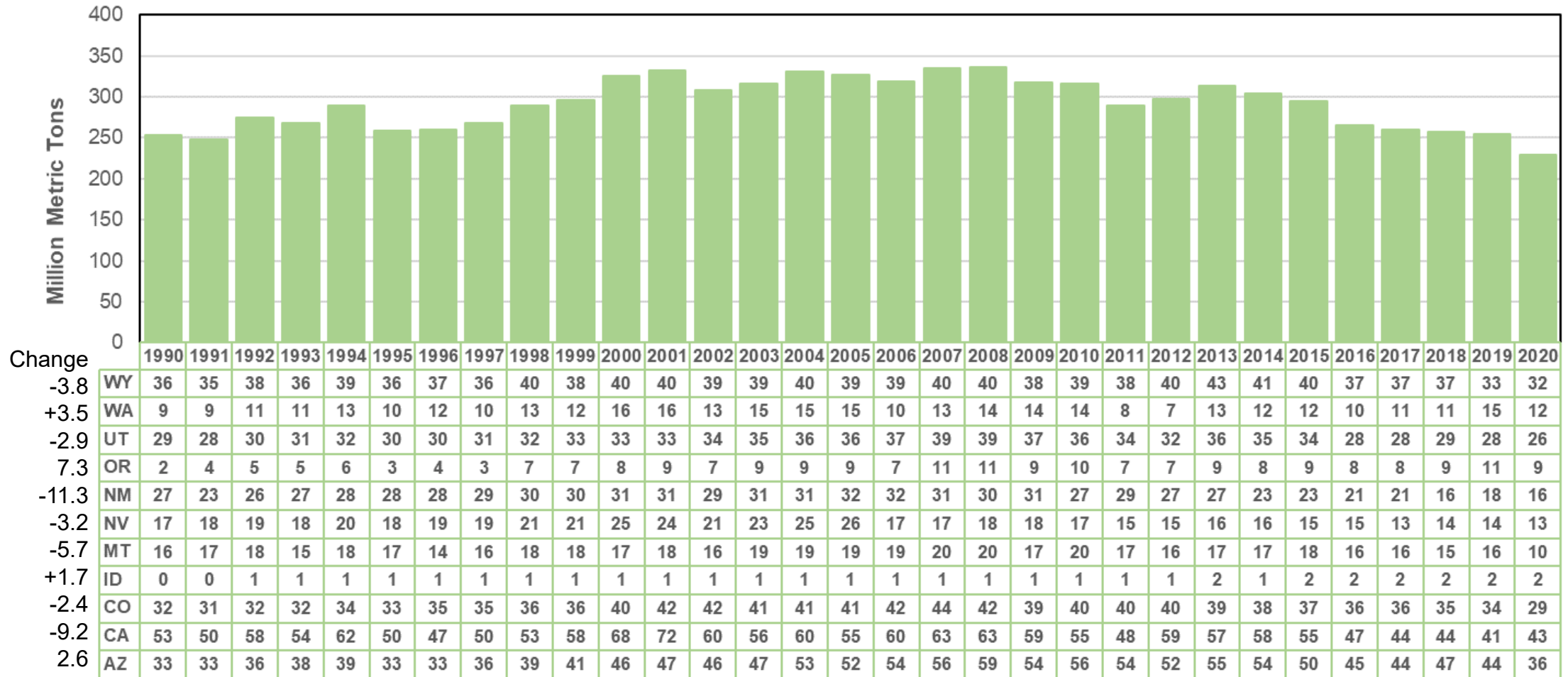

Source: EIA

Emissions are adjusted for generation within the Western Interconnect

2020 estimates are subject to adjustment



# Northwest Greenhouse Gas Emissions

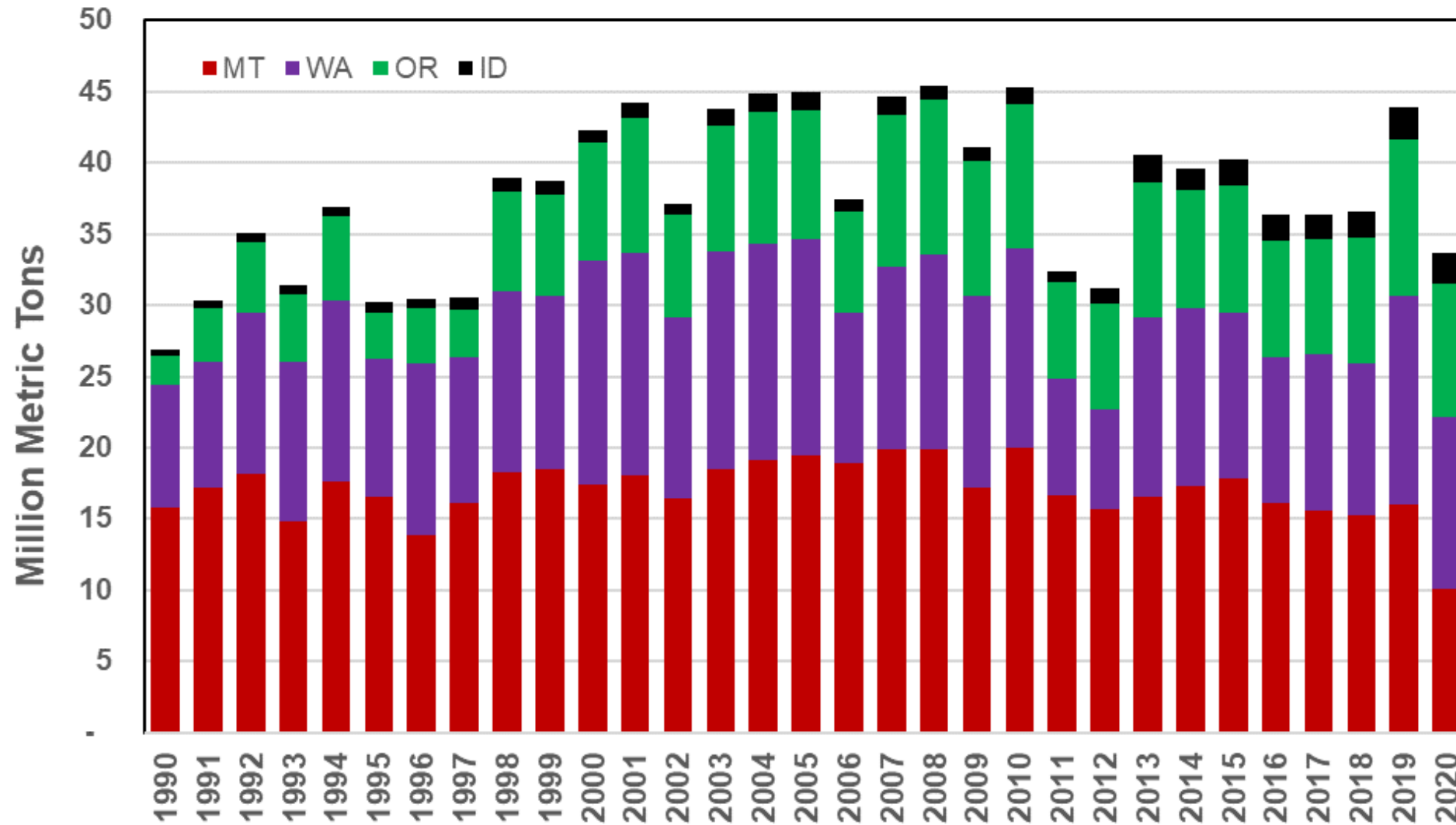

Source: EIA

# Modeling Process



# Load Forecast

- Regional load forecast from IHS
  - Forecast includes energy efficiency
- Add net meter resource forecast
  - Input annually with hourly shape
- Add electric vehicle forecast
  - Input annual with hourly shape
- Future load shape differs from today's load shape

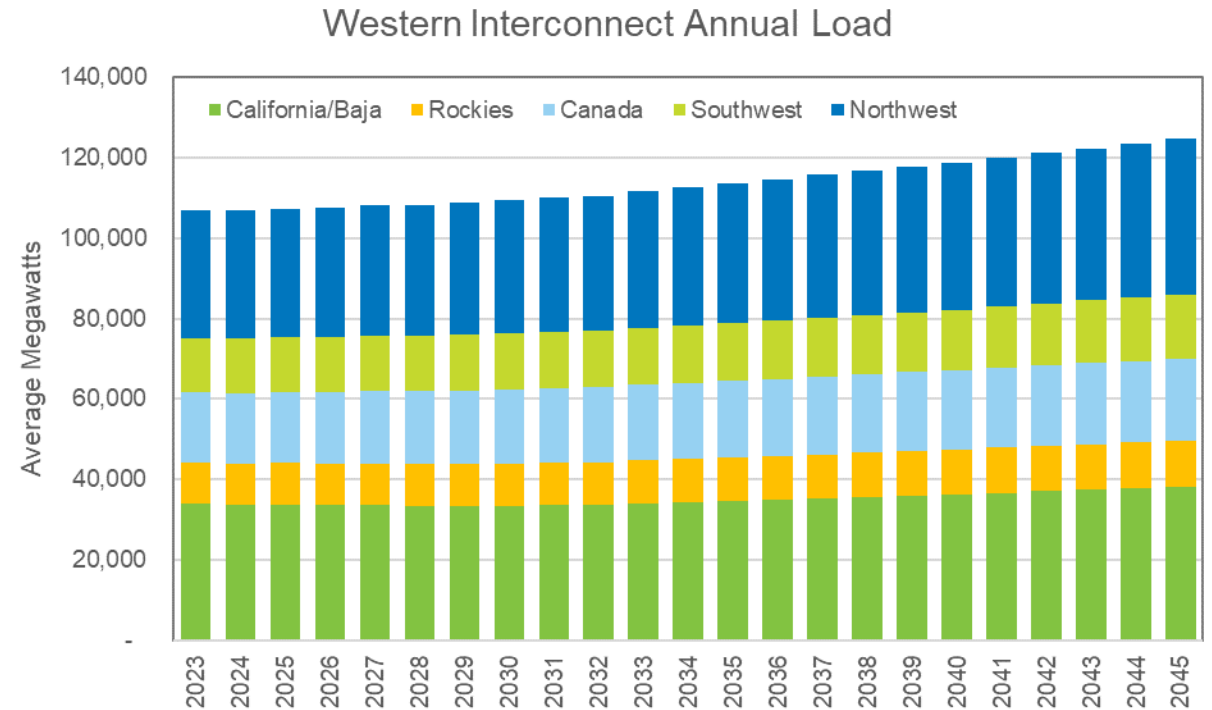

# Electric Vehicle and Solar Adjustments

## Roof Top Solar

- EIA existing estimates for history
- IHS regional growth rates

Western Interconnect Rooftop Solar Capability

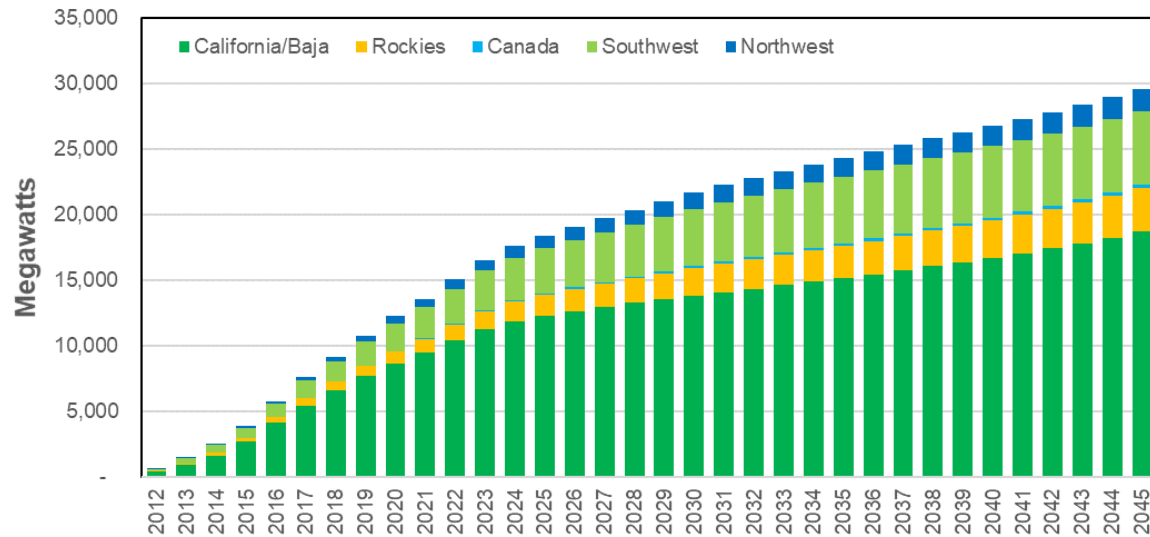

## Electric Vehicles

- Penetration rates increase each year
- 15-65% light duty (2040)
- 12-15% medium duty (2040)
- 5% heavy duty (2040)

Western Interconnect Transportation Electrification

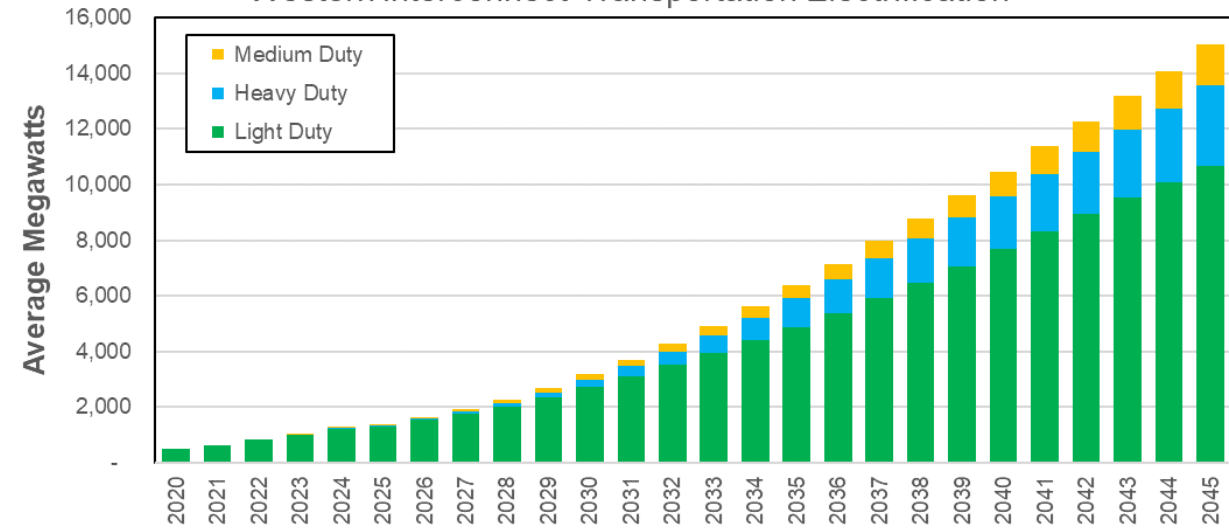

# Northwest GHG Emission Prices

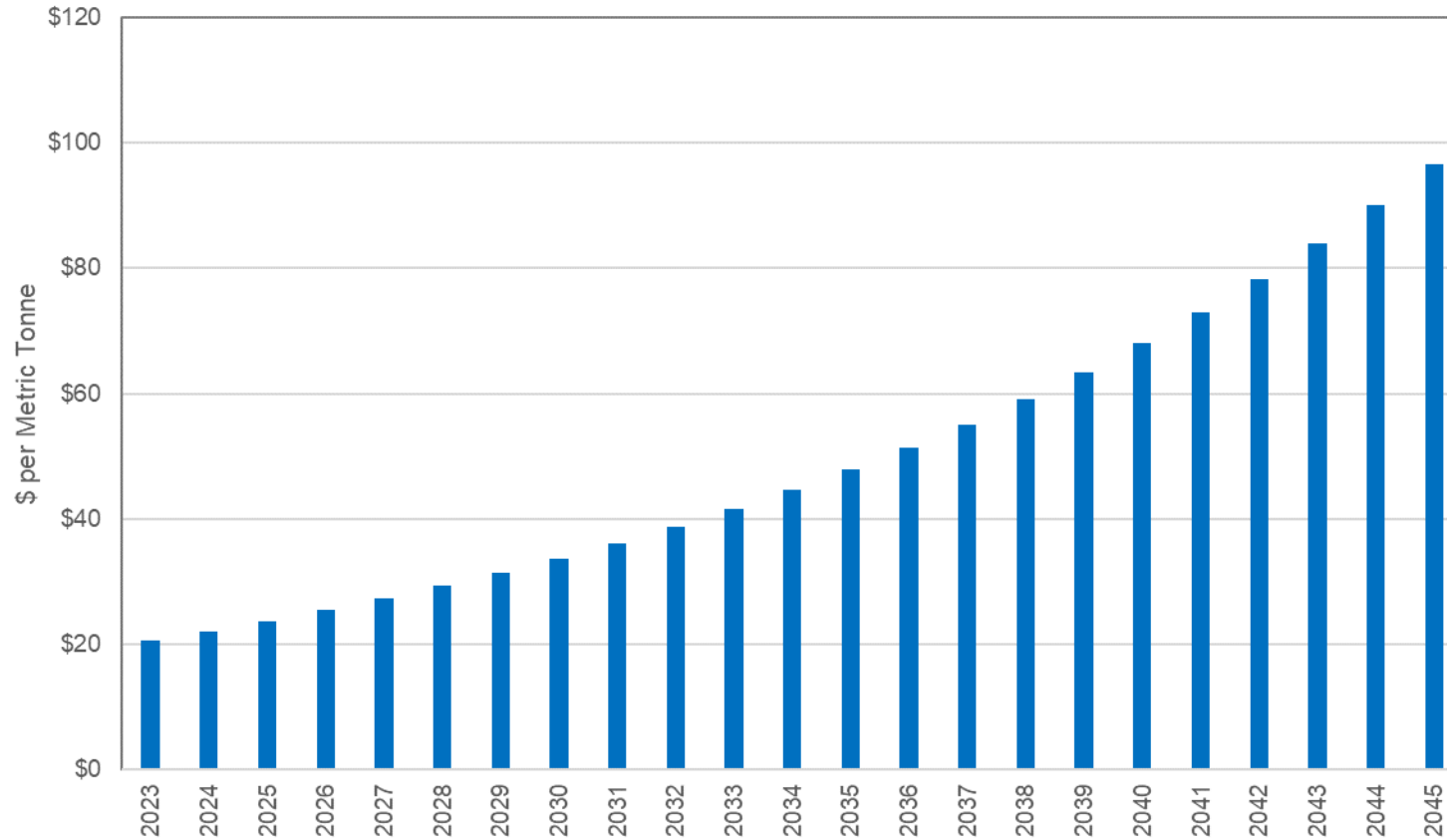

- \$41.47 levelized
- Assumes California Emission Prices for the Northwest from the Revised 2019 IEPR Carbon Price Projections as placeholder for WA Climate Commitment Act and OR Climate Protection Program
- To address imports, exporting region includes a carbon price adder to transfer power



# New Resource Forecast (Western Interconnect)

*Draft Forecast*

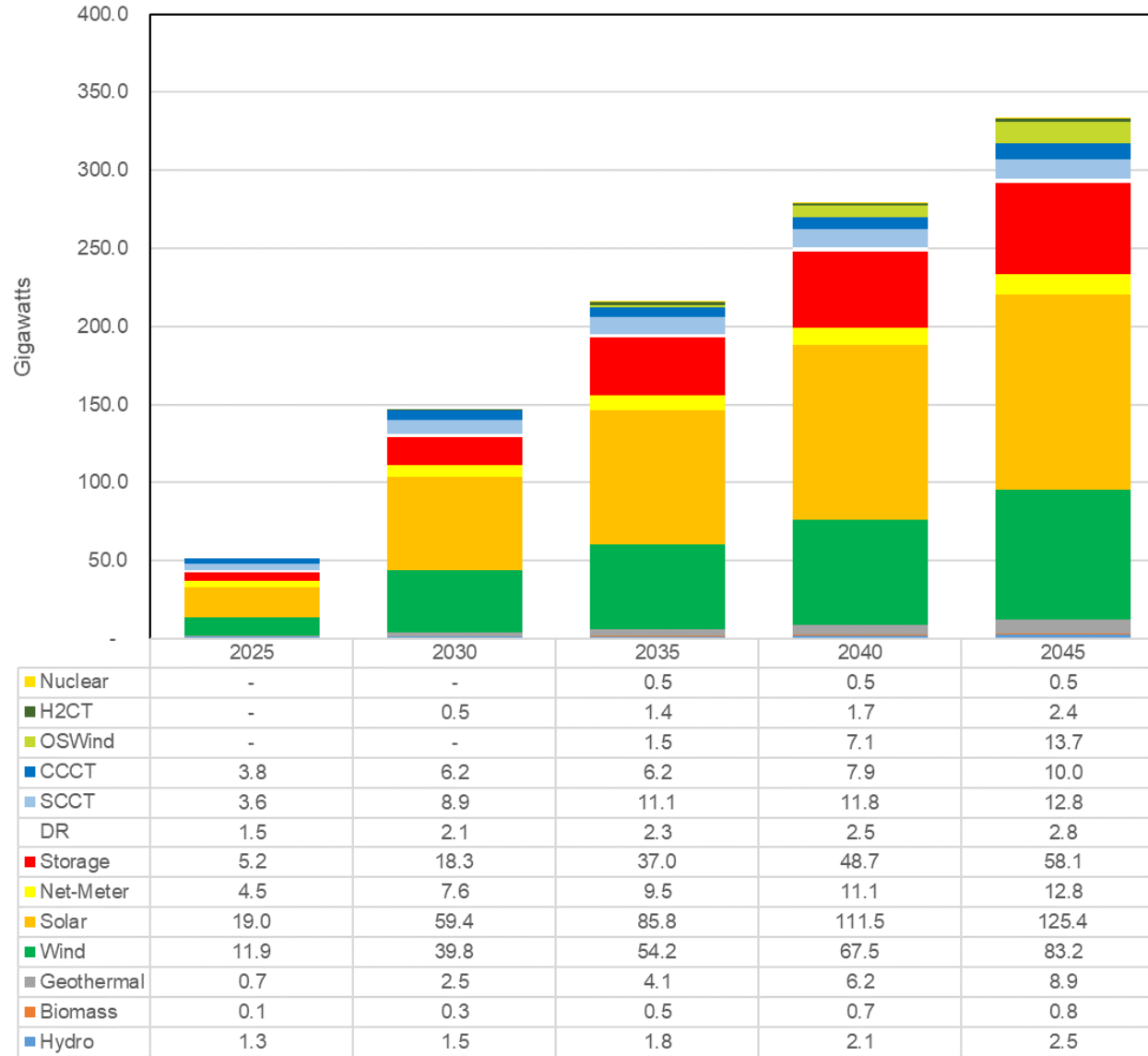

*Draft Forecast*

# U.S. West Resource Type Forecast

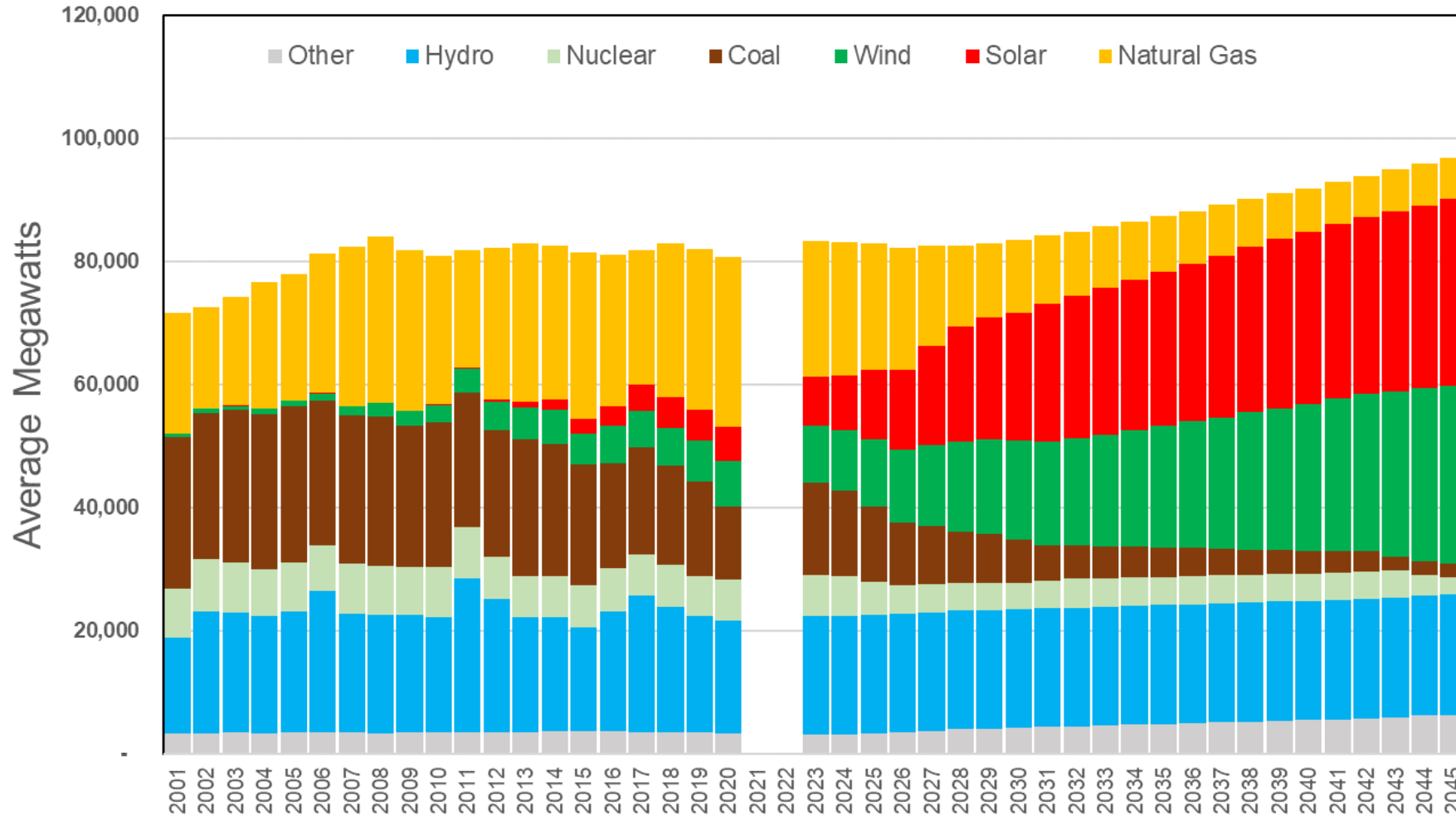

Significant changes  
2045 to 2023 (aGW)

Solar:	+ 22.5
Wind:	+ 20.2
Nat Gas:	- 15.6
Coal:	- 13.4
Nuclear:	- 4.0
Other:	+ 3.3
<b>Total:</b>	<b>+ 13.4</b>



*Draft Forecast*

# Northwest Resource Type Forecast

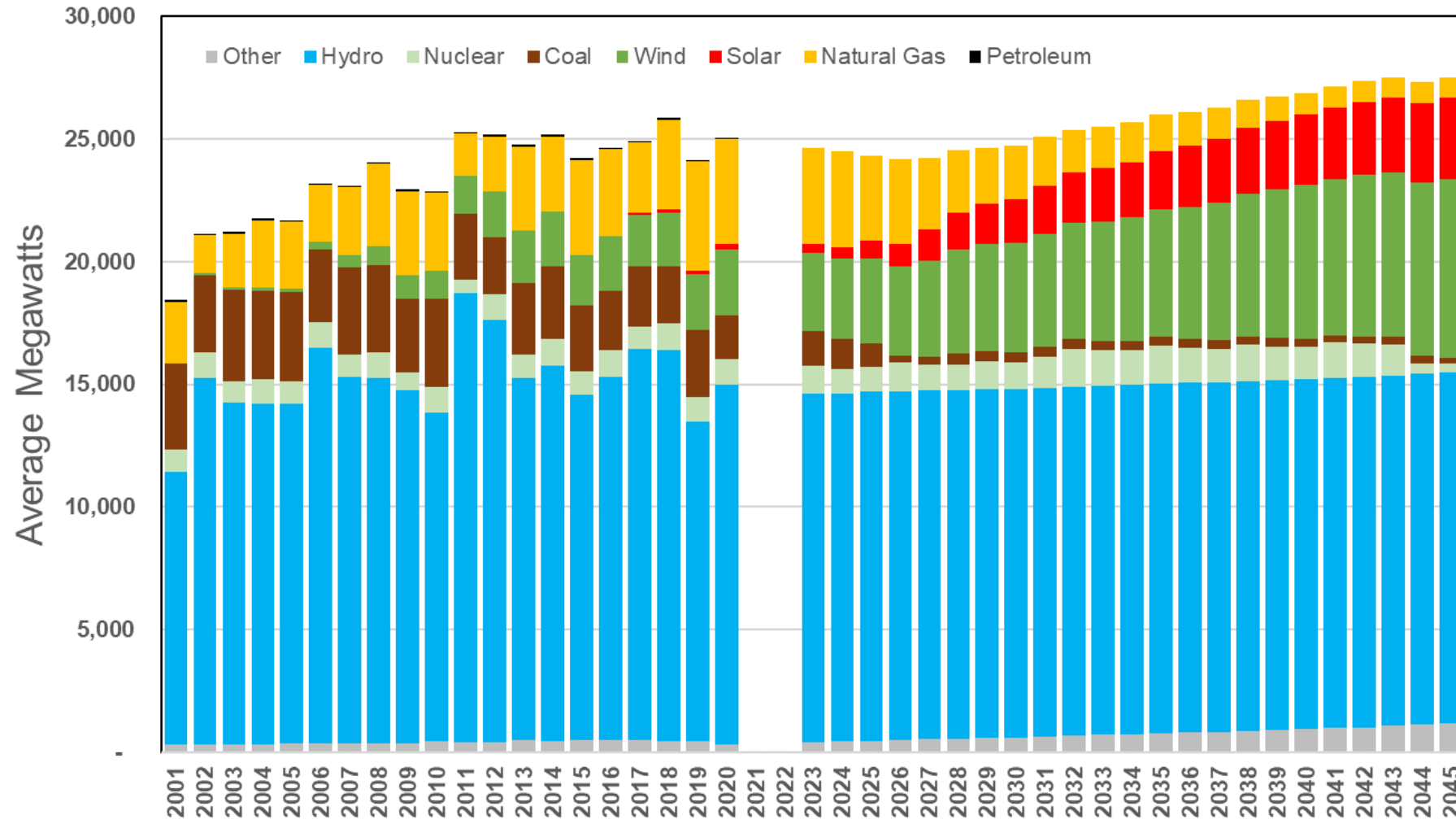

Significant changes (aGW)  
2045 to 2023

Solar: + 2.9  
 Wind: + 4.0  
 Nat Gas: - 3.1  
 Coal: - 1.1  
 Other: + 0.8  
 Nuclear: - 0.8  
 Total: + 2.9



# Greenhouse Gas Forecast U.S. Western Interconnect

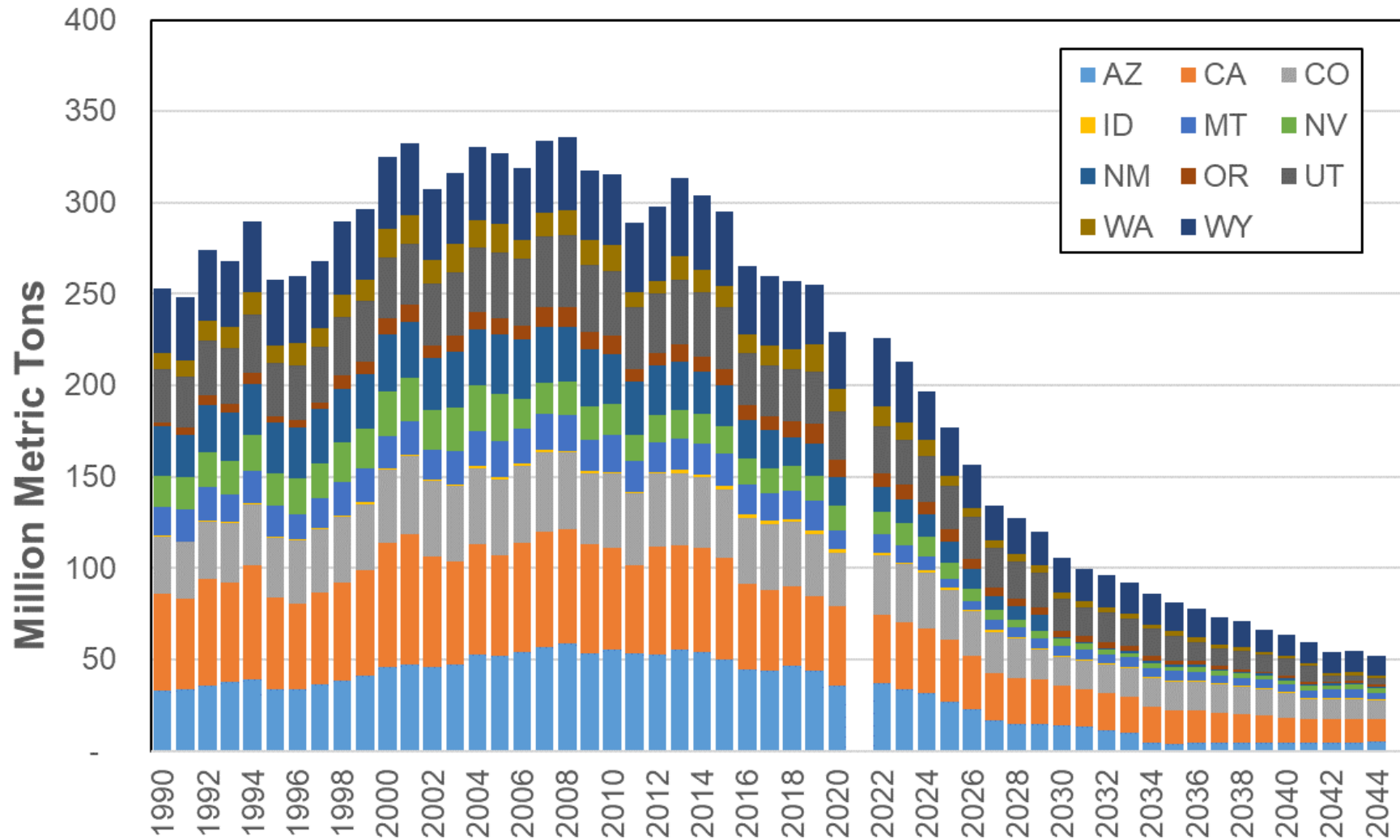

# Greenhouse Gas Forecast Northwest States

*Draft Forecast*

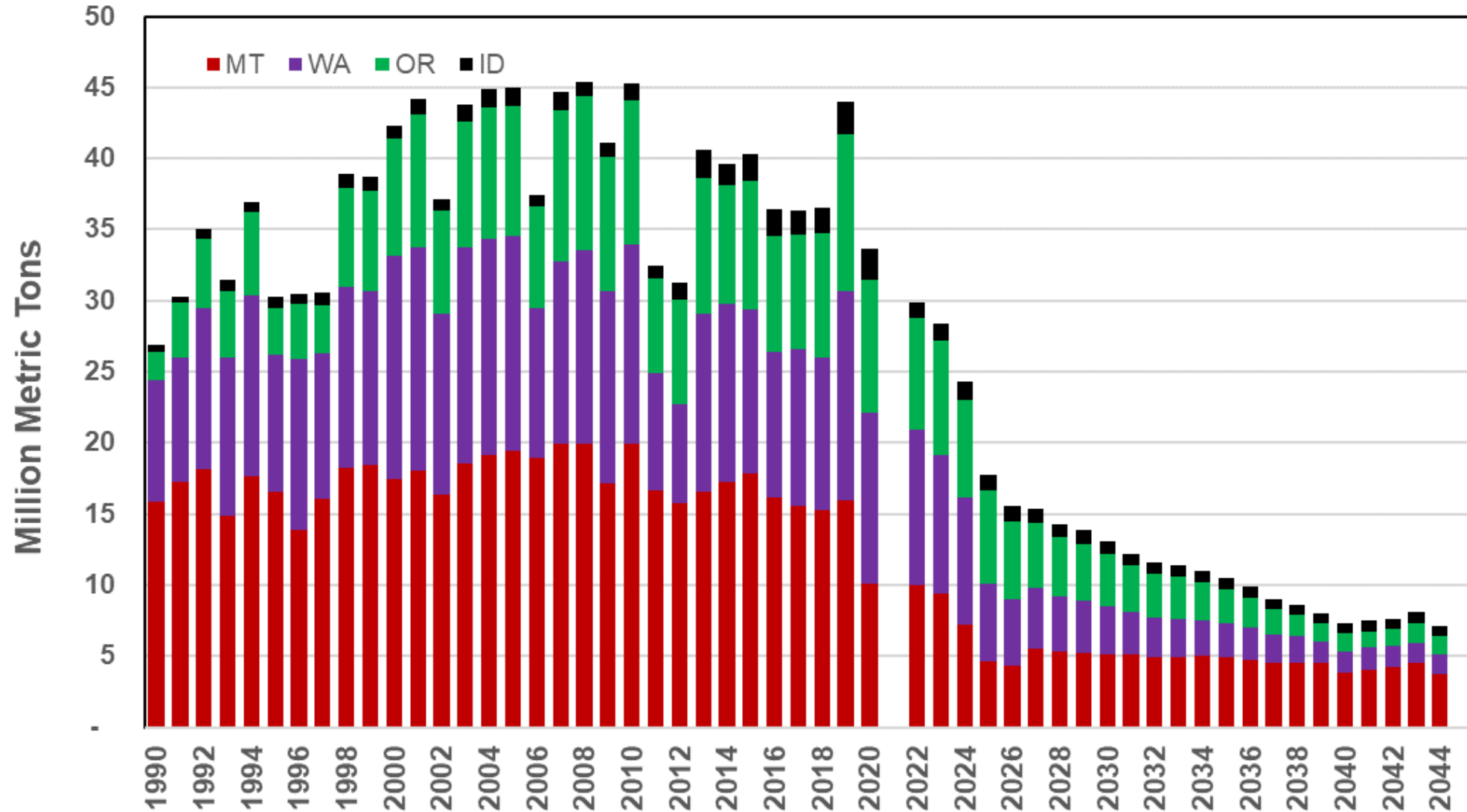

draft

# Mid-C Electric Price Forecast

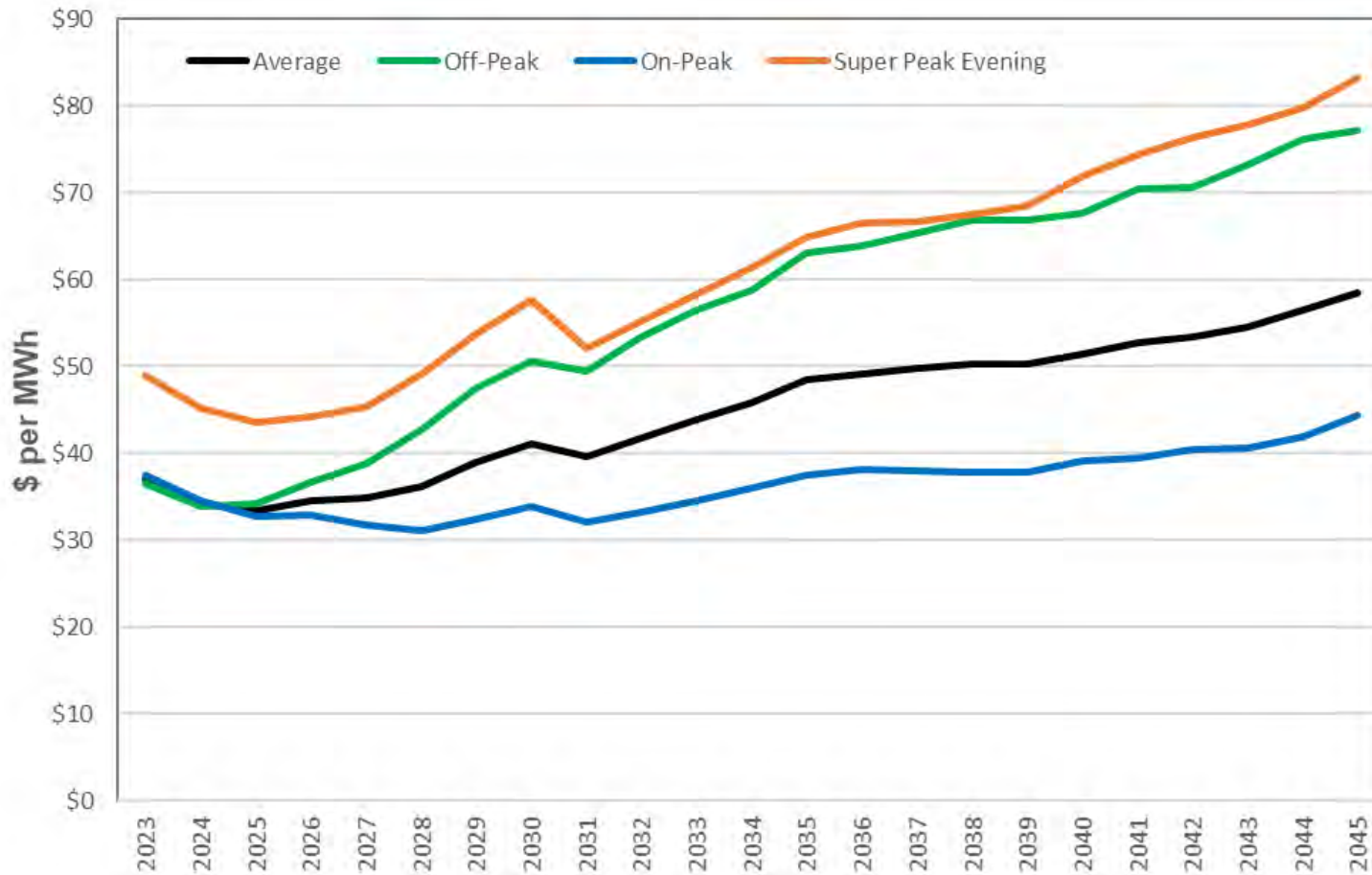

- Levelized Prices:
  - 2023-45: \$41.76/MWh
- Off-peak prices overtake on-peak in 2023 on an annual basis
- Evening peak (4pm-10pm) and off-peak prices remain high

# Hourly Wholesale Mid-C Electric Price Shapes

Winter: Dec 16 - Mar 15

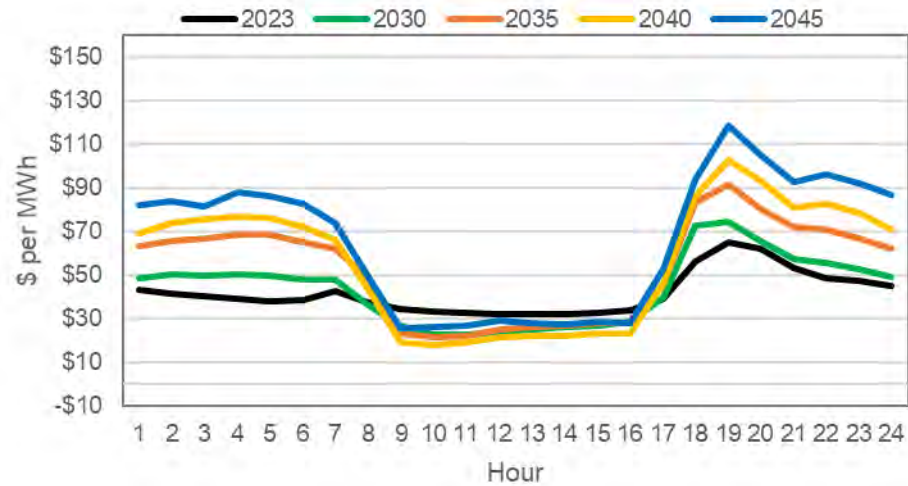

Spring: Mar 16 - Jun 15

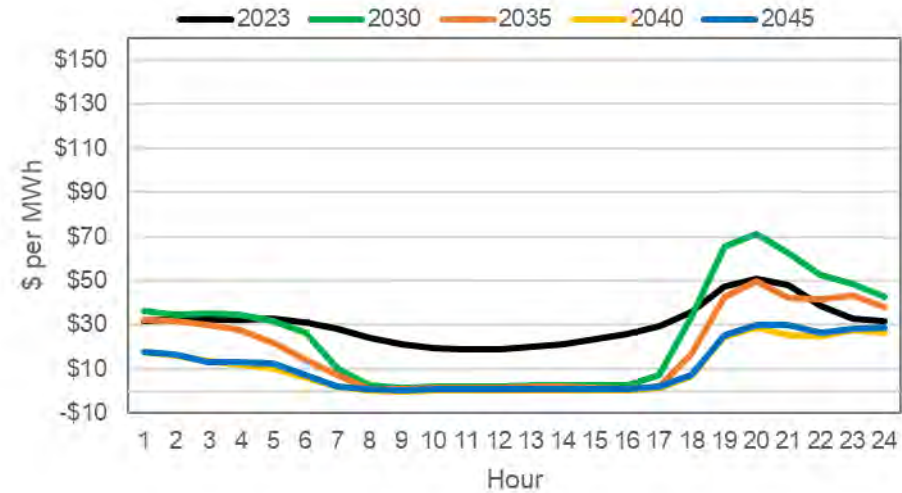

Summer: Jun 16 - Sep 15

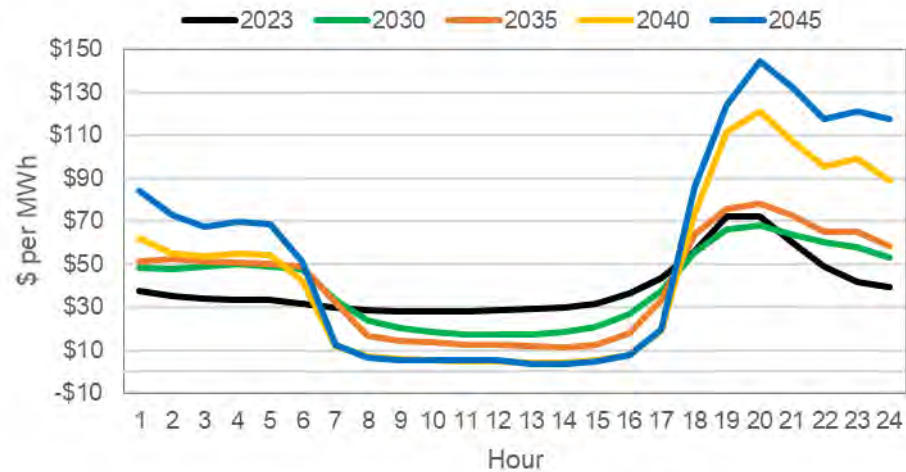

Fall: Sep 16 - Dec 15

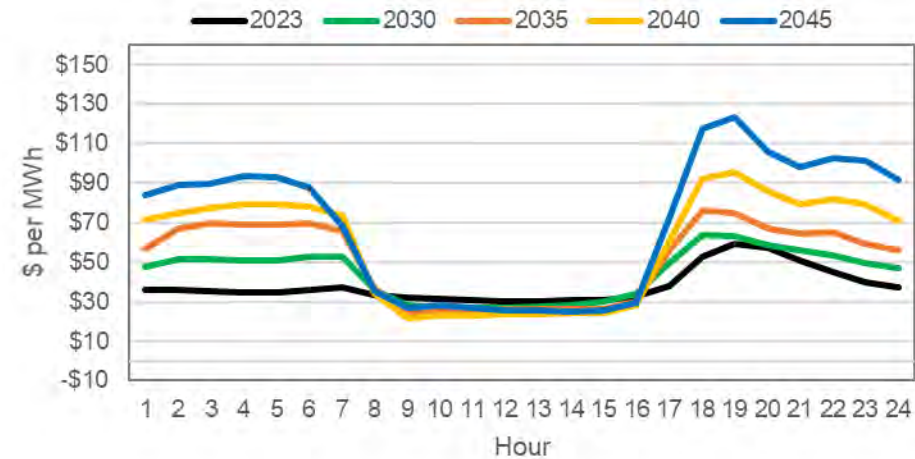

*Draft Forecast*

# Mid-C Electric Price Comparison vs. Previous IRPs

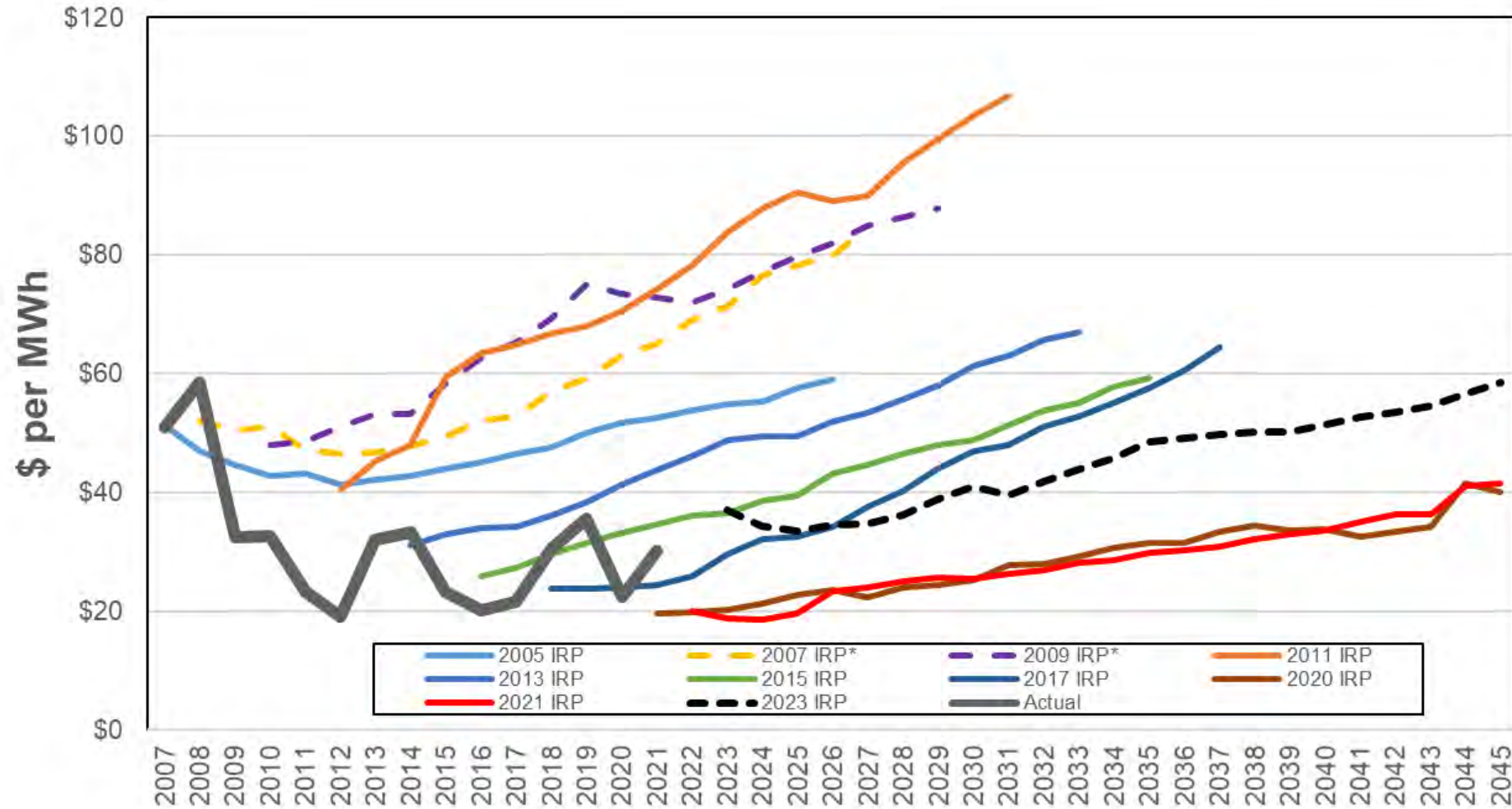

\* These forecasts use price scenarios without GHG "taxes" to make all forecasts consistent



# Next Steps

- Conduct stochastic studies and verify resource adequacy
- Update price forecast this summer for final IRP analysis
  - Update gas prices (including stochastics),
  - Western Resource Adequacy Program (WRAP)
  - New IHS Markit forecast (load forecast and new regional resource forecast), if available
  - WA and OR carbon pricing update, if available

# Data Availability

## Outputs

- Expected Case: annual Mid-C prices by iteration
- Expected Case: hourly Mid-C prices
- Regional resource dispatch
- Regional GHG emissions

## Third Electric Technical Advisory Committee Meeting Notes 3/9/22

### Introduction, John Lyons

**Gall, James:** I think if you can see the screen, I think you're ready to go. I'll just hit the button when you ask me to.

**Lyons, John:** OK, sounds good. Again, welcome to all of you participating in our third Technical Advisory Committee meeting. We're going to start with the introductory slides. I'll go through that quickly and then get to the presentations. You'll notice on the top, we have started the recording and the transcription. If you don't want to be recorded, you would have to sign off, otherwise, we should be good to go. So next slide, James.

**Lyons, John:** Meeting guidelines, we're still working remotely, but are heading back towards the office. Hopefully the next meeting, there's a good chance it would be in person. We will still offer the online version for people that would like to participate that way. This is our stakeholder feedback form. Should say forum not form but where we get to answer questions and take comments, we share all the responses with the TAC members that we get from email and other ways. If people give us a call, those will be showing up in the appendix. We are working on developing a form for comments and updating the website. You will notice, if you've gone out there, we have revamped the website to make it a little more user friendly to get around as we start posting all of the data. We are still on Microsoft Teams and will keep adding Microsoft Teams option even once we get back to in person meetings. The presentations I sent it out this morning, the updated set. We will have the set also posted on the website in the next couple of days. Meeting notes are getting posted and they are the transcriptions. I do have to go in and edit them for clarity, and sometimes it picks up some odd things and twists some words around. So, I do have to edit those, and I get them down to a decent size. We are also posting the recordings. We've got that figured out now. There's links on the website for the IRP and that'll be for both the gas and the electric side. And that goes to our YouTube page because they're so large. Next slide please.

**Lyons, John:** A couple of virtual TAC meeting reminders, I think we're all really good on this, but still good to refresh our memory on that. Please mute your microphones unless you're commenting or asking a question. You can also use the raise hand function or the chat box. Several of us from Avista will be watching the chat box to see if there are questions. If we don't get it to them right away, we're usually waiting for a moment when we can get those slipped in there. But we will get to those. Please respect the pause. It's always a little difficult when you're in an online environment to see what's going on, so we'll give some time for that. Try to state your name before commenting. The transcription is pretty good picking up who it is, but it helps everyone else who's not seeing the transcription live. It is a public advisory meeting, so all the comments and questions are documented and recorded. Next slide.

**Lyons, John:** IRP, for those of you that are new to the process, it's required every two years in Idaho, and it used to be every two years in Washington. Now it's every four years with an update at two years. Essentially, it's another full IRP. It's a 20-year look into the future. We do have some additional years in these earlier ones to get to 2045 to look at the Clean Energy Transformation Act in Washington. And traditionally, we have gone a little over 20 years to get those end effects. We start with the current and projected load and resource position. Figure out what we have, what we need, and then look at the different resource choices available to us, including conservation and demand response. We've been looking at transmission and distribution and we're going to see more integration on that. And the goal is a set of avoided cost, which is going to let developers and new technologies know what the price point is they're having to go up against and we're actually going to be talking about some preliminary costs today. Then we run market and portfolio scenarios for those uncertain future events, big picture issues that if we have a fundamentally different future, alters the trajectory of the plan. Next slide.

**Lyons, John:** So, the Technical Advisory Committee meeting. I'll let people go through this on their own or if they need it as a refresher, but this is the public process. We try to go through all the questions, but once you've made a point, you know this isn't one where we can rehash the same thing over and over again. because, we have quite a bit of data that we're trying to get through, but that hasn't really been too much of a problem in our TAC meetings. Some key dates to remember though: October 1, 2022, that is the due date for study requests from TAC members. If there are some small things after that we can get to, we will try to do that, but that's the date you need to get those in so we have plenty of time to finish them before the IRP is wrapped up. External draft will be released on Saint Patrick's Day of next year and then public comments would be due May 12<sup>th</sup> in 2023. The final IRP would be published on and submitted to both commissions on June 1<sup>st</sup>, 2023, that is later than what we would normally do, but we have an all-source RFP out right now and we want to give time to complete that RFP and have the new resources put in. Next slide, please, James.

**Lyons, John:** Here's our ongoing schedule. Our next meeting would be August of 2022 and you can see the dates for the rest of the meetings through March 2023. We are going to be picking dates on those soon, but that's the months and then the agenda for today. After this introduction, Mike will be talking about our existing resource overview. Then James will be handling the resource requirements. That was the presentation we weren't able to get to last time because we had such a good discussion going on the economic and load forecast. Then a break. Then DNV is the consultant we've hired to do the non-energy impact study. That's the first time we've done this sort of study. So, I think we're going to have some pretty good discussion on that. Then we'll have an hour for lunch, and then we'll conclude with the natural gas and wholesale electric price forecasts and adjourn around two. Any other questions before we get going?

**Kinney, Scott:** Hey, John, this is Scott. Can I just do a quick welcome?

**Lyons, John:** Ah yes, please, Scott.

**Kinney, Scott:** Alright. Thanks John. This is Scott Kinney, Director of Energy Supply at Avista and I see a lot of familiar names on our list and a lot of new ones to me. So welcome to our TAC meeting today. You all play an important part in this process and we welcome the feedback and the information that you can provide us in into the process and you'll see with the agenda today that we're really starting to get into some of the key data and information that will be important for the assumptions that we bring into our modeling that will occur later this year. So again, we thank you for your participation today and look forward to the engagement.

**Lyons, John:** Scott, would you like to say anything about starting live on the EIM?

**Kinney, Scott:** Thanks, John. We did successfully join the Western Energy Imbalance Market last Wednesday at midnight. We've had about a week now of operating experience in the market and we're getting a better feel for how we participate and how and the benefits that the market can bring us. And we can probably share more of that if people are interested in a future meeting after we get a little bit more operating experience under our belt.

### **Existing Resource Overview, Mike Hermanson**

**Lyons, John:** OK, excellent, let's move on. James, if you want to quit sharing and Mike if you want to put your existing resources presentation up. Mike Hermanson is our newest team member here. We did introduce him last time and put him on the spot, so now you'll get to hear him talk a little more. So, if you want to take it away, Mike.

**Hermanson, Mike:** Thanks, John. My name is Mike Hermanson and I'm a power supply analyst here at Avista. I'm going over the existing resources Avista currently utilizes. I've broken them down into four different groups of Avista owned hydro, Avista owned thermal, contracted resources, and customer owned resources.

**Hermanson, Mike:** We have 8 hydroelectric projects on 2 river systems. Spokane and Clark Fork rivers. This map shows the location of those. Five are considered run of river and three have storage reservoirs. Both of the watersheds that supply these projects are snow dominated, so the hydrograph follows the pattern of high flows in the spring and low flows during the late summer and fall. The Spokane River Project includes six projects that start at Post Falls coming out of Lake Coeur d'Alene and ending at Little Falls, which is right at the beginning of the Spokane Indian Reservation.

**Hermanson, Mike:** This chart shows the different attributes, so you'll notice that the total nameplate capacity for the project is 189.2. The nameplate capacity is rating by the manufacturer and under certain conditions, more energy can be produced so the maximum capability is 10 megawatts more at 199.4. Actual output, of course, is dependent on the amount of water in the system and varies year to year. Expected

generation based on the 80-year hydrologic record is 119.5 average megawatts. Currently there is a project at Post Falls that is slated and that will add 3.8 megawatts of incremental winter capacity and four average megawatts of annual energy.

**Hermanson, Mike:** The two Clark Fork projects are significantly larger than the Spokane projects with a combined nameplate capacity of 783.2 megawatts and Max capability of 880.5 megawatts and the expected annual energy is 320 average megawatts. Avista owns 7 thermal resources with three different fuel types, coal, natural gas and biomass. The maximum winter capacity is 864 megawatts. And then the summer capacity is 759 megawatts. The winter capacity is larger because natural gas is more efficient at lower temperatures.

**Hermanson, Mike:** I'm going to kind of go through each one of these. And also you can see here from the map that it's distributed. You know we have one in eastern Montana. Over in Boardman Oregon, Coyote Springs, up northeast Washington Kettle Falls and then three located in the Spokane area: Northeast, Rathdrum and then Boulder Park. Colstrip is a coal generating facility in eastern Montana. It's owned by a group of utilities and Avista owns 15% of units three and four. The Max net capacity is 222 megawatts, that's the 15% share of those two units, but after 2025 energy generated at this facility will not be used to serve Washington customers. Coyote Springs 2 is a natural gas fired combined cycle combustion turbine. Produce 50% more electricity than a single cycle combustion turbine that utilize waste heat from the gas turbine to power a steam turbine. The Max winter capacity of this facility is 317 megawatts and max summer capacity is 286 megawatts. Three facilities that are simple cycle and these are all located in the Spokane area, the largest is Rathdrum at 176 megawatts, winter Max and 126 summer. Boulder Park has six natural gas internal combustion reciprocating engines that generate 24.6 megawatts and then we have Northeast, which is 2 aeroderivative simple cycle combustion turbine units max at 68 megawatts. And in the winter and in the summer 42 megawatts. Northeast is only allowed to operate 100 hours per year based on the air operating permit. The final one of the thermal facilities owned by Avista is the Kettle Falls Generating Station. It utilizes waste wood products from area mills to fuel an open loop steam plant. It's among one of the largest biomass generation plants in North America. The max capacity is 50 megawatts. And there is a 7.5 MW gas combustion turbine at the facility that is also utilized.

**Hermanson, Mike:** In addition to resources owned by Avista, we have long term power purchase agreements for hydro, natural gas, wind and solar. You can see from this table that the agreements have various terms. Some are significant resources such as the Lancaster Gas Plant Agreement ending in October 2026 and then some go all the way out to 2042. We have contracts with three PUDs with projects on the Columbia River. The total capacity of the projects which Avista has a share of ranges from 840 megawatts to 1,254 megawatts. And those are the total capacities of those facilities. Avista has a share of those. This table shows the shares, and the table shows the current contracted share for each project. We have a total on-peak capability of 231

megawatts. And in 2020, this share was 143.9 average megawatts. There's also a line item, the Canadian Entitlement, which is a portion that is returned to Canada per the terms of the Columbia River Treaty for management of storage water and upstream reservoirs and for coordinated flood control and power generation optimization. The mid-Columbia PUD's contracts change over the next 20 years, and this chart shows peak capability that is currently contracted through 2050. It increases up to a peak in 2028 and then decreases going out into the out years. We currently have contracts for three variable energy resources, two wind projects and one solar. The Palouse Wind Project is a 30-year contract signed in 2011. This project has a capability of 105 megawatts. The output is variable based on the wind and in 2021 the output was 41.2 average megawatts. The Rattlesnake Flat Wind Project is a 20-year contract and has a capability as 160.6 megawatts. Though the project is limited by transmission to 244 megawatts. In 2021, output was 48.3 average megawatts. And finally, we have the Adams-Nielsen Solar Facility. The contract was signed in 2017 with the project entering service at the end of 2018. It has the capability of 19.2 megawatts and in 2021 had an output of 4.95 average megawatts.

**Hermanson, Mike:** Avista has a number of contracts under the Public Utility Regulatory Policies Act. The PURPA statute, as it's known, requires electric utilities to purchase power from cogeneration facilities with small power production facility and small power production facilities of 80 megawatts or less. As you can see from this table, there's quite a range and power production from a small 20 kW hydro in Northeast Washington all the way up to a 60 MW wood waste facility in Lewiston. ID. The total capability from these projects is 109 megawatts with an estimated annual energy of 73 average megawatts.

**Hermanson, Mike:** The last resource to cover is customer owned generation. At the end of 2021, there were almost 1,800 customer installed systems. They're primarily rooftop solar but do include some combined wind, combined solar and biogas. The average system is 7.63 kW, so as you can see there was a decreasing trend in system installation that started in 2018, but the renewal of some tax incentives contributed to an increase in 2021. In 2021, we estimated that the customer installed systems provided an estimated 1.21 average megawatts to the system. There's a question about Colstrip. I don't know if someone.

**Gall, James:** This is James. I can answer that one. Doug is asking a question about Colstrip, I'll just read the question. I assume Colstrip will continue to provide power to Avista customers in Idaho, Oregon, etc. How does this work from an accounting perspective? For example, how is Avista stating that none of the energy produced by Colstrip is not directed to Washington? Does Avista have any future plans to relinquish its ownership in Colstrip? First comment on this is Colstrip serves currently Washington and Idaho customers. We do not have any electric service territory in Oregon. The Washington law does not allow us to deliver coal energy into the State of Washington. If the plant is still operating in 2026, we'd still have to work through how the current

Washington share would be treated if the plant is not shut down. I don't know if Scott Kinney, if you want to add an update.

**Kinney, Scott:** Sure, James, you did a pretty good job of covering it and of course our integrated resource planning process will help inform the value or the economics around Colstrip as it pertains to serving Idaho customers 2026 and beyond. So as this analysis continues and we do our modeling, it will determine if there is economic value or not. And then if that is the case, then we will start a process to work with the Commissions in Washington and Idaho to talk about the need to potentially allocate specific resources to states which we have not done in the past. We've always used a system approach with an allocation based on our load that we serve in each state, which is 1/3 Idaho and 2/3 Washington. Again, this process will inform our decision going forward with regards to Colstrip and then we'll evaluate what options are best for our customers.

**Gall, James:** OK. I see Jim. Jim Woodward, your hand is up.

**Woodward, Jim (UTC):** I think Joni Bosh from NVEC maybe beat me to it. I'm happy to go or if she wants to go either way.

**Gall, James:** Why don't you go ahead and ask your question? Then we'll get to Joni's question next.

**Woodward, Jim (UTC):** Sure. I actually have two questions. The first one concerns the Chelan PUD contract, which I think was a few slides back. Just wanted to confirm that this reflects contracts with Chelan through the latest one signed at tail end of December, beginning of this year are those updated numbers on that slide?

**Gall, James:** They should be, yes.

**Woodward, Jim (UTC):** OK. Thanks for confirming. And my second question, probably goes more with slide 17 the customer owned generation. Is your team including in these specifics, community solar? Or is this just private individual customer? Was it Rathdrum a couple slides back there, there were a couple projects that evolved project status? They were originally community solar and now they're serving different purposes. Wonder if you could come in on the community solar side of this?

**Gall, James:** Sure. Avista created one community solar. I don't know if you want to back up one slide where there was the list. The Boulder Park Solar farm in the Spokane Valley is a community solar project that was developed as part of a tax incentive package a few years back. That project was always owned by Avista, but the benefits went to customers who signed up for the program. So that's an investor resource. There's also a project in Rathdrum, Idaho that was used for customers participating in My Clean Energy. Again, that's an Avista owned project that the renewable benefits go to those participating customers. The Adams-Nielsen Solar Facility in Lind, Washington, that is part of the Solar Select project. And in that case the project is owned by a third party that we contract through a PPA to buy the renewable energy on behalf of those customers until that program expires and I think five more years and then it will be an



Avista purchased resource. Other than that, I don't recall that there are any other community solar facilities on our system. So, all of the small solar are our customer owned.

**Woodward, Jim (UTC):** Thanks, James. And just to clarify the Adams-Nielsen project you mentioned, which I think was a couple slides back. At least right now, is that technically classified as community solar? No, I think it's on your next slide up.

**Gall, James:** It is a PPA and is owned by a third party, but the output is intended for specific commercial industrial customers through the Solar Select program. That's a seven-year program.

**Woodward, Jim (UTC):** Thanks for that clarification. Sounds like it has hybrid characteristics. Appreciate that rundown.

**Gall, James:** Yeah, definitely. OK, I'll start to read off questions and Mike, maybe this next one's about Nine Mile if you want to go back to the Spokane River slide. This is Joni's question, and I don't know if you have the answer. I don't necessarily have the answer top of my head with why Nine Mile's maximum capability is greater than its name plate. I don't know if anybody on the call from Avista may have an answer. Hearing silence, so we may have to get back to Joni on that answer. So, go ahead.

**Hermanson, Mike:** Yeah, I don't have an answer.

**Kalich, Clint:** James, I'll take a stab at it. This is Clint Kalich with Avista. The nameplate capacity is based on system conditions at some measured values, so it's some optimal level of head and so forth. You end up with your maximum capability being affected by a lot of other operational situations. For example, and I can't speak specifically to Nine Mile. If you're operating elevation is reduced or if there are changes, this is a very old facility, so we've changed out some of the hardware. Think of the actual turbine that sits in the turbine bay. They don't necessarily change the sticker that goes on the generator, so maybe the turbines themselves connected to the generator don't have the ability to turn that generator at its full capacity. That's my understanding, especially as you retrofit over time. You literally don't change the generator metal plate that has name plate on it and the technology will change and they won't affect or change the name plate sitting on the generator. So that is not the most specific answer, but it gives the general indication of what the delta can be from.

**Gall, James:** Thanks, Clint. Next question from Ben Otto. Do we have an update on the arbitration currently underway among the six Colstrip owners?

**Gall, James:** Scott, I'm going to defer to you if you want to answer that question since I I'm not aware of any updates.

**Kinney, Scott:** I don't have much of an update either. I just know that both the arbitration and the legal challenges are going through their processes and I'm not aware of the current time frames or dates associated with those efforts.

**Gall, James:** Next question from Doug. Has anyone challenged Washington State on legality of banning energy imports of Colstrip on the basis of Interstate Commerce rules? I'm not aware of that. I don't know if anybody else from Avista or otherwise are aware of any legal challenges.

**Joni Bosh (Guest):** This is Joni. The law says the bills of customers cannot have coal in the bill, so it was the same thing Oregon had done a couple years earlier. And so that respects the Interstate Commerce rule part.

**Gall, James:** Thanks Joni. And I think that's all the questions and I'll turn it over to you Mike to finish up.

**Hermanson, Mike:** OK. Thanks. Just to summarize everything, this pie chart shows the mix of generation in 2021 generation was 1,336 average megawatts. And this shows the generation by resource type. The largest percentages from hydro, 31% of Avista owned Hydro and then we have 10% from the mid-Columbia Hydro. Then we have natural gas next at 31% and coal at 13%. And to round that out, this chart shows generation and market purchases in comparison to native loads and net sales transaction as you can see here. The generation that we have exceeds our native load, so we are a net exporter of energy and then we have the net sales transactions and market purchases to balance that out. So that is the summary of all the resources that we currently utilize.

**Gall, James:** Right. Thanks, Mike. I just want to poll the crowd to see if there's any additional questions on Mike's presentation. While you're thinking about that, this is a good overview of our resources because the next presentation is going to compare these resources to the loads we saw forecasted by Grant on the last TAC meeting. You may see some of these resources again today in our discussion on non-energy impacts. If there's any last question? Alright. I'm going to start transitioning to the next slide deck.

**Hermanson, Mike:** OK. Thanks.

**Gall, James:** Mike, if you want to release control. Bear with me one moment. I've got to shift things around between screens. I think I just saw a question pop up. Art is asking of the renewable resources do you see any greater production capacity output? As far as renewables, with that are better production or better capacity factors and the Northwest, might be a little bit of a challenge. Palouse (Wind) is pretty efficient compared to other regional resources but going east to Montana is likely to provide better production than locally. Obviously, there's also hydro options that are better renewable resource options in many cases compared to wind and solar. So hope that helps to answer your question, Art. If you have a follow up, go ahead and ask.

**Art Swannack Whit Co Comm (Guest):** I just was curious if that's what we expect going forward. Whenever you put in wind or solar in our area, you're going to have this low actual generation rate versus what it has for listed capacity.

**Gall, James:** It will definitely be below. Are you never going to have a 100% wind production? I would expect the capacity factors do improve over time with newer facilities as turbine technology gets better. Same with solar. But you know it's a matter of what percentage of the energy its able to capture from the wind that's available. If you had a wind site that blew all the time obviously you would have a higher capacity factor. It's a combination of the wind available and the turbine's capability of capturing that renewable energy. In Montana you're likely to see around 50% capacity factors. The Northwest it's going to be definitely below 40%. Offshore wind has some potential to have higher capacity factors than what we're seeing on the land. And solar you're looking at less than 25% capacity factor when you have tracking solar compared to the DC rating.

### **Load & Resource Balance Update, James Gall**

**Gall, James:** OK, so this next presentation is going to try to outline what our resource need is for this IRP subject to a few changes we're going to talk about in this presentation. First, we've had some major L&R (load and resource) changes since our last IRP. We went through the load forecast change on the last TAC meeting. We've also signed an agreement with an industrial customer for 30 megawatts of demand response. That was all part of the Washington rate case settlement and we signed two contracts since the last IRP with Chelan County PUD. Chelan County PUD has two projects that we purchased from Rocky Reach and Rock Island. And just to give you an indication of the size of those projects, which Mike went through already, about 54 average megawatts is about a 5% share. So currently we have a 5% share going through 2030. We signed an additional 5% share from our previous RFP that starts in 2024 and then goes out ten years and that was included in the IRP update last year. And then at the end of December (2021) we signed an additional contract that starts in 2026 for 5% and then increases to 10% in 2031 as the existing slice we have expires. We have a quite a bit of extra renewable energy since the last IRP but also this resource, while it's renewable, provides a capacity resource to meet our peak demand in both winter and summer.

**Gall, James:** With those changes since the last IRP, this is our resource position. Our first resource shortfall is in August of 2027, 127 megawatts and then also in December or sorry, January 2027, 162 megawatts. We're technically short beginning in November of 2026 when that Lancaster contract expires that Mike had mentioned earlier. With some load growth, we increase those deficits to January shortfall of around 200 megawatts and just under 200 megawatts in August. As you stretch out over time, you may remember in Grant's load forecast, the summer peak load grows faster than winter. We expect a summer deficit by a larger position and the outer time periods starting in 2034 or actually I think it looks like 2033. What this chart tries to show is not only our comparison to loads versus our resources, but we're also trying to take into account what's called a planning reserve margin were using 16% in the winter and 7% in the

summer and this is until the Western Resource Adequacy Program (WRAP) finalizes their requirements to participate in that program. Avista is intending to participate in the program. At this time, we expect that the WRAP will lower our resource need for winter planning purposes and slightly lower our positions for the summer planning positions. In the first TAC meeting, we went through a presentation on how those changes might look for this L&R. But until we have further information, we are going to be still planning for our current methodology until that program's information is more publicly available. I'll pause there if there's any questions.

**Kinney, Scott:** Hey, James, this is Scott. Maybe I'll just add quickly for the schedule of the WRAP. We are currently participating in what's called the non-binding trial this year, 2022, that will help inform and maybe make modifications to the program. And basically we're operating as if we're part of the program, but there's no financial penalties for it and then there will be a FERC filing hopefully in the May time frame of this year and will work through the FERC approval process with the intent to hopefully start a binding program sometime in 2024.

**Gall, James:** Thank you, Scott. Thanks for jumping in. I was meaning to ask you to do that. Alright, so shifting over to energy, so when we.

**Kinney, Scott:** Looks like somebody's hand is raised James.

**Gall, James:** OK. Go ahead.

**Katie Ware:** Hi, this is Katie Whare from Renewable Northwest.? Stop me if you can't hear me.

**Gall, James:** We can hear you.

**Katie Ware:** OK. I think at the previous TAC meeting you mentioned that Avista would be using the methodology for capacity planning that the WRAP has I guess determined to be in the preliminary design at least. And it seems maybe you're taking a shift away from that in this meeting. Do I have that right?

**Gall, James:** No, we are still planning on using the WRAP. At this point in time we don't have enough information to show our position for it. Until we have that information and a go ahead on the WRAP like Scott had mentioned, we want to continue showing what our position is without the WRAP.

**Kinney, Scott:** I'll just add I think our intent is like James said is from the resource capacity contribution methodology and calculation. I think we intend to use the WRAP methodology for that because it's been, I think, fairly well vetted and we've got some agreement in the region to go to that standard. But I guess it's a little too early from a commitment to using the benefit of the program from a resource, future resource need, perspective since we haven't got commitment to move into the full binding program.

**Gall, James:** Thanks Scott. There's another hand up by Mike Louis.

**Mike Louis (IPUC):** Hi, James. My question is related to the previous question. What is the company's current thinking with regard to the reliability target for the company versus the reliability target that WRAP will use? Just to clarify, would the company be using a different planning reserve margin target or another type of reliability target, will it be customized for Avista system or was the company thinking that they would be adopting the same reliability target that the WRAP uses?

**Gall, James:** I think the intention is to use the same reliability target the WRAP proposes for our region and from an historical POV. When the WRAP first started being discussed they didn't have a regional perspective, now they do. That makes us quite a bit more comfortable with some of the estimates we're seeing for the planning margin targets and how resources are counted towards meeting those targets. The next question is Avista comfortable with those targets? And I think when we see the final PRM quantities that are really required, I will need to look at the risk and market exposure we have and take that and probably come back to the TAC to see if it's appropriate to continue with the WRAP's proposal or do we need something greater than the WRAP's targets. I think changes that we're going to make in our energy planning should alleviate some of those concerns and we're going to get to some of that discussion on the next slide. Does that answer your question Mike?

**Mike Louis (IPUC):** My thinking here on this James is that the planning reserve margin is dependent upon the resource mix that you would have within the company system versus what you would have across the region. It seems to me that if you had a loss of load expectation or loss of load hour type of reliability target starting that from that with regards to it being more of a policy question. And then determining what your PRM would be based upon the resource mix within your system. It may be different than what was then the resource mix you would have within the region. And so, the PRM might be different and so I'm looking for some rationale as to why you would want to align those two when you eventually get to answering that question.

**Gall, James:** Alright. Thanks Mike for the perspective.

**Kinney, Scott:** James, can I add just a brief piece to this? Mike, we will definitely evaluate the WRAP versus our internal resources and in our thoughts to, as James indicated, try to reduce risk. But one thing that's important the WRAP program will provide when we get to the full binding program is an operational component we will be able to share amongst the participants on a real time basis if actual loads or operating conditions are significantly different than what was planned or estimated. And so that again will help us be able to leverage diversity across a fairly large footprint. Now that includes utilities all the way down to Arizona to help eliminate or reduce risk on the operational front. That's something else that needs to be factored into the evaluation.

**Mike Louis (IPUC):** I appreciate that. Thank you very much. That's all I've got.

**Gall, James:** Thank you. All right, I think the next question was from Joni Bosh. Do we have a more specific estimate on what the WRAP impact might be in terms of

megawatts needed? We had a preliminary estimate shown in our first TAC meeting. This is a slide from the first TAC meeting that shows the benefit. You can see that January value here. It's a little less than 200 megawatts in this example and then summer is around 50 megawatts of benefit in the outer years. This is a significant benefit, but these are definitely subject to change. We have not seen, at least I have not seen, final PRM requirements yet and final QC values yet for resources. We're expecting to see at least a better benefit in the winter than in the summer. And then I think the next I saw Jim's hand went up next, Jim, ask your question.

**Woodward, Jim (UTC):** Thanks, James. Just given the discussion around WRAP, it sounds like Avista's overall path forward with WRAP seems to be unchanged, but perhaps your team is waiting to make decision points around certain benefits. I just wanted to clarify, there's been discussion around the planning reserve margin when it comes to a specific resource attributes. I think you use QCC. Oftentimes I use ELCC nomenclature. For those capacity contributions, is the path forward there still to ultimately adopt the WRAP values or is that one of the benefit pieces that Avista is withholding judgment on right now?

**Gall, James:** Yeah, it is. As long as we're moving forward with the WRAP, we will be adopting the WRAP's QCC value or else.

**Woodward, Jim (UTC):** OK. Thanks for confirming that.

**Gall, James:** Yeah. Now if it all falls apart, I hope it doesn't, but then we have to go back and reevaluate. Alright, I see a question from Art. Will we see a snapshot of how the WRAP worked before finalizing the IRP? We did a presentation at the first TAC meeting, Scott led that. And there's some slides out there in that TAC meeting, I'd recommend looking at that. Will we do another presentation? We might do that just to give the TAC a little bit more information on the final situation for the WRAP. It's a good suggestion. Mike, your hand went back up. Did you have a follow up question?

**Mike Louis (IPUC):** Just an additional question. What I heard the first time with regards to the ELCC or the capacity contribution, whatever acronym you want to use, was that you were going to adopt the same methodology, but then I just heard that you were going to use the QCC from the WRAP. Which one is it?

**Gall, James:** The WRAP uses the term QCC as qualifying capacity credit. And ELCC is effective load carrying capability, but from a renewable variable resource point of view, I think the intention is those two values are the same. So ELCC would be synonymous with the QCC value. The QCC is the official terminology that the WRAP uses for resource contribution and that's what will be used.

**Mike Louis:** OK, but will you be using the same methodology to develop it, or will you be adopting their values?

**Gall, James:** They provide values based on data that we submit for each resource type. And they will assign us a QCC value for those resources.

**Mike Louis (IPUC):** OK. And will that be specific to your system then? Will that QCC value then be determined specific for your system and the capability of the resources within your system?

**Gall, James:** It's based on our resource's capability to satisfy the regional load. Of the system, not Avista. It's a regional value to meet regional loads because there is this operational sharing agreement like Scott had mentioned. So that in the case we are short you know we can lean on and get power from other utilities that may be long.

**Mike Louis (IPUC):** Thank you for that. Thank you.

**Gall, James:** OK. I think we got all the questions, feel free to ask more. I am a little conscious on time just because we didn't make it through the last TAC meeting, and we do have a guest coming in at 10 to discuss the non-energy impact study. Hopefully we can get through the rest in the next 15 to 20 minutes because I'm guessing there's going to be some controversial discussion towards the end. Mike, your hand just went back up this, do you have another question? Or is that from before? OK. Alright so on the system energy position, what this chart is trying to represent is our position from an energy production capability. This compares your load forecast on average to your expected capability of your resources so that would be for example your average hydro conditions when would be your average wind conditions and natural gas turbine would be how much it could produce in potential outages. We do include a contingency factor to protect our customers against potential for higher loads than average or lower hydro than average.

**Gall, James:** This analysis shows that we are in a short position from an energy perspective. Beginning in 2027. We have larger deficits both in summer and winter. The reason why the annual deficit is significantly less is we have significant surplus in the in the springtime period. The next slide will show how that distribution works. One thing I do want to mention is we are evaluating changing our contingency metric, it's historically been just around hydro and load, but with the additional renewable energy that we've added to our system over the last several years, we would like to include some of those risk metrics as well, especially as we go forward in the event we add additional wind and solar resources.

**Gall, James:** This next chart is taking the same information from the previous chart and looking at this from a monthly level. We have three different forecast for two years shown. We'll start with the blue bars representing 2025. You can see in 2025 we are long in each month by at least around 200 megawatts. You can see the length that was mentioned in Q2 from our hydro runoff, but as resources are planned to exit, this assumes Lancaster exiting in 2026 and as well as Colstrip exiting in 2026, you can see the short positions in the Q1, Q3 and Q4 periods, but in the spring period we still have significant length due to hydro runoff. As we add resources in this next plan, we will be looking to fill resource deficits in these periods where we're short? One thing we're still evaluating and seeking input on is should we be satisfying this full deficit. This deficit

does include a risk factor, or should there be a market component that we're willing to rely on the market for a portion of fulfilling some of that risk in bad hydro or higher loads, so that's something that we're still evaluating. Previous IRPs did not plan resources for this monthly energy level, so this would be a significant change for this plan by planning to this level. The next part of the presentation is going to discuss some of the proposed changes with CETA in Washington. I'm going to stop there. Katie, you have your hand up.

**Katie Ware:** Thanks James. So I hear that you're still considering how the market might be able to mitigate some of the risk that you're showing here. You mentioned on a previous slide, but I'm curious whether you're setting aside a certain amount of transmission capacity for market imports or how you're going about that planning. I may have missed you say that in a previous slide.

**Gall, James:** I didn't mention transmission. This is more about how much generation we want to plan for to handle that contingency risk of poor hydro or wind or higher loads from a transmission perspective. We have access to a significant amount of capacity through BPA to the Mid-C or other parties. It's something that our group not necessarily has spent a lot of time on in the IRP process concerned with access to market. At least in capacity constrained periods. Hopefully that helps.

**Katie Ware:** Yep, thank you.

**Gall, James:** Alright, so the next part of the presentation is looking at the Washington CETA plan, proposed planning requirements and their latest draft rules. And I thought it was important to bring this to the TAC before the rules are finalized to get some general understanding of how we think the rules may impact us. Any questions brought up for discussion could be helpful as we work with the WUTC to finalize these rules. I'll walk through what we're trying to analyze, and I have some tables and charts that show what our positions look like. Our understanding of the new requirements for meeting CETA and what this has to do with is how we show that we are compliant with the 80% 2030 carbon neutral target and then the 2045 target. In the current draft rules, there is a planning requirement which we're going to be talking about today. It's designed so that we design our system to deliver renewable energy to load. There's also an operating requirement that is really concentrated on the creation of renewable energy and retaining non-power attributes. That's not something we're going to be talking about today. We're going to be focused on the planning side of this and how we would plan our system to be capable of delivering renewables to load.

**Gall, James:** There's two compliance mechanisms that we have to watch out for in this planning requirement. The first is we need to have renewable generation equal to or greater than 80% of our retail load as our primary compliance in 2030. I'll go through an example of what primary compliance is. The remaining amount of our retail load needs to be met through an offset using alternative compliance. Alternative compliance, at this moment, could be all unbundled RECs, an energy transformation project or a



compliance payment. There's not a lot of information out there yet on energy transformation projects. Compliance payment is likely a last resort option, so most alternative compliance will be met through an unbundled REC or a primary compliance renewable. Right now, in the draft rule, there is discussion of a planning standard time step that's not discussed. It's something that I think still needs to be addressed in the rule. What I mean by this is should we be planning to meet load on hourly basis, should it be a monthly basis maybe it's a monthly on/off peak basis.

**Gall, James:** But we still need to get a full description of that in the in the rule. Now we're going to be talking about monthly in this example. Risk level is another concern. Do we plan for average conditions? Do we plan for something less than average conditions? The CETA rule has a four-year requirement that we would plan to have renewables over a four-year period. That takes some of the planning risk off the table or at least minimizes it, but we still need to understand the risk level intended by the Commission.

**Gall, James:** I'm going to show some tables in the next couple slides and this slide outlines some of the assumptions I made in this table's creation. What we're assuming here is monthly retail load versus generation. We're not talking about hourly yet or even on/off peak by month for illustrative purposes. And what we're assuming here is any renewable generation that exceeds the monthly retail load is going to qualify as alternative compliance. Like I mentioned before, we could look at this from an on/off peak perspective. For this expected case methodology, we're assuming this is median hydro, which is actually called out in the CETA law. It uses expected loads and then historical average wind and solar.

**Gall, James:** One of the major issues, at least for Avista, is how do we allocate resources between states. We're using what's called the PT ratio. It's how we allocate cost for resources and other company expenses between states and that's 65.5% to Washington and the remaining to Idaho. Our existing hydro will be using that ratio for wind, but we assume that Washington could purchase the hourly generation of the wind production from Idaho for a fee. For solar, our current solar facility we mentioned earlier, the Adams-Nielsen Solar project is already allocated to 100% to Washington. And for Kettle Falls, it's similar to our wind in that we assume it's allocated 65% Washington, then a purchase from the remaining share from Idaho. Keep in mind, at that facility only 95% of the generation qualifies too. There's a little bit of gas required for startups and potentially some old growth wood from Canada. Lastly the assumption for the new Chelan contracts, we're following the same methodology we proposed in our previous IRP and CEIP that it would be allocated using the PT ratio plus the potential for a Washington purchase from Idaho. Joni, your hand is up. Go ahead and ask your question.

**Joni Bosh (Guest):** Thanks. I'm kind of puzzled by the second point where it says renewable generation exceeding monthly retail load qualifies as alternative compliance. Are you saying that renewable generation, you're just talking about the RECs because

alternative compliance is pretty closely defined in statute? Are you talking about the energy itself and is it within that month?

**Gall, James:** Yep. If we had a monthly planning standard, anytime your renewable energy is exceeding your retail load, it would not be serving customers. It would be theoretically sold off system. We from a planning position would not be able to count that excess generation towards primary compliance. That is our understanding now from an operational point of view. If we retained those RECs that would still qualify, but from a planning point of view, our understanding, and this is a good reason why we're having this discussion, is we would not be able to rely on that resource for primary compliance. And maybe it's best to show this in the next table. So, if I don't quite answer your question or there's still some misunderstanding of what we think is how all this works, please come back and bring that up.

**Joni Bosh (Guest):** Sure.

**Gall, James:** OK, this table is 2030. This is a forecast we have each month and on the left we have our sales forecast and average megawatts. And we get to reduce that sales forecast by our PURPA generation from in state Washington and that calculates what is called net retail load. That net retail load is what we're targeting to be 100%, where 80% would need to be met by primary compliance resources. The next block where we have Washington share, the PT ratio share of hydro, wind, solar and biomass. Then we have added to that energy we could exchange with Idaho that we described. That's the wind, biomass and Chelan PUD contracts and that total generation is on the bottom, on average, is 577 megawatts of renewable generation that we could allocate to Washington on a monthly basis. What we can show is on that primary compliance column that shows any time that the renewable generation is less than retail load, it would count towards primary compliance. When the renewable generation exceeds native net load, then that would count towards alternative compliance. We have done that. Right there is the amount of generation that is meeting load and the amount that is exceeding load that would count towards alternative compliance from a planning perspective. In 2030, if all things go as average conditions as planned, we are just under 80% primary compliance and then just over 9% from an alternative compliance. To meet the 2030 law, we would need to add 10% of our retail load for alternative compliance and a little bit more for a primary compliance. So I want to go back to that. Joni, is this making sense of how you envision this planning requirement or do you have any other questions?

**Joni Bosh (Guest):** I will have questions. I wasn't sure about this chart when I was looking at it yesterday, so that you're talking about over the year you're looking at rather than monthly like on the previous slide.

**Gall, James:** Yeah, you look at each month to decide whether or not the resource would count towards primary or alternative. But we're still shooting for 80% renewable

over the year. Actually, it's really over a four-year period. So, for the four-year period, it had to be 80%. I didn't want to show all four years on the chart, so I left it at one year.

**Joni Bosh (Guest):** Right.

**Gall, James:** If we add the next year and 2031 was 81% and then 81 or 80, we hit 80% and would be compliant over that four-year period.

**Joni Bosh (Guest):** This looks like if, and I'm sort of guessing here, that the hydro, the access to hydro that you have in the spring pretty much gets you to the 80%.

**Gall, James:** Yeah. So that access to hydro in Q2 since you're limited at 100%, so you're taking the amounts between theoretically 80 and 100 for those months and that can help you offset your shortfalls in the other months.

**Joni Bosh (Guest):** Right.

**Gall, James:** It gets you to that 80%, but we're not counting all the generation that's in excess of load doesn't count, but up to the 100% it would count.

**Joni Bosh (Guest):** And then the excess you're treating as RECs rather than as energy that would be applied to the 20%?

**Gall, James:** Right.

**Joni Bosh (Guest):** And so, the average line at the bottom? Is that just something you'd multiply by 12? Is that how you're treating that?

**Gall, James:** Oh, that is just if you take the amounts each month and multiplied by how many hours in each month, then divide all of those by 8760. That's the average over the course of the year.

**Joni Bosh (Guest):** Right. OK.

**Gall, James:** You would do this on a MW hour basis in reality. The problem with just showing MW hours it's harder to relate for a lot of us.

**Joni Bosh (Guest):** Uh-huh. And these are all average MW hours on this.

**Gall, James:** Yeah, average megawatts, yes.

**Joni Bosh (Guest):** Average megawatts. OK, thank you.

**Gall, James:** Yep.

**Joni Bosh (Guest):** Yeah, I'll look at this. Thanks.

**Gall, James:** And you know, the Commission could ask us to do this on an hourly basis. They may ask us to do this on a on/off peak monthly basis from a planning perspective. I think it makes the most sense to keep it at no less than monthly on/off peak. Because when you go down to the hourly basis, you're making a lot of

assumptions on how we may deliver power. Where monthly on/off peak, might be more reliable, and then then drilling down to the hourly level. But the Commission is still, I think, wrestling through some of those decisions on how the utility should plan for this. I wanted to go through this as our vision of what this might look like. I don't know when the final rules will be made. I think it's final in maybe June, but there might be a draft coming up shortly.

**Gall, James:** I also want to keep in mind that while right now we are a little over 10% short on the alternate compliance, there is definitely a REC market available including RECs from our Idaho hydro production that could be available to offset that. Where I think I'm going here is 2030, from an average energy point of view, is pretty much compliant with the CETA law assuming that we were able to get normal conditions and the energy we could transfer from for the wind, biomass and Chelan PUD contracts are able to be transferred to Washington. We're looking pretty good to meet that 2030 law.

**Joni Bosh (Guest):** Can I have some clarification real quickly before I moved just back on that one, I may have misunderstood. I may have confused myself. So, all of your hydro is in your hydro column, your alternative compliance column then is all RECs.

**Gall, James:** Sure, go ahead. We're showing here the amount of energy that we produce. That exceeds load, so it's our generation. It creates a REC. We hold that REC, so we're not buying a REC, this is just how much the company allocated to Washington is exceeding its load. Whether you call that a REC or excess renewable generation, it's still from our understanding of how the law works, is that would count towards alternative compliance. Even though we generated it, we retain the REC. It may have been sold off system, but that's our understanding how alternative compliance would work in that situation.

**Joni Bosh (Guest):** Hey. I'm not sure I agree, but I'm going to look at this and then I'll get a hold of you. Thanks.

**Gall, James:** OK, that works for me.

**Joni Bosh (Guest):** Yep.

**Gall, James:** Of course, that could change in the next month.

**Joni Bosh (Guest):** Yeah, exactly.

**Gall, James:** So just to wrap things up, to show the full 20-year look out in the future. The green bars represent how much under this methodology we could count towards primary compliance, which is the amount that's under the monthly retail load. The blue is showing the excess generation by month which would be alternative compliance. The black line represents what the target is for the primary compliance goal, where it's 80% through 2033, then ratchets up by 5% every four years until you had 100% in 2045. One way to look at this is if you compare the green bars to the black line that shows our shortfall for primary compliance and then the shortfall between the top of the graph and

the blue represents the shortfall from alternative compliance. I would remind everybody that from an alternative compliance point of view, I think of Avista has RECs or renewable hydro from Idaho that is available that could be sold so long as there is no national or state RPS in Idaho. We may not be planning to build resources to meet alternative compliance needs but the primary compliance is what our modeling will try to solve in our resource strategy. There could be an adjustment for risk as we mentioned before, but right now, our position is looking pretty good to meet the 2030 law, at least on an average point of view. That's the last slide I have. We're at the time I was hoping for, and if there's any questions, go ahead. OK, so I think we're planning on taking a break at this point. We were planning on getting back together at 10:00 for a non-energy impact presentation from DNV. So why don't we go on break and I will see all at 10:00 o'clock.

### **Non-energy Impact Study, DNV**

**Gall, James:** I just want to do a quick check to see Stephanie if you are online.

**Whalley, Stephanie:** Yes, I'm here.

**Gall, James:** OK, I think the plan is that if you can share your screen, if you want to. See if you're able to do that.

**Whalley, Stephanie:** Sure.

**Gall, James:** We can always do it as well if something doesn't work out. I'll stop presenting. Alright, I do see it. It seems like it's working, so we'll just give everybody a couple more minutes to come back from break and then we'll introduce you and we will get started.

**Whalley, Stephanie:** OK, sounds great.

**Gall, James:** OK, hopefully everybody made it back. I have 10:00 o'clock. I want to introduce DNV to the TAC. A few months ago, we contracted with DNV, specifically with a Stephanie Whalley, who's going to be presenting today, and Shawn Bodmann to conduct a supply side non-energy impact study as one of the to do items out of the last IRP. The UTC Staff recommended as we look at the non-energy impacts to the resources that we look to acquire and own. We've been working with DNV for the last several months putting together what are the costs and benefits to societal cost, at least to our customers and others as well. I want to turn it over to Stephanie and if you want to go through your presentation and we welcome questions at any time, or do you want to have them at the end? It's up to you and.

**Whalley, Stephanie:** That sounds great to me. We can take questions as we go along. And we'll also have a discussion time at the end if there's any larger questions.

**Gall, James:** OK. And then if you have a message you want to put in chat for a question, I'll try to interrupt stepping in at the appropriate time and read those off. So, with that go ahead and take it away.

**Whalley, Stephanie:** OK, great. Thanks, James. Good morning everyone. As James said, I'll be presenting on the non-energy impact study that we've been doing with Avista for the last several months. I'll begin with a brief overview of the project and then present the approach we used to gather and apply the non-energy impact values. Following that, I'll show some of the results from this study, the study and then cover some of the gap analysis components where we identified key data gaps that could potentially benefit from additional research. And then finally conclude with a discussion.

**Whalley, Stephanie:** OK, so what is a supply side non energy impact? It's essentially an externality which is an impact that is not reflected in the cost of a good. And in this case, energy. On this slide, you can see some examples of what is typically included in the cost of energy and then what typically isn't. For many things, the line between what's included in the cost of energy and not, it is pretty clear. For instance, the examples here: jobs, direct economic impacts, fuel costs, those are part of the cost of energy. Whereas things like health impacts due to emissions or fatalities throughout the supply chain likely are not part of the cost. But there are other cases, for instance water use, which we have listed here in both examples where the line can be a little bit less clear. For instance, when water is used to produce electricity the costs of withdrawing the water or processing it. That would be assumed to be part of the cost of energy, but there may be other societal or environmental costs that aren't included into that. The cost that's paid for that water. And a lot of those sort of external costs can be a little bit more challenging to quantify using that water example.

**Whalley, Stephanie:** The goal of this project was to provide Avista with quantitative dollars per MW hour estimates of non-energy impacts for a variety of generation technologies and scenarios. To do this, we started out with a jurisdictional scan to identify non-energy impacts that might be currently in use by other jurisdictions. The jurisdictional scan didn't turn out very much, so it won't be the focus today, but the key take away and the reason it's worth mentioning is that this is a pretty new approach that we're taking here.

**Whalley, Stephanie:** The next part of the project was to develop the NEI database. Much of our discussion today and the presentation will focus on how we identified readily available non-energy impact values and monetization approaches. Then after the database development, we moved on to database application, so this is where we're taking that database and then we're applying it to Avista's scenarios. And then finally, we have the gap analysis where we looked along that whole process as we're developing the database and identified key area metrics that were missing in the data that could benefit from additional research.

**Whalley, Stephanie:** OK, so next I'm going to discuss the approach that we took specifically for assembling the database and then applying the database to Avista scenarios. Our approach was to identify readily available non-energy impact values and monetization approaches. We primarily used federal regulatory and then some academic publications. While primary research could be more closely tailored to the specific jurisdiction to the specific resources, using secondary research, particularly at this stage of the process, provided a number of benefits as we're starting to quantify and monetize non-energy impacts. This approach cost less than primary research can be conducted, conducted faster and then can also be used to identify and prioritize gaps for additional research.

**Whalley, Stephanie:** This slide summarizes the database compilation approach we took. The approach involved identifying any values, that the figure to the left, and then also monetizing those values and throughout the whole process we identified any gaps in the data that could benefit from additional research. For some metrics, such as emissions, we were able to use values directly from Avista, but for most other metrics we relied on values from other publications or sources. Whenever possible, we tried to use the same source for all of the different generator technologies we were considering to minimize differences and methodologies across technologies for the same metric.

**Whalley, Stephanie:** That is the kind of wrapping up the approach component. Uh, we unit found a number of limitations, but also benefits of using secondary research. A couple of things to note, values are not always compatible across regions for a variety of reasons, such as different economic conditions, environmental conditions or concerns. Also, sometimes studies are outdated. Some generator types, for instance, were primarily installed many decades ago, so there is limited information about what the impacts of a new facility might be. Newer technologies sometimes also don't have a lot of good source data because the technologies are developing so quickly, and the studies can rapidly be out of date. And like I had mentioned in the prior slide, we did try to use consistent sources whenever possible to minimize methodology differences, but in some cases that's unavoidable. If not, all technologies are covered in the same source. Some sources had relatively opaque methodologies, so that made it a little bit harder to know exactly what some of the assumptions were. And finally, there were gaps of course in the secondary research and this was the biggest problem when it came to monetization.

**Whalley, Stephanie:** This slide shows the different metric categories that we considered and then the boxes represent each NEI metric that we looked at. The green shapes are the ones that we were able to monetize and then the blue ones we were typically able to quantify to some level, but we were not able to fully monetize them. For public health, we looked at the impacts of fine particulate matter PM 2.5, sulfur dioxide and then nitrogen oxides. And for the green ones, I'm going to go through them, but we'll talk more in depth about those in the results section. The green ones, the monetized ones, will go into more detail in a little bit. For safety, we looked at direct

fatalities from construction and operations. And indirect fatalities from supply chain activities. For energy security, we focused on energy burden, which is the proportion of household income spent on electricity and heating. And we addressed this metric qualitatively by assessing whether a resource is expected to increase or decrease the levelized cost of energy. We did this under the assumption that if there's a higher-level cost of energy, that energy would be more expensive for the end user.

**Whalley, Stephanie:** For the environment we identified land use for most technologies and were able to identify some values for project phases beyond operations, so in some cases going back to manufacturing, construction and through decommissioning. However, a land use which was difficult to monetize as we'd want to have the value for the externalities component of the land use. In most cases the land use for either purchase or leasing should already be included in the cost of energy. But for certain types of land use, we expect that there is some level of externality. There just wasn't a readily available source.

**Gall, James:** Hey, Stephanie, we have a hand up on a question from Heather. Heather, would you like to ask your question?

**Whalley, Stephanie:** Sure.

**Moline, Heather (UTC):** Awesome. Thanks. This is Heather from Washington UTC. The price of a resource as reflected in the price per MW hour would capture whether a resource has a higher levelized cost, and as such whether a customer would have to pay more for it than another resource. I guess my question is I never thought of adding additional NEIs almost supply side to account for. An increase or decrease in energy burden to me, that's already kind of implicit in a price.

**Whalley, Stephanie:** Sure. And that's essentially where we ended up, so essentially in the report we discussed that more in terms of how there are these other burdens, but we didn't factor it into the final dollar per MW hour.

**Bodmann, Shawn:** When we were talking to about this, James - jump in on this, one of the things we talked about was part of the process here right. The IRP process is to take those LCOS for the different sources and do the computations you need to do in order to get them to that you know the cost per MW that a customer would pay.

**Gall, James:** This is James. And I think the whole concept here is energy burden is a function of cost, utility cost or resource cost. But it has an effect on the customer that needs to be considered and in part of the CETA requirements that we include in the CEIP these customer benefit indicators, energy burden shows up and we have metrics for that. I think this is just connecting the dots between that affordability customer benefit indicator and what we're doing through our resource planning. I did see another hand up and I think it was Joni. Do you have a question or comment?

**Joni Bosh:** Yeah, I have a shared I think some of the concerns Heather just raised. It seemed to me like energy security rather than being energy burden might be something



like how can you depend on your power or how many outages do you have? That kind of stuff of is it a neighborhood more likely to lose their power than other neighborhoods. So, if you could talk about that a little bit because energy burden is just calculated on your income and what you're paying for your bill.

**Whalley, Stephanie:** Sure, we did explore looking at it in terms of outages and from that perspective, the challenge was we were trying to tie the NEI metrics to specific resources. Whereas a lot of the outage issues and whatnot would require a different level of analysis then we were focusing on here.

**Joni Bosh:** Sorry. Some of these values, and I have to admit I haven't read the report yet but heard some of these values going to be in some cases positive numbers for some resources and negative numbers for the exact same value for other resources.

**Whalley, Stephanie:** We were not looking at one resource displacing a different one. We were looking at the impact of each individual one, so economic impacts are generally positive. Whereas, safety, public health, those tend to be negative impacts for everything. Excuse me.

**Joni Bosh:** OK.

**Bodmann, Shawn:** A bit more on energy security. This is Sean from DNV. We were looking at a definition of energy security as access to affordable energy and so those reliability statistics is the access part. As Stephanie was saying, that was outside of what we were able to assess when we're talking about a specific generation source. That left the affordability part. That's why we have energy burden here for energy security.

**Gall, James:** I want to add one more thing on security and a lot of it has to do with reliability. Some of this comes down to the resource choices, or really the transmission or distribution system. If I have a resource that doesn't matter necessarily where it's at, it could be a transmission or distribution issue that is there. The cause of the energy security issue rather than the specific resource, some resources that you may locate on the distribution system may or may not benefit energy security. I don't think it's necessarily a resource specific value. It may be a value of the security that we would apply to certain resources. That's why I went after the discussions with DNV. I think it's something we need to explore after the fact on a resource specific basis, but maybe a locational basis of the resource. Alright, I'll turn it back over to Stephanie.

**Gall, James:** I don't think there's any more questions yet.

**Whalley, Stephanie:** I think we stopped with land use, so water use. We identified water use for the operations phase for many technologies as well and we focused on water consumption. That's water that's lost during the process either, evaporation or from other reasons. Like land use, we found it was difficult to monetize this one as the cost for withdrawing the water or utility costs would be assumed to be part of the cost of

energy, whereas the sort of externality costs there, so potential. Like tradeoffs for using water for electricity versus something else was more challenging to monetize.

**Gall, James:** We have a question from Joni on the chat, Stephanie, on water contamination. You have a thought on how that would be evaluated?

**Whalley, Stephanie:** Are you thinking water contamination where you have to keep the water in a holding pond or water treatment or environmental contamination?

**Joni Bosh:** Some process that ends up being unusable, let's say.

**Whalley, Stephanie:** Yes. So that would fall under water consumption because it can't be returned to the environment, that's the portion we focused on. But we didn't find.

**Joni Bosh:** I would say. I'm sorry. It's not a volume question to me, it's a contamination problem.

**Whalley, Stephanie:** OK, so in terms of keeping it out of the system? I'm trying to think.

**Joni Bosh:** Yeah, I mean, if it has to be treated before it can be safely released into a creek or something like that, or if it has to be contained for some reason, or if it goes through a process and ends up contaminated. I'm just curious why it's just water use rather than say, water degradation. Or both.

**Whalley, Stephanie:** I believe that was actually part of water consumption, because it can't be immediately returned to the environment. But we did not find a good way to monetize that. From what I'm remembering from the specific definition from the source as it was, it could be evaporation, which is what I mentioned, but also if it can't be returned to the system or the environment for contamination reasons.

**Gall, James:** This is at James I want to add one thing here and with quite a bit of discussion on water issues and if there is a clean-up process or a consumption of water, those are usually embedded into the cost of the resource. There is an impact, but it is one of those impacts that are embedded into the cost of the resource when we're trying to do here is estimate the impacts that are not included in the resource cost and if there is a contamination problem that extends outside the resource cost, that's one issue. We're trying to capture the values that are not already included in the resource cost.

**Whalley, Stephanie:** And for wildlife impacts, we identified bird fatalities for fossil fuels, nuclear and wind but we were not able to monetize those impacts. And for wildfire, we were unable to find a resource specific wildfire risk value, so we used greenhouse gas emissions as a proxy for climate change impacts. As climate change has increased, the severity can impact the timing of wildfires. We did see some research looking at length of transmission lines and those types of metrics that might be worth further pursuing, but there wasn't anything that was resource specific.

**Whalley, Stephanie:** OK. And then for economic impacts. Actually, induced jobs really does fall under this induced value add because they work together. But we were looking

at the jobs and value-added impact that were above and beyond the direct jobs created by constructing and operating a generator. We'll go into more detail on that and the public health and safety as we move into the results section in a couple slides.

**Gall, James:** Stephanie, there's another question from Jim Woodward. It's a good time. We can ask that question.

**Whalley, Stephanie:** Perfect.

**Woodward, Jim (UTC):** Thanks, James. Hi, Stephanie. Thanks for this presentation so far. I raised my hand when you mentioned, I'm going to admittedly paraphrase you, but wildfire serving as a proxy for climate change. And that that did get me thinking that maybe I missed it, but I haven't seen too much in the way of in the way of looking at climate change, especially in GHG emissions, reflected here and maybe this is what I call a sandbox question because I know on a different set of metrics front customer benefit indicator metrics. This may be outside your specific purview, but at some point NEIs stop and CBIs begin and there may be some overlap but some complementarity as well. I just wondered if you could speak a little bit more to GHG emissions and is that a part of this or is that really outside this quantification focus right here?

**Whalley, Stephanie:** Sure. Under wildfire, we used greenhouse gas emissions as a more qualitative discussion of which resource types might be more likely to have a higher wildfire risk. It's admittedly a bit of a stretch, but there is some research showing the connection between climate change and wildfires. We didn't use greenhouse gas emissions in other aspects here because James I believe the social cost of carbon goes into another part of your analysis. That's outside of what we did.

**Gall, James:** That's correct. So, Jim, as you know, we have to include the social cost of carbon in our evaluation for the resource plan for the State of Washington. We didn't want to have DNV spent a lot of time on the carbon side of the non-energy impact since those are already included elsewhere. In the event of wildfire, if that if it looks like that any could potentially be at least proportionally accounted for in that side of things. If there's other non-carbon related wildfire risks such as transmission lines, that might be something that we need to look at in that gap analysis.

**Woodward, Jim (UTC):** Thanks. That's helpful. Again, just trying to delineate where the focus of one set of indicators stop, there wouldn't begin, so thanks.

**Bodmann, Shawn:** Speaking to Heather's comment in the chat, so you know that trend, I think the transmission is really the most direct risk for wildfires. If you have a high voltage line going through a wooded area. This study was just looking at the generation. We didn't have any sort of transmission data or scenarios that we could take into account. That piece of wildfire risk is just is just outside of what we were analyzing here.

**Whalley, Stephanie:** These tables summarized the data coverage by generator type of the NEI metrics that we looked at on the last slide. Most of these, you'll see a check if we have information for that particular resource and any for economic, there's a few that

have sort of the squiggly line here and that's because we used a different method to approximate impacts and we weren't able to fully quantify those in the same way, but we'll get into more details on that in the economics results discussion. One of the key things to note here is that the newer generator types such as hydrogen electrolyzers, batteries, non-natural gas generator types tend to have fewer identified values and this falls along the line of earlier discussions where it sometimes takes a while for the secondary resources to catch up with the technologies. Conversely, you can see that the more established technologies do have pretty good coverage for most metrics. So now natural gas. We had liquid air, renewable natural gas, trying to remember what the other ones are off the top my head, I think there's another hydrogen one.

**Gall, James:** Yeah, this is James here is, think about biofuels, hydrogen, liquid air, RNG. The idea here is using a gas turbine technology, but it's not burning natural gas to create power.

**Whalley, Stephanie:** All right. Are there any other questions on the approach before the next section? OK. So next I will walk through the results of focusing on the NEI values that we were able to monetize. Public health, safety and economic impacts, and then we'll look at an example of how we applied the database too. The scenarios we're looking at. Starting with public health, we looked at fine particulate matter, sulfur dioxide and nitrogen oxides. These were readily available values. I mean, these are all specifically for the operational impacts. The values we used here you can see are primarily from Avista and in some cases also from EGRID and for the cost component of the calculation, we used EPA's COBRA model to calculate the dollars per ton. The COBRA model produces cost estimates per unit of emissions for every county in the United States, so the model results are primarily dependent on the location of the facility and how those emissions would disperse throughout the United States. It's important to note, like emissions that go into Canada aren't accounted or into Mexico or not accounted for in the model there's some, dependent on population level. All these other different things that can go into the cost estimation. To the right of this slide, you can see an example of the summary output from COBRA. It provides the change and incidents like increase of various health impacts as well as the monetary impacts of those. And the costs associated with these emissions cover everything from increased mortality through more minor impacts such as increased numbers of restricted activity days. And they are focused on respiratory and cardiovascular impacts.

**Gall, James:** Stephanie, you have a question from Heather.

**Whalley, Stephanie:** Sure.

**Moline, Heather (UTC):** Thanks, Heather from UTC here. I want to make sure I'm understanding the scope of this. When natural gas is extracted from the ground, there may be some public health and emissions impacts there, but we're specifically talking about when electricity is generated from natural gas, so specific to the generation plant and not the very beginning of that process for example.

**Whalley, Stephanie:** That's right. Yes. This is operations focus because that's where we were able to find the emissions values. Theoretically if, for instance, emissions estimates from a natural gas extraction facility, we could put that into COBRA and get an estimate. But we don't have those values at this point. OK. So, we took the tons per MW hour from the emissions values. And then the dollars per ton from the COBRA models to calculate the monetized health impacts in terms of dollars per MW hour. And you'll notice for some of the impacts, we focus on the dollar per MW hour and then some per MW. But since this is based on electricity generation, we've used MW hours here. This figure shows the monetized health impacts from fine particulate emissions for existing and proposed generator types. As I had mentioned in the prior slide, the COBRA model produces county level impacts for the entire United States. We've summarized those into three categories here. The dark blue bars show the impacts on the county where the resource would be located. He caught the site county here. The light blue summarizes the impacts on Avista's territory. And if the facility would be located within Avista's territory, you'd get the total impact on Avista's territory by summing the dark blue and the light blue bars. And then the green bars are the impact for the rest of the United States. And another note, for hydro, wind, solar, nuclear that don't have operational PM 2.5 emissions, we've collapsed those here into to single row.

**Whalley, Stephanie:** For existing resources, Colstrip and Kettle Falls have the largest impact on the United States as a whole. Another thing to note is Colstrip, which is in Montana, you can see here has very little. There's tiny little lines of four Avista in the site county so you can see how the location of the resource does impact these results here. Joni, I see you have a question.

**Joni Bosh:** What's the difference between the proposed and the existing?

**Whalley, Stephanie:** Thank you. The existing are Avista's current facilities and then the proposed are some of the other potential sites that they had asked us to look at, like Kettle falls, I think that would be a potential expansion of the current facility. Same for Colstrip. And then like some of these other ones, it says northern Idaho, so it's more of a general location and when that's the case, we typically used one of Avista's existing facilities as the location.

**Joni Bosh:** So, this is over a period of time between or measured at what 2030 or 2045 or what's the time?

**Whalley, Stephanie:** We used \$2021, but this is per MW hour. I mean that's like.

**Joni Bosh:** I'm not quite sure I'm following Colstrip, for example. So, if you could talk through Colstrip between existing and future Colstrip is out in 2025, out of bills.

**Gall, James:** This is James I just want to clarify this section. The bottom is if we had it as a resource option to choose between for alternatives to our preferred resource strategy. So, we're selecting resources, these are the values we would assign for a new generator for resource selection. So the Colstrip one on the bottom would represent, not

that we're going to go out and build a coal plant, but if we had a coal plant as an option that was located in Colstrip, this would be the NEI for PM 2.5 for that resource.

**Joni Bosh:** Using current technologies rather than the existing Colstrip technologies?

**Gall, James:** Using the newer technology, which is why the emissions are lower.

**Joni Bosh:** OK.

**Gall, James:** Those are all resource options, so when we do our resource selection, we can include these values in addition to utility costs values to have a more comprehensive cost analysis.

**Joni Bosh:** OK. Thanks.

**Gall, James:** I want to add one other thing on Kettle Falls and this one is a debatable issue that we probably still need to wrestle with. Kettle Falls, you can see there is high levels of PM 2.5 at least per MW hour. That resource uses waste products, so the question is, that waste product, would it be burned otherwise or be emitted into the atmosphere in another way. On a net basis while the plant is emitting this amount of PM 2.5 would it have already reached the atmosphere regardless of whether it was burned at our facility? This is one of the plants that we have questions whether or not there should be this value, obviously there is emissions, but would those emissions happen regardless of Avista combusting it in their generator. I see two hands went up, three hands now. I think it went Heather, Jim then Art. Will try to go in that order. So Heather, you want to go first.

**Moline, Heather (UTC):** OK, sure. Thanks, Heather from UTC. I'm going back to my question from before. I definitely know that there's data about pollution around coal mining facilities, but I don't think that's included here. Not because there isn't data on pollution around coal mining facilities, but because this is specific to where coal is to Colstrip, which is where coal becomes electricity, meaning we're talking specifically at a generation site or later than that on the supply chain. I guess again, just trying to understand the scope of this study, if you could help me there.

**Whalley, Stephanie:** Sure, we focus specifically on operations, but that's certainly an area that could be worth the additional research because there are studies looking at, as you mentioned, health impacts around mining. But that's not something we included here.

**Gall, James:** Jim do you want to go next?

**Woodward, Jim (UTC):** Thanks James. And my question was precipitated by your comment. I was almost going to raise a question around a supply chain. Because that's how I characterized. I guess you could say Avista is based on this study I think current accounting a Kettle Falls. At this point, are you saying that what we're seeing here and what we're seeing in maybe study results assumes that Avista would take ownership of those impacts, whether it's actually occurring at the endpoint or it would occur via

alternative scenario versus have decisions based on what we're viewing here already been made to say, and I'm going to speak just as an example like 20% going into Kettle Falls. If let's say 20% of those impacts would have occurred regardless, that's not reflected here. If that makes sense. Is right now the current state sort of airing on the higher side of Avista accounting for everything versus have our carve outs already been made. If that makes sense.

**Gall, James:** Yeah, this is everything. There's no carve out yet at this time.

**Woodward, Jim (UTC):** OK, so if anything based on current thinking, these are high end estimates, they could potentially go down?

**Gall, James:** For the Kettle Falls one, yes.

**Woodward, Jim (UTC):** OK. Alright. Thanks.

**Gall, James:** Yeah, we still need to work through that and understand what happens to that fuel if we don't take it. Somebody else would take it. Would it just be the same result? Because this is a true wood waste facility. We're not out harvesting trees to burn.

**Woodward, Jim (UTC):** Right, just wondering what we're seeing here could be how that might change going forward? Thanks.

**Gall, James:** Yep. And Art, you're next.

**Art Swannack Whit Co Comm (Guest):** I just was thinking about your comment about would it be burned somewhere else, the wood waste at Kettle Falls. I don't know if it's that simple and I've got two thoughts. One, it could be incorporated into some recycling type thing where they use composting as part of the factor in that, which would then bring in what's it emitting at that point, which would be probably a different substance than burn particles. Or, you know, we're also having regulations now on methane emissions from landfills and saying so, I think it's going to be tough to say what the other end result of biomass would be other than we know they've said biomass is supposedly granted some status as a positive thing for energy generation, so I don't. I'm just commenting that to me it's going to be tough to do that analysis.

**Gall, James:** I agree. It's been a good discussion. Obviously, this generates a lot of thoughts and that's what we're here for. So, I'll let Stephanie keep going and keep asking questions. We have until 11:30, a little less than another hour, so continue.

**Whalley, Stephanie:** OK, sounds good. Next, this is the figure for sulfur dioxide in health costs per MW hour. Coal has the largest impact compared to the other resources here which is to be expected based on sulfur content and these impacts are nearly all outside of Avista's territory. Next, this figure shows the operational nitrogen oxide's health costs per MW hour, again for proposed and existing resources. For existing resources, Northeast natural gas has the highest health costs throughout the US and in the Avista territory. Colstrip had the next highest cost per MW hour throughout the US. I think one thing to note, like we are looking at dollars per MW hour, which I think gives

us the cleanest comparison across technologies. But when there are large differences in the amount of electricity produced. That's another factor to think about here.

**Gall, James:** Art, I still see your hand up. Did you have another question or was this done before?

**Art Swannack Whit Co Comm (Guest):** I don't see my hand up.

**Gall, James:** Must be frozen on my end. Sorry.

**Whalley, Stephanie:** OK. Any questions on public health before we move to safety? For safety, we looked at direct fatalities which occurred during construction and operations and could include things like workplace accidents, catastrophic failures, things like that. And indirect fatalities, which include accidents related to production and transportation of materials, including things like construction operations and decommissioning. Whereas for public health we were only able to really focus on operations for safety, we do include the larger life cycle.

**Whalley, Stephanie:** I think I just missed part of that comment. Let me look at it. Yes. We focused on deaths and not injuries in this case. That was primarily driven by data availability here as well. In terms of the costs, we used the EPA's value of a statistical life which is the same value embedded in the COBRA model used for public health.

**Whalley, Stephanie:** And then we looked at fatalities per MW hour. Then the value of a statistical life to monetize dollars per MW hour. This figure shows the monetized fatality impacts. The light blue bars are from a single paper that didn't distinguish between direct and indirect fatalities, but they are both included in those bars.

**Whalley, Stephanie:** And then for coal and natural gas, we were able to distinguish between the two. Wind had the highest dollar per MW hour impact here. And the source had discussed some potential reasons for that included lots of smaller accidents, like plane and helicopter crashes related to wind farms a blade transport crashes into. The authors had suggested there might be more reported fatalities because of increased scrutiny around certain wind projects. Coal had the next highest impacts and that was largely driven by mining risks. And then hydro's numbers were relatively high. This appeared to be driven by rare catastrophic events like dam failures.

**Whalley, Stephanie:** Before we move on, anything on safety?

**Joni Bosh:** I had a question. This is Joni from Northwest Energy Coalition again. I'm struggling here with the idea of only fatalities and some of these seem to be pretty much widespread. I mean, you were talking about potential airplane crashes or whatever and not including injuries and not including long term illness. I think that's something that needs to be discussed a little more because I'm not sure I need to go and look at what you actually measured here for various fatalities. For solar, I'm curious what were they?



**Whalley, Stephanie:** OK, so I don't remember that one off the top of my head, but I don't know if Sean, you might have the report open. We might be able to say something there now or maybe in a little bit.

**Bodmann, Shawn:** But I don't have it open. I'll go check it out.

**Joni Bosh:** OK. Thanks.

**Whalley, Stephanie:** And did you have another question on fatalities or we can maybe come back to that when we get to the discussion so that we have time to double check.

**Joni Bosh:** Yeah, continue.

**Whalley, Stephanie:** OK, great. Next, economic impacts. We used NREL's Jedi models for most economic impacts. They have six different models grouped by technology type. You specify the location, year of construction and then size for each simulated facility. We used Jedi default assumptions for other inputs such as share of local labor, financial parameters, decommissioning rates, and technology, like the specific technology components of the facilities. To the right here you can see an example of the Jedi output. Impacts broken up into construction and operational impacts. Additionally they're broken out into direct, indirect and induced impacts. Direct impacts include labor directly related to things like construction or operations focusing really on the onsite component of the labor and impacts. Indirect impacts are the more supporting industries, including things like construction material, gravel, fuel, those types of supporting industries. The third component is induced impacts. And these are the impacts related to reinvestment in spending driven by direct and indirect impacts. For instance, increased like people going out to restaurants more or things like that that are driven by the economic activity from construction and operations. The Jedi models give us the direct, indirect and induced jobs for construction and operations, and then they also monetize those impacts in three different ways. Earnings focuses on essentially wages paid in those cases, but we used valued added because we're trying to find which impacts made the most sense when looking from a non-energy impact. That line between what's already in the cost for energy and what's not. The value added is the difference between total gross output and the cost of those intermediate inputs. It's similar to GDP, gross domestic product. We focused for the NEI economic impacts on value added induced impacts.

**Whalley, Stephanie:** Before I move on, we also did have a few exceptions. Don't want to go into too many details because they were a number of things that we had to look at a little bit differently. For offshore wind, we had to make an adjustment to the induced impact based on the factor that was in the model. For coal with carbon capture, we adjusted the impact we had from the coal model. And then the biggest gap here that we will talk more about when we get into the gap analysis. There is no solar PV Jedi model. Or no up-to-date one. So, that was a limitation here.

**Whalley, Stephanie:** This figure shows the construction impacts for each proposed generation resource. We didn't include existing projects here because the impacts have already occurred. Other things to note, resources with longer construction periods and more infrastructure needed to support that generation tend to produce more induced impacts. And for construction, we used dollars per MW as it is more of a size dependent metric. This figure shows the operations impacts in terms of dollars per MW hour. The Jedi outputs showed the results in terms of dollars per megawatts, but we did convert to MW hours because the operations have a lot of a variable impacts, but that does in certain instances drive some of the variation you're seeing here particularly for hydro. Any questions on the economic impact here?

**Joni Bosh:** I do have a quick question. This is Joni again. Is this chart actually saying, let's say Kettle Falls first line in both has a more positive economic impact than Rocky Reach Hydro, is that with this chart is saying?

**Whalley, Stephanie:** Yes. In terms of non-energy impacts, the value add.

**Gall, James:** Per MW hour though.

**Whalley, Stephanie:** Right. Yes, that's another important distinction.

**Gall, James:** Yeah, because Kettle is 50 megawatts and Rocky Reach is 1,200.

**Joni Bosh:** Right. Well, that's what I was trying to figure out. It seems like. OK. Yeah.

**Bodmann, Shawn:** And it's just induced. Right. It's just the additional economic impacts from the direct and the indirect jobs that are being provided there.

**Gall, James:** Kettle has quite a bit of a trucking industry that supports that plant, which is why that one pops out.

**Joni Bosh:** OK.

**Whalley, Stephanie:** OK. So, one more question, go back.

**Woodward, Jim (UTC):** Thanks, Stephanie. I was actually waiting or deliberating whether I ask this question now or wait till the end of this session, but I'll go ahead and ask it now because I did look ahead in the slides. What I'm curious about is, I see these existing and proposed view graphs and I think I understand the meaning behind that. However, was there any analysis done to overlay these study results, especially from a price or cost standpoint? Based on the approach of Avista and my understanding, pretty much all three of the IOUs took in the 21 IRP, where they essentially used a proxy value across the board. Because if not, I would find that interesting to see how we're trending. Because my understanding is that's not conveyed in this existing and proposed parallel graph. That's basically looking at Avista's current fleet, if you will, or portfolio versus where the company plans to go as opposed to previous NEI treatments and NEI quantification the company did in 2021.

**Gall, James:** Jim, we didn't do any NEI treatment for supply side resources ever before. We did it for energy efficiency. The energy efficiency study had a kind of a blanket covering. And since then we have started looking at and breaking it down by resource type for energy efficiency. But this is the first of its kind for supply side resources.

**Woodward, Jim (UTC):** So basically, this is compared to zero in 2021?

**Gall, James:** Correct.

**Woodward, Jim (UTC):** OK. I think I'm going to ask the question.

**Gall, James:** Actually, I think probably the first ones to start looking at this in an IRP as well. So, it might be zero for a lot of entities out there.

**Whalley, Stephanie:** Right. We didn't. We didn't find any other spots they were looking for the through the jurisdictional scan.

**Gall, James:** We got about 30 minutes left. I'm hoping we can get through the next couple because there's going to be a bit of discussion I would imagine towards the end. Go ahead Stephanie.

**Whalley, Stephanie:** This is an example of how we apply the database to the various proposed or existing resources. This is looking at specifically the monetized impacts for a proposed large wind farm in Eastern Washington. The graph on the left, this waterfall chart, shows how the NEIs interact with each other. You see that the economic operational impacts are positive, that first light blue bar. Then the safety or fatality impacts are negative in the green bar public health, because specifically operations is zero here and then you get the total dollars per MW impact in the dark blue bar here. On the right, this is the impacts per MW, which were only the construction impacts. So that's a single value here. It's important to keep in mind that as we've talked throughout this and at the beginning when we were looking at the different NEI metrics we were considering that there are other impacts that these do not particularly include. We face this challenge with trying to figure out how to monetize all of the different impacts that that we did identify. Are there any questions on application?

**Whalley, Stephanie:** We'll move on to the gap analysis. Throughout this process we did identify a number of data gaps. This slide summarizes what those gaps are as well as where we thought they best fit on the value in effort diagram. On the X-axis you can see the estimated level of research effort we think would be needed to address the gap with the greater the effort, the further to the right the categories are on this chart. The Y-axis shows estimated value of the additional research with the highest value at the top. One thing that might stick out to you is if you look at this, there's really nothing on the low effort side. The study we just completed was trying to pick up as many of those lower effort pieces as we could. Moving into the mid effort and especially high value economic impacts from solar PV. NREL doesn't have a current Jedi model for solar PV. For the other resources we looked at, economic impacts tended to be some of the larger ones. We also had an old model that could potentially be updated, which is why

it's more in the mid-level of effort. You can see there's also the higher effort. High value are wildfires and trying to figure out how to quantify those impacts. Economic impacts and public health impacts for batteries, we also identified as high value but also high effort. This is a summary of the gaps. We will also have discussion after this or we could start it now. This is our summary of the gaps from this study.

**Whalley, Stephanie:** So are there? Let's see. I'm just trying to look through the comments here. I haven't had a chance to read them. I think there might have been another question.

**Gall, James:** Let's go to Art's question on chat. He's asking about negative impacts to wildlife or changing weather downstream from wind turbines. Obviously, that's probably a gap that maybe we add to the list. But any thoughts on that one?

**Whalley, Stephanie:** Yes. We did not consider weather impacts from wind turbines. The wildlife impacts we did see some bird fatalities from wind turbines. We did not quantify, or we did not monetize those, and that was another one where it's challenging to monetize what that actually looks like in terms of dollar value.

**Gall, James:** Go ahead, Art.

**Art Swannack Whit Co Comm (Guest):** These are couple things I've heard about regarding this issue and I would look at beyond birds. One of the big issues is bats also. We know we have problems nationally and locally with bat populations survival. I think that's a valid thing to try and look at. I don't know how easy it's going to be on wildlife biology major, but farming county commissioner so we've heard about some of this stuff early on. The weather is one that I've heard more in the last five years from people that are farming downstream from where the primary wind blows. And you're taking energy out of the air, so you do affect what they get for weather and how that affects what's going on in the climate downstream for a ways from these. And I think it's another fact that hasn't been talked about, but it would be interesting to see the data on that if there's any out there. I think it's relevant.

**Whalley, Stephanie:** Sure, and on the wildlife we did talk about that. We didn't find a good source that crossed resources, but that's certainly something that we should add to this. They also talked a little bit about offshore wind was one of the things we're considering marine wildlife impacts, there's fish impacts, lots of different wildlife impacts and one of the challenges we were facing is just trying to find something that was more generalized across resources. So many of those resources are very specific to a specific location, technology type and ecosystem.

**Bodmann, Shawn:** Many of the wind farm permitting studies I've seen, bat and bird mortality is one of the things they look at specific to the sighting of that development.

**Gall, James:** This is James I have a question to the TAC. You see this list of gap analysis and effort and value is their areas of preference. I'm curious if anybody has, when we look at this again, try to continue this work as there are areas that you think we

should concentrate at. I'm writing down a lot of the comments that have been made so far but with this list is there any thoughts that you would like to see preference for? Jim, you have a comment.

**Woodward, Jim (UTC):** I do, James. I guess it's sort of a comment maybe a little bit of saving face from my previous question to be completely honest, but when we're talking about gap analysis here, I'm equating next steps and where do we go. What I'd be curious in is, again confirming that, NEIs have not been considered for supply chain options in any previous IRP cycle. I do wonder what's the result of this so far based on these numbers run by DNV. I wondered if your team had plans to let's say initially feed this cost information into the 2021 PRS to see how the results may change or if they would change. I'm just wondering if that data point would be helpful to let this group then see a chart of where we go from here. Had you planned or are any steps like that underway right now?

**Gall, James:** As far as implying that the last IRP we had not discussed that we were planning on included in the new IRP. Maybe I'm just looking at the dollars we're talking about here. Would it have an impact on the previous plan? I don't think it likely would have a major impact. The only one that I would say is probably at risk would be the Kettle Falls discussion we had on emissions, but some of the early discussions we had on that plant is if we did expand it, there would be an emissions reduction. So that would need to be flushed out a little bit more, but given the dollar quantities here, I don't think it would have had a significant impact on the previous plan. Will it have an impact on the new plant? It likely it could, but I think they are reasons why this is important is when we come up with these non-energy or customer benefit indicators for Washington, this is a way to prioritize the value of some of these non-energy impacts as far as how they relate to the customer benefit indicators, because what we're seeing is the customer benefit indicators we discussed in the last TAC meeting, some of them are counter to each other. We can't necessarily improve some metrics and improve and prove all of them that there's going to be weightings between each of those by putting this into a financial term, this creates the kind of the weighting through the economic value at least for the ones that we can quantify. So there there's value in keeping it, including it would have an impact in the last plan. It's hard to say if it would have, but looking at the resources that we picked, I had the feeling that it may not have had a radical change in resource selection.

**Woodward, Jim (UTC):** That's helpful James, getting your gut reaction there. I am also glad you raised the CBI. I'd almost forgot the NEI / CBI interface because while this study and this discussion has been focused on the non-energy impacts, the CBIs are there and there is, at least in my mind, maybe some sort of interaction overlap, whatever you want to say. OK, so at least in terms of further study, I'd be curious to see how this effort better relates to that, because I think ultimately the idea is to go towards where possible, where feasible, a quantification of not only NEIs but also CBIs where it makes sense. Obviously, some won't. I think other discussions have indicated some

won't allow for that, but others may. Maybe in terms of gap analysis, almost an interaction overlap analysis of how this effort is dovetailing with Avista's plan, future work on CBI and evolving those.

**Gall, James:** Yep, and that's going to be on our agenda if it fits the August or September meeting. That's the plan to discuss how this all connects and fits together.

**Woodward, Jim (UTC):** Great. Looking forward to it.

**Gall, James:** Yep. Any other thoughts, priorities, questions or ideas? I know there's more slides from Stephanie, but I just want to wrap this thought up on the slide and move on.

**Terri Carlock:** James, this is Terry Carlock. It's not so much from this slide. It's a follow up to your discussion with Jim and the overlap for August and September meetings that type of thing. Are you anticipating for those meetings some more results and evaluation with and without? Just so I have a better idea how this works.

**Gall, James:** I think we were going to talk about the process and how it would be used at that time. I don't anticipate we will have results yet about with and without these benefits and costs, that might come later. I think we want to talk about how the process would work, how it fits together before we share results, just in case there are ideas for changes that will need to be made. And then another question we have is this a requirement for Washington and what's Idaho's thoughts on including this or not including it.

**Terri Carlock (IPUC):** Thank you.

**Gall, James:** Alright, there's another hand up, Gavin, do you have a comment?

**Gavin Tenold (Guest):** Yeah, is there a plan to separate? How would this visualization you're looking at change if you were to separate commercial rooftop and utility solar in terms of the gap analysis? Or are we lumping them all together there? Would wonder those categories move at all on the visualization?

**Gall, James:** I think it would be best to have a separate analysis for each one. Stephanie, you have any additional thoughts on that one.

**Whalley, Stephanie:** Yeah. Specifically, for the economic impact is that the question? I think that this top one here.

**Gavin Tenold (Guest):** Yeah.

**Whalley, Stephanie:** I had NREL's model I think it was 7 years ago. I'd have to go back and look at it to remember if they had broken out rooftop from the other two. Lots of times their models have a variety of scenarios. They might have community and utility. They may not have rooftop, but they might have had all three. Shawn has talked to NREL and they do have a model and are considering updating it. If they update it and it

has all three, then I'd put it at the same level. But if it was broken out, I just don't remember.

**Bodmann, Shawn:** Another thing to clarify here, value means the informational value of having that gap filled in, not necessarily the monetary value that would result from that particular NEI. Right. And so solar and battery are high in the informational value because that's likely to be a big part of future generation mixes. In knowing that information for those technologies specifically is going to be very helpful. They may or may not have high economic values in terms of jobs or induced dollars.

**Gavin Tenold (Guest):** I was just wondering if we're able to separate them to help guide the conversation. I think that would be valuable.

**Gall, James:** I agree. Alright, we got 10 minutes left before our break. Stephanie, want to finish up? I know we have some more conversation coming.

**Whalley, Stephanie:** Actually, the next slide is just to open the discussion. I think we're in good shape just to carry on with other discussion I think I had one last slide that I wasn't planning to present that has the abbreviation breakout for anyone who might be reviewing the slides at a later point, so I'll open it up for discussion.

**Gall, James:** I see a couple hands up. I think, Heather, you're first.

**Moline, Heather (UTC):** Thanks, Heather from UTC. I think we talked about some of the price impacts of water contamination being included in the resource cost, and then similarly, when we were talking about energy burden, I think my point was wouldn't the resource cost in and of itself reflect what the potential burden of paying for that resource is to a customer? I wondered if you could just tease out for me a little bit, and I think the explanation of energy burden you gave is the impacts to the levelized cost of energy of a resource? How is that not reflected in a resource cost?

**Whalley, Stephanie:** I think the cost impact should be the relative comparison in the cost comparison. I think the reason we talked about it in the report and brought it up here is that trying to draw the connection between the resource costs and how they vary and the impacts on the customer because while they're tied, there is a different impact on the customers based on how much their energy would cost. I think that's the way to draw the comparison and we used the levelized cost of energy for our discussion point, but we weren't suggesting using that as a separate number to add onto the monetization component of the non-energy impacts. Does that help?

**Moline, Heather (UTC):** Got it. OK. It's more a conversation point that different resources have different prices and as such have different impacts on the customer. It's not necessarily that you all are recommending adding or subtracting any amount to what that cost is in order to emphasize the effect on energy burden.

**Whalley, Stephanie:** Right. I think that's a good summary of what we were trying to do, yes, more qualitative discussion. And then could you repeat your question on water contamination costs?

**Moline, Heather (UTC):** Oh no. I was just giving an example that some impacts are already included in the cost of a resource. Thank you.

**Whalley, Stephanie:** Oh, sure.

**Gall, James:** Joni, go ahead.

**Joni Bosh:** Thanks. This is just a clarification and thank you for Shawn for sending the abstract. I'll see if I can find a way to open it to the full study, but it says it's from 2016 and I'm curious is this worldwide or limited to the United States because, I can't find that in the abstract. First question.

**Bodmann, Shawn:** It's worldwide.

**Joni Bosh:** OK. And second, I'm having trouble with my computer so I can't pull up a separate presentation to look backwards, some of these measurements seem to be very broadly based and some are very narrowly based. Is there going to be a summary table that we can look at all these again because just trying to figure out what the sources are on this. The fatalities come from across the world, where I could imagine there might be fewer safety standards, say in China, when they're putting together a wind project as opposed to the NOx and SOx measurements. I'm just curious.

**Bodmann, Shawn:** I don't think that we have a table that compiles all that together in a single place. Case we did as part of the deliverables that we gave to Avista, we have a spreadsheet that has all these values in it, and we tried to annotate that spreadsheet with the specific source for each of the values. It's a very long table that spreadsheet has a lot of rows in it. For each row, where we have a value we tried to make sure that we annotated it so that someone could go back in and do that kind of identification that you asked about.

**Joni Bosh:** And that you've provided to the utility, right?

**Bodmann, Shawn:** Yeah, this to have that.

**Gall, James:** This is James, we are going to be providing this draft report in the next couple weeks to the TAC to provide any other comments and also I've been taking down notes as well from the comments. We will also be providing the tables as well. I don't know if it'll be the full spreadsheet, but will be providing the tables that are in the spreadsheet form from the study as well at that time.

**Joni Bosh:** I would be curious, this is just a very small thing, but looking at the safety fatality injuries that are historically in the United States versus worldwide. I'm just curious why is it? Was it just lack of data or you couldn't extract it from that study?



**Bodmann, Shawn:** That study doesn't go into a lot of detail about where in the supply chain the fatalities come from.

**Whalley, Stephanie:** I think the ideal approach for that specific metric would have been to use global numbers for the supply chain and then use US numbers for the more direct impacts, but that source didn't split them out. For instance, a lot of solar panels aren't manufactured in the USA, but we weren't able to disaggregate.

**Joni Bosh:** OK, I guess I'm trying to remember back on which slide where I think Heather was asking about mining. Mining is to me a part of the supply chain save coal, but I you did or didn't include that for the pollution impacts.

**Whalley, Stephanie:** For pollution, like the public health impacts, that was only operations or safety, including fatalities that did include mining and upstream life cycle.

**Bodmann, Shawn:** The mining pollution, except where that would have resulted in a fatality, that's not included in what we have. The pollution effects that we have are from the generation part of the energy production.

**Joni Bosh:** So only at the point of generation, not what it took to generate.

**Bodmann, Shawn:** That's right.

**Joni Bosh:** I'll think about that one.

**Gall, James:** We're at 11:30. I know we want to get to our lunch break. Any last comments? Thoughts? I see a comment from Patrick. I don't know if that's a comment or question. If it's a question, maybe you want to go ahead and take yourself off mute and ask, but if it's just a comment we can move on to lunch unless there's something else that's pressing.

**Whalley, Stephanie:** James Patrick is from the DNV team and actually did the calculations for coal and natural gas externalities.

**Gall, James:** Got it. Excellent. Alright. With that, I think we will take a break. We'll be back at 12:30 Pacific Time and I just want to thank DNV for presenting. This is great work. Looks like there's a lot more work that needs to be done and we're going to have to figure out how to do that going forward, but we will be sharing a draft of this presentation and of the other report very shortly with for your comment and suggestions. So again, thank you DNV team and I will see you all at 12:30.

**Whalley, Stephanie:** Thank you.

### **Natural Gas Price Forecast, Tom Pardee**

**Pardee, Tom:** James, let me know when you're ready to start.

**Gall, James:** John's going to kick us off and we'll get going.

**Lyons, John:** I think we're all set. Looks like we've got quite a few people back online here in time. I can see your natural gas price forecast up online.

**Pardee, Tom:** Perfect. Thanks for confirming that.

**Lyons, John:** If you want to get started up then.

**Pardee, Tom:** Hopefully everybody had a good break up to catch up on some emails and maybe take a walk outside. I'm Tom Pardee, the natural gas IRP manager. This is named Natural Gas Price Forecasts, but there's some market dynamics involved in it. Before I start flipping through the slides, this is last year's Annual Energy Outlook from the EIA. I am aware that they just released one in March, but for the price forecasts it simply wasn't quite enough time for us to do the prices and the stochastics prior to this meeting. I believe that we're intending on updating the price prior to the final IRP, but for the RFP that's going out, this will be the price forecasts used. Interrupt me at any time for any questions. I like that type of dialogue better.

**Pardee, Tom:** OK, the Annual Energy Outlook. On the chart on the left, you have your reference case in the black and this is in trillion cubic feet. Going back to 2000, there is only about 20 trillion cubic feet being produced and this is dry production. The difference between dry production and what they call wet gas is wet gases liquids. Think of that as propane, butane or even oil. This is only the dry gas and I'll cover the associated gas from the oil in future slides and so you can see they have a number of different scenarios on here and it looks like the colors didn't transfer over, but they're all in the same order. The high oil and gas production is going to lead to the lower prices here. When you're looking at what they're expecting to produce from a dry production side here by 2050, there it looks like we're going to be around 42 TCF of production over that year. Let me explain the difference between the chart on the left and right. The chart on the right is just US consumption. If you're looking at why it's less than what is being produced, that would be explained by the exports, so you wouldn't have Mexico exports on here, we export to Canada in the east. And then there's also the LNG exports. With the production you have some inferred prices on here, like any supply and demand, what you're going to have is the more production you have, the lower the price. The chart on the left, you'll see the high oil and gas supply to that 52 TCF figure is going to equate to lower overall gas price on the chart on the right. To note, these are in 2020 or real dollars, so it won't have that rising effect that the nominal or inflated dollars would normally have. But essentially think of it as what the expected price would be is roughly less than \$4 throughout the timeframe here and the overall production is expected to be somewhere around 42 TCF by 2050.

**Pardee, Tom:** So, where do we obtain this production from? This is the primary areas that we get this production from. The southwest, if you've heard of the Permian Basin, that's what's in the southwest. It's mostly oil, but there's some other dry spots in there that they do drill for. And then the east, most probably heard of Marcellus and then the Utica. It's a pretty prolific shale resource that comes out of the east there. Gulf Coast is

Haynesville and some other areas and then the rest of the United States. What do we get here in our service territories? Do we get a lot of our gas or some of our gas from the Rockies? The Rockies regions. But primarily from Canada. So, with this production is the oil, so the other was the dry gas, this is the oil. Any oil extraction has associated gas. Think of this as people or companies are primarily drilling for that WTI oil. The Permian, again that's in the southwest, you'll see the blue there, that's the largest drilling region for oil at this time. And then another thing of note that is falling off a little bit was in North Dakota in the Bakken. You can see there's some still in the Gulf Coast for oil.

**Pardee, Tom:** Everybody is likely heard of the Ukraine scenario in Russia. What is being discussed is banning Russian oil and gas imports and what that could do. Even Elon Musk has stated that the US needs to start producing oil as quickly as possible to counter dependence on Russian oil and natural gas and what that could do. If it does start to ramp up, it could push these projections up in the short term. Maybe they would stay the same because of the way that shale production comes off. It's very high in the front end and then it really goes down to the smaller percentage later in its life. But you would potentially see a vast increase and associated gas from these new drilling rigs that may be coming online due to that scenario in Ukraine.

**Pardee, Tom:** The natural gas consumption by sector, you can see there's electric power on the very top. Commercial residential transportation, we have trucks, we have the waste management runs on compressed natural gas. Think of that as the large vehicles that use that to power their rigs, industrial and then liquefaction, so LNG. You can see they're expecting natural gas consumption by sector through 2050 to be right around 96 BCF a day. Most of these do not decline. There could be some discussion on that as to whether or not residential might decline based on some policy, whether electric might decline. But anything I've seen to date, they're not expecting a huge delta in the amount of power or the amount of gas that the power sector uses or any of these other major classes of customers. To give you an idea of that, what this represents here on the left is the natural gas disposition by sector and net exports. What you're what you're looking at here is the 10-year basis.

**Pardee, Tom:** And if I were to exit this presentation and put numbers on there, you would see electric power actually is an increase. I think at the very end it's around 12 BCF a day by 2050. Now I mean this is just the projection. It's likely going to be wrong, but again a lot of these that have come out, even with all the renewables in the news and more renewables being taken, there's still the need for backup and for when the wind isn't blowing in, the sun has been shining for that power to be there and. But having said that in their reference case, they are assuming that some gas plants or some delta is coming off probably based on some may be more inefficient plants.

**Gall, James:** Tom, you have a question from Fred.

**Pardee, Tom:** Go ahead, Fred.

**Fred Heutte (NWEAC) (Guest):** Hi everybody Fred here from Northwest Energy Coalition. I'm just trying to interpret this slide a little bit. Net exports, that's the lowest bar there on the graph on the left, the gray part. It makes me wonder, lots of things about the AEO making me wonder, current exports out of the US are over 10 billion cubic feet a day. And this chart does not represent that. It's not a hard number to figure out the amount of LNG export capacity, there's a dozen now, roughly speaking LNG export terminals, most of them are in the Gulf Coast, they're really big. It's not hard to track what they're doing it. And I just have to say that a lot of the assumptions about gas, and this is one, have to be revised going forward and it's no longer just a notional thing. What's been happening the last six months of course with Ukraine and what's happening with global gas markets and ultimately with the overall production of shale gas in the country, where most of the shale plays are now in decline. I mean the really big ones are still growing like Marcellus. But I just have to say it's reaching the point now where I've been grumbling about the AEO and the other national forecasts for quite awhile now. I think we actually have to confront the issue. Are they really assessing the situation as it actually is going to be going forward? The export quantities here really suggest to me that they are not.

**Pardee, Tom:** I don't disagree with you. I'm not sure these projections are right. In fact, I'll say they're wrong. But you know, I've looked at their new one, the new Annual Energy Outlook the 2022 one, and it doesn't differ vastly now on the net export piece here I would say what that is that we would be exporting to Canada as well but we also import from Canada.

**Fred Heutte (NWEAC) (Guest):** Yeah, exactly. I'm not sure.

**Pardee, Tom:** So that's likely where that delta is.

**Fred Heutte (NWEAC) (Guest):** Alright, fair enough. That's a complicated story. The amount of exports from Canada has been limited, has been reduced by the vast expansion of shale development in the US, which also has led to a vast expansion of exports. A fair point, I have to go back and look at the numbers, but I just think that we are seeing a pretty dramatic and this is not just because of what's happening with Russia and Ukraine, all that's very much a gas story. In addition to the war part of it and the disruption that's already causing any gas markets globally is going to affect us because we're now exposed to those events by the very fact that we're exporting gas and that the demand for exports as long as the global prices are a fair bit higher than the domestic price, that producers are going to export.

**Pardee, Tom:** Yep.

**Fred Heutte (NWEAC) (Guest):** Because I can make more money doing that which is going to raise, and this is really my underlying point, which is going to raise our prices going forward. Not to jump too far ahead, but that's the real conclusion I've reached, which is we have to look seriously now at a higher gas price deck than we have been the \$3 to \$4 range per million BTU that also underlies market prices. It could go back to

that I suppose, but we have to think seriously now about what? Through the next part of this decade, the remainder of the decade, what are the gas prices likely to be? Exports is just one factor in that. Sorry to jump in and make a lot of comments, but that's the way I'm seeing it.

**Pardee, Tom:** Yeah, you're good. Thanks for those comments Fred. On the LNG, you can see where some of these exports are basically going to I mentioned Mexico that's in the lighter blue. Then you have the LNG that's in the dark blue. you'll see the net imports from Canada. We also have LNG imports, that's mostly on the East Coast and they're in small quantities, but they're the net effect. It's about seven or eight TCF overall. One thing about why I was a little hesitant on including this chart, I have to be honest. That's why it's important to understand is because LNG, and I think Fred alluded to this, LNG is really up, it has a higher demand or uptake based on the price of oil. Think of oil, not just what we would use for gasoline, but for heating oil or bunker fuel. Those types of things start to come into view when you're looking to how you can most efficiently or cheaply heat your home. That's really where it's been tied to that and historically that's where the LNG price has been tied to is the price of oil. I know there's some different ways of pricing LNG now, but overall think of LNG as having a price tied to oil because you can switch it out. You can switch out LNG potentially at a cheaper price. It of course depends but it's based on oil price. If say oil is \$140 a barrel now, LNG is in the money as far as switch over. I wanted to include this rig count, it's important. Really stopped being a one to one. Let me explain this a little bit. When you're looking in the historics prior to shale, so take 2008 and go back, that's really conventional drilling. When you just basically think of it as strong going into the ground. It's really more of a known production quantity, you put it in the ground because there's a high likelihood that the oil is going to be prolific there or enough to offset.

**Pardee, Tom:** What they do now, and I know most of us on the phone, have heard of this, but essentially what they can do now is they can do horizontal drilling or vertical or, all kinds of even essentially make whichever you want the drilling rig and then they set charges at the end of the line and you can go 6 miles out. They set charges in the line. Why that's important is because now one line it might cost \$15 million, but it might be more cost effective than say drilling a mile line. The cost might be more but it's going to be a higher production and so why I wanted to show this is that even though the oil and gas rigs are lower than what they have been in the US, and this is US, by the way, this is an international, but so gas has that associated production that comes from the oil. The oil does matter as well, but you can see there's been an uptick and that's due to the price of oil going up. Now there's been some corrections and some bankruptcies since COVID, but I think for the most part that's all been all the takeovers and mergers have occurred. Fred, did you have another question?

**Fred Heutte (NWEA) (Guest):** No, I think I need to figure out how to get my hand to go down.

**Pardee, Tom:** Oh no, that's good. I also wanted to include this. This is something we get from NBC Energy. And. Not as in BC Energy and National Bank of Canada is NBC and S&P Global, so they come out with the morning commentary. What we saw in the prior slide was just forecast so they're going to take their economic indicators into play. But what's interesting is and the chart on the left is going to show you that over the past say 4 winters production has mostly increased year over year and I'll explain what those dips are 2020 to 2021 or that red line that was six BCF that came off. There was some cold weather in the southern United States for a lot of this production is and so with production in warmer states, they don't have protective equipment, so I think I've heard windmills, has protective equipment as well, but if you remember the energy event that happened in in Texas in 2020 or the winter of 2021 that occurred in February and that's where they were having to buy energy at exorbitant amounts and there is a decent amount of press about that and the reliability of electric and gas was not there. That's the story of those two big blips. But just overall of note that you know from just 2018, the winter of 2018, we've risen almost 10 BCF. Now if that's sustainable, I don't know.

**Pardee, Tom:** Also, of note, if you look at the LNG export, this is something my friend was alluding to. We've had a number of new facilities come in and there's one Canada LNG that's just north of Vancouver or quite a bit north of Vancouver, but on the West Coast of Canada that's been approved and is in construction and has the ability to export as much as three BCF a day, maybe a little bit over three BCF today. You can see the amount of additional demand LNG is pulling and with that, if production doesn't come on, it will raise prices because it's that same supply and demand conundrum that affects everything. Are there any questions before I get into the expected prices and I'll explain how these were put together? Any market questions? Perfect. OK.

**Pardee, Tom:** We have two energy forecasting consultants doing fundamental forecasts and we use the NYMEX, or the forward prices forward price curve, and we also used the Annual Energy Outlook of 2021. You can see the vast differences mostly where the price differences are going to come from is expected uptake of demand and of course the cost or the uptake, or production of supply. I think more studies provides a better idea of what a better average might be. Rather than taking a single study and saying that's good, we've included a number of studies. We have the actual market right on this day and that was done on February 16<sup>th</sup>. We took the market price on February 16<sup>th</sup> of this year and then we had a recent study from our consultant and another study.

**Pardee, Tom:** We'll be updating along with the Annual Energy Outlook for the next round of prices, but you can see that expected price starts a little warm, a little higher in 2023. That's the seasonality that seems the forwards are doing to us these days and the near term is always priced a little higher or it has been priced a little higher due to supply fears and potentially weather-related fears and storage. But what you'll see is this forecast expects by 2045 we'd end up somewhere between \$5.50 and \$6. Let me show you what this looks like on the levelized basis. These are our local basins, we have a code that's up in Canada. It comes in at the Idaho border at Kingsgate, but think

of where AECO is right around Calgary, Rockies, Sumas. The Rockies is down and say California and Wyoming, Sumas over on the west side of Washington state. It's at the Huntington, it's the other side of Huntington and Canada. It's at the border, the transfer point. Moline is in Southern Oregon. And Stanfield is kind of where the two pipes meet. The two pipelines being Northwest Pipeline and GTN. And that's an important factor because that's close to where our Coyote Springs plant is. What you'll notice here, and I guess a benefit for us, is that Henry Hub is the highest price on here. Saying that differently, although Sumas can go higher during certain points of the season, overall, it's a lower price than the Henry Hub. AECO is where we primarily transact for our thermal plants. Avista you'll note here is the lowest price on here. Taking it on a levelized basis from 2023 through 2045, we're starting between \$3 and \$4 for all of these basins including Henry Hub, and that's really where it starts to differ by basin. At the end you have \$6, between a little over \$4 for AECO and about \$6 for Henry Hub. Let me show you what this looks like on a levelized cost. Taking those costs from the prior chart, what this shows is essentially an average price. We use some other financial terms in here like our capital rate, but essentially it's the price throughout this time series on a levelized basis. AECO is just a little over \$3 and Henry Hub is hitting around \$4.10 over this time frame and the others are roughly in between.

**Gall, James:** So, for that question.

**Pardee, Tom:** What is it like? Yeah.

**Fred Heutte (NVEC) (Guest):** Hi, this is Fred again. I have two points I want to make. First is the Henry Hub or the NYMEX prices are an enormous market in the short run. They always like to brag they've got the third largest commodity market in the world with a trillion dollar plus turnover. I mean real money. For about two years you have a real market with lots of buyers and sellers, a lot of in-depth insight into what the prospects are for gas supply and demand, all of that. And then after that it just falls off the cliff, which to me is not surprising in a commodity market. But it really says is the people who actually do have skin in the game don't want to make bets out beyond about two years, the market interest, number of contracts available to buy or sell. All you know is around 200,000 right now for each month drops down to maybe 15 or 20,000 a year or two from now and then goes off to virtually nothing going forward, so I don't hold those future prices in very much regard at all. You can look at fundamental analysis, how much gas is out there, how much demand do you expect and come up with some estimates, but I really don't think of them as being market set prices, futures in any real fashion. That's the first point. The second point is about the differentials. And this is a complicated issue. I'm certainly no expert on it. I know a lot of attention is paid to for example, the differential between Kingsgate and Henry Hub, or AECO, any of them. It's a pretty important thing because a lot of contracts are written in a way that regarding those spreads and there are a lot of factors that go into why those prices stay very similar or converging. You're showing it, a bit of convergence, a bit of dissimilarity here, actually that's the AECO price is 25% less than the Henry Hub price here. And I also wonder

about that in particular because of the LNG export issue you mentioned with at least one maybe there are only ever be one, but we now know there will be one LNG export terminal way up north in BC that's going to pull from the same supply region that most of our supply, the Northwest comes from and we get some Rockies gas, but most of it is from BC and Alberta and that's up to three BCF a day. I'm trying to remember off the top of my head, I think BC and Alberta now are around 10 or 11 BCF a day production. You could correct me if I'm not right and it's higher. It's gone higher and it could go a little higher potentially, but they're already drilling in the best.

**Pardee, Tom:** It's about 15 or 16.

**Fred Heutte (NVEC) (Guest):** Rocks they've got and that costs or that amount can only continue if the price goes up. I really wonder about the differentials here going forward and whether the national services that you're subscribing to really, I'm not asking for any proprietary information, but really how much in-depth analysis do they do or are they basically just doing trend projections. That's my concern here because I think we've had two or three decades where we haven't had to worry too much about gas price in the northwest, we're a small part of the market for what BC and Alberta produce after all. And for the most part those prices have been pretty close to Henry or even below as you're pointing out. But is that really going to continue in the future? I think there's a very good question.

**Pardee, Tom:** No, I agree with you. And actually, how we how will weight these, we can mostly find liquidity on the market for three years. That's roughly what it is now. I agree with you. Sometimes it's harder to get out in that third year for sure, but on ICE where our traders are, buyers transact roughly about three years. In this forecast there's a specific weighting that we do to this and I didn't include it and I can in the final pitch. It it's really how we will blend these because that's important as well. As you're mentioning Fred, for the first two years we take the forward market. In this price, in other words, what the forward say for that day is what we consider the best estimate. But after that we don't consider it a very good indicator, and we really reduce it fairly quickly after the that third year. Good points, fair points.

**Pardee, Tom:** I do know, I mean, I can't tell you that. IHS is one of our consultants and I'd say they're probably the best in the industry. I could, we could probably get them. I can ask some of their analysts to see if they're looking at just trending. I doubt it. So what they generally will do is they put it into their overall global model. That will affect prices, so they have people that will look in and say we think that LNG is going to go on here and it's in this specific location and what is that going to do to the price of supply. In other words, how that global model interacts is what they will mostly do their reporting on. So fair point. Spread on a basis to Henry Hub this is just a levelized, and it was what Fred was just mentioning, is throughout the timeframe here what you're looking at is comparing Henry Hub is zero here, how much further down below is that right. AECO is a dollar, over a dollar basis on levelized cost basis lower than Henry Hub. Now there is some seasonality to this. So just keep in mind the levelized is just, think of it as an



average of what the basis is to Henry Hub. It doesn't mean it's always going to be a dollar, of course, like Sumas will be higher in December than Henry Hub or potentially in January, but say maybe in June, it's not as high or it's much lower. But this is roughly what the spread is we're looking at between the hubs. Rockies has the least amount and then you'll go down from there.

**Pardee, Tom:** Running into the stochastics here, so stochastic forecast input, that's the expected price that we put in there from the past couple slides that I've gone over. The pyramids are what the 95th percentile of this forecast is, and then you have the 50th percentile, so that's just below the average on some of these. You'll have the average in the bar, the light yellow bar or orange. I shouldn't say colors because I'm mostly color blind. Then you have the 25th percentile in that green sideways square. These are in nominal dollars. We're running between just south of \$4 in 2023 and then by 2045 we're expecting it to be somewhere around \$6.

**Pardee, Tom:** And my final slide is this histogram of where those prices lie. The frequency of \$4.20 looks like it has the highest frequency. In other words, the amount of draws had the most in that bin for between \$4.11 and \$4.20 or \$4.21 and \$4.30. But it's a fairly good distribution. And you can see the higher price on, and I think that's probably toward the end, is around that \$5.96 range. Is there any questions? That's it for me.

**Fred Heutte (NWECC) (Guest):** Not really a question, but just a suggestion which is not asking you to shift this kind of analysis. But I wonder if it would be possible to run as a scenario another stochastic approach where the price at the center of the distribution is a fair bit higher. I mean not crazy high, but you know 6 bucks instead of 4 bucks to reflect a potential for a different pricing environment going forward.

**Pardee, Tom:** Yes.

**Fred Heutte (NWECC) (Guest):** Number of reasons for that, just to say for over the last year ago compared to now gas price today is about \$4.50 at Henry Hub. It was about half that or maybe a little bit more than half that a year ago. It has been going up for the last six months and now we have the disruption with the war in Ukraine and European situation, they're very dependent on gas there, a lot of supply is going to flow to them to replace the Russian gas. It's a short-term thing, perhaps, but really the question I have is over the long run. If we're in a higher gas price environment, it's not just that the company is buying gas for customers directly, but also the effect in the power market. I really want to encourage an alternative gas price analysis this time that doesn't just include the higher prices like the stochastic approach here does, but in fact has a higher base or central priced ends so we could see what that looks like and consider what the potential resource, a good resource portfolio will look like if that happens.

**Gall, James:** Hey, Fred, this is James Gall. We will do that scenario just to let you know and all previous IRP's we've done a high and a low gas price forecast. If you're

interested in seeing how our portfolio changed in that scenario last time that's available in our IRP.

**Fred Heutte (NVEC) (Guest):** Yeah, I can go back and pick it up. But you know, there's a whole lot of material to look at. But thanks for the reminder.

**Gall, James:** Yeah. I don't know if we'll do a full stochastic study on high, but we will do a high case. I'm glad you're on board with us to keep looking at this rather than let it go.

**Fred Heutte (NVEC) (Guest):** Yeah. Thanks.

**Pardee, Tom:** Yep. Any other questions? I will say one last thing. I have seen one of the recent studies that we need to update from our consultant and to your point Fred, it is a higher overall price by probably at least \$0.40, so you'll see that reflected in in the prices that we use in the IRP's.

### **Electric Price Forecast, Lori Hermanson**

**Gall, James:** I guess it's a good time to transition to the next forecast which makes all this important on the gas side. Why we talked about it is like Fred mentioned, the impact to the electric price forecast, which we're going to transition to now. Lori is going to go through our price forecast. We have about an hour, so we have a little bit more time than expected. I'm going to turn over to Lori. She was gracious enough to take on the price forecasts this time around. I've been doing it since 2004. This will be her first shot at it, and I'll turn it over to you, Lori.

**Hermanson, Lori:** OK. Can you see that? And can you hear me OK?

**Pardee, Tom:** Yeah, we can see it in here Lori.

**Hermanson, Lori:** OK, perfect. Thanks. I'm Lori Hermanson, senior resource analyst. A little bit newer to the group, not as new as Mike, but as James said this is my first time through this. Just to give you an overview before I get started, this is a preliminary price forecast analysis. We're going to use it for comparing the RFP responses that we expect to come in the end of this month if I have my dates right or early April. Later this summer we'll be updating this for new gas prices and other assumptions such as new IHS forecast and things like that, possibly FERC form 714's if those are in by then. Any of that data we're going to be incorporating the most recent assumptions and that will go into this IRP. And then finally we haven't completed our stochastics yet on the electric price forecast. After we've done that, we will be sharing the results with the TAC.

**Hermanson, Lori:** Just to back up and talk about why we do this. Price forecasts are basically trying to estimate the value of resources within the Western interconnect and of course this feeds our IRP and is just to establish the dispatch of the dispatchable resources and all of these resulting prices that we get from it helps inform our avoided cost. Finally, it could change our resource selection based on the resources in other

areas of the Western Interconnect. For example, if there's a lot of solar in California and Arizona, maybe there wouldn't be as much solar selected up here. So that's not determined, but it's a possibility that it could change as a resource selection.

**Hermanson, Lori:** Our methodology, we use Energy Exemplar's Aurora. It's a third-party production cost model that incorporates electric price fundamentals market and it simulates the dispatch of generation and the regional load, and the outputs we get are the market prices that include both electric, just a base electric and then also an emissions price, our regional mix, our transmission usage, our greenhouse gas emissions, power plant margins, generation levels, fuel costs and then of course our variable power supply costs.

**Hermanson, Lori:** This is a historical look at the Mid-C electric prices and as you can see in the late 1990s, we had cheap natural gas and good hydro, so the prices were fairly low. We had the 2001 energy crisis and prices skyrocketed. The natural gas market tightened during the early to mid-2000s, we had higher prices until shale development increased supply and brought prices down. Finally, in 2021 we had some higher prices, a combination of a handful of things like the Heat Dome, low hydro year and maybe a little fear in the market. But higher prices there, and you see the forecast as of the end of February forwards going out for a few years.

**Hermanson, Lori:** This is a look at the historical generation mix for the Western Interconnect. I don't think any of this is surprising. Some of the big changes are increases in renewables such as solar and wind. There is an increase in natural gas, but that's mostly to offset coal plants being retired and that's everything I had to say on that slide.

**Hermanson, Lori:** This is basically the same look at the generation mix for the Northwest, which includes Idaho, Montana, Oregon, Washington and hydro at the bottom. You can see the variability in our hydro over the last 20 years and the significant changes you'll see as the natural gas, or I'm sorry, it's the coal plants are being retired that's being offset by natural gas and then there's increases in renewables such as solar and wind.

**Gall, James:** And Lori, have a hand up from Mike Louis.

**Hermanson, Lori:** OK.

**Mike Louis (IPUC):** Hi, Lori. I would like to go back to the methodology that's going to be used in this IRP. My understanding and could you tell me? The first question is the methodology that you plan to use this year the same as the methodology that was used in the previous IRP?

**Hermanson, Lori:** Yeah.

**Mike Louis (IPUC):** My understanding is that you used some market prices to make some adjustments for specific hubs in the Aurora generated price. My understanding is that it wasn't just a purely Aurora generated electricity price. Could you confirm that?

**Hermanson, Lori:** OK. I might need James to weigh in on that. I know that we do have one difference in this, and I'll talk about it more in a later slide. But since some of the legislation is up in the air and Washington and Oregon, we know there's going to be an emission price component, but we don't know what that is. In the mean time we have a placeholder of California's emission price. But in regards to the rest of your question, James, do you want to comment on that?

**Gall, James:** I'll try it. Mike, I'm a little confused. I'm not sure what you're referring to as far as adjustments. We did not adjust any prices from our last IRPs or runs, so maybe that's not the right question. Maybe I'm confusing something.

**Mike Louis (IPUC):** I may have got that wrong, James, but I seem to remember there were some changes made in the last IRP that basically didn't produce a pure Aurora generated electricity price. I'll dig something up and see if I can adjust my question. How's that?

**Gall, James:** Yeah. I can see maybe you're thinking about our RFP when we evaluated our last round of bids. We combined an Aurora forecast in a forward market.

**Mike Louis IPUC):** It could be.

**Gall, James:** Yeah, but in the IRP, we typically forecast out far enough where we don't make any near-term market adjustments.

**Mike Louis (IPUC):** OK, let me see if I can dig this up so I could ask a more precise question.

**Gall, James:** Alright, no problem.

**Mike Louis (IPUC):** Yep, thank you.

**Hermanson, Lori:** This slide is a closer view of the 2020 fuel mix, both for the Northwest and for the Western Interconnect. You can see for the Northwest where 59% hydro compared to 24% in the WECC, about half of nuclear compared to the WECC at 4%. Wind is on par with what you're seeing in the WECC. Solar we're a little bit lower at 1%. Coal we're about half of what you're seeing in the Western interconnect. And then also natural gas we're about half of what you're seeing in the Western interconnect, so the Northwest has greenhouse gas emission where it was 75% greenhouse gas emissions free and 2020, whereas for the Western Interconnect they are 49%.

**Hermanson, Lori:** Here's the collection of charts that is basically indicators of what's happening in the market and what we're seeing is the markets tightening. This first chart is a comparison between the natural gas and on peak electric prices. In the past, there's

been a very tight correlation between natural gas and electric prices and each years IRP was pretty close to that relationship.

**Hermanson, Lori:** A natural gas and on peak electric was pretty close to that line in the last two IRPs, and the 2020 and 2021 IRP just starting to see a little bit of splintering or divergence from that from that tight line. And then in the 2023 IRP with these preliminary price forecasts, you're seeing a huge divergence and so basically that splintering is indicating that maybe there's more impacting the prices than just the cost of natural gas. The spark spreads are an indication of the profitability of the gas turbines historically used. See that it has been around 7700 and these last few years, with the exception of 2020, we're seeing a lot more disparity there and higher margins, higher profitability. In the future, as we see carbon emissions as a component of the price, you should see some decreases in the spark spread going forward regarding the implied market heat rate in the past.

**Hermanson, Lori:** The efficiencies of the units that are being run, around 8 thousand and in the future or I'm sorry, whoops, and the more recent years of 2018 through 2021, you're seeing a more in the 12,000 level and so that's indicating there's this more inefficient mix of units being run in the Northwest, and those are the units that are setting marginal price. Finally, standard deviation of the Mid-C prices, while there was some volatility in the early years, it really spikes in these later years and you're seeing not only more volatility but more differential between on-peak and off-peak prices.

**Hermanson, Lori:** This slide is a closer look at that implied market heat rate, the efficiencies of the units being operated in the Northwest and it's basically the last five years on a monthly basis. Again, you're seeing higher levels of that implied market heat rate, which is indicating more inefficient units being operated.

**Hermanson, Lori:** In regards to greenhouse gas emissions, these are numbers for the entire Western Interconnect in millions of metric tons. The trend is that it's coming down. Up and to the left, you can see the percent change either plus or minus. Some of the states leading the pack are Wyoming, New Mexico and California. Wyoming, I think, in 2019 they converted a coal plant to natural gas. I think that's causing that big drop between 2019 and 2020 because that conversion was in 2019. New Mexico and California having some larger decreases. So same look, basically the greenhouse gas emissions, but only for the Northwest and same thing, you're seeing this downward trend. Maybe in 2020 there is, if I'm remembering right, it was retirement of units one and two at Colstrip.

**Gall, James:** Lori, Mike, his hand up still, I don't know. Mike, did you have another question or comment, or was it left up from last time?

**Mike Louis (IPUC):** Sorry about that. I need to figure out how to turn it off.

**Gall, James:** No problem.

**Hermanson, Lori:** An overall look at our modeling process. We start with Energy Exemplar's 2020 database and from what I understand they get that database or they update that database from various sources such as NERC and EIA. And then the FERC Form 714 and Statistics Canada. We started with that database. That database is an update from the one that we used in the last IRP. To that we add other inputs such as our 80-year hydro and natural gas prices, both deterministic and stochastic. We add in regional loads, our loads and resources and other operational details. After that we run a capacity expansion module and that tells us how many new resources to add, and then we also include retirements or conversions such as the one I mentioned earlier like a coal plant being converted to natural gas. We may tweak that by adding additional new resources to meet planning targets.

**Hermanson, Lori:** After that, we run stochastics on our electric prices to test for resource adequacy. Then we'd rerun a capacity expansion module, maybe adjust again for meeting those targets and by either increasing or decreasing those new resource adds. Then we'd run another full stochastics and deterministic forecast, and then finally we'd run our scenarios that James was talking about earlier with high gas prices, low gas prices and others that we've collectively decided to do. So, where we are in the process, we're just starting our stochastic. We're about halfway through this process and later this summer, after all this is finalized, will meet again and update on where this all shakes out.

**Hermanson, Lori:** This is the load forecast, we get the regional load forecast from IHS and their forecast includes energy efficiency. We add to that net metering and electric vehicles including the hourly shape and then all this goes into Aurora to determine what the load shape is and how it differs over the 22-year planning horizon.

**Gall, James:** Question from Jim, Lori.

**Hermanson, Lori:** OK.

**Woodward, Jim (UTC):** I appreciate the discussion so far. I had a quick question regarding the confidentiality, if any, of the data. Given you know this is run out of Aurora, that Energy Exemplar maintains, is there any again confidentiality or sensitivity around those database prices for public purposes of discussion or review.

**Gall, James:** I'll try to answer that Lor. The input database is a proprietary input database. Some of the information we're getting from IHS is as well. The output prices on the other hand, we will provide on an hourly level to the TAC. It'll be on our website.

**Hermanson, Lori:** OK.

**Gall, James:** Including, if you're interested in the last IRP, all of our prices are included on the website. We're trying to keep the output as much as possible available. The inputs that are not proprietary, we try to provide those when possible as well, such as the natural gas price forecasts we use will be available.

**Woodward, Jim (UTC):** That helps, James I guess, just trying to wonder if we do have questions forthcoming on the outputs we may I guess start to hit up on you or your team. Let us know if we start to hit up on confidentiality concerns as far as drivers for those prices. Is that fair to say?

**Gall, James:** Yep, I think that is appropriate.

**Woodward, Jim (UTC):** OK. Thanks.

**Hermanson, Lori:** And I have a slide about the outputs at the end. Usually what comes out of this process. We'll talk more about that in detail as we get towards the end too.

**Hermanson, Lori:** This is a closer look at our rooftop solar as well as our electric vehicles forecasts for the 22 years and rooftop solar. We start with EIA estimates for historical and then we use IHS's regional growth rates for electric vehicles. This is a snapshot in time, these penetration rates, but for 2040 were using 15 to 65% penetration for light duty, 12 to 15% for medium duty and 5% for heavy-duty vehicles.

**Hermanson, Lori:** I touched on this earlier. There's a lot of new legislation in the Northwest. For Washington, it's the Climate Commitment Act. For Oregon, the Climate Protection Program. And until those are more finalized and we know what the emission prices are going to be, in this preliminary forecast, we included a carbon price forecast based on California's emissions prices. The source for that was the 2019 EPRI carbon price projections. On a levelized basis, it was about \$41.47. In addition, we also included an adder to the transmission cost for regions exporting into the northwest. This is our new resource forecasts that came out of our capacity expansion module we ran. This is comparable to what the Northwest Power Planning and Conservation Council has come up with some nuances. I think they may have more wind and we have more solar, but they're in the ballpark. And you can see, not surprisingly, renewables are increasing, coal is declining, natural gas as increasing somewhat to offset the coal, and there's increases in storage is the general trend here. As far as the resource, both historical and forecast by resource type, this is a look at the entire Western Interconnect, the major changes similar to what you've seen earlier increases in renewables. The change for 2023 to 2045 are about 42.7 average gigawatts for renewables. You see gas, or I'm sorry, coal units being retired and being replaced and actually natural gas coming off. And then there's a few other smaller resource types in there. As far as the northwest, the hydro now it's flat after the stochastics, there will be some variability in that hydro. You can see renewables are increasing for 2023 to 2045, natural gas and coal are coming off and there's a few changes in the smaller categories.

**Hermanson, Lori:** Greenhouse gas forecasts for the entire Western Interconnect for historical and forecast going forward. Basically, you're seeing that same trend. Emissions are coming down and this is broken out by state. When you see a huge decline in in Arizona and California, those bigger drivers that are dropping off, but everybody is trending off. And same thing greenhouse gases, both historical and forecast for the Northwest. Again, trending downwards, you see some retirements

around 2025. One of those is Colstrip and I think there's a Centralia plant retirement there in that time frame. The general trend is reductions overall.

**Hermanson, Lori:** This is our electric price forecasts for the expected forecast. Both on an average off-peak, on-peak and super evening peak. you're seeing something similar to the last IRP where there's that differential between on-peak and off-peak, but it's a more pronounced margin between those, so they start out on par in 2023 and by 2025 you start to see this fracturing with the off-peak prices being pretty high, similar to that super peak evening price on a levelized basis these costs are \$41.76 per MW hour.

**Gall, James:** Lori, I want to make a point here. In the last IRP, we were in the high 20s for prices, so we're seeing a significant increase in our price forecasts right now. So, it's going to have some effects on the resource choices in the next plan.

**Hermanson, Lori:** This is a similar look at the Mid-C, but on a seasonal basis for a handful of years. You're seeing the same sort of trend each season. However, in winter, summer and fall you're seeing more pronounced evening peak prices where the middle of the day is suppressed due to solar and possibly EV charging causing this upward spike in the evenings. This is our Mid-C price forecast compared to our IRP. All of our price forecasts from our past IRP is comparing them with how actuals are coming online in the actuals are this thick gray line and for this 2023 IRP, we're looking at the dotted black line. You can see the last IRP was 2021, this red line, so you can see how much it's increased. This black dotted line does include that carbon price, but without carbon, it would probably be in between the two. We plan to run a no carbon case so we can quantify that differential. You're seeing higher prices, those James just mentioned.

**Hermanson, Lori:** Next steps as I mentioned, we're starting to do our stochastic modeling, starting to build those cases in Aurora. We'll be running stochastics to verify our resource adequacy later this summer. We plan to update the price forecast and other assumptions such as changes from the WRAP program, IHS forecast and any more information on Washington and Oregon carbon pricing as well.

**Hermanson, Lori:** Finally, these are the outputs from this whole process of the deterministic electric price forecasts. Typically, if this were final, we would be posting all this on our website, but since its preliminary, maybe we post it after it's finalized. If anybody has any interest in the meantime reach out to us and we can provide these outputs now. That's everything I had unless anybody had any questions?

**Gall, James:** Not hearing any questions. This is the last presentation. It looks like we are going to end a little early, which is not a necessarily a bad thing, but I want to leave the line open if there's any additional thoughts. While you're thinking, next steps where we're going to take a break from TAC meetings for a little while we start evaluating the RFP results. I think our next meeting, John, you presented that earlier is in August.

**Lyons, John:** Yes, next TAC in August.



**Gall, James:** OK, so what we'll be doing before August, we'll settle on a date and get that out to each of you. I'm also remembering next steps. We will be sending you a copy of the DNV study. Also be on the lookout, we may start posting more additional data as we find it available on our website. Like John mentioned, there is a new website available to look at. It's better organized, so please check that out. Is there anything else John or Lori, or from Avista before we call it a day?

**Lyons, John:** No, I think that's it besides my Wiener dogs barking in the background.

**Gall, James:** Any questions? Jim has a question, go ahead.

**Woodward, Jim (UTC):** Thanks, James. Regarding there is going to be a little bit of a break between now and the next meeting in late summer. Was wondering if the team had plans to add significant data updates to the website. Would you perhaps sync that with an email out to the group just to alert us? Or are we basically on point to check your website periodically. Just kind from a public participation notice standpoint.

**Gall, James:** I think we'll send out an email if there's something significant. So that's a good reminder. Thank you.

**Woodward, Jim (UTC):** Sure thing. Thank you.

**Gall, James:** Alright. You guys have been quiet. We thank you for participating today. Lots of good input, especially in the NEI presentation. And again, thank you and I hope you have a great rest of your day and for some of you I will be seeing you in a couple hours that are in the CEIP discussion.

**Gall, James:** Alright, thank you.

**Woodward, Jim (UTC):** Thanks everyone. Take care.



***2023 Electric Integrated Resource Plan***  
**Technical Advisory Committee Meeting No. 4 Agenda**  
**Wednesday, August 10, 2022**  
**Microsoft Teams Virtual Meeting**

<b>Topic</b>	<b>Time</b>	<b>Staff</b>
Introductions	9:00	John Lyons
Electric Conservation Potential Assessment	9:05	AEG
Break		
Electric Demand Response Study	10:35	AEG
Lunch	11:30	
Clean Energy Survey	12:30	Mary Tyrie
Adjourn	2:00	

---

## Microsoft Teams meeting

**Join on your computer or mobile app**

[Click here to join the meeting](#)

**Or call in (audio only)**

[+1 509-931-1514,,184108690#](#) United States, Spokane

Phone Conference ID: 184 108 690#

[Find a local number](#) | [Reset PIN](#)

[Learn More](#) | [Meeting options](#)

---



# 2023 IRP Introduction

2023 Avista Electric IRP

TAC 4 – August 10, 2022

John Lyons, Ph.D. Senior Resource Policy Analyst

# Meeting Guidelines

- IRP team is working remotely and is available for questions and comments
- Stakeholder feedback form
  - Responses shared with TAC at meetings, by email and in Appendix
  - Would a form and/or section on the web site be helpful?
- IRP data posted to web site – updated descriptions and navigation are in development
- Virtual IRP meetings on Microsoft Teams until able to hold large meetings again
- TAC presentations and meeting notes posted on IRP page
- This meeting is being recorded and an automated transcript made

# Virtual TAC Meeting Reminders

- Please mute mics unless commenting or asking a question
- Raise hand or use the chat box for questions or comments
- Respect the pause
- Please try not to speak over the presenter or a speaker
- Please state your name before commenting
- Public advisory meeting – comments will be documented and recorded

# Integrated Resource Planning

The Integrated Resource Plan (IRP):

- Required by Idaho and Washington\* every other year
  - Washington requires IRP every four years and update at two years
- Guides resource strategy over the next twenty + years
- Current and projected load & resource position
- Resource strategies under different future policies
  - Generation resource choices
  - Conservation / demand response
  - Transmission and distribution integration
  - Avoided costs
- Market and portfolio scenarios for uncertain future events and issues

# Technical Advisory Committee

- Public process of the IRP – input on what to study, how to study, and review of assumptions and results
- Wide range of participants involved in all or parts of the process
  - Please ask questions
  - Always soliciting new TAC members
- Open forum while balancing need to get through topics
- Welcome requests for new studies or different modeling assumptions.
- Available by email or phone for questions or comments between meetings
- Due date for study requests from TAC members – October 1, 2022
- External IRP draft released to TAC – March 17, 2023, public comments due – May 12, 2023
- Final 2023 IRP submission to Commissions and TAC – June 1, 2023

# 2023 IRP Progress Update

- Please provide any feedback on Washington and Regional Carbon Pricing Assumptions by August 15<sup>th</sup>
- Schedule changes:
  - Oct 12<sup>th</sup> TAC moved to Oct 11<sup>th</sup>
  - Move Global Climate Change Studies from Oct 11<sup>th</sup> meeting to Sept 28<sup>th</sup> meeting
  - Move L&R and load forecast from September 28<sup>th</sup> meeting to Oct 11<sup>th</sup> meeting
- Public Participation Partner's (P3) reach out opportunity (Date TBD)



# 2023 IRP TAC Meeting Schedule

- TAC 4: August 10, 2022
- TAC 5: September 7, 2022
- TAC 6: September 28, 2022
- TAC 7: October 11, 2022
- Technical Modeling Workshop: October 20, 2022
- Washington Progress Report Workshop: December 14, 2022
- TAC 8: February 16, 2023
- Public Meeting Gas & Electric IRPs: March 8, 2023
- TAC 9: March 22, 2023

# Today's Agenda

- 9:00 Introductions, John Lyons
- 9:05 Electric Conservation Potential Assessment, AEG
- Break
- 10:35 Electric Demand Response Study, AEG
- 11:30 Lunch
- 12:30 Clean Energy Survey, Mary Tyrie
- 2:00 Adjourn Electric IRP



# Avista 2022 Electric Conservation Potential Assessment



Date: 8/10/2022

Prepared for: Avista Technical Advisory Committee

# Agenda

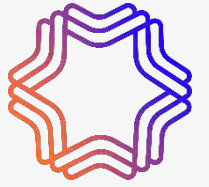

- ✔ AEG Introduction
- ✔ Study Objectives
- ✔ AEG's CPA Methodology
- ✔ Electric CPA Draft Results Summary
- ✔ Electric DR Analysis Summary



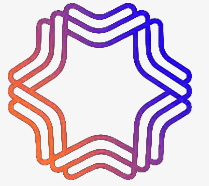

# AEG Introduction



**Eli Morris**  
Project Director



**Kelly Marrin**  
Demand Response Lead

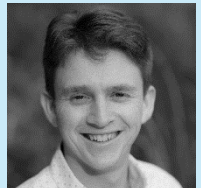

**Max McBride**  
Energy Efficiency Lead Analyst



**Andy Hudson**  
Project Manager

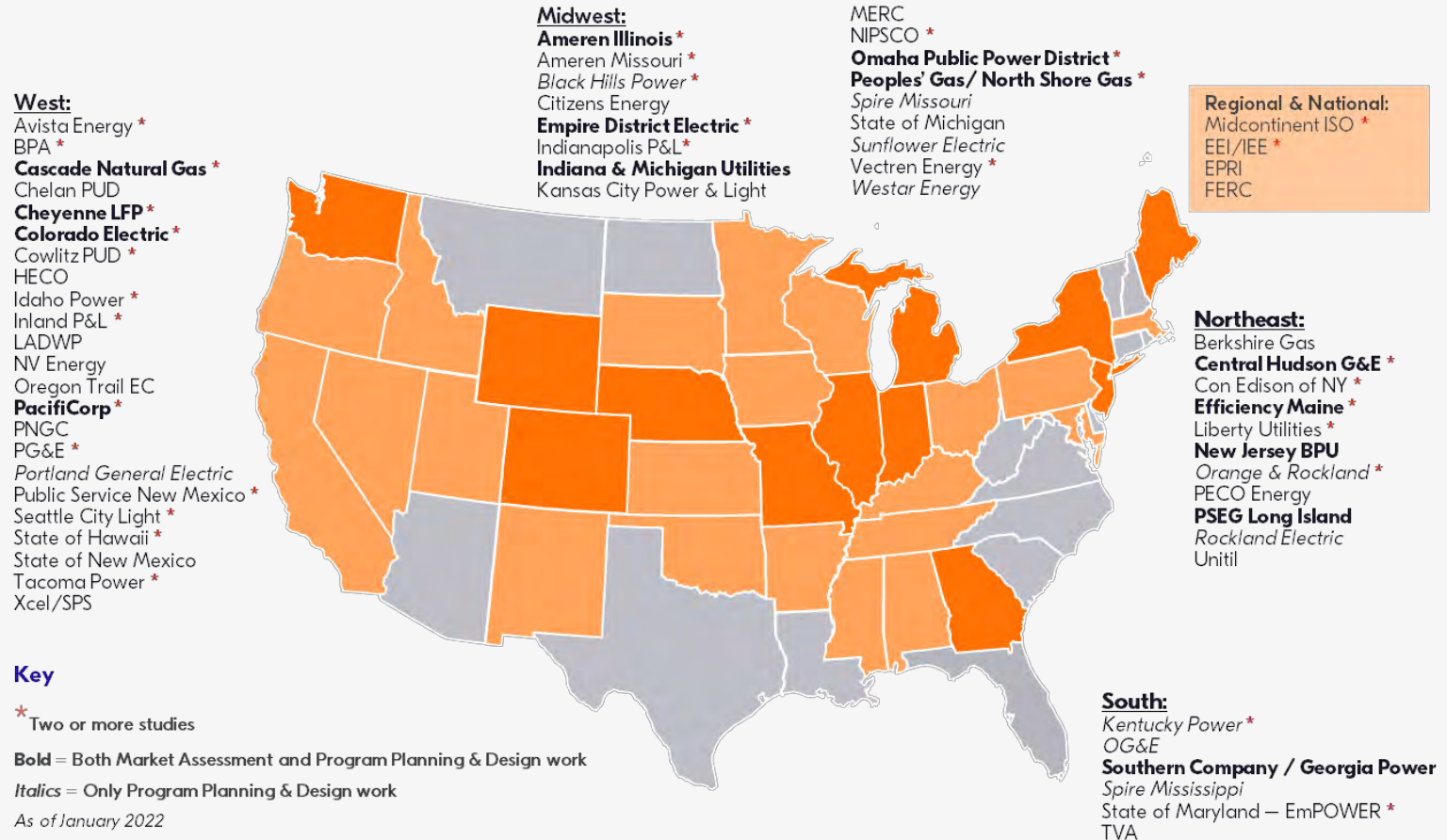

✔ 60 potential studies in last 5 years, many of these in the Pacific Northwest

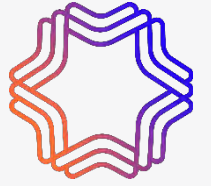

# CPA Objectives

- ✔ Assess a broad set of technologies to identify long-term energy efficiency and demand response potential in Avista's Washington and Idaho service territories to support:
  - Integrated Resource Planning
  - Portfolio target-setting
  - Program development
- ✔ Provide information on costs and seasonal impacts of conservation to compare to supply-side alternatives
- ✔ Understand differences in energy consumption and energy efficiency opportunities by income level
- ✔ Ensure transparency into methods, assumptions, and results



# AEG CPA Methodology

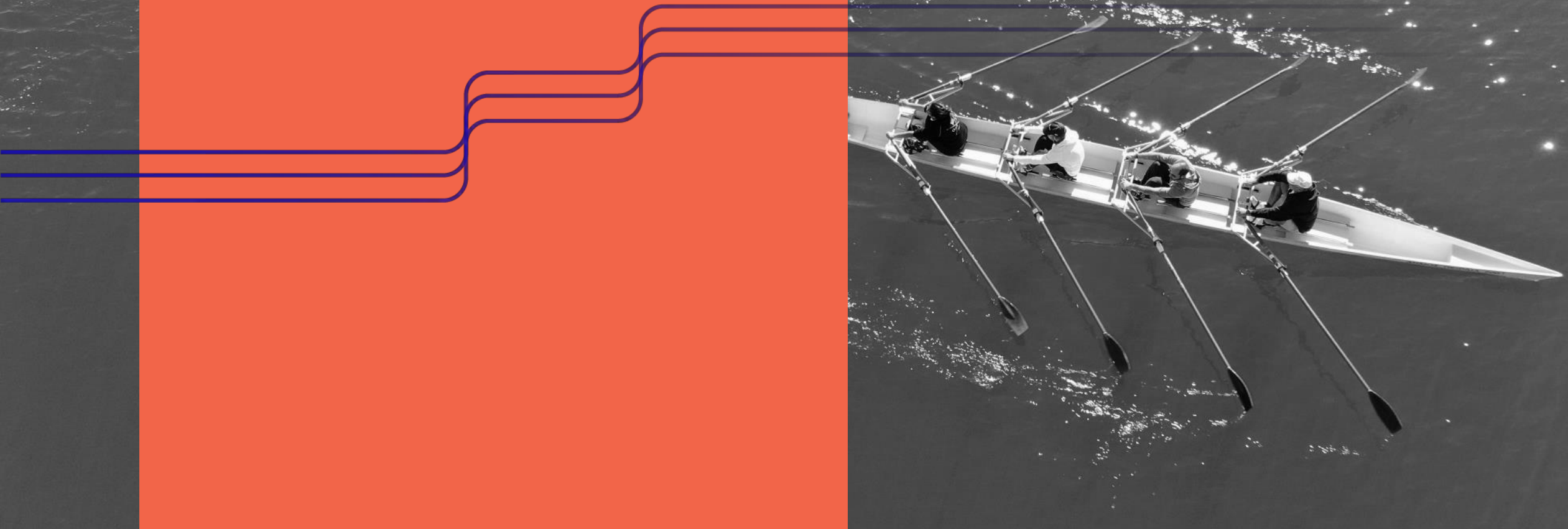

# AEG's Modeling Approach

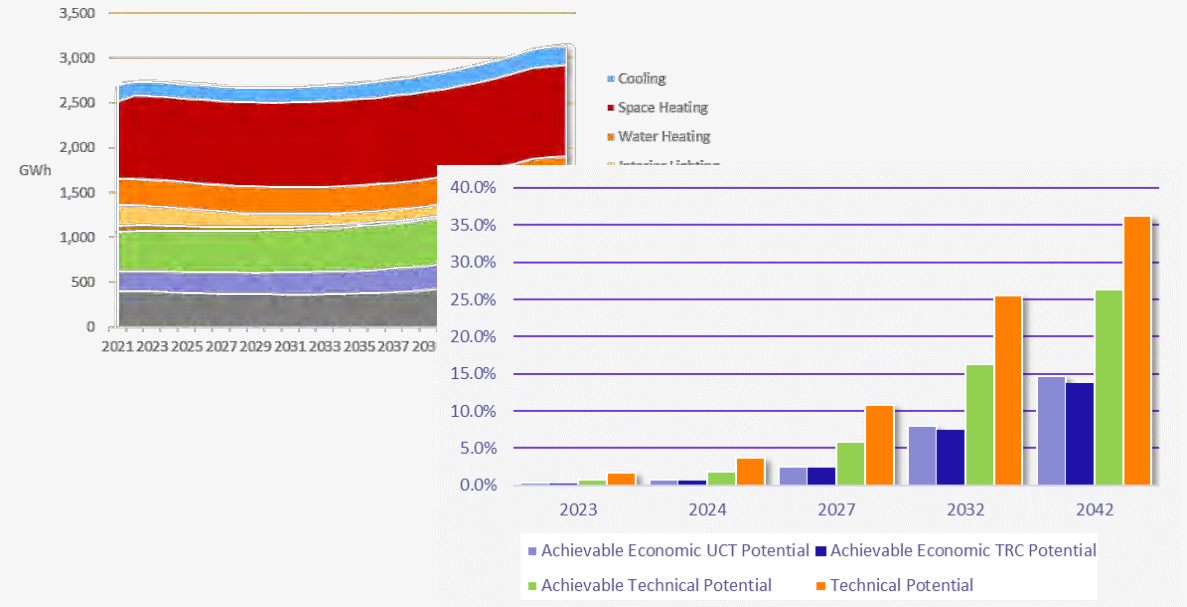
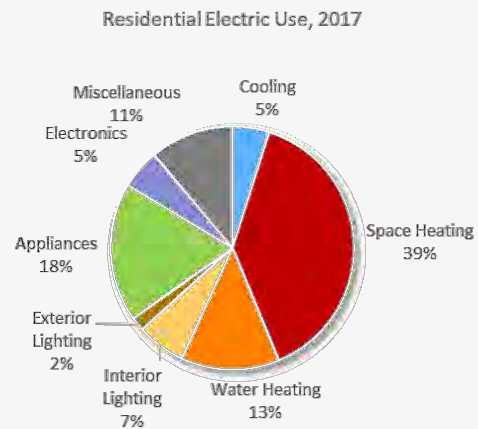
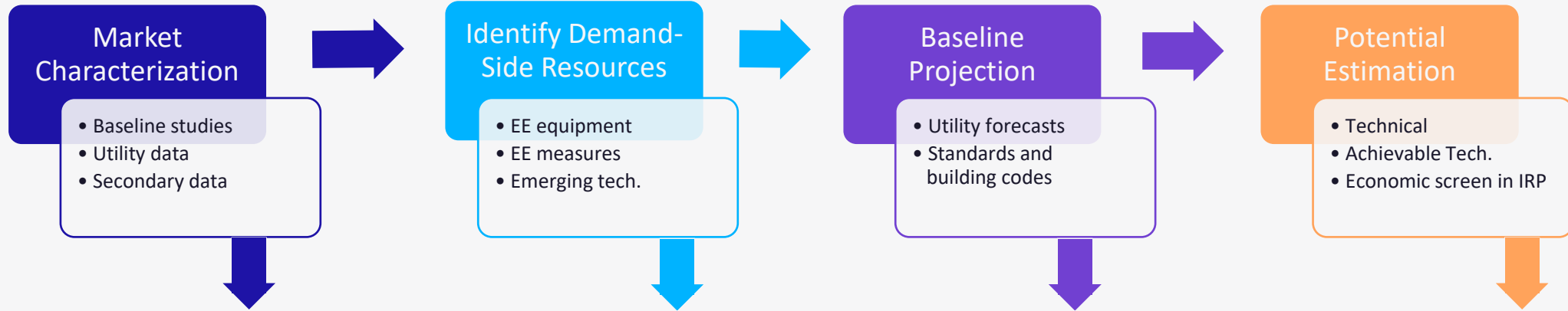
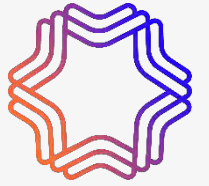



# Key Sources of Data

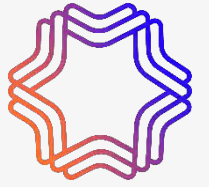

Data from Avista is prioritized when available, followed by regional data, and finally well-vetted national data.

## Avista data sources:

- ✓ 2013 Residential GenPop Survey
- ✓ Historical energy, peak loads, and customer counts
  - CPA Base Period: Sept 2020 – Aug 2021
- ✓ Forecast data and load research
- ✓ Recent-year program accomplishments and plans

## Additional sources:

- ✓ U.S. DOE's Annual Energy Outlook
- ✓ U.S. DOE's projections on solid state lighting technology improvements
- ✓ Technical Reference Manuals and California DEER
- ✓ AEG Research

## Regional data sources:

- ✓ NEEA studies (RBSA 2016, CBSA 2019, IFSA)
- ✓ Regional Technical Forum and NW Power and Conservation Council methodologies, ramp rates, and measure assumptions

# Residential Customer Segmentation

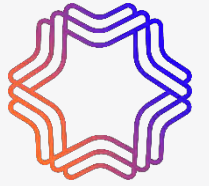

- ✔ This CPA enhances the residential segmentation to distinguish low-income households within each housing type rather than a single grouped “low income” segment.
- ✔ AEG cross referenced geographic data from Avista’s customer database with data from the US Census American Community Survey to estimate the presence of low-income households within Avista’s service territory (WA Census blocks shown at right).
  - “Low Income” was defined by household size. In Washington the threshold is 80% of Area Median Income, and in Idaho it is 200% of the Federal Poverty Level.
- ✔ Data from NEEA’s Residential Building Stock Assessment (RBSA II, 2016) was used to differentiate energy characteristics of low-income households, including differences in building shells, energy use per customer, and presence of energy-using equipment

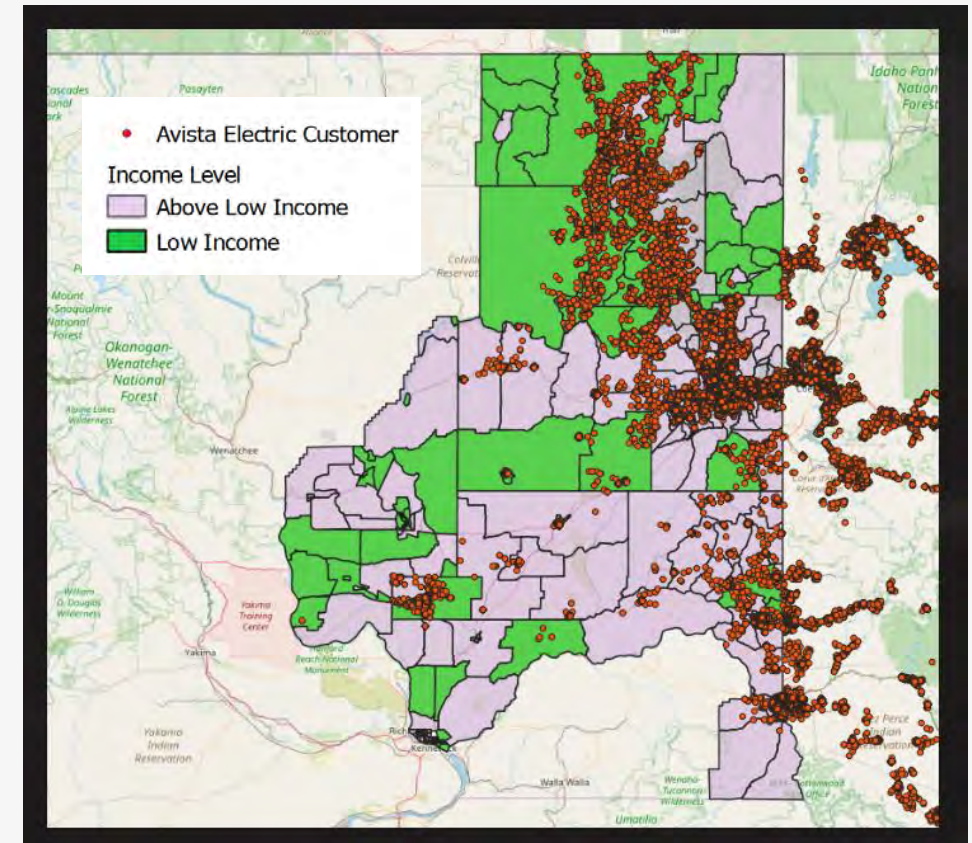

# Market Profiles

## Example – Idaho Residential

- ✔ Always calibrated to Avista’s use-per-customer at the household level
- ✔ Breaks down energy consumption to the end use and technology level
- ✔ Defines the **saturation** (presence of equipment) and the annual consumption of a given technology where it is present (**Unit Energy Consumption – UEC**)
- ✔ Refer to data sources slide

Idaho Residential Electricity Use

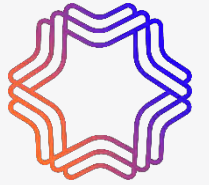
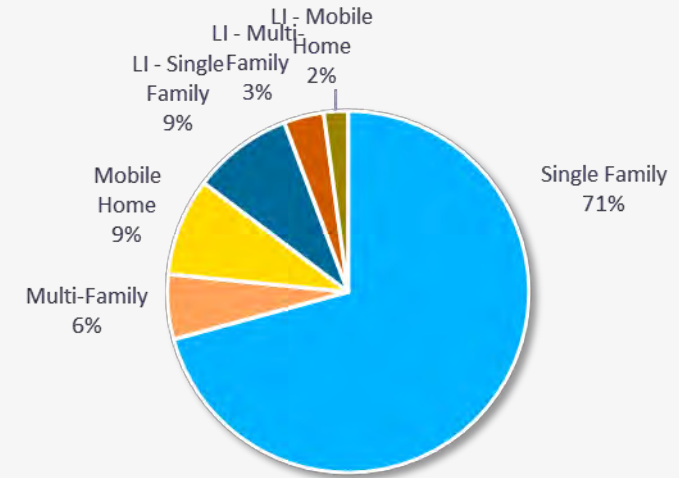

ID Residential Intensity (kWh/HH)

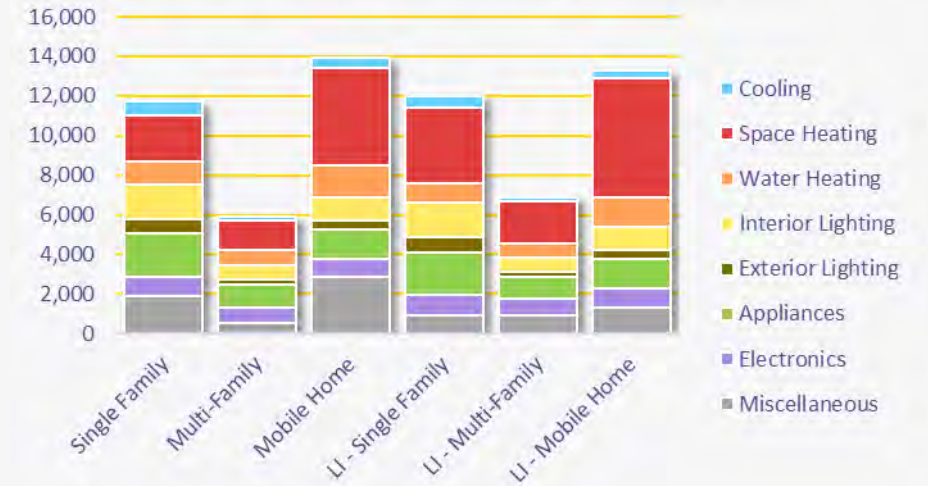

Single Family Reg. Income Profile (excerpt)

End Use	Technology	Saturation	UEC (kWh)	Intensity (kWh/HH)	Usage (MWh)
<b>Cooling</b>	Central AC	33%	1,432	471	37,616
	Room AC	11%	487	52	4,127
	Air-Source Heat Pump	14%	1,476	207	16,539
	Geothermal Heat Pump	1%	1,300	11	855
	Ductless Mini Split Heat Pump	1%	517	6	450
<b>Space Heating</b>	Electric Furnace	5%	16,251	830	66,273
	Electric Room Heat	9%	1,616	139	11,100
	Air-Source Heat Pump	12%	9,954	1,230	98,255
	Geothermal Heat Pump	1%	8,539	62	4,946
	Ductless Mini Split Heat Pump	1%	4,977	54	4,328
<b>Water Heating</b>	Water Heater (<= 55 Gal)	46%	2,364	1,096	87,540
	Water Heater (> 55 Gal)	3%	2,144	71	5,669

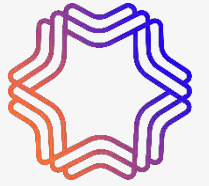

# Two Levels of Savings Estimates

## NW Power Council Methodology

This study develops two sets of estimates:

- **Technical potential (TP)**: upper bound on potential, assuming all of the most energy efficiency opportunities are adopted without consideration of cost or customer willingness to participate.
  - This may include emerging or very expensive ultra-high efficiency technologies
- **Technical Achievable Potential (TAP)** is a subset of TP that accounts for customer preference and likelihood to adopt through **both** utility- and non-utility driven mechanisms, but does not consider cost-effectiveness

In addition to these estimates, the study produces cost data for the Total Resource Cost (TRC) and Utility Cost Test (UC)T perspectives that can be used by Avista's IRP process to select energy efficiency measures in competition with other resources (see next slide)

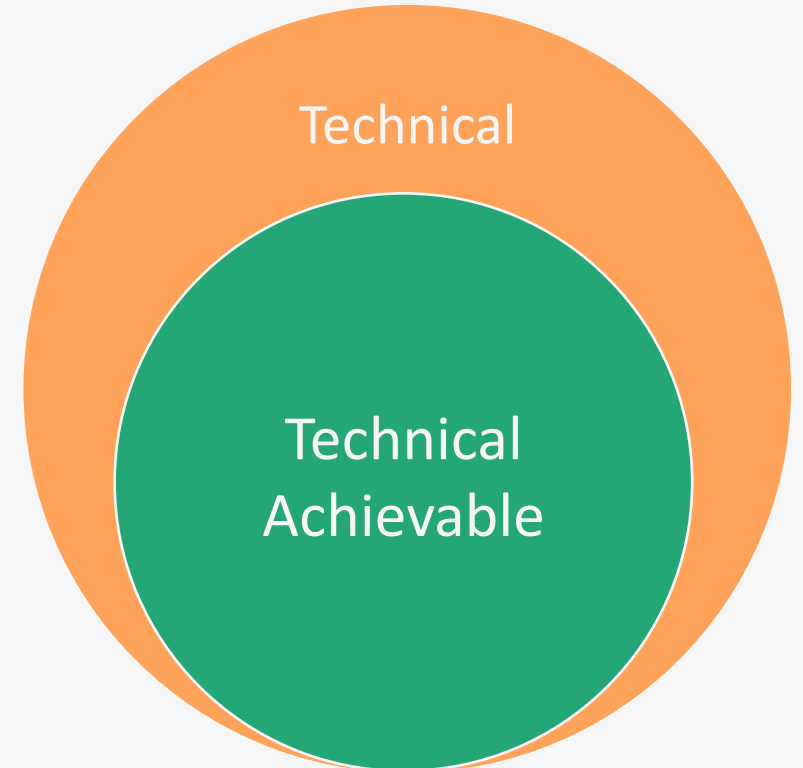

# Levelized Costs

## Two Cost-Effectiveness Tests

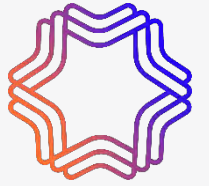

AEG provided a levelized cost of conserved energy (\$/kWh) for each measure within the technical achievable potential within Avista's Washington and Idaho territories from two perspectives.

- ✔ Utility Cost Test (UCT): Assesses cost-effectiveness from a utility or program administrator's perspective.
- ✔ Total Resource Cost Test (TRC): Assesses cost-effectiveness from the perspective of the utility and its customers. Includes quantifiable and monetizable non-energy impacts if they can be quantified and monetized.

Component	UCT	TRC
Measure Incremental Cost		Cost
Incentive	Cost	
Administrative Cost	Cost	Cost
Non-Energy Benefits*		Benefit
Non-Energy Costs* (e.g. O&M)		Cost

\*Council methodology includes monetized impacts on other fuels within these categories

Both values are provided to Avista for all measure level potential, so that the IRP can use the appropriate evaluation for each state: TRC for WA and UCT for ID.

# Potential Estimates

## Achievability

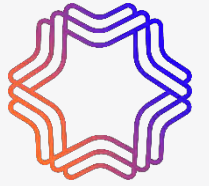

All potential “ramps up” over time – all ramp rates are based on those found within the NWPCC’s 2021 Power Plan

### ✔ Max Achievability

- NWPCC 2021 Plan allows some measures max achievability to reach up to 100% of technical potential
- Previous Power Plans assumed a maximum achievability of 85%
- AEG has aligned assumptions with the 2021 Plan and measures such as lighting reach greater than 85%

✔ Note that Council ramp rates are agnostic to delivery to acquisition mechanism and include potential that may be realized through utility DSM programs, regional initiatives and market transformation, or enhanced codes and standards

### Measures examples over 85% Achievability:

- All Lighting
- Washers/Dryers
- Dishwashers
- Refrigerators/Freezers
- Circulation Pumps
- Thermostats
- C&I Fans

# Electric CPA Draft Results

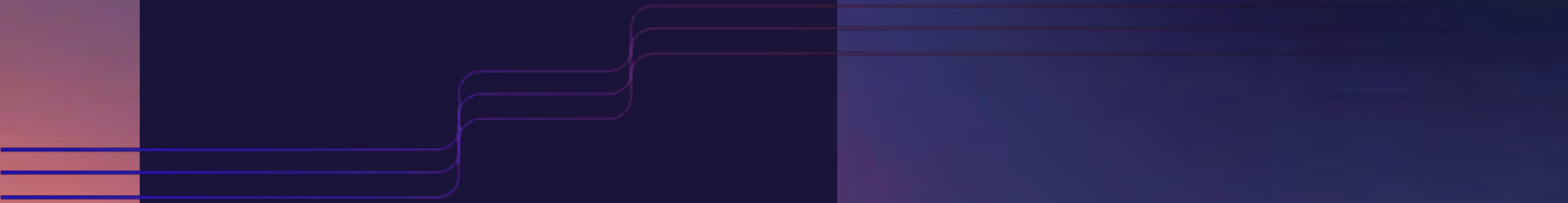



# Energy Efficiency Potential (WA & ID, All Sectors)

Draft results indicate energy savings of ~1.1% of baseline consumption per year are Technically Achievable.

- ✔ 183 GWh (20.9 aMW) in next biennial period (2023-2024)
- ✔ 1,193 GWh (136.2 aMW) by 2032
- ✔ 1,929 GWh (220.2 aMW) by 2042

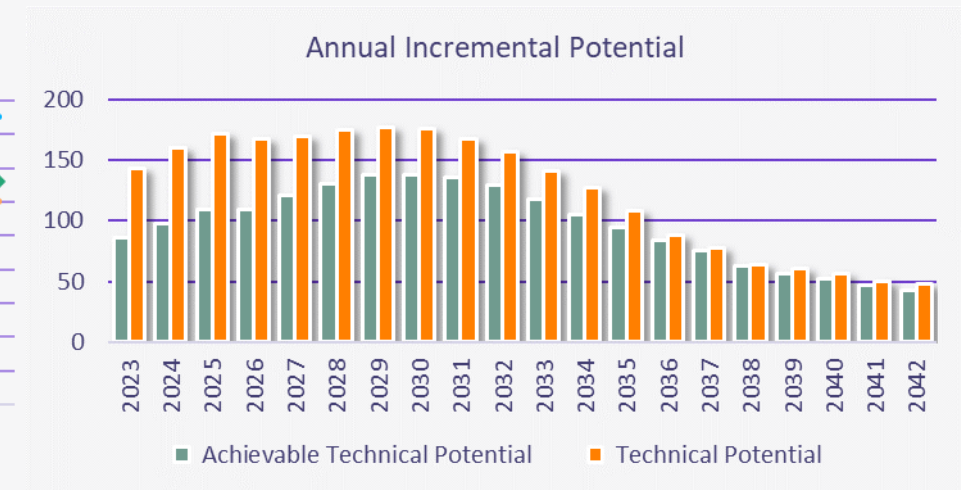
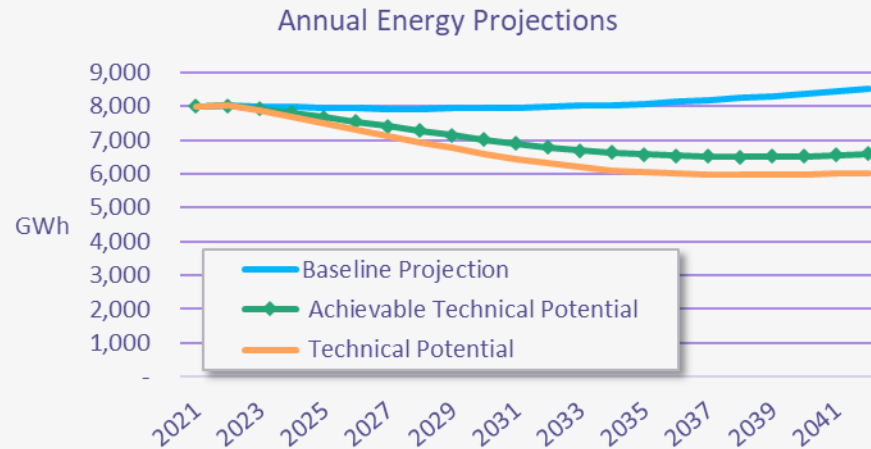





# Energy Efficiency Potential, Continued

## Potential Summary – WA & ID, All Sectors

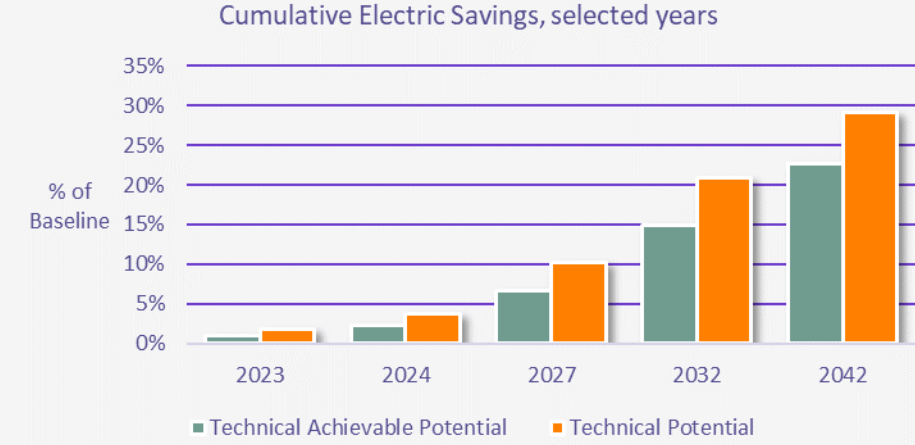
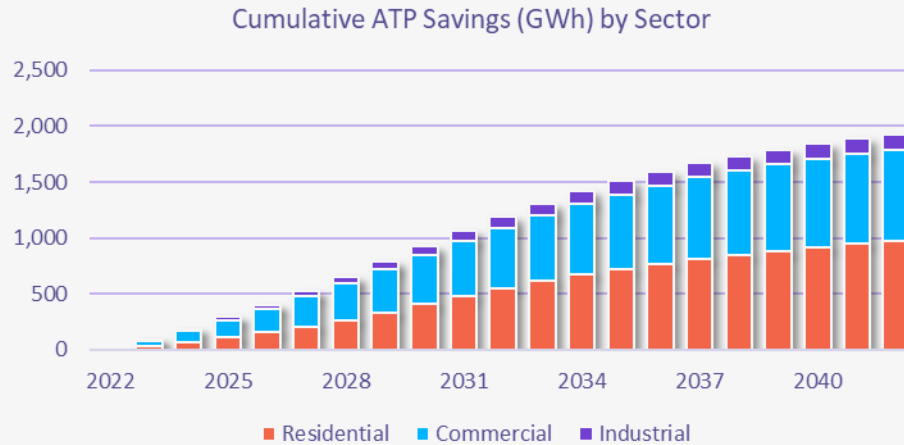

Summary of Energy Savings (GWh), Selected Years	2023	2024	2027	2032	2042
<b>Reference Baseline</b>	8,009	7,996	7,933	7,982	8,520
<b>Cumulative Savings (GWh)</b>					
Technical Achievable Potential	86	183	522	1,193	1,929
Technical Potential	144	304	813	1,665	2,486
<b>Energy Savings (% of Baseline)</b>					
Technical Achievable Potential	1.1%	2.3%	6.6%	15.0%	22.6%
Technical Potential	1.8%	3.8%	10.3%	20.9%	29.2%
<b>Incremental Savings (GWh)</b>					
Technical Achievable Potential	86	97	121	130	43
Technical Potential	144	160	170	157	48



# EE Potential, Continued

## Potential Summary – State Comparison

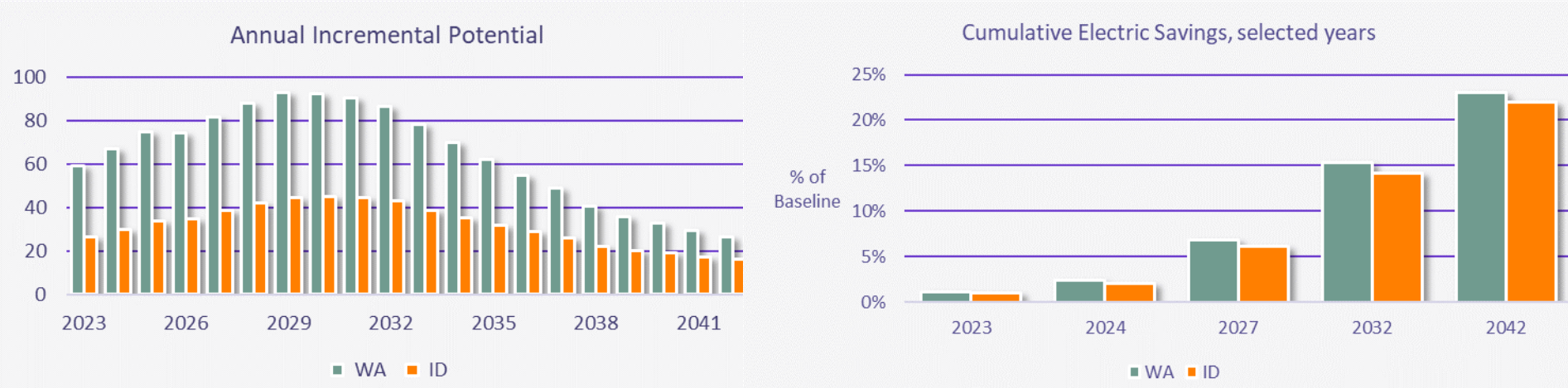

Summary of Energy Savings (GWh), Selected Years	2023	2024	2027	2032	2042
<b>Reference Baseline</b>					
Washington	5,309	5,301	5,256	5,277	5,608
Idaho	2,700	2,695	2,678	2,705	2,912
<b>Cumulative Savings (GWh)</b>					
Washington	59	127	358	809	1,289
Idaho	26	57	165	384	640
<b>Energy Savings (% of Baseline)</b>					
Washington	1.1%	2.4%	6.8%	15.3%	23.0%
Idaho	1.0%	2.1%	6.1%	14.2%	22.0%
<b>Incremental Savings (GWh)</b>					
Washington	59	67	82	87	27
Idaho	26	30	39	43	16

# EE Potential - Top Measures

## Cumulative Potential Summary – WA

### Top Measure Notes

- ✔ Some expensive or emerging measures have significant technical achievable potential, but may not be selected by the IRP due to costs
- ✔ Heat Pump measures, including DHPs and HPWHs, have significant annual energy benefits, however since heat pumps revert to electric resistance heating during extreme cold, they may not have a corresponding winter peak benefit
- ✔ In addition to being expensive, some emerging tech measures are included in Technical Achievable which may not prove feasible for programs at this time, but can be kept in mind for future programs

Rank	Measure / Technology	2032 Achievable Technical Potential (MWh)	% of Total	TRC Levelized \$/kWh
1	Residential - Connected Thermostat - ENERGY STAR (1.0)	66,516	8.2%	\$0.25
2	Commercial - Linear Lighting	56,757	7.0%	\$0.00
3	Commercial - Ductless Mini Split Heat Pump	46,099	5.7%	\$0.89
4	Residential - Windows - Low-e Storm Addition	42,942	5.3%	\$0.21
5	Residential - Water Heater (<= 55 Gal)	38,857	4.8%	\$0.12
6	Residential - Home Energy Management System (HEMS)	26,551	3.3%	\$0.35
7	Commercial - HVAC - Dedicated Outdoor Air System (DOAS)	18,215	2.3%	\$1.30
8	Residential - Windows - Cellular Shades	16,852	2.1%	\$0.62
9	Commercial - Retrocommissioning	13,583	1.7%	\$0.01
10	Commercial - Strategic Energy Management	11,198	1.4%	\$0.18
11	Commercial - HVAC - Energy Recovery Ventilator	10,374	1.3%	\$0.13
12	Commercial - Server	9,551	1.2%	\$0.01
13	Commercial - Refrigeration - High Efficiency Compressor	9,429	1.2%	\$0.40
14	Residential - Windows - High Efficiency (Class 22)	9,328	1.2%	\$0.54
15	Commercial - High-Bay Lighting	9,066	1.1%	\$0.00
16	Commercial - Insulation - Wall Cavity	8,551	1.1%	\$0.03
17	Residential - Windows - High Efficiency (Class 30)	8,417	1.0%	\$0.42
18	Commercial - Ventilation - Demand Controlled	8,267	1.0%	\$2.15
19	Residential - Insulation - Floor Installation	8,249	1.0%	\$0.17
20	Commercial - Desktop Computer	7,884	1.0%	\$0.11
<b>Total of Top 20 Measures</b>		<b>426,685</b>	<b>52.7%</b>	
<b>Total Cumulative Savings</b>		<b>809,194</b>	<b>100.0%</b>	

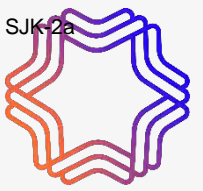

# EE Potential - Top Measures

## Cumulative Potential Summary – ID

### Top Measure Notes

- ✔ Some expensive or emerging measures have significant technical achievable potential, but may not be selected by the IRP due to costs
- ✔ Heat Pump measures, including DHPs and HPWHs, have significant annual energy benefits, however since heat pumps revert to electric resistance heating during extreme cold, they may not have a corresponding winter peak benefit
- ✔ In addition to being expensive, some emerging tech measures are included in Technical Achievable which may not prove feasible for programs at this time, but can be kept in mind for future programs

Rank	Measure / Technology	2032 Achievable Technical Potential (MWh)	% of Total	UCT Levelized \$/kWh
1	Commercial - Linear Lighting	27,909	7.3%	\$0.00
2	Commercial - Ductless Mini Split Heat Pump	17,184	4.5%	\$0.59
3	Residential - Water Heater (<= 55 Gal)	16,791	4.4%	\$0.09
4	Residential - Windows - Low-e Storm Addition	13,713	3.6%	\$0.17
5	Residential - Connected Thermostat - ENERGY STAR (1.0)	11,260	2.9%	\$0.20
6	Residential - Home Energy Management System (HEMS)	10,512	2.7%	\$0.27
7	Residential - Windows - Cellular Shades	8,363	2.2%	\$0.49
8	Commercial - HVAC - Dedicated Outdoor Air System (DOAS)	7,942	2.1%	\$0.86
9	Residential - Insulation - Floor Installation	7,934	2.1%	\$0.13
10	Commercial - Engine Block Heater Controls	7,437	1.9%	\$0.01
11	Commercial - Refrigeration - High Efficiency Compressor	6,570	1.7%	\$0.16
12	Commercial - Retrocommissioning	6,391	1.7%	\$0.01
13	Commercial - Refrigeration - Floating Head Pressure	6,079	1.6%	\$0.06
14	Residential - Advanced New Construction Design - Zero Net Energy	5,436	1.4%	\$0.10
15	Industrial - Linear Lighting	5,385	1.4%	\$0.01
16	Residential - Insulation - Ceiling Installation	5,247	1.4%	\$0.16
17	Commercial - Strategic Energy Management	5,164	1.3%	\$0.12
18	Commercial - Server	4,976	1.3%	\$0.01
19	Commercial - Insulation - Wall Cavity	4,457	1.2%	\$0.02
20	Residential - TVs	4,225	1.1%	\$0.00
<b>Total of Top 20 Measures</b>		<b>182,975</b>	<b>47.6%</b>	
<b>Total Cumulative Savings</b>		<b>384,102</b>	<b>100.0%</b>	

# Comparison with 2020 Electric CPA



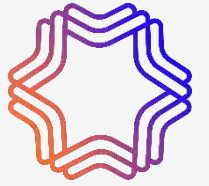

# Achievable Potential Comparison

## Comparison with Prior Potential Study (2022-2042 TAP)

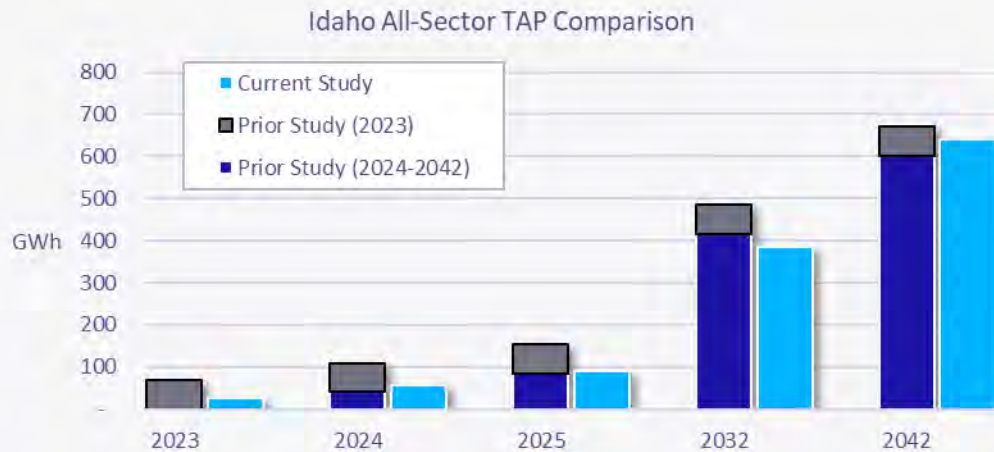
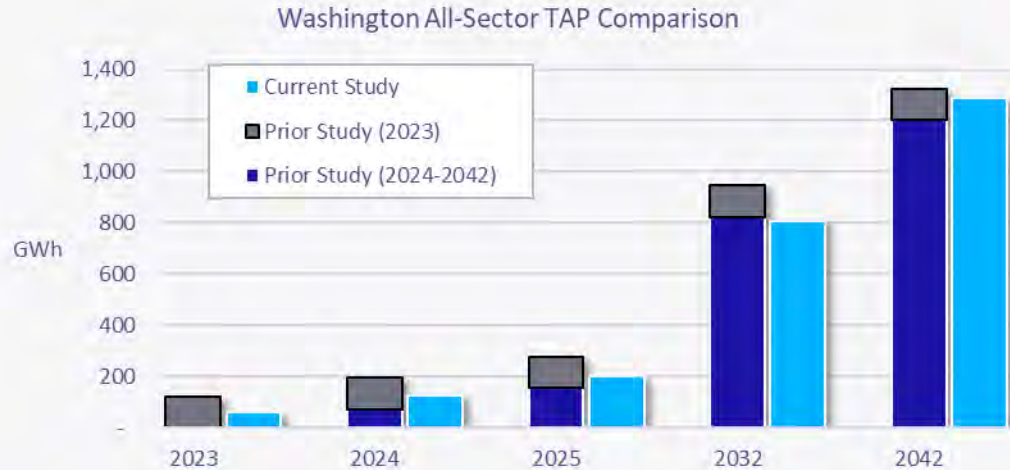

Sector (All States)	End Use	Prior CPA 2042 MWh	Current Study 2042 MWh	Diff.
<b>Residential</b>	Cooling	112,802	75,404	-37,398
	Heating	403,894	453,969	50,075
	Water Heating	220,393	227,303	6,910
	Interior Lighting	18,040	29,624	11,584
	Exterior Lighting	1,320	10,922	9,601
	Appliances	85,150	96,145	10,995
	Electronics	56,747	59,310	2,563
	Miscellaneous	46,509	20,171	-26,339
<b>Commercial</b>	Cooling	130,699	127,447	-3,252
	Heating	89,773	113,699	23,925
	Ventilation	100,043	119,087	19,045
	Water Heating	21,941	25,733	3,791
	Interior Lighting	195,773	192,109	-3,663
	Exterior Lighting	52,777	48,740	-4,037
	Refrigeration	107,229	105,453	-1,776
	Food Preparation	7,662	26,932	19,270
<b>Industrial</b>	Office Equipment	13,101	45,382	32,282
	Miscellaneous	9,240	14,077	4,837
	Cooling	4,218	11,895	7,677
	Heating	461	6,912	6,451
	Ventilation	12,137	5,346	-6,791
	Interior Lighting	42,345	22,883	-19,462
	Exterior Lighting	4,745	18,386	13,641
	Motors	60,407	62,550	2,142
Process	6,055	8,346	2,291	
Miscellaneous	678	1,511	833	
<b>Grand Total</b>		<b>1,804,139</b>	<b>1,929,335</b>	<b>125,196</b>

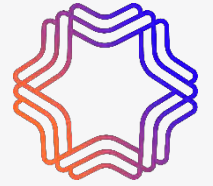

# Supply Curves – Compare to Prior CPA

## WA & ID Technical Achievable Potential

WA - TRC 10-yr Conservation Supply Curve Comparison

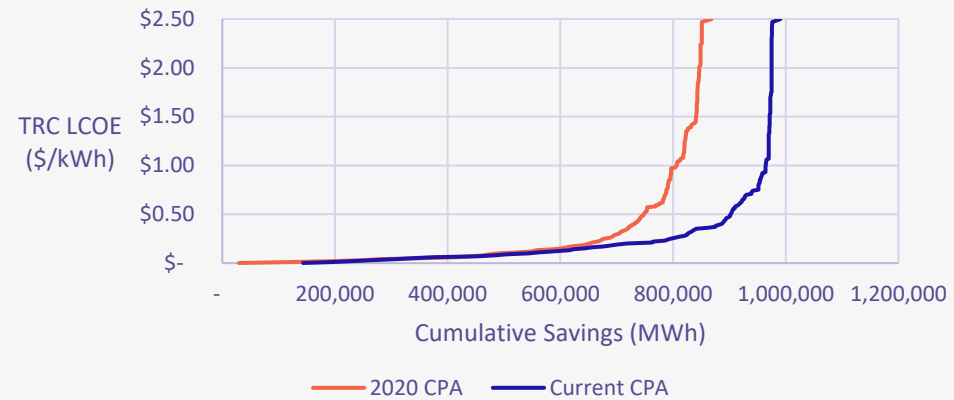

ID - UCT 10-yr Conservation Supply Curve Comparison

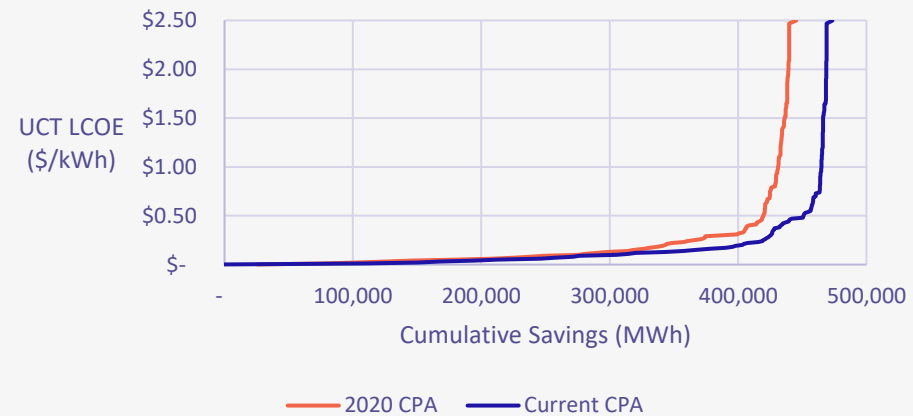

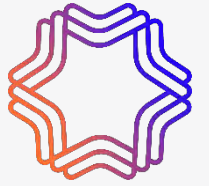

# Sector-Level Notes

## Comparison with Prior Potential Study – Technical Achievable

### Residential:

- ✔ Updates to RTF Workbooks and latest Avista TRM are driving increase in potential across weatherization measures.
  - Low-E Storm Addition, Floor Insulation and Cellular Shades are the largest increases.
- ✔ Ductless Mini Split Heat Pump measures showing less potential driven by RTF savings update.

### Commercial:

- ✔ Similar lighting potential. New LED replacement with Controls measure offsets increase in LED saturation.
- ✔ Increase in potential across Food Preparation and Office Equipment end uses driven by updates to ENERGY STAR specifications and market data.
- ✔ Updated savings characterizations across HVAC and water heating measures leading to lower potential estimates in those end uses.

### Industrial:

- ✔ Industrial measure data was revised to reflect the newest iteration of the 2021 Industrial Tool (v8), updating savings and costs for many measures.
- ✔ Pumping measures showing increased potential due to explicit accounting for Avista pumping rate schedule and the new Pumping measures from the V8 Industrial Tool update.
- ✔ Fan controls also have greater savings as a result of the measure data update



Thank you.  
Questions?

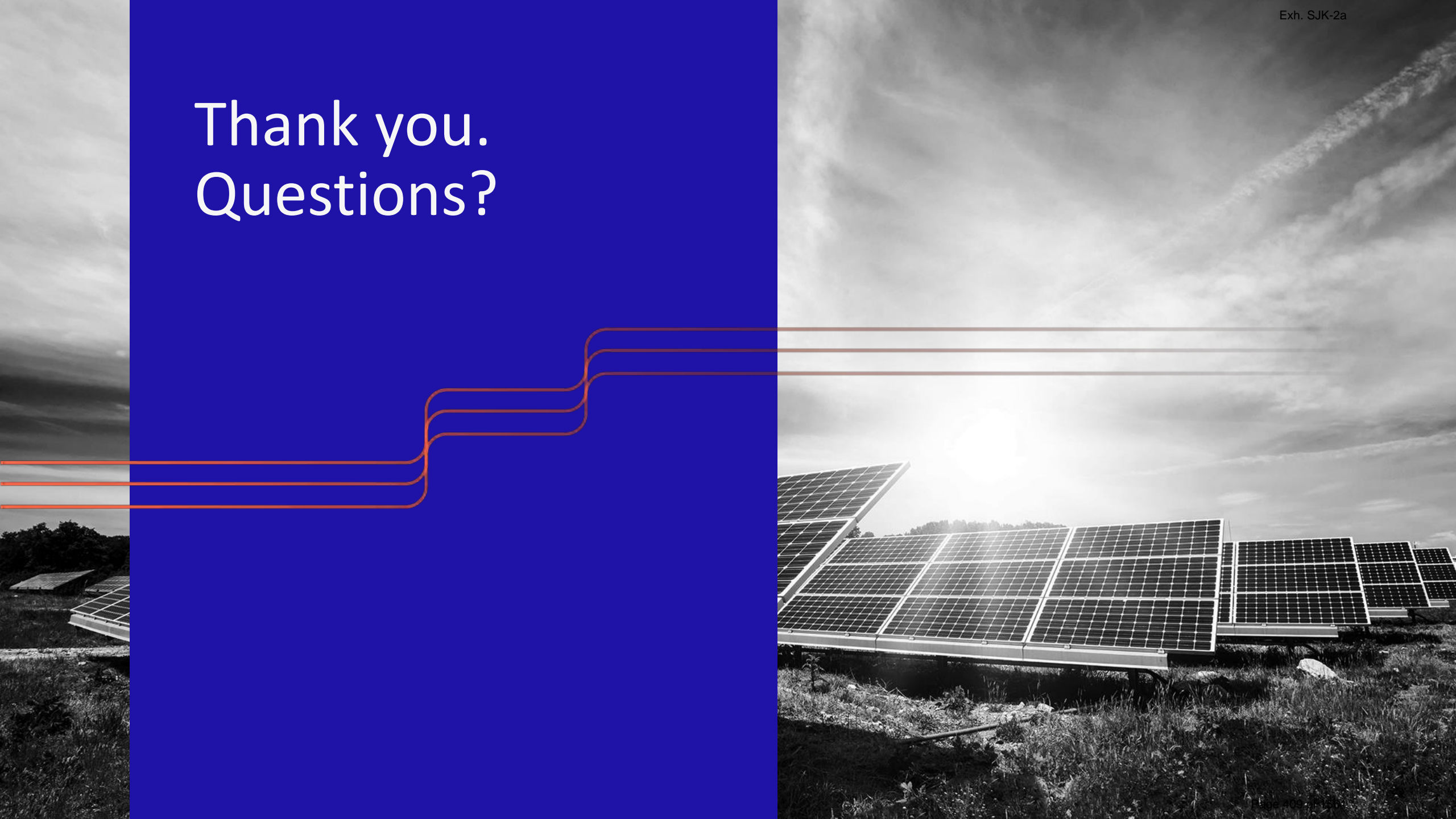

# Demand Response

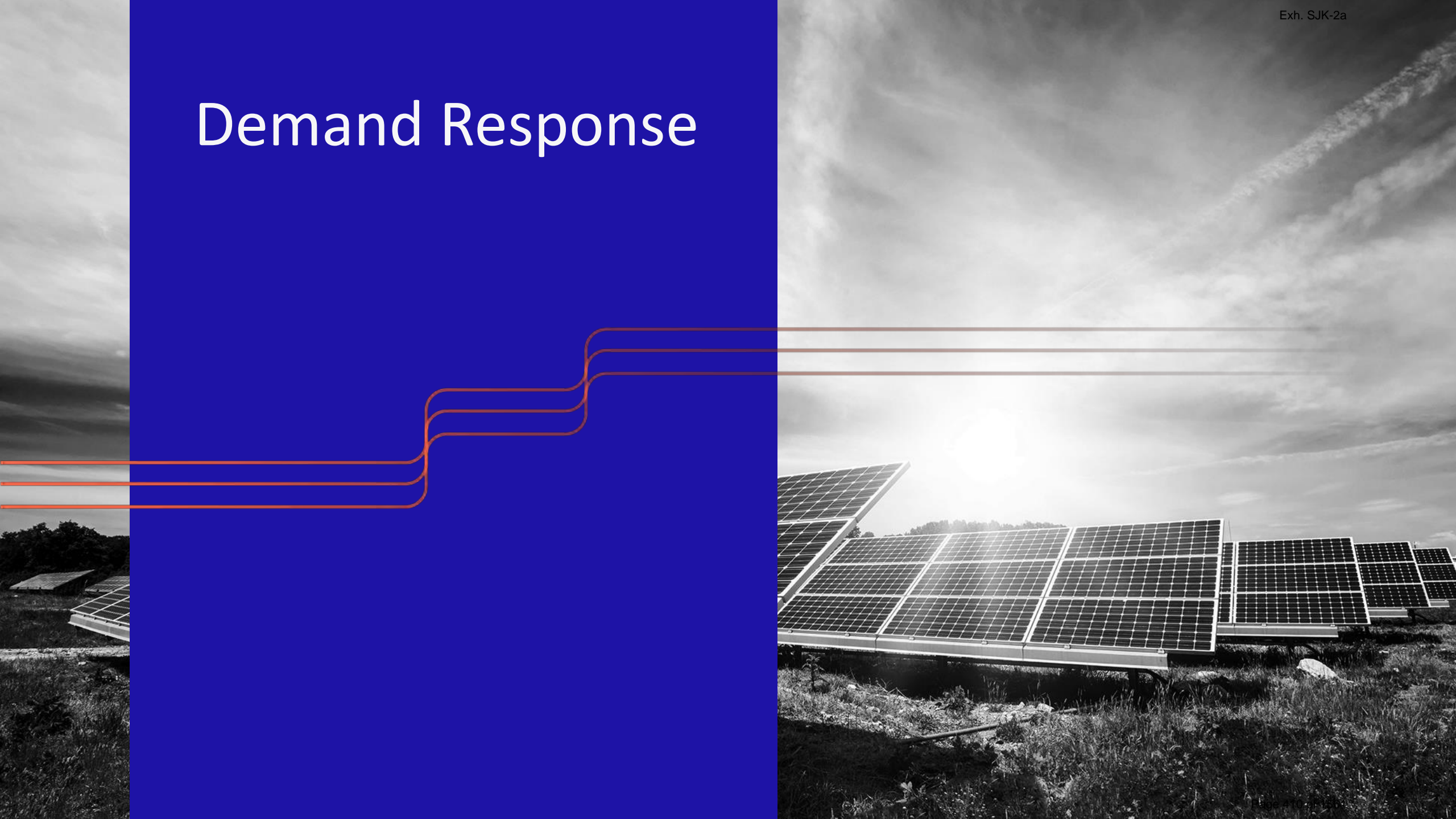

# Approach to the Study

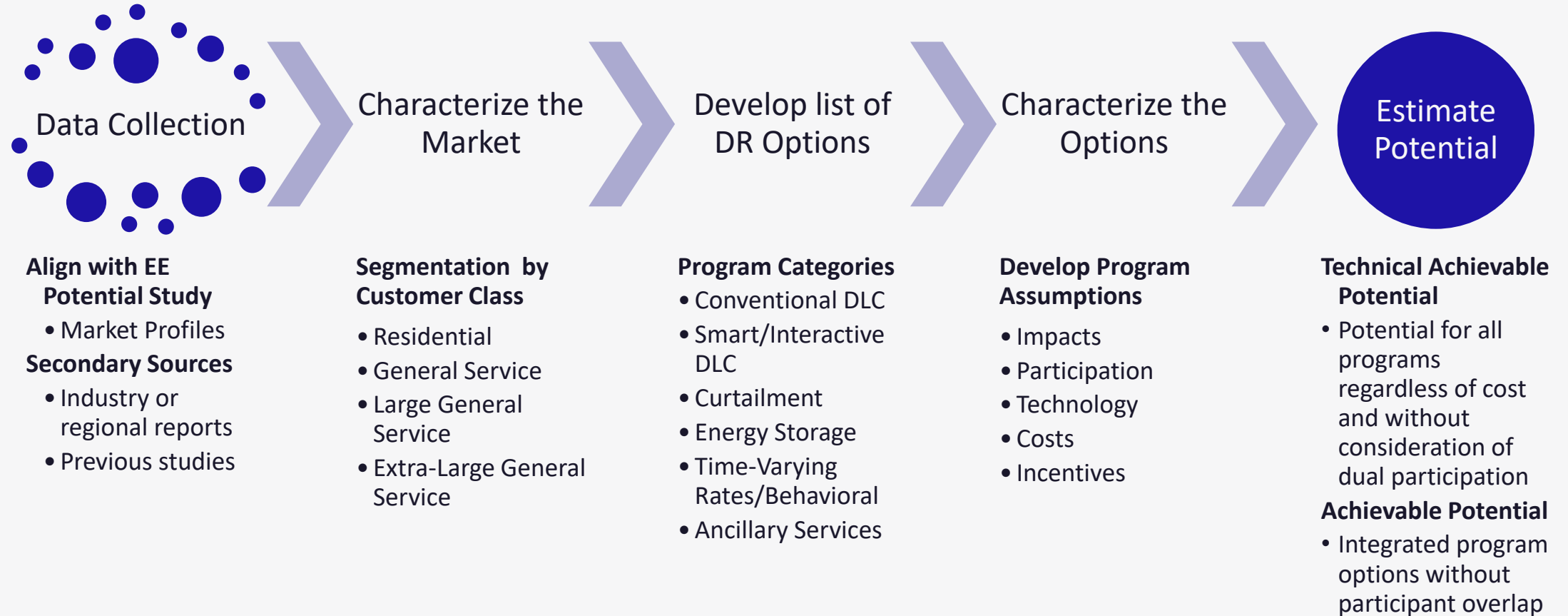

# All Program Options

Conventional DLC	Central AC Water Heating Electric Vehicle Charging
Smart/Interactive DLC	Grid-Interactive Water Heating Smart Thermostats (Cooling/Heating) Smart Appliances
Third Party Curtailment	Capacity Bidding Emergency Curtailment
Energy Storage	Battery Storage Thermal Storage
Time-Varying Rates/Behavioral	Behavioral Time-of-Use Electric Vehicle Time-of-Use Variable Peak Pricing

# Avista Pilot Program Scenario

Avista plans to run the following DR Pilot Programs in Washington:

- ✔ CTA-2045 HPWH
- ✔ CTA-2045 ERWH
- ✔ Time-of-Use Opt-in
- ✔ Peak Time Rebate

All Pilot Programs will run for a three-year period starting in 2024

The TOU Opt-in Pilot will have an optional two-year extension pending results

# Advanced Metering Infrastructure (AMI) Assumptions

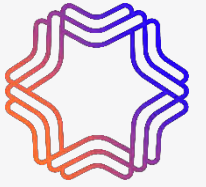

## Some of the options require AMI

- ✔ DLC Options- No AMI Metering Required
- ✔ Dynamic Rates- require AMI for billing

## Washington

- ✔ Assume 100% throughout study for all sectors

## Idaho starting AMI rollout in 2024

- ✔ 36-month deployment schedule

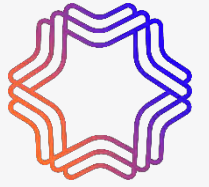

# Assumptions and Updates

## **Smart Thermostat - Heating Program will piggyback off Cooling Program**

- ✔ Shared Admin, Development, and O&M Costs

## **Grid-Interactive Water Heaters**

- ✔ Split results across water heater type- ER and HP
  - Lowered CTA-2045 impacts to reflect "BPA 2018" peak mitigation strategies

## **Dynamic Rates**

- ✔ PTR for Residential and General Service
- ✔ VPP for Large and Extra-Large General Service
- ✔ Added EV TOU

## **Program Impact and Cost assumptions mainly based on NWPCC 2021 Power Plan assumptions**

- ✔ Diverged from these where appropriate
  - Customization for Avista's service territory
  - Where NWPCC program information wasn't available

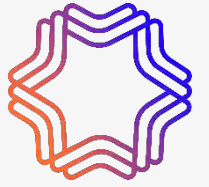

# Program Impact Calculation

$$\begin{aligned} & \textit{Program Impact}_{year,program} \\ &= \textit{Per Customer Peak Impact}_{y,p} * \textit{Eligible Participants}_{y,p} * \textit{Participation Rate}_{y,p} \\ & * \textit{Equipment Saturation Rate}_{y,p} \end{aligned}$$



# Baseline Characterization



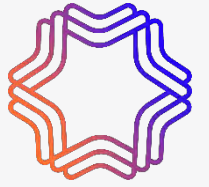

# Baseline Comparisons to 2020 Study

Summer Baseline Forecast

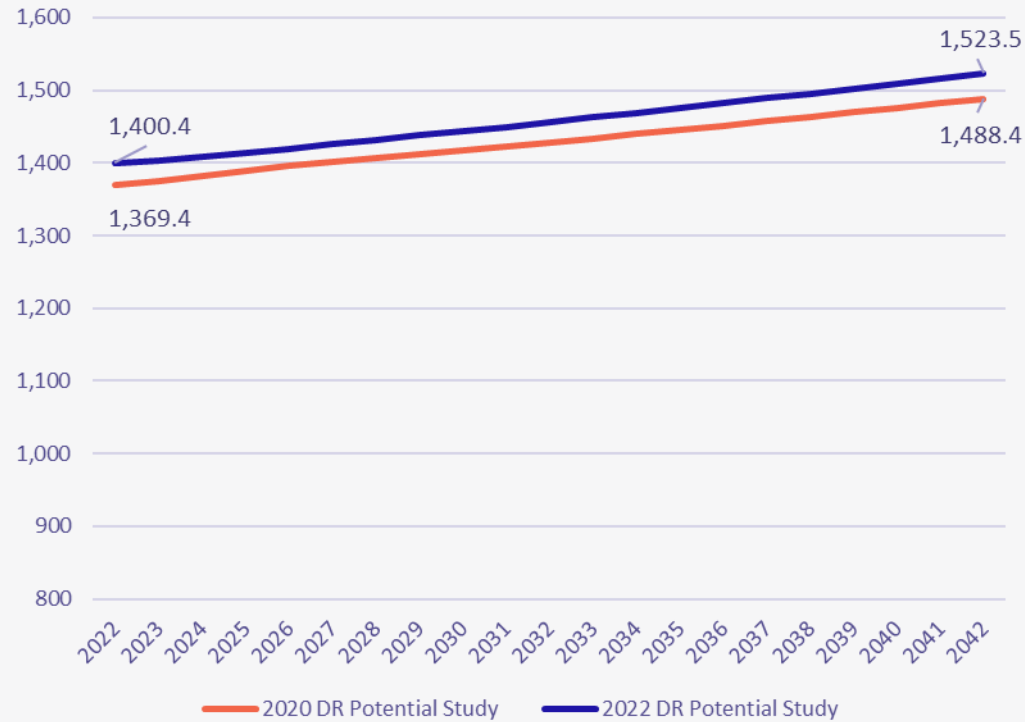

Winter Baseline Forecast

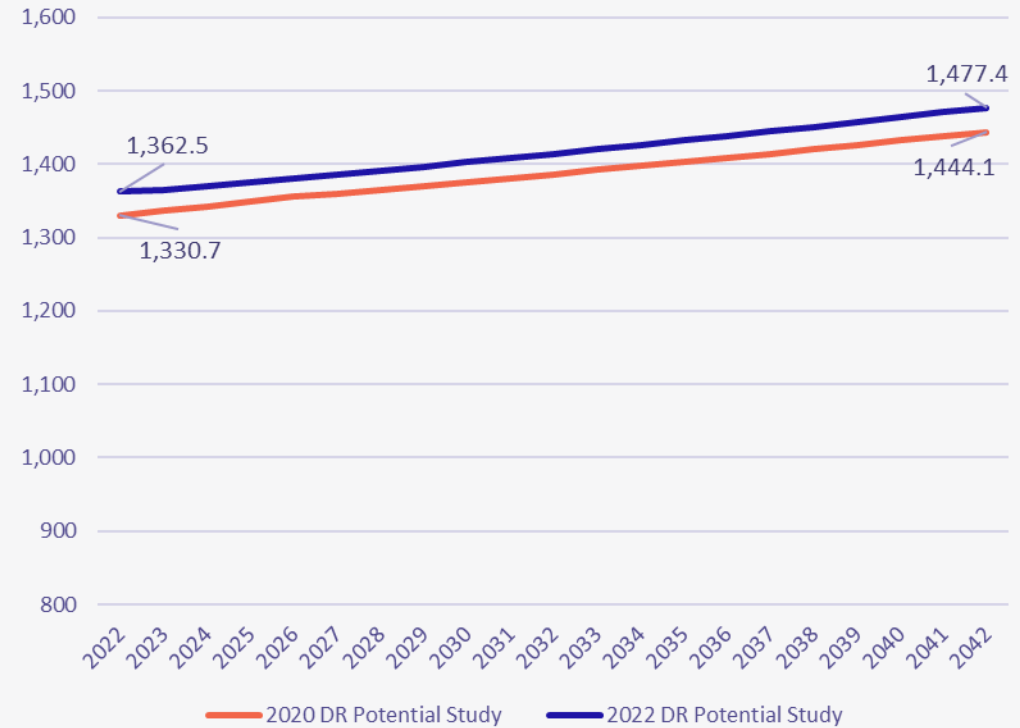

# Achievable Potential





# All Program Options

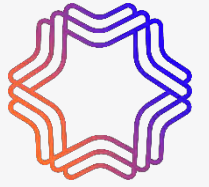

# Potential by Season

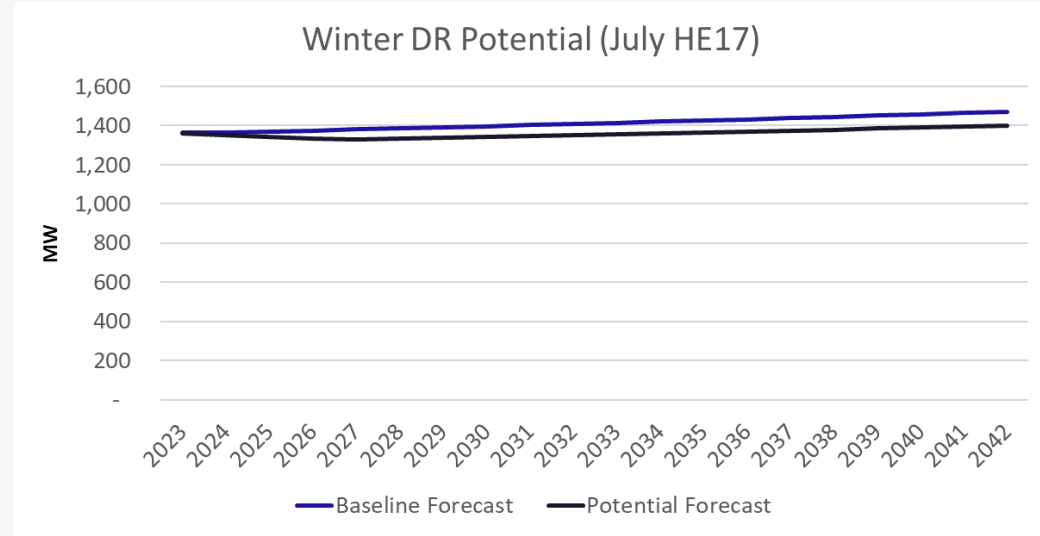
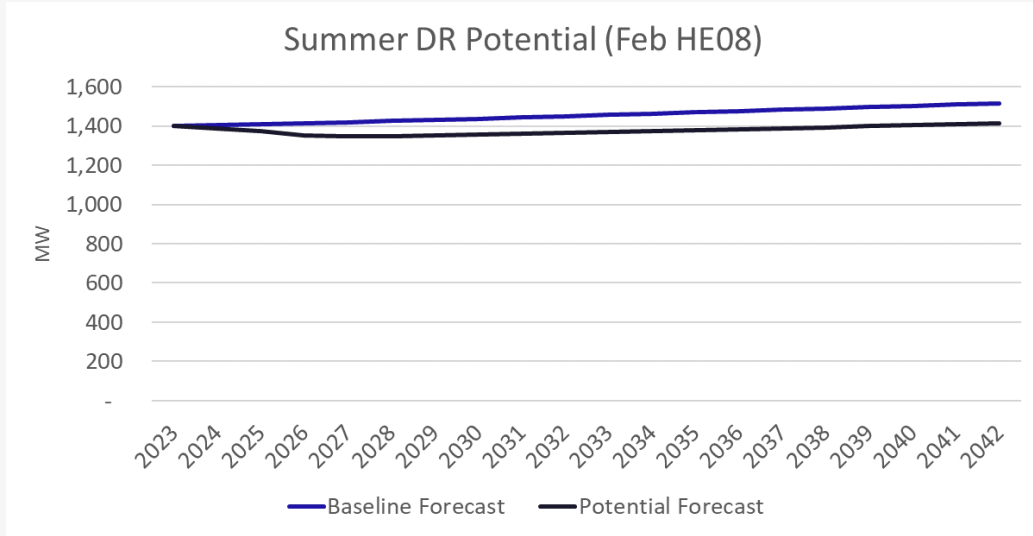

Summer Potential	2023	2024	2027	2032	2042
Baseline Forecast	1,400	1,404	1,420	1,450	1,516
Achievable Potential	0.5	17.5	72.3	84.3	102.6
% of Baseline	0.0%	1.2%	5.1%	5.8%	6.8%
Potential Forecast	1,400	1,386	1,348	1,365	1,414

Winter Potential	2023	2024	2027	2032	2042
Baseline Forecast	1,363	1,366	1,381	1,408	1,471
Achievable Potential	0.5	14.8	49.4	57.6	69.3
% of Baseline	0.0%	1.1%	3.6%	4.1%	4.7%
Potential Forecast	1,362	1,351	1,331	1,351	1,401

# Summer DR Potential

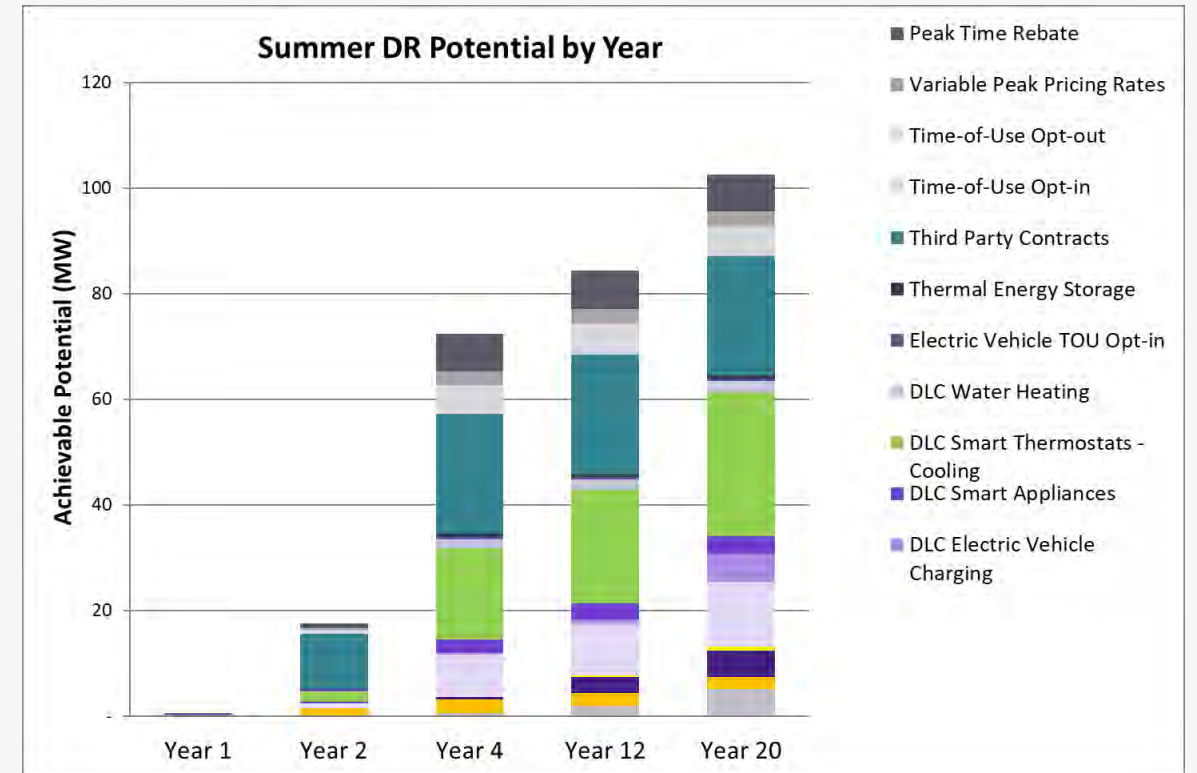
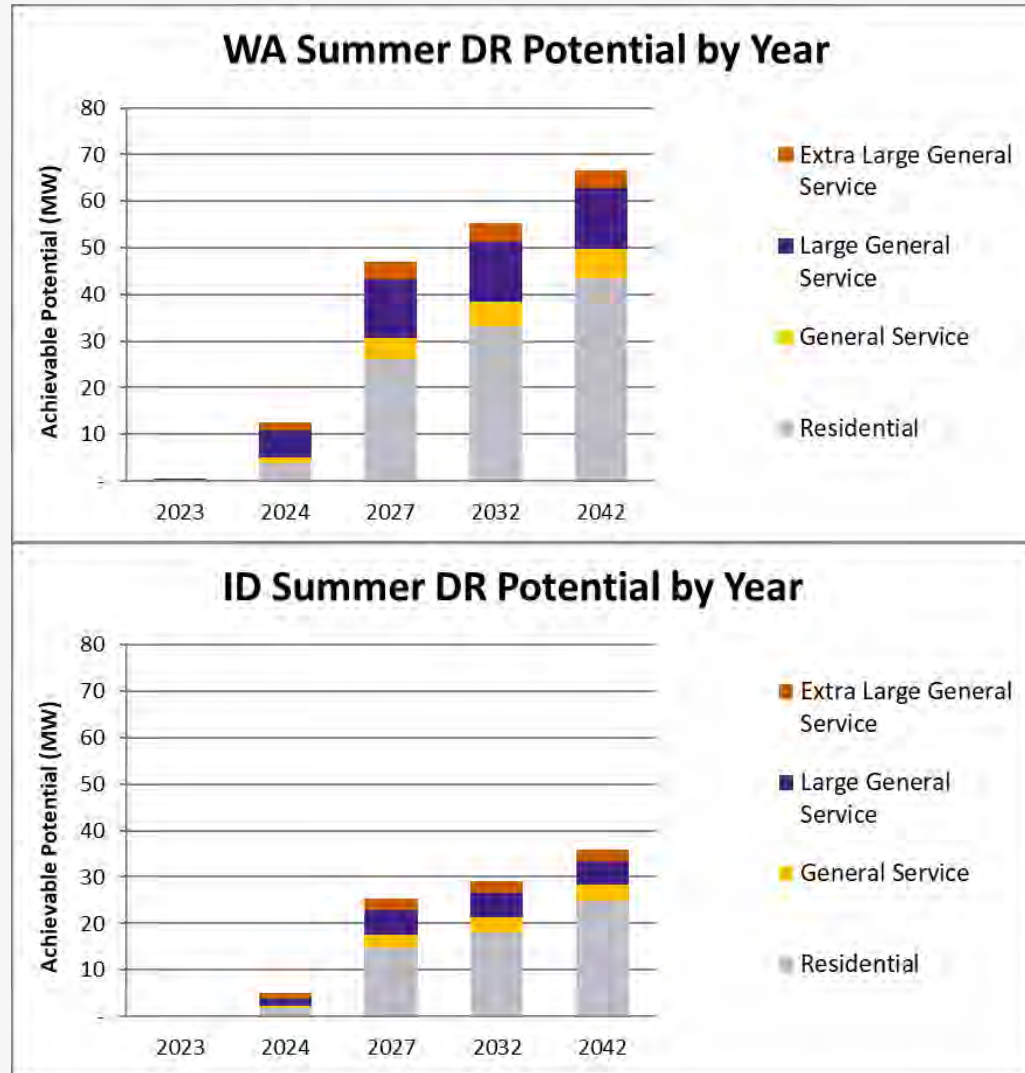
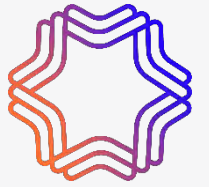

# Winter DR Potential

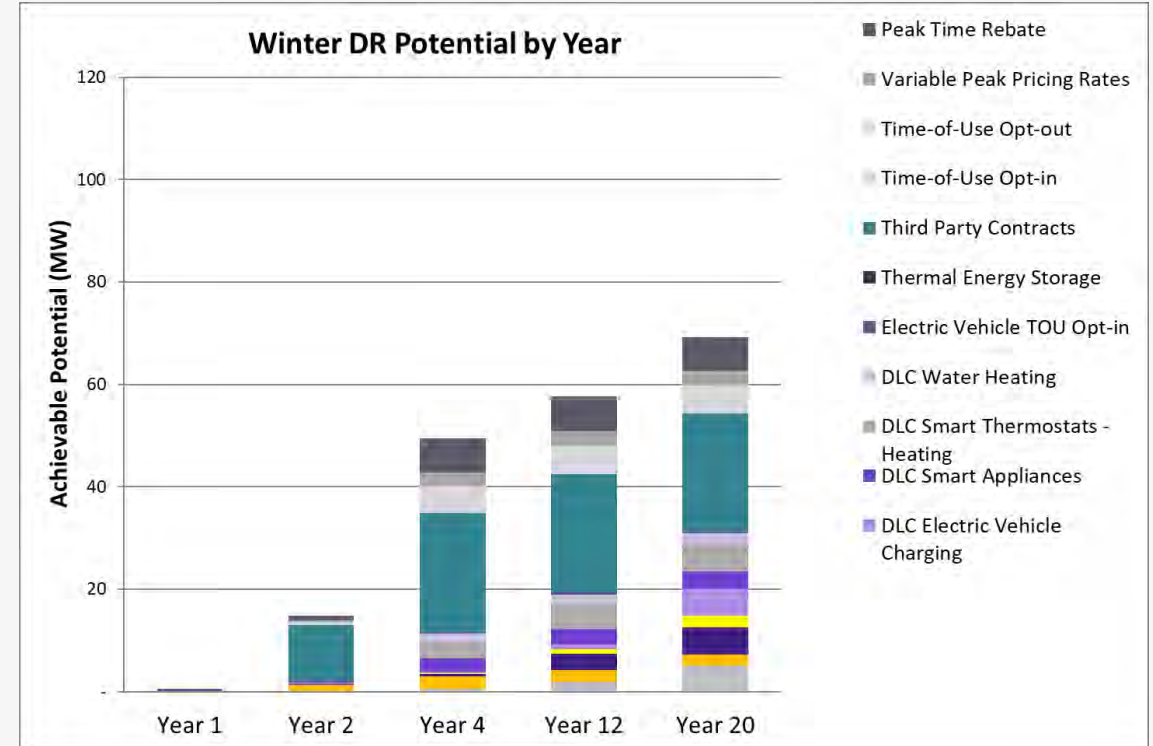
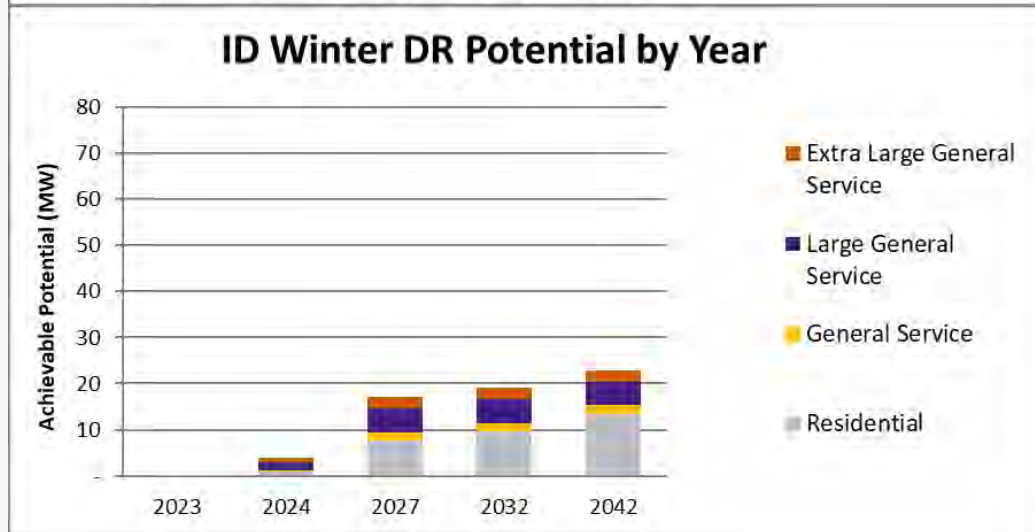
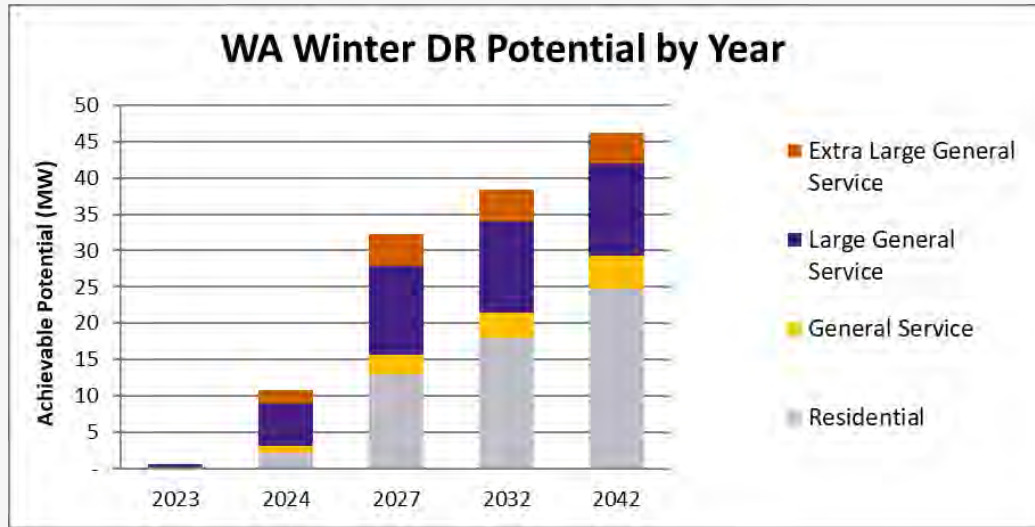
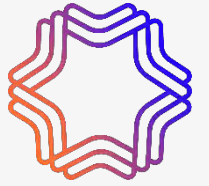



# Pilot Program Scenario WA



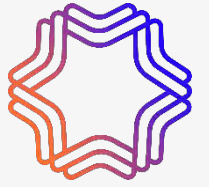

# Pilot Programs Summer DR Potential

Pilot Summer Potential	2024	2025	2026	2032	2042
<b>Baseline Forecast (MW)</b>	<b>941</b>	<b>944</b>	<b>948</b>	<b>975</b>	<b>1,024</b>
<b>Achievable Potential (MW)</b>	<b>0.1</b>	<b>0.2</b>	<b>0.4</b>	<b>12.9</b>	<b>16.2</b>
Pilot-CTA-2045 HPWH	0.0	0.0	0.0	0.2	0.8
Pilot-CTA-2045 ERWH	0.0	0.1	0.1	1.7	4.9
Pilot-Time-of-Use Opt-in	0.1	0.1	0.1	4.9	4.7
Pilot-Peak Time Rebate	0.0	0.1	0.1	6.1	5.7

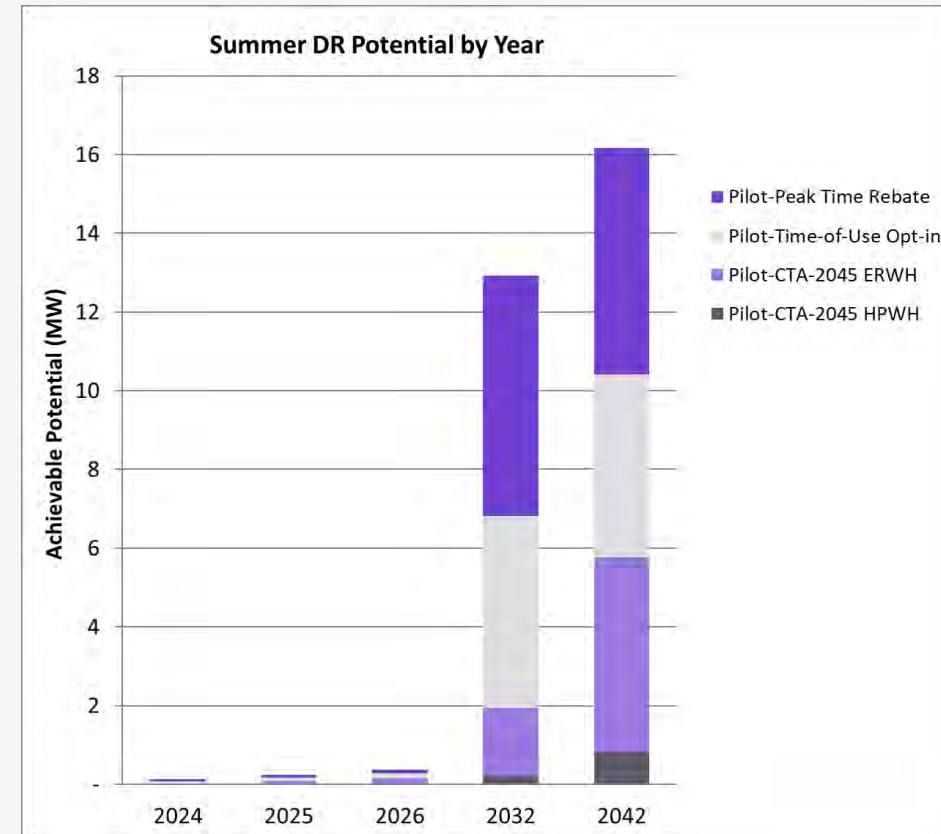

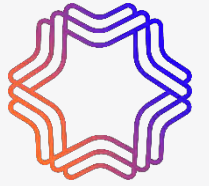

# Pilot Programs Winter DR Potential

Pilot Winter Potential	2024	2025	2026	2032	2042
<b>Baseline Forecast (MW)</b>	<b>910</b>	<b>914</b>	<b>917</b>	<b>942</b>	<b>988</b>
<b>Achievable Potential (MW)</b>	<b>0.1</b>	<b>0.2</b>	<b>0.4</b>	<b>12.7</b>	<b>17.3</b>
Pilot-CTA-2045 HPWH	0.0	0.0	0.0	0.5	2.2
Pilot-CTA-2045 ERWH	0.0	0.1	0.2	1.9	5.3
Pilot-Time-of-Use Opt-in	0.1	0.1	0.1	4.6	4.4
Pilot-Peak Time Rebate	0.0	0.1	0.1	5.7	5.4

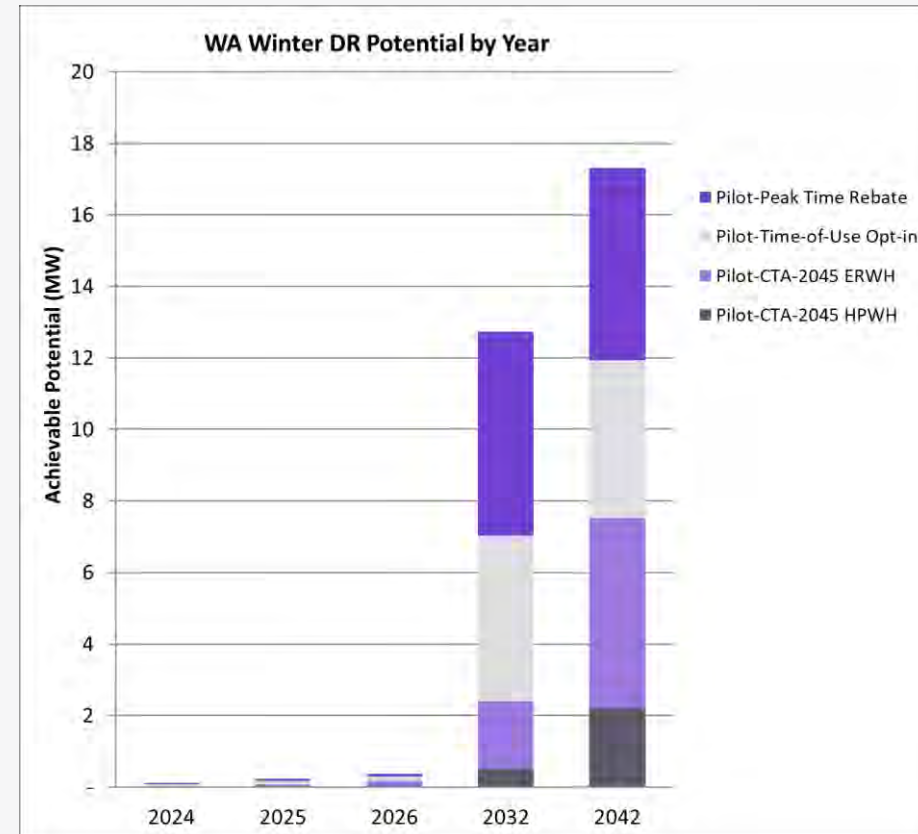

# Demand Response Program Costs



# Developing Demand Response Resource Costs

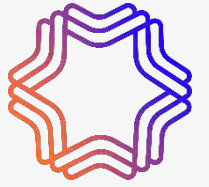

- ✔ DR Programs have both upfront and ongoing costs according to the table below
- ✔ DR costs are amortized over 10 years to allow programs time to fully ramp up
- ✔ Levelized costs are presented in \$/kW-year

One-Time Fixed Costs	One-Time Variable Costs	Ongoing Costs
Program Development Costs (\$/program)	Equipment Costs (\$/participant)	Administrative Costs (shared costs)
	Marketing Costs (\$/participant)	O&M Costs (\$/participant)
		Incentives (\$/participant or \$/kW)

# Example: Residential Grid-Interactive Electric Resistance Water Heaters

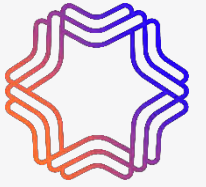

Cost Type	Unit	Cost
Development	\$/program	\$34,000
Administrative	\$/program/yr	\$40,800
O&M	\$/participant/yr	\$0
Marketing	\$/new participant	\$60
Equipment	\$/new participant	\$170
Incentive	\$/program/yr	\$24

# Program Costs

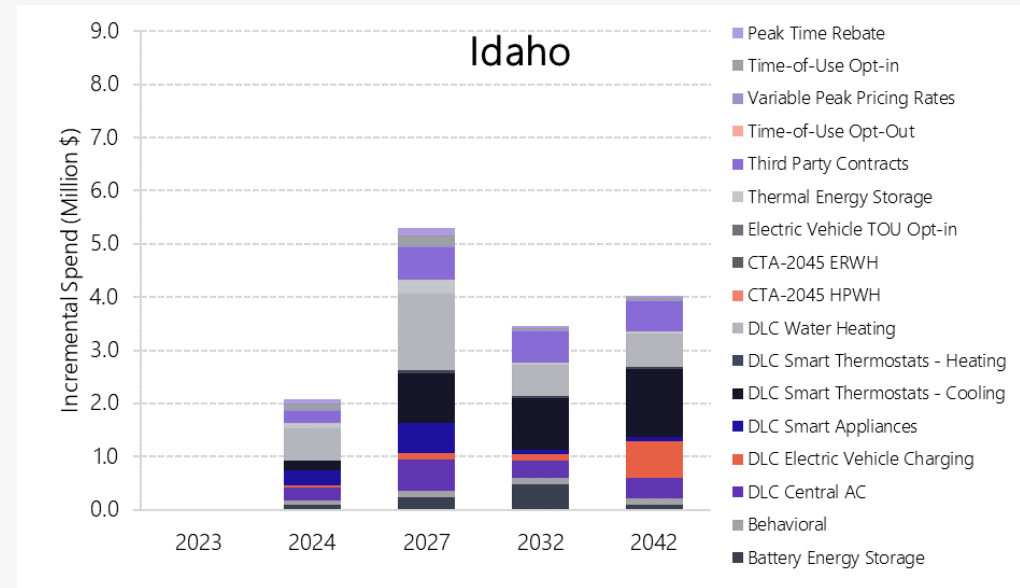
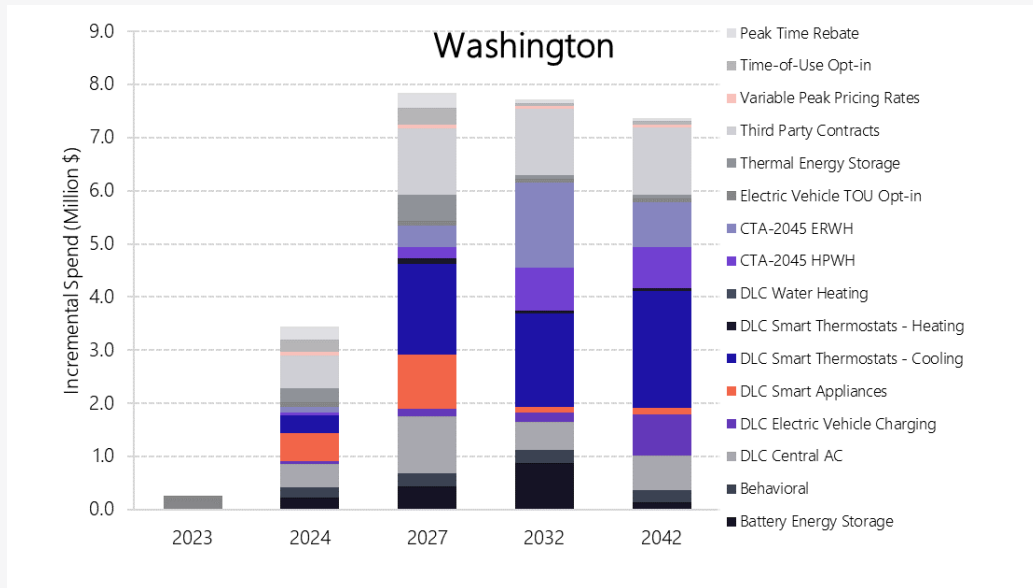

# Thank You.

Eli Morris, Managing Director  
emorris@appliedenergygroup.com

Kelly Marrin, Managing Director  
kmarrin@appliedenergygroup.com

Max McBride, Lead Analyst  
mmcbride@appliedenergygroup.com

Andy Hudson, Project Manager  
ahudson@appliedenergygroup.com

---



# Appendix





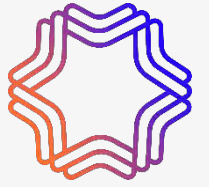

# Baseline Projection

- ✔ “How much energy would customers use in the future if Avista stopped running conservation programs now and in the absence of naturally occurring efficiency?”
  - The baseline projection answers this question
- ✔ The baseline projection is an independent end-use forecast of electric or natural gas consumption at the same level of detail as the market profile

## The baseline projection:

### Includes

- To the extent possible, the same forecast drivers used in the official load forecast, particularly customer growth, natural gas prices, normal weather, income growth, etc.
- Trends in appliance saturations, including distinctions for new construction.
- Efficiency options available for each technology , with share of purchases reflecting codes and standards (current and finalized future standards)
- Expected impact of appliance standards that are “on the books”
- Expected impact of building codes, as reflected in market profiles for new construction
- Market baselines when present in regional planning assumptions

### Excludes

- Expected impact of naturally occurring efficiency (except market baselines)
  - **Exception:** RTF workbooks have a market baseline for lighting, which AEG’s models also use.
- Impacts of current and future demand-side management programs
- Potential future codes and standards not yet enacted

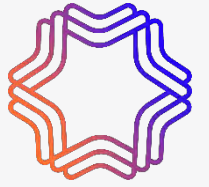

# Conventional DLC Assumptions

Conventional DLC Assumptions		Program Option	Residential	General Service	Large General Service	Extra Large General Service	Source
	Peak Impacts	Central AC	0.5 kW	1.25 kW			NWPCC DLC Switch Cooling
		Water Heating	0.5 kW	1.26 kW			Best Estimate based on Industry Exp.
		Electric Vehicle Charging	0.5 kW				Avista Background and Research
	Steady-State Participation	Central AC	10%	10%			NWPCC DLC Switch Cooling
		Water Heating	15%	5%			Best Estimate based on Industry Exp.
		Electric Vehicle Charging	25%				NWPCC Electric Resistance Grid-Ready

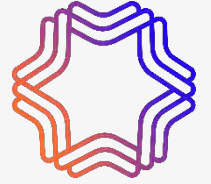

# Smart/Interactive DLC Assumptions

		Program Option	Smart/Interactive DLC Assumptions			Extra Large General Service	Source
			Residential	General Service	Large General Service		
Smart/Interactive DLC Assumptions	Peak Impacts	Smart Thermostats - Cooling	0.5 kW	1.25 kW			NWPCC Smart Thermostat- Cooling (Adjusted for proposed cycling strategy)
		Smart Thermostats - Heating	1.09 kW	1.35 kW			NWPCC Smart Thermostat- Heating
		Grid-Interactive WH (ER)	0.35-0.37 kW	0.87 kW			BPA 2018 Peak Mitigation (ER)
		Grid-Interactive WH (HP)	0.09-0.22 kW	0.21 kW			BPA 2018 Peak Mitigation (HP)
		Smart Appliances	0.14 kW	0.14 kW			Ghatikar, Rish. Demand Response Automation in Appliance and Equipment. Lawrence Berkley National Laboratory, 2015
		Third Party Curtailment			10%	21%	21%
	Steady-State Participation	Smart Thermostats - Cooling		20%	20%		
Smart Thermostats - Heating			5%	3%			Piggybacks off of cooling- Adjusted down to reflect realistic participation for space heating in Avista's territory
Grid-Interactive WH (ER)			50%	50%			Reflects Rollout → Ten-Year Ramp Rate
Grid-Interactive WH (HP)			50%	50%			Reflects Rollout → Ten-Year Ramp Rate
Smart Appliances			5%	5%			2015 ISACA IT Risk Reward Barometer - US Consumer Results. October 2015
Third Party Contracts				15%	21%	22%	Best Estimate based on Industry Exp.

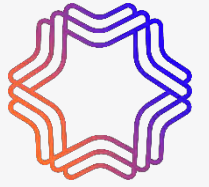

# Time-Varying Rates/Behavioral Assumptions

	Program Option	Residential	General Service	Large General Service	Extra Large General Service	Source
<b>Time-Varying Rates/Behavioral Assumptions</b>	Behavioral	2%				Opower documentation for Behavioral DR with Consumers and DTE
	Time-of-Use Opt-In	2.9%-5.7%	0.1%-0.2%	1.3%-2.6%	1.6%-3.1%	Brattle Analysis and Estimate - PacifiCorp 2019 opt-in scenario
	Time-of-Use Opt-Out	1.7%-3.4%	0.1%-0.2%	1.3%-2.6%	1.6%-3.1%	Brattle Analysis and Estimate - PacifiCorp 2019 opt-out scenario
	Time-of-Use Electric Vehicles		0.1%-0.2%	1.3%-2.6%		Brattle Analysis and Estimate - PacifiCorp 2019 opt-in scenario
	Variable Peak Pricing	8%-10%	3%-4%	3%-4%	3%-4%	OG&E 2020 Smart Hours Study
	Behavioral	20%				PG&E rollout with six waves
	Time-of-Use Opt-In	13%	13%	13%	13%	Best estimate based on industry experience; Brattle Analysis and Estimate
	Time-of-Use Opt-Out	74%	74%	74%	74%	Best estimate based on industry experience; Brattle Analysis and Estimate
	Time-of-Use Electric Vehicles		13%	13%		Best estimate based on industry experience; Brattle Analysis and Estimate
	Variable Peak Pricing	25%	25%	25%	25%	OG&E 2020 Smart Hours Study

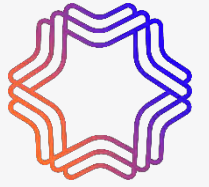

# Energy Storage Assumptions

Energy Storage Assumptions		Program Option	Residential	General Service	Large General Service	Extra Large General Service	Source
Energy Storage Assumptions	Peak Impacts	Battery	2 kW	2 kW	15 kW	15 kW	Typical Battery Size Per Segment
		Thermal	0.5 kW	1.26 kW			2016 Ice Bear Tech Specifications
	Steady-State Participation	Battery	0.5%	0.5%	0.5%	0.5%	Best Estimate Based on Industry Exp.
		Thermal		0.5%	1.5%	1.5%	Best Estimate Based on Industry Exp.







# Avista IRP Clean Energy Research

April 2022

# Research Overview

## Objectives

Determine willingness to pay for the implementation of clean energy among Avista customers

-  Establish baseline of environmental concerns; perceived responsibility of individuals, businesses, and Avista specifically
-  Understand customer tradeoffs between bill increases and carbon emission goals
-  Explore perceptions associated with Avista should they invest in carbon-neutral or carbon-free emissions
-  Gauge perceptions specific to natural gas preferences and tradeoffs
-  Quantify differences by state, customer type, green perceptions, and demographic factors

## Methodology



### Web survey with Avista customers.

- Customers from Washington, Idaho, and Oregon sourced randomly by email
- Survey optimized for both desktop and mobile
- Conducted in April 2022
- Final sample size of n=1,100



### Proportional representation of state and service type.

WA	ID	OR	G	GE	E
52%	29%	20%	25%	47%	29%

### Respondents screened to ensure appropriate target



- Avista customer age 18+
- Has or shares household finance and utility bill responsibility
- Not employed by a utility company, or in media, advertising, or market research firm

## Report Interpretation

- All significant differences are reported at the 95% confidence level or higher. The total sample size of n=1,100 has a maximum sampling variability of +/-3.0% at the 95% level.
- Some percentages may not add to 100% due to rounding







# Analysis Approach

This study incorporates a conjoint exercise to force tradeoffs between various green initiatives and customer willingness to pay.

Respondents review various combinations of **energy goals**, **timeframes for that goal**, **energy sources**, and **potential bill increases**, and select their “most preferred” from a series of options (including an option for “none” each time).

Subsequent analysis produces utility scores for each individual attribute, allowing us to calculate which combination has the broadest appeal.

	<b>Energy Goal</b>	Investing in renewables to achieve carbon neutrality Providing 100% carbon-free power by only generating energy through clean energy sources
	<b>Goal Timeframe</b>	In the next year In the next 5 years (by 2027) In the next 10 years (by 2032) In the next 25 years (by 2047)
	<b>Bill Increase</b>	2% monthly increase 5% monthly increase 10% monthly increase 20% monthly increase 50% monthly increase 100% monthly increase
	<b>Energy Source</b>	Sourced locally Sourced regionally Sourced from anywhere





# Key Takeaways

## Price is Important.



When faced with tradeoffs, price is the prevailing factor. While the majority of customers find importance in sourcing green or local energy, they are only willing to pay so much. Anything beyond a 10% monthly bill increase shows significant declines in popularity.

If bill increases to invest in carbon-free or carbon-neutral options are kept below 10%, the specific energy goal, timeframe, local vs. regional source are less important.

## Some customers see beyond price



Increases beyond 10% monthly still appeal to a certain subset of customers, particularly those who place great importance on “green,” and/or when the goal can be achieved within the next 10 years.

## Any increase to invest in “green” energy will alienate some customers



Overall, roughly one in five do not find importance in being “green”

When evaluating various green investment options, 17% reject all, including more ambitious outcomes for just a 2% increase

Three in ten say they would be likely to seek bill assistance or consider moving to another state if bill were to increase due to Avista investing in carbon-free or carbon-neutral energy



Detailed Findings:  
**Green Insights**



At a personal level, the concept of being environmentally friendly or “green” is important to nearly eight in ten customers

### Personal Importance of “Green”

(n=1,100)

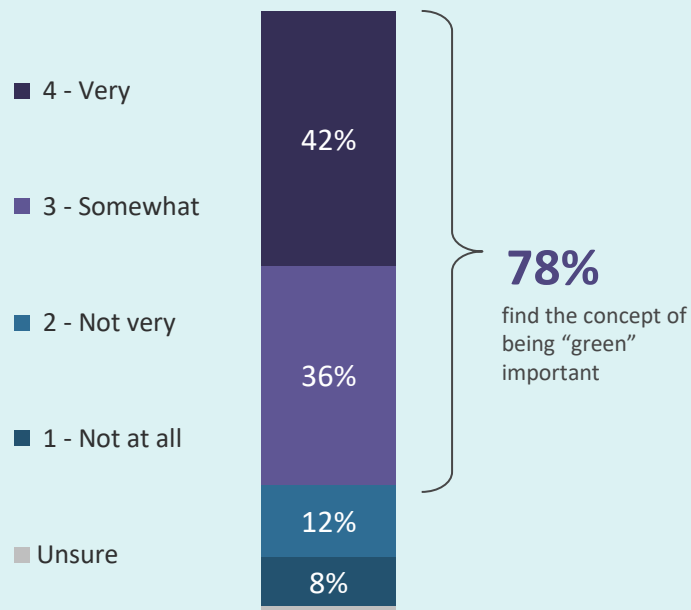

### Key Differences and Insights



#### Green importance differs by state.

Customers in **Oregon** and **Washington** are significantly more likely than those in Idaho to find the concept of “green” to be important.



83%



80%



71%



#### Green importance differs by area.

Customers in **urban** areas are significantly more likely than those in rural areas to find the concept important.



urban

84%



suburban

80%



rural

75%



#### Green importance differs by gender.

**Women** are significantly more likely than men to find it important.



85%



73%



#### Green importance is consistent across age and income categories.

# Customers place similar importance on the “green” responsibility of themselves, businesses, and utility companies

## Importance of “Green” For...

(n=1,100)

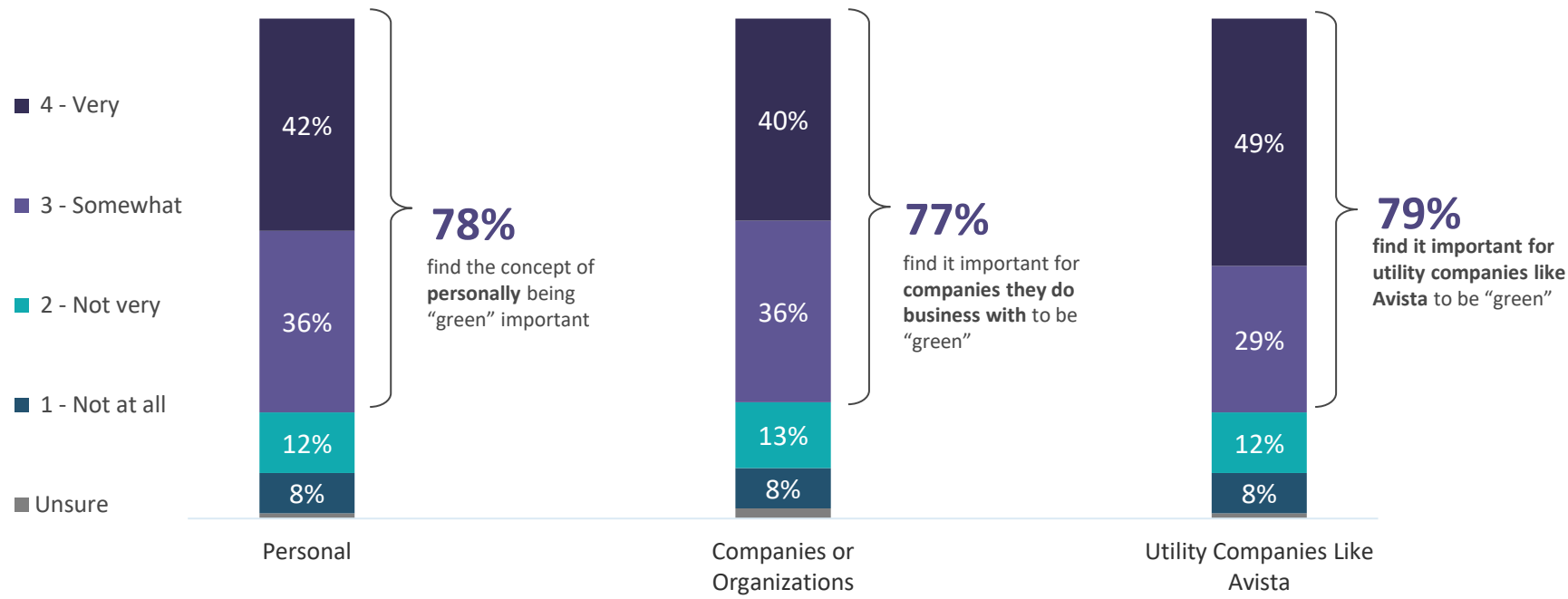

Q1. How important is the concept of being environmentally friendly or "green" to you personally?  
 Q3. How important is it for general companies or organizations you do business with to be environmentally friendly or "green?"  
 Q4. How important is it specifically for utility companies like Avista to be environmentally friendly or "green?"



Personal importance to be “green” is driven by responsibility to protect the planet; for those believing it is not important to personally be green, cost is the main reason

### Why is it Important?

(n=860)



To protect our planet/environment (38%)



Good for the future/future generations (24%)



Responsibility/right thing to do/stewardship (16%)



To address climate change/global warming (13%)

*“If we take care of our planet, it will in turn last for generations to come. If we take care of it, it will always take care of us.”*

*“Every person has to take responsibility for the environment. We are stewards of the Earth after all. That responsibility cannot, and should, not be abrogated. If we don't stand up and insist on choices that protect that for which we are responsible then no one will and we necessarily choose a very dark alternative for an uncertain and unjust future.”*

### Why is it NOT Important?

(n=224)



Cost/it's expensive (29%)



Not real/hoax/misinformation (25%)



“Green” is worse for the environment, not better (20%)



Politics/Political Agenda (17%)

*“In the 60+ years I've been around, the air land and waters have markedly improved. As the current crop of ‘renewables’ are unreliable and expensive, good ol' fossil fuels are the best bang for bucks.”*

*“Because the terms ‘environmentally friendly’ and ‘green’ have been distorted to the point where they have little relevance to actually protecting the environment.”*

Q2A. Why is it [very/somewhat important] to personally be environmentally friendly or "green?"

Q2B. Why is it [not very/not at all important] to personally be environmentally friendly or "green?"



# Solar and wind are commonly associated with both renewable and clean energy

## Top Sources Associated With...

■ Renewable Energy ■ Clean Energy

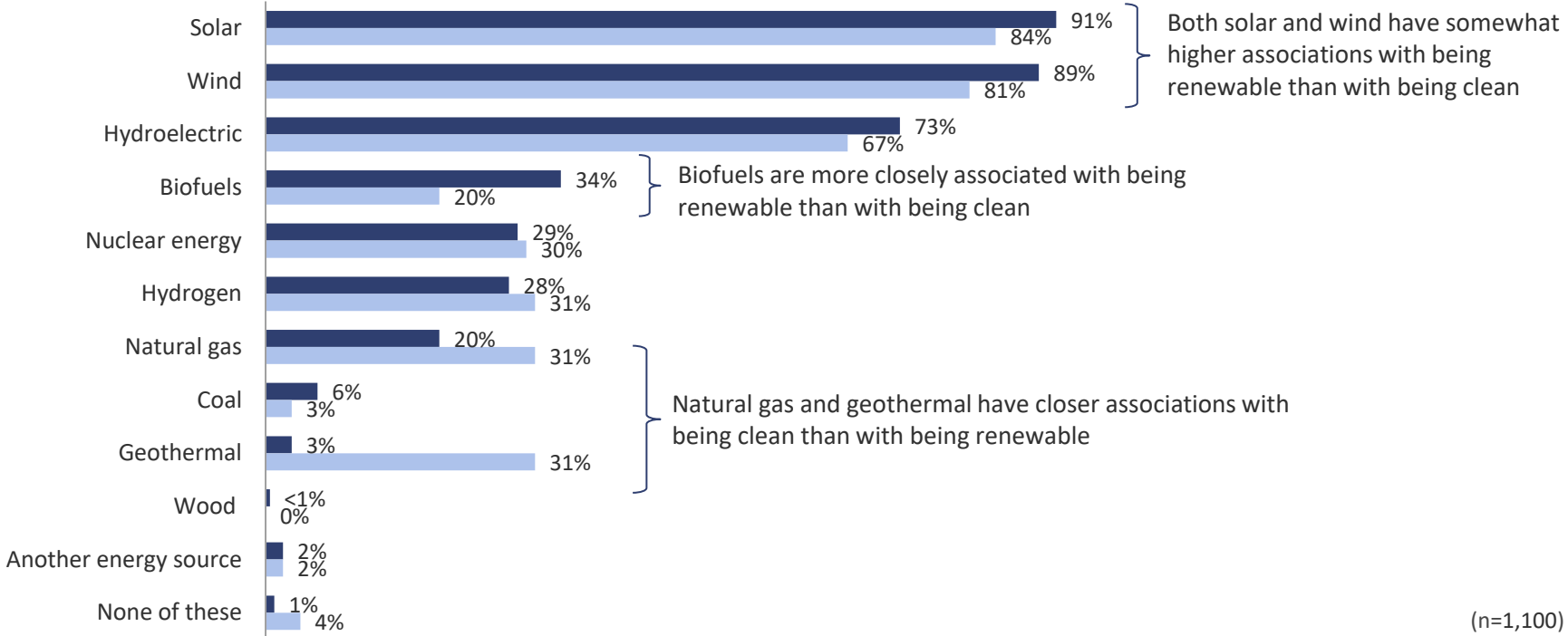

(n=1,100)

Q6. When you hear the words "renewable energy," what sources come to mind?  
 Q7. When you hear the words "clean energy," what sources come to mind?



# When considering potential utility company initiatives, customers place highest importance on generating power from local and renewable resources

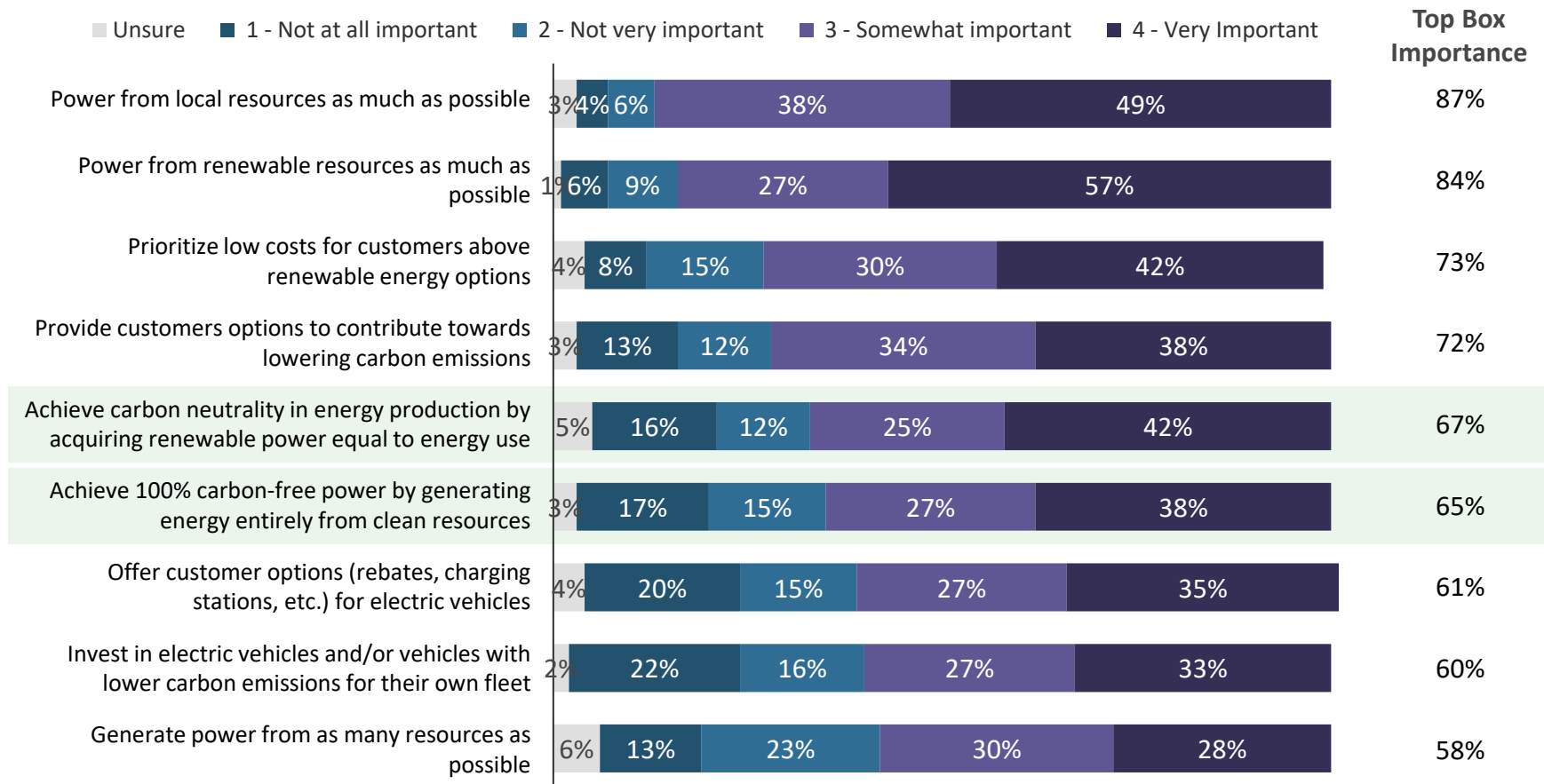

# Customers place near equal importance on Avista achieving carbon neutrality and on achieving 100% carbon-free power

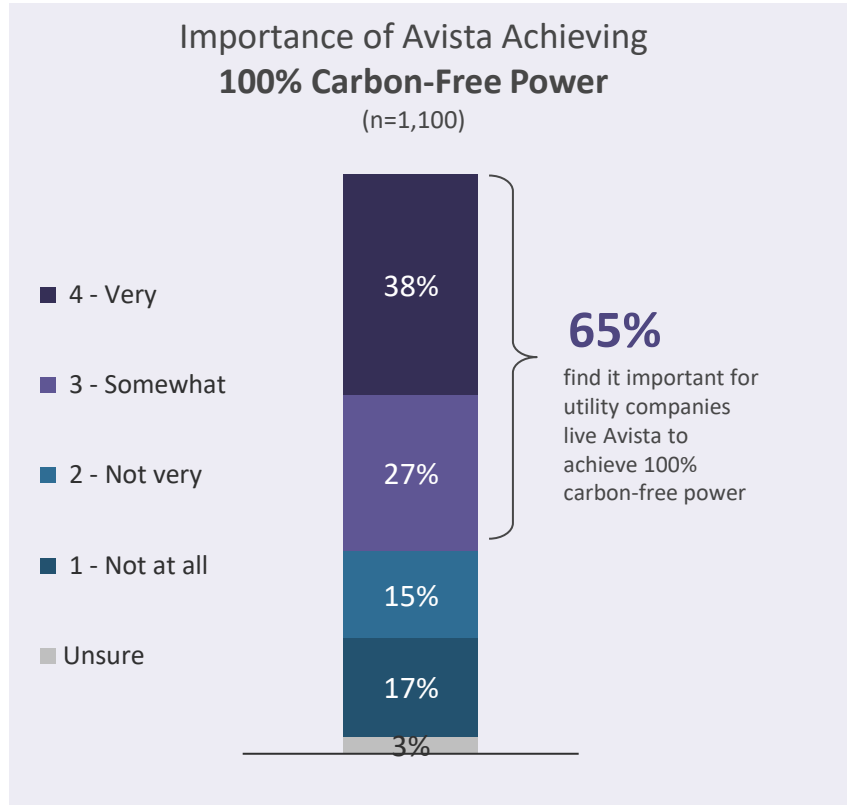
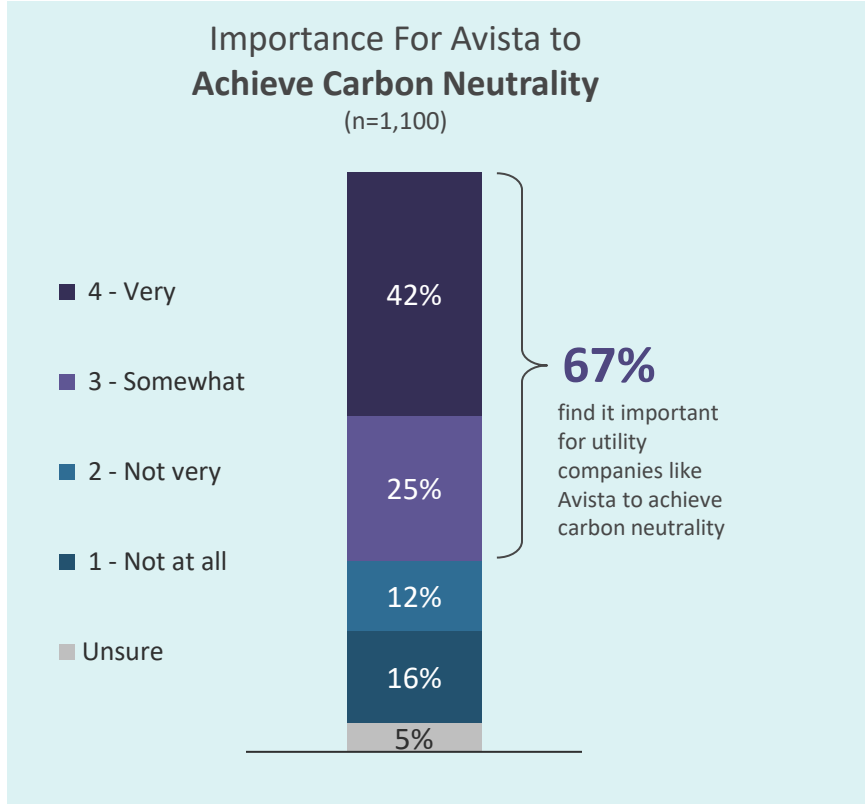

Q5. How important is it for utility companies like Avista to do each of the following?  
 Achieve carbon neutrality in energy production by acquiring renewable power equal to energy use.  
 Achieve 100% carbon-free power by generating energy entirely from clean resources.



# The importance of Avista achieving these goals differs by certain key audiences

## Key Differences and Insights: Carbon Neutrality

**Carbon neutrality importance differs by state.**  
 Customers in **Oregon** are significantly more likely than those in Idaho to say it is important for to achieve carbon neutrality.



**Carbon neutrality importance differs by area.**  
 Customers in **urban** areas are significantly more likely than those in rural areas to find the achievement important.



**Carbon neutrality importance differs by gender.**  
**Women** are significantly more likely than men to find it important.



**Importance of carbon neutrality differs by income.**  
 Those making **\$150K+** in household income are significantly more likely than those making less than \$60K to say it is important.

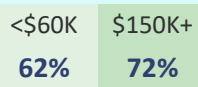

## Key Differences and Insights: 100% Carbon-Free

**Carbon-free power importance differs by state.**  
 Customers in **Oregon** are significantly more likely than those in Idaho to find an achievement of 100% carbon-free to be important.

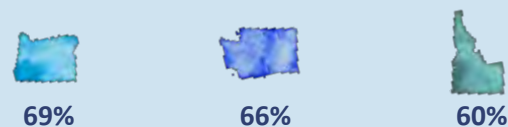

**Carbon-free power importance differs by area.**  
 Customers in **urban** and **suburban** areas are significantly more likely than those in rural areas to find the achievement important.



**Importance of 100% carbon-free power differs by gender.**  
**Women** are significantly more likely than men to find it important.







**Importance is consistent across age and income categories.**



Detailed Findings:  
**Green Investment**







# Conjoint Results Summary: Overall Feature Scoring

Category	Attribute	Result	Meaning
 <b>Energy Goal</b>	Investing in renewables to achieve carbon neutrality	0.55	If all other factors are held consistent, providing 100% carbon-free energy vs. investing in carbon neutrality has almost no impact
	Providing 100% carbon-free power by only generating energy through clean energy sources	0.59	
 <b>Goal Timeframe</b>	In the next year	0.60	There is a drop-off in utility at the 25-year level; however, there is little differentiation between <i>in the next year, five years, or ten years</i> when all other factors are held consistent
	In the next 5 years (by 2027)	0.59	
	In the next 10 years (by 2032)	0.59	
	In the next 25 years (by 2047)	0.52	
 <b>Bill Increase</b>	2% monthly increase	0.83	If all other factors are held consistent, the monthly bill increase has the biggest impact; utility drops off considerably with more than a 10% increase
	5% monthly increase	0.78	
	10% monthly increase	0.69	
	20% monthly increase	0.53	It should be noted, however, that those placing high importance on being green demonstrate a willingness to pay beyond the 10% mark
	50% monthly increase	0.36	
	100% monthly increase	0.25	
 <b>Energy Source</b>	Sourced locally	0.59	Though 87% find sourcing power locally to be important, ultimately there is little differentiation between <i>local, regional, and anywhere</i> , when considering other factors along with locality
	Sourced regionally	0.58	
	Sourced from anywhere	0.55	
 <b>None</b>		0.39	Overall, 17% of respondents said no to all options presented, indicating no willingness to pay for green investments

(n=1,100)





C2. Now, we will present you with a series of 12 screens, each with a set of options for an energy package that could be made available in the future for your home. For each set, please indicate the one you would be most likely to choose. You can always select “none” if you would not select any of the options.

# Conjoint Results Summary: Feature Scores by Personal Green Importance

Category	Attribute	Feature Score by Green Importance		
		Very (n=445)	Somewhat (n=399)	Not (n=331)
 <b>Energy Goal</b>	Investing in renewables to achieve carbon neutrality	0.67	0.53	0.38
	Providing 100% carbon-free power by only generating energy through clean energy sources	0.76	0.54	0.35
 <b>Goal Timeframe</b>	In the next year	0.79	0.54	0.33
	In the next 5 years (by 2027)	0.76	0.54	0.35
	In the next 10 years (by 2032)	0.72	0.55	0.38
	In the next 25 years (by 2047)	0.59	0.52	0.39
 <b>Bill Increase</b>	2% monthly increase	0.87	0.86	0.71
	5% monthly increase	0.88	0.78	0.60
	10% monthly increase	0.85	0.65	0.45
	20% monthly increase	0.74	0.46	0.24
	50% monthly increase	0.53	0.30	0.13
	100% monthly increase	0.42	0.17	0.04
 <b>Energy Source</b>	Sourced locally	0.72	0.55	0.39
	Sourced regionally	0.73	0.55	0.37
	Sourced from anywhere	0.69	0.51	0.34
 <b>None</b>		0.14	0.43	0.80

C2. Now, we will present you with a series of 12 screens, each with a set of options for an energy package that could be made available in the future for your home. For each set, please indicate the one you would be most likely to choose. You can always select “none” if you would not select any of the options.

# Conjoint Results Summary: Feature Scores by Service Type





Category	Attribute	Feature Score by Service Type		
		Gas Only (n=271)	Dual (n=513)	Electric Only (n=316)
 <b>Energy Goal</b>	Investing in renewables to achieve carbon neutrality	0.57	0.56	0.54
	Providing 100% carbon-free power by only generating energy through clean energy sources	0.61	0.60	0.58
 <b>Goal Timeframe</b>	In the next year	0.63	0.60	0.58
	In the next 5 years (by 2027)	0.62	0.59	0.57
	In the next 10 years (by 2032)	0.61	0.59	0.57
	In the next 25 years (by 2047)	0.52	0.52	0.51
 <b>Bill Increase</b>	2% monthly increase	0.83	0.84	0.82
	5% monthly increase	0.79	0.79	0.76
	10% monthly increase	0.71	0.70	0.66
	20% monthly increase	0.56	0.53	0.50
	50% monthly increase	0.39	0.35	0.35
	100% monthly increase	0.28	0.24	0.24
 <b>Energy Source</b>	Sourced locally	0.61	0.59	0.57
	Sourced regionally	0.60	0.59	0.56
	Sourced from anywhere	0.57	0.55	0.53
 <b>None</b>		0.36	0.38	0.42

C2. Now, we will present you with a series of 12 screens, each with a set of options for an energy package that could be made available in the future for your home. For each set, please indicate the one you would be most likely to choose. You can always select “none” if you would not select any of the options.



# Conjoint Results Summary: Optimal Feature Combination

Unsurprisingly, the optimal utility results from customers achieving the most for the lowest cost. While this is not a realistic scenario, it provides a baseline for any changes made to move toward carbon-free or carbon-neutral energy in the future. Subsequent slides show change from optimal should other factors be considered.

	Category	Attribute
	Energy Goal	Investing in renewables to achieve carbon neutrality
	Goal Timeframe	In the next year
	Bill Increase	2% monthly increase
	Energy Source	Sourced locally





(n=1,100)

C2. Now, we will present you with a series of 12 screens, each with a set of options for an energy package that could be made available in the future for your home. For each set, please indicate the one you would be most likely to choose. You can always select “none” if you would not select any of the options.



# Conjoint Summary: Difference from Optimal Combination (Based on Goal)

## Optimal Feature Combination

	<b>Energy Goal</b>	Investing in renewables to achieve carbon neutrality
	<b>Goal Timeframe</b>	In the next year
	<b>Bill Increase</b>	2% monthly increase
	<b>Energy Source</b>	Sourced locally

If all other factors are held consistent, providing 100% carbon-free energy vs. investing in carbon neutrality has almost no impact





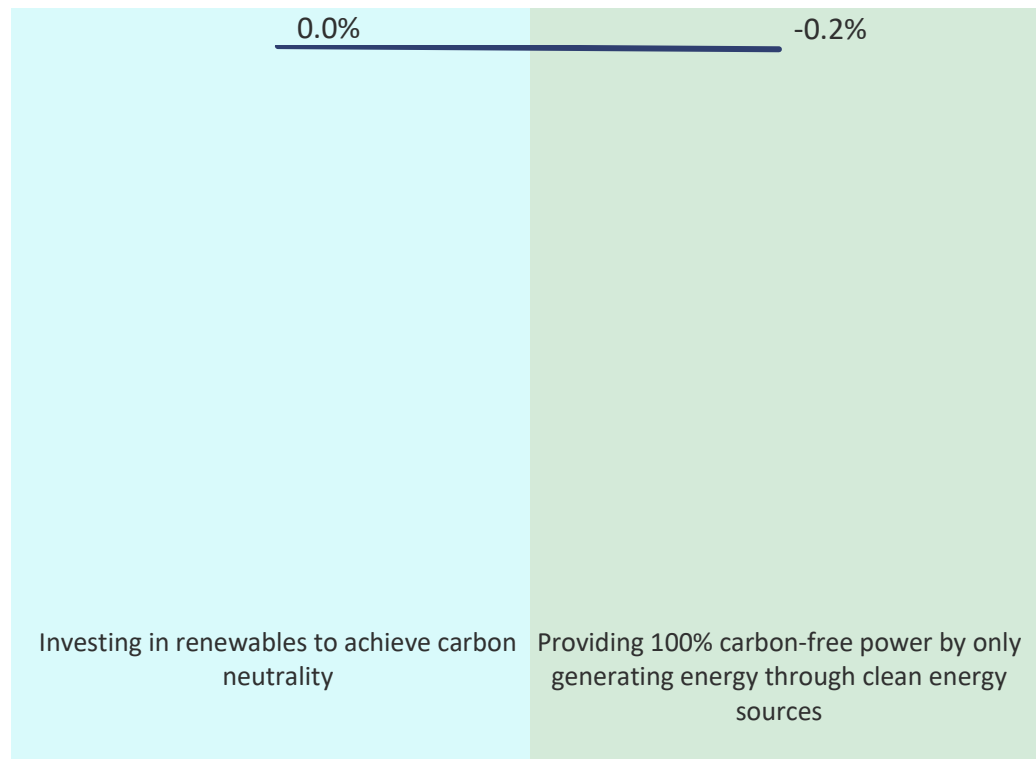

## Change from Optimal Based on Goal



# Conjoint Summary: Difference from Optimal Combination (Based on Timeframe)

## Optimal Feature Combination

	<b>Energy Goal</b>	Investing in renewables to achieve carbon neutrality
	<b>Goal Timeframe</b>	In the next year
	<b>Bill Increase</b>	2% monthly increase
	<b>Energy Source</b>	Sourced locally

If all other factors are held consistent, a shorter timeline has minimal impact; utility drops off after 10 years





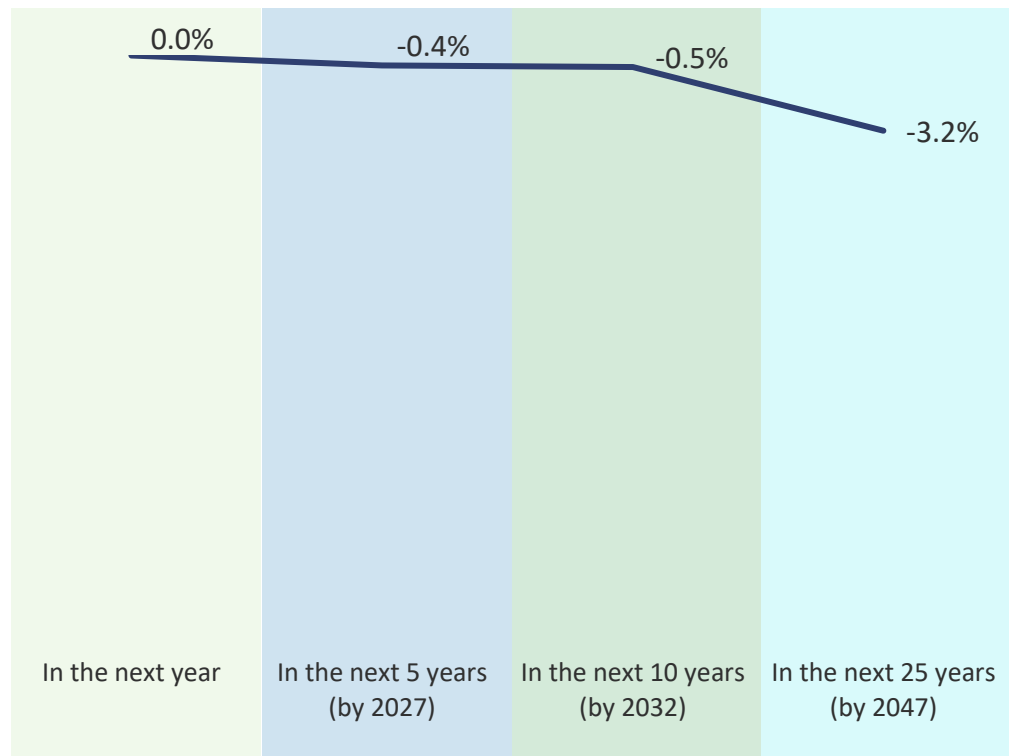

## Change from Optimal Based on Timeframe





# Conjoint Summary: Difference from Optimal Combination (Based on Bill Increase)

## Optimal Feature Combination

	<b>Energy Goal</b>	Investing in renewables to achieve carbon neutrality
	<b>Goal Timeframe</b>	In the next year
	<b>Bill Increase</b>	2% monthly increase
	<b>Energy Source</b>	Sourced locally

If all other factors are held consistent, the monthly bill increase has the biggest impact; utility drops off considerably with more than a 10% increase

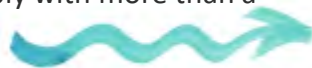



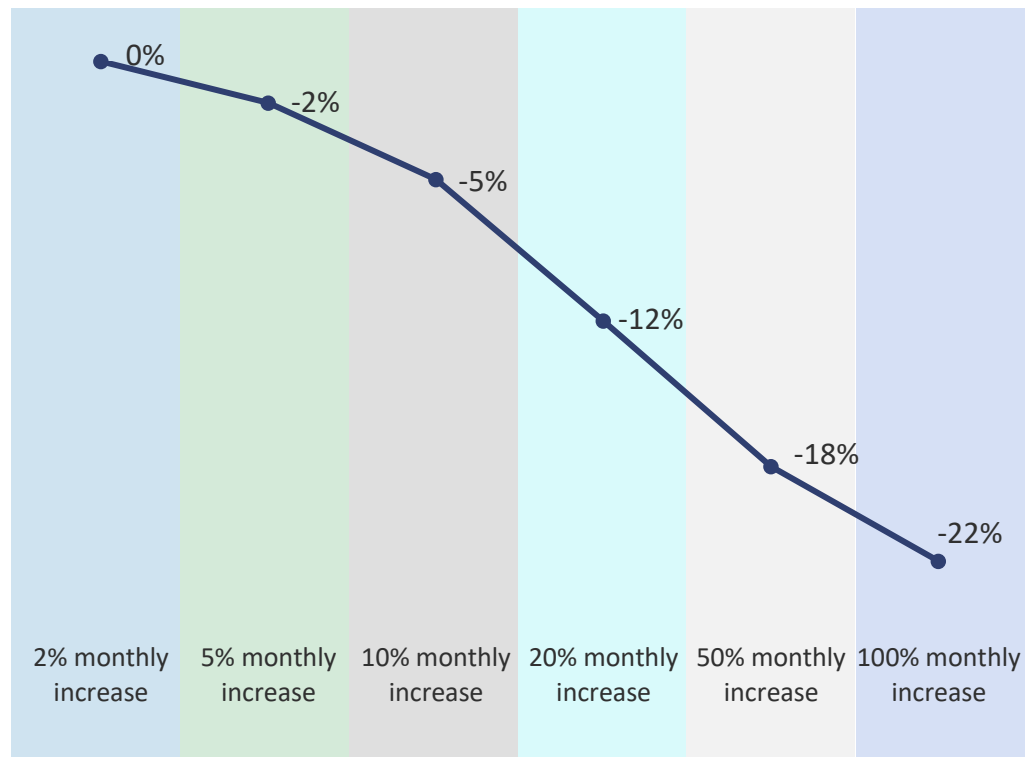

## Change from Optimal Based on Monthly Bill Increase



# Conjoint Summary: Difference from Optimal Combination (Based on Source)

## Optimal Feature Combination

	<b>Energy Goal</b>	Investing in renewables to achieve carbon neutrality
	<b>Goal Timeframe</b>	In the next year
	<b>Bill Increase</b>	2% monthly increase
	<b>Energy Source</b>	Sourced locally

If all other factors are held consistent, the source of energy has almost no impact; energy sourced locally or regionally is only slightly more preferred



## Change from Optimal Based on Source

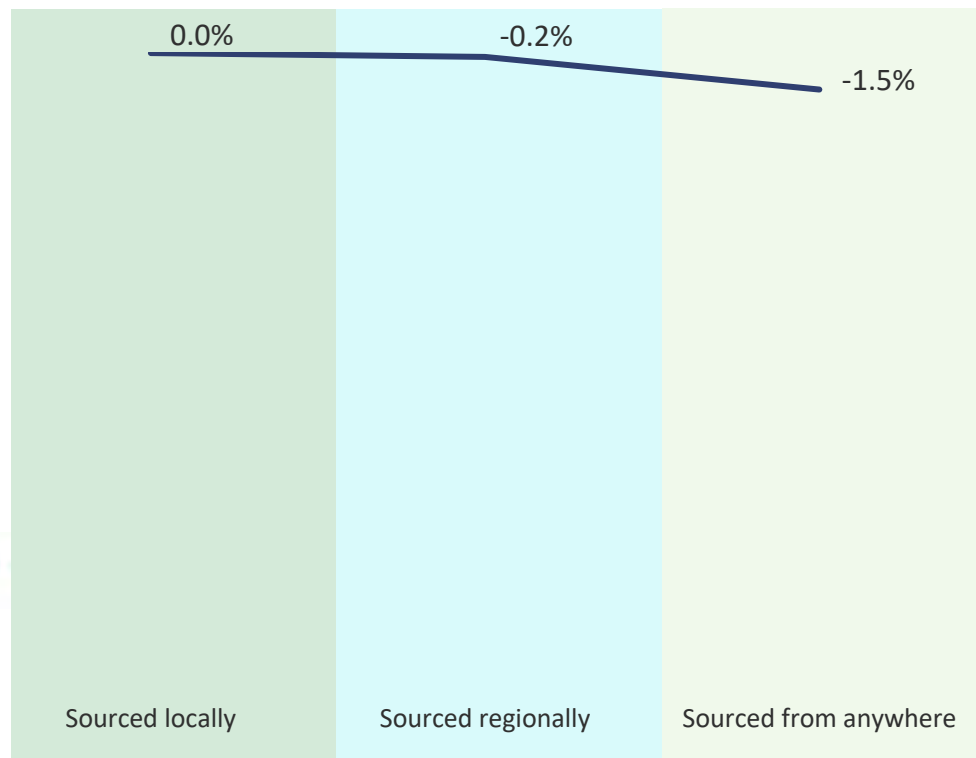

Detailed Findings:  
**Investment Support**



# Three in five customers say Avista should invest in carbon-neutral energy even if it involves a rate increase for customers

## Should Avista invest in carbon-neutral or carbon-free energy, even if it involves a rate increase for customers?

(n=1,100)

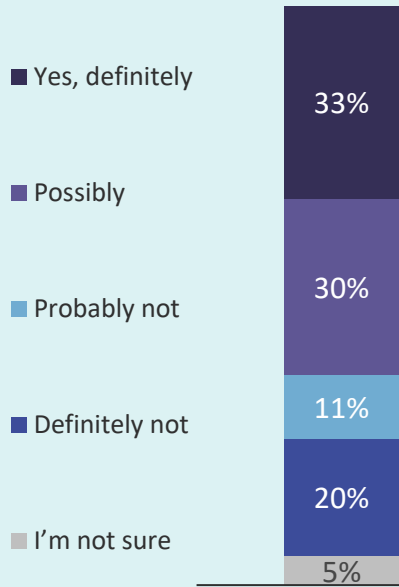

## Key Differences and Insights



### Investment sentiment differs by income.

Those with **higher household incomes** are significantly more likely than those making \$60K or less to agree Avista definitely should invest, even if it involves a rate increase.

<\$60K	\$60K+
28%	42%



### Investment sentiment differs by area.

Customers in **urban** areas are significantly more likely than those in rural areas to believe Avista should definitely invest.



urban  
40%



suburban  
36%



rural  
29%



### Lack of investment support differs by gender.

While those **supporting** investment is consistent across gender, **men** are significantly more likely than women to **definitely not** support investment.



15%



23%









### Support is consistent across age and state.



Supporters say the main reason Avista should invest in carbon-neutral energy is to “save the planet,” while the main reason to not invest among detractors is “consumer cost”

### What is the main reason to invest?





(n=697)

-  To save the planet (21%)
-  For a cleaner environment (19%)
-  For cleaner air (16%)
-  To fight climate change (16%)
-  Depends on cost effectiveness (16%)
-  It's the right thing to do (16%)

*“Finite resources are finite. It doesn't matter that you save money today but have fewer or no energy sources later.”*

### What is the main reason to NOT invest?

(n=345)

-  Consumer costs/expensive (57%)
-  Don't believe in it/hoax/impossible (17%)
-  Unnecessary/will not change anything (16%)
-  Politics/political agenda (10%)

*“Carbon neutral and carbon free energy are ridiculous ideas that only increase the cost of energy for everyone.”*

C3A. In your opinion, what is the main reason Avista should invest in carbon-neutral or carbon-free energy, even if it involves a rate increase for customers?

C3B. In your opinion, what is the main reason or reasons Avista should not invest in carbon-neutral or carbon-free energy? Page 461 of 1561



# Nearly seven in ten customers would be likely to “make at home-sacrifices” if their bill increased due to Avista’s investment in carbon-neutral energy

### If Avista did go that route, and your bill increased, how likely would you be to take each of the following actions?

(n=1,100)

**Top Box**  
67%

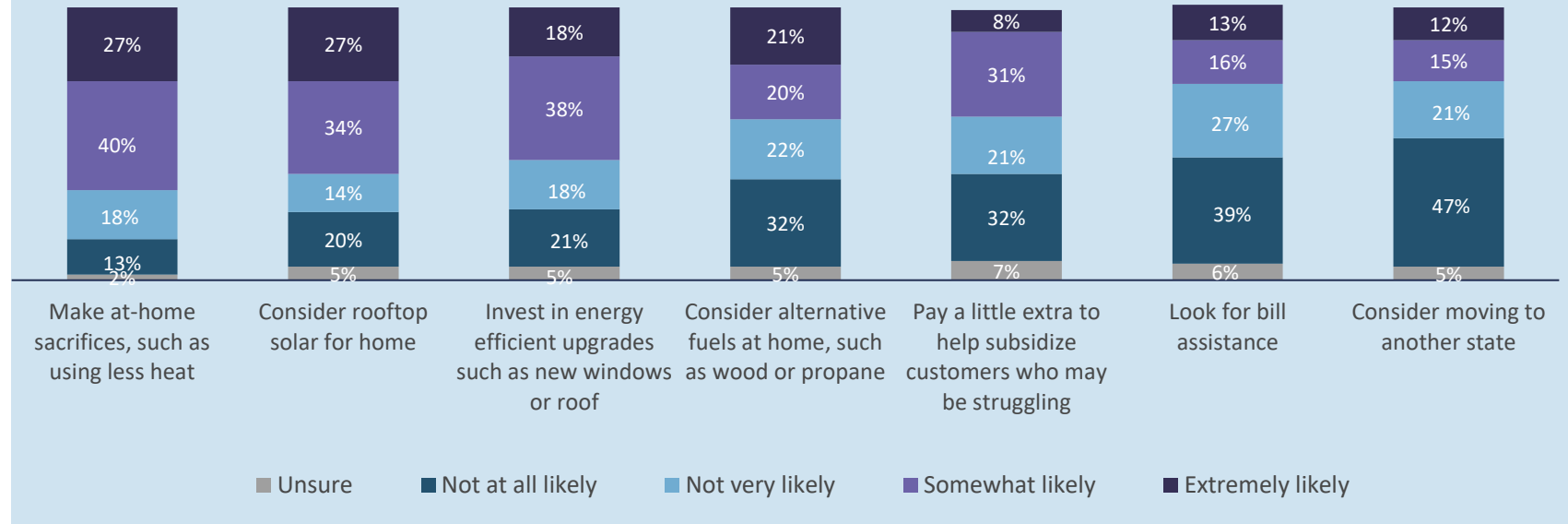

Just over a quarter indicate they'd seek bill assistance should rates rise due to Avista pursuing carbon-neutral or carbon-free options; for over half, this would take a 10% increase or more

### Likelihood to Seek Bill Assistance if Bill Increased (n=1,100)

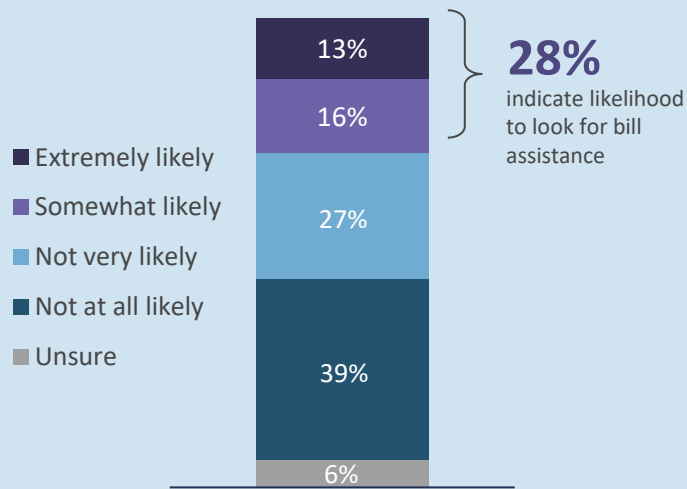

### Level of Bill Increase That Would Drive Seeking Assistance (Among Those Likely to Seek Assistance; n=313)

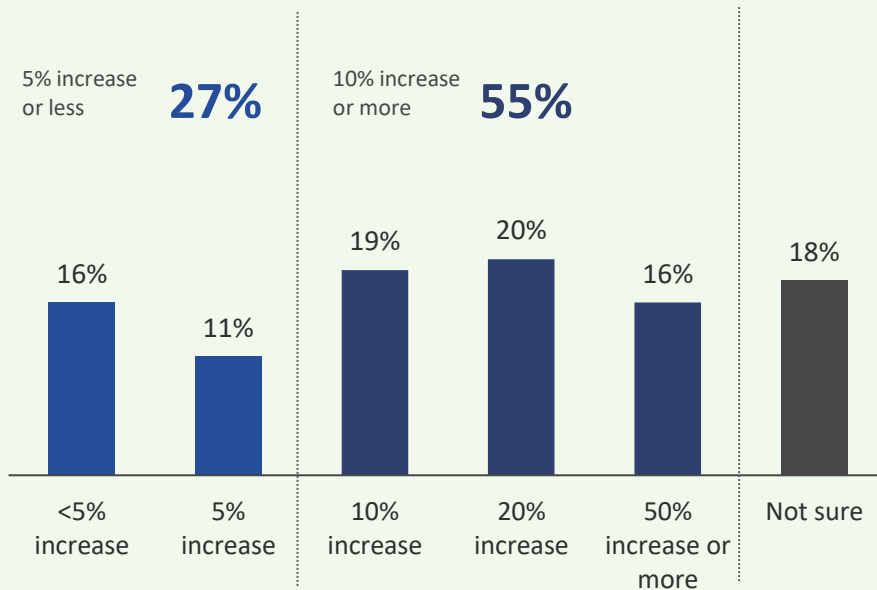

C4. If Avista did go that route, and your bill increased, how likely would you be to take each of the following actions? *Look for bill assistance*

C5. What level of bill increase would you envision driving you to seek bill assistance?



Roughly a third indicate they'd consider moving to another state should rates rise; however, there is uncertainty around what threshold of increase would drive this decision

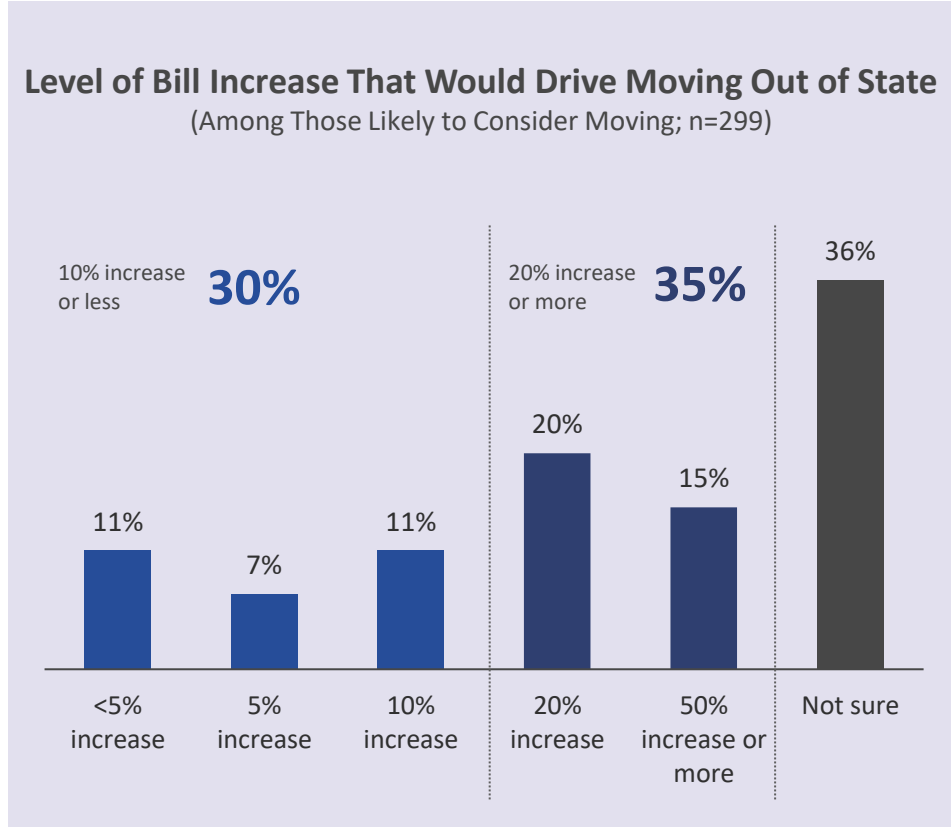
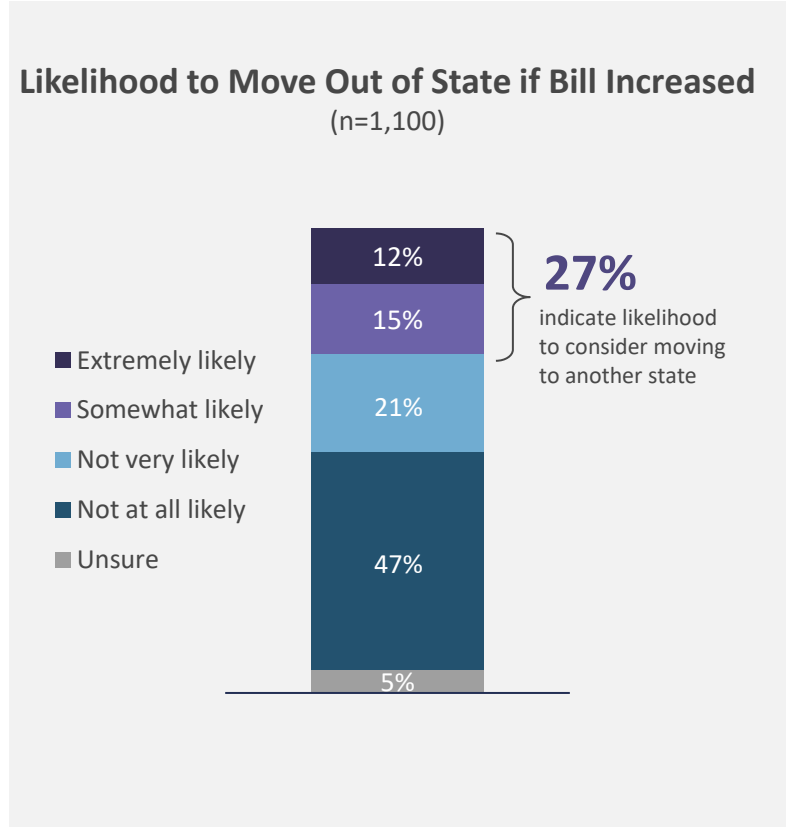



# Over half of customers say their favorability would not be impacted if Avista does not achieve carbon neutrality by 2027

## Favorability of the Company if Avista is not able to Achieve Carbon Neutrality by 2027

(n=1,100)

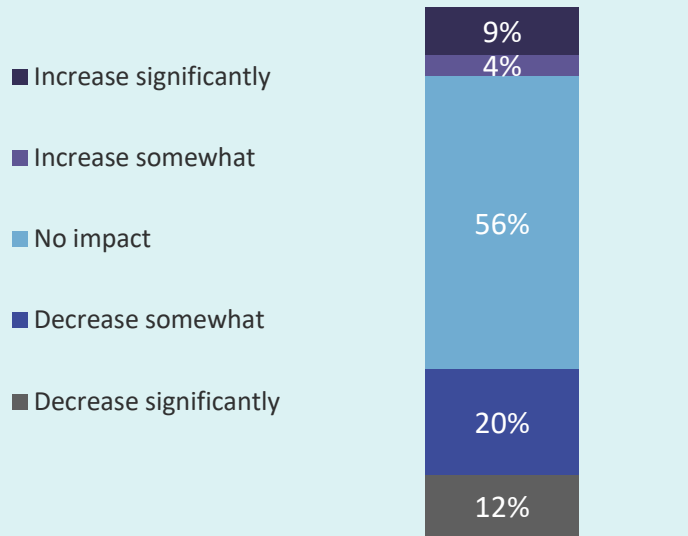

### Potential decreased favorability differs by age.

Younger participants are significantly more likely than older participants to say their favorability of Avista would decrease significantly if Avista is not able to achieve carbon neutrality by 2027.

Age Group	Percentage
18-54	15%
55+	10%



Potential decreased favorability is consistent across state, gender, area of residence, and income categories.

# Nearly half say their favorability would not change if Avista does not achieve carbon free by 2045

## Favorability of the Company if Avista is not able to Provide 100% Carbon-Free Power by 2045

(n=1,100)

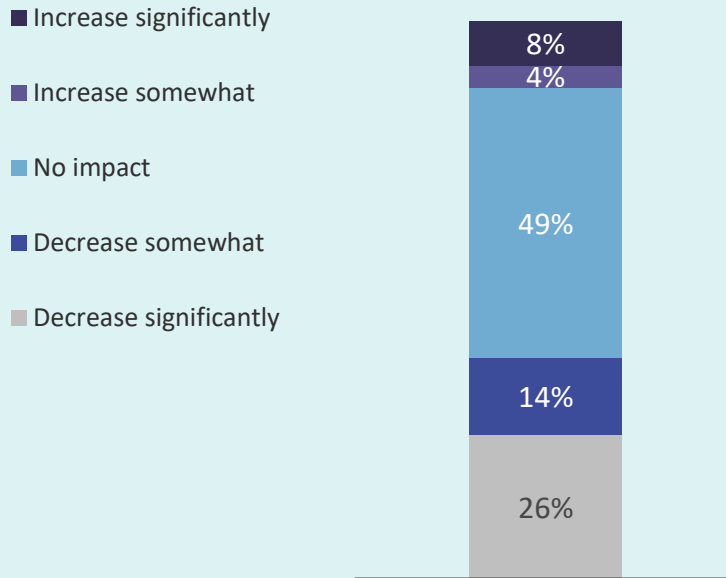

### Potential favorability differs by state.

Customers in **Oregon** and **Washington** are significantly more likely than those in Idaho say their favorability of Avista would decrease significantly.



29%



27%



21%



### Potential favorability differs by area.

Customers in **urban** and **suburban** areas are significantly more likely than those in rural areas to decrease favorability.



urban

32%



suburban

28%



rural

21%



### Potential favorability differs by household income

Those with **higher household incomes** are significantly more likely than those making \$80K or less to decrease favorability.

<\$80K

23%

\$80K+

33%



Detailed Findings:  
**Natural Gas Insights**



# Nearly half of customers would **not** consider switching from natural gas to help reduce carbon emissions

## Likelihood to Consider Switching From Natural Gas to Another Energy Source

(Among Gas Customers, n=784)

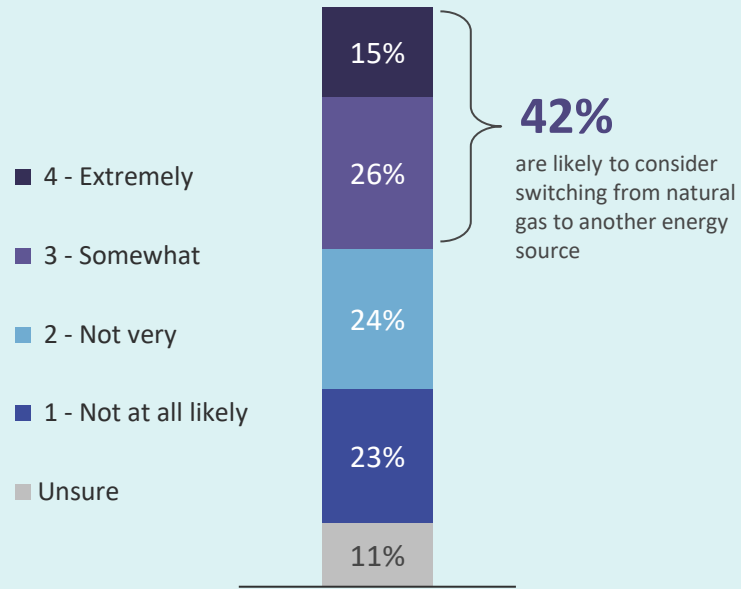

# Three-quarters gas customers agree eliminating natural gas should be entirely voluntary

## Agreement Concerning Eliminating Natural Gas In Home

(Among Gas Customers; n=784)

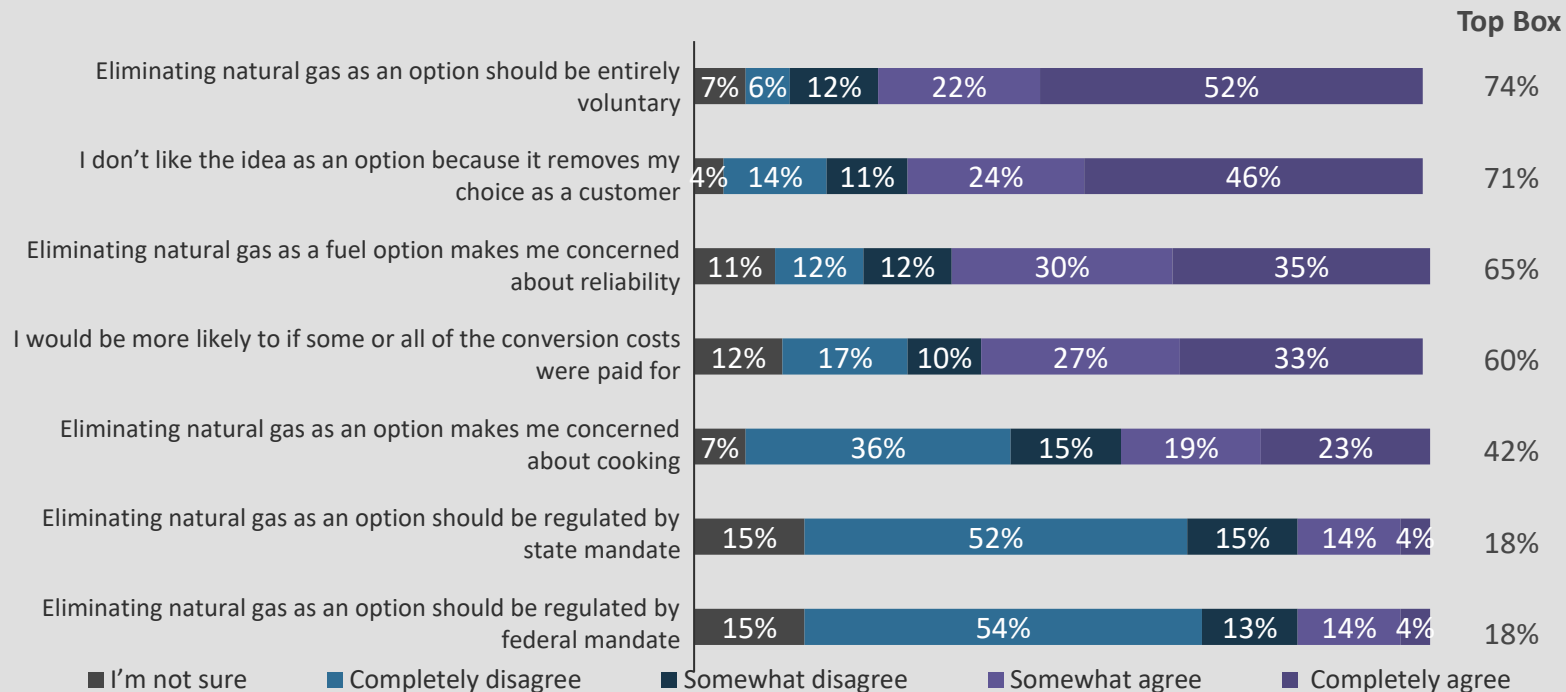

N2. How much do you agree or disagree with the following statements concerning natural gas in your home?

# Six in ten would be more likely to convert from natural gas if some or all conversion costs were covered; of these, 59% would be willing to pay under \$1000

## Would be More Likely to Convert if Some or All Conversion Costs are Covered

(Among Gas Customers, n=784)

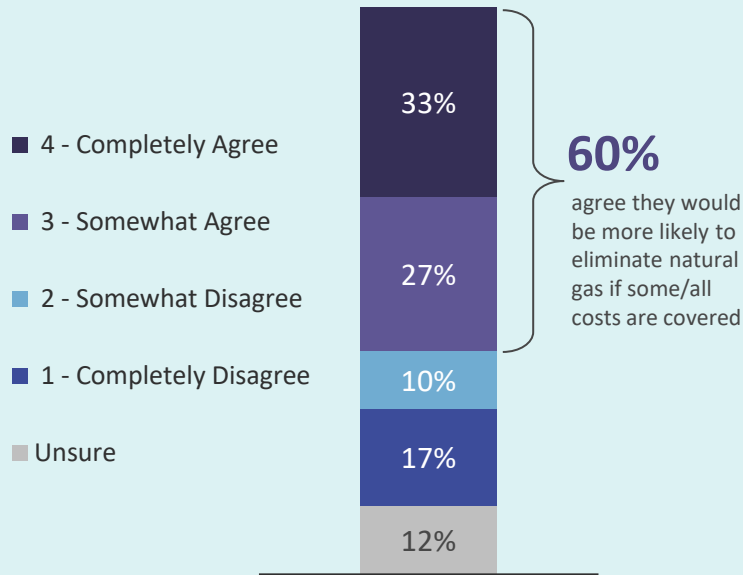

## Maximum Personal Contribution

(Among Gas Customers More Likely to Convert If Some/All Costs Are Covered; n=473)

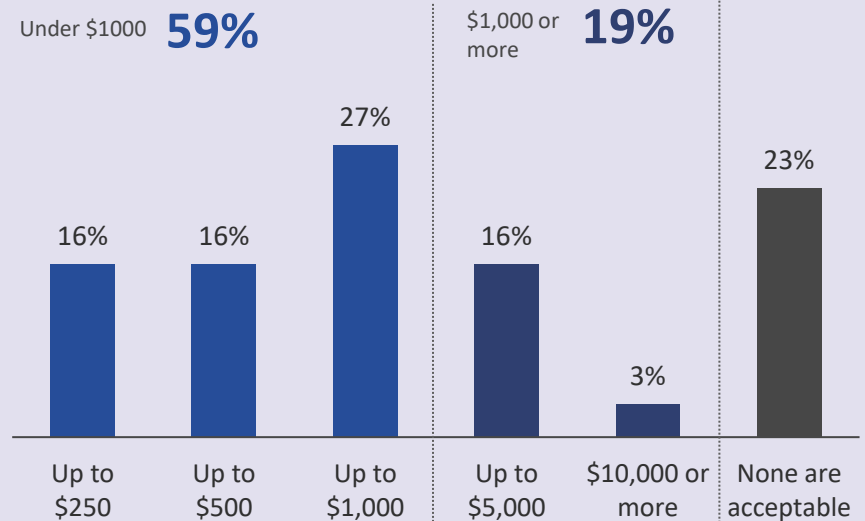

N2. How much do you agree or disagree with the following statements concerning natural gas in your home?

*I would be more likely to eliminate natural gas as an option in my home if some or all of the conversion costs were paid for by the electric utility and/or government incentives*

N3. If you did have to contribute some costs towards converting from natural gas in your home, how much would you consider your maximum level of contribution?



## Customer Demographics



# Demographics

Education	Total (n=1,100)	WA (n=569)	ID (n=316)	OR (n=215)
High school or less	7%	5%	10%	7%
Trade or Technical School	6%	6%	9%	4%
Some college	20%	20%	20%	21%
Graduated college	36%	37%	35%	33%
Graduate/professional school	26%	28%	22%	30%

Age	Total (n=1,100)	WA (n=569)	ID (n=316)	OR (n=215)
18-24	1%	<1%	2%	--
25-34	5%	4%	9%	4%
35-44	13%	15%	14%	9%
45-54	14%	14%	14%	12%
55-64	23%	21%	26%	22%
65-74	25%	24%	24%	31%
75+	12%	16%	4%	16%
Refused	6%	5%	7%	7%

Home Type	Total (n=1,100)	WA (n=569)	ID (n=316)	OR (n=215)
Single family dwelling	83%	92%	64%	87%
A duplex or triplex	4%	2%	7%	3%
In a building with 4 or more units	6%	2%	16%	2%

Income				
Median	~\$70K	~\$78K	~\$62K	~\$66K

Household				
Mean # of people	2.4	2.5	2.2	2.2

Gender				
Women	46%	44%	47%	53%
Men	46%	49%	45%	40%
Non-binary or Other	<1%	1%	1%	--
Prefer not to say	7%	7%	7%	8%





## TAC 4 Meeting Notes: Wednesday, August 10, 2022

### **Attendees:**

John Barber, Customer; Andrew Barrington, Avista; Shawn Bonfield, Avista; Alexa Bouvier, Idaho Office of Energy Resources, Annette Brandon, Avista; Terrence Brown, Avista; Michael Brutocao, Avista; Erik Budberg (Guest); Logan Callen, City of Spokane; Terri Carlock, IPUC; Travis Culbertson, IPUC; Mike Dillon, Avista; Nelli Doroshkin, Invenergy; Justin Dorr, Avista; Chris Drake, Avista; Michael Eldred, IPUC; Donn English, IPUC; Ryan Finesilver, Avista; Grant Forsyth, Avista; James Gall, Avista; Annie Gannon, Avista; Amanda Ghering, Avista; John Gross, Avista; Leona Haley, Avista; Lori Hermanson, Avista; Mike Hermanson, Avista; Kevin Holland, Avista; Andy Hudson, AEG; Tina Jayaweera, Power Council; Lance Kaufman, Western Economics; Kevin Keyt, IPUC; Anna Kim, Oregon PUC; Kathlyn Kinney, Biomethane, LLC; Scott Kinney, Avista; Dan Kirschner, Northwest Gas Association; Doug Krapas, (Guest); Ben Kropelnicki, Jakob Lahmers, MDC Research; Jeff Larsen, Guest; Avista; Mike Louis, IPUC; John Lyons, Avista; Patrick Maher, Avista; Jaime Majure, Avista; Kelly Marrin, AEG; Max McBride, AEG; Lisa McGarity, Avista; Ian McGetrick, Idaho Power; Andrew Mentzer, OEMR; Heather Moline, UTC; Jody Morehouse, Avista; Eli Morris, AEG; Richard Newton NWLECET (Guest); Fuong Nguyen, AEG; Irene O'Reilly, MDC Research; Tom Pardee, Avista; Mike Parvinen, CNGC; Liz Reichart, WA Department of Commerce; Jean Richardson (Guest); John Rothlin, Avista; Gurvinder Singh, PSE; Natasha Siores, Northwest Natural Gas; Darrell Soyars, Avista; Dean Spratt, Avista; Marissa Steketee (Sapere), AES; Jason Talford, IPUC; Taylor Thomas, IPUC; Charlee Thompson, NW Energy Coalition; Natalie Tyler, energy-solution.com; Mary Tyrie, Avista; Dave Van Hersett, Customer; Ken Walter, AEG; Katie Ware, Renewable NW; Mitch Warren, Kalesnikoff; Michael Whitby, Avista; Bill Will (Guest); Kirsten Wilson, WA DES; and Yao Yin, IPUC

### **Introduction, John Lyons - Avista**

**John Lyons:** [Recording started 9:07 am] OK. All right. Thank you on that. Some reminders since it's a virtual meeting, please mute your mics unless commenting or asking a question. We have the raise hand function and we've got other Avista members watching as we're presenting, we'll try to get those in. If we don't get to it right away, usually we're just waiting for a pause where we can ask the question for you. We ask you to remember to respect the pause, sometimes it takes people a little bit of time to work with the technology, as we're already experiencing, turning mute on and off. You can also just go into the chat and leave comments and questions there. If you are speaking, please try to remember to state your name before commenting. The recording and transcription software does a pretty good job of picking up who's talking, but every now and then, we'll say it gets a little creative on who it says it is. That's been interesting. It is a public advisory meeting, so we'll document comments and the recording when we do the meeting notes. Those do get edited. I take out the umms and try to clean up the language. Anything I add goes in brackets. Next slide.

**John Lyons:** Integrated resource planning is required by Idaho and Washington every other year. Washington now requires it officially every four years and an update at two

years. Since we have an Idaho requirement, we do a full IRP every two years. Our resource strategy over the next 20 plus years. The 20 plus is to get us to 2045 and a little later for some end effects. 2045 is the full 100% requirement for the Clean Energy Transformation Act in Washington. We start with current and projected load and resource positions to know where we're at and where we think we need to be over that planning horizon. We also look under strategies for different future policies since we don't know what the future is going to entail, we think about an expectation of what the future will be, then we run different scenarios to figure out what if there are some major changes. We look at generation, resource choices, possible changes in cost and technology. We look at conservation and demand response like we'll be talking about today; and what's available both technologically and economically, and what we think we're going to get. We'll look at demand response types of programs, so shifting resources or needs off so we can get a little further with the resources we have at hand at a certain point in time. Transmission and distribution integration, there is a distribution planning process developing much like we have for the IRP. That should be later this year. Then one of the big things that comes out of the IRP is a set of avoided costs. Basically, if you have people that want to participate in the market to supply resources, they will have an idea of what our avoided cost is. The way regulation works, we should be ambivalent to not, ambivalence is probably not the right word, but we're fine if we own a resource or we pay for energy efficiency to prevent the need for a resource based on that avoided cost plus some extra benefits we'll talk about today, an extra 10% for energy efficiency, we do market and portfolio futures then for uncertain future events and issues like a high natural gas price scenario like we are experiencing right now, or a low natural gas price scenario. We are going to have some base case issues that are involved with climate change, but we could do some others with climate. Or technology. What, if suddenly, small modular reactors take off and become very cost effective and everything pans out perfectly on them. You could run a scenario to see how the future would change. And next slide please.

**John Lyons:** The Technical Advisory Committee, that we're in right now, is the public process of the IRP. It's input on what to study, how to study and reviewing our assumptions and results. We do have a pretty wide variety of people in here, some are very technical, utility industry analysts and specialists, and then we have people that are very new to the process. They're customers, they could be very large customers or just individual residential customers that are interested in the process we do. Please ask questions. We're glad to answer those. We're always soliciting new TAC members. If you do have people that you think would like to be involved, our process to join the TAC is very easy. It's basically let us know you're interested, and we just add your name to the list with your e-mail. It is an open forum, but we're always trying to balance the needs to get through topics. If other people have already said the same thing, you want to say you could just put it in the notes a thumbs up, a plus one, I agree. Something like that, so we can keep things moving along. We do welcome requests for new studies or different modeling assumptions. Usually what happens is we will bring forth a proposal and then people can discuss it. Do they like it? Do they want tweaks? Do some things need to be run as scenarios, other types of models? And also if we're going to have time or capability or data to run those models. As I talked about earlier, we're always available

by e-mail or phone for questions or comments between meetings. If you think of something later and wish you had said that, just reach out to one of us, to James or myself we are on the website, so it's probably easier to get a hold of us and our contact information. The due date for study requests from TAC members is October 1<sup>st</sup>, 2022. Depending on the type of study or what you're asking for, there might be a little slippage there. If it's something we're already doing or close to doing, but October 1<sup>st</sup>, if you can get us the request by then, then we should be able to handle it. The external IRP draft will be released to this group on Saint Patrick's Day 2023 because nothing says celebrate Saint Patrick's Day like an IRP. I suppose we'll have to do a green cover on that one. Public comments will be due May 12<sup>th</sup>, 2023. Good. We have some applause there. The final 2023 IRP submission to both commissions and the TAC will be June 1<sup>st</sup>, 2023. So, a big and long project. It has been getting longer over time, but that's the goal there.

**James Gall:** Hey, John, if you don't mind, I just want to make another point

**John Lyons:** Yes.

**James Gall:** We will be filing an IRP update in the State of Washington on January 1<sup>st</sup> or might be 2<sup>nd</sup>. That will be an update to a lot of the assumptions that would be in the final IRP, but it's really focused on a single expected case. There will be an intermediate filing then, but it will not be a complete IRP. It'll be similar to the one that we had done last time for Washington, I guess it would have been in 2020.

**John Lyons:** Yeah. We had another filing that was similar, but this one won't have the final preferred resource strategy nailed down.

**James Gall:** Correct.

**John Lyons:** We talked about that one or two TAC meetings ago. We will also let the TAC know and give you plenty of time, so you know what's coming down the pike for us in progress updates. Any feedback that you have for Washington and regional carbon pricing assumptions, we were asking for that by August 15<sup>th</sup>. We've got another five days there, or if you have any questions on that. We've had some slight schedule changes. We moved the October 12<sup>th</sup> TAC to October 11<sup>th</sup> to accommodate the two-day Energy Efficiency Advisory Group that is on the 12<sup>th</sup> and 13<sup>th</sup>. October 11<sup>th</sup> is the date we are going to have our TAC meeting and we are going to have a room. We don't expect a lot of people to show up but depending on how many do we do have some bigger meeting rooms here at Avista. It'll be nice. I know we've got a couple of people that are planning to attend. It looks like Heather Moline has a question.

**Heather Moline:** Thanks. This is Heather Moline with Washington UTC. How flexible can you be on that August 15<sup>th</sup> date?

**John Lyons:** I think, James, I'll leave that to you. Since you're the one you, you and Lori are running the models.

**James Gall:** Probably an extra week is probably OK, but we have to lock and load our model probably fairly shortly thereafter.

**Heather Moline:** OK. Thank you.

**John Lyons:** OK. Other questions before we move on then. Looks like at Jean Richardson.

**Jean Richardson:** Will these slides be available or sent out after this meeting?

**John Lyons:** Yes, they'll be posted to the website probably by tomorrow.

**Jean Richardson:** Thank you.

**John Lyons:** OK. Are there other questions? OK. We are moving the global climate change studies from the October 11<sup>th</sup> to the September 28<sup>th</sup> meeting. That October meeting was getting quite busy. We're also going to move the load and resource and load forecast presentations from September 28<sup>th</sup> to the October 11<sup>th</sup> meeting based off of the initial agenda we sent with the Work Plan a while ago and then the WRAP update moves from September 7<sup>th</sup> to October 11<sup>th</sup>. That's the Western Resource Adequacy, is that program James, I always forget on the last one.

**James Gall:** It is and due to all the changes, we're going to put an updated Work Plan on the website and also put a schedule out there for each TAC meeting with the agenda topics that hopefully will be available in the next day or two.

**John Lyons:** We're trying to clean that up as we move along and are also still figuring out the date for it, but we're going to have a public participation partners reach out opportunity. A third party is going to host one or more meetings to get some feedback from the advisory groups on what we could do better to have participation on all these advisory groups because we're starting to get quite a few of them to make sure they're all working in harmony and moving along to the same goals and objectives. Any other changes we need to add in there James. I think we got everything.

**James Gall:** I think we're good.

**John Lyons:** OK. We move on to the next one. Rest of the meeting schedule we've got today, then September 7<sup>th</sup> and 28<sup>th</sup> for the 5<sup>th</sup> and 6<sup>th</sup> TAC meetings. As we get closer to running models, stuff starts coming by a little quicker. That October 11<sup>th</sup> meeting for the 7<sup>th</sup> TAC. October 20<sup>th</sup> there will be a technical modeling workshop. That'll be pretty much for people interested in the nitty gritty details of the modeling for the IRP. Everyone in the TAC is welcome to participate if they want, but it's going to be a nerd fest of energy modeling. The Washington Progress report workshop will be on December 14<sup>th</sup>. So going through where we are on the progress report for the IRP,

February 16<sup>th</sup> will be the 8<sup>th</sup> TAC meeting. March 8th will be the public meeting for gas and Electric IRP'S and will probably be similar to what we've done before. It's a high-level overview and we would break out for discussions to let us know what they're thinking, and we'll wrap up with what should be the final TAC 9 meeting on March 22<sup>nd</sup> for the 2023 IRP.

**James Gall:** John, I want to add one thing really quick for the September 7<sup>th</sup> meeting, it's going to be a 1/2 day meeting we're leaning towards the afternoon. If there's any feedback you would like to put in the chat if you prefer afternoons or mornings, but it should be about a 3 ½ hour meeting and we're going to try to keep all the TAC meetings to that 3 ½ to 4-hour time levels.

**John Lyons:** Since we've got the consultant in, we're trying to get it all done at once for the two sides.

**James Gall:** Today, you definitely don't have to stay if you're only interested in electric. You can leave after lunch, but it's up to you.

**John Lyons:** Today's agenda after I'm done here with the introductions and we'll get into the electric conservation potential assessment by AEG and they'll explain what that is and the results of that totally, and for Washington and Idaho specifically. We'll take a break after that, then they will talk about the demand response study and the results of that 11:30 to 12:30. We'll take an hour for lunch. At 12:30, Mary Tyrie will go over the Clean Energy Survey, so there's some interesting results of what customers are actually thinking about clean energy. We have our ideas and notions of what that's going to be, but this is actually coming from the customer. So that's an interesting one. At 2 o'clock we will adjourn the electric IRP and start right up in the gas IRP. Again, it's on this same phone call. You can either stay on it if you're interested in that, or we'll start seeing some people probably drop off and a different group come on that's more interested with the gas side of things.

**James Gall:** Actually, to interrupt again John, but the gas side will start joining at 12:30 for the Clean Energy Survey as well.

**John Lyons:** OK, good to know that because it does cover both.

**James Gall:** We'll probably have a quick introduction to the gas folks when they arrive.

**John Lyons:** OK. Any other questions before we move on to AEG? Well, hearing none then, Eli I think you're up now.

**Eli Morris:** I am. Thanks John.

**John Lyons:** OK. And we can hear you. Thank you.

## **Electric Conservation Potential Assessment, Eli Morris and Max McBride, AEG**

**Eli Morris:** Great. And good morning everyone. Thanks for having us today and he's going to share the slides. So hopefully everyone can see them.

**John Lyons:** I can see them.

**Eli Morris:** Eli again, thanks for having us here to present on the electric conservation potential assessment [CPA], then energy efficiency demand response and then natural gas this afternoon. Andy if you could advance to the next slide. In terms of the agenda that we have here. Thanks, Andy. We'll do quick AEG introductions. We're going to go over the objectives for this study and then a brief overview of the methodology. We know a lot of you have seen this methodology at other meetings, but we're happy to dive deeper, if necessary, but we'll try to cover that quickly so that we can get into the results of the CPA, the energy efficiency, and then after the break, we'll come back and talk about demand response.

**Eli Morris:** On the next slide, just a brief overview of AEG and I guess I should introduce myself. I'm Eli Morris, managing director at AEG. I lead our market assessment practice area, which includes the potential study work we do for Avista and other utilities. And I'll talk a little bit more about that. But wanted to introduce a few others on the AEG team who will be participating today. Kelly Marrin is managing director at AEG. She leads our research and analytics practice area and she's leading the demand response analysis. I don't think she's on right now, but she'll be on after the break to present on demand response. Max McBride is lead analyst at AEG and he's leading the energy efficiency analysis on this project. He'll be presenting on the energy efficiency results. Andy Hudson is project manager for this project. And then we're also joined by Ken Walter, who is overseeing the energy efficiency analysis like he did on the previous Avista potential study. Ken doesn't have a speaking role this morning. We're going to let him save his voice for this afternoon on natural gas, but he's here to help answer any questions anybody might have.

**Eli Morris:** A little bit about AEG, we work with electric and natural gas utilities across the country on the full lifecycle of demand side management. We're talking today about market assessment and potential studies. We also support implementation planning and evaluation for utilities and you can see a map of where we've conducted these potential studies. We do a lot of them across the country and especially a lot for utilities in the Northwest including the last several for Avista.

**Eli Morris:** On to the next slide, just a high-level overview of the objectives for this project. The key objective is to identify the long-term energy efficiency and demand response potential within Avista's electric service territory in Washington and Idaho. And to look at a robust set of opportunities we're identifying the full potential opportunities that can feed into the context of today's discussion, the IRP. That also feeds directly into portfolio level target setting for Avista and then the details of the study can also be useful for program development. We provide information on costs and seasonal impacts for the

IRP. And that's what allows the IRP to compare energy efficiency to supply side alternatives when assessing the costs like John was talking about. The potential study goes pretty deep into different segmentation and end uses within the Avista service territory. So, we're understanding differences in consumption before we even look at the potential and that includes identifying opportunities by income levels. We'll talk a little bit about the methodology we use this time. It's an enhancement over what we've done last time to provide deeper insight into Avista's customers and consumption and potential by income level. And then making sure our analysis is transparent. That's part of why we're here today to make sure everyone is seeing the results before they're finalized and before the report comes out. And we always strive to have that transparency and to share all the information that's necessary to really understand and review the results. With that, I'm going to turn it over to Max to start with methodology.

**Max McBride:** My name is Max McBride. Can you see me if my camera working?

**Eli Morris:** Doesn't look like it Max.

**James Gall:** We do.

**Eli Morris:** Looks like maybe it's covered.

**Max McBride:** Not covered. Maybe having some technical difficulties on my end. Maybe I'll try leaving the meeting quick and joining again.

**Eli Morris:** And maybe while Max does that just so we can keep moving I can talk through this slide at a very high level, describing the four steps in our modeling process. I already talked a little bit about market characterization process and that's really trying to understand Avista's customer consumption and number of customers by segment and end use within their service territory. We'll talk about how we do that, but that's really the key foundation of the study, the grounding and the base sales and truing that up to Avista's actual sales. We're then identifying the measures that we're going to assess in the study. That's a really robust list of energy efficiency technologies, electric technologies in this case. But this methodology will also apply on the gas side and fully understanding the applicability of those measures and also the costs in savings so that we can use those to estimate the potential and then feed that to Avista's IRP model to do the economic screening. From there, we're coming up with a baseline projection of consumption in the absence of future intervention. We're trying to understand what would happen if Avista didn't offer new energy efficiency programs. What would that baseline consumption be so that we make sure we avoid double counting and that accounts for things like changes in codes and standards that are going to affect consumption but doesn't assume that energy efficiency measures or installed through Avista's programs. And then based on that potential baseline forecast, we layer on the energy efficiency measures to identify what the potential would be if those interventions did occur under different scenarios. And we'll talk about the different types of potential that we look at and then how that flows through to the IRP and the other processes on the Avista side. Max, were you able to get set-up?

**Max McBride:** I'm back, but it looks like my front-facing camera is not working for me at the moment and getting some notifications on my Teams levels now.

**Eli Morris:** OK. Well, why don't you just proceed without video? I covered the methodology slide, but I'll turn it over to you on data.

**Max McBride:** OK. I guess I'll go back a bit and introduce myself. My name is Max McBride, I'm a lead analyst at AEG and I've been involved in two cycles of this CPA as well as many other CPAs in the Pacific Northwest. Eli covered the high-level methodology. On this slide you can see some of our key data sources that help inform the study. The key point of this slide is to indicate that we're using as much of this specific data to help inform or suggestions around how customers are using their energy. Additionally, we use the RTF Northwest Power Council assumptions to help inform our measure levels assumption, costs, failing lifetimes, as well as some of the adoption rates that help drive the potential forecast. If anyone has any questions, please let me know. One of the big enhancements from previous CPAs was how we segmented residential customers and specifically how we identified two different income levels within each respective residential segment, those segments being single family, multifamily and mobile homes. We cross-reference Avista customer data against census data to develop above a low income and low-income customer splits. From there we mapped in RSA data to help inform and differentiate building characteristics and how those perspective customers are using their energy. Looks like Tina, you got a question.

**Tina Jayaweera:** Thank you. I'm wondering about the sample size from the RSA for low income. Did you narrow that to just Eastern Washington and how robust is the low-income population represented in the Avista territory through RSA, since sample sizes are limited in many of the cases?

**Ken Walter:** I didn't want to jump in on you, Max, but I'm happy to field that one, Tina. Since my voice is new on this one, this is Ken Walter. As Eli mentioned earlier, I have been managing all the AEG sort of umbrella, although Max has been more involved in the day-to-day speaking to RSA, sample sizes for low income, you're correct that it's limited. I think we had to go out to all State of Washington rather than being able to constrain to eastern and to Avista's territory in order to have a good sample size to distinguish average non low income from average low-income customer. I don't have the numbers in front of me for the specifics, but I think it was somewhere in the low hundreds like under 100 homes

**Tina Jayaweera:** Across all building types?

**Ken Walter:** I think that was single family specific. It was about 40 or 50 multifamily homes and around 100 give or take single family homes that were low income specifically.



**Tina Jayaweera:** OK. I guess then the follow up question for Avista is if you've done some work to try to classify their low-income populations, and I'm wondering if there's been any cross check between them or if there's been anything from their work through the CEIP and other studies to validate the data?

**Ken Walter:** Ryan, that one might go to you. I'm not sure what the more recent data is from your side.

**Ryan Finesilver:** Good morning everyone. My name is Ryan Finesilver. I'm one of the managers in our energy efficiency department. It's a good question. I believe a lot of the information came from a lot of similar sources. But Tina, we can take that as an action item to double check and see what the correlation is and make sure we're matching up with what's in our CEIP data.

**Tina Jayaweera:** OK. Thank you.

**Max McBride:** Thank you for the question. Once we've segmented out the residential customers, we try to understand how they're using energy and that's templating form of market profiles. Andy, could you move on to the next slide please? Then our market profiles, we calibrate Avista use per customer. We calibrate the use per customer to the forecast and billing data. From there we break down that household consumption into end use and technology level, naturalizations and unit energy consumption so you can see in the table in the bottom the saturation of various technologies in the home, the UTC which translates to, if the technology exists, how much it will consume, which then leads to a household intensity. Which is saying in an average home across all single-family regular income, this is how much energy because it's just that technology will use from there stacked up and end use level, which leads to some of the differentiations you're seeing in that stacked bar chart per Idaho residential intensity. As you can see, you got some differentiations not only between the different segment types and how they use their energy, but also between the different income level types and how those households use their energies. All this to just say how customers are currently using their energy will help better inform the baseline and potential for tasks that we are developing. I think we have a question here.

**Tina Jayaweera:** It's Tina again. Thanks. I notice you have air source heat pumps for cooling and space heating, which makes sense, but I'm noticing the saturations are different and I don't quite understand that. Then under the UTC is it correct to assume this is just the UTC for that end use of cooling, not the annual total consumption of the unit?

**Max McBride:** Correct. For the specific end use, that's how much the component of an air source heat pump or a geothermal heat pump is using to cool a home while the corresponding space heating consumption is covered in the space heating end use, but when we're modeling the opportunity of the usage of those pieces of equipment, as well as the savings, are modeled together. I'll have to double check back in our source market profiles, but that's a very good observation about the air source pump's

saturations not aligning. There's a calibration step in market profiles, but I have to double check with the table that we brought into the presentation. Thanks for that observation.

**Tina Jayaweera:** Thank you. And then just to confirm that the water heating saturations, these are electric water heaters only, right? So, the bats would be the gas.

**Max McBride:** Correct, and in the gas presentation, you'll see that those will cover the gaps, saturation of water heaters.

**Tina Jayaweera:** OK. Thank you.

**Max McBride:** From our market profiles, we developed a forecast and from that forecast we calculate two different levels of saving estimates. The highest level being technical potential, which is an upper bound, assuming that the most energy efficient opportunities are adopted without consideration of cost or customer's willingness to participate in programs. Then technical achievable potential is a subset of that technical potential which factors in market adoption. But there's not a consideration of a cost effectiveness, but with those technical achievable, we include a cost output. That factors in the total resource cost test, the TRC, and the utility cost test, the UCT, that will be used in Avista's IRP process to select cost effective opportunities. What's in that subset of technical achievable potential and that cost output is in the form of levelized costs. For each respective measure permutations, the levelized cost of energy, the dollar per kWh is calculated for Washington. The levelized cost is calculated using the TRC and in Idaho the levelized cost is calculated using the UCT and in the table off to the right you can see some of the costs and benefits that are included within these two respective cost tests.

**Tina Jayaweera:** Sorry, it's Tina again. So as John mentioned earlier, the conservation also gets the 10% credit, which I'm guessing is happening in the IRP model itself and not being accounted for here. But I just wanted to check on that.

**James Gall:** This is James.

**Ken Walter:** The 10% is applied in the avoided costs. It's included in what's provided, it's done in the IRP model. Sorry, I'm crossing two things there. Sorry, James.

**James Gall:** You got it right Ken. We add the 10% on the IRP side, so that'll be applied in our PRiSM model. And in our technical workshop that John had mentioned earlier, we'll cover how that all works out in that tool.

**Tina Jayaweera:** OK. And is it then applied on both the Idaho and Washington sides?

**James Gall:** It is only applied in Washington.

**Tina Jayaweera:** Ah. OK. All right. Thanks.

**Max McBride:** These potential estimates, they all ramp up over time and the adoption that customers choose for each perspective measures is based off of the ramp rates from the Northwest Power Plan, it's 2021 Power Plan. Each measure in the Power Plan is given a max achievability. Generally speaking, the majority of measures maximum achievability is 85%, but with the new update certain measures achievability is greater than 85% and those measures are included in that little table off to the right. One note is that Power Council ramp rates are agnostic to delivery and acquisition method and include potential that may be realized through a utility DSM programs. So, they count for assumed utility intervention throughout the length of the study. Any last questions about methodology before we dive into the draft results? Hearing none, I think we can move forward.

**Max McBride:** At a utility perspective, including both Washington and Idaho territories over the entire length of study, there's assumed to be an average of 1.3% achievable technical savings of the baseline consumption per year. That translates to around 1,929 GWh of achievable technical potential by 2042 by the end of the 20-year forecast. And as you can see, this relates back to the Power Council ramp rates over the length of the study, the incremental potential ramps up which corresponds with increased customer adoption of measures and then by the latter half of the study as measures become more saturated, the incremental potential starts to decrease as there's less remaining opportunity. This is a byproduct of the Power Council ramp rates. Breaking up the potential, the top left corner by sector, you can see the opportunity for the residential, commercial and industrial sectors. The majority of this opportunity is primarily driven by the original consumption of each of those sectors. A good example there is the industrial sector uses a lot less energy than the commercial and residential and so the opportunity isn't as large as the residential and commercial sectors. And then I think a good illustration here is the savings as a percent of the baseline and a couple years of the study length. In the orange, you have the technical potential which achieves around 33% savings to the baseline and the technical achievable which is around 25% of the baseline by the end of the study forecast. This is somewhat typical using Power Council methodology, you'll see around the 85% of the technical potential aligned with the technical achievable we control. Because then I think you have a question.

**Kirsten Wilson:** Yes, Kirsten Wilson and I'm curious about the commercial ramp rate, especially with the Clean Building Act and its drive to increase efficiency in the next three to five years. I would expect more at the front end on the commercial side than I'm seeing.

**Ken Walter:** The ramp rate here is still based on 2021 Power Plans, so only to the extent that those assignments included that thought would those be included here. We haven't accelerated things to reflect that because there's still a lot of uncertainty about what specific things would actually be part of that. There's a general push to make them more efficient but isolating that to a specific measure or program would be harder.

**Kirsten Wilson:** OK. Thanks.

**Max McBride:** Any other questions? Getting a bit more granular, this is a comparison of the annual incremental potential between Washington and Idaho. As you can see, Washington's incremental potential is nearly double that of Idaho's, and that's primarily driven by the fact that the Washington baseline or consumption is around double of Idaho's. But when you look at the cumulative energy savings as a percent of the baseline. The opportunities in both Washington and Idaho are comparable, but not the same because within those two states there's different allocation of customer types. Different end uses that are driving some of the differences between the two states. With that being said, the savings as percent of the baseline are slightly higher in Washington than they are in Idaho. Next slide.

**Max McBride:** Looking at Washington. This is the list of the top measures that are outputted from the study. I think it's always a fun slide to get in front of everyone because you can see some of the granular outputs of the model and what the model is indicating are high opportunity measures in a service territory. Another thing I'd like to point out is that this is the technical achievable potential. This is not taking into account cost effectiveness. In that far right column of the table, you can see the levelized cost of each respective measure. Even though an opportunity may have a lot of technical equal potential, it may not be cost effective at a TRC or UCT level. A good example of that is mini split heat pumps, dedicated outdoor air system. Those are measures with opportunity, but they are expensive and not necessarily cost effective. Question?

**Tina Jayaweera:** Yes, thank you. Can you speak to the methodology you used to differentiate between say, residential windows, different permutations showing up several times. Here are the Class 22, Class 30, Low-e additions, and these could be competing options. And I'm wondering how you're accounting for the competition within different metric groups?

**Max McBride:** Yeah, it's a great question.

**Ken Walter:** I can field that if you'd like Max. Unless you want it.

**Max McBride:** Go for it, Ken.

**Ken Walter:** OK, so measures that are in direct competition, like the different window classes, we constrain the applicability so that the opportunities are distributed unless we have a specific reason to focus on one over the other, we'll just split them evenly. This is interesting because we're doing technical achievable here. We're not really running either of them through cost effectiveness. That's what you're seeing there between, for example, Row 12, which is a class 22 window and 15 which is a class 30. That's just an even split. Some of the other ones can actually be done on top of each other. The low-E storm edition. That's up at the very top. That's actually an external kind of a slap on, and that doesn't necessarily mean you can physically install that and upgrade to a triple pane window or whatever at the same time. We try to be careful about what can actually layer and what needs to be separated or split.

**Tina Jayaweera:** Do you revisit that assumption once you have some data on the economics of it, because if, say the Class 22 is cost effective and the Class 30 is not, then that should change the adoption and thus the potential and the savings for a low-E would be quite different if you were putting it on the class 22 versus a single pane, which is what it's intended for?.

**Ken Walter:** That is true. Yes, when it comes to things that are layered, one thing I think we can just, hard to speak collectively and in terms of the road map model. Any measures that have overlapping applicability to the same end use whether we're talking about the air conditioner upgrades and insulation, or we're talking about different layers of windows. If you can do multiple things in a system, the savings are actually converted to a percent of baseline, and then you can multiply them all together. Basically, as you step your way through, each successive measure is getting savings from an already reduced load and that's how we account for exactly like you say, if you change the baseline conditions to a certain extent, you reduce the amount of savings that are available from other measures that get added on.

**Tina Jayaweera:** OK, I guess I'm not entirely getting how that deals with the competition, but we don't need to dwell on it more. Thanks.

**Max McBride:** Is there any other questions about some of these top measures? Hearing none, we can move on to Idaho. In Idaho, we're using the utility cost test to inform the levelized cost. As you can see, commercial linear lighting, it's both a top measure in Washington and in Idaho, and that's primarily a byproduct of controls being installed with the addition of an LED. And then water heaters. Thermostats and home energy management systems are also showing a lot of opportunity in Idaho. And some of the applicability and saturations differences are taking into account codes and standards. In Washington low flow shower heads are code, but in Idaho there's still remaining opportunity for those respective measures.

**Tina Jayaweera:** This is Tina again. I know you started with the Council's plan supply curves, but there have been a number of updates since those were developed by the RTF and so have you incorporated the RTF updates, the low flow shower heads for example, has been deactivated by the RTF since the plan work was done.

**Ken Walter:** They have deactivated it, yes. So really this is addressing, especially because of its continued use of code, and they're looking in a lot of cases. They're really looking at Washington specifically, although they are looking region wide. There is still survey data from RBSA that says there are plenty of households that are out there that haven't done this yet. There is opportunity to do it as a retrofit or an intervention measure and especially if they haven't done it yet. They're probably not going to be turning it over due to some big home renovation or code thing. So really this is a remaining opportunity of holdouts. It's not completely constrained by our TFD activation.

**Eli Morris:** And I think generally to your question, Tina, we're using the ramp rates from the Council Plan, but we're using updated sources like RTF, like Avista, TRM like RSA.

Excuse Me, the RSA may not be more up to date, but we're primarily relying on the Power Plan for just the ramp rates.

**Tina Jayaweera:** I see. OK. Well, I would just add that the RTF deactivated not just because of codes but also because of lack of confidence in the savings. There was more to it, just that the Washington code was in place. We have very little data supporting savings around low flow shower heads unfortunately.

**Max McBride:** And I guess just to reiterate Eli's point, you know we're using the most up-to-date Avista TRM values as well as our TF workbooks where available to characterize the energy savings cost and lifetimes of these respective measures, but when a regional source is not available, we broaden our scope to help inform the energy savings opportunities. Any last questions on the top measures before we move on to a comparison of the current results versus the previous?

**Max McBride:** All right. I think we're ready to move on. Comparing the achievable potential between the two studies you can see that in terms of the 2042, what kinds of potential, there's a slight increase. But given that the previous studies forecast start was two years earlier, we subtract off the savings in those early years so it's a better comparison of achievable technical potential between the two studies. And then off to the right, you can see an end use level comparison across the three sectors that looks at the achievable technical potential that falls within each respective end use and the difference between the savings in the previous study and the current study. And a lot of those differences are driven by updates to the market characterization, but also updates to measure level savings using the most up-to-date sources. But by the end of the study, looking at the 2042 versus the current around 238 thousand increase in savings. Now the question, Tina.

**Tina Jayaweera:** Are you going to go into the details there? One of the things I'm surprised by is the significant increase in the residential interior lighting, and I'm wondering if you can explain that a little bit further.

**Ken Walter:** Max, you're more up to date on the DOE sources we use for those LEDs. It's just an initial burst. It's just the first year or two before we used the RTF assumptions of 100% LED baseline starting very soon. I think it's just a higher savings in the LEDs.

**Max McBride:** It's a shift to, I think higher or less lumen per watt LED forecast in the future. But we are using RTF market baseline to help inform some of those opportunities.

**Tina Jayaweera:** I guess to better understand I would need to see the number of bulbs that you're talking about on the savings per bulb.

**Max McBride:** Correct. We can get back to you with data. Move on to the next slide. Looking at the achievable technical potential and its associated LTOE cost, we generate a 10-year conservation supply curve. And on top you have a comparison of the current CPA against the 2020 CPA for Washington using the TRC and on the bottom you have

a comparison between two CPAs, but Idaho using the UCT. The shapes of the supply curves are very comparable. Looking at the current TRC in Washington looked like there's slightly more possible active opportunity and not cost-effective low-cost opportunity. And that \$0.50 to a dollar range. Well, in Idaho, a slight decrease, only positive opportunities and that dollar to \$1.50 range. I don't high level. There are some updates that are driving some changes in the potential. Main updates this time around were to the latest RTF workbooks and latest investments CRM as we had mentioned earlier which you know, are driving an increase in weatherization potential and as you saw the Low E storm additions. Measure update resulted in a pretty substantial increase from the previous study and then ductless heat pumps. Well pumps are showing less potential based off of an RTF settings update, but also some of the values that are coming from the TRM. For commercial, similar lighting potential there is higher market share with LED bulbs, but the addition of controls that get installed with the fixture are offsetting some of that increase in saturation. And then updates to food prep and office equipment using the latest Energy Star specifications and market data are driving an increase in potential across those end uses. And then an industrial measure data was updated to reflect the newest iteration of the industrial tool from the 2021 Plan and a big update was made in the segmentations where we broke out specific billing line pumping to isolate that load more accurately and that led to an increase in specific pumping potential in the industrial sector because we were more accurately able to characterize that specific use. Looks like we have a question.

**Heather Moline:** This is Heather with UTC. Just wondering if AEG or anyone else had comments on the discrepancies between code and Energy Star and RTF updates and maybe market realities on the ground specifically related to food preparation for example and maybe the food industry more broadly. A reality of the pandemic and supply chain and whatnot is that restaurants can't afford up to code equipment, if it's even available on the market. So welcome anyone's thoughts on that, or any other sort of bullet here where that might be applicable.

**Max McBride:** Yeah, that's a really good point. There are a lot of current supply chain issues, but we are using Power Plan assumptions that inform the adoption of some of these measures. Which may not necessarily reflect some of those trends.

**Eli Morris:** And we typically assume that the codes and standards are going to be complied with, so we're not assessing the potential for code compliance or to what extent customers are choosing or just need to because of market conditions to not comply with code. That is built into our baseline that we're assessing the potential for the assumption that customers are complying with code or minimum standards. Or potentially going above code when we're looking at market baselines.

**Max McBride:** Are there any other questions?

**Eli Morris:** Well, I'll jump back in. Thanks, Max. That was the last slide we had on the energy efficiency portion unless there are other questions. I know we're running a little bit ahead of time. I think we proposed to take a short break as planned and then come

back with DR, but did want to at least pause and see if there were any additional questions. Thanks to everyone who asked questions along the way. But any other questions on the electric energy efficiency study?

**Tina Jayaweera:** This is Tina. A quick question for I think maybe for Avista. How are these being bundled into the IRP model?

**James Gall:** I think I could take that. It's James with Avista. It's a good lead into a point I wanted to make before we go on break, I'm going to share my screen quick and hopefully you can see that. This is our IRP website and I think the answer to your question. We have loaded two documents on there that shows energy efficiency measure list for both Idaho and Washington which has the complete list of each measure we're modeling and how this works is, I'll just go into the Idaho file as an example. It is a little large. Both of these are about 30 megawatts, but we take that list of each individual measure and our IRP model will select that measure to serve load if it's cost effective compared to other resources. Is that the answer to the question you're looking for?

**Tina Jayaweera:** So, you're not bundling at all, you're looking at each individual measure as a resource option.

**James Gall:** Correct. And that measure list that's on the website right now will be the same list, same savings costs that we load into our model. Obviously, this is draft, but that's a measure-by-measure selection.

**Tina Jayaweera:** OK, Matt must be computationally intensive. Thank you.

**James Gall:** It's not so bad. It works, but before we go on break, I just wanted to mention that these are out there for review. These are not final, and we appreciate any feedback that TAC members have on what AEG came up with. I do expect there'll be some minor changes as we review the data, but if you have feedback, please contact the IRP team or Ryan Finesilver. So, with that, John, we're on schedule to go on break till 10:35.

**John Lyons:** I think that makes sense to go ahead and do that, unless there's anything you want to point out, James.

**James Gall:** Unfortunately, a different file that's still trying to load. There it is. Real quick, this is the Idaho version. You can see there's each individual measure and then actually I should have AEG go through this, but that's OK. It has all the information about each measure. Just as an example, how large this is, it is 7,600 rows, so it is quite comprehensive. There is the definitions and then if you scroll to the right, the utility cost, the savings and kilowatt hours. Then there's maximum potential savings. That's a technical, sorry. And then there's more savings there and it just keeps going all the way across. There is quite a bit of data available if you are wishing to review it.



**Tina Jayaweera:** I saw earlier there was a summer and winter peak savings and so how are those being defined and how are they being used? I was expecting that you would rather actually have a shape associated with each measure, and then that would give you influence on capacity.

**James Gall:** Correct.

**Tina Jayaweera:** Or is that they aren't being used?

**James Gall:** Yes. Two things get used. The hourly shape of each measure is used to calculate energy savings from a financial point of view. We value that shape versus an energy price forecast and the peak capacity for summer, winter actually. I believe we're going to be moving to monthly peaks and that is used to determine its peak capability to meet system peaks. Theoretically the hourly shape would line up with the monthly peak for each month for determining the savings against the load forecast for peak. So, they're both used since our model, when it does its capacity expansion, is a monthly model. We use monthly peak values and then the energy is used, as far as an avoided calculated, it's avoided costs essentially just for energy and that's actually something we'll cover in that technical workshop in October.

**Tina Jayaweera:** OK. I'll wait till then. Thank you.

**James Gall:** Yep. I think we're ready for a break if there's no other questions.

**John Lyons:** Yeah, I think we're good, James.

**James Gall:** Alright, we'll see everybody at 10:35.

### **Demand Response Potential Study, Kelly Marrin, AEG**

**John Lyons:** OK, everyone we will start to come and back together here. Any questions that came up while you while we were on break before we move on to the electric demand response study? OK, well not hearing any then if we want to have AEG share their slides for the DR study. All right. And I'm seeing the slide deck up now. All right, take it away.

**Kelly Marrin:** All right. Hi, I'm Kelly Marrin. I'm probably a familiar face to many of you. William actually presented at the last stakeholder meeting, but he's on vacation camping this this week, so I'll be taking over for him to present the results. I will do my best. I have a cheat sheet from him and I'm pretty confident I can answer most of your questions. We will go ahead and walk through the DR [demand response] You can go to the next slide, Andy.

**Kelly Marrin:** Alright, so first we'll talk a little bit about the approach to the study. Similar to the approach that we have used in past years, it also should look very familiar and

similar to the approach that we use for the energy efficiency potential study. First phase is data collection. We do align as much as we can with the with the EE study, we use the same market profiles and saturations that the EE study uses, so we start out on the same page. We use different secondary sources for DR mostly to do our program characterization, which I'll talk a little bit more about as we move through this slide. But that's really looking at impacts, participation rates, costs of the key drivers for demand response that comes usually from secondary sources – Power Council assumptions or direct experience from Avista. Then once we've done all our data collection, we go ahead and characterize the market in alignment with the EE potential study, but because DR doesn't exist outside of programs, we tend to do our segmentation differently. We segment by customer class because that's how DR programs are generally rolled out, aligning more with residential and small, medium and large C&I versus building type like the potential study. That's a key difference you have to shift thinking a little bit for DR. Then we develop a list of DR options and I have a couple slides on those, so I'm not going to go through them on here, but needless to say, they are very comprehensive. Then we characterize those options. The key things that we use to characterize are listed there, the impacts, the participation rates, the acceptance rates, the technology that could be used to enable response costs and incentives. And then finally, we estimate potential, and for DR, we do two key levels of potential. We're looking at technical achievable potential which is the potential for all the programs regardless of cost and without consideration of dual participation. And then we also look at achievable potential and those are integrated programs. So that takes into account the dual participation or overlap, but these still that we're going to show you today for achievable are not screened for cost effectiveness. They are all of the programs that we've considered. I'll pause for any questions on the general approach, and it should be pretty familiar to most.

**Tina Jayaweera:** Kelly, this is Tina. I've asked this question before, so apologies for asking again, but how is the interaction with energy efficiency accounted for in the potential?

**Kelly Marrin:** Right. We're accounting for energy efficiency mostly through the saturations. As the purchasing decisions for saturations change throughout the potential study, for example, as more water heater, heat pump water heaters or heat pumps or the grid interactive water heaters are coming online, those are being changed over time in the potential study. That's the key way that the two studies interact. There's that implicit assumption that all of the energy efficiency will be acquired. We do it from the base case I believe. I would have to talk to Tommy to find out exactly which saturations he's using. We might have to get back to you on that. Let me see. Like I said, he left me a cheat sheet but I don't.

**Tina Jayaweera:** OK, that's fine.

**Kelly Marrin:** I think we might have to circle back because I'm not sure if it's assuming achievable technical like achievable happens in the EE study and those are the saturations that we're using. Or if we're looking at naturally occurring and codes and

standards. My guess is, it's the latter, so it would incorporate all the naturally occurring naturally occurring EE and any codes and standards that are changing, but it doesn't implicitly account for the EE piece. But we could do that and it's something that we've thought a lot about so. Let me make a note of that. Anything else?

**Kelly Marrin:** Alright, one thing that's a little bit different is that I'm going to go through two things. We looked at this as all the program options, but we also did a pilot scenario this year for Avista. There are several programs that they're actually considering implementing as pilots and have a plan to implement, and so while this is all the program options, I'm also going to show you a list of the pilot scenario which accounts for a realistic implementation scenario of a selection of these programs. These are all the programs and I have two sets of potential estimates also and this is that very comprehensive list that I mentioned on the slide before. We have two different types of direct load control. We refer to the first type as conventional DLC – switches, central air conditioning, water heating and EV charging. Charging might actually go into smart interactive, but that's the Smart Interactive DLC. Interactive water heaters, smart thermostats and smart appliances, and I think we could make an argument for EV chargers to be in either of those groups, either or both, depending on how we're controlling them. Third party curtailment, so that's a capacity bidding or emergency curtailment. Think of emergency curtailment as the more, I don't want to say old, but it's sort of like the old school contracts with the very largest customers type of curtailment, whereas capacity bidding could be more available to. Medium small, small, medium and large DLC and they're participating with a third party. Then we have energy storage, battery storage and thermal storage. We also have a selection of time varying rates and behavioral, so behavioral DR, TOU, EV TOU, variable peak pricing and peak time rebate is actually not noted there, but it was also included. Any questions on the program options?

**Tina Jayaweera:** Kelly.

**Kelly Marrin:** Yes.

**Tina Jayaweera:** In regard to the battery storage, is that like a residential battery or can you explain more.

**Kelly Marrin:** Yes. Primarily residential batteries is what we're thinking. I can just double check and see which. Let's see. Yeah, it looks like we only have it eligible for residential.

**Tina Jayaweera:** OK. And then with that, I'm assuming that would or can be paired with solar or something like that?

**Kelly Marrin:** I think it's sort of an implicit assumption, but we it's not specific. Oh, here we go. Sorry. I'm looking at my energy storage assumptions now. Battery. No, we have battery for residential general service, large and extra large. We do have battery eligible for all of the different sizes. They're really just an estimate of the kW. For the size of the

customer, so it doesn't necessarily depend on solar or no solar. Hopefully that answers your question.

**Tina Jayaweera:** Yeah. Thank you.

**Kelly Marrin:** Anymore on the programs? All right. In addition to those programs, which is, like I said, all the considered programs. We also ran a separate scenario that's a pilot program scenario and this really focuses on just these four. They're really three programs, but the subset of four that Avista is actually looking at implementing in Washington. The two that go together are the grid interactive or the CTA 2045 water heaters, both for heat pump and electric resistance heat. We actually broke out the impacts this time. That's why they're up there separately, even though they would be run as a single program, a time of use opt in and then a peak time rebate. All the programs would run for a three-year period starting in 2024 and then until you opt out. It has an option for a two-year extension depending on the results. But the scenario that you'll see here assumes that these pilots run into real programs and then estimates the achievable potential from just these programs, and you'll notice that the impacts are very delayed. Since we're taking into account this more delayed implementation schedule that allows for a pilot period in testing. Questions on the pilot programs? OK.

**Kelly Marrin:** Alright, we'll cover a few of the assumptions. AMI is a key assumption really for just the dynamic rates. For DLC options, we don't have to have AMI required, but for the dynamic rates they do need AMI for billing. We assume 100% AMI throughout the study for all sectors in Washington and then for Idaho we assume that the AMI rollout starts in 2024 and there's a 36-month deployment schedule and the importance of this is it affects eligibility. Who's eligible to participate in those dynamic rates in each state. The next slide.

**Kelly Marrin:** All right, there are a few updates and some key assumptions. For this study, relative to our previous studies, we have a smart thermostat heating program and it's important to note that program is going to essentially piggyback off the cooling program. That just means that they're sharing the administration development O&M costs. So those levelized costs might look a little lower than you might expect because it's sort of a shared program. We're assuming that you can get somebody on the cooling program and then you don't have to spend a lot of additional extra money having a whole other program to then recruit people onto the heating program. It's a way to add additional programs and options for customers to have demand response without burdening those programs with the full development and admin costs. I noted this earlier, but the grid interactive water heaters we've split those results across water heater type. We are showing separate impacts for electric resistance and heat pump and then we lowered the CTA 2045 impacts relative to what we had before, which were the Council impacts to really reflect that BPA 2018 study. We thought that the lower impacts. Were more realistic given the load that we're actually seeing and is estimated through like the EU study for water heaters, electric resistance and heat pump water heaters in Avista's territory. That's why we made that adjustment. Dynamic rates, we have PTI for residential and general service and we have a VP for large and extra-large general

service. And then we also added an EV TOU rate. And then finally, it's just a note that the program impacting cost assumptions are primarily based on the Power Council's 2021 plan. However, we did diverge where between us and Avista, we thought it was appropriate. Again, either we were customizing for Avista's territory or perhaps the information wasn't available. And I did just mention one on the grid interactive water heaters as we were talking through this slide. Any questions? I'm not going to go through detailed assumptions in this presentation like going through all the assumptions. I think sometimes we've done that before. I do have my cheat sheet so we can talk through any if there are specific programs that you want to dive into. And I see 10 new raising your hand, but we can certainly make them available to stakeholders after the call in a more summarized format so that people can review assumptions and then we could have a subsequent conversation about that or get feedback from you all. Go ahead Tina.

**Tina Jayaweera:** Thanks. Are you going to go into what the actual deployment assumptions are like X number of events for Y number of hours and that type of stuff?

**Kelly Marrin:** We haven't done that in the past. Let's see if we have time and I can see if I can pull some of that up. And if there is a specific program that you're interested in, we can talk about that. I'll just make a note that that's something that folks are interested in in talking through. Because I don't think we've presented that on one of these before, but we certainly could.

**Tina Jayaweera:** I'll give you, well you and Avista, the context of why I'm asking the question is because in our 2021 Plan, we started with the traditional DR assumption of 4 hours per event, 5 events per season, what most people think of as a DR for DLC at least. But when we were doing our modeling, we found that actually wasn't where the needs were, and the needs were defined differently. We revisited our assumptions throughout our portfolio models and not knowing where Avista needs are and how that all rolls out, I don't know if there needs to be any revisiting of the assumptions on DR, but they do matter.

**Kelly Marrin:** Yeah, they do matter. It's important to discuss. I don't know. Does anyone from Avista want to weigh in or respond to?

**James Gall:** This is James. I have a couple thoughts on that. One, from the energy value of each of these options the makeup of ours, the amount of times it can be called on, where we are going to be modeling that to come up with an energy value. The interesting piece for us is on the capacity value, we call it a peak credit. The Western Resource Adequacy Program is calling this similar to a QCC value which is qualifying capacity credit. The number of hours that each program is available will be assigned a percentage of the potential. For example, if it was a 10 MW program, it may only reduce peak or qualify for reducing peak with the Western Resource Adequacy Program market of say, 6 megawatts. Those estimates the WRAP is still working on trying to figure out how to treat DR as far as capacity credit. That's how it will be used in the IRP. We'll be looking at the number of hours it can provide capacity value and then for energy value of how often it can be called upon.

**Tina Jayaweera:** But interesting things, James. Yeah, I guess I'll say peak impact that you get also is dependent on the number of hours you're assuming the program is being deployed. For example, like Kelly, you have that great interactive water heaters that you lower the impact or like BPA 2018 peak mitigation strategies. I don't know the details of, but the deployment assumptions were but, just checking that it's consistent with what is at least what you know about what is most valuable for the Avista system? Or is it?

**James Gall:** Yeah, I see what you mean. I think the one difference is the WRAP as a region may be treating the value of energy efficiency differently than if we were just a closed Avista system trying to meet resource adequacy or just a Northwest system meeting resource adequacy. This changeover, as we're working through going to the WRAP, I think it's going to challenge a lot of our assumptions of how valuable certain resources are just because of that regional diversity. But it's, as I said, there's nothing final, I think it's a wait and see what they come up with.

**Tina Jayaweera:** What's the timeline for that work?

**James Gall:** I've been told maybe by October we should see something on demand response, but that sometimes doesn't happen.

**Tina Jayaweera:** Thank you.

**James Gall:** Scott, if you want to add anything on their timeline.

**Scott Kinney:** No, I'll just add in I think the hope is by this fall we would have additional modeling completed through the WRAP program that we could leverage, and it may get delayed slightly as that program is ramping in. There's a lot of work being done there. Hopefully in the near future, and I think we're trying to support that by helping to develop, they're not load shapes I guess, but sort of load shapes that represent the full impact of the programs when they're being called. We do have all those assumptions for the different programs, and we've done a lot of DER evaluation work in California. It was a very big struggle moving from utilities looking at deploying programs for their own peak and then trying to move into considering them for resource adequacy because their peaks didn't align with when resource adequacy was needed for the system. And that exact thing that James was just talking about happened for a lot of programs that we're saying as exposed, it's this many megawatts but you put that in the resource adequacy window, and it could even be negative because of the snapback. All those things are really important and we're trying to provide all the information that James and his team need to account for these properly in the IRP.

**Kelly Marrin:** All right. I think we'll move to the next slide. This is our program impacts calculation. I think this is familiar to everybody. It's pretty simple math. We have the per customer peak impact that could be either a nominal like a number or it could be a percent of customer peak. We multiply that by the number of eligible participants. Again,

that could be restricted by whether customers have AMI or not. We multiply that by the participation rate or the acceptance rate that we're assuming and then we multiply that by the equipment saturation rate depending on the program. For some programs, DLC programs, we need to assume the saturation rate which is aligned with the base study and that gives us an impact. Baseline characterization. This is just a quick comparison looking at the baseline compared to the 2020 study. It looks like we have a little bit slightly higher usage for residential and commercial and that's the key difference here between 2020 and 2022. You can see it's shifted up a little bit in this new study versus the old study. Not a huge change, we have a little bit higher baseline. And this year versus last year? What's the Y axis? Oh, megawatts at a certain network. Peak megawatts, sorry. Yes, it would be peak megawatts. I don't actually know exactly what hours we're using for these. It aligns with Avista's summer peak. I'm assuming it's July and then their winter peak, which is probably in January. We should have labels on those.

**Kelly Marrin:** Now we'll go into our potential results. You can go to the next slide. Again, these are achievable potential. Go back up one more. Sorry, Andy. So it's EV potential so that it is integrated. It is accounting for eliminating overlap of participants across programs where we would be trying to target the same load. Those are really like smart thermostats and DLC. Those are the two that people think of most often trying to target that same air conditioning load with two different technologies. We need to account for those overlaps. Again, this is the scenario that includes all the programs that we considered for this study. So, apples to apples with the previous potential study right now, you can go to the next slide.

**Kelly Marrin:** This is the overall view of potential by season we have summer on the left and winters on the right. We're looking at a total reduction of about 125 megawatts of the achievable potential and that's about 8.3% of the baseline forecast. Once we get out to 2042, in the winter, it's close to 100 megawatts and 6.2% of the forecast out in 2042. Go ahead, Tina.

**Tina Jayaweera:** Sorry, I'm just beating this bush but. It's just a single hour peak. How are you defining?

**Kelly Marrin:** I don't think it is a single hour and I would have Michael look it up. We're going to be back together this afternoon so I can look that up and let you know exactly what the definition is for peak for summer and winter. Are you going to be back, this afternoon?

**Tina Jayaweera:** For gas. Well, I may be.

**Kelly Marrin:** Well, we do have an electric section this afternoon for an hour or so, hopefully you can make that part, Tina.

**Tina Jayaweera:** OK.

**Kelly Marrin:** I can look up the definition, but I think it's a couple of hours. I don't know if it's two hours or 4 hours, but I don't think it's a single hour. I would have to actually go back and look it up to see exactly how we defined the summer and winter peak for the Axis. We can do that.

**Tina Jayaweera:** All right.

**Kelly Marrin:** This slide has just the potential. On the left-hand side, we're showing the breakout of how it falls between residential, general service, large and extra-large. Washington at the top. Idaho is on the bottom. This is a pretty typical to what we usually see in potential studies and similar to what we saw last time. Most of the potential is in the residential class, with some general service and large general service, and then a little bit up here in extra-large. That's the typical fallout that we see in DR and then on the left-hand side, you're looking at the potential by year and that's also by program options. All the different options are there on the right, and some of the key ones, the TOU opt in, variable peak pricing, smart DLC thermostats, cooling and good interactive water heaters and 3<sup>rd</sup> party curtailment. Those are the ones that float to the top. They floated to the top last time as well and this is again typical of what we're seeing across the country as we look at these different types of DR programs. Let's see if there's anything else we want to say. Are there any other questions about this summer potential? You can see that the CTA 2045, the heat pump water heaters is really tiny. You almost can't even see it. And that's just a factor of the saturation of those water heaters, so most of them are electric resistance heat water heaters. Batteries are really small. Again, low saturation of batteries and thinking of some others that people have mentioned or might be interested in. HVAC rebates up there, I know that's of interest in the area. A pretty decent chunk, but smaller than you opt in close to the same size. Third party contracts is pretty big. It usually is. It's the vast majority of the impacts coming from the General service class. Any other questions on summer DR?

**Kelly Marrin:** All right. And then we can shift to winter. Winter is similar. A little lower, we're just under 100 megawatts. Again, we have the biggest opportunities from TOU and VPP in the winter. No smart thermostat this time, but we do for DLC. The biggest one is really the great interactive water heaters and then again, we have third party curtailment showing up here. Similar split on class, residential carrying the vast majority with the C & I having less and again most of that C & I potential is really coming from the third party program. Water heaters are big in the winter. They're probably the single largest driver of potential.

**Tina Jayaweera:** This is Tina, I have another question.

**Kelly Marrin:** Yeah, go ahead.

**Tina Jayaweera:** I know there's been a lot of supply chain delays on the CTA 2045 and I'm not sure where the Washington law stands in terms of when that requirement goes into place. I know it was delayed because of those supply chain concerns and so I guess I'm not entirely positive I'm going to getting the coloring right, but I'm also surprised by



the magnitude of the CTA 2045, especially for the electric resistance water heaters within a short, fairly short amount of time, just because of how water heaters have a 12-year lifetime. They have to be turned over, so it takes a while to build out that capability. I'm wondering how that was accounted for.

**Kelly Marrin:** I would probably actually have to turn it to somebody from the EE side. I don't know because we're using the saturations from the EE potential study. It looks like we have a saturation in 2023 of 45% is what I'm showing. I don't know if Max or Ken are still on, if not, we might have to circle back with them.

**Tina Jayawerra:** 45%?

**Kelly Marrin:** Yep, that's what I'm showing.

**Tina Jayaweera:** It's 45% of electric water heaters are CTA 2045.

**Kelly Marrin:** Maybe that's something we need to revisit in Washington.

**Tina Jayaweera:** OK.

**Kelly Marrin:** I think we might have let our guys go.

**Ken Walter:** Well, I'm here, Kelly. I was just going to say that doesn't sound completely consistent with our assumptions. So, we just need to revisit how that got connected because I know we did some work around that, and I think we were expecting that they weren't going to become widely available until possibly as late as 2025.

**Kelly Marrin:** OK, so maybe we just have a roll out issue. Starting at 2023. OK. Good. See Tina it's good you're here.

**Tina Jayaweera:** Thank you for saying that.

**Kelly Marrin:** You know, some of these things you don't notice them yourself and then it just takes someone looking at it with a fresh set of eyes to say, hey, wait a minute, what about that? You're right. We need to look at that. I've got that flagged and I'll highlight it in my sheet here and take her a look at that. Make sure we have a sort of an implied roll up schedule because it doesn't look like we have one on the water heat on this sheet that I'm looking at.

**Kelly Marrin:** All right. Let's get our pilots scenario. This is interesting, and like I said, this was kind of fun. It was a selection of the programs that Avista is actually planning on rolling out. Basically, what we did was overlay an actual realistic implementation schedule for these programs. That includes a pilot period. It's peak time rebate, the water heater program, the two water heater programs are the two water heater technologies as one program and then a time of use opt in program, and you can see that these two peak time rebate and TOU have very similar impacts. Again, we're accounting for the

fact that they would both be available in the territory. You can imagine that if you were to choose one instead of the other. As may happen in a pilot scenario, if one has much better impacts than the other than we would probably be about 10 megawatts for dynamic pricing just in general, although I think peak time rebate has a little bit different impact assumptions coming out of the PGE pilot and then the TOU. That's the potential for just the pilot. So, looking at 34 megawatts in 2022 or 2042, sorry, most of it coming from water heat, with about 10 megawatts from pricing. Alright, yes, peak time rebate does have a slightly higher impact. The per participant impact for residential is 7% to 8% winter and summer, whereas for the TOU we have 3% to 6% winter and summer. That's why we have a little bit of a difference in the megawatts there.

**Kelly Marrin:** And then if you flip to winter, it's the same programs in winter and kind of the same story for winter. We don't have smart thermostats or anything in here to really shake things up. We're looking at slightly lower potential or actually a slightly higher potential in the wintertime with water heaters making up the difference between the TOU programs, dropping down a tiny bit.

**Kelly Marrin:** OK, I think that's it for potential. We have a few slides on levelized costs. I think these are pretty draft, the levelized cost so, I guess we'll just take these with a grain of salt. We'll talk about the methodology first. First, we want to talk a little bit about developing the resource costs. That's important to note that DR programs have upfront and ongoing costs, the one-time and one-time fixed costs. One-time fixed cost would be program development costs. Those only happen in the beginning. Then we have a one-time variable cost like an equipment cost or marketing cost. And then we also have ongoing costs. Those are administrative costs, O&M costs, incentives and marketing costs. I think we've said this before we presented, this can be one time, but they can also be ongoing. Usually, we have the marketing cost the way we look at it as dollar per new participant. It is one time per participant, but they are ongoing through the life of the program. The costs are amortized over 10 years so that it gives enough time for the programs to ramp up and we present the levelized cost and dollar per kW year. And again, most of the costs that we use do come from the Power Council assumptions, although some have been customized a little bit to Avista based on their own experience. All right. Next slide.

**Kelly Marrin:** Here's just an example. This is for residential grid interactive water heaters, DR water heaters. We have a program development cost of \$34,000 and administrative cost of \$40,800. We don't really have an O&M cost for this program. Marketing of \$60 per participant, equipment of \$170 per participant, and an incentive of \$24 per participant. This is a good example of how these costs look for different programs.

**Tina Jayaweera:** Sorry, is there a typo on the incentive in the unit? Should that be dollar per participant per year? Or if not.

**Kelly Marrin:** Oh yes. Yes, there is, per participant per year. Yeah. OK. So it starts with a "p". Yes, that would be very low. I don't think anyone would participate. That's all we

were having. All right. And then I think you can go to the next page. Again, these are sort of our first cut at the levelized cost for each program. We have the megawatts shown there in 2042, so that you can get a sense of the size of the program. Small programs just because they're sort of levelized over a smaller number of megawatts tend to have much higher costs and larger programs have lower costs. This is just a factor of being able to spread costs out over more megawatts. But these again, look pretty similar to the way they've looked in previous years. Some of the expensive programs are still the same ones: battery storage, EV charging, smart appliances, heat pump water heaters – the CTA 2045 Thermal Energy storage. These are still pretty expensive programs that probably wouldn't make it through a cost effectiveness analysis and then again, similar to what I've seen for all the years we've been doing this, rates tend to be very cost effective. Third party programs tend to be very cost effective because of the way that our apps go out and you're basically paying a set dollar per MW or dollar per kW value. Any I don't think there are any big surprises here. Any questions on levelized costs?

**Kelly Marrin:** I think one thing that's kind of important to note in the rates because they do always look so cheap, is that we don't account for, we're really just accounting for the things that I talked about above – the administrative cost, O&M, the marketing, recruitment incentives which aren't there for most of the rates. But it doesn't account for if a utility doesn't have a rate in place. All of the upfront costs that it takes to actually justify implementing a rate and doing a rate case and designing a rate so that all of that is not included. That's sort of a hidden cost in the rates, but we don't have a good way of accounting for that, so just a little caveat there on the rates. And I think that's our last slide. There might be one more, but nope. We went a little quicker. Any other questions? I'm looking back. Have a couple of outstanding questions. I'll just recap and then we can add to it if we need to. Looks like we got a raised hand there. OK, great. Sorry. I was looking at my notes. Go ahead, raised hand. Can't see everybody.

**Gurvinder Singh:** Hi, Kelly, this is Gurvinder. I was curious about the T&D benefit. How does that figure into the levelized cost or is that done in the portfolio model?

**Kelly Marrin:** For the DR the T&D benefit, I think I'll defer to James because I don't think we're accounting for that explicitly.

**James Gall:** I'll take that one. If there is a benefit, we bring that in right now, we have losses benefit for T&D. I'm trying to think there could be some non-energy impacts we have not done a study on that yet to determine those impacts. We also, I believe, can apply a T&D capital avoidance adder, which is similar to what we do with energy efficiency. But beyond that we just have those impacts.

**Tina Jayaweera:** Sorry, this is Tina. I just want to follow up, there was a good question from Gurvinder. So, you don't have a deferred T&D benefit for DR. We don't have a specific one for DR at this time. We could use the energy efficiency differential value. But we don't have a specific one, the DR and what's the reasoning behind that?

**Jams Gall:** Most of the time DR is, you know, the impact is going to be very site specific on each feeder. I guess you have to come up with either a feeder-by-feeder level impact or you have to come with a generic average and if it's the generic average, it's probably going to be very similar to the energy efficiency value. Which is essentially the same concept your overall T&D Investments would be less, but unless you go feeder-by-feeder coming up with specific demand response potential by that feeder, it'd be difficult to have a specific value where the customer is necessarily going to be when you're developing the potential anyway. You don't know if it's going to be near a congested feeder or a high-capacity value of feeder. So, you average over, and I guess that we can definitely use the energy efficiency deferral value. It's a dollar per kilowatt. I think meets that request. Any other questions?

**James Gall:** Kelly, we'd have a few minutes. I don't know if you wanted to try to address Tina's question from earlier on some programs. I don't know what the right word is program. How you know, number of hours or when they are. Don't know if you wanted to share anything there.

**Kelly Marrin:** Let me see. What I can find here? No, if we have them all in a centralized location. Where's the one that he sent you, James?

**James Gall:** If you're looking for the spreadsheet, I have it open right now. It's the impacts by hour. Is that the one you're thinking?

**Kelly Marrin:** That's the one I was thinking of.

**James Gall:** Alright, I'll share my screen.

**Kelly Marrin:** OK.

**James Gall:** And if you can guide me where you'd like me to go, happy to do it.

**Kelly Marrin:** Yeah, I mean, we can talk through this a little bit. This is what I was referring to when I was talking about the fact that we're trying to help make some assumptions about how the impacts actually fall out for these different programs. We do have them based in this case. It's based on system-peak hours, so the dark green, if you look at the top. There's a summer and a winter here, but the first dark green. Oh no, wait, the 10:00 AM is probably your winter and the 19 is your summer, so we have the winter peak in the morning. And then you have an event window around that for each program, so you can see the length of the different events. So, for smart thermostat heating we've got a 3-hour event, so that's columns P and Q. If we just look at one program, then we would have a 3-hour window and we have an impact there. And then we have a prequel and a post. Well, it's not a prequel, it's a preheat and a post and a snapback. Looks like we actually need to take out the impact underneath that for heating, I don't think it's eligible for summer, just like the thermostats are there. But this is the spreadsheet that we're working with that we've sent to James to start to think about how the different programs respond on a 24-hour basis in a winter versus the summer event.

**James Gall:** I see Yao, you have your hand up.

**Yao Yin:** Yeah. So why do we use a system peak hours here to plan those programs instead of net peak.

**Kelly Marrin:** Can you clarify what you mean by net peak.

**Yao Yin:** Which is the peak minus renewables, like peak minus solar.

**Kelly Marrin:** I think that that is with this would be right, James, because this is the this.

**James Gall:** Definitely for our system it would be the same. We don't have enough solar at this time to impact the peak and if it was a customer side solar it would definitely be accounted for. Now if we had substantial solar growth in our service territory, you could see a movement of that peak hour by an hour or two in the summer. But at this time, there's not enough solar to the change that peak.

**Yao Yin:** Thank you. That makes sense.

James Gall: I think we'll try to make this spreadsheet available once it's final and we'll get that out on the TAC website as well.

**Kelly Marrin:** Hopefully this will help Tina with some of those questions about how many events, it doesn't have the number of events, but we could include that so that you have a full set of assumptions about the number of hours we're assuming it can be called per year. The duration of those each of those events and then what's happening to the load like the percent shifted versus conserved essentially.

**Tina Jayaweera:** Yeah, that was helpful. I was a little surprised about the different lengths of events for different programs. I think your appliances have maybe 4 hours and your water heating was two hours or I can't remember the details, but.

**Kelly Marrin:** Yeah. And primarily we're getting those from secondary sources where we're looking at how utilities are or we're seeing similar utilities actually operating those programs. That's where we're pulling those durations from instead of just assuming a four-hour event for all the programs.

**Tina Jayaweera:** OK. Thank you.

**Kelly Marrin:** OK. Got 5 more minutes I think, right. Any final questions? Like I said, I have a list of some follow-ups. The interaction of the saturations and then specifically with respect to heat pump water heaters where it looks like we might have an actual error and issue that needs to be addressed. And then the definition of summer and winter peak. Whether that's a single hour, multiple hours in which month? Those are my two

questions that I couldn't answer. Anything else? Alright, well, maybe we're giving people 4 minutes back. OK.

**John Lyons:** Yes, let's take our lunch break here. Enjoy that extra 4 minutes. Savor it. We will be back at 12:30 for the Clean Energy Survey. Enjoy your lunch.

**James Gall:** Thanks everybody.

### **Clean Energy Survey, Mary Tyrie**

**John Lyons:** Hello everyone and welcome back to Avista's Technical Advisory Committee meeting. We'll give a minute or two here for people to get logged back on and hopefully you had a relaxing lunch. This next presentation that Mary Tyrie is doing on clean energy strategy covers both gas and electric, so we'll be transitioning over in between electric and gas. Tom, would you like to take it away, so you can welcome the gas folks that are now joining us.

**Tom Pardee:** Welcome all the gas TAC members, like John mentioned, we have an integrated portion of this today, which is one reason why we have the electric folks on this as well. I'm going to introduce Mary in a minute. Before that, I wanted to give a schedule update on the natural gas TAC. We did move the August TAC out about a month to September 21<sup>st</sup> because we understand everybody is busy and asking for two TACs within the same month is asking for quite a bit. Based on that, we also moved our final scheduled TAC to November 10<sup>th</sup>. That's on the website, the schedule is kept current on that external website and we can send that link out to all the folks on the on the call [<https://www.myavista.com/about-us/integrated-resource-planning>]. One other thing on the TAC schedule, we may add an additional TAC based on all the things that are going on in Washington with the CCA and some things with the Climate Protection Plan in Oregon as well. That would be likely in a February 23<sup>rd</sup> time frame, but just wanted to note that because in general we've probably kept it to four TAC meetings on the gas side over the prior IRPs, but we're already planning for number 5 and likely a number 6. Meetings are getting a little shorter in general, but definitely having to expand the number of them. The other thing as mentioned with John on the electric side, we will be producing files and putting them on that same website. So be looking be on the lookout for those. And finally, today's results for the DSM side for the CPAs that AEG will go over, sorry, that's a lot of acronyms. That is going to be for primarily Washington and Idaho for the CPA. The Energy Trust of Oregon [ETO] had some hiccups with some folks of theirs being out on leave, so we pushed them to the next TAC meeting to allow some time to finish those up. They will be presenting on September 21<sup>st</sup> for the non-low income and all the other portions of studies that will be reviewed by AEG today. And so finally, Mary, are you online?

**Mary Tyrie:** Yes, I am.

**Tom Pardee:** Excellent. I'm going to introduce Mary. She has been integral with this Action Item given to us by the Oregon Commission. Mary is the Manager of Corporate Communications. The specific request and a brief bit of background on this, is the Oregon Commission asked us to conduct market research to reflect the willingness of Oregon customers to pay for various carbon reduction strategies. As many of you know, we are separated group wise in the IRP in years past, and this last July, we came under a single group. In talking to my new group members, we felt it was a good opportunity to. Actually, that was two Julys ago, I guess so July of 2020. We felt it was a good opportunity to get the pulse of this across the system and across the electric and natural gas sides of the house. Mary's going to take you through this study that's going to lay this out. She's been a part of this prior to this. She does a great job of it. Mary, take it away. Thank you.

**Mary Tyrie:** Thank you, Tom for the introduction. I'm going to be on camera just here during this first part of the introduction and then I'll go off camera while I'm doing the presentation. But I wanted to also introduce a couple of guests that we have with us today from the research company that we used, MDC research. They're based in Portland. I have Irene O'Reilly who's our account manager and one of the vice presidents, Jake. Jake, I'm not sure. I'm going to say your last name correctly, Lamers.

**Jake Lahmers:** Lahmers. You were very close.

**Mary Tyrie:** Lahmers, you're not lame.

**Jake Lahmers:** No one gets that right so.

**Mary Tyrie:** Alright, so I've asked them to join us in case there are any technical questions and the background on how we performed the research and analysis. So, with that, I'm going to go ahead and go off camera to share my screen. And like magic, you should all be able to see that now. Would that be a yes?

**Lori Hermanson:** Yep, we can see it.

**Mary Tyrie:** Thank you. I think at some point we'll trust technology and we won't have to ask that question. As Tom was saying, I was approached by him based on the request from Oregon. And as we continue to talk through it, we decided we might broaden this survey out and really look at it from the perspective of the IRP and the planning purposes and even other parts of our business could benefit from understanding this. We are trying to look at what customers. I'm going to switch to the next step here or slide but look at their willingness to pay for the implementation of clean energy. And as we were doing this, we looked, we talked to customers from Washington, Idaho, and Oregon. We wanted to look at is there some sort of a baseline of environmental concerns, perceived responsibilities of individuals versus businesses versus Avista specifically. We were also looking at understanding customer tradeoffs between billing increases and carbon emission goals.

**Mary Tyrie:** Looking at the perceptions associated with Avista, should we invest in a carbon neutral plan or a carbon free emissions plan gauging perception specific to natural gas and some of the trade-offs there and then looking at differences by state, customer type, green perceptions, and some of the other demographic factors. This was a web survey, and we did both desktop and mobile optimization. And it was conducted in April. The sample size was a little bit over 1,000 customers. You can see here the proportion of customers by state and then also by the fuel type.

**Mary Tyrie:** We always in the surveys that we do, make sure that our customers are 18 or older that they do share in household finances or have a responsibility with the utility bill and that they're not employed by a utility company or in market research or advertising.

**Mary Tyrie:** So, with this survey and one of the reasons it was online only was we chose to do a conjoint exercise. The conjoint is a way to force trade-offs, and so it gives the customers several options to choose from and there are multiple options that are presented and then it helps us to look at that customer's willingness to pay for different types, you know, I'm sorry I'm stumbling here a little bit. I'm going to step back. What we were doing with this conjoint was trying to better understand and force trade-offs for the green initiatives and our customers willingness to pay. We looked at the various things listed here. The energy goal, the goal time frame, how much of a bill increase customers would be willing to pay, and then where the energy is sourced. We'll come back to this as we get further into the research findings. What this does though, with the conjoint, is it provides a utility score, and that utility score allows the work in the background to show what individuals are willing to do in a tradeoff manner. What that does is rather than just coming out and asking the customer a question, would you be willing to pay more for green energy? Where we found customers are like oh yeah, I would pay more, but when the rubber really hits the road, we have found that they're like, OK, why? Why is my bill going up? I don't want to pay for that. And that's not all customers. That's a generalization and an example. But what this conjoint, what the intent was, was to look at these forced trade-offs and better understand where people would land within each one of these areas. Tom, I can't see questions if they are coming up and the way I just explained that, probably there's some questions.

**Tom Pardee:** I'll let you know when they come up, Mary.

**Mary Tyrie:** Alright, thank you. We found the key takeaways here and this is giving you the high-level overview of what we found and will go through these in much more detail throughout this presentation. We found prices really important when they are faced with those trade-offs, price was the prevailing factor. We have some customers that are willing to invest more, but for the most part, that was the determining factor. Anything beyond a 10% monthly billing increase really showed a decline in popularity. If we did increase beyond 10%, that was an appeal to a certain subset of customers, generally those that looked at themselves as having a very high importance of green and they also would like to achieve these goals in a shorter amount of time. There are some people that, we're just against this altogether, so any increase to invest in green energy would



alienate some people. We had 17% that rejected all options they were provided. Including the more ambitious option, which we thought was more ambitious with having just a 2% increase. We had three of 10 say they would likely seek bill assistance or consider moving to another state if their bill would were to increase due to Avista investing in carbon free or carbon neutral energy.

**Mary Tyrie:** As we look at the detailed findings around the importance of being environmentally friendly or green, the question we asked was how important is the concept of being environmentally friendly or agreeing to you personally? 78% of those respondents were in that top box saying somewhat or very important. We did find some differences on the customers by state. You can see Idaho 71% versus Oregon 83%. Differences by where people live, so rural, suburban or urban. And then women were significantly more likely than men to find being green important. The age and income categories, they were more consistent.

**Mary Tyrie:** We ask the questions here. How important is the concept of being environmentally friendly or green to you personally, and then how important is it for general companies or organizations, and also how important is it specifically to Avista? And you can see that it's very similar the importance across the across the board on that top box 78% for personal, 77% for companies and organizations and then utility 79%.

**Mary Tyrie:** This gives you some ideas on why they thought it was important to be personally, environmentally green, or why they didn't find it to be important. The top is where we have the two top boxes and then the lower is not very or not important at all. So, 38% of the people that answered this said that to protect our planet's environment, it's good for future generations was 24%, responsibility 16% and then to address climate or global warming 13%. Why it's not important of the 224 people that responded in the not very or not at all important areas, cost was the highest 29%. Some people believe it's not real, it's a hoax. Green is worse for the environment, not better, or it's political. There's a political agenda behind it. There's some verbatim over on the right. And I do believe you all got these slides, we're kind of ripping through them, so you can look at the verbatim's and such later, or as we're going. Here we asked when you hear the words renewable energy, what sources come to mind. We also asked when you hear the words clean energy, what sources come to mind? These were two different questions, but we put them on the same slide here to compare them. The renewable energy is designated with the dark blue and then you see the clean energy with the lighter blue. No surprise, both solar and wind are up there at the top and they have a slightly higher association with being renewable rather than clean. And then you can go down the list. Here is hydroelectric, biofuels, natural gas is in there showing that at 31% clean, geothermal 31% clean, but people aren't considering those to be in that renewable category as much. And then biofuels are associated with being renewable and not so much as clean. We asked a question on how important is for utility companies like Avista to do each of the following. This was a rating, it's very important to not important at all, or you could answer unsure.

**Mary Tyrie:** When you go down the list, you can see it decreases a little bit, 87% of the customers that answered this said that power from local resources as much as possible. The 87% was derived from those top box scores. Again, that somewhat important and very important. We'll see this again as we continue through this deck, that power from local resources as much as possible. Then power from renewable resources as much as possible, it was 84%. Low cost for customers, 73%. Provide customer options to contribute towards lowering carbon emissions was at 72%, achieve carbon neutrality in energy. By acquiring renewable power equal to the energy that is used, at 67%. Achieving 100% carbon free by generating energy entirely from clean resources, you can see those are pretty close there to ways that we would get to an energy goal 67% and 65%. We asked a couple of other questions in here so other customer options, providing rebates or charging stations for electric vehicles. So again, you know how important are the customers seeing that as a utility offering. Invest in electric vehicles, were lower carbon emissions. So that's at 60% and then generating power from as many resources as possible, 58%. Excuse me so this harkens back to that carbon neutral or carbon free power, so you can see it was pretty close there. The 67 and 65. Sorry, my mouse is moving quickly here. The importance of Avista achieving these goals can differ by state and audiences. You can see on the left we've got carbon neutrality, on the right it's the 100% carbon free. Over on carbon neutrality. It's by state, 61% in Idaho, 67% in Washington and 73% in Oregon, we put these on together so you could see the difference between carbon free and carbon neutral, and where people were differing and how they differed by each other. Again, by where people live. Whether they are rural, suburban, or urban. And then by gender. And there was a difference in carbon neutrality by income. The folks that we're making \$150K in household income were more likely than those making less than \$60K to say it's important. Age and income on carbon free were more similar.

**Mary Tyrie:** Here's where we started with the conjoint results. So, what we did is we presented the customers with a series of 12 screens and each one had a set of energy packages that they were able to choose from. And we talked about them as hypothetical and if they were made available in the future for your home, we asked them. They had to answer. They could choose none if they wanted. But they were required to answer, and this is where that forced trade off came. This is sometimes considered to be really redundant to customers when they're participating in surveys. We were cognizant of that as well and trying to get enough information from customers to be able to have some findings that were able to give us some direction or help us guide us in the work that we're doing. Again, you saw these earlier, these attributes that we were looking at. So, the energy goal and what this does is it shows a utility score here and this score is based on a zero to 100 and what it is the result of the customer choosing the various options that were given to them. And so, the higher the score, the more important the lower the score. I shouldn't say more important had more weight. The lower the score would mean that it wasn't potentially as, it wasn't chosen as much. So, you could see on the energy goal where we have a carbon neutrality and then providing 100% carbon free power, the 55 versus 59. It's pretty close. There's not a lot, hardly any impact there, in the difference. The goal time frame in the next year, in the next five years, 10 years or 25 years. There is a drop off in the utility score at the 25-year level. There's little difference in the next

year, five or ten years when all other factors were held consistent. And again, with the billing increase, if all other factors are held consistent, the monthly bill increase has the biggest impact. Utility scores drop after that 10% increase. And we're noting here again that there are those that have high importance on being green, they are the ones that mostly were demonstrating the willingness to pay beyond that 10% mark. Where it's sourced. This goes back to the slide I mentioned where 87% those top box scores said that they would like that their power sourced locally. When we look at it in the conjoint analysis, where we're forcing the trade-offs, there was little differentiation between local, regional, or anywhere else. And then 17% of the respondents said no to all of the options, so no indication or willingness to pay for green investments. When we look at the customers by their stated personal importance of green. They were able to say very, somewhat, or not. And when we pulled it out that way, you see the list again of attributes and you can see by the coloring there. How people responded. So, if they were not, if they felt like green wasn't important, you can see down on the none. They were the ones primarily that were saying, yeah, none of these work for me. The folks that were in the very important category. If you pull out some of the numbers that are higher, you can see here the darker greens you've got 2/5 and 10% on the monthly increases. When should it happen in the green period here and then slightly more on the 100% carbon free. It's a lot of information to digest on these.

**Mary Tyrie:** On this one, we're looking at the scores by their service type. We wanted to know if this would differentiate between gas only or dual fuel customers or our electric only customers. Again, the green is where we see our highest numbers on the utility scores. And when we roll it all up. This is the ultimate feature combination. The ultimate utility results when we're looking at the utility scores, customers achieving the most for the lowest cost, so what they really stated was that they would like to invest in renewables to achieve carbon neutrality. They would like that to happen in the next year. They would like that to be with a 2% monthly increase. And they would like that to be sourced locally. On here, what we're doing is we're looking at the difference between the combinations. So, looking at the ultimate future combination of investing in renewables to achieve the carbon neutrality in the next year to percent monthly increase in source locally. If all the factors are held consistent, 1% carbon free energy versus investing in carbon neutrality had almost no impact.

**Mary Tyrie:** This was the time frame. You can see in the next year and the next five years, 10 years or in 25 years, and this is where you can see that after 10 years it is starting to drop 25 years. There is the more significant drop. The monthly bill increase, when we're holding all the other factors consistent on the monthly billing increase, it has that biggest impact on the utility drops off considerably. When you get to that 10% range. We included some what we thought were very aspirational levels, this 2% and some that might seem like ridiculously high. Which may or may not be, but we really gave the customer a lot of choices here. And then this is looking at the source from anywhere, regionally or locally. There is a very slight preference on local and regional versus anywhere.

**Mary Tyrie:** OK, some of the findings we had here on investment support, so we asked “should Avista invest in carbon neutral carbon free when it involves a rate increase?” What you see here is 33% said yes. 30 possibly and the arrow that you see over on the right is pointing to that 20%, their lack of investing support differs by gender. So, on this one supporting investment is consistent across gender. Men are significantly more likely than women to not support the investment. It's consistent across age and state. There are some changes there and working backwards here, obviously in where people live, and then the investment sentiment differs by income. So, the 28% under 60 or the 60 plus. 42% of folks with the higher income are more likely to say that we should invest, even if it involves a rate increase. Here we're seeing that again. Investing carbon neutral, what are the main reasons we should and what are the main reasons we shouldn't? So, the main reasons to invest are to save the planet. Cleaner environment, cleaner air, fight climate change. Depends on cost effectiveness and it's the right thing to do. Not to invest. These are very similar to what we saw earlier. Consumer costs, it's expensive, don't believe it's a hoax, it won't change anything, there's political agenda behind it. If Avista did go this route and your bill increased, how likely would you be to take each of the following actions? We asked what would they do. The top box over on the left and the top response was they would make sacrifices such as using less heat, 60% in that top box said that they would consider rooftop solar for their home, invest in energy efficiency upgrades such as new windows or roof.

**Mary Tyrie:** And then 41% said that they would actually consider alternative fuels such as wood or propane. There were some people that said that they would pay a little bit extra to help folks, subsidized customers who may be struggling. We had 28% of the respondents say that they would need to look for bill assistance. And 27% said that they would actually consider moving to another state. This is breaking out just the bill assistance and looking at what the increases would look like to drive that customer to seek assistance. So, 28% indicated they would be likely to seek or look for bill assistance. When asked that question, if we were to increase your bill and then what level? So, you can see the under 5%, 5%, 10%, 20% or 50%; those numbers 10% or more increase in a bill would create, 55% of the customers that responded to that. In that 28% say I would need to seek assistance. And this one is showing the folks that stated that they would move out of state. So, what level of billing increase would drive you to move out of state? We did have 36% of the customers that said they weren't sure, 35% said it would take 20% or more, 30% said 10% increase or less.

**Mary Tyrie:** We asked the question if Avista wasn't able to achieve carbon neutrality by 2027, how would this affect your favorability for the company? And over half the customers said that their favorability would not be impacted. There was a difference, by age. We did see the younger 18 to 54, saying that 15% of them said that they would have a decreased favorability for Avista versus the 10% at 55 plus. And this breaks it out further so you can see potential by state where they live and then also their income.

**Mary Tyrie:** And then we did ask some specific natural gas questions. They were looking at fuel switching and things like that. How likely would you be to consider switching from natural gas to another energy source to help reduce carbon emissions? And 42% of the

folks that answered this question, these were among the gas customers that we had, the 42% in that top box said they were somewhat or extremely likely would consider switching. We asked how much do you agree or disagree with the following statements concerning natural gas in your home. Again, looking at our top box scores, as we go down the list here, eliminating natural gas as an option should be entirely voluntary.

**Mary Tyrie:** I don't like the idea as an option because it removes my choice as a customer. Eliminating natural gas as a fuel option makes me concerned about my reliability. I'd be more likely to if someone paid for the conversion costs, some or all. Eliminating natural gas as an option makes me concerned about cooking. Eliminating natural gas as an option should be regulated by a state mandate. So this is where it kind of changes. It drops to 18% and the number gets higher where you're seeing disagreement. And eliminating natural gas as an option should be regulated by a federal mandate. In that same category, I would be more likely to eliminate natural gases and option in my home if some are all of the conversion costs were paid by the electric utility and or government entities.

**Mary Tyrie:** And then we asked what the contribution would be. So, if they had to contribute to the cost of converting, what was their max level of contribution. More likely to convert if some or all of the costs were covered. So, 60%. We're in that top box and then personal contribution. Under \$1,000, 59% were in that range, with 27% of those people being up to \$1,000. And then \$1,000 or more, you see it drops there to the 19%. And then we did have a contingency of people that just said none, 23% of those folks. And then we have a slide here on the demographics. And that concludes the deck here in the presentation. Are there any questions? Any thoughts?

**James Gall:** And Mary, we do have a question on the chat.

**Mary Tyrie:** OK.

**James Gall:** This is from Heather Moline. This is where the demographic self-reported.

**Mary Tyrie:** Yes. We asked the questions of them, but they do. Yes, they report their own.

**James Gall:** Any other questions for Mary, we are a little bit ahead of schedule. We'll give it a little bit of time before we move on.

**Heather Moline:** This is Heather from UTC. If there are no other questions, I would just love some reactions from Avista staff like what are your takeaways from this?

**James Gall:** Good question. I wonder if he wants to take the first shot at that. I have some thoughts, but Tom, go ahead first if you want to react to the gas side.

**Tom Pardee:** I can put one in context. I can't remember which slide it was. I'd have to pull it back up, but there was one that said, "how likely are you to think more poorly of

the company if we didn't meet our goals." If you take the somewhat likely that you would not think so. Mary, can you find that, it's like slide 30? I'd have to find it. Hold on. Yeah, right here. Thank you. Favorability of Avista if it is not able to provide 100% carbon free power by 2045. If we did not provide 100% carbon free power and then increase significantly, increase somewhat. So that's 12% and then we add that to no impact in there. So, you're talking 63% of people that based on the survey, and again I have to be careful because surveys are tricky things, and I think Mary and friends can talk much more broadly about this. But depending on how you phrase the question, you can have different results. So, that would mean that 63% of survey respondents would essentially be no impact to how they view Avista. And does that mean that they don't care? I don't think so. But that is something that sticks out to me is as important for us to remember. When Mary was going through this, and James and I and the team have seen this a couple times now, I think it would be helpful to break this out maybe by state. And I know that on a summary level, it's broken out by state, but maybe just so that Heather, you and in Washington can see how this differs from basically taken into context for Washington only. I think we need to better understand how this does impact some of our decisions as far as our sourcing and the amount of clean renewable that we that we do to meet our goals and so James go ahead if you have any further thoughts.

**James Gall:** Yeah. I'd like Mary, if you don't mind going to the summary slide of the conjoint analysis that had the preferred scenario. I guess I don't know what right word for that is, but I think you know what I'm talking about. Yes, this one right here. What was very clear to me, first is I think there's some differences between our customers and maybe the state goals that we have for Washington. I think obviously the state is a lot more aggressive and its desire to be clean then maybe our customer base. So that's one observation, but two, our customers, no matter what state they're in, Idaho or Washington on the electric side, are interested in clean resources. And the issue I think it comes down to is affordability. And this is maybe something for the Idaho Commission to think about where even Idaho customers are very interested in clean energy, but at a limited cost. So that's one take away on the electric IRP side where we have clean energy goals required in the State of Washington but not Idaho. But there seems to be interest in the State of Idaho for clean resources, but subject to some cost constraints that are likely more minimal than in Washington. The source locally is another interesting concept where traditionally in IRPs we look at the financial benefits of local versus distant, and usually that has to do with the availability of resources or costs. But that source locally actually matches up well when we did our non-energy impact study a few months back, where there's added economic value for sourcing resources locally. I think there's some support to use that economic value in our analysis to provide an incentive to choose local resources versus maybe resources out of state or out of our system. But I welcome anybody else from Avista who has any thoughts. I don't know if Scott is still on or anybody else from different departments as well to comment.

**Scott Kinney:** James is Scott. I agree with what you and Tom have both stated and you both hit on some of my thoughts that I was thinking of sharing. One of the other ones that I think I want to spend a little bit more time to think about, but I think it's important

for us to try to understand too, is the slide Mary, and I don't remember which one it is, you don't need to pull it up, but just the comments on providing or allowing customer choice. With their energy needs. I think that's another area I think for us to maybe spend a little bit more time thinking about and how important that may be to our customer base as we continue our transition to a cleaner portfolio, but doing it in a way that meets our customer's needs.

**James Gall:** Right. And we have another question in the chat. I think this might be for Mary, it's from Charlene. Or, sorry, Charlee, are there any next steps for the public perception study?

**Mary Tyrie:** Next steps, so explain what you mean. Next steps for an additional study?

**James Gall:** They'll turn that over to Charlee and go ahead.

**Charlee Thompson:** Hi, this is Charlee. And I was just curious if there is an additional study? I was assuming not but how are these results going to be incorporated, which is what we were just covering? And just overall, what one of us is looking to do now that we have the key findings all laid out.

**Mary Tyrie:** Right. Thank you for clarifying that, Charlee. We don't have anything specific as far as next steps on additional research, but there will be a lot of dissecting of this information to help inform the plan going forward. And like Scott mentioned or others, it's how do we look at that customer, the comments, the verbatim that are out there? Understanding customer's choice, what are those points? Either resonate well with a customer or create concern. I do have to say one of the things that I pulled out was on the natural gas stuff as well, and I think it was on the same slide Scott was talking about, but it's about fuel switching and they're talking about let's go back to wood burning. We've had a concerted effort for clean air and wood burning with our regional clean air group. There's a lot of things in there that if you were to make changes, what are the other consequences that might come from it? I've shared this deck with several people in the organization and will continue to share it. There's a lot of interest in the information that we found here. And I said earlier, there's so much to digest in it. It's going to take us a little time to continue to work through it.

**Charlee Thompson:** Thanks.

**Tom Pardee:** So, I'm going to go back. Scott and Mary both alluded to this, it's like 32. That's entirely what we're seeing from a couple of the climate policies is more of an electrification type or eliminating natural gas. If you just look at the top one, if you have the purple up and then that 7% which has, I'm not sure that's 81%, what that question is eliminating natural gas as an option should be entirely voluntary. So, 81%. Basically, you agree or in that same kind of region, we'll say 74%. That tells me maybe, even James alluded to this, it's a little bit contradictory to what we're seeing in these policies. As Mary stated, there's a lot of things to think about in here. It's a one-time look, but I think there's some good information in here.

**James Gall:** Just to add on to that, Tom and this slide, thanks for bringing it back up. The reliability I'm thinking about, from fuel switching from natural gas to electric. A lot of our customers use natural gas as a reliability or resiliency effort compared to electric. If your power goes out, you still have natural gas to provide heating or hot water and on a lot easier basis than you do if you're an all-electric home. And that came out as number three reason why they're concerned. I would also expect there's concerns about just having too much power on the grid. I don't know if the customer is leaning into that, but that resiliency effort or benefit of natural gases is definitely becoming clear from our customers. Looks like Katie, you have your hand up. Go ahead.

**Katie Ware:** Thanks. I'm curious for the survey how much education was provided to customers before the questions were provided. There's a lot of nuance behind some of these concepts including earlier questions around carbon neutrality investments versus generation, things like that. I'm curious whether it's a step provided any context or whether they were just questions that were sort of check the box.

**Mary Tyrie:** We tried in the questions to explain what we were asking them. We did not provide them with education. When to go back to an earlier question, see if we can. How important is it for utility companies like Avista to do each of the following: achieve carbon neutrality in energy production by acquiring renewable power equal to energy use or achieve 100% carbon free power by generating energy entirely from clean resources. We do understand that those aren't terms customers are constantly using or referring to. It is a very challenging nut to crack, but we tried to be as clear as we possibly could in asking the question. You're right, there are new ones here.

**James Gall:** James again, we have a little bit of time. There was the question of reactions of the survey to Avista. I was just curious from a TAC member perspective, if anybody had any thoughts from the TAC on reactions. Either gas or electric. If there's no volunteers, that's OK too. All right, Heather, thank you for volunteering. Go ahead.

**Heather Moline:** I'm happy to have this. We can't get anybody else to Heather from ...

**James Gall:** We can barely hear you.

**Heather Moline:** It should pick up volume as I keep speaking

**James Gall:** OK, there you go.

**Heather Moline:** Heather from UTC. Yeah. Analyzed way too many surveys in grad school. And frequently you see outcomes at odds with desired outcomes at odds with willingness to contribute to those outcomes. This is just a standard thing in survey. We want XYZ to happen, but I don't know how much I personally want to contribute to make sure XYZ happens. That's just unfortunately typical of surveys. And this kind of strikes me here a little bit. The next thing is the role of choice in this conversation is interesting to me from the perspective of, it's not like customers can switch their utility. Wanting to



maintain customer choice while putting this in the context of one, do customers have a choice about who provides their power and two, I think I've even heard staff say before: How much time do your customers spend thinking about their utility and about the power they're provided on a day-to-day basis and that's a pretty humbling reality, I think. The latter is all these big changes that folks, in their daily lives, just don't have time for it, don't have desire for, et cetera. So those are a couple of my initial takeaways.

**James Gall:** Thank you, Heather, for volunteering. Any other thoughts?

**Lisa McGarity:** Well, I'll go James on the slide where it, I think it was about a customer's willingness to pay for equipment upgrades. That's kind of pretty telling as I think to Heather's point, that people really don't want to invest in it.

**Terri Carlock:** And this is Terri Carlock from Idaho [IPUC]. And I know that there have been a couple of items where we've talked about Idaho being different than Washington and we, as well as customers, are interested in clean energy. But we are an economic regulatory state and so the amount of cost-effective changes is what we will look at. And I don't think that has changed. That doesn't mean we're not interested and that we don't think is the direction that resources will go. But we are looking at the economics behind it.

**James Gall:** Thank you Terri. Anyone else? I don't want to cut us off too early because I know we had a 2 o'clock start with AEG and I don't know if AEG is ready to go early or not. There is another hand. Go ahead Katie.

**Katie Ware:** Thanks, James. Could you say a little bit more about the purpose for the study itself and then how Avista envisions using the results to guide the strategy in the various states that Avista serves? I know that you made some statements throughout the presentation that broke down state by state and you know this is what customers say versus this is where the policies are headed. And that makes it seem like Avista is incorporating the results in strategies moving forward. I'm just curious whether you could say a little bit more about that.

**James Gall:** I'm going to turn to Tom. Do you want to remind everybody about the origin of this? And then I'll take the second-half of that question.

**Tom Pardee:** Yeah. I'm going to restate it again. This is a study request from specifically the 2021 Natural Gas IRP. It was to conduct market research to reflect the willingness of Oregon customers to pay for various carbon reduction strategies. To give some more context on that, Oregon has a Climate Protection Plan that was signed by Governor Brown. So, what that does is it has specific yearly goals we're currently in in that program. It started in 2022, and as you may or may not know, Washington has the Climate Commitment Act. That's a little bit different program, but there's still that same emissions goal. And so, with these policies and the electric side has the similar ones, the Climate Protection Plan for Oregon is more specific to natural gas, but they definitely have something like it for electric and the same with Washington with CETA. We're just

starting with the intent of this and that opportunity to do a survey. We figured it was a good time to reach out to our customers and say, hey, what do you guys think, is this going the right direction? And so that's where this study came from.

**James Gall:** I see Anna came on camera. Do you want to respond?

**Anna Kim:** Since I'm Oregon PUC, I feel like I'm somewhat compelled to make comment on this presentation. First of all, really appreciate the strategy of doing the conjoint analysis. Which is exactly I think what I had in my mind when I was seeing that recommendation written. I appreciate that. The question about what would it take you to move out of state, that just seemed a little, I don't know, seemed like a pretty extreme option. And I'm just wondering if you think that might have changed how people who were taking the survey might be perceiving the survey itself, because it just seemed a little extreme. Is that something you've ever asked any of your customers? How would we \*\*\*\* you off enough that you'll move out of our service territory and maybe out of the entire state? It just seemed a little more over the top than the other stuff you were testing.

**James Gall:** Yeah, I'm going to make a quick response this James at Avista, a lot of our service territory are border states. This comes up a lot and where people choose to live on the economic benefits between one state or another. But I'd love to hear Mary's take on that one as well.

**Mary Tyrie:** I was just frantically trying to look for our survey instrument here. Irene, are you still on?

**Irene O'Reilly:** Yes.

**Mary Tyrie:** Did we actually ask that question or was that a customer response?

**Irene O'Reilly:** We did ask that question. It might be worth noting that in both our initial outreach survey invitations to customers and then again on the landing page and the initial couching of the survey itself, we really did position this, and we really put a lot of effort into positioning all of this as hypotheticals because the last thing we want is somebody walking away and saying I just heard my bill is going up 10%. We've had a lot of effort into making sure that we're grounding this and we're going to test some ideas here. Some of these are a little extreme and we know that, but it's all part of this process to really understand where those tradeoffs are in terms of that question itself. It was asked within that litany of some of the other questions of which of these might happen should this scenario arise. So, it was in there directly, but it was positioned in terms of bigger picture hypotheticals.

**Anna Kim:** That makes sense. I appreciate that. I think at least when you send it to us at the PUC, it would be helpful to put some more framing around that information so that we can understand the context of the border states and how that topic came up because the slides made it seem like it was a huge topic on its own, since it was mentioned a couple of times and so just thinking that that would help us not to overreact hearing that.

**Tom Pardee:** This is Tom and I guess my perception of it would be, maybe some people can get mad and going to say I'm just going to leave. But if you say you know it, it might be more of that hardline sentiment around it. Maybe you say, well, how upset would you be with 20%? And some people will say, well, I really wouldn't like that, that wouldn't be good. And I'd take some time to think about what I want to do or as far as understanding how the customers are thinking about what's that impact to them would be. I almost see it as those are the people that really feel fiercely about it, about some type of an impact where it's not to say that they would definitely move, but it's almost like that would really make me mad, right. And so, you would also wonder too, within the survey of say it's a 20% increase, I can't remember but say it's 20%. Well, if 20% monthly increase is going to make you, force you to move, how likely would you be able to spend the money to move? There's kind of that back and forth of is it realistic that someone could move based on a percent increase. I just read it as more of these are the people that would really be frustrated by it.

**Anna Kim:** Thanks Tom for that context. I really appreciate the way you're thinking about this because that is definitely a valid interpretation. My knee jerk interpretation is, well, maybe we should discount the majority of these respondents because they are into hyperbole. But I think your interpretation gets more to the intent of what they're trying to say, their response. And one other thing, when you send this to us, could you send the actual instrument as well? Would really appreciate seeing what they saw.

**Tom Pardee:** So, was this web form Mary, can you help? Guide me on that. Is that something that we could share? Or in what form?

**Mary Tyrie:** Yes, we can share the conjoint part of it. I don't believe, and Irene correct me if I'm wrong, the 12 slides I haven't seen those. I know how they were laid out, but would we be able to share all the options they saw in the conjoint?

**Irene O'Reilly:** We can share the actual survey instrument. We can share the conjoint design, so we can start to see what combinations and it's not going to get to that level of this person saw these 12 screens. But overall, here's a course of various combinations that would have been shown to people.

**Anna Kim:** Certainly, got it. That's exactly what I'm looking for. Thank you.

**James Gall:** Alright, I'm going to try to circle back to Kate's question about how the company's going to utilize this. We've mentioned a few things that maybe are IRP methodologies lined up with some of the customer sentiment. But I don't think there is anything specific yet how the company is going to use a survey in the IRPs at this time. But that doesn't mean that will not change prior to completing the IRP by the summertime. There's another comment. Go ahead.

**Scott Kinney:** Hey, James. This is Scott. So just one other thought I wanted to share. Recognizing that CETA only pertains to the State of Washington, but one of the focuses

of CETA is equity. I think this survey can help us and we need to spend some additional time internally at the company thinking about how we could utilize this information as we set our strategies and make our decisions going forward, bringing into consideration equity. Equity is a focus for our company, both as our customers, and also as our employees. I think we need to take additional time with regards to the information provided here and how we can inform our decisions going forward through the equity filter.

**James Gall:** I'm going to read off another question from Andrew Menzer. How could the survey data be used to support AIJA funding opportunities specifically, just as components, I don't know exactly what that question pertains to, so I will let it up to Avista. Please respond if you have any ideas on that answer. It's not a comforting response. Maybe I'll turn it back over to Andrew if you could provide us a little more context of your question.

**Andrew Menzer:** Hi. Can you guys hear me, OK?

**James Gall:** Yes.

**Andrew Menzer:** Great. I appreciate the opportunity to ask the question. With all of the IGA funding coming down the pipeline for greater resilience and a lot of the federal programming opportunities that are going to be forthcoming, I guess I'm just curious. Specifically, it sounds like a lot of these questions get at the equity question, which I think was just touched on. And so, I'm wondering if you can extrapolate some of the data, some metrics or some rubrics that would fit into these funding opportunities, especially for some of your disenfranchised populations in Idaho and in Washington.

**James Gall:** I think this survey gives us that opportunity to do that when that time arrives. Good point. Thank you. I don't know if anybody else has thoughts on that.

**Scott Kinney:** James, this is Scott. I'll comment a little bit on that. With the ability to acquire or get federal funding for some of our infrastructure needs going forward, that's an area that we're evaluating, and this is information that maybe we can use to help us in that assessment. Again, we're still trying to get our hands around what are those opportunities that we may have as a utility to receive some of those funds that may be available. But I think we'll take that comment into consideration as we continue to evaluate what opportunities we have.

**James Gall:** Any other questions for Avista or for Mary on the presentation? I think we have a couple options. We can either take a break and resume at 2:00 o'clock or we could start early if AEG is ready to go. Maybe, the first question is AEG ready to go?

**Tom Pardee:** I see Ken online. Ken, Are you ready for this?

**James Gall:** We have a recommendation for a break.

**Ken Walter:** I personally am. Yeah, I'm not sure who else we have. I think most of the rest of the AEG team was planning on getting here at 2, but I was really curious about the survey stuff. It's my other bread and butter.

**James Gall:** Alright, that sounds like we should break till 2 and we'll get started again. I think I would like to have another break when you think is appropriate during your gas presentation, but I think this concludes the electric portion of the TAC. Electric TAC members are welcome to stay through the gas TAC process. Again, if you're leaving, thank you for participating and we will have slides on our website as soon as possible along with the recording of the presentations. Alright, we'll see everybody at 2 o'clock.

**End Electric Portion of TAC**



*2023 Electric Integrated Resource Plan*  
**Technical Advisory Committee Meeting No. 5 Agenda**  
**Wednesday, September 7, 2022**  
**Microsoft Teams Virtual Meeting**

<b>Topic</b>	<b>Time</b>	<b>Staff</b>
Introductions	12:30	John Lyons
IRP Generation Option Transmission Planning Studies	12:40	Dean Spratt
Distribution System Planning within the IRP	1:45	Damon Fisher
Break		
Social Cost of Greenhouse Gas for Energy Efficiency (WA only)	3:00	James Gall
Avoided Cost Rate Methodology	3:15	Clint Kalich
Adjourn	4:00	



# 2023 IRP Introduction

2023 Avista Electric IRP

TAC 5 – September 7, 2022

John Lyons, Ph.D. Senior Resource Policy Analyst

# Meeting Guidelines

- IRP team is working remotely and is available for questions and comments
- Stakeholder feedback form
  - Responses shared with TAC at meetings, by email and in Appendix
  - Would a form and/or section on the web site be helpful?
- IRP data posted to web site – updated descriptions and navigation are in development
- Virtual IRP meetings on Microsoft Teams until able to hold large meetings again
- TAC presentations and meeting notes posted on IRP page
- This meeting is being recorded and an automated transcript made



# Virtual TAC Meeting Reminders

- Please mute mics unless commenting or asking a question
- Raise hand or use the chat box for questions or comments
- Respect the pause
- Please try not to speak over the presenter or a speaker
- Please state your name before commenting
- Public advisory meeting – comments will be documented and recorded

# Integrated Resource Planning

The Integrated Resource Plan (IRP):

- Required by Idaho and Washington\* every other year
  - Washington requires IRP every four years and update at two years
- Guides resource strategy over the next twenty + years
- Current and projected load & resource position
- Resource strategies under different future policies
  - Generation resource choices
  - Conservation / demand response
  - Transmission and distribution integration
  - Avoided costs
- Market and portfolio scenarios for uncertain future events and issues

# Technical Advisory Committee

- Public process of the IRP – input on what to study, how to study, and review of assumptions and results
- Wide range of participants involved in all or parts of the process
  - Please ask questions
  - Always soliciting new TAC members
- Open forum while balancing need to get through topics
- Welcome requests for new studies or different modeling assumptions.
- Available by email or phone for questions or comments between meetings
- Due date for study requests from TAC members – October 1, 2022
- External IRP draft released to TAC – March 17, 2023, public comments due – May 12, 2023
- Final 2023 IRP submission to Commissions and TAC – June 1, 2023

# Remaining 2023 IRP TAC Meeting Schedule

- TAC 5: September 7, 2022
- TAC 6: September 28, 2022, 12:30 – 4:00 pm
- Public Participation Partners opportunity to comment on Avista’s advisory groups
  - September 12, 2022, 11:00 am to 12:00 pm or September 13, 2022, 9:00 am to 10:00 am
- TAC 7: October 11, 2022, 9 am – 3:30 pm
- Technical Modeling Workshop: October 20, 2022
- Washington Progress Report Workshop: December 14, 2022
- TAC 8: February 16, 2023
- Public Meeting Gas & Electric IRPs: March 8, 2023
- TAC 9: March 22, 2023

# Today's Agenda

- 12:30 Introductions, John Lyons
- 12:40 IRP Generation Option Transmission Planning Studies, Dean Spratt
- 1:45 Distribution System Planning within the IRP, Damon Fisher
- Break
- 3:00 Social Cost of Greenhouse Gas for Energy Efficiency (WA Only), James Gall
- 3:15 Avoided Cost Rate Methodology, Clint Kalich
- 4:00 Adjourn



# Integrated Resource Plan (IRP) Transmission Planning Studies

Dean Spratt, Transmission Planning  
Technical Advisory Committee Meeting  
September 07, 2022

# FERC Standards of Conduct

## Summary of requirements

- Non-public transmission information can not be shared with Avista Merchant Function employees.
- There are Avista Merchant Function employees attending today.
- We will not be sharing any non-public transmission information. Avista's OASIS is where this information is made public.

# Agenda

- Introduction to Avista System Planning
  - Useful information about Transmission Planning
  - Overview of recent Avista projects
- Generation Interconnection Study Process
  - Integrated Resource Plan (IRP) Requests
  - Large Generation Interconnection Queue
  - Transition to Cluster Study Process



# Introduction to Avista System Planning

Avista's System Planning Group includes:

- Distribution Planning
- Transmission Planning
  - Focus on reliable electric service
    - Federal, regional, and state compliance
    - Regional system coordination
  - Provide transmission service and system analysis
    - Planned load growth and changing generation mix/dispatch
    - Interconnection of any type of generation or load
      - We are ambivalent about type (must perform though)

# Information About Transmission Planning

- Our focus is the Bulk Electric System (BES)
  - Avista's 115 kV and 230 kV facilities (>100 kV)
- We identify issues where Avista's BES won't reliably deliver power to our customers
- Then we develop plans to fix it
  - "Corrective Action Plans"
  - Mandated and described in NERC TPL-001-4
- We live in the world of NERC Mandatory Standards
  - Energy Policy Act of 2005

# NERC Standard TPL-001-4

- Describes outage conditions we must study
  - P0: everything online and working
  - P1: single facility outages, like a transformer
  - P2, P4, P5 & P7: multiple facility outages
  - P3 & P6: overlapping combination of two facilities

Standard TPL-001-4 — Transmission System Planning Performance Requirements

Table 1 – Steady State & Stability Performance Planning Events						
<b>Steady State &amp; Stability:</b>						
a. The System shall remain stable. Cascading and uncontrolled islanding shall not occur.						
b. Consequential Load Loss as well as generation loss is acceptable as a consequence of any event excluding P0.						
c. Simulate the removal of all elements that Protection Systems and other controls are expected to automatically disconnect for each event.						
d. Simulate Normal Clearing unless otherwise specified.						
e. Planned System adjustments such as Transmission configuration changes and re-dispatch of generation are allowed if such adjustments are executable within the time duration applicable to the Facility Ratings.						
<b>Steady State Only:</b>						
f. Applicable Facility Ratings shall not be exceeded.						
g. System steady state voltages and post-Contingency voltage deviations shall be within acceptable limits as established by the Planning Coordinator and the Transmission Planner.						
h. Planning event P0 is applicable to steady state only.						
i. The response of voltage sensitive Load that is disconnected from the System by end-user equipment associated with an event shall not be used to meet steady state performance requirements.						
<b>Stability Only:</b>						
j. Transient voltage response shall be within acceptable limits established by the Planning Coordinator and the Transmission Planner.						
Category	Initial Condition	Event <sup>1</sup>	Fault Type <sup>2</sup>	BES Level <sup>3</sup>	Interruption of Firm Transmission Service Allowed <sup>4</sup>	Non-Consequential Load Loss Allowed
<b>P0</b> No Contingency	Normal System	None	N/A	EHV, HV	No	No
<b>P1</b> Single Contingency	Normal System	Loss of one of the following: 1. Generator 2. Transmission Circuit 3. Transformer <sup>5</sup> 4. Shunt Device <sup>6</sup>	3Ø	EHV, HV	No <sup>8</sup>	No <sup>12</sup>
		5. Single Pole of a DC line	SLG			
<b>P2</b> Single Contingency	Normal System	1. Opening of a line section w/o a fault <sup>7</sup>	N/A	EHV, HV	No <sup>8</sup>	No <sup>12</sup>
		2. Bus Section Fault	SLG	EHV HV	No <sup>8</sup> Yes	No Yes
		3. Internal Breaker Fault <sup>8</sup> (non-Bus-tie Breaker)	SLG	EHV HV	No <sup>8</sup> Yes	No Yes
		4. Internal Breaker Fault (Bus-tie Breaker) <sup>8</sup>	SLG	EHV, HV	Yes	Yes

Standard TPL-001-4 — Transmission System Planning Performance Requirements

Category	Initial Condition	Event <sup>1</sup>	Fault Type <sup>2</sup>	BES Level <sup>3</sup>	Interruption of Firm Transmission Service Allowed <sup>4</sup>
<b>P3</b> Multiple Contingency	Loss of generator unit followed by System adjustments <sup>9</sup>	Loss of one of the following: 1. Generator 2. Transmission Circuit 3. Transformer <sup>5</sup> 4. Shunt Device <sup>6</sup>	3Ø	EHV, HV	No <sup>8</sup>
		5. Single pole of a DC line	SLG		
<b>P4</b> Multiple Contingency (Fault plus stuck breaker <sup>10</sup> )	Normal System	Loss of multiple elements caused by a stuck breaker <sup>10</sup> (non-Bus-tie Breaker) attempting to clear a Fault on one of the following: 1. Generator 2. Transmission Circuit 3. Transformer <sup>5</sup> 4. Shunt Device <sup>6</sup>	SLG	EHV	No <sup>8</sup>
		6. Loss of multiple elements caused by a stuck breaker <sup>10</sup> (Bus-tie Breaker) attempting to clear a Fault on the associated bus	SLG	HV	Yes
<b>P5</b> Multiple Contingency (Fault plus relay failure to operate)	Normal System	Delayed Fault Clearing due to the failure of a non-redundant relay <sup>11</sup> protecting the Faulted element to operate as designed, for one of the following: 1. Generator 2. Transmission Circuit 3. Transformer <sup>5</sup> 4. Shunt Device <sup>6</sup> 5. Bus Section	SLG	EHV, HV	Yes
		6. Loss of multiple elements caused by a stuck breaker <sup>10</sup> (Bus-tie Breaker) attempting to clear a Fault on the associated bus	SLG	EHV	No <sup>8</sup>
<b>P6</b> Multiple Contingency (Two overlapping singles)	Loss of one of the following followed by System adjustments <sup>9</sup> 1. Transmission Circuit 2. Transformer <sup>5</sup> 3. Shunt Device <sup>6</sup>	Loss of one of the following: 1. Transmission Circuit 2. Transformer <sup>5</sup> 3. Shunt Device <sup>6</sup>	3Ø	EHV, HV	Yes
		4. Single pole of a DC line	SLG		



## TPL-001-4, cont.

- A couple of NERC directives for the above faults
  - “The System shall remain stable”
    - Cascading and uncontrolled islanding shall not occur
  - “Applicable Facility Ratings shall not be exceeded”
    - Equipment ratings, voltage, fault duty, etc
  - “An objective of the planning process is to minimize the likelihood and magnitude of Non-Consequential Load Loss following planning events”

# Two Approaches to Reliability Issues

- Transmission Operations (TO) are guided by significantly different standards than Transmission Planning (TP).
- TO standards provide *flexibility* that TP standards do not allow
  - Operators can push system limits to **SAVE** the interconnected system
    - Shed load, overload equipment, etc – all short term
    - The planned system should give them the tools to do this
    - The standards continue to define this balance

# Standards are a Roadmap

- **Western Systems Coordinating Council (WSCC)**
  - Ensure that disturbances in one system do not spread to other systems.
    - Operating agreement with 40 electric power systems established in 1967
- **Western Electricity Coordinating Council (WECC)**
  - Responsible for coordinating and promoting electric system reliability established in 2002
- **North American Electric Reliability Council (NERC)**
  - Ensure the reliability of the North American bulk power system reformed in 2006; Corporation in 2007
    - Established as a voluntary organization in 1968

# Recent Transmission Projects

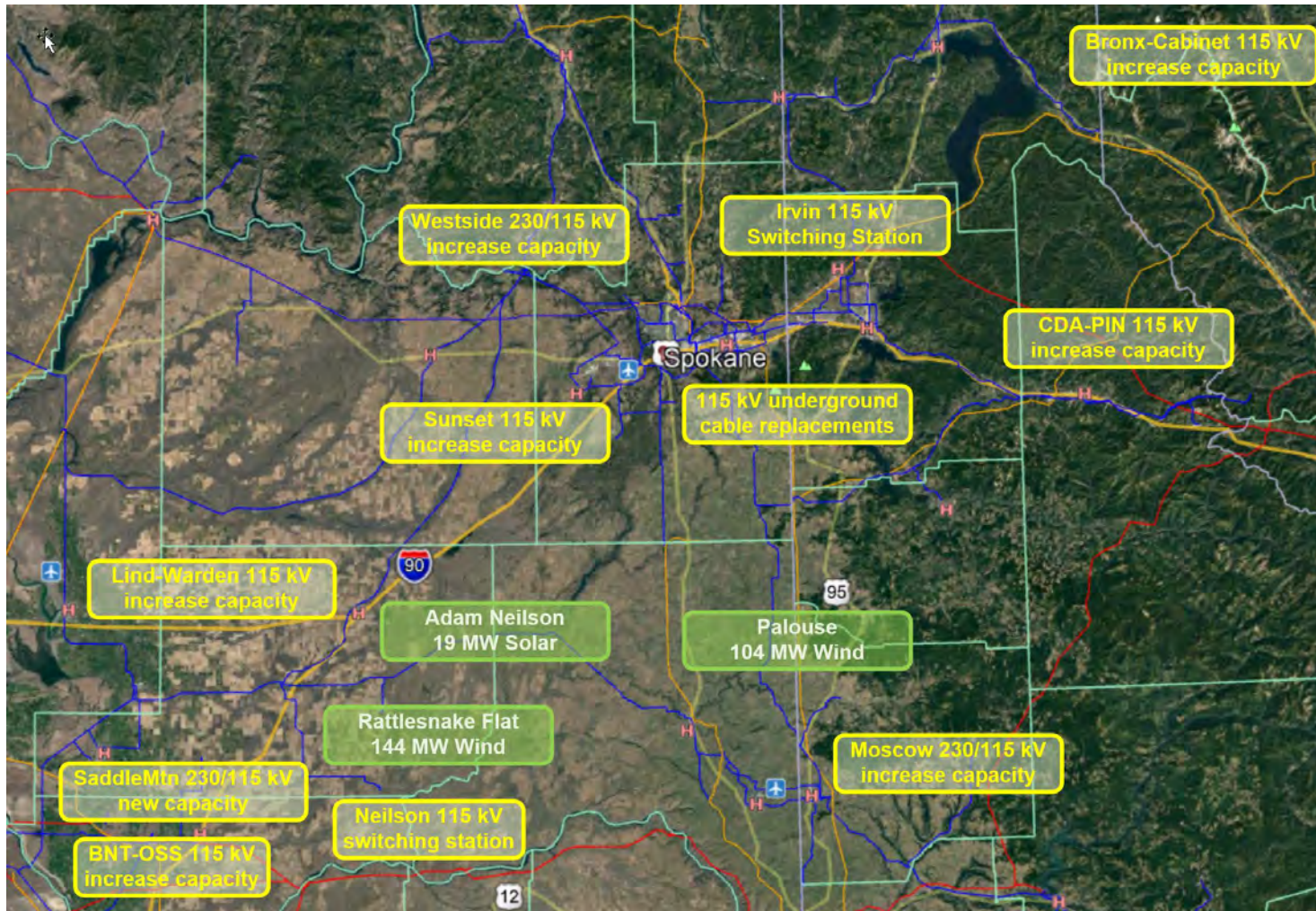

# Non-Wire Alternatives are Considered

- We are documenting this with more clarity
- Non-wire options require robust wires to perform
  - Avista is working on the transmission fundamentals

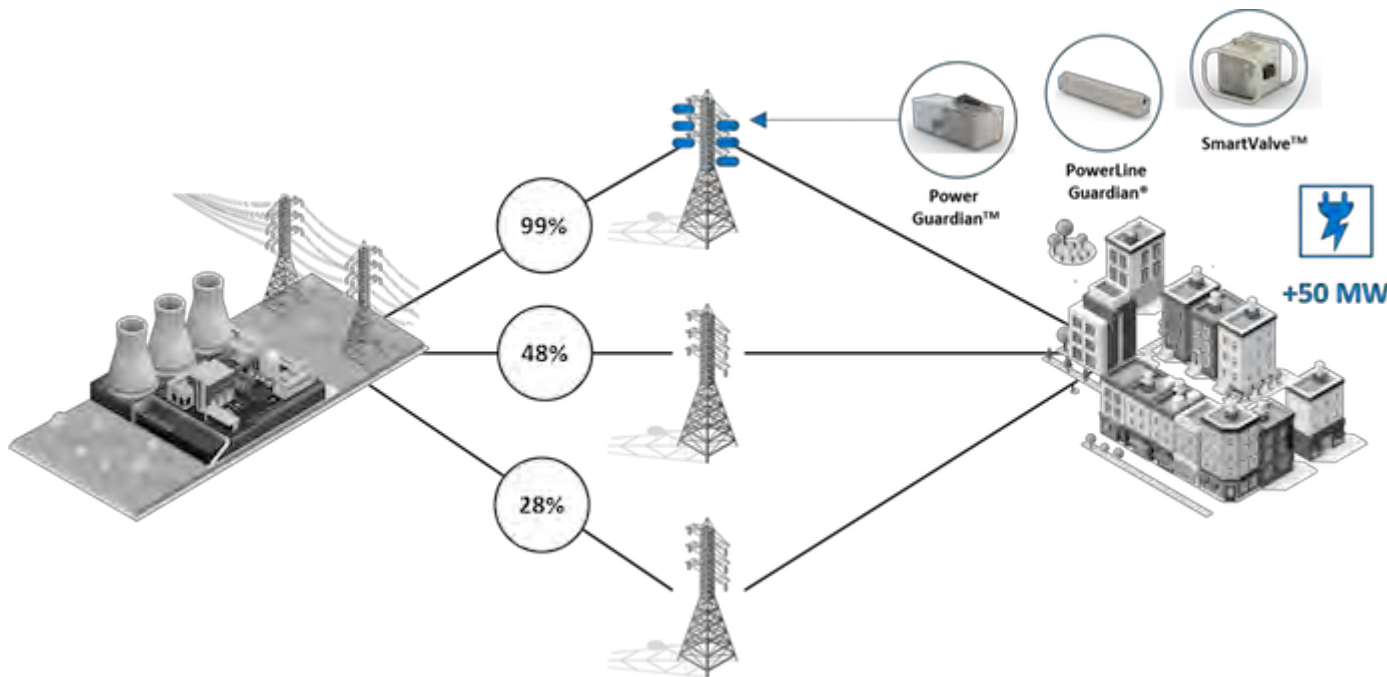



# Evaluated Batteries for T-1-1

- TPL-001-4 ~ T-1-1 for long lead equipment
  - Double transformer outages
    - Shawnee 230/115 kV outage followed by a concurrent outage of Moscow 230/115 kV transformer.
  - Could we mitigate performance issues with storage?
    - Yes...but... We would need a 125 MW battery
      - Typical charge is 8 hours, discharge for 12 to 16 hours
      - Transformer outage is weeks to months
    - A third transformer is a better solution
      - Robust performance and much less \$\$\$\$

Requisitions: Requisitions >  
Requisition 162964

Description	M08 - Westide 250/280MVA, 230-115-13.8kV, three phase auto transformer.	Status	<a href="#">Approved</a>
Created By	Wilson, Barnes Scott (Scott)	Change History	No
Creation Date	12/06/2017 12:49:35	Urgent Requisition	No
Deliver-To	One Time Ship To	Attachment	<a href="#">View</a>
Justification	This is the second transformer associated with the Westside Substation rebuild.	Note to Buyer	Quote attached. Bid evaluation sheet pre Shelly Campbell.

**Details**

Line	Description	Need-By	Deliver-To	Unit	Quantity	Qty Delivered	Qty Cancelled	Open Quantity	Price	Amount (USD)
1	250/280MVA, 230-115-13.8kV, three phase auto transformer.	10/03/2018 12:51:34	One Time Ship To	Each	1	1	0	0	2397826 USD	2,397,826.00
2	SFRA Testing at factory and field	10/03/2018 12:51:34	One Time Ship To	Each	1	1	0	0	5400 USD	5,400.00
<b>Total</b>										<b>2,403,226.00</b>

# Generation Interconnection Study Process

## Process for Generation Requests

- Two sources:
  - External developers
    - Enter via the OATT
  - Internal IRP requests
    - Feasibility Light Study...then OATT
      - AVA Merchant MUST follow the OATT just like external parties
- Typical process:
  - Hold a scoping meeting to discuss particulars
  - Outline a study plan
  - Augment WECC approved cases for our studies
  - Analyze the system against the standards
  - Publish our findings and recommendations

# Transition - Serial to Cluster Study Process

## Challenges with Serial Interconnections

- Large serial queues become difficult to process efficiently
- Interdependency of projects becomes complicated
  - Studying single projects is inefficient compared to studying projects in a group
  - Projects that do not reach commercial operation may cause re-studies
  - System Upgrade allocation
- The serial process is difficult for the developers and the utility

# Serial Process was Complex and Slow

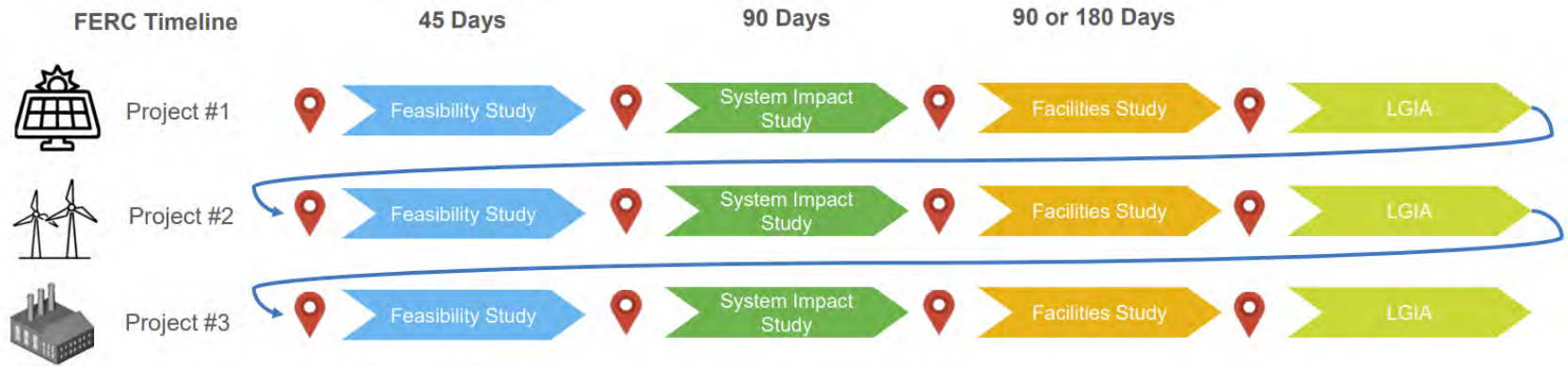

Interconnection Requests necessitated a better Process

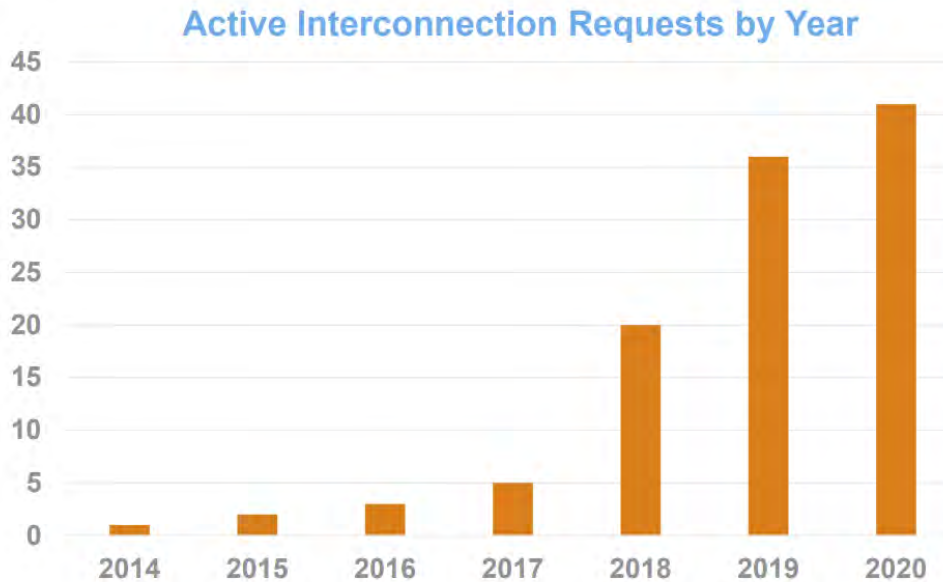

# Two-Phase Cluster Study Process

## Benefits and Objectives

- Create a more efficient process
- Design a process with definitive timelines that can be consistently met
- Allocate System Upgrades proportionally
- Ensure commercially viable projects have a clear path for development
- Alleviate the backlog in the queue



# Current Interconnection Queue

Serial or Cluster Number	Project Name	Former Queue Number	Max MW Output	Type	County	State
LGIA	Saddle Mountain	46	126	Wind	Adams	WA
LGIA	Taunton	52	100	Solar	Adams	WA
LGIA	Asotin	60	150	Solar	Asotin	WA
LGIA	Kettle Falls	66	71	Wood Burner/ CT	Stevens	WA
Senior	Aurora	59	116	Solar/Storage	Adams	WA
Senior	Post Falls	63	26	Hydro	Kootenai	ID
Senior	Elf II	79	2.1	Solar	Spokane	WA
Senior	Elf I	80	19	Solar	Spokane	WA
Senior	Acadia	84	5	Solar	Stevens	WA
Senior	Lolo Solar	97	100	Solar/Storage	Nez Perce	ID
TCS-02	Rattlesnake II	62	123.2	Wind	Adams	WA
TCS-03	Old Milwaukee	67	80	Solar/Storage	Adams	WA
TCS-04	Sprague	73	94	Solar/Storage	Adams	WA
TCS-05	Royal City	76	114.12	Solar	Grant	WA
TCS-06	Ralston	81	94	Solar/Storage	Adams	WA
TCS-07	Rainier	85	5	Solar	Adams	WA
TCS-08	Wahatis	99	200	Solar/Storage	Franklin	WA
TCS-09	Stringtown	100	100	Solar/Storage	Spokane	WA
TCS-10	Harrington	103	40	Solar	Lincoln	WA
TCS-11	Latah	104	120	Wind	Spokane	WA
TCS-12	Orin	105	5	Solar	Stevens	WA
TCS-14	Cloudwalker	110	375	Wind/Solar/Storage	Garfield	WA
TCS-16	Daydreamer	112	125	Solar/Storage	Lincoln	WA
TCS-18	Dry Falls	119	200	Solar/Storage	Grant	WA

# Transmission Integration Cost Estimates

POI Station or Area	Requested (MW)	POI Voltage	Cost Estimate (\$ million)
Big Bend area near Lind (Tokio)	100/200	230kV	138.2
Big Bend area near Odessa	100	230kV	167.1
Big Bend area near Odessa	200/300	230kV	168.0
Big Bend area near Othello	100/200	230kV	222.2
Big Bend area near Othello	300	230kV	262.4
Big Bend area near Reardan	50	230kV	9.7
Big Bend area near Reardan	100	230kV	10.3
Clarkston/Lewiston area	100/200/300	230kV	1.9
Kettle Falls substation, existing POI	12/50	115kV	1.8
Kettle Falls substation, existing POI	100	115kV	24.9
Lower Granite area	100/200/300	230kV	2.9
Northeast substation, existing POI	10	115kV	1.6
Northeast substation, existing POI	100	115kV	6.7
Palouse area, near Benewah (Tekoa)	100/200	230kV	2.4
Rathdrum substation, existing POI	25/50	115kV	11.5
Rathdrum substation, existing POI	100	230kV	16.7
Rathdrum substation, existing POI	200	230kV	27.0
Rathdrum Prairie, north Greensferry Rd	100	230kV	32.7
Rathdrum Prairie, north Greensferry Rd	200	230kV	43.0
Rathdrum Prairie, north Greensferry Rd	300	230kV	54.4
Rathdrum Prairie, north Greensferry Rd	400	230kV	91.5
Thornton substation, existing POI	10/50	230kV	1.9
West Plains area north of Airway Heights	100	115kV	2.4
West Plains area north of Airway Heights	200/300	115kV	4.7

*Assume anti-islanding scheme is in place, but no remedial Action Scheme (RAS)*

# Reardan: 100 MW

Choice of interconnection point may result in extensive system reinforcements

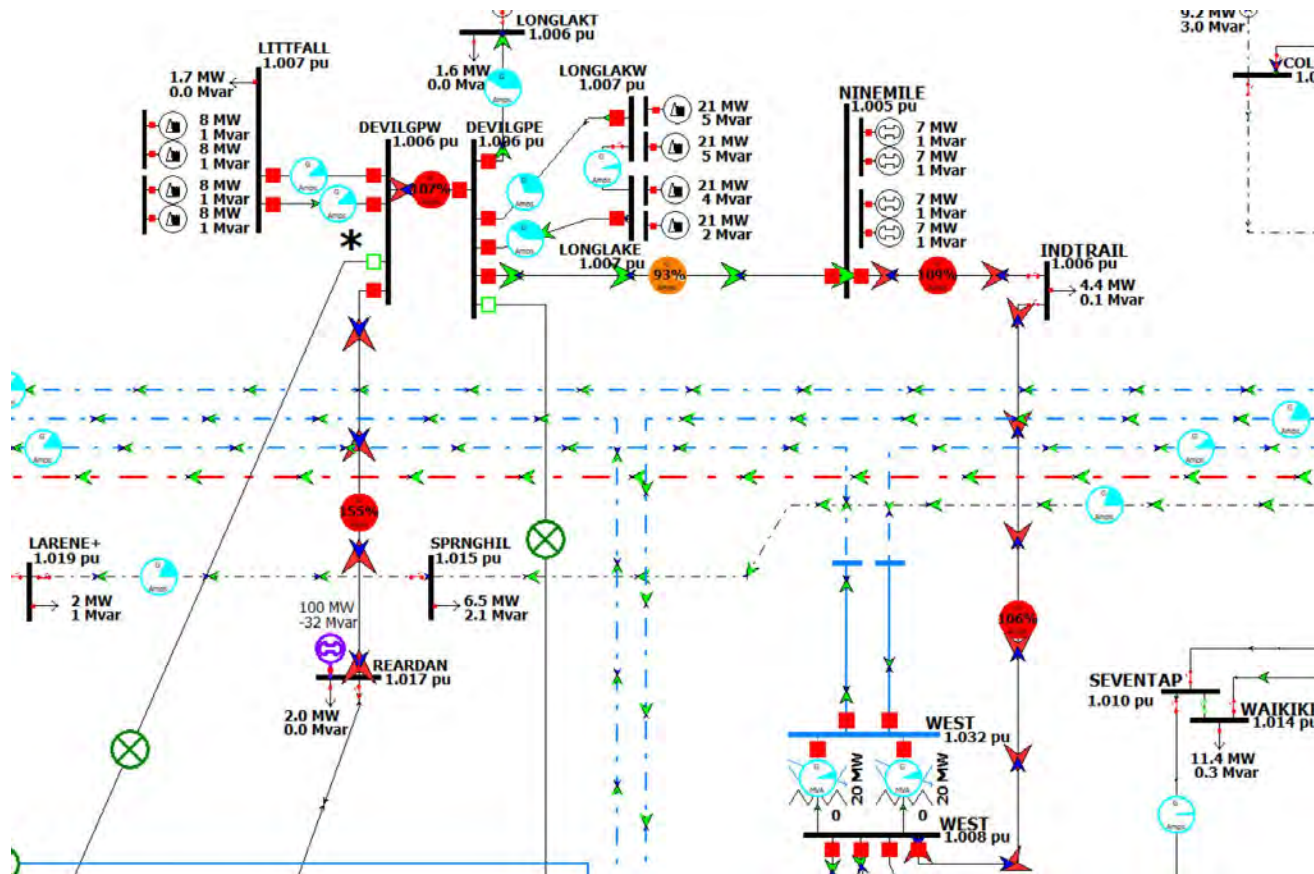







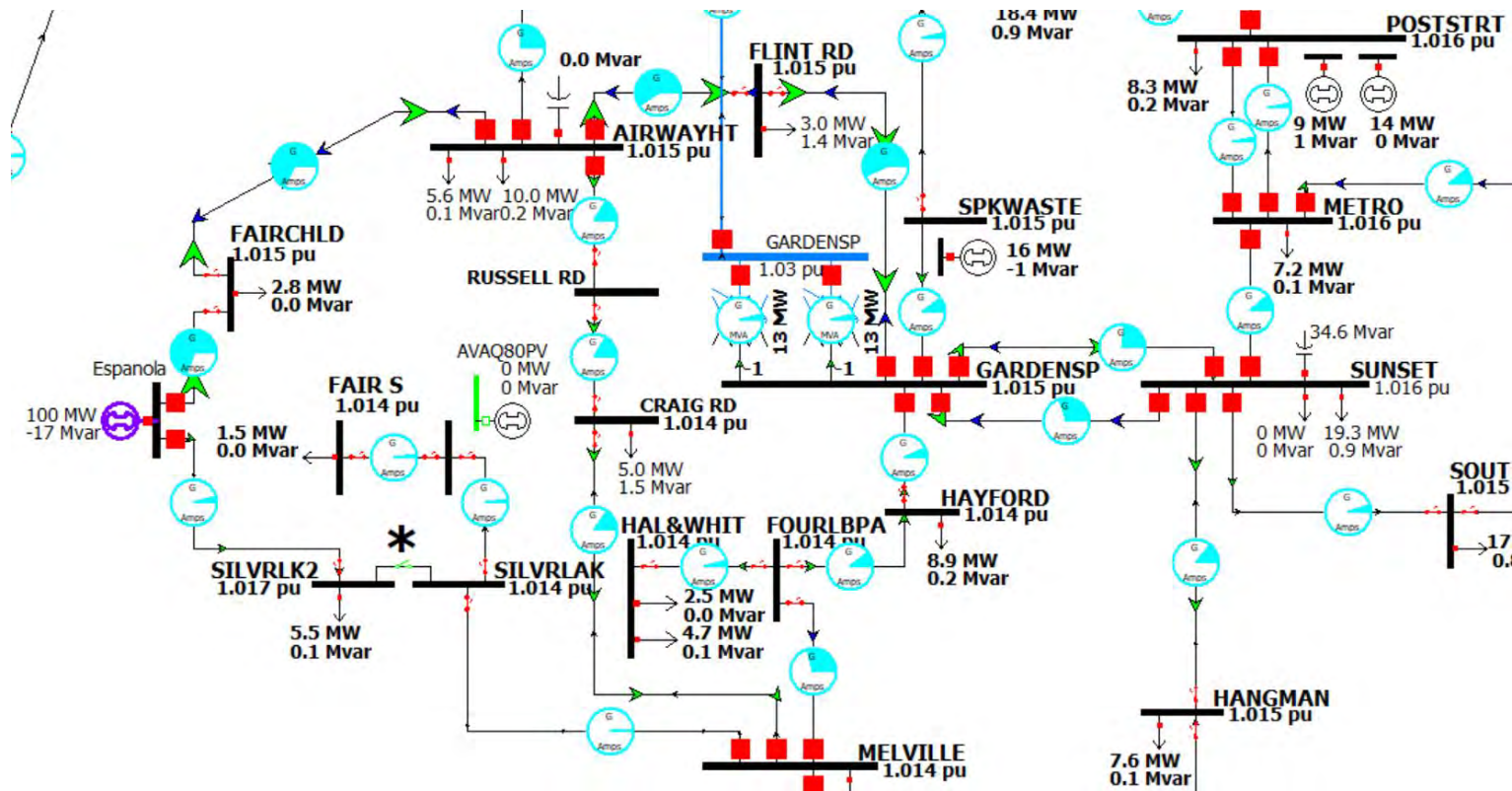











# Espanola: 100 MW

Optimizing the interconnection point is a key benefit of the Cluster Study process



# Questions?

**Refer to Avista's OASIS link for information regarding System Planning and the Interconnection Process:**  
**<http://www.oasis.oati.com/avat/index.html>**

  Generation Interconnection
  Generation Interconnection Queue Reform
  Application Documents
  Draft Tariff
  Phase One Reports
  Stakeholder Meeting Presentations
  TCS Queue, Plan, Map and Base Cases
  FERC Filing



# Distribution Resource Planning

Damon Fisher, System Planning  
Fifth Technical Advisory Committee Meeting  
September 7, 2022

# Goals of Electric Distribution Planning

- Ensure electric distribution infrastructure to serve customers now and in the future with a focus on:
  - Safety
  - Reliability
  - Capacity
  - Efficiency
  - Level of service
  - Operational flexibility
  - Corporate/Regulatory goals
  - Affordability



# Primary Goal of Distribution Resource Plan

- Where possible, solve distribution grid deficiencies using distributed energy resources (DER) that also contribute to system resource needs as identified in the Integrated Resource Plan.

# Can IRP resource needs and distribution “fixes” be aligned? Certainly.

- Not without challenges.
  - Temporal need
  - Grid operation and flexibility
  - Resource adequacy- a new distribution definition?
  - System Protection

# Typical Distribution System Deficiencies

- Low Voltage
- Capacity (Substation/Feeder)
- Asset Condition
- Contingency Switching Limits

# What are DER's? – Distribution's Perspective

- Anything that can reduce demand or support voltage

## **Real**

Targeted Energy Efficiency

Targeted Demand Response

## **Apparent**

Storage (Load shifting)

Generation (Load service)



# System Resources vs. Feeder Demand

System loads at various levels

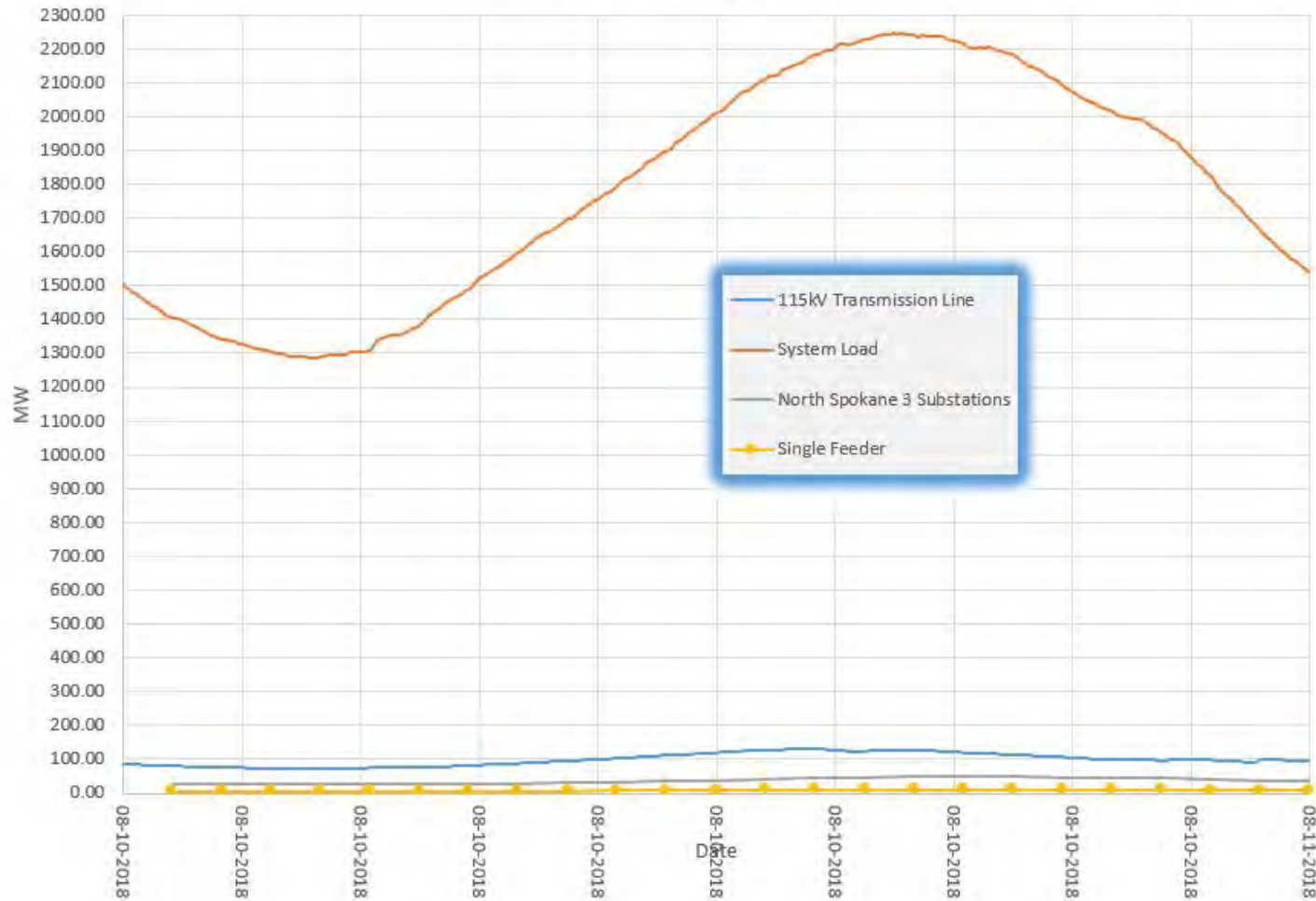

# System Resources vs. Feeder Demand

System loads at various levels

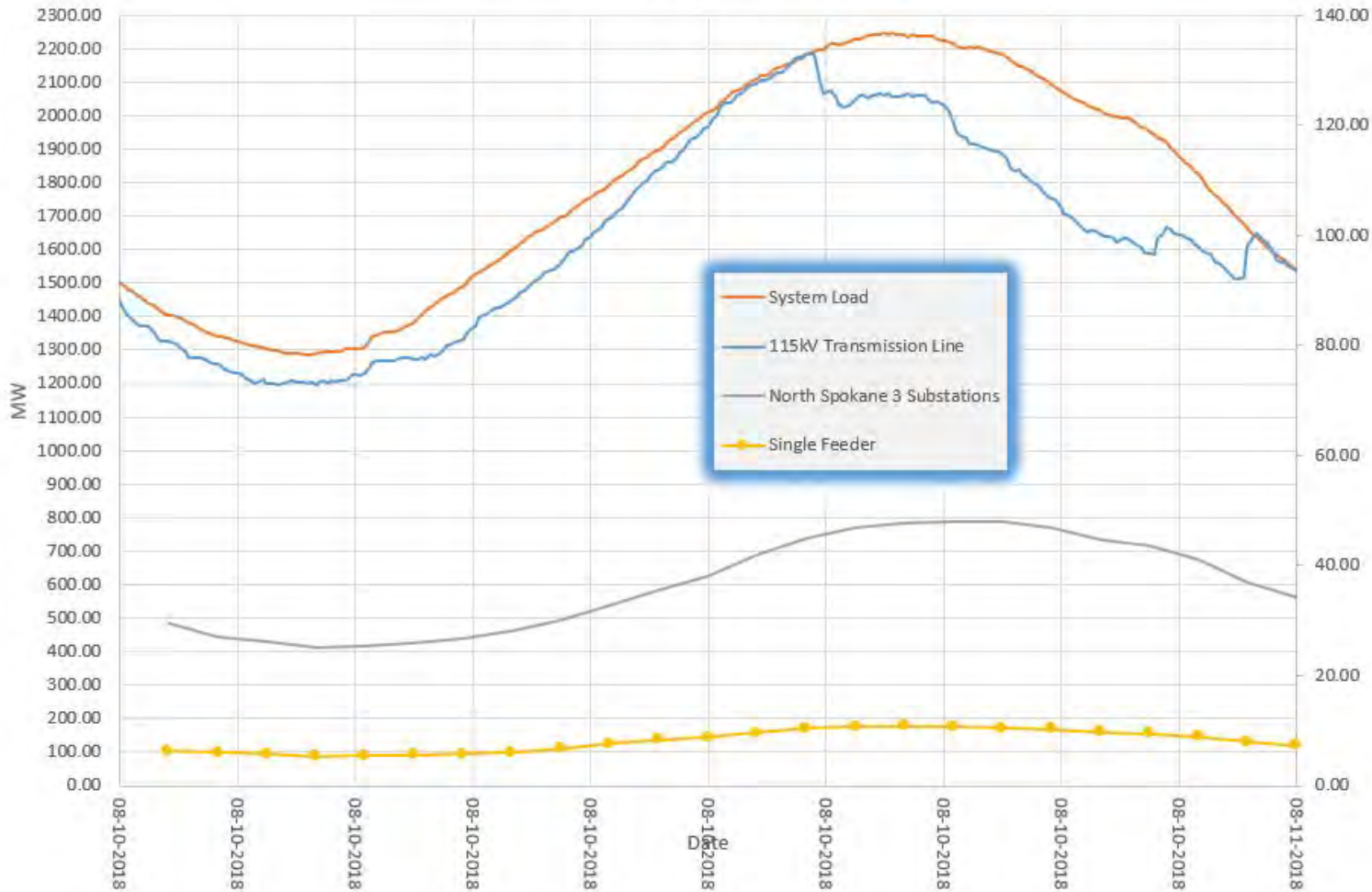

# It Is All About Curves

- The ideal curve-

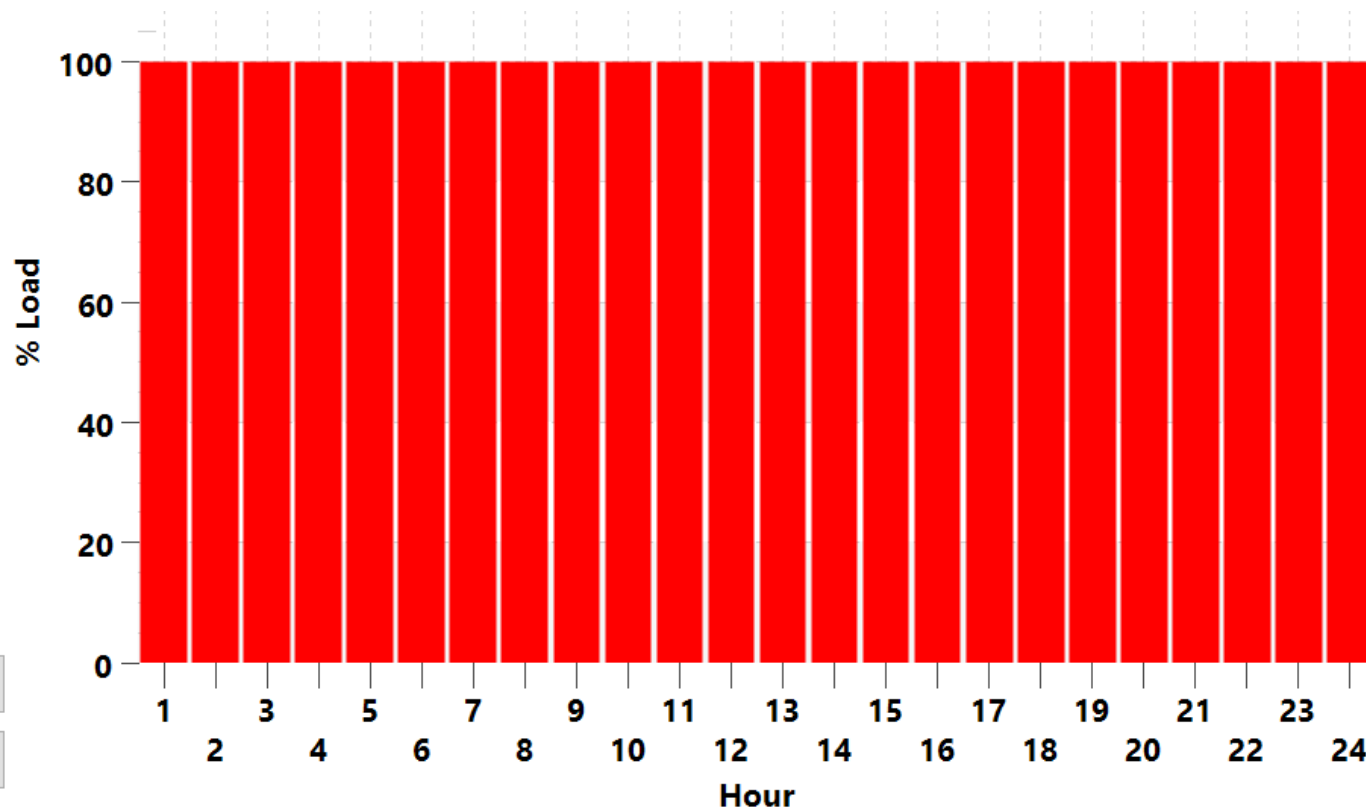

# It is all about curves

- A real curve (not ideal)-

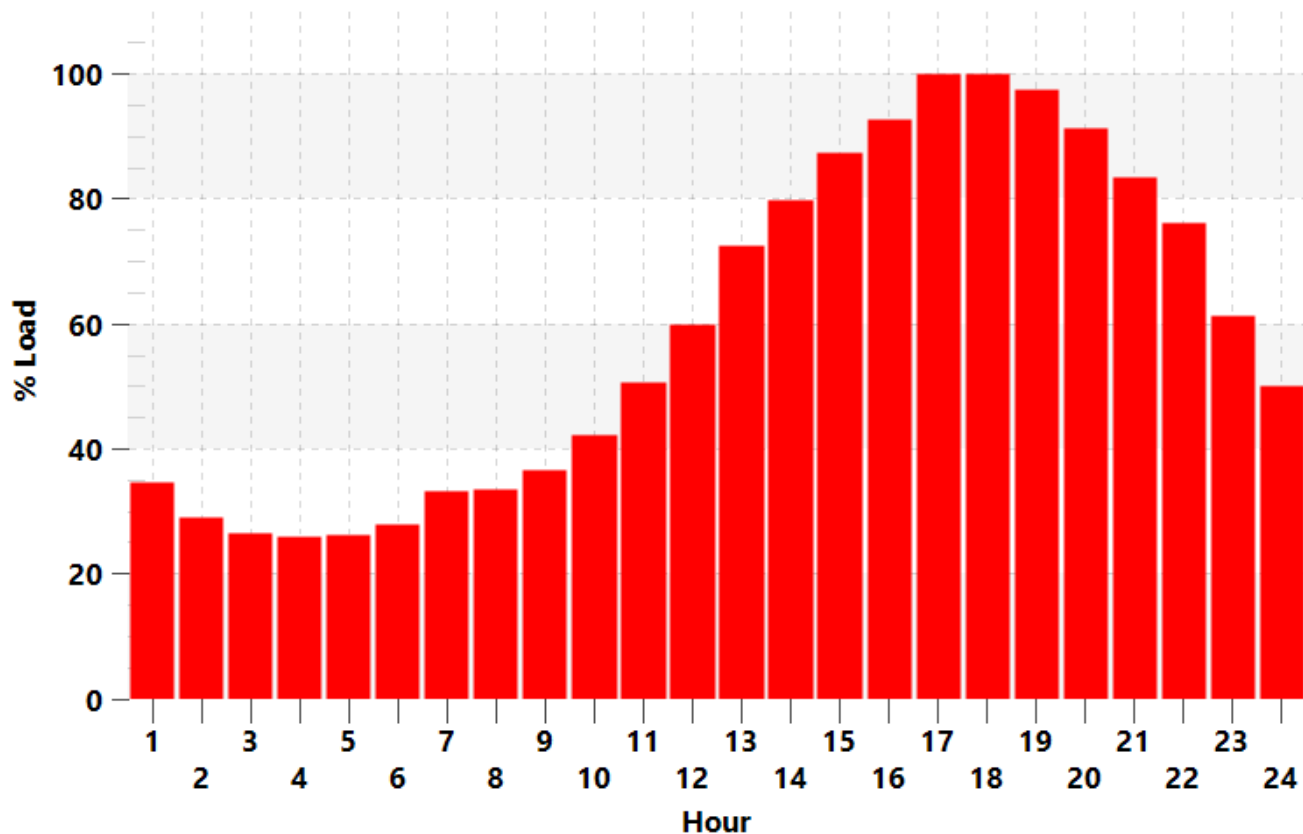

# Can We Fix Curves with PV? Community Solar – Summer

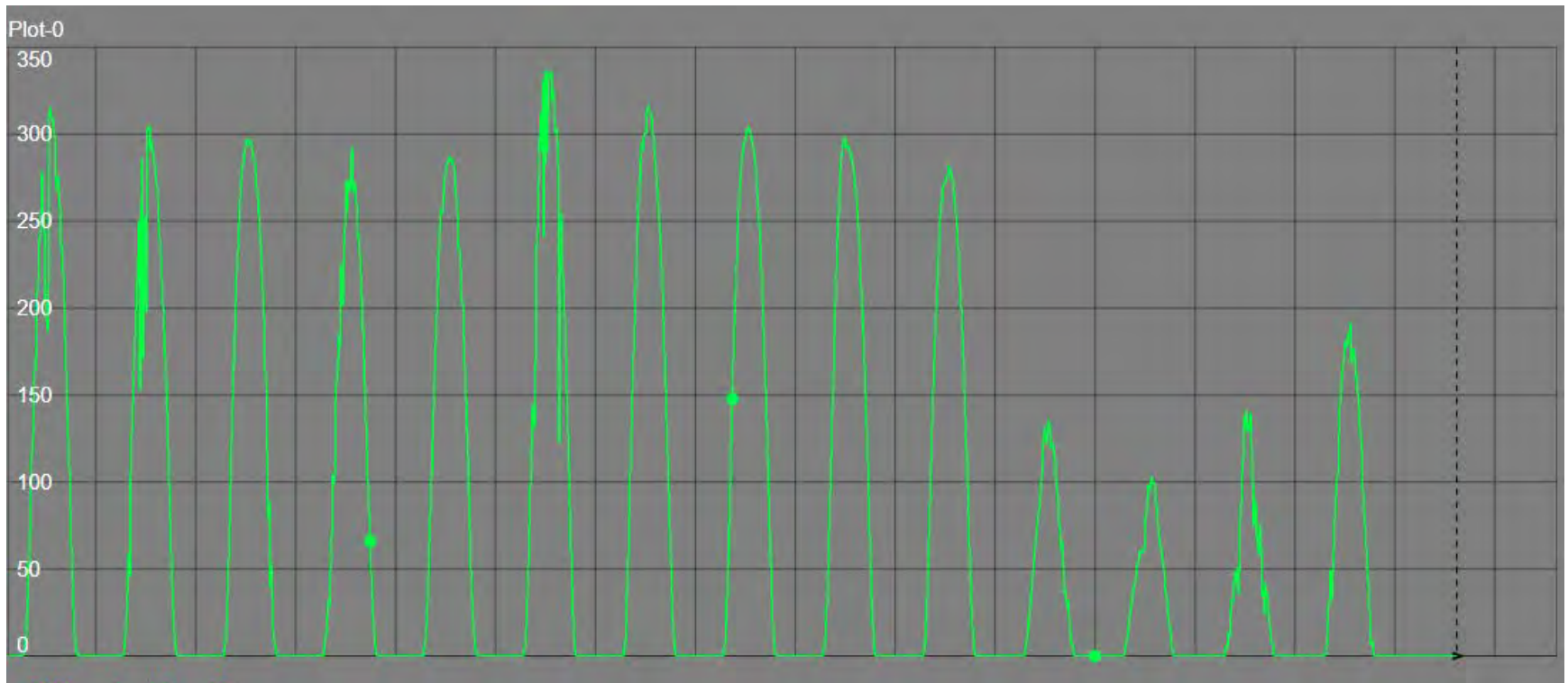

# Can We Fix Curves with PV? Community Solar – Winter

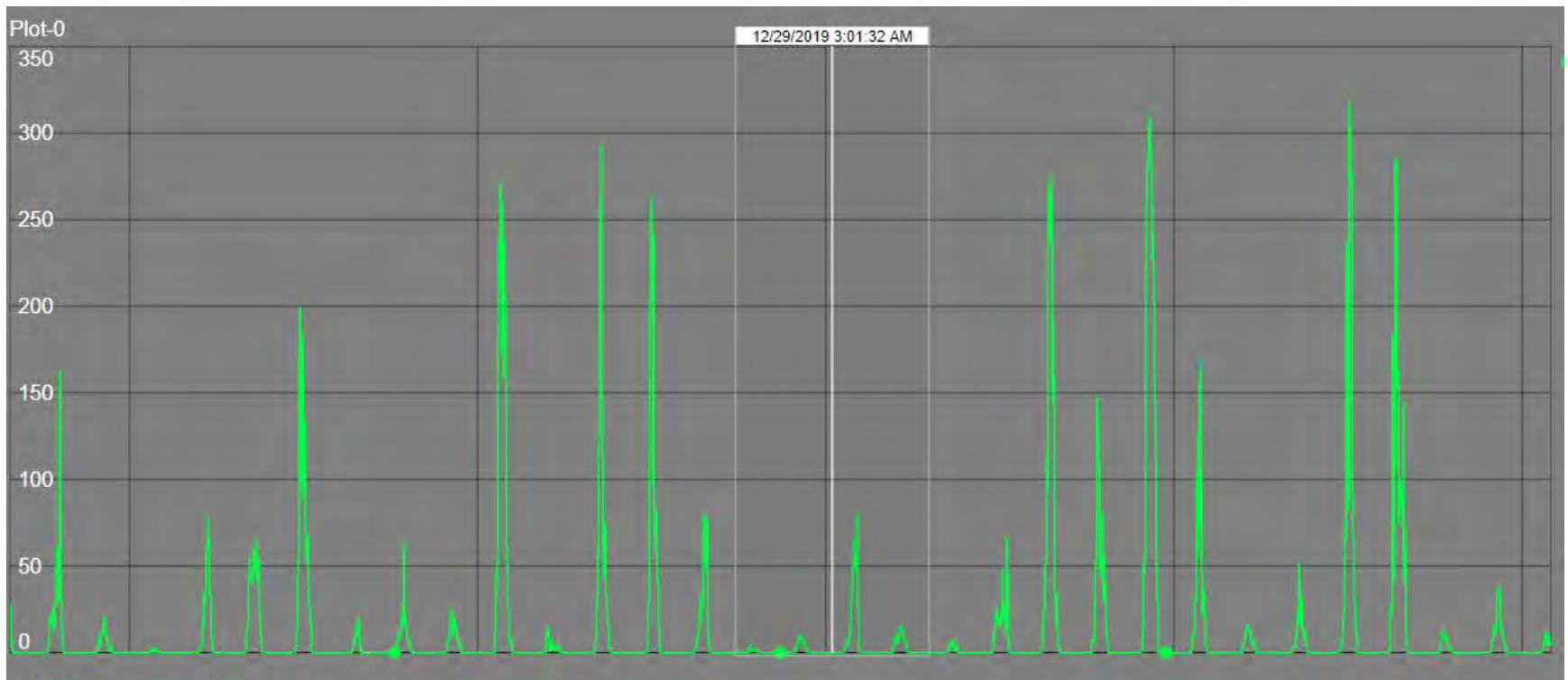

# Can We Fix Curves with Just PV? Community Solar – Cloudy Day, Battery

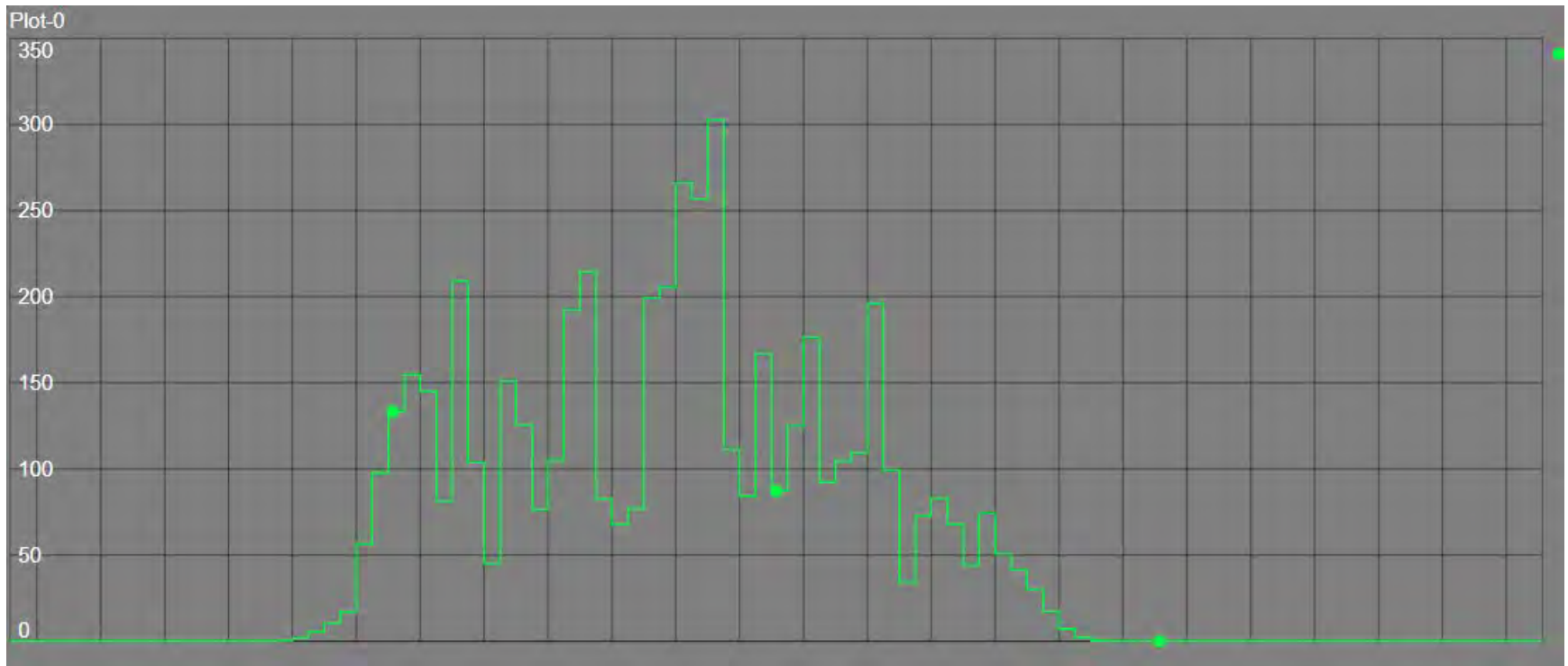

# DRP Implementation-

- Spatial Load Forecasting
- Spatial DER Forecasting (gap)
- System Performance Criteria
- DER Acquisition and Implementation Processes (in process)
- Engineering/Operational Expertise (in process)
- Time series analysis
- Hosting capacity maps (in process)
- Non-Wired and Wired Playbook (in process)



	Reliability					Safety		Capacity				Power Quality		
	Prevention (SAIFI)	Outages			Vulnerable Customer	Mitigate Wildfire	Short Circuit	Load Growth		Peak Support		8,760 Hours	Voltage	Flicker & Harmonics
		Shorten (SAIDI)	Shorten (CAIDI)	Reduce (CEMI3)				Transportation Electrification	Electrification (replace gas)	Summer	Winter			

**Non-Wires Alternatives**

Transmission Connected														
Remedial action schemes														
Dynamic line rating														
Series compensation														
Hydrogen fuel-cell														
Storage														
Short-duration (<=8hrs.) - lithium (NMC, LFP, LTO)														
Medium-duration (>8hrs.& <=72hrs.)														
Long-duration (>72hrs.)														
Distribution Connected														
Natural gas generation														
Distribution automation FDIB (FLISB)														
Resource aggregation - virtual power plant														
Automatic feeder reconfiguration (load shift)														
Load balancing														
Demand response														
Energy efficiency														
Remedial action schemes														
Wind														
Solar														
Hydrogen fuel-cell														
Storage														
Short-duration (<=8hrs.) - lithium (NMC, LFP, LTO)														
Medium-duration (>8hrs.& <=72hrs.)														
Long-duration (>72hrs.)														
Portable storage														
Immediate response storage (e.g., fly-wheel)														
Behind the Meter														
Wind														
Solar														
Natural gas generator														
Demand response														
Hydrogen fuel-cell														
Storage														
Short-duration (<=8hrs.) - lithium (NMC, LFP, LTO)														
Medium-duration (>8hrs.& <=72hrs.)														
Long-duration (>72hrs.)														
Microgrid														
Eco-district														
Fossil generation														
Renewable generation														
Stand-alone Storage														
Fossil generation w/ storage														
Renewable generation w/ storage														

DRAFT



# Generation Integration Costs

- 5MW – assuming dedicated feeder bay and SCADA comms required - \$975,000 to \$1,350,000
- 1MW – assuming a feeder tap, viper, and SCADA comms required - \$170,000 to \$254,000
- 500kW - assuming tap the feeder with some upgrades - \$24,000 to \$36,000
- 100kW - assuming tap the feeder, not a net-metered project - \$8,000 to \$12,000

# Questions?





# Social Cost of Greenhouse Gas for Energy Efficiency (Washington State Methodology)

James Gall, Integrated Resource Planning Manager  
Electric IRP, Fifth Technical Advisory Committee Meeting  
September 7, 2022

# Requesting TAC Input

- Avista must include the Social Cost of GHG for Energy Efficiency selected
  - Per Clean Energy Transformation Act (CETA) for Washington customers.
- There are three proposed options to incorporate the non-energy impact into resource planning.
- Levelized SCGHG is estimated at \$125.84 per metric ton.
  - Awaiting WUTC's official pricing.

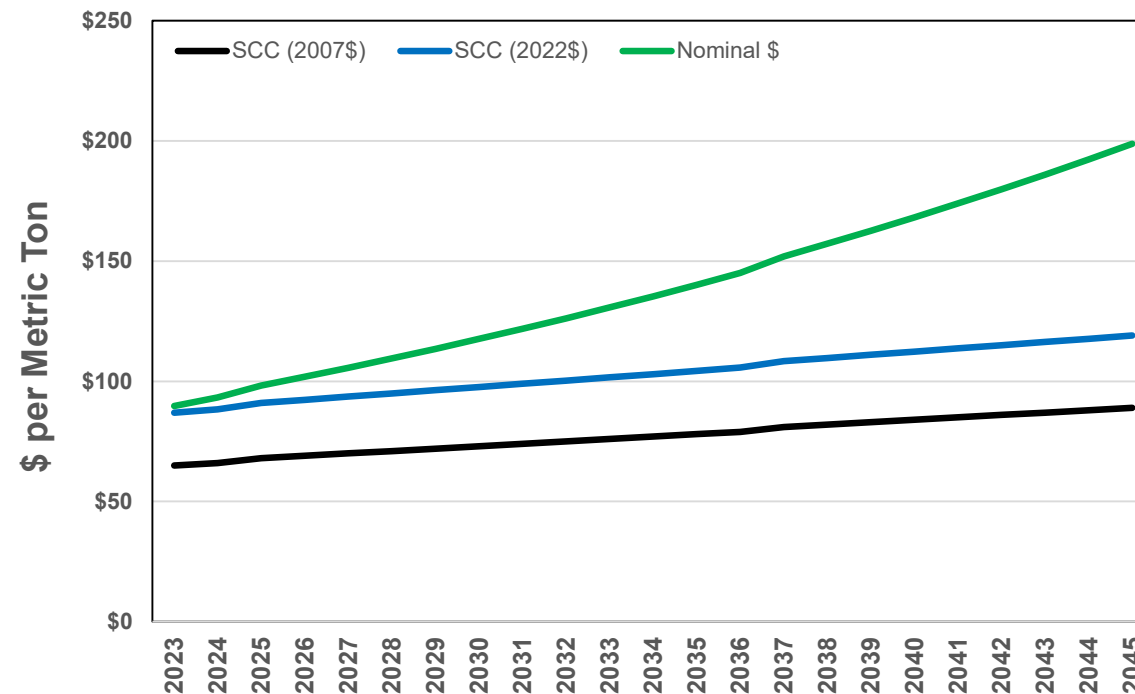

# Methods Studied in the 2021 IRP

## 1) Incremental Method

- Uses regional GHG incremental emissions rate for the Northwest

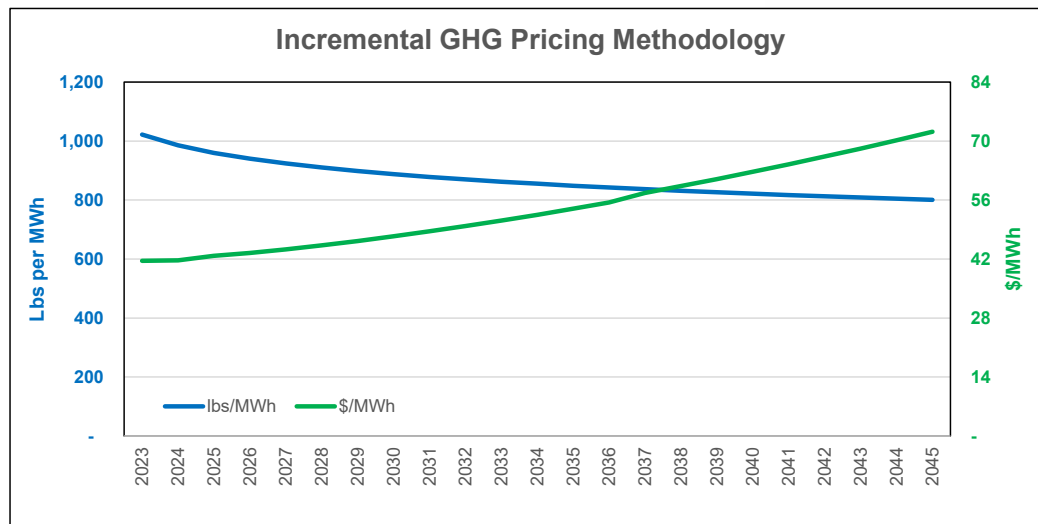

- Each MWh of energy efficiency receives a credit toward avoided cost for savings priced at the SCGHG.
- Results in \$50.32/MWh credit

## 2) Average Method

- Uses regional GHG average emissions rate for the Northwest

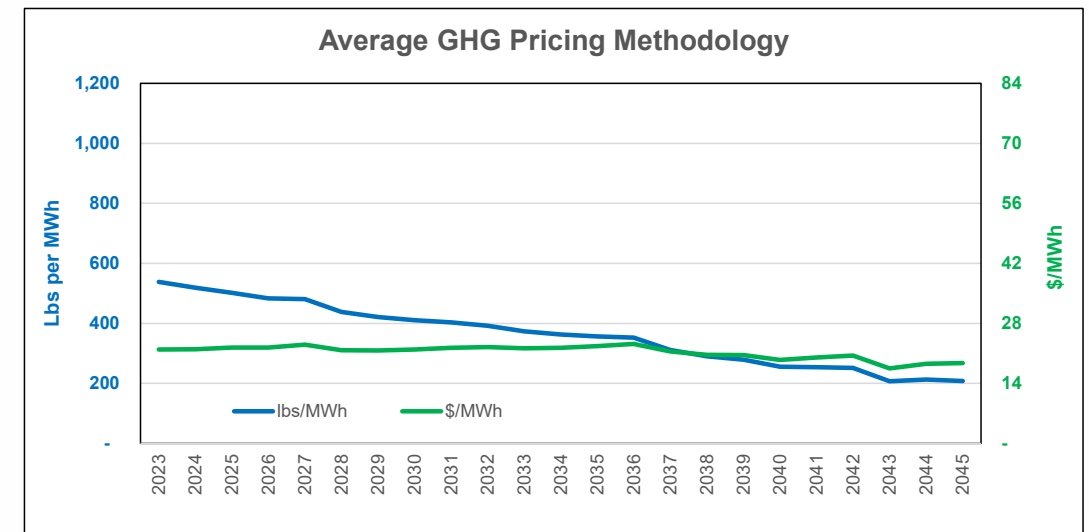

- Each MWh of energy efficiency receives a credit toward avoided cost for savings priced at the SCGHG.
- Results in \$21.70/MWh credit

### 3) Wholesale Price Method

- Apply SCGHG to all resources in the dispatch within Aurora model.
- Creates new wholesale price forecast for energy efficiency avoided cost.
- Caution: some wholesale price forecasts with SCGHG have an overbuild of renewables creating lower wholesale marginal prices.

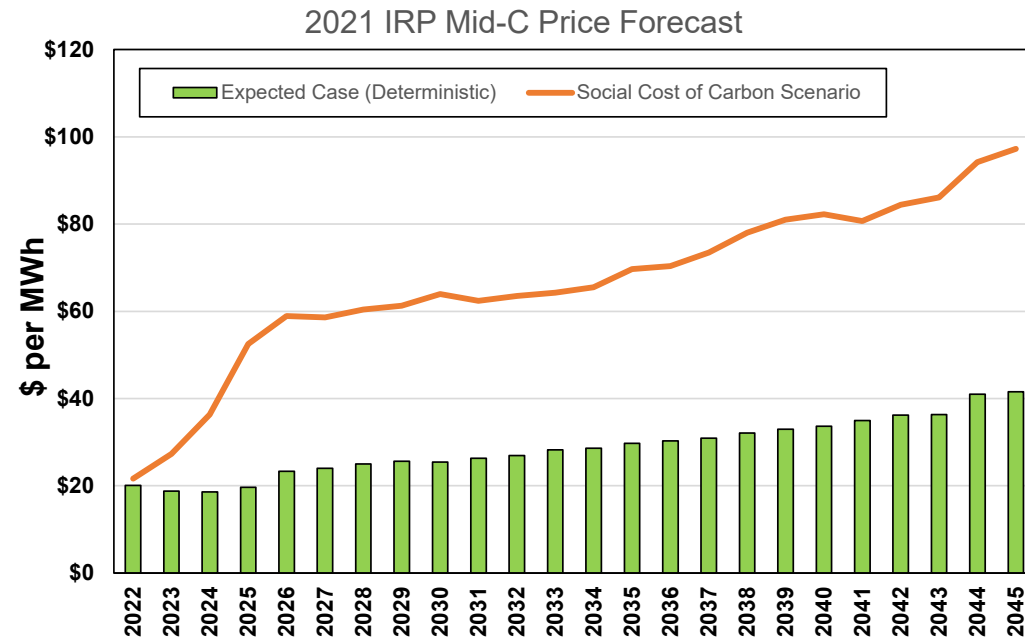

# Results from 2021 Electric IRP

## Washington only savings (GWh)

<b>GWh Savings</b>	<b>Incremental Method</b>	<b>Average Method</b>	<b>Wholesale Price Method</b>	<b>No SCGHG</b>
10-year savings	507.8	452.4	506.6	370.8
20-year savings	772.4	671.5	769.4	557.9



# Options for 2023 IRP

- Incremental Method
  - SCGHG adder will be reduced to account for CCA price already included in dispatch.
- Average Method
  - SCGHG adder will be reduced to account for CCA price already included in dispatch.
- Market Dispatch Method
  - All regional resources dispatched with SCGHG.



# Valuing QF Resources (Avoided Costs)

Fifth Electric Technical Advisory Committee

September 7, 2022

Clint Kalich, Senior Manager—Resource Analysis

[clint.kalich@avistacorp.com](mailto:clint.kalich@avistacorp.com)

# Agenda

- Define qualifying facility or QF
- Detail sizes in Federal, Idaho and Washington
- Describe Washington QF methodologies (published vs. IRP method)
- Define Idaho QF Rate methodologies (published SAR vs. IRP method)

# PURPA Regulations

## For Avista, defined by federal government and two states

- Federal Rules (Public Utilities Regulatory Policy Act of 1978)
  - Buy all cogeneration, and non-cogeneration up to 80 MW, at rates defined by state rules
  - Qualifying non-cogeneration, with a couple of exceptions, defined as renewable resources
  - Rates based on utility-avoided energy and capacity values
- Idaho Implementation
  - Small QF uses “Published SAR Method” rate for up to 10 aMW (100 kW wind/solar)
  - Negotiated rate for larger QFs based on “IRP Methodology”
- Washington Implementation
  - Published rate for QFs up to 5 MW based on IRP Methodology
  - Negotiated rate for larger QFs based on IRP Methodology

# QF Published Rate Eligibility

## Washington

- Projects up to 5 MW receive payments using a published rate schedule
- Projects over 5 MW receive a negotiated rate
  - Based on conceptual methodologies of published rates
  - Adjustments (up/down) can be applicable to the extent the larger resource differs from the value streams reflected in the published rate schedule

# Washington State Avoided Costs

(IRP-Based Methodology)

# Washington QF Value Streams

Payment consists of value streams dependent on resource/products offered

- Commodity Energy
- Peaking Capacity Value
- Clean Energy Premium
- Transmission
- Contingency Reserves
- Integration Charge for variable generation resources (wind/solar)
- Others

# Commodity Energy – Washington

The most basic value associated with electricity provided to the grid

- Latest-approved IRP energy price forecast
- Priced in two blocks of on- and off-peak periods each month
  - Hours 0700-2200 defined as on-peak
  - Hours 0000-0700 and 2200-2400 are off-peak
- Payment is monthly for each MWh of facility production delivered to grid during that month



# Transmission Credits and Charges – Washington

## Portfolio savings or costs associated with transporting energy to/from market

- Credit paid in addition to others in hours IRP shows imported market power
- Charge in addition to others in hours IRP shows imported market power
- Rate equals BPA hourly Point-To-Point transmission tariff rate
- Credits and charges billed monthly for each MWh of forecast facility production delivered to grid during a month
  - Not a real-time credit/charge but is determined based on IRP data at the time of contracting
  - Rate escalates with IRP inflation forecast
- For published rates, billed as adjustment to Commodity Energy rate equal to:
  - Delivered energy (MWh) \* Transmission credit/charge

# Variable Energy Resource Integration Charge – Washington

## Cost of incremental capacity services necessary to support grid reliability

- Avista applies variable energy resource (VER) integration charge to all such resources, whether owned or contracted for
- Covers various incremental ancillary services
  - Regulation, load following, forecast error
- Priced at VER integration study rate \* QF nameplate capacity
- Discount will not apply until VER study is complete
- For published rates, billed as reduction to Commodity Energy rate equal to:
  - Delivered energy (MWh) \* VER integration charge

# Peaking Capacity Value – Washington

The value of providing electricity to the grid during times of system peak demands

- Fixed costs from one of two utility options:
  - Fixed costs associated with the last-approved- IRP's first capacity addition fixed cost
  - Fixed costs associated with bids in most recent WAC 480-107 compliant RFP
- Paid based on Qualifying Capacity Contribution (QCC) factor
  - Will update QCC for 2023 IRP to Western Power Pool figures once available
- For published rates, value is paid monthly as a per-MWh rate:
  - Total annual value (TAV) = Nameplate Capacity \* QCC \* Price
  - Rate equals total annual value divided by annual energy output in MWh

# Defining Qualifying Capacity Credit (QCC)

2021 IRP Data will be updated with WPP values once approved (WA & ID IRP Method)

**Table 9.12: Peak Credit or Equivalent Load Carrying Capability Credit**

Resource	Peak Credit (percent)
Northwest solar	2
Northwest wind	5
Montana wind <sup>11</sup> 100-200 MW	35 to 28
Hydro w/ storage	60-100
Hydro run-of-river	31
Storage 4 hr duration	15
Storage 8 hr duration	30
Storage 12 hr duration	58
Storage 16 hr duration	60
Storage 24 hr duration	65
Storage 40 hr duration	75
Storage 70 hr duration	90
Demand response	60
Solar + 4 hr Storage <sup>12</sup>	17
Solar + 2 hr Storage <sup>13</sup>	12

<sup>11</sup> Net of transmission losses. Montana wind peak credits decline with additional capacity, the first 200 MW is 35 percent, the next 100 MW is 30 percent, and another 100 MW is 28 percent. Avista does not assume any Montana wind beyond 400 MW.

<sup>12</sup> This assumes the storage resource may only charge with solar. This specific option was not modeled within the PRS and is shown as a reference only. Avista only modeled solar plus storage where the storage resource could be charged with non-solar as well to reflect long-term utility operations.

<sup>13</sup> Avista limited solar plus storage to these two scenarios; many other options are likely including different durations and storage to solar ratios. Specific configurations would need to be studied to validate peak credits for those configurations.

From p. 9-28 of 2021 Avista Electric IRP

# Contingency Reserves – Washington

## Cost of regional obligation to hold capacity in the case of generation outages

- Avista holds 3% of all generation on its grid, irrespective of technology type or ownership
- Charge compensates for this cost
- For published rates, a reduction equal to:
  - Peaking Capacity Value \* QF nameplate capacity
- For published rates, billed as a reduction to Peak Capacity Value equal to:
  - Delivered energy (MWh) \* Contingency Reserve charge

# Clean Energy Premium Value – Washington

Value of providing electricity to the grid that does not contain CO<sub>2</sub>e

- Latest-approved IRP total resource value less Energy less Peaking Capacity Values
- For published rates, value is added to the commodity energy schedule

# Other Value Streams

## Washington

- QF payments are based on generic resource type
- Some resources might have values above the generic assumptions
  - e.g., dispatch flexibility, storage, interruption rights, local distribution benefits
  - It is not expected these values will be large for most resources, especially if small in size (i.e., < 5 MW)
- Avista must be able to confirm additional values before a payment is defined

# Idaho State Avoided Costs

## (SAR-Based Methodology)



# Surrogate Avoided Rates (SAR)

## Idaho

- Published rate based on IPUC-managed model
  - Based on the fixed and variable costs of a combined-cycle gas turbine
  - Natural gas fuel price updated annually using an EIA gas price forecast
- Different pricing by resource type
  - Wind, solar, hydro, non-seasonal hydro, and other
- On- and off-peak production rates for two seasons of the year
  - Energy and capacity value combined into one figure
  - VER discount per 2007 wind integration study (to be updated with new study)

# Surrogate Avoided Rates (SAR), Continued

## Idaho

- Note on capacity payments
  - Renewed contracts receive full capacity payment as part of production rate
  - New contracts receive capacity payment starting with first year the utility is capacity deficit
- Renewable energy credits are kept by the QF

# Idaho State Avoided Costs

(IRP-Based Methodology)

# Differences between Idaho and Washington QF Rates

- Idaho has its own and varying size limits for published QF rates
  - Wind and solar projects  $\leq 100$  kW
  - Non-wind, non-solar  $\leq 10$  aMW
- Projects ineligible for published rates receive IRP-Methodology rates
  - Same methodology as described for Washington, EXCEPT
  - Peaking capacity value based on portfolio capacity cost rather than a single peaking resource technology
    - Calculated as the difference between PRS and PRS absent the energy and capacity constraints
  - Peaking capacity value is paid on a per-MW rather than per-MWh basis
  - VER charge is billed on a nameplate per-MW basis
  - Large QFs retain 50% of renewable energy credits

**Thank You**

## TAC 5 Meeting Notes: Wednesday, September 7, 2022

### Attendees:

(360)620-9803; Aubrey Newton-LIUNA NW (Guest); Bill Garry (Guest); Shawn Bonfield, Avista; Annette Brandon, Avista; Terrence Browne, Avista; Michael Brutocao, Avista; Charlee Thompson, NW Energy Coalition; Kelly Dengel, Avista; Donn English, IPUC; Nelli Doroshkin, Invenergy; Doug Krapas (Guest); Chris Drake, Avista; Ellie Hardwick, REC/NIPPC; Ryan Finesilver, Avista; Damon Fisher, Avista; Grant Forsyth, Avista; Fred Heutte, NWECC; James Gall, Avista; Annie Gannon, Avista; Gavin Tenold, (Guest); Amanda Ghering, Avista; John Gross, Avista; Jared Hansen, Idaho Power; Nora Hawkins, Washington Department of Commerce; Lori Hermanson, Avista; Mike Hermanson, Avista; Kevin Holland, Avista; Jason Talford, IPUC; Jeff Larsen; John Barber, Customer; Clint Kalich, Avista; Kathlyn Kinney (Biomethane, LLC) (Guest); Kevin Keyt, IPUC; Ben Kropelnicki, Avista; Lance Kaufman, Westernnecon.com; John Lyons, Avista; Patrick Maher, Avista; Jaime Majure, Avista; Mallorie Davies, nwlaborers.org; Ian McGetrick, Idaho Power.com; Michael Eldred, IPUC; Tom Pardee, Avista; Liz Reichart, Washington Department of Commerce; John Robbins, amerghi.com; Darrell Soyars, Avista; Collins Sprague, Avista; Dean Spratt, Avista; Tina Jayaweera, (Guest); Tom Handy (Guest); Travis Culbertson, IPUC; Hannah Wahl, Puget Sound Energy; and Jim Woodward, UTC.

### Introduction, John Lyons

**John Lyons:** OK. I started the transcription and the recording for the meeting for you should have all gotten the little recording transcription. I don't know why it comes up as a warning, but we've got that and it is working now. You'll notice we are still trying to get someone that has the software to combine the slide decks from last time. Because we have the big hour time slot for lunch last time we want to have that spliced together. You will notice when that gets out there the transcript is available on the side of the recording deck. You can toggle it on and off and then I'm still editing a version of them because the transcription is generally quite good, but sometimes it gets a little wonky. And that way we also will be able to publish that with the IRP when it comes out. This is our fifth Technical Advisory Committee meeting. We were together last about a month ago. Next slide, James. We'll just do the quick introduction here.

**John Lyons:** Meeting guidelines, we've gone over this before, but for those of you that are new, this is basically the big portion of the public participation for the IRP where we go through what we have going on and get input from everyone. It's being recorded and we have the transcript being made and that will get published on the website. If you want to go next slide.

**John Lyons:** TAC reminders, just the usual if you can keep your phone on mute if you're not talking to give chance for people to talk up and it is helpful to try to state your name

before commenting for the transcription software. It usually does a fairly good job of who it is, though, and then we will document and record all of those. Next slide.

**John Lyons:** This is required by both States and looks into the future of what we have for resources and what we plan to need for resources. In particular, we're going to be talking about transmission and distribution today. And avoided costs. We're hitting some of the big pieces on that. We did conservation and demand response last time and then we also are going to be starting to talk about different market and portfolio scenarios that we'll be doing into the future. Next slide please.

**John Lyons:** Big pieces here. We are always looking for new members and we had a couple of them that signed up recently. I appreciate you TAC members that have been saying you might be interested in this, and people have been following through and getting added to the TAC. It's an easy process to join. You just ask and give us an e-mail and we're happy to have you here and you can participate in as much or as little of it as you want. The due date for study request from TAC members is coming up on October 1<sup>st</sup>. Again, there might be a little slippage in there if we have studies that are similar to something we're already doing, but the earlier you get that in and the more time we have to be able to figure out how we're going to model that and run that through the system. James, is there anything else you wanted to add on that?

**James Gall:** There is actually, so thanks for asking. We're going to be presenting, or at least having a discussion, at the October 11<sup>th</sup> meeting. There will be an opportunity to modify what we're planning on studying for scenarios, but it's best if you can get them in early so we can be prepared for that. Thank you.

**John Lyons:** Also, because sometimes we do have questions to refine or make sure that what we're planning on doing matches what is going to give you the answer that you're looking for. The external IRP draft will be released on Saint Patrick's Day 2023 and the public comments will be due by May 12<sup>th</sup>. Review as much or as little of that as you can. The more comments we get the better the IRP it makes, Final submission will be June 1<sup>st</sup>, 2023, we will also have that Washington update report due either January first or second. It'll have everything but the Preferred Resource Strategy like we talked about last meeting. Rest of the schedule here you can see on September 12<sup>th</sup> and 13<sup>th</sup> you should have seen an e-mail that I sent out from Public Participation Partners. They've got two opportunities where they are going to discuss how we could better serve all of our advisory groups. That will be going on and you just call in on those. We have the October 11<sup>th</sup> meeting that is going to be our first one in the office. Again, we are still going to be doing it online like this, but the Avista folks will be in the office and available. We already have a few people that plan to be here in town for the Energy Efficiency Advisory Group the next two days after that.

**John Lyons:** Technical modeling workshop that James was just talking about on October 20<sup>th</sup>. The Progress Report Workshop, December 14<sup>th</sup>. The 8<sup>th</sup> TAC meeting on February 16<sup>th</sup>, March 8<sup>th</sup> will be our public meeting for Gas and Electric IRPs. We'll be able to go

through and we'll do a very high-level overview at that presentation and break out into smaller groups for people to discuss what they're thinking about the IRPs. And then March 22<sup>nd</sup> will be the final TAC meeting for the 2023 Electric IRP.

**John Lyons:** Going to go to the next slide, James. Today's agenda, after the introductions, Dean is going to talk to you about generation options for transmission planning studies and he's already got his camera turned on there. So, everything you ever wanted to know about transmission and were afraid to ask, go for it. They're always interesting. We'll take a break after his presentation or no, we'll then go right into Damon Fisher's. Then we'll take a break. Damon will be talking about distribution planning. We've got the long range and the short range for getting power to people and businesses, so this is always quite interesting. After the break, James will be talking about the social cost of greenhouse gas for energy efficiency. This is an addition under CETA, Washington only, it doesn't impact Idaho. He'll have a brief presentation on that and then Clint, back by popular demand since he hasn't gotten to do a presentation for the IRP in a while, he'll talk about avoided cost rate methodology and what the differences are between the calculations done in Idaho and in Washington. And then we plan to wrap it up about 4 o'clock today. Unless there's any other questions, I think we're ready to have Dean take it away. Thank you, Dean.

### **IRP Generation Option Transmission Planning Studies, Dean Spratt**

**Dean Spratt:** Alright. Thanks, John. I'm going to ask really quick, everybody can hear me, OK?

**John Lyons:** Yes, I can.

**Dean Spratt:** Good. We had the Internet.

**John Lyons:** Were you going to share your screen? For the presenter, OK.

**Dean Spratt:** I'm going to in a sec.

**John Lyons:** I'll stay on just to tell you that that's showing.

**Dean Spratt:** Good. When it gets there. Thanks.

**John Lyons:** Yes.

**Dean Spratt:** Where the Internet goes down on the floor I'm working off of, so I had to do a scramble up to your floor, John, actually. James and I are sitting together across from each other as I'm putting this together. Tell me when you can see a mountain in the background.

**John Lyons:** We've got the mountain in the background. They're a lovely view.

**Dean Spratt:** Step one is good, then it should have a presentation showing.



**John Lyons:** And we see it now. Thank you.

**Dean Spratt:** Awesome. Alright. I think I'm going to get rid of my video camera. I just figured I'd turn it on, and I'll probably turn it back on at the end for questions. I'm not sure how we're doing for bandwidth so with what happened on the 4th floor I'm not going to take any chances. OK. Good afternoon, everyone. Again, thanks John for the lead in and getting me started. Today, we're here to discuss. Sorry. Good things in my rearranged in different spots here. Bear with me a sec. Alright. Today we're here to discuss IRP generation integration options and the transmission planning studies behind those and transmission planning as a whole. Feel free to interrupt if you have any questions, but the way the presentation is put together, there's going to be a good 15 minutes at the end of the presentation for questions if you want to gather your thoughts and wait till the end, we can always go back on the slides and go through any of the questions that might come up. With that, I'm going to start moving forwards.

**Dean Spratt:** I'll try again. Beautiful. That's like hitting a button and nothing happens. For us lots of rules with regard to the transmission system. Let's start off with a summary of the standards of conducts. First of all, non-public transmission information cannot be shared with the Avista merchant function employees. There are merchant function employees around me now as I'm speaking and attending this meeting. We will not share any non-public transmission information. Avista's Oasis, our SharePoint site, our IRP site is where that information is made public.

**Dean Spratt:** If I hit twice to advance slides here. I'm getting used to my setup. The agenda for this hour is, first an introduction to Avista system planning, useful information about what we do in planning and an overview of some of our more recent projects. Then we'll move into the second half of this presentation – generation interconnection study process where we go over the integrated resource plan request as this pertains to this meeting plus an overview of the large generation interconnection queue. Large generation Interconnection request and then our company is transitioning into what we're calling the cluster study process, I'll talk to that just briefly.

**Dean Spratt:** Introduction. I'm sorry, it's system planning, at Avista includes distribution planning which we'll hear from later today. And it includes transmission planning where we focus on reliable electric service. We have to meet federal, regional and state compliance requirements and then we work with our neighbors, putting together a regional system coordination. So that's in building our cases and also working through projects that are across the border into our neighboring utilities.

**Dean Spratt:** Then, as our group, we provide transmission service and system analysis. This is planning for low growth in the future 5 to 10-year horizon and then the change in generation mix that I kind of use the word changing because of obviously renewables coming on to the system, but also coal and some other generation moving off systems. So as a transmission planner, we see the overall flow within our system and over the top of us across other interconnecting systems, changing over time, and then the generation

dispatch has changed quite a bit. Also, as we went into the EIM energy imbalance market and our peakers run when they typically wouldn't have 10 – 20 years ago. And John, I'm getting an interesting little feedback. Is that sound OK to you?

**John Lyons:** I got it briefly there and now seems to have gone away.

**Dean Spratt:** OK, sounds good. I didn't know if it was something I was doing on my side or just something that was coming in going out as long as you guys can hear me. Fine. I'm going to continue on. Thanks John.

**Dean Spratt:** It helps to know what we would consider transmission, so our focus is the bulk electric system. At Avista, that's 115 kV and 230 kV facilities for FERC. That's anything above 100 kV and interconnected transmission below 100 kV that impacts the bulk electric system. We identify issues where Avista's Bulk System won't reliably deliver power to our customers. Then from there we develop plans to fix it. They're officially called corrective action plans. They're spelled out within the NERC TPL standards. And they're describing it in pretty good detail. There's a handful of rules around that, so I'm not going to talk in too much detail. I end up reading that too many times. And then for us on the transmission side, we live in a world of NERC mandatory standards. This changed considerably for us with the Energy Policy Act of 2005 which specifically drove NERC development, forced compliance with mandatory reliability standards in the United States, we try to maintain that as we go. The TPL standard requires that the bulk electric system will operate reliably over a broad spectrum of system conditions and following a wide range of probable contingencies.

**Dean Spratt:** May have heard some of these acronyms. Of PTO, what used to be n -, 1 pretty much means that there are no contingency systems running and operate optimal scenario which you plan for all lines and service. So pretty much it's a no brainer that we have to have a system that runs that way any season.

**Dean Spratt:** And from there we start stressing the system. P1 or N minus ones or single facility outages. That's a loss of a transformer. Transmission circuit transformer or shunt device. That's a pretty straightforward outage. Our system has to build, handle those regularly, then we get into the bigger hits of the system, which is a P2, P4, P5 or P7. Which is a loss of a bus, protection system failure, equipment failure. For example, circuit breaker and then a loss of a multiple circuit tower, so a double line circuit. And lost on that, which takes out two lines at a time, impacts us as well. Then it gets to be bigger numbers from there, those first zero through 5 plus a 7<sup>th</sup> is about 1000 kVs. Then we run each one of those against themselves. And the P3 and P6, which is the loss of a generator, or a loss of an element followed by the loss of another element. Overlapping combination of two facilities and that pushes that number up into hundreds of thousands of contingencies. This is spelled out in the TPL standard. Our system model covers the Western seaboard, so it goes from Canada through the West Coast down into Mexico and then stops at the AC/DC AC converters around the continental divide. We routinely verify scenarios through summer peak, winter peak light and low conditions, stressed

transfer conditions, high hydro, low hydro. And as I mentioned before, we run greater than 1100 - thousand duties as we're taking a look at any changes to the system or evaluating alternatives with these generation interconnects or project or system reinforcement projects. So steady state and stability performance for planning events.

**John Lyons:** Dean looks. Looks like we have a question from Fred Heutte.

**Dean Spratt:** OK, let's have it.

**Fred Heutte (NWECC):** Yeah, it's Fred here.

**Dean Spratt:** Hello, Fred.

**Fred Heutte (NWECC):** Energy coalition. Good afternoon, everybody. So, I just want to be clear. You mentioned that your modeling only covers the specific side of the system and I'm wondering why if that's the case, why you're not doing a full WECC model.

**Dean Spratt:** I apologize. The WECC model is in my opinion, the Western seaboard. We use the work approved cases as our starting point and we use all of that case to zero down into our area. I apologize if I was not clear, but it's the WECC approved case.

**Fred Heutte (NWECC):** OK, so you're using their base cases then?

**Dean Spratt:** That is correct.

**Fred Heutte (NWECC):** OK. Thanks.

**Dean Spratt:** Yeah, I apologize some people I have received sounds like the way the system is modeled don't know the full bounds of where the beginning, the end of our interconnect model is. I usually try to just toss out there, Mexico up to Canada and then over just past the continental divide from the ocean. Good question. Any other questions while we're on that stopping point?

**Dean Spratt:** Hearing none, I'll continue on so steady state and stability performance for planning events per TPL standard systems shall remain stable. This is a nice way to say you shouldn't have governors going out, or governor's generators that are going out of step shouldn't be doing damage to equipment for normal outages. Then they define a step further. These problems fan out, cascade, so it's not a rolling outage that falls into the next neighboring utility that falls into the next neighboring utility, or there shouldn't be uncontrolled islanding as well. And beyond that, facility ratings that would be seeded, so equipment ratings such as voltage fault duty, approach ratings, et cetera. And then we're doing all this to minimize the likelihood and magnitude of non-consequential load loss following planning events. Trying to keep the lights on is that underlying goal here.

**Dean Spratt:** Quick discussion about real time versus the planning. Transmission operations will operate in the real time frame are guided by significantly different standards than transmission planning in our group. Transmission operation standards have flexibility that our standards do not allow, so operators can push the system to save the interconnected system, so there's more flexibility for them, and as such they can shed

load. They can overload equipment, they can use short term ratings. There's a handful of things in their toolbox that we do not plan to. We try to make sure that we have plenty of capacity in the system to give them those tools to do operations control. And then the standards continue to find this balance between what we're going to do in real time and what we're going to plan for in the five to 10-year time planning horizon.

**Dean Spratt:** Just a quick note, our standard usually looks at, so TPL standard usually looks at peak conditions with the loss of one element followed by the loss of another element and usually stops there and real time. There are quite often 5 to 25 outages at a given time. And then they're taking these outages in the fall, which are just starting into now when the loads are down. And they can take multiple outages on the system to get systems things fixed and systems corrected. And they have to run after all the planned outages. Also, under the N minus 1, state or loss of a credible, credible multiple contingencies, they follow that, and they let outages happen to get things rebuilt or fixed or changed based on those studies. OK.

**Dean Spratt:** So, in the beginning each will tell you was an island and operated and planned to the relevant standards. Later the system became interconnected, which required much further coordination, which borne some earlier study groups and coordinating councils. These were to ensure that disturbances in one system did not spread over to other systems. It started with an agreement between 40 electric power systems for the Western Systems Coordinating Council. Over time that migrated up or into the Western Electric Electricity Coordinating Council, WECC, whose directive is responsible for coordinating and promoting electric system reliability. And then paralleling this across the nation was the North American Electric Reliability Council, which ensures the reliability of the North American bulk power system. So those are where the standards came from over time that we operate to and those are the groups that we'd worked with to make sure that as we expanded our system, it was coordinated well with the other systems across the area and across the nation.

**John Lyons:** Looks like we have another question. Fred, do you have another question?

**Dean Spratt:** Thanks John.

**Fred Heutte (NWECC):** Yeah, another one. I'm trying not to get too deep into the technical stuff here, but I do want to ask it quickly. I presume you're using the base cases and you know your own data. And are you, I presume you were running both power flow and production cost modeling. And I'm wondering what models you use for each of those.

**Dean Spratt:** Yeah. I'm going to draw a line in the middle of that. We do use power flow program to take a look at the reliability of the system, but out of our group, we don't do the production cost modeling. That's handed over to the IRP team to work through that and then we support them on those models and systems.

**Fred Heutte (NWECC):** OK, what kind of power flow model are you using? Just for info, because I don't want to get into the details.

**Dean Spratt:** Oh, I love getting in the details. We use Power World here. We originally used Siemens' products, PTI and then we transitioned to, and we use PTI for power flow. Then we use the PSLF for dynamic analysis and we transitioned to Power World. Gosh, it's maybe been 18 years ago now. If I was to pick out a wild guess prior to Power World having it and established dynamics engine. We used Power World for steady state studies and then used GE PSLF for a dynamic analysis and we're currently using Power World for all system studies.

**Fred Heutte, NWECC:** OK, that's really helpful. Just for everybody else listening, basically Avista is modeling major power flow applications, and I think along with many in the West, you're now focusing on Power World. But the real question I'm heading toward here is actually you just refer to it in areas, you're not doing both the power flow and production cost. So, there's been a lot of discussion in the West about what we call round trip modeling, which basically means the ability to take the same basic description of the system, use it in a power flow model, export the results and test specific hours in the production cost model, export, and test specific hours in the power flow model. Bring those results back, and that way the really important thing about the round trip, which really was pioneered by Northern Tier Transmission group, and now WECC is doing that, is to be able to say, OK, if you have a system change, looking at the production costs like a yearlong study hour-by-hour, and you're looking at changes in the resource mix in particular. For example, coal retirement, a lot of new renewables, whatever they change might be when you look in more detail using the power flow analysis to a specific hour or a group of 456 key hours throughout the year, does this system look under both normal conditions and under stress. But the question I'm getting at here really is Avista, how are you resolving any questions that arise from either the power flow or the production cost side? And do you data exchange with the IRP side or how does that work?

**Dean Spratt:** I'll talk to the planning side to differentiate between the two. We have a couple avenues. One, there's a mod 33 where we have to verify models against real known events, so that's being done by a third party for us at the moment, so that is always happening in the background and then above and beyond, I guess as you see that in real time or operations, folks are planning for outages and then measuring to see how close they were with planned outages. So that said, some feedback mechanism we have for our model. The real time on the planning side to your question, we usually look at every resource and how it's performed over the last year. And then come up with a set of assumptions that covers the corner cases. I think is what you're getting at on the power flow side to make sure that if wind is up and hydro is down, it could cause an issue as opposed to wind up and hydro up. And then we usually build sensitivity cases to cover the most probable set of conditions we could run into and then we usually stress the system pretty well as far as path flows and generation combinations to root out any problems that might show up to be able to at least have an answer that the system will hold up to that stress or when we get into that condition we're going to have an operating procedure to adjust generation or reconfigure the system to manage through those stress points.

**Dean Spratt:** So that's the first part. Now to your production cost model question. You know we go through quite a few iterations on the transmission planning side with their detailed model all the way down to the 115 [kV] for every load across our system. And the impacts of any line element within that system and that's I think the mismatch and I don't want to talk over James, but I'll probably give James a chance to comment here. Their production cost model does not need that level of detail accuracy. It goes, probably I'm going to guess, two or three steps above that because they're really not worried about the reliability for a two MW distribution substation out in the Big Bend area. It's just that a group of loads within the Big Bend area for a total of 80 megawatts and that's probably the area that's required for their level of research or analysis where we have to look at every line out of service, what's the impacts, and it doesn't hold up for voltage stability. Thermal violations, just a different set of needs for each model.

**James Gall:** OK.

**Dean Spratt:** I'm going to stop there. I don't want to get too far off in the weeds as well. And then I don't know if James or John, if you want to follow up with the production model side.

**James Gall:** I'll try to be really brief.

**Fred Heutte (NWECC):** And, sorry to interrupt, this is Fred. One more very quick question. Who's doing your outside mod 33 reviews?

**Dean Spratt:** Western Power Pool, I think it's called Nest now, but Northwest Power Pool has done it in the past and they're in the process of working through that now.

**Fred Heutte (NWECC):** OK. Yeah, I didn't realize that. That's interesting to find out. Thanks.

**Dean Spratt:** You're welcome. Good questions by the way.

**James Gall:** I'll be really quick, this is James. Avista, on the production cost model side, we use Aurora and Aurora is a little bit less granular than maybe what Dean was thinking, but it's on a regional basis of choosing when to dispatch resources so it only includes major transmission interconnections between regions, but nothing below that at this time, at least how we set up the model. But there hasn't been yet any, I'd say back and forth information sharing on the dispatch model compared to the power flow model at this time. Go forward, Dean.

**Dean Spratt:** Yeah. And I'll follow up with one thing that's unique about our system, which has been nice. I had worked at PacifiCorp before. Avista System's got a pretty robust 230 kV network that's looped through a couple different portions of our system, actually quite a few different portions on our system, so it is convenient in the sense you can model it as James was alluding to with a pretty straightforward model and not have the impacts that transfers across internal systems or trying to do a transfer from an East to our West type system. If that helps, Fred.

**Fred Heutte (NVEC):** I started looking for the mute button here. Thanks. It is helpful background. Thanks.

**Dean Spratt:** Yeah, anytime and keep up the questions which I know James loves them. I'm getting better at fielding them. My problem is if I get too far in the weeds, sometimes someone's got to pull me back, or at least throw something at me. All right. Moving on, I'm going to the next slide. Where are we now? So, corrective action plans have resulted in improved reliability for load service and generation across Avista's system. This is a quick picture of our system and I'll double check. Can you guys see me moving the wand across here?

**John Lyons:** Yes, we can.

**Lori Hermanson:** I can see it.

**Dean Spratt:** Perfect. Thanks. I'm not going to be in too much detail, but this GIS image of our footprint, I'll call it that. It's beyond our balancing authority, but as you can see in the yellow or 115 kV and 230 kV upgrades across our system, as we ran into aging condition, capacity issues, reliability issues, these are some of the bigger projects that we had put into the system. Then in the center of our system, which is convenient for a few of the renewable projects that had come on recently for some wind and some solar. And then let me use an example, a reinforcement up here in the Sandpoint area, which is north of Lake Pend Oreille. We have one line into this load center and then our neighbor utility has two other 115 kV lines and we ran into a reliability issue carrying the load center in the winter months. We coordinated a project between us and them to reinforce and rebuild some of the older line sections to be able to carry that load throughout. So, this was a good decade ago. Now we're wrapping those things up today, but three lines in the area got reinforced to carry the load center. That's just this project. And that's just a quick example of regional coordination on the transmission system. These are things that are in place, I think mostly today, except for Sunset, I think that's being wrapped up as we speak. I think it will be done next spring and then this doesn't have too many forward-looking projects. This gives a feel for where re-enforcements are and how they're spread out across the system.

**Dean Spratt:** I just wanted to make a comment. I'm not aware alternatives are considered, pretty much anything is considered, when we look at how we can fix and reinforce system. Just like any anything, we're bound by costs, and we need to look at different alternatives. This is something we looked at a while ago, they changed the name. They call it Powell Lane Guardian, I was going to go with the old name, but the idea here, this is just a generation center transmission moving power to a load center. Under N - 0, one of the lines tends to load up, the other two are unloaded. You can add something to the lines here to resist the power flow across this corner, so more power flows on the lines to get more capacity out of that set of transmission lines. So, there are many things to do this. You could put series capacitors on this line, series reactors on this line, phase shifting transformers, if these guys obviously add more generation to the load center there there's

many options. I just want to make a comment that we document these with more clarity as we're doing power flow studies and getting results onto paper and then this is just a comment from a previous person but non wire options require robust wires to perform. One thing that seems like it always works is when you're moving large amounts of power, transmission is good at doing that job. So, if we're putting generation in Big Bend and we're trying to feed a load center and the Spokane area, there are a handful of ways to tackle that, but transmission usually is the winner as most cost effective. And quick example, we have a load center at the Moscow-Pullman area fed by two auto transformers. One at Shawnee substation. The other one in Moscow substation. In the past, we only had to do n - 1 studies, or in this case t - 1 studies, a loss of 1 transformer. More recently, since 2014, we've had to look at the loss of both transformers, how we'd survive that outage. We did take a quick look at batteries to tackle that load center. We really need 125 megawatts worth of source and the 125 megawatts needs to run for weeks, if not months, based on outages. This is just a quick bill for a transformer to point, \$4,000,000 is a third, transformers better solution. So just to add a quick high level couple of examples.

**Dean Spratt:** That wraps up the transmission planning portion of the talk. I'm at the half hour mark, so I'm going to finish, I'm going to move on into the generation interconnection portion of this discussion. I'm going to carry it forward from here, and like I mentioned, there will be some time for questions at the end. So, two ways to get generation request one from external developers who enter via the Open Access Transmission Tariff or internal through IRP requests. Typical process. We hold a scope of meeting to discuss what the project entails, outline a study plan, augment a WECC proof case for our studies. Analyze the system against the standards and published bindings recommendations. Boilerplate standard, standard, standard planning stuff or standard planning. I'm going to talk to our study process for interconnections, the transition, our serial process. So, I apologize looking at my notes in the wrong spot, challenges with the serial interconnections, so large serial queues become difficult to process efficiently. Interdependency of projects becomes complicated, and the serial process is difficult for developers in the utility. So, we began the new generation or connection study process in 2022. We put the pieces together over the last year and this is the first year that we've implemented it and we're calling it the transition cluster study year. The serial process was complex, so one project would come in, we go through a feasibility system impact, carry it to a facility study, and if it finished that process, sign in an interconnection agreement, then somewhere in the process of this, we kicked off the next one or if not, waiting for the completion of the last one. And then, you can see the serial nature once you get to multiples of these, it ends up requiring a lot of manpower. Winter connection request necessitated a better process, and this is just to give you a feel of the interconnections that we've been requested, interconnections requested for transmission over the last handful of years, so it used to be very manageable in the two to five range over the last, I'd say from 2000s forwards. And then over the last three or four years, it's really ramped up and we really hit the bottleneck spot where we knew we had to do



something different over 2019 and 2020. And this continues to, at this level if not more projects. So that brought us. Hi, Jim.

**Jim Woodward (UTC):** I jump in for a moment. This is Jim Woodward, Washington Staff. Hi there, informative presentation so far. Thank you as always. Interested in acronym definition from a public access standpoint on this call. LGIA, I get that IA is interconnection agreement can you define LG?

**Dean Spratt:** Oh yeah, and I apologize. Good question and I catch myself skipping acronyms. I try to read them out as I see them, but that one was kind of buried so Large Generation Interconnection Agreement.

**Woodward, Jim (UTC):** Great. Thank you.

**Dean Spratt:** Not a problem. It does seem a little confusing because it doesn't jump right out at you and it's not spelled out in the slides, so I apologize. Good question. So Avista, like I had mentioned, is transitioning to a two-phase cluster study process to create a more efficient process, design process, definitive timelines that can be consistently met. This is one that as a planner we really wanted to pin down just to keep these projects moving so they don't get backed up, allocate system upgrades proportionally to commercial. This is another big one. Things that are ready to go forward have a clear path to get there, so that's one of the things that was difficult and serial process. There might be four or five, I'll call them tire kickers, that held out in the process for multiple years. And then there's a couple of projects within that kind of bogged down process that really wanted to get going and move.

**Dean Spratt:** The cluster study process really brings that forward. So, I think we're especially going through the process now we're on the right track with the cluster study process then obviously alleviate the backlog and the existing queue. So, this one, I'll just use the diagram.

**Dean Spratt:** Each year now, we're going to take all the study request via at load generation. I apologize. Load generation request, not load. And then we're going to move those into specific areas so they can be studied logically together. Then that's going to move into a phase one study. Preliminary results back to the customers, decide if they want to move into a phase two study. Phase two study is going to be a lot more detailed. Studied. Take a little more time and if they finish that, that'll come to completion. This will give us everybody that's interested in connecting into our system in a year and then our engineering team can start going down the road to putting together facility studies to decide what's the best way or what's going to take to integrate those customers and then we can sign our generation interconnection agreements and move on to getting maybe two or three or four at a time generation customers. Integrated onto the system. So, a much better process. Just figured I'd give a quick overview for people who haven't had a chance to look at our new process. Here is the current Interconnection Queue. This is listed by the serial process. These are ones that are in the process either all the way to LGIA or at least at the system impact stage, I think actually at the facility study stage, if I

remember correctly. These are working through the old serial queue and that's why they're senior projects to the new TCS which is transitioned cluster study process.

**Dean Spratt:** There's about 700 megawatts worth of this generation that's moving through the queue at the moment. And then this transition cluster study process, I think 1,600 megawatts, yeah, 600 megawatts are in the 22-transition cluster study process at the moment, as you can see it is pretty well spread out across our system, a pretty good generation mix across the system and pretty good variability in size as well. Like I mentioned before, I'm enjoying the cluster study process. It's been a good transition for Avista. Here's a summary of the transmission integration cost estimates for the IRP request. Big Bend, it's kind of a problem area for us. We've used up most of the 115 kV capacities, so expansion in that area is going to require 230 kV expansion and then these are common reference names, either substations or areas across Avista's system. That's the results of the study. And I'm going to go through more quick slides.

**Dean Spratt:** An example of one of the flexibilities within the cluster study process is that if there's something that really doesn't fit well, we can adjust the interconnection point or interconnection voltage with the customer and not have to go back to the beginning and start over in the serial process. This is 100 megawatts near the town of Reardan. This is originally how it was studied. I dropped it off on the 115 kV system. The line can't carry that much generation, so requires reconductored at the substation, Devil's Gap can't carry that much generation with required reinforcements and under N minus one, which we have to operate to, it overloads lines into the load center, which down here is the West Plains, which is West Spokane. So, it requires some line reinforcements as well throughout that conductor.

**Dean Spratt:** And then moving forward in the cluster study process. Reardan is roughly to the West a little bit further. This interconnection potential site is about, if I remember correctly, two miles from Reardan, about four miles from where we have existing 115 kV and the West Plains area. But forgive me on the numbers, it's four miles longer to integrate to this point as opposed to Reardan. Don't worry about the exact lengths. Regardless, by dropping off the generation inside of the load center, you can see it performs considerably better with nothing more than IT integration station at the point of interconnection. And I think that is all I had for today. You can refer to our Avista OASIS link for system planning information, interconnection process information, and more information with the transition we're calling generation interconnection queue reform. I'm going to stop at that point I double check my time which looks like I'm doing perfect on time and then ask if there's any other questions.

**James Gall:** Yeah, well. And they're Dean. Go, Jim.

**Woodward, Jim (UTC):** Hi there, Jim, thank you. And thanks Dean for an informative presentation. I'm along the same theme of my question. Before you go back to your slide 18. I'm assuming, sorry, I'm assuming POI is that point of interconnection, the voltage.

**Dean Spratt:** Correct.

**Woodward, Jim (UTC):** OK. Thank you.

**Dean Spratt:** Yeah, so project area requested amount in steps of a roughly 100, best integration voltage and then rough estimate on cost.

**James Gall:** This is James at Avista. Thanks Jim, for bringing this up to talk about how this is all used in the IRP process. So, when we select new resources or evaluate new resources in our capacity expansion model to meet our future load obligations, this table is actually pretty integral in the choices of resources. When we look at whether it's wind, solar, storage, or whatever resource it is, we're looking at these costs in addition to the generation costs and depending on the resource need, could drive us towards an off-system resource or whether we should be building new transmission in our system integrating resources. This is a major component of the planning process, especially when you start to see \$100 to \$200 million investments required in certain locations which will impact resource selection on location. So, look for this when we get into our capacity expansion side of the IRP. When we go to most likely the technical meeting in October and we don't necessarily model specific locations. We look at this as a guidebook for interconnection costs, because we don't know where a future resource may connect, but this gets us an idea of what the possibilities are for low cost resources versus higher cost options. Thank you, Dean. Are there any other questions? We're quite a bit ahead of schedule. Alright, Dean, sounds like you're off the hook.

**James Gall:** We'll have an additional document that's kind of new to the IRP probably in the next few weeks and it's going to detail a lot of these options that you're seeing on the screen right now. Look for that in the coming weeks. I don't know if Dean, if you want to mention anything about what you're putting together as documentation.

**Dean Spratt:** Yeah. So, as I mentioned to James a little bit earlier through this process, we've gone through a couple of iterations on the report that we generate to bring these numbers forwards. And to James's comment of his general request, we roughly need 100 megawatts in this general area to be able to come up with a number, we on the planning side have to figure out. Well, if it's generally speaking there, or what's the best place to put it in the world of our transmission system. That's where some of the specificity that I think James is saying he didn't ask for his into this table. As we have the land, it is somewhere to be able to get an estimate for switching station or reinforcements from that switching station into our system, our load centers. That report James and I had talked about a landing place. I think we're going to on the planning side, find a place on OASIS that's consistent. There's just a couple of different folders and I'm going to work with our transmission contracts group to pull into one spot so it's easier to find. I believe we're working on the beginning of the report, the ins and outs of it, the report style, I'll call it that. We have a couple different drivers for why we do studies and I'm trying to firm that up as well. So that'll be a little bit clearer. I think going forward, that's a function of this cluster study process to make sure it's clear for all customers. And then that should be available, and I think maybe James was alluding to there's a little bit more detail as far as constraints within the system that we're putting in the assumptions and a little bit more information

about the system overall and then some contingency results as well. And I hope to have that done, I'm going to guess by the end of the month. I'll give myself a little time. Mainly, it's a pretty short lift as far as what I need to get done, but it's got a handful of eyes on it, so it might take a little more time. Does that answer what you were asking James.

**James Gall:** Definitely Dean, thank you.

**Dean Spratt:** James had said it wasn't the worst report he's ever seen.

**James Gall:** Yeah, it is great.

**Dean Spratt:** He said, that was nice information. Thank you.

**James Gall:** Yep. So, Dean, Are you ready and willing, I guess is the right term.

**Dean Spratt:** Damon, you mean?

**James Gall:** Damon. I mean Damon. Yeah. Sorry that might help.

**Dean Spratt:** All say really quick, thanks for your attention and thanks for the good questions. That's always fun to talk about the transmission system. It's just hard to know when to start or where to start, where to stop. But again, thanks for your attention.

### **Distribution System Planning within the IRP, Damon Fisher**

**James Gall:** Damon you're on mute. Still on mute. Not your day.

**John Lyons:** We're going to do distribution planning charades so.

**Damon Fisher:** How about now?

**John Lyons:** We can hear you.

**Damon Fisher:** All right. It's a challenge, but it's fixed. Can you see me? You can see me. You can't hear you, and you can hear me, right? So. Let me share my screen.

**James Gall:** And we can see your screen.

**Damon Fisher:** OK. Get my other screen up here. I'll go ahead and hide myself, so you don't have to see me, but I do have a face. So now you know who's talking. My name's Damon Fisher and I'm in the system planning group, in particular the distribution planning group. And I'm going to speak to you today about distribution resource planning, which is a relatively new concept in the industry. As the you know, utilities move glacially, this is something that's been being kicked around, at least Avista for a few years and we've been preparing for it. Getting modeling up to snuff and everything because it's a fundamental change to how distribution has been typically done. And so just a background of what the goals of distribution planning are, the first three on this list are probably the most of what distribution planning is about: safety, reliability and capacity. Traditionally it's been good enough to think about those things mostly. Most recently, the corporate and regulatory

goals have been bubbling up to the top there, and those would be, as you all know, the CETA – Clean Energy Transformation Act and then our corresponding Clean Energy Implementation Plan, which puts some requirements on distribution planning. Back in 2019, House Bill 1126 also addressed distribution resource planning. We've been heading that direction to get ourselves in a position to incorporate resources as Dean mentioned non-wires alternatives. There's a point where IRP resources, the stuff that the IRP group does, and distribution planning can cross and benefit both sides of the equation. That's where distribution resource planning falls. It's from a distribution perspective we're not really interested in resources.

**Damon Fisher:** Sounds odd. The distribution system is always connected to an infinite supply of energy, right? You know the transmission system. So, the IRP guys and transmission folks have always done a good job making sure that those are energized. And from a distribution perspective, it's not much to think about there. There's not much to think about in terms of supply, so where did DER come into this? So, DR just distribution resource. A distributed energy resources has a proper.

**James Gall:** We have some background noise, Damon. Go ahead.

**Damon Fisher:** OK. Distributed energy resources, do you have a proper definition? Let's just call them resources that are on the distribution grid for our purposes today and they can be generation or demand response or energy efficiency, things like that. Anything that would solve if you will, a deficiency in the distribution system. Right? The challenge with that is, can a resource, let's just use a battery for instance, can a battery on the distribution system be used as a resource to meet resource needs for the system and fix a deficiency on the distribution grid? Maybe you have a battery at the end of a long feeder to support voltage or fix some thermal issue or something like that. And can they operate, solve both problems with that? There are some challenges there, so that'll be a temporal need of grid operation flexibility which still has to happen.

**Damon Fisher:** Resource adequacy from a transmission perspective, from a utility scale generation perspective, is well known. Is it there when I need it? Can I ask for it? Essentially, and so from a distribution perspective, is that resource there when I need it not because it's a resource, but because it's fixing a problem? It'd be a different twist on the resource adequacy definition from a distribution perspective. And then system protection becomes a bit of a challenge when many of these DERs get on the system. Islanding and things like that become issues and safety issues as well. It's typical distribution deficiencies, low voltage capacity, asset condition capacity, and asset condition are the primary issues that we run into. Today, capacity generally is a new load addition. So, we get some block load additions and that's on the edges of the distribution system. Asset condition is simply our stuff is getting old and it can be a challenge to replace. And contingency situations, are we able to maintain this thing, can we offload these customers over to somewhere else? If the flexibility exists? Those are some of the primary issues that we run into on the distribution system that could potentially be solved with a DER. There's more that they can do, but generally speaking, the primary thing that

DER is going to do is reduce demand or support voltage. And I defined them two different ways here and I don't know if this makes sense or if it's even necessary to do, but in my mind, there's targeted energy efficiency and targeted demand response. These two things would actually change the load and so those are real. You're changing the load and then apparently would be storage or generation. Those two things don't change the load at all. They just move when the load happens essentially.

**Damon Fisher:** There are couple ways to think about it, here are the primary thoughts in my mind about what DERs are potentially in any combination of those things. Just to give you an understanding of the scales of things that we deal with on the distribution level. This is a curve. It's a real curve that happened in 2018, I think on some day in the summer and that curve is the system load. That occurred that day, and then the next line down, the next blue line, is a single 115 kV transmission line in the north and it was in North Spokane. And then the gray line is three substations that are in North Spokane. The yellow line is a single feeder. This gives you a visual representation of the scale of things that we're talking about here. You could see down the distribution, I mean you know all the distribution, all the yellow lines, all 300 and something yellow lines that we have add up to well they don't add up to that orange line, but some are up there high and so on an individual basis, if I'm fixing a feeder problem from a system point of view, it's small magnitudes.

**Damon Fisher:** And then this is the same graph with the transmission and distribution. Or the 115 transmission and the distribution put on the right axis. What you consider in this business is do the peaks line up? If I do lower that yellow line, does it make the effect on the orange line, the top line that I want it to make, are those peaks lining up? They don't necessarily line up. It's kind of interesting and some of our feeders are very long. That peak isn't very peaky. It's very long and flat and so it becomes difficult to shave the top of that peak off. It has to happen over quite a long period of time.

**Damon Fisher:** It's all about the curves. I've shown you several curves. Let's say this is one feeder's curve. This is a goofy looking curve because this doesn't happen anywhere, but the ideal curve would be that all the assets on that feeder, all their capacities are used at 100%, or let's say the capacity of the feeder is usually 100% all the time. That's maximizing your investment in that capital. This doesn't happen, and this wouldn't happen, you wouldn't load it to 100% anyways, you'd lower some load so that you have some contingency capacity. You can move things around anyway. This this would be ideal.

**Damon Fisher:** This is reality. This is a real curve on a feeder over a course of 24 hours in the summer. So, this thing is the reason the system needs to be able to handle the peak of that curve. The wires need to be big enough. The regulators need to be big enough. The transformer needs to be big enough. And so, you're setting the price really for the facilities based on that peak, when you're not there very often here, you're at the peak two hours. The rest of the time those assets are sitting idle, if you will. They're being used, but they're not getting the full value out of them. The idea behind this matching of

DERs, well not of fixing a deficiency on the distribution grid and being a resource for the system as a whole would be to take non-wire alternatives and fix this. Let's say that this peak is above 100%. I could take a battery. I can charge it in the middle of the night. I can bring up all hours one through 10 or higher. And then I can discharge it during hours 14 through 20 or whatever. When I'm discharging the amps through that feeder source is lower. Basically, what I did is made this curve look a little closer to this flat one and the concept is while that battery is doing this for the distribution system, it's also a source and available as a source, and so that battery can be sitting there idle not fixing this issue because this issue only appears during several summer months. Shoulder months, winter or whatever, it might not be an issue at all, and it might be freely available as a resource for the system as a whole. But that requires everything lining up. And then another point of reference here is we do have a couple of, this one isn't very large, it's only I think it might be main played at 500 KVA. But I'm not sure, it only hits around 350. Usually this is our community solar summer. This is what it looks like during the summer. This was back in 2018. We had significant smoke from fires, and you can see that where half the generation from this, the small facility, went away when the smoke rolled in, but generally speaking it's pretty reliable on a daily basis, as long as there're no clouds or anything like this. This was very sunny leading up to the smoke rolling in. On our system during the summer, these curves here generally don't extend long enough into our peak load. We have the duck curve problem here as well that maybe you've heard about where solar rolls off faster than load rolls off and so you get a goofy looking shape where it climbs, and it looks like a duck's head. This is that same facility in the middle of winter. This is in December.

**Damon Fisher:** This becomes problematic if this facility was installed to solve an issue on the grid occurring in the winter. This problem may, I don't know for sure, it's not trying to solve one and this is just data I'm looking at. But if I was trying to solve a problem with this it would be difficult, I think to do that and as a resource, it's not very reliable in the winter and I think this is just typical of Spokane winters.

**Damon Fisher:** And here's a sunny day in the summer. Sunny, cloudy day. It was a sunny day, so the peak got up to here but the angulations throughout the day, as clouds moved over and passed. They are kind of significant. You can fix something like this with a battery probably you could. You wouldn't get all your capacity, you wouldn't have reliable nameplate capacity by any stretch of the imagination, but with a battery you could smooth that out probably. That might serve its purposes.

**Damon Fisher:** The state of distribution resource planning at Avista right now is in serious flux, so this is a heavy lift and we've been lifting it for a while. We're getting to a critical mass where we have hired consultants in various aspects to help us move forward much more quickly and get more mud on the wall than we've been able to do internally because internally we can't dedicate resources to just this essentially. We have other day-to-day activities that need to happen. We have done some things. We've developed our own process for spatial load forecasting, which is something that is necessary for this, and

spatial DER forecasting is still a gap, but we're working on that as part of the Clean Energy Implementation Plan, we're working on actually, James is working on an RFP for a DER potential report, which will include it'll be locationally reported. So, on a feeder basis I believe anyways that's being worked on now and I believe that's going to be presented to this group in the next bit. I don't know exactly when or what meeting but it will be presented to this group.

**James Gall:** Damon, it'll be September 28<sup>th</sup>.

**Damon Fisher:** September 28<sup>th</sup>. Thanks, James.

**James Gall:** Yeah. And while you brought that subject up, if you know of any vendors that that can perform that type of work, please bring them up or send them to me at the 28<sup>th</sup> meeting.

**Damon Fisher:** Then there's system performance criteria. So we actually just put out a. Yeah.

**James Gall:** OK. Hey, Damon, wave a hand up by Jim Woodward.

**Damon Fisher:** Jim, go ahead.

**Jim Woodward (UTC):** Thanks, James. Hi, Damon. Thanks for your talk so far. I guess for folks on the call, I just wanted to orient and James, you maybe this you know, clarifications more to you but the brief reference to the potential assessment mapping this back to Damon's reference to versus Clean Energy Implementation Plan that's largely helping to address condition 14, is it around the DER potential assessment work plan or plan that's ultimately going to roll into Avista's 2023 IRP just to make sure I'm tracking correctly what we're talking about.

**James Gall:** Correct. Yeah. There's a Work Plan that's required in the condition you're referencing and then the plan is to hire a consultant to help us come up with this spatial forecast of resources for inclusion in our 2025 IRP. Thanks.

**Woodward, Jim (UTC):** Great. And if we have additional questions, probably save those till the 9/28 meeting, I guess.

**James Gall:** That's a good point to bring up and think about, because we're going to be going to an outside party to look for help and we also need any guidance from this technical advisory group for whether or not we've hit the mark on what we're looking for in that RFP, but more to come.

**Woodward, Jim (UTC):** Thanks.

**Damon Fisher:** OK. System performance criteria. This brings into question several things about system performance. What Avista wants for system performance and what we want for our customers, and we've been working on that for a while. I think we've got a draft out for comment internally for system performance. System performance, the criteria is really important because it defines the weight you put on reliability, resiliency and things



like that. System performance criteria will drive the solutions you get to or when you even need to look for a solution. That's a really important document and we've put a lot of effort into that. We think we're getting there, it's out for internal comment right now. Then time series analysis, this is something we've been working on for years to get in, we use Synergy Electric for modeling our distribution system. Doing time series analysis is important, especially when you're talking about battery schedules, radiation, daytime, nighttime, all these things matter. When do things line up? It's not a simple matter of doing peak load analysis anymore. Getting all the data set up, getting the model set up, has been a challenge and we've come a long way to get there. I think we're there. We've got a lot more, our data set is a lot richer now that we have AMI, at least in Washington and Bixby I think is another data set, and their insight into the usage of energy. I think we're doing OK there in terms of modeling. We are behind the curve well, I guess most utilities are, we still have quite a few 60 or 70 feeders that we only know what they're doing if we go out there and look at the analog dials once a month, but we have a program internally to work on getting those stations SCADA and everything. It's just a matter of time and resources. But in terms of those in the State of Washington, AMI really helps with that because we can roll that AMI data. The granular data that we're measuring at the point of use. So, we put in the smart meters I guess would be another name for them, we put the smart meters in, and get 5-minute data back from those. That's quite helpful in understanding what the systems do in any given point in time. And you can roll that up into stations where you don't have SCADA, you're not measuring in any kind of real time way. So, DER acquisition and implementation process.

**Damon Fisher:** That's kind of being played in the last bullet item there, non-wired, wired playbook acquisition implementation. Some of the stuff has already started. The process to acquire DR and energy efficiency, that's maybe not DR so much, but energy efficiency is pretty much in place. I think we've been doing that for years. In fact, I came into the company in the Energy Efficiency Group. These are things that have been done outside of the grid. They've just been done. So, in energy efficiency we've had DR pilots. I don't know if we have one going right now. Maybe someone can speak to that from Avista, but we've been down the DR road, but this is kind of a new concept, at least for Avista. It's been done at other utilities recently, when you do discover that deficiency in the grid, you try to acquire if you will capacity or whatever through a DR.

**Damon Fisher:** There's too many DRs, demand response or energy efficiency. We have a group that knows that stuff well. The process to actually identify deficiency and go to that group and say, what can you do for us on this feeder. And then the process of understanding what you can get from that. Does it actually solve the problem? And that that's a point that I'm not sure how people deal with it, but it is a point of concern. If energy efficiency doesn't always equate to capacity or peak load. How long does it last? Does it get stale? People move in, move out. What are these measures that are being done for energy efficiency? That's not to get a handle on, and I think every utility will have to get a handle on it and maybe some have, but some of them probably pretty straightforward it's the summertime peak or overloaded. Go change the air conditioners. Pretty

straightforward I think, but marginally speaking, I think efficiency gains are getting fewer and fewer for HVAC equipment and stuff like that, but the acquisition process is in the hard assets, the batteries and the solar. Those could be third party where we just put an RFP out very similar to what happens right now with what the IRP ends up doing and putting out. RFPs for this would be something James, actually, I think would it be, James I don't know, but if. OK. Yeah.

**James Gall:** No, I don't do that. But we have a wholesale marketing group that releases the RFP. I help look at it, but I'm not the one on that one.

**Damon Fisher:** Right. That process is in place, but it's always on a utility scale transmission slide thing, system resource thing. Capacity. So, scale down everything on the distribution side, stuff is going to be scaled down accordingly. But the process probably wouldn't be any different, right where I need two megawatts in four hours of battery storage on a feeder. RFP and you get your proposals back. As far as internal, that's another question. Batteries and solar. Internally, it touches every piece of the company supply chain, everywhere, expertise, training. It's not a small event to move into construction and installing batteries and generation, at least solar. Well, I don't know, wind and that stuff probably wouldn't happen on the distribution side, but maybe it would, I don't know, but it's not a small thing to think about. It's big actually to bring it internally and do it. I don't know where we'll end up with that, but that's where we are, so the expertise is in process. We're all learning how to do this, what it is, what we want it to do, what we don't want it to do, and the ability to manage it. All these great assets, all these small generators, and all over the grid can become overwhelming and DERs as a distribution energy resource management tool.

**Damon Fisher:** I think, I'm not sure, but we are in the process of implementing advanced distribution management system. We're scoping it now I think to go out for RFP. I don't know what the time scale is on it or anything, but I believe there's some elements of distribution resource management in that so it's quite complicated. It's very complicated and it's a I don't know if it's a philosophical point, but it is an interesting thing to think about anyways is most of our distribution system is unsupervised. It just it just works on its own. The future, I don't know where we end up with that with all these DERs and if we get them all out there and the thing goes dark. Can we turn it back on? It is a little nerve wracking to think about.

**Damon Fisher:** Then hosting capacity maps. I was hoping to have a demo for you today, but we're having some technical issues. We do have a hosting capacity map. It's not exposed externally or anything like that. I imagine at some point it will be exposed externally because that's the point of it. But we have been working on that and so we've automated some of that process to analyze and I'll go over what exactly it is here in a second and then non-wired and wired playbook. We've hired a consultant to essentially write the process. So, we were looking at non-wire. All this stuff plays together, so non-wired alternatives fit right into this. This distribution resource notion, and so it's all in there. This is going to be basically a process diagram and define exactly how we go about

looking at this thing. And so, we expect to have that back here early next year, I think. Anyway, I'll show you some of that here in a second. So, I just bumbled through this. Anybody have any questions about any of this stuff?

**James Gall:** Damon?

**Damon Fisher:** Yeah.

**James Gall:** We have a question on the chat I'll read to you. OK, this is Avista focused on front of the meter DERs for example, utility owned batteries near substation or customer behind the meter DERs. And there's a second part of that question, what is Avista's DERs capability and ability to aggregate. DERs? Third part of the question, does Avista, run any locational specific RFPs for non-wire alternative solutions? I can repeat those if you need.

**Damon Fisher:** Let's see if I can answer relatively quickly. The first one is no preference as of yet. But I suspect that in terms of learning and getting to a comfort zone, we'd probably lean towards our side of the meter. The second deal was what are our DERs capabilities, is that right or our ability to aggregate?

**James Gall:** Correct.

**Damon Fisher:** I don't believe we have any ability to do that. Let's say that right at this point. We're not rewriting it, but we're going out for bid to replace our distribution management system with an advanced distribution management system. And it's, I believe has DER capabilities it built in. And then the last question was, have we done an RFP, locational RFP for any DER? And is that in the context of fixing an aggregate issue or just in general?

**James Gall:** I can answer both ways. How about that? I think we have an answer to both of them.

**Damon Fisher:** The first part to fix aggregate issue, no. But we do have a couple of generators that are connected to the distribution system. I believe Lind went out for an RFP and so did our community solar. But neither one of those were solving any kind of issue or anything like that, at least on the distribution grid.

**James Gall:** Tina's hand is raised. Tina, you want to ask your question?

**Tina Jayaweera (Power Council):** Thank you. This is Tina from the Northwest Power and Conservation Council. I was wondering, have you done any analysis on demand voltage regulation where you're basically tweaking the voltage at the end of the line up or down to increase or decrease the loads?

**Damon Fisher:** We do have a system in place now to adjust voltage for that, for conservation, and I believe it's been in place for quite a while. I think we're just refining how we measure our savings on that right now. I don't believe it's a positive feedback loop like you're measuring voltage at the end of the line. I think that's what you asked.

And then signal back to the voltage regulators or anything like that. I think it's more of a calculated CVR.

**Tina Jayaweera (Power Council):** Yeah, my recollection is you did have a big CVR project on your system that you implemented. I don't know, maybe 10 years ago now, 5 – 10 years ago. I don't recall how large it is in terms of encompassing your territory, but also you mentioned the duck curve and the issues with oversupply versus undersupply. There's a little bit more focus on the DVR side where you can actually either go up or down to absorb some of that extra energy. Or save during the peak time. So, just curious how that might fit into the system.

**Damon Fisher:** It certainly could. We're just getting traction on all this stuff right now. I don't know if this is the point I should say this, but we are going to as part of the Clean Energy Implementation Plan, we will be working on it in what we're calling the DPAG. So, it'd be the distribution planning advisory group. That would be an external facing group, very similar to this IRP TAC group. We'll be implementing that and hopefully getting great ideas like this one to try out and see if they fit into the scheme of things. There just simply isn't a lot of writing on the wall right now in terms of what Avista would be comfortable with, what our system is comfortable with. So, this still has to be technically possible and have the technical expertise to do it. It's a lot of balls to juggle, but nothing really has been written off as not doable.

**Tina Jayaweera (Power Council):** Alright, great. Thank you.

**Damon Fisher:** Back here I mentioned this non-wired / wired playbook. Here is a draft, not vetted in any significant manner but the process maybe, it could probably be better. See what I can do here. This is probably a more up to date than that screenshot, but this is, don't take any of this home with you, this is all very much unvetted and just a first approximation of what a process might look like. If you have some sort of deficiency across the top, whatever it might be, and down the side these are the things that could potentially fix that. That's pretty simple to think about. And then at least in this iteration of it, you get a number one, two, three or four where four would be a done deal that fixed your problem. One might be maybe right and then a color coding. Green, Avista's comfortable with it. You can see these are where wire alternatives, green would be Avista is comfortable with that technology with that approach whatever it might be. And then down here we have the non-wire version of the same thing and so what would happen? Essentially low growth and I really don't know what's going on with these column headers, but they're pretty goofy looking, but that's transportation.

**Damon Fisher:** So, you go down that column and maybe our policy is to go find the fours and threes and evaluate them in more detail. I don't know what it will be yet, but you go down the column and then down here the non-wire alternative. There are other alternatives, other things to look at, maybe simply load balancing or something like that. You see this blue here. Hydrogen fuel cell maybe. Maybe some local generation or something and it's blue, meaning that at least in this, I don't know if it. There's a legend

anyway, so blue would mean it's probably more appropriate for a pilot. We're not comfortable with the technology. We don't know much about it. There's a third color, which I don't see on here. That would be maybe because it's way out there for us or something like that. No one's gone through any of this in any significant manner. So, don't get heartache over any number you might see in here, but you could see probably more interesting lists of the solution possibilities. So, distribution connected, all these things could fix something, they are all something we could use.

**Damon Fisher:** And same with behind the meter. Are all these something that we would use? Probably not the approach that we will end up with. It might not look exactly like this, but it doesn't seem unreasonable to narrow down your options, it's always fun to say the world's your oyster and everything, but then when it gets to the point where you got to pick something or do something, then then you get paralysis. This is something that we've hired out and we're having done for us, so this must be an earlier version of it with the set of numbers, circles, and the hosting capacity maps.

**Damon Fisher:** In terms of getting DR on the grid like generation, it's a process, you can't just connect and start putting energy on the system without analyzing it and figuring out is it going to cause problems. Was it not going to cause problems? Things like that. So, the idea behind the hosting capacity map is that you pre analyze and you know in a way, that's comfortable, in a way that's detailed enough that you're comfortable to say to third party developers look at that map and if you see a spot where you know there's five megawatts of capacity. I know that if that's the spot you pick, you know the process that you have to go through is less than the process if we're starting from scratch. It'd be used to guide third party folk's generators that want to connect for whatever reasons. It'll guide them into parts of the system that could use the support. The support could be simply, OK, you could put that energy on there or the support could be well over here where we're having some voltage issues or something like that. And so, it would be great if you could attach over here anyway. The hosting capacity map is used to guide those decisions.

**Damon Fisher:** And finally on that map, we could look at the map internally and say to ourselves, well, you know we are a little weak over there for any DR or anything like that, so maybe we need to do some investing of our own to make support the grid a little better and to make it more palatable for DR attachment. Unfortunately, I'm not able to show you this map. We do have one. It's a technology issue and it's being worked on so, if you haven't seen one, several utilities have them outward facing. I think PGE does. PDT does for sure. So, if you're interested, you could go to their website and look for it and see what they've done. There's a lot of, yeah.

**James Gall:** Damon, this is James. What's the plan for the hosting capacity maps from a public point of view? I mean, is this something you guys are going to put on our website, OASIS, or what's the plan there.

**Damon Fisher:** The plan is to open enough information to let folks make the decisions that we think they should be making from that information. And so, the exact details of

what that is. Different utilities do it differently, some people only show three phase lines, some show all their lines. Of course, you can't expose any customer information or anything like, so there's a little bit of tiptoeing around it to figure out exactly what you can show without giving information that isn't public or for people to consume. First, timelines are concerned, we have one right now, it's just not showable. It's been analyzed, it actually does convey information that could be useful. It's not entirely done right; it was a simplistic analysis. I think internally we would like to do a more sophisticated analysis. The point I made earlier, the analysis needs to give us the comfort that it is detailed enough so that when a customer does choose a location, we feel confident in the capacity at that location. I don't think we're entirely there yet, but that's being worked on, the timeline is a resource question. We're having technical issues right now. There are all sorts of other aspects of modeling that are being worked on. I can get back to you on that. I don't know that we have a timeline on that one actually.

**James Gall:** Thanks, Damon. We have a hand up. Nora, do you want to ask your question or comment?

**Nora Hawkins (COM):** Thanks, James. You know that hosting capacities is one of my favorite topics, so thanks for calling on me. Just wanted to ask, is distribution substation loading part of that hosting capacity analysis in addition to the hosting capacity of the feeder lines? And also, once you publish that hosting capacity analysis, do you have a plan of how often it would be updated?

**Damon Fisher:** The final look of it from the final data that would be involved in it is not yet known. I mean it clearly would be from a generation perspective that would be for sure the notion has been kicked around internally anyways to be a loading capacity map as well. Which seems is, which is intriguing to me. We do get a lot of requests for load additions and if we can alleviate some of that and guide them to places where there is capacity, and so I suspect that we probably will include loading. I think that's what you asked. What was the rest of your question? I'm sorry.

**Nora Hawkins (COM):** Just curious how often it would be updated.

**Damon Fisher:** How often? Well, you know data gets stale. That's a very good question and it needs to be thoughtful. I think what we would do is we'd look at our system and do some sort of study where we can get a feel for how often the system changes significantly and I suspect that it might be driven by a queue process where we have hosting capacity. We have capacity here. Someone has asked and applied to attach. That would change so the next person looking at it, they can't see the old data. They got to know even though the new one isn't attached is very similar I think to how transmission works with their queue, but it might be driven by that. It might be driven by the number of requests to attach, which could be few to none or many. I'm not sure, but there is some trigger anyways to do it. And it may be simply automated, we might just update every month or something like that but it'd be a regular update. The frequency of which is yet to be determined.

**Nora Hawkins (COM):** Thank you.

**Damon Fisher:** Mm-hmm. Do you have any suggestions?

**Nora Hawkins (COM):** I don't at this time.

**Damon Fisher:** OK. Just for some magnitudes here I think this group is really concerned about the cost of resources. For me, this doesn't include the resource. This is the integration cost, so anywhere from 5 megawatts, it was our standard. I think it's 2.1 megawatts and above would be a dedicated feeder. So, a 5 MW generator would need a dedicated feeder. And so that would be the cost for that dedicated feeder bay. Not the cost of the 5 MW generation. If that makes sense. This just gives you an idea of the magnitudes we're talking about and I think you can see that these magnitudes are significantly different than what Dean had showed earlier. Of course, this is the small distribution system, but I think, James, would you use these? Put them in your optimization model?

**James Gall:** Yeah, definitely. The plan is we have a set of supply side resources to use to fill our resource needs. Some of those are utility scale and some of those are distribution scale, so we need not only interconnection cost, the interconnect, the utility scale resources like Dean had presented earlier will also need cost to interconnect. These distribution scale resources, I think the illustration here is not free. And like I think Damon, you mentioned not to the same magnitude. I just did some rough math after you said that, we're talking about 400 megawatts. If you split this up and there are \$1,000,000 each and if you did 400 megawatts that's 80 of these projects.

**Damon Fisher:** Yeah.

**James Gall:** If you did five MW projects times \$1.3 million, that's \$104 million. They do add up. It's something to think about. It's not necessarily a lower cost alternative to utility scale because you're going to have a higher generation costs per MW unit as well. That's why we do an RFP to figure out which is the least cost for our customers.

**Damon Fisher:** Yeah, I think that's one of the, as just a generator, if that's all it does, it can be kind of expensive to do things on the distribution grid from a utility perspective. That's the whole notion of combining benefits to make these things happen so.

**James Gall:** I think that's the area where we're going is that combined benefit, how can we leverage a, we'll call it a system asset, for a local distribution issue and we're not there yet, but we're getting there.

**Damon Fisher:** Yeah, there's a lot of complications with all that. We'll get there and we'll have a much better understanding of it in the future. But just now we're making some decent progress and defining what that looks like. And then of course, we'll have to go through it and learn stuff. We'll have to go through the process and learn from our mistakes, if you will, and our successes. It's slow going but, that's the future, so we'll get

there. And then I think that that might do it for my presentation. I got scolded for going long last year, so I didn't go long this year.

**James Gall:** We do have a question. Jim, do you want to go for it?

**Jim Woodward (UTC):** Thanks, James. Thanks, Damon for the overview. My question is more process related. Earlier, I asked you and James about the Clean Energy Implementation Plan for Avista and some of those conditions for approval that was passed back in June. Another one of those conditions that affects distribution planning is the forthcoming formation of your company advisory group around distribution planning. I think it's the DPAG is the acronym you're using. Would you mind giving us an update on where you are in that process?

**Damon Fisher:** There's been a group meeting about it several times already, and I believe we'll have something working on the website so that there's a presence on the website and I don't know exactly where we ended up on that or if a decision has been made, but it should be very near or in the same spot as the IRP. It is on our corporate web site the process is ongoing. I think it will be officially announced before the end of the year. It's moving forward with the end of the year I believe as a goal for announcement.

**Jim Woodward (UTC):** OK. And that just to clarify that meeting you've had, is that a company internal meeting, is that what you said? Great.

**Damon Fisher:** Yeah, just internal meetings. Figuring out the logistics of it all.

**Jim Woodward (UTC):** Right.

**Damon Fisher:** Just simply putting something on our website is a process.

**Jim Woodward (UTC):** For sure. Yeah. And you know that's helpful and totally understand if the following isn't ready for prime time, but any thoughts yet on recruitment or who would be in the parties to tee up such advisory group or is that decision all still in the works?

**Damon Fisher:** They're still in the works, but I think it's been kicked around a little bit. This group and the efficiency group at least would be starting points for recruitment of people that want to participate. Then there will be other groups, I think, that would like to participate. There might be a way on the website for someone to choose to participate.

**Jim Woodward (UTC):** OK.

**Damon Fisher:** I don't know if that seems reasonable. Does that seem reasonable that we go to the advisory groups that we already have and recruit there?

**Jim Woodward (UTC):** Yeah. I think there's some guidance in the conditions list that was approved. I mean just my personal reaction, first blush, that sounds like a decent start. There are other advisory groups that were teed up specifically along the lines of the CEIP, the Equity Advisory Group, does come to mind.



**Damon Fisher:** Yeah.

**Jim Woodward (UTC):** It looks like Annette is wanting to contribute to this exchange.

**Annette Brandon:** I can, if you don't mind. So, I haven't been intimately involved, Jim with what Damon is doing or his group. But what I do know is that we will get a work plan pulled together and by the end of the year we'll at least start the process of getting everyone set up and it probably will start with inviting the people of the other advisory groups. And then I would imagine there'll be some discussions in there about how we might recruit others. But that's the steps that we outlined in the plan.

**Jim Woodward (UTC):** Thanks, Annette, that helps. And I guess for interested parties who might like more information between now and then would just be wondering the best point of contact. Is that more in your shop, and not Damon, or are you teeing that up just kind of wondering who's on first for that effort.

**Damon Fisher:** Actually, our Rates group is leading the effort. But you could tie up any question you want with me and I'll either know the answer or I'll find it for you.

**Jim Woodward (UTC):** OK, so you don't mind soliciting some inquiries? If any folks on this call might want to follow up. We all get a lot of e-mail. I just wanted to make sure that you're OK with that.

**Damon Fisher:** Now that's cool, yeah.

**Jim Woodward (UTC):** Thank you.

**Damon Fisher:** Any other questions?

**James Gall:** Alright, Damon, thank you very much for presenting today. And right now, it's time for a break. We are about 15 minutes ahead of schedule. So, we'll come back at 2:45 if that works for everybody and we'll start on the Social Cost of Greenhouse Gas for energy efficiency and then get into avoided costs shortly thereafter, and if all goes well, we might be able to get out of here a little bit early today. I will see you all in 15 minutes.

### **Social Cost of Greenhouse Gas for Energy Efficiency (WA only), James Gall**

**James Gall:** OK. In our 2021 IRP, we had a little bit of discussion of how we should treat social cost of greenhouse gas for energy efficiency. I want to bring that back to the TAC because we went through an IRP, we chose the methodology last time and I wanted to show the comparison of what other methodologies could have been and see if there are any opinions that TAC members want to share on the method we chose, whether or not we should change methods, or stay on what we're currently doing. I'll try to walk through those methods in the next 15 – 20 minutes.

**James Gall:** I'll try to keep this short; we'll see how it goes, but feel free to ask questions as we go. I'll try to explain it the best I can, so starting off with the presentation, as many of you know, we have to include a social cost of greenhouse gas for our resource options in an IRP in Washington State. Specifically, energy efficiency is called out in the act. The social cost of carbon is from a federal study, but the State of Washington, specifically the UTC, derives the official prices used each year based on an inflation adjustment. The chart down below is an estimate of what we believe the social cost of carbon will be once UTC makes their adjustment and it could change a little bit. But the nominal dollars are shown in green, and blue is the real dollars \$2022, and black is the original values from the federal study that was conducted in 2008 or 2009. That cost is leveled around \$126 per metric ton. The question is how should we include the \$126 for energy efficiency valuation? There are a couple of different methods for doing this. I'm going to walk through three different methods. I'll show some results from the last IRP as well. Feel free to ask questions, provide comments. So, what you think we should be doing and if you have better ideas or a fourth option, glad to hear about them. The first method is we.

**Kelly Dengel:** Thank you. Already have a question.

**James Gall:** OK, alright.

**Kelly Dengel:** From Jim.

**James Gall:** Go ahead.

**Jim Woodward (UTC):** Hey there, James, Jim Woodward, Washington Staff. Thanks for this discussion. This walk through that we're going to do. I raised my hand because I did see an item on the previous slide. If you go back to your slide 2.

**James Gall:** Sure.

**Jim Woodward (UTC):** I guess that sub bullet at the bottom there says awaiting Washington UTC's official pricing, if I'm interpreting that correctly. I went on our website, the Commission's website, this morning and I believe it is updated per a consent item on the July 28<sup>th</sup> open meeting around adopting a \$21 essentially accounting for inflation, etcetera. So hopefully that's addressed, if I'm misinterpreting what that statement is and you're awaiting something else, we can have that discussion, but I did want to confirm that I think that's up to date.

**James Gall:** Yeah, I think I heard John, maybe you can clarify. There was going to be an adjustment made.

**John Lyons:** Yeah, Jim, when I was talking with Jade [Jarvis, WUTC] about another issue last week, I believe it was either last week or the week before, and he said that it was going to be updated. There was apparently a slight tweak that had to be made in the numbers. We just wanted to make sure we're using the correct one, but that may have been solved now. We would have checked this on the slide deck before it went out on Thursday of last week. I think we checked this on Wednesday of last week.

**Shawn Bonfield:** Jim, one thing Jade mentioned it might be on the open meeting next week. I believe the next open meeting is September 15<sup>th</sup> is when there might be a correction to that. I think that's why we said we're awaiting.

**John Lyons:** Yeah.

**Jim Woodward (UTC):** OK. It sounds like that's in the works. I cross walked it with the order that came out of 728, so you may be tracking, and I'm not responsible for that, that falls into another Staff members purview. It sounds like you're tracking it. Let me know if beyond next week you need anything else, but as you know, I'm the overall Avista contact for planning, but sounds like you're tracking. I just wondered if that was sort of a tacit action item request of staff, of me there. So hence I want to just offer it up.

**James Gall:** Thanks, Jim. Now I think we got it handled, but just don't go ahead.

**Jim Woodward (UTC):** Oh, and sorry, James. As long as I was talking, the only other question, it was more of a bookend or placeholder. I get that this is discussing energy efficiency, but this doesn't substitute per se towards the CETA requirement to account for the social cost of greenhouse gases in Avista's resource decisions. Most supply and demand correct, I mean, we're just talking admittedly about CETA here, but this applies to the full resource portfolio.

**James Gall:** Correct, the requirement for social cost or greenhouse gas does like you say, apply to the whole portfolio, at least the Washington assets.

**Jim Woodward (UTC):** OK.

**James Gall:** But I think the issue here is there's different methodologies that have been discussed in the region and Avista chose a methodology I think that's counter to what some other entities have chosen and we wanted to revisit that as we have new TAC members and new staff members as well.

**Jim Woodward (UTC):** OK.

**James Gall:** To make sure this is still the right method, or if we should change.

**Jim Woodward (UTC):** Sure. No, that's great. I again, just wanted the overall context of having this discussion and SCGHG applies to more than just the E, the DSM resource. So, I will mute and stop distracting you.

**James Gall:** That's alright. OK, let's first talk about the incremental method. This is actually the method that the IRP used and the 2021 we actually ran a scenario on the second method as well. Think of it as a credit to energy efficiency programs. What we'd look at first is what is the region looks like from an emissions point of view. We calculate using the Aurora model in our price forecast, to come up with the incremental emissions rate for each MW hour of load. As a forecast between now and the end of our planning cycles, that's that blue line shown there. We see there was additional load, or load was reduced, the change in emissions in the region would be 1,000 pounds per MW hour and

that slightly declines down to 800 pounds per MW hour by 2045. That's looking at all of the northwest. This approach takes that efficiency of greenhouse gas per MW hour and applies the carbon pricing that we showed on slide two to that emission rate, so that's that green line. The green line goes to the right axis and dollars per MW hour comes out to about \$50 a MW hour. And how this works is when we evaluate energy efficiency, there's a cost of energy efficiency. Then you look at multiple value streams and some of those value streams are the value of energy. There are non-energy impacts and then this is a third value stream along with others. That comes out to around \$50 a MW hour, so it's calculating an avoided cost, since that's going to be a topic of the afternoon of energy efficiency, but only towards social cost of carbon on an incremental basis.

**James Gall:** Compared to the second method. It's the same method except instead of looking at the incremental emission rate, you're looking at the average emission rate of the region, which is significantly less because as loads grow and more renewables are on the system, at least forecast to be on the system, you have a much lower emission intensity rate than you do from an incremental basis. Because incremental typically is a gas plant for the most part versus on average, you have several types of resources. The second option has a lower emissions credit for social cost of carbon. Applying that at lower emission intensity rate times the social cost of carbon. These were two different studies we ran in the last IRP. Again, our Expected Case, the amount that was used for setting our efficiency target was using the incremental method.

**James Gall:** And then the third method, I think it was used by most utilities. I think the Power Council also uses a similar method as this. And what you're trying to do here instead of applying a credit towards energy efficiency, you're including the social cost of greenhouse gas and dispatch of your resources in your price forecast. At Avista, we do a price forecast and we're trying to simulate what prices are going to be in the future. Our future marketplace, so in the chart down on the bottom and that green bar, that was our price forecast in the 2021 IRP, and we wanted to do this type of methodology. We ran a price forecast using the social cost of carbon as a dispatch adder, think of it as a carbon tax essentially on resource dispatch. And we got the orange line as a result. In this scenario, the social cost actually would be higher in the first four years we phased it in for this theoretical scenario.

**James Gall:** In this example, instead of an avoided cost of that resource at energy efficiency, resource getting either the \$50 credit or the \$21 credit, it would get this credit of the orange line rather than the credit plus the green line. The green bar for example, and I say this is the method I think most utilities are using at least a couple of them in Washington. The downside or caution of this method is that in some forecasts, if you include social cost of carbon, and depending on the market dynamics, the price of the wholesale market price could crash where you have an overbuild of renewables, so you could end up with even lower prices. And in some studies, and I'm not saying that's going to happen for our case, but just because you include the social cost of carbon in your price forecast doesn't mean it's going to result in higher prices.

**James Gall:** So that's just a word of caution. We looked at how much energy efficiency was selected in Washington over the three different methods. We also showed an example of what if we didn't have social cost of carbon. And just looking at the 10-year savings, we had about 508 GW hours of savings in Washington using the method we chose called the wholesale price method. That third option was about the same value. And then using that average method, is no surprise that its lower emission price came out to even a lower savings, but still greater than no social cost of carbon. So that's the results from last time. I'm curious to hear if there's any concern by any of the TAC members of our current approach. I would lean towards continuing to use our incremental approach versus moving to the third option.

**James Gall:** The average approach is also of some interest because I don't think it's clear necessarily in statute of what inclusion of social cost of carbon means. My real concern of both of these methods, and this was brought up I think in a public workshop pre-COVID, is if we use pricing of the region or regional emissions, the utility is subsidizing the region to its own energy efficiency from a greenhouse gas perspective. So, we're reducing our load to benefit other utilities theoretically from a greenhouse gas perspective, and should our customers be paying for that? I guess that was the biggest concern with methods one and three. Because as we reduce load through energy efficiency, that does not necessarily mean that we're going to reduce greenhouse gas emissions for our resources because when we decided to dispatch our resources, it's to a regional market rather than our resources. So, to me this is a little bit of a controversial method no matter if you choose any of these three options because we're pricing our customers to reduce emissions for others. Just like to stop there, open it up for any comments or thoughts if there are any. Jim, go ahead.

**Jim Woodward (UTC):** I think I'm still formulating a perspective on this, James, but could kind of help me. What I'm struggling with a little bit is your cautionary note on the previous slide around the wholesale price method, cautioning around a potential overbuild. I guess you say overbuild renewables and then you go to the next slide where the wholesale price is coming in a little bit, at least from a savings standpoint, a little bit below your incremental method, I guess is that only in terms of this renewables overbuild is sort of externality that's not captured on that table on the next slide.

**James Gall:** Yes. It was not a result in the last RFP, but when we ran the last IRP, we included social cost of carbon for our dispatch, we got this resulting price forecast. If you look at other forecasts that we've done, and others in the region have done, when they've included the social cost of carbon, this incentive got so great that the market was flooded with renewables. Whether or not that's real or not, if that that happened where you had a majority of the hours of a year that are renewables with the zero marginal cost, this price could actually dive down and be below the price forecast that you see here in the green line. We didn't see that in the last IRP. I'm just saying that could be a result in this next IRP if we chose this path. What it comes down to is what is a realistic build out of new resources? I guess one could argue that we would not change their new resource build

out and we would get a similar chart as this. That's definitely one option but that's the word of caution. We could end up with lower prices.

**Jim Woodward (UTC):** Sure is. Is there some potential to, let's say hypothetically, you did switch methods, you did go to that wholesale price method? Talking about an overbuild of renewables, is it feasible to detect that in the model runs and dare I say if that looks like it may be happening, not to say it will, but if it occurs, you could add corresponding modeling constraints to avoid that unrealistic play out. Or am I mixing apples and oranges here?

**James Gall:** Yeah, I think you could do that. I think it really comes down to what is the objective of the policy, is our objective of the policy to include regional? Let's just say the objective of this policy is to include an adder based on regional emission rates. Then if that's the objective method, one or two achieves that method 3. My real concern is that you're trying to simulate a future that doesn't exist. Because there's not a social cost or carbon requirement to and dispatch of resources in the future, it's not a market impact. You're trying to simulate an impact of a market that doesn't exist. You could create externalities like you're saying that are not realistic. To me, these first two methods make more logical sense in the world we are in from a marketing perspective. I guess the reason why I think this relates more to option one is because some of this gets you to that incremental emission cost, but that incremental emission cost could get so high that you go negative, so this method protects you from that outcome. But again, are we, or utility customers, should we be paying to reduce emissions of other generation outside of our utility by increasing our cost? It's a policy question I don't think was really addressed in the rulemaking or in the legislation. But when it comes to implementation of how we address this, it does matter, and it really impacts to our customers because you can see the differences in savings we're asked to achieve based on different methodologies.

**Jim Woodward (UTC):** Would you say, James, your reference to market. You know it's not reflected anywhere. But how about, obviously policy only starts getting more complicated, pulling in dependencies now on Washington Climate Commitment Act. Does that then start to create a market where the price signals may be approximated by this wholesale price option. I'm just thinking out loud here, but you know CCA may play into this.

**James Gall:** Yep. So that's my last slide. So, let's talk about that real quick because you're right, the CCA does account for some of these pricing. The CCA prices, which we really don't know where those prices are going to end up. I know Ecology has done a study and we've floated out some prices in our previous TAC meeting, or prior to our previous TAC meeting, about those prices we're going to assume in this IRP. Our plan is to include those obviously in our dispatch model. Whether or not it's the incremental or average method, we would not double count those costs, so let's just use the incremental method. For example, we include the price forecast for emissions that we sent out a few weeks ago. We would then take the difference between those two and account for the total social cost of carbon. I would argue that the incremental method with an adder for

the difference between the social cost of carbon and the CCA price gets you halfway between methods. Versus if we had this, the market dispatch method that we just used, social cost of carbon, obviously the CCA would be kind of ignored in that example.

**Jim Woodward (UTC):** You know, things seem that helps in and I'll say a couple additional thoughts and then I realized that I am dominating the airwaves here. So, I will mute because you know the power of a team and it'll be interesting to see what other folks offer. But I guess a couple of thoughts, this slide is helpful, and it starts to paint the interaction effects. I also hear you that you know the CCA is late breaking and it's already September, but we still don't quite know how things framework wise may work by January 1. To me, weighing it's all cost benefit weighing right to me. That uncertainty, coupled with at least in Washington, again, I know that you know, Avista is, you know in 2023 you're ultimately getting a full IRP. But the way Washington views it, it's an IRP Progress Report, maybe there's benefit potentially to, if nothing else, remaining consistent with 2021 IRP sticking with the incremental method one more cycle. Because that's what you went within 2021. Once we get to 2025, you know the CCA will have been a bit more mature. At least it will have been in place for a couple years. Certainly, just my humble opinion and I'm not directing one option over another, maybe there's an argument to be made from a consistency standpoint. Stick with 2023 what you did with 2021 and then, more broadly, reassessed come 2025.

**James Gall:** Yeah. Thank you. Thank you for that.

**Jim Woodward (UTC):** There's my two cents.

**James Gall:** Alright, anybody else have questions they want to add. I mean that's definitely one option that's similar to what we're thinking, but love to hear others. I'm not actually opposed to doing any of the methods. It's about the same amount of work either way, but I guess we can if you do have something you comes to mind after the fact, please send us an e-mail. And it's good, even if you don't have a comment, you at least understand a little bit about what we're doing with energy efficiency for this topic and it's definitely on the utility side, it's been in a number of conversations of how to address the issue.

### **Avoided Cost Rate Methodology, Clint Kalich**

**James Gall:** So, so I'll leave it open for another 30 seconds or so and then we'll turn to other avoided costs topics so. Alright, Clint, Are you ready?

**Clint Kalich:** As ever, I'll be, I suppose.

**James Gall:** OK. Are you going to run your own slideshow, or do you want some help?

**Clint Kalich:** Well, I'll take some help today. Why not?

**James Gall:** OK, alright, so bear with me. I got to find it.

**Clint Kalich:** Do you want to hand it over? I can pull it up on the screen.

**James Gall:** I think you should go ahead and run it. That would be best.

**Clint Kalich:** Alright, I'll do it.

**James Gall:** And just by the way, Clint, we are almost back on schedule. So, let's do that.

**Clint Kalich:** I had this up and then had to reboot my computer, I was having some technical difficulties, so let's go ahead and off the PowerPoint. Sure that. OK folks, looks like it's on the screen.

**John Lyons:** Yes, we can see it.

**Clint Kalich:** Good afternoon. My name is Clint Kalich. You've probably seen me at least monitoring or being an observer of these meetings. I've been involved in the avoided costs in Idaho and Washington for a couple decades now, at least, and my history goes pre Avista. Long, interesting road for QFs [qualifying facilities]. This is law, as you'll see shortly from 1978. Interestingly enough, it's still not settled law, it seems like or settled implementation. There's a lot of disagreements and even within the utility industry, I think there's a lot of complexity, especially with all the new requirements you just heard about for social cost of carbon as an example, and all of those things affect avoided cost. I don't have pretty pictures because it doesn't feel to me like there's a lot of pretty pictures that go along with avoided cost, but let's just dive in and see how this goes. I'm going to talk about what a QF is. In order to be a qualifying facility, have to meet certain requirements and one of them, and it matters because it's priced differently in Washington and Idaho and in many states based on the size of the queue of resources and how you qualify.

**Clint Kalich:** And then I'm going to do a little bit deeper dive into the Washington QF methodologies and while I call it the Washington QF methodology, that probably isn't exactly the correct way to describe it. I think in Washington, we've been asked to provide broader descriptions and detail in documentation around the QF methodology is it applies to both published and the IRP methods. So, the IRP method in both states, Washington and Idaho, are very similar. But I'm going to focus on what I call at least in this example, the Washington QF method and then I'll step over and try to explain a little bit about the differences between the Idaho and the Washington QF methodology. A lot of the heavy lifting today will be around the Washington QF methodologies.

**Clint Kalich:** Let's talk about what this act is. It certainly goes back probably before most of us were in industry and any of us might even have been born. In 1978, out of one of the earlier energy crises we had in this country, there was a strong push by many to allow non-utility generation onto a grid that traditionally was dominated by utilities and excluding non-utility generation. The law in 1978 essentially requires utilities to buy all cogeneration and non-cogeneration up to 80 megawatts at rates defined by state rules. The federal government says you're going to buy this stuff, but we're going to let the States and the public utility commissions specifically define how and what you buy within the act itself. Generally, we're talking about renewable resources. People sometimes forget about



resources that maybe in 1970 were considered renewable and maybe the best example of that is municipal solid waste combustion or a waste product. I remember and maybe some others on the Avista call here can remember we had a project one time that was going to use some waste products out of a coal mine. So, it was a waste fuel, a waste product that somehow qualified. I think ultimately the project never came to fruition.

**Clint Kalich:** The point is, it's not always a renewable resource, although generally that's the case and the other piece that's really important out of the Policy Act itself and positions taken by the federal government since that time is the rates are based on utilities' avoided cost of energy and capacity. There are really two values that are focused on energy and capacity and it's interesting how those have somewhat changed over time because some would argue, possibly myself included, that a lot of the non-energy capacity values we talked about today like greenhouse gas benefits and risk reduction, those types of things really aren't an energy and capacity value, but I'm not sure that the industry or others would take that position today. In other words, I don't know what the right word might be. I might use the term scope creep. Some of us might have seen that if we've worked with consulting as I have, a scope creep where things have changed, interpretations have changed. At the end of the day, under state rules in both states and especially in Washington, the definition of the capacity value is modified a little bit. We'll talk about those values later today.

**Clint Kalich:** Let's talk about Idaho first. In Idaho, there really are two types of rates. The first is what they call the published rate, or the published surrogate avoided resource method. The SAR method and that is defined, and I'll talk about it later. It has a specific definition. It's priced based on models that the Commission itself runs and it provides rates based on the resource type up to 10 average megawatts. That means not a project with a nameplate capacity of 10 megawatts but actually can generate up to 10 megawatts on average. So, you could have a 30 MW wind farm that generated on average 3 megawatts, and it would qualify, excuse me 10 average megawatts. In other words, it generated a third of the time, or a third of its nameplate capacity on average, and it would qualify under Idaho's old rules. But I use that as a bad example because when solar actually excluded from this, but they're thrown in a separate bucket, so think of a different resource.

**Clint Kalich:** Hydro, you can have hydro with a maybe it just runs for a couple months of the year, so on average it's less than 10 megawatts for the year. So it would qualify potentially for published rates and then again wind and solar because of some, what I would define as folks taking advantage of some of the higher rates for the SAR methods, the Commission reduced the qualification for wind and solar specifically the variable energy resources down to 100 kilowatts. So hard to get published rates. And Idaho, if you're wind or solar, you have to be 100 kilowatts or less. Otherwise, you end up with what's called the negotiated rate, which is what it says. You get to negotiate the contract much as you would do with the traditional contract sale to the yield. That utility is a

response to a request for proposals or other negotiation. But that negotiated rate needs to be based on what's defined as the IRP methodology, which we'll cover a little bit later.

**Clint Kalich:** And then there's our Washington service territory. If you're selling a QF resource of a qualifying facility, which is what you have to become under the 1978 federal rule, become a qualifying facility to meet the requirements, you can obtain a published rate which is somewhat similar to it's published. It's a surrogate method in Idaho, except that the published rate in Washington is based on the IRP methodology. But the rates are published so you know what they are ahead of time, and you can qualify as a QF up to five megawatts of nameplate capacity in Washington State you would obtain published rates. If you're over 5 megawatts now, you're ending up in a negotiated rate associated with that, so you don't get the rates that are published in tariff in Washington State. If you're over 5 megawatts, but you're basing it on again the IRP methodology, there'll be some updated assumptions. Let's say the gas prices changed or the utility positions have changed, you would update those in the model, but you still would be based on the same methodology used to define those published rates. And by the way, for published rates in Washington that cycles every November. So, we've got that coming up fairly soon where we will revisit it and make a filing around published rates.

**Clint Kalich:** Let's talk about Washington QF. Already talked about the five MW requirement that you receive a published rate if you're over 5, you get a negotiated rate, and I think the key here with the negotiated rate if you're over 5 megawatts is there can be an adjustment. Both you know a positive from the QF perspective or a negative in the sense of a reduction in the payment you receive as a QF based on the value streams that you're providing. So, we're going to take a closer look at how you generate power, how much flexibility you might provide the utility, those types of things where the resource sits in our system, how it contributes to our peak requirements, especially for the capacity payment. That's the nice thing about larger projects. They can receive a negotiated rate. So, from the utility perspective, again, revisiting the original intent of PURPA, which is to provide third party opportunity to provide power to the utility but at avoided cost for capacity and energy. That means the utility should pay no more than what it costs, but also no less than its avoided cost. To the extent on a larger project, you can identify additional value or additional cost, those things should be part of the contract.

**Clint Kalich:** Let's talk about the IRP based methodology because in Washington, it drives both the published rate and the negotiated rate. We actually have a write up of a strawman proposal we're working on. It documents substantially what was provided last November in our filing. But we talked about the key components, the first and I'll go through each one of these with a slide. There's a commodity energy that traditional value that you're paid for energy you bring onto the grid, there's the peaking capacity value which is how you beat our generation at times of system peak, there's that clean energy premium which is driven by a number of different things. There's transmission costs and values, whether we can reduce the amount of transmission we need to procure to serve our loads or in fact, especially when we're surplus, we may have to procure transmission

actually to export the surplus QF power to the grid to sell it in times we don't need it. There's a concept called contingency reserves I'll talk about. And then for variable energy resources, when in solar I will talk as well about integration charges and finally a category called other, and I'll talk about those as well. I'm not looking to see here, James, if we got any questions or comments before I dive in, good.

**Clint Kalich:** Let's talk about commodity energy. As it says up here, this is the most basic value associated with energy provided to the grid electricity. Under Washington rule, we use the latest approved IRP energy price forecast. The way the schedule works, and the published schedule. is there are two blocks of on and off-peak power each month. So, in each month you have a price that you would be paid for generation between zero, 700 and 2200. The remaining hours then are defined as off peak, so there's different prices for those two periods. If you generate power between zero, 700 and 2200 in the month of July 2024, there's a schedule price you are paid for every unit of energy, every amount of MW hours you provide at that time frame and similar in the off-peak hours, you would get the off peak price. We pay that based on the MW hours of facility production delivered to the grid during that month. So pretty straightforward, at the end of the month the MW hours are looked at, the timing of their deliveries are considered, the on peak hours are paid at the on peak price and the off peak powers energy are paid at the off peak price.

**Jim Woodward (UTC):** Hey, Clint.

**Clint Kalich:** One thing I want to talk about in Washington, a number of the costs, even though they may not be really energy related necessarily and they may have more to do with the actual size of the project not based on its energy production, but we're asked by the Washington, yes.

**Jim Woodward (UTC):** Hey there, Clint, Jim Woodward, Washington UTC staff just figured probably OK to offer. I raised my hand but conversation OK to interject. That didn't mean to.

**Clint Kalich:** Please.

**Jim Woodward (UTC):** Awesome. I just had a quick question regarding your previous slide. That first bullet, the latest approved IRP energy price forecast per some related discussions or conversations that have been going on. Just wanted to clarify, there's an energy piece and MW hour piece that is based on a forecast and there's the capacity piece, the capacity portion and just wondering are we talking here about more or less the updated annual forecast piece or the capacity piece with that first bullet.

**Clint Kalich:** Yeah. So, by the latest approved IRP, and Jim after our last conversation, I should have made a bit of a modification here. But latest approved, I guess it still works as a bullet. It's just a question of who approves it, but it looks like we're moving in a direction where it was based on the utility's recent energy price forecast, which it says IRP, but we essentially use it for whatever analysis we're doing for an acquisition. Whether it's an IRP we're looking at, to forecast future prices or we're doing an RFP or

let's say somebody gives us an unsolicited offer, we would be looking at that, that price forecast to have an updated price. But once it's set in the published rate tariff, it would stay that way for a year anyway. So, it would still be based on whatever the energy forecast was at the time the tariff was approved.

**Jim Woodward:** OK. I appreciate that clarification, Clint. Thank you.

**Clint Kalich:** Yeah. And I apologize, I cannot for whatever reason, I don't see the hand waves. So please do interject if you have questions. Happy to pause.

**Clint Kalich:** Let's talk about transmission and I call it credits and charges. These are portfolio by portfolio. I mean our generation portfolio as we work to serve our load, you're going to have savings or costs associated with transporting energy to or from the marketplace. So oftentimes, I think of electricity as we know is kind of a curious thing about how it moves around. But you can think of a transmission line as a pipeline essentially to a market. The Mid-C is the predominant market for us, and we have transmission rights to move power back and forth and we have a lot of rights that are sunk costs. We've already paid for them. It won't matter if the queues there or not, if it's surplus, we don't have an impact. But to the extent we end up with more generation placed on the system on a given hour relative to the firm transmission that we already have. In other words, we've already used that firm transmission with our existing resources, we either would have to procure additional short-term transmission or if we wanted to bring generation into our system in that hour. Or if we're surplus and selling to the market, we would have to buy incremental transmission to export the power. The IRP methodology looks at each hour across the time horizon and it looks is the utility long or short, in other words, are we selling in that hour, and do we have enough transmission and if we don't, we would be buying incremental, or alternatively and often is the case we actually are short in that hour we're importing from the marketplace, and we would have to buy transmission. If we don't have to buy that transmission, it's an additional value that is credited to the QF. That's what's going on to the extent that we're reducing our imports and transmission expense associated with that, we provide additional value to the QF. The flip side is if the QF producing power at a time, let's say in the spring when we have lots of hydro and it's all flowing and we're trying to dump it at the Mid-C, and by dump, I mean just get it off our system. We don't have any other place to put it and we increase our short-term transmission costs. We need to charge for that.

**Clint Kalich:** We use the BPA hourly point to point transmission tariff because Bonneville has 75% of the market there and we generally are buying that tariff. Again, just like with the energy, we are charging this amount, we convert this cost to a per MW hour average price and we credit or charge it against the QF rate, the rate the Bonneville transmission tariff escalates with the IRP inflation forecast. Right now, I believe that the rate converges to just under \$6 per MW hour to the extent we need to buy incremental transmission. So, we would escalate that through with inflation. In the published rates, it's the transmission component equal to the delivered energy times the transmission credit or charge in that time period. And again, because say in the spring, we tend to be long, you're more likely

to have a charge on transmission versus other months of the year in the fall for example, where we actually might be importing enough power that we would actually provide a credit to the QF. It's essentially an adder or credit to the commodity energy rate schedule that's provided as part of our tariff.

**Clint Kalich:** The next piece is the variable energy resource integration charge, and we have a work group on VERs for the variable energy resource effort we're working on right now. We actually have an older study we're trying to update. We've contracted with Energy Strategies, a consulting company to update that study. But the idea of variable energy resources, unlike traditional utility generation resources are not something the utility controls. Unfortunately, just like the weather itself, there's a lot of uncertainty around how accurate the forecast is. For example, a wind forecast 90 minutes before the delivery hour still has an error, a mean average error for the statisticians on the call, of around 30%. Which leads to a large amount of variation that the system has to stand ready to serve. If the forecast for wind from the supplier is 100 megawatts and if the actual delivery is only 50 megawatts, we had to make up that 50 megawatts in real time and we had to hold our schedule for that hour. Alternatively, if the schedule is for 50 MW hours and we got 150 MW hours, we have to have resources that actually can back down to hold that schedule. It requires us to the term I use as deoptimize our other traditional resources. And that substantially is the cost that we're accounting for here and it falls into three buckets. There's regulation, which is the within 10-minute movements. For these resources besides the forecasting error, which I just talked about, there's regulation in the sense that there's a lot of volatility and solar actually has an interesting perspective. If it doesn't have batteries because with cloud cover within a 10-minute window, you can have quite a bit of variability in the regulation window. That's 10-minute variability load following is within the hour.

**Clint Kalich:** Periods of time where you also have the forecast and the delivery might be 50 megawatts, but the wind resource starts at 25 and ends up at 75 and averages to 50 for the hour. While you have 50 megawatts delivered, 50 megawatts, unlike a contract we might have with a third party isn't delivered constantly or predictably for the hour. So again, we have to have standby resources, standby capacity from other resources like our hydro and thermal assets, they stand ready to serve to deal with this variability. The integration study rate is multiplied by the nameplate capacity of the resource. That's traditionally how this is done.

**Clint Kalich:** The good news, I think for QFs today is we're not proposing, as we haven't in our recent filings, any discount on VERs until we complete our new study. The study that we currently have, and we use the information in our IRP and other planning, is from 2007. While we still think there's a lot of validity to that study today, I think many people are concerned that the study is just too old to use, and it also didn't consider solar. So, is it fair to charge for integration? It's charged to a solar facility that's based on the cost of that study, which back in 2007, was based on wind.

**Lance Kaufman:** Is that for both the small or the standard rate and the large QF? And methodology.

**Clint Kalich:** It would be. That's right for both. That's absolutely true. Yes, it would be the same rate for both. Once it's implemented, and if you have interest or concerns about the variable energy resource integration charge, I would encourage you to participate in our work group. I think we just hit a milestone with Energy Strategies where they did a lot of the original work, which includes citing up to 2,500 megawatts of wind and solar on our system or around our system. They did all the work around calculating the incremental regulation load forecasting, load following and forecast error, so those results will be published in a week or so and provided to the work group. If you're interested in that, e-mail one of us, and we'll get you hooked up with that because there's a public process.

**James Gall:** Clint, can you remind everybody when that meeting is next week?

**Clint Kalich:** I'd like to do that. I think it's the 13th.

**James Gall:** Yeah, 13<sup>th</sup> at 1:00 o'clock.

**Clint Kalich:** So, you can remind them, you just did so. Again, just reach out and we'd be happy to have you join that. We do have representatives on that work group from both Idaho and Washington Commissions and a few other interested parties as well.

**Woodward, Jim (UTC):** Hey there, Clint.

**Clint Kalich:** Yes.

**Jim Woodward (UTC):** Hi, Jim Woodward, Washington Staff again, just wanted to clarify that time stamp around that second main bullet from the bottom. When you know it says the discount want to plan until the VR study is complete with next week's work group and the report coming out. It sounds like there's still some process, steps to go through in terms of in Washington. We're not looking to have this sort of impact that this potentially would be maybe November of 2023. Is that a fair assessment or are we talking about something,

**Clint Kalich:** Yeah, I'm hopeful we'll get to it by just by that time in 2023. Yes. There'll be nothing, no overall proposal in in this filing. Now, if you're a large QF and let's say you came in next year in February and the version has been completed, you might be subject to this charge. But for published rates, there wouldn't be any proposal to include it. So, until the studies complete. Yeah.

**Jim Woodward (UTC):** OK. Great. Thanks.

**Clint Kalich:** And it's a pretty simple piece of math. To figure out what the cost is not simple, but once you've determined what the cost is, again in Washington, there's a requirement that we charge it based on a per MW hour charge. We don't think of this cost as a per MW hour, but that's what Washington has asked us to do. It keeps things simpler. We take the cost, and we convert it to a per MW hour charge and we just multiply it times

delivered MW hours, all hours would get the same charge. More to come on that as we work through that.

**Lance Kaufman:** Would all resources get the same charge? Also solar versus wind?

**Clint Kalich:** That's a good question, Lance. And I think at this point in time, I'm not sure that we have an answer to that. I think the data will lead us there. The numbers I've seen from other studies show there's a differentiation between those two resources. My expectation is they'll be different rates for wind and solar.

**Lance Kaufman:** One thing that I've thought about you can maybe put on the back burner is how to deal with potentially a solar resource displacing a wind or vice versa.

**Clint Kalich:** Sounds good. And that's a great thing I think at a workshop to talk about or if you're not able to participate in the workshop, if you'd be kind enough to send off an e-mail or something like that around those concepts. We can definitely consider that in the work. Both we and certainly Energy Strategies want to have a study at the end of the day that people look toward as leading edge on this problem. So definitely want to talk about those things to the extent those costs belong. Another challenge we've had, sometimes there's a mix of what should be in a variable energy resource integration charge versus what might be considered more of a capacity or an energy value, a commodity value. Those are important concepts to discuss, and we have discussed them both with the consultant. We will discuss those with the work group as well. So, look forward to that.

**Clint Kalich:** Early in the slides, I talked about energy and capacity being the traditional avoided costs. This is the capacity value concept. This is the value, if you're a QF looking at it from a utility perspective, what's the value provided to the grid during times of system peak demand when James and friends are doing their Integrated Resource Plan, one of the key drivers is the reliability piece and reliability is heavily affected by the ability to bring generation to bear when loads are high. If you're in California today, right now many people are very concerned about grid reliability as they go through record loads down there.

**Clint Kalich:** That's really what this is intended is to incent generation that provides value to us during times when we actually need the power to serve our customers reliably. There are two options in Washington that you can price the capacity, the on peak contribution. The first one is the fixed costs associated with the last approved IRP's first capacity addition. So that's one option. I believe that's likely what Jim will be filing coming up here in November. That said, we're finishing up an RFP and we may be able to pull some data out to use in support of that through the RFP process. I don't know, we've fully determined which one, but Washington allows you to use one of those two methods.

**Clint Kalich:** Once you've identified the resource, it sets the value of capacity. Then we use what's called a qualifying capacity contribution factor, and I do have one picture in here. It's not really a picture, it's a table. But in our 2021 filing for November, we're going to use the latest information we have from our last IRP, unless we can get something

that's publicly available out of the Western Power Pool under the WRAP program. The WRAP program is an attempt regionally to identify how much each resource, technology type and location, it differentiates where you're located, how much each resource can bring to bear as it helps you qualify towards meeting your regional reliability obligations. In the interim and last year, we used the data from the recent IRP for each one of the resources and that qualifying capacity contribution is multiplied times the nameplate capacity. If you look down at the bottom, the total lineal value is equal to the nameplate capacity times the qualifying capacity contribution times the value or the price.

**Clint Kalich:** In Washington, there's a preference to convert all this to per MW hour pricing. We divide the total value by the MW hours expected to be delivered by that QF resource type. That QF technology. And in fact, here are the qualifying capacity credits. Again, I emphasize that once the Power Pool Data is available, and that's what we're using for our planning now, it will be the Power Pool numbers we'll convert. But these are from the last IRP. So, if you have a Northwest solar facility, your peak credit is equal to 2% of the, if you remember here are one of these two utility options, whatever that value is, you're paid 2% of it. If you're wind, it's 5%.

**Clint Kalich:** You can see here based on if you have batteries or some storage type technologies, you can get some value. Same thing with hydro and those types of things and you can see even here if you have a solar resource with some storage added to it, you definitely get more value. For example, if you have 4 hours of storage, you get a 17% benefit relative to a 2% benefit. You can see what the difference there would be. Jim.

**Jim Woodward (UTC):** Hey there, Jim Woodward again. Just wondering as far as the interplay with the Western Power Pool, based on some of our ongoing conversations, it sounds like the Power Pool is rolling out their publicly available QCCs on a rolling basis and given that for purposes of your companies avoided cost filing in November and then the 2023 IRP. Are you using the Western Power Pools QCCs as they become available, so you will maybe have some from the 2021 IRP and others from the Western Power Pool, or are you waiting to change everything over? I guess it's more of a timing question.

**Clint Kalich:** Yeah. Well, I think there's that, Jim. And also, will we get the combination of resources, for example, solar plus 4-hour, maybe we'll just simply make a decision, and this is probably part of the discussion as you know, Jim, of course we're working with Staff and some other interested parties on exactly how all this would play out. But my recollection is for storage, I don't know with solar, for example, exactly how much variability there is around the resource technology types and maybe that argues for a lower number. The other thing to keep in mind again it references the most recent IRP. It'll be interesting to see where we land on that specifically in our filing. We'll certainly have a proposal there for people to look at and hopefully it's a proposal that some of the interested parties and Staff can come to a conclusion or agreement on before we make that filing. That's certainly our hope.

**Lance Kaufman:** And Clint, the numbers here are particularly for a winter capacity, right?



**Clint Kalich:** These are for our system, so this would be our system value. Because I think, Lance, we've had these discussions before. We have needs both in the winter and summer. So, depending on the resource type, let's pick a good one. Solar is always a little sensitive. Let's assume you had a hydro project that tied to an irrigation canal. You'd have some pretty nice contribution in the summer, but we get nothing in the winter. If you need both in order to get qualifying capacity, one doesn't help you without the other, so you get a different value relative to a more traditional resource that would provide you capacity in both. Say storage with 70-hour duration, which you would theoretically be able to exercise both in the summer and winter. Avista, some people think of it as being dual peaking, we still see extreme weather events, winter is driving our demand requirement. It doesn't discount the value of a summer resource, but if you bring only summer, just like if you're only bringing winter, you have the risk of not being able to meet the other obligation and your qualifying capacity credit will go down.

**Lance Kaufman:** Do you know? In the event that Avista does become summer peaking, would you expect these numbers to change?

**Clint Kalich:** I think they will change, but maybe not as drastically as people think. Just because we have a marginally larger need in the summer, it doesn't mean that we don't have a need in the winter as well. It'll be interesting to see how those change and we're working on understanding how they might change. Again, keep in mind, I know it's sometimes hard to wait, but the rules around the Western Power Pool. They just literally filed their tariff, and the tariff does not include, I don't think they published even in draft under confidentiality, the business documents to support how all the math is happening. So, there's a lot of unknowns around the specifics of how this math is done. The thing I like about it is a regional entity is doing the work. So, it's not done until a lot of folks that are providing contributions to the methodologies, et cetera. But and we're confident that once those are done, we'll be able to support them, but we haven't actually seen the data in a public format yet. I think we have to wait and see and in the interim, we have this.

**Lance Kaufman:** How would you deal with it? How would you deal with a situation where you have, say a winter need in the first few years of your IRP and then it's a summer need in the later years of your IRP? Summer capacity needed.

**Clint Kalich:** Haven't thought that one through, Lance. I don't know that we've had to really worry too much about that in the past. Again, I think there's enough of an overlap or it's not as if the winter requirement would go away, so it still substantially exists. Again, open to ideas. And Lance, you're one of the folks working with us and the Commission Staff to work on this, I think we're going to learn this together as we go forward. So, open to proposals. Maybe not here today, but certainly open to ideas that you might have. This has all gotten much more complicated in the last few years. I mean, infinitely more complicated than it has been in the past, and that's why I said early on in this discussion, it's almost as if the [unknown] hasn't been defined. It just keeps moving the targets, they just keep moving as we change what energy and capacity mean to utility and to the

industry. But absolutely other information, this would be what we would use, which was the 2021 IRP data.

**Clint Kalich:** Let's talk about another reserve product for wind and solar, a variable energy charge. There are some conceptual similarities here, but in the northwest, we're part of a what we call a reserve sharing agreement with all the utilities and that reserve sharing agreement requires no matter what resource type you bring to the grid in an hour. So, if you schedule 100 megawatts of energy delivery in an hour, you have to hold back or demonstrate three megawatts of capacity on standby. In other words, if you only had a 100 MW resource, you couldn't generate 100 megawatts in a given hour. You'd have to back off. At least, be 97.X megawatts because you have to hold back 3% of your capacity to handle times when there's an issue on the grid, whether it's a failure of your resource or failure of somebody else's resource. The idea being, with a reserve sharing agreement, everybody gets to hold less, so you don't have to hold as much.

**Clint Kalich:** In theory, if you only had one resource and you didn't have any connectivity, you'd have to carry almost 100% in reserve capacity. If the one resource failed, the second one would stand in and theoretically you could even take it further. What are the statistical probabilities that two resources would fail and therefore you need a third resource? The nice thing about this coordination, the contingency reserve sharing concept that's been in the northwest for decades, is we only have to carry 3%. If you bring us a QF resource and schedule 100 megawatts, we're going to have to take 3 megawatts of another resource on our system and hold it back. And there's a cost of capacity to do that. We know what the cost of capacity is. We defined it above with regard to the peaking value of capacity. So, we take this 3% times the nameplate capacity of the plant and we convert that to a per MW hour rate and that becomes a contingency reserve charge or discount to the payment in the published and also the unpublished QF rate.

**Clint Kalich:** And then we get to the clean energy premium value. And really what this is, is a value of providing electricity to the grid that doesn't have CO<sub>2</sub> or CO<sub>2</sub> equivalents associated with it. How do we get to that value? Well, we take the total resource value less the energy payment that we make, less the capacity payment value we pay you and that's the energy premium. James shared earlier about the social cost of carbon as an example, that increases the value of not only conservation but other non-carbon emitting resources, so those two values are not really reflected in the peaking capacity. In fact, in solar and wind you're getting a substantial reduction in peaking value relative to a traditional resource. One of the ways you get some of that back and more potentially is through the clean energy premium value and this can be fairly substantial. We add that to the commodity energy schedule that's provided in the published tariff in Washington for a Washington QF.

**Jim Woodward (UTC):** Sure. Clint, to help some folks on the call get a better understanding of what this might, you know be analogous relate to the clean energy premium that roughly approximates. A lot of us may be more familiar with the environmental attributes of renewable energy REC prices. Is that kind of on par with what

we're talking about here? Trying to quantify those clean attributes that perhaps had not previously been in Avista Schedule 62, is that what we're getting at here with this clean energy premium?

**Clint Kalich:** Well, conceptually I think that's true, but similar to short term capacity, a lot of times people talk about capacity value really depends on the timeframe over which you offer it. If you're talking about in the short-term day ahead, hour ahead markets, the value capacity is very small. Similarly, in a REC market, the REC seemed to be worth a lot less than the cost of building something new. The value that's provided here is a clean energy premium probably is, at least for long term resources, greatly higher than the value of a traditional REC. So, it's more than just the renewable energy credit. And there's new laws beyond, say I-937, that required that we have the Climate Commitment Act. For example, we have CETA. So, a lot of mandates that are driving us to get clean energy that probably the value goes beyond just a simple REC value, but conceptionally, I think you're right. I think it's similar, it is exactly the environmental attributes relative to a traditional carbon emitting resource.

**Jim Woodward:** It's almost the environmental attributes associated with the capacity portion, not just a per unit energy, but the capacity portion of said clean resources that kind of a fair way to modify. Again, just trying to relate one to another here.

**Clint Kalich:** Well, this is somewhat of a fixed cost that ultimately is put out and converted to a per MW hour price. So, it is if you purchase a wind resource instead of building a gas resource, you're going to pay some premium for a long time, and you can convert it on a per MW hour or calculate it on a present value is a total block of value and charge it. But I think of as what it says. It's a clean energy premium. It's the value of having something that's non-emitting.

**Jim Woodward (UTC):** OK. Thank you.

**Clint Kalich:** It's a substantial component of the total. And because QFs as I explained in the early slides are substantially non-emitting resources in most cases, especially in today's environment. Those resources traditionally benefit and would qualify for the clean energy premium.

**Clint Kalich:** Let's talk about other value streams. I don't want to dive too deeply on these because they're somewhat squishy and I don't mean that in a negative sense. I mean, it's difficult oftentimes to quantify what other values we're not quantifying in the other, the other six or seven items. So again, remember that the QF payments are especially for published rates based on a generic resource type. We're going to pay you for a solar resource, and we're going to pay you for a wind resource or a hydro resource and it's based upon some assumed hydro shape. In other words, what's the average delivery shape of that resource and especially for larger assets or complicated assets, they may have attributes that are different, but they may be able to bring you additional value and some of the ones that are the most obvious to me at least are things such as dispatch flexibility. Let's pretend for a minute that you want to build a 25 MW wind farm.

Traditionally you would put that energy on me. I'd have to take it all the time. Well, what if I had the right to back that down? Because sometimes on my system, I don't have a need for the energy. Or we talked about the integration charges. Sometimes the cost of me having other resources stand by to deal with the variability of that wind is more expensive than the value of that wind itself, especially in times where there's lots of energy on the system. Can you provide me the ability to back you down? And if you're able to provide me the ability on call to back you down, there's value in that.

**Clint Kalich:** That comes from that, so we should compensate you for that. You might build a battery associated with your solar farm or whatever resource it is. And there's more value associated, maybe that battery has different technologies than our standard assumed battery in different ways that we can dispatch it. The dispatch flexibility, interruption rights are somewhat the same depends on how you look at it, but I'll leave them the same. And there may be some local distribution benefit values that can be identified, those are again difficult to quantify but to the extent they exist there's a value stream there that needs to be quantified and provided to the QF. Again, these aren't really for published, even though I listed kind of the published. This is the IRP methodology these probably are for resources that are larger, especially because if you're trying to get value for flexibility where our operators and our traders can extract that value out of the marketplace, you need to have a larger resource or it's just not something that overcomes the administrative cost, the metering cost. And just the idea of bringing that problem into our larger solution as we try to meet our portfolio.

**Clint Kalich:** I think the key points in the last bullet, which is if you perceive you're bringing additional value as a QF, we need to be able to confirm that additional value before we identify and price it and put it into your tariff. Not your tariff rate or your contract rate, I guess if it's negotiated it wouldn't be a tariff rate, it would be through contract. I think that's it for Washington. How am I doing on time? I've got to speed up a little bit. I think I've got just a couple slides in Idaho because really want to talk about the differences.

**Clint Kalich:** But in Idaho, there's what's called a surrogate avoided rate, and it's based on an IRP, I mentioned earlier, an Idaho Public Utility Commission managed model. It's based on the fixed and the variable costs of a combined cycle gas turbine, the surrogate avoided resource is considered to be a CCCT in Idaho.

**Clint Kalich:** Natural gas prices are updated annually and there are various other assumptions on inflation, but at the end of the day, the Idaho Commission publishes rates and they vary based on resource type, and they're known and measured and available on websites for the IPUC. As I recall, you're talking about when you have a solar array to hydro rate. They also have a non-seasonal hydro rate and then what they qualify as and other type of resource if it doesn't follow into those. They also provide an on off, just like in Washington, the published rate, there's an on and off-peak production rate, and there's two seasons of each year. I'm not going to say what I can't remember exactly which months they are, but there's a valuation to recognize that especially energy is more value in certain times of the year than other times. There's two seasons and each season you

have an on, off peak price. So, in Idaho you're going to be exposed to four different rates each month, whereas in Washington it's two. There's also in Idaho a variable energy resource discount, so if you are in Idaho, you will have a discount if you have a variable energy resource because Idaho recognizes that 2007 study and continues to use it for QS in Idaho. If you're wind or solar.

**Clint Kalich:** Continuing on, I wanted to make a note on the capacity payments. I want to point out relative to Washington, a couple things. In Idaho, if you have a renewed contract, in other words, if you had a QF contract in place and you renew that contract, you'll receive the full capacity payment as part of your production rate. So even if the utility is long for five years, you won't have a reduction in the capacity payment because of the fact that utility is long. You actually continue to get the full payment, but a new contract will only start receiving capacity payments or have the value calculated based on the first year the utility is actually deficit. So, if we're not needing new resources until 2030, you won't receive the capacity payment until 2030. The other nuance for the surrogate avoided resource that gets published rates is the renewable energy credits are kept by the QF. So, the environmental attributes in Idaho the QF gets to retain those utility gets no value. We don't pay for those for the renewable energy credits. And we also don't get them. Those are important I think to QFs in Idaho, whereas in Washington the attributes are retained by the utility. The IRP based methodology, if you're larger, remember if you're over 100 kilowatts wind and solar or above 10 average megawatts for resources that are other than those you have an IRP based methodology. I went through that methodology for Washington. It's nearly identical. I only wanted to point a couple differences in Idaho.

**Clint Kalich:** There's the 100 kilowatts in the 10 MW break. But the key in Idaho is projects that are ineligible for those published rates get an IRP methodology rate. The peaking capacity value, and this is maybe a technical thing that most people aren't going to be too excited about, but in Idaho, the peaking capacity value, we actually think this is a superior methodology, is based on the portfolio capacity cost rather than a single peaking resource technology type. In other words, over the IRP planning time frame, we're going to add various capacity resources to the portfolio. It could be some wind that has some capacity value, some batteries, some pumped storage hydro, we could have a gas CCCT added. The idea there is on a present value basis we take the full combination of the portfolio capacity resources and that provides a capacity avoided cost for our portfolio, whereas in Washington it's identified as a single resource, a single point in time. So, in Idaho we use that portfolio value to set the capacity payment. We also pay that peaking capacity value. On a per MW basis, rather than on the energy you deliver, it's a capacity value. We pay it based on the capacity of the asset itself and how it delivers on peak. Same thing with the variable energy resource charge, the VER charge, the integration charge that's built on a nameplate basis. The other nuance for IRP methodology projects in Idaho is the large QF retains half of the renewable energy credits. While in Idaho we don't explicitly pay for renewable attributes, we do retain 50% of the renewable energy credits associated with the QFs output. I think we're getting, yes, we're

not only getting to the end, we are at the end. I don't know if there are any further questions. We are at 4:00 o'clock.

**Lance Kaufman:** But I had a couple of quick questions on the Washington method for the reserve and also for the transmission.

**Clint Kalich:** Sure.

**Lance Kaufman:** When and how do you treat the reserve charges in a situation where you also have an avoided resource that's being factored in?

**Clint Kalich:** The value of the avoided capacity resource also would have the same constraint placed against it. So those resources already would have, they would be assumed. I'm sorry, let me get that right. The value that capacity is not derated by that 3%. So therefore, that's why we're derating the avoided cost by the 3%. So, 100 MW resource, we assume it provides us 100 megawatts of capacity and we value it that way.

**Lance Kaufman:** Will you incorporate a reserve charge in the avoided cost in both years, where there is an avoided resource and years where there's not, or one or the other, or neither?

**Clint Kalich:** Yes. That charge as proposed would be applied in all years, just like with any resource we would have today. We would have an avoided capacity cost associated with deoptimizing our existing resource portfolio. It's a cost we would always incur irrespective of our on peak hour contribution or on peak hour deficit position. The on peak is what defines when we need to build new resources and that's magnified by the fact that we carry contingency and planning reserves. But the contingency obligation affects us in all hours. So, if the price is highest in hour ending 1700, we can't maximize our hydro operations to the peak of our capacity because we do have to hold back. So, it affects us in every hour as far as how we operate our assets and the optimizes our system.

**Lance Kaufman:** Is that the same for transmission? Also, that the treatment of the transmission is the same regardless of whether you are avoiding a resource or not. Yeah, I've seen it just is not clear to me how it functions.

**Clint Kalich:** Now the transmission actually is done differently. So, if you look at the large file that we submit to the Commission, I think Lance, you've seen it, maybe you haven't, we go in actually from the IRP. We look at the actual utility position each hour out of the IRP and we look at our transmission rights in that hour and we define if we are surplus or deficit each hour.

**Lance Kaufman:** Yeah, I follow that part of the model. I'm just curious about if there's a different treatment when you have an avoided resource versus not having an avoided resource.

**Clint Kalich:** Well, I'm trying to think if you're asking for utility resources. Is that the question?

**Lance Kaufman:** Right. You have some years where you have no avoided resource, so there's no capacity payment and some years where there's an avoided resource and a capacity payment in those years. And I'm wondering for the distinction between years where there's no avoided resource and years where there is an avoided resource. Do you have differential treatment for the transmission avoidance or transmission charge?

**Clint Kalich:** On a resource that would come on to our system, we would ensure that we actually had firm transmission capacity to go with it. So, we'd actually burden that resource with that cost of transmission, so that, if anything, would increase the capacity value of that of the avoided resource and its capacity payment.

**Clint Kalich:** Actually I think about all of these. Some of these nuances are a little bit difficult to ferret out and some of it's a little bit of art. That's why we have these conversations and discussions and questions you're asking right now, but I'd actually wouldn't mind deep diving with you a little bit offline on that if you wouldn't mind, Lance. I think it's a good conversation to have. The goal of our filing in all of our states is to reflect all of our costs. And I think by that conversation, we both would understand the two positions and we'd be able to hopefully come to agreement on it. And if we didn't, at least we'd both be a little bit clearer to as to the other's position.

**Lance Kaufman:** I don't have a position particularly, I'm just curious how you guys operate the model, but I certainly can work it through offline.

**Clint Kalich:** Yeah. The key concept though is to the extent that we have surplus transmission, we have lots of surplus transmission. We're actually not charging the QF to take any surplus. So, we may have surplus power to our needs in a given hour, but we're not going to try to charge the queue up for that transmission. Similarly, if we actually are deficient and we have to import power trying to credit the QF for that avoided transmission expense that we would incur, we view it as a benefit to the QF as requested by and expected by the Commissions. So that's where we should be coming from on that component. Anyway, that's all I had today. Unless there's other questions.

**James Gall:** I think that wraps up today's TAC meeting. Again, if you have any questions or any follow up, please give John or myself an e-mail or call. We will get the slides posted and the notes as soon as we can for this meeting in the prior one. Again, just to remind you, we'll have another electric TAC meeting on September 28<sup>th</sup>. It'll be same time from 12:30 to 4:00. Thank you everybody and have a great rest of your day.



***2023 Electric Integrated Resource Plan***  
**Technical Advisory Committee Meeting No. 6 Agenda**  
**Wednesday, September 28, 2022**  
**Microsoft Teams Virtual Meeting**

<b>Topic</b>	<b>Time</b>	<b>Staff</b>
Introductions	12:30	John Lyons
Supply Side Resource Cost Assumptions, including DER	12:40	IRP Team
Variable Energy Resource Integration Study Update,	1:45	Lori Hermanson
Break		
All-Source RFP Update	2:30	Chris Drake
Global Climate Change Studies, Impacts to Avista Loads & Resources	2:45	Mike Hermanson
Adjourn	4:00	





# IRP Introduction

2023 Avista Electric IRP

TAC 6 – September 28, 2022

John Lyons, Ph.D. Senior Resource Policy Analyst

# Meeting Guidelines

- IRP team is working remotely and is available for questions and comments
- Stakeholder feedback form
  - Responses shared with TAC at meetings, by email and in Appendix
  - Would a form and/or section on the web site be helpful?
- IRP data posted to web site – updated descriptions and navigation are in development
- Virtual IRP meetings on Microsoft Teams until able to hold large meetings again
- TAC presentations and meeting notes posted on IRP page
- This meeting is being recorded and an automated transcript made

# Virtual TAC Meeting Reminders

- Please mute mics unless commenting or asking a question
- Raise hand or use the chat box for questions or comments
- Respect the pause
- Please try not to speak over the presenter or a speaker
- Please state your name before commenting
- Public advisory meeting – comments will be documented and recorded

# Integrated Resource Planning

The Integrated Resource Plan (IRP):

- Required by Idaho and Washington\* every other year
  - Washington requires IRP every four years and update at two years
- Guides resource strategy over the next twenty + years
- Current and projected load & resource position
- Resource strategies under different future policies
  - Generation resource choices
  - Conservation / demand response
  - Transmission and distribution integration
  - Avoided costs
- Market and portfolio scenarios for uncertain future events and issues

# Technical Advisory Committee

- Public process of the IRP – input on what to study, how to study, and review of assumptions and results
- Wide range of participants involved in all or parts of the process
  - Please ask questions
  - Always soliciting new TAC members
- Open forum while balancing need to get through topics
- Welcome requests for new studies or different modeling assumptions.
- Available by email or phone for questions or comments between meetings
- Due date for study requests from TAC members – October 1, 2022
- External IRP draft released to TAC – March 17, 2023, public comments due – May 12, 2023
- Final 2023 IRP submission to Commissions and TAC – June 1, 2023

# Remaining 2023 Electric IRP TAC Meeting Schedule

- TAC 7: October 11, 2022, 9 am – 3:30 pm
- Technical Modeling Workshop: October 20, 2022
- Washington Progress Report Workshop: December 14, 2022
- TAC 8: February 16, 2023
- Public Meeting Gas & Electric IRPs: March 8, 2023
- TAC 9: March 22, 2023

# Today's Agenda

- 12:30            Introductions, John Lyons
- 12:40            Supply Side Resource Cost Assumptions, Avista IRP Team
- 1:45             Variable Energy Resource Integration Study Update, Lori Hermanson
- Break
- 2:30             All-Source RFP Update, Chris Drake
- 2:45             Global Climate Change Studies, Impacts to Avista Loads & Resources, Mike Hermanson
- 4:00             Adjourn



# Supply Side Resource Options Resources Considered

Avista IRP Team  
Electric IRP, 6<sup>th</sup> Technical Advisory Committee Meeting  
September 28, 2022





# Inflation Reduction Act

Tom Pardee, Natural Gas Planning Manager  
Electric IRP, 6<sup>th</sup> Technical Advisory Committee Meeting  
September 28, 2022

# IRA Overview

- Signed August 16, 2022, and became Public Law No: 117-169
- New “technology-neutral” clean electricity production and investment credits
- Extension and expansion of the renewable electricity production tax credit (PTC) and energy tax credit (ETC)
- Zero-emissions nuclear power production credit
- Clean hydrogen production credit
- Expansion of the credit for carbon capture and storage
- Energy manufacturing credits

# IRA Details

- \$14,000 in direct consumer rebates for heat pumps or other energy efficient home appliances (\$2,000 annual credit against tax liability)
- Up to \$7,500 in tax credits for new electric vehicles and \$4,000 for used electric vehicles
- Production Tax Credits
  - (Geothermal, Wind and Biomass)
  - \$0.026 per kWh tax credit
  - Nuclear
  - \$0.015 per kWh tax credit plus \$0.003 base credit (\$0.018 total per kWh credit)
- Investment Tax Credit (Battery Storage, Pumped Hydro, Solar)
  - Costs incurred in 2022 and 2032 qualify for a 30% tax credit
  - Credit falls to 26% in 2033, 22% in 2034, 10% in 2035/2036, and 0% in 2037
  - Extends to battery storage
  - Additional 10% low-income tax credit
  - Domestic production at 10%

## Not Modeled

- Renewable Natural Gas (RNG)
- Carbon Capture
- Synthetic Methane
- Biodiesel
- Non-Commercial Technologies

## Modeled But Covered in TAC 7

- Ammonia
- Hydrogen



# Supply Side Resource Options Resources Considered

Michael Brutocao, Natural Gas Analyst  
Electric IRP, 6<sup>th</sup> Technical Advisory Committee Meeting  
September 28, 2022

# Overview & Considerations

- The assumptions discussed are “today’s” estimates – likely to be periodically revised.
- IRP supply-side resources are commercially available technologies with potential for development within or near Avista service territory.
- Resource costs vary depending on location, equipment, fuel prices and ownership; while IRPs use point estimates, actual costs will be different.
- Certain resources will be modeled as purchase power agreements (PPA) while others will be modeled as Avista “owned”. These assumptions do not mean they are the only means of resource acquisition.
- No transmission or interconnection costs are included at this time.
  - Interconnect included for off-system resources.
- An Excel file has been distributed with all resources, assumptions and cost calculations for TAC members to review and provide feedback.

# Proposed Natural Gas Resource Options

## Peakers

- Simple Cycle Combustion Turbine (CT)
  - CT Frame
  - 180 MW
- Reciprocating Engines
  - 185 MW

## Baseload

- Combined Cycle CT (CCCT)
  - 312 MW (1x1 w/DF)

Natural gas turbines are modeled using a 30-year life with Avista ownership

# Renewable Resource Options - Solar

## All Purchase Power Agreement (PPA) Options

### Solar

- Residential (6 kW AC)
  - New & existing
  - With & without battery
- Commercial (1 MW AC)
  - With & without battery
- Fixed PV Array (5 MW AC)
  - With & without battery
- On-System Single Axis Tracking Array (100 MW AC)
  - With & without 100 MW 4-hour lithium-ion battery
  - With 100 MW 2-hour lithium-ion battery
  - With 50 MW 4-hour lithium-ion battery
- Off-system Single Axis Tracking Array (100 MW AC) located in southern PNW



# Renewable Resource Options - Wind

## All Purchase Power Agreement (PPA) Options

### Wind

- On-system wind (100 MW)
- Off-system wind (100 MW)
- Montana wind (100 MW)
- Offshore wind (100 MW)
  - Share of a larger project

# Other “Clean” Resource Options

- Geothermal PPA (20 MW)
  - Off-system PPA
- Biomass (58 MW)
  - i.e. Kettle Falls 3 or other
- Nuclear PPA (100 MW)
  - Off-system PPA share of a mid-size facility
- Renewable Hydrogen
  - Fuel Cell (25 MW)
- Ammonia (74 MW)
  - Natural Gas Turbine

# Storage Technologies

## Lithium-Ion

- Assumes: 86% round trip efficiency (RTE), 15-year operating life
- Assumes Avista ownership
- 5 MW Distribution Level
  - 4 hours (20 MWh)
  - 8 hours (40 MWh)
- 25 MW Transmission Level
  - 4 hours (100 MWh)
  - 8 hours (200 MWh)
  - 16 hours (400 MWh)

## Other Storage Options

- Assumes Avista ownership
- 25 MW Vanadium Flow (70% RTE)
  - 4 hours (100 MWh)
- 25 MW Zinc Bromide Flow (67% RTE)
  - 4 hours (100 MWh)
- 25 MW Liquid Air (65% RTE)
  - 8 hours (400 MWh)
- 100 MW Iron Oxide (65% RTE)
  - 100 hours
- 100 MW Pumped Hydro
  - 16/24 hours (1,600/2,400 MWh)
- 400 MW Pumped Hydro
  - 8.5 hours (3,400 MWh)

# Resource Upgrades

- **Rathdrum CT** *[natural gas peaker]*
  - 5 MW by 2055 uprates
  - 10 MW Inlet Evaporation



# Supply Side Resource Options Capital Costs

Michael Brutocao, Natural Gas Analyst  
Electric IRP, 6<sup>th</sup> Technical Advisory Committee Meeting  
September 28, 2022

# Fueled Generation

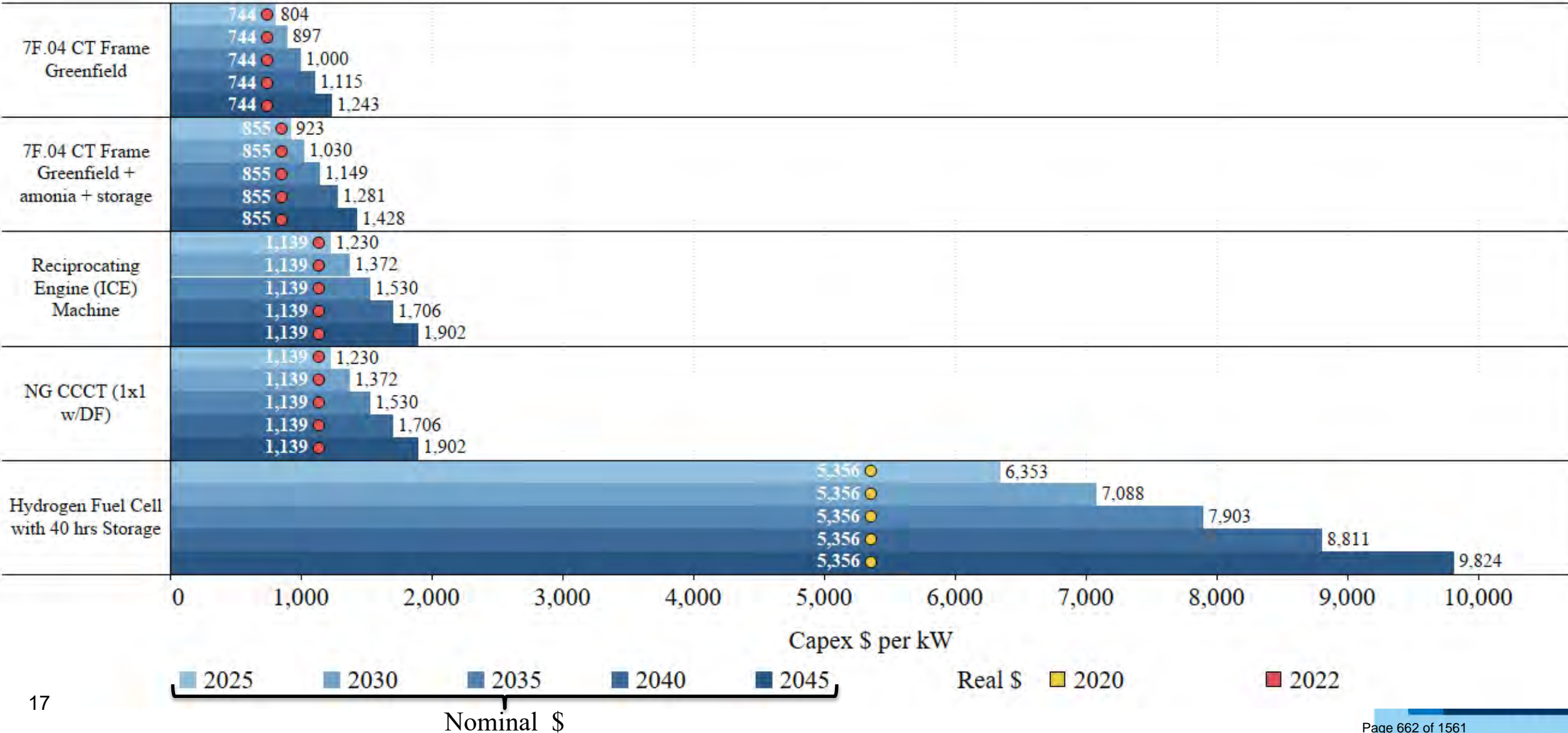

# Geothermal & Nuclear

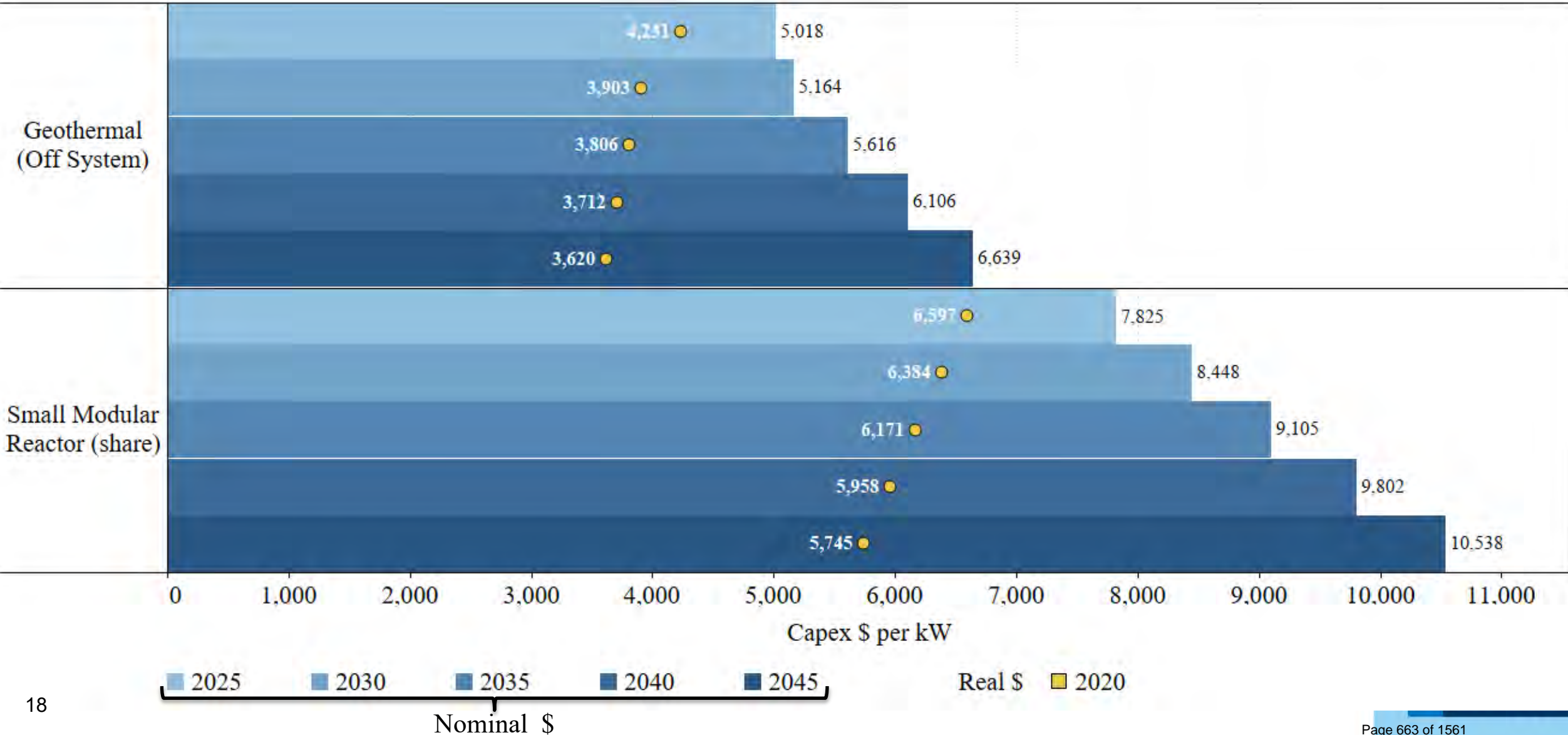

# Storage

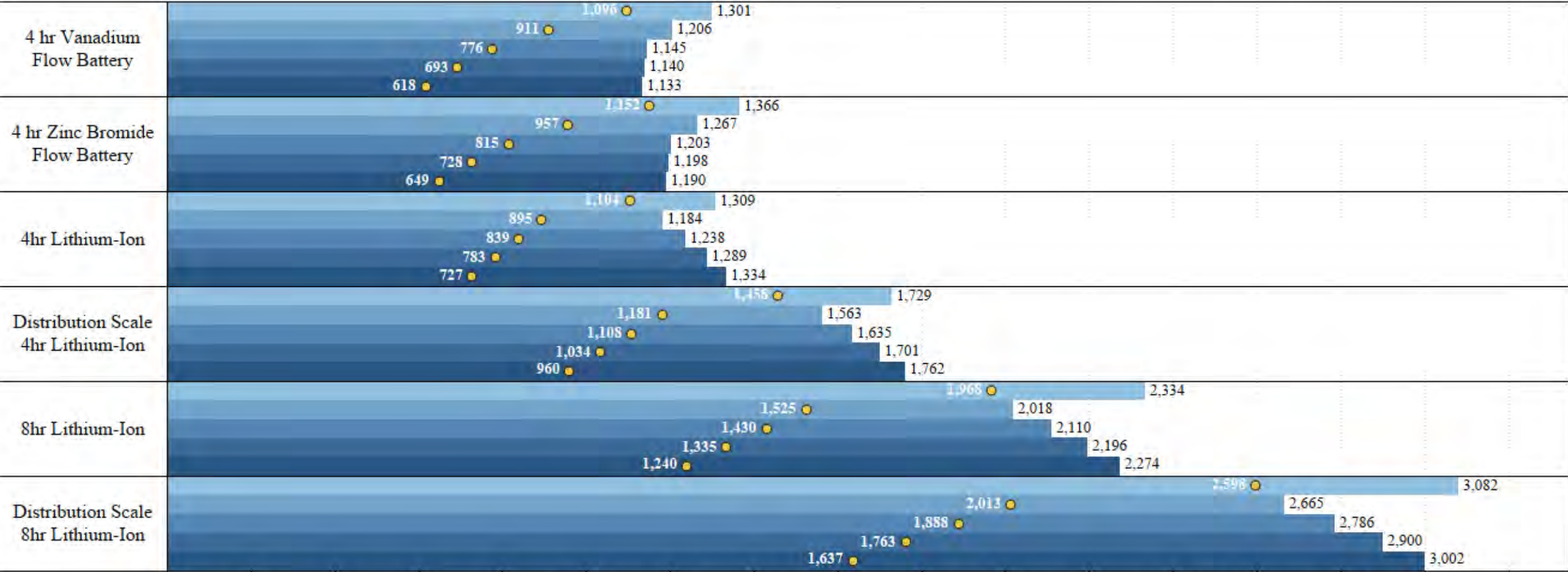

0 200 400 600 800 1,000 1,200 1,400 1,600 1,800 2,000 2,200 2,400 2,600 2,800 3,000 3,200

Capex \$ per kW

2025 2030 2035 2040 2045 Real \$ 2020

Nominal \$



# Storage Continued

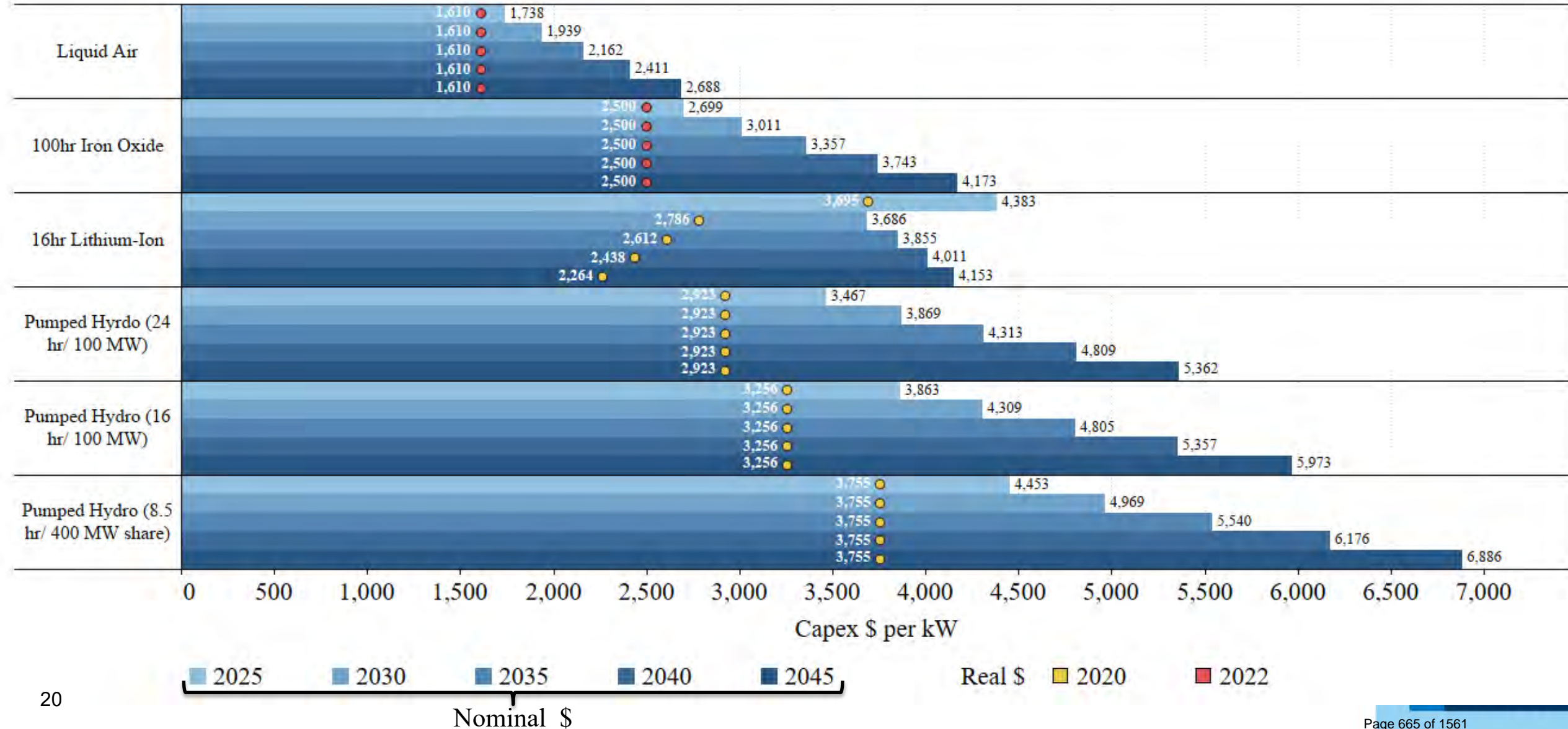

# Solar + Storage

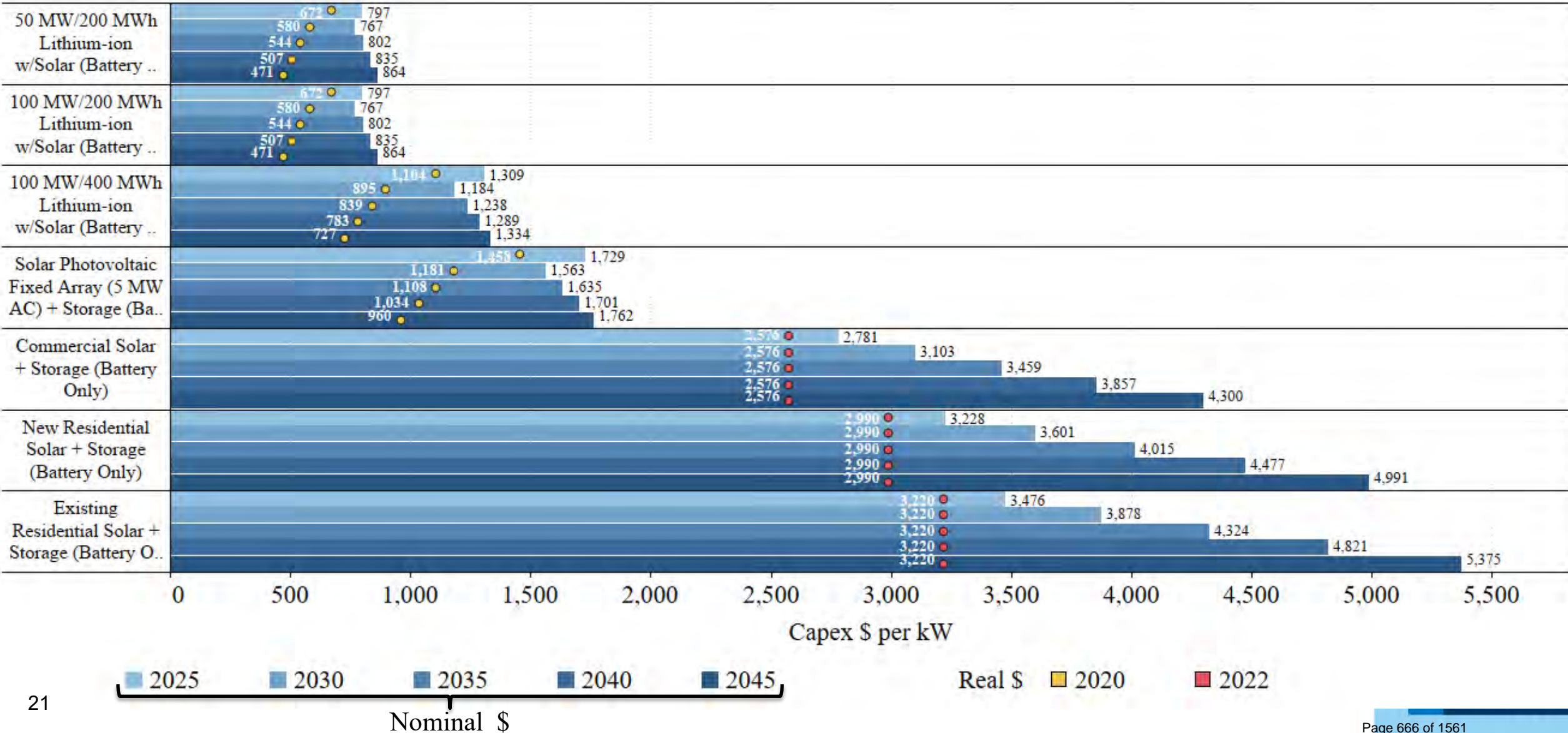

# Solar PPA

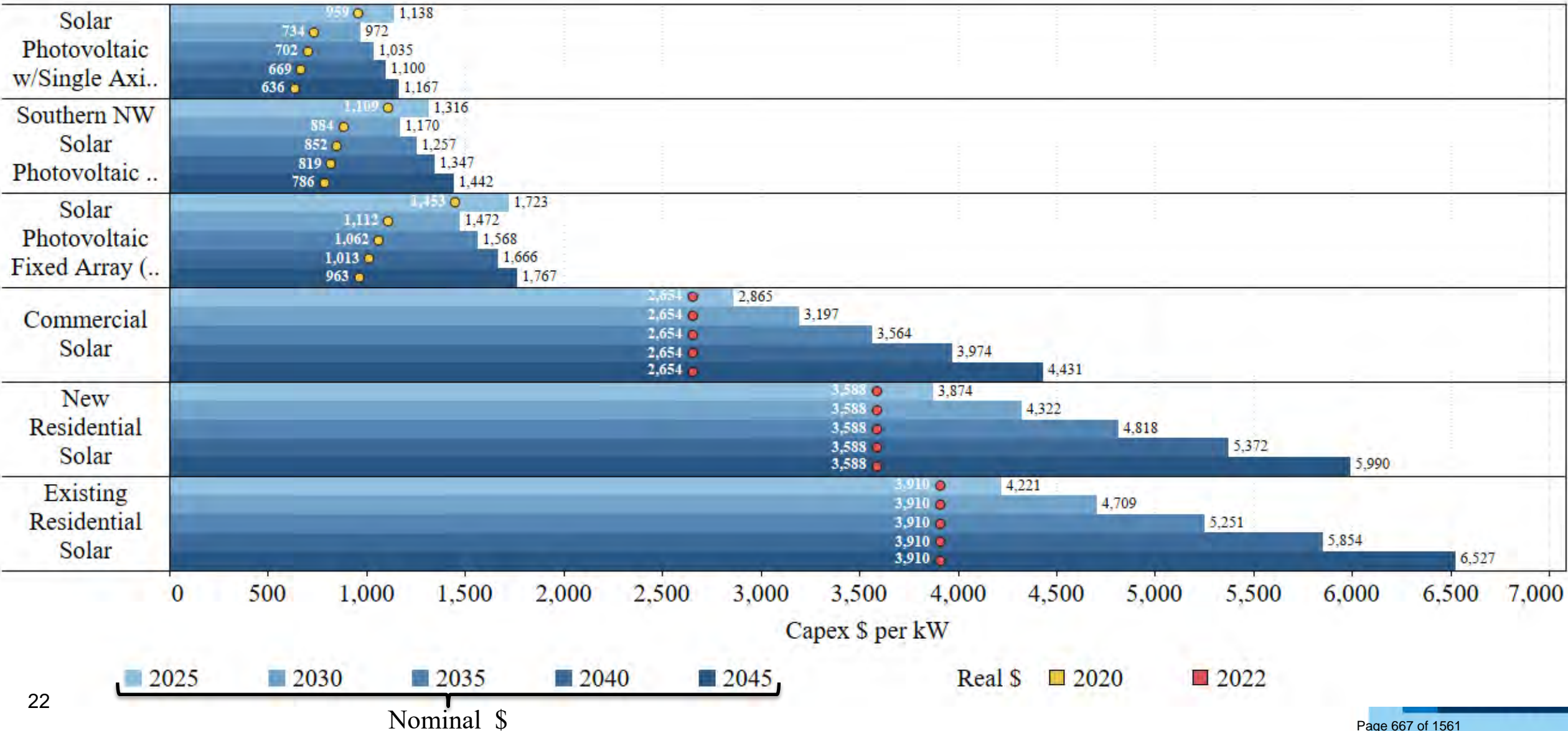

# Wind PPA

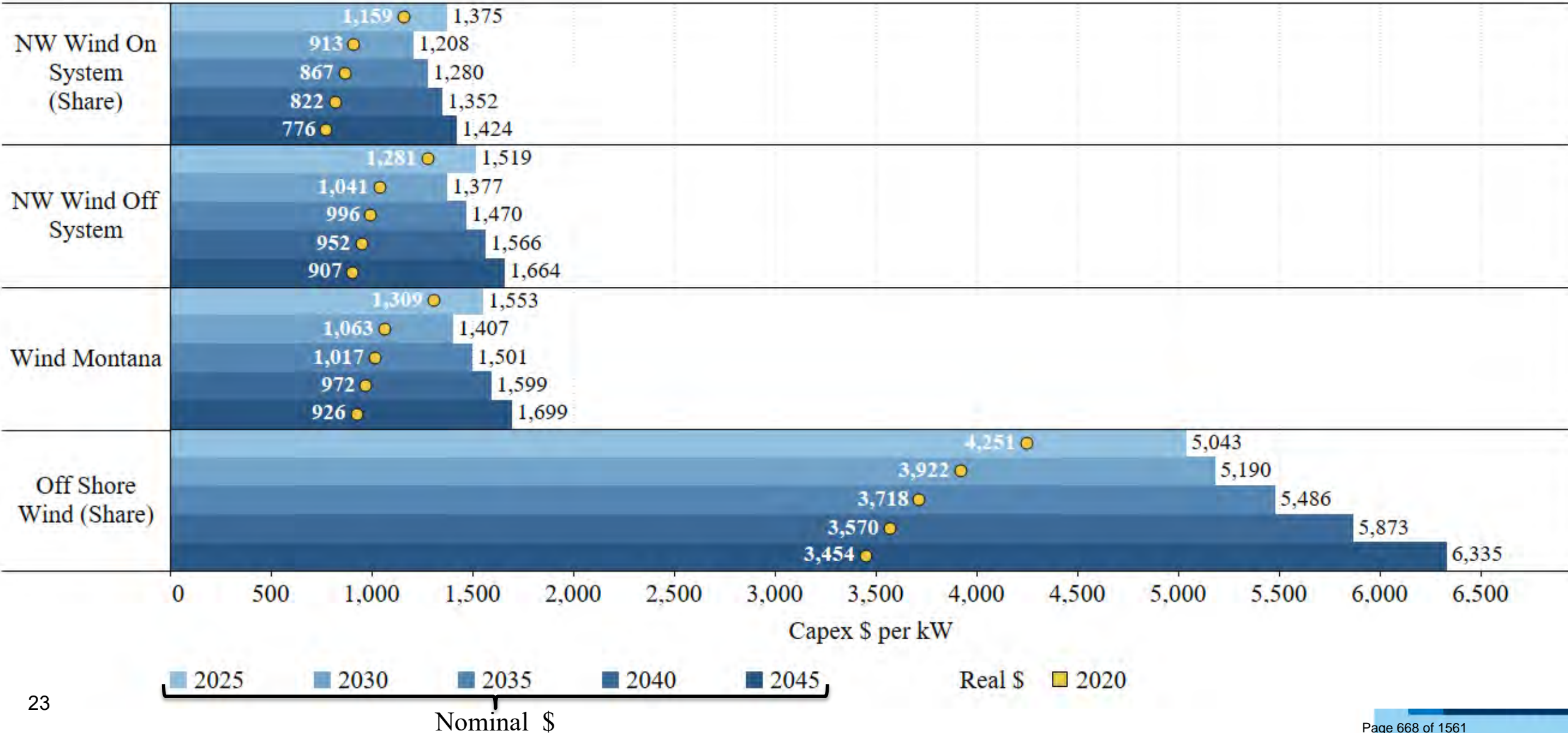

# Upgrades & Biomass

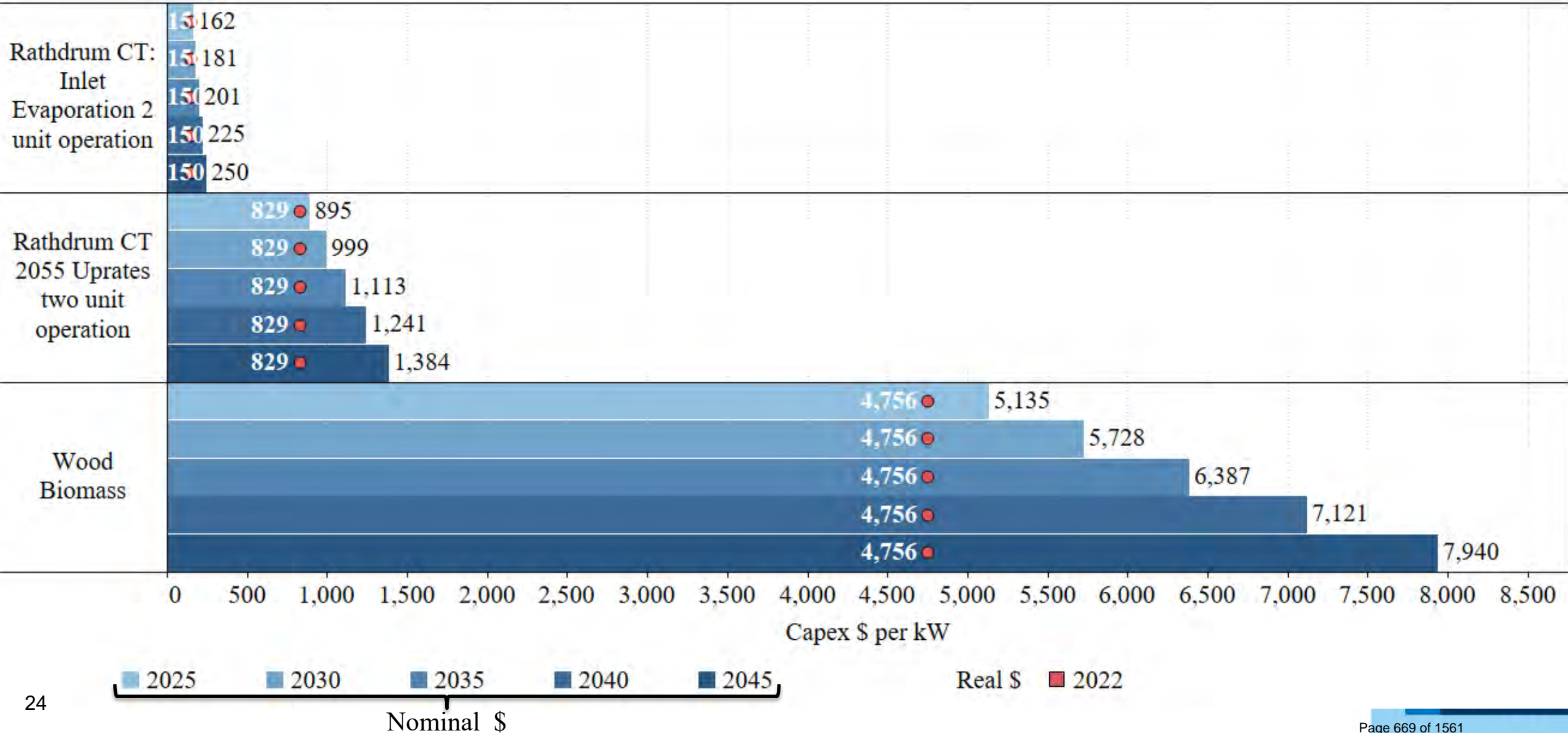



# Supply Side Resource Options Levelized Costs

Michael Brutocao, Natural Gas Analyst  
Electric IRP, 6<sup>th</sup> Technical Advisory Committee Meeting  
September 28, 2022

# Natural Gas Fixed & Variable Costs – nominal \$ (Idaho)

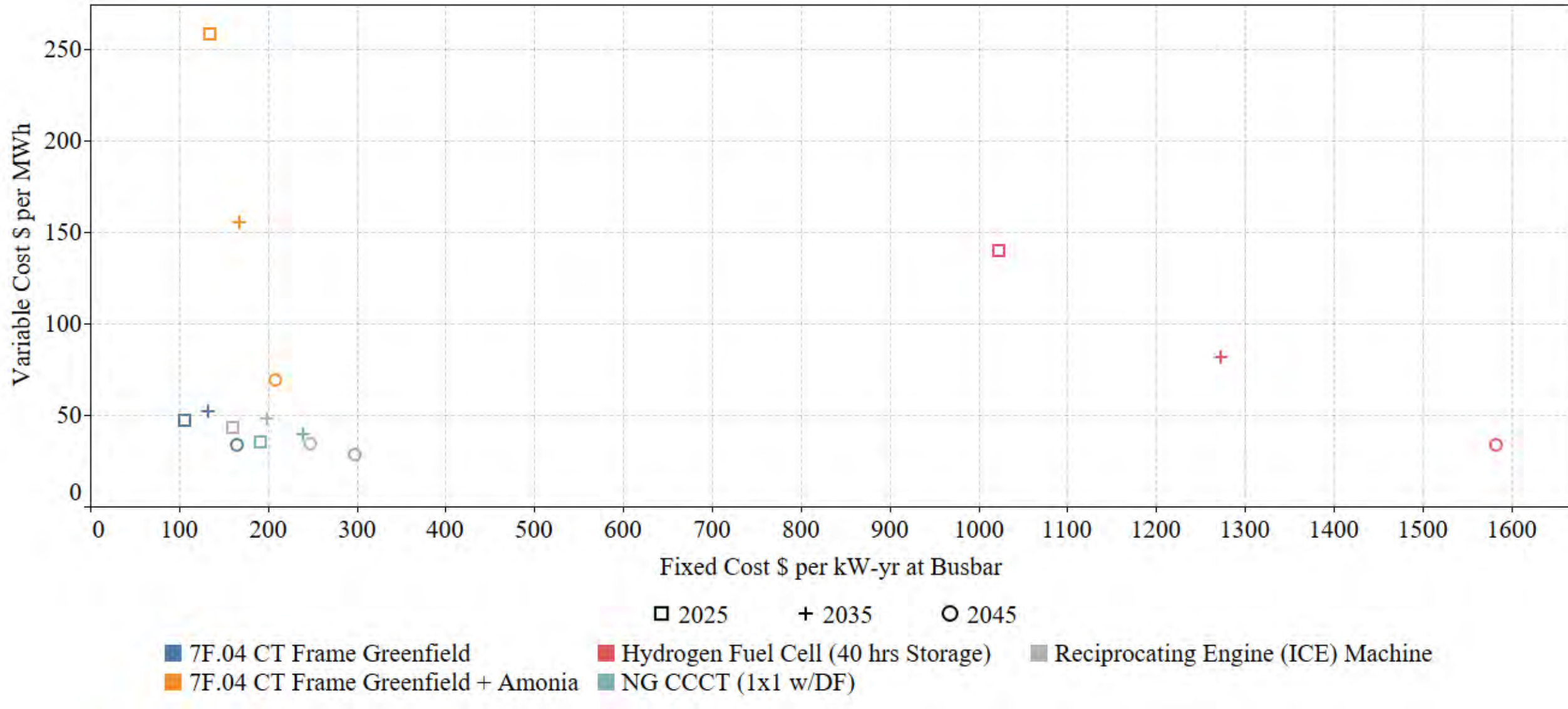

# Natural Gas Fixed & Variable Costs – nominal \$ (Washington)

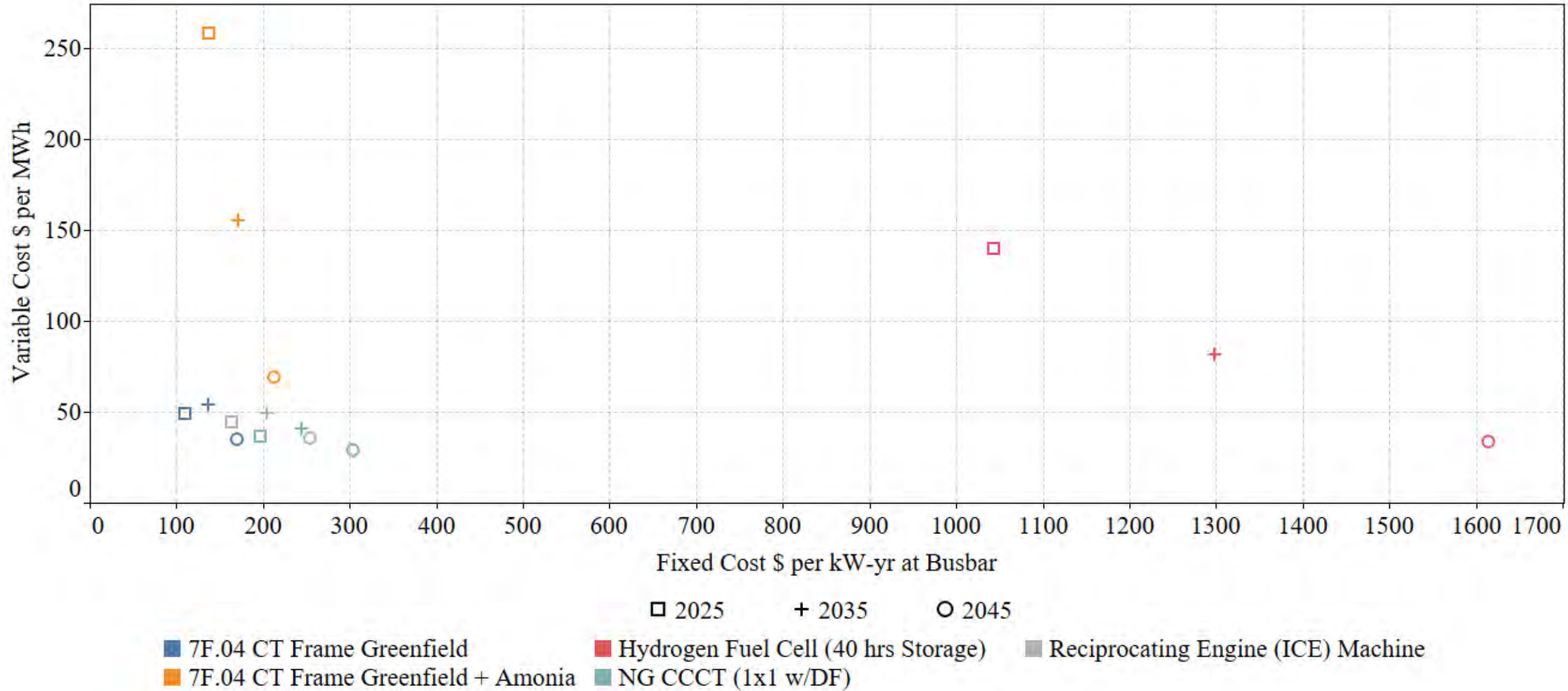



# Facility Upgrade Cost Analysis – nominal \$

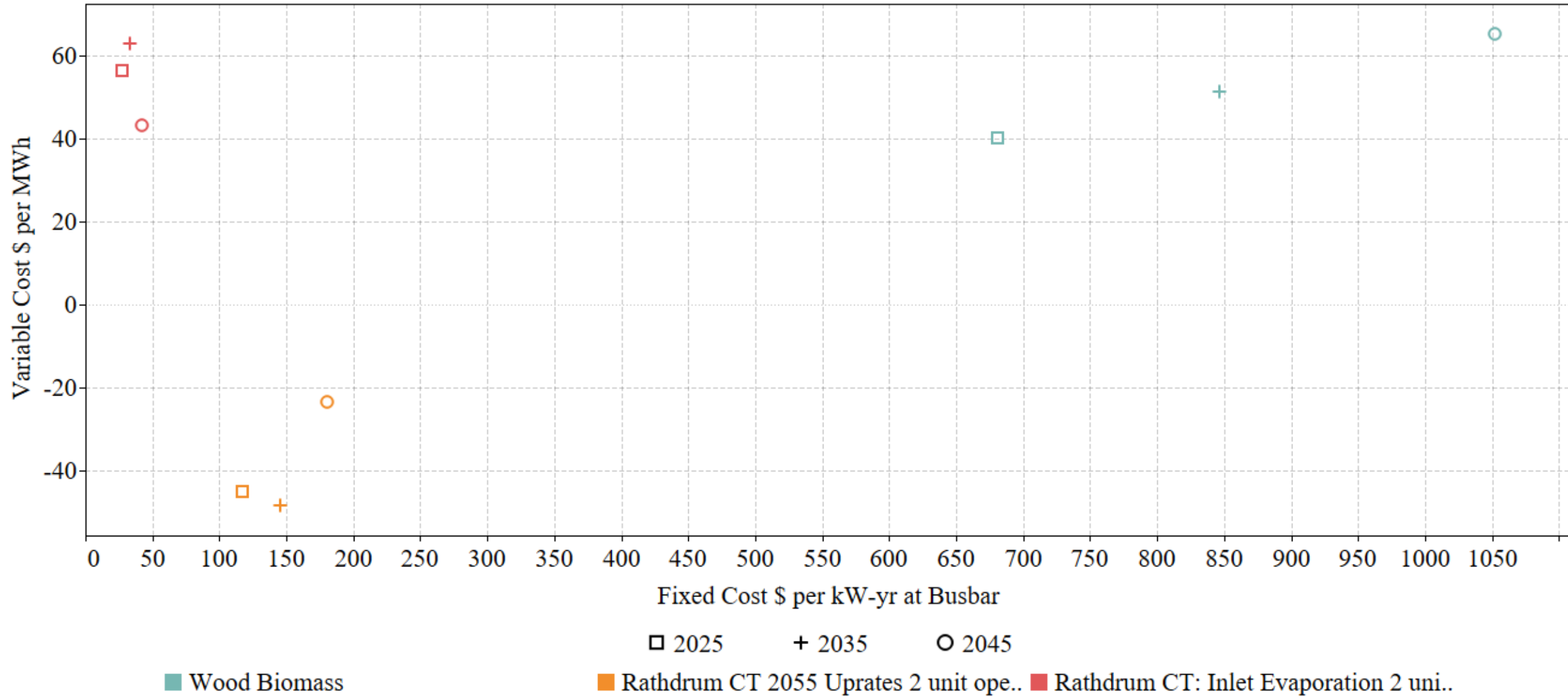

# Storage Cost Analysis – nominal \$

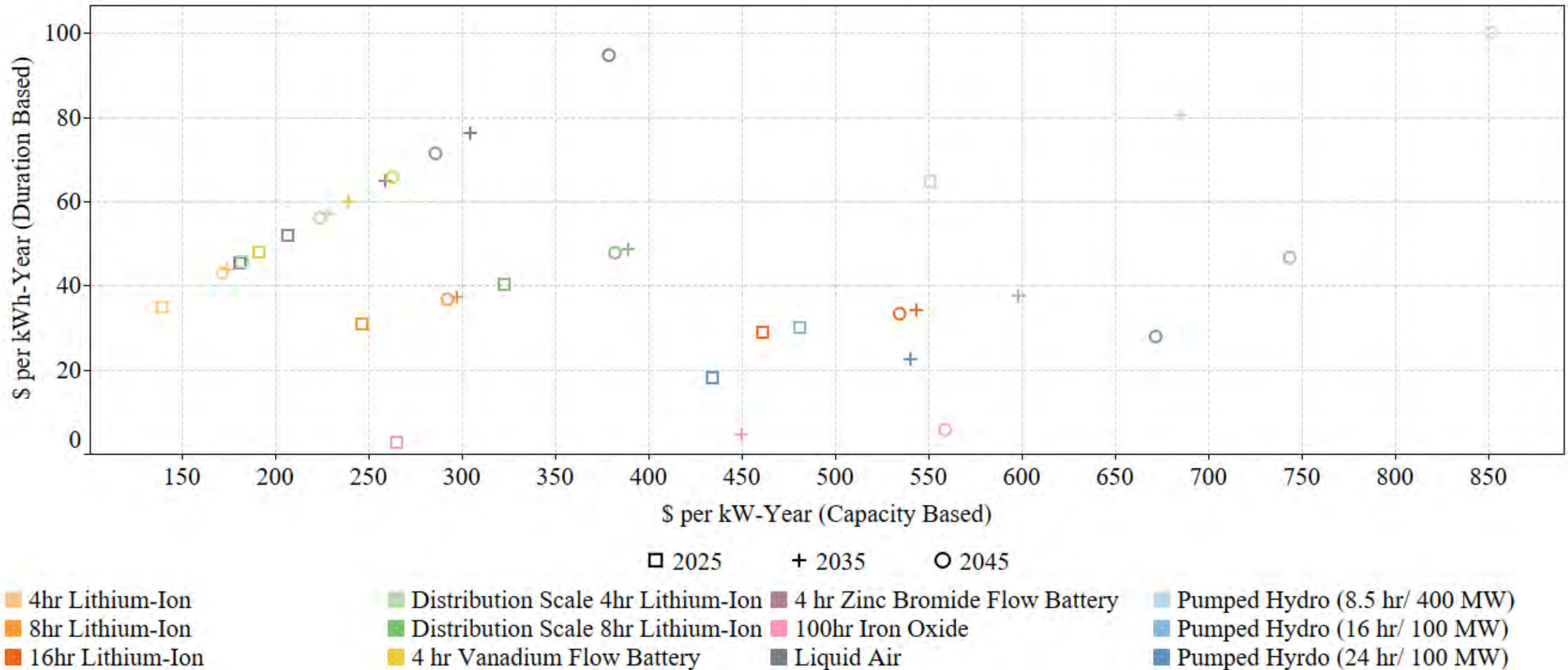

# Fueled Generation Fixed Cost (Levelized) - Idaho

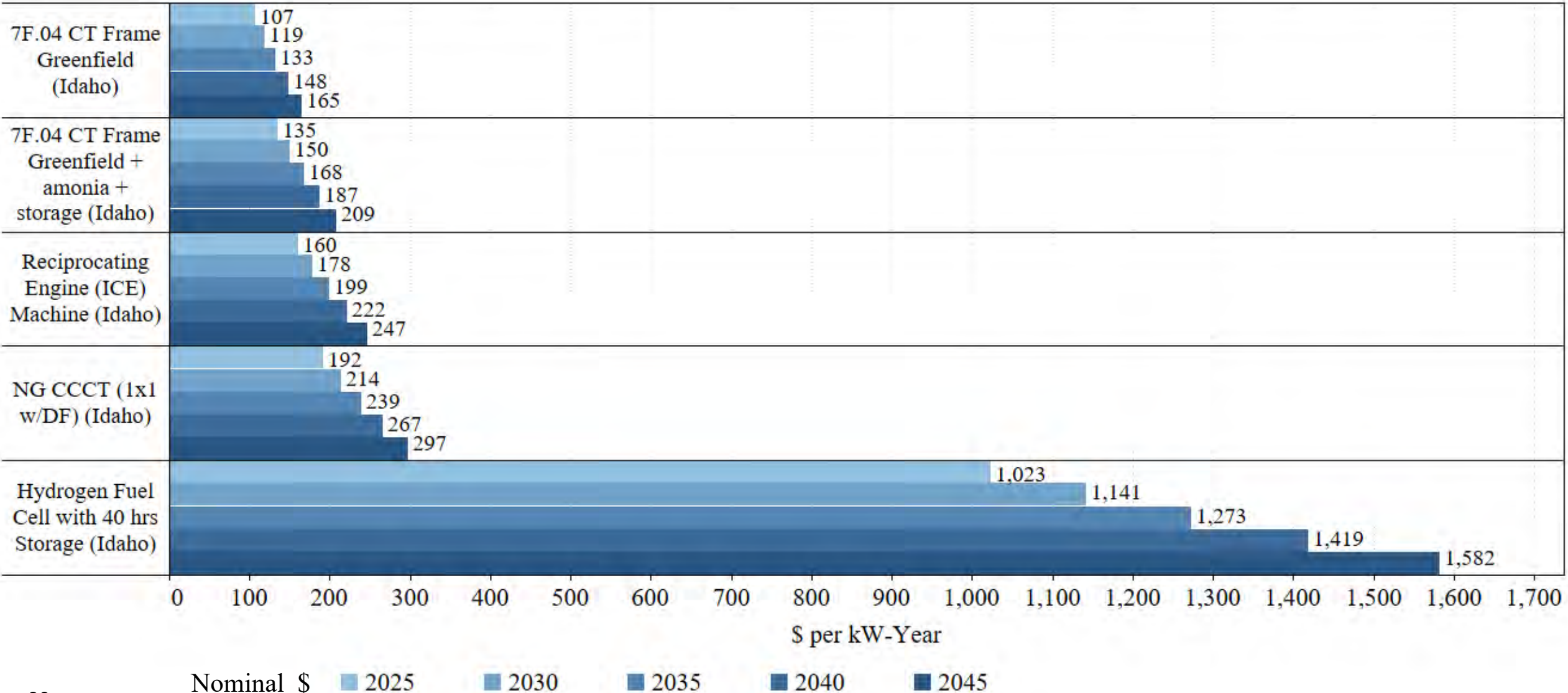

# Fueled Generation Fixed Cost (Levelized) - Washington

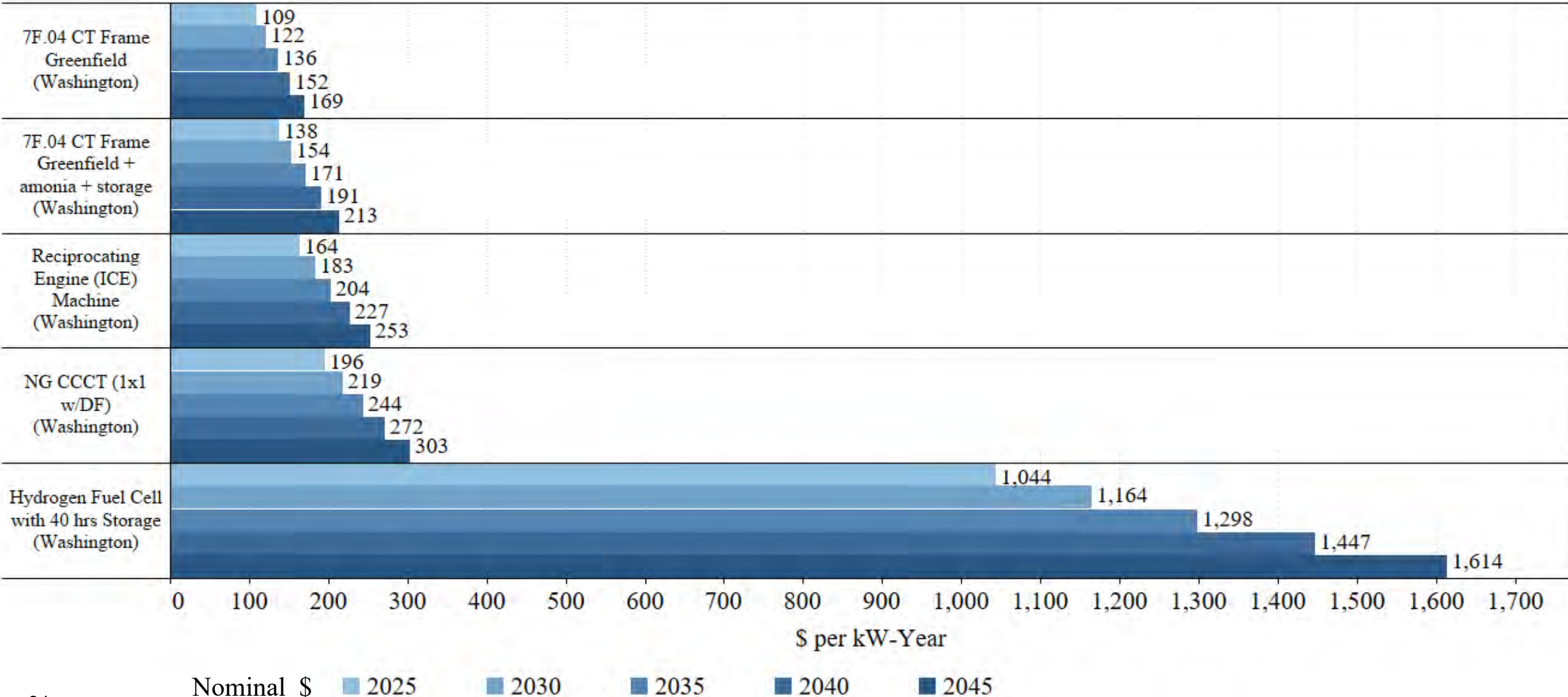

# Geothermal/Nuclear Implied Energy Payment (Levelized)

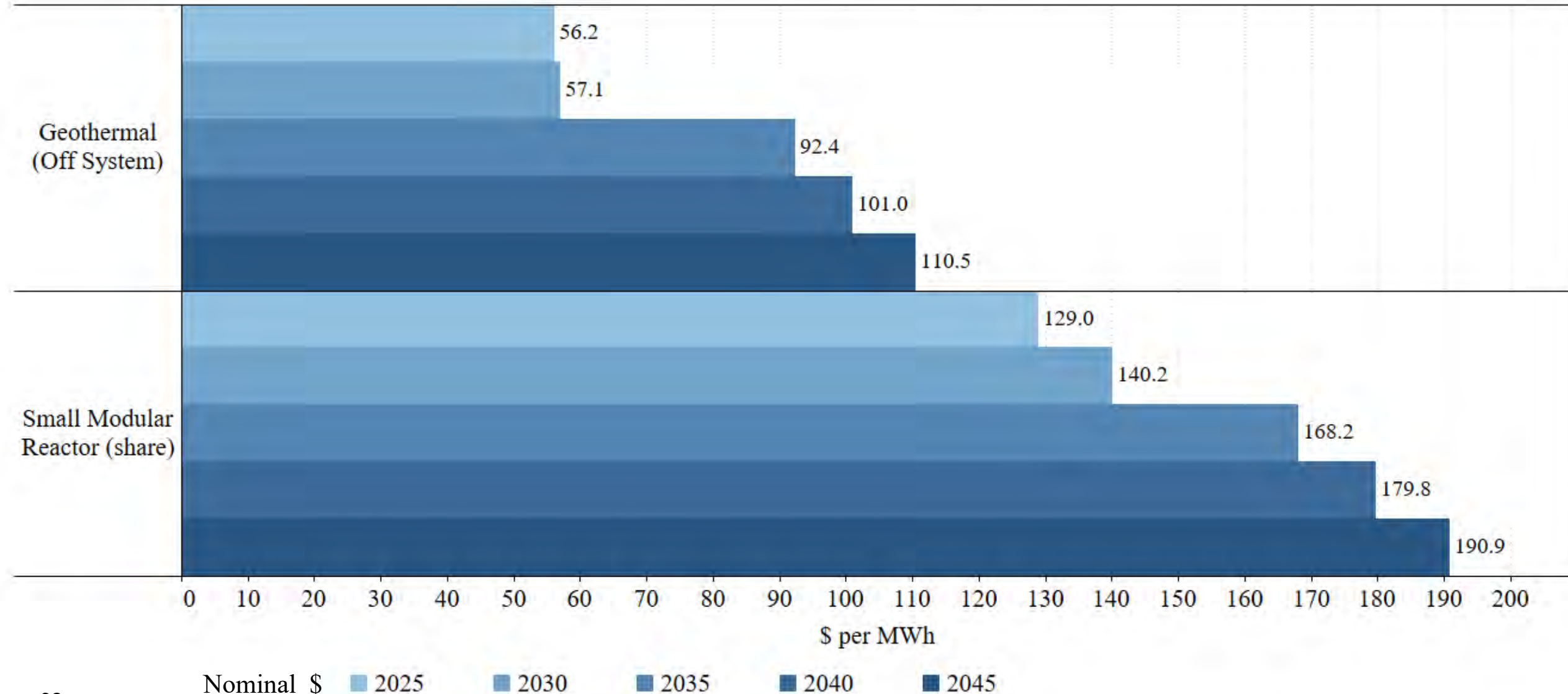

# Storage Fixed Cost (Levelized)

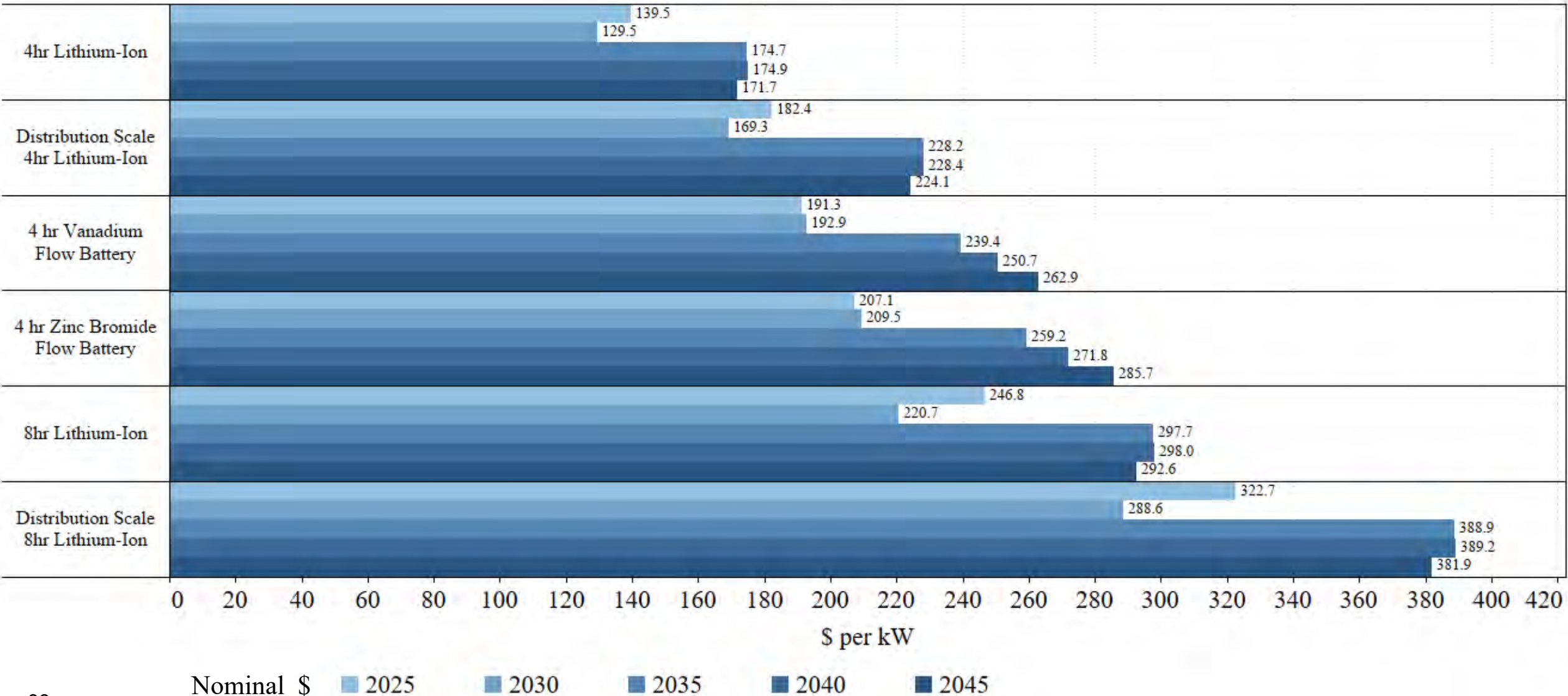

# Storage Fixed Cost (Levelized) Continued...

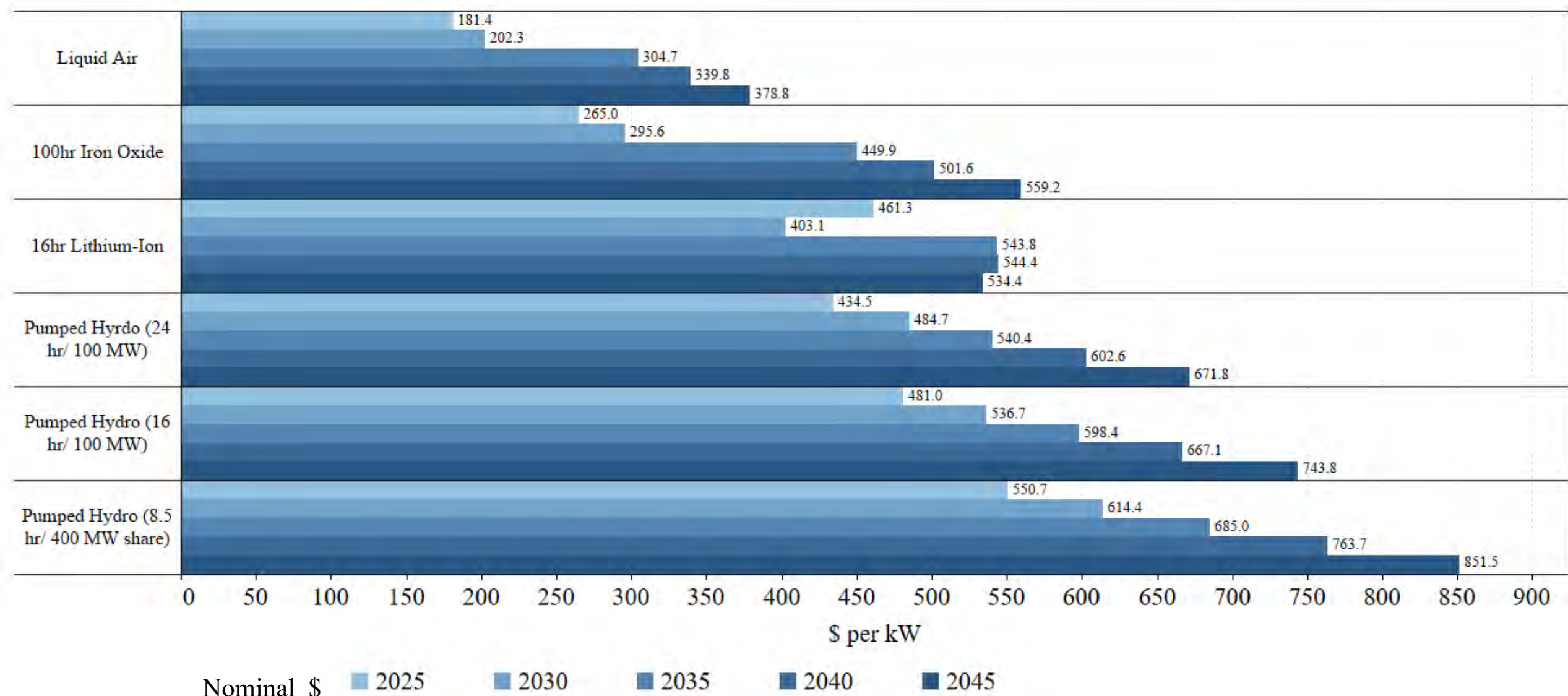

# Storage Implied Capacity Payment (Levelized)

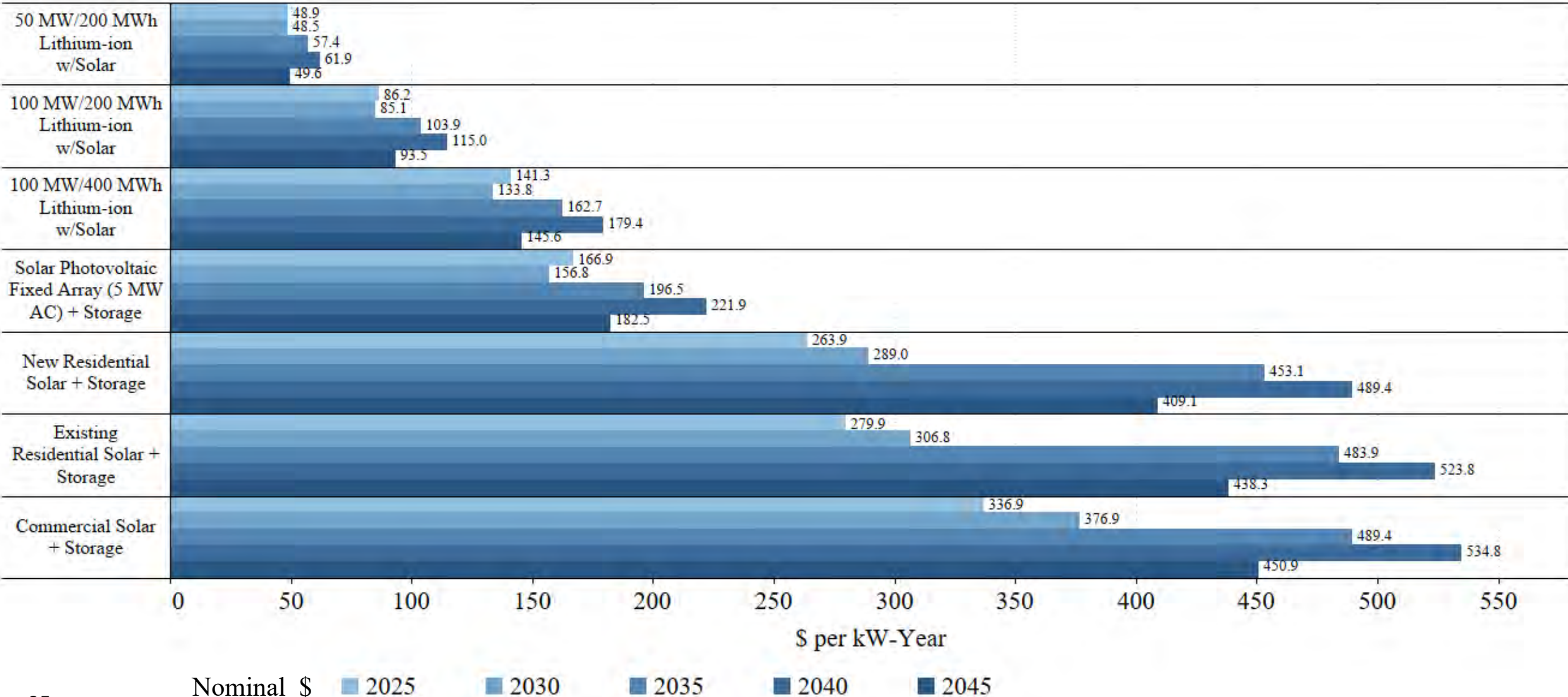



# Solar PPA Price/Implied Energy Payment (Levelized)

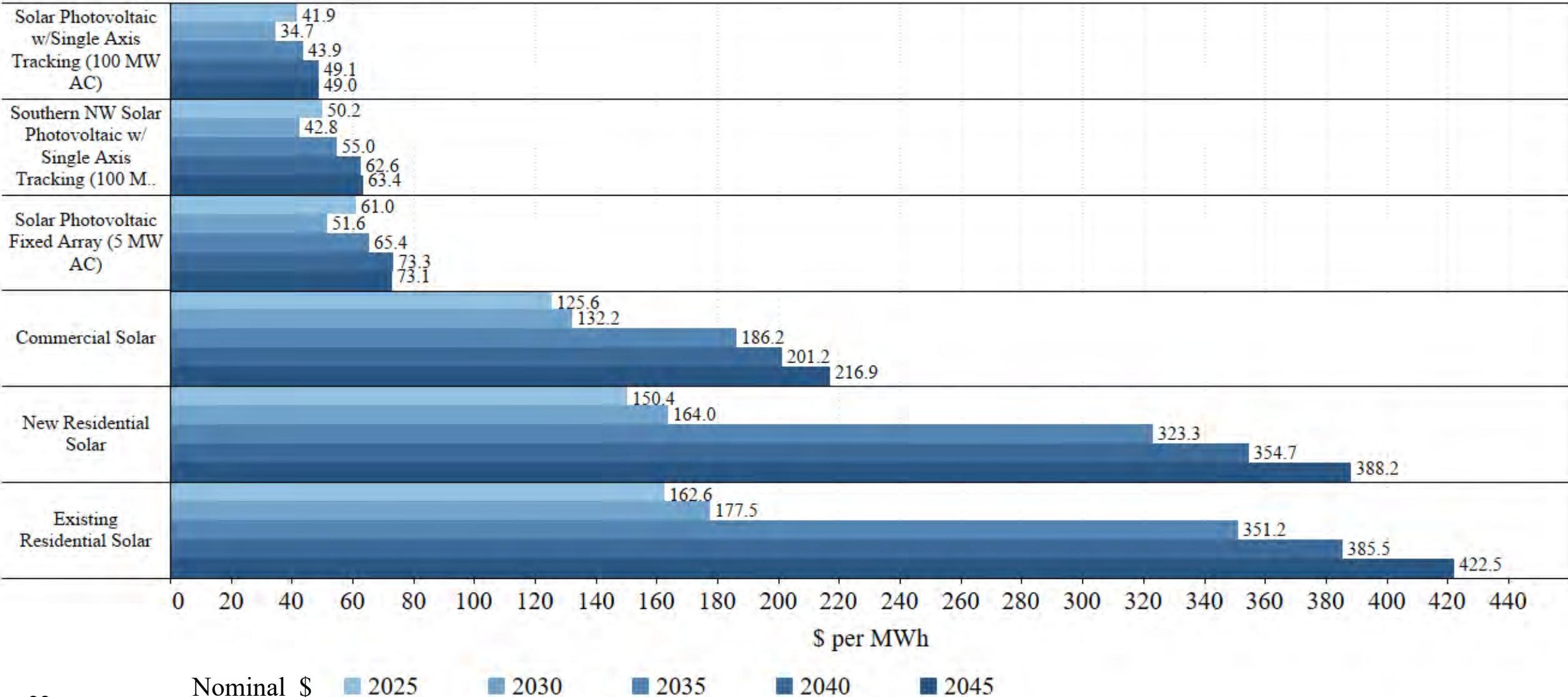

# Wind PPA Price/Implied Energy Payment (Levelized)

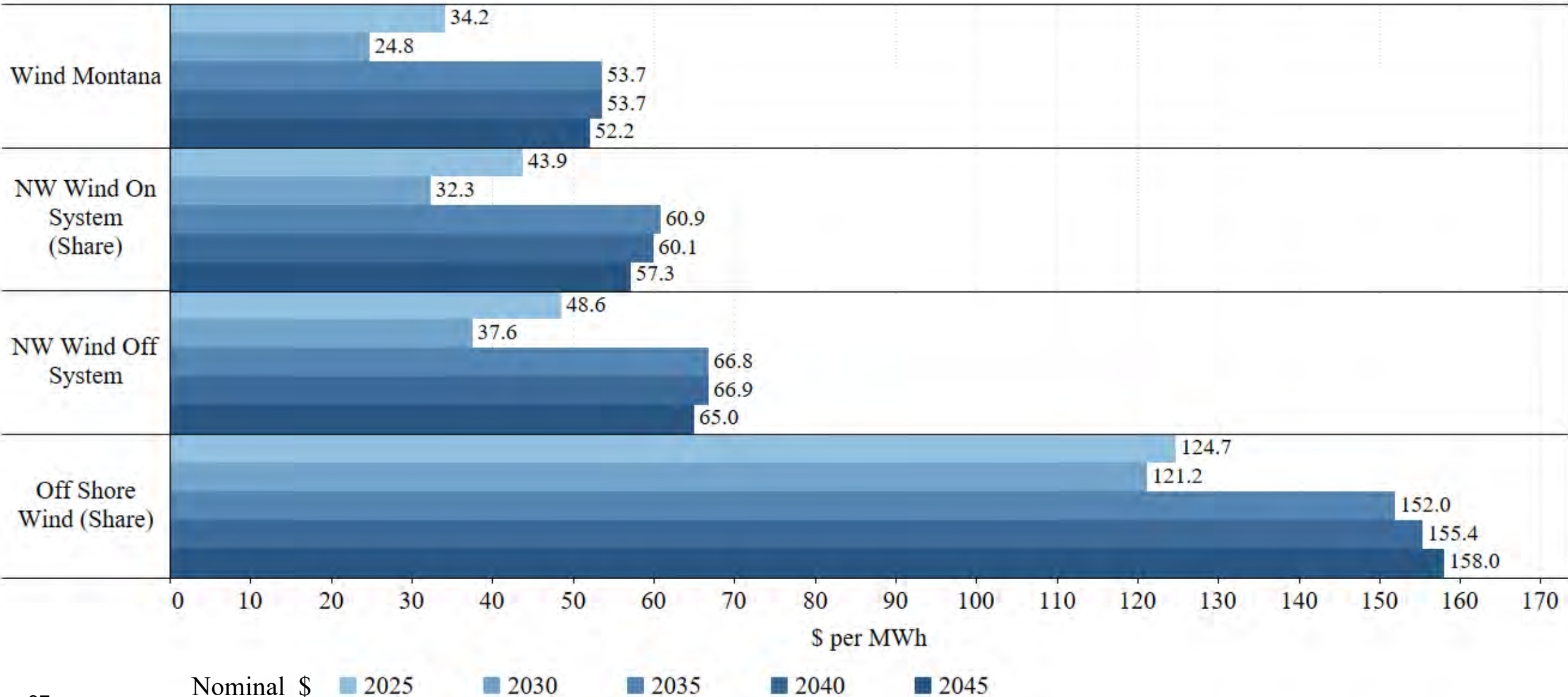

# Upgrades & Biomass Fixed Cost (Levelized)

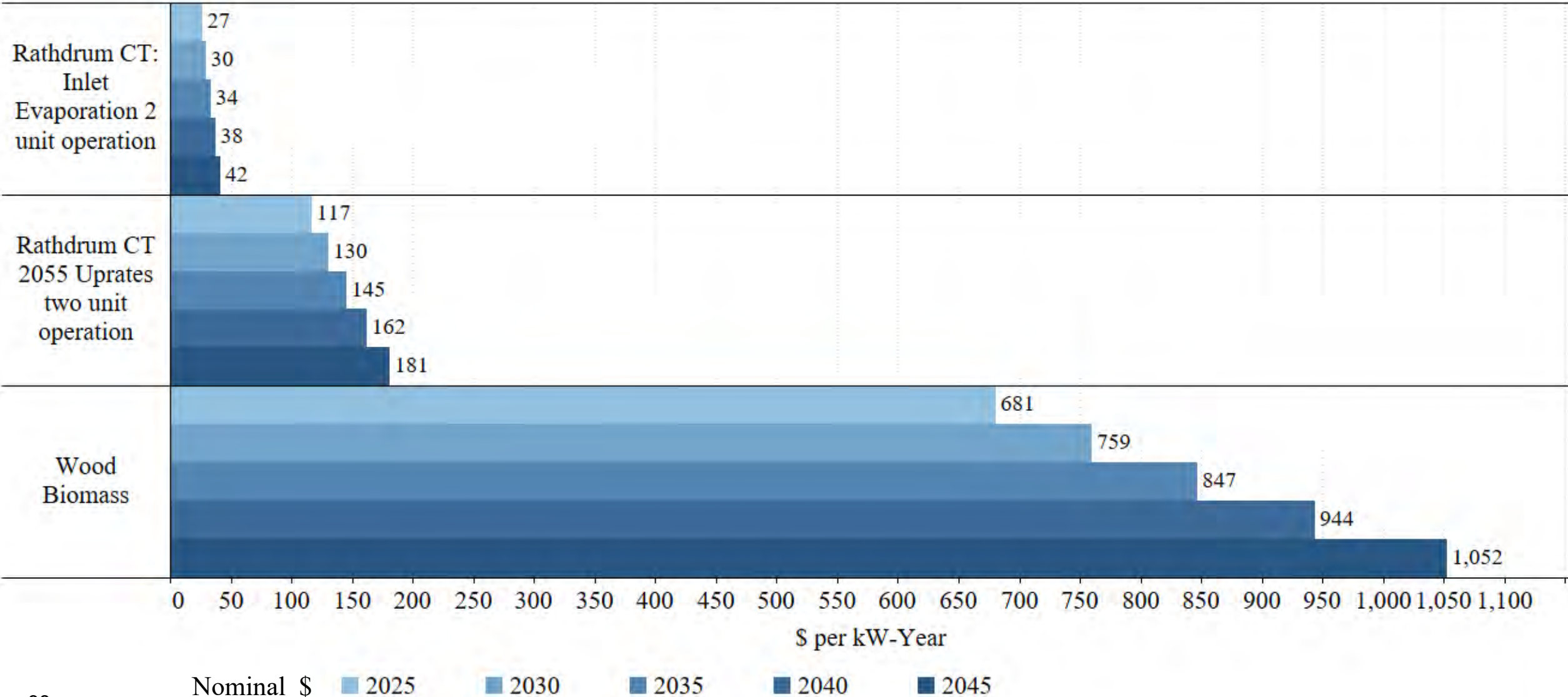



# Supply Side Resource Options Excel Workbook – Methodology and Navigation

Michael Brutocao, Natural Gas Analyst  
Electric IRP, 6<sup>th</sup> Technical Advisory Committee Meeting  
September 28, 2022



# Variable Energy Resources Integration Study Update

2023 Avista Electric IRP

TAC 6 – September 28, 2022

Lori Hermanson, Senior Power Supply Analyst

# VER Integration Study – Purpose and Overview

- Consistent application supporting varying analyses
  - Integrated Resource Planning
  - Resource acquisition processes (e.g., RFP)
  - Transmission tariff rates
  - PURPA avoided cost calculations
- Define “Consumptive Capacity” (CC) associated with incremental variable energy resources
- Determine Costs
  - Current costs under varying scenarios
  - Projected future costs under IRP Preferred Resource Strategy

# VER Integration Study Scope

- Included
  - Consumptive capacity and its costs
  - Impacts of EIM ("fast") markets
  - Potential future portfolio VER buildouts
  - Sensitivity scenarios
- Not included
  - Alternative capacity resources (e.g. batteries)
  - New utility-controlled storage
  - VER-driven investments in existing infrastructure
  - Distributed generation or response beyond what's in IRP

# Assumptions for ADSS Modeling

- Base case assumptions for all portfolio mixes (2-4 hours per run)
  - 13 VER portfolios (base + 12)
  - Include EIM regional diversity
  - Include carbon costs (CCA)
- Modeling sensitivities for 400 MW wind case
  - Addresses next 10+ years of PRS
  - Hydro (low/base/high)
  - Market prices (low/base/high)



# VER Study Workplan Overview

- Phase I Results – Energy Strategies
  - VER scenarios and profiles – *completed*
  - VER reserve analysis – *completed*
  - VER Work group presentation– *completed*
  - Slides and recording of presentation on IRP website
- Production Cost Modeling (Avista ADSS) – 1Q23
- Phase II Deliverables (ES) – 2Q23
  - Finalize calculation of integration costs
  - Presentation and report with full analysis and results
  - Tool to calculate reserves for future scenarios/mixes

# Phase I Results – Reserves

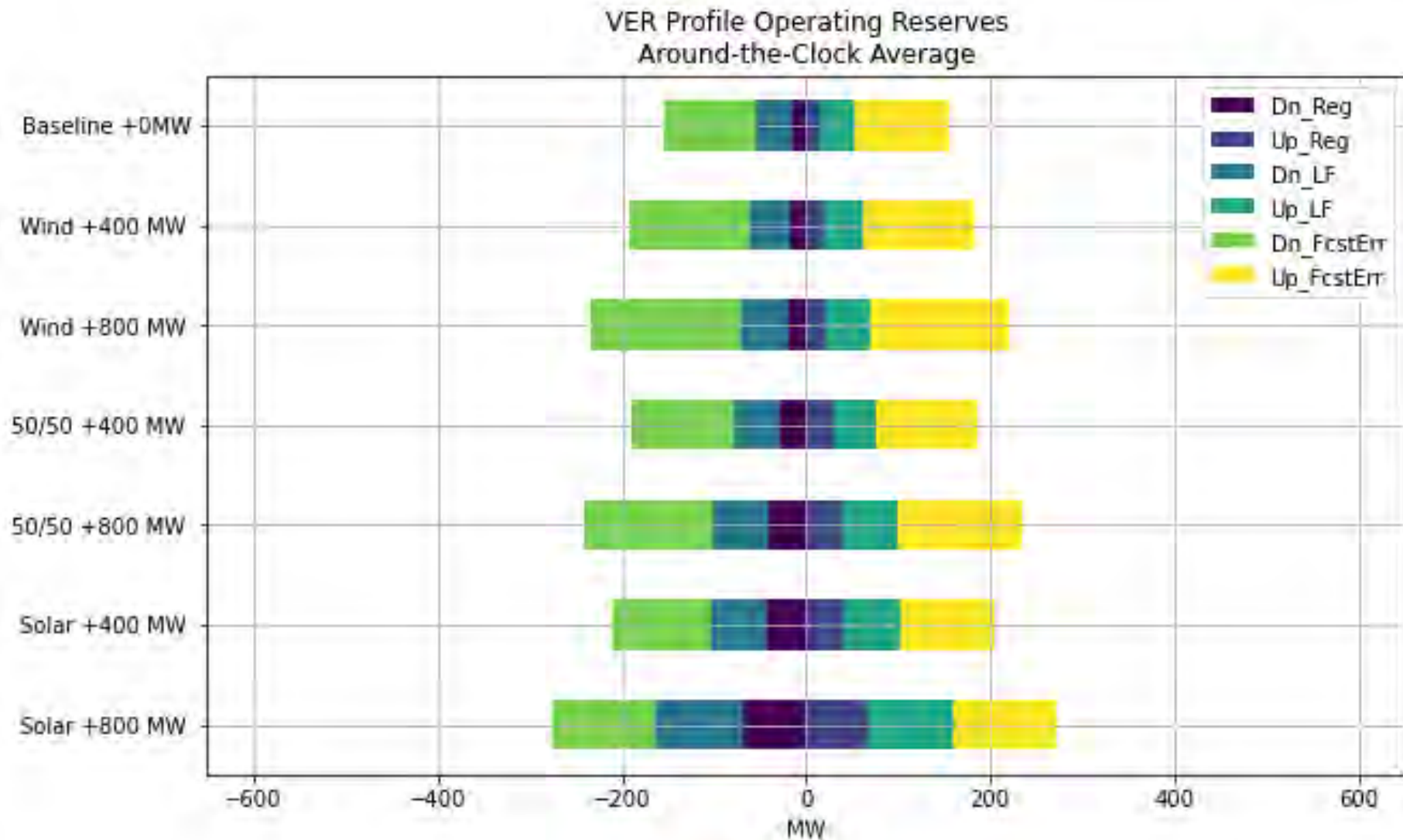



# Avista Utilities IRP TAC - RFP Update

2023 Electric IRP  
6<sup>th</sup> Technical Advisory Committee Meeting  
September 28, 2022

Chris Drake, Wholesale Marketing Manager

# 2022 All Source RFP Target Timeline

- February 18, 2022 – Avista releases All Source RFP
- February 28, 2022 – Bidders' conference
- March 25, 2022 – RFP bids due
- April 25, 2022 – Summary of Proposals posted
- June 10, 2022 – Short-listed Bid selection/notification
- July 18, 2022 – Detailed proposals due from Short-listed Bidders
- Sep 2, 2022 – Final price refresh request from Short-listed Bidders
- Oct 2022 – Proposal(s) selected for negotiations
- Nov/Dec 2022 – IE report to commission

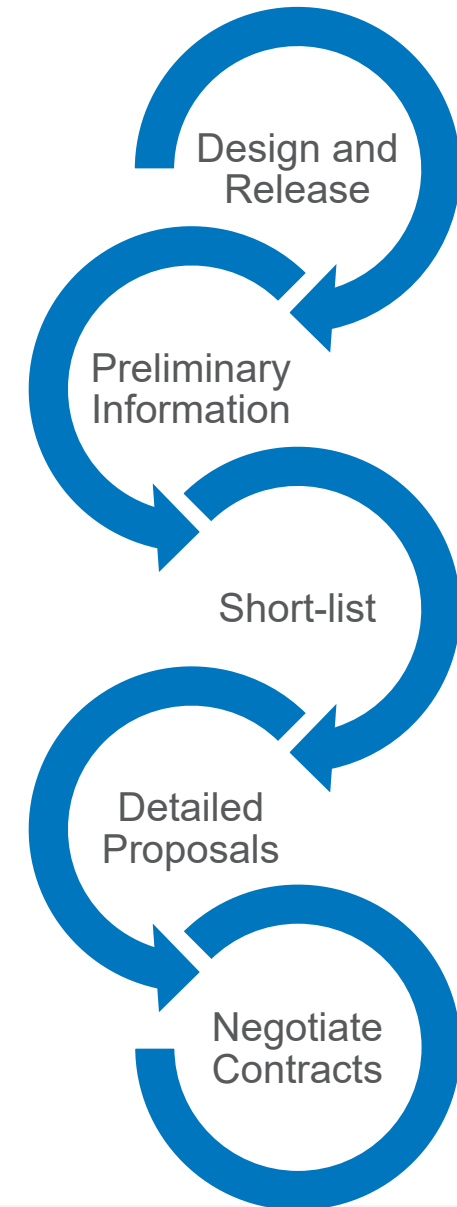

# 2022 All Source RFP and Proposal Highlights

## Request for Proposals

- Shortfalls in 2026 (flexible CODs)
- 162 MW winter capacity
- 127 MW summer capacity
- Renewable and monthly energy resources also required

## Responses

- 21 developers
- 11 technology types
- 32 proposals with options
- 56 total projects to analyze
- Avista and Sapere analysis completed mid-June to identify short list

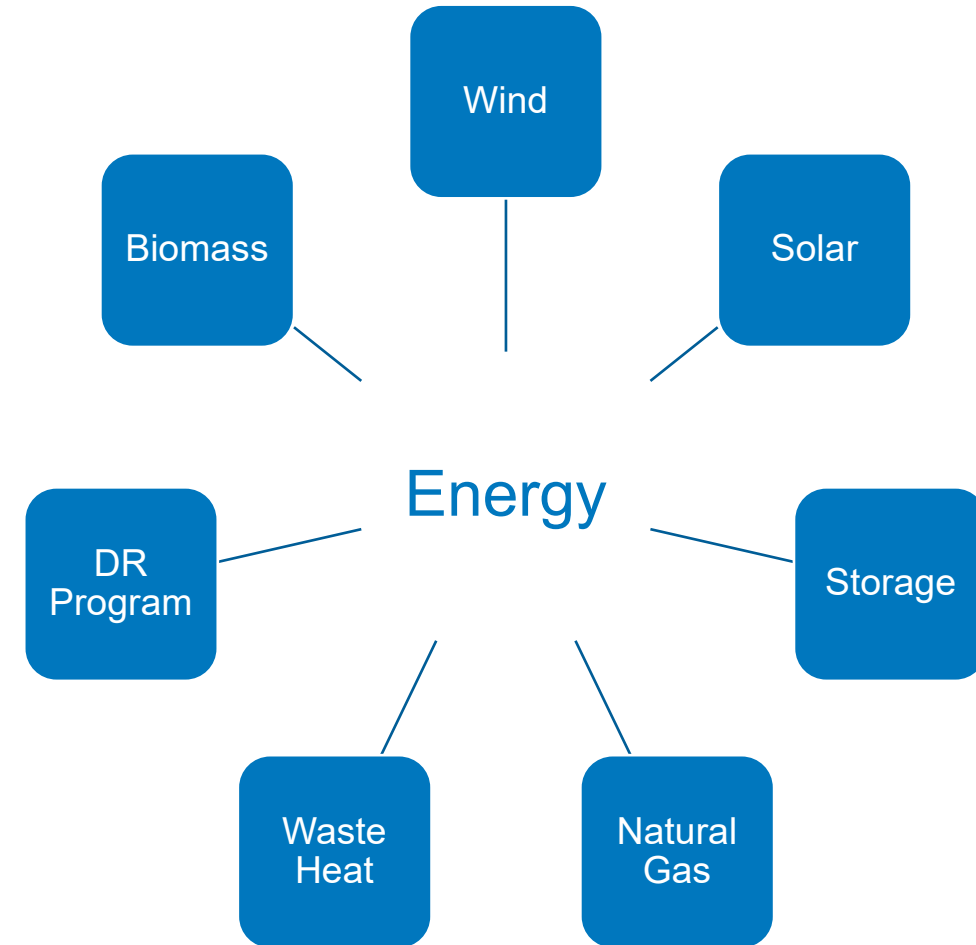

# 2022 RFP Responses

## Number of Proposals and Capacity by Type

Resource	Type	# of Proposals	Total Capacity (MW) <sup>1</sup>
Wind	Wind	12	1804.7
	Wind + Storage	6	856.2
	Wind + Solar	1	404
	Wind + Solar + Storage	4	2159.8
Solar	Solar	6	749.9
	Solar + Storage	7	660
Storage	Battery	6	643
	Pumped Storage Hydro	3	393.3
Other	Biomass	2	226
	Waste Heat	1	9.9
	Geothermal	1	8
	Hydro	1	38.7
	Demand Response	3	25.84
	Natural Gas	3	280

<sup>1</sup> Some bidders provided multiple bids or capacity options. Within each type only the initial capacity is

4 included. Posted at [www.myavista.com/AllSourceRFP](http://www.myavista.com/AllSourceRFP).

# Independent Evaluator (IE) – Sapere Consulting

- IE's role includes, but not limited to, the following:
  - Professional assistance in design and evaluation
  - Ensure RFP is conducted in accordance with Idaho and Washington resource acquisition rules
  - Ensure process is fair and transparent
  - Assess Avista's process of scoring bids and selection of shortlists is reasonable
  - Review all third party and Avista proposals
    - Non-Financial Scoring
    - Financial Modeling and Scoring



# Evaluation Process – Short List Selection

## Initial Screen Evaluation Scoring Matrix

Weighting						
20%	40%	5%	20%	10%	5%	100%
Risk Management	Financial Energy Impact <sup>1,2</sup>	Price Risk	Electric Factors	Environmental <sup>2</sup>	Non-Energy Impact <sup>2</sup>	Total Score
Developer Experience, Proven Technology, etc.	Financial Analysis of Price to include PPA/Ownership, capacity costs/value, transmission, cost of carbon, etc.	Potential for change in costs, fixed vs variable pricing, variable energy, etc.	Interconnection status and transmission plan	Permitting such as Conditional Use Permit, SEPA, Studies, etc.	Energy security, benefit to service territory, named communities, DEI, etc.	

<sup>1</sup>Financial evaluation based on highest score of Capacity or Energy.

<sup>2</sup>Clean Energy Implementation Plan Customer Benefit Indicators (where applicable) are included in Non-Energy Impact as well as Financial Energy Impact and Environmental criteria.



# Equity Considerations

*Develop, strengthen, and support policies and procedures that distribute and prioritize resources to historically and currently marginalized customers, including tribes.*

- RFP Stakeholder Input
  - Draft RFP filed with Washington Utilities and Transportation Commission (UTC) and shared with Idaho Public Utilities Commission (PUC), Avista's IRP TAC and Equity Advisory Group among others
  - RFP document including preliminary information requested from bidders, evaluation methodology and scoring incorporated stakeholder feedback
  - Final RFP approved by UTC
  
- Scoring matrix included Customer Benefit Indicators (CBI)
  - Non-Energy Impacts – Energy resiliency, security, diversity, labor and location in named community
  - Financial Impacts – consideration for quantifiable cost impacts of economic, public health and safety
  - Environmental Factors – such as air quality impacts

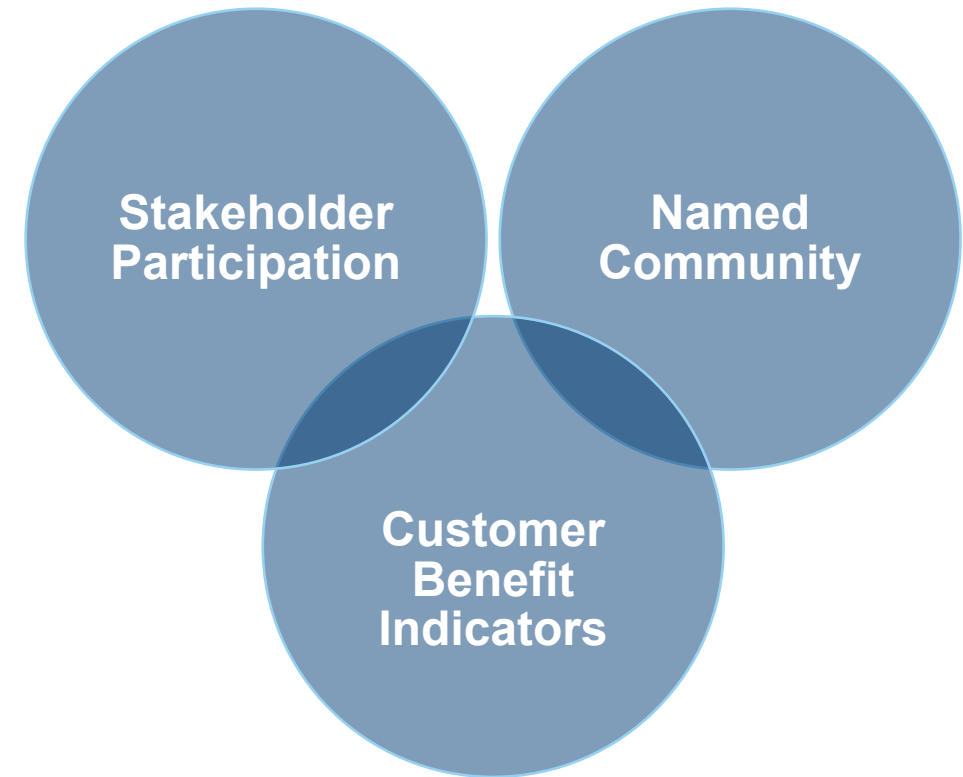

# Evaluation Process – Detailed Proposals

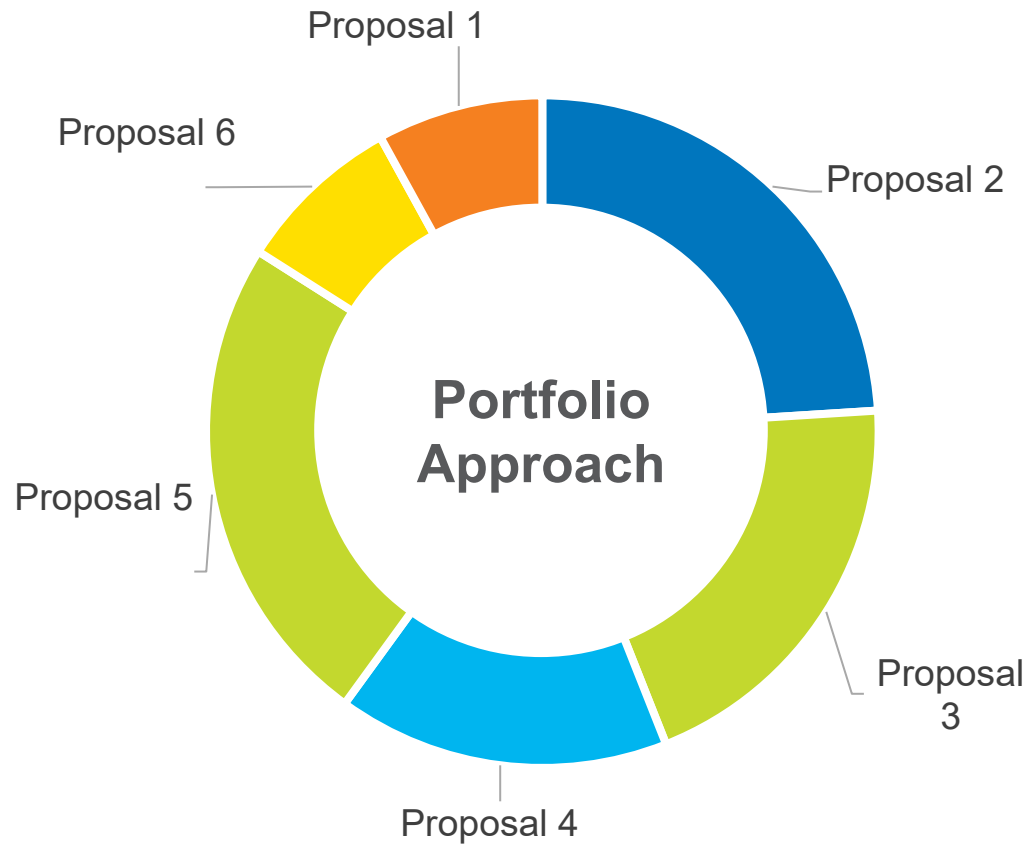

- Short list identified based on natural break points in scoring matrix
  - June 10, 2022
- Detailed proposals due from Short-listed Bidders
  - July 18, 2022
- Price refresh after Inflation Reduction Act
  - September 2, 2022
- Financial modeling
  - Portfolio approach (one or many resources selected)
  - Several scenarios to be modeled

# Thank you...





# IRP Climate Change Analysis

Impact of forecasted streamflow and temperature changes on hydrogeneration and load

Mike Hermanson, Senior Power Supply Analyst  
Electric IRP, 6<sup>th</sup> Technical Advisory Committee Meeting  
September 28, 2022

# Overview

- Data sources and methodology
- Hydrogeneration
- Load forecast
- Peak load forecast
- Use in IRP Modeling

# Data Sources

- Climate and Hydrology Datasets for RMJOC Long-Term Planning Studies: Second Edition
  - River Management Joint Operating Committee (RMJOC)
    - BPA, US Army Corps of Engineers, US Bureau of Reclamation
  - Research Team
    - University of Washington, Oregon State University
- Part I – Unregulated stream flows
- Part II – Reservoir Regulation and Operations

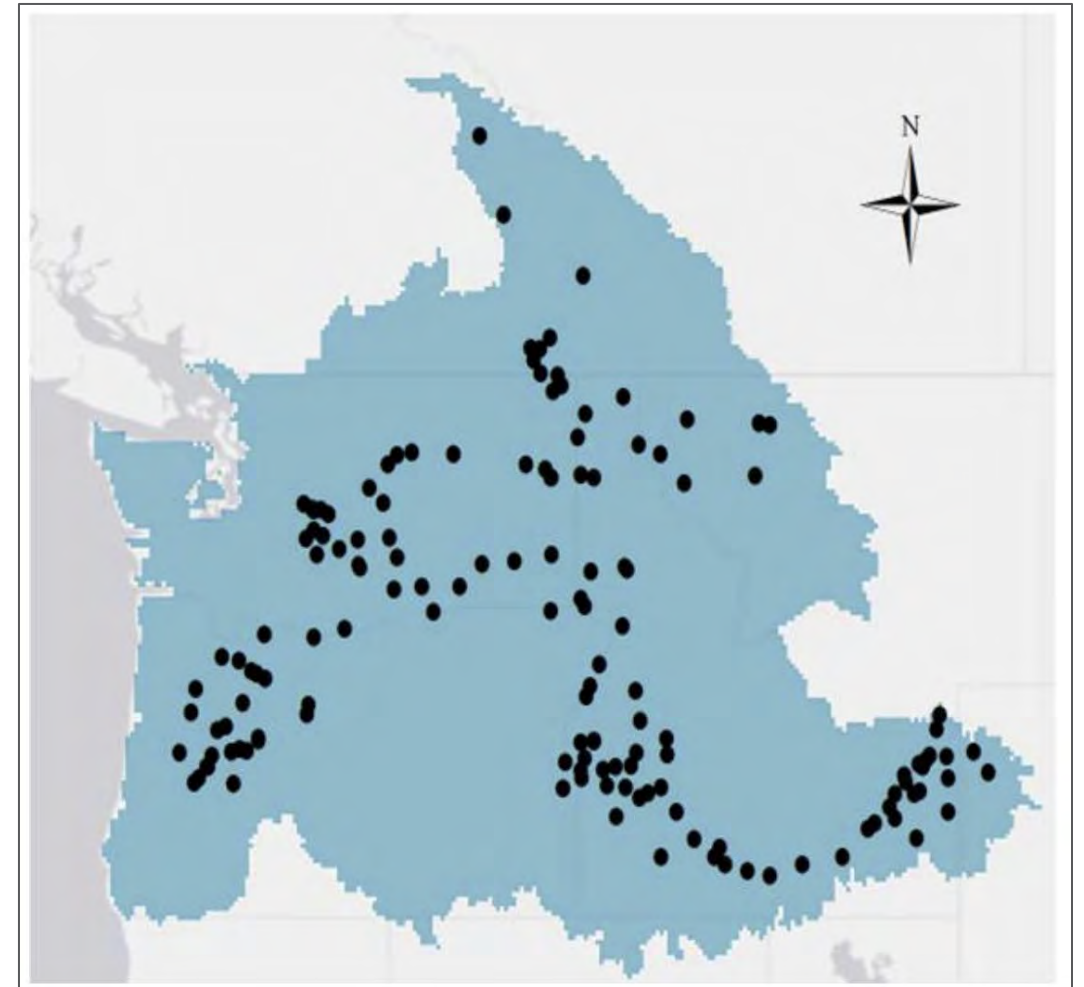

# Global Climate Models

- Global Climate Models (GCMs)
  - Coarse resolution ranging from 75 to 300 km grid size
  - Provides projections of temperature and precipitation
  - Multiple Representative Concentration Pathways (RCP 4.5, RCP 6, RCP 8.5)
  - 10 GCM models used in study
    - CanESM2 (Canada)
    - CCSM4 (US)
    - CNRM-CM5 (France)
    - CSIRO-Mk3-6-0 (Australia)
    - GFDL-ESM2M (US)
    - HadGEM2-CC (UK)
    - HadGEM2-ES (UK)
    - Inmcm4 (Russia)
    - IPSL-CM5-MR (France)
    - MIROC5 (Japan)

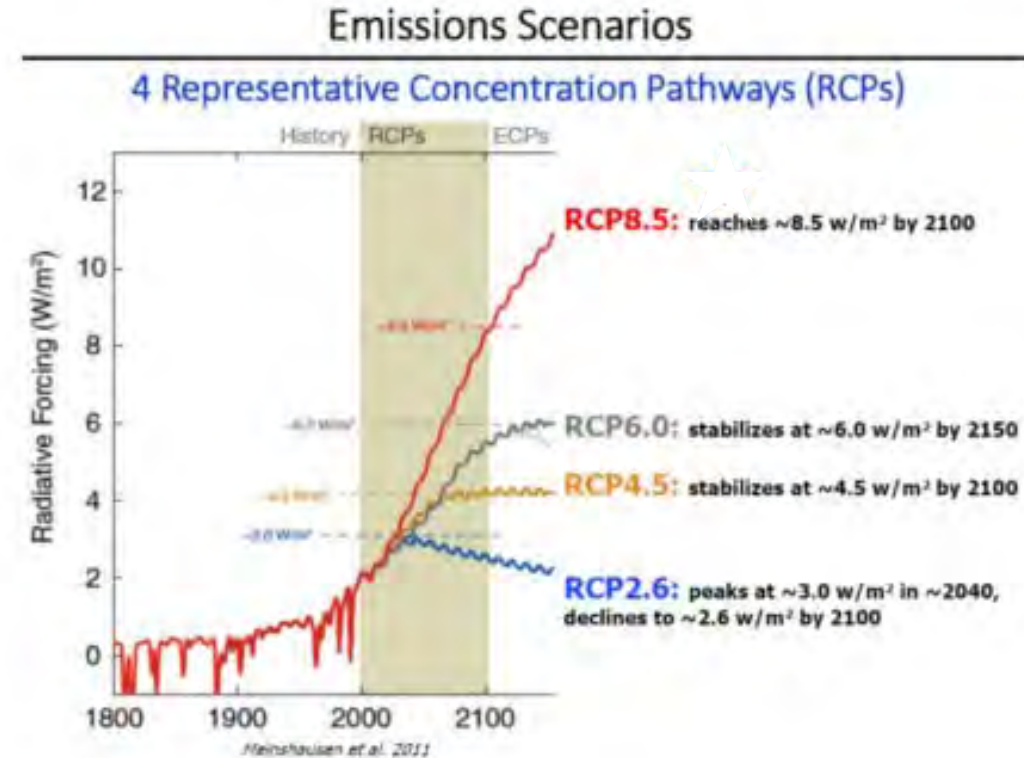

# Representative Concentration Pathways

- Description by Intergovernmental Panel on Climate Change (IPCC)
  - RCP2.6 – stringent mitigation scenario
  - RCP4.5 & RCP6.0 – intermediate scenarios
  - RCP8.5 – very high GHG emissions
- RMJOCII Study evaluated RCP4.5 and RCP8.5
- RCP4.5 and RCP6.0 similar within the IRP planning horizon

	Scenario	2046-2065		2081-2100	
		Mean	Likely range	Mean	Likely range
Global Mean Surface Temperature Change (C°)	RCP2.6	1.0	0.4 to 1.6	1.0	0.3 to 1.7
	<b>RCP4.5</b>	<b>1.4</b>	<b>0.9 to 2.0</b>	<b>1.8</b>	<b>1.1 to 2.6</b>
	<b>RCP6.0</b>	<b>1.3</b>	<b>0.8 to 1.8</b>	<b>2.2</b>	<b>1.4 to 3.1</b>
	RCP8.5	2.0	1.4 to 2.6	3.7	2.6 to 4.8



# Downscaling Techniques

- Downscale GCM data to finer resolution necessary to model hydrology
  - Statistical methods to represent variation within large grid size
  - Two methods used (BCSD, MACA)
    - Bias Corrected Spatial Disaggregation
    - Multivariate Adaptive Constructed Analog

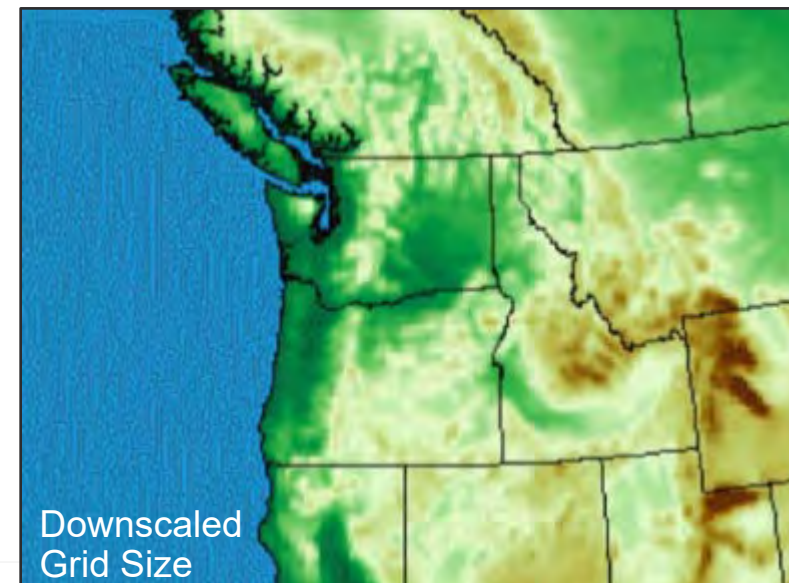
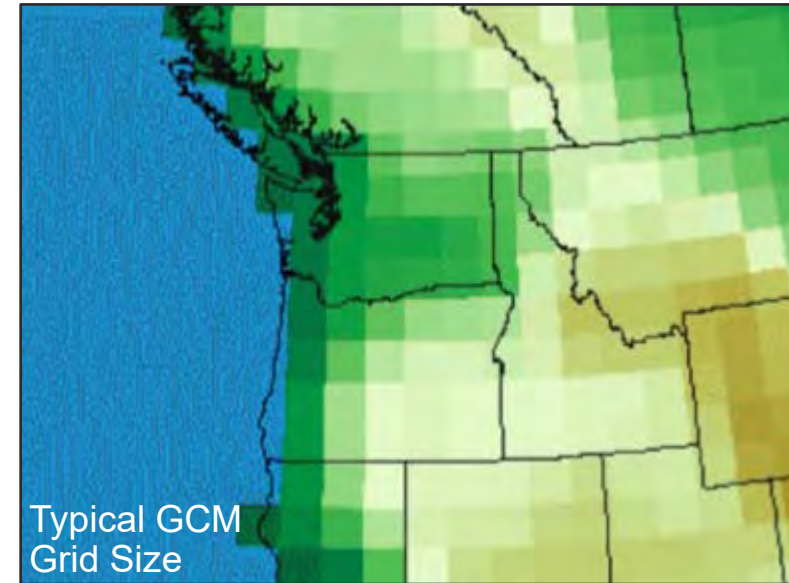

# Modeling Climate Change Impacts on Hydrogeneration

- Hydrologic models
  - Downscaled temperature and precipitation is input to hydrologic models.
  - Hydrologic models use soil, geology, slope, vegetation, aspect, snow cover, etc. to model how precipitation translates into runoff and streamflow.
  - 2 different hydrology models used.
    - 1 version of PRMS model
    - 3 versions of VIC model
- Hydro regulation models
  - Unregulated streamflow is input to reservoir models of Columbia River system to generate regulated flows.

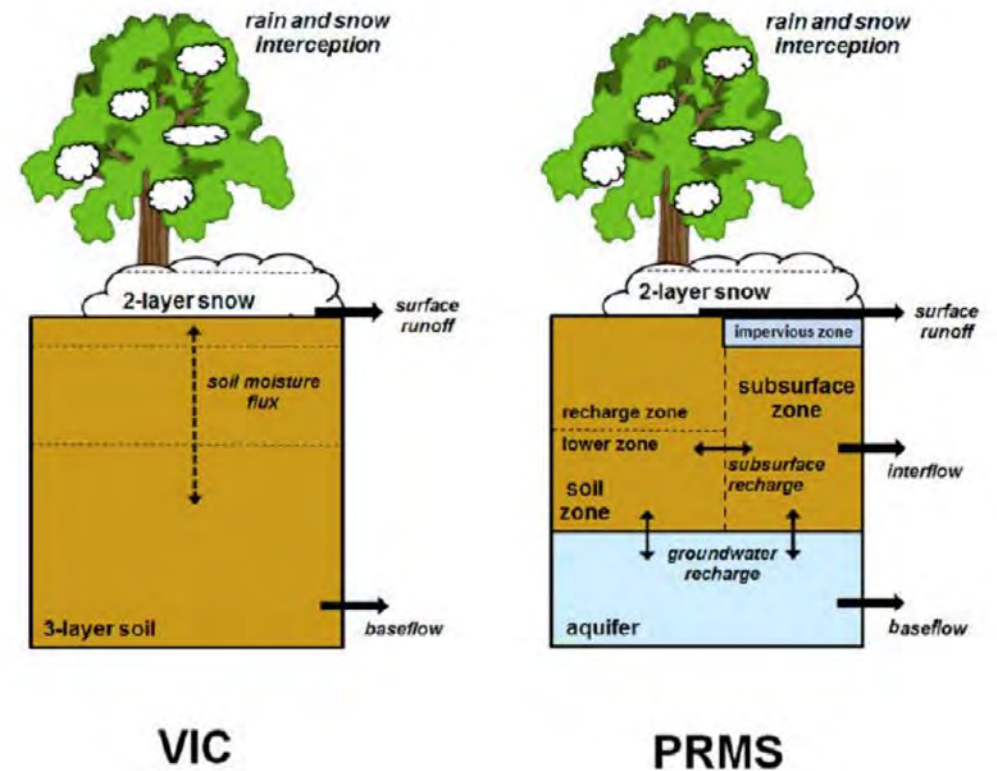

# Modeling Climate Change Impacts on Hydrogeneration

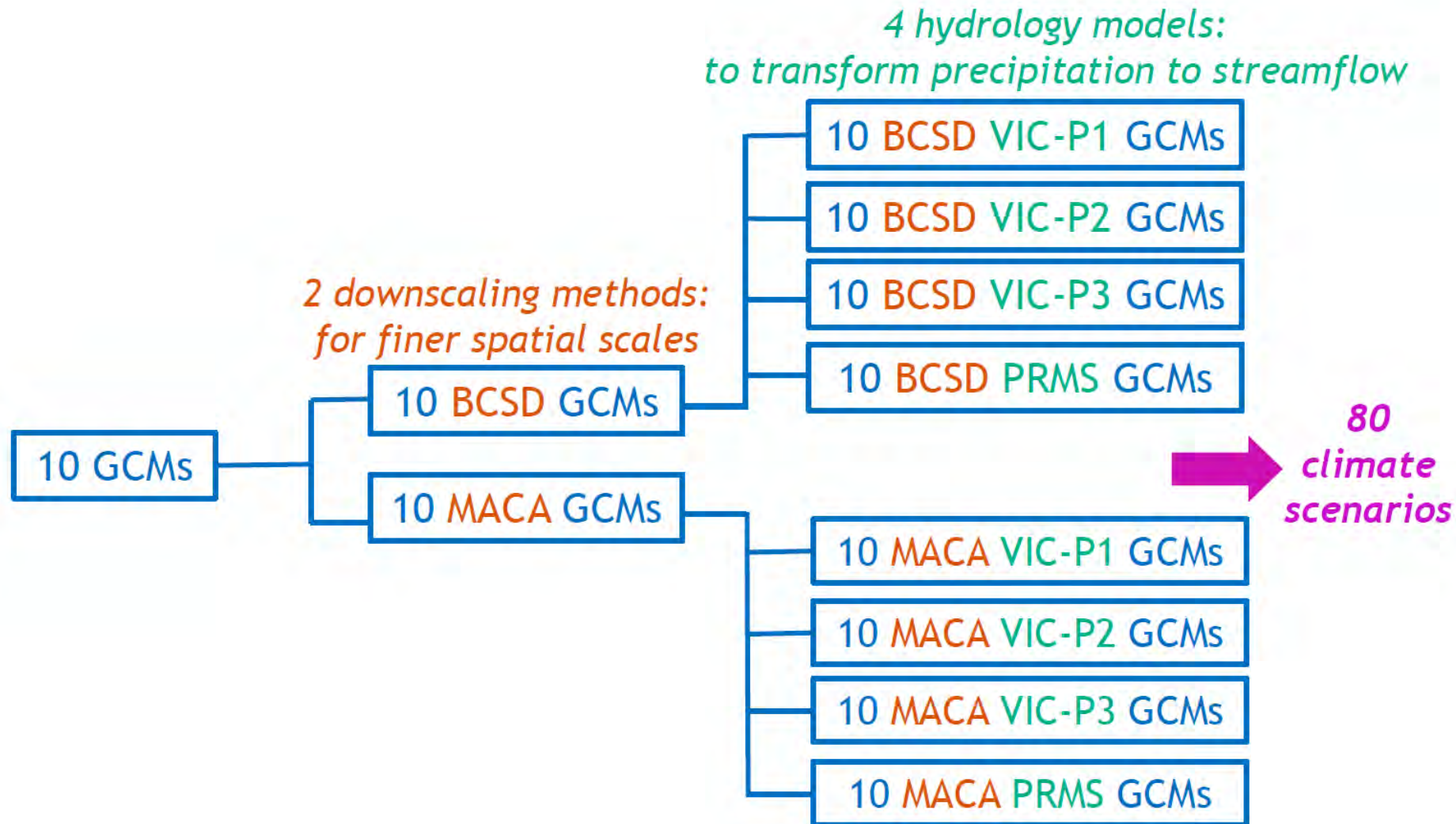

# Modeling Climate Change Impacts on Hydrogeneration

- Comparison of hydrogeneration used for previous IRP to estimated hydrogeneration based on stream flows from climate change modeling.
- Previous IRP utilized modeled regulated flows for water years 1929-2008 provided by BPA.
- BPA selected 19 of the 80 scenarios that encompass a sufficient range of uncertainty.
- Streamflows for 19 scenarios for the period of 2019-2049 were used to develop estimates of generation.
- Regression models based on relationship of baseline flows to generation for Avista projects.
- Mid-C generation from BPA Hydsim model of climate change scenarios.

# Modeling Recent 30-Year Hydrogeneration

- BPA is moving to using recent 30-year period for planning purposes.
- BPA is finalizing 90-year (1928-2018) regulated flow data set and is not yet available.
- Utilized actual river flow data for 2009-2021 in regression models utilized for climate change modeling to add to the current 80-year record and create a recent 30-year dataset.
- Used actual 2009-2021 Mid-C generation.

# Results

## Comparison of Annual (aMW)

	80-Year Hydro (1929-2008)	Recent 30-Year (1991-2021)	Climate Change RCP8.5 (2019-2049)	Climate Change RCP4.5 (2019-2049)
Mean	598	595	628	645
Median	597	585	620	636
Standard Deviation	142	137	149	169
10 <sup>th</sup> Percentile	424	437	454	447

- Recent 30-year shows slight decrease in annual energy
- Climate change scenarios show an increase in annual energy consistent with the projection of overall increase in precipitation in the Northwest

# Results

## Comparison of Monthly (aMW)

Impact of Climate Change Forecasted River Flows on Monthly Median Avista Hydro Generation

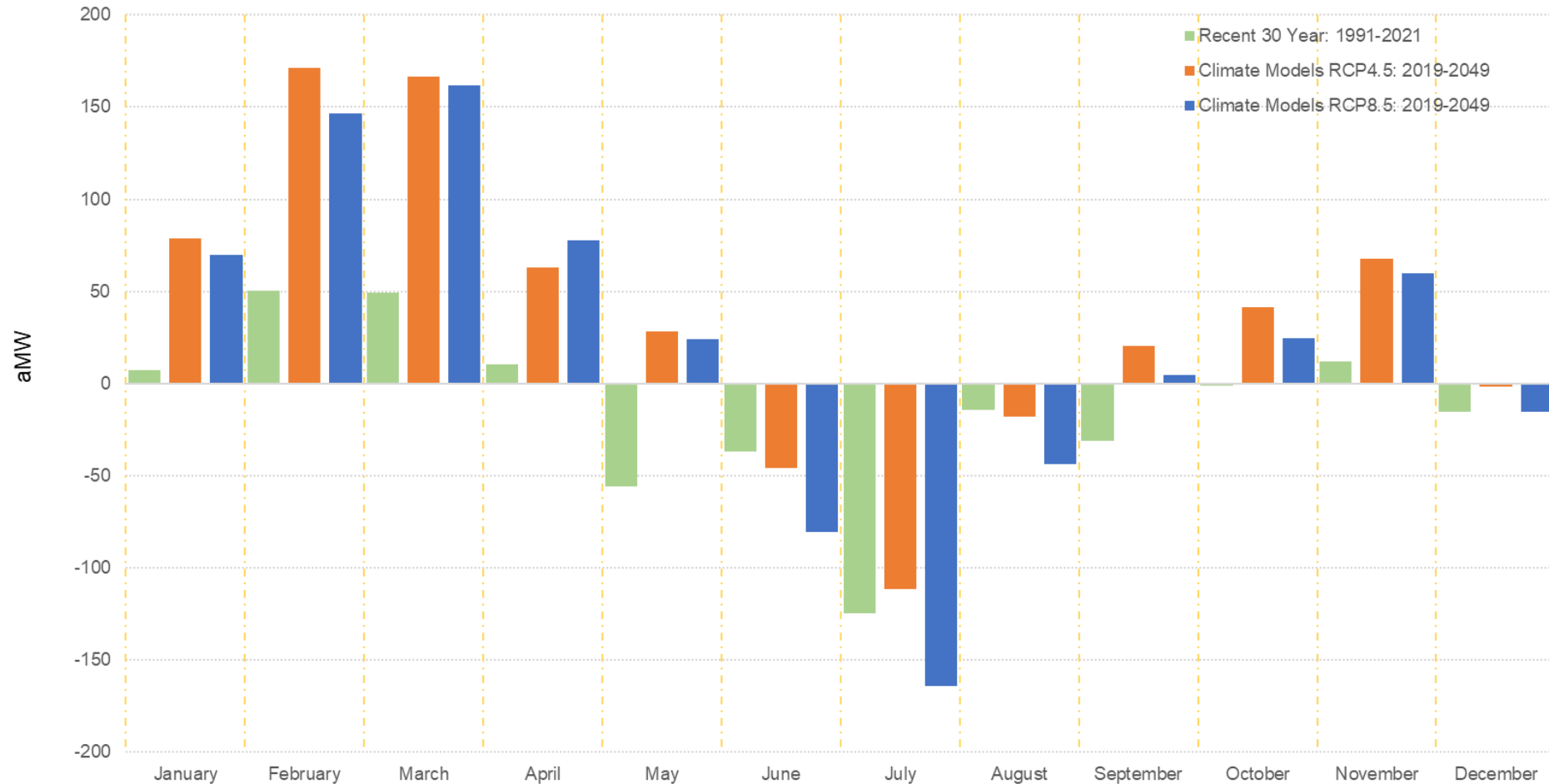

# Results

## Variability of Climate Models

Climate Change Models by Month compared to 80 year & 30 year hydro

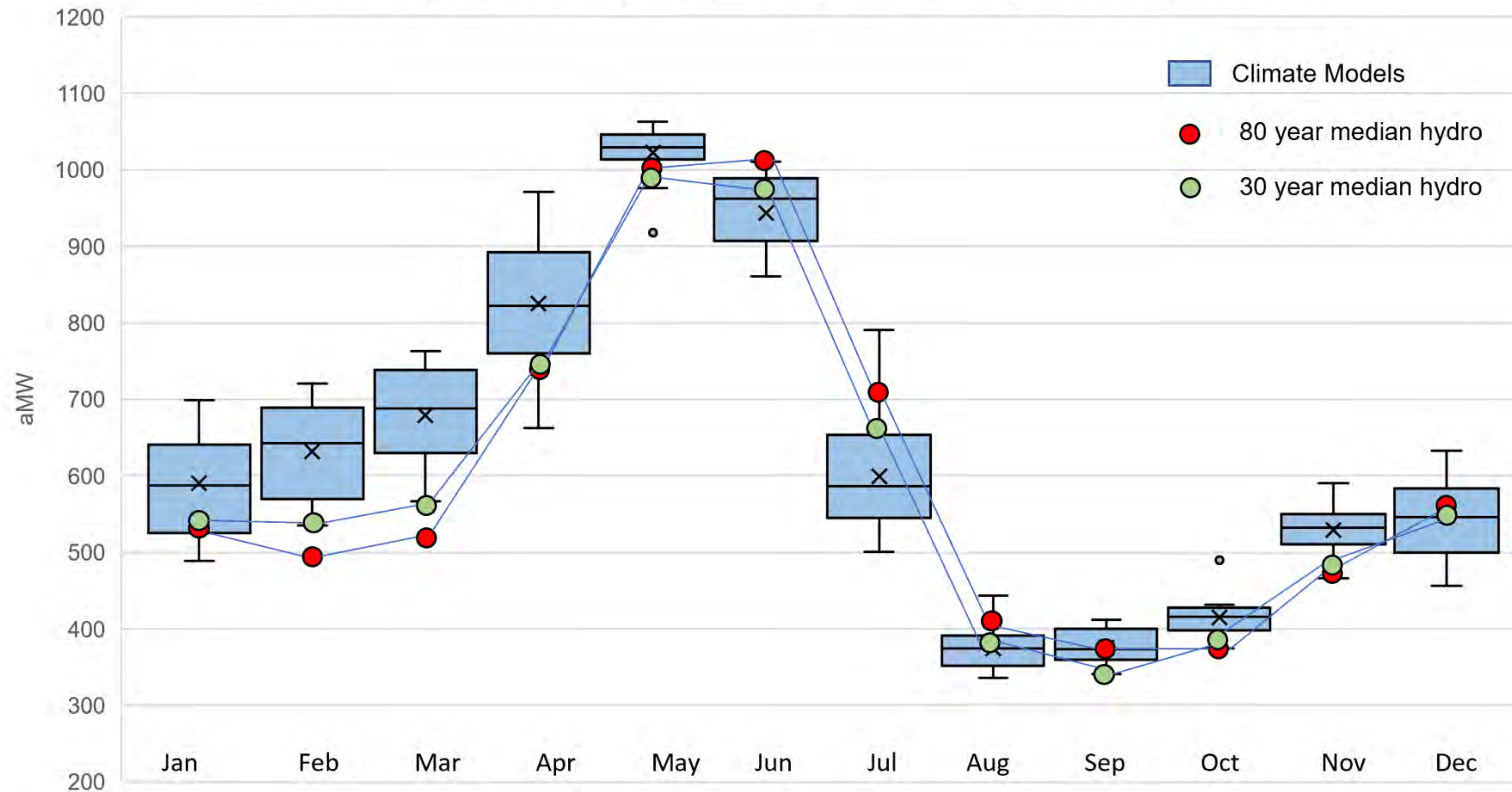



# Results

## 2019-2049 Trend

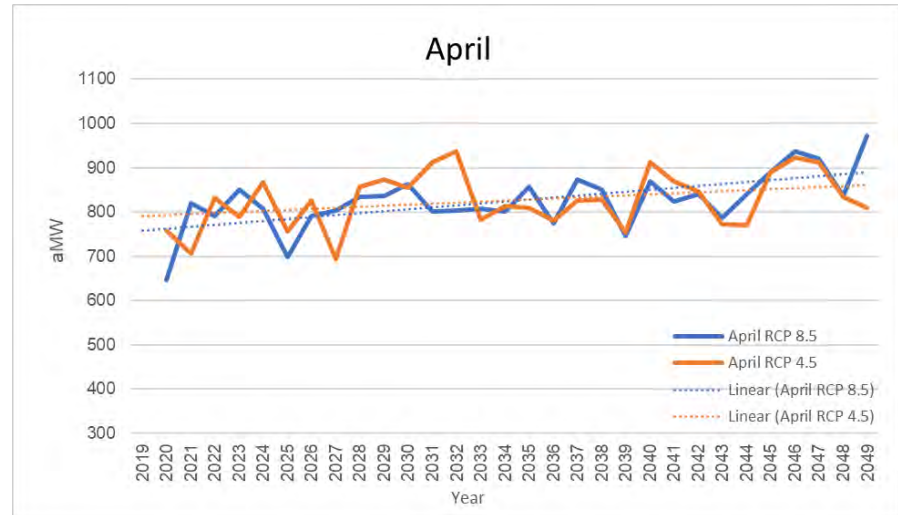
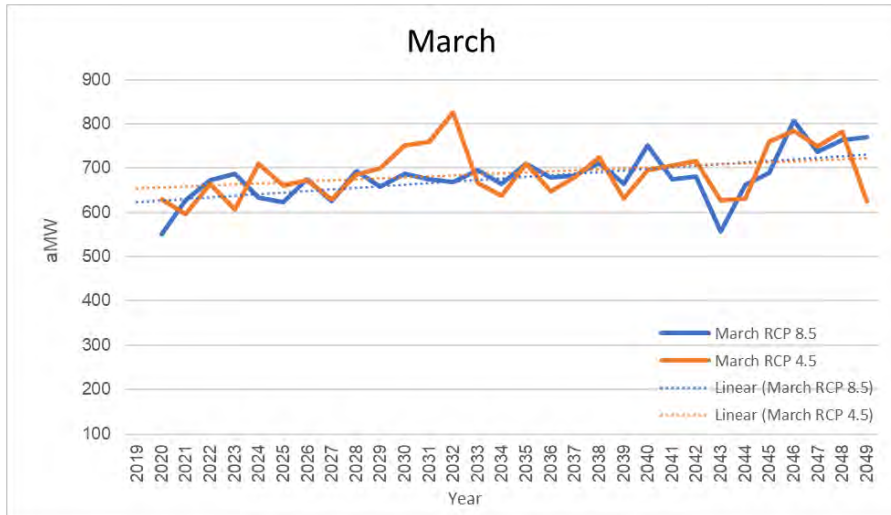
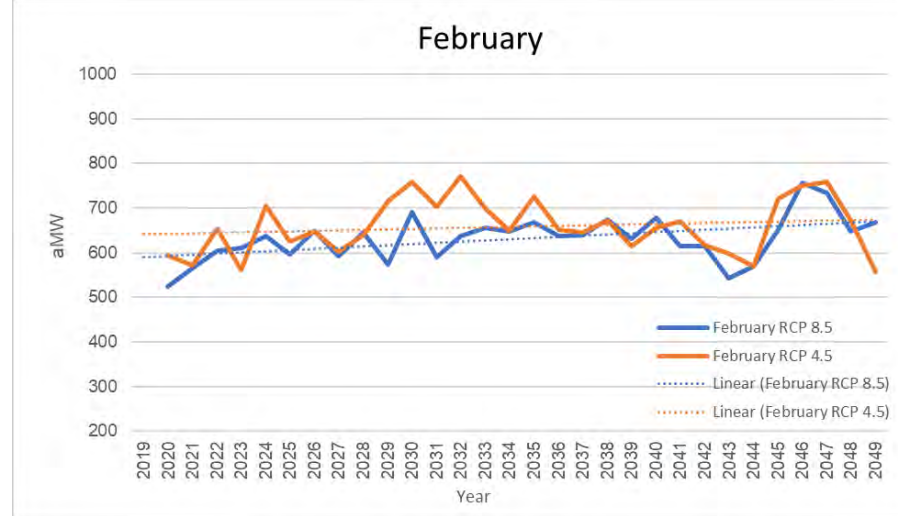
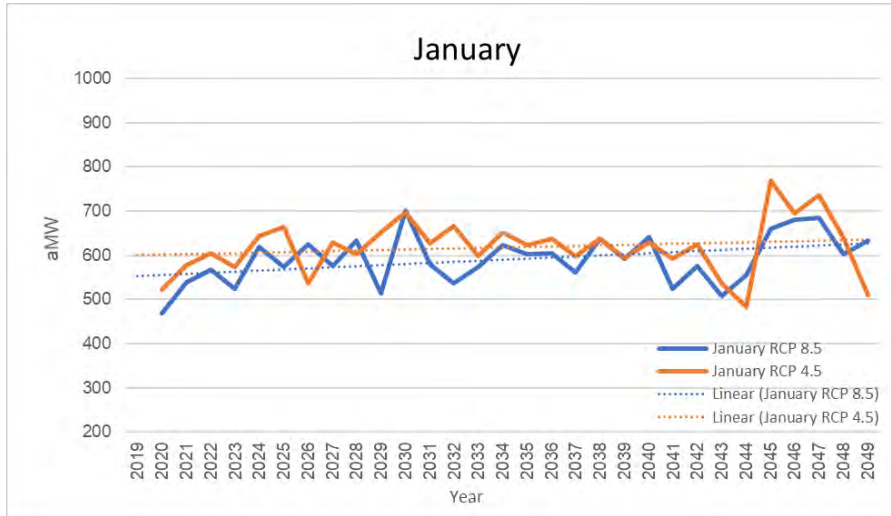

# Results

## 2019-2049 Trend

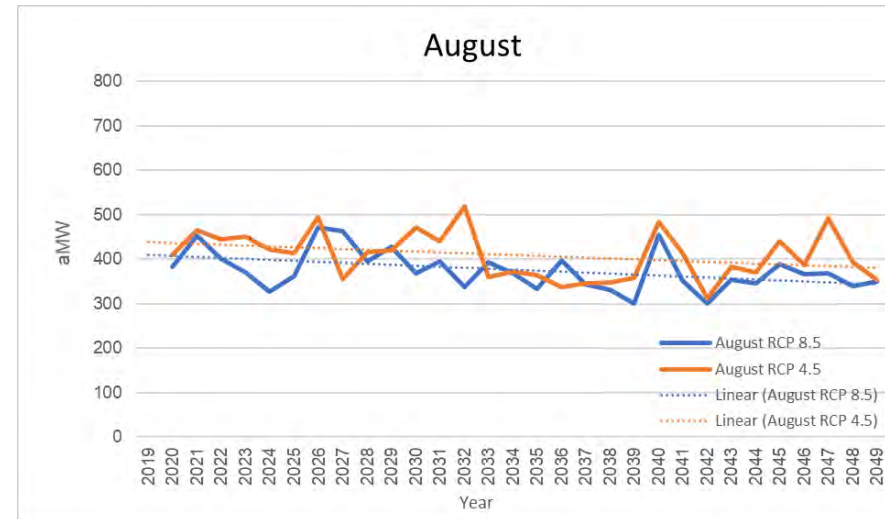
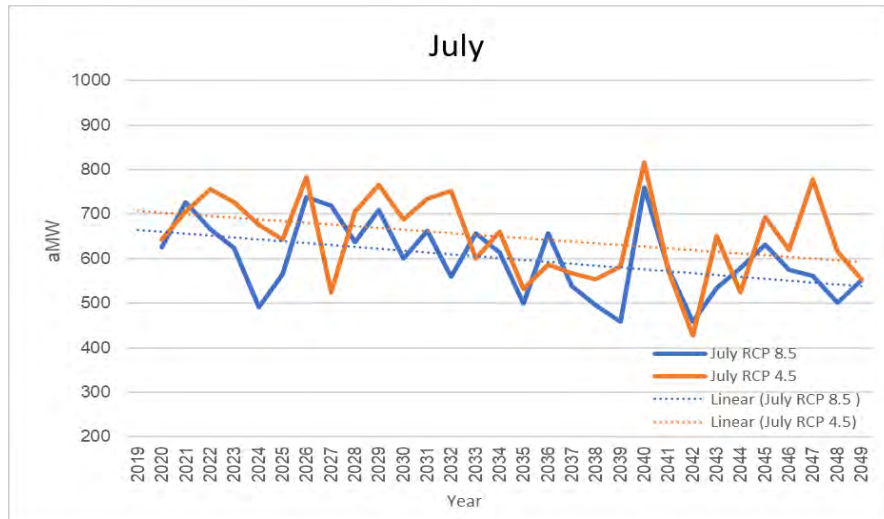
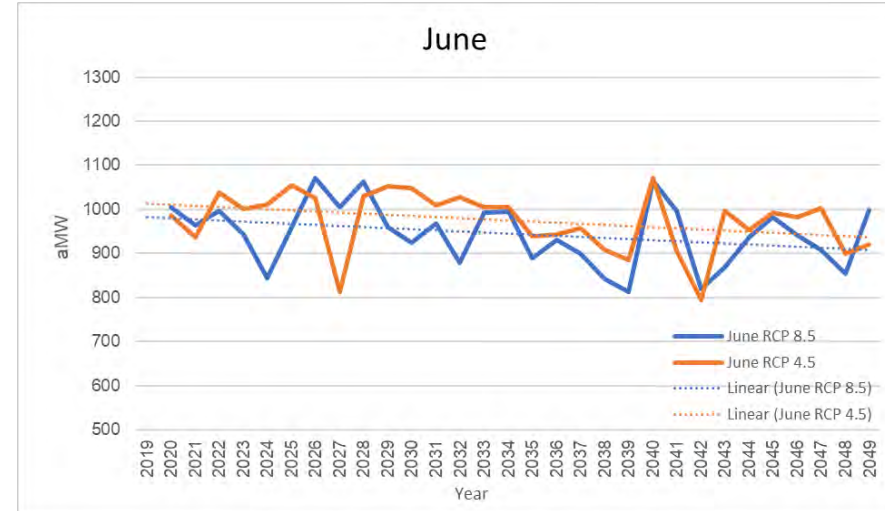
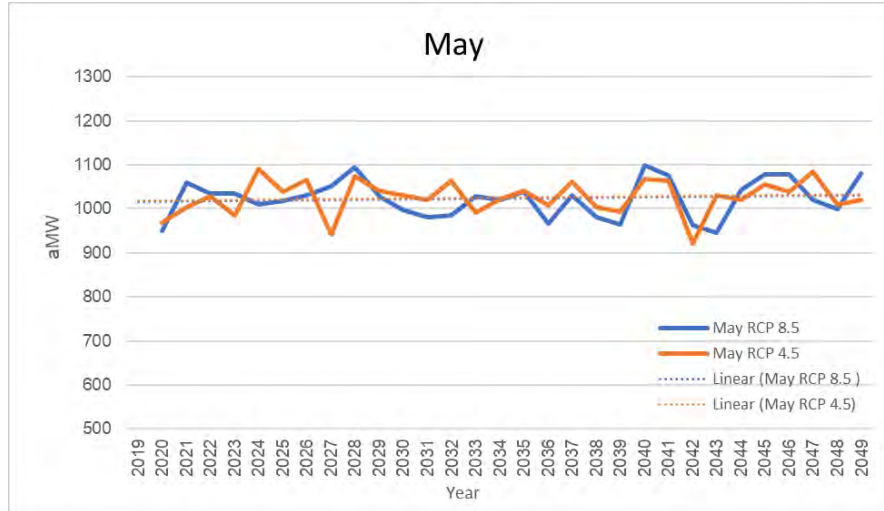

# Results

## 2019-2049 Trend

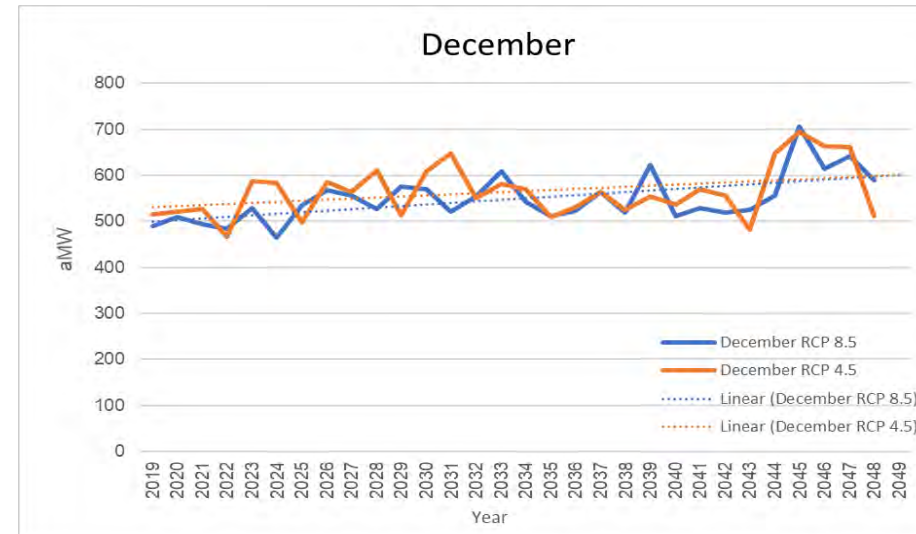
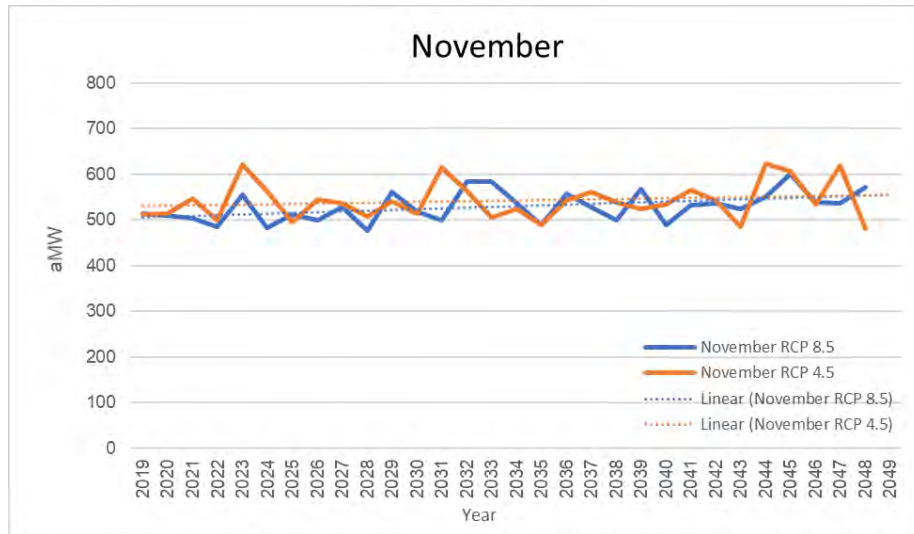
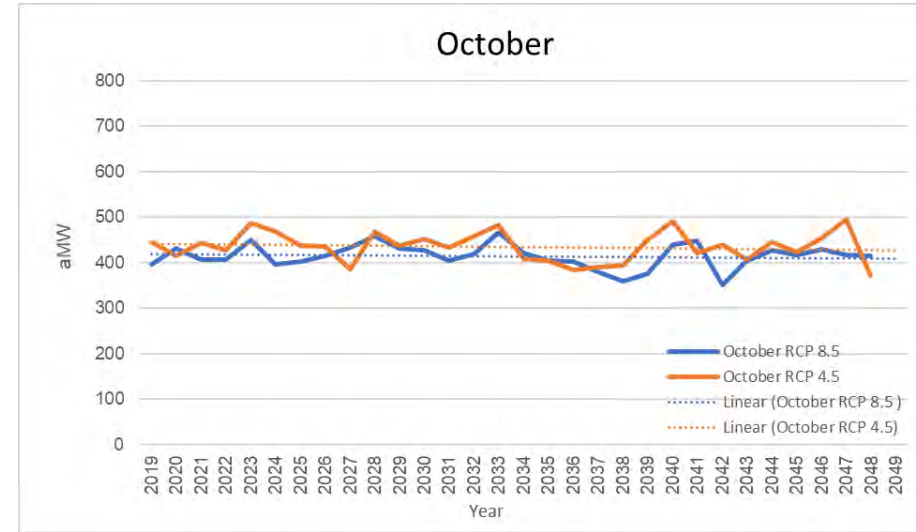
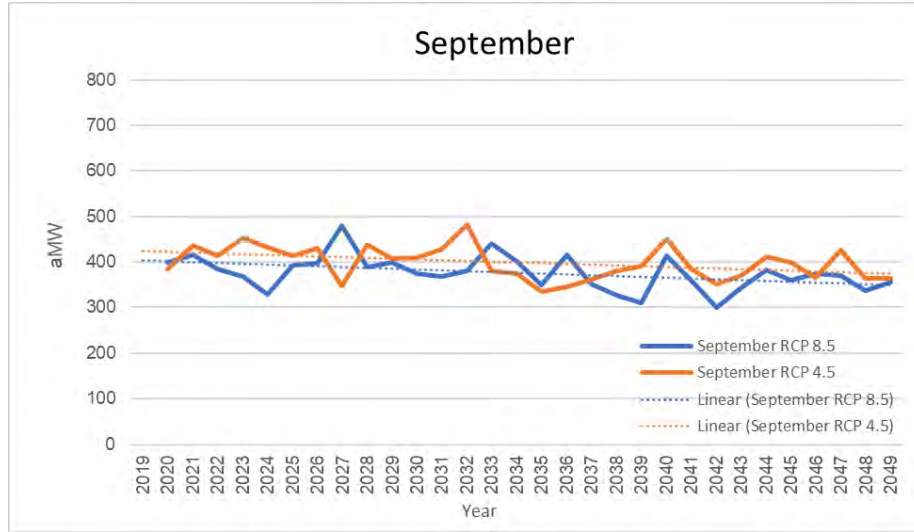

# Results

## Comparison of RCP4.5 and RCP8.5 for 2019-2049

Avista Hydrogeneration - Comparison of Emission Scenarios

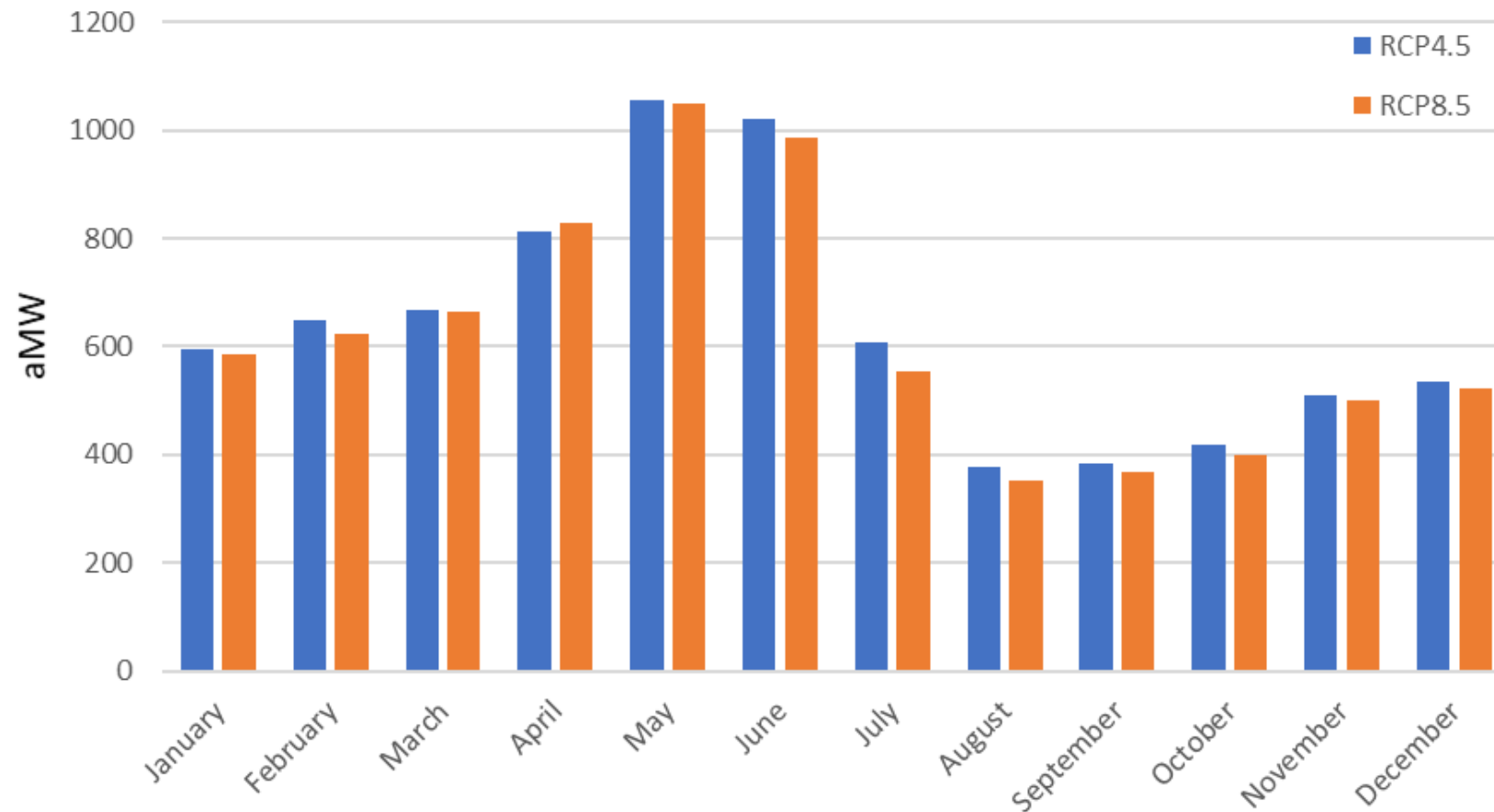

# Climate Change Impacts to Load

- Daily max and min temperature for Spokane airport through 2049 that correspond to the 19 BPA scenarios.
- Load forecasting model utilizes monthly heating degree days (HDDs) and cooling degree days (CDDs) as inputs to econometric model.
- Utilized the median average daily temperature of the climate models to calculate daily HDDs and CDDs and then summed monthly.
- Load forecast utilizes a 20-year moving average.

# Climate Change Impacts to Load

- Heating Degree Days Baseline Data

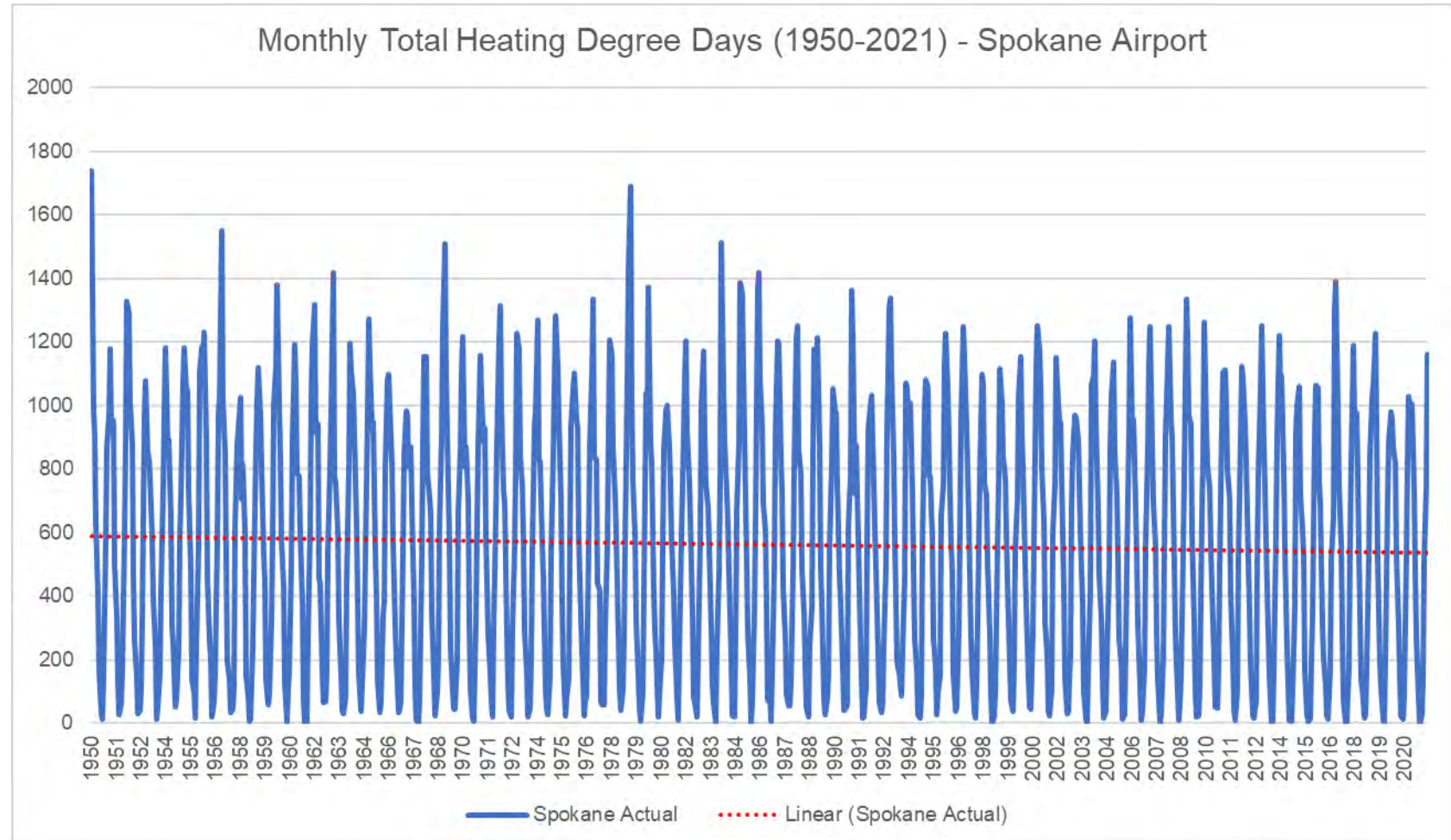

# Climate Change Impacts to Load

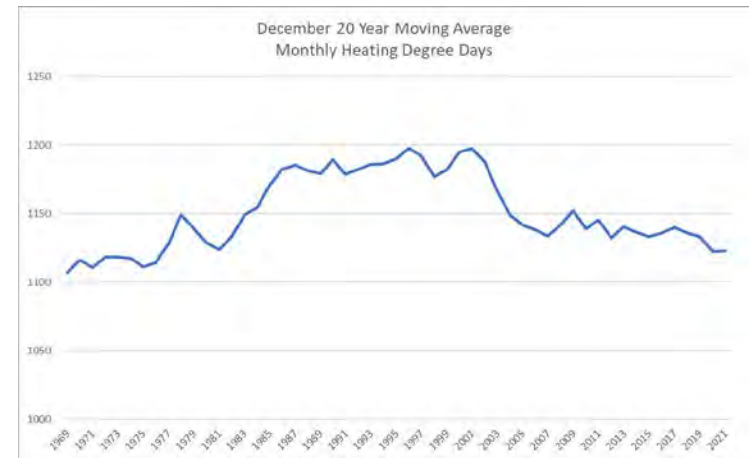
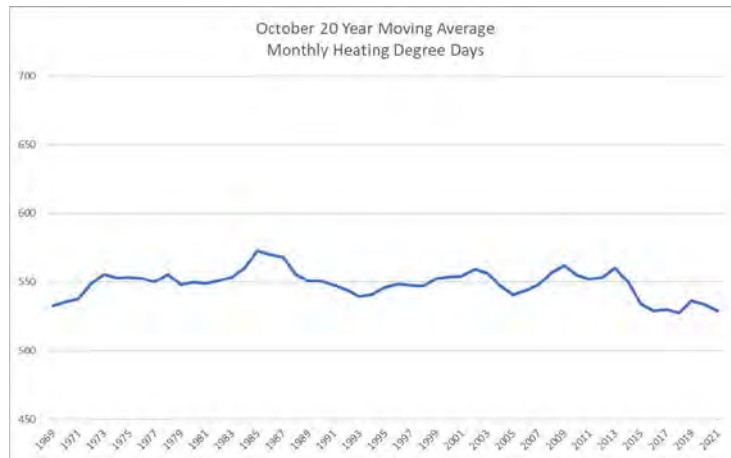
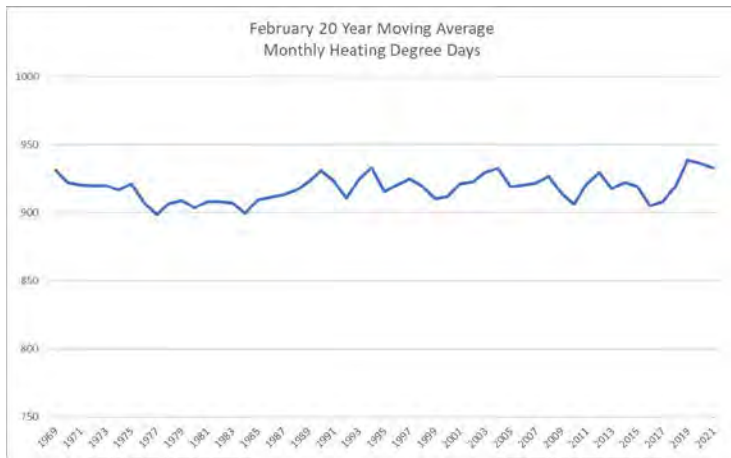
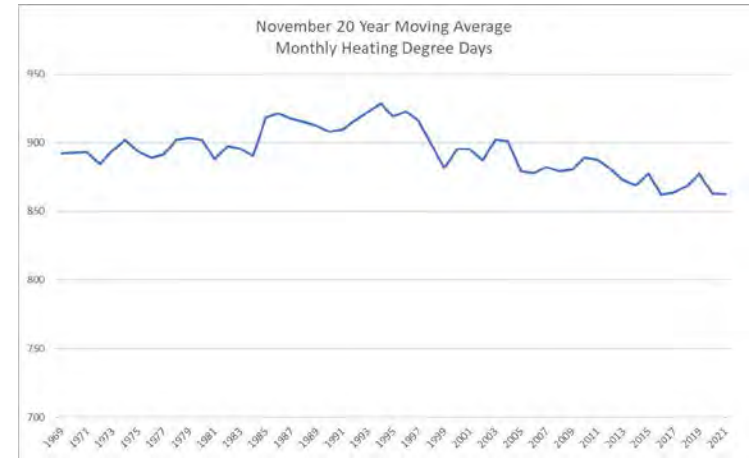
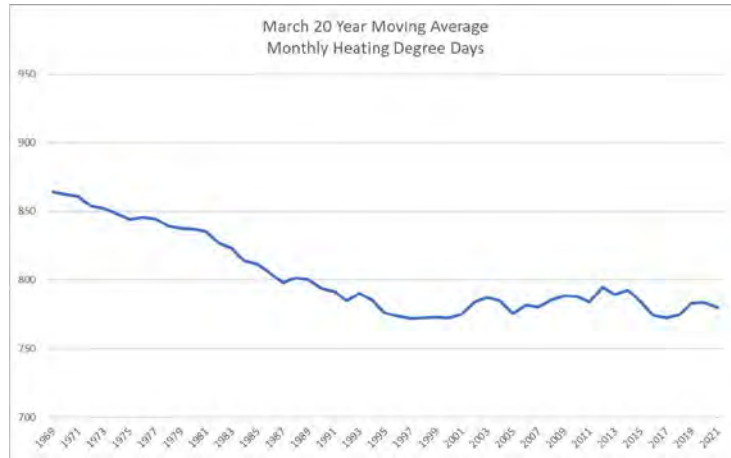
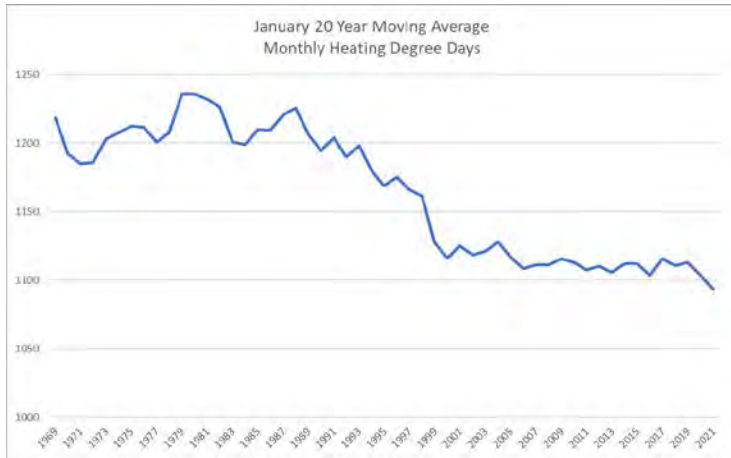

# Climate Change Impacts to Load

Median Monthly HDDs - RCP4.5

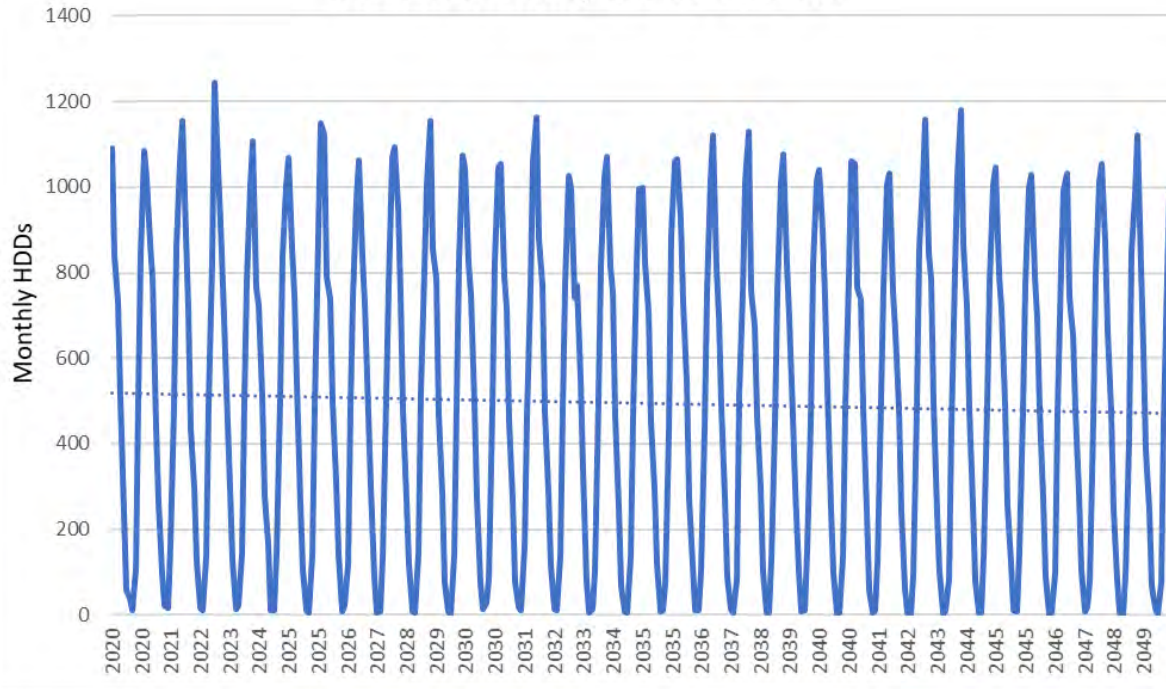

Median Monthly HDDs - RCP8.5

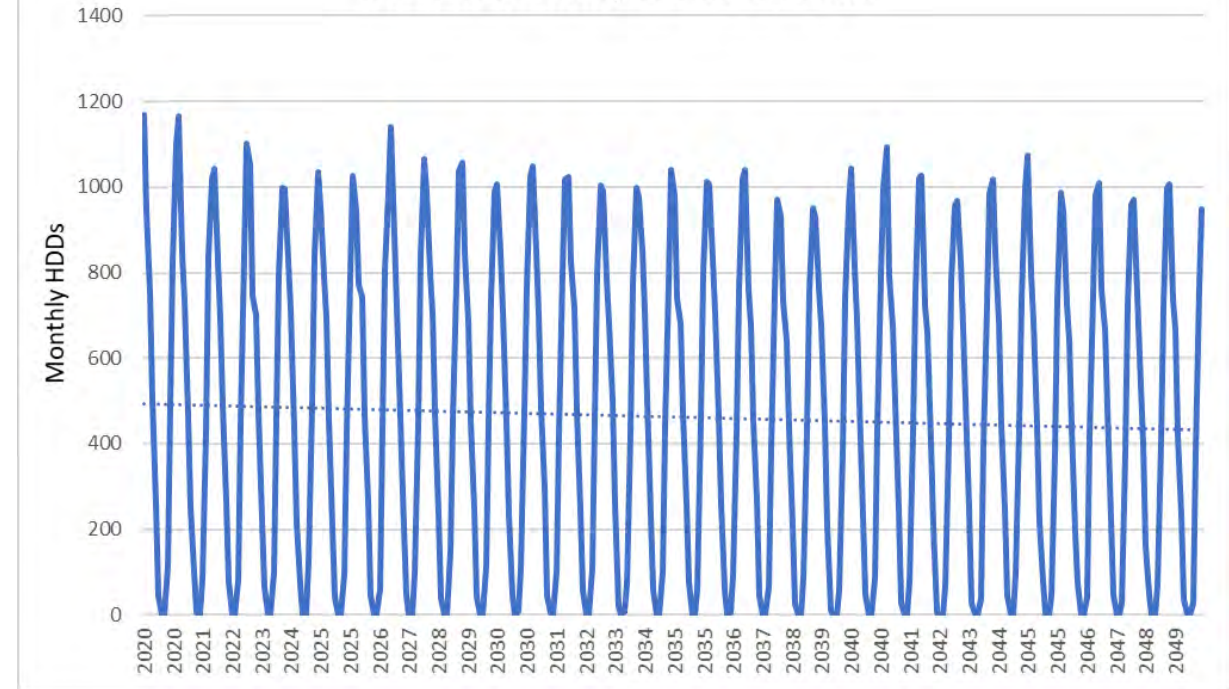



# Climate Change Impacts to Load

- Cooling Degree Days Baseline Data

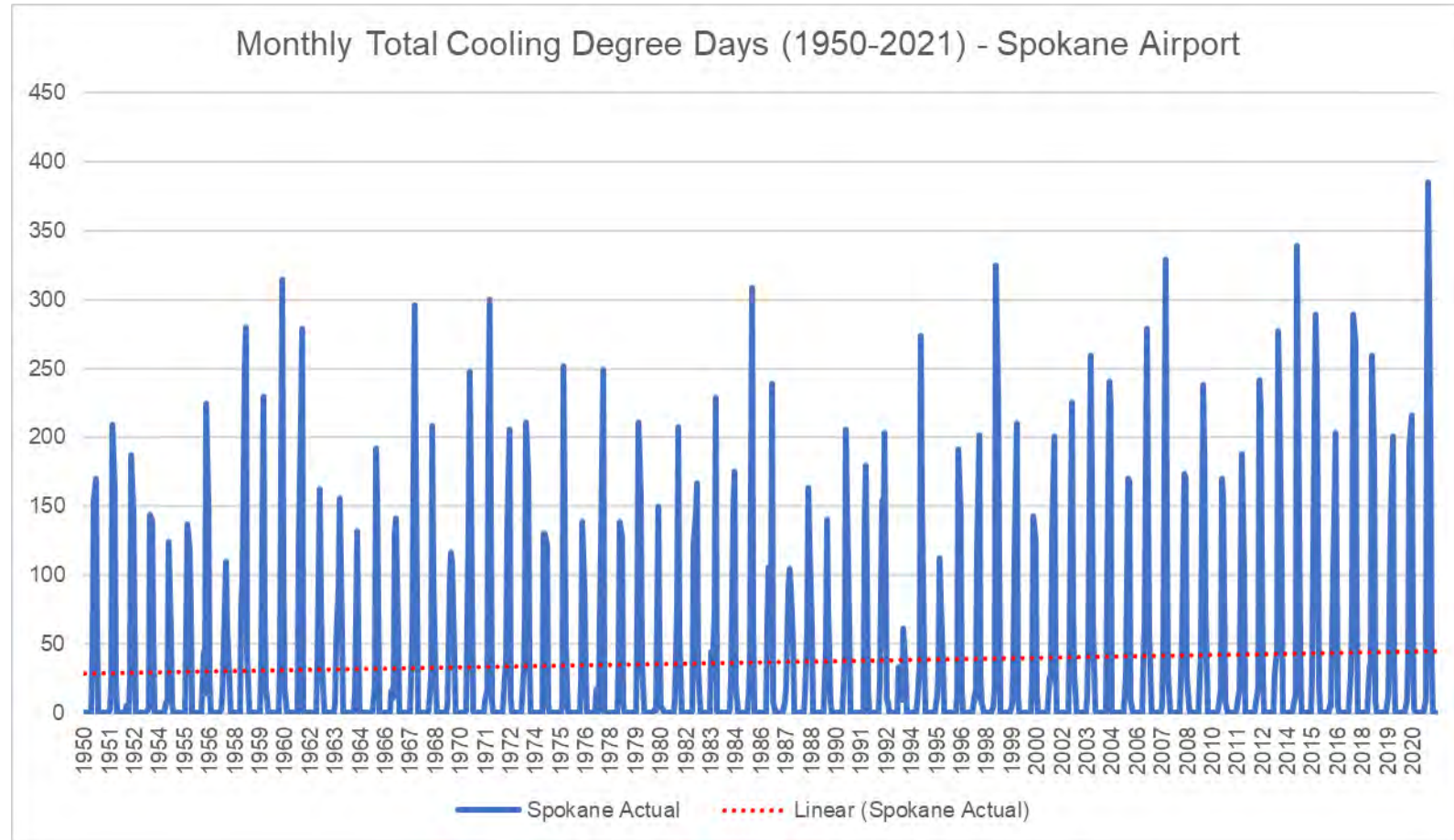

# Climate Change Impacts to Load

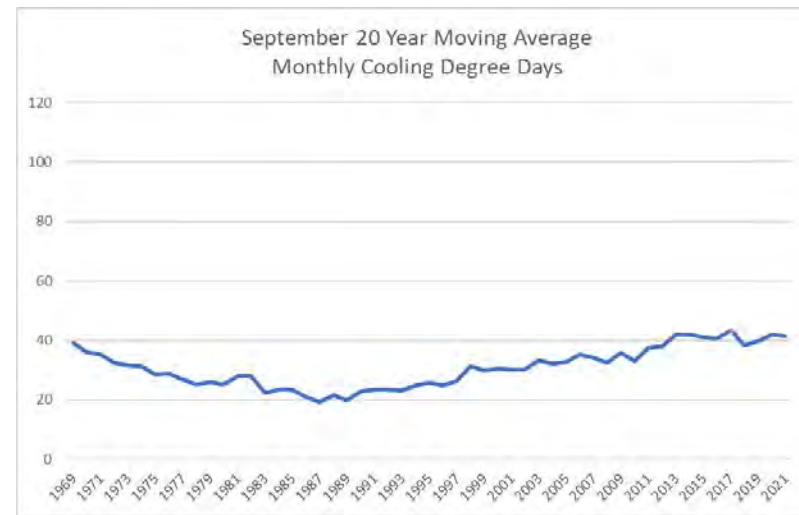
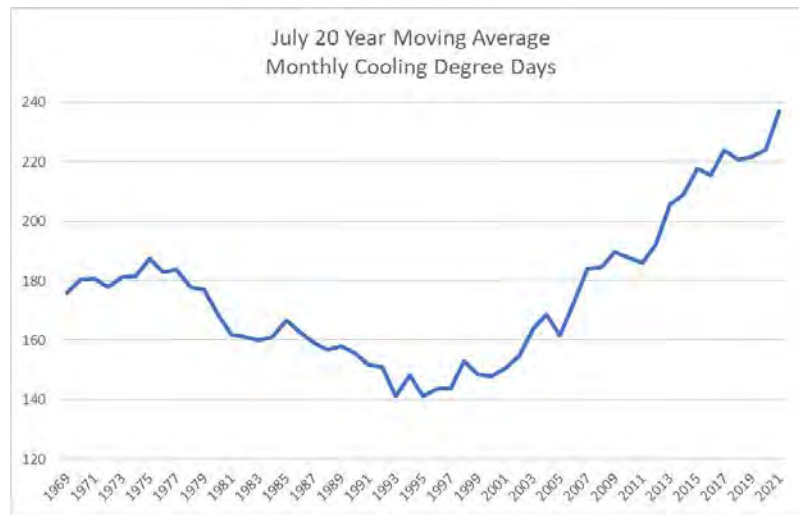
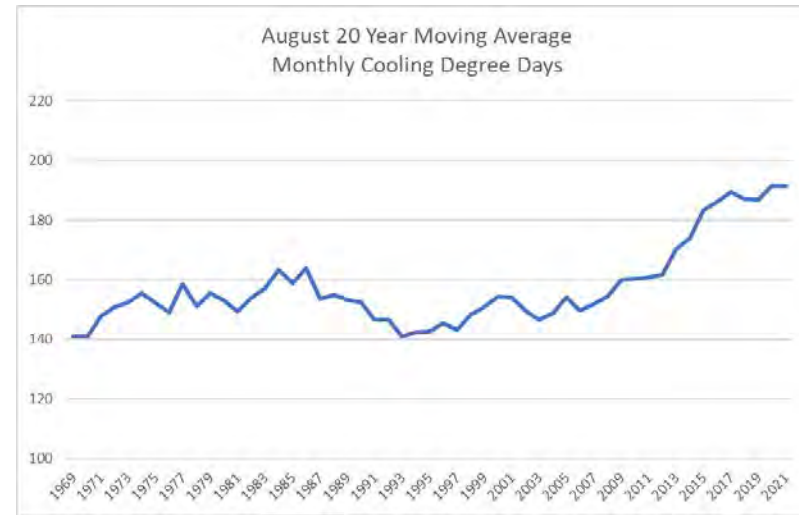
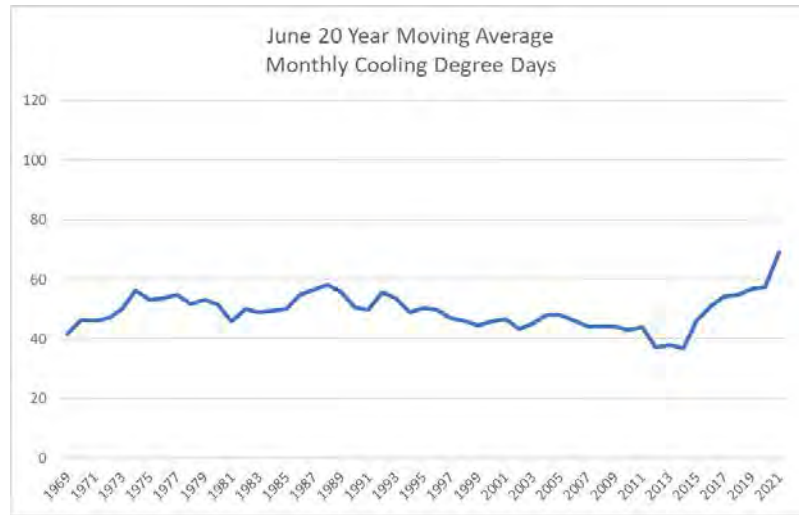

# Climate Change Impacts to Load

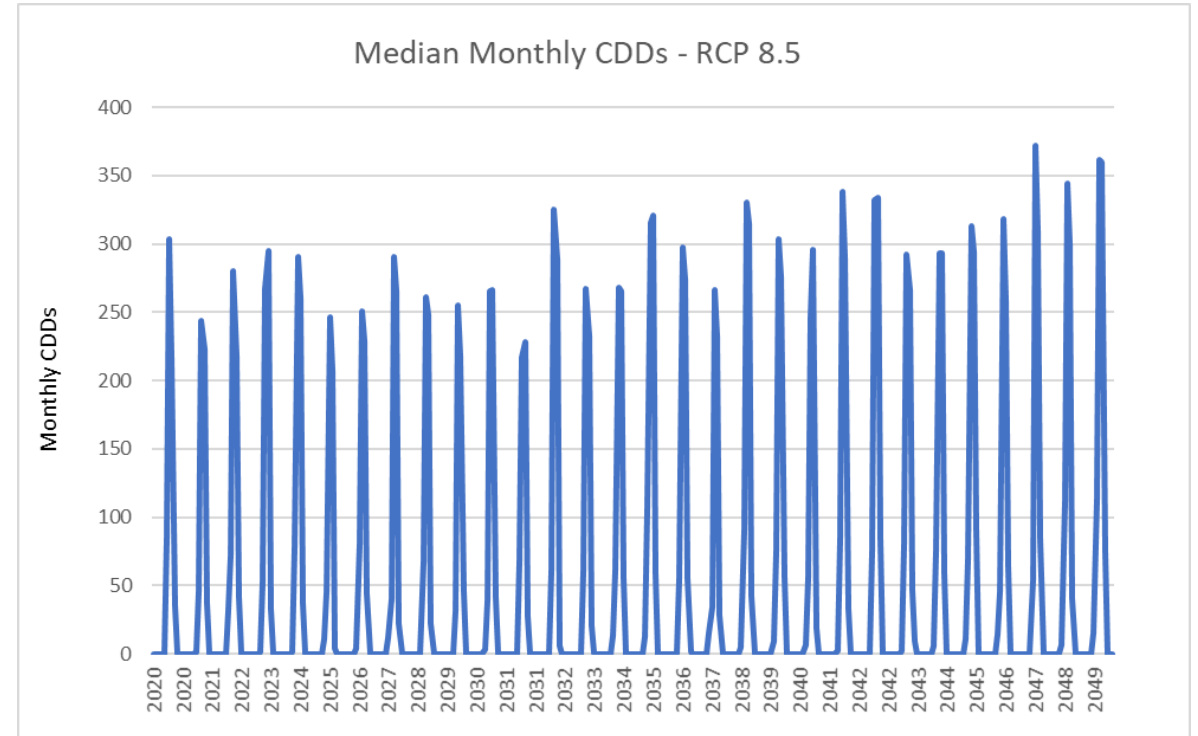
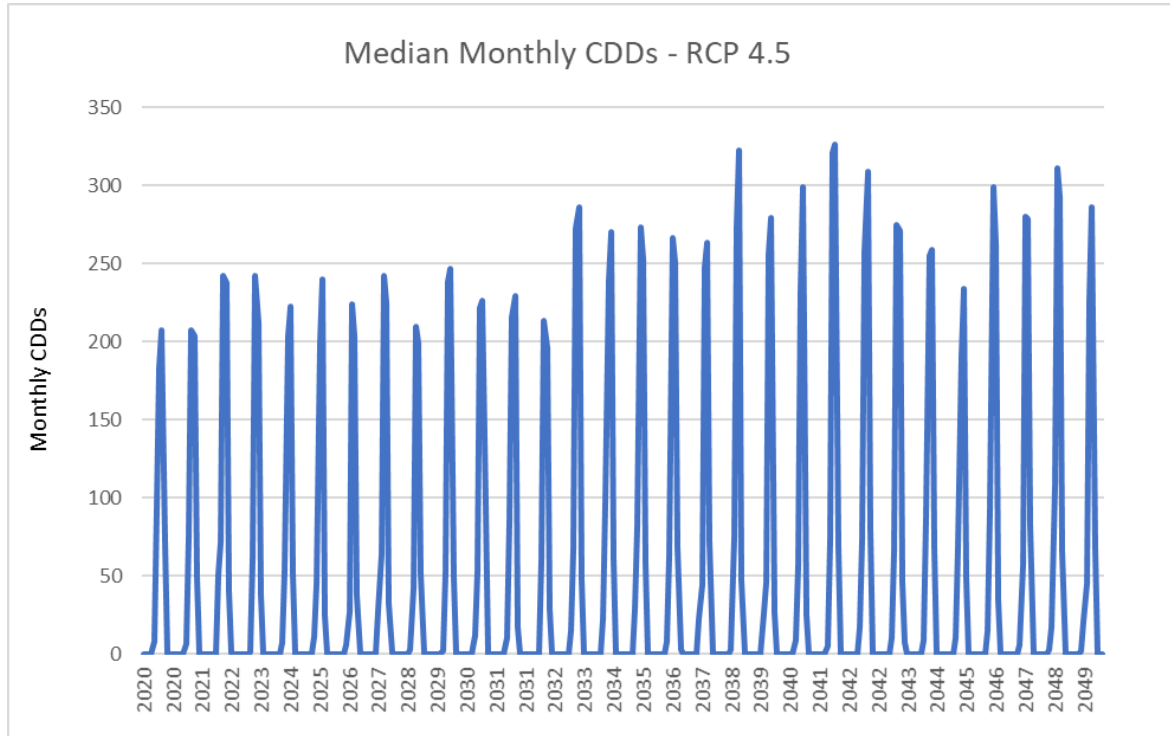

# Impacts to Load

- Load forecast utilizes 20-year rolling average which phases into the climate change forecast.

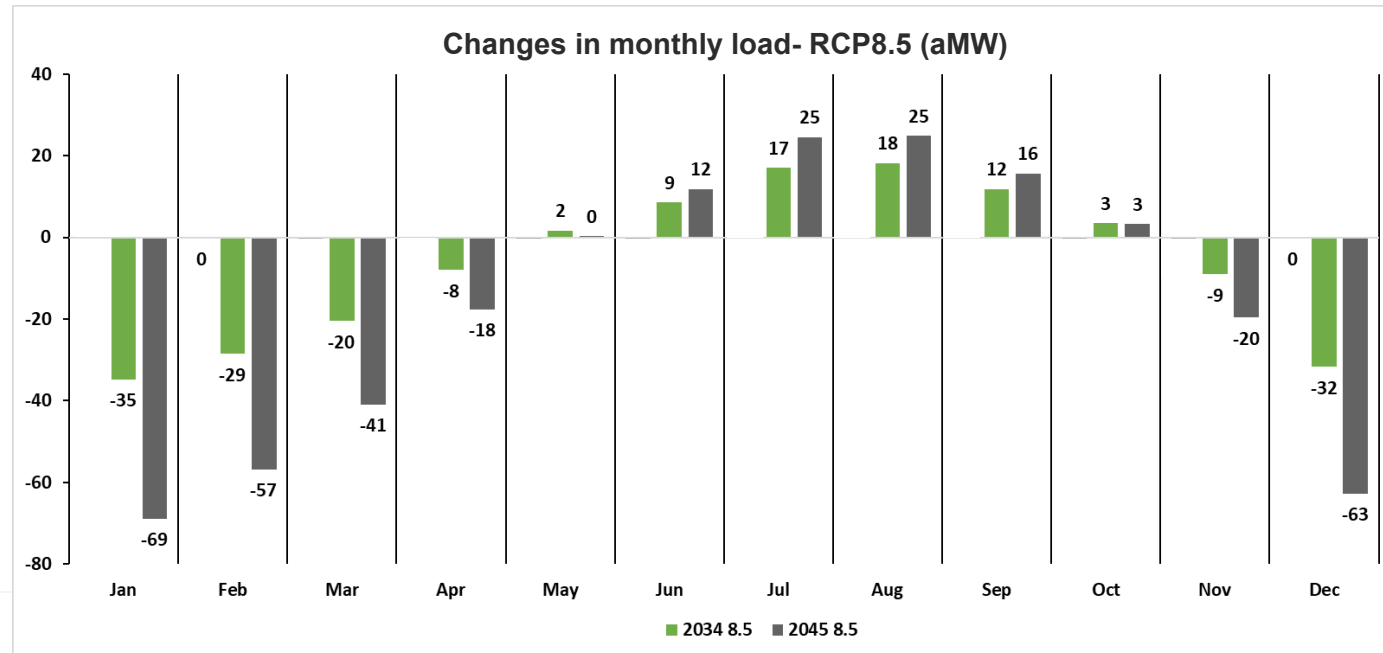
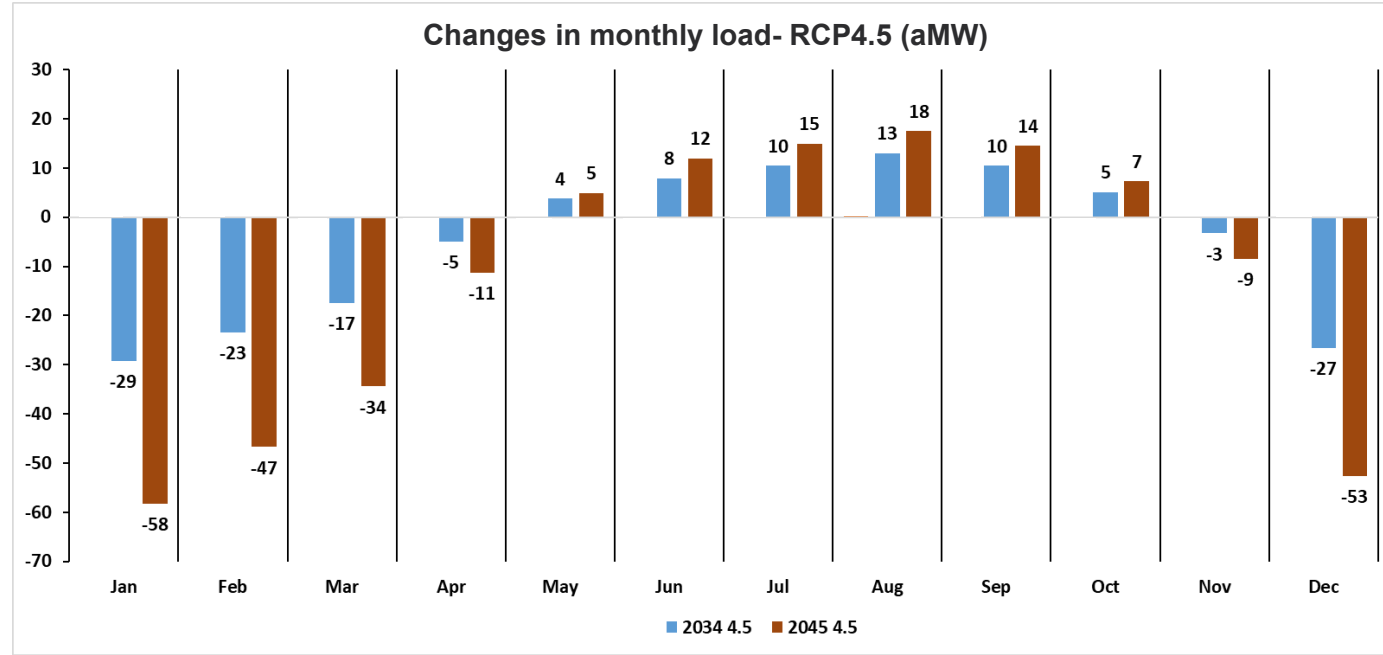

# Climate Change Impacts to Peak Load

- Peak load model utilizes minimum/maximum daily average temperature for each month.
- Median of minimum/maximum average daily temperature for each month of all models.
- Summer and winter peak is the highest/lowest for each time period.
- Winter peak is based on a 76-year\* moving average, summer peak is based on a 20-year moving average.

\* Spokane temperature data changed in 1947.

# Climate Change Impacts to Peak Load

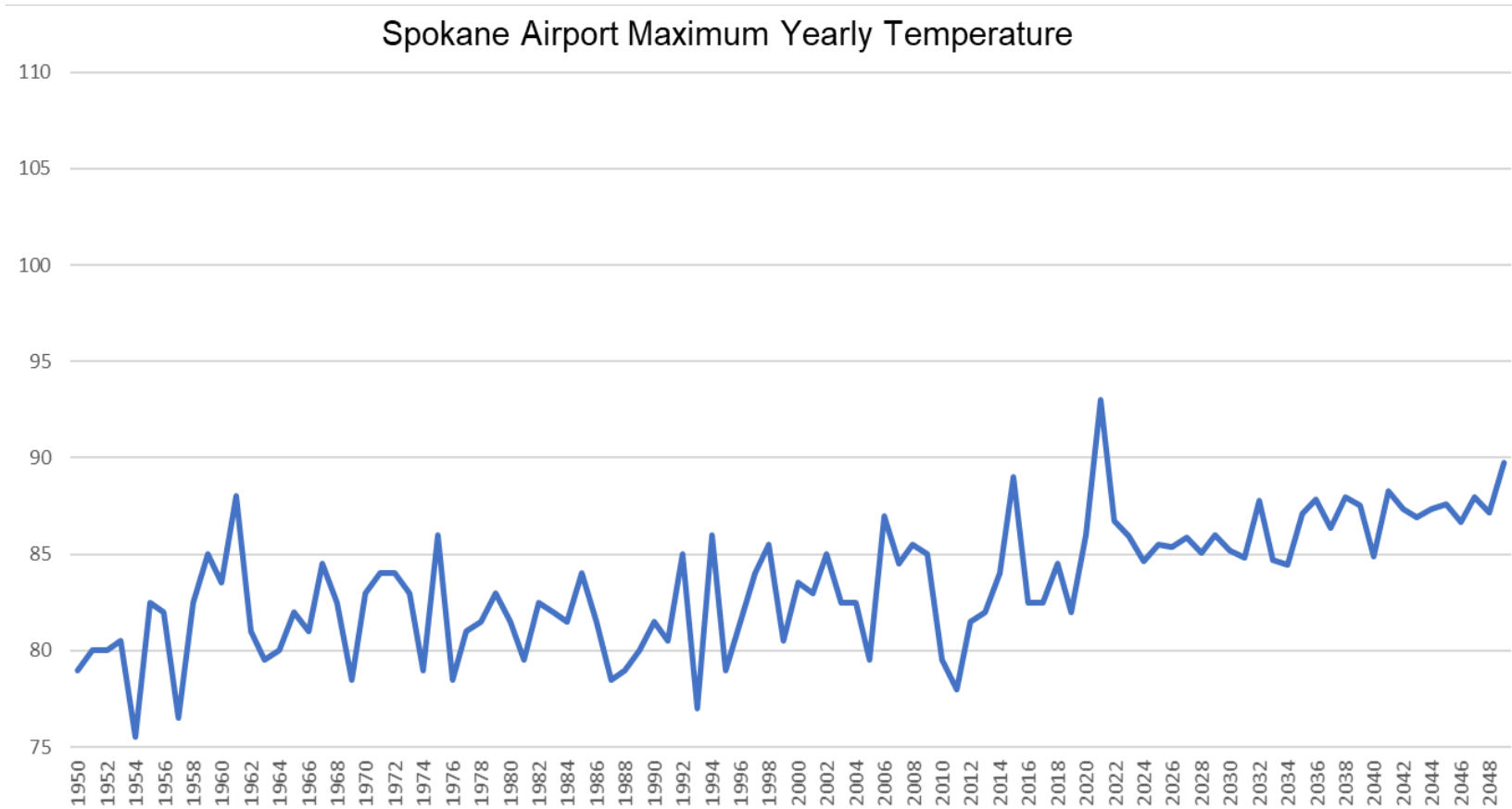

# Climate Change Impacts to Peak Load

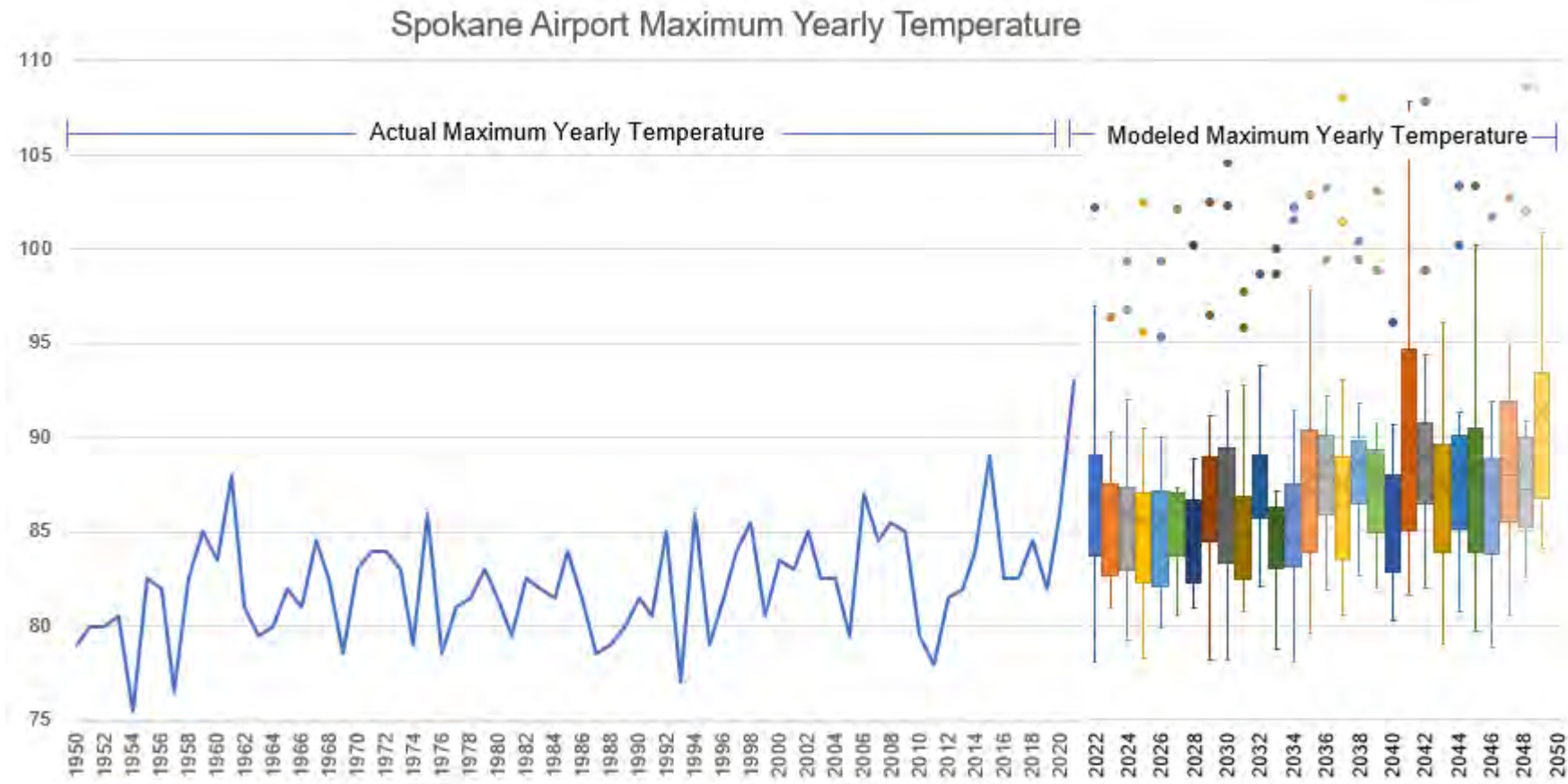

# Climate Change Impacts to Peak Load

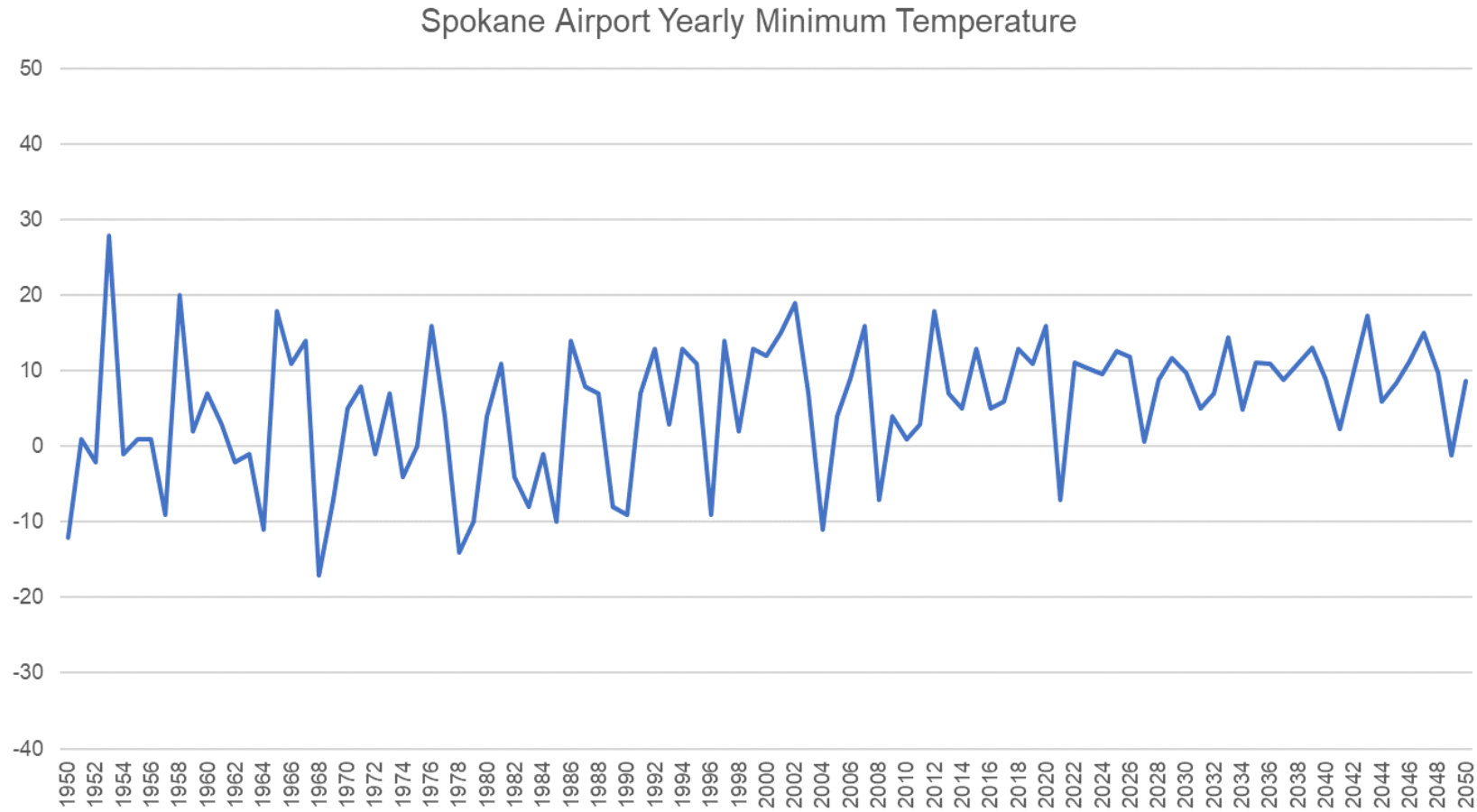



# Climate Change Impacts to Peak Load

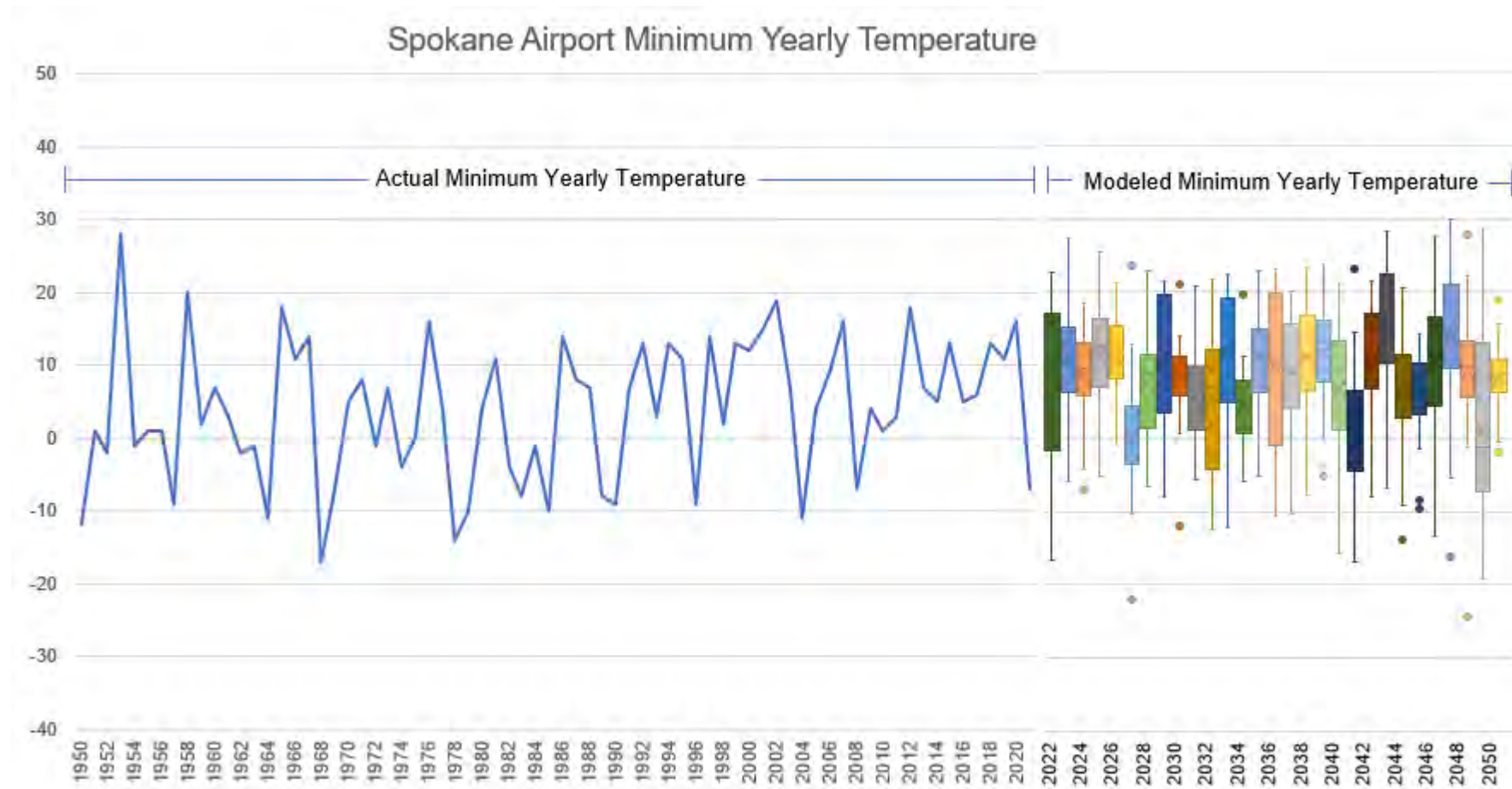

# Climate Change Impacts to Peak Load

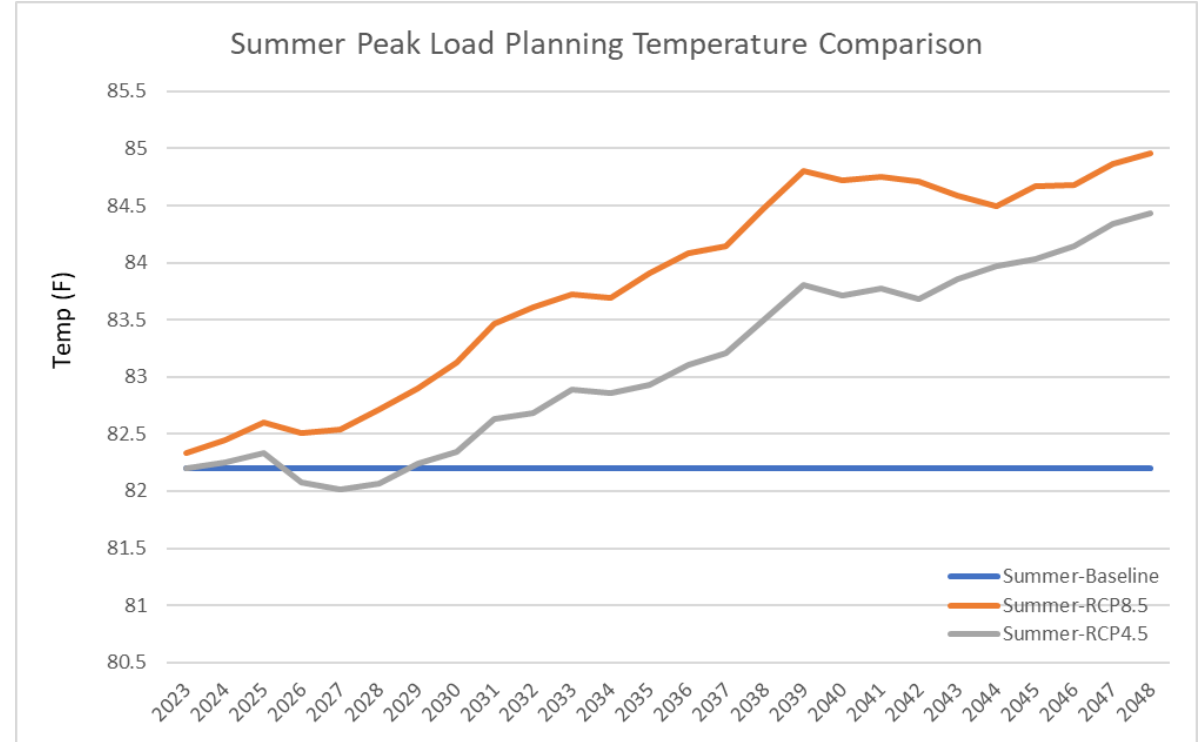
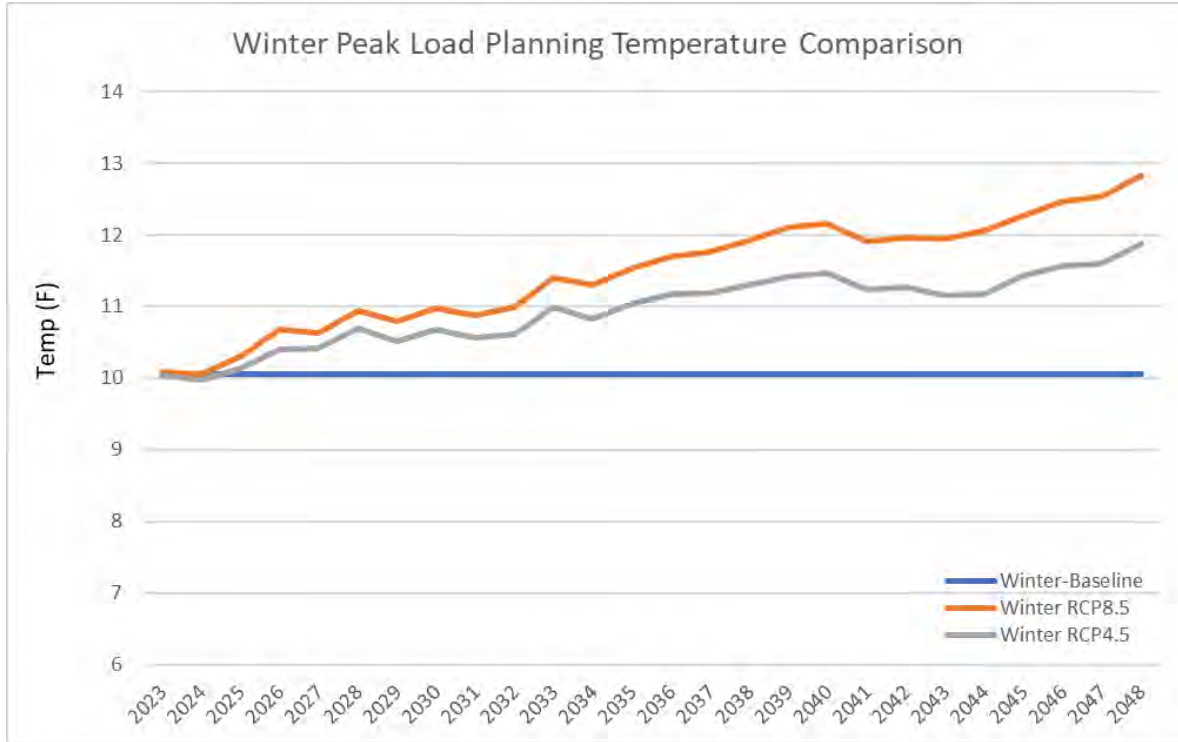

# Climate Change Impacts to Peak Load

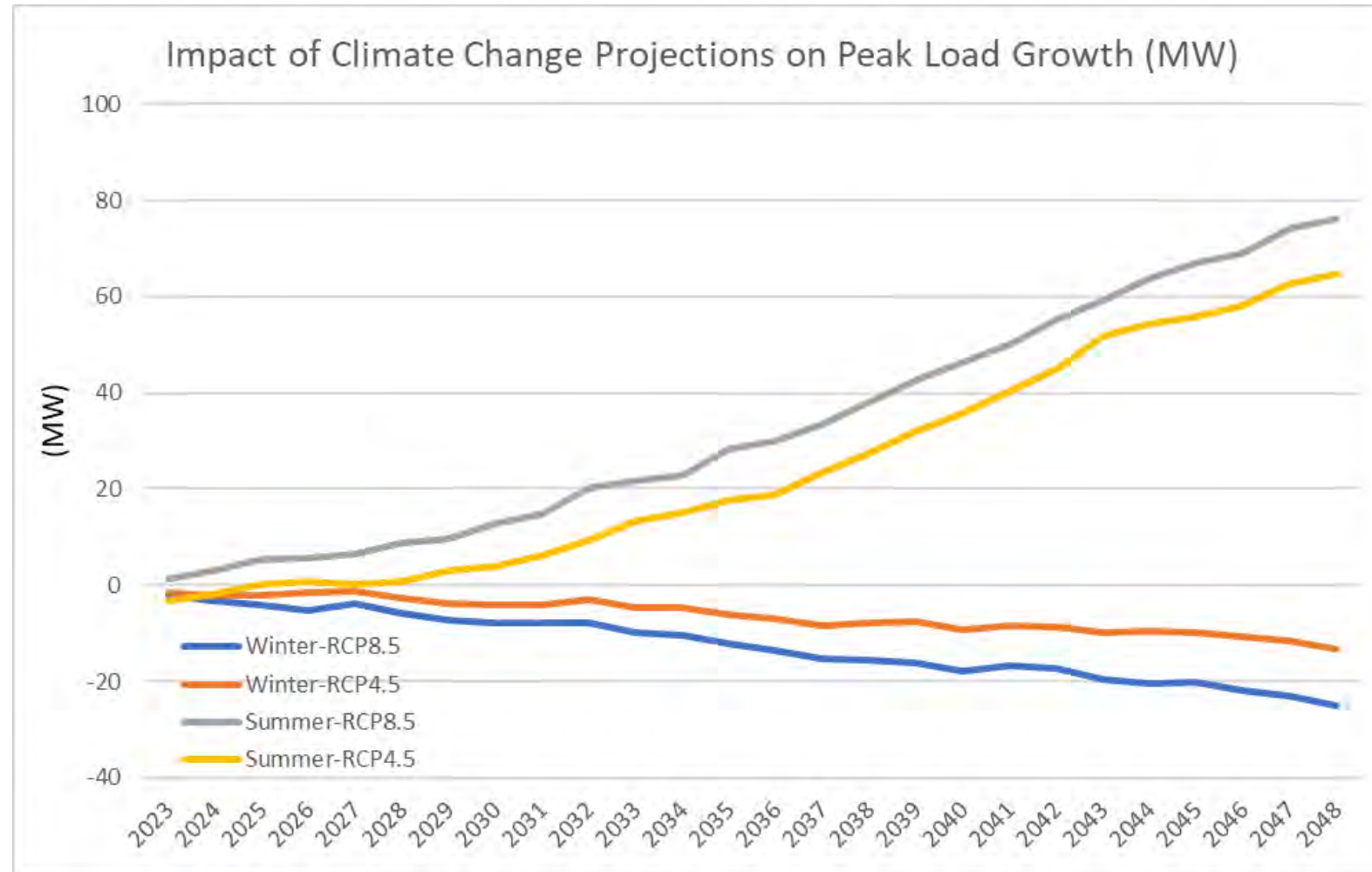

# Climate Change Impacts to Peak Load

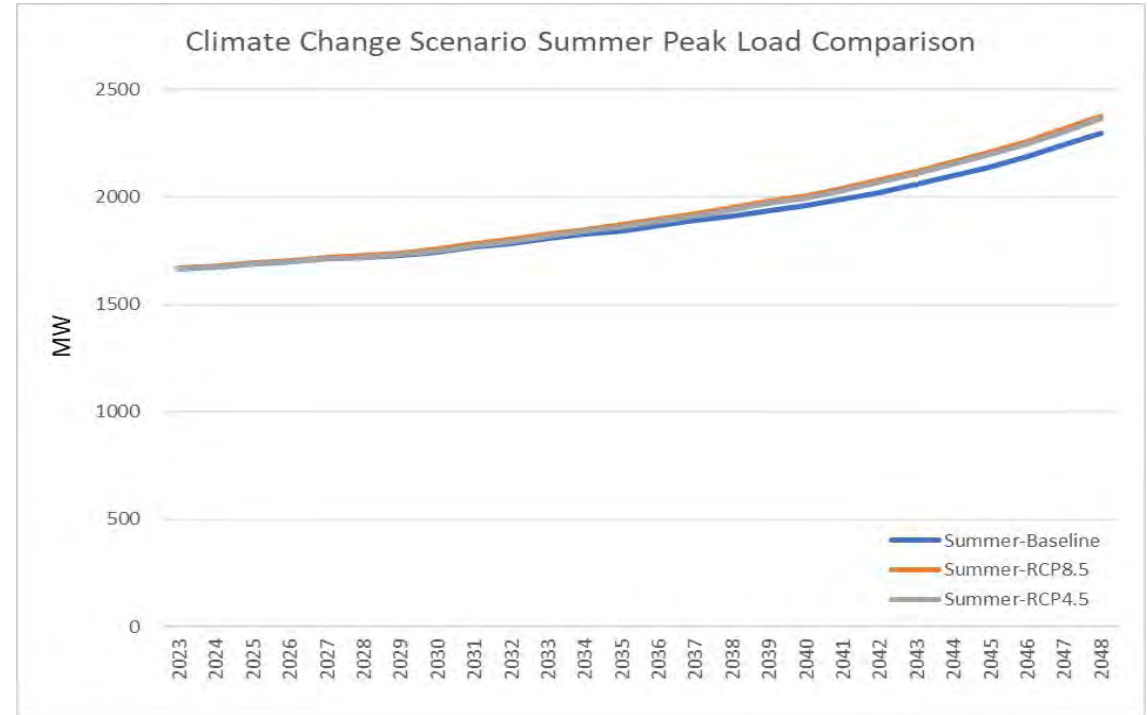
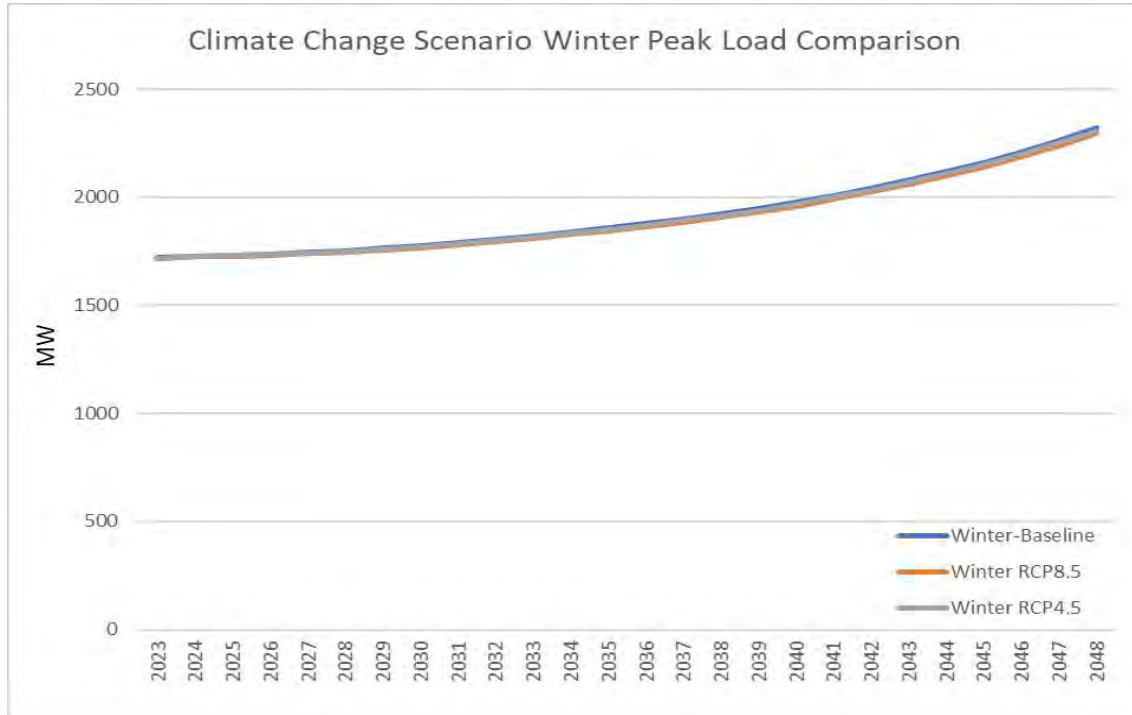

# Climate Change Impacts to Peak Load

- Capacity of gas turbines decreases as temperature increases.

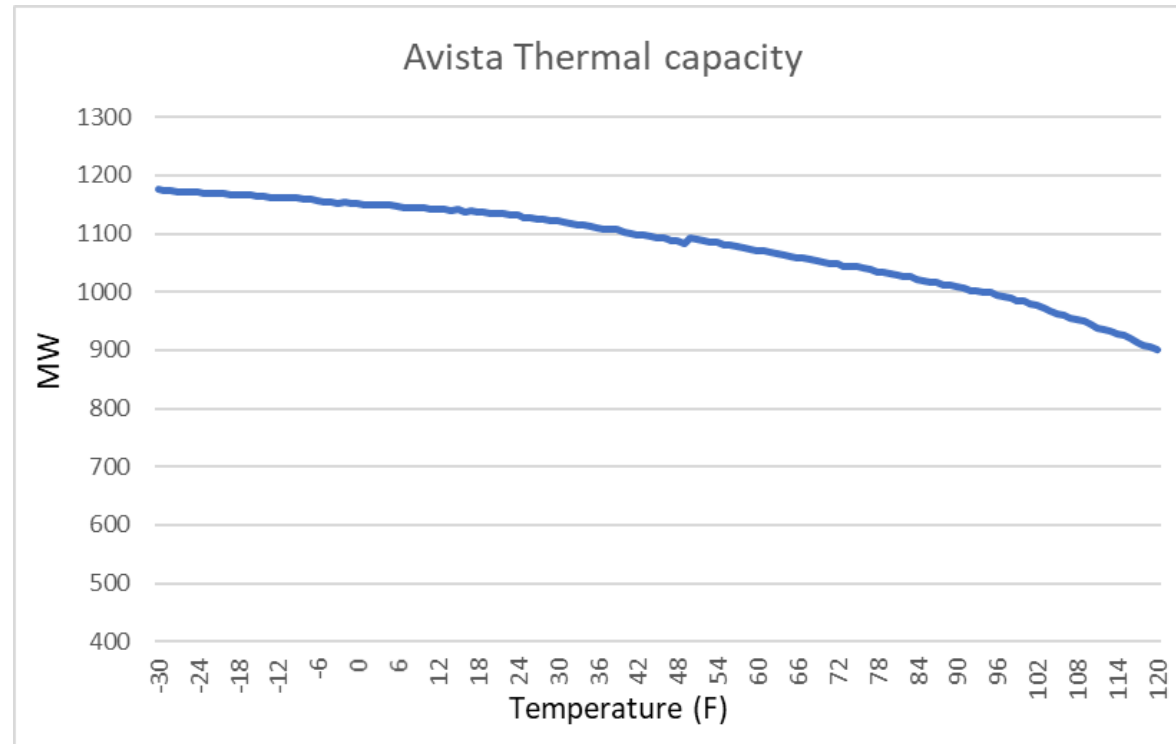

- Will increased maximum temperatures reduce capacity during extreme heat events?

# Climate Change Impacts to Peak Load

- Historical yearly maximum temperatures similar to median yearly maximum modeled temperatures
- No difference in thermal capacity when comparing historical data to median of climate models

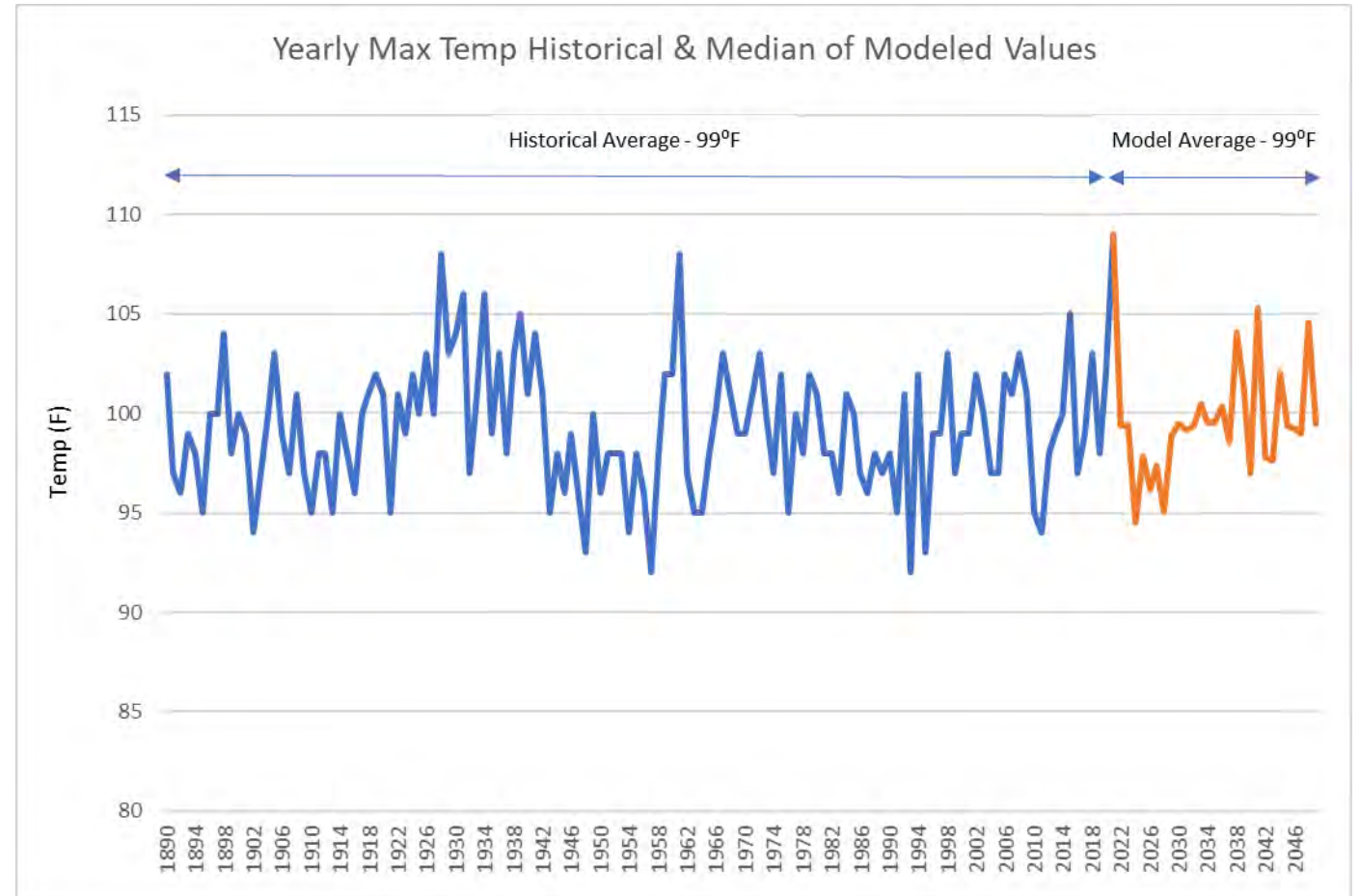

# Climate Change Impacts to Peak Load

- Thermal capacity is reduced by 22 MW at the 95<sup>th</sup> percentile of yearly maximum, maximum temperatures

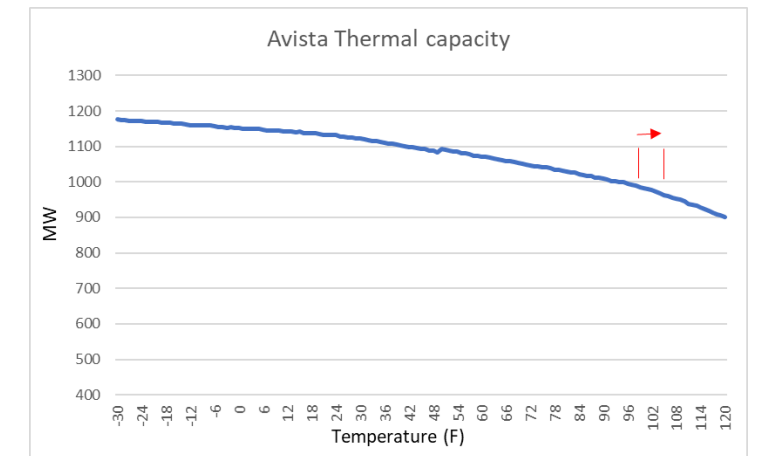
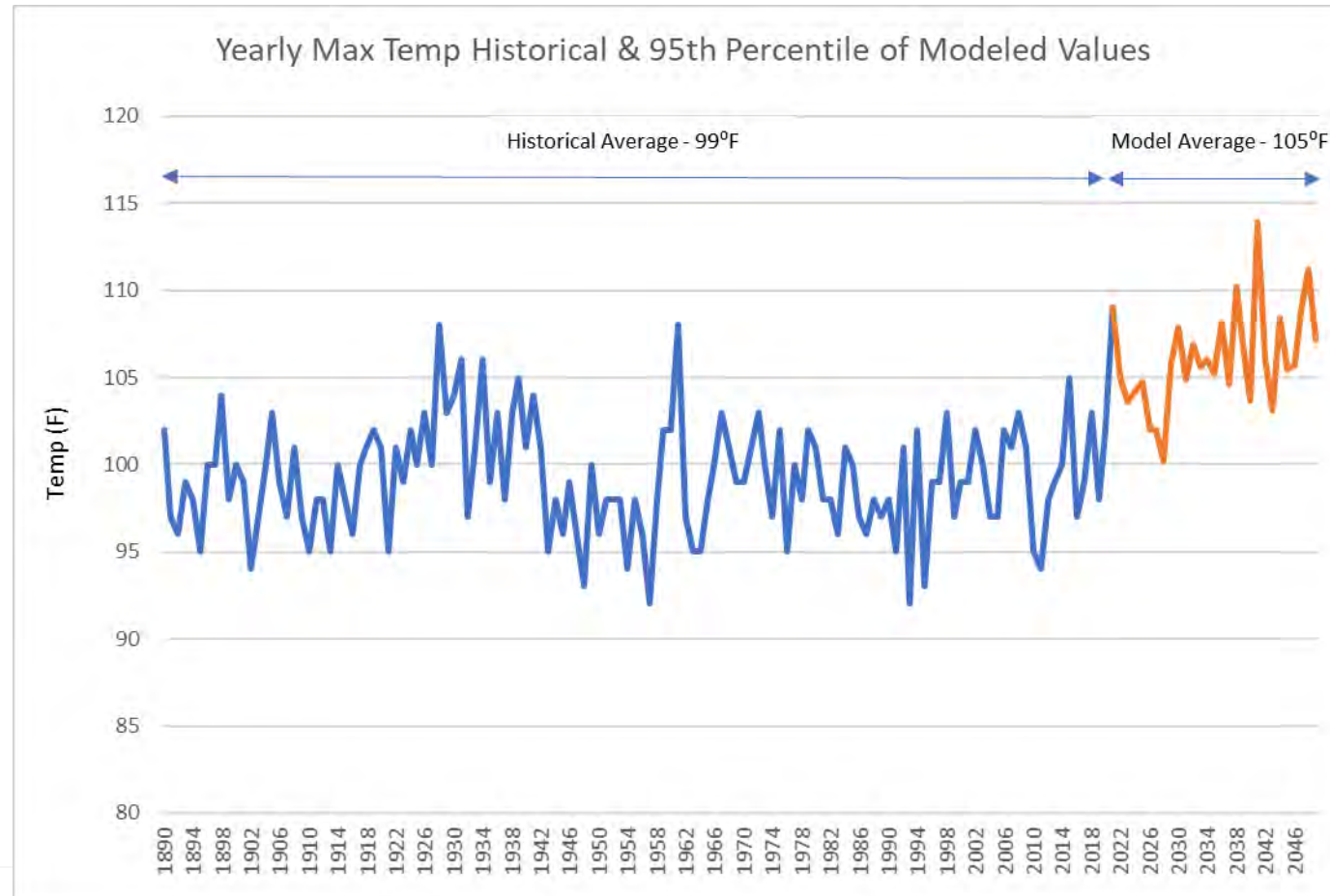

# Climate Modeling and Peak Load Risk

- Capacity risk is addressed with the planning reserve margin.
- Given the variance of the climate change models, what is the risk associated with climate change at the extremes of the modeling, and does that risk increase over the planning horizon?

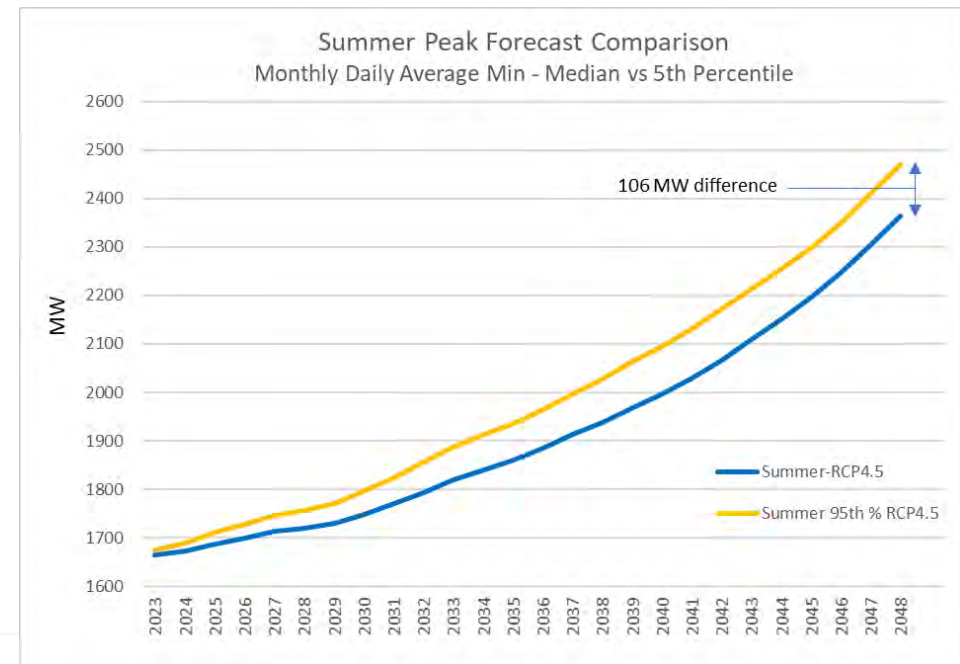
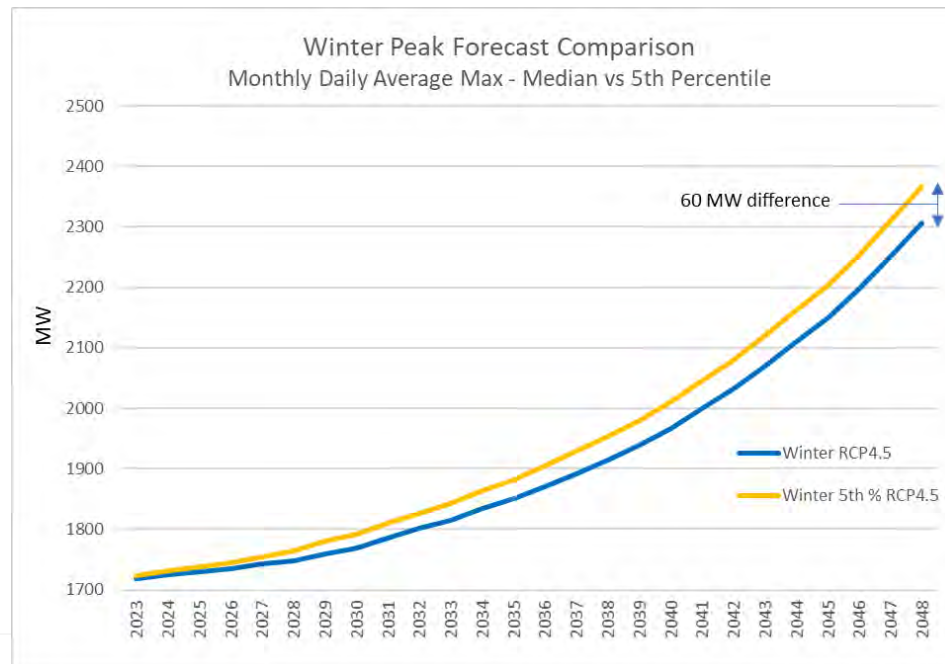



# Climate Change – Net Impact

Net Impact of 30 Year, RCP4.5, & RCP8.5 Forecasts on Hydrogeneration & Loads

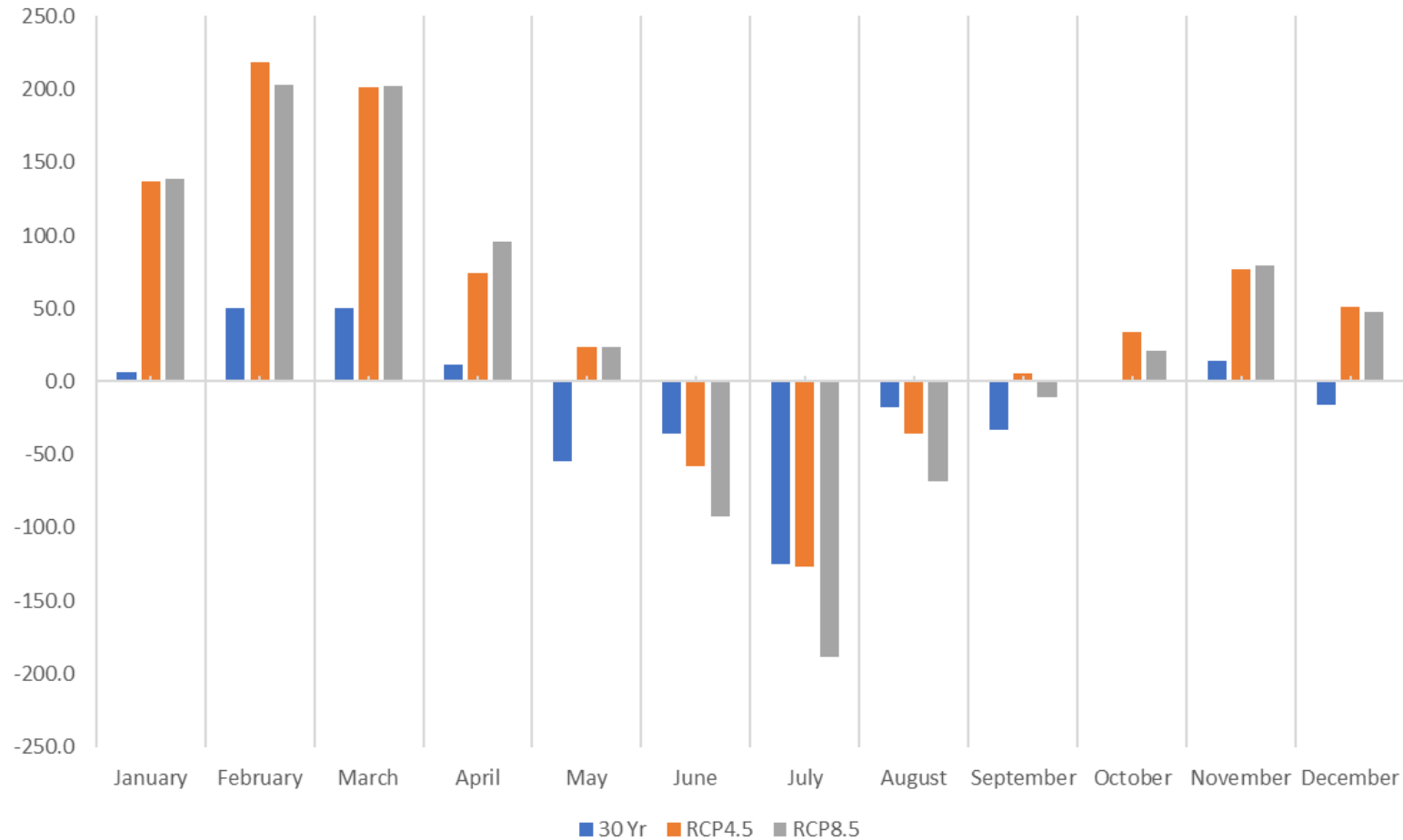

Difference from current  
80 year hydro record

Month	30 Yr	RCP4.5	RCP8.5
January	6	137	139
February	50	218	203
March	50	201	202
April	11	74	96
May	-54	23	24
June	-36	-58	-92
July	-125	-127	-189
August	-17	-36	-69
September	-33	6	-11
October	0	34	21
November	14	76	80
December	-16	51	48

# Climate Change – Net Impact

Climate Change Scenario Winter Peak Load Comparison

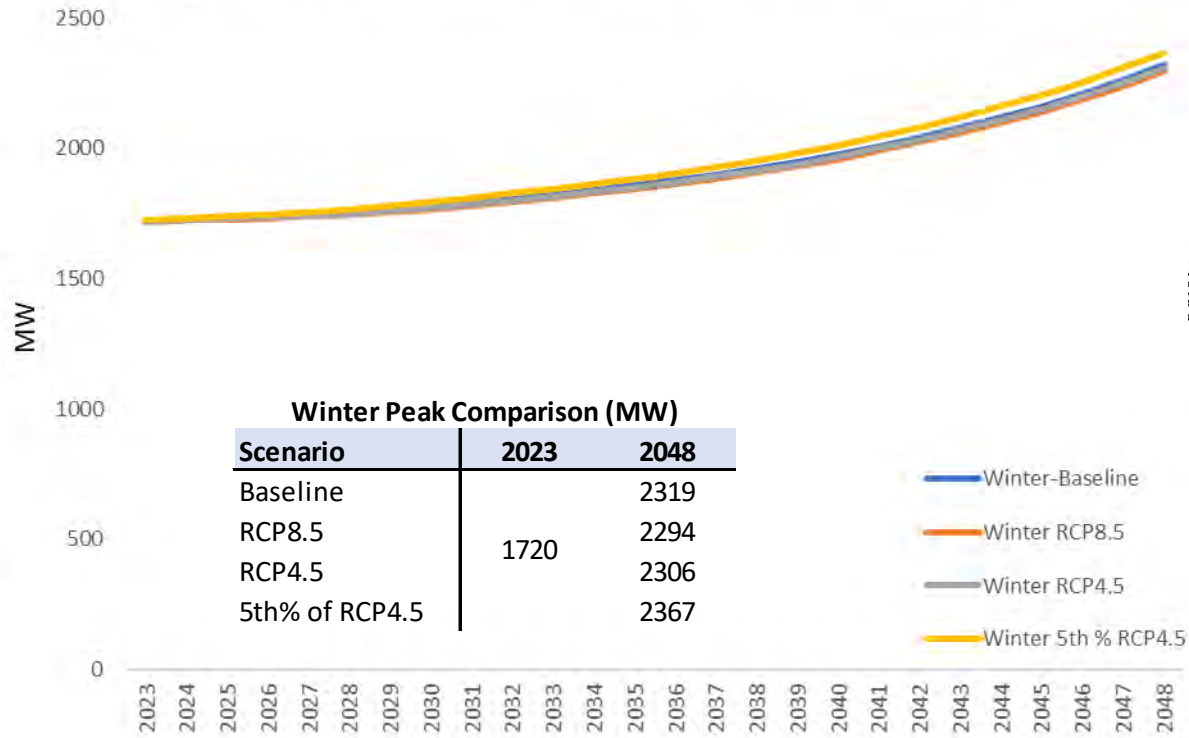

Climate Change Scenario Summer Peak Load Comparison

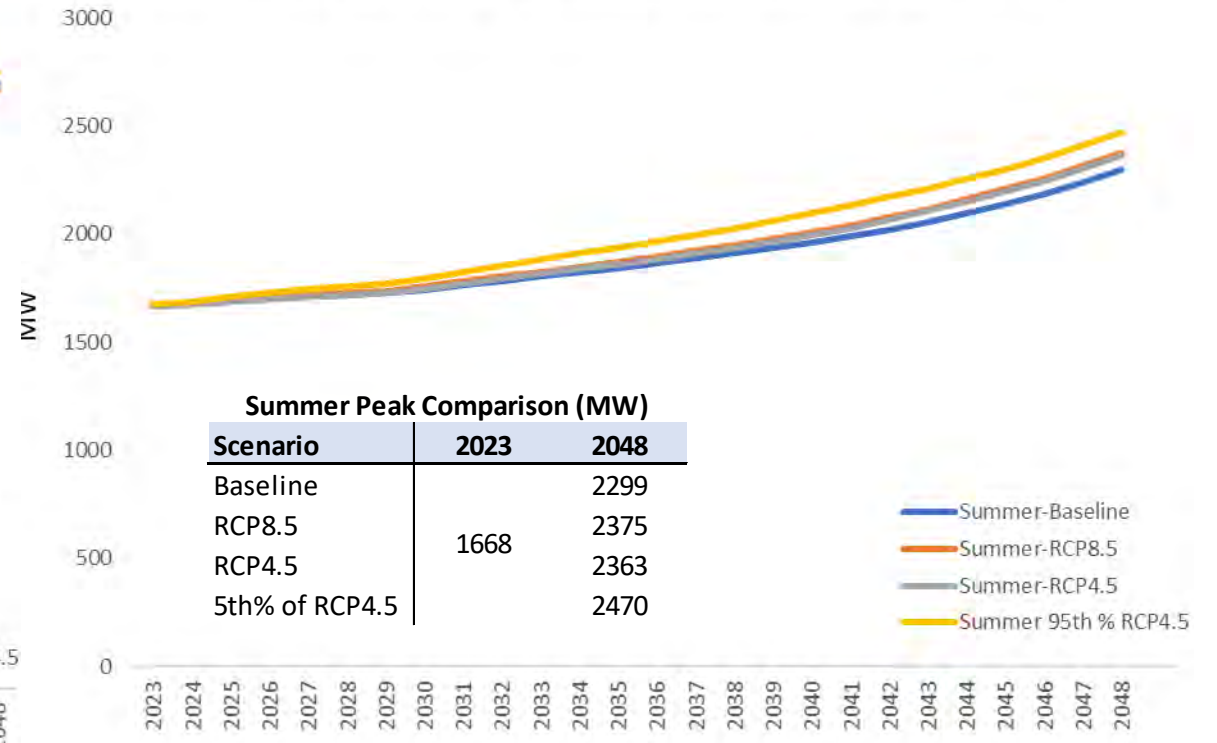

# IRP Climate Change Approach

- Use RCP4.5 Scenario
  - Description by Intergovernmental Panel on Climate Change (IPCC)
    - RCP2.6 – stringent mitigation scenario
    - RCP4.5 & RCP6.0 – intermediate scenarios
    - RCP8.5 – very high GHG emissions
  - RCP4.5 & RCP6.0 are similar in IRP planning horizon
- Hydrogeneration – Move from median of 80-year (1929-2008) to median of previous 30 years throughout planning horizon
- Energy Load Forecast – move from static assumed temperature to moving average of previous 20 years throughout planning horizon
- Peak Load Forecast – move from static assumed temperature to moving average of previous 20 years (summer peak) and 76 years (winter peak)

## TAC 6 Meeting Notes: Wednesday, September 28, 2022

### Attendees:

John Barber, Customer; Shawn Bonfield, Avista; Annette Brandon, Avista; Terrence Browne, Avista; Michael Brutocao, Avista; Travis Culbertson, IPUC; Mallorie Davies, LIUNA; Kelly Dengel, Avista; Nelli Doroshkin, Invenergy; Chris Drake, Avista; Michael Eldred, IPUC; Donn English, IPUC; Ryan, Finesilver, Avista; Damon Fisher, Avista; Grant Forsyth, Avista; James Gall, Avista; Bill Garry (Guest); Amanda Ghering, Avista; John Gross, Avista; Tom Handy (Guest); Jared Hansen, Idaho Power; Ellie Hardwick, REC/NIPPC; Nora Hawkins, Washington Department of Commerce; Lori Hermanson, Avista; Mike Hermanson, Avista; Kevin Holland, Avista; Fred Huette, Northwest Energy Coalition; Tina Jayaweera, Northwest Power and Conservation Council; Clint Kalich, Avista; Lance Kaufman, Aegis Insight; Kevin Keyt, IPUC; Kathlyn Kinney, Biomethane, LLC; Doug Krapas, IEP Co.; Ben Kropelnicki, Avista; Jeff Larsen, Guest; John Lyons, Avista; Patrick Maher, Avista; Jaime Majure, Avista; Ian McGetrick, Idaho Power; Aubrey Newton, LIUNA NW; Tom Pardee, Avista; Liz Reichart, Washington Department of Commerce; John Robbins, Mitsubishi; Darrell Soyars, Avista; Collins Sprague, Avista; Dean Spratt, Avista; Jason Talford, IPUC; Gavin Tenold, Northwest Renewables; Charlee Thompson, Northwest Energy Coalition; Hannah Wahl, Puget Sound Energy; Jim Woodward, UTC.

### Introductions, John Lyons

**Lyons, John:** I don't know why they call it a warning, but just to let you know that we are recording this meeting and those will be made available when we publish the IRP. James, do you want me to try to share my screen for the presentation or do you just want to do it for that short first one?

**Gall, James:** I'll let you do it. I will take my agenda screen off and go ahead.

**Lyons, John:** OK, now we'll see if I can actually get this to work, which is always fun. And are we seeing my screen now, James?

**Gall, James:** I see your screen.

**Lyons, John:** All right. OK, welcome to Avista's 6<sup>th</sup> Technical Advisory Committee meeting. We're trying to wait as people are coming in, they're able to see that. My name's John Lyons. I am a senior resource policy analyst here on the team and I've been working at Avista for quite some time doing IRPs. I'm going to start with the introduction and then we'll go on from there. So, usual meeting guidelines, I think all of us have been through enough online meetings, we should be in good shape on that. We are going to continue using Microsoft Teams and we will keep offering a virtual IRP meeting option, but we are going to transition back to offering in person meetings starting in October.

**Lyons, John:** Reminder, just mute your microphones unless you're commenting or asking a question. You can also use the raise hand or chat function if you have questions or comments, and we ask you to respect the pause. We'll have some awkward periods of

silence, but that's mainly just to give a chance for people to get off mute or to think about the things that we're asking about. If you can remember, state your name before commenting. That does help with this transcription software. It usually is quite good at picking up who is speaking as far as what it says. Sometimes it gets a little confused and can be quite amusing at that, but we will have that available. It is a public advisory meeting, so the comments are going to be documented and made available with the IRP.

**Lyons, John:** This is for development of the IRP itself and I'm just cruising through these first slides since we just had our last meeting a few weeks ago. If you are new to the TAC and you do have questions, feel free to reach out to anyone on Avista's IRP group and we're happy to answer questions. My number and e-mail are also on the IRP website. This is the public process for the Integrated Resource Plan. We get the input on what we're going to study, how we're going to study, and review of those assumptions. We do have a very wide range of people on the call, some of them are very adept and very knowledgeable about different parts of the process, some just have specific areas they're interested in or they're new to the process. Doesn't matter what your background is. If you're interested in it, we're glad to have you here and to answer questions. We are coming up on the due date for his new study request and that's October 1<sup>st</sup>. There's a little bit of slippage in there, especially if it's something that we're already studying, or we can do some minor work on that. James, do you have any other things you'd want to say about that? OK.

**Gall, James:** I just realized, October 1<sup>st</sup> is Saturday. So maybe the 3<sup>rd</sup> would be fine and the reason why that date is we're going to be preparing for our presentation on the 11<sup>th</sup> to go over scenarios. So, there will be an opportunity to talk about those scenarios on that date and if there are ideas generated in that discussion that are easy to do, we can talk about them at that time. But just so that we can get everything organized for the 11<sup>th</sup>. And the 3<sup>rd</sup> would be great. Thanks.

**Lyons, John:** OK, good. And the earlier you get stuff to us, the more time we have to plan for it, ask any follow up questions, make sure we're understanding what you would like from us, and that we're able to do that. If you do have things that come up later and we're not able to get them in this round, we're doing these on an ongoing basis, so it can always become an Action Item for the next IRP.

**Lyons, John:** We will be releasing an external draft to the TAC on March 17, 2023. And we'll ask for public comments due back by May 12<sup>th</sup>, and you can review the entire document or just the parts that you're most interested in. The final 2023 IRP submission will then be June 1, 2023. Our remaining meetings, as James said, we have our October 11<sup>th</sup> meeting, that's a long one from 9 AM to 3:30 PM. We have a technical modeling workshop on October 20<sup>th</sup>. That is going to be a more detailed than normal, meaning getting into the modeling aspects of this. If you're more interested in that, by all means come to it. Even if you don't feel that you're quite to that level or an expert on that, you are still welcome at the meeting, but that's going to be a very modeling intensive meeting. We'll have the Progress Report for Washington for that workshop, December 14<sup>th</sup>. TAC 8

will be on February 16, 2023. March 8<sup>th</sup> we will have a public meeting jointly for the gas and electric IRPs and that is more for the general public that you're welcome to if you're on the TAC, but it's generally more for customers that are interested, but maybe not where they want to participate in the TAC. We'll have an overview session and opportunities to break out into discussion groups. We'll wrap up with a 9<sup>th</sup> and final TAC meeting on March 22<sup>nd</sup>, so you'll have gotten the draft one IRP and then we'll be able to have some discussions on that.

**Woodward, Jim (UTC):** John.

**Lyons, John:** Yes. Jim.

**Woodward, Jim (UTC):** Hi, Jim Woodward, Washington Staff. By chance, the October 11<sup>th</sup> meeting. Have you sent out Teams invites for that yet?

**Lyons, John:** I am not sure if we did. And I apologize too. This last one I thought I had sent them out and they only went out to some members. So that's what I resent yesterday I will check that. If it hasn't gone out, I will send that out.

**Woodward, Jim (UTC):** Thank you.

**Gall, James:** And we will get times for the next two meetings as well, probably posted on our website soon. If there's preferences, please put that in the chat on the evenings or afternoons or mornings are best.

**Woodward, Jim (UTC):** Thanks.

**Lyons, John:** OK. Thank you, Jim. Any other questions? OK, so for today's agenda, after the introduction, we will start with the supply side resource cost assumptions. You'll hear from several members of the IRP planning team going into all the details and assumptions of the different types of resources: size, cost, availability for wind, different types of solar, different locations, gas plants, battery storage, all of those sorts of things. You will hopefully have seen there was a spreadsheet sent out. I think that was early or late last week that showed all of the data. I did send those out separately because I know some companies and organizations have security settings, so they're not able to receive spreadsheets. The spreadsheet is also available on the IRP website. You can download it from there. After the supply side assumptions, we will talk about the variable energy resource integration study update. Lori Hermanson will take care of that. We'll have a short break then get into an update from Chris Drake on the all-source RFP that is out there and we're getting it refined. You'll hear more about that. That's a short presentation We'll aim for the global climate change studies impacts to Avista loads and resources and that will be with Mike Hermanson. We plan to wrap up by 4:00 today. If there are no other questions, I will relinquish control here for the supply side resource options. Oh, website yes.

**Gall, James:** Before we do that, John, I want to just go over the website really quick. Share my screen. Bear with me. I'm a little slow. OK. I just want to remind everybody

about the website – how to get there, what's out there and the expectations going forward. If you just go to myavista.com, and you go to About Us. And you don't have to do the survey, but I click on Integrated Resource Planning. We have two tabs down on the bottom, electric IRP and gas IRP. On the electric side, we have each of our TAC meetings. We are trying to get all the agendas posted as soon as possible. The presentations are posted and notes and also the video recordings are going to be posted. You will start to see a meeting invites on the website, just in case you don't get it in the e-mail, which is just a handy way to have it. And we'll be planning on posting quite a bit of documents and data in the next several weeks as we're getting closer to our modeling run. You'll see this document section start to get quite larger. We'll try to send out emails occasionally to notify when bigger documents are coming but be on the lookout for that. Any website questions? Otherwise, we can get started on the first agenda item. OK. I think we're going to turn it over to Tom Pardee first. Tom, you want to show your screen, is that your plan?

**Pardee, Tom:** Hey, James I think we're going to wait on the fuel side until the next meeting. Oh, I meant the IRA section, let me open that.

**Gall, James:** And while you're doing that, I just wanted to bring up, in our Washington CEIP, the Clean Energy Implementation Plan, there was a condition number 36, which is related to this presentation that we're going to be going through, which is an opportunity for the public to comment on our resource cost assumptions. We're going to go through those cost assumptions and also show our spreadsheet work with all the assumptions. Michael Brutocao is going to go through those after Tom does a quick review on the IRA, but we'll be welcoming comments or ideas on any changes on those over the next probably 30 or so days. Jim, you have a hand up.

**Woodward, Jim (UTC):** Thanks James. Figured given your public service announcement this was a good time to ask this question. Regarding the connection to Avista's CEIP, I think and I appreciate you initially starting this discussion with that e-mail you sent to the TAC back on July 29<sup>th</sup> with some of those sensitivity analyses, if now's a good time or when we get into the actual discussion, just wondering if you heard back from folks since that e-mail was sent out? Where we are today versus when you initially sent that message out at the end of July.

**Gall, James:** I don't recall getting any feedback. I remember there was a response, but I don't remember any follow up required on it. I have to go back and look since it's been a few months. I'll look into that while Tom is presenting.

**Woodward, Jim (UTC):** Thanks.

### **Supply Side Resource Cost Assumptions Including DER, Planning Team**

**Pardee, Tom:** All right. Any quick questions before we get into the Inflation Reduction Act? This is signed into law in August. There's the public law number if you're interested

in reading it in detail. This is a big deal for a lot of the credits that we'll be talking about. There are energy manufacturing credits, that's basically US made materials. There's an expansion of credit for carbon capture and storage. Carbon capture hasn't really had much of a credit in the past. And with that, and the storage additive, it starts to put some of these future technologies into more focus, potentially becoming more cost effective, which we'll show in a bit. Another big piece of this is a clean hydrogen, there's a specific pounds equivalent is what they consider green, but a full of credit for a kilogram of hydrogen. There's a little less than 9 kilograms that make up an MMBTU or 1,000,000 BTU's of energy. We'll show you what that does as far hydrogen, the expected hydrogen curve.

**Pardee, Tom:** Hydrogen has been spoken of more in recent years for its energy potential and as the possibility of potentially replacing some of the gases and fuels that we utilize. Another thing that's happened in this IRA is the zero emissions nuclear power production credit. This is something that was out there. I'll go into this in a little bit more detail on the next slide. This IRA has a technology neutral clean energy. What that means is it allows electricity production and investment tax credits, and in some of these cases where you are an independent producer or a public utility, you can actually get the payment for those credits is more of a game changer than a lot of these type of laws than we've seen in the past. That third bullet is the extension and expansion of the renewable energy production tax credit. What does that mean? Here are some of the specific details, and so the production tax credit, that's what we use for geothermal, wind and biomass, it's about two and a half cents tax credit. Nuclear is about 1 1/2 cent per kWh tax credit, but then there's also a base credit within there of that 0.3 cents, essentially. It's about 1.5 or excuse me 1.8 cents. Total credit now nuclear is pretty expensive, but this does help continue to keep nuclear at least in the discussion points.

**Pardee, Tom:** The different vehicle here is the investment tax credit. This is where battery storage, pumped hydro and solar is how we modeled and so one other thing that I should mention is this, this IRA starts in 2023 and goes through 2032. Within this investment tax credit, if you have costs incurred, it says by 2022, but basically before 2032 you can qualify for a 30% tax credit. And then it falls by 4% in 2033, and another 4% in 2034 and down to 10% through 2036. And finally, if nothing else is done at 0%, but it does extend the battery storage expands, to excuse me, extends to battery storage. Again, that's a big deal, especially with the different battery technology types that we've been looking at. There is an additional 10% income, low-income tax credit. What that means is if you're in a certain area, if you have a certain income level, then you would potentially get that extra 10% and this also has that domestic production kicker on it. Now there are other pieces to the IRA that you might be interested in such as energy efficiency pieces. There are some individual details on that. As far as residential customers and how much it'll cover, but essentially it is a technology neutral act. It provides the ability to get those rebates for either a gas or electric side appliance on energy efficiency. And there's some other things in the IRA that we don't need to talk about, like the medical costs and prescription costs. But overall, that's the impact for our supply side resources. And I'll open it up for any



questions. If not, then I will kick it over to Michael to go over how these actually are implemented within the costs. OK.

**Brutocao, Michael:** Right. Trying to present my screen here.

**Woodward, Jim (UTC):** Hey there, Tom.

**Pardee, Tom:** Yeah. Hi, Jim.

**Woodward, Jim (UTC):** Hi there, Jim Woodward, Washington Staff. This was kind of an afterthought of my part, but your previous slide that talked about some of the new tax credits for the IRA, I was just wondering around the battery sourcing requirements when you're getting to some of the electric vehicle stuff. If you could provide a few details there and how much, I know other folks and other circles have been talking about, how some of those sourcing requirements could possibly mute the impact of such credits. Is that something the team has considered?

**Pardee, Tom:** Like a new vehicle, it's extending to \$7,000 tax credit, for used vehicle it's \$4,000. Some of the nuances, like a lot of the bills that are passed, don't have the details. As we mentioned, that the domestic production has an added kicker to the savings or tax credits. You would have to have the lithium, for example, for the EV battery be sourced in the US, I can't answer that right now. We don't have those details yet, but that could have an impact on the sourcing of it. But as far as electric vehicles, in my understanding of it and if someone else has a different understanding, please speak up, it is stuck to that \$7,000 for new electric vehicles and \$4,000 for the used market. And I think you can use that every three years, in other words you could get that tax incentive every three years if you so choose. But the materials might be an issue, the lithium, cobalt, depending on what kind of battery. That might be an issue if there is a piece tied to the electric production for the vehicle. But as far as I recall, it is just those two specific amounts, the \$7,000 for new and \$4,000 for used.

**Gall, James:** I'll add one thing just to put this in relevance to this TAC meeting versus maybe the next one. The EVs are going to be assumption that's in our load forecast and that load forecast discussion is going to be at our October 11<sup>th</sup> meeting and we made quite a bit of changes to the forecast for EVs and that might bring up an interesting question. If that's maybe something we should study as far as a scenario that's a lower case or higher case, depends on your point of view, but that might be more for a load forecast question. But, on the resource side, obviously lithium is an input and is available for tax credits now, but if there are sourcing issues we are assuming for this IRP right now that it would get the full credit. But obviously we won't know for sure whether or not a resource does until we get into the acquisition phase. With that, I'll turn it over to Michael, go ahead, Jim, sorry.

**Woodward, Jim (UTC):** No, that's helpful, James in some ways I guess given we have a packed agenda today, maybe stay tuned for more discussion of this on the 11<sup>th</sup>.

**Gall, James:** Yep, definitely.

**Woodward, Jim (UTC):** Thanks.

**Gall, James:** Alright, go ahead Michael.

**Brutocao, Michael:** Yep. Yeah, no other questions. Just double checking, can you see my presentation.

**Gall, James:** Yes, we can.

**Brutocao, Michael:** OK, great. We'll start on the resources considered, going over each resource and the next section is going to go over CapEx costs. Then some graphs showing the levelized cost and all of that data comes from a workbook that I'll present later. Digging into the details on that, that workbook is on the website and something you can access. We can dig in as much as you'd like, but all the background data is already out there. So, overview and consideration. Again, these are just estimates as of today. All the resources are commercially available technologies. They're within or near our territory.

**Brutocao, Michael:** Resource costs, as we said before, these are estimates. When we get down to an actual specific resource, costs are going to change depending on the location. The resources are modeled, some are PPAs and others are modeled as Avista owned. Within that CapEx, or within all the costs, there's no transmission or interconnection costs included, except for, I believe one resource maybe two. An interconnect for offshore wind and another wind facility that would be off system. It's included in those. There's an Excel file that's already been distributed and is on the website.

**Brutocao, Michael:** There's three resources that we've evaluated that are natural gas fueled. Two peakers and one base load. These are modeled with the 30-year life. And at any time, feel free to just jump in. I won't be able to see hands raised, but just interrupt me with any questions. On the solar side.

**Gall, James:** Michael, you got your firsthand.

**Brutocao, Michael:** All right.

**Woodward, Jim (UTC):** Hey there, Michael, Jim. I'll stop saying my organization. I think you all know me by now. Just wondering that footnote on the previous slide around the 30-year. The Avista ownership and the 30-year life, was wondering and maybe this isn't germane to this slide but was wondering 30 years from now is about 7 years past 2045 in Washington, which is the 100% clean target. Just wondering if that's a basis for consideration here whether we're talking about company ownership could mean, thinking out loud here, but allocation to Idaho. I saw the 30 years I know it's 2022 by my last recollection. Is Washington 2045 target factoring in here?

**Gall, James:** Mike, mind if I jump in on this one?

**Brutocao, Michael:** Absolutely, yeah.

**Gall, James:** Alright, obviously we are serving two different states. Resources can be picked for either one. But what the 30 years referred to is how we're going to amortize the dollars that are used to select the resource. That could be through a PPA, or it could be through ownership, but it's the amortization of the capital that the 30 years referred to. Let's just for example, if we went to the extreme where we picked a resource for Washington. If we had or we needed to stop using that resource past 2045, there would be some adjustment that would have to be made in that situation, but this 30 years, is just really for amortization. But you know, there was Idaho as well, so.

**Woodward, Jim (UTC):** Thanks. So, on your mind, but doesn't have to be hashed out here.

**Gall, James:** Yeah, we model all of these resources, we come up with the levelized value based on a life and that doesn't mean that resource will be serving for that full life because it could be a PPA that's shorter.

**Woodward, Jim (UTC):** Thanks.

**Brutocao, Michael:** Just feel free to interrupt with any questions. Our solar resources, and this is also solar plus storage, there are six solar resources modeled residential both new and existing residential solar, each one of those right about 6 kilowatts AC. And in terms of the model, I understand that these are grouped together, so we would pick a resource based on there being a thousand of these are six megawatts. It's not just picking and saying we're going to take one of them because it's so small. I believe the same goes for commercial. On system as well as off system. Residential solar is going to have new solar with a battery as well as without, then existing with a battery and without.

**Brutocao, Michael:** Same goes for each of these resources. The kind of unique ones over here would be the utility scale 100 MW facilities that are off system. We model that with the battery on system. However, we modeled with three different batteries and capacities for those batteries. The 100 MW 4-hour lithium ion or 100 MW 2-hour and then 50 MW 4-hour.

**Brutocao, Michael:** Wind resources we modeled are PPAs as well, four of them: on system, off system wind, Montana wind and offshore project, this is that one I mentioned earlier that does include interconnection costs. Other clean resource options, geothermal – which would be off system, biomass facility, and nuclear. The renewable hydrogen as well as ammonia, which would be used for storage on a natural gas turbine.

**Woodward, Jim (UTC):** And Michael?

**Brutocao, Michael:** Yes.

**Woodward, Jim (UTC):** Jim, again, if you could go back to the previous slide with the wind. I'm wondering a little clarification for offshore share of a larger project. Are you implying a joint venture with other utilities or what's that terminology shared a larger project mean?

**Brutocao, Michael:** That that would be my understanding. We wouldn't build a 100 MW there, maybe build a GW facility and have 100 MW share of the facility. James, you may be able to speak to that assumption better.

**Gall, James:** You got it right, Michael. I think that the point here with the sizes is when we select resources, we're not going to let our model pick any random size. We have to typically take them in certain unit sizes and that's what Michael is representing here. It could be like Michael said, a GW and we could take it in 100 MW chunks for our portion and that could be the same with even the onshore projects and Montana, for example, there are large systems being developed and we would just let our model pick them in 100 MW slices.

**Woodward, Jim (UTC):** That's helpful. So, these really here are estimates versus necessarily the actual project size? OK.

**Gall, James:** The reason why we do it this way is there are economies of scale, typically with larger projects that we want to capture, for example, an offshore wind. If it was only 100 megawatts, it's going to cost a whole lot more than if it was the share of a larger project. The other thing I'd mention is for a lot of these resources, this is the minimum take and we will allow the model to take larger amounts as well. For example, Montana, when I think how the model might work is it can't take 25 but it has to take 100. But it could take 125 if it met that first threshold and depending on the resource, if it's scalable that way when typically scalable solar, scalable that way gas turbines you got to take a whole turbine with the exception of, you could take smaller bites. But we're trying to make a reasonable acquisition of how we would acquire these resources.

**Brutocao, Michael:** Right. Thanks for the question, Jim. Couldn't tell if that was even.

**Robbins, John:** Yeah. Sorry. Do we have time for another question on this slide?

**Brutocao, Michael:** Absolutely.

**Robbins, John:** Great. John Robbins from Mitsubishi Power. Actually, it's on the next slide where you show the ammonia combustion. Yeah. I'm just curious, could you elaborate a little bit on why ammonia was chosen here as say opposed to hydrogen or some other renewable fuel for the gas turbine?

**Brutocao, Michael:** I think we are modeling hydrogen as well, but I can let James elaborate on the ammonia and why that was a selected resource for consideration.

**Gall, James:** Yeah, what it came down to is storage for an acceptable period of time. Hydrogen is definitely capable of running through a gas turbine, but we're concerned about the storage duration. We're located in the northwest, that could be a little bit of a challenge. But ammonia, our understanding is that we can take hydrogen and then store it as ammonia and burn it through a turbine. Actually, I think your company has some technology that can do that. Is it helpful?

**Robbins, John:** It is. I appreciate that. Thank you.

**Gall, James:** I'm glad you brought this up because ammonia has gotten, I think a lot of attention in other parts of the world and not so much in this country, but it is I would say, a low-cost storage vessel. It looks like I can't say the fuel is necessarily low cost, but we're going to actually have a projection of that fuel cost at our October 11<sup>th</sup> meeting, same with hydrogen as well. So, look forward to that.

**Robbins, John:** Very good. Thank you.

**Brutocao, Michael:** Thank you for the question. For the storage technologies, there are six lithium-ion batteries that we evaluated. The two with shorter durations, the 4-hour, 8-hour are included as well on a distribution level. Assuming 86% round trip efficiency if 15-year operating life in Avista ownership and then other storage options over here. These are vanadium flow, zinc bromide, liquid air, iron oxide and then three pumped hydros. This is 16 hours at 1600 MW hours and 24 hours at 2400 MW hours. And then 400 MW pumped hydro is 8 1/2. Hours, 3400 MW hours.

**Brutocao, Michael:** The last resource, upgrades. It's two upgrades from CT, and this is an update I made. If you're following along on a separate slide deck that's supposed to be online, it's a little confusing. The five megawatts by 2055 upgrades, it said before, not the year 2055, but 2,155 degrees Fahrenheit upgrades and then a ten MW inlet evaporation. And that update will be posted online. OK, hearing no questions, I'll get into the capital costs.

**Brutocao, Michael:** Again, these are all available in the workbook as well if you want to look at the actual numbers. The graphs I guess aren't but one thing I'll note here is, it seems like a lot going on. In this section, and I believe the next section, the red dots are going to represent the dollar values in 2022 U.S. dollars. That would be your real dollar values and then yellow dots are where our assumptions are our data came from. Those units were in 2020 dollars, so I believe we got a lot of inputs from NREL, and NREL has provided a lot of inputs in 2020 U.S. dollars. Blue line or these blue bars are representing costs in nominal dollars. In 2020 the first bar in each section is going to be that nominal cost in 2025. And then each five-year increment up to 2045. These are CapEx dollars per kilowatt for generation resources. And same thing, these yellow are 2020 real U.S. dollars and then with inflation that cost would then be, take geothermal in 2030, would be \$5,164 that year. That would be equivalent \$3,903 in 2020 U.S. dollars. So, there's geothermal and nuclear facilities, storage facilities. Again, CapEx dollars per kilowatt. And I suppose instead of, highlighting and you're trying to read through each of these, I'll pause on each slide. These are those larger sized batteries and no, these are all the, not all lithium ion, sorry. We have a vanadium and zinc bromide down here.

**Gall, James:** Michael, I just wanted to add one thing while you're flipping through there on our assumptions of where we got the data for this. Most of the ones that are in red dots in \$2022 are Avista estimates. And the 2020 come from, can you remind everybody what the NREL source was for those ones?

**Brutocao, Michael:** Yeah, it comes from mineral and let me get the actual title of the document here. One second, while I'm pulling that up. So, it was storage. Apologize if the this is awkward silence for anybody. But I thought it might be better than me trying to talk through each value and resource but. The document where these yellow values are coming from, I am having a difficult time pulling it up on this screen but it's the 2022 annual technology baseline. I think if you just looked up and roll 2022 ATB, you'd be able to find that document. And then it's actually the second version, so it was revised or corrected on would that be July 21st of this year? And that's the workbook where we pull this data and also within the Excel workbook, tried where possible. Hopefully I didn't miss any, but to know where our resource came from so that you could cross check if you would like to verify. See what adjustments were made or were not made. Solar PPA. Wind BPA. Again, any questions really ask.

**Brutocao, Michael:** For example, here this would be unreliable estimates and you can see in real assuming on a real dollar basis that these are going to be getting cheaper over time. And so that's why essentially, this first year, this dip here would be the resources becoming cheaper. The technology is improving at a rate, or the cost of the technology is becoming cheaper at a rate greater than the rate of inflation, which we used, so effectively it became. The best way to explain it.

**Gall, James:** Jim, you have your hand up. Go ahead.

**Woodward, Jim (UTC):** Thanks, James. Thanks, Michael for walking us through. I guess a couple observations. There's a magnitude difference and you know perhaps the team has some explanation for that between the NREL estimates and what you're seeing as far as the capital cost. I guess that's observation one. Perhaps could provide an insight, kind of an observation too though is the trend. If I'm seeing these graphs right, it's one thing if there's a bit of magnitude difference, but NREL is coming down whereas I want to say Avista's estimate is kind of the opposite way. It's going up, so that actually is raising more eyebrows for me than the cost difference, so maybe if you want to take the discussion that direction, I'd appreciate it.

**Brutocao, Michael:** Yeah. Are you saying that these yellow dots are moving to the left over time, whereas the bar, the blue bars are moving to the right?

**Woodward, Jim (UTC):** Yeah.

**Brutocao, Michael:** Yeah. So, what this would be is the real dollar value is saying that \$776 today. If I have that money today and I say invest that in a Treasury bill, but something that is inflation protected and it's going to increase. So that next year, we have 1% inflation or 10% inflation, say I'd multiply this value by 1.1. Next year I'm going to have 700 and or I guess  $776 + 10\%$  of this, a 10% increase. And say that next year. And this isn't the best example to use and not on my toes here with the math, but.

**Gall, James:** Michael, want to help on that one?

**Brutocao, Michael:** Or use \$100 as an example. If I have \$100 today. Then, in real dollar values, I might say that in 20 years I have \$100 in real 2022 U.S. dollars. Now if I invested that and it grew by the rate of inflation. That actual dollar figure is going to be greater because it's being inflated over time, so if it's today I have \$100. At the end of the year, there was 10% inflation. Then next year, that \$100 is \$110 for the blue line. Next year for the yellow dot, that \$100 would still be \$100.

**Gall, James:** So that's the values you're seeing here in the blue are end use estimates in nominal dollars. So, there's no difference between our assumption and NREL forecasts in real dollars. And we have to forecast in nominal dollars. That we were adding inflation effects to NREL's estimates. Yep.

**Woodward, Jim (UTC):** James, could you repeat? So, what you're saying, take the top set of bars, the northwest wind on system, you're saying that \$1,375 I guess is that Avista's reflection of NREL's \$1,159 factoring in inflation?

**Gall, James:** Correct. That's the inflation rate added to the \$1,159 though, like Michael said, we have 10% inflation recently because NREL gives U.S. data in 2020 dollars, they're not making any assumption on inflation between 2020 and now, so we have to add inflation. Yeah. So, the theory.

**Woodward, Jim (UTC):** OK, so maybe I'm getting thrown by the legend. I see the 2020 real dollars. I guess what's throwing me is that you see how it's, maybe I'm implying it, but there's a slope. The bars are going one way and then the little circular icon slope is going the other way. I was reading into that slope, but everyone on the phone should not read into that.

**Gall, James:** Yeah, the theory is, over time, you're going to get more efficient at building something. And it's going to lower cost in real dollars. So, you'll see when getting cheaper in real dollars. The theory is that 20 years from now, we're going to be more efficient. We can produce that and lower cost in today's dollars. But you have to add inflation to that to get to a value. What we would actually pay for that resource in that future year. So, I think NREL refers to a technological innovation cost change. That's what you're seeing in yellow.

**Brutocao, Michael:** Maybe this is a good example. Where we have a straight line. Here in every year, the real dollar estimate, it is flat. Saying effectively there's no, this may be one way to interpret it, but there's no technological improvement with respect to how much it costs to. But if we were to say there's no technological improvement, and the relative cost doesn't change, then this dollar value today we expect by 2025 that would be \$5,135. And then as that grows, it's just saying that, like anything, the cost of a candy bar maybe is \$0.05, maybe I shouldn't even estimate 5-10 cents way back in the day, say and then today it's \$1.20. That's what this is showing. These are all 10 cent candy bars and then. Well, now it's now, it's about 20, and now it's about 40.

**Woodward, Jim (UTC):** Yeah, that helps. I guess for me at least for Staff, a big take away and this discussion is helpful. A big take away of these slides is not, when I got this draft right ahead, I was thinking we had two sets of CapEx. CapEx cost being represented, that's not in fact what's going on. It's basically Avista taking the NREL estimates depending on the year 2020, 2022 and applying inflation to those. So, we're talking about the same set of cost data, just with different financial supply to them, is that correct?

**Brutocao, Michael:** Everything you stated is correct, yes.

**Woodward, Jim (UTC):** OK. Thanks.

**Brutocao, Michael:** Yeah. And maybe after this I can update and maybe put a little legend here. It says nominal U.S. dollars and something I should have done before, but that could maybe help clarify.

**Woodward, Jim (UTC):** Thanks.

**Gall, James:** Michael, we have another hand up. Go ahead, Alexandra.

**Karpoff, Alexandra:** Hi, my name is Alexandra Karpoff. I'm an analyst with PSE. I was just looking at your wind costs. I'm not sure if that's forward or backwards. I know that you said that transmission and interconnection costs aren't included except in a couple of these systems. But I'm just wondering what accounts for the difference in capital cost between your various different wind systems?

**Brutocao, Michael:** Yeah. So, on system versus off system as these are both the same resource, this would be, I think just tax rates. So, the taxes on that.

**Gall, James:** I think that one's tax rates and then Montana has the transmission interconnect.

**Brutocao, Michael:** Yeah. And I think potentially Montana may be using a different wind class. Just based on location.

**Karpoff, Alexandra:** OK.

**Brutocao, Michael:** But yeah, effectively. Capture it.

**Karpoff, Alexandra:** Tax rates and then offshore wind also had the interconnection included right and said, OK.

**Brutocao, Michael:** Yes. Let's say start here. Northwest wind on system, when we take it off system, the impact is due to taxes. Wind from Montana, I believe maybe a combination of taxes as well as a different wind speed class that we assume and then the offshore wind is just. This one actually includes the cost, the interconnect cost.

**Karpoff, Alexandra:** Thank you.

**Brutocao, Michael:** Absolutely. These will be the last one, so they're more questions on this slide. On those slides, just let me know. I'm going to try to move through these kind



of quick because we have 20 minutes left for this section, but all this data is again available within the workbook. Thanks, I got this pulled up. This is the NREL file, where much of this data comes from. This would be the first tab that you would see just so you can visually say yeah, this is the correct one and it's the corrected version. If so, these are all levelized costs. Every value in here is going to be nominal dollars to like the blue bars. And in the previous section. Apologize and I'm not sure this was the best way to show it, but at least squares typically it's going to move from left to right over time, so each movement over for a given resource or color is going to be a 10-year jump.

**Brutocao, Michael:** These would be costs in Idaho, based on Idaho's tax rates, and then in Washington. Very similar layout of this slide, but just a different tax rate. I've been showing what those other values are. What the values are for Washington.

**Woodward, Jim (UTC):** Hey Michael, with these two state comparison slides, this is Jim again from Washington Staff. You mentioned the tax rate is different between two states. I'm noticing, as best I could tell slight differences, especially at the greater fixed cost, there's a bit of an escalator for Washington, let's say above the \$1,000 per kilowatt set of the graph. Is it really just tax rate or are there other factors like state energy policy factors like the CCA, the Climate Commitment Act, and the carbon price mattering here? Or again, is it just really a tax rate difference?

**Brutocao, Michael:** Yeah. This is just a tax rate difference I believe and throughout all these slides that are being presented in the workbook, the cost of carbon has not been brought into these resources for analysis.

**Woodward, Jim (UTC):** OK.

**Brutocao, Michael:** For this portion, I think that's applied later in the model. I don't know, James, if you agree or disagree on that?

**Gall, James:** Yeah, I agree. It'll be applied in our dispatch model. We're just trying to show comparison of raw costs here.

**Woodward, Jim (UTC):** Thanks.

**Gall, James:** Yeah. And in Washington, there's a sales tax and there is also an excise tax on natural gas. That's your two major differences. Where you could, some people argue, maybe there's a difference in labor costs and stuff like that, but they're using the same values.

**Brutocao, Michael:** What's the time here? Try to get through kind of quick, but please any questions, feel free to stop me. Also, if you would like, you can also send an e-mail to myself or James with any questions you might have afterwards.

**Brutocao, Michael:** There's upgrades that we looked at. We move through a little faster pace on my end at least. This is at very busy graph, but typically if resources share the same color. You can move left to right and see. This is 4-hour lithium ion, 8-hour lithium

ion, 16, pumped hydro. And this one might get away with people up here, but moving I guess down and to the right.

**Brutocao, Michael:** And this was another slide where I updated the titles or the Access titles. So, if you're following along the left one shows duration based there though Y-axis the X-axis is going to be capacity based. Levelized costs. These are dollars per kilowatt year for fueled generation resources and this is in Idaho. And the next one we'll see is Washington. You can see moved up a little bit, are geothermal and nuclear implied energy payments. These are PPAs in dollars per MW hour.

**Gall, James:** Michael, can you go back to the previous chart really quick, I just want to highlight one thing for people that are watching. This chart showing dollar per kilowatt year. This is your kind of your capacity payment, fixed costs. And so, if you think about what we file for PURPA, for example, we have a levelized cost of the fixed cost. This is that portion and then there would be the variable operating costs on top of it, which we saw in the previous chart versus the next couple of charts I think we're going to show as the levelized energy cost. That's all-in cost divided by the megawatt hours versus this is just the capacity.

**Brutocao, Michael:** Thank James.

**Gall, James:** Yep.

**Brutocao, Michael:** I'm here, we see storage fix cost, otherwise these are those batteries. I believe on this slide and the next and maybe a couple others, you'll notice this dip actually may be due to the costs, the CapEx cost so. Highlight this.

**Gall, James:** CapEx and ITC.

**Brutocao, Michael:** OK. I was going to say, I believe that ITC on these storage resources and I think this continues to show the other ones. But you'll notice this dip in the earlier years, I suppose that dip would be due to CapEx cost coming down, but also the jump up here in 2035, 2045, that's due to the ITC decreasing or going away. There would be solar plus storage. And again, these are in the workbook. And that's that jump, tax credits going away, solar PPA, wind resources and this may be the last slide, or maybe there's no more. These were maybe instead of highlight this early, these are all levelized costs. This is assuming we the project comes online and 2045 that levelized cost is, in that year, \$52.20. The years are identifying when the project comes online, when it starts.

**Gall, James:** Yeah. And we're going to assume that that's the price for the life of the PPA. So, like you said, 52 bucks, that's 52 bucks for 20 years.

**Brutocao, Michael:** Thank you. Now, I believe this should be the last slide. Upgrades. To upgrades and bypass. Alright, so next we'll go over that workbook. It's posted online and believe you may have received it within an e-mail as well. And just double checking, James, can you see this?

**Gall, James:** We can see it and you got plenty of time.

**Brutocao, Michael:** Maybe a little small here. First, I'll just go over the layout of the work. The layout of the workbook and then I'll get into some other things. These first five tabs here, these are all going to be inputs. These feed into our calculations. These colorful tabs, at least these six here, these are separating out each resource based on it. Just to get it into a group. Solar PPA, solar is red right, when is it going to be in green? I'm just breaking out each resource by category.

**Brutocao, Michael:** Maybe I'll just go through this. These six tabs will be where you could actually look into a specific resource and look at the financial assumptions we made. Something in this tab, you can modify this and say I want to look at it at your 2030. And you can look at our cost assumptions, all the inputs that filter into here, how that impacts your financials, and the PPA rate. That can be any year, I think 2023 through 2045.

**Brutocao, Michael:** Then all of these values, this is actually just a formula. It's looking at the PPA summary tab, so those values are all solved for through a macro and paste it over here. And this is where you can look at what PPA rates are for each year. For each resource, and then also just not as well formatted, but the capacity payments. These are denoting that these are per kilowatt month versus the PPA rate. Just per MW hour.

**Brutocao, Michael:** Also on this tab, well, maybe I come back to it later. When there is a PPA, what we assume, maybe what the targeted free cash flow is for an owner. That's where you could change these values around, but we're assuming 7 1/2% now. And then over to the right, these last three tabs, this summarizes your three PPA tabs. Upgrade summary is all the resources within the upgrade tab. And so, on storage tab. And your fueled generation is going to be your fuel Gen tab. So, all those slides, those graphics were pulled from, these years. Or the combined cycle is in Idaho. That's where those values came on the slides. If you want to look at other years and the levelized cost summary here. Again, these are hardcode or not hardcoded, but paste it in through the macro, which I guess I'll go over in a little bit. And then kind of a color for the color scale to show which are generally the cheapest. I apologize if this is too small, so this is our implied energy payment dollars per MW hour and then over to the right, all those resources which don't have values, those will be on the right and these are capacity payments. So, dollars per kilowatt year.

**Gall, James:** And Michael, right there real quick just from a modeling flow for later on when we get into our PRiSM model. This sheet right here that Michael's showing is our input into PRISM which selects resources. We're going to take these dollars whether they're dollars per MW hour or dollars per kilowatt year. These are the values you're going to see translate into our PRiSM model that's going to select our resources. Go ahead.

**Brutocao, Michael:** Yeah. Just to reiterate these first five tabs, these are inputs that feed into these six tabs here, which is where you'll see the calculations occurring. The results from these six tabs flow into summarized tabs or summary tabs to compare them all to each other over time period. This first tab, so here's the data real tab. Here's some of the data points that we are using. You can expand them and look into look into each one.

Colors coordinate to which tabs they would feed into. You can see which resource it's for here. Just kidding. Dragging down this, these are all CapEx because they're in the CapEx tab or group and then you can see the source of this where we got the data from. This would be that internal document and you can see which resource we picked in particular, or comparative to, and then over here in column B this is just denoting if there's a net capacity factors, and these aren't going to be in, those aren't dollars. So, there's nothing there. But if there are dollar values, they're dollar figures. There should be a base here included to show that these are all in 2020 dollars.

**Brutocao, Michael:** As far as coloring over here, just to make it a little easier to follow. Anything that's in gray or blue is going to be straight from unreal. Anything in green is just referencing another field where different resource assumptions, so this would be for new residential solar plus storage for the solar piece of it. We want it to reference the new residential solar and that was me working in this saying if this gets updated, I don't have to update two of them, so I just update the one and we know that it's going to track through to the solar plus storage calculation as well.

**Brutocao, Michael:** And then on the nominal tab, a lot of the same things here. However, this first column instead of denoting what the base here is, there's some adjustment. So maybe there's an adjustment from DC to AC or it's an adjustment for these costs to get them into nominal, the real dollar values into nominal dollar values. We use the CPI inflator, and this is our forecast, and we say take that real dollar value from the data real tab and inflate it to this year so that these are now in nominal dollars so that I'd be able to have green cells here and then anything that's in white is still referencing that data real tab. This was the year that it began, this was a 2022 base year. So, these were in 2022 real dollars and now they're resource above. They're all in real or nominal dollars.

**Brutocao, Michael:** Summations tab, you can see some of the larger assumptions that feed in. These rates here, these are going to feed into everywhere they are used, they're consistent across all tabs. If anything is referencing a property tax rate, it's at 1% or federal or state taxes, these will be applied where they are used to every resource that's the same value. Debt to equity ratio. Finding a project or financing a project, a lot of these came from, suppose I didn't know that here, but this is what is being targeted or not targeted, but used on some of these. Workbooks say where we're calculating it's just referencing back and saying here's our debt portion. Here's our equity portion. On the same tab, if you scroll over to the right, you can see for different resources the tax depreciation schedules. And for those resources and then our capital recovery and tax rates for those other resources or not included here.

**Brutocao, Michael:** And finally. I think I didn't know this, but those CapEx costs on NREL, where you look at just the CapEx field, it tends to include, would be tab XS a cap construction financing factor. That's our AFUDC and we decided to take that out and include our own calculations for those. So, when we're applying the capital financing factors, that's where this value comes from or is reintroduced into the modeling accounted for and the full cost. And this is mislabeled. This shouldn't say dollars. To percentage but.

**Brutocao, Michael:** I see I'm at my time, but I'll at least go through the macro section. Well, it'll say this first. I could go through each resource and show you the nuances of what changes, maybe a little bit from one tab to the to the next.

**Brutocao, Michael:** No. Because that's a PPA, say maybe different than an ownership storage or a fuel generation calculation. A lot of these are unique and vary the structure and layout. But. And these are the kind of financial they guess we can look into this later, but if you were to use this workbook and you want to you say I disagree with these values or some of the assumptions. Again, you can change those inputs to whatever you think they may be or whatever you're interested in looking at and go to this macros tab and click on one of these two buttons to save time because this top one, these take a bit longer. If you say change the symptoms for an ownership of storage for example, you could click this button here, it's going to run a macro and it'll remind you when you last ran it and that it was completed.

**Brutocao, Michael:** And then just kind of interesting, the runtime. But those macros, when they go through what they're doing is basically say we update this to 20 37, OK, that PPA rate updated automatically and it solved to a 7.5% free cash filled. Maybe if we updated some of the inputs and then change that, it wouldn't actually pan out properly, because you're changing the cost, say the fixed cost, so the macro actually comes in and pastes this formula in here so that you can just flip through this and look at individual years, but before pasting that value in, the macro will go in. It'll update this year and then for each resource it's going to solve, and it's going to say OK, what PPA rate? It's going to solve for the PPA rate that gets free cash flow,  $t = 7.5\%$  or whatever we have. If you were to update this, whatever we're targeting in here, then once it solves it, it's going to copy that value over and it's going to paste it and it's appropriate location over here and the summary tabs are also going to grab the appropriate values and paste them in so that would be that piece.

**Brutocao, Michael:** I know I'm over time here, so if there's questions, let me know. Otherwise, I can go through this if we'd like showing what each line item is doing. Again, that's going to change for each resource though as well. I don't know, James. What do you think?

**Gall, James:** Michael, because of the time. Let's pause here and let people think about this one and then we have our technical workshop again in October and maybe we visit this if there's some questions that come up for those that want to get into the nuts and bolts of this.

**Pardee, Tom:** Hey, James.

**Gall, James:** That works for everybody. Yep, Tom.

**Pardee, Tom:** James, I have that last slide that shows what we didn't model. Do you want to go over that now or you want to go over that in a future meeting?

**Gall, James:** Yeah, let's hit that one and then then we'll move to Lori's presentation, because I want to make sure we get through that and have a break before Chris comes back.

**Pardee, Tom:** Sounds good. This shouldn't take long, Michael, I'll steal it from you, basically.

**Brutocao, Michael:** Yeah, if you can. And any questions? Feel free to e-mail.

**Gall, James:** Yeah, and if you could, if you have, because this was a condition in the CEIP if there's an opportunity for questions and changes. And if you could get us comments or what you think should be different in the next month that would be appreciated.

**Pardee, Tom:** So just to check, can everybody see this?

**Gall, James:** Yes.

**Pardee, Tom:** Won't take long, so I broke it into two separate sections. The one is large resources, one is small. On the small resource side, I'll go backwards. Digesters we didn't model, cogen, the hydrokinetics pipeline, or landfill gas we will. Excuse me. On the large resource options, we didn't model any of the RNG, so RNG would be wastewater treatment plant, the landfill was mentioned on the right, dairy or food or solid waste carbon capture wasn't synthetic. Methane was not modeled, biodiesel, noncommercial technologies, hydro upgrades to our own Avista projects, coal or existing third-party purchases from PUDs.

**Gall, James:** And I'll want to add something to discuss reasons why we chose not to model these and that really has to do with likely resources to be purchased to an RFP process, sometimes we do get some of these other options, but most of this is just data availability or lack of commercial acquisition probability. I'll put it that way. And then there's also on the small resources, those typically come in under PURPA. So, we felt the resources we put together are likely good options from an IRP perspective, but it doesn't limit the options the one category around here. I think that's maybe some consideration is RNG which actually Tom is going to go through a lot of RNG analysis tomorrow at our gas meeting. But RNG is going to be a very scarce resource between the two different fuels that we serve between gas and electric. We're reserving as much RNG as possible for the gas side. If there is plentiful RNG to go around, that would be an option. But for the electric side, right now that's why we're assuming no RNG for the electric side at this time. Looks like Jim's got a question or comment. OK, Jim disappeared. But Tina, go ahead.

**Tina Jayaweera (Guest):** Thanks. Today in The Oregonian, there was an article about the hybrid wind solar battery project. The Wheat Bridge facility that PGE is co-ownership and I saw solar post storage, but I was wondering if you look at a wind plus storage plant.

**Gall, James:** Yeah, and there's a reason why we didn't model it together. We've actually been looking at wind plus storage through a few processes and there's not necessarily a cost advantage absent transmission for that combination at least how we saw it. The resource could be picked together in the IRP model, but we're not seeing a reason to combine it absent maybe a transmission benefit from a distant resource, so the one that comes to mind is Montana. It would be the one option where that could be considered to be a little bit of a savings. We did some analysis on that. It's a little bit of a challenge to pay for the transmission through a battery, but that's the reason why we chose not to combine those, at least the wind with the storage.

**Tina Jayaweera (Guest):** OK, so you don't get the inverter advantage that you do with.

**Gall, James:** Exactly.

**Tina Jayaweera (Guest):** Got it.

**Gall, James:** Yeah, and it used to be the tax credit advantage, but that's gone away.

**Tina Jayaweera (Guest):** Thanks, that's helpful.

**Gall, James:** Yep.

**Woodward, Jim (UTC):** Hey, James, can you hear me now?

**Gall, James:** Yep. Yeah, we can hear you.

**Woodward, Jim (UTC):** Great. Thanks. My main question was clarifying. When the draft slides sent out yesterday, or rather late last week, this slide I believe was kind of tucked in with the Federal IRA discussion. But this is more within the modeling within the cost assumptions that we just went through, correct?

**Gall, James:** Yeah, this is it. It just sent out, unfortunately by speaker rather than order.

**Woodward, Jim (UTC):** Yeah, no problem. Just want to make sure I wasn't missing something big.

**Gall, James:** Yep. These aren't reflective of tax credits, which obviously some of these would get a tax credit.

**Woodward, Jim (UTC):** And I guess just cause while I was in mute, per our brief exchange earlier on the call, it sounds like. Again, with the connection back to the CEIP, sounds like there hasn't been too much chatter around some of these cost assumptions. Even though you did send something out back in July, so it's really just looking for feedback now moving forward into early October, is that correct?

**Gall, James:** That's correct. I went back and just checked. Make sure I didn't miss any emails from anybody. And we've not received any comments yet, but definitely look forward to comments in the next month or so we as we prepare the Washington Progress Report filing.

**Woodward, Jim (UTC):** Thanks.

**Variable Energy Resource Integration Study Update, Lori Hermanson**

**Gall, James:** Looks like no more hands up, so maybe it's a good time to transition to Lori's presentation on variable energy resources.

**Hermanson, Lori:** OK. Can you see my screen?

**Gall, James:** We can.

**Hermanson, Lori:** OK, I'm Lori Hermanson, a Senior Power Supply Analyst on the Resource Planning team and hopefully my voice holds out because I've been coughing all afternoon. We had a variable energy workshop, a VER workshop a couple weeks ago. I know the stakeholder work group conflicted with TAC meetings of other utilities, so not everybody was able to participate. We wanted to provide an opportunity to give a high-level review of some of this, but it could be redundant for those that were able to participate.

**Hermanson, Lori:** Just to let you know that our last variable energy integration study was done in 2007. It was a robust study and has held the test of time. But as we look forward to our clean energy goals of 2045, we anticipate more additions of renewable resources and wanted to update that study. Our former study addressed wind integration and this new study addresses both wind and solar. Basically, we use an integration study for our IRP planning process. We use it for our IRP or our IRP acquisitions, transmission tariff rates, and it's used in the calculation of our PURPA cost. It basically defines the consumptive capacity associated with incremental VER resource additions and it helps us to determine the cost of those incremental resource additions.

**Hermanson, Lori:** So, what's included in this integration study that's currently in process is those consumptive capacity and costs that we just mentioned, impacts of EIM since we recently joined the market earlier this year, March of this year. It'll include the impacts of that. Also, it gives us a way to calculate integration for future VER build outs and not only incremental amounts but then the mixes of wind and solar and then also included in the study are some sensitivity scenarios. What was not included in this current integration study are things like batteries, new utility-controlled storage, VER driven investments in existing infrastructure and finally distributed generation. There were two phases in this integration study, we retained the services of Energy Strategies. They are doing the first phase where they estimate the reserves and they come up with the profiles of these varying amounts of incremental resource adds and then mixes of sun and wind, and then they hand it off to us, we're going to do some ADSS modeling. We had some discussion with our work group as to what's an appropriate amount of modeling that we would do and we're going to be using ADSS, which is an in-house production cost modeling software that's really good at handling hydro or, utilities like us that are predominantly or a good percentage hydro resources, we'll be using that for this next phase. Energy



Strategies started with 13 VERs portfolios. Basically, there is the base and then a low, medium, high of these different incremental adds. The low, medium, high were book ends of wind and mixes of wind and solar. The incremental levels of VER that we looked at basically addressed the levels of potential VER resource adds that have been forecasted in our last IRP and could also encompass electrification and then the book ends or the mixes of the types of VER.

**Hermanson, Lori:** The types of wind and solar would give us an estimation that we could calculate any kind of scenario that would come up in the future. In our base assumptions, we proposed that we would include EIM, the regional diversity benefit and the carbon cost. We did those 13 VER portfolios. That first level was 400 MW incremental add of resources and that gets us through the first 10 plus years of our Preferred Resource Strategy and the solar wasn't selected in the last IRP until after those ten years. Because of the modeling time, if you were to do those nine cases of varying hydro and varying market prices, that's 117 models at two to four hours each. It's 470 hours of modeling time. So, it's a significant amount of modeling time. And we discussed with the work group that we would just model that first level in the production cost model ADSS to determine the integration costs, because that would basically cover us for the next 10 years. And then, so just a review of the overall workplan the energy strategies was tasked with.

**Woodward, Jim (UTC):** Hi, Lori.

**Hermanson, Lori:** Yeah, Jim.

**Woodward, Jim (UTC):** Hi. Thanks. Yeah. Jim Woodward, Washington Staff. Could you go back to your last slide?

**Hermanson, Lori:** Sure.

**Woodward, Jim (UTC):** Thanks. I recall and full disclosure did enjoy participating in the VER meeting earlier this month. This ADSS modeling slide did have me recall there was a little bit of discussion near the end of that meeting earlier this month around intra hour modeling and essentially how granular to go and some different perspectives were shared. Just wondering if the Avista team thought anymore about that. I don't think he's on this call, but I recall Clint saying that even if intra hour approach isn't taken, there'd be some documentation that essentially the same results could be achieved. Just wanted to revisit that topic a bit to see if there's been any more discussion.

**Hermanson, Lori:** There has been, and I think Clint is on the phone. I believe the consultants were saying that they did in their development of profiles and in the modeling that they did encompasses the intra hour impacts and they were going to include the write up of that in their documentation. Clint, are you on the line and is there anything you wanted to add to that as well?

**Kalich, Clint:** I don't know that I do, Jim. I'm hopeful we'll be able to successfully run ADSS with an intra hour type of sampling that confirms that information, but Energy Strategies thought it was less necessary than I did to do that testing. We'll see how it

goes. It's a lot of modeling, but this is phase one of a VERs study. So, my expectation is we're going to learn a few things and there'll be an add-on phase and certainly that would be a piece we want to look at to decide if we have adequately accounted for that impact. From my perspective, you're talking about mostly an opportunity for another commodity market, in other words an intra hour market opens up. So, you have an opportunity to reoptimize and reduce your forecast error and potentially chase another market opportunity. That's what EIM does. But we need data for that. And again, I would hope that we're accounting for those types of values in the commodity side. Again, more to come and it's not on the back burner. It's part of the study. The discussion will be there now.

**Woodward, Jim (UTC):** Thanks, Clint. Sounds like a little learning by doing, but you're still tracking that that intra hour piece. Thanks for that update.

**Hermanson, Lori:** OK, so the work plan and phase one has been completed by Energy Strategies, but just a review of what they've been working on. They develop those various scenarios and profiles that we talked about, the base plus the 12, and the 12 encompasses the different layers of or the different incremental amounts of resource adds and also encompasses the mixes. So, 100% wind to a mix of 50/50 wind, solar to 100% solar. Those are all the scenarios they developed profiles for seven years, statistically correlated to our area, they calculated reserves and from those seven-year profiles of those 13 scenarios, and then they presented to our work group of a couple weeks ago. There are slides and recordings, you may have seen this earlier when James was on our website, but there was a VER workgroup section right after the IRP. So, if you wanted to, if you missed the workgroup, you can catch the slides and the recording there.

**Hermanson, Lori:** Phase one or the next phase is what Avista will be working on, and we anticipate doing that first quarter of 2023 because we're trying to wrap up the IRP and competing projects going on. But we'll do that production cost modeling and hand the results to Energy Strategies hopefully second quarter of 2023, they'll finalize the calculation of the integration costs, and do another presentation and write the document and give us a tool that is informed by all their analysis of those varying levels of incremental resources and mixes. Down the road, if we have a PPA or something through the IRP or RFP process that comes in, we can put that into that tool and calculate based on the size and the mix of the resource what that actual integration cost is for that resource.

**Hermanson, Lori:** Finally, this information is on our website. For those of you that may have missed it or if you want to review it, but this is a high-level review of the reserves that came out of that phase one part of the work and you can see based on the base load and the different levels of the mixes, and different levels of resource adds, how that impacts the resources. There's a larger disparity between regulation and forecast error as you add more incremental levels of VERs and the load following required to handle those deltas in all those scenarios.

**Hermanson, Lori:** That's pretty much everything I have. If you want to dive deeper, all the information is on our website and I'm open to any questions. James, it sounds like maybe there's no questions.

**Gall, James:** All right. Well, we're about 5 minutes ahead of schedule, which is great. We were planning on coming back at 2:30 for the second half of the presentation. So why don't we just stick with that time? It'll be a little bit longer break, but how about 2:30? Come back and we'll talk about the RFP and climate change work so.

### **All-Source RFP Update, Chris Drake**

**Lyons, John:** OK, everyone, we're going to give it another minute or two and we'll get started back up. We've got Chris Drake up on deck, Chris, check your microphone really quick.

**Drake, Chris:** Can you hear me now?

**Lyons, John:** Yes, we can.

**Drake, Chris:** Alright.

**Lyons, John:** I see the RFP update slide up there too. So, we'll get started in just a couple of minutes. Make sure we don't jump, jump ahead, and start before 2:30.

**Drake, Chris:** Sounds good.

**Lyons, John:** Were there any questions that came up during the break from any of the TAC members? Also remember if you do come up with any questions, comments or ideas afterwards, you can send them to any member of the IRP planning team or to myself. My name, e-mail and phone number are on the website, and I can always distribute them as needed to. Alright, we're at 2:30 now, so we will move ahead. We've got Chris Drake, who has been working on the request for proposal for all sources for Avista. So, Chris, if you're ready, go ahead and take it away.

**Drake, Chris:** Thanks, John. Chris Drake with the Wholesale Contracts Group in Power Supply and I'd like to provide an update on the RFP, mainly going to be focused on process, but we also have some summaries of aggregated results from the proposals as well. Please stop me if you have any questions and John maybe if a hand is raised or something, give me a holler as I'll be looking at the slides.

**Lyons, John:** Will do.

**Drake, Chris:** Let's start with the recap here on the timeline, things actually started in 2021 with the release of the IRP and identifying a need in the IRP but went through a process last year including draft RFPs that were put out for stakeholder comment. Our independent evaluator on board, it culminated in the release this February. We had initial

bids, as well as a short-listing process, in June and since July we've been looking at the detailed proposals, completing that final analysis, and going through internal reviews. But we had a price refresh targeted for earlier in August, but we pushed that back until September for developers to be able to incorporate the effects of the Inflation Reduction Act, and that brings us to September. Hopefully here by the end of September, if not early October, we're hoping to select the proposals for negotiations. So, not a whole lot of specifics that we can share, but that's where we are in the process.

**Drake, Chris:** We were pleased with the response to the RFP with over 20 developers and nearly a dozen different types of technology with all the different options. We were looking at nearly 60 projects that we analyzed and again, these were proposals that were based on the RFP identified needs of winter and summer capacity as well as renewable and monthly energy needs. And we did post on our website some aggregate numbers for proposals. And so, there's additional detail on myavista.com if you're interested, but here's the summary table that shows we had lots of wind and solar, and lots of hybrid wind and solar with storage. And as I mentioned, also had a pretty good representation of other technologies including biomass, waste, geothermal, hydro, demand response and natural gas. Because of this, was intending to have a self-built bid submitted. We did do an RFI and selected Sapere Consulting. Our independent evaluator has been assisting us with the design of the RFP and the main focus of doing their independent analysis based on the approved and published evaluation methodology. They did their analysis in parallel with ours and we continue to work closely with them as we complete this phase of the RFP.

**Drake, Chris:** This slide gives a bit of a snapshot for a list of purposes. What the scoring matrix looks like and some of the criteria that we used to score as well as some of those weighting factors of financial, energy impact, or customer impact, the highest weighting. We incorporated everything that we knew at the time as well as tried to anticipate this growing focus on equity and affordability. And so that's built into not only the non-energy impact component, but also in environmental and cost impact. It's spread across those three different criteria. But obviously as you look at risk management, the ability for the developer to complete the project, the technology, whether it is commercially available technology. Financial, energy impact basically cost, but there's a lot that goes into that. Obviously, it's a pretty detailed analysis. That's under that umbrella. The financial analysis now price risk we look at, and whether that proposal is a fixed price or based on index, if this is variable energy, all those types of components. Electric factors is really kind of a transmission piece and whether these projects were able to deliver energy to our system. Or if they're on system, if there are constraints there and then environmental as you imagine, the permits and things like that and then again non-energy impact, energy security, economic benefit for projects that are located in our service territory as well as some diversity, equity and inclusion components.

**Drake, Chris:** This slide is a bit more detail on our outreach efforts and trying to make sure that we do have that equity focused as it incorporates not only cost but other

components, energy security and other things. I apologize, my Venn diagram looks like I've got Mickey Mouse ears instead of a true crossover there. But we are trying to incorporate stakeholder participation from communities that can benefit potentially from economic development. All of these different customer benefit indicators.

**Drake, Chris:** For the evaluation process, again we shortlisted proposals and based on a natural break point we felt like we had a good representation of various technologies and proposals in the short list. A diagram here is again for illustrative purposes. But whether you look at those as different proposals or different technologies, we were plugging in and removing different proposals as we did this iterative portfolio approach for the detailed proposals. Again, as I mentioned earlier, the price refresh was purposely pushed back in time to incorporate the IRA. Effects were applicable for some of the projects. James, I'm don't know if you have any additional comments from the financial modeling perspective.

**Gall, James:** Really quick, we take a two-step approach. One looking at the price and value of each resource as compared to a market forecast and then a secondary step is looking at how these resources meet our portfolio needs, kind of how we do an IRP. What we've done is take each of these resources and put it into our IRP model to help us figure out what is the right resource strategy going forward. And we can't get in all the details of which of those resources will come out on in time. But we're trying to use a consistent RFP evaluation approach when we do IRP evaluations.

**Drake, Chris:** Thanks, James. Again, we're in the point in the process where we are working through final analysis and internal reviews. But if we proceed with contracting some of those, it'll be several months until we would be able to announce successful bids coming out of this process. That's where we are in the process, we're tracking on the target schedule so far. That's the update for today, but we'll open it up to questions if there are some.

**Woodward, Jim (UTC):** Hey there, Chris, Jim Woodward, Washington Staff. Not sure if you saw my hand raised or not. So good to talk with you again. I know you and I and the team have been meeting a little bit over the last few weeks, couple months, and apologies if you had touched upon this. But with that price refresh bullet, I think on your previous slide. If you wouldn't mind going back to that. Was just wondering on a couple details there. Whether you know that forthcoming update or refresh, is that really just an update on the current scored and ranked list of bids? Or could that refresh be a catalyst to possibly rescore and re-rank?

**Drake, Chris:** Yeah, good question. The price refresh is something that we had scheduled, and it was for the short list of projects. We were at this point in the process focused on the shortlisted bids and we had scheduled estimated time for a price refresh. But then with the additional legislation that was passed, we adjusted that deadline in order for bids to incorporate as applicable, possible benefits to customers that we might be able to include in their price refresh.

**Woodward, Jim (UTC):** OK, thanks. So, it sounds like you're adjusting the timeline a little bit, but it's really focused on the shortlisted bidders as opposed to a reopen. Is that accurate to say?

**Drake, Chris:** Correct. We only request. Yeah. So, once we short list, we move on to those bids and we're focused on those for the detailed proposals as well as updates to pricing.

**Woodward, Jim (UTC):** Thanks.

**Drake, Chris:** Yeah, I know. Probably add that while we target some scheduled price refresh times as part of the RFP and at some point, it becomes the shortlisted bit. But you know bidders are certainly able to provide us updated pricing at any time. But once we make the shortlist, then we're focused on that group. Well, if there's no other questions, thank you for your time this afternoon.

**Gall, James:** Thanks Chris. We're going to move to the last topic of the presentation today and probably the longest subject as well. I'll introduce Mike Hermanson and he's going to discuss some climate change work he's been working on and how climate change could impact the utility from a generation and a load point of view. I'll turn it over to Mike.

### **Global Climate Change Studies, Impacts to Avista Loads & Resources, Mike Hermanson**

**Hermanson, Mike:** OK. Thanks, James. As he said, my name is Mike Hermanson, and I'm going to be presenting the climate change analysis that was conducted for use in the IRP modeling that will be moving to and specifically how we are looking at the impacts to hydrogeneration from changes in stream flow and the impacts to load from temperature changes.

**Hermanson, Mike:** First, going over the data sources and the methodology, and then I'll move on to the results for hydrogeneration. The load forecast and then the peak load forecast and then describe how we're going to be using that in the IRP modeling.

**Hermanson, Mike:** The principal data source used in our analysis is from studies that were conducted by the River Management Joint Operating Committee, kind of a long name there, which is comprised of the BPA, U.S. Army Corps of Engineers, and the Bureau of Reclamation. This group has been studying climate change in the Columbia Basin for some time. They first released a study in 2011. Our analysis is based on data from the second study conducted by this group, which was released in 2018, the first part and 2020 was the 2nd part. The study utilized a research team from the University of Washington and Oregon State University.

**Hermanson, Mike:** The first part of the study, which was released in 2018, was development of a data set for unregulated stream flows. So, stream flows that would occur

if there were no reservoirs or hydroelectric facilities on the in the system. The second evaluated the reservoir regulation operations under these various stream flow regimes that they developed.

**Hermanson, Mike:** Developing estimates of stream flow under climate change scenarios is a multi-step process. It starts with a set of global climate models, also referred to as global circulation models. And these GCMs, they have a coarse resolution with grid sizes that range from about 75 to 300 kilometers. The models output projections of temperature and precipitation under different scenarios of carbon emissions, which are called representative concentration pathways. There's chart to the right here shows the difference between the different emissions scenarios. You can see from that, there's four different scenarios and significant divergence starts to materialize in the latter half of this century, 2050 to 2100.

**Hermanson, Mike:** The study evaluated two different representative concentration pathways, the RCP 4.5 and 8.5. I should also mention that in this study, there were 10 different global circulation models that were used, and you can see the list there developed by different research groups throughout the world. These ten studies, I believe they felt represented a good representation of different outcomes that are predicted in the future. There are four different concentration pathways that are out there, and they looked at two in the RMJOC studies.

**Hermanson, Mike:** A little bit of background on the different scenarios we have, the description I found in the Intergovernmental Panel on Climate Change, that international organization that seems to be the consortium or the central point of all the different climate change studies gather there and so that group, the IPCC, described the pathways RCP 2.6 as a very stringent mitigation scenario, so quite a bit of reduction in carbon emissions. RCP 4.5 and 6.5 are described as intermediate scenarios and RCP 8.5 is described as very high greenhouse gas emissions. The other thing that is of note is that within the IRP planning horizon, the RCP 4.5 and 6.0 are very similar with the mean and the likely temperature range actually higher for the CPP 4.5 scenarios.

**Hermanson, Mike:** Models with the resolution of 75 to 300 kilometers are not very useful in evaluating changes in hydrology. So, data from the models need to be downscaled and downscaling is the process of using data within a larger grid that's at a finer scale, such as elevation to introduce differences at that finer scale. This graphic shows the typical resolution of a GCM. At the top you'll see that is not very useful in describing how stream flow is going to be changed in a sub watershed that has an impact on different river reaches.

**Hermanson, Mike:** The lower graphic shows the grid size at the downscaled size and as you can see that the representation of the different elevation features and different hydrologic features such as the canopy cover and soils and geology are all at a much finer scale that's more descriptive of how hydrology will react to temperature and precipitation changes. Once you have the downscaled GCM data, it provides precipitation

and temperature data for on a daily basis and that is then used in hydrology models to project stream flows. The hydrology models simulate snow accumulation and melting and movement through the watershed based on such variables as slope aspect, which direction the slope is facing, geology, soils, and vegetative cover. And so that takes that precipitation and then the input of the different temperatures then determines whether that precipitation is falling as snow. If it falls as snow, how long does that snow last? You can see how the different temperatures then manifest themselves throughout the hydrologic system through these different models.

**Hermanson, Mike:** In this study, they used two different hydrology models and then for one of them, they used three different versions of input data. Essentially you have four different versions of hydrology that are being represented for each of the different temperature and precipitation and combinations. The result of all of this is that you get quite a number of resulting permutations at the end of it. Ten different global climate models. You have two different greenhouse gas emission scenarios, two different downscaling methods, four different hydrology models. You end up with numerous scenarios to evaluate. On top of that, each scenario has daily stream flow data for every location throughout the Columbia Basin and it's daily for 100 years plus. And so, luckily, BPA did an exercise where they evaluated the data from all of these models and then zeroed in on 19 different specific scenarios that they felt represented a good range of potential outcomes, and so we used those 19 models to conduct our analysis. Once we have the 19 different models, those different scenarios of stream flows, the next step was to use stream flows at each of the Avista facilities to determine how those translate into generation. This was done with regression models of stream flow and generation for each facility.

**Hermanson, Mike:** BPA completed evaluation of generation for the Mid-C facilities that we have contracts with. Those were used directly for generation at each facility under the various climate scenarios was compared to hydro generation used in the previous RFP which is generation based on water years from 1929 to 2008.

**Hermanson, Mike:** In addition to the climate scenarios, we also conducted an evaluation of generation under stream flows for the most recent 30 years. This provides an indication of climate change impacts by restricting that look back period to 30 years and we also decided to do that because BPA recently announced that they were moving to using a 30-year record for their planning purposes, so the 1929 to 2008 data set we use is developed by BPA, but they have not released the 1929 to 2018 data set yet. So, we used actual river flow and mid sea generation data to create a recent 30-year data set. And once BPA releases their dataset that's 90 years of hydro data, we will be evaluating that.

**Hermanson, Mike:** OK, so that was all of the setup and the methodology. Now we actually move on to some results here. Everything I present now will be based on the 80-year hydro record, the recent 30-year and the combination of the 19 different climate change scenarios for two different emission scenarios, the RCP 4.5 and 8.5. The 80-year



hydro record is important because that's what we've used in previous IRP modeling. It's used in rate case work to estimate hydrogeneration, so it's our baseline and looking at the recent 30-year and the two different climate change scenarios gives us an indication of what changes we'll see in our hydro portfolio generation.

**Hermanson, Mike:** This shows the annual statistics. The annual average production is slightly lower for the recent 30-year, but the climate change scenario's annual average production is greater, which is consistent with the climate change scenarios generally heard about that predicted an increase in annual precipitation in the northwest.

**Hermanson, Mike:** This chart shows the difference between the recent 30-year and both climate change scenarios and 80-year record, and it's on a monthly basis. This essentially shows the impact to our modeling assumptions as compared to assumptions used in the previous IRP. As you look at this, it's consistent with the general projection of climate change impacts in the northwest where we have additional generation in the winter, late winter, early spring, and decreased generation in the summer months and a slightly increased generation moving through the fall into the early winter, but not as pronounced as we see in the February, March, April time frame.

**Hermanson, Mike:** Essentially this is representing an earlier snowpack release, and also more releases of water during the year as precipitation falling as rain at lower elevations and coming earlier in the year and that not as much snow melt occurring and it occurring earlier in the year, and then less precipitation during the summer months.

**Hermanson, Mike:** The other thing is that we're looking at 19 different studies. There is considerable variance amongst all the different climate scenarios. This chart shows the climate scenarios as a box and whisker plot, and then on that is the 80-year and the 30-year monthly generation. Those are the actual values plotted against the projected distribution of each month. The actual, the 80-year and the 30-year hydro both, for the most part fall within the range of outcomes predicted by the models. The difference is of course when you look at the median of the models and then compare that to the actual. There is some definite inherent risk in using these climate change models going forward, especially in those months where we see the significant changes, there's quite a bit of variability. We don't see as significant changes occurring in the fall months and those also have the tightest band of generation in the climate models. That's one thing we want to keep in mind as we use this data and go forward is the variance amongst those.

**Hermanson, Mike:** We also wanted to evaluate the progression of changes to generation over the IRP planning horizon. How does how did these changes manifest themselves over that whole IRP planning horizon, the 25-year, I believe 30-year period. These charts show the annual generation for each year. The RCP 8.5 is shown in blue, and the RCP 4.5 is shown in orange. The four charts are for those winter and early spring months and you can see that during January, February, March and April, there is an increasing trend moving from 2019 to 2049.

**Hermanson, Mike:** As we move through that planning horizon, the impact of climate change increases, which is not a surprising result, but important to consider as we look to see how we integrate this information into our planning assumptions. Throughout the year, you can see that May is actually kind of flat. June, July and August show a decreasing trend and then moving on to the fall and winter months. They show relatively small amounts of change going throughout the planning horizon.

**Hermanson, Mike:** The other thing we were looking at is which of the emission scenarios will we eventually use. We wanted to compare the whole portfolio of hydrogeneration in the different emission scenarios and this shows that on a monthly basis, and generally speaking, the RCP 4.5 scenario is slightly larger in most instances with the exception of April, which the RCP 8.5 has a slightly larger, but as you can see the differences are very small in comparison to the actual portfolio size.

**Hermanson, Mike:** It wraps up the impacts to hydrogeneration and I'll circle back at the end here to bring it back together and put the two pieces together. But so now I'm going to look at the evaluation of load. To evaluate changes to load, we use the daily max and minimum temperatures at the Spokane Airport from each of the 19 climate scenarios used in the hydrogeneration evaluation. It works out pretty well because our econometric load forecasting model uses heating degree days and cooling degree days as an input.

**Hermanson, Mike:** And so, we are ready to put new assumptions for temperature into those models and then get the output. We looked at the different ways to do that and decided that we would take the median of the 19 climate models and then use that to generate the heating degree days and cooling degree days that we need to input into the load forecasting model.

**Hermanson, Mike:** The load forecasting model uses a 20-year moving average. In the previous IRPs, the baseline was taking the previous 20 years and then holding that constant throughout the planning horizon. There was also a climate change scenario which took a trended temperature and moved that through the planning horizon. There was a climate change component to that, but it was basically trending the previous 20 years and trending that forward. This time we took the actual climate data from the models and then input that into the load forecasting model. Before looking at the climate results, it is useful to look at the trend, the actual trend of historic data.

**Hermanson, Mike:** This chart shows the total monthly heating degree days from 1950 to 2021, and as you can see it has a declining trend. These charts show that. And then, just looking at it every month all in the same chart and then looking at it on a monthly basis. These charts show the 20-year moving average of the monthly heating degree days. January, March and November all show an overall declining trend. Again, this is just historic data. February and October are flat and then you actually see a slight increase in the December trend of the heating degree days.

**Hermanson, Mike:** Looking now at the heating degree day data from the climate models. These charts show the median monthly heating degree days over the planning horizon

for both emission scenarios. As you can see, they are slightly declining trend over time and with the RCP 4.5 slightly less than the RCP 8.5. Actually, somewhat of a continuation of a trend that was already existing in the historic data.

**Hermanson, Mike:** Now moving on to the cooling degree days. This chart shows the monthly total cooling degree days for 1951 to 2021 and this shows a general increase over that period. Even though there's obviously significant volatility but looking at the overall trend as was with the heating degree days that there is a general upward trend here in the cooling degree days.

**Hermanson, Mike:** These charts similarly show the 20-year moving average of monthly cooling degree days. As you can see, the largest increase is in July and August. Again, that's historic data. Now moving on to the model data we have the RCP 4.5 on the left and RCP 8.5 on the right, and each of them showing the general increase in the number of cooling degree days as we go throughout the planning horizon.

**Hermanson, Mike:** This chart shows the output once we put the median values into the load forecasting model. We compared the output of the forecasting model when using the 20-year moving average of the climate models and the 20-year moving average moving through the climate models with a case of keeping it static throughout the planning period instead of just looking at the end result. What are the temperatures? In 2045, we had this moving average and as these charts show, the temperatures in 2034 and then also in 2045, and at the top is the 4.5 emission scenario and at the bottom is the 8.5 emission scenario.

**Hermanson, Mike:** The graph shows the impact at 2034 is less than the impact at 2045, because as you phase in the climate change data, you start to see more impact of the decrease in heating degree days as it reduces the load during the winter and early spring and later fall months. Then the increase in cooling degree days increases our load during the summer months. I'll be tying these both together and as you might imagine, we have a dual effect here of having increased generation and decreased load during the winter, early spring months and increased load and decrease generation from hydro during the summer months. That creates a net effect that is larger than either of the two separately. In addition to the monthly energy, there's an impact to peak load. Our peak load model utilizes the minimum and maximum temperature for each month to calculate peak load.

**Hermanson, Mike:** We determine the minimum and maximum temperature for each month for each climate scenario, and then use the median monthly value in the peak load forecast model. Once we did it for each month, we used the largest monthly value to establish the summer and winter peak load. The summer peak load for each year going through the planning horizon uses a 20-year moving average in the winter. Peak is based on a 76-year moving average. 76-year period might seem a little odd but the reason we chose that is that the temperature location for Spokane historical temperature changed in 1947 to the Spokane Airport's present location. We started from 2022 and went back to 1947 and then kept that 76-year moving average and moved that forward through the

planning horizon. And we use that to the 76-year, the larger planning horizon on the winter peak because we wanted to catch more of the variability within those data sets.

**Gall, James:** Mike, you have a hand up from Grant.

**Hermanson, Mike:** Yes.

**Forsyth, Grant:** Hey, sorry, Mike, just to clarify on the on the temperature data, the 1947, the problem is when they move the temperature, some months went through a noticeable shift in the profile of temperature, and so that's usually not a problem unless the temperature shows that change because of that move. And it clearly does in some of the months. And so that's part of the reason we restricted it to 47. That's all.

**Hermanson, Mike:** OK, great. Thank you for making that clarification. This chart combines historical and model data, and it shows an increase in both. This is the Spokane Airport maximum yearly temperature. The variability is reduced in the model values and that's a result of using the median of the 19 different scenarios. You lose some of the volatility that you usually see in year-to-year maximum temperatures.

**Hermanson, Mike:** This next chart gives an indication of the variability within that range and there's definitely some upside risk, at least that's what the climate models show. They tend to have a lot of outlier models going outside of the box and whisker plots and so that was definitely one thing that we kept in mind as we went through our analysis. This chart shows the historical and modeled yearly minimum temperature which is essentially flat. But when you add in the variability of all the different models.

**Hermanson, Mike:** Climate change, we always consider that to be an increase in temperatures, but there is also the risk that some of these climate models might miss some of the potential lower temperatures and we want to make sure that we don't get rid of the volatility we've seen historically especially when doing peak load planning. Don't want to minimize the risk of not having enough peak load during those winter months.

**Hermanson, Mike:** These charts show the peak load temperatures that are used for each of the peak loads forecast for each year. Each of these planning temperatures were used in the modeling to get the peak load. This is actually the 20-year and 76-year moving average going through the planning horizon. And as you can see the winter, the baseline if we kept things static versus the RCP 8.5 in orange and the RCP 4.5 in gray. There's an increase throughout the planning horizon.

**Hermanson, Mike:** This chart shows how those temperatures translate into actual additions to the peak load forecast that we have that are specifically attributed to climate change. Changes in temperature, as you can it ranges between just above 60 to a little below 80 in the winter months and then we'll have a decrease in peak load in the winter months, on the order of 10 to 20 megawatts.

**Hermanson, Mike:** That was just looking at the climate impacts in isolation. But I think, as James mentioned, we'll be talking about updates to load forecasting at the next IRP

meeting, and this gives you a little bit of a preview. The impacts from adding in new estimates of EV adoption and adding in medium duty EVs and also adding in the new restriction on new natural gas and commercial buildings, they all have a dramatic impact on our peak load forecast. When you look at the winter, climate change barely registers as an impact to the peak load. It's actually a reduction in the peak load forecast. Moving over to the summer on the right side, you have about 10 to 20 MW increase, but the dramatic impact is really from the adoption of assumptions of EVs and the assumptions on the increase in electrified heating as a result of the natural gas prohibition and commercial buildings. We looked at one additional impact of climate change, which is the impact to capacity at some of our thermal generation due to increase in temperatures. At higher temperatures, gas turbine capacity decreases. So, you have the potential for having the highest at the maximum temperature of a summer month. Having your highest peak load at that point in time, you could also have likely having your highest temperature. This chart shows the decrease in thermal capacity with temperature for the Avista portfolio.

**Hermanson, Mike:** Our question was, are we going to be seeing increased maximum temperatures? This is a little different than the previous temperature data, we were looking at average daily temperature. What we wanted to look at now was the maximum daily temperature. The hottest point of the day, what is occurring and what kind of impact will that have on thermal generation. To evaluate this impact, we looked at a comparison of the historical yearly maximum temperatures to the median of the modeled yearly maximum temperatures. We have the historical in blue and the modeled median maximum temperature for the year in orange. There's actually no increase in the average temperature between the historical and the planning horizon. On the face of it, we didn't see a need to adjust our peak load forecast, but we also wanted to evaluate risk because we knew that the variability of those climate models was significant and wanted to look at what happens at the extremes, knowing that there's a risk that temperature can be greater than the median. We looked at the historical versus the 95<sup>th</sup> percentile of the model temperatures. The historical average goes from 99 to a modeled average of 105 degrees, and when that occurs, we have a reduction of 22 megawatts of capacity.

**Hermanson, Mike:** When we look at that, we're considering taking that into account in our planning reserve margin that we look at on our peak planning. In a similar vein, we also looked at the average energy, not just peak energy. Given the wide variance in the modeled temperatures, we looked at the 95<sup>th</sup> percentile and then I looked at it in comparison to looking at the impact on generation. We wanted to look at the impact on load and that's peak load, I misspoke when I said average energy, we wanted to look at the impact to our peak load during these more extreme events, and so instead of using the median temperature for the peak load, we looked at the 95<sup>th</sup> percentile of the model temperatures, and so both the summer and winter peaks increase throughout the planning horizon. And this is if you use the 5<sup>th</sup> percentile in the in the winter months, the lowest temperatures. And if you use the 95<sup>th</sup> percentile of temperatures in the summer months, you see that there's a 60 MW difference in the winter and then 106 MW difference

in the summer months. And again, this is something we're taking into consideration as we look at the planning reserve margin that we consider. As I mentioned previously, unfortunately the climate change increases generation at the same time that it decreases loads and decreases generation at the same time when it increases loads. So, you get a net impact that is larger than the two separately.

**Hermanson, Mike:** This chart shows the monthly difference between the generation and loads from the previous IRP, those with the most recent 30-year, and those of the climate models. And as you can see, it's a similar story as to the other two separately, but just an increase across the board with a maximum impact in the month of July under the RCP 4.5 scenarios of a net loss of 127 megawatts and under the RCP 8.5 loss of 189 megawatts. Though we will have an additional surplus in January, February and March that are actually greater than the loss in the summer months.

**Hermanson, Mike:** And then to summarize the changes from the peak load. This looks at the winter peak on the left side, we have in 2023 our current winter peak that we're planning to is 1,720 MW. Now if we were to just go without any climate change scenarios, that would increase to 2,319 MW. And then if we use the 8.5 emission scenario that will go up to 2,294 MW. So, it'll be reduction from the baseline, a little less reduction if we look at the 4.5 emission scenarios, just down to 2,306 MW. But if you actually use the 5<sup>th</sup> percentile of the RCP 4.5 scenario then you actually see an increase over the baseline, so you go to a 2,367 MW. That's in a scenario where you have colder temperatures that are predicted by the climate models. It's definitely something to keep in consideration in our peak planning. Moving over to the summer months, our baseline currently we are at 1,668 MW for 2023. And then our baseline is about 2,300 MW with the RCP 8.5 scenario that moves up to 2,375 MW, a slightly less increase using the RCP 4.5 scenario. About 12 megawatts less and when you go to the extremes of the climate models, you have fairly significant increase to 2,470 MW. Above that 2,300 MW number and that is almost a 170 MW increase attributable to the climate change.

**Hermanson, Mike:** So, to wrap it all up. What we are planning to do after evaluating all of this data? We've decided to use the RCP 4.5 scenario and that was based on the description by the IPCC and some other research that I've done evaluating the differences between these emission scenarios. I think the kind of description in the IPCC document characterizes what I saw on other documents and the stringent mitigation scenario at 2.6, but RCP, 4.5 and 6.0 are more immediate scenarios and they have a recognition of all the different climate policies that are being put into action over the next 50 years. And so, with the RCP 8.5, some people characterize it as business as usual, but essentially it's doing nothing. And I think we can see that doing nothing is not what is occurring. The RCP 4.5 and 6.0 scenarios seem more in line with what is likely to occur. And then also within the planning horizon, the 4.5 scenario and the 6.0 scenario are very similar. And so, we made a decision to go with the 4.5 scenario for hydrogeneration. Our plan is to move to this is for our baseline planning. And we're not talking about using this as our

climate scenario and then having the baseline be different. This would be our baseline assumptions for the IRP modeling.

**Hermanson, Mike:** For hydrogeneration, we move from using the median of the 80-year 1929 to 2008 hydro record to using the previous 30 years. And that would be our base point. The 2023 assumption in the model would be that we look back at the 30 years and then for each subsequent year we move through the modeling, through the planning horizon, you would start to integrate the climate models. At the end of the planning period, the hydro generation would be based specifically on the climate models.

**Hermanson, Mike:** In the energy and the load forecast, we are planning to do something similar, use historic data and then extend into the future with the climate change data and continue to use for each year the previous 20 years and so using that moving average and that's both for the energy and for the monthly load forecast and then also looking at the peak load forecast using 20 years for the summer peak and then 76 years for the winter peak.

**Hermanson, Mike:** That was a lot of information. I didn't hear any questions, but I'm open to any questions that anybody has with our analysis or our plan moving forward.

**Gall, James:** Dave has his hand up, Dave, go ahead.

**Dave van Hersett (Guest):** How's that? Can you hear me now?

**Hermanson, Mike:** Yep.

**Dave van Hersett (Guest):** OK. On your 20-year forecast, just to give me a general feel. What was the number of customers that increased over that 20-year period? Approximately.

**Hermanson, Mike:** You know, I don't have that off the top of my. Are you talking on the?

**Dave van Hersett (Guest):** Just any one of these, because you're making a large increase in megawatts over the time. I just wondering if it went from you know 300,000, 400,000, or something, or can't remember how the numbers.

**Gall, James:** Grant, do you have that off the top of your head?

**Forsyth, Grant:** I need to look that up. So let me see if I can find it on customers.

**Dave van Hersett (Guest):** Yeah, I'm trying to get a feel for the customer load or the load per customer increasing over time, or decreasing, or staying about the same. It's kind of what I was wondering also.

**Hermanson, Mike:** Well, there is the EV component to it so we have a new EV forecast that we're working with and that is the significant increase. The use per customer is going to go up as you add EVs to each of those customers, both residential and commercial. And this doesn't have any assumptions of building electrification in it. The only building electrification is on the commercial side. Adding the new commercial customers will no

longer be available to have natural gas and so there is an increase in the per customer commercial use due to that.

**Dave van Hersett (Guest):** OK, so if there's 330,000 customers now, we might be going to over 20 years, 400,000 customers or something like that?

**Forsyth, Grant:** This is Grant. Let me just do this really quick. So, we're starting out now, and this is Washington and Idaho, combined, and it's all commercial, industrial and residential we have about 406,000 almost 407,000 customers. By 2045. We'll have about 497,000, almost 498,000 customers.

**Dave van Hersett (Guest):** OK. About a 20% increase or thereabouts. OK.

**Forsyth, Grant:** Right. And that's largely driven by the big driver that is going to be residential and that's going to be a function of population growth. You asked about use per customer, so use per customer continues to fall until you get to about 2035 because that's when the EV part really starts to have a big impact and then you start to see a reversal of a historic trend of declining use per customer to where use per customer starts to rise. And it's strongest in Washington because that's where we're currently predicting to have most EVs, the bigger proportion of EVs is currently predicted to be in Washington. By the time you get to 2045, your use per customer on residential in Washington is basically returned to what you had let's say around 2009, 2010.

**Dave van Hersett (Guest):** OK.

**Forsyth, Grant:** You bet.

**Dave van Hersett (Guest):** No, thank you.

**Gall, James:** Any other questions, thoughts? Looks like Jim, you got your hand up. Go ahead.

**Woodward, Jim (UTC):** Thanks James and thank you Mike, really enjoyed this afternoon's presentation. My question was one of context and where this all fits in. I actually had to step away briefly right when you finished the presentation, so apologies if you did address this, if not, I'm asking a question. In the 2021 IRP and in Washington rule the last cycle address climate change via that scenario. You know that climate change scenario? Just wondering if this analysis heading into 2023 is, and granted the nomenclature varies by company, but is this centrally getting built into Avista's Base Case this time around or are we still talking about this updated analysis being used for that climate change scenario?

**Hermanson, Mike:** This is using the RCP 4.5 emission scenario and using a 30-year moving average that phases in the climate change data, is what we're proposing or what we're planning for the Base Case.

**Woodward, Jim (UTC):** The Base Case. OK. Thanks very much for clarifying that.



**Forsyth, Grant:** This is Grant. When I present on October 11<sup>th</sup>, when I present the new energy forecast that assumes the RCP 4.5, I mean, in other words, the Base Case. That were the baseline case. I'm going to present for energy on October 11<sup>th</sup> assumes RCP 4.5 data Mike gave to me. So, in other words load profile that's being used to allocate the energy forecast assumes 4.5.

**Woodward, Jim (UTC):** Thanks Grant for confirming that on the load side too. Appreciate it.

**Forsyth, Grant:** This is Grant. May I just raise a quick issue. Just in case people are unaware of this, they are now reviewing the building code for residential gas connects. That is something that James, Mike and I have been talking about that's potentially another factor down the road that could really shift both energy and peak around if we have to essentially adjust for some kind of significant restrictions on residential gas connects going forward.

**Gall, James:** Are there any other questions? I think if there's not, we can move on to the last bit of the presentation about next TAC meetings since we've alluded to it quite a bit. But I just want to put some silence there in case something comes to mind. OK. I'll let Mike turn the screen off. Thank you, Mike. Great presentation. I'm just going to share my screen briefly and talk about the next TAC meeting because it's quite packed, the agenda is packed and leads to the Progress Report portion of this IRP process, but it is an all-day meeting again, on October 11<sup>th</sup> and that will be in person as an option. But we will also have Teams available as well. We're going to start up at 9:00 am, and we're going to talk about the DER potential study scope. That's another one of those requirements from the Washington CEIP process. That will be a study that we're going to look for consulting help to identify how much of the DERs are available in our Washington service territory.

**Gall, James:** The next presentation will be on load forecasting which Grant alluded to. And thanks Dave for some ideas for Grant to present on, and then the next part of the presentation will take that load forecast and give you an updated resource balance. So that resource balance is what we'll be looking at to acquire resources to meet in the IRP process. We'll go over our wholesale price forecast for both wholesale electric, natural gas, and will also include hydrogen and ammonia in that forecast as well. We will also talk about the Western Resource Adequacy Program market, which is where we're transitioning our planning metrics towards. So, what I mean by that is how much resources we need to acquire for making sure we have enough peak generation, and winter and summer, and then we will have a presentation on the Clean Energy Implementation Plan on how that's used in this IRP or should I say the Progress Report portion and how those Customer Benefit Indicators that are derived in the CEIP process are going to be used. And lastly, we'll talk about portfolio and market scenarios. If you get any ideas you'd like to see, get them to us by Monday the 3<sup>rd</sup> and we can include those in the presentation. Otherwise, we'll talk about some of the ideas we have and then see if there's anything else we want to add at that meeting. We're about 20 minutes early, which is great. I just want to leave it open again if there are any questions or thoughts

before we call it a day. All right, you guys are too easy. Have a good evening and I will see you all in a couple weeks.

**Woodward, Jim (UTC):** Thanks a lot. Take care.



***2023 Electric Integrated Resource Plan***  
**Technical Advisory Committee Meeting No. 7 Agenda**  
**Tuesday, October 11, 2022**  
**Microsoft Teams Virtual Meeting**  
**With an in-Person Option**

<b>Topic</b>	<b>Time</b>	<b>Staff</b>
Introductions	9:00	John Lyons
DER Potential Study Scope	9:15	James Gall
Load Forecast Update	9:45	Grant Forsyth
Break	10:30	
Load & Resource Balance (Resource Need)	10:40	Lori Hermanson
Natural Gas Market Dynamics	11:00	Tom Pardee/ Michael Brutocao
Lunch	11:30	
Wholesale Electric Price Forecast	12:30	Lori Hermanson
WRAP Update	1:00	James Gall
Clean Energy Implementation Plan (CEIP) Update & Customer Benefit Indicator's (CBI) use in the IRP	1:30	Annette Brandon
Break	2:30	
Portfolio & Market Scenario Options	2:40	James Gall
Adjourn	3:30	



# IRP Introduction

2023 Avista Electric IRP

TAC 7 – October 11, 2022

John Lyons, Ph.D. Senior Resource Policy Analyst

# Meeting Guidelines

- IRP team is working remotely and is available for questions and comments
- Stakeholder feedback form
  - Responses shared with TAC at meetings, by email and in Appendix
  - Would a form and/or section on the web site be helpful?
- IRP data posted to web site – updated descriptions and navigation are in development
- Virtual IRP meetings on Microsoft Teams until able to hold large meetings again
- TAC presentations and meeting notes posted on IRP page
- This meeting is being recorded and an automated transcript made

# Virtual TAC Meeting Reminders

- Please mute mics unless commenting or asking a question
- Raise hand or use the chat box for questions or comments
- Respect the pause
- Please try not to speak over the presenter or a speaker
- Please state your name before commenting
- Public advisory meeting – comments will be documented and recorded

# Integrated Resource Planning

The Integrated Resource Plan (IRP):

- Required by Idaho and Washington\* every other year
  - Washington requires IRP every four years and update at two years
- Guides resource strategy over the next twenty + years
- Current and projected load & resource position
- Resource strategies under different future policies
  - Generation resource choices
  - Conservation / demand response
  - Transmission and distribution integration
  - Avoided costs
- Market and portfolio scenarios for uncertain future events and issues

# Technical Advisory Committee

- Public process of the IRP – input on what to study, how to study, and review of assumptions and results
- Wide range of participants involved in all or parts of the process
  - Please ask questions
  - Always soliciting new TAC members
- Open forum while balancing need to get through topics
- Welcome requests for new studies or different modeling assumptions.
- Available by email or phone for questions or comments between meetings
- Due date for study requests from TAC members – October 1, 2022
- External IRP draft released to TAC – March 17, 2023, public comments due – May 12, 2023
- Final 2023 IRP submission to Commissions and TAC – June 1, 2023



# Remaining 2023 Electric IRP TAC Meeting Schedule

- Technical Modeling Workshop: October 20, 2022 (9 am to 12 pm PST)
- Washington Progress Report Workshop: December 14, 2022 (9 am to 10:30 am PST)
- TAC 8: February 16, 2023 (9 am to 4 pm PST)
- Virtual Public Meeting Gas & Electric IRPs: March 8, 2023 (12 to 1 pm and 5:30 to 6:30 pm PST)
- TAC 9: March 22, 2023 (9 am to 4 pm PST)

# Today's Agenda

9:00	Introductions, John Lyons
9:15	DER Potential Study Scope, James Gall
9:45	Load forecast Update, Grant Forsyth
10:30	Break
10:40	Load & Resource Balance (Resource Need), Lori Hermanson
11:00	Wholesale Price Forecast Natural Gas & Electric, Avista IRP Team
11:30	Lunch
12:30	Wholesale Price Forecast Natural Gas & Electric (continued)
1:00	WRAP Update
1:30	Clean Energy Implementation Plan Update & Customer Benefit Indicator's Use in the IRP, Annette Brandon
2:30	Break
2:40	Portfolio & Market Scenario Options, James Gall
3:30	Adjourn



# Distributed Energy Resource Potential Study

James Gall, Integrated Resource Planning Manager  
Electric IRP, Seventh Technical Advisory Committee Meeting  
October 11, 2022

# CEIP Commitment #14

- Avista will include a Distributed Energy Resources (DERs) potential assessment for each distribution feeder no later than its 2025 electric IRP.
- Avista will develop a scope of work for this project no later than the end of 2022, including input from the IRP TAC, EEAG, and DPAG.
- The assessment will include a low-income DER potential assessment.
- Avista will document its DER potential assessment work in the Company's 2023 IRP Progress Report in the form of a project plan, including project schedule, interim milestones, and explanations of how these efforts address WAC 480-100-620(3)(b)(iii) and (iv).

WAC 480-100-620(3)(b)(iii) and (iv).

(iii) Energy assistance potential assessment – The IRP must include distributed energy programs and mechanisms identified pursuant to RCW [19.405.120](#), which pertains to energy assistance and progress toward meeting energy assistance need; and

(iv) Other distributed energy resource potential assessments – The IRP must assess other distributed energy resources that may be installed by the utility or the utility's customers including, but not limited to, energy storage, electric vehicles, and photovoltaics. Any such assessment must include the effect of distributed energy resources on the utility's load and operations.

# Distributed Energy Resource

- Forecast for each distribution feeder (361 originating in Washington)
- Washington only study
- New Generation & Storage
  - Residential and Commercial Solar
  - Residential and Commercial Storage
  - Other Renewables (i.e. wind, small hydro, fuel cell, ICE)
- Load Management
  - Energy Efficiency
  - Demand Response
    - Includes electric vehicles
    - Should we conduct a study future locations for electric vehicles (MDV, HDV, LDV)?

# New Generation & Storage

- Potential assessment for each option for each year between 2025 and 2045
  - Forecast should consider existing policies and cost/pricing outlooks for the customer demographics and building potential.
  - A scenario for future customer electrification impacting its demand should be included to the extent it could affect generation.
- The analysis shall include a scenario for feeders within Highly Impacted or Vulnerable Population area identifying the upper bound limits excluding financial limitations of the customer.

# Load Management

- Uses current potential assessment for energy efficiency and demand response.
  - Low-income efficiency is addressed in the energy efficiency CPAs.
- Requirement is a geographic dispersion assessment by feeder for each calendar year for each load management resource type.
- Building space and water heating electrification scenario.

# Schedule and Tasks

## Task 1: July 2023

- A survey of other utility or other entity efforts to conduct similar DER potential studies. The study shall include comparison of the other utility's size, rates, climate, and customer demographics.
- A summary of best practices for development of future adoption of new DER technologies.
- An overview of Avista's current DER resources (i.e., 2022 baseline).

## Task 2: September 2023

- A description of the methodology used to develop the estimates for each DER and related scenarios.

## Task 3: Draft March 2024 and Final May 2024

- Matrix including each feeder and the amount of DER resources in kW and/or kWh for each resource type by year and customer class.

## Task 4: 2024 Q2

- Present draft results of study to Electric and Natural Gas Integrated Resource Planning Technical Advisory Committee, Energy Efficiency Advisory Group, and the Distribution Planning Advisory Group.

## Task 5: Draft April 2024, Final Report June 2024

- Final report including tasks 1 through 4.
- Summary of comments and suggestions from non-Avista parties and how they are addressed in the final report.
- Recommendations for future studies.
- Documentation of methods and procedures to transition Avista to be able to update these forecasts for future use.





TAC Meeting  
October 11, 2022

# 2023 IRP: Updated Energy and Peak Forecasts

Grant Forsyth, Ph.D.  
Chief Economist  
[Grant.Forsyth@avistacorp.com](mailto:Grant.Forsyth@avistacorp.com)

# Outline

- **Significant Model Updates**
- **Long-run Energy Forecast Update**
- **Peak Load Forecast Update**

**The world since February 2020:**

**“...all are punish’d.”**

- **The Prince, Romeo and Juliet, Act 5, Scene 3**

# Significant Model Updates

- **More aggressive EV forecast with an explicit separation between residential and commercial schedules.**
- **LDV EV forecast out to 2030/31 lines up with Avista's EV transportation plan in terms of forecasted percent of sales. Assumes WA-ID combined reaches 15% of sales by 2030/31 and 38% by 2045.**
- **MDV forecast for commercial assumes WA-ID combined reaches 25% of sales by 2045.**
- **More aggressive solar forecast with an explicit separation of residential and commercial solar customers.**
- **Climate change is in the base-line energy and peak forecasts using RCP 4.5.**
- **Energy and peak adjustments for WA's newly announced restrictions on commercial gas connects.**
- **Long-term GDP growth is an explicit choice variable after 2026.**
- **Improved treatment of energy load profiles for climate, solar, EVs, and gas restriction impacts.**
- **Higher residential customer growth for the 2023-2028 period.**

# Long-term Energy Forecast: Residential Customer Growth

Annual Residential Customer Growth Rates

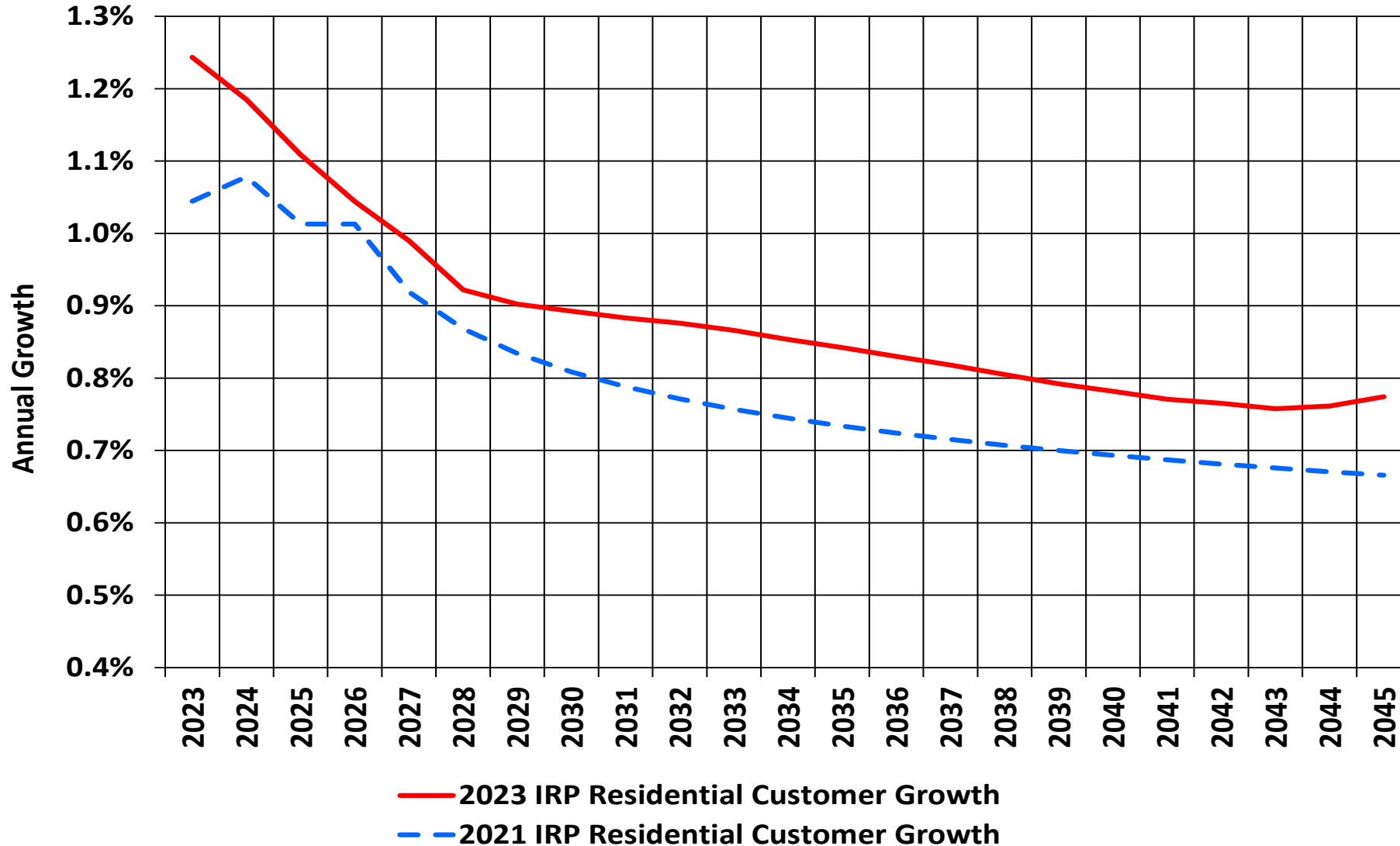

IRP	Avg. Annual Growth
2021 IRP	0.80%
2023 IRP	0.89%
2023 WA	0.69%
2023 ID	1.25%

**Comments**

- From 2027 on, the time-path reflects IHS population forecasts.
- The higher growth rate in this IRP reflects higher forecasted growth in ID.



# Long-term Energy Forecast: Residential Solar Penetration

## Projected Base-Line Residential Solar Customers

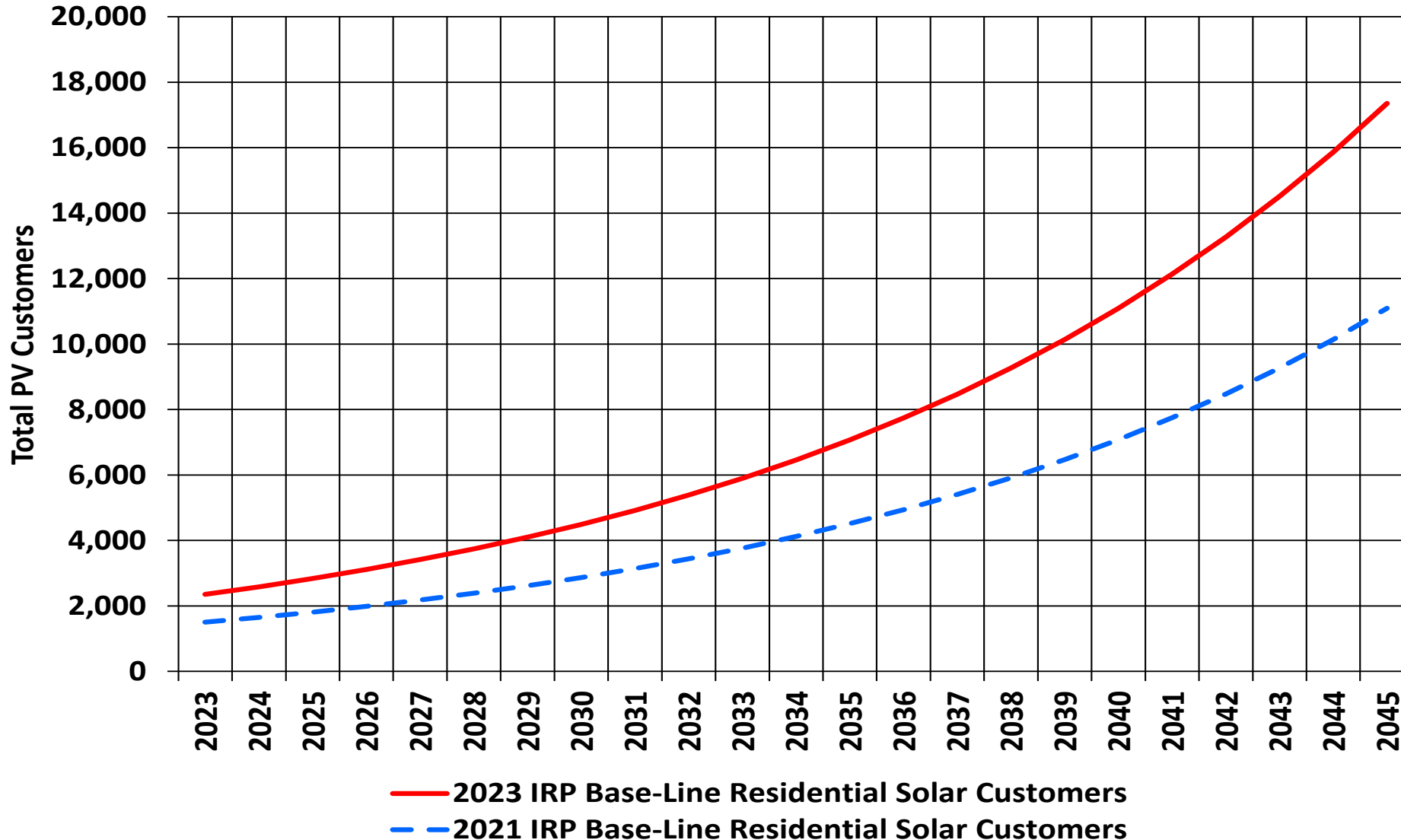

- Comments**
- Solar penetration now higher than 2021 IRP.
  - Current penetration is 0.6% of residential customers. This is projected to grow to 4% by 2045.
  - Current system size is around 7,000 watts, with the assumption of 8,900 watts by 2045
  - This remains a highly uncertain projection given on-going changes to public policy.



# Long-term Energy Forecast: Light Duty EVs, 2023-2045

Share of WA-ID LDV Sales

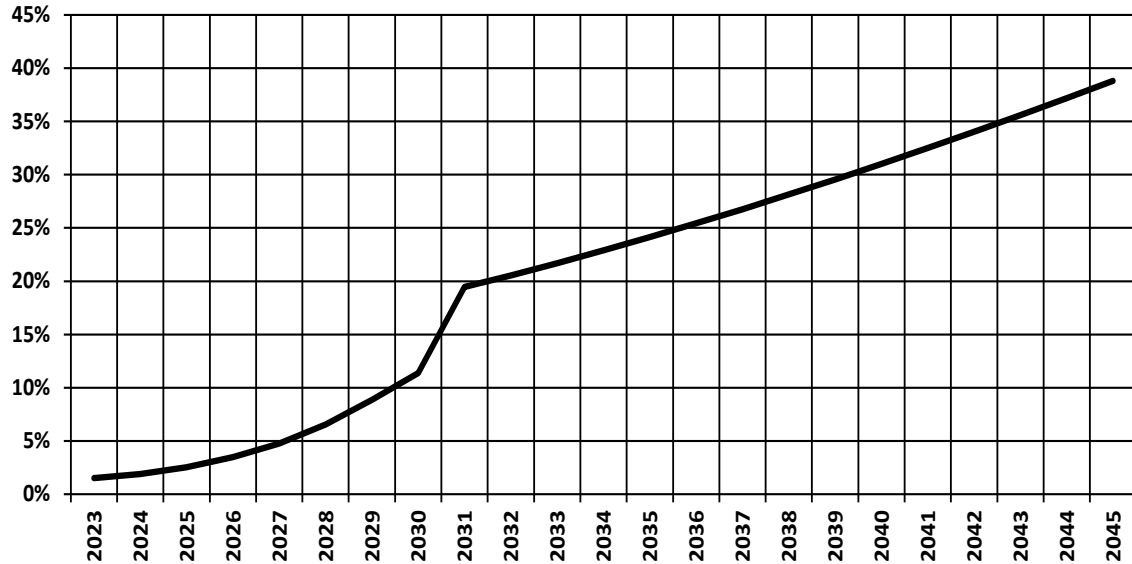

Projected Residential LDVs

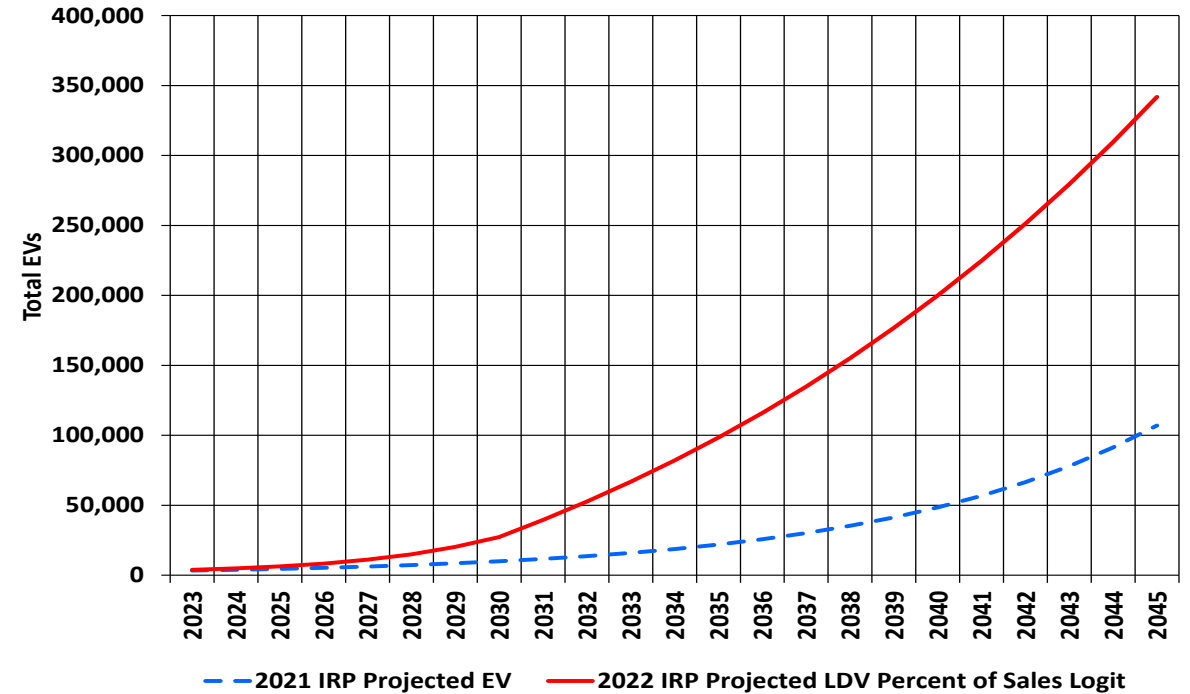

Comments

- Current light duty EVs are around 3,900. This is projected to grow to 342,000 by 2045—nearly 40% of all LDV sales.
- Current penetration is 0.5% of household vehicles. This is projected to grow to 27% by 2045.
- This remains a highly uncertain forecast given on-going changes in the EV industry and public policy.

# Long-term Energy Forecast: Medium Duty EVs, 2023-2045

Share of WA-ID MDV Sales

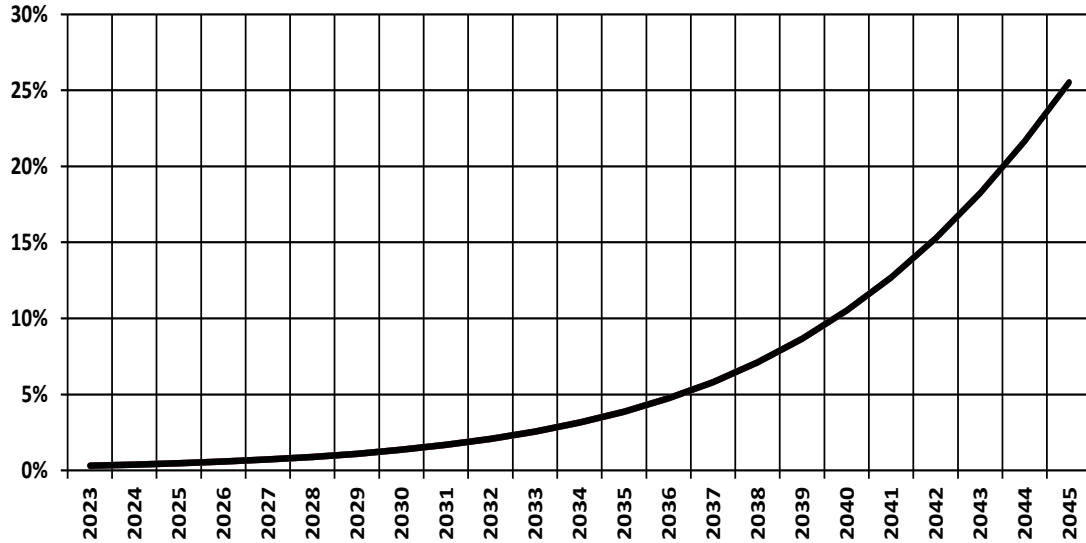

Projected Commercial MDVs

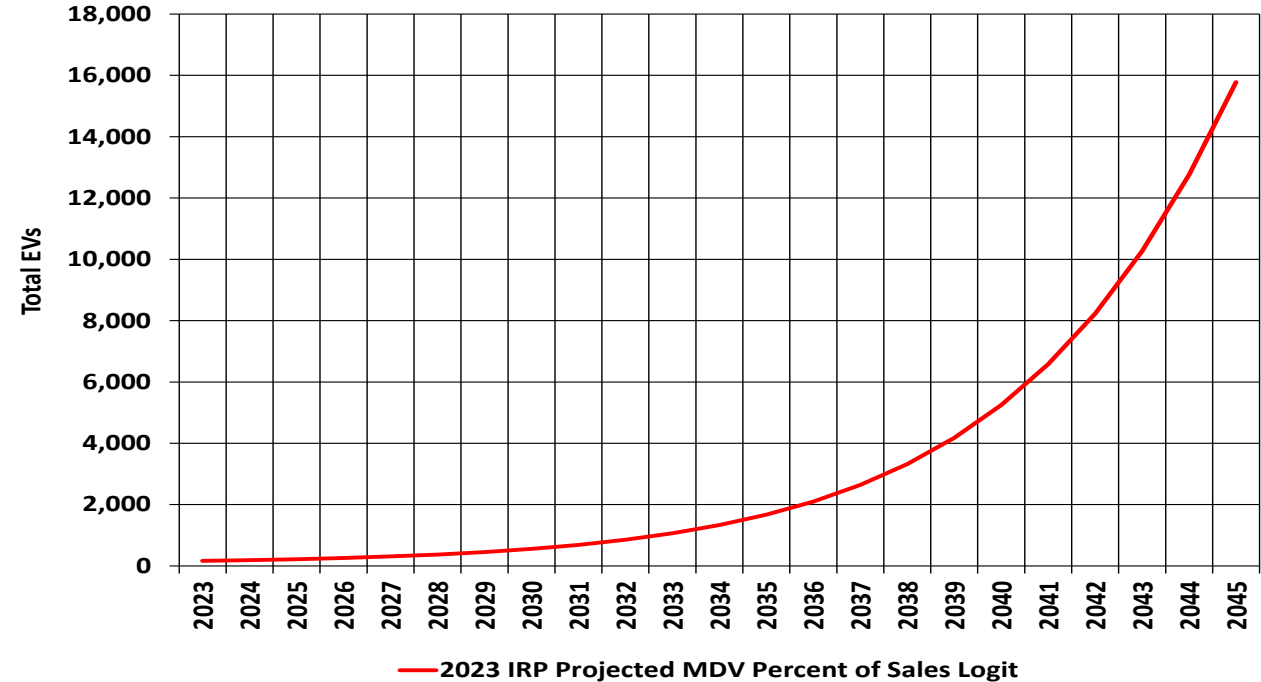

**Comments**

- Current medium EVs are approximately 170 (very rough estimate). This is projected to grow to over 15,000 by 2045—just over 25% of all MDV sales.
- Current penetration is 0.25% of all commercial vehicles (very rough estimate). This is projected to grow to 13% by 2045.
- Even more so than LDV, the MDV forecast is highly uncertain given on-going changes in the EV industry and public policy.



# Long-term Energy Forecast: Native Load

Native Load Forecast, Average Megawatts

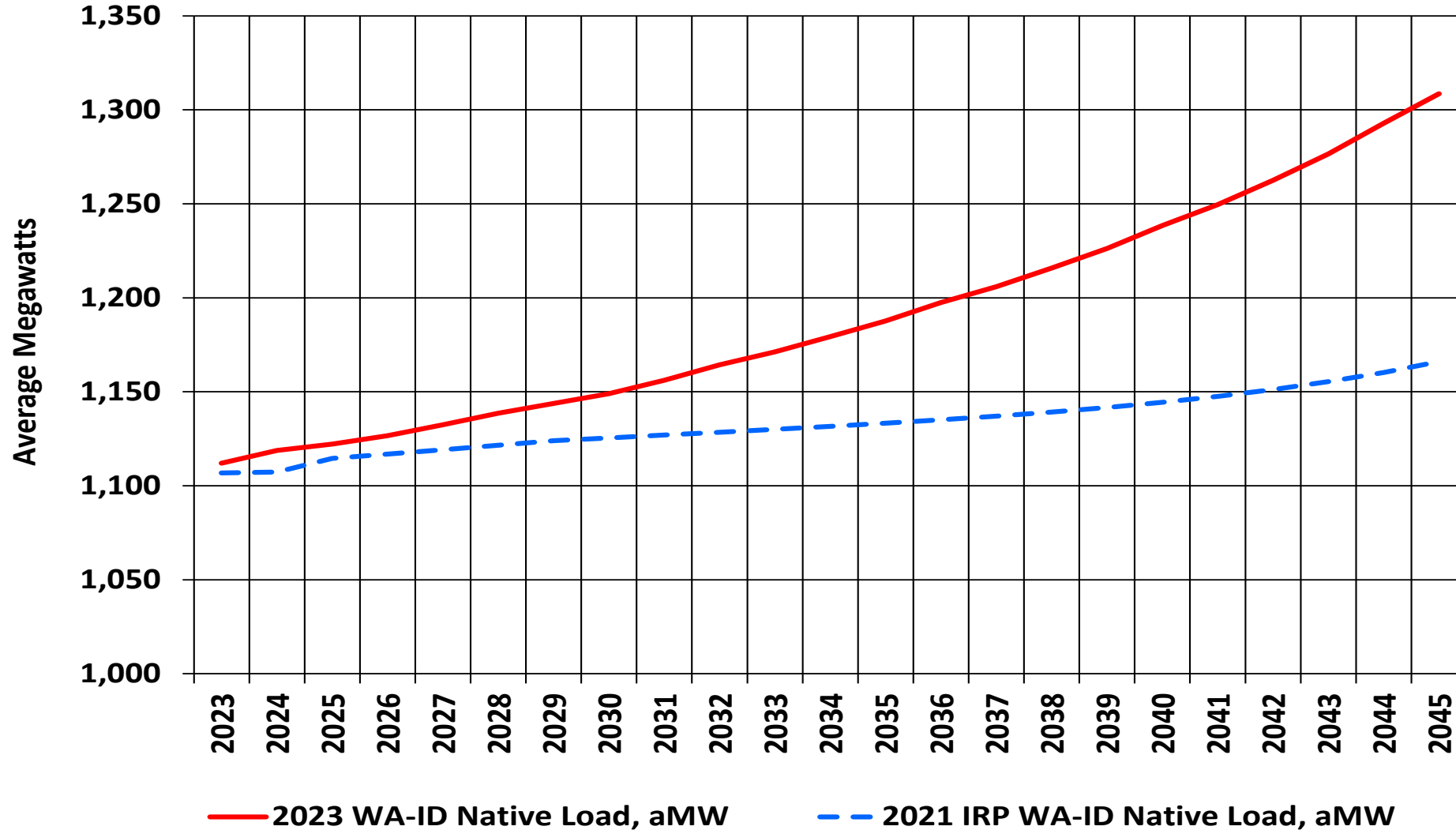

IRP	Avg. Annual Growth
2021 IRP	0.24%
2023 IRP	0.74%
2023 WA	0.72%
2023 ID	0.77%

- Comments**
- Higher load because of stronger customer growth, a lot more EVs, and adjustments for gas.
  - Most of the change reflects EVs





# Long-term Energy Forecast: Native Load with MDV EVs

### Native Load Forecast, Average Megawatts

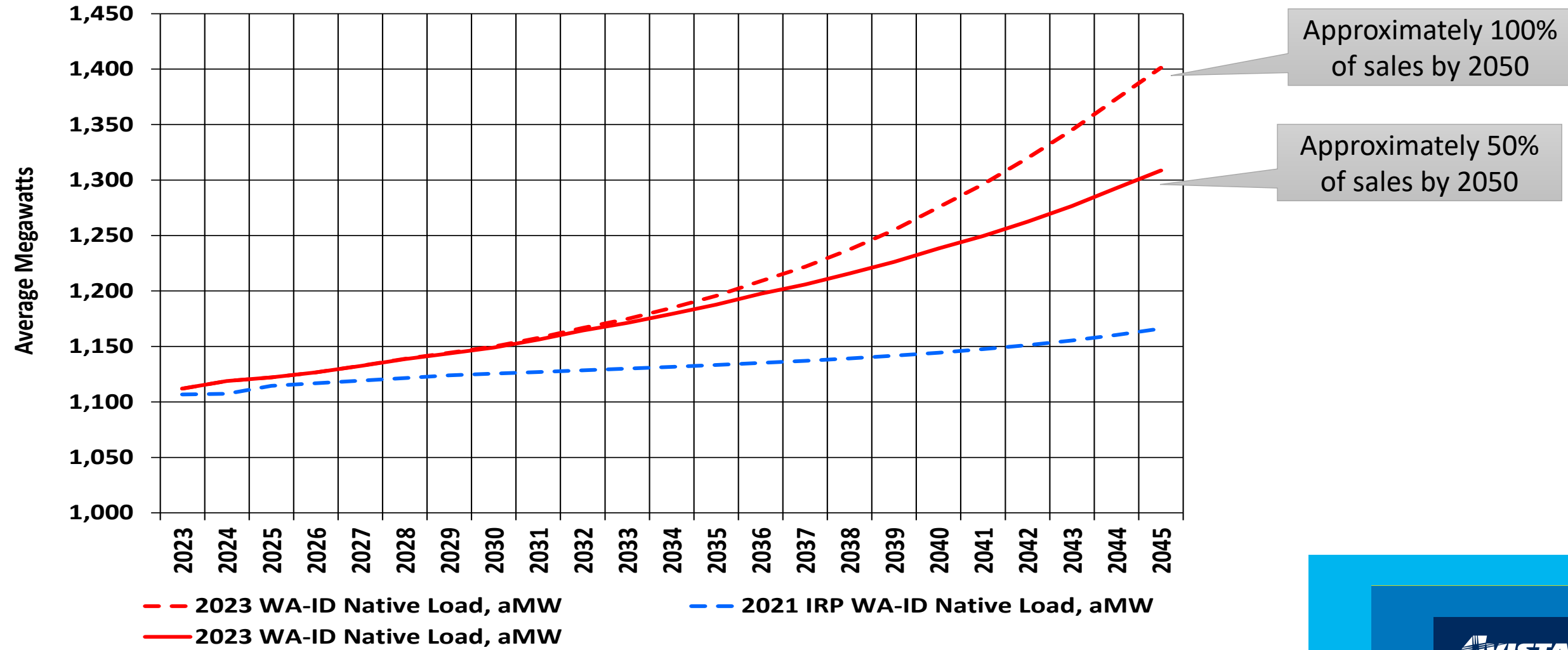

Approximately 100% of sales by 2050

Approximately 50% of sales by 2050



# Long-term Energy Forecast: High-Low Based on Economics

WA-ID System Average Megawatts

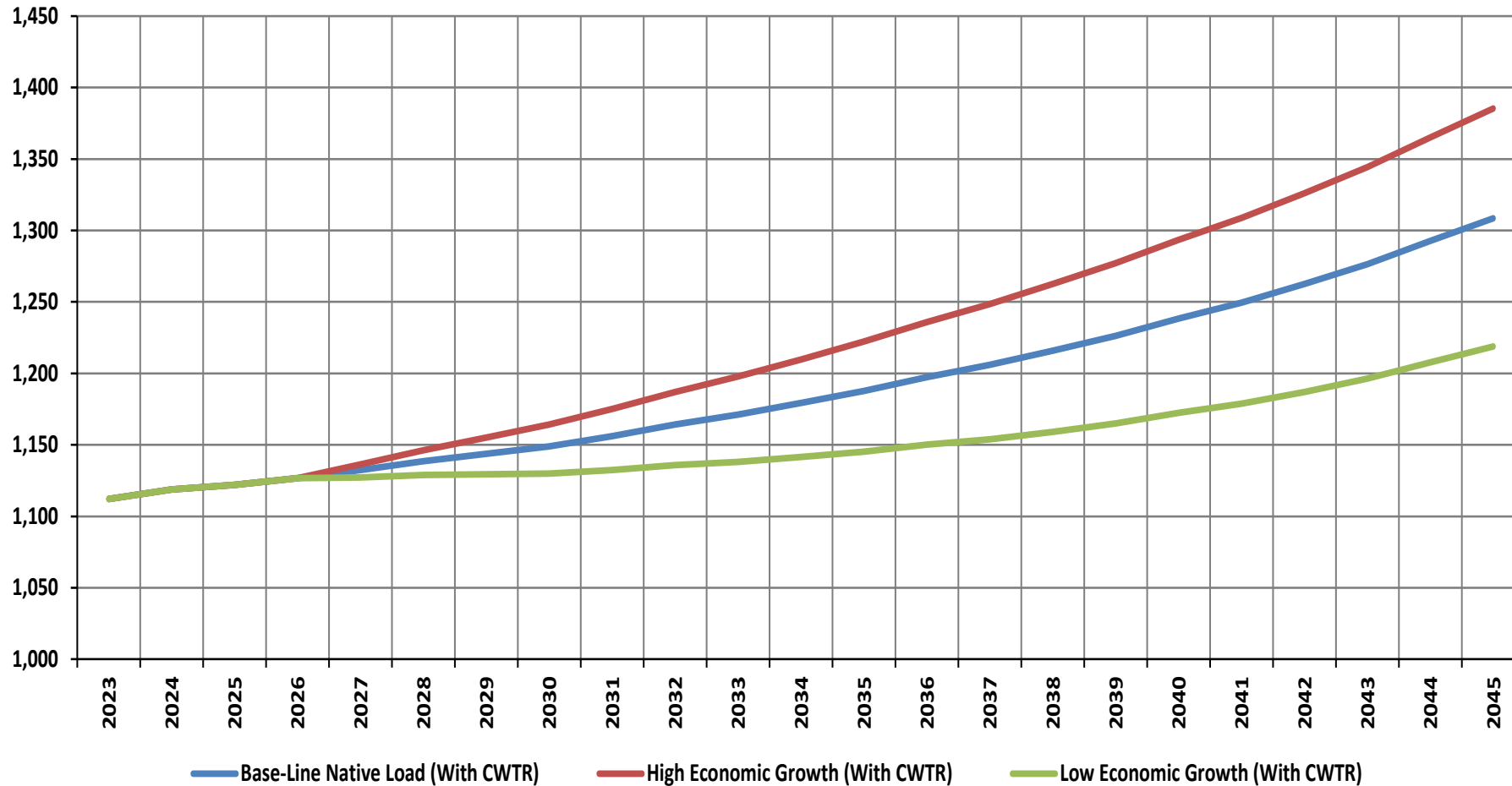

Variable	Base-Line	High	Low
GDP Growth	1.80%	2.40%	1.20%
WA Avg. Annual Res. Cus. Growth	0.69%	0.83%	0.47%
ID Avg. Annual Res. Cus. Growth	1.25%	1.55%	0.86%
WA-ID Avg. Annual Res. Cus. Growth	0.89%	1.09%	0.61%

**Comments**

- Base-line GDP growth is the Fed’s estimate.
- Historically, the stronger U.S. growth, the stronger population growth to our service areas.



# Long-term Energy Forecast: UPC Trends

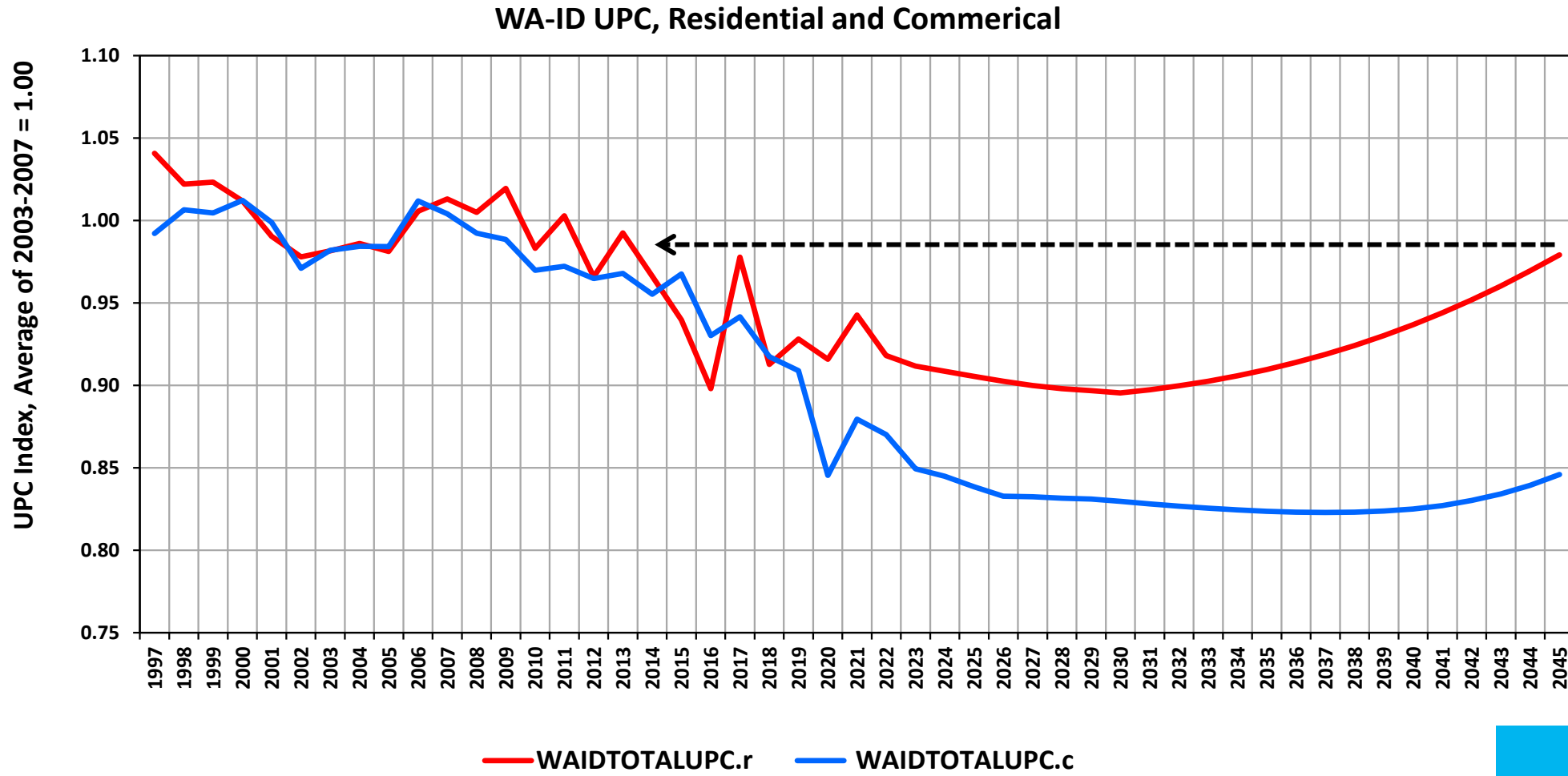

# Long-term Energy Forecast: State Native Load

State Native Load Forecast, Average Megawatts

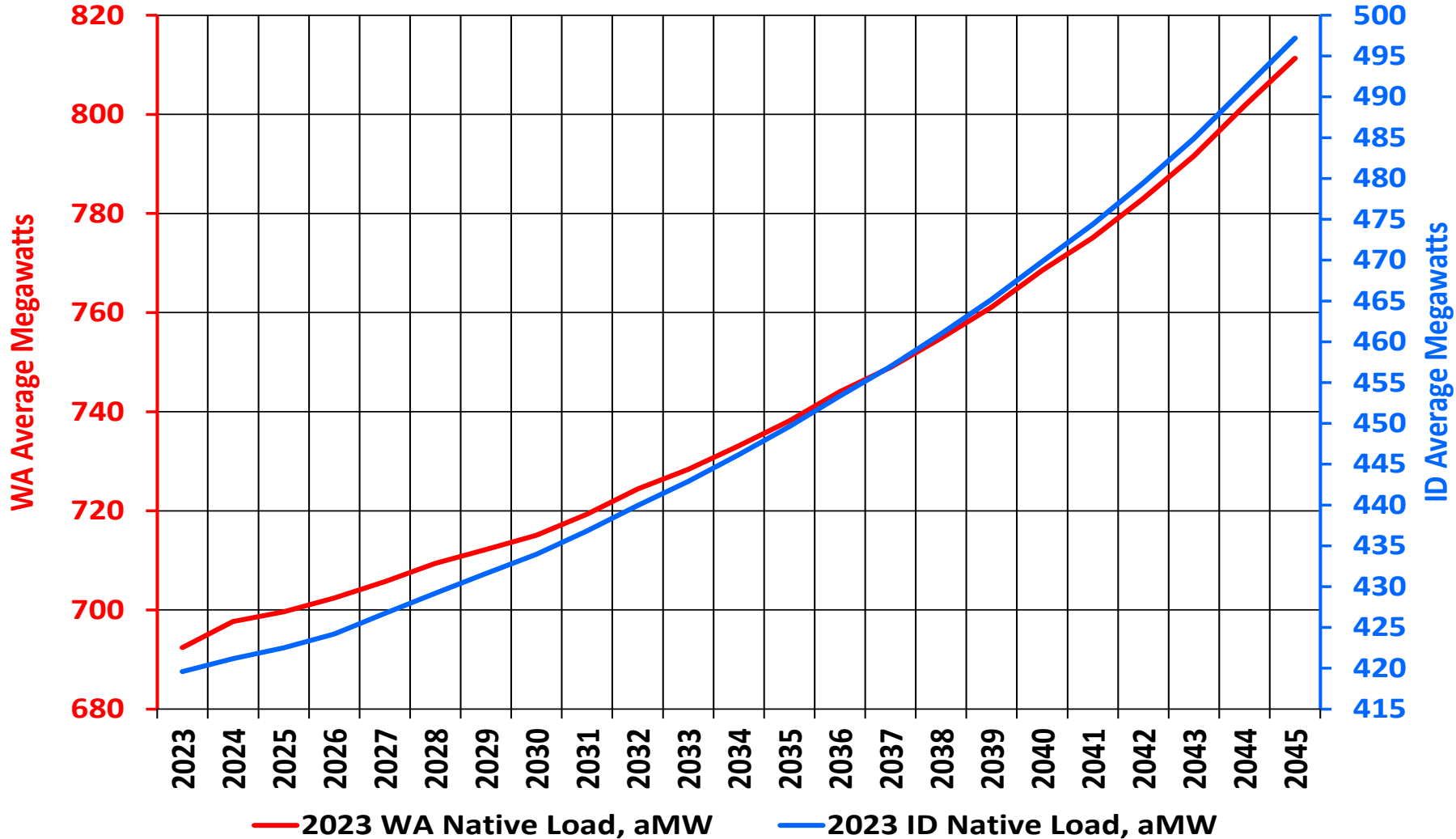

IRP	Avg. Annual Growth
2023 IRP	0.74%
2023 WA	0.72%
2023 ID	0.77%



# Peak Load Forecast: Winter and Summer Forecast

Winter and Summer Peak Including All Adjustments, Megawatts

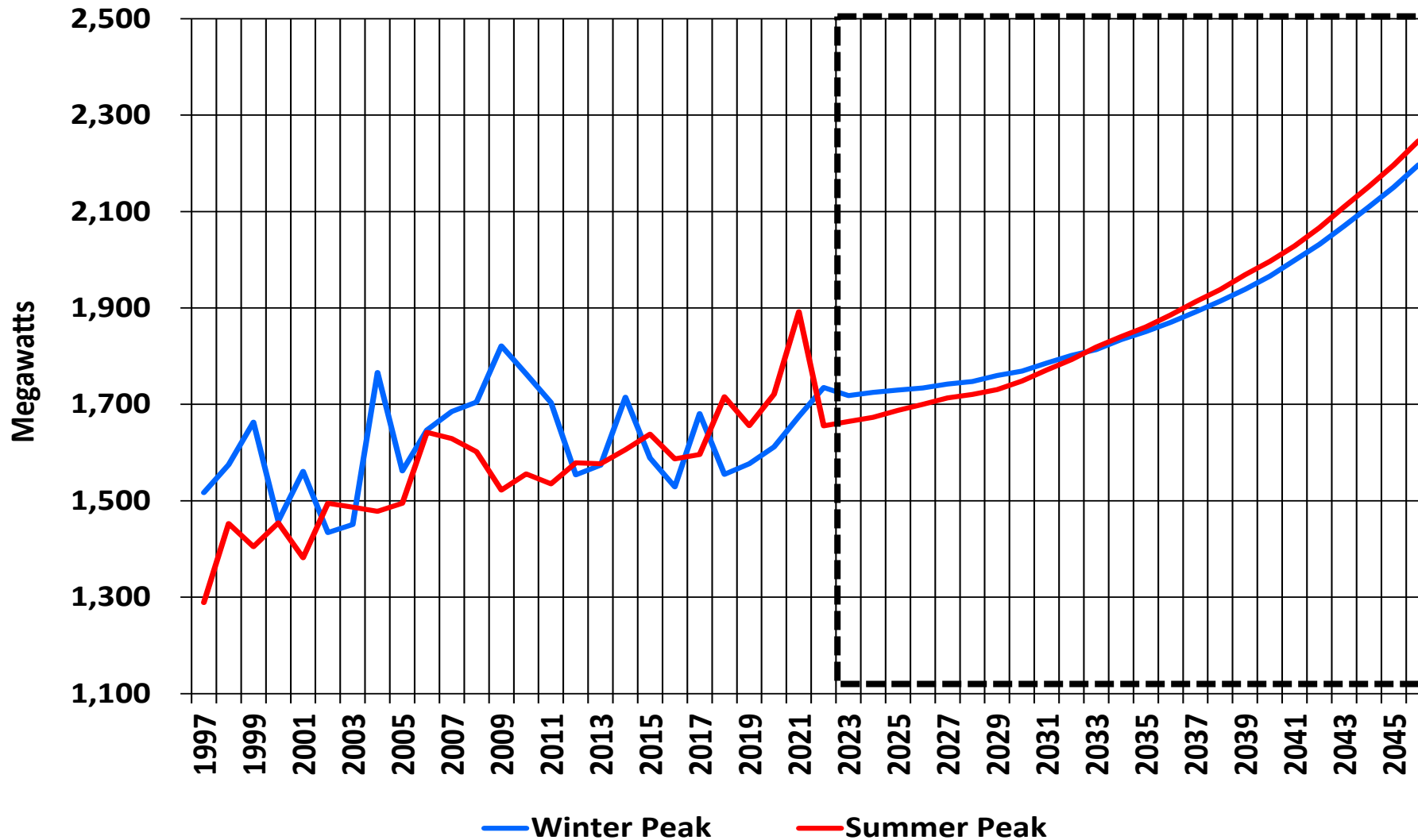

Peak	Avg. Growth 2023-45
Winter	1.02%
Summer	1.25%

**Comments**

- Reflects RCP 4.5.
- Over the forecast horizon, winter and summer peaks will be closer than previous IRPs. This largely reflects the impact of EVs and gas restrictions.



# Peak Load Forecast: Change in IRP Summer Peak

Summer Peak (RCP 4.5)

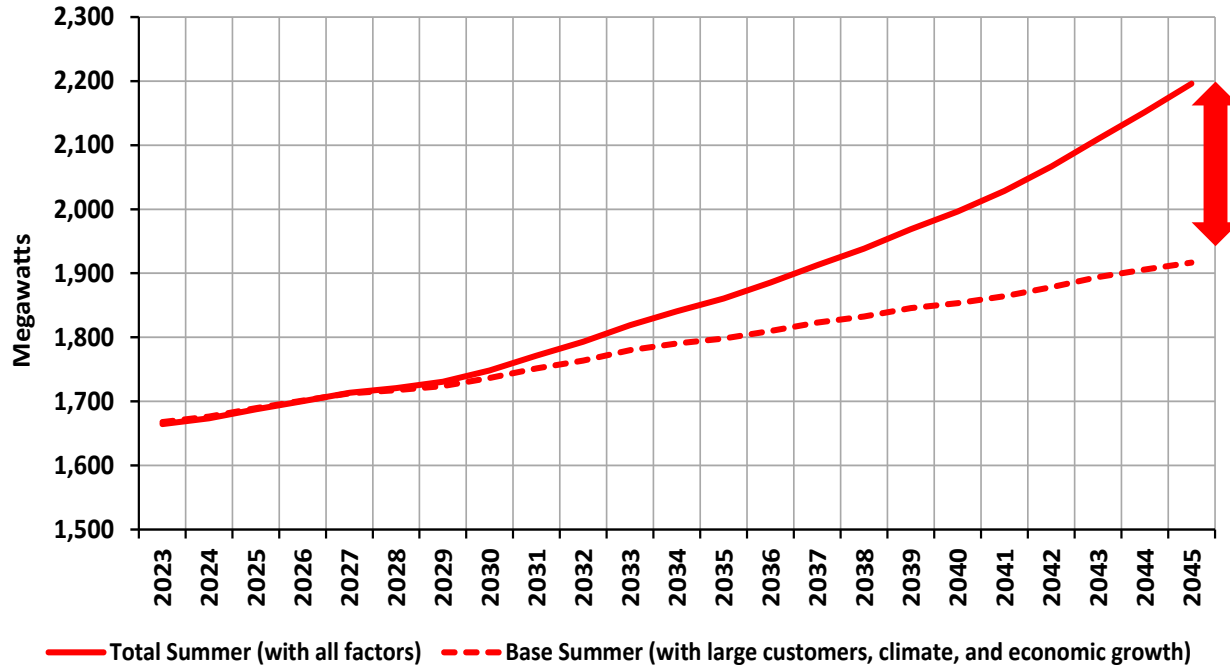

Summer Peak Additions (RCP 4.5)

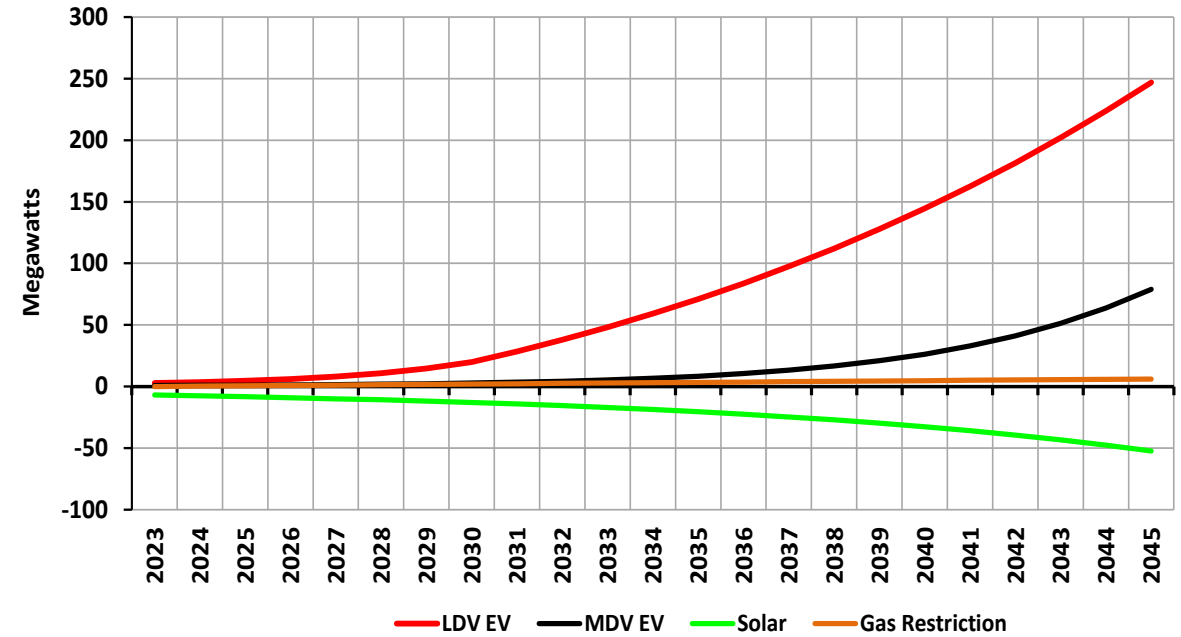

### Comments

- Economic growth and climate impacts are being dominated by EV additions.
- By 2045, 117% of additions over the base summer peak are from EVs (both LDVs and MDVs). The 117% reflects a significant negative impact from solar by 2045.
- Gas restriction impacts are modest and solar is not significant late 2030s.

# Peak Load Forecast: Change in IRP Winter Peak

Winter Peak (RCP 4.5)

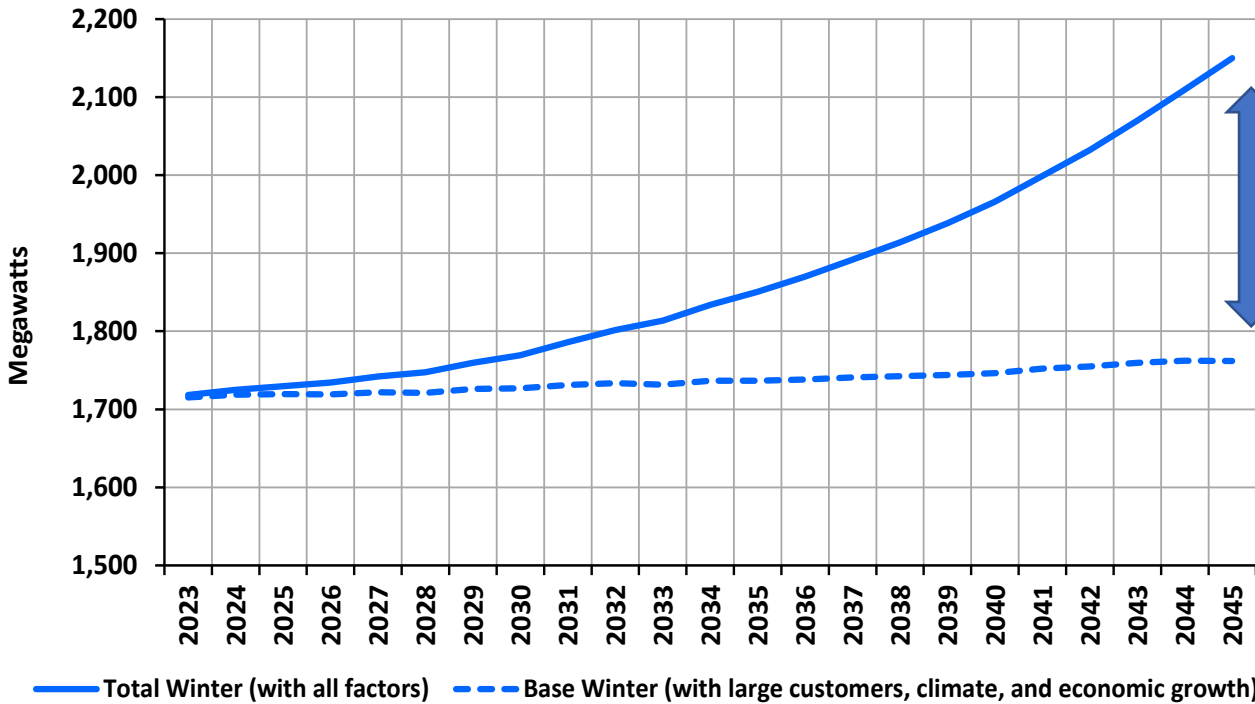

Winter Peak Additions (RCP 4.5)

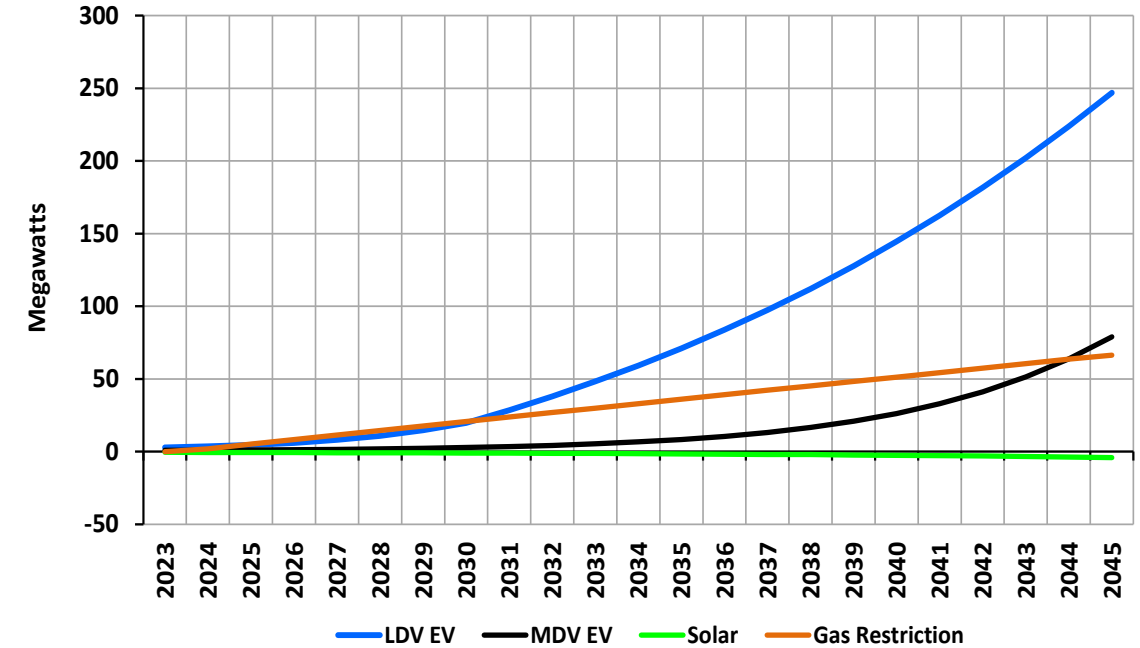

### Comments

- Economic growth and climate impacts are being dominated by EV additions.
- By 2045, 84% of additions over the base winter peak are from EVs (both LDVs and MDVs).
- Gas restriction impacts are significant by early 2030s, and solar is never significant.

# Peak Load Forecast: Change in IRP Summer Peak

Summer Peak: Current and Previous IRP, Megawatts

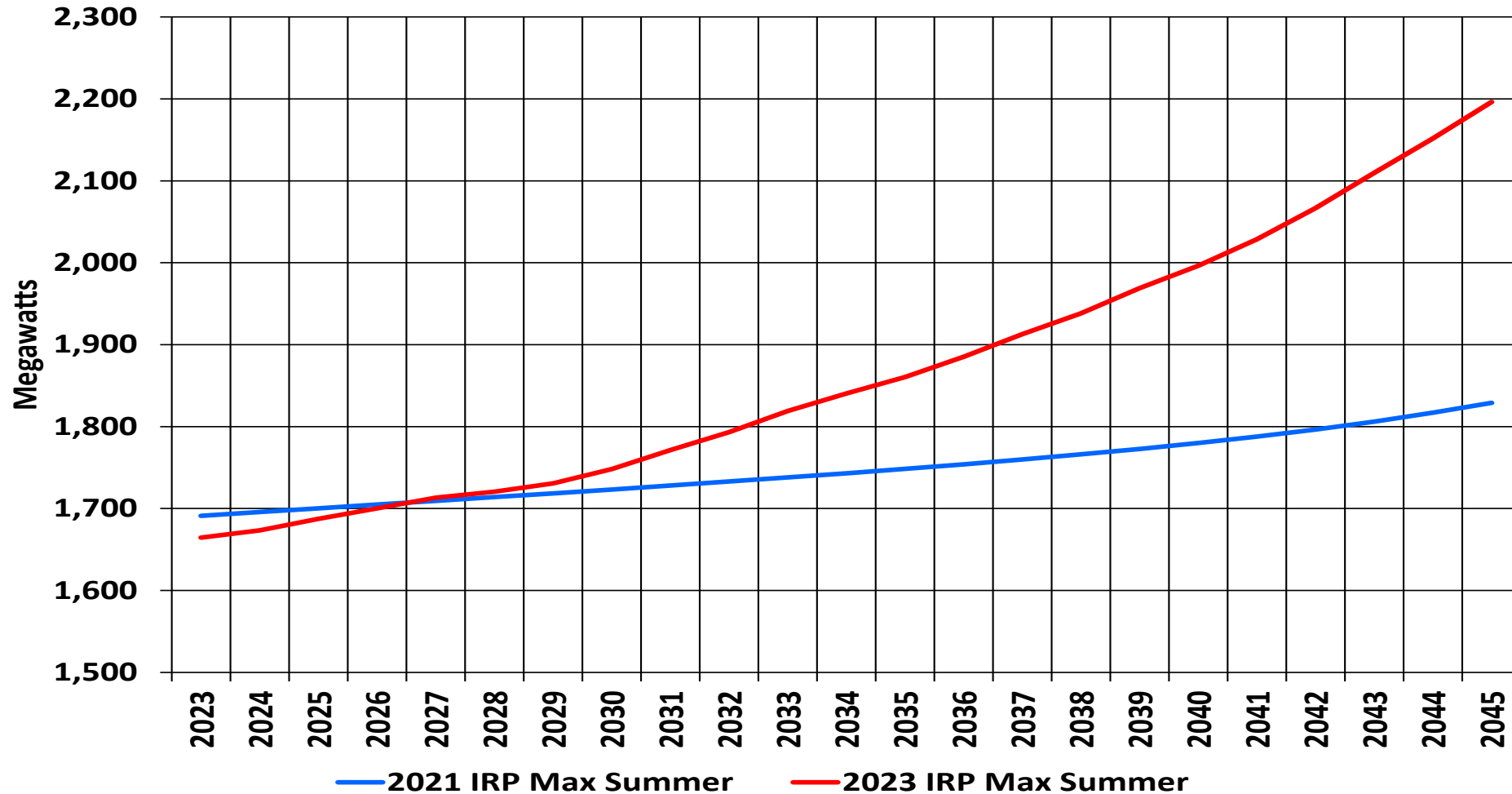



# Peak Load Forecast: Change in IRP Winter Peak

Winter Peak: Current and Previous IRP, Megawatts

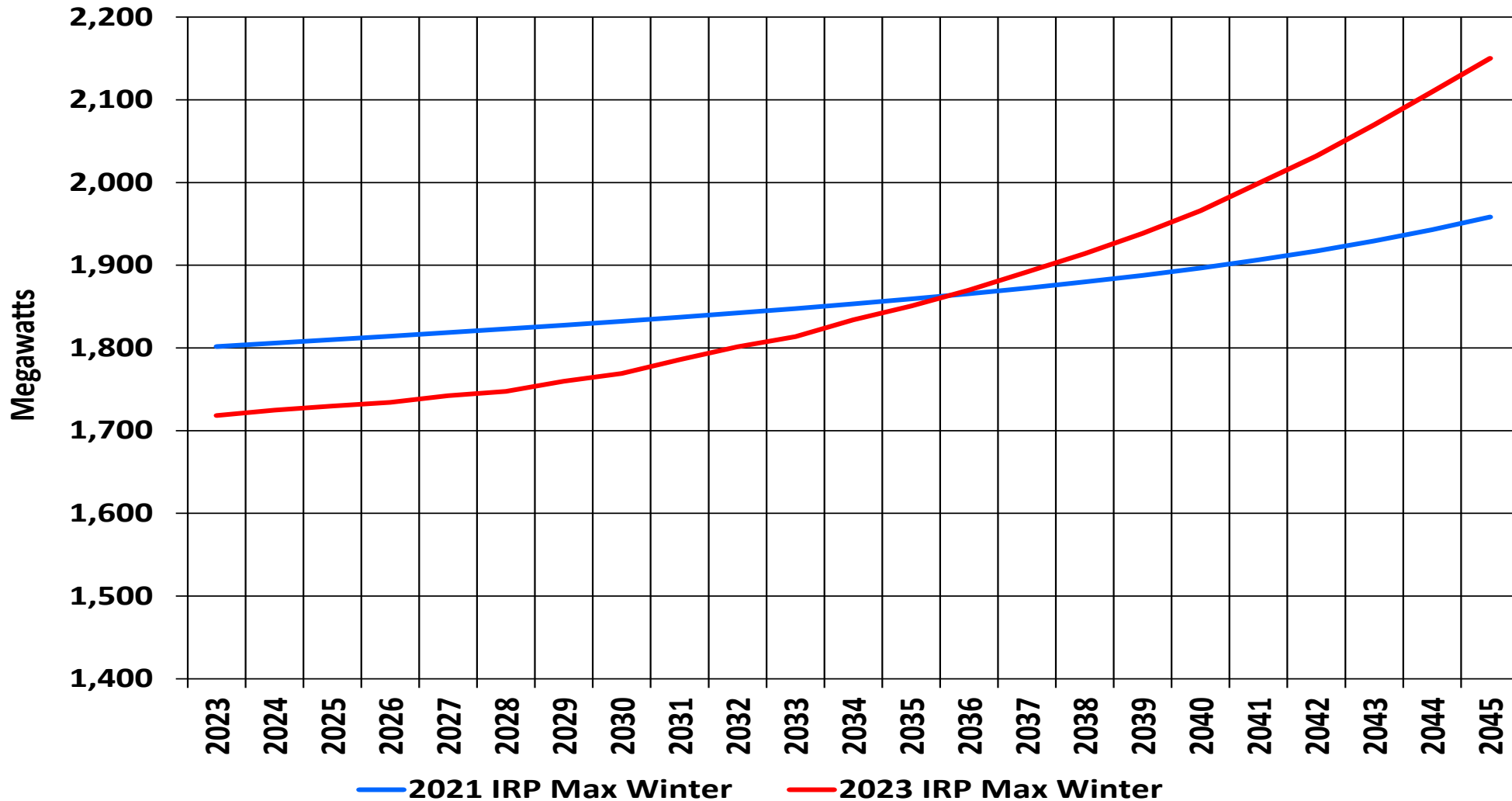

# Questions?



# Loads & Resources Update

2023 Avista Electric IRP

TAC 7 – October 11, 2022

Lori Hermanson, Senior Power Supply Analyst

# Major L&R Changes Since 2021 IRP

- Load forecast
- Incorporates climate change impacts – hydro & loads
- Used WRAP QCCs for peak capacity contributions
- 30 MW industrial demand response (Washington Rate Case Settlement)
- Chelan County PUD purchase
- Assumed retirement dates for Colstrip (2025), Northeast (2035), Boulder Park and Kettle Falls CT (2040)
- Additional RFP resources - not included

# Peak Planning Assumptions

- Peak load forecast
- Planning reserve margins
  - Winter – 22%
  - Summer – 13%
- Regulation – 16 MW
- Operating reserves for borderline contracts – average 16 MW (varies by month)
- Use WRAP's Qualifying Capacity Credits (QCC) for generation and demand response resources
  - Not incorporating the WRAP's planning reserve margins, but will share the impacts of these PRMs (slide 7)

## Winter Peak Load & Resource Balance

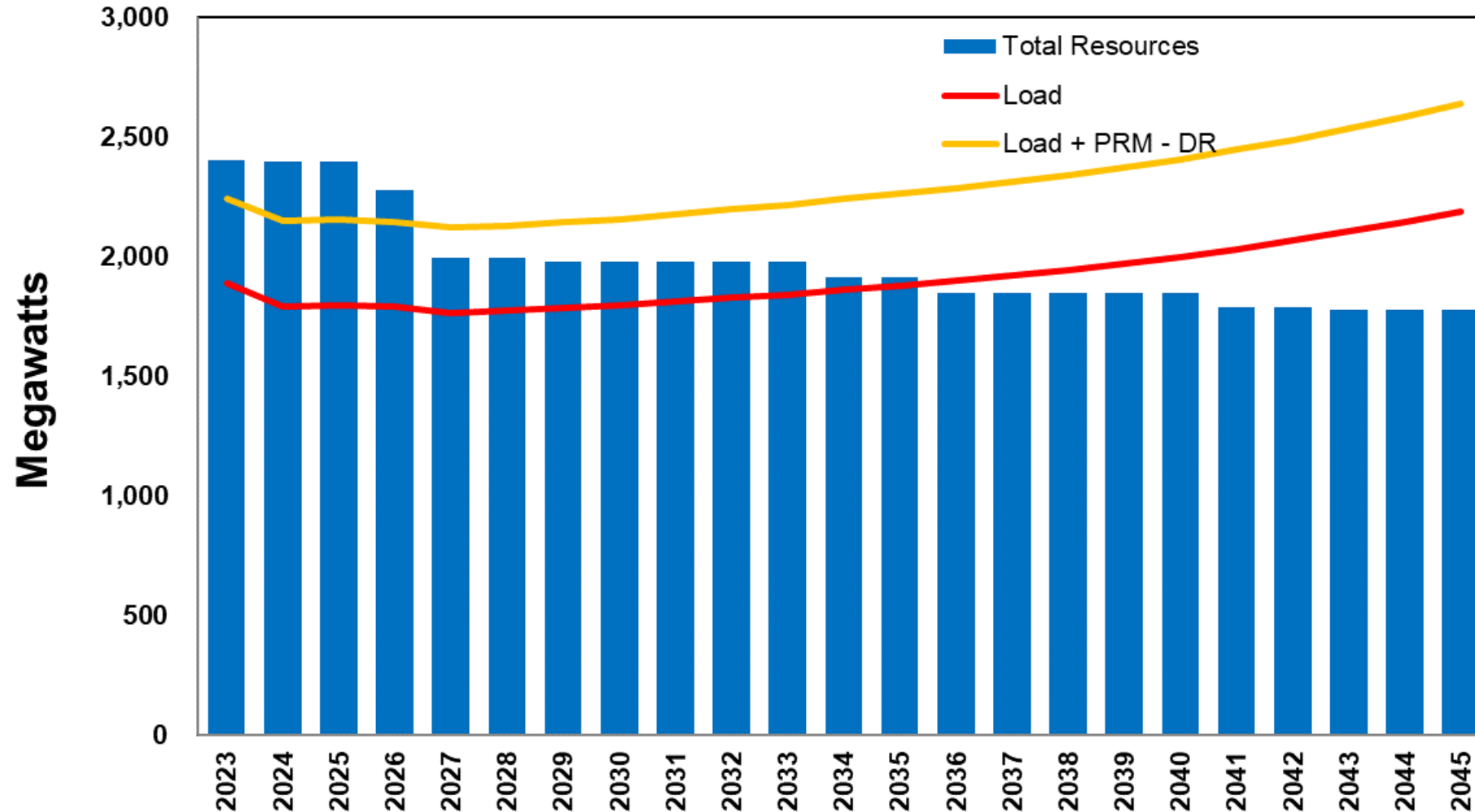

## Summer Peak Load & Resource Balance

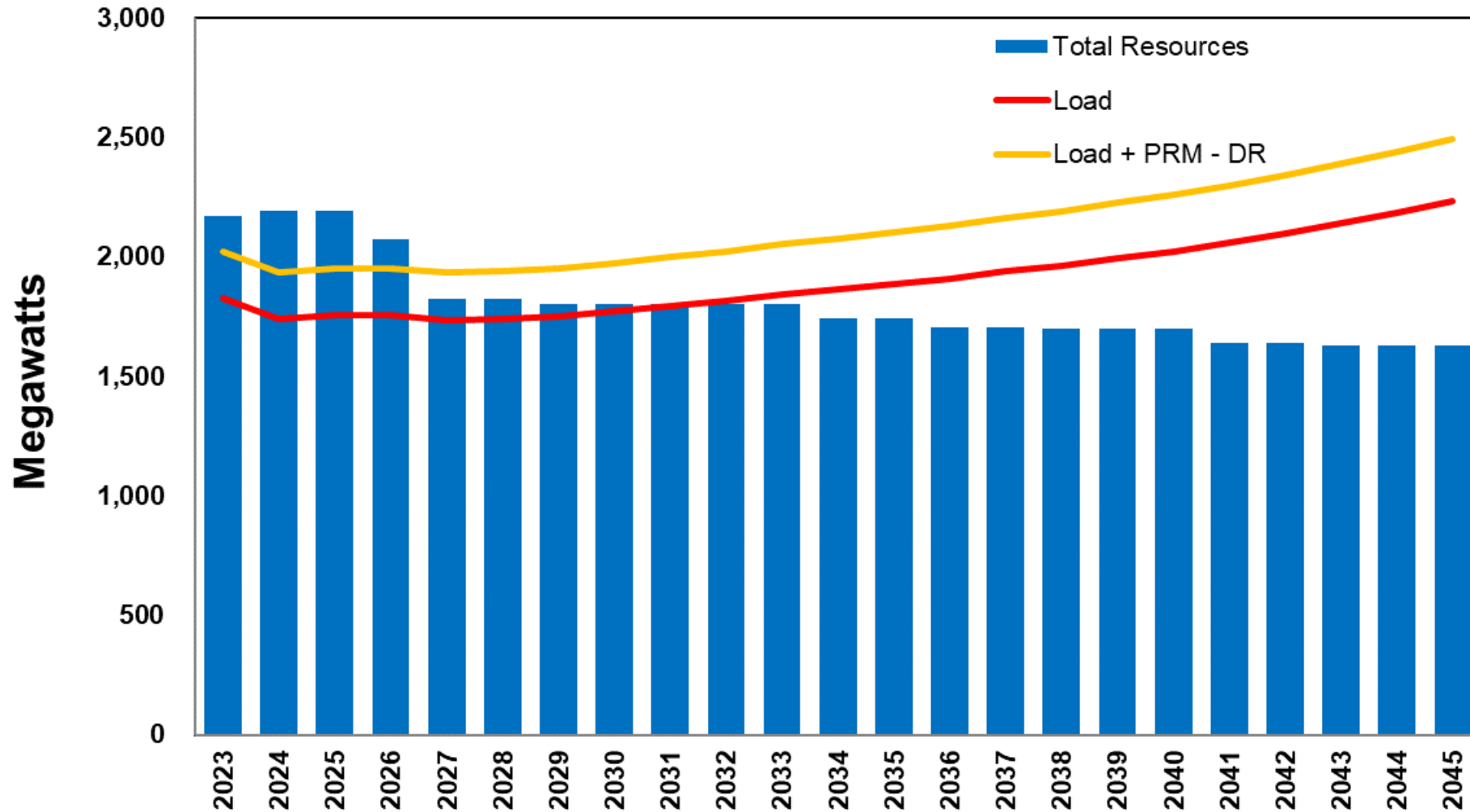

## System Peak Capacity Position

Using historical peak planning criteria

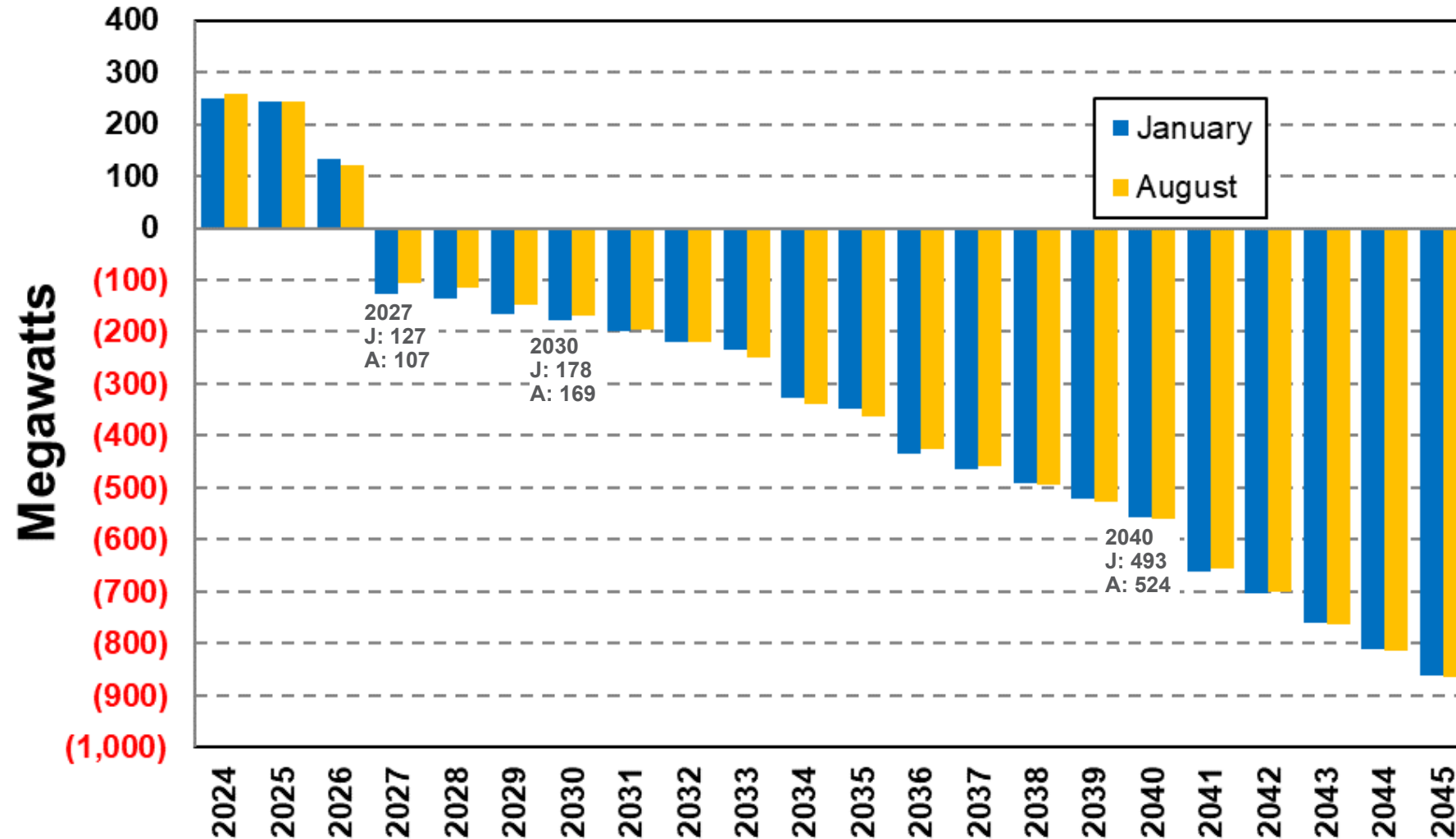



## System Capacity Position

Using Western Resource Adequacy Program Planning Reserve Margins

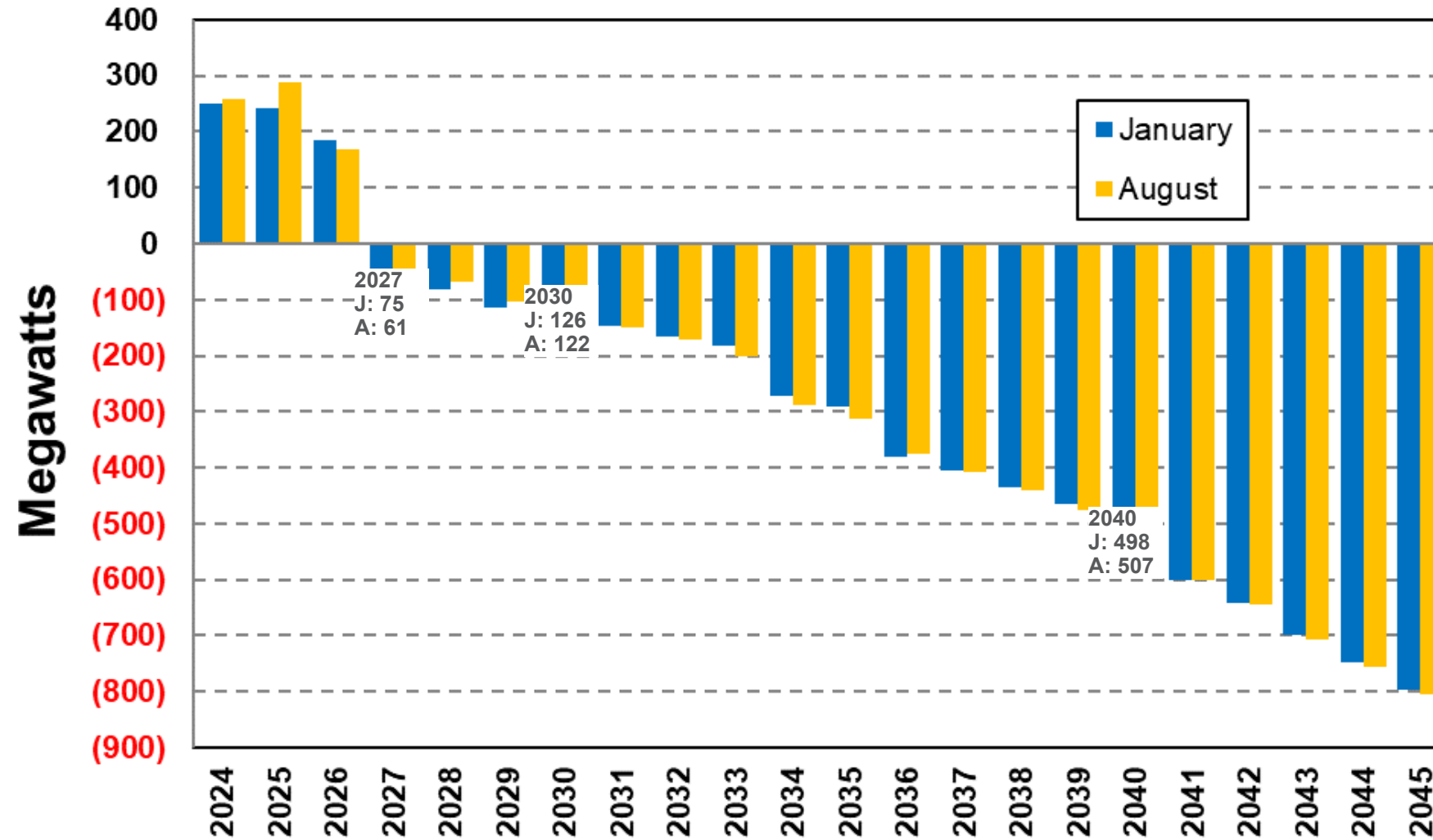

7 Seasonal winter/summer peak not included at this time, short position begins in Jan 1, 2027

# Energy Planning

- Expected energy load forecast
- Production capability generation forecast
  - Normal weather conditions
  - Machine hour limits
  - Maintenance and forced outages
- Incorporates climate change impacts – hydro & loads
- Includes contingency for changes in load and variable generations

# Energy Contingency

- Difference between average generation and load conditions with extreme conditions.
- Previous IRP
  - Difference between 90<sup>th</sup> percentile of load and average load + difference between 10<sup>th</sup> percentile of hydro generation and average generation
- 2023 IRP
  - Developed a dataset of load and renewables generation (varying hydro, wind and solar) for the period 1948-2019
  - Used average minus 95<sup>th</sup> percentile of the net of load minus renewable generation

**Energy Contingency for Load and Renewable Variability 2023 (aMW)**

	Jan	Feb	Mar	Apr	May	June	July	Aug	Sept	Oct	Nov	Dec	Avg
Previous IRP	209	240	244	227	196	291	307	171	118	117	168	175	205
2023 IRP	227	216	211	253	186	320	306	170	118	120	170	125	202
Change	18	-24	-33	26	-10	29	-1	-1	0	3	2	-50	-3

**DRAFT**

# System Planning Energy Position – Monthly (aMW)

	Jan	Feb	Mar	Apr	May	Jun	Jul	Aug	Sep	Oct	Nov	Dec
2024	204	185	347	429	422	485	292	176	276	290	259	292
2025	212	207	360	375	507	590	298	175	275	286	259	293
2026	91	59	208	332	355	397	126	28	113	131	(130)	(120)
2027	(197)	(204)	(53)	149	296	299	(117)	(215)	(137)	(119)	(149)	(141)
2028	(203)	(221)	(57)	123	288	286	(139)	(229)	(140)	(131)	(163)	(159)
2029	(202)	(204)	(39)	138	334	273	(150)	(249)	(151)	(132)	(164)	(151)
2030	(204)	(208)	(30)	136	220	267	(158)	(259)	(158)	(133)	(169)	(158)
2031	(211)	(208)	(22)	123	291	268	(150)	(261)	(154)	(136)	(176)	(163)
2032	(203)	(218)	(22)	118	307	271	(146)	(262)	(156)	(139)	(181)	(167)
2033	(209)	(211)	(22)	126	359	260	(157)	(272)	(156)	(145)	(179)	(170)

# Proposed CETA Compliance Methodology

- CEIP outlines 2023-2025 clean energy targets
- 2026-2029 target continue trend to 2030
- “Use” rules for CETA compliance not complete
  - If clean generation exceeds monthly “net” retail sales, it qualifies as alternative compliance after 2030
  - Renewable energy can be sourced from allocated Washington share or purchased from Idaho customers (wind/new PPA hydro)
  - Assumes Idaho allocated hydro available after 2030 for alternative compliance

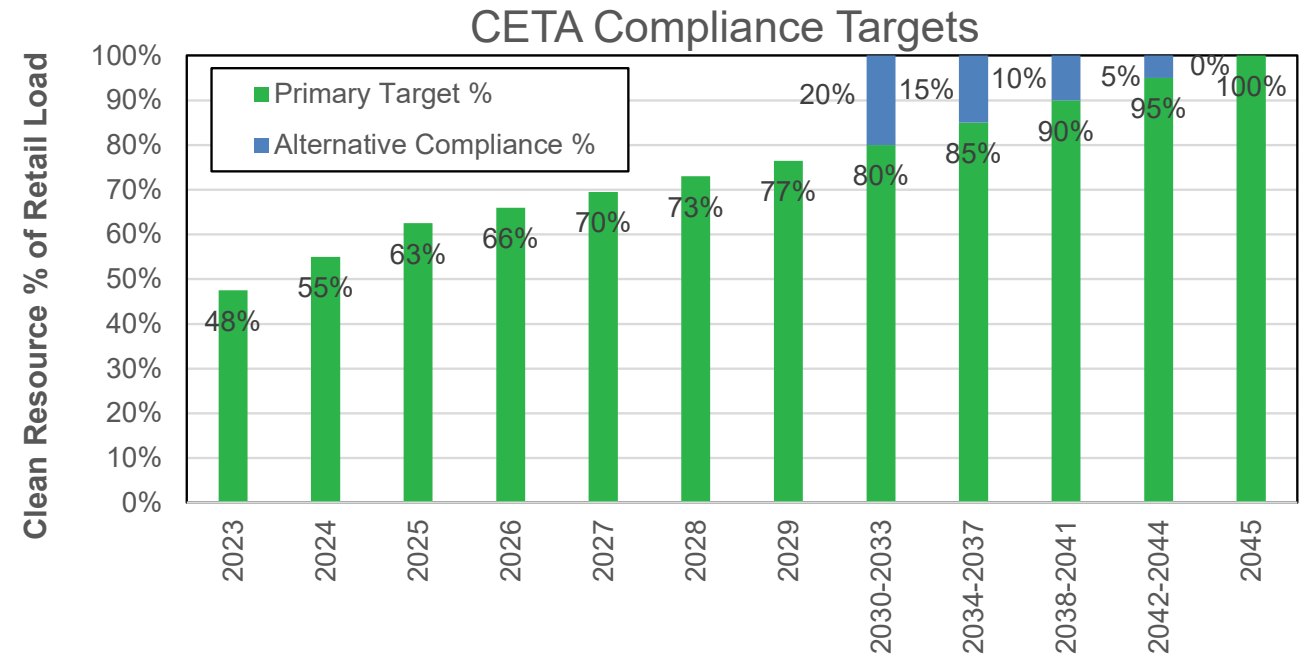

*Production/Load risk still needs to be accounted for with compliance windows*

## Washington Clean Energy Position

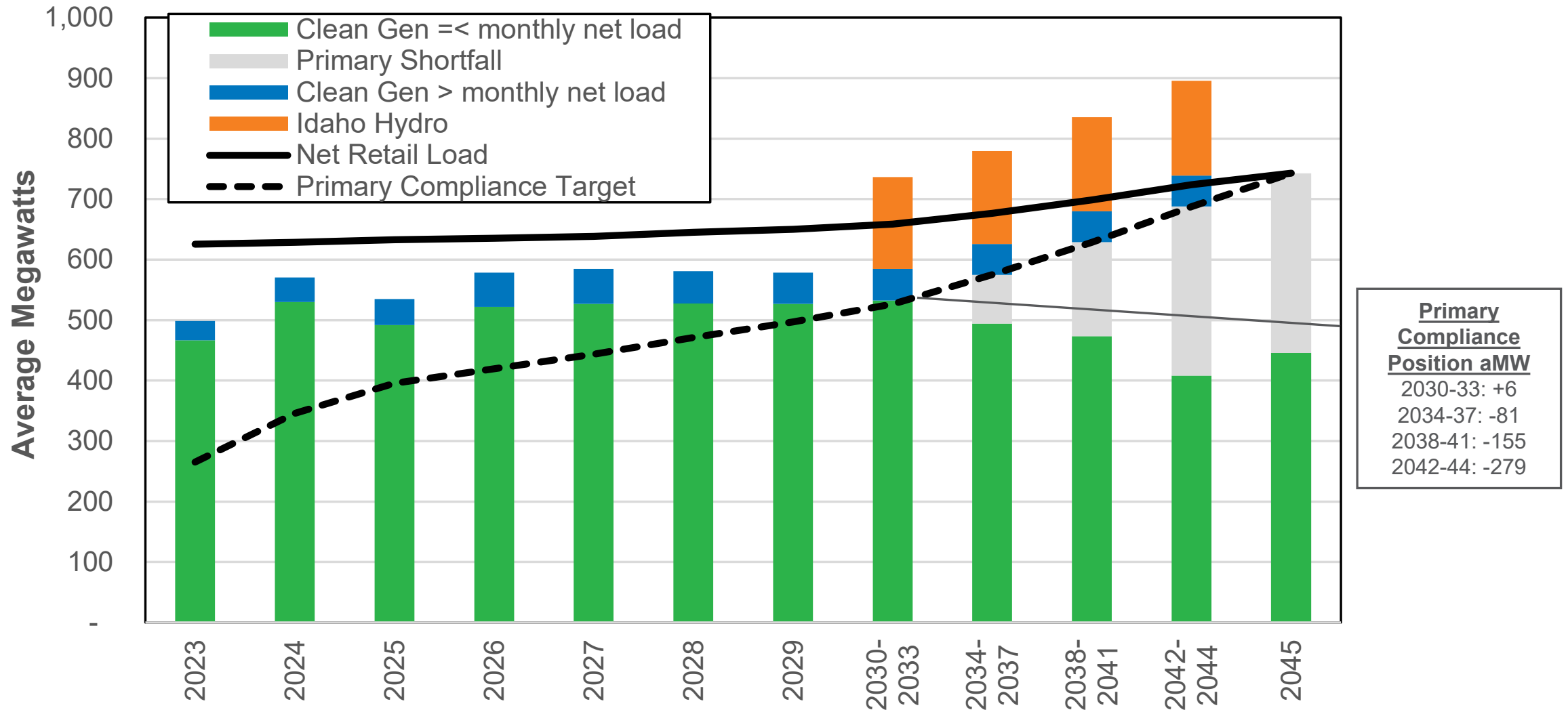



# Natural Gas Market Dynamics and Prices

Michael Brutocao

Tom Pardee

DRAFT

## Wood Mackenzie – Legal Disclaimer

The foregoing [chart/graph/table/information] was obtained from the North America Gas Service™, a product of Wood Mackenzie.” Any Information disclosed pursuant to this agreement shall further include the following disclaimer: "The data and information provided by Wood Mackenzie should not be interpreted as advice and you should not rely on it for any purpose. You may not copy or use this data and information except as expressly permitted by Wood Mackenzie in writing. To the fullest extent permitted by law, Wood Mackenzie accepts no responsibility for your use of this data and information except as specified in a written agreement you have entered into with Wood Mackenzie for the provision of such of such data and information."



# Natural gas remains strategically important in North America as it represents at least a third of total energy demand over the next 30 years

The pace of energy transition threatens gas demand growth as fossil fuel demand wanes in the long term

## Primary energy demand mix in North America

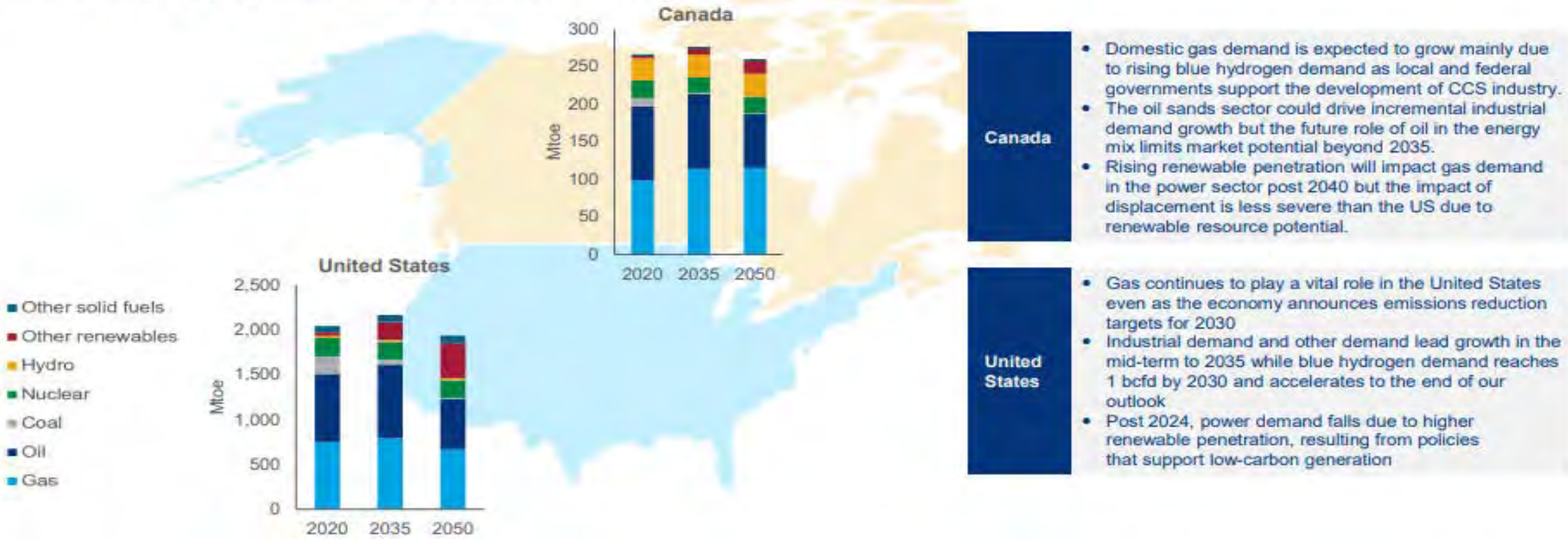

# US regional demand: the Gulf Coast stands out as domestic demand increases despite peaking in late 2030s

## Gulf Coast

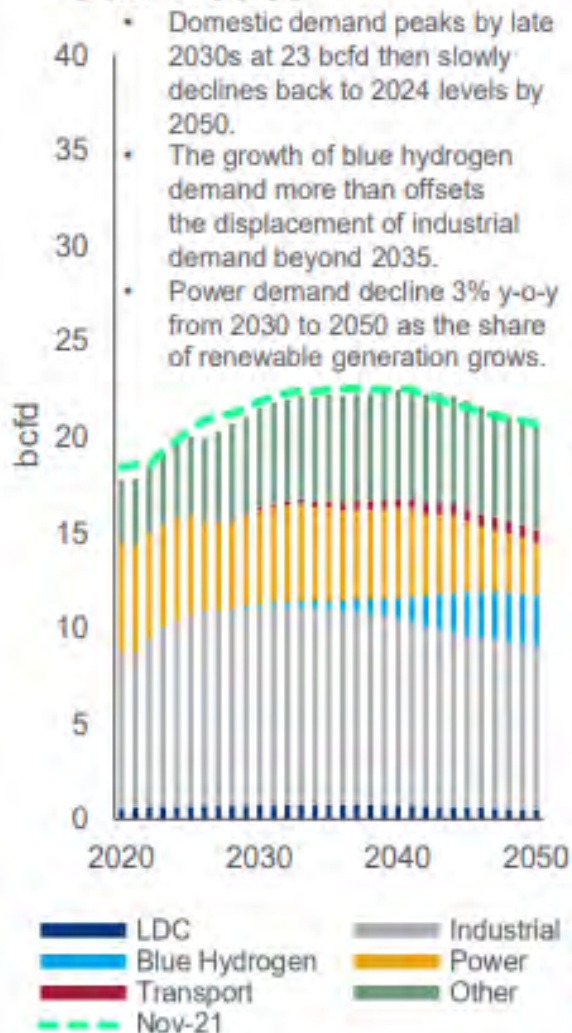

## Pacific

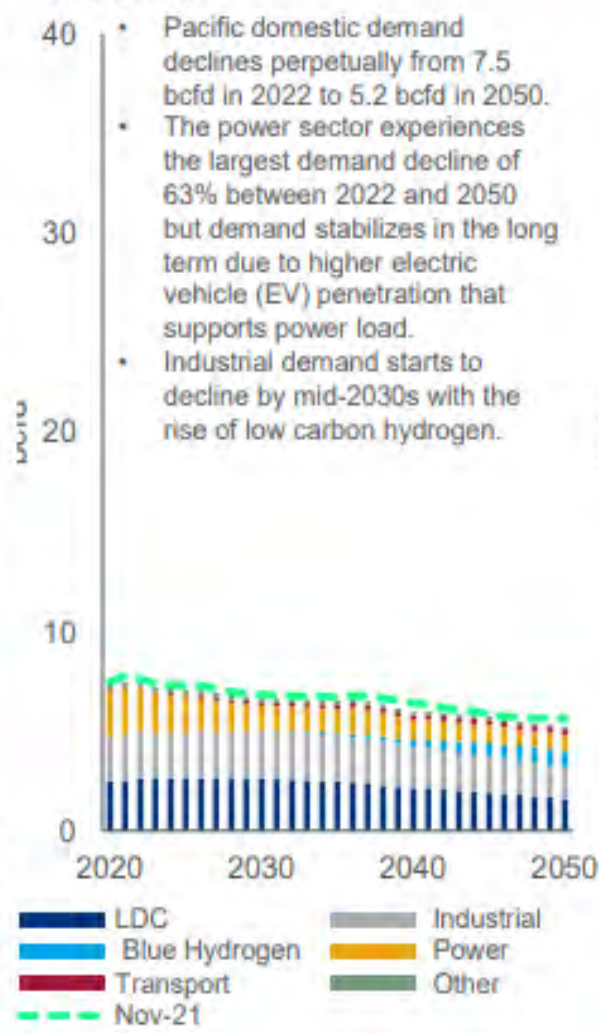

## Midwest

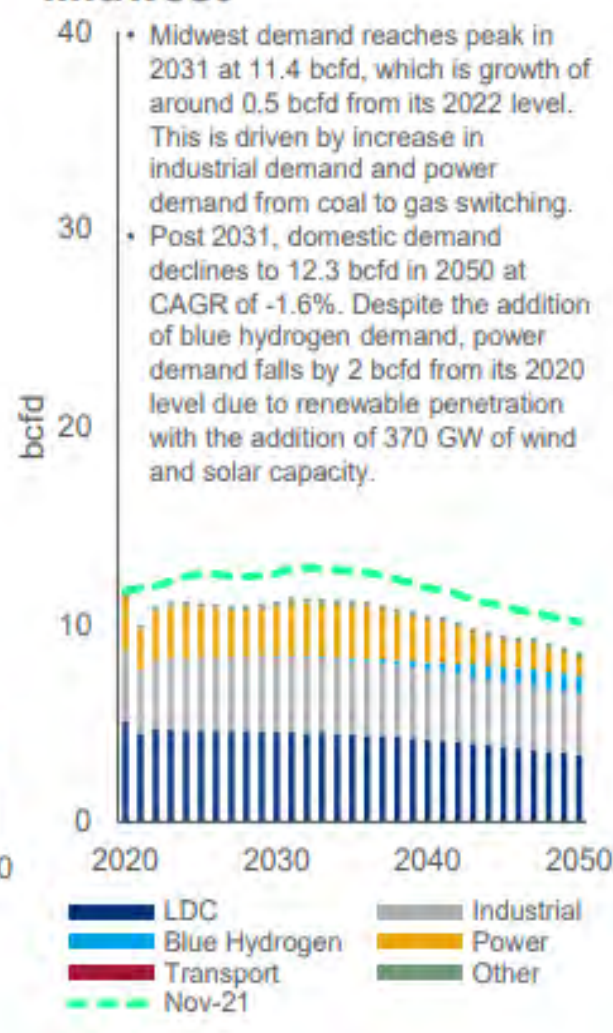

## Northeast

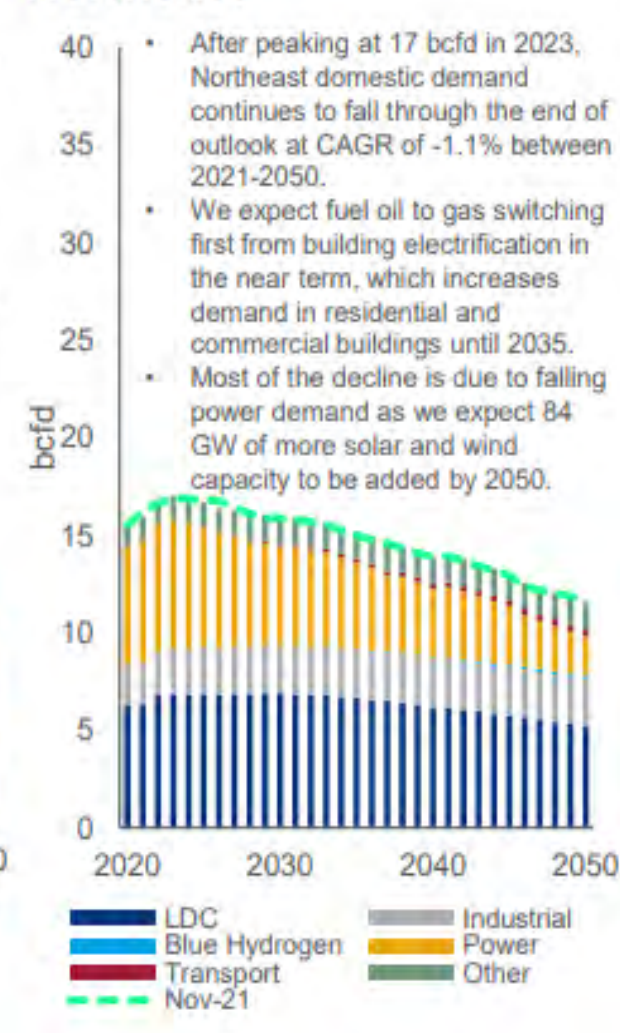

# North American domestic demand reaches its peak in the early 2030s; longer term growth only from blue hydrogen and transport sectors

Energy transition impacts power demand the most with demand falling by almost two thirds between 2022 and 2050

North America gas demand by sector

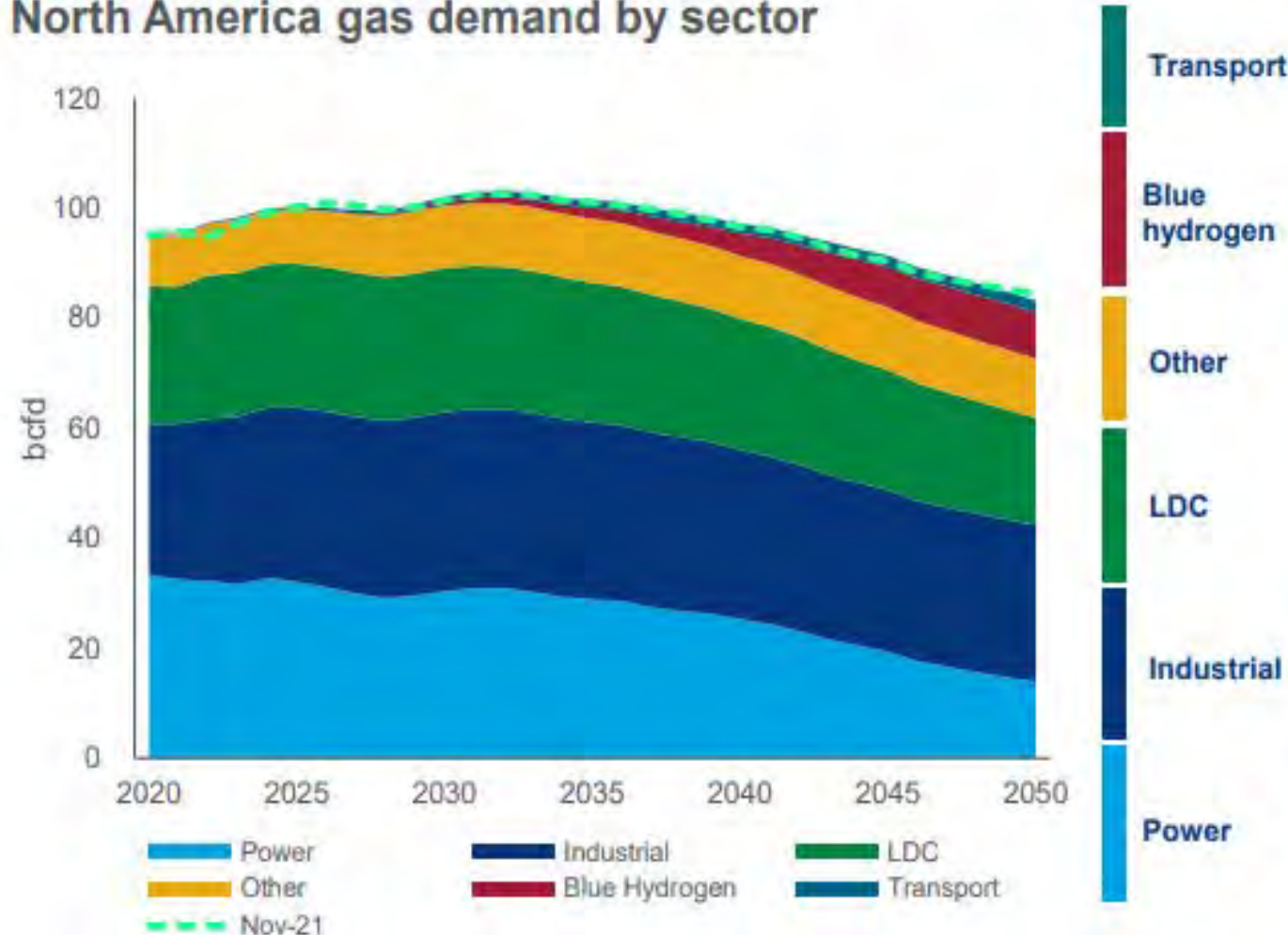

**Transport**  
Transportation demand includes gas consumed in natural gas vehicles (NGV) and small-scale bunkers. Most of the growth is attributed to NGV demand, driven by heavy long-haul trucks and freight rails

**Blue hydrogen**  
Low-cost natural gas supply in both US and Canada support blue hydrogen projects where demand grows to 8.5 bcf/d by 2050. We expect clean energy policies, such as Canada's federal carbon price and US 45Q incentive, to drive its growth.

**Other**  
Other demand includes lease & plant fuel and pipeline losses, which is the gas used within the industry. The two biggest components to its growth are supply and LNG export losses

**LDC**  
Residential and commercial demand reach a peak in 2029 and declines as hydrogen and building electrification accelerate to displace gas in the long-term. Heating electrification in the US will reach 68% penetration by 2050.

**Industrial**  
Post 2031, industrial demand deviates from GDP growth and continues to decline as we expect net zero targets and clean energy policies to drive low-carbon hydrogen to replace grey hydrogen from Steam Methane Reformers (SMRs) in the ammonia, refining, and methanol sectors.

**Power**  
In the near term out to 2024, power demand grows due to coal-to-gas switching and retirements. Post-2024, gas demand in the power sector starts to structurally decline with the accelerated renewable build-out spurred by policy incentives.

# Accelerated coal retirements allows for more coal-to-gas switching in the 2020s but gas burns decline over time with higher renewable penetration

Power load has been revised higher mostly in the late 2040s due to higher EV conversion, heating electrification and stronger industrial requirements

### North America power generation by type

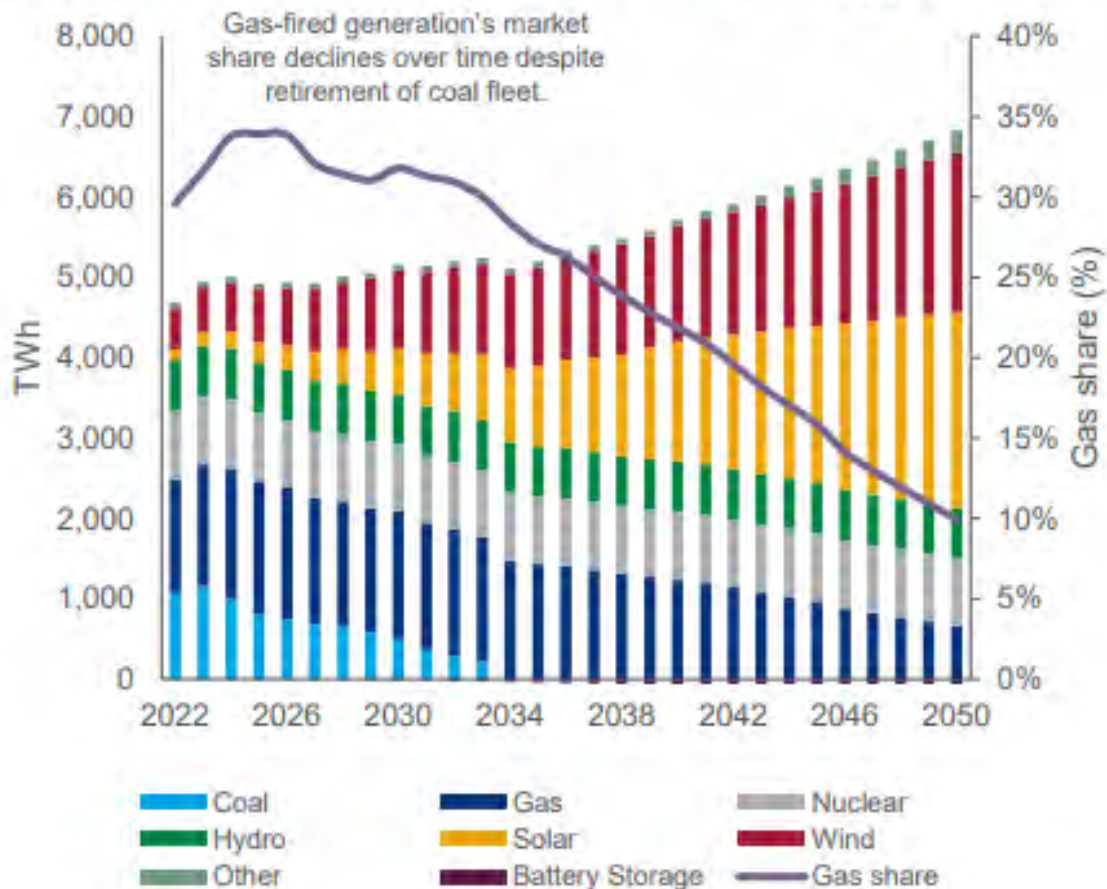

### Levelized cost of energy (LCOE)

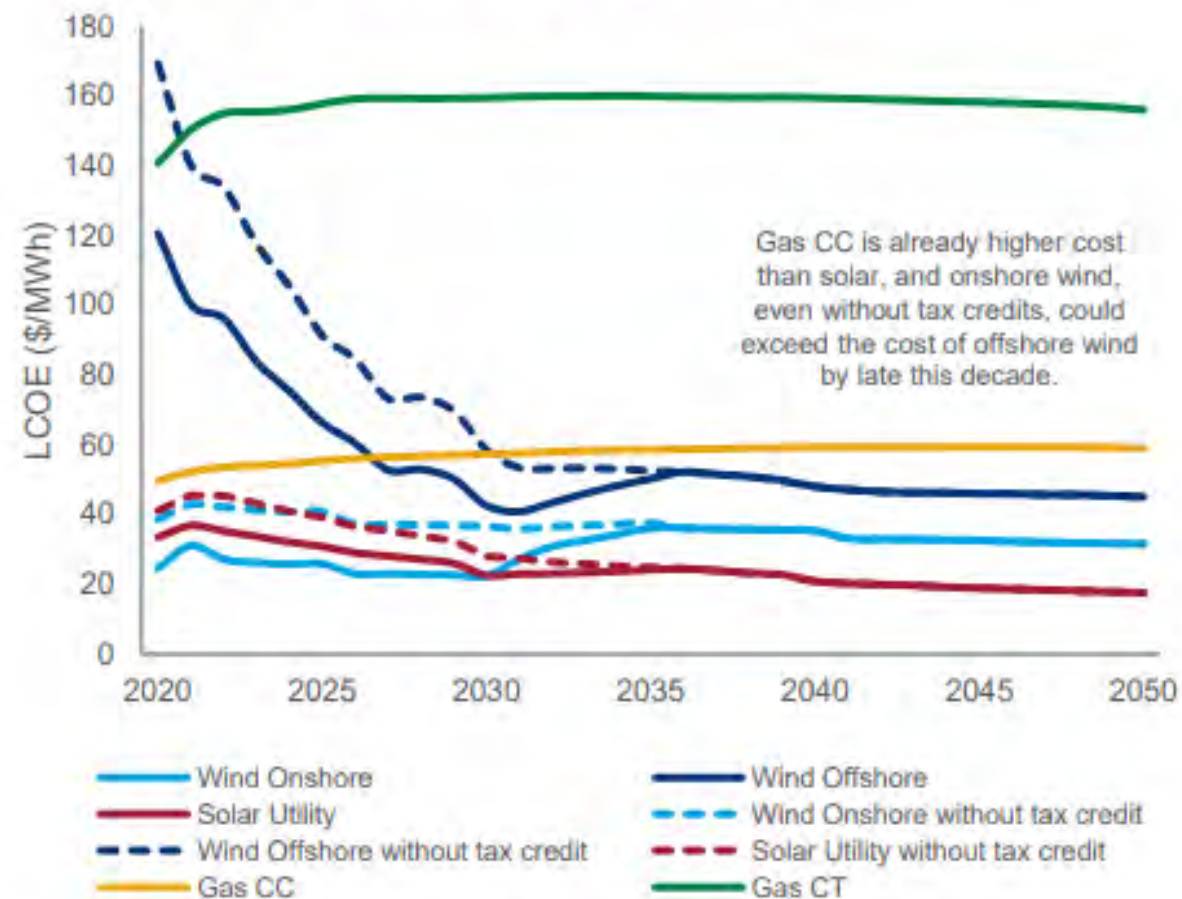

## North America has large quantities of gas resources available

In addition to commodity prices, factors such as well economics, infrastructure development, and investor sentiment will dictate how much resource is ultimately produced

### Remaining gas resources for key onshore North America regions

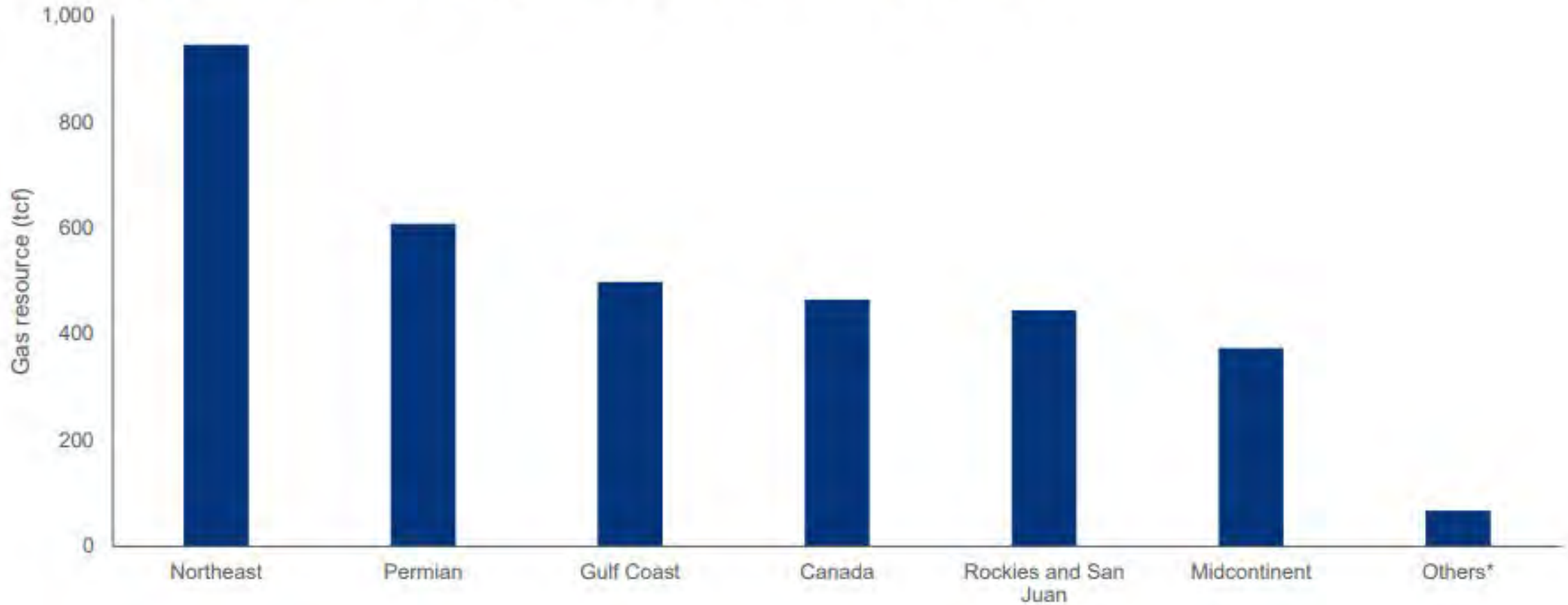

# LNG Exports

The United States became the world's largest LNG exporter in the first half of 2022

Monthly U.S. liquefied natural gas (LNG) exports (Jan 2016–Jun 2022)  
billion cubic feet per day

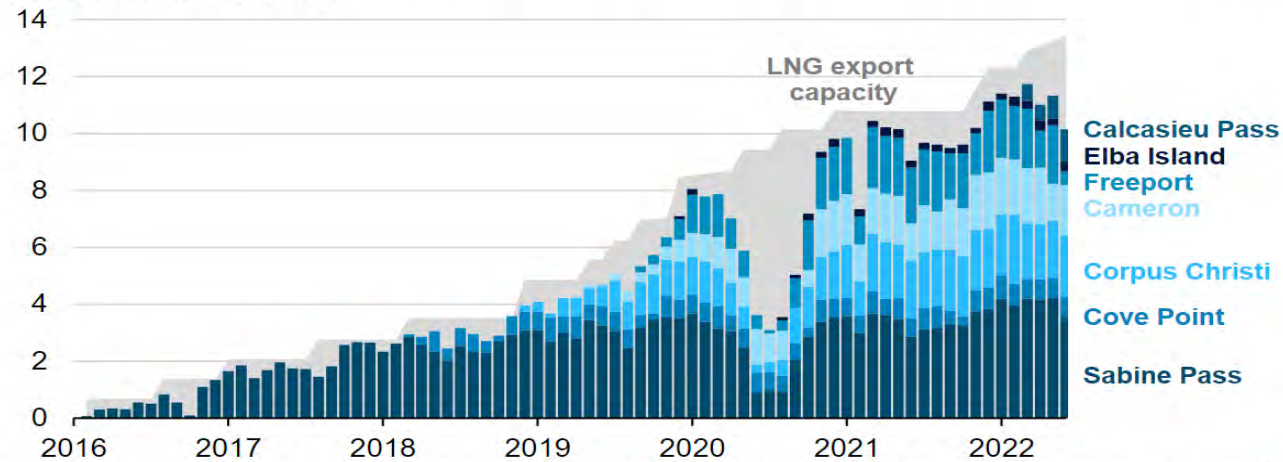

Data source: U.S. Energy Information Administration, [Liquefaction Capacity Table](#), and U.S. Department of Energy [LNG reports](#)  
Note: June 2022 LNG exports are EIA estimates based on tanker shipping data. LNG export capacity is an estimated peak LNG production capacity of all operational U.S. LNG export facilities.



## US exports more LNG to Europe, less to Asia, Brazil, Mexico.

Exports of U.S. liquefied natural gas, first half 2021 vs. first half 2022.

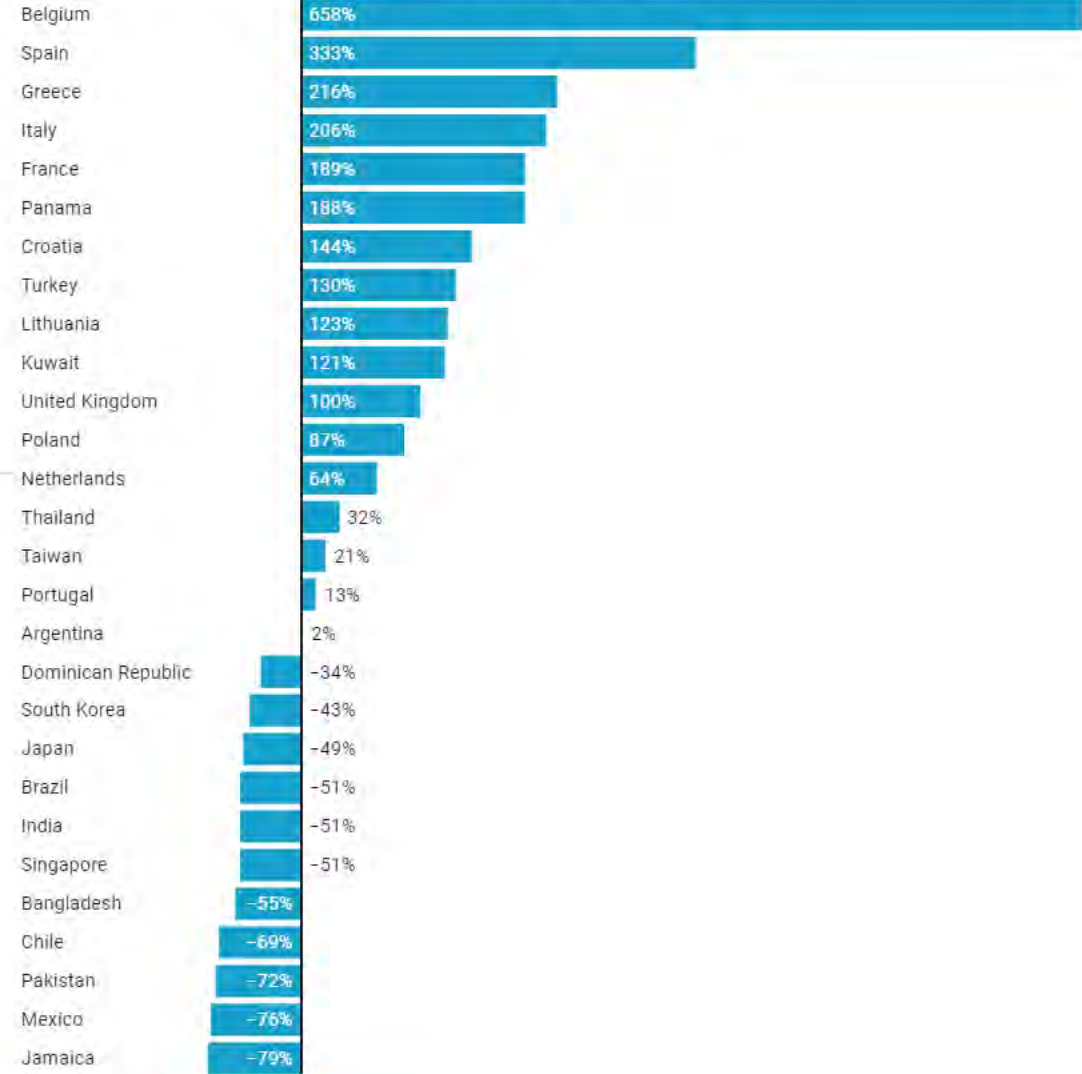
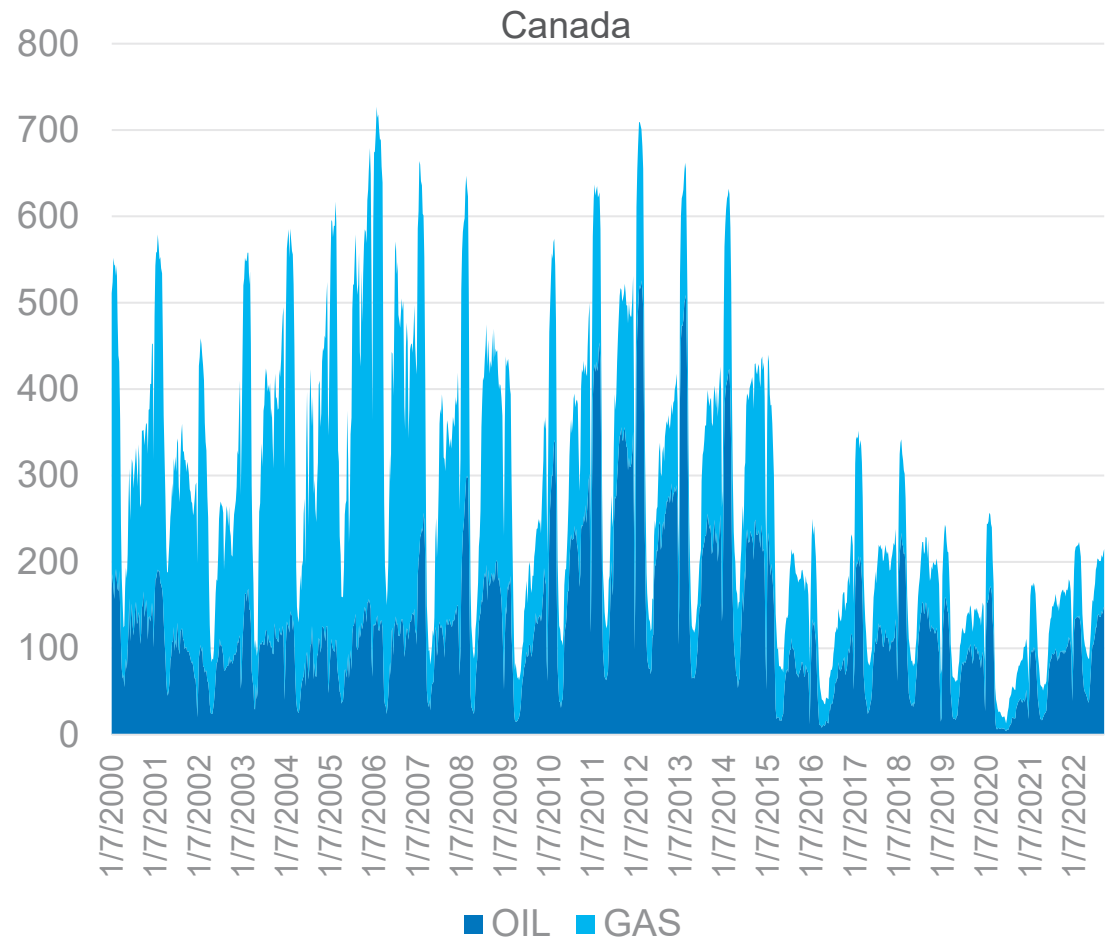
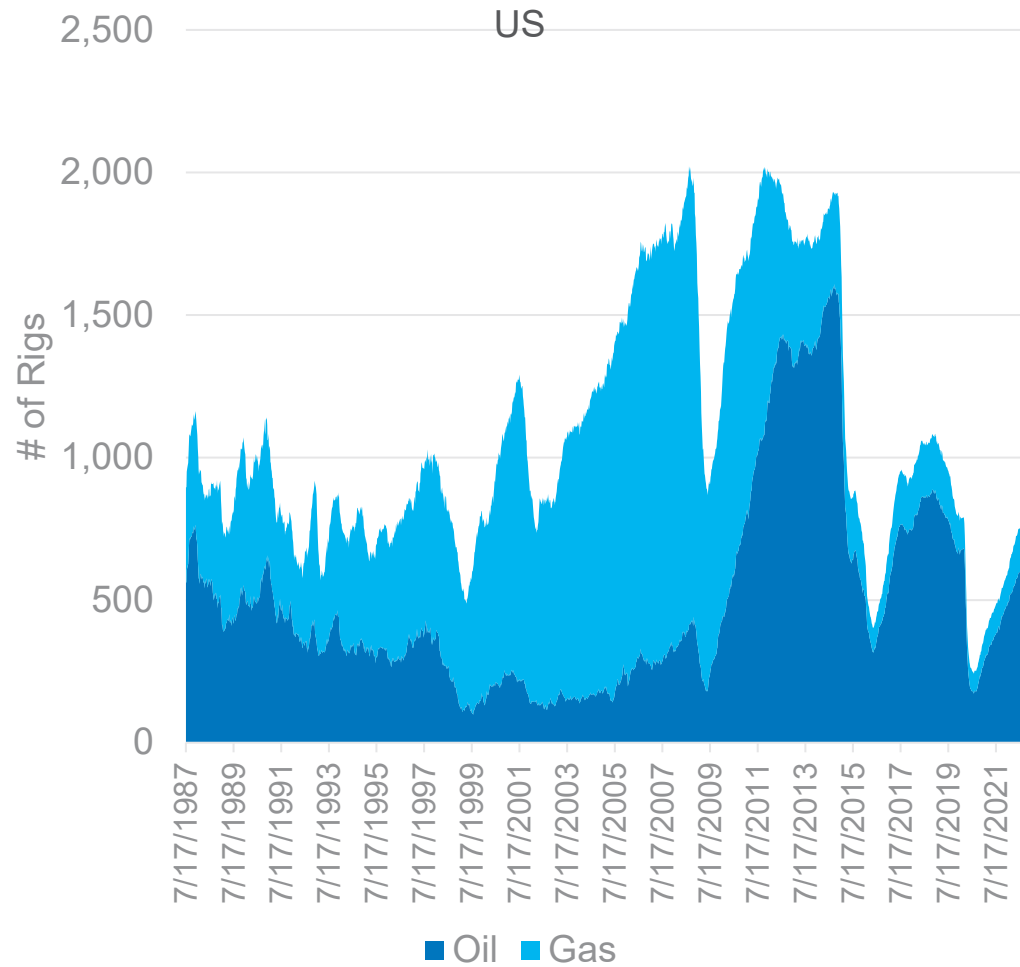
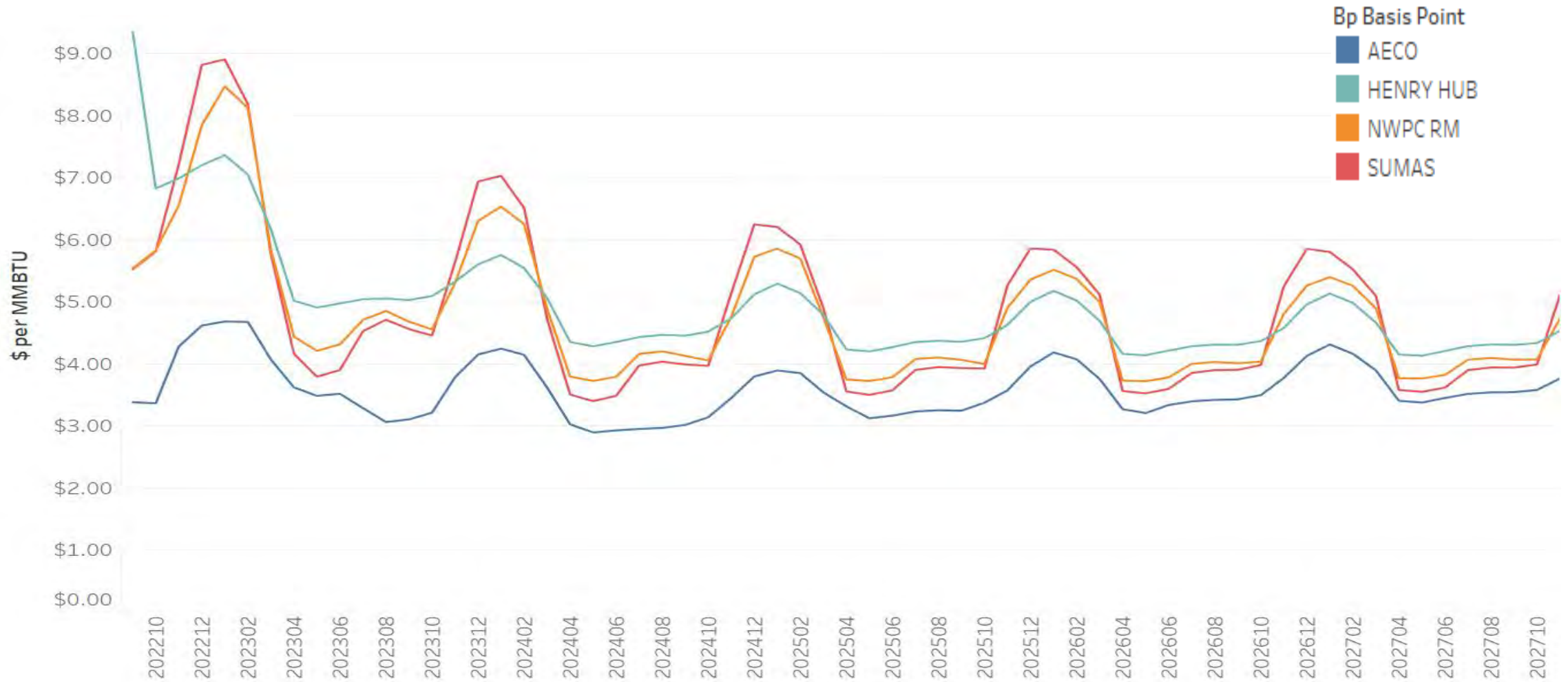

Chart: Reuters staff • Source: Refinitiv • [Get the data](#)

# North American Rig Count



# Forward Prices (9/23/2022)





# Price Forecast Blending

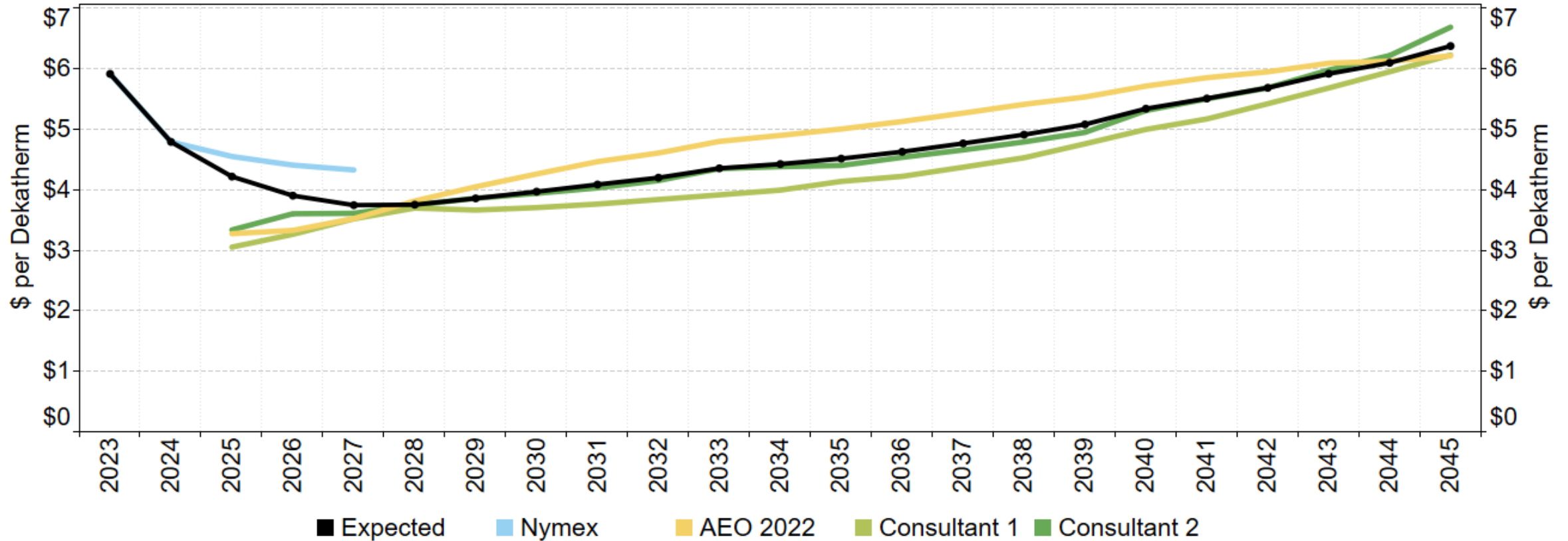

	2023	2024	2025	2026	2027	2028	2029	2030	2031	2032	2033	2034	2035	2036	2037	2038	2039	2040	2041	2042	2043	2044	2045
<b>Expected</b>	100%	100%	75%	50%	25%																		
<b>NYMEX</b>	100%	100%	75%	50%	25%																		
<b>AEO 2022</b>			8%	17%	25%	33%	33%	33%	33%	33%	33%	33%	33%	33%	33%	33%	33%	33%	33%	33%	33%	33%	33%
<b>Consultant 1</b>			8%	17%	25%	33%	33%	33%	33%	33%	33%	33%	33%	33%	33%	33%	33%	33%	33%	33%	33%	33%	33%
<b>Consultant 2</b>			8%	17%	25%	33%	33%	33%	33%	33%	33%	33%	33%	33%	33%	33%	33%	33%	33%	33%	33%	33%	33%

# Expected Case Price Forecasts

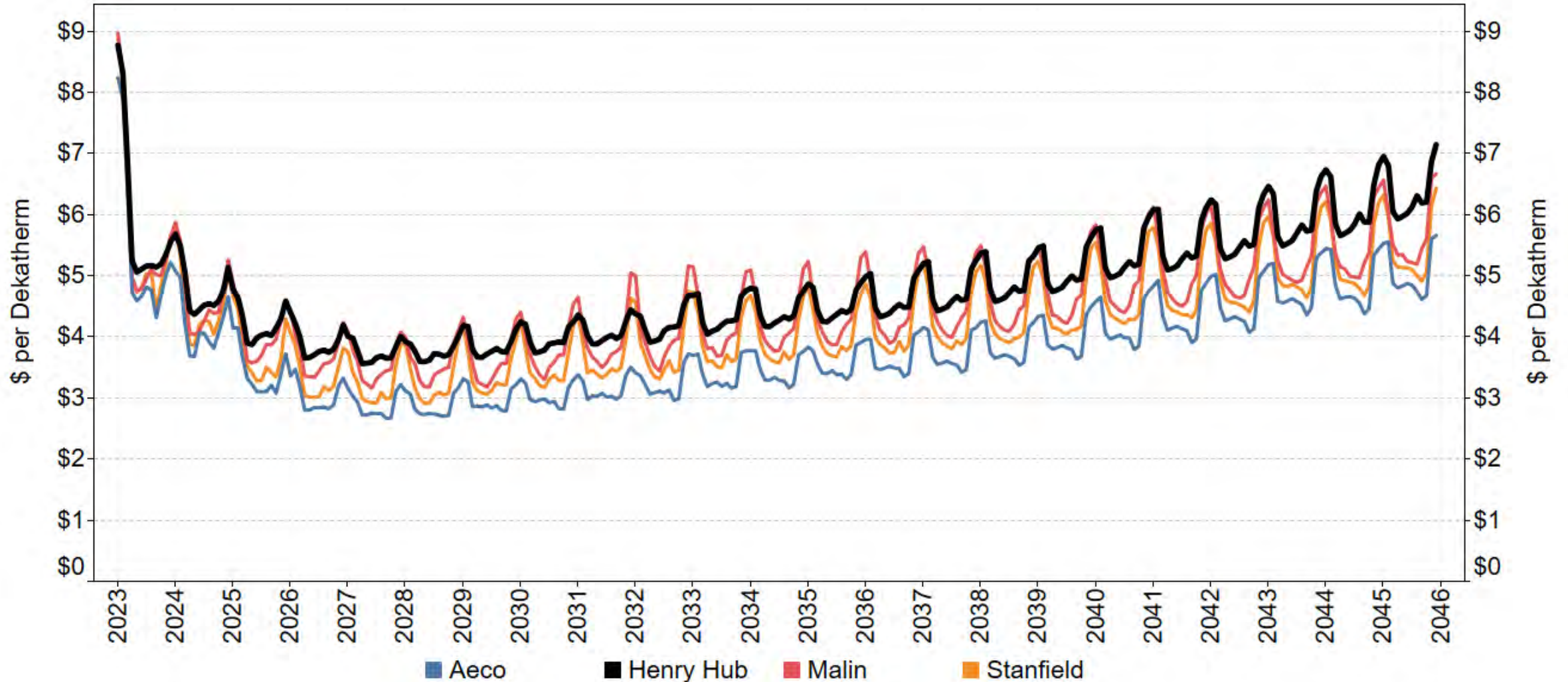

# Levelized Costs (2023 – 2045)

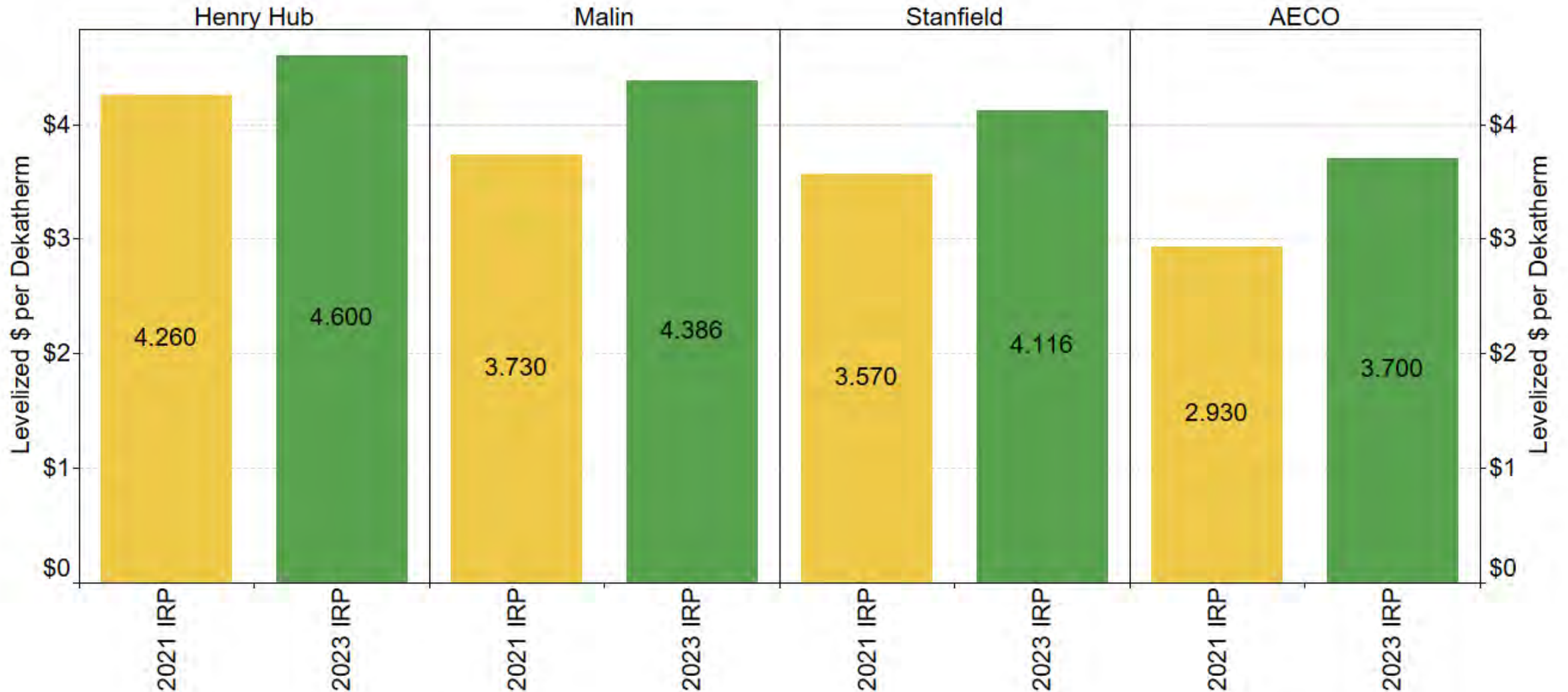

# PLEXOS Stochastics

## 4.3.1. Autocorrelation Model

In the autocorrelation model, the differential equation is:

$$e_t = a \times e_{t-1} + (1-a) \times r_t \times P_t \times S$$

where:

$e_t$  is the error for time period  $t$

$a$  is the autocorrelation parameter (between 0 and 1)

$r_t$  is a normal distributed random number

$P_t$  is the expected value (profile value) in period  $t$

$S$  is the error standard deviation

The input parameters here are the [Autocorrelation](#) and the [Error Std Dev](#) (alternatively [Abs Error Std Dev](#)). Autocorrelation is expressed as percentage value (between 0 and 100). The higher the autocorrelation, the more the 'randomness' of the errors is dampened and smoothed out over time. The higher the standard deviation, the greater the volatility of the errors. Because the error function can produce any positive or negative value (at least in theory) it is often necessary to bound the profile sample values produced by this method. The Variable properties [Min Value](#) and [Max Value](#) are used for this purpose. The actual sample value used at any time is simply the sum of the profile value and the error (which may be positive or negative) bounded by the min and max values.

Table 2 shows some simple example input where the profile value is static but has an error function with standard deviation of 28%. In a real application the profile value would change across time *e.g.* read from a flat file. Figure 6 shows the resulting distribution of sample values from 1000 samples, which follows a normal distribution. Figures 7 and 8 shows the output sample 1 profiles with the autocorrelation parameter set to 0% and 75% respectively. Note that the overall distribution of the sample values is still normal as in Figure 6, but the individual sample volatility is damped.

# PLEXOS Stochastics Continued

Without Autocorrelation

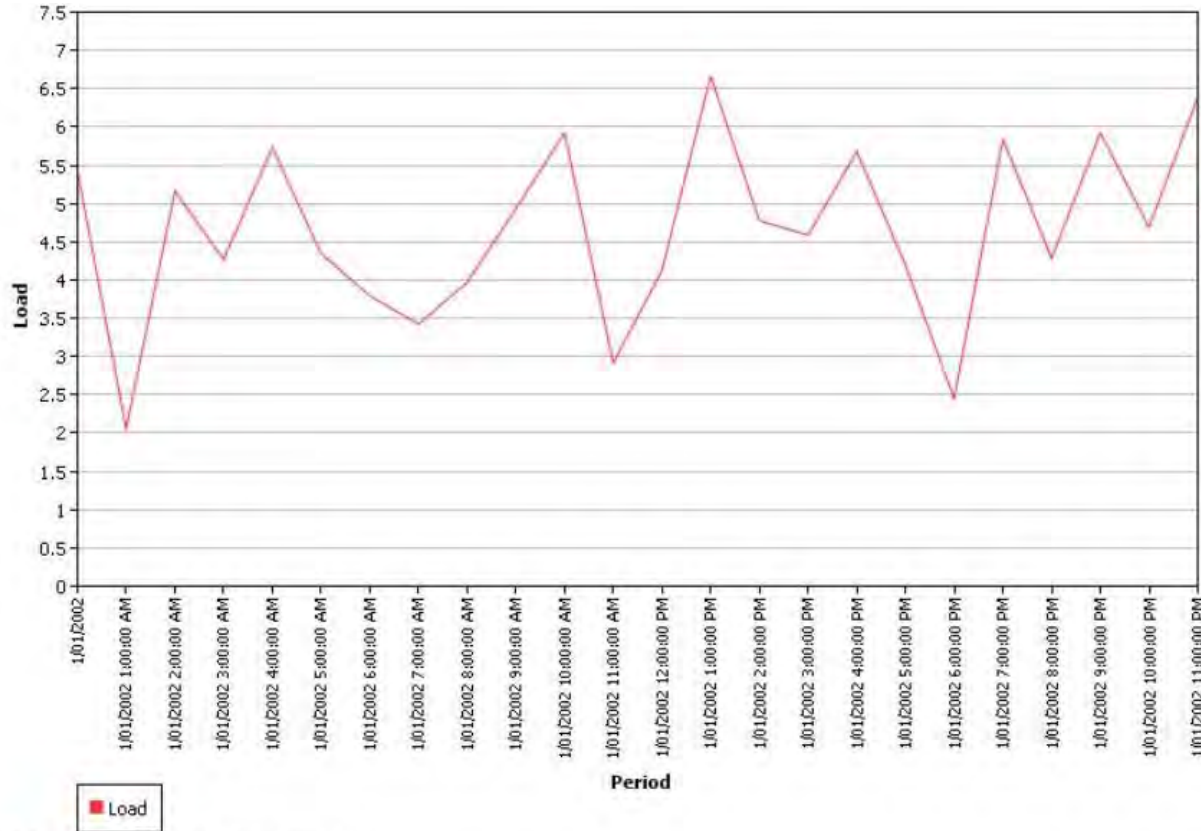

With Autocorrelation

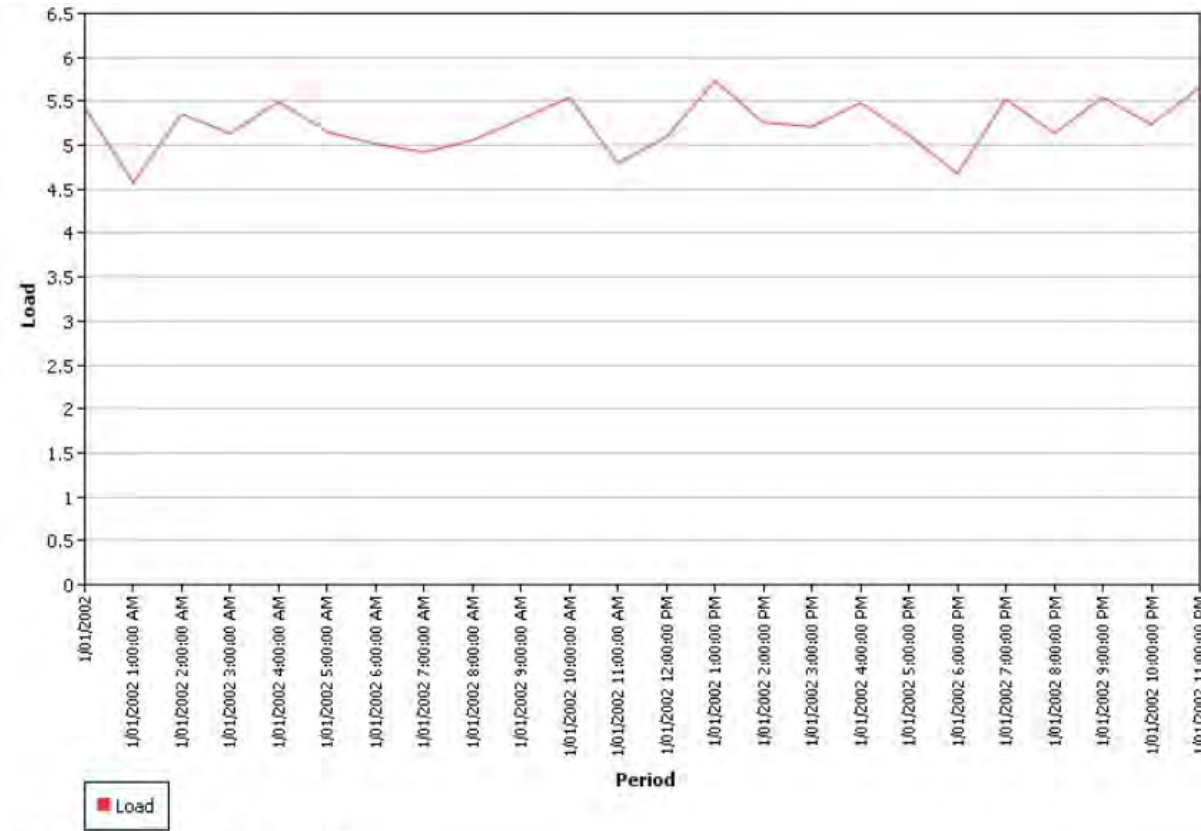
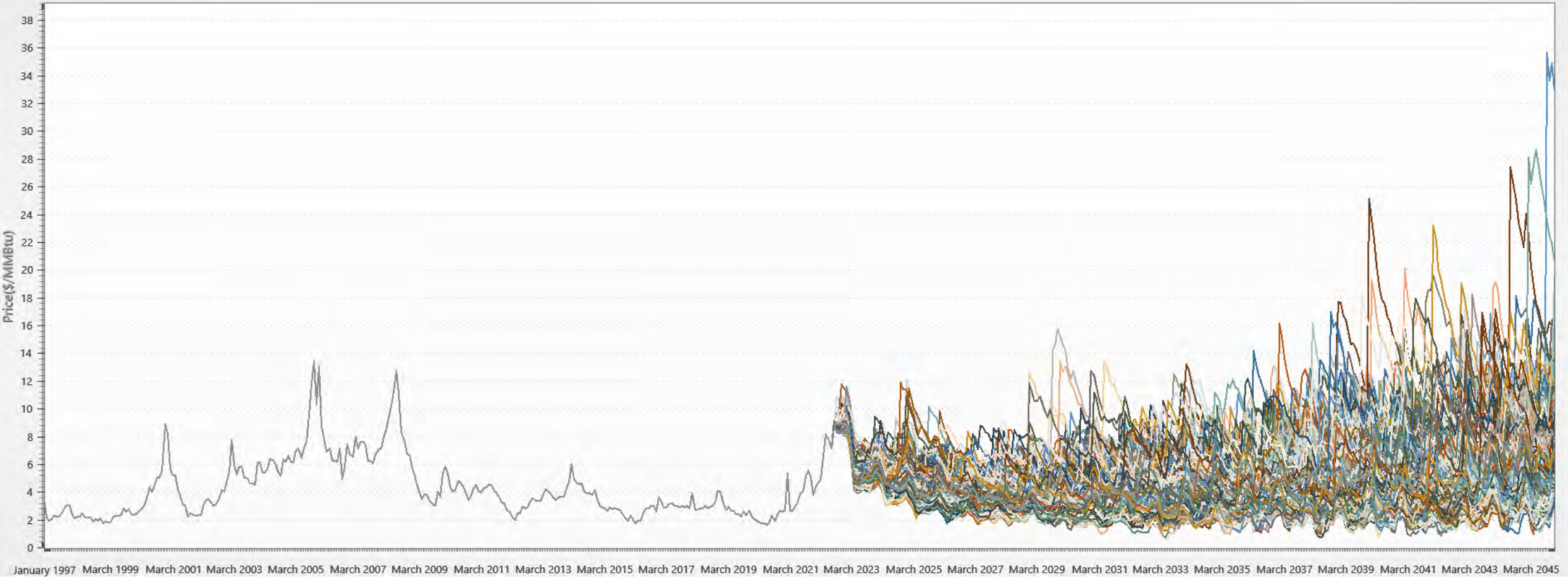

Figure 7: Sample 1 Profile with No Autocorrelation

Figure 8: Sample 1 Profile with 75% Autocorrelation

# Stochastics: Henry Hub (300 Draws)



# Stochastics: Henry Hub Levelized Prices (300 Draws)

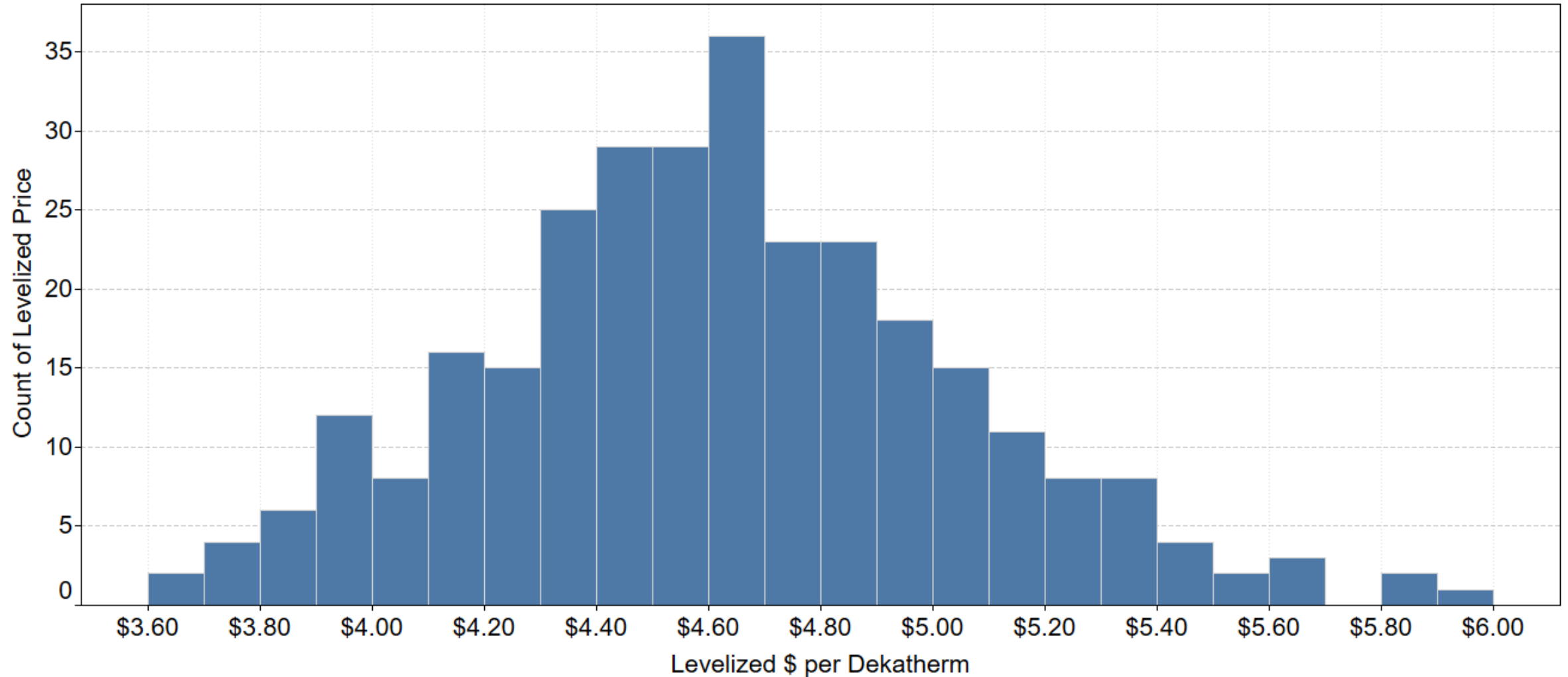

# Results: Henry Hub Stochastics (300 Draws)

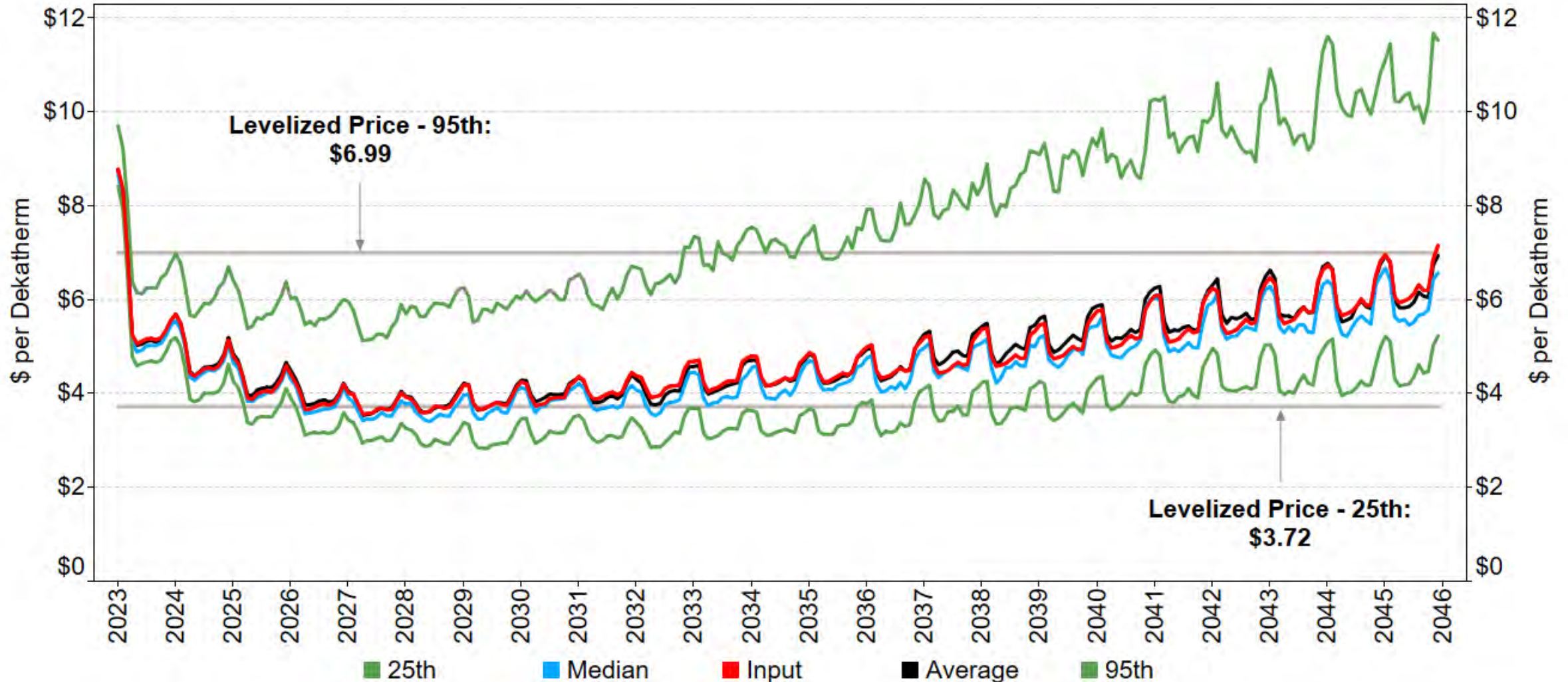



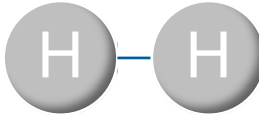

# Green Hydrogen (H<sub>2</sub>)

- Hydrogen is the most abundant element in the universe
- The lightest element and wants to escape making it harder to contain
- Highly combustible
- Tax credits from IRA assumed at a levelized credit for the full \$3 per kg incentive from green H<sub>2</sub>

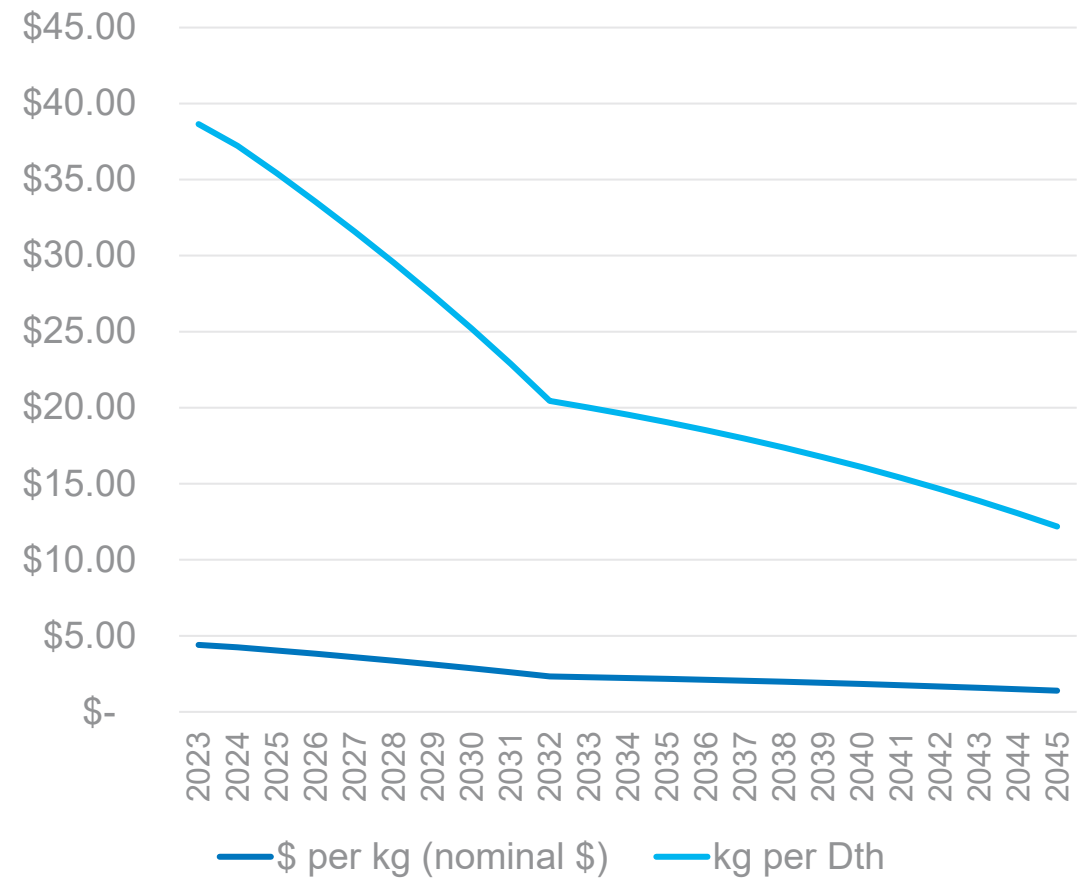

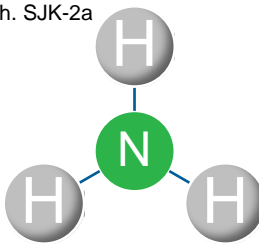

# Ammonia

- One of the most produced chemicals in the United States
- Usually shipped as a compressed liquid in steel containers
- Not highly flammable
- Can be used as a fuel in emission-free fuel cells and turbines
- Can be made using green H<sub>2</sub> from water electrolysis and nitrogen separated from the air
  - Fed into the “Haber Process” and combined at high temperatures and pressures to produce ammonia

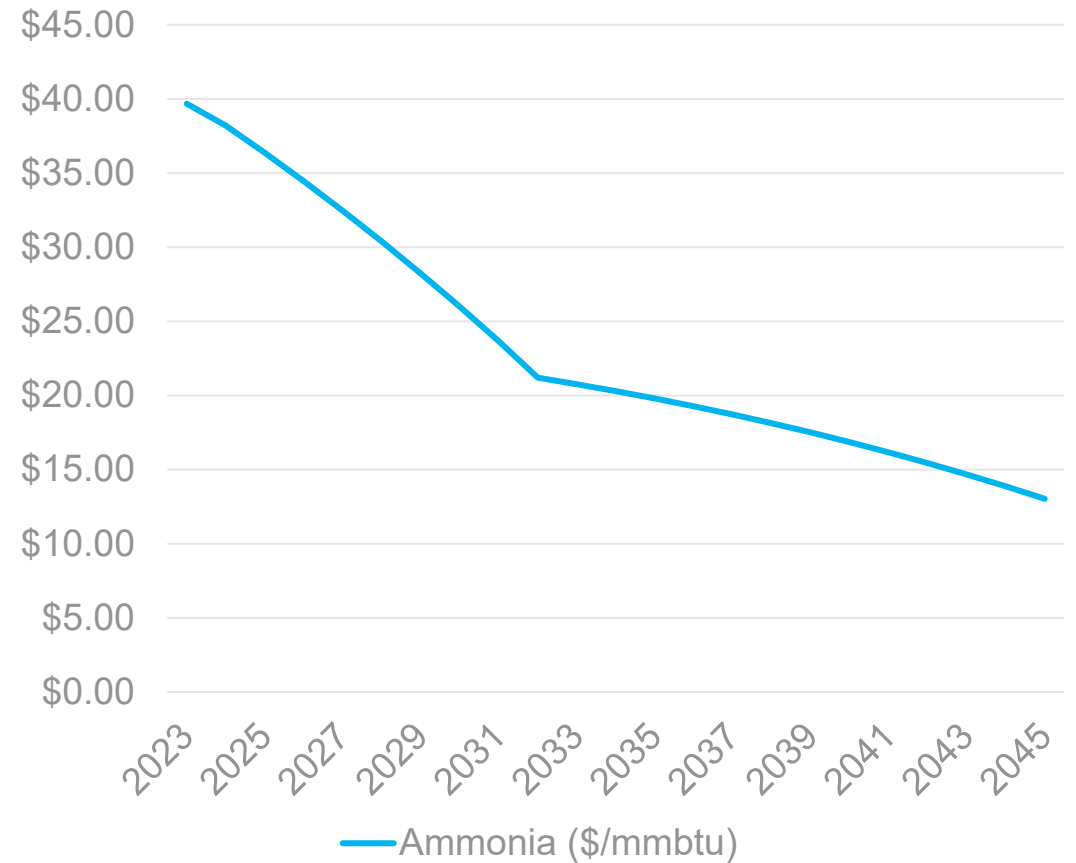



# Electric Wholesale Market Price Forecast

Lori Hermanson, Senior Resource Analyst  
Electric IRP, Seventh Technical Advisory Committee Meeting  
October 11, 2022

# Overview

- This market price forecast will be used in the IRP
- Updated from draft price forecast presented in March
  - Loads
  - Climate impacts for hydro and loads
  - Natural gas and carbon prices
  - Consultant inputs
- Stochastics electric price modeling in process

# Market Price Forecast – Purpose

- Estimate “market value” of resources options for the IRP
- Estimate dispatch of “dispatchable” resources
- Informs avoided costs
- May change resource selection if resource production is counter to needs of the wholesale market

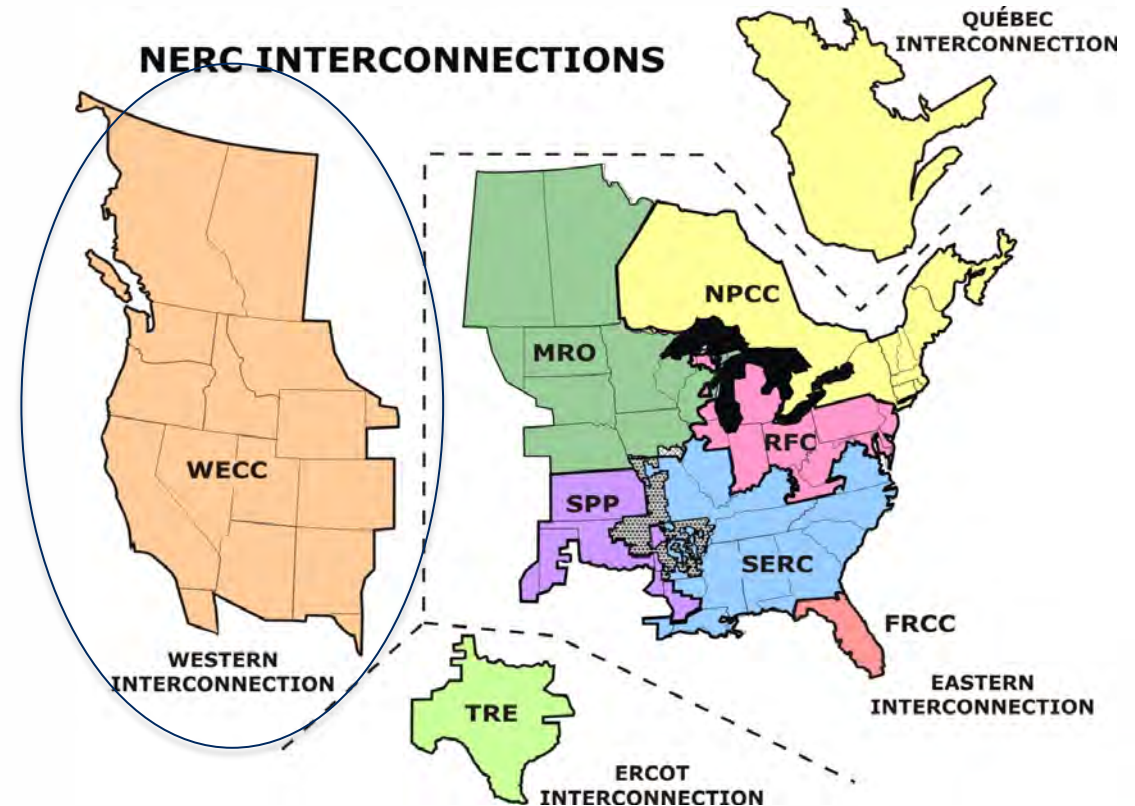

Source: NERC

# Methodology

- 3<sup>rd</sup> party software - Aurora by Energy Exemplar
- Electric market fundamentals - production cost model
- Simulates generation dispatch to meet regional load
- Outputs:
  - Market prices (electric)
  - Regional energy mix
  - Transmission usage
  - Greenhouse gas emissions
  - Power plant margins, generation levels, fuel costs
  - Avista's variable power supply costs

# Modeling Process



# Load Forecast

- Regional load forecast from IHS
  - Forecast includes energy efficiency
- Add net meter resource forecast
  - Annual input with hourly shape
- Add electric vehicle forecast
  - Annual input with hourly shape
- Future load shape differs from today's load shape

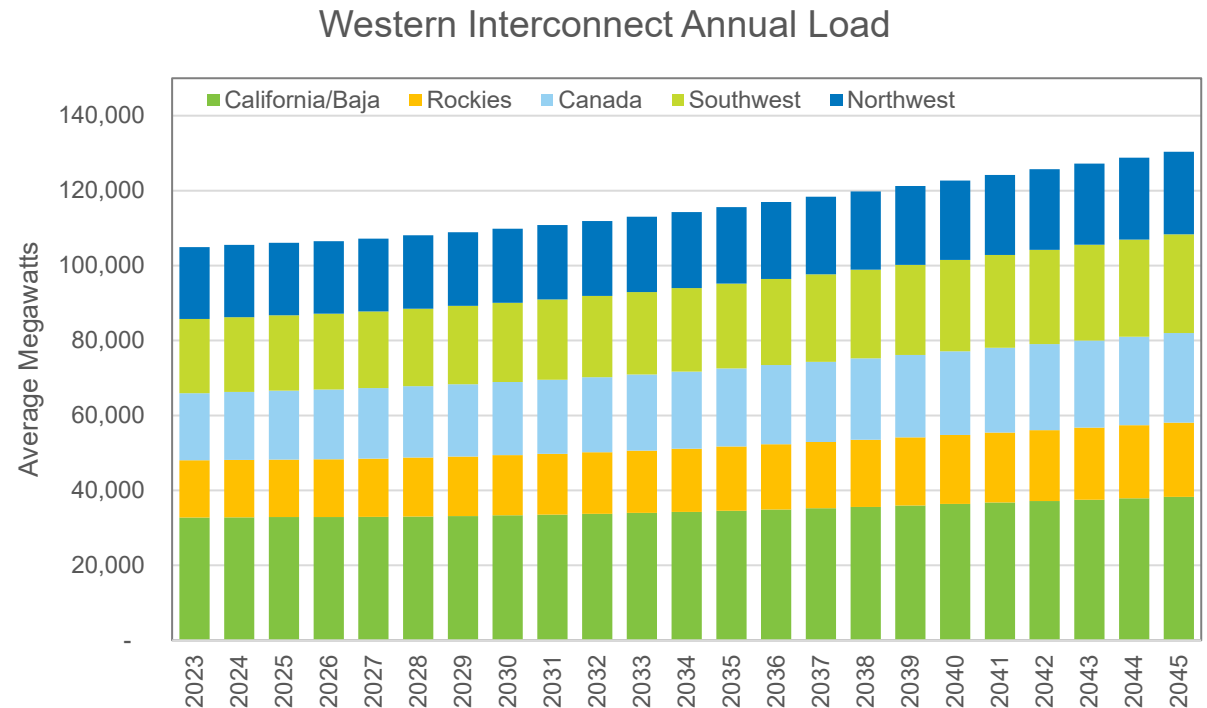



# Electric Vehicle and Solar Adjustments

## Roof Top Solar

- EIA existing estimates for history
- IHS regional growth rates

Western Interconnect Rooftop Solar Capability

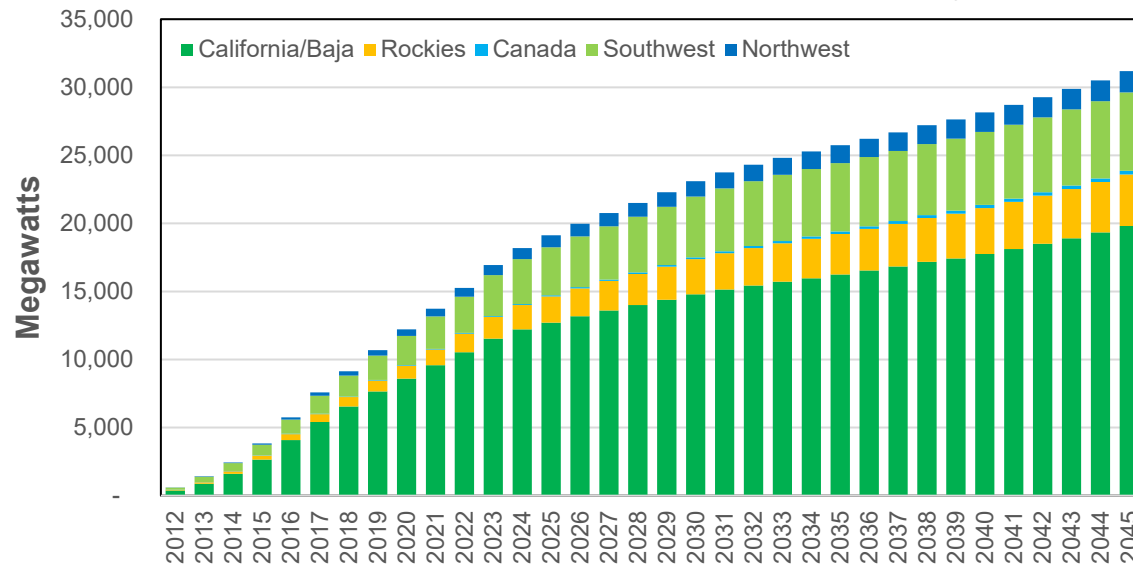

## Electric Vehicles

- Penetration rates increase each year
- 15-65% light duty (2040)
- 12-15% medium duty (2040)
- 5% heavy duty (2040)

Western Interconnect Transportation Electrification

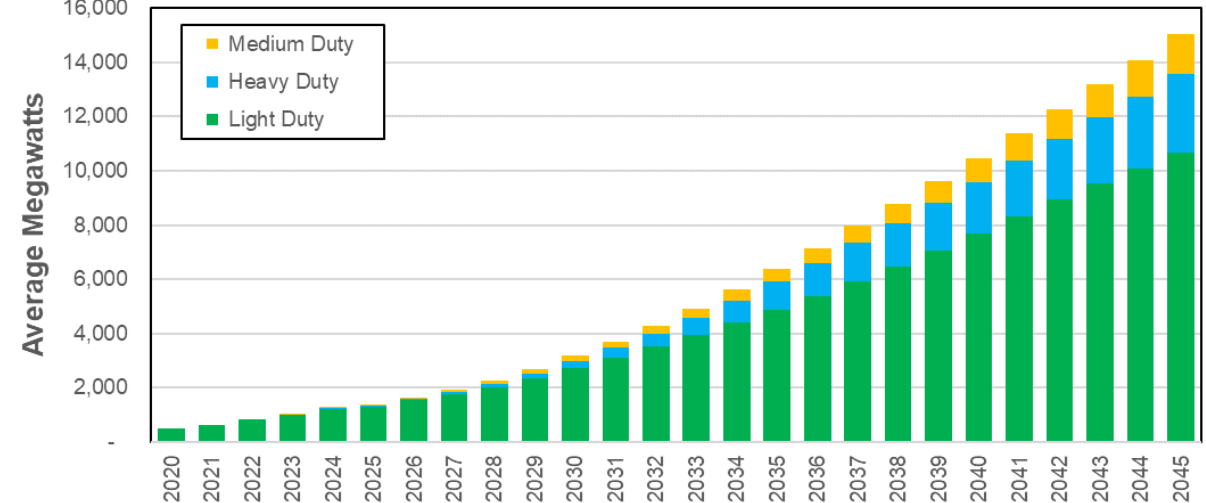

*Draft Forecast*

# WECC Weighted GHG Emission Prices

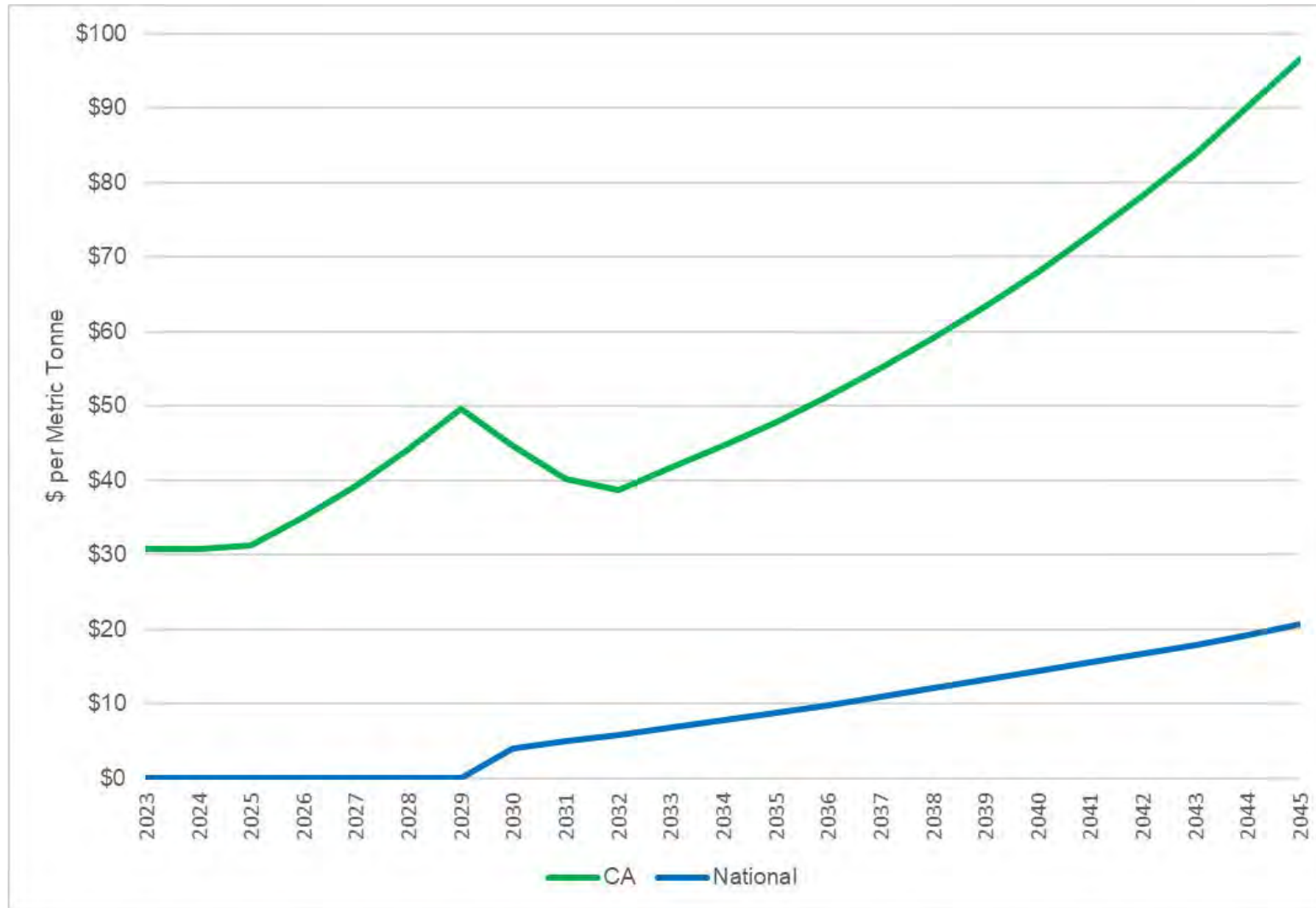

- CA current prices + 2030 national carbon price
- \$5.43 levelized per Metric Tonnes (WA)
- Revised 2019 IEPR Carbon Price Projections (CA) and national price estimate (consultant)
- To address imports, exporting region incurs a carbon price adder to transfer power
- CCA rules are not final; still determining the price forecast impact from CCA; will publicize final price forecast when complete

# New Resource Forecast (Western Interconnect)

*Draft Forecast*

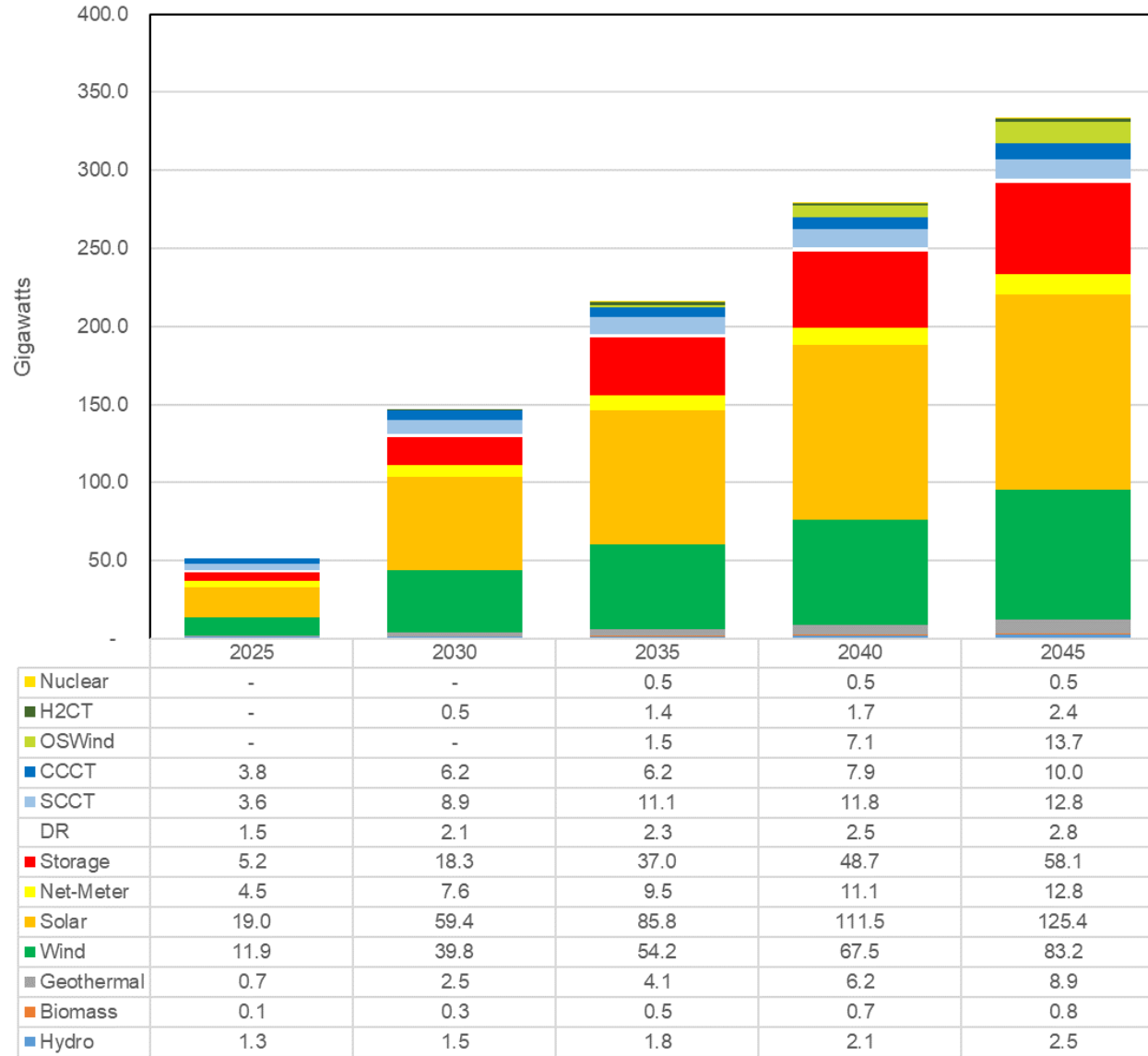

*Draft Forecast*

# U.S. West Resource Type Forecast

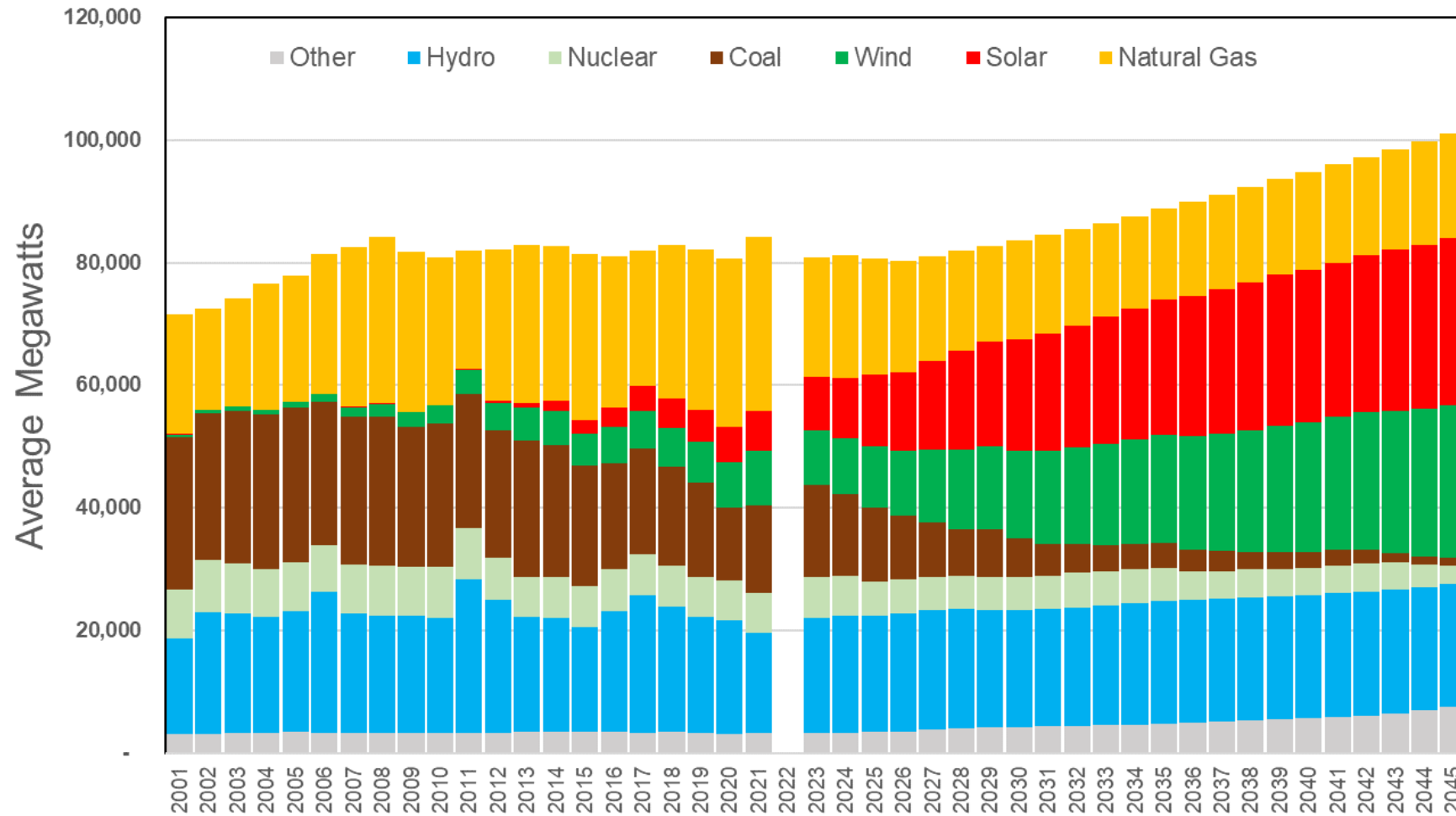

Significant changes  
2045 to 2023 (aGW)

Solar:	+ 18.4
Wind:	+ 16.0
Nat Gas:	- 2.4
Coal:	- 13.6
Nuclear:	- 3.9
Other:	+ 5.7
<b>Total:</b>	<b>+ 20.2</b>



# Northwest Resource Type Forecast

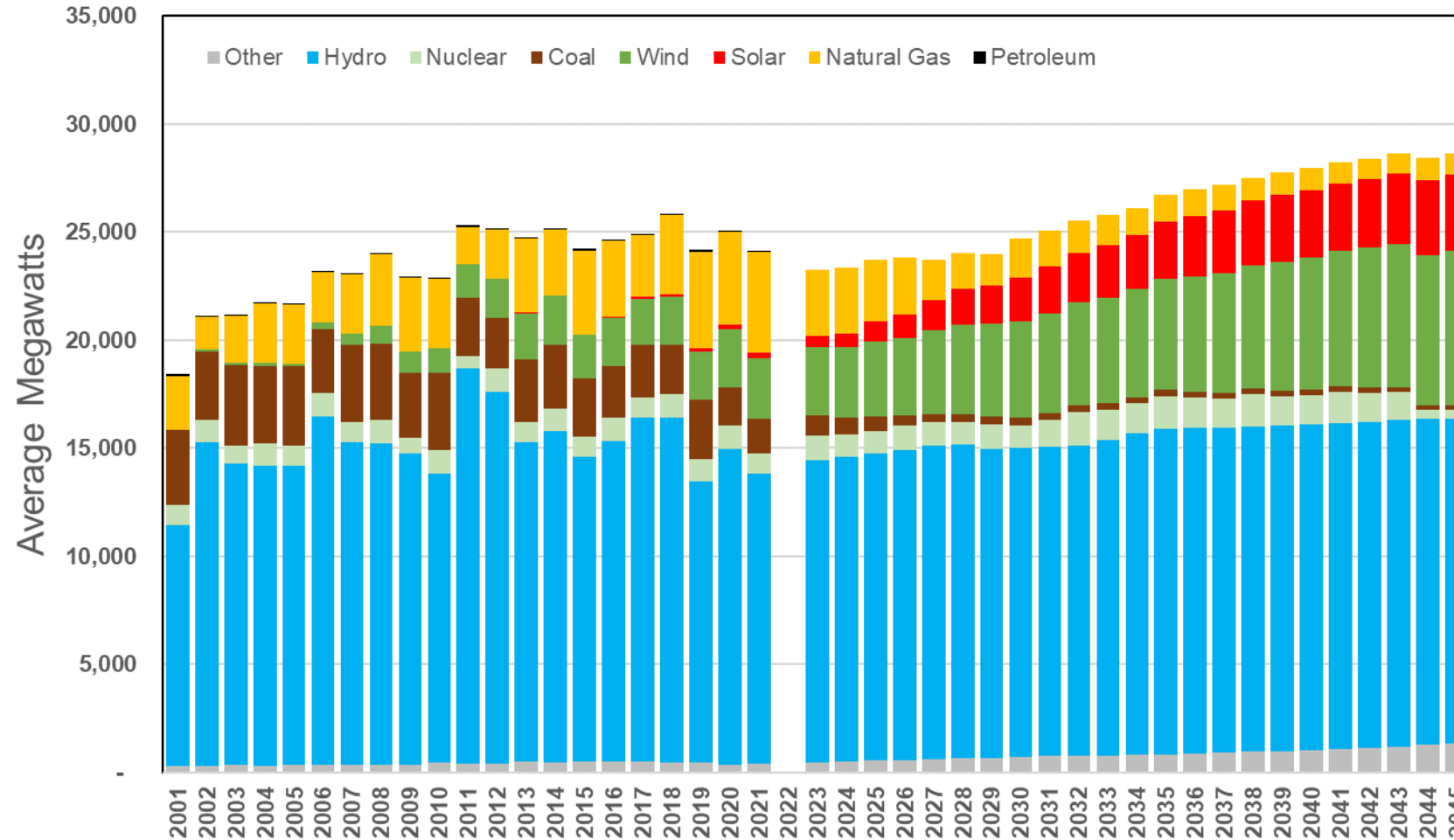

Significant changes (aGW)  
2045 to 2023

- Solar: + 3.0
- Wind: + 4.0
- Nat Gas: - 2.1
- Coal: - 0.7
- Other: + 0.2
- Nuclear: - 0.8
- Total: + 5.4



# Greenhouse Gas Forecast U.S. Western Interconnect

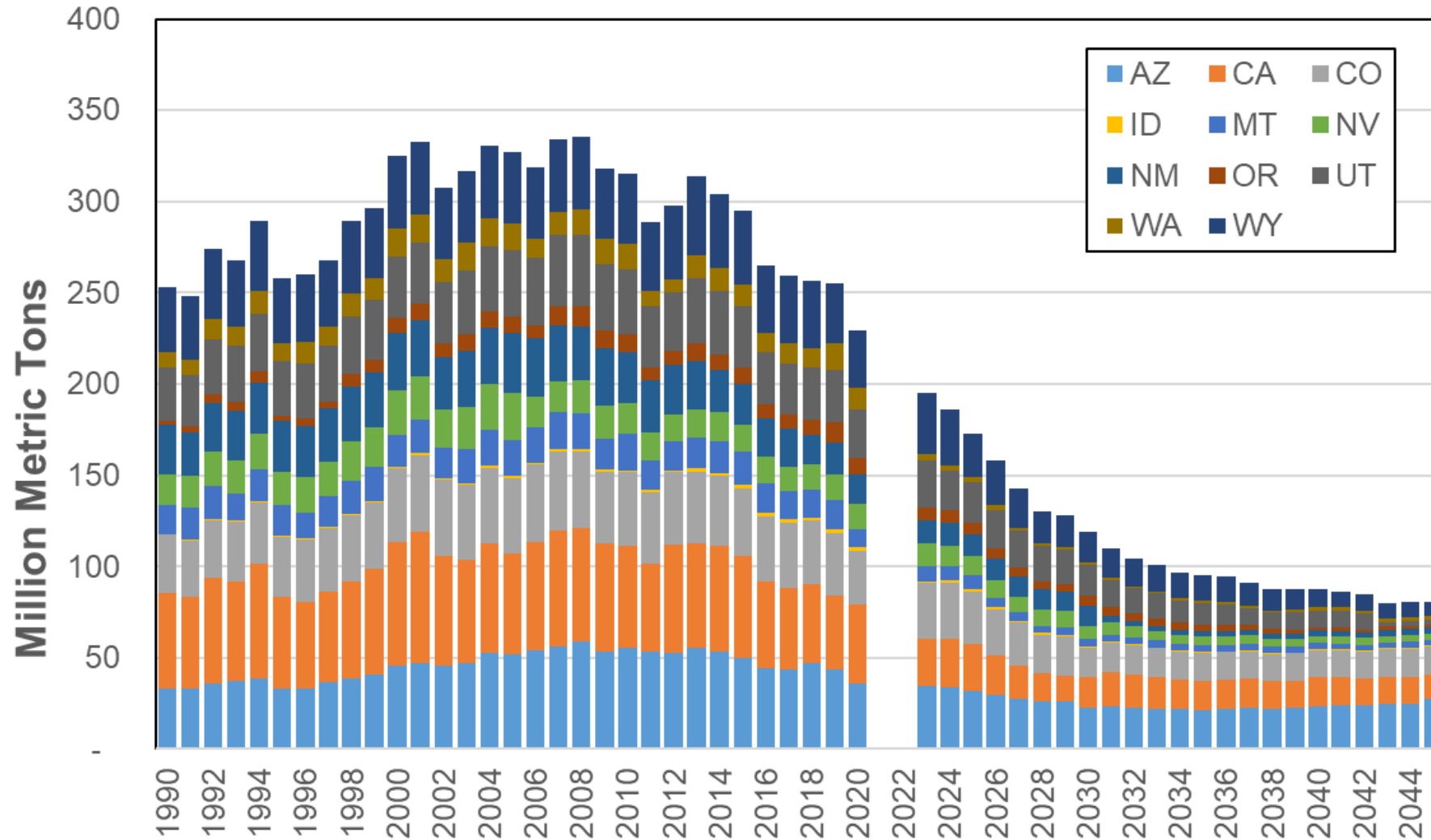

# Greenhouse Gas Forecast Northwest States

*Draft Forecast*

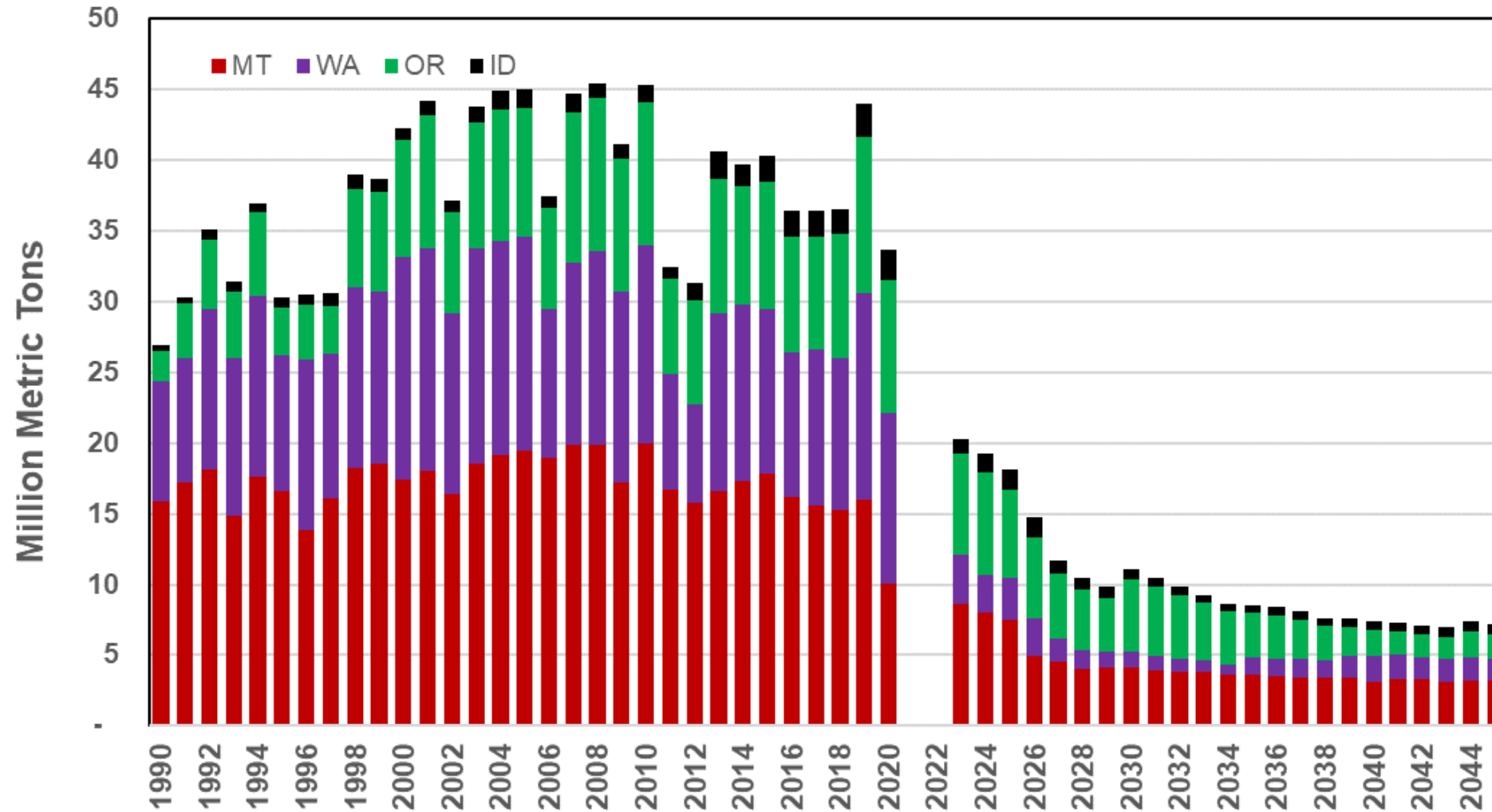

*Draft forecast*

# Mid-C Electric Price Forecast

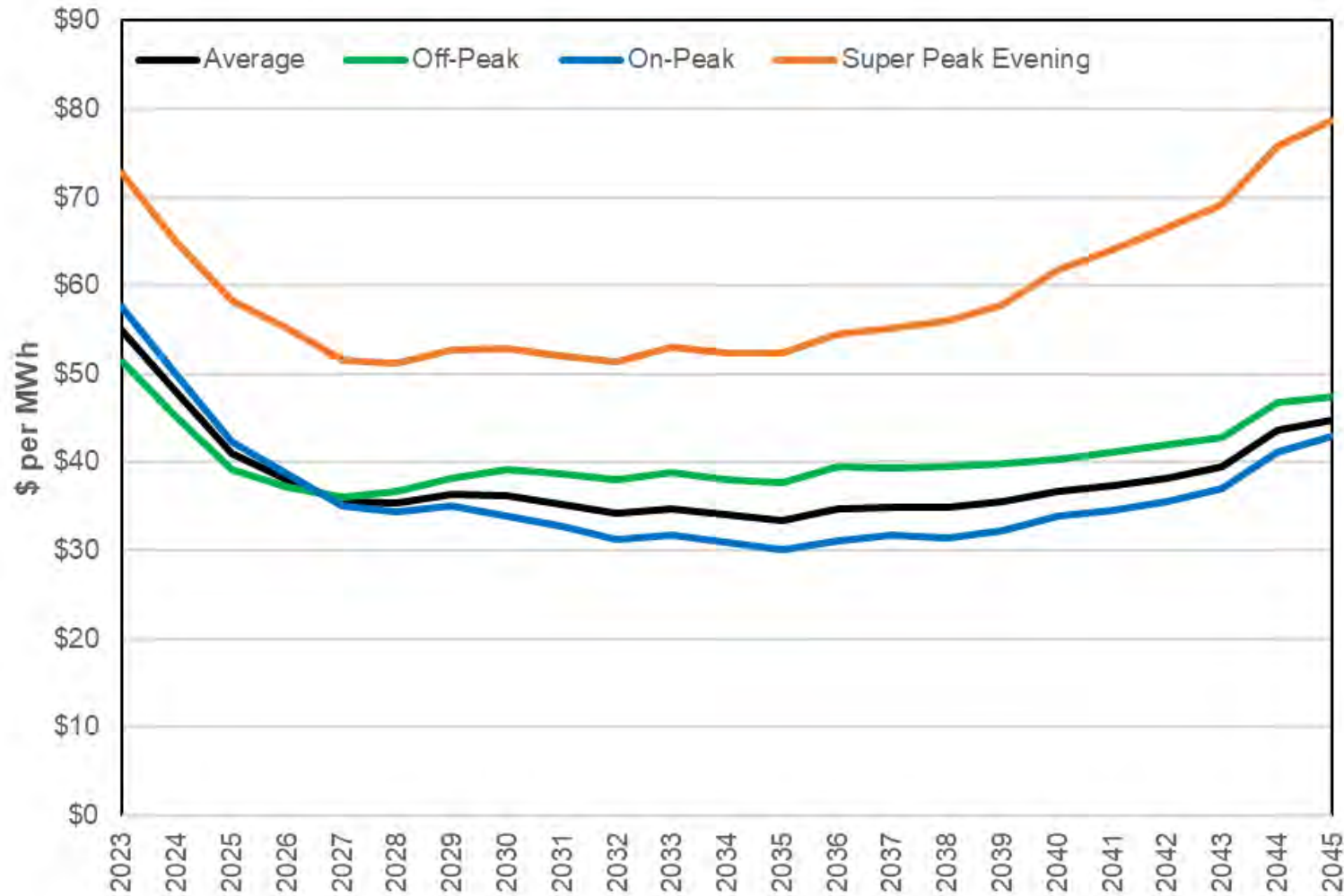

- Levelized Price:
  - 2023-45: \$38.16/MWh
- Off-peak prices overtake on-peak in 2027 on an annual basis
- Super peak evening (4pm-10pm) prices remain high



# Hourly Wholesale Mid-C Electric Price Shapes

Winter: Dec 16 - Mar 15

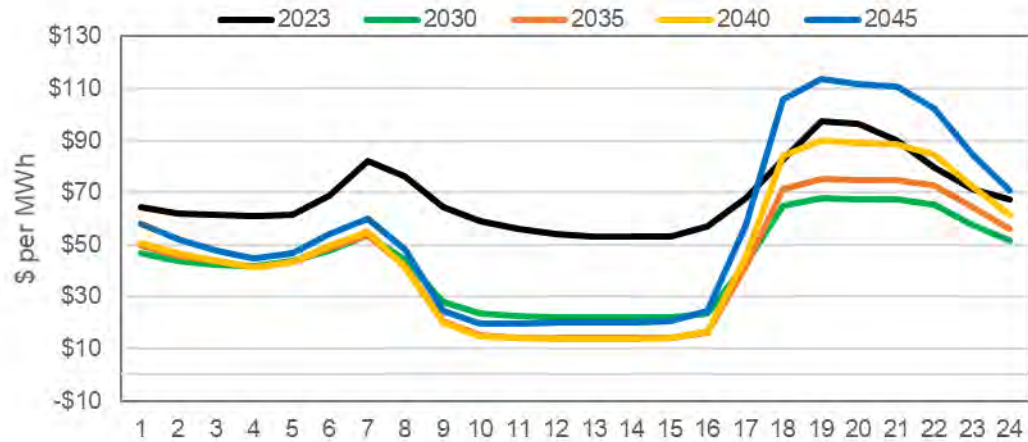

Spring: Mar 16 - Jun 15

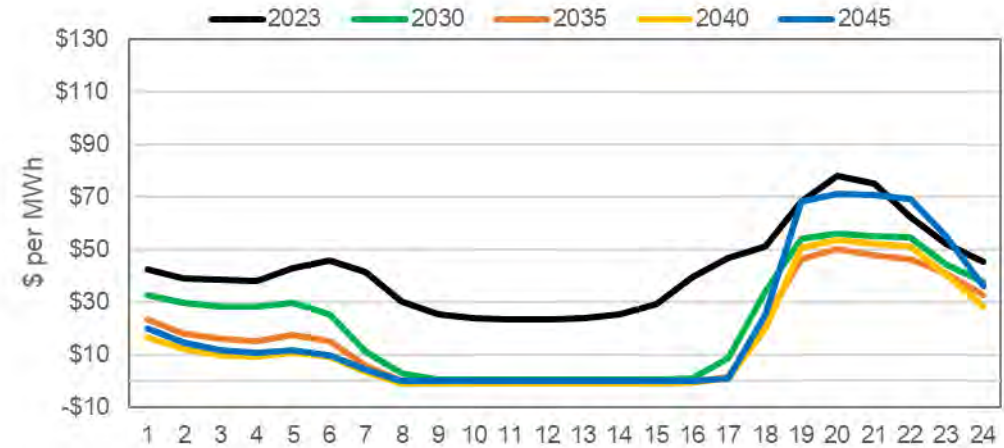

Summer: Jun 16 - Sep 15

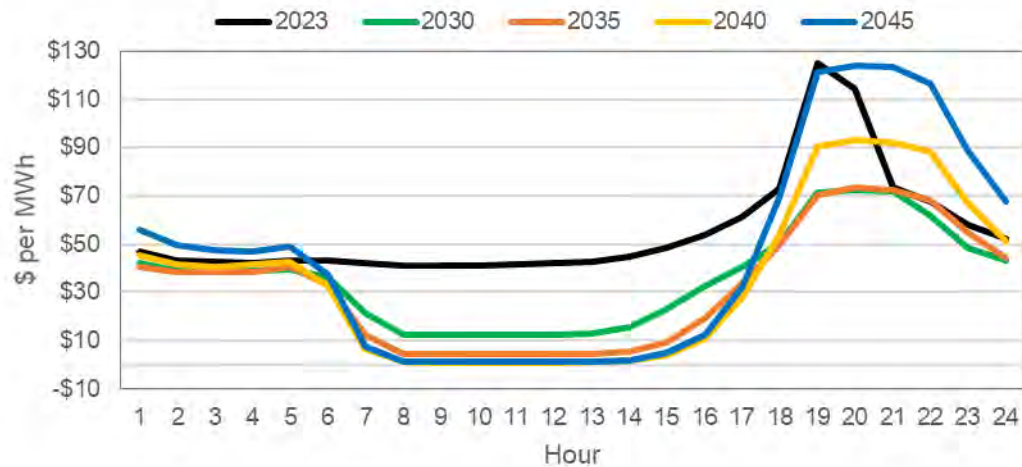

Fall: Sep 16 - Dec 15

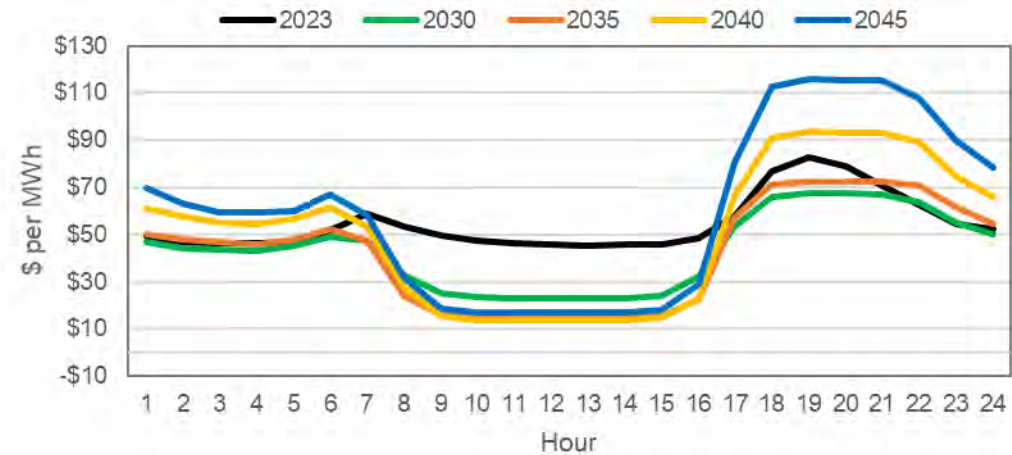

# Data Availability

## Outputs

- Expected Case: annual Mid-C prices by iteration
- Expected Case: hourly Mid-C prices
- Regional resource dispatch
- Regional GHG emissions



# WESTERN RESOURCE ADEQUACY PROGRAM

**Review of preliminary, non-binding WRAP regional data for the  
current participating footprint**

**Avista IRP TAC Meeting  
October 11, 2022**

[Link to public webinar](#)

# OVERVIEW

- » *Reliability first!* Implementing a west-wide resource adequacy program must be a priority for the region as the regions resource mix changes
- » Currently 26 utilities are participating in the WRAP non-binding program phase
- » Western Power Pool is the Program Administrator and filed a tariff with FERC seeking program approval by the end of the year
- » Southwest Power Pool is the Program Operator and performed all modeling and data analysis

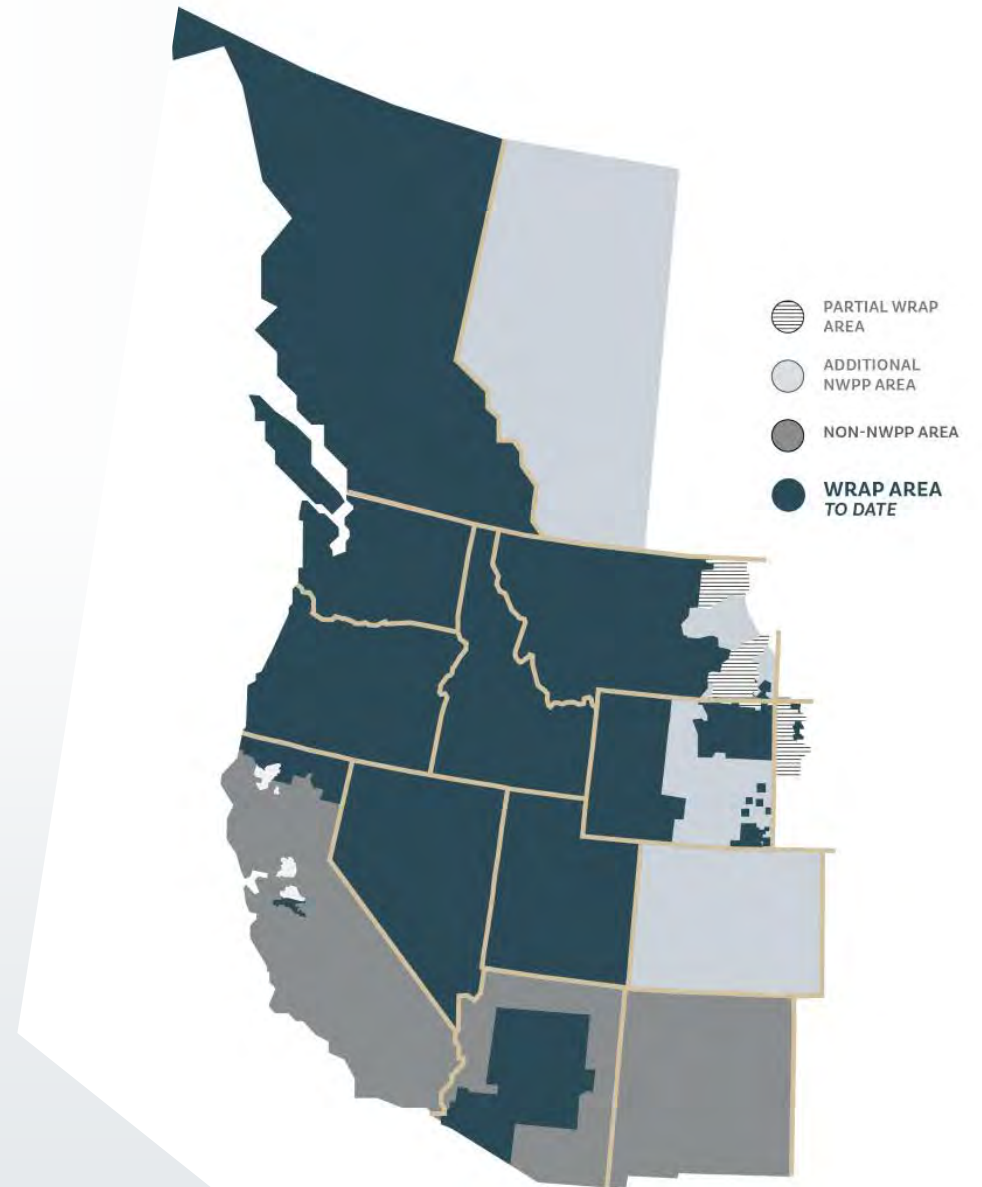

# TODAY'S OBJECTIVES

- » Provide an overview of the loads and resources in the WRAP MW footprint
- » Provide an overview of installations and nameplate for wind and solar
- » Provide an overview of the QCC and ELCC values for each resource class
- » Provide an overview of Planning Reserve Margin values (PRM)

# BEFORE WE BEGIN

- » Modeling provided utilizes WRAP program design, assuming full binding implementation of the WRAP as designed
  - Metrics assume diversity benefit and a level of forward procurement on aggregate that is not presently expected without implementation of the WRAP
- » Modeling was performed based on the current footprint of participants
  - Changes to WRAP participation in future phases will impact these metrics
  - These assessments cannot account for adequacy needs or activities of non-participating load or resources
- » Be aware of the limits of drawing regional conclusions from aggregate information
  - Information is best applied at individual LREs; WRAP's scope does not include matching LREs in need of additional forward procurement with available resources
  - It cannot be assumed that all resources modeled in the loss of load expectation study will be available to the WRAP footprint

Northwest % - Winter 2023-2024

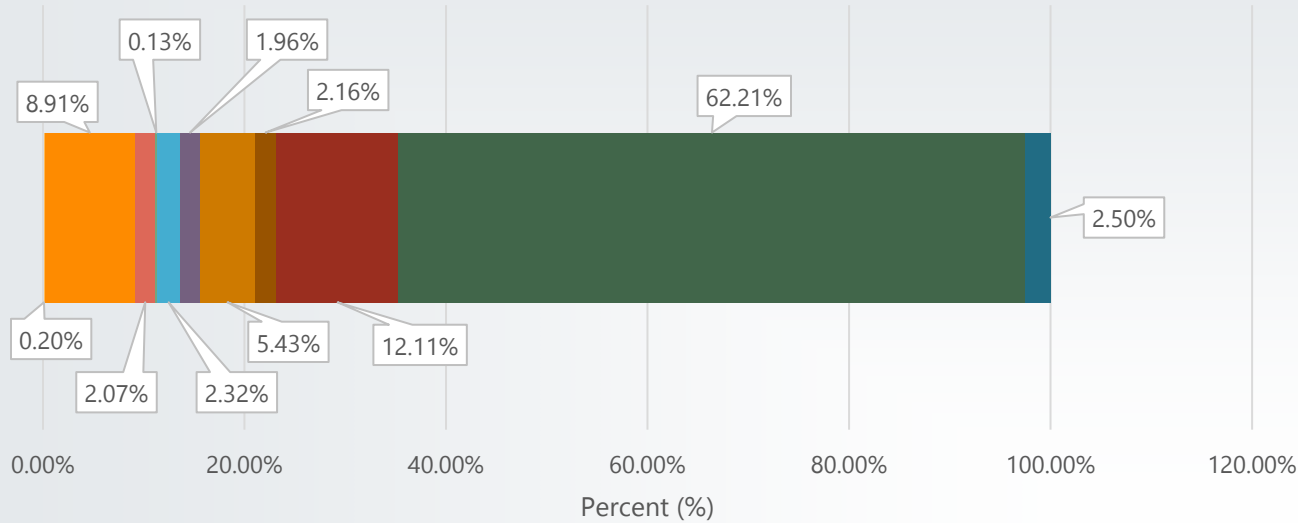

- Battery
- Combined Cycle
- Coal
- DR
- Gas Turbine
- Nuclear
- Run-of-River
- Solar
- Wind
- Hydro
- Other

Northwest % - Winter 2026-2027

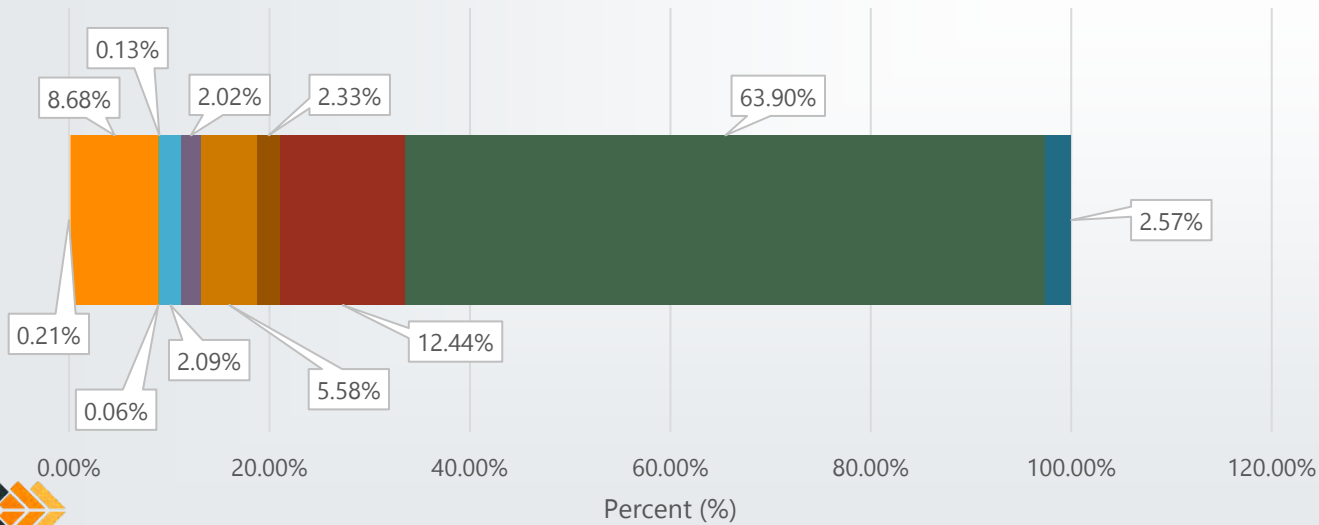

- Battery
- Combined Cycle
- Coal
- DR
- Gas Turbine
- Nuclear
- Run-of-River
- Solar
- Wind
- Hydro
- Other

# NORTHWEST WINTERS

## *Percentage*

Northwest % - Summer 2024

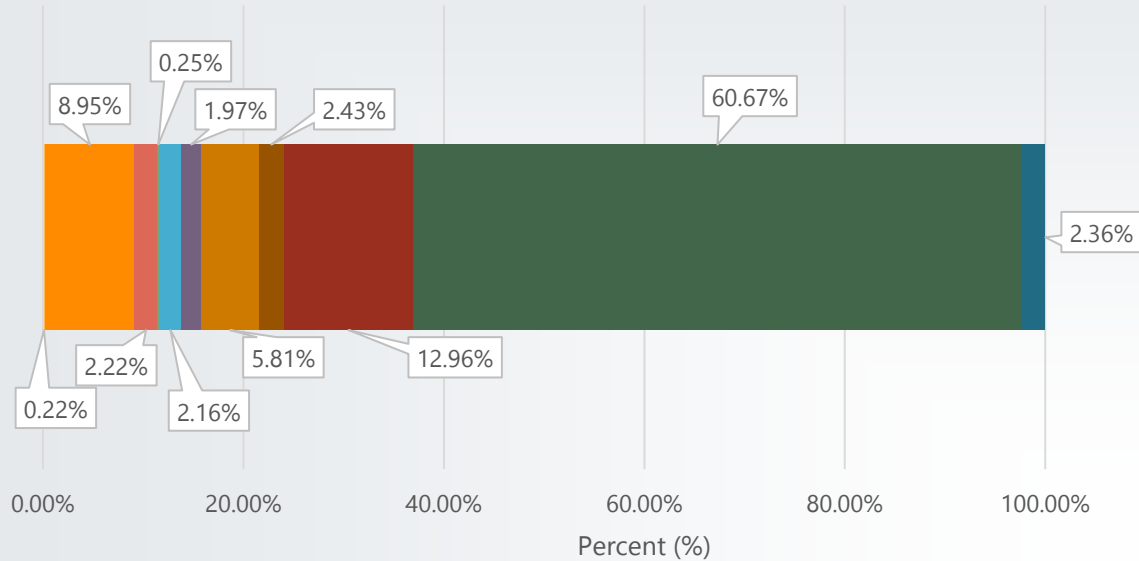

Northwest % - Summer 2027

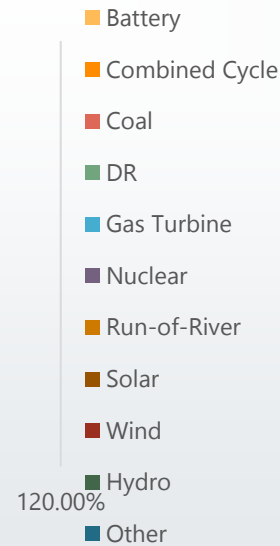
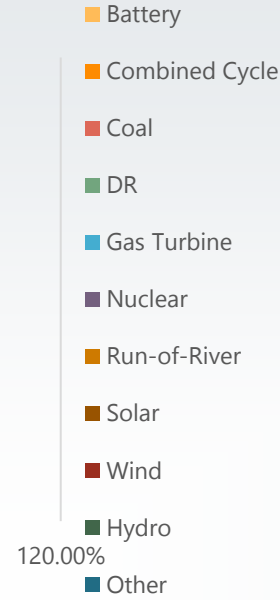
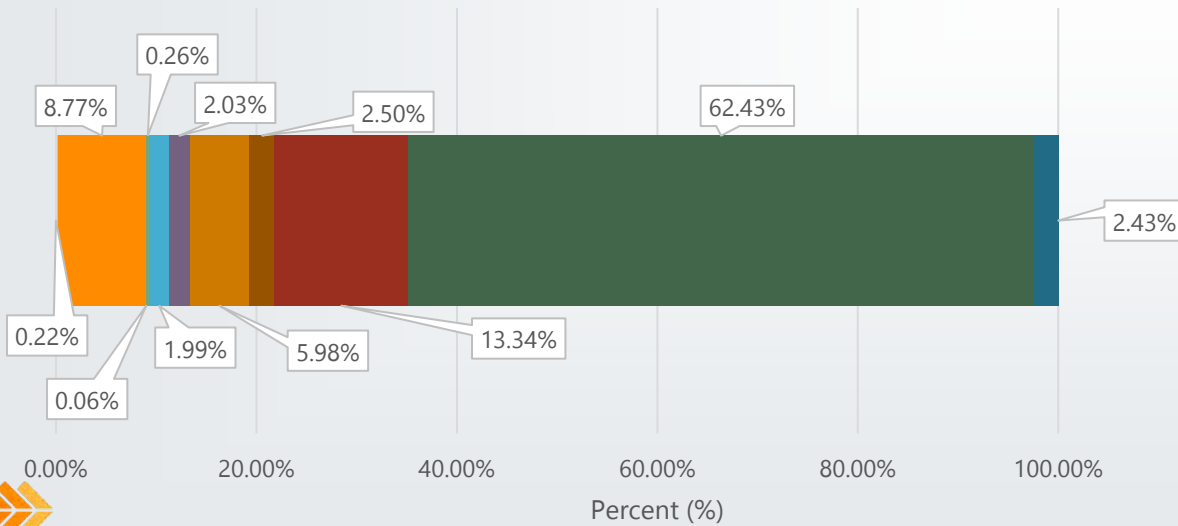

# NORTHWEST SUMMERS

## Percentage



# KEY REMINDERS

- » Not all resources shown in the preceding slides can be assumed to be available to the WRAP footprint for resource adequacy purposes
  - Planned outages are not considered; they will be managed by LREs from their surplus
  - Does not account for activities and needs of neighboring, non-participating regions or entities
  - Based on information and projections provided by participants
- » Aggregate information does not give insight into whether individual participants have enough supply
  - WRAP motivates participants to acquire the necessary capacity
  - Cannot assume this has yet happened or will happen without binding implementation of WRAP

# WIND ZONES



Zone	# of Plants	Nameplate Capacity (MW)
Wind VER1	54	5,734
Wind VER2	44	2,400
Wind VER3	23	1,378
Wind VER4	24	2,429
Wind VER5	Aggregate	747
<b>Total</b>	<b>146</b>	<b>12,688</b>



# SOLAR ZONES

Zone	# of Plants	Nameplate Capacity (MW)
Solar VER1	159	2,138
Solar VER2	108	9,024
<b>Total</b>	<b>267</b>	<b>11,162</b>

# PEAK LOAD

Non-coincident 1-in-2 (P50) Peak Load

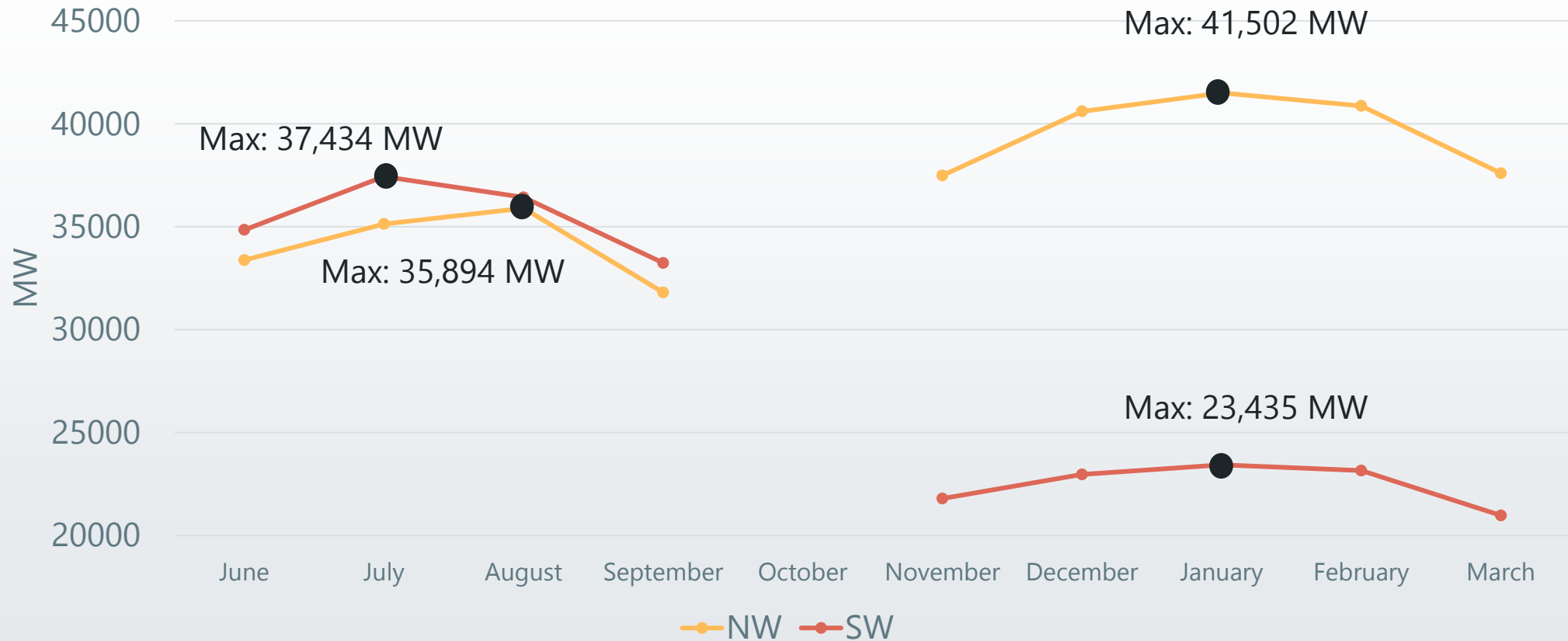

# WIND ELCC - WINTER

ELCC by Zone

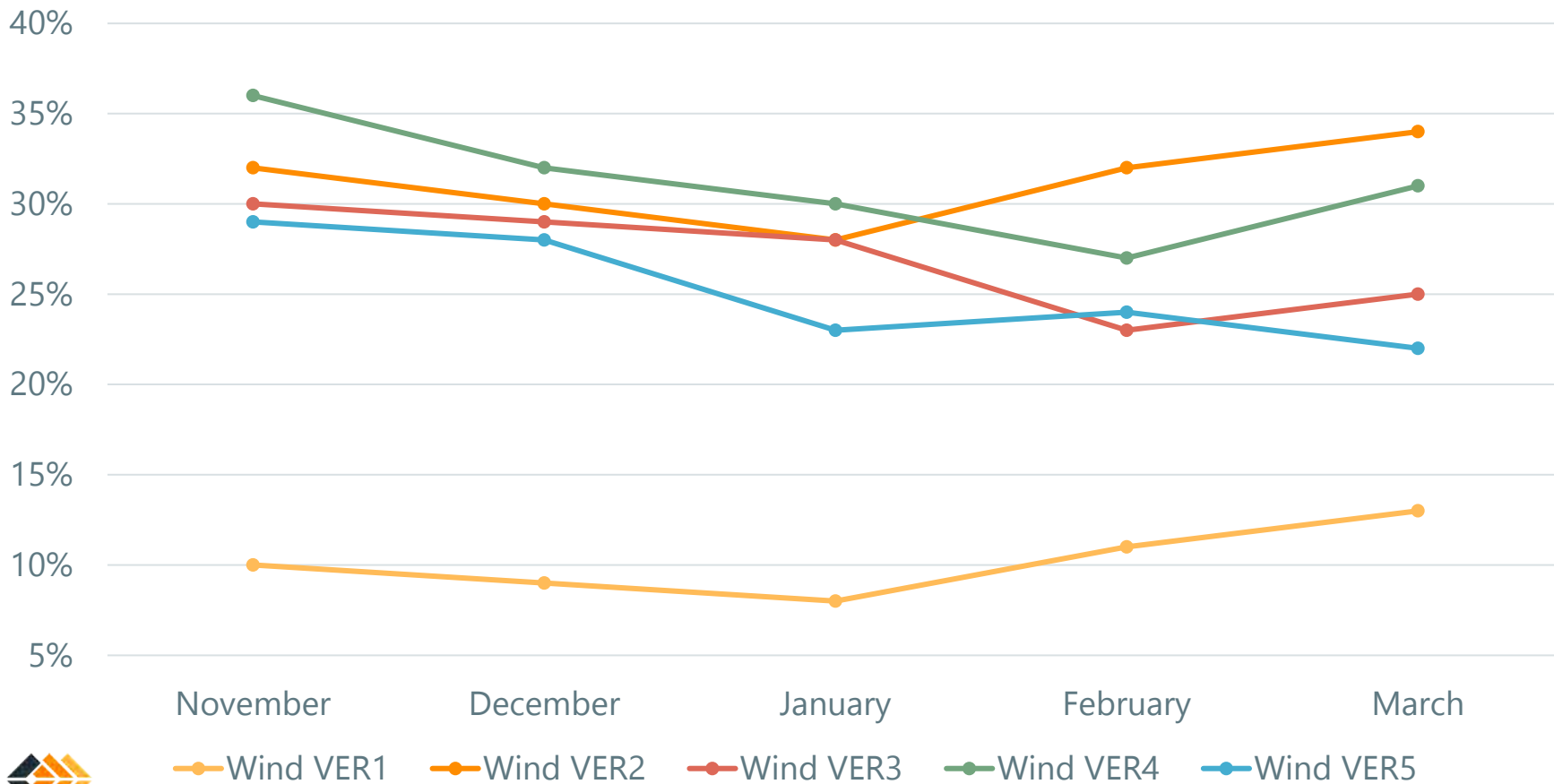

# WIND ELCC - SUMMER

ELCC by Zone

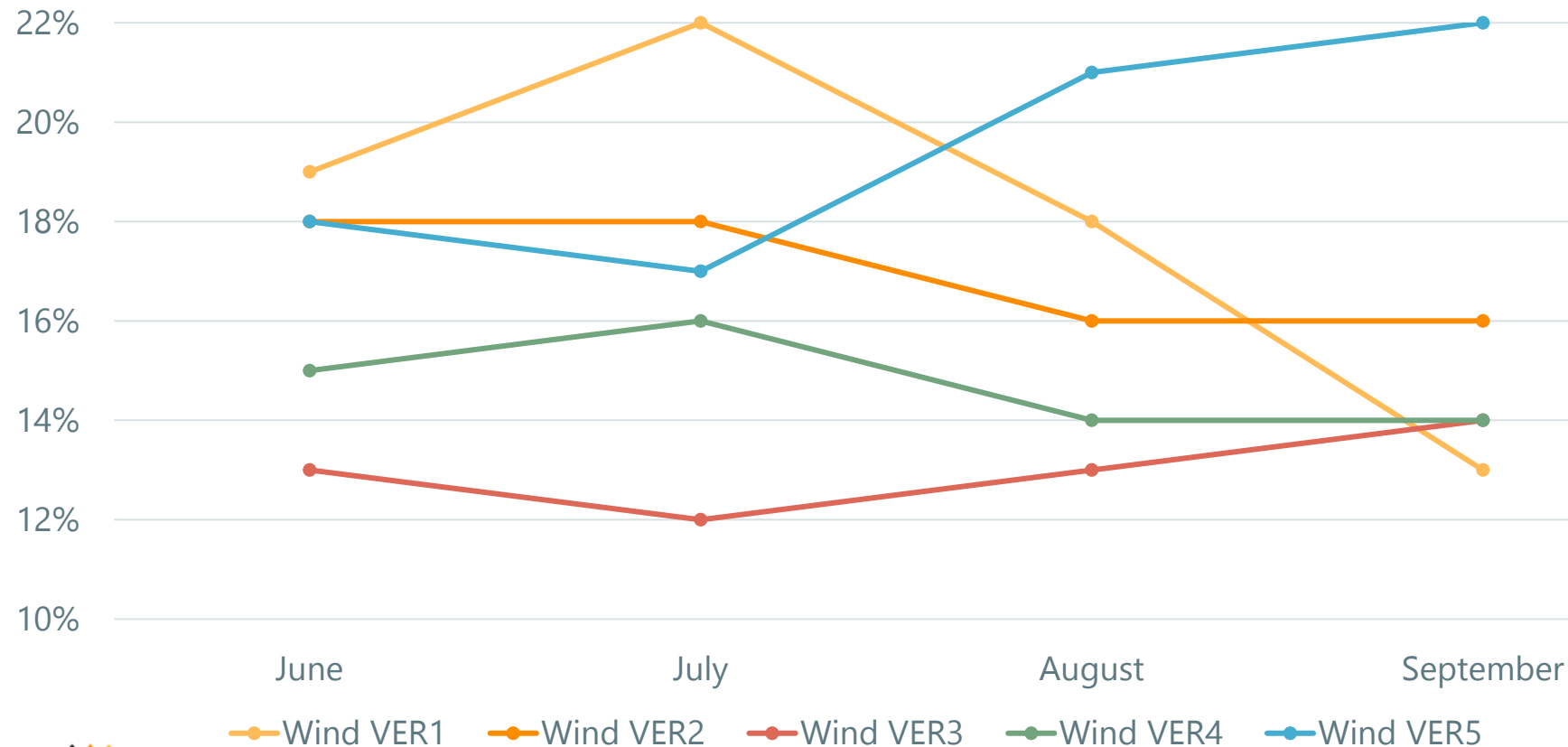

# WIND ELCC –

## WIND AT INCREMENTAL GW INSTALLATIONS

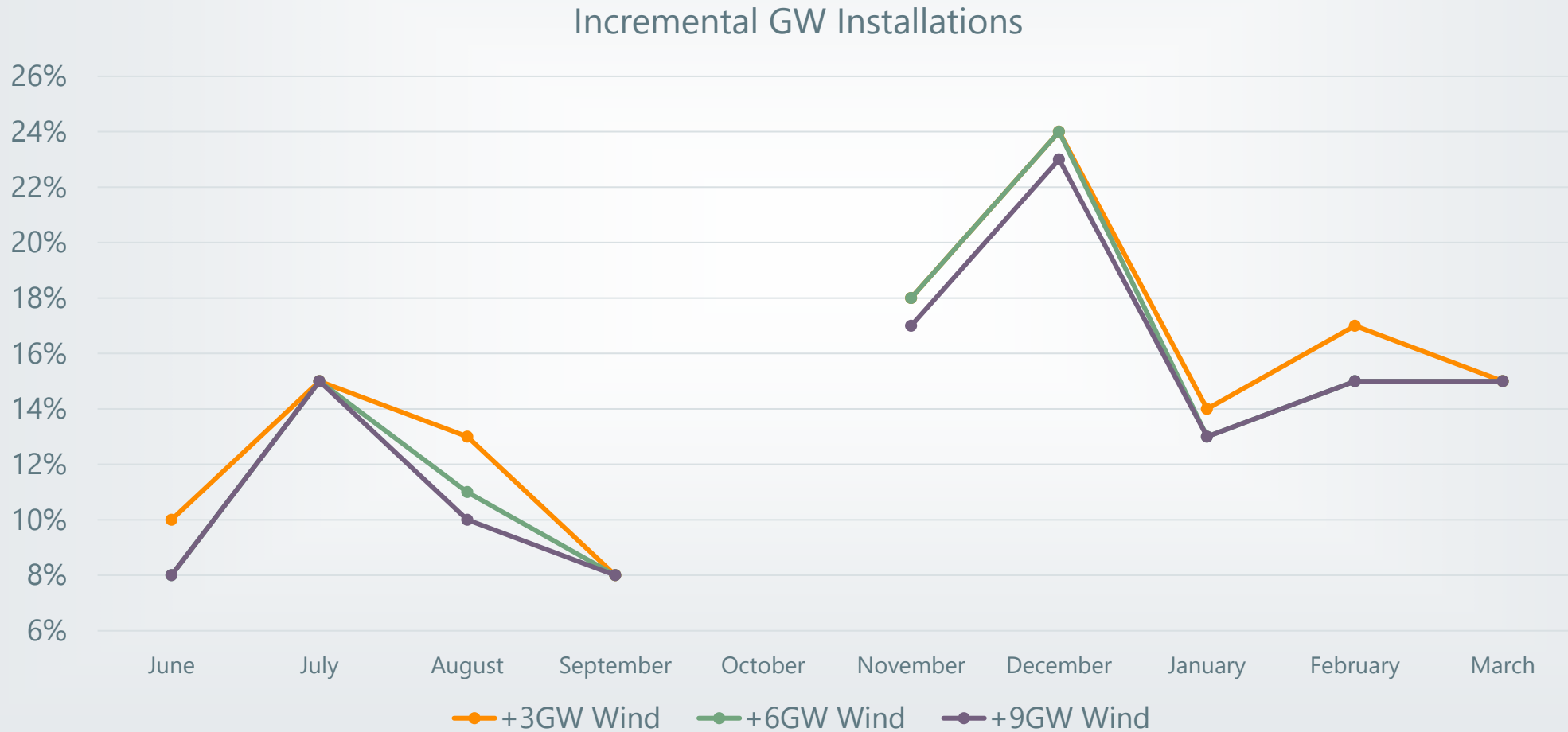

# SOLAR ELCC - WINTER

ELCC by Zone

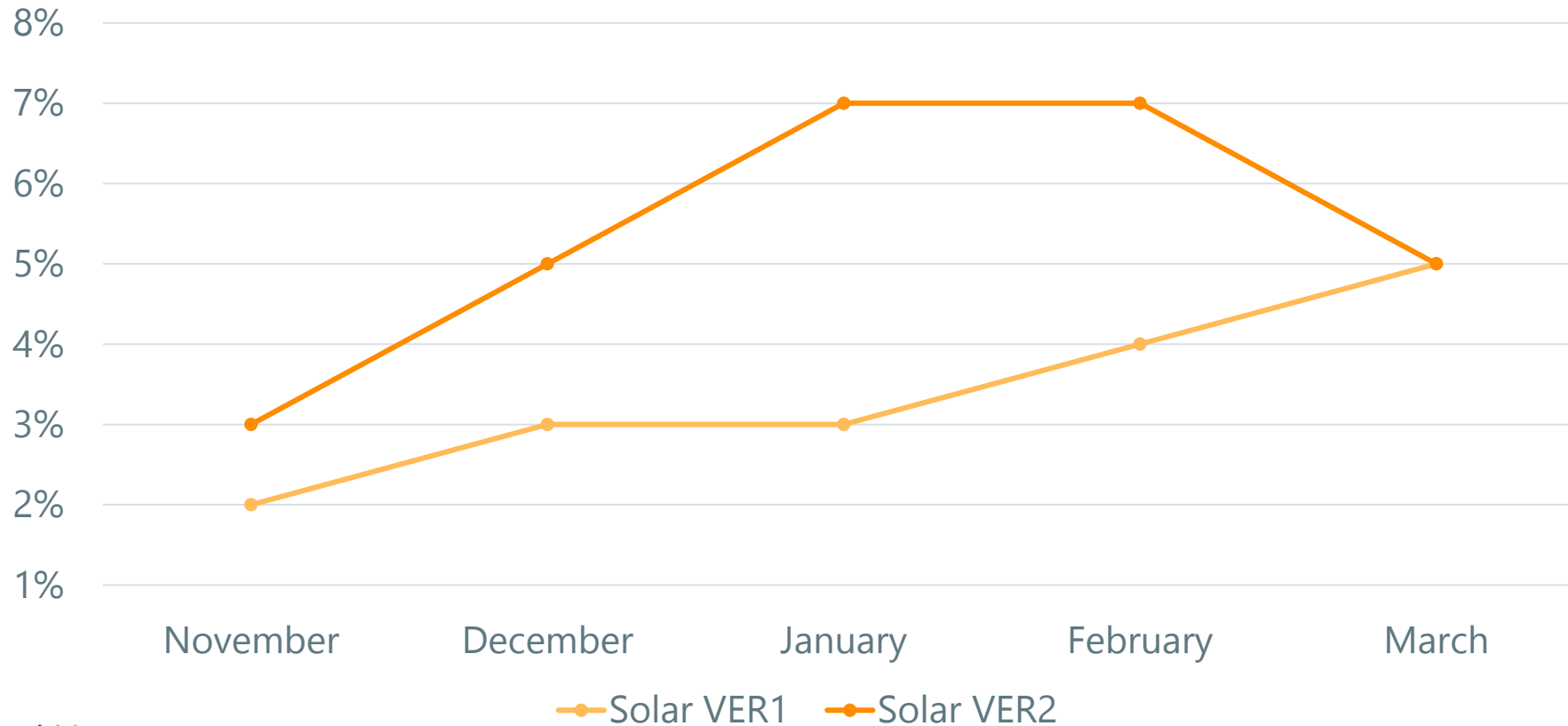



# SOLAR ELCC - SUMMER

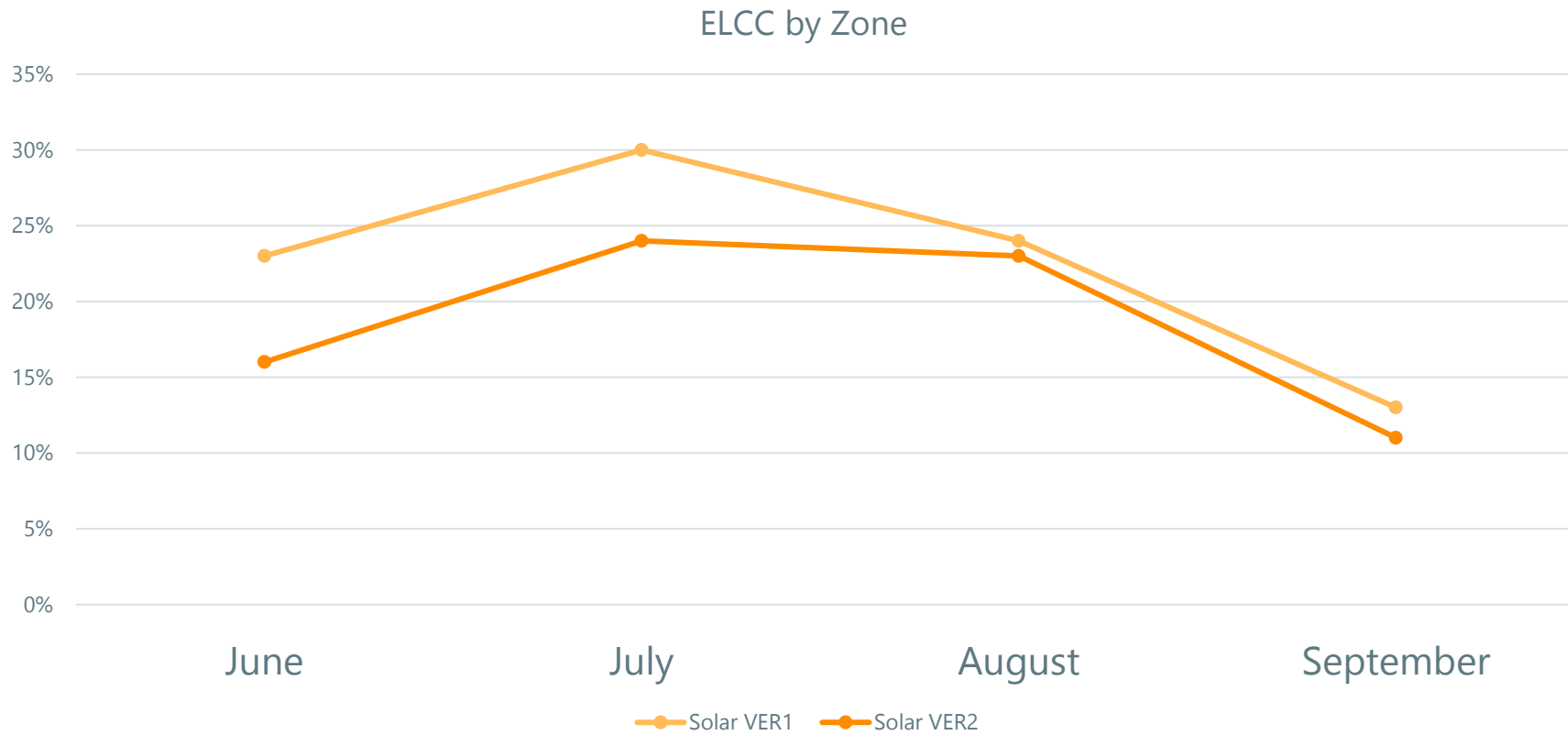

# SOLAR ELCC –

## *SOLAR AT INCREMENTAL GW INSTALLATIONS*

Incremental GW Installations

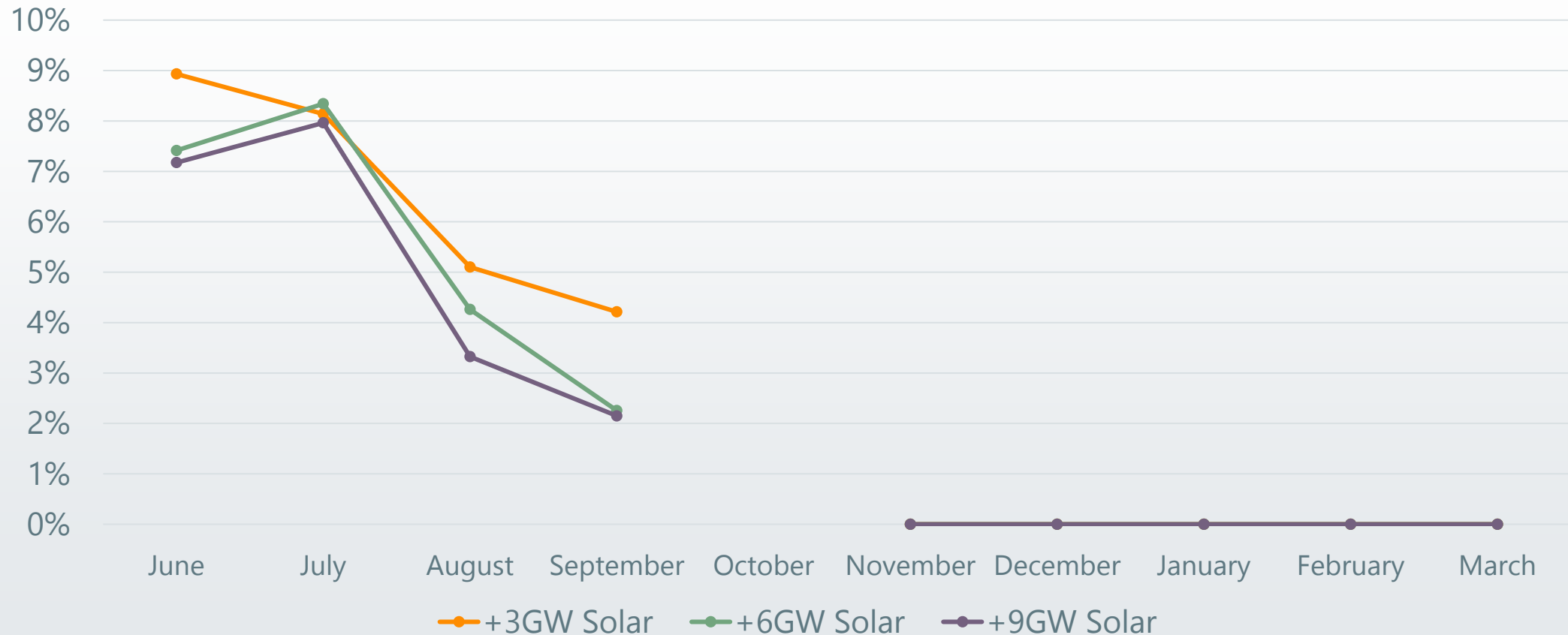

# RUN-OF-RIVER QCC

## WINTER

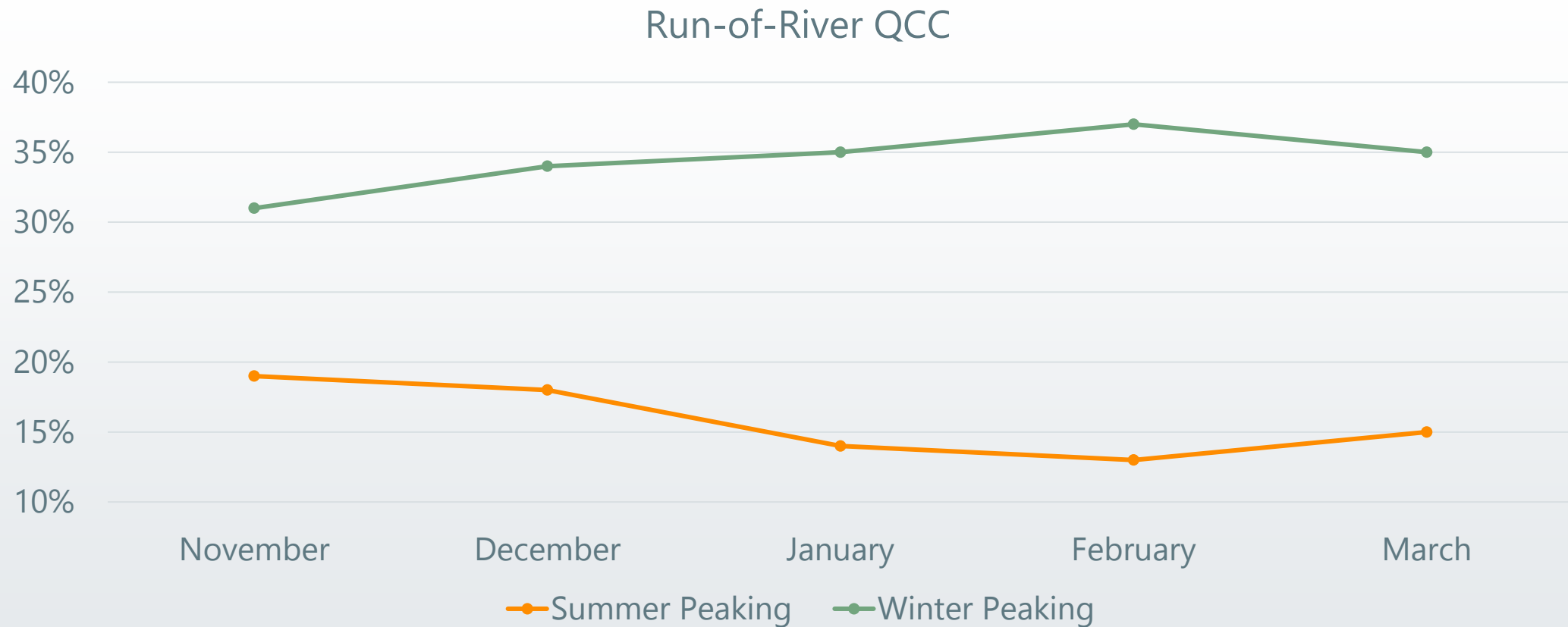

# RUN-OF-RIVER QCC

## SUMMER

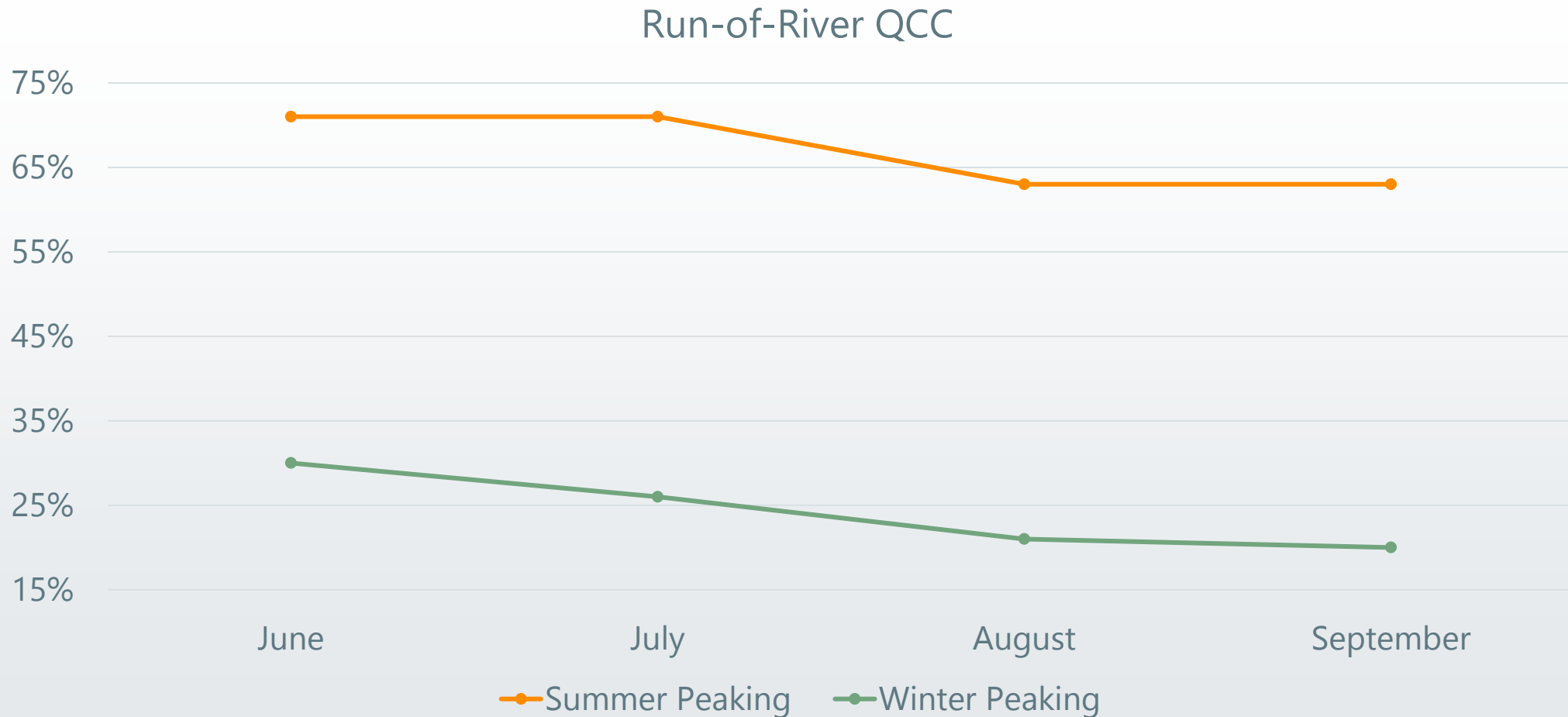

# STORAGE HYDRO QCC - WINTER

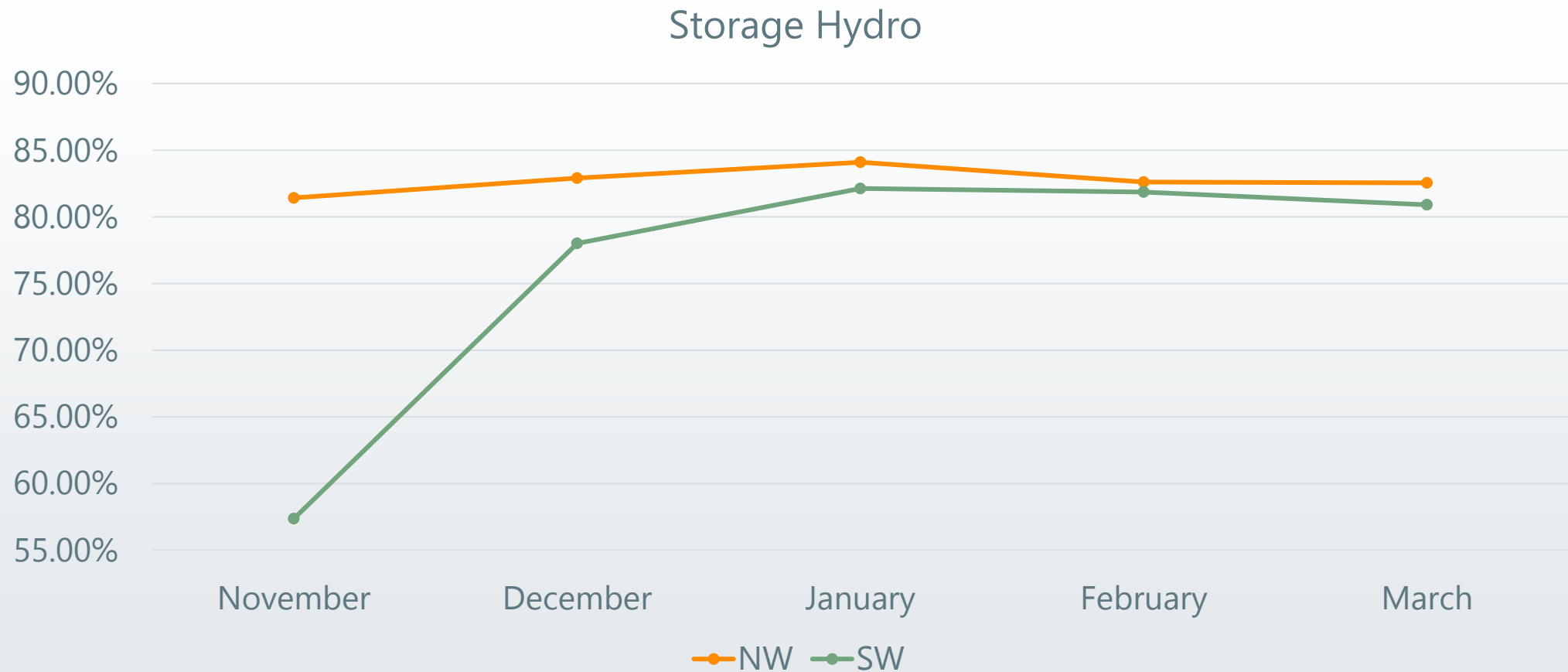

# STORAGE HYDRO QCC - SUMMER

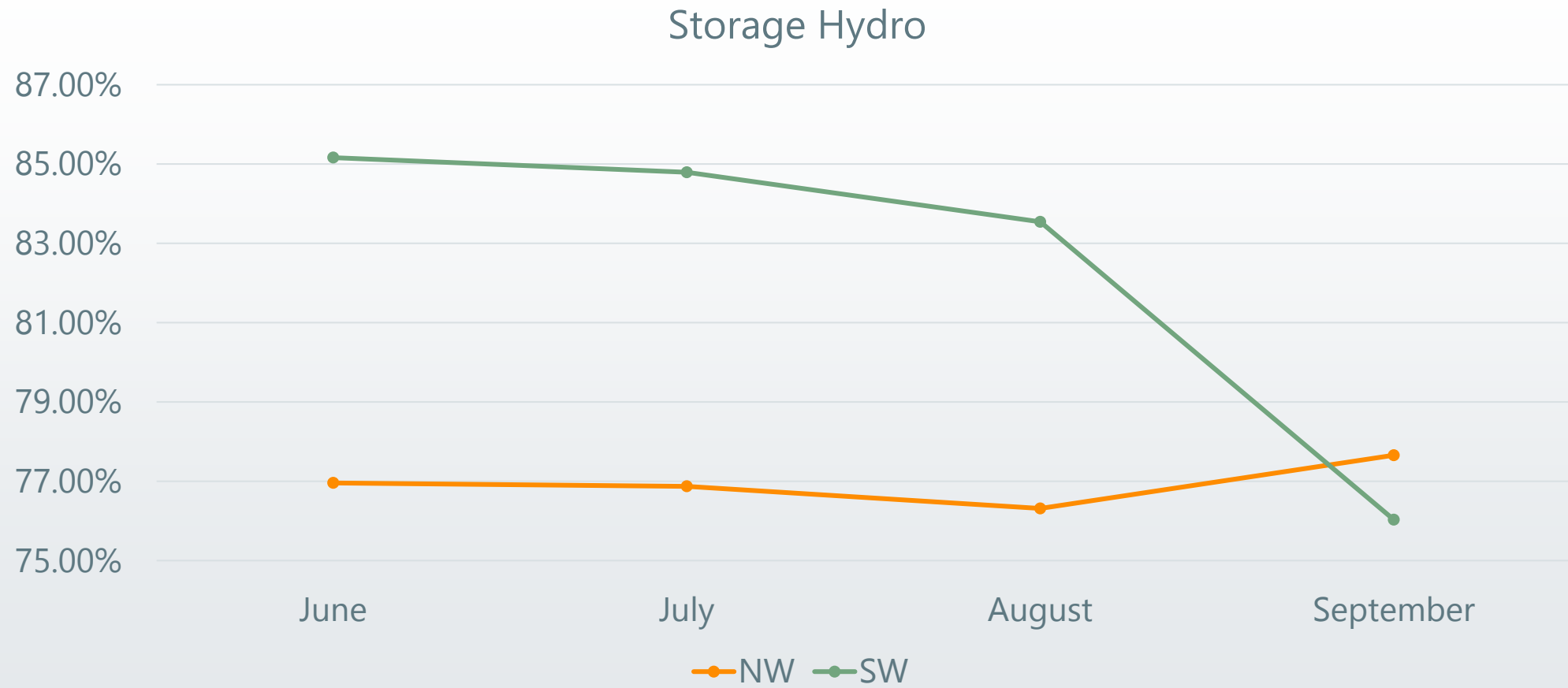

# THERMAL QCC- WINTER

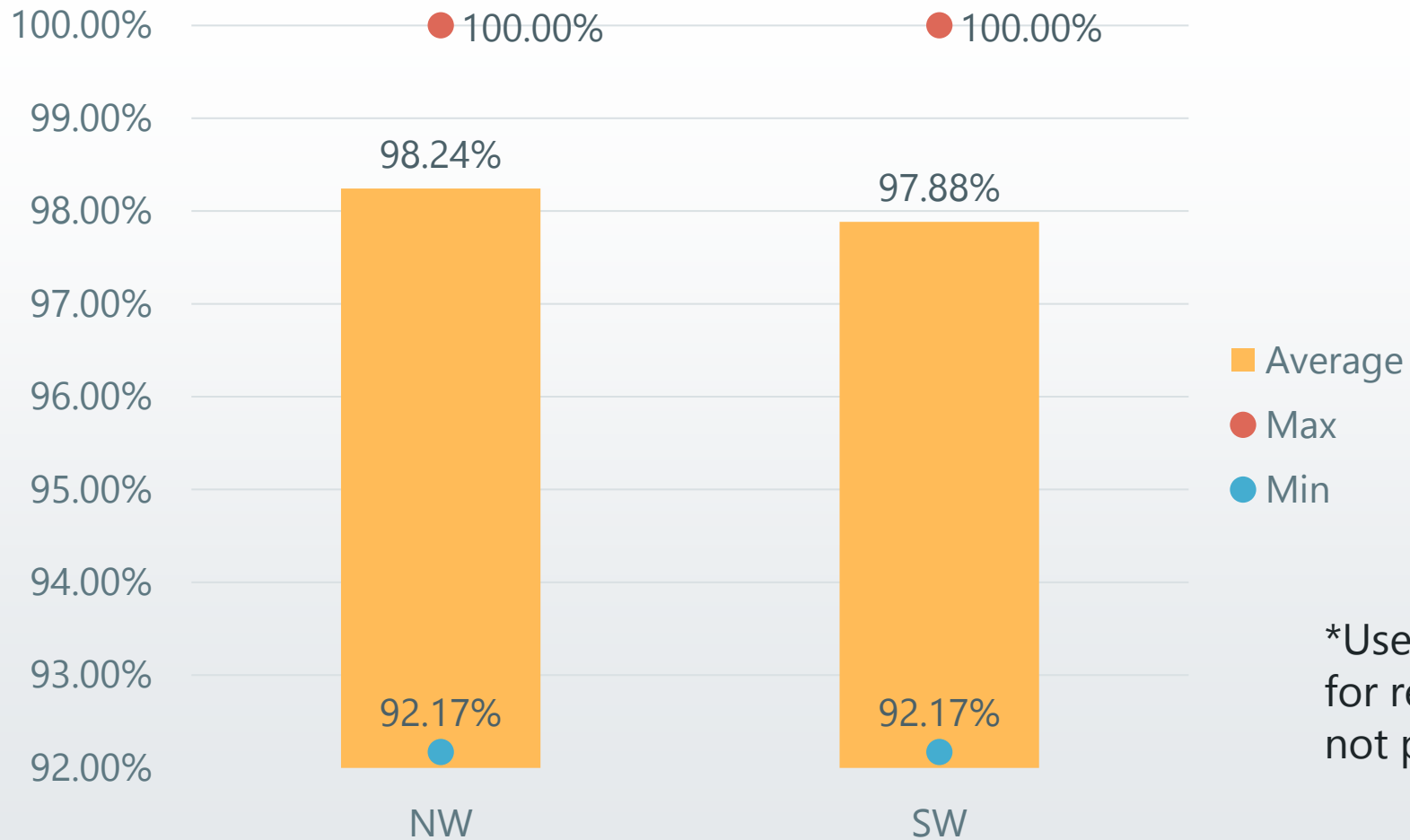

\*Uses indicative values for resources that did not provide GADS data

# THERMAL QCC- SUMMER

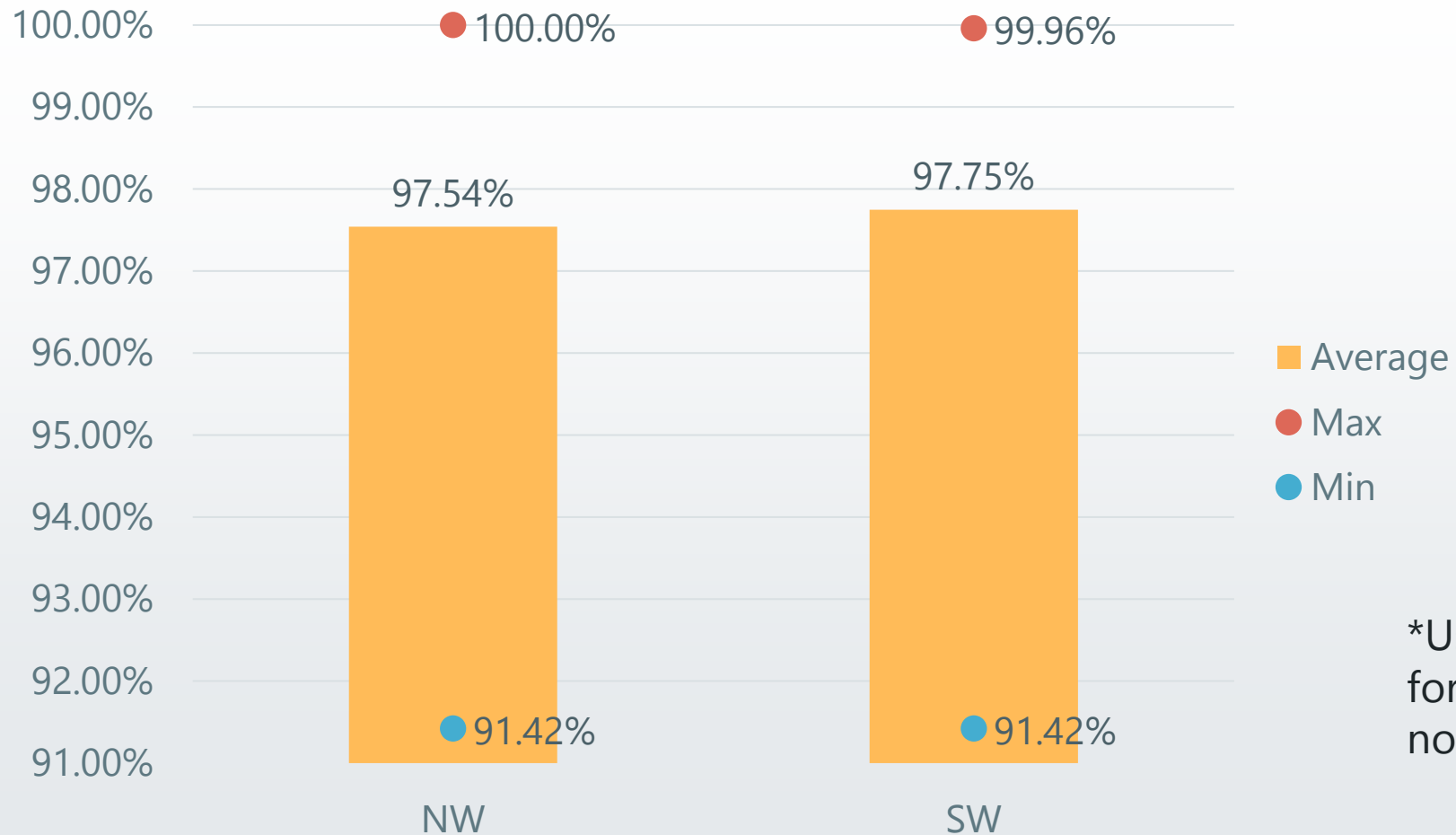

\*Uses indicative values for resources that did not provide GADS data



# PRM CONSIDERATIONS

- » Attempting to maintain 0.1 LOLE across the season
- » Allow up to 0.01 LOLE in each individual month
- » Non-Coincidental Peak load for a given month is a significant factor in calculation of PRM (lower load months will have higher PRM value)

# PRM – NORTHWEST (UCAP)

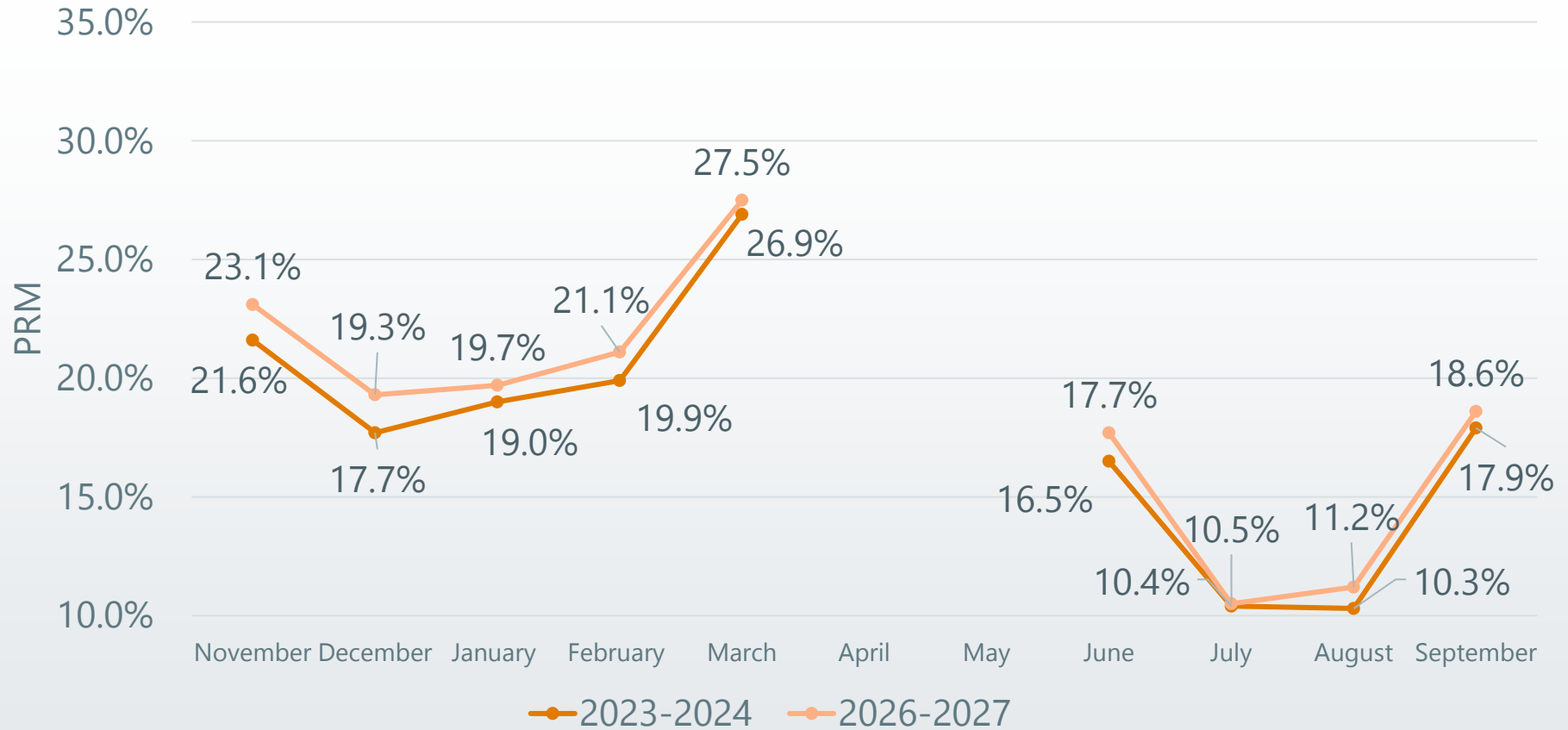

# CURRENT PHASE ACTIVITIES

PO = Program Operator  
LOLE = Loss of Load Expectation  
ELCC = Expected Load Carrying Capacity



# WRAP – PHASED ROLL OUT

## Non-Binding Forward Showing

Winter 22-23, Summer 23, Winter 23-24, Summer 24, Winter 24-25

## Binding Program With Transition Provisions (FS and Ops)

Summer 25, Winter 25-26, Summer 26, Winter 26-27, Summer 27, Winter 27-28

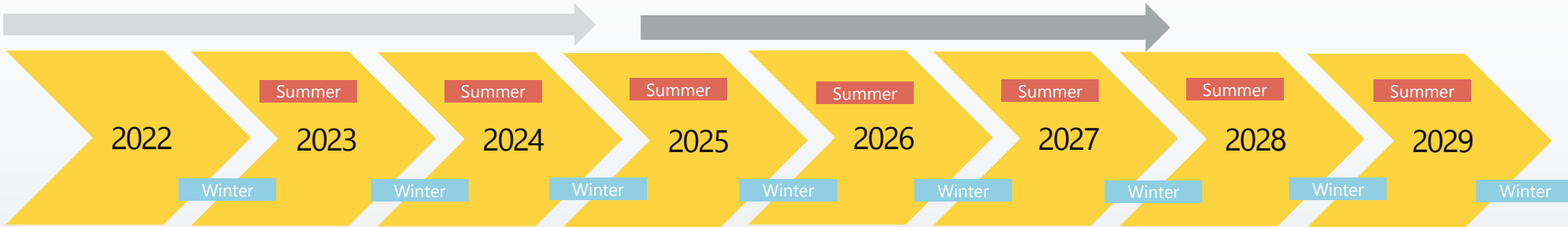

## Non-Binding Operations Program

Summer 23 (trial – will include testing scenarios), Winter 23-24, Summer 24, Winter 24-25

## Binding Program Without Transition Provisions

Summer 28 and all seasons following

# THANK YOU

*For general inquiries or to be added to our mailing list:  
[wrap@westernpowerpool.org](mailto:wrap@westernpowerpool.org)*



# Washington Resource Selection & Customer Benefit Indicators

Annette Brandon, Wholesale Marketing Manager  
Electric IRP, Seventh Technical Advisory Committee Meeting  
October 11, 2022

# CEIP Development

## **Integrated Resource Plan (IRP) – Filed final April 30, 2021**

20+ year resource planning identifying customer future resource needs

## **Clean Energy Action Plan (CEAP) – Filed jointly with IRP**

Sets **10-Year targets** for resources based on the lowest reasonable cost plan including; filed jointly with IRP

## **Public Participation Plan – May through September 2021**

Provides **road map** for engagement and solicitation of input from customers, Equity Advisory Group, and existing Advisory Groups (including Stakeholders from public agencies)

## **Clean Energy Implementation Plan (CEIP) 2022-2025 – Filed October 1, 2021**

CEIP establishes the **actions** the utility will take to comply with CETA goals over the next four years.

- Informed by Public Participation Process
- Identifies the projects, programs and investments
- Ensures Customer Benefit are attributes of those actions.
- **Approved June 2022 with Conditions**



## **2021 Clean Energy Implementation Plan**



# Public Participation Groups and Process

**Equity is at the core of the transition to clean energy.** Company must ensure the “equitable distribution of energy and nonenergy benefits and reductions of burdens to vulnerable populations and highly impacted communities” in development of CEIP.

## Benefits/Barriers “Equity Areas”

- Benefits of Clean Energy
- Ensure benefits are equitably distributed
- Barriers to participation

## Identify Named Communities

- Who is likely to be most impacted?
- Highly Impacted Communities
- Vulnerable Populations

## Customer Benefit Indicators

- Ensure customers are receiving benefits of clean energy
- Measurements for accountability

## Specific Actions – What specific steps will Avista take?

- Clean Energy resources – ensure CBIs are attributes mix of renewable, energy efficiency, demand response

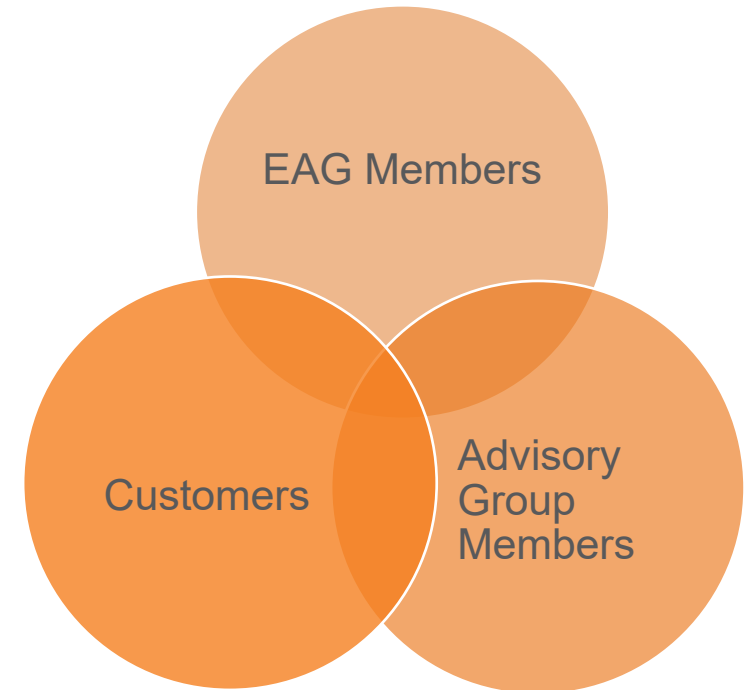



# What is a “Customer Benefit Indicator”?

“...is an attribute, either quantitative or qualitative, of resources or related distribution investments associated with customer benefits described in RCW 19.405.040(8).”

## Equity

- Equitable distribution of energy and non-energy benefits and reductions of burdens (non-energy impacts) to vulnerable populations and highly impacted communities

## Public Health / Environment

- Long-term and short-term public health and environmental benefits and reductions of costs and risks;
- Such as less air pollution which results in lower asthma rates

## Energy Security and Resiliency

- Energy Security – strategic objective to maintain energy services and protecting against disruption
- Energy Resiliency – ability to adapt to challenging conditions from disruptions

## Cost and Risk Reduction

- Lowers customer costs
- Reduces risk

How can we ensure our customers benefit from the clean energy implementation actions we are taking?

Which resources or investment could provide benefits to our customers?

How can we measure how we are doing?

\*RCW 19.405.040(8) “... through the equitable distribution of energy and nonenergy benefits and reduction of burdens to vulnerable populations and highly impacted communities; long-term and short-term public health and environmental benefits and reduction of costs and risks; and energy security and resiliency. “

# Customer Benefit Indicator – Process

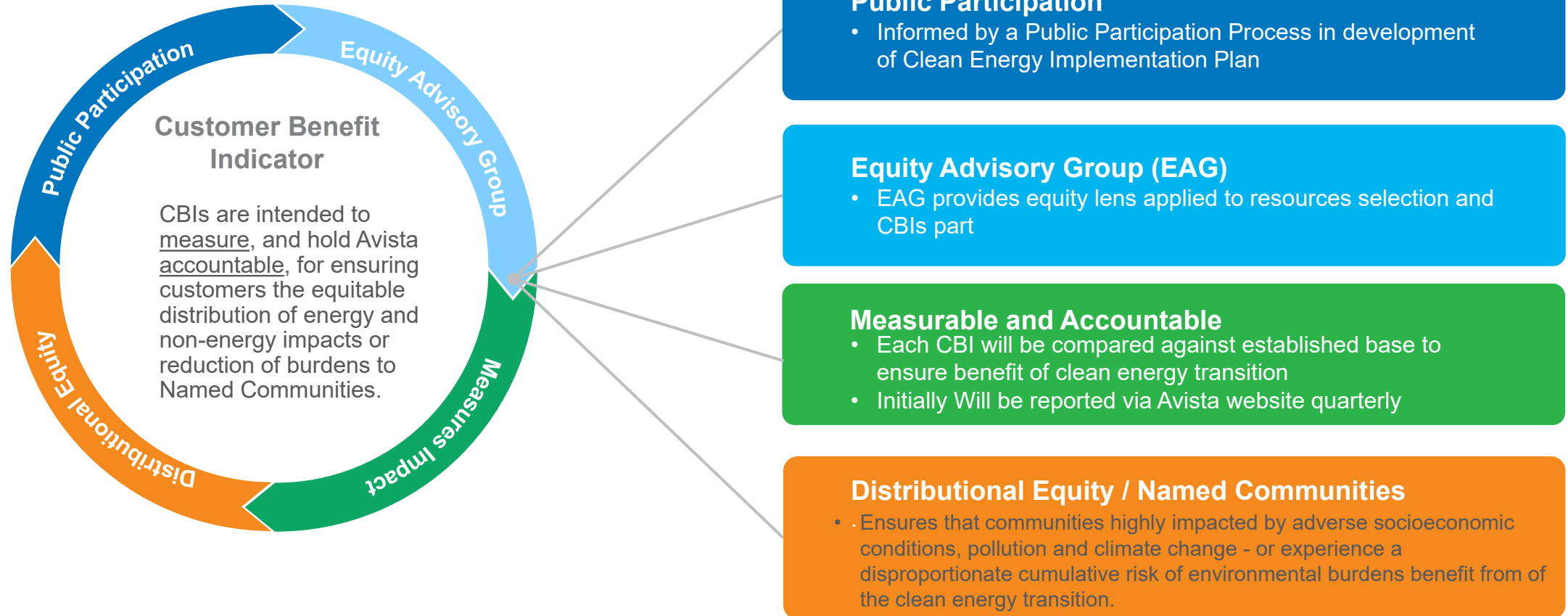

# Approved Customer Benefit Indicator (CBI) by Equity Area

- Participation in Company Programs
- Number of Households with high energy burden (>6%)

## Affordability



- Outreach and Communication
- Transportation Electrification

## Access



- Named Community Clean Energy
- Investment in Named Communities

## Community Development



- Energy Availability
- Energy Generation Location
- Residential Arrearages and Disconnections

## Energy Resiliency & Security



- Outdoor Air Quality
- Greenhouse Gas Emissions

## Environmental



- Employee diversity
- Supplier diversity
- Indoor Air Quality

## Public Health



Several Impact multiple benefit areas:

- Energy
- Non-energy
- Reduction of burdens
- Public Health and Environmental
- Energy Security and Resiliency
- Cost and Risk Reduction

# What is a Non-Energy Impact?

- **NEIs are at the vital intersection of energy and equity and central part of the metrics of equity**
- Non-energy impacts is a way to understand the total contribution of investments that goes beyond the simple energy and demandsavings
- These impacts (either positive or negative) can come in the form of economic, social, and/or personal ways.
- Non-energy impacts can be called many things, but they all mean the same thing: non- energy impacts (NEIs), NEBs, co-benefits, etc.

## Societal Benefits

Public Health	Economic Development
Improved Air Quality	Increased Employment
Water quality and quantity	Energy Security
Benefits to Low Income families	

## Participant Benefits

O & M Savings	Employee Productivity Increase
Health Benefits	Property Value Increase
Comfort Increase	Benefits to Low Income Customers

## Utility Benefits

Peak Load Reduction	Less Debt Write Off
Transmission and Distribution Savings	Lower Collection Costs
Reduced arrearages	Fewer customer calls

# Non-Energy Impacts in IRP

## Supply-Side Resources

**Public Health**  
PM2.5, SO2, NOx

**Safety**  
Direct and indirect  
fatalities per GWh

**Environment**  
Land use, water use,  
wildfire risk

**Economic**  
Jobs, earnings, output,  
value add added

## Demand-Side Resources\*

**Income & Health**  
Economic Develop. (income)  
less missed days of work

**Health**  
Related to avoided costs such as  
medical

**Property Value**  
Noise, visual air/temperature

**Energy Burden**  
Reduction in costs related to utility  
bill

## IRP Resource Selection

- Non-energy impacts quantified from DNV (third party) analysis in economic potential.
- Non-energy impacts quantified from DNV (third party) analysis in supply-side resource selection as adder.
- Not all NEIs are able to be quantified due to lack of data or difficulty in obtaining data.
- Additional study may be performed for Supply side resources.
- Phase II Demand Side Resource NEI Study to occur in 2022.

# Customer Benefit Indicator and Non-Energy Impact Clean Energy Implementation Plan Condition #2



- Avista will apply Non-Energy Impacts (NEIs) and Customer Benefit Indicators (CBIs) to all resource and program selections in determining its Washington resource strategy
- Avista agrees to engage and consult with its applicable advisory groups (IRP Technical Advisory Committee (TAC) and Energy Efficiency Advisory Group (EEAG)) regarding an appropriate methodology for including NEIs and CBIs in its resource selection.
- Avista will consult with its EAG after the development of this methodology to ensure the methodology does not result in inequitable results

# CBIs and Resource Measurements Not applicable to Resource Selection

The following CBIs are measurement tools for implementation of various resources or to address qualitative inequities primarily in Named Communities



## (1) Participation in Company Programs

- Participation in Weatherization Programs
- Saturation rates for energy assistance
- Number of residential appliance and equipment rebates to Named Communities / rental units
- Measures impact of the success of execution of BCP
- Coordinated effort with CBI (3) Methods/Modes of Communication
- May be used in program prioritization



## (2) Number of households with a high energy burden

- Number of households with a high energy burden (>6%) will be tracked separately for all electric customers, known low income, and Named communities
- Average Excess Burden per Household
- IRP will forecast total cost and indirectly impacts to energy burden
- Not measured directly for EE. Embedded with NEI for bad debt, O & M (participant) and thermal comfort.



## (3) Availability of Methods/Modes of Communication

- Number of contacts for each energy assistance and energy efficiency outreach event offered, and impressions from energy assistance and energy efficiency marketing
- Track increased availability of translation services
- Intended to address barriers to participation/access; not selection criteria

# CBIs and Resource Measurements Not applicable to Resource Selection Continued



## (4) Transportation Electrification

CBO – Community Based Organization

- Number of Trips provided by CBO
- Number of annual passenger miles provided by CBOs
- Number of Public Charging Stations located in Named Communities.
- Measurement of plan implementation In accordance with TE Plan



## (6) Named Community Investments

- Incremental annual spending of investments in Named Communities
- Annual number of customers and/or CBOs
- Quantification of annual energy and non-energy benefits from investments (if applicable)
- Results measurement of individual investments not identified in RFP



## (11) Employee Diversity (12) Supplier Diversity

- 11 – employee diversity equal to communities served by 2035
- 12 – Supplier Diversity of 11% by 2035
- Intended to address “public health threat” or other historical/current inequities resulting from systemic racism (or other inequities)



## (14) Residential Arrearages and Disconnections for non-payment

- Number and percent of residential electric disconnections for non-payment per month
- Residential arrearages for residential electric data by month by known low income, vulnerable populations, highly impacted communities and all customers
- Indirectly associated with access to clean energy or programs which may impact affordability and energy burden.
- Not directly related to specific action



# CBIs and Resource Selection

## Applicable CBIs and Metrics

CBIs which can be quantified for use in the Integrated Resource Plan

May be applicable to one or more resource type

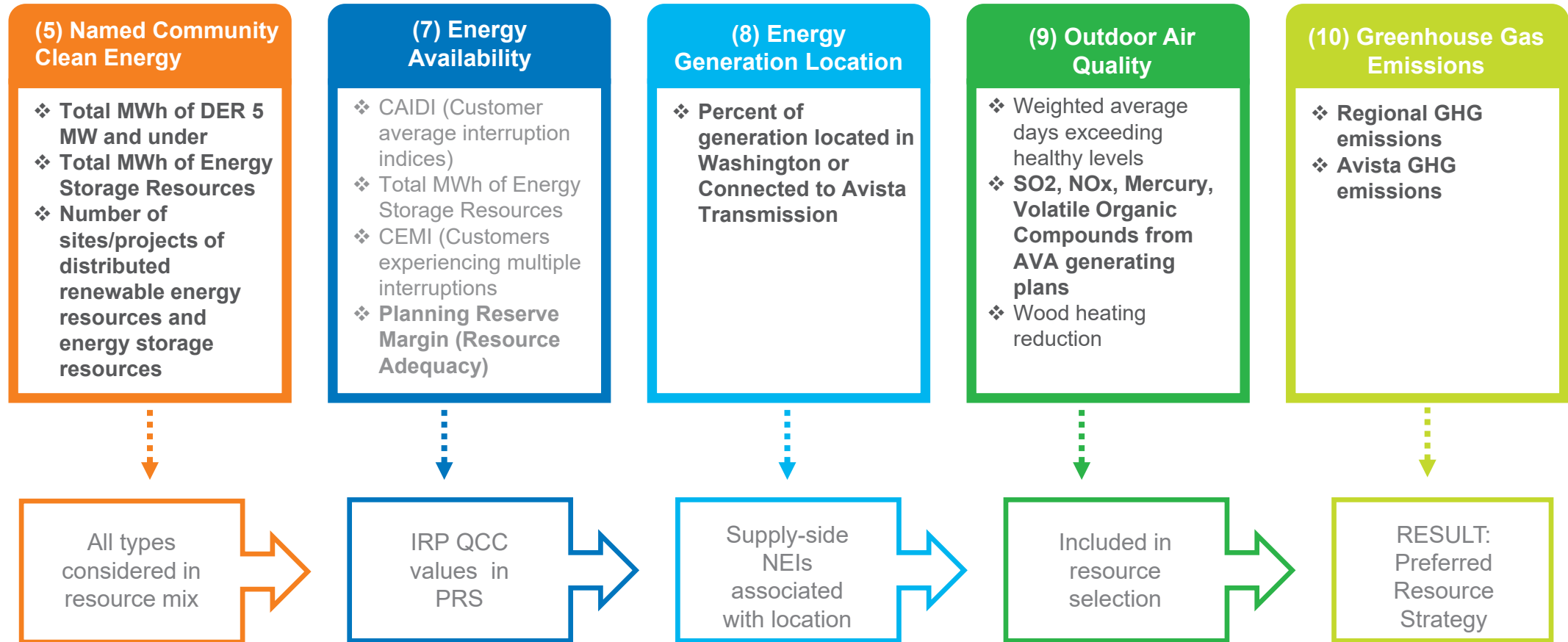

# CBIs and Resource Selection Applicable CBIs and Metrics

## (5) Named Community Clean Energy

- ❖ Total MWh of DER 5 MW and under
- ❖ Total MWh of Energy Storage Resources
- ❖ Number of sites/projects of distributed renewable energy resources and energy storage resources

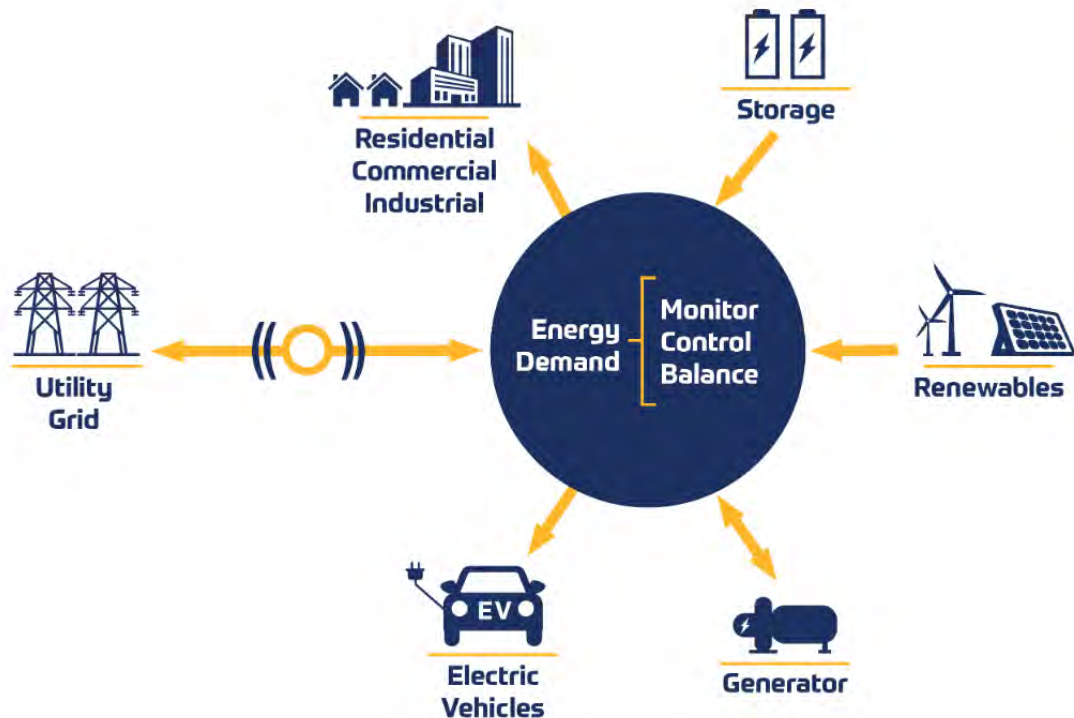

- ✓ DER and Energy Storage included as options in the preferred resource strategy analysis.
- ✓ Baseline in development.
- ✓ Named Community Investment Fund may be additional method for incorporating into overall Business strategy

# CBIs and Resource Selection Applicable CBIs and Metrics

## Baseline

### Resource Adequacy Planning Margin

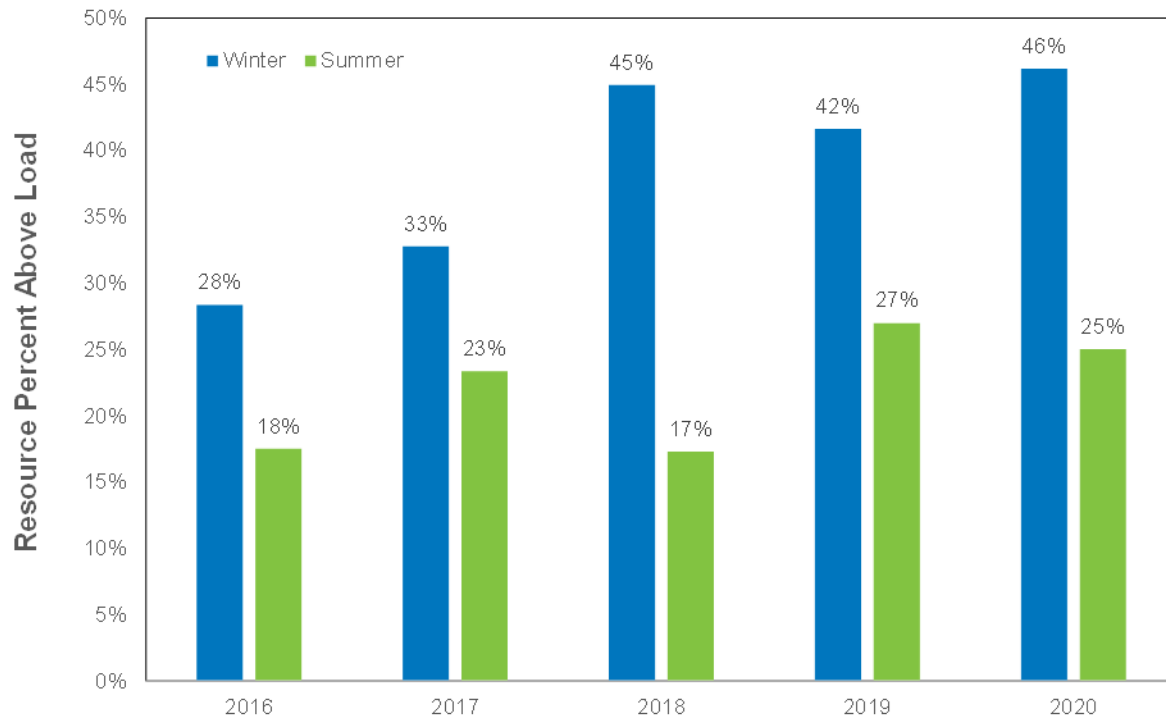

## (7) Energy Availability

- ❖ Customer Average Interruption Duration (CAIDI)
- ❖ Frequency of outages for all customers, vulnerable populations, highly impacted communities. Avista will measure using IIEE Index, Customers experiencing multiple outages (CEMI)
- ❖ **Resource Adequacy – Planning Reserve Margin**

- ✓ CAIDI and CEMI reporting metrics
- ✓ **Resource Adequacy** – Avista will maintain its current planning margin targets of 22% winter and 13% summer until the Western Resource Adequacy Program (WRAP) is implemented

# CBIs and Resource Selection Applicable CBIs and Metrics

## (8) Energy Generation Location

❖ % of Generation located in WA or AVA Transmission

### Baseline

Percent of Generation located in Washington or Connected to Avista Transmission System

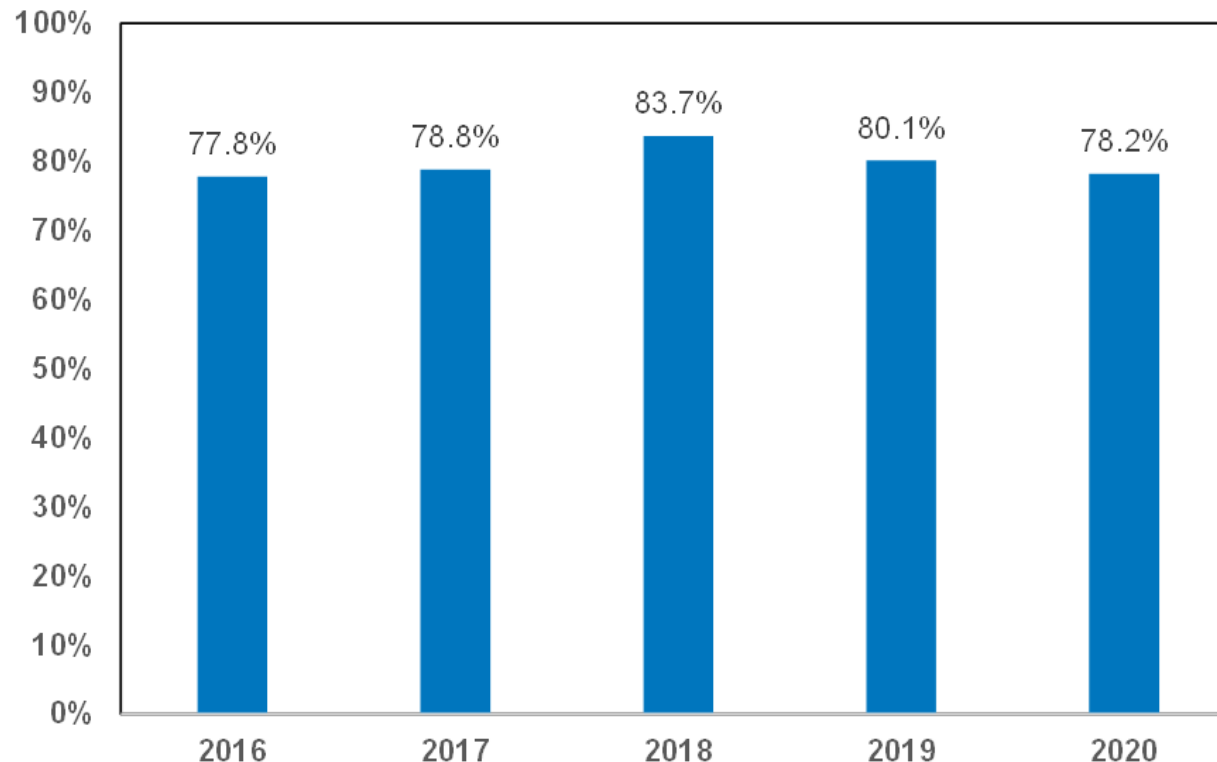

- Will track and have economic benefit of new resource options within Avista's service territory in IRP Selection Process
- Included in RFP Selection Criteria

# CBIs and Resource Selection

## Applicable CBIs and Metrics

NEI will help to account for the impact of air emissions in new resource selection

### (9) Outdoor Air Quality

- ❖ Weighted average days exceeding healthy levels
- ❖ SO<sub>2</sub>, NO<sub>x</sub>, Mercury, Volatile Organic Compounds from AVA generating plans
- ❖ Wood heating reduction

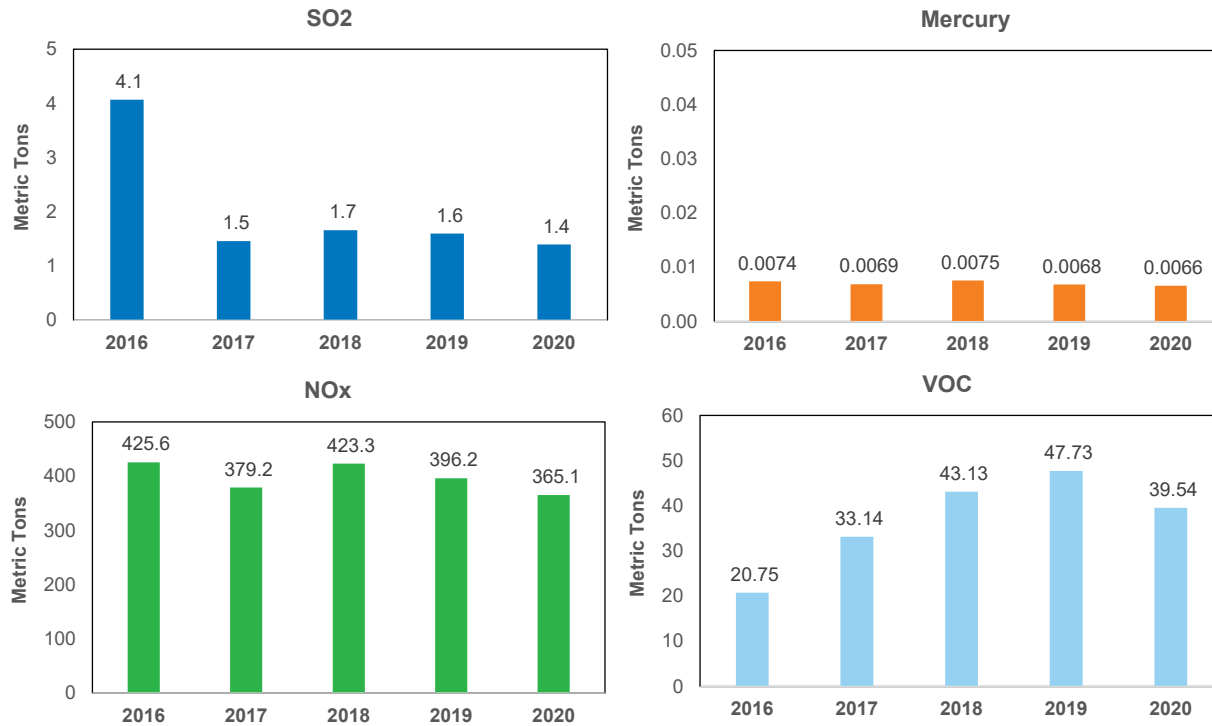

Baseline - Avista's Generation Outdoor Air Emissions

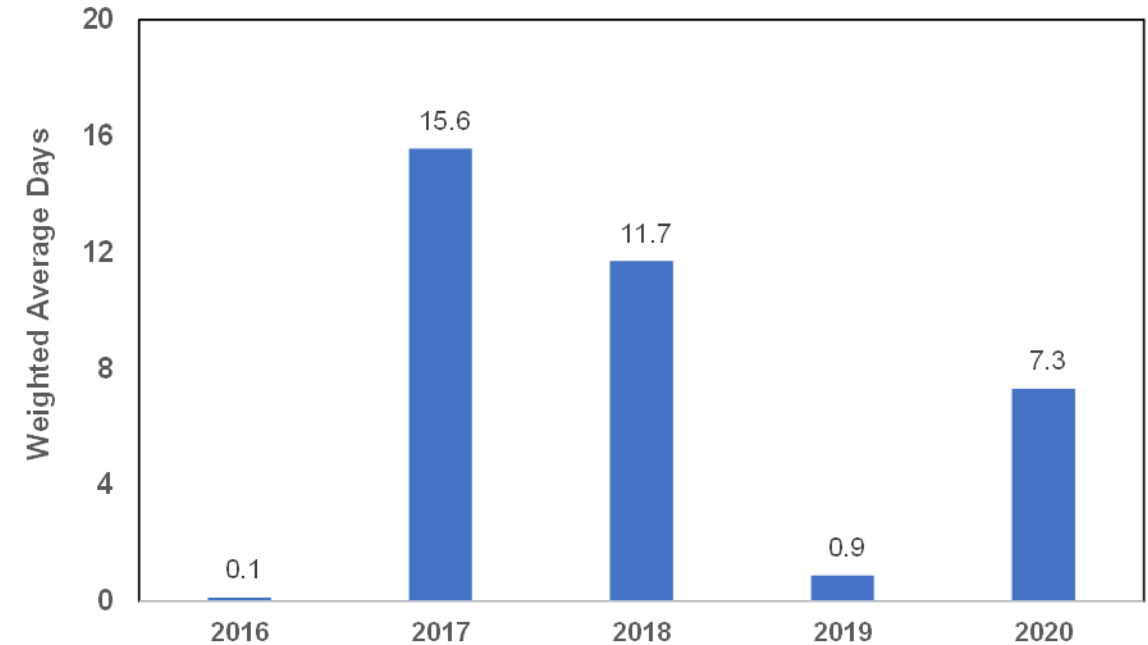

Baseline – Weighted Average Days Exceeding Healthy Levels

# CBIs and Resource Selection

## Applicable CBIs and Metrics

NEI will help to account for the impact of GHG Emissions

(10) Greenhouse Gas Emissions

- ❖ Regional GHG emissions
- ❖ Avista GHG emissions

Baseline - Region GHG Emissions

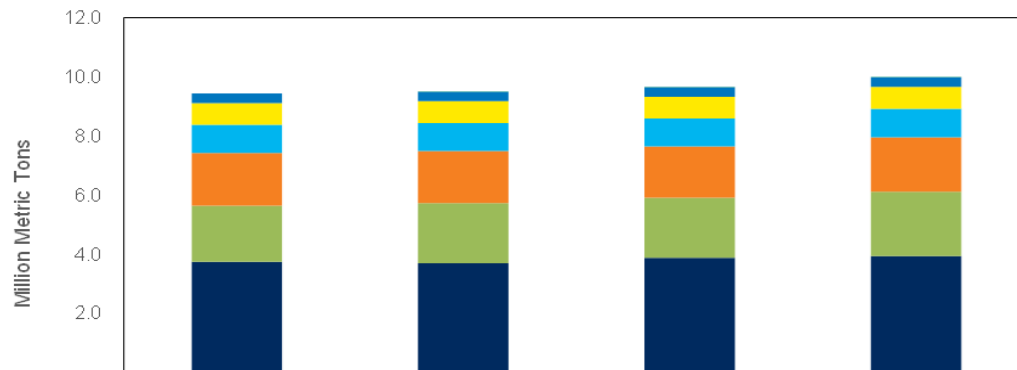

	2016	2017	2018	2019
Electric Power Serving ID	0.01	0.01	0.01	0.01
Waste Management	0.33	0.32	0.32	0.32
Large Sources	0.73	0.74	0.73	0.75
Agriculture	0.96	0.95	0.95	0.95
Electric Power Serving WA	1.78	1.76	1.73	1.84
Res. & Com. Fuels	1.89	2.03	2.04	2.17
Transportation	3.76	3.71	3.89	3.95
<b>Total</b>	<b>9.45</b>	<b>9.51</b>	<b>9.66</b>	<b>10.00</b>

Baseline - Avista GHG Emissions

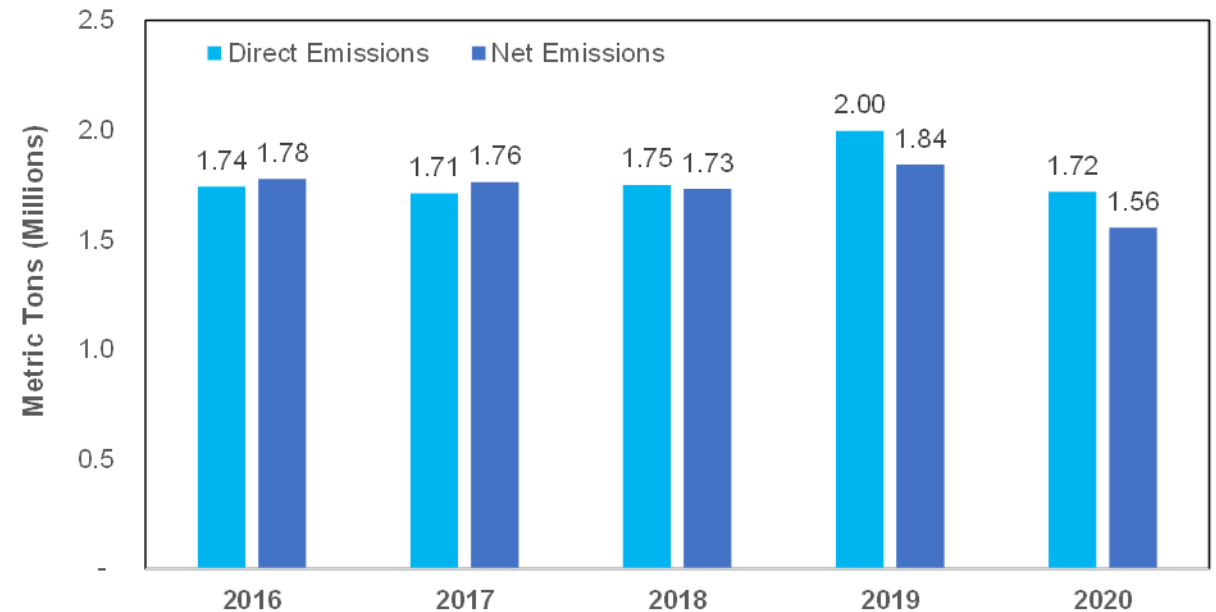

# CBI in IRP / Progress Report

## Resource Selection

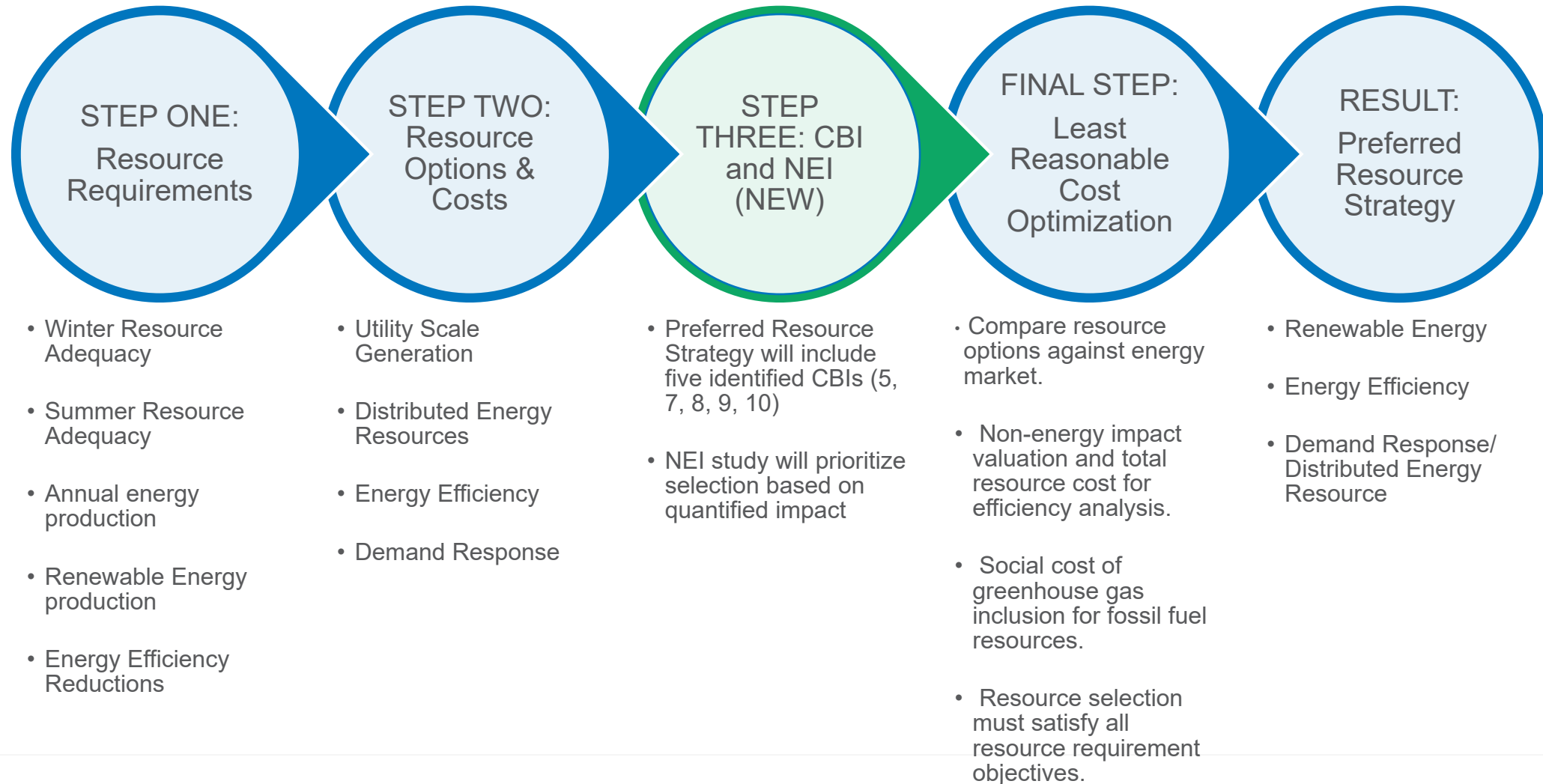



# Implementation



# Implementation – Resource and Program Selection and Prioritization

- Several CBIs, while not utilized in IRP, will be utilized in program selection and/or prioritization.
- Other CBIs are more applicable to measurement of success of Company efforts in areas such as:
  - Access to clean energy – i.e. increased participation in programs
  - Overcoming barriers to participation – i.e. increased translation services
  - Methods and modes of Communication – i.e. reaching additional customers as measured in saturation rate for all and Named Communities



# Named Community Investment Fund

## 40% or up to \$2.0 million

- Supplement and support energy efficiency efforts targeted to Named Communities

## 20% or up to \$1.0 million

- Investments in distribution resiliency efforts for Named Communities

## 20% or up to \$1.0 million

- Incentives or grants to develop projects by local customers or third parties

## 10% or up to \$500,000

- Used for newly developed targeted outreach and engagement efforts specifically for Named Communities.

## 10% or up to \$500,000

- Used for other projects, programs or initiatives specific to Named Communities

## May be used for:

- Distributed Energy Resources
- Economic Development
- Other – as identified by EAG or other Named Community members



# Evaluation Process – All Source RFP

## Initial Screen Evaluation Scoring Matrix

Weighting						
20%	40%	5%	20%	10%	5%	100%
Risk Management	Financial Energy Impact*	Price Risk	Electric Factors	Environmental	Non-Energy Impact**	Total Score
Developer Experience, Proven Technology, etc.	Financial Analysis of Price to include PPA/Ownership, capacity costs/value, transmission, cost of carbon, etc.	Potential for change in costs, fixed vs variable pricing, variable energy, etc.	Interconnection status and transmission plan	Permitting such as Conditional Use Permit, SEPA, Studies, etc.	Energy security, benefit to service territory, named communities, DEI, etc.	

\*Financial evaluation based on highest score of Capacity or Energy.

\*\* Non-Energy Impact includes impact of Clean Energy Implementation Plan Customer Benefit Indicators (where applicable).

# 1<sup>st</sup> Yr. Customer Benefit

Energy  
Impact



Non-Energy  
Impact

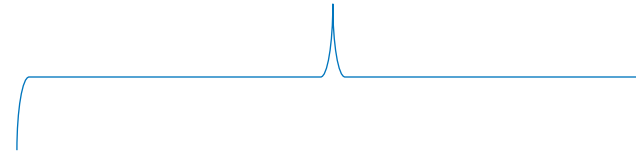

Measure	Bill Savings	Energy Burden (NEI Only)	Air Quality	Named Community Investment	Total Benefit	NEI contribution to total benefit
LI-Building Envelope-Windows*	\$0.60	\$0.69	\$1.95	\$0.15	\$3.39	82%
LI-Building Envelope-Energy Star Rated Doors	\$16.19	\$17.61	\$48.63	\$5.09	\$87.52	81%
LI-Building Envelope-Attic Insulation*	\$0.06	\$0.03	\$0.05	\$0.03	\$0.17	67%
LI-Building Envelope-Air Infiltration	\$63.10	\$33.79	\$50.55	\$23.92	\$171.36	63%
LI-Building Envelope-Floor Insulation*	\$0.12	\$0.06	\$0.06	\$0.06	\$0.29	60%
LI-Building Envelope-Wall Insulation*	\$0.14	\$0.07	\$0.07	\$0.07	\$0.35	60%
LI-HVAC-Air Source Heat Pump	\$87.84	\$35.64	\$35.59	\$41.79	\$200.86	56%
LI-HVAC-Ductless Heat Pump (w FAF)	\$301.62	\$133.65	\$72.54	\$142.76	\$650.58	54%
LI-HVAC-Duct Insulation*	\$0.27	\$0.12	\$0.01	\$0.12	\$0.52	48%
LI-HVAC-Duct Sealing	\$70.99	\$27.73	\$1.53	\$21.86	\$122.12	42%
LI-Hot Water-Heat Pump Water Heater	\$58.73	\$19.08	\$0.00	\$17.23	\$95.04	38%
LI-Lighting-Outreach/Direct Install LED	\$0.10	\$0.03	\$0.00	\$0.02	\$0.16	35%



# 2023 IRP Scenario Analysis

James Gall, Integrated Resource Planning Manager  
Electric IRP, Seventh Technical Advisory Committee Meeting  
October 11, 2022

# 2023 IRP vs 2023 Progress Report

- Washington Progress Report to be filed on January 3, 2023. This report includes only scenarios that estimate avoided costs.
  - Progress report will be based on a stochastic study of 300 potential futures with varying market drivers.
  - Due to the resource acquisition process, the progress report will have a “planning” portfolio based on IRP resource options to meet resource shortfalls rather than actual resources from the RFP.
- 2023 IRP will include the scenario analysis
  - 2023 IRP will have signed PPAs/projects from the RFP.
- 2023 IRP is an Idaho only filing, but due to portfolio impacts of Washington policy this IRP will consider scenarios related to Washington policy.

# Proposed Market Scenarios

- 300 Stochastics
  - Load, fuel prices, wind, hydro, inflation
- High natural gas prices
- Low natural gas prices
- National greenhouse gas price
- No Climate Commitment Act
- Climate Commitment Act (CCA) dispatch pricing options for thermal units outside Washington (2023-2025)
  - No CCA Pricing
  - PT Ratio CCA Pricing
  - Full CCA Pricing

# Proposed Portfolio Scenarios

## Resource/Planning Margin Portfolios

- Idaho Colstrip exit selected by model
  - 1 or 2 units
  - PT ratio shares vs entire units
- WRAP planning reserve margin
- WRAP planning reserve margin + risk
- Market only (for avoided costs)
- No CETA (for avoided costs)
- No WA SCGHG (for avoided costs)
- Resource allocation (TBD)

## Load Portfolios

- Low economic conditions
- High economic conditions
- Building electrification
  - Washington new residential construction only
  - All Washington customers transition by 2050
  - Space Heating Above 40 degree + Water Heat
- High transportation electrification



## 2023 Electric IRP TAC 7, October 11, 2022, 9:30 am to 4:00 pm

### In Person Attendees:

Shay Bauman, Washington Attorney General's Office; Shawn Bonfield, Avista; Annette Brandon, Avista; Michael Brutocao, Avista; Kelly Dengel, Avista; Michael Eldred, Idaho Public Utilities Commission (IPUC); Grant Forsyth, Avista; James Gall, Avista; Annie Gannon, Avista; Amanda Ghering, Avista; Lori Hermanson, Avista; Mike Hermanson, Avista; Clint Kalich, Avista; Ben Kropelnicki, Avista; Callan Logan, City of Spokane; John Lyons, Avista; Jaime Majure, Avista; and Tom Pardee, Avista.

### Online Attendees:

Andrew Argetsinger, Tyr Energy; John Barber, Customer; Marie Barlow, New Sun Energy; Tamara Bradley, Avista; Molly Brewer, UTC; Terrence Browne, Avista; BCraig (Guest); Nathan Critchfield, Puget Sound Energy; Travis Culbertson, IPUC; Darwin (Guest); Kevin Davis, IEP Co.; Chris Drake, Avista; Ryan Finesilver, Avista; Damon Fisher, Avista; Nick Jay Gemperle, Puget Sound Energy; John Gross, Avista; Leona Haley, Avista; Fred Heutte, NWECC; Allison Jacobs, Puget Sound Energy; Tina Jayaweera, NWPPC; Alexandra Karpoff, Puget Sound Energy; Kristina Kelly, Guest; Paul Kimball, Avista; Doug Krapas, IEPCo; Jeff Larsen, Guest; Mike Louis, IPUC; Patrick Maher, Avista; Meredith Mathis, Guest; James McDougall, Avista; Lorin Molander, Puget Sound Energy; Hanna Navarro, UTC; Mike Neher (Guest); Lloyd Reed (Guest); John Robbins, Wartsilla; Stewart Rosman, Clearway Energy; Sashwat Roy, Renewable NW; Darrell Soyars, Avista; Art Swannack, Whitman County Commission; Jason Talford, IPUC; Brandon Taylor, Guest; Gavin Tenold, Northwest Renewables; Charlee Thompson, Northwest Energy Coalition; Jtaylor; L Thomas, (Guest); Taylor Thomas, IPUC; Tyler Tobin, Puget Sound Energy; Bill Will (Guest); Andrew W. Wood, DNV; Jim Woodward, UTC; Jisong Wu, Guest; Kelly Xu, Guest.

### Introductions, John Lyons

**Annie Gannon:** Hi, I'm Annie, in our Corporate External Communications and as a reminder on the microphones, there's a flashing green, it's working, if not, you just press the button that's flashing red.

**Michael Eldred:** Michael Eldred, Idaho Commission staff.

**Anette Brandon:** And I'm Annette Brandon. I'm in Wholesale Power Marketing.

**Kelly Dengel:** Hello. I'm Kelly Dengel. I'm a project manager within the Power Supply department.

**Grant Forsyth:** Grant Forsyth, Avista.

**Logan Callen:** Logan Callen, City of Spokane.

**Shay Bowman:** Shay Bowman. And I'm a regulatory analyst with Public Counsel at the [Washington] Attorney General.

**Michael Brutocao:** Michael Brutocao, natural gas analyst with Avista.

**Tom Pardee:** Tom Pardee, Avista.

**Mike Hermanson:** Mike Hermanson, Avista.

**Lori Hermanson:** Lori Hermanson of Avista.

**James Gall:** And James Gall of Avista.

**John Lyons:** OK. And do we want to try to go through on the phone or that might be a little difficult on the phone? At this point we have about 24.

OK. So, I think skip going through [names] on the phone with that many. If you want to bring up the slide deck, James, for the Introduction, we have a very full schedule today. We'll try to cruise through the Introductions here rather quickly. And James will be sharing that. Hopefully you'll be seeing that. For those of you online, can you see the presentation now? OK. Thank you.

**John Lyons:** Let's go the next slide. OK, so meeting guidelines, we are still technically working remotely, but we're in the office at least Tuesday. James is here most days and if we need to be, we can all be here in the office. It's a stakeholder feedback forum, so we do share responses from the TAC members by e-mail and then in the appendix. As you may have heard just a minute ago that the recording has started. We also do a transcription. I edit the transcription, it does take a while because some of the transcription is, shall we say, unique, as we can now see that on the bottom of the screen here on our end. We will post that on the website, updated description and navigation we're working on with that.

**John Lyons:** As far as some of the virtual TAC meeting reminders, please mute your mics unless you're commenting or asking a question. Lori is watching her screen for any chats. If we don't get to you right away, it's usually because we're waiting for a pause point to get in and insert the question. You can also use the raise hand function. Please try to respect the pause. It will probably be a little harder with those of us in the room because we can see each other a lot more easily. But if we've got those quiet pauses, we're trying to give people time to unmute themselves and say something, please try not to speak over the presenters or the speakers, and if you can state your name before commenting, especially in the room, because in the room the software won't be picking up who's speaking. It'll just all say James or Lori, depending on how it's set up. So, if you want to say that usually I can figure that out in the context, but sometimes gets a little tough.

**John Lyons:** And it is a public advisory meeting so all those comments will be documented and recorded, that doesn't mean you have to work extra hard on eloquence. Just get the idea down. An IRP is required in Idaho every two years and it's generally a 20-year plan. You'll see it goes a little bit longer now because of the Clean Energy Transformation Act in Washington, and Washington now requires an IRP every four years and an update after two years. It guides our resource strategy. What we think we're going to need and what we think is going to be the best overall solution for meeting those needs. When we actually get into the RFPs and figuring out what we're going to choose, it could be a little different. The IRP uses current and projected load and resource position and looks at different futures. We look at different generation resource choices, what's available, and different technologies. We look at conservation and demand response and we treat those like another resource. Transmission and distribution integration are becoming a bigger part of the planning environment, and those of you on the TAC list will be probably getting an e-mail soon about the Distribution Advisory Group. They are busy getting that lined up and start going by the end of the year. We eventually end up with a series of avoided cost that go out through the whole IRP. We have market and portfolio scenarios for uncertain future events and issues that we will be talking about towards the end of today.

**John Lyons:** This is the public process. Wide range of people that are involved, what their background is, and what they're interested in. If you've got questions, please ask, especially for those of us that work on this all the time, we can start swinging acronyms around worse than most economists. But, and being an economist myself, I'm quite guilty of that. But we also ask questions. We're always soliciting new members. We actually picked up four this week already. If you have someone that's interested in all or part of it, they're more than welcome to participate. All you need to do is send us an e-mail and let us know that you'd like to be part of it. We're available by e-mail or phone for questions or comments between meetings. If you think of something else. If you need some more explanation, we can also set up times to talk to you on that study request technically due on October 1<sup>st</sup>, but we have a little bit of slippage on that and we'll be talking about that especially later today when we talk about some of the different scenarios.

**John Lyons:** The external draft will be released March 17th and then public comments will be due May 12, 2023, so you'll have time to review as much or as little as you want. If there's a particular area you're involved with and you're interested in, you can look at that. But if you got a chance and want to look at the whole document, we always appreciate that and then we'll submit the final to both commissions and the TAC on June 1<sup>st</sup> next year.

**James Gall:** John, there'll be a Progress Report sent out on January 4<sup>th</sup>, which we'll talk about later today, but it'll be like a draft IRP. You'll see a lot of the draft content in that Progress Report work. The only thing we won't have this time would be the Preferred Resource Strategy analysis. It's kind of a mini version of it to see where we're going. We did ask for an extension this time because of the current RFP that we talked about in the last TAC meeting.

**John Lyons:** So, remaining schedule October 20<sup>th</sup>, that is the nerd festival for the Technical Modeling workshop. I see some grins in the room because we're excited for that. If you're really into the minutiae of the modeling, that is the meeting for you. If not so much, you may want to take a pass on that one, but you're still welcome to participate no matter your level. The Washington Progress Report Workshop will be December 14<sup>th</sup>. February 16<sup>th</sup>, we'll have a virtual meeting for gas and electric IRPs similar to what we've done before. We'll probably have a recorded message for that too. So, people could watch it ahead of time and then comment and we'll have some sort of breakout sessions for more individualized discussions for specific topics. We'll have an afternoon one and an evening one and then the final TAC 9 will be March 22<sup>nd</sup>.

**John Lyons:** Today's agenda. After this introduction, James will talk about the distributed energy resources potential study scope. I believe that went out with the presentation slides the other day. Grant will be talking to us about the load forecast update. Then Lori will cover the load and resource balance or resource need, looking at what resources we have, where the shortages are, and how they change over time. Then we'll have a short discussion on wholesale price forecasts for natural gas and electric, where those prices are looking based on the current modeling. Then we'll have lunch and then wrap up the price forecast and we'll have the WRAP update and that's the resource adequacy. Annette Brand is going to be talking about the Clean Energy Implementation Plan update and the Customer Benefit Indicators and how those fit in with the IRP. This is the first time we've done that in an IRP, to really start implementing them. We started in the last IRP, but it's transitioning now where we're putting those into action. And then James will wrap up the day with portfolio and market scenario options. Basically, we have some ideas based on discussions we've had with TAC members and amongst ourselves of what we want to study and then we'll open it up for other options that people would like to say.

### **Distributed Energy Resource (DER) Potential Study Scope, James Gall**

**John Lyons:** And with that, James, if you want to take it away for the distributive energy resources discussion. A little awkward to run on one screen. For those of you on the phone, James is we're working off a Surface and usually he has multiple screens at his desk.

**James Gall:** I Will Survive alright. There we go. OK. Lori, can you see what we're supposed to see? OK. Well, thank you everybody. We're going to talk about a new topic in an IRP and that's a distributed energy resource potential study. The origins of this are part of the Washington IRP rules and also part of a commitment that we made in our Clean Energy Implementation Plan (CEIP) earlier this year. What Washington is looking for is a way to understand the potential for customers or at least customer located generation or energy efficiency by location, at least in this example. So, what our commitment is to, at least from the CEIP, is to come up with an assessment by feeder. We want to look at the total, like we traditionally do in an IRP, but look at the geographic dispersion of different resource opportunities.

**James Gall:** We've committed to doing a study for the 2025 IRP and we're actually seeking comment on how we're going to achieve this. So that's what we're here today to do is to understand what the study is. Get any feedback that you may have to make the study better or get the information that you think would be useful for us.

**James Gall:** This is kind of an interesting topic because traditionally an IRP looks at the whole system. We don't get really down into the details of the distribution feeders, so this is likely to be more part of the distribution advisory committee that's coming next year. And they will use this study to help them figure out where new generation could be sited or where we could find energy efficiency or demand response in our system. And then that could help influence us in the IRP to see if those solutions on the local level help the larger system that would go into an IRP. We will be seeking comment from those of you that are participating in our EEG meeting tomorrow and Thursday, I'll give this same presentation on Thursday as well and then the DPAG which is that distribution planning group that John had mentioned earlier, they'll be starting next year. I don't think we're going to be able to get that part of this commitment completed unless that group starts earlier. But the idea is again that where is local generation going to occur, where is energy efficiency going to occur.

**James Gall:** We're also looking at this from a low-income perspective. That's also part of the Washington State rule where we need to not only know where there's potential, but where could we provide help. There's a low-income opportunity for extra energy efficiency or say, extra rooftop solar as one example. There will be a part of the assessment we'll get to in a minute. The last bullet I wanted to mention is, at least for this Progress Report we're getting ready to file, we'll include a project schedule and milestones and some discussion of how this will meet the rules in Washington. But at the end of the day, the scope of work which we're going through today is going to cover all of those topics.

**James Gall:** What's going to be in this study that we're going to do? First, we're going to be looking for outside help from a consultant to help with this study. We're looking for a forecast for each of our distribution feeders of how much new generation or storage could be coming online or what there could be if we had incentives. If you think about it that way and then also load management. This is I'd say pretty intensive, which is why we're seeking outside help because there are 361 feeders originating in Washington. Some of those actually go over to Idaho. But if you think about what you're trying to look at for each neighborhood, the potential for solar or storage and you have to look at, the roof, what angle it is, what usage the customer may have, what is their income. There's a large analytical aspect of trying to figure out what would be a realistic potential for residential commercial storage or solar. Also, we want to have this consultant look at is there any opportunity for other small renewables that are probably less likely to happen. And I flipped over that second bullet, it's a Washington only study. That's what was asked for in the CEIP. Right now, it's designed through the CEIP to be funded by the CEIP. So, it'd be a Washington only expense. If Idaho is interested in a similar study, we could look at that, but we need some guidance from the Idaho if that's something they would like us to add to this study. Load management. We talked a little about generation, about solar and storage, but we're also looking at this from a load management perspective. And that's

through mostly energy efficiency. We do an energy efficiency potential study that looks at the different programs that could be available to our customers with a system wide basis. But now we're looking at it from a geographic dispersion, where would that savings likely occur by neighborhood. That's a little bit of a nuance compared to our traditional CPAs for example. And same thing with the demand response.

**James Gall:** There's some discussion, at least in Washington on the DER, about electric vehicles and what their future are. We're going to talk about EVs quite a bit at the load forecast session. But in this study, we do want to look at where are EVs likely to provide demand response as a benefit. And that makes us start to question whether or not we should be adding a portion of the study that looks at EV locations. Where are EVs likely to show up from a medium duty heavy duty or light duty vehicle? Now our scope of work leaves EVs out, but we're interested in any feedback if we should be doing an EV load potential study. If you're passionate about that, please let us know. That's something we're debating whether or not to include, we do want to include it from a DR perspective. But what I'm talking about here is not necessarily what is the potential for demand reduction, but where would the vehicles show up? It's maybe the same thing.

**James Gall:** Just to dig in a little bit deeper on this assessment, we're trying to look at for each of those options we mentioned, whether it's load management or new generation, we want to know the potential by location by year between 2025 and 2045. It's basically an annual forecast by feeder. And we're asking for them to consider the existing policies, price outlooks, customer demographics, and building potential to figure out what is this trend going to look like for where are these resources are going to be located.

**James Gall:** We want to look at electrification to the greatest extent we can, because there are trends potentially building code changes or even in the investment, or sorry in the Inflation Reduction Act, there are incentives to potentially electrify buildings. So, we want to understand where in our system there may be more likelihood of electrification. We kind of know in total but we don't know exactly, at least haven't done a study yet, on where specifically we're likely to see electrification occur. We also want to know, looking at Highly Impacted and Vulnerable Population areas. So those of you that followed the CEIP process, we have identified or at least the state has identified, and we have identified areas within our service territory that are Highly Impacted communities are Vulnerable Populations. As part of our CEIP, there are certain requirements to help with an equitable transition for those communities. So, in this study, we want to look at not only what is the likelihood of DERs from their perspective without assistance, but what if we have assistance for those communities, how would the potential, the ER change. So, what is the potential for more solar or energy efficiency if there's funding for those activities, that's what we're looking for there.

**James Gall:** And the load management side, again, this is mostly focused on energy efficiency and demand response. What we want to do is look at our current conservation potential assessment and DR assessment. And then disperse that across our service territory to understand what feeders that savings is likely to occur. We already estimate

what the low-income potential is, and it's really just trying to disperse where that is and understand where that savings is occurring.

**James Gall:** And then again, we'll want to look at building space and water electrification scenarios as well. Because one thing that's interesting about energy efficiency is when you know there's energy efficiency for gas and electric, but what happens is if you have a customer that is a current gas heating customer, a lot of their energy efficiency on the electric side is ignored until they become an electric customer. So, we want to understand what is the new efficiency at the home. The electric side of the business really never looked at from an efficiency point of view because it's been a gas customer. That will be an additional understanding of what the savings potential is. If you had a customer convert from gas to electric, you have a question from Mike, go ahead.

**Mike Louis (IPUC):** Hi, James, this is Mike Louis from the Idaho Public Utilities Commission. James is any part of the scope going to be looking at valuation of DERs?

**James Gall:** Right now, this is just a potential assessment, so the evaluation will occur from a distribution point of view when our distribution group starts looking at is there a problem on a feeder. They will evaluate whether or not a wired solution or DER incentive could be more, which is most cost effective. That's when the evaluation would occur there. I really see this as less of an IRP value, but more of a distribution benefit of understanding our system where we can evaluate alternatives to serve that future customer load. Or should they deliver it to customer load? Because what we're worried about is if you have additional load on certain feeders, we may have enough power supply, but do we have enough delivery capability to get it to customers? That is that when they start looking at the economics of different options to increase deliverability, that's where that evaluation will occur.

**Mike Louis:** OK. Thank you, James. My concern is related to if DER was to move to more of a net billing type of situation. If you're identifying avoided costs of DERs for that purpose, it might be useful to at least make sure that whatever information is gathered could be used to help substantiate that. Thanks.

**James Gall:** Thank you. The other piece I think where there could be some evaluation is on the low income and called Named Communities and what's called the Named Community Fund in Washington where we'll be looking to invest in these communities and this will give us an idea of which communities we could look for those investments. I really see this as a study that prepares us to do something with it that may be outside of the IRP. But it got inserted in this IRP really because there's a public forum to take comment on. More to come, but likely less than the IRP and more in the Distribution Planning Group and the Energy Efficiency group. Any other questions? Yeah. Alright, a quick question. Go ahead.

**Logan Callen:** Logan Callen, City of Spokane. Will this report look at load management kinds of generation and storage? Will it look at some of the technologies that blend those two, like EV vehicle to grid or water heater to grid, is that part of this?

**James Gall:** I think about the load management side, that's the vehicle to grid. Water heater, that's demand response. I don't know if you've caught one of our TAC meetings where we went through all the different demand response programs are but those are what those are. They'll be looking at where are EV vehicles likely to be located, where are electric water heaters likely to be located. That's exactly what the study is looking at.

**Lori Hermanson:** You have another question from John Barber, OK.

**John Barber:** Hi James, in the distributed resources part of the study is there going to be any consideration given to the possibility of Avista building or installing a localized resource on private property? What I was thinking is somebody may have a great roof for solar cells but not be in a position to install them themselves. Avista might be able to install cells there. And some kind of an arrangement between the owner of the property and Avista to make it worth their while as opposed to simply having an Avista resource here or a private resource there. Some kind of a blended sharing.

**James Gall:** Yep. I think that's something we can look at. We're definitely considering that on the low-income locations, the non-low income, that's something we can look at adding to the scope. We'll discuss that. That's not a bad idea because we were looking at one end is what our customers is going to bring in, then you can go to the full other end of the spectrum where it's everything that's possible, and where do you stop on that. Good comment, we'll definitely think about that one. One thing I do worry about, and we'll get to this in the schedule, is I don't know if anybody's ever done this before. So, what is this going to take and not from just work, but just a timeline and is this possible.

James Gall: Maybe that's a good segue to the next the last slide here and what our schedule is. So again, we're looking for our consultant to do this work. Again, I don't know if this has ever really been done to this, this level and scope. I know Sacramento, California has done a similar study, but I don't know if they've done it to quite to this extent, but with the first task of the consultant that will be due in July and we'll be making this sort of a public process where the consultant will report out some of the work to the TAC, into the distributed planning group. Likely the energy efficiency group as well. But we want to have them do a survey of other efforts and potential studies like this, just so that we can get some idea, remission. Anything, ideas, maybe like the idea that John had. Is there something that we should be adding to understand what we should be looking at in this study or potentially even future studies, but also want to understand, you know what? Compare those utilities to us from a you know, are they from a rate perspective, where DER is really are attractive is in high rate communities we're actually call it a lower electric rate community. So that might be a major difference or the climate for example California or the Southwest definitely has a more of a solar favorability than maybe the northwest. So understanding those differences and then demographics as well, I mean income and Spokane is a lot different than income and in California so. Understanding the differences between the utilities may explain why there may be more of an interest in this and those locations, but also best practices which I've talked about. We'll also want to have an overview of what the current DER situation is that Avista. I know we do have around 10



megawatts of solar on our system, but just kind of be illustrative of what our system looks like really against other systems.

James Gall: In September, we would like to know what the methodology the consultants going to come up with the help us figure out what this potential is. I'm assuming they're going to have some algorithm of some kind to calculate how uptake will be for different solar or storage and then have a report out in March that will report out to this TAC and the other advisory groups with their first draft of their estimates by feeder and then final report in May and then in Q2 will present the final results at the different public advisory committees. We will get a report hopefully in April of 2024 and the final report will be in June and it will be used for the 2025 IRP where to the greatest extent we can. Like, I said. I'm not sure that it's value in the IRP will be that relevant until the distribution planning group is kind of used it to see if there is going to be potential on their side of the business to help the distribution side and we would the whole idea I think behind this is if you have a distribution problem you could solve it through local generation and that local generation could solve the distribution problem but also help solve a power supply issue or shortfall that we would have. So, it's going to be a long cycle process to fully utilize this idea. We got one great comment from John. I just want to open up if there's any other comments we have. We did send out a draft of the of the scope of work. Feel free to edit that or add your ideas, e-mail it to anybody here at Avista. We will probably not release the request for proposals from different consultants until closer to the end of the year, so maybe the next month to six weeks. Looking for that feedback but all this. Leave it open right now. If there's any ideas or comments.

Shay Bauman: OK, I thought it quick question. I guess when do you see like the distribution planning advisory group being involved in this and how do you make the statement that in them,

James Gall: my hope is there are leading this? Starting next year and it again, it's kind of an awkward thing. It got kind of plugged into the IRP through the CEIP process. But really I see this as a distribution planning process product that they're going to be using it as an option to evaluate against other solutions for delivery. We're still arguing internally who owns this. So, nobody wants to own it.

**John Lyons:** They're the subject matter experts actually, but it ended up in the CEIP. So yeah, it's.

**James Gall:** But it is in the IRP rule. The IRP rule says we shall do this study and I get the idea of why. But like I said, it's got to be a feedback loop through that process.

John Lyons: So we may very well expect too that this very first one. May not be as where we want it, but it's a good first start. And then we'll figure out what did we learn from it from this experience and how could we. And then once they get a chance to start implementing it on the distributed energy distribution side, then they can look at, are there other ways we can improve this? Do we need the data differently, do we need to analyze it a different way? And I think that that we probably will have to do at least two or three

iterations before we start, and then I think we'll see some benefit from it. But before it really takes effect.

**James Gall:** Yeah. I don't want to just characterize this, only the distribution side of it going to see benefit. But I also see that the low-income side through the Named Community Fund, that will be another piece. Understanding that demographic better, what the opportunity is there, and if there is opportunity that say the Named Community Fund for example, then that could be part of an input into the IRP as well.

**John Lyons:** This may also help especially with reliability and some of the Named Communities what we're finding those issues.

**Lori Hermanson:** James, you have another question from Art.

**James Gall:** OK. What Art?

**Art Swannack:** John, as I was looking at this, I'm wondering when they're doing this evaluation, the consultant, are they looking at the potential for something that could be cited somewhere along that power line or are they looking at stuff that's likely to happen because I've seen studies where they say, well, there's all this potential. Let's go with broadband. We have all this area we can connect to, but it really doesn't mean anything. So how tightly is that evaluation going to be limited?

James Gall: Yeah. And that's actually where I'm a little bit worried is that's kind of like what John's coming is there's just spectrum of this is you know where you're at today versus the. Potential of what's out there. What I mean by that is, is based on roof size and acreage, right, that's your upper limit. But that's not going to happen. So that's where I'm hoping that the consultant is going to come up with a way to see what is likely and that's where I'm going back to that September task two is what's the methodology developed the estimates. So, we could figure out what is the realistic potential. And where to stop, uh? As far as how far to the, I won't call it right or left, but it's, you know you go from you can go to all potential to none. How far on that spectrum do you go that would imagine they're going to look at you know not only the physical limitations of the building and site but income and I have no other. No other idea what else would assume? Probably the usage of the home or business. There's got to be some way to determine what that effort potential is.

**John Lyons:** So similar to an achievable versus a technical achievable the efficiency side. But I don't think anyone has actually done that

**Art Swannack:** Well, one way I would look at this would be to take and throw in realistic timelines on when something could happen. So, whether you're talking a small wind project, how long does it take permitting and other stuff to happen before you could actually make it? Even if it was available and then throw in some blocks of those times when they're saying, yeah, you could do all this. OK, how much can we do in one year? How much could happen in five years? How much could happen in 10 years?

**James Gall:** OK. That might be a better idea than doing. We have this annual look at it. Maybe it's better to look at 5-year increments.

**Art Swannack:** It's going to be more realistic for what the permitting, the environmental studies, everything else. If you start looking at actual construction now, a house might be a one-year block. What's the acceptance rate on people's houses and what's the availability of the actual material to do it with. So those are things that pop in my head.

**John Lyons:** If we can make some limitations of, you can only get so many per year for, say, the first five years and then future you would expect you could add some more resources.

**James Gall:** Yeah, we might remember the conversation at the gas TAC last time about converting from gas for electrification. How quickly can you convert water heaters or space heaters? Same concept.

**John Lyons:** Yeah, only so many electricians that are going to be doing this or solar contractors or.

**James Gall:** Yeah. Again, that's the best practices, we don't know what we're doing here. So, we're going to have to try to look to others and get ideas from you all to make this a useful report. OK. Any other ideas on there? Well, thank you Art, we appreciate it.

**John Lyons:** I think Kelly is next.

**James Gall:** OK.

**Kelly Dengel:** Hi, this is Kelly from Avista. Do you have an idea of vendors who can satisfy this body of work?

**James Gall:** I've had a couple reach out so I'm expecting possibly it could be multiple vendors. For example, we could have one vendor do the energy efficiency demand response side, we could have another vendor do the generation side. I think that's more likely to happen, but we'll see when we get proposals back and then if we do, say, an EV option as well, that could be even a third vendor, there's never a shortage of consultants looking for work. That's where we found whether or not they do a good job or not, that's a little debate.

John Lyons: That's a different study.

Alright, I'm going to transition over to Grant's slide deck. So, bear with me.

### **Load Forecast Update, Grant Forsyth**

**Grant Forsyth:** So hopefully I'm going to do a sound check and people hear me online.

**Nathan Critchfield:** Yes, we can hear you.

**Grant Forsyth:** I just heard somebody exit. They know what's coming. So they're running for personal survival. So what? I'm going to talk about is updated energy and peak load forecast. Now, if you remember, I don't know in the spring very early spring, I did an initial look at this, received some feedback and from that feedback I went back and reran both the energy and peak forecast and I will tell you if resulted in a fundamental change from what you saw in the spring, I mean like a fundamental change, if you remember back when I presented the original 2023 RFP. Again in the spring, it's there wasn't a huge change from the 2021 IRP. This is a huge change, OK, so we're going to talk about what I changed based on that feedback in the very early spring. I talked about the long run energy forecast updates and then we'll move on to the peak. And you know just so you all know here. This I love Shakespeare and, you know, really since February 2020, I think the end of Romeo and Juliet, when the Prince of Verona is, is talking about the unfortunate death of Romeo and Juliet, and he's talking to the community at large in Verona. He says all or punish it. Right. And this is the reality of the world we're living. And so as you're working through this presentation with me and you still uncomfortable, you've been punished.

**Grant Forsyth:** Next slide. Big changes. OK, so this is what's different. We have a more aggressive EV forecast and an explicit separation between residential and commercial schedules. In terms of EVs. There's an EV forecast of light duty vehicles through residential. There's a completely separate forecast for medium duty via tables for the commercial side. We also based on new rules, have lined up the EV forecast the residential side. It is lines up with Avista's EV transportation plan in terms of forecasted percent of sales.

**Grant Forsyth:** Assumed Washington, Idaho combined reaches 15% and 30% of sales by 2030-31 and 38% by 2045. That's 15%. By 2030-31, is what's in the transportation plan. So that lines it up and I'm also changing the EV forecasts in terms of the methodology I start with the percent of sales of both EV light duty and medium duty and then translate that percentage sales into what does that mean for actual light duty vehicles and medium duty vehicles. You want to talk a little bit about what light duty vehicles mean. Our light duty is pretty much residential cars. It would be something like the Leaf, it would be something like a Tesla. That's what I mean by light duty.

**Grant Forsyth:** Medium duty is anything from basically a delivery van up to something larger than that in the forecast that I've developed through the way I've set up the potential load, it's heavily weighted towards medium duty, not heavy-duty vehicles. HDEV, the heavy-duty vehicles, the big semi electric trucks, really that's not yet reflected. So, the load functions are really heavily weighted towards what was considered the smaller and medium sized in the class. Answer your question, John. OK. Anything else? OK.

**Grant Forsyth:** With MD, the medium duty vehicles, we assume, and this is a new part of the forecast, that what should be in Idaho combined reaches 25% of sales by 2045.

Now we know that there's an agreement, there's a memo of understanding in Washington State to have, I think, 100% of sales by 2050 of medium duty vehicles EV for commercial. In other words, by 2050, 100% of commercial vehicle sales will be electric. If you look at my forecast in the spreadsheet, I think we've held it at 50%, by 2050, and the reason for that is we think it's going to be really hard just from a production and turnover point of view to get to 100% by 2050. Now it could change, but for now that's what we're assuming.

Grant Forsyth: But 25% by 2045, which is the end of the IRP forecast. We have a more aggressive solar forecast with an explicit separation, again at residential and commercial solar customers. But I will just tell you. It's more aggressive, but it's mostly more aggressive on the residential side. We still don't have that much on the commercial side in terms of solar, excluding our own community solar projects. And we tend to be accumulating the commercial side. I mean, we accumulate every year some new commercial private, commercial solar, but it's at a pretty modest place.

Grant Forsyth: Climate change is in the baseline energy and keep forecast, and this was using RCT 4.5 and this is exactly the same data that might permits and talked about in the last TAC meeting. Mike and I have synced up our data on this issue, so I'm using that in the baseline energy and peak forecast for climate change is now in the baseline. They energy and peak estimates for Washington newly announced restrictions on commercial gas connection that is built into both forecast now because what's going to happen is because the building code essentially prohibits in Washington, new gas connects on the commercial side. That means gas penetration on the commercial side will begin to decline over time. That shifting the weight of load away from gas towards electric and we need to incorporate that into the forecast. Now there are some, there's a movement to doing this also for residential and that's not yet explicitly treated in the model, but if that gets passed, we'll have to do that, correct, James?

**Grant Forsyth:** We're waiting to see what the State of Washington decides to do on the residential side. Thought about those scenarios. So, I mean, in the end, we're moving in that direction. It's not a question of if, it's just when and the timing of it. I've also incorporated long term GDP growth in an explicit choice variable after 2026. If you remember one of the things I'm not going to go over today is a whole bunch of underlying modeling assumptions. I'm bootstrapping off my forecast that goes into our financial model, it ends in 2026. What I've done is after 2026, I've built in an explicit long-term assumption for GDP growth that I can change in the model, it mostly impacts the industrial side. I've tried to make that a little more realistic. There's an improved treatment of energy load profiles. This is something where we improved upon, probably still need to maybe work on it a little bit going forward, but I think I've done a better job in the model of accounting for how the load profile currently is and how it's going to change as a result of climate, solar, EV, and gas restriction impacts.

**Grant Forsyth:** And finally, higher residential customer growth for the 2023 – 2028 period. Part of that really reflects the fact that I use some external forecasts to help me set up residential customer growth, which is where most of the growth occurs and some of those forecasts come from IHS CONNECT and they've definitely revised things up in

this period, especially for Idaho. To give you an example, last year this Spokane MSA grew about 1.1% for population growth. Kootenai was like 4%. And so that does shift things around a bit.

**Grant Forsyth:** This is what the customer forecast looks like now. OK, the 2021 IRP, the red is the current one. The big difference from just a few months ago in terms of the 2023, is that earlier period is just higher, it now sits above that early period of the blue line. It's six or seven months ago, it was about the same, so it's that early, appeared to be shifting up in large part because Idaho, and you can see the difference there and how you know the difference between Washington over the IRP period and Idaho over the IRP period 0.7% about versus 1.25%. That's a huge difference because it's a compounding growth rate. So, it makes a big difference in terms of how customers are going to accumulate.

**Grant Forsyth:** So long term energy forecast, residential solar penetration. A few months ago, the blue line and the red line were almost the same. Red Line is much higher now. And you can see the assumptions, the basic assumptions I'm assuming about system size haven't changed and so it's just assuming that we have a more aggressive penetration occurring over time. And just as a reminder, I do assume that system size increases over time. Because I'm assuming cost declined, but also technology improves, and so system size is gradually increasing as well. However, this whole thing remains highly uncertain because of ongoing changes to policy in this area.

Grant Forsyth: Alright, so the long term it came light duty EV. OK, so again you can see, let's start on this graph here with the red and blue line. This shows a really a pretty big difference from the last IRP to the current IRP. And from just what I had shown in the spring, much more aggressive. The black line shows you the percent of sales projection and it looks a little bit strange, and that's because up to the 2030-31 period I'm matching with Rendall Farley's Transportation Plan. And then after we get to that early 2030 period, I assume the percent of sales accumulates using a logic function. Now, so if you were to carry this the line all the way out to 2070, right, or, you know, pretty far out, you would see that black line of reach a point and stop accumulating. It gets closer to 100% once you get farther and farther out in time. But if it looks a little strange, it's because its matching what the transportation plan up to that early 2030 period. And then I assume a more aggressive logic accumulation, more aggressive than what we saw in the spring or the last IRP.

**Grant Forsyth:** This is medium duty EVs, and again this is new, brand-new addition to the model, again the black line is really a logic model. I mean it's accumulating if we would push it out to 2070 or even further, we see that black line start to merge and converge to 100%. But for now, it kind of looks a little bit exponential when you take that percent of sales assumption and translate it into number of vehicles, that's what you get in the red line. And we're going to go from essentially no medium duty vehicles at the current time up to about 16,000 in our service area. Now that doesn't sound like very much, but it we're going to see it in fact it adds a tremendous amount of load.

Grant Forsyth: So native load, this is what it looks like. OK, when you add in all of that. So the blue line is from the last IRP in the spring, the red line would have been just slightly above that blue line, but now you add in all of those EV both light duty and medium duty along with, you know, climate change effects, the gas effects. You get really a huge shift in load. Like so, if you want to look at what you know. So what happens if we do get to 100% of sales by 2050? What if we reach that memo of understanding we have with other states, right. What does that look like? So the red line, the solid red line is what you saw before approximately 50% of sales by 2050. If we get to 100%, that line is going to go up even more. It's quite a large shift, probably about 17. About 100 average megawatts.

Grant Forsyth: So, the here's the thing, right? I mean, we're all very interested in, you know, you know shifting from the internal combustion engine to electric duty vehicles. The problem is, you know, from a planning point of view, it has the potential to quickly add enormous amounts of load to the system. Right, so this is long term. This is high and low. So the right, the blue is the baseline case. The red is what we get if we have high economic growth. And so what I'm doing in this case is essentially allowing both the high cases where economic growth in the US is higher than we think it will be and population growth to the region, which means customer growth will be higher than we expect it to be. See the numbers there now in terms of the baseline case where GDP growth that 1.8% is built in after 2026. I assume 1.8% GDP growth, that is the Federal Reserve's current long-range forecast for GDP growth. But I will just warn you that might be high given the changes that we're seeing in demographics and productivity growth in the US, but for now, I'm going to just use the Fed's Outlook as the baseline.

**Grant Forsyth:** And then I eventually allowed GDP growth to change between 2.4% in the high case and down to 1.2% in the low case. And again, most of that GDP growth effect is really going to be impacting the industrial side. What does use per customer look like? Well, it's interesting it fundamentally changes the trend and use per customer starting in the early 2030s.

Grant Forsyth: And So what I'm showing you here is what is what is used for customers like for residential and commercials for the red is used for customers in Washington, Idaho combined use for customer residential. This blue is used for customer commercial. Right. And you can see that, you know, you get up to 2023 and before 2023 is actual. And what you can see there is that we've had for many decades now declining use for customers, right? If you add in all of these things we've been talking about like EVs, gas restrictions and so forth, there's a certain point where the additions of these things. What we're reverse use per customer, especially on the residential side, so that on the residential side, by the time you get to 2045 according to the model and we're going to be back to the use per customer we had in the 2010. 2016 period roughly.

Grant Forsyth: So there's a major reversal of the long term trend in use per customer and that's going to occur. Under the current scenario that we have in the case of commercial, the introductions of medium duty vehicles, the electric vehicles really stops the decline in use per customer. On the commercial side. And remember, we have to fill the in gas restrictions on the residential side that red lines going to rise even faster.

**James Gall:** Grant does the commercial one. Does that include the gas restrictions for commercial customers?

Grant Forsyth: Yes, it does. Now this is this graph little bit hard to explain. Looks like they're lying on top of each other, but the red line, the axis for the red line is. The red the access for the blue line is the blue axis, the reddest Washington the blue is Idaho. And what I just want to demonstrate is that they actually when you separate out the two jurisdictions, they have a similar load growth. So the for the total combined area, it's about .74% load growth. Energy growth Washington is 0.72, Idaho was 0.77 you know, James asked me why are they so close? Because all the EV are really coming in on the Washington side. The gas restrictions are on the Washington side. The reason they end up being so close is because of that assumed population of customer growth in Idaho helps offset some of that. So you get a very similar growth rate between the two jurisdictions.

Grant Forsyth: It's like, OK, so let's move on to peak here, right. So peak fundamentally changes right now. Remember there's a whole bunch of things going on in here, right? So reflects climate change. It reflects all the other kind of things we built in here. You know, the gas restrictions. Solar is now more treated in here more I think.

**Grant Forsyth:** Clearly, these are treated more clearly in this, and so what happens is that over the time period, summer is growing faster than winter is what you would expect. Some of that is that climate change impact. But they're not that different. And the reason they're not that different is because that EV impact is bringing the summer and winter closer together. Even with climate change built into the model. As you can see, peak rapidly ramps up, especially once you get past the early 2030s. And again, the addition of these EVs, what it's doing is it's helping also equalize the peak load. I mean between winter and summer peak. Right now, we're still winter peaking, but compared to previous, they're much closer, and that's that EV component, making them closer even though we have climate change in the model.

**Grant Forsyth:** And then there's the electrification for commercial. That's the other thing that's interesting is on the commercial side, when you adjust the load profile for that, if you look at climate change only, you would expect the amount of the share of load in any given year to decline in the winter months. But if you are shifting people away from gas towards electric, that helps reverse that trend.

**Logan Callen:** Logan Callen, City of Spokane. When you're talking about those gas restrictions, are you taking the assumed amount of gas that maybe would be there converted to BTUs and kind of figure out how much electricity?

**Grant Forsyth:** Yes, that's going to be needed for that. The way it works in the model is it's all driven by an estimate of the penetration ratio of gas. I have an estimated penetration ratio since we serve all houses in our jurisdiction with electric or businesses, or electric customers are households or account of businesses. I approximate what the penetration



is by essentially taking those customers and divide it into the number of either residential customers of gas. Or commercial customers of gas to get the penetration, it's just an approximation. In the model, as the penetration of gas increases over time, you're shifting weight towards gas away from electric, and that tends to depress use for customer on the electric side.

**Grant Forsyth:** If that penetration rate starts to decline because of restrictions. Right. What happens is you're shifting the weight towards electric away from gas and you use per customer begins to rise. And So what I'm doing in the model is I'm essentially taking the IRP forecast for gas customers in Washington commercial customers and I'm holding it constant from I think 2026 forward. I'm just saying, OK? It's not going to change. That's the current assumption. Now in reality, we might have a decay of commercial gas customers and we're talking about the how would you build in this because some people's gas systems might fail and they decide not to replace them. But for now, I'm just holding it constant. So gas customers, commercial gas customers are being held constant over the time horizon to 2045. But at the same time, we are adding commercial customers on the electric side. So that penetration rate begins to shrink, it falls OK, that's how I'm estimating for that kind of shrinkage. What does that mean for the change in use per customer and how does it affect you know, what does that mean in terms of shift to blow? That makes sense.

**Logan Callen:** It does, yeah.

**Lori Hermanson:** Grant, we have a question from Art.

**Grant Forsyth:** Go ahead Art.

**Art Swannack:** Quick question on this stuff. I notice you're focusing on peaks, which is normal, but what about daily load and weekly load? Because it seems to me like you're changing the entire structure of how power is demanded during the day or during the night in the system. And maybe the ability of the company to maintain and manage systems because of that. Is that going to be talked about it all?

**Grant Forsyth:** The answer is yes, this is something that James and I, we've been talking about among other people. There's this macro level that I'm looking and when you shift down to that lower level, we do need to do more work on modeling load profiles over shorter time periods. So, we are working on that. I think one of the things that we're also going to ultimately build into those shapes is time of use pricing, which we're also working on.

**Art Swannack:** OK. Thanks.

**James Gall:** And one more thing, that's why the importance of that Distribution Planning Group is to understand how those local profiles are going to change or delivering energy to those customers. Because if you have a lot of EVs in a certain future, that's going to change our system and that's why we're doing that potential assessment. That's why

we're setting up a Distribution Planning Group, so we're really paying attention to the macro level down to the micro level. We've also had to restructure how we even forecast our future loads hourly because our future is going to look different. We may even have to do a new load forecasting style next IRP. We're wrestling with a lot of these challenges.

**Lori Hermanson:** We have another question from Gavin.

**Grant Forsyth:** Shoot.

**Gavin Tenold:** I just heard the word time of use and thought I'd just ask the question. I noticed in the DER scope that we spoke about earlier, it didn't seem like we were considering time of use, but we just had a mention of time of use when we're talking about winter and summer peaks and EVs. I'm wondering is that on the table in terms of the DER Scope that we've already reviewed?

**James Gall:** Yeah. It's still under the demand response section of the DER. There are 16 different programs and time of use is one of those programs. So, a time of use, critical peak pricing, and peak time rebate are the three rate structure products that we're looking at for demand response and then there is a variety of utility control demand response that would be water heaters, thermostats, EVs, batteries. There are probably a couple other ones we haven't thought of, but that's supposed to be comprehensive. Does that answer your question?

**Gavin Tenold:** No, I guess, James, it didn't. That didn't read clearly from the quick read I gave where it said that the consultant would be using current, I forget the word, I'd have to go back in here, but it seemed like it was using current billing structures.

**James Gall:** Yeah, I think maybe the issue is they would use that for determining potential, but I guess we have that as an option. That's a good comment and I'll see if I can maybe restructure that, take that into account because we are doing pilots on time of use. That is going to start next year sometime, so that's a likely future outcome. So, I'll look into that. It's a good comment Gavin. Thank you.

**Gavin Tenold:** Thank you.

Grant Forsyth: OK. So sort of moving along here too. If we just focus on the summer peak for a moment. I want to talk about kind of what's driving decomposing changes a little bit. So if you look. If you look at the graph on your left right, it's just summer peak, RCP 4.5. It's two red lines with an arrow in between them. That dotted red line is the base summer peak. OK if I include large customers climate and economic growth, but exclude everything else. So it's basically what would the PB if we just had make sure our large customers were added in. We had the climate change in there and the economic growth was added in. Like, because there's an economic growth factor that also goes into peak and then the red line is that total summer peak I showed you on the previous slide. And so it gives us kind of, you know, what are these other factors other than climate customers and economic growth, what is what is it doing? What what's it contributing? And that's the graph on the right. The summer peak additions, again assuming you know RCP 4.5. You

know it's summertime, so we're not really getting much contribution from solar until you get to 2045. The gas restrictions don't really have a big impact that, you know, gas is primarily used for heating load, right? And so that is what is making that big difference shown by that arrow on the graph on the left. Well, it's all the EV that we're assuming that are going to be accumulating in the service territory. That's making the difference between that dotted line and the red line primarily. Another question from Fred Huette, you bet Fred.

**Fred Huette:** Hi, good morning, everybody. Fred here at Northwest Energy Coalition. I'm wondering about the gas portion. I like this because it's really isolating the effects of decarbonization primarily from transportation from EVs. But I'm wondering also about what are you doing in particular because that does run in the summer obviously and is that significant if a lot of switching happens from gas, water, and heat to electric. Does that, by say the mid to late 2030s, does that have much of an effect? I just don't know.

**Grant Forsyth:** Yeah, that's a good question. And so, Fred, this goes back to something James mentioned earlier about maybe needing a different type of forecasting mechanism or structure to capture that because it is not captured in this. You can get a hold on there. Well, that's just for the commercial water heating. I'll put this way, to pull out specifically the gas water heater component, you would need something like an end use model which is something we've been talking about. My thought is actually for this kind of a broadly, say decarbonization of new load, which comes from buildings and from transportation, all of it is manageable load. Basically, you know heat pumps and you know load management on the heating side, the HVAC side, and you know controllable water heater is especially heat pump water heaters on the water side. And you know what heating is not a huge factor in, I would say mid to late summer demand, but it's there, it's something to consider.

**Fred Huette:** OK. Thanks.

**Grant Forsyth:** Yep. We look at winter, again, same kind of graph. If you look at the one on your left, the solid one is the total winter that I've shown you before with all the factors in there and then you have base winter which again just large customer's climate and economic growth is built in. This is where again the gap between the dotted and the solid is quite large, but again, most of it is made-up by EVs. Solar in our jurisdiction just won't contribute much in the winter in terms of managing peak, so it's basically a flat line near zero out to 2045. Please note that the gas restriction does start to really matter once you get out in the late 2030s. And this is just commercial. So, if we're going to go to a situation where we have severe restrictions on residential gas, we could see some potentially pretty big peak loads in the winter. Because again, that gas was covering a tremendous amount of load.

**Grant Forsyth:** Any questions about that. I was a little bit surprised on the gas restriction side, but again, once we factored, you know, James gave me some load profile stuff, we've talked about, yelled at each other about it for a while, and in the end what we come up with is the gas restrictions have some profound impacts, but residentially, your

residential is more profound. It may be spiritually unsettling when we see the final numbers.

**John Gross:** Grant, this is John Gross. Have quick question on the gas restrictions. For the peak winter, what ambient temperature does that correlate with?

**Grant Forsyth:** Yeah, something like that. I have to go back, John. I'd have to go back and look, I think I have Tom Pardee and James, help me with this because we tried to make sure we integrated in the temperature component, which is complicated, but I can't remember the exact details of it.

**James Gall:** Well, it changes over time, but I think it ends up around 10 degrees average cold. Is that that average day, 10 degrees, your coldest from what you might plan to do is going to be on the distribution side, probably substantially colder.

**Lori Hermanson:** We have another question.

**James Gall:** Gavin, go ahead.

Gavin Tenold: Is there a time of day that the winter peak seems to average at?

James Gall: It happens on two different hours, typically in a switch depending on. You know what month it is or how people are behaving, but it's usually 7:00 to 8:00 AM and 5:00 to 6:00 PM and it could be either of those or both of those. It's definitely a winter's challenge because of that.

**Gavin Tenold:** Have you looked at on-site storage in parallel with the solar?

James Gall: That is something we are evaluating this plan as an option, yes. But again, in the summer, in the winter, the solar production isn't very. As much so that storage energy is going to have to come from somewhere,

Grant Forsyth: and let me just point out, and I mentioned this to some people in Olympia recently, some policymakers, solar is also potentially problematic if we're going to have constant wildfire smoke. This, that smoke does seriously depress the solar generation. As we're factoring in the solar component, I mean I think a lot of times I think what built in here is best case. But if we've got it, climate situation where the fire thing is going to be difficult for a prolonged number of years. Solar generation maybe won't be as strong as we potentially think. It just depends.

**Lori Hermanson:** You want to go ahead with your question?

**Fred Heutte:** Yeah, just to respond to that, it's Fred Heutte again. There're two aspects to it. One is longer term effect of a smoky situation. We just had one of those in Portland this week actually. Although the smoke went away yesterday for at least a day or two. And then the other issue is a kind of a short run issue. We saw kind of a natural experiment

a month ago in Southern California. When the smoke and actually the hurricane came in, the remnants of a hurricane came in and solar production in Southern California really went down. But load also went down because it was a hot period in early September. It was kind of a race to see which one was going to decline faster. It was actually a pretty serious problem for the California ISO and the utilities to manage because it was difficult to predict whether the solar would fall as fast as load or not as fast. And then the longer issue I think you're pointing to is if there's a lot of elevated particulates that's going to decrease solar output. I don't really know the science around that, but I presume there is, there must be some analysis of that. If you have an extended period of smoke, what it does to both demand and to solar would be a pretty important thing to look at. And we're all experiencing those kind of conditions right now, including over here on the West side.

**Grant Forsyth:** Yeah, I agree. I'd have to try to go and look and see if you know there's an endless supply of desperate PhD students. So, I'm assuming that probably somebody is looking at this issue.

**Lori Hermanson:** Art, you want to ask your question?

**Art Swannack:** Yeah. Again, real quickly on that smoke thing a couple of years ago we had that situation. It seems there should be some data in the system already as to what happened to loads, I'd expect with more people staying indoors trying to stay comfortable and out of the smoke, you'd end up with more utility use. But that's a guess on my part.

**Grant Forsyth:** No, I agree it. It depends a little bit on to what extent, what health warnings they have issued. I think that's true Art. I would say that we have already looked at. I mean I've seen some of the solar data that the power supply guys. I've seen the time series of it when we've had heavy smoke periods, it really does kind of collapse. That's true. But I guess, from modern solar, it's in the long run, might be kind of complicated like everything else. Well, the other thing to remember on that is when you got smoke out there, you're actually depositing particulates on to panels. So, you've got a cleaning issue besides just having sunlight moving through the air issue. I had thought about that, but that's actually a good point. The other thing with wildfires is just the destruction of the physical capital itself, which could become problematic too, depending on whether wildfires are occurring.

**Grant Forsyth:** OK, change in summer peak. I did a quick calculation here. I said OK, what would happen if we got 100% of medium duty vehicle EV sales by 2050, that red line that you see, that's where we currently are on the forecast. The blue line is where we currently are, I'm sorry, the blue line is the 2021 IRP, the 2023 is the red line. So, if we can see what was in the last IRP was in the current IRP. But if I did have 100% of sales by 2050 instead of 50%. That red line by 2045 would be about 2,500 megawatts instead of the current 2,200. That means that if we get to 100% of sales instead of 50%, we're talking about roughly another 300 megawatts of peak. Which is a lot every hour. And by that point, we'll have maybe some form of hopefully well managed, well understood time of use pricing that may mitigate some of that. That's not taken into account. But is sort of

a warning sign if we're really going to set policies that accumulated quickly and they work. Peak managing peak could be a problem. You have another question from Art?

**Art Swannack:** Just a quick comment on that. When you're talking medium duty vehicles, you're talking a whole different use demographic. And those guys, say delivery vehicles, they've got to work when they've got to work. So, I don't know how much flex you're going to have in charging that vehicle because it's still going to take how many hours to get back up so they can use it all day the next day. I'd wonder about flex.

**Grant Forsyth:** No, I agree. I'm glad you asked that question because when I was working on this, trying to build in medium duty vehicles, there's a shocking lack of research on this compared to light duty vehicles. When you look at the research on light duty vehicles, there's a lot of it, you tend to see a very similar load profile across jurisdictions. Of the MDV studies, I did find is that the usage profile is much less similar compared to residential, it really depends on the business model of the firm and when they have to use those vehicles. So, coming up with a typical load profile of a of MDV is much harder. It's harder because again, the dispersion across firms and how their business model is set up. But it's also difficult because we don't have really as much data on MDVs as we do on light duty vehicles used for residences. Now I will say that there was one really good study that I leaned on pretty heavily for this and it was actually done at Federal Way, WA. It's a real study working with a Frito Lay distributor who had pretty large or delivery trucks that were all electric. And they did essentially a study of how that worked. But what came out of the review of that study, and a few others that were available, is again, this idea that the typical load profile of a commercial user is hard to identify because they seem so different depending on the users. But I agree, time of use pricing, the effectiveness of it may depend significantly between residential and commercial users. I think that's a good point. That's one of those things that's going to require learning by doing as we set up the time of use models. Anything else?

**Kelly Dengel:** Hi, this is Kelly from Avista. When you say the heavy-duty vehicle are you assuming that vehicle takes at least a one MW charge?

**Grant Forsyth:** Probably. I mean, what I've been able to read about those particular vehicles, you really do need a special charging infrastructure to handle them. The other thing I've learned about is that there's just not that many out there, and as a result, good data about how users might behave within a service territory is not clear.

**James Gall:** When I check one thing though, you mentioned heavy duty, we're not including in this forecast any heavy-duty. Medium duty is below that. Think of a semi-truck as your heavy duty with this is everything below that right above your F-150 or 350.

**Grant Forsyth:** And again, trying to set up the typical annual load amount again I'm using the studies about the Frito Lay Company. I'm using some analysis that was done out of California. Again, I just had to kind of piece this together. And my hope is as time goes on, I'll get better information about how this segment is going to evolve. And so, we can improve those estimates of load, load profile, all those things.

**Fred Heutte:** Hi there. A little bit on the heavy-duty vehicles. Here in Portland, Oregon, Daimler Truck, North America and PGE have combined on what they call Electric Island. It's kind of a demonstration. It's a project that has those high throughput chargers and is designed to charge up to Class 8 trucks because that's what Daimler manufacturers here in Portland. The Freightliner and Western Star trucks and that facility is open to the public. So, anybody can use it. I don't know that PGN may have some data that looks at usage patterns there. This really raises the question that I think is a big issue for some of the medium duty, and definitely heavy duty, which is fleet management as opposed to residential or other kinds of charging and what the different effects of not only their usage patterns, but how those patterns can be modified by rate design. All these things are converging. The other thing I would observe is if you looked at this chart and then saw added another bit to go up to 2500. With all of the medium duty EV sales, it is a lot, but it's not doubling the load and we're putting in effect most or all transportation on the grid. I think it's a big hill to climb, but I think it's a hill we can climb if we manage the load effectively, that's the big challenge in my view.

**Grant Forsyth:** Well, I would say there are, maybe the answer is, it's like I told somebody in Olympia, utilities have to be conservative we tend to be more conservative than what people want because we're supposed to be the guarantors of reliability. A lot of these technologies that we could use in some ways haven't been fully developed or fully put into place. I'm always really conservative about the ability to meet this. I agree it's possible, but there could be some big road bumps in the way, and I just think people should be aware of that.

**Fred Huette:** Yeah, I would really agree with that. Especially the part about, believe it or not, being conservative. We need utilities to manage the grid in such a way that the lights really do stay on and there are lots and lots of challenges to doing that and a whole bunch of new challenges here. But I also think early awareness, like you're trying to do here, of those prospects are important. But we also have some time. I mean the 2030s and 2040s are pretty far away, although things move fast. But I think that early learning of this is really important and building that in the new kinds, I think as you suggested, maybe some thinking about new ways of not throwing out the old methods at all, but new ways to address a quite different demand mix where it's no longer just OK the demand shows up because there's population growth and economic growth and new technology coming on new kinds of lighting and all the rest of it, but which is more or less independent function here. The ability to shape load going forward is increasingly important in my view for lots of reasons, but especially for this new kind of load coming on the system from the transportation side and the building side, where I think much of it, maybe not all of it, but much of it is manageable with the combination of program design and rate design. I really appreciate where you're going with this for that reason.

**Grant Forsyth:** No, and I would just say I appreciate that too, your comment. I think the utilities are nervous at the moment because we are facing a potential double whammy of managing this transition. The one is the issue of EVs, but layering on top of it these

potential gas restrictions especially in Washington at a level of complexity that I would diplomatically say makes us a bit nervous. Anything else?

**Grant Forsyth:** Same thing. We can do the same calculation here. Is this is looking at winter? You have a similar effect in terms of what happens if you get to 100% of sales by 2050. So, same kind of story. And with that, questions, there's been many. I think we probably or I'm running out of time I might be out of time James. I had 45 minutes. I think I did take 45 minutes.

**James Gall:** We are only four minutes behind schedule, so we're going to take a break. Good job. And we'll be back. We'll come back at 10:45. Thank you, Grant.

### **Load & Resource Balance / Resource Need, Lori Hermanson**

**John Lyons:** Back at 10:45. We're going to get started up again. Lori Hermanson is going to talk to you about load and resource updates. Any questions before we get going? Hopefully, those of you online can see the load and resource update presentation. Again, OK, good. Alright, well take it away Lori.

Lori Hermanson: OK, we'll get started on the loads and resources. Grant set us up for perfectly for the loads and resources. James actually presented on this back in March. We had a preliminary position, then a lot of things are up in the air like the Western regional Resource adequacy program. We didn't have CC QCC back then which are qualifying capacity credit. And so this is just an update from what in a lot of other things have changed. So this is an update from what James has presented back in March. So things that have changed as you saw. Grant already updated us on the load forecast. That's significantly changed our baseline now incorporates climate change. And so that's both impacts the hydro and loads.

Lori Hermanson: We've incorporated that qualifying capacity credits for the contributions of the resources and that's based on the WRAP program. We have since, based on the Washington rate case settlement, we also have a large industrial customer demand response program of about 30 MW. From our last IRP or renewable IRP that was the end of 2020, if I remember anything or RFP, we got another slice of Chelan County, so that's also included in this loading force position included in this. There are also several retirement dates. Colstrip retiring in 2025, Northeast retiring in 2035, Boulder Park and Kettle Falls CTs retiring at 2040. And then one thing that is not included on this, that will be changing it shortly is we recently had an RFP. Chris presented on the short list of those last TAC meeting. And so those are not included in these, but of course would change our L&R position.

Lori Hermanson: So. I'm just starting at a high level. This is what our winter loads and resources balance looks like and this is based on January's for all these years our total resources that you can see there in are in blue and our load just straight native load is the red line and then the yellow line is our load plus our planning reserve margins net of demand response so that 30 MW program that I mentioned and you can see that. By



2027, on an annual basis, we're going to be short and pretty much short from there on out, so there's definitely a resource need.

**Lori Hermanson:** And this is from a summer perspective, looking at based on our August positions. August for the whole planning horizon, again, our resources, our loads and then our load netted with our including our planning reserve margins that also net of command response. And again you'll see on an annual position we're going to be short by 2027 and that's due largely to Lancaster being that contract ending in October of 2026.

**Lori Hermanson:** Regarding peak planning and some of our assumptions that are included here. We start with Grant's peak planning or peak forecast peak load forecast. Historically, we've included some planning reserve margins both for winter and for summer. So, our last IRP and for this loads and resource position, we assumed 22% for winter and 13% for summer. It looks like we have a question.

**Sashwat Roy:** Hi, Lori, this is Sashwat with Renewable Northwest. Could you remind us how the planning reserve margins are calculated? Is it an output of a loss of load study or are they kind of deterministic in terms of how you set them?

**Lori Hermanson:** James, you want to?

**James Gall:** Sure, hi Sashwat, so the planning margins we're using right now, the 22% and 13% are the results of our resource adequacy study from our prior IRPs. Then we're going to be looking at transitioning those to using the WRAP planning margins as a scenario in this IRP. Once it's binding, we'll be using those going forward, but those are from our resource adequacy study from our previous IRP.

**Sashwat Roy:** OK. And the RA studies are using loss of load metrics right?

**James Gall:** The WRAP study?

**Sashwat Roy:** No, you mentioned the previous RA studies in the previous step.

**James Gall:** Yeah, loss of load probability, which was 5% LOLP was our target. So essentially what we're doing is, is we're showing an L&R position very similarly to our previous IRP, but changing the structure to follow what our future would look like under a WRAP. So, this is kind of I'd say a midpoint transition to a future WRAP methodology.

**Sashwat Roy:** OK, got it. Thank you.

**Lori Hermanson:** Also included in our peak planning assumptions are some regulation reserves and 16 megawatts and we've included operating reserves. These vary by month. These are for various contracts that we have that are bordering our service territory and on average that's another 60 megawatts. And included in this L&R position are the qualifying capacity credits that I mentioned. These are from the WRAP program. They also provided us with planning reserve margins, this first look that I'm going to show you

on the next slide is including their QCCs but not their planning reserve margins. Mike Louis, it looks like you have a question.

**Mike Louis:** Yeah, this is Mike Louis from the IPUC. I think you just answered my question. But I'd like to get clarification. So, you're going to be using the QCCs from the WRAP study, but not the planning reserve margins for your system. Is that correct?

**Lori Hermanson:** That's correct. We're showing you our L&R. We'll show it to you right here both with and without the WRAP's PRMs. But yeah, right now, we're going to stick with. And, like James said, maybe scenarios around the other.

**James Gall:** I want to have one thing, Mike, the reason why we chose to do that for use the QCC, we actually didn't see a material difference in the resource values overall. Between our previous methodology and using the QCCs so this was just a better way to transition to using the WRAP where we show our resources in the same methodology as the WRAP and then eventually we'll have to change the planning margin to match the WRAP once that's in full force and we're going to cover that this afternoon so.

**Lori Hermanson:** Fred, did you have a comment?

**Fred Heutte:** Yeah, that's right. Yeah, go ahead.

**Mike Louis:** Well, oh never mind. Can I follow up really quick?

**Lori Hermanson:** Yeah, go ahead.

**Mike Louis:** Yeah. So, what I heard there at the end was that you would be transitioning eventually to using the same planning reserve margins as the WRAP for your system. In planning that. Wouldn't you know if you're? If your system if Avista system has different penetration levels of different types of resources than the rest of the rest of the WRAP planning regions, wouldn't the planning of reserve margins need to be different?

**James Gall:** I think maybe misunderstood what I said. We will be using the WRAP planning margins once it's full force. And what happens in the WRAP is they will assign, and I'll cover this afternoon, is there's different planning reserve margins for different zones and there's different QCCs for different zones, so that might be a good question for later this afternoon.

**Mike Louis:** OK. Thanks. Thanks for that, James.

**James Gall:** Yep.

**Lori Hermanson:** Fred, do you have a question or comment?

**Fred Huetten (ENW):** Yeah, and this is Fred. Just to note that I'm on the planning review committee for the WRAP. We've looked in great detail at their approach. I would say I

have significant reservations about applying their approach to QCC and the PRM to a planning approach that we have here. Their design is really aimed at operational time starting you know with the forward showing period you know seven months ahead of the season. And then for the operational time, ahead of the day, the dispatch day and there are a number of elements of that approach that I think are good and there are some that I think are problematic. And a lot of it is new stuff. They have a brand new, never been tested before, approach to storage hydro. For example I have some concerns about how they're actually implementing ELCC analysis for a number of the resource categories. I'm not saying it's bad, I'm just saying it's not tested. We don't really have a good sense yet of what the results of their approach are. And in fact, on some of the details, and in addition, it's not just about the QCC for resources. It's also about how they're calculating load projections, which is another whole topic. So, my sense is, I think personally it's premature to apply the WRAP QCC to a planning context like we have here. That's my opinion. You know we still don't even have a full view of what the results actually are because the WRAP is taking the approach of not releasing very much public data at this point about their initial assessment. I just think that there's a lot of questions out there about this.

**Lori Hermanson:** OK. And Jim and looks like you have a comment or question?

**Jim Woodward:** Thanks Lori. Mostly just a clarification question around your last bullet there with the QCC values or applied to generation demand response resources. I was aware that I think, James, you and I have been in other virtual rooms where we've talked about the WRAP rolling out their QCC values, agreed upon values, again on a rolling basis and there was at one point going to be mostly application of the WRAP values. But perhaps some residual values around battery and some hybrid battery renewable resources. That bullet at the bottom of slide 5 suggest everything's WRAP. Is that the case or is there sort of a hybrid approach, not to use hybrid again, but I think you know what I mean.

**James Gall:** Yeah, I'll take that. Jim, all the resources that we own today are available in a QCC value. The ones you're referring to that we're still waiting for on the WRAP, which I'll address in this afternoon presentation, those apply to resources we don't currently have. So, I'd say that issue is more of an issue related to how do we select resources going in the future rather than what our current position is.

**Jim Woodward:** OK. This gets into sort of the intersection of the RFP and some of those resources that, like you said, Avista doesn't already have yet. OK.

**James Gall:** Yeah. And then, I think we'll cover a lot of that this afternoon. So maybe anything WRAP question or related, maybe we should save till later so we can get through this one because this is really on where we're at today before the WRAP because like Fred was saying, which is why we're not using WRAP planning margin. We want to show where we're at today, pre-WRAP, what it could look like post WRAP, and then we'll address all the kind of the unknowns in the WRAP presentation.

**Lori Hermanson:** Perfect setup for my next slide. Here's our position based on a capacity position. Using those historical peak planning margins that we talked about, the 22% and the 13%, and again, like we saw before when we're looking at the entire L&R position, we're going to be short in 2027. You can see the amounts by winter, by summer, and you can see how that grows as load grows and EVs come on, and things like that. This is again with our current planning reserve margins. My next slide is if we were to incorporate the WRAP's planning reserve margins and again the winter one is less, it's 19% for January, and then August like our traditional ones about 13%. But the WRAP for us for August would be 10.3%. So, it's considerably, or slightly smaller. But you can see where our position is, it doesn't change it drastically, but you do see some differences there.

**Lori Hermanson:** So far as energy planning, again, we start with the expected energy load forecast that Grant developed and presented on earlier today and we include our generation forecast based and that's how we think it's going to produce based on weather conditions and run time limits for the machines and maintenance and forced outages and things like that. What is new this time is we incorporated climate change impacts and so we've done scenarios on this and past IRPs. But this IRP it's included in our base. And then finally the reserve contingency or the risk contingency we've done this in the past on looking at hydro and loads, but what we're doing since we're adding on more and more renewables, what is new to our L&R and going to be included in this time IRP is the energy contingency based on renewables as well.

**Lori Hermanson:** I think I lost my clicker.

**James Gall:** OK, I'll go there. I will try to go to slide 9. Everyone knew the battery was going to die at some point and just we were hoping to make it to lunch,

**Lori Hermanson:** It actually says I have battery, but it's not advancing anymore.

**James Gall:** OK bear with me. Yeah, we got it.

**Lori Hermanson:** OK, so just diving a little deeper into the energy contingency, again, I mentioned the difference before, we always had a risk contingency based on the variability and loads and the variability and hydro. And so, all of that is based on average. But what is the volatility in both of those. What if it's drastically different than average and so we include this energy contingency. For the 2023 IRP, this energy contingency was based on varying hydro, wind, solar, and loads and then taking the 95<sup>th</sup> percentile of the loads minus the renewable generation and the 5<sup>th</sup> percentile for the hydro. Did I get that right?

**James Gall:** Correct.

**Lori Hermanson:** OK. Because I was not the person that did this, I just wanted to make sure I said that right, next slide. This is a look at the energy position on a monthly basis. We're looking at average megawatts. And as you can see in 2026, the end of 2026, our contract with Lancaster ends and so that's when we're short. And then on an annual basis,

you start seeing us being short starting in 2027 and we were always typically long in second quarter due to hydro runoff. But you know that average amount that we're short continues to increase as our loads increase and our load profile shifts and changes.

**James Gall:** Yeah, and one new thing I'll mention this IRP versus previous IRPs. We used to win our planning for energy. We used to plan for this and the average of all these shortfalls and now we're transitioning to, we need to actually plan for, these shortfalls each month. We'll be looking at, we changed our model to actually acquire resources based on monthly shortfalls. So, we'll be looking at which resources can help us serve somewhere. And when from an energy perspective versus historically, we only looked at peak, summer, winter and annual energy positions. Now we'll be looking at monthly peaks, monthly energy positions to fill our resource needs. So, it's the big change in the IRP. You'll see that in the nerd modeling fest in two weeks in the PRISM model when we go over that. But it's a big change for us. I think I'm next on the next slide,

**Lori Hermanson:** I think so.

**James Gall:** OK. I'm going to briefly talk about what our needs are for CETA compliance, because we think about what our different energy needs between capacity or peak needs that Lori mentioned in energy. There's also a CETA requirement as well. And these next few slides are going to outline those needs. Our CEIP that we've we filed and got a conditional approval on earlier this year, they set specific targets for 2023 through 2025, which you can see on the chart there on the right, go up to almost 63% in 2025. We're assuming those targets will continue to trend towards 100%, or I should say 80%, primary compliance by 2030. We're assuming a trend there from that current trajectory offered by 2030. And then by 2030, we need to acquire 80% of our net retail load as primary compliance and then the remaining 20% as alternative. Then we staircase those compliance requirements towards 100% by 2045. As you can see those blocks after 2030 are four-year windows versus annual windows because those are four-year compliance window. It's a little unclear before 2030 if those are supposed to be 4-year compliance windows or not but regardless of the compliance window before 2030 will see in the next chart, that's not too relevant to our resource needs.

**James Gall:** To wrap this up on this slide, used rules for what does it mean to be a primary compliance renewable versus an alternative compliance renewable. It's still not clear in the rules and there has been a lot of discussion on that over the last maybe 18 months in the rulemaking process in Washington, but we're still awaiting those rules. So, we have to make assumptions for now and what our assumption is if the clean resource that we control for Washington exceeds the net retail sales for a month, we're going to assume that's alternative compliance and the reference there is maybe going back to this chart. You see we're very long April through June. So, a renewable that exceeds our load in those months would likely count as alternative, but the renewables that are below our load level, they would count towards primary compliance. That's actually one of the reasons why we're shifting to this monthly need because we see there's going to be a shift towards how we account for renewable energy in CETA that could be monthly, could

be hourly, could be annually, we don't know, but we're at least taking this monthly approach for now.

**James Gall:** Another assumption is that renewable energy can be sourced from our Washington share, or certain resources from our Idaho share, for this primary compliance. That would include wind or new hydro PPAs or Kettle Falls as well. And anything new that we assigned or are acquiring this RFP that we are working on. There's a process of renewable resources that are system allocated that could be allocated for Washington, this purpose, but there's about if we assume a resource that is system allocated gets allocated to Washington, there has to be replacement resource that would go to Idaho. Just because you shift energy around between states doesn't mean you still don't have to acquire something. And then lastly, we are not assuming the hydro, you think about Noxon and Cabinet our Spokane system, we're not assuming that is available in Washington for primary compliance. We will assume that as alternative compliance with the same assumption we've been using since last IRP. So, with all that said, what does this look like? This is an extremely complicated chart, so I'll try to make sense of it here, but the dotted line is really what our primary compliance target, that is that 80% by 2030 and then the block line is our net retail load. You can see initially in 2023, our load may be above 600 megawatts, but we are not required to have that amount of renewable energy in CETA. The required amount is that dotted line. The bars represent the renewable energy that is available. So, in green are that clean energy that's less than that monthly load and then the blue energy represents the amount that is exceeding that monthly load. The blue would count towards alternative compliance and the green could count towards primary compliance. You can see through 2030 we have excess renewable energy based on the resource acquisitions we've done to date and we're estimating to be about 6 megawatts by 2030. That first compliance period, we have enough primary compliance likely to meet that shortfall on that. The only caveat on that length is risk. We are still looking at adding a risk consideration. What happens if we don't get the renewable energy, we think we'll get, or we have higher loads, or we have less hydro. We will be adding a risk factor for the primary compliance target. That would likely show a short position or a slightly short position in 2030 from an alternative compliance point of view.

**James Gall:** And the blue and the orange, we have plenty of alternative compliance through 2044. We'll be in this IRP trying to demonstrate what is our need for primary compliance to hit 2045 goals. That's that gray bar area that is our shortfall, our need. We're looking for resources that can meet summer needs, winter needs, and we'll see what we come up with in our resource strategy at a future meeting, but this should outline what our needs are about 279 average megawatts by 2044 and then quite a bit more after 2045, so any questions? None yet, I must have explained it really well. That's the last slide I have. OK. Will transition to the next presentation. Believe. Tom, you're next.

### **Natural Gas Market Dynamics, Tom Pardee and Michael Brutocao**

**James Gall:** And then after Tom and Michael will take a lunch break. We're having lunch in the hallway here. You can bring it in here about the lunchroom. Whatever works. So. Lori, let me know when you see slide.

**Lori Hermanson:** OK.

**James Gall:** Alright, Tom, can you check on the mic?

**Tom Pardee:** Can everybody hear me online?

**Several Participants:** Sounds good. Yes.

**Tom Pardee:** Alright, thank you.

**James Gall:** Give me there. You have a question?

**Lori Hermanson:** Maybe he accidentally hit. OK, alright, we'll go. I don't know if it's going to get that working.

**James Gall:** Alright, we'll keep going.

**Tom Pardee:** I'm not going to read this to you. This is our one of our consultants. We have two consultants. For us to use this information to share with you, we need to show their formal legal disclaimer which you'd like to read through it. Please do. It just basically restricts your use of this to this. And so basically take this as any advice from them.

**Tom Pardee:** OK. Natural gas, what this looks like, we primarily get our natural gas mix from Canada. We'll be talking about Canada and this as well. And when I say that, it's 90% of our total LDC wise is what I should say is where we get our gas from Canada. For the power generation side, for the electric folks here, we basically get all of our gas from Canada. That's why it's important to have Canada within this set of fundamentals.

**Tom Pardee:** What you'll see here is in both cases it's going to show you the energy demand mix. For Canada, it looks like gas is rising through 2050, is what they're expecting and, oil is following a little bit. You'll see the kind of the inverse on the United States side. The oil situation they're expecting to go lower for some of the reasons that we talked about in these TAC meetings. And location and some other demand things that Grant covered and gas as well. I have some further charts in here that will display that a little bit more discreetly. It's still a primary energy driver or energy supply source in the US and Canada. So go ahead.

**Tom Pardee:** This is a better chart for where we're talking here. Gulf Coast is the Henry Hub, that's where everything is a basis of. That's if you're buying kind of your basic hamburger. You have to buy the basic hamburger and where you're getting, what else you're getting on top of that hamburger, is maybe the basis for example Henry Hub, the NYMEX, which is on the NASDAQ. You got to pair that with where your actual location is

the most cost is expected. Continue to grow mostly through 2040. Where we'll put our time into today is that Pacific region though is you can see, it's lower, but overall, it's showing demand, a reduction of demand through 2050. Policies in California that Grant talked about earlier, policies in Oregon and Washington, are definitely affecting that as far as the commercial side, residential side as well. And you can see in this forecast they actually think that blue hydrogen is going to come into the picture sometime in the early to mid-2030s. Hydrogen is made from natural gas, so you're stripping, you're using it as a fuel, and you're separating the hydrogen from the carbon. There's a lot of different forms of hydrogen, so you could use nuclear, so it's the energy that it's that's used for splitting water.

**John Lyons:** There is gray hydrogen from natural gas, blue hydrogen, which is reformed from natural gas with the carbon sequestered, and green hydrogen using renewable energy for electrolysis from water. All of these forms of hydrogen have different environmental characteristics.

**Tom Pardee:** One thing that I'll point out on the Pacific region for the power use. You can see the power generation in the Pacific region is expected to continually decline. Again, for some of the reasons that we've talked about in here primarily for Washington, and really on the West Coast, there's a lot of legislation that's trying to start to help with the carbon content within the power side and of course the natural gas side as well. So that's why you'll see they're probably going to assume the same thing that James and team will come up with on the power side is where it's where it's needed. It's mostly going to be used in those peak situations or the really cold days.

**Tom Pardee:** What does that mean for North America overall? This is a high macro level we're going back to again. The peak they're expecting in the 2030s, blue hydrogen there, transport sectors. The interesting thing in this, though along with the power and then the blue hydrogen, is the overall demand loss from 2035. You can see it within the LDC there, specifically as residential and commercial demand reaches a peak at the end of this decade. They're starting to capture policy that's driving more carbon friendly technologies within the fundamentals that we've used in these forecasts.

**Tom Pardee:** I wanted to include this because coal retirement is something that, it's a little bit past, it's a little bit of a dinosaur now. But when they talk coal to gas switching, there's something that I mentioned at our TAC meeting last week and that they were saying something like \$15 an MMBtu is what it would take to switch back to coal. That's a lot. It used to be \$4 or \$5, but because of all the environmental policies and probably because a lot of these plants are starting to not produce as much and maybe not being maintained. It it's costing more and more to force that coal to gas switch. But another thing I'll point out is this gives you a more accurate percent of gas share. As for the overall power generation, you can read the types, coal, hydro, etcetera, there's battery storage in there, but you can see over the long term by 2050 they're expecting power generation from natural gas to really only be account for about 10% of the total. That's pretty drastic, right now it's around a third of the total demand. And for the reasons that we've talked about, again wind and you can see on the right, the chart on the right, so gas combined



cycles, it already has a higher cost than wind or solar. When you hear gas is cheaper, that's not necessarily the case. It's really dependent on the technology. And even, it points out even without the tax credit, they're expecting the technology is getting more mature on the wind and the solar side of course and just the efficiency and the overall cost of maintenance. Gas is putting that levelized cost of energy at a much higher level as compared to these other kind of carbon friendly resources.

**Tom Pardee:** I'd be remiss not to explain the gas resource potential. So, what this is, is this is what the calculators for remaining gas resources in North America, OK. If you were to look at a map, you'd see northeast has Marcellus and Utica, they're big basins. Permian is down in Texas, that's mostly oil related, but because associated gas comes with oil drilling, you're essentially getting that as added benefit or some kicker to drilling for oil. The Gulf Coast of course is around Henry Hub area, Louisiana. That's where you'll have a lot of the LNG facilities. Canada again where we get ours. Rockies, in San Juan, we do have a position in Rockies. And so not on the electric side, but on the power side. There is some, excuse me, not on the electric side, but on the gas side there we do have some transportation from the Rockies and so it does come into the energy mix for the Northwest. Midcontinent and others. Anyways, there's still, if you look at the overall gas resource potential, there's still quite a substantial position of gas resources that's available for extraction.

**Tom Pardee:** LNG exports. When you take into consideration what Russia, what's going on with Russia and Ukraine, we start to look at the importance of energy independence. Europe didn't have it. They relied on a lot of imports from Russia. They didn't really import much LNG from United States, and Australia, among others. So, what you'll see here, especially in the first part of 2022 is LNG facilities and you can see by color code. They're starting to ramp up to nearly as much capacity as possible now. Elba Island, I think. No, it's Freeport. So, Freeport did go out, it had a problem. I think it was in June. And so that capacity came offline. But other than that, they're running these facilities as hard as possible. And to explain what's happened year-over-year because of the Russia and Ukraine War. The exports that we're going to Asia essentially are now going to Europe. So, if you see that slip, Japan, Brazil, India, Singapore, Chile. All of those exports that were, this is a year-over-year switch. Now if you see up top, Belgium, Spain, Greece, Italy. A lot of the exports we're filling up their storage facility for their storage facilities for this winter. A lot of the sales that they had and selling to Europe and have a lot of the cargo is actually will, can potentially change mid transport. They're having a lot of margin problems with it, in other words, covering margin for some of these commodity prices has become a real issue in Europe as well.

**Tom Pardee:** The rig count. I like throwing this in because it's interesting to see how far the technology of natural gas has come for drilling. On the left is the US. Gas differs by color there. Pay attention to that what you'll see mostly is the oil on the US side is the heavy user of the North American rigs. So, the drilling rigs, these technologies all work in the same fashion. You can drill horizontally, vertically, you can drill miles out, et cetera. That's where the costs come from, and the seasonality is really dependent on the left-hand side, is really dependent on the oil crashes. So, in 2014 there was one, and then of

course in COVID there was another, and once the market starts to come back on, that's generally when the rig counts come back on. But just as a final note on this, you can see how much so we're at near high production levels of gas, but if you looked at history, especially in the 2009 through 2015 range, we had nearly 2,000 rigs. We're around 700 and 800 rig counts. They've gotten a lot better with the technology. Canada is interesting because a lot of their soil content, they essentially need to have it more frozen. They drill in the winter and that's why you see that spike seasonality for forward prices. These are from September 23<sup>rd</sup>. You can see in the near-term prices spiked quite a bit and they maintain this for some time now after the Ukraine thing. But also, there's a lot of demand for natural gas right now. And so, what you're seeing is, is that in the near term or how commodities work, that's going to be higher because there's fear in the market that there may not be as much gas as needed to cover extreme events. Storage isn't as full as it has normally been and some other factors, LNG exports again are higher than or as high as they've ever been. Mexico exports is the same. There's just a lot of demand through a lot of sectors that are affecting these prices. But the good news is, is that on the power side, we get almost all of our gas from AECO. We have contracts. Generally, will get from AECO that's up in Canada by Calgary. So go ahead James. I'll turn this over to Michael.

**Michael Brutocao:** All right. This graph depicts our expected natural gas price forecast and what we did was we blended it. It's a blend of four different forecasts. In the beginning, or at the bottom, I guess you can see what those blended percentages are. We start in the near term fully weighted on NYMEX. I forget what date this was drawn on, but, in the beginning that light blue line at the top, we're fully weighted on that for the first two years. Then we bring in AEO, the Annual Energy Outlook, from 2022. And then two of our consultants. Consultant one and consultant two. We solely blend those in over the next three years and then starting in 2028, our forecast is an equally weighted blend of those three resources all the way through 2045. And that black line is the blended price forecast. OK. We take that blended forecast, and that's going to be the black line that was for Henry Hub, and then we apply what the forecasted based system for initials are at AECO, Malin, and Stanfield. This chart will show what those what those results are.

**Michael Brutocao:** And then comparing this to the 2021 IRP, if we take the levelized cost, this would be a 23-year levelized cost through 2045. We can see that at each basin were higher, in this current IRP, so that would be the green bars are the 2023, yellow are 2021 IRPs. We have our expected price forecast, but we don't certainly know what the actual price is going to be in the future. We want to plan for other possible scenarios, so, we will run stochastics.

**Michael Brutocao:** This is pulled from PLEXOS. You can read it. That basically explains what the variables are that are included in this stochastic process and explains what they do, but primarily it's the error, standard deviation and autocorrelation factors are the main inputs.

**Michael Brutocao:** Here are two graphs that depict what those might look like. On the left we can see what the error standard deviation would look like without autocorrelation. This is a price draw, I think the input average price was \$5, and you can see it jumps

around one period to the next. There's no real momentum or consistency. It can go up or down. So, we apply an autocorrelation factor to reflect more reality. What we've seen in the past. Prices do spike, but they don't tend to jump around as much as the graphic on the left-hand side. The autocorrelation factor smoothed out those effects.

**Michael Brutocao:** When we run these draws in PLEXOS, this is a depiction of what the results look like. On the left-hand side, you can see historically what those monthly average prices are. And then on the right, where we get all these lines, these are all the results of those stochastic draws. You can see a lot of those months are in the lower portion of it and some are spiking at the higher, up to the \$30 range. I should also mention, we put a lognormal distribution on the error of standard deviations so you're going to get spikes in the upward higher price direction more so than the lower. It'll be right skewed. If we take those 300 draws and we levelized them from 2023 through 2045, we get this histogram, this distribution, and you can see it's right skewed, the lognormal distribution. These are the levelized dollars. These are in dollars per dekatherm.

**Michael Brutocao:** And then looking at these, breaking it out, we plan for in addition to the expected case price, we would have a high case and a low case for prices. Those two green lines are sort of the jaws, you can see it's the 25<sup>th</sup> lowest percentile price in a given month and the 95<sup>th</sup> highest. Of those draws, that levelized 95<sup>th</sup> percentile is at \$6.99, the 25<sup>th</sup> levelized is at \$3.72. You can see where the median and average prices are compared to the input price that we fed the model, which is in red. That's all.

**James Gall:** What is the, before you move over to Tom? These are all inputs into our resource strategy model and our price forecast for wholesale, which Lori will cover in a bit, but two new fuels to the package that we've got modeled necessarily the same way as the past because we're trying to look at alternatives to natural gas that Tom covered.

**Tom Pardee:** Yes. As we talked about before, green hydrogen is taking renewable energy and then splitting water to come up with hydrogen as the energy, a singular energy. The fun facts on the left you can read. It's the most abundant element in the universe. It's the lightest element. That's actually important because it does want to escape and I'll explain why we have the ammonia in here on the next slide, but that helps to explain it, in addition to it's highly combustible. It's something that wants to leave constantly and it's not very stable. The biggest thing that's really happened with hydrogen, we keep hearing how hydrogen is maybe the next bridge fuel. It's the next fuel that can be in the mix as part of a clean energy future. So, we talked about this in the last TAC and one big thing that's happened is tax credits from the Inflation Reduction Act passed in August of this year.

**Tom Pardee:** There's different incremental costs that they can help with this credit within that act. Essentially, the levelized credit you can get is up to \$3 per kilogram incentive. So, say it cost \$6, you can essentially halve your costs per kilogram. Now we're looking at the chart on the right. If you look at it per kilogram, say it's \$5 in 2023, that's going to go all the way down. So, what we have in this assumption is about \$0.70 and we converted that to nominal dollars. But essentially \$0.70 is what some of the studies are

expecting as far as a final cost. When you put that into dekatherms or MMBtu you get that curve that looks, you can see more clearly how the IRA has affected this price. At a dekatherm level, it's around \$40 for green hydrogen now is what we're estimating. Then you can see where that splits, that's really where the IRA stops. OK. At least currently, it only goes through 2032, but then with the other levelized cost and we assume the efficiency through technology, we're expecting somewhere in the neighborhood of \$12 to \$13 per dekatherm.

**Tom Pardee:** To show this as a comparison, I mentioned that hydrogen wants to escape. Hydrogen is very combustible. The reason why ammonia is brought into this, everybody here has heard of ammonia it, but the reason why we would think about it on a power plant basis is because it's not highly flammable. You can ship it more easily. You can ship it as a compressed liquid. It can be used in emission free fuel cells and turbines. So that's what we'd be looking at it. I put the other piece in there to show maybe what the process is like because I was interested, but what you're looking at this for, including transportation to get it from the production facility. And the physical transport to get it a plant is above the hydrogen price, of course, and it's about \$40 a dekatherm. It goes all the way out through 2045. And as you know, higher than the price of hydrogen. When we're modeling this, this would be potentially a resource to use in the combined cycle or a gas turbine as a natural gas alternative. Are there any questions? I think that's the end of this section.

**James Gall:** We have lunch next, so I don't know., we've got one. Logan, go ahead.

**Logan Callen:** Yeah. This is Logan, City of Spokane. I have a question on the gas pricing. We're looking at Henry Hub, getting the futures on Henry Hub, doing all that kind of work. But we're buying on AECO, so are you assuming that basis to stay the same? Is there some kind of analysis on how the basis is moving in the future as well or can you speak to that concept?

**Michael Brutocao:** Yes, the basis differential that we applied is constant for whether it's expected low or high case, but that's a forecast that we have from one of the consultants.

**Logan Callen:** Gotcha.

**Michael Brutocao:** So flat for every year it's the same. I believe it changes over time.

**Logan Callen:** OK. So, it's a basis curve used at least,

**Michael Brutocao:** Yes. that's one thing they thought about like what we can do, an example will give us their forecast.

**Logan Callen:** Perfect. Thanks.

**Tom Pardee:** Oh yeah, go ahead Fred.

**Fred Heutte:** Yeah, this is Fred, realizing that I'm in the way to lunch, just very quickly, I've often had lengthy things to say about the gas forecast. This time I'll only say that I just don't believe that Wood Mac midterm forecast for the mid to late 2020s and on, going back down to \$4 a million BTU. They are very smart people. But I think the two things that really matter now are the exports. Which are not going to decrease and are most likely going to increase. The projections are for a lot of new export terminal capacity to come online in the next three to five years that will have a significant effect on domestic prices. When the facility went out, whichever one it was, back in June, it had an immediate effect on both global prices and US prices because it shut in export volumes that then were on the US market and dropped the price in the US market by a couple dollars. It was a pretty significant effect. The export volumes really set direction on pricing going forward. And the second thing is that expanded amount of export volume adds to other gas demand that's growing in the domestic markets and puts a lot more pressure on domestic production and at some point, every shale play that's produced such a prodigious amount of gas will peak out and start entering a decline period. Good arguments about when that will happen, but that will also increase price pressure going forward. I guess my recommendation is not to get rid of the Wood Mac forecast of course, but rather I think we should consider both that kind of median forecast and the high forecast as roughly having equal weight going forward because it's, in my view, just as likely we'll see \$6 to \$8 a million BTUs through the rest of the decade just as likely as it will be that we'll see \$4 a million BTUs. This has all kinds of consequences for power planning. I'll just leave it there and just say that's my opinion, for what it's worth. Thanks.

**Tom Pardee:** Thanks Fred. Art, you want to go ahead?

**Art Swannack:** Yeah, real quick question, the ammonia pricing you got on there being a farmer in quite familiar with anhydrous ammonia, is that product using, is that price created with green hydrogen price or, is that price at current markets? Because they use regular natural gas to make it now.

**Tom Pardee:** Yeah, that would be a green hydrogen price.

**Art Swannack:** OK. Thank you.

**James Gall:** A question for you Art, what is the price for non-green, just curiosity if you know.

**Art Swannack:** I can tell you my fertilizer this year, the bill, I was thinking the same thing for spring crop fertilizing was the same price as my entire previous year's fertilizer price for spring and fall crop. So again, I think it's \$0.75 per pound of NH<sub>3</sub> is what they were charging.

**James Gall:** Alright. Well, we'll have to convert that out later so.

**Lori Hermanson:** What, you can't do that in your head?

**James Gall:** I have no idea to do that. Any other questions? All right. I guess we'll break for lunch and will be back at 12:30 and we'll continue on with the wholesale price forecast.

**John Lyons:** So, once you just outside the hall here where the drinks were this morning and you're welcome to eat in here or in the cafeteria. And we'll meet back up in a full hour.

**James Gall:** We have enough leeway. So, still full hour then. We'll be back at 12:45.

**John Lyons:** So those are the online we're going to cut the sound here.

**James Gall:** So yeah, I'll do that.

**[Hour Lunch Break]**

### **Wholesale Electric Price Forecast, Lori Hermanson**

**John Lyons:** OK, so welcome back from lunch. Hopefully everyone online can hear us now. We'll see if we get thumbs up there, Lori.

**Online:** Yep.

**John Lyons:** OK, thank you. Good. I was going to say hopefully everyone's getting a good nap after lunch. Right. We'll see how awake we can stay here in the office. Otherwise, any questions come up over lunchtime that anyone would like to ask here or online? I hear deathly silence. It's like I'm given a quiz. It's kind of fun. So, if you want to you want to do the intro on this James?

**James Gall:** Yeah, the topic and why it's important. Lori is going to cover our wholesale electric price forecast. The reason why we like to talk about what's going on in the region. We talked about gas prices earlier and gas prices are a major input into what's going on in the region. But this will be used for helping us figure out is solar better, or gas, or how to value storage, but this is really used for doing the financial evaluation side of the resources decision making. So that's an important topic, I'd say it's getting less and less important as time goes on due to some other requirements in Washington, but still important. And Lori's going to provide you some of the interesting results that we've seen going on in the region and some of the complications that have arisen since she did this work. So, Lori, go for it.

**Lori Hermanson:** We presented on this, I believe at the last March meeting, and we gave you a preliminary look at the price forecast. We've done a lot of updates and things have been changing even up until last week. So, it's already outdated. We'll give you an update and it's still not final and we'll continue to keep you abreast of how it shakes out. Basically, we do the price forecast for the IRP. It's a regional look that includes the entire WECC and things could have been updated since this is ended last in March. We updated our

load, our load forecast. We've included climate impacts for hydro and load. New carbon prices have been included. Natural gas prices have been updated. Michael and Tom just presented on those as well. We include some other inputs from various consultants. All of those things have been updated since last March. All these things will be included in our statistics and our stochastics as we continue through the process, so I'll talk about that more as we go through this.

**Lori Hermanson:** What's the purpose of this and why do we do this? We're trying to estimate that last marginal price, or that last marginal resource, so that we can determine what the prices are for the market and estimate the dispatchable resource that informs our avoided costs which are used for our QFs and our PURPAs We've also used these prices to evaluate our RFP responses that we just received earlier this year and it helps us inform our resource selection.

**Lori Hermanson:** We start with Aurora, which is our modeling software, that third party software. Energy Exemplar is the company that owns and developed it. It's a production cost model that includes the electric market fundamentals. We use this model to generate dispatch to meet the regional loads. The regional loads are formed by, in particular consultants, and then the output of this process are the electric market prices, the regional energy mix, the transmission and where there's constraints, the greenhouse gas emissions, plant margins, generation levels, fuel cost, and our value for our variable power supply cost.

**Lori Hermanson:** This is our modeling process and basically start with a database that comes from Energy Exemplar and we're currently using the 2020 database that's imported by various public resources such as EIA, which is the Electric Information Administration, and other public sources. When we get that database, we usually validate it and clean it up, and we add other things like our hydro. In the past we've included our 80-year hydro, but this year, and it was presented our last TAC meeting, we are now moving to, since we're including climate in our Base Case. We moved from our 80-year hydro to our 30-year hydro with these climate impacts. We update for natural gas prices, we update for regional loads, and we include our own resource loads, our own resources and loads, and of course update for any operational details of machines and how they operate. At that point, we run a capacity expansion model and that determines the build out based on all that information that we've just input and we determine whether or not we have the appropriate planning reserve margins and this is an iterative process. If we're not meeting loads and various resources earning various regions of the West, then we make adjustments to that. After we run a deterministic study, we test our resource adequacy through stochastics and that's where we would take the 300 runs of natural gas prices that Michael presented earlier, and we include additional testing around other risk factors such as other fuels, different variability on renewables, inflation and things like that, and stochastics to determine whether or not we can meet load a large percent of the time. And based on that, we may need to rerun the capital expansion module and then after all that has been validated, we have one final run of the deterministic study, and then all of the stochastics. After that we would run some sensitivities on various scenarios. Where we're at in the process now, we've been through it several times, both for the RFP

and then as we're proceeding through the IRP. We're currently between steps four and five. We're validating our deterministic study and getting ready to run stochastics on that once that's been validated. [3:50;09 recoring]

**Lori Hermanson:** As far as our load forecast, this is informed by IHS. Their forecast includes energy efficiency. We add to that a forecast for net metering and electric vehicles, and we get the hourly shape of those, all that by region and how the hourly shape will differ over the planning horizon. This is just a closer look at the roof top solar shapes over the planning horizon. It's informed by EIA, but it includes regional growth rates and then as far as electric vehicles, you can see the build out of that over time. But if you're just looking at, for example a snapshot of 2040 that's taking in consideration that there would be a penetration of about 15% to 65% of the light duty vehicles, 12% to 15% of the medium duty and then 5% of the heavy duty.

**Lori Hermanson:** And then far as the greenhouse gas emissions. This is one of the things that continues to change. The CCA or the Climate Commitment Act. Jim, looks like you have your hand up.

**Jim Woodward:** Thanks. Lori. Could you go back to the previous slide?

**Lori Hermanson:** Sure.

**Jim Woodward:** Thanks, and full disclosure, I did miss the morning session and I know that we are all following up later in October. So, if that's the short answer to the question I'm about to ask, great. But was wondering with particularly the adjustments here. Let's take rooftop solar, for instance. Right now, for the load forecast, is that largely factoring in as a decrement to the load forecast versus a resource I guess in the load resource balance mix?

**James Gall:** Hey, Jim, it's James. This is referring to the regional analysis for the price forecast. I think what you're talking about is Avista's load forecast and EVs and solar. Is that what you're referring to?

**Jim Woodward:** Yeah, I saw this and I was trying to catch up on the slides from this morning. If this is better reserved, again, I know we're tight on time. If this is better reserved for our one-on-one meeting later this month, that's fine. I just saw this and figured that I'd ask.

**James Gall:** Yeah, that is probably better for that meeting because we covered that earlier today. This slide is really on the regional look rather than Avista.

**Jim Woodward:** OK. I will hold this over then.

**James Gall:** Thanks.



**Lori Hermanson:** OK. On the greenhouse gas emission prices, this is one of those things that is continually moving since the Climate Commitment Act. Some of this is late breaking as of last week, but with our latest read, and this may be changing as we go, but we basically did a weighted average between California's current prices and then transitioning to a national 2030 national carbon price. The way we read the Climate Commitment Act rules is that there's basically the allowances for the utilities, but then there's a true up. The effect of that would be that there's no carbon prices until 2030.

**James Gall:** Maybe 2031.

**Lori Hermanson:** Then if you take the weighting of those, the levelized price for Washington is \$5.43 per metric ton. And so basically the green line is California's price based on their current prices right now. And then the other one is all the other states basically having no carbon price until about 2030 and then it starts at basically a weighted price between California's and the national carbon price.

**James Gall:** I'm going to pause your really quick there because of the changes in the reading of the new rules. I think what Lori's talking about is probably what our price forecast will be the next time. The prices that she's going to show you in a little bit are using the old methodology that we sent out in an e-mail a few weeks ago, maybe a month ago, and due to this new change in the how we read the rules, we're going to have to rerun the price forecast again and we'll share those results once they're available. So going forward, we'll have, like Lori said, we have California price, no, it will be a national price that is a one third weighting. For Avista's plants. It'll be that national price, one third weighting, but it won't use the CCA prices since we will have allowances to those.

**Lori Hermanson:** And I also have that slide in here as well. I had it, but I pulled it at the last minute. What's actually included in here, I'm not reflecting here, but this will be our next run. OK, the new resource forecast, this basically comes from the output from our, this is just illustrating the output from our capital expansion module that we run and how the build outs will be over time, or projected to be over time. And you can see, solar and wind are increasing, you see coal going away and. Oops, sorry about that. I think you clicked something and that's OK.

**James Gall:** Yeah. I'll try to fix this. I apologize, we'll start over.

**Lori Hermanson:** Let's see if I oh, there it is. OK, so here we are. Basically, no surprise to anybody. See the renewables increasing. Both wind and solar increasing, coal is dropping off and it's being replaced by some natural gas. And then this is both historical and forecast of the WECC by resource type and so you're seeing more of the same basically, renewables forecasted to increase by about 34 average gigawatts and coal, nuclear natural gas decreasing by about 20 average gigawatts.

**Lori Hermanson:** And then this is a look at the region. Same thing, historical and forecasted, but again increases in renewables of about 7 average megawatts. And

then you see natural gas, coal and nuclear declining. Our greenhouse gas emissions, you know, basically aligns with what you're seeing in the resource mix for the region and for the Northwest, but this is the WECC and again you see the resources declining over time. And then for the Northwest States of Washington, Idaho, Oregon and Montana, again, you see emissions declining and that big drop around 2025-26 is due to Colstrip retiring, and then also the Centralia plant is retired during that timeframe.

**Lori Hermanson:** This is the price forecast over time, so both average, off peak, on peak and super evening peak pricing and very similar to what we showed last time, but you see around 2026-27 that the off peak is crossing over and being priced at higher than on peak and so this is something that we started to see in the last IRP. And again, I've been seeing in our price forecast that we did prior to evaluate pricing the RFP resources that also as we're proceeding through this IRP so the levelized price is \$38.16. I think the last IRP was the high \$20s if I remember right.

**James Gall:** A similar trend that Michael showed, gas prices were higher and now, like I said, we're starting to see some of that thing. The same result.

**Lori Hermanson:** And those deep super peak evening prices are remaining high. This is the same sort of look only on a seasonal basis. You're seeing that same shift or same shape, all of them with a morning peak and again an evening peak. Some of them are more pronounced with certain seasons.

**James Gall:** We're seeing that solar is really having an impact in all seasons. And in the forecast now, which is going to have, electric pricing is important to model for storage, because we think about how you're going to choose the storage resource, how is it going to be valued? And its arbitrage is valued? And is it cost effective? Or is a peaker worth more whether it's hydrogen or natural gas? But these shapes are what we will value each of the resource options that we have. This shape versus looking at the IRP forecast 10 years ago. We didn't see this dramatic of a curve difference in the evening versus the middle of the day. So, it will have an impact on our resource selection.

**Lori Hermanson:** And then finally, the outputs of this entire process where we do our price forecast, and these things will be posted on our website soon, although we're about ready to update them, again, we may wait again to post them. But annual Mid-C prices by iteration, the hourly Mid-C prices, the regional resource dispatch as well as our greenhouse gas emissions. That's pretty much everything I had. Are there any questions?

**James Gall:** One thing, like Lori mentioned, we're going to be rerunning this with the carbon pricing rule changes and I think what we'll try to do is update the output slides then send those out to the TAC, when they're available. And then all of the data output will get those on the website, probably once we're through that whole process that Lori mentioned earlier. That might be another month out and we'll get those outputs. But does remind me on data for Grant's load forecast, we'll post the data for that forecast this week and that will include the EV, to break out for EV and solar all the breakouts of the different load impacts Grant went over today. They will be on the website, I think. Is there anything else

we can put on the website now? I think climate change stuff, or I can't recall. But keep an eye out for it. We're trying to publish as much data as we can that we can make public. So, be on the lookout for that. I think that's as it gets ready.

**John Lyons:** And we are also planning to do a kind of overview like we did last time. Probably going to get that out earlier this time. You could go to that spreadsheet that gives you an idea of what's in each of the spreadsheets because it's going to be a lot of data out.

**Clint Kalich:** I was just curious. I think some on the Planning team has seen this paper by E3 where they're arguing out 25 years from now or so, there won't even be enough non-zero incremental costs and wholesale market to actually generate an hourly price. In other words, you'll just be flooded with renewables. Those pictures didn't stand out that that was the case. Do you have anything come out of what you saw in your modeling relative to some of those more runs being made more theoretically run by E3 and others? Are you seeing that kind of thing? Didn't look like it from the,

**James Gall:** I think you still have impacts of outside the region. There's still thermal cost base. And then also in order for a model to solve at least the storage question, you have to put an arbitrage cost in there a hurdle rate for a storage resource to dispatch this hour versus this hour. So that could be part of it. But I kind of agree with E3's thinking is. I don't know how would you know what market behavior is going to be like, so that could be one future. I don't know if this is right or wrong, but you're in a world that's all renewable. What is the price? I think it becomes opportunity cost and bidding logic. I don't know.

**Clint Kalich:** Back to the future, back to the nuclear. Too cheap to meter. Yeah, maybe that's the case.

**James Gall:** Maybe this doesn't matter anymore.

**Lori Hermanson:** So, it looks like we don't have any other questions, alright.

### **WRAP Update, James Gall**

**James Gall:** Originally, we were going to have Scott Kinney, who's our Vice President of Energy Resources, come do a presentation on the WRAP. And unfortunately, he wasn't able to make it, so I'm going to attempt to be Scott or at least channel Scott's thoughts on the WRAP, because he's our representatives on the WRAP. I think you've maybe heard Fred Heutte earlier talk about, he's also on one of the committees there, and Fred are you still there? If there's a question that comes up, I can't answer, you may have an answer to that. Appreciate the help.

**James Gall:** But can everybody see it on the screen? OK, alright, so. One thing I'm going to be doing is this is a presentation that the WRAP had given a couple weeks ago to the public and we took some slides out of that presentation that we're to share today that are

more representative to the Northwest. But if you're interested in listening to the full webinar, there is a 2-hour recording you can link to it from this link here that will post with the slides. But if you have the time, they answered questions and during that webinar that maybe it's similar ones you may have, but it's about 2 hours and they go through the full slide deck. But again, I'm going to try to focus on what's relevant to the northwest and then also maybe speak to it from Avista's perspective. But feel free to ask questions.

James Gall: Lori's going to also be a big part of trying to do our submittal, so she may have some answers as well. She's been contacting them quite a bit lately. Alright, so let's try to go to the next slide. OK, what the WRAP is looking for is the reliability model. It stands for Western Resource Adequacy Program and what they're after is trying to come up with a set of common planning methodology for resource adequacy across the West or at least the footprint that they cover. On the map to the right, in black are the areas that are participating in the WRAP. There are currently 26 utilities participating in this, what we call the non-binding programs. You may hear that term nonbinding. So, there's going to be a period of time, I believe until about 2025 that's called nonbinding. What nonbinding means is that you submit to the WRAP what resources you have available, but you're not obligated to be penalized if you do not have enough resources to meet your planning margin requirements. After 2025, there will be a transitional phase where utilities can participate partially without being penalized if they're not fully met the resource adequacy comments, but at the end is supposed to be where all participating utilities have met their resource adequacy requirements. Going forward, the penalty that I'm talking about is if a utility does not have enough resources, they'll be penalized at 150% of the cost of a natural gas peaker. That creates an incentive to build generation or acquire generation through contract to satisfy your requirements. We'll get through what all these requirements are and thank you. Earlier today we talked about QCCs and PRM and we'll get to what all that means as we get through this and feel free again, ask questions, jump in and I hope we'll try to address some of the questions that were brought up earlier.

**James Gall:** Objectives today, we're going to do overview the footprint of the WRAP, we'll cover real quickly what the resources are in the region. We'll probably try to spend less time on that, but more focused on the QCC or ELCC values of each resource class. And then what the planning margins are, what the WRAP is coming up with, and then we'll try to also mix in here how this is going to relate to this resource planning process.

**James Gall:** Eventually this is going to be a fully binding program. Right now, this is assuming this diversity benefit, that's the whole idea of this WRAP. If I'm short, maybe somebody else's long because the weather patterns are different, that's the whole benefits of this WRAP. This is all based on the participants that are in this non-binding proposal. One utility drops out, for example, let's use a large utility like Pacificorp. If they dropped out, that's a different resource mix that is left and that's going to impact QCC values. That's going to impact planning versions. It's really important to know who is in and who is out before we can make this all work. There are some notes there from the WRAP to be aware of limits on drawing regional conclusions from aggregate information. Because what we're going to show is aggregate information. They could be different for each utility or each resource. We'll talk a little bit about that from a business perspective.

**James Gall:** As we go through this, that first slide is just a makeup of the resources. And actually, Lori showed this earlier where the generation is coming from in what's called this Northwest zone. As you may have guessed, it's mostly hydro in that green area and then you have coal, I believe in the red. On the right, you can see a legend and it works its way from bottom, corresponding to the right of the chart works left. So, battery would be on your left of the chart, so there's not a lot of battery resources. I think there was a comment earlier about there's not QCC values for batteries and these hybrid systems. That's one of the reasons why is there. The region tried to focus on the resources that are plentiful to come up with QCC values so they could get a program started and not try to focus on resources that are maybe a very small portion of the system. They are going to be coming later and actually if you listen to the recording, they do discuss that a little bit more in detail. But as we transition over the future, these percentages are going to change, and that means that QCC values will change, planning margins will change. I think that's really one of the challenges of an IRP is this snapshot. Now how do we use this in the future? And we're going to have to make some assumptions about what that future looks like until the WRAP and time has passed for those studies to be done, or how the WRAP will look like, say, 10 years from now or 20 years from now.

**James Gall:** This is for summer. Similar look is winter, obviously mostly hydro, coal and natural gas and. So similar to a snapshot.

**James Gall:** A key reminder, and I don't want to go through all of these, but one of these notes really stood out to me as we were preparing for our submittal. That's the first sub bullet on the top. It says planned outages because even though you have all these resources that are available to you, you're going to have units that are out on maintenance and when we're submitting our WRAP proposal, we have, this is our load, these are our resources. But wait, we have these units on maintenance and we're going to have to now start planning on when do we take units on maintenance. We're going to have to take units on maintenance, likely some winter months, some summer months. But we need to be thoughtful and in a coordinated way to make sure we can still meet our WRAP compliance. That was kind of one of those interesting, I wouldn't call aha moments, but something we're going to be cognizant of in the future when we plan our maintenance going forward. And let's just skip the rest of those for now, just from a time point of view.

**James Gall:** What I'm going to go through next is some of the different zones for calculating ELCCs for different resources. They're not treating a wind resource in the northwest the same as one in Montana or Wyoming or elsewhere. They came up with five zones for wind. Each of these zones have really different wind patterns. And what I'm going to show in the next couple slides is what the resulting QCC values are for each of those zones. One thing they recommend is these are averages for the regions. Each of the utilities submits their wind data and they will have unique QCCs. For example, our Rattlesnake and Palouse Wind are going to be similar to the regional values, but they will be different based upon their characteristics. This is also a breakdown of how much wind is in each of the areas as well.

**James Gall:** Similar thing for solar. There are two zones for solar, one north of the California and Nevada border and South. As you can see in the South, there's a lot more megawatts but less projects. Big projects and there's lots of small projects that don't accumulate to a lot of capacity. But again, they're going to show you that QCC values on our original makeup.

**James Gall:** Before we get to that peak load and this is what the peak load is in the northwest and southwest, both somewhere in winter. You can see in the Northwest the peak load is still winter peaking. The Southwest is definitely summer peaking, but the amount of loads is actually pretty similar to the Northwest and then Southwest you can see that doesn't have quite the winter peak. I believe this is non-coincident peak load. Yeah. This is that on the top when they do their modeling, they're doing hourly studies that will calculate coincident peak loads. Each utility submits a peak load but also submits hourly load data that they use to create a symmetric model that has all the regions within it so they can calculate a coincident peak.

**James Gall:** OK, so some of the resulting ELCCs for each of the regions. I apologize, there's five regions. These are five different values of winter wind ELCCs. In the Northwest, I would concentrate on zones one and three. We typically model wind projects in Washington and then also ones in Montana. The results show, in the Northwest, that's at location one, very low ELCC values in that 10% range. In Montana, quite a bit higher in that 30% range. Our proposal this IRP is we will use these values for new resource alternatives. Historically, we've done our own calculations based on our loads, not the region. We will be transitioning to these values for new resources comparing to what our values, where I'd say the Northwest is very similar and values may be slightly higher ELCC values for when the Northwest and then Montana is slightly lower values compared to our old method and previous IRPs.

**James Gall:** And then we have the summer values. You can see in the northwest summer is actually a little bit higher for the northwest and then Montana in red is actually quite a bit lower and that's pretty consistent with what we see with the data out of Montana is a lot less wind in the summer compared to winter. And then northwest, we definitely get a spike in June and July, and then less wind. It's pretty consistent with how we see our projects performing.

**James Gall:** One thing that's important is how will ELCC change over time as more and more wind is added to the system. This chart is trying to illustrate that there will be small reductions in ELCC over time for these projects. They show an additional 3, 6 and 9 gigawatts of added generation. One thing they mentioned on the call was you don't see a dramatic reduction because there's already a lot of saturation of wind in the Northwest. I think the idea here is that ELCCs will be fairly stable at least for wind. When we get to solar, there will be some more instability, probably with solar for future ELCC reductions. The one I'm most curious about is what they're going to show for storage, but they have not done that analysis yet.

**James Gall:** Moving on to solar ELCC. Again, there's two zones, called the northern zone and the southern zone. The winter, you can see these are pretty small values, not a lot of solar potential in the winter. A little bit more in the South, but I believe these average around 3%. I think we had 2% in our previous IRP. So not a not a big surprise here as many of you know, most of the utilities, when we're peaking in the winter it's usually dark. Without storage technology, solar doesn't help quite that that much for summer. It's a different story. You can see around 20%, you'll see values in the southwest. It's a little bit higher in the northwest and that has to do with that penetration. I believe the more solar you have on the system; those values will fall.

**James Gall:** It's just to a point where you're fully saturated and that's what you're seeing here. The saturation you could see. You start adding more and more solar. The ELCC falls in the summer months where if you have 3 gigawatts, you're at 9% in June, then you go down to 7% as you get to 9 gigawatts. So, there will be a reduction and then obviously in the winter, there's no change, it's around zero.

**James Gall:** Other resources that the region looks at. Obviously, solar and wind get a lot of the attention, but in reality, other resources make up most of the capacity in the system today and run of river hydro. These are just a summation of all the individual projects. Avista, like we said before, we submit our projects, and we get unique QCC values for those resources. But this is a generic average of run of river hydro. An example of run of river hydro could be the Spokane River, Monroe Street, Post Falls. Those projects are run a river which means they have no storage, and you can see the higher values in the winter when there's more flow, lower values in the summer when there's less flow. What we observed is the QCCs really represent the average energy these units are going to generate in those months are typically the resulting QCC values. And then here's summer as well. What's interesting is their slide says summer, but they show some in winter. So, but I'll have to winter peaking, I guess. OK. There we go. Yep. And I think the summer peaking would be more like an irrigation versus a natural run of river.

**Clint Kalich:** They must have a set of qualifications, which...

**James Gall:** Yeah, like I said, for us, we submit the data based on like a 10-year history there, right, Lori. And then they give us a resulting QCC by month.

**James Gall:** Storage. The projects in our case, it's Noxon, Cabinet, Long Lake Little Falls, and then we also have Mid-Columbia projects that fall in this bucket. You can see they're fairly high QCC values on average it's around 80% in the northwest. Southwest looks like a little bit less in November. But how this works is we submit ten, I think it's ten years of historical hydro data, and they're looking at how well our units perform and have ability to generate over historical peak hours. Actually, for Avista, most of our winter months our QCC values are a little bit higher than these, than the region, which is a good thing. That position as well in the future WRAP, but when you transition over to summer you can see ELCC in the Northwest fall quite a bit, down to that 77%. Our units are very consistent with that. You have less water available. That means you can't run your units over a longer

duration to meet a peak. At least for our units, it's fairly consistent with what we're seeing here, although I think June, we typically have a higher value.

**James Gall:** And then the thermal resources where we're talking about here is natural gas, coal, very high QCC values. It's a forced outage rate that reduces these values or how the units may operate based on ambient weather conditions. For example, a natural gas plant typically can produce more in the winter because the ambient temperatures versus the summertime. But very high percentages here, you see there's a range they showed between 92% and 100%. I think most of our facilities came out in the high 90s. And if you're interested in how Avista is performing in ELCC, when we walk through the PRiSM model in a couple weeks, we'll have an L&R, that load and resource balance, with a summation of all of our resources by category. And you can see how much we assume each resource contributes towards meeting our peak requirements, and then we'll also show our assumptions for each of the new resource alternatives, how much QCC value we're going to assume.

**James Gall:** Again, thermal in the summer, not a large change there. It is a little bit less because some of the gas plants on average are in here.

**James Gall:** Alright, so let's go to planning reserve margin. What they're trying to do is calculate a 0.1 LOLE across the season. I'm not going to get into how all that works. I myself had to go back and read it again just to make sure I understood it. But think about you have a season that you're trying to get a 1-in-10 occurrence or trying to prevent more than 1-in-10 occurrence, but on a monthly level. They're also looking at what is the probability of having a monthly occurrence. Maybe the lower value of 0.01. If you think about you have 0.01 every month that adds up to 0.12. I would say they have this a little bit of a binding constraint of the annual versus summer. So, they're trying to add enough resources to limit your outage to that 0.01 per month but adding up over a year to 0.1.

**James Gall:** The results are shown here. I think Lori mentioned earlier that 20% or 18%, I think you talked about for 19%.

**Lori Hermanson:** 19% in winter and 10.3% in August.

**James Gall:** Thank you. But in reality, we're planning, at least illustratively, for those two months. But in the WRAP, we actually have to meet capacity in five winter months and then five summer months. Those have different planning margins in each of those months. They're also showing how those planning margins may change over time as well. We don't have a forecast out to 2045 but that planning margin should be. One thing we could do is leave it at that final year, we could maybe escalate it. I think we talked about maybe there's more risk in the outer years. Maybe we should increase our planning margin over time, but those are things we're considering. The idea is that as a region we would have lower planning margins than we would individually. Like Lori showed earlier, we're at 22% in the winter, we get a shift down to the 19% range, except for March. March is still pretty high. Then summer, we're at 13%, we're shifting down to that 10-11% range.



There is definitely value in the WRAP because we see this as a savings to our customers by building less capacity, in exchange, for a little bit more coordination.

**James Gall:** What's next? Right now, there's been a lot of work that's been done over this last year, getting data, running models to come up with these valuations. And we just submitted our summer and winter of this year and next year's non-binding program. It's going to operate, again in this non-binding program, for a few more years. There is a submittal to FERC, I believe, to approve the tariffs that are created under this program. And once that's done, then this will slowly transition to a binding program.

**James Gall:** The rollout is going to take some time. There's going to be, like mentioned earlier, this non-binding portion through 2025. There will be a transitional process to 2028 and then by 2028 there will be hopefully a fully binding program.

**James Gall:** This is going to take quite a while for its fully implemented, so we're going to continue to proceed with caution on this. This could change, it depends on who drops out, who stays in. We're going to probably keep thinking about the WRAP as a scenario, at least for now. If we see more and more momentum in the next IRP time period, maybe that will be our base case at that time. That's all I have. I didn't hear any questions yet.

**Lori Hermanson:** We have one. Go ahead, Sashwat.

**Sahswat Roy:** Hey, James, thanks for the presentation. This is really helpful. You mentioned that Avista would use QCC values for this IRP. How do you see the storage QCCs coming out of WRAP? And how does that affect your modeling right now because I'm not sure they've shared that with utilities or they've definitely not shared that with the stakeholders? So, how does that work?

**James Gall:** They brought this up in the webinar, where the slides come from, they're assuming right now if you have a 5-hour battery, you would essentially get 100% QCC value. We're thinking about using that as a starting point. So, a four-hour battery would get an 80% QCC, anything above 5 hours would get 100%. But our worry is that's probably not a realistic value for say a 2040 storage resource. We're going to have to look at some other studies that have been done in the region to try to come up with an ELCC for the future. We would likely trend down the ELCC values of this five-hour level to something that's less, or more duration over time. We haven't fully figured that out yet. We need some more time, and we'll obviously bring that back to the TAC once we've settled on that, but for there's also resources that have solar and storage. We're thinking about that similarly where, let's just say you had a solar plus storage resource that can only charge with solar. We look at how much solar can you charge that battery and use it in the winter. Is there enough energy there to get you four hours or five hours? I think we came up with, I can't remember, was it two or three hours. But we're going to look at it from that perspective. Similar with demand response. We have demand response that we submitted this time and I think there was a similar 5-hour threshold.

**Sashwat Roy:** Yeah, and just to point on the hybrid resources. I think you mentioned solar, the battery being charged by solar. I think with the recent IRA provisions, I think that ITC recapture risk goes away.

**James Gall:** OK.

**Sashwat Roy:** I would suggest not having that limitation on just getting the batteries charged by solar. The 30% ITC takes care of that. The batteries are able to charge from the grid and not have that ITC recaptured. So, I think that limitation in future RFPs, that limitation going away as well. I'd recommend modeling solar plus storage with higher storage to generation ratios as well as removing that limitation of just having the solar to charge the batteries. I think those would increase the ELCC values as well.

**James Gall:** OK.

**Sashwat Roy:** I'm waiting for the WRAP to showcase their battery ELCCs. They mentioned initially they were going for that five-hour duration based on the capacity critical hours but then they said that they would look at ELCC for batteries. I think we have enough evidence from how the California ISO, they have had batteries for the last couple of years now, so there is enough operational data out there to see how the batteries functioned during summer heat events and all of that. There's definitely data out there. Looking forward to how Avista does this as well. We'd be happy to help out in any way we can if with this.

**James Gall:** Yeah. I think I heard on the call; they're going to shoot for maybe next year to get that storage analysis complete. But it's a good point on the RA. We will make sure we take that into account. There are situations that we are monitoring that do require a solar charge. Those instances will still have that limitation, but we will make that change.

**Sahwat Roy:** OK. Thank you.

**James Gall:** Jim, go ahead.

**Jim Woodward:** Thanks James. Like Sashwat, I appreciate the presentation, this helps a lot. Would you mind going back to, depending on what your counter is, I think it's slide 14 and 15 in Scott's presentation here, or 94-95 in the whole deck. It's the solar ELCC by season.

**James Gall:** Do you want summer or winter?

**Jim Woodward:** I think either's fine cause what I'm curious about is the categorization of the fact that there are two essentially, solar categories by latitude. That demarcation makes somewhat sense to me, but I'm a little curious as to whether the load, pre-load, load, following aspects, essentially longitudinal dependent aspects. Are those factored into these categories covering a certain purview. And then other projects, specific

characteristics factoring into the ultimate QCC value. Are those longitudinal dependencies in the project specific sort of bucket? That's not really represented here.

**James Gall:** Yeah, and I'm going to take a little bit of a shot at this from what I heard on the call. When every project submits their individual data, which is going to be different for where the projects are at, and this is a result of the average of all of those individual resources. I don't know if there's anybody on the call that's been on that call or I don't know if Fred's on there. I think that's what this is supposed to represent.

**Jim Woodward:** Kind of the average. I'll respect the pause here in case anyone else wants to chime in.

**James Gall:** Yeah, and Lori added one of the comments.

**Lori Hermanson:** I think they also pointed out that there's a lot more penetration in the south than the north, so that was another reason for the grouping as they did on the solar specifically.

**Jim Woodward:** OK. I think you had another slide in terms of overall project, Lori. What you're getting at with the penetration, the North would have lower penetration and probably the West side of the north would have the lowest of all. I'm just thinking here, extrapolating out the wind, the five wind regions that makes sense and like you said, Montana is very different from Gorge wind, etcetera. I was just thinking from a solar project standpoint, a project located closer to the load centers of, let's say Seattle and Portland, not talking about the Avista service territory, might be competitive in terms of, coterminous with, the actual load, late afternoon, whereas the sun would be already setting. Further east of that makes sense. Just again wondering if that consideration was somehow factored in beyond this two solar category designation.

**James Gall:** Based on just the submittal of the data itself, I think that is taken into account. Again, I think it is an average of all that the resources that were submitted.

**Jim Woodward:** OK.

**James Gall:** Clint, you got a comment.

**Clint Kalich:** Just I would say I would hope that the zones they took were a result of the data they analyzed, but certainly we could ask. Well, I don't know, maybe we could ask that question, but you look at that and you think coastal BC, Northern BC, it's hard to believe that would be the same as southeast Idaho.

**James Gall:** But again, back to two-hour time change on the time changes exactly.

**Clint Kalich:** It's a good question Jim. I, Like the regulators, have a seat at the table for the WRAP, and they all probably should learn more about that going forward. And we will, yeah.

**James Gall:** Go ahead.

Jim Woodward: Yes, things as long as I had a little bit more airtime here. I was wondering James, there have been a couple references at least as long as I've been able to attend the presentations today about, risk about WRAP moving forward and you know once you get to the binding phase, you know, just kind of wondering you know broad brush you know Avista, you know you have your position, you know or the company has its position right now versus you know other players in the program that maybe depend a lot more on market transactions and just wondering what the current sort of cross section of that is in terms of current utility participants, if you might want to offer something on that front if you don't want to understand, but just thought I'd pose the question.

**James Gall:** I think you bring up an interesting point. There are a number of utilities that are short and would be subject to those penalties. I think that's why, we go back to the last slide here, there is this transition option between 2025 and 2028 where those utilities may not see the full fine or penalty but can still participate and get some of the benefits. But I think it's imperative that you as a regulator, and other states as well, are trying to encourage the utilities to participate so that we can from a society point of view, lower cost to all customers. I think there is a risk because they see penalties that they wouldn't normally see. But if we can get that encouragement from maybe your side of the business to join and participate. This can work out for everybody. Clint?

**Clit Kalich:** Well, I have to say something, Jim, because as somebody that's been in this for decades, some of those folks being short in the marketplace have been leaning on some of the rest of us for many years for capacity just to be direct about it. Theoretically, being in the WRAP, for those short entities, should still be of benefit to their customers by being in the WRAP, but only if the regulators, because apparently, they haven't done it on their own. Only if the regulators put the pressure on, to say if you're not in the WRAP, you need to meet your own planning criteria and actually build resources or enter into long term contracts to serve and ensure that reliability. Because even if we're in WRAP, and if the rest of the system goes down, it isn't very good for the rest of us. My hope is on regulatory side, that the benefit of being in the WRAP will be more than the benefit of not being in the WRAP. And to me that's a societal regulatory enforcement aspect and going into this new world full of renewables, and variable loads, and getting rid of natural gas and coal, seems like we're becoming more and more reliant and have less and less fat in the system. And if everybody isn't contributing, we're going to have a much, in my view, higher probability of an outage that affects more than just those utilities that chose not to carry their weight. So anyway, Jim, I couldn't help but take that opportunity to make that plug. Thank you.

**Jim Woodward:** Sure. No, way to internalize that free ridership, way to turn this back on us lowly staff over here in Olympia. Thanks, Clint.

**James Gall:** I'm looking at some notes, Scott. There are a couple points I wanted to make about who the WRAP is, I didn't bring that up. The WRAP is ran by the Western Power

Pool, but a lot of this work being done is by the Southwest Power Pool. Actually SPP. They are the contractor to help organize and build this program since they've actually done this in the Midwest. Are there any other questions? Otherwise, we can move on to the next topic. No, OK, alright. Back to the agenda and that would be Annette. Are you ready? All right. I'm going to get slides transitioned over to you. Annette is going to be talking about our Clean Energy Implementation Plan, a new term to the IRP called the Customer Benefit Indicator and how those are used in an IRP or how we propose to use them in the IRP but give me one moment to get the slide deck working.

### **Clean Energy Implementation Plan (CEIP) Update & Customer Benefit Indicator's (CBI) use in the IRP, Annette Brandon**

**Annette Brandon:** OK, my name's Annette Brandon, and I'm Wholesale Marketing Manager in Energy Resources and this is my first in person presentation, like third in my whole career. So, Shawn I going to look at you since you're right ahead of me on this. Today the main purpose for this meeting, or for this presentation, is to discuss how we might incorporate Customer Benefit Indicators and non-energy impact into our resource selection process. We haven't done that before. It was part of the development of the CEIP and will be rolled into the next Clean Energy Action Plan. But before we get to that, I wanted to. OK, thanks. OK. Can you hear me? OK. Can you hear me now?

**Lori Hermanson:** Yeah, I think it's better.

Annette Brandon: OK. So, let's start over and leave off the part about Shawn. The purpose of this meeting today is to take a look at our Customer Benefit Indicators that we agreed to in the Clean Energy Implementation Plan and non-energy impacts and how we might use those in resource selection. We haven't done that before, so we wanted to make sure that we got some good feedback around that. This really is intended to be informational, or I'm sorry interactive, so it's a whole hour. Please interrupt whenever with any ideas or anything that you might want to discuss. The other thing that you'll notice is that there's a lot of words in this presentation. That's because for a lot of the people that didn't make it today, I wanted them to still be able to read the slide deck and get an understanding of what was going on so that we could continue to involve them in any feedback that we might get.

**Annette Brandon:** Just to remind us all where we started, the CEIP was developed in this process starting with the Integrated Resource Plan. That's the long term that we're talking about today. That final was filed on April 30<sup>th</sup> in 2021. At that same time, we saw the Clean Energy Action Plan that sets the 10-year target of resources and they're filed together. The Clean Energy Action Plan does have some of those clean energy components that filter through to the Clean Energy Implementation Plan. That was the first time that we filed that. Then the public participation plan was filed May 1<sup>st</sup> and then revised on July 30<sup>th</sup> based on some input from stakeholders. But that really outlined how we were going to ensure that we had this participation from various stakeholders in the

development of the plan. And then finally, we filed the Clean Energy Implementation Plan on October 1<sup>st</sup>, and it was approved in June 2022 with conditions.

**Annette Brandon:** This process did have a heavy public participation process in the development of the plan. It was very important that we heard from those individuals within our service territory that could help us make these decisions. The orange bubbles over there talked about the primary groups that we relied on. The Equity Advisory Group, that's a new advisory group that we just started up for this purpose and then it will continue as we go on to give us an equity lens to pretty much anything that we do as a company. Tamara is on the line too, which if you have any direct questions about how those meetings have been going, she's been facilitating that. Those members are made-up of individuals from tribes or individuals from named communities. That's vulnerable, populations, public health, disabilities, a lot of different voices, so that we could make sure that we were really taking a good look at characteristics within our service territory. And the existing advisory group members also participated. And finally, customers participated also. We didn't get quite as much customer participation as we had hoped. But Tamara is leading the effort to get a public participation process going to bring in more customers. She's hired a consultant. They're working on that and hopefully that will help us bring in that group. I won't read through everything, but on a high level, these blue areas are where they helped us. We did get really good feedback on benefits and barriers in equity areas. The conversations went on how might customers benefit from the transition to clean energy in affordability or in access to clean energy. That's how the conversations went. And then that got the conversation going and we learned more about our service territory. They helped us to identify our Named Communities, highly impacted communities and vulnerable populations. Those are areas within our service territory that are disproportionately impacted by climate change or may have limited ability to participate because of socioeconomic or sensitive factors. Customer Benefit Indicators were a big thing that came out of the process and a big topic of conversation when we came to getting our plan approved. I have got another slide where we've talked about that. And then finally, we looked at all of our specific actions. Which is a combination of our resources that we utilize to meet those goals. The 2030 goal to be carbon neutral in 2045 to be 100% clean.

**Annette Brandon:** So that brings us to almost the main topic of the day. What exactly is a Customer Benefit Indicator? The blue box is how it's written in the WAC, so it's an attribute either qualitative or quantitative. I just read it backwards, but of resources or related distribution investments associated with Customer Benefit Indicators described in RCW blah blah blah. I quoted that at the bottom, but really as we were developing this, the questions were how can we ensure that our customers are benefiting from the clean energy implementation action actions we're taking, which resources or investments can we utilize for that and how can we measure that? The areas that we really wanted to focus on and these are statutory benefit areas is inequity. I've got them underlined here for equity because there's really 3 embedded in that one sentence. It's really equitable distribution of energy, non-energy, and reduction of burdens to our vulnerable populations and highly impacted communities. We really need to take a good look at how we might help overcome any kind of limitations that areas had. Also, public health and

environmental. Energy security and resiliency, and cost and risk reduction. We took a look at all of these as we were developing.

**Annette Brandon:** This slide is kind of repetitive, I just liked all the colors so I thought I'd pull it in, and it would give you one group that showed how the process went. We started with our public participation plan which was developed in coordination with the plan. We ensured that we had that equity voice from our Equity Advisory Group. Ultimately, we came up with measures, Customer Benefit Indicators, that are measurable and hold us accountable. And that's really important because the Commission will look at that to see how we are doing. Customers will want to make sure that they understand how we're doing. We have some requirements in the general rate case that we keep a list of indicators, not just equity indicators, but other equities on our website. I can't remember seeing if that was quarterly. That's what I put on this slide. But I can't remember. OK. Those will be available soon on our website, within the next quarter, February 15<sup>th</sup>. But ideally the long-term goal is to make it so that these metrics are available on our web page and someday maybe in some kind of an interactive way where customers can go in and see how they're being impacted as kind of a long-term goal. But we'll see what happens. Finally, distributional equity or named communities. I threw that term distributional equity in there, because we're going to start hearing that more throughout the Commission as we're looking at business plans and whatnot. So really what we're doing there is just we're just making sure that we're taking in consideration those social, economic conditions, pollution, climate change, how it impacts various groups within our service territory and to make sure that we are accounting for those differences.

**Annette Brandon:** OK, here's really the nuts and bolts. These are our approved Customer Benefit Indicators. For ease of discussion, I grouped them by equity area. That's affordability, access, community development, energy resiliency, security, environment, and public health. And then what the metric is; how we're going to measure it is in the bullet point. But what I wanted to stress here today is that this makes it look like it's not nearly as complicated as it is. Our group that's measuring these things, for instance participation company programs, it's really not just one, it's really three, because we have to know named communities, all customers, and low income for instance. The analytics group is really tracking, I'm thinking it's close to like 55 or something they're up to now. But each of these equity areas ultimately do reside in one of those benefit areas on the right that we talked about in that previous slide. We need to come up with a way to really describe this to our customers that make sense because it's a lot easier to say what do you think about affordability than it is for us to say, what do you think about energy, non-energy reduction of burdens. We're working on that, so that when we translate it into the regulatory arena that it's clear for all our stakeholders.

**Tamara Bradley:** 59 indicators so far.

**Annette Brandon:** Awesome. That's so far. I guess before I move on to Customer Benefit Indicators, I know this is super fun for everyone in the afternoon. Are there any questions on that? No. OK. These are really how, as a company right now, we're going to be looking at equity until we develop something different.

**Annette Brandon:** Along with Customer Benefit Indicators are non-energy impacts. I don't have to read everything on this slide, but it does give some good information as to what those might be. The bullet points are just different ways that I heard it described. But really, the top one is the one that that makes most sense to me. And that's just that they're really a vital intersection of energy and equity and really an essential metric of equity. So, that sounds a lot like a Customer Benefit Indicator. The two are very much correlated, not exactly, but there is some correlation. If you look down societal benefits, you can see that where public health, well, public health is a statutory benefit area. You know energy security is the same.

**Annette Brandon:** Primarily what we're looking at in resource selection is those participation benefits and societal benefits. And I thought about taking off the utility benefit box. But really, I think it's important to have that on there because that really impacts all of our customers. So, if we have peak load reduction and we don't have to build more resources, well that's saving customers. And same with transmission and distribution. If we have a distributed energy resource project that saves us from having to change our T&D system, again, it helps customers. I wanted to leave that on there for that reason. Just to think that even though the utility benefits, we pass that on to our customers. The customer benefits,

**Annette Brandon:** This is a little bit of a repeat of the last slide except for it is giving the sections in the report that was developed from our third-party expert in this, DNV. And these are the areas that they focused in on in their summaries. You can see public health. Public health is both your supply side resource and demand side, resource safety, environmental, environmental which includes wildfire risk. I want to point that out since Grant was talking about earlier today. And then economics, with your jobs and your earnings and value added. Those are for your supply side resources and for the demand side, they're not drastically different except for your property value and your energy burden. Both sides, supply and demand, third-party DNV developed these, but some of the non-energy impacts are not quantifiable or the data was difficult to obtain and that resulted in outside of the scope. Additional study may be performed on the supply side resources. Ryan Finesilver and his group are planning on doing demand side resource sometime in 2022. Unless that's a typo.

**James Gall:** Demand side management is the owner versus energy efficiency, which is.

**Annette Brandon:** OK. There we go. All of this rolls into condition #2. A lot of our meetings that we're having lately are saying, well, we're doing this for this condition, and this is the condition that says that we're going to bring in the non-energy impacts and the Customer Benefit Indicators to resource selections. This is the first step, to consult with our TAC, that's here today, but we also run it through the Energy Efficiency Group and eventually, the last bullet, will consult with the EAG once we're through developing it. We'll make sure that we haven't missed something and that they'll have a say in the matter also. And that's a natural progression of where we're going as a company and the things that we do. Likely, the EAG is going to be involved in one way or another. There are only



a certain amount of people who only meet once a month, so they can't do every single thing. But we're going to make sure that we have their voices heard in what we do.

**Annette Brandon:** There is a lot of information here on this slide. How I have it set up is on the left-hand side is the Customer Benefit Indicator. In the middle is just a reminder of what those metrics are. On the right side are the reasons why we feel that they're really measurements after the fact, or perhaps to be used in program selection versus or program prioritization. Excuse me, versus used in the IRP as an upfront method. For participation in company programs, we really felt like that was a measurement of the success of the execution of the energy efficiency BCP. It's also very much a coordinated effort with the availability of modes and methods of communication. The CBI #3, the two really do intersect. And then what we're thinking is that it might be used in program prioritization. So, in energy efficiency, if Ryan's group has 10 measures that might be chosen or deemed to be cost effective, whatever the right terminology is. Then it might be that OK, we know we can reach 50 customers with this versus 10 customers with that, or something like that. That's what we're thinking on that one. Now I want I want to pause for a minute and make sure that this works for everyone and see as we go through it because it's a little bit tedious, but we want to make sure there's an understanding of what we're doing. So, anybody on the phone? OK. I thought Jim.

**Jim Woodward:** Surprise Annette, I thought I'd hold my participation for others. But I have a feeling that you're leaning on me a little bit for participation in this section, which is great, which is awesome. Just a clarification question because, I like what I'm seeing thus far. Reference to the CEIP and the conditional approval or essentially the conditions list that we all know and love from last June. What the exercise we're doing right now is this, more or less trying to fulfill, I think it was condition 35, where we're essentially going through each of the CBIs and you've talked about the NEIs, the non-energy impacts as well, but especially each of the CBIs to rationalize whether or not this factors into resource decisions. I'm just trying to get my groundings within what we're doing right here, how it relates back to the original CEIP and probably more importantly the conditions list. Does that give you enough to work with?

**Annette Brandon:** Shawn, do you have #35? I can't. I pulled this one, number two, but I can't remember what #35 was off the top of my head, but it sounds right. That's right. Yeah, I'm getting shakes of heads yes or nods. So, I guess it's not only #2, but also #35. But also, what I wanted to remind is that I did present CBIs, when was it, already at a TAC meeting. It was a while ago, but we didn't go through how we're going to use them. We went through what they were, but not how we're going to use them. That's what different in this conversation. So, I think the answer is, yeah.

**Jim Woodward:** OK, great. And so, I think we're on the same page there. 35, at least my reading of that condition is, obviously having this participatory component of this. But you know there would then be sort of a documentation in the 2023 IRP Progress Report that essentially reflects us going through each of these CBIs right now and whether or not they pertain to the resource selection is that what you and your team were thinking, there's essentially going to be a write up reflecting this?

**Annette Brandon:** Yes, totally. And that's another reason why I kept so many words on this. So that when it comes time to documenting that, I don't forget what we said.

**Jim Woodward:** OK, great. Yeah. I, for one, I'm tracking, but I'm using up a lot of oxygen, so I will mute and let others chime in if they want to.

**Lori Hermanson:** Tamara did add something in the chat here about #35, and she says it's not every CBI is relative to resource selection. To be walking people through that which is the incentive is today's agenda.

**Annette Brandon:** Right. So, we're on the same page. Thanks Tamara. That's why I'm calling this measurement, instead of calling it not applicable, because it sounds better to call it a measurement. That's what we're doing, that's exactly what we're doing, right. And then this will just get transferred into full written sentences in the update. The second one is the number of households with high energy burdens. The IRP does forecast total cost and indirectly that impacts energy burden. It will be a one for one because we do need the resource. But what we're trying to do is choose resources that check all the boxes which are lowest cost and meet the other requirements of the IRP. And so indirectly, it's like we're saving customers, it's kind of an opportunity cost there, but that's how that will work. They're not measured directly for energy efficiency, but it's embedded in the NEI, the non-energy impact, for bad debt, O&M and thermal comfort, not O&M participation participants, operation and maintenance expense.

**Annette Brandon:** The availability of modes and methods of communication. That CBI really is intended to address barriers. It was a way that we could think about how we might get more people into our plans. Some of the feedback we received was that sometimes they are not getting to the plans just because they don't understand, or they must speak English, or they don't have the Internet. So, they can't get to where the plans are described or something like that. What we thought is, we need a better way. We don't know what that way is, but that's where we're going to on this metric.

**Annette Brandon:** To continue on, transport electrification, that really is the measurement of plan implementation and that's in accordance with the TEP plan that Rendall and his group files. Not sure how often that gets updated, but when we developed this metric, we really didn't want to be serving two masters. We wanted to recognize that it does impact the Clean Energy Implementation Plan, but also that transportation electrification is something that has to be filed with the Commission separately. For here, we'll just measure that we're making the progress that we had intended. Named Communities investments. That's really a measurement of individual investments not identified in the RFP, not identified in the IRP or in the RFP. Those are conversations that Kelly and Tamara and everyone else that's involved and Amanda that's involved with the Named Community Investment Fund. That will be new investments that may be identified from an individual in the named community. I think we're still working through exactly how we're going to choose those, but that's outside of this process. Employee diversity and supplier diversity. These metrics were developed because we heard we need a way to

address systemic racism that may have embedded bias in some of our programs. And we thought well with employees, supplier diversity, we are getting more diverse so that we can apply that lens towards external communities. And so, we link those up, but that's not something that we can check a box in the in the IRP. Residential arrearages and disconnections. This is indirectly associated with access to clean energy, but it wouldn't be a resource choice because we don't plan to disconnect our customers from a resource that we chose, but it does help to address energy security in the terms of what Public Council and Staff was wanting us to address.

**Annette Brandon:** Now let's talk about the CBIs that are applicable. This is the last of the ones that I'm calling measurements that are not applicable. Is there any? Is there anything that we should know, or anyone that has any disagreements on that? Or any way that we could look at that through a different lens than how we thought of it? I would really like to encourage anyone on the phone that does have ideas to e-mail us, to e-mail any of us. Go ahead, Art.

**Art Swannack:** Well, brief comment. It seems to me like when you get up, what is it, two slides or a slide above that, when you get into affordability. The one that says #2 on it, number of households with high energy burden. It seems like. Oh, there we go. They're going to be a conflict between clean energy, resource selection and affordability for those households. That seems something like that should be considered and what the resource selection criteria is in the end.

**James Gall:** Hi Art, I'll try to respond. I completely agree with you. The challenge is how do we take a CBI that's looking at, almost at the household level. I think the challenge we, or the solution we came up with, is we plan our system for least reasonable cost. We're going to show those costs. But how do we know, how can we translate that to the actual CBI? That's where we had the stumbling block of can we forecast out who's going to have energy burden? I think that would be a goal, but I think you're right. This is one of them that is on that borderline of something we can try to forecast, but I don't know if we have the information yet to be able to forecast will our preferred strategy increase or decrease high energy burden? That's something we're going to have to think about and look at. But I agree with you, that's definitely, of any of the ones that are on this list of not in the IRP. This is probably the one that is most questionable. Can we get there?

**Annette Brandon:** The person that's in charge of getting all of our data is also trying to bring in some other data that might be able to allow us to forecast them better. We don't have that data yet and I'm not sure how he's going to incorporate it.

**James Gall:** This might be one for the 2025 IRP.

**Shawn Bonfield:** The challenge is energy burden really has three main components, income, use and rates. And we can't affect income in reality, we can maybe affect affordability in terms of the customer's disposable income, how much they use towards energy. And then efficiency, what they use, we have limited effect on what a customer uses to put on that participation, energy efficiency, codes. Resource selection affects one

part of rates and it's about 50% of what a customer pays, is that right, James, in terms of the resources power supply roughly? And so, it's really hard to take all of those variables into consideration for resource selection and really understand our forecast. The impact on energy burden that a single resource selection may have.

**Art Swannack:** It seems like you could take something along the lines of bracketing for people in a certain income level, this percent of their income should be the max that they need to use towards the energy based on historical uses and then somehow categorize that going forward as to the changes in energy price with all of the mandates being added on. And I know this is getting into multivariate analysis. It's way beyond my math level. Maybe it's in John's, but it's something that comes to my mind. It's like affordable health insurance. You have 9% of income towards health insurance is a maximum or else you get these big fines at the federal level. I'm just thinking that one needs to be explored more and maybe 2025 is when it gets enough data you can use it, but it does need to be tracked because watching your forecast going way out in the next 10-15 years, you're going to have a continually increasing need for more power. And I suspect it's going to be an increasing cost of power as we go at the same time. Thanks.

**James Gall:** Thanks, Art. Appreciate the comment. We'll see what we can do. We've been definitely struggling with that one.

**Shay Bauman:** I was just going to add another really helpful comment about affordability too. Mulling it over in my head here with all the multivariate, but another thing that I was going to add is I don't necessarily think that supplier diversity is not applicable. I know it's not something that you can forecast in an IRP, but I do know that in different RFPs and whatever it is a criteria that some utilities use to evaluate bids. I get what you meant by putting it on this list, but I think as you discuss each CBI and how that will apply to resource selection. That's something to think about as well.

**Annette Brandon:** and honestly, when I get to the end, if I stop talking so much, but I fully agree. To me, these are like measurements and may be used in program selection, but not up front in this process. And as a matter of fact, we did have those in our recent RFP that we're working on. I've got a slide on that, that we'll get to.

**Annette Brandon:** So, these are the ones that we do think we can get into the IRP. Even though each box has a dashed line that goes down to the other box, really, it's all of them over to the very first box. All five of them are applicable to IRP selection. On #5, that's the Named Community clean energy, that's distributed energy resources. We'll track those that are 5 megawatts and under, and storage resources, and also the distributed resources. Distributed renewable energy resources and energy storage. I've got a slide for each of these. Seems like this is taking too much time and let me know. Energy availability, planning, reserve margin. Not all three, but planning reserve margin, generation location as a percentage, generation located in Washington or connected to this transmission. Outdoor air quality, we measure SO<sub>x</sub>, NO<sub>x</sub>, mercury, et cetera. Greenhouse gas emissions will measure both regional and Avista greenhouse gas. We'll have all these types in the resource mix. Then that will incorporate in with the IRP QCC

values. All of that will be considered. Supply side will. NEI and associated location will be included and then eventually we'll wind up with the Preferred Resource Strategy.

**Annette Brandon:** Yeah, I was just thinking agenda. Well, what I could do. I mean let me know, but this gives more information, these slides give more information as to what our baselines are, which are in our plans, which most of you have seen already. OK, go ahead, Jim.

**Jim Woodward:** Thanks, Annette. With slide 12, a couple thoughts, I guess what I'm observing is and ahead of saying that I think it makes sense. What I'm observing is the vast majority of these CBIs and measures or metrics are inherently quantitative. They are measurable. And again, given the IRP has traditionally been a very analytically intensive plan, that makes sense that there is a broad overlap. What I'm wondering and maybe I'm not seeing it, and again, we're halfway through your slides. While there should be a large overlap, the more quantitative or analytical CBIs naturally do flow to the IRP that might not be exclusive or maybe that should not be exclusive. Now I'm getting into qualitative CBI considerations, and this goes into some of the weighting criteria that the CEIP rule goes into. Maybe you can answer this with an example, where are some qualitative. CBI is more of a qualitative nature that looked to be potential candidates for Avista's 2023 IRP.

**James Gall:** You saw the list before, the ones we're excluding. This is what's remaining. And I think all of them are really quantified and that at the end of the day is a Customer Benefit Indicator. At least the ones that we've captured is, can we quantify them? And if we can quantify them, then can we forecast them so everything that we've tried to create all the CBIs are basically quantifiable and we don't really have unquantifiable CBIs. But what I think I would go with your question though, is if you want to go back Annette to the ones that are not included in the IRP, go back to, yeah, these ones just as an example. These are the unquantifiable ones related to the IRP were qualitatively we're going to create programs based on energy efficiency selection and then it goes back to that execution. Where I'm thinking I'm going here is, the qualitative impacts are really the CBIs that don't fit into the IRP. But there really is not a single CBI that's not, call it quantitative. They're all quantitative.

**Annette Brandon:** These ones that are qualitative though we're not just forgetting about them, they're going into resource selection and weighting in that resource selection. And I've got an example here that Ryan has put together for energy efficiency that shows how that fits in and also from the RFP. I thought about could we have some kind of a toggle for participation in company programs where we toggle where one was yes or two was no. But even that that didn't really work super well. Sorry, that's OK. Yeah, I know. I'm running out of time. That's what we're kind of out on that Jim. If that helps. But again, we'll document all this why and the.

**Jim Woodward:** Yeah, I don't. And again, I appreciate that in it. I do, again there are always risks with thinking out loud, but going back to June, going back to the broad set of negotiations, the exercise and efforts we did back in the spring. To me, just hearing again,

my lowly perspective here, but to me equating qualitative. There's quantitative and qualitative CBIs and now equating qualitative to not being within the IRP purview, even though they do still pertain to resource selection, that's where I personally am getting tripped up a little bit because I just don't think that may have been the intent of all the discussion around the conditional list last spring and whether we may need to take a broader view, a broader lens to see how some qualitative considerations might factor in the IRP because I think other companies are doing a qualitative consideration. How that actually looks from a process standpoint, I'm not sure, but other Washington IRPs might be going in that direction, at least for their 2023 IRP Progress Report.

**James Gall:** Yeah, Jim, this is James. Maybe you can provide an example of that. But is there a qualitative CBI that you're thinking of that we should be including that's on our list or maybe something that's not on our list?

**Jim Woodward:** Well, I'm going with the CBIs that I see on the screen. What I haven't done is, kind of participating like everybody else is both on the on the call and the room. Has there been a crosswalk that all of these CBIs Annette on your slides do they correspond to essentially, there's CBIs in the original plan, and they're also CBIs in between condition 18, and I'm scrolling through this very fast, 26 in the conditions list.

**Annette Brandon:** Yeah, most of those were metrics. I'm sorry to interrupt. Most of those were metrics. Only one additional CBI. I didn't list every single metric, because that would have been, I think Tamara said, we are up to 59.

**Jim Woodward:** Yeah, I mean it's a difficult exercise. I completely agree with you on that front. I'm just wondering if we're giving it the exhaustive treatment, because again that was the reason, Annette, for my initial question. Are we today trying to fulfill condition #35 and if we are I do have reservations about that. If this is just one way of helping to fulfill condition #35, then that's fine. I think this is definitely an appropriate discussion to have. But is this all we need to do? That's the question I'm posing back to you and your team.

**James Gall:** I think we're being exhaustive of all the opportunities to include the CBIs that we agreed to in the IRP. Obviously, the one comment on the energy burden is maybe one to add. Maybe I'll challenge you, Jim, maybe in our next meeting that we're going to have, is there a CBI that you feel that we're not incorporating or even anybody else that either quantitatively or qualitatively that we're missing? Please bring that to our attention because what we're trying to do here is to come to some agreement of what we can quantify qualitatively or quantitatively. In our case, they're all quantitatively that we can plan to and model to ahead of time. If you see something that we don't have, that's what I'm.

**Jim Woodward:** Sure. I'm looking for, and we're not saying. Well, how about James, to help me fulfill that request because I think that's a good request. What I would appreciate seeing is a crosswalk maybe from both the CBIs in your plan filed back in October, as well as the CBIs and the conditions list that was approved. How those are each at least considered if not selected for incorporation the IRP. But how are those considered on

these slides if I if I get that piece? That's I think, that's what, I could certainly weigh in I think with your question James but what you're I think suggesting I do is cross walking on my own. I don't think I'd be able to do that ahead of our one-on-one meeting.

**Annette Brandon:** Well, I'm sorry Shay, just one second. So, really, that's what I've done here generally. That's what my goal was. Your crosswalk, from transport electrification, for instance, or let's use supplier diversity. I'm saying employee and supplier diversity is a measurement, not a resource indicator. And the reasons why we think this way at Avista, and we're not saying we're 100% right, that's why we're having this open conversation. How are we going to put that into the IRP? Because we can't query all, how many energy efficiency projects are there like 5,000 or something and see if they have employer / supplier diversity. But back to Shay's point, what we can do is one, we're getting through resource selection, we can say, do you have a diversity program? Yes. We're going to give you more weight towards choosing your resource because you have that, which helps us satisfy the CBI. Now I've interrupted Shay here, so I think I'm going to let her talk now.

**Shay Bauman:** That's all good. I'm glad I waited because I've just continued to add things that I wanted to say in response. But responding a little bit to Jim's point about should we be including qualitative, some of these qualitative measures and resource selection. I'm going to do the same request that you've asked. I think I do need to give this more thought on if I think any of the qualitative measures should be included further than what you've already done. But I will say that I think we need to be careful with it because there are some qualitative measures, I've seen other utilities apply that I don't agree with and I don't think makes sense in resource selection or in that process. That's something to think about as well as I think. I don't think that we can fully satisfy commitment #35 today. I think we're, as Annette said, we're getting feedback and hoping to get to that point, but there's still the Progress Report, as well as future IRPs where they're being. Avista, they're going to have to discuss each of those CBIs and how each is applicable. So, I thought I feel comfortable with that process and what we're doing here today. Definitely more to think about on the qualitative versus quantitative, but I do think that we're on the right path and there's still much work to be done.

**Shawn Bonfield:** When you say you've seen other measures you didn't agree with both further measures?

**Annette Bonfield:** Yeah, I'd love to see that Shay, send it over.

**Shay Bauman:** Well, one example I'd say in a different IRP, is the company was using number of translated materials to determine what resources to get. I don't know how that works. But yeah, it's not. I don't want it.

**Annette Brandon:** And that's one of our measurements.

**Shay Bauman:** And I think it's relevant and important, but you shouldn't choose the resource based on how well you can translate I don't think. I don't know, but I have seen it.

**Shawn Bonfield:** And then, maybe clarify a couple of things based on what Jim had said. One, correct me if I'm wrong, but what you presented here is the final list of approved conditions and metrics. No further crosswalk needs to be done from what we've proposed in the CEIP to what was actually approved. Is that right?

**Annette Brandon:** Yes, where I want to quantify is that when we look at this list back here. These are the CBIs, there's 14 of them, but there's like 30 - 32 actual metrics. So, ways we're going to measure. So, participation in company programs for instance, I think there's like 3 or 4 metrics and then you have to add on those metrics being tracked by individual population types. That's where we get to our 59. These are everything that's been approved. I just didn't. I mean that's slide wouldn't have been able to be found but go ahead.

**Shawn Bonfield:** The pieces, like James alluded to it, that all of our CBIs and metrics are quantitative metrics. They are not.

**James Gall:** We don't have any qualitative metrics, it's not a line. While indoor air quality is one that we want to quantify that we can't, but we could probably qualitatively talk about that here. But other than that, one I'm struggling to find one which we haven't.

**Shawn Bonfield:** We have a condition that will develop a metric for that in the future. So, they're all qualitative.

**Annette Brandon:** Some got transferred to quantitative that are in the non-energy impact study.

**James Gall:** And that actually brought up something that's important here, and that's how we're doing that prioritization. I think that came up in non-energy impact analysis where we're quantifying each of these benefits, it is going to help us prioritize selection. For example, outdoor air quality, which is on our list and there's, go to that chart.

**Annette Brandon:** Let's go to here, let's jump way ahead.

**James Gall:** All right. So outdoor air quality is a metric. We can assign a value to that and then we will choose resources if that value is significant enough to use that resource less. That's how you can prioritize it, that resource. Or from an economic point of view, if I choose resource "Y" as low in economic impact versus resource "X" as high valuation, I can include that in my evaluation and then report out how that affects the CBI. We're using the NEI as a way to prioritize our resources. And then report the result back because the CBIs are indicators, that doesn't know that you're trying to measure something to show progress. That's what the importance to the CBI is. And if your CBI is not moving positively, then maybe you have either, it's not justifiable based on the other impacts it



has elsewhere, or you've not quantified the decision properly for that particular item. So, our approach is to use the non-energy impacts in the IRP to prioritize the Customer Benefit Indicators and then report back out. The results of those Customer Benefit Indicators, based on our resource collection, and if there is not a consistent directional impact or at least a positive directional impact, then we may go back and either revise or explain why we don't see a positive relationship to that CBI. So anyway, we're running out of time on this topic, let's try to wrap it up in the next 10 minutes.

**Annette Brandon:** OK. Go ahead, Jim.

**Jim Woodward:** Thanks, Annette and James. Appreciate what you just said. I will make an observation that this discussion today that was facing us front and center last spring was there's ample opportunity for confusion because of, I'll just say the language we're all speaking. I've heard CBI, Customer Benefit Indicator, mentioned. I've heard non-energy impact. I think there may have been some discussion around metrics and specific actions also in your informative presentation. All that being said, especially for the broader audience here, it's easy to confuse those terms. And so, with condition 35, that's specifically focused on CBIs. That's my observation. That's my comment there. As far as looking at fulfillment of condition 35, I guess, Annette, this will factor into our discussion later in October. What I see on, I think it's slides 10 through 14 of your presentation here, you start off with CBIs that are not applicable and then you get into CBIs that are applicable. What I heard maybe with your exchange with Shawn, these four slides are your crosswalk of your original plan filed as well as any additional CBIs that came out of the conditions list back in June to essentially take all of those applicable Customer Benefit Indicators to see if they apply or not. These four slides represent your crosswalk. Is that a fair statement?

**Annette Brandon:** Yes, I would say for this presentation though, because I do have an Excel document that has every single thing spelled out and then our reason next to it. But that would have been a lot to put in this presentation. I'm happy to share that with you also.

**Jim Woodward:** That would be great. That would help me fulfill your request of me later this month.

**Annette Brandon:** OK. That's no problem. Again, back to what I said, if you have ideas, please send them our way. Anybody that has an idea, you could put it in. I don't even know because I mean, we thought this through, and these are the ways that we know that we can do it and we're learning through this CBI process especially with the help of our expert in data, that several of the things that we really want to do, there's just no data out there. We have to keep that in mind, that's not an excuse, it's the challenge to find a way. Is there data or how might we incorporate it? I'm way over time here. Real quick, each of these slides, I just put the base lines in so that everybody had it in one spot, what our baselines are and what our goal is. And then in the right-hand corner I put which one, so like this one, #7, the bold means that's the one we're using. That's what all of these slides are. This slide, I think this could probably be like the last slide, James,

**James Gall:** Sure.

**Annette Brandon:** OK, so this slide actually goes back to Deborah, when she was reviewing our Clean Energy Implementation Plan. Deborah from Staff wanted some kind of a visual like flow chart. We pulled this together for her. It doesn't exactly look like this, but it's pretty similar to what we filed in our CEIP. We really start out with step one with resource requirements. And all of the requirements, resource adequacy, annual energy production, all of those. And then we evaluate what the resource options are and costs. Then #3, that's our new thing, that's what we're doing today. What CBI can we use? And know which ones we don't, and then also use the NEI study to help prioritize. That's really the new step. And then the final thing is we've come up with the least reasonable cost and then eventually the Preferred Resource Strategy. So that step three, that's the new one, that's what is incorporated.

**Annette Brandon:** I have this last section here that you can all look at. If you've been involved with our RFP, you have already seen these already, but this is another place, Jim, where I gave some explanations as to certain CBIs are measurements, like access to clean energy, et cetera. And then the Named Community fund might be used for a variety of options.

**Annette Brandon:** And then we've talked about this evaluation process for the all-source RFP, but it's important to note here that financial impact, environmental and non-energy impact and even I think maybe some price risk, are CBIs embedded in those for resource selection.

**Annette Brandon:** This slide Ryan presented at his energy efficiency meeting last week or last month, sometime within the last month. And this is just another way of how we're incorporating non-energy impact and associated Customer Benefit Indicators. This is only one slide, and, in that meeting, he had some slides where he walked through how they were related. I was going to have him bring that up today. But now that we're out of time, we'll stop there.

**James Gall:** Alright, I think we're going to take a break. Sounds like Jim, we will talk about this a little more in the next couple of weeks. And then Shay, appreciate any comments you have. And then anybody else on the phone too. All right, we'll take a break. Let me just check our schedule, because we got to be done by 3:30. Let's take a 10-minute break. Then we'll finish up with the last presentation on portfolio and market scenarios and then we'll call it a day,

### **Portfolio & Market Scenario Options, James Gall**

**John Lyons:** Alright, we're going to start back up again. This is our last presentation of the day. James is going to talk about the scenario analysis and what our basic ideas are to start with, and you can add your input.

**James Gall:** You might recall John reminding everybody to turn in what scenarios you like us to model for the IRP. And we could get some background from the TAC members. We're going to cover the whole plan here. Today is going to cover what's in the IRP versus Progress Report versus scenarios and then cover which ones we are thinking about doing. This is your opportunity to maybe say we should be looking at something in addition or we should maybe remove something. So hopefully this will be a discussion. I would like to WRAP up hopefully around 3:30. I think what we planned right, so we'll try to keep this to 30 minutes if possible.

**James Gall:** I'll get going here. Again, this is a unique situation from an IRP perspective. We are working on a full IRP and we're also working on a Progress Report. That full IRP, which really is only filed in Idaho, that will take place in June. We're really talking about scenarios for that full IRP, but we will be filing a Progress Report January 3<sup>rd</sup> in Washington and the idea there is that Progress Report by rule does not require scenario analysis. That's really where our Preferred Resource Strategy is. Although we think there's a few scenarios that are important for avoided cost that we plan on filing on the 3<sup>rd</sup>. One interesting thing I heard from a TAC member last week actually is maybe that the filing for the Progress Report is due January 3<sup>rd</sup>, but there's also language in there that talks about two years after your last IRP. That would be March 31<sup>st</sup>. I'm kind of curious on Jim's interpretation of what that is, but I think our plan is January 3<sup>rd</sup> we will file a Progress Report.

**John Lyons:** Yeah, I thought the write up was the first one was due January 1<sup>st</sup> and then two years thereafter.

**James Gall:** Yeah, that's our read and that's what we're planning. But I guess said, a TAC member had that question. But if Jim you have a different interpretation let us know. We're planning on filing that Progress Report on the 3<sup>rd</sup> and like I mentioned earlier that will include most of the IRP. The chapters, the load forecast, our L&R positions, at least through the RFP. Our price forecast will have a rough preliminary resource strategy, but not scenarios that we're going to be talking about today. The scenarios we'll be studying will be for the June filing and keep in mind we are in the process of negotiating PPAs for different projects in the RFP. The resource strategy we have today versus what we might have to show you in January or February when we expect to have all those contracts signed will be different and then we may want to go back and think about the scenarios that we've talked about here at that time. The last bullet, keep mind this IRP is an Idaho only filing, but we are looking at portfolio impacts of Washington policy. So, electrification, things that we've been talking about all day, whether it's space and water heating or transportation, those are important especially to look at the full impact of our portfolio not just to Idaho. We want to make the scenarios applicable to Avista. Idaho specific scenarios, we want to look at those as well, but we're not just focusing on Idaho scenarios for the filing but more of the company as a whole.

**James Gall:** Some of the options we're looking at on the market scenarios. I want to differentiate market from portfolio. What I mean by market is the wholesale marketplace that we interact in. Lori's talk showed her price forecast earlier. That's what we're talking

about. How does the external environment around us impact our portfolio. That's why we run 300 stochastics of load, fuel prices, wind, hydro and inflation to see how that marketplace changes. That may influence our resources, or we run high and low gas prices. Michael showed two gas price levels earlier, those would be the high and low gas prices we're considering. Those would be a scenario that we would evaluate our portfolio against. I believe the high and low are required by Idaho statutes. We want to look at a national greenhouse gas price option. What happens to our portfolio if there is a national greenhouse gas price that likely would be lower than what Washington is looking at, but maybe higher than obviously what Idaho is looking at? We want to understand that scenario and understand that risk. Our proposal for that one was shown in Lori's earlier presentation of what the national price could look like. The last bullet, this one's interesting because there was a lot of debate in the rulemaking process of how the CCA, the Climate Commitment Act, is going to impact dispatch of generation resources. And up until I think they'll final rule as we thought there was going to be an impact to dispatch of our resources, the final rule how we read it now is there would be a limited impact on resources in the Northwest.

**James Gall:** The reason why has to do with how credits or allowances are given to utilities. The current rule that's out there today, like Lori mentioned earlier, there is what's called the true up. So, whatever the utility emits or purchases, they will be trued up the next year. And what that true up does is it gives us an allowance to cover the emissions that we emitted the prior year and how we view that is that's not going to necessarily impact our dispatch of our resources, but it could dispatch resources that are outside the system trying to export or import energy into Washington. That will probably get transitioned into our Base Case. We could run a scenario that shows what the dispatch, if we had that price as a dispatch contributor, we could show that scenario, but that's really the same thing as the national greenhouse gas price. We could either scrap that last topic because of that new rule change or run maybe a high greenhouse gas price scenario. I don't know if there's people to share that opinion are on what the new role is or not. But interested to hear if anybody has comments on that, but otherwise we probably scrap the last bullet item. It's based on our reading of the final rule. OK. I'll just respect the pause for a few more seconds.

**James Gall:** Each of our portfolios that we're going to evaluate in the IRP will be looked at against these price forecasts. They'll be part of the evaluation of our resource strategy, particularly that 300 stochastics will be our Base Case forecast, and then we'll test against the four bullets below that. That's fairly similar to what we looked at in the prior IRPs where we'd want to look at it from high and low gas prices. We looked at it from different carbon pricing and then also the no Climate Commitment Act is actually required in the State of Washington to look at that from an incremental cost basis for avoided costs as well.

**James Gall:** Moving on to portfolio scenarios. Usually this is the greatest interest in an IRP. How could our portfolio be different than our Preferred Resource Strategy? When I broke this into the two different categories, one is resource planning or planning margin portfolios, and the other one is load portfolios. We'll start on the left and we'll go to the

load scenarios in a little bit. The first resource planning scenario has to do with Colstrip. As many of you know, we cannot serve Washington customers after 2026 with coal. But 35% of our load is Idaho and Colstrip until it's retired, assuming it is not retired. Will Colstrip continue beyond 2026? And if it does, it could be allocated to Idaho. If it's still operating, it will be allocated to Idaho how it is today and then the remaining share could be allocated to our shareholders. But what we want to test here is does it make sense for Idaho to exit the plant in 2025. Does it make sense to continue operating as one unit, or two units, or changing its share of those units? We want to test the economics. Is Idaho better off to keep a portion or all of Colstrip for its load? That's the purpose of the first bullet there. Again, our Base Case is that Colstrip is out of the portfolio by 2025, and then this will test alternative economic scenarios if it remains for Idaho.

**James Gall:** We have two WRAP scenarios proposed. One of them, which Lori talked about earlier, which is a lower reserve margin. We will show in that scenario what the savings of the WRAP is, but we're also cognizant of the amount of risk that the planning margin is not going to be, that's not going to be what's reflected for the next 25 years. So, we're evaluating adding a higher planning margin than what the WRAP currently has. To see what the resource strategy is with the higher planning margin than what the WRAP currently has.

**James Gall:** We have three portfolios that we will evaluate for avoided cost. These are things we've been doing for probably 10-15 years. But looking at our cost to serve our customers with only market power, what it would look like without CETA, and then what it would look like without the Washington social cost of greenhouse gas, which is a requirement for Washington loads to evaluate resource selection with the social cost are going to have gas, so we're going to model scenarios without those components. That helps us figure out avoided cost. It also helps us figure out incremental costs for the CEIP. So those are required. Then resource allocation. This is an interesting topic. And what I mean by resource allocation is currently when we acquire a resource, it's traditionally, with some exceptions, allocated based on our historical load. So, 65% of the cost of that resource is essentially allocated to Washington and 35% is allocated to Idaho. This scenario looks at what if there are certain resources we want to allocate differently. We could allocate resources entirely to Washington or Idaho. We will forecast new resources based on the state's needs. But what about historical resources? Could we look at what if Coyote Springs, for example, only served Idaho, or only served Washington? That's what we're talking about in this example. And the reason why it's to be determined. I think this will be ultimately impacted by the final RFP resource selection. I think this is something we're going to want to revisit at a future task meeting to see if this scenario is still necessary or not.

**James Gall:** OK. Moving on to load portfolios, we want to evaluate and test changes to our portfolio due to load. Traditionally, we've always done low and high economic conditions. I believe these are also required in the Idaho IRP requirements where we look at high and low loads. I think Grant had shared what those forecasts look like with higher economic or lower economic growth, and we'll be able to evaluate resource changes there. OK. Jim, you have a question.

**Jim Woodward:** Thanks, James. Clarification question on, the last bullet under your resource planning margin portfolios, the resource allocation item that you briefly discussed. So just on my end connecting the dots, I'm going to bring up the CEIP again, the Clean Energy Implementation Plan, what you're planning to do under that sort of grouping your category is that largely going to satisfy, I think it was condition eight in the approved conditions list?

**James Gall:** Can you remind me what condition 8 is?

**Jim Woodward:** Sure. I'll go ahead, and maybe the easiest thing for me to do, if I can leverage this chat window rather than, it's a paragraph. I'm just going to plop it in the message chat and go from there. And whether you want to discuss it now. I'll pop it in there and then you can react to it after you finish your load portfolios side, but I think hopefully it's showing on your end.

**James Gall:** Alright. I do see it. I'll just read it off. The condition that Jim's referring to is related to our use of resources that are currently allocated to both states that could be reallocated to Washington. It says Avista and its IRP resource selection model for the 2023 IRP will give the model the option to meet CETA goals with the choice between Idaho allocation and existing renewable resource at market price limited to Kettle Falls, Palouse, Rattlesnake Flat, Chelan PUD, or acquiring a new 100% allocated Washington renewable resource for primary compliance. Further, the model will have the option to acquire new 100% allocated resources, market RECs, or allocate RECs to meet alternative compliance. Jim, I don't think this is what our, this portfolio, is not the intention of that. What that is referring to, that condition, is something where you actually implemented in our Base Case of our model where the model will have the ability to choose between those resources or building resources. That's not going to be a scenario that is going to be a choice the model has built in. That condition will be met through that structure of the decision making of the model, which is actually no different than what we had in our previous IRP. This scenario, I think it is to illustrate, if we didn't give it that choice, this is what it would look like. But we're not planning on showing that portfolio in the Progress Report, but it would be in the final IRP. But again, I think this is really going to wait until our full list of resources is publicly known, before we decide if this is even necessary.

**Jim Woodward:** OK, James. Because my questions on it. Yeah. No, that's helpful. I'm cognizant of time as well. I know on the 20<sup>th</sup>; I believe you are having a technical modeling workshop. We can talk about this a little bit more now or since you're talking about the Base Case versus a scenario, we may want to talk about this more in depth then?

**James Gall:** Yeah, I think that's best for that meeting because I'll actually show you how that's done in the model. I know the person who got that condition in there will be interested in that component.

**Jim Woodward:** OK, that's fine. We can hold that over till the 20<sup>th</sup> then.

**James Gall:** OK. I was going to talk about electrification next. Before I go there, are there any other questions? I went through a lot, didn't hear a lot of feedback. So, it's either great or I confused everybody, one of the two. I'll go with that I confused everybody. No, I'm just joking. OK.

**John Lyons:** You confused everyone greatly.

**James Gall:** Or it's almost time everyone wants to go home. It could be that too. That's why I saved this for the end. All right, so electrification. There's a lot going on in this area, so I think it's important for us to study building electrification. The first scenario we want to look at, and it could be our Base Case by the time we get to March, is what if all new residential construction in Washington is that gas ban, I guess for lack of a better word. If that happens, what does our load look like? For now, it will be a scenario, it could be our Base Case assumption. But for now, that will be a scenario. We want to understand that impact. Again, remind you, I think on commercial it was around 70 megawatts, the peak winter peak. I think we did some analysis; it was 200 or 300 megawatts of a peak impact for new residential only. We've started down the path on that analysis. That's the first electrification scenario, that's new construction, and then we get into existing customers. So, what happens if all of our Washington customers transitioned from gas to electric? That's something we looked at last IRP. We will we visit that analysis from last IRP and show that result. And then the last IRP, we also we called this hybrid scenario where space heating was. We looked at electrifying space heating when it was above 40 degrees. We will look at that scenario as well. That was pretty important because it showed a large transformation from gas to electric, but it didn't have the same effects on peak demand that the second scenario in that list does. We also included water heat as well. There will be three electrification scenarios. There is a potential for a change in our Base Case or our load forecast that Grant talked about, and this will be a feedback loop from our Natural Gas IRP. For those of you that follow our natural gas IRP, electrification is an option that Tom and Michael's model will include the serve future gas loads. If the gas IRP finds electrification is a cost-effective way to meet gas load, maybe it's water heating or maybe it's space heating, whatever option that looks like, we would then put that feedback loop back into the electric IRP. But that's something we won't know until next year, when Tom is finishing up his analysis on the gas IRP. We'll wait and see on that one. But regardless of if there is any movement for fuel use there, we'll model the higher end scenarios at least in these scenarios. The last electrification or load scenario is a high transportation electrification. Grant alluded to what if we have higher loads from a faster transition from gasoline to electric. We'll evaluate those as well. Mostly that will be impacts to the peak but also smaller impacts to energy as well.

**James Gall:** That is the proposed list. I've included the items on here from the TAC that submitted anything. I'm just curious if there's something we missed. I'm guessing there's not a lot of feedback yet because we passed the deadline, but if there's something that comes to mind, let us know. We set that deadline because we wanted to be able to talk about those items here today, but we'll start modeling these scenarios over the next few months. If you have some idea you want to run by us, let us know sooner than later. There

are certain portfolios, studies we can do, that are easy and some of them that are difficult. For example, a market scenario like these, these take a lot more time to put together than doing a portfolio model. If you do come up with something you want us to look at, if it is portfolio related, we have a little bit more time to take that input, but if it is market related, we'd like to know sooner than later. That's all the slides I have. Are there any thoughts or questions, Jim? Go for it.

**Jim Woodward:** Hey, James. Long time, no talk to, so on the load portfolio side I'll just sort of echo a comment I gave your colleague Tom Pardee, I think at the last gas IRP TAC meeting. You have sort of the low and the high economic conditions, but given you talked about interplay with the gas side for all Washington customers. If I heard you right, gas to electric more or less. I had asked Tom whether there was an option to consider rather than just low and high, more of a sensitivity analysis. Maybe quartiles or something like that. Feel free if you want to talk with him and follow up with me. But perhaps, rather than just guardrails, there'd be a little bit of granularity. That might be the appropriate word to use here. Does that make sense?

It does. And maybe, we could probably come up with a scenario that reflects maybe pieces of each of those three scenarios as a fourth. We could call it a probable scenario. But I get what you're saying. You want something that's not zero and not everything. Something in between. I don't know if we call it a probable scenario.

**Jim Woodward:** Yeah, you're tracking or we're on the same page. Feel free to think that over and reach out if you have additional questions, but that at least on my end, is the only thing I might add. At least right now.

**James Gall:** Maybe Tom [Pardee] and I will strategize on what that could look like and maybe we'll have something for you to ponder in a couple weeks.

**Audience:** Question about economic conditions and indicators for a recession.

**James Gall:** Yeah, that's why we do the scenarios, we don't know.

**John Lyons:** That's the problem. We do have some that are trailing high and some that are trailing low and there's not a real definitive answer that we've got right now as far as where we're going. There are a lot of indicators for a recession right now, but it hasn't been called by the Bureau of Economic Indicators. So, it's not an official recession yet, even though you've had two quarters more than two quarters now of lower growth.

**James Gall:** The reality, and this goes back to TAC meetings from John and I, our distant, distant, distant past of boom-and-bust cycles where you have that slow economic growth and then you have high economic growth, and you have low, and really are expected cases kind of split that. But you're going to have cases where you're in both of those scenarios, but long term can't, that's why you plan for the expected case, but I don't know the economy is likely not to be low forever or high forever.



**John Lyons:** Well, used to be our main growth driver was really just economic growth. Now we're in this period where it's not just economic growth, it's electrification and weather are the bigger drivers. Now it's which one overcomes which and then and we haven't had the Federal Reserve having to fight inflation for the first time in 30 years. Now all the sudden they got to taste for it and they're going to keep going for a while, but it ain't going well for them. But unemployment still relatively low. It's a really odd situation to be in right now. But that's my answer since Grant left.

**James Gall:** Yeah, I say the purpose of the load portfolio is, I mean there is a purpose of them. It's really to see how does the resource strategy change. At least in the past studies, when we do low economic growth, we don't need to acquire resources, but our rates are typically higher. Higher growth, we acquire more resources, but usually there's more load and rates are not as directly impacted. There are some lessons. Learning just what is the purpose of the narrow, it's really just what is the resource need look like. Would that trigger us to acquire resources earlier? For years, we've seen this cliff of 2027 coming and it didn't matter what scenario we looked at, we're going to need to acquire something for 2027 now that we're trying to wrap that up, maybe they do have some relevance for that next acquisition. Should we acquire more or less? Or when would that next acquisition be? So finally, we're getting to the point where these matter, where before, it didn't matter.

**John Lyons:** Theoretically interesting.

**James Gall:** There you go. Theoretically interesting academic exercise. If you have feedback comments, just shoot us an e-mail. We're happy to talk about them. Sounds like we'll maybe add one more to this list. And then one of them will have to discuss more once we finalize the new resources from the RFP. With that, I don't think we have anything else to talk about. Next meeting is the 20<sup>th</sup> for the modeling exercise that we will be posting the PRiSM model out on our website. John will send out an e-mail when that's available that will go out three business days before the next meeting. That will be the primary discussion at that meeting. I think we originally had on the agenda PRISM model, talk about risk. I don't know if we had Aurora on that agenda, but if there is enough interest in Aurora, we can always bring that in. But the goal was to spend most time on PRiSM and our resource acquisition model.

**John Lyons:** Just to walk through the assumptions and how it works making choices.

**James Gall:** And then we also have the model available for everybody to use as well. If you care to use it, we'll walk through that. So, with that, I think we're done for the day, unless there's any comments or hands up now? OK. Well, appreciate the time and effort. This is new to have a few people here. That's good. John and I talked to several TAC members at lunch. There's a lot more interaction with people in the room, so I think this is something we're going to want to continue to do and encourage people to come for a meeting like this.

**John Lyons:** And we also are able to have those discussions during lunch too and at breaks.

**James Gall:** Appreciate your patience with the long day and taking out the full day of your work schedule. So.

**John Lyons:** And for those of you from outside, just grab one of us so we can escort you back to the entryway.

**James Gall:** Those you on the phone. We're going to let you go.



***2023 Electric Integrated Resource Plan***  
**Technical Advisory Committee Meeting No. 8 Agenda**  
**Wednesday, December 14, 2022**  
**Microsoft Teams Virtual Meeting**

<b>Topic</b>	<b>Time</b>	<b>Staff</b>
Introductions	9:00	John Lyons
Resource Acquisitions	9:05	Chris Drake
Placeholder Resource Strategy <ul style="list-style-type: none"> <li>• Energy Efficiency</li> <li>• Demand Response</li> <li>• Resource Selection</li> <li>• Avoided Cost</li> </ul>	9:40	James Gall
CBI Forecast	10:10	Mike Hermanson
Progress Report Outline	10:35	Lori Hermanson
Next Steps	10:50	James Gall
Adjourn	11:00	



# IRP Introduction

2023 Avista Electric IRP

TAC 8 – December 14, 2022

John Lyons, Ph.D. Senior Resource Policy Analyst

# Remaining 2023 Electric IRP TAC Meeting Schedule

- Virtual Public Meeting Gas & Electric IRPs: March 8, 2023 (12 to 1 pm and 5:30 to 6:30 pm PST)
- TAC 9: March 15, 2023 (9 am to 4 pm PST)

## Other Important Dates

- Washington Progress Report – January 3, 2023
- External IRP draft released to TAC – March 31, 2023, public comments due – May 12, 2023
- Final 2023 IRP submission to Commissions and TAC – June 1, 2023

# Today's Agenda

- 9:00 Introductions, John Lyons
- 9:05 Resource Acquisitions, Chris Drake
- 9:40 Placeholder Resource Strategy, James Gall
- Energy Efficiency
  - Demand Response
  - Resource Selection
  - Avoided Cost
- 10:10 CBI Forecast, Mike Hermanson
- 10:35 Progress Report Outline, Lori Hermanson
- 10:50 Next Steps, James Gall
- 11:00 Adjourn



# 2022 RFP Resource Acquisitions

Chris Drake, Manager of Resource Optimization and Marketing  
Technical Advisory Committee Meeting No. 8  
December 14, 2022

# Avista's Kettle Falls Biomass upgrade

## Capacity, Energy, Financial

- 11 MW net capacity increase
- 18 MW from 3<sup>rd</sup> party steam
- ~\$50 Levelized Cost of Energy over 20 years
- \$11.2 million incremental capital into KF

## Environmental, Community

- ~100,000 CO<sub>2</sub>e sequestered annually
- ~30% reduction in annual NO<sub>x</sub> emissions, CO, and VOCs intensity
- Delay or eliminate need for ash disposal landfill (~\$10 million savings)
- Anticipated 15 new FTEs from biochar/steam contractor

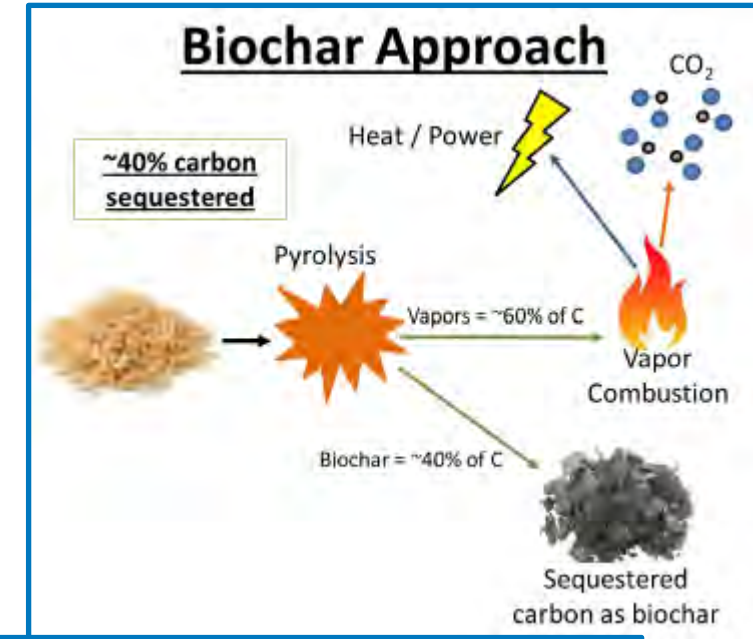





# Columbia Basin Hydropower

## Irrigation Hydro

- 23-year supply deal in total
- Projects ramping in between 2023 and 2030
- 100% of the output from 7 hydro projects throughout central Washington (3 BPA, 2 Grant, 2 Avista BAs)
- Approximately 145 MW of max generation.
- March–October generation shaped like solar generation with no hourly variability (and includes off-peak energy)

## Facilities

- Main Canal Headworks
- Summer Falls
- Russell D. Smith
- Eltopia Branch Canal (EBC)
- Potholes East Canal (PEC)
- Potholes East Headworks (PEC Headworks)
- Quincy Chute





# 2023 Placeholder Resource Strategy

James Gall, Manager of Integrated Resource Planning  
Technical Advisory Committee Meeting No. 8  
December 14, 2022

# Safe Harbor Statement

This document contains forward-looking statements. Such statements are subject to a variety of risks, uncertainties and other factors, most of which are beyond the Company's control, and many of which could have a significant impact on the Company's operations, results of operations and financial condition, and could cause actual results to differ materially from those anticipated.

For a further discussion of these factors and other important factors, please refer to the Company's reports filed with the Securities and Exchange Commission. The forward-looking statements contained in this document speak only as of the date hereof. The Company undertakes no obligation to update any forward-looking statement or statements to reflect events or circumstances that occur after the date on which such statement is made or to reflect the occurrence of unanticipated events. New risks, uncertainties and other factors emerge from time to time, and it is not possible for management to predict all of such factors, nor can it assess the impact of each such factor on the Company's business or the extent to which any such factor, or combination of factors, may cause actual results to differ materially from those contained in any forward-looking statement.

# Other Caveats

- **Avista is negotiating with 2022 All-Source Request for Proposals (RFP) shortlist bidders. The Placeholder Resource Strategy will significantly change to include new resources after RFP negotiations conclude. Changes will be reflected in the June 2023 IRP Filing.**
- IRP resource options are primarily “new” resource options - RFP will determine if existing resources can be acquired at similar or lower cost than the assumed IRP options.
- Not all resources within an IRP option list are bid into RFPs, also costs are based on Bidder’s pricing not generic estimates used in IRPs.
- Avista may not be able to physically retire or exit certain resources as the IRP PRiSM model determines because of contract limitations.
- No future state specific resource cost allocation agreement has been made.
- Forward looking rates include non-modeled power supply cost escalating at 3.8% per year-
  - **THIS IS NOT A RATE FORECAST**
  - This is for informational purposes only

# Resource Needs Begin November 2026

## Capacity Needs

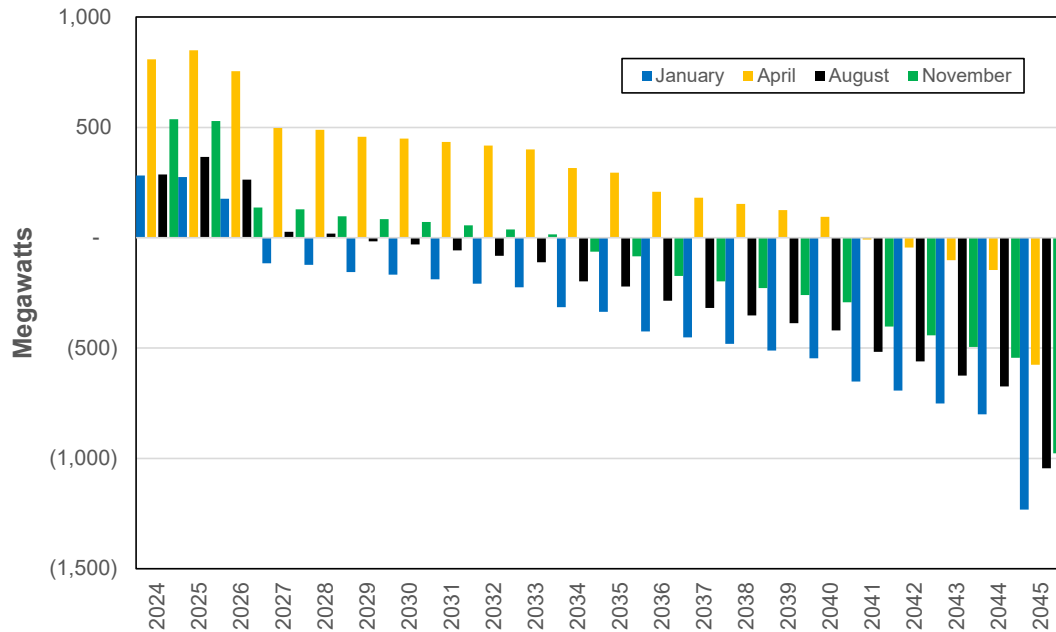

## Energy Needs

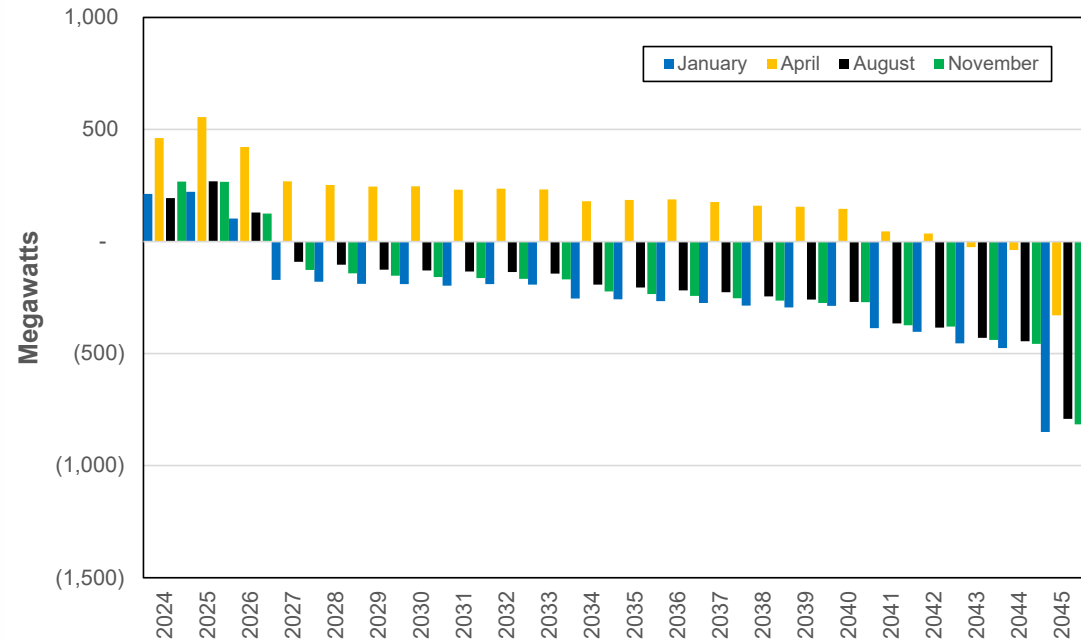

# CETA Renewable Energy Goal

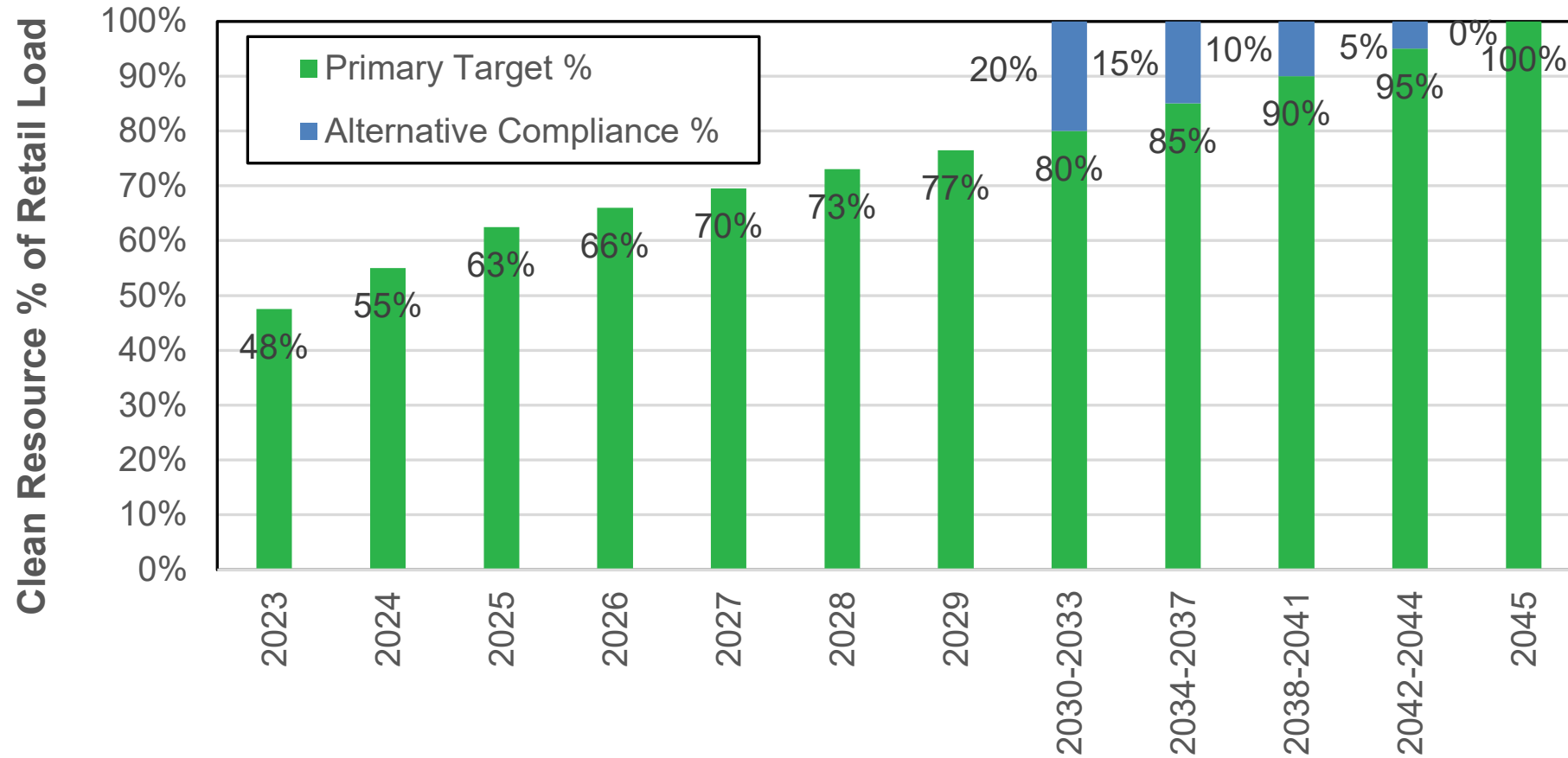

# Named Community Investment Fund Projects

- Methodology
  - Spending constraints
    - \$2 million annually in low-income energy efficiency beyond cost effective programs.
    - \$500k distributed energy resources (\$100k for program administration).
  - Results
    - 2.4 GWh additional EE through 2033 (0.7 percent increase).
    - 700 kW annual Low Income Community additions 2024 through 2033 with funding from state low-income community solar funding.
    - After 2034, 100 to 200 kW solar programs w/ storage.
    - Additional programs from the remaining funding will be included as projects are known.
      - (if they have an effect on power supply needs)

# 2024-2045 Cumulative Energy Efficiency Supply Curve Washington Jurisdiction Comparison between 2021 IRP

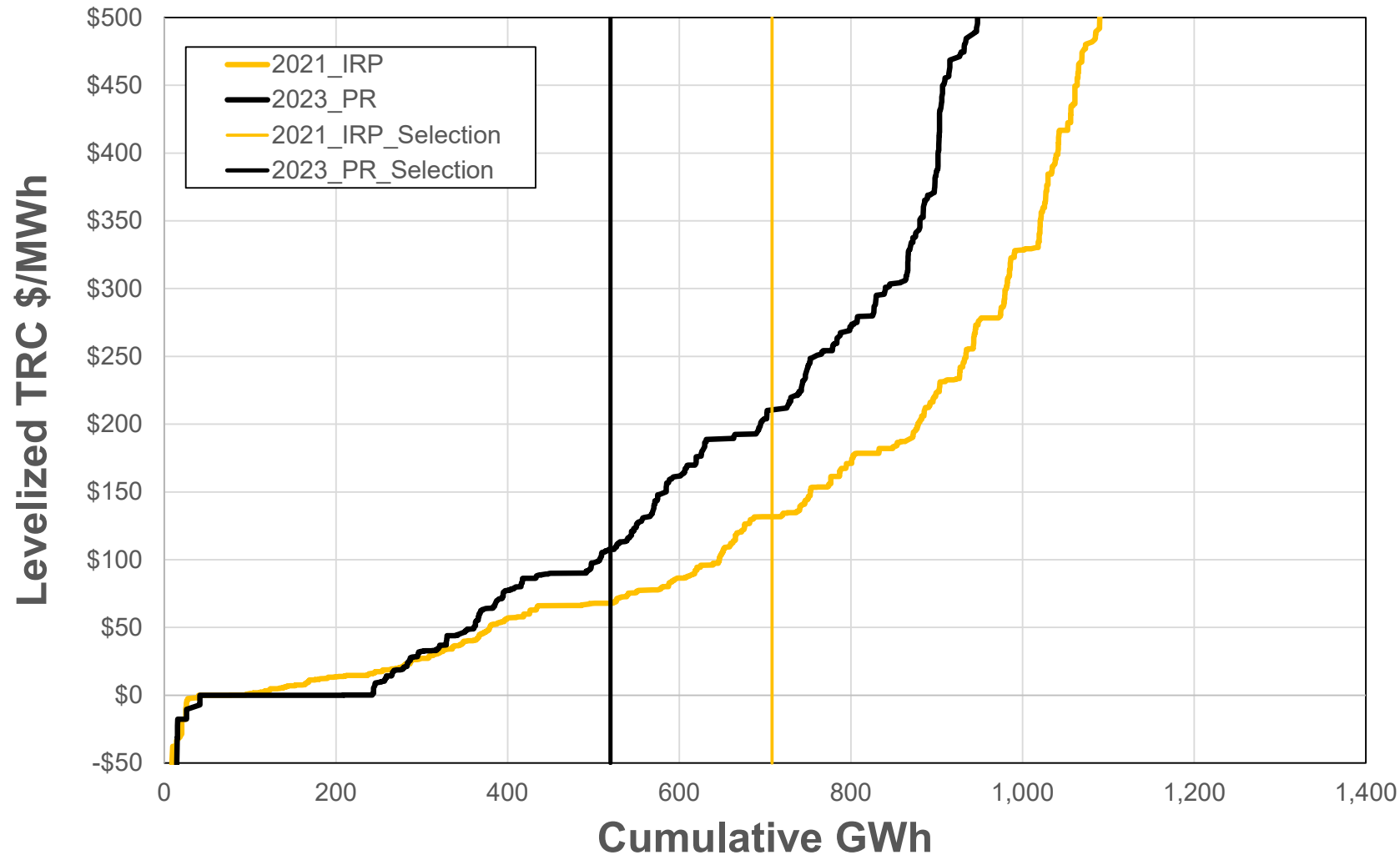



# Cumulative Energy Efficiency End Use Results (GWh)

End Use	Washington			Idaho		
	2024	2033	2045	2024	2033	2045
Appliances	0.5	6.2	8.2	0.2	1.5	1.9
Electronics	0.2	6.4	13.3	0.1	3.0	6.3
Exterior Lighting	6.0	77.5	164.3	3.1	40.1	83.0
Food Preparation	0.1	2.6	11.2	0.0	0.0	0.0
Interior Lighting	0.2	1.4	1.7	0.1	1.9	2.0
Miscellaneous	2.2	24.2	36.7	1.1	11.9	17.9
Motors	3.9	59.5	60.2	0.0	0.3	0.4
Office Equipment	0.1	6.9	14.6	0.0	1.5	2.7
Process	1.4	18.8	22.0	1.1	14.3	16.1
Refrigeration	2.6	17.7	19.0	1.9	19.7	21.1
Ventilation	0.4	4.6	7.0	0.2	2.1	3.1
Water Heating	1.3	16.8	25.5	0.9	10.2	16.5
Space Heating/Cooling	5.1	80.8	115.7	0.9	19.6	33.2
<b>Total</b>	<b>24.1</b>	<b>323.3</b>	<b>499.3</b>	<b>9.6</b>	<b>125.8</b>	<b>204.2</b>
<b>2021 IRP equivalent</b>	<b>41.8</b>	<b>526.3</b>	<b>708.0</b>	<b>13.2</b>	<b>138.6</b>	<b>202.2</b>

# Cumulative Energy Efficiency Segment Results (GWh)

Segment	Washington			Idaho		
	2024	2033	2045	2024	2033	2045
College	0.7	7.5	12.2	0.4	3.7	5.7
Grocery	1.1	15.2	23.9	1.2	16.9	26.3
Health	0.6	5.3	7.4	0.0	0.4	0.6
Industrial	2.5	32.5	48.5	2.0	25.3	35.3
Large Office	0.7	7.2	12.1	0.6	5.8	9.8
LI - Mobile Home	0.3	5.0	8.4	-	-	-
LI - Multi-Family	0.9	14.1	21.0	-	-	-
LI - Single Family	4.9	69.1	79.4	-	-	-
Lodging	1.1	8.9	14.2	0.5	5.0	6.8
Miscellaneous	1.4	16.1	30.6	1.2	16.2	29.3
Mobile Home	0.1	3.9	8.5	-	-	-
Multi-Family	0.0	1.6	2.7	-	-	-
Pumping	0.6	8.2	10.4	0.4	5.2	6.1
Restaurant	1.1	14.6	21.9	0.7	9.1	13.6
Retail	2.6	28.1	49.5	1.6	19.2	30.7
School	1.1	14.9	28.2	0.1	0.9	1.7
Single Family	1.8	37.7	57.7	0.3	11.0	25.5
Small Office	1.2	16.7	32.2	0.3	3.2	6.2
Warehouse	1.4	16.9	30.5	0.3	4.0	6.5
<b>Total</b>	<b>24.1</b>	<b>323.3</b>	<b>499.3</b>	<b>9.6</b>	<b>125.8</b>	<b>204.2</b>

# Lower Washington Energy Efficiency Goals

## Lower Avoided Costs & Lower Potential

2024-2025 Biennial Conservation Target (MWh)	
CPA Pro-Rata Share	64,667
EIA Target	64,667
Decoupling Threshold	3,233
Total Utility Conservation Goal	67,900
Excluded Programs (NEEA)	-10,162
Utility Specific Conservation Goal	57,739
Decoupling Threshold	-3,233
EIA Penalty Threshold	54,505

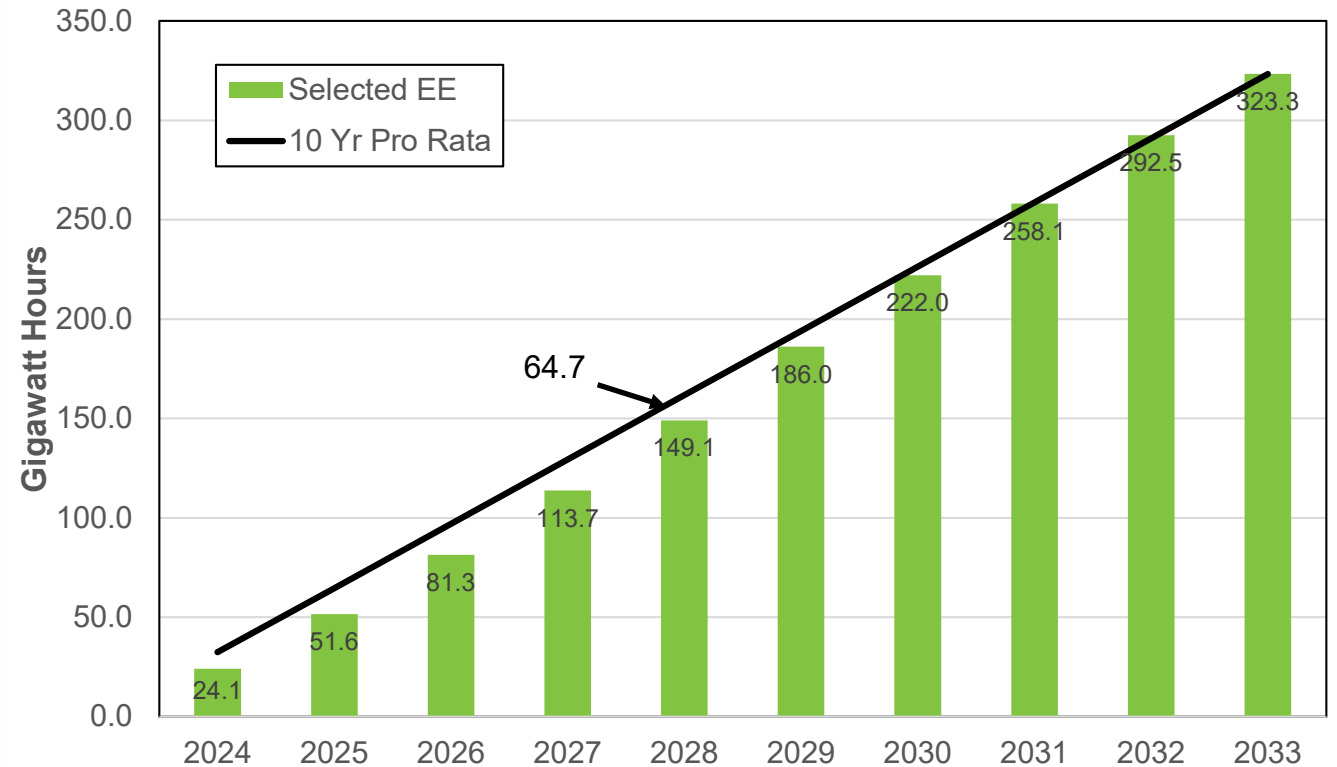

# 24-yr Levelized Avoided Cost for Energy Efficiency

## Washington

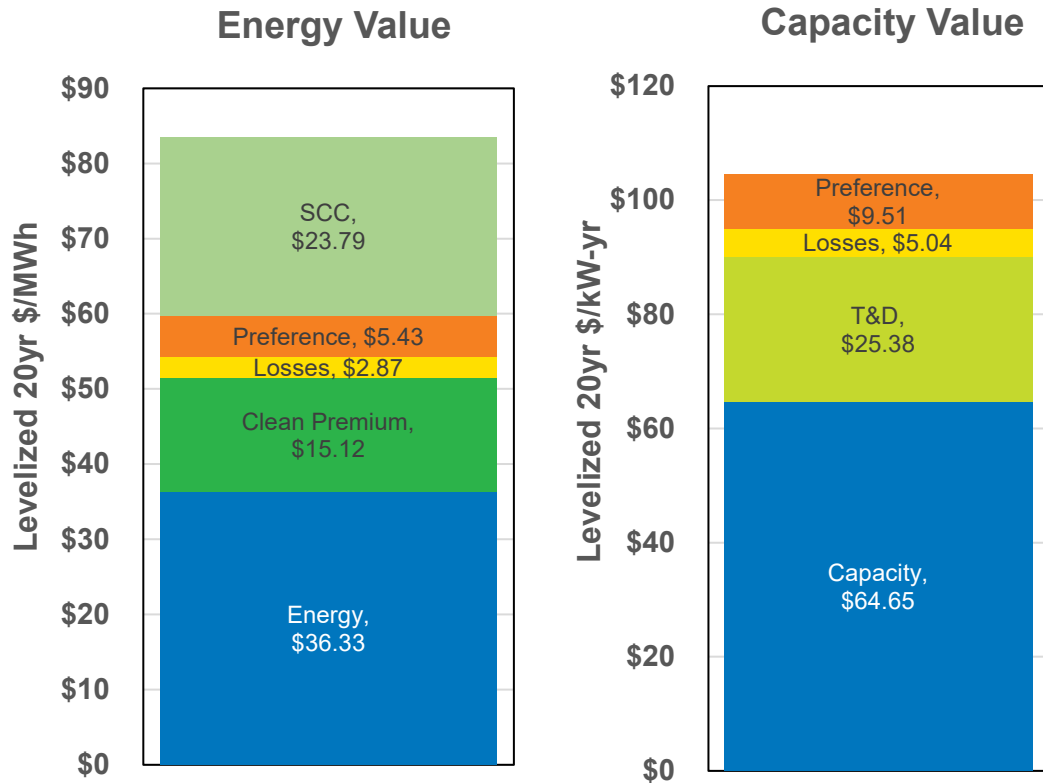

## Idaho

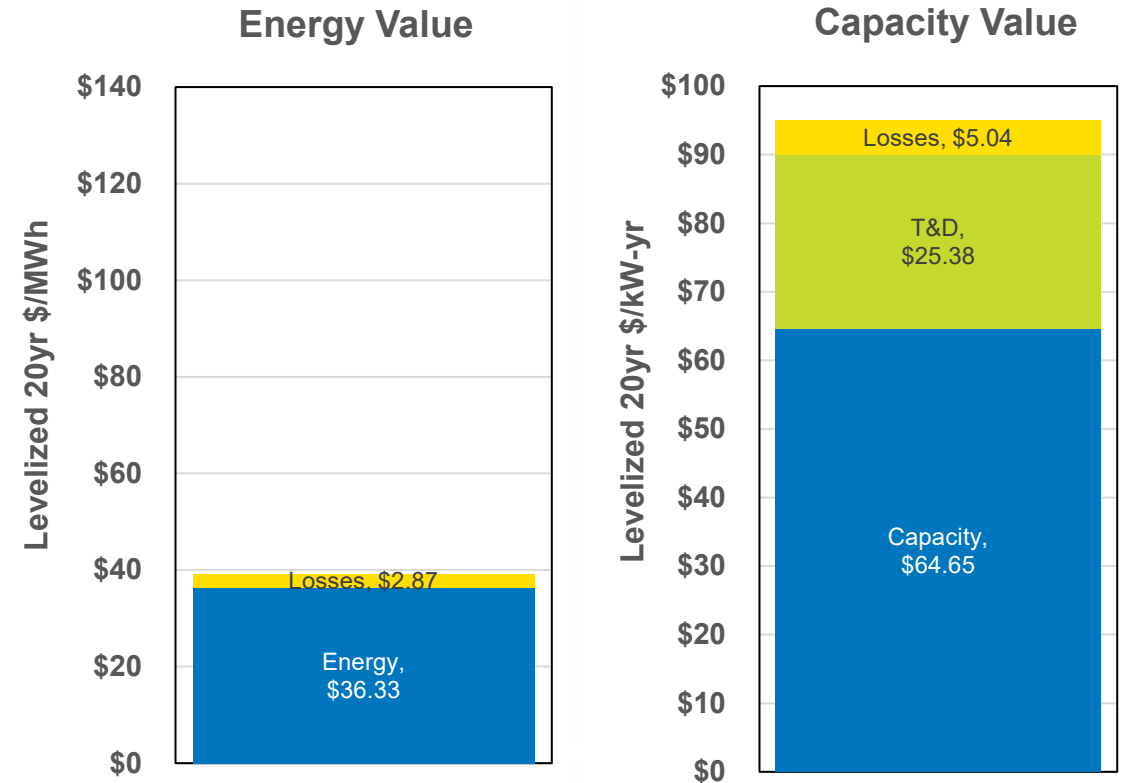

# Demand Response

- 30 MW of industrial demand response already contracted
- Avista is preparing 3 opt-in pilot programs:
  - Time of use rates
  - Peak time rebate
  - CTA-2045 water heaters
- 2023 IRP Progress Report Results
  - 2025 start date, only Washington programs selected (2045 cumulative savings shown)
    - Time of Use: 6.6 MW
    - Peak Time Rebate and Variable Peak Pricing is on the margin, but not selected.

# “Placeholder” PRS Selection (MW)

	2024	2025	2026	2027	2028	2029	2030	2031	2032	2033	2034	2035	2036	2037	2038	2039	2040	2041	2042	2043	2044	2045	2024-2033	2034-2045
<b>Washington</b>																								
Demand Response	0.0	6.8	0.0	0.0	0.0	0.0	0.0	0.0	0.0	0.0	0.0	0.0	0.0	0.0	0.0	0.0	0.0	0.0	0.0	0.0	0.0	0.0	7	0
Natural Gas	0.0	0.0	0.0	0.0	0.0	0.0	0.0	0.0	0.0	0.0	0.0	0.0	3.3	0.0	0.0	0.0	0.0	0.0	0.0	0.0	0.0	0.0	0	3
Baseload Renewable	0.0	0.0	0.0	0.0	0.0	0.0	0.0	20.0	0.0	0.0	0.0	0.0	0.0	0.0	0.0	0.0	0.0	0.0	0.0	0.0	0.0	20.0	20	20
Nuclear	0.0	0.0	0.0	0.0	0.0	0.0	0.0	0.0	0.0	0.0	0.0	0.0	0.0	0.0	0.0	0.0	0.0	0.0	0.0	0.0	0.0	0.0	0	0
NW Wind	0.0	0.0	0.0	0.0	0.0	0.0	150.0	0.0	0.0	0.0	0.0	0.0	0.0	0.0	0.0	0.0	0.0	140.0	105.0	0.0	137.2	508.4	150	891
Montana Wind	0.0	0.0	0.0	125.1	0.0	0.0	0.0	0.0	174.9	0.0	0.0	0.0	0.0	0.0	0.0	0.0	0.0	0.0	0.0	0.0	0.0	0.0	300	0
Off Shore Wind	0.0	0.0	0.0	0.0	0.0	0.0	0.0	0.0	0.0	0.0	0.0	0.0	0.0	0.0	0.0	0.0	0.0	0.0	0.0	0.0	0.0	0.0	0	0
Distributed Solar/ wStorage	0.7	0.7	0.7	0.7	0.7	0.7	0.7	0.7	0.8	0.8	0.2	0.2	0.2	0.2	0.2	0.2	0.2	0.2	0.2	0.2	0.2	0.2	7	2
Utility Scale Solar	0.0	0.0	0.0	0.0	0.0	0.0	0.0	0.0	0.0	0.0	0.0	0.0	0.0	0.0	0.0	0.0	0.0	0.0	0.0	0.0	0.0	0.0	0	0
Short Duration Storage (<8hr)	0.0	0.0	0.0	25.0	0.0	35.7	0.0	0.0	0.0	0.0	0.0	0.0	0.0	0.0	0.0	0.0	51.5	0.0	0.0	0.0	25.0	0.0	61	76
Medium Duration Storage (8-24hr)	0.0	0.0	0.0	0.0	0.0	0.0	0.0	0.0	0.0	0.0	0.0	0.0	0.0	0.0	0.0	0.0	0.0	0.0	0.0	0.0	0.0	0.0	0	0
Long Duration Storage (>24hr)	0.0	0.0	0.0	0.0	0.0	0.0	0.0	0.0	147.4	0.0	0.0	0.0	0.0	0.0	59.8	0.0	0.0	75.8	0.0	68.0	0.0	318.8	147	522
<b>Total</b>	<b>0.7</b>	<b>7.4</b>	<b>0.7</b>	<b>150.8</b>	<b>0.7</b>	<b>36.4</b>	<b>150.7</b>	<b>20.7</b>	<b>323.1</b>	<b>0.8</b>	<b>0.2</b>	<b>0.2</b>	<b>3.5</b>	<b>0.2</b>	<b>60.0</b>	<b>0.2</b>	<b>51.7</b>	<b>216.0</b>	<b>105.2</b>	<b>68.2</b>	<b>162.4</b>	<b>847.4</b>	<b>692</b>	<b>1,515</b>
<b>Idaho</b>																								
Demand Response	0.0	0.0	0.0	0.0	0.0	0.0	0.0	0.0	0.0	0.0	0.0	0.0	0.0	0.0	0.0	0.0	0.0	0.0	0.0	0.0	0.0	0.0	0	0
Natural Gas	0.0	0.0	0.0	186.2	0.0	0.0	0.0	0.0	0.0	0.0	0.0	0.0	1.7	0.0	0.0	0.0	0.0	0.0	0.0	0.0	0.0	0.0	186	2
Baseload Renewable	0.0	0.0	0.0	0.0	0.0	0.0	0.0	0.0	0.0	0.0	0.0	0.0	0.0	0.0	0.0	0.0	0.0	0.0	0.0	0.0	0.0	0.0	0	0
Nuclear	0.0	0.0	0.0	0.0	0.0	0.0	0.0	0.0	0.0	0.0	0.0	0.0	0.0	0.0	0.0	0.0	0.0	0.0	0.0	0.0	0.0	0.0	0	0
NW Wind	0.0	0.0	0.0	0.0	0.0	0.0	0.0	0.0	0.0	0.0	0.0	0.0	0.0	0.0	0.0	0.0	0.0	0.0	0.0	0.0	0.0	0.0	0	0
Montana Wind	0.0	0.0	0.0	0.0	0.0	0.0	0.0	0.0	0.0	0.0	0.0	0.0	0.0	0.0	0.0	0.0	0.0	0.0	0.0	0.0	0.0	0.0	0	0
Off Shore Wind	0.0	0.0	0.0	0.0	0.0	0.0	0.0	0.0	0.0	0.0	0.0	0.0	0.0	0.0	0.0	0.0	0.0	0.0	0.0	0.0	0.0	0.0	0	0
Distributed Solar/ wStorage	0.0	0.0	0.0	0.0	0.0	0.0	0.0	0.0	0.0	0.0	0.0	0.0	0.0	0.0	0.0	0.0	0.0	0.0	0.0	0.0	0.0	0.0	0	0
Utility Scale Solar	0.0	0.0	0.0	0.0	0.0	0.0	0.0	0.0	0.0	0.0	0.0	0.0	0.0	0.0	0.0	0.0	0.0	0.0	0.0	0.0	0.0	0.0	0	0
Short Duration Storage (<8hr)	0.0	0.0	0.0	0.0	0.0	0.0	0.0	0.0	0.0	0.0	0.0	0.0	0.0	0.0	0.0	0.0	0.0	0.0	0.0	0.0	37.8	0.0	0	38
Medium Duration Storage (8-24hr)	0.0	0.0	0.0	0.0	0.0	0.0	0.0	0.0	0.0	0.0	0.0	0.0	0.0	0.0	0.0	0.0	0.0	0.0	0.0	0.0	0.0	0.0	0	0
Long Duration Storage (>24hr)	0.0	0.0	0.0	0.0	0.0	0.0	0.0	0.0	0.0	0.0	0.0	0.0	0.0	0.0	31.3	0.0	0.0	39.7	0.0	35.6	0.0	79.0	0	185
<b>Total</b>	<b>0.0</b>	<b>0.0</b>	<b>0.0</b>	<b>186.2</b>	<b>0.0</b>	<b>0.0</b>	<b>0.0</b>	<b>0.0</b>	<b>0.0</b>	<b>0.0</b>	<b>0.0</b>	<b>0.0</b>	<b>1.7</b>	<b>0.0</b>	<b>31.3</b>	<b>0.0</b>	<b>0.0</b>	<b>39.7</b>	<b>37.8</b>	<b>35.6</b>	<b>0.0</b>	<b>79.0</b>	<b>186</b>	<b>225</b>

Used for Energy Efficiency Potential Study Only- Will change after all RFP resources are added.



# Transmission Needs

- Most generation selection is off-system or up to interconnection limits before major transmission upgrades needed.
- 2045 renewable & long-duration storage requirements will require significant build outs in Big-Bend and Rathdrum areas.
- Earlier construction may be necessary if low-cost interconnection resources are purchased by other utilities.

# Washington CETA Clean Energy Comparison (aMW)

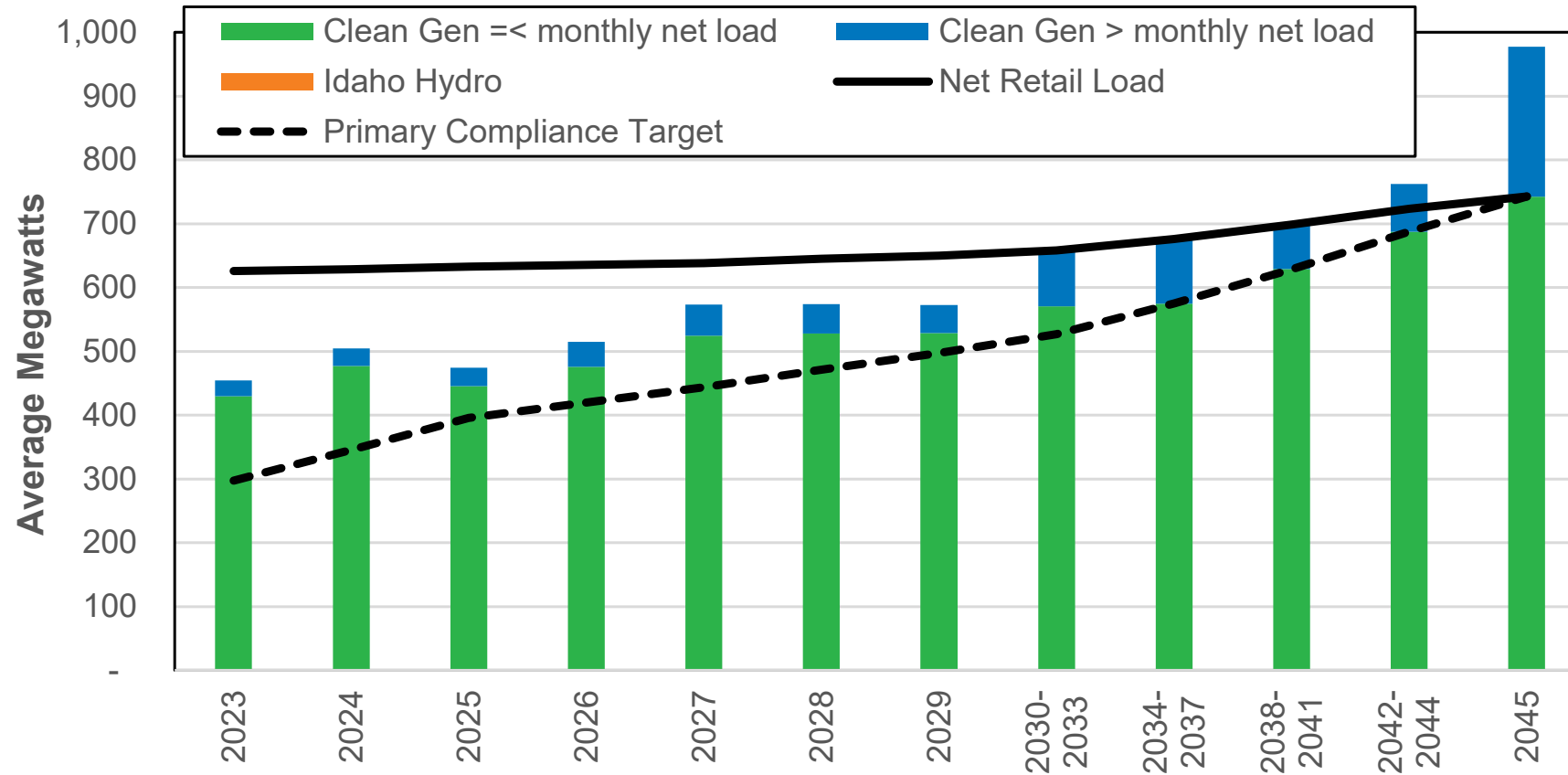



# CETA Cost Cap Analysis

- Cost cap compares utility's strategy to an "Alternative Least Reasonable Cost Portfolio"
  - How do we define this portfolio?
  - When does "alternative" begin?
    - For example, should this portfolio exclude past decisions to acquire resources used to comply with CETA?
      - Without excluding these resources, the incremental cost will be too low over time as base cost will include higher priced resources.
    - Do we need to maintain a resource portfolio over time with "theoretical" resources we would have acquired?
  - Should Preferred Resource Strategy reflect changes if cost cap is reached?

# CETA Cost Cap Analysis Example

- Assumes No Columbia Basin Hydro. (Chelan PUD #2/#3 can be added for final IRP)
- Assumes CS2 available in 2045.
- Assumes no CETA compliance requirements.
- Includes Social Cost of Greenhouse Gas.
- **Cost cap reached in final compliance period.**

	2026- 2029	2030- 2033	2034- 2037	2038- 2041	2042- 2045
Cost Cap Spending Limit	\$136m	\$159m	\$183m	\$210m	\$244m
PRS w NCF spending	\$10m	\$40m	\$51m	\$43m	\$212m
Delta	\$125m	\$118m	\$133m	\$167m	\$31m



# CBI Forecast

Mike Hermanson, Senior Power Supply Analyst  
Electric IRP, 8<sup>th</sup> Technical Advisory Committee Meeting  
December 14, 2022

# Background

- Customer Benefit Indicators (CBIs) are required to ensure equitable distribution of energy and non-energy benefits and reductions of burdens to highly impacted communities and vulnerable populations.

Who?	Benefits					
Highly impacted communities and vulnerable populations	Energy Benefits		Non-Energy Benefits		Reduction of Burdens	
All Customers, including highly impacted communities and vulnerable populations	Public Health	Environment	Cost Reduction	Risk Reduction	Energy Security	Resiliency

# Background

- CEIP includes 14 CBIs:

1. Participation in Company Programs	<b>8. Energy Generation Location</b>
<b>2. Number of households with a High Energy Burden (&gt;6%)</b>	<b>9. Outdoor Air Quality</b>
3. Availability of Methods/Modes of Outreach and Communication	<b>10. Greenhouse Gas Emissions</b>
4. Transportation Electrification	11. Employee Diversity
<b>5. Named Community Clean Energy</b>	12. Supplier Diversity
<b>6. Investments in Named Communities</b>	13. Indoor Air Quality
<b>7. Energy Availability</b>	14. Residential Arrearages and Disconnections for Nonpayment

- 7 CBIs forecasted in IRP modeling.

# Number of households with a High Energy Burden (>6%)

- High energy burden is annual energy cost (electric & gas) greater than 6% of annual income.
- Forecasted by:  
*(PRS rates x annual energy usage)/annual income*
- Forecast includes:
  - Reductions in energy usage from low-income energy efficiency programs selected by PRiSM.
  - Historic income increases for specific income groups projected forward.

#2a: WA Customers with Excess Energy Burden (Before Energy Assistance)

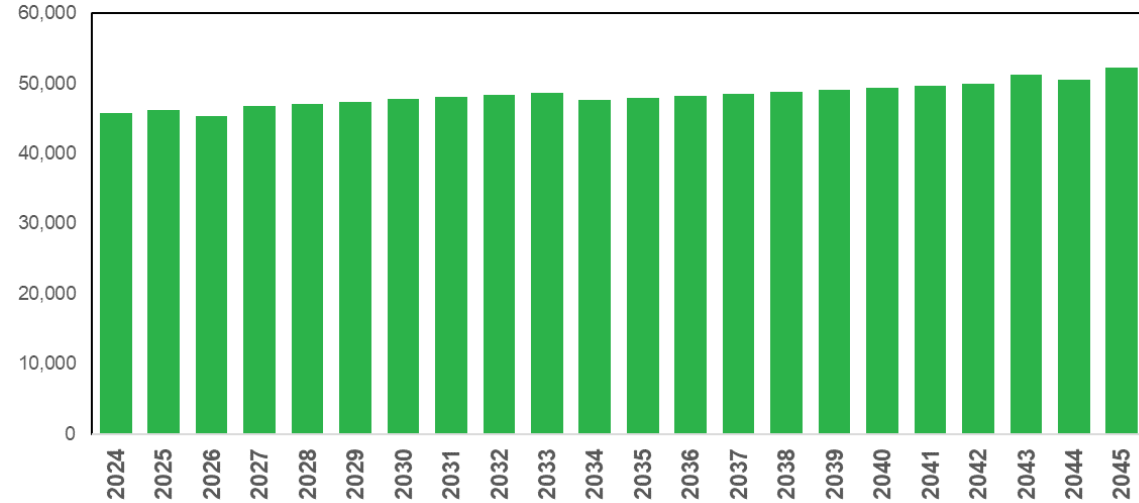

#2b: Percent of WA Customers with Excess Energy Burden (Before Energy Assistance)

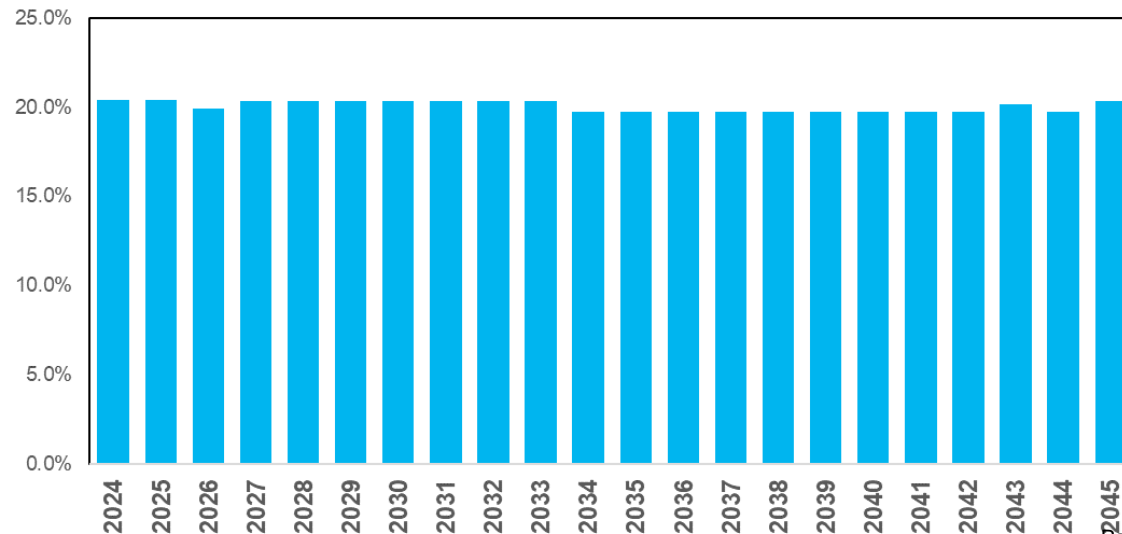

# Number of households with a High Energy Burden (>6%)

- Excess energy burden amount in excess of 6% of annual income.

#2c: Average Excess Energy Burden  
(Before Energy Assistance)

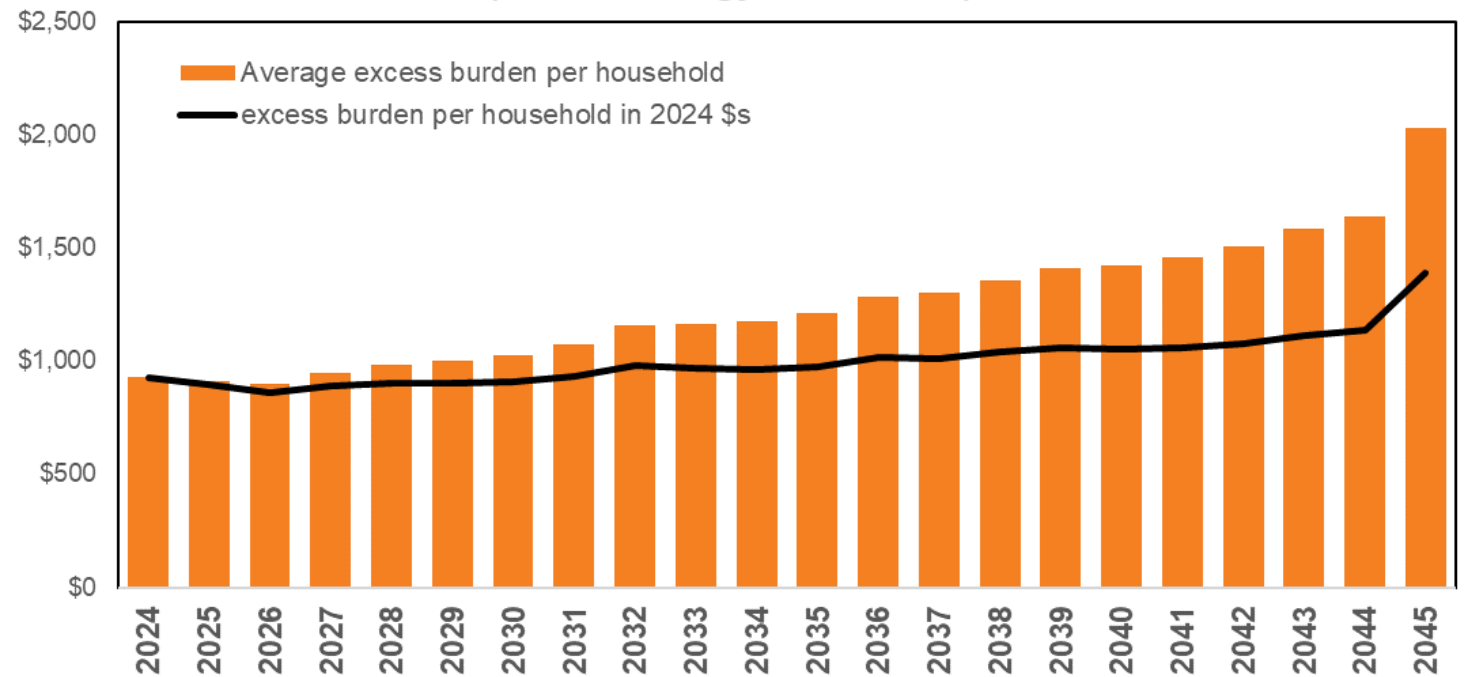

# Named Community Clean Energy

- DER generation includes:
  - PURPA generation in named communities
  - Community solar
  - Customer net metering
- Community solar selected between 2024 – 2033 supported by tax incentives.
- Community solar with battery storage selected after 2034.

#5a: Total MWh of DER <5MW in Named Communities

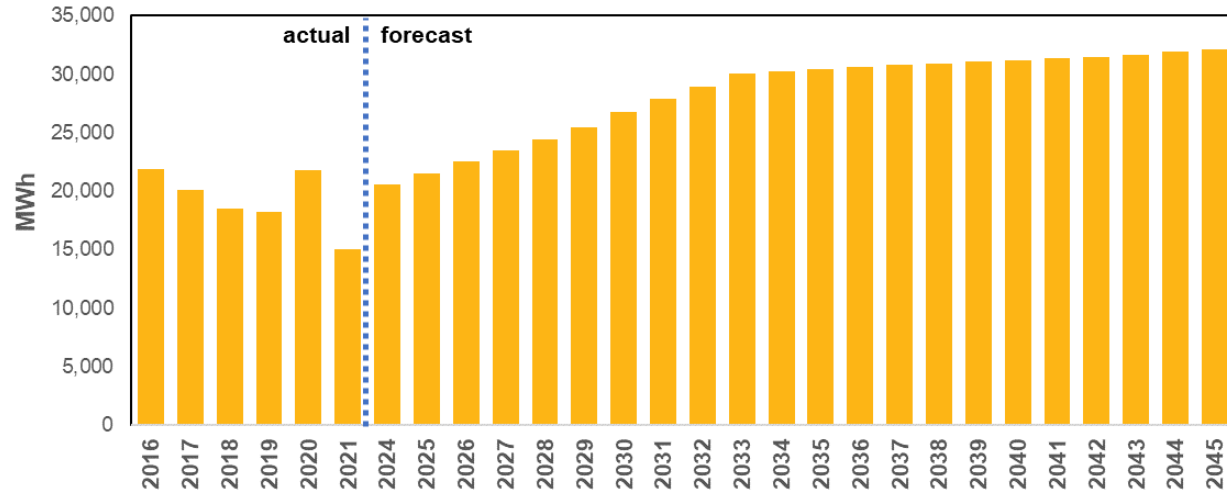

#5b: Total MWh Capability of DER Storage <5MW in Named Communities

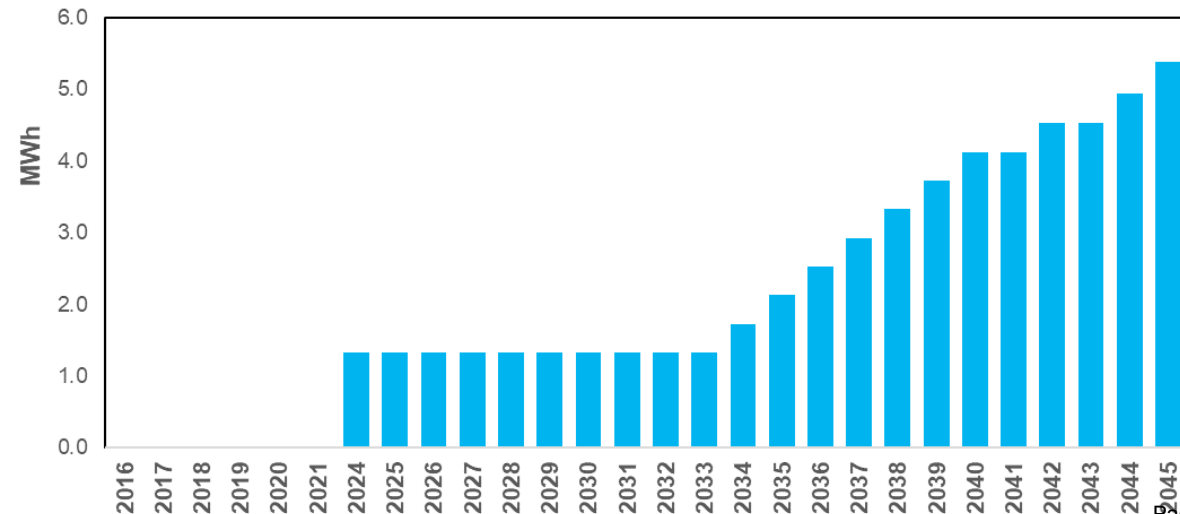



# Investments in Named Communities

- Includes low-income EE investment and likely named community demand response investment.
- Annual NEI and utility benefit is the market value or established NEI unit rate of energy associated with EE and named community demand response.
- Investment declines as EE opportunities decline over the planning horizon.

#6: Approximate Low Income/Named Community Investment and Benefits

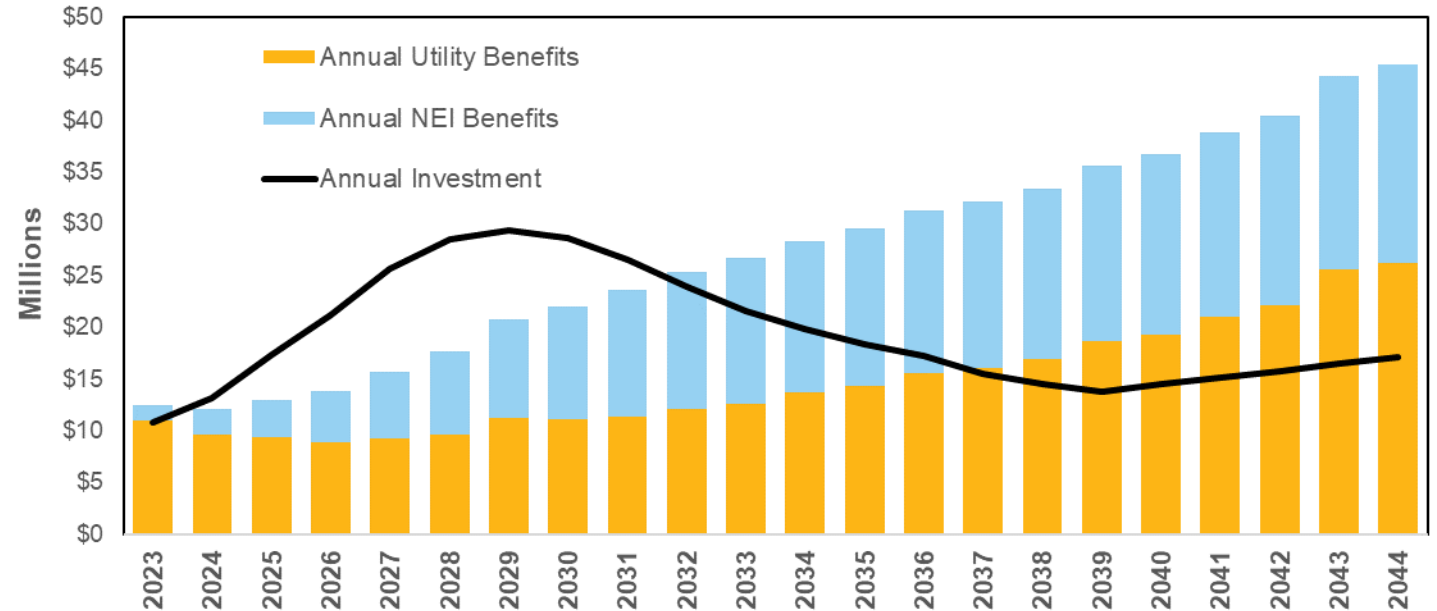

# Energy Availability

- Energy availability is related to energy resiliency.
- Planning margins:
  - Winter – 22%
  - Summer – 13%
- Energy needs drive selection so resources exceed the planning margin.
- After resource additions planning margin decreases but does not reach target.

#7: Energy Availability- Planning Margin

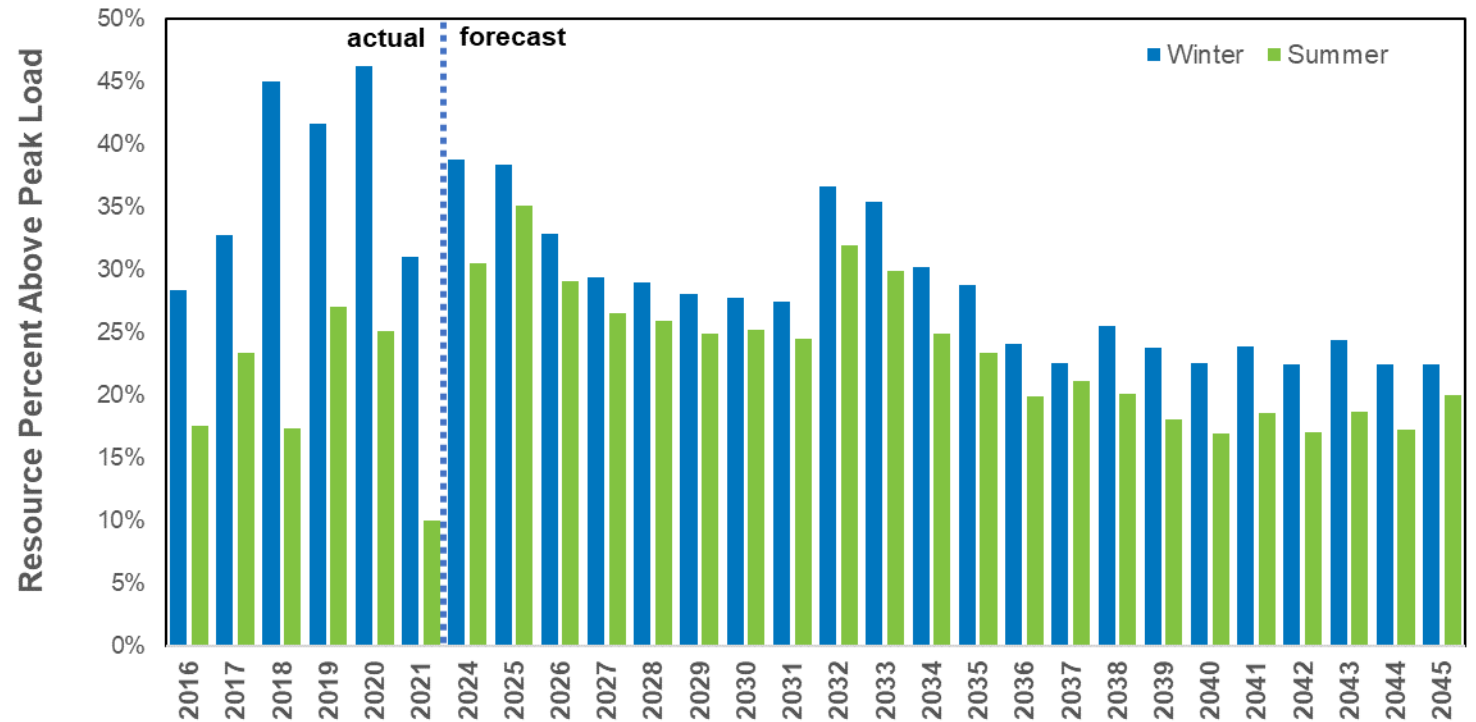

# Energy Generation Location

- Energy generation location and connectivity is related to customer energy security.
- As a % of load, WA located and/or connected to Avista transmission system decreases as more off system wind generation is added over the planning horizon.

#8: Generation in WA and/or Connected Transmission System  
(as a Percent of System Load)

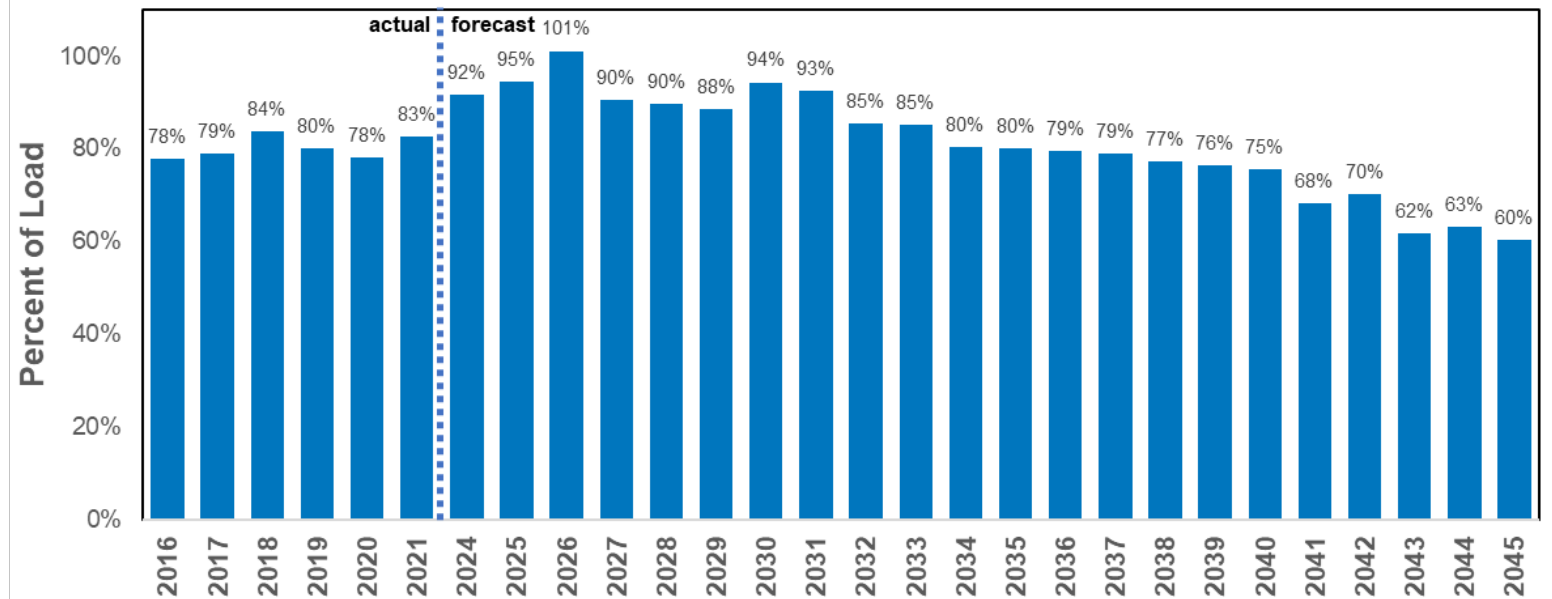

# Outdoor Air Quality

- Emissions related to thermal generation located in WA.
- SO<sub>2</sub> results related to non-detect field measurements. In the process of confirming results.
- NO<sub>x</sub> emissions reduce over time as a result of decreased emission rates from Kettle Falls upgrade and decreased dispatch of Kettle Falls.

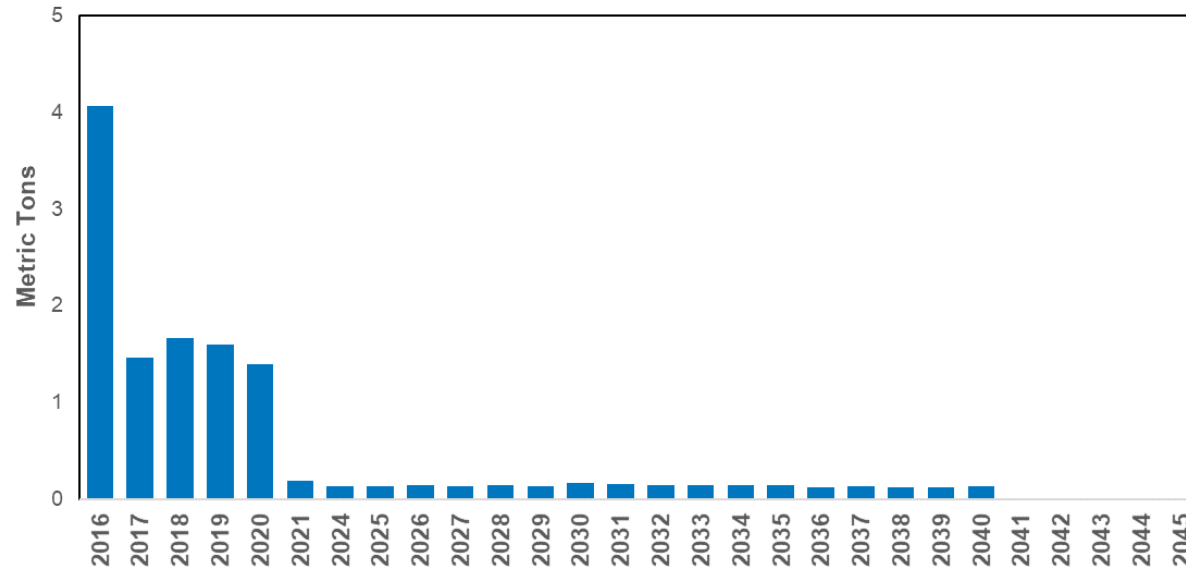
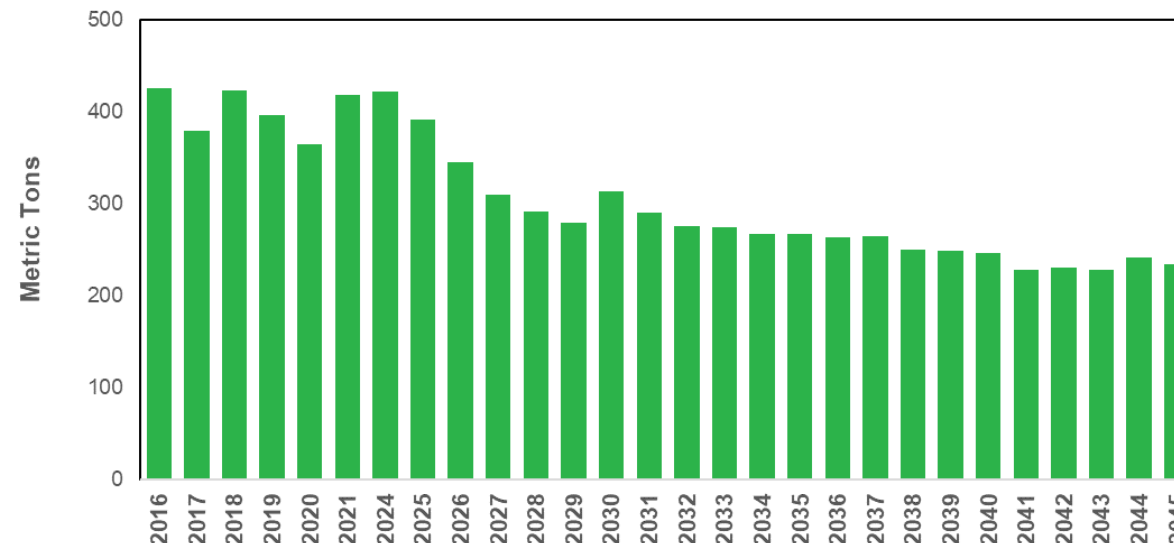
#9a: SO<sub>2</sub>#9b: NO<sub>x</sub>

# Outdoor Air Quality

- Emissions related to thermal generation located in WA.
- Small reduction in Mercury emissions.
- VOC emissions reduce over time as a result of decreased emission rates from Kettle Falls upgrade and decreased dispatch of Kettle Falls.

### #9c: Mercury

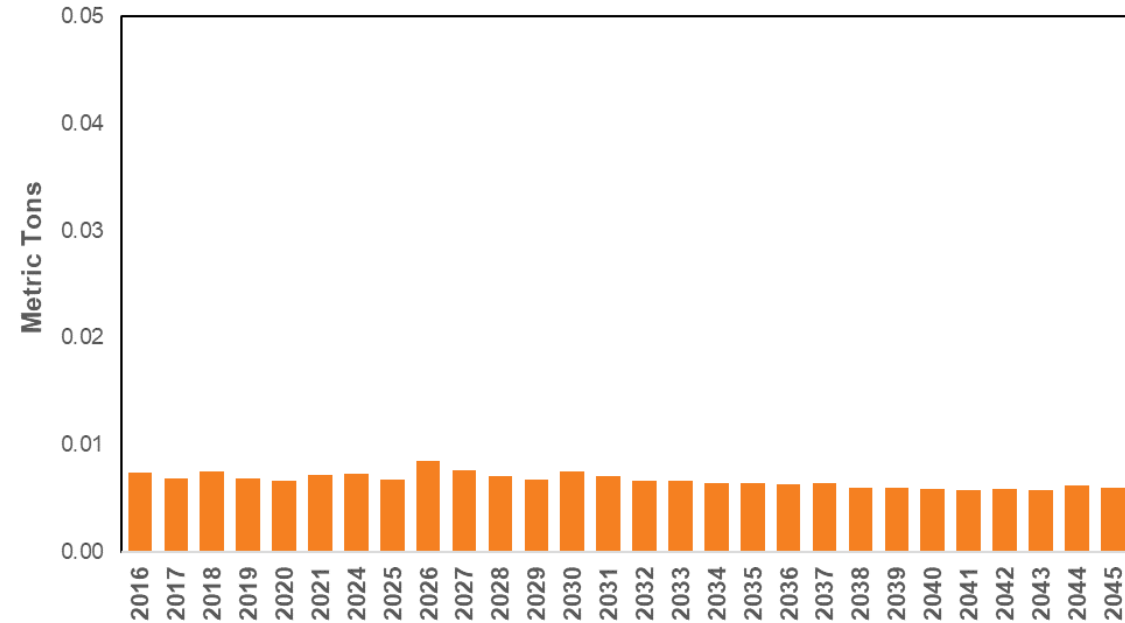

### #9d: VOC

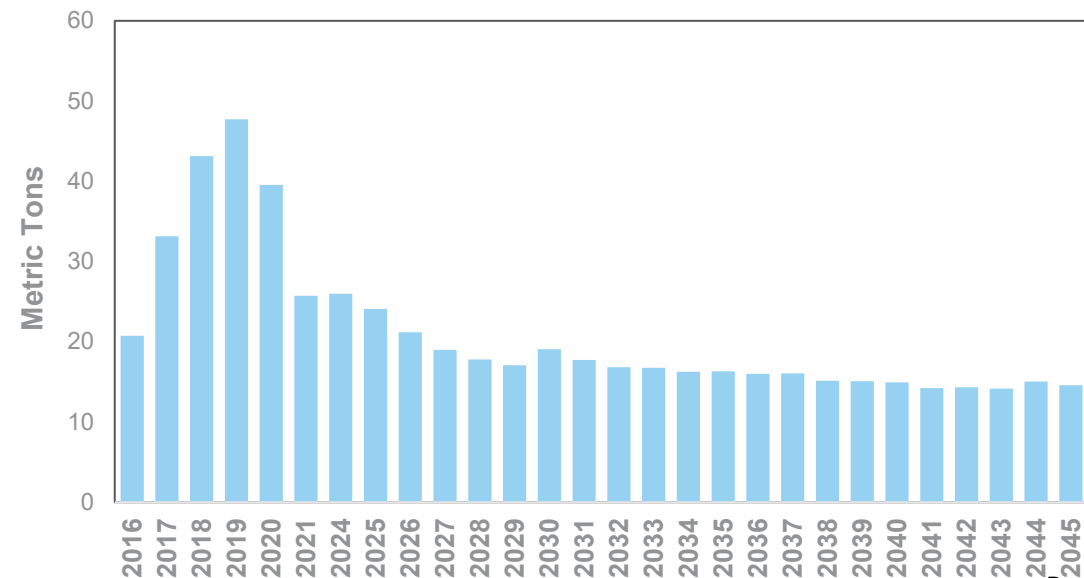

# Greenhouse Gas Emissions

- Direct emissions are the WA portion of total system emissions.
- Net emissions are the WA portion of total system emissions net of market transactions.
- Significant reduction in 2025 from use of Colstrip for WA retail load.
- Net emissions begin to exceed direct emissions as more market purchases used to supply WA retail load.

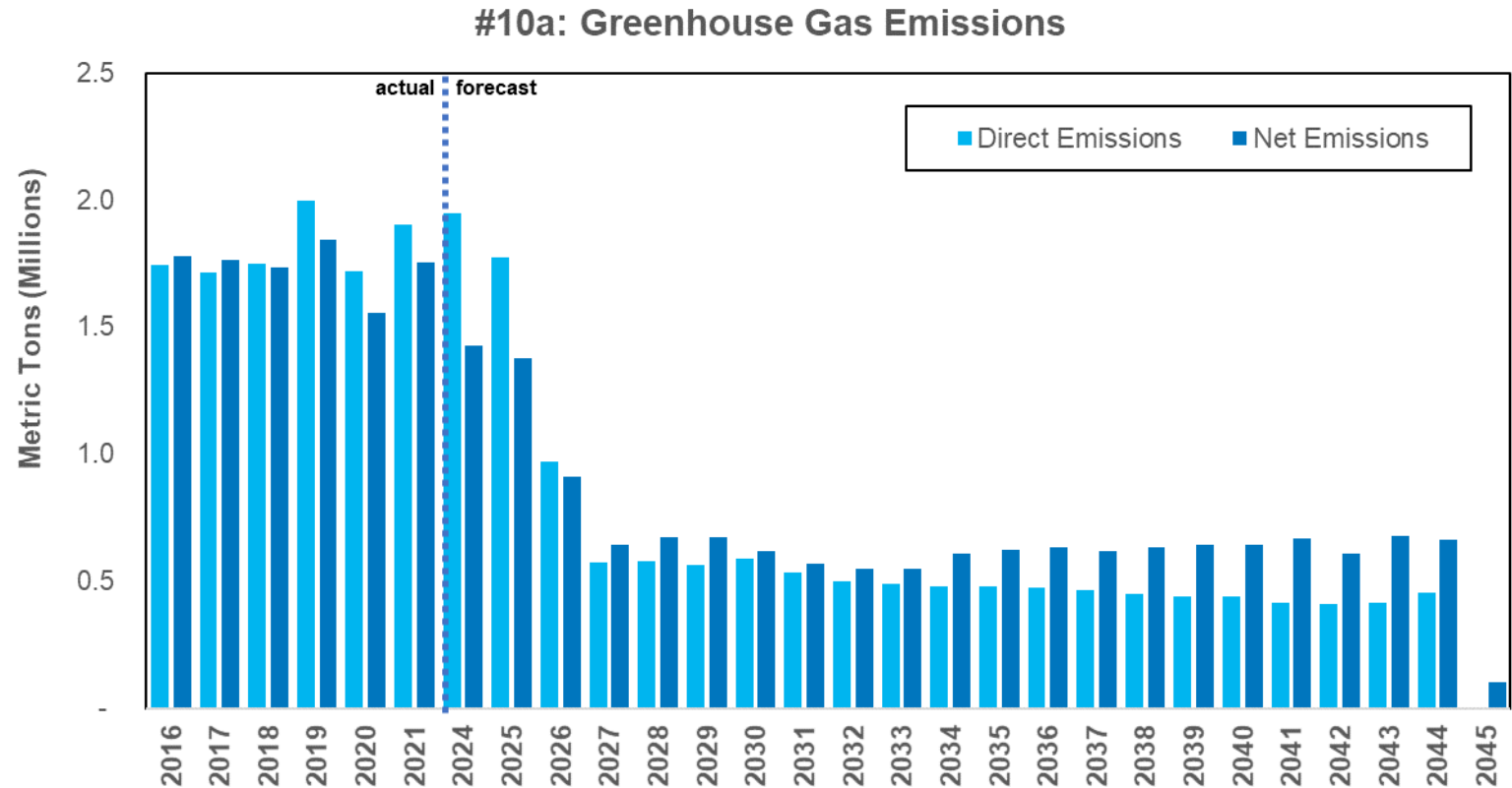

# Greenhouse Gas Emissions

- Agriculture & large sources held constant over forecast period.
- Electric power from IRP modeling.
- Waste Management increases in proportion to population.
- Residential & commercial fuels from Gas IRP forecast.
- Transportation:
  - Rail held constant
  - Air increases in proportion to population
  - Auto from EV forecast

#10b: Regional Greenhouse Gas Emissions

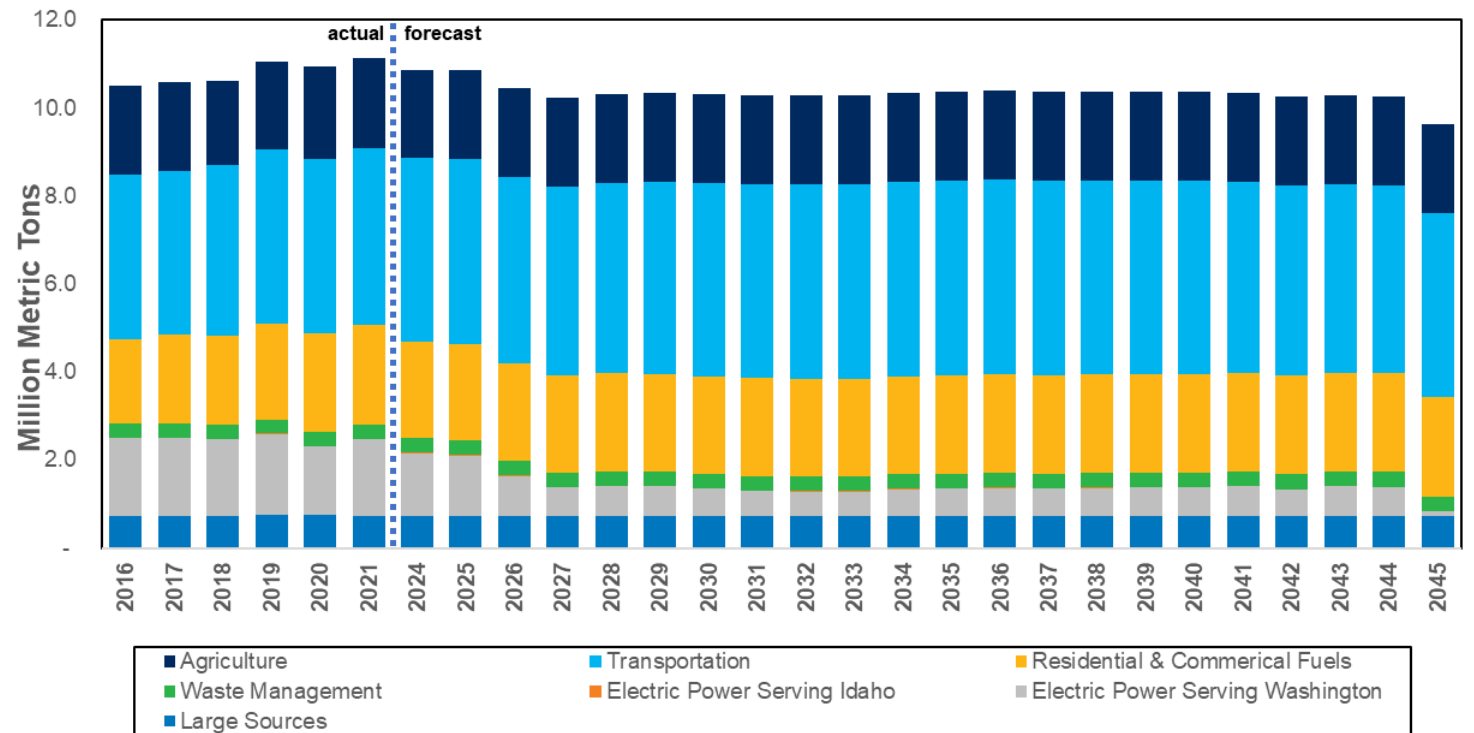

# Greenhouse Gas Emissions

- Electric vehicle forecast from load forecast.
- In 2045 28.6% of vehicles are electric.
- Forecast includes increased gas efficiency over the planning horizon.
- 0.12 MMT increase over planning horizon.
- 1.16 reduction over no electric vehicle scenario.

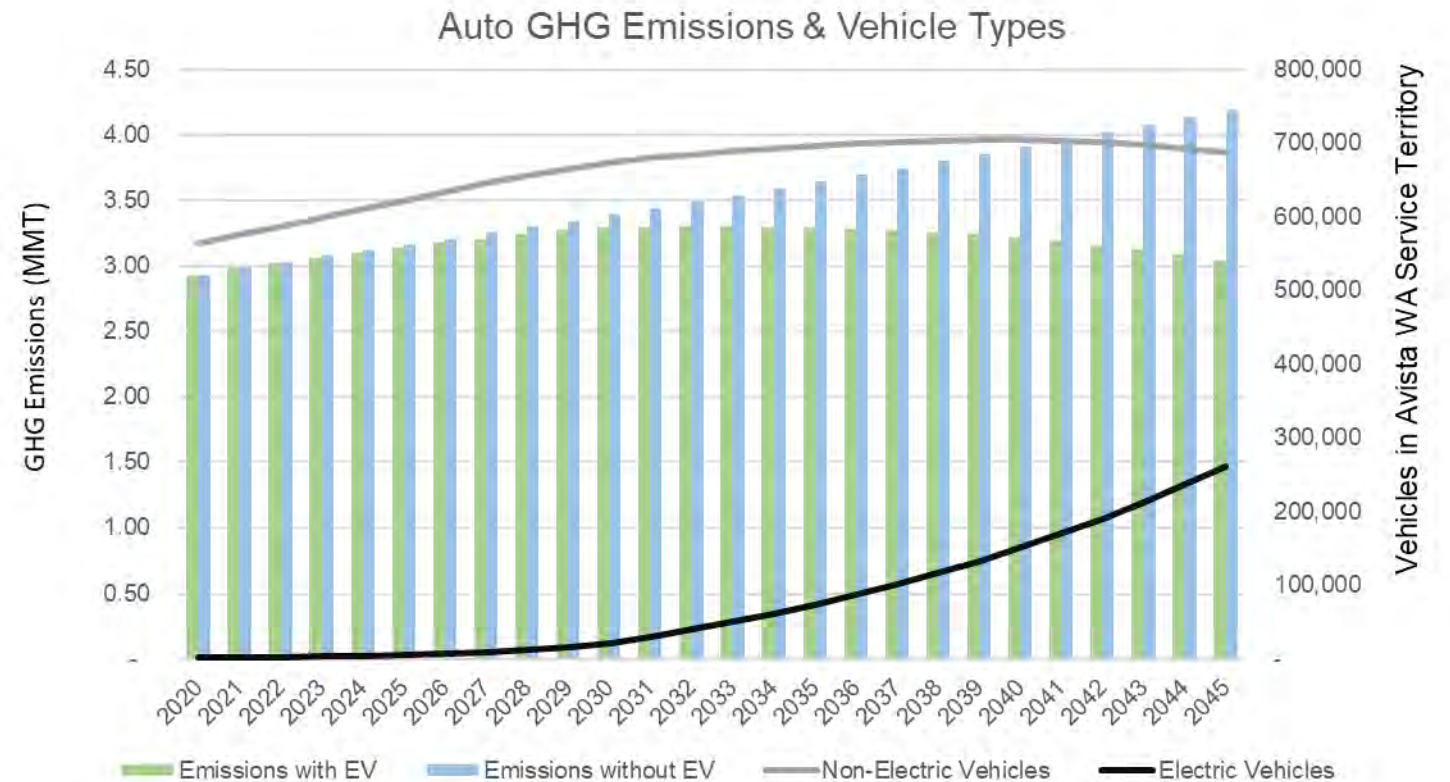

\*Emission estimates do not include full life cycle carbon emissions associated with each vehicle type





# 2023 Progress Report Outline

Lori Hermanson, Senior Power Supply Analyst  
Technical Advisory Committee Meeting No. 8  
December 14, 2022

# Progress Report Outline

- Chapter 1 - Progress Report Introduction
- Chapter 2 - Economic and Load Forecast
- Chapter 3 - Existing Supply-side Resources
- Chapter 4 - Long-term Position
- Chapter 5 - Distributed Energy Resources (includes EE and DR)
- Chapter 6 - Supply-side Resource Options
- Chapter 7 - Transmission & Distribution
- Chapter 8 - Market Analysis
- Chapter 9 – Placeholder Resource Strategy
- Chapter 10 - Customer Impacts



# Next Steps

James Gall, Manager of Integrated Resource Planning  
Technical Advisory Committee Meeting No. 8  
December 14, 2022

## Next Steps

- Washington Progress Report to be filed **January 3, 2023**
- Virtual Public Meetings on **March 8, 2023**
- Schedule Changes
  - Combines February and March meetings
    - Next TAC meeting **March 15, 2023**, 9am to 4pm (in person/ Teams)
  - Draft IRP release moved to **March 31, 2023**
- File final IRP **on June 1, 2023**
- Schedule may change subject to RFP negotiations

## TAC 8 Meeting Notes: Wednesday, December 14, 2022

### Attendees:

Ernesto Avelar, LIUNA; John Barber, Customer; Shay Bauman, PCU; Shawn Bonfield, Avista; Annette Brandon, Avista; Lauren Breynaert, Climate Solutions; Michael Brutocao, Avista; Logan Callen, City of Spokane; Nathan Critchfield, Puget Sound Energy; Travis Culbertson, IPUC; Thomas Dempsey, Myno; Mike Dillon, Avista; Nelli Doroshkin, Capital Power Corporation; Chris Drake, Avista; Michael Eldred, IPUC; Ryan Ericksen, Avista; Ryan Finesilver, Avista; Grant Forsyth, Avista; James Gall, Avista; Bill Garry, Hillside Park Owner's Association; Amanda Ghering, Avista; Leona Haley, Avista; Tom Handy, Whitman County Commission; Kevin Holland, Avista; Lori Hermanson, Avista; Mike Hermanson, Avista; Fred Heutte, NWECC; Clint Kalich, Avista; Kevin Keyt, IPUC; Scott Kinney, Avista; Doug Krapas, IEP Co.; Jeff Larsen, Guest; Kimberly Loskot, IPUC; John Lyons, Avista; Patrick, Maher, Avista; Jaime Majure, Avista; Stuart McCausland, Tyr Energy; James McDougall, Ian McGetrick, Idaho Power; Mike Miller, Guest; Aubrey Newton, LIUNA; Catherine Olsen, City of Spokane; Tom Pardee, Avista; John Robbins, Mitsubishi; Sashwat Roy, Renewable Northwest; Jennifer Snyder, UTC; Collins Sprague, Avista; Dean Spratt, Avista Darrell Soyars, Avista; Art Swannack, Whitman County Commission; Jason Talford, IPUC; Gavin Tenold, Northwest Renewables; Taylor Thomas, IPUC; Charlee Thompson, Northwest Energy Coalition; Dave van Hersett, Customer; Christopher Wayland, Clearway Energy; Bill Will, WASEIA; Jim Woodward, UTC; Yao Yin, IPUC

### Introduction, John Lyons

**John Lyons:** OK. And James, do we want to give it another minute or two? We still have people trickling in here.

**James Gall:** I think that's a good idea. We only have two hours, but we'll try to be quick as we can. But we do want to make sure everybody has a chance to participate here at the beginning because there's a lot of interesting stuff in the first few minutes of the meeting.

**John Lyons:** I was going to say not my first slides, other than we do have some changes in timing for things being released. How and where we have added the numbers jump right up there, James.

**James Gall:** OK, go for it.

**John Lyons:** I think we're ready to start. Again, hello, I'm John Lyons with Avista. Welcome to the 8<sup>th</sup> Technical Advisory Committee meeting. This is going over our Progress Report, what's going on with that and when it's being submitted. And James, if

you want to pop up that first slide deck for the introductions. OK. And hopefully everyone is now starting to see the IRP Introduction presentation.

**Hermanson, Lori:** I can see it, John.

**John Lyons:** OK, good. And if we want to go to the next slide. We're going to go through this quicker than we normally do because we have a very full agenda today for two hours. Actually, I have to change that to TAC nine meeting will be February 16<sup>th</sup>, 2023, and that'll be a full day meeting. It'll be both in person and online. Then we will have a series of virtual public meetings for gas and yes.

**James Gall:** John, sorry that meeting's going to be moved. We'll talk about that later in the presentation.

**John Lyons:** OK. So that actually, that is going to be the March 5<sup>th</sup>, is that the March 15<sup>th</sup>? OK, so it is correct. TAC just goes away on this slide, but we do have the virtual public meetings, gas and electric IRP meeting. It'll be similar to the last time, but there'll be a prerecorded message that we will show and then there'll be time in the afternoon and the evening for customers and other interested parties to participate, ask questions of subject matter experts and let us know their opinions. Then the 9<sup>th</sup> TAC meeting will be March 15<sup>th</sup>. Other important dates, the Washington Progress Report that we're talking about today will be submitted on January 3<sup>rd</sup>. The external IRP draft is going to be released on March 31<sup>st</sup> with public comments due on May 12<sup>th</sup>. We originally were going to do that on March 17<sup>th</sup>, but we are going to need those extra couple of weeks to be able to get everything finished and then we'll finalize the 2023 IRP and submit to both commissions on June 1<sup>st</sup>, 2023, and it'll be available to the TAC.

**John Lyons:** And today's agenda. After this introduction, Chris Drake is going to talk to you about some of our recent resource acquisitions. And then James will go over the placeholder resource strategy and discuss amounts of energy efficiency, demand response, resource selection and avoided cost. He'll discuss more about why it's a placeholder strategy because we are still working on the 2023 All Source Request for Proposals and negotiations for that. After that, Mike Hermanson will discuss the Customer Benefit Indicators forecast, and then Lori will go over the outline of the Progress Report and James will wrap up with next steps. With that, James, if you want to take it away or no, Chris? We want to get Chris on.

### **Resource Acquisitions, Chris Drake**

**Chris Drake:** Good morning. We wanted to take an opportunity to provide updates on some recent resource acquisitions. While neither was due to a signed purchase power agreement as a result of the RFP, they're either related or timely. Again, just appreciate the opportunity to share with the TAC the updates on resource acquisitions. To back up a bit and recap, we are currently in the final stages of the 2022 All-Source RFP. As you recall, we released the All-Source RFP in February. We had a bidder's conference that

same month, received initial bids by the end of March, posted a summary in accordance with the rules there of the summary bids in April. We selected and notified shortlisted bidders in early June, received detailed proposals from shortlisted bidders in July and had a final price refresh. In September, so we're currently in the negotiation phase, but do not have additional details to share at this time other than we are continuing the RFP process but would like to share some resource acquisition. So next slide please.

**Chris Drake:** Again, there isn't a power purchase agreement between Avista Power Supply and Avista Generation, Production and Substation Support. But the Kettle Falls Biomass upgrade was selected as one of the top finishers in the RFP process. Our Generation, Production and Substation Support group is moving ahead on supporting the contracts. To enable this upgrade, this is an 11 MW increase in capacity at the plant at the Kettle Falls Generating Station. It'll actually get 18 megawatts of energy from the new steam gasifier. You can see the estimated levelized cost of energy and there is an Avista capital portion as well the investment by the gasifier biochar system as well.

**Chris Drake:** The biochar approach basically is a way to not only produce steam, but also sequester the carbon associated with that timber. Now the Kettle Falls Generating Station is net zero carbon based on the fact that the timber is recently sequestered. However, the biochar actually does remove that from the atmosphere, so there's a reduction in CO<sub>2</sub> as well as some additional reductions in emissions. Another big benefit of the program, or the upgrade, is a delay in our ash disposal needs. It is quite a system there that infrastructure that needs to be installed as part of that biochar gasifier that the steam component, if you will of this upgrade, and there's some new FTEs [full time employees] that go along with that. And our next slide please. And if you have questions, please jump in. I just got the two slides here and so I can move ahead on this one if there are questions on Kettle Falls, happy to move back to that.

**Yao Yin (IPUC):** This is Yao Yin from Idaho Public Utilities Commission. I'd like to know why Avista invests in this project as well. Is it \$11.2 million from Avista?

**Chris Drake:** Correct. A lot of the investment, the capital investment, is going to be from the gasifier, the biochar system. And so, it really minimizes the capital investment needed by Avista. The capital investment by Avista is on the upgrades to the existing plant in order to achieve the additional capacity. It's not the investment in the biochar, so that company will build that project, and we will do upgrades to the plant to bring the upgrade all together. It was a lower cost to upgrade then that a lot of other options.

**Yao Yin (IPUC):** Thank you. So, in general, when would Avista collaborate with the bidder in terms of investment? What I mean, how does Avista decide whether the company should invest or need? What are the criteria?

**Chris Drake:** Sure. Well, let me back up again and say this is similar. We look at this like a fuel supply agreement and rather than doing upgrades to the plant to burn more wood and basically the existing process, this is a way to have a bit of a different fuel supply. We're bringing in the wood byproduct, the timber industry wood byproducts, some of it

will go into the plant to the existing process and some of it will go into this new system that's being installed by the subcontractor. We're not paying for that biochar gasifier system to be built. It's like a fuel supply and our investment is predicated on the biochar system being in place. There's little risk for Avista other than if the biochar system does not come together, we'd have to regroup on how to upgrade the plant. But the capital outlines would come in sequence based on progress made on the gasifier.

**Yao Yin (IPUC):** Thank you.

**Doug Krapas (IEP):** So, just to be clear, you're not actually converting the existing combustion system to gasification, you're installing a new gasification system. Right.

**Chris Drake:** Correct. There will be the existing processes. And what happens is basically we're able to add more steam to the system with less fuel and some additional benefits, that fuel that's used to generate the steam has some environmental benefits as well as some disposal benefits. Next slide, James.

**Chris Drake:** The other resource acquisition and this agreement was completed about a week ago. And again, it was not part of the 2022 All-Source RFP. We participated in a competitive process that was outside of the RFP and it was on a parallel timeline. So, we were able to use the RFP matrix for comparison purposes, where it did finish favorably. The Columbia Basin Hydropower is seven projects, there's three irrigation districts in central Washington. And this is hydro that is generated based on the irrigation needs in the central part of the state. And these systems, these seven projects will be layered in over seven years and it's a 23-year deal in total. But the way that the projects, the current contracts with other counterparties expire, we'll start to pick them up in 2023 with the last one coming online for us in 2030. 100% of this of the output would go to Avista. It's approximately 145 megawatts of max generation. It is seasonal based on irrigation needs. Basically, from mid-March to mid-October. It looks a lot like solar but has some additional capacity, benefits and off-peak energy. It doesn't provide winter peaking but provides some significant capacity to our summer needs. Questions on Columbia Basin Hydro?

**Doug Krapas (IEP):** These are low head turbines?

**Chris Drake:** I'm not sure. Kevin, do you know, or James? I'm not positive, there's seven different projects and they range from two or three megawatts. The biggest one is over 90 megawatts and might have to look at how they're those are all configured.

**Holland, Kevin:** This is Kevin Holland. I wouldn't be able to comment specifically from a technical perspective on whether they're low head turbines or not. I'm not a hydro expert. I apologize, but they are essentially run of river, run of the canal, if you will type projects. There really isn't a lot of storage or need for backing up head water against the tail race. In that respect, yes, there's not a huge drop involved. It's more that the canals as they move from the north part of the state down to the South part of the state are decreasing in altitude. The water just naturally runs that way.



**Chris Drake:** I would imagine the larger plants are less so, and the smaller plants are more low head, but we could get some additional details on those. But again, probably one other comment on them. Kind of an interesting benefit here, as you can imagine, our irrigation needs can increase in a dry summer, so their variability complements river hydro generation and arguably in a lower hydro year, irrigation generation will be greater. They're unique projects and some of them are already interconnected in our BA, so they're a local renewable resource I'm excited to add to our portfolio. That's all I had prepared. James, if there's other questions, happy to field them. OK.

**Doug Krapas (IEP):** I do have one more question circling back to the biochar gasification system. What is the capacity of that unit that you're proposing to be installed?

**Chris Drake:** It increases the Kettle Falls Generating Station by a net 11 megawatts, but the biochar will be able to produce 18 megawatts of steam or the steam from that biochar facility will allow the generating station to generate 18 megawatts. It's taking a little bit more fuel for the additional capacity as well as taking some of the fuel that would otherwise be burned in the plant and using it in the gasifier to achieve some additional benefits. I think this is something that as we get a little further along, we can have potentially have our Generation Production Substation Support folks provide a more detailed overview. But it is an interesting project.

**James Gall:** Chris, this is James. Doug has some questions on the production side from the gas fire. I know Thomas Dempsey is on the call. I don't know if you want to say a couple of words on that side of the fence of how this works with Kettle Falls. Maybe he disappeared, but.

**Doug Krapas (IEP):** Do you know what the amount of additional wood capacity usage is going to be?

**Chris Drake:** I don't have that right in front of me, but there is an incremental wood supply requirement, but we get a little bit more bang for the buck with the gasifier. It's not one for one on if we just increase the capacity 11 megawatts with the existing process.

**Doug Krapas (IEP):** OK. Primarily hog fuel.

**Chris Drake:** Yeah, exact same fuel. Still hog fuel.

**Doug Krapas (IEP):** OK.

**James Gall:** And unfortunately, looks like we lost Thomas. He was our expert on this project who recently retired and was going to join us but looks like he left the meeting.

**Chris Drake:** I'd offer that up potentially as maybe a deeper dive sometime or an opportunity to provide some additional detail. It is an interesting project.

**Doug Krapas (IEP):** Appreciate that. I would be interested in more detail. Thanks.

**Chris Drake:** Thank you.

### **Placeholder Resource Strategy, James Gall**

**James Gall:** Thank you, Chris. We're going to move on in the agenda and bear with me just a minute while I transition the slides. For some reason it keeps wanting to flip the screens on me. I'd just like to welcome you all this this morning. Now we're going to talk about the Placeholder Resource Strategy. And like John and Chris mentioned, we were in the process of a resource acquisition, and we were also in a process of required deadlines to complete resource strategy analysis for different commissions. What I'm going to present today is what our resource strategy looks like today. This includes the acquisitions that Chris had mentioned both at Columbia Basin Hydro and Kettle Falls, they also include other acquisitions we made in the last year as well, which have been talked about with the Chelan County PUD. Again, this is.

**Hermanson, Lori:** Hey, James, are you showing your slides?

**James Gall:** I thought I was, am I not?

**Hermanson, Lori:** It might just be me, but I'm still seeing Columbia Basin Hydropower.

**James Gall:** OK, alright, that's not good. I will try again.

**Shawn Bonfield:** James, we could see your slide.

**James Gall:** OK.

**Annette Brandon:** Yeah, I could see it. Also, the Placeholder Resource Strategy slide.

**James Gall:** Perfect. OK, hopefully. That got on to everybody's now.

**John Lyons:** Also, James in the meeting chat, there are some notes from the project developer about the facility and feedstock in there.

**James Gall:** Excellent.

**John Lyons:** Doug, if you want to take a look at that.

**James Gall:** OK, let's get into this and feel free to interrupt me, ask questions. We know we only have two hours, but I think there will be a lot of questions on this presentation and I'm sure the next one as well. If we get too behind time, I'll try to run through this, but I don't want to prevent anybody from asking questions.

**James Gall:** And I'll skip through the Safe Harbor statement, but I will briefly talk about other caveats because they are important in this type of analysis. First, I've already mentioned this and you're going to hear this multiple times, this analysis is going to be redone once we have the All-Source RFP results. There are a few other caveats you got to mention when we're talking about resource strategy forecasting and one thing is in an IRP, we're looking at new resource options. But when we actually go to acquire resources, you may have noticed that existing resources, at least in our last several RFPs, come in

at a lower cost than the new resource options. And there's also less risk involved with those resources. You don't have the construction risk and the counterparty risk of those resources. So, there are going to be differences between IRP forecasts and what is actually acquired.

**James Gall:** Another thing to keep in mind is not all resources that we evaluated in the IRP, even the ones that are cost effective and selected, are even bid into an RFP and when there's not a developer bidding in a type of resource that is off the table because Avista is typically not in the business of developing assets, at least not in the last 20 years outside of upgrading existing facilities like at Kettle Falls. Another thing to keep in mind is we may not be able to retire or exit resources as the modeling dictates because of contract limitations. Also, the IRP is looking at resource needs based on state level resource requirements, but our current regulatory system is that our resources are allocated based on historical share of load. The resource decisions that you see in the next few slides are by state. But when it actually comes to regulatory recovery and how the system is operated, those resources are shared resources or system resources. There's been a lot of discussion in past IRPs if we should look at different allocation methodologies.

**James Gall:** But for right now. Any required resources are a system resource. The last statement we're going to be talking about rates a little bit today. We typically only forecast power supply rates. But you also have transmission, distribution and general expense that is going to have to be escalated to come up with a real rate forecast that's used to do some of our incremental cost analysis. And while it says that's at 2% a year, that's the typo that is needs to be updated to I think it's a little bit over 3%. We'll fix that in the final slide. And just a quick reminder, while we're showing rate forecast, this is not a specific rate forecast because what we're trying to illustrate is average rates. Average customers, not particularly residential, commercial, or industrial. So that is for more informational purposes than anything. Alright, so to get started I just want to remind everybody about our capacity and energy needs.

**James Gall:** And this is representing the work that was shown in the prior TAC meeting plus the acquisitions for Columbia Basin Hydro and Kettle Falls. We still have a resource deficit need beginning in 2026 in November after our Lancaster contract expires. You can see on the left side is our capacity need and on the right side is our energy need. What we show in the left is three or four different months for capacity and what we're reflecting here is to satisfy need for the peak load. It shows here in January the driver of our resource need followed by August prior to Columbia Basin Hydro being selected. January and August, we're kind of a dual resource need but now that the January need is significantly higher. We still need power in other months as well. You can see in April, we're actually long until the late 2030s. Typically that's hydro runoff and we have more capability and lower loads on the energy side, it's a little different than capacity where capacity is looking at one hour peak needs, energy needs is the average month, so we're trying to make sure we have enough energy created over that month to supply our customers adjusting for risk.

**James Gall:** Again, like the previous chart, it looks very similar with a couple exceptions. One of the similarities is April is in that Q2 month, Q2 months are long for a period of time, but the other months are significantly short beginning in the end of 2026. We will be looking for resources that meet these need profiles. So, making sure we have resources that can produce capacity or peak needs in both winter and summer, but also producing energy in all of the different months as well, but that are needed and preferably less energy and in Q2. Another quick reminder before we get to the resource strategy is what our CETA goals are.

**James Gall:** And this chart is trying to illustrate the percentages of primary compliance and alternative compliance needed. Currently Avista has an agreement for these percentages through 2025 of clean energy to meet it. As a percent of our net retail load between 2026 and 2030. Those are proposal requirements and will be settled during a future Clean Energy Implementation Plan process. Between 2030 and 2045, those are the minimum requirements we're proposing as well. The final values on those will probably be settled in a future CEIP process as well, but those are the planning targets. We're assuming there's still some rulemaking that needs to be completed to determine what qualifies as primary compliance.

**James Gall:** Our renewable resource and what is alternative compliance we've talked about in previous TAC meetings, how we're going to handle this until there are official rules. Our current assumption is that any production of clean energy that is above our Washington retail load for a given month would count as alternative compliance or a REC purchase would count as alternative compliance. But all other clean energy would count towards primary compliance, and there will be some discussion about that written up in the Progress Report that goes out in a couple weeks if you want more details on that.

**James Gall:** Getting into the resource strategy, we're going to talk a little bit about the Named Community Investment Fund. You may remember if you followed our Clean Energy Implementation process, we were going to set aside about 1% of revenue requirement towards investments in our Named Communities that were identified in the CEIP process. And that's a little bit of a challenge from an IRP perspective because we're trying to forecast new resources and there's this unknown factor about how those dollars will be invested because they're supposed to be a partnership with the communities to try to figure out what and how those are best used. That funding may not actually go towards energy projects that are directly impacted by the IRP. We tried to strategically think about how much of that funding could go towards projects for energy resources, type of projects. What I mean by energy resources is what can affect our resource needs so one of them that's definitely called out in the Named Community Investment Fund is close to \$2,000,000 for energy efficiency. The intent is that this \$2,000,000 is to be spent on additional energy efficiency beyond what is cost effective. That is something we can actually directly model in this IRP, and we've done that where the model will figure out what is the most cost-effective energy efficiency and then we can tell it to go and acquire an additional \$2,000,000 more per year of energy efficiency. That results in about 2.4

extra GW hours of energy efficiency through 2033, it's about a 7% increase and you may think that's not a lot of increase. That's true and I'm going to get into why. That is because when you're trying to get into higher levels of energy efficiency, it costs more for less savings than the rest and we have a slide on that later and illustrate why that is.

**James Gall:** In addition to that, we found that we can set aside dollars of our 1% towards community solar based projects or distributed solar and storage projects. And what we found was the best cost-effective way to serve these communities is to use some additional funding from the low-income community solar program that is available in the State of Washington through 2033 where there's funding to pay for most of the cost of solar. We think about 700 kilowatts of community based solar could be added per year between 2024 and 2033 with that funding. And then after 2034, when the funding goes away, if it does go away, there would be smaller community solar projects. And the intent here is that these community solar projects would be designed in a way that the value streams of that community solar is used to offset the lowest income customers. We're going to talk about that more later when we get into the CBIs and energy burden. Stay tuned for that. There will also be quite a bit of additional funding beyond these levels that that the Equity Advisory Group may select to pursue, but we don't know whether or not they're going to affect Power Supply needs. When projects come online, we'll incorporate them in our planning. Until then, we're just going to set aside a dollar limitation to our analysis to depict the best cost-effective programs for the dollar limitations and see how that transpires. I'm going to pause if there are any questions on this slide or comments.

**James Gall:** OK. And I just want to make sure this is clear. This is for Washington and not Idaho. Just to be clear. OK, so this is a bonus slide. It's not in the slide deck to talk a little bit about why energy efficiency has changed. Why it gets more expensive and less return for energy efficiency than we just talked about in the previous slide.

**James Gall:** This is a technical meeting, so we're going to have a fun technical chart, and this is a reminder for those who've maybe taken microeconomics, but this is what's called the supply curve. And we have a demand line. This is illustrating the amount of energy efficiency available in our potential study between our last IRP and this IRP. The orange line is the previous IRP, and the black line is this Progress Report. Our potential has shifted to the left, so that means there's less potential available to us and our avoided cost, which is where that is on the left side, or I should say we back up a little bit. Sorry. So how this works is that this chart is moving from cumulative energy efficiency and then as it steps up, that is the price of that energy efficiency or cost to our customers to what's called a TRC. And we don't need to get into that. When the model selects energy efficiency it is looking at alternative costs. So, you're trying to look at a price. Let's just use \$100 for example. And at \$100, that's where that black line approximately crosses the other black line, that amount of energy efficiency would be cost effective. If you go to the orange line, you can see that those two lines cross around \$125.00. So, we've seen two changes since the last IRP. We've seen a little bit lower avoided cost and we've seen lower potential, so we're seeing lower energy efficiency. Another thing we're noticing is,

like I mentioned before, when we talked about the low-income potential, when you spend more, it gets more expensive. So, you're starting to get into a steeper point of that curve. When we looked at spending an additional \$2,000,000 for low income solar, you're not getting a lot of extra potential because those costs are greater than the programs that we're already implementing.

**James Gall:** Getting to the results for Washington and Idaho, here are some examples of the energy efficiency we found that are cost effective. Most of the energy efficiency is in space heating and cooling, followed by industrial motors and exterior lighting, that's where a majority of our savings is coming from. From Washington point of view, it's a little bit higher energy efficiency savings potential as a percentage of load compared to Idaho due to higher avoided costs in Washington compared to Idaho. But I'll leave this chart there for you guys to take away later today and look at if you're interested in different technology types that are cost effective. This one is the same data but carved out a little bit differently. Looking at the end user for the energy savings.

**James Gall:** Where you can see low income in Washington, low-income single-family homes is the largest saver, followed by industrial and retail. Idaho is retail, single-family homes, industrial, and grocery stores. Another slide. I don't want to spend a lot of time on, but there for you to look at later for those of you interested in our target goals for energy efficiency, we have a two-year target for a 2024 - 2025 biennium. How this target works is you look at your 10-year potential and you take a pro rata share of that, which means it's the average energy efficiency over those 10 years. And for this case, you can see in the green bars on the right that is our annual selection of energy efficiency. We average that and it comes out to about 64.7 GW hours that's going to be required between 2024 and 2025, which is a reduction in potential since the previous IRP. And then how those 64 GW hours, that comes from our resource planning analysis gets translated down to 54 GW hours for the penalty threshold in Washington after we exclude decoupling and adjustments. I don't know if Ryan Finesilver is on if he wants to add anything to that this slide or not.

**Ryan Finesilver:** No, thanks, James. I think you touched on everything that we need to. Really that top line, that CPA pro rata share is the number before any of the other deducts that are somewhat on agreement, or also getting us to the expectation to meet our I-937 requirements, or the EIA penalty threshold which is the bottom line. So, comparison to that CPA pro rata share is probably the number that most would take interest in for this venue.

**James Gall:** Thanks, Ryan. Any questions on the energy efficiency? I think this is the last energy efficiency slide. Fred, go ahead.

**Fred Heutte (NWECC):** Morning, everybody. Fred here at Northwest Energy Coalition. I can't help but observe. And this is not necessarily to ask for a change in this analysis, but I can't help but observe in a week when we have both EIM and Mid-C prices above \$400.00 a MW hour, that it might be time to rethink the economics on the customer side.

Resources, especially energy efficiency and demand response. Just saying we're being dragged into a new era here and it's not very comfortable.

**James Gall:** Yeah. I'll have a quick response to that. I agree with you Fred. The market today is definitely a little bit of a challenge for those of you that may not be following day-to-day markets, natural gas prices on the western side of the state are radically high levels we've never seen before in pricing, and it's related that to the energy market as well. One of the challenges within IRP forecasts is short term dynamics. Going to continue forever, part of this analysis where we are assuming that gas prices do return to normal, power prices return to normal, but that may not happen because we're assuming utilities will build resources to make sure this doesn't continue to happen. But like you've stated Fred, it may not happen.

**Fred Heutte (NVEC):** Yeah, well gas at \$40 a million BTU is definitely not quote unnormal and there's a lot of questions I have about why it happened because it's not that cold. I mean it's going to be cold later this week, but it's not even close to historically cold and we've had some cool weather over the last month, but that happens too. Why is the market so sensitive to this? There are lots of factors there. I think we're going to find out more. But for me, the real issue is what is normal? Many more also has changed. It's not \$3 per million BTU and you know that directly effects market prices and sets an outer bound on cost effectiveness. Now it's going to be double that probably you know that. Henry Hub Price has been around a \$6 to \$8 range and seems to be staying in that range right now. That looks a lot different than the planning models have shown up to now, and some point I've been raising for a long time that we should be ready for this kind of period. It might only last a couple weeks. This particular moment with these super high prices might only last a week or two, but then added up, if we have a whole winter like this, that's a whole different situation. Just what I'm really trying to say is I think we need to rethink our views a bit and not just about energy efficiency and DR but across the board about what the interaction is between utility resources and market needs or market opportunities. I'm not asking you to rewrite the IRP obviously right now, but this is an important point we got to think about. Thanks.

**James Gall:** Yeah. Thanks, Jim. You have your hand up. Go ahead.

**Woodward, Jim (UTC):** Thanks, James. I had a pretty quick clarification question around the slope on the line on the graph, the 64.7 and I think just to confirm you basically said that's your regression for the energy efficiency between 2024 out to 2033.

**James Gall:** Yeah. So, 2033, that is for each in the green bar that was selected by the model and then the black line represents the pro rata share. Because the selection is not linear, there's a little bit of a curve in there you can't see, but the state law requires a linear interpretation of that curve. We have to go with a higher amount than what would be selected due to how the state laws or rule is written.

**Woodward, Jim (UTC):** That makes sense. Thanks for clarifying. My second comment was for my understanding and for other folks on this call probably, but admittedly at a high

level, the story you're telling is this is somewhat analogous to what I think we've heard a lot from the Power Council since their 2021 plan came out around energy efficiency is getting more expensive and there's less bang for the buck across the northwest. Is that a good sort of benchmark that this isn't just Avista unique? This is what we're increasingly encountering across the Pacific Northwest.

**James Gall:** Ryan, do you want to respond to Jim's statement?

**Finesilver, Ryan:** Hey, Jim. Yeah, I think you hit that correctly. We are seeing that shift. I'd say you're correct, I do want to clarify though within the context of this being a company resource is where we should really be looking at this. Our commitment to providing customers with energy efficiency options doesn't change our approach. We still want as many customers to participate as possible and we are continuing to pursue all cost-effective conservation and that means we are looking at our incentives and we know that inflation is a thing and we've seen a 20% cost increase in just equipment in general. We are continuing to look at our annual plans in the context of making sure customers, we're addressing that first-year installation cost. We're continuing that commitment. When we're talking in this concept, when we hear energy efficiency is decreasing, it's in a resource context.

**Woodward, Jim (UTC):** Thanks, Ryan. Helpful and thanks for confirming my sort of analogy argument I used just a minute or so ago.

**James Gall:** All right. Are there any other questions before we move on? Alright, one thing to think about is the energy efficiency selection and quantities as we work our way through. When we add the additional resources from the RFP, I don't anticipate the selection amount being too materially different. There is a chance it could slightly decrease as our avoided cost of capacity may lower as we acquire resources that pushes out a capacity need longer. But I don't see a significant change to these numbers when we finalize these in the next couple months. I think I left this slide in there as well for those of you interested in avoided cost and this is showing both Washington and Idaho's avoided cost and how they're calculated. I don't want to get into the details just because of a timing point of view, but I'll circle this back to that supply curve. Our modeling looks at these costs when it's selecting resources and some of these costs are direct inputs as benefits and some are indirect benefits when it's choosing between energy efficiency and other resources. Really think about is if you're trying to compare how much we could get even if there were higher avoided costs. Let's just say that \$100 avoided cost is where we end up, which is approximately what Washington is, we take that line and follow that across. Now we're getting around 500 GW hours. Last IRP that was maybe 625 [GWh], so that potential is declining. Like I mentioned before, that avoided cost, we were probably around \$125 last time. We're at about \$115 this time with the capacity and some of that reduction has to do with how we're looking at social cost of carbon savings for energy efficiency and that's reduced since the last IRP.



**James Gall:** OK, let's move on to demand response. We've seen a little bit of change there and there are some updates since the last IRP on demand response as well to talk about. First off, we do have 30 MW industrial demand response program contracted for, and as Fred mentioned with prices as high as we have seen today, I'm sure that resource is contemplated and possibly used. We're also exploring opt in pilots for time of use rates and peak time rebates. There's a public process currently in progress to set those programs up to begin in 2024. If you're interested in learning more about those and want to be involved, please e-mail us and I can get you in contact with Leona Haley who's running those programs. And we're also going to be starting up a CTA 2045 water heater pilot as well. That was a commitment from our previous CEIP. We'll probably have a public process to be involved in that one as well I would imagine. Leona, I don't know if you're on, if you want to say anything on that process or not.

**Haley, Leona:** Hi everyone. Leona Haley. I work in the energy efficiency group with Ryan and thanks James, I think you said it well. We are in the development stages of these pilot programs and working closely with our stakeholders to iron out a lot of the details and nuances. We are looking at the end of March for our final design for the pricing pilots. And maybe some sort of a design for the water heater program as well as we work with others in the region to try and get cost down.

**James Gall:** Thanks Leona.

**Haley, Leona:** Thanks.

**James Gall:** In my forecasting ability the resources we have as options is about 16 different programs we evaluated. Only one of them was found cost effective. That's the time of use rates, peak time rebate and variable peak price, the next two on that list looked like they could be cost effective. I think really what's driving the reduction in demand responses are forecast of how much these will help us contribute to peak savings in a future world where there's significant variable resources. But right now, it looks like just one project selected when we get all the additional resources, we'll see how that changes. But Fred, you have your hand up. Go ahead.

**Fred Heutte (NVEC):** Yeah, just a quick question about working with others on, I think it was about the letter here, program costs. Just curious what you're doing and who are the others you're working with because that's a big issue for a lot of us around the region right now.

**Haley, Leona:** Right, yes, absolutely. We had initial conversations with Portland General when Portland and Bonneville Power did their initial study. The cost estimate for the utility provided communication device to fit into the water heater or the portal was significantly less than what we're seeing those costs now. That's one of the main issues and there are advantages in purchasing power when you can go in together and buy a larger quantity and spread it out amongst more utilities.

**Fred Heutte (NWEA):** Yeah, I'm talking with NEEA about exactly those issues and it's a chicken and egg thing to some degree because these are, I presume you're talking about chip costs and other kinds of electronic costs. And of course, they're all having supply chain issues. But this is new stuff. And getting the cost down requires a bigger, more orders, so that they can scale that up. We don't have that. Works because it's for all kinds of electronic devices. These are the issues when you're developing something new. Anyway, it would be interesting following up with you about that because we all have an interest in trying to figure this out and get to the extent we have across our region, some purchasing power and bring the cost down, that would be a good thing to coordinate on.

**Leona Haley:** Yeah, sounds good. Let's follow up. Thank you.

**James Gall:** Alright. Any other thoughts on demand response? Otherwise, we'll move to supply side resources. Alright, so I apologize for the complicated chart here, but this is a good table by state of the preliminary resource selection. We model 2024 through 2045, and on the right, I have some summaries for over 10 years. But we're looking at is, like I've mentioned before, we do need new capacity resources in 2027 and based on the requirements for Washington. And for Idaho, we see an interesting difference in selection. Washington there is definitely a renewable energy storage lean to the resource selection and then on the Idaho side more natural gas. The early years and long-term duration storage in the later years I don't want to focus too much on the early years because those are going to be replaced with actual resources offered to us through the RFP process, but I'd rather focus on the findings from the later years because you're likely to see those selections be similar and then in the outer years, the interesting thing is that significant amount of renewables are needed beyond that 2035 period for Washington to meet CETA, particularly to get closer to that 100% requirement in 2045. You can see in 2045, there's a significant need compared to the previous years. Now whether or not we would get all those in one year, that's something to be said yet, but we would expect we no longer are able to serve Washington with our Coyote Springs plant that's 300 megawatts or more than on a cold day like we have today. But there's going to be a significant capacity and energy need to replace that resource at that time.

**James Gall:** The other thing that's very fascinating in the results is this long duration storage selection, where our modeling really focused on two technologies selected that are really not commercially available today. One of those is iron oxide and the other one is ammonia-based storage. Those two resources are the ones that make up long duration storage, that's 700, 800 megawatts. Of this total, over the next 24 years, 700 megawatts of our portfolio is based on technologies that we've not seen in commercial scale yet, but they are out there a number of years. If they're not available, we're going to have to look at other alternatives. Short duration storage right now is the only other option to capacity needs in that long term duration or long term needs to meet the CETA requirements in Washington.

**James Gall:** There is some risk if those technologies don't come around, how do we get to this 100% in Washington requirement. Another couple things to mention, the amount

of renewables selected. There's definitely a bias towards wind in our resource strategy. Some of the wind selected are renewals of our existing PPA contracts. But we will need additional transmission to bring on these renewable resources and that's going to be discussed in the next slide. I see a hand up. Go ahead.

**Sashwat Roy (RNW):** Hey, James, this is Sashwat with Renewable Northwest. Can you hear me?

**James Gall:** Yes, I can go ahead.

**Sashwat Roy (RNW):** OK. Thanks. First a question on your comment on the fact that the short term, the near-term results could be overlooked because of the RFP. Could you talk about how in terms of the years that kind of pans out here? So, looking at the 2027 gas build out in Idaho, does that change with the RFP results coming in or I'm just trying to think about which year do we talk about in terms of the?

**James Gall:** I'll try to answer your question without getting too specific. The intent of the RFP is to find resources that can meet our energy needs and capacity needs through at least 2030 and obviously those resources will continue on for a period of time. There will be resources selected that will replace the resources selected here. There could be some similarities, it could be some differences. I don't want to get into that. But, like I mentioned before, in those caveats, those are real caveats. There are existing resources out there that we model that didn't get bid. We have a list of resources that were bid into the RFP by technology type and location on our website that might help you with some indication of what's going to replace these. At the next TAC meeting, we'll go into what resources were selected and how that changes the results as well. Keep in mind, the IRP planning requirements are different than acquisition requirements.

**Sashwat Roy (RNW):** Yeah. Thank you.

**James Gall:** In Washington, you may know that in an IRP you have to use social cost of carbon for resource decisions and actual acquisitions. It's more of what is the plan, what are the requirements and your operations that could be the CCA or if they're depending on how you read that law, there's differences. We also have to manage a system where, remember in an IRP where we're selecting resources by state and currently we don't allocate resources by state in the same way an IRP does. There will be an area of discussion I think for this utility in the next several years, how do we navigate two different state policies? Those are things we're going to wrestle with.

**Sashwat Roy (RNW):** That's really helpful. And just a final question on whether you're planning to present on the WRAP obligations or the Western Resource Adequacy Program, where Avista with regards to if they plan to join the 2025 compliance for the binding season. Where Avista is in terms of that? Is that something on the agenda for the next TAC?

**James Gall:** It's not on the agenda. We could briefly talk about it now. I don't know if Scott Kinney, if you're available to say, maybe a quick word or two on the WRAP.

**Scott Kinney:** Sure. We are committed to the program. We think the program does provide value to not only our customers, but the region as a whole. We've been asked by the end of this year to, pending FERC approval of the tariff which is ongoing, to formally commit to the full program with an indication of when we would choose to join the full binding program. Participants have a choice to join the full binding program as early as the summer of 2025 and as late as the winter of 2028. As each participant signs on to the full program by the end of the year, they will be indicating what their preferred season is to go binding, and so I think after that, after we get an indication of who's going to participate and when they will go binding. I think people will then reassess if there is a critical mass to start the program earlier if those participants choose to do that. There is an opportunity though to change your binding season. So, if someone were to commit to the summer of 2025 for their first binding season, they actually have until May of next year to change that season again. Depending on how many other participants are agreeing to go earlier or not. That's where we're at in the process. We're currently evaluating for us when is that first binding season, when is it preferred for us. We'll make that selection and sign on to the program by the end of the year.

**Sashwat Roy (RNW):** That's really helpful. Thanks, Scott and thanks, James.

**James Gall:** Alright, so just a couple last words on this resource strategy. It's mostly used for this energy efficiency potential for this report, but it will get replaced and we'll have a final resource strategy. But another thing I wanted to mention since you brought this up on the QCCs or the WRAP. We are using WRAP methodology for resource planning until we have a binding program in place. We will continue to use our similar planning margins that we have done in the past. Think about that as there's an accounting mechanism of how you account for resources or WRAP is created and we're using that process. But the level of resource need that the WRAP will bring that is not included yet at this time. We also have to forecast how we think resources are going to qualify for capacity in the future, so there with this movement towards more variable energy resources and storage, it's anticipated that the QCC values that are in place today for say a storage resource or a wind or solar resource will be lower in the future and that was an area of discussion in the last IRP meeting we had, how we're going to deal with that and what our solution was to that issue.

**James Gall:** We looked at a regional study that was done by E3, that's publicly available, looked at a reduction in ELCC values for the region and we're using those reductions for this analysis. You'll be able to see those specific assumptions in the report that will be out in a couple of weeks. That's probably the main driver I mentioned earlier on why not a lot of demand response is selected because of the expectation that there's going to be a very low ELCC value for DR in the future.

**James Gall:** I want to talk a little bit about transmission, and this is an area that the IRP is not spending a lot of time on and frankly for the reason before, because there wasn't necessarily a lot of transmission needs to meet. The resources that were selected in previous IRPs that really has changed in this IRP. We've always looked at interconnection

costs in prior plans and which we did today, but we're starting to see that the quantity of resources selected really will require substantial long term transmission needs that will take years to build.

**James Gall:** First off, the model typically picks off system resources to avoid, substantial local transmission infrastructure upgrades. For example, you saw that in the previous slide, there's some Montana wind selected. There's also some transmission or sorry, some resources that may come on through Bonneville, but at a certain point of time in that later 2040s, those resources are likely to meet our capacity to import. So, we will likely need to build new transmission within our system to bring renewables in. What we're seeing is that Big Bend area is the likely area for new resources and then also Rathdrum area could need upgrades as well if this long duration storage idea works out.

**James Gall:** That's really for the 2040s, but in order to get a multimillion-dollar transmission projects completed, it's going to take decades. This is something we need to start looking at now is how we can integrate those future resources. The other concern really also is even if Avista doesn't select those resources, other utilities may and that could force our ability to need more resources early from a competition point of view. Or other utilities could be looking at resources within our service territory, so transmission is definitely a need. The other thing to think about it is not on the slide here. The amount of renewables on our system. Do we have enough transmission to export that extra power when we don't need it? We do have available, Bonneville Power, we could acquire on a short-term basis, but we need to look at do we have the proper access to markets whether it's Mid-C or others for power when we are long. Go ahead Jim, you have a question.

**Woodward, Jim (UTC):** Thanks, James. If possible, would go back to your demand response discussion on the prior slide.

**James Gall:** Yep.

**Woodward, Jim (UTC):** Just wanted to clarify, you mentioned an E3 study regarding perhaps why DR may not get picked up as much as we would think, and this question goes to benchmarking Washington's various IOUs. Just wondered what E3 said. That was because for Puget across the mountains, there wasn't another E3 study done, perhaps a separate one, and the results were opposite that DR values went up significantly. Just trying to benchmark how we're getting reverse trends here potentially.

**James Gall:** OK. Interesting. I'll walk you through how we think QCC would work. First, what we're seeing is if you had a 6-hour program in the WRAP you would qualify for 100% QCC. If you had 10 megawatts of savings, that's where 10 megawatts if it lasted 6 hours. If you lasted 4 hours, you would get 4 out of the six, so  $4 / 6$  times 10 megawatts, that's your savings. But we know that from other work we've done, short-term reductions don't necessarily lead to reliability because you still have loads and other hours and you're basically shifting load around. The E3 study I'm referring to is one done for the region in 2019 and we'll have references of that document, but that was a regional study. They looked at an ELCC analysis as you bring on additional DR, additional storage, and

additional wind and solar. We'll have a reference in the document, but it's the Northwest study in 2019. I think if you just type in those keywords, you'll find it. But I'm interested in that you're finding the Puget study had increasing amounts, I wondering if that's for their system or if that's a regional analysis. I'm curious that you brought that up.

**Woodward, Jim (UTC):** The only thing I might offer right now is that Puget E3 study, I believe timestamp wise was later that was regarding that company's 2021 IRP. You referenced 2019, there might be again a year, year and a half lag there. I know that again don't follow-up as closely, but there was a lot of activity around there revising ELCC values near the end of their 2021 IRP process. Again, this study is probably late 2021 versus your 2019 study.

**James Gall:** One thing to think about, we're trying to replicate what the WRAP will want us to achieve from a reliability perspective. And my hope is that the WRAP will conduct these studies in the future so that we can have something to plan to. But this is going to take time. I appreciate the comment and we'll look into that one. If there are other regional studies that forecast QCC values over time, that would be appreciated as well for the next round of this process.

**Scott Kinney:** Hey, James, this is Scott. Can I just add in a little bit because there's been a lot of conversation around this specific subject with the WRAP development. SPP has been hired as our program operator and they've committed to do some further analysis specifically around demand response and the ELCC methodology. I think the intent is to try to have those results within a year. To help inform that specific program, so just some additional information.

**James Gall:** Yeah. Thanks, Fred. Go ahead.

**Fred Heutte (NWECC):** I'm actually on the WRAP Program Review Committee, so I think we'll have some role, I guess, in looking at all that going forward. I have to say I am rather skeptical about the ability of ELCC to effectively represent the real value of the kind of time shifting resources, energy demand response and storage. ELCC has a lot of complicated aspects to it. I'm not saying it's not possible, but I'm concerned about that. So, we don't really have a drop-in replacement. As I've said for looking at those issues. But I think it needs to be an open question, but I think also that seeing what comes out of the WRAP process will be a pretty important thing to track. Thanks.

**James Gall:** All good points. I'll keep this in mind just from a perspective point of view with the resources we're acquiring, we're likely capacity sufficient through in the next 8 years, if not longer. We have time to figure this out. Obviously, we want to make sure we plan to make the right decisions for after that period. But I don't anticipate needs immediately to implement.

**Fred Heutte (NWECC):** If I could add one more point to that, which is the context is really changing. You already got the aim, which probably is not a real factor here. But with the potential of going into a day ahead market in the near future, whether it's EDAM or the

SP Markets Plus that also will change things. To what degree in the future that DR and storage support Avista's selling and the WRAP program, as well the operational period, those are things to keep an eye on. I guess I'm saying, we all recognize things are changing and Avista has some real opportunities there.

**James Gall:** Thanks Fred. Alright, some more results to show and then we'll try to transition to the CBI results. From a CETA perspective, this shows how we meet the CETA, I can't call it obligations, we don't necessarily have the official rules on that, but how we modeled it. This is showing the amount of primary and alternative compliance of how we model it. You can see in the green is the primary compliance where we're exceeding the requirement, and in the early years at least the current plan is to sell off those RECs. To other entities as we described in our CEIP. And then as we approach the later end of the plan, we will actually have to substantially extra resources because we're trying to acquire renewable energy in months where there is not a significant availability. So, you actually are adding more renewable energy than needed to meet the law. That's what I mentioned earlier about can we access markets to sell off extra power. Because we see in this 2040s to 2045 time period where we'll have significant extra power to lay off of our system. Fred, I still see your hand up. If you have any comment.

**Fred Heutte (NWECC):** No, I forgot to put it down because you have to do this extra little step. Teams is wonderful, isn't it?

**James Gall:** Yes, it is. Alright. So really quick, the last thing I want to talk about is cost cap analysis and this is more of a plea maybe to our folks listening from the Commission, because this is going to be an issue we're going to have to figure out over the next coming years. The first thing is in a cost CAP analysis, we're required to compare our resource strategy in a CEIP setting rather than an IRP setting. What's called an alternative least reasonable cost portfolio. That's a mouthful. But my real question is, as this is really again just something to think about as we march through time, what does this portfolio look like, how do we define it? There's no definition necessarily. And then when does an alternative begin? The issue I'm seeing here is if we created an alternative least reasonable cost portfolio today, we would be looking at, not you know what that scenario is, what resources would we pick when we don't have a CETA world. I know there's requirements, you still have to have social cost of carbon, you still have to not include coal, but we probably would be building less renewable resources. We would likely be building natural gas turbines, but that part is understood. But when does that begin? Because we've already made choices for resource acquisition that are likely different than what we would have made otherwise that have added cost to our customers to comply with future obligations. Should we be looking at this alternative least cost portfolio as what our resource strategy maybe was in 2019 or is this something that you changed to make it look like what it would have been in that realm when you exclude our resources that we may have acquired already?

**James Gall:** Anyway, these are issues we need to think about because you get a different result depending on what resources are included, because if you're already including

resources that are higher cost in your base when you're calculating the 2% cost, cap, your true incremental cost is going to then be way above the 2% cost cap because you're increasing your base level cost. As an illustration, I've got a cost cap analysis for this resource strategy. The only resources I didn't remove or only resource I should say I removed was the Columbia Basin Hydro that was just signed, but should we be removing our Chelan deals as well?

**James Gall:** But what we're seeing is in that methodology, we're not approaching the cost cap, but in that 2042 to 2045 period, that number shrinks quite a bit. You see \$31 million there. I'm not sure if the cost cap will be looked at from 2042 to 2045 or if that's going to be 2045 in the future, but there is going to be probably cost cap pressure in that 2045 period based on the resource strategy we see here. Depending on how we define it. I do see maybe other utilities rather than Avista, this could be a bigger issue for them, but I don't see a need to figure this out, at least for Avista until later, but it's something that think about in the rulemaking process as we go through CETA. So go ahead, Jim, you had a comment.

**Woodward, Jim (UTC):** Thanks James. And Full disclosure, when I read the draft slides, these couple slides, I figured we're going to, as you introduce them, nudge for Staff reaction, Staff's response. So, I did research to confirm perspectives here a bit if you want to go back to the last slide.

**James Gall:** Sure.

**Woodward, Jim (UTC):** Again, speaking for Staff, especially really for Jim Woodward here, never the Commission, but I don't know if you're going to like this, but I see a couple questions here as far as the alternative portfolio. There is a definition within the IRP CEIP rules, this is WAC 480-100-605, and it references, essentially the 2030 and 2045 standards. And if those were in alternative universes kind of go away, how would the portfolio change while still counting for other others like the social cost of greenhouse gases? So that was my, high-level attempt to address that definition question. You're probably tracking that already, but I just figured I'd refer you there probably. I'll pause, is that what you were getting at or were you deep diving further into that first question?

**James Gall:** It's further into that and that part I get very clear but it's more of when does that begin. Think of this scenario, we acquired Chelan PUD resources, as we are acquiring other resources that are renewable and if we had done an alternative resource, can you make the argument those resources are required, likely CETA, or at least the pricing was result of CETA, and how those are arranged? If we did not have CETA, would we have made those decisions? I don't know that answer. Would we have paid the price that we did? I don't know that answer, but those past decisions, when you build those into your alternative case at higher costs, reflect a lower cost cap than what would likely be without CETA. And that's the concern I have is that the cost cap calculation is overestimating the true cost or just well it's underestimating the incremental cost of those resources. Because if the portfolio you're comparing it to already includes all the choices



you made to comply with CETA, you're overestimating how much resources you already have in your base portfolio. This might be too much detail for this, but it's something we need to think about in a workshop setting in the future.

**Woodward, Jim (UTC):** Sure. I'll get to the cost cap or phrase you used in a moment. Let me know, it's 10:22 and you have until 11:00 o'clock, if this is the best forum or not. As far as that, where does alternative begin? Again, just Jim Woodward for Staff. But. Based on the IRP CEIP rule making, the adoption order in 191023, we see things differently. And when I say differently, what I was tracking with your description, which was helpful was a decision point maybe back in 2021. And the two portfolios especially alternative portfolio remains somewhat constant, and the delta essentially caught the incremental planning cost increases. The adoption order seems to get at that. That's likely not the case that you have, subsequently decision points, let's say in 2023 and 2025 where you reevaluate your alternative LC portfolio such that, and I agree with you, or I hear you that that potentially would mean that the delta over time remains lower than it would be in the scenario you described. But again, I can send you a couple paragraph references that our interpretation of it seems to be more that it's dynamic, that you reevaluate the portfolio. You don't just do it in 2021 and then keep that going for the 25 years. Do you see where I'm coming from there, because it seems like that's running counter to what you're describing here.

**James Gall:** Well, I would say what you describe, and I don't, maybe we should pause here. I'll say one thing before we move on what you're describing, I guess creates a scenario that we will be exceeding the cost cap based on selection from a theoretical point of view, because you're basically increasing your alternative cost. To justify being below it, and I'll stop there. Alright, let's move on.

**Woodward, Jim (UTC):** Sure. I will come in through your use of cap. I understand where you may, perhaps, why are you using cap? However, this is another thing, the adoption order is pretty clear and I'm going to actually use some specific language from that order where this incremental cost, planning incremental cost calculation, it's not a strict cost cap. It's more of an alternative pathway for compliance. Thinking of that as a cost cap may have some unintended consequences. I mean, I do want to just flag the use of cost cap because Staff understanding based on the adoption order should be interpreted there. There's a lot of context there and using it as a hard and fast cost cap may not be the way to go, and this may be playing out at other dockets and you know, just leave it. Leave it there. Again, this is a technical advisory committee. I just wanted to bring this forward because we do talk about technical topics here, but you're under time constraints, whether we want to table this and move on and figure out another time to hash this out.

**James Gall:** Let's do that.

**Woodward, Jim (UTC):** I'm open to it.

**James Gall:** We'll follow up after the new year.

**Woodward, Jim (UTC):** OK.

**CBI Forecast, Mike Hermanson**

**James Gall:** Alright, let's move on to CBIs. I know there's a lot of folks interested in that. Mike, are you? Did you want to share your screen or how do you want to proceed with this?

**Hermanson, Mike:** Yeah, I will do that.

**James Gall:** OK, I will stop sharing.

**Mike Hermanson:** OK, I'm going to be going over how the Customer Benefit Indicators will be impacted over the planning horizon by the preferred resource strategy. So CETA requires that utilities ensure that customers are benefiting from the transition to clean energy through the equitable distribution of energy and non-energy benefits and reduction of burdens to highly impacted communities and vulnerable populations. To do that in the context of our IRP planning process and the resource strategy, we assess the progress of meeting these goals by establishing Customer Benefit Indicators in the Clean Energy Implementation Plan. Avista's CEIP identifies 13 CBIs and there was a 14<sup>th</sup> that was added during the approval process. Seven of the CBIs have elements that can be forecasted based on the Preferred Resource Strategy. Those are the number of households with a high energy burden named community clean energy investments and investments in named communities, energy availability, energy generation, location and outdoor air quality. And then greenhouse gas emissions.

**Mike Hermanson:** The first one is high energy burden and high energy burden is annual energy cost that exceeds 6% of annual income. To estimate the energy burden of Avista customers, we have census and third-party income data, and we can associate that with customer usage and the billed amounts that these customers have each year. And then we can determine, along with the income, whether that exceeds 6%. We can do that in the current period and then we can forecast future energy burden by estimating usage over time for those customers taking into account the low-income energy efficiency programs, we can then forecast income using historical income growth according to income levels, and then we can also forecast energy costs from rates that are projected with the Preferred Resource Strategy. With those forecasts, we can estimate the number of customers with an energy burden that's in excess of 6% for each year of the planning horizon. Between 2024 and 2045, the number of energy burdened customers increases from approximately 46,000 to about 52,000. This increase though is commensurate with the customer growth. So as a percent of total customers energy burden customers remains at approximately 20%.

**Mike Hermanson:** The other metric that we can evaluate is whether the magnitude of the energy burden is increasing. This chart shows the amount of energy burden, which is the dollar value above 6% of annual income. That's shown in the orange bars. This amount increases over the planning horizon, but this is in nominal dollars and not adjusted for inflation. The black line shows the amount in 2024 dollars and when adjusted for inflation, the average energy burden above the 6% increases from \$930 to \$1400 annually.

**Mike Hermanson:** The next metric is the amount of clean energy, amount of clean energy distributed energy resources. That's a mouthful. That's located within named communities and put into place. As part of the Preferred Resource Strategy, this chart shows the actual projects and projected annual generation in megawatt hours. Clean DERs includes PURPA generation, community solar and customers with net metering that are located within the geographic identifier. Geographic areas of identified named communities. The actual data from 2016 to 2021 has a little more variation and that's because the forecast we have actual generation from the PURPA resources that we were able to calculate. The forecast uses the five-year average of the PURPA generation plus additional resources from the Preferred Resource Strategy. The forecasted amount shows significant increases between 2024 and 2033. That's from community solar that is supported by tax incentives. And then you see a more modest increase in the remaining planning horizon period.

**Mike Hermanson:** The lower chart shows DER storage and as you can see there are currently no storage DER. There is one project that we are aware of in 2024 and so that accounts for the first 10-year period and then in the period between 2034 and 2045, storage is selected in conjunction with the solar projects. This chart shows the investments in named communities. This includes low income, energy efficiency and community demand response investments. So approximately 90% of the investment is in energy efficiency.

**Mike Hermanson:** On this chart, the utility benefit is the market value of energy and then the non-energy benefits utilize the NEI study and what's been assumed per MW hour as the non-energy benefits and then you multiply that by the amount of energy efficiency you have. The investment ramps up until 2029 and then decreases. The decrease is due to the reduction of energy opportunity, energy efficiency opportunities, as energy efficiency measures are implemented as James discussed previously. As the cost increases and the potential decreases.

**James Gall:** Mike, I just want to add one thing. And then my calculation of this chart, the community solar was included as well, so we need to add that to the bullets.

**Mike Hermanson:** Yep. Thanks for that addition.

**Mike Hermanson:** Energy availability is related to the energy resiliency CBI and it's a measure of the capability of our system to respond to peak demand. The historical values show the amount of energy we were capable of delivering during peak times for each year. Instead of using our peak planning, we were actually able to look at the peak for

that particular year. You can see that in 2021, we have the lowest value for the summertime period and that was the result of the 2021 Heat Dome Peak event. In that particular instance, we still had 10% margin available. But as I said, that's the lowest of the period and in and forecast into future years, the energy availability is measured against our peak resource capability versus our forecasted peak demand.

**Mike Hermanson:** And for many years we exceed our planning margin of 22% in the winter and 13% in the summer. And this is because of our energy needs. Our energy needs drove the resource selection, not the peak capacity, and you can see energy is added during the planning horizon. You can see that the peak capacity needs, or peak capacity ability, increases and then it steadily decreases until more resources are added. Energy generation location is related to customer energy security and it is a measure of the percent of load located in Washington or is connected to Avista transmission.

**Mike Hermanson:** The percentages increase from the in the current period going up through 2026 with the additions of Columbia Basin Hydro and the upgrades at Kettle Falls. But going out the remainder of the planning horizon falls because a lot of the new generation that's added is off system and as James discussed in his presentation, the need for additional transmission to bring that to the Avista system.

**Mike Hermanson:** The next CBI is looking at outdoor air quality and this is specifically related to thermal generation. The thermal generation located in Washington includes Kettle Falls biomass, the Kettle Falls, natural gas combustion turbine, Boulder Park natural gas and Northeast gas. The first chart is sulfur dioxide and that goes to nearly zero over the planning horizon. We did get a change in our emission rates due to getting a non-detect on the last emission testing done at Kettle Falls and we are still evaluating that. But with that last test result, the projection looks like this is going to zero and then looking at the NOx emissions, those are reduced over the planning horizon as a result of decreased emission rates resulting from the Kettle Falls upgrade, but also over the period there's a decreased dispatch of Kettle Falls just due to its price of dispatch versus the market price of power.

**Mike Hermanson:** The next air quality measures are mercury, where you see a slight reduction. VOC follows a similar path as the NOx and it has reduced again due to the decreased emission rates from the Kettle Falls upgrade, but also the decreased dispatch of Kettle Falls.

**Mike Hermanson:** The final CBI is greenhouse gas emissions. The first one we're going to look at is emissions from Avista facilities. This chart shows direct emissions and net emissions. Direct emissions represent the Washington portion of total system emissions, while the net emissions are emissions, net of market transactions. You can see there's a significant reduction in emissions in 2025 when Colstrip is removed from serving Washington retail load. And then you can also see, which is interesting, that over the planning horizon net emissions begin to exceed direct emissions as more market purchases are used to supply Washington retail load.

**Mike Hermanson:** And finally, we think it's important to put emissions associated with electric generation in the context of all greenhouse gas emissions. This chart shows estimated emissions from Avista's Washington service territory associated with AG waste management such as wastewater management and solid waste management. Large sources, such as industrial sources transportation, which includes rail, air and auto transportation, residential and commercial fuels such as natural gas, wood, propane. Then we have electric generation serving Idaho and electric generation serving Washington.

**Mike Hermanson:** The forecast is based on a methodology used by the Department of Ecology in their statewide greenhouse gas emissions assessment, though their assessment goes through only 2018, they're currently working on an update to that which will be out at the end of the year, but it will only go through 2019. We extrapolate their results into the future. This is focused just on the Avista service territory. We have to take the Washington State emissions and then use data to apportion that to the Avista service territory.

**Mike Hermanson:** Going into the future, AG [agriculture] is held constant. The factors that are associated with that we have no reason to increase or decrease over time. Waste management increases proportional to population. The large sources are an average of the last five years, and those values are reported to the Department of Ecology and available publicly. As I said, transportation includes air, rail and auto. The air we increased in proportion to population. Rail is held constant, and the auto forecast we do according to the EV forecast that is part of our load forecast.

**Mike Hermanson:** As you can see, transportation is the largest contributor to regional greenhouse gas emissions. Over the planning horizon, total emissions is roughly constant, but there are changes in the balance of EVs and internal combustion vehicles. To show that I broke that out separately. This chart shows how that changes over the planning horizon. The green bars are the forecast that includes EVs and the blue bars are the forecast if you did not have any EVs and all new vehicles would be internal combustion. The black line shows the growth in EVs and the gray line shows the number of internal combustion vehicles which continues to increase until about 2040 and then by 2045, 28.6% of vehicles are electric. This forecast also incorporates increased fuel efficiency over the planning horizon. So, with EVs there's a small increase in emissions overall for the auto sector. But when you compare that to a scenario where there are no EVs, there's actually a difference of 116 million metric tons of emissions. That's all I have for the CBI forecast that was associated with the Preferred Resource Strategy.

**James Gall:** And before we go to Jim, a couple comments, and thanks Mike for putting this together. One, I can go back to the previous chart. Part of this is some advertising for tomorrow. Do you see a residential/commercial line on there that's not decreasing, which is counterintuitive to what we've seen and what's expected in the CCA. I would ask you to join our natural gas TAC meeting tomorrow. It will explain the dynamics of how the CCA interplays with our resource strategy. The second comment is the CCA has very

aggressive emission reduction goals and we're not showing them here, partly because some of these emissions are outside of the CCA and some of these, like electric vehicles for example. In order to achieve the goals that would require a substantial change in transportation as Mike is showing and that would be a substantial increase in load. That's something to think about. Should we be planning our system for multiples of the amount of EVs we forecasted or what we forecasted here?

**James Gall:** A lot to think about on here, but this is a good way to show how our customer benefit indicators are looking. Not all of these are I'd say improving and how do we judge between each of these CBIs. That's something that's been discussed at prior TAC meetings and that's where we've included non-energy impacts to help prioritize between the two. Also, on the biggest one I see on here that's not improving is the energy burden, and that's where we need to look at energy assistance. There are provisions in CETA to increase energy assistance and when we factor in the energy assistance is when solves some of those CBI issues. I'll turn it over to Jim. Hopefully this is quick. We maybe need to reserve 10 minutes for the last two slide decks, but if we can get the other comments in the next four or five minutes, that would be great. Thanks.

**Jim Woodward (UTC):** Sure. Thanks, James. Mike, appreciate the conversation. Can you go to your next slide? I'm going to try to make these quick, but I do have a few questions. With this chart, I'm just trying to understand Mike, the green bar and the blue bar emissions with electric vehicles, emissions without electric vehicles. My intuition was, and maybe you're not reflecting this or that wasn't the intention of this slide, but emissions with EVs was essentially EVs on Avista system that you would have to account for and where I'm going with this is, to me it seems like those two legends should be switched. Am I misinterpreting something here?

**Mike Hermanson:** It's emissions of all vehicles when the vehicle mix includes EVs, is the green bar. So, when you when you have those emissions and then essentially that removes the emissions from the transportation sector and switches it over to the electric sector. The emissions without EVs, meaning that no EVs are purchased and going forward it's just internal combustion vehicles.

**Jim Woodward (UTC):** So, you're basically saying this emissions chart is for you mentioned Avista's service territory, but these aren't how shall I say this, direct emissions for Avista that you know if they're more cars and trucks that remain? Internal combustion or gas? Overall, the service territory is going to be higher emissions, whereas where I'm going is if there's a greater number of EVs on Avista's system charging, right?

**Mike Hermanson:** Right.

**Jim Woodward (UTC):** Based on your fuel mix, more EVs on Avista's system could potentially increase Avista direct emissions. I mean that's where I'm having to make this logically. Do you understand where I'm coming from?

**Mike Hermanson:** Yeah, so in this slide here, the emissions are electric power serving Washington includes increased load from EVs already.

**Jim Woodward (UTC):** OK.

**Mike Hermanson:** And here, transportation emissions are you can see, there's a slight increase going here. And then these transportation emissions include the emissions from EVs directly. It's embedded now in the electric and then emissions from the internal combustion. And so, the next chart was to illustrate. I guess the thought was that while you would have increasing electric emissions as a result of having more load from EVs that your transportation emissions would in fact go down when in fact that's not really what's happening. You're just getting that held constant instead of having an increase.

**Jim Woodward (UTC):** OK. I'll double check this slide, but that explanation I think is helpful. My last question, it goes back to your listing of the CBIs, that's I think a few slides ago. I think it's actually a beginning of your section. Yeah. So, this one. Was wondering, first of all, I really appreciate this discussion. Is this basically laying the groundwork for, I know James and I have talked about the maximum customer benefit sensitivity that's in the IRP rule, is this laying the groundwork for some CBI quantitative analysis that could inform an updated version of that sensitivity for the 2023 IRP report?

**James Gall:** I think it does lay the groundwork. We need to decide what does that scenario look like. And we'll probably have a call, I'll try to schedule next month with you, to outline what this could look like. But yeah, the idea is we're trying to quantify and forecast, and then if we want to maximize, we had to decide what maximize means and then how do we deal with differences between improvements in one CBI versus the other.

**Jim Woodward (UTC):** Great. Thanks, James. I'll stay tuned and I realized my last question or comment was answered because the draft, I don't think I was seeing things, but the draft report only had I think 13 CBIs on this slide originally, not the 14<sup>th</sup>. But thanks Mike for adding that. I think we're good.

**Mike Hermanson:** Yeah. No, I realized that after going back through some material and made that update. The updated slides will have that.

**Jim Woodward (UTC):** Thanks so much.

### **Progress Report Online, Lori Hermanson**

**James Gall:** So, let's try to get you all done and out of here by 11. And Lori, do you want to show your screen? I'm hoping we can get through this before 11. I think we can. So. Go for it, Lori.

**Lori Hermanson:** OK. Can you see him see my screen?

**James Gall:** We can.

**Lori Hermanson:** OK, I'll try to go through this as quick as possible. We wanted to give you a preview of what you're going to see with our January 3<sup>rd</sup> filing. Chapter one is the Progress Report introduction. This is the first time we've done a Progress Report. It outlines what this is and why we do it. We do it every two years following an IRP. We're going to discuss the new requirements they've evolved. And we also discussed the public involvement and how that's helped shaped our Progress Report as well as our eventual IRP report. Chapter 2 is the economic and load forecast that of course covers our regional economic conditions. It covers our load, our energy and peak load forecast, as well as load forecast scenarios. Chapter 3, there's been a lot of changes since the 2021 IRP. We've included an existing resources chapter in the Progress Report and that will give you an overview of our own generating resources as well as our contractual resources and obligations, and we also cover our environmental considerations. Chapter 4, our long-term position, is our loads and resources overview. We discussed reliability planning, our reserve margins, and our resource flexibility compared to our resource requirements.

**Lori Hermanson:** Chapter 5, distributed energy resources. In the past we've had separate chapters on EE & DR, and we've had our distributed energy resources throughout our IRP. This time around, we brought them all together in this distributed energy resources chapter, and we're going to discuss energy efficiency, demand response, rooftop solar, EVs, as well as the potential studies for DER and EV and any other customer owned distributed energy resources. Chapter 6 is the overview of our supply side resources, basically cost and operating characteristics of everything that was modeled in this IRP. Chapter 7, distribution and transmission, covers our regional transmission planning issues as well as our 10-year plan. Our public involvement process for this as well as distribution planning and it also talks about storage benefits to our distribution system.

**Lori Hermanson:** Our market analysis chapter, Chapter 8, is our price forecast. It includes modeling assumptions and all the components of our analysis and modeling, and an overall look at our wholesale market. Chapter 9, this is our placeholder resource strategy, and this is done to evaluate EE & DR and will be updated in our future filing in June, which will include everything for our final resources that resulted from our last RFP. Finally, Chapter 10, customer impacts. This includes energy and non-energy benefits, reductions of burdens to our named communities, long term and short-term public health and environmental benefits, cost, risks and energy security risk. This is where we discuss our CBIs and what's included in our IRP modeling and that's about it. So, James, you want to take the last item?

**James Gall:** Sure. I will share my screen so I'm sure I'm in the wrong screen. Try that one. OK, so just to wrap things up, I appreciate Lori burning through that really quickly. We will be sending that out on January 3<sup>rd</sup> to this TAC. It'll also be filed with the Washington Commission. And then we'll continue working on the full IRP and we'll have a draft of that out March 31<sup>st</sup>, which is been moved from the March 17<sup>th</sup> deadline. Before I get to the virtual public meeting, I just wanted to remind everybody, we are going to



combine the February and March meetings and put that on March 15<sup>th</sup>. That's going to be a full day meeting in person and on Teams. The reason for combining those meetings is we are a little bit concerned about making sure we get the RFP completed before we do another presentation. We don't want to do any more preliminary analysis. Until we've locked those resources in, the major changes you're going to see from the Progress Report versus the final IRP is the resource selection. But we'll conduct the scenario and sensitivity analysis as well. So that will be added to the report that you see on March 31<sup>st</sup>.

**James Gall:** On March 8<sup>th</sup>, we are planning on doing a virtual public meeting and TAC members are welcome, but this is designed for the general public. We will be creating some videos for people to watch ahead of time to learn about what our plan is and then we'll have two listening sessions to take comments and answer questions from the general public on that day.

**James Gall:** Like I said before, we are working on getting those RFP's contracts and acquisitions wrapped up. We may reach back out to the TAC if we were not able to meet the deadlines we have here. If we need additional time. So, with that, I think that's it. I'm actually surprised we were able to finish three minutes early with how things were going so. If there are any last questions, please bring them up now. Otherwise, we look forward. Jim's hand is up, so go ahead, Jim.

**Jim Woodward (UTC):** Thanks, James. Sorry if I was going to unmute and let you know. Thanks for this discussion. Realizing that you know the obvious updates regarding ongoing contract discussions, notwithstanding what you file on January 3<sup>rd</sup>. Will Avista file to the extent it's able the data supporting the Progress Report or are we largely just looking at a PDF here?

**James Gall:** You'll get the PDF, and we will be posting all of our PRiSM models and input data that we would normally provide in other previous or IRP processes. That is our intent.

**Jim Woodward (UTC):** OK, great. So, you know notwithstanding, there will be updates coming, but you will plan to circulate the data. Thank you.

**James Gall:** It will be probably a smaller quantity just because we don't have the all the scenarios conducted for this process, but it will be there.

**Jim Woodward (UTC):** Got it. Thanks.

**James Gall:** All right. Well, thank you very much. We appreciate the time, the great questions and perspectives. A lot is happening in Power Supply at Avista, not only for acquisitions in the market we're in today that was referenced earlier by Fred. And again, if you're interested, the Gas Technical Advisory Process will have a meeting tomorrow and hopefully we'll see a lot of you there. Thanks.

**Jim Woodward (UTC):** Thanks much.

**Charlee Thompson:** Thanks all.





***2023 Electric Integrated Resource Plan***  
**Technical Advisory Committee Meeting No. 9 Agenda**  
**Tuesday, April 25, 2023**  
**Microsoft Teams Virtual Meeting**

<b>Topic</b>	<b>Time</b>	<b>Staff</b>
Introductions & Process Update	9:30	John Lyons
Resource Acquisitions/Divestures	9:45	Chris Drake
Preferred Resource Strategy <ul style="list-style-type: none"> <li>• Energy Efficiency</li> <li>• Demand Response</li> <li>• Resource Selection</li> <li>• Avoided Cost</li> <li>• Market Dependence</li> </ul>	10:30	IRP Team
Lunch	11:30	
Preferred Resource Strategy (continued)	12:30	IRP Team
Portfolio Scenario Analysis	1:00	IRP Team
Action Items For 2025 IRP	2:15	IRP Team
Adjourn	2:30	

---

## Microsoft Teams meeting

**Join on your computer, mobile app or room device**

[Click here to join the meeting](#)

Meeting ID: 215 771 721 354

Passcode: 83Wps4

[Download Teams](#) | [Join on the web](#)

**Or call in (audio only)**

[+1 509-931-1514,,529807680#](#) United States, Spokane

Phone Conference ID: 529 807 680#

[Find a local number](#) | [Reset PIN](#)

[Learn More](#) | [Meeting options](#)

---



# Introduction

Avista IRP Team  
Technical Advisory Committee Meeting No. 9  
April 25, 2023

# Remaining 2023 Electric IRP TAC Meeting Schedule

- Today is the final TAC meeting for this IRP
- This meeting is being recorded and notes transcribed
- External IRP draft released to TAC on April 11, 2023, after completion of 2022 All-Source RFP
- Public comments due by May 12, 2023, via email, call, or letter
- Final 2023 Electric IRP submission to both Commissions and TAC on June 1, 2023
- Commissions will issue more details about process and timelines for feedback and comments
- 2025 IRP schedule will be sent to TAC and posted on website as developed

# Today's Agenda

- 9:30 Introductions, John Lyons
- 9:45 Resource Acquisitions/Divestitures, Chris Drake
- 10:30 Preferred Resource Strategy, IRP Team
- Energy Efficiency
  - Demand Response
  - Resource Selection
  - Avoided Cost
- 11:30 Lunch
- 12:30 Preferred Resource Strategy (continued), IRP Team
- 1:00 Portfolio Scenario Process, IRP Team
- 2:15 Action Items of 2025 IRP, IRP Team
- 2:30 Adjourn



# 2022 All Source RFP Update to IRP TAC #9

Chris Drake, Manager of Resource Optimization and Marketing  
Technical Advisory Committee Meeting No. 9  
April 25, 2023

# Agenda – All Source Request for Proposal (RFP)



Process



Evaluation



Results



# 2022 All Source RFP Design and Regulatory Process

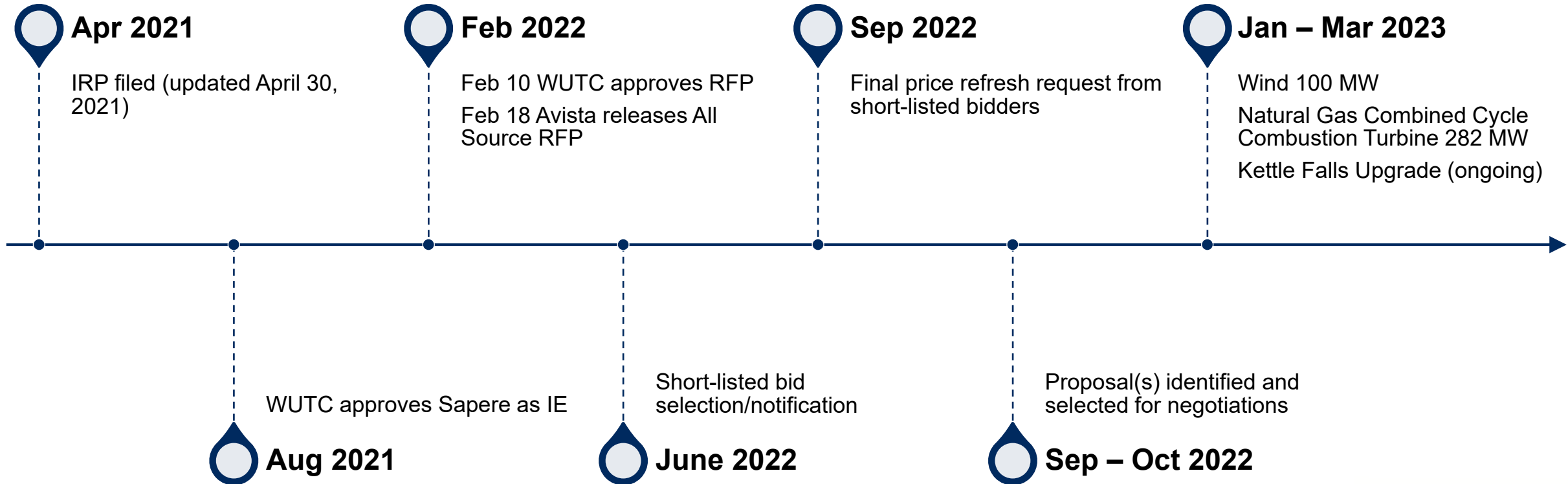

# 2022 All Source RFP and Proposal Highlights

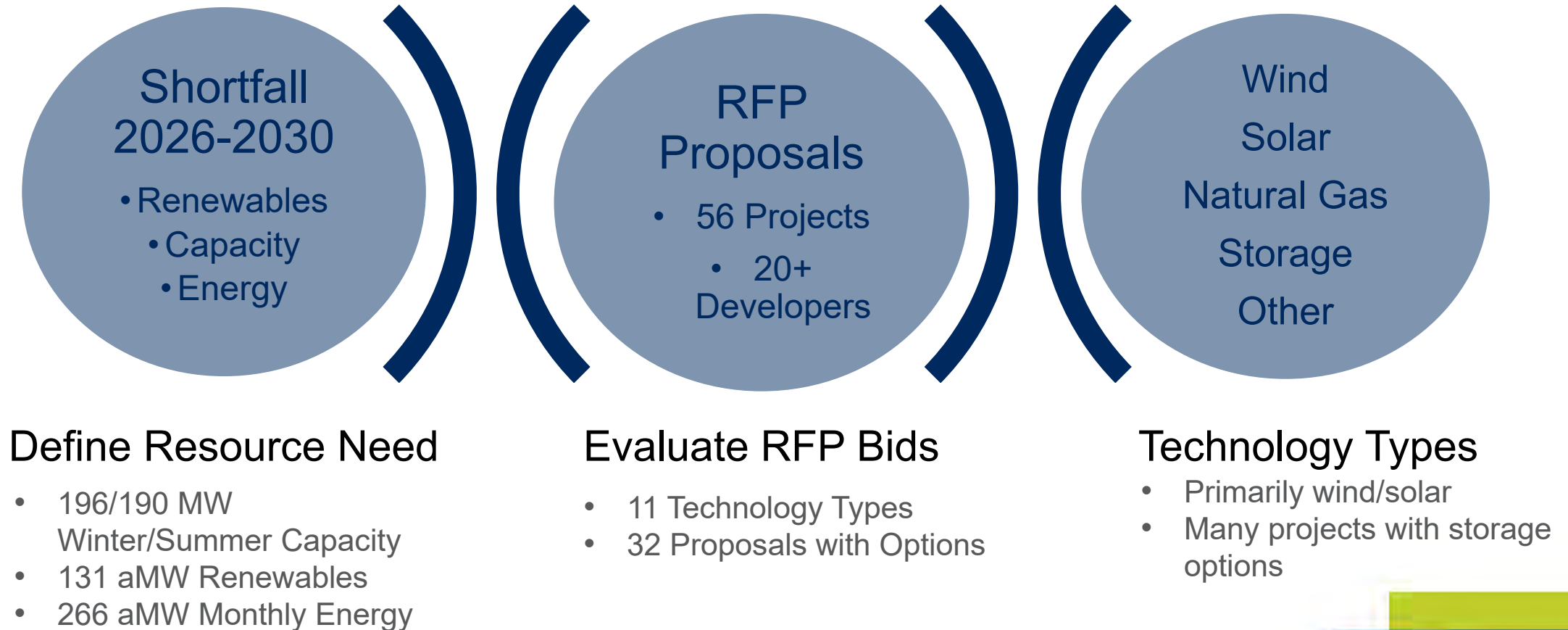

# Independent Evaluator (IE)

	<h2>Advise</h2>	<ul style="list-style-type: none"> <li>• Advise on Avista's Development of RFP</li> </ul>
	<h2>Evaluate</h2>	<ul style="list-style-type: none"> <li>• Parallel evaluation of Risks, Burdens, and Benefits</li> </ul>
	<h2>Verify</h2>	<ul style="list-style-type: none"> <li>• Inputs, Assumptions and Scoring</li> </ul>
	<h2>Ensure</h2>	<ul style="list-style-type: none"> <li>• Fair, transparent, and proper evaluation process</li> </ul>

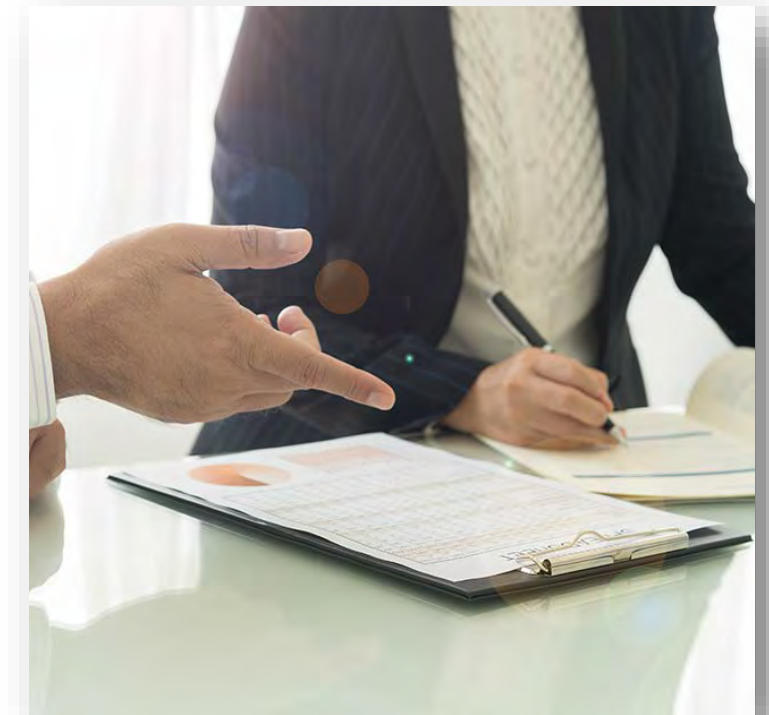



# RFP Results – Contracted Resources



## Natural Gas 280 MW

- Lancaster Combined Cycle Combustion Turbine
- 15-year extension



## Wind 100 MW

- 30-year Commercial Operation Date 1/1/2026



## Biomass 11.2 MW net

- Kettle Falls Generating Station upgrade
- 20-year subcontracts

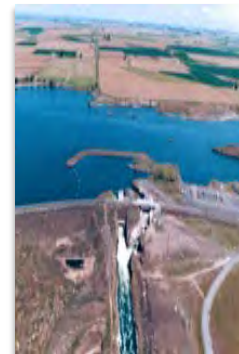

## Seasonal Hydro 146 MW

- Columbia Basin Hydropower
- Irrigation-based hydroelectric

# Columbia Basin Hydropower (non-RFP)

## Project Description

- Located in Central Washington
- 7 projects which layer in from 2023 through 2030 – expire 12/31/45

## Contract Term

- 23-Year Purchase Power Agreement

## Energy Impacts (Capacity, Energy)

- 146 MW of additional capacity
- Generation mid-March through mid-October, summer peaking

## Additional Factors

- Separate bidding process but evaluated using All-Source RFP process



# Wind - PPA

## Project Description

- 100 MW Wind farm

## Contract Term

- 30-year Power Purchase Agreement
- COD - Commercial operation date by Jan 2026

## Energy Impacts (Capacity, Energy)

- 100 MW



# Lancaster Natural Gas CCCT

## Project Description

- Combined cycle combustion turbine in Rathdrum, Idaho

## Contract Term

- PPA extends Avista's existing PPA at the end of the current 25-year deal (15 years, 11/1/2026 – 12/31/2041)

## Energy Impacts (Capacity, Energy)

- 280 MW
- Project contributes significant capacity and energy benefits

## Additional Factors

- Optimize existing natural gas resource
- No new natural gas development
- Avista has control of natural gas transportation to facility
- Facility is directly connected to Avista's balancing authority





# Kettle Falls Upgrade

## Myno Steam Supply

### Project Description

- Myno to construct Carbon Reduction Facility (CRF) adjacent to KFGS
- CRF provides steam enabling KFGS to increase maximum net generation
- Avista utilizes and expands existing biomass feedstocks to sell to the CRF

### Contract Term

- 20-Year Agreement

### Energy Impacts (Capacity, Energy)

- 11.2 MW capacity increase
- Greater than 100% capacity factor as CRF offsets some steam generation by KFGS

### Additional Factors

- 30% reduction in NOx emissions intensity (/MWh)
- 30% reduction in CO/VOC emissions intensity (/MWh)
- Potential delay in Avista expansion of ash disposal facility

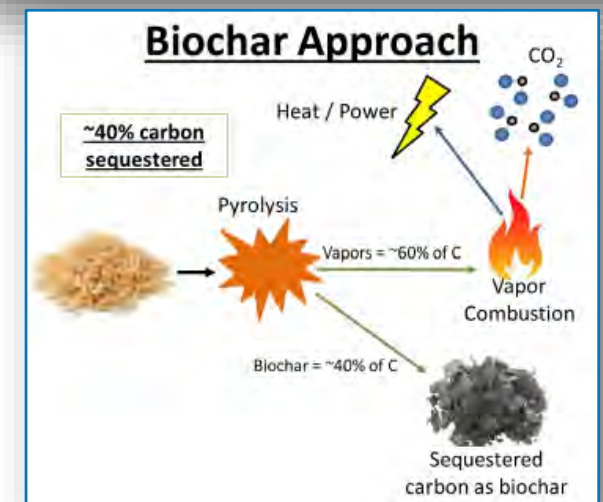

# Colstrip Divestiture

- Ownership of Colstrip
  - Transfers to Northwestern Energy December 31, 2025
- Remediation
  - Avista retains remediation obligations, and
  - Voting rights with respect to remediation activities
- Transmission
  - Colstrip Transmission System rights are not transferred





# 2023 Preferred Resource Strategy

Avista IRP Team  
Technical Advisory Committee Meeting No. 9  
April 25, 2023

# Safe Harbor Statement

This document contains forward-looking statements. Such statements are subject to a variety of risks, uncertainties and other factors, most of which are beyond the Company's control, and many of which could have a significant impact on the Company's operations, results of operations and financial condition, and could cause actual results to differ materially from those anticipated.

For a further discussion of these factors and other important factors, please refer to the Company's reports filed with the Securities and Exchange Commission. The forward-looking statements contained in this document speak only as of the date hereof. The Company undertakes no obligation to update any forward-looking statement or statements to reflect events or circumstances that occur after the date on which such statement is made or to reflect the occurrence of unanticipated events. New risks, uncertainties and other factors emerge from time to time, and it is not possible for management to predict all of such factors, nor can it assess the impact of each such factor on the Company's business or the extent to which any such factor, or combination of factors, may cause actual results to differ materially from those contained in any forward-looking statement.

# Resource Commitments (Total 976 MW of Transactions)

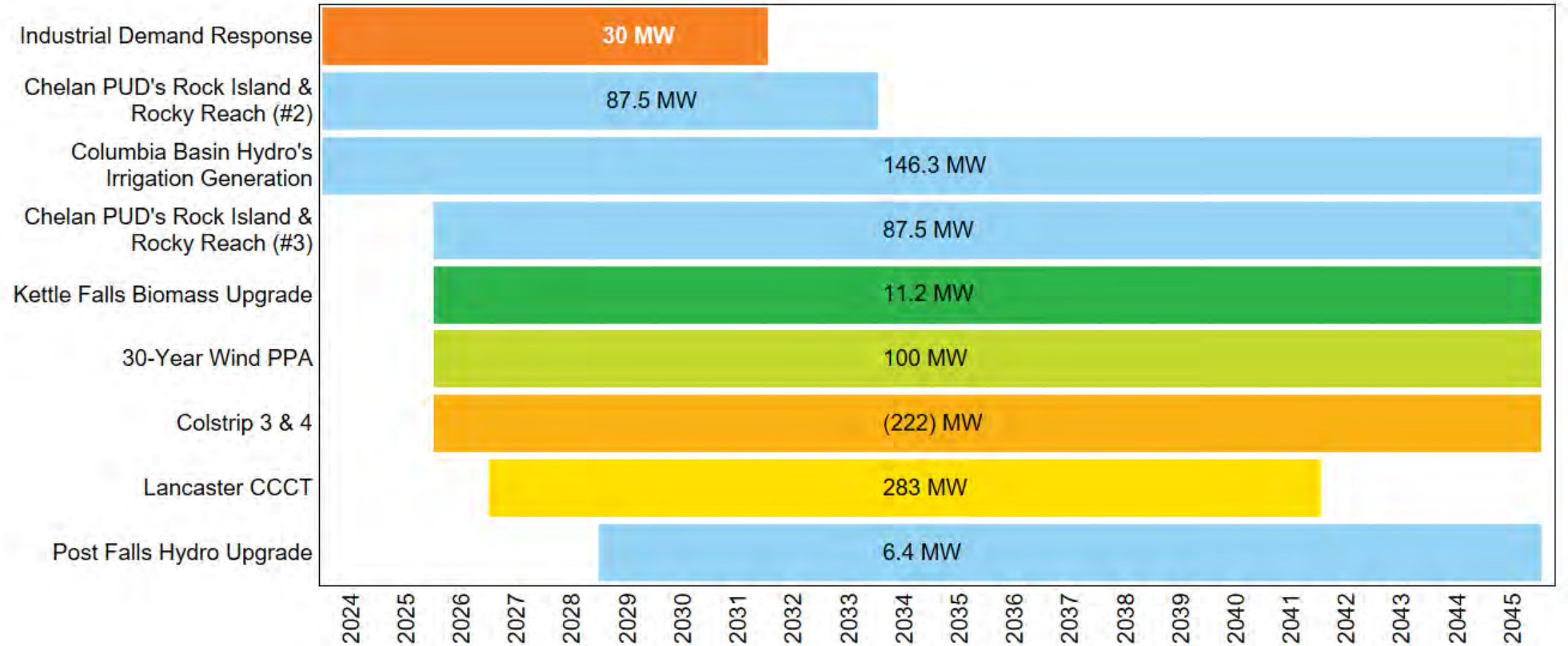

# Resource Position

Winter Peak

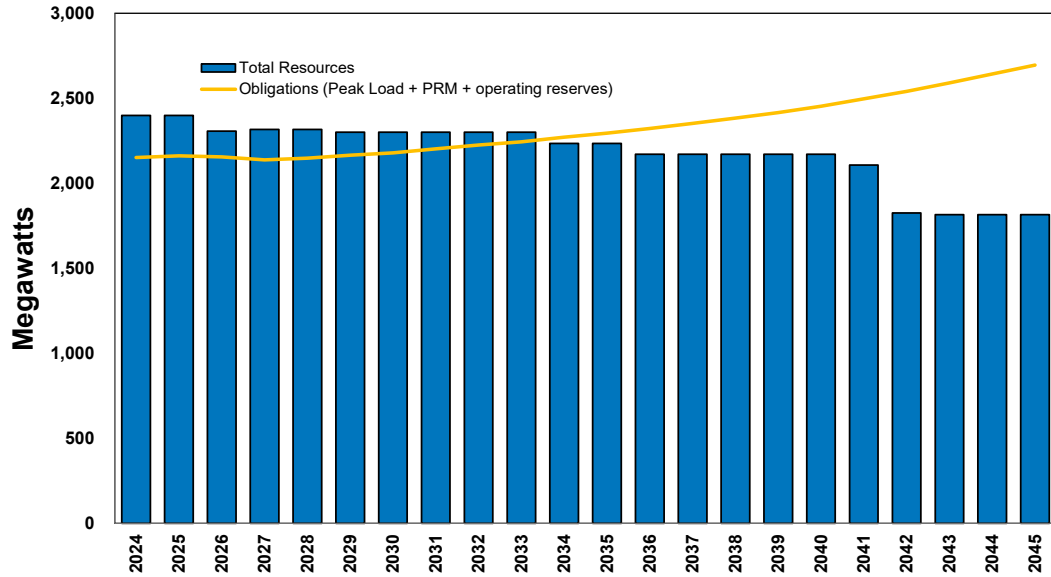

Summer Peak

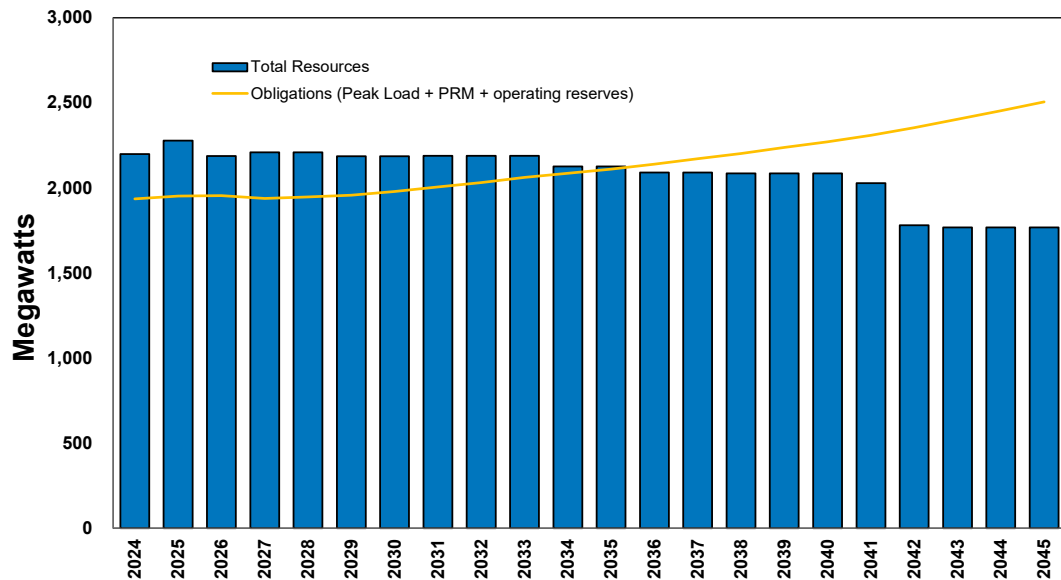

## Energy Position

Month	2025	2030	2035	2040	2045
January	218	109	35	-3	-829
February	216	76	27	-26	-823
March	375	260	210	168	-603
April	551	427	360	311	-326
May	691	604	540	486	-17
June	737	621	540	447	-175
July	395	240	200	104	-672
August	266	135	59	-8	-766
September	339	222	176	135	-603
October	346	218	148	81	-677
November	261	116	27	-20	-818
December	297	147	69	-17	-851

## Assumed Retirements

Resource	Fuel Type	Year	January Capacity MW
Colstrip Units 3 & 4	Coal	2025	222.0
Northeast Units A & B	Natural Gas	2035	66.0
Boulder Park (1-6)	Natural Gas	2040	24.6
Kettle Falls CT	Natural Gas	2040	11.0
Rathdrum Units 1 & 2	Natural Gas	2044	176.0
<b>Total</b>			<b>499.6</b>



# CETA Renewable Energy Goal

## Potential CETA Requirements

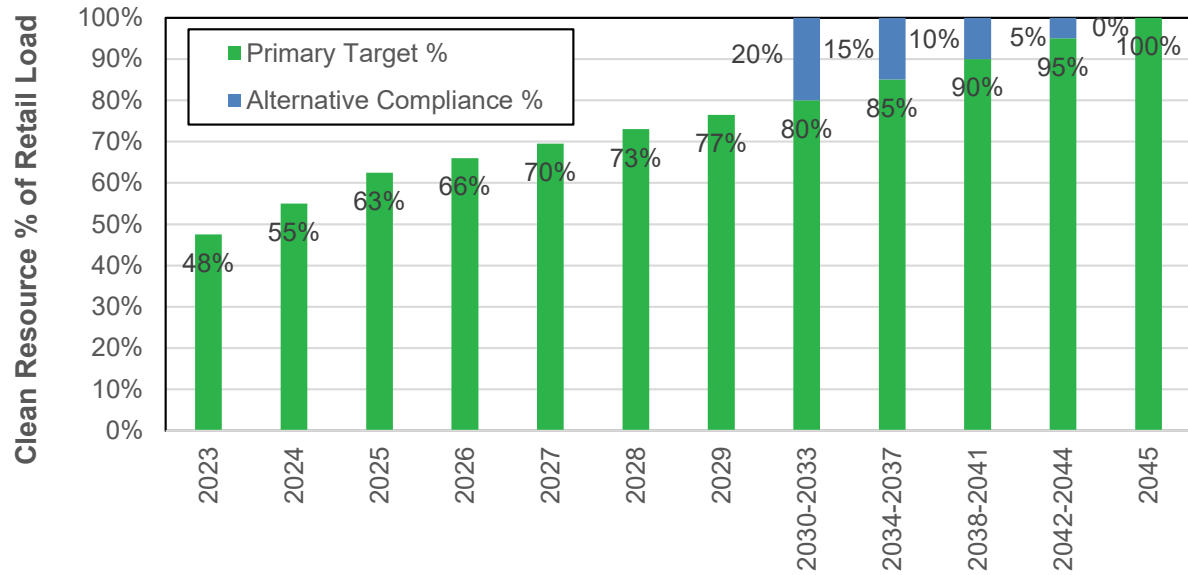

## CETA Position

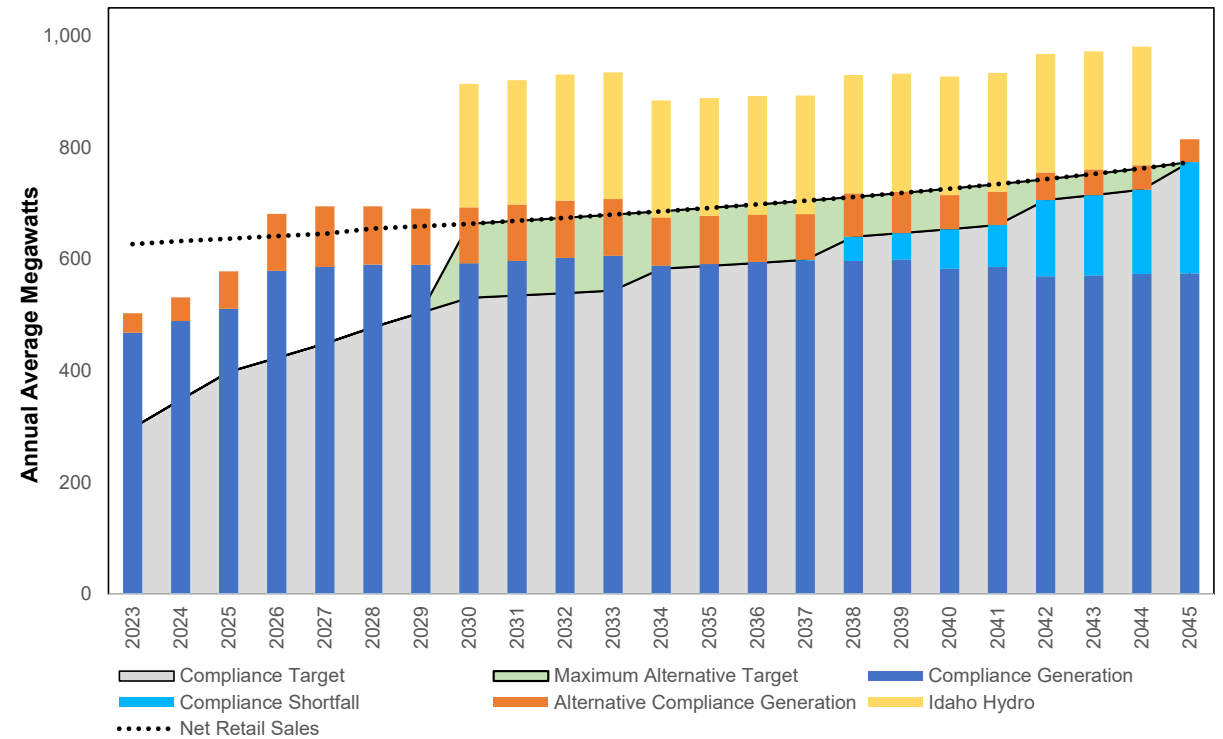

# What is PRISM?

- Preferred Resource Strategy Model
- Mixed Integer Program (MIP) used to select new resources to meet resource needs of our customers



The user interface



The solver interface



The solver



# Objective Function

Intro to linear programming: <https://www.youtube.com/watch?v=Uo6aRV-mbeg>

Minimize: (WA “Societal” NPV<sub>2023-45</sub>) + (ID NPV<sub>2023-45</sub>)

Where:

WA NPV<sub>2023-45</sub> = Market Value of Load + Existing & Future Resource Cost/Operating Margin + Social Cost of Carbon + EE TRC + NEI

ID NPV<sub>2023-45</sub> = Market Value of Load + Existing & Future Resource Cost/Operating Margin + EE UTC

Subject to:

Generation Availability & Timing

Energy Efficiency Potential

Demand Response Potential

Monthly Peak Requirements

Monthly Energy Requirements

Monthly Clean Energy Targets

Optimization Tolerance: 0.0001 or 1,500 seconds (Note: certain studies longer solution times allowed)

# Optimized Cost vs. Actual Costs

- Objective function includes social costs that are not part of utility revenue requirement.
- This is used for resource optimization only.
- Social costs may include:
  - Energy Efficiency
    - TRC
    - Non-energy impacts
    - Power Act 10% adder
    - T&D Savings
  - Social Cost of Carbon
- Actual costs illustrate expected cost ratepayers will pay.
- Estimate annual revenue requirements.
- Estimate average energy rates.

# Named Community Investment Fund Projects

- Methodology
  - Spending constraints
    - \$2 million annually in low-income energy efficiency beyond cost effective programs.
    - \$400k distributed energy resources (plus \$100k for program administration).
    - Takes advantage of state incentive funding.

Program	Distribution Level Solar	Distribution Level Storage	Energy Efficiency
2024-2033	791 kW per year	Not selected	222 MWh per year
2034-2045	150 kW per year	193 kW (773 kWh) per year	2.2 MWh per year

# 2024-2045 Cumulative Energy Efficiency Supply Curve

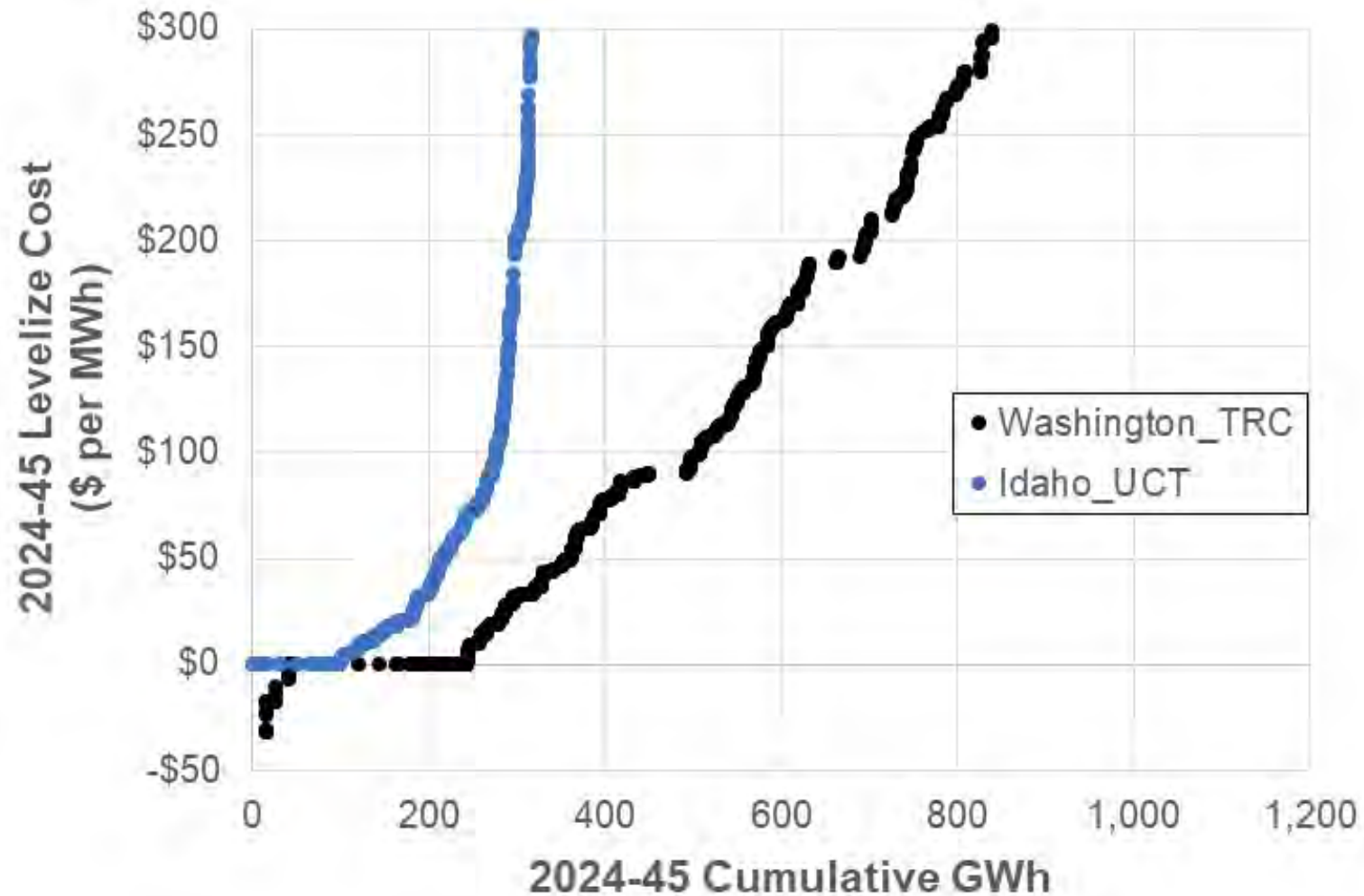

# Annual Historical and Forecasted Energy Efficiency

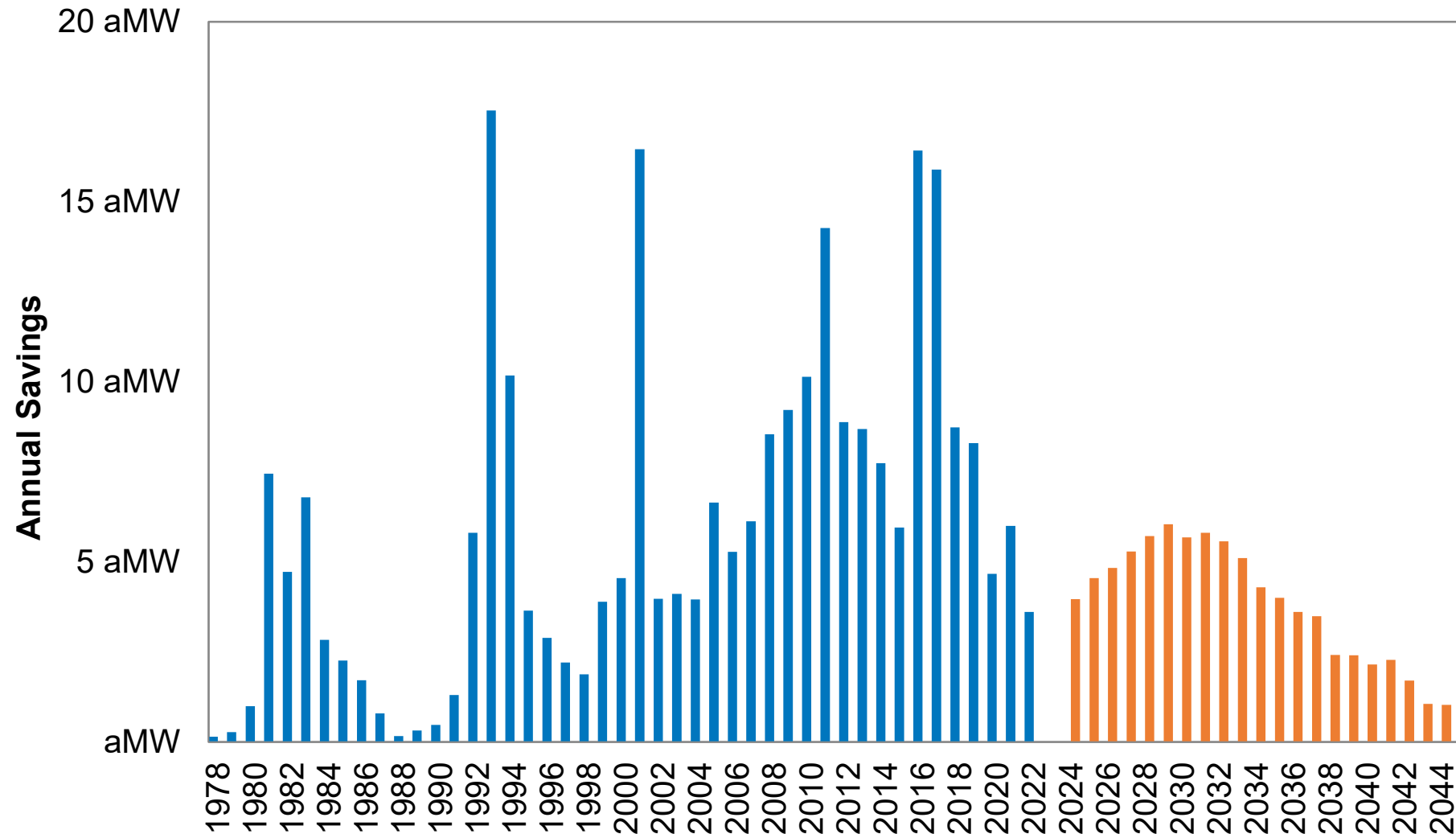

# Savings Types by State & Washington Biennial Target

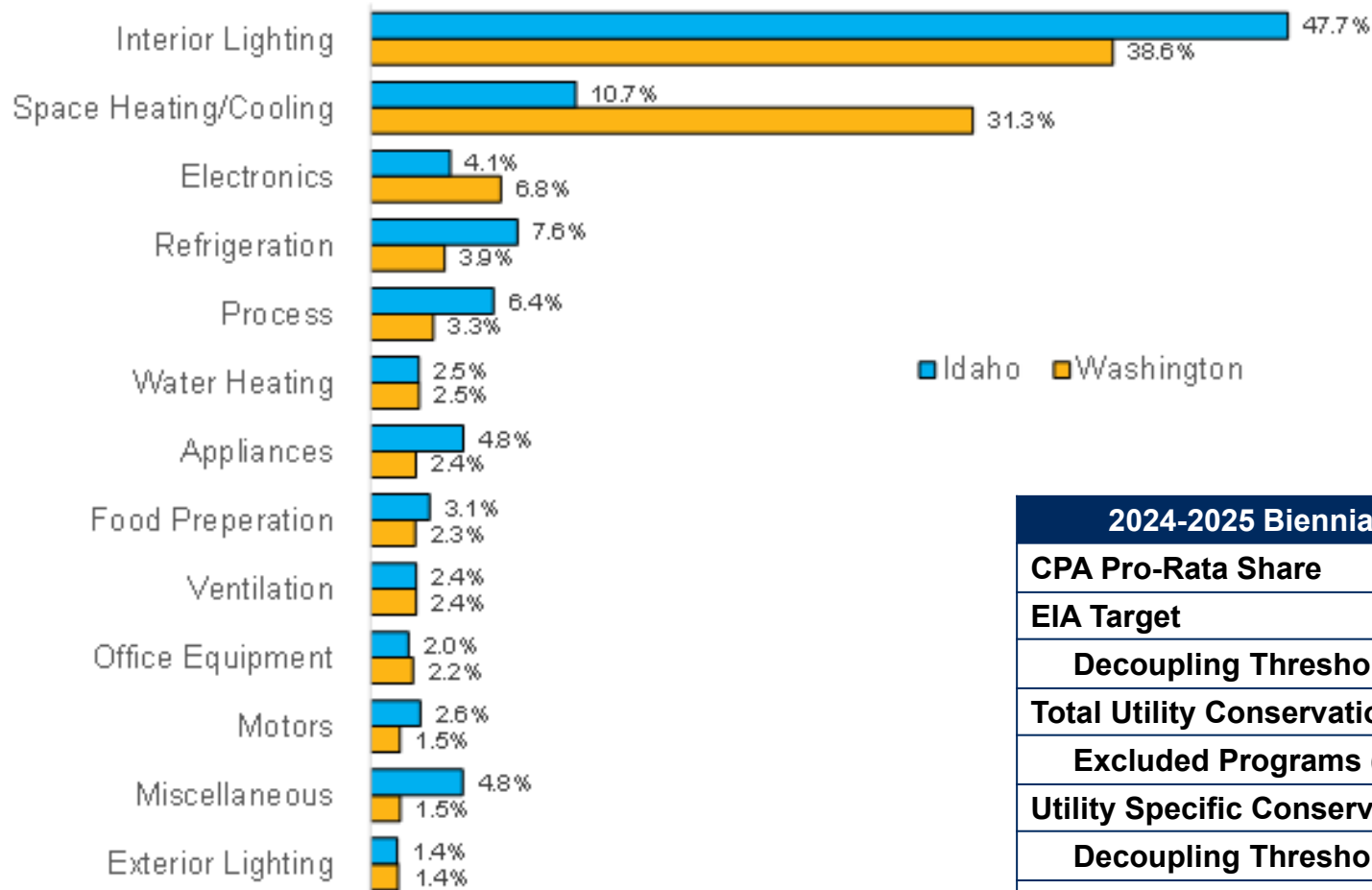

2024-2025 Biennial Conservation Target (MWh)	
CPA Pro-Rata Share	63,374
<b>EIA Target</b>	<b>63,374</b>
Decoupling Threshold	3,226
<b>Total Utility Conservation Goal</b>	<b>66,600</b>
Excluded Programs (NEEA)	-10,162
<b>Utility Specific Conservation Goal</b>	<b>56,438</b>
Decoupling Threshold	-3,226
<b>EIA Penalty Threshold</b>	<b>53,212</b>



# Demand Response

- 30 MW of industrial demand response already contracted
- Avista is preparing 3 opt-in pilot programs:
  - Time of use rates
  - Peak time rebate
  - CTA-2045 water heaters
- 2023 IRP Progress Report Results
  - 2025 start date, only Washington programs selected (2045 cumulative savings shown)
    - Time of Use: 6.6 MW
    - Peak Time Rebate and Variable Peak Pricing is on the margin, but not selected.

# Supply-Side Resource Selection

Resource	Time Period	Jurisdiction	Capacity (MW)	Energy Capability (aMW)
NW Wind	2030	WA	200	63
Montana Wind	2032	WA	200	97
Natural Gas CT	2034	ID	90	86
Renewable Fueled CT	2036	WA	88	31
Long Duration Storage (>24 hr)	2039	WA	52	-1
PPA Wind Renewal	2041	WA	140	53
Renewable Fueled CT	2041	WA	74	26
Natural Gas (ICE)	2041	ID	46	46
PPA Wind Renewal	2042	WA	105	36
Renewable Fueled CT	2042	WA	186	65
Natural Gas CT	2042	ID	102	97
Long Duration Storage (>24 hr)	2043	WA/ID	68	-1
NW Wind	2044	WA	100	31
Long Duration Storage (>24 hr)	2044	WA/ID	50	-1
NW Wind	2045	WA	200	63
Renewable Fueled CT	2045	WA	348	122
Natural Gas (ICE)	2045	ID	65	65
Short Duration Storage (<8 hr)	2045	ID	25	0
<b>Total New Resources</b>			<b>2,139</b>	<b>878</b>

*Renewable fuel may require 800 to 2,000 MW of renewable capacity to create renewable fuel needed using a 20% round trip efficiency subject to further analysis*



# Transmission Needs

- Most generation selection is off-system or up to interconnection limits before major transmission upgrades needed.
- 2045 renewable & long-duration storage requirements will require significant build outs in Big-Bend and Rathdrum areas.
- Earlier construction may be necessary if low-cost interconnection resources are purchased by other utilities.

# Washington CETA Clean Energy Comparison (aMW)

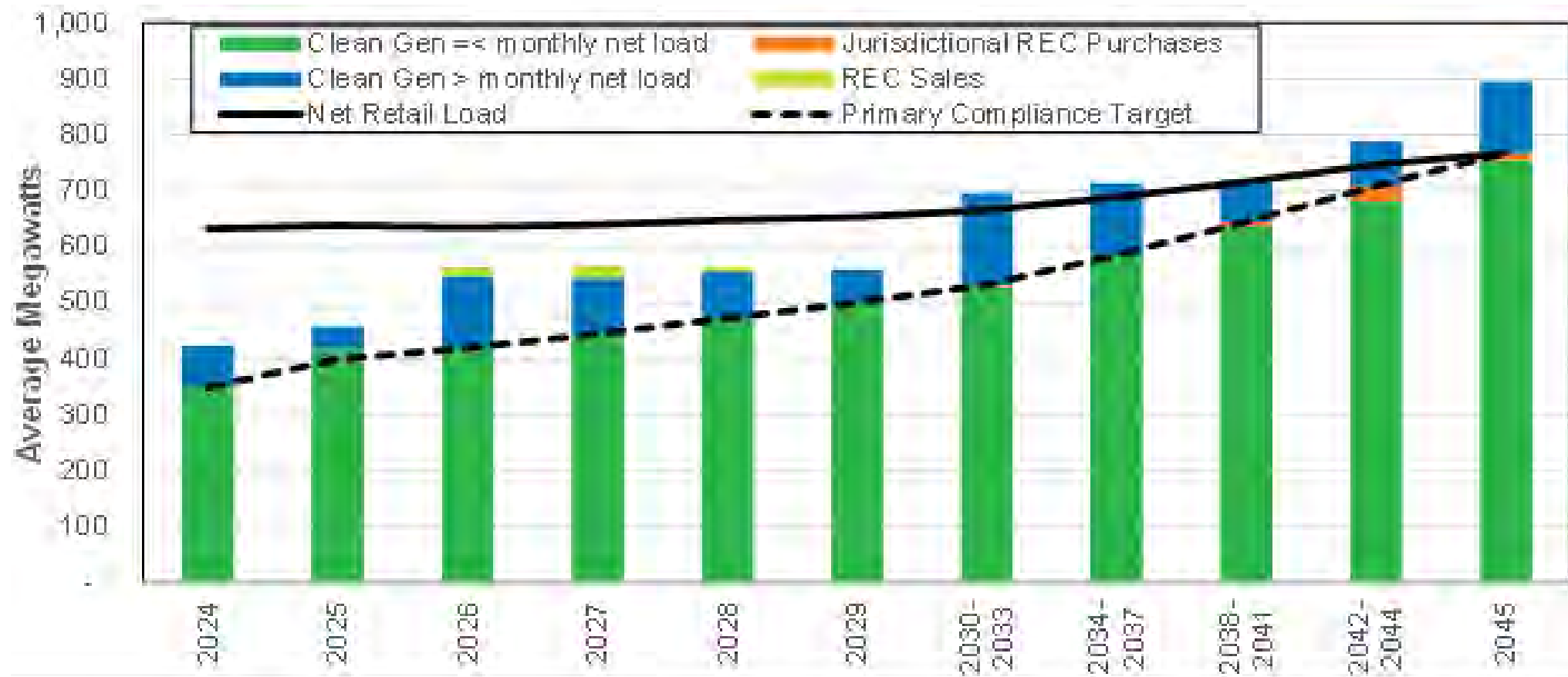

# Clean Energy Creation

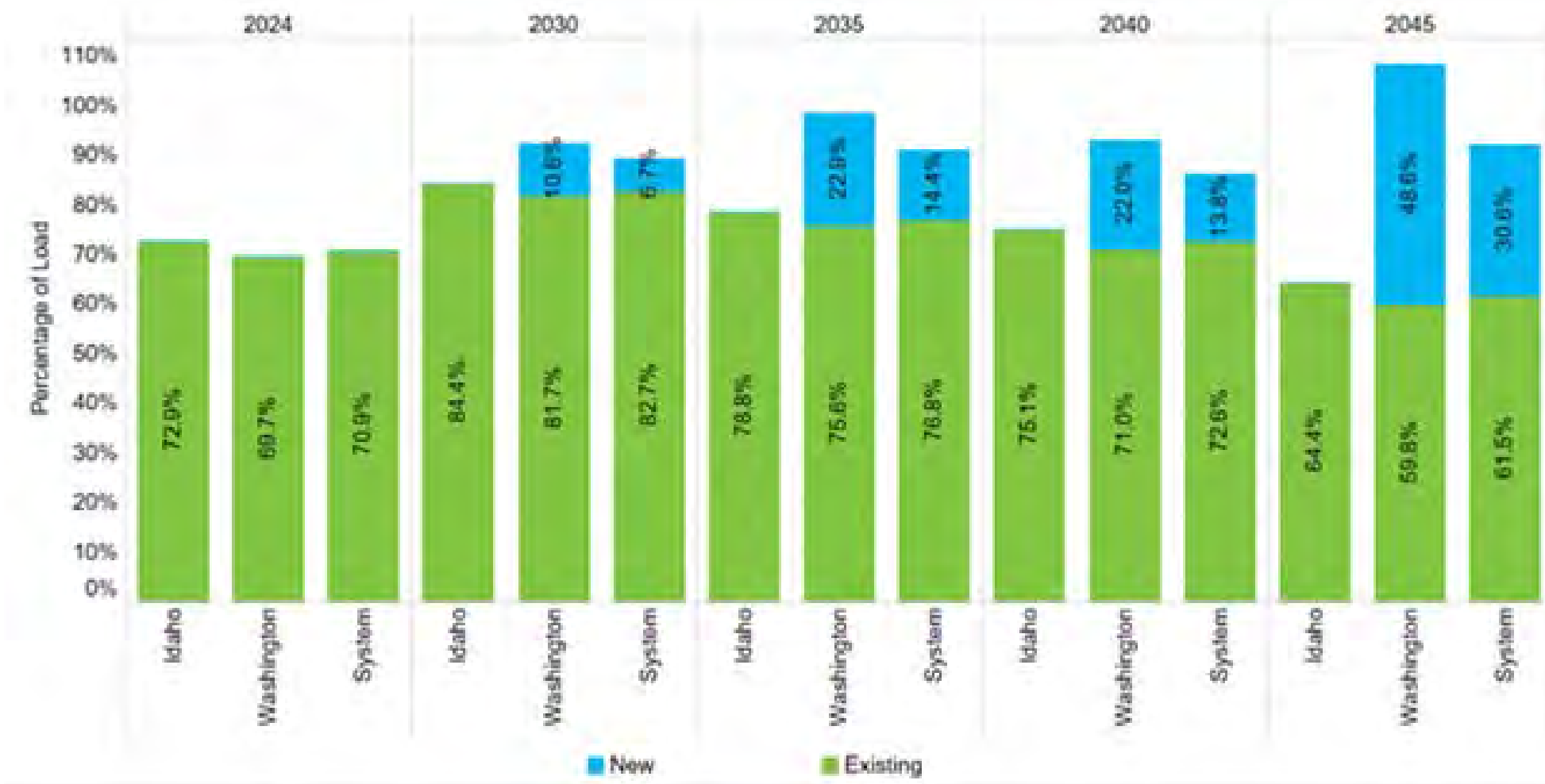

# Emissions Forecast

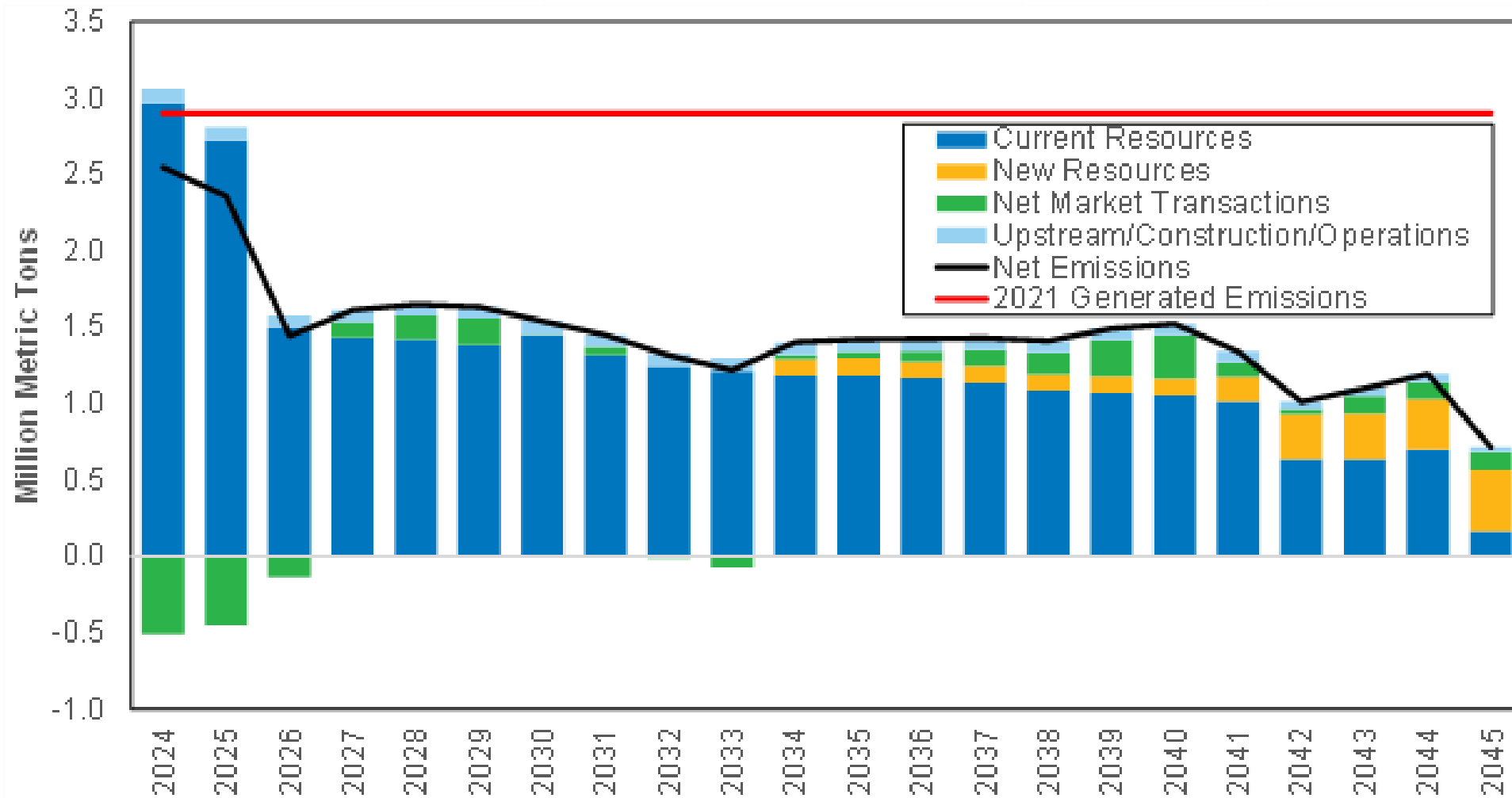

# Cost and Rate Forecast

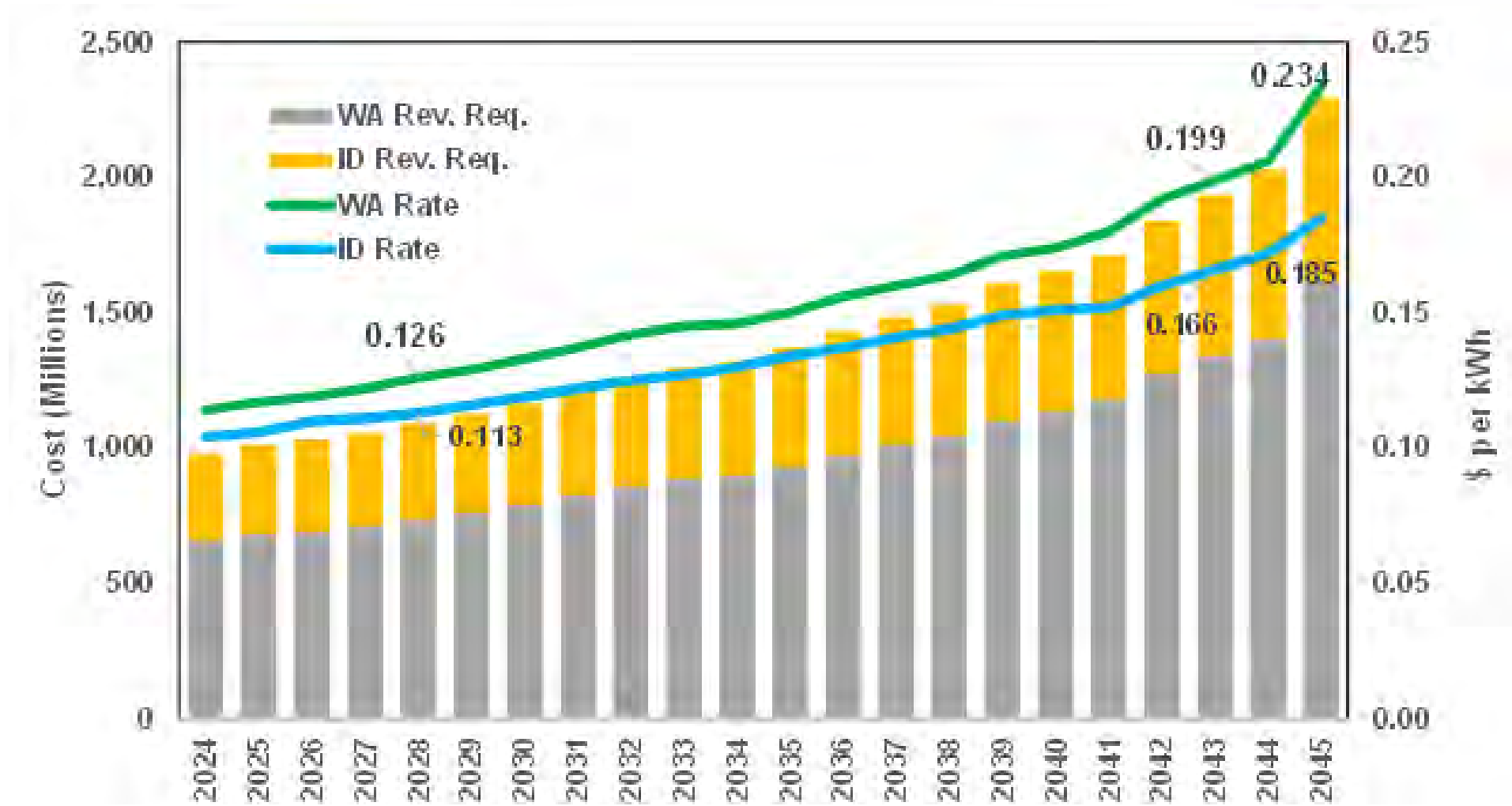

# Avoided Cost- IRP Methodology

Year	Flat (\$/MWh)	On-Peak (\$/MWh)	Off-Peak (\$/MWh)	Clean Energy Premium (MWh)	Capacity (\$/kW-Yr)	Clean Capacity Premium (\$/kW-Yr)
2024	\$42.87	\$46.10	\$38.56	\$0.00	\$0.0	\$0.0
2025	\$35.87	\$38.33	\$32.57	\$0.00	\$0.0	\$0.0
2026	\$33.24	\$35.07	\$30.80	\$0.00	\$0.0	\$0.0
2027	\$29.89	\$30.82	\$28.65	\$0.00	\$0.0	\$0.0
2028	\$29.83	\$29.90	\$29.74	\$0.00	\$0.0	\$0.0
2029	\$29.93	\$29.52	\$30.46	\$0.00	\$0.0	\$0.0
2030	\$34.65	\$33.66	\$35.97	\$0.00	\$0.0	\$0.0
2031	\$32.57	\$31.59	\$33.87	\$0.00	\$0.0	\$0.0
2032	\$31.63	\$30.36	\$33.33	\$0.00	\$0.0	\$0.0
2033	\$32.57	\$31.17	\$34.44	\$0.00	\$0.0	\$0.0
2034	\$33.11	\$31.58	\$35.14	\$3.74	\$93.0	\$63.3
2035	\$34.41	\$32.40	\$37.11	\$3.82	\$94.8	\$64.6
2036	\$35.06	\$32.84	\$38.03	\$3.89	\$96.7	\$65.9
2037	\$36.67	\$34.93	\$38.98	\$3.97	\$98.7	\$67.2
2038	\$36.37	\$34.58	\$38.76	\$4.05	\$100.6	\$68.6
2039	\$37.51	\$35.26	\$40.50	\$4.13	\$102.7	\$69.9
2040	\$39.50	\$37.60	\$42.02	\$4.22	\$104.7	\$71.3
2041	\$39.70	\$37.85	\$42.16	\$4.30	\$106.8	\$72.8
2042	\$41.46	\$40.31	\$42.99	\$4.39	\$108.9	\$74.2
2043	\$42.40	\$41.44	\$43.69	\$4.47	\$111.1	\$75.7
2044	\$47.58	\$46.70	\$48.76	\$4.56	\$113.3	\$77.2
2045	\$47.48	\$46.42	\$48.88	\$4.65	\$115.6	\$78.8
<b>20 yr. Levelized</b>	<b>\$34.87</b>	<b>\$34.67</b>	<b>\$35.15</b>	<b>\$1.41</b>	<b>\$35.0</b>	<b>\$23.8</b>
<b>22 yr. Levelized</b>	<b>\$35.44</b>	<b>\$35.20</b>	<b>\$35.76</b>	<b>\$1.55</b>	<b>\$38.6</b>	<b>\$26.3</b>



# Market Reliance Modeling

Assessment of market reliance risk due to variations in load, hydro, and renewable generation

Mike Hermanson, Senior Power Supply Analyst  
Electric IRP, TAC  
April 25, 2023

# Overview

- Loss of Load Probability (LOLP) analysis was conducted for the 2021 IRP
- 2023 IRP utilizes Western Resource Adequacy Program (WRAP) to address resource adequacy
- We are utilizing the same modeling approach to assess market reliance to serve load under various load, hydro, renewable and outage scenarios



# Modeling Framework

- Excel based model with VBA code and linear optimization Excel Add-in What'sBest!

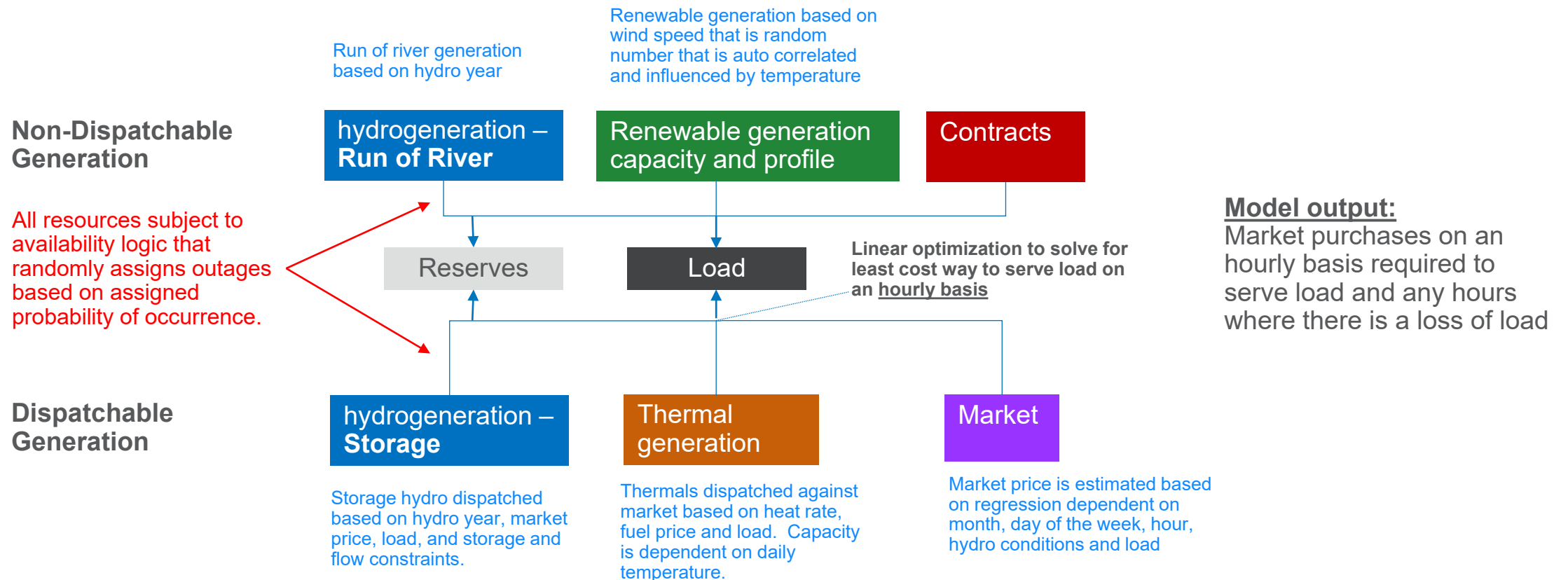

# Inputs - 2030

- 1,000 draws of load, hydro, and wind
- Thermal generation represents availability. Thermal dispatched according to market prices and heat rate

## Load (aMW)

	Average	Max	Min
Average Load	1,067	1,255	1,014
Winter Peak	1,679	1,906	1,422
Summer Peak	1,627	1,871	1,438

## Generation (aMW)

	Average	Max	Min
Annual Hydro	739	851	554
Wind	191	217	167
Coyote Springs	290	300	270
Lancaster	248	256	234
Rathdrum	143	153	126
Northeast	53	57	46
Kettle Falls CT	5	7	4
Boulder	19	21	16
Kettle Falls	55	57	52
<b>TOTAL</b>	<b>1743</b>	<b>1919</b>	<b>1469</b>

# Results 2030

- Market purchases driven by market price/hydro dispatch

Average Market Purchases by Month/Hour																								
Month	Hours																							
	1	2	3	4	5	6	7	8	9	10	11	12	13	14	15	16	17	18	19	20	21	22	23	24
1	52	112	127	132	89	76	116	115	88	65	17	13	19	23	33	44	6	1	4	12	46	76	65	134
2	53	107	124	125	86	72	92	85	63	40	8	8	12	17	29	39	9	1	1	4	26	53	52	124
3	30	65	73	75	52	37	49	43	29	13	1	1	1	4	12	19	6	0	1	0	9	26	29	72
4	30	80	113	109	56	37	43	33	17	2	0	0	0	0	1	7	0	0	0	0	0	31	43	89
5	8	34	49	58	18	9	9	4	1	0	0	0	0	0	0	1	0	0	0	0	0	5	19	48
6	9	38	55	59	23	11	7	2	1	0	0	0	0	0	0	0	0	0	0	0	0	1	16	51
7	9	20	23	23	17	10	8	4	3	3	3	3	3	2	1	1	0	0	0	1	5	10	14	30
8	12	27	29	30	21	13	11	10	11	13	14	18	19	17	14	13	5	1	4	12	30	38	27	38
9	8	9	10	10	8	11	19	14	13	11	7	8	11	11	11	12	2	0	1	3	19	22	15	19
10	16	20	19	21	22	28	45	49	38	21	2	1	4	6	18	27	6	0	0	0	16	28	19	33
11	46	81	87	87	78	65	92	96	77	55	14	10	16	19	31	43	3	0	1	7	38	66	51	97
12	70	135	149	152	119	91	122	124	103	77	24	19	27	30	52	41	3	0	4	13	54	98	85	164

99th Percentile Market Purchases																								
Month	Hours																							
	1	2	3	4	5	6	7	8	9	10	11	12	13	14	15	16	17	18	19	20	21	22	23	24
1	381	520	553	556	480	455	574	578	480	483	160	140	175	235	355	415	117	37	84	146	386	458	415	553
2	378	507	546	540	465	431	494	483	418	318	104	102	127	169	290	352	119	27	38	80	211	377	358	531
3	279	408	423	426	383	344	387	339	267	147	25	23	38	92	148	204	116	14	22	18	129	240	292	412
4	148	386	473	468	271	170	182	156	109	42	0	0	0	0	13	71	3	3	3	3	5	138	151	391
5	72	225	314	361	180	84	95	61	30	12	2	0	2	0	0	29	0	1	0	0	8	65	111	259
6	104	222	278	304	176	112	100	57	20	12	4	0	0	1	0	0	0	0	0	0	11	40	126	240
7	112	211	226	220	194	130	128	86	65	78	61	61	56	53	30	34	0	0	0	17	85	172	178	282
8	201	278	283	270	247	212	222	203	194	200	207	224	229	168	125	119	69	32	68	118	300	315	276	338
9	180	197	194	191	194	211	261	234	207	175	118	140	152	129	122	141	54	13	31	52	223	241	232	256
10	234	264	261	267	273	292	337	349	314	212	41	30	63	91	191	263	91	8	3	18	171	270	240	301
11	381	455	468	474	460	444	499	492	421	354	135	112	147	159	264	317	69	13	48	97	273	398	373	487
12	431	551	573	576	532	470	535	520	467	413	156	137	166	178	276	226	69	6	79	124	294	456	448	585

# Results - 2030

- Regular market conditions

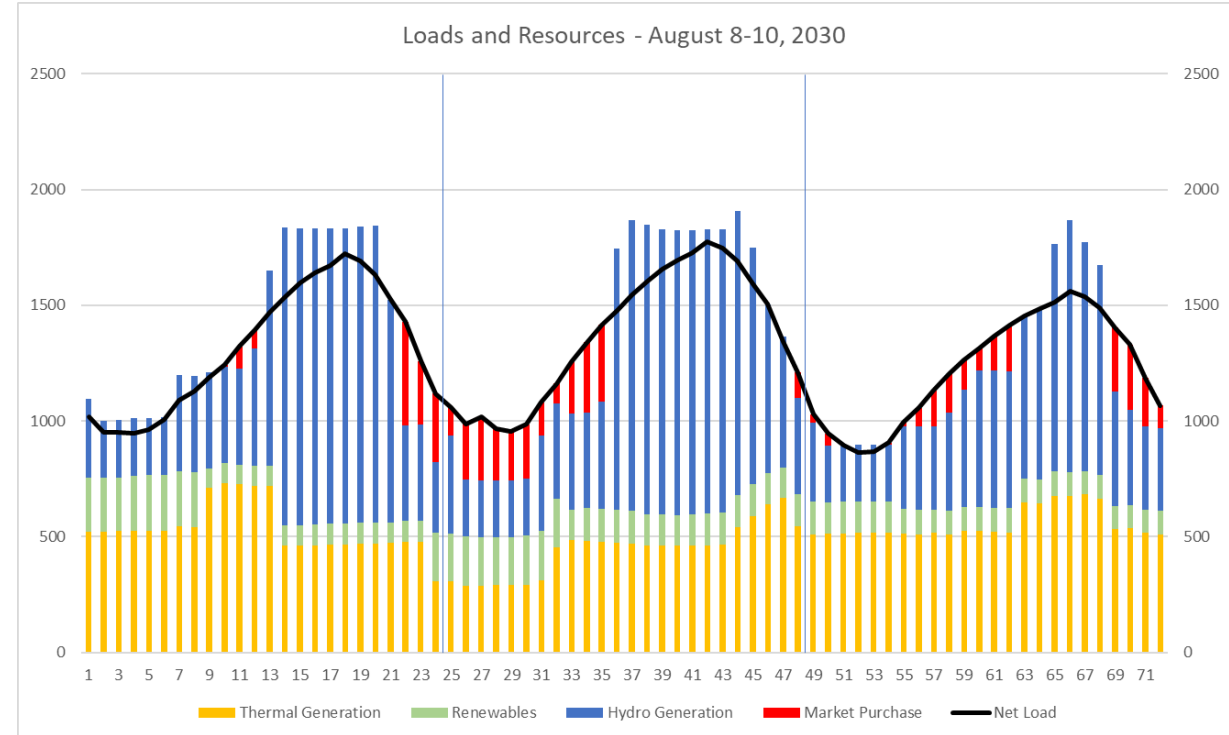
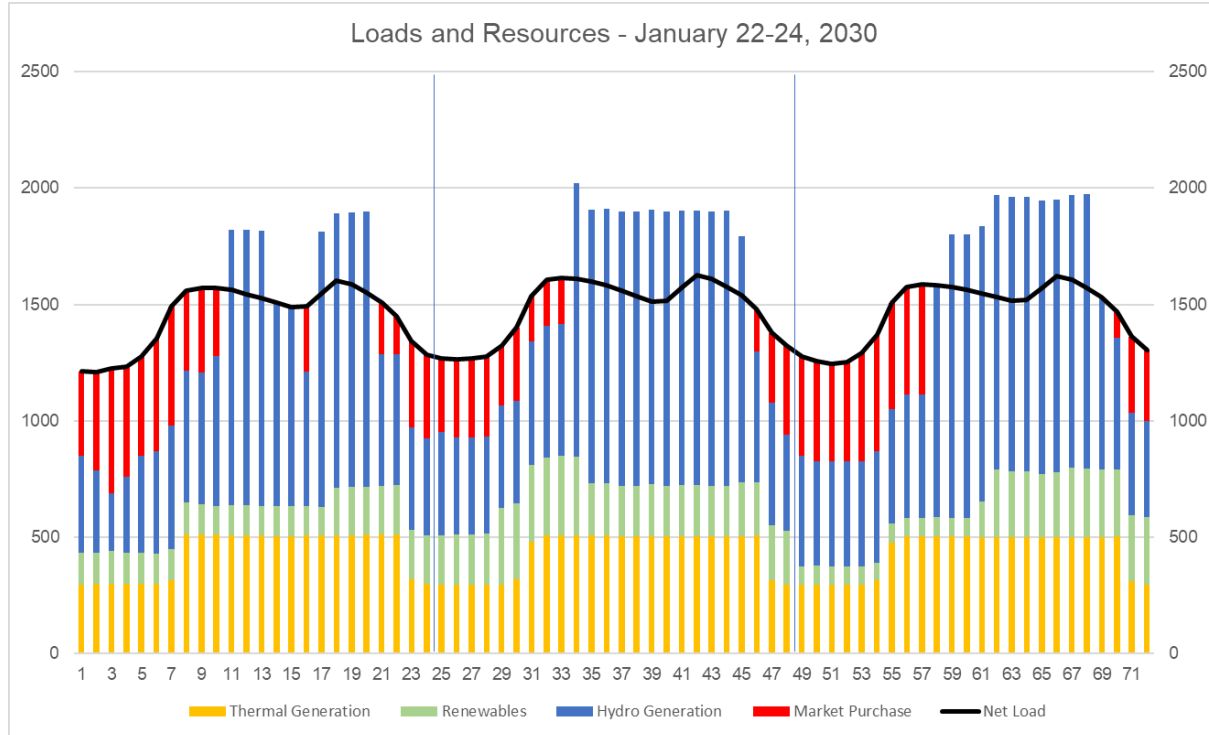

# Results - 2030

- Regional market constrained conditions (high/low temperatures)

50th Percentile Market Purchases During Regional Market Constrained Conditions																								
Months	Hours																							
	1	2	3	4	5	6	7	8	9	10	11	12	13	14	15	16	17	18	19	20	21	22	23	24
1	188	288	322	334	264	272	404	414	292	317	195	184	186	212	224	264	160	137	140	157	235	259	236	327
2	208	274	337	321	285	284	370	356	258	301	138	164	179	270	242	299	232	75	124	155	202	257	223	324
3	0	0	0	0	0	0	0	0	0	0	0	0	0	0	0	0	0	0	0	0	0	0	0	0
4	0	0	0	0	0	0	0	0	0	0	0	0	0	0	0	0	0	0	0	0	0	0	0	0
5	0	0	0	0	0	0	0	0	0	0	0	0	0	0	0	0	0	0	0	0	0	0	0	0
6	206	257	417	418	306	196	139	168	238	319	79	0	0	0	0	0	0	0	0	0	0	252	256	242
7	122	109	113	119	129	104	118	84	112	116	118	116	156	147	93	138	44	39	33	121	161	141	120	123
8	78	119	119	108	112	100	76	85	94	116	146	158	168	164	186	165	108	105	105	127	210	193	172	164
9	56	102	85	103	73	119	162	213	185	221	0	0	0	0	0	0	0	0	0	0	0	204	134	151
10	84	109	63	48	51	93	179	166	30	132	0	0	0	0	0	0	0	0	0	0	0	76	169	160
11	312	351	362	377	380	389	505	425	384	466	332	259	264	298	332	370	260	224	253	258	304	333	317	389
12	224	309	360	370	298	289	428	375	308	369	167	198	215	225	290	244	142	115	112	162	279	324	325	410

99th Percentile Market Purchases During Regional Market Constrained Conditions																								
Month	Hour																							
	1	2	3	4	5	6	7	8	9	10	11	12	13	14	15	16	17	18	19	20	21	22	23	24
1	434	540	588	590	523	529	686	697	500	565	461	423	368	430	501	549	342	251	242	334	467	549	518	615
2	444	566	624	612	528	570	735	644	349	521	241	265	307	380	490	600	348	216	255	322	394	524	491	590
3	0	0	0	0	0	0	0	0	0	0	0	0	0	0	0	0	0	0	0	0	0	0	0	0
4	0	0	0	0	0	0	0	0	0	0	0	0	0	0	0	0	0	0	0	0	0	0	0	0
5	0	0	0	0	0	0	0	0	0	0	0	0	0	0	0	0	0	0	0	0	0	0	0	0
6	514	571	657	677	645	319	224	168	238	319	79	0	0	0	0	0	0	0	0	0	0	448	344	409
7	235	237	273	326	297	214	214	201	203	212	198	193	229	199	116	138	44	39	33	168	222	242	239	308
8	263	296	314	306	269	250	236	250	235	278	304	329	343	305	356	350	246	169	219	273	438	397	375	420
9	173	218	320	456	319	375	445	499	337	512	0	0	0	0	0	0	0	0	0	0	0	337	181	292
10	115	172	200	208	149	229	349	380	126	142	0	0	0	0	0	0	0	0	0	0	0	226	248	463
11	558	607	644	651	648	681	737	735	548	598	549	491	499	555	536	559	549	387	457	480	456	557	537	656
12	461	580	622	641	555	547	654	598	501	612	386	349	431	401	491	467	254	192	278	353	492	562	578	663

# Results - 2030

- Constrained regional market

Loads and Resources: August 3-5, 2030 - Iteration 255

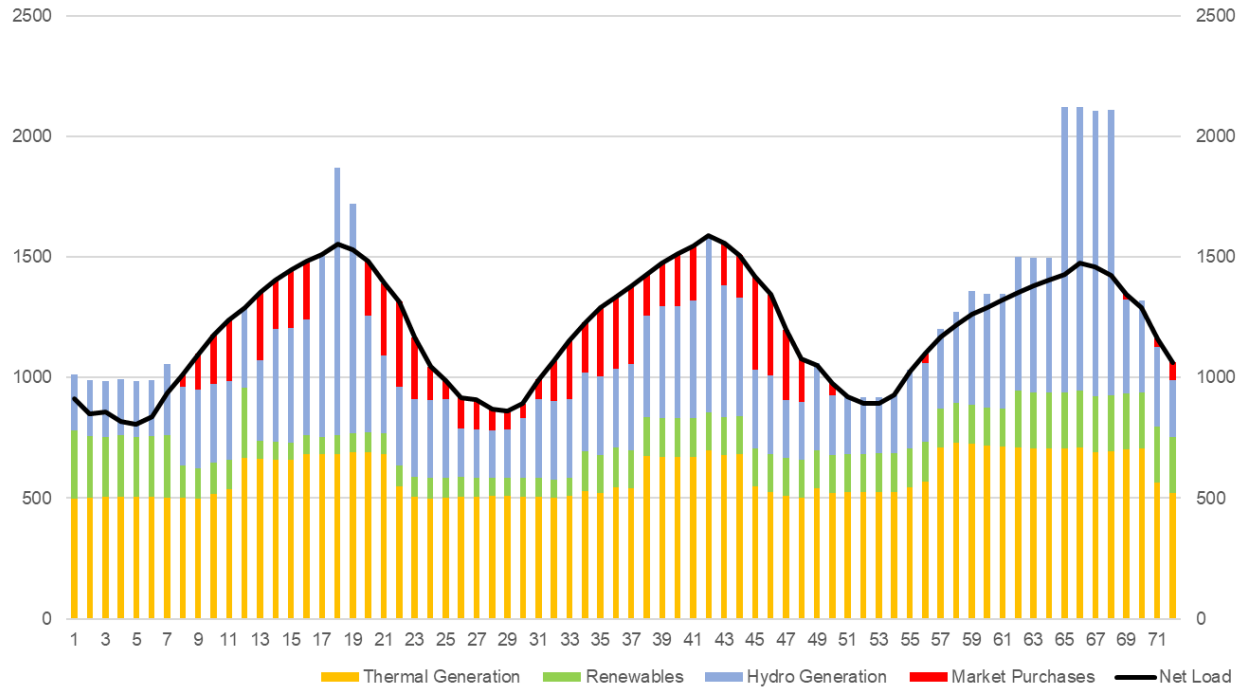

Loads and Resources: December 29-31, 2030 - Iteration 138

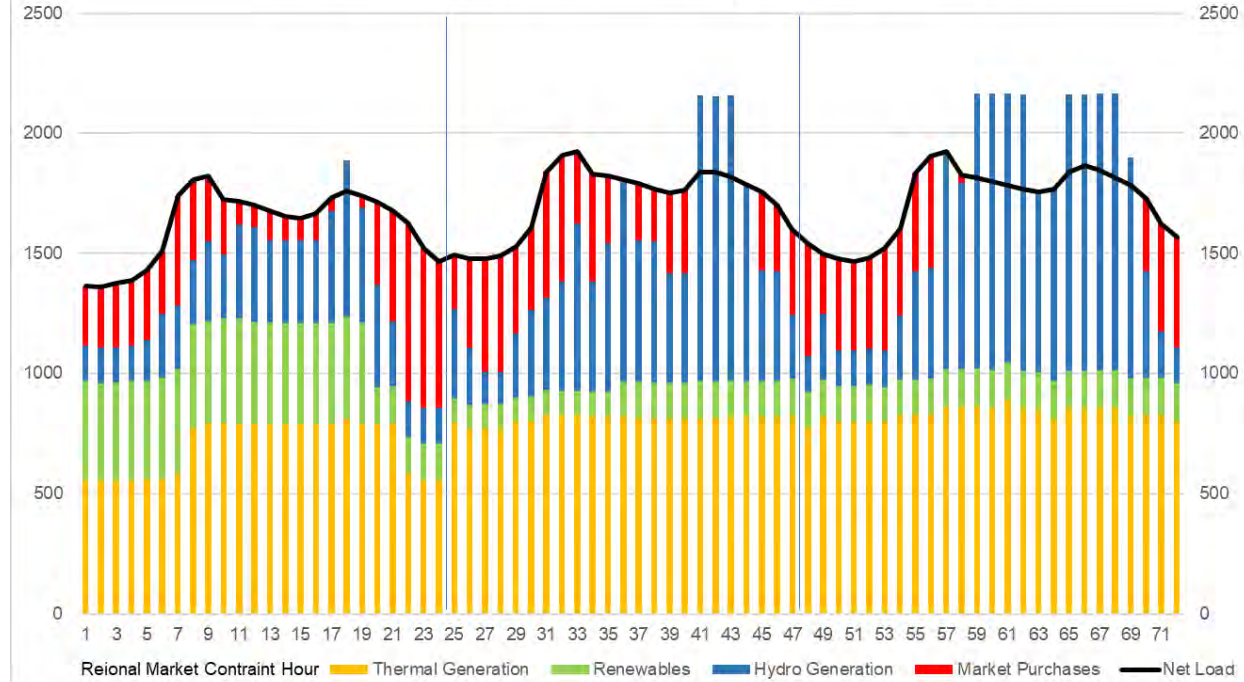

Price



Price



# Inputs - 2045

- 1,000 draws of load, hydro, and wind
- Thermal generation represents availability. Thermal dispatched according to market prices and heat rate

## Load (aMW)

	Average	Max	Min
Average Load	1,262	1,291	1,242
Winter Peak	2,134	2,219	2,026
Summer Peak	2,052	2,332	1,839

## Generation (aMW)

	Average	Max	Min
Annual Hydro	685	790	511
Wind	362	392	332
Coyote Springs 2	96	100	91
New CT Frames	177	183	166
New ICE Units	106	109	100
New Ammonia Units	652	678	614
Kettle Falls	55	56	51
<b>TOTAL</b>	<b>2,133</b>	<b>2,308</b>	<b>1,865</b>

# Results 2045

- Market purchases during all hours

Average Market Purchases by Month/Hour																									
Month	Hours	1	2	3	4	5	6	7	8	9	10	11	12	13	14	15	16	17	18	19	20	21	22	23	24
1		346	390	386	385	375	382	428	420	399	372	300	253	238	224	212	189	167	177	209	205	202	300	459	482
2		310	348	347	354	336	338	379	364	329	281	203	174	165	153	147	136	112	106	140	144	154	194	388	422
3		214	248	248	254	237	238	268	239	202	169	103	88	76	82	94	72	42	37	53	52	60	118	263	309
4		96	143	152	159	131	112	101	79	64	46	18	10	9	14	17	11	4	1	1	1	3	20	115	173
5		21	45	52	56	40	29	15	9	5	3	1	1	1	0	0	0	0	1	2	1	0	0	17	52
6		26	50	52	55	40	28	17	9	6	4	3	2	1	0	0	1	1	4	8	4	2	1	15	62
7		82	92	89	82	69	58	53	48	51	46	34	34	36	33	29	25	17	30	44	29	31	64	136	168
8		139	138	125	114	106	103	99	96	111	118	115	130	154	160	159	147	83	63	77	90	148	267	282	244
9		90	99	87	84	81	84	99	107	118	117	104	100	107	104	105	97	60	23	23	35	87	188	207	162
10		122	122	116	118	112	134	206	238	232	209	119	86	112	119	122	95	67	35	9	25	77	171	257	204
11		269	268	254	256	262	292	365	374	341	306	226	174	167	154	145	132	90	48	63	92	117	231	386	369
12		384	397	387	387	377	394	444	434	406	362	273	222	208	192	182	174	151	133	160	169	197	270	481	500

95th Percentile Market Purchases																									
Month	Hour	1	2	3	4	5	6	7	8	9	10	11	12	13	14	15	16	17	18	19	20	21	22	23	24
1		663	716	710	710	705	715	768	771	764	746	697	663	643	613	569	472	418	479	516	507	472	728	813	813
2		627	673	671	679	656	656	717	726	698	656	593	556	528	492	474	366	347	386	402	455	442	530	761	750
3		520	566	567	573	546	546	597	597	575	537	423	373	299	327	379	240	164	209	247	253	265	381	616	635
4		321	418	430	446	395	356	323	274	235	183	100	63	55	81	91	74	31	0	0	0	12	137	350	456
5		82	178	222	251	157	103	73	59	38	18	0	0	0	0	0	0	0	4	0	0	0	87	179	
6		147	235	247	262	203	154	86	61	50	33	15	4	0	0	0	0	1	20	50	22	3	100	268	
7		311	329	325	313	291	262	239	217	239	233	194	203	205	147	139	143	129	183	229	175	206	315	467	467
8		396	396	379	359	344	343	327	316	343	370	386	424	471	498	524	533	333	297	340	351	525	653	603	533
9		310	333	312	309	305	315	331	342	359	360	348	353	382	381	389	367	217	122	144	172	284	526	484	425
10		376	379	370	376	362	390	486	528	523	501	413	339	395	404	408	328	178	123	49	118	189	485	551	490
11		572	571	562	562	563	597	685	705	678	635	566	511	491	462	426	334	228	227	268	281	289	591	717	682
12		701	715	704	707	697	712	769	772	740	703	645	577	537	489	448	387	403	404	444	467	443	613	816	820



# Results 2045

- Market purchases during all hours

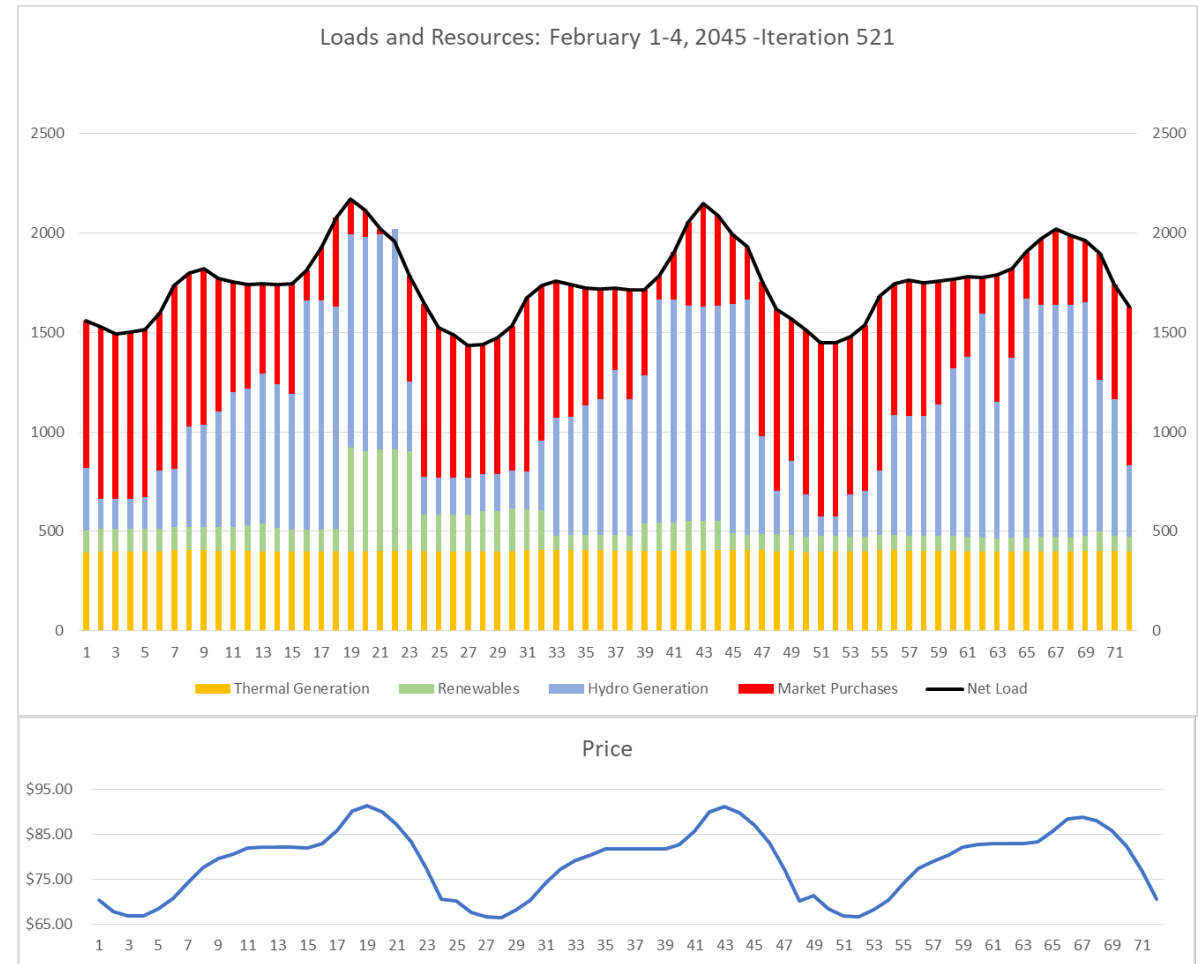
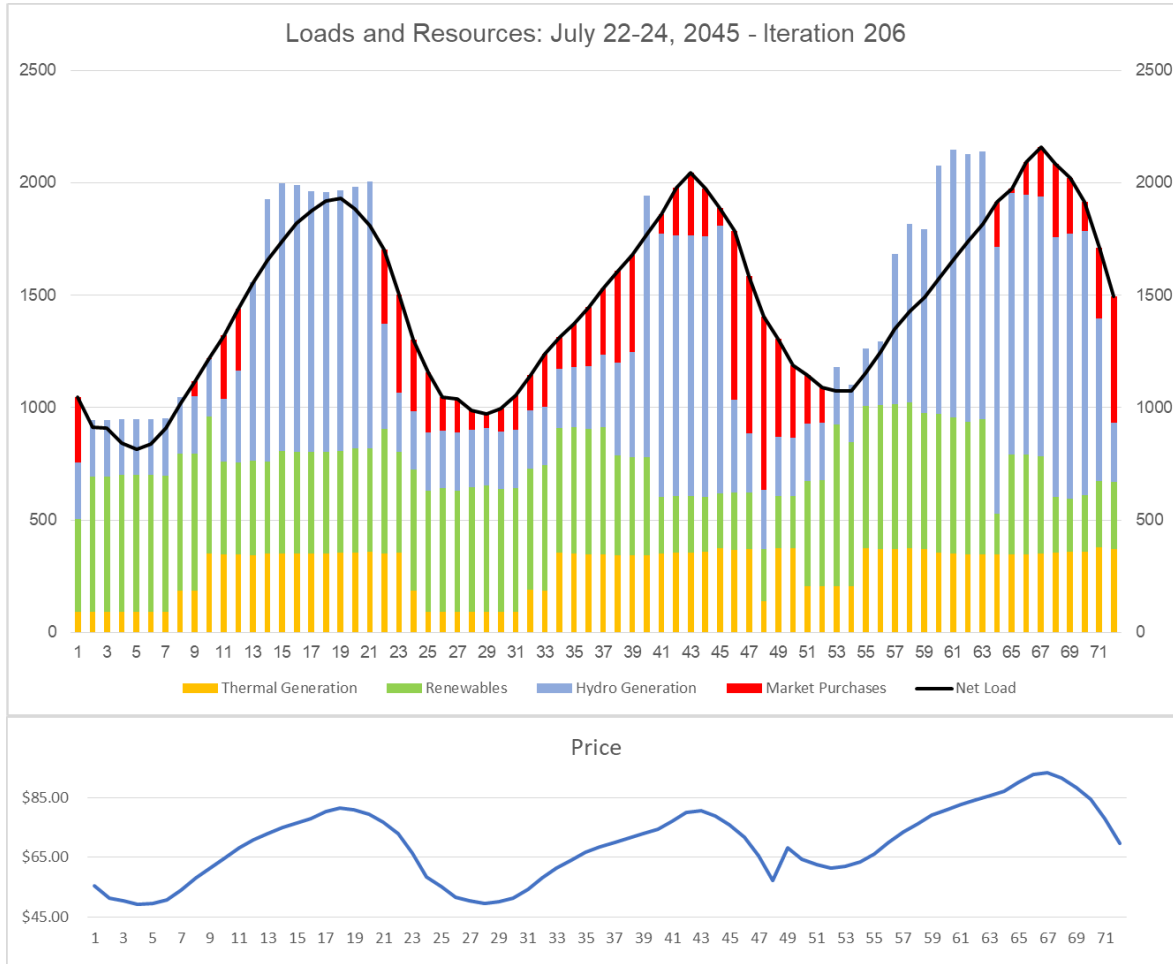

# Results 2045

- Market purchases during regional market constrained hours

50th Percentile Market Purchases During Regional Market Constrained Conditions																									
		Hour <input type="button" value="v"/>																							
Month <input type="button" value="v"/>		1	2	3	4	5	6	7	8	9	10	11	12	13	14	15	16	17	18	19	20	21	22	23	24
1		255	286	302	297	305	338	401	414	390	350	283	275	265	232	209	185	175	184	189	194	209	263	361	389
2		318	246	235	254	258	311	403	388	333	292	279	213	199	190	221	181	140	131	164	165	184	193	238	359
3		0	0	0	0	0	0	0	0	0	0	0	0	0	0	0	0	0	0	0	0	0	0	0	0
4		0	0	0	0	0	0	0	0	0	0	0	0	0	0	0	0	0	0	0	0	0	0	0	0
5		0	0	0	0	0	0	0	0	0	0	0	0	0	0	0	0	0	0	0	0	0	0	0	0
6		401	251	85	87	81	64	216	272	269	203	197	48	19	34	26	28	49	110	165	97	57	62	145	166
7		125	101	102	63	65	61	74	100	126	149	161	222	257	202	109	83	66	103	129	94	57	136	221	209
8		95	81	76	90	65	56	54	64	109	114	131	134	172	186	191	93	75	88	104	73	93	278	303	237
9		104	134	177	199	142	133	223	273	259	292	291	260	284	285	292	327	271	19	111	104	27	520	425	493
10		125	182	363	352	298	311	161	256	77	73	121	105	265	267	257	171	242	79	121	123	350	453	228	298
11		374	378	418	422	458	502	592	553	437	339	187	105	186	142	172	200	136	176	167	143	164	196	442	445
12		343	366	348	354	376	396	440	429	374	321	282	264	221	222	214	232	250	184	216	237	247	288	401	494

95th Percentile Market Purchases During Regional Market Constrained Conditions																									
		Hour <input type="button" value="v"/>																							
Month <input type="button" value="v"/>		1	2	3	4	5	6	7	8	9	10	11	12	13	14	15	16	17	18	19	20	21	22	23	24
1		796	825	843	850	853	891	930	934	937	917	878	842	824	800	771	718	655	636	674	683	719	860	908	919
2		807	833	791	796	777	839	905	892	842	757	839	819	786	743	818	644	431	447	501	487	424	695	823	846
3		0	0	0	0	0	0	0	0	0	0	0	0	0	0	0	0	0	0	0	0	0	0	0	0
4		0	0	0	0	0	0	0	0	0	0	0	0	0	0	0	0	0	0	0	0	0	0	0	0
5		0	0	0	0	0	0	0	0	0	0	0	0	0	0	0	0	0	0	0	0	0	0	0	0
6		527	516	458	504	416	428	380	475	408	244	200	53	79	140	172	256	359	464	517	442	344	248	524	737
7		446	440	430	393	375	337	319	329	389	413	411	436	489	403	309	302	327	384	437	384	329	523	632	601
8		473	424	445	431	394	380	394	408	478	531	584	644	702	757	778	635	492	496	554	535	632	872	809	677
9		533	532	618	645	607	648	675	721	581	605	624	639	814	814	822	862	835	752	482	750	801	887	724	770
10		538	770	825	818	614	655	673	605	758	761	775	718	733	737	752	761	688	626	210	468	912	817	739	859
11		730	746	723	741	796	828	902	902	875	816	724	576	662	623	553	562	441	494	492	451	536	672	903	875
12		801	851	848	843	849	866	886	884	879	872	820	746	690	668	655	593	633	638	657	653	649	788	894	929

# Results 2045

- Market purchases during all hours

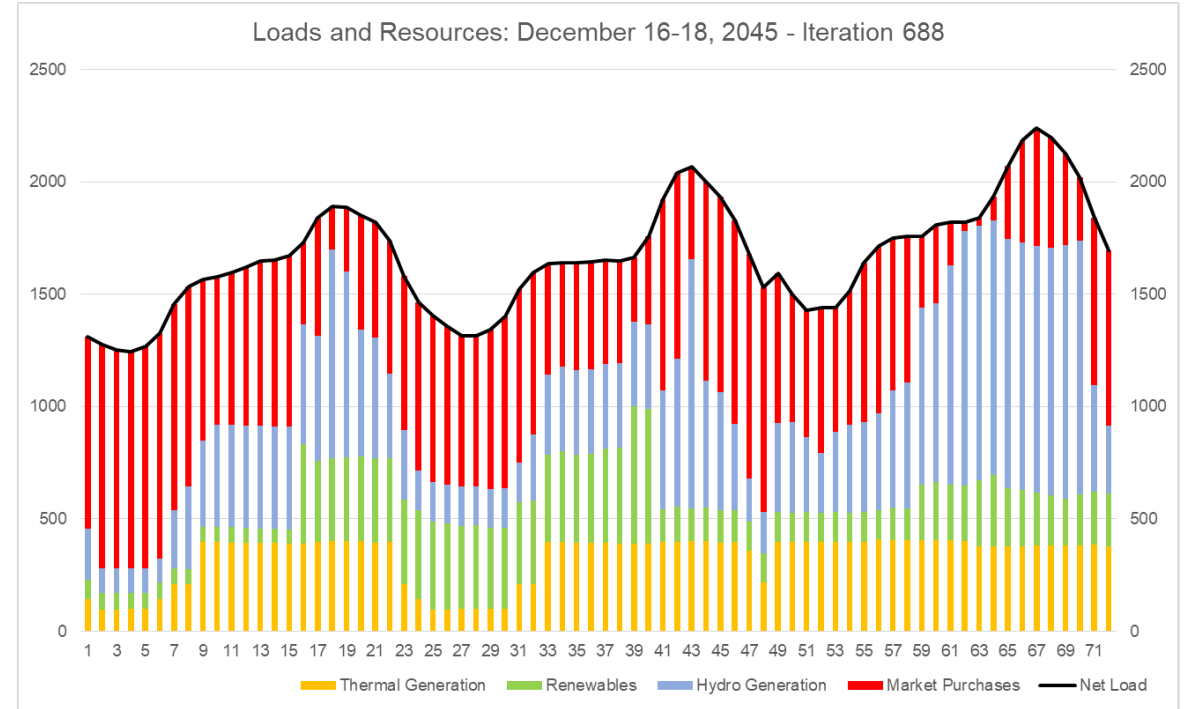
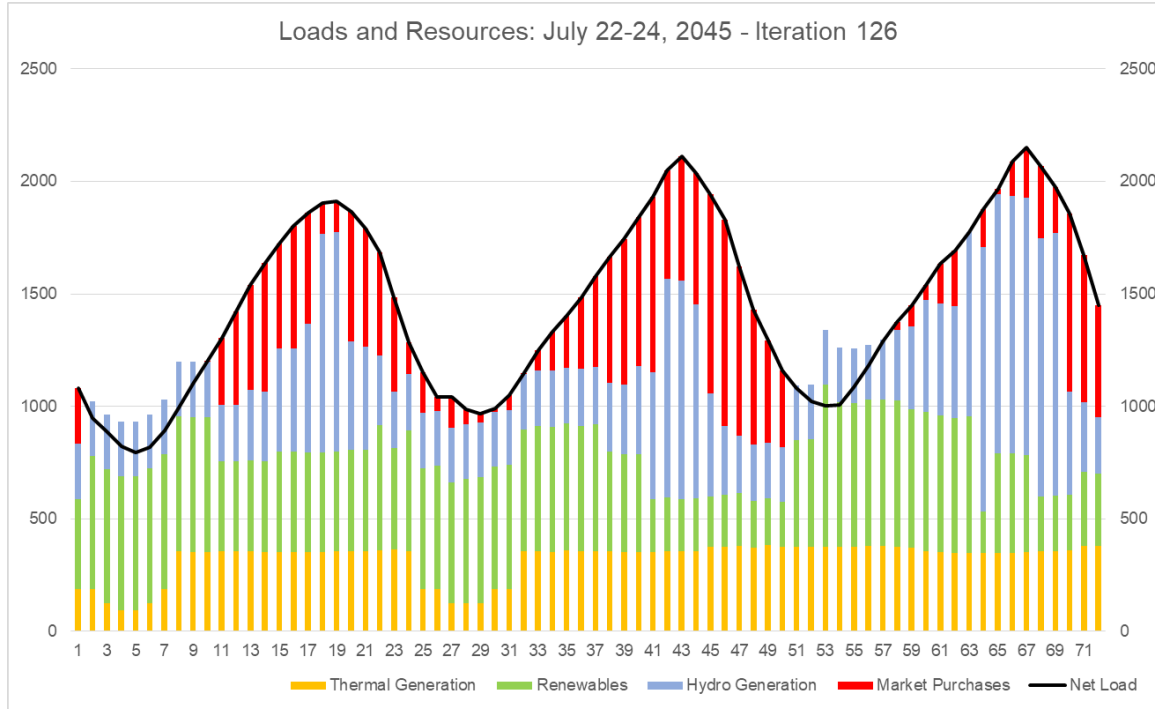



# 2023 Portfolio Scenario Analysis

Avista IRP Team  
Technical Advisory Committee Meeting No. 9  
April 25, 2023

# Scenario Overview

1. Preferred Resource Strategy
2. Alternative Lowest Reasonable Cost Portfolio
3. Baseline Portfolio
4. No Resource Additions
5. No CETA/No New Natural Gas Plants
6. WRAP Planning Reserve Margin (PRM)
7. WRAP PRM w/ No Qualifying Capacity Credit (QCC) Changes
8. Variable Energy Resources (VERs) Assigned to Washington
9. Low Economic Growth
10. High Economic Growth
11. High Electric Vehicle Growth
12. WA Space/Water Heat Electrification
13. WA Space/Water Heat Electrification w/ Natural Gas Backup
14. Combined Electrification
15. Clean Portfolio by 2045
16. Social Cost Included for Idaho
17. WA Maximum Benefit Scenario

## 2. Alternative Lowest Reasonable Cost

### Purpose & Assumptions

- Understand financial impact of CETA compliance for Washington
- Used for CETA cost cap calculation
- Assumes SCGHG is included, along with other NEI values for Washington
- Does not assume NCIF or CETA clean energy targets

### Results & Comparison to PRS

- WA Costs \$7.8 million lower (Levelized)
  - \$81 million less in 2045 or 5% lower rates
  - Idaho financial impacts de minimis
- 2045 impact is mostly due to retaining Coyote Springs 2
- Natural Gas CT is selected for WA (247 MW) in exchange for Renewable Fueled CTs
- Storage selection is increased due to model not trying to meet monthly renewable energy targets
- Idaho's portfolio has reductions in Natural Gas CT and increase in energy storage

# 3. Baseline Portfolio

## Purpose & Assumptions

- Represents least cost portfolio to meet customer requirements
  - Does not include CETA goals or SCGHG
  - Non-Energy Impacts (NEI) still included for Washington
- Used to estimate premiums for Avoided Cost Calculations
- Values rate impact of including SCGHG

## Results & Comparison to PRS

- WA Costs \$13 million lower (levelized)
  - \$203 million less in 2045 or 13% lower rates
  - Idaho financial impacts de minimis
- More resources are chosen as a system resources rather than by state
- Natural Gas CT is selected for WA (431 MW) in exchange for Renewable Fueled CTs
  - Wind/Storage significantly lower, but selected
- Idaho's resource selection lowers Natural Gas in exchange for additional energy storage and some wind, demand response is selected

## 4. No Resource Additions

### Purpose & Assumptions

- Used to determine capacity pricing for Avoided Cost Calculation
- Retains PRS's Energy Efficiency results

### Results & Comparison to PRS

- Financial and resource selection results are not material other than used for avoided cost estimates
- Power supply cost are derived by 100% reliance on energy market for open positions rather than adding resources



## 5. No CETA/No New Natural Gas CT

### Purpose & Assumptions

- Starts with Baseline portfolio assumptions, but does not allow new natural gas resources to be selected
- The results are used for estimate clean capacity premiums for avoided cost calculation

### Results & Comparison to PRS

- Financial and resource selection results are not material other than those used for avoided cost estimates

## 6. WRAP Planning Reserve Margin

### Purpose & Assumptions

- Uses WRAP PRM rather than Avista's PRM

Month	WRAP	2023 IRP
Jan	19.0%	22.0%
Feb	19.9%	22.0%
Mar	26.9%	22.0%
Apr	23.4%	22.0%
May	20.0%	13.0%
Jun	16.5%	13.0%
Jul	10.4%	13.0%
Aug	10.3%	13.0%
Sep	17.9%	13.0%
Oct	19.8%	22.0%
Nov	21.6%	22.0%
Dec	17.7%	22.0%

- Purpose is to understand alternative resource selection with differing PRM

### Results & Comparison to PRS

- Overall cost changes are de minimis
  - WA is slightly higher and ID slightly less
- WA resource selection increases wind and energy storage, decreases renewable fuel CT
- ID resource selection marginally increase energy storage and selects demand response
- No material resource selection changes prior to 2032

# 7. WRAP PRM, but no QCC Reductions

## Purpose & Assumptions

- Understand impact of Avista assumption to lower QCC values of VERs, Storage, and demand response

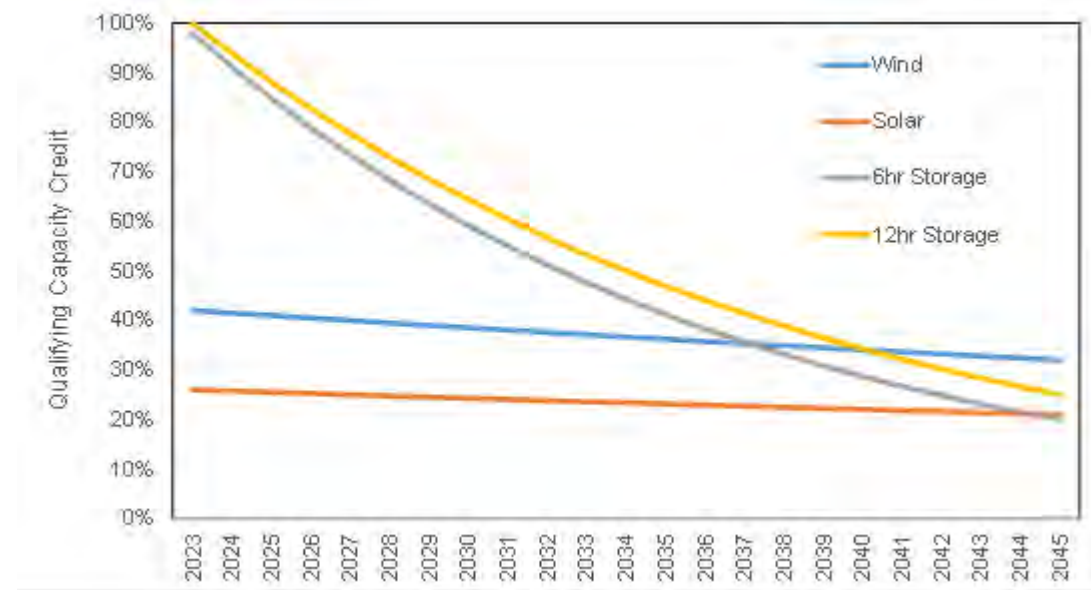

## Results & Comparison to PRS

- Total portfolio cost decrease, PVRR is \$106 million less, or \$9.2 million per year, but savings are after 2034 (less than 1%)
- Insignificant cost changes are likely due to monthly energy targets for both CETA and reliability
- Model tends to select additional wind and storage and less Renewable Fueled CTs for Washington.
- Idaho resource selection lessens natural gas CTs and increases energy storage and demand response

## 8. VER's Assigned to Washington

### Purpose & Assumptions

- Purpose is to understand resource selection if existing wind/solar only serve the Washington jurisdiction
- Avista does not separate PPA contract costs to protect pricing confidentiality, therefore only system costs are shown

### Results & Comparison to PRS

- Total portfolio costs increase by \$29 million PVRR, or 0.2%
- Washington's wind resource need declines by 100 MW, remaining portfolio is similar to PRS
- Idaho's resource need increases Natural Gas CTs and slightly lessens energy storage

# 9. Low Economic Growth

## Purpose & Assumptions

- Understand resource strategy changes with lower load growth due to less economic expansion

<b>Economic Growth</b>	<b>Average Annual Native Load Growth (%)</b>
Expected Case	0.85
Low Growth	0.53

## Results & Comparison to PRS

- PVRR are less due to lower loads, but rates increase 4% higher for both states
- Lower loads do not dilute utility fixed costs, only power supply costs
- Lower loads remove the mid-2030s capacity resource needs in both states
- Washington still requires similar renewable energy resources, but less renewable fueled CTs
- Idaho also needs less Natural Gas CTs, but energy storage slightly increases.

# 10. High Economic Growth

## Purpose & Assumptions

- Understand resource strategy changes with higher load growth due to greater economic expansion

Economic Growth	Average Annual Native Load Growth (%)
Expected Case	0.85
High Growth	1.11

## Results & Comparison to PRS

- PVRR are higher due to higher loads, WA rate declines by less than 1% and ID declines by 5%
- Higher loads dilute utility fixed costs, only power supply costs, Idaho benefits from higher loads more than Washington likely due to lower cost resource selection
- Higher growth does not move resource need sooner, just higher capacity requirements later in the study horizon
- Washington will need to increase wind and energy storage, but small amounts of renewable fueled CTs are replaced with geothermal as compared to the PRS
- Idaho requires additional Natural Gas CTs, energy storage, and demand response

# Load Forecast Scenario Highlights

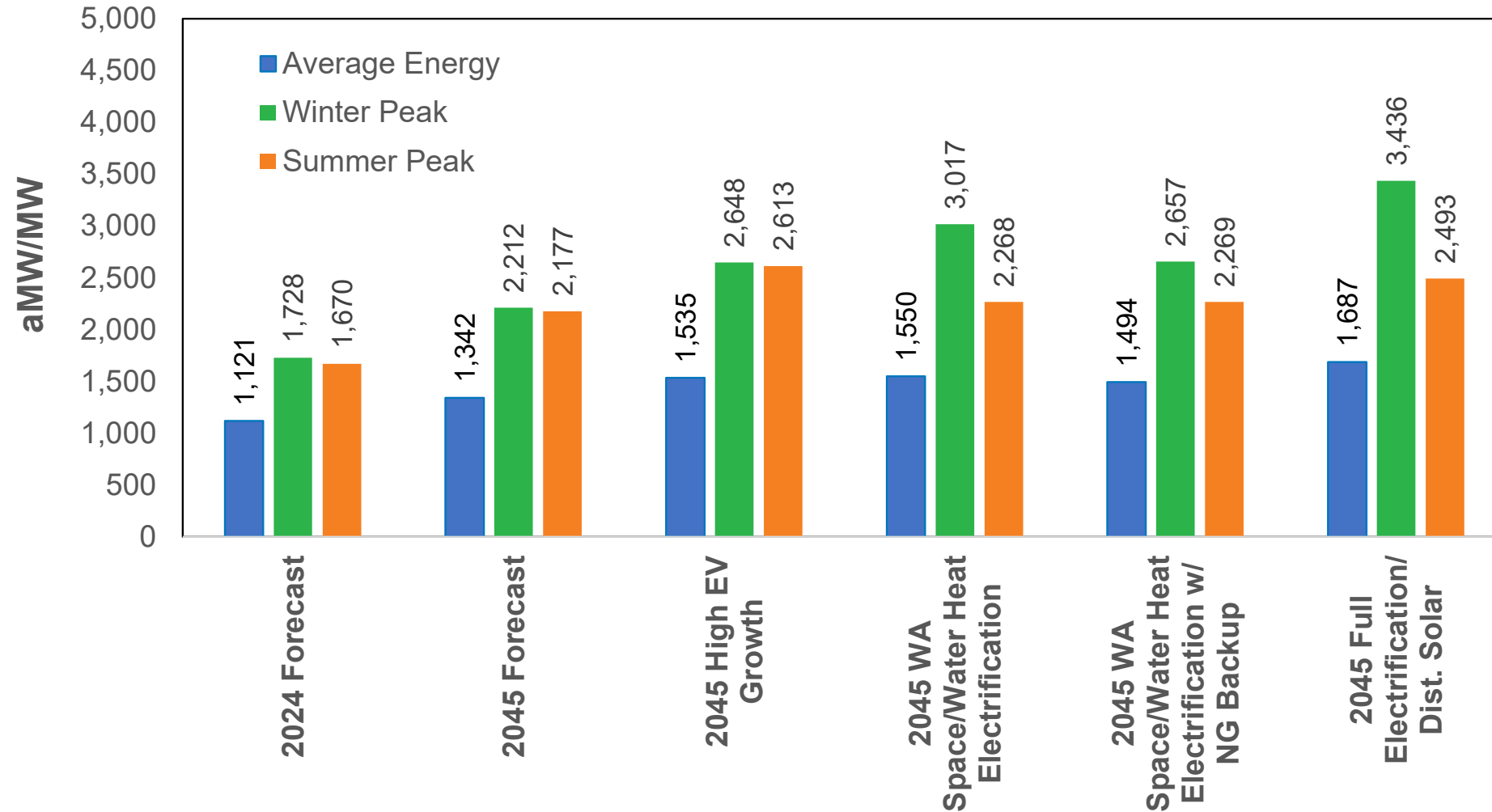

# 11. High Electric Vehicle Growth

## Purpose & Assumptions

- Understand resource strategy implications for electric vehicle growth
- Assumes 100% light duty vehicle sales by 2050 in Washington and 75% in Idaho
- 95% of medium duty vehicle sales are electric by 2040 in Washington and 75% in Idaho load forecast
  - PRS assumes 35% LDV and 15% MDV by 2050

## Results & Comparison to PRS

- PVRR cost increases 2.3%
- 2045 rates: WA: 3% reduction, ID: 0.5% increase (results likely due to shift in resource selection for Idaho)
- **Does not include T&D costs discussed later**
- Washington resource strategy similar to PRS, just higher resource need, with resources needed sooner (mid-2030s)
- Idaho resource selection slightly reduces Natural Gas CTs (-11 MW), but increases energy storage by 94 MW



# Building Electrification Load Forecasts (Winter Peak)

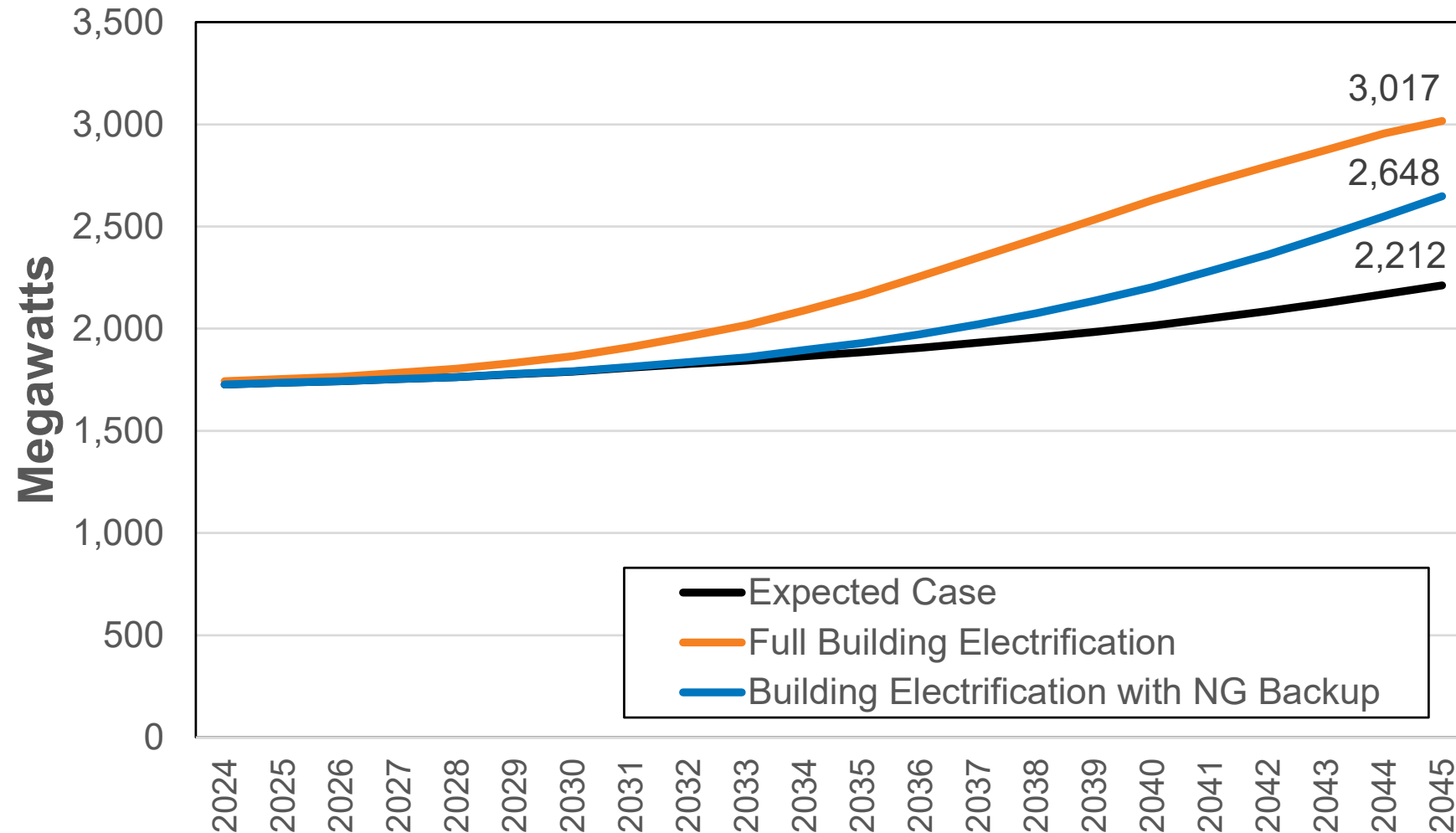

# 12. Washington Space/Water Heat Electrification

## Purpose & Assumptions

- Understand resource strategy implications for space/water heat electrification
- Assumes gradual shift of existing natural gas customers to electric using a combination of heat pumps/resistance heat with heat pump water heat for Washington customers only

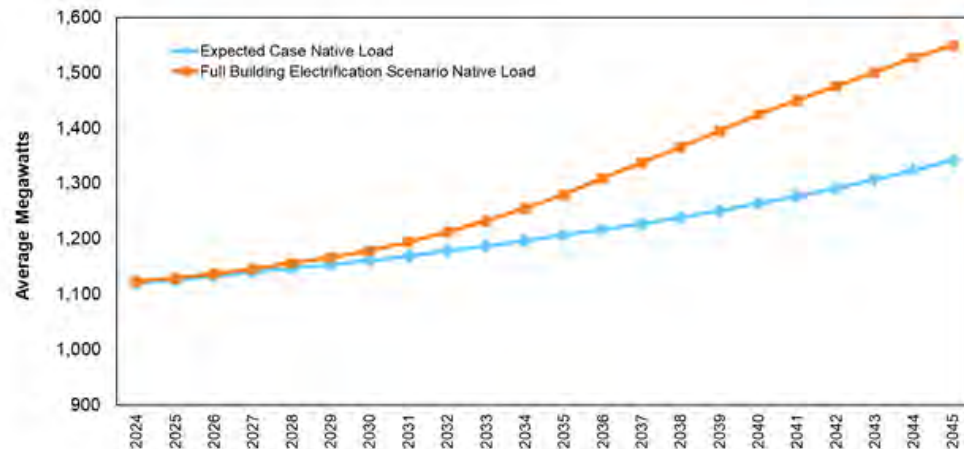

## Results & Comparison to PRS

- 2045 Rates: WA 11% higher (13% with all transmission costs)
  - Does not include T&D costs discussed later
  - Idaho could have rate impacts depending on transmission infrastructure cost allocation (rate impact is ~5%)
- Washington resource strategy is similar to PRS, just higher resource need, with resources needed sooner (early 2030s), energy storage has the most significant increase (805 MW)
- Idaho resource selection slightly reduces Natural Gas CTs (-37 MW), but increase energy storage by 68 MW

# 13. Washington Space/Water Heat Electrification w/ Natural Gas Backup

## Purpose & Assumptions

- Assumes space heating with heat pump technology, but shifts to natural gas when temperatures are below 40 degrees for Washington customers
  - Current central heat pump technology limits. Does assume lower temps for limited ductless technology applications
  - Strategy allows for reduction in natural gas usage without stressing winter peak needs as much as full electrification
  - Represents proposed building codes

## Results & Comparison to PRS

- 2045 Rates: WA 4% higher
  - Does not include T&D costs discussed later
  - Idaho could have rate impacts depending on transmission infrastructure cost allocation (rate impact is ~5%)
- Washington resource strategy is similar to PRS and #12, but resource selection is between scenarios in resource need
- Idaho resource selection slightly reduces Natural Gas CTs (-32 MW), but increases energy storage by 82 MW

# 14. Combined Electrification

## Purpose & Assumptions

- Assumes highest load potential
  - Combines scenario #11 and #12 load impacts
- Useful in understanding boundaries of load growth for existing customers in extreme electrification efforts

## Results & Comparison to PRS

- 2045 Rates: WA 16.5% higher (4 cents/kWh)
  - Does not include T&D costs discussed later
  - Idaho could have rate impacts depending on transmission infrastructure cost allocation (rate impact is ~5%)
- Capacity resources needed by 2032
- Washington resource strategy requires additional wind and energy storage, but also includes nuclear (350 MW) and geothermal (40 MW) and biomass (58 MW) as resource selections
- Idaho resource selection slightly reduces Natural Gas CTs (-21 MW), but increases energy storage by 100 MW

# Transmission Estimates (included in IRP modeling)

- Resource connection costs from IRP transmission studies from resource selection
  - \$304 million (2023\$) to be online 2030 to 2045 (PRS \$249 million)
- Major transmission improvements for energy delivery
  - North Idaho and Spokane, upgrading Big-Bend area for wind integration, import connection with BPA and others, plus 3<sup>rd</sup> party upgrades to interconnect off-system generation
    - \$715 million (2023\$) to be online by 2040-2045 (PRS \$250 million)
- 3<sup>rd</sup> party transmission wheeling
  - \$62 million (\$32 million PRS)
- Current net book value is \$0.7 billion

# Customer Delivery Costs (T&D Investments)

- Electrification Portfolio's require new T&D investments
- At this time only Portfolio #14 is being estimated
- These estimates require additional analysis and are based on preliminary estimates without conducting detailed engineering analysis
  - Further analysis will need to be completed as part of Distribution Planning Advisory Group (DPAG)
- 1,450 MW of delivery capability (include 1-20 winter weather event) mostly in urban/suburban areas
- 75% of system is likely to require upgrades
- 36 new distribution substations by splitting up existing feeders (create 145 new feeders)
- 6 new 230/115 kV switching stations
- 32,000 new service transformers
- 163 miles of distribution lines
- 72 miles of 115kV, 30 miles of 230 kV
- 1,900 miles customer conductor
- 46 FTE support staff (not including engineers/crew to construct infrastructure)

# Preliminary Cost and Impacts

- Total cost in 2023\$ is \$1.9 billion (\$3.3 billion nominal cost)
- Estimates used per substation is \$57 million
- For this estimate additional upgrades begin in 2028 and escalate through 2045
- With inflation, customer revenue requirement is \$2.2 billion for these investments (present value) when amortized over 50 years
- As a comparison: current net book of WA distribution assets is ~\$1 billion

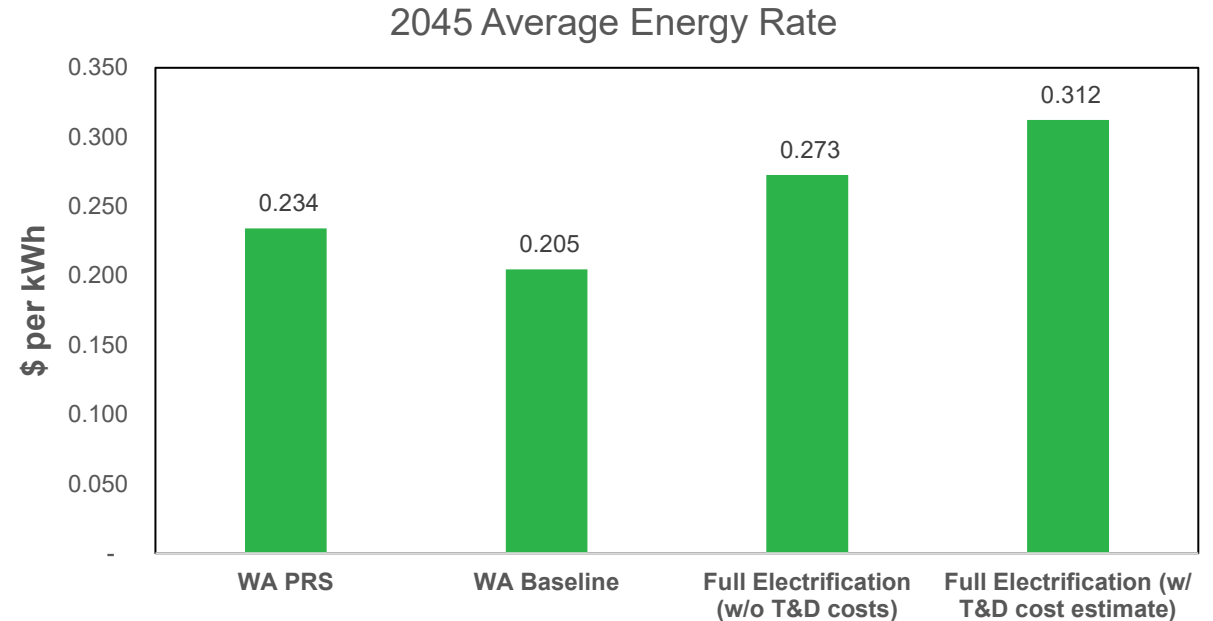

# 15. Clean Portfolio by 2045

## Purpose & Assumptions

- Assumes Avista retires all natural gas resources by 2045
- Resource additions are only renewable or not emitting for both states

## Results & Comparison to PRS

- 2045 Rates: WA 2.6% higher, Idaho 40% higher (+7.4 cents) compared to PRS
- Idaho's new resource portfolio would require 236 MW of wind, 378 MW renewable fueled CTs, 90 MW of DR/energy storage, and geothermal
- Idaho's resource selection moves up to 2032 vs. 2034
- Washington's portfolio as compared to the PRS is largely unchanged
- Idaho's share of greenhouse gas emissions fall by 717,000 metric tons in 2045



# 16. Social Cost Included For Idaho

## Purpose & Assumptions

- Determines if Idaho's resource selection changes if NEI and SCGHG costs are included for the Idaho resource selection
- Result of concern by a customer in the IRP public meeting
- Indirectly demonstrates the premium of CETA over the social cost/benefit in Washington

## Results & Comparison to PRS

- Resources for Idaho do change
  - 100 MW less natural gas CT
  - 31 MW less energy storage
  - 116 MW added Renewable Fueled CT
  - 20 MW added geothermal
- Idaho 2045 rate is 1.8% higher
- Washington resources and costs are largely unchanged but demonstrates a 25% premium in cost of CETA vs. using only social cost of resource decisions

# 17. Washington Maximum Customer Benefits

## Purpose & Assumptions

- Washington state required scenario used to understand cost/benefits of increasing customer benefit indicators.
- Portfolio is designed to achieve the following goals:
  - Select resources either within Washington or connected to Avista's system
  - Reduce air emissions (i.e., NOx)
  - Increase investment in name communities for energy bill offsets
  - No nuclear
- Further discussion and design will be discussed in the 2025 IRP

## Results & Comparison to PRS

- Increases solar by 817 MW with 676 MW directly benefiting low-income customers to reduce energy burden from \$2,045 per year to \$632 per year
- 228 MW of hydrogen fuel cells
- 591 MW of energy storage (long-duration)
- Reduction of 100 MW of wind capacity
- 40 MW of geothermal (not restricted, but may not meet proximity requirement)
- Costs of this scenario increase average energy rates in 2045 by 29% or 6.8 cents per kWh

# Scenarios

	1- Preferred Resource Strategy	2- Alternative Lowest Reasonable Cost Portfolio	3- Baseline Portfolio	4- No Resource Additions	5- No CETA/ No new NG	6- WRAP PRM	7- WRAP PRM No QCC Changes	8- VERs Assigned to Washington	9- Low Economic Growth Loads	10- High Economic Growth Loads	11- High Electric Vehicle Growth	12- WA Space/ Water Electrification	13- WA Space/ Water Electrification w/NG Backup	14- Combined Electrification	15- Clean Portfolio by 2045	16- Social Cost Included for Idaho	17- WA Maximum Customer Benefits
<b>Washington</b>																	
NG CT	0	247	431	0	0	0	0	0	0	0	0	0	0	0	0	0	0
Solar	10	51	0	0	0	11	11	11	10	11	97	11	161	11	10	84	827
Storage Added to Solar	0	25	0	0	0	1	0	0	1	1	0	0	1	0	1	37	1
Wind	945	843	364	0	400	1,028	1,145	845	905	1,045	1,245	1,545	1,345	1,545	1,009	905	845
Storage	130	494	265	0	795	365	454	125	298	209	492	935	569	1,231	91	123	591
Hydrogen/Ammonia	696	88	0	0	79	578	312	682	366	646	707	890	767	712	704	682	228
Other "Clean" Baseload	0	0	0	0	0	20	78	20	98	20	98	98	98	447	33	20	40
Existing Plant Upgrades	0	0	3	0	0	6	6	0	3	3	0	0	0	3	0	0	3
DR Capability	7	7	7	0	7	7	7	7	7	7	7	7	7	7	7	7	7
EE- Winter Capacity	57	57	57	57	55	57	57	57	57	57	57	57	57	58	57	57	58
EE- Summer Capacity	59	60	59	59	59	60	59	59	59	59	59	60	60	60	59	59	60
<b>Idaho</b>																	
NG CT	304	264	164	0	0	302	278	318	229	349	293	267	272	283	0	203	271
Solar	0	0	0	0	0	0	0	0	0	0	0	0	0	0	0	0	0
Storage Added to Solar	0	0	0	0	0	0	0	0	0	0	0	0	0	0	0	0	0
Wind	0	0	36	0	0	0	0	0	0	0	0	0	0	0	236	0	0
Storage	67	89	176	0	350	87	126	42	77	112	161	135	149	167	18	36	85
Hydrogen/Ammonia	0	0	0	0	0	0	0	0	0	0	0	0	0	0	377	115	0
Other "Clean" Baseload	0	0	0	0	0	0	0	0	0	0	0	0	0	0	65	20	0
Existing Plant Upgrades	0	0	2	0	0	4	4	0	2	2	0	0	0	2	0	0	2
DR Capability	0	0	11	0	0	0	5	0	0	7	0	0	0	0	7	0	0
EE- Winter Capacity	24	25	24	24	22	24	24	24	24	24	24	24	26	26	27	24	24
EE- Summer Capacity	24	26	24	24	21	26	26	24	24	24	25	24	25	26	28	26	24



# Portfolio Cost & Rate Impacts

Scenario	WA- PVRR (\$ Mill)	ID-PVRR (\$ Mill)	TOTAL PVRR (\$ Mill)	WA 2030 Rate (\$/kWh)	WA 2045 Rate (\$/kWh)	ID 2030 Rate (\$/kWh)	ID 2045 Rate (\$/kWh)
1- Preferred Resource Strategy	10,213	4,783	14,996	0.133	0.234	0.119	0.185
2- Alternative Lowest Reasonable Cost Portfolio	10,122	4,778	14,900	0.132	0.222	0.119	0.181
3- Baseline Portfolio	10,064	4,789	14,852	0.133	0.205	0.119	0.184
4- No Resource Additions	9,966	4,713	14,679	0.133	0.194	0.119	0.169
5- No CETA/ No new NG	10,158	4,821	14,980	0.133	0.223	0.119	0.188
6- WRAP PRM	10,217	4,778	14,995	0.133	0.242	0.119	0.186
7- WRAP PRM No QCC Changes	10,126	4,763	14,889	0.133	0.233	0.119	0.179
8- VERs Assigned to Washington	10,205	4,819	15,024	0.133	0.234	0.120	0.184
9- Low Economic Growth Loads	10,119	4,697	14,816	0.134	0.243	0.120	0.192
10- High Economic Growth Loads	10,279	4,868	15,148	0.132	0.233	0.117	0.176
11- High Electric Vehicle Growth	10,541	4,812	15,354	0.133	0.227	0.119	0.186
12- WA Space/ Water Electrification	11,283	4,843	16,126	0.131	0.259	0.119	0.195
13- WA Space/ Water Electrification w/NG Backup	10,787	4,800	15,586	0.132	0.244	0.119	0.194
14- Combined Electrification	11,655	4,879	16,533	0.131	0.273	0.119	0.195
15- Clean Portfolio by 2045	10,227	4,902	15,130	0.133	0.240	0.119	0.259
16- Social Cost Included for Idaho	10,219	4,801	15,021	0.133	0.235	0.118	0.188
17- WA Maximum Customer Benefits	10,594	4,769	15,363	0.134	0.302	0.119	0.182

# Portfolio Cost vs. Risk

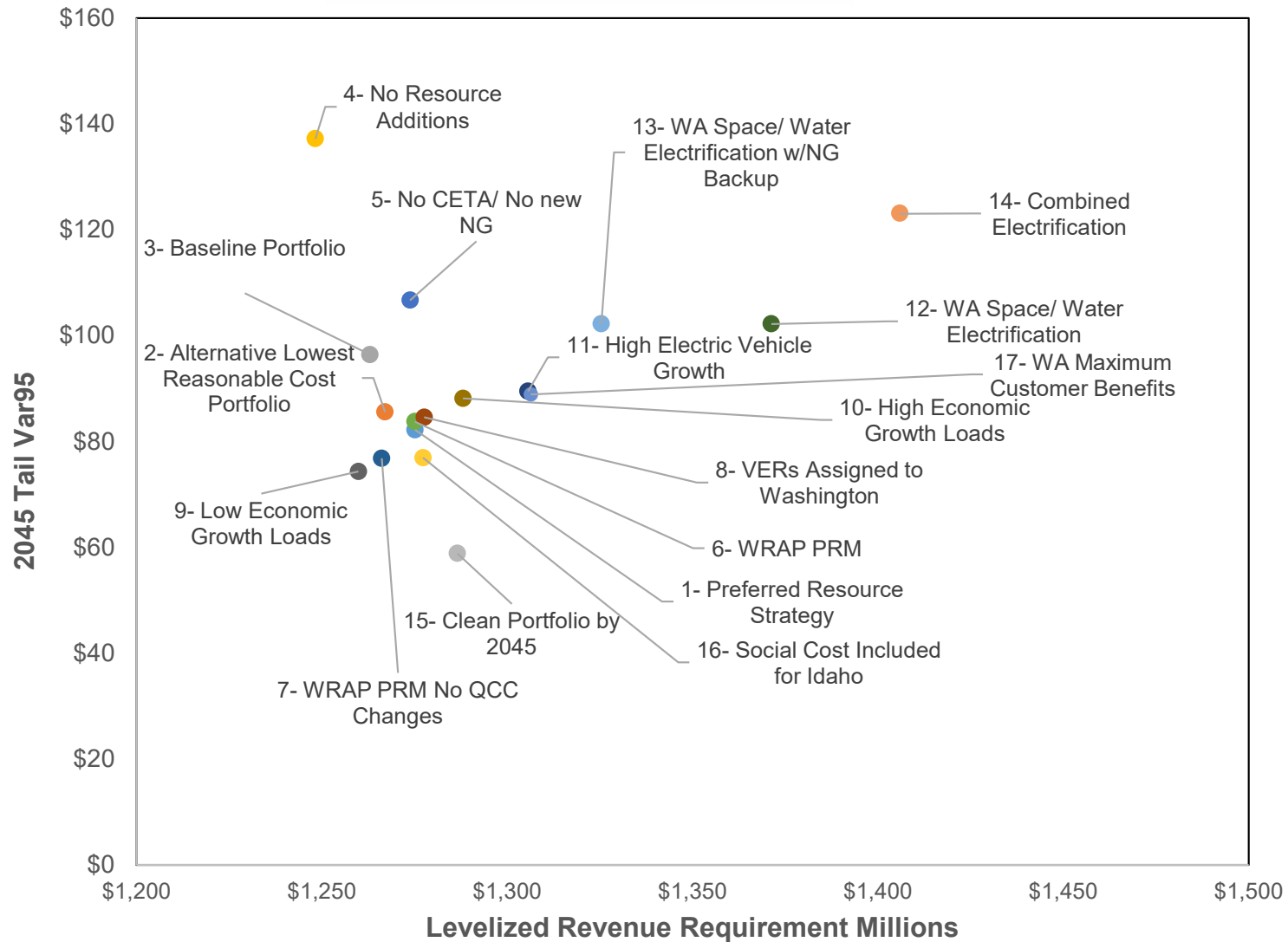

# Greenhouse Gas and Cost Comparison to PRS

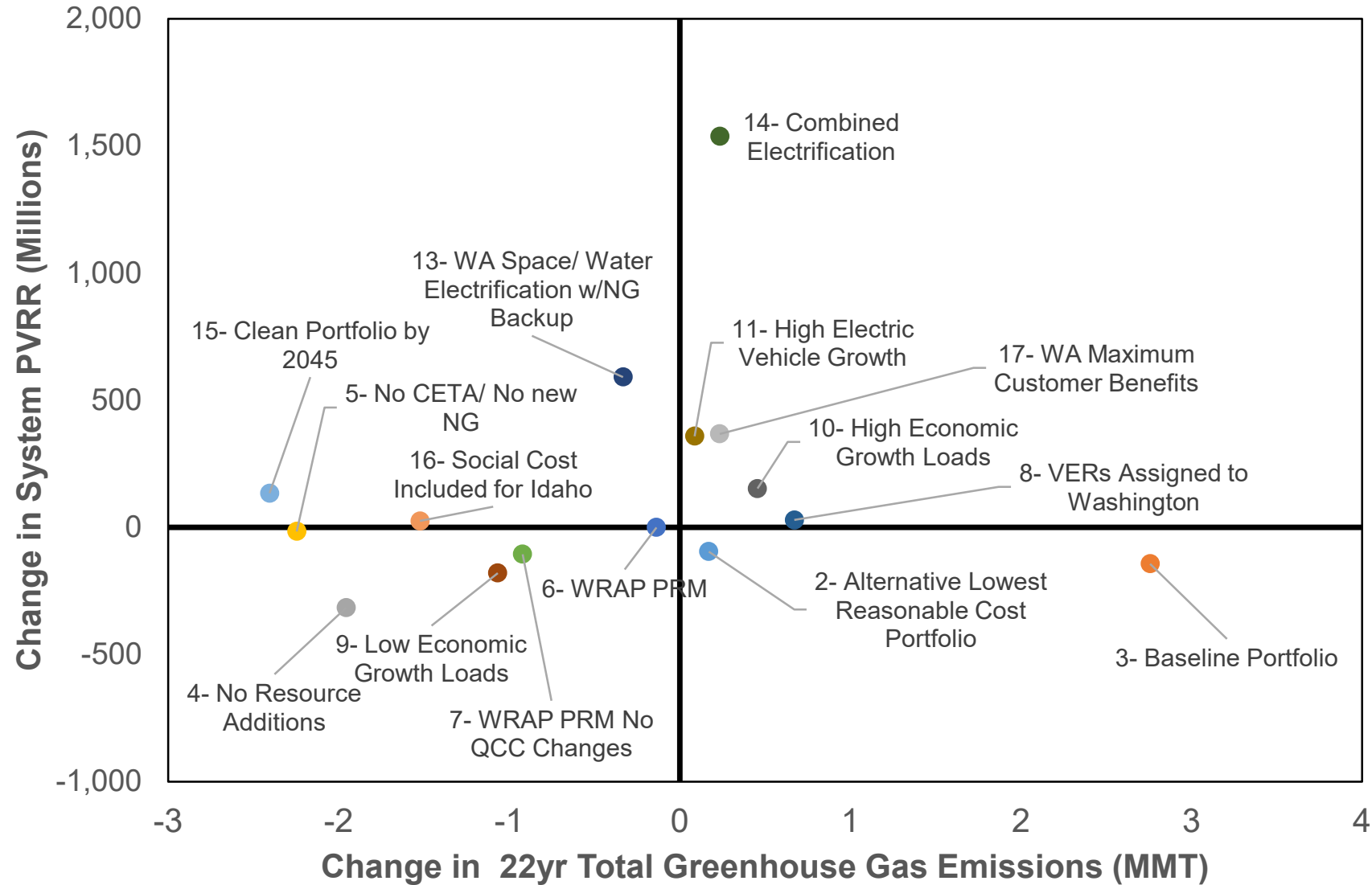

# Greenhouse Gas Emission Savings

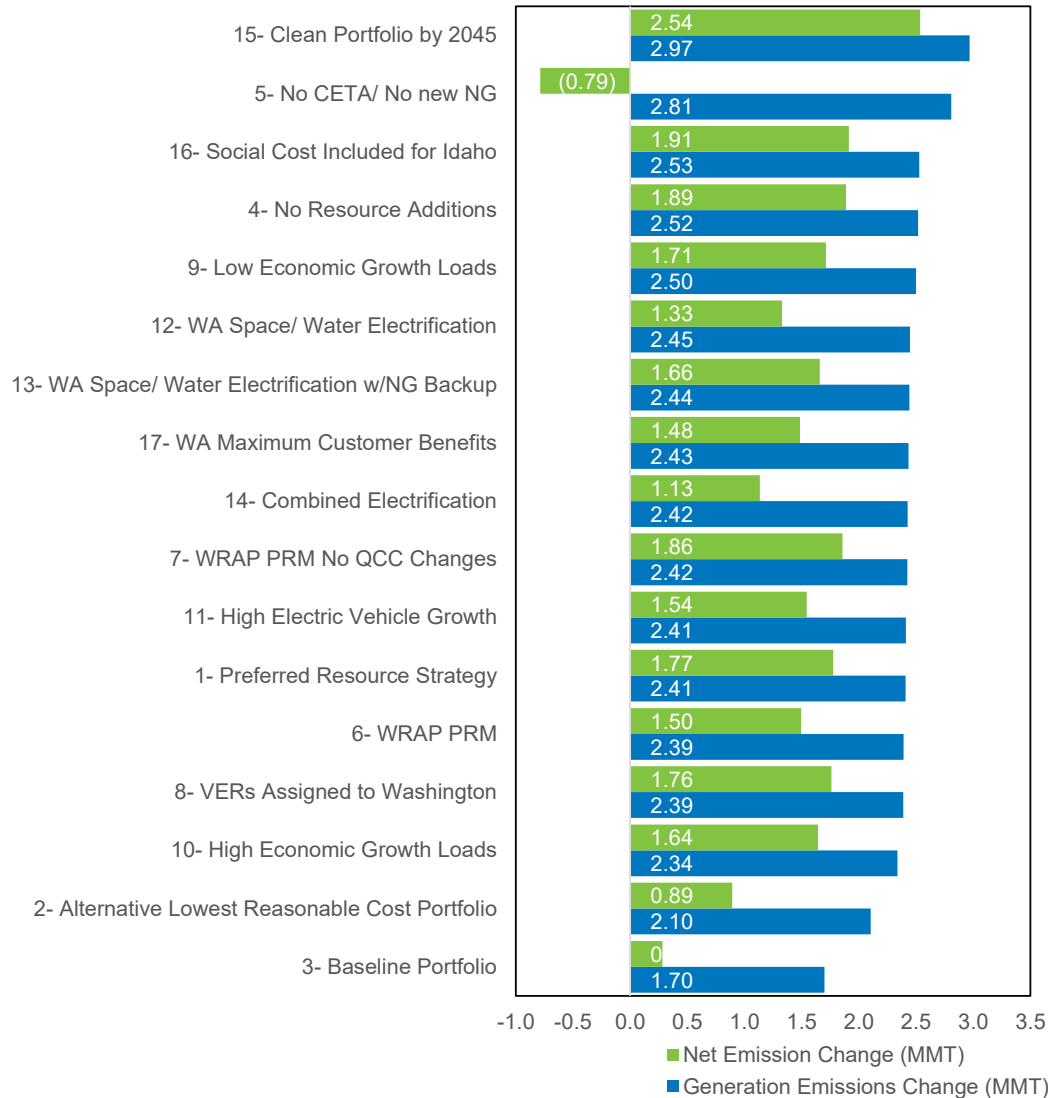

## 2045 Greenhouse Emission Savings for Electrification

### Transportation:

PRS: 1.7 million tonnes

High EV Scenario: 3.7 million tonnes

### Natural Gas (assumes 75% of NG IRP)

Full electrification: up to 730,000 tonnes

w/ NG backup: 118,000 tonnes



# Market Pricing Sensitivities

## Percent Change Compared to Expected Case Market Price Forecast

Portfolio	Change in PVRR vs Expected Case Market Pricing				Change in Levelized GHG MT vs Expected Case Market Pricing		
	High NG Prices	Low NG Prices	National GHG Price		High NG Prices	Low NG Prices	National GHG Price
1- Preferred Resource Strategy	1.8%	-3.1%	-0.1%		-11%	6%	-9%
3- Baseline Portfolio	2.1%	-3.3%	0.0%		-12%	7%	-11%
15- Clean Portfolio by 2045	1.6%	-2.9%	-0.1%		-9%	6%	-8%
Portfolio	Change in PVRR vs PRS				Change in Levelized GHG MT vs PRS		
	High NG Prices	Low NG Prices	National GHG Price		High NG Prices	Low NG Prices	National GHG Price
3- Baseline Portfolio	-0.6%	-1.1%	-0.8%		4%	7%	4%
15- Clean Portfolio by 2045	0.6%	1.0%	0.8%		-4%	-6%	-4%

## Jurisdictional Cost Changes Compared to Expected Case Market Price Forecast

Portfolio	Change in PVRR vs Expected Case Market Pricing					
	Washington			Idaho		
	High NG Prices	Low NG Prices	National GHG Price	High NG Prices	Low NG Prices	National GHG Price
1- Preferred Resource Strategy	1.2%	-2.7%	-0.2%	3.3%	-4.0%	0.1%
3- Baseline Portfolio	1.8%	-3.1%	-0.1%	2.8%	-3.8%	0.0%
15- Clean Portfolio by 2045	1.3%	-2.7%	-0.2%	2.3%	-3.4%	0.0%





# Action Items for 2025 IRP

Avista IRP Team  
Technical Advisory Committee Meeting No. 9  
April 25, 2023

# 2023 Action Items

1. Incorporate the results of the DER potential study where appropriate for resource planning and load forecasting.
2. Finalize the Variable Energy Resource (VER) study. This study outlines the required reserves and cost of this energy type. Results of this study will be available for use in the 2025 IRP.
3. Study alternative load forecasting methods, including end use load forecast considering future customer decisions on electrification. Avista expects this Action Item will require the help of a third-party. Further, studies shall continue the range in potential outcomes.
4. Investigate the potential use of PLEXOS for portfolio optimization, transmission, and resource valuation in future IRPs.

## 2023 Action Items (Continued)

5. Continue to work with the Western Power Pool's WRAP process to develop both Qualifying Capacity Credits (QCC) and Planning Reserve Margins (PRM) for use in resource planning.
6. Evaluate long-duration storage opportunities and technologies, including pumped hydro, iron-oxide, hydrogen, ammonia storage, and any other promising technology.
7. Determine if we can estimate energy efficiency for Named Communities versus low-income.
8. Study transmission access required to access energy markets as surplus clean energy resources are developed.

# Remaining Tasks for 2023 IRP

- How can TAC members help
  - Request areas to clarify
  - Analysis that should be conducted
  - Opinions of the plan- provide comments before its filed
  - Additional action items
- Planned work
  - Update market risk section
  - Document clean up
  - Provide more analysis on electrification impacts

# Filing Plan

- File with state commissions on June 1, 2023.
- Document and Appendices will be available online
  - including data and models.
- Printed copies available upon request.

## TAC 9 Meeting Notes: Tuesday, April 25, 2023

### Attendees:

Michael Andrea, Avista; Andrew Argetsinger, Tyr Energy; John Barber, Customer; Shay Bauman, PCU; Shawn Bonfield, Avista; Maureen Boyd, Guest; Annette Brandon, Avista; Kate Brouns, Renewable NW; Terrence Browne, Avista; Logan Callen, City of Spokane; Kevin Davis, IEP Co.; Shubhra Deb Paul, IPUC; Joshua Dennis, UTC; Mike Dillon, Avista; Chris Drake, Avista; Avery Dunn, Guest; Michael Eldred, IPUC; Ryan Finesilver, Avista; Grant Forsyth, Avista; James Gall, Avista; Annie Gannon, Avista; William Garry, Hillside Park Owners Association; Amanda Ghering, Avista; Leona Haley, Avista; Tom Handy, Whitman County Commission; Lori Hermanson, Avista; Mike Hermanson, Avista; Fred Heutte, NWECC; Kevin Holland, Avista; Tina Jayaweera, NWPPC; Dan Johnson, Avista; Steve Johnson, Consultant; Philip Jones, Consultant; Kevin Keyt, IPUC; Doug Krapas, IEP Co; Ben Kropelnicki, Avista; Dave Lockhart, Guest; Kimberly Loskot, IPUC; Mike Louis, IPUC; John Lyons, Avista; Patrick Maher, Avista; James McDougall, Avista; Ian McGetrick, Idaho Power; Tom Pardee, Avista; Lance Ragan, LIUNA; Jared Schmutz, Avista; Frederic Short, Guest; Collins Sprague, Avista; Darrell Soyars, Avista; Jennifer Snyder, UTC; Dean Spratt, Avista; Lisa Stites, Grant County PUD; Jason Talford, Guest; Taylor Thomas, IPUC; Charlee Thompson, NW Energy Coalition; Dave van Herset, Customer; Bill Will, WASEIA; Yao Yin, IPUC;

### Introduction, John Lyons

**Lyons, John:** Hopefully you'll get the little warning saying it's being recorded, and we'll have notes. They'll do the automatic transcription. We already released the external IRP draft on April 11<sup>th</sup>. We waited a little bit on that. We were going to do it at the end of March. But we wanted to get the final contract signed for the all-source RFP. We're asking to get public comments by May 12<sup>th</sup>, and you can send them by e-mail, you can give us a call, or if you want to do a formal letter with comments, you can do that as well. We'll submit the final IRPs with the complete appendices to both commissions on June 1<sup>st</sup>. The commissions will give you more details on what their process is going to be after that. They'll take public commentary. And you can go on from there when we get ready to fire up the next IRP for 2025, we'll send that out to the same TAC list here. And we'll also post on the website as that list gets developed and we will be here in the not too distant future will be producing the work plan.

**Lyons, John:** Today's agenda. After the introductions, we've got Chris Drake to talk about resource acquisitions and divestitures in the early part of this plan. Then we'll get into the Preferred Resource Strategy. That's going to be a team effort with the IRP team to cover the energy efficiency numbers, demand response, resource selections for new resources, and what the avoided costs are for all of the new resources after they're taken into

account. We'll take an hour break for lunch and then come back to finish up the Preferred Resource Strategy section. Then we'll go into the portfolio scenario process and the results and what we worked, and then we'll conclude the day with Action Items for the 2025 IRP. So, the things that we still need more work on and we're going to be working on going into the future. And with that, James, if we do, we have any other things we want to take care of you. Are we ready to have Chris go into it?

**James Gall:** Just one minor change. The agenda, there will be another topic likely after lunch related to the Preferred Resource Strategy that's on the market dependence. We're going to be looking at how much market reliance we have now that we have our WRAP, which is a resource adequacy program, versus just what Avista would normally plan for. More details to come on that. But I'd like to welcome back Chris to the TAC.

### **Resource Acquisitions/Divestitures, Chris Drake**

**Gall, James:** Chris led our request for proposal process and he's been quite busy with acquisitions, but I just saw a hand up then went away. But if there's still a hand, go ahead. Otherwise, we'll move on. OK.

**Forsyth, Grant:** That that was me. James, this is Grant. Sorry, that was an accident.

**Gall, James:** I guess we'll allow that. OK. Chris, whenever you're ready, you can share your screen.

**Drake, Chris:** OK. Can you see that?

**Gall, James:** We can see that and just feel free to interrupt Chris as you need to for questions, and I'll monitor the chat in case something comes up.

**Drake, Chris:** Perfect. I can't see the chat right now but let me know if something comes up in the chat. And as James noted, please feel free to raise your hand as well and we can have a discussion as we go through this. Thanks for the opportunity to provide an update on the 2022 All-Source RFP. Looking back here, just about a two-year effort in the RFP and so we spend a little bit of time going back and talking about the RFP design and the initial process as well as getting bids and evaluations and getting to the results and the negotiation phase. As we look back to April 2021 when the IRP was filed, it did trigger an all-source RFP and we were coming out of the end of the 2020 Renewable RFP. We can't really incorporate a deal until it's done. So unfortunately, we did have to file an update there, April 30<sup>th</sup>, but it's still showed a need within four years. We began the all-source RFP process, and we anticipated having an Avista self-build. We did an RFI and selected an independent evaluator, Sapere, and then we went through working with external stakeholders and Commission Staff as we designed the RFP. That was approved in February of 2022. We released that and we had bidders, conferences and different Q&As that were posted online and got to March when we received the initial round of bids and went through the process of evaluating those. Got to a short list, and

then in September we had a final price refresh and selected projects to begin negotiations towards the end of September, early October and then here in the last couple of months we have wrapped up contract negotiations and we'll cover those in a bit more detail.

**Drake, Chris:** Some of the highlights, going back to the request, we were looking for renewables, capacity, energy, all those different needs that we identified in the IRP in the 2026 to 2030 time frame. Both winter and summer capacity needs, as well as monthly energy and renewables. We were pleased with the response to the RFP. We had over 20 developers and nearly 60 projects. It was about a dozen technology types and about 32 proposals with different options, but we evaluated six scenarios, 60 projects. Again, not surprisingly, there was predominantly wind and solar and a lot of those projects had storage options. We had natural gas, we had standalone storage as we listed on our website back in March or April of 2022. You can see the other resources as well, but again, as we were anticipating a self-build as well as in the past we have sometimes engaged to independent evaluator.

**Drake, Chris:** We selected Sapere, and they assisted us with the design early on of the RFP. They had a pretty good template coming out of the 2020 Renewable RFP. But as we looked at this from an all-source lens, we were able to work with Sapere on that final design of the RFP. They conducted their own parallel evaluation of the bids as they came in using the published valuation methodology. We went through a process, we had similar rankings, but if we had any differences in the itemized scoring, we went through that with Sapere, and for the most part quickly accepted their scoring there. We were aligned well on ranking, but did step through all those to ensure that we dotted all the Is and crossed all the Ts. Sapere produced a report as well. We'll talk a little bit more about the wrap up here in a bit.

**Drake, Chris:** I think we've seen this slide here in previous TAC updates. But again, the evaluation scoring matrix sticks criteria with the heaviest weighting on financial impact and again some of the things that we did in 2022 that we built on from 2020, but just additional emphasis on equity. It doesn't just show up in the non-energy impact category as it's embedded in a couple of pieces of environmental as well as some of the financial, energy, but that was a continuation of some of the non-energy impact focus that we've had previously. We were trying to incorporate the Customer Benefit Indicators; the Clean Energy Implementation Plan was on a bit of a parallel process. As far as timeline. Those weren't formalized when we when we released the RFP, but we tried to incorporate those as best as we understood how they were proposed.

**Drake, Chris:** Here are a few results. We did extend the Lancaster Natural gas plant. I've got some slides over a little bit more detail. We'll just cover these real quick at a high level. A new wind contract, we have the Kettle Falls biomass upgrade, and then we have the seasonal hydro that was not a formal part of the RFP. We did evaluate it within the RFP for comparison purposes. That was a separate competitive process that kicked off prior to us releasing RFP that we participated in, but we did evaluate that for comparison purposes to ensure that it would have fared well in the RFP.



**Drake, Chris:** Real quick on Columbia Basin. It's seven different projects which are layering in between now and 2030 as those current agreements expire and it's 146 megawatts of additional capacity. And it looks a little bit like solar. We're getting this from mid-March to mid-October, but we get some good coincidence generation with our summer peaking and also as a little bit of a contrast to solar, we get early morning, evenings and nighttime generation as well.

**Drake, Chris:** On the wind PPA, more details to come on this, but for now we're just announcing that that we did complete a 30-year deal, and this would be coming online in January of 2026.

**Drake, Chris:** Again, most of you are probably familiar with the Lancaster facility out of Rathdrum, Idaho. This extends the current agreement, which ends at the end of October in 2026. We've extended that for 15 years, actually 15 years and a couple months. We're rounding out to the end of 2041. Again, no new natural gas. We're optimizing an existing resource that provides a lot of reliability and flexibility to our system. And again, this is a project where we have the control of the natural gas transportation and it is directly connected to our BA, so some value there as well.

**Gall, James:** Hey, Chris, you have a question on the chat from Yao. How does the Columbia Basin hydro price compare to the other selected projects from the RFP? Are they similar?

**Drake, Chris:** When we evaluated it in the context of the RFP, again, it was not a formal bid, but it would have finished in the top results.

**Drake, Chris:** Kettle Falls, we announced this early on. There isn't a power purchase agreement between Power Supply and our Generation and Production Substation Support groups that will be operating, installing this upgrade and working with minimal, but it is an interesting project where we're getting additional steam instead of trying to supercharge the boiler. We're getting additional steam from a carbon reduction facility that's basically taking hog fuel, and it is a process that sequesters the carbon into a biochar, as well as creates volatile gases that are able to be burned to create steam. You get sequestered carbon that can be used in agricultural products. And we get steam out of the hog fuel and it's a little bit more bang for the buck than trying to rebuild the boiler. It's 11.2 MW net capacity increase, but actually greater than 100% capacity factor because we can reduce a little bit of the steam coming out of the boiler and generator with this with this CRF, so and on a per MW hour basis, there's also some reductions in emissions. Again, not over all planned reduction reactions, but per MW hour and then potentially some delay of the expansion of the ash disposal facility, depending on if there's a secondary market for some of the ash as well.

**Gall, James:** Chris, you have a question from Jared. Hey there. I guess not. I'll wait. We are getting some in the chat?

**Drake, Chris:** I see one in the chat though. OK.

**Gall, James:** Yeah. Are you going to read them or can you see them?

**Drake, Chris:** Yeah. The question there is. Actually, I guess we have one from you as well. Kettle Falls project, because we're 25,000 tons of emissions. James, can I defer to you a little bit on the emissions one?

**Gall, James:** For Kettle Falls, my understanding is Kettle Falls is exempt from the CCA because it's a biomass resource that is carbon neutral. There might be more legal terms around that. But as it is exempt, the CT that is attached to the.

**Gall, James:** The plan, you can see it in the picture on the left that steam coming off or next to the I think it's that green building next to the steam you see on the left that plant while his gas it is below the 25,000 ton. So that facility is exempt for now. And then, Doug's question. I'll read that out. Has Avista established contracts for the additional hog fuel supply and if so, from where, and any other wood sources other than hog fuel?

**Drake, Chris:** The primary approach will be to leverage existing contracts. It does require more supply, but that's part of the ongoing contract negotiations and additional support as we finalize negotiations with the carbon direction facility. But yes, it would require additional hog fuel, but the plan would be to leverage existing relationships and contracts within our wood basket.

**Drake, Chris:** Final slide is just a recap here since I believe the last TAC was before the deal for Colstrip. We would transfer ownership at the end of 2025. Avista retains the remediation and obligations that are currently on the books, as well as things that could be incurred between now and the end of 2025. We'll continue to be involved from that respect and then the deal does not speak to the CTS, the Colstrip Transmission System. We're saving those rights. And I think that's my last slide. Let me go back to the Teams slide. Any other questions? We still have a hand up? OK. Any other questions?

**Drake, Chris:** I guess we do have some reporting requirements and we'll continue to work through those as we wrap up the 2022 All-Source RFP process. It's complete as far as we've finished up on the remaining negotiations. But, we do still have some close out there from a reporting standpoint and some other activities.

**Gall, James:** Are there any questions for Chris?

**Lyons, John:** And then as far as it is all hog fuel from mills, we also can buy forest slash and we do, I always forget what the name of it is basically, if you're doing tree trimming and taking trees out locally, urban forestry, I guess. We can't do a treated wood, basically it has to be untreated wood waste. Or slash we do get, we do get some of that. I just wanted to add that in there.

**Gall, James:** Thanks John. Alright.

**Drake, Chris:** Perfect. OK, well, if nothing else or if other questions come up, I'm available. OK.

**Gall, James:** Hand up from Jennifer. Go ahead Jennifer.

**Snyder, Jennifer (UTC):** But just a real quick question, as far as the biochar, do you have a set plan of where that goes or?

**Drake, Chris:** Yes.

**Snyder, Jennifer (UTC):** You'll find places. Is it another revenue stream too?

**Drake, Chris:** Good question. So, that is part of the cost analysis there and the subcontract negotiations that are ongoing with Myno is that potential revenue stream there associated with the biochar. That's correct.

**Gall, James:** But Chris isn't Myno, they're the ones that are owning the biochar and will be marketing that not Avista. That will not be a benefit for us other than the benefit of the steam at a theoretically lower cost than it would be directly from burning biomass. Looks like we have another question in chat, just confirming, you say that 65% of wood supply comes from Canada. I think John you're probably the expert on that.

**Lyons, John:** Yeah, it is roughly 65%. It varies a little bit year-to-year to based on who has the most lumber or most hog fuel at the cheapest price. But it is about 65% from Canada.

**Drake, Chris:** As you can imagine, you look at the price as well as your trucking cost as well. And so it's finding that balance.

**Lyons, John:** And just to give you an idea it's still, if I remember right, Chris, isn't it about 50 truckloads a day?

**Drake, Chris:** That sounds about right, yeah.

**Lyons, John:** 50 tractor and trailer loads a day. I believe they're 53-foot trailers. That come in so to give you an idea of how much wood is coming in every day.

**Gall, James:** OK, any other questions? We'll shift to the Preferred Resource Strategy and one thing to keep in mind is we kept delaying, I guess you could say maybe six months, to get this all put together for this RFP because at the end of the day our resource strategy is dependent on the resources we have available to us and what you're going to see today is our resource need is definitely shifted out a number of years and most of the resources we have acquired are 1, capacity resources and 2, we have clean energy resources. It puts us in our a very good position to meet both CETA requirements along with requirements for reliability.

**Preferred Resource Strategy: Energy Efficiency, Demand Response, Resource Selection, Avoided Cost and Market Dependence, IRP Team**

**Gall, James:** John, just to check really quick, can you see the slide?

**Lyons, John:** Yes, I can.

**Gall, James:** All right. And I think, Lori, if you're ready to go? Lori's going to start it off. Lori Hermanson, she'll present a few slides and then I'll take over, and then we'll shift over to Mike Hermanson towards the end. And since we're ahead of schedule, we might get through this before lunch. We'll see. There'll be plenty of time for questions, so please don't hesitate to raise your hand or put something in chat.

**Hermanson, Lori:** Alright, thanks, James. Can you advance to the next slide?

**Gall, James:** Sure, you want me to skip this one or? Alright.

**Hermanson, Lori:** That's fine because you have most of the presentation. That's if you don't mind advancing it. Just a reminder, we have our Safe Harbor statements because a lot of this is forward-looking, a lot of uncertainty. We're making assumptions for the planning horizon. So just to let you know that things are likely to turn out differently than we assumed. So just a summary of our resources.

**Hermanson, Lori:** As for the whole horizon, it includes 30 megawatts of industrial demand response. We've acquired two additional slices of Chelan PUD, each for 87.5 megawatts. The addition of Columbia Basin Hydro, that Chris talked about earlier, contributes 146 megawatts. We have the Kettle Falls upgrade of 11.2 megawatts. We have the 30-year wind PPA of 100 megawatts, and of course we're at the end of 2025 transitioning our ownership of Colstrip 3 and 4 to Northwestern. We have the Lancaster CCCT, combined cycle combustion turbine, that we're renewing or extending that contract for 15 years and that's 283 megawatts. Finally, we have an expected upgrade at the Post Falls Hydro facility and that would be 6.4 megawatts. Over the planning horizon, those are the resources that you can expect to come online and one of them dropping off.

**Hermanson, Lori:** As far as our loads and resources position that was assumed for the IRP. In the top left-hand corner, looking at it from a winter peak position, we were proposed to be slightly short in 2033 and then that shortage increasing over the time horizon as far as our summer peak down in the lower left-hand corner, we were projected to be short in 2036. And of course, that shortage increasing over the rest of the planning period.

**Hermanson, Lori:** From an energy perspective, we look pretty good until about 2040 when you see a short a number of months and then by 2045, due to retirements and such, we're even more short in most, pretty much all the months. Bottom right-hand corner, the retirements that were assumed for the IRP. Colstrip Units 3 and 4. We show those transferring over to Northwestern at the end of 2025, so that's a reduction of 222 megawatts. Northeast A&B, we have retiring 2035, Boulder Park in 2040 as well as Kettle Falls CT, and finally the Rathdrum units retiring in 2044.

**Gall, James:** One quick thing to note is that the charts on the left don't include the retirements. They're not 100% sure those are the dates, so the left indicates where we're

at with the existing resources and then for the IRP, we made these assumptions for retirements.

**Hermanson, Lori:** And I should mention that they include our typical planning reserve margin as opposed to the WRAP planning margin at least for this interim binding or non-binding period. So that's assuming our traditional planning reserve margins.

**Gall, James:** Thanks.

**Hermanson, Lori:** And then this is a Washington centric slide. But far as CETA and our renewable energy got goals, the chart on the left-hand side shows the projection for the planning horizon TO 2045, the first four years, the first compliance period of 2023 through 2026. Those targets have been approved and anything from 2027 we're assuming that it has not necessarily been approved and then also you see in 2030, the law allows for the alternative compliance, and so we would use that at a decreasing amount to help us get to our 100% by 2045.

**Hermanson, Lori:** And then the graph on the left is a similar look, only from our position. You can see all of this is based on our native, or sorry, our net retail sales and that's the dotted line that you see with a slight escalation through 2045. The darker blue lines shows our generation that is compliant.

**Hermanson, Lori:** And it our generation that's allocated to Washington, that we're generating below the retail sales amounts and that's on a monthly basis. Again, the law is not specific yet on whether or not that's going to be annually, monthly, or hourly, but for our purposes of our IRP, we assumed monthly. The light blue you see at the end of the horizon we're short from years 2038 out. We'll need the orange alternative compliance to help us make up that difference. To meet our portion of net retail sales, so again, that's on a monthly basis. The yellow is the Idaho hydro that we can use to meet our compliance, meeting the alternative compliance, and we would have to compensate Idaho for their portion that we would use to meet these Washington goals. I think that's pretty much everything. Did I miss anything on that, James?

**Gall, James:** We'll get to that more when we get to the resource strategy. There'll be a second chance to go through our CETA position. I did see a chat question. I'm assuming that's why Kevin maybe popped his camera on to respond to Doug's question. I'll read out the questions. Why didn't Avista maintain some of its coal and gas assets to serve its non-Washington customers?

**Holland, Kevin:** I think, James, you could probably answer this as well as I could, but I'll take a shot at it and then you can clean up. Sure, go ahead.

**Gall, James:** Can I hit the gas side first and then they'll let you insert the coal side. How about that? On the on the natural gas side, the proposed retirements are really related to the age at the facility and when we expect their actual life to the end. We're not assuming any retirements of the natural gas side for any related purposes to Washington other than Coyote Springs in 2045, which is not addressed on that slide. At this time, we would be

retaining that resource until it's economic to retire from an operations point of view. But I'll let you, Kevin, answer the question.

**Holland, Kevin:** Thanks James. There are probably two answers to this, or an answer and then maybe a supplementary rationale, but the basic answer is that we don't at this time allocate resources specifically to jurisdictions that we serve. They're system resources, and that's why the decision was made with regards to Colstrip. And I think maybe James can also talk about potentially.

**Gall, James:** Colstrip has a few economic challenges in the long term for operations having to do with the emission control expectations required by the federal government. Also, the rising fuel costs and rising maintenance costs. In the 2021 IRP, we conducted analysis on the long-term cost effectiveness of the facility. We found that it was slightly not cost effective, even for Idaho customers, based upon the expectations of coming costs for the plant. We conducted a similar analysis before we made the decision to transfer to Northwestern. If you look at Northwestern's IRP, they don't as well assume that plant is going to be available long term as well. But, based on the information we have today, this seemed to be the best economic decision to transfer the asset to Northwestern in 2026. I don't want to add anything else. Otherwise, there's another question in the chat, but I'll pause there on Colstrip before I go to the next question.

**Gall, James:** OK. Question from Josh Dennis, what percentage of annual average megawatts is alternative compliance for 2023? And I think the short answer to that is zero. Our understanding of CETA compliance regulations prior to 2030, there is no alternative compliance requirement. All of our compliance for the 43% or sorry 48%. Will be from renewable resources that we own and control. I don't think there's a restriction on RECs. I don't know if that's clear to us, but we have the resources to meet that requirement. There will be zero alternative compliance for 2023 through 2029. And Darrell you hopped on there, I don't know if you had anything to add on Colstrip or not.

**Soyars, Darrell:** Nothing specific. You mentioned the deal with Northwestern, which is still I believe, it's just now ending our 90-day period. There's lots of details to be worked out between now and the end of 2025. So, stay tuned.

**Gall, James:** Alright. Another question from Jennifer on the set of slide, what is the orange bit labeled in 2023? How this works, on that slide on the right, we don't know what the final use rules are going to be to comply with CETA in 2030. What we did for this IRP is assumed that we have a monthly requirement to comply; what that means is if our renewable energy production for a given month is greater than the retail sales for that month, then that excess generation is assumed to be alternative compliance. In 2023, if we had an average hydro year in the May – June time period, we generate more renewable energy than our retail load, that orange bar represents that surplus energy that would qualify as alternative compliance under that assumption. But again, there is no determination of alternative compliance versus primary compliance at this time. This is an assumption that we made for modeling purposes to drive the model to make resource

acquisitions for 2045. Selected energy resources and capacity resources to have enough renewable capacity for Washington on a monthly basis to meet this obligation to be 100% by 2045. Hopefully that helps, Jennifer.

**Gall, James:** Alright, so I'm going to go to the next slide unless there's any other questions. I'm going to talk a little about how we fill these gaps Lori talked about before. We have to meet this gap here in light blue for CETA. We have capacity gaps back here on winter peak and summer peak. We have energy gaps. We have these three targets we're trying to optimize our resource strategy for capacity by month, energy by month and renewable energy by month for Washington. We're trying to do this in a least cost way, taking into account societal costs and in Washington and then least cost in Idaho.

**Gall, James:** So how do we do this? I'm going to cover three slides that we covered in our technical workshop back in November – December last year. We use a model called PRISM. PRISM stands for Preferred Resource Strategy Model. It was developed in house, back in the 2003 IRP was its first use, and it has been modified heavily over the years since it's been about 20 years. It's a mixed integer program used to select new resources to meet those resource deficits you saw earlier. The model is actually in Excel. It's available on our website from the Progress Report we filed in the summer. You have that version of the model. We will have a new version of the model that we used for this IRP. When we file the final IRP, we'll give out all of our scenarios and our Preferred Resource Strategy version of the model at that time. It's an Excel model, it's fully functional for you to use. Keep in mind that you'll need a solver to solve for the solution. If you choose to solve it, we use a technology called What's Best, which is from Lindo Systems. It is the user interface, but the actual solver used is Gurobi and those are their add in to Excel so that it can solve the mathematical formula that is entered.

**Gall, James:** What's really driving the resource selection is this objective function. We're trying to minimize costs. From a Washington perspective, we're trying to minimize the societal cost. From an Idaho perspective, we're trying to minimize power costs. We're looking at 2023 to 2045 and I'm not going to get into the full mathematical details of the model, but it's here on the screen and available for you in the slides we sent out. Our objective is to find the most economic resource strategy that fits in the availability of resource options that's also trying to meet our energy cost effective energy efficiency goals, demand response potential. We're also looking at our monthly peak capacity, energy requirements, and monthly clean energy commitments like I mentioned before.

**Gall, James:** When you do these types of solutions, you have a what's called a tolerance, or how accurate they are for finding the best solution and this model solves pretty quick, so we're able to have a very precise decision sometimes when you're trying to decide on very small dollar amounts for a certain resource. For example, if it's, say a community solar resource, you can have movements and decisions because as a percentage of the total net present value 0.0001 can be \$100,000. We try to solve this as tight as possible, but otherwise you get very long solution times. If you wanted to solve it down to the least cost to the 10s of dollars or 10s of cents. If you want to know more about linear

programming or mixed integer programming, I have a YouTube link there, not advertising for it, but it's a good educational tool to learn more about programming. For a solution, there's two types of solutions we look at for cost. First one is what we use for our objective function, that's the social cost for Washington. That's not the cost when you solve your solution, what customers actually pay, customers pay what's called the revenue requirement and we will be showing our results in that revenue requirement point of view. But the model solves for additional cost beyond revenue requirement.

**Gall, James:** Specifically in Washington for energy efficiency, when you use the TRC we also have non-energy impacts for resource choices. We have a 10% adder for energy efficiency as well, to add to savings and then for thermal resources we have a societal cost of carbon. So that is used in the objective function. But when we show cost, those are not included.

**Gall, James:** I see a question from Tina. Is risk quantified or considered in the optimization process? We are not directly assigning or optimizing for risk. What we do though is we look at 500 different futures and we take the expected value of those 500 futures. We also quantify the volatility or variability in the results of those 500 cases. We're not solving for our risk, with the exception of using a risk adjusted value as our expected value. Years ago, we did what's called an efficient frontier approach, where we would solve for a portfolio at different levels of risk. We moved away from that technique when CETA was passed because it restricted the resource choices we had. But this time we're solving least costs. But looking at risk when we compare our portfolio scenarios and we'll have a slide on that later today if we can get to it.

**Gall, James:** We're going to be showing actual costs, or I should say, expected cost. We typically show things in annual revenue requirement, and then we'll also show costs and average energy rates. So that's not necessarily the customer rate for residential or commercial. It's just an average rate for all classes of customers. You'll see lots of slides on that later today.

**Gall, James:** I failed to mention one thing that's in this objective function. And that is what's called the Named Community Investment Fund, which was created out of our Clean Energy Implementation Plan in Washington. That sets aside approximately \$5 million towards investments in Named Communities. To figure out how those dollars are going to be accounted for in a resource strategy, we really don't know, so we made some assumptions on where those dollars could go into. For example, of that \$5 million, some of the dollars could go towards projects that have nothing to do with energy resource needs so, but there's also other projects that could. We decided to take a portion of the \$5 million that are going into this fund and let the model estimate where those dollars could be spent. For example, we have a \$2,000,000 low-income energy efficiency component to that Named Community fund. And what we have the model do is try to find energy efficiency projects above cost effectiveness that will help low-income customers. We put a constraint in the model to force it to acquire more energy efficiency or find the least cost energy efficiency above \$2,000,000 a year, above what would otherwise be



cost effective. We also included \$400,000, or really \$500,000, towards distributed energy resources. Really leveraging Washington State's grant for community solar so that the model would select additional community solar resources. But beyond these two components, we built into our PRiSM model, that's what we're assuming goes towards the Named Community Investment fund. There will likely be other projects as the that fund works with the Equity Advisory Group, but it's difficult to estimate what's going to happen because not all those dollars are going to go towards energy efficiency projects. So, for what was selected in the model with these assumptions, we had around 800 kilowatts of community solar each year for the first 10 years while that grant was in place, a substantially lesser amount after the grant expired in 2034, down to \$150,000.

**Gall, James:** On the storage side we did not see any cost-effective storage in the first 10 years but in the final 10 years we saw the model moving towards a combined solar and storage resource to use that \$400,000 and that \$400,000 does escalate with inflation. So, it grows over time and solar and storage costs are expected to decline. We see some storage selected. And then for energy efficiency, we saw quite a bit more in the first 10 years versus the last 10 years, 222 additional MW hours per year, but only 2.2 MW hours per year in the last 10 years. And really what we're seeing from our energy efficiency potential is in the last 10 years, there's less and less energy efficiency that's available or cost effective because most of the energy efficiency in the twenty-year plan is selected in the first 10 years.

**Gall, James:** While we're on energy efficiency, I wanted to illustrate what the potential is and what the costs are for energy efficiency. What you have here is a supply curve for both our Washington customers and Idaho customers. Idaho is in blue; Washington is in black. For Washington, we're using the TRC method and how this works is going on the X-axis you have additional energy efficiency and then on the Y-axis you have the TRC cost. If we did all available energy efficiency in Washington for the year at around \$800 and say 50 GW hours over the 20-year period, but that last GW hours is going to cost you \$300.00 a MW hour. And then on the Idaho side, if we did all cost, or call all energy efficiency, we could get around 300 GW hours using the UCT method, which is the utility cost method.

**Gall, James:** Just to help understand what the difference between those two are and Ryan can jump in if I misspeak here. But the TRC represents a look at the cost and benefit from a societal level that looks at the things beyond energy for the customer that is based on the actual cost of the program and then the energy it saves, versus the UCT looks at more of what the utility is contributing to the program offering and versus the energy it saves. Hopefully I got that right, Ryan.

**Finesilver, Ryan:** Yep, great job.

**Gall, James:** All right, so how you can look at this is you have two different supply curves and if you have an avoided cost, or how much you're willing to spend, you can identify how much you're going to select. At \$100 a MW hour, that's just a nice round number you

see here. We could get around 300 GW hours for Idaho and around 500 GW hours for Washington. Keep in mind, our Washington loads are about double the size of our Idaho loads. You can see, as you go up in avoided cost in Idaho, there's not too many additional options available, but in Washington as you raise your costs, there are additional items available.

**Gall, James:** When we analyzed energy efficiency, the avoided costs in Washington are higher than they are in Idaho, because in Washington we have to include a social cost of greenhouse gas, we have the 10% Power Act adder, and we have NEI cost. We assume Idaho is a lower avoided cost. I think those are both shown in the draft resource plan, if you're interested in the avoided cost. But as far as the selections, orange is our forecast for new energy efficiency, and this is combined for both states and compared to history to give you a perspective of how much energy efficiency we're looking at. In history, we've had a lot of ups and downs over the years, but we've been on a down trajectory over the last say five or six years. What we're expecting is to slowly increase over the next say eight years and then slowly decline as the measures are taken up. If there's some new energy efficiency options out there that become available, maybe you see this continuing to flatten out. But based on what technology we know is available today, we expect a decline. And as far as what type of measures are selected, or at least what energy uses they're affecting, it's still in the interior lighting, space, heating and cooling are a majority of the resource selections. A little bit less space heating and cooling in Idaho than compared to Washington. This has to do with avoided cost. But we have more interior lighting in Idaho compared to Washington as a percentage of the total. We have electronics, refrigeration and processes and then slower percentages with the other options that are available.

**Gall, James:** And for those of you interested in the biennial target for Washington, we're at around 53,000 MW hours for the next two years. To get you a comparison, say the last biennium we were at around 89,000 MW hours, so definitely a reduction in the target. And when you think about comparing the previous IRP versus this one, a few things have changed. One is the potential is a little bit lower. And then the previous plan options, and then also the avoided cost, we found a little bit of reduction going to avoided cost mostly related to the social cost of greenhouse gas effect on the market. So, we saw a little bit of a reduction there, which lowered the targets.

**Gall, James:** I see a question. For the cumulative energy efficiency chart, could you clarify if the vertical axis was avoided, cost benefit, or cost to capture those savings? This is the cost to capture those savings under the UTC method in Idaho and the TRC method in Washington. This is not what it cost. So, you compare your avoided cost to these values, where they cross over would be the amount you would expect over the 20 years.

**Gall, James:** Alright. Any last questions on energy efficiency? Otherwise, we'll move to demand response. OK, so for demand response you might remember, I think we looked at around 15 different measures and this is going to be the results of what was selected in the Preferred Resource Strategy. But keep in mind, like Lori had mentioned earlier, we

have a 30 MW industrial demand response program already contracted. That was actually a resource that was picked in our 2021 IRP. And then we're also looking at three pilot programs that are starting in the next couple months. That's time of use rates, peak time rebate, and the CTA 2045 water heaters. And I think I saw Leona on here, I don't know if you are prepared, I don't know if you want to just do any quick advertisement for those pilot programs, if you don't mind.

**Haley, Leona:** Oh yeah, absolutely. Hi everyone. Leona, Haley in the Energy Efficiency Work Group. I'm leading a cross organizational team on the pricing pilots that we have. We just filed the end of March, and I can put that link for our filing in the chat here in a minute for our time of use and peak time rebate pilots. It'll be over a two-year period after we go live. We're looking at a go live date around Q2 of 2024. And then the CTA 2045, we're working with several folks in the region, other utilities, NEEA and so on to try to have a pilot in a very cost-effective fashion. So, getting the cost of some of those components down and that's the main focus at this time for demand response efforts. Although we do keep an eye on several different demand response programs throughout the country and look at their cost effectiveness through the IRP process. Are there any questions from anybody? Great. I'll go ahead and get that in the chat then.

**Gall, James:** Alright.

**Haley, Leona:** Yes, in Washington.

**Gall, James:** Thank you. These are for Washington as far as the how the model selected based on the different options that were available, the time of use was the only one selected. It provided around 6.6 megawatts of capacity savings and the model found that that one is cost effective, mostly because there is energy savings related to it based on the analysis that we got from AEG. The rest of the demand response, one of them, I think the root reason for not a lot of selection, although if more resources in demand response were selected peak time rebate and variable peak pricing are the closest ones, but really has to come down to how much you can rely on these resources for meeting peak needs. What I mean by that is qualifying capacity credit and the WRAP. There's still quite a bit of discussion on how well demand response will contribute towards the WRAP's resource adequacy requirements. What we assumed was, I believe it was five. If your program could last for five hours of reduction, you would get 100% QCC. But that value would decline over time as less and less high QCC resources are available in the marketplace. So, if the QCCs remain high based on the WRAP's analysis you may see these two additional programs selected, but at this time just the time of use was the most cost effective. Time of use has some benefits I would say especially for the electric vehicle side. We'll wait and see what the electric vehicle uptake really is. But I could see that value growing over time depending on the uptake in EVs.

**Gall, James:** OK. Let's shift over to supply side resources and this is kind of an eye chart, I apologize. This is a list of resource selections to meet the need beyond 2030. As we mentioned before, our resource need we've met through the RFP, most of our needs

unless we have substantial load growth, but we have no need for large-scale utility resources until as early as 2030. And how this chart is broken up, we have the resource type on the left, I'll get into what some of these names mean, but then we have the year it would be needed for the jurisdiction that selected it. What I mean by that is, our model can select every source for a specific jurisdiction or a resource for both jurisdictions if that is more economic. And then we have the capacity or capability of the unit. Think of that as a name plate size and how much energy it can produce. As you might see on the bottom there, there's a lot less energy produced than the capacity or capability it's offering. The capability is not the QCC value or the qualifying capacity value. That number would be lower for some and somewhat similar to the value you see there for others. I get started and I'll get to some editorial reasons on how some of these resources are selected and why.

**Gall, James:** To get started, the first resource the model found to be cost effective was Northwest wind, which is a resource that would be connected to our system. Likely in Eastern Washington, potentially north Idaho, and the driver behind that is CETA and needs in the outer years, but not necessarily by 2030. And what we see is a crossover point where the tax incentives that are available through the IRA, combined with expected lowering costs of wind energy, get to a point where it's cost effective to build resources ahead of need. There's a gap between this 2030 and 2032 period where there seems to be an economic advantage, and we'll see if that actually occurs or not, but that would be the first selection. Then in 2032, an additional 200 megawatts of Montana wind came up as cost effective and that would be utilizing a portion of either Northwestern transmission or Colstrip transmission that we retain.

**Gall, James:** After that, the first Idaho resource was a natural gas CT, and this is really replacing the lost capacity from the retirement, or expected retirement, of Northeast. Also, you have load growth. And then in Washington in 2036, I'm going to make a correction to the chart, it says renewable fuel, but it should be renewable fueled CT. What that means is we know there's a need for a renewable capacity resource. The big question I think if you look at IRPs across the Northwest is there's needs for a capacity for a resource that looks like a natural gas CT, but a lot of people or utilities are uncertain on how that's going to be created. For us, we used an ammonia fired gas turbine as the surrogate for this resource. For those of you not familiar with what ammonia is or what it could be, we could take green hydrogen that is created through the grid power or a dedicated resource to create hydrogen and then use that hydrogen to create ammonia. That ammonia could be stored in a storage tank, it can be dispatched through a natural gas turbine to provide capacity and energy. When you see renewable fuel on here, keep in mind that is the technology or concept behind that. I don't know if that technology is going to prove out in the long run or it could be that we have hydrogen-based CTs or synthetic natural gas or renewable natural gas, regardless of the end fuel type, that style of resource is needed in 2036.

**Gall, James:** The next resource where you see long duration storage. The reference resource behind that technology is iron oxide batteries, and there are firms trying to create long duration iron oxide batteries. And so that's what that resource represents, 52 megawatts in 2039, because that's an energy resource. We throw a minus 1 up there for energy. That means it's not creating energy it's just moving energy and there are losses associated with that energy. There are also losses related with renewable fueled CTs, which I'll get to in a minute.

**Gall, James:** I did see a question show up from Doug on ammonia. Or is this aqua ammonia? My understanding is this likely is aqua based ammonia where my, and I'm not an engineer, limited understanding of this, but it's more stable to store in an aqueous state and that would by the time it gets to the turbine away from the storage resource then I think it would have to be more of a gaseous form, so hopefully that answers your question.

**Gall, James:** The next resource after the long duration storage is 2041, which is hopefully a renewal of a wind PPA that we have in our contract today and then additional capacity needed in 2041 for Washington and Idaho as we start to see other resources retire. We know both based CT in Washington and then a natural gas ICE machine, or internal combustion was the most cost effective, and for Idaho, and 2042 we have another PPA wind renewal.

**Gall, James:** And then additional renewable based CT units along with gas units and long duration storage, there's definitely a theme going on for our long-term needs. It's long duration style capacity resources along with wind and you might be asking why not solar and really the reason why not solar is its lack of production in the winter. We have a substantial amount of energy needed in the winter.

**Gall, James:** We also have needs in the summer, but that winter need is greater than summer and that wind resource provides you with a mixture of energy and in all seasons. So that's why wind is showing up more prevalently.

**Gall, James:** One advantage with Columbia Basin Hydro, which Chris had talked about earlier, is it does give us a summer resource. For those of you who might remember our last IRP or some of our discussions and the tax we had a summer need for a while and that helped solve the capacity needed.

**Gall, James:** Mike Louis has a question, can you explain the rationale used to designate between Idaho and Washington? Sure. So how our model works, and I'm going to go back to this slide here on capacity, for each of these targets we're trying to meet somewhere in winter peak needs and energy. We create an L&R or resource need for both states. We have an energy need and a capacity need by month for both Idaho and Washington. And what the model does is it tries to select resources to meet each individual need for each jurisdiction. Because Washington has requirements to be 100% clean by 2045, you're going to get a different resource selection for Idaho versus Washington because of that restriction on thermal based resources in Washington, where Idaho focuses on the least cost. What you might see out of this is the natural gas

resources that are selected at similar times as the renewable field CTs for Washington, those are still a lower cost option based on our assumptions. Hopefully that answers your question, Mike.

**Gall, James:** One other note, I wanted to bring up about this ammonia-based CT is it requires a substantial amount of energy to create that ammonia and you could argue, and we haven't completely finished up the amount of capacity needed to create the fuel that's going to be used in these ammonia turbines. That's something we'll have in the final IRP. But we may need an additional 800 to 2,000 megawatts of renewable energy capacity to create the ammonia needed. The reason why you need such a substantial amount of energy is we think ammonia is around a 20% round trip efficiency. So, what we're going to be doing in the next couple months is looking at when is this ammonia turbine going to be dispatched and when would we need that fuel created and try to come up with a forecast on how much additional renewable resources we would need to create that ammonia. Now a lot of that energy could come from the market or come from access of this production of these resources or from other utilities, but we're also seeing there could also be onsite. Or ammonia production facilities with an onsite resource that's not created or connected to the grid. Just a couple things on ammonia to advertise it a little bit more as an option. We're starting to see agriculture look at ammonia, as a green ammonia option for fertilizer creation. There's been a number of facilities proposed. If you look in the news every once in a while you might see a proposal, but there's maybe economies of scale for ammonia production for AG, then also for power, but the root of that is hydrogen. And if you look at the natural gas IRP, there is something called synthetic methane that helps meet some of the environmental goals in Oregon and somewhat in Washington. But that synthetic natural gas is hydrogen based, which is also the basis of ammonia in this example.

**Gall, James:** I would expect there to be quite a bit of investment in the region for hydrogen and potentially ammonia, but again, we'll see where the technology goes. That's the one advantage we have at Avista is this need is out there and 2036, that's 13 years away. We have some time to see how all the technologies evolve. Maybe pumped storage is the right solution. I don't know, but we have some time to see what happens.

**Gall, James:** I'm going to pause there. If there's any thoughts or comments on the resource strategy before we continue. Alright, I'll keep going. Let's talk about transmission. That's one thing I'd say regionally, some utilities do a good job at this, others maybe not so much, but we have to have new transmission and make sure we can move all these selected resources to the load centers. How we analyze this in an IRP is I would say somewhat simplistic depending on which resources are selected, we have a different cost assigned to it. If it's an off-system resource, there's a cost to wheel it to our system. And if it's on our system, we have an interconnection cost. What happens though, if you select too many resources in the same area, you may have to build a much larger transmission project than what they would look like individually. It's \$100 a kWh to

connect, but if you wanted to build three of those, it might be a billion dollar project to get that built.

**Gall, James:** So, what we found was there is need for some large transmission projects based on this resource strategy. It has to do with the renewable goals and the long duration storage requirements, based on where we think these resources would likely end up. For the renewable resources we would need transmission capacity additions in the Big Bend area, which if you think about what that is, that's the Othello area, similar to where our solar resources at Adams Nielsen or Rattlesnake Flat Project. We would need additional transmission in those areas and then also Rathdrum - Spokane would need to be reinforced if that's the future location of CTs of any technology.

**Gall, James:** I saw a question from Steve. NOx output related to renewable fueled CTs. Steve is on to something there. That is one downside to ammonia-based CTs, and actually even hydrogen-based CTs. My understanding is they do have higher NOx levels. Our expectation would be that any ammonia fired CT is going to have run hour limits due to those emissions, depending on what type of controls that can be developed. I've heard numbers that maybe five times the amount of NOx compared to a natural gas CT. I wouldn't take that home, but I've heard the numbers out there. That's something I asked when I talked to two different ammonia turbine vendors and they're still working it out on the technologies to control NOx, but that's a good question, Steve. Thanks.

**Gall, James:** One last point on transmission and I'd say a risk for resource strategy planning is when we build transmission, or we have an existing transmission system. Other utilities or independent power producers can basically take that transmission. For example, let's just say we had spare capacity, which we do today, to add a renewable resource. Let's say the southern part of our system. But if another utility contracts with a company that wants to build, say, a solar facility and wheels that off our system, there may not be transmission available for us to use to build the resource we need later so.

**Gall, James:** All the analysis that we've done on transmission need here could really change if, for example, a utility west of the Cascades came over here to bring a renewable resource they built over here in eastern Washington to the west side. This is something we're going to have to look at every IRP to see what's available today and what could be taken from us, or shouldn't say taken, we are getting compensated for that. But what may not be available for Avista customers long term. We're going to have to have a consistent review of what's available and what's going to cost the build new so. Alright, Phil, I see you hopped on camera. I don't if you had a question.

**Philip Jones:** No, I don't. I had another meeting. I just jumped back in. Sorry.

**Gall, James:** That's alright. Welcome.

**Philip Jones:** Thank you.

**Gall, James:** All right. We're going to go on to CETA again. I promised another CETA slide. And this is a view of how CETA is met based on the resource selection. How this

works, is that black solid line represents our net retail load forecast. We have slow growth from our customers through around the 2030 period. But then after 2030, you start to see growth increased. This is largely due to electric vehicle projections, somewhat building electrification from the new building codes. That's the retail sales and this is net of PURPA that we're allowed to reduce from our retail sales target for CETA. This dotted line represents the goal that we set in our model to meet with clean energy and think about this as that primary compliance target goal where we need to have the equal or greater amount of renewable energy produced within a month compared to our load. That's the assumption for this dotted line. The green bars represent how much energy the model selected to use for meeting this target. The blue bars represent the amount above that monthly load. Going back to 2024, like I mentioned earlier, we have certain months that we generate more clean energy than our monthly load. That's what this represents here. In light green are REC sales. We allow the model to have a limited amount of REC sales from Washington. We don't want to have the model selling off excess RECs and building resources. Because then you're basically becoming an arbitrage model, that's not the goal of a utility. We're not building resources to sell off to other utilities.

**Gall, James:** There's a limited amount of sales options in there. But any amount above the dotted line represents what theoretically could be sold off if needed, but that's not the objective. In Orange you can see some limited times where our model selects to transfer RECs from Idaho to Washington. What this means is that, like I think Kevin mentioned earlier, all of our resources today are separated by what we call the PT ratio. If we had a 100 MW resource, Idaho customers pay around 34 ½% of that cost. Washington pays the remaining amount and theoretically all the energy and renewable energy benefits are split between those two states. One of our concepts to meet CETA, because of this allocation issue, is certain resources that we've used historically to meet I 937, such as our wind resources, our biomass resources and then any new hydro contracts, those resources are again allocated to each state, but the renewable energy attributes could be transferred from one state to the other and compensated for if needed for compliance.

**Gall, James:** And then we also assumed that any hydro, legacy hydro. Think about Noxon and Cabinet, or Spokane River, those would not be used for primary compliance, but only alternative compliance. So, what the model's finding is it does need to use some of Idaho's share of renewable resources in this 2038 to 2044 period, even in a little bit in 2045. There is going to have to be some renewable energy transactions between states. Looks like even a little bit starting in 2030. So, we still have resource allocation issues to work through. And when we are complying with CETA, how do we make sure that's understandable, how resources are treated by each state, and how the money flows between different customer types.

**Gall, James:** Another interesting slide is showing the amount of clean energy as a percentage of load. In 2024, if we had average or expected hydro, expected wind production, from our system point of view we're around 71% clean energy. This also assumes that we did not sell any of the renewable energy credits off. We have a little bit



higher value in Idaho versus Washington, and this has to do with how we allocated the PURPA sources. There's more PURPA generation in Idaho than there is in Washington, which is why you see a little bit higher value for Idaho. But as you go through time with the model, selecting renewable resources for Washington, and not for Idaho, you see the Washington amount growing. So, we have around 90% and 2030. And close to 100% in 2035 on an annual average basis and declines a little bit in 2040. But by 2045, it's well over 100% of our load, again because the model is trying to solve monthly targets rather than annual targets. And you have months of the year where you have a lot of renewable energy production but not a lot of load, then you have months of the year that renewables don't produce a lot of energy, but there's a lot of load. So, we do have this this issue of trying to figure out how to match up production of renewable energy with when customers actually use it. And that's where storage comes into play.

**Gall, James:** There was a question, why Idaho's clean energy production drops so low by 2045? The reason for the decline is expiring contracts. For example, our Palouse and Rattlesnake wind contracts are expiring before 2045, so they lose that energy amount, also some of our hydro contracts expire as well. So that is the reason for the lowering.

**Gall, James:** For those of you that are interested in greenhouse gas emissions, this is a forecast of our emissions and red is how this works, it is the total amount of actual emissions from our generating facilities in 2021. That's just under 3,000,000 tons. This is just looking at production of greenhouse gas emissions from our own facilities, it does not consider emissions from energy we buy or sell. We'll get to that in a little bit.

**Gall, James:** And what's shown in blue is our forecast for those same existing resources. And as you saw in this red line, we expect actually a little bit more emissions in 2024. A small drop in 2025. And then when Colstrip exits to portfolio, we'd be down to about a 1.5 million tons or about a 50% reduction in emissions in 2026 and that slowly declines over time as we expect our gas fired facilities to dispatch less as the region acquires more renewable energy and storage. That's the reason for the reduction. Then by 2042, Lancaster exits the portfolio and then Coyote exits the portfolio for Washington in 2045. That's the expected reductions. You can see small reductions or increases for these new resources in orange. This is related to Idaho, and these are really offsetting lost existing natural gas resources. Before I continue on, I saw a couple of questions pop up that are maybe related to the prior slide. I'm going to finish this slide and then I'll go back to those questions.

**Gall, James:** Green here represents market transactions and how this works is we know there is an emissions content associated with any time we buy or sell power. So, the green of the portion of these bars represent that relationship. In these first three years on average for the year, we are actually a seller. So theoretically our emissions would be declining below 3 million tons for the sales that we are selling. If you wanted to shift that responsibility to the buyer of the energy versus after 2026, we are buying energy on occasion except for 2033, we're a net seller. But when we are buyers, this is the amount

of emissions associated with those purchases. And I think we're using the 0.437 tons of emissions tons per megawatt hour for that assumption.

**Gall, James:** We also have accounting for emissions associated with upstream operations or construction estimates. And if you think about what that is, I think Chris had mentioned the 50 truckloads of biomass that is delivered each day to Kettle falls, that's a diesel fired truck that's moving that wood from the woods to the plant. That could be emissions from that, or it could be emissions associated with the creation of the wind turbines or the storage facility. So that's the emissions associated with the facility or operating the facility, it's also the amount of emissions associated with, say, the natural gas production of methane, losses from the production of natural gas, so those are all baked into the this light blue color. If you net all the positives and the negatives of emissions, you end up with this black line. Again, it's a similar path to our total emissions now in Washington. They have created the Climate Commitment Act that's going to have its own accounting of emissions. Once that's settled out, in the 2025 IRP we might be showing a forecast that looks a lot more like how that method is for calculating those emissions.

**Gall, James:** OK, so let's go to the questions. Question from Steve. Does the model assume that the hydro sold off and some hours of the month can be sold without its attributes, so that the hydro can be counted for CETA compliance for that month? What we are assuming is, this is the monthly model, and if you're selling a resource within that month and not the renewable energy attribute, it's obviously keeping that. We're basically just accounting for RECs and energy, and not within the hour. What happens within the month? We have no way yet of distinguishing what is sold versus what is kept. So, it's just a monthly look at the net energy position. Hopefully that helps. I know we've had a lot of debate over the last couple years on how to do this, but right now it's just a monthly look at what is your capability compared to your load.

**Gall, James:** And then a question from Jason, will the decrease in Idaho clean energy creation have an impact on the transfer of RECs from Idaho to Washington? Answer to that is yes, when you get out in this 2042 to 2045 period, the only transferable resource is Kettle Falls and a little bit from the Columbia Basin Hydro and Chelan contracts. When in reality, what the model does is the loss of Rattlesnake Flats and Palouse Wind are actually picked up by Washington right here in these PPA renewals that you see here in 2042 and 2041. They get picked up that way, but a limited amount here. Good observation.

**Gall, James:** OK, so to move on, let's talk a little bit about rates and how cost come out when you add these resources. And how this works is, I'm showing two different values, I like to concentrate on the rate of energy rather than cost because cost doesn't include load growth. So how this works, we have in gray is the Washington revenue requirement and in orange is the Idaho revenue requirement. Again, as I mentioned earlier, this is the expected cost for customers, not the optimization value of the resource decisions, because the optimization value has societal cost we talked about earlier.

**Gall, James:** This is the revenue requirement and how this is calculated is we have two types of costs that go into revenue requirement. One is power costs. Those are things that we directly model. For example, the fuel to run turbines or the market price of power and buy and sell power. The capital cost of our resources versus other costs which are not included, that's transmission, distribution, corporate overheads and how this is done as we look at all the costs we add up that we actually are modeling the power cost side and compare that to our revenue requirement as a whole. Power costs are let's just say less than half of our total revenue requirement, that difference is other costs that are to serve our customers. We escalate those other costs by historical inflation. So that's around historical inflation of those costs, that's around 3%.

**Gall, James:** I think I saw a question from Tom that's related to that. You have those costs inflating. You have our power costs inflating as well based on our expectations of cost changes for resources and cost changes for commodities such as electricity and natural gas and ammonia and other resources options and that is the creation of these revenue requirements. As you add resources, you start to see additional costs combined with your existing and then what we do is take those revenue requirements you see in the bars and divide by the expected retail sales to get an average rate. Today we're approximately around \$0.10 a kWh and what we forecast is in Idaho, for example, there's pretty much just an inflationary upward trajectory. There are a few bumps in here as you have to add new resources, but by 2028 it looks like around 11 cents, around \$0.18 by 2045. On the Washington side, it's a little different story because you have CETA requirements and what happens here is you get a slightly more upward trajectory, but it's still following the Idaho inflationary trajectory until you get to, what I would call more difficult periods where you're trying to comply with CETA on that monthly level and then eventually, theoretically, to the hourly level in 2045 where you start to see more rapid escalation of rates in the last five years for Washington.

**Gall, James:** So, you end up with a gap between the states of today. It's maybe around a penny or less upwards to the five cents a kWh towards the end. And this is really having to do with higher cost renewable fuel source capacity. Energy resources that are potentially higher cost than market and storage resources complying to 100% renewable energy versus say 95% or 98% where you have a substantial cost, and we haven't got to the point yet where we modeled every hour. It's entirely possible we would need additional resources or markets to comply with the 100% in 2045.

**Gall, James:** This number has a chance to go up based on future analysis and more clarification on policy for 2045. But the other factor to consider is CETA's 2% cost cap per year. And when we've done that analysis, we're well under the cost cap until 2044. But in 2045, there is a chance to exceed that cost cap depending on how the calculations are conducted at that time. So again, 2045 will be a little bit of a challenge from a rate perspective, also from a reliability perspective and compliance perspective. But this gives you an idea of where the cost projections are going for the resource strategy shown.

**Gall, James:** This afternoon, we're going to get into the scenario analysis so we can see how these rate projections change based on different assumptions for the portfolio. That's actually a little bit more entertaining than this. My last slide before I turn this over to Mike is on avoided cost. Before I go there, it looks like another question came up. Does any of the escalation in costs include increased cost due to climate change? I think the best way to respond to that is we have forecasted changes in our load and our hydro from changing temperatures and river flows that are based on the RCP forecasts. I think Mike Hermanson went over that in a previous TAC meeting. We're not assuming any costs on the T&D side besides those that are already baked into our starting point, which I think there is a number of costs for wildfires built in there, but we're not showing anything explicit in the non-power costs besides related to hydro or our load forecast.

**Gall, James:** OK, so back to avoided cost. Avoided costs get used for PURPA acquisitions. They're helpful in understanding what our costs are in general. If you go back to the supply curve of energy efficiency, we do a similar, but separate of what it costs for energy efficiency. This will give you an idea of the different breakdown of what costs we were considering when we're looking at PURPA resources or when we are acquiring new resources in between IRPs. How this works is it's mostly cost per MW hour and then we have some capacity costs over here on the right, but I'll cover the energy costs first. We have three different types of energy. We have flat energy, which means energy delivered the same amount every hour of the year on peak and off peak, which is more focused on energy delivered during the middle of the day for on peak and at night and off peak. And essentially what these are is the Mid-C price forecast that Lori has shared in the past. We're around \$34 - 35 a megawatt hour. We expect prices off peak to barely flatten out today. On peak. Prices are generally higher than off peak prices, but we're starting to see in shoulder months like March, potentially in October where off peak prices can exceed on peak prices. When you have solar production and lower loads.

**Gall, James:** And so far, it depends on what's happening from a load perspective. Those are our energy cost forecasts, and then we have what we call a clean energy premium due to CETA, we have to acquire clean energy, which is very well known. This is the incremental premium above the strict energy costs that are over here that we would be willing to pay for that energy, it's around \$3, beginning 2034. That's our first year of energy clean energy need. Historically, this number is around \$15, but I'll explain why that has changed in this IRP. It really has to do with capacity. As you may have seen from our resource choices, we are looking for capacity and energy, but mostly focused on capacity and because the IRA and forecasts for renewable energy are fairly cheap, just on creating the energy that energy premium is going to be expected to be very low. But there is going to be a premium on creating clean energy when you need it. So, we created what's called a clean energy capacity premium. That adds to our capacity costs. Our capacity cost, which is supposed to identify how much we're willing to pay for new capacity, that starts in 2034 around \$93.00 a kilowatt year. But if we wanted to get clean capacity, that avoided cost, you have to add these together and you get around \$150.00 a kilowatt year. This

demonstrates both the premium required to create, to buy capacity, both with clean energy or non-clean energy.

**Gall, James:** And that escalates each year as well. We're going to cover this a little bit more in the scenarios and how these are derived. But for those of you that are interested in avoided costs, that's available to you. That's all my slides. We're going to take a break at 11:30 for lunch. We can move on to Mike's presentation, we can have some discussion, or we could move to lunch earlier. I would like some discussion. I don't know there's been a few questions in chat, but I haven't heard any comments or opinions from the TAC while going through this. I'd like to hear what people thoughts are. I saw a hand go up. Go ahead, Tina.

**Tina Jayaweera (Guest):** OK. Thank you. I'm wondering if you've considered redefining your on peak and off peak. As you noted, off peak is starting to be higher than on peak, well pretty soon. Given all the changes, it seems like those are antiquated blocks that are being defined.

**Gall, James:** Yeah, I think maybe from an IRP perspective, maybe we just drop on / off peak, it might be the solution, and just use the flat price. Obviously, there's a market that trades those products and I don't know how those are going to move into more of an EIM that's every five minutes and maybe on peak or goes away when we have the EDAM market. I don't know where that's going, but I show it there because that's how power is traded. But I agree with your point. The future is going to look different.

**Tina Jayaweera (Guest):** OK. Yeah. Since you brought it up, what does Avista have planned about the EDAM? Has that been decided?

**Gall, James:** I'm going to kick that over to Kevin. I don't know if, Kevin, if you have any thoughts on that one?

**Tina Jayaweera (Guest):** And for those who don't know, EDAM is extended day ahead market. That the California is.

**Holland, Kevin:** Sorry, can you ask the question again?

**Tina Jayaweera (Guest):** Oh, I was just wondering what Avista's plans are around the EDA, if you're going to be participating, if that's decided?

**Holland, Kevin:** We're evaluating both EDAM and SP Markets Plus at this time. We're involved in both of those processes going forward. We continue to evaluate which one will be the best option for Avista. The final decision won't be made for some time until a lot of those evaluation outcomes are reviewed. And at least, there is a group of participants that are in the same position as we are, market participants that are in the same position as we are that have hired some consultants to do an evaluation for us under various scenarios and we have recently received some information. We're going back to clarify some of their results. So those evaluations are still underway Tina.

**Tina Jayaweera (Guest):** OK. Thank you. So maybe it'll come into effect for the next IRP. Although I guess you're starting that pretty soon, so who knows.

**Holland, Kevin:** Yeah, we would. I would hope that we'll have some more clarity going forward, but there's a lot of chips involved in that and we're seeing how they fall and obviously you know there are a couple of entities that have already elected where they're going. I think Powerex/BC Hydro has elected to go to SPP and Pacific Power as elected to go to EDAM. Depending on the outcome of the study and how potentially other participants elect will have an influence on where Avista goes as well as the economics.

**Tina Jayaweera (Guest):** Great. Thank you.

**Gall, James:** Thanks, Tina. Open up to any other comments, thoughts or questions. I can go back to previous slides if you'd like. Just crickets. Alright, must be perfect then and I don't think that's the case.

**Steve Johnson (Guest):** This is Steve Johnson. James.

**Gall, James:** Hi, Steve.

**Steve Johnson (Guest):** Maybe you talked about this, or maybe we'll talk about this, I was trying to scan through the slides, but does the IRP analysis get a handle on the risk that the portfolio faces in more critical load and resource events. You know the June event, the business done in September and August, pretty famous now. Does it have a finger on how well the portfolio performs when subject to those kind of events?

**Gall, James:** Yeah. I think the best way to answer that is we have a load forecast that is obviously not based on those events but based on one-in-two peak forecast. You have an expected load, let's just say our expected load was going to be 1,750 megawatts in the peak. But then you have one of these events and your load like we saw in the September event went to say 1,900 megawatts. So, you have this increase, there's definitely a risk that loads will be higher than your expectations. You also have the other risks that you're going to have less generating resources when it comes time to meet your load. You know you have a forced outage, or you could have a bad wind event or bad hydro event. What we're using is our expectations and then you add two things to those expectations to evaluate risk and those are really driven by that Western Resource Adequacy Program methodology. One is planning margin, which you're adding to your load to cover changes in load because you don't know what those changes loaded are going to be. The other change is the qualifying capacity, credit assigned to resources, which that's looking at the historical variation of those resources and what's the chance of an outage. And that's actually a new component that we didn't have in previous IRPs, that outage chance in our planning margin. So, the risk of those events are covered.

**Gall, James:** And meeting the WRAP. If the WRAP is telling all the participants, you should go out and acquire access to resources above your need. And then if an event happens, whether it's on your system, or the system in general, we can then as a utility community, try to help each other out. That basically creates a market to move energy

between utilities in case that event happens. I guess the risk is, what happens if you know the WRAP did not create a high enough planning margin to meet one of these events you're talking about? And I think that's a real risk.

**Gall, James:** One thing we're going to show, and Mike is going to show this after lunch is how much we're dependent upon the market. As you might remember in previous IRPs, we picked a planning margin that was based on 5% loss of load probability but still relied on I think it was 330 megawatts of the market. But when you go to this WRAP world, your planning margin is actually going to be lower than what each utility would plan for individually and now you're relying on the region to meet that need and we want to show how much we're relying on that regional market. That's what we're going to get to this afternoon. But I think just to remind you or everybody's the planning margins we assumed were not WRAP planning margins. We have a scenario that shows that. We're still assuming a higher planning margin than WRAP proposes, and we'll get to that this afternoon as well. But hopefully that answers your question.

**Steve Johnson (Guest):** Thank you. Yeah, I'm also trying to figure out how you represent prices or whether you feel like you have a good handle on what those kind of weather events cause prices to do. Aside from how deep you are or not in the market for either capacity or energy, but it sounds like you got some slides this afternoon, so I'll wait for that. Thank you.

**Gall, James:** Yeah. Those slides may not address the price component. On the price side, I'd say we're doing a price forecast and we evaluate each of those resource options against the price forecast. And when you do 300 futures that we're doing, you're going to have events where prices get very high and certain resources are going to respond to those and provide value to the system and when those occur, that value is included in the value that we assign the resources when the model is making that decision. I guess then the question is, are those events going to occur more often than we assume or at higher prices than we assume? What we're seeing in the price forecast at least is this, and I think Lori had shown some slides on this from last December, but middle of the day prices are going to be very low, but mornings and evening prices are very high. Resources that can produce in those periods of times are going to have more value to the system. That could include energy storage, a gas peaker, or renewables. Those resources that can basically produce energy when solar is not are going to have higher values.

**Steve Johnson (Guest):** Thank you. It was Tina's question about on peak / off peak that prompted me to think about the evening / morning conditions under certain weather events. Thanks James.

**Gall, James:** Yeah. I want to go back to the chat. I saw a couple questions pop up. Jason asked earlier, you mentioned that shoulder season avoided costs can exceed on peak avoided costs. Can you clarify, expand on that? I think it might be best to show a slide from a previous TAC meeting, but I'll try to explain it. Think about on peak as say 7:00 AM to 10:00 PM at night. What's happening is you have a substantial amount of solar,

mostly from southwestern areas of the US dumping or creating lots of energy. Most of that energy isn't all during that those 16 hours, it's mostly in the middle of the day. So, what's happening is when you have a large solar production and may not have a large amount of load, you're going to drive prices down during the middle of the day. But that 16-hour block, that's considered on peak, the beginning of it, and the end of it is extremely expensive. But the middle of it is very cheap. When you average those 16 hours, you get prices that are considered on peak, that back to Tina's point, are lower than off peak just because the middle of the day drives prices down.

**Gall, James:** And if you have our draft IRP out there, if you go to the market chapter, there's some pictures of what that looks like that might be the best way to look at it.

**Gall, James:** Hopefully that answers your question. Tom asked a question, have scenarios been built that do not include the Lower Snake River dam production? I'd say the answer to that is no. And just a little bit of background on the Snake River dams. Those are facilities that are, I would say, in our service territory or near our service territory, but they do not serve Avista customers directly, they serve customers that are reliant on the Bonneville Power Administration and what a scenario would look like to Avista without that resource is the market prices that we're using would be different and they would be different depending on the resources selected to replace that generation. If those resources went away and were replaced with say nuclear, maybe prices would be lower. But if they replace them with say, natural gas, maybe the prices would be higher. It would depend on what replaces those resources. Now if no resources were replaced with them, then you would definitely see higher prices. And I see a hand came up. Fred, go ahead.

**Fred Heutte (NVEC):** Morning, everybody. Fred Heutte, Northwest Energy Coalition. I just quickly say that on the Lower Snake issue, which we're very interested in, I'm sure most people know that we've sponsored a couple studies of replacement resource mixes for the Lower Snake dams if and when they come out. Energy Strategies, in Salt Lake City, which is a pretty well-respected firm, did the studies and showed that we could replace the Lower Snake dams with a resource mix that's both quite clean, renewable energy storage, customer side resources like energy efficiency, demand response, rooftop solar, etcetera and actually do a better job, meaning the load needs especially in the public power side, Bonneville and public power. Which we think would, if over time reduce costs, especially in the stress condition periods of the year, which is basically mid-winter and late summer. It's not just that if you take the dams away, costs would go up. There would be a replacement mix. And the question is how much would that cost and what would it do? But we're pretty confident that it would actually improve things for the region overall.

**Gall, James:** Any other comments or questions were getting close to the lunch hour that we're going to take a break on, but we have a little bit of time. OK.

**Holland, Kevin:** Hey, James.



**Gall, James:** Yep, go ahead Kevin.

**Holland, Kevin:** This is this is Kevin. I just wonder if on Jason's earlier question. If you have the answer about the avoided cost exceeding. Oh, it was on peak. Not off peak. My fault. I misread the question. Thank you.

**Gall, James:** Alright, I was going to see if I could pull up a slide that might illustrate this. Actually, I have one right here. This is kind of what I was referring to in my discussion where we are starting to see the period of on peak, the 7:00 AM to hour 22 and let's just look at summer where we're forecasting to have a lot of solar. You see prices and the future are pretty low in this period. But they're high in this period, which is still an on peak hour. But when you average prices throughout this period, they come out lower than the off peak which are from this hour 23 to 26. It's kind of a misleading statement. We really have a historical market period of time where things are changing, maybe we need to have more price points to buy at. We do have 5-minute basis to buy at, but maybe in the in the forward time, maybe we need to have four blocks of power for each day. Maybe instead of two. But back to Steve's comment earlier, resources that are flexible that can generate here definitely have more value than those that can generate during these times. Any other thoughts before we break for lunch. OK, Steve got his hand up. Go ahead, Steve.

**Steve Johnson (Guest):** Just a quick suggestion on your avoided cost, capacity columns and your slide. Just maybe label those so that people would understand that the capacity and clean capacity premium are additive.

**Gall, James:** OK. Yeah.

**Steve Johnson (Guest):** It's could kind of get there, but because obviously paying capacity is lower then and it is a premium implying additional, but it could just be easier for people to use. Thanks.

**Gall, James:** I can do that and obviously that's discussed in the document, but you're the second person to make that comment to me, so maybe that's an indication of a change though. Thank you. Well, why don't we take a break and we'll come back at 11:30? Or sorry at 1:30 or 12:30. I apologize, 1:30 Idaho Time, 12:30 Washington time, or at least Washington, North Idaho time. And we'll finish off the market dependence presentation from Mike Hermanson, then we'll get into the scenarios, and then talk about Action Items and maybe we'll get done early. We'll see. But with that, we'll take a break for an hour. And if somebody from Avista could make sure you leave the Team meeting open. I'm going to stop sharing and stop the recording and then we'll turn it back on when I get back.

**[Lunch Break]**

**Portfolio Resource Strategy Continued, IRP Team**

**Gall, James:** It's 12:30. Well, wait another minute or so for folks to return. John, if you're out there in Teams land or whatever, we'd call this virtual land.

**Lyons, John:** Yes. Teams wasteland.

**Gall, James:** Yeah. And I would assume my mic's ready to go as well. I think he's going to go first, so.

**Lyons, John:** There he is.

**Gall, James:** Mike, I'm going to stop presenting. I'll let you share your screen.

**Hermanson, Mike:** OK.

**Gall, James:** And we'll give it maybe 30 seconds for people to join. And I think what we'll do is after this presentation, maybe we'll take a quick 5-minute break before we get into the scenarios.

**Hermanson, Mike:** Sounds good.

**Gall, James:** OK. Maybe before you start. Mike. I just want to make sure there were no more comments or questions that folks came up with during lunch on the previous material. If something does come up, feel free to put that in the chat and maybe we can address that after Mike's presentation. Alright, I'll let you go for it, Mike.

**Hermanson, Mike:** OK, so my name is Mike Hermanson and I'm a Senior Power Supply Analyst. I'm going to be going over market reliance modeling that we did as part of this new current IRP effort. This analysis stems from the loss of load probability analysis that was conducted for the 2021 IRP. That analysis evaluated the probability of not being able to meet native load given variability in renewable generation, unit outages, load variation and hydro variation. Lots of load modeling provided information to determine if resources that were selected for specific scenarios would meet our reliability requirements.

**Hermanson, Mike:** As James mentioned, we are entering the WRAP and are in a non-binding period I believe, although there's several different kinds of iterations that we go through until we're fully in the WRAP. For this 2023 IRP, we decided to use the same planning reserve margin that was used in the 2021 IRP but used that in conjunction with the qualifying capacity credits that are assigned to each of our resources through the WRAP program. For this IRP, we conducted a similar study, but rather than limit the available market in the model such that load loss would occur, what we evaluated was the reliance on the market to meet load. Previously, the model would be run, and we would cap our market availability at 330 megawatts. So, if our resources given all of the variables and loads and everything could not and then add on 330 megawatts. You're not meeting the load. Then we would get a loss of load event. The model that we use to test reliability is based in Excel and it utilizes VBA code to facilitate Monte Carlo analysis. That allows us to look at thousands of different iterations of all the different variables that contribute to whether we're going to meet load. Back to the question that I believe Steve Johnson asked, what happens when you have a high load and unit outages and different

hydro? We run this model 1,000 times to put all of those different constraints together and find out what happens. This model also uses What's Best, like the PRiSM model does, and we use it to dispatch resources to serve load and meet other constraints. The model is an out of one hour time step over a one-year period. The model optimizes to serve load with a specified amount of generation from run of river facilities, contracts, and renewables, and then the balance is met with dispatch generation from hydro storage, thermal generation batteries, and then market purchases and sales. The dispatch is linearly optimized to minimize cost from the thermal and the market purchases and then all of this is done to meet our hourly load.

**Hermanson, Mike:** And then the risk evaluation is done by running the model repeatedly and each time selecting a random weather year for load and different renewable generation profiles, different hydro years. And then we also have forced outages that are selected based on rates that are established from each of the generation resources. From the output we were able to see the quantity and timing of market purchases to evaluate our market exposure.

**Hermanson, Mike:** We looked at it for two different periods, 2030 and 2045. This table shows the range of the input variables over the 1,000 model runs. On average, our native load was 1,067 aMW and our winner peak was 1,679 aMW and our summer peak was 1,627 aMW. Also in this table is the maximum / minimum of each of those inputs. As I said, there's 1,000 different draws and so that was the average, the range of those inputs that we would see. In the lower table is the hydro and the wind generation that we saw on average, and the maximum and minimum. Also listed is the capacity of each of the thermal facilities. These capacities incorporate the maintenance and outages, and also the variability to some of our thermals from temperature.

**Hermanson, Mike:** You can see that when you total it all out, we on average had 1,743 average megawatts of generation that we were either receiving or had availability to generate in our summer peak of 1,627 aMW. So, we had a little bit more generation on average available than we did have load. Similarly, a little bit more generation on the max and the min side. But the model output is 8,760 market purchases, so hourly purchases for every hour of the year. The model is making purchases to meet load, but it can also dispatch generators in relation to market price and market sales to minimize overall system cost. There are 1,000 different one-year runs.

**Hermanson, Mike:** The top chart is looking at a summation of that and it's looking at the average for that month for that particular year. We have months coming down the vertical column, horizontal is ours, and you can see periods of time that the model is purchasing and how much it's actually purchasing. As you would expect, during Q2 when hydro is the largest, we don't have very many market purchases and also, you'll see in the next chart, this timing is reacting to the market variable within the model.

**Hermanson, Mike:** And now you get out to the 99<sup>th</sup> percentile. This is over 1,000 runs. What were the largest market purchases for those hours and during those months? And

you can see that they're significantly more, almost three times as large, but similar patterns. I'm going to flip to the next slide, and we can get a look at what some specific days actually look like. These graphs are two example days showing which generators are running to meet load. The yellow bars represent thermal, the green is renewables, blue is hydro and then the red is our market purchases. The black line represents load. When generation is above load, it is sold to the market and then below the bar graph is the market price. You can actually see that the hydro is being dispatched and sold when the market price is high and then market purchases are making up the difference during the periods of the lower market price.

**Hermanson, Mike:** The graph on the left is during the winter, and the graph on the right is during the summer, and these are average conditions. I just pulled out a couple out of a few specific iterations and pulled out a couple of different days. You can see it's just optimizing our system to minimize cost and going on to the other thing that we wanted to look at was what happens when...

**Gall, James:** Mike, can I stop you there? You got a hand up, question from Fred.

**Hermanson, Mike:** Oh, sure. Yeah.

**Fred Heutte:** This is Fred from the Northwest Energy Coalition. Again, this this could actually wait. You don't have to answer right away, but I'm actually interested in the fact that during the low load hours and low market price hours, you're getting a lot more market purchases. And I guess mostly the hydro is being dispatched down. So, I'm just wondering first question, is that using all the available range in the hydro, or do you know what, what are the, maybe a better way to ask it, what are the constraints on hydro dispatch across the day, how much of that can you actually do?

**Hermanson, Mike:** The hydro dispatch actually mimics what are our constraints are based on the operating parameters of each of those facilities. For instance, at Cabinet, we have a minimum flow requirement. We have to meet a minimum flow and then we also have reservoir constraints of how much hydro you could hold before it had to release some. We tried as best as we can to simulate the actual operating condition of the hydro. It's linearly optimized at a whole year scale, and so it's finding the best possible solution within those constraints of the minimum reservoir, the upper reservoir for each of the different facilities have different constraints on the Spokane River system. We have some really tight reservoir operating in the summer months. We are able to mimic that and so. It's a fairly good representation of the flexibility of the hydro dispatch, but are you suggesting why wouldn't we flex anymore?

**Fred Heutte:** No, it did not at all. I think that makes sense. Yeah, just, I presume the model, can you know dispatch as much flexibility as you've got so, but no more?

**Hermanson, Mike:** Right.

**Gall, James:** Yeah. And I was going to say, it's James again, the method we're using, I called a bucket of MW hour. So, this might be, if you're going to put on extreme, this more

conservative or more liberal in its flexibility. I'd say this is probably more liberal on its flexibility because we're modeling as a bucket of MW hours rather than modeling the physical characteristics of the reservoir and the flows. That's a weakness in this. We're trying, we acquired PLEXOS, to solve some of those issues. Next IRP we'll use a different technology to hopefully do this work that Mike's been leading.

**Fred Heutte:** OK, so that that means that, just like with the Power Council, with their new Genesis model, they're now able to look at every dam, or I guess even every generator independently. That would be more possible I guess with PLEXOS. Is that what you're saying?

**Hermanson, Mike:** Yeah.

**Gall, James:** Yeah, that's easy. That's exactly right. We'll model, go ahead and tell everybody about PLEXOS, Mike for hydro.

**Hermanson, Mike:** Well, yeah. PLEXOS is, like James said, is based on looking at the reservoir as megawatts as opposed to actual water. PLEXOS represents the system as a hydrologic system, and each of the generators is independent and tied to a reservoir, and the reservoir is actually moving water up and down and reacting to the geometry of the reservoir and those height dynamics. I think more accurately represents a lot of the constraints that we have in the hydro system and while this attempts to, I think it does a decent job of representing our hydro operations, it's definitely a little more flexible and doesn't represent the real world, especially as you're managing a whole reservoir within a foot of elevation difference.

**Fred Heutte:** Thanks. I guess one other question is, can wait till the end. I know you're going to talk about 2045 also, you didn't show an analysis of the current dispatch in market purchases. I'm wondering, I don't need necessarily see all the details, but I'm just wondering if it looks all that different from now till 2030 and if so, what would make the change in that? Particularly in the market purchase pattern, which is, the point of this particular analysis.

**Hermanson, Mike:** Our analysis was generating in our market purchases it's in. We're about in the similar range. On the average side we didn't, we just looked at a whole year and just looked at average purchases, but it's in the same range.

**Fred Heutte:** OK. It's interesting to me because on the West side, we always think of mid-winter purchases, and both morning and evening, and then late summer. But you're not really showing a lot of purchases after midnight. But that's when you have a lot of hydro flexibility and market prices are really low. So, saving up water overnight would make sense for later in the day.

**Hermanson, Mike:** I would say one other item about this particular model is that the market price we used is a regression developed market price. That was a technique we used and going into the forward years we could probably look at pointing that a little better to market expectations as we move into the outer years.

**Gall, James:** Yeah. And I'll just add the add this really quick referring to that the charts I showed earlier before lunch where we had that significant price reduction in the middle of the day. That's not reflected in the in this in this model. If we put in those market prices, we may see a different dispatch and that's what I'd say also the differences. We see actuals, it's we're moving water based on load is one thing but also where the market is. The model here is responding to low prices at night and higher prices in certain hours. So, I guess it really comes down to what price you give it. We're going to do more work on that.

**Fred Heutte:** Yeah. Thanks. One more thought, just a quick one, which is I think this really demonstrates the value of flexibility. Here it's for the hydro particularly, but we ought to be thinking and that's a pretty significant factor obviously for Avista, we ought to be thinking more I hope about the flexibility value of storage and demand response. And you already are thinking about that, but it really shows here the value of that to be able to find the best market prices. When you actually need to go to the market. What the best conditions are for doing that? Thanks. This is a really helpful analysis.

**Gall, James:** Mike, we have a hand up and a question in chat. I'll read the question in the chat. I think we might have answered it. But just in case, what sampling distributions were used for each of the variable subject to mid? I think the MCC is Mid-C sampling, were the distributions based on actual data or another method?

**Hermanson, Mike:** So Mid-C hydro is that?

**Mike Louis:** No, it was a Monte Carlo, sorry, I shouldn't have abbreviated that. Sorry about that, Mike.

**Hermanson, Mike:** We did 1,000 runs and then took. So, I guess there was no sampling distributions necessarily. They're each a little different, and hopefully there's an answering your question. For the outage rates for each of the different thermal facilities, we put in outage rates based on historical information. For hydro, we had 80 years of hydro, and we were selecting from one of those hydro years. For temperatures, we had a whole series of temperatures going back to 1947 and then actually in the 2045 we incorporated some of the climate change temperatures going back. It was a random pull from those distributions based on historical data.

**Mike Louis:** OK. Thanks, Mike. That's a that's a pretty good explanation. That's all I wanted to hear. Thanks.

**Gall, James:** Go ahead, Steve.

**Steve Johnson (Guest):** Hey, James, thanks. Just a quick comment really just very interested in knowing how well your model can predict price events, where market resources get somewhat scarce, and I don't mean scarce in a physical sense necessarily, though close to that line, but particularly financially scarce, where we see very high price spikes that are sustained sometimes over a period of time, four days a week or they elevate prices thereafter for an extended period of time through winter sometimes. If you

can just generally speak to that as we go, I think that dialogue with Fred helped reveal what the hydro modeling can and can't do or what it's capturing how much it's capturing. But this is a fundamentalist model, so you take gas prices, resources, hydro capacity, dispatch cost and then you get a price market price. But what we often see are very, shall we call it, erratic prices or less, I think predictable prices during these for long. Heat or cold events and so forth and I'm not sure how well the model, anybody's model, can actually predict that price is at \$200? Is it \$250? Is it \$500? Is it \$1,000? Does it last an hour, two days, a week, these kind of reoccurring price lags. Just keep that in mind as you're discussing this. I don't think there's one answer but love to hear more about that as you move through the presentation. I may have to be off the call on and off, so I apologize.

**Gall, James:** I think you're going to get that answered in the next slide maybe.

**Hermanson, Mike:** Yeah. So, probably one of the more important pieces we did was to evaluate market reliance during periods when the market might be constrained. We simulated this by evaluating periods when the average daily temperature was 83 degrees or below 2 degrees. During those periods, our load is higher than normal, most likely other market participants loads would be higher. We would just look at those specific periods and see what kind of reliance we have in the market. It's not going to impact the market price during those. We had no mechanism to take the market price and make it differentiate from its normal pattern, but what it did look at is what our resources are doing in relation to the market in relation to those periods when we've got significant load and possibly outages or different hydro conditions. And so, the market conditions or the market purchases are similar. We still have that price signal that's coming through in the midday when we would see lower market purchases. And during that hydro period, we're not getting any market purchases during those 3 months, during those high and low temperature periods, because we're using most of our hydro just to serve load and then rather than serving load at a certain time, saving them and purchasing at the market. I will show you two example days and you'll get a sense for that. You can see these graphs show the details during the three-day period and in these instances, there are days when the market purchases are necessary to serve load rather than just to optimize around price. You can see that in this middle picture, that's when the real market reliance comes up and you can also see it when you look over here is an interesting scenario where we actually have less reliance on the market because the renewable generation was significantly larger during this particular 24-hour period. But as you move through the next two days, we actually have some additional hydro available. But this market reliance here and this middle day is true, but it actually is, it could be potentially met with, some of the. I'm actually jumping ahead to 2045, so I'll back off that comment and we'll move on to 2045 where we, but it's within our 330 MW market threshold that we used to use in our loss of load probability analysis.

**Hermanson, Mike:** So now going on to 2045, we had 1,000 draws of load and hydro and wind. And this table shows the inputs for 2024, including the average and peak load and

the available generation in 2045 is considerably different, with nearly twice as much wind, Coyote Springs is at one-third capacity, and there's a significant amount of new ammonia fueled turbines, which has an interesting impact on the system. This is the Preferred Resource Strategy, and we have on average more generation available either via the hydro and wind or the capability with the thermals and then also our max and min those are very close also.

**Hermanson, Mike:** So, in 2045, the pattern of market purchases is really similar to 2030, though the quantities in some instances are three times greater, even though the relationship of loads and resources is similar. The primary driver of this is the marginal cost to run the turbines, turbines fueled with ammonia. There's a high price to run those, so it elects to go to the market rather than run the ammonia. But like I said, similar pattern, it's reacting to the price. This is just pulling three days in the summer, three days in the winter. You can see here that the market purchases, especially in the winter period, are quite substantial, but you'll also notice that our thermal generation is low in comparison to what it was in 2030 and that's largely due, or entirely due, to the marginal cost of running the ammonia, the market price that we have for natural gas versus ammonia, I think it's almost four times greater for the ammonia and, as James had mentioned, just the round trip efficiency of ammonia and the amount of generation it takes to actually just create it is substantial. And so, it's just going to the market.

**Hermanson, Mike:** This is looking at market purchases during regionally constrained conditions, again during the. I should mention that the top chart is the 50<sup>th</sup> percentile, so just average or median, and then the bottom chart is the 95<sup>th</sup> percentile, so the extreme range of market purchases that were happening during that year. And again, during these high hydro months, we basically just have enough hydro to meet load, so there's no market purchases.

**Hermanson, Mike:** This slide shows an example of the summer three-day period and winter three-day period. As you can see, the market purchases, we don't have any room for sales, and that's again largely due to the marginal cost of the ammonia. You can see the thermal generation is quite low and then the market purchases is just the relationship between how much renewables and how much hydro we're going to have and the balance left after the thermals that are below the marginal cost of the Mid-C prices.

**Hermanson, Mike:** But we also ran the model where the model could go to the market for 1,000 megawatts so we would never lose load. But we also ran the model with just allowing it to go to the market for 330 megawatts of power. In those instances, we still never had any losses of load and that's because we still have 600 megawatts of capacity waiting to respond if the market liquidity becomes an issue. It's just a matter of cost. I think we've established that the market reliance is largely driven by what's available from renewables and hydro. And also, what kind of marginal cost we have on our thermal resources. And that's it for that analysis.

**(End of Mike's Segment)**



**Gall, James:** Thank you, Mike. Just one thought to think about for the TAC and maybe those that are following CETA. 2045 is going to be interesting, where we have this goal as a state to be 100% renewable. And you know there is a marketplace to interact with, and obviously these charts are showing our system that's got Idaho as well. But you know when we go to the market, how do we identify what's clean or not clean? How do we plan for what this looks like? And one thing we're going to do with this model is a test to see, take one of these draws of the 1,000 and try to calculate how many of the hours we can serve directly with our resources, from renewable resources, where you change the dispatch optimization of hydro not necessarily to dispatch to price but dispatch to serving customers with 100% to see if it's possible. Because I think one of the biggest challenges when you do these plans out to 2045 for this 100% is how much can you rely on the market, how much do you need to build yourself? What time periods do we have enough renewable resources and when during a day or a month. I think that analysis will show maybe some shortcomings of the strategy, or maybe we can serve 100% of the draws. I don't know, but that's the next steps with this. Obviously, there's PLEXOS, we're going to be doing similar work with this in the next IRP as well. But appreciate the work on this Mike. That's very telling about what a world looks like in the future.

**Gall, James:** Let's take a quick 5-minute break and then we'll wrap things up with the portfolio scenario analysis maybe around 1:10 PM. How about that? So, we're a little bit behind, but it's always good to take a quick break after lunch. We'll be back at 1:10.

#### **(5 Minute Break)**

**Gall, James:** A quick audio test. Can you hear me?

**Hermanson, Lori:** Yeah, we can hear you.

**Gall, James:** OK, good. Because my microphone died over the break. I ran out of battery. Alright. And you see the right slides, Lori.

**Hermanson, Lori:** Yep, I do.

**Gall, James:** OK, alright, we'll give everybody another minute or two to get back.

#### **(Alternative Policy Assumptions)**

**Gall, James:** OK, so we're at 1:10. We'll get started on the next presentation. This presentation is one of my favorites because we go through scenario analysis of alternative policy assumptions and see how our resource strategy would change or how costs and rates would change. There's a lot of insights to be gathered out of this presentation and hopefully it'll drive policy or changes in assumptions, or even potentially changes to the Preferred Resource Strategy as we finalize the plan. Again, feel free to jump in with questions or comments. I can see the chat and slideshow, so don't worry about interrupting me.

**Gall, James:** We conducted 17 scenarios if you include the Preferred Resource Strategy. I'm not going to go through the list here because I'll have a slide on each of the different

portfolios. I guess we can get started with the first several. The first several really have to do with avoided costs, so, I might go through those fairly quickly. That gives us more time to talk about some of the more interesting ones that are later in the slide deck. The first alternative, lowest reasonable cost portfolio, we call portfolio 2, this is a portfolio designed to help us understand the cost cap of CETA. It assumes the social cost of greenhouse gas is still included in our resource decision making along with other non-energy impacts, but it does not assume we have CETA or does not assume we have the Named Community Investment Fund. Basically, it's a difference in cost if we did not have clean energy targets, we still would have the targets for monthly energy and capacity. It's just they would not have to have clean energy or capacity for each month, but there still is a financial penalty to thermal resources in regards to the social cost of greenhouse gas. And as you can see on the right, we'll show what some of the results are. And then on the left are some of the assumptions or drivers of the portfolio. As you might expect in Washington, we do have lower costs. As you're lowering the amount of renewables or storage that needs to be acquired in the outer years of the plan, also you have the financial benefit of not replacing Coyote Springs 2 in 2045, where there's likely useful life of that facility beyond 2045. Some of the changes in resources are natural gas is still selected in Washington even with a social cost of greenhouse gas penalty over the renewable fuels. There is a mixture of both resources still selected. But, natural gas pops up in that scenario. Storage is actually selected as well because it's no longer trying to meet a monthly renewable energy target. What happens with storage is you're using energy from one period to move it to another period. And when you relieve constraints, you get different results. And then from the Idaho perspective. This is more of a Washington centric portfolio, but when you change anything to Washington, there is actually an impact on Idaho because there are resources that are shared. And so, there is a small reduction in gas for Idaho in exchange for some more energy storage. The costs for Idaho were fairly de minimis, but again, in Washington about 5% lower rates and in 2045 and the scenario.

Gall, James: Jennifer asked a question. What's the emissions impact? We'll get to that question towards the end of the slide deck. I have a slide on emissions, so we'll get to that then. Only so much I can put on a slide. Alright, so we're going to the next one. I call this the baseline portfolio. Basically, it's the same portfolio assumptions as the previous scenario, the one exception is the social cost of greenhouse gases is eliminated for Washington. This helps us figure out that capacity premium for avoided cost, but it also shows a step-by-step rate impact for Washington on two major policy decisions. Again, you can see a lower rate in Washington, about 13% lower by 2045. Again, Idaho does not see a major impact. What you do see is more resources are chosen on a system basis rather than a state basis. We have a table at the end of this, that you also have in your slide deck, that shows the selections of each of these portfolios if you want to compare them. But since this is just high level, one of the drivers with us moving to a separate state model is different policy goals in each state. But when you have similar policy goals in each state like this scenario, you get similar resources for each state, which is expected in that second bullet. Again, more natural gas CTs for Washington. Storage

is significantly lower, but they are still selected. I had mentioned earlier there are cost effective wind and potentially energy storage specifically for our batteries out in the future as costs decline. Those resources are selected in the outer years.

**Gall, James:** Again, Idaho had some small changes for natural gas, and some wind and demand response was selected. Really what happens is the model spins trying to be so precise when it solves and if you pick a different set of resources, it may leave small needs, which we're seeing in demand response because it's one of those, I call it a marginal cost resource. Anyway, interesting portfolio, mostly used for our avoided cost. When I look at comparing this cost to the Preferred Resource Strategy, that difference in cost helps us calculate those capacity premiums. Those renewable energy premiums that you saw out of avoided cost earlier.

**Gall, James:** The fourth portfolio is really simple, we don't add any resources whatsoever. The whole purpose of this is to validate the avoided cost of capacity. When I presented that earlier, that cost of capacity, dollar per kilowatt of raw capacity in the PRS presentation is the difference between this portfolio and the previous portfolio on slide four. That difference in cost is that avoided cost of capacity. That's the only reason this one is used. It's in our list. I left it in here similarly with #5, we run a portfolio without CETA requirements, but also no new natural gas requirements. What I mean by that is we did not allow the model to pick natural gas and that helped us figure out what that clean capacity cost is that was presented earlier. The reason why we had to go to this portfolio is we had the PR [planning reserve] capacity premiums or avoided costs are done on a portfolio level. So, this was a new concept to help us carve out how much of our capacity need is derived from clean versus just what is derived from a need for physical capacity. This is actually a new and important portfolio for that purpose.

**Gall, James:** We are getting into more of the policy scenarios. This is the first one we looked at; it was a WRAP planning reserve margins. As Mike had mentioned earlier, we're moving towards the WRAP and we're in this non-binding phase. We probably will still be in a non-binding phase in the next IRP and Avista has chosen not to adopt WRAP planning margins until we're going to a binding phase, or at least an indication that we'll be in a binding phase given our resource needs, not until 2034. Maybe it doesn't matter as much, but we wanted to conduct a portfolio analysis, if we chose to use the WRAP planning margin percentages rather than our percentages, that we've used in this IRP, which are based on percentage derived from previous IRPs. The table on the left shows the WRAP percentages at least as they are today. They change each year when the WRAP does new analysis on what the planning margin should be. But generally, in the winter and summer it is lower and the shoulder months which typically is not a binding period for us, but they would likely be higher and actually the WRAP does not require capacity in certain months. I believe it's April. I think October, there might be one other month and those are in interpolated estimates because there's not a WRAP requirement for those months.

**Gall, James:** So, what we found was there's not a significant cost impact to the portfolio. Really, it's a resource shuffle, I'll call it that, where we saw a little bit more wind energy and storage in Idaho, a little bit less renewable fuel CTs. And then in Idaho, a little bit more storage in demand response. Largely the impact of our resource strategies really driven by the monthly energy targets that we give the model and capacity. But what you still have is those monthly energy targets. That's why most of the portfolio remains unchanged and we're only seeing fringe changes in this scenario.

Gall, James: But if you go to the next portfolio, which is very similar, we're looking at the WRAP planning margin but there's two sides of the WRAP that you have to look at. One is planning reserve margin, which we just talked about, but the other side of it is qualifying capacity credit. How much capacity each resource credits you towards meeting that planning margin and we assume that planning or QCCs will decline over time as the region has more and more variable energy resources and storage and less firm resources like coal and natural gas. We would expect the QCC values to decline. The chart on the left represents that assumption. You can see, more lines on the bottom are wind and solar. They start off with the low QCC and have a small decline in QCC, where storage starts off with a very high QCC and declined significantly. Another resource that I didn't put on here, it is in the IRP document, but demand response has a very similar curve as the storage curve. What this scenario looks at is how our portfolio selection would be different if we maintained the QCC values from today. Let's assume that storage, a 6-hour batter or 4-hour battery, which may give you an 80-90% QCC value, remains as a high QCC value for all time and the reason why that happens we're not going to get into, but it could happen for a number of reasons, but let's assume that happened. What would our portfolio look like? The idea here is that cost would be less because you're actually selecting resources that are lower cost because they have lower durations. For example, the renewable fueled CTs are ammonia turbines. There is less of those resources and you're picking maybe more shorter duration energy storage. You're also picking, say more wind because you're not expecting that decline in that QCC value. Basically, you need less resources which relates to lower costs in this future.

**Gall, James:** Same with Idaho as Washington, just it's just less resources because of higher QCCs and you can depend more on lower or shorter duration resources like storage and demand response. This is something that we're going to be monitoring over the next couple years. I know that at our one of our regional meetings this topic came up and we're hoping that the WRAP can do more analysis on long term qualifying capacity credits. But you know if they can't, what can the region do to meet that gap because we're trying to create resource plans based on an assumption that resource can meet capacity needs. But we don't really have a definite value of what capacity is going to be as a value in in the region. I see Fred with your hand up. You have a question or comment?

**Fred Heutte:** Yeah, more of a comment than a question, thanks. I'm Fred here at Northwest Energy Coalition. I'm a member of the WRAP Program Review Committee. We're just getting our real work going and we have, I think, a call next week, actually in a

couple weeks. We've done about a year of prep work to get ready for this and the Program Review Committee will be looking at any modifications to the way the WRAP program is set up. There's kind of a defined process to go through where the Advisory Committee on that anyway. So that said, I appreciate the extended discussion here about how you're approaching the WRAP and what I would say the trade-offs are in using its approaches for this kind of short-term perspective. Really, it's oriented toward both the planning period, seven months ahead the season, and then also with close to operating time as you mentioned earlier this morning. If one region has a little bit of a need, another one or utility, others can help out in a more effective way. All that said, the notion of getting a single approach to resource adequacy, qualification you called here called qualifying capacity contribution, it's a good idea to do that. But I have been a little unsettled about the application of this to longer term planning like the IRP for a while. So just wanted to say I appreciate you walking through this. And I'm not quite sure yet what I think about this and how you're going about it, but I think it the early response I've heard from a lot of people is just to say, well, we have this WRAP here QCC now and the whole PRM and the other aspects of the WRAP, we should just fold those into our IRP. But I'm actually hearing from a lot of the other utilities that they're not really ready for that either. I think the caution here is warranted. It's an important thing to consider. There's some new thinking about resource performance that's in the WRAP that I think is pretty good, but it's also kind of a grab bag of different strategies for dealing with that. So just to say at this point that I think you're heading in the right direction. Not simply folding it into the IRP is a good step. Thanks.

Gall, James: Appreciate the comment. Know there was previous meetings, there was some discussions of some alternative views that we should be using WRAP values, or this forecast, which is from E3 from a study they did four years ago. It's best to show both and understand the differences and we'll probably end up somewhere in between, I would imagine, at some point but appreciate the comment.

**James Gall:** We'll go to the next portfolio, and this is an interesting one. I can't get too detailed on the costs on this one. There's two variable energy resources, Palouse Wind and Rattlesnake, they are allocated to both of our states. But in Idaho, from a rates treatment, they are treated a little differently as far as how we recover those costs and what we wanted to study here was if those resources were allocated 100% to Washington for their remaining PPA term. How does that impact the portfolio? What I really like to show everybody is the cost to each state for that change, but then I realized if you do that, you start showing what the prices is of those contracts. So, I tried to leave it as a system value. What I found was is if you moved those resources to Washington, there is an increase in cost by around \$29 million or 0.2% present value. I didn't show the right value on there, just cause it's kind of immaterial, but what it does from a resource strategy point of view is Washington's need does decline by 100 megawatts. That's actually a little bit, maybe less than the Washington share of those two resources, which are around 250 megawatts. Idaho has a slight increase of natural gas and a little bit less energy storage when it does that. But I guess the takeaway here from a system level, there is value in

those resources in the long run for both states. There's also the flexibility to move the REC value, or the renewable energy value, from one state to the other. An interesting scenario came up in one of the previous TAC meetings.

**Gall, James:** I just see a note here from Mike Louis. What reliability LOLE targets is used to develop the WRAP PRM and the 2023 IRP PRM? I'll go back to that. The WRAP, and if somebody on here can correct me if I'm wrong, I believe it's a 1-in-10-year LOLE. Which is a different metric than the 2020 IRP values we are using that 5% loss of load probability analysis that we've done for the previous two or three IRPs. So, a different methodology to develop them. Like I said, they are very similar in results, but I believe that the WRAP is a 1-in-10 LOLE, which for those of you that are reliability nerds or understand what LOLE and LOLP is a little bit different. LOLP looks at the percentage of your simulations that have a resource shortfall. So, we ran 1,000 simulations, we would want fifty of those simulations or less to have a problem. You could have multiple problems within that simulation, but it still counts as one versus LOLE would run those thousand simulations and they you would count if there were multiple instances within the same simulations they would count individually. That's where they're doing basically a metric in 1-in-10 and that metric versus the LOLP we're using 1-in-20. They are different metrics, but they're looking at the world in a slightly different way. LOLP was a metric really designed for the Northwest. I think the Power Council may have been the origin of that. But I'll stop there. I think you might have to comments on this. So, I'll let you go ahead.

**Fred Heutte:** Yeah, really quickly because I don't want to delve deeply into this and that would be a dangerous thing for me to do anyway, because I'm not really an expert, but I actually think that the 1-in-10 LOLE is when you when you listen, when you talk to the people who really do this kind of really deep thinking about this stuff, there is actually a fair bit of disagreement about the details about how to do that. But I think what happened was 1-in-10 LOLE was sufficiently OK for everybody across the whole WRAP footprint, across the entire West. And also, it's been used of course in the east by SPP, which is the program operator. I don't think it's bad. I actually think an LP approach is a better one, especially for hydro and renewable based systems. But really the bigger question is now being raised, and the Council is kind of now in the lead on this, even as John Fazio has just retired. Is there now adopting a four-part metric for looking at resource adequacy and this is I think going to be an issue for the WRAP going forward. Once there's real experience with the current approach, will it really make all that much difference to switch from 1-in-10 LOLE to some multi metric or some other approach? Yeah, it could a little bit at the margins, but I think the bigger value here is that gets everybody on the same page as kind of an advisory approach. LOLP, i don't think it's a bad idea, so that's my general sense of it and I don't know how you guys are thinking about it really. But the I think we're in the let's not let the perfect be the enemy of the good territory here.

**Gall, James:** You know, for the well, one of the few times, Fred, I don't think I can disagree with anything you said there. Alright, so let's move on.

**Gall, James:** We'll start on some of the load portfolio analysis and these actually can get quite interesting as I go further. We'll start with the low economic growth scenario. You might see there on our expected case is about 0.85% expected growth where a lot of that growth is at the end of the 20-year period. What happens if we have lower growth? This is where you look at present values of revenue requirements. It doesn't make a lot of sense to compare that to a Preferred Resource Strategy because you have a different whole set of loads. It's better to look at rates. We found rates actually are higher when you have lower loads. And the reason for that is you have less energy to spread over, spread out higher non-power costs. Think about your transmission or distribution and your A&G costs, you have less kilowatt hours to spread that over, so you see slightly higher rates. But the other thing is that our resource need does get moved out further, so lower loads will need resources later. We still need the same type of resource, just less of each type in both states, but again lower loads move our resource deficit out to closer to the end of the 2030s rather than the mid-2030s. Versus if you had higher growth, which we were assuming at one point 1% growth rate in this case, you actually do see lower rates a little bit more of an effect in Idaho than in Washington.

**Gall, James:** Back to that dilution effect, but we did not see a real move in resource need by this higher growth rate. But we will need higher amounts of each of the resources that are selected and in the Preferred Resource Strategy, you do see there's a little bit of geothermal starts to pop up in this case, but other than that, most of the portfolio is very similar in this scenario.

**Gall, James:** OK, so now getting into the more interesting scenarios, this is a summary of the load forecast we're assuming. We've done three electrification analyses, really four, but you'll see why I mean three here in a minute. How this works, on the left is our 2024 load forecast just as a comparison, the blue is average energy and then in the green and orange is peak. You can see our winter peak is slightly higher than our summer peak on an expected basis. You go to 2045 and you can see the growth between those two. So, in the third case, this is for 2045, this is a comparison to the 2045 load forecast. I call that Expected Case if we had the High EV case and I'll get into the next slide what the High EV case assumes, you can see that both energy and winter/summer peak all increase quite a bit. Energy is up around 200 megawatts on average and peaks are up around 400 megawatts. That gives you an indication of what we're assuming when the energy shows up, so around a 2-to-1 ratio of a peak versus energy.

**Gall, James:** And then on the next scenario, that's a space and water heat electrification scenario. In this scenario, we're only looking at a change in how many customers are switching from gas to electric. For those of you that follow the natural gas IRP, they've done some electrification analysis and we looked at how much of those customers would be switched over theoretically to electric in a world where there's electrification movement. You can see that in 2045, the amount of additional energy is only around 200 megawatts on average in that year. The winter peak is over 800 megawatts higher for the Washington component of our service territory because natural gas is primarily used in the winter and

we're going to be having to heat homes with electric in that scenario. The gas side, or sorry in the summer, there is a small increase in electric load and that's primarily due to electric water heaters in that scenario.

**Gall, James:** We ran a second scenario of electrification in Washington, where natural gas continued to be used, but only in a backup capacity. And what I mean by that is when temperatures were below 40 degrees, or approximately 40 degrees, natural gas would be used and when temperatures were above 40 degrees, electric could be used. And we found there was still a significant increase in winter peak need, but the amount of winter peak compared to full electrification is less, around 300 megawatts less.

**Gall, James:** The last scenario we combined, I don't know if I'd call it necessarily a worst-case scenario, but a highest load possible scenario from electrification where we took the EV scenario, the third set of bars there, combine it with the fourth set of bars on the space and water heating electrification. But in that scenario, we also assumed that there would be an increase in distributed solar from customers putting more solar on their roofs, either from incentives or from higher rates that maybe enable more solar at the time we did the analysis we didn't really have a good estimate on how many customers would switch and add solar to their home, at the end of the day it comes down to policy choice for rate design. But we made an assumption on the amount of solar and we'll get to how each of these portfolios interact with our resource needs. We'll start with the high electric vehicle growth. In this case, we're assuming 100% of vehicle sales by 2050 in Washington are electric and then 75% in Idaho. This scenario is actually an Idaho and Washington scenario for additional load growth. We also assume higher medium duty EV sales growth than our Base Case. Our Base Case is actually very moderate in our forecast for EVs, where it was 35% of new sales and 15% of medium duty sales by 2050. This is, I guess a significant increase, which is maybe more in line with some of the Western state's objectives for EV sales. In this case, costs are not surprisingly higher, but when you look at a rate point of view in Washington, there is a slight reduction of 3%. The slight reduction or increase in Idaho rates. Again, that's likely due to a resource shift of selections. So, EV's from a rate perspective can be a benefit because again, you're taking existing costs and amortizing it over more loads.

**Gall, James:** I'm going to stop real quick because I are recording just ended, so I'm going to start that back up. We lost 6 minutes of our recording, so I'll turn that back on. You might see a message on your screen.

**Gall, James:** OK, so back to electrification. For this study, we did not include any T&D costs. We are going to talk about that later because we did attempt to study that in the last scenario. As far as resource selection, very similar, but in Washington, resources are needed earlier, but the same resource types, it's just like high or low cases, you need more of those resources. Idaho had a little bit of a different resource strategy in the way it just picked a little bit less gas turbines and more energy storage, which was kind of an interesting result.



**Gall, James:** Alright, so the next scenario. Just to give you an indication of how we put in in per year for the amount of additional load for these two electrification scenarios, you can see a trending approach of electrification because what would likely happen in reality if people electrify, it would be as their furnace fails or water heater fails, there's going to be a switch out. So, we assume a gradual change out that aligned with our natural gas IRP's forecast. And what we assume in this case, in our gas system about 75% of our gas system are also Avista electric customers. So, you would get 75% of those customers, and then 80% of those customers would be electrified by 2045 in this case. But you can see how the winter peak load grows much faster under the full application case. And then with the backup, you can see some of the differences. And I see Tina has a hand up. Go ahead Tina.

**Tina Jayaweera (Guest):** Thanks. When you're talking about buildings electrifying is this residential and commercial and are you also looking at industrial electrification?

**Gall, James:** Yeah. A good question. This is just residential and commercial. Industrial, we have not addressed that one yet. I don't know exactly what will happen from the load point of view. Some industries might electrify, others may not, so we decided to leave that one out. But good question.

**Tina Jayaweera (Guest):** OK, but all commercial buildings are also going electric. OK.

**Gall, James:** Yeah. I have a commercial electric, sorry commercial and residential, 80% of the of the former gas load.

**Tina Jayaweera (Guest):** Thanks.

**Gall, James:** Yep. Good, Fred.

**Fred Heutte:** Yeah, I actually have a question about the vehicle electrification. If you want, you could finish this section and then we can go back.

**Gall, James:** OK, alright, we'll do that. Alright so. Just more on this scenario. Again, I have another chart down but this gradual shift as far as cost and resource strategy we are in this case, additional load does not necessarily lower rates. Where you start to see higher rates due to electrification, around 11% higher plus T&D costs, which we'll get to in a little bit since this scenario is Washington focused, Idaho does not see a major impact. A little bit of resource choice differences, but one thing I wanted to note here that's interesting is when you have significant load in one state, the model is wanting to build new transmission to serve that generation and we modeled transmission to be not state driven. Let's just for example, if we had to build a \$500 million transmission line, those costs are allocated partially to tariff customers that are on our transmission system that are not customers and then the rest of it gets allocated between the two states and we follow that cost allocation methodology. In this case, while Idaho doesn't have a significant resource change like you see on the bottom bullet, but it had a higher rate impact due to those transmission costs and that was around 5%. That's an interesting insight and maybe some of our rate design that we'll have to review if this if this ever happens. Going

back to Washington's resource needs. Again, more load, you need resources sooner. But the most interesting difference was the amount of energy storage resources was significantly higher for Washington that would be likely the long duration storage. Was the resource that was picked there the iron oxide?

**Gall, James:** This one is with the natural gas backup, which we went over those assumptions. This is more of a direction of what the current building code is in Washington. Again, this has lower load than the previous case, but some of the similar impacts. Rates were around 4% higher in this case versus 11%. This is a way, or a strategy, to have some electrification with lower rate impacts. The resource strategies didn't significantly differ from the previous resources as far as resources that were selected.

**Gall, James:** Alright, so now I would say the more interesting one that I have a little bit more detail on the T&D costs is the combined electrification. We're combining scenarios #11 and #12 trying to understand a boundary of load growth in extreme electrification. We are seeing higher costs just from power supply efforts around four cents a kWh, that's not including T&D, which I have some slides on. What that looks like, we still have the same issue for Idaho transmission, but we start to need resources sooner. A common theme there. Then because of the load increase and the desire for Washington to be 100% clean by 2045, you start to see some new resources get picked because you start to run into transmission limitations. That includes nuclear, geothermal, biomass. All those resources would be needed to meet these loads. In Idaho, just a few small changes in that resource strategy. This is I'd say more fascinating just because you're getting to a point where you have to start doing things significantly different because you're running into new constraints versus some of the other scenarios you might be able to get away with adding resources within your transmission system. But this one really requires quite the substantial build out, not just in the distribution system, but also in the transmission system. We'll get into what that looks like in the next couple slides. On transmission, like I mentioned earlier, we do model somewhat specific cost for connecting certain assets and then if you have too many assets in one location, you have to start building additional assets that may have a different cost curve. So, the ones that are connected to resources that are selected that haven't had connection cost, we estimate that to be around \$300 million to be online in that 2030 to 2045 period. That's about a \$50 million increase just in interconnection cost from the PRS.

**Gall, James:** But for the major transmission improvements I mentioned earlier, we need to strengthen our tie between North Idaho and Spokane and upgrading the Big Bend area for wind integration. But we're also seeing we would need additional connections with external parties such as Bonneville and others, and those connections would increase our PRS transmission costs from \$250 million to closer to \$700 million. We would also need additional third-party wheeling. That budget would double compared to the PRS and just to give you an idea, it's around a billion dollars of new transmission. Our current net book value is around \$0.7 billion, so it's more than doubling our transmission. Obviously

this is a resource strategy, not a transmission strategy, and there may be additional investments that would be needed for a full on engineering level study that our folks in transmission would do. Those are included in these costs, including the rates I showed earlier. But the ones that are not included are T&D costs and we get a lot of questions on what would T&D costs look like or what do you have to do to your system to meet this additional load. I'd say this it's going to require quite the study, but we try to do a high-level analysis by talking to some of our experts at Avista. What our system would likely need to pull this off and obviously you can't do this overnight. It's going to take a long time to do this. But here were our assumptions and we'll get to how that affects rates in a little bit. We only had time to look at the full electrification portfolio. We looked at the highest load possible scenario.

**Gall, James:** Again, I mentioned probably the place for this analysis will be the Distribution Planning Advisory Group, the DPAG. I think they had their first meeting around a month ago. I encourage you, if you're interested in this topic, to come to those meetings. I'm guessing at some point in the future this is going to come up as a topic, they'll be able to do a deep dive analysis into it.

**Gall, James:** So, what do we have to do from a planning point of view to serve this level of distribution load? We would need a plan for a higher level of load compared to what we plan on the distribution level or on the supply side level. It's around 14,150 megawatts they would need to plan for and that's for a 1-in-20 winter weather event. I think they use a 1-in-10, but they use a different, they use a daily low or daily high and we look at it daily average, so that's about equivalent to 1-in-20 weather event for our purposes and they would need to replace around 75% of the system it would happen to have impacts.

**Gall, James:** On the scenario, our gas system is as mostly in suburban or urban areas, and the rural areas have typically less natural gas penetration. So, we think around 75% of the system is a high-level estimate. There are really two strategies from my understanding of serving a higher load amount. One is to basically take your existing system and split it up more, so you're creating more feeders. The other option is you upgrade the voltage of your existing system. I would imagine that our engineers are going to debate both of those options in the future. But for this analysis, we assumed breaking up the system into smaller feeders would be that the solution. That creates 145 new feeders. I think we're closer to 400 feeders right now in the system. That would require 36 new substations and six new switching stations. Think about your distribution system, is your residential commercial and then we need 6 new transmission connections between the lower voltage and the higher voltage. We estimate around 32,000 new service transformers. Those are serving 4 to 6 customers for each transformer we would need to upgrade. We're only around 163 miles to transfer of distribution lines. That's one of the advantages of this strategy versus upgrading your voltage is you'd have to replace more distribution lines. This strategy is more on substations and less on replacing conductors.

**Gall, James:** There'd also be a transmission side in addition to the transmission I showed earlier. We would need almost 100 miles of new transmission as well. For load service, also the biggest, the mileage is actually what I call customer conductor for layman's terms. That's basically your connection point between the service transformer and your meter where those were not necessarily designed for the amount of load a customer would have being fully electric and have one or two EVs that could draw as much as, say, a Tesla could draw instantaneously. That's a large body of work. And there's going to be people required to do that work. That's embedded into the cost of that construction, which I'll get to that in a minute. But you also need support staff. So, if we were going to hire more. Alignment to build these facilities, more engineers, you need to hire more accountants, you got to hire more HR people. It kind of cascades. We also assumed an additional 46 employees in addition to the crews to actually hire those people to operate our company. So how this comes out is in today's dollars around \$1.9 billion of distribution and transmission infrastructure. Nominally that's around \$3.3 billion when you space this over time, because you're going to do one or two feeders every year. It's just some numbers to throw out there, those substations. What this comes out to is if you take that total cost and divide that by the number of substations, I had here 36 it's around \$57 million of substation in today's dollars. We assume costs would begin in, say, 2028 and increase every year to 2045 when you add substations, and then we would levelized this cost out over 50 years of its life. Before I get to the rate effect, just as a comparison, we talked about \$2 billion, roughly today's dollars that's compared to book value of our distribution assets is around a billion dollars. Which obviously that's depreciated over some older periods, but you're talking about tripling your book value of the distribution assets.

**Gall, James:** How does this look like from a rates point of view? I'm going to move to this bar right here. The 27 cents. This is the value that comes out of our PRISM model from the analysis that I showed two slides ago. If you add all of these costs divided by the same kilowatt hours, we get to around \$0.31 per kWh. It's about a four-cent premium for this distribution system for the Washington customer. To compare that to alternative scenarios we're around \$0.23 in the PRS, the baseline is around \$0.20. So, it gives you a comparison of rate impacts in 2045 for the average customer. That's a lot to go through. I'm going to pause here if there's any questions related to this. And then if there's not, we can move to that EV question from Fred. All right. OK. Fred, if you're still there? OK.

**Fred Heutte:** Still here. Actually, this last part was pretty interesting as well. I would just quickly observe, it is a lot of money, but if this kind of scenario actually played out, you get a much stronger system out of all that. I think that would have a lot of benefit and it doesn't look like it would break the bank. I mean over time you can spread the costs out, like you say, over 50 years. Actually, one quick question here. Do you have a rough idea of how much of this is currently doing on distribution level, upgrade and management per year just by comparison. I would say for Oregon, PacifiCorp and PGE, which have somewhat different systems here, specific core is really spread out their costs of running around \$400 million a year here right now for that. And you know that could increase in

the future. But I'm just curious what the relative amount of increase would be for the distribution system.

**Gall, James:** I think maybe the best way to illustrate that is this \$57 million a substation. My understanding is we do normally about one or two of those a year. So, you're talking about going from one to two to three to five. That might give you a magnitude.

**Fred Heutte:** It's a significant increase, yeah.

**Gall, James:** Yep, and I think the biggest concern is just, as people, it's a supply chain that's where a lot of the questions that came up when I went around talking to people about the scenario. OK.

**Fred Heutte:** Yeah, OK, back to my EV question. Whenever you go to slide 12, because I have that question, kind of a couple related issues. Is it really simply, actually, I'm wondering for your EV high / low growth scenario, you may have covered this, but what are you roughly assuming about load management for that new load? Half of it would be load managed, or more, or less, or kind of just to shape the load within the day?

**Gall, James:** I'm going to hope that Grant Forsyth can answer that question. I know he has an assumption that we used for how much of that would show up on peak. But I see he's on, but I don't know if he's looking there. Yes.

**Forsyth, Grant:** Yeah, this. Yeah, this is Grant. I was having to respond to a text so Fred, could you restate that question again for me?

**Fred Heutte:** Yeah, just real quick, and I'm not really looking for details here, but just roughly speaking your thought about how much of the new EV load can be managed so it doesn't all land on peak?

**Forsyth, Grant:** Oh yeah, so, the problem is, there is a time of use process that's going on right now. I think Leona has been working on that with Rendall Farley and the problem is that in theory we could shift some of that load, but I think we remain somewhat suspicious we're going to be able to shift all that load. Getting a simulation of what that might look like is still a work in progress.

**Fred Heutte:** Yeah. So, for this analysis though, are you assuming that there would be any load management or just assuming it would be whenever somebody wants to charge, they're going to go ahead and do it?

**Forsyth, Grant:** Yeah, right now there is no time of use pricing built in. We basically assume that they would charge more or less when they would, when they want to. We tried to look at some load profiles and I tried to build some of that in. But those load profiles as we look at other utilities or look at studies of EVs, may not always correctly reflect or reflect time of use pricing, which is again, it's something I think we're moving to.

**Gall, James:** Yeah. I think we would.

**Fred Heutte:** Yeah, I think, go ahead, sorry.

**Gall, James:** I was going to say, we have time of use selected now. Then the question is, is how much time of use you credit? Would that increase and I don't think we have an answer. I would argue that number we have there might be slightly high, but I don't know how much you're going to get customers to move over.

**Fred Heutte:** Yeah, I think the great parlor game right now is trying to figure all this out because we know that if there have been, I'm sure you're aware, there have been a number of pilot programs around the country, actually around the world, now looking at this issue and some of them show pretty significant reduction in peak demand from EVs. Some show quite a bit less, so the issue out there is how will people want to respond to the price signals and maybe programmatic load management and know what segments of the market will be more responsive. There's a ton of issues there. I just wanted to get clear about what your current assumption is, knowing this is going to be a work in progress going forward.

**Forsyth, Grant:** Yeah.

**Gall, James:** Yep, when Grant and I have an interesting observation. I saw someone from our data but go ahead.

**Forsyth, Grant:** Sorry, James. The other thing Fred, is I think on the residential EVs, there's a lot more information about their how people respond to time of use pricing. The thing that I discovered looking at the research was on the commercial side there's much less good data as far as I'm concerned. At least I could find, showing how the commercial side should be shaped. It really strongly depends on the type of businesses you're serving in your service territory, what their business model looks like, and how easy is it for them to really shift their charging based on time of use, pricing. That's a big uncertainty as far as I'm concerned.

**Fred Heutte:** Fuel cell and electric vehicles. You can go buy them now, actually. But there's a lot of, I don't know. We don't have a lot of knowledge yet about how the bigger vehicles will go on the grid. What they'll need. Fleets are one thing, and regular delivery trucks, or other large trucks are another thing. School buses can be managed pretty well. Transit has to be used around the clock. I mean, there's so many different pieces to that puzzle. I just wanted to recognize that if you don't have any other comments, I do have a question here about the chart.

**Gall, James:** OK, I'll have a couple comments and we'll go to that. One thing, you're going to see on an Action Item later today. We're running on time actually. Regarding the issue you're bringing up, and we're coming up with some solutions on how to better forecast EVs and actually electrification through that Action Item. But the other comment is what we're seeing from the customers. We do have insight into how they're charging, most of the customers with the residential EVs, in order to participate in our free charger program, they have to try to shift their load to off peak hours. And what we're seeing is they use the setting on their car that says I want the car to be ready by a certain time, and what we're seeing is that the customers that are using that feature we're seeing instead of charging

going continuously overnight in a nice managed way, we're seeing all of the charging show up at 4 or 5 or 6 AM. All at the same time. Just because you can shift all of your load to maybe off peak, that could create a peak of energy need in the morning essentially. So, we're going to have to figure out how to manage loads going forward.

**Fred Heutte:** Exactly right, because you don't want that peak to over to overlap. Because this morning peak goes back to the previous discussion. There's a lot of cheap energy available in the middle of the night. How do you get more access to that? OK, that's great. Looking at the chart here, it was interesting to me that some of these, it's not just about the EV scenario, but the others as well. Like the EV scenario ends up in 2045 forecast, just to start with summer and winter approximately peak or approximately equal, and then that's the same for the high EV. But the others, it's interesting to me that the winter peak is quite a bit higher. So, the system moves from dual peak to winter peak in these with this additional, I guess the big difference is the building electrification.

**Gall, James:** Yep.

Fred Heutte: That's interesting because I mean that makes common sense because the bars are going to charge you around. But winter peak, you know, relating to eating load coming over from the gas side primarily that's going to show up. And I think it really does show up here. The other thing that I've noticed is it's, you know, it's a big difference, but it's not an impossible and you know it it's not doubling loader peak to do this. You know each kind of electrification but it's a significant effect.

**Gall, James:** It is doubling the state load.

**Fred Heutte:** Ah, OK.

**Gall, James:** It gets washed out a little bit with Idaho, but the Washington load is doubling.

**Fred Heutte:** If you split this chart even further, which I don't recommend doing in one chart, but Washington would then show a much. OK that that makes a lot of sense. Thanks.

**Gall, James:** Yep. Alright, I'm going to try to get through the rest of the deck and in the next 10 minutes so we can get to John's final presentation. I'll try to be quick. I got, I think, three left to go through. Our clean portfolio by 2045. This looks at what if we tried to convert all of our load to clean resources by 2045, essentially you leave out Coyote Springs 2 in 2044 and you don't select the natural gas peakers for Idaho. This is more of an Idaho centric scenario. What we found was rates are around 40% higher for Idaho. That's about \$0.07. And the portfolio for Idaho, you have another 200 megawatts of wind and then Idaho starts to select the ammonia-based turbines, around 400 megawatts. They start to see more DR, energy storage, geothermal. The resource need is earlier then it was in the PRS. Again, Washington doesn't remain basically unchanged, but for the emission savings this is one of them. I do have on here is around 700,000 metric tons of savings in that final year in exchange for about 7 cents a kWh.

**Gall, James:** The next one is another clean energy view for Idaho. We had a customer in our public meeting who wanted to us to look at what if you simply included the social costs that you include for Washington into Idaho to see how that resource strategy looks. We included the non-energy impacts for resources and also the social cost of carbon for the Idaho resource selection to see if the portfolio would change. Here's a list of the resource changes. A little bit less gas for Idaho, about 100 megawatts, a little bit less energy storage. Really that just moved to the renewable field. CTs are the ammonia turbines, little bit more geothermal. Rates were around 2% higher, which is very similar to what Idaho customers indicated they're willing to pay for clean energy, which is around 2%. One of the observations also out of this is if you think about a resource, if you wanted to have a least cost societal plan, this is what this demonstrates. But then you look at Washington. You're paying a 25% premium to go 100% versus maybe the societal benefit. That's an observation from the analysis.

**Gall, James:** Last one, we don't need to get into too much detail because this is going to see a life again in the 2025 IRP where there is a requirement to look at what's called a Washington maximum customer benefit scenario. That's going to be between us and the TAC to create this scenario. I'll try to create what it could look like, but the idea here is in Washington, we have what are called Customer Benefit Indicators and the goals of those indicators are to illustrate progress or benefits to customers as we transition to cleaner energy. Some of those Customer Benefit Indicators are resources that are in Washington that help with the economics of the state, reduced air emissions, investments in the Named Communities. I have a no nuclear option there, because that's going to hold over from the last time. There's a list of Customer Benefit Indicators in our Clean Energy implementation Plan you can look at. But what we're trying to do here, is look at how a resource change would impact those Customer Benefit Indicators and try to go to the extreme level of benefit towards those Customer Benefit Indicators. For example, one of those Customer Benefit Indicators is to reduce the number of customers that are energy burdened, which means that 6% of your income or more is taken up by energy costs. So, one way to reduce energy burden, which would be to give those customers rooftop solar or to give them community solar. That was one of the outcomes of this scenario where the only way we found to lower burdens besides just giving rebates to those customers would be to increase solar by around 800 megawatts, where 700 megawatts was directly benefiting those customers and that took their energy burden from \$2,000 a year to around \$600 a year in 2045.

**Gall, James:** We also, because we're trying to focus on reducing air emissions, i.e., NO<sub>x</sub>, which you know our previous Preferred Resource Strategy had NO<sub>x</sub> as an outcome of ammonia. So, if you did not have NO<sub>x</sub>, if you couldn't create NO<sub>x</sub>, you'd have to move to a hydrogen-based fuel cell for capacity. We saw an increase in that technology, also additional energy storage. You would need to move to more iron oxide batteries. In this case, we have less wind and an increase in geothermal, really as a result of moving from solar to other technologies. But the cost side, on average, was a substantial increase in the scenario around 29% or 7 cents a kWh. We're going to need to talk about this some



more between now and the 2025 IRP. This is something to think about. And then what CBI should we look at improving or which are a priority over the others and that will be some topics in the next TAC process.

**Gall, James:** This is for you guys, the key for later. I don't want to leave it up here now, but this is a summary of the resource selection by state and scenario. That will be there for you. It's also in our draft. I also have other charts in here that compare each of the portfolios to each other. This one is mostly on cost and rates. There are directional changes. So, if you see an error, that means the rates are 3% higher or lower. Where the orange bar means it's within 3%, so that's there for you.

**Gall, James:** I think it was brought up earlier about risk. This chart shows how portfolios have higher risk, at least from the market point of view. You can see the PRS is here in the middle, but depending on which resource strategy, you may increase your risk. Is that risk increase or decrease worth the additional cost that you're paying. That's there for you as well.

**Gall, James:** It was brought up earlier about the greenhouse gas emissions for each of the portfolios. I have this version of it. This is looking at total missions over the 22-year period compared to cost versus this one shows the cost, or the emissions in, I believe this is in 2045. I think there was a question earlier, what's the emissions increase for the No CETA case? There was an increase in portfolio 5, but all the rest of the portfolios, including the baseline, had lower emissions. You can compare the emissions amount compared to, say, the PRS, which is right here, as another illustration of emissions. Where this is our change in emissions from 2045 to 2022 and green, that's the net emission change and then the generation is in blue. If you want to compare that to how much we're saving from a transportation point of view, saves around 2,000,000 tons a year by 2045 from Transportation High EV cases around 2.7. And then if you're interested in how much emissions those electrification cases save, we have those amounts as well, 700,000 tons for the full application case from natural gas and 118,000 with natural gas backup. If you combine these values over here with the savings are over here, it might be an indication of the emission savings.

**Gall, James:** Real quick. Lastly, before we move to John's presentation on what's next, we did some sensitivities on market prices. We found that three of the portfolios made the most sense to study against market prices. We looked at a high market price case, a low market price case, and a case with national greenhouse gas pricing. Essentially, if you have a more gas reliant portfolio, high gas prices harm you. Low gas prices help you. And if you have more renewables, a greenhouse gas price helps you, you're avoiding those potential risks. These basically follow general ideas on what you'd expect the outcomes would be. They show you some percentages, changes, and costs. This is all described in the document. With that, I'm going to stop and turn it over to John to wrap us up so we can get done by 2:30.

### **Action Items for 2025 IRP, John Lyons**

**Lyons, John:** OK. Thanks, James. We'll see if I can get the slide showing now.

**Gall, James:** I see your screen.

**Lyons, John:** Alright, with the Action Items hopefully.

**Gall, James:** Yes.

**Lyons, John:** All right. For the Action Items that we have here, we aren't covering what we've done for this IRP, that is in the document. This is what we're going to be doing for the next IRP, our marching orders going on from here. So first one is to incorporate all the results for the distributed energy resource potential study where they make sense for resource planning and load forecasting. As that gets wrapped up, we'll be able to put those numbers in there and use those finalizations of the variable energy resource study. I believe we had some of the preliminary work in there, but this will be finalizing that and putting it into the next IRP because it has been a while since we had updated that piece.

**Lyons, John:** We are also going to study the different load forecasting methods, in particular looking at an end use load forecast for future customer decisions on electrification. This is going to be a fundamental change to our load forecasting that Grant goes over for each IRP. We are expecting this is going to need a third party since this is not something we've done before, and it will need additional outside help staffing. Probably all of the above, and then we can do studies looking at a range of potential outcomes for the electrification.

**Lyons, John:** James already brought up about the use of PLEXOS today. We are going to investigate potential use of that for portfolio optimization, transmission and resource valuation in future IRPs. James, any of these you wanted to comment on here?

**Gall, James:** Last thing on PLEXOS, we have acquired it and we will definitely be using it for resource valuation. Yet to be seen on whether or not we can use it for portfolio optimization. But I saw Fred's hand just go up.

**Fred Heutte:** Yeah. And I just know a little bit about PLEXOS. It's not just a model, it's kind of like a family of models and everybody knows every family has a lot of personalities. PacifiCorp ran into a lot of trouble with PLEXOS. They do a lot of really advanced work, though, and I'm hoping your experience with it will be a little calmer anyway. But if you could, at the next work group meeting, talk a bit more about your ideas about PLEXOS and maybe a little bit about your view of how to use the model effectively. I think that would be very helpful.

**Gall, James:** Definitely plan on it. So right now, we're completing a back cast comparison, so we can show those, and we're going to do a back cast against the IRP at some point. It'll be on a future TAC. Go ahead, John.

**Lyons, John:** OK. There we go. We got it to move finally. Continued work on the WRAP process in looking at the QCCs and the PRMs for use in resource planning. We've had a lot of discussion on that, and we are going to continue having that as we look into those in the WRAP and how we're going to incorporate that in resource planning.

**Lyons, John:** Evaluate the long duration storage opportunities in technology. Continued work on pumped hydro, iron oxide, hydrogen storage, ammonia storage and any other technologies that come up. We are watching for those, we're doing research into them as they become more than here's a good idea to actually having products out in the field and see how those operate.

**Lyons, John:** We are going to determine if we can estimate energy efficiency for Named Communities versus low-income communities. That's one area where we still need some more data on, and how we can do that. And then study transmission access that's going to be needed to access energy markets as we get an overabundance of surplus clean energy resources. We've talked about a lot of these already today. Any other pieces you want to add on those, James?

**Gall, James:** Go ahead, keep going.

**Lyons, John:** All right. So, what we've got for the remaining tasks for the 2023 IRP. If there's any areas that TAC members would like us to clarify, if you look through the document that we sent out earlier this month, if there's something that's not making sense that you would like us to tweak or explain better. We had a couple little things today that we were able to pick up on for some of the charts that we can update, but anything like that is always helpful because we get so focused on it, sometimes it makes sense to us, but we want to make sure this is more accessible to everyone else. Any other analysis that should be conducted. So, if you see any missing pieces in these Action Items that you would like to see us do, let us know. Any opinions of the plan, comments that you can give us. If there's something we can fix, rectify, make it better, we would like to do that. And again, any other additional not just analytical Action Items, but other research Action Items that you'd like to see for the next IRP. And then on the planned work, updated market risk section, we already talked about that earlier today about the risks of relying on the market. We are still doing some document cleanup. I think we sent out a fairly clean draft for this IRP.

**Lyons, John:** There's still a couple of little pieces that we always seem to find, as well as every time James and I have looked at an IRP that we've published, usually within about a minute of it being printed, we find an error, that just seems to work out that way. But the more of those we can find the better. And then we're going to have more analysis on the electrification impacts that we will update.

**Gall, James:** And most of that one is related to the T&D costs we just shared that were not in the draft. I think most of the planned work you saw here is things that we shared today that we couldn't get in the draft.

**Lyons, John:** All right, excellent. And then finally, we're going to be filing the plan with both Idaho and Washington on June 1st. Document and appendices are going to be available online. It's going to include the data and models that will be posted on the website. We do get a limited number of copies printed. If you really want one, let us know so we could get that out to you. Most people do want them electronically and they are fairly pricey to print out. But if you really need one, we can do that for you. Just reach out to us and we can make that happen. James, anything else you'd like to wrap up with here?

**Gall, James:** No, I appreciate everybody's time and commitment to Avista's TAC process. We had more meetings. I think in this process than any IRP in the past. I appreciate the comments, the questions, the ideas, and the chance to share ideas. I look forward to wrapping this up through the Commission processes and I'm sure we'll see lots of filed comments and we'll see where this this goes and like I said earlier, we're going to be in a very good position to meet the CETA requirements and also to meet our reliability requirements for both states. We have around 10 years to figure out the hard stuff, so we're in good shape for the future unless something changes, I guess that's always the risk, but I think with that everybody have a great rest of your day. We're done 3 minutes early.

**Lyons, John:** All right. Thank you very much everyone for your time today.



# 2023 Electric Integrated Resource Plan

## Appendix B – Work Plan





# **Work Plan for Avista's 2023 Electric Integrated Resource Plan**

**For the  
Technical Advisory Committee,  
Washington Utilities and Transportation Commission,  
&  
Idaho Public Utility Commission**

**December 8, 2022 (update)**

## 2023 Electric Integrated Resource Planning (IRP) Work Plan

This plan outlines the process Avista will follow to develop its 2023 Electric IRP for filing with the Washington and Idaho Commissions by June 1, 2023<sup>1</sup>. This plan serves as the two-year IRP progress report for Washington and the required IRP in Idaho. Avista uses a transparent public process to solicit technical expertise and feedback throughout the development of the IRP through a series of Technical Advisory Committee (TAC) meetings and public outreach to ensure its planning process considers stakeholder input prior to Avista's decisions on how to meet customer electric needs.

The 2023 IRP process will be similar to those used to produce the previous IRPs and will incorporate any resource acquisitions from the 2022 All Source Request for Proposals (RFP) and meet capacity requirements as set by the proposed Western Power Pool's Western Resource Adequacy Program. The IRP process intends to follow the RFP schedule for resource acquisition to guide consistency between the RFP and the IRP. Exhibit 1 shows the planned 2023 IRP timeline for work products. Avista plans to use Aurora for electric market price forecasting, resource valuation and for conducting Monte-Carlo style risk analyses of the electric marketplace. Aurora modeling results will be used to select the Preferred Resource Strategy (PRS) and alternative scenario portfolios using Avista's proprietary PRiSM model. This tool fills future capacity and energy (physical/renewable) deficits while accounting for environmental laws and regulations using least cost techniques. Qualitative risk evaluations involve separate analyses. Avista plans to add a new analysis in the 2023 IRP to evaluate market risk given the lower reliability metrics created by a regional coordinated resource adequacy standard and is currently evaluating which model to use for this analysis. Avista contracted with Applied Energy Group (AEG) to conduct energy efficiency and demand response potential studies. Lastly, Avista plans to utilize results from its non-energy impact study by DNV to develop its resource plan and improve customer benefit indicators for Washington customers.

Avista intends to use both detailed site-specific and generic resource assumptions in the development of the 2023 IRP. The assumptions will utilize Avista's research of similar generating technologies, engineering studies, generalized RFP results, and the Northwest Power and Conservation Council's studies to estimate resource costs. Avista will rely on publicly available data to the maximum extent possible and provide its cost and operating characteristic assumptions for review by stakeholders. The IRP may model certain resources as Power Purchase Agreements (PPA) rather than Company owned because these third party provided resources are more likely to be lower cost. Avista will not model potential contracts with existing regional resources.

Avista intends to create a PRS using market and policy assumptions based final rules from the Clean Energy Transformation Act (CETA) and the Climate Commitment Act (CCA) for Washington and using the least cost planning methodology in Idaho. The plan will also include a

---

<sup>1</sup> Avista proposes to file a request with the Idaho PUC to extend the IRP filing from April 1, 2023 to June 1, 2023. Further, Avista is currently discussing options to meet the WUTC requirement to file a progress report on January 1, 2023.



chapter outlining the key components of the Preferred Resource Strategy with a description of which state policy is driving each resource need. The IRP will include a limited number of scenarios to address alternative futures in the electric market and public policy, such as electrification of the transportation and buildings. TAC meetings help determine the underlying assumptions used in the IRP including market scenarios and portfolio studies. Although, Avista will also engage customers using a public outreach and informational event as well as providing transparent information on the IRP website. The IRP process is technical and data intensive; public comments are encouraged as timely input and participation ensures inclusion in the process resulting in a plan submitted according to the proposed schedule in this Work Plan. Avista will make all data available to the public *except* where it contains market intelligence or proprietary information. The planned schedule for this data is shown in Exhibit 2. Avista intendeds to release slides and data five days prior to its discussion at Technical Advisory Committee meetings and expects any comments within two weeks after the meeting.

The following topics and meeting times may change depending on the availability of presenters and requests for additional topics from the TAC members. The timeline and proposed agenda items for TAC meetings follows:

- **TAC 1: Wednesday, December 8, 2021:**
  - 2021 IRP Action Item Review,
  - Summer 2021 Heat Event Review,
  - Draft NWPP Resource Adequacy Program Overview,
  - Resource Adequacy Program Impact to the IRP,
  - IRP Resource Adequacy/Resiliency Planning Discussion,
  - TAC Survey Results and Discussion,
  - Washington State Customer Benefit Indicators,
  - 2023 IRP Workplan.
- **TAC 2: Tuesday, February 8, 2022:**
  - Process Update,
  - Demand and Economic Forecast,
  - Preliminary Load & Resource Balance.
- **TAC 3: Wednesday, March 9, 2022:**
  - Preliminary Natural Gas Market Overview and Price Forecast,
  - Preliminary Wholesale Electric Price Forecast,
  - Non-Energy Impact Study (DNV),
  - Existing Resource Overview.
- **TAC 4: August 10, 2022: 9:00am to 2:00pm (PST)- Remote Only<sup>2</sup>**
  - Conservation Potential Assessment (AEG),
  - Demand Response Potential Assessment (AEG),
  - Clean Energy Customer Survey.

---

<sup>2</sup> Natural Gas CPA 1:45pm to 3:00pm (PST)

- **TAC 5: September 7, 2022: 8:30am to 2:00pm (PST)- Remote Only**
  - IRP Generation Option Transmission Planning Studies,
  - Distribution System Planning Within the IRP,
  - Western Resource Adequacy Program Update.
  - Social Cost of Greenhouse Gas for energy efficiency (WA only),
  - Washington Avoided Cost Rate Methodology.
- **TAC 6: September 28, 2022: 8:30am to 2:00pm (PST)- In Person & Remote**
  - Supply Side Resource Cost Assumptions, including DERs,
  - Ancillary Services and Intermittent Generation Analysis Update,
  - All-Source RFP Update,
  - Energy and Peak Forecast Update,
  - Load & Resource Balance Update.
- **TAC 7: October 12, 2022: 9am to 4pm (PST)- In Person & Remote**
  - Hydro Impacts from Global Climate Change Studies,
  - Load Impacts from Global Climate Change Studies,
  - DER Potential Assessment Study Scope for 2025 IRP,
  - Clean Energy Implementation Plan Update & Customer Benefit Indicator's in the IRP,
  - Final Wholesale Natural Gas and Electric Price Forecast,
  - Discuss portfolio and market scenarios options.
- **Technical Modeling Workshop: October 20, 2022, 9am to 12pm (PST)- Remote Only**
  - PRiSM model overview,
  - Risk Assessment overview,
  - Washington use of electricity modeling.
- **Progress Report Workshop: December 14, 2022, 9am to 10:30am (PST)- Remote Only**
  - Review Washington IRP Progress Report
- ***Virtual Public Meeting- Natural Gas & Electric IRP (March 8, 2023)***
  - Recorded presentation
  - Daytime comment and question session (12pm to 1pm- PST)
  - Evening comment and question session (5:30pm to 6:30pm- PST)
- **TAC 8: March 15, 2023: 9am to 4pm (PST)- In Person & Remote**
  - RFP Update,
  - Wholesale Market Scenario Results,
  - Final Preferred Resource Strategy,
  - Market risk assessment,
  - Portfolio scenario analysis,
  - Final report overview & comment plan,
  - Action Items.

## ***2023 Electric IRP Report Outline***

This section provides a draft outline of the expected major sections in the 2023 Electric IRP.

- 1. Executive Summary**
- 2. Introduction, Stakeholder Involvement, and Process Changes**
- 3. Economic and Load Forecast**
  - a. Economic Conditions
  - b. Avista Energy & Peak Load Forecasts
  - c. Load Forecast Scenarios
- 4. Existing Supply Resources**
  - a. Avista Resources
  - b. Contractual Resources and Obligations
  - c. Customer Generation Overview
- 5. Long-Term Position**
  - a. Regional Capacity Requirements
  - b. Energy Planning Requirements
  - c. Reserves and Flexibility Assessment
- 6. Transmission Planning & Distribution**
  - a. Overview of Avista's Transmission System
  - b. Future Upgrades and Interconnections
  - c. Transmission Construction Costs and Integration
  - d. Merchant Transmission Plan
  - e. Overview of Avista's Distribution System
  - f. Future Upgrades and Interconnections
- 7. Distributed Energy Resources Options**
  - a. Energy efficiency potential
  - b. Demand response potential
  - c. Supply side resource options
  - d. Named Community Actions
- 8. Supply Side Resource Options**
  - a. New Resource Options
  - b. Avista Plant Upgrades
  - c. Non-Energy Impacts
- 9. Market Analysis**
  - a. Wholesale Natural Gas Market Price Forecast
  - b. Wholesale Electric Market Price Forecast
  - c. Scenario Analysis
- 10. Preferred Resource Strategy**
  - a. Preferred Resource Strategy
  - b. Market Exposure Analysis
  - c. Avoided Cost
  - d. Customer Benefit Indicator Impact
- 11. Portfolio Scenarios**
  - a. Portfolio Scenarios
  - b. Market Scenario Impacts
- 12. Action Plan**

**Draft IRP will be available to TAC members on March 17, 2023.** Comments from TAC members are expected back to Avista by May 12, 2023. Avista's IRP team will be available for conference calls or by email to address comments with individual TAC members or with the entire group if needed.

---

### **Exhibit 1: 2023 Electric IRP Timeline**

---

<b><u>Task</u></b>	<b><u>Target Date</u></b>
Update and finalize energy & peak forecast	May 2022
Transmission & distribution studies complete	June 2022
Identify Avista's supply resource options	July 2022
Finalize demand response options	July 2022
Finalize energy efficiency options	July 2022
Finalize natural gas price forecast	August 2022
Finalize electric price forecast	October 2022
Determine portfolio & market future studies	October 2022
<b>Due date for study requests from TAC members</b>	<b>October 1, 2022</b>
Finalize PRiSM model assumptions	October, 2022
Simulate market scenarios in Aurora	November 2022
Portfolio analysis	February 2022
<b>Writing Tasks</b>	
Finalize 2023 IRP Work Plan	January 15, 2022
<b>Washington IRP Progress Report</b>	<b>January 3, 2023</b>
External draft released to the TAC	March 31, 2023
<b>Public Comments from TAC due</b>	<b>May 12, 2023</b>
Final IRP submission to Commissions and TAC	June 1, 2023

---



---

### **Exhibit 2: Public Data Release Schedule**

---

<b><u>Task</u></b>	<b><u>Targeted Release</u></b>
Draft Peak & Energy Load Forecast	May 2022
Supply Side Resource Options	June 2022
Energy Efficiency Potential Study	July 2022
Demand Response Potential Study	July 2022
Transmission Interconnect Costs	July 2022
Supply Side Resource Options Cost	September 2022
Wholesale Natural Gas Price Forecast	August 2022
Wholesale Electric Price Forecast	September 2022
Final Peak & Energy Load Forecast	September 2022
Climate Change Impact Study Data	October 2022
Load scenario Data	October 2022
Draft PRiSM model	November 2022
PRS PRiSM model & Results	February 2023
Final PRiSM model & Results	March 2023

---

# 2023 Electric Integrated Resource Plan

## Appendix C – AEG Conservation Potential and Demand Response Potential Assessments



# AEG

## AVISTA ELECTRIC CONSERVATION POTENTIAL ASSESSMENT FOR 2022-2045



Prepared For: Avista Corporation  
By: Applied Energy Group, Inc.  
Date: December 9, 2022  
AEG Key Contact: Andy Hudson

This work was performed by

Applied Energy Group, Inc. (AEG)  
2300 Clayton Road, Suite 1370  
Concord, CA 94520

Project Director: E. Morris

Project Manager: A. Hudson

Project Team: K. Marrin  
K. Walter  
F. Nguyen  
T. Williams  
R. Strange  
M. McBride  
G. Wroblewski  
K. Billeci  
S. Chen  
L. Khan  
C. Struthers

# CONTENTS

1	INTRODUCTION .....	1
	Summary of Report Contents .....	1
	Abbreviations and Acronyms .....	2
2	ENERGY EFFICIENCY ANALYSIS APPROACH AND DATA DEVELOPMENT .....	4
	Overview of Analysis Approach .....	4
	Data Development .....	9
	Data Application .....	11
3	ENERGY EFFICIENCY MARKET CHARACTERIZATION .....	16
	Energy Use Summary .....	16
	Residential Sector .....	17
	Commercial Sector .....	20
	Industrial Sector .....	23
4	BASELINE PROJECTION .....	25
	Residential Sector Baseline Projections .....	25
	Commercial Sector Baseline Projections .....	28
	Industrial Sector Baseline Projections .....	31
	Summary of Baseline Projections Across Sectors and States .....	33
5	CONSERVATION POTENTIAL .....	35
	Overall Summary of Energy Efficiency Potential .....	35
	Summary of Conservation Potential by Sector .....	37
	Residential Conservation Potential .....	37
	Commercial Conservation Potential .....	41
	Industrial Conservation Potential .....	45
6	DEMAND RESPONSE POTENTIAL .....	50
	Study Approach .....	50
	Market Characterization .....	51
	Baseline Forecast .....	51
	Characterize Demand Response Program Options .....	53
	Integrated DR Potential Results .....	60
	Pilot Program Potential Results .....	67
A	MARKET PROFILES .....	A-1
B	MARKET ADOPTION (RAMP) RATES .....	B-1
C	MEASURE DATA .....	C-1
D	DEMAND RESPONSE POTENTIAL APPENDIX .....	D-1



# LIST OF FIGURES

Figure 2-1	LoadMAP Analysis Framework .....	5
Figure 2-2	Approach for Conservation Measure Assessment .....	8
Figure 3-1	Sector-Level Electricity Use in Base Year 2021, Washington.....	16
Figure 3-2	Sector-Level Electricity Use in Base Year 2021, Idaho .....	17
Figure 3-3	Residential Electricity Use and Winter Peak Demand by End Use (2021), Washington .....	18
Figure 3-4	Residential Electricity Use and Winter Peak Demand by End Use (2021), Idaho .....	19
Figure 3-5	Residential Intensity by End Use and Segment (Annual kWh/Household, 2021), Washington.	19
Figure 3-6	Residential Intensity by End Use and Segment (Annual kWh/Household, 2021), Idaho .....	20
Figure 3-7	Commercial Electricity Use and Winter Peak Demand by End Use (2021), Washington .....	21
Figure 3-8	Commercial Electricity Use and Winter Peak Demand by End Use (2021), Idaho .....	22
Figure 3-9	Commercial Electricity Usage by End Use Segment (GWh, 2021), Washington .....	22
Figure 3-10	Commercial Electricity Usage by End Use Segment (GWh, 2021), Idaho .....	23
Figure 3-11	Industrial Electricity Use and Winter Peak Demand by End Use (2021), All Industries, Washington. 24	
Figure 3-12	Industrial Electricity Use and Winter Peak Demand by End Use (2021), All Industries, Idaho..... 24	
Figure 4-1	Residential Baseline Projection by End Use (GWh), Washington.....	26
Figure 4-2	Residential Baseline Projection by End Use – Annual Use per Household, Washington.....	26
Figure 4-3	Residential Baseline Projection by End Use (GWh), Idaho .....	27
Figure 4-4	Residential Baseline Sales Projection by End Use – Annual Use per Household, Idaho .....	28
Figure 4-5	Commercial Baseline Projection by End Use, Washington .....	29
Figure 4-6	Commercial Baseline Sales Projection by End Use – Annual Use per Square Foot, Washington. 30	
Figure 4-7	Commercial Baseline Projection by End Use, Idaho.....	30
Figure 4-8	Commercial Baseline Sales Projection by End Use – Annual Use per Square Foot, Idaho.....	31
Figure 4-9	Industrial Baseline Projection by End Use (GWh), Washington.....	32
Figure 4-10	Industrial Baseline Sales Projection by End Use – Annual Use per Employee, Washington.....	32
Figure 4-11	Industrial Baseline Projection by End Use (GWh), Idaho .....	33
Figure 4-12	Industrial Baseline Sales Projection by End Use – Annual Use per Employee, Idaho .....	33
Figure 4-13	Baseline Projection Summary (GWh), Washington and Idaho Combined.....	34
Figure 5-1	Cumulative Energy Efficiency Potential as % of Baseline Projection, Washington .....	36
Figure 5-2	Cumulative Energy Efficiency Potential as % of Baseline Projection, Idaho .....	36
Figure 5-3	Technical Achievable Conservation Potential by Sector, Washington and Idaho Combined.....	37
Figure 5-4	Residential Cumulative Conservation Potential as a % of the Baseline Projection, Washington .....	38
Figure 5-5	Residential Cumulative Conservation Potential as a % of the Baseline Projection, Idaho.....	39

Figure 5-6	Residential Cumulative Technical Achievable Potential by End Use, Washington.....	39
Figure 5-7	Residential Cumulative Technical Achievable Potential by End Use, Idaho .....	40
Figure 5-8	Commercial Cumulative Conservation Potential, Washington .....	42
Figure 5-9	Commercial Cumulative Conservation Potential, Idaho .....	43
Figure 5-10	Commercial Cumulative Technical Achievable Potential by End Use, Washington .....	43
Figure 5-11	Commercial Cumulative Technical Achievable Potential by End Use, Idaho .....	44
Figure 5-12	Industrial Cumulative Conservation Potential as a % of the Baseline Projection, Washington.	46
Figure 5-13	Industrial Cumulative Conservation Potential as a % of the Baseline Projection, Idaho.....	47
Figure 5-14	Industrial Cumulative Technical Achievable Potential by End Use, Washington.....	47
Figure 5-15	Industrial Cumulative Technical Achievable Potential by End Use, Idaho .....	48
Figure 6-1	Demand Response Analysis Approach .....	50
Figure 6-2	Coincident Peak Load Forecast by State (Summer).....	53
Figure 6-3	Coincident Peak Load Forecast by State (Winter).....	53
Figure 6-4	Summary of Integrated TOU Opt-In Potential (MW @ Generator).....	61
Figure 6-5	Summary of Summer Potential by Option – TOU Opt-In (MW @ Generator) .....	61
Figure 6-6	Summer Potential by Class – TOU Opt-In (MW @Generator), Washington.....	63
Figure 6-7	Summer Potential by Class – TOU Opt-In (MW @Generator), Idaho .....	63
Figure 6-8	Summary of Winter Potential by Option – TOU Opt-In (MW @ Generator).....	64
Figure 6-9	Winter Potential by Class – TOU Opt-In (MW @Generator), Washington .....	65
Figure 6-10	Winter Potential by Class – TOU Opt-In (MW @Generator), Idaho .....	66
Figure 6-11	Summary of Summer Potential by Option (Pilot MW @ Generator) .....	68
Figure 6-12	Summary of Winter Potential by Option (Pilot MW @Generator) .....	69
Figure D-1	Summary of Summer Potential by Option – TOU Opt-Out (MW @Generator) .....	D-4
Figure D-2	Summary of Winter Potential by Option – TOU Opt-Out (MW @ Generator) .....	D-6
Figure D-3	Summary of Summer Potential by Option – Stand Alone (MW @Generator) .....	D-7
Figure D-4	Summary of Winter Potential by Option – Stand Alone (MW @Generator).....	D-9
Figure D-5	Summary of Summer Potential by Option – Stand Alone Pilot (MW @Generator) .....	D-10
Figure D-6	Summary of Winter Potential by Option – Stand Alone Pilot (MW @Generator) .....	D-10

# LIST OF TABLES

Table 1-1	Explanation of Abbreviations and Acronyms.....	3
Table 2-1	Overview of Avista Analysis Segmentation Scheme.....	6
Table 2-2	Number of Measures Evaluated.....	9
Table 2-3	Data Applied for the Market Profiles .....	12
Table 2-4	Data Needs for the Baseline Projection and Potentials Estimation in LoadMAP .....	12
Table 2-5	Residential Electric Equipment Standards .....	13
Table 2-6	Commercial and Industrial Electric Equipment Standards .....	13
Table 2-7	Data Needs for the Measure Characteristics in LoadMAP.....	14
Table 3-1	Avista Sector Control Totals (2021), Washington .....	16
Table 3-2	Avista Sector Control Totals (2021), Idaho.....	17
Table 3-3	Residential Sector Control Totals (2021), Washington .....	17
Table 3-4	Residential Sector Control Totals (2021), Idaho.....	18
Table 3-5	Commercial Sector Control Totals (2021), Washington.....	20
Table 3-6	Commercial Sector Control Totals (2021), Idaho .....	21
Table 3-7	Industrial Sector Control Totals (2021) .....	23
Table 4-1	Residential Baseline Sales Projection by End Use (GWh), Washington .....	25
Table 4-2	Residential Baseline Sales Projection by End Use (GWh), Idaho .....	27
Table 4-3	Commercial Baseline Sales Projection by End Use (GWh), Washington .....	28
Table 4-4	Commercial Baseline Sales Projection by End Use (GWh), Idaho .....	29
Table 4-5	Industrial Baseline Projection by End Use (GWh), Washington.....	31
Table 4-6	Industrial Baseline Projection by End Use (GWh), Idaho .....	32
Table 4-7	Baseline Projection Summary (GWh), Washington and Idaho Combined .....	33
Table 5-1	Summary of Energy Efficiency Potential, Washington .....	35
Table 5-2	Summary of Energy Efficiency Potential, Idaho .....	36
Table 5-3	Technical Achievable Conservation Potential by Sector, Washington and Idaho Combined.....	37
Table 5-4	Residential Conservation Potential, Washington .....	38
Table 5-5	Residential Conservation Potential, Idaho.....	38
Table 5-6	Residential Top Measures in 2024, Washington.....	40
Table 5-7	Residential Top Measures in 2024, Idaho .....	41
Table 5-8	Commercial Conservation Potential, WA.....	42
Table 5-9	Commercial Conservation Potential, Idaho.....	42
Table 5-10	Commercial Top Measures in 2024, Washington.....	44
Table 5-11	Commercial Top Measures in 2024, Idaho .....	45
Table 5-12	Industrial Conservation Potential, Washington .....	46
Table 5-13	Industrial Conservation Potential, Idaho.....	46
Table 5-14	Industrial Top Measures in 2024, Washington.....	48
Table 5-15	Industrial Top Measures in 2024, Idaho .....	49
Table 6-1	Market Segmentation.....	51
Table 6-2	Baseline Customer Forecast by Customer Class, Washington .....	51
Table 6-3	Baseline Customer Forecast by Customer Class, Idaho.....	52

Table 6-4	Baseline July Summer System Peak Load (MW @Generation) by State .....	52
Table 6-5	Baseline February Winter System Peak Forecast (MW @Generation) by State .....	52
Table 6-6	Steady-State Participation Rate Assumptions (% of eligible customers).....	58
Table 6-7	DSM Per Participant Impact Assumptions .....	59
Table 6-8	Summary of Integrated TOU Opt-In Potential (MW @ Generator), Summer.....	60
Table 6-9	Summary of Integrated TOU Opt-In Potential (MW @ Generator), Winter.....	60
Table 6-10	Summary of Summer Potential by Option – TOU Opt-In (MW @ Generator).....	62
Table 6-11	Summer Potential by Class – TOU Opt-In (MW @ Generator), Washington.....	62
Table 6-12	Summer Potential by Class – TOU Opt-In (MW @ Generator), Idaho .....	62
Table 6-13	Summary of Winter Potential by Option – TOU Opt-In (MW @ Generator).....	64
Table 6-14	Winter Potential by Class – TOU Opt-In (MW @Generator), Washington .....	65
Table 6-15	Winter Potential by Class – TOU Opt-In (MW @Generator), Idaho .....	65
Table 6-16	Levelized Program Costs and Potential (TOU Opt-In Winter).....	67
Table 6-17	Summary of Summer Potential by Option (Pilot MW @ Generator) .....	68
Table 6-18	Summer Potential by Class (Pilot MW @ Generator), Washington .....	68
Table 6-19	Summary of Winter Potential by Option (Pilot MW @ Generator) .....	69
Table 6-19	Winter Potential by Class (Pilot MW @ Generator), Washington .....	69
Table B-1	Measure Ramp Rates.....	B-1
Table D-1	End Use Saturations by Customer Class and State.....	D-1
Table D-2	DSM Program Event Hours.....	D-3
Table D-3	Summary of Summer Potential by Option – TOU Opt-Out (MW @Generator) .....	D-5
Table D-4	Summary of Winter Potential by Option – TOU Opt-Out (Winter MW @Generator).....	D-6
Table D-5	Summary of Summer Potential by Option – Stand Alone (MW @ Generator).....	D-8
Table D-6	Summary of Summer Potential by Option – Stand Alone (MW @ Generator).....	D-9
Table D-7	Summary of Summer Potential by Option – Stand Alone Pilot (MW @ Generator).....	D-10
Table D-8	Summary of Winter Potential by Option – Stand Alone Pilot (MW @ Generator) .....	D-11
Table D-9	Summer Peak Ancillary Service Option, TOU Opt-in (@Generator) .....	D-12
Table D-10	Winter Peak Ancillary Service Option, TOU Opt-in (MW @Generator).....	D-12

# 1 | INTRODUCTION

In October 2021, Avista Corporation (Avista) engaged Applied Energy Group (AEG) to conduct a Conservation Potential Assessment (CPA) for its Washington and Idaho service areas. AEG first performed an electric CPA for Avista in 2013; since then, AEG has performed both electric and natural gas CPAs for Avista's planning cycles. The CPA is a 20-year study of electric and natural gas conservation potential, performed in accordance with Washington Initiative 937 and associated Washington Administrative Code provisions. This study provides data on conservation resources to support the development of Avista's 2022 Integrated Resource Plan (IRP). For reporting purposes, the potential results are separated by fuel. This report documents the electric CPA.

Notable updates from prior CPAs include:

- The analysis base year was brought forward from 2019 to 2021.
- For the residential sector, the study still incorporates Avista's GenPOP residential saturation survey from 2012, which provides a more localized look at Avista's customers than regional surveys. The survey provided the foundation for the base year market characterization and energy market profiles. The Northwest Energy Efficiency Alliance's (NEEA's) 2016 Residential Building Stock Assessment II (RBSA) supplemented the GenPOP survey to account for trends in the intervening years.
- The residential segmentation was expanded to include household counts and energy characteristics of low-income customers by dwelling type.
- For the commercial sector, the analysis was performed for the major building types in the service territory. Results from NEEA's 2019 Commercial Building Stock Assessment (CBSA), including hospital and university data, provided useful information for this analysis.
- The industrial segmentation was expanded to include a segment related to the pumping consumption.
- The list of energy conservation measures was updated with research from the Regional Technical Forum (RTF). In particular, light-emitting diode (LED) lamps continue to drop in price and provide a significant opportunity for savings, even accounting for RTF market transformation assumptions.
- Measure characterizations, which previously relied on data from the Northwest Power and Conservation Council's (NWPPCC or Council) Seventh Power Plan, is now updated to the 2021 Power Plan, including measure data, adoption rates, and updated measure applicability.
- The study incorporates updated forecasting assumptions that align with the most recent Avista load forecast.

Enhancement retained from the previous CPA include:

- Analysis of economic potential was excluded from this study. Avista will screen for cost-effective opportunities directly within the IRP model. As such, economic potential and achievable potential have been replaced by a Achievable Technical Potential case.
- In addition to analyzing annual energy savings, the study also estimated the opportunity for reduction of summer and winter peak demand. This involved a full characterization by sector, segment, and end use of peak demand in the base year.

## Summary of Report Contents

The report is divided into the following chapters, summarizing the approach, assumptions, and results of the electric CPA.

- **Chapter 2 – Energy Efficiency Analysis Approach and Data Development.** A detailed description of AEG's approach to estimating the energy efficiency potential and documentation of data sources used.

- **Chapter 3 – Energy Efficiency Market Characterization** presents how Avista’s customers use electricity today and what equipment is currently being used.
- **Chapter 4 – Energy Efficiency Baseline Projection** presents the baseline end-use projections developed for each sector and state, as well as a summary.
- **Chapter 5 – Conservation Potential.** Energy efficiency potential results for each state across all sectors and separately for each sector.
- **Chapter 6 – Demand Response Potential.** Demand response potential results for each state across all sectors and separately for each sector.
- **Appendices A through D** provide backup detail on market profiles, market adoption (ramp) rates, measure data, and demand response.

There are three types of tables presented in the report to easily distinguish between the types of data presented. There is one type of table for each: general Avista data, Washington-specific data, and Idaho-specific data.

### Abbreviations and Acronyms

Table 1-1 provides a list of abbreviations and acronyms used in this report, along with an explanation.

Table 1-1 Explanation of Abbreviations and Acronyms

Acronym	Explanation
A/C	Air Conditioning
AEG	Applied Energy Group
AEO	EIA's Annual Energy Outlook forecast
AMI	Advanced Metering Infrastructure
BEST	AEG's Building Energy Simulation Tool
BYOT	Bring Your Own Thermostat
C&I	Commercial and Industrial
CBSA	NEEA's Commercial Building Stock Assessment
CPA	Conservation Potential Assessment
DEER	California Database for Energy Efficient Resources
DEEM	AEG's Database of Energy Efficiency Measures
DLC	Direct Load Control
DR	Demand Response
DSM	Demand Side Management
EIA	U.S. Energy Information Administration
EPRI	Electric Power Research Institute
EUI	Energy Use Index
EVSE	Electric Vehicle Supply Equipment
HVAC	Heating Ventilation and Air Conditioning
IFSA	NEEA's Industrial Facilities Site Assessment
IRP	Integrated Resource Plan
LCOE	Levelized cost of energy
LED	Light Emitting Diode Lamp
LoadMAP	AEG's Load Management Analysis and Planning™ tool
MW	Megawatt
MWh	Megawatt Hour
NEEA	Northwest Energy Efficiency Alliance
NWPCC	Northwest Power and Conservation Council
O&M	Operations and Maintenance
PTR	Peak Time Rebate
RTF	NWPCC's Regional Technical Forum
RBSA	NEEA's Residential Building Stock Assessment
TOU	Time-of-Use
UEC	Unit Energy Consumption
VPP	Variable Peak Pricing

## 2 | ENERGY EFFICIENCY ANALYSIS APPROACH AND DATA DEVELOPMENT

This section describes the analysis approach taken and the data sources used to develop the energy efficiency potential estimates. The demand response analysis discussion can be found in [Chapter 6](#).

### Overview of Analysis Approach

To perform the potential analysis, AEG used a bottom-up approach following the major steps listed below. These steps are described in more detail throughout this section.

1. Perform a market characterization to describe sector-level electricity use for the residential, commercial, and industrial sectors for the base year 2021.
2. Develop a baseline projection of energy consumption and peak demand by sector, segment, and end use for 2021 through 2045.
3. Define and characterize several hundred conservation measures to be applied to all sectors, segments, and end uses.
4. Estimate Technical and Achievable Technical Potential at the measure level in terms of energy and peak demand impacts from conservation measures for 2023-2045.

### LoadMAP Model

AEG used its Load Management Analysis and Planning tool (LoadMAP™) version 5.0 to develop both the baseline projection and the estimates of potential. AEG developed LoadMAP in 2007 and has enhanced it over time, using it for the Electric Power Research Institute (EPRI) National Potential Study and numerous utility-specific forecasting and potential studies since that time. Built in Excel, the LoadMAP framework (see Figure 2-1) is both accessible and transparent and has the following key features:

- Embodies the basic principles of rigorous end-use models (such as EPRI's REEPS and COMMEND) but in a more simplified, accessible form.
- Includes stock-accounting algorithms that treat older, less efficient appliance/equipment stock separately from newer, more efficient equipment. Equipment is replaced according to the measure life and appliance vintage distributions defined by the user.
- Balances the competing needs of simplicity and robustness. This is done by incorporating important modeling details related to equipment saturations, efficiencies, vintage, and the like, where market data are available, and treats end uses separately to account for varying importance and availability of data resources.
- Isolates new construction from existing equipment and buildings and treats purchase decisions for new construction and existing buildings separately.
- Uses a simple logic for appliance and equipment decisions. Other models available for this purpose embody complex decision-choice algorithms or diffusion assumptions. The model parameters tend to be difficult to estimate or observe, and sometimes produce anomalous results that require calibration or even overriding. The LoadMAP approach allows the user to drive the appliance and equipment choices year by year directly in the model. This flexible approach allows users to import the results from diffusion models or to input individual assumptions. The framework also facilitates sensitivity analysis.
- Includes appliance and equipment models customized by end use. For example, the logic for lighting is distinct from refrigerators and freezers.
- Can accommodate various levels of segmentation. Analysis can be performed at the sector level (e.g., total residential) or for customized segments within sectors (e.g., housing type or income level).



- Can incorporate conservation measures, demand-response options, combined heat and power, distributed generation options, and fuel switching.

Consistent with the segmentation scheme and market profiles described below, LoadMAP provides projections of baseline energy use by sector, segment, end use, and technology for existing and new buildings. It provides forecasts of total energy use and energy efficiency savings associated with the various types of potential.<sup>1</sup>

Figure 2-1 LoadMAP Analysis Framework

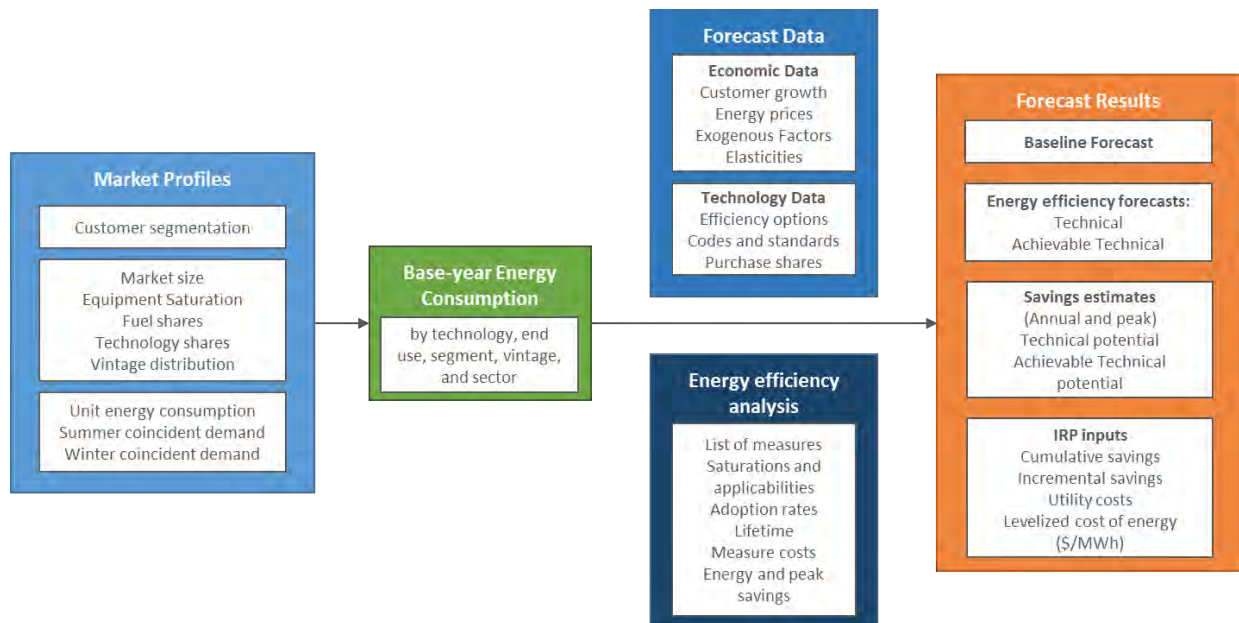

## Definitions of Potential

AEG's approach for this study adheres to the approaches and conventions outlined in the National Action Plan for Energy Efficiency's Guide for Conducting Potential Studies<sup>2</sup> and is consistent with the methodology used by the Northwest Power and Conservation Council to develop its regional power plans. The guide represents the most credible and comprehensive industry practice for specifying conservation potential. Two types of potential were developed as part of this effort:

- **Technical Potential** is the theoretical upper limit of conservation potential. It assumes that customers adopt all feasible efficient measures regardless of their cost. At the time of existing equipment failure, customers replace their equipment with the most efficient option available. In new construction, customers and developers choose the efficient equipment option relative to applicable codes and standards. Non-equipment measures, which may be realistically installed apart from equipment replacements, are implemented according to ramp rates developed by the NWPCC for its 2021 Power Plan, applied to 100% of the applicable market. This case is provided primarily for planning and informational purposes.
- **Achievable Technical Potential** refines Technical Potential by applying market adoption rates that account for market barriers, customer awareness and attitudes, program maturity, and other factors that may affect market penetration of energy efficiency measures. AEG used achievability assumptions from the NWPCC's 2021 Power Plan, adjusted for Avista's recent program accomplishments, as the customer adoption rates for this study. For the achievable technical case, ramp rates are applied to between 85% - 100% of the

<sup>1</sup> The model computes energy and peak-demand forecasts for each type of potential for each end use as an intermediate calculation. Annual-energy and peak-demand savings are calculated as the difference between the value in the baseline projection and the value in the potential forecast (e.g., the technical potential forecast).

<sup>2</sup> National Action Plan for Energy Efficiency (2007). *National Action Plan for Energy Efficiency Vision for 2025: Developing a Framework for Change*. [www.epa.gov/eeactionplan](http://www.epa.gov/eeactionplan).

## 2022-2045 Avista Electric CPA | Energy Efficiency Analysis Approach and Data Development

applicable market, per NWPCC methodology. This achievability factor represents potential that all available mechanisms, including utility programs, updated codes and standards, and market transformation, can reasonably acquire. Thus, the market applicability assumptions utilized in this study include savings outside of utility programs.<sup>3</sup> The market adoption factors can be found in [Appendix B](#).

- Note that the previous CPA used ramp rates from the NWPCC’s Seventh Power Plan, which assumed a fixed 85% achievability for all measures. In the 2021 Power Plan, some measures have this limit increased.

## Market Characterization

To estimate the savings potential from energy efficient measures, it is necessary to understand how much energy is used today and what equipment is currently being used. The characterization begins with a segmentation of Avista’s electricity footprint to quantify energy use by sector, segment, end-use application, and the current set of technologies used. To complete this step, AEG relied on information from Avista, NEEA, and secondary sources, as necessary.

### Segmentation for Modeling Purposes

The market assessment first defined the market segments (building types, end uses, and other dimensions) that are relevant in the Avista service territory. The segmentation scheme for this project is presented in Table 2-1.

Table 2-1 *Overview of Avista Analysis Segmentation Scheme*

Dimension	Segmentation Variable	Description
1	Sector	Residential, commercial, industrial
2	Segment	Residential: single family, multifamily, manufactured home, differentiated by income level Commercial: small office, large office, restaurant, retail, grocery, college, school, health, lodging, warehouse, and miscellaneous Industrial: total
3	Vintage	Existing and new construction
4	End uses	Cooling, lighting, water heat, motors, etc. (as appropriate by sector)
5	Appliances/end uses and technologies	Technologies such as lamp type, air conditioning equipment, motors by application, etc.
6	Equipment efficiency levels for new purchases	Baseline and higher-efficiency options as appropriate for each technology

With the segmentation scheme defined, AEG then performed a high-level market characterization of electricity sales in the base year to allocate sales to each customer segment. AEG used Avista data and secondary sources to allocate energy use and customers to the various sectors and segments such that the total customer count, energy consumption, and peak demand matched the Avista system totals from 2021 billing data. This information provided control totals at a sector level for calibrating LoadMAP to known data for the base year.

### Market Profiles

The next step was to develop market profiles for each sector, customer segment, end use, and technology. The market profiles provide the foundation for the development of the baseline projection and the potential estimates. A market profile includes the following elements:

- **Market size** is a representation of the number of customers in the segment. For the residential sector, it is the number of households. In the commercial sector, it is floor space measured in square feet. For the industrial sector, it is overall electricity use.

<sup>3</sup> Council’s 7<sup>th</sup> Power Plan applicability assumptions reference an “Achievable Savings” report published August 1, 2007. <http://www.nwcouncil.org/reports/2007/2007-13/>

## 2022-2045 Avista Electric CPA | Energy Efficiency Analysis Approach and Data Development

- **Saturations** define the fraction of homes or square feet with the various technologies (e.g., homes with electric space heating).
- **UEC (unit energy consumption) or EUI (energy use index)** describes the amount of energy consumed in 2021 by a specific technology in buildings that have the technology. UECs are expressed in kWh/household for the residential sector, and EUIs are expressed in kWh/square foot for the commercial sector.
- **Annual Energy Intensity** for the residential sector represents the average energy use for the technology across all homes in 2021 and is the product of the saturation and UEC. The commercial sector represents the average use for the technology across all floor space in 2021 and is the product of the saturation and EUI.
- **Annual Usage** is the annual energy use by an end-use technology in the segment. It is the product of the market size and intensity and is quantified in GWh.
- **Peak Demand** for each technology, summer peak and winter peak, is calculated using peak fractions of annual energy use from AEG's EnergyShape library and Avista system peak data.

The market characterization is presented in [Chapter 3](#), and market profiles are presented in [Appendix A](#).

### Baseline Projection

The next step was to develop the baseline projection of annual electricity use and peak demand for 2021 through 2045 by customer segment and end use without new utility programs. The savings from past programs are embedded in the forecast, but the baseline projection assumes that those past programs cease to exist in the future. Possible savings from future programs are captured by the potential estimates. The projection includes the impacts of known codes and standards, which will unfold over the study timeframe. All such mandates that were defined as of July 2022 are included in the baseline.

The baseline projection is the foundation for the analysis of savings from future conservation efforts as well as the metric against which potential savings are measured. Although AEG's baseline projection aligns closely with Avista's, it is not Avista's official load forecast.

Inputs to the baseline projection include:

- Current economic growth forecasts (i.e., customer growth, income growth)
- Electricity price forecasts
- Trends in fuel shares and equipment saturations
- Existing and approved changes to building codes and equipment standards
- Avista's internally developed sector-level projections for electricity sales

AEG also developed a baseline projection for summer and winter peaks by applying peak fractions from the market profiles to the annual energy forecast in each year. The baseline projection is presented in [Chapter 4](#).

### Washington HB 1444

Washington's HB 1444 established energy efficiency standards around equipment that exceed federal standards. These energy efficiency measures include but are not limited to showerheads, aerators, commercial food service equipment, and office equipment. This study's foundational setup included assumptions of HB-1444's impact on the available market for energy efficiency measures in Washington.

### Conservation Measure Analysis

This section describes the framework used to assess conservation measures' savings, costs, and other attributes. These characteristics form the basis for measure-level cost-effectiveness analyses and for determining measure savings. For all measures, AEG assembled information to reflect equipment performance,

incremental costs, and equipment lifetimes. We used this information along with the 2021 Power Plan's updated ramp rates to identify achievable technical measure potential.

### Conservation Measures

Figure 2-2 outlines the framework for conservation measure analysis. The framework involves identifying the list of measures to include in the analysis, determining their applicability to each sector and segment, fully characterizing each measure, and calculating the levelized cost of conserved energy (LCOE). Potential measures include the replacement of a unit that has failed or is at the end of its useful life with an efficient unit, retrofit, or early replacement of equipment, improvements to the building envelope, the application of controls to optimize energy use, and other actions resulting in improved energy efficiency.

AEG compiled a robust list of conservation measures for each customer sector, drawing upon Avista's measure database, the RTF, and the 2021 Power Plan deemed measures database, as well as a variety of secondary sources. This universal list of conservation measures covers all major types of end-use equipment, as well as devices and actions to reduce energy consumption.

Since an economic screen was not performed in this study, we calculated the LCOE for each measure evaluated. This value, expressed in dollars per first-year megawatt hour (\$/MWh) saved, can be used by Avista's IRP model to evaluate measure economics. To calculate a measure's LCOE, first-year measure costs, annual non-energy impacts, and annual operations and maintenance (O&M) costs are levelized over a measure's lifetime, then divided by the first-year savings in MWh. Note that while non-energy benefits are typically included in the numerator of a traditional Total Resource Cost economic screen, the LCOE benefits have not been monetized. Therefore, these benefits are instead subtracted from the cost portion of the test. These non-energy benefits are not included in the Utility Cost Test used in Idaho.

Figure 2-2 Approach for Conservation Measure Assessment

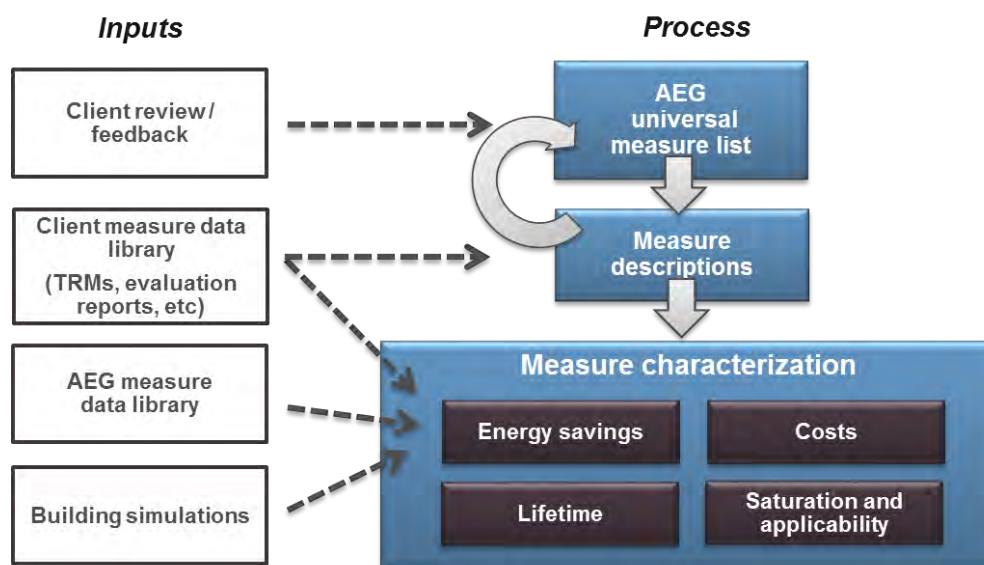

The selected measures are categorized into the two following types according to the LoadMAP taxonomy:

- Equipment measures** are efficient energy-consuming pieces of equipment that save energy by providing the same service with a lower energy requirement than a standard unit. An example is an ENERGY STAR refrigerator that replaces a standard efficiency refrigerator. For equipment measures, many efficiency levels may be available for a given technology, ranging from the baseline unit (often determined by code or standard) up to the most efficient product commercially available. For instance, in the case of central air conditioners, this list begins with the current federal standard SEER 13 unit and spans a broad spectrum up

to a maximum efficiency of a SEER 24 unit. The 2021 Power Plan’s “Lost Opportunity” ramp rates are primarily applied to equipment measures.

- **Non-equipment measures** save energy by reducing the need for delivered energy but do not involve replacement or purchase of major end-use equipment (such as a refrigerator or central air conditioner). An example would be a programmable thermostat that is pre-set to run heating and cooling systems only when people are home. Non-equipment measures can apply to more than one end use. For instance, the addition of wall insulation will affect the energy use of both space heating and cooling. The 2021 Power Plan’s “Retrofit” ramp rates are primarily applied to no-equipment measures. Non-equipment measures typically fall into one of the following categories:
  - Building shell (windows, insulation, roofing material)
  - Equipment controls (thermostat, compressor staging, and controls)
  - Equipment maintenance (cleaning filters, changing setpoints)
  - Whole-building design (building orientation, advanced new construction designs)
  - Lighting retrofits (assumed to be implemented alongside new LEDs at the equipment’s normal end of life)
  - Displacement measures (ceiling fan to reduce the use of central air conditioners)
  - Commissioning and retrocommissioning (initial or ongoing monitoring of building energy systems to optimize energy use)

We developed a preliminary list of conservation measures, which was distributed to the Avista project team for review. The list was finalized after incorporating comments. Next, the project team characterized measure savings, incremental cost, service life, and other performance factors, drawing upon data from the Avista measure database, the 2021 Power Plan, the RTF deemed measure workbooks, simulation modeling, and other well-vetted sources as required. Measure data can be found in [Appendix C](#). Table 2-2 summarizes the number of measures evaluated for each segment within each sector.

Table 2-2 *Number of Measures Evaluated*

Sector	Total Measures	Measure Permutations w/ 2 Vintages	Measure Permutations w/ Segments
Residential	106	212	1,272
Commercial	140	280	3,080
Industrial	90	180	360
<b>Total Measures Evaluated</b>	<b>336</b>	<b>658</b>	<b>4,712</b>

## Data Development

This section details the data sources used in this study, followed by a discussion of how these sources were applied. In general, data sources were applied in the following order: Avista data, Northwest regional data, and well-vetted national or other regional secondary sources.

### Avista Data

Our highest priority data sources for this study were those that were specific to Avista.

- *Customer Data:* Avista provided billing data for the development of customer counts and energy use for each sector. We also used the results of the Avista GenPOP survey, a residential saturation survey.
- *Load Forecasts:* Avista provided an economic growth forecast by sector; electric load forecast; peak-demand forecasts at the sector level; and retail electricity price history and forecasts.

## 2022-2045 Avista Electric CPA | Energy Efficiency Analysis Approach and Data Development

- *Economic Information:* Avista provided a discount rate and line loss factor. Avoided costs were not provided due to the economic screen being moved to the IRP model.
- *Program Data:* Avista provided information about past and current programs, including program descriptions, goals, and achievements to date.

### Northwest Energy Efficiency Alliance Data

The NEEA conducts research for the Northwest region. The following studies were particularly useful:

- RBSA II, [Single-Family Homes Report 2016-2017](#).
- RBSA II, [Manufactured Homes Report 2016-2017](#).
- RBSA II, [Multifamily Buildings Report 2016-2017](#).
- [2019 Commercial Building Stock Assessment](#) (CBSA), May 21, 2020.
- [2014 Industrial Facilities Site Assessment](#) (IFSA), December 29, 2014.

### Northwest Power and Conservation Council Data

Several sources of data were used to characterize the conservation measures. We used the following regional data sources and supplemented them with AEG's data sources to fill in any gaps.

- [RTF Deemed Measures](#). The NWPCC RTF maintains databases of deemed measure savings data.
- [NWPCC 2021 Power Plan Conservation Supply Curve Workbooks](#). To develop its 2021 Power Plan, the Council used workbooks with detailed information about measures.
- [NWPCC, MC and Loadshape File](#), September 29, 2016. The Council's load shape library was utilized to convert CPA results into hourly conservation impacts for use in Avista's IRP process.

### AEG Data

AEG maintains several databases and modeling tools that we use for forecasting and potential studies. Relevant data from these tools have been incorporated into the analysis and deliverables for this study.

- **AEG Energy Market Profiles:** AEG maintains regional profiles of end-use consumption. The profiles include market size, fuel shares, unit consumption estimates, annual energy use by fuel (electricity and natural gas), customer segment, and end use for ten (10) regions in the U.S. The U.S. Energy Information Administration (EIA) surveys (RECS, CBECS, and MECS), as well as state-level statistics and local customer research provide the foundation for these regional profiles.
- **Building Energy Simulation Tool (BEST):** AEG's BEST is a derivative of the DOE 2.2 building simulation model, used to estimate base-year UECs and EUIs, as well as measure savings for the HVAC-related measures.
- **AEG's Database of Energy Efficiency Measures (DEEM):** AEG maintains an extensive database of measure data, drawing upon reliable sources, including the California Database for Energy Efficient Resources (DEER), the EIA Technology Forecast Updates – Residential and Commercial Building Technologies – Reference Case, RS Means cost data, and Grainger Catalog Cost data.
- **Recent studies:** AEG has conducted numerous studies of energy efficiency potential in the last five years. We checked our input assumptions and analysis results against the results from these other studies, which include but are not limited to Tacoma Power, Idaho Power, and PacifiCorp.

### Other Secondary Data and Reports

Finally, a variety of secondary data sources and reports were used for this study. The main sources include:

- **Annual Energy Outlook (AEO):** Conducted each year by the U.S. EIA, the AEO presents yearly projections and analysis of energy topics. For this study, we used data from the 2021 AEO.

- **Local Weather Data:** Weather from National Oceanic and Atmospheric Administration’s National Climatic Data Center for Spokane, Washington, was used as the basis for building simulations.
- **EPRI End-Use Models (REEPS and COMMEND):** These models provide the elasticities we apply to electricity prices, household income, home size, and heating and cooling.
- **DEER:** The California Energy Commission and California Public Utilities Commission sponsor this database, which is designed to provide well-documented estimates of energy and peak demand savings values, measure costs, and effective useful life for the state of California. We used the DEER database to cross-check the measure savings we developed using BEST and DEEM.
- **Other relevant regional sources:** These include reports from the Consortium for Energy Efficiency, the Environmental Protection Agency, and the American Council for an Energy-Efficient Economy.

## Data Application

We now discuss how the data sources described above were used for each step of the study.

### Data Application for Market Characterization

To construct the high-level market characterization of electricity use and households/floor space for each sector, we used Avista billing data and customer surveys to estimate energy use.

- **Residential Segments.** Avista estimated the number of customers and average energy use per customer for each segment based on its GenPOP survey matched to billing data for surveyed customers. AEG compared the resulting segmentation with data from the American Community Survey regarding housing types and income and found that the Avista segmentation corresponded well with the American Community Survey.
- **C&I Segments.** We relied upon the allocation from the previous CPA. For the previous study, customers and sales were allocated to building type based on SIC codes, with some adjustments between the C&I sectors to better group energy use by facility type and predominate end uses.

### Data Application for Market Profiles

The specific data elements for the market profiles, together with the key data sources, are shown in Table 2-3. To develop the market profiles for each segment, AEG performed the following steps:

1. Developed control totals for each segment. These include market size, segment-level annual electricity use, and annual intensity.
2. Used the Avista GenPOP Survey; NEEA’s RBSA, CBSA, and IFSA; and AEG’s Energy Market Profiles database to develop existing appliance saturations, appliance and equipment characteristics, and building characteristics.
3. Ensured calibration to control totals for annual electricity sales in each sector and segment.
4. Compared and cross-checked with other recent AEG studies.
5. Worked with Avista staff to vet the data against their knowledge and experience.

## 2022-2045 Avista Electric CPA | Energy Efficiency Analysis Approach and Data Development

Table 2-3 Data Applied for the Market Profiles

Model Inputs	Description	Key Sources
Market size	Base-year residential dwellings, commercial floor space, and industrial employment	Avista billing data Avista GenPOP Survey NEEA RBSA and CBSA AEO 2019
Annual intensity	Residential: Annual use per household Commercial: Annual use per square foot Industrial: Annual use per employee	Avista billing data AEG's Energy Market Profiles NEEA RBSA and CBSA AEO 2019 Other recent studies
Appliance/equipment saturations	Fraction of dwellings with an appliance/technology Percentage of C&I floor space/employment with equipment/technology	Avista GenPOP Survey NEEA RBSA and CBSA AEG's Energy Market Profiles
UEC/EUI for each end-use technology	UEC: Annual electricity use in homes and buildings that have the technology EUI: Annual electricity use per square foot/employee for a technology in floor space that has the technology	NWPCC RTF and 2021 Power Plan and RTF HVAC uses: BEST simulations using prototypes developed for Idaho Engineering analysis DEEM Recent AEG studies
Appliance/equipment age distribution	Age distribution for each technology	RTF and NWPCC Seventh Power Plan data NEEA regional survey data Utility saturation surveys Recent AEG studies
Efficiency options for each technology	List of available efficiency options and annual energy use for each technology	AEG DEEM AEO 2019 DEER RTF and NWPCC 2021 Plan data Previous studies
Peak factors	Share of technology energy use that occurs during the peak hour	EnergyShape database

## Data Application for Baseline Projection

Table 2-4 summarizes the LoadMAP model inputs required for the baseline projection. These inputs are required for each segment within each sector, as well as for new construction and existing dwellings/buildings.

Table 2-4 Data Needs for the Baseline Projection and Potentials Estimation in LoadMAP

Model Inputs	Description	Key Sources
Customer growth forecasts	Forecasts of new construction in residential, commercial, and industrial sectors	Avista load forecast AEO 2021 economic growth forecast
Equipment purchase shares for baseline projection	For each equipment/technology, purchase shares for each efficiency level; specified separately for existing equipment replacement and new construction	Shipments data from AEO and ENERGY STAR AEO 2021 regional forecast assumptions <sup>4</sup> Appliance/efficiency standards analysis Avista program results and evaluation reports
Utilization model parameters	Price elasticities, elasticities for other variables (income, weather)	EPRI's REEPS and COMMEND models AEO 2021

<sup>4</sup> We developed baseline purchase decisions using the EIA's *Annual Energy Outlook* report (2016), which utilizes the National Energy Modeling System to produce a self-consistent supply and demand economic model. We calibrated equipment purchase options to match manufacturer shipment data for recent years and then held values constant for the study period. This removes any effects of naturally occurring conservation or effects of future energy efficiency programs that may be embedded in the AEO forecasts.



## 2022-2045 Avista Electric CPA | Energy Efficiency Analysis Approach and Data Development

AEG incorporated known future equipment standards as of May 2022, as shown in Table 2-5 and Table 2-6. The assumptions tables here extend through 2025, after which all standards are assumed to hold steady.

Table 2-5 Residential Electric Equipment Standards

End Use	Technology	2021	2022	2023	2024	2025
Cooling	Central AC	SEER 13.0		SEER 14.0		
	Room AC	EER 10.8				
Cool/Heating	Air-Source Heat Pump	SEER 14.0 / HSPF 8.2		SEER 15.0 / HSPF 8.8		
Water Heating	Water Heater (≤55 gallons)	EF 0.95				
	Water Heater (>55 gallons)	EF 2.0 (Heat Pump Water Heater)				
Lighting	General Service	Federal Backstop (45 lm/w lamp)				
	Linear Fluorescent	T8 (92.5 lm/W lamp)				
Appliances	Refrigerator & Freezer	25% more efficient than the 1997 Final Rule (62 FR 23102)				
	Clothes Washer	IMEF 1.84 / WF 4.7				
	Clothes Dryer	3.73 Combined EF				
Miscellaneous	Furnace Fans	ECM				

Table 2-6 Commercial and Industrial Electric Equipment Standards

End Use	Technology	2021	2022	2023	2024	2025
Cooling	Chillers	2007 ASHRAE 90.1				
	Roof Top Units	2007 ASHRAE 90.1				
	PTAC	EER 11.9				
Cool/Heating	Heat Pump	EER 11.3/COP 3.3				
	PTHP	EER 11.9/COP 3.3				
Ventilation	All	Constant Air Volume/Variable Air Volume				
Lighting	General Service	Federal Backstop (45 lm/w lamp)				
	Linear Lighting	T8 (92.5 lm/W lamp)				
	High Bay	High-Efficiency Ballast				
Refrigeration	Walk-In	24% more efficient than 2017				
	Reach-In	40% more efficient				
	Glass Door	12-28% more efficient				
	Open Display	10-20% more efficient				
	Icemaker	15% more efficient				
Food Service	Pre-Rinse	1.0 GPM				
Motors	All	Expanded EISA 2007				

### Conservation Measure Data Application

Table 2-7 details the energy efficiency data inputs to the LoadMAP model, describes each input, and identifies the key sources used in the Avista analysis.

## 2022-2045 Avista Electric CPA | Energy Efficiency Analysis Approach and Data Development

Table 2-7 Data Needs for the Measure Characteristics in LoadMAP

Model Inputs	Description	Key Sources
Energy Impacts	The annual reduction in consumption attributable to each specific measure. Savings were developed as a percentage of the energy end use that the measure affects.	Avista measure data NWPCC workbooks, RTF NWPCC 2021 Plan conservation workbooks BEST AEG DEEM AEO 2021 DEER Other secondary sources
Peak Demand Impacts	Savings during the peak demand periods are specified for each electric measure. These impacts relate to the energy savings and depend on the extent to which each measure is coincident with the system peak.	Avista measure data BEST AEG DEEM EnergyShape
Costs	Equipment Measures: Includes the full cost of purchasing and installing the equipment on a per-household, per-square-foot, per employee or per service point basis for the residential, commercial, and industrial sectors, respectively. Non-equipment measures: Existing buildings – full installed cost. New Construction - the costs may be either the full cost of the measure, or as appropriate, it may be the incremental cost of upgrading from a standard level to a higher efficiency level.	Avista measure data NWPCC workbooks, RTF NWPCC 2021 Plan conservation workbooks AEG DEEM AEO 2021 DEER RS Means Other secondary sources
Measure Lifetimes	Estimates derived from the technical data and secondary data sources that support the measure demand and energy savings analysis.	Avista measure data NWPCC workbooks, RTF NWPCC 2021 Plan conservation workbooks AEG DEEM AEO 2021 DEER Other secondary sources
Applicability	Estimate of the percentage of dwellings in the residential sector, square feet in the commercial sector, or employees in the industrial sector where the measure is applicable and where it is technically feasible to implement.	Avista measure data NWPCC workbooks, RTF NWPCC 2021 Plan conservation workbooks AEG DEEM DEER Other secondary sources
On Market and Off Market Availability	Expressed as years for equipment measures to reflect when the equipment technology is available or no longer available in the market.	AEG appliance standards and building codes analysis

### Data Application for Achievable Technical Potential

To estimate Achievable Technical Potential, two sets of parameters are needed to represent customer decision-making behavior with respect to energy-efficiency choices.

- Technical diffusion curves for non-equipment measures.** Equipment measures are installed when existing units fail. Non-equipment measures do not have this natural periodicity, so rather than installing all available non-equipment measures in the first year of the projection (instantaneous potential), they are phased in according to adoption schedules that generally align with the diffusion of similar equipment measures. Like the 2019 CPA, we applied the “Retrofit” ramp rates from the 2021 Power Plan directly as diffusion curves. For technical potential, these rates summed up to 100% by the 20th year for all measures.

## 2022-2045 Avista Electric CPA | Energy Efficiency Analysis Approach and Data Development

- **Adoption rates.** Customer adoption rates or take rates are applied to technical potential to estimate Achievable Technical Potential. For equipment measures, the Council’s “Lost Opportunity” ramp rates were applied to technical potential with a maximum achievability of 85%-100%, depending on the measure. For non-equipment measures, the Council’s “Retrofit” ramp rates have already been applied to calculate technical diffusion. In this case, we multiply each of these by 85% (for most measures) to calculate Achievable Technical Potential. Adoption rates are presented in [Appendix B](#).

### 3 | ENERGY EFFICIENCY MARKET CHARACTERIZATION

This chapter presents how Avista’s customers in Washington and Idaho use electricity in 2021, the base year of the study. We begin with a high-level summary of energy use by state and then delve into each sector.

#### Energy Use Summary

Total electricity use for Avista in 2021 was 7,996 GWh, 5,277 GWh in Washington, and 2,719 GWh in Idaho. The residential sector accounts for around 50% of annual energy use in both states, followed by commercial at around 40% of annual energy use. For winter peak demand, the total system peak in 2021 was 1,559 MW: 1,089 MW in Washington and 494 MW in Idaho. In both states, the residential sector represents the largest share of the winter peak.

Figure 3-1 Sector-Level Electricity Use in Base Year 2021, Washington

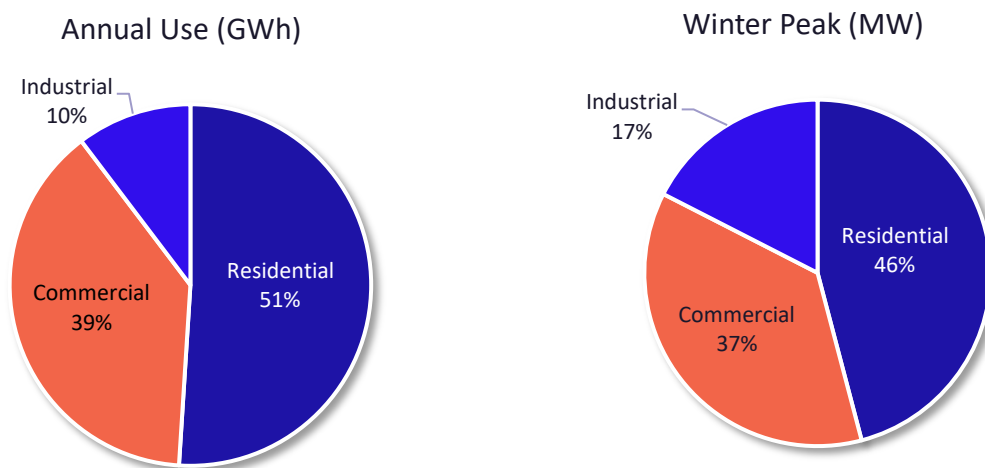

Table 3-1 Avista Sector Control Totals (2021), Washington

Sector	Annual Electricity Use (GWh)	% of Annual Use	Winter Peak Demand (MW)	% of Winter Peak
Residential	2,692	51%	500	46%
Commercial	2,041	39%	399	37%
Industrial	544	10%	190	17%
<b>Total</b>	<b>5,277</b>	<b>100%</b>	<b>1,089</b>	<b>100%</b>

## 2022-2045 Avista Electric CPA | Energy Efficiency Market Characterization

Figure 3-2 Sector-Level Electricity Use in Base Year 2021, Idaho

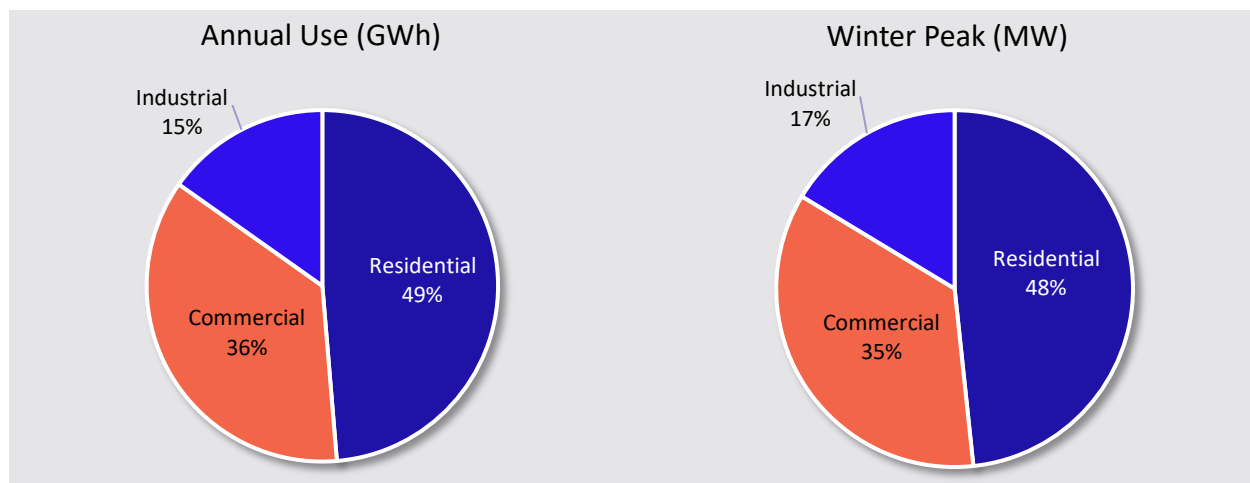

Table 3-2 Avista Sector Control Totals (2021), Idaho

Sector	Annual Electricity Use (GWh)	% of Annual Use	Winter Peak Demand (MW)	% of Winter Peak
Residential	1,324	49%	239	48%
Commercial	982	36%	175	35%
Industrial	413	15%	81	16%
<b>Total</b>	<b>2,719</b>	<b>100%</b>	<b>494</b>	<b>100%</b>

## Residential Sector

The total number of households and electricity sales were obtained from Avista's customer database. In 2021, Avista provided electric service to 234,506 households in Washington; those households used a total of 2,692 GWh with a winter peak demand of 500 MW. The average use per household at 11,479 kWh is about average compared to other regions of the country. In 2021, Avista provided electric service to 120,131 households in Idaho; those households used a total of 1,324 GWh with winter peak demand of 239 MW. The average use per household was 11,017 kWh. Table 3-3 and Table 3-4 show the total number of households and electricity sales in the six residential segments for each state.

Table 3-3 Residential Sector Control Totals (2021), Washington

Segment	Number of Customers	Electricity Use (GWh)	% of Annual	Annual Use/Customer (kWh/Household)	Winter Peak
Single Family	97,304	1,310	49%	13,466	233
Multi-Family	12,712	96	4%	7,516	20
Mobile Home	8,704	156	6%	17,891	40
Low Income Single Family	62,690	796	30%	12,702	149
Low Income Multi-Family	45,261	221	8%	4,894	32
Low Income Mobile Home	7,836	113	4%	14,358	26
<b>Total</b>	<b>234,506</b>	<b>2,692</b>	<b>100%</b>	<b>11,479</b>	<b>500</b>

2022-2045 Avista Electric CPA | Energy Efficiency Market Characterization

Table 3-4 Residential Sector Control Totals (2021), Idaho

Segment	Number of Customers	Electricity Use (GWh)	% of Annual	Annual Use/Customer (kWh/Household)	Winter Peak
Single Family	79,840	937	35%	11,731	155
Multi-Family	13,065	77	3%	5,876	15
Mobile Home	8,275	115	4%	13,946	27
Low Income Single Family	9,913	119	4%	11,990	24
Low Income Multi-Family	6,890	47	2%	6,868	10
Low Income Mobile Home	2,148	29	1%	13,303	7
<b>Total</b>	<b>120,131</b>	<b>1,324</b>	<b>100%</b>	<b>11,017</b>	<b>239</b>

Figure 3-3 and Figure 3-4 show the distribution of annual electricity use by end use for all customers in Washington and Idaho, respectively. Two main electricity end uses —space heating and miscellaneous— account for approximately 50% of total usage. Miscellaneous includes furnace fans, pool pumps, electric vehicles, and other “plug” loads (all other usages, such as hair dryers, power tools, coffee makers, etc.). The figures show estimates of winter peak demand by end use. As expected, space heating is the largest contributor to winter peak demand, followed by miscellaneous water heating and lighting.

Figure 3-5 and Figure 3-6 present the electricity intensities by end use and housing type for Washington and Idaho, respectively. Mobile homes have the highest use per customer at 17,891 kWh/year in Washington and 13,946 kWh/year in Idaho.

Figure 3-3 Residential Electricity Use and Winter Peak Demand by End Use (2021), Washington

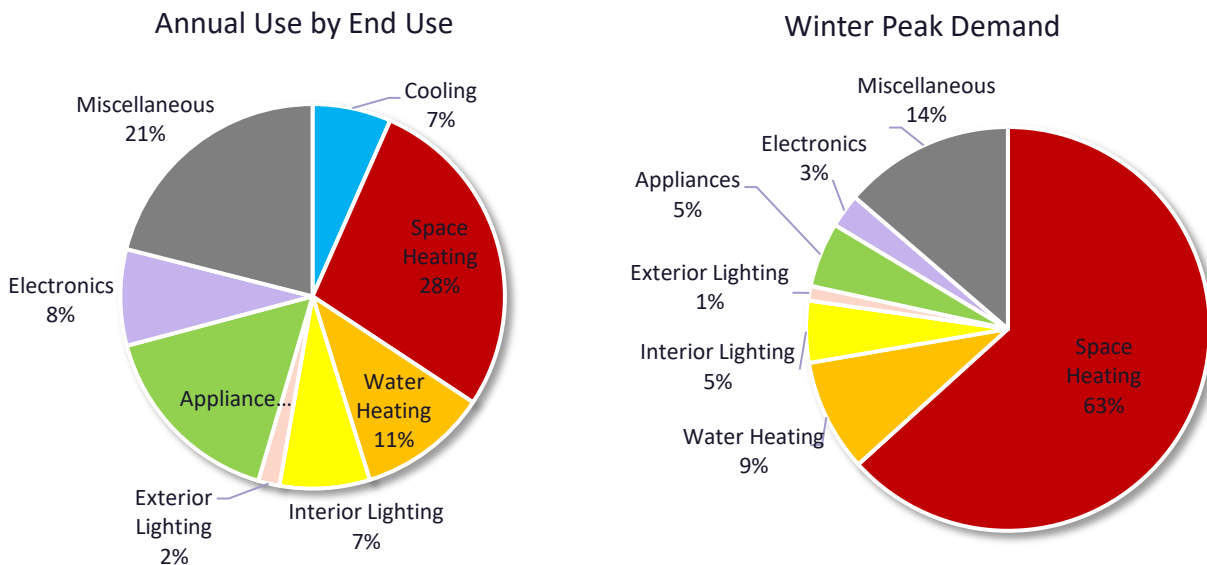

2022-2045 Avista Electric CPA | Energy Efficiency Market Characterization

Figure 3-4 Residential Electricity Use and Winter Peak Demand by End Use (2021), Idaho

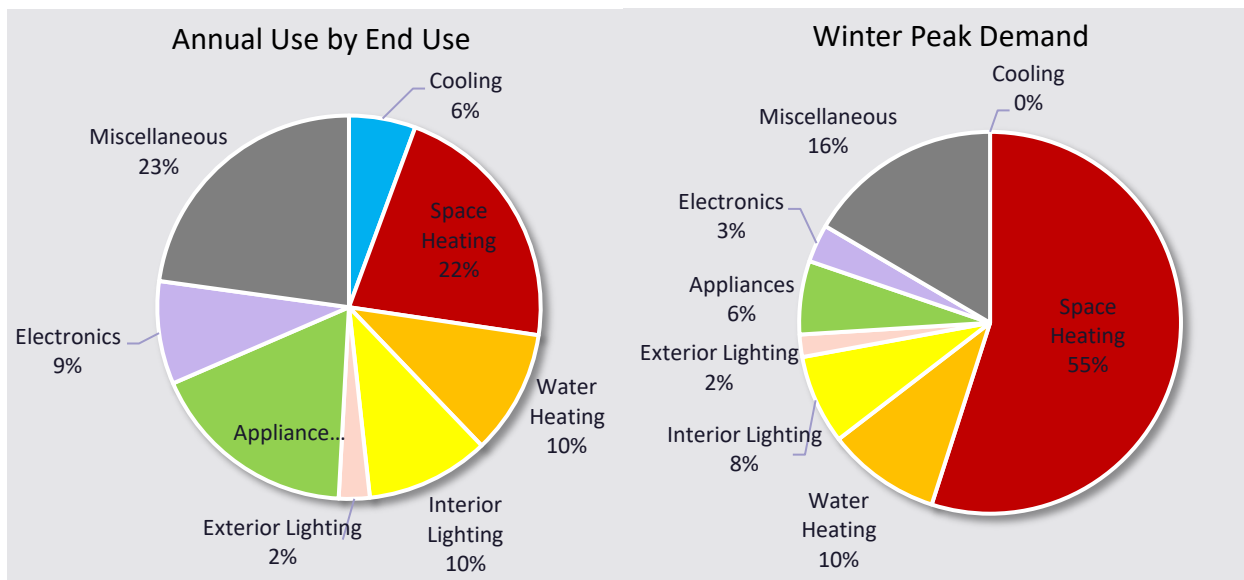
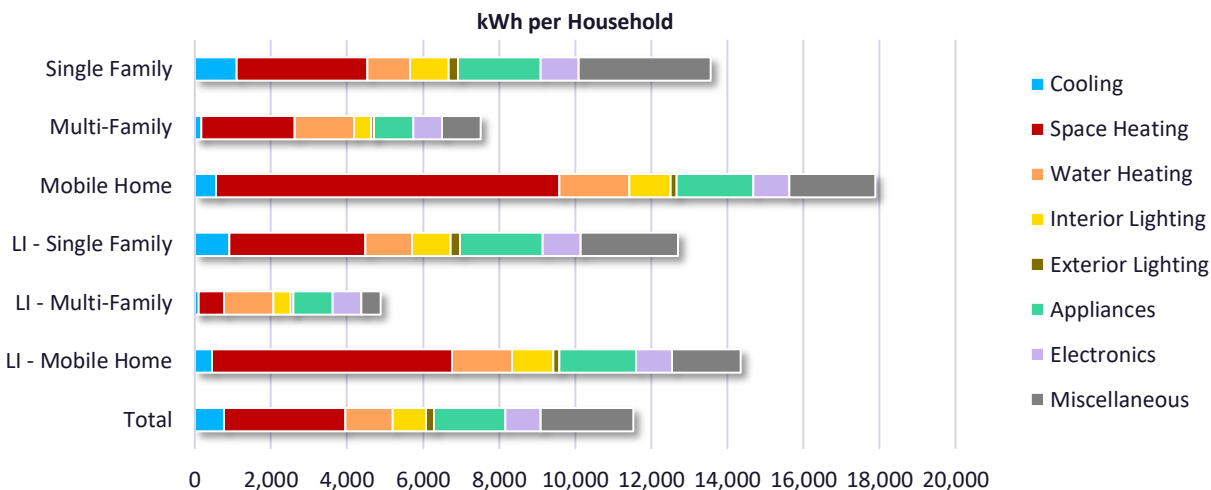
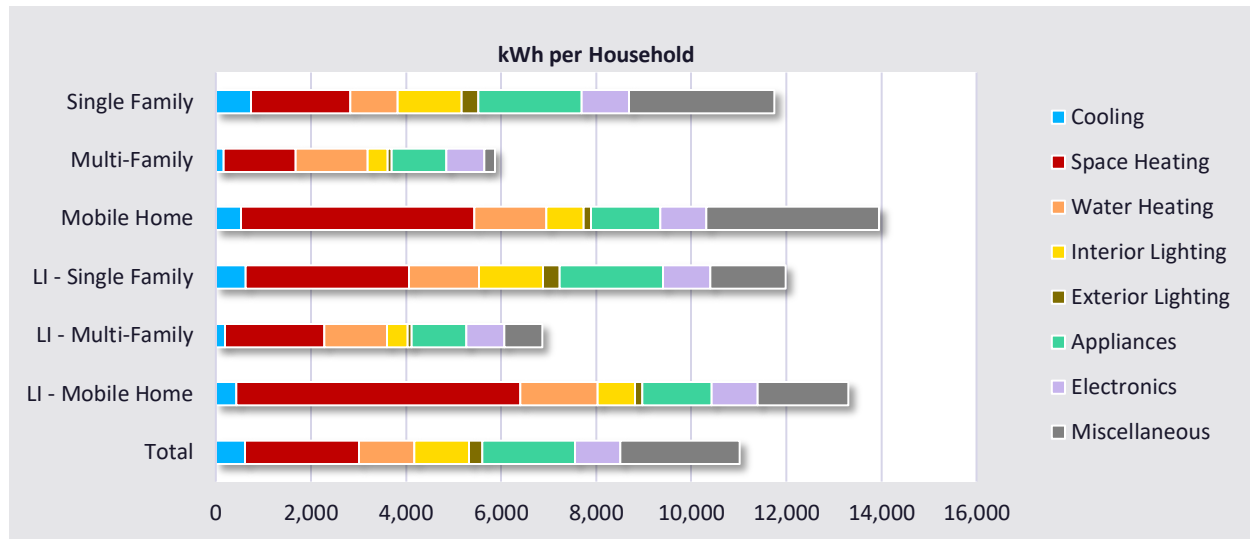

Figure 3-5 Residential Intensity by End Use and Segment (Annual kWh/Household, 2021), Washington



## 2022-2045 Avista Electric CPA | Energy Efficiency Market Characterization

Figure 3-6 Residential Intensity by End Use and Segment (Annual kWh/Household, 2021), Idaho



## Commercial Sector

The total electric energy consumed by commercial customers in 2021 was 2,041 GWh in Washington and 982 GWh in Idaho. Avista billing data, CBSA, and secondary data were used to allocate this energy usage to building type segments and to develop estimates of energy intensity (annual kWh/square foot). Using the electricity use and intensity estimates, AEG inferred floor space (the unit of analysis in LoadMAP for the commercial sector). The average building intensities by segment are based on regional information from the CBSA; therefore, the intensity is the same in both states. However, the overall end-use mix is different due to the different mix of building types.

Table 3-5 Commercial Sector Control Totals (2021), Washington

Segment	Electricity Sales (GWh)	% of Total Usage	Intensity (kWh/sq.ft)
Small Office	193	9%	14.3
Large Office	159	8%	25.9
Restaurant	257	13%	46.0
Retail	452	22%	11.9
Grocery	124	6%	28.2
College	114	6%	15.3
School	188	9%	10.0
Health	52	3%	17.7
Lodging	196	10%	18.3
Warehouse	143	7%	6.1
Miscellaneous	163	8%	9.4
<b>Total</b>	<b>2,041</b>	<b>100%</b>	<b>13.8</b>



## 2022-2045 Avista Electric CPA | Energy Efficiency Market Characterization

Table 3-6 Commercial Sector Control Totals (2021), Idaho

Segment	Electricity Sales (GWh)	% of Total Usage	Intensity (kWh/sq.ft)
Small Office	40	2%	14.3
Large Office	124	6%	25.9
Restaurant	151	7%	45.9
Retail	217	11%	11.9
Grocery	142	7%	28.2
College	58	3%	15.3
School	11	1%	10.0
Health	4	0%	17.7
Lodging	85	4%	18.3
Warehouse	35	2%	6.1
Miscellaneous	114	6%	9.4
<b>Total</b>	<b>982</b>	<b>100%</b>	<b>15.9</b>

Figure 3-7 and

Figure 3-8 show the distribution of annual electricity consumption and winter peak demand by end use across all commercial buildings in Washington and Idaho, respectively. Electric usage is dominated by lighting and ventilation, which comprise almost 35% of annual electricity usage. Lighting and ventilation also make up the largest portions of winter peak; however, electric space heating represents a greater part of the peak than it does annual energy.

Figure 3-7 Commercial Electricity Use and Winter Peak Demand by End Use (2021), Washington

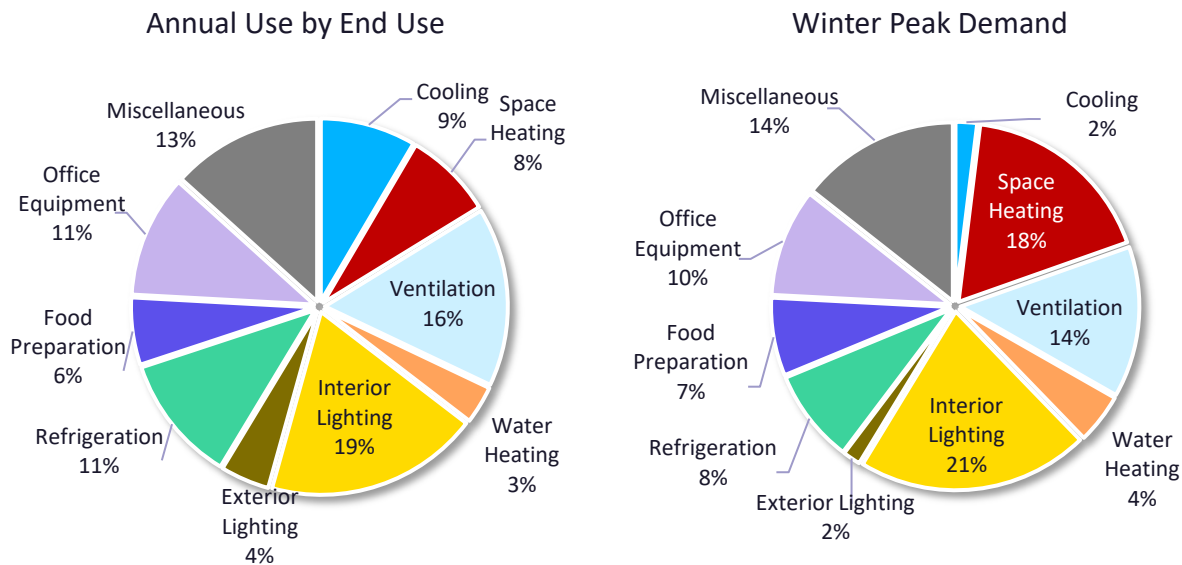

Figure 3-8 Commercial Electricity Use and Winter Peak Demand by End Use (2021), Idaho

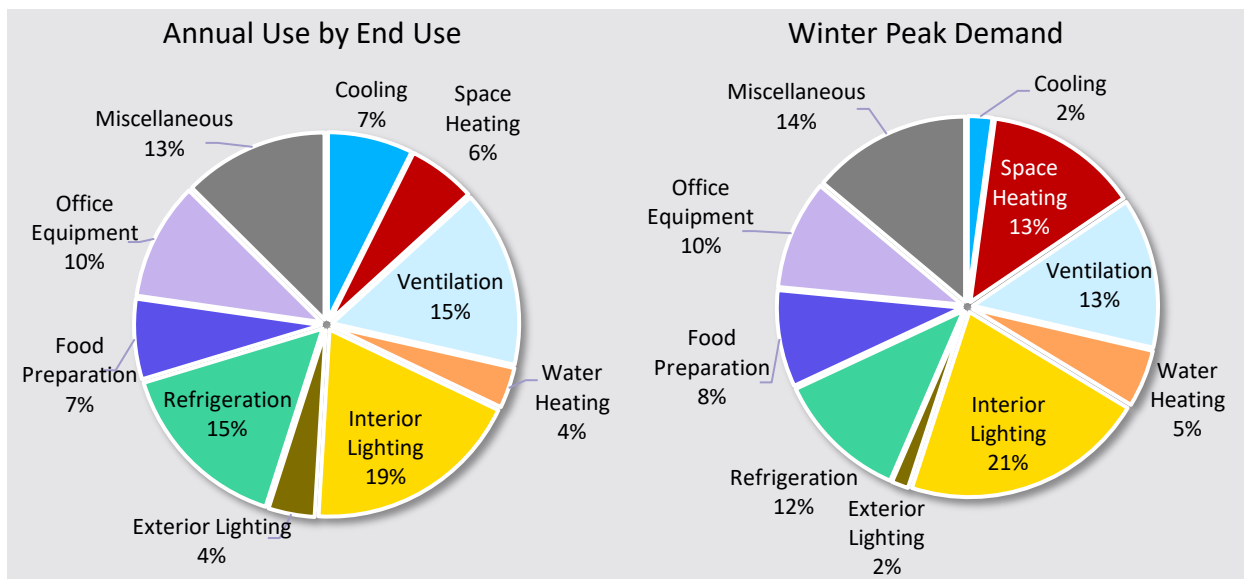

Figure 3-9 and Figure 3-10 present the electricity usage in GWh by end use and segment for Washington and Idaho, respectively. In Washington, large offices, retail, and miscellaneous buildings use the most electricity in the service territory. For Idaho, large and small offices are more balanced in terms of total consumption. HVAC and lighting are the major end uses across most segments, aside from large offices and grocery, where office equipment and refrigeration equipment, respectively, are highly concentrated.

Figure 3-9 Commercial Electricity Usage by End Use Segment (GWh, 2021), Washington

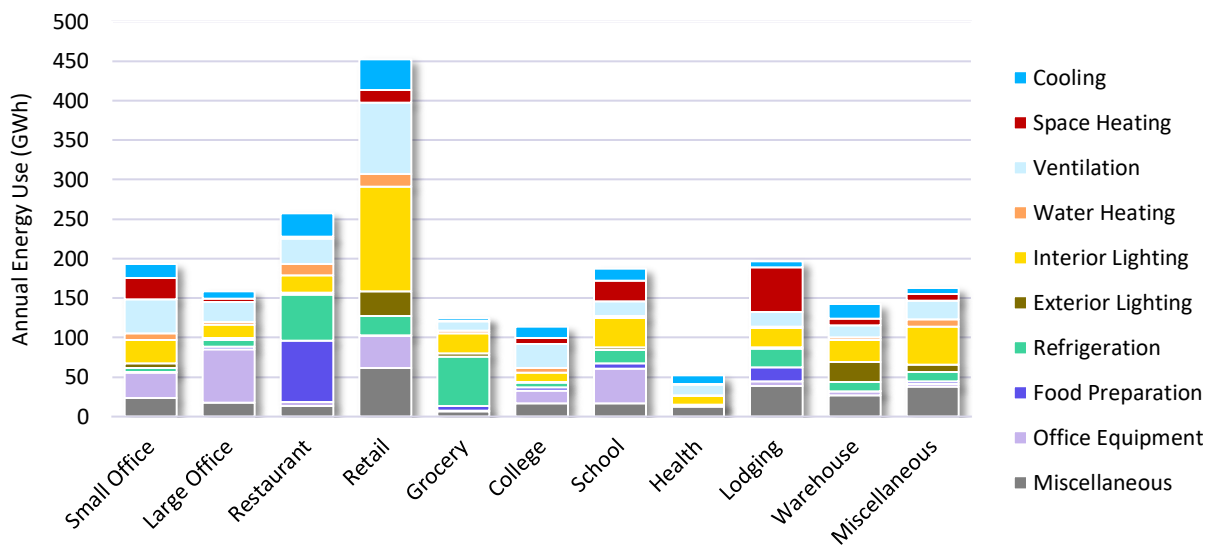
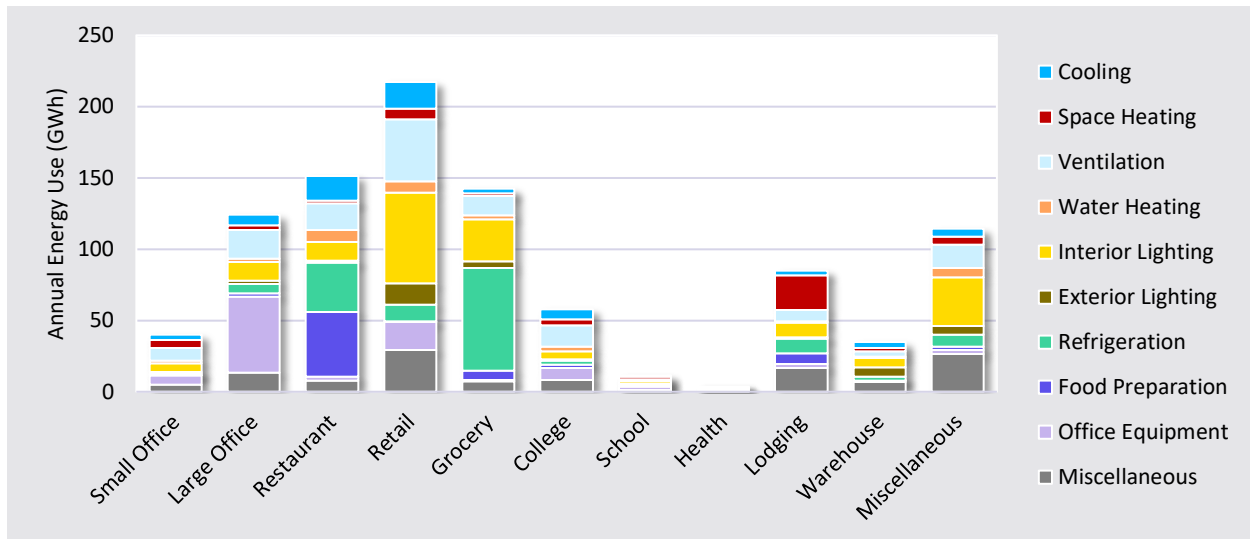

Figure 3-10 Commercial Electricity Usage by End Use Segment (GWh, 2021), Idaho



### Industrial Sector

The total electricity used by Avista’s industrial customers in 2021 was 958 GWh, 544 GWh in Washington, and 423 GWh in Idaho. Avista billing data and load forecast, NEEA’s IFSA, and secondary sources were used to develop estimates of energy intensity (annual kWh/employee). We infer the number of employees (the unit of analysis in LoadMAP for the industrial sector) using the electricity use and intensity estimates.

Table 3-7 Industrial Sector Control Totals (2021)

State	Electricity Sales (GWh)	Intensity (Annual kWh/employee)
Washington	544	99,315
Idaho	413	120,096

Figure 3-11 and Figure 3-12 show the distribution of annual electricity consumption and winter peak demand by end use for all industrial customers in Washington and Idaho, respectively. Motors are the largest overall end use, accounting for over 50% of energy use. Note that motors include a wide range of industrial equipment, such as air compressors and refrigeration compressors, pumps, conveyor motors, and fans. The process end use accounts for over 15% of annual energy use, which includes heating, cooling, refrigeration, and electro-chemical processes.

2022-2045 Avista Electric CPA | Energy Efficiency Market Characterization

Figure 3-11 Industrial Electricity Use and Winter Peak Demand by End Use (2021), All Industries, Washington

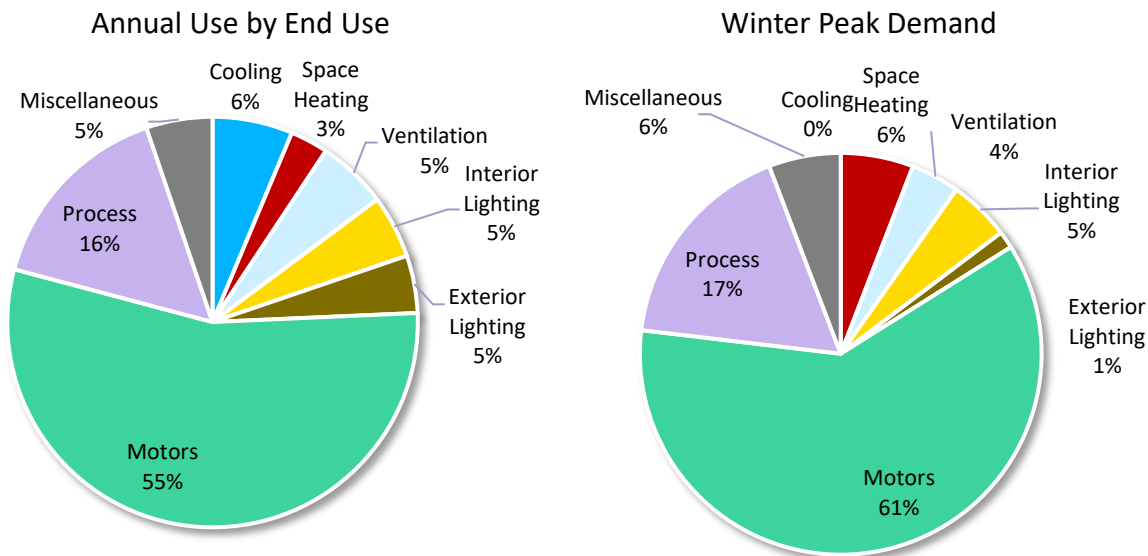
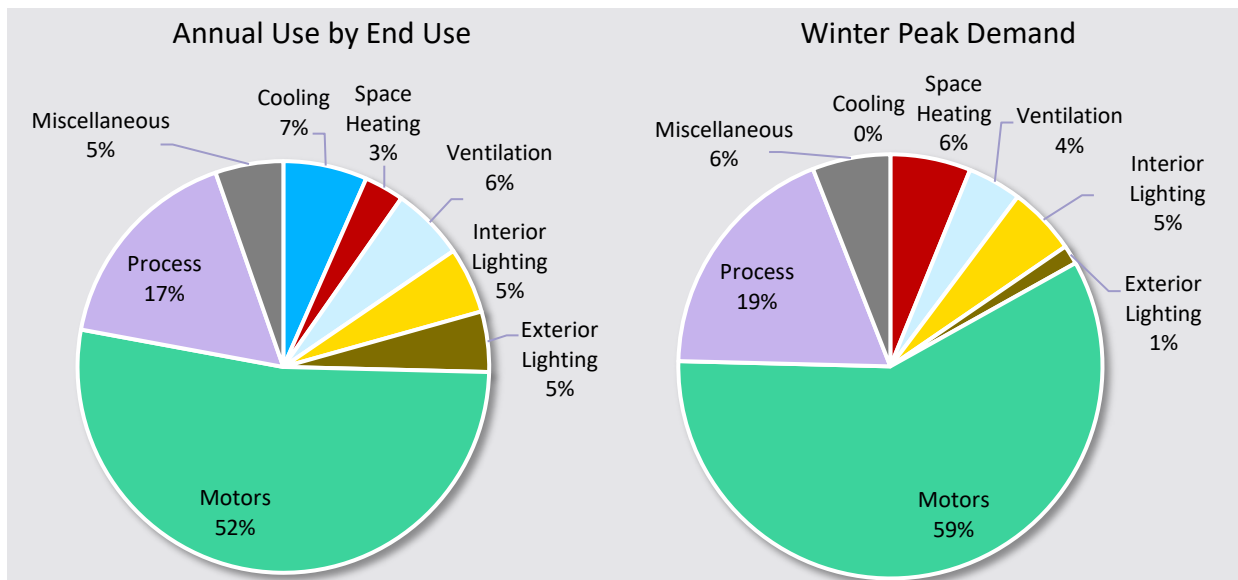

Figure 3-12 Industrial Electricity Use and Winter Peak Demand by End Use (2021), All Industries, Idaho



## 4 | BASELINE PROJECTION

Prior to developing estimates of energy efficiency potential, AEG developed a baseline end use projection to quantify the likely future consumption in the absence of any future conservation programs. The baseline projection is the foundation for the analysis of savings from future conservation efforts as well as the metric against which potential savings are measured.

This chapter presents the baseline projections developed for each sector and state (as well as a summary), which include projections of annual use in GWh. Annual energy use for 2021 reflects weather-normalized values, while future years of energy use and peak demand reflect normal weather, as defined by Avista.

### Residential Sector Baseline Projections

Table 4-1 and Table 4-2 present the baseline projection for electricity by end use for the residential sector in Washington and Idaho, respectively. Overall, in Washington, residential use increases from 2,692 GWh in 2021 to 3,069 GWh in 2045, an increase of 14%. Residential use in Idaho increases from 1,324 GWh in 2021 to 1,721 GWh in 2045, an increase of 30%. This reflects substantial customer growth in both states. Figure 4-1 and Figure 4-3 display the graphical representation of the baseline projection in each state.

Figure 4-2 and Figure 4-4 present the baseline projection of annual electricity use per household in each state. Most noticeable is that lighting use decreases throughout the time period – this is the combined effect of the RTF market baseline assumptions and the EISA lighting backstop coming into effect in 2023.

Table 4-1 Residential Baseline Sales Projection by End Use (GWh), Washington

End Use	2021	2023	2024	2025	2035	2045	% Change ('21-'45)
Cooling	179	148	149	150	168	205	15%
Space Heating	748	796	797	799	820	865	16%
Water Heating	294	297	297	297	300	308	5%
Interior Lighting	205	181	169	156	100	98	-52%
Exterior Lighting	48	42	40	37	21	18	-64%
Appliances	440	450	455	458	505	556	26%
Electronics	219	224	226	228	258	300	37%
Miscellaneous	568	568	566	563	583	830	46%
Generation	-10	-12	-13	-15	-41	-112	1043%
<b>Total</b>	<b>2,692</b>	<b>2,694</b>	<b>2,685</b>	<b>2,674</b>	<b>2,714</b>	<b>3,069</b>	<b>14%</b>

Figure 4-1 Residential Baseline Projection by End Use (GWh), Washington

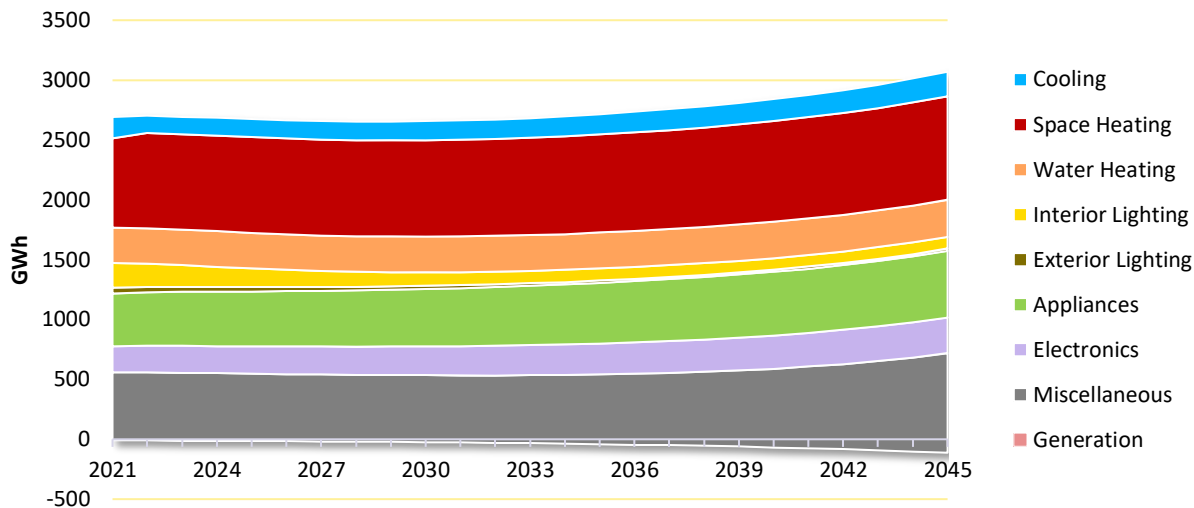

Figure 4-2 Residential Baseline Projection by End Use – Annual Use per Household, Washington

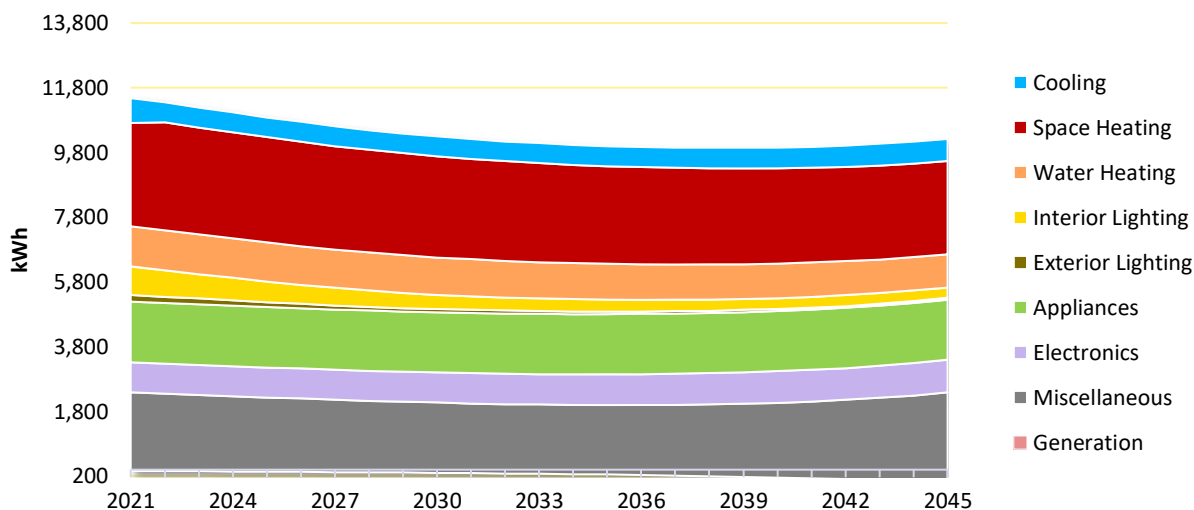

Table 4-2 Residential Baseline Sales Projection by End Use (GWh), Idaho

End Use	2021	2023	2024	2025	2035	2045	% Change ('21-'45)
Cooling	74	63	63	64	75	96	30%
Space Heating	288	309	311	313	334	366	27%
Water Heating	139	143	144	145	159	176	26%
Interior Lighting	138	125	117	109	73	75	-46%
Exterior Lighting	35	30	28	26	16	15	-57%
Appliances	234	242	244	247	281	323	38%
Electronics	115	119	120	121	141	170	47%
Miscellaneous	302	311	315	318	369	512	69%
Generation	-1	-1	-1	-1	-3	-10	1163%
<b>Total</b>	<b>1,324</b>	<b>1,341</b>	<b>1,342</b>	<b>1,342</b>	<b>1,445</b>	<b>1,721</b>	<b>30%</b>

Figure 4-3 Residential Baseline Projection by End Use (GWh), Idaho

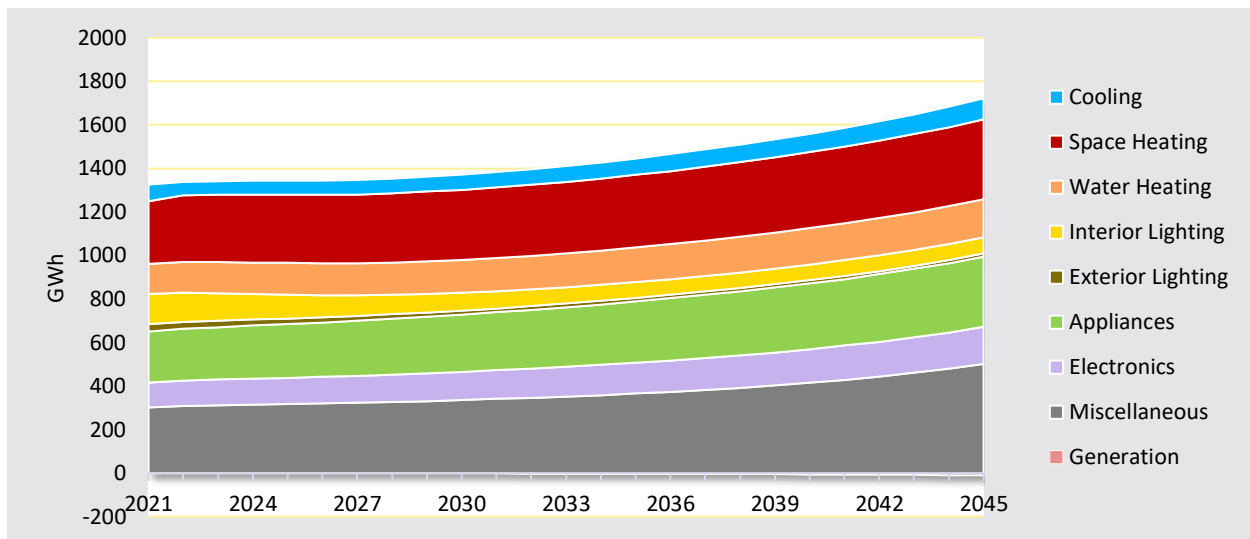
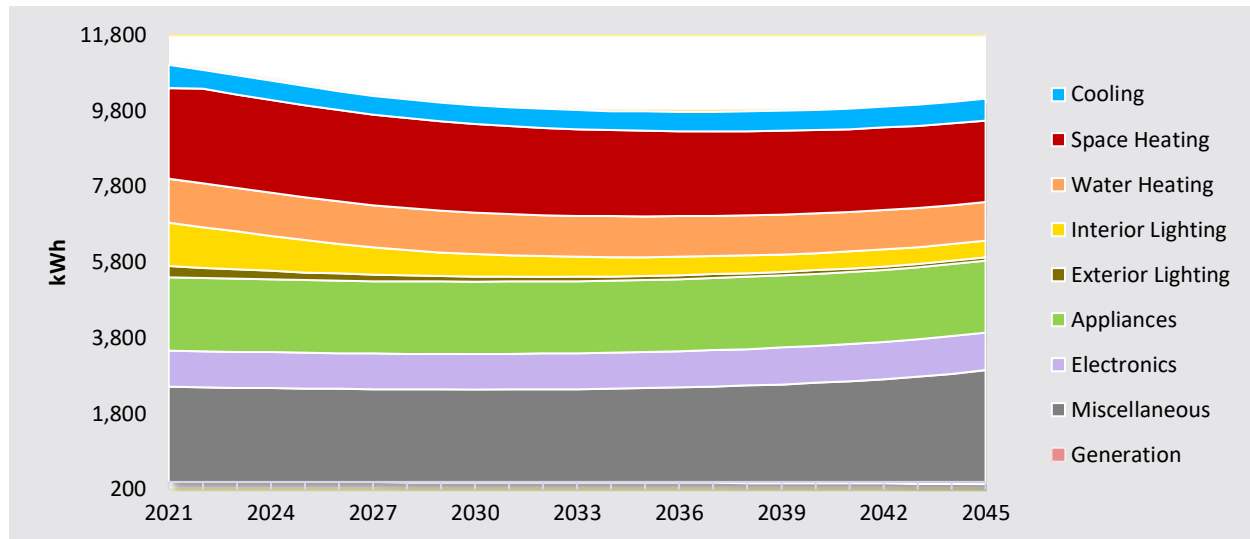



Figure 4-4 Residential Baseline Sales Projection by End Use – Annual Use per Household, Idaho



### Commercial Sector Baseline Projections

In Washington, annual electricity use in the commercial sector grows during the overall forecast horizon, starting at 2,041 GWh in 2021, and increasing to 2,197 in 2045, an increase of 8%. In Idaho, annual electricity use will grow from 982 GWh in 2021 to 984 GWh in 2045, an increase of 0.2%.

Table 4-3 Commercial Baseline Sales Projection by End Use (GWh), Washington

End Use	2021	2023	2024	2025	2035	2045	% Change ('21-'45)
Cooling	172	174	174	175	180	189	9%
Space Heating	159	162	163	165	179	195	23%
Ventilation	323	317	314	311	284	283	-12%
Water Heating	68	68	68	67	59	57	-16%
Interior Lighting	386	385	384	379	369	384	-1%
Exterior Lighting	88	87	86	84	76	80	-10%
Appliances	230	232	233	234	248	268	17%
Electronics	121	124	125	126	138	151	25%
Miscellaneous	221	224	225	227	242	259	18%
Generation	272	276	278	280	304	331	22%
<b>Total</b>	<b>2,041</b>	<b>2,049</b>	<b>2,051</b>	<b>2,048</b>	<b>2,079</b>	<b>2,197</b>	<b>8%</b>

Table 4-4 Commercial Baseline Sales Projection by End Use (GWh), Idaho

End Use	2021	2023	2024	2025	2035	2045	% Change ('21-'45)
Cooling	72	72	72	72	73	75	4%
Space Heating	58	56	56	57	58	61	5%
Ventilation	150	144	142	140	124	121	-20%
Water Heating	35	35	35	35	38	40	17%
Interior Lighting	185	181	179	177	170	176	-5%
Exterior Lighting	39	38	37	36	31	32	-19%
Appliances	151	147	147	147	151	156	3%
Electronics	68	68	68	69	74	79	16%
Miscellaneous	100	98	98	99	102	105	5%
Generation	123	122	123	123	130	139	13%
<b>Total</b>	<b>982</b>	<b>960</b>	<b>958</b>	<b>955</b>	<b>951</b>	<b>984</b>	<b>0.2%</b>

Figure 4-5 Commercial Baseline Projection by End Use, Washington

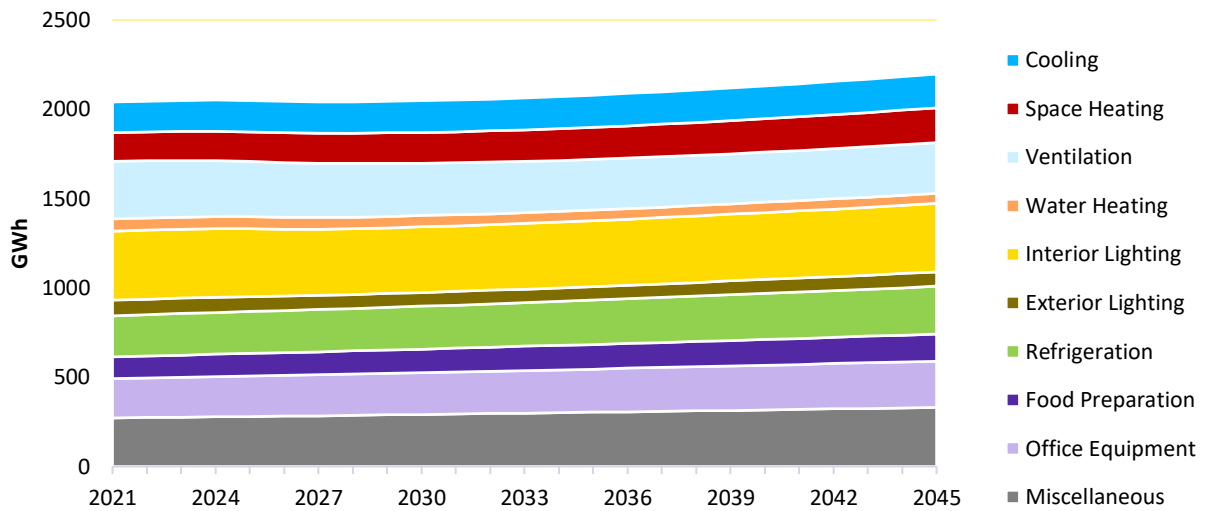

Figure 4-6 Commercial Baseline Sales Projection by End Use – Annual Use per Square Foot, Washington

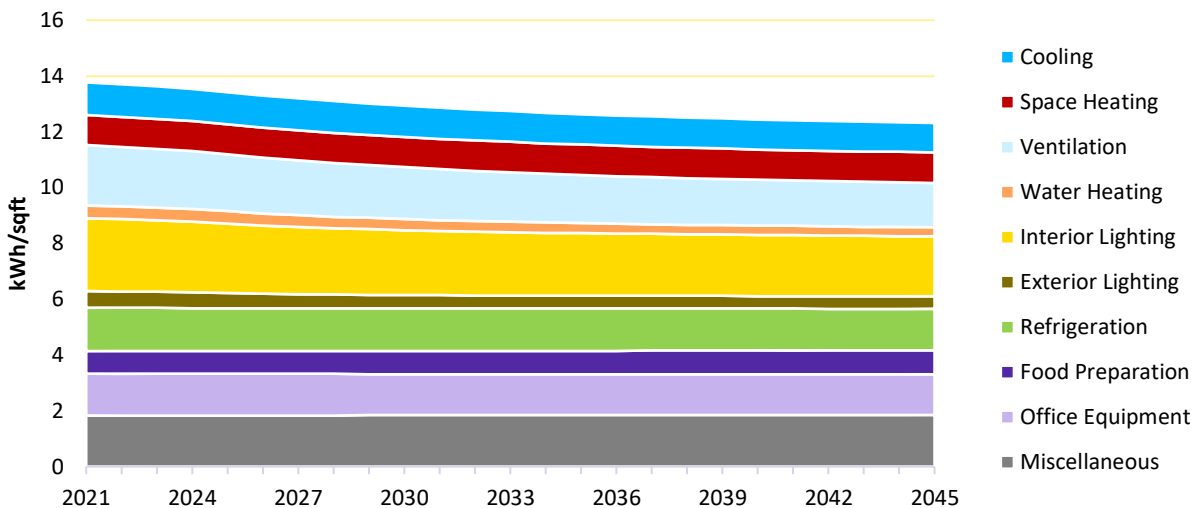

Figure 4-7 Commercial Baseline Projection by End Use, Idaho

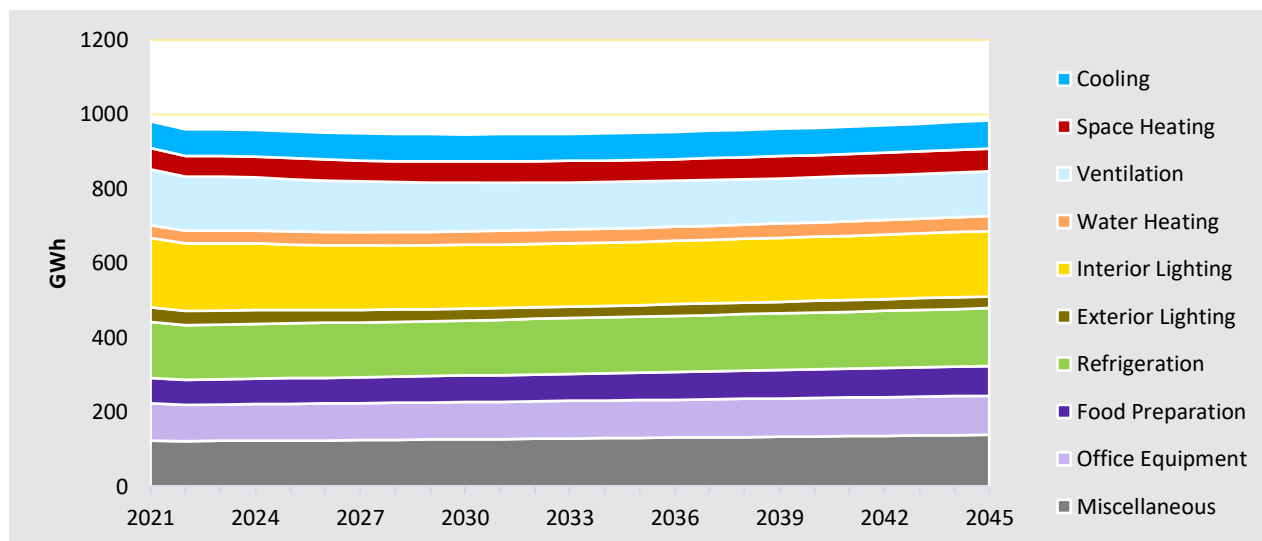
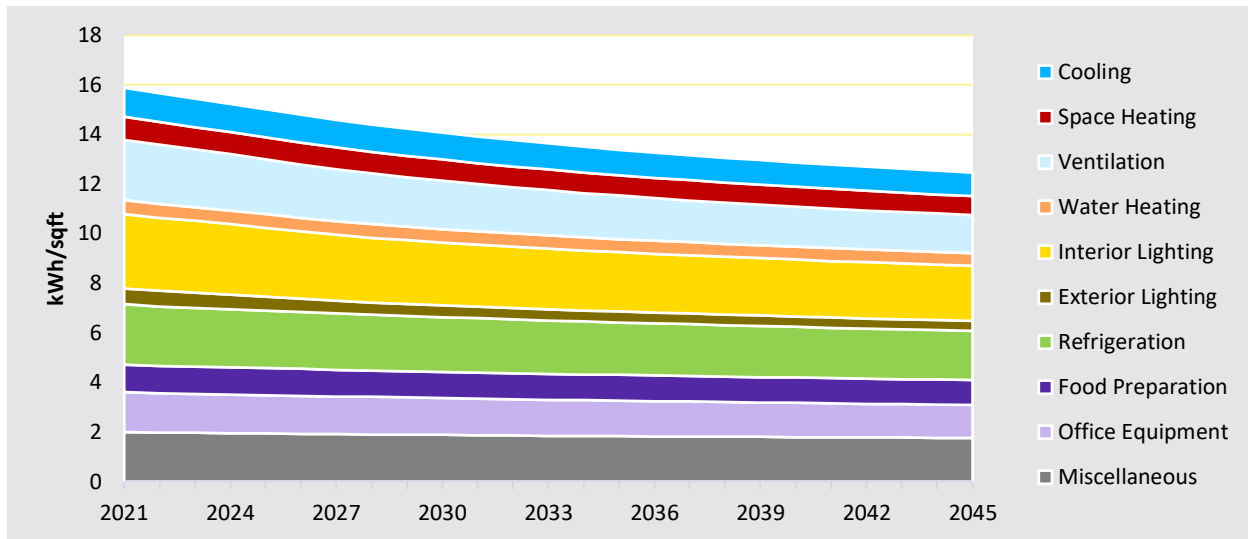

Figure 4-8 Commercial Baseline Sales Projection by End Use – Annual Use per Square Foot, Idaho



### Industrial Sector Baseline Projections

Annual industrial use declined by 7% through the forecast horizon, consistent with trends from Avista's industrial load forecast. Overall, in Washington, industrial annual electricity use decreases from 544 GWh in 2021 to 534 GWh in 2045. In Idaho, annual electricity use drops from 413 GWh in 2021 to 316 GWh in 2045.

Table 4-5 Industrial Baseline Projection by End Use (GWh), Washington

End Use	2021	2023	2024	2025	2035	2045	% Change ('21-'45)
Cooling	34	37	37	36	35	34	-2%
Space Heating	16	17	17	17	17	17	1%
Ventilation	30	31	30	30	25	22	-25%
Interior Lighting	27	28	27	27	24	23	-15%
Exterior Lighting	25	24	23	22	19	18	-26%
Process	85	92	92	92	90	87	3%
Motors	299	307	307	307	305	304	2%
Miscellaneous	28	30	30	30	30	29	2%
<b>Total</b>	<b>544</b>	<b>565</b>	<b>565</b>	<b>561</b>	<b>544</b>	<b>534</b>	<b>-2%</b>

Table 4-6 Industrial Baseline Projection by End Use (GWh), Idaho

End Use	2021	2023	2024	2025	2035	2045	% Change ('21-'45)
Cooling	27	27	26	26	23	20	-25%
Space Heating	13	13	12	12	11	10	-22%
Ventilation	24	22	22	21	16	14	-43%
Interior Lighting	21	20	20	19	16	14	-35%
Exterior Lighting	20	17	17	16	13	11	-43%
Process	69	68	67	67	60	54	-22%
Motors	217	209	208	207	191	176	-19%
Miscellaneous	22	21	21	21	19	17	-21%
<b>Total</b>	<b>413</b>	<b>398</b>	<b>394</b>	<b>391</b>	<b>350</b>	<b>316</b>	<b>-24%</b>

Figure 4-9 Industrial Baseline Projection by End Use (GWh), Washington

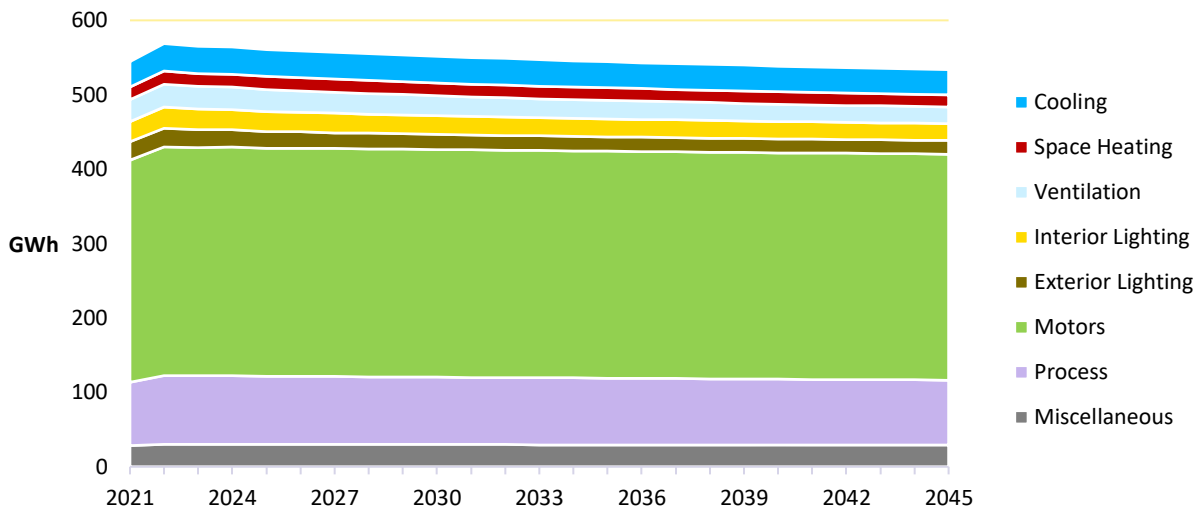

Figure 4-10 Industrial Baseline Sales Projection by End Use – Annual Use per Employee, Washington

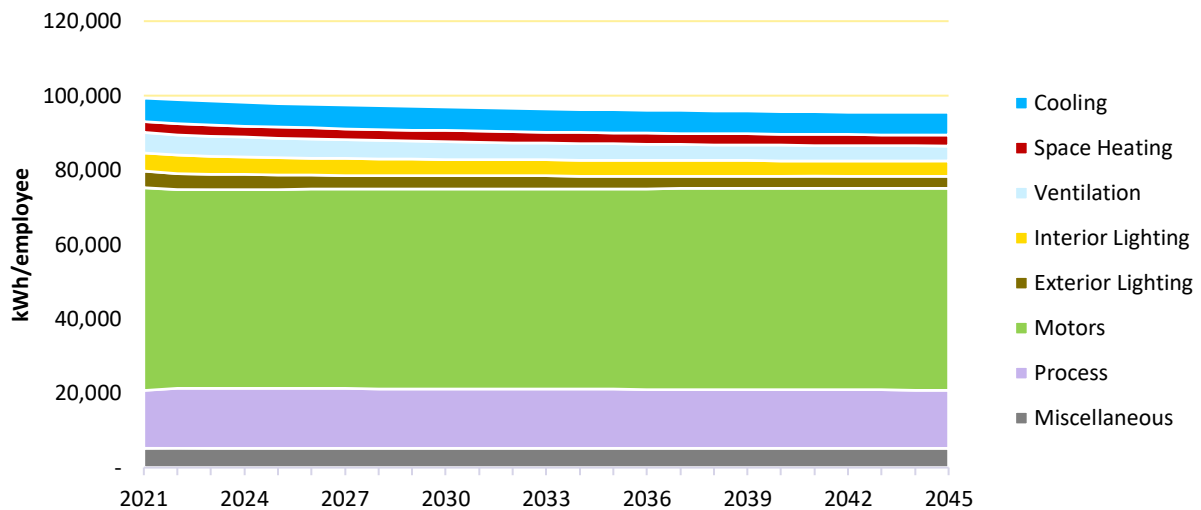

Figure 4-11 Industrial Baseline Projection by End Use (GWh), Idaho

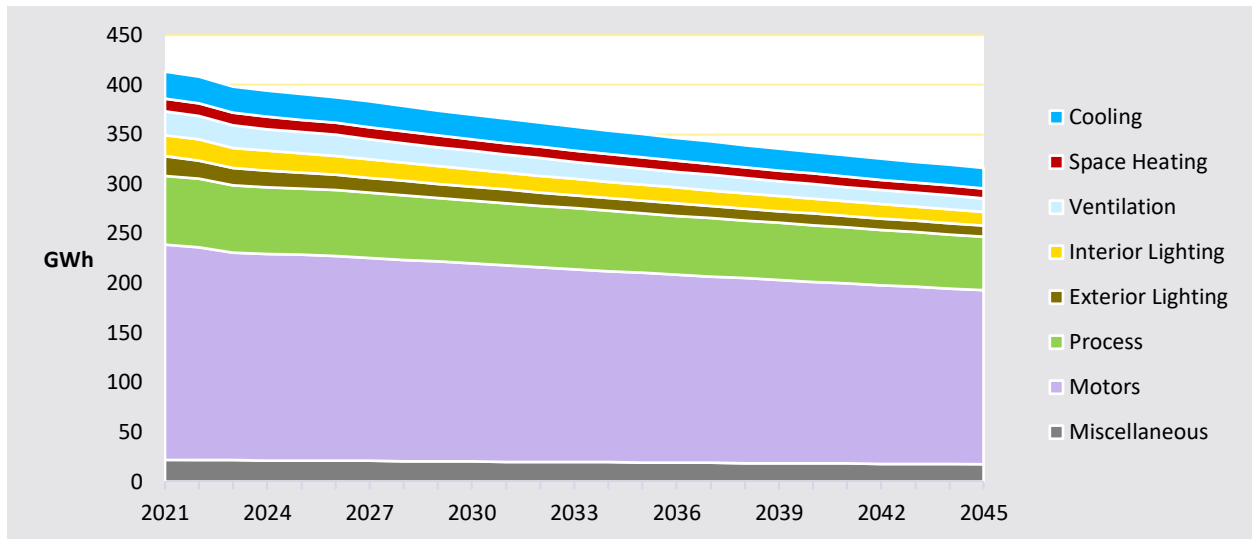
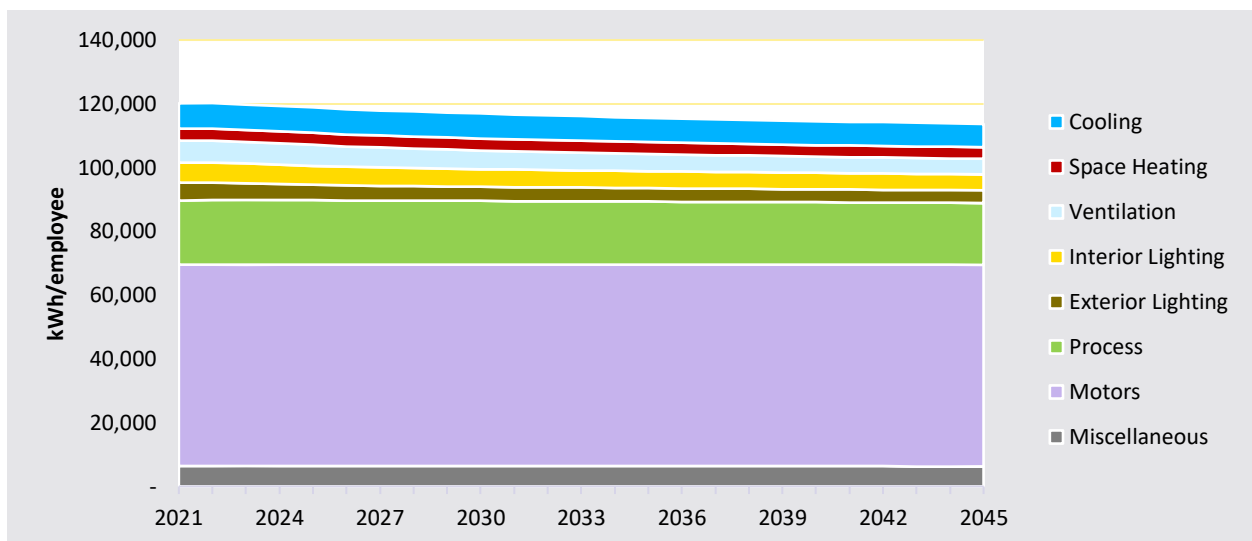

Figure 4-12 Industrial Baseline Sales Projection by End Use – Annual Use per Employee, Idaho



### Summary of Baseline Projections Across Sectors and States

Table 4-7 and Figure 4-13 provide a summary of the baseline projection for annual use by sector for the entire Avista electric service territory. Overall, the projection shows steady growth in electricity use, driven primarily by customer growth forecasts.

Table 4-7 Baseline Projection Summary (GWh), Washington and Idaho Combined

End Use	2021	2023	2024	2025	2035	2045	% Change ('21-'45)
Residential	4,015	4,035	4,027	4,016	4,159	4,791	19%
Commercial	3,023	3,010	3,010	3,003	3,031	3,181	5%
Industrial	958	964	959	952	894	850	-11%
<b>Total</b>	<b>7,996</b>	<b>8,009</b>	<b>7,996</b>	<b>7,971</b>	<b>8,084</b>	<b>8,821</b>	<b>10%</b>

Figure 4-13 Baseline Projection Summary (GWh), Washington and Idaho Combined

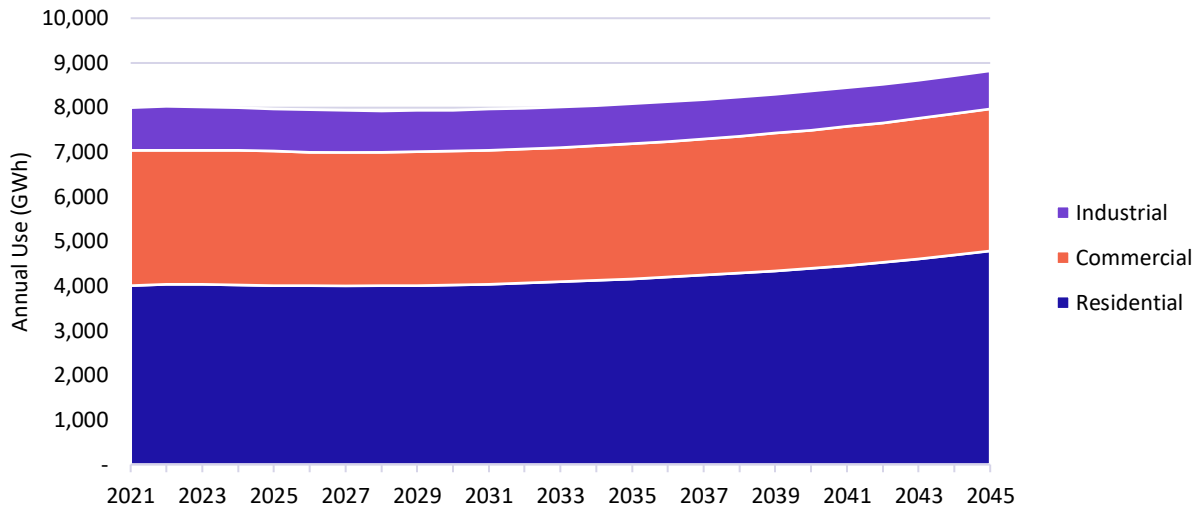

## 5 | CONSERVATION POTENTIAL

This chapter presents conservation potential results, beginning with a summary of annual energy savings across all three sectors, followed by detailed savings for each sector. Potential is presented for annual energy savings (GWh and aMW) as well as the winter peak demand savings (MW) for selected years. Note that all savings are presented at the customer meter (i.e., excluding line losses).

### Overall Summary of Energy Efficiency Potential

#### Summary of Annual Energy Savings

Table 5-1 and Table 5-2 summarize the energy efficiency potential for each state relative to the baseline projection. Potential as a percent of the baseline projection in each state is shown graphically in Figure 5-1 and Figure 5-2.

- Technical Potential** reflects the adoption of all conservation measures regardless of cost-effectiveness. For Washington, first-year savings are 100 GWh or 1.9% of the baseline projection. Cumulative savings in 2045 are 1,749 GWh or 30.2% of the baseline. For Idaho, first-year savings are 46 GWh or 1.7% of the baseline projection. Cumulative savings in 2045 are 887 GWh or 29.3% of the baseline.
- Achievable Technical Potential** modifies Technical Potential by accounting for assumed customer adoption. In Washington, first-year savings potential is 59 GWh or 1.1% of the baseline. In 2045, cumulative achievable technical savings reach 1,346 GWh or 23.2% of the baseline projection. Achievable Technical Potential is approximately 77% of Technical Potential in Washington throughout the forecast horizon. For Idaho, first-year savings are 26 GWh or 1.0% of the baseline, and by 2045, cumulative achievable technical savings will reach 678 GWh, or 22.4% of the baseline. In Idaho, Achievable Technical Potential reflects 76% of Technical Potential throughout the forecast horizon.

Table 5-1 Summary of Energy Efficiency Potential, Washington

	2023	2024	2025	2035	2045
<b>Baseline Projection (GWh)</b>	5,309	5,301	5,283	5,338	5,800
<b>Cumulative Savings (GWh)</b>					
Achievable Technical Potential	59	127	202	1,020	1,346
Technical Potential	100	212	331	1,399	1,749
<b>Cumulative Savings (aMW)</b>					
Achievable Technical Potential	7	14	23	116	154
Technical Potential	11	24	38	160	200
<b>Cumulative Savings as a % of Baseline</b>					
Achievable Technical Potential	1.1%	2.4%	3.8%	19.1%	23.2%
Technical Potential	1.9%	4.0%	6.3%	26.2%	30.2%



Table 5-2 Summary of Energy Efficiency Potential, Idaho

	2023	2024	2025	2035	2045
<b>Baseline Projection (GWh)</b>	2,700	2,695	2,688	2,747	3,021
<b>Cumulative Savings (GWh)</b>					
Achievable Technical Potential	26	57	91	490	678
Technical Potential	46	98	154	681	887
<b>Cumulative Savings (aMW)</b>					
Achievable Technical Potential	3	6	10	56	77
Technical Potential	5	11	18	78	101
<b>Cumulative Savings as a % of Baseline</b>					
Achievable Technical Potential	1.0%	2.1%	3.4%	17.8%	22.4%
Technical Potential	1.7%	3.6%	5.7%	24.8%	29.3%

Figure 5-1 Cumulative Energy Efficiency Potential as % of Baseline Projection, Washington

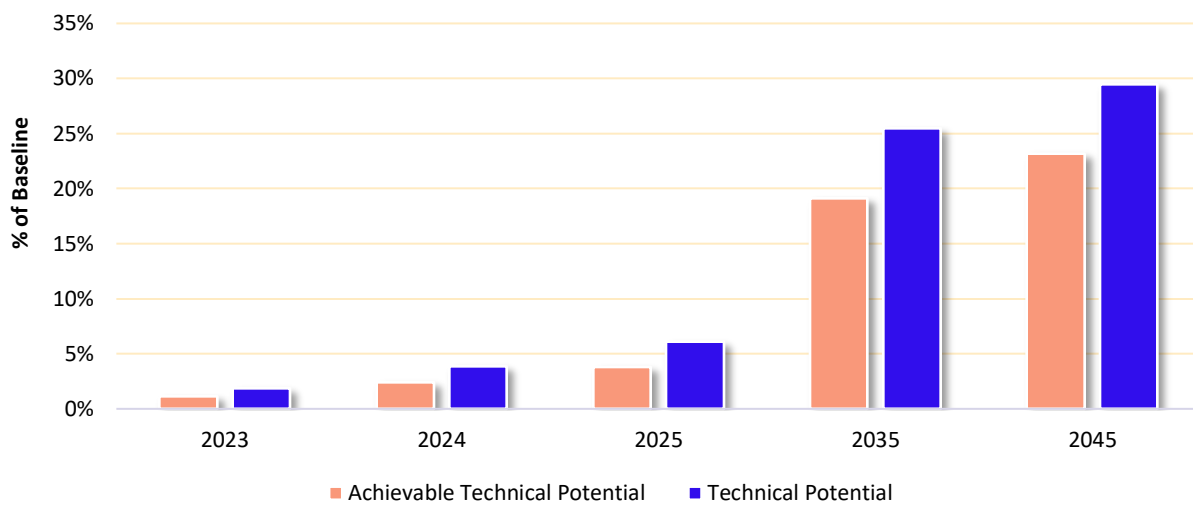
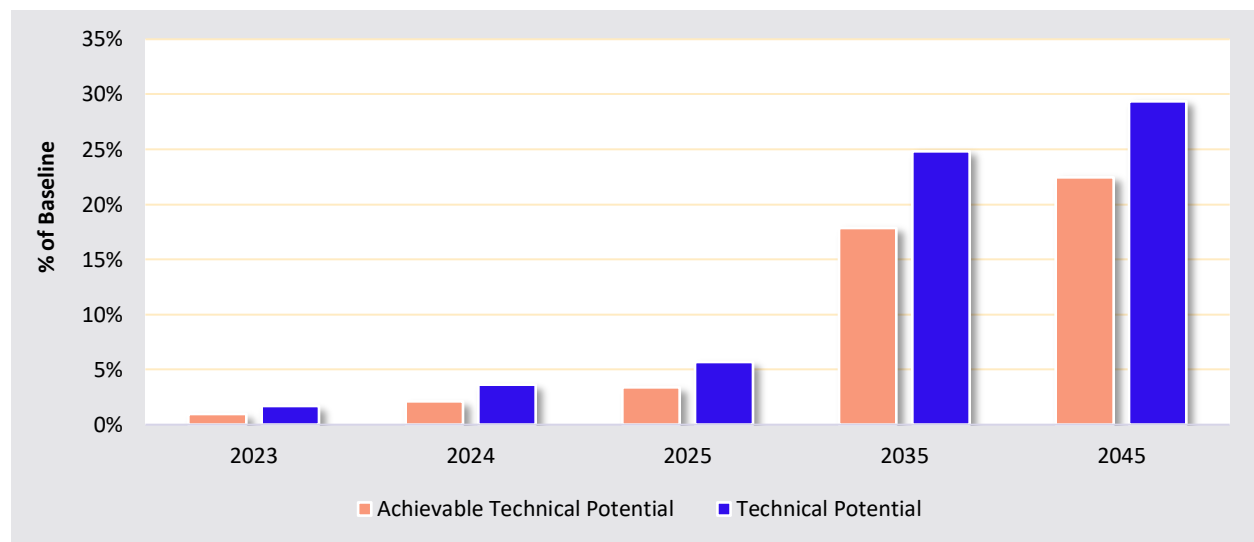

Figure 5-2 Cumulative Energy Efficiency Potential as % of Baseline Projection, Idaho



## Summary of Conservation Potential by Sector

Table 5-3 and Figure 5-3 summarize the Achievable Technical Potential by sector for both states combined. As shown, the commercial sector represents the largest share of Achievable Technical Potential in the early years, with the residential sector representing larger potential over the longer term.

Table 5-3 Achievable Technical Conservation Potential by Sector, Washington and Idaho Combined

	2023	2024	2025	2035	2045
<b>Cumulative Savings (GWh)</b>					
Residential	31	67	109	722	1,046
Commercial	47	99	156	667	836
Industrial	8	18	28	121	141
<b>Total</b>	<b>86</b>	<b>183</b>	<b>293</b>	<b>1,510</b>	<b>2,023</b>
<b>Cumulative Savings (aMW)</b>					
Residential	3	8	12	82	119
Commercial	5	11	18	76	95
Industrial	1	2	3	14	16
<b>Total</b>	<b>10</b>	<b>21</b>	<b>33</b>	<b>172</b>	<b>231</b>

Figure 5-3 Achievable Technical Conservation Potential by Sector, Washington and Idaho Combined

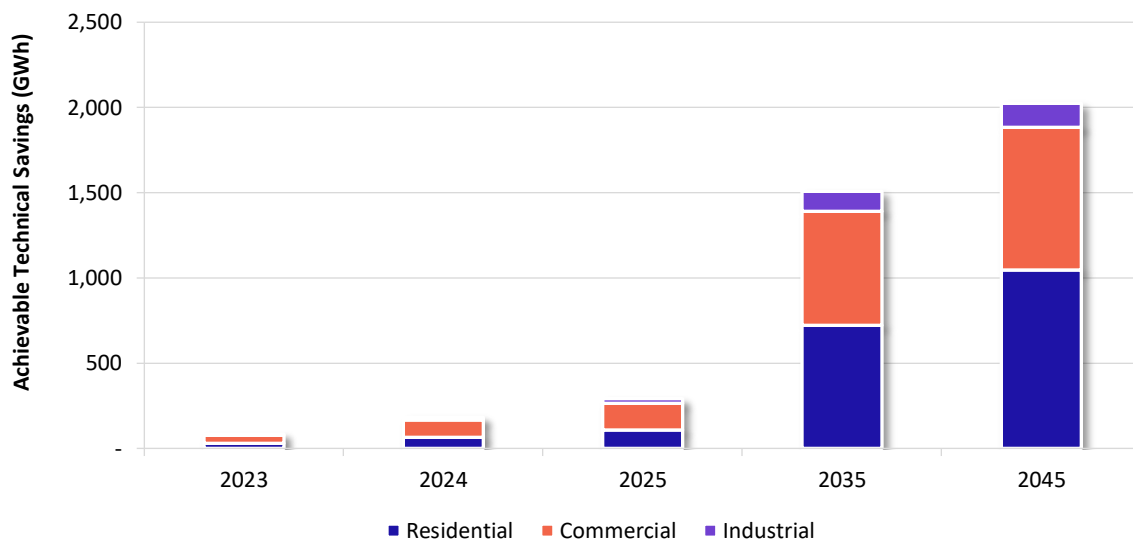

## Residential Conservation Potential

Table 5-4 and Table 5-5 present state-specific estimates of conservation potential for the residential sector in terms of annual energy savings. In Washington, residential Achievable Technical Potential in 2023 is 23 GWh or 0.9% of the baseline projection. By 2045, cumulative Achievable Technical Potential reaches 700 GWh or 22.8% of the baseline projection. In Idaho, 2023 Achievable Technical Potential is 7 GWh or 0.6% of the baseline, and by 2045 cumulative Achievable Technical potential reaches 40 GWh or 20.1% of the baseline.

## 2022-2045 Avista Electric CPA | Conservation Potential

Figure 5-4 and Figure 5-5 show potential as a percent of the baseline projection in each state.

Table 5-4 Residential Conservation Potential, Washington

	2023	2024	2025	2035	2045
<b>Baseline Projection (GWh)</b>	2,694	2,685	2,674	2,714	3,069
<b>Cumulative Savings (GWh)</b>					
Achievable Technical Potential	23	50	82	505	700
Technical Potential	45	97	155	764	979
<b>Cumulative Savings (aMW)</b>					
Achievable Technical Potential	3	6	9	58	80
Technical Potential	5	11	18	87	112
<b>Cumulative Savings as a % of Baseline</b>					
Achievable Technical Potential	0.9%	1.9%	3.1%	18.6%	22.8%
Technical Potential	1.7%	3.6%	5.8%	28.2%	31.9%

Table 5-5 Residential Conservation Potential, Idaho

	2023	2024	2025	2035	2045
<b>Baseline Projection (GWh)</b>	1,341	1,342	1,342	1,445	1,721
<b>Cumulative Savings (GWh)</b>					
Achievable Technical Potential	7	16	27	218	346
Technical Potential	18	38	61	344	486
<b>Cumulative Savings (aMW)</b>					
Achievable Technical Potential	1	2	3	25	40
Technical Potential	2	4	7	39	55
<b>Cumulative Savings as a % of Baseline</b>					
Achievable Technical Potential	0.6%	1.2%	2.0%	15.1%	20.1%
Technical Potential	1.3%	2.8%	4.5%	23.8%	28.2%

Figure 5-4 Residential Cumulative Conservation Potential as a % of the Baseline Projection, Washington

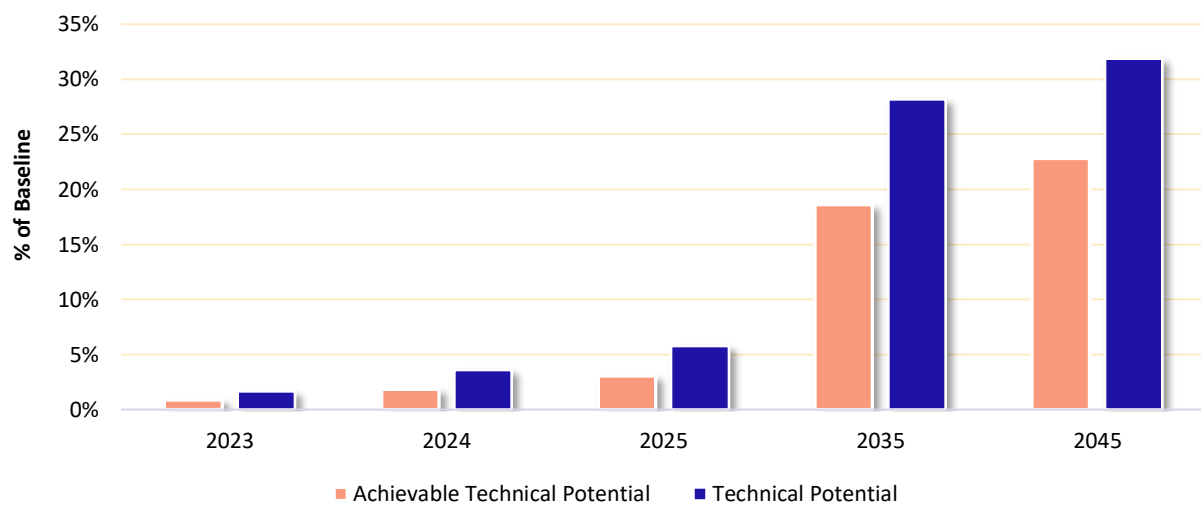

Figure 5-5 Residential Cumulative Conservation Potential as a % of the Baseline Projection, Idaho

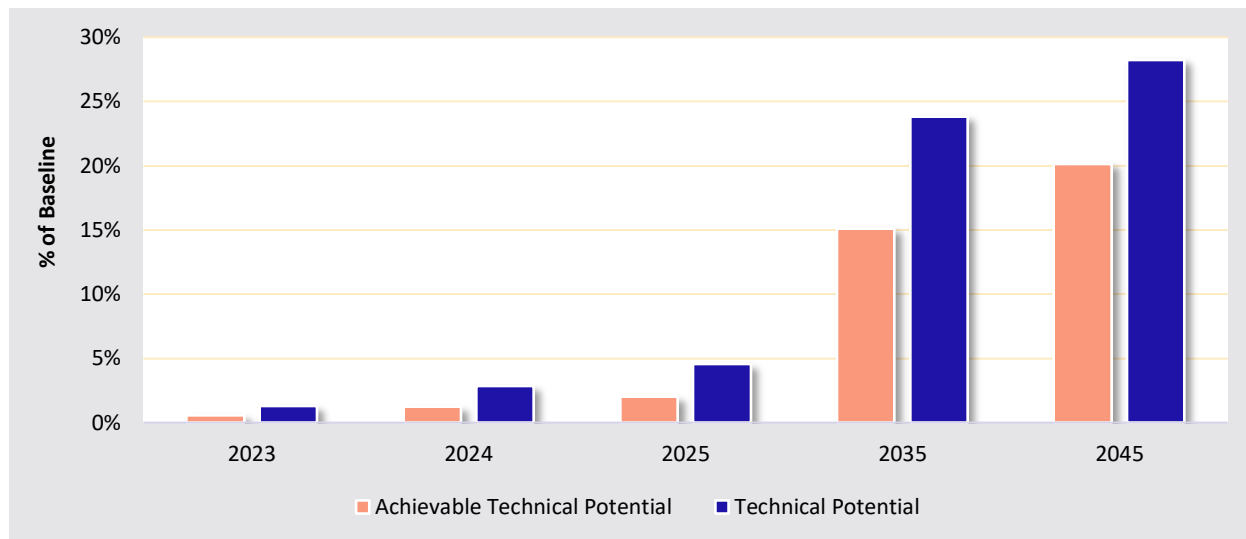

Figure 5-6Error! Reference source not found. presents the cumulative residential Achievable Technical Potential by end use in Washington. Space heating and water heating account for a substantial portion of the savings throughout the forecast horizon. Weatherization, ductless heat pumps, and heat pump water heaters account for a large portion of potential over the 20-year study period. LED lighting, while still present, is reduced in comparison to prior studies, as RTF market baseline assumptions and the Washington state lighting standard have moved a substantial amount of potential from those technologies into the baseline projection.

Figure 5-6 Residential Cumulative Achievable Technical Potential by End Use, Washington

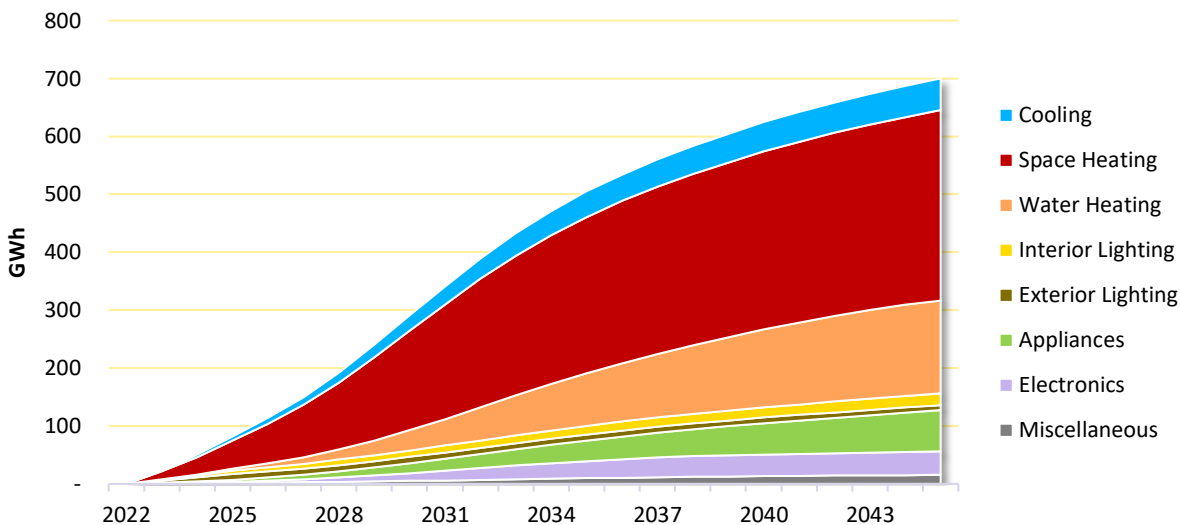

Table 5-6 identifies the top 20 residential measures from the perspective of cumulative Achievable Technical Potential for Washington in 2024, the second year of the planning horizon. The top three measures include ENERGY STAR- Connected Thermostat, Windows – Low-e Storm Addition, and Exterior Lighting – Photovoltaic Installation. Note that achievable technical savings do not screen for cost-effectiveness, and some measures are expected to be screened out during the IRP process.

Table 5-6 Residential Top Measures in 2024, Washington

Rank	Residential Measure	2024 Cumulative Energy Savings (MWh)	% of Total
1	Connected Thermostat - ENERGY STAR (1.0)	8,611	17%
2	Windows - Low-e Storm Addition	5,390	11%
3	Exterior Lighting - Photovoltaic Installation	5,250	10%
4	HVAC - Maintenance and Tune-Up	4,798	10%
5	Home Energy Management System (HEMS)	4,079	8%
6	General Service Lighting	1,586	3%
7	Windows - High Efficiency (Class 22)	1,422	3%
8	Windows - High Efficiency (Class 30)	1,253	2%
9	Insulation - Floor Installation	1,177	2%
10	Water Heater (<= 55 Gal)	1,026	2%
11	Insulation - Ceiling Upgrade	1,006	2%
12	Insulation - Wall Cavity Upgrade	973	2%
13	Insulation - Ceiling Installation	958	2%
14	Building Shell - Air Sealing (Infiltration Control)	955	2%
15	Insulation - Floor Upgrade	913	2%
16	Building Shell - Whole-Home Aerosol Sealing	865	2%
17	Interior Lighting - ENERGY STAR Skylights	847	2%
18	Supplement Central System with Ductless Mini Split Heat Pump	839	2%
19	Exterior Lighting - Timeclock Installation	635	1%
20	Interior Lighting - Occupancy Sensors	574	1%
<b>Total of Top 20 Measures</b>		<b>43,157</b>	<b>86%</b>
<b>Total Cumulative Savings</b>		<b>50,176</b>	<b>100%</b>

Figure 5-7Error! Reference source not found. presents the cumulative residential Achievable Technical Potential by end use in Idaho. Results are similar to Washington, where the majority of the savings come from space heating and water heating measures.

Figure 5-7 Residential Cumulative Achievable Technical Potential by End Use, Idaho

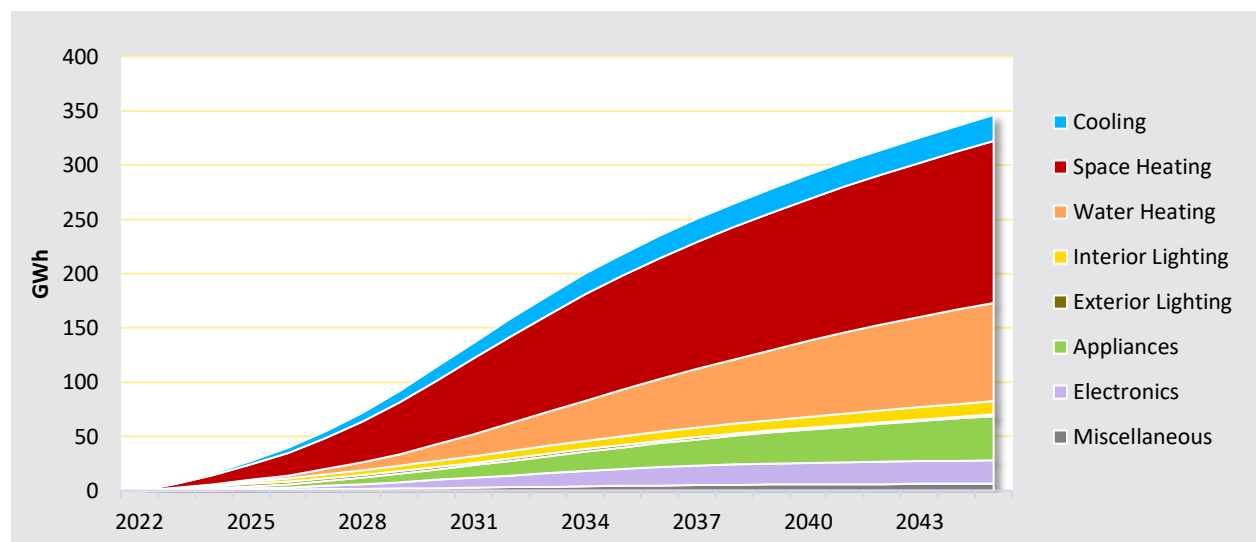

Table 5-7 shows the top residential measures for Idaho in 2024. The top three measures include ENERGY STAR-Connected Thermostat, Windows – Low-e Storm Addition and Home Energy Management Systems. Note that Achievable Technical Potential is not screened for cost-effectiveness, and some measures are expected to be screened out during the IRP process.

Table 5-7 Residential Top Measures in 2024, Idaho

Rank	Residential Measure	2024 Cumulative Energy Savings (MWh)	% of Total
1	Windows - Low-e Storm Addition	1,797	11%
2	Home Energy Management System (HEMS)	1,459	9%
3	Connected Thermostat - ENERGY STAR (1.0)	1,340	8%
4	Exterior Lighting - Photovoltaic Installation	1,253	8%
5	Insulation - Floor Installation	1,079	7%
6	HVAC - Maintenance and Tune-Up	936	6%
7	Insulation - Ceiling Installation	649	4%
8	Insulation - Wall Cavity Upgrade	574	4%
9	Water Heater (<= 55 Gal)	454	3%
10	Interior Lighting - ENERGY STAR Skylights	441	3%
11	Supplement Central System with Ductless Mini Split Heat Pump	428	3%
12	Building Shell - Whole-Home Aerosol Sealing	424	3%
13	Windows - High Efficiency (Class 22)	354	2%
14	Building Shell - Air Sealing (Infiltration Control)	327	2%
15	Windows - High Efficiency (Class 30)	295	2%
16	Insulation - Ceiling Upgrade	290	2%
17	Insulation - Wall Sheathing	288	2%
18	Interior Lighting - Occupancy Sensors	288	2%
19	Refrigerator - Decommissioning and Recycling	284	2%
20	Insulation - Floor Upgrade	248	2%
<b>Total of Top 20 Measures</b>		<b>13,210</b>	<b>81%</b>
<b>Total Cumulative Savings</b>		<b>16,366</b>	<b>100%</b>

## Commercial Conservation Potential

Table 5-8 and Table 5-9 present state-specific estimates of conservation potential for the commercial sector. For Washington, Achievable Technical Potential is 31 GWh in 2023 or 1.5% of the baseline projection. By 2045, achievable technical savings are 560 GWh or 25.5% of the baseline projection. For Idaho, first-year Achievable Technical Potential is 16 GWh or 1.6% of the baseline, and by 2045, cumulative Achievable Technical Potential reaches 276 GWh or 28.0% of the baseline.

Table 5-8 Commercial Conservation Potential, Washington

	2023	2024	2025	2035	2045
<b>Baseline Projection (GWh)</b>	2,049	2,051	2,048	2,079	2,197
<b>Cumulative Savings (GWh)</b>					
Achievable Technical Potential	31	66	104	444	560
Technical Potential	48	100	155	546	666
<b>Cumulative Savings (aMW)</b>					
Achievable Technical Potential	4	8	12	51	64
Technical Potential	6	11	18	62	76
<b>Cumulative Savings as a % of Baseline</b>					
Achievable Technical Potential	1.5%	3.2%	5.1%	21.3%	25.5%
Technical Potential	2.4%	4.9%	7.6%	26.3%	30.3%

Table 5-9 Commercial Conservation Potential, Idaho

	2023	2024	2025	2035	2045
<b>Baseline Projection (GWh)</b>	960	958	955	951	984
<b>Cumulative Savings (GWh)</b>					
Achievable Technical Potential	16	33	52	223	276
Technical Potential	24	50	77	274	327
<b>Cumulative Savings (aMW)</b>					
Achievable Technical Potential	2	4	6	25	31
Technical Potential	3	6	9	31	37
<b>Cumulative Savings as a % of Baseline</b>					
Achievable Technical Potential	1.6%	3.4%	5.4%	23.5%	28.0%
Technical Potential	2.5%	5.2%	8.1%	28.8%	33.2%

Figure 5-8 Commercial Cumulative Conservation Potential, Washington

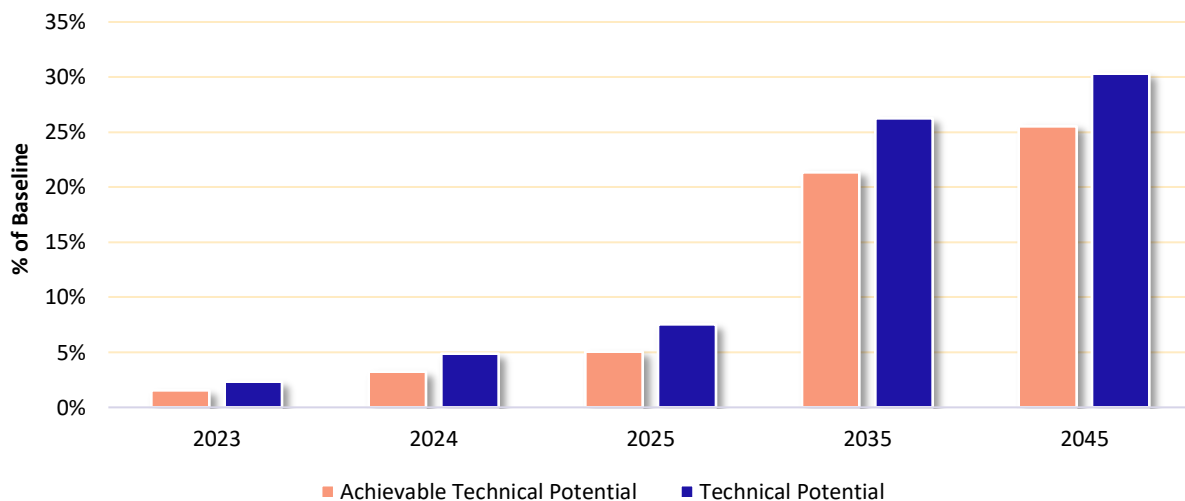

Figure 5-9 Commercial Cumulative Conservation Potential, Idaho

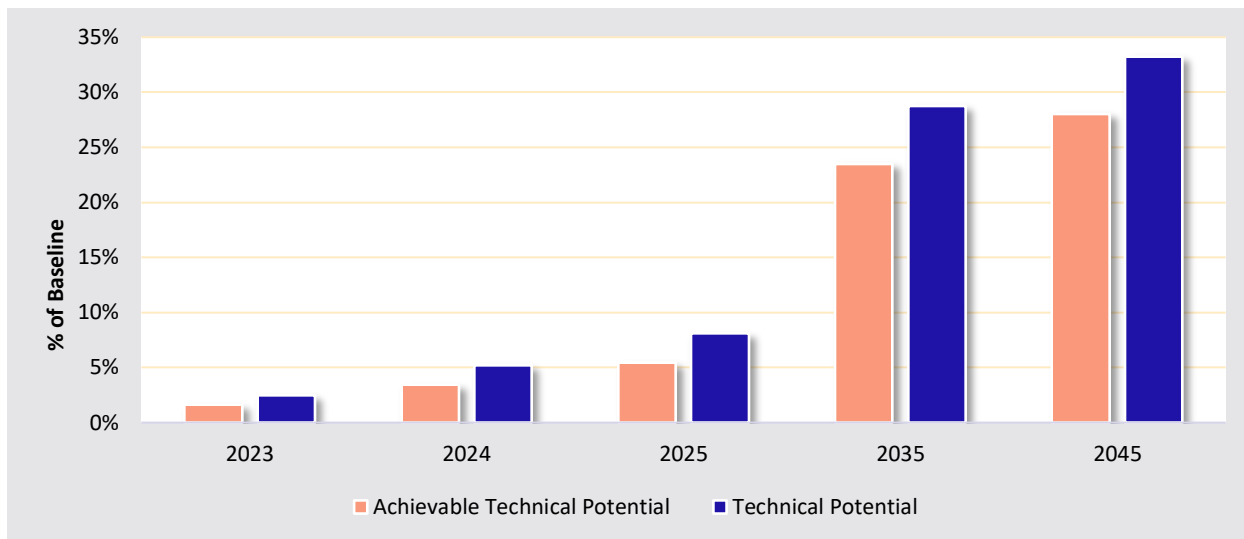

Figure 5-10 presents a forecast of cumulative commercial energy savings by end use in Washington. HVAC end uses (cooling, space heating and ventilation) paired with interior lighting account for a substantial portion of the savings throughout the forecast horizon.

Figure 5-10 Commercial Cumulative Achievable Technical Potential by End Use, Washington

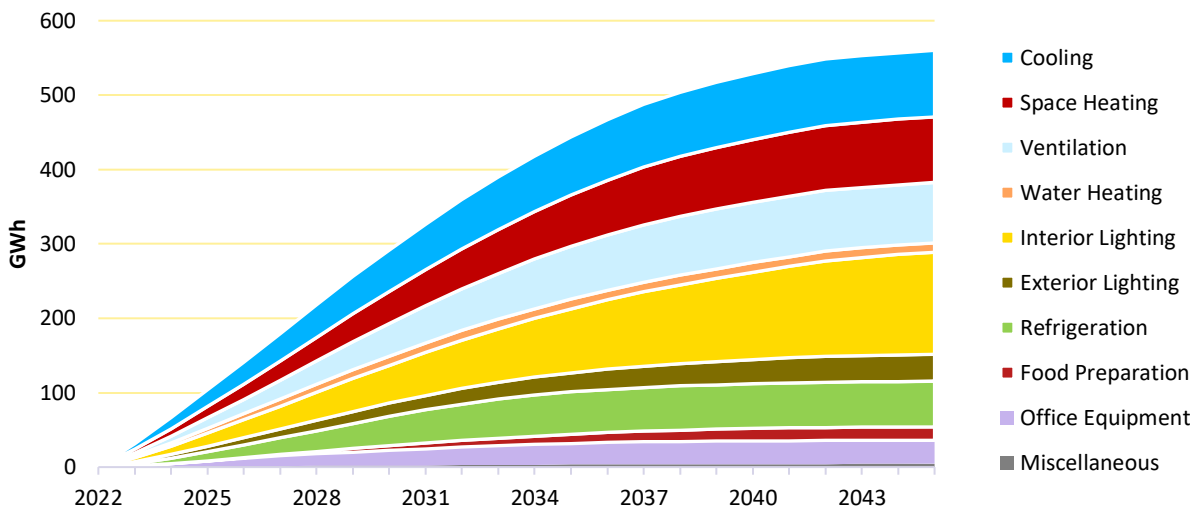

Table 5-10 identifies the top 20 commercial sector measures from the perspective of annual energy savings in 2024 in Washington. Linear lighting is included in the top 3 measures. Although the market has seen significant penetration of LEDs in some applications, newer systems – particularly those with built-in occupancy sensors or other controls – still represent significant savings opportunities. Whole building measures such as Retrocommissioning and Strategic Energy Management contribute a significant portion to the potential.



Table 5-10 Commercial Top Measures in 2024, Washington

Rank	Commercial Measure	2024 Cumulative Energy Savings (MWh)	% of Total
1	Ductless Mini Split Heat Pump	13,661	21%
2	Linear Lighting	8,342	13%
3	Retrocommissioning	5,042	8%
4	Strategic Energy Management	3,951	6%
5	HVAC - Dedicated Outdoor Air System (DOAS)	2,727	4%
6	Ventilation - Demand Controlled	2,572	4%
7	Chiller - Chilled Water Reset	1,857	3%
8	Water Heater - Pipe Insulation	1,589	2%
9	Exterior Lighting - Photovoltaic Installation	1,540	2%
10	Desktop Computer	1,441	2%
11	High-Bay Lighting	1,363	2%
12	Refrigeration - High Efficiency Compressor	1,288	2%
13	Ventilation - Permanent Magnet Synchronous Fan Motor	1,191	2%
14	Chiller - Thermal Energy Storage	1,110	2%
15	Water Heater - Motion Control Faucet	1,044	2%
16	Advanced Kitchen Ventilation Controls	995	2%
17	Water Heater - Solar System	934	1%
18	Ventilation - Fan Drive Improvements	923	1%
19	General Service Lighting	851	1%
20	Chiller - Variable Speed Fans	791	1%
<b>Total of Top 20 Measures</b>		<b>53,214</b>	<b>80%</b>
<b>Total Cumulative Savings</b>		<b>66,201</b>	<b>100%</b>

Figure 5-11 presents a forecast of cumulative commercial energy savings by end use in Idaho. Similar to Washington, HVAC end uses (cooling, space heating, and ventilation) paired with interior lighting account for a substantial portion of the savings throughout the forecast horizon.

Figure 5-11 Commercial Cumulative Achievable Technical Potential by End Use, Idaho

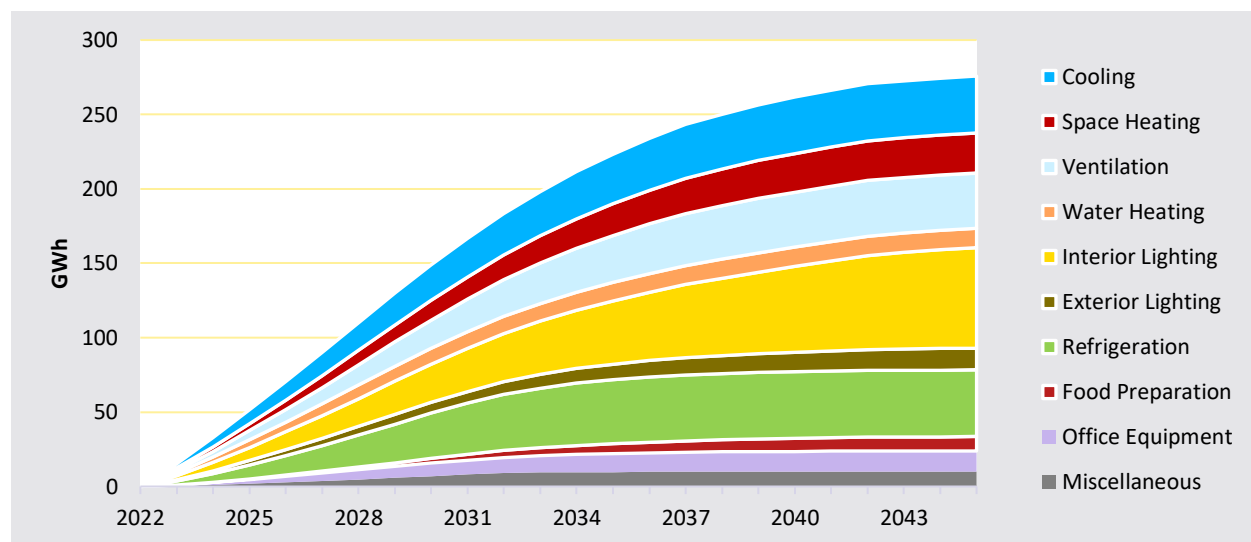

Table 5-11 identifies the top 20 commercial-sector measures from the perspective of annual energy savings in 2024 in Idaho. Ductless mini split heat pump is the number one measure in Idaho. In both states, linear lighting is included in the top 3 measures. Whole building measures such as Retrocommissioning and Strategic Energy Management contribute a significant portion to the potential.

Table 5-11 Commercial Top Measures in 2024, Idaho

Rank	Commercial Measure	2024 Cumulative Energy Savings (MWh)	% of Total
1	Ductless Mini Split Heat Pump	5,176	16%
2	Linear Lighting	4,124	13%
3	Retrocommissioning	2,445	7%
4	Strategic Energy Management	1,866	6%
5	HVAC - Dedicated Outdoor Air System (DOAS)	1,115	3%
6	Ventilation - Demand Controlled	1,011	3%
7	Refrigeration - High Efficiency Compressor	951	3%
8	Water Heater – Drain water Heat Recovery	939	3%
9	Refrigeration - Floating Head Pressure	827	3%
10	Engine Block Heater Controls	818	2%
11	Chiller - Chilled Water Reset	782	2%
12	Water Heater - Pipe Insulation	722	2%
13	Exterior Lighting - Photovoltaic Installation	664	2%
14	High-Bay Lighting	641	2%
15	Ventilation - Permanent Magnet Synchronous Fan Motor	552	2%
16	Water Heater - Motion Control Faucet	532	2%
17	Chiller - Thermal Energy Storage	470	1%
18	Water Heater - Solar System	460	1%
19	Desktop Computer	448	1%
20	General Service Lighting	428	1%
<b>Total of Top 20 Measures</b>		<b>24,970</b>	<b>76%</b>
<b>Total Cumulative Savings</b>		<b>32,835</b>	<b>100%</b>

## Industrial Conservation Potential

Table 5-12 and Table 5-13 present state-specific estimates for the two levels of conservation potential for the industrial sector. For Washington, Achievable Technical Potential in the first year, 2023, is 5 GWh, or 0.9% of the baseline projection. In 2045, savings reach 85 GWh or 16.0% of the baseline projection. For Idaho, Achievable Technical Potential in the first year, 2023, is 4 GWh or 0.9% of the baseline projection. In 2045, savings reach 56 GWh or 17.7% of the baseline projection.

## 2022-2045 Avista Electric CPA | Conservation Potential

Table 5-12 Industrial Conservation Potential, Washington

	2023	2024	2025	2035	2045
<b>Baseline projection (GWh)</b>	565	565	561	544	534
<b>Cumulative Savings (GWh)</b>					
Achievable Technical Potential	5	10	16	72	85
Technical Potential	7	14	21	88	104
<b>Cumulative Savings (aMW)</b>					
Achievable Technical Potential	1	1	2	8	10
Technical Potential	1	2	2	10	12
<b>Cumulative Savings as a % of Baseline</b>					
Achievable Technical Potential	0.9%	1.8%	2.9%	13.2%	16.0%
Technical Potential	1.2%	2.4%	3.8%	16.2%	19.5%

Table 5-13 Industrial Conservation Potential, Idaho

	2023	2024	2025	2035	2045
<b>Baseline Projection (GWh)</b>	398	394	391	350	316
<b>Cumulative Savings (GWh)</b>					
Achievable Technical Potential	4	7	12	49	56
Technical Potential	5	10	15	63	74
<b>Cumulative Savings (aMW)</b>					
Achievable Technical Potential	0	1	1	6	6
Technical Potential	1	1	2	7	8
<b>Cumulative Savings as a % of Baseline</b>					
Achievable Technical Potential	0.9%	1.9%	2.9%	13.9%	17.7%
Technical Potential	1.2%	2.5%	4.0%	18.0%	23.3%

Figure 5-12 Industrial Cumulative Conservation Potential as a % of the Baseline Projection, Washington

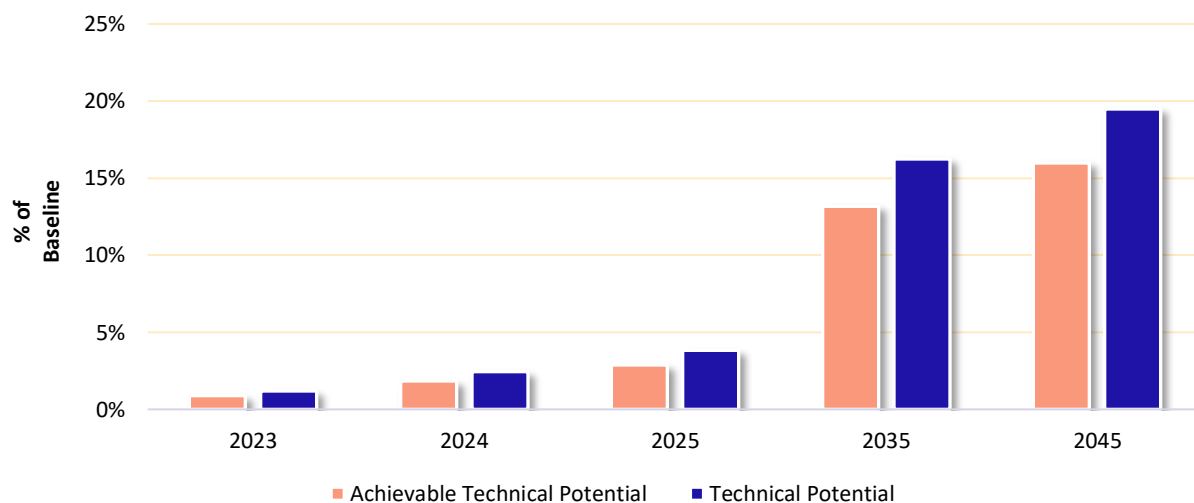

Figure 5-13 Industrial Cumulative Conservation Potential as a % of the Baseline Projection, Idaho

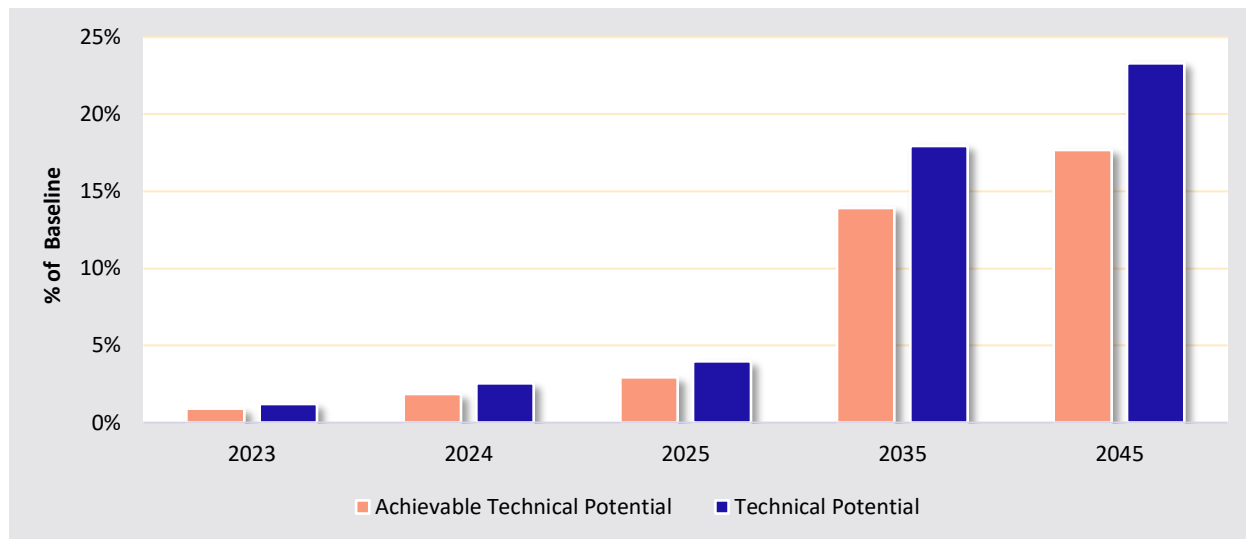

Figure 5-14 presents a forecast of cumulative industrial energy savings by end use in Washington. The motor and lighting end uses make up most of the savings potential in the study horizon.

Figure 5-14 Industrial Cumulative Achievable Technical Potential by End Use, Washington

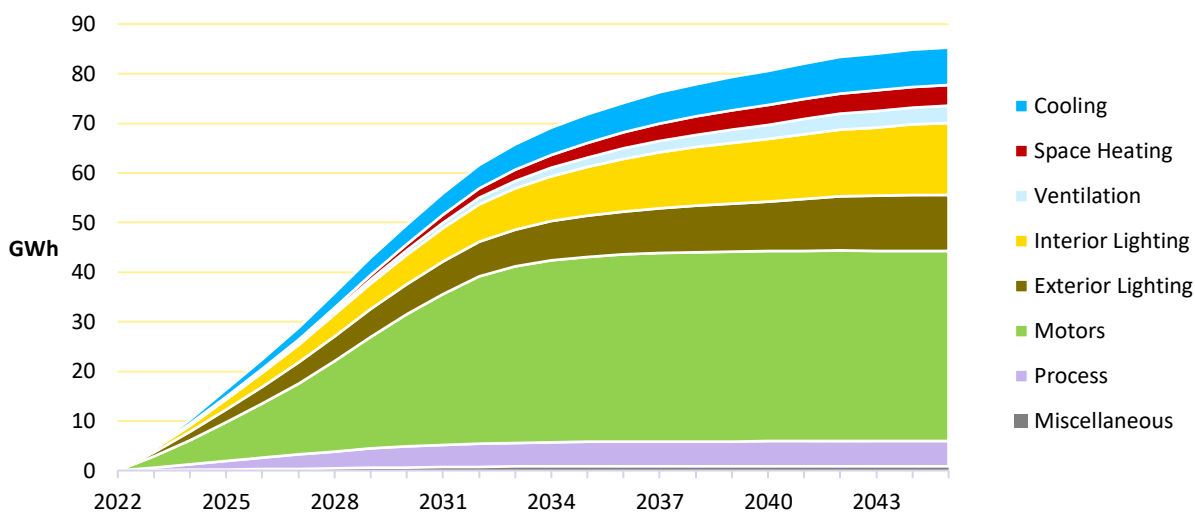

Table 5-14 identifies the top 20 industrial measures from the perspective of annual energy savings in 2024. In Washington, the top measure is linear lighting, which includes savings for network embedded controls. The measure with the second highest savings is pumping system – system optimization, which is the bi-product of the baseline consumption of pumping systems. Retrocommissioning, which targets multiple end uses, rounds out the top three.

Table 5-14 Industrial Top Measures in 2024, Washington

Rank	Measure	2024 Cumulative Energy Savings (MWh)	% of Total
1	Linear Lighting	981	10%
2	Pumping System - System Optimization	878	9%
3	Retrocommissioning	838	8%
4	Exterior Lighting - Photovoltaic Installation	616	6%
5	Strategic Energy Management	590	6%
6	Fan System - Flow Optimization	532	5%
7	High-Bay Lighting	530	5%
8	Fan System - Equipment Upgrade	523	5%
9	Pumping System - Variable Speed Drive	469	5%
10	Process - Tank Insulation	427	4%
11	Exterior Lighting - Retrofit - Enhanced Controls	370	4%
12	Pumping System - Equipment Upgrade	356	3%
13	Material Handling - Variable Speed Drive	300	3%
14	Compressed Air - End Use Optimization	257	2%
15	Destratification Fans (HVLS)	233	2%
16	Refrigeration - High Efficiency Compressor	229	2%
17	Chiller - Chilled Water Reset	205	2%
18	General Service Lighting	198	2%
19	Chiller - Variable Speed Fans	187	2%
20	Advanced Industrial Motors	184	2%
<b>Total of Top 20 Measures</b>		<b>8,901</b>	<b>86%</b>
<b>Total Cumulative Savings</b>		<b>10,317</b>	<b>100%</b>

Figure 5-15 presents a forecast of cumulative industrial energy savings by end use in Idaho. Similar to Washington, the motor and lighting end uses make up most of the savings' potential in the study horizon.

Figure 5-15 Industrial Cumulative Achievable Technical Potential by End Use, Idaho

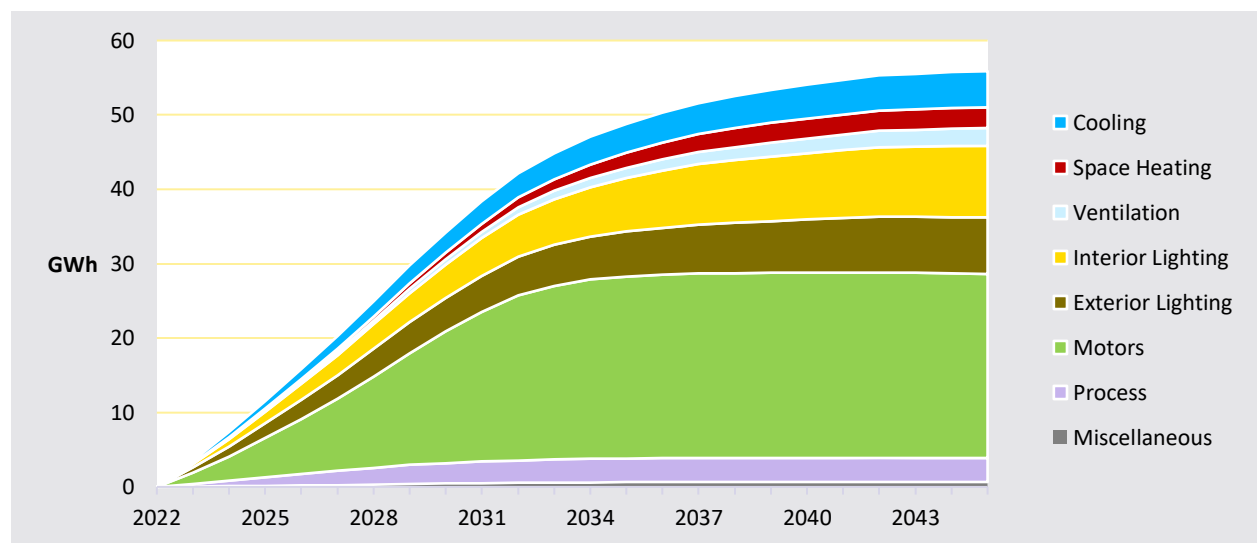

Table 5-15 identifies the top 20 industrial measures from the perspective of annual energy savings in 2024 in Idaho. Similar to Washington, the top three measures are linear lighting, pumping system – system optimization and Retrocommissioning.

Table 5-15 Industrial Top Measures in 2024, Idaho

Rank	Measure	2024 Cumulative Energy Savings (MWh)	% of Total
1	Linear Lighting	775	11%
2	Retrocommissioning	629	9%
3	Pumping System - System Optimization	541	7%
4	Exterior Lighting - Photovoltaic Installation	447	6%
5	High-Bay Lighting	424	6%
6	Strategic Energy Management	414	6%
7	Fan System - Flow Optimization	391	5%
8	Fan System - Equipment Upgrade	384	5%
9	Pumping System - Variable Speed Drive	289	4%
10	Exterior Lighting - Retrofit - Enhanced Controls	276	4%
11	Process - Tank Insulation	238	3%
12	Material Handling - Variable Speed Drive	220	3%
13	Pumping System - Equipment Upgrade	219	3%
14	Destratification Fans (HVLS)	195	3%
15	Compressed Air - End Use Optimization	175	2%
16	Refrigeration - High Efficiency Compressor	169	2%
17	General Service Lighting	155	2%
18	Chiller - Chilled Water Reset	152	2%
19	Chiller - Variable Speed Fans	138	2%
20	Advanced Industrial Motors	125	2%
<b>Total of Top 20 Measures</b>		<b>6,358</b>	<b>87%</b>
<b>Total Cumulative Savings</b>		<b>7,346</b>	<b>100%</b>

## 6 | DEMAND RESPONSE POTENTIAL

AEG has been working with Avista to estimate demand response (DR) potential since 2014. During that first study, AEG and The Brattle Group assessed winter demand response potential for Avista's C&I sectors in Washington and Idaho. Since then, AEG has performed four additional DR potential assessments including the current study expanding the scope and making improvements along the way as additional DR programs are run around the country.<sup>5</sup> For the current study, along with updating program potential performed in the previous studies, AEG assessed a set of pilot programs based on Avista's planned demand response program roll-out beginning in 2024.

The current study provides demand response potential and cost estimates for the 23-year planning horizon (2023-2045) to inform the development of Avista's 2023 IRP. Through this assessment, AEG sought to develop reliable estimates of the magnitude, timing, and costs of DR resources likely available to Avista over the 23-year planning horizon. The analysis focuses on resources assumed achievable during the planning horizon, recognizing known market dynamics that may hinder resource acquisition. DR analysis results will also be incorporated into subsequent DR planning and program development efforts.

### Study Approach

Figure 6-1 outlines the analysis approach used to develop potential and cost estimates, with each step described in more detail in the subsections that follow.

Figure 6-1 Demand Response Analysis Approach

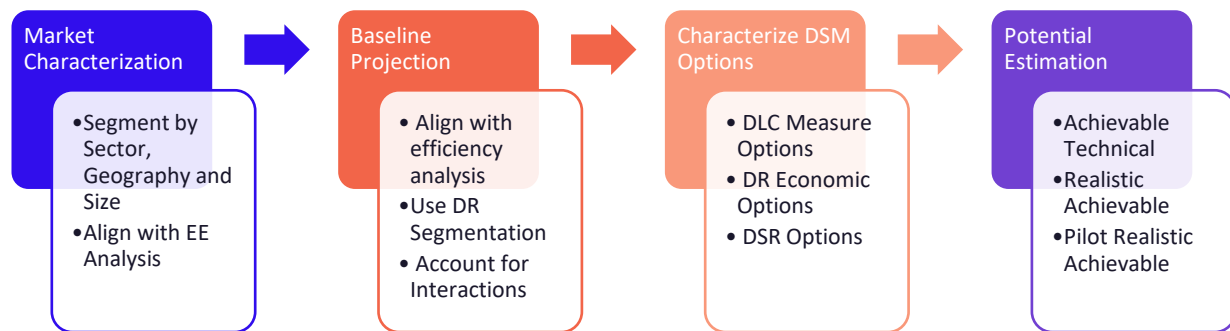

AEG estimated demand response potential across the following scenarios:

- **Achievable Technical Potential or Stand Alone.** In this scenario, program options are treated as if they are the only programs running in the Avista territory and are viewed in a vacuum. Potential demand savings cannot be added in this scenario since it does not account for program overlap.
- **Achievable Potential or Integrated.** In this scenario, the program options are treated as if the programs were run simultaneously. To account for participation overlap across programs that make use of the same end-use, a program hierarchy is employed. For programs that affect the same end use, the model selects the most likely program a customer would participate in, and eligible participants were chosen for that program first. The remaining pool of eligible participants will then be available to participate in the secondary program. This scenario allows for potential to be added up as it removes any double counting of savings.
- **Achievable Potential or Pilot Offerings.** In this scenario, AEG utilized the latest information from Avista regarding upcoming pilot offerings and expected program participation to forecast the first three years of each program. Avista plans to offer three new pilot programs beginning in 2024: Peak Time Rebate, Time-

<sup>5</sup> Since the 2014 study, AEG has expanded the study to include potential for the residential sector, summer, and an assessment of ancillary services for each program.

of-Use Opt-in, and Grid-Interactive Water Heaters. AEG forecasted the potential for these programs to 2045 as if the programs ramped up to fully-fledged programs after the pilots.

## Market Characterization

The first step in the DR analysis was to segment customers by service class and develop characteristics for each segment. The two relevant characteristics for DR potential analysis are end-use saturations of the controllable equipment types in each market segment and coincident peak demand in the base year. Market characteristics, including equipment saturation and base year peak consumption, are consistent with the energy efficiency analysis (see [Chapter 2](#) for more information on the market profiles).

As in previous studies, AEG used Avista’s rate schedules as the basis for customer segmentation by state and customer class. Table 6-1 summarizes the market segmentation developed for this study.

Table 6-1 Market Segmentation

Market Dimensions	Segmentation Variable	Description
1	State	Idaho Washington
2	Customer Class (by rate schedule)	Residential Service General Service: Rate Schedule 11 Large General Service: Rate Schedule 21 Extra Large General Service: Rate Schedule 25 <sup>6</sup>

AEG excluded Avista’s two largest industrial customers from the analysis because they are so large and unique that a segment-based modeling approach is not appropriate. To accurately estimate DR potential for these customers, we would need to develop a detailed understanding of their industrial processes and associated possibilities for load reduction. We would also need to develop specific DR potential estimates for each customer. Avista may wish to engage these large customers directly to gauge interest in participating in DR programs.

## Baseline Forecast

Once the customer segments were defined and characterized, AEG developed the baseline projection. Load and consumption characteristics, including customer count and coincident peak demand values, were provided by Avista load forecasts and aligned with the energy efficiency analysis.

## Customer Counts

Avista provided actual customer counts by rate schedule for Washington and Idaho over the 2018-2020 timeframe and forecasted customer counts over the 2021-2026 period. AEG used this data to calculate the growth rates by customer class across the final two forecasted years, and projected customer counts through 2045. The average annual customer growth rate for all sectors is 1.1% in Washington and 1.5% in Idaho.

Table 6-2 and Table 6-3 show the number of customers by state and customer class for selected years.

Table 6-2 Baseline Customer Forecast by Customer Class, Washington

Customer Class	2023	2024	2025	2035	2045
Residential	120,160	123,096	124,664	140,976	159,476
General Service	16,976	17,214	17,421	19,573	21,992
Large General Service	858	849	846	827	817
Extra Large General Service	120,160	123,096	124,664	140,976	159,476

<sup>6</sup> Excluding the two largest Schedule 25 and Schedule 25P customers.



Table 6-3 Baseline Customer Forecast by Customer Class, Idaho

Customer Class	2023	2024	2025	2035	2045
Residential	234,506	238,867	241,392	264,323	289,812
General Service	23,539	23,825	24,095	26,542	29,226
Large General Service	1,772	1,767	1,764	1,745	1,730
Extra Large General Service	22	21	21	21	21

### Summer and Winter Peak Load Forecasts by State

Summer and winter peak loads forecasts were developed by state, first by developing a growth rate utilizing forecasted electricity sales data provided from Avista for 2025 and 2026. The growth rate was applied to Avista's system winter and summer peaks for 2020 to develop a forecast by state and sector through 2045. Next, AEG developed the coincidence peak forecast for each segment utilizing load factors from Avista's 2010 load research study. The load factors were applied to 2020 actual electricity sales data to derive coincident peak demand estimates for the four customer classes. Finally, AEG used Avista's peak demand data to develop the individual state contribution to the estimated coincident peak values. These represent each state's projected demand at the time of the system peak for both summer and winter.<sup>7</sup>

Table 6-4 and Table 6-5 show the summer and winter system peak for selected future years.<sup>8</sup> The summer and winter system peaks are expected to increase by 33% and 24% respectively, between 2023-2045.

Table 6-4 Baseline July Summer System Peak Load (MW @Generation) by State

State	2023	2024	2025	2035	2045
Idaho	464	465	467	509	615
Washington	940	943	948	1,040	1,249
<b>Summer Total</b>	<b>1,404</b>	<b>1,408</b>	<b>1,415</b>	<b>1,548</b>	<b>1,864</b>

Table 6-5 Baseline February Winter System Peak Forecast (MW @Generation) by State

State	2023	2024	2025	2035	2045
Idaho	455	456	462	481	562
Washington	910	913	927	969	1,131
<b>Winter Total</b>	<b>1,365</b>	<b>1,369</b>	<b>1,389</b>	<b>1,450</b>	<b>1,693</b>

Figure 6-2 shows the state contribution to the estimated system coincident summer peak. In 2023, system peak load for the summer is 1,404 MW at the grid or generator level. Washington contributes 67% to the summer system peak, while Idaho contributes 33%. Summer coincident peak load is expected to grow by an average of 1.5% annually from 2022-2044.

<sup>7</sup> The month of July at hour ending 17 was used for the summer peak while February at hour ending 08 was used for the winter peak.

<sup>8</sup> As previously noted, these peaks exclude the demand for Avista's largest industrial customers.

Figure 6-2 Coincident Peak Load Forecast by State (Summer)

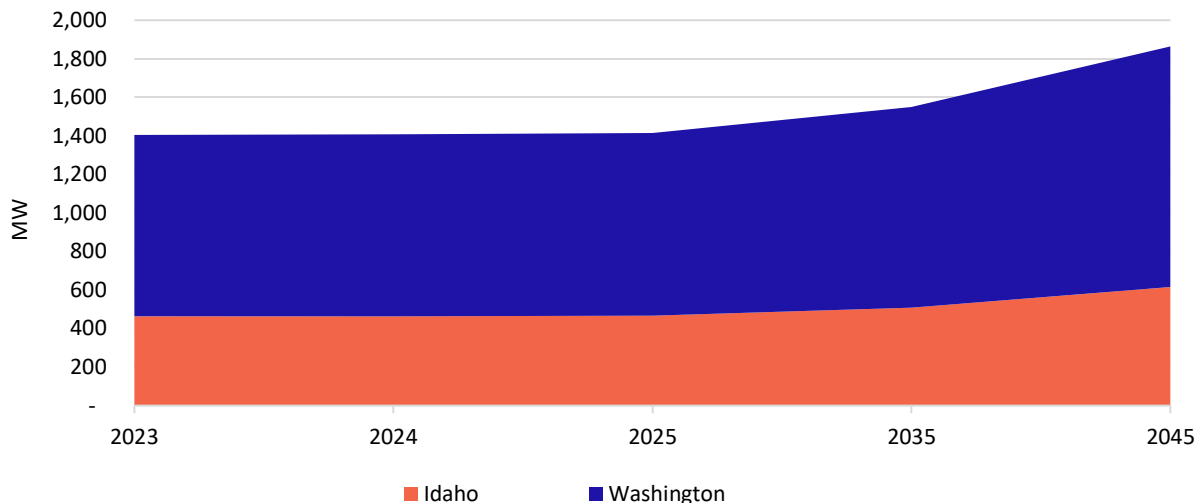
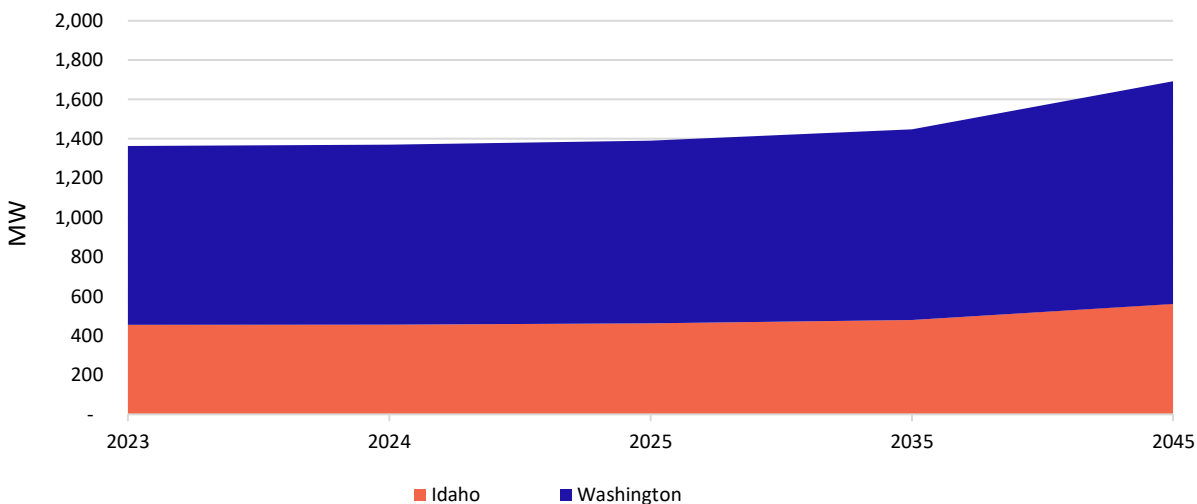

Figure 6-3 shows the state contribution to the estimated system coincident winter peak forecast. In 2023, system peak load for the winter is 1,365 MW at the grid or generator level. The winter system peak is about 3% lower than the summer peak. Like in summer, Washington contributes 67% to the winter system peak, while Idaho contributes 33%. Over the study period, winter coincident peak load is expected to grow by an average of 1.09% annually.

Figure 6-3 Coincident Peak Load Forecast by State (Winter)



### Characterize Demand Response Program Options

Next, AEG identified and described the viable DR programs for inclusion in the analysis and developed assumptions for key program parameters, including per customer impacts, participation rates, program eligibility, and program costs. AEG considered the characteristics and applicability of a comprehensive list of options available that could be feasibly run in Avista’s territory. Once a list of DR options was determined, AEG

characterized each option. Several options could also have an ancillary component depending on the end use and if they could be used as a fast DR tool.<sup>9</sup>

Each selected option is described briefly below.

## Program Descriptions

### *Direct Load Control of Central Air Conditioners*

The Direct Load Control (DLC) of Central Air Conditioners (Central AC) targets Avista's Residential and General Service customers with qualifying equipment in Washington and Idaho. This program directly controls Central AC load in summer through a load control switch placed on a customer's air conditioning unit. During events, the Central AC units are cycled on and off. Participation is expected to be shared with the Smart Thermostats DLC-Cooling program in the integrated scenario since the programs target the same end-use technology.

### *DLC Smart Thermostats - Heating/Cooling*

These programs use the two-way communicating ability of smart thermostats to cycle heating and cooling end uses on and off during events. The programs target Avista's Residential and General Service customers with qualifying equipment in Washington and Idaho. This program was assumed to be Bring Your Own Thermostat (BYOT); therefore, no equipment or installation costs were estimated. The cooling and heating programs are modeled separately because the impact assumptions are quite different; however, the heating program is assumed to piggyback off the cooling program.<sup>10</sup> Therefore, development and administrative costs were estimated only for the cooling program. In addition, the participation in the heating program was a subset of the cooling program participants based on typical heating program participation rates.

### *CTA-2045 Grid Interactive Water Heater*

The CTA-2045 Grid Interactive Water Heater program targets Avista's Residential and General Service customers in Washington. These water heaters contain a communicating module interface and can seamlessly fit into a DR program as these become more prevalent in the Avista territory. Idaho is not mandating this equipment yet; therefore, this program is only modeled for Washington. Water heaters would be completely turned off during the DR event period. Water heaters of all sizes are eligible for control. A \$150 cost to Avista is expected for each module with an additional provisioning cost of \$100 for each customer (since only 20% of customers will need help provisioning, a \$20 average provisioning cost is applied.) To provide additional granularity, AEG broke out the participation in this program across electric resistance and heat pump water heaters in the state of Washington, according to the latest saturation surveys used in the energy efficiency study. Results are presented separately in this study across the two end-use types. This program is planned to be offered as a pilot starting in 2024 and is included in the pilot section of this report.

### *DLC Water Heating*

Because the Grid Interactive Water Heater program is only available in Washington, the DLC Water Heater program targets Avista's Residential and General Service customers in Idaho. This program directly controls water heating load throughout the year for these customers through a load control switch. Water heaters would be completely turned off during the DR event period. The event period is assumed to be 50 hours during the summer months and another 50 hours during the winter months. Water heaters of all sizes are eligible for control. AEG assumes a \$160 cost to Avista for each switch, a \$200 installation fee, and a permit and license cost of \$100 for residential participants (\$125 for general service participants).

### *DLC Smart Appliances*

The DLC Smart Appliances program uses a wi-fi hub to connect smart wi-fi enabled appliances such as washers, dryers, refrigerators, and water heaters. During events throughout the year, the smart appliances are cycled on

<sup>9</sup> For those programs, ancillary services potential was also estimated and is presented in [Appendix D](#).

<sup>10</sup> Since the cooling program is bearing the brunt of the costs of the whole BYOT program, the leveled costs presented in the appendix reflect very small costs for the heating portion of the program and relatively large costs for the cooling portion

and off. The program targets Avista's Residential and General Service customers in Washington and Idaho. A low steady-state participation rate of 5% is assumed for this program.

### *Third Party Contracts*

Third Party Contracts are assumed to be available for General Service, Large General Service, and Extra Large General Service customers year-round. For the Large and Extra Large General Service customers, AEG assumes they will engage in firm curtailment. It is also assumed that participating customers will agree to reduce demand by a specific amount or curtail their consumption to a predefined level at the time of an event. In return, they receive a fixed incentive payment in the form of capacity credits or reservation payments (typically expressed as \$/kW-month or \$/kW-year). Customers are paid to be on call even though actual load curtailments may not occur. The amount of the capacity payment typically varies with the load commitment level. In addition to the fixed capacity payment, participants typically receive a payment for energy reduction during events. Because it is a firm, contractual arrangement for a specific level of load reduction, enrolled loads represent a firm resource and can be counted toward installed capacity requirements. Penalties may be assessed for under-performance or non-performance. Events may be called on a day-of or day-ahead basis as conditions warrant.

This option is typically delivered by load aggregators and is most attractive for customers with a maximum demand greater than 200 kW and flexibility in their operations. Industry experience indicates that aggregation of customers with smaller-sized loads is less attractive financially due to lower economies of scale. In addition, customers with 24x7 operations, continuous processes, or with obligations to continue providing service (such as schools and hospitals) are not often good candidates for this option.

For general service customers, AEG simulated a demand buyback program. In a demand buyback program, customers volunteer to reduce what they can on a day-ahead or day-of basis during a predefined event window. Customers then receive an energy payment based on their performance during the events.

### *DLC Electric Vehicle Charging*

DLC Electric Vehicles Smart Chargers can be switched off during on-peak hours throughout the year to offset demand to off-peak hours. Avista currently has an Electric Vehicle Supply Equipment (EVSE) program in place for residential, commercial electric vehicle fleets, and workplace charging locations. AEG used the most recent per-customer program impacts from the EVSE program results for the study, assuming that, on average, 75% of electric vehicle load could be curtailed. Avista requested that this program be viewed as a fully-fledged program starting in 2024 to reflect the technology rollout. An EVSE rebate will be incentivized at a cost of \$500<sup>11</sup> to Avista. An electric vehicle forecast was provided to AEG and provided the basis for estimating per-customer EV loads for this program, as well as the number of customers who could participate in an electric vehicle program.

### *Electric Vehicle Time-of-Use*

There is currently an Electric Vehicle Time-of-Use (TOU) program being run in Avista's territory. This program had limited marketing and is currently only being utilized by a few companies totaling five vehicles in the General Service and Large General Service customer classes. The forecasted potential for the electric vehicle TOU program estimated in this study opens up this program to the full fleet of electric vehicles across the General Service and Large General Service classes according to the 2022 electric vehicle forecast provided by Avista and is presented as a new program beginning in 2024.

### *Time-of-Use Pricing*

The TOU pricing rate is a standard rate structure where rates are lower during off-peak hours and higher during peak hours during the day, incentivizing participants to shift energy use to periods of lower grid stress. For the TOU rate, there are no events called, and the structure does not change during the year. Therefore, it is a good default rate for customers that still offers some load-shifting potential. We assume two scenarios for the TOU rate. An opt-in rate where participants will have to choose to go on the rate and an opt-out rate where participants will automatically be placed on the TOU rate and will need to request a rate change if required.

<sup>11</sup> Based on program values from Clark Public Utility, PSE Washington, and Tacoma Public Utility which all use \$500 for their EVSE rebate

This rate is assumed to be available to all service classes. The TOU Opt-in program is planned to be offered as a pilot offering starting in 2024 and is included in the pilot section of this report.

### *Variable Peak Pricing*

The Variable Peak Pricing (VPP) rate is composed of significantly higher prices during relatively short critical peak periods on event days to encourage customers to reduce their usage. VPP is usually offered in conjunction with a time-of-use rate, which implies at least three time periods: critical peak, on-peak and off-peak. The customer incentive is a more heavily discounted rate during off-peak hours throughout the year (relative to a standard TOU rate). Event days are dispatched on relatively short notice (day ahead or day of), typically for a limited number of days during the year. Over time, event-trigger criteria become well-established so that customers can expect events based on hot weather or other factors. Events can also be called during times of system contingencies or emergencies. In past studies, this rate has been assumed to be offered to all service classes; however, with the addition of Peak Time Rebate this year, VPP will only be considered for large and extra-large Service customers.

### *Peak Time Rebate*

The Peak Time Rebate (PTR) program offers participants an incentive for every kW saved during designated times of high energy demand. Events are called several times per season, and participants are given incentives in the form of \$/kWh saved during the event relative to their baseline usage across previous seasons. The assumptions for this program were based primarily on the results of Portland General Electric's PTR program and are offered to residential and general service customers, as not to overlap with the VPP program. In addition, PTR is planned to be offered as a pilot program starting in 2024 and is included in the pilot section of this report.

### *Ancillary Services*

Ancillary services refer to functions that help grid operators maintain a reliable electricity system. Ancillary services maintain the proper flow and direction of electricity, address imbalances between supply and demand, and help the system recover after a power system event. In systems with significant variable renewable energy penetration, additional ancillary services may be required to manage increased variability and uncertainty. In addition, Ancillary Services can provide fast DR response during grid emergencies. AEG assumes ancillary service DR capabilities are available across all sectors. Ancillary Service options can be offered to customers who are already on programs with ancillary capabilities for an additional incentive. For this study, ancillary programs were modeled for several parent programs: Smart Thermostats- Heating/Cooling, DLC Water Heating, CTA-2045 Water Heating, Electric Vehicle Charging, and Battery Energy Storage. Ancillary service results are presented in [Appendix D](#) for the Integrated Opt-in scenario.

### *Thermal Energy Storage*

Ice Energy Storage, a type of thermal energy storage, is an emerging technology that is being explored in many peak-shifting applications across the country. This technology involves cooling and freezing water in a storage container so that the energy can be used later for space cooling. More specifically, frozen water takes advantage of the large amount of latent energy associated with the phase change between ice and liquid water, which will absorb or release a large amount of thermal energy while maintaining a constant temperature at the freezing (or melting) point. An ice energy storage unit turns water into ice during off-peak times when price and demand for electricity are low, typically at night. During the day, at peak times, the stored ice is melted to meet all or some of the building's cooling requirements, allowing air conditioners to operate at reduced loads.

Ice energy storage is primarily being used in non-residential buildings and applications, as modeled in this analysis, but may see expansion in the future to encompass smaller, residential systems as well as emerging grid services for peak shaving and renewable integration. Since the ice energy storage is used for space cooling, AEG assumes this program would be available during the summer months only.

### *Battery Energy Storage*

This program provides the ability to shift peak loads using stored electrochemical energy. Currently, the main battery storage equipment uses lithium-ion batteries. They are the most cost-effective battery type on the market today. AEG assumes the battery energy storage option will be available for all service classes, with the size and cost of the battery varying depending on the level of demand of the building.

### *Behavioral DR*

Behavioral DR is structured like traditional demand response interventions, but it does not rely on enabling technologies, nor does it offer financial incentives to participants. Participants are notified of an event and simply asked to reduce their consumption during the event window. Generally, notification occurs the day prior to the event and are deployed utilizing a phone call, email, or text message. The next day, customers may receive post-event feedback that includes personalized results and encouragement.

For this analysis, we assumed the Behavioral DR program would be offered as part of a Home Energy Reports program in a typical opt-out scenario. As such, we assume this program would be offered to residential customers only. Avista does not currently have a Home Energy Report program in place. Therefore, the Behavioral program is expected to bear the full cost of the program implementation.

### *Program Assumptions and Characteristics*

The key parameters required to estimate the potential for a DR program are participation rate, per-participant load reduction, and eligibility or end use saturations.<sup>12</sup> The development of these parameters is based on research findings and a review of available information on the topic, including national program survey databases, evaluation studies, program reports, and regulatory filings. AEG's assumptions of these parameters are described below.

#### *Participation Rate Assumptions*

Table 6-6 below shows the steady-state participation rate assumptions for each demand side management (DSM) option as well as the basis for the assumptions. Participation for space cooling is split between DLC Central AC and Smart Thermostat options, so in total, they don't exceed 30%.<sup>13</sup>

---

<sup>12</sup> End Use Saturations used in this study are provided in [Appendix D](#).

<sup>13</sup> NWPCC assumption of 30% participation for a space cooling DR program.

Table 6-6 Steady-State Participation Rate Assumptions (% of eligible customers)

DSM Option	Residential Service	General Service	Large General Service	Extra Large General Service	Basis for Assumption
DLC Central AC	10%	10%	-	-	NWPC DLC Switch cooling assumption
DLC Smart Thermostats - Heating	5%	3%	-	-	Piggybacks off cooling- Adjusted to reflect realistic participation for space heating
CTA-2045 Grid Interactive Water Heater (ER/HP)	50%	50%	-	-	NWPC Grid Interactive Water Heater Assumptions- Ten Year Ramp Rate
DLC Smart Thermostats - Cooling	20%	20%	-	-	NWPC Smart Thermostat cooling assumption
DLC Smart Appliances	5%	5%	-	-	2017 ISACA IT Risk Reward Barometer – US Consumer Results, October 2017
Third Party Contracts	-	15%	20%	20%	Industry Experience
DLC Electric Vehicle Charging	15%	-	-	-	1/3 of TOU opt-in participation rate (17% lowered to 15% based on Avista decision)
Time-of-Use Opt-in	13%	13%	13%	13%	Industry experience; Winter impacts ½ of summer impacts.
Time-of-Use Opt-out	74%	74%	74%	74%	
Electric Vehicle TOU Opt-in		51%	51%		Based on DTE program achieving 2500 EV enrollments in 3 years, with similar base EV population
Variable Peak Pricing			25%	25%	OG&E 2019 Smart Hours Study
Peak Time Rebate	15%	15%			2021 PGE Res Pricing and Behavioral Pilot Flex PTR Evaluation
Thermal Energy Storage	-	1%	2%	2%	Industry Experience
Battery Energy Storage	1%	1%	1%	1%	Industry Experience
Behavioral	20%	-	-	-	PG&E rollout with six waves (2017)

### Load Reduction Assumptions

Table 6-7 presents the per participant load reductions for each DSM option and explains the basis for these assumptions. The load reductions are shown on a kW basis for technology-based options and a percent load reduction otherwise.

Table 6-7 DSM Per Participant Impact Assumptions

DSM Option	Residential	General Service	Large General Service	Extra Large General Service	Basis for Assumption
DLC Central AC	0.5 kW	1.25 kW	-	-	NWPC DLC Switch cooling assumption was close to 1.0 kW reduced to adjust for Avista proposed cycling strategy,
DLC Smart Thermostats - Heating	1.09 kW	1.35 kW	-	-	NWPC Smart thermostat heating assumption (east)
CTA-2045 Grid Interactive Water Heater (ER/HP)	ER: 0.35-0.37 kW HP: 0.9-0.22 kW	ER: 0.87 kW HP: 0.21 kW	-	-	BPA 2018 Peak Mitigation (ER/HP)
DLC Smart Thermostats - Cooling	0.50 kW	1.25 kW	-	-	NWPC DLC Switch cooling assumption was close to 1.0 kW reduced to adjust for Avista proposed cycling strategy
DLC Smart Appliances	0.14 kW	0.14 kW	-	-	Ghatikar, Rish. Demand Response Automation in Appliance and Equipment. Lawrence Berkley National Laboratory, 2017.
Third Party Contracts	-	10%	21%	21%	2012 Statewide Load Impact Evaluation of California Aggregator Demand Response Programs Volume 1: Ex post and Ex ante Load Impacts; Christensen Associates Energy Consulting; April 1, 2013
DLC Electric Vehicle Charging	0.54 kW	-	-	-	75% of Avista Light-Duty Vehicle Average Load
Time-of-Use Opt-in	6%	0%	3%	3%	Best estimate based on industry experience; Winter impacts ½ of summer impacts
Time-of-Use Opt-out	3%	0%	3%	3%	
Electric Vehicle TOU Opt-in		7%	7%		Brattle Analysis and Estimate, based on DTE rate differential of 2.5
Variable Peak Pricing	10%	4%	4%	4%	OG&E 2019 Smart Hours Study; Summer Impacts Shown (Winter impacts ¾ summer)
Peak Time Rebate	7.1% (W) 8.2% (S)	3.6% (W) 4.1% (S)			PGE Res Pricing and Behavioral Pilot Flex PTR Evaluation 2021: 0.159 or 8.2% in summer, 0.134 or 7.1% in winter
Thermal Energy Storage		1.68 kW	8.4 kW	8.4 kW	2016 Ice Bear Tech Specifications
Battery Energy Storage	2 kW	2 kW	15 kW	15 kW	Typical Battery size per segment
Behavioral	2%	-	-	-	Opower documentation for BDR with Consumers and Detroit Energy



### Other Cross-cutting Assumptions

In addition to the above program-specific assumptions, there are three that affect all programs:

- **Discount rate.** A nominal discount rate of 5.21% was used to calculate the net present value of costs over the useful life of each DR program. All cost results are shown in nominal dollars.
- **Line losses.** Avista provided a line loss factor of 6.16% to convert estimated demand savings at the customer meter level to the generator level. Results in the next section are reported at the generator level.
- **Shifting and Saving.** Each program varies in the way energy is shifted or saved throughout the day. For example, customers on the DLC Central AC program are likely to pre-cool their homes prior to the event and turn their AC units back on after the event (snapback effect). The results in this report only show the savings during the event window and not before and after the event. However, shifting and savings assumptions were provided to Avista for each program to inform the IRP results.

### Integrated DR Potential Results

This section presents analysis results for demand savings and levelized costs for all considered DR programs. In the interest of succinctness, AEG only presents the Integrated TOU Opt-in scenario results in this chapter. The integrated approach represents Realistic Achievable Potential and is the most realistic scenario allowing for multiple DR programs to be run at the same time employing a hierarchy that eliminates double counting of impacts. Integrated TOU opt-out and stand-alone scenario (Achievable Technical Potential) results can be found in [Appendix D](#).

All potential results represent savings at the generator.<sup>14</sup> The following sections separate out the integrated potential results for the summer and winter seasons.

#### Summary TOU Opt-in Scenario

Table 6-8, Table 6-9, and Figure 6-4 show the total summer and winter demand savings for selected years. These savings represent integrated savings from all available DR options in Avista's Washington and Idaho service territories.

- **Summer TOU Opt-In Scenario.** Total potential savings are expected to increase from 0.3 MW in 2023 to 149 MW by 2045. The percentage of system peak increases from 0% in 2023 to 8.0% by 2045.
- **Winter TOU Opt-In Scenario.** The total potential savings are expected to increase from 0.03 MW in 2023 to 111 MW by 2045. The percentage of system peak goes from 0% in 2022 to 6.1% by 2045.

Table 6-8 Summary of Integrated TOU Opt-In Potential (MW @ Generator), Summer

	2023	2024	2025	2035	2045
Baseline Forecast (MW)	1,404	1,408	1,415	1,548	1,864
Achievable Potential (MW)	0	18	39	105	149
Achievable Potential (% of baseline)	0.0%	1.3%	2.8%	6.8%	8.0%
Potential Forecast	1,404	1,390	1,376	1,443	1,715

Table 6-9 Summary of Integrated TOU Opt-In Potential (MW @ Generator), Winter

	2023	2024	2025	2035	2045
Baseline Forecast (MW)	1,365	1,369	1,376	1,505	1,816
Achievable Potential (MW)	0	15	31	75	111
Achievable Potential (% of baseline)	0.0%	1.1%	2.2%	5.0%	6.1%
Potential Forecast	1,365	1,354	1,345	1,430	1,705

<sup>14</sup> Line losses were applied to all savings potential as well as demand forecasts to present the results in terms of generation as opposed to meter.

Figure 6-4 Summary of Integrated TOU Opt-In Potential (MW @ Generator)

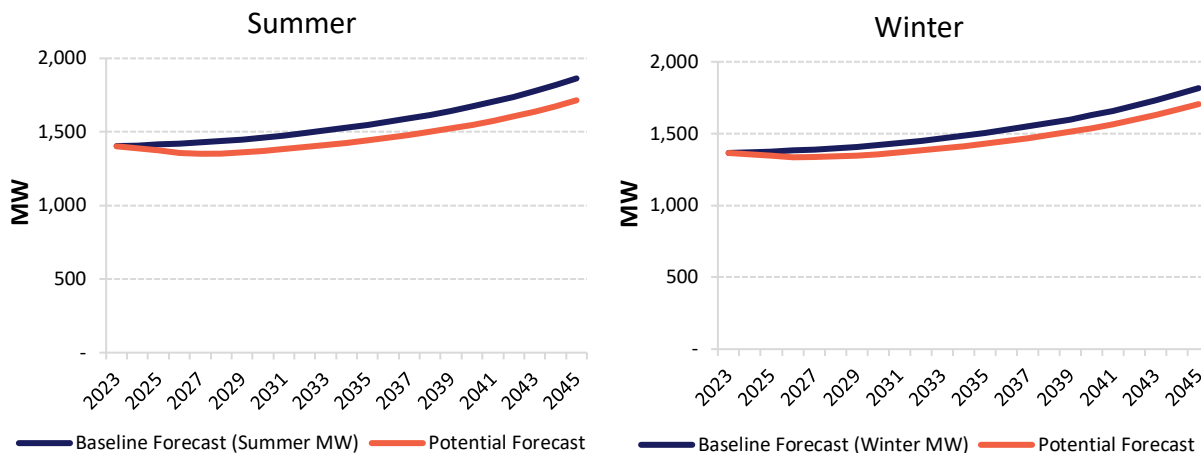

Summer Opt-in TOU Scenario

Key findings from the summer integrated Opt-in TOU scenario include:

- DLC Smart Thermostats have the highest potential savings; they are expected to reach 30.7 MW by 2045.
- DLC Electric Vehicle Charging (29.3 MW) and Third Party Contracts (29.1 MW) have the next-highest potential savings, respectively.
- Most of the DR potential in both Washington and Idaho comes from the residential customer class.

Potential by DSM Option

Figure 6-5 and Table 6-10 show the summer demand savings from individual DR options. The savings represent integrated savings from all available DR options in Avista’s Washington and Idaho service territories. Only the current EV TOU offering is set to begin in 2023. All other options begin in 2024.

Figure 6-5 Summary of Summer Potential by Option – TOU Opt-In (MW @ Generator)

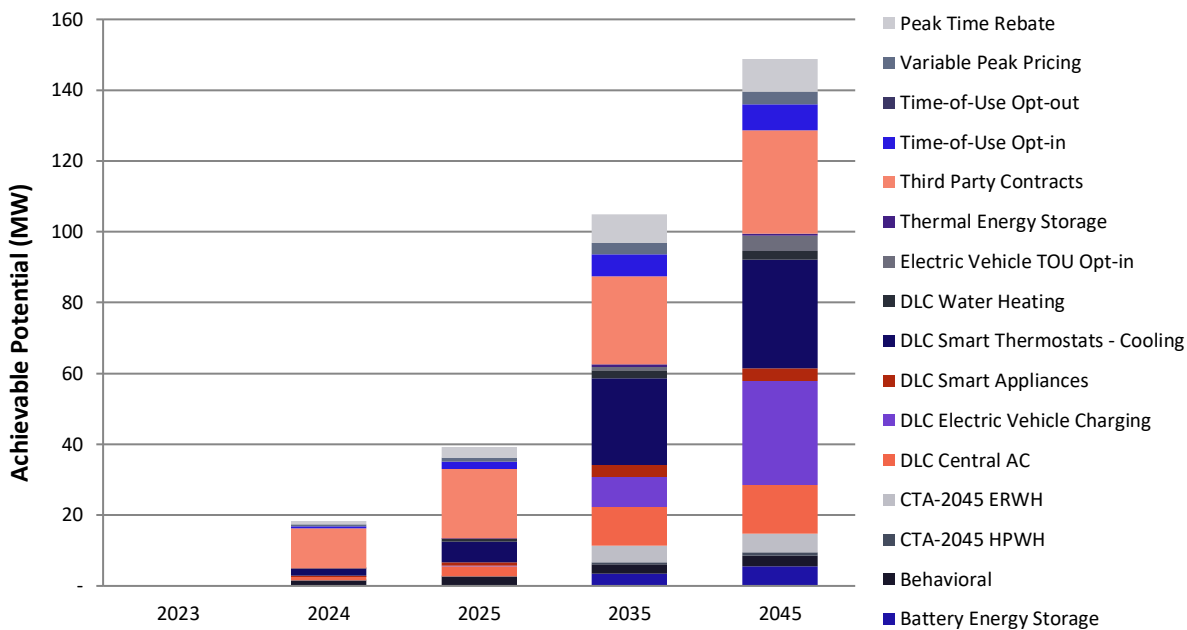

## 2022-2045 Avista Electric CPA | Demand Response Potential

Table 6-10 Summary of Summer Potential by Option – TOU Opt-In (MW @ Generator)

	2023	2024	2025	2035	2045
Battery Energy Storage	-	0.1	0.2	3.4	5.5
Behavioral	-	1.4	2.5	2.7	3.0
CTA-2045 HPWH	-	0.0	0.0	0.6	1.0
CTA-2045 ERWH	-	0.0	0.1	4.6	5.3
DLC Central AC	-	0.9	2.9	11.1	13.7
DLC Electric Vehicle Charging	-	0.0	0.2	8.4	29.3
DLC Smart Appliances	-	0.3	0.9	3.3	3.7
DLC Smart Thermostats - Cooling	-	1.9	5.9	24.5	30.7
DLC Smart Thermostats - Heating	-	-	-	-	-
DLC Water Heating	-	0.2	0.6	2.2	2.4
Electric Vehicle TOU Opt-in	0.0	0.1	0.1	1.0	4.2
Thermal Energy Storage	-	0.1	0.2	0.7	0.7
Third Party Contracts	-	11.2	19.5	24.9	29.1
Time-of-Use Opt-in	-	0.7	2.2	6.3	7.2
Variable Peak Pricing	-	0.4	1.1	3.2	3.7
Peak Time Rebate	-	1.0	3.1	8.0	9.2

*Potential by Sector and Segment*

Table 6-11 and Table 6-12 show the total summer demand savings by class for Washington and Idaho, respectively. Washington is projected to save 97 MW (7.7% of summer peak demand) by 2045, while Idaho is projected to save 52 MW (8.4% of summer peak demand) by 2045.

Table 6-11 Summer Potential by Class – TOU Opt-In (MW @ Generator), Washington

	2023	2024	2025	2035	2045
<b>Baseline Forecast (MW)</b>	<b>940</b>	<b>943</b>	<b>948</b>	<b>1,040</b>	<b>1,249</b>
<b>Achievable Potential (MW)</b>	<b>0</b>	<b>13</b>	<b>26</b>	<b>69</b>	<b>97</b>
Residential	-	4.1	10.6	41.9	59.2
General Service	0.0	1.3	2.5	8.8	15.6
Large General Service	0.0	5.8	9.6	13.8	16.3
Extra Large General Service	-	1.8	3.0	4.3	5.5

Table 6-12 Summer Potential by Class – TOU Opt-In (MW @ Generator), Idaho

	2023	2024	2025	2035	2045
<b>Baseline Forecast (MW)</b>	<b>464</b>	<b>465</b>	<b>467</b>	<b>509</b>	<b>615</b>
<b>Achievable Potential (MW)</b>	<b>0</b>	<b>5</b>	<b>14</b>	<b>36</b>	<b>52</b>
Residential	-	1.9	5.8	22.6	32.5
General Service	0.0	0.6	1.6	5.2	9.8
Large General Service	0.0	1.7	4.1	5.7	6.6
Extra Large General Service	-	1.2	2.0	2.8	3.3

Figure 6-6 Summer Potential by Class – TOU Opt-In (MW @Generator), Washington

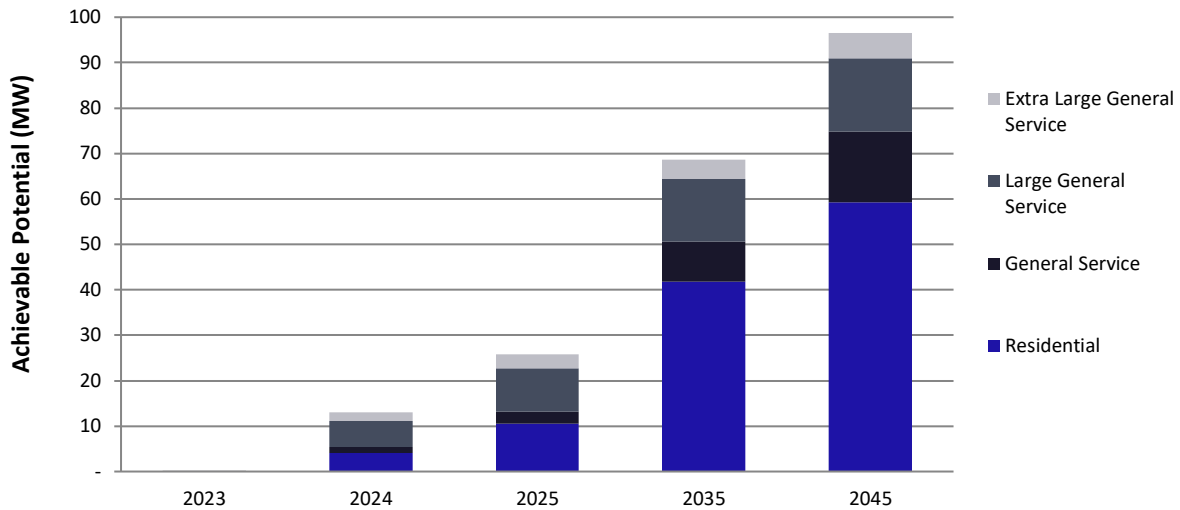
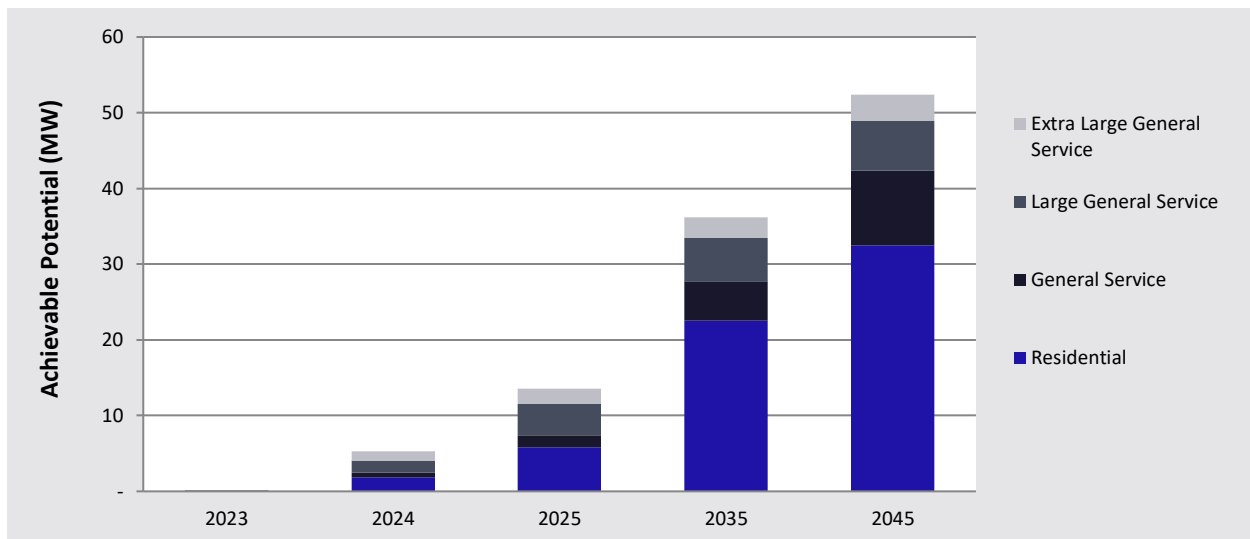

Figure 6-7 Summer Potential by Class – TOU Opt-In (MW @Generator), Idaho



### Winter TOU Opt-in Scenario

Key findings from the winter integrated Opt-in TOU scenario include:

- The highest potential options are Third-Party Contracts (29.6 MW in 2045) and DLC Electric Vehicle Charging (29.3 MW in 2045).
- DLC Smart Thermostats have much lower potential savings for heating (5.8 MW by 2045) than cooling as the heating program will piggyback off the cooling program and be a subset of the cooling participants.
- In past years, Variable Peak Pricing has shown high potential savings in both summer and winter seasons. However, since Variable Peak Pricing is only being considered for large and extra-large customer classes in this study, the potential is much lower (3.7 MW by 2045)<sup>15</sup>.

<sup>15</sup> The PTR Program is modeled to target residential and general service customers

Potential by DSM Option

Figure 6-8 and Table 6-13 show the total winter demand savings from individual DR options for selected years. These savings represent integrated savings from all available DR options in Avista’s Washington and Idaho service territories. The total potential savings in the Winter TOU Opt-in scenario are expected to increase from 0.03 MW in 2023 to 111 MW by 2045. The respective increase in the percentage of system peak goes from 0% in 2022 to 6.1% by 2045.

Figure 6-8 Summary of Winter Potential by Option – TOU Opt-In (MW @ Generator)

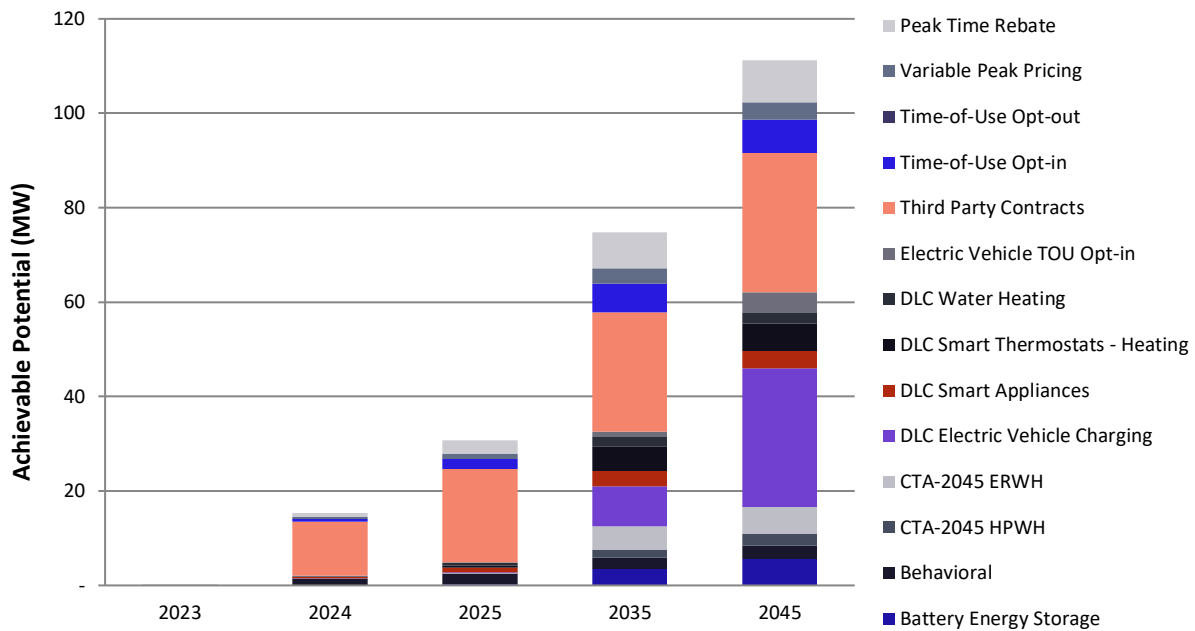

Table 6-13 Summary of Winter Potential by Option – TOU Opt-In (MW @ Generator)

	2023	2024	2025	2035	2045
Battery Energy Storage	-	0.1	0.2	3.4	5.5
Behavioral	-	1.3	2.3	2.5	2.9
CTA-2045 HPWH	-	0.0	0.0	1.6	2.6
CTA-2045 ERWH	-	0.0	0.1	5.0	5.7
DLC Central AC	-	-	-	-	-
DLC Electric Vehicle Charging	-	0.0	0.2	8.4	29.3
DLC Smart Appliances	-	0.3	0.9	3.3	3.7
DLC Smart Thermostats - Cooling	-	-	-	-	-
DLC Smart Thermostats - Heating	-	-	0.5	5.2	5.8
DLC Water Heating	-	0.2	0.6	2.2	2.4
Electric Vehicle TOU Opt-in	0.0	0.1	0.1	1.0	4.2
Thermal Energy Storage	-	-	-	-	-
Third Party Contracts	-	11.4	19.9	25.3	29.6
Time-of-Use Opt-in	-	0.6	2.1	6.1	7.0
Variable Peak Pricing	-	0.4	1.1	3.3	3.7
Peak Time Rebate	-	0.9	2.9	7.6	8.8

*Potential by Sector and Segment*

Table 6-14 and Table 6-15 show the total winter demand savings by class for Washington and Idaho, respectively. Washington is projected to save 74 MW (8.5% of winter system peak demand) by 2045, while Idaho is projected to save 38 MW (6.2% of winter system peak demand) by 2045.

Table 6-14 Winter Potential by Class – TOU Opt-In (MW @Generator), Washington

	2023	2024	2025	2035	2045
<b>Baseline Forecast (Winter MW)</b>	<b>910</b>	<b>913</b>	<b>918</b>	<b>1,006</b>	<b>1,212</b>
<b>Achievable Potential (MW)</b>	<b>0</b>	<b>11</b>	<b>20</b>	<b>50</b>	<b>74</b>
Residential	-	2.3	5.5	24.9	38.1
General Service	0.0	1.1	1.9	6.8	13.5
Large General Service	0.0	5.7	9.5	13.5	16.0
Extra Large General Service	-	2.0	3.4	4.8	6.0

Table 6-15 Winter Potential by Class – TOU Opt-In (MW @Generator), Idaho

	2023	2024	2025	2035	2045
<b>Baseline Forecast (Winter MW)</b>	<b>455</b>	<b>456</b>	<b>458</b>	<b>499</b>	<b>604</b>
<b>Achievable Potential (MW)</b>	<b>0</b>	<b>4</b>	<b>11</b>	<b>25</b>	<b>38</b>
Residential	-	0.9	3.2	12.6	19.4
General Service	0.0	0.5	1.2	3.7	8.2
Large General Service	0.0	1.7	4.1	5.6	6.6
Extra Large General Service	-	1.3	2.1	2.9	3.4

Figure 6-9 Winter Potential by Class – TOU Opt-In (MW @Generator), Washington

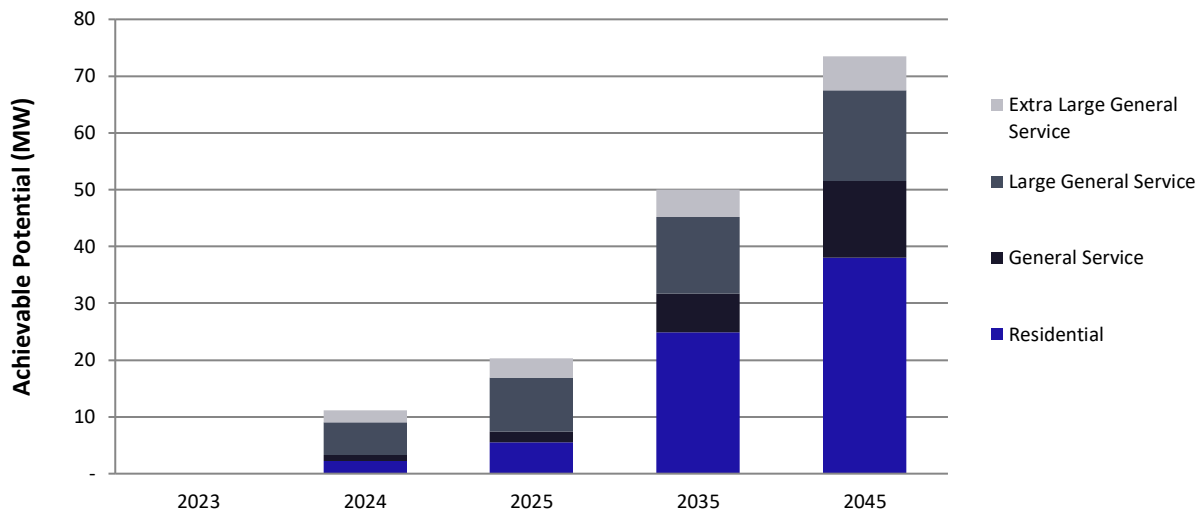
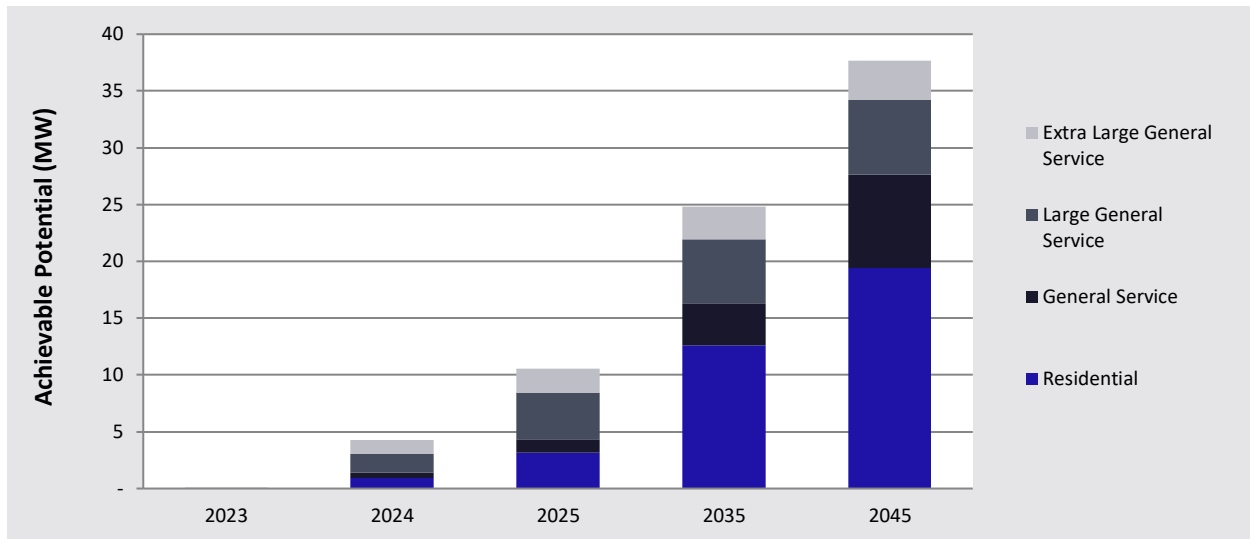

Figure 6-10 Winter Potential by Class – TOU Opt-In (MW @Generator), Idaho



### Levelized Costs

Table 6-16 presents the levelized costs per kW of equivalent generation capacity over 2023-2032 for Washington and Idaho. The ten-year NPV MW potential by program is also shown for reference in the first two columns. Some options are only available in summer or winter, such as Thermal Energy Storage, Smart Thermostat programs, and DLC Cooling.

Key findings include:

- The Third Party Contracts option delivers the highest savings in 2031 at approximately \$75.28/kW-year cost in winter and \$76.70/kW-year cost in summer. Capacity-based and energy-based payments to the third-party constitutes the major cost component for this option. All O&M and administrative costs are expected to be incurred by the representative third-party contractor.
- The Variable Peak Pricing option has the lowest levelized cost among all the DR options. It delivers 19.20 MW of winter savings in 2031 at \$37.80/kW-year system-wide and 18.77 MW of summer savings at \$38.67/kW-year system-wide. Enabling technology purchase and installation costs for enhancing customer response is a large part of deployment costs.

Table 6-16 Levelized Program Costs and Potential (TOU Opt-In Winter)

Program	NPV Winter Potential MW	NPV Summer Potential MW	Winter Levelized Costs	Summer Levelized Costs
Battery Energy Storage	7.16	7.16	\$863.37	\$863.37
Behavioral	18.23	19.45	\$145.50	\$136.42
CTA-2045 HPWH	2.93	1.12	\$1,001.06	\$2,626.31
CTA-2045 ERWH	10.06	9.33	\$557.55	\$600.93
DLC Central AC		57.42		\$160.23
DLC Electric Vehicle Charging	13.79	13.79	\$907.76	\$907.76
DLC Smart Appliances	18.26	18.26	\$398.72	\$398.72
DLC Smart Thermostats - Cooling		125.07		\$135.30
DLC Smart Thermostats - Heating	24.39		\$25.81	
DLC Water Heating	12.00	12.00	\$622.13	\$622.13
Electric Vehicle TOU Opt-in	1.73	1.73	\$569.25	\$569.25
Thermal Energy Storage		4.05		\$879.99
Third Party Contracts	172.78	169.57	\$75.28	\$76.70
Time-of-Use Opt-in	36.11	37.77	\$76.37	\$73.01
Variable Peak Pricing	19.20	18.77	\$37.80	\$38.67
Peak Time Rebate	45.84	48.56	\$56.09	\$52.95

### Pilot Program Potential Results- Washington

The following section presents the results of the pilot program scenario. Avista expects to implement three pilot programs in Washington beginning in 2024, TOU Opt-in, Peak Time Rebates<sup>16</sup>, and Grid-interactive Water Heating. Each pilot will run for three years; the TOU Opt-in will have an optional two-year extension depending on results.<sup>17</sup> Each program will be offered to residential and general service customers only.

The potential results include the first three years of the pilot programs, then ramp up to a fully-fledged program for the remainder of the study horizon. The results of the Grid-Interactive Water Heater Program are split out by electric resistance and heat pump water heaters according to saturation levels in Washington.

Key findings include:

- By the end of the three-year pilot period, Grid-Interactive Water Heating presents the greatest potential savings, with the majority stemming from electric resistance water heaters. Combined, this program could reach nearly 0.2 MW in potential savings by 2026.
- Among rate options, TOU Opt-in is expected to achieve slightly higher potential at 0.13 MW savings by the end of the pilot period, while Peak Time Rebate is expected to reach just under 0.1 MW.

### Summer Integrated Pilot Scenario

Figure 6-11 and Table 6-17 show the total summer demand savings from individual DR pilot options. These savings represent integrated savings from all available DR options in Avista's Washington service territory. Total potential savings for summer pilot programs are expected to increase from 0.1 MW in 2024 to 18.3 MW by 2045. Over the first three years of the pilot, the Grid-Interactive Water Heating Program is expected to have the most potential (0.2 MW by 2026), with the majority of the potential coming by way of electric resistance water heaters. Table 6-18 shows the total summer demand savings by class. The pilot programs are projected

<sup>16</sup> It should be noted that the results of the Peak Time Rebate potential reflect the impacts from a Portland General Electric pilot program which included significant customer education and feedback. However, other PTR programs (such as in California) achieved zero savings.

<sup>17</sup> Potential results for the TOU Opt-in Pilot do not include the two-year extension and are based on a three-year pilot.



## 2022-2045 Avista Electric CPA | Demand Response Potential

to save 18.3 MW (1.5% of summer peak demand) by 2045, with most of the potential coming from the residential class.

Figure 6-11 Summary of Summer Potential by Option (Pilot MW @ Generator)

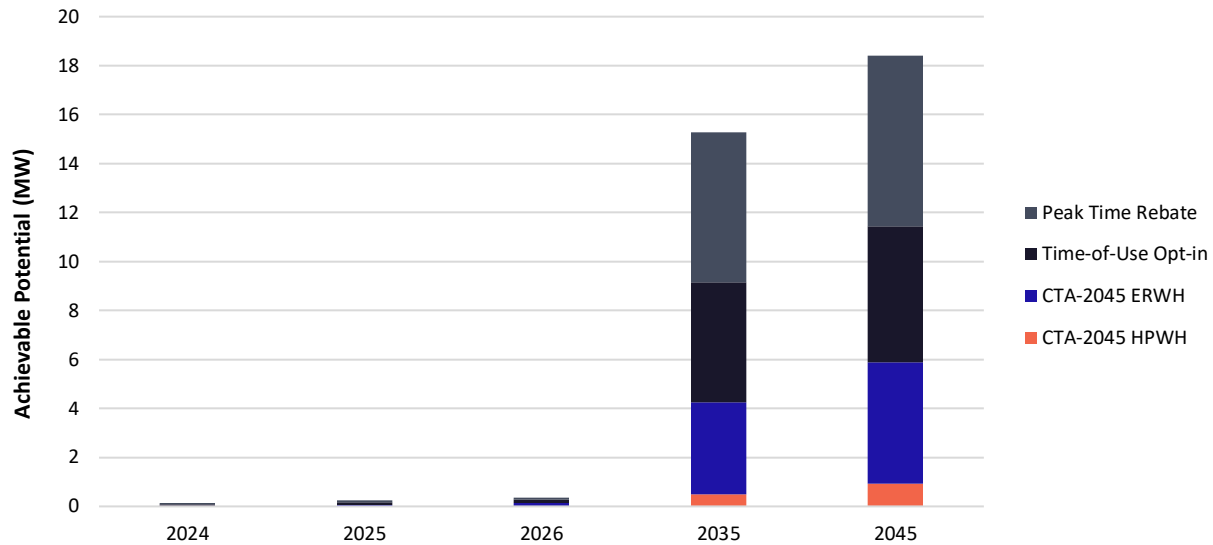

Table 6-17 Summary of Summer Potential by Option (Pilot MW @ Generator)

	2024	2025	2026	2035	2045
<b>Baseline Forecast (MW)</b>	<b>943</b>	<b>948</b>	<b>952</b>	<b>1,040</b>	<b>1,249</b>
<b>Achievable Potential (MW)</b>	<b>0.1</b>	<b>0.3</b>	<b>0.4</b>	<b>15.1</b>	<b>18.3</b>
CTA-2045 HPWH	0.0	0.0	0.0	0.5	1.0
CTA-2045 ERWH	0.0	0.1	0.2	4.0	5.3
Time-of-Use Opt-in	0.1	0.1	0.1	4.1	4.6
Peak Time Rebate	0.0	0.1	0.1	6.5	7.4

Table 6-18 Summer Potential by Class (Pilot MW @ Generator), Washington

	2024	2025	2026	2035	2045
Residential	0.1	0.2	0.4	13.5	16.2
General Service	0.0	0.0	0.0	1.6	2.1

### Winter Integrated Pilot Scenario

Figure 6-12 and Table 6-19 show the total winter demand savings from individual DR pilot options. These savings represent integrated savings from all available DR options in Avista's Washington service territory. Total potential savings for winter pilot programs are expected to increase from 0.1 MW in 2024 to 19.6 MW by 2045. Over the first three years of the pilot, the Grid-Interactive Water Heating Program is expected to have the most potential (0.2 MW by 2026), with the majority of the potential coming by way of electric resistance water heaters. Table 6-20 shows the total winter demand savings by class. The pilot programs are projected to save 19.6 MW (1.6% of summer peak demand) by 2045, with most of the potential coming from the residential class.

Figure 6-12 Summary of Winter Potential by Option (Pilot MW @Generator)

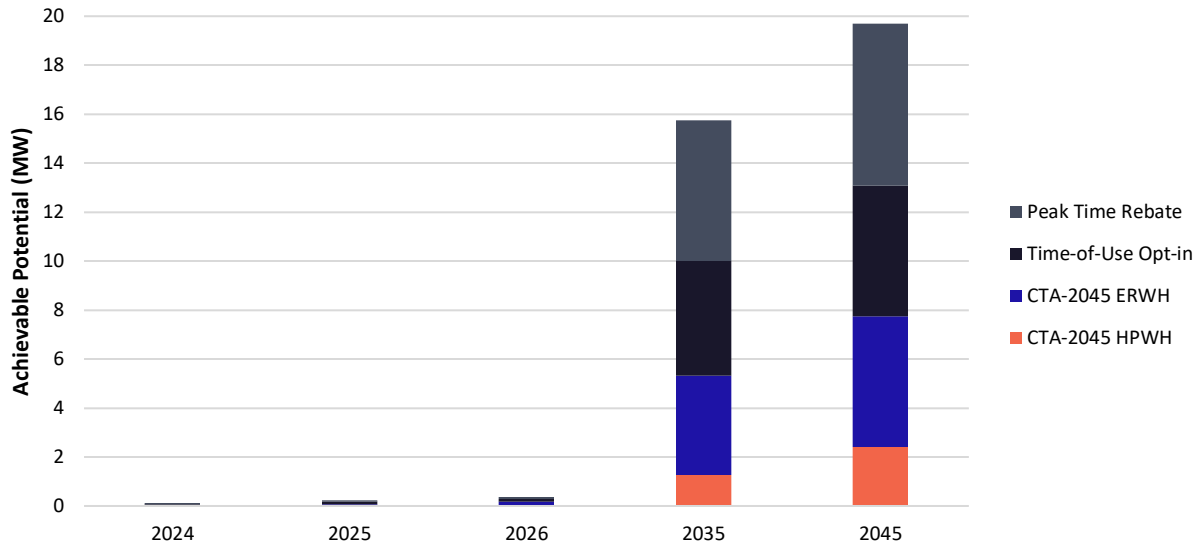

Table 6-19 Summary of Winter Potential by Option (Pilot MW @ Generator)

	2024	2025	2026	2035	2045
<b>Baseline Forecast (MW)</b>	<b>913</b>	<b>918</b>	<b>921</b>	<b>1,006</b>	<b>1,212</b>
<b>Achievable Potential (MW)</b>	<b>0.1</b>	<b>0.3</b>	<b>0.4</b>	<b>15.6</b>	<b>19.6</b>
CTA-2045 HPWH	0.0	0.0	0.0	1.4	2.6
CTA-2045 ERWH	0.0	0.1	0.2	4.3	5.7
Time-of-Use Opt-in	0.1	0.1	0.1	3.8	4.3
Peak Time Rebate	0.0	0.1	0.1	6.1	7.0

Table 6-20 Winter Potential by Class (Pilot MW @ Generator), Washington

	2024	2025	2026	2035	2045
Residential	0.1	0.2	0.4	13.8	17.1
General Service	0.0	0.0	0.0	1.9	2.5

## A | MARKET PROFILES

This appendix presents the market profiles for each sector and segment for Washington and Idaho, in the embedded spreadsheet.



## B | MARKET ADOPTION (RAMP) RATES

This appendix presents the Power Council's 2021 Power Plan ramp rates we applied to technical potential to estimate Achievable Technical Potential.

Table B-1 Measure Ramp Rates

Ramp Rate	2022	2023	2024	2025	2026	2027	2028	2029	2030	2031	2032	2033	2034	2035	2036	2037	2038	2039	2040	2041
LO12Med	11%	22%	33%	44%	55%	65%	72%	79%	84%	88%	91%	94%	96%	97%	99%	100%	100%	100%	100%	100%
LO5Med	4%	10%	16%	24%	32%	42%	53%	64%	75%	84%	91%	96%	99%	100%	100%	100%	100%	100%	100%	100%
LO1Slow	1%	1%	2%	3%	5%	9%	13%	19%	26%	34%	43%	53%	63%	72%	81%	87%	92%	96%	98%	100%
LO50Fast	45%	66%	80%	89%	95%	98%	99%	100%	100%	100%	100%	100%	100%	100%	100%	100%	100%	100%	100%	100%
LO20Fast	22%	38%	48%	57%	64%	70%	76%	80%	84%	88%	90%	92%	94%	95%	96%	97%	98%	98%	99%	100%
LOEven20	5%	10%	15%	20%	25%	30%	35%	40%	45%	50%	55%	60%	65%	70%	75%	80%	85%	90%	95%	100%
LO3Slow	1%	1%	3%	6%	11%	18%	26%	36%	46%	57%	67%	76%	83%	88%	92%	95%	97%	98%	99%	100%
LO80Fast	76%	83%	88%	92%	95%	97%	98%	99%	99%	100%	100%	100%	100%	100%	100%	100%	100%	100%	100%	100%
Retro12Med	11%	11%	11%	11%	11%	10%	8%	6%	5%	4%	3%	3%	2%	2%	1%	1%	0%	0%	0%	0%
Retro5Med	4%	5%	6%	8%	9%	10%	11%	11%	11%	9%	7%	5%	3%	1%	1%	0%	0%	0%	0%	0%
Retro1Slow	0%	1%	1%	1%	2%	3%	4%	6%	7%	8%	9%	10%	10%	9%	8%	7%	5%	4%	2%	2%
Retro50Fast	45%	21%	14%	9%	6%	3%	1%	1%	0%	0%	0%	0%	0%	0%	0%	0%	0%	0%	0%	0%
Retro20Fast	22%	16%	11%	8%	7%	6%	5%	5%	4%	3%	3%	2%	2%	1%	1%	1%	1%	1%	1%	0%
RetroEven20	5%	5%	5%	5%	5%	5%	5%	5%	5%	5%	5%	5%	5%	5%	5%	5%	5%	5%	5%	5%
Retro3Slow	1%	1%	2%	3%	5%	7%	8%	10%	11%	11%	10%	9%	7%	6%	4%	3%	2%	1%	1%	1%



## C | MEASURE DATA

Measure level assumptions and data are available in the “Avista 2022 DSM Potential Study Measure Assumptions” workbook provided to Avista alongside this file.





## D | DEMAND RESPONSE POTENTIAL APPENDIX

### Equipment End Use Saturation

The end use saturation data is required to further segment the market and identify eligible customers for direct control of different equipment options. The relevant space heating equipment for DR analysis are electric furnaces and air-source heat pumps. Table D-1 below show saturation estimates by state and customer class for Washington and Idaho respectively. We assume slight growth trends in Central AC, Space Heating, and Electric Vehicle saturations through 2045. For Advanced Metering Infrastructure (AMI), Avista began their rollout in Washington in 2019 is expected to be fully rolled out by the start of the study. In Idaho, the AMI rollout has begun in 2022 and is expected to be complete by 2024.

Table D-1 End Use Saturations by Customer Class and State<sup>18</sup>

State	Customer Class	End Use Saturation	2023	2024	2025	2035	2045	Source
WA	Res	Central AC	43%	44%	46%	49%	56%	EE Study/Baseline Survey
WA	Res	Elec Space Heat	21%	21%	21%	21%	21%	EE Study/Baseline Survey
WA	Res	CTA-2045 ER Water Heat	0.4%	1.3%	6.6%	16%	22%	EE Study/Baseline Survey
WA	Res	CTA-2045 HP Water Heat	0.3%	0.8%	3.4%	8%	14%	EE Study/Baseline Survey
WA	Res	Elec Vehicles	0.3%	0.4%	0.6%	1.5%	8.3%	EE Study/Baseline Survey
WA	Res	Appliances	100%	100%	100%	100%	100%	Standard
WA	Res	AMI	100%	100%	100%	100%	100%	AMI program
WA	GS	Central AC	21%	21%	21%	21%	21%	EE Study/Baseline Survey
WA	GS	Elec Water Heat	0.0%	0.0%	0.0%	0.0%	0.0%	EE Study/Baseline Survey
WA	GS	CTA-2045 ER Water Heat	0.4%	1.2%	6.1%	14%	18%	EE Study/Baseline Survey
WA	GS	CTA-2045 HP Water Heat	0.2%	0.6%	3.5%	9.2%	17%	EE Study/Baseline Survey
WA	GS	Elec Space Heat	11%	11%	11%	11%	11%	EE Study/Baseline Survey
WA	GS	Thermal	59%	59%	59%	59%	59%	EE Study – Roof Top Unit
WA	GS	AMI	100%	100%	100%	100%	100%	AMI program
WA	LGS	Thermal	11%	11%	11%	11%	11%	EE Study - Chiller
WA	LGS	AMI	100%	100%	100%	100%	100%	AMI program
WA	XL LGS	Thermal	11%	11%	11%	11%	11%	EE Study - Chiller
WA	XL LGS	AMI	100%	100%	100%	100%	100%	AMI program
ID	Res	Central AC	45%	46%	48%	51%	59%	EE Study/Baseline Survey
ID	Res	Elec Space Heat	22%	22%	22%	22%	22%	EE Study/Baseline Survey
ID	Res	Elec Water Heat	46%	46%	45%	45%	43%	EE Study/Baseline Survey
ID	Res	CTA-2045 ER Water Heat	0%	0%	0%	0%	0%	EE Study/Baseline Survey
ID	Res	CTA-2045 HP Water Heat	0%	0%	0%	0%	0%	EE Study/Baseline Survey
ID	Res	Elec Vehicles	0.5%	0.6%	1.0%	2.4%	13%	EE Study/Baseline Survey
ID	Res	Appliances	100%	100%	100%	100%	100%	Standard
ID	Res	AMI	33%	66%	100%	100%	100%	3-year AMI deployment
ID	GS	Central AC	18%	18%	18%	18%	18%	EE Study/Baseline Survey
ID	GS	Elec Water Heat	40%	40%	40%	40%	40%	EE Study/Baseline Survey
ID	GS	CTA-2045 ER Water Heat	0%	0%	0%	0%	0%	EE Study/Baseline Survey
ID	GS	CTA-2045 HP Water Heat	0%	0%	0%	0%	0%	EE Study/Baseline Survey

<sup>18</sup> R = Residential, GS = General Service, LGS = Large General Service, XL LGS = Extra Large General Service

## 2022-2045 Avista Electric CPA | Demand Response Potential

ID	GS	Elec Space Heat	10%	10%	10%	10%	10%	EE Study/Baseline Survey
ID	GS	Thermal	61%	61%	61%	61%	61%	EE Study – Roof Top Unit
ID	GS	AMI	33%	66%	100%	100%	100%	3-year AMI deployment
ID	LGS	Thermal	7.9%	7.9%	7.9%	7.9%	7.9%	EE Study - Chiller
ID	LGS	AMI	33%	66%	100%	100%	100%	3-year AMI deployment
ID	XL LGS	Thermal	7.9%	7.9%	7.9%	7.9%	7.9%	EE Study - Chiller
ID	XL LGS	AMI	100%	100%	100%	100%	100%	3-year AMI deployment

### Mechanism and Event Hours

Table D-2 lists the DSM options considered in the study, including the eligible sectors, the mechanism for deployment, and the expected annual event hours (summer and winter hours combined if both seasons are considered). Ancillary services were broken out this year as subsets of viable parent programs to capture a more accurate depiction of their potential savings.

## 2022-2045 Avista Electric CPA | Demand Response Potential

Table D-2 DSM Program Event Hours

DSM Option	Eligible Sectors	Annual Seasonal Hours	Average Event Duration (hours)	Estimated Number of Events per Year
Ancillary Battery Storage	Summer DR Event	36	6	6
Ancillary Cooling	Summer DR Event	36	3	12
Ancillary DLC WH	Summer DR Event	50	3	17
Ancillary EV	Summer DR Event	528	6	88
Ancillary Third Party	Summer DR Event	30	4	8
Battery Energy Storage	Summer DR Event	36	6	6
Behavioral	Summer DR Event	40	6	7
CTA-2045 ERWH	Summer DR Event	75	3	25
CTA-2045 HPWH	Summer DR Event	75	3	25
DLC Central AC	Summer DR Event	50	3	17
DLC Electric Vehicle Charging	Summer DR Event	528	6	88
DLC Smart Appliances	Summer DR Event	528	6	88
DLC Smart Thermostats - Cooling	Summer DR Event	36	3	12
DLC Water Heating	Summer DR Event	50	3	17
Electric Vehicle TOU Opt-in	Summer DR Event	528	6	88
Peak Time Rebates	Summer DR Event	40	4	10
Thermal Energy Storage	Summer DR Event	36	6	6
Third Party Contracts	Summer DR Event	30	4	8
Time-of-Use Opt-in	Summer DR Event	528	6	88
Time-of-Use Opt-Out	Summer DR Event	528	6	88
Variable Peak Pricing Rates	Summer DR Event	80	4	20
Ancillary Battery Storage	Winter DR Event	36	6	6
Ancillary DLC WH	Winter DR Event	50	3	17
Ancillary EV	Winter DR Event	528	6	88
Ancillary Heating	Winter DR Event	36	3	12
Ancillary Third Party	Winter DR Event	30	4	8
Battery Energy Storage	Winter DR Event	36	6	6
Behavioral	Winter DR Event	40	6	7
CTA-2045 ERWH	Winter DR Event	75	3	25
CTA-2045 HPWH	Winter DR Event	75	3	25
DLC Electric Vehicle Charging	Winter DR Event	528	6	88
DLC Smart Appliances	Winter DR Event	528	6	88
DLC Smart Thermostats - Heating	Winter DR Event	36	3	12
DLC Water Heating	Winter DR Event	50	3	17
Electric Vehicle TOU Opt-in	Winter DR Event	528	6	88
Peak Time Rebates	Winter DR Event	40	4	10
Third Party Contracts	Winter DR Event	30	4	8
Time-of-Use Opt-in	Winter DR Event	528	6	88
Time-of-Use Opt-Out	Winter DR Event	528	6	88
Variable Peak Pricing	Winter DR Event	80	4	20

### Integrated TOU Opt-out Achievable Technical Potential Results

In the TOU opt-out scenario, customers are placed on the Time-of-Use rate by default and will need to go through an added step to switch rates. Therefore, most potential among the rate design options are concentrated in TOU. Most of the participants are likely to be on the TOU pricing rate and we see a much lower savings potential for the Variable Peak Pricing Rates (1.1 MW by 2045 for summer and winter potential) and Peak Time Rebates (2.8 and 2.7 MW by 2045 for summer and winter potential respectively).

#### Summer Integrated TOU Opt-out Results

Figure D-1 and Table D-3 show the total summer demand savings from individual DR options. These savings represent integrated savings from all available DR options in the Washington and Idaho service territories.

- The highest savings potential is DLC Smart Thermostats, expected to reach savings of 30.7 MW by 2045.
- The next three biggest potential options in summer include, DLC Electric Vehicle Charging (29.3 MW), Third Party Contracts (29.1 MW), and Time-of-Use Opt-out (28.2 MW).
- The total potential savings in the summer TOU Opt-in scenario are expected to reach 161 MW by 2045, or 9% of system peak.

Figure D-1 Summary of Summer Potential by Option – TOU Opt-Out (MW @Generator)

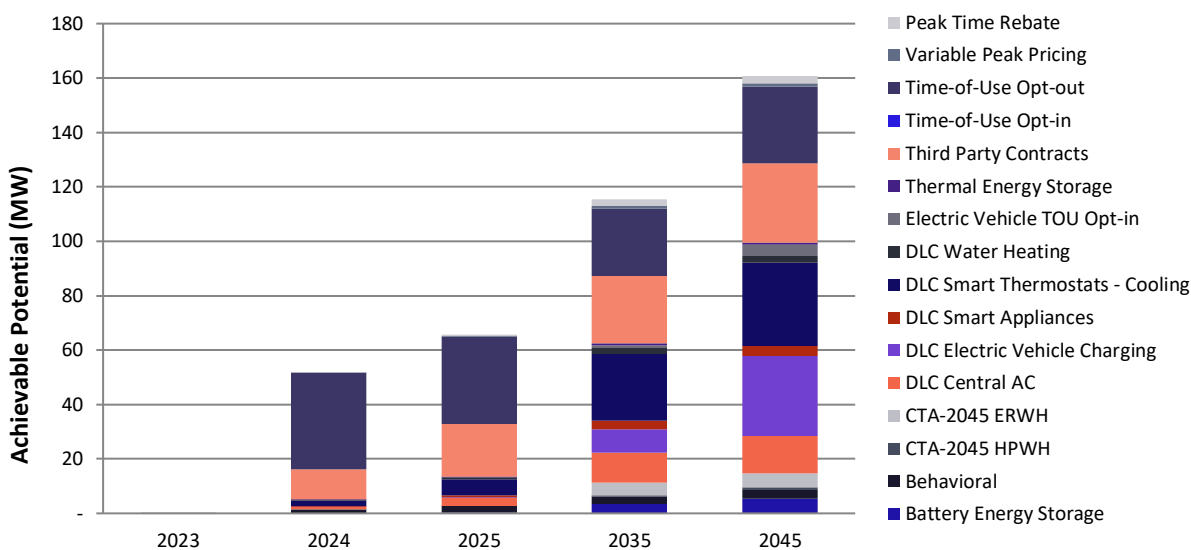

Table D-3 Summary of Summer Potential by Option – TOU Opt-Out (MW @Generator)

	2023	2024	2025	2035	2045
Achievable Potential (MW)	0	52	66	115	161
Battery Energy Storage	-	0.1	0.2	3.4	5.5
Behavioral	-	1.4	2.5	2.7	3.0
CTA-2045 HPWH	-	0.0	0.0	0.6	1.0
CTA-2045 ERWH	-	0.0	0.1	4.6	5.3
DLC Central AC	-	0.9	2.9	11.1	13.7
DLC Electric Vehicle Charging	-	0.0	0.2	8.4	29.3
DLC Smart Appliances	-	0.3	0.9	3.3	3.7
DLC Smart Thermostats - Cooling	-	1.9	5.9	24.5	30.7
DLC Smart Thermostats - Heating	-	-	-	-	-
DLC Water Heating	-	0.2	0.6	2.2	2.4
Electric Vehicle TOU Opt-in	0.0	0.1	0.1	1.0	4.2
Thermal Energy Storage	-	0.1	0.2	0.7	0.7
Third Party Contracts	-	11.2	19.5	24.9	29.1
Time-of-Use Opt-in	-	-	-	-	-
Time-of-Use Opt-out	-	35.4	32.1	24.6	28.2
Variable Peak Pricing	-	0.0	0.2	1.0	1.1
Peak Time Rebate	-	0.1	0.5	2.5	2.8

### Winter Integrated TOU Opt-out Results

Figure D-2 and Table D-4 show the total winter demand savings from individual DR options for selected years. These savings represent integrated savings from all available DR options in Avista's Washington and Idaho service territories.

- The highest savings potential is Third Party Contracts, expected to reach savings of 30.7 MW in 2045.
- The next two biggest potential options include DLC Electric Vehicle Charging (29.3 MW) and Time-of-Use Opt-out (27.4 MW).
- The total potential savings in the winter TOU Opt-out scenario are expected to reach 123 MW by 2045, or 7% of system peak.

Figure D-2 Summary of Winter Potential by Option – TOU Opt-Out (MW @ Generator)

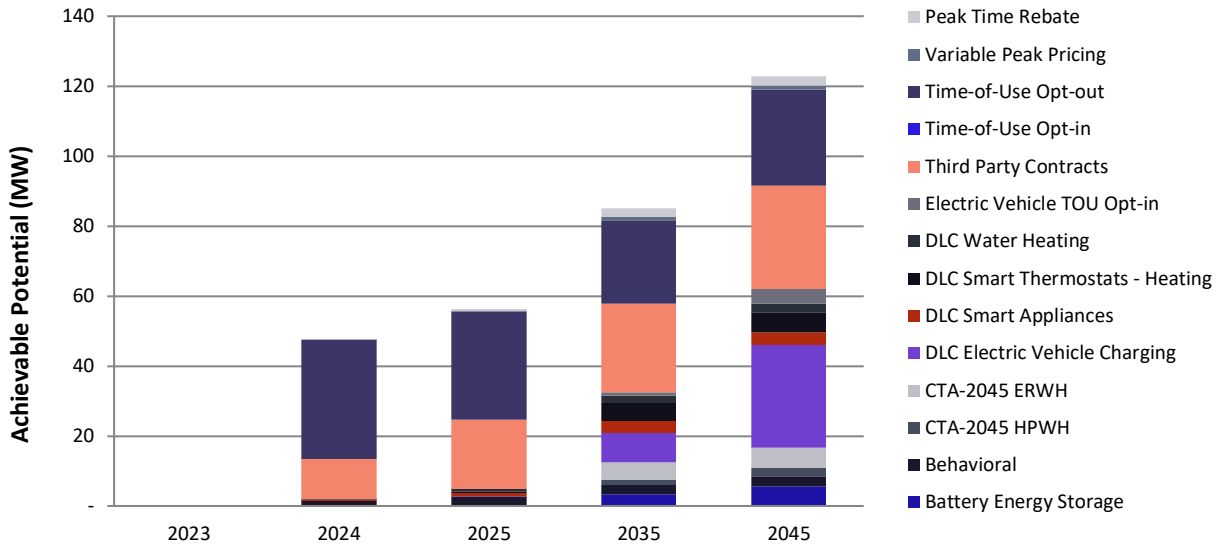

Table D-4 Summary of Winter Potential by Option – TOU Opt-Out (Winter MW @Generator)

	2023	2024	2025	2035	2045
Achievable Potential (MW)	0	48	56	85	123
Battery Energy Storage	-	0.1	0.2	3.4	5.5
Behavioral	-	1.3	2.3	2.5	2.9
CTA-2045 HPWH	-	0.0	0.0	1.6	2.6
CTA-2045 ERWH	-	0.0	0.1	5.0	5.7
DLC Central AC	-	-	-	-	-
DLC Electric Vehicle Charging	-	0.0	0.2	8.4	29.3
DLC Smart Appliances	-	0.3	0.9	3.3	3.7
DLC Smart Thermostats - Cooling	-	-	-	-	-
DLC Smart Thermostats - Heating	-	-	0.5	5.2	5.8
DLC Water Heating	-	0.2	0.6	2.2	2.4
Electric Vehicle TOU Opt-in	0.0	0.1	0.1	1.0	4.2
Thermal Energy Storage	-	-	-	-	-
Third Party Contracts	-	11.4	19.9	25.3	29.6
Time-of-Use Opt-in	-	-	-	-	-
Time-of-Use Opt-out	-	34.1	30.9	23.8	27.4
Variable Peak Pricing	-	0.0	0.2	1.0	1.1
Peak Time Rebate	-	0.1	0.5	2.3	2.7

### Stand Alone Achievable Technical Potential Results

This section presents the stand-alone potential. For this scenario, we do not combine the potential savings and only show individual potential contributions by program for each scenario. Since the different rate options do not influence other rates in the stand-alone scenario, each rate has a larger potential savings than in the Opt-out/Opt-in scenarios.

### Summer Stand-Alone Results

Figure D-3 and Table D-5 show the summer demand savings from individual DR options. These savings represent the individual stand-alone savings from all available DR options in Washington and Idaho service territories.

- The largest potential option is TOU Opt-out, contributing 39.6 MW in 2045.
- The next two biggest potential options include DLC Smart Thermostats – Cooling (30.7 MW), DLC Electric Vehicle Charging (29.3 MW), and Third Party Contracts (29.1 MW).
- When each TOU option is examined as an individual program, the Time-of-Use Opt-out option has a much larger potential savings than if participants could opt-in to the rate. The TOU Opt-out option makes up the second-largest savings potential in the stand-alone case and is expected to reach 31.1 MW by 2045.

Figure D-3 Summary of Summer Potential by Option – Stand Alone (MW @Generator)

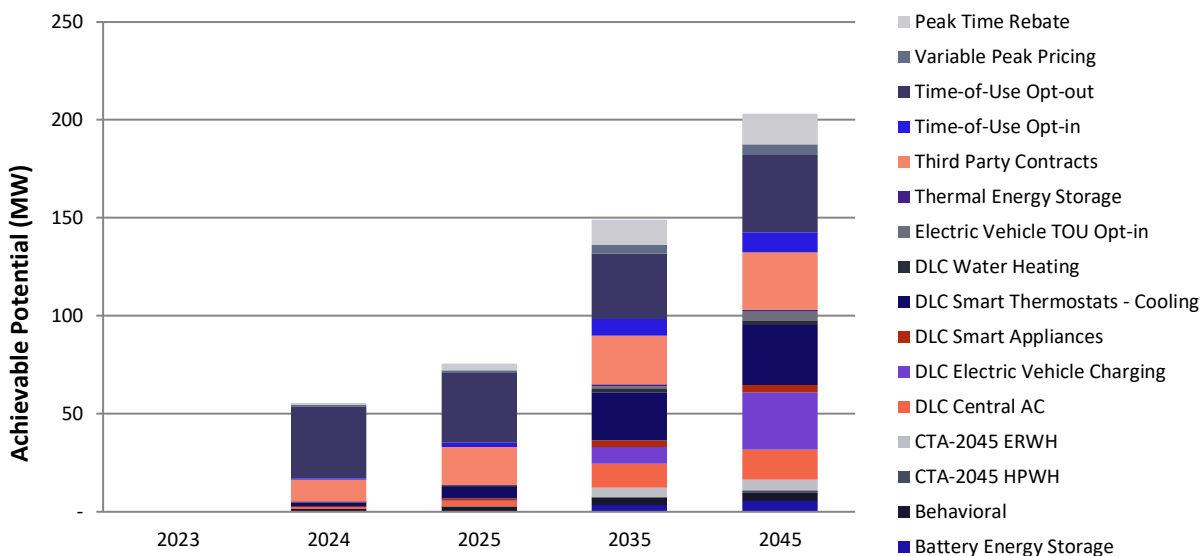

## 2022-2045 Avista Electric CPA | Demand Response Potential

Table D-5 Summary of Summer Potential by Option – Stand Alone (MW @ Generator)

	2023	2024	2025	2035	2045
Achievable Potential (MW)	0	55	75	149	203
Battery Energy Storage	-	0.1	0.2	3.4	5.5
Behavioral	-	1.4	2.6	3.7	4.4
CTA-2045 HPWH	-	0.0	0.0	0.6	1.0
CTA-2045 ERWH	-	0.0	0.1	4.6	5.3
DLC Central AC	-	1.0	2.9	12.3	15.4
DLC Electric Vehicle Charging	-	0.0	0.2	8.4	29.3
DLC Smart Appliances	-	0.3	0.9	3.3	3.7
DLC Smart Thermostats - Cooling	-	1.9	5.9	24.5	30.7
DLC Smart Thermostats - Heating	-	-	-	-	-
DLC Water Heating	-	0.2	0.6	2.2	2.4
Electric Vehicle TOU Opt-in	0.0	0.1	0.1	1.1	4.7
Thermal Energy Storage	-	0.1	0.2	0.8	0.8
Third Party Contracts	-	11.2	19.5	24.9	29.1
Time-of-Use Opt-in	-	0.7	2.3	8.6	10.3
Time-of-Use Opt-out	-	37.0	35.2	33.3	39.6
Variable Peak Pricing	-	0.4	1.4	4.7	5.4
Peak Time Rebate	-	1.0	3.4	12.8	15.5

### Winter Stand Alone Results

Figure D-4 and Table D-6 show the winter demand savings from individual DR options. These savings represent stand-alone savings from all available DR options in Washington and Idaho service territories.

- The largest potential option is TOU Opt-out, contributing 38.3 MW by 2045.
- The next biggest options include Third Party Contracts and DLC Electric Vehicle Charging, contributing 29.6 MW and 29.3 MW by 2045, respectively.
- Since the different rate options do not influence other rates in the stand-alone scenario, each rate has a larger potential savings than in the Opt-out/Opt-in scenarios.



Figure D-4 Summary of Winter Potential by Option – Stand Alone (MW @Generator)

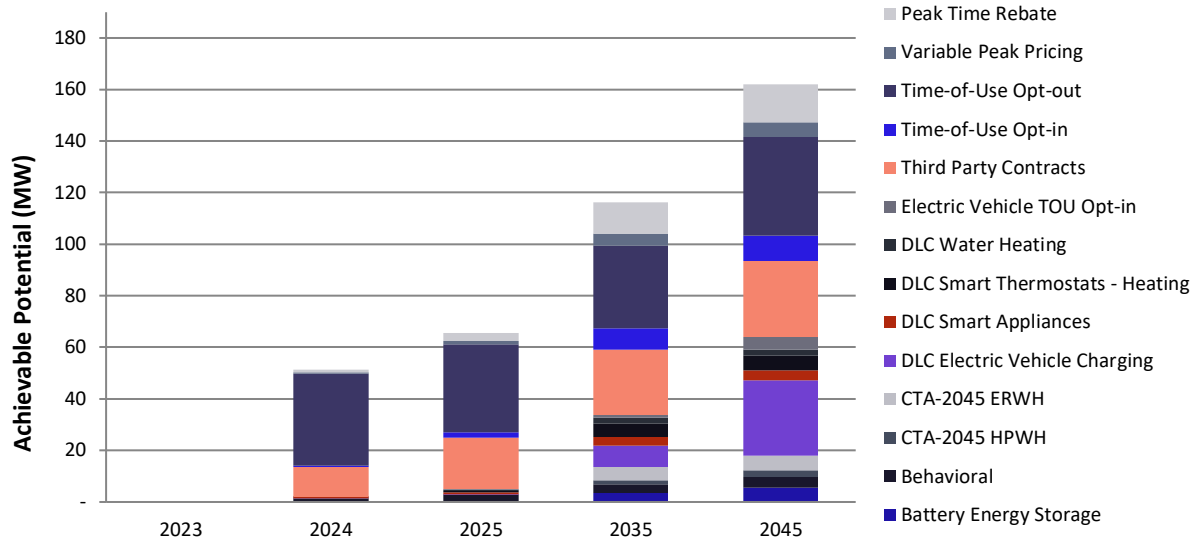

Table D-6 Summary of Summer Potential by Option – Stand Alone (MW @ Generator)

	2023	2024	2025	2035	2045
Achievable Potential (MW)	0	51	66	116	162
Battery Energy Storage	-	0.1	0.2	3.4	5.5
Behavioral	-	1.3	2.4	3.5	4.2
CTA-2045 HPWH	-	0.0	0.0	1.6	2.6
CTA-2045 ERWH	-	0.0	0.1	5.0	5.7
DLC Central AC	-	-	-	-	-
DLC Electric Vehicle Charging	-	0.0	0.2	8.4	29.3
DLC Smart Appliances	-	0.3	0.9	3.3	3.7
DLC Smart Thermostats - Cooling	-	-	-	-	-
DLC Smart Thermostats - Heating	-	-	0.5	5.2	5.8
DLC Water Heating	-	0.2	0.6	2.2	2.4
Electric Vehicle TOU Opt-in	0.0	0.1	0.1	1.1	4.7
Thermal Energy Storage	-	-	-	-	-
Third Party Contracts	-	11.4	19.9	25.3	29.6
Time-of-Use Opt-in	-	0.7	2.2	8.3	9.9
Time-of-Use Opt-out	-	35.7	34.0	32.1	38.3
Variable Peak Pricing	-	0.4	1.4	4.8	5.5
Peak Time Rebate	-	0.9	3.2	12.1	14.8

Pilot Stand Alone Results

Figure D-5 and Table D-7 show the summer demand savings from individual DR pilot options. These savings represent stand-alone savings from all available DR options in Avista’s Washington and Idaho service territories. Total potential savings for summer pilot programs are expected to reach 22.2 MW by 2045.

Figure D-5 Summary of Summer Potential by Option – Stand Alone Pilot (MW @Generator)

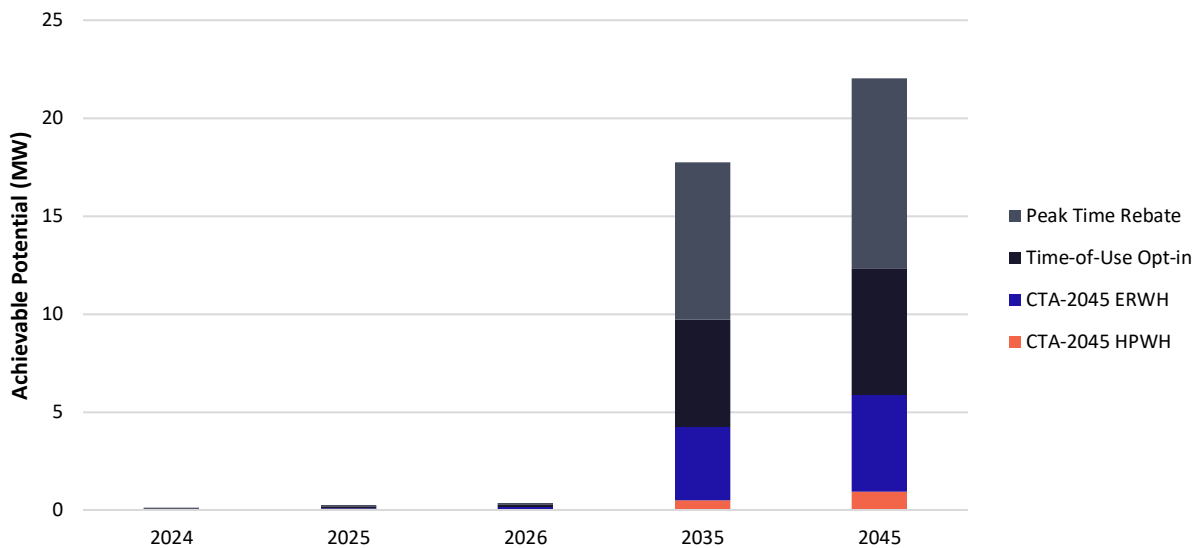

Table D-7 Summary of Summer Potential by Option – Stand Alone Pilot (MW @ Generator)

	2024	2025	2026	2035	2045
Achievable Potential (MW)	0.1	0.3	0.4	17.8	22.2
CTA-2045 HPWH	0.0	0.0	0.0	0.5	1.0
CTA-2045 ERWH	0.0	0.1	0.2	4.0	5.3
Time-of-Use Opt-in	0.1	0.1	0.1	4.7	5.6
Peak Time Rebate	0.0	0.1	0.1	8.6	10.3

Figure D-6 and Table D-8 show the winter demand savings from individual DR pilot options. These savings represent stand-alone savings from all available DR options in Washington and Idaho service territories. Total potential savings for winter pilot programs are expected to reach 23.3 MW by 2045.

Figure D-6 Summary of Winter Potential by Option – Stand Alone Pilot (MW @Generator)

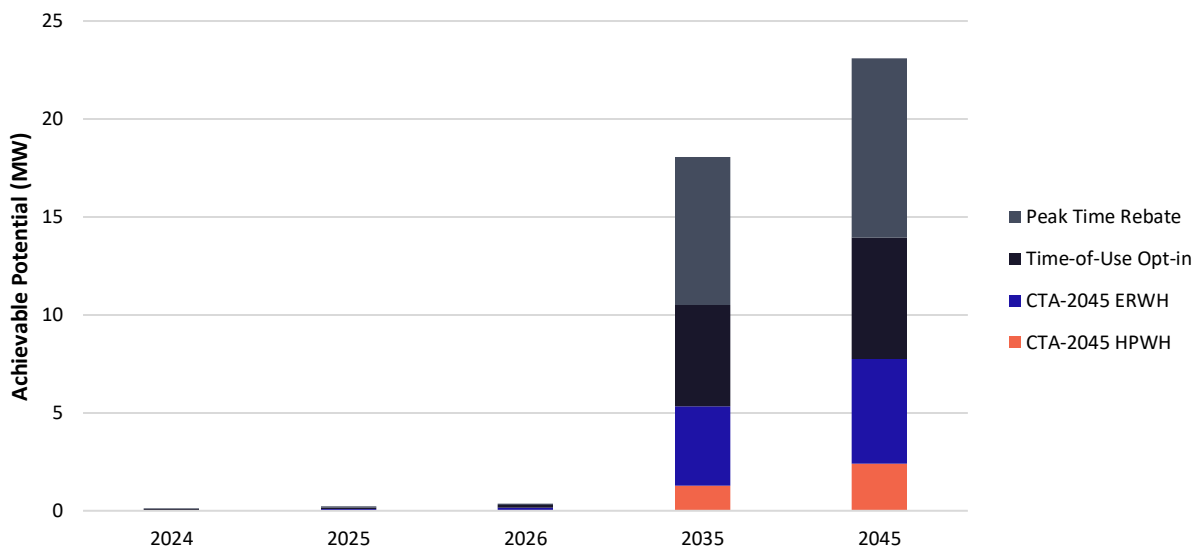

Table D-8 Summary of Winter Potential by Option – Stand Alone Pilot (MW @ Generator)

	2024	2025	2026	2035	2045
Achievable Potential (MW)	0.1	0.3	0.4	18.1	23.3
CTA-2045 HPWH	0.0	0.0	0.0	1.4	2.6
CTA-2045 ERWH	0.0	0.1	0.2	4.3	5.7
Time-of-Use Opt-in	0.1	0.1	0.1	4.4	5.2
Peak Time Rebate	0.0	0.1	0.1	8.0	9.8

## Ancillary Services

Traditionally, ancillary services have been defined broadly as an option for Avista to use that stem from other DR programs at their disposal. This year, AEG wanted to provide Avista with feasible ancillary programs that are subsets of several programs defined above. AEG chose eight parent programs on which to base ancillary options: Battery Storage, DLC Water Heating (Idaho only), Grid-Interactive Water Heating (Washington only), Smart Thermostats Cooling and Heating, DLC Electric Vehicle Charging, and Third Party Contracts. The results in this section are considered to be separate from the achievable potential discussed earlier in this chapter.

The ancillary programs were replicas of their parent programs with several exceptions. For participation, AEG assumed the same participation as the parent program for Battery Energy Storage, Electric Vehicle Charging, DLC Water Heating, and CTA-2045 Water Heating, projecting that the same customers would also be eligible for an ancillary program. Participation in Third Party Contracts was based on the saturations of EMS systems for commercial customers in the PacifiCorp territory, and the participation in Smart Thermostat Programs was assumed to be half of their respective parent programs.

For Impact assumptions, AEG assumed the same impacts for ancillary Battery Energy Storage, DLC Water Heating, and CTA-2045 Water Heating programs as their parent programs. For Ancillary Third Party Contracts, AEG assumed a 75% realization rate of the parent impact since there is more of a change a C&I customer will contribute less on an ancillary option. For Smart Thermostat and EV DLC Charging options, AEG assumed half the impacts of their respective parent programs.

Since the ancillary programs are subsets of the main programs, AEG assumed the ancillary programs would take half of the administrative and development costs of the parent programs to implement. In addition, to avoid double counting, equipment costs and O&M costs were assumed to be zero for all ancillary programs. The ancillary programs assume the same annual marketing and recruitment costs and incentive costs as their parent programs.

Table D-9 and Table D-10 show the summer and winter demand savings from individual DR options for selected years of the analysis. These savings represent integrated savings from all available DR options in Avista's Washington and Idaho service territories.

The results show that an ancillary service option run through the EV DLC program would garner the most potential savings in both summer and winter seasons. This is due to the high potential impact per customer of this program at 75% of an average participant's EV load, as well as the inclusion of the latest EV forecast.

## 2022-2045 Avista Electric CPA | Demand Response Potential

Table D-9 Summer Peak Ancillary Service Option, TOU Opt-in (@Generator)

Summer Potential	2023	2024	2025	2035	2045
Baseline Forecast (Summer MW)	1,404	1,408	1,415	1,548	1,864
Achievable Potential (MW)	-	2	5	26	45
Achievable Potential (%)	0%	0%	0%	2%	2%
Ancillary Battery Storage	-	0.1	0.2	3.4	5.5
Ancillary Cooling	-	0.5	1.5	6.1	7.7
Ancillary DLC WH	-	0.2	0.6	2.2	2.4
Ancillary HPWH	-	0.0	0.0	0.6	1.0
Ancillary ERWH	-	0.0	0.1	4.6	5.3
Ancillary EV	-	0.0	0.1	5.5	19.1
Ancillary Heating	-	-	-	-	-
Ancillary Third Party	-	1.4	2.5	3.2	3.7

Table D-10 Winter Peak Ancillary Service Option, TOU Opt-in (MW @Generator)

Winter Potential	2023	2024	2025	2035	2045
Baseline Forecast (Summer MW)	1,365	1,369	1,376	1,505	1,816
Achievable Potential (MW)	-	2	4	22	40
Achievable Potential (%)	0%	0%	0%	1%	2%
Ancillary Battery Storage	-	0.1	0.2	3.4	5.5
Ancillary Cooling	-	-	-	-	-
Ancillary DLC WH	-	0.2	0.6	2.2	2.4
Ancillary HPWH	-	0.0	0.0	1.6	2.6
Ancillary ERWH	-	0.0	0.1	5.0	5.7
Ancillary EV	-	0.0	0.1	5.5	19.1
Ancillary Heating	-	-	0.1	1.3	1.4
Ancillary Third Party	-	1.5	2.5	3.2	3.8



Applied Energy Group, Inc.  
2300 Clayton Road, Suite 1370  
Concord, CA 94520



# 2023 Electric Integrated Resource Plan

## Appendix D – DNV Non-Energy Impact Studies





FINAL REPORT

# Non-energy Impacts

Avista

Date: September 08, 2021







## Table of Contents

1	INTRODUCTION.....	4
2	OVERVIEW OF APPROACH.....	5
3	DETAILED MEASURE MAPPING METHODOLOGY .....	6
3.1	Conduct Jurisdictional Scan of Existing NEI Studies.....	6
3.2	Mapping NEI measures in the Database.....	6
3.3	Mapping Avista measures to the Database.....	7
4	DETAILED CONFIDENCE FACTOR METHDOLOGY .....	9
4.1	Develop the Confidence Factor.....	9
5	DETAILED PLAUSIBILITY FACTOR METHODOLOGY .....	12
6	DETAILED EXAMPLE OF COMBINED SCORE CALCULATION.....	15
7	ECONOMIC ADJUSTMENT METHDOLOGY .....	17
7.1	Construct the Economic Adjustment Factors .....	17
8	UTILITY-SPECIFIC CALCULATION AND SELECTION METHDOLOGY .....	27
8.1	Database Exclusion Criteria .....	28
8.2	Match Database to Avista TRM.....	30
8.3	Avista-Specific NEI Calculation .....	31
8.4	Identifying Best NEI Estimate from all Potential Matches.....	32
9	FINAL RESULTS .....	36
9.1	Avista-specific NEI Example .....	36
9.2	Total NEI Value Example .....	37
10	GAP ANALYSIS APPROACH .....	38
10.1	Measures Without NEI Values .....	38
10.2	Heavily Discounted NEIs.....	39
10.3	NEIs Not Previously Studied .....	39
11	FRAMEWORK FOR FUTURE RESEARCH.....	40
11.1	Prioritization Criteria and Assignment of Levels of Priority.....	40
11.2	Framework output .....	41
11.3	Avista-Specific Gap Analysis Example.....	43
11.4	Prioritization of Research .....	43
12	REFERENCES.....	46
13	APPENDICES .....	47
13.1	Appendix A: NEI Studies List .....	47
13.2	Appendix B: Confidence Factor Scoring.....	49
13.3	Appendix C: Plausibility Scoring Metrics .....	1
13.4	Appendix D: Plausibility Combinations .....	1
13.5	Appendix E: Non-energy Impact Theory .....	1



## List of Figures

Figure 1. NEI Calculation and Selection Process .....	27
Figure 2. Example of 2 Potential Matches .....	31
Figure 3. Amalgamation of NEI Categories into Measure's Total NEI .....	33
Figure 4. Impact of NEIs on consumer surplus .....	2
Figure 5. Impact of EE on O&M costs and profit .....	3

## List of Tables

Table 1. Example of Standard Level of Aggregation details for one measure in the Avista TRM .....	7
Table 2. Example of Concatenated Matching IDs .....	7
Table 3. Questions used to Calculate Confidence Factor Score, and the Reasons for Each Question .....	9
Table 4. Example Confidence Factor Calculation .....	10
Table 5. Level of Matching Scoring Table .....	12
Table 6. Age of Study Scoring Table .....	12
Table 7. Example of Plausibility Factor Scoring .....	14
Table 8. Confidence Factor Scoring Examples – Study0004 .....	15
Table 9. Variables with descriptions, years, and sources use to calibrate NEIs to a different state or region .....	18
Table 10. Customer Weighted Residential Health Costs, 2018 .....	26
Table 11. Match level Accuracy Example .....	28
Table 12. Studies Meeting Criterion 1 and Whether they Pass Criterion 2: Confidence in Study .....	28
Table 13. Example of Relevancy of NEI by End-Use .....	30
Table 14 - Example of Standard Level of Aggregation for Avista Measures .....	30
Table 15. Example of Concatenated Matching IDs .....	30
Table 16. Choosing Best Match by Combined Score to Represent O&M NEI Value for Avista Measure - LTGO: Lamp - TLED - 2 3 or 4 foot .....	34
Table 17. Choosing Best Match by NEI Ratio when Combined Score are Tied .....	34
Table 18. Example of Final Results .....	37
<b>Table 19. NEI Values Exist for a Similar Measure</b> .....	38
Table 20. Studies with Heavily Discounted NEIs .....	39
Table 21. Framework Prioritization Scoring .....	40
Table 22. Prioritization of Proposed Future NEI Studies .....	42
Table 23. Recommended Gap Studies and NEIs Addressed .....	44
Table 24. List of Studies in the Database .....	48
Table 25. Confidence Factor Scoring for Database Studies .....	50
Table 26. End-Use UEC Change Score .....	1
Table 27. CBECS End-Use Energy Consumption Scoring .....	1
Table 28. RECS End-Use Energy Consumption Scoring .....	2
Table 29. Plausibility Factor Scoring Table (assumes equal weighting) .....	1

**Primary Contact**

Amit Kanungo, Head of Section, Principal Engineer, Measurement & Verification

DNV Energy

[amit.kanungo@dnv.com](mailto:amit.kanungo@dnv.com)

Mobile +1-415-516-6504

Direct +1-510-891-0446 x 44123

**Project Manager**

Andrew Wood, Senior Consultant, Policy Advisory and Research

DNV Energy

[andrew.w.wood@dnv.com](mailto:andrew.w.wood@dnv.com)

Direct +1 971-334-0035

**Avista Contract Manager**

Ryan Finesilver, Energy Efficiency Planning & Analytics Manager

Direct +1 509-495-4873

[Ryan.Finesilver@avistacorp.com](mailto:Ryan.Finesilver@avistacorp.com)

# 1 INTRODUCTION

DNV's Non-energy Impact (NEI) Database (the "Database") allows DNV to map published NEI values to Avista's Technical Reference Manual (TRM). The values produced are adjusted to account for differences in economic and programmatic conditions. The overall goal of this NEI research is to develop the most comprehensive set of NEI values possible based on published research and to identify gaps where additional research is necessary to quantify the value of occurring NEIs. The results can be used to report, evaluate, and market energy efficiency programs across Avista's Residential and Commercial and Industrial (C&I) sectors.

The overall process for estimating the NEIs is broken down into seven tasks:

- Task 1: Map Avista measures to DNV's NEI Database
- Task 2: Assign confidence factors
- Task 3: Assign plausibility factors
- Task 4: Estimate economic adjustment factors
- Task 5: Adjust Database values to calculate utility specific NEIs
- Task 6: Choose the best value for each NEI/measure combination
- Task 7: Gap analysis

This report is constructed from the individual memos provided throughout the duration of this project and provides the necessary documentation to establish the final NEI values as viable impacts results from the installation of energy efficiency measures.

## 2 OVERVIEW OF APPROACH

The Database approach identifies NEIs from the existing literature and assigns those NEIs to relevant Avista programs and measures. DNV's NEI Database contains 50 separate residential and C&I NEIs from 46 publicly available studies. After assigning the NEI to Avista programs and measures, we adjust the estimates based on plausibility, confidence, and economic adjustment factors. The adjustments improve transferability of the research to Avista territory. They also adjust the NEI values to account for uncertainty stemming from extremely high or low values, the quality of the methods used in the original study, the age of the original study, and differences in economic conditions between the area covered by the original study and Avista service territory.

The NEI Database approach consists of the following 7 tasks:

- Task 1. Map Avista measures to DNV's NEI Database** - NEI studies can vary considerably in how they aggregate information when reporting a quantified NEI value. The goal in this step is to standardize the Avista measure descriptions into the same taxonomy as we have assigned to the measures from all of the studies in the Database. We then use those standardized descriptions to match the Avista measures to those in the Database.
- Task 2. Assign confidence factors** - DNV assigns a Confidence Factor (CF) to each study to reflect how well the study follows research best practices. The CF is used to discount the NEI values matched to Avista's measures to provide a conservative estimate of NEI values in our Database. Furthermore, the studies and measures in the Database are sorted from highest confidence to low confidence, so that the matching look-up value select the higher confidence values first.
- Task 3. Assign plausibility factors** - DNV developed a Plausibility Factor (PF) for each study to further account for nuances in NEI research outside of the actual study methodology. The PF is also used in conjunction with the CF for discounting NEI values and for identifying best-fit values in the event of multiple measure-by-NEI matches.
- Task 4. Estimate economic adjustment factors** - DNV uses publicly available data to develop factors that adjust NEI's based on the economic activity of the original jurisdictions to Avista's service territory.
- Task 5. Adjust Database values to calculate utility-specific NEIs** – All NEIs from the Database that match Avista measures are scored according to the combined Confidence and Plausibility scores, creating the “combined score.” This combined score, along with the economic adjustment factor, are applied to the study NEI value to make it utility-specific (or more specific, where possible) as well as to discount the value based on how applicable it is. This process is reflected in the following equation:

**Equation 1: Discount and geographically adjust NEI value**

$$\text{Utility – specific NEI} = \text{Study NEI Value} * \text{Combined Score} * \text{Economic Adjustment Factor}$$

- Task 6. Choose the best value for each NEI/measure combination** – The automated Database process can produce multiple matches between the published NEI values and the Avista TRM. A multi-level ranking approach identifies the best fit for each NEI-by-measure combination. When there are multiple options for a top value, the most conservative estimate is flagged and the DNV NEI team reviews all potential matches to identify the best fit. The results produce a single matched value as the final recommended NEI for each measure-by-NEI combination.
- Task 7. Gap analysis** – DNV identifies areas in which follow-up research is necessary to confirm or quantify NEIs occurring within Avista territory. This process involves:
- a. Conducting a gap analysis to identify Avista measures lacking NEIs; and,
  - b. Developing and applying a framework to prioritize future research.

### 3 DETAILED MEASURE MAPPING METHODOLOGY

This section describes how DNV mapped each measure in Avista's data to DNV's Database.

#### 3.1 Conduct Jurisdictional Scan of Existing NEI Studies

The Database contains 46 different NEI studies as part of the NEI database, including studies from literature reviews from Ohio and Ontario and those referenced by the Massachusetts NEI Framework project. We start the process with a jurisdictional scan (JS) to determine the following information from each available NEI study:

- Categories of NEIs
- Quantified NEI values and their units
- Level of aggregation, specifically whether the NEI was identified by sector, program, end-uses, or detailed measures
- Rigor and methodology used to calculate NEIs
- Plausibility of applying the study to other programs
- Economic factors related to the original jurisdiction for each study

Thus, the JS provides the foundation for gathering inputs not only for identifying NEI values, but also the inputs needed to adjust those values based on our various adjustment factors.

#### 3.2 Mapping NEI measures in the Database

DNV standardizes the names of NEIs reported by each of the 46 JS studies. For example, many NEIs are similar in nature but were described differently (e.g., "Avoided Operation and Maintenance" vs "O&M avoided"). DNV also created a list of standard NEI names that we assigned to the observed NEIs identified across all the studies in the JS. We create a "crosswalk" that maps the unique NEI names from the original studies to our standardized names.

NEI studies can vary considerably in how they aggregate information when reporting a quantified NEI value. Some studies may report NEI results for specific segment-program-measure level descriptions, such as "C&I-small business retrofit-4-ft linear LED lamp. Other studies may only report NEIs for C&I lighting retrofits, while some may simply report the NEIs that are associated with a prescriptive C&I program.

NEIs can also vary by the fuel-type that was examined as part of the study, such as electricity, natural gas, or kerosene. For example, an NEI study conducted for an electric-only utility might provide different values for insulation measures than one conducted for a gas and electric utility. In addition, the units in which the NEI are reported can be fuel-specific, such as \$/kWh or \$/therm.

DNV refers to the combination of the following classes of fuel saved, program participant populations, programs, and measure descriptions as the "level of aggregation" (LoA). Below is a list of the seven LoAs we classified for use in this study:

1. **Fuel (Level 0):** Identifies the fuel studied in the JS report (electricity, gas, or both).
2. **Sector (Level 1):** Identifies the population being served by the program (C&I or Residential).
3. **Program Level (Level 2):** Designates the class of program within the sector (Low Income, New Construction, Retrofit).
4. **Prescriptive/Custom (Level 3):** Separates programs into Prescriptive or Custom.
5. **End-use Level (Level 4):** High-level description of end-use systems modified through a program type.
6. **Broad Measure Level (Level 5):** High-level description of measure within an end-use (e.g., LED Lighting)
7. **Detailed Measure Level (Level 6):** Detailed-level description of measure within an end-use (e.g., Linear LED)

We standardized and assign the LoAs to each measure in the 46 studies contained in the Database.

### 3.3 Mapping Avista measures to the Database

DNV then standardizes and assigns the same LoAs listed above to each of Avista's measures. All the studies in the JS had an original (observed) LoA, but they varied in terminology from study to study. As such, DNV reviewed the Avista TRM to identify the observed LoA in Avista's programs and measures. The result was a list of fuels, sectors, programs, sub-programs, end-uses and measures in TRM, which we refer to as the **Avista TRM**.

DNV reviewed all original LoA across the JS and the Avista TRM to assign a standard set of naming conventions. During the LoA assignment process, DNV analyzed Avista's tracking data to identify the programs in which each measure was installed. In cases where a certain measure in Avista's TRM was installed across different program types (e.g., Custom HVAC measure being installed in a New Construction and Retrofit program), DNV created duplicate rows in the TRM and delineated between the two by adding a program type to column H of the 'NEI Breakout' worksheet in the attached results workbook.

#### 3.3.1 Match JS to Avista TRM

In the subsequent stages of this project, DNV will map the JS measures to the Avista TRM using the standard set of Level 0 through Level 6 match codes. The match codes are assigned to the Avista TRM using the same match code dictionary used in the JS. Table 1 below illustrates how a Linear LED measure in the JS is broken out into the LoA.

**Table 1. Example of Standard Level of Aggregation details for one measure in the Avista TRM**

Standard Levels of Aggregation	Example of Standard Levels of Aggregation Details
Detailed Measure Level (Level 6)	Linear LED
Broad Measure Level (Level 5)	LED
End-Use Level (Level 4)	Lighting
Prescriptive/Custom (Level 3)	Prescriptive
Program Level (Level 2)	Retrofit
Sector (Level 1)	C&I
Fuel (Level 0)	Electricity
Standard NEI Category Example	O&M-Participant-C&I

Table 2 illustrates how these Standard LoA and the Standard NEI Categories come together to form the matching IDs.

**Table 2. Example of Concatenated Matching IDs**

Match Level ID	Concatenated Matching ID
6	Electricity_C&I_Retrofit_Prescriptive_Lighting_LED_Linear LED
5	Electricity_C&I_Retrofit_Prescriptive_Lighting_LED
4	Electricity_C&I_Retrofit_Prescriptive_Lighting
3	Electricity_C&I_Retrofit_Prescriptive
2	Electricity_C&I_Retrofit

A match occurs when the concatenated match codes exist in both the Avista TRM and in one or more studies in the JS. All potential matches are created using mutual exclusivity.



First, all matches are identified that happen at a Level 6. Next, all matches are identified that happen at a Level 5, but which did not happen at a Level 6. This process is done all the way through Level 2, and then a match level is assigned, and all potential matches are preserved. Lastly, the top values are chosen by ranking the potential matches from most specific (i.e., Level 6) to least specific (i.e., Level 2).

The following is an outline of how the six levels of matching are used to generate a list of results utilizing the above Avista lighting measure in Tables 1 and 2 as an example. Initially, a lookup of the Level 6 ID in Table 2 is performed in the JS to check for any exact matches. A current look in the JS shows that there are no exact matches at a Level 6, so the code then checks for any matches using the Level 5 ID. The JS does not contain any matches at a Level 5 either, so the next step is to check for any matches using the Level 4 ID. This time the output shows 7 matches spanning 4 different studies at a Level 4. This process continues using the Level 3 and 2 IDs until a list of all potential matches are generated.



## 4 DETAILED CONFIDENCE FACTOR METHODOLOGY

This section describes how DNV assigns the Confidence Factor to each study in the Database.

### 4.1 Develop the Confidence Factor

At times, the Avista TRM matched to more than one study in the Database. DNV's Confidence Factor (CF) informs the selection of one study's NEI over another. DNV considers six different questions that relate to best practices in NEI research to develop each CF. Each question has a set of fixed responses, outlined in Table 3.

Each question is also assigned a weight based on significance. These weights can be adjusted and used to reflect whether one or more questions are determined to be more important than others in determining which study to use.

#### 4.1.1 Confidence Factor Scoring Inputs

To assign a CF to each of the studies in the Database, DNV examined each report in the context of the following questions. Table 3 presents the possible responses to each of the confidence factor criteria, and their associated scores in parentheses.

**Table 3. Questions used to Calculate Confidence Factor Score, and the Reasons for Each Question**

Question	Possible Responses (scores)	Intention of question
1. Is the study measure specific?	<ul style="list-style-type: none"> <li>a. Measures have specific NEIs associated with them (3)</li> <li>b. Measures are identified by the study, but in aggregate (2)</li> <li>c. Measures are not reported at all (1)</li> </ul>	Studies providing values tied to specific measure groups are more robust than those that provide combined NEIs across multiple measures or do not distinguish which measures are included in the sample.
2. Is the study segmented by sector?	<ul style="list-style-type: none"> <li>a. Study identified NEIs related to sample segments (3)</li> <li>b. Study identifies sample segments used to design sample frame, but NEIs are not specific to segments (2)</li> <li>c. Sample not segmented at all (1)</li> </ul>	The impact of measures on participants varies by participant characteristics such as income level and industry. Studies that account for these differences are regarded as providing greater precision in results than those that do not.
3. Was the sample drawn using a statistical method?	<ul style="list-style-type: none"> <li>a. Study reports statistically significant sample results with precision levels (3)</li> <li>b. Study uses statistical sampling, but results are not always statistically significant (2)</li> <li>c. Does not use statistical sampling (1)</li> </ul>	Statistical sampling accounts for key differences in respondents and/or measures that create variance in NEI estimates. NEI studies that use stratified sampling and provide statistically significant results are regarded as superior to those that do not.
4. Does the study incorporate identifiable economic factors?	<ul style="list-style-type: none"> <li>a. Approach clearly isolates/identifies relevant economic factors (3)</li> </ul>	NEIs result from changes to either consumer or producer surplus. As such, they should relate to some aspect of the household or firm decision-making

	<p>b. They used some economic factors based on theory, although not clearly identified in study (e.g., property values) (2)</p> <p>c. Economic factors are not identified, and cannot be inferred (1)</p>	<p>process such as improved costs, revenues, living conditions, etc. Studies that isolate NEIs that tie to identifiable economic factors provide greater confidence than those that are less specific about the factors that justify NEIs.</p>
<p>5. Does the study consider any of the following when appropriate: Open-ended questions, Additivity, Double Counting</p>	<p>a. Accounts for Open-ended questions, Additivity, and Double Counting (3)</p> <p>b. Accounts for two out of the three factors (2)</p> <p>c. Accounts for only one of the factors (1)</p> <p>d. No evidence to suggest any of the factors were accounted for (0)</p>	<p>Best practices in NEI research document the need for studies to tie NEI estimates to known factors (such as utility bills) or derive estimates from factors that are known, such as hours to do a task and wages. Research also clearly documents the need to account for non-additivity of multiple NEIs. Finally, more rigorous studies take steps to ensure that NEIs are distinct across NEI categories.</p>

#### 4.1.2 Confidence Factor Scoring

DNV applied the rating system presented in Table 3 to construct the confidence factor for each study as follows:

- DNV recorded the numeric score (0-3) for each of the five questions for each study.
- A weighted score was calculated by multiplying the numeric score for each question by the question's weight. In the calculation, each of the five questions was given an equal weight; however, the weights can be adjusted in the final Database.

##### Equation 2: Confidence Factor Score Calculation Using Weights

$$\text{Confidence Factor Score} = \frac{(Q1 \text{ Score} * Q1 \text{ Weight}) + (Q2 \text{ Score} * Q2 \text{ Weight}) + (Q3 \text{ Score} * Q3 \text{ Weight}) + (Q4 \text{ Score} * Q4 \text{ Weight}) + (Q5 \text{ Score} * Q5 \text{ Weight})}{\text{Max Total Score}}$$

- An example of how the weights are applied for two of the studies is shown in Table 4. If the question weights ("Q Weight") are adjusted, then the max score will also adjust:

**Table 4. Example Confidence Factor Calculation**

Study_ID	Q1 Score	Q2 Score	Q3 Score	Q4 Score	Q5 Score	Weighted Total Score	CF (Percent of Max)
Q Weight (0-1)	1	1	1	1	1	Max = 15 Min = 5	CF Max = 100% CF Min = 50%*
Study0001	3	3	3	3	3	15	100%
Study0002	2	3	3	3	3	14	93%

\*DNV sets of CF floor of 50%

- The weighted scores were summed to create an aggregate score for each study. The maximum possible weighted score was 15, while the lowest score was five.
- The weighted CF was calculated by dividing the aggregate score by the maximum possible score of 15. Studies with higher CFs typically contain more granular measure details and have more identifiable economic factors.

- 
- The DNV method includes a CF “floor” of 50%, meaning no CF will drop below 50%, regardless of the answers to the five scoring questions. The DNV NEI team believes that NEIs should not be discounted to zero, but some discounting is appropriate. DNV reasoned that reducing NEIs from studies with a low confidence factor by 50% allows some value of NEI to be recognized, while still reducing the value to reflect our lack of confidence in the estimate.

Table 25 and Appendix B: Confidence Factor Scoring contain a table that shows the CF scores and adjusted CF for each study in the Database.

## 5 DETAILED PLAUSIBILITY FACTOR METHODOLOGY

DNV developed a Plausibility Factor (PF) to further account for nuances in NEI research outside of the actual study methodology. The Plausibility Factor (PF) considers three variables:

1. Level of matching (Level 6, Level 5, etc.) represents how specifically the measures in the study match to Avista's measures
2. Age of the study
3. Changes in energy consumption within an end-use category over time

These inputs account for factors that impact NEI values that are not included in the CF, since the factors depend on data outside of the study. Similar to the CF inputs, each of these three inputs can receive a different weight to reflect greater or lesser relative importance. By default, DNV set all weights to 1 to represent equal importance for each factor. DNV calculated a PF score from 0% to 100%, with the higher the score representing a higher level of plausibility.

### 5.1.1 Plausibility Factor Scoring Inputs

#### 5.1.1.1 Level of Matching

We used the level of matching discussed in Section 3.2 to provide the first input to the PF. Higher level matches indicated that the study from the Database closely represented the measure in the Avista TRM, and therefore received a higher score. Table 5 shows how the matching level translated into a PF input for matching. DNV's calculation does not typically result in the use of a prior studies with a level of match of 3 or lower. The level of match is typically 4 or greater for all NEI estimates used in the final calculations.

**Table 5. Level of Matching Scoring Table**

Match Level	Match Level Description	Example	Score
Level 6 Match	Detailed Measure	Air Source Heat Pump	6
Level 5 Match	Broad Measure	Heat Pump	5
Level 4 Match	End-Use	HVAC	4
Level 3 Match	Prescriptive/Custom	Prescriptive	3
Level 2 Match	Program	Retrofit	2

#### 5.1.1.2 Age of the Study

Existing studies are affected by the economic, programmatic, demographic, and other factors relevant at the time those studies took place. As the studies age, these factors can shift, which decrease the relevance of the study to current programs and measures. For example, the Great Recession affected programs running in the 2009-2015 time period. Also, NEI research has evolved substantially over the last several years (Skumatz, 2016). This adjustment factor is designed to represent this potential decrease in relevance and discount NEI values based on it. DNV grouped the studies into the categories shown in Table 6, assigning higher scores for more recently published studies.

**Table 6. Age of Study Scoring Table**

Age of Study	Score
Five years or less	4

Six to ten years	3
11-15 years	2
Greater than 15	1

### 5.1.2 Change in End-Use Unit Energy Consumption

The third aspect of the PF calculation accounts for technological change in measure energy consumption over time. DNV assumed that if a study from the Database analyzed an end-use that has had a large change in energy consumption over the last several years, then the age of the study, in combination with the end-use category, provides important insight into whether the study's NEI results should be further discounted. For example, a study published prior to 2013 (with energy efficiency data from 2012 or older) that analyzed lighting NEIs would almost certainly have little coverage of LEDs in the measure-mix of the study. Therefore, the NEIs in that study related to lighting measures should be discounted to account for the large change in lighting energy consumption.

To calculate this value, DNV reviewed historical end-use energy consumption from the 2003 and 2012 Commercial Building End-Use Survey (CBECS) and the 2009 and 2015 Residential End-Use Consumption Survey (RECS) published by the Energy Information Administration.<sup>1</sup> CBECS and RECS provide tables reporting the unit energy consumption (UEC) of end-use technologies over time. DNV used the UEC/sq ft and UEC/household reported in CBECS and RECS, respectively, to measure change in energy consumption in each end use category over time. By calculating the Compound Annual Growth Rate (CAGR) between the earlier study and later study, DNV assumed that constant energy consumption over time for a specific end-use (indicated by a low CAGR %) showed that a study of that end-use would still be reliable today.

Appendix C: Plausibility Scoring Metrics contains tables that show the scoring inputs by the different CAGR categories and UEC numbers by end-use categories in CBECS and RECS.

### 5.1.3 Plausibility Factor Scoring

DNV constructed the plausibility factor for each study, end-use, and matching level combination as follows:

- DNV recorded the numeric score for each of the three factors.
- DNV assigned a weight to each score. By default, the weights are all set to 1.
- The weighted scores were summed to create an aggregate score for each study, end-use, and matching level combination.

#### Equation 3: Plausibility Factor Score Calculation Using Weights

$$Plausibility\ Factor\ Score = \frac{(Age\ of\ Study\ Score * Age\ of\ Study\ Weight) + (UEC\ Change\ Score * UEC\ Change\ Weight) + (Match\ Level\ Score * Match\ Level\ Weight)}{Max\ Total\ Score}$$

- A PF was calculated by dividing the aggregate score by the maximum possible score of 13. Studies with higher PFs are typically more recent.

<sup>1</sup> For further details on RECS, see: <https://www.eia.gov/consumption/residential/data/2009/index.php?view=consumption>  
<https://www.eia.gov/consumption/residential/data/2015/index.php?view=consumption>

For further details on CBECS, see: [https://www.eia.gov/consumption/commercial/archive/cbeecs/cbeecs2003/detailed\\_tables\\_2003/2003set19/2003html/e06a.html](https://www.eia.gov/consumption/commercial/archive/cbeecs/cbeecs2003/detailed_tables_2003/2003set19/2003html/e06a.html)  
<https://www.eia.gov/consumption/commercial/data/2012/c&e/cfm/e6.cfm>

- The DNV method includes an PF “floor” of 50%, meaning no PF will drop below 50%, regardless of the scores attached to the three factors.

The PF scores apply to a measure within a study. Table 7 shows examples of PF scores for different combinations of study age, UEC change score, and match level. Table 29 in Appendix D: Plausibility Combinations show all possible combinations of PF factors and the resulting adjusted PF score.

**Table 7. Example of Plausibility Factor Scoring**

Age of Study Score (A)	Unit Energy Consumption Change Score (B)	Matching Level Score (C)	Total Score (A+B+C)	% of Max Score (A+B+C)/13	Adjusted Plausibility Factor (No PF below Min PF)
4	3	6	13	100%	100%
3	3	6	12	92%	92%
4	3	4	11	85%	85%

## 6 DETAILED EXAMPLE OF COMBINED SCORE CALCULATION

Equation 4 below shows an example calculation of the CF score for NEI Framework Study Report (Study 04). This example uses Equation 2 referenced above and utilizes the CF question scoring for that Study 04 further detailed in Table 8. The calculation also assumes an equal weight of 1 for Q1-Q5.

### Equation 4: Confidence Factor Calculation Example

$$\text{Confidence Factor Score (Study0004)} = \frac{(3 * 1) + (3 * 1) + (2 * 1) + (2 * 1) + (1 * 1)}{15} = \frac{11}{15} = 0.73$$

**Table 8. Confidence Factor Scoring Examples – Study0004**

Confidence Factor Question	Score	Rational
Q1 - Is the study measure specific?	3	The study reports NEI values for specific measures such as boilers, thermostats, and heat pumps.
Q2 - Is the study segmented by sector?	3	The sample design is segmented by sector (Residential, Low-income, and C&I) and initiatives (e.g. multifamily retrofit, home energy services, lighting, new construction). NEI results were linked to all sector initiatives.
Q3 - Was the sample drawn using statistical method?	2	The study used statistical sampling, but some results regarding electric hot water measures were not statistically significant.
Q4 - Does the study incorporate identifiable economic factors?	2	The study identified several property value NEIs based on the Hedonic Price theory.
Q5 - Does the study not consider any of the following when appropriate: Open-ended questions, Additivity, Double Counting	1	This study cites coordination across its approach in order to avoid double counting across both residential and C&I sectors. This study aimed to eliminate possible double counting by recommending that Program Administrators do not count existing property value NEIs for measures with property value and other NEIs. The report did a review of TecMarket Works (2007) study which included open-ended questions, but there was no evidence in the report to suggest they accounted for this or additivity.

Equation 5 below shows an example calculation of the PF score for Study0004. It is based on Equation 3 referenced above. The study was published in 2018 and therefore gets an Age of Study Score of 4. The UEC and Match level scores depend on the measure being matches to the measures in the original study. For the purposes of this example, the calculation will assume a Level 5 match to an HVAC measure. Because the measure falls under HVAC end-use, the UEC score is 3. The Match Level score is 5 due to it being a level 5 match. An equal weight of 1 is used for each factor. The Max Total Score possible for the PF is 13.

### Equation 5: Plausibility Factor Calculation Example

$$\text{Plausibility Factor Score (Study0004)} = \frac{(4 * 1) + (3 * 1) + (5 * 1)}{13} = \frac{12}{13} = 0.92$$



If either the CF or the PF were less than 0.5, we would adjust them to 0.5 at this point before multiplying them together. As both are above 0.5, no minimum adjustment is needed.

The Combined Score is the product of the CF and PF and is the factor by which the Study NEI value is discounted prior to any economic adjustments.

**Equation 6: Combined Score Calculation Example**

$$\text{Combined Score (Study0004)} = CF * PF = 0.73 * 0.92 = 0.67$$

Therefore, the Study NEI value retains 67% of its original value prior to economic adjustments.

If both the CF and PF were set to the 0.5 individual value minimum, then the combined score would be 25%. Therefore, the maximum adjustment taken in the study is to discount an NEI to 25% of its original value.



## 7 ECONOMIC ADJUSTMENT METHDOLOGY

This section describes how DNV developed economic factors that adjust the Database NEIs to account for differences in economic activity between a study's original jurisdiction and Avista's service territory. DNV's Database already contains economic adjustment factors at the state level (e.g., Massachusetts versus Washington), so for Avista's analysis the focus was on developing intrastate economic adjustment factors that can be applied at the service-territory level.

### 7.1 Construct the Economic Adjustment Factors

During the NEI jurisdictional scan (JS) to develop the Database, DNV identified various economic factors on which NEIs from each study are based, either explicitly (stated in the study) or implicitly (assumed based on economic theory). DNV used publicly available data to develop factors that adjust the NEI based on the economic activity in the original jurisdiction to the intended jurisdiction.

DNV identified eight economic factors that can be used to adjust the NEIs. The factors are broken into Residential and C&I categories and include the following.

Residential economic adjustment factors:

- **Property Value** – Noise, visual, and air/temperature NEIs that are reflected in the differences in home values.
- **Income & Health Impacts (loss of income)** – Economic development NEIs related to income, as well as health NEIs related to longer life or missed days at work can be adjusted using differences in income.
- **Health Impacts (avoided costs)** – Health and safety NEIs related to avoided medical costs in hospitals. These NEIs are adjusted using the differential in medical costs between jurisdictions.
- **Age of Home** – Fire related NEIs using the differential in the age of homes between jurisdictions.
- **Utility Cost - Residential** – NEIs that result from changes to utility costs such as bad debt, arrearages, and hedging. These NEIs can be adjusted using the ratio of the average utility cost per MMBtu by sector (commercial, industrial, residential).

Commercial and Industrial economic adjustment factors:

- **Labor Costs (wage-based)** – Operations and maintenance (O&M) NEIs are largely a function of the time spent to maintain, repair, or replace equipment. These NEIs are adjusted using wage differentials in C&I settings.
- **Revenue & Productivity** – NEIs that change the profitability or operating costs for C&I customers other than what can directly be attributed to O&M. Comfort changes in C&I applications result in productivity NEIs. Changes may also affect the durability of a product or the amount of sales revenue. These NEIs can be adjusted using differentials in output or GDP.
- **Utility Cost - C&I** – NEIs that result from changes to utility costs such as bad debt, arrearages, and hedging. These NEIs can be adjusted using the ratio of the average utility cost per MMBtu by sector (commercial, industrial, residential).

The following sections discuss the economic adjustment factors:

- Section 7.1.2 discusses the values already contained in the Database and how to use them with newly developed, Avista values
- Section 7.1.3 presents the economic variables used for the adjustment factors
- Section 7.1.4 discusses economic adjustment factors for NEIs applicable to residential programs
- Section 7.1.5 discusses economic adjustment factors for NEIs applicable to C&I programs
- Section 7.1.6 discusses how these economic adjustments are applied to create NEI values representative of Avista's service territory
- Section 7.1.7 provides an example of economic adjustment for a residential NEI

## 7.1.2 Between State and Within State Adjustments

DNV developed adjustments to account for economic differences within the state of Washington. The JS already contains factors used for state-to-state comparison, so the updated factors address how Avista's service territory differs from that of Washington as a whole. The study uses the state-level adjustments to modify NEI values from their original jurisdiction, but it will now also include these service territory-level adjustments.

Most data used for the Avista adjustments are identified by county or area and not by specific utility service territory. Avista provided a geographic distribution of customers that DNV used to weight county-level economic data to a utility-level adjustment that could be compared with the state as a whole. These customer distributions were identified for each sector (Residential and C&I). With both the state and Avista adjustment factor representing relational qualities, the two can be multiplied together to form a single ratio for comparing Avista's service territory to that of the original study jurisdiction (See example in Section 7.1.7).

### Equation 7: Relating Avista service territory to original state

$$\frac{\text{Economic Adjustment}_{WA}}{\text{Economic Adjustment}_{study\ state}} * \frac{\text{Economic Adjustment}_{Avista}}{\text{Economic Adjustment}_{WA}} = \frac{\text{Economic Adjustment}_{Avista}}{\text{Economic Adjustment}_{study\ state}}$$

## 7.1.3 Variables Used for Adjustment

Table 9 shows the variables, along with their description, year, and source, used to create the economic adjustment factors. These variables will be used in the formulas described in the subsequent sections. A more extensive bibliography can be found in Section 12.

**Table 9. Variables with descriptions, years, and sources use to calibrate NEIs to a different state or region**

Variable Name	Description	Year	Source
Median Home Value/Rent per Square Foot	The variable is equal to the median home value (\$) divided by the square footage of the home. The value is the sum of the value per square foot of single-family attached houses, single-family detached houses, and mobile homes.	2018	Zillow, 2018
Square Foot	Total square footage of residency. These values are only available by the census regions <sup>2</sup> of (1) New England, (2) Middle Atlantic, (3) East North Central, (4) West North Central, (5) South Atlantic, (6) East South Central, (7) West South Central, (8) Mountain North, (9) Mountain South, and (10) Pacific. Individual states are imputed with the values from their region. Home types included in data: single-family attached houses, single-family detached houses, apartments in a building with 2 to 4 units, apartments in a building with 5 or more units, and mobile homes.	2015	EIA, 2018

<sup>2</sup> For more information about how states are divided into census regions, please visit <https://www.eia.gov/consumption/residential/terminology.php>

County Median Rental Price per Square Foot	This variable is equal to the median Zillow Rent Index over the course of a 12-month period. It includes all homes (own/rent/multifamily).	2017	Data World, 2020
Median Age of Structure	This variable is the median age of the structure from the ACS data. It is available at the state level and county level. State level adjustments use 2017 data, county level adjustments use the 2020 5-year detailed table.	2017/2019	US Census Bureau, 2018
Average Health Care Spending – State	Health care spending (\$) in a state divided by the population of the state. This amount includes both public and private health care spending for goods and services. The health care spending does not include operation and maintenance costs, construction, or research and development.	2014	KFF, 2014
Average Health Care Spending - County	Standardized per capita medical costs using the Medicare fee-for-service population.	2018	Centers for Medicare & Medicaid Services, 2020
Median (household) Income by Age Group of Head of household	Median (household) income (\$) from ACS data. These data are broken out by the householder age group or by education and are used to make the state adjustment.	2017	US Census Bureau, 2018
Median household income estimates	Income estimates for the counties of Washington based on census data.	2017	Washington Office of Financial Management, 2017
Age Bracket	Householder age groups: under 25 years old, 25 to 44 years, 45 to 64 years, and 65 years and over.	2017	US Census Bureau, 2018
Total Energy Price per Million Btu	The cost of total energy per million Btu in (USD). This accounts for primary energy (coal, natural gas, petroleum, biomass) and retail electricity.	2017	EIA, 2018
Retail Sales of Electricity to Ultimate Customers	Total revenue from sales of electricity broken out by sector (residential, commercial, industrial, transportation).	2019	EIA, 2020
Median Wage Dollar	Median hourly wage (\$) by state.	2017	BLS, 2018
Add updated wage	Median hourly wage (\$) by statistical area.	2019	BLS, 2020

GDP	Gross domestic product (GDP) is an economic measure for the value of output in a given area. The data are measured by 2-digit NAICS and by state.	2016	BEA, 2018
GDP - County	Updated GDP values for Washington counties segmented by 2-digit NAICS.	2019	BEA, 2020
Home Type	The classification of residential location: single-family attached house, single-family detached house, apartment in a building with 2 to 4 units, apartment in a building with 5 or more units, or mobile home.	2015	EIA, 2018

## 7.1.4 Residential Economic Adjustment Factor

This section covers the state and Avista economic factors used to adjust NEIs for residential programs. Residential adjustment factors are based on the economic principle of household utility maximization. These factors consider how the new technologies associated with energy programs affect a participant's economic wellbeing aside from the direct changes in energy consumption. Further detail explaining the economic theory behind residential economic factors can be found in Appendix E: Non-energy Impact Theory. Each factor discussed in Section 7.1.4.1 generates a single value for a geographic region. Section 7.1.6 describes how these geographic values are used in relation to one another.

### 7.1.4.1 Types of Residential Economic Adjustment Factors

Each adjustment factor will result in a single monomial represented by  $X_{Avista}$ , where "X" represents the specific economic adjustment being discussed. This holds for both the residential adjustment factors and the C&I adjustment factors in Section 7.1.5. Use of these monomials and interpretation will follow in Section 7.1.6 with an example in Section 7.1.7.

DNV created five general adjustment factors for NEIs associated with residential programs:

- Property value related adjustments
- Income and health impacts (loss of income) related adjustments
- Health impacts (avoided costs) related adjustments
- Age of home related adjustments
- Utility costs related adjustments

## Property Value

### State-to-State Adjustment

Most Residential NEIs impact a home's value; therefore, differences in property value serve as the key variable for adjusting most residential NEIs. These NEIs will include, but are not limited to: comfort, aesthetics, noise, and home durability and improvements.

DNV created a property value adjustment factor based on single family attached houses, detached houses, and mobile homes. The general formula consists of a factor that relates the home value to the building stock in the state, calculated for each state in the U.S.<sup>3</sup>

<sup>3</sup> Note to the reader: This equation takes a similar form for many of these NEI category calibrations. The values within the summation will end up as the sum of monomials by home type (and later by NAICS code or industry). The final output for  $X_{state}$  will be a single monomial specific to that state.

$$Property\ Value_{State} = \left[ \sum \left( \frac{Median\ Home\ Value\ per\ Square\ Foot}{Square\ Foot} \times \frac{\%\ of\ Square\ Footage\ within\ Each\ Home\ Type}{Non-Apartment\ Home\ Type} \right) \right]_{State}$$

#### Intrastate Adjustment

DNV then used median county rental price per square foot (Zillow Rent Index (ZRI) Summary, 2017) to develop the Avista property value adjustment. DNV used count of residential customers to weight the county level rental prices. Note that while the state-level adjustment used only non-apartment home types, the Avista adjustment used all home types, due to the data available.

$$Property\ Value_{Avista} = \left[ \sum (Median\ Rental\ Price\ per\ ft^2 \times \% \ Customers)_{WA\ County} \right]_{Avista}$$

#### Income and Health Impacts (loss of income)

##### State-to-State Adjustment

This adjustment factor considers two different categories of NEIs, both adjustable by income: 1) NEIs associated with the income adjustment relate to economic development benefits, both direct and indirect, and 2) monetization of health impacts, or lost income experienced by participants due to the illness or death. Consequently, the economic adjustment factor for both categories is determined using a formula that relates the income in Avista to the income in the corresponding state from the JS. The general formula consists of a factor that accounts for the distribution of median household income by age of the head of household, calculated for each state in the U.S.

$$Income\ and\ Health\ Impacts_{State} = \left[ \sum \left( \frac{Median\ HH\ Income\ by\ Age\ Group\ of\ Head\ of\ HH}{Head\ of\ HH} \times \frac{\% \ of\ Head\ of\ HH\ Within\ Each\ Age\ Bracket}{Age\ Bracket} \right) \right]_{State}$$

##### Intrastate Adjustment

The 2017 county household median income (Washington Office of Financial Management, 2017) was used for developing the Avista income and health impacts factor. DNV used count of residential customers to weight the county level income to a single Avista median income.

$$Income\ and\ Health\ Impacts_{Avista} = \left[ \sum (Median\ Household\ Income \times \% \ Customers)_{WA\ County} \right]_{Avista}$$

#### Health Impacts (avoided costs)

##### State-to-State Adjustment

Other healthcare impacts are derived from the value associated with avoided healthcare costs. The monetization of these impacts is measured by the avoided costs associated with medical treatment. The formula consists of one factor that represents the average health care spending per resident. This factor is determined for both WA and the state from which the respective study in the JS was completed.

$$Health\ Impacts\ (avoided\ costs)_{State} = [Average\ Health\ Care\ Spending]_{State}$$

### Intrastate Adjustment

Data used for state adjustments did not have information at the county level, so new data was identified for developing county-level factors for Washington health impacts (Medicare Geographic Variation, Public Use Files, 2018). DNV then used count of residential customers to weight the county level health costs to a single Avista health cost.

$$\text{Health Impacts (avoided costs)}_{Avista} = \left[ \sum (\text{Per Capita Health Spending} \times \% \text{ Customers})_{WA \text{ County}} \right]_{Avista}$$

### Age of Home

#### State-to-State Adjustment

For NEIs related to fire damage, DNV investigated factors that are considered indicative of home fires. Of the available economic data, age of home (ACS 1 Year Detailed Tables State, 2017) was identified as the best variable corresponding with incidence of fires. Therefore, this economic adjustment factor will be used to relate the distribution of the age of a home in WA to the corresponding state from the JS. The formula consists of one factor that represents the median age of residential homes.

$$\text{Age of Home}_{State} = [\text{Median Age of Home}]_{State}$$

#### Intrastate Adjustment

To get Washington county median age of home, DNV used an updated census dataset segmented by county (ACS 5 Year Detailed Tables County, 2020). DNV then used count of residential customers to weight the county level health costs to a single Avista health cost.

$$\text{Age of Home}_{Avista} = \left[ \sum (\text{Median Age of Home} \times \% \text{ Customers})_{WA \text{ County}} \right]_{Avista}$$

### Utility Cost – Residential

#### State-to-State Adjustment

The final residential NEI adjustment factor applies to utility NEIs, or NEIs that result from changes to utility costs. This adjustment factor can be applied to NEIs that include but are not limited to transmission and distribution savings, arrearages, and bad debt write-offs. These NEIs can be adjusted using the average utility cost per MMBtu in each state.

$$\text{Residential Utility Costs}_{State} = \frac{\text{Total Residential Energy Revenue}_{State}}{\text{Total Residential Energy Usage MMBtu}_{State}}$$

#### Intrastate Adjustment

For Avista, DNV used updated EIA information containing residential utility costs segmented by utility service territory (EIA Electricity Data, 2019). These data were then used to compare the revenue per residential energy consumption for Avista to the state total's revenue per residential customer.

$$\text{Residential Utility Costs}_{Avista} = \frac{\text{Total Residential Energy Revenue}_{Avista}}{\text{Total Residential Energy Usage MMBtu}_{Avista}}$$

## 7.1.5 C&I Economic Adjustment Factors

This section covers the state and Avista economic factors used to adjust NEIs for commercial and industrial programs. C&I adjustment factors are based on the theory of profit maximization. These factors consider how the new technologies associated with energy programs affect a participant's marginal cost or total profit. Further detail explaining the economic theory behind C&I economic factors can be found in Appendix E: Non-energy Impact Theory. Each factor discussed in Section 7.1.5.1 generates a single value for a geographic region. Section 7.1.6 describes how these geographic values are used in relation to one another.

### 7.1.5.1 Types of C&I Economic Adjustment Factors

As with the residential adjustment factors, each adjustment factor will result in a single monomial represented by  $X_{Avista}$ . Use of these monomials and interpretation will follow in Section 7.1.6 with an example in Section 7.1.7.

#### Labor Costs (wage-based)

##### State-to-State Adjustment

Many C&I NEIs relate to cost savings such as O&M and other labor costs. These NEIs include, but are not limited to: operation and maintenance, administrative, material handling and material movement. The adjustment factor for these NEIs represents the variation in wages across states (BLS, Occupational Employment Statistics - Wage, 2018). This factor is determined for both WA and the state from which the respective study in the JS was completed.

$$\text{Labor costs (Wage – based)}_{State} = [\text{Median Hourly Wage}]_{State}$$

##### Intrastate Adjustment

DNV identified county level median wage for Washington counties for all jobs covered by unemployment insurance, except for private households and federal government (Washington Employment Security Department, 2018). DNV then used count of C&I customers to weight the county level wage data to a single Avista median hourly wage.

$$\text{Labor costs (Wage – based)}_{Avista} = \left[ \sum_{WA\ County} (\text{Median Hourly Wage} \times \% \text{ Customers}) \right]_{Avista}$$

#### Revenue & Productivity

##### State-to-State Adjustment

NEIs that correspond to changes in revenue and productivity are more appropriately adjusted using a measure of output than the measure of wages. DNV used GDP to reflect the level of output in a state (BEA, 2018). NEIs associated with this adjustment factor include, but are not limited to: energy savings, durability, product quality and life, sales revenue, and output. This factor is determined for both WA and the state from which the respective study in the JS was completed.

$$\text{Revenue and Productivity}_{State} = [GDP]_{State}$$

##### Intrastate Adjustment

DNV further differentiates the revenue and productivity of the Avista service territory using county level per capita GDP (BEA, 2019). DNV then used count of C&I customers to weight the county level GDP to a single Avista GDP.

$$Revenue\ and\ Productivity_{Avista} = \left[ \sum (Per\ Capita\ GDP \times \% \text{ Customers})_{WA\ County} \right]_{Avista}$$

## Utility Cost – C&I

### State-to-State Adjustment

The final C&I NEI adjustment factor applies to utility NEIs, or NEIs that result from changes to utility costs such as bad debt, arrearages, and hedging. Assuming average cost pricing, we use the combined average energy price for each sector (commercial and industrial) to represent the C&I cost of service.

$$C\&I\ Utility\ Costs_{State} = \left[ \sum \left( \frac{Total\ C\&I\ Energy\ Revenue}{Total\ C\&I\ Energy\ Usage\ MMBtu} \right)_{Sector} \right]_{State}$$

### Intrastate Adjustment

For Avista, DNV used updated EIA information (EIA Electricity Data, 2019) containing utility costs segmented by sector and utility service territory. The same process as at the state level was then applied to create a Avista specific C&I utility cost that could be compared to entire state.

$$C\&I\ Utility\ Costs_{Avista} = \left[ \sum \left( \frac{Total\ C\&I\ Energy\ Revenue}{Total\ C\&I\ Energy\ Usage\ MMBtu} \right)_{Sector} \right]_{Avista}$$

## 7.1.6 Final Economic Adjustment Calculation

The resulting output from the above calculations created values usable in two separate ratios for each NEI category. The first set of values (state-level) provides the necessary inputs for a state index from which to compare Washington's economic environment to that of an NEI study's original jurisdiction.

$$Index_{state} = \frac{X_{WA}}{X_{Original\ Jurisdiction}}$$

The second set of values (utility-level) provides the necessary inputs for a Avista-specific index to compare against Washington as a whole. This allows the NEI study to account for diversity in the populations served throughout the state by different utility providers. This index takes the form:

$$Index_{utility} = \frac{X_{Avista}}{X_{WA}}$$

When multiplied together, the Washington values will cancel out and leave a single index with which to compare Avista's service territory to the economic conditions of the original jurisdiction. One important limitation to note is the potential for discrepancy between each Washington value. In order to create a true representation of Avista's economic standing in relation to the state as a whole, the data used to create the utility value was also used to create a new Washington value. In some cases, this was because updated data were being used, and in others it was because the original state comparison used state values instead of county or service territory values. While identified as a potential limitation, this NEI study is comparing relational differences, which are more accurately depicted when the same data used for Avista's value is also used to make a new Washington value. The resulting index is shown below:



$$Index_{Avista} = \frac{X_{WA}}{X_{Original\ Jurisdiction}} * \frac{X_{Avista}}{X_{WA}}$$

With the final index created to relate Avista's service territory to the original jurisdiction, NEIs can now be calibrated to work across jurisdictions in respect to economic conditions. This is done by multiplying the index by the NEI value to scale it from one region to another. For example, if the index was equal to 0.7 (meaning Avista's economic environment for this NEI was determined to be about 70% of the original jurisdiction), and the original NEI value was \$10/unit, the calibrated NEI was \$7/unit. This interpretation follows for all indexes created to calibrate NEIs with the final product taking the form:

$$NEI_{Calibrated} = Index_{Avista} \times NEI_{Uncalibrated}$$

### 7.1.7 Example - Residential Health Impacts Adjustment

For the purposes of providing an example, DNV chose a 2018 study from Massachusetts containing values for residential health and safety NEIs. This example will focus on a 95% efficient boiler corresponding to NEI generation of \$0.88/installed measure/year.

#### State-to-State Adjustment

Average residential health care spending differs between Massachusetts and Washington. Using the publicly available data (KFF, 2014), the state-to-state index will be 0.75.

$$Health\ Index_{WA} = \frac{\$7,913\ per\ Person\ Health\ Care\ Spending_{WA}}{\$10,599\ per\ Person\ Health\ Care\ Spending_{MA}} = 0.75$$

#### Intrastate Adjustment

A different and newer dataset (Medicare Geographic Variation, Public Use Files, 2018) was then used to create the Avista and updated Washington value with which to further account for economic differences impacting residential health spending. This new dataset is segmented by county and lists a new Washington value per capita value of \$8,163 standardized per capita health costs. Developing county weights from the tracked energy savings means the Avista adjustment accounts for how much of a county's population Avista serves. These weights can then be applied to the county health data (Table 10).

**Table 10. Customer Weighted Residential Health Costs, 2018**

County	Percent of Tracked Energy Savings (MMBtu)	Per Capita Health Costs (Dollars)	Energy Savings Weighted Health Costs (Dollars)
Adams	1.38%	\$9,414.98	\$129.61
Asotin	3.77%	\$8,736.82	\$329.51
Cowlitz	0.00%	\$8,382.29	\$0.36
Ferry	0.24%	\$6,524.97	\$15.60
Franklin	0.05%	\$8,711.85	\$4.55
Grant	0.18%	\$7,701.36	\$13.91
Island	0.04%	\$6,848.45	\$2.64
Kitsap	0.31%	\$7,557.13	\$23.15
Klickitat	0.19%	\$7,334.36	\$14.18
Lewis	0.27%	\$7,891.11	\$21.25
Lincoln	1.25%	\$8,980.77	\$112.42
Mason	0.39%	\$7,668.88	\$30.04
Pend Oreille	0.20%	\$6,887.21	\$13.48
Pierce	1.08%	\$8,241.44	\$88.68
San Juan	0.61%	\$6,928.36	\$42.42
Skagit	0.11%	\$8,374.49	\$9.35
Skamania	0.09%	\$7,292.57	\$6.88
Snohomish	0.12%	\$8,170.77	\$9.55
Spokane	77.67%	\$9,043.92	\$7,023.99
Stevens	5.58%	\$7,466.22	\$416.33
Walla Walla	0.02%	\$8,479.68	\$1.70
Whitman	6.46%	\$8,233.42	\$531.58
<b>Avista Value</b>	<b>Sum of weighted health cost</b>		<b>\$8,841</b>

Summing the customer weighted health costs produces a rounded value of \$8,841 per capita health spending in the Avista service territory. The intrastate index comparing Avista with the rest of the state is then 1.08.

$$Health\ Index_{Avista} = \frac{\$8,841\ per\ Person\ Health\ Care\ Spending_{Avista}}{\$8,163\ per\ Person\ Health\ Care\ Spending_{WA}} = 1.08$$

#### Adjusted NEI Value

The final Avista health impacts economic adjustment for a value that originally came from Massachusetts would then be 0.75 x 1.08, or 0.81. The economically adjusted NEI value would then be \$0.71/installed measure/year.

$$\$0.88/Installed\ Measure/Year_{MA} * 0.81_{Health\ Adj} = \$0.71/Installed\ Measure/Year_{Avista}$$

## 8 UTILITY-SPECIFIC CALCULATION AND SELECTION METHDOLOGY

DNV's NEI database contains multiple NEI values from different studies that can be applied to a single energy program measure. The goal of this analysis is to consider all options from the database, then choose the one that best represents each Avista energy program measure. This process, depicted in Figure 1, allows for a tailored NEI valuation approach with scalable specificity and confidence. For this analysis, DNV applies restrictions so NEI values are produced with a high level of specific matching accuracy and confidence in the study from which the value originates. The steps for producing these values are:

1. Restrict the Database to studies with a high degree of confidence and to values that are attributed to a specific technology (**Section 8.1**).
2. Use a standardized measure mapping to identify all possible relationships between Avista TRM and Database (**Section 8.2**).
3. Translate all potential values from their original jurisdiction to the Avista service territory, then modify with each value's associated CF and PF. Each value's unit from the original study is then converted to a standard unit (**Section 8.3**).
4. Choose the best NEI value by ranking of confidence, plausibility, and relationship of NEI value with the measure technology's energy impact (**Section 8.4**).

**Figure 1. NEI Calculation and Selection Process**

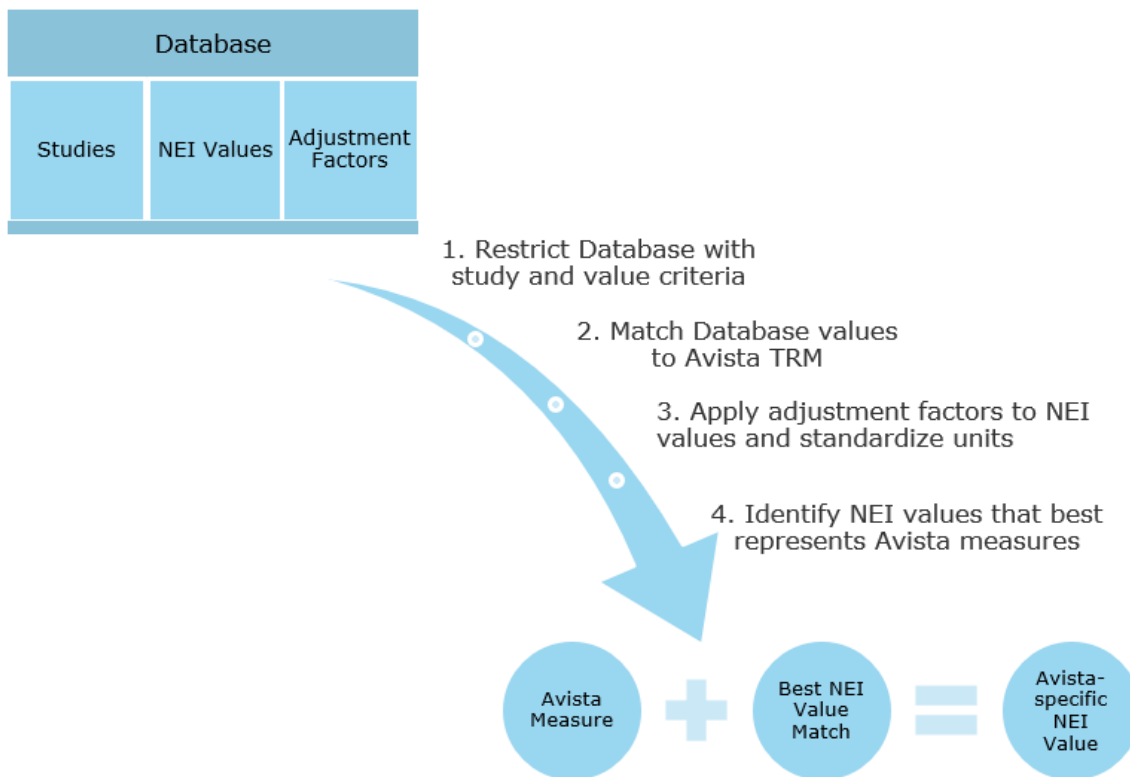

## 8.1 Database Exclusion Criteria

The first step for producing results with a high degree of confidence is to remove studies that do not meet a certain set of criteria. DNV uses three criteria to apply to the Database for producing NEI values for Avista's TRM. Note that the confidence factors (CF) and plausibility factors (PF) referenced in Section 4 and Section 5, respectively, help with this filtering but are not the only tools used. The exclusion criteria include:

1. **Accuracy of Match** – use only study NEIs where values have been identified at an end-use level specificity (e.g., HVAC, lighting, hot water) or higher (e.g., HVAC - New furnace replacement, Lighting - LED exit signs).
2. **Confidence in Study** – of all studies passing the first criteria, use only studies with CF in the top 50<sup>th</sup> percentile.
3. **Relevancy of NEI** – of all studies passing the first and second criteria, use only NEI values where the category of NEI is applicable to the measure with which it is being matched (e.g., NEI for indoor air quality is applicable to HVAC measures, but not lighting measures).

### 8.1.1 Accuracy of Match

DNV's NEI database includes studies ranging from very specific NEI estimates for measure types (Level 6 below), to those with broad NEI estimates referencing all aspects of a given program (Level 2 below). As detailed in Section 3.2, DNV maps measures in the NEI database to Avista's TRM using 7 LoAs. DNV places extra importance on the ability for Avista measures to match with the Database by at least the end-use level (Level 4). This idea is in line with the CF scoring Question 1: ("Is the study measure specific?"). While this question could be weighted heavier in the CF calculation to exemplify the importance of using end-use relationships, the analysis team found a restriction of the database more appropriate. Therefore, DNV considers only values in the database with the ability to match Avista measures by end-use. Table 11 provides an example of the threshold of what is and is not included according to Criterion 1 (Accuracy of Match). 23 of the 46 studies contained in the database passed Criterion 1.

**Table 11. Match level Accuracy Example**

Match Level Accuracy	Example	Does this pass Criteria 1?
Program Level	Study 20 reports NEI values that can be applied across an entire residential low-income program, but values are not associated with specific end-use technologies.	No
End-use Level	Study 47 reports NEI values for specific end-use technologies (water pipe insulation, showerheads, wall insulation) within a residential low-income program.	Yes

### 8.1.2 Confidence in Study

DNV then selects studies for which there is the most confidence. DNV chooses the best studies by selecting those in the top 50<sup>th</sup> percentile based on the assigned CF scoring. The median CF of the 23 studies to pass Criterion 1 (Accuracy of Match) was 0.66667. This further exclusion drops the number of studies to be used for the Avista valuation from 23 to 12, with Table 2 showing the CFs of the 23 studies to pass Criterion 1 and whether that study also passes Criterion 2 (Confidence in Study).

**Table 12. Studies Meeting Criterion 1 and Whether they Pass Criterion 2: Confidence in Study**

Confidence Factor	Study ID	Does this pass Criteria 2?
-------------------	----------	----------------------------

0.5	Study 0008	No
0.5	Study 0009	No
0.5	Study 0015	No
0.5	Study 0017	No
0.53333	Study 0011	No
0.53333	Study 0014	No
0.53333	Study 0016	No
0.53333	Study 0039	No
0.6	Study 0041	No
0.6	Study 0042	No
0.6	Study 0046	No
0.66667	Study 0010	Yes
0.66667	Study 0012	Yes
0.73333	Study 0004	Yes
0.73333	Study 0007	Yes
0.8	Study 0032	Yes
0.86667	Study 0002	Yes
0.86667	Study 0003	Yes
0.86667	Study 0005	Yes
0.86667	Study 0040	Yes
0.93333	Study 0047	Yes
0.93333	Study 0048	Yes
1	Study 0001	Yes

### 8.1.3 Relevancy

The last step for restricting the database values is to classify potential values as relevant or not relevant. The Database contains studies with NEI categories that might not make sense for the specific, matched Avista measures. DNV created a matrix to assign each level 4 match and NEI category combination a relevancy flag. Table 13 shows an example of where relevancy varies by end-use, but these designations can also vary by fuel, sector, program, and whether a measure is custom or prescriptive. Values stemming from combinations that are deemed not relevant are removed from the database.

**Table 13. Example of Relevancy of NEI by End-Use**

Level 4 Measure Categorization	NEI Category		
	O&M - Participant - Residential	Indoor Air Quality - Participant - Residential	Lighting Quality and Lifetime - Participant - Residential
Gas, Residential, Retrofit, Prescriptive, Hot Water	Relevant	Relevant	Not Relevant
Gas, Residential, Retrofit, Prescriptive, HVAC	Relevant	Relevant	Not Relevant
Electric, Residential, Retrofit, Prescriptive, Lighting	Relevant	Not Relevant	Relevant

## 8.2 Match Database to Avista TRM

After paring down the Database to relevant studies and NEI categories, DNV matches the measures in the Database to the Avista TRM using the standard set of Level 0 through Level 6 match codes. As discussed in Section 3.2, DNV standardizes and assigns the same LoAs listed above (Section 8.1.1) to each Avista measure. All studies in the Database had an original (observed) LoAs, but they varied in terminology from study to study. As such, these standardized codes assigned to both the Avista TRM and the Database provide matches between the two at each LoAs. A Linear LED measure is broken out into the LoAs as follows:

**Table 14 - Example of Standard Level of Aggregation for Avista Measures**

Standard Levels of Aggregation	Example of Standard Levels of Aggregation Details
Detailed Measure Level (Level 6)	Linear LED
Broad Measure Level (Level 5)	LED
End-Use Level (Level 4)	Lighting
Prescriptive/Custom (Level 3)	Prescriptive
Program Level (Level 2)	Retrofit
Sector (Level 1)	C&I
Fuel (Level 0)	Electricity

The following table illustrates how these Standard LoAs come together to form the matching IDs.

**Table 15. Example of Concatenated Matching IDs**

Match Level ID	Concatenated Matching ID
6	Electricity_C&I_Retrofit_Prescriptive_Lighting_LED_Linear LED
5	Electricity_C&I_Retrofit_Prescriptive_Lighting_LED

4	Electricity_C&I_Retrofit_Prescriptive_Lighting
3	Electricity_C&I_Retrofit_Prescriptive
2	Electricity_C&I_Retrofit

A match occurs when the concatenated match codes exist in both the Avista TRM and in one or more studies in the Database. First, all matches are identified that happen at a Level 6. These observations are kept and designated as a Level 6 match. Next, all matches are identified that happen at a Level 5, but which did not happen at a Level 6. These matches are designated as a Level 5 match. DNV iterated this process to Level 4 (end-use) for Avista, meaning a study value has to match with the Avista measure at least by end-use for the value to be considered.

Using the measure from Table 14, Figure 2 shows an example where 2 values are identified as potential matches. One is a perfect match (designated as Level 6 match), while the other only matches to broad measure level (LED) but not to the detailed measure level (Linear LED), thus designating it a Level 5. There can be many potential matches in this instance with values coming from multiple studies. All options will be considered, but only the best fit based on CF and PF is selected as representing that Avista measure (Section 8.4).

**Figure 2. Example of 2 Potential Matches**

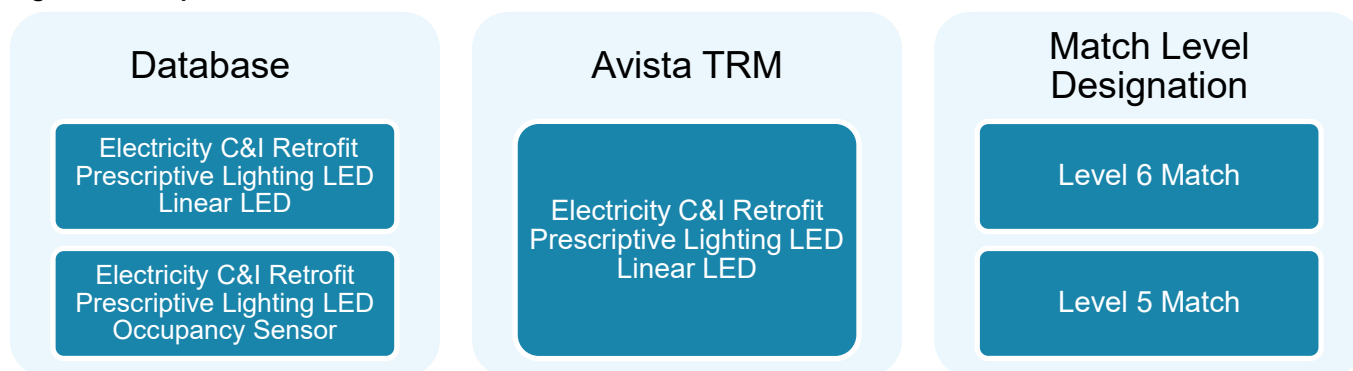

### 8.3 Avista-Specific NEI Calculation

After the Database is restricted and all potential matches with Avista's TRM are identified, values are standardized so they can be compared and ultimately applied. This standardization is done in 2 steps:

1. Apply economic adjustment factors, CF, and PF
2. Standardize units

#### 8.3.1 Apply Adjustment Factors, CF, PF

As discussed in Section 7, the economic adjustment factor gets applied to the original NEI value to account for socio-economic differences between where the original study took place and Avista's service territory. Then, this economically adjusted NEI value is multiplied by the CF and PF to derate final values, which helps account for unknowns in the original study or the strength of the NEI applicability.

#### Equation 8: Create Avista-Specific NEI

$$NEI\ Value_{original\ Jurisdiction} * CF * PF * Economic\ Adjustment_{Avista} = NEI\ Value_{Avista}$$

NEI values can now be applied to Avista's service territory, but not all values are in the same unit. Having the same unit can be important for choosing a top value in the case where there are multiple values from which to choose and for applying values consistently across the TRM.

### 8.3.2 Standardize Units

This analysis uses \$/kWh or \$/Therm as the final unit for reporting NEI values. After restricting the database to studies with a high degree of confidence (Section 8.1.2), many of the values are already in \$/kWh or \$/Therm and are ready to be applied after Equation 8.

For NEI values that are not already in \$/Therm or \$/kWh, this analysis uses a combination of tracking data and information from the TRM to convert. As an example, consider a value with the original value reported in \$/project/lifetime. Information necessary for making this conversion are the measure lifetime, the measure energy impact, and the number of measures per project. Synthesis of these variables is shown below:

- **Measure Lifetime** – This variable is taken from the TRM; however, it is not available for every measure. Measures without a stated lifetime will not consider any NEI values where the original value is reported by lifetime.
- **Energy Impact** – This value is derived from the historic tracking data as the average reported energy impact by measure type. Measures without an observed energy impact in the tracking will not consider any NEI values for which the original value was reported in anything except \$/kWh or \$/Therm.
- **Number of Measures per Project** – For units needing conversion from per building, per project, per participant, etc., ratios are developed from the tracking data to approximate what this rate might be. These ratios are developed with respect to match level and sector, so for the example of \$/project/lifetime for residential there are 3 ratios that can be applied depending on match level:
  - Level 6 Ratio – Average of all tracking data for the number of identical level 6 measures installed for a single project.
  - Level 5 Ratio – Average of all tracking data for the number of identical level 5 measures installed for a single project.
  - Level 4 Ratio – Average of all tracking data for the number of identical level 4 measures installed for a single project.

The final unit conversion for a residential NEI that's originally reported as \$/project/lifetime and is matching to a Avista measure as a Level 5 (L5) is then:

#### Equation 9: Example of unit conversion for Avista-specific NEI

$$\$NEI \text{ per energy impact}_{Avista} = \frac{\$NEI \text{ per project per lifetime}}{\text{Lifetime of measure}_{Avista}} * \frac{1}{\text{Average \# of L5 measures per project}} * \frac{1}{\text{Energy impact per measure}_{Avista}}$$

For measures that have an observed impact on both electricity and gas usage, this conversion includes the Mmbtu ratio of energy-specific impact to create a \$/kWh and \$/Therm value that avoids any double counting.

## 8.4 Identifying Best NEI Estimate from all Potential Matches

The result of Sections 8.1, 8.2, and 8.3 is a list of standardized NEI values linking to specific studies that can be applied to the correspondingly mapped Avista measure. The database contains studies with different areas of focus, meaning a single Avista measure can end up with multiple NEI categories all working toward an inclusive NEI total (Figure 3).



**Figure 3. Amalgamation of NEI Categories into Measure's Total NEI**

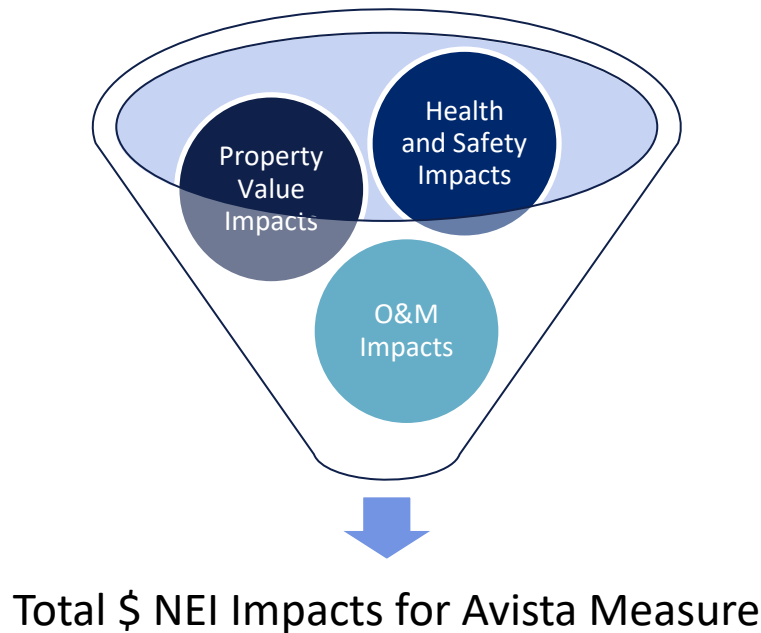

Each combination of Avista measure and NEI category can have multiple studies competing for which provides the best NEI value estimate. Because there can be only one study value associated with each NEI-measure combination, DNV chooses the best based on the product of the CF and PF, then in rare cases of a tie, the most conservative value estimate takes precedent (Section 8.4.1).

After identifying the study value that best estimates each possible measure-NEI combination, results are subject to engineering review. This review provides a more in-depth analysis of the relevancy of measure-NEI combinations than what was done in Section 8.1.3 as well as reviewing the magnitude and sign (+/-) of NEI estimates (Section 8.4.2).

### 8.4.1 Assignment of Best Value

Assignment of the best value to represent a unique Avista measure-NEI combination depends first on the Combined Score (CF × PF). In the rare event of a tie where values from two studies have the same Combined Score, the NEI ratio (\$NEI: \$Energy Impact) is used to choose the most conservative estimate.

#### Combined Score

The Combined Score is created by multiplying the CF (ranking of study) by the PF (ranking of match level, age of study, and end-use energy consumption changes). This Combined Score identifies the NEI value estimate with the best combination of study confidence and accuracy of study-to-Avista measure similarity.

Table 16 shows an example where Avista measure “LTGO: Lamp - TLED - 2 3 or 4 foot” corresponds with the measure mapping detailed in Section 8.2. This designation matches with 3 potential value estimates originating from 3 separate studies for the NEI category Operations and Maintenance (O&M). The table shows all potential studies match at a Level 4, meaning the Database does not currently have O&M values specific to LED lighting for measure categorizations that otherwise match at least at a Level 4 (Electricity C&I Retrofit Prescriptive Lighting). In this instance, the value from Study 01 is chosen because it has the highest combined score.

**Table 16. Choosing Best Match by Combined Score to Represent O&M NEI Value for Avista Measure - LTGO: Lamp - TLED - 2 3 or 4 foot**

Measure Mapping	Study ID	NEI Value	Match Level	Combined Score
Electricity, C&I, Retrofit, Prescriptive, Lighting, LED, Linear LED	01	\$0.022/kWh	4	0.65
	02	\$0.012/kWh	4	0.53
	05	\$0.007/kWh	4	0.60

**NEI Ratio**

It is uncommon for ties to occur between potential values when ranking by combined score. However, when they do, the analysis team selects the NEI value with the most conservative estimate. This metric is developed as an NEI ratio relating the value of the NEI to the value of energy. This ratio is calculated by taking the absolute value of the NEI and dividing by the absolute value of the average Avista consumer price for the energy type in dollars:

**Equation 10: NEI Ratio**

$$NEI\ Ratio = \frac{|\$NEI\ per\ energy\ unit|}{|Average\ Avista\ consumer\ price\ of\ energy\ per\ unit|}$$

The average Avista consumer price of energy per unit represents the monetary impact of the energy savings that will be felt by installing a particular measure. That means the NEI ratio is a comparison of the (monetized) non-energy impact with the (monetized) energy impact. The analysis team calculates average costs using combined residential and C&I energy usage and come out to \$0.88/Therm for natural gas (Utility Natural Gas Sales, 2020) and \$0.09/kWh for electricity (Utility Electricity Sales, 2020).

Table 17 shows an example where two studies compete to provide the NEI value for Bad Debt Write-Offs associated with the Avista Measure "Duct Sealing: single family; electric." Both study values have the same combined score, so in this case the one from Study 47 is chosen to represent the Avista measure because it has the lower NEI ratio.

**Table 17. Choosing Best Match by NEI Ratio when Combined Score are Tied**

Measure Mapping	Study ID	NEI Value	Match Level	Combined Score	NEI Ratio
Electricity, Residential, Low-Income, Prescriptive, HVAC	47	\$0.004/kWh	4	0.79	0.04
	48	\$0.050/kWh	4	0.79	0.60

**8.4.2 Review of Results**

The best study values to represent each NEI-measure combination as identified in Section 8.4.1 are output and reviewed. During the review process, a senior engineer considers the following questions for each NEI value estimate:

1. *Do all potential NEI-measure combinations make sense at the most detailed level?* A more detailed relevancy than that discussed in Section 8.1.3 is completed for each NEI-Measure combination. This catches nuances at the end-use level such as a situation where NEI generation from reduced incidence of fires makes sense for water heaters

(Level 4 = Hot Water), but not for aerators (Level 4 = Hot Water). The associated NEI values are removed if an NEI-measure combination is flagged by a senior engineer.

2. *Do value estimates for all potential NEI-measure combinations have the correct sign?* During the engineering review, NEI value estimates are reviewed with respect to if they are a negative or positive. If the sign seems incorrect (e.g., negative for LED O&M), the source study for this value is investigated along with the match-level and the specific measure. It could be the case that the value matched at a Level 4, but when considering the actual Avista measure the sign is incorrect. If this is the case, the analysis team identifies if there is a next best estimated NEI value not chosen in Section 8.4.1 with the correct unit, then applies it for review with the rest of the top values with respect to question 3.
3. *Do chosen NEI value estimates have the correct magnitude for what can be expected?* During the engineering review, chosen NEI value estimates are reviewed if the NEI ratio described in Section 8.4.1 is greater than 1. DNV uses this threshold because it identifies scenarios where the NEIs are the main impact from the measure's implementation, and energy is the secondary impact. While it is possible for a measure to generate more value from quantifiable NEIs than from energy impacts, it is not common. Usually, if an NEI ratio is greater than 1, it is the result of uncertainty in the unit conversion when the original study does not report values in \$/kWh or \$/Therm. If this is the case, the analysis team reviews the NEI estimates and assesses if it is defensible for the NEI ratio to be greater than 1. If not, an alternative source for the NEI is used.

## 9 FINAL RESULTS

The final output from this process is a list of Avista measures that have reasonable, defensible, and quantifiable NEIs. Each of these measures can be generating value from multiple NEI categories, with the value of each category linked to a specific study.

### 9.1 Avista-specific NEI Example

This section will walk through an example calculation to illustrate how Equation 8 mentioned above (and restated below) is used to generate a Avista-specific NEI value. The example will consider how the NEI quantifying changes in bad debt write-offs is calculated for a *low-income window replacement* measure matching at a Level 5 to the Database. The original study for this NEI is the *Washington Low Income Weatherization Program Evaluation, Measurement & Verification Report (2020)* referred to as Study 48.

$$NEI\ Value_{original\ Jurisdiction} * CF * PF * Economic\ Adjustment_{Avista} = NEI\ Value_{Avista}$$

1. **Start with the unadjusted NEI value from the original study.** For this example, the starting value from Study 48 is \$0.0295 per kWh from the Database. This value was calculated by dividing the 2016-2017 total program non-energy benefit for economic impact in Study 48's Table 6-5 by the net verified kWh savings in Study 48's Table 6-3.

$$NEI\ Value_{original\ Jurisdiction} = \frac{\$10,024}{339,561\ kWh} = \$0.03/kWh$$

2. **Multiply the unadjusted NEI value by the CF and PF.** The starting NEI is first adjusted to 2021 dollars using the consumer price index (Consumer Price Index, 2020). This adjustment happens so values reflect current monetary impacts and better align with data used for economic adjustment factors. This value is then adjusted by its corresponding assigned CF and PF from the Database to obtain the Combined Score. The CF for Study 48 is 0.933, and the PF for a Level 5 match assuming a 50% minimum floor is 0.846. These values are obtained from the Database.<sup>4</sup>

$$NEI\ Value_{original\ Jurisdiction\ 2018\ \$} * CF * PF = Adjusted\ NEI\ Value$$

$$\frac{\$0.03}{kWh} * 0.933 * 0.846 = \frac{\$0.024}{kWh} = Adjusted\ NEI\ Value$$

3. **Multiply by the Economic Adjustment Factor.** The economic adjustment factor used for the NEI category *Bad Debt Write-offs – Utility – Residential* is the residential utility cost factor. Since this was a Washington study, the state-to-state adjustment factor is 1. If the original study was completed in a different state, then a ratio would be used to adjust the value from the original state to Washington state. For the intrastate adjustment, DNV calculated an Avista utility cost of \$8,997 per customer. For all of Washington, this value is \$8,820.

$$Adjusted\ NEI\ Value * Economic\ Adjustment_{All\ Washington} * Economic\ Adjustment_{Avista} = NEI\ Value_{Avista}$$

$$\frac{\$0.024}{kWh} * 1 * \frac{\$9,232}{\$8,820} = \frac{\$0.025}{kWh}$$

Thus, the final *Bad Debt Write-offs – Utility – Residential* NEI value for Avista for this low-income window measure is \$0.025 per kWh.

<sup>4</sup> Study 48 scored 14 out of 15 possible, so the CF for this would be 93% (14/15=.93). The scoring was based on the 5 CF questions previously detailed in Section 4. For the PF, the study scored a 4 for Age, 2 for UES change, and 5 for Match score. This would result in the study receiving a score of 11 out of a possible 13, so the PF for this would be 85% (11/13=.846).

## 9.2 Total NEI Value Example

Table 18 shows an example of three Avista measures and the associated NEI values. As described in the beginning of Section 8.4, these NEI categories can be added together to estimate the total NEI of a specific measure.

**Table 18. Example of Final Results**

Avista Measure	Total NEI Value	Health and Safety	Thermal Comfort	Bad Debt Write Offs	Other NEI Categories
Windows, Low-Income Retrofit Program	\$0.46/kWh	\$0.32/kWh	\$0.08/kWh	\$0.03/kWh	\$0.03/kWh
Air source Heat Pump, Retrofit Program	\$0.032/kWh	\$0.000009/kWh	\$0.0003/kWh	-	\$0.03/kWh
Duct Sealing, Low-Income Retrofit Program	\$0.29/Therm	\$0.023/Therm	\$0.006/Therm	-	\$0.261/Therm
Heat Pump Water Heater, Retrofit Program	\$0.002/kWh	\$0.00001/kWh	-	-	\$0.00199/kWh

Avista should use the results of this analysis to calculate the planned or actual NEI value generated by a program, measure, portfolio, etc. This segmentation into different categories also provides estimates for value generation for perspective program participants. In a marketing aspect, the O&M value can be factored into benefit-cost-ratios when participants are considering whether to undergo certain energy-use upgrades.

## 10 GAP ANALYSIS APPROACH

The purpose of the gap analysis is to classify the measures and initiatives that currently lack NEIs and identify areas in which follow-up research is worthwhile to confirm or quantify NEIs occurring within Avista territory. The gap analysis includes the following activities:

- Identify energy-efficiency measures that do not have NEIs
- Identify gaps where no NEI is matched to the TRM but NEIs exist in the published literature
- Identify NEIs that are heavily discounted
- Inventory NEI types that have not been previously studied
- Identify initial priority opportunities for future research based on the potential value gained compared to the cost to conduct the research.

### 10.1 Measures Without NEI Values

Of the 1,767 measures in the final TRM, 48% (n=843) of them were matched to NEI values in the Database. DNV began the gap analysis review by cataloguing the 924 unmapped measures into groups to determine whether there are any similarities to measures mapped to NEIs. This was done by sorting measures by match code irrespectively of program type in the TRM. We then flagged any measure without a mapped NEI that was “similar” to a measure mapped to an NEI. 15 unmapped measures for which a similar measure with an NEI was identified. Avista could potentially calculate NEIs for these 15 based on the differences between the unmapped measure and the similar mapped measure(s) identified.

Table 19 shows the 15 unmapped measures for which a similar measure with an NEI was identified. Avista could potentially calculate NEIs for these 15 based on the differences between the unmapped measure and the similar mapped measure(s) identified.

**Table 19. NEI Values Exist for a Similar Measure**

Sector	Fuel	Measure Group	Measures without NEI Values	Measures with NEI Values
Residential	Gas	Air Sealing	1	2
	Gas	Gas Furnace	1	2
	Gas	High Efficiency Windows	5	1
	Gas	Insulation	8	3
<b>Total</b>			<b>15</b>	<b>8</b>

In addition, two (2) of the unmapped measures did not receive an NEI value from the Database despite being matched to an NEI value; this was because calculating the NEI requires a unit conversion in order to properly allocate the NEI value to the Avista per unit measure savings. NEI values that are not already in \$/Therm or \$/kWh require a unit conversion. This conversion could not be performed for measures missing a mean savings value in the tracking data and/or an expected useful lifetime estimate. Unit conversation gaps can often be filled by use of assumptions that are developed based on program information or measure characteristics. The resulting NEIs are often then estimates until sufficient program activity occurs to calculate a more confident per unit NEI value.

## 10.2 Heavily Discounted NEIs

As discussed in Section 8.3.2, values in the Database must be standardized so they can be compared and accurately applied. This standardization is done in two steps:

1. Apply economic adjustment factors, CF, and PF
2. Standardize units

DNV flagged high-value NEIs that were discounted to less than 60% of their original value as a result of the first standardization step. This process identified 39 measures in the Avista TRM as heavily discounted NEIs. The heavily discounted NEIs come from the following studies in Table 20:

**Table 20. Studies with Heavily Discounted NEIs**

Study ID	Title	State	Year
Study0002	Final Report – Commercial and Industrial Non-Energy Impacts Study	MA	2012
Study0004	Non-Energy Impact Framework Study Report	MA	2018

There are a variety of reasons why the NEI values from a study may be discounted. For example, in Study0004 the original values were discounted in part because the original study only incorporated economic factors based on theory (e.g., property value based on the Hedonic Price theory), although they did not clearly identify the factors in the study. Section 5 details how the original NEI values were further discounted to account for the age of the study, changes in energy consumption over time, and how well the measures in the study matches to those in Avista’s TRM. Furthermore, Section 7 also explains how the original NEI values were further discounted to account for socio-economic differences between where the original study took place (MA) and Avista’s service territory. As shown in Table 20 above, the heavily discounted NEI values are taken from studies that originally took place in the Northeast region of the United States.

## 10.3 NEIs Not Previously Studied

WAC 480-100-640 (2)(a)(i) requires that Avista demonstrate progress towards ensuring all customers benefit from the transition to clean energy through,

“the equitable distribution of energy and nonenergy benefits and reductions of burdens to vulnerable populations and highly impacted communities; long-term and short-term public health and environmental benefits and reductions of costs and risks; and energy security and resiliency.”

DNV used this legislative requirement as a guide for our review. The energy security and resiliency benefit identified in the CETA legislation is the only NEI type for which there are no estimates available in the Database. Possible research areas to address this gap include,

- Property durability and resilience to climate change impacts
- Customer-specific outage costs and value of uninterrupted service

## 11 FRAMEWORK FOR FUTURE RESEARCH

The team developed a framework for prioritizing NEI research. This section describes the framework DNV created and the results of gap analysis.

### 11.1 Prioritization Criteria and Assignment of Levels of Priority

The prioritization framework is based on scoring two criteria: level of effort and value. Table 21 summarizes the four criteria and the associated scoring. Each criterion is discussed in more detail in the sections that follow.

**Table 21. Framework Prioritization Scoring**

Criterion	Priority Score (higher score = higher priority)		
	1	2	3
<b>Value of NEI Research</b>	Low value study. Meets 1 Utility Priority criterion, but NEI values already exist for measure group; or meets 0 Utility Priority criteria.	Moderate value, meets 1 Utility Priority criterion and no NEI values exist for measure group; or meets 2-3 Utility Priority criteria, but NEI values exist for measure group.	High value study. No NEI values for measure group and 2-3 Utility Priority criteria met.
<b>Level of Effort</b>	High level of effort, might require additional primary research	Moderate level of effort, further secondary research is likely to produce NEI values	Low level of effort, missing values likely easily accessible in regional databases (RTF, 2021 Power Plan, NEEA)
<b>Utility Priority</b>	Meets 1 of these criteria: <ol style="list-style-type: none"> <li>1. NEIs applicable to measure group with low cost-effectiveness; or,</li> <li>2. CETA benefit categories, or</li> <li>3. High install measure group</li> </ol>	Meets 2 of the criteria	Meets all 3 of the criteria

#### 11.1.1 Value of NEI Research

The “Value of NEI Research” criterion assigns higher priority to studies that will provide NEIs to address identified gaps for measures within initiatives and measure groups, and lower priority to studies for which the targeted group of initiatives and measures has existing NEIs. The Value of NEI Research criterion also depends on three Utility Priority criteria that account for the specific needs of Avista and the legislative requirements that a gap study should meet:

- Satisfies any requirements mandated by the CETA legislation—benefits low income households, has nonenergy benefits related to public health, energy security, or the environment,
- Top measure in the PY2021 projected program savings; and
- Had a TRC benefit-cost ratio of less than 1.2, but more than 0.00 in Avista’s 2021 program plan



- **High value:** A measure would be scored as high value if it does not have NEI values assigned it. A high value gap would also meet at least 2 of the Utility Priority criteria, as it is important to ensure the gaps being filled will meet the needs of Avista and the legislative requirements.
- **Moderate value:** Filling an NEI gap for a measure group would be considered of moderate value if it either of the following conditions are met:
  - No NEI values exist, but it would meet 1 Utility Priority criterion
  - NEI values do exist, but it would meet 2 to 3 Utility Priority criteria
- **Low value:** A measure would be score as low value if it already has NEI values associated with it or if filling the gap would not meet any of the Utility Priority criterion. These gaps would be assigned the lowest priority.

There is the highest value in filling gaps for measure groups that do not currently have NEI values associated with them. Because there is such a large gap, any secondary research into this NEI category would lead to better understanding these gaps and perhaps even conservative estimates that can be applied at a broad range of programs and end-uses. There is still moderate value in filling gaps for measure groups that have incomplete NEI values, if the measure meets multiple Utility Priority criteria. Further research into these NEI categories should be more focused on specific areas, with existing Database studies providing background on what to expect.

### 11.1.2 Level of Effort

The “Level of Effort” criterion assigns higher priority to research that can be completed with a lower level of effort, and thus faster and at a lower cost. Level of effort is an important planning and fiscal management metric to consider. DNV completed preliminary cost estimate ranges for the proposed studies, basing estimates on the number and types of gaps identified for the target NEIs and the type of research proposed to achieve study objectives.

- **High effort:** In order to fill the identified NEI gap, additional primary research could be required to generate a value estimate. For example, measures that did not match with the jurisdictional scan could require a new primary research study if there is no available NEI study applicable to those measures.
- **Medium effort:** All NEI gaps not clearly in the high effort or low effort category.
- **Low effort:** The NEI gap is due to a unit conversion issue, which means the bridge between Avista’s measure and DNV’s program exists but there is not enough information with regards to installed energy savings or installation lifetime to do the conversion. This information can be identified or approximated using similar measures, engineering review, or with the addition of supplemental data.

Measures with missing measure lifetime or observed energy impact values that are easily accessible in regional data sources such as the Regional Technical Forum (RTF) or 2021 Power Plan) were assumed to require the least amount of effort to address.

## 11.2 Framework output

DNV added the NEI gap’s value and effort scores together to calculate the final score for any NEI gap under consideration. The higher the score, the higher priority for future research. The highest priority gaps are easy and valuable to fill. The companion excel sheet has the full break down of each measure and the priority criteria assigned. The highest possible

score for an NEI gap is a 6, which represents a low effort, high value gap. While none of the NEI gaps identified in this analysis scored as a 6, several received a 5. Table 22 shows the top priorities based strictly on our scoring framework.

**Table 22. Prioritization of Proposed Future NEI Studies**

Total Score	Sector	Measure Group	Measure	Recommended Gap Study
5	Residential	Air Sealing	Insulated Door_R2.5 - R5_HZ2_Zonal (Energy Star Rated or Insulated R5)	Residential Weatherization
5	Residential	ELV Thermostat	Line Voltage Communicating Thermostat	Residential ELV Thermostat
5	Residential	ELV Thermostat	Line Voltage Thermostat	Residential ELV Thermostat
5	Residential	Gas Furnace	High Efficiency Wall Furnace (AFUE 90%)	None
5	Residential	Heat Pump Water Heater	Tier2-3 HPWH	Residential Heat Pump Water Heater
5	Residential	High Efficiency Windows	G Windows Dual Pane <0.30 U-value	Residential Weatherization
5	Residential	High Efficiency Windows	G Windows Single Pane <0.30 U-value	Residential Weatherization
5	Residential	High Efficiency Windows	Low E Storm Window	Residential Weatherization
5	Residential	High Efficiency Windows	NG Storm Windows	Residential Weatherization
5	Residential	High Efficiency Windows	Windows	Residential Weatherization
5	Residential	Insulation	G Attic Insulation	Residential Weatherization
5	Residential	Insulation	G Wall Insulation	Residential Weatherization
4	Commercial	Commercial Oven	Efficient convection oven full size	None
4	Commercial	Compressed Air	Compressed Air	None
4	Commercial	Food Cabinet	Efficient hot food holding cabinet, Double Size	None
4	Residential	High Efficiency Mobile Homes	Energy Star Homes - Manufactured, Electric, Dual Fuel	None
4	Residential	Insulation	Attic Insulation_R0 - R38_HZ2_Zonal	Residential Weatherization
4	Residential	Insulation	Attic Insulation_R0 - R49_HZ2_Zonal	Residential Weatherization
4	Residential	Insulation	Floor Insulation_R0 - R19_HZ2_Zonal	Residential Weatherization
4	Residential	Insulation	Floor Insulation_R0 - R30_HZ2_Zonal	Residential Weatherization
4	Residential	Insulation	G Floor Insulation	Residential Weatherization
4	Residential	Insulation	Wall Insulation_R0 - R11_HZ2_Zonal	Residential Weatherization

One additional gap that was not evaluated in this framework was the Economic Development NEI that was originally transferred from the following report that was prepared for Pacific Power by ADM: Washington Low Income Weatherization Program Evaluation, Measurement & Verification Report 2016-2017 (2020). This study met the confidence threshold used in the valuation process, although the Economic Development NEI was excluded from the final results after meeting with ADM and confirming we would need to calculate a per-kWh economic impact using lifetime savings before applying this NEI to Avista's measures.

### 11.3 Avista-Specific Gap Analysis Example

This section walks through an example that illustrates how DNV applied the gap analysis framework discussed in Section 11 to Avista-specific measures. In this example, we focus on the "High Efficiency Wall Furnace (AFUE 90%)" measure in Avista's Gas Residential HVAC program.

First, DNV assessed the NEI gaps applicable to the measure in order to determine the 'Level of Effort' that filling the gaps would require:

- The measure does not have a mapped NEI value, but it is similar to other measures that mapped to an NEI value; and
- This specific measure was not implemented recently, preventing DNV from having the necessary information to calculate an NEI value.
- Based on the Framework Prioritization Scoring in Table 21, this measure would receive a score of 3 for the Level of Effort criterion. Since similar measures exist that were installed and have calculated NEIs, the level of effort required to find a proxy value for the missing information required is low.

Next, the 'Value of NEI Research' is determined by looking at the 'Utility Priority' criteria and whether NEI values already exist for the measure:

- This measure met the following 1 out of 3 Utility Priority criteria:
  - o The measure has 'Health and Safety – Participant' benefits that are applicable to the CETA legislation.
- No NEI values are mapped to the measure.
- Based on the Framework Prioritization scoring in Table 21, this measure would receive a score of 2 for the Value of NEI Research criterion. The value of filling this NEI gap is moderate.

Lastly, DNV calculated the final priority score by adding together the level of effort score (3) plus the Value of NEI Research score (2), resulting in a NEI Study Priority score of 5 — filling its NEI gaps would be low effort and moderate value.

### 11.4 Prioritization of Research

DNV identified two studies that could quantify NEIs in all but one of the CETA benefit categories for 45 high priority measures. Table 5 summarizes each study and the NEIs addressed.

**Table 23. Recommended Gap Studies and NEIs Addressed**

Recommended Gap Study	Measure Group	# of Measures with Priority Gaps	# of Measures with Any Gaps	CETA-Benefits Addressed	NEI Values Addressed by Research											
					CETA-NEIs		Additional NEIs									
					Avoided pollution - Societal	Health and safety - Participant	Fires/insurance damage - Participant	Productivity - Participant	Thermal Comfort - Participant	Ease of Selling or Leasing - Participant	Noise - Participant	O&M - Participant	Other - Participant	Other Impacts - Utility	Bad Debt Write-offs - Utility	Calls to utility - Utility
Residential ELV Thermostat	ELV Thermostat	2	2	Public Health, Environmental	X				X						X	X
Residential Weatherization	Air Sealing	1	3	Low Income Households, Public Health, Environmental	X	X	X		X		X		X	X	X	X
Residential Weatherization	High Efficiency Windows	5	7	Public Health		X			X		X			X	X	X
Residential Weatherization	Insulation	2	8	Public Health, Environmental	X	X			X		X	X		X	X	X
Residential Heat Pump Water Heater	Heat Pump Water Heater	1	2	Low Income Households, Public Health, Environmental	X	X	X		X	X		X			X	X

### Study 1: Residential Weatherization

DNV proposes that a residential weatherization study should be completed first, due to the significant existing gap in available NEI information regarding these measures. Conducting research to address the NEI gaps in the weatherization measures scoring high in the prioritization framework would address the following CETA benefit requirements:

- Public health—Avoided pollution
- Environment—Avoided pollution
- Reduction of burdens to vulnerable populations—Low income programs

DNV recommends a residential weatherization study that encompasses the Air Sealing, High Efficiency Windows, and Insulation measure groups due to the overlap in research that would be required to address the gaps. This study could potentially provide NEI values for 14 measures for which NEI values currently do not exist. This research would also touch on 4 measures in low income programs that are receiving heavily discounted NEI values. The high priority NEI gaps are in gas measures in Avista's Multifamily Weatherization, Shell, and HVAC programs. These measures did not receive any NEI values and stand out as top energy savers in Avista's PY2021 Plan and/or have low cost-effectiveness that would increase with the addition of non-energy benefits. Cross-program or cross-measure proxies may be used where applicable if no further studies can be found to fill the NEI gaps.

### Study 2: Residential ELV Thermostat

Another study we recommend pursuing is a residential electronic line voltage thermostat non-energy impacts study. Conducting research to address the NEI gaps in the line voltage thermostat measures scoring high in the prioritization framework would address the following CETA benefit requirements:

- Public health—Avoided pollution, health & safety
- Environment—Avoided pollution

This study would address both the communicating and non-communicating ELV thermostats in Avista's Multifamily Weatherization program. Both measures are currently receiving partial NEI values due to a unit conversion gap. Further research to provide these measures with all of the NEI values they were matched to in the jurisdictional scan would be low effort and of moderate value to Avista.

### Study 3: Low-Income Heat Pump Water Heater

Another small low effort, moderate value study we recommend pursuing is a low-income heat pump water heater non-energy impacts study. Conducting research to address the NEI gap in the low-income heat pump water heater measure would address the following CETA benefit requirements:

- Public health—Avoided pollution, health & safety
- Environment—Avoided pollution
- Reduction of burdens to vulnerable populations—Low income programs

This study would address the unit conversion gap in the Tier 2-3 Heat Pump Water Heater measure in Avista's Low-Income portfolio. The measure is missing an observed savings value that is required to calculate some of the NEI values matched to the measure in the jurisdictional scan.

## 12 REFERENCES

- ACS 1 Year Detailed Tables State. (2017). Retrieved from U. S. Census: [https://www2.census.gov/programs-surveys/acs/summary\\_file/2018/data/1\\_year\\_detailed\\_tables/State/](https://www2.census.gov/programs-surveys/acs/summary_file/2018/data/1_year_detailed_tables/State/)
- ACS 5 Year Detailed Tables County. (2020). Retrieved from U. C. Bureau: [https://www2.census.gov/programs-surveys/acs/summary\\_file/2019/data/5\\_year\\_by\\_state/](https://www2.census.gov/programs-surveys/acs/summary_file/2019/data/5_year_by_state/)
- BEA. (2018, May). *Regional Price Parities by state*. Retrieved from Bureau of Economic Analysis: <https://apps.bea.gov/iTable/iTable.cfm?acrdn=6&isuri=1&reqid=70&step=1%23reqid=70&step=1&isuri=1>
- BEA. (2019). Retrieved from GDP and Personal Income by County: <https://apps.bea.gov/itable/iTable.cfm?ReqID=70&step=1>
- BLS. (2018, March). *Occupational Employment Statistics - Employment*. Retrieved from Bureau of Labor Statistics: [https://www.bls.gov/oes/current/oes\\_research\\_estimates.htm](https://www.bls.gov/oes/current/oes_research_estimates.htm)
- BLS. (2018, March). *Occupational Employment Statistics - Wage*. Retrieved from Bureau of Labor Statistics: <https://www.bls.gov/oes/tables.htm>
- BLS. (2019). Retrieved from Occupational Employment Statistics: [https://www.bls.gov/oes/current/oes\\_44060.htm](https://www.bls.gov/oes/current/oes_44060.htm)
- Bureau, U. C. (2015). *ACS Educational Attainment by Degree-Level and Age-Group (American Community Survey)*. Retrieved from <http://www.higheredinfo.org/dbrowser/index.php?measure=93>
- Consumer Price Index. (2020). Retrieved from Federal Reserve Bank of Minneapolis: <https://www.minneapolisfed.org/about-us/monetary-policy/inflation-calculator/consumer-price-index-1913->
- EIA. (2016). *State Energy Data System 2016: Consumption Technical Notes*. Energy Information Administration: State Energy Data System.
- EIA. (2018, May). *Residential Energy Consumption Survey (RECS)*. Retrieved from Energy Information Agency: <https://www.eia.gov/consumption/residential/data/2015/index.php?view=microdata>
- EIA. (2018, June 29). *State Energy Data System (SEDS): 1960-2016 (complete)*. Retrieved from Energy Information Agency: <https://www.eia.gov/state/seds/seds-data-complete.php?sid=US#Consumption>
- EIA Electricity Data. (2019). Retrieved from EIA: <https://www.eia.gov/electricity/data.php#sales>
- Guzman, G. G. (2018). *Household Income: 2017 (Tables B19049, B25007, B20004)*. US Census Bureau. Retrieved from US Census Bureau: <https://www.census.gov/content/dam/Census/library/publications/2018/acs/acsbr17-01.pdf>
- KFF. (2014). *Health Care Expenditures per Capita by State of Residence*. Retrieved from Kaiser Family Foundation: <https://www.kff.org/other/state-indicator/health-spending-per-capita/?currentTimeframe=0&selectedRows=%7B%22wrapups%22:%7B%22united-states%22:%7B%7D%7D,%22states%22:%7B%22all%22:%7B%7D%7D%7D&sortModel=%7B%22colId%22:%22Health%20Spending%20per%20Capita%22>,
- Medicare Geographic Variation, Public Use Files. (2018). Retrieved from Centers for Medicare & Medicaid Services (CMS): [https://www.cms.gov/Research-Statistics-Data-and-Systems/Statistics-Trends-and-Reports/Medicare-Geographic-Variation/GV\\_PUF](https://www.cms.gov/Research-Statistics-Data-and-Systems/Statistics-Trends-and-Reports/Medicare-Geographic-Variation/GV_PUF)
- NAICS. (2017). *North American Industry Classification System*. Washington D.C.
- USCB. (2018). *Household Income: 2017 (Tables B19049, B25007, B20004, B25127, B25037)*. US Census Bureau. Retrieved from US Census Bureau: <https://www.census.gov/content/dam/Census/library/publications/2018/acs/acsbr17-01.pdf>
- Utility Electricity Sales. (2020). Retrieved from U.S. Energy Information Administration: <https://www.eia.gov/electricity/data.php#sales>
- Utility Natural Gas Sales. (2020). Retrieved from U.S. Energy Information Administration: [https://www.eia.gov/naturalgas/ngqs/#?report=RP4&year1=2019&year2=2019&company=ID\\_Name](https://www.eia.gov/naturalgas/ngqs/#?report=RP4&year1=2019&year2=2019&company=ID_Name)
- Washington Employment Security Department. (2018). Retrieved from Median and hourly wages: <https://esd.wa.gov/labormarketinfo/median-hourly-wages>
- Washington Office of Financial Management. (2017). Retrieved from Median Household Income Estimates: <https://ofm.wa.gov/washington-data-research/economy-and-labor-force/median-household-income-estimates>
- Zillow. (2018). *Zillow Research*. Retrieved from Zillow: <https://www.zillow.com/research/data/>
- Zillow Rent Index (ZRI) Summary. (2017). Retrieved from data.world: <https://data.world/zillow-data/zri-summary>

## 13 APPENDICES

### 13.1 Appendix A: NEI Studies List

Table 24 below shows the list of studies in the Database, including the Study ID, study title, jurisdiction covered in the study, and the published year. DNV does not change the Study ID once the study enters the database. DNV does remove studies from the database over time so some Study IDs are missing from this list (ex. Study 26 has been removed).

**Table 24. List of Studies in the Database**

Study_ID	Title	State	Year
Study0001	AEP Ohio Non-Energy Impact - Final Report	OH	2018
Study0002	Final Report – Commercial and Industrial Non-Energy Impacts Study	MA	2012
Study0003	C&I New Construction NEI Stage 2 Final Report	MA	2016
Study0004	Non-Energy Impact Framework Study Report	MA	2018
Study0005	Non-Energy Impacts (NEIs) Final Report	MA	2018
Study0006	Non-energy Benefits to Implementing Partners from the Wisconsin Focus on Energy Program: Final Report	WI	2003
Study0007	Non-Energy Impacts (NEI) Evaluation Final Report	NY	2006
Study0008	Determining the Full Value of Industrial Efficiency Programs	WA	1999
Study0009	Ancillary savings and production benefits in the evaluation of industrial energy efficiency measures	CA	2005
Study0010	Capturing the Multiple Benefits of Energy Efficiency	USA	2014
Study0011	Productivity benefits of industrial energy efficiency measures	USA	2001
Study0012	Energy efficiency and carbon dioxide emissions reduction opportunities in the U.S. iron and steel sector	USA	1999
Study0013	Non-Electric Benefits from the Custom Projects Program: A look at the effects of custom projects in Massachusetts	MA	2007
Study0014	Exploring the Application of Conjoint Analysis for Estimating the Value of Non-Energy Impacts	USA	2007
Study0015	C&I Prescriptive Non-Electric Benefits	USA	2003
Study0016	Multiple Benefits of Business Sector Energy Efficiency: A survey of Existing and Potential measures	USA	2015
Study0017	Energy Conservation Also Yields: Capital, Operations, Recognition and Environmental Benefits	USA	2012
Study0019	An Evaluation of the Energy and Non-energy impacts of VT's Weatherization Assistance Program, for VT State Office Of Economic Opportunity	VT	1999
Study0020	Low Income Public Purpose Test (LIPPT 2000)	CA	2000
Study0021	Washington Low-income Weatherization Program, for Pacific Power	WA	2007
Study0022	Low-income Arrearage Study for PacifiCorp	UT	2007
Study0023	2004-2006 Oregon REACH Program	OR	2008
Study0024	Energy Smart Program Evaluation, Oregon HEAT	OR	2008
Study0025	Analysis of Low Income Benefits in Determining Cost-effectiveness of Energy Efficiency Programs	MA	2004
Study0027	Program Progress Report of National Weatherization Assistance Program (Schweitzer and Tonn)	USA	2002



Study0028	Analysis of PG&E's Venture Partners Pilot Program, - PG&E Low Income Weatherization Assistance Program 1994	CA	1994
Study0029	Evaluation of NU - MA ESP Program NEBs	MA	2002
Study0030	Evaluation of NU - CT ESP Program NEBs	CT	2002
Study0032	Non-Energy Benefits / Non-Energy Impacts (NEBs/NEIs) and their Role & Values in Cost-Effectiveness Tests: State of Maryland	MD	2014
Study0033	Memo from J. Oppenheim to Laura McNaughton Low income DSM NEB	USA	2000
Study0034	An Update of the Impacts of Vermont's Weatherization Assistance Program, for VT State OEO Weatherization. Program	VT	2007
Study0035	Low Income Pub Ben Evaluation, Non-Energy Benefits of Wisconsin Low Income Weatherization. Assistance Program, Wisconsin Dept of Admin, DOE	WI	2005
Study0036	Low Income Pub benefits, Wisconsin DOE	WI	2007
Study0037	Assessment of Green Jobs Created by the OPA Multifamily Buildings Programs, for Ontario Power Authority	MA	2009
Study0039	Development and Application of Select Non-Energy Benefits for the EmPOWER Maryland Energy Efficiency Programs	MD	2014
Study0040	C1641: Impact Evaluation of the Business and Energy Sustainability Program (prepared for CT Energy Efficiency Board (EEB))	CT	2018
Study0041	New Jersey Natural Gas 2015 SAVEGREEN Evaluation Final Report	NJ	2015
Study0042	Human Health Benefits of Reducing Residential Wood Smoke Emissions in Puget Sound Energy's Service Territory	WA	2018
Study0043	Preliminary Report: Quantifying the Health Benefits of Reduced Wood Smoke from Energy Efficiency Programs in the Pacific Northwest	PNW	2014
Study0044	Public Health Benefits per kWh of Energy Efficiency and Renewable Energy in the United States: A Technical Report	USA	2019
Study0045	Assessment of the Costs Avoided through Energy Efficiency and Conservation Measures in Maryland	MD	2014
Study0046	Macroeconomic Impacts of Rhode Island Energy Efficiency Investments	RI	2014
Study0047	Final Washington Low Income Weatherization Program Evaluation for Program Years 2013-2015	WA	2018
Study0048	Washington Low Income Weatherization Program Evaluation, Measurement & Verification Report	WA	2020
Study0049	Human Health Benefits of Reducing Residential Wood Smoke Emissions in PacifiCorp's Washington State Service Territory	WA	2018
Study0050	Human Health Benefits of Reducing Residential Wood Smoke Emissions in Avista Corporation's Service Territory	WA	2018

## 13.2 Appendix B: Confidence Factor Scoring

Table 25 below shows the CF scoring for the Database studies. Each of the questions are given a weight of 1. The weighted total score is the sum of the scores for each individual question, and a minimum CF floor of 50% is used. Note that some Study ID numbers are omitted in the table below since their CF scores could not be assessed. Original copies of those studies could not be found were only referenced in a different study.

**Table 25. Confidence Factor Scoring for Database Studies**

Study_ID	1. Is the study measure specific?	2. Is the study segmented by sector?	3. Was the sample drawn using statistical method?	4. Does the study incorporate identifiable economic factors?	5. Does the study not consider any of the following when appropriate: Open-ended questions, Additivity, Double Counting	Weighted Total Score	Adjusted Confidence Factor (no CF below Minimum CF)
Study0001	3	3	3	3	3	15	100%
Study0002	3	3	2	3	2	13	87%
Study0003	3	3	2	3	2	13	87%
Study0004	3	3	2	2	1	11	73%
Study0005	3	3	3	3	1	13	87%
Study0006	1	1	1	2	2	8	53%
Study0007	2	3	2	3	1	11	73%
Study0008	3	2	1	1	0	7	50%
Study0009	2	3	1	1	0	7	50%
Study0010	2	2	2	2	2	10	67%
Study0011	3	2	2	1	0	8	53%
Study0012	3	3	2	1	1	10	53%
Study0013	2	2	2	1	0	7	50%
Study0014	2	1	1	2	2	8	53%
Study0016	3	2	1	2	0	8	53%
Study0017	2	2	1	1	0	6	50%
Study0020	1	3	1	1	1	7	50%
Study0022	1	2	3	2	1	10	67%
Study0025	1	3	1	2	1	8	53%
Study0031	1	2	1	2	3	9	60%
Study0032	2	3	3	2	2	12	80%
Study0035	1	2	2	2	2	9	60%
Study0039	1	2	1	3	1	8	53%
Study0040	3	3	3	3	1	13	87%
Study0041	3	1	2	2	1	9	60%



Study0042	3	3	1	2	0	9	60%
Study0043	3	3	3	3	1	13	87%
Study0044	1	3	3	1	1	9	60%
Study0045	1	1	1	3	0	6	50%
Study0046	1	3	1	3	1	9	60%
Study0047	3	3	3	3	2	14	93%
Study0048	3	3	3	3	2	14	93%
Study0049	3	3	2	3	0	11	73%
Study0050	3	3	2	3	0	11	73%

### 13.3 Appendix C: Plausibility Scoring Metrics

Table 26 shows the scoring assignment for the end-use UEC efficiency change index. End-use categories that change very little over time are scored higher (maximum of 3) while technologies that change significantly over time are scored lower.

**Table 26. End-Use UEC Change Score**

Compound Annual Growth Rate by end-use	UEC change score	
CAGR <= 3%	End-use with little change over time	3
CAGR >3% but <6%	End-use with some change over time.	2
CAGR >=6%	End-use with significant change over time.	1

Table 27 shows the end-use UEC scores for 2003-2012 using data from CBECS.

**Table 27. CBECS End-Use Energy Consumption Scoring**

Electricity energy intensity (thousand Btu/square foot in buildings using electricity for the end use)											
	Total	Space heating	Cooling	Ventilation	Water heating	Lighting	Cooking	Refrigeration	Office equipment	Computing	Other
All Buildings-2003	50.7	2.4	6.9	6.2	1.3	19.1	0.3	5.4	1	2.2	6
All buildings - 2012	50	1.7	8.3	8.1	0.5	8.7	3.7	9.1	2.1	5.2	9.1
Compound Annual Growth Rate (CAGR) in UEC	-3.2%	3.9%	-2.0%	-2.9%	11.2%	9.1%	-24.4%	-5.6%	-7.9%	-9.1%	-4.5%
CAGR % of Total Change		(1.21)	0.63	0.91	(3.47)	(2.83)	7.55	1.75	2.45	2.83	1.40
ABS of CAGR	3.2%	3.9%	2.0%	2.9%	11.2%	9.1	24.4%	5.6%	7.9%	9.1%	4.5%
Efficiency change index		1.21	0.63	0.91	3.47	2.83	7.55	1.75	2.45	2.83	1.40
1-3 Score (3 is best, 1 is worst)		2.0	3.0	3.0	1.0	1.0	1.0	2.0	1.0	1.0	2.0

Table 28 shows the end-use UEC scores for 2009-2015 using data from RECS.

**Table 28. RECS End-Use Energy Consumption Scoring**

	Average site energy consumption (million Btu per household using the end use)					
	Total	Space heating	Water heating	Air conditioning	Refrigerators	Other
All homes-2009	89.6	38.7	16.0	6.8	4.3	26.7
All homes - 2015	77.1	35.3	14.8	7.1	2.6	20.2
Compound Annual Growth Rate (CAGR) in UEC	3.1%	1.6%	1.3%	-0.8%	8.6%	4.8%
CAGR % of Total Change		51%	42%	-27%	280%	155%
ABS of CAGR	3.1%	1.6%	1.3%	0.8%	8.6%	4.8%
Efficiency change index		51%	42%	-27%	280%	155%
1-3 Score (3 is best, 1 is worst)		<b>3.0</b>	<b>3.0</b>	<b>3.0</b>	<b>1.0</b>	<b>2.0</b>

## 13.4 Appendix D: Plausibility Combinations

Table 29 shows the PF scores for the possible combinations of study age, UEC efficiency change index, and match level. Studies that are less than 5 years old receive the highest Age of Study Score while studies that are greater than 15 years old receive the lowest score.

**Table 29. Plausibility Factor Scoring Table (assumes equal weighting)**

Age of Study Score (<5, score=4) (6-10, score=3) (11-15, score=2) (>15, score=1) (A)	Unit Energy Consumption Change Score (B)	Matching Level Score (C)	Total Score (A+B+C)	% of Max Score (A+B+C)/13	Adjusted Plausibility Factor (No PF below Min PF)
4	3	6	13	100%	100%
4	3	5	12	92%	92%
3	3	6	12	92%	92%
4	2	6	12	92%	92%
4	3	4	11	85%	85%
3	3	5	11	85%	85%
2	3	6	11	85%	85%
4	2	5	11	85%	85%
3	2	6	11	85%	85%
4	1	6	11	85%	85%
4	3	3	10	77%	77%
3	3	4	10	77%	77%
2	3	5	10	77%	77%
1	3	6	10	77%	77%
4	2	4	10	77%	77%
3	2	5	10	77%	77%
2	2	6	10	77%	77%
4	1	5	10	77%	77%
3	1	6	10	77%	77%
4	3	2	9	69%	69%
3	3	3	9	69%	69%
2	3	4	9	69%	69%
1	3	5	9	69%	69%
4	2	3	9	69%	69%
3	2	4	9	69%	69%
2	2	5	9	69%	69%
1	2	6	9	69%	69%
4	1	4	9	69%	69%
3	1	5	9	69%	69%
2	1	6	9	69%	69%
3	3	2	8	62%	62%

2	3	3	8	62%	62%
1	3	4	8	62%	62%
4	2	2	8	62%	62%
3	2	3	8	62%	62%
2	2	4	8	62%	62%
1	2	5	8	62%	62%
4	1	3	8	62%	62%
3	1	4	8	62%	62%
2	1	5	8	62%	62%
1	1	6	8	62%	62%
2	3	2	7	54%	54%
1	3	3	7	54%	54%
3	2	2	7	54%	54%
2	2	3	7	54%	54%
1	2	4	7	54%	54%
4	1	2	7	54%	54%
3	1	3	7	54%	54%
2	1	4	7	54%	54%
1	1	5	7	54%	54%
1	3	2	6	46%	50%
2	2	2	6	46%	50%
1	2	3	6	46%	50%
3	1	2	6	46%	50%
2	1	3	6	46%	50%
1	1	4	6	46%	50%
1	2	2	5	38%	50%
2	1	2	5	38%	50%
1	1	3	5	38%	50%
1	1	2	4	31%	50%

## 13.5 Appendix E: Non-energy Impact Theory

### NEIs for Residential Programs

A key concern for program evaluation is ensuring that the benefits claimed by utilities reflect true economic gains to the jurisdiction. This theoretical background focuses on how incentivizing technological change through EE results in economic benefits that manifest through increased wellbeing for consumers and increased profit for producers. We then define the factors used to adjust different types of NEIs that apply to residential programs.

EE programs result in NEIs that impact consumer or producer surplus<sup>5 6 7</sup>, which reflect changes to the economic efficiency of society. By incorporating NEIs into TRC cost-efficiency tests, policy makers can better measure the economic efficiency of EE programs on the population.<sup>8</sup>

The concept of NEIs stems largely from the hedonic price theory of property values and wages developed by Rosen.<sup>9</sup> This theory states that “housing prices reflect differences in the quantities of various characteristics of housing and that these differences have significance in applied welfare analysis.”<sup>10,11</sup> Rosen (1976) shows that house price is derived from the wellbeing (utility) that one receives from occupying a residence with a given set of attributes. One set of the attributes included in the individual’s utility are the improved amenities, health, and well-being resulting from EE measures:

$U(z, x, s)$ :

Where

Hedonic  $z$  - measures the individual attributes of each housing unit

$x$  – all other goods the household can purchase

$s$  – measures the characteristics of the household residents (are they old, do they swim, how many people, how many cars)

The individual’s utility function and budget constraints are then used to determine the individual’s marginal utility (or demand) for the housing attributes at different prices, holding their income constant. The price function shows the bundles of housing attributes at which the household’s willingness to pay for a property with that bundle of attributes is equal to its market price.

Given Rosen’s theory, an individual’s demand for housing represents the trade-off they are willing to make between receiving bundles of these attributes at different prices, given their income constraint and level of technology in the home. The maximum bundle of attributes they can afford is restricted by their income and a measure of their total wellbeing. Figure 4 shows an individual’s demand for the housing attributes they receive at different prices before EE improvements (Demand

<sup>5</sup> Consumer Surplus as defined by Nicolson (1995) is “the Difference between the total value consumers receive from the consumption of a particular good and the total amount they pay for the good. It is the area under the compensated demand curve and above the market price, and can be approximated by the area under the Marshallian demand curve and above the market price.”

<sup>6</sup> Producer Surplus as defined by Nicolson (1995) is “the additional compensation a producer receives from participating in market transactions rather than having no transactions. Short-run producer surplus consists of short-run profits plus fixed-costs. Long-run producer surplus consists of short-run producer surplus plus increased rents earned by inputs. In both cases the concept is illustrated as the area below market price and above the respective supply (marginal cost) curve.”

<sup>7</sup> Nicholson, Water. “Microeconomic Theory: Basic Principles and Extensions.” Sixth edition. Dryden Press. Harcourt Brace College Publishing. 1995.

<sup>8</sup> The Total Resource Cost (TRC) Test measures the net cost of an energy conservation program, viewing the program as a utility resource option. Both utility and participant costs and benefits are included. The TRC Test reflects the impacts of a program on both participating and non-participating customers. The test provides a measure of the cost-effectiveness of a utility-sponsored EE program, per the California Standard Practice Manual. [https://beopt.nrel.gov/sites/beopt.nrel.gov/files/help/Total\\_Resource\\_Cost\\_Test.htm](https://beopt.nrel.gov/sites/beopt.nrel.gov/files/help/Total_Resource_Cost_Test.htm)

<sup>9</sup> Rosen, Sherwin. “Hedonic Prices and Implicit Markets: Product Differentiation in Pure Competition,” *Journal of Political Economy* 82, no. 1 (Jan. - Feb., 1974): 34-55.

<sup>10</sup> Freeman III, Merick A. “The Measurement of Environment and Resource Values: Theory and Methods.” *Resources for the Future*. Washington D.C. 1993.

<sup>11</sup> Rosen makes a similar case for the value of wages.



no EE). The supply of housing attributes is measured by S, providing a market clearing price for housing of P. Notice that the demand curve extends above the market clearing price, P. This is because residents would be willing to pay incrementally more for the initial set of housing attributes from market clearing point C up to point A, but they only pay one price for each unit of housing they purchase. The amount measured by triangle ABC is called Consumer Surplus. It measures the additional benefit consumers receive for paying only one price for the housing attributes they receive, rather than separate prices for each unit they receive.

Introducing EE improvements into their existing home represents a technological change to the home that raises the level of attributes the homeowner receives at each price point. In economic theory, this is explained as increasing the homeowner's utility (or wellbeing) while holding their income constant. In other words, when a person invests in improved insulation for their home, they receive energy impacts through reduced costs, but they also experience greater comfort and possibly greater health. The impact of these added benefits to consumers is shown by shifting their demand curve up to the right. This means for all prices, they now receive additional housing attributes that were previously only attainable through increased income. This implies that investing in EE measures increases the value of a home because the overall bundle of attributes offered by the home increases. However, the resident does not have to pay any more for their home because their price is fixed (i.e., they have a mortgage or lease with a fixed price). Therefore, they are seen to receive increased benefit, or wellbeing, beyond what they originally paid.<sup>12</sup>

In another example, an upgraded HVAC system can increase health and improve comfort. These benefits provide a range of benefits that were not included in price P, the price the homeowner paid for their home. This increase in benefits reflects an increase in that resident's demand for their home, shifting the demand curve out and to the right. This shift means that residents would be willing to pay more for each additional unit of housing they receive, however, the price they pay is fixed at point P\* since they are most likely locked into a mortgage or lease. The additional benefits they receive can be measured by the area ACED. Residents will receive these benefits until they sell their home, at which time the benefits translate into an increase in property value and are included in the price of their home. The focus on NEI studies is to estimate these economic benefits absent the market transaction.<sup>13</sup>

**Figure 4. Impact of NEIs on consumer surplus**

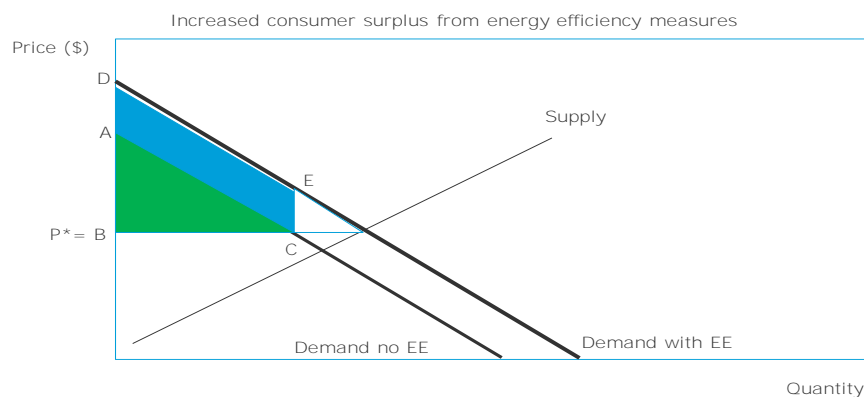

## NEIs for C&I Programs

For commercial and industrial (C&I) customers, NEIs reflect increased profitability resulting from EE measures. The increase in profitability can exist either because the installed measures decreased the cost of production (such as reduced O&M costs) or increased revenue (such as increased sales or production). Theoretically, a firm would be willing to pay more for a

<sup>12</sup> Once they sell their home, this increased value will translate into an increase in price, but they still receive the increased value in terms of increased wellbeing prior to selling their home.

<sup>13</sup> The willingness-to-pay techniques outlined in 110 are well documented and used extensively to estimate such impacts

facility that either lowered its costs of production or increased revenues. Again, because rents typically do not change unless the firm renegotiates a lease or sells the facility, this provides increased profitability.

Figure 5 presents the impact of EE measures on the O&M costs and profitability of a firm. The figure shows that, prior to installing EE measures, the firm operates with marginal costs  $MC_1$ , which reflects the cost of producing each additional unit of a product, with market clearing price of  $P^*$ , denoted by point B. The firm's profit can be measured by the area of the shape ABC. If the firm then installs EE equipment that reduces their marginal costs of production, this shifts the marginal cost curve out and to the right. This means they can produce more for each unit of cost they incur. This change in costs results in an increase in profitability that can be measured by the shape ACD. This increase in profit is one measure of NEIs resulting from the installation of EE measures. Other NEIs may impact profit through direct revenue increases resulting from increased sales.

**Figure 5. Impact of EE on O&M costs and profit**

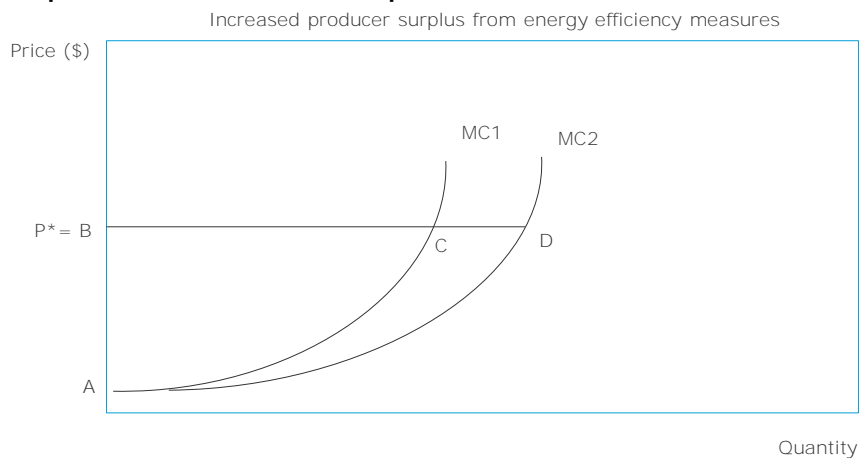

Finally, firms may also experience an increase in revenue resulting from increased sales. For example, installing LEDs is argued to improve the visual display of showrooms. If this results in greater sales, this will increase the firm's revenue directly which can be measured by the formula:

$$\text{Revenue} = (\text{Price of the good}) \times (\text{Quantity sold})$$



## **About DNV**

DNV is a global quality assurance and risk management company. Driven by our purpose of safeguarding life, property and the environment, we enable our customers to advance the safety and sustainability of their business. We provide classification, technical assurance, software and independent expert advisory services to the maritime, oil & gas, power and renewables industries. We also provide certification, supply chain and data management services to customers across a wide range of industries. Operating in more than 100 countries, our experts are dedicated to helping customers make the world safer, smarter and greener.



FINAL REPORT

# Supply Side Non-Energy Impacts

Avista

**Date:** April 8, 2022





## Table of contents

1	INTRODUCTION.....	1
2	METHODOLOGY OVERVIEW.....	1
3	DATABASE COMPILATION .....	2
3.1	Database structure .....	2
3.2	Non-energy impact metrics .....	4
3.3	Summary of compiled data .....	34
3.4	Database application .....	34
3.5	Issues and data gaps .....	35
4	OVERALL IMPACTS.....	38
5	APPENDICES .....	41
5.1	Appendix A: Detailed Methods .....	41
5.2	Appendix B: Detailed Non-Energy Impacts Values .....	48

## List of figures

Figure 3-1. Operational PM <sub>2.5</sub> emissions per MWh by generation type .....	6
Figure 3-2. Operational SO <sub>2</sub> emissions per MWh by generation type.....	6
Figure 3-3. Operational NO <sub>x</sub> emissions per MWh by generation type .....	7
Figure 3-4. Operational PM <sub>2.5</sub> health costs per MWh by generation type .....	9
Figure 3-5. Operational SO <sub>2</sub> health costs per MWh by generation type .....	10
Figure 3-6. Operational NO <sub>x</sub> health costs per MWh by generation type .....	11
Figure 3-7. Fatalities by generation type .....	13
Figure 3-8. Monetized fatalities by generation type.....	15
Figure 3-9. Land use by generation type by MW .....	19
Figure 3-10. Operational water consumption by generation type by MWh.....	20
Figure 3-11. Avian fatalities per MWh .....	23
Figure 3-12. Construction jobs by proposed generation type.....	26
Figure 3-13. Construction economic induced impact by proposed generation type .....	27
Figure 3-14. Operations jobs by generation type .....	30
Figure 3-15. Operations Economic Impact by Generation Type .....	32
Figure 5-1. Fatalities per TWh from original paper .....	41

## List of tables

Table 3-1. Database resource types .....	2
Table 3-2. Generation resource phase.....	3
Table 3-3. Public health metric descriptions.....	4
Table 3-4. Dollars per ton by County.....	8
Table 3-5. Safety metric descriptions .....	12
Table 3-6. Land use phase descriptions .....	17
Table 3-7. Land use value coverage by phase .....	18
Table 3-8. Economic metric descriptions .....	24
Table 3-9. Summary of Construction Induced Value Add .....	28
Table 3-10: Summary of Operations Induced Value Add .....	33
Table 3-11. Summary of data completeness.....	34
Table 3-12. Gap analysis .....	35
Table 4-1. Net Resource Benefits for Existing Avista Resources.....	39
Table 4-2: Net Resource Benefits for Potential Resource Alternatives .....	40



Table 5-1. Fatalities from the U.S. natural gas and oil extraction industry by state, 2015-2017 .....	42
Table 5-2. U.S. pipeline fatalities and injuries to industry employees and members of the public, 2005-2020 .....	43
Table 5-3. US coal mining fatalities .....	44
Table 5-4. US rail fatalities .....	45
Table 5-5. Specific JEDI models .....	46
Table 5-6. JEDI imputes for specific plants .....	46
Table 5-7. Operational Emissions in Tons per GWh .....	48
Table 5-8. Operational Public Health Costs in Dollars per MWh .....	50
Table 5-9. Fatalities per TWh .....	52
Table 5-10. Monetized Fatalities per MWh .....	54
Table 5-11. Land Use in Acres per MW .....	56
Table 5-12. Water Use in Gallons per MWh .....	58
Table 5-13. Avian fatalities per GWh .....	60
Table 5-14. Construction Jobs and Economic Impacts .....	62
Table 5-15. Operations Jobs and Economic Impacts .....	64



## 1 INTRODUCTION

The goal of this project is to provide Avista with quantitative (\$/MWh, \$/kW) estimates of non-energy impacts (NEIs) for a variety of generation technologies and scenarios. Washington's Clean Energy Transition Act (CETA; <https://www.commerce.wa.gov/growing-the-economy/energy/ceta/>) requires investor-owned utilities to consider equity-related NEIs in integrated resource plans (IRPs). To accomplish this, DNV is building and applying a supply-side NEI database. As part of a previous project, DNV provided Avista with demand-side NEIs for measures included in energy efficiency programs. With the addition of supply-side NEIs, Avista, its advisory groups, and the Utilities and Transportation Commission (UTC) will be able to assess the full societal costs and benefits of all possible permutations of generation and efficiency options in future IRPs.

## 2 METHODOLOGY OVERVIEW

To compare the sustainability of different generator types, academic researchers use a method known as multi-criteria decision analysis (MCDA).<sup>12</sup> This process is conceptually similar to the preferred resource strategy (PRS) used in Avista's 2021 IRP to consider the different effects of each generator type on a variety of factors. Academic MCDA tends to include a wider range of sustainability effects than the PRS, specifically additional health, environmental, and economic effects; these are exactly the types of effects that Avista wants to quantify. These additional effects will help Avista factor into the PRS calculations more of these hidden costs and benefits that go beyond levelized cost of delivered energy to its customers (LCOE). DNV will add a monetization step to the MCDA methods to align the data into units that make it easier to integrate into the PRS.

Estimating NEIs can be a very complicated and nuanced endeavor. Specific documentation guidelines for investor-owned utilities are still being developed and will likely vary by state once completed.

DNV's approach is designed to produce defensible, levelized costs and benefits per MWh or kW, in such a way that they can be added directly to Avista's existing LCOE by generator type, for a variety of additional sustainability effects not yet considered in Avista's 2021 IRP. The approach follows four stages:

1. Conduct a jurisdictional scan to identify additional NEIs being used elsewhere and not listed in the RFP
2. Identify NEIs available through federal and regulatory publications
3. Where necessary, convert NEI units to \$/MWh and/or \$/kW values and apply discount rates
4. Conduct a gap analysis to provide recommendations to prioritize future research based on the necessary level of effort and anticipated value to Avista

Where available, DNV leveraged existing metanalytic data published by regulatory and government institutions such as the Environmental Protection Agency (EPA) and the National Renewable Energy Laboratory (NREL). Such official values should be readily defensible. In cases where institutional studies were not available, DNV conducted secondary research to identify data sources. Cases in which DNV was unable to identify a published data source are part of the gap analysis.

After compiling a database of NEI types (e.g., health) and values (\$/MW or \$/MWh) by generation technology, DNV applied the information in the database to the specific generation technologies and scenarios identified in the RFP and Avista's current generation assets.

<sup>1</sup> Klein, S.J. and Whalley, S. (2015). Comparing the sustainability of U.S. electricity options through multi-criteria decision analysis. *Energy Policy* 79(2015)127–149. <http://dx.doi.org/10.1016/j.enpol.2015.01.007>

<sup>2</sup> Nock, D. and Baker, E. (2019). Holistic multi-criteria decision analysis evaluation of sustainable electric generation portfolios: New England case study. *Applied Energy* 242 (2019) 655–673. <https://doi.org/10.1016/j.apenergy.2019.03.019>



### 3 DATABASE COMPILATION

Database compilation involves conducting secondary research to identify and catalog the NEI values in terms of native units (e.g., tons of pollution per MWh) and to monetize those units (\$/MWh or \$/MW) for each level in the database. Once prepared, the database is a single location that DNV and Avista can apply to specific scenarios and generation assets.

#### 3.1 Database structure

The database includes NEI impacts disaggregated by resource type, location, and lifecycle phase whenever possible. The resource types are shown in Table 3-1. These resources include both current and potential resource types. The abbreviations in the table are used in the tables and figures throughout the report. The database application is explained in Section 3.4.

**Table 3-1. Database resource types**

Group	Technology	
	Abbreviation	Generator Types
<b>Biomass</b>	Biomass	Biomass
<b>Coal</b>	Coal	Coal
	Coal CCS	Coal with Carbon Capture
<b>Hydro</b>	Hydro-PB	Pumped hydro - brownfield
	Hydro-GF	Pumped hydro - greenfield
	Hydro-Res	Reservoir hydro
	Hydro-RR	Run-of-river hydro
	Hydro-RRS	Run-of-river hydro with storage
<b>Hydrogen electrolyzer</b>	HE-LG	Hydrogen electrolyzer - large
	HE-SM	Hydrogen electrolyzer - small
<b>Lithium-ion storage</b>	Batt-LG	Lithium-ion Storage - Large
	Batt-SM	Lithium-ion Storage - Small
<b>Natural gas</b>	NG-Aero	Natural gas Aero Turbine
	NG-CCCT	Natural gas CCCT
	NG-CT	Natural gas CT
	NG-ICE	Natural gas internal combustion engine
<b>Non-natural gas</b>	NNG-Bio	Non-natural gas (Bio-fuel)
	NNG-CF	Clean Fuel Turbine
	NNG-Hyd	Non-natural gas (Hydrogen)
	NNG-LAir	Non-natural gas (Liquid air)
	NNG-Ren	Renewable natural gas storage tank
<b>Nuclear</b>	Nuclear	Nuclear
<b>Solar</b>	Solar-Com	Community solar
	Solar-Rft	Rooftop solar
	Solar-Utl	Utility-scale solar
<b>Wind</b>	Wind-LG	Large wind
	Wind-Off	Off-shore wind
	Wind-SM	Small Wind

**Near/Away:** For some NEI metrics, the database also includes values disaggregated into near and away from the resource site. Near-resource site impacts occur at the operations facility or nearby communities whereas impacts away from the resource site may occur in a different county, state, or country. This distinction provides the flexibility to assign near-facility impacts within or without Avista's territory depending on the location of the resource.





**Generation Resource Phase:** When possible, NEI metrics are also disaggregated by generation resource phase, including construction, operations, mining, and decommissioning, which are further described in Table 3-2.

**Table 3-2. Generation resource phase**

Phase	Description
<b>Construction</b>	Impacts specific to construction or manufacturing of the generation resource
<b>Operation</b>	Impacts associated with the operations of the generation resource
<b>Mining</b>	Impacts associated with fuel mining
<b>Decommissioning</b>	Impacts associated with decommissioning and disposing of the generation resource



## 3.2 Non-energy impact metrics

This section describes DNV's methods for determining values for each of the NEI types.

### 3.2.1 Public health

Electricity-generating technologies can cause a variety of public health impacts across their life cycles, from construction and manufacturing of components to operations and mining to decommissioning. Operational impacts due to particulate matter 2.5 (PM<sub>2.5</sub>), sulfur dioxide (SO<sub>2</sub>), and nitrogen oxide (NO<sub>x</sub>) emissions are readily available across many electricity-generating technologies.<sup>3</sup> These emissions values can be used to estimate monetized health impacts across different counties in the US by utilizing readily available tools from the EPA. Table 3-3 summarizes the metrics used to quantify operational public health impacts.

**Table 3-3. Public health metric descriptions**

Metric	Description	Sources
<b>PM<sub>2.5</sub> Health Effects</b>	Particulate matter 2.5 (PM <sub>2.5</sub> ) emissions are produced through fossil fuel, biomass, and other combustion to generate electricity. Increased PM <sub>2.5</sub> emissions are associated with increased mortality rates, respiratory and cardiovascular illnesses, and other impacts which the COBRA model monetizes. DNV used information from eGRID and the EPA to estimate PM <sub>2.5</sub> emissions and COBRA to monetize them, resulting in a dollar per MWh value.	COBRA <sup>4</sup> ; eGRID <sup>5</sup> ; EPA <sup>6</sup>
<b>SO<sub>2</sub> Health Effects</b>	Sulfur dioxide (SO <sub>2</sub> ) emissions are also emitted through combustion to produce electricity. Increased SO <sub>2</sub> emissions are associated with increased respiratory diseases and breathing difficulty. <sup>7</sup> DNV used the eGRID emissions estimates and the COBRA model to produce a dollar per MWh health impact metric.	COBRA <sup>8</sup> ; eGRID <sup>9</sup>
<b>NO<sub>x</sub> Health Effects</b>	Nitrogen oxides (NO <sub>x</sub> ) are also produced through combustion to generate electricity. Increased NO <sub>x</sub> emissions are associated with increased respiratory diseases, particularly asthma, hospital admissions, and emergency room visits. <sup>10</sup> DNV used the eGRID emissions estimate and the COBRA model to produce a dollar per MWh health impact for NO <sub>x</sub> .	COBRA <sup>11</sup> ; eGRID <sup>12</sup>

<sup>33</sup> These emissions and health impacts do not include health impacts from upstream or downstream activities including mining, drilling, manufacturing, or disposal. Additionally, they do not include operational health impacts from soil or water contamination.

<sup>4</sup> User's Manual for the Co-Benefits Risk Assessment Health Impacts Screening and Mapping Tool (COBRA). 2021. US EPA. November 2021. <https://www.epa.gov/cobra>.

<sup>5</sup> United States Environmental Protection Agency (EPA). 2022. "Emissions & Generation Resource Integrated Database (eGRID), 2020" Washington, DC: Office of Atmospheric Programs, Clean Air Markets Division. Available from EPA's eGRID web site: <https://www.epa.gov/egrid>.

<sup>6</sup> Estimating Particulate Matter Emissions for EGRID. 2020. US EPA. July 2020. [https://www.epa.gov/sites/default/files/2020-07/documents/draft\\_egrid\\_pm\\_white\\_paper\\_7-20-20.pdf](https://www.epa.gov/sites/default/files/2020-07/documents/draft_egrid_pm_white_paper_7-20-20.pdf).

<sup>7</sup> United States Environmental Protection Agency (EPA). (n.d.). "Sulfur Dioxide Basics" EPA. Retrieved February 1, 2022, from <https://www.epa.gov/so2-pollution/sulfur-dioxide-basics#effects>

<sup>8</sup> Ibid

<sup>9</sup> Ibid

<sup>10</sup> United States Environmental Protection Agency (EPA). (n.d.). "Basic Information about NO<sub>2</sub>" EPA. Retrieved February 1, 2022, from <https://www.epa.gov/no2-pollution/basic-information-about-no2#Effects>

<sup>11</sup> Ibid

<sup>12</sup> Ibid



### 3.2.1.1 Emissions values

The EPA has a comprehensive database of environmental characteristics of almost all electric power generated in the US. The Emissions and Generation Resource Integrated Database (eGRID) contains data on emissions, emissions rates, generation, heat input, and many other characteristics.<sup>13</sup> Values from eGRID were used to supplement data provided directly by Avista for existing and proposed generation resources. DNV combined information from the two sources for plant annual heat input from combustion (MMBtu), total emissions from NO<sub>x</sub> (tons), total emissions from SO<sub>2</sub> (tons), and plant annual net generation (MWh). Total emissions from PM<sub>2.5</sub> are not available in eGRID, however, the EPA provides PM<sub>2.5</sub> estimates for most electric generating units in a separate database based on the EPA's National Emissions Inventory (NEI).<sup>14</sup> Total emissions for PM<sub>2.5</sub>, NO<sub>x</sub>, and SO<sub>2</sub> were converted into tons/MWh based on the annual net generation from each electric generating unit.

Figure 3-1 through Figure 3-3 present the PM<sub>2.5</sub>, SO<sub>2</sub>, and NO<sub>x</sub> emissions per MWh for both existing and proposed generation types. Both the existing and proposed biomass plants have the highest PM<sub>2.5</sub> emissions rates, followed by the existing and proposed coal plants. It is important to note that while for most technologies, the assumed counterfactual would be producing no emissions or similar emissions if the fuel were burned in a different power plant, the biomass counterfactual is less well defined. The Kettle Falls biomass facility burns sawmill or chip mill biomass residuals. In the absence of the Kettle Falls facility, it is difficult to say how the waste material would have been used and what the likely emissions would have been. The existing and proposed coal plants also had the highest SO<sub>2</sub> emissions, while the Northeast natural gas plant had the highest NO<sub>x</sub> emissions. Hydro, wind, and solar had no PM<sub>2.5</sub>, SO<sub>2</sub>, or NO<sub>x</sub> emissions. For SO<sub>2</sub> and NO<sub>x</sub>, the coal with carbon capture and storage resource is assumed to have the same emissions rate as the current Coal Strip facility, as this is the best available data. In practice, the SO<sub>2</sub> and NO<sub>x</sub> emissions rate for the coal with carbon capture and storage may be lower.

<sup>13</sup> United States Environmental Protection Agency (EPA). 2022. "Emissions & Generation Resource Integrated Database (eGRID), 2020" Washington, DC: Office of Atmospheric Programs, Clean Air Markets Division. Available from EPA's eGRID web site: <https://www.epa.gov/egrid>.

<sup>14</sup> US EPA. 2020. Review of Estimating Particulate Matter Emissions for EGRID: Draft White Paper. [https://www.epa.gov/sites/default/files/2020-07/documents/draft\\_egrid\\_pm\\_white\\_paper\\_7-20-20.pdf](https://www.epa.gov/sites/default/files/2020-07/documents/draft_egrid_pm_white_paper_7-20-20.pdf).



Figure 3-1. Operational PM<sub>2.5</sub> emissions per MWh by generation type

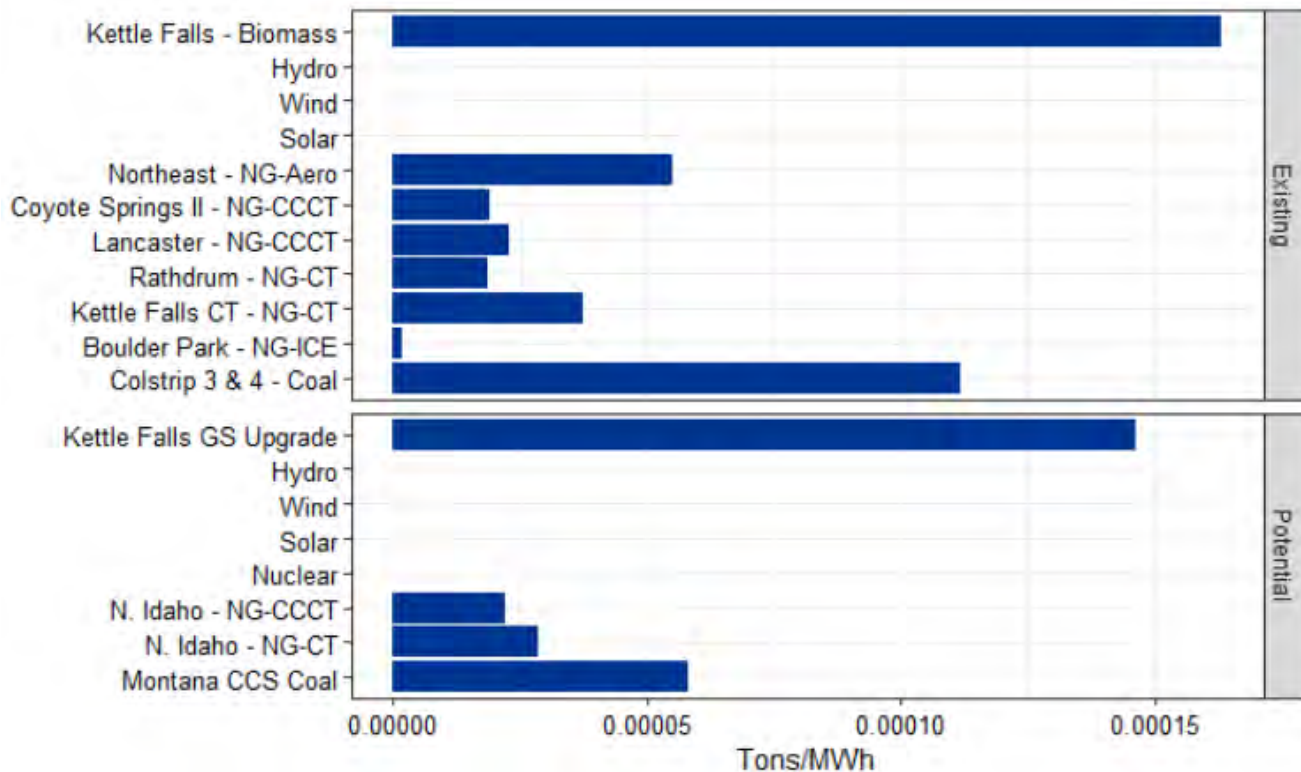

Figure 3-2. Operational SO<sub>2</sub> emissions per MWh by generation type

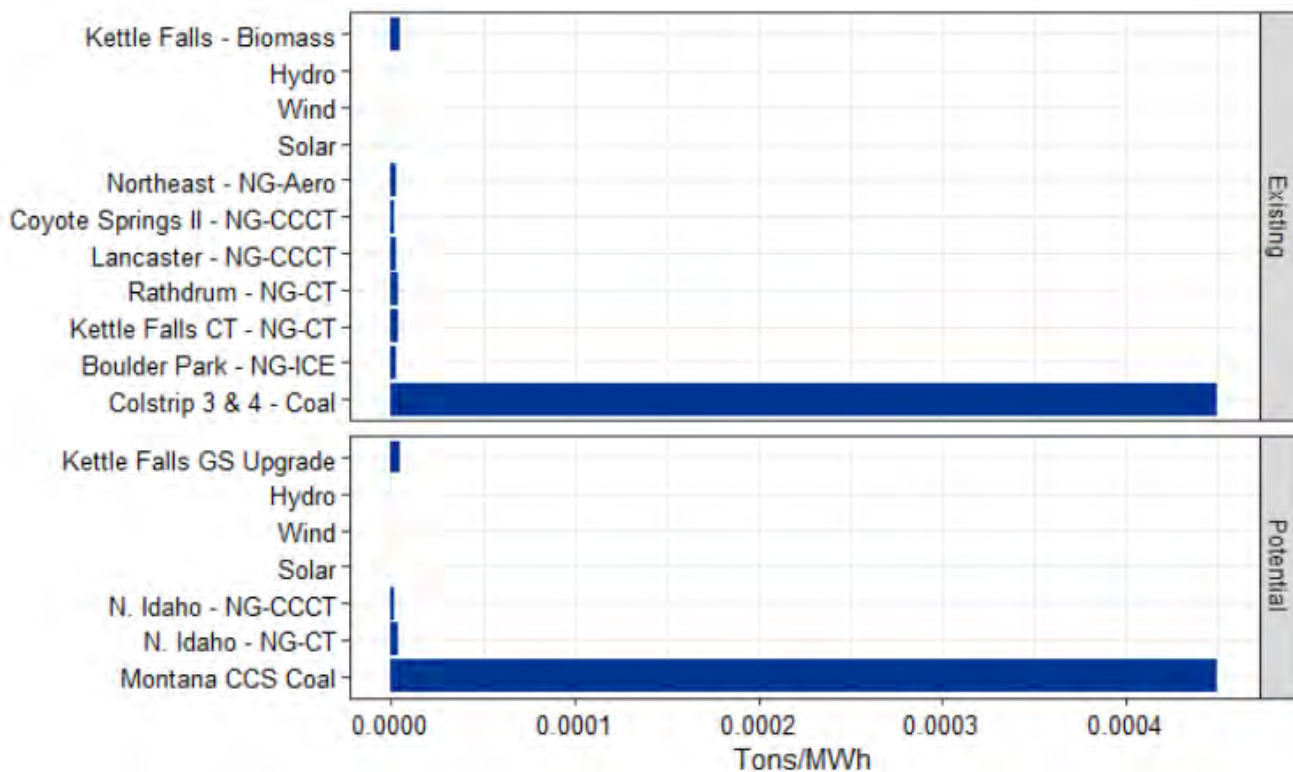
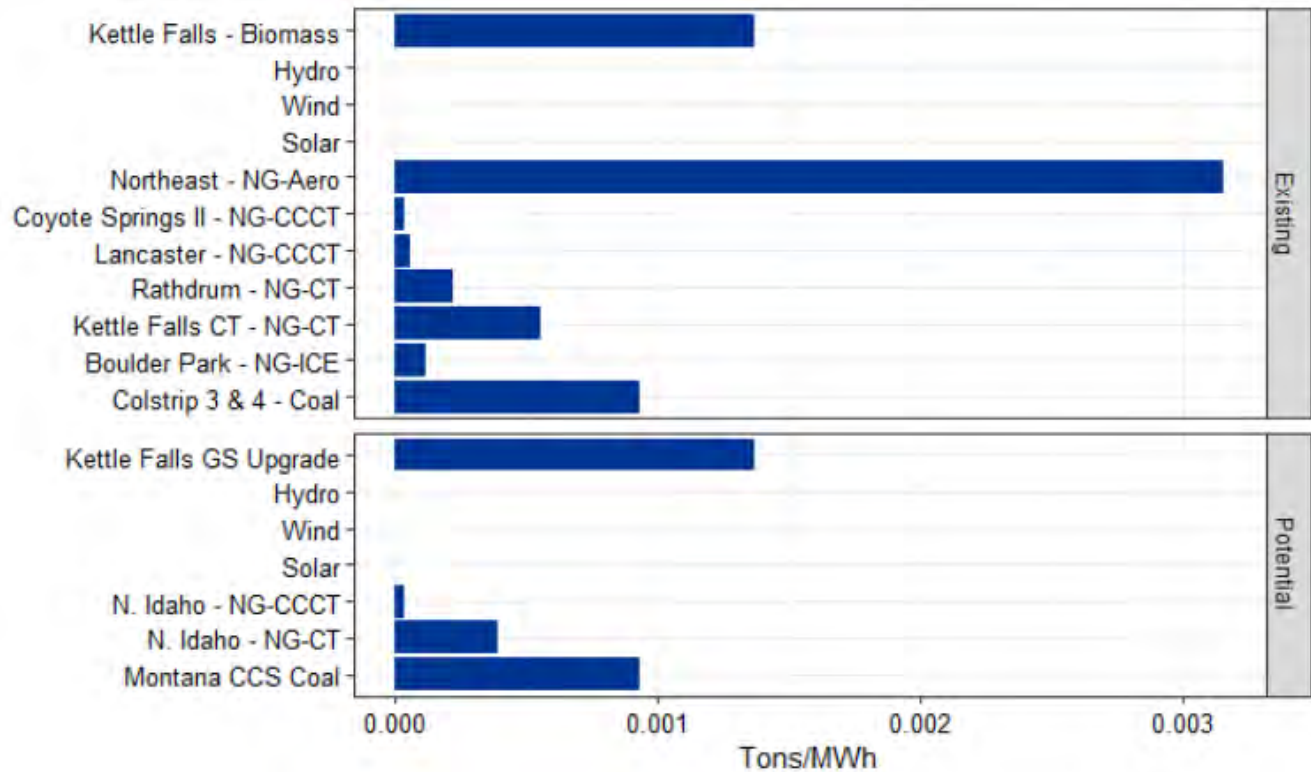



Figure 3-3. Operational NO<sub>x</sub> emissions per MWh by generation type



### 3.2.1.2 Monetized impacts

Co-Benefits Risk Assessment (COBRA) is a screening and modeling tool provided by the EPA that can be used to explore how changes in air pollution can affect human health in different areas of the country and estimate the economic value of the health benefits associated with those changes.<sup>15 16</sup> Emissions changes are entered at the county, state, or national level, and COBRA uses an air quality model to estimate the effects of those emissions changes across the country. The model then estimates the number of health incidences avoided and the economic value for health impacts such as mortality, non-fatal heart attacks, and respiratory admissions. The monetization for these health conditions is based on values such as the willingness to pay, the cost of illness, and the value of a statistical life that were collected from various literature reviews. DNV modeled the impacts of PM<sub>2.5</sub>, SO<sub>2</sub>, and NO<sub>x</sub> emissions in the counties where combustion generation technologies, including coal, natural gas, and biomass, either exist or are proposed. When emissions are changed in one county, the COBRA model produces the monetized impacts for every county in the United States. DNV categorized those impacts in the following way:

- **Site county:** The monetized health costs in the county where the generation resource is located. Resources may be located within or outside Avista's territory.
- **Avista territory:** The monetized health costs in Avista's territory. If the site county is within Avista's service territory, those costs are not included in this estimate; in this case, total cumulative effects within Avista territory will equal the sum of the site county and Avista territory effects.

<sup>15</sup> User's Manual for the Co-Benefits Risk Assessment Health Impacts Screening and Mapping Tool (COBRA). 2021. US EPA. November 2021. <https://www.epa.gov/cobra>.

<sup>16</sup> It should be noted that this study assumes Avista complies with existing permitting laws that establish maximum levels of pollution that utilities are allowed to produce. While legally acceptable, these allowances do not imply that only pollution over those thresholds results in harm. Instead, they essentially establish a maximum amount of harm that a utility is legally allowed to cause.



- **Other US:** The monetized health costs for the rest of the United States

DNV combined emissions information from eGRID and Avista with the monetized health impacts from COBRA to estimate the economic impact on health from a one-ton increase in PM<sub>2.5</sub>, SO<sub>2</sub>, NO<sub>x</sub> (Equation 1).

**Equation 1. Monetized health impacts**

$$\text{Monetized Health impacts} \left[ \frac{\$}{MWh} \right] = \text{Emissions} \left[ \frac{\text{tons}}{MWh} \right] \times \text{Health Impacts from pollutant} \left[ \frac{\$}{\text{ton}} \right]$$

Table 3-4 displays dollars per ton of PM<sub>2.5</sub>, NO<sub>x</sub>, and SO<sub>2</sub> for each of the counties where an existing plant is located. COBRA estimates the public health costs of a change in pollutant levels by county. Estimates were only available for combustion generation technologies such as coal, gas, or biomass. The counties included in the table above are where existing plants are currently located.

**Table 3-4. Dollars per ton by County**

Plant County	PM2.5 (\$/ton)			NOx (\$/ton)			SO2 (\$/ton)		
	Site County	Avista Territory	US-Other	Site County	Avista Territory	US- Other	Site County	Avista Territory	US-Other
Rosebud, MT	118.81	172.40	51,361.34	7.88	33.59	9,973.72	12.22	75.28	22,473.09
Kootenai, ID	30,724.75	13,558.21	23,330.00	1,508.19	761.88	4,304.93	2,060.74	1,071.30	10,101.90
Spokane, WA	52,237.59	9,523.47	17,869.91	2,678.17	489.07	3,266.53	3,749.00	713.52	7,578.78
Morrow, OR	1,268.66	2,891.67	23,471.96	65.68	290.51	3,038.00	253.43	1,192.13	13,335.49
Stevens, WA	10,222.35	6,399.56	21,922.87	609.91	566.63	3,954.48	867.26	866.72	9,184.79



Figure 3-4 presents the operational health costs per MWh for PM<sub>2.5</sub> emissions for each existing and proposed combustion resource. Renewable resources including solar, wind, and hydro do not have any reported operational PM<sub>2.5</sub>, SO<sub>2</sub>, or NO<sub>x</sub> emissions. For existing resources, Colstrip and Kettle Falls have the largest impact on the US as a whole. This is expected, as biomass and coal produce more PM<sub>2.5</sub> than natural gas. Since Colstrip is in Montana, which is not in Avista territory, there are fewer Avista impacts. The population for Stevens county, where Kettle Falls is located, is much larger than the county where Colstrip is located, which would explain why Kettle Falls has a much larger site county impact than Colstrip.

**Figure 3-4. Operational PM<sub>2.5</sub> health costs per MWh by generation type**

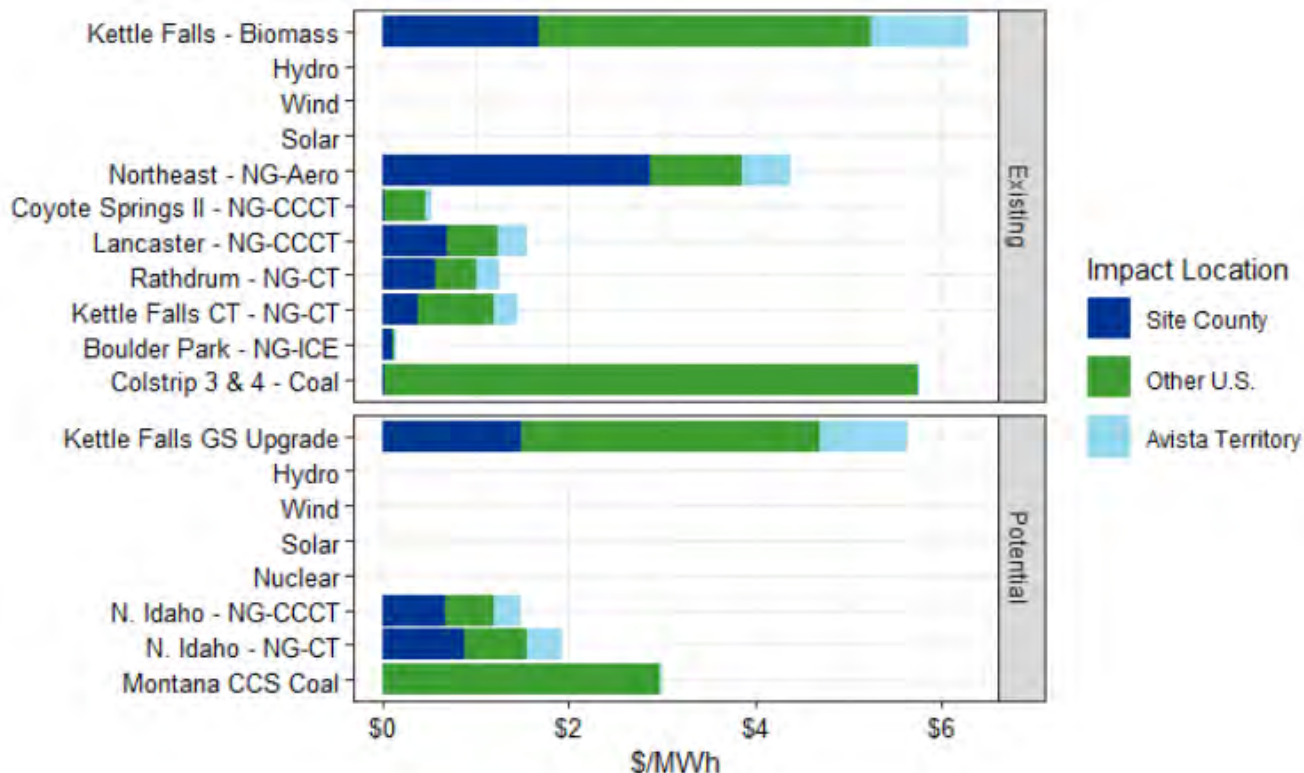



In Figure 3-5, the operational SO<sub>2</sub> health costs per MWh are shown for existing and proposed resources and by impact location. Coal has the largest impact compared to the other resources. These impacts are nearly all outside of Avista's territory.

**Figure 3-5. Operational SO<sub>2</sub> health costs per MWh by generation type**

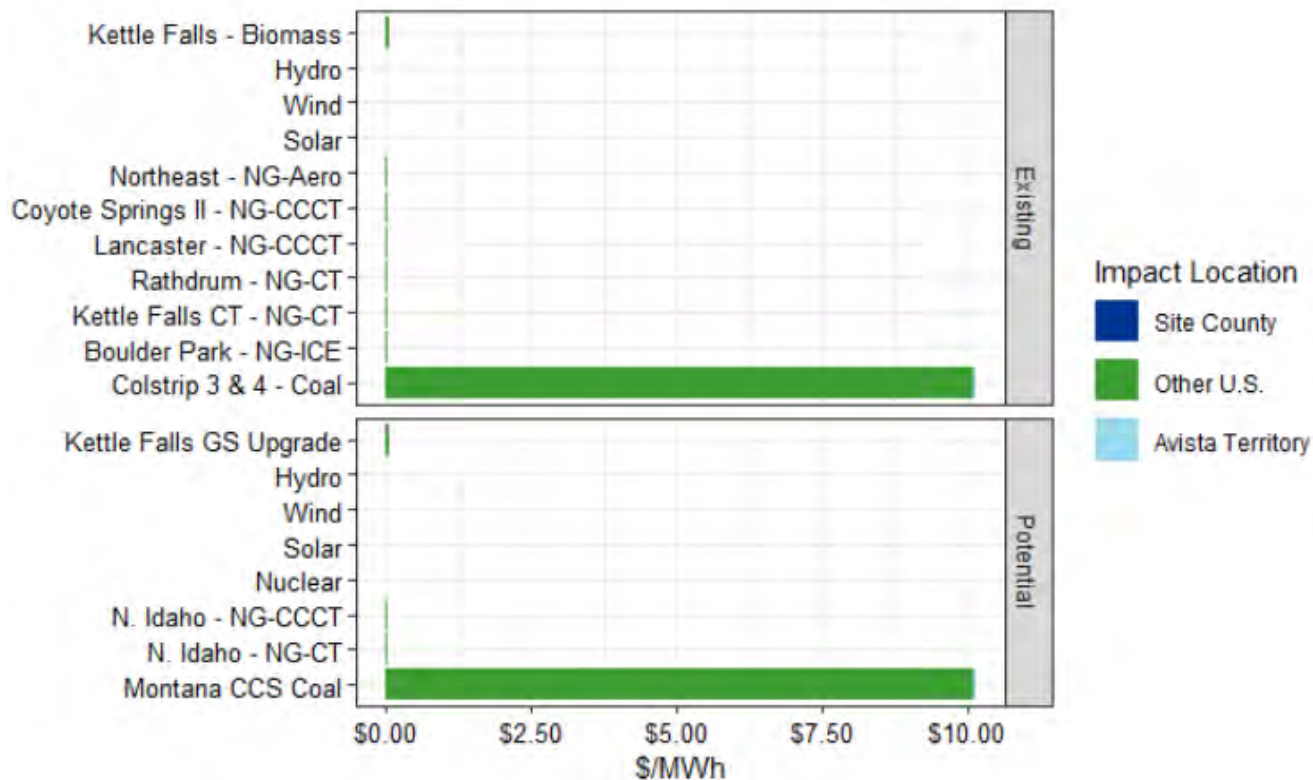
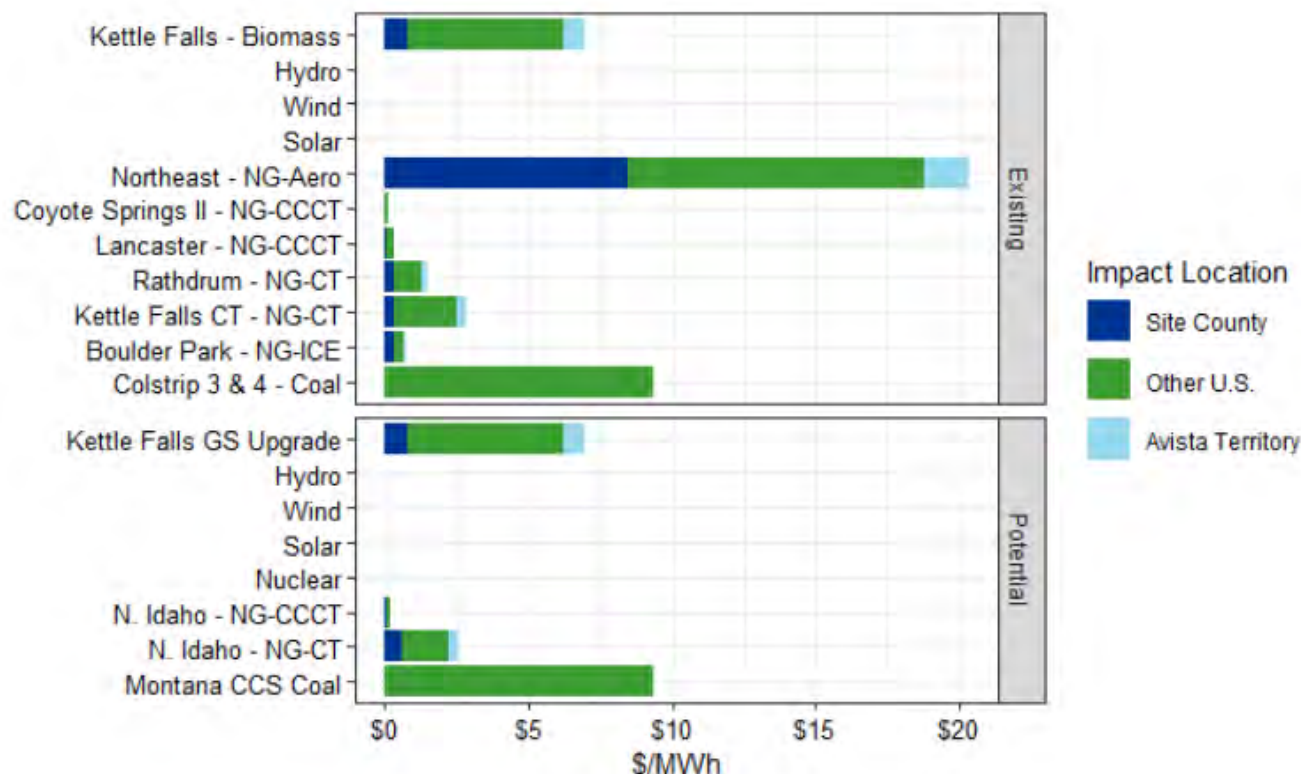





Figure 3-6 shows the operational NO<sub>x</sub> health costs per MWh for existing and proposed resources by impact location. For existing resources, Northeast natural gas has the highest NO<sub>x</sub> health costs per MWh throughout the US and in Avista's territory. Additionally, Colstrip had the next highest health costs per MWh throughout the US, and Kettle Falls had the second-highest NO<sub>x</sub> health costs in Avista's territory. For proposed facilities, the Colstrip resources had the highest national NO<sub>x</sub> health costs and Kettle Falls had the highest health costs within Avista's territory.

**Figure 3-6. Operational NO<sub>x</sub> health costs per MWh by generation type**





### 3.2.2 Safety

Electricity generating facilities have safety impacts associated with all supply-chain phases. These impacts can include injuries or fatalities related to mining, construction, operation, maintenance, or decommissioning of the facility. Because the monetary cost of injuries is not easily transferable across regions, and because of limited data regarding injuries, DNV used only fatalities as the benchmark for resources safety. <sup>17</sup>Table 3-5 presents an overview of the safety metrics and sources. Available safety information is not always disaggregated by supply-chain activity, so this report specifies when safety estimates apply to the whole supply chain or whether estimates apply to certain aspects of the supply chain.

**Table 3-5. Safety metric descriptions**

Metric	Description	Sources
<b>Direct fatalities from construction and operation</b>	Direct fatalities that occur during the construction and operation of an energy resource. These fatalities could be from normal workplace accidents, catastrophic failures, and public interaction.	Balancing safety with sustainability <sup>18</sup> ; BLS <sup>19</sup> ; BTS <sup>20</sup> ; MSHA <sup>21</sup> ; CDC <sup>22</sup> ; DOT <sup>23</sup>
<b>Indirect fatalities due to supply-chain activities</b>	Indirect fatalities occur from accidents related to the production and transportation of materials used in either construction, operation, or decommissioning. This can include mining for fuel or base materials and accidents related to the processing and transportation of these raw materials.	

<sup>17</sup> DNV recognizes fatalities and injuries might already be contained within insurance costs for specific facilities. A significant portion of fatalities comes from indirect supply-chain activities, though, and might therefore fall out of insurance costs for the generating facility. Further research would be needed to identify what proportion of these fatalities are already being quantified by insurance.

<sup>18</sup> Sovacool, Benjamin K., Rasmus Andersen, Steven Sorensen, Kenneth Sorensen, Victor Tienda, Arturas Vainorius, Oliver Marc Schirach, and Frans Bjørn-Thygesen. 2016. "Balancing Safety with Sustainability: Assessing the Risk of Accidents for Modern Low-Carbon Energy Systems." *Journal of Cleaner Production* 112 (January): 3952–65.

<sup>19</sup> "Census of Fatal Occupational Injuries (CFOI) - Current and Revised Data." 2018. Bls.gov. December 18, 2018. <https://www.bls.gov/iif/oshcfoi.htm>.

<sup>20</sup> "Train Fatalities, Injuries, and Accidents by Type of Accident | Bureau of Transportation Statistics." n.d. Www.bts.gov. <https://www.bts.gov/content/train-fatalities-injuries-and-accidents-type-accidenta>.

<sup>21</sup> "Coal Mining Fatality Statistics: 1900-2013." 2013. Msha.gov. 2013. <https://arlweb.msha.gov/stats/centurystats/coalstats.asp>.

<sup>22</sup> "CDC - Fatalities in the Oil and Gas Extraction Industry (FOG) - NIOSH Workplace Safety & Health Topic." 2021. Www.cdc.gov. June 24, 2021. <https://www.cdc.gov/niosh/topics/fog/default.html>.

<sup>23</sup> 2022. Dot.gov. 2022. [https://portal.phmsa.dot.gov/analytics/saw.dll?Portalpages&PortalPath=%2Fshared%2FPDM%20Public%20Website%2F\\_portal%2FSC%20Incident%20Trend&Page=Significant%20Incidents%20Consequences](https://portal.phmsa.dot.gov/analytics/saw.dll?Portalpages&PortalPath=%2Fshared%2FPDM%20Public%20Website%2F_portal%2FSC%20Incident%20Trend&Page=Significant%20Incidents%20Consequences).



### 3.2.2.1 Fatality values

Fatality estimates for biomass, biofuels, hydro, nuclear, solar, and wind include reported fatalities from all aspects of the supply chain in aggregate. These values were calculated from a proprietary database to which DNV does not have access and come from accidents happening in many different countries.<sup>24</sup> The source data for these resources does not disaggregate fatalities by specific supply chain activity. For coal and natural gas, DNV developed fatality estimates using publicly available data for US production,<sup>25,26</sup> transportation,<sup>27,28</sup> and generation<sup>29</sup> (See Appendix A for more details). Fatality values are shown in Figure 3-7 and are reported in fatalities per GWh because fatalities are closely tied to fuel inputs for fossil fuel generation, and the amount of fossil fuel inputs is more dependent on output than capacity.

Figure 3-7. Fatalities by generation type<sup>30</sup>

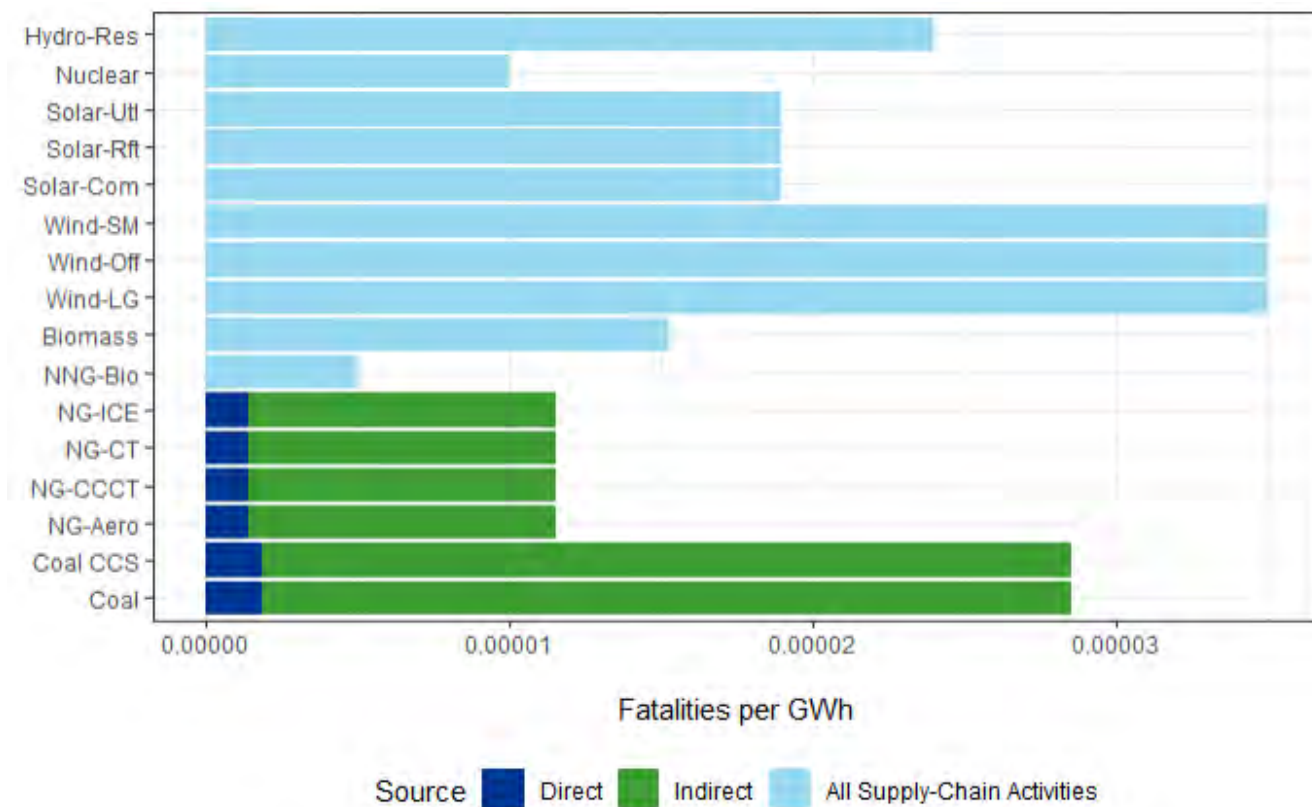

Fatalities per GWh were highest for wind, followed by coal, and hydro. Wind fatalities may be higher due to the relatively high frequency of small aircraft collisions with wind turbines, dangerous maintenance work on top of turbines, and potential increased documentation due to active monitoring of operations by critics and advocates. Coal has the second-highest level

<sup>24</sup> Sovacool, Benjamin K., Rasmus Andersen, Steven Sorensen, Kenneth Sorensen, Victor Tienda, Arturas Vainorius, Oliver Marc Schirach, and Frans Bjørn-Thygesen. 2016. "Balancing Safety with Sustainability: Assessing the Risk of Accidents for Modern Low-Carbon Energy Systems." *Journal of Cleaner Production* 112 (January): 3952–65.

<sup>25</sup> "CDC - Fatalities in the Oil and Gas Extraction Industry (FOG) - NIOSH Workplace Safety & Health Topic." 2021. [www.cdc.gov](https://www.cdc.gov/niosh/topics/fog/default.html). June 24, 2021.

<sup>26</sup> "Coal Mining Fatality Statistics: 1900-2013." 2013. [Msha.gov](https://arlweb.msha.gov/stats/centurystats/coalstats.asp). 2013.

<sup>27</sup> 2022. [Dot.gov](https://portal.phmsa.dot.gov/analytics/saw.dll?Portalpages&PortalPath=%2Fshared%2FPDM%20Public%20Website%2F_portal%2FSC%20Incident%20Trend&Page=Significant%20Incidents%20Consequences). 2022.

<sup>28</sup> "Train Fatalities, Injuries, and Accidents by Type of Accident | Bureau of Transportation Statistics." n.d. [www.bts.gov](https://www.bts.gov/content/train-fatalities-injuries-and-accidents-type-accidenta).

<sup>29</sup> "Census of Fatal Occupational Injuries (CFOI) - Current and Revised Data." 2018. [Bls.gov](https://www.bls.gov/iif/oshcfoi1.htm). December 18, 2018.

<sup>30</sup> Fatality rates are not sub-technology specific, meaning the same estimate is applied for coal and coal with carbon capture, all natural gas sub-technologies, and solar.



of fatalities likely because mining is a dangerous job. When compared to a similar resource like natural gas, it is important to note that electricity production accounts for the vast majority of coal use (91.5%).<sup>31</sup> For natural gas, the extraction and transportation values, while high for the entire industry, are being multiplied by the percentage of natural gas that goes for electricity production (38%).<sup>32</sup>

When further comparing coal against the resource with the third-highest fatalities per GWh (Reservoir Hydro), the values are not perfectly relatable because they come from different sources. Reservoir Hydro comes from a proprietary database. While DNV cannot look at all incidences in the database, the top eight are shown to be catastrophic dam failure accidents.<sup>33</sup> It is unknown if this database accounts for accidents during construction or mining of raw material, which would create a more even comparison with coal.

### 3.2.2.2 Monetized Impacts

Figure 3-8 presents the monetized impacts from fatalities by generation type. DNV monetized fatalities using the EPA's value of a statistical life,<sup>34</sup> adjusted to 2021 dollars using the Federal Reserve's Consumer Price Index.<sup>35</sup> This conversion is seen in Equation 2. This analysis treats fatalities consistently across all generation types and supply chain activities, so the proportional difference between resource sites is the same in Figure 3-8 as it is in Figure 3-7.

#### Equation 2. Monetized safety

$$\text{Monetized safety} \left[ \frac{\$}{MWh} \right] = \text{Safety} \left[ \frac{\text{Fatalities}}{MWh} \right] \times \text{Value of a Statistical Life} \left[ \frac{\$10,742,916.67}{\text{Fatality}} \right]$$

<sup>31</sup> [Use of coal - U.S. Energy Information Administration \(EIA\)](#)

<sup>32</sup> <https://www.eia.gov/energyexplained/natural-gas/use-of-natural-gas.php#:~:text=The%20commercial%20sector%20uses%20natural,combined%20heat%20and%20power%20systems.>

<sup>33</sup> Sovacool, Benjamin K., Rasmus Andersen, Steven Sorensen, Kenneth Sorensen, Victor Tienda, Arturas Vainorius, Oliver Marc Schirach, and Frans Bjørn-Thygesen. 2016. "Balancing Safety with Sustainability: Assessing the Risk of Accidents for Modern Low-Carbon Energy Systems." *Journal of Cleaner Production* 112 (January): 3952–65.

<sup>34</sup> US EPA. n.d. "Mortality Risk Valuation." Accessed February 23, 2022. <https://www.epa.gov/environmental-economics/mortality-risk-valuation>.

<sup>35</sup> Federal Reserve Bank of Minneapolis. n.d. Review of Consumer Price Index, 1800-. <https://www.minneapolisfed.org/about-us/monetary-policy/inflation-calculator/consumer-price-index-1800->.



Figure 3-8. Monetized fatalities by generation type

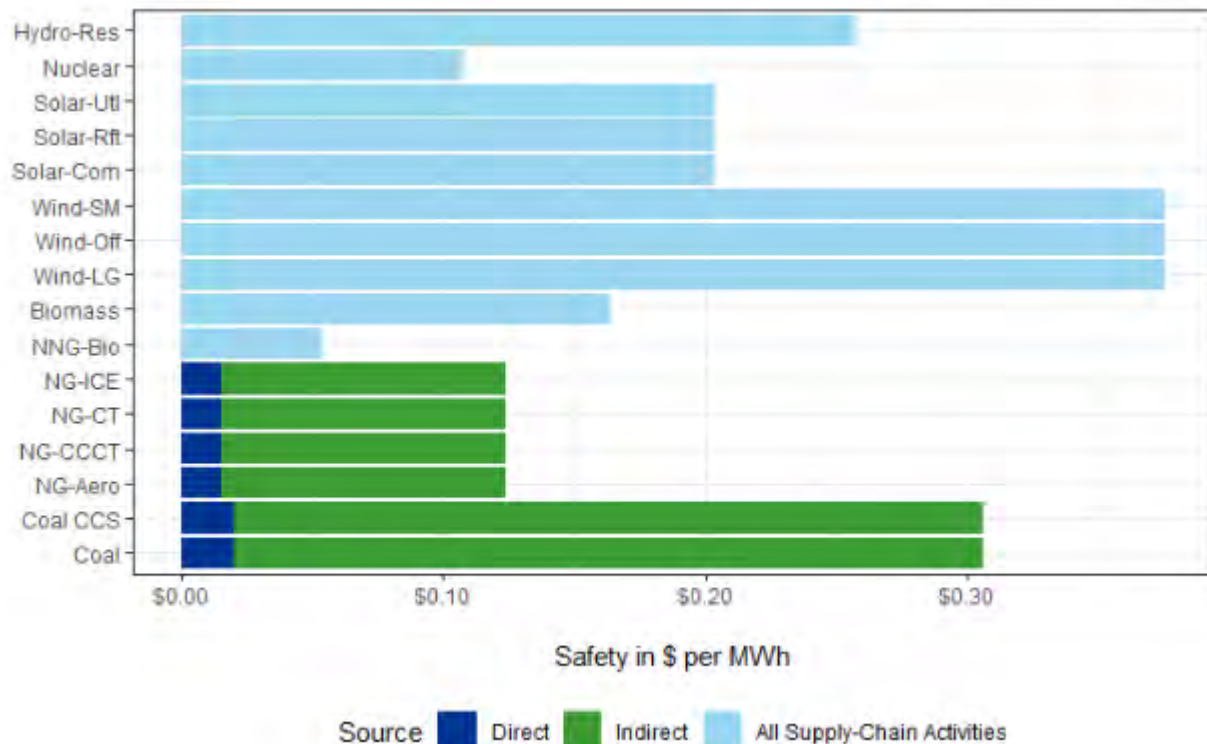

### 3.2.3 Reliability and resiliency

The reliability and resiliency impact of generation resources could be negative or positive to Avista's customers. While some types of resources may be able to increase reliability and resiliency in certain circumstances, there are no generalizable reliability and resiliency impacts by generation resource. Detailed modeling would be necessary to assess the reliability and resiliency impacts of the existing and proposed resources as these benefits are based on the location of the resource and its interaction in the larger transmission and distribution grid. Further, any benefits may not be societal impacts, but rather impacts only to specific customers.

### 3.2.4 Energy security

The IEA<sup>36</sup> defines energy security as "the uninterrupted availability of energy sources at an affordable price." This definition has broad implications. National energy policy plays a role in the availability of fuel and other imports necessary to generate energy. At a more local scale, the uninterrupted availability component can be considered via distribution system reliability and resiliency metrics. DNV recommends using energy burden as a metric for the affordability component of the definition. Energy burden is often a component of housing burden, which is directly factored into the Washington Health Disparities score. Additionally, energy burden is also an often-considered equity-related metric.

Energy burden is calculated as the proportion of household income spent on electricity and heating. As such, the effects of different generation resources on household income and the cost of electricity are the necessary components for estimating energy burden effects. While some of these aspects are addressed by the Economic NEIs, DNV suggests addressing this metric qualitatively by assessing whether a resource is expected to increase or decrease customer's energy costs through

<sup>36</sup> <https://www.iea.org/topics/energy-security>



the IRP's revenue requirement or energy rate calculation of future energy costs. This serves as an indicator of how expensive energy will be to the end user to maintain affordability of energy.



### 3.2.5 Environment

Electricity-generating technologies have a variety of environmental impacts throughout their life cycles. DNV considered land use, water use, wildfire risk, and wildlife impacts. These metrics vary substantially in data availability across technologies and project phases.

#### 3.2.5.1 Land use

Land use represents the indirect and on-site operational costs of a power plant during its operation. Land use affects all generation technologies via fuel extraction for fossil fuels and nuclear and use of land for energy generation rather than food production for renewables. Table 3-6 presents the descriptions of the types of land uses included in the values for each phase.

**Table 3-6. Land use phase descriptions**

Land Use Phase	Description	Sources
<b>Construction</b>	Land used during manufacturing, construction, and for key construction inputs such as gravel.	NREL <sup>37</sup> ; DNV subject matter experts; Stevens et al <sup>38</sup>
<b>Mining</b>	Land used for fuel mining and production.	
<b>Operations</b>	Land used for resource operations.	
<b>Decommissioning</b>	Land used to store, dispose of, or recycle the components of the resource following operations.	

<sup>37</sup> National Renewable Energy Laboratory (NREL). Review of Land Use by System Technology. Energy Analysis. <https://www.nrel.gov/analysis/tech-size.html>.

<sup>38</sup> Stevens, Landon, Barrett Anderson, Colton Cowan, Katie Colton, and Dallin Johnson. 2017. Review of The Footprint of Energy: Land Use of U.S. Electricity Production. Strata Policy. <https://docs.wind-watch.org/US-footprints-Strata-2017.pdf>.



### Land use values

DNV compiled land use values from NREL, Stevens et al, and internal subject matter experts. Table 3-7 summarizes the land use value coverage by generator type and phase. Checks indicate identified values, circles indicate missing values, and blank cells indicate phases where no value is expected (fuel mining for renewables). While DNV was able to identify values for most phases that are expected to have the largest land use, most generator types are missing construction and manufacturing land use as well as decommissioning.

**Table 3-7. Land use value coverage by phase**

Group	Technology		Phase			
	Abbreviation	Generator Types	Construction	Operation	Mining	Decommissioning
<b>Biomass</b>	Biomass	Biomass	○	✓	○	○
<b>Coal</b>	Coal	Coal	○	✓	✓	○
	Coal CCS	Coal with Carbon Capture	○	✓	✓	○
<b>Hydro</b>	Hydro-PB	Pumped hydro - brownfield	○	○		○
	Hydro-GF	Pumped hydro - greenfield	○	○		○
	Hydro-Res	Reservoir hydro	✓	✓		○
	Hydro-RR	Run-of-river hydro	○	○		○
	Hydro-RRS	Run-of-river hydro with storage	○	○		○
<b>Hydrogen electrolyzer</b>	HE-LG	Hydrogen electrolyzer - large	○	✓		○
	HE-SM	Hydrogen electrolyzer - small	○	✓		○
<b>Lithium-ion Storage</b>	Batt-LG	Lithium-ion Storage - Large	○	○		○
	Batt-SM	Lithium-ion Storage - Small	○	○		○
<b>Natural gas</b>	NG-Aero	Natural gas Aero Turbine	○	✓	✓	○
	NG-CCCT	Natural gas CCCT	○	✓	✓	○
	NG-CT	Natural gas CT	○	✓	✓	○
	NG-ICE	Natural gas internal combustion engine	○	✓	✓	○
<b>Non-natural gas</b>	NNG-Bio	Non-natural gas (Bio-fuel)	○	○		○
	NNG-CF	Clean Fuel Turbine	○	○		○
	NNG-Hyd	Non-natural gas (Hydrogen)	○	○		○
	NNG-LAir	Non-natural gas (Liquid air)	○	○		○
	NNG-Ren	Renewable natural gas storage tank	○	✓		○
<b>Nuclear</b>	Nuclear	Nuclear	○	✓	✓	○
<b>Solar</b>	Solar-Com	Community solar	✓	✓		✓
	Solar-Rft	Rooftop solar	✓	✓		✓
	Solar-Utl	Utility-scale solar	✓	✓		✓
<b>Wind</b>	Wind-LG	Large wind	✓	✓		○
	Wind-Off	Off-shore wind	✓	✓		○
	Wind-SM	Small Wind	✓	✓		○

The assembled land use values are reported in acres per MW in Figure 3-9. Reservoir hydro had the highest land use per per MW. It is important to note that actual land use for the reservoir and operational building may be greater or smaller depending on the local topography. The next highest land use was for onshore wind, which includes both direct and indirect land use. Actual land use for a project may vary, depending on how much of the land can be used for other activities such as farming. Offshore wind land use is limited to the land needed onshore to connect the resource to the grid and does not





account for the ocean surface area occupied. Construction land use for hydro, solar, and wind includes the land needed for mining raw materials needed to manufacture or construct the resources. Natural gas mining includes the land needed for frac sand mining as well as fracking. Coal mining assumes that surface mining accounts for two-thirds of the mining while underground mining accounts for the remaining third.

**Figure 3-9. Land use by generation type by MW**

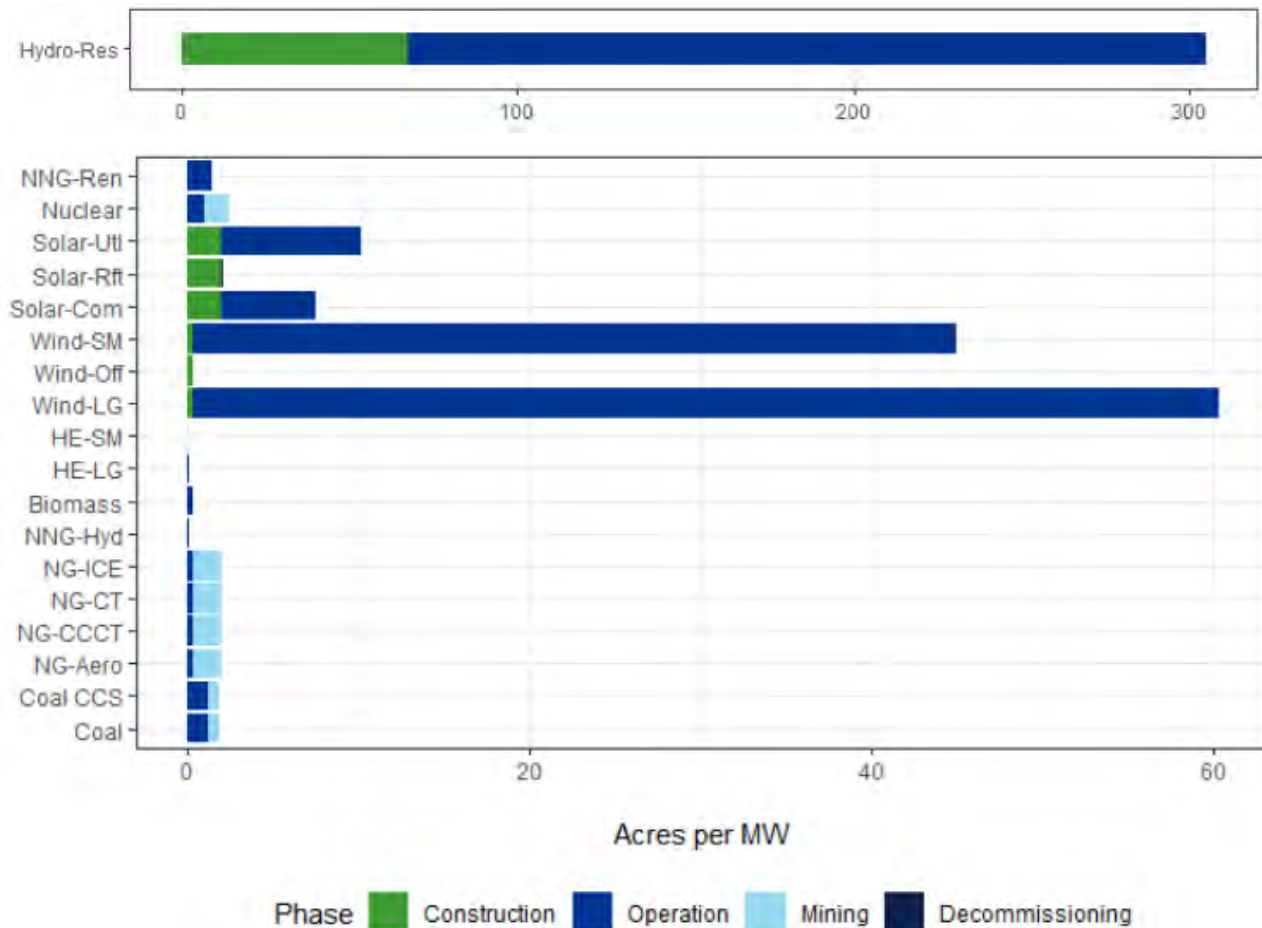

**Monetized impacts**

Given the cost of the land is part of capital cost or the cost of the products Avista acquires, DNV does not propose to include these land impacts as a non-energy impact. There could be additional land use impacts considered such as the effect of property values on neighboring lands. These impacts could be both positive (i.e. hydro reservoir) or negative in the case of power production facilities. DNV recommends further study on this topic as part of its study gaps section.



### 3.2.5.2 Water use

Water is often used throughout the lifecycle phases of electricity generation. It is commonly used in sustainability models and can vary substantially across generation resources.

#### *Water use values*

Water consumption during operations is a readily available metric for most generation resources. Water consumption is the water that is withdrawn and lost through evaporation, transpiration, or other causes. As water consumption is typically associated with the amount of electricity generated, this analysis compares water consumption in gallons per MWh. All water consumption values are from Macknick et al.<sup>39</sup>

Figure 3-10 shows the operational water use by generation type. Reservoir hydro has the highest operational water consumption based on evaporative water losses from the reservoir. The United State Geological Survey (USGS) estimates there is 21 inches of evaporation in Lake Couer d Alene which is centrally located relative to Avista hydro resources.<sup>40</sup> With an approximate surface area of 5,600 acres, water loss from the Noxon reservoir is approximately 2,000 gallons/MWh. This value could vary dramatically based on the surface area of the reservoir as well as the weather. The water consumption for coal, biomass, natural gas, and nuclear assume a cooling tower is used. Solar uses minimal water, assuming that the panels are washed periodically.

**Figure 3-10. Operational water consumption by generation type by MWh**

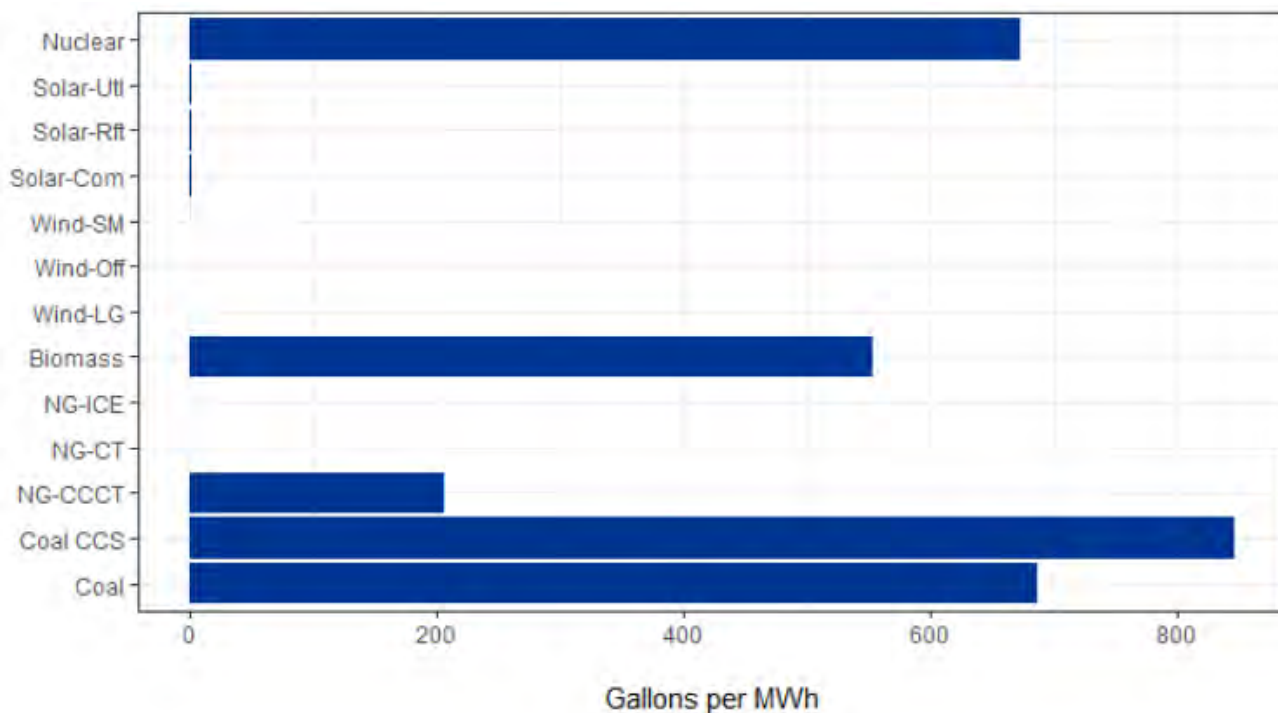

<sup>39</sup> Macknick, J, R Newmark, G Heath, and K C Hallett. 2012. "Operational Water Consumption and Withdrawal Factors for Electricity Generating Technologies: A Review of Existing Literature." *Environmental Research Letters* 7 (4): 045802.

<sup>40</sup> Maupin, M.A., and Weakland, R.J., 2009, Water budgets for Coeur d'Alene Lake, Idaho, water years 2000–2005: U.S. Geological Survey Scientific Investigations Report 2009-5184, 16 p.

***Monetized impacts***

DNV recommends only monetizing water consumption for resources that do not have the cost of water included as part of the resource's cost. In this event, Avista could use the Spokane, WA commercial water utility rates for water use greater than 1,000 cubic feet<sup>41</sup> as an approximation for this non-energy impact.

---

<sup>41</sup> Spokane City. 2022 Commercial Utilities Rates. Spokane City Public Works & Utilities. Accessed February 16, 2022. <https://my.spokanecity.org/publicworks/utility-billing/commercial-rates/>.



### 3.2.5.3 Wildfire risk

Fossil fuels contribute to wildfires through climate change effects, and as of 2014, wildfires were not included in the EPA's social cost of carbon calculations.<sup>42 43</sup> DNV was unable to identify a readily identifiable monetized wildfire metric. Because climate change has increased the severity and timing of wildfires,<sup>44</sup> greenhouse gas (GHG) emissions per MWh could serve as a proxy for wildfire risk. Avista currently factors this risk using the Social Cost of Carbon in its IRP's Washington Preferred Resource Strategy Analysis. Further research to develop a wildfire risk assessment could consider fire risk by technology which could result in a wildfire, length of long-range transmission lines by existing or proposed resource, or the wildfire risks associated with specific locations.

<sup>42</sup> Environmental Defense Fund, Institute for Policy Integrity, and NRDC. 2014. Review of Flammable Planet: Wildfires and the Social Cost of Carbon. [https://costofcarbon.org/files/Flammable\\_Planet\\_Wildfires\\_and\\_Social\\_Cost\\_of\\_Carbon.pdf](https://costofcarbon.org/files/Flammable_Planet_Wildfires_and_Social_Cost_of_Carbon.pdf).

<sup>43</sup> Avista uses the social cost of carbon as set in Executive Order 12866. This executive order cites that its estimates come from The DICE (2010), FUND (2012), and PAGE (2009) models, all versions of which were prior to the 2014 Environmental Defense Fund analysis of the EPA social cost of carbon. Additional research into available documentation of those three models failed to identify wildfire costs as included in them. The closest, specific cost cited was for the FUND model (<http://www.fund-model.org/files/documentation/Fund-3-9-Scientific-Documentation.pdf>), which considers timber production. However, that document makes no reference to the effects of fires either on timber production or independent of it. DICE documentation lists similar, high-level cost factors as FUND, and the HOPE model documentation does not list any specific cost factors.

<sup>44</sup> US EPA. 2016. "Climate Change Indicators: Wildfires | US EPA." US EPA. July 2016. <https://www.epa.gov/climate-indicators/climate-change-indicators-wildfires>.



### 3.2.5.4 Wildlife impacts

Different generation technologies can adversely affect wildlife through climate change effects or direct contact with native species. Impacts can occur throughout the lifecycle of generation resources and can be highly variable depending on the location of the resource. One commonly cited metric for wildlife impacts is avian fatalities from direct and indirect operations of electricity generation. These fatalities include birds crashing into generators as well as the impacts of mining on avian populations. Figure 3-11 presents the avian fatality rates for combustion technologies, wind, and nuclear. Nuclear had the highest fatality rate, followed by wind, and fossil fuels. DNV did not monetize these impacts, as there was no readily available monetary value to use.

**Figure 3-11. Avian fatalities per MWh**

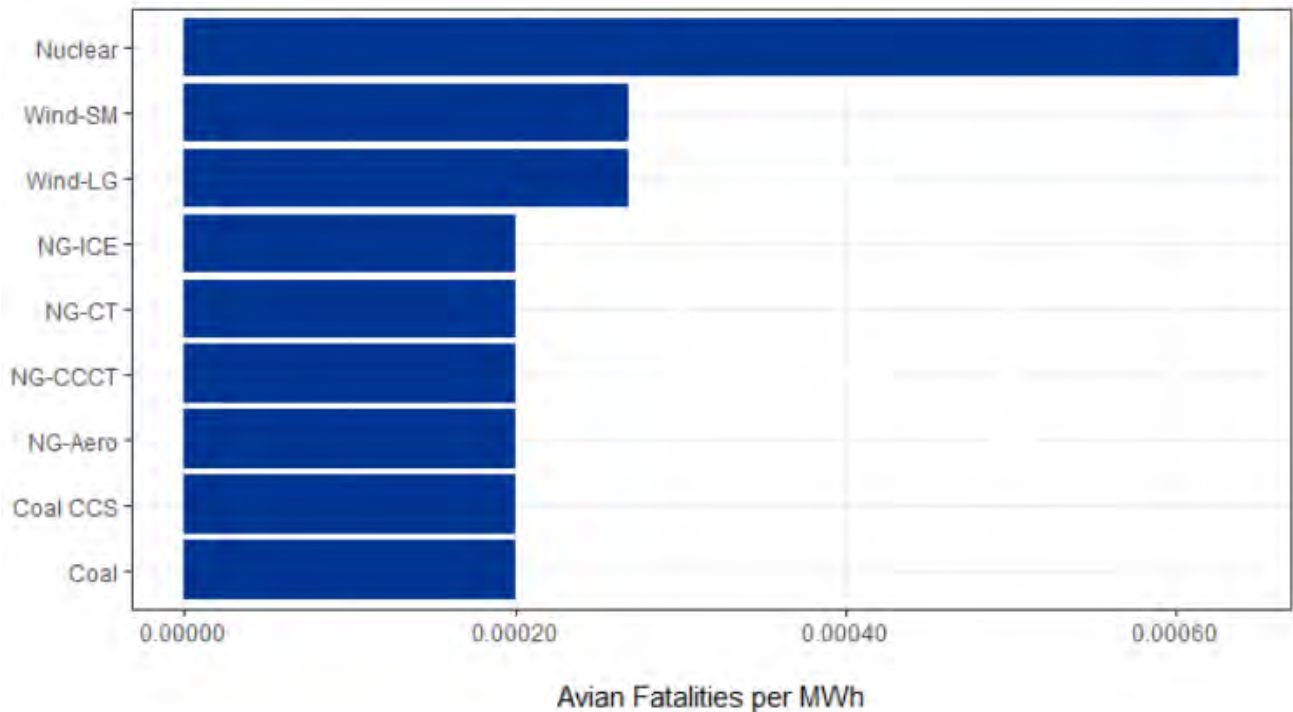

In addition to a dearth of monetized values of wildlife impacts, it should be noted that wildlife impacts are often included in environmental impact studies that are required as part of the permitting and relicensing process for specific generation assets. This often results in remediation costs being embedded in the cost of that generation resource. For example, to mitigate fish impacts, a hydro plant might be required to build and maintain fish hatcheries or dissolved gas might be rectified through improvements to spillway processes.



### 3.2.6 Economic

Jobs are the economic impact most directly affected by adding or retiring new generation, and there are readily available data on these effects. The NREL Jobs and Economic Development Impact (JEDI) models include job effects for a variety of generation technologies, including multiplier effects that take into account direct, indirect, and induced jobs. These multiplicative effects represent the full GDP effects of the jobs split into construction and operation phases. Table 3-8 describes the economic metrics produced by the JEDI model. When applying the economic metrics to the generation resources, DNV used the value added metric.

**Table 3-8. Economic metric descriptions**

Metric	Description	Sources
<b>Jobs</b>	Construction period jobs refer to full-time equivalent jobs for a year during construction period. Operating year jobs refers to the ongoing or permanent full-time equivalent jobs for each year of operation.	JEDI <sup>45</sup>
<b>Earnings</b>	Refers to the wage and salary compensation paid to workers. This monetizes the job impacts.	
<b>Output</b>	This covers all costs associated with the resource.	
<b>Value Added</b>	The difference between total gross output and the cost of intermediate inputs. It is comprised of payments made to workers (wages and salaries and benefits), proprietary income, other property type income (payments from interest, rents, royalties, dividends, and profits), indirect business taxes (excise and sales taxes paid by individuals to businesses, and taxes on production and imports less subsidies. It is equivalent to gross domestic product.	

Each of the metrics is further disaggregated into the following types of impacts:

- **Direct:** Labor directly related to onsite development, construction, and operations
- **Indirect:** Supporting industry impacts
- **Induced:** Impacts due to reinvestment and spending driven by the direct and indirect impacts

It should be noted that Avista already accounts for direct impacts in the cost to commission and run facilities and indirect costs would be assumed to be included in the costs of materials and other supporting services. Therefore, only induced impacts represent NEIs.

There are 6 JEDI models that applied to Avista's existing and proposed resources, wind (large and small), off-shore wind, pumped hydro (greenfield and brownfield), coal, biomass, and natural gas (CT and CCCT). The JEDI models include default values but also allow users to specify many inputs. For the purposes of this study, DNV specified location, year of construction, resource size, and percent local for each existing and proposed resource. More detailed methods can be found in appendix A on model versions and assumptions.

<sup>45</sup> Jobs and Economic Development Impact Models (JEDI). Biofuels, Coal, Conventional Hydropower, Marine and Hydrokinetic Power, Natural Gas, and Wind. NREL.



## Exceptions

DNV used slightly different methods for some of the resources as described here.

**Offshore wind:** The JEDI model for offshore wind is in beta. The direct economic impacts reported by the model were reasonable and in-line with expected values. However, DNV observed that the indirect and induced economic impacts from the JEDI model were much higher than for any other model and implied an unreasonably high multiplier (approximately 12:1 and 9000:1, respectively). To compensate, DNV used the direct impacts produced by the JEDI model and applied indirect and induced job multipliers from The Economic Policy Institute<sup>46</sup> (EPI) to estimate indirect and induced job impacts. The EPI study reports multipliers by major industries and sub-industries that corresponds with a two-digit code. DNV used the multipliers reported for the major industry, utilities, and sub-industry, electric power generation, transmission, and distribution, that corresponds with the two-digit code 12 in this source.

**Solar PV:** NREL does not provide JEDI models for solar PV. DNV could not identify any unbiased, third-party reports of the job impacts for solar PV installations. Organizations representing the solar PV installation industry publish reports, but DNV did not have confidence in the impartiality of these sources. To provide job values, DNV estimated direct, indirect, and induced jobs using capital cost assumptions from Avista's 2021 IRP and jobs per capital outlay ratios from EPI<sup>47</sup> for the Construction industry type (code 15). DNV assumed capital costs of \$1000 per kW for large scale solar projects and \$2000 per kW for small scale solar projects based on information from Avista. These numbers were used alongside the EPI Construction jobs per million dollars in final demand to calculate direct, indirect, and induced jobs per MW.

**Coal with carbon capture:** Carbon capture technology is too new for there to be reliable information or models related to construction or operations costs. However, there are established models for coal plants without carbon capture. To reflect the additional equipment needed for carbon capture, DNV multiplied the economic impacts for standard coal plants by 1.2 the ratio of the LCOE of coal with carbon capture to standard coal.

For **clean fuel non-natural gas**, DNV estimated operations economic benefits by using the proposed N. Idaho CCCT values but scaled to the MW and MWh values associated with this resource

### 3.2.6.2 Construction impacts

Benefits from construction are valued on a per MW basis because size is the main driver of how much a project will cost. Avista already accounts for the direct and indirect impacts as part of the cost of commissioning a facility. Therefore, only the induced impacts represent NEIs.

<sup>46</sup> Bivens, Josh. 2019. Updated Employment Multipliers for the U.S. Economy. Economic Policy Institute. January 23, 2019. <https://www.epi.org/publication/updated-employment-multipliers-for-the-u-s-economy/>.

<sup>47</sup> Bivens, Josh. 2019. Updated Employment Multipliers for the U.S. Economy. Economic Policy Institute. January 23, 2019. <https://www.epi.org/publication/updated-employment-multipliers-for-the-u-s-economy/>.



Figure 3-12 shows the direct, indirect, and induced construction jobs for proposed generation resources. The figure does not include the construction economic impacts for existing generation resources, as those impacts were already realized. While the direct and indirect jobs are not considered to be NEIs, they do provide useful context for interpreting the induced jobs. Rooftop solar is expected to produce the most jobs overall, although pumped hydro projects would produce more direct jobs. Greenfield and brownfield hydro projects are likely to be large, capital-intensive projects. In contrast, while any, single rooftop solar project would be very small, a very large number of these projects could be completed. It should also be noted that DNV utilized a different method to estimate Solar PV job impacts, so these values should be interpreted with caution.

**Figure 3-12. Construction jobs by proposed generation type**

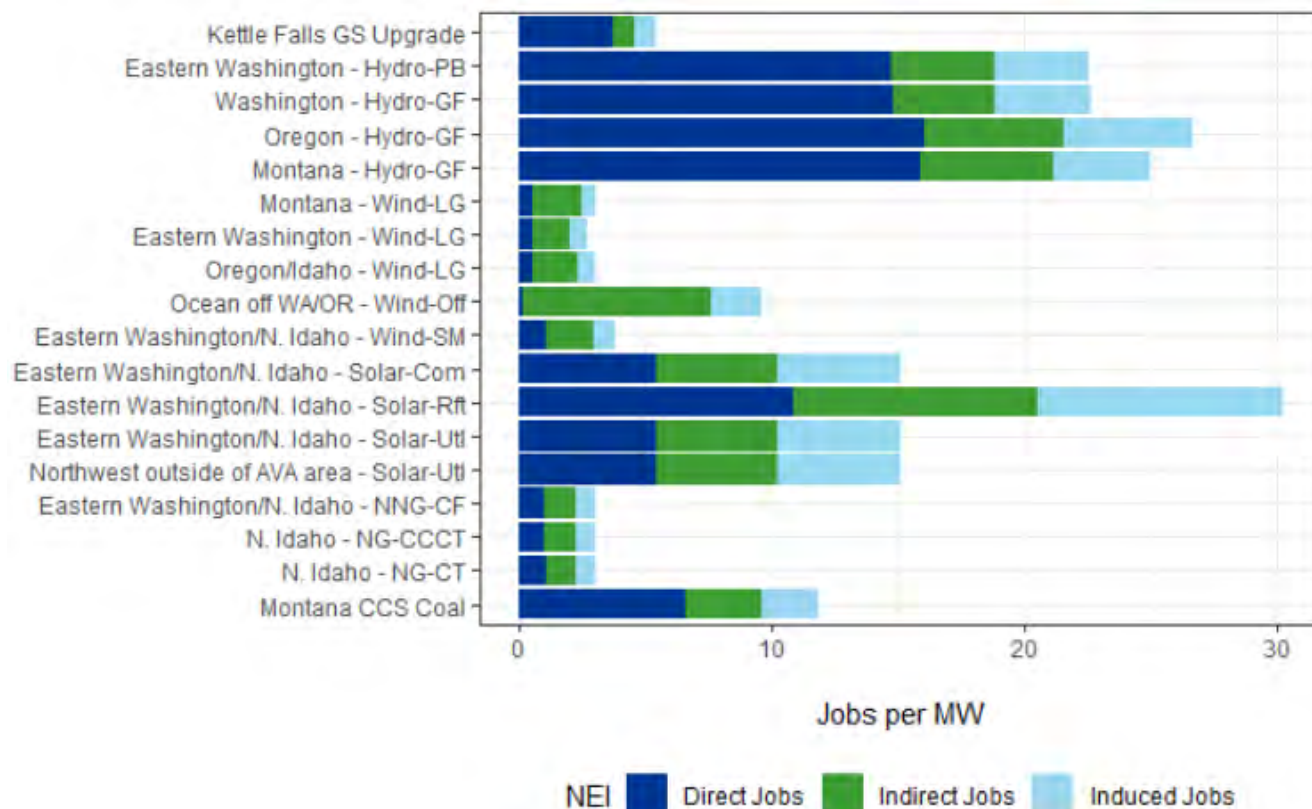





Figure 3-13 and Table 3-9 show the construction economic impacts (local impacts, value-add) by proposed generation type. DNV could not identify a trustworthy value for solar PV wages, so those generation types are left off the figure. Across the remaining generation types, wages are similar, so the relative levels of monetized values are similar to those for jobs.

**Figure 3-13. Construction economic induced impact by proposed generation type**

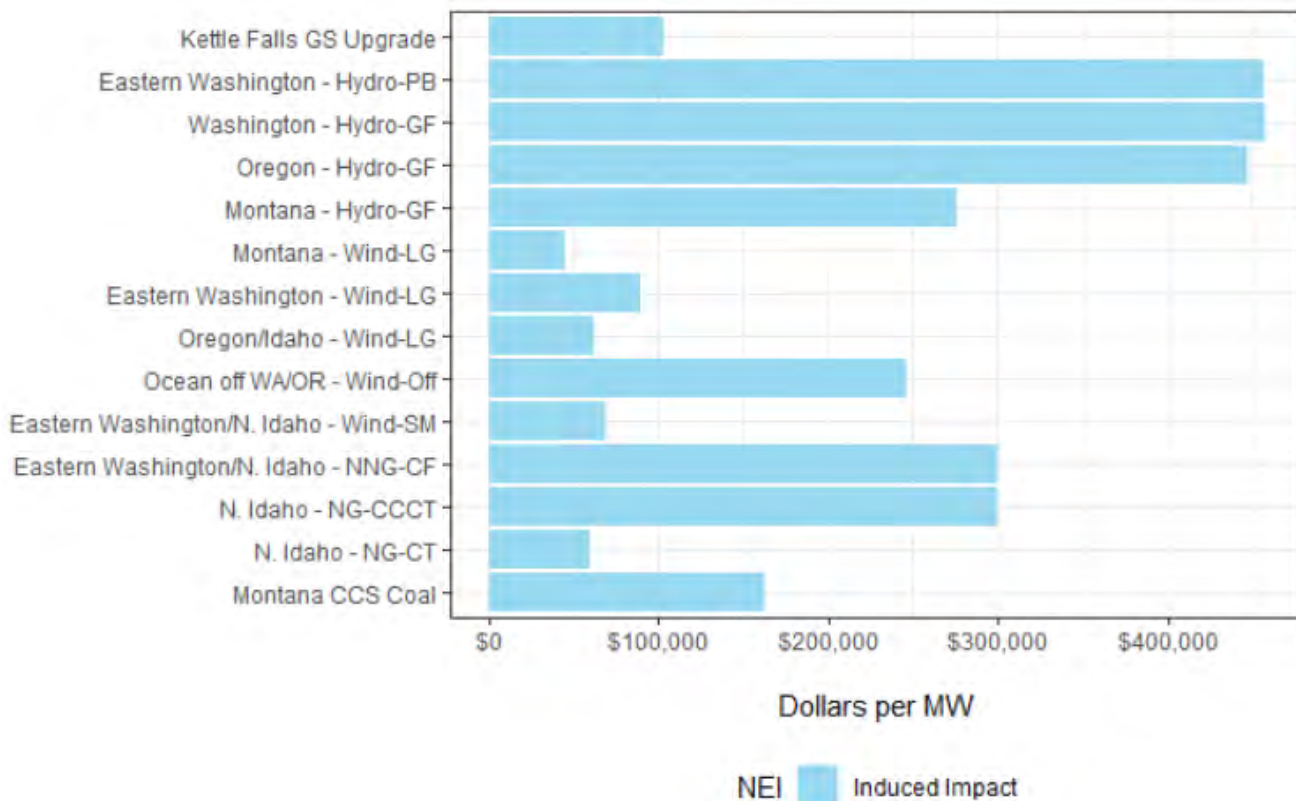



Table 3-9. Summary of Construction Induced Value Add

Fuel Type	Resource Name	Economic Construction (\$/MW)
Batt-LG	Eastern Washington/N. Idaho	Gap
Batt-SM	Eastern Washington/N. Idaho	Gap
Biomass	Kettle Falls GS Upgrade	102,800
Coal CCS	Montana CCS Coal	162,822
HE-LG	Eastern Washington	Gap
HE-SM	Eastern Washington	Gap
Hydro-GF	Montana	275,500
Hydro-GF	Oregon	448,000
Hydro-GF	Washington	458,000
Hydro-PB	Eastern Washington	456,600
NG-CCCT	N. Idaho	300,280
NG-CT	N. Idaho	59,000
NNG-Bio	Eastern Washington/N. Idaho	Gap
NNG-CF	Eastern Washington/N. Idaho	300,280
NNG-Hyd	Eastern Washington/N. Idaho	Gap
NNG-LAir	Eastern Washington/N. Idaho	Gap
NNG-Ren	Eastern Washington/N. Idaho	Gap
Nuclear	Eastern Washington/N. Idaho	Gap
Solar-Com	Eastern Washington/N. Idaho	Gap
Solar-Rft	Eastern Washington/N. Idaho	Gap
Solar-Utl	Eastern Washington/N. Idaho	Gap
Solar-Utl	Northwest outside of AVA area	Gap
Wind-LG	Eastern Washington	89,600
Wind-LG	Montana	44,267
Wind-LG	Oregon/Idaho	62,267
Wind-Off	Ocean off WA/OR	245,978
Wind-SM	Eastern Washington/N. Idaho	68,600



### 3.2.6.3 Operations impacts

Operational economic impacts affect those directly employed by the generation resource, those supporting the project, and communities and businesses that benefit from the greater economic potential this project provides. Figure 3-14 shows the direct, indirect, and induced construction jobs for existing and proposed generation resources per MWh. DNV could not identify a trustworthy source for solar PV operations jobs. Almost all of the costs for solar PV are incurred during the construction phase, so DNV expects solar PV operations jobs to be very low per GWh. Hydro resources generate the most jobs during the operations phase as well. The most common types of indirect jobs created by the hydro resources are “professional services”, “wholesale trade”, and “retail trade”.



Figure 3-14. Operations jobs by generation type

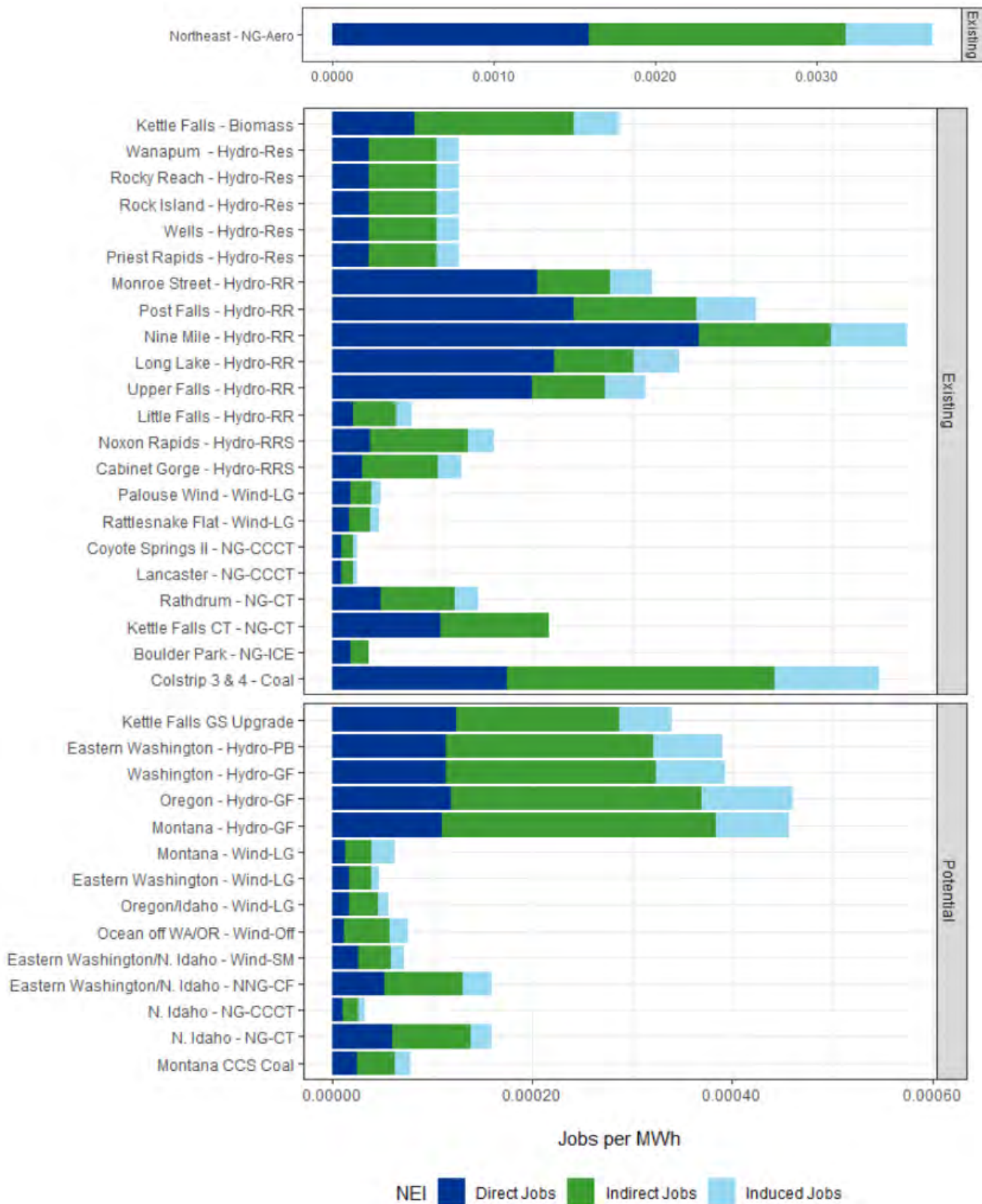



Figure 3-15 and Table 3-10 shows the operations economic impacts (local impacts, value-add) by generation type. Hydro resources generate the most economic value during operations phases, driven by the job impacts.



Figure 3-15. Operations Economic Impact by Generation Type

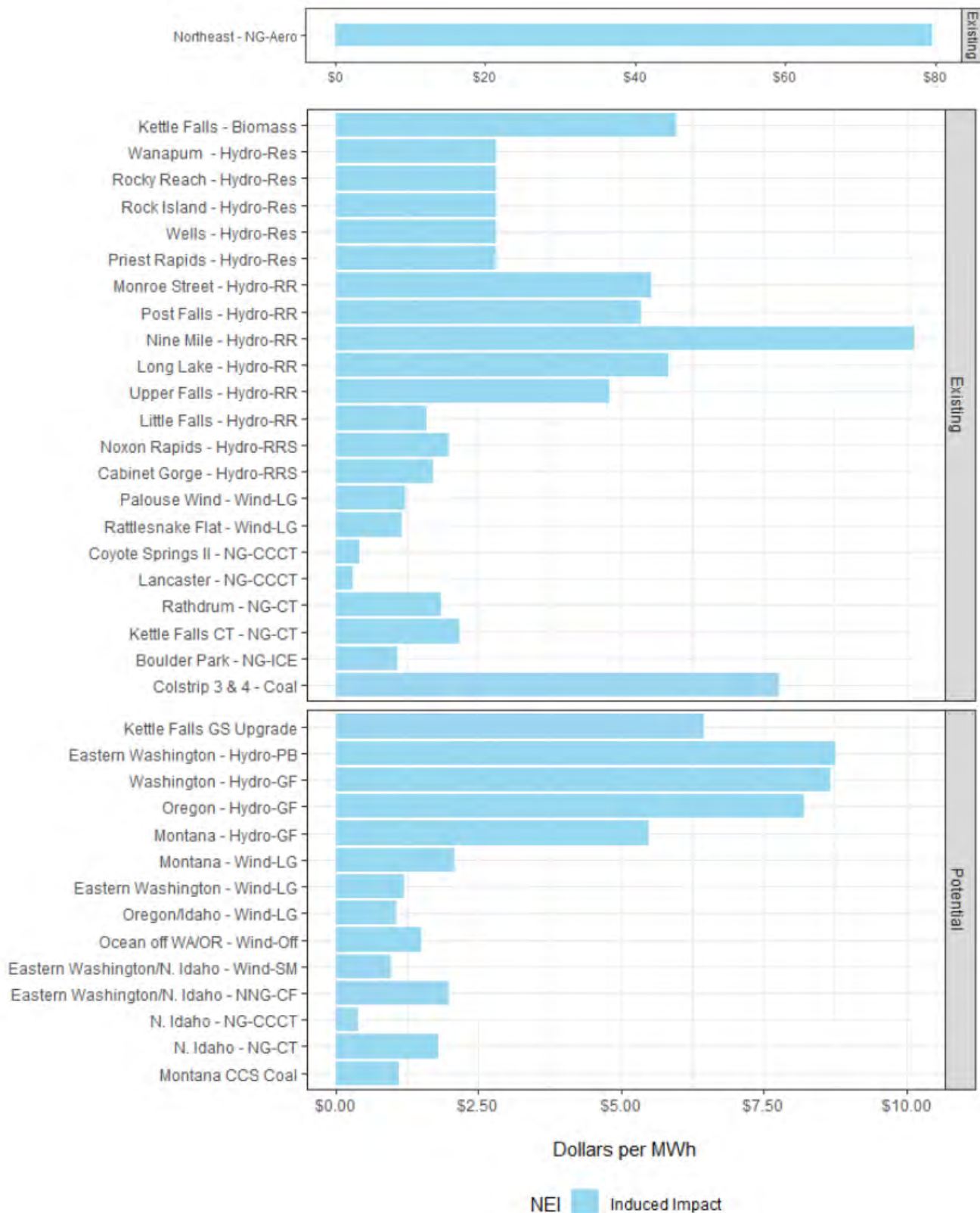



Table 3-10: Summary of Operations Induced Value Add

Existing/ Potential	Fuel Type	Resource Name	Economic Operations (\$/MWh)	
Existing	Biomass	Kettle Falls	5.98	
	Coal	Colstrip 3 & 4	7.77	
	Hydro-Res		Priest Rapids	2.82
			Rock Island	2.82
			Rocky Reach	2.82
			Wanapum	2.82
			Wells	2.82
	Hydro-RR		Little Falls	1.59
			Long Lake	5.84
			Monroe Street	5.54
			Nine Mile	10.16
			Post Falls	5.34
	Hydro-RRS		Upper Falls	4.80
			Cabinet Gorge	1.70
	NG-Aero		Noxon Rapids	1.98
			Northeast	79.53
	NG-CCCT		Coyote Springs II	0.42
			Lancaster	0.30
	NG-CT		Kettle Falls CT	2.17
			Rathdrum	1.83
NG-ICE		Boulder Park	1.09	
Solar-Utl		Adams Neilson	Gap	
Wind-LG		Palouse Wind	1.21	
		Rattlesnake Flat	1.15	
Potential	Batt-LG	Eastern Washington/N. Idaho	Gap	
	Batt-SM	Eastern Washington/N. Idaho	Gap	
	Biomass	Kettle Falls GS Upgrade	6.46	
	Coal CCS	Montana CCS Coal	1.11	
	HE-LG	Eastern Washington	Gap	
	HE-SM		Eastern Washington	Gap
			Montana	5.48
			Oregon	8.22
	Hydro-GF		Washington	8.68
			Eastern Washington	8.77
	Hydro-PB		Eastern Washington	8.77
	NG-CCCT		N. Idaho	0.40
	NG-CT		N. Idaho	1.79
	NNG-Bio		Eastern Washington/N. Idaho	Gap
	NNG-CF		Eastern Washington/N. Idaho	1.99
	NNG-Hyd		Eastern Washington/N. Idaho	Gap
	NNG-LAir		Eastern Washington/N. Idaho	Gap
	NNG-Ren		Eastern Washington/N. Idaho	Gap
	Nuclear		Eastern Washington/N. Idaho	Gap
	Solar-Com		Eastern Washington/N. Idaho	Gap
Solar-Rft		Eastern Washington/N. Idaho	Gap	
Solar-Utl		Eastern Washington/N. Idaho	Gap	
		Northwest outside of AVA area	Gap	
Wind-LG		Eastern Washington	1.21	
		Montana	2.08	
		Oregon/Idaho	1.06	
Wind-Off		Ocean off WA/OR	1.50	
Wind-SM		Eastern Washington/N. Idaho	0.97	



### 3.3 Summary of compiled data

Table 3-11 summarizes the NEI value coverage by generator type. In general, older generator types tended to have more readily available information than newer resource types.

**Table 3-11. Summary of data completeness**

Group	Generator Types	Public Health	Safety	Environment			Economic
				Land Use	Water Use	Wildlife	
<b>Biomass</b>	Biomass	✓	✓	✓	✓		✓
<b>Coal</b>	Coal	✓	✓	✓	✓	✓	✓
	Coal CCS	✓	✓	✓	✓	✓	✓
<b>Hydro</b>	Hydro-PB						✓
	Hydro-GF						✓
	Hydro-Res		✓	✓			✓
	Hydro-RR						✓
	Hydro-RRS						✓
<b>Hydrogen Electrolyzer</b>	HE-LG			✓			
	HE-SM			✓			
<b>Lithium-ion Storage</b>	Batt-LG						
	Batt-SM						
<b>Natural gas</b>	NG-Aero	✓	✓	✓	✓	✓	✓
	NG-CCCT	✓	✓	✓	✓	✓	✓
	NG-CT	✓	✓	✓	✓	✓	✓
	NG-ICE	✓	✓	✓	✓	✓	✓
	NNG-Bio		✓				
<b>Non-natural gas</b>	NNG-CF						
	NNG-Hyd			✓			
	NNG-LAir						
	NNG-Ren			✓			
<b>Nuclear</b>	Nuclear		✓	✓	✓	✓	
<b>Solar</b>	Solar-Com		✓	✓	✓		✓
	Solar-Rft		✓	✓	✓		✓
	Solar-Utl		✓	✓	✓		✓
<b>Wind</b>	Wind-LG		✓	✓	✓	✓	✓
	Wind-Off		✓	✓	✓		✓
	Wind-SM		✓	✓	✓	✓	✓

### 3.4 Database application

DNV applied the values in the database to existing and proposed Avista generation resources. The first step in this process was to obtain information about each generation resource from Avista, including technology type, capacity, and operating output over the past 3 years.

The next step was to match each generation resource to the resource type in the database. Then DNV could assign NEIs based on the per MWh or per MW values for each NEI type to new generation resources and resources already operated by Avista. Benefits appear as positive values and costs appear as negative values. The values are then summed to produce a final, total NEI value for each resource.





### 3.5 Issues and data gaps

This section documents the areas where there was insufficient information to provide an estimated NEI value for any specific NEI types for specific resources. In addition to documenting the NEIs for which values are not readily available, DNV estimates the research value and research effort that it would take to fill each gap using a high, medium, low designation on each dimension. Table 3-12 summarizes the NEIs, the gaps, and the value and effort of addressing each one. Finer-grained gaps are also identified in the database.

**Table 3-12. Gap analysis**

NEI	Resource	Description	Additional Research Description	Value	Effort
<b>Public Health</b>	All	Emissions data only available for operation phase	Locate emissions for mining, construction, decommissioning then monetize	Medium	High
	All	Soil and water contamination effects not included	Locate emissions data for these effects, including for supply-chain, plant operations, and decommissioning. Locate monetary costs of those types of contamination and multiply	Low	High
	Nuclear	Public health risks of transport and long-term storage of radioactive wastes as well as risks of catastrophic failures was not included	Identify risk analysis data for nuclear operations and waste management	Low	Medium
	Biomass	Counterfactual emissions for the biomass if not used in the power plants was not modeled	Identify likely alternative treatment of the biomass material and the resulting emissions	Low	Medium
<b>Safety</b>	Hydro, Nuclear, Solar, Wind, Biomass, Biogas	Fatalities data are reported in aggregate across the supply chain and within proprietary databases	Locate original data or conduct original research to disaggregate fatalities. Low effort approach could develop reasonable ratios for fatalities in each phase of supply chain and apply those ratios to the overall aggregate number.	Low	High/Low
<b>Reliability &amp; Resiliency</b>	All	Specific metrics on reliability and grid resiliency could not be calculated for this study. Monetizing these metrics is an additional challenge	An analysis of how different IRP scenarios are likely to affect grid reliability, especially in named communities would help address CETA concerns	Medium	High
<b>Energy Security</b>	All	This study considered LCOE values as proxies for the cost of energy	An analysis of how different IRP scenarios are likely to affect energy burdens, especially for named communities would help address CETA concerns	High	High



NEI	Resource	Description	Additional Research Description	Value	Effort
<b>Environment: Wildfires</b>	All	Comparative data for wildfire risks for different generation technologies is not readily available. Monetizing these risks is an additional challenge	Investigate the California wildfire risk assessment system and consider adapting for use in Washington. This assessment is done at the state level in California, so a statewide, rather than utility specific effort would be reasonable.	High	High
<b>Environment: Land use, Water use monetization</b>	All	The current study used publicly available, but somewhat arbitrary sources to monetize land and water values	Establish a more robust source(s) for these values, possibly applying more site-specific values or possibly blending values from multiple sources	Low	Medium
<b>Environment: Wildlife monetization</b>	All	Estimates of the monetary value of wildlife are not readily available.	Conduct additional secondary research with the EPA and conservation groups for data. Primary research would be very difficult and expensive.	Low	High
<b>Environment: Surface air effects</b>	Wind	Potential surface air effects of wind turbines was not considered	Obtain recent data, if available, on surface air downwind of wind turbines. Monetize those impacts.	Low	High
<b>Economic</b>	Hydrogen Electrolyzer	These technologies are too new to have robust, publicly available economic impact models.  LCOEs for HE are based on compression, transportation, and storage costs, assuming a source of hydrogen is already accessible. The cost to produce the hydrogen is not included.	Conduct additional primary and secondary research into the costs to produce the storage tanks and facilities for these resources.  Conduct additional research to price hydrogen generation and add to the LCOEs  Create an economics impacts model similar to JEDI	Medium	High
<b>All</b>	Non-natural gas	Publicly available data for this technology were not readily available	Additional research on the facilities that produce this fuel are needed to estimate the NEIs associated with it, including economic modeling.  Combustion pollutants are likely to be similar to geologic natural gas, so public health impacts likely to be similar to gas turbine plants	Medium	High
<b>Economic</b>	Solar PV,	NREL does not publish a JEDI model for these resources, and no equivalent models are publicly available	Identify a reasonable number for wage earnings for solar PV installation and operations  Develop economic models for indirect and induced jobs	High	Medium



NEI	Resource	Description	Additional Research Description	Value	Effort
<b>All</b>	Battery Storage	Publicly available data for this technology were not readily available	Additional research on the facilities that produce this fuel are needed to estimate the NEIs associated with it, including economic modeling	High	High
<b>Economic</b>	Nuclear	NREL does not publish a JEDI model for these resources, and no equivalent models are publicly available	Nuclear plants are established technology so information on operational costs should be available.	Low	Low
<b>Decommissioning</b>	All	Data on decommissioning costs was not readily available	Locate data on these costs for established technologies. Survey permitting requirements for decommissioning financing for newer technologies	Medium	High



## 4 OVERALL IMPACTS

The NEI database can be applied to Avista's specific existing and proposed resources to estimate the overall NEIs for each resource. The impacts are aggregated by NEI metric. Some metrics are reported per MWh while others are reported by MW, depending on whether the impact is fixed or variable with electricity production.

The aggregated impacts per MWh include the following components:

- **Economic - Operations:** Induced value-added economic impacts of operations. Avista already accounts for the direct impacts as part of the cost of energy production. Therefore, only the induced impacts represent NEIs. These impacts are reported as benefits.
- **Public Health:** Health impacts occurring throughout the United States due to operations. These impacts are reported as costs.
- **Safety:** Direct and indirect fatalities occurring during construction, operations, and mining. These impacts are reported as costs.

The aggregated impacts per MW include the following components:

- **Economic - Construction:** Induced value-added economic impacts of resource operations. These impacts are reported as benefits for proposed facilities only.



Table 4-1. Net Resource Benefits for Existing Avista Resources

Fuel Type	Resource Name	Economic Operations (\$/MWh)	Safety (\$/MWh)	Public Health (\$/MWh)	Net (\$/MWh)
Biomass	Kettle Falls	5.98	-0.16	-13.36	-7.54
Coal	Colstrip 3 & 4	7.77	-0.31	-25.26	-17.80
Hydro-Res	Priest Rapids	2.82	-0.26	0.00	2.56
Hydro-Res	Rock Island	2.82	-0.26	0.00	2.56
Hydro-Res	Rocky Reach	2.82	-0.26	0.00	2.56
Hydro-Res	Wanapum	2.82	-0.26	0.00	2.56
Hydro-Res	Wells	2.82	-0.26	0.00	2.56
Hydro-RR	Little Falls	1.59	Gap	0.00	1.59
Hydro-RR	Long Lake	5.84	Gap	0.00	5.84
Hydro-RR	Monroe Street	5.54	Gap	0.00	5.54
Hydro-RR	Nine Mile	10.16	Gap	0.00	10.16
Hydro-RR	Post Falls	5.34	Gap	0.00	5.34
Hydro-RR	Upper Falls	4.80	Gap	0.00	4.80
Hydro-RRS	Cabinet Gorge	1.70	Gap	0.00	1.70
Hydro-RRS	Noxon Rapids	1.98	Gap	0.00	1.98
NG-Aero	Northeast	79.53	-0.12	-24.73	54.67
NG-CCCT	Coyote Springs II	0.42	-0.12	-0.67	-0.37
NG-CCCT	Lancaster	0.30	-0.12	-1.94	-1.76
NG-CT	Kettle Falls CT	2.17	-0.12	-4.30	-2.26
NG-CT	Rathdrum	1.83	-0.12	-2.79	-1.08
NG-ICE	Boulder Park	1.09	-0.12	-0.92	0.04
Solar-Utl	Adams Neilson	Gap	-0.20	0.00	-0.20
Wind-LG	Palouse Wind	1.21	-0.38	0.00	0.83
Wind-LG	Rattlesnake Flat	1.15	-0.38	0.00	0.78



Table 4-2: Net Resource Benefits for Potential Resource Alternatives

Fuel Type	Resource Name	\$/MWh				\$/MW
		Economic Operations	Safety	Public Health	Net	Economic Construction
Batt-LG	Eastern Washington/N. Idaho	Gap	Gap	0.00	0.00	Gap
Batt-SM	Eastern Washington/N. Idaho	Gap	Gap	0.00	0.00	Gap
Biomass	Kettle Falls GS Upgrade	6.46	-0.16	-12.71	-6.41	102,800
Coal CCS	Montana CCS Coal	1.11	-0.31	-22.49	-21.69	162,822
HE-LG	Eastern Washington	Gap	Gap	0.00	0.00	Gap
HE-SM	Eastern Washington	Gap	Gap	0.00	0.00	Gap
Hydro-GF	Montana	5.48	Gap	0.00	5.48	275,500
Hydro-GF	Oregon	8.22	Gap	0.00	8.22	448,000
Hydro-GF	Washington	8.68	Gap	0.00	8.68	458,000
Hydro-PB	Eastern Washington	8.77	Gap	0.00	8.77	456,600
NG-CCCT	N. Idaho	0.40	-0.12	-1.75	-1.48	300,280
NG-CT	N. Idaho	1.79	-0.12	-4.52	-2.86	59,000
NNG-Bio	Eastern Washington/N. Idaho	Gap	-0.05	0.00	-0.05	Gap
NNG-CF	Eastern Washington/N. Idaho	1.99	Gap	0.00	1.99	300,280
NNG-Hyd	Eastern Washington/N. Idaho	Gap	Gap	0.00	0.00	Gap
NNG-LAir	Eastern Washington/N. Idaho	Gap	Gap	0.00	0.00	Gap
NNG-Ren	Eastern Washington/N. Idaho	Gap	Gap	0.00	0.00	Gap
Nuclear	Eastern Washington/N. Idaho	Gap	-0.11	0.00	-0.11	Gap
Solar-Com	Eastern Washington/N. Idaho	Gap	-0.20	0.00	-0.20	Gap
Solar-Rft	Eastern Washington/N. Idaho	Gap	-0.20	0.00	-0.20	Gap
Solar-Utl	Eastern Washington/N. Idaho	Gap	-0.20	0.00	-0.20	Gap
Solar-Utl	Northwest outside of AVA area	Gap	-0.20	0.00	-0.20	Gap
Wind-LG	Eastern Washington	1.21	-0.38	0.00	0.83	89,600
Wind-LG	Montana	2.08	-0.38	0.00	1.70	44,267
Wind-LG	Oregon/Idaho	1.06	-0.38	0.00	0.68	62,267
Wind-Off	Ocean off WA/OR	1.50	-0.38	0.00	1.12	245,978
Wind-SM	Eastern Washington/N. Idaho	0.97	-0.38	0.00	0.59	68,600



## 5 APPENDICES

### 5.1 Appendix A: Detailed Methods

#### 5.1.1 Safety

##### 5.1.1.1 Biomass, bio-fuel, hydro, nuclear, solar, wind

Fatality estimates for electricity generation from biomass, bio-fuels, hydro, nuclear, solar, and wind come from a 2015 paper titled *Balancing safety with sustainability: assessing the risk of accidents for modern low-carbon energy systems*<sup>48</sup>. The authors of this paper develop their own dataset of energy value chain accidents. They explain the requirements for being included in the dataset as, “this means it must have occurred at a nuclear, renewable, hydrogen, or hydroelectric energy facility, its associated infrastructure, or within its fuel cycle (mine, transportation by truck or pipeline, enrichment facility, manufacturing plant, etc.)” The authors provide examples from this research such as a 2013 accident in Noxen, Pennsylvania where 5 people died when a helicopter crashed into a wind farm during bad weather, or a 2013 accident in Catanzaro, Italy, where 2 welders are killed in an explosion while working at a biofuel plant.

The authors further go on to normalize fatalities by energy use and describe using a subset of incidences ranging from 1990 – 2013. Because DNV does not have access to this full database, values cannot be disaggregated into direct and indirect fatalities. Figure 5-1 shows the graphical results of this study in fatalities/TWh:

**Figure 5-1. Fatalities per TWh from original paper**

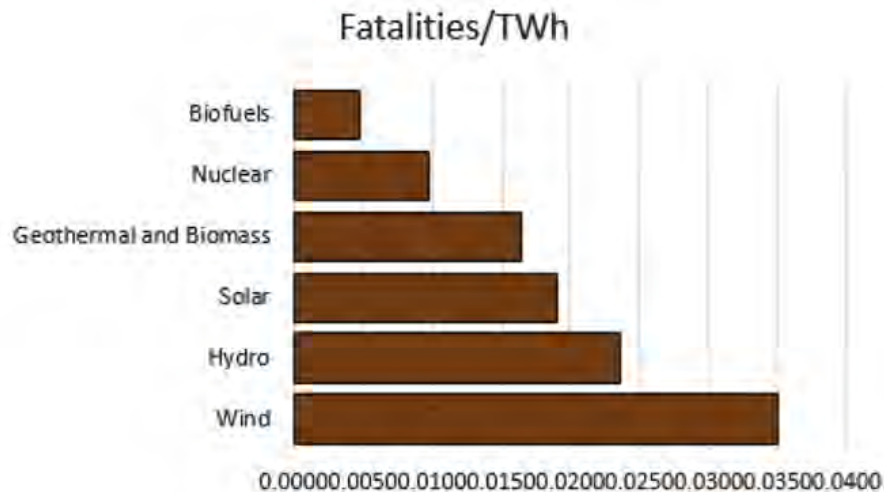

##### 5.1.1.2 Fossil fuels (natural gas and coal)

Fatality estimates for natural gas and coal are developed using publicly available data regarding US production, transportation, and generation. It is necessary to calculate new numbers because most of the value chain for these generation types takes place in the US and estimates from secondary research is not available for current, US-only values. DNV aggregates values from multiple sources to produce values for coal and natural gas.

<sup>48</sup> Sovacool, Benjamin K., Rasmus Andersen, Steven Sorensen, Kenneth Sorensen, Victor Tienda, Arturas Vainorius, Oliver Marc Schirach, and Frans Bjørn-Thygesen. 2016. “Balancing Safety with Sustainability: Assessing the Risk of Accidents for Modern Low-Carbon Energy Systems.” *Journal of Cleaner Production* 112 (January): 3952–65.



## Natural gas

### Extraction

DNV developed numbers for natural gas using industry statistics related to extraction, transportation, and generation. For extraction, DNV used the National Institute for Occupational Safety and Health (NIOSH) database of Fatalities in the Oil and Gas Extraction Industry (FOG)<sup>49</sup>. This database includes land-based and offshore worker fatalities related to the U.S. oil and gas extraction industry only.

**Table 5-1. Fatalities from the U.S. natural gas and oil extraction industry by state, 2015-2017**

State	fatalities in 2015-2016	fatalities in 2017
Texas	45	44
North Dakota	13	3
Oklahoma	8	6
Louisiana	4	4
New Mexico	5	3
Colorado	<3	<3
Illinois	<3	<3
Ohio	<3	<3
West Virginia	<3	<3
Wyoming	<3	<3
California	<3	0
Kansas	<3	0
Kentucky	<3	0
Pennsylvania	<3	0
Virginia	<3	0
<b>Total</b>	<b>92</b>	<b>69</b>

Source: NIOSHA FOG database

The FOG data does not separate out which fatalities occurred from oil or natural gas extraction. DNV used the ratio between U.S. oil and natural gas production, which was 59% natural gas and 41% oil in 2019,<sup>50</sup> to disaggregate fatalities by fuel. This ratio makes the simplifying assumption that the risks from oil extraction and natural gas extraction are equal. DNV was unable to find any studies comparing the safety of oil vs. gas extraction and so this ratio approach could be applied absent newer evidence. Multiplying the average total fatalities from 2015-2017 by 59% produces a value of 31.7 fatalities per year from natural gas extraction.

### Transportation

Besides fatalities from oil and gas extraction, there are also fatalities from the operation of gas pipelines. The federal Pipeline and Hazardous Material Safety Administration (PHMSA)<sup>51</sup> publishes records of "significant" pipeline incidents which involve either an injury or a fatality to either industry employees or members of the public.

<sup>49</sup> "CDC - Fatalities in the Oil and Gas Extraction Industry (FOG) - NIOSH Workplace Safety & Health Topic." 2021. [www.cdc.gov. June 24, 2021.](https://www.cdc.gov/niosh/topics/fog/default.html)

<sup>50</sup> According to the EIA the U.S. produced an average of 111.5 billion cubic feet per day and 12.8 million barrels of oil in 2019. Because one barrel of oil has the energy equivalent of 6,000 cubic feet of gas, this works out to a ratio of 59% natural gas and 41% oil on an equivalent basis.

<sup>51</sup> 2022. [Dot.gov. 2022.](https://portal.phmsa.dot.gov/analytics/saw.dll?Portalpages&PortalPath=%2Fshared%2FPDM%20Public%20Website%2F_portal%2FSC%20Incident%20Trend&Page=Significant%20Incidents%20Consequences)



**Table 5-2. U.S. pipeline fatalities and injuries to industry employees and members of the public, 2005-2020**

Calendar year	Total fatalities	Total injuries
2005	16	46
2006	19	34
2007	15	46
2008	8	54
2009	13	62
2010	19	103
2011	11	50
2012	10	54
2013	8	42
2014	19	93
2015	9	48
2016	16	86
2017	7	30
2018	6	78
2019	11	35
2020	15	43
<b>Total</b>	<b>202</b>	<b>904</b>

Source: PHMSA

This source shows that over the 2005-2020 period there have been 202 fatalities and 686 injuries from these significant incidents.<sup>52</sup> While these data are for all types of pipelines, other studies have shown that 91% of these incidents were related to gas pipelines in general and 78% were related to gas distribution lines in particular.<sup>53</sup> By taking the average of this 16 year period, multiplying by 91% for the share of fatalities from natural gas pipeline operation, the yearly fatality rate from operation of natural gas pipelines is 11.5.

While most natural gas is delivered via pipelines, there has been increasing interest in the transportation of liquified natural gas (LNG) due to the challenges of building new pipeline capacity. LNG is primarily delivered by truck due to severe restrictions on LNG transport by rail.<sup>54</sup> One case study of LNG transport in New England indicated that this method of transportation is very safe.<sup>55</sup>

#### Generation

Lastly, DNV used the Census of Fatal Occupational Injuries (CFOI)<sup>56</sup> from the U.S. Bureau of Labor Statistics to develop fatality estimates from natural gas electricity generation. This source claims there were 5 fatalities in fossil fuel electric power generation (NAICS code 221112) for 2019. According to the EIA<sup>57</sup>, 2019 energy production from natural gas was 46.7% of US energy production from fossil

fuels, meaning there were 2.3 fatalities per year from natural gas generation.

#### Total

The last thing to consider with fatalities of natural gas extraction and transportation is the proportion of gas that goes to electricity generation compared with the proportion of gas that goes to other end uses. EIA's 2020 numbers for natural gas consumption by sector<sup>58</sup> calculates 38% of this is for electric power. Using this, the final value for fatalities per year associated with natural gas electricity generation is:

#### Equation 3

$$\text{Fatalities per year} = (31.7_{\text{extraction}} + 11.5_{\text{transportation}}) * 0.38_{\text{electricity generation}} + 2.3_{\text{generation}} = 18.7$$

<sup>52</sup> [Oracle BI Interactive Dashboards - SC Incident Trend \(dot.gov\)](https://www.oracle.com/instantcloud/intermediate-features/interactive-dashboards-sc-incident-trend/)

<sup>53</sup> [State Gas Pipelines - Pipeline Accidents \(ncsl.org\)](https://www.ncsl.org/state-gas-pipelines/pipeline-accidents/)

<sup>54</sup> [Risk Assessment of Surface Transport of Liquid Natural Gas \(dot.gov\)](https://www.riskassessmentofsurfacetransportofliquidnaturalgas.com/)

<sup>55</sup> "Over the past 45 years, Engie has contracted with motor carriers to transport LNG to 42 storage facilities in New England. During this time, these carriers have completed over 300,000 truck trips up to 150 miles with only two incidents. One was a truck rollover and the other was a truck engine fire. In both examples the LNG product in the cargo tank was not released." (Source: [Risk Assessment of Surface Transport of Liquid Natural Gas \(dot.gov\)](https://www.riskassessmentofsurfacetransportofliquidnaturalgas.com/))

<sup>56</sup> "Census of Fatal Occupational Injuries (CFOI) - Current and Revised Data." 2018. Bls.gov. December 18, 2018. <https://www.bls.gov/iif/oshcfoi1.htm>.

<sup>57</sup> <https://www.eia.gov/energyexplained/electricity/electricity-in-the-us.php#:~:text=Most%20electricity%20is%20generated%20with,wind%20turbines%2C%20and%20solar%20photovoltaics.>

<sup>58</sup> <https://www.eia.gov/energyexplained/natural-gas/use-of-natural-gas.php#:~:text=The%20commercial%20sector%20uses%20natural,combined%20heat%20and%20power%20systems.>



To convert this number into fatalities per unit of energy, DNV used the 2020 EIA U.S. electricity generated by major source<sup>59</sup>. For natural gas, this was  $1.624 \times 10^9$  MWh, resulting in a per MWh value of  $1.152 \times 10^{-8}$  fatalities.

## Coal

### Extraction

Estimates for coal extraction come from the U.S. Department of Labor's Mine Safety and Health Administration (MSHA)<sup>60</sup>. DNV chose to average total fatalities from 2005 to 2020 to match the process used for natural gas. This comes to an average of 21.25 fatalities per year from coal extraction. These fatality values are shown in Table 5-3.

**Table 5-3. US coal mining fatalities**

Calendar year	Total fatalities
2005	23
2006	47
2007	34
2008	30
2009	18
2010	48
2011	20
2012	20
2013	20
2014	16
2015	12
2016	8
2017	15
2018	12
2019	12
2020	5
<b>Total</b>	<b>340</b>

### Transportation

For valuing coal transportation DNV calculated the average number of US train fatalities<sup>61</sup> from 2005 to 2020 and came up with 9.94 fatalities per year. These yearly values are shown in Table 5-4.

<sup>59</sup><https://www.eia.gov/tools/faqs/faq.php?id=427&t=3,%20multiply%20by%20share%20of%20natural%20gas%20going%20to%20electricity%20https://www.eia.gov/tools/faqs/faq.php?id=50&t=8>

<sup>60</sup> "Coal Mining Fatality Statistics: 1900-2013." 2013. Msha.gov. 2013. <https://arlweb.msha.gov/stats/centurystats/coalstats.asp>.

<sup>61</sup> "Train Fatalities, Injuries, and Accidents by Type of Accident | Bureau of Transportation Statistics." n.d. Wwww.bts.gov. <https://www.bts.gov/content/train-fatalities-injuries-and-accidents-type-accidenta>.



Table 5-4. US rail fatalities

Calendar year	Total fatalities
2005	33
2006	6
2007	9
2008	27
2009	4
2010	8
2011	6
2012	9
2013	11
2014	5
2015	11
2016	7
2017	7
2018	7
2019	3
2020	6
<b>Total</b>	<b>159</b>

According to the National Railway Labor Conference's latest estimate<sup>62</sup>, coal accounted for 13% of carloads in the US.

#### *Generation*

Lastly, DNV used the Census of Fatal Occupational Injuries (CFOI)<sup>63</sup> from the U.S. Bureau of Labor Statistics to develop fatality estimates from natural gas electricity generation. This source claims there were 5 fatalities in fossil fuel electric power generation (NAICS code 221112) for 2019. According to the EIA<sup>64</sup>, 2019 energy production from natural gas was 28.4% of US energy production from fossil fuels, meaning there were 1.42 fatalities per year from natural gas generation.

#### *Total*

The last thing to consider for coal is the proportion of coal used for electricity generation. According to EIA<sup>65</sup>, this is 91.5%. When factoring this into all the steps above, the safety value of coal is shown in

<sup>62</sup> [Coal In Decline: The Impact on Railroads - NRLC \(raillaborfacts.org\)](#)

<sup>63</sup> "Census of Fatal Occupational Injuries (CFOI) - Current and Revised Data." 2018. Bls.gov. December 18, 2018. <https://www.bls.gov/iif/oshcfoi1.htm>.

<sup>64</sup> <https://www.eia.gov/energyexplained/electricity/electricity-in-the-us.php#:~:text=Most%20electricity%20is%20generated%20with,wind%20turbines%2C%20and%20solar%20photovoltaics.>

<sup>65</sup> <https://www.eia.gov/energyexplained/coal/use-of-coal.php>



#### Equation 4

$$\text{Fatalities per year} = (21.25_{\text{extraction}} + (9.94_{\text{US rail}} * 0.13_{\text{coal rail}})) * 0.915_{\text{electricity generation}} + 1.42_{\text{generation}} = 22.04$$

To convert this number into fatalities per unit of energy, DNV used the 2020 EIA U.S. electricity generated by major source<sup>66</sup>. For coal, this was  $773 \times 10^8$  MWh, resulting in a per MWh value of  $2.851 \times 10^{-8}$  fatalities.

## 5.1.2 Economic

To produce job, output, earnings, and value added estimates DNV used applicable JEDI models downloaded from NREL's website. These models and model versions can be found below in Table 5-5.

**Table 5-5. Specific JEDI models**

Category	Model Version
Biopower	JEDI Biopower Model rel. B12.23.16
Coal	JEDI Coal Model rel. C12.23.16
Conventional hydro	JEDI CHydro Model rel.CH12.23.16
Marine and hydrokinetic	JEDI MHydro Model rel. MH12.23.16
Natural gas	JEDI NGas Model rel. NG4.17.17
Land based wind	JEDI Land Based Wind Model Beta rel. W10.30.20
Offshore wind	JEDI OffShore Wind Model rel.2021-2

The main inputs for the models are specified location, year of construction, resource size, and percent local, DNV used the information for existing and proposed resource given from Avista (Table 5-6). JEDI models have additional default values for local content that are derived from industry norms. DNV used the default values for biopower, coal, marine and hydrokinetic, natural gas, and land-based wind.

**Table 5-6. JEDI imputes for specific plants**

Plant Name	Category	Location	MW	Start Date	Capacity Factor
Colstrip 3 & 4	Coal	Colstrip, MT	1,480	1984/1986	
Rathdrum	Natural gas CT	Rathdrum, ID	166	1995	11.7%
Northeast	Natural gas Aero Turbine	Spokane, WA	62	1978	0.1%
Boulder Park	Natural gas ICE	Spokane Valley, WA	25	2002	
Coyote Springs II	Natural gas CCCT	Boardman, OR	306	2003	70.3%
Lancaster	Natural gas CCCT	Rathdrum, ID	256	2001	63.9%
Kettle Falls CT	Natural gas CT	Kettle Falls, WA	7	2002	2.0%
Kettle Falls	Biomass	Kettle Falls, WA	51	1983	59.6%
Noxon Rapids	Storage Hydro	Noxon, MT	555	1959	37.4%
Cabinet Gorge	Storage Hydro	Cabinet, ID	260	1952	43.2%
Monroe Street	Run-of-river hydro	Spokane, WA	15	1890	64.1%
Post Falls	Run-of-river hydro	Post Falls, ID	15	1906	60.6%
Nine Mile	Run-of-river hydro	Nine Mile Falls, WA	38	1908	35.8%
Little Falls	Run-of-river hydro	Ford, WA	35	1910	56.2%
Long Lake	Run-of-river hydro	Ford, WA	88	1915	82.0%
Upper Falls	Run-of-river hydro	Spokane, WA	10	1922	66.4%
Palouse Wind	Large Wind	Approx Oksdale, WA	105	2010	39.9%
Rattlesnake Flat	Large Wind	Approx Lind, WA	144	2020	0.3%
Adams Neilson	Large Solar	Lind, WA	20	2019	27.0%
Wanapum	Reservoir hydro	Grant County, WA	2,258	1950s	25.9%
Rocky Reach	Reservoir hydro	Chelan County, WA	1,300	1950s	51.8%
Rock Island	Reservoir hydro	Chelan County, WA	629	1950s	45.4%

<sup>66</sup><https://www.eia.gov/tools/faqs/faq.php?id=427&t=3,%20multiply%20by%20share%20of%20natural%20gas%20going%20to%20electricity%20https://www.eia.gov/tools/faqs/faq.php?id=50&t=8>



Plant Name	Categorization	Location	MW	Start Date	Capacity Factor
<b>Wells</b>	Reservoir hydro	Douglas County, WA	774	1950s	64.6%
<b>Priest Rapids</b>	Reservoir hydro	Grant County, WA	956	1950s	57.1%
<b>Potential Resource</b>	Large wind	MT	150	Post 2025	45.0%
<b>Potential Resource</b>	Large wind	Eastern WA	150	Post 2025	35.3%
<b>Potential Resource</b>	Large wind	Oregon/ID	150	Post 2025	35.3%
<b>Potential Resource</b>	Off-shore wind	Ocean off WA/OR	150	Post 2030	50.0%
<b>Potential Resource</b>	Small wind	Eastern WA/N. ID	50	Post 2025	35.3%
<b>Potential Resource</b>	Utility-scale solar	Eastern WA/N. ID	100	Post 2025	24.2%
<b>Potential Resource</b>	Community solar	Eastern WA/N. ID	5	Post 2025	20.0%
<b>Potential Resource</b>	Rooftop solar	Eastern WA/N. ID	0	Post 2025	15.0%
<b>Potential Resource</b>	Utility-scale solar	Northwest outside of AVA area	100	Post 2025	24.2%
<b>Potential Resource</b>	Natural gas CT	N. ID	50	Post 2025	11.5%
<b>Potential Resource</b>	Natural gas CCCT	N. ID	250	Post 2025	57.0%
<b>Potential Resource</b>	Pumped hydro - greenfield	WA	200	Post 2027	12.5%
<b>Potential Resource</b>	Pumped hydro - greenfield	OR	200	Post 2027	12.5%
<b>Potential Resource</b>	Pumped hydro - greenfield	MT	200	Post 2027	12.5%
<b>Potential Resource</b>	Pumped hydro - brownfield	Eastern WA	500	Post 2027	12.5%
<b>Potential Resource</b>	Hydrogen electrolyzer - small	Eastern WA	5	Post 2025	n/a
<b>Potential Resource</b>	Hydrogen electrolyzer - large	Eastern WA	50	Post 2025	n/a
<b>Potential Resource</b>	Clean Fuel Turbine	Eastern WA/N. ID	50	Post 2035	11.5%
<b>Potential Resource</b>	Non-natural gas (Hydrogen)	Eastern WA/N. ID		Post 2035	n/a
<b>Potential Resource</b>	Renewable natural gas storage tank	Eastern WA/N. ID		Post 2035	n/a
<b>Potential Resource</b>	Non-natural gas (Bio-fuel)	Eastern WA/N. ID		Post 2035	n/a
<b>Potential Resource</b>	Non-natural gas (Liquid air)	Eastern WA/N. ID		Post 2025	n/a
<b>Potential Resource</b>	Nuclear	Eastern WA/N. ID	200	Post 2030	92.4%
<b>Potential Resource</b>	Biomass	Kettle Falls GS Upgrade	25	Post 2025	70.0%
<b>Potential Resource</b>	Coal with Carbon Capture	Montana CCS Coal	200	Post 2030	80.0%
<b>Potential Resource</b>	Lithium Ion Distribution scale	Eastern WA/N. ID	1	Post 2025	n/a
<b>Potential Resource</b>	Lithium Ion Utility scale	Eastern WA/N. ID	1	Post 2025	n/a

## Exceptions

Mentioned previously in section 3.2.6, offshore wind used JEDI estimates from direct impacts and used multipliers from EPI to estimate indirect and induced job impacts. The EPI study reports multipliers by major industries and sub-industries that corresponds with a two-digit code. DNV used the multipliers reported for the major industry, utilities, and sub-industry, electric power generation, transmission, and distribution, that corresponds with the two-digit code 12 in this source. These multipliers were 3.99 for indirect impacts and 1.65 for induced impacts.

The JEDI model for run-of-the-river hydropower requires project cost inputs in order to reflect jobs, earning, output, and value added according to the project specifications. In the absence of project specific project costs, these inputs were scaled in reference to the default MW project size of 5 MW. Therefore, any project costs are multiplied by the proportion of the project MW size to 5 MW.



## 5.2 Appendix B: Detailed Non-Energy Impacts Values

This appendix includes the applied NEI values and monetized values for each NEI category.

### 5.2.1 Public health

Table 5-7 shows the applied operational emissions values and Table 5-8 shows the monetized health impacts from the emissions.

**Table 5-7. Operational Emissions in Tons per GWh**

Type	Technology Abbreviation	Generator Name/ Location	NOx	SOx	PM2.5	
Existing	Biomass	Kettle Falls	1.37	0.01	0.16	
	Coal	Colstrip 3 & 4	0.93	0.45	0.11	
	Hydro-Res	Wanapum		0.00	0.00	0.00
		Rocky Reach		0.00	0.00	0.00
		Rock Island		0.00	0.00	0.00
		Wells		0.00	0.00	0.00
		Priest Rapids		0.00	0.00	0.00
		Monroe Street		0.00	0.00	0.00
	Hydro-RR	Post Falls		0.00	0.00	0.00
		Nine Mile		0.00	0.00	0.00
		Long Lake		0.00	0.00	0.00
		Upper Falls		0.00	0.00	0.00
		Little Falls		0.00	0.00	0.00
	Hydro-RRS	Noxon Rapids		0.00	0.00	0.00
		Cabinet Gorge		0.00	0.00	0.00
	NG-Aero	Northeast	3.16	0.00	0.05	
	NG-CCCT	Coyote Springs II		0.03	0.00	0.02
		Lancaster		0.06	0.00	0.02
	NG-CT	Rathdrum		0.22	0.00	0.02
		Kettle Falls CT		0.55	0.00	0.04
NG-ICE	Boulder Park		0.11	0.00	0.00	
Solar-Utl	Adams Neilson		0.00	0.00	0.00	
Wind-LG	Palouse Wind		0.00	0.00	0.00	
	Rattlesnake Flat		0.00	0.00	0.00	
Potential	Biomass	Kettle Falls GS Upgrade	1.37	0.01	0.15	
	Coal CCS	Montana CCS Coal	0.93	0.45	0.06	
	Hydro-PB	Eastern Washington		0.00	0.00	0.00
		Washington		0.00	0.00	0.00
	Hydro-GF	Oregon		0.00	0.00	0.00
		Montana		0.00	0.00	0.00
	HE-LG	Eastern Washington	-	-	-	
	HE-SM	Eastern Washington	-	-	-	



Type	Technology Abbreviation	Generator Name/ Location	NOx	SOx	PM2.5
	Batt-LG	Eastern Washington/N. Idaho	-	-	-
	Batt-SM	Eastern Washington/N. Idaho	-	-	-
	NG-CCCT	N. Idaho	0.03	0.00	0.02
	NG-CT	N. Idaho	0.39	0.00	0.03
	NNG-Bio	Eastern Washington/N. Idaho	-	-	-
	NNG-Hyd	Eastern Washington/N. Idaho	-	-	-
	NNG-LAir	Eastern Washington/N. Idaho	-	-	-
	NNG-CF	Eastern Washington/N. Idaho	-	-	-
	NNG-Ren	Eastern Washington/N. Idaho	-	-	-
	Nuclear	Eastern Washington/N. Idaho	-	-	0.00
	Solar-Com	Eastern Washington/N. Idaho	0.00	0.00	0.00
	Solar-Rft	Eastern Washington/N. Idaho	0.00	0.00	0.00
	Solar-Utl	Eastern Washington/N. Idaho	0.00	0.00	0.00
		Northwest outside of AVA area	0.00	0.00	0.00
	Wind-LG	Montana	0.00	0.00	0.00
		Eastern Washington	0.00	0.00	0.00
	Wind-Off	Oregon/Idaho	0.00	0.00	0.00
		Ocean off WA/OR	0.00	0.00	0.00
	Wind-SM	Eastern Washington/N. Idaho	0.00	0.00	0.00



Table 5-8. Operational Public Health Costs in Dollars per MWh

Type	Technology Abbreviation	Generator Name/ Location	NOx			SOx			PM2.5			Total Impact, All Regions	
			Site County	Avista Territory	Other U.S.	Site County	Avista Territory	Other U.S.	Site County	Avista Territory	Other U.S.		
Existing	Biomass	Kettle Falls	\$ 0.83	\$ 0.77	\$ 5.40	\$ 0.00	\$ 0.00	\$ 0.05	\$ 1.67	\$ 1.04	\$ 3.58	\$ 13.36	
	Coal	Colstrip 3 & 4	\$ 0.01	\$ 0.03	\$ 9.31	\$ 0.01	\$ 0.03	\$ 10.11	\$ 0.01	\$ 0.02	\$ 5.73	\$ 25.26	
	Hydro-Res	Wanapum		\$ -	\$ -	\$ -	\$ -	\$ -	\$ -	\$ -	\$ -	\$ -	\$ -
		Rocky Reach		\$ -	\$ -	\$ -	\$ -	\$ -	\$ -	\$ -	\$ -	\$ -	\$ -
		Rock Island		\$ -	\$ -	\$ -	\$ -	\$ -	\$ -	\$ -	\$ -	\$ -	\$ -
		Wells		\$ -	\$ -	\$ -	\$ -	\$ -	\$ -	\$ -	\$ -	\$ -	\$ -
		Priest Rapids		\$ -	\$ -	\$ -	\$ -	\$ -	\$ -	\$ -	\$ -	\$ -	\$ -
	Hydro-RR	Monroe Street		\$ -	\$ -	\$ -	\$ -	\$ -	\$ -	\$ -	\$ -	\$ -	\$ -
		Post Falls		\$ -	\$ -	\$ -	\$ -	\$ -	\$ -	\$ -	\$ -	\$ -	\$ -
		Nine Mile		\$ -	\$ -	\$ -	\$ -	\$ -	\$ -	\$ -	\$ -	\$ -	\$ -
		Long Lake		\$ -	\$ -	\$ -	\$ -	\$ -	\$ -	\$ -	\$ -	\$ -	\$ -
		Upper Falls		\$ -	\$ -	\$ -	\$ -	\$ -	\$ -	\$ -	\$ -	\$ -	\$ -
	Hydro-RRS	Little Falls		\$ -	\$ -	\$ -	\$ -	\$ -	\$ -	\$ -	\$ -	\$ -	\$ -
		Noxon Rapids		\$ -	\$ -	\$ -	\$ -	\$ -	\$ -	\$ -	\$ -	\$ -	\$ -
		Cabinet Gorge		\$ -	\$ -	\$ -	\$ -	\$ -	\$ -	\$ -	\$ -	\$ -	\$ -
	NG-Aero	Northeast		\$ 8.46	\$ 1.54	\$ 10.32	\$ 0.01	\$ 0.00	\$ 0.02	\$ 2.87	\$ 0.52	\$ 0.98	\$ 24.73
	NG-CCCT	Coyote Springs II		\$ 0.00	\$ 0.01	\$ 0.11	\$ 0.00	\$ 0.00	\$ 0.03	\$ 0.02	\$ 0.05	\$ 0.44	\$ 0.67
		Lancaster		\$ 0.08	\$ 0.04	\$ 0.24	\$ 0.00	\$ 0.00	\$ 0.02	\$ 0.70	\$ 0.31	\$ 0.53	\$ 1.94
	NG-CT	Rathdrum		\$ 0.34	\$ 0.17	\$ 0.96	\$ 0.01	\$ 0.00	\$ 0.04	\$ 0.58	\$ 0.25	\$ 0.44	\$ 2.79
		Kettle Falls CT		\$ 0.34	\$ 0.31	\$ 2.18	\$ 0.00	\$ 0.00	\$ 0.03	\$ 0.38	\$ 0.24	\$ 0.82	\$ 4.30
NG-ICE	Boulder Park		\$ 0.31	\$ 0.06	\$ 0.37	\$ 0.01	\$ 0.00	\$ 0.02	\$ 0.10	\$ 0.02	\$ 0.03	\$ 0.92	
Solar-Utl	Adams Neilson		\$ -	\$ -	\$ -	\$ -	\$ -	\$ -	\$ -	\$ -	\$ -	\$ -	
Wind-LG	Palouse Wind		\$ -	\$ -	\$ -	\$ -	\$ -	\$ -	\$ -	\$ -	\$ -	\$ -	
	Rattlesnake Flat		\$ -	\$ -	\$ -	\$ -	\$ -	\$ -	\$ -	\$ -	\$ -	\$ -	
Potential	Biomass	Kettle Falls GS Upgrade	\$ 0.83	\$ 0.77	\$ 5.40	\$ 0.00	\$ 0.00	\$ 0.05	\$ 1.50	\$ 0.94	\$ 3.21	\$ 12.71	
	Coal CCS	Montana CCS Coal	\$ 0.01	\$ 0.03	\$ 9.31	\$ 0.01	\$ 0.03	\$ 10.11	\$ 0.01	\$ 0.01	\$ 2.98	\$ 22.49	
	Hydro-PB	E. WA		\$ -	\$ -	\$ -	\$ -	\$ -	\$ -	\$ -	\$ -	\$ -	
		WA		\$ -	\$ -	\$ -	\$ -	\$ -	\$ -	\$ -	\$ -	\$ -	
	Hydro-GF	Oregon		\$ -	\$ -	\$ -	\$ -	\$ -	\$ -	\$ -	\$ -	\$ -	
		Montana		\$ -	\$ -	\$ -	\$ -	\$ -	\$ -	\$ -	\$ -	\$ -	
	HE-LG	E. WA		\$ -	\$ -	\$ -	\$ -	\$ -	\$ -	\$ -	\$ -	\$ -	
	HE-SM	E. WA		\$ -	\$ -	\$ -	\$ -	\$ -	\$ -	\$ -	\$ -	\$ -	
	Batt-LG	E. WA/N. ID		\$ -	\$ -	\$ -	\$ -	\$ -	\$ -	\$ -	\$ -	\$ -	
	Batt-SM	E. WA/N. ID		\$ -	\$ -	\$ -	\$ -	\$ -	\$ -	\$ -	\$ -	\$ -	
NG-CCCT	N. ID		\$ 0.05	\$ 0.03	\$ 0.15	\$ 0.00	\$ 0.00	\$ 0.02	\$ 0.68	\$ 0.30	\$ 0.52	\$ 1.75	





Type	Technology Abbreviation	Generator Name/ Location	NOx			SOx			PM2.5			Total Impact, All Regions
			Site County	Avista Territory	Other U.S.	Site County	Avista Territory	Other U.S.	Site County	Avista Territory	Other U.S.	
	NG-CT	N. ID	\$ 0.58	\$ 0.29	\$ 1.67	\$ 0.01	\$ 0.00	\$ 0.04	\$ 0.88	\$ 0.39	\$ 0.67	\$ 4.52
	NNG-Bio	E. WA/N. ID	\$ -	\$ -	\$ -	\$ -	\$ -	\$ -	\$ -	\$ -	\$ -	\$ -
	NNG-Hyd	E. WA/N. ID	\$ -	\$ -	\$ -	\$ -	\$ -	\$ -	\$ -	\$ -	\$ -	\$ -
	NNG-LAir	E. WA/N. ID	\$ -	\$ -	\$ -	\$ -	\$ -	\$ -	\$ -	\$ -	\$ -	\$ -
	NNG-CF	E. WA/N. ID	\$ -	\$ -	\$ -	\$ -	\$ -	\$ -	\$ -	\$ -	\$ -	\$ -
	NNG-Ren	E. WA/N. ID	\$ -	\$ -	\$ -	\$ -	\$ -	\$ -	\$ -	\$ -	\$ -	\$ -
	Nuclear	E. WA/N. ID	\$ -	\$ -	\$ -	\$ -	\$ -	\$ -	\$ -	\$ -	\$ -	\$ -
	Solar-Com	E. WA/N. ID	\$ -	\$ -	\$ -	\$ -	\$ -	\$ -	\$ -	\$ -	\$ -	\$ -
	Solar-Rft	E. WA/N. ID	\$ -	\$ -	\$ -	\$ -	\$ -	\$ -	\$ -	\$ -	\$ -	\$ -
	Solar-Utl	E. WA/N. ID	\$ -	\$ -	\$ -	\$ -	\$ -	\$ -	\$ -	\$ -	\$ -	\$ -
	Solar-Utl	Northwest outside of AVA area	\$ -	\$ -	\$ -	\$ -	\$ -	\$ -	\$ -	\$ -	\$ -	\$ -
	Solar-Utl	Montana	\$ -	\$ -	\$ -	\$ -	\$ -	\$ -	\$ -	\$ -	\$ -	\$ -
	Wind-LG	E. WA	\$ -	\$ -	\$ -	\$ -	\$ -	\$ -	\$ -	\$ -	\$ -	\$ -
	Wind-LG	Oregon/ID	\$ -	\$ -	\$ -	\$ -	\$ -	\$ -	\$ -	\$ -	\$ -	\$ -
	Wind-Off	Ocean off WA/OR	\$ -	\$ -	\$ -	\$ -	\$ -	\$ -	\$ -	\$ -	\$ -	\$ -
	Wind-SM	E. WA/N. ID	\$ -	\$ -	\$ -	\$ -	\$ -	\$ -	\$ -	\$ -	\$ -	\$ -



## 5.2.2 Safety

Table 5-9 shows the applied fatalities per TWh and Table 5-10 shows the monetized impacts.

**Table 5-9. Fatalities per TWh**

Type	Technology Abbreviation	Generator Name/ Location	Direct Fatalities	Indirect Fatalities		Total Fatalities
			Construction and Operation	Mining	Operation	All Value Chain
Existing	Biomass	Kettle Falls	0.0153	-	-	0.0153
	Coal	Colstrip 3 & 4	0.0018	0.0251	0.0015	0.0285
	Hydro-Res	Wanapum	0.0240	-	-	0.0240
		Rocky Reach	0.0240	-	-	0.0240
		Rock Island	0.0240	-	-	0.0240
		Wells	0.0240	-	-	0.0240
		Priest Rapids	0.0240	-	-	0.0240
		Monroe Street	-	-	-	-
	Hydro-RR	Post Falls	-	-	-	-
		Nine Mile	-	-	-	-
		Long Lake	-	-	-	-
		Upper Falls	-	-	-	-
		Little Falls	-	-	-	-
	Hydro-RRS	Noxon Rapids	-	-	-	-
		Cabinet Gorge	-	-	-	-
	NG-Aero	Northeast	0.0014	0.0074	0.0027	0.0115
	NG-CCCT	Coyote Springs II	0.0014	0.0074	0.0027	0.0115
		Lancaster	0.0014	0.0074	0.0027	0.0115
	NG-CT	Rathdrum	0.0014	0.0074	0.0027	0.0115
		Kettle Falls CT	0.0014	0.0074	0.0027	0.0115
NG-ICE	Boulder Park	0.0014	0.0074	0.0027	0.0115	
Solar-Utl	Adams Neilson	0.0190	-	-	0.0190	
Wind-LG	Palouse Wind	0.0350	-	-	0.0350	
	Rattlesnake Flat	0.0350	-	-	0.0350	
Potential	Biomass	Kettle Falls GS Upgrade	0.0153	-	-	0.0153
	Coal CCS	Montana CCS Coal	0.0018	0.0251	0.0015	0.0285
	Hydro-PB	Eastern Washington	-	-	-	-
	Hydro-GF	Washington	-	-	-	-
		Oregon	-	-	-	-



Type	Technology Abbreviation	Generator Name/ Location	Direct Fatalities	Indirect Fatalities		Total Fatalities
			Construction and Operation	Mining	Operation	All Value Chain
		Montana	-	-	-	-
	HE-LG	Eastern Washington	-	-	-	-
	HE-SM	Eastern Washington	-	-	-	-
	Batt-LG	Eastern Washington/N. Idaho	-	-	-	-
	Batt-SM	Eastern Washington/N. Idaho	-	-	-	-
	NG-CCCT	N. Idaho	0.0014	0.0074	0.0027	0.0115
	NG-CT	N. Idaho	0.0014	0.0074	0.0027	0.0115
	NNG-Bio	Eastern Washington/N. Idaho	0.0050	-	-	0.0050
	NNG-Hyd	Eastern Washington/N. Idaho	-	-	-	-
	NNG-LAir	Eastern Washington/N. Idaho	-	-	-	-
	NNG-CF	Eastern Washington/N. Idaho	-	-	-	-
	NNG-Ren	Eastern Washington/N. Idaho	-	-	-	-
	Nuclear	Eastern Washington/N. Idaho	0.0100	-	-	0.0100
	Solar-Com	Eastern Washington/N. Idaho	0.0190	-	-	0.0190
	Solar-Rft	Eastern Washington/N. Idaho	0.0190	-	-	0.0190
	Solar-Utl	Eastern Washington/N. Idaho	0.0190	-	-	0.0190
		Northwest outside of AVA area	0.0190	-	-	0.0190
		Montana	0.0350	-	-	0.0350
	Wind-LG	Eastern Washington	0.0350	-	-	0.0350
		Oregon/Idaho	0.0350	-	-	0.0350
	Wind-Off	Ocean off WA/OR	0.0350	-	-	0.0350
	Wind-SM	Eastern Washington/N. Idaho	0.0350	-	-	0.0350



Table 5-10. Monetized Fatalities per MWh

Type	Technology Abbreviation	Generator Name/ Location	Direct Fatalities	Indirect Fatalities		Total Fatalities	
			Construction and Operation	Mining	Operation	All Value Chain	
Existing	Biomass	Kettle Falls	\$0.16	-	-	\$ 0.16	
	Coal	Colstrip 3 & 4	\$0.02	\$0.27	\$0.02	\$ 0.31	
	Hydro-Res	Wanapum		\$0.26	-	-	\$ 0.26
		Rocky Reach		\$0.26	-	-	\$ 0.26
		Rock Island		\$0.26	-	-	\$ 0.26
		Wells		\$0.26	-	-	\$ 0.26
		Priest Rapids		\$0.26	-	-	\$ 0.26
	Hydro-RR	Monroe Street		-	-	-	-
		Post Falls		-	-	-	-
		Nine Mile		-	-	-	-
		Long Lake		-	-	-	-
		Upper Falls		-	-	-	-
		Little Falls		-	-	-	-
	Hydro-RRS	Noxon Rapids		-	-	-	-
		Cabinet Gorge		-	-	-	-
	NG-Aero	Northeast	\$0.02	\$0.08	\$0.03	\$ 0.12	
	NG-CCCT	Coyote Springs II		\$0.02	\$0.08	\$0.03	\$ 0.12
		Lancaster		\$0.02	\$0.08	\$0.03	\$ 0.12
	NG-CT	Rathdrum		\$0.02	\$0.08	\$0.03	\$ 0.12
		Kettle Falls CT		\$0.02	\$0.08	\$0.03	\$ 0.12
	NG-ICE	Boulder Park	\$0.02	\$0.08	\$0.03	\$ 0.12	
	Solar-Utl	Adams Neilson	\$0.20	-	-	\$ 0.20	
	Wind-LG	Palouse Wind		\$0.38	-	-	\$ 0.38
Rattlesnake Flat			\$0.38	-	-	\$ 0.38	
Potential	Biomass	Kettle Falls GS Upgrade	\$0.16	-	-	\$ 0.16	
	Coal CCS	Montana CCS Coal	\$0.02	\$0.27	\$0.02	\$ 0.31	
	Hydro-PB	Eastern Washington		-	-	-	
		Washington		-	-	-	
	Hydro-GF	Oregon		-	-	-	
		Montana		-	-	-	
	HE-LG	Eastern Washington		-	-	-	
	HE-SM	Eastern Washington		-	-	-	
Batt-LG	Eastern Washington/N. Idaho		-	-	-		



Type	Technology Abbreviation	Generator Name/ Location	Direct Fatalities	Indirect Fatalities		Total Fatalities
			Construction and Operation	Mining	Operation	All Value Chain
	Batt-SM	Eastern Washington/N. Idaho	-	-	-	-
	NG-CCCT	N. Idaho	\$0.02	\$0.08	\$0.03	\$ 0.12
	NG-CT	N. Idaho	\$0.02	\$0.08	\$0.03	\$ 0.12
	NNG-Bio	Eastern Washington/N. Idaho	\$0.05	-	-	\$ 0.05
	NNG-Hyd	Eastern Washington/N. Idaho	-	-	-	-
	NNG-LAir	Eastern Washington/N. Idaho	-	-	-	-
	NNG-CF	Eastern Washington/N. Idaho	-	-	-	-
	NNG-Ren	Eastern Washington/N. Idaho	-	-	-	-
	Nuclear	Eastern Washington/N. Idaho	\$0.11	-	-	\$ 0.11
	Solar-Com	Eastern Washington/N. Idaho	\$0.20	-	-	\$ 0.20
	Solar-Rft	Eastern Washington/N. Idaho	\$0.20	-	-	\$ 0.20
	Solar-Utl	Eastern Washington/N. Idaho	\$0.20	-	-	\$ 0.20
		Northwest outside of AVA area	\$0.20	-	-	\$ 0.20
		Montana	\$0.38	-	-	\$ 0.38
	Wind-LG	Eastern Washington	\$0.38	-	-	\$ 0.38
		Oregon/Idaho	\$0.38	-	-	\$ 0.38
	Wind-Off	Ocean off WA/OR	\$0.38	-	-	\$ 0.38
	Wind-SM	Eastern Washington/N. Idaho	\$0.38	-	-	\$ 0.38



## 5.2.3 Environment

### 5.2.3.1 Land Use

Table 5-11 presents the applied land use in acres per MW.

**Table 5-11. Land Use in Acres per MW**

Type	Technology Abbreviation	Generator Name/ Location	Land Use (Acres/ MW)					
			Construction	Mining	Operation	Decommissioning	Total	
Existing	Biomass	Kettle Falls	-	-	0.30	-	0.30	
	Coal	Colstrip 3 & 4	-	0.72	1.18	-	1.90	
	Hydro-Res	Wanapum		67.36	-	237.55	-	304.91
		Rocky Reach		67.36	-	237.55	-	304.91
		Rock Island		67.36	-	237.55	-	304.91
		Wells		67.36	-	237.55	-	304.91
		Priest Rapids		67.36	-	237.55	-	304.91
		Monroe Street		-	-	-	-	-
	Hydro-RR	Post Falls		-	-	-	-	-
		Nine Mile		-	-	-	-	-
		Long Lake		-	-	-	-	-
		Upper Falls		-	-	-	-	-
		Little Falls		-	-	-	-	-
	Hydro-RRS	Noxon Rapids		-	-	-	-	-
		Cabinet Gorge		-	-	-	-	-
	NG-Aero	Northeast		-	1.66	0.34	-	2.00
	NG-CCCT	Coyote Springs II		-	1.66	0.34	-	2.00
		Lancaster		-	1.66	0.34	-	2.00
	NG-CT	Rathdrum		-	1.66	0.34	-	2.00
		Kettle Falls CT		-	1.66	0.34	-	2.00
	NG-ICE	Boulder Park		-	1.66	0.34	-	2.00
	Solar-Utl	Adams Neilson		1.98	-	8.10	0.04	10.12
	Wind-LG	Palouse Wind		0.28	-	60.00	-	60.28
Rattlesnake Flat			0.28	-	60.00	-	60.28	
P O	Biomass	Kettle Falls GS Upgrade	-	-	0.30	-	0.30	



Type	Technology Abbreviation	Generator Name/ Location	Land Use (Acres/ MW)				
			Construction	Mining	Operation	Decommissioning	Total
	Coal CCS	Montana CCS Coal	-	0.72	1.18	-	1.90
	Hydro-PB	Eastern Washington	-	-	-	-	-
		Washington	-	-	-	-	-
	Hydro-GF	Oregon	-	-	-	-	-
		Montana	-	-	-	-	-
	HE-LG	Eastern Washington	-	-	0.03	-	0.03
	HE-SM	Eastern Washington	-	-	0.01	-	0.01
	Batt-LG	Eastern Washington/N. Idaho	-	-	-	-	-
	Batt-SM	Eastern Washington/N. Idaho	-	-	-	-	-
	NG-CCCT	N. Idaho	-	1.66	0.34	-	2.00
	NG-CT	N. Idaho	-	1.66	0.34	-	2.00
	NNG-Bio	Eastern Washington/N. Idaho	-	-	-	-	-
	NNG-Hyd	Eastern Washington/N. Idaho	-	-	0.10	-	0.10
	NNG-LAir	Eastern Washington/N. Idaho	-	-	-	-	-
	NNG-CF	Eastern Washington/N. Idaho	-	-	-	-	-
	NNG-Ren	Eastern Washington/N. Idaho	-	-	1.36	-	1.36
	Nuclear	Eastern Washington/N. Idaho	-	1.42	0.97	-	2.39
	Solar-Com	Eastern Washington/N. Idaho	1.98	-	8.10	0.04	10.12
	Solar-Rft	Eastern Washington/N. Idaho	1.98	-	0.00	0.04	2.02
	Solar-Utl	Eastern Washington/N. Idaho	1.98	-	8.10	0.04	10.12
		Northwest outside of AVA area	1.98	-	8.10	0.04	10.12
		Montana	0.28	-	60.00	-	60.28
	Wind-LG	Eastern Washington	0.28	-	60.00	-	60.28
		Oregon/Idaho	0.28	-	60.00	-	60.28
	Wind-Off	Ocean off WA/OR	0.28	-	-	-	0.28
	Wind-SM	Eastern Washington/N. Idaho	0.28	-	44.70	-	44.98



### 5.2.3.2 Water Use

Table 5-12 presents the applied water use in gallons per MWh.

**Table 5-12. Water Use in Gallons per MWh**

Type	Technology Abbreviation	Generator Name/ Location	Water Use (Gallons/ MWh)	
Existing	Biomass	Kettle Falls	553	
	Coal	Colstrip 3 & 4	687	
	Hydro-Res		Wanapum	4491
			Rocky Reach	4491
			Rock Island	4491
			Wells	4491
			Priest Rapids	4491
			Monroe Street	-
	Hydro-RR		Post Falls	-
			Nine Mile	-
			Long Lake	-
			Upper Falls	-
			Little Falls	-
	Hydro-RRS		Noxon Rapids	-
			Cabinet Gorge	-
	NG-Aero	Northeast	-	
	NG-CCCT		Coyote Springs II	205
			Lancaster	205
	NG-CT		Rathdrum	0
			Kettle Falls CT	0
NG-ICE	Boulder Park	0		
Solar-Utl	Adams Neilson	1		
Wind-LG		Palouse Wind	0	
		Rattlesnake Flat	0	
Potential	Biomass	Kettle Falls GS Upgrade	553	
	Coal CCS		Montana CCS Coal	846
			Eastern Washington	-
	Hydro-PB	Washington	-	
	Hydro-GF	Oregon	-	
	HE-LG	Montana	-	
	HE-LG	Eastern Washington	-	
	HE-SM	Eastern Washington	-	
	Batt-LG	Eastern Washington/N. Idaho	-	
	Batt-SM	Eastern Washington/N. Idaho	-	
	NG-CCCT	N. Idaho	205	
	NG-CT	N. Idaho	0	





Type	Technology Abbreviation	Generator Name/ Location	Water Use (Gallons/ MWh)
	NNG-Bio	Eastern Washington/N. Idaho	-
	NNG-Hyd	Eastern Washington/N. Idaho	-
	NNG-LAir	Eastern Washington/N. Idaho	-
	NNG-CF	Eastern Washington/N. Idaho	-
	NNG-Ren	Eastern Washington/N. Idaho	-
	Nuclear	Eastern Washington/N. Idaho	672
	Solar-Com	Eastern Washington/N. Idaho	1
	Solar-Rft	Eastern Washington/N. Idaho	1
	Solar-Utl	Eastern Washington/N. Idaho	1
	Wind-LG	Northwest outside of AVA area	1
	Wind-LG	Montana	0
	Wind-LG	Eastern Washington	0
	Wind-Off	Oregon/Idaho	0
	Wind-Off	Ocean off WA/OR	0



### 5.2.3.3 Wildlife Impacts

Table 5-13 presents the applied values for avian fatalities per GWh.

**Table 5-13. Avian fatalities per GWh**

Type	Technology Abbreviation	Generator Name/ Location	Wildlife Impacts (Avian Fatalities/GWh)	
Existing	Biomass	Kettle Falls	-	
	Coal	Colstrip 3 & 4	0.20	
	Hydro-Res	Wanapum		-
		Rocky Reach		-
		Rock Island		-
		Wells		-
		Priest Rapids		-
		Monroe Street		-
	Hydro-RR	Post Falls		-
		Nine Mile		-
		Long Lake		-
		Upper Falls		-
		Little Falls		-
	Hydro-RRS	Noxon Rapids		-
		Cabinet Gorge		-
	NG-Aero	Northeast	0.20	
	NG-CCCT	Coyote Springs II	0.20	
		Lancaster	0.20	
	NG-CT	Rathdrum	0.20	
		Kettle Falls CT	0.20	
NG-ICE	Boulder Park	0.20		
Solar-Utl	Adams Neilson	-		
Wind-LG	Palouse Wind	0.27		
	Rattlesnake Flat	0.27		
Potential	Biomass	Kettle Falls GS Upgrade	-	
	Coal CCS	Montana CCS Coal	0.20	
	Hydro-PB	Eastern Washington	-	
		Washington	-	
	Hydro-GF	Oregon	-	
		Montana	-	
	HE-LG	Eastern Washington	-	
	HE-SM	Eastern Washington	-	
	Batt-LG	Eastern Washington/N. Idaho	-	
	Batt-SM	Eastern Washington/N. Idaho	-	
	NG-CCCT	N. Idaho	0.20	
NG-CT	N. Idaho	0.20		



Type	Technology Abbreviation	Generator Name/ Location	Wildlife Impacts (Avian Fatalities/GWh)
	NNG-Bio	Eastern Washington/N. Idaho	-
	NNG-Hyd	Eastern Washington/N. Idaho	-
	NNG-LAir	Eastern Washington/N. Idaho	-
	NNG-CF	Eastern Washington/N. Idaho	-
	NNG-Ren	Eastern Washington/N. Idaho	-
	Nuclear	Eastern Washington/N. Idaho	0.64
	Solar-Com	Eastern Washington/N. Idaho	-
	Solar-Rft	Eastern Washington/N. Idaho	-
	Solar-Utl	Eastern Washington/N. Idaho	-
		Northwest outside of AVA area	-
		Montana	0.27
	Wind-LG	Eastern Washington	0.27
		Oregon/Idaho	0.27
	Wind-Off	Ocean off WA/OR	-
	Wind-SM	Eastern Washington/N. Idaho	0.27



### 5.2.4 Economic

Table 5-14 shows the applied construction jobs and economic impacts. Table 5-15 shows the applied operations jobs and economic impacts.

**Table 5-14. Construction Jobs and Economic Impacts**

Type	Technology Abbreviation	Generator Name/ Location	Direct Impact				Indirect Impact				Induced Impact				
			Jobs/MW	Earnings in 2021\$/MW	Output in 2021\$/MW	Value Added in 2021\$/MW	Jobs/MW	Earnings in 2021\$/MW	Output in 2021\$/MW	Value Added in 2021\$/MW	Jobs/MW	Earnings in 2021\$/MW	Output in 2021\$/MW	Value Added in 2021\$/MW	
Existing	Biomass	Kettle Falls	3.00	\$300,603	\$372,189	\$330,178	0.71	\$47,638	\$147,929	\$86,588	0.69	\$45,105	\$136,686	\$83,037	
	Coal	Colstrip 3 & 4	5.44	\$466,653	\$902,905	\$597,432	2.44	\$110,203	\$345,878	\$176,486	1.82	\$79,865	\$250,743	\$133,446	
	Hydro-Res	Wanapum		15.51	\$1,106,541	\$2,034,243	\$1,335,911	4.25	\$285,630	\$901,729	\$517,882	3.92	\$260,677	\$789,639	\$480,274
		Rocky Reach		15.51	\$1,106,541	\$2,034,243	\$1,335,911	4.25	\$285,630	\$901,729	\$517,882	3.92	\$260,677	\$789,639	\$480,274
		Rock Island		15.51	\$1,106,541	\$2,034,243	\$1,335,911	4.25	\$285,630	\$901,729	\$517,882	3.92	\$260,677	\$789,639	\$480,274
		Wells		15.51	\$1,106,541	\$2,034,243	\$1,335,911	4.25	\$285,630	\$901,729	\$517,882	3.92	\$260,677	\$789,639	\$480,274
		Priest Rapids		15.51	\$1,106,541	\$2,034,243	\$1,335,911	4.25	\$285,630	\$901,729	\$517,882	3.92	\$260,677	\$789,639	\$480,274
	Hydro-RR	Monroe Street		1.07	\$87,838	\$202,703	\$128,378	4.26	\$358,108	\$1,317,568	\$621,622	2.16	\$148,649	\$452,703	\$277,027
		Post Falls		1.55	\$82,759	\$200,000	\$117,241	5.28	\$317,241	\$1,296,552	\$496,552	2.57	\$117,241	\$379,310	\$200,000
		Nine Mile		1.07	\$85,106	\$202,128	\$130,319	4.26	\$61,170	\$1,319,149	\$622,340	2.15	\$148,936	\$454,787	\$276,596
		Long Lake		1.07	\$85,227	\$201,136	\$131,818	4.26	\$354,545	\$1,318,182	\$621,591	2.15	\$150,000	\$453,409	\$276,136
		Upper Falls		1.07	\$90,000	\$200,000	\$130,000	4.26	\$350,000	\$1,320,000	\$620,000	2.15	\$150,000	\$450,000	\$280,000
	Hydro-RRS	Little Falls		15.20	\$1,085,714	\$1,965,714	\$1,302,857	4.11	\$277,143	\$874,286	\$502,857	3.83	\$254,286	\$771,429	\$468,571
		Noxon Rapids		15.86	\$925,045	\$1,817,838	\$1,087,027	5.22	\$240,000	\$771,351	\$382,703	3.74	\$164,505	\$516,216	\$274,775
	NG-Aero	Cabinet Gorge		16.29	\$932,692	\$1,858,462	\$1,083,077	5.63	\$261,923	\$851,154	\$435,000	4.03	\$177,692	\$570,000	\$302,308
		Northeast		0.92	\$141,129	\$196,129	\$150,968	0.85	\$54,677	\$199,516	\$114,839	0.65	\$44,677	\$135,323	\$82,258
	NG-CCCT	Coyote Springs II		0.98	\$139,608	\$196,699	\$147,712	1.03	\$52,255	\$190,359	\$104,281	0.71	\$38,137	\$109,902	\$63,595
		Lancaster		1.07	\$134,727	\$196,680	\$141,211	1.19	\$51,914	\$206,328	\$100,039	0.76	\$34,648	\$111,211	\$58,984
	NG-CT	Rathdrum		1.07	\$135,060	\$197,169	\$141,566	1.19	\$52,048	\$206,867	\$100,301	0.76	\$34,699	\$111,506	\$59,157
		Kettle Falls CT		0.97	\$141,667	\$197,222	\$151,389	0.83	\$54,167	\$200,000	\$115,278	0.69	\$44,444	\$136,111	\$81,944
NG-ICE	Boulder Park		0.92	\$139,200	\$179,200	\$149,200	0.84	\$54,000	\$196,800	\$113,200	0.64	\$44,000	\$133,600	\$81,200	
Solar-Utl	Adams Neilson		5.45	\$293,973	-	-	4.80	\$258,912	-	-	4.88	\$263,227	-	-	
Wind-LG	Palouse Wind		0.63	\$45,810	\$50,000	\$47,143	1.50	\$109,143	\$316,095	\$173,048	0.67	\$46,857	\$144,952	\$90,381	
	Rattlesnake Flat		0.56	\$41,319	\$45,486	\$42,569	1.50	\$41,319	\$316,042	\$172,986	0.66	\$46,528	\$143,819	\$89,653	
Potential	Biomass	Kettle Falls GS Upgrade	3.72	\$371,600	\$460,400	\$408,000	0.88	\$58,800	\$182,800	\$107,200	0.84	\$55,600	\$168,800	\$102,800	
	Coal CCS	Montana CCS Coal	6.63	\$569,380	\$1,101,667	\$728,948	2.97	\$134,462	\$422,018	\$215,337	2.22	\$97,446	\$305,941	\$162,822	
	Hydro-PB	E. WA		14.75	\$1,052,400	\$1,933,000	\$1,270,200	4.04	\$271,400	\$856,800	\$492,200	3.73	\$247,800	\$750,800	\$456,600
		WA		14.81	\$1,056,500	\$1,937,000	\$1,274,000	4.05	\$272,350	\$858,500	\$493,000	3.74	\$248,500	\$753,000	\$458,000
	Hydro-GF	OR		16.04	\$1,076,500	\$1,994,500	\$1,254,000	5.50	\$290,000	\$861,500	\$477,500	5.11	\$269,000	\$775,000	\$448,000
		MT		15.91	\$929,000	\$1,821,500	\$1,091,000	5.24	\$240,500	\$773,000	\$383,500	3.76	\$165,000	\$518,000	\$275,500
	HE-LG	E. WA		-	-	-	-	-	-	-	-	-	-	-	
HE-SM	E. WA		-	-	-	-	-	-	-	-	-	-	-		



Type	Technology Abbreviation	Generator Name/ Location	Direct Impact				Indirect Impact				Induced Impact			
			Jobs/MW	Earnings in 2021\$/MW	Output in 2021\$/MW	Value Added in 2021\$/MW	Jobs/MW	Earnings in 2021\$/MW	Output in 2021\$/MW	Value Added in 2021\$/MW	Jobs/MW	Earnings in 2021\$/MW	Output in 2021\$/MW	Value Added in 2021\$/MW
	Batt-LG	E. WA/N. ID	-	-	-	-	-	-	-	-	-	-	-	-
	Batt-SM	E. WA/N. ID	-	-	-	-	-	-	-	-	-	-	-	-
	NG-CCCT	N. ID	1.07	\$134,720	\$196,680	\$141,200	1.19	\$51,920	\$206,360	\$100,040	0.76	\$34,640	\$111,240	\$300,280
	NG-CT	N. ID	1.08	\$134,800	\$196,600	\$141,200	1.20	\$52,000	\$206,400	\$100,000	0.76	\$34,600	\$111,200	\$59,000
	NNG-Bio	E. WA/N. ID	-	-	-	-	-	-	-	-	-	-	-	-
	NNG-Hyd	E. WA/N. ID	-	-	-	-	-	-	-	-	-	-	-	-
	NNG-LAir	E. WA/N. ID	-	-	-	-	-	-	-	-	-	-	-	-
	NNG-CF	E. WA/N. ID	1.07	\$134,720	\$196,680	\$141,200	1.19	\$51,920	\$206,360	\$100,040	0.76	\$34,640	\$111,240	\$300,280
	NNG-Ren	E. WA/N. ID	-	-	-	-	-	-	-	-	-	-	-	-
	Nuclear	E. WA/N. ID	-	-	-	-	-	-	-	-	-	-	-	-
	Solar-Com	E. WA/N. ID	5.45	\$293,973	-	-	4.80	\$258,912	-	-	4.88	\$263,227	-	-
	Solar-Rft	E. WA/N. ID	10.90	\$587,946	-	-	9.60	\$517,824	-	-	9.67	\$526,454	-	-
	Solar-Utl	E. WA/N. ID	5.45	\$293,973	-	-	4.80	\$258,912	-	-	4.88	\$263,227	-	-
		Northwest outside of AVA area	5.45	\$293,973	-	-	4.80	\$258,912	-	-	4.88	\$263,227	-	-
	Wind-LG	MT	0.57	\$31,733	\$36,067	\$32,267	1.91	\$96,000	\$306,867	\$136,867	0.59	\$25,267	\$80,800	\$44,267
		E. WA	0.56	\$40,667	\$44,867	\$41,933	1.50	\$109,200	\$316,000	\$172,933	0.66	\$46,467	\$143,667	\$89,600
	Wind-Off	OR/ID	0.56	\$35,933	\$40,400	\$37,467	1.83	\$108,000	\$308,867	\$154,400	0.68	\$35,800	\$104,933	\$62,267
		Ocean off WA/OR	0.15	\$11,227	\$11,227	\$11,227	7.49	\$770,052	\$1,816,213	\$991,067	1.96	\$120,076	\$412,474	\$245,978
	Wind-SM	E. WA/N. ID	1.08	\$54,400	\$59,000	\$55,200	1.92	\$94,600	\$314,800	\$144,200	0.84	\$38,200	\$125,200	\$68,600



Table 5-15. Operations Jobs and Economic Impacts

Type	Technology Abbreviation	Generator Name/ Location	Direct Impact				Indirect Impact				Induced Impact				
			Jobs/MW/h	Earnings in 2021 \$/MW/h	Output in 2021 \$/MW/h	Value Added in 2021 \$/MW/h	Jobs/MW/h	Earnings in 2021 \$/MW/h	Output in 2021 \$/MW/h	Value Added in 2021 \$/MW/h	Jobs/MW/h	Earnings in 2021 \$/MW/h	Output in 2021 \$/MW/h	Value Added in 2021 \$/MW/h	
Existing	Biomass	Kettle Falls	<0.0001	\$3.40	\$3.40	\$3.40	0.0002	\$11.26	\$35.23	\$19.87	<0.0001	\$3.25	\$9.87	\$5.98	
	Coal	Colstrip 3 & 4	0.0002	\$15.71	\$15.71	\$15.71	0.0003	\$15.71	\$64.08	\$30.18	0.0001	\$4.63	\$14.64	\$7.77	
	Hydro-Res	Wanapum		<0.0001	\$2.81	\$2.81	\$2.81	<0.0001	\$4.73	\$17.54	\$10.15	<0.0001	\$1.53	\$4.64	\$2.82
		Rocky Reach		<0.0001	\$2.81	\$2.81	\$2.81	<0.0001	\$4.73	\$17.54	\$10.15	<0.0001	\$1.53	\$4.64	\$2.82
		Rock Island		<0.0001	\$2.81	\$2.81	\$2.81	<0.0001	\$4.73	\$17.54	\$10.15	<0.0001	\$1.53	\$4.64	\$2.82
		Wells		<0.0001	\$2.81	\$2.81	\$2.81	<0.0001	\$4.73	\$17.54	\$10.15	<0.0001	\$1.53	\$4.64	\$2.82
		Priest Rapids		<0.0001	\$2.81	\$2.81	\$2.81	<0.0001	\$4.73	\$17.54	\$10.15	<0.0001	\$1.53	\$4.64	\$2.82
	Hydro-RR	Monroe Street		0.0002	\$15.51	\$15.51	\$15.51	<0.0001	\$5.54	\$22.15	\$12.18	<0.0001	\$3.32	\$8.86	\$5.54
		Post Falls		0.0002	\$17.37	\$17.37	\$17.37	0.0001	\$6.68	\$28.06	\$12.03	<0.0001	\$2.67	\$9.35	\$5.34
		Nine Mile		0.0004	\$27.35	\$27.35	\$27.35	0.0001	\$10.16	\$39.06	\$21.09	<0.0001	\$5.47	\$16.41	\$10.16
		Long Lake		0.0002	\$16.52	\$16.52	\$16.52	<0.0001	\$6.24	\$23.56	\$12.69	<0.0001	\$3.22	\$9.67	\$5.84
		Upper Falls		0.0002	\$14.41	\$14.41	\$14.41	<0.0001	\$6.40	\$20.81	\$11.21	<0.0001	\$3.20	\$8.01	\$4.80
	Hydro-RRS	Little Falls		<0.0001	\$1.59	\$1.59	\$1.59	<0.0001	\$3.18	\$11.14	\$6.36	<0.0001	\$1.06	\$2.65	\$1.59
		Noxon Rapids		<0.0001	\$2.74	\$2.74	\$2.74	<0.0001	\$4.60	\$18.87	\$9.26	<0.0001	\$1.17	\$3.73	\$1.98
		Cabinet Gorge		<0.0001	\$2.18	\$2.18	\$2.18	<0.0001	\$3.79	\$15.15	\$7.38	<0.0001	\$1.04	\$3.31	\$1.70
	NG-Aero	Northeast	0.0016	\$106.04	\$106.04	\$106.04	0.0016	\$121.95	\$413.56	\$243.89	0.0005	\$42.42	\$132.55	\$79.53	
	NG-CCCT	Coyote Springs II		<0.0001	\$0.57	\$0.57	\$0.57	<0.0001	\$0.68	\$2.22	\$1.24	<0.0001	\$0.25	\$0.73	\$0.42
		Lancaster		<0.0001	\$0.53	\$0.53	\$0.53	<0.0001	\$0.59	\$2.16	\$1.10	<0.0001	\$0.18	\$0.57	\$0.30
	NG-CT	Rathdrum		<0.0001	\$3.24	\$3.24	\$3.24	<0.0001	\$3.60	\$13.26	\$6.72	<0.0001	\$1.10	\$3.48	\$1.83
		Kettle Falls CT		0.0001	\$2.17	\$2.17	\$2.17	0.0001	\$3.26	\$9.77	\$5.43	0.0000	\$1.09	\$3.26	\$2.17
NG-ICE	Boulder Park		<0.0001	\$1.45	\$1.45	\$1.45	<0.0001	\$1.63	\$5.61	\$3.26	0.0000	\$0.54	\$1.81	\$1.09	
Solar-Utl	Adams Neilson		-	\$-	\$-	\$-	-	\$-	\$-	\$-	-	\$-	\$-	\$-	
Wind-LG	Palouse Wind		<0.0001	\$1.48	\$1.48	\$1.48	<0.0001	\$1.54	\$5.48	\$3.60	<0.0001	\$0.64	\$1.97	\$1.21	
	Rattlesnake Flat		<0.0001	\$1.28	\$1.28	\$1.28	<0.0001	\$1.47	\$5.21	\$3.44	<0.0001	\$0.60	\$1.84	\$1.15	
Potential	Biomass	Kettle Falls GS Upgrade	0.0001	\$5.22	\$5.22	\$5.22	0.0002	\$11.48	\$36.14	\$20.48	<0.0001	\$3.52	\$10.57	\$6.46	
	Coal CCS	Montana CCS Coal	<0.0001	\$2.24	\$2.24	\$2.24	<0.0001	\$2.24	\$9.12	\$4.29	<0.0001	\$0.66	\$2.08	\$1.11	
	Hydro-PB	E. WA		0.0001	\$8.58	\$8.58	\$8.58	0.0002	\$14.61	\$54.06	\$31.23	<0.0001	\$4.75	\$14.25	\$8.77
		WA		0.0001	\$8.68	\$8.68	\$8.68	0.0002	\$14.61	\$53.88	\$31.51	<0.0001	\$4.57	\$14.16	\$8.68
	Hydro-GF	OR		0.0001	\$9.13	\$9.13	\$9.13	0.0003	\$14.61	\$54.34	\$31.51	<0.0001	\$5.02	\$14.16	\$8.22
		MT		0.0001	\$7.76	\$7.76	\$7.76	0.0003	\$12.79	\$53.42	\$26.03	<0.0001	\$3.20	\$10.50	\$5.48
	HE-LG	E. WA	-	-	-	-	-	-	-	-	-	-	-	-	
	HE-SM	E. WA	-	-	-	-	-	-	-	-	-	-	-	-	
	Batt-LG	E. WA/N. ID	-	-	-	-	-	-	-	-	-	-	-	-	
	Batt-SM	E. WA/N. ID	-	-	-	-	-	-	-	-	-	-	-	-	
	NG-CCCT	N. ID	<0.0001	\$0.64	\$0.64	\$0.64	<0.0001	\$0.80	\$2.95	\$1.47	<0.0001	\$0.23	\$0.76	\$0.40	
	NG-CT	N. ID	<0.0001	\$3.18	\$3.18	\$3.18	<0.0001	\$3.57	\$12.90	\$6.55	<0.0001	\$0.99	\$3.38	\$1.79	



Type	Technology Abbreviation	Generator Name/ Location	Direct Impact				Indirect Impact				Induced Impact			
			Jobs/MWh	Earnings in 2021 \$/MWh	Output in 2021 \$/MWh	Value Added in 2021 \$/MWh	Jobs/MWh	Earnings in 2021 \$/MWh	Output in 2021 \$/MWh	Value Added in 2021 \$/MWh	Jobs/MWh	Earnings in 2021 \$/MWh	Output in 2021 \$/MWh	Value Added in 2021 \$/MWh
	NNG-Bio	E. WA/N. ID	-	-	-	-	-	-	-	-	-	-	-	-
	NNG-Hyd	E. WA/N. ID	-	-	-	-	-	-	-	-	-	-	-	-
	NNG-LAir	E. WA/N. ID	-	-	-	-	-	-	-	-	-	-	-	-
	NNG-CF	E. WA/N. ID	<0.0001	\$3.18	\$3.18	\$3.18	<0.0001	\$3.97	\$14.61	\$7.31	<0.0001	\$1.15	\$3.77	\$1.99
	NNG-Ren	E. WA/N. ID	-	-	-	-	-	-	-	-	-	-	-	-
	Nuclear	E. WA/N. ID	-	\$-	\$-	\$-	-	\$-	\$-	\$-	-	\$-	\$-	\$-
	Solar-Com	E. WA/N. ID	-	\$-	\$-	\$-	-	\$-	\$-	\$-	-	\$-	\$-	\$-
	Solar-Rft	E. WA/N. ID	-	\$-	\$-	\$-	-	\$-	\$-	\$-	-	\$-	\$-	\$-
	Solar-Utl	E. WA/N. ID	-	\$-	\$-	\$-	-	\$-	\$-	\$-	-	\$-	\$-	\$-
		Northwest outside of AVA area	-	\$-	\$-	\$-	-	\$-	\$-	\$-	-	\$-	\$-	\$-
		MT	<0.0001	\$0.79	\$0.79	\$0.79	<0.0001	\$1.29	\$9.01	\$5.73	<0.0001	\$1.18	\$3.79	\$2.08
	Wind-LG	E. WA	<0.0001	\$1.34	\$1.34	\$1.34	<0.0001	\$1.55	\$5.48	\$3.60	<0.0001	\$0.63	\$1.94	\$1.21
		OR/ID	<0.0001	\$1.19	\$1.19	\$1.19	<0.0001	\$1.64	\$4.96	\$2.98	<0.0001	\$0.60	\$1.79	\$1.06
	Wind-Off	Ocean off WA/OR	<0.0001	\$0.91	\$0.91	\$0.91	<0.0001	\$3.63	\$3.63	\$3.63	<0.0001	\$1.50	\$1.50	\$1.50
	Wind-SM	E. WA/N. ID	<0.0001	\$1.36	\$1.36	\$1.36	<0.0001	\$1.49	\$5.63	\$3.30	<0.0001	\$0.52	\$1.81	\$0.97







## About DNV

DNV is a global quality assurance and risk management company. Driven by our purpose of safeguarding life, property and the environment, DNV enable our customers to advance the safety and sustainability of their business. DNV provide classification, technical assurance, software and independent expert advisory services to the maritime, oil & gas, power and renewables industries. DNV also provide certification, supply chain and data management services to customers across a wide range of industries. Operating in more than 100 countries, our experts are dedicated to helping customers make the world safer, smarter and greener.

# 2023 Electric Integrated Resource Plan

## Appendix E – Transmission Designated Network Study





# Designated Network Resource Study

2022

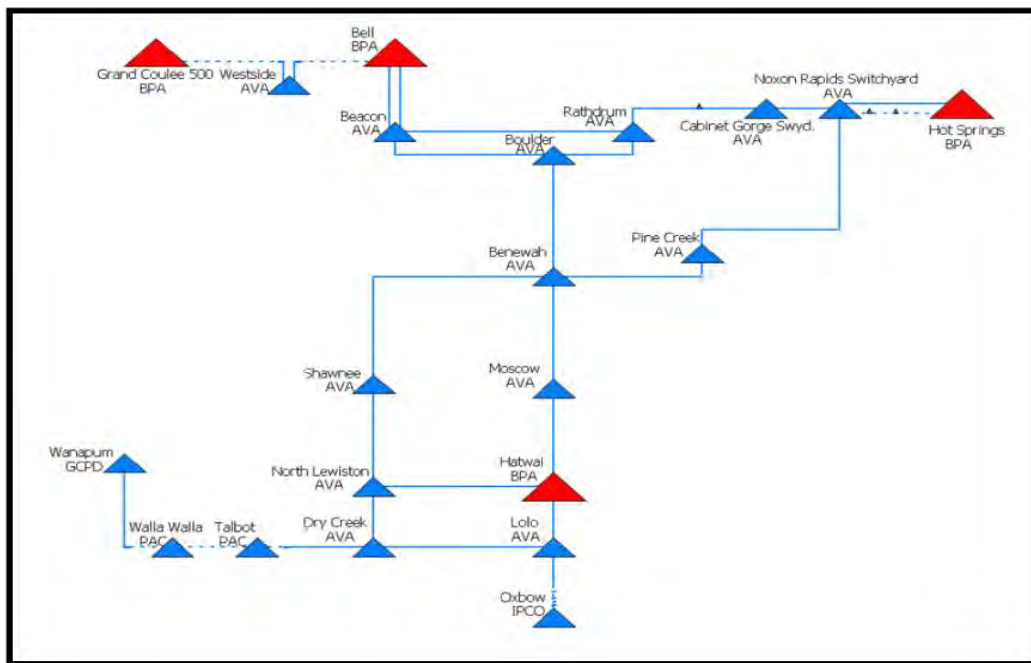

Avista 230kV Transmission System

Transmission System Planning  
 Avista Utilities  
 PO Box 3727, MSC-16  
 Spokane, WA 99220  
 TransmissionPlanning@avistacorp.com

Prepared by: Dean Spratt

Version	Date	Description	Author	Review
A	8/9/2022	Initial draft for review	Spratt	-
B	08/25/22	Updated (4) existing facility estimates	Spratt	Power Supply
C	08/30/22	Updated 115kV line estimates	Spratt	-
0	12/xx/22	Release to Customer	Spratt	Gross

## Table of Contents

1. Executive Summary .....	3
1.1. Results Summary .....	3
2. Scope of Study .....	4
2.1. Large Generation Interconnection Requests .....	5
3. Description of proposed Interconnections .....	6
3.1. Big Bend Area near Lind (Tokio).....	7
3.3. Big Bend Area near Odessa .....	10
3.5. Big Bend Area near Othello .....	13
3.6. Big Bend Area near Reardan .....	16
3.8. Clarkston/Lewiston Area .....	19
3.9. Kettle Falls Substation - Existing Generation Site.....	21
3.11. Lower Granite Area .....	24
3.12. Northeast Substation - Existing Generation Site .....	26
3.14. Palouse area near Benewah (Tekoa).....	29
3.15. Rathdrum Substation - Existing Generation Site.....	31
3.17. Rathdrum Prairie, north Greensferry Rd.....	34
3.19. West Plains Area .....	39

# 1. Executive Summary

On November 30, 2021, Avista System Planning received a study request from Avista's Power Supply Department to complete a study identifying the system impacts of integrating additional generation for native load retail customers at the following interconnection points:

- New generation sites
  - Big Bend area near Lind 100MW
  - Big Bend area near Odessa 100, 200 and 300MW
  - Big Bend area near Othello 100, 200 and 300MW
  - Big Bend area near Reardan 50 and 100MW
  - Clarkston/Lewiston area 100, 200 and 300MW
  - Lower Granite area 100 and 300MW
  - Palouse area, near Benewah 100 and 200MW
  - Palouse area, near Tekoa 100 and 200MW
  - Rathdrum Prairie, near Lancaster Rd 100, 200, 300 and 400MW
  - Tokio area, northeast of Ritzville 100 and 200MW
  - West Plains area, north of Airway Heights 100, 200 and 300MW
- Existing generation sites (increase capacity or add generation to existing POI)
  - Kettle Falls 12, 50 and 100MW
  - Northeast 10 and 100MW
  - Palouse 10 and 50MW
  - Rathdrum 25, 50, 100 and 200MW

## 1.1. Results Summary

This study presents interconnection impacts and cost estimates associated with the integration of the above resources as Network Resource Interconnection Services (NRIS). During the study process, Avista's System Planning department conducts steady state power flow analysis to determine transmission system reinforcements necessary to integrate each project. Following is a summary of the study results:

POI Station or Area	Requested (MW)	POI Voltage	Cost Estimate (\$ million)
Big Bend area near Lind (Tokio)	100/200	230kV	138.2
Big Bend area near Odessa	100	230kV	167.1
Big Bend area near Odessa	200/300	230kV	168.0
Big Bend area near Othello	100/200	230kV	222.2
Big Bend area near Othello	300	230kV	262.4
Big Bend area near Reardan	50	115kV	9.7
Big Bend area near Reardan	100	115kV	10.3
Clarkston/Lewiston area	100/200/300	230kV	1.9
Kettle Falls substation, existing POI	12/50	115kV	1.8
Kettle Falls substation, existing POI	100	115kV	24.9

POI Station or Area	Requested (MW)	POI Voltage	Cost Estimate (\$ million)
Lower Granite area	100/200/300	230kV	2.9
Northeast substation, existing POI	10	115kV	1.6
Northeast substation, existing POI	100	115kV	6.7
Palouse area, near Benewah (Tekoa)	100/200	230kV	2.4
Rathdrum substation, existing POI	25/50	115kV	11.5
Rathdrum substation, existing POI	100	230kV	16.7
Rathdrum substation, existing POI	200	230kV	27.0
Rathdrum Prairie, north Greensferry Rd	100	230kV	32.7
Rathdrum Prairie, north Greensferry Rd	200	230kV	43.0
Rathdrum Prairie, north Greensferry Rd	300	230kV	54.4
Rathdrum Prairie, north Greensferry Rd	400	230kV	91.5
Thornton substation, existing POI	10/50	230kV	1.9
West Plains area north of Airway Heights	100	115kV	2.4
West Plains area north of Airway Heights	200/300	115kV	4.7

Table 1: Summary of Estimates for Generation Interconnection Requests

The Point of Interconnection (POI) estimates for integration onto Avista's existing transmission system, listed in Table 1, are based on previous Designated Network Resource Studies and Large Generation Interconnection Request study results. The POI designations conform to the latest Avista *SP-SPP-02 – Facility Interconnection Requirements*.

## 2. Scope of Study

This study evaluates the impacts of the proposed interconnections on the reliability of the transmission system. Results are based on steady state contingency analysis, operational knowledge of the system, and results from previous generation integration studies. The study considers existing generating facilities, pending senior queued serial process interconnection requests, and interconnection requests currently in Avista's generation interconnection process. This study is for Avista's Power Supply Department to evaluate bundled retail service for native load customers only and does not replace tariffed generation interconnection process requirements for any future projects.

This interconnection study report includes the following information:

- Full contingency analysis identifying facility thermal and voltage violations resulting from the interconnection at the requested facility output level(s).
- Description and non-binding, good faith cost estimate of facilities required to interconnect the project to the Avista Transmission System and maintain reliable performance.

The transmission additions simulated in the study cases are based on the best information available at the time the study was initiated. The findings included in this study do not assure that the proposed Generation Project will be allowed to operate at full or reduced capacity under any or all operating conditions. Avista cannot guarantee future analysis (i.e. Transmission Service Requests or Operational Studies) will not identify additional problems or system constraints that require mitigation or reduced

operation. It is possible that the actual plan of service will differ from the plan of service studied, and System Planning reserves the right to restudy this request if necessary.

This study utilizes the annual Cluster Study base cases. Refer to *Avista's 2022 Generator Interconnection Cluster Study Plan*<sup>1</sup> for additional information regarding the study cases used, assumptions, and methodology.

## 2.1. Large Generation Interconnection Requests

Prospective generation may request interconnection studies to understand the cost and timelines for integrating potential new generation projects. These requests follow an interconnection process outlined in Avista's Open Access Transmission Tariff (OATT) that has been accepted by FERC. After this process is complete, a contract offer to integrate the project may occur and negotiations can begin to enter into an interconnection agreement. Table 2 lists information associated with potential third-party resource additions currently in Avista's interconnection queue.<sup>2</sup>

Serial or Cluster Number	Former Queue Number	Max MW Output	Type	County	State
Senior	46	126	Wind	Adams	WA
Senior	52	100	Solar	Adams	WA
Senior	60	150	Solar	Asotin	WA
Senior	66	71	Wood Burner/ CT	Stevens	WA
Senior	59	116	Solar/Storage	Adams	WA
Senior	63	26	Hydro	Kootenai	ID
Senior	79	2.1	Solar	Spokane	WA
Senior	80	19	Solar	Spokane	WA
Senior	84	5	Solar	Stevens	WA
Senior	97	100	Solar/Storage	Nez Perce	ID
TCS-02	62	123.2	Wind	Adams	WA
TCS-03	67	80	Solar/Storage	Adams	WA
TCS-04	73	94	Solar/Storage	Adams	WA
TCS-05	76	114.12	Solar	Grant	WA
TCS-06	81	94	Solar/Storage	Adams	WA
TCS-07	85	5	Solar	Adams	WA
TCS-08	99	200	Solar/Storage	Franklin	WA
TCS-09	100	100	Solar/Storage	Spokane	WA
TCS-10	103	40	Solar	Lincoln	WA
TCS-11	104	120	Wind	Spokane	WA
TCS-12	105	5	Solar	Stevens	WA
TCS-14	110	375	Wind/Solar/Storage	Garfield	WA
TCS-16	112	125	Solar/Storage	Lincoln	WA
TCS-18	119	200	Solar/Storage	Grant	WA

<sup>1</sup> [https://www.oasis.oati.com/woa/docs/AVAT/AVATdocs/2022\\_Generator\\_Interconnection\\_Cluster\\_Study\\_Plan\\_-\\_Final.pdf](https://www.oasis.oati.com/woa/docs/AVAT/AVATdocs/2022_Generator_Interconnection_Cluster_Study_Plan_-_Final.pdf)

<sup>2</sup> [https://www.oasis.oati.com/woa/docs/AVAT/AVATdocs/Transition\\_Cluster\\_Study\\_Queue\\_V2.pdf](https://www.oasis.oati.com/woa/docs/AVAT/AVATdocs/Transition_Cluster_Study_Queue_V2.pdf)

Table 2: Existing Large Generation Interconnection Requests

### 3. Description of proposed Interconnections

Large Generation Interconnection Requests (LGIR) are typically integrated onto Avista’s transmission system at 115kV or 230kV. The backbone of the Avista transmission system is operated at 230kV. A station-level drawing of Avista’s 230kV Transmission System including interconnections to neighboring utilities is shown below. Avista’s 230kV Transmission System is interconnected to the BPA 500kV transmission system at the Bell, Hatwai, and Hot Springs substations.

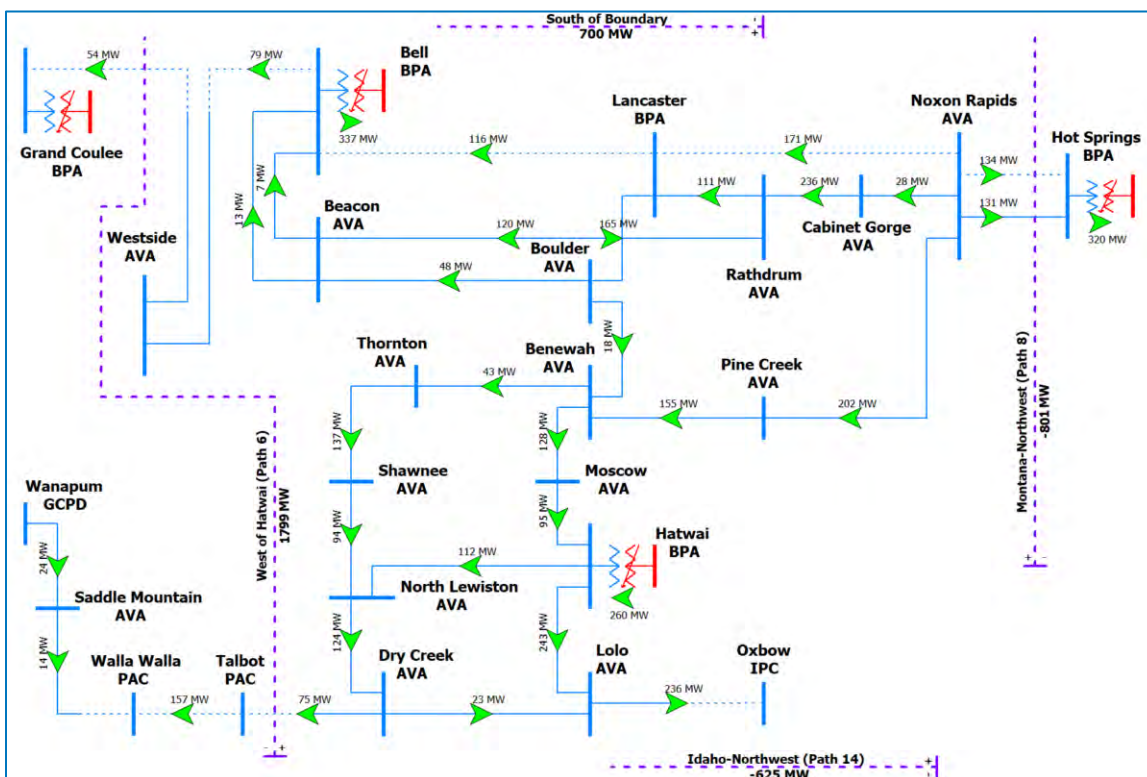

Figure 1: Avista 230kV Transmission System

The following sections describe the proposed generating facilities that have requested integration onto Avista’s Transmission System. Assumptions, alternatives, and system performance are detailed for each individual Point of Interconnection (POI).



## 3.1. Big Bend Area near Lind (Tokio)

### 3.1.1. Project description and one-line diagram

Customer has requested that 100 to 200MW of new generation be integrated onto Avista's transmission system in the Lind area. The 115kV system in the Big Bend area, specifically the Lind area, is near capacity with existing generation, plus the previously queued Interconnection Requests. Previous studies have shown that new generation in this area will require an expansion of the 230kV network into the area.

This study will assume that the 1<sup>st</sup> phase of the 230kV expansion would add a 230kV hub approximately 15 miles east of Lind then build a (53) mile radial 230kV transmission line connecting the new hub station into Avista's primary load center with a termination at the Shawnee station. This request was modeled as a new 230kV system expansion as shown below.

These results are similar for the request at Tokio, given this location is within 20 miles of 230kV network expansion.

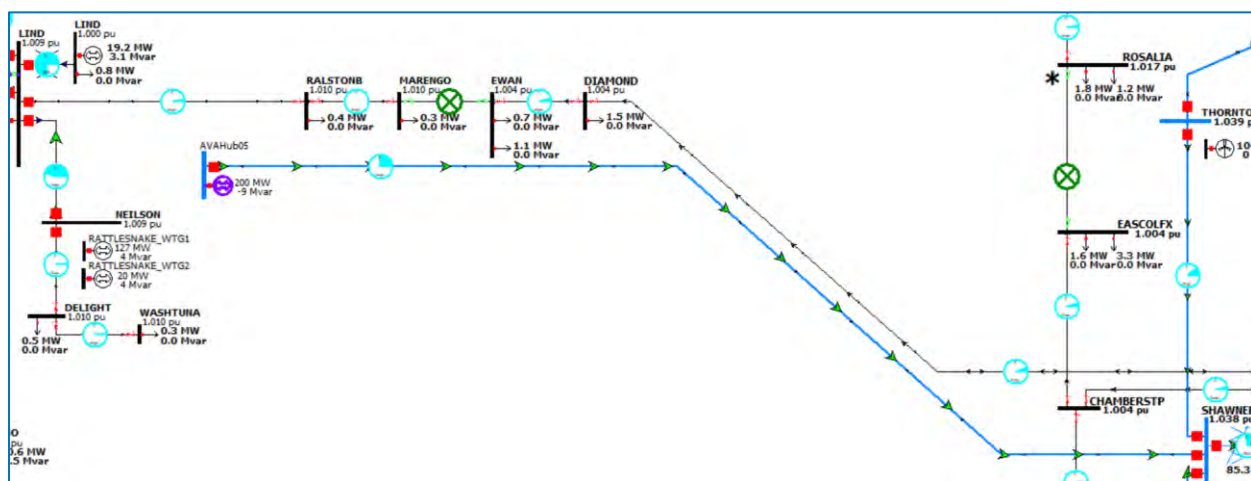

Figure 2: Proposed Generation at a 230kV Hub near Lind, 2027 Heavy Summer

System performance in this area is dominated by several factors:

- 230kV expansion transfers the proposed generation into the Palouse area.
- System flows are typically north to south.
- Existing local generation (104MW) from Palouse Wind.

In general, new generation in this area will sink into local load. As the local load service is met the additional power will flow south into the Clarkston/Lewiston load center.

### 3.1.2. Contingency Analysis

The worst system performance was during heavy summer conditions with high north to south ID-NW transfers. The issues identified below can be mitigated by adjustments to ID-NW flows. The spring and winter scenarios did not identify any issues.

Row Labels	27 HS Base	27 HS 100 MW	27 HS 200 MW
P1			
N-1: Hatwai - Lolo 230kV			
Clearwater - North Lewiston 115kV			96.4
P2			
BF: IW18 Talbot-Walla Walla, Walla Walla-Saddle Mountain			
WALAWALA (41131) -> WALA BPA (41129) CKT 3 at WALA BPA	99.1	100.2	101.2
BF: IW5 Walla Walla-Wallula, Talbot-Walla Walla			
WALAWALA (41131) -> WALA BPA (41129) CKT 3 at WALA BPA	95.5	96.5	97.6
WW CEN T (45347) -> MILL CRK (45205) CKT 1 at MILL CRK	95.7	95.7	95.8
BF: IW10 Hurricane-Walla Walla, Walla Walla 230/69 kV Transformer			
WW CEN T (45347) -> MILL CRK (45205) CKT 1 at MILL CRK	95.6	95.7	95.8
Lolo - Oxbow 230kV (Lolo - Imnaha)			95.3
BF: IW4 Walla Walla-Saddle Mountain, Walla Walla 230/69 kV Transformer			
WW CEN T (45347) -> MILL CRK (45205) CKT 1 at MILL CRK	96.2	96.3	96.4
BF: 206A Brownlee-NorthPowder, Brownlee-Oxbow #2, Brownlee T231 & T232 GSU			
DXBOW (60275) -> BROWNLEE (60095) CKT 1 at DXBOW	96	96.8	97.6
BF: IW6 Walla Walla 230/69 kV Transformer, Hurricane-Walla Walla			
WW CEN T (45347) -> MILL CRK (45205) CKT 1 at MILL CRK	95.1	95.2	95.3
Lolo - Oxbow 230kV (Lolo - Imnaha)			95.3

Table 3: Contingency Results, Heavy Summer 2027

The worst performing contingency is shown below. This is a N-1-1 loss of the 230kV lines going south into Clarkston/Lewiston, showing the system would be capable of absorbing the full output of the proposed generation.

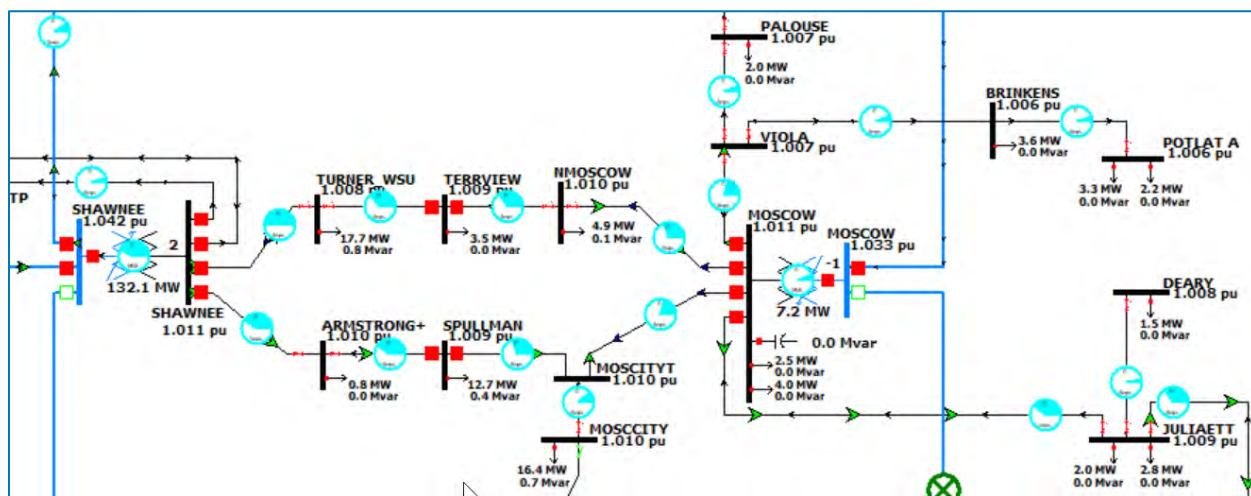

Figure 3: Worst Performing Contingency, Heavy Spring 2027

A three-phase short circuit fault at the new radially fed 230kV hub is approximately 1,000MVA, therefore new generation should be limited to about 300MW to maintain grid stability. Generation additions beyond this limit, should require a second 230kV line into the area to complete a more robust system network.

### 3.1.3. Integration costs

The Shawnee substation has a 230kV main/aux arrangement with space for a new line position and will also require a new 230kV auxiliary circuit breaker for reliability.

POI Station or Area	Cost Estimate (\$ million)
Point of Interconnection station	
New 230kV AVAHub05 station – property, termination, comms and metering	16.5
Projects necessary to mitigate new system violations at 100/200MW	
New (53) mile AVAHub05-Shawnee 230kV SCT transmission line	119.3
New 230kV line position and aux breaker at Shawnee	2.4
<b>total</b>	<b>138.2</b>

Table 4: Generation Interconnection Request Estimate

Estimates assume that the Interconnection Customer will be responsible for the lead line up to the change of ownership, which is a dead-end tower at the POI substation.

### 3.3. Big Bend Area near Odessa

#### 3.3.1. Project description and one-line diagram

Customer has requested that 100 to 300MW of new generation be integrated onto Avista's transmission system in the Odessa area. The 115kV system in the Odessa area is near capacity and existing generation at Devils Gap and Stratford is already being curtailed for multiple N-1 operational issues. Previous studies have shown that new generation in this area will require an expansion of the 230kV network.

This study assumes that the first phase of that expansion would add a 230kV hub near Odessa substation, then build a (64) mile radial 230kV transmission line that will connect to the new hub station into Avista's primary load center with a termination at the planned Bluebird station. This request was modeled as a new 230kV system expansion as shown below.

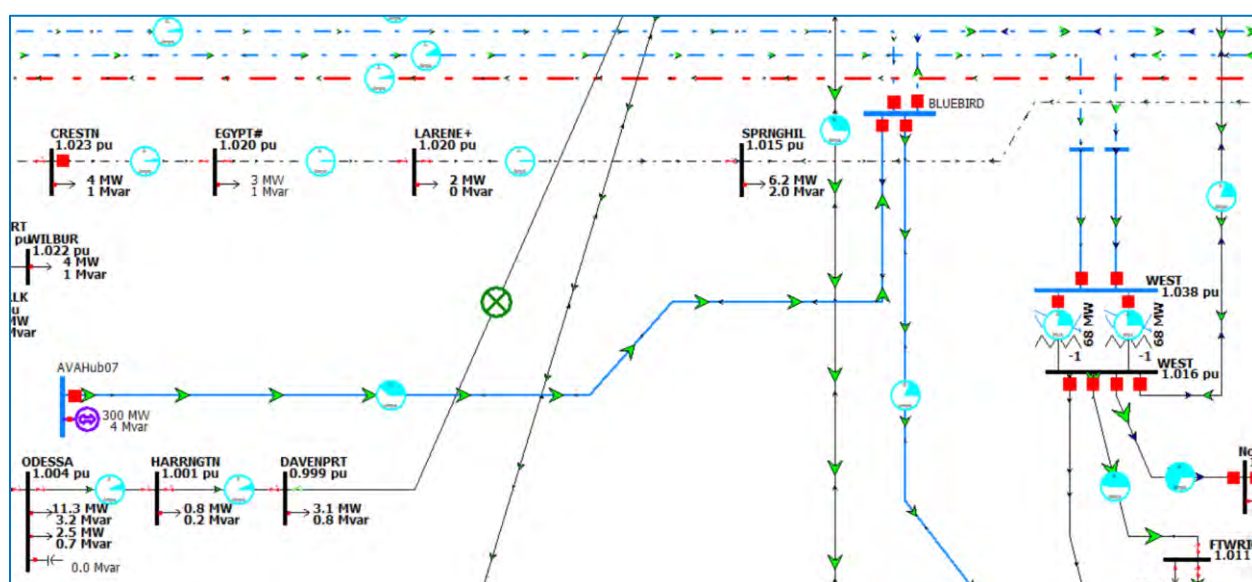

Figure 4: Proposed Generation at Bluebird 230kV, 2027 Heavy Summer

System performance in this area is dominated by several factors:

- 230kV expansion transfers the proposed generation into the West Plains area.
- System flows are typically east to west in the spring and west to east during heavy summer.
- No existing local generation.

In general, new generation in this area will sink into local load. As the local load service is met the additional power will flow east into the greater Spokane area.

#### 3.3.2. Contingency Analysis

The worst system performance was during heavy summer conditions. The issues identified below result from moving power from the West Plains into the downtown Spokane load center. The spring and winter scenarios did not identify any issues.

Row Labels	27 HS Base	27 HS 100 MW	27 HS 200 MW	27 HS 300 MW
P1				
N-1: Garden Springs - Sunset#2 115kV				
Garden Springs - Sunset#1 115kV			101.6	111.8
N-1: Garden Springs - Sunset#1 115kV				
Garden Springs - Sunset#2 115kV			101.6	111.8
P2				
BF: R427 Beacon North & South 230kV				
BELL S2 (40088) -> BELL BPA (40087) CKT 6 at BELL S2	113.8	112.9	111.9	111.1
Francis and Cedar - Northwest 115kV	95.9	96.1	96.3	96.5
Northwest - Westside 115kV		95	95.2	95.4
BF: A600 Beacon North & South 115kV				
Francis and Cedar - Northwest 115kV	100.2	98.8	97.4	96.1
Northwest - Westside 115kV	98.3	97.2	96.1	95.1
BF: AXXX9 Airway Heights - Garden Springs 115kV, Garden Springs - Sunset#1 115kV				
Garden Springs - Sunset#2 115kV			104	114.2
BF: AXXX10 Garden Springs - Westside 115kV, Garden Springs - Sunset#2 115kV				
Garden Springs - Sunset#1 115kV				103.7
BF: AXXX4 Garden Springs - Sunset#1 115kV, Ninth & Central - Sunset 115kV				
Garden Springs - Sunset#2 115kV				95.3

Table 5: Contingency Results, Heavy Summer 2027

The worst performing contingency is shown below. This is a N-1 loss of a 115kV line connecting the West Plains to downtown Spokane. Showing the system will need reinforcements as the proposed generation increases over 100MW.

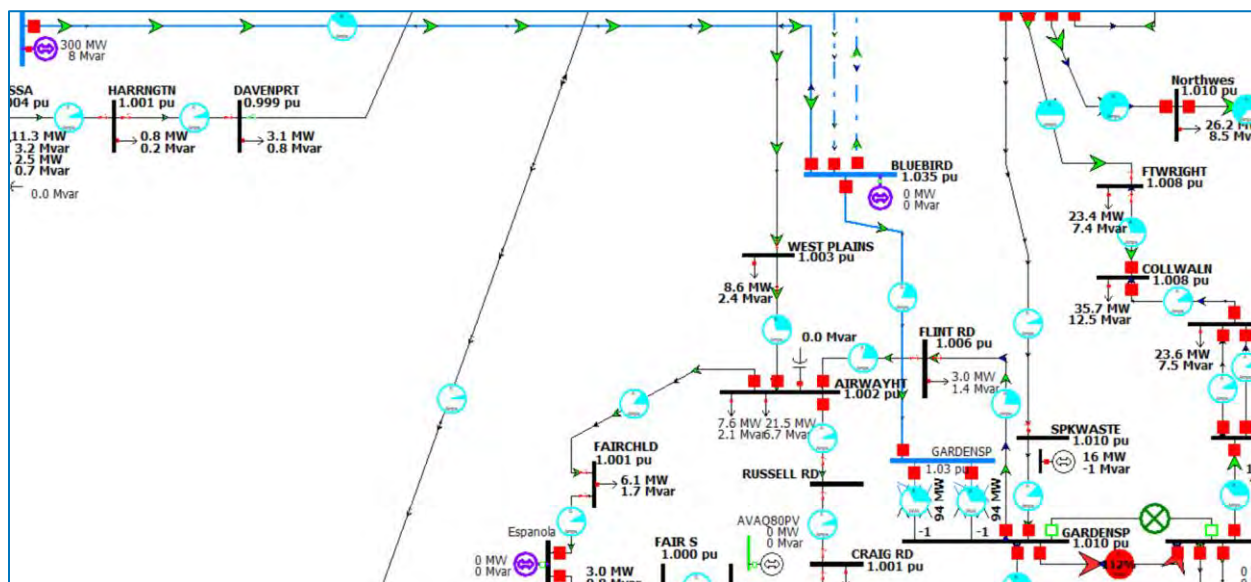

Figure 5: Worst Performing Contingency, Heavy Summer 2027

A three-phase short circuit fault at the new radially fed 230kV hub is approximately 950MVA, therefore new generation should be limited to about 300MW to maintain grid stability. Generation additions beyond this limit, should require a second 230kV line into the area to complete a more robust system network.

### 3.3.3. Integration costs

The planned Bluebird substation has a 230kV double breaker double bus arrangement with space for a new line position.

POI Station or Area	Cost Estimate (\$ million)
Point of Interconnection station	
New 230kV AVAHub07 station – property, termination, comms and metering	16.5
Projects necessary to mitigate new system violations at 100MW	
New (64) mile AVAHub07-Bluebird 230kV SCT transmission line	148.7
New 230kV line position and xfmr breaker at Bluebird	1.9
<b>total</b>	<b>167.1</b>
Projects necessary to mitigate new system violations at 200/300MW	
New (64) mile AVAHub07-Bluebird 230kV SCT transmission line	148.7
New 230kV line position and xfmr breaker at Bluebird	1.9
Rebuild GardenSprings-Sunset #1 115 kV (fix 2.3mi 556aac)	0.9
<b>total</b>	<b>168.0</b>

Table 6: Summary Estimates for Generation Interconnection

Estimates assume that the Interconnection Customer will be responsible for the lead line up to the change of ownership, which is a dead-end tower at the POI substation.

## 3.5. Big Bend Area near Othello

### 3.5.1. Project description and one-line diagram

Customer has requested that 100 to 300MW of new generation be integrated onto Avista's transmission system in the Othello area. The 115kV system in the Big Bend area is near capacity with existing generation, plus previously queued Interconnection Requests. Previous studies have shown that new generation in this area will require an expansion of the 230kV network into the area.

This study assumes that the second phase of a Big Bend 230kV expansion would add a 2<sup>nd</sup> 230kV hub approximately 6 miles east of Othello, then Avista would build a (30+53) mile radial 230kV transmission line connecting the new hub station into Avista's primary load center with a termination at the Shawnee station. This request was modeled as a new 230kV system expansion as shown below.

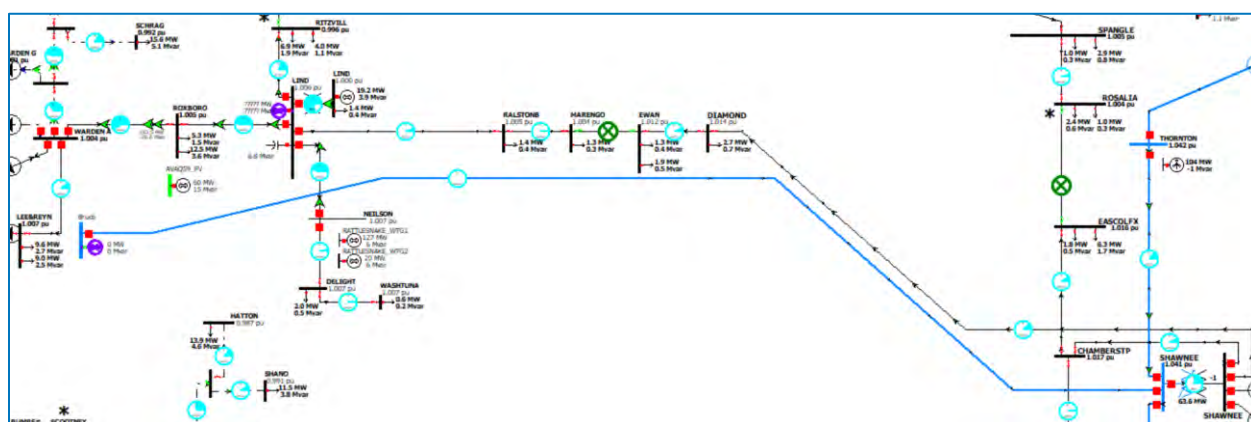

Figure 6: Proposed Generation at Shawnee 230kV, 2027 Heavy Summer

System performance in this area is dominated by several factors:

- 230kV expansion transfers the proposed generation into the Palouse area.
- System flows are typically north to south.
- Existing local generation (104 MW) from Palouse Wind.

In general, new generation in this area will sink into local load. As the local load service is met the additional power will flow south into the Clarkston/Lewiston load center.

Additionally, this long of a radial 230kV line will only support about 200MW, to meet the 300MW generation requested the above 230kV expansion would also need to be networked. This will require an additional 17 miles of new 230kV transmission and a new 230kV line termination into the existing Saddle Mountain substation as shown below.

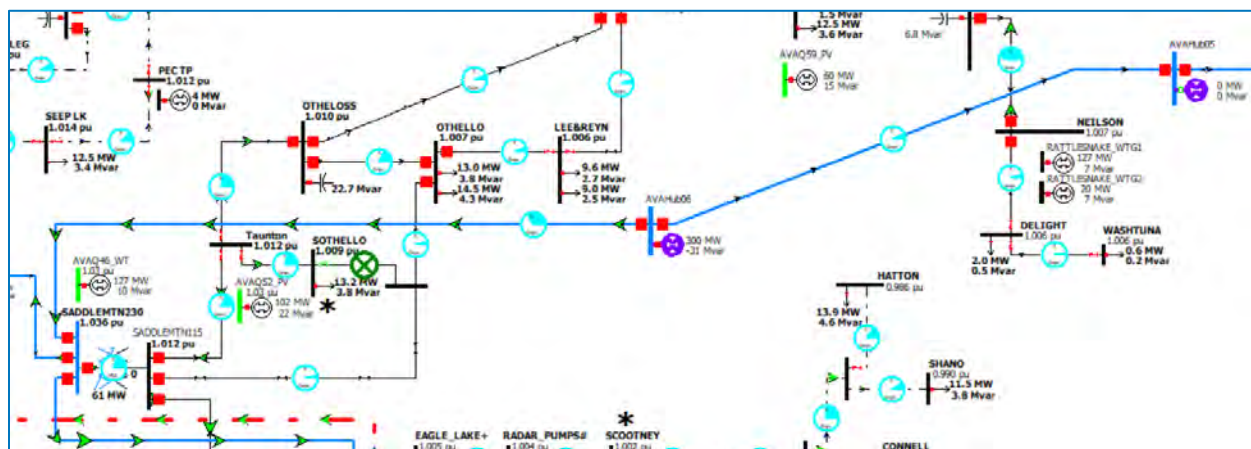

Figure 7: Proposed Generation at 230kV networked, 2027 Heavy Summer

### 3.5.2. Contingency Analysis

The worst system performance was during heavy summer conditions with high north to south ID-NW transfers. The issues identified below can be mitigated by adjustments to ID-NW flows. The spring and winter scenarios did not identify any issues.

Row Labels	27 HS Base	27 HS 100 MW	27 HS 200 MW	27 HS 300 MW
P1				
N-1: Hatwai - Lolo 230kV				
Clearwater - North Lewiston 115kV			96.4	
P2				
BF: IW18 Talbot-Walla Walla, Walla Walla-Saddle Mountain				
WALAWALA (41131) -> WALA BPA (41129) CKT 3 at WALA BPA	99.1	100.2	101.2	100.6
BF: IW5 Walla Walla-Wallula, Talbot-Walla Walla				
WALAWALA (41131) -> WALA BPA (41129) CKT 3 at WALA BPA	95.5	96.5	97.6	
WW CEN T (45347) -> MILL CRK (45205) CKT 1 at MILL CRK	95.7	95.7	95.8	96
BF: IW10 Hurricane-Walla Walla, Walla Walla 230/69 kV Transformer				
WW CEN T (45347) -> MILL CRK (45205) CKT 1 at MILL CRK	95.6	95.7	95.8	95.8
Lolo - Oxbow 230kV (Lolo - Imnaha)			95.3	
BF: IW4 Walla Walla-Saddle Mountain, Walla Walla 230/69 kV Transformer				
WW CEN T (45347) -> MILL CRK (45205) CKT 1 at MILL CRK	96.2	96.3	96.4	96.3
BF: 206A Brownlee-NorthPowder, Brownlee-Oxbow #2, Brownlee T231 & T232 GSU				
DXBDW (60275) -> BROWNLEE (60095) CKT 1 at DXBDW	96	96.8	97.6	96.3
BF: IW6 Walla Walla 230/69 kV Transformer, Hurricane-Walla Walla				
WW CEN T (45347) -> MILL CRK (45205) CKT 1 at MILL CRK	95.1	95.2	95.3	95.3
Lolo - Oxbow 230kV (Lolo - Imnaha)			95.3	

Table 7: Contingency Results, Heavy Summer 2027



The worst performing contingency is shown below. This is a N-1-1 loss of the 230kV lines going south into Clarkston/Lewiston, showing the system would be capable of absorbing the full output of the proposed generation.

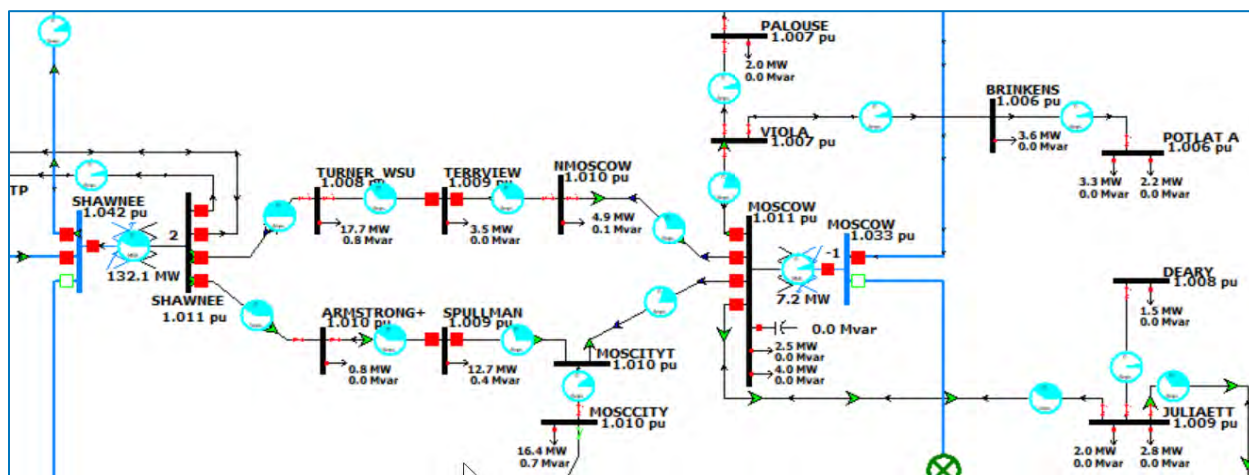

Figure 8: Worst Performing Contingency, Heavy Spring 2027

A three-phase short circuit fault at the new longer radially fed 230kV hub is approximately 650MVA, therefore new generation should be limited to about 200MW to maintain grid stability. Generation additions beyond this limit, should require a second 230kV line into the area to complete a more robust 230kV network.

### 3.5.3. Integration costs

The Shawnee substation has a 230kV main/aux arrangement with space for a new line position and will also require a 230kV auxiliary circuit breaker for reliability. The Saddle Mountain substation additionally has space to terminate a new line position.

POI Station or Area	Cost Estimate (\$ million)
Point of Interconnection station	
New 230kV AVAHub06 station – property, termination, comms and metering	16.5
Projects necessary to mitigate new system violations at 100/200MW	
New 230kV AVAHub05 station – property, termination, comms and metering	16.5
New (53) mile AVAHub05-Shawnee 230kV SCT transmission line	119.3
New (30) mile AVAHub05- AVAHub06 230kV SCT transmission line	67.5
New 230kV line position and aux breaker at Shawnee	2.4
<b>total</b>	<b>222.2</b>
Projects necessary to mitigate new system violations at 300MW	
New 230kV AVAHub05 station – property, termination, comms and metering	16.5
New (53) mile AVAHub05-Shawnee 230kV SCT transmission line	119.3
New (30) mile AVAHub05- AVAHub06 230kV SCT transmission line	67.5
New 230kV line position and xfmr breaker at Shawnee	2.4
New (17) mile AVAHub06- SaddleMtn 230kV SCT transmission line	38.3
New 230kV line position at Saddle Mountain	1.9
<b>total</b>	<b>262.4</b>

Table 8: Generation Interconnection Request Estimate

Estimates assume that the Interconnection Customer will be responsible for the lead line up to the change of ownership, which is a dead-end tower at the POI substation.

### 3.6. Big Bend Area near Reardan

#### 3.6.1. Project description and one-line diagram

Customer has requested that 50 to 100MW of new generation be integrated onto Avista's transmission system in the Big Bend area near Reardan. The Devils Gap – Lind 115 kV line is normally operated open at Ritzville, therefore any additional generation will flow north into Devils Gap, where the local hydro generation is using most of the existing transmission capacity and currently is curtailed under N-1 conditions. Adding generation only exacerbates the known issues as shown below.

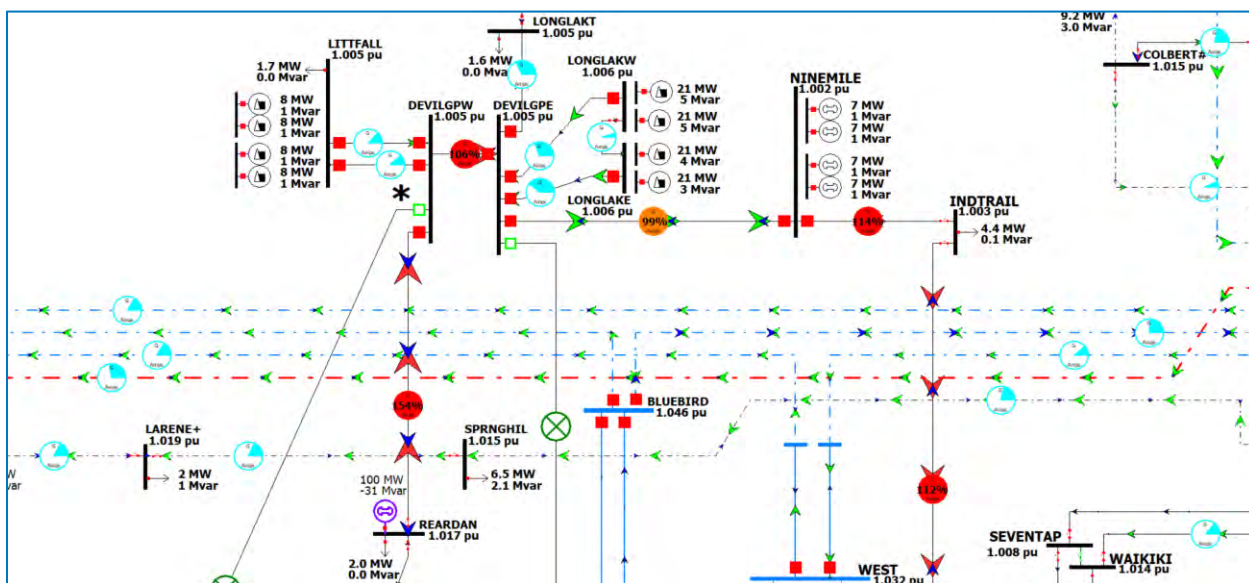

Figure 9: Proposed Generation at Reardan, 2027 Heavy Spring

Given the existing 115kV system into Devils Gap is near capacity, this request was modeled as a new 115kV switching station in the West Plains load center near Espanola on the Airway Heights – Melville 115kV line as shown below.

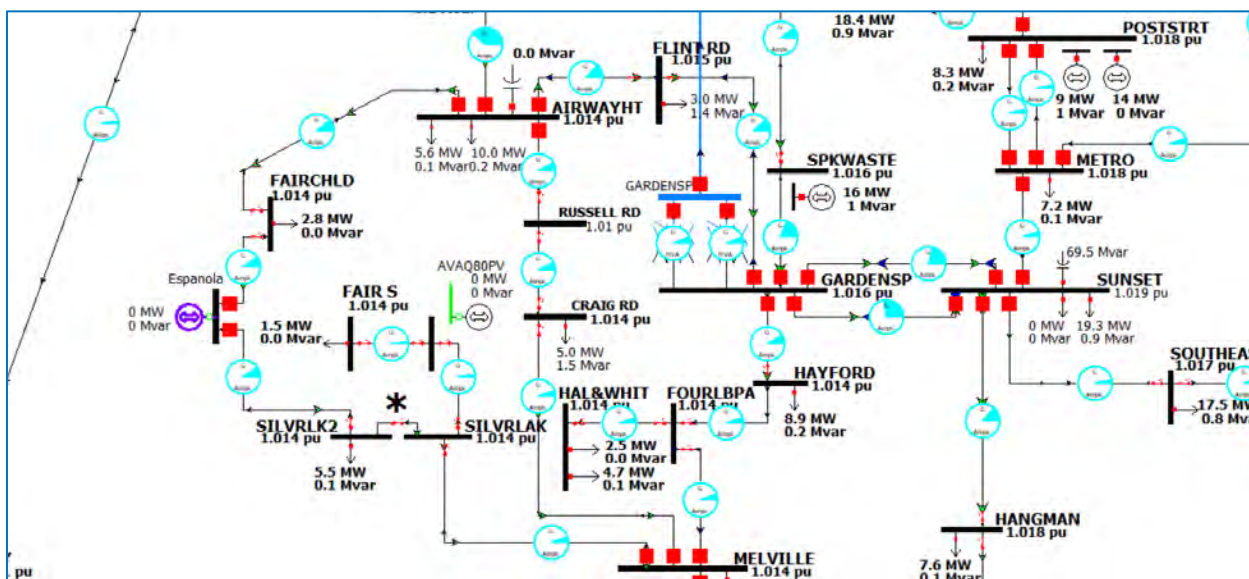

Figure 10: Proposed Generation into West Plains, 2027 Heavy Spring

System performance in this area is dominated by several factors:

- 115kV expansion transfers the proposed generation into the West Plains area.
- West Plains area load is 77MW to 160MW
- Existing local generation (18MW) from Waste to Energy.

In general, new generation in this area will sink into local load. As the local load service is met the additional power will east into the downtown Spokane load center.

### 3.6.2. Contingency Analysis

Worst system performance was during heavy spring conditions with high east to west transfers and during heavy summer conditions. Outages on the 230kV system results in overloads on the underlying 115kV system, as shown below. The winter scenarios did not identify any issues.

The worst system performance was during heavy spring conditions with high north to south ID-NW transfers. The issues identified below can be mitigated by adjustments to ID-NW flows. The spring and winter scenarios did not identify any issues.

Row Labels	27 HSp Base	27 HSp 50 MW	27 HSp 100 MW
P1			
N-I: Airway Heights - Garden Springs 115 kV			
Cheney Tap 115 kV (Four Lakes Tap - Melville)			105.3
P2			
BF: AXXX31 Airway Heights - Melville 115kV, Melville - Silver Lake 115kV			
Airway Heights - Garden Springs 115 kV (Airway Heights - Flint Rd)			99.4
Airway Heights - Garden Springs 115 kV (Flint Rd - Garden Springs)			97.2
BF: AXXX9 Airway Heights - Garden Springs 115kV, Garden Springs - Sunset#1 115kV			
Cheney Tap 115 kV (Four Lakes Tap - Melville)			104.6
P2.1			
N-I: Airway Heights - Garden Springs 115 kV Open @ AIR			
Cheney Tap 115 kV (Four Lakes Tap - Melville)			105.4
N-I: Airway Heights - Garden Springs 115 kV Open @ GSP			
Cheney Tap 115 kV (Four Lakes Tap - Melville)			102.9

Table 9: Contingency Results, Heavy Spring 2027

The worst performing contingency is shown below.

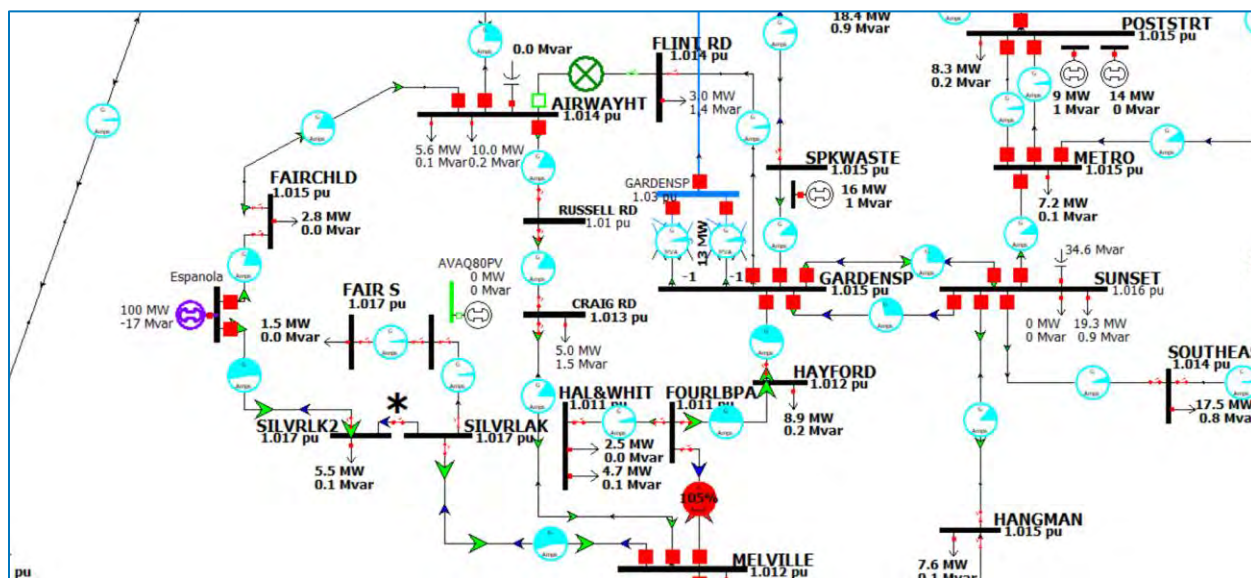

Figure 11: Worst Performing Contingency, Heavy Spring 2027

### 3.6.3. Integration costs

Integration will require a new Avista 115kV POI station on the west edge of the West Plains 115kV system.

POI Station or Area	Cost Estimate (\$ million)
Point of Interconnection station	
New 115kV Espanola station – property, termination, comms and metering	9.1
Loop-in AirwayHeights-Silverlake 115kV into POI station	0.6
Projects necessary to mitigate new system violations at 50MW	
None	0
<b>total</b>	<b>9.7</b>
Projects necessary to mitigate new system violations at 100MW	
Rebuild GardenSpr-Melville 115kV (4LK-MVL, fix 0.6mi 266acsr)	0.6
<b>total</b>	<b>10.3</b>

Table 10: Generation Interconnection Request Estimate

Estimates assume that the Interconnection Customer will be responsible for the lead line up to the change of ownership, which is a dead-end tower at the POI substation.

### 3.8. Clarkston/Lewiston Area

#### 3.8.1. Project description and one-line diagram

Customer has requested that 100 to 300MW of new generation be integrated onto Avista’s transmission system in the Clarkston/Lewiston area. This request was modeled as a new 230kV line position at the Lolo substation as shown below.

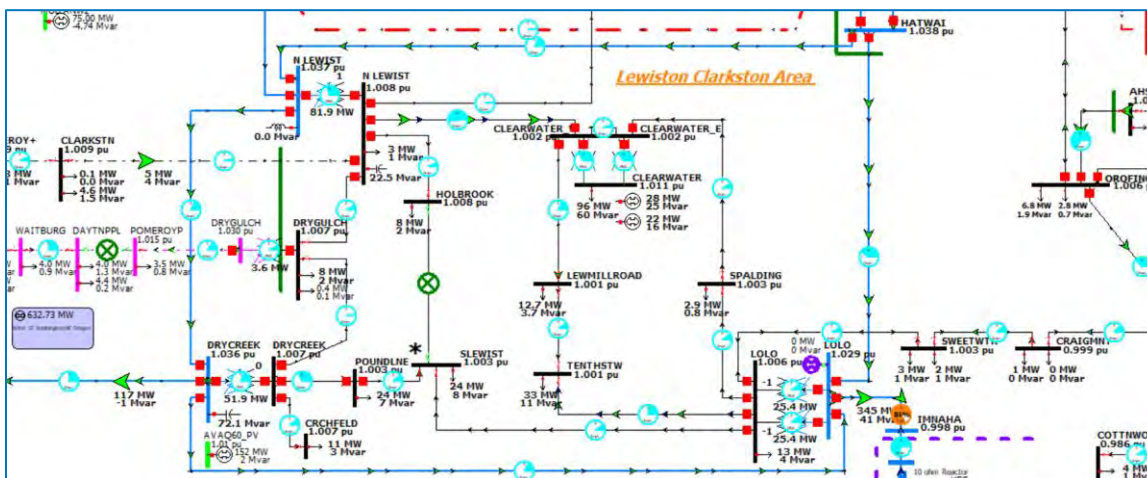

Figure 12: Proposed Generation at Lolo 230kV, 2027 Heavy Summer

System performance in this area is dominated by several factors:

- High ID-NW transfers south in late spring and early summer. Idaho Power manages ID-NW flows and will insert line reactors or redispatch generation to mitigate overloads on the Lolo-Oxbow 230kV line.
- Large wind penetration to the west around the Walla Walla and Wallula load centers.
- Existing local generation (behind the meter 48MW) from Potlatch Forest Industries.

In general, new generation in this area will sink into local load. As the local load service is met the additional power will flow south into Idaho, west into southeast Washington or up onto BPA’s 500kV system at Hatwai.

#### 3.8.2. Contingency Analysis

The worst system performance was during heavy summer conditions with high north to south ID-NW transfers. The issues identified below can be mitigated by adjustments to ID-NW flows. The spring and winter scenarios did not identify any issues.

Row Labels	27 HS Base	27 HS 100 MW	27 HS 200 MW	27 HS 300 MW
P1				
N-I: Talbot - Walla Walla 230kV				
Lolo - Oxbow 230kV (Lolo - Imnaha)				<b>95.5</b>
P2				
BF: IW18 Talbot-Walla Walla, Walla Walla-Saddle Mountain				

Row Labels	27 HS Base	27 HS 100 MW	27 HS 200 MW	27 HS 300 MW
WALAWALA (41131) -> WALA BPA (41129) CKT 3 at WALA BPA	99	100.1	101.3	102.5
Lolo - Dxbow 230kV (Lolo - Imnaha)				97.4
BF: IW5 Walla Walla-Wallula, Talbot-Walla Walla				
WALAWALA (41131) -> WALA BPA (41129) CKT 3 at WALA BPA	95.4	96.4	97.5	98.6
Lolo - Dxbow 230kV (Lolo - Imnaha)				97.2
BF: IW10 Hurricane-Walla Walla, Walla Walla 230/69 kV Transformer				
Lolo - Dxbow 230kV (Lolo - Imnaha)		95.3	97.5	99.7
BF: 206A Brownlee-NorthPowder, Brownlee-Dxbow #2, Brownlee T231 & T232 GSU				
DXBOW (60275) -> BROWNLEE (60095) CKT 1 at DXBOW	96.4	98.3	99.7	101.1
Lolo - Dxbow 230kV (Lolo - Imnaha)				96.5
BF: IW6 Walla Walla 230/69 kV Transformer, Hurricane-Walla Walla				
Lolo - Dxbow 230kV (Lolo - Imnaha)		95.3	97.5	99.7

Table 11: Contingency Results, Heavy Summer 2027

The worst performing contingency is shown below. This is a non-credible loss of the three 230kV lines into Lolo, showing that the 115kV system would be capable of absorbing the full output of the proposed generation.

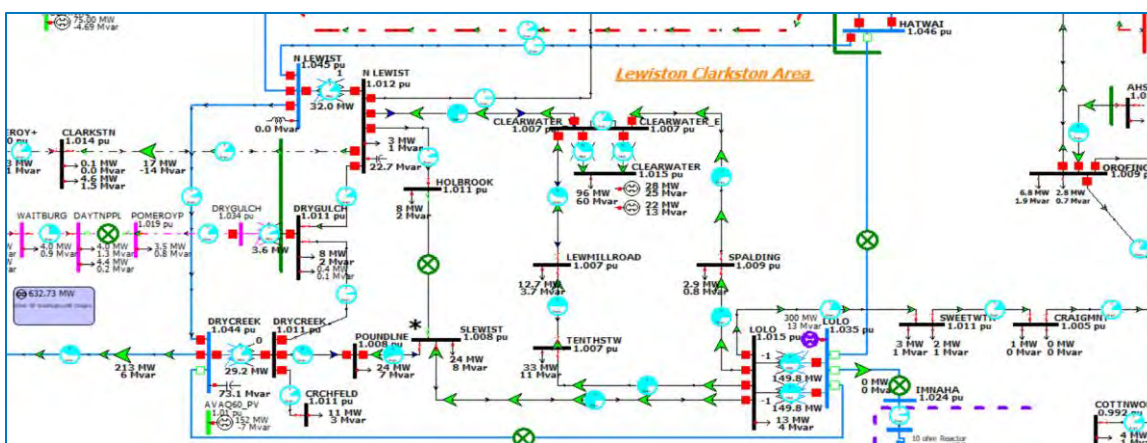

Figure 13: Worst Performing Contingency, Heavy Summer 2027

### 3.8.3. Integration costs

The Lolo substation has a 230kV double breaker bus arrangement with space for a new line position.

POI Station or Area	Cost Estimate (\$ million)
Point of Interconnection station	
New 230kV position at Lolo substation	1.9
Projects necessary to mitigate new system violations at 100/200/300MW	
None	0
<b>total</b>	<b>1.9</b>

Table 12: Generation Interconnection Request Estimate

Estimates assume that the Interconnection Customer will be responsible for the lead line up to the change of ownership, which is a dead-end tower at the POI substation.

### 3.9. Kettle Falls Substation - Existing Generation Site

#### 3.9.1. Project description and one-line diagram

Customer has requested that 12, 50 and 100MW of new generation be added to the existing Kettle Falls generation site. This request was modeled as a new 115kV line position at the Kettle Falls substation as shown below.

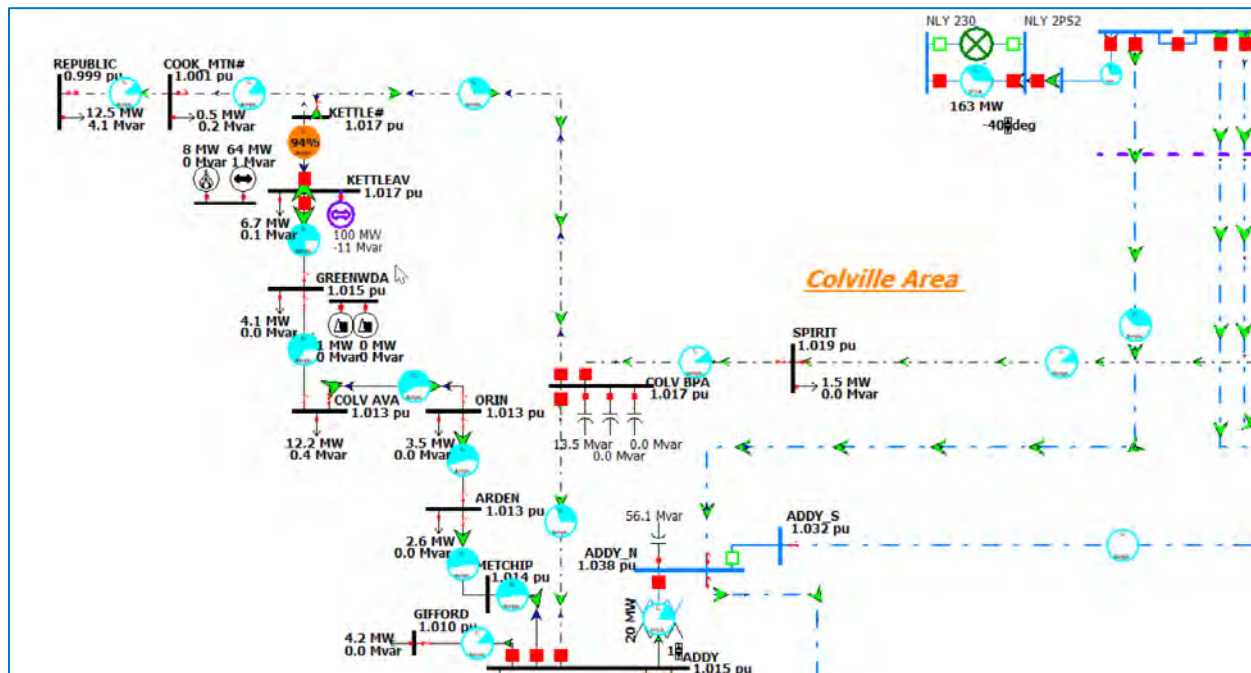

Figure 14: Proposed Generation at Kettle Falls, 2027 Heavy Spring

System performance in this area is dominated by several factors:

- North to south flows on BPA’s 230kV system and limited by the South of Boundary cut plane.
- integration primary flows into the West Plains area.
- Kettle Falls area load is 46MW to 62MW
- Existing local generation (74MW) from Kettle Falls and Meyer Falls.

In general, new generation in this area will sink into local load. As the local load service is met the additional power will flow south into the greater Colville area.

#### 3.9.2. Contingency Analysis

The worst system performance was during heavy spring conditions with high South of Boundary transfers.

Row Labels	27 HS <sub>p</sub> Base	27 HS <sub>p</sub> 12 MW	27 HS <sub>p</sub> 50 MW	27 HS <sub>p</sub> 100 MW
PI				
N-I: Addy - Kettle Falls 115 kV				
Colville - Kettle Falls 115 kV (Kettle Falls - Republic Tap)		101.1	152.3	219.9
T-I: Addy #3 230/115 kV				

Row Labels	27 HS <sub>p</sub> Base	27 HS <sub>p</sub> 12 MW	27 HS <sub>p</sub> 50 MW	27 HS <sub>p</sub> 100 MW
Colville - Kettle Falls 115 kV (Kettle Falls - Republic Tap)				<b>95.7</b>
T-1: Bell #1 500/230 kV				
Colville - Kettle Falls 115 kV (Kettle Falls - Republic Tap)				<b>97.4</b>
T-1: Boundary 230/115 kV				
Colville - Kettle Falls 115 kV (Kettle Falls - Republic Tap)				<b>100.5</b>
N-1: Kettle Falls Tap 115 kV				
Addy - Kettle Falls 115 kV (Arden Tap - Metchip)				<b>102.1</b>
Addy - Kettle Falls 115 kV (Arden Tap - Drin)				<b>104</b>
Addy - Kettle Falls 115 kV (Colville - Greenwood)				<b>115.2</b>
Addy - Kettle Falls 115 kV (Colville - Drin)				<b>106.5</b>
Addy - Kettle Falls 115 kV (Greenwood - Kettle Falls)				<b>133.7</b>
Addy - Kettle Falls 115 kV (Addy - Metchip)				<b>102.1</b>
N-1: Addy - Colville BPA 115 kV				
Addy - Kettle Falls 115 kV (Colville - Greenwood)				<b>103.7</b>
Addy - Kettle Falls 115 kV (Greenwood - Kettle Falls)				<b>120.6</b>
G-1: Boundary Units 1-6				
Colville - Kettle Falls 115 kV (Kettle Falls - Republic Tap)				<b>97</b>
G-1: Box Canyon Units 1-4				
Colville - Kettle Falls 115 kV (Kettle Falls - Republic Tap)				<b>95.9</b>
N-1: 3TM Boundary - Box Canyon - Colville BPA 115 kV				
Colville - Kettle Falls 115 kV (Kettle Falls - Republic Tap)				<b>107.7</b>
N-1: Addy - Bell 115 kV				
Colville - Kettle Falls 115 kV (Kettle Falls - Republic Tap)				<b>99.8</b>
N-1: Addy - Devils Gap 115 kV				
Colville - Kettle Falls 115 kV (Kettle Falls - Republic Tap)				<b>96.6</b>
N-1: Nine Mile - Westside 115 kV				
Colville - Kettle Falls 115 kV (Kettle Falls - Republic Tap)				<b>95.7</b>
N-1: Airway Heights - Devils Gap 115 kV				
Colville - Kettle Falls 115 kV (Kettle Falls - Republic Tap)				<b>95.5</b>
N-1: Devils Gap - Nine Mile 115 kV				
Colville - Kettle Falls 115 kV (Kettle Falls - Republic Tap)				<b>95.2</b>
<b>P7</b>				
N-2: Beacon - Greensferry 230 kV & Boulder - Lancaster 230 kV				
Boulder - Rathdrum 115kV (Moab - Pleasant)	<b>96.1</b>	<b>96.1</b>	<b>96.1</b>	<b>96.1</b>
Boulder - Rathdrum 115kV (Pleasant - Idaho Rd)	<b>101.5</b>	<b>101.5</b>	<b>101.5</b>	<b>101.6</b>
N-2: Bell - Boundary #3 230 kV & Addy - Bell 115 kV				
Colville - Kettle Falls 115 kV (Kettle Falls - Republic Tap)				<b>108.9</b>
N-2: Boundary - Usk 230 kV and 3TM Boundary - Box Canyon - Colville 115 kV				
Colville - Kettle Falls 115 kV (Kettle Falls - Republic Tap)				<b>107</b>

Table 13: Contingency Results, Heavy Spring 2027



The worst performing contingency is shown below.

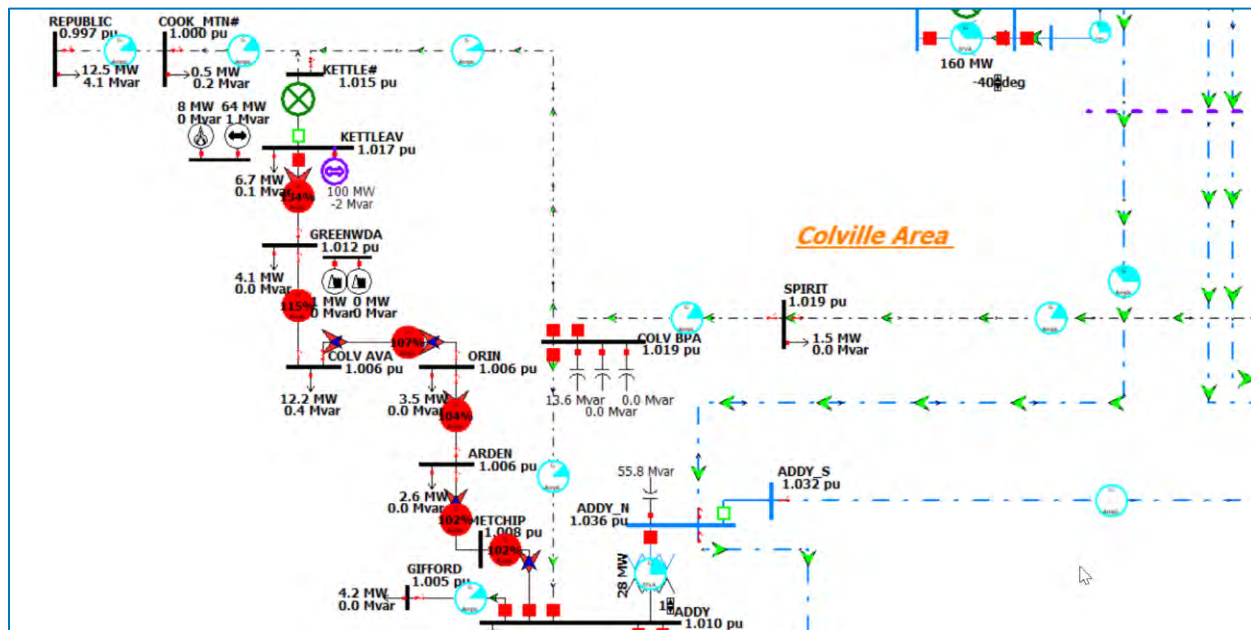

Figure 15: Worst Performing Contingency, Heavy Spring 2027

### 3.9.3. Integration costs

The Kettle Falls substation has a 115kV single bus arrangement with space for a new line position.

POI Station or Area	Cost Estimate (\$ million)
Point of Interconnection station	
New 115kV line position at Kettle Falls w/ metering & termination str	1.6
Projects necessary to mitigate new system violations at 12/50MW	
Upgrade protection at Kettle Falls A621 – KettleFalls 115kV Tap position	0.2
<b>total</b>	<b>1.8</b>
Projects necessary to mitigate new system violations at 100MW	
Upgrade protection at Kettle Falls A621 – KettleFalls 115kV Tap position	0.2
Rebuild Addy-KettleFalls 115kV (all sections, fix 27.1mi 556AAC)	23.1
<b>total</b>	<b>24.9</b>

Table 14: Generation Interconnection Request Estimate

Estimates assume that the Interconnection Customer will be responsible for the lead line up to the change of ownership, which is a dead-end tower at the POI substation.

### 3.11. Lower Granite Area

#### 3.11.1. Project description and one-line diagram

Customer has requested that 100 to 300MW of new generation, north of Lower Granite Dam, be integrated onto Avista’s transmission system in the Palouse area. This request was modeled as a new 230kV line position at Shawnee substation as shown below.

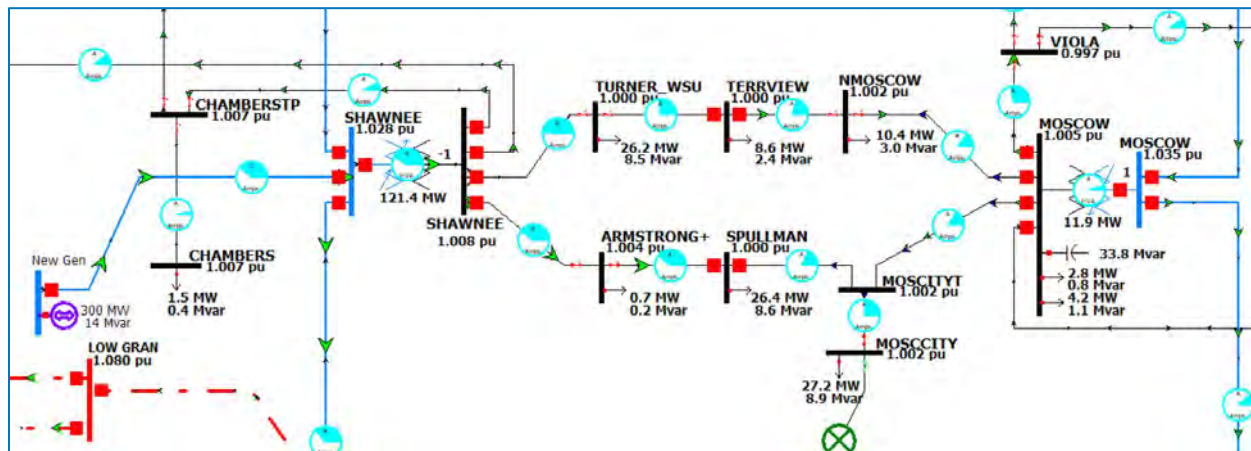

Figure 16: Proposed Generation at Shawnee 230kV, 2027 Heavy Summer

System performance in this area is dominated by several factors:

- System flows are typically north to south.
- Existing local generation (104 MW) from Palouse Wind.

In general, new generation in this area will sink into local load. As the local load service is met the additional power will flow south into the Clarkston/Lewiston load center.

#### 3.11.2. Contingency Analysis

The worst system performance was during heavy summer conditions with high north to south ID-NW transfers. The issues identified below can be mitigated by adjustments to ID-NW flows. The spring and winter scenarios did not identify any issues.

Row Labels	27 HS Base	27 HS 100 MW	27 HS 200 MW	27 HS 300 MW
P1				
N-I: Hatwai - Lolo 230kV				
Clearwater - North Lewiston 115kV			96.4	97.5
P2				
BF: IW18 Talbot-Walla Walla, Walla Walla-Saddle Mountain				
WALAWALA (41131) -> WALA BPA (41129) CKT 3 at WALA BPA	99.1	100.2	101.2	102.3
BF: IW5 Walla Walla-Wallula, Talbot-Walla Walla				
WALAWALA (41131) -> WALA BPA (41129) CKT 3 at WALA BPA	95.5	96.5	97.6	98.5
WW GEN T (45347) -> MILL CRK (45205) CKT 1 at MILL CRK	95.7	95.7	95.8	95.8
BF: IW10 Hurricane-Walla Walla, Walla Walla 230/69 kV Transformer				

WW GEN T (45347) -> MILL CRK (45205) CKT I at MILL CRK	95.6	95.7	95.8	96
Lolo - Oxbow 230kV (Lolo - Imnaha)			95.3	96.5
BF: IW4 Walla Walla-Saddle Mountain, Walla Walla 230/69 kV Transformer				
WW GEN T (45347) -> MILL CRK (45205) CKT I at MILL CRK	96.2	96.3	96.4	96.6
BF: 206A Brownlee-NorthPowder, Brownlee-Oxbow #2, Brownlee T231 & T232 GSU				
DXBOW (60275) -> BROWNLEE (60095) CKT I at DXBOW	96	96.8	97.6	98.3
BF: IW6 Walla Walla 230/69 kV Transformer, Hurricane-Walla Walla				
WW GEN T (45347) -> MILL CRK (45205) CKT I at MILL CRK	95.1	95.2	95.3	95.5

Table 15: Contingency Results, Heavy Summer 2027

The worst performing contingency is shown below. This is a N-1-1 loss of the 230kV lines going south into Clarkston/Lewiston, showing the system would be capable of absorbing the full output of the proposed generation.

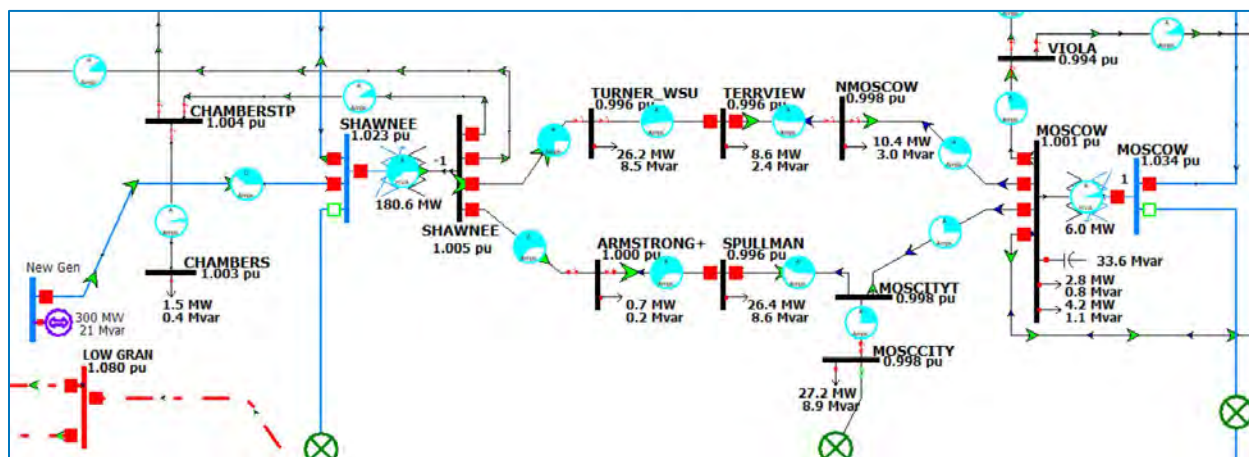

Figure 17: Worst Performing Contingency, Heavy Spring 2027

### 3.11.3. Integration costs

The Shawnee substation has a 230kV main/aux arrangement with space for a new line position and will also require a new 230kV auxiliary circuit breaker for reliability.

POI Station or Area	Cost Estimate (\$ million)
Point of Interconnection station	
New 230kV line position and aux breaker at Shawnee	2.4
New 230kV termination structure, comms and metering	0.5
Projects necessary to mitigate new system violations at 100/200/300MW	
None	0
<b>total</b>	<b>2.9</b>

Table 16: Generation Interconnection Request Estimate

Estimates assume that the Interconnection Customer will be responsible for the lead line up to the change of ownership, which is a dead-end tower at the POI substation.

### 3.12. Northeast Substation - Existing Generation Site

#### 3.12.1. Project description and one-line diagram

Customer has requested that 50 and 100MW of new generation be integrated onto Avista’s transmission system in the northern Spokane area. This request was modeled as a new 115kV line position at Northeast substation as shown below.

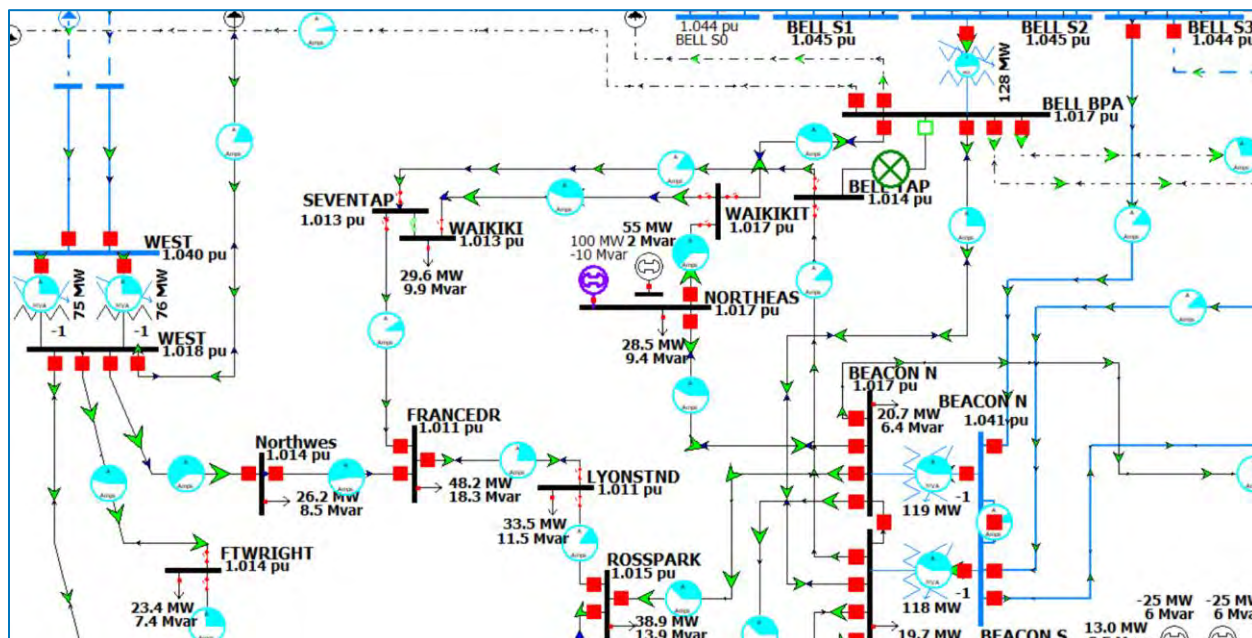

Figure 18: Proposed Generation at Northeast, 2027 Heavy Summer

System performance in this area is dominated by several factors:

- Site is between the two primary sources for the Spokane area, which are Bell and Beacon substations.
- North to south flows during heavy summer.
- Loading on this 115kV line is 24MW to 59MW
- Existing local generation (55MW) from Northeast CT’s.

In general, new generation in this area will sink into local load. As the local load service is met the additional power will flow south into the greater Spokane area.

#### 3.12.2. Contingency Analysis

The worst system performance was during heavy summer conditions with high north to south flows.

Row Labels	27 HS Base	27 HS 10 MW	27 HS 100 MW
PI			
N-I: Bell - Northeast 115 kV			
Beacon - Northeast 115 kV			105.6
N-I: Beacon - Northeast 115 kV			

Row Labels	27 HS Base	27 HS 10 MW	27 HS 100 MW
Bell - Northeast 115 kV (Waikiki Tap - Northeast)			102.7
T-1: Bell #6 230/115 kV			
Bell - Northeast 115 kV (Waikiki Tap - Northeast)			108.9
P2			
BF: A370 Bell S1 & S2 230 kV			
Bell - Northeast 115 kV (Waikiki Tap - Northeast)			105.7
BF: A388 Bell S2 & S3 230 kV			
Bell - Northeast 115 kV (Waikiki Tap - Northeast)			101
BF: B356 Bell 115 kV, Bell-Northeast			
Beacon - Northeast 115 kV			105.5
BF: R427 Beacon North & South 230 kV			
BELL S2 (40088) -> BELL BPA (40087) CKT 6 at BELL S2	103.2	101.1	
BF: A600 Beacon North & South 115 kV			
Francis and Cedar - Northwest 115 kV	101.2	101.2	101.3
Northwest - Westside 115 kV	99.1	99.1	99.2
Bell - Northeast 115 kV (Waikiki Tap - Northeast)			102
BUS: Beacon North 115 kV			
Bell - Northeast 115 kV (Waikiki Tap - Northeast)			102.6
BUS: Bell S2 230 kV			
Bell - Northeast 115 kV (Waikiki Tap - Northeast)			106.7
P2.1			
N-1: Bell - Northeast 115 kV Open @ NE			
Beacon - Northeast 115 kV			105.8

Table 17: Contingency Results, Heavy Summer 2027

The worst performing contingency is shown below.

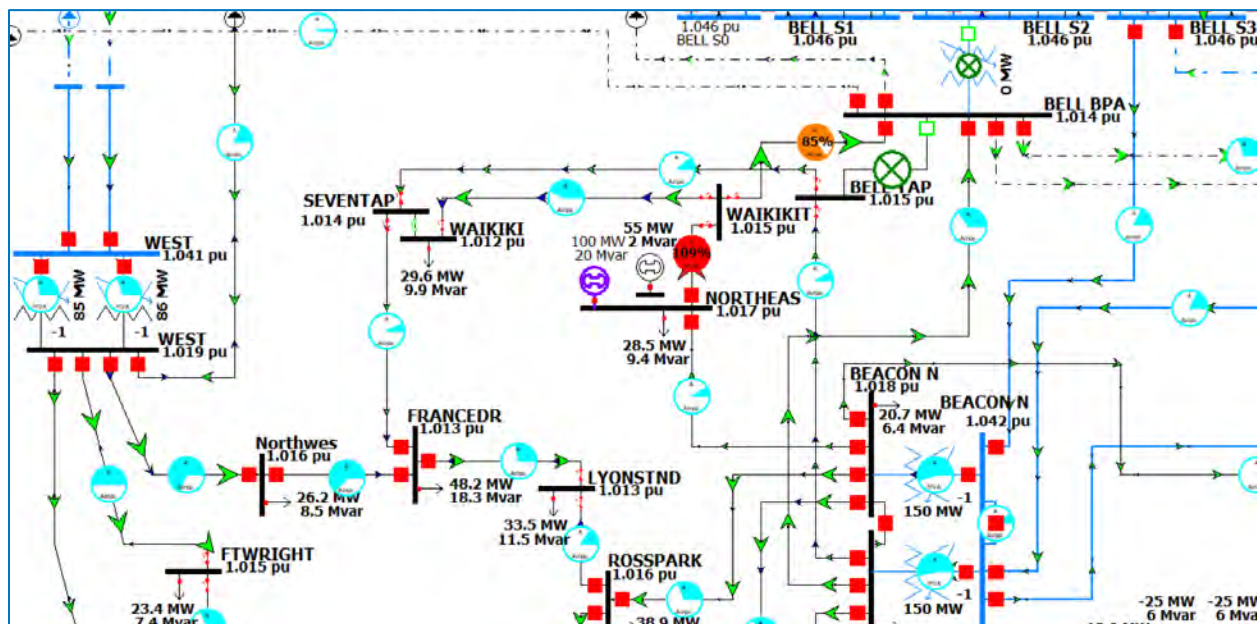

Figure 19: Worst Performing Contingency, Heavy Spring 2027

### 3.12.3. Integration costs

The Northeast substation has a 115kV single bus arrangement with space for a new line position.

POI Station or Area	Cost Estimate (\$ million)
Point of Interconnection station	
New 115kV line position at Northeast w/ metering & termination structure	1.6
Projects necessary to mitigate new system violations at 10MW	
None	0
<b>total</b>	<b>1.6</b>
Projects necessary to mitigate new system violations at 100MW	
Rebuild Beacon-Northeast 115kV (fix 5.25mi 556acsr)	3.9
Rebuild Bell-Northeast 115kV (fix 1.53mi 556acsr)	1.2
<b>total</b>	<b>6.7</b>

8Table 18: Generation Interconnection Request Estimate

Estimates assume that the Interconnection Customer will be responsible for the lead line up to the change of ownership, which is a dead-end tower at the POI substation.

### 3.14. Palouse area near Benewah (Tekoa)

#### 3.14.1. Project description and one-line diagram

Customer has requested that 100 to 200MW of new generation be integrated onto Avista’s transmission system in the northern Palouse area. This request was modeled as a new 230kV line position at Benewah substation as shown below.

These results are similar for the request at Tekoa, given this location is within 10 miles of Benewah substation.

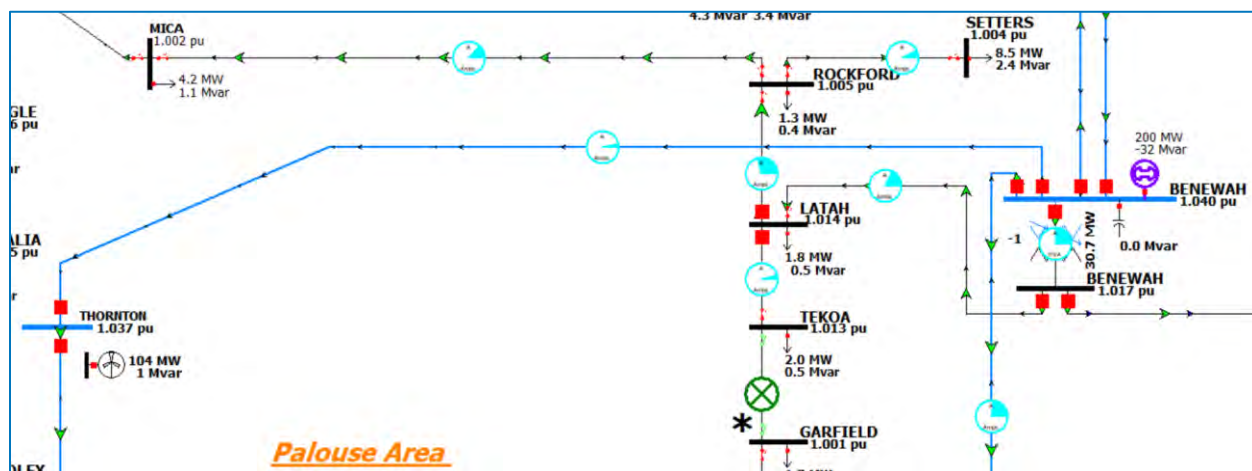

Figure 20: Proposed Generation at Benewah 230kV, 2027 Heavy Summer

System performance in this area is dominated by several factors:

- System flows are typically north to south.
- Existing local generation (104 MW) from Palouse Wind.

In general, new generation in this area will sink into local load. As the local load service is met the additional power will flow south into the Clarkston/Lewiston load center.

#### 3.14.2. Contingency Analysis

The worst system performance was during heavy summer conditions with high north to south ID-NW transfers. The issues identified below can be mitigated by adjustments to ID-NW flows. The spring and winter scenarios did not identify any issues.

Row Labels	27 HS Base	27 HS 100 MW	27 HS 200 MW
P1			
N-1: Hatwai - Lolo 230 kV			
Clearwater - North Lewiston 115 kV		95.2	95.7
P2			
BF: IW18 Talbot-Walla Walla, Walla Walla-Saddle Mountain			
WALAWALA (41131) -> WALA BPA (41129) CKT 3 at WALA BPA	99	99.6	100.2
BF: IW5 Walla Walla-Wallula, Talbot-Walla Walla			
WALAWALA (41131) -> WALA BPA (41129) CKT 3 at WALA BPA	95.4	96	96.6
WW GEN T (45347) -> MILL CRK (45205) CKT 1 at MILL CRK	95.6	95.7	95.7

BF: IW10 Hurricane-Walla Walla, Walla Walla 230/69 kV Transformer WW CEN T (45347) -> MILL CRK (45205) CKT 1 at MILL CRK	95.3	95.4	95.4
BF: IW3 Walla Walla-Wallula, Walla Walla 230/69 kV Transformer WW CEN T (45347) -> MILL CRK (45205) CKT 1 at MILL CRK	96.4	96.5	96.5
BF: IW4 Walla Walla-Saddle Mountain, Walla Walla 230/69 kV Transformer WW CEN T (45347) -> MILL CRK (45205) CKT 1 at MILL CRK	96	96.1	96.1
BF: 206A Brownlee-NorthPowder, Brownlee-Oxbow #2, Brownlee T231 & T232 GSU OXBOW (60275) -> BROWNLEE (60095) CKT 1 at OXBOW	96.5	96.9	97.3
BF: IW6 Walla Walla 230/69 kV Transformer, Hurricane-Walla Walla WW CEN T (45347) -> MILL CRK (45205) CKT 1 at MILL CRK			95

Table 19: Contingency Results, Heavy Summer 2027

The worst performing contingency is shown below. This is a N-1-1 loss of the 230kV lines going south into Clarkston/Lewiston, showing the system would be capable of absorbing the full output of the proposed generation.

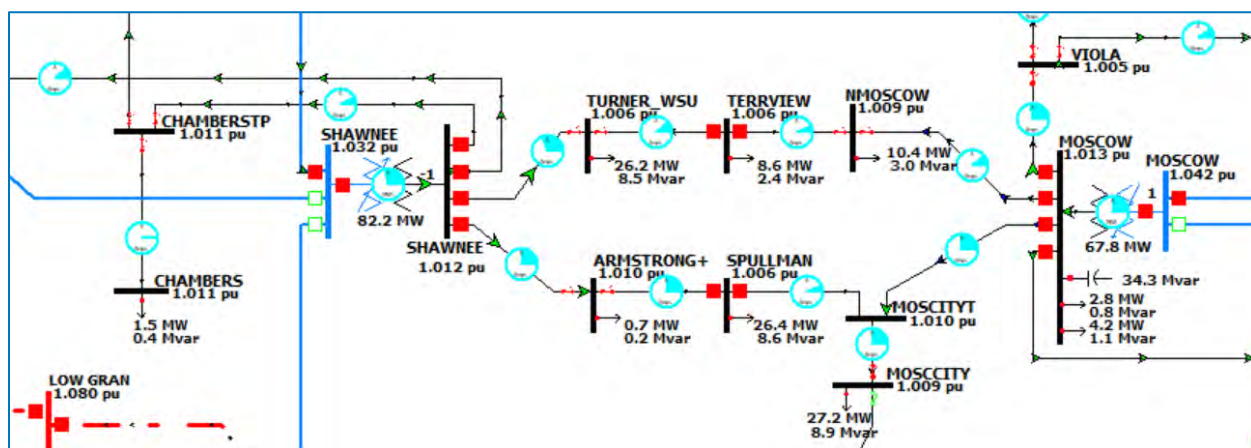

Figure 21: Worst Performing Contingency, Heavy Spring 2027

### 3.14.3. Integration costs

The Benewah substation has a 230kV double breaker double bus arrangement with space to terminate a new line position.

POI Station or Area	Cost Estimate (\$ million)
Point of Interconnection station	
New 230kV line position at Benewah	2.4
Projects necessary to mitigate new system violations at 100/200/MW	
None	0
<b>total</b>	<b>2.4</b>

Table 20: Generation Interconnection Request Estimate

Estimates assume that the Interconnection Customer will be responsible for the lead line up to the change of ownership, which is a dead-end tower at the POI substation.



## 3.15. Rathdrum Substation - Existing Generation Site

### 3.15.1. Project description and one-line diagram

Customer has requested that 25, 50, 100 and 200MW of new generation be integrated onto Avista's transmission system in the northern Rathdrum Prairie area. The 25MW and 50MW requests were modeled as a new 115kV line position at Rathdrum substation. The 100MW and 200MW requests were modeled as a new 230kV line position at Rathdrum substation.

The existing Rathdrum CT's utilize 140 MW of the available integration capacity on the 115kV portion of the Rathdrum substation, leaving only 60 MW available per Avista's interconnection standard. Both integration points are shown below.

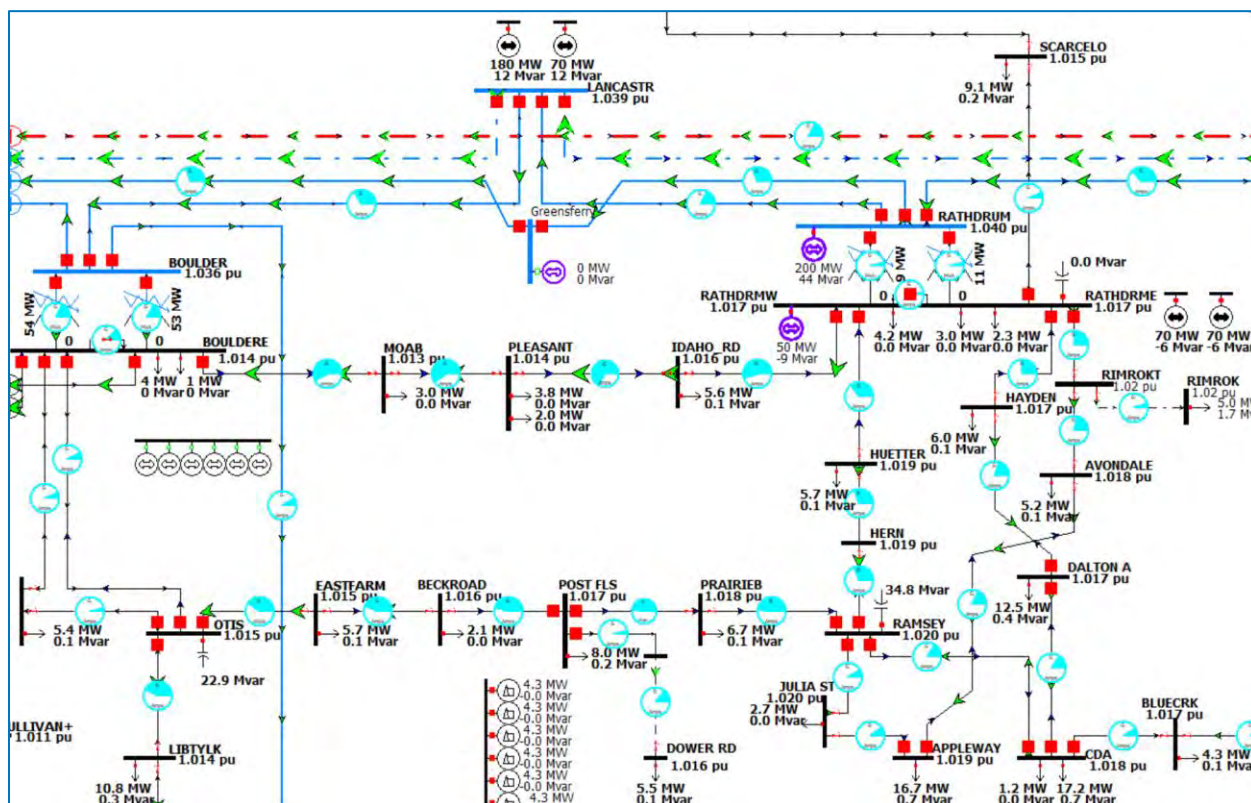

Figure 22: Proposed Generation at Rathdrum, 2027 Heavy Spring

System performance in this area is dominated by several factors:

- High east to west transfers on the Cabinet – Rathdrum and Lancaster – Noxon 230kV transmission lines during spring runoff.
- Typical outflows to the west on the Beacon – Rathdrum, Bell – Lancaster, and Boulder – Lancaster 230kV transmission lines.
- Load in the Coeur d' Alene area is primarily served from the Rathdrum station.
- Existing local generation (440MW) from Boulder, Lancaster, Post Falls, and Rathdrum stations.

In general, new generation in this area will sink into local load. As the local load is met the additional power will typically flow west into the Spokane load center or further west on BPA's 230kV system and up onto BPA's 500kV system at Bell.

### 3.15.2. Contingency Analysis

Worst system performance was during heavy spring conditions with high east to west transfers. Outages on the 230kV system results in overloads on the underlying 115kV system, as shown below. The summer and winter scenarios did not identify any issues.

Row Labels	27 HSp Base	27 HSp 25 MW	27 HSp 50 MW	27 HSp 100 MW	27 HSp 200 MW
<b>P2</b>					
BF: R427 Beacon North & South 230 kV					
Boulder - Irvin #1 115 kV (Boulder - Spokane Industrial Park)	100.3	102.1	104	106.8	113.4
Boulder - Irvin #1 115 kV (Irvin - Spokane Industrial Park)					95.8
<b>P7</b>					
N-2: Beacon - Greensferry 230 kV & Boulder - Lancaster 230 kV					
Boulder - Rathdrum 115kV (Moab - Pleasant)	99.1	102.9	106.8	108.8	118.7
Boulder - Rathdrum 115kV (Boulder - Moab)	96.3	100.1	103.9	105.9	115.9
Boulder - Rathdrum 115kV (Pleasant - Idaho Rd)	104.5	108.3	112.2	114.2	124.1
Post Falls - Ramsey 115kV (Post Falls - Prairie)					98
Boulder - Rathdrum 115kV (Idaho Rd - Rathdrum)					99.6
N-2: Greensferry - Rathdrum 230 kV & Lancaster - Rathdrum 230 kV					
Boulder - Rathdrum 115kV (Moab - Pleasant)	98	104.4	110.7	120.3	142.6
Boulder - Rathdrum 115kV (Boulder - Moab)	95.2	101.6	107.9	117.5	139.8
Boulder - Rathdrum 115kV (Pleasant - Idaho Rd)	103.4	109.8	116.1	125.7	148
Post Falls - Ramsey 115kV (Post Falls - Prairie)				99.2	118.5
Boulder - Rathdrum 115kV (Idaho Rd - Rathdrum)				100.8	118
Post Falls - Ramsey 115kV (Prairie - Ramsey)					103.4
Otis Orchard - Post Falls 115 kV (East Farms Tap - Beck Road Tap)					98.3
Otis Orchard - Post Falls 115 kV (Beck Road Tap - Post Falls)					99.9
N-2: Beacon - Boulder 230 kV & Boulder - Irvin #2 115 kV					
Boulder - Irvin #1 115 kV (Boulder - Spokane Industrial Park)	99.3	101.4	103.5	105.4	111.7
N-2: Beacon - Boulder 230 kV & Beacon - Greensferry 230 kV					
Boulder - Irvin #1 115 kV (Boulder - Spokane Industrial Park)	95.4	97.4	99.5	102.5	109.9

Table 21: Contingency Results, Heavy Spring 2027

The worst performing contingency is shown below. This shows the underlying 115kV system over capacity for the double-circuit outage.

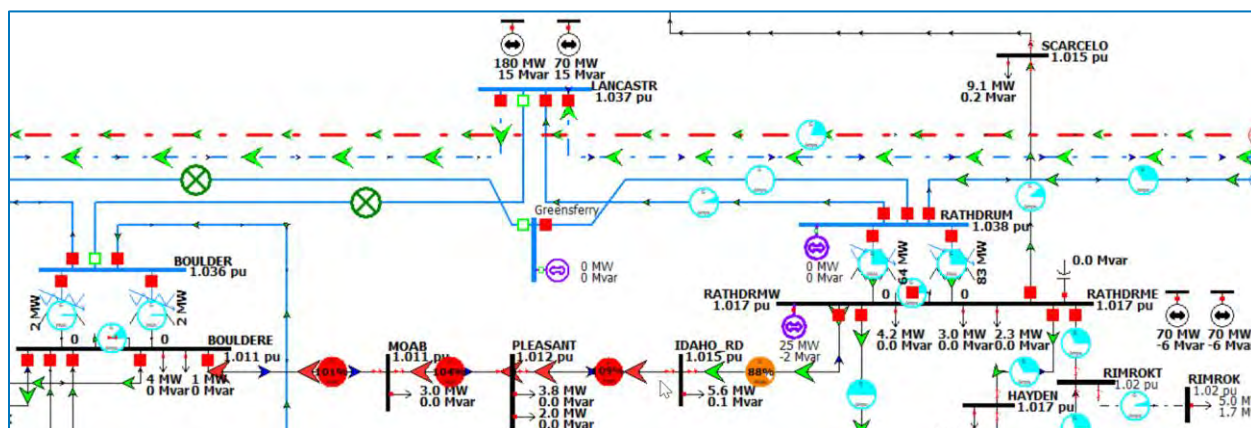

Figure 23: Worst Performing Contingency, Heavy Spring 2027

### 3.15.3. Integration costs

BPA's Lancaster substation is a 230kV ring-bus arrangement and is not designed to be expanded. Integration will require a new Avista 230kV POI station west of BPA's Lancaster station.

POI Station or Area	Cost Estimate (\$ million)
Point of Interconnection station	
New 115kV line position at Rathdrum w/ metering & termination str	1.6
New 230kV line position at Rathdrum w/ metering & termination str	1.9
Projects necessary to mitigate new facility violations at 25/50MW at 115kV	
Rebuild Boulder-Irvin #1 115kV (BLD-SIP, fix 1.8mi 556aac)	0.7
Rebuild Boulder-Rathdrum 115kV (BLD-IDR, fix 9.2mi 250cu & 337acsr)	9.2
<b>total</b>	<b>11.5</b>
Projects necessary to mitigate new facility violations at 100MW at 230kV	
Rebuild Boulder-Irvin #1 115kV (BLD-SIP, fix 1.8mi 556aac)	0.7
Rebuild Boulder-Rathdrum 115kV (fix 11.2mi 250cu, 337acsr & 556aac)	11.2
Rebuild PostFalls-Ramsey 115kV (PF-PRA, fix 2.9mi 250cu)	2.9
<b>total</b>	<b>16.7</b>
Projects necessary to mitigate new facility violations at 200MW at 230kV	
Rebuild Boulder-Irvin #1 115kV (BLD-SIP, fix 1.8mi 556aac)	0.7
Rebuild Boulder-Rathdrum 115kV (fix 14.7mi 250cu, 337acsr & 556/795aac)	14.7
Rebuild PostFalls-Ramsey 115kV (all sections, fix 4.9mi 250cu & 556aac)	4.9
Rebuild OtisOrchards-PostFalls 115kV (EFM-PF, fix 4.8mi 250cu & 556aac)	4.8
<b>total</b>	<b>27.0</b>

Table 22: Generation Interconnection Request Estimate

Estimates assume that the Interconnection Customer will be responsible for the lead line up to the change of ownership, which is a dead-end tower at the POI substation.

## 3.17. Rathdrum Prairie, north Greensferry Rd

### 3.17.1. Project description and one-line diagram

Customer has requested that 100 to 400MW of new generation be integrated onto Avista's Transmission System in the Rathdrum Prairie area near Greensferry Road. This request was modeled as a new station approximately 2.75 electrical miles southwest of Rathdrum station on the Beacon – Rathdrum 230kV Transmission Line as shown below.

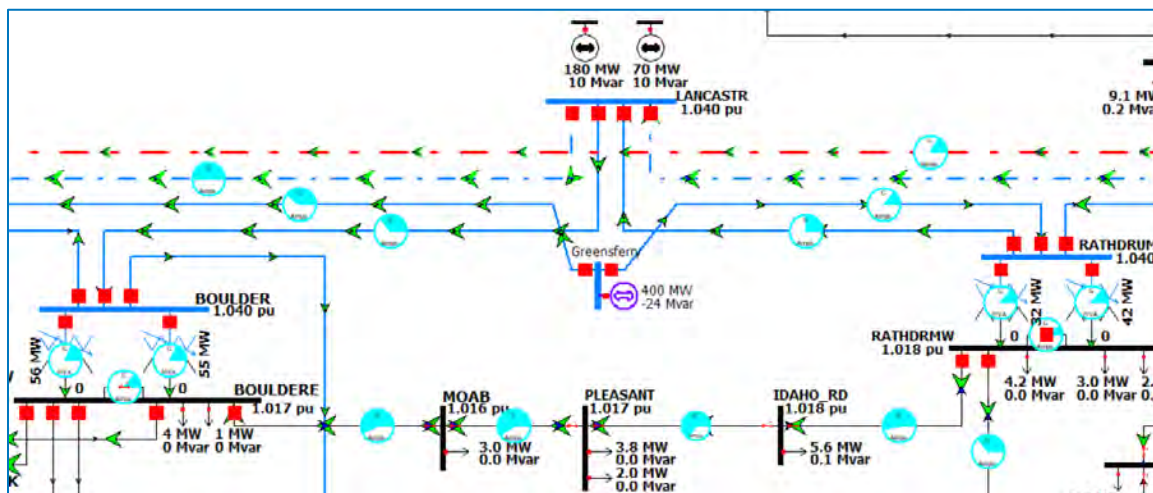

Figure 24: Proposed Generation at Greensferry 230kV, 2027 Heavy Spring

System performance in this area is dominated by several factors:

- High east to west transfers on the Cabinet – Rathdrum and Lancaster – Noxon 230kV transmission lines during spring runoff.
- Typical outflows to the west on the Beacon – Rathdrum, Bell – Lancaster, and Boulder – Lancaster 230kV transmission lines.
- Load in the Coeur d' Alene area primarily served from the Rathdrum station.
- Existing local generation (440MW) from Boulder, Lancaster, Post Falls, and Rathdrum stations.

In general, new generation in this area will sink into local load. As the local load is met the additional power will typically flow west into the Spokane load center or further west on BPA's 230kV system and up onto BPA's 500kV system at Bell.

### 3.17.2. Contingency Analysis

Worst system performance was during heavy spring conditions with high east to west transfers and during heavy summer conditions. Outages on the 230kV system results in overloads on the underlying 115kV system, as shown below. The winter scenarios did not identify any issues.

Many of the summer overload conditions are present with or without the added generation, due to isolation from P2 outages at Rathdrum. Mitigation for these issues are not included in the Network Upgrades and are shown here for reference only.

Row Labels	27 HS <sub>p</sub> Base	27 HS <sub>p</sub> 100MW	27 HS <sub>p</sub> 200MW	27 HS <sub>p</sub> 300MW	27 HS <sub>p</sub> 400MW
<b>NA</b>					
N-2 (ADJ): Beacon - Greensferry 230kV and Bell - Lancaster 230kV					
Boulder - Rathdrum 115kV (Pleasant - Idaho Rd)				95.2	103
Boulder - Irvin #1 115kV (Boulder - Spokane Industrial Park)				99.6	106
Boulder - Rathdrum 115kV (Moab - Pleasant)					97.6
<b>P2</b>					
BF: R427 Beacon North & South 230kV					
Boulder - Irvin #1 115kV (Boulder - Spokane Industrial Park)	96.5	102.8	109.1	115.4	121.7
Boulder - Irvin #1 115kV (Irvin - Spokane Industrial Park)				97.7	104
BF: R454 Boulder-Lancaster, Boulder #2 230/115 Transformer					
Boulder - Rathdrum 115kV (Pleasant - Idaho Rd)					95.2
BF: R554 Boulder-Lancaster, Boulder #1 230/115 Transformer					
Boulder - Rathdrum 115kV (Pleasant - Idaho Rd)					95.2
<b>P7</b>					
N-2: Beacon - Greensferry 230kV & Boulder - Lancaster 230kV					
Boulder - Rathdrum 115kV (Pleasant - Idaho Rd)	99.7	109.6	119.5	129.3	139.3
Boulder - Rathdrum 115kV (Moab - Pleasant)		104.2	114.1	123.9	133.8
Boulder - Rathdrum 115kV (Boulder - Moab)		101.4	111.2	121.1	131
Boulder - Rathdrum 115kV (Idaho Rd - Rathdrum)			96	103.6	111.2
Post Falls - Ramsey 115kV (Post Falls - Prairie)				101.8	110.4
LANCASTR (40624) -> BELL S3 (40090) CKT 1 at LANCASTR					102.6
Post Falls - Ramsey 115kV (Prairie - Ramsey)					97.2
N-2: Greensferry - Rathdrum 230kV & Lancaster - Rathdrum 230kV					
Boulder - Rathdrum 115kV (Pleasant - Idaho Rd)	96.7	95.4			
N-2: Beacon - Boulder 230kV & Boulder - Irvin #2 115kV					
Boulder - Irvin #1 115kV (Boulder - Spokane Industrial Park)		99.8	105	110.2	115.4
Boulder - Irvin #1 115kV (Irvin - Spokane Industrial Park)					97.5
N-2: Beacon - Boulder 230kV & Beacon - Greensferry 230kV					
Boulder - Irvin #1 115kV (Boulder - Spokane Industrial Park)		97.6	104.7	111.9	119.1
Boulder - Irvin #1 115kV (Irvin - Spokane Industrial Park)					101.2
<b>SSEE-2c</b>					
SUB: Beacon 230 & 115 (AVA)					
Ninth and Central - Opportunity 115kV (Chester - Nelson Tap)					95.4
Ninth and Central - Opportunity 115kV (Chester - Opportunity)					101.3

Table 23: Contingency Results, Heavy Spring 2027

Row Labels	27 HS <sub>p</sub> Base	27 HS <sub>p</sub> 100MW	27 HS <sub>p</sub> 200MW	27 HS <sub>p</sub> 300MW	27 HS <sub>p</sub> 400MW
<b>NA</b>					
N-2 (ADJ): Beacon - Greensferry 230kV and Bell - Lancaster 230kV					
Boulder - Irvin #1 115kV (Boulder - Spokane Industrial Park)					101.9
<b>PI</b>					
N-1: Boulder - Irvin #2 115kV					
Boulder - Irvin #1 115kV (Boulder - Spokane Industrial Park)					97.9

Row Labels	27 HS Base	27 HS 100MW	27 HS 200MW	27 HS 300MW	27 HS 400MW
P2					
BF: R427 Beacon North & South 230kV					
Boulder - Irvin #1 115kV (Boulder - Spokane Industrial Park)	97.6	104.6	111.2	118.2	124.9
Boulder - Irvin #1 115kV (Irvin - Spokane Industrial Park)				97.1	103.8
Bell - Northeast 115kV (Bell - Waikiki Tap)	103	99.5	96.3		
Francis and Cedar - Northwest 115kV	99	95.9			
Northwest - Westside 115kV	97.5	95.1			
BUS: Beacon North 230kV					
Boulder - Irvin #1 115kV (Boulder - Spokane Industrial Park)					97.3
BF: A624 Rathdrum East & West 115kV					
Post Falls - Ramsey 115kV (Post Falls - Prairie)	136.6	137.2	138.2	138.9	139.5
Otis Orchard - Post Falls 115kV (East Farms Tap - Beck Road Tap)	108.4	108.9	109.6	110.1	110.7
Otis Orchard - Post Falls 115kV (East Farms Tap - Otis Orchard)	118.2	118.7	119.5	120	120.5
Otis Orchard - Post Falls 115kV (Beck Road Tap - Post Falls)	104.9	105.3	106.1	106.6	107.1
BF: IW18 Talbot-Walla Walla, Walla Walla-Saddle Mountain					
WALAWALA (41131) -> WALA BPA (41129) CKT 3 at WALA BPA	99.2	99.4	99.8	100	100.3
BF: IW5 Walla Walla-Wallula, Talbot-Walla Walla					
WALAWALA (41131) -> WALA BPA (41129) CKT 3 at WALA BPA	95.6	95.9	96.2	96.4	96.6
BF: A600 Beacon North & South 115kV					
Boulder - Irvin #1 115kV (Boulder - Spokane Industrial Park)	111.8	113.2	114.5	115.9	117.3
Boulder - Irvin #1 115kV (Irvin - Spokane Industrial Park)					96.3
Ninth and Central - Opportunity 115kV (Chester - Opportunity)			96.9	100.4	104
Francis and Cedar - Northwest 115kV	117.9	117	116	115.1	114.2
Northwest - Westside 115kV	112.7	112	111.3	110.5	109.8
BF: A506 Rathdrum 115kV, Pine Street-Rathdrum					
Ramsey - Rathdrum #1 115kV (Huetter - Rathdrum)	106.3	109.6	113.2	116.5	119.8
Ramsey - Rathdrum #1 115kV (Hern - Huetter)		96.7	100.3	103.7	107
Ramsey - Rathdrum #1 115kV (Hern - Ramsey)		96.7	100.3	103.7	107
BF: A638 Rathdrum 115kV, Appleway-Rathdrum					
Ramsey - Rathdrum #1 115kV (Huetter - Rathdrum)	99	102.4	105.9	109.3	112.6
Ramsey - Rathdrum #1 115kV (Hern - Huetter)				96.5	99.9
Ramsey - Rathdrum #1 115kV (Hern - Ramsey)				96.5	99.9
BUS: Rathdrum East 115kV					
Ramsey - Rathdrum #1 115kV (Huetter - Rathdrum)	106.2	109.5	113	116.4	119.7
Ramsey - Rathdrum #1 115kV (Hern - Huetter)		96.6	100.2	103.5	106.8
Ramsey - Rathdrum #1 115kV (Hern - Ramsey)		96.6	100.2	103.5	106.8
BF: A645 Otis Orchards 115kV, Boulder-Otis Orchards					
Boulder - Irvin #1 115kV (Boulder - Spokane Industrial Park)			95.1	98.3	101.2
BF: A505 Rathdrum East 115kV, Coeur d'Alene 15th St-Rathdrum					
Ramsey - Rathdrum #1 115kV (Huetter - Rathdrum)				98.2	101.5
BF: A642 Otis Orchards 115kV, Otis Orchards-Post Falls					
Boulder - Irvin #1 115kV (Boulder - Spokane Industrial Park)				96.9	99.9
BUS: Otis Orchards 115kV					
Boulder - Irvin #1 115kV (Boulder - Spokane Industrial Park)				96.2	99.2
BF: A388 Bell S2 & S3 230kV					
Boulder - Irvin #1 115kV (Boulder - Spokane Industrial Park)					97.4
P2.1					

Row Labels	27 HS Base	27 HS 100MW	27 HS 200MW	27 HS 300MW	27 HS 400MW
<b>N-1: Opportunity - Otis Orchards 115kV Open @ OTI</b>					
Boulder - Irvin #1 115kV (Boulder - Spokane Industrial Park)				95.4	98.7
<b>P7</b>					
<b>N-2: Beacon - Greensferry 230kV &amp; Boulder - Lancaster 230kV</b>					
Boulder - Rathdrum 115kV (Pleasant - Idaho Rd)			97.6	108.6	119.6
Boulder - Rathdrum 115kV (Moab - Pleasant)				95.2	106.2
Boulder - Rathdrum 115kV (Boulder - Moab)					102.9
Boulder - Rathdrum 115kV (Idaho Rd - Rathdrum)					102.5
<b>N-2: Beacon - Boulder 230kV &amp; Boulder - Irvin #2 115kV</b>					
Boulder - Irvin #1 115kV (Boulder - Spokane Industrial Park)					100.3
<b>N-2: Beacon - Boulder 230kV &amp; Beacon - Greensferry 230kV</b>					
Boulder - Irvin #1 115kV (Boulder - Spokane Industrial Park)					97.4
<b>N-2: Boulder - Otis Orchards #1 115kV &amp; Boulder - Otis Orchards #2 115kV</b>					
Boulder - Irvin #1 115kV (Boulder - Spokane Industrial Park)					96.1
<b>SSEE-2b</b>					
<b>N-2 (ROW): College &amp; Walnut - Westside 115kV and Garden Springs - Westside 115kV</b>					
Francis and Cedar - Northwest 115kV	101.6	99	96.2		
Northwest - Westside 115kV	99	97			
<b>SSEE-2c</b>					
<b>SUB: Beacon 230 &amp; 115 (AVA)</b>					
Boulder - Irvin #1 115kV (Boulder - Spokane Industrial Park)	105.6	109	112.3	115.7	119.2
Boulder - Irvin #1 115kV (Irvin - Spokane Industrial Park)					98.1
Ninth and Central - Opportunity 115kV (Chester - Opportunity)				100	108.6
Francis and Cedar - Northwest 115kV	122.5	120.1	117.8	115.6	113.3
College and Walnut - Westside 115kV (Fort Wright - Westside)	98.9	96.4			
Northwest - Westside 115kV	116.4	114.5	112.7	110.9	109.2

Table 24: Contingency Results, Heavy Summer 2027

The worst performing contingency is shown below. This shows the underlying 115kV system over capacity for the double-circuit outage and that the 230kV system begins to overload at the maximum proposed generation level.

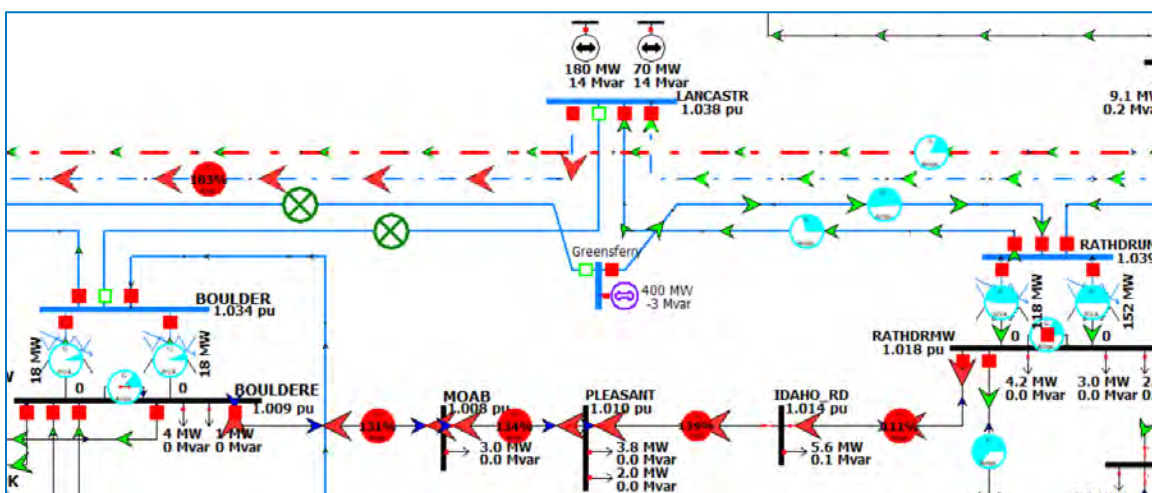

Figure 25: Worst Performing Contingency, Heavy Spring 2027

### 3.17.3. Integration costs

BPA's Lancaster substation is a 230kV ring-bus arrangement and is not designed to be expanded. Integration will require a new Avista 230kV POI station west of BPA's Lancaster station.

POI Station or Area	Cost Estimate (\$ million)
<b>Point of Interconnection station</b>	
New 230kV (3) position Greensferry station	16.5
Loop-in Beacon-Rathdrum 230kV into POI station	1.4
<b>Projects necessary to mitigate new facility violations at 100MW</b>	
Rebuild Boulder-Irvin #1 115kV (BLD-SIP, fix 1.8mi 556aac)	0.7
Rebuild Boulder-Rathdrum 115kV (fix 11.2mi 250cu, 337acsr & 556aac)*	11.2
Rebuild PostFalls-Ramsey 115kV (PF-PRA, fix 2.9mi 250cu)*	2.9
<b>total</b>	<b>32.7</b>
<b>Projects necessary to mitigate new facility violations at 200MW</b>	
Rebuild Boulder-Irvin #1 115kV (BLD-SIP, fix 1.8mi 556aac)	0.7
Rebuild Boulder-Rathdrum 115kV (fix 14.7mi 250cu, 337acsr & 556/795aac)*	14.7
Rebuild PostFalls-Ramsey 115kV (all sections, fix 4.9mi 250cu & 556aac)*	4.9
Rebuild OtisOrchards-PostFalls 115kV (EFM-PF, fix 4.8mi 250cu & 556aac)	4.8
<b>total</b>	<b>43.0</b>
<b>Projects necessary to mitigate new facility violations at 300MW</b>	
Rebuild Boulder-Irvin #1 115kV (BLD-SIP, fix 1.8mi 556aac)	0.7
Rebuild Boulder-Rathdrum 115kV (all sections, fix 19.2mi)*	19.2
Rebuild PostFalls-Ramsey 115kV (all sections, fix 9.0mi)*	9.0
Rebuild OtisOrchards-PostFalls 115kV (all sections, fix 7.6mi)*	7.6
<b>total</b>	<b>54.4</b>
<b>Projects necessary to mitigate new facility violations at 400MW</b>	
Rebuild Boulder-Irvin #1 115kV (BLD-SIP-IRV, fix 4.4mi 556aac & 795 aac)	2.5
Rebuild Boulder-Rathdrum 115kV (all sections, fix 19.2mi)*	19.2
Rebuild PostFalls-Ramsey 115kV (all sections, fix 9.0mi)*	9.0
Rebuild OtisOrchards-PostFalls 115kV (all sections, fix 7.6mi)*	7.6
Rebuild Bell-Lancaster 230kV (fix 23.5mi 1272 acsr)*	35.3
<b>total</b>	<b>91.5</b>

Table 25: Generation Interconnection Request Estimate

Estimates assume that the Interconnection Customer will be responsible for the lead line up to the change of ownership, which is a dead-end tower at the POI substation.



### 3.19. West Plains Area

#### 3.19.1. Project description and one-line diagram

Customer has requested that 100 to 300MW of new generation be integrated onto Avista’s transmission system in the West Plains area. This request was modeled as a new 230kV line position at planned Bluebird substation as shown below.

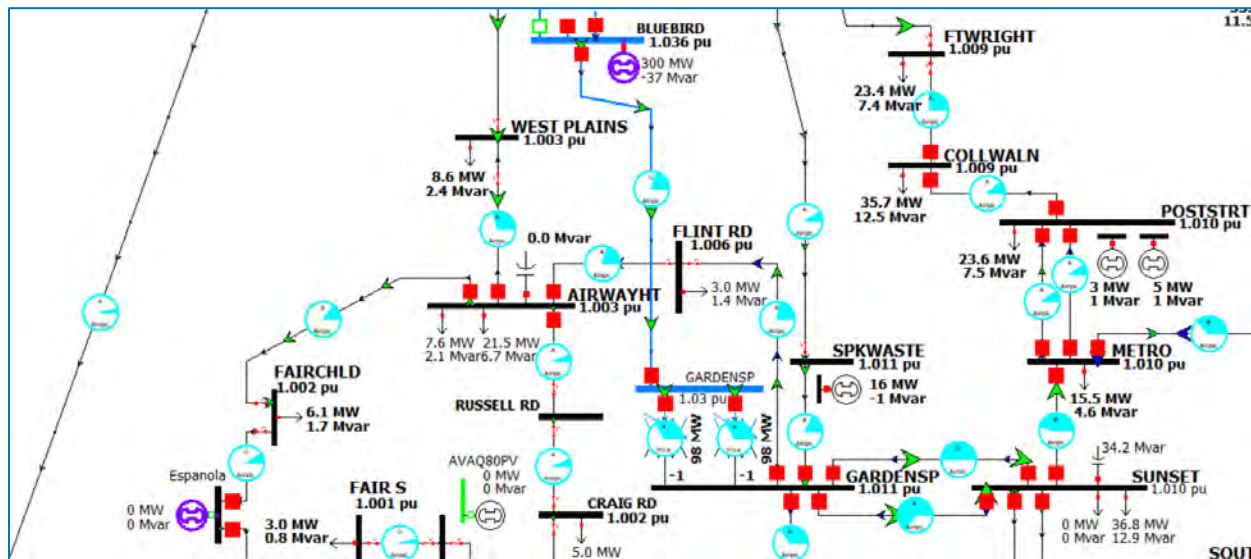

Figure 26: Proposed Generation at Bluebird 230kV, 2027 Heavy Summer

System performance in this area is dominated by several factors:

- 230kV integration primary flows into the West Plains area.
- West Plains area load is 77MW to 160MW
- Existing local generation (18MW) from Waste to Energy.

In general, new generation in this area will sink into local load. As the local load service is met the additional power will flow east into the greater Spokane area.

#### 3.19.2. Contingency Analysis

The worst system performance was during heavy summer conditions. The issues identified below result from moving power from the West Plains into the downtown Spokane load center. The spring and winter scenarios did not identify any issues.

Row Labels	27 HS Base	27 HS 100 MW	27 HS 200 MW	27 HS 300 MW
P1				
N-I: Garden Springs - Sunset#2 115kV				
Garden Springs - Sunset#1 115kV			101.6	111.8
N-I: Garden Springs - Sunset#1 115kV				
Garden Springs - Sunset#2 115kV			101.6	111.8
P2				
BF: R427 Beacon North & South 230kV				
BELL S2 (40088) -> BELL BPA (40087) CKT 6 at BELL S2	113.8	112.9	111.9	111.1

Row Labels	27 HS Base	27 HS 100 MW	27 HS 200 MW	27 HS 300 MW
Francis and Cedar - Northwest 115kV	95.9	96.1	96.3	96.5
Northwest - Westside 115kV		95	95.2	95.4
BF: A600 Beacon North & South 115kV				
Francis and Cedar - Northwest 115kV	100.2	98.8	97.4	96.1
Northwest - Westside 115kV	98.3	97.2	96.1	95.1
BF: AXXX9 Airway Heights - Garden Springs 115kV, Garden Springs - Sunset#1 115kV				
Garden Springs - Sunset#2 115kV			104	114.2
BF: AXXX0 Garden Springs - Westside 115kV, Garden Springs - Sunset#2 115kV				
Garden Springs - Sunset#1 115kV				103.7
BF: AXXX4 Garden Springs - Sunset#1 115kV, Ninth & Central - Sunset 115kV				
Garden Springs - Sunset#2 115kV				95.3
SSEE-2c				
SUB: Beacon 230 & 115 (AVA)				
Francis and Cedar - Northwest 115kV	102.9	101.6	100.4	99.2
Northwest - Westside 115kV	100.4	99.4	98.5	97.6

Table 26: Contingency Results, Heavy Summer 2027

The worst performing contingency is shown below. This is a N-1 loss of a 115kV line connecting the West Plains to downtown Spokane. Showing the system will need reinforcements as the proposed generation increases over 100MW.

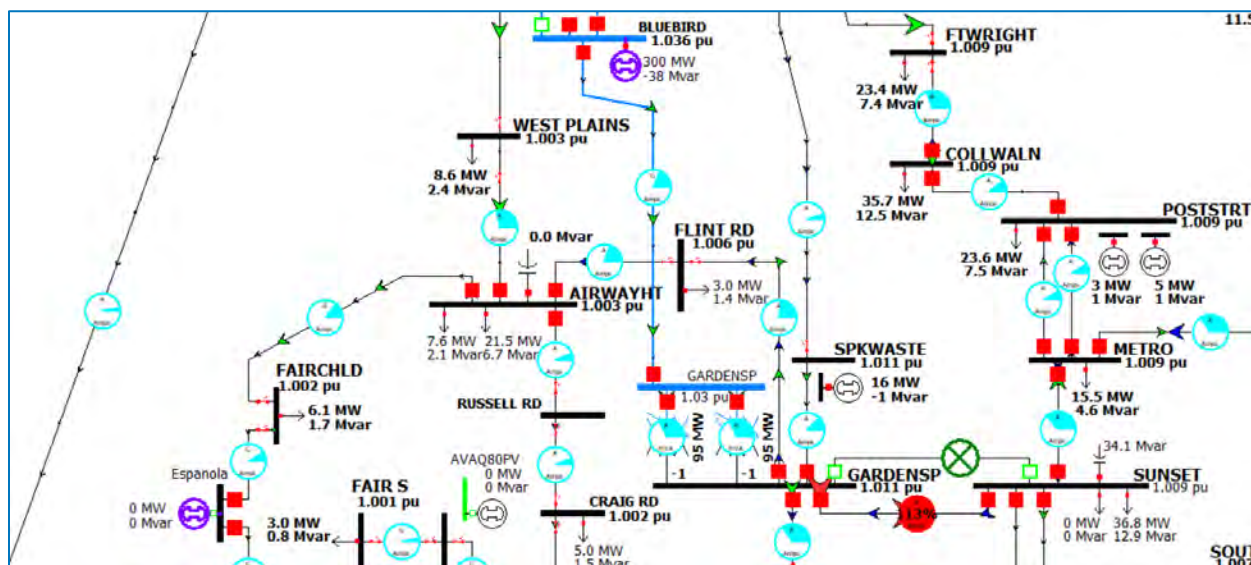

Figure 27: Worst Performing Contingency, Heavy Summer 2027

### 3.19.3. Integration costs

The planned Bluebird substation has a 230kV double breaker double bus arrangement with space for a new line position.

POI Station or Area	Cost Estimate (\$ million)
Point of Interconnection station	
New 230kV line position at Bluebird 230kV	1.9
New 230kV termination structure, comms and metering	0.5
Projects necessary to mitigate new system violations at 100MW	
None	0
<b>total</b>	<b>2.4</b>
Projects necessary to mitigate new system violations at 200/300MW	
Rebuild GardenSprings-Sunset #2 115 kV (fix 2.3mi 556aac)	2.3
<b>total</b>	<b>4.7</b>

Table 27: Generation Interconnection Request Estimate

Estimates assume that the Interconnection Customer will be responsible for the lead line up to the change of ownership, which is a dead-end tower at the POI substation.

# 2023 Electric Integrated Resource Plan

## Appendix F – Inputs and Results



## Appendix F Content

The Company makes data input files and results in native format, models, and other various content used for its Integrated Resource Planning process available to stakeholders. Non-confidential, non-proprietary IRP content can also be found at [Integrated Resource Planning \(myavista.com\)](https://myavista.com). In a manner to further increase transparency and provide clarity for stakeholders, the following table provides context on data files, models and other content included in Appendix F.

File Name	Folder	File Type	Description of Content
Supply Side Resource Options 5.5.2023	Market Modeling Inputs and Results	Excel	Supply side resource option assumptions for cost, size, availability.
Avista DR Potential Inputs Levelized Cost	Market Modeling Inputs and Results	Excel	Winter and summer peak energy DR program impacts and levelized cost.
Load Forecast for 2023 Progress Report_Update	Market Modeling Inputs and Results	Excel	Energy forecast, peak forecast, retail sales, load split percentages, PHEV and customer rooftop solar.
Market Modeling Results	Market Modeling Inputs and Results	Excel	Market modeling results to include stochastic off-peak/on-peak/flat Mid-C prices, stochastic greenhouse gas, hourly Mid-C prices, stochastic historical regional resource dispatch, deterministic hourly Mid-C prices, deterministic monthly Mid-C prices scenarios, deterministic annual greenhouse gas emissions and deterministic regional resource dispatch.
Natural Gas Expected Price Forecast - Final	Market Modeling Inputs and Results	Excel	Monthly natural gas price forecast used for the IRP, both stochastic and deterministic, as well as basin percentage spreads.
Social Cost of Carbon	Market Modeling Inputs and Results	Excel	Social cost of carbon in 2007 and 2022 dollars, nominal and levelized.
PRiSM Results_031323	PRiSM Model Files	Excel	Scenario list, summary data, sensitivity summary, sensitivity data, summary resources PRS, existing resources, annual summary by scenario, summary table of PVRR (\$ Mill) by state and select years, cost vs risk by scenario, clean goal, GHG emissions, avoided costs for SR/EE.

PRiSM Model Guide	PRiSM Model Files	Word	User guide for the PRiSM models.
01_PRiSM_8.0_Expected Case_030223_PRS	PRiSM Model Files	Excel	PRiSM model - must have Gurobi license to run. Preferred resource strategy, deterministic scenario. Includes a summary of resource selected, position summary, clean goal progress, loads & resources by state and system, demand response, resource data, energy efficiency selected, Aurora resource results, transmission annual revenue requirement from amortization model, annual cost of resource options, resources (MWh), hydro & contracts market value, non-energy impacts, general assumptions, emissions, conservation load value (\$/MW), new CapEx and energy burden.
02_PRiSM_8.0_Expected Case_030223_Alternative Lowest Reasonable Cost	PRiSM Model Files	Excel	PRiSM model - must have Gurobi license to run. Alternative lowest reasonable cost, deterministic scenario. Includes a summary of resource selected, position summary, clean goal progress, loads & resources by state and system, demand response, resource data, energy efficiency selected, Aurora resource results, transmission annual revenue requirement from amortization model, annual cost of resource options, resources (MWh), hydro & contracts market value, non-energy impacts, general assumptions, emissions, conservation load value (\$/MW), new CapEx and energy burden.
03_PRiSM_8.0_Expected Case_030223_Baseline	PRiSM Model Files	Excel	PRiSM model - must have Gurobi license to run. baseline, deterministic scenario. Includes a summary of resource selected, position summary, clean goal progress, loads & resources by state and system, demand response, resource data, energy efficiency selected, Aurora resource results, transmission annual revenue requirement from amortization

			model, annual cost of resource options, resources (MWh), hydro & contracts market value, non-energy impacts, general assumptions, emissions, conservation load value (\$/MW), new CapEx and energy burden.
04_PriSM_8.0_Expected Case_030223_No Additions	PriSM Model Files	Excel	PriSM model - must have Gurobi license to run. No additions, deterministic scenario. Includes a summary of resource selected, position summary, clean goal progress, loads & resources by state and system, demand response, resource data, energy efficiency selected, Aurora resource results, transmission annual revenue requirement from amortization model, annual cost of resource options, resources (MWh), hydro & contracts market value, non-energy impacts, general assumptions, emissions, conservation load value (\$/MW), new CapEx and energy burden.
05_PriSM_8.0_Expected Case_030223_NoCETA-NCIF- SCGHG-NG	PriSM Model Files	Excel	PriSM model - must have Gurobi license to run. No CETA/NCIF/SCGDG/NG, deterministic scenario. Includes a summary of resource selected, position summary, clean goal progress, loads & resources by state and system, demand response, resource data, energy efficiency selected, Aurora resource results, transmission annual revenue requirement from amortization model, annual cost of resource options, resources (MWh), hydro & contracts market value, non-energy impacts, general assumptions, emissions, conservation load value (\$/MW), new CapEx and energy burden.
06_PriSM_8.0_Expected Case_030223_WRAP_PRM	PriSM Model Files	Excel	PriSM model - must have Gurobi license to run. WRAP PRM, deterministic scenario. Includes a summary of resource selected, position summary, clean goal progress, loads & resources by state and

			system, demand response, resource data, energy efficiency selected, Aurora resource results, transmission annual revenue requirement from amortization model, annual cost of resource options, resources (MWh), hydro & contracts market value, non-energy impacts, general assumptions, emissions, conservation load value (\$/MW), new CapEx and energy burden.
07_PriSM_8.0_Expected Case_030223_WRAP_PRM_No _QCC_Changes	PriSM Model Files	Excel	PriSM model - must have Gurobi license to run. WRAP PRM/No QCC changes, deterministic scenario. Includes a summary of resource selected, position summary, clean goal progress, loads & resources by state and system, demand response, resource data, energy efficiency selected, Aurora resource results, transmission annual revenue requirement from amortization model, annual cost of resource options, resources (MWh), hydro & contracts market value, non-energy impacts, general assumptions, emissions, conservation load value (\$/MW), new CapEx and energy burden.
08_PriSM_8.0_Expected Case_030223_VERStoWA	PriSM Model Files	Excel	PriSM model - must have Gurobi license to run. VER + storage WA, deterministic scenario. Includes a summary of resource selected, position summary, clean goal progress, loads & resources by state and system, demand response, resource data, energy efficiency selected, Aurora resource results, transmission annual revenue requirement from amortization model, annual cost of resource options, resources (MWh), hydro & contracts market value, non-energy impacts, general assumptions, emissions, conservation load value (\$/MW), new CapEx and energy burden.



## Appendix F

09_PriSM_8.0_Expected Case_030223_LowEconGrowth	PRiSM Model Files	Excel	PRiSM model - must have Gurobi license to run. Low economic growth, deterministic scenario. Includes a summary of resource selected, position summary, clean goal progress, loads & resources by state and system, demand response, resource data, energy efficiency selected, Aurora resource results, transmission annual revenue requirement from amortization model, annual cost of resource options, resources (MWh), hydro & contracts market value, non-energy impacts, general assumptions, emissions, conservation load value (\$/MW), new CapEx and energy burden.
10_PriSM_8.0_Expected Case_030223_HighEconGrowth	PRiSM Model Files	Excel	PRiSM model - must have Gurobi license to run. High economic growth, deterministic scenario. Includes a summary of resource selected, position summary, clean goal progress, loads & resources by state and system, demand response, resource data, energy efficiency selected, Aurora resource results, transmission annual revenue requirement from amortization model, annual cost of resource options, resources (MWh), hydro & contracts market value, non-energy impacts, general assumptions, emissions, conservation load value (\$/MW), new CapEx and energy burden.
11_PriSM_8.0_Expected Case_030223_HighEVGrowth	PRiSM Model Files	Excel	PRiSM model - must have Gurobi license to run. High EV growth, deterministic scenario. Includes a summary of resource selected, position summary, clean goal progress, loads & resources by state and system, demand response, resource data, energy efficiency selected, Aurora resource results, transmission annual revenue requirement from amortization model, annual cost of resource options, resources (MWh), hydro & contracts market value,

			non-energy impacts, general assumptions, emissions, conservation load value (\$/MW), new CapEx and energy burden.
12_PriSM_8.0_Expected Case_030223_WA All electric gas scenario	PriSM Model Files	Excel	PriSM model - must have Gurobi license to run. WA all electric gas, deterministic scenario. Includes a summary of resource selected, position summary, clean goal progress, loads & resources by state and system, demand response, resource data, energy efficiency selected, Aurora resource results, transmission annual revenue requirement from amortization model, annual cost of resource options, resources (MWh), hydro & contracts market value, non-energy impacts, general assumptions, emissions, conservation load value (\$/MW), new CapEx and energy burden.
13_PriSM_8.0_Expected Case_030223_WA Electrification_NG_Backup	PriSM Model Files	Excel	PriSM model - must have Gurobi license to run. WA electrification with NG backup, deterministic scenario. Includes a summary of resource selected, position summary, clean goal progress, loads & resources by state and system, demand response, resource data, energy efficiency selected, Aurora resource results, transmission annual revenue requirement from amortization model, annual cost of resource options, resources (MWh), hydro & contracts market value, non-energy impacts, general assumptions, emissions, conservation load value (\$/MW), new CapEx and energy burden.
14_PriSM_8.0_Expected Case_030223_Combined_Electrification	PriSM Model Files	Excel	PriSM model - must have Gurobi license to run. Combined electrification, deterministic scenario. Includes a summary of resource selected, position summary, clean goal progress, loads & resources by state and system, demand response, resource data, energy efficiency selected, Aurora resource results,

			transmission annual revenue requirement from amortization model, annual cost of resource options, resources (MWh), hydro & contracts market value, non-energy impacts, general assumptions, emissions, conservation load value (\$/MW), new CapEx and energy burden.
14_PriSM_8.0_Expected Case_030223_Combined_Electrification_with_Dist_Costs	PriSM Model Files	Excel	PriSM model - must have Gurobi license to run. Combined electrification with distribution costs, deterministic scenario. Includes a summary of resource selected, position summary, clean goal progress, loads & resources by state and system, demand response, resource data, energy efficiency selected, Aurora resource results, transmission annual revenue requirement from amortization model, annual cost of resource options, resources (MWh), hydro & contracts market value, non-energy impacts, general assumptions, emissions, conservation load value (\$/MW), new CapEx and energy burden.
15_PriSM_8.0_Expected Case_030223_Clean_Portfolio	PriSM Model Files	Excel	PriSM model - must have Gurobi license to run. Clean portfolio, deterministic scenario. Includes a summary of resource selected, position summary, clean goal progress, loads & resources by state and system, demand response, resource data, energy efficiency selected, Aurora resource results, transmission annual revenue requirement from amortization model, annual cost of resource options, resources (MWh), hydro & contracts market value, non-energy impacts, general assumptions, emissions, conservation load value (\$/MW), new CapEx and energy burden.

16_PriSM_8.0_Expected Case_030223_Social Cost included for Idaho	PRiSM Model Files	Excel	PRiSM model - must have Gurobi license to run. Social cost included for Idaho, deterministic scenario. Includes a summary of resource selected, position summary, clean goal progress, loads & resources by state and system, demand response, resource data, energy efficiency selected, Aurora resource results, transmission annual revenue requirement from amortization model, annual cost of resource options, resources (MWh), hydro & contracts market value, non-energy impacts, general assumptions, emissions, conservation load value (\$/MW), new CapEx and energy burden.
17_PriSM_8.0_Expected Case_030223_MaxCustomerBenefit	PRiSM Model Files	Excel	PRiSM model - must have Gurobi license to run. Max customer benefit, deterministic scenario. Includes a summary of resource selected, position summary, clean goal progress, loads & resources by state and system, demand response, resource data, energy efficiency selected, Aurora resource results, transmission annual revenue requirement from amortization model, annual cost of resource options, resources (MWh), hydro & contracts market value, non-energy impacts, general assumptions, emissions, conservation load value (\$/MW), new CapEx and energy burden.
01_PriSM_8.0_Expected Deterministic Case_030223_PRS	PRiSM Model Files	Excel	PRiSM model - must have Gurobi license to run. PRS, deterministic scenario. Includes a summary of resource selected, position summary, clean goal progress, loads & resources by state and system, demand response, resource data, energy efficiency selected, Aurora resource results, transmission annual revenue requirement from amortization model, annual cost of resource options, resources (MWh), hydro & contracts market value, non-energy

			impacts, general assumptions, emissions, conservation load value (\$/MW), new CapEx and energy burden.
01_PriSM_8.0_High Gas Price Case_030223_PRS	PriSM Model Files	Excel	PriSM model - must have Gurobi license to run. High gas price case - PRS, deterministic scenario. Includes a summary of resource selected, position summary, clean goal progress, loads & resources by state and system, demand response, resource data, energy efficiency selected, Aurora resource results, transmission annual revenue requirement from amortization model, annual cost of resource options, resources (MWh), hydro & contracts market value, non-energy impacts, general assumptions, emissions, conservation load value (\$/MW), new CapEx and energy burden.
01_PriSM_8.0_Low Gas Price Case_030223_PRS	PriSM Model Files	Excel	PriSM model - must have Gurobi license to run. Low gas price case - PRS, deterministic scenario. Includes a summary of resource selected, position summary, clean goal progress, loads & resources by state and system, demand response, resource data, energy efficiency selected, Aurora resource results, transmission annual revenue requirement from amortization model, annual cost of resource options, resources (MWh), hydro & contracts market value, non-energy impacts, general assumptions, emissions, conservation load value (\$/MW), new CapEx and energy burden.
01_PriSM_8.0_National CO2 Price Case_030223_Least Cost	PriSM Model Files	Excel	PriSM model - must have Gurobi license to run. National CO2 – least cost, deterministic scenario. Includes a summary of resource selected, position summary, clean goal progress, loads & resources by state and system, demand response, resource data, energy efficiency selected, Aurora resource results,

			transmission annual revenue requirement from amortization model, annual cost of resource options, resources (MWh), hydro & contracts market value, non-energy impacts, general assumptions, emissions, conservation load value (\$/MW), new CapEx and energy burden.
01_PriSM_8.0_National CO2 Price Case _030223_PRS	PriSM Model Files	Excel	PriSM model - must have Gurobi license to run. National CO2 – PRS, deterministic scenario. Includes a summary of resource selected, position summary, clean goal progress, loads & resources by state and system, demand response, resource data, energy efficiency selected, Aurora resource results, transmission annual revenue requirement from amortization model, annual cost of resource options, resources (MWh), hydro & contracts market value, non-energy impacts, general assumptions, emissions, conservation load value (\$/MW), new CapEx and energy burden.
03_PriSM_8.0_Expected Deterministic Case _030223_NoCETA-NCIF_SCGHG	PriSM Model Files	Excel	PriSM model - must have Gurobi license to run. Expected case - no CETA/NCIF/SCGHG, deterministic scenario. Includes a summary of resource selected, position summary, clean goal progress, loads & resources by state and system, demand response, resource data, energy efficiency selected, Aurora resource results, transmission annual revenue requirement from amortization model, annual cost of resource options, resources (MWh), hydro & contracts market value, non-energy impacts, general assumptions, emissions, conservation load value (\$/MW), new CapEx and energy burden.

03_PriSM_8.0_High Gas Price Case_030223_NoCETA-NCIF_SCGHG	PriSM Model Files	Excel	PriSM model - must have Gurobi license to run. High gas price - no CETA/NCIF/SCGHG, deterministic scenario. Includes a summary of resource selected, position summary, clean goal progress, loads & resources by state and system, demand response, resource data, energy efficiency selected, Aurora resource results, transmission annual revenue requirement from amortization model, annual cost of resource options, resources (MWh), hydro & contracts market value, non-energy impacts, general assumptions, emissions, conservation load value (\$/MW), new CapEx and energy burden.
03_PriSM_8.0_Low Gas Price Case_030223_NoCETA-NCIF_SCGHG	PriSM Model Files	Excel	PriSM model - must have Gurobi license to run. Low gas price - no CETA/NCIF/SCGHG, deterministic scenario. Includes a summary of resource selected, position summary, clean goal progress, loads & resources by state and system, demand response, resource data, energy efficiency selected, Aurora resource results, transmission annual revenue requirement from amortization model, annual cost of resource options, resources (MWh), hydro & contracts market value, non-energy impacts, general assumptions, emissions, conservation load value (\$/MW), new CapEx and energy burden.
03_PriSM_8.0_National CO2 Price Case_030223_NoCETA-NCIF_SCGHG	PriSM Model Files	Excel	PriSM model - must have Gurobi license to run. National CO2 price - no CETA/NCIF/SCGHG, deterministic scenario. Includes a summary of resource selected, position summary, clean goal progress, loads & resources by state and system, demand response, resource data, energy efficiency selected, Aurora resource results, transmission

			annual revenue requirement from amortization model, annual cost of resource options, resources (MWh), hydro & contracts market value, non-energy impacts, general assumptions, emissions, conservation load value (\$/MW), new CapEx and energy burden.
15_PriSM_8.0_Expected Deterministic Case _030223_Clean_Portfolio	PriSM Model Files	Excel	PriSM model - must have Gurobi license to run. Expected case – clean portfolio, deterministic scenario. Includes a summary of resource selected, position summary, clean goal progress, loads & resources by state and system, demand response, resource data, energy efficiency selected, Aurora resource results, transmission annual revenue requirement from amortization model, annual cost of resource options, resources (MWh), hydro & contracts market value, non-energy impacts, general assumptions, emissions, conservation load value (\$/MW), new CapEx and energy burden.
15_PriSM_8.0_High Gas Price Case _030223_Clean_Portfolio	PriSM Model Files	Excel	PriSM model - must have Gurobi license to run. High gas price – clean portfolio, deterministic scenario. Includes a summary of resource selected, position summary, clean goal progress, loads & resources by state and system, demand response, resource data, energy efficiency selected, Aurora resource results, transmission annual revenue requirement from amortization model, annual cost of resource options, resources (MWh), hydro & contracts market value, non-energy impacts, general assumptions, emissions, conservation load value (\$/MW), new CapEx and energy burden.
15_PriSM_8.0_Low Gas Price Case _030223_Clean_Portfolio	PriSM Model Files	Excel	PriSM model - must have Gurobi license to run. Low gas price – clean portfolio, deterministic scenario. Includes a summary of resource selected,



			position summary, clean goal progress, loads & resources by state and system, demand response, resource data, energy efficiency selected, Aurora resource results, transmission annual revenue requirement from amortization model, annual cost of resource options, resources (MWh), hydro & contracts market value, non-energy impacts, general assumptions, emissions, conservation load value (\$/MW), new CapEx and energy burden.
15_PriSM_8.0_National CO2 Price Case _030223_Clean_Portfolio	PriSM Model Files	Excel	PriSM model - must have Gurobi license to run. National CO2 price – clean portfolio, deterministic scenario. Includes a summary of resource selected, position summary, clean goal progress, loads & resources by state and system, demand response, resource data, energy efficiency selected, Aurora resource results, transmission annual revenue requirement from amortization model, annual cost of resource options, resources (MWh), hydro & contracts market value, non-energy impacts, general assumptions, emissions, conservation load value (\$/MW), new CapEx and energy burden.
Final Avista Electric Measure List	Energy Efficiency	Excel	List of residential, commercial and industrial energy efficiency measures along with an introduction includes instructions, notes and sources.
Avista 2022 Electric CPA – Summary and IRP Inputs v3	Energy Efficiency	Excel	Achievable technical potential energy savings, winter peak savings, summary peak savings inputs used in IRP.
2030 330 MW Summary Results	Market Reliance Analysis	Excel	Monthly results by hour of market reliance analysis.
2030 1,000 MW Summary Results	Market Reliance Analysis	Excel	Monthly results by hour of market reliance analysis.
2045 330 MW Summary Results	Market Reliance Analysis	Excel	Monthly results by hour of market reliance analysis.

2045 1,000 MW Summary Results	Market Reliance Analysis	Excel	Monthly results by hour of market reliance analysis.
-------------------------------	--------------------------	-------	--

# 2023 Electric Integrated Resource Plan

## Appendix G – Distributed Energy Resource Potential Assessment Scope of Work



**Avista RFP No. R-XXXXX**

**Distributed Energy Resource Potential Assessment  
Statement of Work**

**12/27/2022**

- 1. Purpose.** Avista desires to utilize a third-party Consultant to conduct a Distributed Energy Resource (“DER”) potential assessment (“Study”) to determine a reasonable potential of new generation, storage, and controllable load impacts on a localized basis. This study is required by the Washington Utility and Transportation Commission (“WUTC”) as part of the conditions of Avista’s Clean Energy Implementation Plan<sup>1</sup>.
- 2. Overview – Project Summary.** This Statement of Work (“SOW”) details the scope of work to be provided by the Consultant (the “Services”) and deliverables to be created (the “Deliverables”) for the Study (as used in this SOW, the Services and Deliverables will be referred to, collectively, as the “Project”).
- 3. Scope of Work.**

Consultant shall conduct an analysis to identify the customer potential for each DER type for Avista’s Washington service territory on a geographic basis and deliver results in a report document. Data should be provided in the most granular aggregation available, i.e. census block and for each Avista electric feeder in Washington state. DER is defined in WAC 480-100-605 as:

*Distributed energy resource means a non-emitting electric generation or renewable resource or program that reduces electric demand, manages the level or timing of electricity consumption, or provides storage, electric energy, capacity, or ancillary services to an electric utility and that is located on the distribution system, any subsystem of the distribution system, or behind the customer meter, including conservation and energy efficiency.*

For the purposes of this study, the following DERs will be considered. Avista will separately address energy efficiency and demand response.

- Electric Vehicles
  - Residential and commercial charging for Class 1 through 8 on-road vehicles at designated residence and commercial facility locations.
  - Public charging and in-route dedicated commercial fleet charging for Class 1 through 8 on-road vehicles, including along major travel corridors.
- New Generation & Storage
  - Residential and Commercial Solar.
  - Residential and Commercial Storage.
  - Other Renewables (i.e. wind, small hydro, fuel cell, ICE).

---

<sup>1</sup> Avista will include a Distributed Energy Resources (DERs) potential assessment for each distribution feeder no later than its 2025 electric IRP. Avista will develop a scope of work for this project no later than the end of 2022, including input from the IRP TAC, EEAG, and DPAG. The assessment will include a low-income DER potential assessment. Avista will document its DER potential assessment work in the Company’s 2023 IRP Progress Report in the form of a project plan, including project schedule, interim milestones, and explanations of how these efforts address WAC 480-100-620(3)(b)(iii) and (iv).

## I. Electric Vehicles

For each Washington census block, an assessment of electric vehicle demand shall be estimated for every 5 years beginning in 2025 through 2050. The assessment shall consider all on-road vehicle class types,<sup>2</sup> classes 1 through 8, with charging estimates at facility or residence locations at the feeder level, as well as high-power public and in-route fleet charging locations at the feeder level. The number of vehicles by vehicle class, census block, feeder, and time period is required. In developing EV adoption forecasts, they shall be consistent with state policy mandates such as light-duty (class 1 and 2) vehicles reaching 50% sales penetration by 2030 and 100% by 2035. The best available literature shall be used to develop a probable electrification forecast for medium and heavy-duty vehicles, Class 3-8<sup>3</sup> as a baseline scenario. The forecast should consider potential growth in both residential and commercial customers. EV forecasts should include a second scenario for feeders within Highly Impacted or Vulnerable Population<sup>4</sup> areas where the light duty vehicle forecast is not restricted by economic disadvantages, as assisted aid or economic incentives for EV purchases could occur. Forecasts shall include aggregated hourly load usage for each vehicle type per month and weekday, with charging locations at the facility/residence and public/in-route fleet locations.

## II. New Generation & Storage

Avista requires an assessment for potential customer-owned solar, storage, and other renewable generation by census block and distribution feeder, for every 5 years beginning in 2025 through 2050. Avista expects the forecast to include an expected case forecast considering existing policies and cost/pricing outlooks for the customer demographics and building potential- the analysis shall consider future customer electrification possibilities impacting its demand. The analysis shall include a second scenario where Highly Impacted or Vulnerable Population areas are no limited to financial constraints as financial assistance or incentives for DER's could occur for the populations. Deliverables shall include, for each scenario, the capacity of each technology and annual energy estimates for generation resources. For storage resources the assumed usable duration in hours of capacity shall be stated.

## III. Data Availability and Assumptions

Avista will provide: GIS data of the geographic location of each feeder and customer within the Washington Avista service area; electric and natural gas monthly billing data for each service point (if required); and, if necessary, Avista's current forecasts for system electric vehicles. Other data will be available on a case by case basis, such as loading and daily load curves by feeder. There are approximately 241 feeders to be evaluated consisting of urban, suburban, and rural areas in eastern Washington.

Avista will provide average and peak monthly electric and natural gas usage for each service point (if required). Avista expects this study will take into account customer demographic, income, use, property limitations, and any other factors discovered within the project research. Avista will provide its current forecasts for system electric vehicles and building electrification if necessary. Other data will be available on a case by cases basis, such as feeder level loads, intra-month level customer load, daily load curves by feeder, as rooftop solar

<sup>2</sup> Vehicle class types, relevant to the project, are described as battery electric vehicles and plug-in electric vehicles for each local charging classifications by the U.S. Department of Energy and U.S. Department of Transportation (further information for makes and models in these classification are listed on the Department's website).

<sup>3</sup> See for example, the National Renewable Energy Laboratory, "Decarbonizing Medium- and Heavy-Duty On-Road Vehicles" (2022), accessible at <https://www.nrel.gov/docs/fy22osti/82081.pdf>

<sup>4</sup> These communities are described as Named Communities, a locational map of these communities in provided in Appendix A.

viability, etc as well as certain information from Avista’s commercial customer database that may be useful in identifying vehicle fleet sizes and locations.

4. **Deliverables.** Consultant shall use commercially reasonable efforts to complete all analyses and provide the resultant Report by June 1, 2024, unless otherwise agreed to by the Parties. Avista strongly opposes the use of acronyms and requests the Report to contain a minimal amount as possible.

Task 1	<p>(a) A survey of other utility or other entity efforts to conduct similar DER potential studies, including EV adoption and load forecasts at the feeder level. The study shall include comparison of the other utility’s size, rates, climate, and customer demographics.</p> <p>(b) A summary of best practices in development of future adoption for new DER technologies.</p> <p>(c) An overview of Avista’s current DER resources (i.e., 2022 baseline).</p> <p>Deliverable: Report document outlining the findings in above items. <b>(Due date: July 2023)</b></p>
Task 2	<p>(a) A detailed explanation of the methodology, systems, and process used to develop the forecasts for each DER, related scenarios, and electric vehicles. Include validation of methodology with actual data (use historical data).</p> <p>(b) A description of the methodology used to develop the electric vehicle forecasts for Class 1-8 vehicles by quantity per feeder location, and hourly load shapes at commercial facilities and residential homes for Class 1-8 on-road vehicles. In particular, a credible method identifying current non-EV vehicle locations at the feeder level, with future electrification scenarios at these locations including growth potential of overall fleet size must be demonstrated. A description of the methodology used to develop load shapes for public and in-route fleet high speed charging locations for Class 1-8 EVs must also be provided. Each type of EV will have unique charging patterns and load profiles, most often with charging occurring at more than one location. All assumptions and methodologies used to develop the various load profiles of each of the class 1 through 8 vehicles must be clearly indicated. For example, a certain portion of residential class 1 and 2 EV’s electrical load will occur at the residential “home” location, a portion at work for some EVs commuting to a work facility with charging available, DC fast charging when taking longer trips, etc. The format of the outputs from these forecasts and load shapes must be specified, in a form that is directly usable for Avista’s System Planning Department.</p> <p>Deliverable: Report document with above information. <b>(Due date: September 2023)</b></p>
Task 3	<p>(a) Matrix including each feeder and the quantity of each electric vehicle by class 1 through 8, for both scenarios.</p> <p>(b) An aggregated hourly load shape for each vehicle class, by weekday and month, as well as average charging session load shape showing kW for each hour of the day, for each vehicle class (see Appendix C for examples). Load shapes for public and in-route fleet high speed charging locations for Class 1-8 EVs must also be provided for each feeder showing the hourly load at each location by vehicle class. These load shapes assume uninfluenced charging behavior (no TOU rate or other DR programs or technologies are applied).</p> <p>(c) A second matrix is required for feeders within Named Communities.</p> <p><b>(Draft December 2023, Final February 2024)</b></p>
Task 5	<p>(a) Matrix including each feeder and the amount of DER resources in kW and/or kWh for each resource type by year and customer class- example shown in Appendix B.</p>

	<p>(b) The summary shall also include an estimated portion of the resource opportunity providing ancillary services<sup>5</sup> along with adjustments for higher potential due to income limits from named communities.</p> <p><b>(Draft March 2024, Final May 2024)</b></p>
Task 6	<p>Present draft results of the study to Avista’s Advisory Committees for comment and questions. Advisory committees may include: Electric Integrated Resource Planning Technical Advisory Committee, Energy Efficiency Advisory Group, Distribution Planning Advisory Group, and the Joint EVSE Stakeholder Group</p> <p><b>(Q1 2024<sup>6</sup>)</b></p>
Task 7	<p>(a) Final report document including tasks 1 through 6,  (b) Summary of comments and suggestions from non-Avista parties and how they are addressed in the final report,  (c) Recommendations for future studies,  (d) Documentation of methods and procedures to transition Avista to be able to update these forecasts for future use.</p> <p><b>(Draft due April 1, 2024, with the final report due June 1, 2024)</b></p>

<sup>5</sup> Ancillary services include the resource’s ability to provide regulation, load following, operating reserves, voltage support.

<sup>6</sup> Future meetings could be remote or in person. Bids should not consider any travel time in preparation of this bid and will be additional cost borne by Avista on a case-by-case basis depending on the need for in person presentations.

### Appendix A Locations of Named Communities

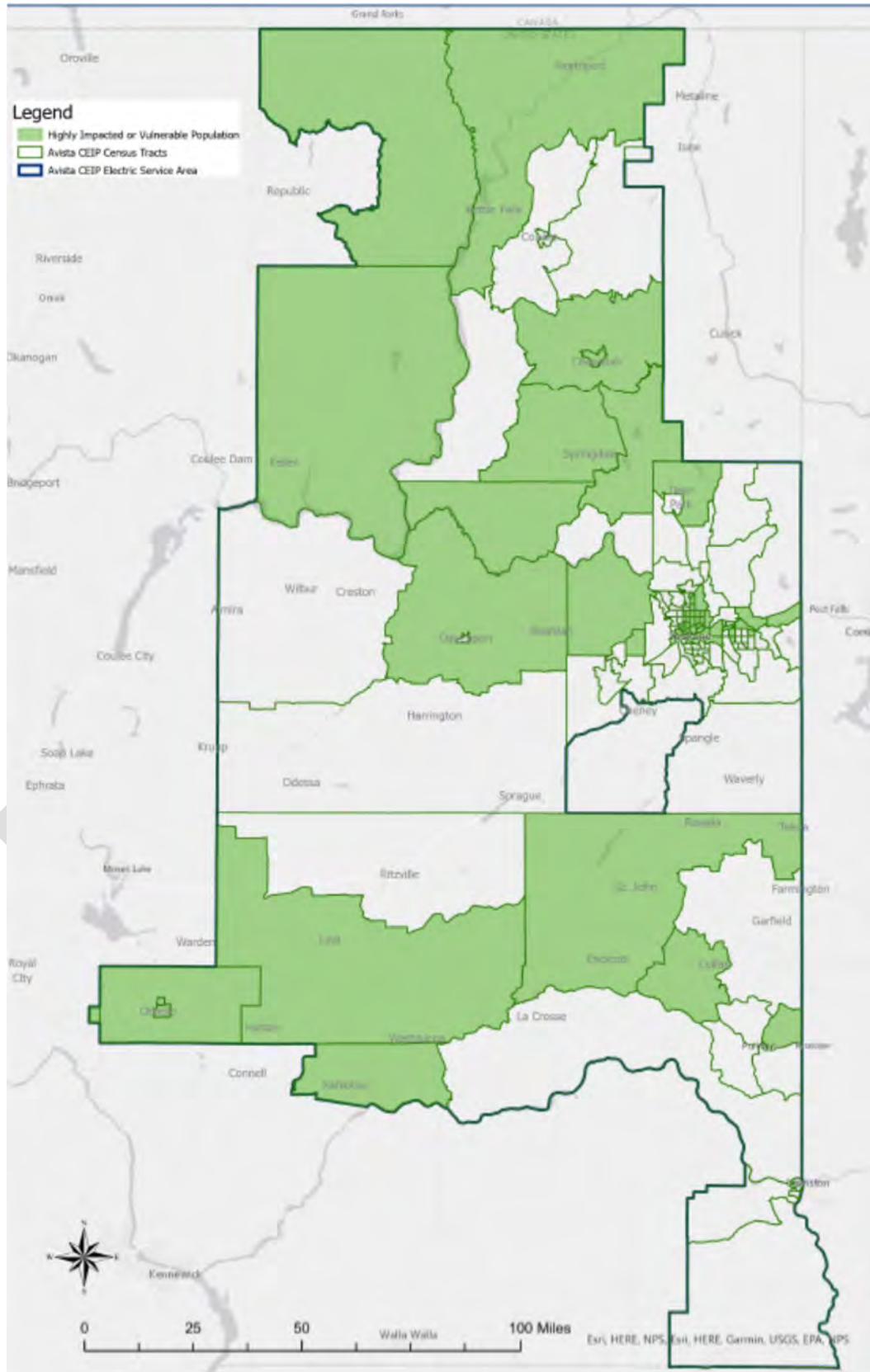



## Appendix B

<b>Feeder Name</b>	<b>State</b>	<b>Customer Class</b>	<b>Year</b>	<b>Technology/ Resource</b>	<b>Load Impact (kW)</b>	<b>Load Impact (kWh)</b>	<b>Ancillary Services (kW)</b>
12F4	WA	Residential	2025	Solar	0.5	12,000	0.05

DRAFT

Appendix C

Uninfluenced Daily Residential Load Profile (aggregated)  
 For Class 1 Electric Vehicles  
 From EVSE Pilot final report (2019), p. 54

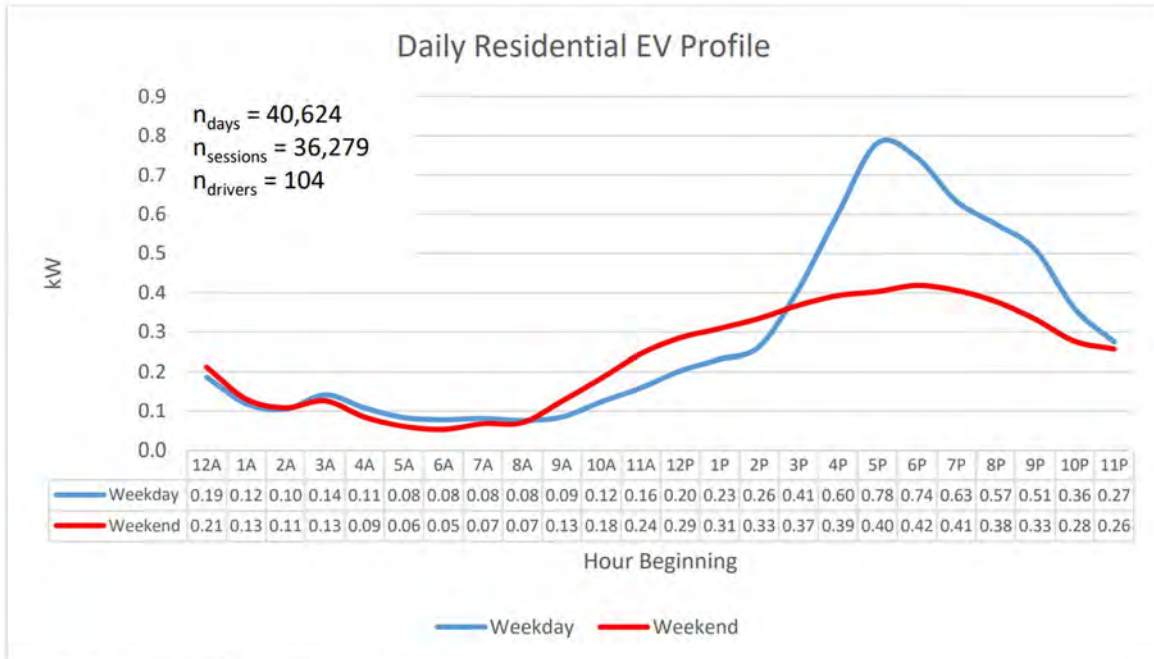
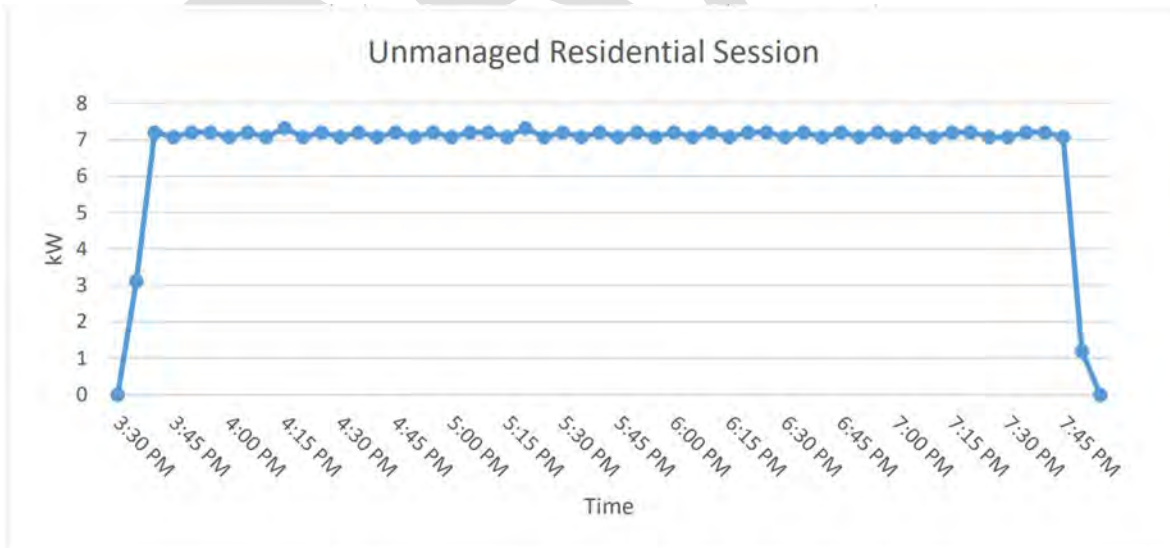

Figure 41. Residential EV aggregate load profile

Unmanaged Residential EV charging session  
 From EVSE Pilot final report (2019), p. 83



DRAFT

# 2023 Electric Integrated Resource Plan

## Appendix H – Confidential Historical Generation Operation Data

Idaho – Confidential pursuant to Sections 74-109, Idaho Code  
Washington – Confidential per WAC 480-07-160





# 2023 Electric Integrated Resource Plan

## Appendix I – Transmission Request Update



# Appendix I

New Resource (>1 MW) Table For Transmission

Resource	Note	Resource Location	POR	POD	Start	Stop	Capacity MW	Year Total
Post Falls	Facility Upgrade	Post Falls	AVA.SYS	AVA.SYS	1/1/2028	Indefinite	8.0	8.0
Wind		E. Washington	AVA.SYS	AVA.SYS	1/1/2030	Indefinite	200.0	200.0
Wind		Montana	Colstrip/BPA or AVAT.NWMT	AVA.SYS	1/1/2032	Indefinite	200.0	200.0
Natural Gas CT	Rathdrum CT Site	Rathdrum, ID	AVA.SYS	AVA.SYS	1/1/2034	Indefinite	90.0	90.0
Renewable Fueled CT	Greensferry Rd	Rathdrum, ID	AVA.SYS	AVA.SYS	1/1/2036	Indefinite	88.0	88.0
Energy Storage	Northeast Site	N. Spokane	AVA.SYS	AVA.SYS	1/1/2039	Indefinite	52.0	52.0
Natural Gas ICE		N. Idaho	AVA.SYS	AVA.SYS	1/1/2041	Indefinite	46.0	
Renewable Fueled CT	Greensferry Rd	Rathdrum, ID	AVA.SYS	AVA.SYS	1/1/2041	Indefinite	74.0	
Wind	PPA Replacement	Big Bend Area	AVA.SYS	AVA.SYS	1/1/2041	Indefinite	140.0	260.0
Natural Gas CT		N. Idaho	AVA.SYS	AVA.SYS	1/1/2042	Indefinite	102.0	
Renewable Fueled CT		Greensferry Rd, ID	AVA.SYS	AVA.SYS	1/1/2042	Indefinite	186.0	
Wind	PPA Replacement	Whitman County, WA	AVA.SYS	AVA.SYS	1/1/2042	Indefinite	105.0	393.0
Energy Storage	Boulder Park Site	Spokane Valley, WA	AVA.SYS	AVA.SYS	1/1/2043	Indefinite	68.0	68.0
Energy Storage	Boulder Park Site	Spokane Valley, WA	AVA.SYS	AVA.SYS	1/1/2044	Indefinite	50.0	
Wind		Off-System	BPA	AVA.SYS	1/1/2044	Indefinite	100.0	150.0
Natural Gas ICE		N. Idaho	AVA.SYS	AVA.SYS	1/1/2045	Indefinite	65.0	
Wind		Off-System	BPA	AVA.SYS	1/1/2045	Indefinite	200.0	
Energy Storage		N. Idaho	AVA.SYS	AVA.SYS	1/1/2045	Indefinite	25.0	
Renewable Fueled CT		Eastern Washington	AVA.SYS	AVA.SYS	1/1/2045	Indefinite	348.0	638.0

2147.0 2147.0

Does not include generation related to ammonia production

# 2023 Electric Integrated Resource Plan

## Appendix J – Confidential Inputs





## Appendix J Content

The Company makes data input files in native format, models, and other various content used for its Integrated Resource Planning process available to stakeholders. Non-confidential, non-proprietary IRP content can also be found at [Integrated Resource Planning \(myavista.com\)](https://myavista.com). In a manner to further increase transparency and provide clarity for stakeholders, the following table provides context on data files, models and other content included in Appendix J.

File Name	Folder	File Type	Description of Content
ARAM_2023 IRP 2030 Base Model with Aurora Price Forecast 330 MW	ARAM-Reliability Studies	Excel	Reliability and market reliance study for select year.
ARAM_2023 IRP 2030 Base Model with Aurora Price Forecast 1,000 MW	ARAM-Reliability Studies	Excel	Reliability and market reliance study for select year.
ARAM_2023 IRP 2045 Base Model with Aurora Price Forecast 330 MW	ARAM-Reliability Studies	Excel	Reliability and market reliance study for select year.
ARAM_2023 IRP 2045 Base Model with Aurora Price Forecast 1,000 MW	ARAM-Reliability Studies	Excel	Reliability and market reliance study for select year.
2023 IRP Stochastic_Archive	Aurora	Aurora zip	Includes deterministic, stochastic, change sets, market scenarios – high natural gas, low natural gas, national CO2 price and Aurora database for US/Canada.

# 2023 Electric Integrated Resource Plan

## Appendix K Resource Portfolio Summary



**Portfolio #1 Preferred Resource Strategy**

Washington:	2024	2025	2026	2027	2028	2029	2030	2031	2032	2033	2034	2035	2036	2037	2038	2039	2040	2041	2042	2043	2044	2045	Total		
Natural Gas	0	0	0	0	0	0	0	0	0	0	0	0	0	0	0	0	0	0	0	0	0	0	0	0	
Nuclear	0	0	0	0	0	0	0	0	0	0	0	0	0	0	0	0	0	0	0	0	0	0	0	0	
Wind	0	0	0	0	0	0	200	0	200	0	0	0	0	0	0	0	0	140	105	0	100	200	945	0	
Solar	1	1	1	1	1	1	1	1	1	1	0	0	0	0	0	0	0	0	0	0	0	0	0	10	
Lithium-Ion Storage	0	0	0	0	0	0	0	0	0	0	0	0	0	0	1	0	0	1	0	1	0	1	1	2	
Flow Battery	0	0	0	0	0	0	0	0	0	0	0	0	0	0	0	0	0	0	0	0	0	0	0	0	
Iron Oxide Storage	0	0	0	0	0	0	0	0	0	0	0	0	0	0	0	52	0	0	0	44	32	0	128	0	
Geothermal	0	0	0	0	0	0	0	0	0	0	0	0	0	0	0	0	0	0	0	0	0	0	0	0	
Hydrogen	0	0	0	0	0	0	0	0	0	0	0	0	0	0	0	0	0	0	0	0	0	0	0	0	
Ammonia	0	0	0	0	0	0	0	0	0	0	0	0	88	0	0	0	0	74	186	0	0	348	696	0	
Liquid Air	0	0	0	0	0	0	0	0	0	0	0	0	0	0	0	0	0	0	0	0	0	0	0	0	
Pumped Hydro	0	0	0	0	0	0	0	0	0	0	0	0	0	0	0	0	0	0	0	0	0	0	0	0	
Biomass	0	0	0	0	0	0	0	0	0	0	0	0	0	0	0	0	0	0	0	0	0	0	0	0	
Retail Pricing	0	7	0	0	0	0	0	0	0	0	0	0	0	0	0	0	0	0	0	0	0	0	0	7	
Demand Response	0	0	0	0	0	0	0	0	0	0	0	0	0	0	0	0	0	0	0	0	0	0	0	0	
<b>Total</b>	<b>1</b>	<b>7</b>	<b>1</b>	<b>1</b>	<b>1</b>	<b>1</b>	<b>201</b>	<b>1</b>	<b>201</b>	<b>1</b>	<b>0</b>	<b>0</b>	<b>89</b>	<b>0</b>	<b>1</b>	<b>52</b>	<b>0</b>	<b>215</b>	<b>291</b>	<b>44</b>	<b>133</b>	<b>548</b>	<b>1,788</b>		
<b>Idaho</b>	<b>2024</b>	<b>2025</b>	<b>2026</b>	<b>2027</b>	<b>2028</b>	<b>2029</b>	<b>2030</b>	<b>2031</b>	<b>2032</b>	<b>2033</b>	<b>2034</b>	<b>2035</b>	<b>2036</b>	<b>2037</b>	<b>2038</b>	<b>2039</b>	<b>2040</b>	<b>2041</b>	<b>2042</b>	<b>2043</b>	<b>2044</b>	<b>2045</b>	<b>Total</b>		
Natural Gas	0	0	0	0	0	0	0	0	0	0	90	0	0	0	0	0	0	46	102	0	0	65	304	0	
Nuclear	0	0	0	0	0	0	0	0	0	0	0	0	0	0	0	0	0	0	0	0	0	0	0	0	
Wind	0	0	0	0	0	0	0	0	0	0	0	0	0	0	0	0	0	0	0	0	0	0	0	0	
Solar	0	0	0	0	0	0	0	0	0	0	0	0	0	0	0	0	0	0	0	0	0	0	0	0	
Lithium-Ion Storage	0	0	0	0	0	0	0	0	0	0	0	0	0	0	0	0	0	0	0	0	0	25	25	0	
Flow battery	0	0	0	0	0	0	0	0	0	0	0	0	0	0	0	0	0	0	0	0	0	0	0	0	
Iron Oxide Storage	0	0	0	0	0	0	0	0	0	0	0	0	0	0	0	0	0	0	0	24	18	0	42	0	
Geothermal	0	0	0	0	0	0	0	0	0	0	0	0	0	0	0	0	0	0	0	0	0	0	0	0	
Hydrogen	0	0	0	0	0	0	0	0	0	0	0	0	0	0	0	0	0	0	0	0	0	0	0	0	
Ammonia	0	0	0	0	0	0	0	0	0	0	0	0	0	0	0	0	0	0	0	0	0	0	0	0	
Liquid Air	0	0	0	0	0	0	0	0	0	0	0	0	0	0	0	0	0	0	0	0	0	0	0	0	
Pumped Hydro	0	0	0	0	0	0	0	0	0	0	0	0	0	0	0	0	0	0	0	0	0	0	0	0	
Biomass	0	0	0	0	0	0	0	0	0	0	0	0	0	0	0	0	0	0	0	0	0	0	0	0	
Retail Pricing	0	0	0	0	0	0	0	0	0	0	0	0	0	0	0	0	0	0	0	0	0	0	0	0	
Demand Response	0	0	0	0	0	0	0	0	0	0	0	0	0	0	0	0	0	0	0	0	0	0	0	0	
<b>Total</b>	<b>0</b>	<b>0</b>	<b>0</b>	<b>0</b>	<b>0</b>	<b>0</b>	<b>0</b>	<b>0</b>	<b>0</b>	<b>0</b>	<b>90</b>	<b>0</b>	<b>0</b>	<b>0</b>	<b>0</b>	<b>0</b>	<b>0</b>	<b>46</b>	<b>102</b>	<b>24</b>	<b>18</b>	<b>90</b>	<b>370</b>	<b>0</b>	
<b>Grand Total</b>	<b>1</b>	<b>7</b>	<b>1</b>	<b>1</b>	<b>1</b>	<b>1</b>	<b>201</b>	<b>1</b>	<b>201</b>	<b>1</b>	<b>90</b>	<b>0</b>	<b>89</b>	<b>0</b>	<b>1</b>	<b>52</b>	<b>0</b>	<b>261</b>	<b>393</b>	<b>68</b>	<b>150</b>	<b>638</b>	<b>2,158</b>	<b>0</b>	
<b>Cumulative Energy Efficiency (aMW)</b>																									
Washington	3	6	10	13	18	22	26	30	35	38	41	44	47	49	51	53	54	56	57	58	59	59	829	0	
Idaho	1	2	4	5	7	8	10	11	13	14	16	17	18	19	19	20	21	21	22	22	23	23	316	0	
<b>Total</b>	<b>4</b>	<b>8</b>	<b>13</b>	<b>19</b>	<b>24</b>	<b>30</b>	<b>36</b>	<b>42</b>	<b>48</b>	<b>52</b>	<b>57</b>	<b>61</b>	<b>65</b>	<b>68</b>	<b>70</b>	<b>73</b>	<b>75</b>	<b>77</b>	<b>79</b>	<b>80</b>	<b>81</b>	<b>82</b>	<b>1,145</b>	<b>0</b>	

**Portfolio #2 Alternative Lowest Reasonable Cost Portfolio**

Washington	2024	2025	2026	2027	2028	2029	2030	2031	2032	2033	2034	2035	2036	2037	2038	2039	2040	2041	2042	2043	2044	2045	Total	
Natural Gas	0	0	0	0	0	0	0	0	0	0	0	0	0	0	0	0	0	0	0	0	0	0	247	247
Nuclear	0	0	0	0	0	0	0	0	0	0	0	0	0	0	0	0	0	0	0	0	0	0	0	0
Wind	0	0	0	0	0	0	200	0	200	0	0	0	0	0	0	0	0	140	105	0	0	0	198	843
Solar	0	0	0	0	0	0	0	0	0	0	0	0	0	0	0	0	0	0	0	0	0	51	51	
Lithium-Ion Storage	0	0	0	0	0	0	0	0	0	0	0	0	0	0	0	0	0	0	0	0	0	25	25	
Flow Battery	0	0	0	0	0	0	0	0	0	0	0	0	0	0	0	0	0	0	0	0	0	0	0	
Iron Oxide Storage	0	0	0	0	0	0	0	0	0	0	0	0	0	0	0	52	0	52	212	39	38	101	494	
Geothermal	0	0	0	0	0	0	0	0	0	0	0	0	0	0	0	0	0	0	0	0	0	0	0	
Hydrogen	0	0	0	0	0	0	0	0	0	0	0	0	0	0	0	0	0	0	0	0	0	0	0	
Ammonia	0	0	0	0	0	0	0	0	0	0	0	0	88	0	0	0	0	0	0	0	0	0	0	88
Liquid Air	0	0	0	0	0	0	0	0	0	0	0	0	0	0	0	0	0	0	0	0	0	0	0	0
Pumped Hydro	0	0	0	0	0	0	0	0	0	0	0	0	0	0	0	0	0	0	0	0	0	0	0	0
Biomass	0	0	0	0	0	0	0	0	0	0	0	0	0	0	0	0	0	0	0	0	0	0	0	0
Retail Pricing	0	7	0	0	0	0	0	0	0	0	0	0	0	0	0	0	0	0	0	0	0	0	0	7
Demand Response	0	0	0	0	0	0	0	0	0	0	0	0	0	0	0	0	0	0	0	0	0	0	0	0
<b>Total</b>	<b>0</b>	<b>7</b>	<b>0</b>	<b>0</b>	<b>0</b>	<b>0</b>	<b>200</b>	<b>0</b>	<b>200</b>	<b>0</b>	<b>0</b>	<b>0</b>	<b>88</b>	<b>0</b>	<b>0</b>	<b>52</b>	<b>0</b>	<b>192</b>	<b>317</b>	<b>39</b>	<b>114</b>	<b>546</b>	<b>1,755</b>	
<b>Idaho</b>																								
Idaho	2024	2025	2026	2027	2028	2029	2030	2031	2032	2033	2034	2035	2036	2037	2038	2039	2040	2041	2042	2043	2044	2045	Total	
Natural Gas	0	0	0	0	0	0	0	0	0	0	90	0	0	0	0	0	0	0	121	0	0	0	53	264
Nuclear	0	0	0	0	0	0	0	0	0	0	0	0	0	0	0	0	0	0	0	0	0	0	0	0
Wind	0	0	0	0	0	0	0	0	0	0	0	0	0	0	0	0	0	0	0	0	0	0	0	0
Solar	0	0	0	0	0	0	0	0	0	0	0	0	0	0	0	0	0	0	0	0	0	0	0	0
Lithium-Ion Storage	0	0	0	0	0	0	0	0	0	0	0	0	0	0	0	0	0	0	0	0	0	0	0	0
Flow Battery	0	0	0	0	0	0	0	0	0	0	0	0	0	0	0	0	0	0	0	0	0	0	0	0
Iron Oxide Storage	0	0	0	0	0	0	0	0	0	0	0	0	0	0	0	0	0	29	0	22	21	18	89	89
Geothermal	0	0	0	0	0	0	0	0	0	0	0	0	0	0	0	0	0	0	0	0	0	0	0	0
Hydrogen	0	0	0	0	0	0	0	0	0	0	0	0	0	0	0	0	0	0	0	0	0	0	0	0
Ammonia	0	0	0	0	0	0	0	0	0	0	0	0	0	0	0	0	0	0	0	0	0	0	0	0
Liquid Air	0	0	0	0	0	0	0	0	0	0	0	0	0	0	0	0	0	0	0	0	0	0	0	0
Pumped Hydro	0	0	0	0	0	0	0	0	0	0	0	0	0	0	0	0	0	0	0	0	0	0	0	0
Biomass	0	0	0	0	0	0	0	0	0	0	0	0	0	0	0	0	0	0	0	0	0	0	0	0
Retail Pricing	0	0	0	0	0	0	0	0	0	0	0	0	0	0	0	0	0	0	0	0	0	0	0	0
Demand Response	0	0	0	0	0	0	0	0	0	0	0	0	0	0	0	0	0	0	0	0	0	0	0	0
<b>Total</b>	<b>0</b>	<b>0</b>	<b>0</b>	<b>0</b>	<b>0</b>	<b>0</b>	<b>0</b>	<b>0</b>	<b>0</b>	<b>0</b>	<b>90</b>	<b>0</b>	<b>0</b>	<b>0</b>	<b>0</b>	<b>0</b>	<b>0</b>	<b>29</b>	<b>121</b>	<b>22</b>	<b>21</b>	<b>70</b>	<b>353</b>	
<b>Grand Total</b>	<b>0</b>	<b>7</b>	<b>0</b>	<b>0</b>	<b>0</b>	<b>0</b>	<b>200</b>	<b>0</b>	<b>200</b>	<b>0</b>	<b>90</b>	<b>0</b>	<b>88</b>	<b>0</b>	<b>0</b>	<b>52</b>	<b>0</b>	<b>220</b>	<b>438</b>	<b>61</b>	<b>135</b>	<b>616</b>	<b>2,108</b>	
<b>Cumulative Energy Efficiency (aMW)</b>																								
Washington	3	6	10	13	18	22	26	31	35	38	41	44	47	49	51	53	54	56	57	58	59	59	829	
Idaho	1	2	4	5	7	9	10	12	14	15	16	17	19	20	20	21	22	23	23	24	24	24	332	
<b>Total</b>	<b>4</b>	<b>9</b>	<b>13</b>	<b>19</b>	<b>25</b>	<b>31</b>	<b>37</b>	<b>42</b>	<b>48</b>	<b>53</b>	<b>58</b>	<b>62</b>	<b>65</b>	<b>69</b>	<b>71</b>	<b>74</b>	<b>76</b>	<b>78</b>	<b>80</b>	<b>81</b>	<b>83</b>	<b>83</b>	<b>1,162</b>	

**Portfolio #3 Baseline Portfolio**

Washington	2024	2025	2026	2027	2028	2029	2030	2031	2032	2033	2034	2035	2036	2037	2038	2039	2040	2041	2042	2043	2044	2045	Total
Natural Gas	0	0	0	0	0	0	0	0	0	0	0	3	74	0	58	0	90	0	209	0	0	0	434
Nuclear	0	0	0	0	0	0	0	0	0	0	0	0	0	0	0	0	0	0	0	0	0	0	0
Wind	0	0	0	0	0	0	200	0	164	0	0	0	0	0	0	0	0	0	0	0	0	0	364
Solar	0	0	0	0	0	0	0	0	0	0	0	0	0	0	0	0	0	0	0	0	0	0	0
Lithium-Ion Storage	0	0	0	0	0	0	0	0	0	0	0	0	0	0	0	0	0	0	25	0	0	0	25
Flow battery	0	0	0	0	0	0	0	0	0	0	0	0	0	0	0	0	0	0	0	0	0	0	0
Iron Oxide Storage	0	0	0	0	0	0	0	0	0	0	0	0	0	0	0	0	0	0	0	44	38	158	240
Geothermal	0	0	0	0	0	0	0	0	0	0	0	0	0	0	0	0	0	0	0	0	0	0	0
Hydrogen	0	0	0	0	0	0	0	0	0	0	0	0	0	0	0	0	0	0	0	0	0	0	0
Ammonia	0	0	0	0	0	0	0	0	0	0	0	0	0	0	0	0	0	0	0	0	0	0	0
Liquid Air	0	0	0	0	0	0	0	0	0	0	0	0	0	0	0	0	0	0	0	0	0	0	0
Pumped Hydro	0	0	0	0	0	0	0	0	0	0	0	0	0	0	0	0	0	0	0	0	0	0	0
Biomass	0	0	0	0	0	0	0	0	0	0	0	0	0	0	0	0	0	0	0	0	0	0	0
Retail Pricing	0	7	0	0	0	0	0	0	0	0	0	0	0	0	0	0	0	0	0	0	0	0	7
Demand Response	0	0	0	0	0	0	0	0	0	0	0	0	0	0	0	0	0	0	0	0	0	0	0
<b>Total</b>	<b>0</b>	<b>7</b>	<b>0</b>	<b>0</b>	<b>0</b>	<b>0</b>	<b>200</b>	<b>0</b>	<b>164</b>	<b>0</b>	<b>0</b>	<b>3</b>	<b>74</b>	<b>0</b>	<b>58</b>	<b>0</b>	<b>90</b>	<b>0</b>	<b>234</b>	<b>44</b>	<b>38</b>	<b>158</b>	<b>1,070</b>
<b>Idaho</b>																							
Idaho	2024	2025	2026	2027	2028	2029	2030	2031	2032	2033	2034	2035	2036	2037	2038	2039	2040	2041	2042	2043	2044	2045	Total
Natural Gas	0	0	0	0	0	0	0	0	0	0	0	2	41	0	32	0	0	0	91	0	0	0	166
Nuclear	0	0	0	0	0	0	0	0	0	0	0	0	0	0	0	0	0	0	0	0	0	0	0
Wind	0	0	0	0	0	0	0	0	36	0	0	0	0	0	0	0	0	0	0	0	0	0	36
Solar	0	0	0	0	0	0	0	0	0	0	0	0	0	0	0	0	0	0	0	0	0	0	0
Lithium-Ion Storage	0	0	0	0	0	0	0	0	0	0	0	0	0	0	0	0	0	0	0	0	0	0	0
Flow Battery	0	0	0	0	0	0	0	0	0	0	0	0	0	0	0	0	0	0	0	0	0	0	0
Iron Oxide Storage	0	0	0	0	0	0	0	0	0	0	0	0	0	0	0	0	0	63	0	24	21	67	176
Geothermal	0	0	0	0	0	0	0	0	0	0	0	0	0	0	0	0	0	0	0	0	0	0	0
Hydrogen	0	0	0	0	0	0	0	0	0	0	0	0	0	0	0	0	0	0	0	0	0	0	0
Ammonia	0	0	0	0	0	0	0	0	0	0	0	0	0	0	0	0	0	0	0	0	0	0	0
Liquid Air	0	0	0	0	0	0	0	0	0	0	0	0	0	0	0	0	0	0	0	0	0	0	0
Pumped Hydro	0	0	0	0	0	0	0	0	0	0	0	0	0	0	0	0	0	0	0	0	0	0	0
Biomass	0	0	0	0	0	0	0	0	0	0	0	0	0	0	0	0	0	0	0	0	0	0	0
Retail Pricing	0	0	0	0	0	0	0	9	2	0	0	0	0	0	0	0	0	0	0	0	0	0	11
Demand Response	0	0	0	0	0	0	0	0	0	0	0	0	0	0	0	0	0	0	0	0	0	0	0
<b>Total</b>	<b>0</b>	<b>0</b>	<b>0</b>	<b>0</b>	<b>0</b>	<b>0</b>	<b>0</b>	<b>9</b>	<b>37</b>	<b>0</b>	<b>0</b>	<b>2</b>	<b>41</b>	<b>0</b>	<b>32</b>	<b>0</b>	<b>0</b>	<b>63</b>	<b>91</b>	<b>24</b>	<b>21</b>	<b>67</b>	<b>388</b>
<b>Grand Total</b>	<b>0</b>	<b>7</b>	<b>0</b>	<b>0</b>	<b>0</b>	<b>0</b>	<b>200</b>	<b>9</b>	<b>202</b>	<b>0</b>	<b>0</b>	<b>5</b>	<b>114</b>	<b>0</b>	<b>91</b>	<b>0</b>	<b>90</b>	<b>63</b>	<b>325</b>	<b>68</b>	<b>60</b>	<b>225</b>	<b>1,458</b>
<b>Cumulative Energy Efficiency (aMW)</b>																							
Washington	3	6	10	13	18	22	26	30	35	38	41	44	47	49	51	53	54	56	57	58	59	59	829
Idaho	1	2	4	5	7	8	10	11	13	14	16	17	18	19	19	20	21	21	22	22	23	23	316
<b>Total</b>	<b>4</b>	<b>8</b>	<b>13</b>	<b>19</b>	<b>24</b>	<b>30</b>	<b>36</b>	<b>42</b>	<b>48</b>	<b>52</b>	<b>57</b>	<b>61</b>	<b>65</b>	<b>68</b>	<b>70</b>	<b>73</b>	<b>75</b>	<b>77</b>	<b>79</b>	<b>80</b>	<b>81</b>	<b>82</b>	<b>1,145</b>

**Portfolio #4 No Resource Additions**

Washington	2024	2025	2026	2027	2028	2029	2030	2031	2032	2033	2034	2035	2036	2037	2038	2039	2040	2041	2042	2043	2044	2045	Total
Natural Gas	0	0	0	0	0	0	0	0	0	0	0	0	0	0	0	0	0	0	0	0	0	0	0
Nuclear	0	0	0	0	0	0	0	0	0	0	0	0	0	0	0	0	0	0	0	0	0	0	0
Wind	0	0	0	0	0	0	0	0	0	0	0	0	0	0	0	0	0	0	0	0	0	0	0
Solar	0	0	0	0	0	0	0	0	0	0	0	0	0	0	0	0	0	0	0	0	0	0	0
Lithium-Ion Storage	0	0	0	0	0	0	0	0	0	0	0	0	0	0	0	0	0	0	0	0	0	0	0
Flow Battery	0	0	0	0	0	0	0	0	0	0	0	0	0	0	0	0	0	0	0	0	0	0	0
Iron Oxide Storage	0	0	0	0	0	0	0	0	0	0	0	0	0	0	0	0	0	0	0	0	0	0	0
Geothermal	0	0	0	0	0	0	0	0	0	0	0	0	0	0	0	0	0	0	0	0	0	0	0
Hydrogen	0	0	0	0	0	0	0	0	0	0	0	0	0	0	0	0	0	0	0	0	0	0	0
Ammonia	0	0	0	0	0	0	0	0	0	0	0	0	0	0	0	0	0	0	0	0	0	0	0
Liquid Air	0	0	0	0	0	0	0	0	0	0	0	0	0	0	0	0	0	0	0	0	0	0	0
Pumped Hydro	0	0	0	0	0	0	0	0	0	0	0	0	0	0	0	0	0	0	0	0	0	0	0
Biomass	0	0	0	0	0	0	0	0	0	0	0	0	0	0	0	0	0	0	0	0	0	0	0
Retail Pricing	0	0	0	0	0	0	0	0	0	0	0	0	0	0	0	0	0	0	0	0	0	0	0
Demand Response	0	0	0	0	0	0	0	0	0	0	0	0	0	0	0	0	0	0	0	0	0	0	0
<b>Total</b>	<b>0</b>	<b>0</b>	<b>0</b>	<b>0</b>	<b>0</b>	<b>0</b>	<b>0</b>	<b>0</b>	<b>0</b>	<b>0</b>	<b>0</b>	<b>0</b>	<b>0</b>	<b>0</b>	<b>0</b>	<b>0</b>	<b>0</b>	<b>0</b>	<b>0</b>	<b>0</b>	<b>0</b>	<b>0</b>	<b>0</b>
<b>Idaho</b>																							
Idaho	2024	2025	2026	2027	2028	2029	2030	2031	2032	2033	2034	2035	2036	2037	2038	2039	2040	2041	2042	2043	2044	2045	Total
Natural Gas	0	0	0	0	0	0	0	0	0	0	0	0	0	0	0	0	0	0	0	0	0	0	0
Nuclear	0	0	0	0	0	0	0	0	0	0	0	0	0	0	0	0	0	0	0	0	0	0	0
Wind	0	0	0	0	0	0	0	0	0	0	0	0	0	0	0	0	0	0	0	0	0	0	0
Solar	0	0	0	0	0	0	0	0	0	0	0	0	0	0	0	0	0	0	0	0	0	0	0
Lithium-Ion Storage	0	0	0	0	0	0	0	0	0	0	0	0	0	0	0	0	0	0	0	0	0	0	0
Flow Battery	0	0	0	0	0	0	0	0	0	0	0	0	0	0	0	0	0	0	0	0	0	0	0
Iron Oxide Storage	0	0	0	0	0	0	0	0	0	0	0	0	0	0	0	0	0	0	0	0	0	0	0
Geothermal	0	0	0	0	0	0	0	0	0	0	0	0	0	0	0	0	0	0	0	0	0	0	0
Hydrogen	0	0	0	0	0	0	0	0	0	0	0	0	0	0	0	0	0	0	0	0	0	0	0
Ammonia	0	0	0	0	0	0	0	0	0	0	0	0	0	0	0	0	0	0	0	0	0	0	0
Liquid Air	0	0	0	0	0	0	0	0	0	0	0	0	0	0	0	0	0	0	0	0	0	0	0
Pumped Hydro	0	0	0	0	0	0	0	0	0	0	0	0	0	0	0	0	0	0	0	0	0	0	0
Biomass	0	0	0	0	0	0	0	0	0	0	0	0	0	0	0	0	0	0	0	0	0	0	0
Retail Pricing	0	0	0	0	0	0	0	0	0	0	0	0	0	0	0	0	0	0	0	0	0	0	0
Demand Response	0	0	0	0	0	0	0	0	0	0	0	0	0	0	0	0	0	0	0	0	0	0	0
<b>Total</b>	<b>0</b>	<b>0</b>	<b>0</b>	<b>0</b>	<b>0</b>	<b>0</b>	<b>0</b>	<b>0</b>	<b>0</b>	<b>0</b>	<b>0</b>	<b>0</b>	<b>0</b>	<b>0</b>	<b>0</b>	<b>0</b>	<b>0</b>	<b>0</b>	<b>0</b>	<b>0</b>	<b>0</b>	<b>0</b>	<b>0</b>
<b>Grand Total</b>	<b>0</b>	<b>0</b>	<b>0</b>	<b>0</b>	<b>0</b>	<b>0</b>	<b>0</b>	<b>0</b>	<b>0</b>	<b>0</b>	<b>0</b>	<b>0</b>	<b>0</b>	<b>0</b>	<b>0</b>	<b>0</b>	<b>0</b>	<b>0</b>	<b>0</b>	<b>0</b>	<b>0</b>	<b>0</b>	<b>0</b>
<b>Cumulative Energy Efficiency (aMW)</b>																							
Washington	3	6	10	13	18	22	26	30	35	38	41	44	47	49	51	53	54	56	57	58	59	59	829
Idaho	1	2	4	5	7	8	10	11	13	14	16	17	18	19	19	20	21	21	22	22	23	23	316
<b>Total</b>	<b>4</b>	<b>8</b>	<b>13</b>	<b>19</b>	<b>24</b>	<b>30</b>	<b>36</b>	<b>42</b>	<b>48</b>	<b>52</b>	<b>57</b>	<b>61</b>	<b>65</b>	<b>68</b>	<b>70</b>	<b>73</b>	<b>75</b>	<b>77</b>	<b>79</b>	<b>80</b>	<b>81</b>	<b>82</b>	<b>1,145</b>

**Portfolio #5 No CETA/No New Natural Gas**

Washington	2024	2025	2026	2027	2028	2029	2030	2031	2032	2033	2034	2035	2036	2037	2038	2039	2040	2041	2042	2043	2044	2045	Total
Natural Gas	0	0	0	0	0	0	0	0	0	0	0	0	0	0	0	0	0	0	0	0	0	0	0
Nuclear	0	0	0	0	0	0	0	0	0	0	0	0	0	0	0	0	0	0	0	0	0	0	0
Wind	0	0	0	0	0	0	200	0	200	0	0	0	0	0	0	0	0	0	0	0	0	0	400
Solar	0	0	0	0	0	0	0	0	0	0	0	0	0	0	0	0	0	0	0	0	0	0	0
Lithium-Ion Storage	0	0	0	0	0	0	0	0	0	0	0	0	0	0	0	0	0	0	0	0	0	0	0
Flow Battery	0	0	0	0	0	0	0	0	0	0	0	0	0	0	0	0	0	0	0	0	0	0	0
Iron Oxide Storage	0	0	0	0	0	0	0	0	0	0	0	0	0	0	34	0	32	69	226	34	38	361	795
Geothermal	0	0	0	0	0	0	0	0	0	0	0	0	0	0	0	0	0	0	0	0	0	0	0
Hydrogen	0	0	0	0	0	0	0	0	0	0	0	0	0	0	0	0	0	0	0	0	0	0	0
Ammonia	0	0	0	0	0	0	0	0	0	0	0	0	79	0	0	0	0	0	0	0	0	0	79
Liquid Air	0	0	0	0	0	0	0	0	0	0	0	0	0	0	0	0	0	0	0	0	0	0	0
Pumped Hydro	0	0	0	0	0	0	0	0	0	0	0	0	0	0	0	0	0	0	0	0	0	0	0
Biomass	0	0	0	0	0	0	0	0	0	0	0	0	0	0	0	0	0	0	0	0	0	0	0
Retail Pricing	0	7	0	0	0	0	0	0	0	0	0	0	0	0	0	0	0	0	0	0	0	0	7
Demand Response	0	0	0	0	0	0	0	0	0	0	0	0	0	0	0	0	0	0	0	0	0	0	0
<b>Total</b>	<b>0</b>	<b>7</b>	<b>0</b>	<b>0</b>	<b>0</b>	<b>0</b>	<b>200</b>	<b>0</b>	<b>200</b>	<b>0</b>	<b>0</b>	<b>0</b>	<b>79</b>	<b>0</b>	<b>34</b>	<b>0</b>	<b>32</b>	<b>69</b>	<b>226</b>	<b>34</b>	<b>38</b>	<b>361</b>	<b>1,281</b>
<b>Idaho</b>																							
Idaho	2024	2025	2026	2027	2028	2029	2030	2031	2032	2033	2034	2035	2036	2037	2038	2039	2040	2041	2042	2043	2044	2045	Total
Natural Gas	0	0	0	0	0	0	0	0	0	0	0	0	0	0	0	0	0	0	0	0	0	0	0
Nuclear	0	0	0	0	0	0	0	0	0	0	0	0	0	0	0	0	0	0	0	0	0	0	0
Wind	0	0	0	0	0	0	0	0	0	0	0	0	0	0	0	0	0	0	0	0	0	0	0
Solar	0	0	0	0	0	0	0	0	0	0	0	0	0	0	0	0	0	0	0	0	0	0	0
Lithium-Ion Storage	0	0	0	0	0	0	0	0	0	0	0	0	0	0	0	0	0	0	0	0	0	0	0
Flow Battery	0	0	0	0	0	0	0	0	0	0	0	0	0	0	0	0	0	0	0	0	0	0	0
Iron Oxide Storage	0	0	0	0	0	0	0	0	54	0	0	0	0	0	19	0	18	38	107	19	21	74	350
Geothermal	0	0	0	0	0	0	0	0	0	0	0	0	0	0	0	0	0	0	0	0	0	0	0
Hydrogen	0	0	0	0	0	0	0	0	0	0	0	0	0	0	0	0	0	0	0	0	0	0	0
Ammonia	0	0	0	0	0	0	0	0	0	0	0	0	0	0	0	0	0	0	0	0	0	0	0
Liquid Air	0	0	0	0	0	0	0	0	0	0	0	0	0	0	0	0	0	0	0	0	0	0	0
Pumped Hydro	0	0	0	0	0	0	0	0	0	0	0	0	0	0	0	0	0	0	0	0	0	0	0
Biomass	0	0	0	0	0	0	0	0	0	0	0	0	0	0	0	0	0	0	0	0	0	0	0
Retail Pricing	0	0	0	0	0	0	0	0	0	0	0	0	0	0	0	0	0	0	0	0	0	0	0
Demand Response	0	0	0	0	0	0	0	0	0	0	0	0	0	0	0	0	0	0	0	0	0	0	0
<b>Total</b>	<b>0</b>	<b>0</b>	<b>0</b>	<b>0</b>	<b>0</b>	<b>0</b>	<b>0</b>	<b>0</b>	<b>54</b>	<b>0</b>	<b>0</b>	<b>0</b>	<b>0</b>	<b>0</b>	<b>19</b>	<b>0</b>	<b>18</b>	<b>38</b>	<b>107</b>	<b>19</b>	<b>21</b>	<b>74</b>	<b>350</b>
<b>Grand Total</b>	<b>0</b>	<b>7</b>	<b>0</b>	<b>0</b>	<b>0</b>	<b>0</b>	<b>200</b>	<b>0</b>	<b>254</b>	<b>0</b>	<b>0</b>	<b>0</b>	<b>79</b>	<b>0</b>	<b>53</b>	<b>0</b>	<b>50</b>	<b>108</b>	<b>334</b>	<b>53</b>	<b>59</b>	<b>434</b>	<b>1,631</b>
<b>Cumulative Energy Efficiency (aMW)</b>																							
Washington	3	6	10	13	18	22	26	30	35	38	41	44	47	49	51	53	54	56	57	58	59	59	829
Idaho	1	2	4	5	7	8	10	11	13	14	16	17	18	19	19	20	21	21	22	22	23	23	316
<b>Total</b>	<b>4</b>	<b>8</b>	<b>13</b>	<b>19</b>	<b>24</b>	<b>30</b>	<b>36</b>	<b>42</b>	<b>48</b>	<b>52</b>	<b>57</b>	<b>61</b>	<b>65</b>	<b>68</b>	<b>70</b>	<b>73</b>	<b>75</b>	<b>77</b>	<b>79</b>	<b>80</b>	<b>81</b>	<b>82</b>	<b>1,145</b>

**Portfolio #6 WRAP Planning Reserve Margins (PRM)**

Washington	2024	2025	2026	2027	2028	2029	2030	2031	2032	2033	2034	2035	2036	2037	2038	2039	2040	2041	2042	2043	2044	2045	Total
Natural Gas	0	0	0	0	0	0	0	0	0	0	0	0	6	0	0	0	0	0	0	0	0	0	6
Nuclear	0	0	0	0	0	0	0	0	0	0	0	0	0	0	0	0	0	0	0	0	0	0	0
Wind	0	0	0	0	0	0	200	0	200	0	0	0	0	0	0	0	0	140	105	0	183	200	1,028
Solar	1	1	1	1	1	1	1	1	1	1	0	0	0	0	0	0	0	0	0	0	0	0	11
Lithium-Ion Storage	0	0	0	0	0	0	0	0	0	0	0	0	0	0	0	0	0	0	0	1	0	0	1
Flow Battery	0	0	0	0	0	0	0	0	0	0	0	0	0	0	0	0	0	0	0	0	0	0	0
Iron Oxide Storage	0	0	0	0	0	0	0	0	0	0	0	0	56	0	50	0	32	50	101	44	32	0	364
Geothermal	0	0	0	0	0	0	0	0	0	0	0	0	0	0	0	0	0	0	0	0	0	20	20
Hydrogen	0	0	0	0	0	0	0	0	0	0	0	0	0	0	0	0	0	0	0	0	0	0	0
Ammonia	0	0	0	0	0	0	0	0	0	0	0	0	0	0	0	0	0	0	78	0	0	500	578
Liquid Air	0	0	0	0	0	0	0	0	0	0	0	0	0	0	0	0	0	0	0	0	0	0	0
Pumped Hydro	0	0	0	0	0	0	0	0	0	0	0	0	0	0	0	0	0	0	0	0	0	0	0
Biomass	0	0	0	0	0	0	0	0	0	0	0	0	0	0	0	0	0	0	0	0	0	0	0
Retail Pricing	0	7	0	0	0	0	0	0	0	0	0	0	0	0	0	0	0	0	0	0	0	0	7
Demand Response	0	0	0	0	0	0	0	0	0	0	0	0	0	0	0	0	0	0	0	0	0	0	0
<b>Total</b>	<b>1</b>	<b>7</b>	<b>1</b>	<b>1</b>	<b>1</b>	<b>1</b>	<b>201</b>	<b>1</b>	<b>201</b>	<b>1</b>	<b>0</b>	<b>0</b>	<b>62</b>	<b>0</b>	<b>50</b>	<b>0</b>	<b>33</b>	<b>190</b>	<b>284</b>	<b>44</b>	<b>216</b>	<b>720</b>	<b>2,016</b>
<b>Idaho</b>																							
Idaho	2024	2025	2026	2027	2028	2029	2030	2031	2032	2033	2034	2035	2036	2037	2038	2039	2040	2041	2042	2043	2044	2045	Total
Natural Gas	0	0	0	0	0	0	0	0	0	0	0	90	4	0	0	0	0	0	122	0	0	90	306
Nuclear	0	0	0	0	0	0	0	0	0	0	0	0	0	0	0	0	0	0	0	0	0	0	0
Wind	0	0	0	0	0	0	0	0	0	0	0	0	0	0	0	0	0	0	0	0	0	0	0
Solar	0	0	0	0	0	0	0	0	0	0	0	0	0	0	0	0	0	0	0	0	0	0	0
Lithium-Ion Storage	0	0	0	0	0	0	0	0	0	0	0	0	0	0	0	0	0	0	0	0	0	0	0
Flow Battery	0	0	0	0	0	0	0	0	0	0	0	0	0	0	0	0	0	0	0	0	0	0	0
Iron Oxide Storage	0	0	0	0	0	0	0	0	0	0	0	0	0	0	0	0	18	27	0	24	18	0	87
Geothermal	0	0	0	0	0	0	0	0	0	0	0	0	0	0	0	0	0	0	0	0	0	0	0
Hydrogen	0	0	0	0	0	0	0	0	0	0	0	0	0	0	0	0	0	0	0	0	0	0	0
Ammonia	0	0	0	0	0	0	0	0	0	0	0	0	0	0	0	0	0	0	0	0	0	0	0
Liquid Air	0	0	0	0	0	0	0	0	0	0	0	0	0	0	0	0	0	0	0	0	0	0	0
Pumped Hydro	0	0	0	0	0	0	0	0	0	0	0	0	0	0	0	0	0	0	0	0	0	0	0
Biomass	0	0	0	0	0	0	0	0	0	0	0	0	0	0	0	0	0	0	0	0	0	0	0
Retail Pricing	0	0	0	0	0	0	0	0	0	0	0	0	0	0	0	0	0	0	0	0	0	0	0
Demand Response	0	0	0	0	0	0	0	0	0	0	0	0	0	0	0	0	0	0	0	0	0	0	0
<b>Total</b>	<b>0</b>	<b>0</b>	<b>0</b>	<b>0</b>	<b>0</b>	<b>0</b>	<b>0</b>	<b>0</b>	<b>0</b>	<b>0</b>	<b>0</b>	<b>90</b>	<b>4</b>	<b>0</b>	<b>0</b>	<b>0</b>	<b>18</b>	<b>27</b>	<b>122</b>	<b>24</b>	<b>18</b>	<b>90</b>	<b>393</b>
<b>Grand Total</b>	<b>1</b>	<b>7</b>	<b>1</b>	<b>1</b>	<b>1</b>	<b>1</b>	<b>201</b>	<b>1</b>	<b>201</b>	<b>1</b>	<b>0</b>	<b>90</b>	<b>66</b>	<b>0</b>	<b>50</b>	<b>0</b>	<b>50</b>	<b>218</b>	<b>406</b>	<b>69</b>	<b>234</b>	<b>811</b>	<b>2,409</b>
<b>Cumulative Energy Efficiency (aMW)</b>																							
Washington	3	6	10	14	18	22	26	31	35	38	42	45	47	50	51	53	55	56	57	58	59	60	835
Idaho	1	2	4	5	7	8	10	12	13	14	16	17	18	19	20	20	21	22	22	23	23	23	320
<b>Total</b>	<b>4</b>	<b>9</b>	<b>13</b>	<b>19</b>	<b>25</b>	<b>31</b>	<b>36</b>	<b>42</b>	<b>48</b>	<b>53</b>	<b>57</b>	<b>61</b>	<b>65</b>	<b>68</b>	<b>71</b>	<b>74</b>	<b>76</b>	<b>78</b>	<b>80</b>	<b>81</b>	<b>82</b>	<b>83</b>	<b>1,155</b>



**Portfolio #7 WRAP PRM (No QCC Changes)**

Washington	2024	2025	2026	2027	2028	2029	2030	2031	2032	2033	2034	2035	2036	2037	2038	2039	2040	2041	2042	2043	2044	2045	Total
Natural Gas	0	0	0	0	0	0	0	0	0	0	0	0	6	0	0	0	0	0	0	0	0	0	6
Nuclear	0	0	0	0	0	0	0	0	0	0	0	0	0	0	0	0	0	0	0	0	0	0	0
Wind	0	0	0	0	0	0	200	0	200	0	0	0	0	0	0	0	0	140	105	110	190	200	1,145
Solar	1	1	1	1	1	1	1	1	1	1	0	0	0	0	0	0	0	0	0	0	0	0	11
Lithium-Ion Storage	0	0	0	0	0	0	0	0	30	0	0	0	0	25	30	25	25	44	212	38	25	0	454
Flow Battery	0	0	0	0	0	0	0	0	0	0	0	0	0	0	0	0	0	0	0	0	0	0	0
Iron Oxide Storage	0	0	0	0	0	0	0	0	0	0	0	0	0	0	0	0	0	0	0	0	0	0	0
Geothermal	0	0	0	0	0	0	0	0	0	0	0	0	0	0	0	0	0	0	0	0	0	20	20
Hydrogen	0	0	0	0	0	0	0	0	0	0	0	0	0	0	0	0	0	0	0	0	0	0	0
Ammonia	0	0	0	0	0	0	0	0	0	0	0	0	0	0	0	0	0	0	0	0	0	312	312
Liquid Air	0	0	0	0	0	0	0	0	0	0	0	0	0	0	0	0	0	0	0	0	0	0	0
Pumped Hydro	0	0	0	0	0	0	0	0	0	0	0	0	0	0	0	0	0	0	0	0	0	0	0
Biomass	0	0	0	0	0	0	0	0	0	0	0	0	0	0	0	0	0	0	0	0	0	58	58
Retail Pricing	0	7	0	0	0	0	0	0	0	0	0	0	0	0	0	0	0	0	0	0	0	0	7
Demand Response	0	0	0	0	0	0	0	0	0	0	0	0	0	0	0	0	0	0	0	0	0	0	0
<b>Total</b>	<b>1</b>	<b>7</b>	<b>1</b>	<b>1</b>	<b>1</b>	<b>1</b>	<b>201</b>	<b>1</b>	<b>231</b>	<b>1</b>	<b>0</b>	<b>0</b>	<b>7</b>	<b>25</b>	<b>30</b>	<b>25</b>	<b>25</b>	<b>184</b>	<b>317</b>	<b>148</b>	<b>216</b>	<b>590</b>	<b>2,012</b>
<b>Idaho</b>	<b>2024</b>	<b>2025</b>	<b>2026</b>	<b>2027</b>	<b>2028</b>	<b>2029</b>	<b>2030</b>	<b>2031</b>	<b>2032</b>	<b>2033</b>	<b>2034</b>	<b>2035</b>	<b>2036</b>	<b>2037</b>	<b>2038</b>	<b>2039</b>	<b>2040</b>	<b>2041</b>	<b>2042</b>	<b>2043</b>	<b>2044</b>	<b>2045</b>	<b>Total</b>
Natural Gas	0	0	0	0	0	0	0	0	0	0	0	0	4	0	0	0	0	90	98	0	0	90	282
Nuclear	0	0	0	0	0	0	0	0	0	0	0	0	0	0	0	0	0	0	0	0	0	0	0
Wind	0	0	0	0	0	0	0	0	0	0	0	0	0	0	0	0	0	0	0	0	0	0	0
Solar	0	0	0	0	0	0	0	0	0	0	0	0	0	0	0	0	0	0	0	0	0	0	0
Lithium-Ion Storage	0	0	0	0	0	0	0	0	44	0	0	0	0	28	0	26	0	0	0	3	25	0	126
Flow Battery	0	0	0	0	0	0	0	0	0	0	0	0	0	0	0	0	0	0	0	0	0	0	0
Iron Oxide Storage	0	0	0	0	0	0	0	0	0	0	0	0	0	0	0	0	0	0	0	0	0	0	0
Geothermal	0	0	0	0	0	0	0	0	0	0	0	0	0	0	0	0	0	0	0	0	0	0	0
Hydrogen	0	0	0	0	0	0	0	0	0	0	0	0	0	0	0	0	0	0	0	0	0	0	0
Ammonia	0	0	0	0	0	0	0	0	0	0	0	0	0	0	0	0	0	0	0	0	0	0	0
Liquid Air	0	0	0	0	0	0	0	0	0	0	0	0	0	0	0	0	0	0	0	0	0	0	0
Pumped Hydro	0	0	0	0	0	0	0	0	0	0	0	0	0	0	0	0	0	0	0	0	0	0	0
Biomass	0	0	0	0	0	0	0	0	0	0	0	0	0	0	0	0	0	0	0	0	0	0	0
Retail Pricing	0	0	0	0	0	0	0	0	0	0	0	0	5	0	0	0	0	0	0	0	0	0	5
Demand Response	0	0	0	0	0	0	0	0	0	0	0	0	0	0	0	0	0	0	0	0	0	0	0
<b>Total</b>	<b>0</b>	<b>0</b>	<b>0</b>	<b>0</b>	<b>0</b>	<b>0</b>	<b>0</b>	<b>0</b>	<b>44</b>	<b>0</b>	<b>0</b>	<b>0</b>	<b>9</b>	<b>28</b>	<b>0</b>	<b>26</b>	<b>0</b>	<b>90</b>	<b>98</b>	<b>3</b>	<b>25</b>	<b>90</b>	<b>413</b>
<b>Grand Total</b>	<b>1</b>	<b>7</b>	<b>1</b>	<b>1</b>	<b>1</b>	<b>1</b>	<b>201</b>	<b>1</b>	<b>275</b>	<b>1</b>	<b>0</b>	<b>0</b>	<b>16</b>	<b>53</b>	<b>30</b>	<b>51</b>	<b>25</b>	<b>274</b>	<b>415</b>	<b>152</b>	<b>241</b>	<b>680</b>	<b>2,426</b>
<b>Cumulative Energy Efficiency (aMW)</b>																							
Washington	3	6	10	14	18	22	27	31	35	39	42	45	48	50	52	54	56	57	58	59	60	60	848
Idaho	1	2	4	5	7	8	10	12	13	14	16	17	18	19	20	21	21	22	22	23	23	23	321
<b>Total</b>	<b>4</b>	<b>9</b>	<b>13</b>	<b>19</b>	<b>25</b>	<b>31</b>	<b>37</b>	<b>43</b>	<b>48</b>	<b>53</b>	<b>58</b>	<b>62</b>	<b>66</b>	<b>69</b>	<b>72</b>	<b>75</b>	<b>77</b>	<b>79</b>	<b>81</b>	<b>82</b>	<b>83</b>	<b>84</b>	<b>1,169</b>

**Portfolio #8 Variable Energy Resources Assigned to Washington**

Washington	2024	2025	2026	2027	2028	2029	2030	2031	2032	2033	2034	2035	2036	2037	2038	2039	2040	2041	2042	2043	2044	2045	Total
Natural Gas	0	0	0	0	0	0	0	0	0	0	0	0	0	0	0	0	0	0	0	0	0	0	0
Nuclear	0	0	0	0	0	0	0	0	0	0	0	0	0	0	0	0	0	0	0	0	0	0	0
Wind	0	0	0	0	0	0	200	0	200	0	0	0	0	0	0	0	0	140	105	0	0	200	845
Solar	1	1	1	1	1	1	1	1	1	1	0	0	0	0	0	0	0	0	0	0	0	0	11
Lithium-Ion Storage	0	0	0	0	0	0	0	0	0	0	0	0	0	0	0	0	0	0	0	0	0	0	0
Flow battery	0	0	0	0	0	0	0	0	0	0	0	0	0	0	0	0	0	0	0	0	0	0	0
Iron Oxide Storage	0	0	0	0	0	0	0	0	0	0	0	0	0	0	0	50	0	0	0	37	39	0	125
Geothermal	0	0	0	0	0	0	0	0	0	0	0	0	0	0	0	0	0	0	0	0	0	20	20
Hydrogen	0	0	0	0	0	0	0	0	0	0	0	0	0	0	0	0	0	0	0	0	0	0	0
Ammonia	0	0	0	0	0	0	0	0	0	0	0	0	74	0	0	0	0	74	200	0	0	334	682
Liquid Air	0	0	0	0	0	0	0	0	0	0	0	0	0	0	0	0	0	0	0	0	0	0	0
Pumped Hydro	0	0	0	0	0	0	0	0	0	0	0	0	0	0	0	0	0	0	0	0	0	0	0
Biomass	0	0	0	0	0	0	0	0	0	0	0	0	0	0	0	0	0	0	0	0	0	0	0
Retail Pricing	0	7	0	0	0	0	0	0	0	0	0	0	0	0	0	0	0	0	0	0	0	0	7
Demand Response	0	0	0	0	0	0	0	0	0	0	0	0	0	0	0	0	0	0	0	0	0	0	0
<b>Total</b>	<b>1</b>	<b>7</b>	<b>1</b>	<b>1</b>	<b>1</b>	<b>1</b>	<b>201</b>	<b>1</b>	<b>201</b>	<b>1</b>	<b>0</b>	<b>0</b>	<b>74</b>	<b>0</b>	<b>0</b>	<b>50</b>	<b>0</b>	<b>214</b>	<b>305</b>	<b>37</b>	<b>39</b>	<b>555</b>	<b>1,691</b>
<b>Idaho</b>	<b>2024</b>	<b>2025</b>	<b>2026</b>	<b>2027</b>	<b>2028</b>	<b>2029</b>	<b>2030</b>	<b>2031</b>	<b>2032</b>	<b>2033</b>	<b>2034</b>	<b>2035</b>	<b>2036</b>	<b>2037</b>	<b>2038</b>	<b>2039</b>	<b>2040</b>	<b>2041</b>	<b>2042</b>	<b>2043</b>	<b>2044</b>	<b>2045</b>	<b>Total</b>
Natural Gas	0	0	46	0	0	0	0	0	0	0	0	0	90	0	0	0	0	0	113	0	0	69	318
Nuclear	0	0	0	0	0	0	0	0	0	0	0	0	0	0	0	0	0	0	0	0	0	0	0
Wind	0	0	0	0	0	0	0	0	0	0	0	0	0	0	0	0	0	0	0	0	0	0	0
Solar	0	0	0	0	0	0	0	0	0	0	0	0	0	0	0	0	0	0	0	0	0	0	0
Lithium-Ion Storage	0	0	0	0	0	0	0	0	0	0	0	0	0	0	0	0	0	0	0	0	0	0	0
Flow battery	0	0	0	0	0	0	0	0	0	0	0	0	0	0	0	0	0	0	0	0	0	0	0
Iron Oxide Storage	0	0	0	0	0	0	0	0	0	0	0	0	0	0	0	0	0	0	0	20	21	0	42
Geothermal	0	0	0	0	0	0	0	0	0	0	0	0	0	0	0	0	0	0	0	0	0	0	0
Hydrogen	0	0	0	0	0	0	0	0	0	0	0	0	0	0	0	0	0	0	0	0	0	0	0
Ammonia	0	0	0	0	0	0	0	0	0	0	0	0	0	0	0	0	0	0	0	0	0	0	0
Liquid Air	0	0	0	0	0	0	0	0	0	0	0	0	0	0	0	0	0	0	0	0	0	0	0
Pumped Hydro	0	0	0	0	0	0	0	0	0	0	0	0	0	0	0	0	0	0	0	0	0	0	0
Biomass	0	0	0	0	0	0	0	0	0	0	0	0	0	0	0	0	0	0	0	0	0	0	0
Retail Pricing	0	0	0	0	0	0	0	0	0	0	0	0	0	0	0	0	0	0	0	0	0	0	0
Demand Response	0	0	0	0	0	0	0	0	0	0	0	0	0	0	0	0	0	0	0	0	0	0	0
<b>Total</b>	<b>0</b>	<b>0</b>	<b>46</b>	<b>0</b>	<b>0</b>	<b>0</b>	<b>0</b>	<b>0</b>	<b>0</b>	<b>0</b>	<b>0</b>	<b>0</b>	<b>90</b>	<b>0</b>	<b>0</b>	<b>0</b>	<b>0</b>	<b>0</b>	<b>113</b>	<b>20</b>	<b>21</b>	<b>69</b>	<b>360</b>
<b>Grand Total</b>	<b>1</b>	<b>7</b>	<b>47</b>	<b>1</b>	<b>1</b>	<b>1</b>	<b>201</b>	<b>1</b>	<b>201</b>	<b>1</b>	<b>0</b>	<b>0</b>	<b>164</b>	<b>0</b>	<b>0</b>	<b>50</b>	<b>0</b>	<b>214</b>	<b>418</b>	<b>57</b>	<b>60</b>	<b>623</b>	<b>2,050</b>
<b>Cumulative Energy Efficiency (aMW)</b>																							
Washington	3	6	10	14	18	22	27	31	35	39	42	45	48	50	52	53	55	56	58	58	59	60	840
Idaho	1	2	4	5	7	8	10	11	13	14	16	17	18	19	19	20	21	21	22	22	23	23	316
<b>Total</b>	<b>4</b>	<b>9</b>	<b>13</b>	<b>19</b>	<b>25</b>	<b>31</b>	<b>37</b>	<b>42</b>	<b>48</b>	<b>53</b>	<b>58</b>	<b>62</b>	<b>65</b>	<b>69</b>	<b>71</b>	<b>74</b>	<b>76</b>	<b>78</b>	<b>80</b>	<b>81</b>	<b>82</b>	<b>83</b>	<b>1,157</b>

**Portfolio #9 Low Economic Growth Loads**

Washington	2024	2025	2026	2027	2028	2029	2030	2031	2032	2033	2034	2035	2036	2037	2038	2039	2040	2041	2042	2043	2044	2045	Total
Natural Gas	0	0	0	0	0	0	0	0	0	0	0	0	3	0	0	0	0	0	0	0	0	0	3
Nuclear	0	0	0	0	0	0	0	0	0	0	0	0	0	0	0	0	0	0	0	0	0	0	0
Wind	0	0	0	0	0	0	200	0	200	0	0	0	0	0	0	0	0	140	105	0	100	160	905
Solar	1	1	1	1	1	1	1	1	1	1	0	0	0	0	0	0	0	0	0	0	0	0	10
Lithium-Ion Storage	0	0	0	0	0	0	0	0	0	0	0	0	1	0	1	0	0	0	0	0	0	1	2
Flow battery	0	0	0	0	0	0	0	0	0	0	0	0	0	0	0	0	0	0	0	0	0	0	0
Iron Oxide Storage	0	0	0	0	0	0	0	0	0	0	0	0	0	40	0	50	0	50	107	50	0	0	297
Geothermal	0	0	0	0	0	0	0	0	0	0	0	0	0	0	0	0	0	0	0	0	20	20	40
Hydrogen	0	0	0	0	0	0	0	0	0	0	0	0	0	0	0	0	0	0	0	0	0	0	0
Ammonia	0	0	0	0	0	0	0	0	0	0	0	0	0	0	0	0	0	0	93	0	0	273	366
Liquid Air	0	0	0	0	0	0	0	0	0	0	0	0	0	0	0	0	0	0	0	0	0	0	0
Pumped Hydro	0	0	0	0	0	0	0	0	0	0	0	0	0	0	0	0	0	0	0	0	0	0	0
Biomass	0	0	0	0	0	0	0	0	0	0	0	0	0	0	0	0	0	0	0	0	0	58	58
Retail Pricing	0	7	0	0	0	0	0	0	0	0	0	0	0	0	0	0	0	0	0	0	0	0	7
Demand Response	0	0	0	0	0	0	0	0	0	0	0	0	0	0	0	0	0	0	0	0	0	0	0
<b>Total</b>	<b>1</b>	<b>7</b>	<b>1</b>	<b>1</b>	<b>1</b>	<b>1</b>	<b>201</b>	<b>1</b>	<b>201</b>	<b>1</b>	<b>0</b>	<b>0</b>	<b>4</b>	<b>40</b>	<b>1</b>	<b>50</b>	<b>0</b>	<b>190</b>	<b>305</b>	<b>50</b>	<b>121</b>	<b>511</b>	<b>1,688</b>
<b>Idaho</b>	<b>2024</b>	<b>2025</b>	<b>2026</b>	<b>2027</b>	<b>2028</b>	<b>2029</b>	<b>2030</b>	<b>2031</b>	<b>2032</b>	<b>2033</b>	<b>2034</b>	<b>2035</b>	<b>2036</b>	<b>2037</b>	<b>2038</b>	<b>2039</b>	<b>2040</b>	<b>2041</b>	<b>2042</b>	<b>2043</b>	<b>2044</b>	<b>2045</b>	<b>Total</b>
Natural Gas	0	0	0	0	0	0	0	0	0	0	0	0	2	0	0	0	0	90	90	0	0	48	231
Nuclear	0	0	0	0	0	0	0	0	0	0	0	0	0	0	0	0	0	0	0	0	0	0	0
Wind	0	0	0	0	0	0	0	0	0	0	0	0	0	0	0	0	0	0	0	0	0	0	0
Solar	0	0	0	0	0	0	0	0	0	0	0	0	0	0	0	0	0	0	0	0	0	0	0
Lithium-Ion Storage	0	0	0	0	0	0	0	0	0	0	0	0	0	0	0	0	0	0	0	0	0	55	55
Flow battery	0	0	0	0	0	0	0	0	0	0	0	0	0	0	0	0	0	0	0	0	0	0	0
Iron Oxide Storage	0	0	0	0	0	0	0	0	0	0	0	0	0	22	0	0	0	0	0	0	0	0	22
Geothermal	0	0	0	0	0	0	0	0	0	0	0	0	0	0	0	0	0	0	0	0	0	0	0
Hydrogen	0	0	0	0	0	0	0	0	0	0	0	0	0	0	0	0	0	0	0	0	0	0	0
Ammonia	0	0	0	0	0	0	0	0	0	0	0	0	0	0	0	0	0	0	0	0	0	0	0
Liquid Air	0	0	0	0	0	0	0	0	0	0	0	0	0	0	0	0	0	0	0	0	0	0	0
Pumped Hydro	0	0	0	0	0	0	0	0	0	0	0	0	0	0	0	0	0	0	0	0	0	0	0
Biomass	0	0	0	0	0	0	0	0	0	0	0	0	0	0	0	0	0	0	0	0	0	0	0
Retail Pricing	0	0	0	0	0	0	0	0	0	0	0	0	0	0	0	0	0	0	0	0	0	0	0
Demand Response	0	0	0	0	0	0	0	0	0	0	0	0	0	0	0	0	0	0	0	0	0	0	0
<b>Total</b>	<b>0</b>	<b>0</b>	<b>0</b>	<b>0</b>	<b>0</b>	<b>0</b>	<b>0</b>	<b>0</b>	<b>0</b>	<b>0</b>	<b>0</b>	<b>0</b>	<b>2</b>	<b>22</b>	<b>0</b>	<b>0</b>	<b>0</b>	<b>90</b>	<b>90</b>	<b>0</b>	<b>0</b>	<b>104</b>	<b>308</b>
<b>Grand Total</b>	<b>1</b>	<b>7</b>	<b>1</b>	<b>1</b>	<b>1</b>	<b>1</b>	<b>201</b>	<b>1</b>	<b>201</b>	<b>1</b>	<b>0</b>	<b>0</b>	<b>6</b>	<b>62</b>	<b>1</b>	<b>50</b>	<b>0</b>	<b>281</b>	<b>395</b>	<b>50</b>	<b>121</b>	<b>615</b>	<b>1,995</b>
<b>Cumulative Energy Efficiency (aMW)</b>																							
Washington	3	6	10	13	18	22	26	30	35	38	41	44	47	49	51	53	54	56	57	58	59	59	829
Idaho	1	2	4	5	7	8	10	11	13	14	16	17	18	19	19	20	21	21	22	22	23	23	316
<b>Total</b>	<b>4</b>	<b>8</b>	<b>13</b>	<b>19</b>	<b>24</b>	<b>30</b>	<b>36</b>	<b>42</b>	<b>48</b>	<b>52</b>	<b>57</b>	<b>61</b>	<b>65</b>	<b>68</b>	<b>70</b>	<b>73</b>	<b>75</b>	<b>77</b>	<b>79</b>	<b>80</b>	<b>81</b>	<b>82</b>	<b>1,145</b>

Portfolio #10 High Economic Growth Load

Washington	2024	2025	2026	2027	2028	2029	2030	2031	2032	2033	2034	2035	2036	2037	2038	2039	2040	2041	2042	2043	2044	2045	Total
Natural Gas	0	0	0	0	0	0	0	0	0	3	0	0	0	0	0	0	0	0	0	0	0	0	3
Nuclear	0	0	0	0	0	0	0	0	0	0	0	0	0	0	0	0	0	0	0	0	0	0	0
Wind	0	0	0	0	0	0	200	0	200	0	0	0	0	0	0	0	0	140	105	0	200	200	1,045
Solar	1	1	1	1	1	1	1	1	1	1	0	0	0	0	0	0	0	0	0	0	0	0	11
Lithium-Ion Storage	0	0	0	0	0	0	0	0	0	0	0	0	0	0	0	0	0	0	0	0	0	0	1
Flow battery	0	0	0	0	0	0	0	0	0	0	0	0	0	0	0	0	0	0	0	0	0	0	0
Iron Oxide Storage	0	0	0	0	0	0	0	0	0	0	0	0	0	0	52	0	32	53	0	39	32	0	209
Geothermal	0	0	0	0	0	0	0	0	0	0	0	0	0	0	0	0	0	0	0	0	0	20	20
Hydrogen	0	0	0	0	0	0	0	0	0	0	0	0	0	0	0	0	0	0	0	0	0	0	0
Ammonia	0	0	0	0	0	0	0	0	0	0	0	0	93	0	0	0	0	0	219	0	0	0	646
Liquid Air	0	0	0	0	0	0	0	0	0	0	0	0	0	0	0	0	0	0	0	0	0	0	0
Pumped Hydro	0	0	0	0	0	0	0	0	0	0	0	0	0	0	0	0	0	0	0	0	0	0	0
Biomass	0	0	0	0	0	0	0	0	0	0	0	0	0	0	0	0	0	0	0	0	0	0	0
Retail Pricing	0	7	0	0	0	0	0	0	0	0	0	0	0	0	0	0	0	0	0	0	0	0	7
Demand Response	0	0	0	0	0	0	0	0	0	0	0	0	0	0	0	0	0	0	0	0	0	0	0
<b>Total</b>	<b>1</b>	<b>7</b>	<b>1</b>	<b>1</b>	<b>1</b>	<b>1</b>	<b>201</b>	<b>1</b>	<b>201</b>	<b>4</b>	<b>0</b>	<b>0</b>	<b>93</b>	<b>0</b>	<b>53</b>	<b>0</b>	<b>33</b>	<b>194</b>	<b>325</b>	<b>40</b>	<b>233</b>	<b>554</b>	<b>1,942</b>
<b>Idaho</b>																							
Idaho	2024	2025	2026	2027	2028	2029	2030	2031	2032	2033	2034	2035	2036	2037	2038	2039	2040	2041	2042	2043	2044	2045	Total
Natural Gas	0	0	0	0	0	0	0	0	0	2	98	0	0	0	0	0	0	90	94	0	0	68	351
Nuclear	0	0	0	0	0	0	0	0	0	0	0	0	0	0	0	0	0	0	0	0	0	0	0
Wind	0	0	0	0	0	0	0	0	0	0	0	0	0	0	0	0	0	0	0	0	0	0	0
Solar	0	0	0	0	0	0	0	0	0	0	0	0	0	0	0	0	0	0	0	0	0	0	0
Lithium-Ion Storage	0	0	0	0	0	0	0	0	1	0	0	0	0	0	0	0	0	0	0	0	0	25	26
Flow battery	0	0	0	0	0	0	0	0	0	0	0	0	0	0	0	0	0	0	0	0	0	0	0
Iron Oxide Storage	0	0	0	0	0	0	0	0	0	0	0	0	0	0	29	0	18	0	0	22	18	0	86
Geothermal	0	0	0	0	0	0	0	0	0	0	0	0	0	0	0	0	0	0	0	0	0	0	0
Hydrogen	0	0	0	0	0	0	0	0	0	0	0	0	0	0	0	0	0	0	0	0	0	0	0
Ammonia	0	0	0	0	0	0	0	0	0	0	0	0	0	0	0	0	0	0	0	0	0	0	0
Liquid Air	0	0	0	0	0	0	0	0	0	0	0	0	0	0	0	0	0	0	0	0	0	0	0
Pumped Hydro	0	0	0	0	0	0	0	0	0	0	0	0	0	0	0	0	0	0	0	0	0	0	0
Biomass	0	0	0	0	0	0	0	0	0	0	0	0	0	0	0	0	0	0	0	0	0	0	0
Retail Pricing	0	0	0	0	0	7	0	0	0	0	0	0	0	0	0	0	0	0	0	0	0	0	7
Demand Response	0	0	0	0	0	0	0	0	0	0	0	0	0	0	0	0	0	0	0	0	0	0	0
<b>Total</b>	<b>0</b>	<b>0</b>	<b>0</b>	<b>0</b>	<b>0</b>	<b>7</b>	<b>0</b>	<b>0</b>	<b>1</b>	<b>2</b>	<b>98</b>	<b>0</b>	<b>0</b>	<b>0</b>	<b>29</b>	<b>0</b>	<b>18</b>	<b>90</b>	<b>94</b>	<b>22</b>	<b>18</b>	<b>93</b>	<b>470</b>
<b>Grand Total</b>	<b>1</b>	<b>7</b>	<b>1</b>	<b>1</b>	<b>1</b>	<b>8</b>	<b>201</b>	<b>1</b>	<b>201</b>	<b>6</b>	<b>98</b>	<b>0</b>	<b>93</b>	<b>0</b>	<b>82</b>	<b>0</b>	<b>50</b>	<b>284</b>	<b>418</b>	<b>61</b>	<b>250</b>	<b>647</b>	<b>2,411</b>
<b>Cumulative Energy Efficiency (aMW)</b>																							
Washington	3	6	10	13	18	22	26	30	35	38	41	44	47	49	51	53	54	56	57	58	59	59	829
Idaho	1	2	4	5	7	8	10	11	13	14	16	17	18	19	19	20	21	21	22	22	23	23	316
<b>Total</b>	<b>4</b>	<b>8</b>	<b>13</b>	<b>19</b>	<b>24</b>	<b>30</b>	<b>36</b>	<b>42</b>	<b>48</b>	<b>52</b>	<b>57</b>	<b>61</b>	<b>65</b>	<b>68</b>	<b>70</b>	<b>73</b>	<b>75</b>	<b>77</b>	<b>79</b>	<b>80</b>	<b>81</b>	<b>82</b>	<b>1,145</b>

**Portfolio #11 High Electric Growth**

Washington	2024	2025	2026	2027	2028	2029	2030	2031	2032	2033	2034	2035	2036	2037	2038	2039	2040	2041	2042	2043	2044	2045	Total
Natural Gas	0	0	0	0	0	0	0	0	0	0	0	0	0	0	0	0	0	0	0	0	0	0	0
Nuclear	0	0	0	0	0	0	0	0	0	0	0	0	0	0	0	0	0	0	0	0	0	0	0
Wind	0	0	0	0	0	0	200	0	200	0	0	0	0	0	0	0	0	140	105	200	200	200	1,245
Solar	1	1	1	1	1	1	1	1	1	1	0	0	0	0	0	0	0	0	0	0	0	86	97
Lithium-Ion Storage	0	0	0	0	0	0	0	0	25	0	0	0	0	0	0	0	0	1	0	0	0	0	26
Flow battery	0	0	0	0	0	0	0	0	0	0	0	0	0	0	0	0	0	0	0	0	0	0	0
Iron Oxide Storage	0	0	0	0	0	0	0	0	0	0	0	0	0	0	0	61	82	84	157	0	82	0	466
Geothermal	0	0	0	0	0	0	0	0	20	0	0	0	0	0	0	0	0	0	20	0	0	0	40
Hydrogen	0	0	0	0	0	0	0	0	0	0	0	0	0	0	0	0	0	0	0	0	0	0	0
Ammonia	0	0	0	0	0	0	0	0	0	0	0	0	81	105	0	0	0	0	82	84	0	354	707
Liquid Air	0	0	0	0	0	0	0	0	0	0	0	0	0	0	0	0	0	0	0	0	0	0	0
Pumped Hydro	0	0	0	0	0	0	0	0	0	0	0	0	0	0	0	0	0	0	0	0	0	0	0
Biomass	0	0	0	0	0	0	0	0	0	0	0	0	0	0	0	0	0	0	0	0	0	58	58
Retail Pricing	0	7	0	0	0	0	0	0	0	0	0	0	0	0	0	0	0	0	0	0	0	0	7
Demand Response	0	0	0	0	0	0	0	0	0	0	0	0	0	0	0	0	0	0	0	0	0	0	0
<b>Total</b>	<b>1</b>	<b>7</b>	<b>1</b>	<b>1</b>	<b>1</b>	<b>1</b>	<b>201</b>	<b>1</b>	<b>246</b>	<b>1</b>	<b>0</b>	<b>0</b>	<b>82</b>	<b>105</b>	<b>0</b>	<b>62</b>	<b>83</b>	<b>224</b>	<b>364</b>	<b>284</b>	<b>283</b>	<b>697</b>	<b>2,644</b>
<b>Idaho</b>	<b>2024</b>	<b>2025</b>	<b>2026</b>	<b>2027</b>	<b>2028</b>	<b>2029</b>	<b>2030</b>	<b>2031</b>	<b>2032</b>	<b>2033</b>	<b>2034</b>	<b>2035</b>	<b>2036</b>	<b>2037</b>	<b>2038</b>	<b>2039</b>	<b>2040</b>	<b>2041</b>	<b>2042</b>	<b>2043</b>	<b>2044</b>	<b>2045</b>	<b>Total</b>
Natural Gas	0	0	0	0	0	0	0	0	0	0	99	0	0	0	0	0	0	0	148	0	0	46	293
Nuclear	0	0	0	0	0	0	0	0	0	0	0	0	0	0	0	0	0	0	0	0	0	0	0
Wind	0	0	0	0	0	0	0	0	0	0	0	0	0	0	0	0	0	0	0	0	0	0	0
Solar	0	0	0	0	0	0	0	0	0	0	0	0	0	0	0	0	0	0	0	0	0	0	0
Lithium-Ion Storage	0	0	0	0	0	0	0	0	0	0	0	0	0	0	0	0	0	0	0	0	25	0	25
Flow battery	0	0	0	0	0	0	0	0	0	0	0	0	0	0	0	0	0	0	0	0	0	0	0
Iron Oxide Storage	0	0	0	0	0	0	0	0	0	0	0	0	0	0	0	0	18	50	0	0	18	50	136
Geothermal	0	0	0	0	0	0	0	0	0	0	0	0	0	0	0	0	0	0	0	0	0	0	0
Hydrogen	0	0	0	0	0	0	0	0	0	0	0	0	0	0	0	0	0	0	0	0	0	0	0
Ammonia	0	0	0	0	0	0	0	0	0	0	0	0	0	0	0	0	0	0	0	0	0	0	0
Liquid Air	0	0	0	0	0	0	0	0	0	0	0	0	0	0	0	0	0	0	0	0	0	0	0
Pumped Hydro	0	0	0	0	0	0	0	0	0	0	0	0	0	0	0	0	0	0	0	0	0	0	0
Biomass	0	0	0	0	0	0	0	0	0	0	0	0	0	0	0	0	0	0	0	0	0	0	0
Retail Pricing	0	0	0	0	0	0	0	0	0	0	0	0	0	0	0	0	0	0	0	0	0	0	0
Demand Response	0	0	0	0	0	0	0	0	0	0	0	0	0	0	0	0	0	0	0	0	0	0	0
<b>Total</b>	<b>0</b>	<b>0</b>	<b>0</b>	<b>0</b>	<b>0</b>	<b>0</b>	<b>0</b>	<b>0</b>	<b>0</b>	<b>99</b>	<b>0</b>	<b>0</b>	<b>0</b>	<b>0</b>	<b>0</b>	<b>0</b>	<b>18</b>	<b>50</b>	<b>148</b>	<b>0</b>	<b>43</b>	<b>96</b>	<b>454</b>
<b>Grand Total</b>	<b>1</b>	<b>7</b>	<b>1</b>	<b>1</b>	<b>1</b>	<b>1</b>	<b>201</b>	<b>1</b>	<b>246</b>	<b>1</b>	<b>99</b>	<b>0</b>	<b>82</b>	<b>105</b>	<b>0</b>	<b>62</b>	<b>100</b>	<b>274</b>	<b>512</b>	<b>284</b>	<b>325</b>	<b>793</b>	<b>3,098</b>
<b>Cumulative Energy Efficiency (aMW)</b>																							
Washington	3	6	10	14	18	22	27	31	35	39	42	45	48	50	52	54	55	57	58	59	60	60	844
Idaho	1	2	4	5	7	8	10	12	13	15	16	17	18	19	20	20	21	22	22	23	23	23	321
<b>Total</b>	<b>4</b>	<b>9</b>	<b>14</b>	<b>19</b>	<b>25</b>	<b>31</b>	<b>37</b>	<b>43</b>	<b>48</b>	<b>53</b>	<b>58</b>	<b>62</b>	<b>66</b>	<b>69</b>	<b>72</b>	<b>74</b>	<b>76</b>	<b>78</b>	<b>80</b>	<b>81</b>	<b>83</b>	<b>83</b>	<b>1,165</b>

Portfolio #12 Washington Space/Water Heating Education

Washington	2024	2025	2026	2027	2028	2029	2030	2031	2032	2033	2034	2035	2036	2037	2038	2039	2040	2041	2042	2043	2044	2045	Total
Natural Gas	0	0	0	0	0	0	0	0	0	0	0	0	0	0	0	0	0	0	0	0	0	0	0
Nuclear	0	0	0	0	0	0	0	0	0	0	0	0	0	0	0	0	0	0	0	0	0	0	0
Wind	0	0	0	0	0	0	200	100	200	0	0	0	0	0	0	0	0	140	305	200	200	200	1,545
Solar	1	1	1	1	1	1	1	1	1	1	0	0	0	0	0	0	0	0	0	0	0	0	11
Lithium-Ion Storage	0	0	0	0	0	0	0	0	0	0	0	0	0	0	0	0	0	0	0	0	0	0	0
Flow battery	0	0	0	0	0	0	0	0	0	0	0	0	0	0	0	0	0	0	0	0	0	0	0
Iron Oxide Storage	0	0	0	0	0	0	0	0	249	0	0	0	0	0	0	108	134	116	0	80	75	173	935
Geothermal	0	0	0	0	0	0	20	20	0	0	0	0	0	0	0	0	0	0	0	0	0	0	40
Hydrogen	0	0	0	0	0	0	0	0	0	0	0	0	0	0	0	0	0	0	0	0	0	158	158
Ammonia	0	0	0	0	0	0	0	0	0	0	0	101	154	100	108	0	0	0	269	0	0	0	733
Liquid Air	0	0	0	0	0	0	0	0	0	0	0	0	0	0	0	0	0	0	0	0	0	0	0
Pumped Hydro	0	0	0	0	0	0	0	0	0	0	0	0	0	0	0	0	0	0	0	0	0	0	0
Biomass	0	0	0	0	0	0	0	0	0	0	0	0	0	0	0	0	0	0	0	0	0	58	58
Retail Pricing	0	7	0	0	0	0	0	0	0	0	0	0	0	0	0	0	0	0	0	0	0	0	7
Demand Response	0	0	0	0	0	0	0	0	0	0	0	0	0	0	0	0	0	0	0	0	0	0	0
<b>Total</b>	<b>1</b>	<b>7</b>	<b>1</b>	<b>1</b>	<b>1</b>	<b>1</b>	<b>201</b>	<b>121</b>	<b>470</b>	<b>1</b>	<b>0</b>	<b>102</b>	<b>155</b>	<b>100</b>	<b>108</b>	<b>108</b>	<b>134</b>	<b>256</b>	<b>575</b>	<b>280</b>	<b>276</b>	<b>588</b>	<b>3,486</b>
Idaho	2024	2025	2026	2027	2028	2029	2030	2031	2032	2033	2034	2035	2036	2037	2038	2039	2040	2041	2042	2043	2044	2045	Total
Natural Gas	0	0	0	0	0	0	0	0	0	0	90	0	0	0	0	0	0	46	131	0	0	0	267
Nuclear	0	0	0	0	0	0	0	0	0	0	0	0	0	0	0	0	0	0	0	0	0	0	0
Wind	0	0	0	0	0	0	0	0	0	0	0	0	0	0	0	0	0	0	0	0	0	0	0
Solar	0	0	0	0	0	0	0	0	0	0	0	0	0	0	0	0	0	0	0	0	0	0	0
Lithium-Ion Storage	0	0	0	0	0	0	0	0	0	0	0	0	0	0	0	0	0	0	0	0	37	0	37
Flow battery	0	0	0	0	0	0	0	0	0	0	0	0	0	0	0	0	0	0	0	0	0	0	0
Iron Oxide Storage	0	0	0	0	0	0	0	0	0	0	0	0	0	0	0	0	18	0	0	0	0	80	98
Geothermal	0	0	0	0	0	0	0	0	0	0	0	0	0	0	0	0	0	0	0	0	0	0	0
Hydrogen	0	0	0	0	0	0	0	0	0	0	0	0	0	0	0	0	0	0	0	0	0	0	0
Ammonia	0	0	0	0	0	0	0	0	0	0	0	0	0	0	0	0	0	0	0	0	0	0	0
Liquid Air	0	0	0	0	0	0	0	0	0	0	0	0	0	0	0	0	0	0	0	0	0	0	0
Pumped Hydro	0	0	0	0	0	0	0	0	0	0	0	0	0	0	0	0	0	0	0	0	0	0	0
Biomass	0	0	0	0	0	0	0	0	0	0	0	0	0	0	0	0	0	0	0	0	0	0	0
Retail Pricing	0	0	0	0	0	0	0	0	0	0	0	0	0	0	0	0	0	0	0	0	0	0	0
Demand Response	0	0	0	0	0	0	0	0	0	0	0	0	0	0	0	0	0	0	0	0	0	0	0
<b>Total</b>	<b>0</b>	<b>0</b>	<b>0</b>	<b>0</b>	<b>0</b>	<b>0</b>	<b>0</b>	<b>0</b>	<b>0</b>	<b>0</b>	<b>90</b>	<b>0</b>	<b>0</b>	<b>0</b>	<b>0</b>	<b>0</b>	<b>18</b>	<b>46</b>	<b>131</b>	<b>0</b>	<b>37</b>	<b>80</b>	<b>402</b>
<b>Grand Total</b>	<b>1</b>	<b>7</b>	<b>1</b>	<b>1</b>	<b>1</b>	<b>1</b>	<b>201</b>	<b>121</b>	<b>470</b>	<b>1</b>	<b>91</b>	<b>102</b>	<b>155</b>	<b>100</b>	<b>108</b>	<b>108</b>	<b>152</b>	<b>302</b>	<b>705</b>	<b>280</b>	<b>313</b>	<b>669</b>	<b>3,888</b>
Cumulative Energy Efficiency (aMW)																							
Washington	3	6	10	14	18	23	28	32	37	40	44	47	50	52	54	56	58	59	61	62	62	63	881
Idaho	1	2	4	5	7	8	10	11	13	14	16	17	18	19	19	20	21	21	22	22	23	23	317
<b>Total</b>	<b>4</b>	<b>9</b>	<b>14</b>	<b>19</b>	<b>25</b>	<b>31</b>	<b>38</b>	<b>44</b>	<b>50</b>	<b>55</b>	<b>60</b>	<b>64</b>	<b>68</b>	<b>71</b>	<b>74</b>	<b>76</b>	<b>79</b>	<b>81</b>	<b>83</b>	<b>84</b>	<b>85</b>	<b>86</b>	<b>1,198</b>

**Portfolio #13 WA Space/Water Heating Electrification w/Natural Gas Backup**

Washington	2024	2025	2026	2027	2028	2029	2030	2031	2032	2033	2034	2035	2036	2037	2038	2039	2040	2041	2042	2043	2044	2045	Total
Natural Gas	0	0	0	0	0	0	0	0	0	0	0	0	0	0	0	0	0	0	0	0	0	0	0
Nuclear	0	0	0	0	0	0	0	0	0	0	0	0	0	0	0	0	0	0	0	0	0	0	0
Wind	0	0	0	0	0	0	200	0	200	0	0	0	0	0	0	0	0	140	236	200	169	200	1,345
Solar	1	1	1	1	1	1	1	1	1	1	0	0	0	0	0	0	0	0	0	0	0	150	161
Lithium-Ion Storage	0	0	0	0	0	0	0	0	0	0	0	0	0	0	0	0	0	0	0	0	0	0	1
Flow battery	0	0	0	0	0	0	0	0	0	0	0	0	0	0	0	0	0	0	0	0	0	0	0
Iron Oxide Storage	0	0	0	0	0	0	0	0	121	0	0	0	0	0	0	59	66	71	93	50	57	52	569
Geothermal	0	0	0	0	0	0	20	0	20	0	0	0	0	0	0	0	0	0	0	0	0	0	40
Hydrogen	0	0	0	0	0	0	0	0	0	0	0	0	0	0	0	0	0	0	0	0	0	39	39
Ammonia	0	0	0	0	0	0	0	0	0	0	0	0	109	80	0	0	0	0	185	0	0	0	728
Liquid Air	0	0	0	0	0	0	0	0	0	0	0	0	0	0	0	0	0	0	0	0	0	0	0
Pumped Hydro	0	0	0	0	0	0	0	0	0	0	0	0	0	0	0	0	0	0	0	0	0	0	0
Biomass	0	0	0	0	0	0	0	0	0	0	0	0	0	0	0	0	0	0	0	0	0	58	58
Retail Pricing	0	7	0	0	0	0	0	0	0	0	0	0	0	0	0	0	0	0	0	0	0	0	7
Demand Response	0	0	0	0	0	0	0	0	0	0	0	0	0	0	0	0	0	0	0	0	0	0	0
<b>Total</b>	<b>1</b>	<b>7</b>	<b>1</b>	<b>1</b>	<b>1</b>	<b>1</b>	<b>201</b>	<b>21</b>	<b>342</b>	<b>1</b>	<b>0</b>	<b>0</b>	<b>110</b>	<b>81</b>	<b>60</b>	<b>66</b>	<b>72</b>	<b>233</b>	<b>471</b>	<b>257</b>	<b>222</b>	<b>800</b>	<b>2,947</b>
<b>Idaho</b>	<b>2024</b>	<b>2025</b>	<b>2026</b>	<b>2027</b>	<b>2028</b>	<b>2029</b>	<b>2030</b>	<b>2031</b>	<b>2032</b>	<b>2033</b>	<b>2034</b>	<b>2035</b>	<b>2036</b>	<b>2037</b>	<b>2038</b>	<b>2039</b>	<b>2040</b>	<b>2041</b>	<b>2042</b>	<b>2043</b>	<b>2044</b>	<b>2045</b>	<b>Total</b>
Natural Gas	0	0	0	0	0	0	0	0	0	0	0	0	90	0	0	0	0	0	135	0	0	46	272
Nuclear	0	0	0	0	0	0	0	0	0	0	0	0	0	0	0	0	0	0	0	0	0	0	0
Wind	0	0	0	0	0	0	0	0	0	0	0	0	0	0	0	0	0	0	0	0	0	0	0
Solar	0	0	0	0	0	0	0	0	0	0	0	0	0	0	0	0	0	0	0	0	0	0	0
Lithium-Ion Storage	0	0	0	0	0	0	0	0	0	0	0	0	0	0	0	0	0	0	0	0	0	81	81
Flow battery	0	0	0	0	0	0	0	0	0	0	0	0	0	0	0	0	0	0	0	0	0	0	0
Iron Oxide Storage	0	0	0	0	0	0	0	0	19	0	0	0	0	0	0	0	0	20	0	0	29	0	68
Geothermal	0	0	0	0	0	0	0	0	0	0	0	0	0	0	0	0	0	0	0	0	0	0	0
Hydrogen	0	0	0	0	0	0	0	0	0	0	0	0	0	0	0	0	0	0	0	0	0	0	0
Ammonia	0	0	0	0	0	0	0	0	0	0	0	0	0	0	0	0	0	0	0	0	0	0	0
Liquid Air	0	0	0	0	0	0	0	0	0	0	0	0	0	0	0	0	0	0	0	0	0	0	0
Pumped Hydro	0	0	0	0	0	0	0	0	0	0	0	0	0	0	0	0	0	0	0	0	0	0	0
Biomass	0	0	0	0	0	0	0	0	0	0	0	0	0	0	0	0	0	0	0	0	0	0	0
Retail Pricing	0	0	0	0	0	0	0	0	0	0	0	0	0	0	0	0	0	0	0	0	0	0	0
Demand Response	0	0	0	0	0	0	0	0	0	0	0	0	0	0	0	0	0	0	0	0	0	0	0
<b>Total</b>	<b>0</b>	<b>0</b>	<b>0</b>	<b>0</b>	<b>0</b>	<b>0</b>	<b>0</b>	<b>0</b>	<b>19</b>	<b>0</b>	<b>0</b>	<b>0</b>	<b>90</b>	<b>0</b>	<b>0</b>	<b>0</b>	<b>0</b>	<b>20</b>	<b>135</b>	<b>0</b>	<b>29</b>	<b>128</b>	<b>420</b>
<b>Grand Total</b>	<b>1</b>	<b>7</b>	<b>1</b>	<b>1</b>	<b>1</b>	<b>1</b>	<b>201</b>	<b>21</b>	<b>361</b>	<b>1</b>	<b>0</b>	<b>0</b>	<b>200</b>	<b>81</b>	<b>60</b>	<b>66</b>	<b>72</b>	<b>253</b>	<b>606</b>	<b>257</b>	<b>250</b>	<b>928</b>	<b>3,368</b>
<b>Cumulative Energy Efficiency (aMW)</b>																							
Washington	3	6	10	14	18	23	27	32	36	40	43	47	49	52	54	56	57	59	60	61	62	62	870
Idaho	1	2	4	5	7	9	10	12	13	15	16	17	18	19	20	21	21	22	23	23	23	23	326
<b>Total</b>	<b>4</b>	<b>9</b>	<b>14</b>	<b>19</b>	<b>25</b>	<b>31</b>	<b>37</b>	<b>44</b>	<b>49</b>	<b>55</b>	<b>59</b>	<b>64</b>	<b>68</b>	<b>71</b>	<b>74</b>	<b>76</b>	<b>79</b>	<b>81</b>	<b>83</b>	<b>84</b>	<b>85</b>	<b>86</b>	<b>1,196</b>

**Portfolio #14 Combined Electrification**

Washington	2024	2025	2026	2027	2028	2029	2030	2031	2032	2033	2034	2035	2036	2037	2038	2039	2040	2041	2042	2043	2044	2045	Total
Natural Gas	0	0	0	0	0	0	0	0	0	0	0	3	0	0	0	0	0	0	0	0	0	0	3
Nuclear	0	0	0	0	0	0	0	0	0	0	0	0	0	0	0	0	0	0	0	0	0	0	349
Wind	0	0	0	0	0	0	200	200	200	0	0	0	0	0	0	0	0	240	305	200	200	0	1,545
Solar	1	1	1	1	1	1	1	1	1	1	0	0	0	0	0	0	0	0	0	0	0	0	11
Lithium-Ion Storage	0	0	0	0	0	0	0	0	0	0	0	0	0	0	0	0	0	0	0	0	0	0	0
Flow battery	0	0	0	0	0	0	0	0	0	0	0	0	0	0	0	0	0	0	0	0	0	0	0
Iron Oxide Storage	0	0	0	0	0	0	0	0	391	0	0	0	0	0	0	131	188	141	50	87	136	108	1,231
Geothermal	0	0	0	0	0	0	0	20	20	0	0	0	0	0	0	0	0	0	0	0	0	0	40
Hydrogen	0	0	0	0	0	0	0	0	0	0	0	0	0	0	0	0	0	0	0	0	0	0	0
Ammonia	0	0	0	0	0	0	0	0	0	0	0	0	177	127	153	0	0	0	256	0	0	0	712
Liquid Air	0	0	0	0	0	0	0	0	0	0	0	0	0	0	0	0	0	0	0	0	0	0	0
Pumped Hydro	0	0	0	0	0	0	0	0	0	0	0	0	0	0	0	0	0	0	0	0	0	0	0
Biomass	0	0	0	0	0	0	0	0	0	0	0	0	0	0	0	0	0	0	0	58	0	0	58
Retail Pricing	0	7	0	0	0	0	0	0	0	0	0	0	0	0	0	0	0	0	0	0	0	0	7
Demand Response	0	0	0	0	0	0	0	0	0	0	0	0	0	0	0	0	0	0	0	0	0	0	0
<b>Total</b>	<b>1</b>	<b>7</b>	<b>1</b>	<b>1</b>	<b>1</b>	<b>1</b>	<b>201</b>	<b>221</b>	<b>611</b>	<b>1</b>	<b>0</b>	<b>3</b>	<b>177</b>	<b>127</b>	<b>153</b>	<b>131</b>	<b>188</b>	<b>382</b>	<b>612</b>	<b>345</b>	<b>336</b>	<b>458</b>	<b>3,957</b>
<b>Idaho</b>	<b>2024</b>	<b>2025</b>	<b>2026</b>	<b>2027</b>	<b>2028</b>	<b>2029</b>	<b>2030</b>	<b>2031</b>	<b>2032</b>	<b>2033</b>	<b>2034</b>	<b>2035</b>	<b>2036</b>	<b>2037</b>	<b>2038</b>	<b>2039</b>	<b>2040</b>	<b>2041</b>	<b>2042</b>	<b>2043</b>	<b>2044</b>	<b>2045</b>	<b>Total</b>
Natural Gas	0	0	0	0	0	0	0	0	0	0	93	2	0	0	0	0	0	46	144	0	0	0	285
Nuclear	0	0	0	0	0	0	0	0	0	0	0	0	0	0	0	0	0	0	0	0	0	0	0
Wind	0	0	0	0	0	0	0	0	0	0	0	0	0	0	0	0	0	0	0	0	0	0	0
Solar	0	0	0	0	0	0	0	0	0	0	0	0	0	0	0	0	0	0	0	0	0	0	0
Lithium-Ion Storage	0	0	0	0	0	0	0	0	0	0	0	0	0	0	0	0	0	0	0	0	0	0	0
Flow battery	0	0	0	0	0	0	0	0	0	0	0	0	0	0	0	0	0	0	0	0	0	0	0
Iron Oxide Storage	0	0	0	0	0	0	0	0	0	0	0	0	0	0	0	18	18	0	0	18	20	93	167
Geothermal	0	0	0	0	0	0	0	0	0	0	0	0	0	0	0	0	0	0	0	0	0	0	0
Hydrogen	0	0	0	0	0	0	0	0	0	0	0	0	0	0	0	0	0	0	0	0	0	0	0
Ammonia	0	0	0	0	0	0	0	0	0	0	0	0	0	0	0	0	0	0	0	0	0	0	0
Liquid Air	0	0	0	0	0	0	0	0	0	0	0	0	0	0	0	0	0	0	0	0	0	0	0
Pumped Hydro	0	0	0	0	0	0	0	0	0	0	0	0	0	0	0	0	0	0	0	0	0	0	0
Biomass	0	0	0	0	0	0	0	0	0	0	0	0	0	0	0	0	0	0	0	0	0	0	0
Retail Pricing	0	0	0	0	0	0	0	0	0	0	0	0	0	0	0	0	0	0	0	0	0	0	0
Demand Response	0	0	0	0	0	0	0	0	0	0	0	0	0	0	0	0	0	0	0	0	0	0	0
<b>Total</b>	<b>0</b>	<b>0</b>	<b>0</b>	<b>0</b>	<b>0</b>	<b>0</b>	<b>0</b>	<b>0</b>	<b>0</b>	<b>93</b>	<b>2</b>	<b>0</b>	<b>0</b>	<b>0</b>	<b>18</b>	<b>18</b>	<b>46</b>	<b>144</b>	<b>18</b>	<b>20</b>	<b>93</b>	<b>451</b>	
<b>Grand Total</b>	<b>1</b>	<b>7</b>	<b>1</b>	<b>1</b>	<b>1</b>	<b>1</b>	<b>201</b>	<b>221</b>	<b>611</b>	<b>1</b>	<b>93</b>	<b>5</b>	<b>177</b>	<b>127</b>	<b>153</b>	<b>149</b>	<b>207</b>	<b>428</b>	<b>755</b>	<b>362</b>	<b>356</b>	<b>551</b>	<b>4,408</b>
<b>Cumulative Energy Efficiency (aMW)</b>																							
Washington	3	7	10	15	19	24	29	33	38	42	46	49	52	54	56	58	60	61	63	63	64	65	910
Idaho	1	2	4	5	7	9	10	12	14	15	16	18	19	20	21	21	22	23	24	24	24	24	335
<b>Total</b>	<b>4</b>	<b>9</b>	<b>14</b>	<b>20</b>	<b>26</b>	<b>33</b>	<b>39</b>	<b>46</b>	<b>52</b>	<b>57</b>	<b>62</b>	<b>66</b>	<b>70</b>	<b>74</b>	<b>77</b>	<b>79</b>	<b>82</b>	<b>84</b>	<b>86</b>	<b>87</b>	<b>88</b>	<b>89</b>	<b>1,245</b>



Portfolio #15 Clean Portfolio by 2045

Washington	2024	2025	2026	2027	2028	2029	2030	2031	2032	2033	2034	2035	2036	2037	2038	2039	2040	2041	2042	2043	2044	2045	Total
Natural Gas	0	0	0	0	0	0	0	0	0	0	0	0	0	0	0	0	0	0	0	0	0	0	0
Nuclear	0	0	0	0	0	0	0	0	0	0	0	0	0	0	0	0	0	0	0	0	0	0	0
Wind	0	0	0	0	0	0	200	0	164	0	0	0	0	0	0	0	0	140	105	100	100	200	1,009
Solar	1	1	1	1	1	1	1	1	1	1	0	0	0	0	0	0	0	0	0	0	0	0	10
Lithium-Ion Storage	0	0	0	0	0	0	0	0	0	0	0	0	0	1	0	0	0	0	0	0	0	1	2
Flow battery	0	0	0	0	0	0	0	0	0	0	0	0	0	0	0	0	0	0	0	0	0	0	0
Iron Oxide Storage	0	0	0	0	0	0	0	0	0	0	0	0	0	0	0	0	33	0	0	57	0	0	89
Geothermal	0	0	0	0	0	0	0	0	0	0	0	0	0	0	0	0	0	0	0	0	13	20	33
Hydrogen	0	0	0	0	0	0	0	0	0	0	0	0	0	0	0	0	0	0	0	0	0	0	0
Ammonia	0	0	0	0	0	0	0	0	0	0	0	0	73	0	48	0	0	48	206	0	0	0	704
Liquid Air	0	0	0	0	0	0	0	0	0	0	0	0	0	0	0	0	0	0	0	0	0	0	0
Pumped Hydro	0	0	0	0	0	0	0	0	0	0	0	0	0	0	0	0	0	0	0	0	0	0	0
Biomass	0	0	0	0	0	0	0	0	0	0	0	0	0	0	0	0	0	0	0	0	0	0	0
Retail Pricing	0	7	0	0	0	0	0	0	0	0	0	0	0	0	0	0	0	0	0	0	0	0	7
Demand Response	0	0	0	0	0	0	0	0	0	0	0	0	0	0	0	0	0	0	0	0	0	0	0
<b>Total</b>	<b>1</b>	<b>7</b>	<b>1</b>	<b>1</b>	<b>1</b>	<b>1</b>	<b>201</b>	<b>1</b>	<b>165</b>	<b>1</b>	<b>0</b>	<b>0</b>	<b>73</b>	<b>1</b>	<b>48</b>	<b>0</b>	<b>33</b>	<b>188</b>	<b>312</b>	<b>157</b>	<b>113</b>	<b>549</b>	<b>1,855</b>
Idaho	2024	2025	2026	2027	2028	2029	2030	2031	2032	2033	2034	2035	2036	2037	2038	2039	2040	2041	2042	2043	2044	2045	Total
Natural Gas	0	0	0	0	0	0	0	0	0	0	0	0	0	0	0	0	0	0	0	0	0	0	0
Nuclear	0	0	0	0	0	0	0	0	0	0	0	0	0	0	0	0	0	0	0	0	0	0	0
Wind	0	0	0	0	0	0	0	0	36	0	0	0	0	0	0	0	0	0	100	100	0	0	236
Solar	0	0	0	0	0	0	0	0	0	0	0	0	0	0	0	0	0	0	0	0	0	0	0
Lithium-Ion Storage	0	0	0	0	0	0	0	0	0	0	0	0	0	0	0	0	0	0	0	0	0	0	0
Flow battery	0	0	0	0	0	0	0	0	0	0	0	0	0	0	0	0	0	0	0	0	0	0	0
Iron Oxide Storage	0	0	0	0	0	0	0	0	0	0	0	0	0	0	0	0	18	0	0	0	0	0	18
Geothermal	0	0	0	0	0	0	0	0	0	0	0	0	0	0	0	0	0	0	0	0	7	7	7
Hydrogen	0	0	0	0	0	0	0	0	0	0	0	0	0	0	0	0	0	0	0	0	0	82	82
Ammonia	0	0	0	0	0	0	0	0	0	0	0	0	40	0	27	0	0	27	128	0	0	74	296
Liquid Air	0	0	0	0	0	0	0	0	0	0	0	0	0	0	0	0	0	0	0	0	0	0	0
Pumped Hydro	0	0	0	0	0	0	0	0	0	0	0	0	0	0	0	0	0	0	0	0	0	0	0
Biomass	0	0	0	0	0	0	0	0	0	0	0	0	0	0	0	0	0	0	0	0	0	58	58
Retail Pricing	0	0	0	0	0	0	0	7	0	0	0	0	0	0	0	0	0	0	0	0	0	0	7
Demand Response	0	0	0	0	0	0	0	0	0	0	0	0	0	0	0	0	0	0	0	0	0	0	0
<b>Total</b>	<b>0</b>	<b>0</b>	<b>0</b>	<b>0</b>	<b>0</b>	<b>0</b>	<b>0</b>	<b>7</b>	<b>36</b>	<b>0</b>	<b>0</b>	<b>0</b>	<b>40</b>	<b>0</b>	<b>27</b>	<b>0</b>	<b>18</b>	<b>27</b>	<b>228</b>	<b>100</b>	<b>7</b>	<b>213</b>	<b>703</b>
<b>Grand Total</b>	<b>1</b>	<b>7</b>	<b>1</b>	<b>1</b>	<b>1</b>	<b>1</b>	<b>201</b>	<b>8</b>	<b>201</b>	<b>1</b>	<b>0</b>	<b>0</b>	<b>114</b>	<b>1</b>	<b>75</b>	<b>0</b>	<b>51</b>	<b>215</b>	<b>540</b>	<b>257</b>	<b>121</b>	<b>762</b>	<b>2,558</b>
Cumulative Energy Efficiency (aMW)																							
Washington	3	6	10	14	18	22	27	31	35	39	42	45	48	50	52	54	56	57	58	59	60	61	848
Idaho	1	3	4	6	7	9	11	13	14	16	17	19	20	21	22	23	23	24	25	25	25	26	353
<b>Total</b>	<b>4</b>	<b>9</b>	<b>14</b>	<b>19</b>	<b>25</b>	<b>31</b>	<b>38</b>	<b>44</b>	<b>50</b>	<b>55</b>	<b>60</b>	<b>64</b>	<b>68</b>	<b>71</b>	<b>74</b>	<b>77</b>	<b>79</b>	<b>81</b>	<b>83</b>	<b>84</b>	<b>85</b>	<b>86</b>	<b>1,200</b>

Portfolio #16 Social Cost Included for Idaho

Washington	2024	2025	2026	2027	2028	2029	2030	2031	2032	2033	2034	2035	2036	2037	2038	2039	2040	2041	2042	2043	2044	2045	Total
Natural Gas	0	0	0	0	0	0	0	0	0	0	0	0	0	0	0	0	0	0	0	0	0	0	0
Nuclear	0	0	0	0	0	0	0	0	0	0	0	0	0	0	0	0	0	0	0	0	0	0	0
Wind	0	0	0	0	0	0	200	0	200	0	0	0	0	0	0	0	0	140	105	0	100	160	905
Solar	1	1	1	1	1	1	1	1	1	1	0	0	0	0	0	0	0	0	0	0	0	74	84
Lithium-Ion Storage	0	0	0	0	0	0	0	0	0	0	0	0	0	1	0	0	0	0	0	0	0	0	37
Flow battery	0	0	0	0	0	0	0	0	0	0	0	0	0	0	0	0	0	0	0	0	0	0	0
Iron Oxide Storage	0	0	0	0	0	0	0	0	0	0	0	0	0	0	0	0	32	0	58	0	32	0	122
Geothermal	0	0	0	0	0	0	0	0	0	0	0	0	0	0	0	0	0	0	0	0	0	20	20
Hydrogen	0	0	0	0	0	0	0	0	0	0	0	0	0	0	0	0	0	0	0	0	0	0	0
Ammonia	0	0	0	0	0	0	0	0	0	0	0	0	65	0	48	0	0	48	150	48	0	324	682
Liquid Air	0	0	0	0	0	0	0	0	0	0	0	0	0	0	0	0	0	0	0	0	0	0	0
Pumped Hydro	0	0	0	0	0	0	0	0	0	0	0	0	0	0	0	0	0	0	0	0	0	0	0
Biomass	0	0	0	0	0	0	0	0	0	0	0	0	0	0	0	0	0	0	0	0	0	0	0
Retail Pricing	0	7	0	0	0	0	0	0	0	0	0	0	0	0	0	0	0	0	0	0	0	0	7
Demand Response	0	0	0	0	0	0	0	0	0	0	0	0	0	0	0	0	0	0	0	0	0	0	0
<b>Total</b>	<b>1</b>	<b>7</b>	<b>1</b>	<b>1</b>	<b>1</b>	<b>1</b>	<b>201</b>	<b>1</b>	<b>201</b>	<b>1</b>	<b>0</b>	<b>0</b>	<b>65</b>	<b>1</b>	<b>49</b>	<b>0</b>	<b>33</b>	<b>188</b>	<b>313</b>	<b>48</b>	<b>133</b>	<b>614</b>	<b>1,858</b>
<b>Idaho</b>	<b>2024</b>	<b>2025</b>	<b>2026</b>	<b>2027</b>	<b>2028</b>	<b>2029</b>	<b>2030</b>	<b>2031</b>	<b>2032</b>	<b>2033</b>	<b>2034</b>	<b>2035</b>	<b>2036</b>	<b>2037</b>	<b>2038</b>	<b>2039</b>	<b>2040</b>	<b>2041</b>	<b>2042</b>	<b>2043</b>	<b>2044</b>	<b>2045</b>	<b>Total</b>
Natural Gas	0	0	0	0	0	0	0	0	0	0	0	0	0	0	0	0	0	0	112	0	0	90	203
Nuclear	0	0	0	0	0	0	0	0	0	0	0	0	0	0	0	0	0	0	0	0	0	0	0
Wind	0	0	0	0	0	0	0	0	0	0	0	0	0	0	0	0	0	0	0	0	0	0	0
Solar	0	0	0	0	0	0	0	0	0	0	0	0	0	0	0	0	0	0	0	0	0	0	0
Lithium-Ion Storage	0	0	0	0	0	0	0	0	0	0	0	0	0	0	0	0	0	0	0	0	0	0	0
Flow battery	0	0	0	0	0	0	0	0	0	0	0	0	0	0	0	0	0	0	0	0	0	0	0
Iron Oxide Storage	0	0	0	0	0	0	0	0	0	0	0	0	0	0	0	0	18	0	0	0	18	0	36
Geothermal	0	0	0	0	0	0	0	0	20	0	0	0	0	0	0	0	0	0	0	0	0	0	20
Hydrogen	0	0	0	0	0	0	0	0	0	0	0	0	0	0	0	0	0	0	0	0	0	0	0
Ammonia	0	0	0	0	0	0	0	0	0	0	0	0	36	0	27	0	0	26	0	26	0	0	115
Liquid Air	0	0	0	0	0	0	0	0	0	0	0	0	0	0	0	0	0	0	0	0	0	0	0
Pumped Hydro	0	0	0	0	0	0	0	0	0	0	0	0	0	0	0	0	0	0	0	0	0	0	0
Biomass	0	0	0	0	0	0	0	0	0	0	0	0	0	0	0	0	0	0	0	0	0	0	0
Retail Pricing	0	0	0	0	0	0	0	0	0	0	0	0	0	0	0	0	0	0	0	0	0	0	0
Demand Response	0	0	0	0	0	0	0	0	0	0	0	0	0	0	0	0	0	0	0	0	0	0	0
<b>Total</b>	<b>0</b>	<b>0</b>	<b>0</b>	<b>0</b>	<b>0</b>	<b>0</b>	<b>0</b>	<b>0</b>	<b>20</b>	<b>0</b>	<b>0</b>	<b>0</b>	<b>36</b>	<b>0</b>	<b>27</b>	<b>0</b>	<b>18</b>	<b>26</b>	<b>112</b>	<b>26</b>	<b>18</b>	<b>90</b>	<b>373</b>
<b>Grand Total</b>	<b>1</b>	<b>7</b>	<b>1</b>	<b>1</b>	<b>1</b>	<b>1</b>	<b>201</b>	<b>1</b>	<b>221</b>	<b>1</b>	<b>0</b>	<b>0</b>	<b>101</b>	<b>1</b>	<b>75</b>	<b>0</b>	<b>50</b>	<b>214</b>	<b>425</b>	<b>74</b>	<b>150</b>	<b>704</b>	<b>2,231</b>
<b>Cumulative Energy Efficiency (aMW)</b>																							
Washington	3	6	10	13	18	22	26	30	34	38	41	44	47	49	51	52	54	55	57	57	58	59	824
Idaho	1	2	4	5	7	8	10	12	13	15	16	17	18	19	20	21	21	22	23	23	23	24	323
<b>Total</b>	<b>4</b>	<b>9</b>	<b>13</b>	<b>19</b>	<b>24</b>	<b>30</b>	<b>36</b>	<b>42</b>	<b>48</b>	<b>53</b>	<b>57</b>	<b>61</b>	<b>65</b>	<b>68</b>	<b>71</b>	<b>73</b>	<b>75</b>	<b>77</b>	<b>79</b>	<b>80</b>	<b>81</b>	<b>82</b>	<b>1,147</b>

**Portfolio #17 Washington Maximum Customer Benefits**

Washington	2024	2025	2026	2027	2028	2029	2030	2031	2032	2033	2034	2035	2036	2037	2038	2039	2040	2041	2042	2043	2044	2045	Total	
Natural Gas	0	0	0	0	0	0	0	0	0	0	0	3	0	0	0	0	0	0	0	0	0	0	3	
Nuclear	0	0	0	0	0	0	0	0	0	0	0	0	0	0	0	0	0	0	0	0	0	0	0	
Wind	0	0	0	0	0	0	200	0	0	0	0	0	0	0	0	0	0	140	105	200	0	200	845	
Solar	1	1	1	1	1	2	2	3	3	3	85	18	23	28	33	38	44	57	72	79	84	248	827	
Lithium-Ion Storage	1	1	1	1	1	1	1	1	2	1	0	0	0	0	0	0	0	0	0	0	0	0	10	
Flow battery	0	0	0	0	0	0	0	0	0	0	0	0	0	0	0	0	0	0	0	0	0	0	0	
Iron Oxide Storage	0	0	0	0	0	0	0	0	0	0	0	0	62	50	0	50	0	50	197	50	32	90	581	
Geothermal	0	0	0	0	0	0	0	0	20	0	0	0	0	0	0	0	0	0	0	0	0	20	40	
Hydrogen	0	0	0	0	0	0	0	0	0	0	0	0	0	0	0	0	0	0	0	0	0	228	228	
Ammonia	0	0	0	0	0	0	0	0	0	0	0	0	0	0	0	0	0	0	0	0	0	0	0	
Liquid Air	0	0	0	0	0	0	0	0	0	0	0	0	0	0	0	0	0	0	0	0	0	0	0	
Pumped Hydro	0	0	0	0	0	0	0	0	0	0	0	0	0	0	0	0	0	0	0	0	0	0	0	
Biomass	0	0	0	0	0	0	0	0	0	0	0	0	0	0	0	0	0	0	0	0	0	0	0	
Retail Pricing	0	7	0	0	0	0	0	0	0	0	0	0	0	0	0	0	0	0	0	0	0	0	7	
Demand Response	0	0	0	0	0	0	0	0	0	0	0	0	0	0	0	0	0	0	0	0	0	0	0	
<b>Total</b>	<b>2</b>	<b>9</b>	<b>2</b>	<b>2</b>	<b>2</b>	<b>3</b>	<b>203</b>	<b>4</b>	<b>25</b>	<b>4</b>	<b>85</b>	<b>21</b>	<b>85</b>	<b>78</b>	<b>33</b>	<b>88</b>	<b>44</b>	<b>247</b>	<b>373</b>	<b>329</b>	<b>116</b>	<b>786</b>	<b>2,540</b>	
<b>Idaho</b>	<b>2024</b>	<b>2025</b>	<b>2026</b>	<b>2027</b>	<b>2028</b>	<b>2029</b>	<b>2030</b>	<b>2031</b>	<b>2032</b>	<b>2033</b>	<b>2034</b>	<b>2035</b>	<b>2036</b>	<b>2037</b>	<b>2038</b>	<b>2039</b>	<b>2040</b>	<b>2041</b>	<b>2042</b>	<b>2043</b>	<b>2044</b>	<b>2045</b>	<b>Total</b>	
Natural Gas	0	0	0	0	0	0	0	0	0	0	90	2	0	0	0	0	0	90	90	0	0	0	0	273
Nuclear	0	0	0	0	0	0	0	0	0	0	0	0	0	0	0	0	0	0	0	0	0	0	0	
Wind	0	0	0	0	0	0	0	0	0	0	0	0	0	0	0	0	0	0	0	0	0	0	0	
Solar	0	0	0	0	0	0	0	0	0	0	0	0	0	0	0	0	0	0	0	0	0	0	0	
Lithium-Ion Storage	0	0	0	0	0	0	0	0	0	0	0	0	0	0	0	0	0	0	0	0	0	0	0	
Flow battery	0	0	0	0	0	0	0	0	0	0	0	0	0	0	0	0	0	0	0	0	0	0	0	
Iron Oxide Storage	0	0	0	0	0	0	0	0	0	0	0	0	0	0	0	0	0	0	0	0	18	67	85	
Geothermal	0	0	0	0	0	0	0	0	0	0	0	0	0	0	0	0	0	0	0	0	0	0	0	
Hydrogen	0	0	0	0	0	0	0	0	0	0	0	0	0	0	0	0	0	0	0	0	0	0	0	
Ammonia	0	0	0	0	0	0	0	0	0	0	0	0	0	0	0	0	0	0	0	0	0	0	0	
Liquid Air	0	0	0	0	0	0	0	0	0	0	0	0	0	0	0	0	0	0	0	0	0	0	0	
Pumped Hydro	0	0	0	0	0	0	0	0	0	0	0	0	0	0	0	0	0	0	0	0	0	0	0	
Biomass	0	0	0	0	0	0	0	0	0	0	0	0	0	0	0	0	0	0	0	0	0	0	0	
Retail Pricing	0	0	0	0	0	0	0	0	0	0	0	0	0	0	0	0	0	0	0	0	0	0	0	
Demand Response	0	0	0	0	0	0	0	0	0	0	0	0	0	0	0	0	0	0	0	0	0	0	0	
<b>Total</b>	<b>0</b>	<b>0</b>	<b>0</b>	<b>0</b>	<b>0</b>	<b>0</b>	<b>0</b>	<b>0</b>	<b>0</b>	<b>0</b>	<b>90</b>	<b>2</b>	<b>0</b>	<b>0</b>	<b>0</b>	<b>0</b>	<b>0</b>	<b>90</b>	<b>90</b>	<b>0</b>	<b>18</b>	<b>67</b>	<b>358</b>	
<b>Grand Total</b>	<b>2</b>	<b>9</b>	<b>2</b>	<b>2</b>	<b>2</b>	<b>3</b>	<b>203</b>	<b>4</b>	<b>25</b>	<b>4</b>	<b>175</b>	<b>23</b>	<b>85</b>	<b>78</b>	<b>33</b>	<b>88</b>	<b>44</b>	<b>338</b>	<b>464</b>	<b>329</b>	<b>134</b>	<b>853</b>	<b>2,898</b>	
<b>Cumulative Energy Efficiency (aMW)</b>																								
Washington	3	7	10	14	19	24	28	33	37	41	44	48	50	53	55	57	58	60	61	62	63	64	890	
Idaho	1	2	4	5	7	8	10	11	13	14	15	16	18	18	19	20	21	21	22	22	22	23	314	
<b>Total</b>	<b>4</b>	<b>9</b>	<b>14</b>	<b>20</b>	<b>26</b>	<b>32</b>	<b>38</b>	<b>44</b>	<b>50</b>	<b>55</b>	<b>60</b>	<b>64</b>	<b>68</b>	<b>71</b>	<b>74</b>	<b>77</b>	<b>79</b>	<b>81</b>	<b>83</b>	<b>84</b>	<b>85</b>	<b>86</b>	<b>1,204</b>	

# 2023 Electric Integrated Resource Plan

## Appendix L Public Participation Comments



## TAC Member Comments

This Appendix covers TAC member emails of comments made during the 2023 IRP. TAC members generally comment during TAC meetings, those comments and questions are covered in the TAC meeting notes in Appendix A. This document covers comments and questions provided directly to Avista outside of the TAC meetings.

## Appendix L: TAC Member Comments Outside of TAC Meetings

<p><b>Tina Jayaweera, Northwest Power &amp; Conservation Council, May 15, 2023</b></p>
<ol style="list-style-type: none"> <li>1. It could use a robust copy edit as there are a handful of typos and discrepancies between text and figures (e.g. Fig 2.2 and 2.4 start year does not correspond to what is in the text, Fig 2.6 data doesn't align with text).</li> <li>2. Next time, for the natural gas market price forecast, consider using the Council's data on projected build out instead of Aurora's WECC database</li> <li>3. Please explain more about how the NH3 turbine acts as a storage resource and how it will be balanced as a generator. It's a pretty new approach, so would like to learn more.</li> <li>4. As noted in the text, there are a number of different GCMs used by the RMJOC and BPA, each with an RCP 4.5 analysis; i.e. there no singular RCP 4.5 model. Which one was selected to represent future temperature conditions and why? Or did you use the median across all 19 like done for the hydro conditions?</li> <li>5. It's not clear in the IRP report, though may be in App C/D which I admittedly didn't dig up. I recall having the discussion at one of the IRPACs about the interaction of DR and EE (more heat pump water heaters because of EE change the DR potential). How, if at all, was this considered?</li> </ol>
<p><b>Final IRP Response</b></p>
<p>Avista has edited and updated the sections of the IRP discussed in this comment. Regarding the natural gas price forecast, Avista will check in with the NPCC during the 2025 IRP process to see if including their forecast is appropriate. Regarding the demand response question, the energy efficiency and demand response analysis use the same baseline equipment forecasts to assess the potential, but the analysis did not consider the potential impact of EE on DR opportunities. Because the IRP is assessing the need for, and economics of, both EE and DR, there is a question of the appropriate amount of EE to assume for the DR analysis. That said, incorporating EE forecasts into the DR potential analysis is something we can explore in the upcoming CPA, if desired.</p>

## Appendix L: TAC Member Comments Outside of TAC Meetings

**Dave Van Hersett, May 1, 2023**

Subject: Comments on 2023 IRP Draft

First, your analysis and presentation is very good. You all are to be complimented on your work. Second, I am 84, a retired Professional Engineer and a veteran. Started in the utility industry in 1967 building generation power plants. Finished my career pioneering industrial and commercial conservation in the 80's selling energy savings to utilities. I have actively participated in TAC at Avista since its inception. I have witnessed how the environmental groups have passed legislation that have resulted in killing the forest products industry and increased the emissions over the State dramatically over the years. When I was in high school in the 50's we went to the lake all summer with no smoke days as the norm. Now, due to the "green" rules, the forests are managed to make fuel for forest fires and not to harvest the timber to the benefit of mankind. I have also witnessed, sadly, that the Utility Commission has changed its mission from that of representing the customer to that of implementing the programs of the current political power. Only 1.5% of Avista customers signed up for green power rates, leaving 98.5% of the customers wanting reliable and low cost energy. The Commission is implementing the will of the 1.5% and ignoring the desire of the 98.5%. The Commission does this by not passing Avista rate increases unless Avista implements programs of the 1.5% and the politicians in power. Avista has modified its business plan from providing low cost reliable power to its customers to that of implementing programs desired by the Commission.

**COMMENTS ON 2023 IRP**

After reading and attending the April 25 presentation of the IRP, I do not see any content on the impact of how our rates compare to that of the world's changing economies. Specifically, the impact that China, India and Russia are having on our state and our nations competitive position to market to the "new" world order. In Washington State we have seen the passage of rules and regulations that impose very significant cost penalties to our businesses that sell products to the domestic and world markets. Examples are airplanes and agricultural products. While we are closing down low cost and reliable fossil fuel generation, the world order is building 60 or more coal generation Plants. Their energy costs will be lower than ours and their emissions will continue to grow negating any environmental benefits that the State of Washington achieves. The result is that as our Washington State businesses costs increase, the world will take their business elsewhere to the lowest price, I call this the Walmart effect.

You are preparing your IRP to meet the artificial regulations, goals and objectives of the current Washington State political trend. You are not including any analysis of the financial penalties our customers will see in their respective competitive markets. We are now recognizing that China is a sole source for many of our nations and states critical materials and components. As our energy rates increase our dependence on our advisories will increase. The IRP does not provide any comparison of how our electric and natural gas rates compare with our significant competitors. An example of one of China's impacts is the closure of 60% of our nations foundries. China did this by making the cost of their castings so low that the US foundry business could not compete and therefore closed. Our Washington State policies to go "Green" by programs like CETA are accomplishing the same effect, they increase our cost of business as compared to that of the new World.

So I would like to see at least one analysis of just how much of a cost premium that our businesses have to face when comparing to our major business competitor like China. In absence of real data on China's energy costs, one could use as a baseline our plentiful and nearby coal fossil fuels and nuclear power generation for energy and capacity. By eliminating the use of Combustion Turbines for energy, the demand for natural gas will be significantly lower and our mix of generation resources will look like it was in the previous decades. The current IRP resource options include significant uses of CT's and other green higher cost resources for energy, very expensive options.

As a side note, the emissions from the 1400 MW Centralia Power plant are 40% less than the 15 vehicle traffic. The Centralia power plant can run the City of Seattle. It would require eight wind units per mile from Seattle to Spokane (some 2000 new units) to replace the 1400 MW Centralia coal fueled Power Plant. Furthermore, emissions from our annual forest fires are many times all the other

## Appendix L: TAC Member Comments Outside of TAC Meetings

combined emissions in the State. Going back to the forest management practices of the 50's and 60's would dramatically reduce the emissions in the state and would drastically lower the price of lumber to lower the cost of housing for our citizens and bring back thousands of jobs. This strategy would meet the goals of the Green movement.

Finally, I wish to thank you for the opportunity to include my two cents as a 50-year residential customer in your valent efforts to provide your customers with low-cost reliable energy resources. I am reminded of an old rule of thumb, the cost of power to the customer is 1/3 generation, 1/3 transmission and 1/3 distribution. You are finally including all of these costs to provide service to your customer. It is looking like that this rule of thumb is not going to be far off.

### Final IRP Response

Time and resource limitations preclude us from studying most international comparisons. Avista chose not include any comparisons in this IRP to China because the focus of the IRP is on how Avista serves customers and participates in regional markets. The IRP does include some details about electricity, natural gas, and hog fuel from the Canadian markets, where we do participate. The Planning Team also tries to keep apprised of current events in the energy industry even if we do not have time to include any of those in the IRP. However, recent industrial energy rates in China based on publicly available research ranges from 8 to 9.5 cents per kWh (likely subject to exchange rate fluctuations and the timing of studies). The U.S. average industrial rate in 2021 was 7.26 cents per kWh. Given the results of this comparison other factors beyond energy costs such as labor costs and regulation may drive trade absent larger energy costs differences.

### Dave Boleneus, January 3, 2023

Dear All,

Happy New Year and thank you's must go out to Dr. John Lyons, Avista planners and others at Avista for many months of diligent work. You have kept all well informed. Now it is time to reflect.

In case you missed the article last week in the Wall St Journal, A quiet refutation of net zero carbon emissions, you should read it.

[https://www.wsj.com/articles/a-quiet-refutation-of-net-zero-climate-change-emissions-energy-global-warming-sec-goals-clean-power-11672262963?mod=opinion\\_lead\\_pos8](https://www.wsj.com/articles/a-quiet-refutation-of-net-zero-climate-change-emissions-energy-global-warming-sec-goals-clean-power-11672262963?mod=opinion_lead_pos8)

The two most authoritative energy concerns in our country, Electric Power Research Institute and National Energy Regulatory Commission....

WSJ: The EPRI report concludes that the utility industry can't attain net zero. "This study shows that clean electricity plus direct electrification and efficiency . . . are not sufficient by themselves to achieve net-zero economy-wide emissions."

In other words, no amount of wind turbines, solar panels, hydropower, nuclear power, battery power, electrification of fossil-fuel technologies or energy-efficiency technologies will get us to net zero by 2050. How a net-zero grid could be built and function would be an issue worth studying if it were possible in the first place. But it simply isn't. So, barring some unforeseen miracle technology, "net zero by 2050" won't happen. <https://lcri-netzero.epri.com/en/executive-summary.html> or full article--  
<https://www.epri.com/research/sectors/lcri/research-results/3002024993>

WSJ: NERC concluded that fossil-fuel plants are being removed from the grid too fast to meet continuing electricity demand, and that is putting most of the country at risk of grid failure and blackouts during extreme weather. The U.S. just got another taste of this during the Christmas electric-grid emergency. [https://www.nerc.com/pa/RAPA/ra/Reliability%20Assessments%20DL/NERC\\_LTRA\\_2022.pdf](https://www.nerc.com/pa/RAPA/ra/Reliability%20Assessments%20DL/NERC_LTRA_2022.pdf)



## Appendix L: TAC Member Comments Outside of TAC Meetings

So there you have it: We are dangerously dismantling our electric grid while burdening it with more demand in hope of attaining the goal of "net zero by 2050," which the utility industry has admitted is a fantasy.

**This information from these authoritative sources begs the question all must ask, rhetorical or otherwise: Is Washington's energy transition merely a ruse leading to a dismantling of our electric grid? Will we arrive at (or can we get to..) where we're going?**

We understand that Avista and other utilities are bound to follow the law, but I think it is time to discuss realities here. Several items raise suspicions and more questions arise as time passes.

Power planners are better authorities in power planning than a one-sided legislature in 2019 that brought CETA or a governor that co-authored a mistake-ridden renewables book. Certainly, the energy transitions in Ontario and Germany provide clear evidence that something is wrong with renewables; they cannot replace fossil fuels as discussed extensively by "Planning Engineer" at JudithCurry.com (Climate Etc.) in the Penetration Problem-The more you do the harder it gets (Oct 2, and Oct. 11 2022) and worsened by the Inflation Reduction Act. All of us rely on--including Avista employees, our families and Avista families--a reliable source of electricity and natural gas so we have a common concern. Can we have that discussion together? <https://judithcurry.com/2022/10/03/the-penetration-problem-part-i-wind-and-solar-the-more-you-do-the-harder-it-gets/...> <https://judithcurry.com/2022/10/11/the-penetration-problem-part-ii-will-the-inflation-reduction-act-cause-a-blackout/#comment-981185>

Passing of CETA came about by a bending of rules far into unreality as I could explain at another time. Also in following of the evidence from the scientific circles as it becomes available, the truth is now revealed (aka, the cat out of the bag): carbon dioxide is not a temperature control knob and now elegantly confirmed by 800,000 years of climate history from glacier ice evidence from several continents, or from earth's several billion years of climate history, with that and related evidence now extensive, incontrovertible, replicated.

The energy transition to net zero is nowhere a success, but a failure everywhere, even a failure where most advanced, in Germany's Energiewende before it has reached its halfway point of renewables which leads us to question the path of energy transition everywhere. Physical barriers to these technologies show that wind and solar will never replace today's energy portfolios. A decade of wind records provides confirming evidence. Global temperature has now leveled off even though carbon dioxide values continue upward. Perhaps we have forgotten that temperatures decreased for two decades in the 60s and 70 before again moving upward, but now stalling again. What! Why? Germany's emissions continue upward while it cannot become 50% renewable because its wind and solar prevents it; Planning Engineer notes "a larger percentage of wind and solar in a portfolio results in erosion of desirable characteristics...and a rapidly decreasing reliability". Italy plans a U-turn from renewables while Germany is dismantling wind turbines to open new coal mines to provide electricity to its people. China, South Korea, and India lead the world in their imports of coal (85% of world's tonnage) to generate electricity as I explained previously yet these countries refuse to reverse citing their citizen's welfare as more important. If Washington State were to reach net zero emissions, Washington's 0.35% share of world emissions would be replaced by China in 50 days provides clear reason to question the effort as silly. And finally, three authoritative sources, the World Bank, Geological Surveys in Finland and United States, and International Energy Agency, show that building an energy system on the net zero basis is unaffordable, costing hundreds of \$Millions of \$billions with resources needed to build but not available on this planet simply confirms the folly because not any of us will see or experience net zero in any lifetime. This information provides more reason to accept the "ruse" as the more likely explanation.

Appendix L: TAC Member Comments Outside of TAC Meetings

What, really, is the future?

Comments and competing views are welcome.

David Boleneus

**Final IRP Response**

Avista appreciates David’s provided material and concerns. Avista is bound by state law to pursue reliable clean energy for Washington customers with the cost cap requirements.

**Dave Boleneus, December 9, 2022**

**Interesting what’s happening outside Avista’s, Washington’s renewable anomaly sphere.**

Although Avista is making giant strides, we often fail to observe what’s happening at a distance.

Chart below shows the expansion of coal generating plants in China and developing countries, while the US bans them (data July 2022). China operates 54% of all coal-electric generating plants in the World and with expansions in coal generation growing, even accelerating there, with 87,600 MWs installed in three years. China is building an average 1 new coal-fired electric generating plant per week. They have 290,554 megawatts planned, under construction or permitted today with 1,074,063 MWs operating, seven times more than the US; that’s 725 new Chinese coal plants coming soon with the average size assumed at 400 MW per plant. New plants announced worldwide are double the number the US will close. Other countries with coal plants planned or underway are India (57,040 MWs), Indonesia (25,959 MWs), Japan (5320 MWs), Turkey (12,228 MWs), South Africa (3250 MWs), Vietnam (15,630 MWs), also S. Korea, Australia, Bangladesh (15,104 MWs), Philippines (3023 MWs); also Ukraine, Poland, Germany. Beyond hydro and waste, the dirt to build clean energy and invisible here is all spewed over there. Does it matter if Washington goes NET ZERO?

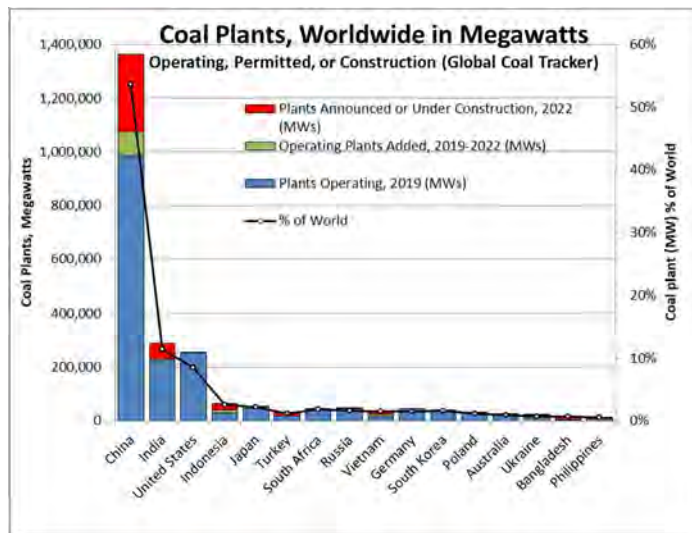

**John Barbor, December 9, 2022 (RE: David Boleneus)**

Seems like there are two points being argued here:

1. Although we are going off of coal, it is still widely used in the rest of the world, and in increasing amounts. True, but ultimately its usage has to go to zero (or nearly so) if there is to be a hope for constraining the increase in the planet’s temperature. So, just because a lot of others haven’t made the decision yet to eliminate its usage doesn’t really mean we should do likewise. Coal’s usage and growth is due to a number of factors, mostly boiling down to vested interests exerting their effect on decision-making bodies, and the fact that it is a known quantity, with abundant technical skill, knowledge and equipment to facilitate and further its

## Appendix L: TAC Member Comments Outside of TAC Meetings

implementation. As the costs of solar and wind continue to diminish, coal will eventually become economically less desirable. At some point, it will be at an economic disadvantage. And if in the meantime we have shown that energy can be supplied without it, the decision to quit coal on a global scale will be pretty straightforward.

2. Producing renewable energy generating equipment requires energy, and since much of that equipment is produced in China, which uses a lot of coal as its source of energy, therefore making that equipment is simply making matters worse. Perhaps true to some extent today, but for tomorrow the story is different. Energy is energy, regardless of how it is produced. Electricity and heat don't care about their source, they are still simply electricity and heat. As renewable energy becomes more prevalent, that energy will become an ever greater factor in the production of additional renewable energy equipment. And, the US is making a big push to create a substantial renewable energy equipment production industry here, where renewable energy will be an increasingly dominant factor. So, the argument that today, dirty energy sources are being used in one country to produce renewable energy products, will become increasingly irrelevant.

John Barber

**Art Swannack, December 12, 2022 (RE: John Barber)**

I'd say there is one key assumption based upon an unknown that is key to John's response and that assumption may not be valid--China, India and others desire to go to renewable energy operated power systems---and we're especially talking two extremely large countries questionable desire to do so. Remember China is known as the Middle Kingdom for a reason. Their long history and nationalistic pride over centuries traditionally has them as the center of the world. That's not rhetoric, it is culture. It also affects decision making.

China's population will soon be number 2 in the world in size and India will become number one. They both need expanding baseload power supply. Solar and wind don't fit that characteristic due to multiple factors beyond cost per mw. To make either or both baseload power they'd have to so overbuild it would seriously drive up the per mw cost in standby panel/system over capacity as to not be competitive with other energy sources. Nuclear is expensive to construct, manage and secure. I expect they'll build more but it takes time. Hydro has been and is being built in smaller projects. I expect three gorges dam took a bit of gloss off that wrapper, so you're looking at natural gas or coal as baseload add on alternatives. Natural gas is easily sellable on the world market compared to coal. Coal is easy for poor people to heat with directly or for generators to make electricity with it.

In reality our over enthusiastic efforts are most likely just driving up our cost of energy vs theirs on a direct cost basis and not creating much of a net decrease in carbon emissions worldwide. I believe the temperature calculation for Washington state's efforts by 2050 is .0015 degree decrease. Likely also decreasing our financial competitiveness due to higher energy and production costs but I'd guess I'm a bit cynical today.

On the political front Nancy Pelosi and her trip to Taiwan simply gave China an excuse to withdraw from the climate change agreement they signed onto. If it was really important to them they'd have used a different card.

Fwiw  
Art

Art Swannack  
Whitman county commissioner  
509 288-1684

Washington state's open public records act is very broad and pretty much anything you send me is available for anyone to see.

**Final IRP Response**

## Appendix L: TAC Member Comments Outside of TAC Meetings

Avista appreciates the discussion between TAC members about the challenges of the Washington CETA requirements and the potential effects on future climate. Avista is bound by state law to pursue reliable clean energy for Washington with the cost cap requirements. Avista encourages TAC members to be involved in state policy making to ensure the citizen's goals and expectations are heard and met.

**Bill Garry, October 20, 2022**

Hi James,

Thanks for your presentation today. I am trying to understand all this, and I have not had much experience at it. I missed a portion of the Greenhouse Gas emissions part of the spreadsheet calculations, which is what I was most interested in. Specifically, was the Kettle Falls facility counted out in future capacity based on GHG emissions? It went by so fast and so small, and I don't have a copy of the spreadsheets to see. I have seen a study about biomass being a big producer of GHG without a quantity and quality of timely tree growth to offset.

I also noted some comments related to community solar which may not be modeled into your 2022-2023 Plan. As you know, the state has approved funding for low-income community solar starting this year to pay \$100 million over the next ten years. These are limited to 199kw arrays each, so they are probably not enough to affect your projections. At \$2.50 per installed watt, the total power produced won't exceed 40 Mw.

Thanks again. I look forward to following your planning process.

Bill Garry

**Avista's Response**

Kettle Falls does not count toward our greenhouse gas emissions in Washington state sense it is treated as carbon neutral. I agree it does have emissions, but in this case we are treating them as zero due to the carbon cycle and state law. Regarding community solar, we do model small solar and I'm working on adding the functionality to add the low-income community solar option to the model to account for the state funding. While you right it won't add to much for the whole state nor will it won't make much of change to the total plan- but it will have an impact on our energy burden calculation for low income customers. My biggest issue is how much we will actually be able to get given the funding is for the whole state and on a first come first serve basis.

I've included a link below to the model in case you are interested below:

<https://www.myavista.com/-/media/myavista/content-documents/about-us/our-company/irp-documents/prism80expected-case101722.xlsm>

**Dave Van Herset, October 18, 2022**

Good morning John and James: [REDACTED]

[REDACTED] In the selection of the generation models to include in your evaluations, as a residential customer, you should include at least one case that looks at generation resources that are not based on political objectives, but one that is based on the lowest cost in the long run. As a residential customer we are looking for low cost reliable generation. It is not in our best interest to select generation resources that are costly and do not improve the world environmental goals.

My desired case would be nuclear base loaded, biomass generation like Kettle Falls that provides lower cost lumber for building housing, and peaking from combustion turbines. This resource mix would

## Appendix L: TAC Member Comments Outside of TAC Meetings

provide lowest long term power cost for my electric bill and would minimize the influence of politics and meet the long term environmental objectives.

The cost of natural gas has increased dramatically due to the politics and will only get worse as natural gas is used to back up wind and solar baseline generation.

Looking forward to reading your workshop report.

Thank you,

Dave Van Herset, Residential Customer of Avista since 1967.

#### **Final IRP Response**

Avista appreciates your comments, concerns, and active participation in the TAC process. Avista is bound by state law to pursue reliable clean energy for Washington within the cost cap requirements. Avista encourages TAC members to be involved in state policy making to ensure the citizen's goals and expectations are met.

#### **Nelli Doroshkin, Invenergy, August 10, 2022**

Of the four carbon price options presented by Avista in its Carbon Pricing Proposal, Invenergy recommends the Ecology Estimate developed by Vivid Economics. Compliance with the CCA is unavoidable, and there is no reason to discount Vivid Economics' well-supported primary analysis. Alternatively, the second scenario may be used; however, the third scenario should not be incorporated into the analysis, as it lacks support.

More broadly, Avista should include the Social Cost of Carbon ("SCC") as an economic dispatch cost in its modeling for IRP, CEAP, and CEIP filings and resource acquisition. At a minimum, Avista should include CCA allowance prices in economic dispatch modeling for IRP/CEAP/CEIP/acquisitions and in operational dispatching/trading. One approach would be to include allowance prices in dispatch modeling and then add in the SCC, net of allowance prices, post-dispatch modeling. This would ensure that the environmental externality cost represented by the SCC is included in resource planning. The first part (allowance prices) would represent the market-priced part of the environmental externality cost of GHG emissions, and the second part (SCC net of allowance prices) would represent the remainder of the environmental externality cost.

Finally, Avista should include carbon pricing, in the form of allowance prices, as an economic dispatch cost in its modeling of the overall regional power system. The CCA will make allowance prices an economic cost of dispatch for any GHG-emitting generation resource serving load in Washington. This will affect the dispatch economics for all GHG-emitting resources and will thus affect wholesale market power prices.

#### **Avista Response**

Hi Nelli,

Thank you for your comments. Regarding your comment on social cost of carbon, your proposed methodology is our planned method for Washington state resource options this IRP and is similar to our prior IRP approach. We will consider your concern of the 3<sup>rd</sup> scenario in our final decision making. Keep in mind the intent of scenario modeling is include uncertainty in policies, while you believe the CCA will continue in its current form for the next 20 years, laws typically change subject to the impacts of the law and without this scenario we do not cover this potential future outcome, further the third scenario represents your last comment on region wide CO2 pricing as these prices post 2030 will be including in the price forecast for all areas, lastly the scenario does include CCA floor pricing through 2030 which is a plausible outcome of the CCA.

## Appendix L: TAC Member Comments Outside of TAC Meetings

Again, thank you for taking the time to respond to our question, also if you have any thoughts on an alternative low price scenario please advise us.

**Final IRP Decision**

See IRP Chapter 8 for a discussion on the final methodology to address CCA pricing in the 2023 IRP.

**Dave Van Herset, August 10, 2022**

1. Using the demographic data of Washington instead of Eastern WA (Avista Service Area) will lead to imperfect results and conclusions. First the weather pattern for the state are very different from the west to the east side. Thus the respective energy usage of the population will vary significantly. Second the demographic incomes of the state population vs eastern are very different. You will find that the average income in western WA is higher than eastern WA. Thus my conclusion is that the results will not be very representative of Avista's customers.
2. The potential generation resource from all of these "estimated" conservation programs is very small and would come into being way out in the future. As a residential customer and as income and the economy dictates, over the years of owning my home since 1967 I have added insulation to my home, upgraded lighting to take advantage of lower energy usage, installed smart thermostat for home heating and cooling, storm windows, to name a few. I did not need a study to install these conservation items, the market place provided the incentives. I did not need the utility to tell me what to do.
3. What are the definitions of 'TRC', 'RTF, and TRM?
4. From an overall perspective, if Avista's rates are the lowest in the state, and only 3997 out of 330,000 avista customers have signed up for the more expensive green power why is Avista being forced to spend so many resources and expense on the IRP and all of the green resources? As I understand, Avista is already way ahead in renewable energy generation of the other utilities in the state, so why penalize existing Avista customers with additional administrative expense of this IRP to serve its customers?
5. Based on my 40 some years of reflections on implementing industrial and commercial conservation programs throughout the state of Washington, the utility commission has morphed its responsibilities from representing the interests of the customers to that of implementing the political objectives of the governor. The Commissioners are appointed by the governor and now the governor is pushing a green program instead of providing low cost reliable electric service to Avista's customers. The result of the commissions directives will result in increasing my power costs by 300 % over the years to come. This large increase in electric service will hit the low-income customers the hardest, just the opposite what the commission is trying to do. I believe that the commissioners should represent the interests of the customers and not those of the objectives of the environmental and green organizations. All of this green generation will only add to the overall expense of Avista's cost of service, resulting in higher utility costs for residential customers like me.
6. So my suggestion is that if the commission wants to do all of these studies, do it at their expense and not mine.
7. Another observation: it seems that the majority of the participants in the TAC process are not actual customers of Avista, they are environmental groups from the west side imposing their wishes with no financial risk or cost to them. So I would recommend that only input from actual customers be used by Avista to build their resource options for the IRP study.

Thank you for the opportunity to participate in the TAC process and give my feedback

**Avista Response**

- 1) Avista agrees with your assessment, although I don't believe we are using any west side information for our planning on the energy efficiency front. We do have to use statewide incomes to set low-income standards, but we use local conditions for weather impacts on loads.
- 2) Thanks for the comment, I believe utility EE programs have become a carrot to encourage behavior or to lower customer burdens of affordability. I think its shown in states with less

## Appendix L: TAC Member Comments Outside of TAC Meetings

aggressive EE utility programs adoption is less, so these efforts have made an impact on loads, whether or not they are societally cost effective- I've not done this math.

- 3) TRC refers to Total Resource Cost- it's a measure that includes customer cost, societal costs, and utility costs to test cost effectiveness- this compares to UCT- or utility cost test-that only measures the savings vs the cost to run the program. These are required methods set by the I-937 law to use TRC.

RTF refers to Regional Technical Forum- see the link on this one: [Regional Technical Forum \(nwccouncil.org\)](http://nwccouncil.org)

- 4) Thanks for the Comment- we have to be 100% carbon neutral by 2030 from CETA, we are not there, and will need to make investments incrementally to get there. From the CEIP's clean energy requirements that were recently approved, over the next four-year window we will not need to add any new renewables to meet those requirements. As whether or not the requirements are too stringent we are forced to meet state law until such laws are changed.
- 5) Thanks for the comment, one of the goals of the IRP is to illustrate the cost of these objectives, the law does limit CETA power acquisition expenses to 2% per year, but those 2% per year does add up over time. The commission and other groups are well aware of the issues effecting low-income groups- which is why the equity provision is within the law. The equity provision will likely further cause additional costs and wealth transfer between customer classes. I suggest you or your contacts participate in the Equity Advisory Group ([Washington's Clean Energy Future \(myavista.com\)](http://Washington's Clean Energy Future)); so your voice is heard and the equity provisions required by law are implemented in a useful manner to our customers.
- 6) Either utility payments or taxes- so probably pay the same either way!
- 7) Thanks for the comment- keep in mind we take comments we don't have to follow them except where they may point out a legally requirement we've missed or makes sense to our management- the only thing we are required to do is respond to official comments. For example, we'll reply with "official" comments in the IRP progress report filing!

#### **Dave Van Hersett, March 22, 2022**

*Executive Summary:* Avista's options for future generation resources should include resources that deliver low-cost reliable generation over the long term – not just the recent fad of the One Percenters.

1. Avista's options should include revised forest management practices that reduce forest fires, provide jobs for its customers, deliver low-cost lumber for housing, and generate biomass generation.
2. If coal is to be replaced, then nuclear should be its replacement. Coal and nuclear generation resources are both base-loaded plants and have a long-term, low-cost profile.
3. Gas turbines should be only used for peaking and filling in when all other sources are not available.
4. Finally, Avista's focus should be on its 300,000 customers, not the one percenters, and to develop strategies that accommodate the state regulations rather than blindly following them to the utilities' corporate advantage.

The above generation strategy is a win for all; the proposed strategy meets both environmental and customers objectives.

*Author's background* are his observations on Avista's proposed generation strategies of their 20-year plans over the years. It is very important to note that when Avista offered higher cost renewable power as an option for its customers, less than 1% of Avista's 330,000 customers signed up for this higher-cost service. Thus 327,000 customers wanted to continue being served with low-cost reliable power

## Appendix L: TAC Member Comments Outside of TAC Meetings

from Avista generation resources. I am one of these 327,000 customers who is looking for resources providing low-cost reliable power. These resources' options include hydropower, coal, nuclear, biomass, and gas turbines.

The 1% (one percenters) have imposed their will on the 327,000 customers without any regard for cost, reliability, animal life, environment, and local or world competitiveness. The resource mix they are imposing includes a significant amount of solar and wind backed up by gas turbines. This strategy requires a much higher investment and yields a higher cost for power. The lower availability and reliability of solar and wind requires backup from an equal amount of gas turbines fueled by natural gas, another fossil fuel resource. The 1% reduce the wind and solar costs by including significant government financial incentives. These incentives are subject to the will and winds of politics over the years to come.

The reason for the abandonment of coal is to meet the requirements of the recent state-imposed regulations for non-fossil fuel generation. The goal of the state regulations' objective is to reduce the carbon emissions to the atmosphere. These regulations do not take into account the new coal generation being implemented around the world especially in China and India. These two countries will be currently building 20-some coal plants the size of the Centralia 1400 megawatt power plant. So what are we accomplishing environmentally by shutting down Centralia and replacing all of our low-cost, reliable coal generation with wind and solar? The world emissions will not be reduced by our action. The only result will be to increase our cost of electricity by up to three times. This will make our industries less competitive in the world trade and will impose a significant economic burden on the Avista customers. Furthermore, as our cost of goods increases, we will purchase lower-cost goods from countries like China, India, etc. Their generation is not as environmentally efficient as ours. The other ploy used by the 1% (one percenters) is to save the birds and wildlife to promote their objectives. Installing thousands of wind turbines will slaughter thousands of birds every day. Remember the spotted owl they used to highlight and promote their environmental objectives? The wind turbines will also kill our national bird, the eagle. I thought it was protected. Why is slaughtering thousands of birds now OK?

How about the one percenters' efforts to limit the harvesting of timber over the past four decades? Now forest fire smoke is the largest polluter of all other pollutants combined on the entire West Coast. The cost of homes is going out of reach of the customers due to higher cost construction and increased demand for housing as our populations grow. Good forest management would reduce our pollution and make lower-cost housing available in one stroke.

Avista vs WWP: What have we gained from Avista since they took over from WWP?

WWP developed low-cost reliable power resources for its customers.

WWP delivered long-term power resources that were not subject to political whims and other inflationary events. Thus, our power costs today remain low and predictable over the years. We are still enjoying the benefits of the low-cost generation resources developed and operated by WWP.

What has Avista accomplished since they took over WWP.

1. First, the officers increased their compensation from ten times the average income of its customers to 100 times the average income of its customers.
2. Next, they tried to sell our utility two times, only to be prohibited by the utility commissions.
3. Recently, Avista is in the process of adopting and implementing the higher-cost generation resources into their long-term generation plan as required by the CETA laws in WA state. The result of this policy will be to increase our customer electric rates by up to 300 per cent. Increasing Avista's revenue may be good for the company but certainly not good for its 327,000 customers.

The reason for the increased cost is the long-term use of natural gas for the back-up fuel for gas turbine generation. Natural gas fuel prices are being driven up by the large increase in demand for natural gas to replace other fossil fueled coal plants in the nation. In the last two years, the Avista



## Appendix L: TAC Member Comments Outside of TAC Meetings

exhibits show that the cost of natural gas has doubled and is predicted to increase even more over the years to come.

Another significant factor is the recent federal government actions to limit the use of fossil fuels and limit the acquisition of new oil and natural gas supplies. In the meantime, our population continues to grow. These are the major contributing factors to the endless increase in natural gas prices. We need to have our generation resources minimize the use of Natural Gas.

*So what solution should Avista be considering to deliver a low-cost and stable-power cost to its customers over the years to come. Develop only new resources that satisfy emission requirements and at the same time provide low-cost reliable power for its customers. Here are the options to include:*

1. *Nuclear generation.* Once installed, nuclear generation cost is very stable and not subject to the political winds to increase its cost. Nuclear is a base-loaded generation resource identical to coal-generation plants' performance characteristics.
2. *Biomass generation* - actually an approved CETA resource. Avista should lobby for incentives for forest-derived fuels as enjoyed by wind and solar. This will make biomass even lower in cost than wind and solar. Biomass fuels from forests will go a long way to reduce the fuels available for forest fires. Forest fires are the largest pollution sources in the PNW. Another benefit of biomass fuels is to improve the production of timber products, lowering the cost to build homes for our citizens. The price of lumber has increased from \$300 per thousand board feet to over \$1100 per thousand board feet in recent years. Going back to the forest management practices of the 60's and 70's would increase lumber production dramatically. Revitalizing the forest products industry would bring back some 30,000 jobs to the Avista service area. The jobs would bring back to life some 13 lumber ghost towns in our area and the town services needed to support the forest products industries.
3. *Finally consider changing the utility business model.* The business risk of Avista is minimal as their service area and rates are protected and controlled by the Utility commissions of Washington and Idaho. As Avista continues its adventures into non-utility areas such as real-estate, it is losing its focus on its primary job, that of providing low-cost reliable power to its 330,000 customers.

Maybe Avista should consider changing its focus to that of its customers instead of its company performance. This could be accomplished by the 330,000 customers voting to convert to a public utility, like Inland Power, etc. These public utilities' boards of directors are actual customers with their own customer services as their primary focus.

Right now Avista is subject to the whims of the politics of Washington State, by the political appointments to the utility commissions, and the lobbying efforts of the one percenters. These commissions adopt and implement the political and environmental objectives of the west side of our state and ignore the desires of the east side 330,000 customers. By changing to a public utility business model, the policies and objectives of the utility become those of its customers rather than the political and environmental objectives of the one percenters and the west siders.

To test the logic of my proposed generation resource plan above, Avista could publish the number of its customers that have actually changed to the "Green Power rate schedule" and determine the number of customers that wish to continue their preference for low-cost reliable generation for the future. These numbers would put into focus for Avista what the desires of the majority of its customers actually want from their utility.

*In Conclusion: The super majority of the 330,000 Avista customers want low-cost, reliable power not subject to the whims of politicians and the one percenters. The options that provide power not subject to the whims of the politicians, one percenters, or the variables of wind and sun are nuclear and biomass generation. Avista should be focused primarily on its customers' needs, not just the political whims of the west side.*

## Appendix L: TAC Member Comments Outside of TAC Meetings

**Final IRP Response**

Avista appreciates your comments, concerns, and participation. Avista is bound by state law to pursue reliable clean energy for Washington with the cost cap requirements. Avista encourages TAC members to be involved in state policy making to ensure the citizen's goals and expectations are met.

**Dave Van Hersett, February 9, 2022****Coal Politics in Washington State**

Background: China has 1400 coal plants, India has 1200 coal plants of the 5000 coal plants in the world. USA has 245 coal plants. China and India alone have 120 new coal plants in construction. This data is from the internet. One will find many different numbers on the internet but the conclusions are the same. While Washington State and the USA is shutting down coal plants, the rest of the world is adding new coal for electric generation and more planet pollution.

Locally, WA state political and environmental groups have joined forces to pass legislation to shut down the Centralia Coal power plant and replace it with wind, solar, biomass and gas turbines. The result for the State of Wash will be to triple our electric rates, making Avista's customers products and living more expensive. We will then import cheaper goods from China and other world countries, resulting in loss of jobs in WA state and the USA. The world coal use will increase in other countries to produce goods for the USA market resulting in an increase in world pollution. So what did we accomplish by not using low cost energy from coal. If we keep our WA cost of business competitive to the rest of the world, we will keep jobs here for our ever-growing population instead of shipping our jobs overseas.

It should be acknowledged that when Avista offered higher cost "green" electricity rates less than one percent of the Avista customers chose higher cost power. More important from an environmental perspective, the USA coal plants are more efficient than those in other countries. Higher efficiency results in lower environmental impacts. So, we should be encouraging more use of high efficiency coal plants here in the USA to "save the world".

To give you an idea how fast our energy costs are rising note that in the last two years the price of natural gas has increased by 200%. Looking forward to seeing how the 2023 IRP natural gas price predictions will be. I expect that one of the major factors for price increase is the increased demand for fuel for power generation. Refer to gas price data in the last two IRP's.

The current WA coal and environmental policy is folly and will result in the opposite of the objective of creating a better environmental world and in the long run will reduce jobs in WA. Remember we live in this world and we get the pollution from China and India and other countries in the world. More important in the near term, Avista customers will be forced to pay a much higher price for both electric and natural gas supplies by only considering wind, solar and natural gas resources. Nuclear and Biomass should be considered as its long run costs are likely to be lower than wind, solar and natural gas. Avista's IRP should include the economic impact on its customers in addition to the current legislative dictated environmental impact's on its customers for resource plans selected for analysis and evaluation. I would expect that the economic impact of higher energy prices on Avista's customers will far exceed the carbon neutral costs to Avista's customers.

**CASE FOR BIOMASS AS A PRIMARY RESOURCE OPTION**

In WA state the major pollution source is forest fires, more than 200 times all the other pollution sources combined in WA state. I-5 auto emissions are 4 times the centralia coal plant. The politicians and environmentalists claim they will save the environment. However, you will need to add 1400 wind mills and 24,000 acres of solar and seven 200 MW gas turbine plants to replace the one 1400 MW coal plant. This does not provide for the ever-increasing population growth. The centralia coal plant can run the city of Seattle by itself. The windmills will kill many more birds every day than the Centralia Coal Plant that does not kill birds. Why then are the Sierra club and other environmental organizations that historically tried to save birds with their policies but now they do not care about the bird deaths? Instead of going after the most significant polluter, forest fires, the politicians spend our

## Appendix L: TAC Member Comments Outside of TAC Meetings

money to build a tunnel to improve the Seattle waterfront. To reduce pollution in Seattle they should have built a major bypass around Seattle to keep traffic flowing.

The solution to improving the environment is to attack the largest polluter first, forest fires. This will require a major change the forest management practices. The approach will be to producing products for mankind like was done in the 50's and 60's. Their efforts and policies starting in the 80's was to shut down harvesting timber from forests to save birds and animals. They proposed letting the forests grow "naturally" resulting in making fuel for forest fires. The result increased forest fires that are now killing birds, burning wildlife, killing people and destroying property.

Holding back timber harvesting has lowered timber supply for sawmills. In the last three years the price of lumber has risen from \$2.50 per MMBDFT to \$1,100 per MMBDFT. Housing is much more expensive now contributing to the shortage of housing for all of WA state residents including the homeless. Home prices in Spokane has risen from \$250,000 to \$600,000 in the last three years. Now the young can not afford to purchase homes contributing to the increase in homelessness.

The solution to improving the environment and economy is to harvest timber for the benefit of mankind. This provides fuel for biomass generation and jobs for our ever-increasing population. Biomass and coal energy will provide low-cost energy for our economy to be competitive in the marketplace and lower Avista's customers cost of living. Eliminating coal generation will drive up our electric and natural gas costs forcing businesses to move to business-friendly locations.

Quoting from the 2023 IRP Plan "Avista intends to create a PRS (Preferred Resource Strategy) using market and policy assumptions based final rules from the Clean Energy Transformation Act (CETA) and the Climate Commitment Act (CCA) for Washington and using the least cost planning methodology in Idaho." End quote. **These are environmental objectives and they do not include providing low-cost energy to Avista's customers. The 2023 IRP should also include the economic impact on its customers as a major consideration.** As the IRP includes "Global Change" impact studies, our impact on Global Change should be calculated and presented for consideration to the selection of resource options. It is likely that our Global impact even with coal is insignificant by only following the legislative dictated options.

#### **Final IRP Response**

Avista appreciates your comments, concerns, and participation. Avista is bound by state law to pursue reliable clean energy for Washington with the cost cap requirements. Avista encourages TAC members to be involved in state policy making to ensure the citizen's goals and expectations are met.

Appendix L: TAC Member Comments Outside of TAC Meetings

Page Left Intentionally Blank

## Appendix L: Public Comments- Public Meeting

**Avista's Natural Gas & Electric Integrated Resource Plan Public Meeting****March 8, 2023**

Avista held two Integrated Resource Planning public meetings on March 8, 2023 in an on-line format. Invites to the meeting were sent to all customers with emails and to all advisory committee members. Meetings were held at 12:00 pm and 5:00 pm. The meeting discussed draft resource plans for both the 2023 Natural Gas and Electric IRPs.

This document summarizes feedback from the participants from these meetings including:

- 1) Poll Question Results
- 2) Table of Questions and Answers
- 3) Follow-up Email Correspondence

**These are results of the poll questions given to the audiences for both public meeting webinars.**

### **Webinar Poll Questions**

**What would you prioritize among the choices below, acknowledging that they are all important?**

- Environmental issues - 12
- A reliable system - 18
- Affordability - 9
- Equitable investments – 1

**How should Avista meet state policy objectives to lessen greenhouse gas emissions on the natural gas system?**

- Invest in renewable or synthetic natural gas - 21
- Use ratepayer funds to subsidize building electrification - 9
- Use taxpayer funds to subsidize building electrification - 2
- Pay state “taxes or fees” to continue to use natural gas - 10

**What type of Demand Response program interests you?**

- Different electric prices by time or day or season (time of use) - 6
- Paid to reduce if utility notifies of an opportunity (peak time rebate) - 12
- Utility controls your thermostat or water heater (direct load control) - 1
- None interest me – 4

**What does an equitable transition to clean energy mean to you? We achieve cleaner energy along with:**

- Affordable costs - 8
- Energy is resilient and secure - 9
- Everyone has access to clean energy - 5
- Improved public health - 2
- Increased economic development for the community – 1

**How much of your bill do you think should go toward assisting individuals and communities who are economically disadvantaged?**

- \$0 per month - 13
- \$5 per month - 10
- \$10 per month - 2
- Greater than \$20 per month – 1

## Appendix L: Public Comments- Public Meeting

**Participant Questions/Comments During the Meetings**

Avista answered these questions during the meeting

The response below are summaries of these response with additional context

<b>Question</b>	<b>Avista Response</b>
How does Avista buy natural gas in advance?	Avista has a hedging program where we're looking ahead up to three years and in the futures markets or the forward market with our local basins we purchase from. Purpose is to try to remove some of the cost risk. Avista also participates in the daily market for the same purpose.
How will Avista be able to reserve and or sell off extra energy during non-peak times?	Avista sells extra energy whenever we're "long" and have more energy than customers need. Revenue from these sales benefit customers.
Is anyone exploring natural gas in Washington or northern Idaho?	There are no known shale formations in either Washington or Idaho. Also, in 2019, the State of Washington signed into law Senate Bill 5145 imposing a permanent ban on the use of hydraulic fracturing.
If electricity is knocked out for a lengthy time, will natural gas still flow to my home in a disaster?	Gas flow along the interstate pipelines, and all of our distribution lines will continue to flow due to the upstream pressure (energy) unless pipes are knocked out, no electricity is necessary. But any appliance that has electric-powered components (fan, electronic ignition for furnace, etc.) will not work. The blower and electric ignition on a furnace won't work without on-site generation, but a gas stove and hot water tank should continue.
Will the OR & WA mandates (CETA, CCA) have cost impacts on Idaho customers?	There are some circumstances where Washington's CCA will have cost impacts on Idaho customers. Avista will minimize these cost as directed by the IPUC.
Is Avista planning on more solar panel generation?	Yes, solar projects are in the resource plans for the benefit of highly impacted communities and vulnerable populations.
I have solar panels that are producing more electricity than I use, can I not receive a credit toward my gas consumption?	Avista has a net-metering program. State-specific information can be found at Getting connected ( <a href="http://myavista.com">myavista.com</a> ). Questions can be directed to <a href="mailto:solar@avistacorp.com">solar@avistacorp.com</a> .
What is the thermal efficiency of your natural gas turbines to produce electrical generation?	There's two typically two types of gas generation that Avista controls. The first ones are typically combined cycle combustion turbines and those are approximately around 50% to 60% efficient. Plants used higher load events are approximately 40% efficient.
Will Avista have battery bank backups for excessive renewable power generation?	It goes back to our resource strategy of needing energy storage. Due to Washington goal 100% clean energy goal by 2045. There will be times of the year we have excess renewables and times, years we will have shortfalls. The IRP plans to store this energy, the big question that we have is

## Appendix L: Public Comments- Public Meeting

	what does that technology that's going to be storing that energy.
How will Avista compensate people who add power to the grid through solar and wind power?	So currently if a customer wants to install solar on their house or their business, we have a net metering program and what happens is if you generate power and that's less than the amount of your demand, you get to reduce that energy use compared to your bill.
How will heat pumps be able to heat when the temps are lower than 20 degrees F?	This might be referring to the building codes that got passed a few months ago where requires heat pumps to be installed and the challenge with heat pumps that were in actually in the law specifically allows you to use backup fuel below 38 degrees. But I have a heat pump that does not work when it gets cold out. It's a brand new heat pump. It's just the technology is not there yet for extreme cold temperatures in our geography to create enough heat during these temperatures. It is worth noting duct less heat pumps to have diminished capability to produce heat in below 38 degree temperatures, but may not be enough to satisfy your heating requirements.
Are you or will you be using salt water for production of synthetic methane now that that technology is available?	This is the first time Avista has modeled methane within the natural gas IRP. So it's not a common technology, however, the chemistry has been around for a long time. Avista will consider salt water if the cost is lower for customers then other alternatives.
What is the expected impact on energy bills as government regulations kick in over time?	Avista has the estimates in its resource plan. We will see cost increases, but it will depend on a many of factors. For electric, we compare an Idaho versus a Washington cost escalator. Using simple numbers to illustrate the concept. if Idaho is increasing around 2%, you might see Washington increase by 3 1/2% a year. So there will be a divergences due to the various state policies and their impacts on customers' bills.
When Avista plans on purchasing power from renewable projects is Avista taking into consideration whether the renewable project has labor standards (prevailing wage, Local hire, Apprenticeship utilization...?)	These are among the considerations when Avista purchases power from renewable projects.
Is gas more costly in the winter?	Generally in the wholesale market, yes, but depends on market supply and demand economics.
Since most fossil fuels will start going away by 2050, what are the long-term goals to provide energy in the future?	Avista's preferred resource strategy can be found in our electric IRP on Integrated Resource Planning ( <a href="http://myavista.com">myavista.com</a> )
What I see missing from this whole discussion is how to help individual homeowners convert their homes to infrastructure that utilizes less gas and more home-generated electricity.	If residential electrification of all homes becomes mandated, it's likely that assistance such as rebates would be available. It is unknown at this



## Appendix L: Public Comments- Public Meeting

	time where it will be utility, customer, or government driven.
At what percentage of electrical generation by renewable sources (wind and solar) that system generation become unstable? What mitigation systems are considered for this possibility?	Variable energy resources such as wind and solar are very intermittent thereby requiring other technologies across the system to compensate for these types of resources. Avista's system is approximately 50% hydro which allows for more flexibility. Avista as well as the Western Resource Adequacy Program are studying the impacts on our system as more of these Variable Energy Resources (VER) are added to our system. In the end stability will depend on the other resources/storage available to integrate VERs.
Regarding synthetic methane, you mentioned that there are different sources of carbon. Seemingly, for it to be emissions free, it would have to be carbon captured from the air that hasn't been retired or already credited for being stored. In order for this to be cost feasible, carbon capture will have to be cheap. Has Avista considered a scenario wherein OR CPP offsets are achieved without synthetic methane, but instead with brown natural gas and lots of carbon capture and storage?	Carbon is found from many sources not only energy so tracking carbon at a wholistic level is impossible. Synthetic methane is a way to reuse carbon with a green energy in the form of hydrogen to deliver with current natural gas infrastructure. Carbon capture may be considered as a resource in future IRPs, especially considering incentives from the Inflation Reduction Act (IRA) help drive down costs of this technology. This would of course need to be added with the energy, brown gas, as you've mentioned.
Isn't it more efficient to use Gas 90% efficiency appliance at home versus converting to electric heat and Avista burn Gas and Coal to send me electricity? We should slow down electric conversion until we have electricity generated without fossil fuels	Direct use is of natural gas especially paired with efficient appliances is the most efficient use. However, Avista also has to balance efficiency and least cost with compliance of federal and state laws in which we operate.
What are the requirements being put in place to ensure that the workers constructing the projects are at least 50% of the local workforce?	There are no specific requirements to use local workforce for construction.
What happens when electric cars come online in significant numbers?	Avista's existing resources nor the regional transmission or distribution can sustain significant increases in electric cars and building electrification. There will need to be significantly more resources, infrastructure development and customer rates would need to increase to accommodate these. Avista is evaluating alternatives to meet this demand if it arrives.
Do you see Avista going to nuclear energy in the future?	Not at this time because of the high costs involved. This may change as the small modular reactors are developed. We will reevaluate nuclear costs with every IRP.
How long would it take to get energy back online in the case of an EMP attack?	The time to get energy back online in the case of an EMP attack varies depending on severity of the event.
Would a Thorium reactor be better than a nuclear reactor for energy production?	Avista is not an expert on nuclear technology, but understands there is potential in using thorium in the future as an alternative.
Will solar power farms be viable in the states like it is in other countries?	Solar farms provide summer capacity and while Avista can have some capacity needs, its winter capacity requirements that are greater for Avista.

## Appendix L: Public Comments- Public Meeting

	Each IRP evaluates solar along with other resources based on the energy and capacity provided and resources are selected by balancing least cost, federal and state requirements, energy/capacity needs and selected accordingly. Often times solar is viable in other states due to incentives, mandates, or limited options for grid power. Also consider just because another area is pursuing a technology does not mean it's the best options for all areas.
Would micro solar grids work in some areas like India is doing?	It is possible if you had a small community of 5 houses off-grid. A micro-grid could serve their energy needs. A storage device would probably be needed as well. Additional resources such as a diesel or gas generator may be needed to provide extra help. Always have to think about reliability, storms, etc. Microgrids aren't reinforced to the same extent as resources on the grid.
Avista should educate public that there are heat pumps that can operate in very cold temp. CO2 as refrigerant units & newer technology like Mitsubishi has cold weather units	This is correct, unfortunately the costs of these technologies are out of reach for most customers. In addition to CO2 heat pumps ground source is another option.
Will this webinar also be available on the web page?	Yes, this will be posted on IRP website.
Where are these fuels coming from minus dump sites?	There's several ways you can get renewable, natural gas. One is from solid waste like a potato processing plant. That solid waste will produce methane as it's an organic and it decomposes. Dairy farms have a large amount of methane and the manure gets put into a sludge pond, and then there's a cap on it. Think of like a parachute type thing or a tarp. It's more complex than that. But I think it's kind of something that, you know, generally captures that methane as it's decomposing.
What are the benefits to customers from Time of Use? ToU does not sound like a benefit to customers.	The price signal is thought to motivate users to modify their usage to lower-priced periods, thereby fewer power purchases from the market (or less required generation) during high priced times (i.e., overall lower rates).
What is an example of a customer energy efficiency project?	Upgrades to more efficient furnaces, lighting, and appliances. Upgrading insulation, using smart thermostats.
I like the idea of geothermal of CO2 batteries for long-duration energy storage.	Geothermal as well as long-duration storage generic resources are evaluated in Avista's electric integrated resource plan. For Avista needs, longer-duration storage of 24 hrs or more is what's needed for our cold winter events.
How will replacing gas turbines meet the Avista goal of clean electricity by 2045?	Avista serves electricity to Washington and Idaho. Washington has the 2045 clean electricity requirements, whereas Idaho does not, just lowest cost. Avista has to balance the needs of both states as well the applicable federal and state requirements while maintaining affordability and a reliable system.

## Appendix L: Public Comments- Public Meeting

And where is the gas purchased from?	It comes primarily from Canada and the Rocky Mountain states (Rockies).
Customer efficiency projects sound like an expense borne by customers.	Only cost-effective energy efficiency resources that are less than purchasing in the market are rebated using customer funds
ToU is beneficial if the grid is strained, keeps it from going down. Strained grid sounds like a resource issue.	This is correct, but reducing demand could be a lower cost alternative, if customers are will to reduce demand and if the costs to develop the program is lower. Although not building additional new generation means older more inefficient technologies will operate since new more efficient machines were not constructed.
Regarding clean energy, while I do NOT condone chemicals going into the atmosphere, has anyone considered how the trees and other plants would feel if we completely got rid of carbon emissions? You want to get rid of more carbon in the atmosphere? Plant more green stuff, trees, hemp, ect. 1 acre of hemp consumes as much carbon as 5 acres of trees and hemp has over 20,000 uses excluding recreational use.	Greenhouse gas emission regulation are designed to reduce levels, they do not eliminate all emissions.
Avista is being forced. No choice. Just explaining Inslee's orders.	Avista must balance state law requirements and customer's expectations of the energy supply.
I think the predictions for synthetic methane use at an affordable price are much more iffy than banking on wind and solar with backup energy storage. Wind and solar are already there economically but I think synthetic methane has a long way to go (even considering the recent advances at PNNL in tri-cities). What are your thoughts on this?	Wind and solar are the same methods proposed to generate the green hydrogen to create the energy side of synthetic methane. In a future where these green resources have a massive buildout to replace carbon resources such as natural gas generation, surplus energy in the middle of the day with solar can be used to create synthetic methane to store electricity in current infrastructure. As we've seen with wind and solar incentives, technology advances would help to drive down these costs over time.
Natural gas is cleanest. My husband retired from southern Calif gas co! Look at Texas and what wind did...FROZEN...people died.	Thank you for the comment
How you're considering the costs of climate change from emissions in Idaho. For instance, how do you add/consider costs to customers for hospital visits due to wildfires, health impacts, flooding due to extreme rain events? Those costs should be added into your cost considerations.	In Idaho, there's not a requirement to include a cost of climate change or direct costs, although we do include a cost for Idaho to account for the risk of a cost. We also conduct scenarios to understand the impacts of the portfolio if those costs were included.
Avista has been great. It's the self appointed bureaucrats who want the impossible. It looks like gas will always be cleaner than batteries and the cost of electricity.	Thank you for the comment
No wind no power. Solar won't run a refrigerator! I know people and renewables don't work.	Thank you for the comment
Solar in the Pacific Northwest? Sounds like an oxymoron. No sun here	Thank you for the comment
When Avista does large scale renewables will Avista make sure these projects create good paying construction jobs like prevailing wage, full family medical, and apprenticeship utilization.	Avista does pay prevailing wages, utilizes apprenticeship labor and additional considerations when hiring for these construction jobs.

Appendix L: Public Comments- Public Meeting

<p>While I agree, during the winter there is a decent amount of wind but those big turbines that are put up cost more to produce than they produce in their lifetime. They just don't make sense to use, they are a waste.</p>	<p>It is incorrect wind requires more energy to produce a wind turbine then it produces in its lifetime, but rather best questioned if the value of the energy created from the wind energy is greater than the cost to produce it (energy, labor, etc). The answer to this question depends on the location of the wind farms installation and the cost or benefits the owner receives.</p>
<p>Three of the EIA's conclusions from their 2022-2050 Energy Outlook are:          1. "Electricity continues to be the fastest-growing energy source in buildings, with renewables and natural gas providing most of the incremental electricity supply"          2. "Renewable electricity generation increases more rapidly than overall electricity demand through 2050." They point out that falling technology costs for wind and solar, along with incentives for those energy sources, will, quote "...SUPPORT ROBUST COMPETITION WITH NATURAL GAS FOR ELECTRICITY GENERATION"          Based on those conclusions, I think this proposal relies too much on natural gas and too little on wind and solar. –And as a result is also not giving enough consideration to improvements in electric transmission capabilities either. What are your thoughts?</p>	<ol style="list-style-type: none"> <li>1) This is likely true due to multiple factors including municipalities requiring electric rather than natural gas, also some building owners are opting for electric to qualify for LEED building status. Most of our residential customers prefer natural gas, but in Washington new construction will be have limited natural gas growth due to restrictions on its use and additional costs to connect will be required to be fully funded by the customer. I don't see much change from past growth in Idaho.</li> <li>2) Avista's plan separates Washington and Idaho generation needs, Avista will have the ability to generate 70% of its energy via renewables next year for either state. Additional wind is within the long term plan for Washington. For Idaho, additional wind could be added if economic. What we are finding is transmission costs could be the limiter of adding wind to Idaho in order to be economic somewhat due to the fact that Washington requirements may absorb available transmission. Our greatest challenge in adding renewables is how much we can add without requiring significant transmission. Right now I think we could only add around 600 MW before we require substantial construction. Depending on customer energy growth, this should be enough to satisfy Washington targets. Another transmission related risk is other utilities siting wind/solar in our area and using our transmission to meet there renewable requirements. Customer will benefit from selling the rights of these assets. I did want to bring up why natural gas is still in our plans, this has to do with reliability serving customers, we must serve customers every hour of the year, including those with extreme cold and heat. Currently natural gas is best positioned to due this. While we are investigating clean technologies, the costs are much higher- such as using ammonia rather than natural gas for WA customers. We'll be required to invest in these types of assets in Washington, but Idaho will restrict this investment until the costs are more inline with</li> </ol>

## Appendix L: Public Comments- Public Meeting

	<p>the least cost methodology to serve customers.</p> <p>3) The Ukraine war has place some pressure on natural gas prices in the US, although I argue this is limited due to the fact the USA does not import much natural gas from overseas, but rather exports it. The northwest's greatest natural gas price risk is what experienced this winter where the west coast had difficulty moving gas to California. Due to California not building enough gas supply lines and limiting their gas storage, they had high demand and prices actually skyrocketed to the highest levels in local history. Avista procures pipeline for our requirements so customers where protected against some of this price pressure, but not there will be some impacts. Renewables can help protect from some of these risk, but only protects us when there is generation, for example solar does not produce much energy in the winter so we are not protected unless we storage the energy from the summer- which will have extreme costs.</p>
--	--

## Appendix L: Public Comments- Public Meeting

**Public Meeting Email Comments & Questions**

Reply comments are included where related to resource planning, comments/questions not related to resource planning were directed to other departments within Avista.

<p><b>Email Comment</b></p> <p>As a resident of Idaho I have a few comments regarding what you're being forced to do to maintain your services for Washington and Oregon.</p> <ol style="list-style-type: none"> <li>1. I agree there should be diversity in the types of energy produced and used, however, it should be cost effective and make good sense. The actions of states such as Washington and Oregon <u>should not impact</u> those who live in states that do not have such restrictive policies that make no sense.</li> <li>2. Wind turbines, solar farms, and any other infrastructure to support this unwise move by those states, should be <u>located within those states boundaries</u>. They should not encroach upon other states to support their poor decisions.</li> <li>3. The costs to meet Washington and Oregon's requirements should be the burden of their taxpayers exclusively. <u>No one outside of those states</u> should be burdened financially or otherwise. Their rates should be high enough to cover the costs.</li> <li>4. The wind turbines being proposed for the Public Land in Southern Idaho is a fine example of what should never be allowed. Why would you put turbines (that are not efficient) in Idaho to support California! California has the same types of landscape and public lands, which should be used for their needs, not ruin the landscape of another state. If a state wants to limit their energy resources, it should not be on the shoulders of other states or its residents.</li> <li>5. Sadly, these are the same states that want to breach dams. The graph shows clearly the impact that would have on your services if that were to happen. If residents don't like having high energy costs, blackout dates, etc. maybe they'd rethink who they vote into public office. This is ludicrous when you look at the entire world and the impact it will have globally. Not even a pin drop in the bucket!</li> </ol> <p>I appreciate the work you do to keep us warm in winter and cool in summer. I look forward to the meeting. Thank you for the opportunity to comment.</p> <p>Wendy Walter Idaho</p>
<p><b>Reply Response</b></p> <p>Wendy,</p> <p>Thanks for the heads up on the email issue and your time to review our plans and comments. We will include your comments in our filings. I understand your point of view on state regulations in other states. I will offer up one benefit for Idaho if generation I built within the state, they do provide high paying jobs and local tax revenue, you can think of similar to a manufacture who exports their goods. Anyway, thank you again for participating.</p> <p>James Gall Manager Integrated Resource Planning, Avista</p>

## Appendix L: Public Comments- Public Meeting

<p><b>Email Comment</b></p> <p>Dear IRP Team,</p> <p>I am an Avista Electric customer in Post Falls ID. As Avista has requested public comment, I read through the TAC 1-8 presentations. In brief, I think you should abandon pursuit of "green" and "equitable" activism and focus on minimizing cost to the end user.</p> <p>I am appalled by the focus on "Renewable Energy" "Clean Energy" and reducing "Greenhouse Gas Emissions". CO2 emissions have improved the climate for both humanity and the ecology. If anything we should be increasing greenhouse gas emissions, not reducing them. I realize much of this is merely required reporting, but you should be pushing back against this foolishness, not playing dumbly into it.</p> <p>I am also deeply offended by the insistence on "equity" which amounts to illegal discrimination. These discussions are present in only TAC 1, 6, and 7, but are nonetheless a fatal hazard to your organization given the political shifts that are occurring. It would behoove you to quietly cut all ties with the "Equity Advisory Group" and all such ideologically motivated organizations.</p> <p>The public utilities should be focused on delivering reliable power at the lowest net cost, without engaging in environmental and social activism. It is true that emissions have some costs associated with them, but they are trivial compared to the cost of "green energy". Enmeshing "equity" concerns in your planning will only lead to grief. Power generation and grid stability is a difficult enough technical challenge on its own. Distracting your organizational focus will only lead to an inability to effectively compete. If you want to stay in business, you have to stay sharp.</p> <p>Sincerely, Paul Spooner P.E.</p>
<p><b>Reply Response</b></p> <p>Hi Paul,</p> <p>Thank you for your comments, we will include your comments in our filing with the commissions. I would also like to let you know most of your concerns and the costs/benefits of those actions will be for Washington customers. For Idaho customers we will be only adding resources based on economic decisions as directed by the Idaho Public Utility Commission.</p> <p>Again, thank you for taking the time to look through our IRP, if you want to be involved more in the Technical Advisory Committee process feel free to let me know.</p> <p>James Gall Manager of Integrated Resource Plans</p>

## Appendix L: Public Comments- Public Meeting

<b>Email Comment</b>
<p>Our planet is in dire trouble. We must act intentionally to reduce our use of fossil fuels, especially. We need to reduce overall energy usage, and work to increase use of renewable energy sources.</p> <p>Diane Packard</p>
<b>Reply Response</b>
<p>Hi Diane,</p> <p>Thank you for your comment. We will include it in our documentation to the utility commissions</p> <p>While it will take time to remove all fossil fuels, Avista's goal is increase clean energy and keep our rates affordable, currently Avista is one the cleanest electric utilities in the nation, but we'll continue to clean our resource portfolio over time.</p> <p>Thank you,</p> <p>James Gall</p>



## Appendix L: Public Comments- Public Meeting

<p><b>Email Comment</b></p> <p>Will the, or have the, mandates (CETA &amp; CCA)from WA &amp; OR have a cost impact on Idaho customers?</p> <p>Asking as we in Idaho should not be burdened with the cost incurring due to other states irrational energy source mandates.</p> <p>Particularly the mandate to new construction be electric heat pump versus 95% gas water heater/boiler/furnace seems very silly as you are burning coal &amp; natural gas to give them electricity.</p> <p>If Idaho is burdened, have you considered a separate LLC or selling the Canadian gas line access to Idaho distribution?</p> <p>Similarly, Idaho customers should pay less per KWH as you can continue to burn Nat Gas to supply Idaho demands. Costs to switch to other sources than gas and coal should be factored only to the KWH sold to customers in WA &amp; OR.</p> <p>What is the average thermal efficiency of burning natural gas to generate electricity at the generation plant sources currently used?</p> <p>What is the average electrical distribution losses (efficiency factor) from the gas thermal plant to a customers home/building?</p> <p>This information is required in order to determine the true real world efficiency comparison to a 95% efficient low carbon condensing boiler/water heater/furnace. The carbon factors in burning natural gas to produce electricity + the distribution line loss factor (that further derates gas electrical production efficiency) has to calculated to know the true total carbon production to send the power to a home in Idaho.</p> <p>I suspect the real world total emissions from production to customer is likely higher or close to same in thermal gas electrical plant + losses versus the carbon cost of 90%+ condensing boiler or furnace.</p> <p>Thank you, looking forward to your presentation meeting upcoming</p> <p>Dave Lockhart</p>
<p><b>Reply Response</b></p> <p>Hi Dave,</p> <p>I have included answers to your questions in your email below. Thanks for participating in our IRP process, your welcome to our Technical Advisory Committee if you desire. Let me know if you would like to be added.</p> <p>Thanks,</p> <p>James Gall</p> <p>Will the, or have the, mandates (CETA &amp; CCA)from WA &amp; OR have a cost impact on Idaho customers?</p> <p><b>As stated in the call yesterday there is potential for impacts to Idaho customers for the CCA, these will be related to one plant we own located in Washington, there will also be impacts to the energy markets that may impact Idaho customers, but those could be both positive or negative and we are unsure of the impact at this time. As far as CETA is concerned the impacts will be limited to the costs the Idaho Public Utility Commission allows us to recover from Idaho customers. As you may have expected the</b></p>

## Appendix L: Public Comments- Public Meeting

Idaho Commission is concerned customers will be shielded from cost from another state. More work needs to be done in this area, but is definitely a concern to Avista.

Asking as we in Idaho should not be burdened with the cost incurring due to other states irrational energy source mandates.

Answered above

Particularly the mandate to new construction be electric heat pump versus 95% gas water heater/boiler/furnace seems very silly as you are burning coal & natural gas to give them electricity.

This is a difficult mandate in our climate, for now natural gas is still allowed for Washington customers for backup heating, but not for water heating. This will propose challenges to acquire additional generation in the long run. While you are correct it is more efficient to using natural gas, Washington's argument is the power will be from clean resource and therefore efficiency is not a main concern. While I can't say I agree with the logic, we have to comply with the laws we are given and try to educate policymakers of the ramifications of these actions.

If Idaho is burdened, have you considered a separate LLC or selling the Canadian gas line access to Idaho distribution?

Avista is considering separating the power supply system from Washington and our IRP models the system this way, I expect there will be future commission proceedings to discuss this.

Similarly, Idaho customers should pay less per KWH as you can continue to burn Nat Gas to supply Idaho demands. Costs to switch to other sources than gas and coal should be factored only to the KWH sold to customers in WA & OR.

This will be the case, when we finalize our IRP later this year, you will see this difference.

What is the average thermal efficiency of burning natural gas to generate electricity at the generation plant sources currently used?

Combined cycle turbines are 50 to 60% efficient at producing electricity from there heat content, our lower efficient technologies used for extreme load conditions are approximately 40% efficient

What is the average electrical distribution losses (efficiency factor) from the gas thermal plant to a customers home/building?

Avista loses around 5.5% of the energy via transmission and distribution

This information is required in order to determine the true real world efficiency comparison to a 95% efficient low carbon condensing boiler/water heater/furnace. The carbon factors in burning natural gas to produce electricity + the distribution line loss factor (that further derates gas electrical production efficiency) has to be calculated to know the true total carbon production to send the power to a home in Idaho.

Agree with your statement if natural gas is used to power the grid, although like I stated earlier Washington requires clean energy. Our goal is keep our gas system for all customers who desire to keep their natural gas.

I suspect the real world total emissions from production to customer is likely higher or close to same in thermal gas electrical plant + losses versus the carbon cost of 90%+ condensing boiler or furnace.

Agree so long as the electric system is not near 100% clean energy.

## Appendix L: Public Comments- Public Meeting

**Email Comment**

I want to thank you for producing that very helpful pre-recorded webinar on your process. I really appreciate the work you're all doing to look ahead for the next 20 years.

I'd like to address all three of the things you're working toward: ...reliable power ...at a reasonably cheap price ...that includes environmental stewardship and sustainability.

I hope you'll help me become better informed if I'm wrong on some of the things I'm going to cover here, but I think this Resource Plan has some problems that need correction.

It's obviously hard to predict what will be happening in a 20 year window. But I think we all, including you folks, need to use the best available information to assure that we are all part of solutions that give us the best possible future, for both ourselves and our kids.

I've been getting some more recent information from the US Energy Information Administration, or EIA. –And Their 2022 Annual Energy Outlook, which is a Projection and analysis of U.S. energy supply, demand, and prices through 2050. I might add that some of you folks here at this meeting may not know this but the EIA is by law instructed to prepare studies, analyses and products that are independent of policy considerations. And they are also legally independent of review by the Executive Branch

Three of their conclusions are:

1. "Electricity continues to be the fastest-growing energy source in buildings, with renewables and natural gas providing most of the incremental electricity supply."
2. "Renewable electricity generation increases more rapidly than overall electricity demand through 2050." They point out that falling technology costs for wind and solar, along with incentives for those energy sources, will, quote "...support robust competition with natural gas for electricity generation"

Based on those two conclusions, I think this proposal relies too much on natural gas and too little on wind and solar. –And as a result is also not giving enough consideration to improvements in electric transmission capabilities either. **What are your thoughts?**

3. "...NATURAL GAS PRODUCTION IS INCREASINGLY DRIVEN BY NATURAL GAS EXPORTS"

Based on that conclusion, It seems you should be thinking more about US independence from international gas prices. This reminds me of how Putin's war in the Ukraine has affected European and world stability in more than one way. We can be more independent of the world's gas prices if we shift more to renewable energy sources here in the US, which are more likely to insulate Avista's customers from large price fluctuations in the future. **What are your thoughts?**

Three final considerations:

A. I think the predictions for synthetic methane use at an affordable price are much more iffy than banking on wind and solar with backup energy storage. Wind and solar are already there economically but I think synthetic methane has a long way to go (even considering the recent advances at PNNL in the Tricities).

B. In general terms, this plan needs to better encompass the needs of all your customers with a perspective that pays more attention to both technological trends and environmental stewardship that will keep our region economically viable and give us a livable environment. **You folks really are** part of getting environmental changes under control in order to give us all better futures.

C. More specifically, **Given the EIA's analyses, can you comment** on how the likely technological improvements in wind and solar power, and the more limited control we have on world gas prices would seem to say we should encourage MORE use of electricity AND GREATER TRANSMISSION capacity for electricity, plus LESS use of gas than you are presently proposing?

Thanks for putting this March, 8th meeting together.

Michael Cantrell

**Reply Response**

Hi Michael,

Thank you for your comments and questions. I've answered some of your comments below in red.

James Gall  
Manager of Integrated Resource Planning, Avista

Three of their conclusions are:

1. "Electricity continues to be the fastest-growing energy source in buildings, with renewables and natural gas providing most of the incremental electricity supply." **This is likely true due to multiple factors including municipalities requiring electric rather than natural gas, also some building owners are opting for electric to qualify for LEED building status. Most of our residential customers prefer natural gas, but in Washington new construction will be have limited natural gas growth due to restrictions on its use and additional costs to connect will be required to be fully funded by the customer. I don't see much change from past growth in Idaho.**

2. "Renewable electricity generation increases more rapidly than overall electricity demand through 2050." They point out that falling technology costs for wind and solar, along with incentives for those energy sources, will, quote "...support robust competition with natural gas for electricity generation"

Based on those two conclusions, I think this proposal relies too much on natural gas and too little on wind and solar. –And as a result is also not giving enough consideration to improvements in electric transmission capabilities either. **What are your thoughts?**

**Avista's plan separates Washington and Idaho generation needs, Avista will have the ability to generate 70% of its energy via renewables next year for either state. Additional wind is within the long term plan for Washington. For Idaho, additional wind could be added if economic. What we are finding is transmission costs could be the limiter of adding wind to Idaho in order to be economic somewhat due to the fact that Washington requirements may absorb available transmission. Our greatest challenge in adding renewables is how much we can add without requiring significant transmission. Right now I think we could only add around 600 MW before we require substantial construction. Depending on customer energy growth, this should be enough to satisfy Washington targets. Another transmission related risk is other utilities siting wind/solar in our area and using our transmission to meet there renewable requirements. Customer will benefit from selling the rights of these assets. I did want to bring up why natural gas is still in our plans, this has to do with reliability serving customers, we must serve customers every hour of the year, including those with extreme cold and heat. Currently natural gas is best positioned to due this. While we are investigating clean technologies, the costs are much higher- such as using ammonia rather than natural gas for WA customers. We'll be required to invest in these types of assets in Washington, but Idaho will restrict this investment until the costs are more inline with the least cost methodology to serve customers.**

3. "...NATURAL GAS PRODUCTION IS INCREASINGLY DRIVEN BY NATURAL GAS EXPORTS"

Based on that conclusion, It seems you should be thinking more about US independence from international gas prices. This reminds me of how Putin's war in the Ukraine has affected European and world stability in more than one way. We can be more independent of the world's gas prices if we shift more to renewable energy sources here in the US, which are more likely to insulate Avista's customers from large price fluctuations in the future. **What are your thoughts?**

**The Ukraine war has place some pressure on natural gas prices in the US, although I argue this is limited due to the fact the USA does not import much natural gas from overseas, but rather exports it. The northwest's greatest natural gas price risk is what experienced this winter where the west coast had difficulty moving gas to California. Due to California not building enough gas supply lines and limiting their gas storage, they had high demand and prices actually skyrocketed to the highest levels in local history. Avista procures pipeline for our requirements so customers where protected against some**

## Appendix L: Public Comments- Public Meeting

of this price pressure, but not there will be some impacts. Renewables can help protect from some of these risk, but only protects us when there is generation, for example solar does not produce much energy in the winter so we are not protected unless we storage the energy from the summer- which will have extreme costs.

Three final considerations:

A. I think the predictions for synthetic methane use at an affordable price are much more iffy than banking on wind and solar with backup energy storage. Wind and solar are already there economically but I think synthetic methane has a long way to go (even considering the recent advances at PNNL in the Tricities). **Agree, the only other option to meet state requirements would be to lose the customer so we'll try to give our customers the option.**

B. In general terms, this plan needs to better encompass the needs of all your customers with a perspective that pays more attention to both technological trends and environmental stewardship that will keep our region economically viable and give us a livable environment. **You folks really are** part of getting environmental changes under control in order to give us all better futures. **It is difficult to balance environment, reliability, and costs. Can't achieve them all, our elected officials typically determines how they balance these factors. In Washington Environmental and Reliability is a priority over cost, while Idaho places cost and reliability above environmental. We are stuck in the middle.**

C. More specifically, **Given the EIA's analyses, can you comment** on how the likely technological improvements in wind and solar power, and the more limited control we have on world gas prices would seem to say we should encourage MORE use of electricity AND GREATER TRANSMISSION capacity for electricity, plus LESS use of gas than you are presently proposing?

**One thing to note, when Avista adds natural gas this does not mean it is operating all the time, most of the time these resources only operate when cost effective- this will depend on how much renewables are on the entire system. Most of our gas additions are for reliability not for energy production. As far as technological improvements for wind and solar will be limited to cost savings rather than efficiency savings. We do expect the cost of renewables to fall in the future. Although past experience tells me the costs are cyclical. As you stated additional transmission is needed- we agree- but we'll need to justify it to get it build and recover the cost of its construction.**

## Appendix L: Public Comments- Public Meeting

<b>Email Comment</b>
<p>1. Get out of Colstrip. We Avista customers are still receiving power from this coal plant, which has been referred to as the dirtiest in the West. Soot pollution from this plant has killed hundreds if not thousands of people over the years (currently estimated at 30 lives/year) and caused many, many thousands of other serious health problems in people. Avista withdrawing from Colstrip will contribute to its ultimate shutdown. I am happy to hear that Avista plans to be out of Colstrip by 2024.</p> <p>2. Avista has committed to supplying 100% clean, renewable electricity to its customers by 2045. I applaud this goal, although it really needs to be 2035. This commitment, and assumption that Avista will make this a reality, was a major factor in the City of Moscow's recently adopted Climate Action Plan (which I and many others worked tirelessly at), and goals for net zero carbon emissions. I expected to hear and see plans from Avista for accomplishing this 2045 goal. Instead I heard about plans for replacing gas turbines. When I asked specifically about this, it seems the response was that Avista was not going to achieve this goal if it was too difficult. It seems to me that Avista is not really serious about this stated goal, and not even trying. This is very disappointing. Where are the plans? No goal is achieved without plans!</p> <p>3. Natural gas is a problem. Some studies indicate its not much better than coal in terms of greenhouse gas production. Avista needs to de-emphasize gas, quit giving rebates to homeowners for switching from electricity to gas. Instead give rebates for switching from gas heating to electric heat pumps which are more efficient and economical than electric resistance or any form of gas heating. Avista needs to eventually work its way out of the gas business. Please establish a goal for 100% clean/sustainable (all) ENERGY production – not just electricity.</p> <p>Sincerely,</p> <p>Al Poplawsky Moscow, Idaho</p>
<b>Reply Response</b>
<p>Hi Al,</p> <p>Thank you for taking the time to participate in our public process. We will include your comments in our filings and to our management. I would like to clarify more about the 2045 goal. Moving to 100% clean energy is a difficult task with a temperate climate we have in the inland northwest, achieving 100% clean energy will require substantial investment in new technologies. Based on what we know today, the cost for a full transition acceptable to Idaho customer is not there yet. While we have the ambition to reach the goal and will move toward that goal over time will require significant technological, economic, and reliability challenges ahead. Until we can overcome these challenges, I don't think any utility in any state will achieve 100% clean energy.</p> <p>Also to note to clarify a couple statements, yes we will be out of Colstrip, but by 12/31/2025. As far as natural gas greenhouse gas emissions, NG produces less than ½ the carbon emissions as coal when producing electricity. The studies you refer to about natural gas being worse than goal blame natural gas leakage into the atmosphere, this is actually very rare and minimal and federal requirements both in Canada and the US minimize these leakages. Unfortunately these studies are taken out of context when produced.</p> <p>Again, thank you for your comments.</p> <p>James Gall Manager of Integrated Resource Planning, Avista</p>

Appendix L: Public Comments- Public Meeting

## Appendix L: Public Comments- Public Meeting

<p><b>Email Comment</b></p> <p>Hi James,</p> <p>Please see below. AI</p> <p>"A recent <a href="#">study</a> by the Environmental Defense Fund found that 3.7% of natural gas produced in the Permian Basin leaked into the atmosphere. That's enough to erase the greenhouse gas benefits of quitting coal for gas in the near term."</p> <p>"The first thing to say is the 3.7% number really jumps off the page," said Daniel Raimi, a researcher at Resources for the Future. "It is a really high emission rate. It is yet another indicator that the U.S. oil and gas system emits more than current EPA estimates would suggest."</p> <p><a href="https://www.scientificamerican.com/article/methane-leaks-erase-some-of-the-climate-benefits-of-natural-gas/">https://www.scientificamerican.com/article/methane-leaks-erase-some-of-the-climate-benefits-of-natural-gas/</a></p>
<p><b>Reply Response</b></p> <p>Thanks for sharing, the article does give a few counter points to the EDF's argument (see below). Regardless methane emissions are real, while as you can see it is greatly debatable on the amounts emitted and there actual greenhouse gas effect. In our planning we call these emissions "upstream" emissions. Typically natural gas creates 117 lbs per mmbtu from combustion, we add 9.8% to this values for these emissions totaling 128.4 lbs/mmbtu. This increase is based on studies for leakage in our sources of natural gas. Coal's emissions are closer to 205 to 210 lbs per mmBTU. In the future you will see less combustion of both coal and natural gas in exchange for renewable energy, but until we see cost effective long duration energy storage moving off natural gas in times renewables are not producing will be a challenge to meet demand.</p> <p>Here are a few other observations from the article:  Energy In Depth, a project of the Independent Petroleum Association of America, has questioned EDF's use of "technology warming potential" (TWP), the environmental group's metric for measuring the climate impact of one technology versus another. Global warming potential, a more commonly used metric for assessing a gas's climate impact, measures the effect of a single pulse of emissions over a 100-year period. Nicole Jacobs, a spokeswoman for Energy In Depth, pointed to other peer-reviewed studies that found leakage rates of between 5-9% were needed to negate gas's advantage over coal. "EDF's use of TWP is an outlier in the scientific community to the extent that I don't think it's even an available option in [life cycle assessment] calculating software," Jacobs said in an email. Hamburg, the EDF scientist, called that argument spurious. EDF's methodology uses the same inputs as global warming potential, but it considers emissions on a continuous basis, reflecting real world conditions. Arguments about the time frame ignore a more important point, he said.</p>



## Appendix L: Public Comments- Public Meeting

**Email Comment**

I won't be able to attend your planned meeting so I am providing my comments by email. The following represents my thoughts.

I live a little bit past Bennet Bay off of Coeur D'alene lake drive with natural gas connections ending around Sunny Side Road. I would like to see these gas connections go further east on Coeur D'alene lake drive. There has been significant increases in the number of houses in this direction to possibly justify extending the gas line further to make natural gas available in this area. Additionally there will be continued building in this popular area of the lake as there is still acreage available to be developed. Especially up Yellowstone Rd where there has already been significant development. This should be something that is considered in the 20 year plan since future Coeur D'alene development can only go and will go in this direction.

Thank you for the opportunity to make comments to you. I appreciate your consideration.

Jon Thoma

**Email Comment**

Avista wants to hear from us? YOU HAVE A MONOPOLY AND YOU ARE HARMING PEOPLE WITH WHAT YOU ARE CHARGING.

Our Comfort Level Billing just increased by nearly 50%!!! Our usage has NOT changed drastically to warrant that! If anything we are using LESS gas because we have been using our woodstove for heat more than we had in the past three years!

I am awaiting a response from Avista on my inquiry sent on Saturday because there is no way that over \$600/month is feasible for any family. Avista clearly drastically raised rates at a time when humans can't afford it! Ridiculous!

Stop being a monopoly and let us choose where to get our energy. Then you might actually have to be competitive with your rates and actually care what the customer can afford.