

Western Electricity Coordinating Council

**Guide to WECC/NERC Planning Standards I.D:
*Voltage Support and Reactive Power***

Prepared by:

Reactive Reserve Working Group (RRWG)

Under the auspices of

Technical Studies Subcommittee (TSS)

Approved by TSS

March 30, 2006

Preface

Voltage stability has been a topic of interest within the Western Electricity Coordinating Council (formerly the Western Systems Coordinating Council) since the early nineties. In 1992, the Technical Studies Subcommittee (TSS) commissioned the Margin Study Work Group (MSWG) to investigate the need for establishing transmission margins. The group issued two reports – one in 1993¹ and the other in 1995².

As a result of the July and August 1996 disturbances in the WECC region, TSS established the Reactive Reserve Working Group (RRWG) in November 1996 in response to the recommendations stemming from a report on these disturbances stating a need to implement the following:

- Reactive Power Margin Studies Methodology
- Undervoltage Load Shedding Schemes Guidelines

The group was mandated to develop a methodology for conducting reactive power reserve studies as well as develop reactive power reserve requirements for the WECC system. The group was also tasked with investigating and reporting on real-time voltage stability assessment methodologies as well as with determining if it is possible to design a generic undervoltage load shedding scheme.

A report entitled “Voltage Stability Criteria, Undervoltage Load Shedding Strategy and Reactive Power Reserve Monitoring Methodology” was prepared by RRWG and subsequently approved by the Western Electricity Coordinating Council (WECC) Board of Trustees in 1998. This document formally established the first set of reliability criteria applicable to WECC member-systems related to the establishment of regimented reactive power margin studies. An accompanying document entitled “Undervoltage Load Shedding Guidelines” was published in 1999 by the Undervoltage Load Shedding Task Force (UVLSTF) in an effort to provide clarity on the complex and the then emerging area of research – undervoltage load shedding (UVLS).

In July 2001, a report entitled “Summary of WECC Voltage Stability Assessment Methodology” was published for the purpose of providing step-by-step guidelines on the undertaking of a reactive power margin study. This report was the culmination of a joint effort between the TSS and the Reliability Subcommittee (RS) and incorporated some changes based upon the experiences of WECC members in implementing the provisions in the predecessor report.

¹ Technical Studies Subcommittee, Margin Study Report, Phase I, August 27, 1993.

² WECC Margin Study Work Group, Phase II Report, June 15, 1995.

Since the establishment of the above reports and guidelines, a new set of criteria has been adopted as part of the overall set of NERC/WECC planning standards, namely Planning Standards I.D – *Voltage Support and Reactive Power* and III.E – *Undervoltage Load Shedding*. These standards formally set out the minimum requirements for NERC Regional Reliability Councils (RRC) in terms of the establishment of Reactive Power Margin studies and UVLS guidelines.

The RRWG group was re-established in 2004 for the purposes of bringing the existing corpus of documents and guidelines on this subject in line with the recent adoption of the aforementioned criteria within the NERC RRC. This document is an accompaniment to the NERC/WECC Planning Standards I.D and draws upon relevant contents from the following WECC documents:

1. *Voltage Stability Criteria, Undervoltage Load Shedding Strategy and Reactive Power Reserve Monitoring Methodology*, May 1998
2. *Undervoltage Load Shedding Guidelines*, 1999
3. *Summary of WECC Voltage Stability Assessment Methodology*, 2001

The purpose of this document is to provide WECC members with a guide in implementing Planning Standards 1.D (or its successor standard) and therefore relevant aspects of the above reports and guidelines have been adopted for this purpose.

Acknowledgements

The 1996 Reactive Reserve Working Group members developed what was then pioneering work in the area of implementing voltage stability criteria and study methodology applicable within the WECC system. The 2004 RRWG team (“RRWG”) wishes to acknowledge the following for their contribution to the original work:

- Abbas Abed (San Diego Gas & Electric Company, Chairman)
- Joaquin Aquilar (El Paso Electric Company)
- Nick Chopra (BC Hydro)
- Peter Krzykos (Arizona Public Service Company)
- Andy Law (Washington Water Power)
- Brian Lee (BC Hydro)
- Frank McElvain (Tri-State Generation & Transmission Association, Inc.)
- Saif Mogri (Los Angeles Department of Water & Power)
- Les Pereira (Northern California Power Agency)
- Craig Quist (Nevada Power Company)
- Ronald Schellberg (Idaho Power Company)
- Joe Seabrook (Puget Sound Energy)
- Chifong Thomas (Pacific Gas & Electric Company)
- Boris Tumarin (El Paso Electric Company)

The following are the members of the 2004 RRWG (listed in alphabetical order by last name):

- Shamir S. Ladhani, ENMAX Power Corporation
- Craig Quist, PacifiCorp
- Joe Seabrook, Puget Sound Energy Inc.
- Chifong Thomas, Pacific Gas & Electric Company

RRWG also acknowledges the valuable input provided by Harrison Clark and Carson Taylor towards the development of this document.

TABLE OF CONTENTS

1.	<i>Introduction</i>	1
2.	<i>Voltage Stability: Foundational Concepts</i>	1
2.1.	Power System Stability Classifications	2
2.1.1.	Rotor Angle Stability	2
2.1.2.	Frequency Stability	2
2.1.3.	Voltage Stability	2
2.2.	Voltage Stability and the Timeframes of Interest	3
2.2.1.	Short-Term Timeframe	3
2.2.2.	Mid-Term Timeframe	4
2.2.3.	Long-Term Timeframe	4
2.3.	Power System Model Representation	4
2.3.1.	Load Model Representation	4
2.3.2.	System Topology Representation	8
2.3.3.	Determination of Critical Bus or Buses	10
2.4.	Static versus Dynamic Analysis	10
2.4.1.	Static Analysis	11
2.4.2.	Dynamic Analysis.....	12
2.5.	Static and Dynamic Reactive Power Resources	13
3.	<i>Planning Standards I.D: An Overview</i>	16
4.	<i>Study Methodology</i>	17
4.1.	Real Power Margin Assessment (P-V Analysis)	17
4.1.1.	Base Cases Preparation	17
4.1.2.	P-V Analysis for WECC-S1 (Transfer Path)	19
4.1.3.	P-V Analysis for WECC-S2 (Load Area).....	23
4.2.	Reactive Power Margin Assessment (V-Q Analysis)	25
4.2.1.	Base Case Preparation.....	25
4.2.2.	V-Q Analysis	25
5.	<i>Other Study Considerations</i>	29

1. Introduction

The purpose of this document is to provide, as an accompaniment to the NERC/WECC Planning Standards (or its successor), specifically Planning Standards I.D – *Voltage Support and Reactive Power*, a guide for assessing conformity of a particular system or transfer path to the standard. This document is not meant to be a successor to the documents referred to in the preface, but complements them for the purposes of analyzing voltage stability and reactive reserve requirements. The contents in this document are arranged as follows:

- Section 2 Voltage Stability: Foundational Concepts
This section provides basic theoretical foundations related to the study of voltage stability.
- Section 3 Planning Standards I.D: An Overview
This section provides a brief overview of Planning Standards I.D.
- Section 4 Study Methodology
This section provides a guide to carrying out the necessary technical analyses for the purposes of evaluating Planning Standards I.D.
- Section 5 Other Study Considerations
This section outlines some considerations when undertaking the analyses as outlined in this document.

2. Voltage Stability: Foundational Concepts

This section provides an overview of the foundational themes relevant to the study of voltage stability. It is noteworthy to state here that research in the area of voltage stability is vibrant and yielding new approaches to its study and therefore its mitigation. The Modeling and Validation Work Group (MVWG), working under the aegis of WECC, is tasked with developing load and generation models aimed at enhancing power system stability analysis. The reader is encouraged to continually consult technical papers, including WECC guidelines and standards, in order to stay current on this subject.

The following will be explored in this section of the document:

- Section 2.1 Power System Stability Classifications
- Section 2.2 Voltage Stability and the Timeframes of Interest
- Section 2.3 Power System Model Representation
- Section 2.4 Static versus Dynamic Analysis
- Section 2.5 Static and Dynamic Reactive Power Resources

2.1. Power System Stability Classifications

An IEEE paper published in May 2004³ has proposed the following three classifications of power system stability:

- Rotor angle stability
- Frequency stability
- Voltage stability

When a particular system is undergoing system instability, more than one of the above types of instability can be present. The primary purpose of classifying power system stability phenomenon is to aid in its analysis as different techniques are employed to ferret out the underlying causes of the symptoms of a particular disturbance. A brief overview of the above classifications is provided next.

2.1.1. Rotor Angle Stability

Rotor angle stability is commonly analyzed in the electric utility industry through the use of time-domain simulations. Rotor angle instability occurs when there is a loss of synchronism at one or more synchronous generators.

2.1.2. Frequency Stability

The system is considered frequency stable when the total generation output matches system load and loss demand. Frequency instability, commonly analyzed through the use of time-domain simulations, may occur as a result of a significant loss of load or generation within a given system.

2.1.3. Voltage Stability

Voltage instability, the focus of this document, is generally characterized by loss of a stable operating point as well as by the deterioration of voltage levels in and around the electrical center of the region undergoing voltage collapse. Voltage collapse, a form of voltage instability, commonly occurs as a result of reactive power deficiency. Unmitigated rotor angle instability can also result in voltage instability.

Voltage stability is commonly analyzed by employing two techniques, namely time-domain (dynamic) simulation and steady-state analysis. Depending on the stability phenomenon or phenomena under investigation, one or both of these techniques may be applied. For example, if steady-state analysis reveals that voltages at the buses at or near induction motor loads drop by more than 10% of their pre-disturbance value, time-domain (dynamic) analysis should be

³ P. Kundur, J. Paserba, V. Ajjarapu, G. Anderson, A. Bose, C. Canizares, N. Hatziargyriou, D. Hill, A. Stankovic, C. Taylor, T. V. Cuseum, V. Vittal, "Definition and Classification of Power System Stability", *IEEE Transactions on Power Systems*, vol. 19, no. 2, pp. 1387 – 1401, May 2004

undertaken to assess the potential for motor stalling (steady-state analysis will not directly yield this information). This may involve extending the model to incorporate aggregate induction motor models at lower voltage buses as necessary.

2.2. Voltage Stability and the Timeframes of Interest

This section provides an overview of the various timeframes of interest when studying voltage stability. Power system equipment such as transformer automatic load tap changers (LTC), Static VAR compensators and automatic switched capacitor banks behave with certain time-constants that need to be considered when studying voltage stability. The following timeframes⁴ are of interest when studying voltage stability:

- Short-term
- Mid-term
- Long-term

The subsections that follow provide a general overview of the power system equipment and the typical timeframes that they may operate in. It is important to note here that some equipment which would typically operate in one timeframe may have controls set such that they would operate in another timeframe (eg., OELs may be set to engage within twenty seconds therefore acting in the short-term timeframe and perhaps before LTC activation). A voltage stability study should take into account the specific nuances of equipment time-constants.

2.2.1. Short-Term Timeframe

Short-term timeframe involves the time taken between the onset of a system disturbance to just prior to the activation of the automatic LTC. Rotor angle instability and voltage instability can occur within this timeframe. The following fast acting, automatically controlled power system equipment may be considered⁵ in assessing system performance within this timeframe:

- Synchronous Condensers
- Automatic switched shunt capacitors
- Induction motor dynamics
- Static VAR Compensators
- Flexible AC Transmission System (FACTS) devices
- Excitation system dynamics
- Voltage-dependent loads

⁴ G. Morison, B. Gao, and P. Kundur, "Voltage stability analysis using static and dynamic approaches," IEEE Transactions on Power Systems, vol. 8, no. 3, pp. 1159 – 1171, August 1993. The paper refers to these as Timeframes 1,2 and 3.

⁵ C. W. Taylor, Power System Voltage Stability. McGraw-Hill, 1994.

The extent to which each of the above components needs to be examined depends upon the size of the disturbance being considered relative to the stiffness of the power system.

2.2.2. Mid-Term Timeframe

Mid-term timeframe refers to the time from the onset of the automatic LTC operation to just prior to the engagement of over-excitation limiters (OEL). During this time, frequency and voltage stability may be of interest.

2.2.3. Long-Term Timeframe

Long-term timeframe refers to the time after OELs engage and includes manual operator-initiated action. During this timeframe, longer-term dynamics come into play such as governor action and load-voltage and/or load-frequency characteristics in addition to operator-initiated manual system adjustments.

2.3. Power System Model Representation

Mathematical representation of power system components has been the subject of much discussion in published technical literature. This section highlights the following areas of model representation germane to the study of voltage stability:

2.3.1 Load Model Representation

2.3.2 System Topology Representation

2.3.1. Load Model Representation

Load representation by way of mathematical models for static and dynamic power system analysis has been given much attention in the recent past⁶ as a result of its impact to the stability of the system. There are two broad categories of load representation namely, static and dynamic.

⁶ See for example - C. W. Taylor, "Concepts of undervoltage load shedding for voltage stability," *IEEE Transactions on Power Delivery*, vol. 7, no. 2, pp. 480– 486, April 1992. "Load representation for dynamic performance analysis," *IEEE Transactions on Power Systems*, vol. 8, no. 2, May 1993. "Standard load models for power flow and dynamic performance simulation," *IEEE Transactions on Power Systems*, vol. 10, no. 3, August 1995. W. Xu and Y. Mansour, "Voltage stability analysis using generic dynamic load models," *IEEE Transactions on Power Systems*, vol. 9, no. 1, pp. 479 – 486, February 1994.

2.3.1.1. Static Load Model Representation

This section provides an overview of the concepts associated with load model representation in static analysis. Static analysis is generally associated with the study of voltage stability in the short-term post-transient to long-term timeframe (i.e., short term transients and dynamics are ignored).

The load drawn by a customer or load drawn in aggregate at a substation is dependent upon the bus voltage and frequency as follows⁷:

$$P = P_o[p_1V^2 + p_2V + p_3][1 + k_p f\Delta f]$$

Where:

- P is the power drawn at the particular bus
- P_o is the power drawn at that bus at the initial system state
- p_1 , p_2 and p_3 are fractional portions of power representing constant impedance, constant current and constant power respectively with their sum equaling 1.0.
- $k_p f\Delta f$ term represents frequency effects on the load.

In terms of voltage stability studies, voltage-dependent load models are exclusively employed as their effects dominate during a voltage collapse scenario under study. In this case, the above equation reduces to:

$$P = P_o[p_1V^2 + p_2V + p_3]$$

The first term in the above equation, p_1V^2 , represents the portion of load that changes by the square of the voltage and is commonly referred to as the constant impedance type load. The second term, p_2V , represents the portion of load that changes in direct proportion to the voltage and is referred to as the constant current type load. The last term, p_3 , represents the portion of load that does not change with variations in voltage and is commonly known as constant power type load.

The chart below provides a current versus voltage graphical representation of the impact of the three different types of load. The variable alpha (α) in the chart represents the voltage exponent of the above equation with $\alpha = 2$ as constant impedance, $\alpha = 1$ as constant current and $\alpha = 0$ as constant power type loads. The term V/V_o represents the change in per-unit voltage from the base scenario.

⁷ P. Kundur, Power System Stability and Control. New York: McGraw Hill Publishing Company, 1994

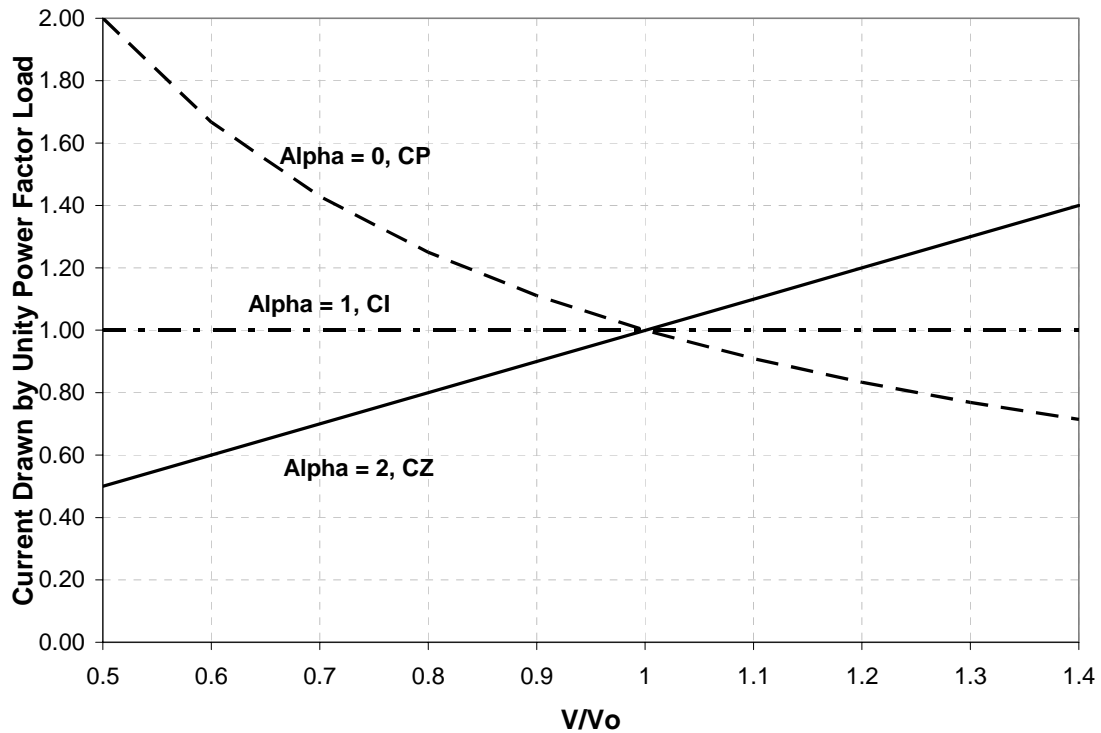

Figure 2.0: Current Versus Voltage Curve for Different Load Characteristics

Figure 2.0 illustrates that when voltages fall below the base scenario ($V/V_o = 1$ pu), constant power type loads tend to draw more current whereas constant impedance type loads tend to draw less current. Therefore, constant power loads tend to exacerbate a voltage collapse condition whereas constant impedance loads tend to provide load relief.

Figure 2.1 indicates the impact of voltage change on the power consumption of different load characteristics. Constant power type load maintains a constant power draw from the system despite the change in voltage. The power drawn by constant current and constant impedance loads fall as the voltages drop with the latter type providing a higher amount of load relief.

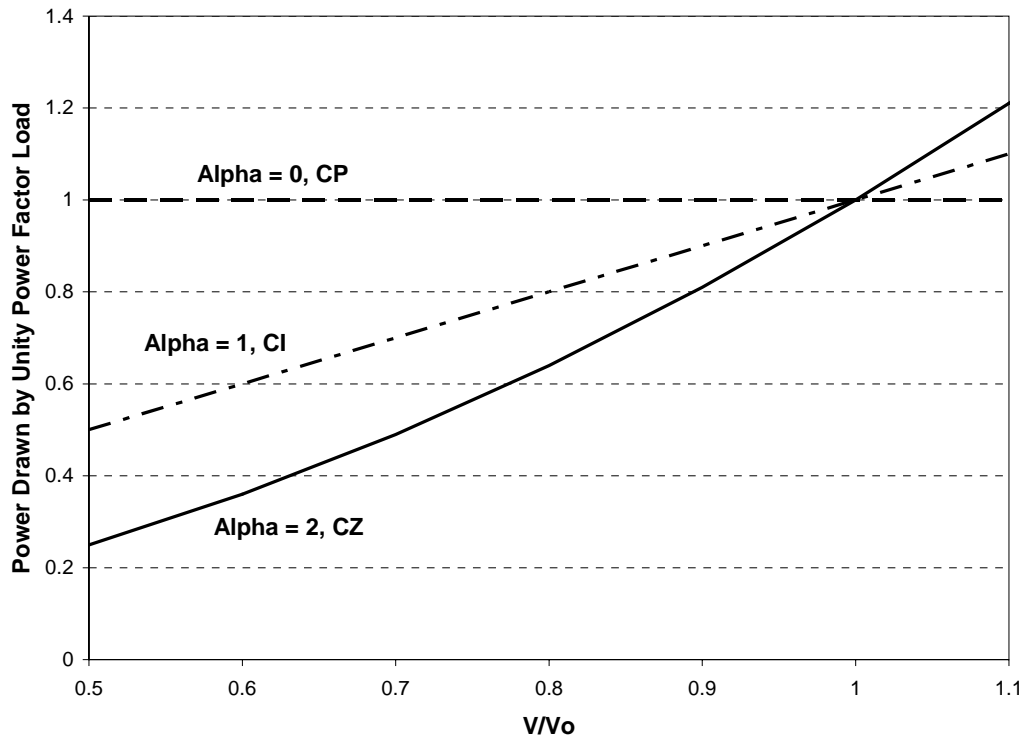

Figure 2.1: Power Versus Voltage Curve for Different Load Characteristics

When considering different timeframes in the study of voltage collapse as discussed previously, dynamic load and equipment models need to be incorporated with the appropriate level of detail based upon the timeframe of interest. For example, to study the impact of stalling induction motors on the voltage stability in a particular area, the analysis may not need to consider frequency-dependent load models nor other equipment and controls such as OEL and slower control LTCs and capacitor banks. In other words, equipment of interest will be the ones reacting in the short-term timeframe as discussed earlier.

2.3.1.2. Dynamic Load Model Representation

This section provides an overview of the concepts associated with load model representation when undertaking dynamic analysis. Dynamic analysis, or time-domain simulation, is generally associated with the study of voltage stability in the short-term timeframe taking into account system transients.

One of the more critical load model representations is that of induction motors. Several mathematical models are available within PSS/E and PSLF and are accompanied with adequate supporting documentation which the reader is encouraged to consult.

Induction motor modeling becomes critical when investigating an area with a high penetration of induction motors as discussed briefly in Section 2.1.3. Technical literature is replete with information on the impact of induction motors and their impact on voltage stability of the system⁸.

2.3.2. System Topology Representation

The decision to include model representation down to distribution-class equipment is left up to each individual WECC member system when submitting the data for inclusion in the WECC base cases. As a result, portions of the WECC base cases include data for distribution class equipment and stations. When undertaking voltage stability studies, loads may be modeled in one of two general manners as shown in Figure 2.2.

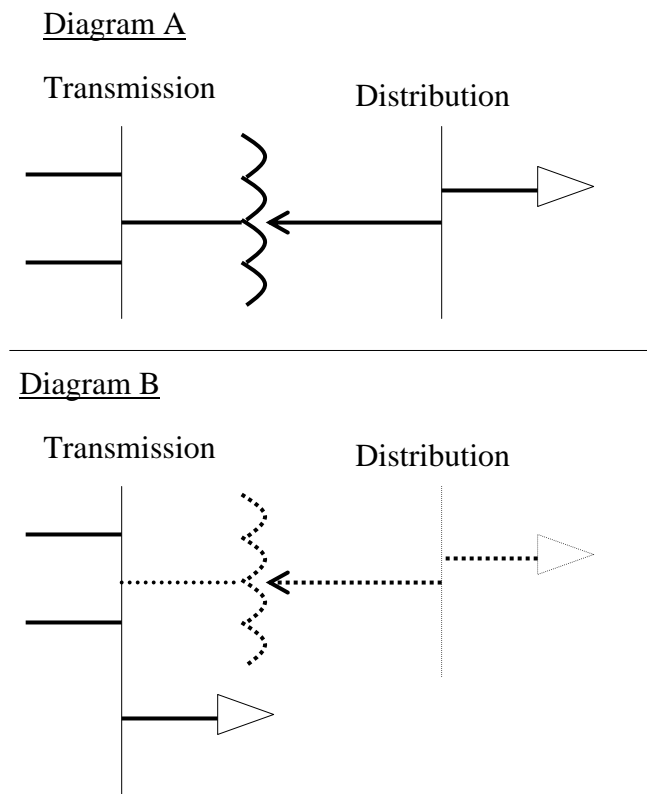

Figure 2.2: Load Models Representation in WECC Base Cases

⁸ See for example, C. W. Taylor, "Power System Voltage Stability", McGraw Hill Education, September 1994.

Load models downstream of the LTC as shown in Diagram A of Figure 2.2 should be represented as voltage-dependent models. As discussed in Section 2.3.1.1, power drawn by voltage-dependent loads will vary in accordance with load characteristics as well as the voltages at the bus. This will allow the magnitude of the distribution loads to change as the LTC changes to maintain voltage on the distribution system.

Diagram B of Figure 2.2 is an example of the load being represented at the transmission bus (upstream of the LTC). In this case, loads should be represented as having constant power characteristics if the analysis conducted is aimed at a review of the mid- to long-term impact of a voltage stability study. This load representation distinction is due to the fact that voltage-dependent models tend to behave as constant power models after the distribution LTCs restore bus voltages. When the transmission bus voltage drops more than five percent, it is likely that the LTC will have reached its tap range limit; in this case, the actual operating voltage will be lower than normal. The current drawn by load at a lower operating voltage will be less in reality than in simulation in the case of constant impedance loads and vice-versa for the constant power loads (as demonstrated in Figure 2.0). If under simulation conditions a particular LTC has reached its tap range, complex load models that reasonably reflect reality should be employed in the model in order to yield more realistic results.

In addition to consideration of load model representations in studies, defining a local area or region of interest for the purposes of voltage stability study is required. The WECC system model contains over 14,000 busses whereas a voltage stability study generally requires only a sub-set of the entire system. Therefore, it is important to establish or define a 'local area' of study such that disturbances beyond this local area will tend to have minimal or no impact upon the voltage stability of the defined local area.

The WECC publication "Undervoltage Load Shedding Guidelines" (1999) provides a method⁹ for determining a local area for the purposes of undertaking voltage stability studies. The method involves assessing the reactive power margin increase at a pilot or a representative bus within the general area of interest as each bus in the system is injected with reactive power support. The busses where reactive power injection resulted in a significant reactive power margin increase at the pilot bus were deemed to define the local area for voltage stability study.

Additional effort should be expended in ensuring that the power system parameters, voltage and reactive power control limits and system topology are reasonably well represented within the local area under consideration.

⁹ Section 4, page 20 of the document

2.3.3. Determination of Critical Bus or Busses

A key element of voltage stability studies is the determination of a critical bus or a cluster of critical busses. These busses can then be monitored as they will invariably form the electrical centroid of a voltage collapse.

In a radial transmission system consisting of a generator serving several loads along a transmission line, the critical or weak bus is generally located electrically and physically furthest away from the generator¹⁰. In a networked or meshed transmission system, finding the weakest bus or a cluster of weak busses is not as intuitive. Industry experience has demonstrated that the weakest bus or set of busses are generally located in locations with reactive power deficiencies.

According to the WECC publication “Voltage Stability Criteria, Undervoltage Load Shedding Strategy, and Reactive Power Reserve Monitoring Methodology” (1998), the critical bus exhibits one or more of the following characteristics under the worst single or multiple contingency¹¹:

- has the highest voltage collapse point on the V-Q curve,
- has the lowest reactive power margin
- has the greatest reactive power deficiency,
- has the highest percentage change in voltage

The publication also confirms one of the well-known characteristics of the power-flow Jacobian at the ‘nose’ (also known as the saddle-node bifurcation) point - the weakest bus will tend to have the highest $\partial Q/\partial V$ component¹² (i.e., highly sensitive reactive power consumption). The WECC document “Undervoltage Load Shedding Guidelines”, published in 1999 provides an example for selecting the critical bus(es).

2.4. Static versus Dynamic Analysis

The two most common methods employed within the electric utility industry for analyzing power system stability are static and dynamic analysis. These are briefly discussed next.

¹⁰ O.O. Obadina, G.J. Berg, “Identifying electrically weak and strong segments of a power system from a voltage stability viewpoint”, IEE Proceedings, Vol. 137, Pt. C, No. 3, May 1990

¹¹ Section 7 of the document

¹² For further explanation, please refer to: Kundur, P, “Power System Stability and Control”, McGraw-Hill Inc., 1994 – or - “Voltage Stability Assessment: Concepts, Practices and Tools,” IEEE Catalog Number SP101PSS, August, 2002.

2.4.1. Static Analysis

Static analysis (also referred to as load-flow or steady-state analysis) reveals equilibrium points of a system under study. The power flow equations employed in static analysis assume constant system frequency; in other words, generation output equals load demand plus losses. Voltage stability studies are frequently undertaken through the use of static analysis. A common use of this is the development of P-V curves as shown in Figure 2.3.

The graph is obtained in power-flow simulation by monitoring a voltage at a bus of interest and varying the power in small increments until power-flow divergence is encountered. Each equilibrium point shown represents a steady-state operating condition. In other words, each point may be considered as representing a system that has been in a stable operating point for over ½ hour. This means that the generation real-power dispatch and all voltage support equipment have been established such that the system meets the NERC/WECC reliability criteria for each operating point on the graph up to and including the operating limit point indicated on the graph. Beyond the operating limit, further increase in power may result in a breach of one or more of the WECC reliability criteria. A series of curves can be produced, each one as shown in Figure 2.3, with each curve depicting one or more transmission outages.

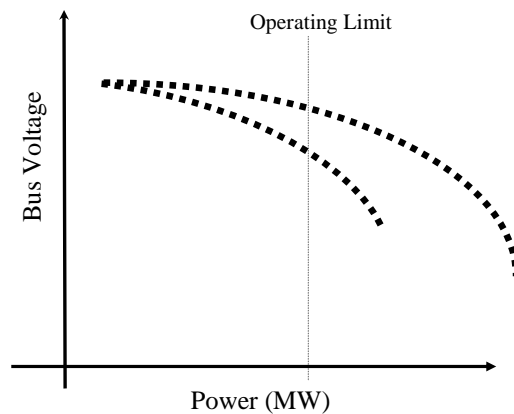

Figure 2.3: Typical Power Versus Voltage Curves

Given that each operating point on the P-V curve represents a unique steady-state operating condition, a pessimistic but realistic generation dispatch is normally employed as load is increased. This concept is explored in Section 4 (Study Methodology).

A post-transient power flow method (also referred to as governor-based power flow method) is used in the case where a contingency results in governor action but before system operators have an opportunity to intervene.

2.4.2. Dynamic Analysis

Dynamic analysis (also referred to as time-domain analysis) is commonly employed in the study of power system stability to reveal system trajectory after a disturbance. In contrast to static analysis in which equilibria points of a P-V curve are not time-dependent, dynamic analysis method reveals the transient and/or the longer-term stability of a power system under study.

The graph below adopted from the “Undervoltage Load Shedding Guidelines” document published by WECC in 1999 provides an example of dynamic analysis undertaken to study voltage stability.

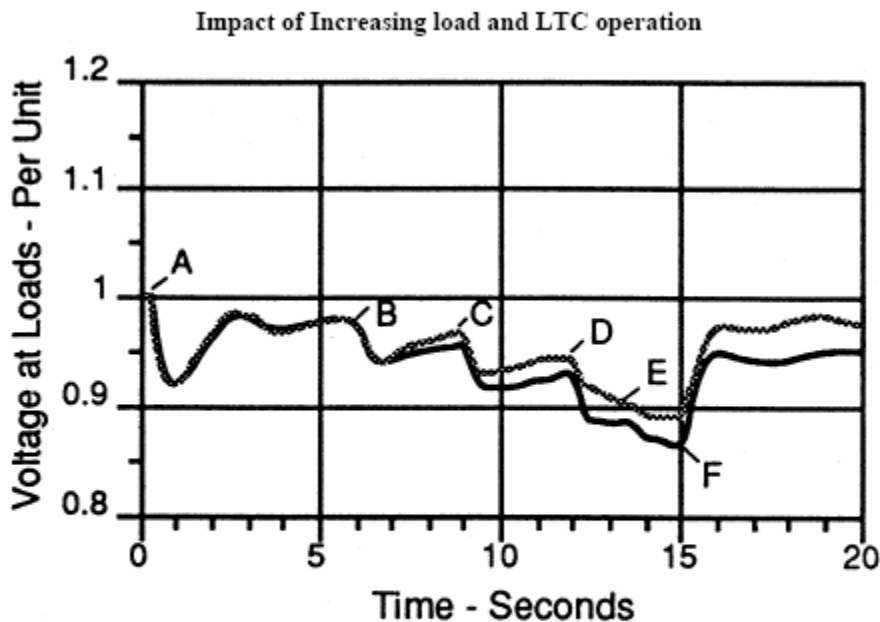

Figure 4-7 Voltage at loads: Gray curve is for industrial load, black curve for residential load. Trip one 500 kV line at Point A. Resistive load added at the residential load bus: 200 MW at points B, C, and D; 100 MW at Point E. At Point F, trip 5% of total load by UVLS with voltage setpoint at 0.9 pu and 1.5 second time delay.

Figure 2.4: Example of Dynamic Simulation Results

2.5. Static and Dynamic Reactive Power Resources

Planning Standard S1 states that reactive power resources in an area should consist of a “balance” between static and dynamic characteristics; Guide G5 of the related set of standards reinforces this notion (refer to Section 4.1.1). Dynamic reactive power resources refer to equipment that can respond within cycles of a disturbance for example, to avert the risk of voltage collapse in instances where static shunt devices are not capable of reacting fast enough. The WECC publication entitled “Voltage Stability Criteria, Undervoltage Load Shedding Strategy and Reactive Power Reserve Monitoring Methodology” (1998) provides guidance on determining the appropriate balance between these types of reactive power resources¹³; this is discussed next.

The recommended method of identifying the appropriate balance between static and dynamic reactive power reserves is to undertake time-domain or dynamic simulations. Alternatively, an approximated method of determining the appropriate balance may be harnessed from the development of the V-Q curves as proposed by CIGRE and incorporated in the aforementioned WECC publication.

The central notion in this method is to incorporate the load-voltage characteristics within the power system model. As discussed in Section 2.2.1, voltage-dependent load characteristics are of interest when considering voltage stability issues in the short-term timeframe (i.e., after the disturbance and just prior to automatic LTC operation).

The minimum required amount of dynamic reactive power resource to obtain a feasible operating point is equal to the reactive-power margin deficit (difference between x-axis and the curve minimum) depicted by the following V-Q curve of a reactive deficient system:

- 1) A curve representing a base loaded or base interface flow case increased by 5% (per WECC-S1 or WECC-S2) incorporating a) voltage-dependent static load models (Section 2.3.1.1), b) worst category B disturbance and c) no LTC operation

In the curve, as shown in Figure 2.5, the model represents a simulation of the system (if the Load or transfer were increased by 5%) in the short-term timeframe incorporating voltage dependent load characteristics as discussed in Section 2.3.1.1.

¹³ Section 9 of the document.

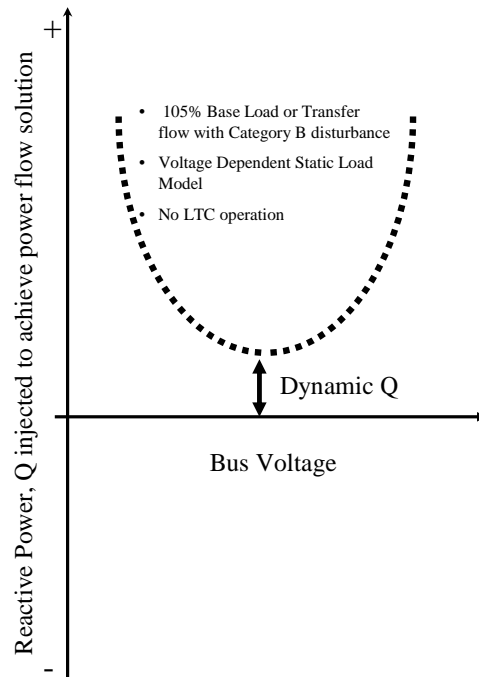

Figure 2.5: Determination of the dynamic reactive power resource requirement.

The reactive margin deficit represents the required reactive power support to meet Planning Standards WECC-S1 or WECC-S2 in the short-term timeframe; this is an approximate method since dynamic reactive power resources refer to equipment that can respond within cycles of a disturbance whereas the short-term timeframe may span seconds. This approach would be less effective in determining the dynamic reactive power resource requirement in an area with a high penetration of induction machines; in such an instance, it is highly recommended that dynamic or time-domain analysis be undertaken.

In the mid-term to long-term timeframe, automatic LTCs restore voltages at load busses resulting in loads behaving with or approaching constant power characteristics. Constant impedance type loads, providing load relief in the short-term timeframe, begin to draw more current as voltage is increased over the mid-term and long-term timeframe. During this period, static reactive power resources can be deployed to provide support. The amount of static reactive power resource required within a reactive-power deficit area is determined as the difference between the minima of the following two V-Q curves of a reactive deficient system (refer to Figure 2.6):

- 1) A curve representing a base loaded or base interface flow case increased by 5% (per WECC-S1 or WECC-S2) incorporating a) constant power load models, b) worst category B disturbance and c) Automatic LTC operation

2) The V-Q curve of Figure 2.5

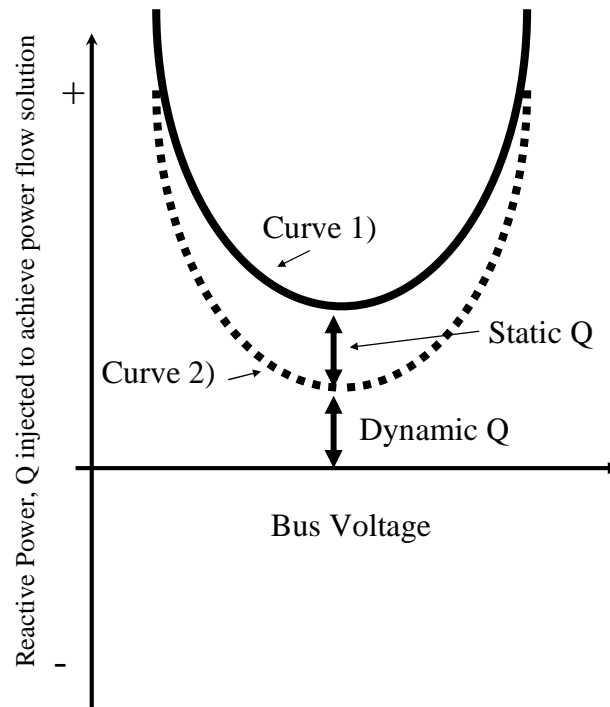

Figure 2.6: Determination of the dynamic reactive power resource requirement.

Therefore the total minimum amount of reactive power resources required to obtain a feasible operating point in a reactive power deficit area is equal to the sum of the dynamic and static reactive power resources as calculated above.

The approach provided above for determination of the amount of dynamic reactive power resources is an approximation and should only be used when more complex load models and/or time-domain simulation tools are not available. Another application of the above method is for screening a set of system scenarios to a handful that would subsequently undergo a more complex level of analysis including the use of time-domain simulations and complex load and motor models.

3. Planning Standards I.D: An Overview

This section provides an overview of NERC/WECC Planning Standards I.D. A discussion on these standards will be presented in order to set the stage for the methodology presented in the next section.

This particular category of standards addresses the risk of widespread voltage collapse by establishing the need for sufficient static and dynamic reactive power support within the power system under consideration. There are five standards under this category, four of which are specific to WECC member-systems (standards WECC-S1 through WECC-S4).

The standard common to all NERC RRC is reproduced below:

- S1. Reactive power resources, with a balance between static and dynamic characteristics, shall be planned and distributed throughout the interconnected transmission systems to ensure system performance as defined in Categories A, B, and C of Table I in the I.A. Standards on Transmission Systems*

Four WECC-specific standards are included in this category are reproduced below for reference:

- WECC-S1 For transfer paths, post-transient voltage stability is required with the path modeled at a minimum of 105% of the path rating (or Operational Transfer Capability) for system normal conditions (Category A) and for single contingencies (Category B). For multiple contingencies (Category C), posttransient voltage stability is required with the path modeled at a minimum of 102.5% of the path rating (or Operational Transfer Capability).*
- WECC-S2 For load areas, post-transient voltage stability is required for the area modeled at a minimum of 105% of the reference load level for system normal conditions (Category A) and for single contingencies (Category B). For multiple contingencies (Category C), post-transient voltage stability is required with the area modeled at a minimum of 102.5% of the reference load level. For this standard, the reference load level is the maximum established planned load limit for the area under study.*
- WECC-S3 Specific requirements that exceed the minimums specified in I.D WECC-S1 and S2 may be established, to be adhered to by others, provided that technical justification has been approved by the Planning Coordination Committee of the WECC.*

WECC-S4 These Standards apply to internal WECC Member Systems as well as between WECC Member Systems.

The next sections discuss how WECC member systems may assess and evaluate conformity of their areas and/or transfer paths to NERC/WECC Planning Standards I.D.

4. Study Methodology

This section outlines the methodology used in assessing and evaluating the conformity of a particular power system or a transfer path with NERC/WECC Planning Standards I.D.

Voltage stability analysis is generally conducted by employing two methodologies, namely static and dynamic analysis as discussed in Section 2.4. Static analysis reveals loss of system equilibrium and is a snapshot in time (i.e., not time dependent). Dynamic analysis, also referred to as time-domain analysis, reveals the system trajectory immediately following a disturbance. Both these methods should be used in a complementary manner thereby providing an overall assessment of the voltage stability of the area under consideration.

This section outlines the methodology for assessing a particular area's or a particular transfer path's conformity with planning standard I.D using P-V and V-Q analysis. P-V analysis of a particular area or of a particular transfer path reveals the static stability margin of that area or of that path while V-Q analysis yields the reactive power margin at a particular bus in the power system under consideration.

4.1. Real Power Margin Assessment (P-V Analysis)

As discussed in Section 3, WECC-S1 and WECC-S2 outline the standards to be applied in the determination of post-transient voltage stability for a transfer path or a load area respectively. These standards establish the real power margin assessment (or P-V analysis) method as the mode in which post-transient voltage stability of a transfer path or of a load area is to be evaluated.

4.1.1. Base Cases Preparation

The WECC methodology for assessment of post-transient voltage stability of a transfer path or of a load area is undertaken with a set of appropriately prepared power-flow cases by incorporating the following:

- a) Establish the case such that it represents critical conditions for the transfer path or for the load area of interest. Refer to guide WECC-G3 which states

Identification of Critical Conditions: It may be necessary to study a variety of load, transfer, and generation patterns to identify the most critical set of system conditions. For example, various conditions should be considered, such as: peak load conditions with maximum imports, low load conditions with minimum generation, and maximum interface flow conditions with worst case load conditions

- b) Load models should be represented as discussed in guide WECC-G5 which states:

Load Voltage Response Assumption: Loads and distribution regulating devices in the study area should be modeled as detailed as is practical. If detailed load models cannot be estimated, the loads can be represented as constant MVA in long-term (post transient) voltage stability study; this representation approximates the effect of voltage regulation by LTC bulk power delivery transformers and distribution voltage regulators. For short-term (transient) voltage stability and dynamic simulation, dynamic modeling of induction motors is recommended

Caution must be taken when incorporating automatic LTC operation with load models represented with constant power characteristics as the current drawn by these will drop when the voltages are increased through LTC operation (refer to Section 2.3.1.1).

- c) Ensure that the swing bus resides outside the study area. The swing bus is a V- δ bus (i.e., the swing bus voltage and angle are the only controls allowed in the base case model) and as such its power output cannot be directly manipulated in the course of the analysis.
- d) A standard power flow solution should be used to solve the base case at this stage of the methodology (i.e., post-transient power flow should not be used). The assumption is that the pre-disturbance condition represents a system that has been in a stable operating point for over ½ hour. This means that the generation real-power dispatch and all voltage support equipment have been established by the operator such that the system meets the NERC/WECC reliability criteria. As such, the use of a governor-based power flow, where a contingency results in governor action but before system operators have an opportunity to intervene, would not be appropriate.

In addition to the above, the base case or cases for transfer path increase (WECC-S1) post-transient voltage stability assessment need to be prepared as follows:

- e) The path interface transfer is at its maximum rating
- f) For nomogram ratings, a range of set of critical conditions outlined in WECC-G3 may be required to be modeled.

In addition to a) through d) above, the base case or cases for load area increase (WECC-S2) post-transient voltage stability assessment need to be prepared as follows:

- e) Load in the area of interest should be modeled with the load forecast normally used for planning in that area. For example, if load representing a one in ten year adverse weather forecast is normally used for steady state and transient dynamic analyses, then it should also be used for post-transient analysis. (For the purposes of developing a P-V curve, it may be desirable to show the curve starting with the area loading at less than planned forecast)

With the cases prepared as discussed above, post-transient voltage stability of a transfer path or of a load area may be undertaken as discussed in the sections that follow.

4.1.2. P-V Analysis for WECC-S1 (Transfer Path)

The post-transient voltage stability analysis methodology for transfer path utilizes the base case prepared in Section 4.1.1 for the transfer path analysis.

The following are the remaining steps to be performed:

- 4.1.2.1 Develop Interface Flow Cases
- 4.1.2.2 Post-Transient Power Flow Analysis
- 4.1.2.3 Develop P-V Curves
- 4.1.2.4 Assess Transfer Path Conformity with WECC-S1

The above will be outlined in the sections that follow.

4.1.2.1. Develop Interface Flow Cases

Develop a series of transfer path interface flow base cases for the selected path, each with an increasing transfer flow beginning at rated transfer and ending at a transfer level at which voltage collapse is expected following a Category B disturbance; the latter will be loosely referred to as the 'nose-point' in the sections that follow. The following need to be considered when developing these cases:

- a) System swing machine output generally accounts for system losses. This machine should not be allowed to exceed its real and reactive power capability (other generators should be re-dispatched in order to ensure this)
- b) Generation supply for increasing transfer levels should come from generators that place the highest stress on the path of interest. Generator active and reactive power capability should not be exceeded during the simulation.

- c) Loads in adjoining areas to the region being studied should be increased in tandem with that of the study area if these areas exhibit similar power demand profiles.
- d) In general load power factor is held constant when load is increased to obtain a particular transfer level. It may be necessary to change the load power factor in which case engineering discretion must be applied.
- e) As the transfer flow is increased, allow the operation of automatic power system devices which can operate up to the end of the mid-term timeframe (i.e., only automatic devices and no operator intervention - refer to Section 2.2). This is to capture the effect of unanticipated increases in power transfer over the interface when the operator may not have a chance to intervene.

Thermal overload conditions may prevail as the transfer flow is increased beyond the rated transfer path capability; this is expected and may be ignored at this stage of the methodology. Refer to guide WECC-G4 which states:

When developing the 105% and 102.5% load or transfer cases to demonstrate conformance with I.D WECC-S1, S2, and S3, conformance with the performance requirement (e.g., facility thermal loading limits) identified in Section I.A is not required.

- f) All transfer paths into the receiving region should be monitored (and not just some).

4.1.2.2. Post-Transient Power Flow Analysis

For each of the cases from the above step, perform a post-transient power flow analysis for a set of worst-case Category B and Category C contingencies. Figure 4.0 provides an illustration of this.

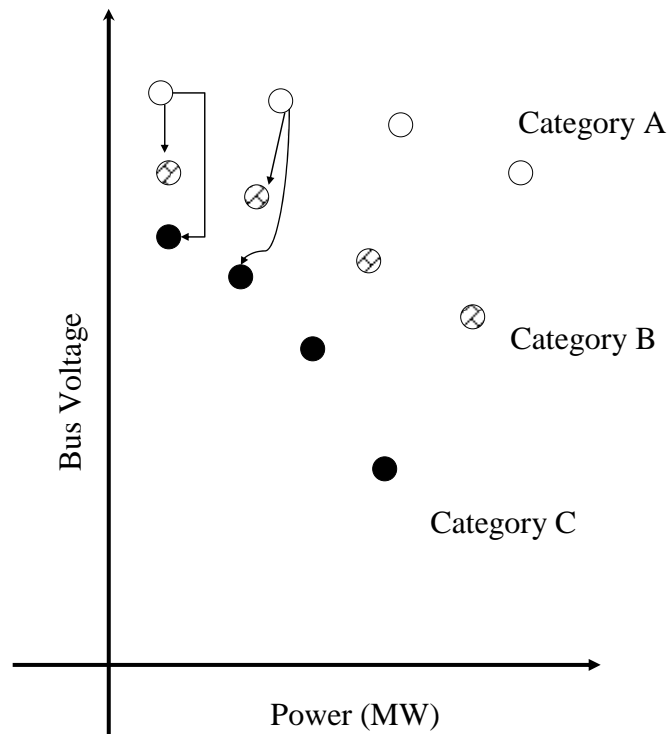

Figure 4.0: Contingency Evaluation Process Illustration

As shown in the above figure, a category B and a category C contingency is applied each transfer flow case as prepared in Section 4.1.2.1. Each point in the figure is a snapshot in time and represents a unique steady-state stable equilibrium point of a system subjected to automatic device operation but before operator intervention.

The post-transient power flow methodology is outlined in Section 6 of the WECC publication “Voltage Stability Criteria, Undervoltage Load Shedding Strategy, and Reactive Power Reserve Monitoring Methodology”.

The post-transient power flow method assumes that all generators operating with unblocked governors will share the generation deficiency or surplus in proportion to their maximum generating capabilities until they reach their maximum or minimum output. The following additional information is incorporated in the post-transient power flow methodology:

- a) After the contingency is applied, automatic operation of system devices, remedial action schemes (RAS), or load shedding schemes with the capability of operating in the short-term to mid-term time frame are incorporated before the case is solved. Manual operator actions are excluded from the simulation.

For example, the post-transient solution may indicate that automatic activation of one or more of the following would have occurred:

- RAS;
- Load shedding;
- Generator tripping schemes;

In this case, the simulation must be performed again incorporating the end result of the above activation.

- b) All generators which manually control a high side remote bus must be set at the pre-disturbance voltage at the terminal bus or local bus. Only generators with automatic controls (i.e., no operator intervention), such as line drop compensation, are allowed to control a high side remote bus.
- c) Whenever it is feasible, switchable capacitors should be modeled as discrete capacitors and not as synchronous condensers. When capacitors/reactors are modeled as synchronous condensers, convert the condensers to fixed capacitors using their pre-disturbance MVAR value.
- d) Adjust, as necessary, Q_{max} for generators with a free governor in accordance with their reactive power capability curve (or other limitations that may limit the reactive power output) for the level of generation determined to be appropriate for the post-transient simulation (i.e., the post-transient P_{gen})
- e) The over-excitation limiter (protecting the generator from thermal overload) is an important controller in system voltage stability. It is important to ensure that an appropriate value of Q_{max} is used during post-transient periods for generators which are equipped with over-excitation limiters. Automatic actions of the protection control associated with over-excitation limiters should be incorporated (e.g., generator unit trip) in the post-transient simulation.

4.1.2.3. Develop P-V Curves

Determine one or more critical busses as discussed in Section 2.3.3. Plot a set of P-V curves as follows:

- Plot the pre-contingency path transfer flows on the abscissa (X-axis) with data obtained from Section 4.1.2.1 (Develop Interface Flow Cases). The range should include flows below the full path rating to that at the 'nose-point'

- Plot the corresponding post-contingency voltages at the critical bus or at a set of critical busses on the ordinate (Y-axis) with data obtained from Section 4.1.2.2 (Post-Transient Power Flow Analysis).

4.1.2.4. Assess Transfer Path Conformity with WECC-S1

The path maximum transfer limit which meets WECC-S1 for post-transient voltage stability is established as the lowest of the following as obtained from the P-V curve developed in Section 4.1.2.3:

- a) 5% below the path flow transfer at the ‘nose-point’ for Category A performance,
- b) 5% below the pre-contingency path flow transfer corresponding to the ‘nose-point’ on the P-V curve representing the worst Category B contingency
- c) 2.5% below the pre-contingency path flow transfer corresponding to the ‘nose-point’ on the P-V curve representing the worst Category C contingency (controlled load shedding is allowed to achieve this)

4.1.3. P-V Analysis for WECC-S2 (Load Area)

The post-transient voltage stability analysis methodology for load area utilizes the base case prepared in Section 4.1.1 for the load area analysis. The following are the remaining steps to be performed:

- | | |
|---------|--|
| 4.1.3.1 | Develop Base Cases |
| 4.1.3.2 | Post-Transient Power Flow Analysis |
| 4.1.3.3 | Develop P-V Curves |
| 4.1.3.4 | Assess Transfer Path Conformity with WECC-S2 |

The above will be outlined in the sections that follow.

4.1.3.1. Develop Base Cases

Develop a series of base cases, each with an increasing load level for the selected area beginning at an appropriate loading level and ending at a load level at which voltage collapse is expected following a Category B disturbance; the latter will be loosely referred to as the ‘nose-point’ in the sections that follow.

Bulleted items a) through d) of Section 4.1.2.1 should be considered in addition to the following when developing these cases:

- a) As the load is increased within the load area, allow the operation of power system devices which can operate (and complete its action) up to the end of the long-term timeframe, including operator intervention but excluding addition of thermal units (which have a long start-up time) to meet the

area load demand. It is assumed that the operator can anticipate area load demand increase and react accordingly, including commitment of generators that would normally be used to supply anticipated area load increase. Thermal overload conditions may prevail as the area loading is increased beyond the forecast planning demand levels despite automatic and manual device intervention; this is expected and may be ignored at this stage of the methodology. Refer to guide WECC-G4 which states:

When developing the 105% and 102.5% load or transfer cases to demonstrate conformance with I.D WECC-S1, S2, and S3, conformance with the performance requirement (e.g., facility thermal loading limits) identified in Section I.A is not required.

- b) All paths through which external generation is supplied into the receiving region should be monitored as area load is scaled up

4.1.3.2. Post-Transient Power Flow Analysis

For each of the cases developed in Section 4.1.3.1, perform a post-transient power flow analysis (discussed in Section 4.1.2.2) for a set of worst-case Category B and Category C contingencies. Figure 4 illustrates this approach which was briefly discussed in Section 4.1.2.2. In the case of load area increase methodology, each point in the figure is a snapshot in time and represents a unique steady-state stable equilibrium point of a system subjected to automatic device operation and operator intervention but excluding operator-initiated introduction of previously off-line generating units that have long start-up time.

4.1.3.3. Develop P-V Curves

Determine one or more critical busses as discussed in Section 2.3.3. Plot a set of P-V curves based on the data obtained in Section 4.1.3.2 as follows:

- Plot the area load magnitude on the abscissa (X-axis). The range should include flows below the full path rating to that at the 'nose-point'
- Plot the corresponding post-contingency voltages at the critical bus or at a set of critical busses on the ordinate (Y-axis).

4.1.3.4. Assess Transfer Path Conformity with WECC-S2

The path maximum transfer limit which meets WECC-S1 for post-transient voltage stability is established as the lowest of the following as obtained from the P-V curves developed in Section 4.1.3.3:

- a) 5% below the area load magnitude at the 'nose-point' for Category A performance,
- b) 5% below the area load magnitude corresponding to the 'nose-point' on the P-V curve representing the worst Category B contingency

- c) 2.5% below the area load magnitude corresponding to the ‘nose-point’ on the P-V curve representing the worst Category C contingency (controlled load shedding is allowed to achieve this)

4.2. Reactive Power Margin Assessment (V-Q Analysis)

Reactive power margin assessment (or V-Q analysis) may be undertaken as an alternative to performing P-V analysis as stated in guide WECC-G2:

Reactive Power Margin Requirements: The development of “Reactive Power Margin Requirements” based on the V-Q methodology developed by TSS (e.g., 400 MVAR at a particular bus) provides one alternate way to screen cases and determine whether or not they likely meet this criteria. The “Reactive Power Margin Requirement” is a proxy for Standards I.D WECC-S1 through WECC-S3.

This section provides a methodology for performing V-Q analysis such that WECC-S1 through WECC-S3 may be satisfied; this methodology is referenced as the “V-Q methodology developed by TSS” in guide WECC-G2 stated above.

4.2.1. Base Case Preparation

The V-Q analysis process begins with the establishment of a base case for load area or transfer path increase based analysis. For the load area increase analysis, establish a base case depicting the planned load forecast for the area under consideration. For the transfer path increase analysis, establish a base case depicting the path transfer at full path rating. Incorporate bulleted items of Section 4.1.1 (Base Cases Preparation) when preparing the base case discussed above.

4.2.2. V-Q Analysis

The post-transient voltage stability analysis using V-Q methodology for transfer path or for load area increase utilizes the corresponding base case prepared in Section 4.2.1. The following are the remaining steps to be performed:

- 4.2.2.1 Develop Scenario Cases
- 4.2.2.2 Post-Transient Power Flow Analysis
- 4.2.2.3 Develop V-Q Curves
- 4.2.2.4 Determine Reactive Power Margin Requirements
- 4.2.2.5 Assess System Performance Against the Reactive Power Margin Requirements

The above will be outlined in the sections that follow.

4.2.2.1. Develop Scenario Cases

Depending on the category of contingency being evaluated and/or the type of study (path increase or load area increase), create a base case depicting a path transfer or area loading at 105% (Category B contingency) or at 102.5% (Category C contingency) of the rated transfer of the path or of the forecast load area demand under consideration. When preparing these cases, incorporate the following:

- Bulleted items of Section 4.1.2.1 (Develop Interface Flow Cases) for the transfer path increase methodology, or
- Bulleted items of Section 4.1.3.1 (Develop Base Cases) for area load increase methodology.

4.2.2.2. Post-Transient Power Flow Analysis

For each of the cases developed in Section 4.2.2.1, perform a post-transient power flow analysis (discussed in Section 4.1.2.2) for a set of worst-case Category B and Category C contingencies.

4.2.2.3. Develop V-Q Curves

Determine a set of critical busses as discussed in Section 2.3.3. Plot a set of V-Q curves for each of the case developed in Section 4.2.1 and Section 4.2.2.2 based on the data obtained in that section as follows:

- 1) Apply a fictitious synchronous condenser at one critical bus.
- 2) Impose the contingency if developing Category B or Category C disturbance curve.
- 3) Solve the base case using either the standard or the post-transient power flow solution method and record the critical bus voltage and the corresponding reactive power output of the synchronous condenser
- 4) Vary the scheduled voltage of the synchronous condenser in small increments (typically less than 0.01 p.u.) and record the corresponding reactive power outputs.
- 5) Plot the voltage magnitude at the critical bus on the abscissa (X-axis).
- 6) Plot the corresponding reactive power output on the ordinate (Y-axis).
- 7) Repeat above steps for the next critical bus or the next contingency as the case may be.
- 8) Repeat 1) through 7) for the next case

4.2.2.4. Determine Reactive Power Margin Requirements

The reactive power margin (RPM) assessment for Category A, and Categories B and C disturbances are discussed in this section. RPM is defined as the negative of the value of the synchronous condenser output at the minimum point of the V-Q curve of the base case as shown in Figure 4.1.

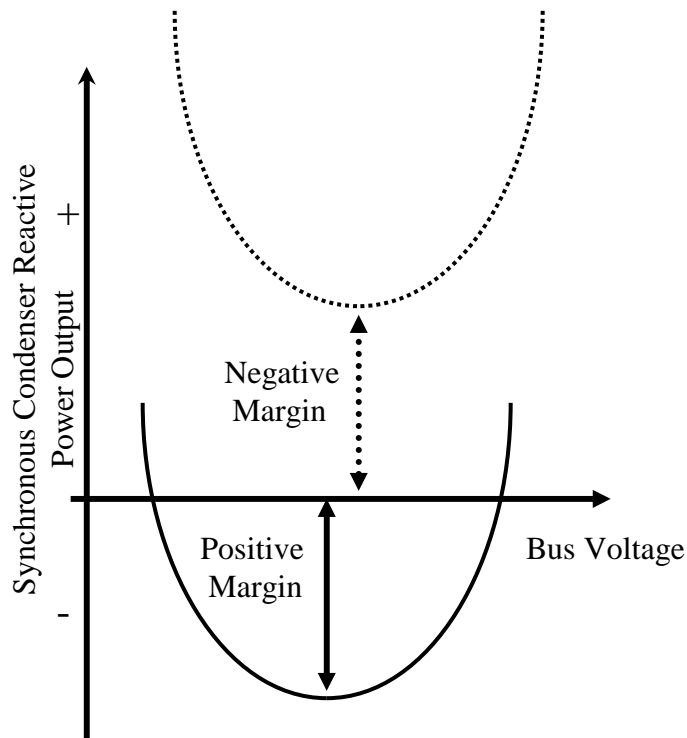

Figure 4.1: Assessment of Reactive Power Margin at a Critical Bus

A positive margin is shown by the solid curve and the negative margin is shown by the dotted curve in the above figure.

The RPM requirement for a category B disturbance at the critical bus under consideration is equal to the change in the RPM between the following two:

- RPM of the scenario case depicting the Category B disturbance with 100% forecast loading or path transfer
- RPM of the scenario case depicting the same Category B disturbance as above with 105% forecast loading or path transfer increase

The RPM requirement for a category C disturbance at the critical bus under consideration is equal to the change in the RPM of the following two:

- RPM of the scenario case depicting the Category C disturbance with 100% forecast loading or path transfer

- RPM of the scenario case depicting the same Category C disturbance as above with 102.5% forecast loading or path transfer increase

A prudent approach in ensuring the viability of proposed counter-measures to ensure post-transient voltage stability is to evaluate RPM requirement of future years. The proposed set of counter-measures (e.g., reactive power resources, controlled load shedding, special protection systems (SPS) / RAS, etc.) can be tested by incorporating these into base cases representing future years and repeating the procedure outlined in this section. The proposed measure or measures may be deemed sound if these indicate that the area under consideration will conform to planning Standards I.D in future years.

4.2.2.5. Assess System Performance Against the Reactive Power Margin Requirements

After the Reactive Power Margin Requirements have been established for the years of interest, the system can be tested to see if it meets these Requirements.

For the load area increase analysis, establish a base case depicting 100% of planned load forecast for the area under consideration. For the transfer path increase analysis, establish a base case depicting the path transfer at full path rating. Incorporate bulleted items of Section 4.1.1 (Base Cases Preparation) when preparing the base case discussed above.

Plot V-Q curves for selected Categories B and C contingencies as in Section 4.2.2.3. Check to see if the reactive margin meets the Reactive Power Margin Requirement established in Section 4.2.2.4 for the same study year, bus and contingency. Reactive Margin Requirements established using a different study year can be used if the system conditions have not changed significantly.

An RPM deficit for Category B contingency indicates that the area or transfer path under consideration will likely not conform with planning standards I.D. For category C contingencies, controlled load shedding is allowed (refer to Table I, Standards I.A of *NERC/WECC Planning Standards*) to enable the system performance to meet Planning Standards.

5. Other Study Considerations

This section provides an overview of considerations when undertaking post-transient voltage stability analysis.

The following should be kept in mind when following the methodology in this document:

- The post-transient voltage stability methodology outlined in this document inherently assumes that the study region under consideration is transiently stable with the system frequency being uniform and turbine outputs have reached steady-state values. These assumptions should be verified by the engineer before commencing studies outlined herein.
- If distribution LTCs are not explicitly modeled thereby employing constant power models on the transmission busses, the resulting assumption is that these LTCs restore bus voltages to their pre-disturbance level. This assumption would be incorrect in the case of LTCs that have reached their tap limits.
- Blocked governor information is available for all governors in the WECC region to facilitate post-transient power flow solution methodology.

The following scenarios/uncertainties should be kept in mind when undertaking post-transient voltage stability studies as these scenarios could be more severe than increasing the load in the load area of interest by 5% or increasing the power transfer over a path by 5% of the Path Rating:

- Customer real and reactive power demand forecast errors
- Outages not routinely studied in the region of interest
- Outages not routinely studied on neighboring systems
- Unexpected generator unit trips following major disturbances
- Lower voltage line trips following major disturbances
- Variations on neighboring system's generation dispatch
- Large and variable reactive exchanges with neighboring systems
- More restrictive reactive power constraints on neighboring system generators than forecast
- Variations in load characteristics, especially in load power factors
- Risk of the next major event during a 30-minute adjustment period or an adjustment period consistent with WECC guidelines/standards (eg. MORC)
- Not being able to readjust adequately to get back to a secure state

- Increases in major path flows following major contingencies due to various factors such as undervoltage load shedding, SPS or RAS
- On-system reactive resources not responding
- Excitation limiters responding prematurely
- Possible RAS failure
- Prior outages of system facilities
- More restrictive reactive power constraints on internal generators than planned.
- Neighboring system voltage profile for the operating condition (the higher the voltage on the neighboring system in the pre-contingency case, the higher the contingency voltage will be in the area under study)

Sensitivity studies should be conducted to test the above scenarios.