



2018 Natural Gas Integrated Resource Plan

August 31, 2018



Safe Harbor Statement

This document contains forward-looking statements. Such statements are subject to a variety of risks, uncertainties and other factors, most of which are beyond the Company's control, and many of which could have a significant impact on the Company's operations, results of operations and financial condition, and could cause actual results to differ materially from those anticipated.

For a further discussion of these factors and other important factors, please refer to the Company's reports filed with the Securities and Exchange Commission. The forward-looking statements contained in this document speak only as of the date hereof. The Company undertakes no obligation to update any forward-looking statement or statements to reflect events or circumstances that occur after the date on which such statement is made or to reflect the occurrence of unanticipated events. New risks, uncertainties and other factors emerge from time to time, and it is not possible for management to predict all of such factors, nor can it assess the impact of each such factor on the Company's business or the extent to which any such factor, or combination of factors, may cause actual results to differ materially from those contained in any forward-looking statement.

TABLE OF CONTENTS: APPENDICES

Appendix	0.1	TAC Member List.....	Page 1
	0.2	Comments and Responses to the 2014 IRP	2
Appendix	1.1	Avista Corporation 2014 Natural Gas IRP Work Plan.....	6
	1.2	IRP Guideline Compliance Summaries	12
Appendix	2.1	Economic Outlook and Customer Count Forecast.....	24
	2.2	Customer Forecasts by Region	41
	2.3	Demand Coefficient Calculations	77
	2.4	Heating Degree Day Data	84
	2.5	Demand Sensitivities and Demand Scenarios.....	90
	2.6	Demand Forecast Sensitivities and Scenarios Descriptions	92
	2.7	Annual Demand, Avg Day & Peak Day Demand (Net of DSM)	96
	2.8	Demand Before and After DSM.....	101
	2.9	Detailed Demand Data	106
Appendix	3.1	Avista Gas CPA Report Final 4/23/2014	118
	3.2	Environmental Externalities.....	212
Appendix	4.1	Current Transportation/Storage Rates and Assumptions	215
Appendix	6.1	Monthly Price Data by Basin	216
	6.2	Weighted Average Cost of Capital	222
	6.3	Supply Side Resource Options	223
	6.4	Avoided Costs Detail.....	224
Appendix	7.1	High Case Demand and Resources Selected Graphs.....	239
	7.2	Other Scenario Peak Day Demand Table	241
Appendix	8.1	Distribution System Modeling	247
	8.2	Oregon Capital	251

Appendix	A	TAC Meeting #1	253
	B	TAC Meeting #2	354
	C	TAC Meeting #3	465
	D	TAC Meeting #4	680

APPENDIX 0.1: TAC MEMBER LIST

Organization	Representatives	
Applied Energy Group	Kurtis Kolnowski	
Avista	Terrence Browne Mike Dillon Ryan Finesilver Grant Forsyth James Gall Justin Dorr John Lyons Annette Brandon	Jody Morehouse Tom Pardee Kaylene Schultz Eric Scott Kerry Shroy Debbie Simock Shawn Bonfield Jeff Webb
Cascade Natural Gas Company	Ashton Davis	
Energy Trust of Oregon	Jack Cullen	
Fortis	Robert Schuster	
Idaho Public Utility Commission	Brad Iverson-Long Stacey Donohue	
Northwest Gas Association	Dan Kirschner	
Northwest Natural Gas	Tammy Linver	
Oregon Public Utility Commission	Lisa Gorsuch	
TransCanada	Jay Story	
Washington Utilities and Transportation Commission	Kathi Scanlan Andrew Rector	
Williams Northwest Pipeline	Mike Rasmuson Rob Harmen	
	Jon Rowley	

APPENDIX 0.2: COMMENTS AND RESPONSES TO 2018 DRAFT INTEGRATED RESOURCE PLAN

The following table summarizes the significant comments on our DRAFT as submitted by TAC members and Avista's responses. This IRP produced reduced forecasted demand scenarios and no near term resource needs even in our most robust demand scenario. We appreciate the time and effort invested by all our TAC members throughout the IRP process. Many good suggestions have been made and we have incorporated those that enhance the document.

Document Reference[1]	Comment/Question	Avista Response
6 - Integrated Resource Portfolio	<p>Low/Medium/High natural gas price forecasts. Reasonable price forecasts are important in developing a utility's avoided cost threshold and determining cost-effectiveness of conservation measures. For Avista's expected case, the company projects its nominal gas price in the 4 dollar per dekatherm (\$/Dth) range for 2026-2027, which amounts to a 30 percent increase over a ten-year span. Beyond 2027, Avista projects an increase to \$7/Dth and a 75 percent increase in natural gas prices in the outer-years. Over the entire IRP planning horizon, Avista projects 133 percent change in natural gas prices. Staff is concerned Avista may perpetuate a high-side bias of natural gas prices. Further, staff recognizes no company can accurately predict future natural gas prices; however, the company must ensure its natural gas price forecasts represent the most reasonable expectation of the future.</p> <p>In July, staff requested the company provide additional information regarding its consultants' gas price forecasts. On July 13, 2018, the company filed confidential electronic workpapers of its gas price forecast data in Docket UG-170940. Staff appreciates Avista prompt response to the data request. Staff also requests a more detailed description of the company's gas price (and expected price strip) forecast at the Henry Hub, including how Avista derived its regional gas price variation from the company's two fundamental price forecasts from credible industry sources. Further, staff asks Avista to explain its blending methodology of its forwards and outer-year price forecasts, and also discuss the qualitative and quantitative factors that correlate with the projected rise in prices, especially in the outer-years of its natural gas price forecast.</p>	<p>Added supplemental language to Chapter 6 beginning with page 125</p>

	<p>Fuel conversion program impact-emerging natural gas demand. Compared to previous IRPs, Avista's new 20-year outlook for customer growth has increased by nearly 12,000 customers. Avista indicates that much of its new, emerging demand is directly related to a conversion program offered in Washington (and Idaho), where customers are offered assistance in converting to natural gas and fuel switching.</p>	
2 - Demand Forecasts	<p>1111 Staff requests additional information on whether Avista is referring to 1) Washington's line extension allowance pilot (LEAP), 2) the company's existing fuel conversion program funded through the electric conservation rider, Electric Schedule 91, or 3) the cumulative impact of LEAP and the fuel conversion program. Staff recommends the company provide additional data, narrative and specificity with regard to projections of emerging natural gas demand related to consumer-funded programs or incentives.</p>	<p>Additional clarification added to page 29 - Chapter 2</p>
6 - Integrated Resource Portfolio	<p>1111 Resource cost test. Avista evaluates the cost effectiveness of demand-side management (DSM) programs against the initial avoided cost curve using appropriate resource cost tests. Staff asks Avista to clarify the resource cost test(s) used.</p>	<p>Added to Chapter 6 page 142</p>
9 - Action Plan	<p>DSM—Integration of ETO and AEG/CPA data. Effective January 1, 2017, Avista transitioned its Oregon gas DSM regular income, commercial, and industrial customer programs to the Energy Trust of Oregon (ETO), with the ETO being the sole administrator. Staff requests additional information about the difference between DSM output data from ETO's RA model and Applied Energy Group (AEG) Conservation Potential Assessment (CPA) tool, which identify the total 20-year cost-effective modeled savings potential to estimate Avista's final savings forecast. For the next IRP, staff recommends the Advisory Group discuss the integration of ETO and AEG/CPA data as well as past program(s) experience, knowledge of current and developing markets, and future codes and standards.</p>	<p>Added to Action Plan section</p>

<p>5 - Policy Considerations</p>	<p>Dynamic-DSM. Avista’s current analytical process for the Conservation Potential Assessment (CPA) is based on a deterministic model, as compared to the assumptions within the expected case. For the 2018 IRP, Avista attempted to apply a dynamic-DSM using the Sendout model, but the company determined an alternate method would be necessary due to current model constraints. As outlined in Avista’s 2019-2020 action plan, the next IRP will contain a dynamic DSM program structure utilizing new analytics. Avista intends to recreate its Sendout model and inputs and transform it into a new Excel-based tool. This new tool and methodology will allow flexibility to model DSM and other potential supply side resources on a case by case basis.</p>	<p>Added specific language to action item. Avista will model on an individual level of DSM measure</p>
<p>9 - Action Plan</p>	<p>Staff suggests Avista discuss whether the company will use individual or bundling of DSM measures, including grouping by dollars or efficiency levels. Avista’s departure from its current modeling also will allow for a unique opportunity for comparison of methodologies. Staff also requests the company evaluate its deterministic and dynamic DSM tools, including the results and benefits of each methodology.</p> <p>Carbon costs. Based on the initial proposed carbon legislation in Senate Bill 6203, Avista modelled Washington carbon costs at \$10 per MTCO_{2e} starting in 2019 and rising to \$30 per MTCO_{2e} by 2030. Further, the company analyzed three carbon sensitivities and associated impacts on demand forecasts to address the uncertainty about carbon legislation. Staff is pleased Avista introduced a new risk scenario in its 2018 IRP: 80% below 1990 emissions.</p> <p>Staff notes that the low-priced natural gas, in addition to carbon taxes or other programs, has led to a higher potential for DSM measures as compared to the previous three IRP’s. Further, Staff recognizes the uncertainties in carbon policy. For the next IRP, Staff suggests the company consult the Commission’s <i>Acknowledgement Letter Attachment</i> in its 2017 Electric IRP (Docket UE-161036), where emissions price modelling is discussed, including the cost of risk of future greenhouse gas regulation, in addition to known regulations.</p>	<p>Added to 2020 Avista Natural Gas IRP Action Item</p>
<p>7 - Alternate Scenarios, Portfolios, Stochastic Analysis</p>	<p>Supply resource comparison. For this IRP, the only case that identifies a resource deficiency is the High Growth/Low Price scenario. At Staff’s request, Avista added Tables 7.2 and 7.3 to this IRP, which includes costs/rates as well as availability. Staff appreciates Avista’s response to this request.</p>	<p>Added detail and explanation within the chapter</p>

7 - Alternate Scenarios, Portfolios, Stochastic Analysis

Renewable natural gas (RNG). Effective July 1, 2018, House Bill 2580 became law and promotes the sustainable development of RNG supply. For the first time in its natural gas IRP, the company identified RNG as a “solve” where landfill RNG is selected as a resource in Idaho. In addition to Tables 7.2 and 7.3, staff requests additional narrative regarding subsidies that may make RNG-qualified renewable fuel a least-cost optimization solution, which may further contribute to the decarbonization of Avista’s natural gas system. Additional data and discussion regarding the company’s RNG resource cost assumptions, including subsidies, rates, plant efficiency and size would be helpful.

Reconcile peak planning standard and natural gas optimization. Avista’s planning standard is determined using the coldest day on record for each service area, which is an aggressive planning standard given a temperature “experienced rarely, or only once.” Further, there is a high correlation between usage and temperature, as depicted in the company’s use-per-customer forecast in Figure 2.2. In this IRP, slightly higher customer growth continues to be offset by lower use-per-customer and an increased amount of DSM, which has eliminated the need for Avista to acquire additional supply-side resources.

Added detail and explanation within the chapter

9 - Action Plan

Yet the company continues to realize unutilized resources like *supply, transportation, storage and capacity*—when combined, create valuable Avista products. With its ongoing surplus and well-positioned resources *exceeding* system demand, Staff suggests providing additional information on optimization benefits, and also analyzing potential risk exposure in its next IRP. Further, Staff recommends discussing with its Advisory Group whether its current coldest day on record planning standard continues to be a prudent long-term planning approach. The company could look at peer utilities in with similar climate and compare Avista’s planning approach.

Added to 2020 Avista Natural Gas IRP Action Item

APPENDIX 1.1: AVISTA CORPORATION 2020 NATURAL GAS INTEGRATED RESOURCE PLAN WORK PLAN

IRP WORK PLAN REQUIREMENTS

Section 480-90-238 (4), of the natural gas Integrated Resource Plan (“IRP”) rules, specify requirements for the IRP Work Plan:

Not later than twelve months prior to the due date of a plan, the utility must provide a work plan for informal commission review. The work plan must outline the content of the integrated resource plan to be developed by the utility and the method for assessing potential resources.

Additionally, Section 480-90-238 (5) of the WAC states:

The work plan must outline the timing and extent of public participation.

OVERVIEW

This Work Plan outlines the process Avista will follow to complete its 2020 Natural Gas IRP by August 31, 2020. Avista uses a public process to obtain technical expertise and guidance throughout the planning period via Technical Advisory Committee (TAC) meetings. The TAC will be providing input into assumptions, scenarios, and modeling techniques.

PROCESS

The 2020 IRP process will be similar to that used to produce the previously published plan. Avista will use SENDOUT® (a PC based linear programming model widely used to solve natural gas supply and transportation optimization questions) to develop the risk adjusted least-cost resource mix for the 20 year planning period.

This plan will continue to include demand analysis, demand side management and avoided cost determination, existing and potential supply-side resource analysis, resource integration and alternative sensitivities and scenario analysis.

Additionally, Avista intends to incorporate action plan items identified in the 2018 Natural Gas IRP including more detailed demand analysis regarding use per customer, demand side management results and possible price elastic responses to evolving economic conditions, an updated assessment of conservation potential in our service territories, consideration of alternate forecasting methodologies, and the changing landscape of natural gas supply (i.e. shale gas, Canadian exports, and US LNG exports) and its implications to the planning process. Further details about Avista’s process for determining the risk adjusted least-cost resource mix is shown in Exhibit 1.

TIMELINE

The following is Avista's TENTATIVE 2020 Natural Gas IRP timeline:

August 31, 2019	Work Plan filed with WUTC
October 2019 through April 2020	Technical Advisory Committee meetings (exact meeting dates <i>subject to change</i>). Meeting topics will include:
October 24	Economic Drivers, Demand Forecast, and Demand Side Management, Market Dynamics
January 23	Existing Infrastructure and Supply Side Resources
March 25	Scenario Analysis, SENDOUT® Preliminary Results, and Natural Gas Prices
April 29	SENDOUT® Final Results and Draft Document Discussion
May 31, 2020	Draft of IRP document to TAC
June 30, 2020	Comments on draft due back to Avista
July 2020	TAC final review meeting (if necessary)
August 31, 2020	File finalized IRP document

EXHIBIT 1: AVISTA'S 2020 NATURAL GAS IRP MODELING PROCESS

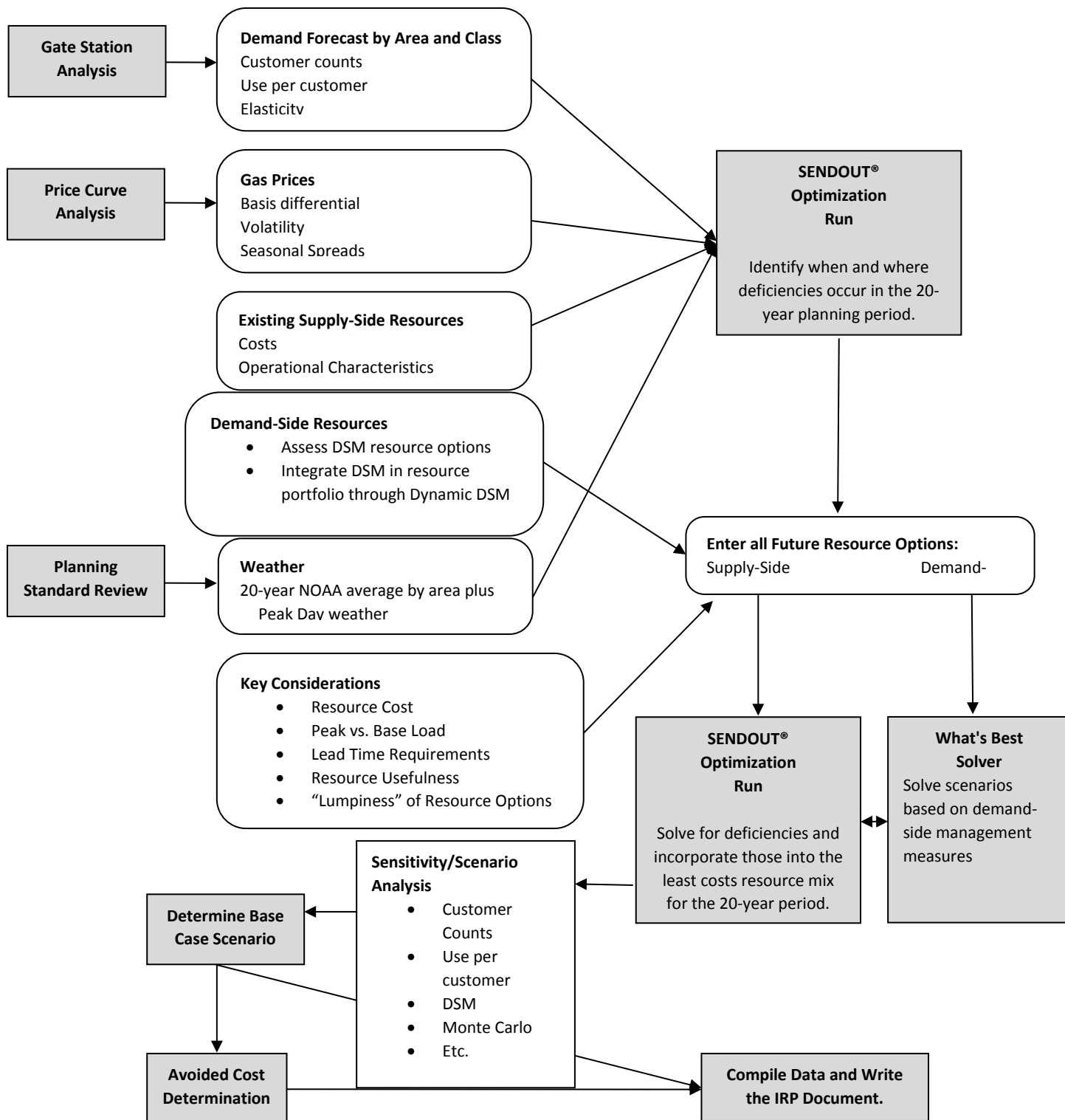

APPENDIX 1.2: WASHINGTON PUBLIC UTILITY COMMISSION IRP POLICIES AND GUIDELINES – WAC 480-90-238

Rule	Requirement	Plan Citation
WAC 480-90-238(4)	Work plan filed no later than 12 months before next IRP due date.	Work plan submitted to the WUTC on August 31, 2017, See attachment to this Appendix 1.1.
WAC 480-90-238(4)	Work plan outlines content of IRP.	See work plan attached to this Appendix 0.1.
WAC 480-90-238(4)	Work plan outlines method for assessing potential resources. (See LRC analysis below)	See Appendix 1.1.
WAC 480-90-238(5)	Work plan outlines timing and extent of public participation.	See Appendix 1.1.
WAC 480-90-238(4)	Integrated resource plan submitted within two years of previous plan.	Last Integrated Resource Plan was submitted on August 31, 2016
WAC 480-90-238(5)	Commission issues notice of public hearing after company files plan for review.	TBD
WAC 480-90-238(5)	Commission holds public hearing.	TBD
WAC 480-90-238(2)(a)	Plan describes mix of natural gas supply resources.	See Chapter 4 on Supply Side Resources
WAC 480-90-238(2)(a)	Plan describes conservation supply.	See Chapter 3 on Demand Side Resources
WAC 480-90-238(2)(a)	Plan addresses supply in terms of current and future needs of utility and ratepayers.	See Chapter 4 on Supply Side Resources and Chapter 6 Integrated Resource Portfolio
WAC 480-90-238(2)(a)&(b)	Plan uses lowest reasonable cost (LRC) analysis to select mix of resources.	See Chapters 3 and 4 for Demand and Supply Side Resources. Chapters 6 and 7 details how Demand and Supply come together to select the least cost/best risk portfolio for ratepayers.
WAC 480-90-238(2)(b)	LRC analysis considers resource costs.	See Chapters 3 and 4 for Demand and Supply Side Resources. Chapters 6 and 7 details how Demand and Supply come together to select the least cost/best risk portfolio for ratepayers.
WAC 480-90-238(2)(b)	LRC analysis considers market-volatility risks.	See Chapter 4 on Supply Side Resources
WAC 480-90-238(2)(b)	LRC analysis considers demand side uncertainties.	See Chapter 2 Demand Forecasting
WAC 480-90-238(2)(b)	LRC analysis considers resource effect on system operation.	See Chapter 4 and Chapter 6
WAC 480-90-238(2)(b)	LRC analysis considers risks imposed on ratepayers.	See Chapter 4 procurement plan section. We seek to minimize but cannot eliminate price risk for our customers.
WAC 480-90-238(2)(b)	LRC analysis considers public policies regarding resource preference	See Chapter 2 demand scenarios

	adopted by Washington state or federal government.	
WAC 480-90-238(2)(b)	LRC analysis considers cost of risks associated with environmental effects including emissions of carbon dioxide.	See Chapters 2 and 6 on demand scenarios and Integrated Resource Portfolio
WAC 480-90-238(2)(b)	LRC analysis considers need for security of supply.	See Chapter 4 on Supply Side Resources
Rule	Requirement	Plan Citation
WAC 480-90-238(2)(c)	Plan defines conservation as any reduction in natural gas consumption that results from increases in the efficiency of energy use or distribution.	See Chapter 3 on Demand Side Resources
WAC 480-90-238(3)(a)	Plan includes a range of forecasts of future demand.	See Chapter 2 on Demand Forecast
WAC 480-90-238(3)(a)	Plan develops forecasts using methods that examine the effect of economic forces on the consumption of natural gas.	See Chapter 2 on Demand Forecast
WAC 480-90-238(3)(a)	Plan develops forecasts using methods that address changes in the number, type and efficiency of natural gas end-uses.	See Chapter 2 on Demand Forecast
WAC 480-90-238(3)(b)	Plan includes an assessment of commercially available conservation, including load management.	See Chapter 3 on Demand Side Management including demand response section.
WAC 480-90-238(3)(b)	Plan includes an assessment of currently employed and new policies and programs needed to obtain the conservation improvements.	See Chapter 3 and Appendix 3.1.
WAC 480-90-238(3)(c)	Plan includes an assessment of conventional and commercially available nonconventional gas supplies.	See Chapter 4 on Supply Side Resources
WAC 480-90-238(3)(d)	Plan includes an assessment of opportunities for using company-owned or contracted storage.	See Chapter 4 on Supply Side Resources
WAC 480-90-238(3)(e)	Plan includes an assessment of pipeline transmission capability and reliability and opportunities for additional pipeline transmission resources.	See Chapter 4 on Supply Side Resources
WAC 480-90-238(3)(f)	Plan includes a comparative evaluation of the cost of natural gas purchasing strategies, storage options, delivery resources, and improvements in conservation using a consistent method to calculate cost-effectiveness.	See Chapter 3 on Demand Side Resources and Chapter 4 on Supply Side Resources
WAC 480-90-238(3)(g)	Plan includes at least a 10 year long-range planning horizon.	Our plan is a comprehensive 20 year plan.
WAC 480-90-238(3)(g)	Demand forecasts and resource evaluations are integrated into the long range plan for resource acquisition.	Chapter 6 Integrated Resource Portfolio details how demand and supply come together to form the least cost/best risk portfolio.
WAC 480-90-238(3)(h)	Plan includes a two-year action plan that implements the long range plan.	See Section 9 Action Plan

WAC 480-90-238(3)(i)	Plan includes a progress report on the implementation of the previously filed plan.	See Section 9 Action Plan
WAC 480-90-238(5)	Plan includes description of consultation with commission staff. (Description not required)	See Section 1 Introduction
WAC 480-90-238(5)	Plan includes description of completion of work plan. (Description not required)	See Appendix 1.1.

APPENDIX 1.2: IDAHO PUBLIC UTILITY COMMISSION IRP POLICIES AND GUIDELINES – ORDER NO. 2534

	DESCRIPTION OF REQUIREMENT	FULLFILLMENT OF REQUIREMENT
1	Purpose and Process. Each gas utility regulated by the Idaho Public Utilities Commission with retail sales of more than 10,000,000,000 cubic feet in a calendar year (except gas utilities doing business in Idaho that are regulated by contract with a regulatory commission of another State) has the responsibility to meet system demand at least cost to the utility and its ratepayers. Therefore, an “integrated resource plan” shall be developed by each gas utility subject to this rule.	Avista prepares a comprehensive 20 year Integrated Resource Plan every two years. Avista will be filing its 2018 IRP on or before August 31, 2018.
2	Definition. Integrated resource planning. “Integrated resource planning” means planning by the use of any standard, regulation, practice, or policy to undertake a systematic comparison between demand-side management measures and the supply of gas by a gas utility to minimize life-cycle costs of adequate and reliable utility services to gas customers. Integrated resource planning shall take into account necessary features for system operation such as diversity, reliability, dispatchability, and other factors of risk and shall treat demand and supply to gas consumers on a consistent and integrated basis.	Avista’s IRP brings together dynamic demand forecasts and matches them against demand-side and supply-side resources in order to evaluate the least cost/best risk portfolio for its core customers. While the primary focus has been to ensure customer’s needs are met under peak or design weather conditions, this process also evaluates the resource portfolio under normal/average operating conditions. The IRP provides the framework and methodology for evaluating Avista’s natural gas demand and resources.
3	Elements of Plan. Each gas utility shall submit to the Commission on a biennial basis an integrated resource plan that shall include:	2018 IRP to be filed on or before August 31, 2018. The last IRP was filed on August 31, 2016.
	A range of forecasts of future gas demand in firm and interruptible markets for each customer class for one, five, and twenty years using methods that examine the effect of economic forces on the consumption of gas and that address changes in the number, type and efficiency of gas end-uses.	See Chapter 2 - Demand Forecasts and Appendix 2 et.al. for a detailed discussion of how demand was forecasted for this IRP.
	An assessment for each customer class of the technically feasible improvements in the efficient use of gas, including load management, as well as the policies and programs needed to obtain the efficiency improvements.	See Chapter 3 - Demand Side Management and DSM Appendices 3 et.al. for detailed information on the DSM potential evaluated and selected for this IRP and the operational implementation process.

	An analysis for each customer class of gas supply options, including: (1) a projection of spot market versus long-term purchases for both firm and interruptible markets; (2) an evaluation of the opportunities for using company-owned or contracted storage or production; (3) an analysis of prospects for company participation in a gas futures market; and (4) an assessment of opportunities for access to multiple pipeline suppliers or direct purchases from producers.	See Chapter 4 - Supply-Side Resources for details about the market, storage, and pipeline transportation as well as other resource options considered in this IRP. See also the procurement plan section in this same chapter for supply procurement strategies.
	A comparative evaluation of gas purchasing options and improvements in the efficient use of gas based on a consistent method for calculating cost-effectiveness.	See Methodology section of Chapter 3 - Demand-Side Resources where we describe our process on how demand-side and supply-side resources are compared on par with each other in the SENDOUT® model. Chapter 3 also includes how results from the IRP are then utilized to create operational business plans. Operational implementation may differ from IRP results due to modeling assumptions.
	The integration of the demand forecast and resource evaluations into a long-range (e.g., twenty-year) integrated resource plan describing the strategies designed to meet current and future needs at the lowest cost to the utility and its ratepayers.	See Chapter 6 - Integrated Resource Portfolio for details on how we model demand and supply coming together to provide the least cost/best risk portfolio of resources.
	A short-term (e.g., two-year) plan outlining the specific actions to be taken by the utility in implementing the integrated resource plan.	See Chapter 9 - Action Plan for actions to be taken in implementing the IRP.
4	Relationship Between Plans. All plans following the initial integrated resource plan shall include a progress report that relates the new plan to the previously filed plan.	Avista strives to meet at least bi-annually with Staff and/or Commissioners to discuss the state of the market, procurement planning practices, and any other issues that may impact resource needs or other analysis within the IRP.
5	Plans to Be Considered in Rate Cases. The integrated resource plan will be considered with other available information to evaluate the performance of the utility in rate proceedings before the Commission.	We prepare and file our plan in part to establish a public record of our plan.
6	Public Participation. In formulating its plan, the gas utility must provide an opportunity for public participation and comment and must provide methods that will be available to the public of validating predicted performance.	Avista held four Technical Advisory Committee meetings beginning in January and ending in April. See Chapter 1 - Introduction for more detail about public participation in the IRP process.

7	<p>Legal Effect of Plan. The plan constitutes the base line against which the utility's performance will ordinarily be measured. The requirement for implementation of a plan does not mean that the plan must be followed without deviation. The requirement of implementation of a plan means that a gas utility, having made an integrated resource plan to provide adequate and reliable service to its gas customers at the lowest system cost, may and should deviate from that plan when presented with responsible, reliable opportunities to further lower its planned system cost not anticipated or identified in existing or earlier plans and not undermining the utility's reliability.</p>	<p>See section titled "Avista's Procurement Plan" in Chapter 4 - Supply-Side Resources. Among other details we discuss plan revisions in response to changing market conditions.</p>
8	<p>In order to encourage prudent planning and prudent deviation from past planning when presented with opportunities for improving upon a plan, a gas utility's plan must be on file with the Commission and available for public inspection. But the filing of a plan does not constitute approval or disapproval of the plan having the force and effect of law, and deviation from the plan would not constitute violation of the Commission's Orders or rules. The prudence of a utility's plan and the utility's prudence in following or not following a plan are matters that may be considered in a general rate proceeding or other proceedings in which those issues have been noticed.</p>	<p>See also section titled "Alternate Supply-Side Scenarios" in Chapter 6 - Integrated Resource Portfolio where we discuss different supply portfolios that are responsive to changing assumptions about resource alternatives.</p>

APPENDIX 1.2: OREGON PUBLIC UTILITY COMMISSION IRP STANDARD AND GUIDELINES – ORDER 07-002

Guideline 1: Substantive Requirements		
1.a.1	All resources must be evaluated on a consistent and comparable basis.	All resource options considered, including demand-side and supply-side are modeled in SENDOUT® utilizing the same common general assumptions, approach and methodology.
1.a.2	All known resources for meeting the utility's load should be considered, including supply-side options which focus on the generation, purchase and transmission of power – or gas purchases, transportation, and storage – and demand-side options which focus on conservation and demand response.	Avista considered a range of resources including demand-side management, distribution system enhancements, capacity release recalls, interstate pipeline transportation, interruptible customer supply, and storage options including liquefied natural gas. Chapter 3 and Appendix 3.1 documents Avista's demand-side management resources considered. Chapter 4 and Appendix 6.3 documents supply-side resources. Chapter 6 and 7 documents how Avista developed and assessed each of these resources.
1.a.3	Utilities should compare different resource fuel types, technologies, lead times, in-service dates, durations and locations in portfolio risk modeling.	Avista considered various combinations of technologies, lead times, in-service dates, durations, and locations. Chapter 6 provides details about the modeling methodology and results. Chapter 4 describes resource attributes and Appendix 6.3 summarizes the resources' lead times, in-service dates and locations.
1.a.4	Consistent assumptions and methods should be used for evaluation of all resources.	Appendix 6.2 documents general assumptions used in Avista's SENDOUT® modeling software. All portfolio resources both demand and supply-side were evaluated within SENDOUT® using the same sets of inputs.
1.a.5	The after-tax marginal weighted-average cost of capital (WACC) should be used to discount all future resource costs.	Avista applied its after-tax WACC of 4.36% to discount all future resource costs. (See general assumptions at Appendix 6.2)
1.b.1	Risk and uncertainty must be considered. Electric utilities only	Not Applicable
1.b.2	Risk and uncertainty must be considered. Natural gas utilities should consider demand (peak, swing and base-load), commodity supply and price, transportation availability and price, and costs to comply with any regulation of greenhouse gas (GHG) emissions.	<p>Risk and uncertainty are key considerations in long term planning. In order to address risk and uncertainties a wide range of sensitivity, scenario and portfolio analysis is completed. A description of risk associated with each scenario is included in Appendix 2.6.</p> <p>One of the key risks is the "flat demand" risk as described in Chapter 1. Avista performed 15 sensitivities on demand. From there five demand scenarios were developed (Table 1.1) for SENDOUT® modeling purposes. Monthly demand coefficients were developed for base, heating demand while peak demand was contemplated through modeling a weather planning standard of the coldest day on record (see heating degree day data in Appendix 2.4).</p>

		<p>Avista evaluated several price forecasts and selected high, medium and low price scenarios for modeling purposes. The annual average prices are then weighted by month using fundamental forecast data. Additionally, the Henry Hub price forecasts are basis adjusted using the same fundamental forecast data.</p> <p>Four supply scenarios were also evaluated, see Table 4.3. These supply scenarios were combined with demand scenarios in order to establish portfolios for evaluation. Ultimately 9 portfolios were evaluated (See Table 6.3 for the PVRr results).</p> <p>Avista stochastic modeling techniques for price and weather variables to analyze weather sensitivity and to quantify the risk to customers under varying price environments. While there continues to be some uncertainty around GHG emission, Avista considered GHG emissions regulatory compliance costs in Appendix 3.2. As currently modeled, we include a carbon adder to our price curve to capture the costs of emission regulation.</p>
	<p>Utilities should identify in their plans any additional sources of risk and uncertainty.</p>	<p>Avista evaluated additional risks and uncertainties. Risks associated with the planning environment are detailed in Chapter 0 Introduction. Avista also analyzed demand risk which is detailed in Chapter 2. Chapter 3 discusses the uncertainty around how much DSM is achievable. Supply-side resource risks are discussed in Chapter 4. Chapter 6 and 7 discusses the variables modeled for scenario and stochastic risk analysis.</p>
<p>1c</p>	<p>The primary goal must be the selection of a portfolio of resources with the best combination of expected costs and associated risks and uncertainties for the utility and its customers.</p>	<p>Avista evaluated cost/risk tradeoffs for each of the risk analysis portfolios considered. See Chapter 5 and 6 plus supporting information in Appendix 2.6 for Avista's portfolio risk analysis and determination of the preferred portfolio.</p>
	<p>The planning horizon for analyzing resource choices should be at least 20 years and account for end effects. Utilities should consider all costs with a reasonable likelihood of being included in rates over the long term, which extends beyond the planning horizon and the life of the resource.</p>	<p>Avista used a 20-year study period for portfolio modeling. Avista contemplated possible costs beyond the planning period that could affect rates including end effects such as infrastructure decommission costs and concluded there were no significant costs reasonably likely to impact rates under different resource selection scenarios.</p>
	<p>Utilities should use present value of revenue requirement (PVRr) as the key cost metric. The plan should include analysis of current and estimated future costs of all long-lived resources such as power plants, gas storage facilities and pipelines, as well as all short-lived</p>	<p>Avista's SENDOUT® modeling software utilizes a PVRr cost metric methodology applied to both long and short-lived resources.</p>

	resources such as gas supply and short-term power purchases.	
	To address risk, the plan should include at a minimum: 1) Two measures of PVRR risk: one that measures the variability of costs and one that measures the severity of bad outcomes. 2) Discussion of the proposed use and impact on costs and risks of physical and financial hedging.	Avista, through its stochastic analysis, modeled 200 scenarios around varying gas price inputs via Monte Carlo iterations developing a distribution of Total 20 year cost estimates utilizing SENDOUT®'s PVRR methodology. Chapter 7 further describes this analysis. The variability of costs is plotted against the Expected Case while the scenarios beyond the 95 th percentile capture the severity of outcomes. Chapter 4 discusses Avista's physical and financial hedging methodology.
	The utility should explain in its plan how its resource choices appropriately balance cost and risk.	Chapter 4, 5, 6, and 7 describe various specific resource considerations and related risks, and describes what criteria we used to determine what resource combinations provide an appropriate balance between cost and risk.
1d	The plan must be consistent with the long-run public interest as expressed in Oregon and federal energy policies.	Avista considered current and expected state and federal energy policies in portfolio modeling. Chapter 6 describes the decision process used to derive portfolios, which includes consideration of state resource policy directions.
Guideline 2: Procedural Requirements		
2a	The public, including other utilities, should be allowed significant involvement in the preparation of the IRP. Involvement includes opportunities to contribute information and ideas, as well as to receive information. Parties must have an opportunity to make relevant inquiries of the utility formulating the plan.	Chapter 1 provides an overview of the public process and documents the details on public meetings held for the 2018 IRP. Avista encourages participation in the development of the plan, as each party brings a unique perspective and the ability to exchange information and ideas makes for a more robust plan.
	While confidential information must be protected, the utility should make public, in its plan, any non-confidential information that is relevant to its resource evaluation and action plan.	The entire IRP, as well as the TAC process, includes all of the non-confidential information the company used for portfolio evaluation and selection. Avista also provided stakeholders with non-confidential information to support public meeting discussions via email. The document and appendices will be available on the company website for viewing.
	The utility must provide a draft IRP for public review and comment prior to filing a final plan with the Commission.	Avista distributed a draft IRP document for external review to all TAC members on July 2, 2018 and requested comments by July 13, 2018.
Guideline 3: Plan Filing, Review and Updates		
3a	Utility must file an IRP within two years of its previous IRP acknowledgement order.	This Plan complies with this requirement as the 2016 Natural Gas IRP was acknowledged on March 21, 2017.
3b	Utility must present the results of its filed plan to the Commission at a public meeting prior to the deadline for written public comment.	Avista will work with Staff to fulfill this guideline following filing of the IRP.
3c	Commission staff and parties should complete their comments and	Pending

	recommendations within six months of IRP filing	
3d	The Commission will consider comments and recommendations on a utility's plan at a public meeting before issuing an order on acknowledgment. The Commission may provide the utility an opportunity to revise the plan before issuing an acknowledgment order	Pending
3e	The Commission may provide direction to a utility regarding any additional analyses or actions that the utility should undertake in its next IRP.	Pending
3f	Each utility must submit an annual update on its most recently acknowledged plan. The update is due on or before the acknowledgment order anniversary date. Once a utility anticipates a significant deviation from its acknowledged IRP, it must file an update with the Commission, unless the utility is within six months of filing its next IRP. The utility must summarize the update at a Commission public meeting. The utility may request acknowledgment of changes in proposed actions identified in an update	The annual update was submitted on March 1, 2018. The filing was primarily an informational filing only as Avista intends to file an updated IRP by August 31, 2018. In addition to the filing, Avista has provided updates and comparisons to its 2016 IRP during its 2018 IRP TAC meetings held on January 25, 2018, February 22, 2018, March 29, 2018, and May 10, 2018, in which Commission Staff and other TAC members were present. In addition the Company provided an update during its Natural Gas Quarterly update meeting held on August 15, 2018. No request for acknowledgement was required as no significant deviation from the 2016 IRP was anticipated.
3g	Unless the utility requests acknowledgement of changes in proposed actions, the annual update is an informational filing that: <ul style="list-style-type: none"> Describes what actions the utility has taken to implement the plan; Provides an assessment of what has changed since the acknowledgment order that affects the action plan, including changes in such factors as load, expiration of resource contracts, supply-side and demand-side resource acquisitions, resource costs, and transmission availability; and Justifies any deviations from the acknowledged action plan. 	The updates described in 3f above explained changes since acknowledgment of the 2016 IRP and an update of emerging planning issues. The updates did not request acknowledgement of any changes.
Guideline 4: Plan Components		
	At a minimum, the plan must include the following elements:	

4a	An explanation of how the utility met each of the substantive and procedural requirements.	This table summarizes guideline compliance by providing an overview of how Avista met each of the substantive and procedural requirements for a natural gas IRP.
4b	Analysis of high and low load growth scenarios in addition to stochastic load risk analysis with an explanation of major assumptions.	Avista developed six demand growth forecasts for scenario analysis. Stochastic variability of demand was also captured in the risk analysis. Chapter 2 describes the demand forecast data and Chapter 7 provides the scenario and risk analysis results. Appendix 5 details major assumptions.
4c	For electric utilities only	Not Applicable
4d	A determination of the peaking, swing and base-load gas supply and associated transportation and storage expected for each year of the plan, given existing resources; and identification of gas supplies (peak, swing and base-load), transportation and storage needed to bridge the gap between expected loads and resources.	Figures 6, 7, and 8 summarize graphically projected annual peak day demand and the existing and selected resources by year to meet demand for the expected case. Appendix 6.1 and 6.2 summarizes the peak day demand for the other demand scenarios.
4e	Identification and estimated costs of all supply-side and demand-side resource options, taking into account anticipated advances in technology	Chapter 3 and Appendix 3.1 identify the demand-side potential included in this IRP. Chapter 4 and 6 and Appendix 6.3 identify the supply-side resources.
4f	Analysis of measures the utility intends to take to provide reliable service, including cost-risk tradeoffs.	Chapter 6 and 7 discuss the modeling tools, customer growth forecasting and cost-risk considerations used to maintain and plan a reliable gas delivery system. These Chapters also capture a summary of the reliability analysis process demonstrated at the second TAC meeting. Chapter 4 discusses the diversified infrastructure and multiple supply basin approach that acts to mitigate certain reliability risks. Appendix 2.6 highlights key risks associated with each portfolio.
4g	Identification of key assumptions about the future (e.g. fuel prices and environmental compliance costs) and alternative scenarios considered.	Appendix 7 and Chapter 7 describe the key assumptions and alternative scenarios used in this IRP.
4h	Construction of a representative set of resource portfolios to test various operating characteristics, resource types, fuels and sources, technologies, lead times, in-service dates, durations and general locations - system-wide or delivered to a specific portion of the system.	This Plan documents the development and results for portfolios evaluated in this IRP (see Table 4.3 for supply scenarios considered).
4i	Evaluation of the performance of the candidate portfolios over the range of identified risks and uncertainties.	We evaluated our candidate portfolio by performing stochastic analysis using SENDOUT® varying price under 200 different scenarios. Additionally, we test the portfolio of options with the use of SENDOUT® under deterministic scenarios where demand and price vary. For resources selected, we assess other risk factors such as varying lead times required and

		potential for cost overruns outside of the amounts included in the modeling assumptions.
4j	Results of testing and rank ordering of the portfolios by cost and risk metric, and interpretation of those results.	Avista's four distinct geographic Oregon service territories limit many resource option synergies which inherently reduces available portfolio options. Feasibility uncertainty, lead time variability and uncertain cost escalation around certain resource options also reduce reasonably viable options. Chapter 4 describes resource options reviewed including discussion on uncertainties in lead times and costs as well as viability and resource availability (e.g. LNG). Appendix 6.3 summarizes the potential resource options identifying investment and variable costs, asset availability and lead time requirements while results of resources selected are identified in Table 6.5 as well as graphically presented in Figure 6.18 and 6.19 for the Expected Case and Appendix 7.1 for the High Growth case.
4k	Analysis of the uncertainties associated with each portfolio evaluated	See the responses to 1.b above.
4l	Selection of a portfolio that represents the best combination of cost and risk for the utility and its customers	Avista evaluated cost/risk tradeoffs for each of the risk analysis portfolios considered. Chapter 6 and Appendix 2.6 show the company's portfolio risk analysis, as well as the process and determination of the preferred portfolio.
4m	Identification and explanation of any inconsistencies of the selected portfolio with any state and federal energy policies that may affect a utility's plan and any barriers to implementation	This IRP is presumed to have no inconsistencies.
4n	An action plan with resource activities the utility intends to undertake over the next two to four years to acquire the identified resources, regardless of whether the activity was acknowledged in a previous IRP, with the key attributes of each resource specified as in portfolio testing.	Chapter 9 presents the IRP Action Plan with focus on the following areas: <ul style="list-style-type: none"> Modeling Supply/capacity/distribution Forecasting Regulatory communication DSM
Guideline 5: Transmission		
5	Portfolio analysis should include costs to the utility for the fuel transportation and electric transmission required for each resource being considered. In addition, utilities should consider fuel transportation and electric transmission facilities as resource options, taking into account their value for making additional purchases and sales, accessing less costly resources in remote	Not applicable to Avista's gas utility operations.

	locations, acquiring alternative fuel supplies, and improving reliability.	
Guideline 6: Conservation		
6a	Each utility should ensure that a conservation potential study is conducted periodically for its entire service territory.	AEG performed a conservation potential assessment study for our 2018 IRP. A discussion of the study is included in Chapter 3. The full study document is in Appendix 3.1. Avista incorporates a comprehensive assessment of the potential for utility acquisition of energy-efficiency resources into the regularly-scheduled Integrated Resource Planning process.
6b	To the extent that a utility controls the level of funding for conservation programs in its service territory, the utility should include in its action plan all best cost/risk portfolio conservation resources for meeting projected resource needs, specifying annual savings targets.	A discussion on the treatment of conservation programs is included in Chapter 3 while selection methodology is documented in Chapter 6. The action plan details conservation targets, if any, as developed through the operational business planning process. These targets are updated annually, with the most current avoided costs. Given the challenge of the low cost environment, current operational planning and program evaluation is still underway and targets for Oregon have not yet been set.
6c	To the extent that an outside party administers conservation programs in a utility's service territory at a level of funding that is beyond the utility's control, the utility should: 1) determine the amount of conservation resources in the best cost/ risk portfolio without regard to any limits on funding of conservation programs; and 2) identify the preferred portfolio and action plan consistent with the outside party's projection of conservation acquisition.	Not applicable. See the response for 6.b above.
Guideline 7: Demand Response		
7	Plans should evaluate demand response resources, including voluntary rate programs, on par with other options for meeting energy, capacity, and transmission needs (for electric utilities) or gas supply and transportation needs (for natural gas utilities).	Avista has periodically evaluated conceptual approaches to meeting capacity constraints using demand-response and similar voluntary programs. Technology, customer characteristics and cost issues are hurdles for developing effective programs. See Chapter 3 Demand Response section for more discussion.
Guideline 8: Environmental Costs		
8	Utilities should include, in their base-case analyses, the regulatory compliance costs they expect for CO ₂ , NO _x , SO ₂ , and Hg emissions. Utilities should analyze the range of potential CO ₂ regulatory costs in Order No. 93-695, from \$0 - \$40 (1990\$). In addition, utilities should perform sensitivity analysis on a range of reasonably possible cost adders for NO _x , SO ₂ , and Hg, if applicable.	Avista's current direct gas distribution system infrastructure does not result in any CO ₂ , NO _x , SO ₂ , or Hg emissions. Upstream gas system infrastructure (pipelines, storage facilities, and gathering systems) do produce CO ₂ emissions via compressors

		used to pressurize and move gas throughout the system. The Environmental Externalities discussion in Appendix 3.2 describes our analysis performed. See also the guidelines addendum reflecting revised guidance for environmental costs per Order 08-339.
Guideline 9: Direct Access Loads		
9	An electric utility's load-resource balance should exclude customer loads that are effectively committed to service by an alternative electricity supplier.	Not applicable to Avista's gas utility operations.
Guideline 10: Multi-state utilities		
10	Multi-state utilities should plan their generation and transmission systems, or gas supply and delivery, on an integrated-system basis that achieves a best cost/risk portfolio for all their retail customers.	The 2018 IRP conforms to the multi-state planning approach.
Guideline 11: Reliability		
11	Electric utilities should analyze reliability within the risk modeling of the actual portfolios being considered. Loss of load probability, expected planning reserve margin, and expected and worst-case unserved energy should be determined by year for top-performing portfolios. Natural gas utilities should analyze, on an integrated basis, gas supply, transportation, and storage, along with demand-side resources, to reliably meet peak, swing, and base-load system requirements. Electric and natural gas utility plans should demonstrate that the utility's chosen portfolio achieves its stated reliability, cost and risk objectives.	Avista's storage and transport resources while planned around meeting a peak day planning standard, also provides opportunities to capture off season pricing while providing system flexibility to meet swing and base-load requirements. Diversity in our transport options enables at least dual fuel source options in event of a transport disruption. For areas with only one fuel source option the cost of duplicative infrastructure is not feasible relative to the risk of generally high reliability infrastructure.
Guideline 12: Distributed Generation		
12	Electric utilities should evaluate distributed generation technologies on par with other supply-side resources and should consider, and quantify where possible, the additional benefits of distributed generation.	Not applicable to Avista's gas utility operations.
Guideline 13: Resource Acquisition		
13a	An electric utility should: identify its proposed acquisition strategy for each resource in its action plan; Assess the advantages and disadvantages of owning a resource instead of purchasing power from another party; identify any Benchmark Resources it plans to consider in competitive bidding.	Not applicable to Avista's gas utility operations.

<p>13b</p>	<p>Natural gas utilities should either describe in the IRP their bidding practices for gas supply and transportation, or provide a description of those practices following IRP acknowledgment.</p>	<p>A discussion of Avista’s procurement practices is detailed in Chapter 4.</p>
<p>Guideline 8: Environmental Costs</p>		
<p>a.</p>	<p>BASE CASE AND OTHER COMPLIANCE SCENARIOS: The utility should construct a base-case scenario to reflect what it considers to be the most likely regulatory compliance future for carbon dioxide (CO₂), nitrogen oxides, sulfur oxides, and mercury emissions. The utility also should develop several compliance scenarios ranging from the present CO₂ regulatory level to the upper reaches of credible proposals by governing entities. Each compliance scenario should include a time profile of CO₂ compliance requirements. The utility should identify whether the basis of those requirements, or “costs”, would be CO₂ taxes, a ban on certain types of resources, or CO₂ caps (with or without flexibility mechanisms such as allowance or credit trading or a safety valve). The analysis should recognize significant and important upstream emissions that would likely have a significant impact on its resource decisions. Each compliance scenario should maintain logical consistency, to the extent practicable, between the CO₂ regulatory requirements and other key inputs.</p>	<p>Avista’s current direct gas distribution system infrastructure does not result in any CO₂, NO_x, SO₂, or Hg emissions. Upstream gas system infrastructure (pipelines, storage facilities, and gathering systems) do produce CO₂ emissions via compressors used to pressurize and move gas throughout the system.</p> <p>The Environmental Externalities discussion in Appendix 3.2 describes our process for addressing these costs.</p>
<p>b.</p>	<p>TESTING ALTERNATIVE PORTFOLIOS AGAINST THE COMPLIANCE SCENARIOS: The utility should estimate, under each of the compliance scenarios, the present value of revenue requirement (PVRR) costs and risk measures, over at least 20 years, for a set of reasonable alternative portfolios from which the preferred portfolio is selected. The utility should incorporate end-effect considerations in the analyses to allow for comparisons of portfolios containing resources with economic or physical lives that extend beyond the planning period. The utility should also modify projected lifetimes as necessary to be consistent with the compliance scenario under analysis. In addition, the utility should include, if material, sensitivity analyses on a range of reasonably possible regulatory futures for nitrogen oxides, sulfur oxides, and mercury to further inform the preferred portfolio selection.</p>	<p>The Environmental Externalities discussion in Appendix 3.2 describes our process for addressing these costs.</p>

APPENDIX 2.1: ECONOMIC OUTLOOK AND CUSTOMER COUNT FORECAST

I. Service Area Economic Performance and Outlook

Avista’s core service area for natural gas includes Eastern Washington, Northern Idaho, and Southwest Oregon. Smaller service islands are also located in rural South-Central Washington and Northeast Oregon. Our service area is dominated by four metropolitan statistical areas (MSAs): the Spokane-Spokane Valley, WA MSA (Spokane-Stevens counties); the Coeur d’Alene, ID MSA (Kootenai County); the Lewiston-Clarkson, ID-WA MSA (Nez Perce-Asotin counties); the Medford, OR MSA (Jackson County); and Grants Pass, OR MSA (Josephine County). These five MSAs represent the primary demand for Avista’s natural gas and account for 75% of both customers (i.e., meters) and load. The remaining 25% of customers and load are spread over low density rural areas in all three states.

Figure 1: Employment and Population Recovery, December 2007- June 2018

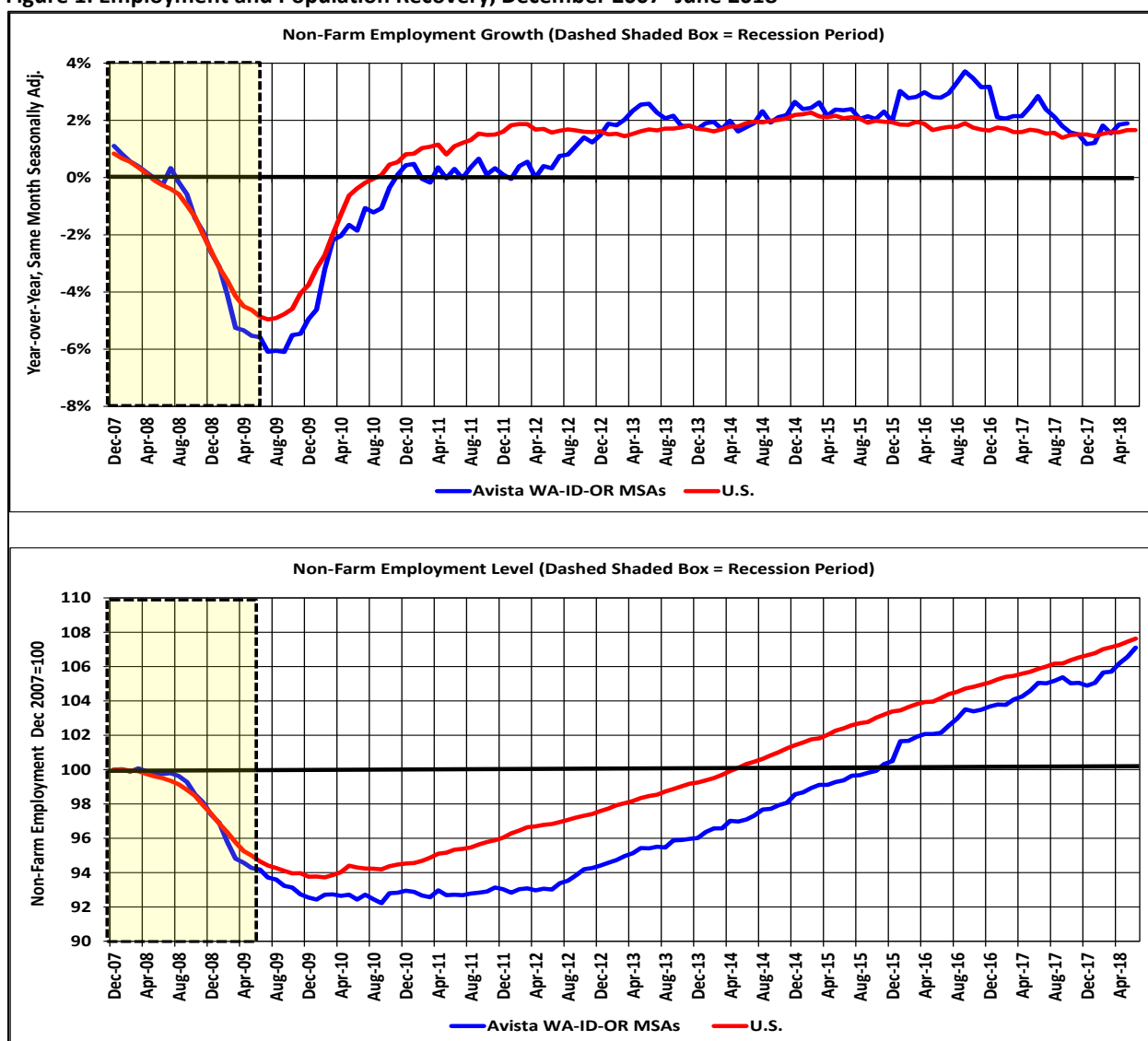

Data source: Employment from the BLS; population from the U.S. Census.

In the wake of the Great Recession, our service area recovered more slowly than the U.S. Although the U.S. recession officially ended in June 2009 (dated by the National Bureau of Economic Research), our service area did

not start a significant employment recovery until the second half of 2012 (Figure 1, top and bottom graph). However, by the end of 2015, year-over-year employment growth exceeded U.S. growth and employment levels returned to pre-recession levels. Due to strong employment growth in 2016 and 2017, the total percentage gain in employment was roughly the same as the U.S. by the middle of 2018. As a result, service area population growth, which is significantly influenced by in-migration through employment opportunities, continued to improve since the last IRP (Figure 2).

Figure 2: Avista MSA Annual Population Growth, 2005-2017

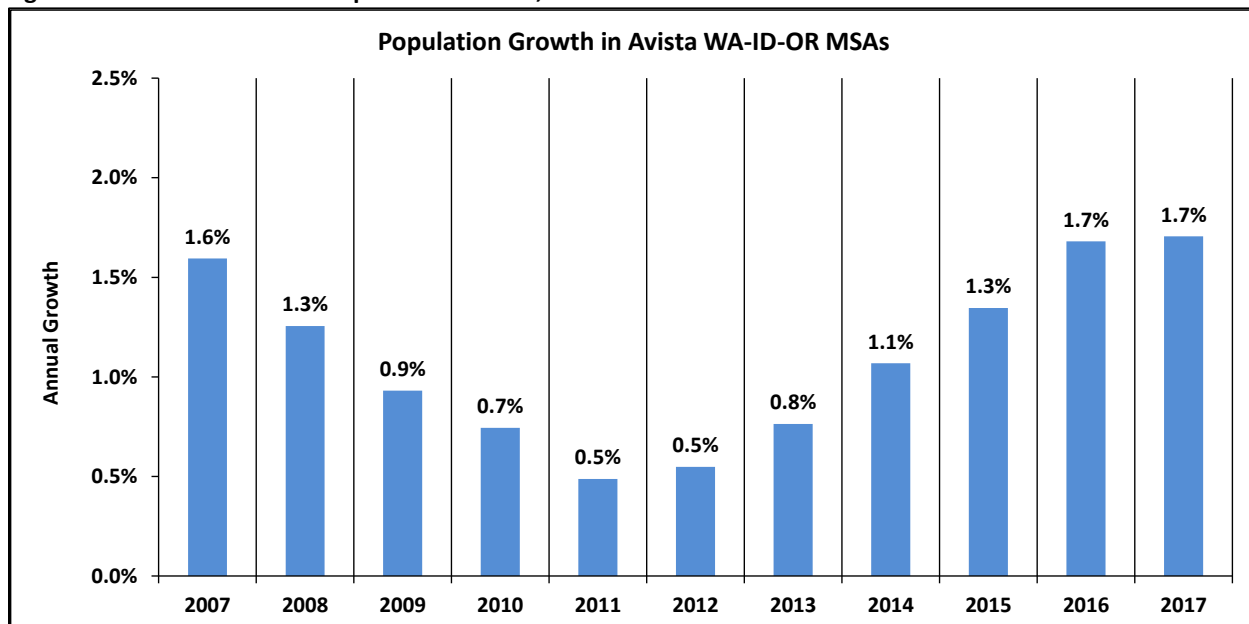

In 2011, Avista’s MSA population growth fell to around 0.6%, the lowest since the late 1980s, but has increased to around 1.7% by 2017. This is important because population growth is a significant contributor to overall customer growth.

Figure 3 shows that compared to forecasted customer growth in the 2016 IRP, actual average customer growth in WA-ID over the 2016-2017 period is considerably higher. This reflects (1) stronger than expected population growth and (2) Avista’s LEAP gas conversion program in WA. The structure of the LEAP program, which expires in September 2019, was unknown at the time of the 2016 IRP. In contrast, OR’s actual growth rate is slightly lower than forecasted over the same period. This reflects actual population growth being lower than the forecast assumption in the 2016 IRP. Given that average annual population forecast over this period was close to actual growth, reflects a lower than expected level of conversions by existing households. This can be seen in Figure 4 (bottom graph) which shows that since 2015, customer growth in the OR service area is nearly identical to population growth. The presence of significant conversions would generate customer growth that exceeds population growth, as can be seen in WA-ID (top graph).

Given the impact of the LEAP program and stronger than expected population growth since 2016 IRP, this IRP shows an upward revision of approximately 16,750 customers in WA-ID by 2037. That is, because the 2018 IRP forecast is starting from a higher than expected base, this generates a higher forecast out to 2037. In contrast, OR’s forecast shows approximately 4,700 fewer forecasted customers in 2037 compared to 2016 IRP. This change reflects lower forecasted population growth compared to the 2016 IRP, especially in the Medford and Klamath service regions. System-wide, this is an upward revision of approximately 13,500 customers. Figure 5 and Table 1 show the change in the customer forecast by for the system and by class between the 2016 and 2018 IRPs.

Figure 3: Comparison of 2014-IRP Customer Growth Forecasts to Actuals, 2016-2017

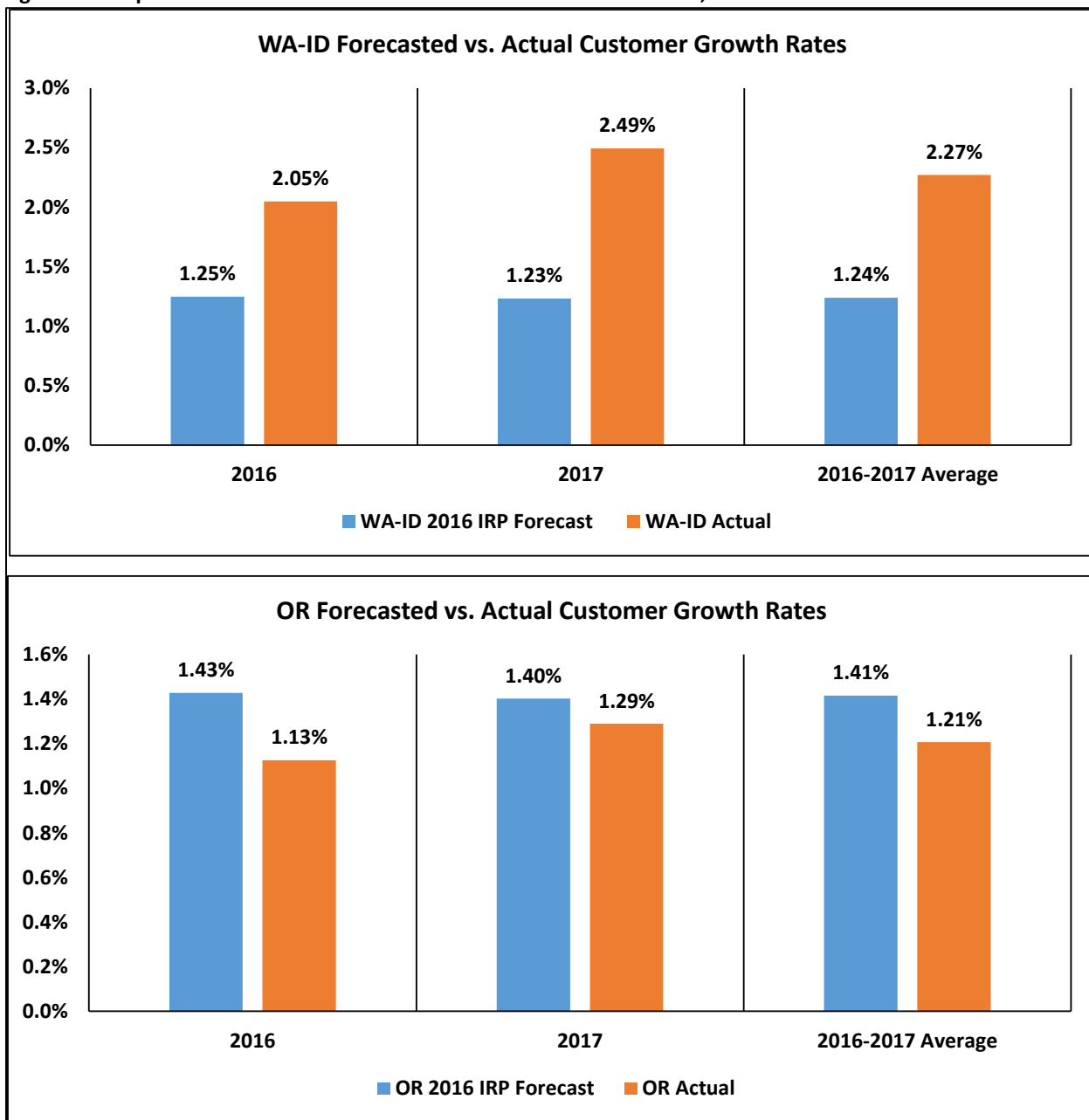

Data source: Company data.

Figure 4: Customer and Population Growth, 2005-2017

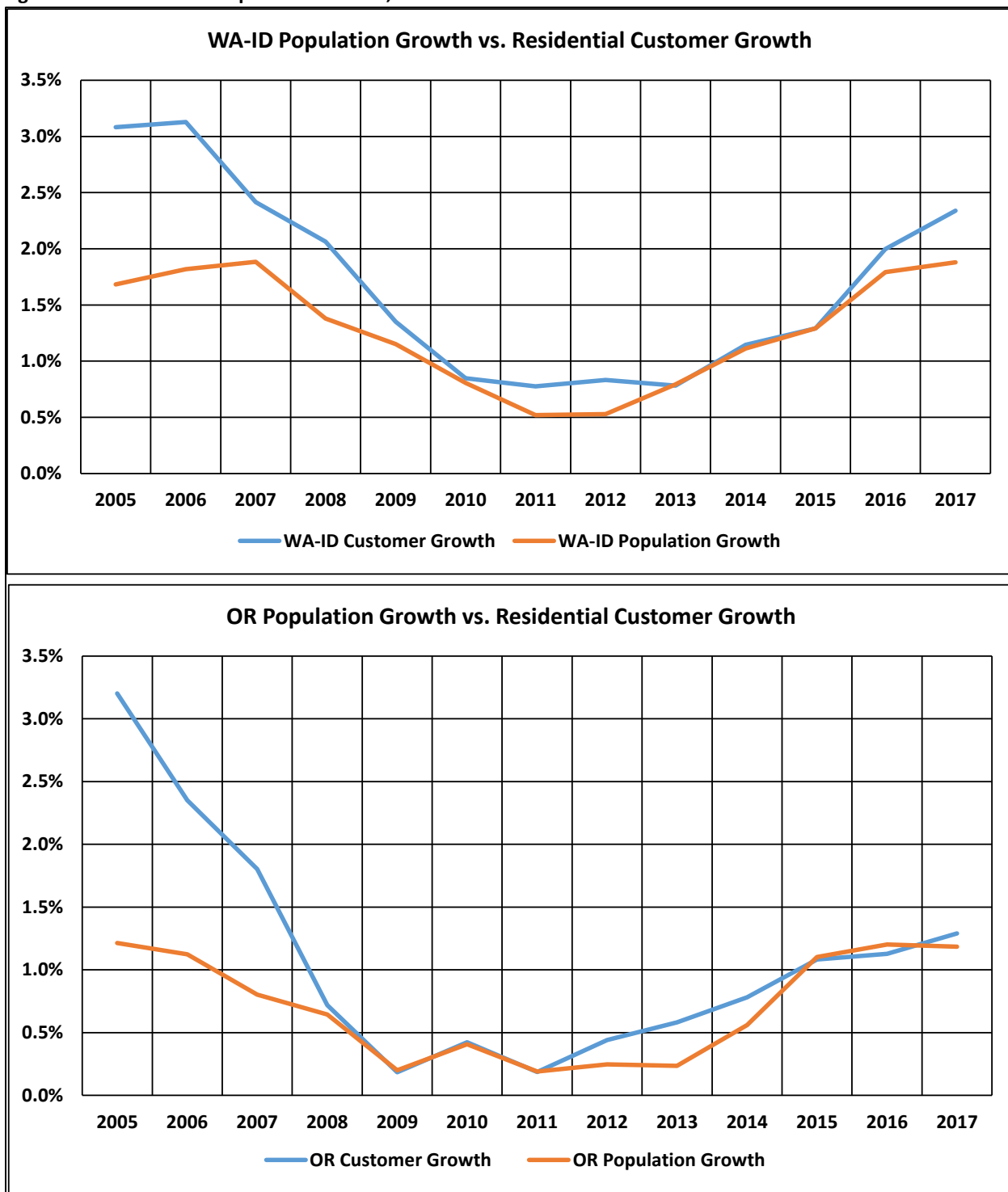

Data source: Company data.

Table 1: Change in Forecast between the 2016 IRP and 2018 IRP in 2037

Area	Residential	Commercial	Industrial	Total Change
WA-ID	+16,174	+608	-32	+16,750
OR	-4,755	+103	-2	-4,654
System	+11,419	+711	-34	+12,906

Figure 5: Comparison IRP Forecasted Customer Growth in WA-ID and OR, 2017-2037

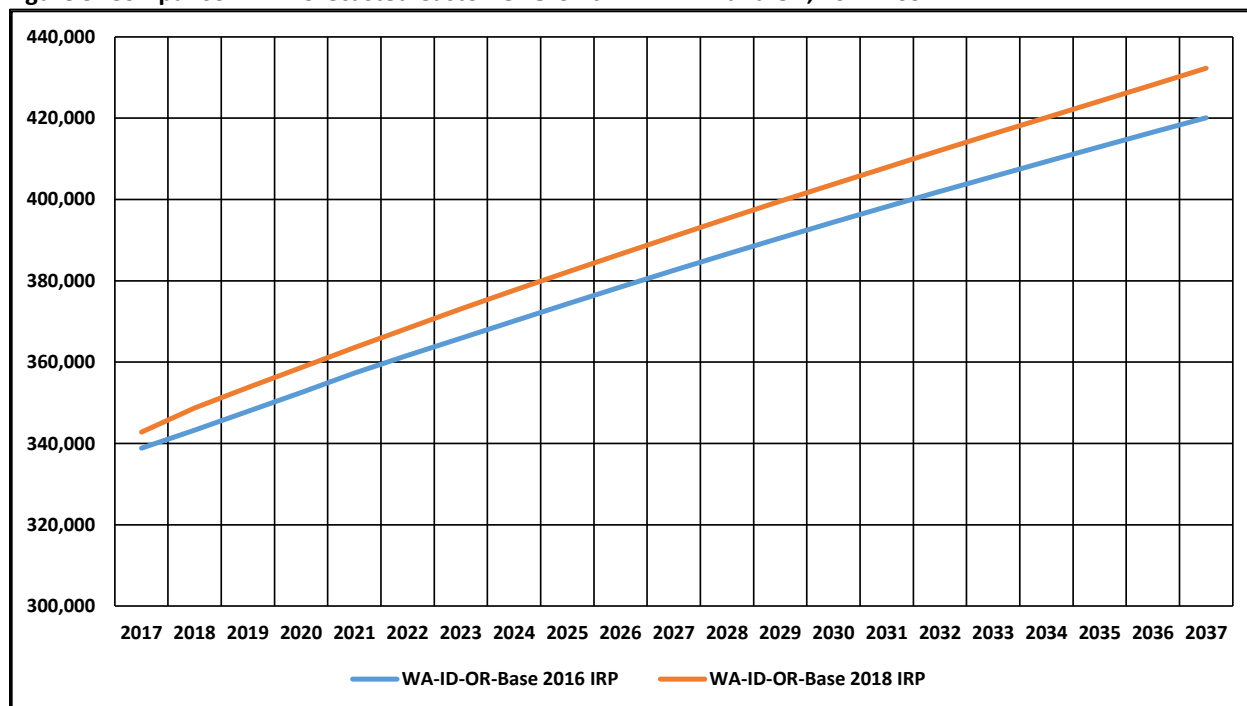

Data source: Company data.

In past IRPs, the modeling approach for the majority of commercial customers *assumed* that residential customer growth is a driver of commercial customer growth. This is still the case for ID and OR. The use of residential customers as forecast driver for commercial customers reflects the historically high correlation between residential and commercial customer growth rates. However, because of the LEAP program, residential customers is no longer the primary driver in the commercial forecast in WA. The LEAP program altered the historical relationship between residential and commercial customer growth because the program was not offered to commercial customers. As a result, population has replaced residential customers as the direct driver of commercial customer forecast.

The forecast for system-wide industrial customers is lower compared to the 2016 IRP. Approximately 90% of industrial customers are in WA-ID. Figure 6 (top graph) shows total system-wide firm industrial customers since 2004. Following a sharp drop over the 2004-2006 period, firm industrial customers have remained stable at around 260. Separating out WA-ID and OR (middle graph), the number of firm customers in WA-ID continuously fell over the 2004-2011 period. In contrast, OR customers increased over the 2004-2011 period (bottom graph). However, after a period of stability during the 2011-2014 period, customer declined modestly. That is, over the last five years there has been no appreciable change in firm industrial customers our service area. Therefore, in contrast to the 2016 IRP which showed a flat industrial base, the current forecast shows a declining base.

Figure 7: Industrial Customer Count, 2004-2017



Data source: Company data.

II. IRP Forecast Process and Methodology

The customer forecasts are generated from forecasting models that are either regression models with ARIMA error corrections or simple smoothing models. The ARIMA error correction models are estimated using SAS/ETS software. The customer forecasts are used as input into Sendout® to generate the IRP load forecasts.

Population growth is the key driver for the residential and commercial customer forecasts. Other variables include (1) seasonal dummy variables and (2) outlier dummy variables that control for extreme customer counts associated with double billing, software conversions, and customer movements from one billing schedule to another.

Population growth forecast is the key driver behind the customer forecast for residential schedules 101 in WA-ID and 410 in OR. These two schedules represent the majority of customers and, therefore, drive overall residential customer growth. Because of their size and growth potential, a multi-step forecasting process has been developed for the Spokane-Spokane Valley, Coeur d’Alene, and Medford MSAs. The process for forecasting population growth starts with an intermediate forecast horizon (seven years). This medium-term forecast is typically used for the annual financial forecast. However, during IRP years, this medium-term forecast horizon is augmented with third party forecasts that cover the next twenty years. Starting with Figure 8, the six-year population forecast is a multi-step process that begins with a GDP forecast that drives the regional employment forecast, which in turn, drives a six year population forecast.

Figure 8: Forecasting Population Growth, 2018-2024

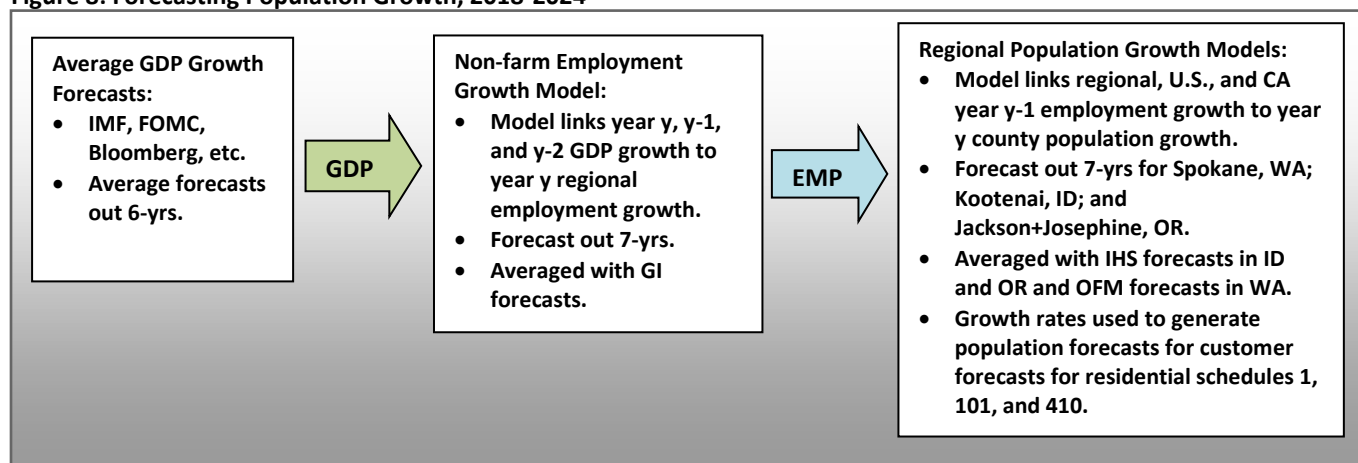

The forecasting models for regional employment growth are:

$$[1] GEMP_{y,SPK} = \vartheta_0 + \vartheta_1 GGDP_{y,US} + \vartheta_2 GGDP_{y-1,US} + \vartheta_3 GGDP_{y-2,US} + \omega_{SC} D_{KC,1998-2000=1} + \omega_{SC} D_{HB,2005-2007=1} + \epsilon_{t,y}$$

$$[2] GEMP_{y,KOOT} = \delta_0 + \delta_1 GGDP_{y,US} + \delta_2 GGDP_{y-1,US} + \delta_3 GGDP_{y-2,US} + \omega_{OL} D_{1994=1} + \omega_{OL} D_{2009=1} + \omega_{SC} D_{HB,2005-2007=1} + \epsilon_{t,y}$$

$$[3] GEMP_{y,JACK+JOS} = \phi_0 + \phi_1 GGDP_{y,US} + \phi_2 GGDP_{y-1,US} + \phi_3 GGDP_{y-2,US} + \omega_{SC} D_{HB,2004-2005=1} + ARIMA\epsilon_{t,y} (1,0,0)(0,0,0)_{12}$$

SPK is Spokane, WA (Spokane MSA), KOOT is Kootenai, ID (Coeur d’Alene MSA), and JACK+JOS is for the combination of Jackson County, OR (Medford MSA) and Josephine County, OR (Grants Pass MSA). $GEMP_y$ is employment growth in year y, $GGDP_{y,US}$ is U.S. real GDP growth in year y. D_{KC} is a dummy variable for the collapse of Kaiser Aluminum in Spokane, and D_{HB} is a dummy for the housing bubble, specific to each region. The average GDP forecasts are used in the estimated model to generate five-year employment growth forecasts. The employment forecasts are then averaged with IHS’s forecasts for the same counties so that:

$$[4] F_{Avg}(GEMP_{y,SPK}) = \frac{F(GEMP_{y,SPK}) + F(GIHSEMP)_{y,SPK}}{2}$$

$$[5] F_{Avg}(GEMP_{y,KOOT}) = \frac{F(GEMP_{y,KOOT}) + F(GIHSEMP_{y,KOOT})}{2}$$

$$[6] F_{Avg}(GEMP_{y,JACK}) = \frac{F(GEMP_{y,JACK}) + F(GIHSEMP_{y,JACK})}{2}$$

Averaging reduces the systematic errors of a single-source forecast. The averages [8.4] through [8.6] are used to generate the population growth forecasts, which are described next.

The forecasting models for regional population growth are:

$$[7] GPOP_{y,SPK} = \kappa_0 + \kappa_1 GEMP_{y-1,SPK} + \kappa_2 GEMP_{y-2,US} + \omega_{OL} D_{2001=1} + \epsilon_{t,y}$$

$$[8] GPOP_{y,KOOT} = \alpha_0 + \alpha_1 GEMP_{y-1,KOOT} + \alpha_2 GEMP_{y-2,US} + \omega_{OL} D_{1994=1} + \omega_{OL} D_{2002=1} + \omega_{SC} D_{HB,2007\uparrow=1} + \epsilon_{t,y}$$

$$[9] GPOP_{y,JACK+JOS} = \psi_0 + \psi_1 GEMP_{y-1,JACK+JOS} + \psi_2 GEMP_{y-2,CA} + \omega_{OL} D_{1991=1} + \omega_{SC} D_{HB,2004-2006=1} + \epsilon_{t,y}$$

$D_{2001=1}$ and $D_{1991=1}$ are a dummy variables for recession impacts. $GEMP_{y-1,US}$ is U.S. employment growth in year $y-1$ and $GEMP_{y-2,US}$ is U.S. employment growth in year $y-2$, and CA is California Employment growth in year $y-1$. Because of its close proximity to CA, CA employment growth is better predictor of Jackson, OR employment growth than U.S. growth. The averages [8.4] through [8.6] are used in [7] through [9] to generate population growth forecasts. These forecasts are combined with IHS's forecasts for Kootenai, ID; Jackson, OR; Josephine, OR, and the Office for Financial Management (OFM) for Spokane, WA in the form of a simple average:

$$[10] F_{Avg}(GPOP_{y,SPK}) = \frac{F(GPOP_{y,SPK}) + F(GOFMPOP_{y,SPK})}{2}$$

$$[11] F_{Avg}(GPOP_{y,KOOT}) = \frac{F(GPOP_{y,KOOT}) + F(GIHSPOP_{y,KOOT})}{2}$$

$$[12] F_{Avg}(GPOP_{y,JACK+JOS}) = \frac{F(GPOP_{y,JACK+JOS}) + F(GIHSPOP_{y,JACK+JOS})}{2}$$

Here, $F_{Avg}(GPOP_y)$ is used to forecast population to forecast residential customers in schedules 101 (WA-ID) and 410 (OR) for the Spokane, Kootenai, and Jackson+Josephine areas. In the case of Spokane, OFM forecasts are used because the IHS's forecasts exhibit a level and time-path that is inconsistent with recent population behavior. The population growth forecasts for the Douglas (Roseburg), Klamath (Klamath Falls); and Union (La Grande) counties come directly from IHS. Since all forecasted growth rates are annualized, they are converted to monthly rates as $F_{Avg}(GPOP_{t,y}) = [1 + F_{Avg}(GPOP_y)]^{1/12} - 1$. By way of example, the following is regression model for residential 101 customers for the Spokane region:

$$C_{t,y,WA101,r} = \alpha_0 + \tau POP_{t,y,SPK} + \omega_{SD} D_{t,y} + \omega_{SC} D_{Jan 2007\uparrow=1} + \gamma_{RAMP} T_{Jan 2007} + \omega_{OL} D_{Oct 2005=1} \\ + \omega_{OL} D_{Aug 2010=1} + \omega_{OL} D_{Sep 2012=1} + \omega_{OL} D_{Feb 2015=1} + \omega_{OL} D_{Oct 2015=1} \\ + \omega_{OL} D_{Feb 2016=1} + \omega_{OL} D_{Mar 2018=1} + ARIMA\epsilon_{t,y} (11,1,0)(0,0,0)_{12}$$

Where:

$\tau POP_{t,y,SPK} = \tau$ is the coefficient to be estimated and $POP_{t,y,SPK}$ is the interpolated population level in month t , in year y , for Spokane. The monthly interpolation of historical data assumes that between years, population accumulates following the standard population growth model: $POP_{y,SPK} = POP_{y-1,SPK} e^r$.

$\omega_{SD} D_{t,y} = \omega_{SD}$ is a vector of seasonal dummy (SD) coefficients to be estimated and $D_{t,y}$ is a vector monthly seasonal dummies to account of customer seasonality. $D_{t,y} = 1$ for the relevant month.

$\omega_{SC} D_{Jan 2007\uparrow=1} + \gamma_{Ramp} T_{Jan 2007} =$ structural change (SC) and trend (Ramp) coefficients and variables that control for the sharp fall in residential customer growth that cannot be fully accounted for by the population variable. This reflects the impact of the housing bubble collapse and the subsequent Great Recession. D_{Jan}

$\omega_{2007 \uparrow = 1}$ takes a value of 1 over both the estimation and forecast period starting in January 2007, and $T_{Jan 2007}$ is a linear time-trend that starts in January 2007 and continues over the estimation and forecast period.

$\omega_{OL} D_{Oct 2005=1}$ = ω_{OL} outlier (OL) coefficient to be estimated and D is a dummy that equals 1 for August 2010. There are three additional outlier dummies that follow August 2010.

$ARIMA_{\epsilon,t,y}(11,1,0)(0,0,0)_{12}$ is the error correction applied to the model's initial error structure. This term follows the following from $ARIMA_{\epsilon,t,y}(p,d,q)(p_k,d_k,q_k)_k$. The term p is the autoregressive (AR) order, d is the differencing order, and q is the moving average (MA) order. The term p_k is the order of seasonal AR terms, d_k is the order of seasonal differencing, and q_k is the seasonal order of MA terms. The seasonal values are related to "k," which is the frequency of the data. With the current data set, $k = 12$.

The customer forecast is generated by inputting forecasted values of $POP_{t,y,SPK}$ into the model estimated with historical data. All customer forecast equations are shown in the last section.

The above describes the population forecast for the annual six-year forecast. For IRP years, the customer forecast needs to be extended out an additional 15 years beyond medium term forecast. This is done using the IHS population forecast for Kootenai, Jackson+Josephine, Douglas, Klamath, and Union counties. That is, IHS is the sole source for forecasted population growth beyond the seven-year time horizon generated by [10] through [12]. In the case of Spokane County, the forecast from Washington's Office of Financial Management (OFM) is instead of IHS's. The choice to use OFM's forecasts reflects the unusually sharp changes that have occurred in the IHS forecasts for the Spokane MSA over a short period of time. Figure 9 shows how much these forecasts have changed in level and shape since June 2012. From the October 2015 to March 2017 forecasts, there was as significant changes for the 2015-2019 period. There is no clear rational for why IHS's forecasts changed so significantly between 2012 and 2017.

Figure 9: Spokane MSA Forecast Comparison

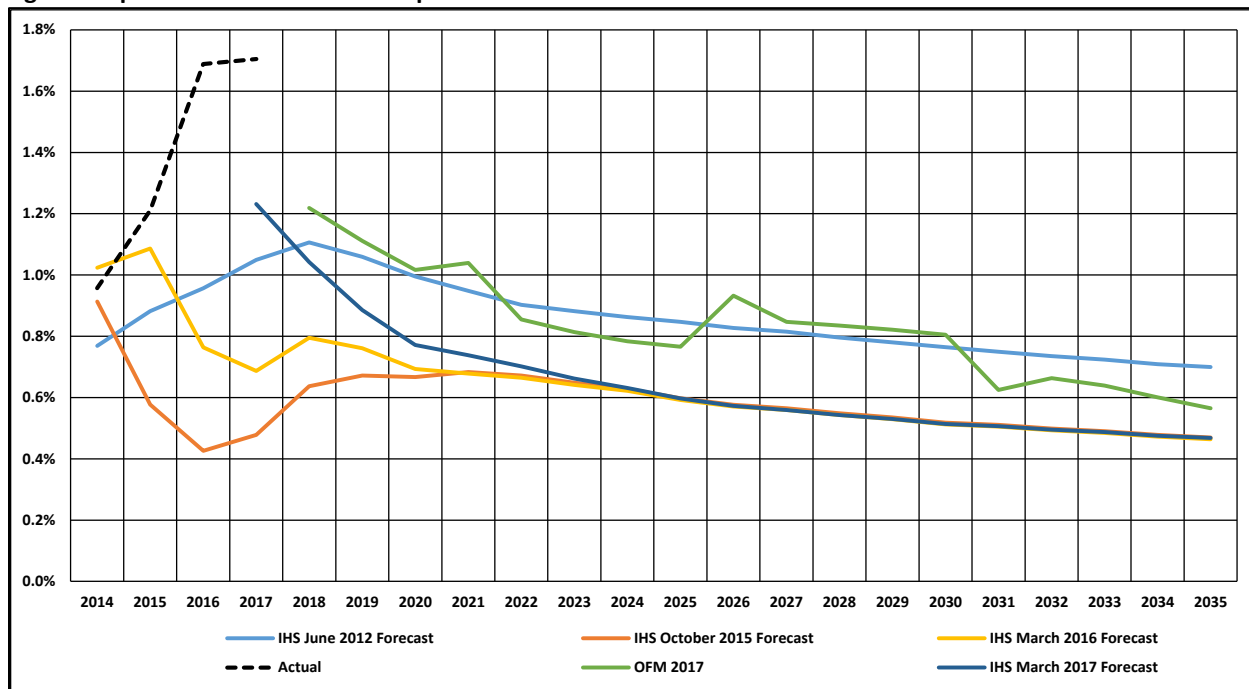

Data source: IHS, Washington State of Office of Financial Management, and U.S. Census.

Figure 10: Annual Customer Growth for the Three Rate Classes, 2005-2017

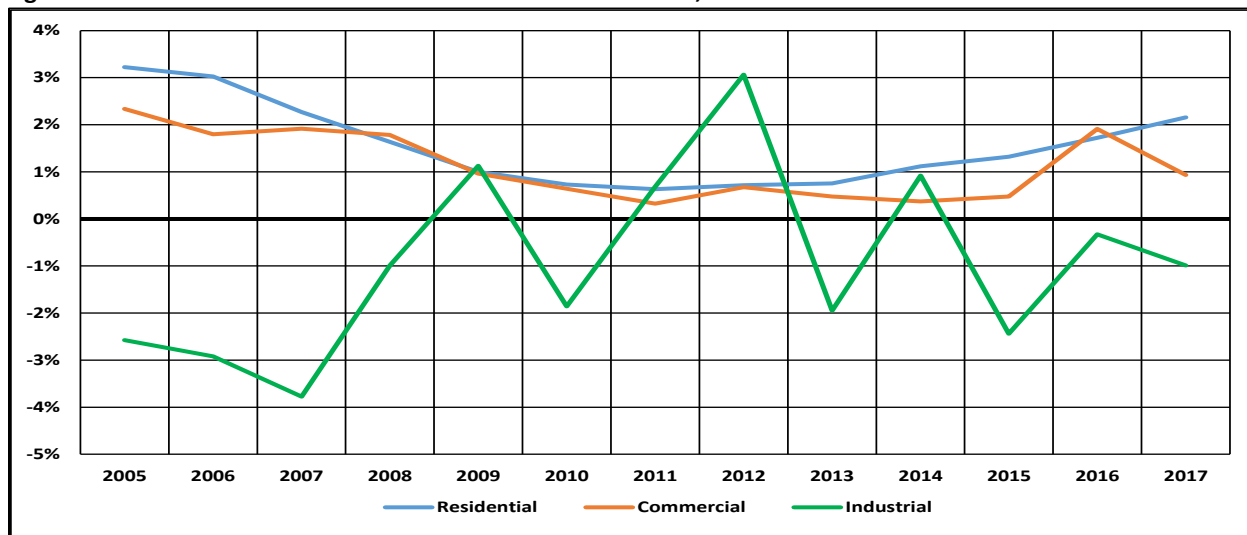

Data source: Company data.

Figure 10 demonstrates that residential and commercial growth rates are highly correlated and maintain similar levels over the long-run—over the period shown, residential and commercial averaged about 1.6% and 1.1%, respectively. This growth is slightly higher than population growth because of the housing boom and existing households converting to natural gas. However, by 2009, with the collapse of the housing bubble and increased natural gas saturation, customer growth moved closer to population growth.

In contrast, the behavior of Industrial customer growth looks quite different. Customer growth is both lower and more volatile. The average growth rate since 2005 is -1.0%, reflecting a trend of nearly flat or slowly declining customers, depending on the jurisdiction. In addition, the standard deviation of year-over-year growth is 1.9% compared to 0.9% for residential and 0.7% for commercial growth. The current IRP forecast reflects this historical trend of weak growth. Some energy industry analysts believe the U.S.’s increased supply of natural gas and oil will attract industrial production back from overseas locations. However, in this IRP, we do not assume plentiful energy supplies in the U.S. will alter long-run trends in industrial customer growth in our service area.

Establishing High-Low Cases for IRP Customer Forecast

The customer forecasts for this IRP include high and low cases that set the expected bounds around the base-case. Table 2 shows the base, low, and high customer forecasts along with the underlying population growth assumption. The underlying population forecast is the primary driver for each of the three cases.

Table 2: Alternative Growth Cases, 2018-2037

Area	Low Growth	Base Growth	High Growth
WA-ID:			
WA-ID Customers	0.9%	1.3%	1.6%
WA Population	0.5%	0.8%	1.1%
ID Population	1.1%	1.6%	2.1%
OR:			
OR Customers	0.6%	0.9%	1.3%
OR Population	0.5%	0.8%	1.1%
System:			
System Customers	0.8%	1.2%	1.5%
System Population	0.5%	0.9%	1.2%

III. IRP Customer Forecast Equations

1. WA residential customer forecast models:

$$[1] C_{t,y,WA101.r} = \alpha_0 + \tau POP_{t,y,SPK} + \omega_{SD} D_{t,y} + \omega_{SC} D_{Jan\ 2007\uparrow=1} + \gamma_{RAMP} T_{Jan\ 2007} + \omega_{OL} D_{Oct\ 2005=1} + \omega_{OL} D_{Aug\ 2010=1} + \omega_{OL} D_{Sep\ 2012=1} + \omega_{OL} D_{Feb\ 2015=1} + \omega_{OL} D_{Oct\ 2015=1} + \omega_{OL} D_{Feb\ 2016=1} + ARIMA\epsilon_{t,y} (11,1,0)(0,0,0)_{12}$$

[1] Model notes:

1. SC dummy and ramping time trend control for a change in the time-path of customer growth starting in January 2007.

$$[2] C_{t,y,WA102.r} = \begin{cases} \frac{1}{12} \sum_{j=1}^{12} C_{t-j} & \text{for remaining months in current year, } y_c \\ C_{cap} & \text{for } y_{c+j} \text{ where } j = 1, \dots, 23 \end{cases}$$

[2] Model notes:

1. WA schedule 102 customers are schedule 101 customers that have been moved to a new low-income schedule. The schedule started in October 2015, so there is insufficient data for a more complicated model. The schedule is currently capped at 300 customers, so the forecast is set at this value following the current year of the forecast. It is possible this cap will increase in the future. The new cap level will be subject to negotiation with regulators.

$$[3] C_{t,y,WA111.r} = \alpha_0 + \omega_{SC} D_{Oct\ 2011\uparrow=1} + \omega_{SC} D_{Oct\ 2013\uparrow=1} + \omega_{OL} D_{Mar\ 2005=1} + \omega_{OL} D_{Dec\ 2006=1} + \omega_{OL} D_{Jan\ 2007=1} + \omega_{OL} D_{Sep\ 2007=1} + \omega_{OL} D_{Nov\ 2007=1} + \omega_{OL} D_{Oct\ 2011=1} + \omega_{OL} D_{Jan\ 2015=1} + \omega_{OL} D_{Feb\ 2015=1} + \omega_{OL} D_{Apr\ 2015=1} + \omega_{OL} D_{Oct\ 2015=1} + \omega_{OL} D_{Feb\ 2016=1} + \omega_{OL} D_{Oct\ 2016=1} + ARIMA\epsilon_{t,y} (1,1,0)(0,0,0)_{12}$$

[3] Model notes:

1. Error structure white noise but not normally distributed.
2. SC dummies control for a step-up in customers starting in October 2011 and October 2013.

2. ID residential customer forecast models:

$$[4] C_{t,y,ID101.r} = \beta_0 + \tau POP_{t,y,KOOT} + \omega_{SD} D_{t,y} + \omega_{SC} D_{Jan\ 2007\uparrow=1} + \gamma_{RAMP} T_{Jan\ 2007} + \omega_{OL} D_{May\ 2005=1} + \omega_{OL} D_{Jul\ 2005=1} + \omega_{OL} D_{Oct\ 2005=1} + \omega_{OL} D_{Dec\ 2005=1} + \omega_{OL} D_{Jun\ 2006=1} + \omega_{OL} D_{Jan\ 2006=1} + \omega_{OL} D_{Jun\ 2007=1} + \omega_{OL} D_{Nov\ 2007=1} + \omega_{OL} D_{Aug\ 2009=1} + \omega_{OL} D_{Aug\ 2011=1} + \omega_{OL} D_{Sept\ 2011=1} + \omega_{OL} D_{Feb\ 2015=1} + ARIMA\epsilon_{t,y} (2,1,0)(0,0,0)_{12}$$

[4] Model notes:

1. SC dummy and ramping time trend control for a change in the time-path of customer growth starting in January 2007.

$$[5] C_{t,y,ID111.r} = \beta_0 + \gamma_{RAMP} T_{Dec\ 2011} + \omega_{SC} D_{Dec\ 2008\uparrow=1} + \omega_{SC} D_{Dec\ 2011\uparrow=1} + \omega_{OL} D_{Nov\ 2008=1} + \omega_{OL} D_{Mar\ 2010=1} + \omega_{OL} D_{Feb\ 2011=1} + \omega_{OL} D_{Nov\ 2011=1} + \omega_{OL} D_{Mar\ 2015=1} + \omega_{OL} D_{Dec\ 2015=1} + ARIMA\epsilon_{t,y} (9,1,0)(0,0,0)_{12}$$

[5] Model notes:

1. SC dummies control for a step-up in customers starting in December 2008 and December 2011.
2. Ramping time trend controls for no customer growth since 2012.

3. WA commercial customer forecast models:

$$[6] C_{t,y,WA101.c} = \alpha_0 + \alpha_1 POP_{t,y,SPK} + \omega_{SD} D_{t,y} + \omega_{OL} D_{Nov\ 2005=1} + \omega_{OL} D_{Feb\ 2007=1} + \omega_{OL} D_{Feb\ 2015=1} + \omega_{OL} D_{Sep\ 2013=1} + \omega_{OL} D_{Oct\ 2013=1} + \omega_{OL} D_{Apr\ 2015=1} + \omega_{OL} D_{Dec\ 2015=1} + \omega_{OL} D_{Feb\ 2016=1} + ARIMA\epsilon_{t,y} (1,1,0)(0,0,0)_{12}$$

[6] Model notes:

1. In the June 2017 forecast, $C_{t,y,WA101.r}$ (residential customers from residential schedule 101) was replaced with POP for Spokane. This was done to account for a new hookup tariff for residential gas customers in WA's LEAP program. This tariff is more generous than the previous long-standing tariff. In addition, any savings in the hookup process could be passed on to the customer for equipment purchases or replacement. Since this tariff change excluded commercial and industrial customers, this significantly accelerated residential hookups but not commercial hookups. As a result, this historical relationship between residential and commercial customer growth has been altered.

$$[7] C_{t,y,WA111.c} = \alpha_0 + \omega_{SD}D_{t,y} + \omega_{SC}D_{Apr\ 2016\uparrow=1} + \omega_{OL}D_{Jan\ 2007=1} + \omega_{OL}D_{Oct\ 2013=1} + \omega_{OL}D_{Nov\ 2013=1} + \omega_{OL}D_{Feb\ 2015=1} + \omega_{OL}D_{Apr\ 2015=1} + \omega_{OL}D_{Dec\ 2015=1} + ARIMA\epsilon_{t,y}(5,1,0)(0,0,0)_{12}$$

[7] Model notes:

1. SC dummy controls for a step-up in customers starting in April 2016.
2. Distribution of error terms not quite normal; however, they do pass the white-noise test.

4. ID commercial customer forecast models:

$$[8] C_{t,y,ID101.c} = \beta_0 + \beta_1 C_{t,y,ID101.r} + \omega_{SD}D_{t,y} + \omega_{SC}D_{Nov\ 2005\uparrow=1} + \omega_{SC}D_{Sep\ 2006\uparrow=1} + \omega_{SC}D_{Nov\ 2007\uparrow=1} + \omega_{OL}D_{Mar\ 2005=1} + \omega_{OL}D_{Jun\ 2005=1} + \omega_{OL}D_{Oct\ 2005=1} + \omega_{OL}D_{Dec\ 2005=1} + \omega_{OL}D_{Mar\ 2007=1} + \omega_{OL}D_{Mar\ 2008=1} + \omega_{OL}D_{Dec\ 2014=1} + \omega_{OL}D_{Feb\ 2015=1} + \omega_{OL}D_{Dec\ 2015=1} + ARIMA\epsilon_{t,y}(10,1,0)(0,0,0)_{12}$$

[8] Model notes:

1. $C_{t,y,ID101.r}$ are residential customers from residential schedule 101. They are being used as a forecast driver because of the historical positive correlation between residential and commercial customer growth. See Tables 5.1 and 5.2.
2. SC dummies control for a step-up in customers in November 2005, September 2006, and November 2007.

$$[9] C_{t,y,ID111.c} = \beta_0 + \gamma_{RAMP}T_{Jan\ 2012} + \omega_{SC}D_{Nov\ 2008\uparrow=1} + \omega_{SC}D_{Nov\ 2011\uparrow=1} + \omega_{SC}D_{Jan\ 2012\uparrow=1} + \omega_{OL}D_{Jan\ 2005=1} + \omega_{OL}D_{Sep\ 2009=1} + \omega_{OL}D_{Feb\ 2011=1} + \omega_{OL}D_{Dec\ 2011=1} + \omega_{OL}D_{Feb\ 2015=1} + \omega_{OL}D_{Dec\ 2015=1} + ARIMA\epsilon_{t,y}(6,1,0)(0,0,0)_{12}$$

[9] Model notes:

1. SC dummies control for a large step-up in customers starting in November 2008 and November 2011.
2. Ramping time trend and SC dummy starting in Jan 2012 control for a slowdown in customer growth.

5. WA industrial customer forecasts models:

$$[10] C_{t,y,WA101.i} = \alpha_0 + \omega_{SC}D_{Apr\ 2008\uparrow=1} + \omega_{SC}D_{Oct\ 2013\uparrow=1} + \omega_{OL}D_{Oct\ 2006=1} + \omega_{OL}D_{Jan\ 2007=1} + \omega_{OL}D_{Feb\ 2007=1} + \omega_{OL}D_{Dec\ 2013=1} + \omega_{OL}D_{Jan\ 2014=1} + \omega_{OL}D_{Jan\ 2015=1} + \omega_{OL}D_{Feb\ 2015=1} + \omega_{OL}D_{Apr\ 2016=1} + \omega_{OL}D_{Mar\ 2017=1} + ARIMA\epsilon_{t,y}(7,1,0)(0,0,0)_{12}$$

[10] Model notes:

1. SC dummies control for a step-down in customers starting in April 2008 and October 2013.

$$[11] C_{t,y,WA111.i} = \alpha_0 + \omega_{OL}D_{Sep\ 2005=1} + \omega_{OL}D_{Oct\ 2006=1} + \omega_{OL}D_{Dec\ 2006=1} + \omega_{OL}D_{Jan\ 2007=1} + \omega_{OL}D_{Feb\ 2007=1} + \omega_{OL}D_{Mar\ 2008=1} + \omega_{OL}D_{Jun\ 2014=1} + \omega_{OL}D_{Feb\ 2015=1} + \omega_{OL}D_{Oct\ 2015=1} + \omega_{OL}D_{Apr\ 2016=1} + ARIMA\epsilon_{t,y}(2,0,0)(0,0,0)_{12}$$

[11] Model notes:

1. Error structure is white noise, but not normally distributed.

6. ID industrial customer forecast models:

$$[12] C_{t,y,ID101.i} = \beta_0 + \omega_{SC}D_{Dec\ 2010\uparrow=1} + \omega_{SC}D_{Nov\ 2011\uparrow=1} + \omega_{SC}D_{Dec\ 2011\uparrow=1} + \omega_{SC}D_{Jun\ 2014\uparrow=1} + \omega_{OL}D_{Mar\ 2005=1} + \omega_{OL}D_{Aug\ 2005=1} + \omega_{OL}D_{Oct\ 2005=1} + \omega_{OL}D_{Feb\ 2006=1} + \omega_{OL}D_{Mar\ 2007=1} + \omega_{OL}D_{Dec\ 2008=1} + \omega_{OL}D_{Jan\ 2011=1} + \omega_{OL}D_{Aug\ 2011=1} + \omega_{OL}D_{Jul\ 2014=1} + \omega_{OL}D_{Jan\ 2015=1} + \omega_{OL}D_{Feb\ 2015=1} + \omega_{OL}D_{Dec\ 2015=1} + \omega_{OL}D_{Jan\ 2016=1} + ARIMA\epsilon_{t,y}(4,0,0)(0,0,0)_{12}$$

[12] Model notes:

1. SC dummies control for step-downs in customers starting in December 2010, November 2011, and December 2011; June 2014 controls for a step-up in customers.

$$[13] C_{t,y,ID111.i} = \frac{1}{12} \sum_{j=1}^{12} C_{t-j}$$

[13] Model notes:

1. Period of restriction reflects the restriction on the UPC model for this schedule.
2. Customer count stabilized in 2012; customer count fluctuates between 31 and 34 without any clear trend or seasonality.

$$[14] C_{t,y,1D112.i} = \frac{1}{12} \sum_{j=1}^{12} C_{t-j}$$

[14] Model notes:

1. Customer count tends to increase in steps following prolonged periods of stability. No clear seasonality present.

7. Medford, OR forecasting models:

The forecasting models for the Medford region (Jackson County) are given below for the residential, commercial, and industrial sectors:

Residential Sector, Customers:

$$[15] C_{t,y,MED410.r} = \alpha_0 + \alpha_1 POP_{t,y,JACK+JOS} + \omega_{SD} D_{t,y} + \gamma_{RAMP} T_{Jan\ 2008} + \omega_{SC} D_{Jan\ 2008 \uparrow = 1} + \omega_{SC} D_{Nov\ 2004 \uparrow = 1} + \omega_{OL} D_{Dec\ 2004 = 1} + \omega_{OL} D_{Dec\ 2005 = 1} + \omega_{OL} D_{Feb\ 2015 = 1} + ARIMA \epsilon_{t,y} (7,1,0)(0,0,0)_{12}$$

[15] Model notes:

1. SC dummy and ramping time trend control for a change in the time-path of customer growth starting in January 2008.
2. POP is Jackson plus Josephine counties.

Commercial Sector, Customers:

$$[16] C_{t,y,MED420.c} = \alpha_0 + \alpha_1 C_{t,y,MED410.r} + \omega_{SD} D_{t,y} + \omega_{OL} D_{Dec\ 2004 = 1} + \omega_{OL} D_{Sep\ 2005 = 1} + \omega_{OL} D_{Nov\ 2009 = 1} + \omega_{OL} D_{Feb\ 2015 = 1} + \omega_{OL} D_{Jan\ 2016 = 1} + ARIMA \epsilon_{t,y} (7,1,0)(1,0,0)_{12}$$

[16] Model notes:

1. $C_{t,y,MED410.r}$ are residential customers from residential schedule 410. They are being used as a forecast driver because of the historical positive correlation between residential and commercial customer growth. However, in the future, POP may become a better driver. Model results with POP are fairly close to model shown above.

$$[17] C_{y,MED424.c} = C_{y-1} + (\hat{\alpha}_0 + \hat{\alpha}_1 \Delta EMP_{y-1,4County})$$

[17] Model notes:

1. This model reflects a recommendation by Oregon staff in the 2016 rate case to include employment as an economic driver for schedule 424 commercial customers. The estimated equation in parenthesis reflects the regression estimated of $\Delta C_{y,MED424.c} = \alpha_0 + \alpha_1 \Delta EMP_{y-1,4County} + \epsilon_t$ using annual customer data since 2004. Annual data is used to smooth over the sometimes volatile changes in the monthly customer number. In addition, customer increases and decreases around the long-run trend tend to occur in steps. The combination of steps and month-to-month volatility creates significant economic problems when trying to model around the monthly data. For example, even with intervention variables, tests for error normality always indicated non-normal error terms with the use of monthly data.
2. $\Delta C_{y,MED424.c}$ is the change in customers in year y (customer change between year y and y-1) and $\Delta EMP_{y-1,4County}$ is the change in total non-farm employment in Jackson, Josephine, Klamath, and Douglas counties in year y-1 (employment change between year y-1 and y-2). Staff originally suggested lagged total employment for Oregon, but the correlation between schedule 424 customers and employment for the three county area is higher. The forecasted employment values for Jackson+Josephine County are derived from the employment growth forecasts used in the Jackson+Josephine County population forecast. The forecasts for Douglas and Klamath counties come from IHS. In IRP years, IHS forecasts for Jackson and Josephine counties will be used for the out years.
3. The annual forecast value for each year, $F(\cdot)$, is assumed to hold for each month of that year. That is: $F(C_{y,MED424.c}) = F(C_{t,y,MED424.c})$. Given the step-like behavior of the monthly series, this is a reasonable assumption.
4. The forecast and regressions for this schedule can be found in the Excel file folder "OR MED-ROS-KLM Sch 424c Cus" for the June 2017 forecast.

$$[18] C_{t,y,MED444.c} = 1 \text{ if } (THM/C_{t,y})_{MED,444.c} > 0$$

[18] Model notes:

1. There is typically only one customer served by this schedule. Therefore, the customer forecast is automatically set to one whenever the load forecast is greater than zero. The June 2017 customer forecast was used and repeated out to monthly until December 2040.

Industrial Sector, Customers:

$$[19] C_{t,y,MED420.i} = \frac{1}{12} \sum_{j=1}^{12} C_{t-j}$$

[19] Model notes:

1. Data starts November 2006. Excluding outliers in November 2006, November 2009, and February 2011, the customer count fluctuates between 9 and 16 without any clear trend or seasonality. Changes in the customer count occur in steps between prolonged periods of stability.

$$[20] C_{t,y,MED424.i} = \frac{1}{12} \sum_{j=1}^{12} C_{t-j}$$

[20] Model notes:

1. Data starts January 2009. Excluding a January 2009 outlier, the customer count fluctuates between 1 and 3 without any clear trend or seasonality. Customer count is most frequently reported as 2; however, starting in March 2018, the customer count fell to one.

8. Roseburg, OR forecasting models:

The forecasting models for the Roseburg region (Douglas County) are given below for the residential, commercial, and industrial sectors:

Residential Sector, Customers:

$$[21] C_{t,y,ROS410.r} = \varphi_0 + \varphi_1 POP_{t,y,DOUGLAS} + \omega_{SD} D_{t,y} + \omega_{OL} D_{Jul\ 2004=1} + \omega_{OL} D_{Nov\ 2004=1} + \omega_{OL} D_{Dec\ 2004=1} + \omega_{OL} D_{Nov\ 2005=1} + \omega_{OL} D_{Dec\ 2005=1} + \omega_{OL} D_{Nov\ 2006=1} + \omega_{OL} D_{Dec\ 2007=1} + \omega_{OL} D_{Feb\ 2008=1} + \omega_{OL} D_{Nov\ 2009=1} + \omega_{OL} D_{Oct\ 2012=1} + \omega_{OL} D_{Apr\ 2014=1} + \omega_{OL} D_{Feb\ 2015=1} + ARIMA\epsilon_{t,y} (12,1,0)(0,0,0)_{12}$$

[21] Model notes:

1. POP is population for Douglas County, OR.

Commercial Sector, Customers:

$$[22] C_{t,y,ROS420.c} = \varphi_0 + \varphi_1 POP_{t,y,DOUGLAS} + \omega_{SD} D_{t,y} + \omega_{SC} D_{Dec\ 2004=1} + \omega_{OL} D_{Nov\ 2004=1} + \omega_{OL} D_{Jan\ 2005=1} + \omega_{OL} D_{Dec\ 2005=1} + \omega_{OL} D_{Mar\ 2006=1} + \omega_{OL} D_{Jan\ 2008=1} + \omega_{OL} D_{Mar\ 2008=1} + \omega_{OL} D_{Mar\ 2009=1} + \omega_{OL} D_{Feb\ 2015=1} + \omega_{OL} D_{May\ 2016=1} + ARIMA\epsilon_{t,y} (9,1,0)(1,0,0)_{12}$$

[22] Model notes:

1. Model does not use schedule 410 customers as driver. This reflects the lack of correlation between residential 410 and commercial 420 customer growth. However, POP was added for the 2018 gas IRP and it is significant at the 10% level
2. The lack of correlation noted in Point 1 could reflect Roseburg's position between larger cities that offer a range of commercial activities. Competition from these cities may be inhibiting commercial growth in Roseburg.
3. SC dummy controls for a significant step-up in customers starting in December 2004.

$$[23] C_{t,y,ROS424.c} = C_{y-1} + (\widehat{\varphi}_0 + \widehat{\varphi}_1 \Delta EMP_{y-1,4County})$$

[23] Model notes:

1. This model reflects a recommendation by Oregon staff in the 2016 rate case to include employment as an economic driver for schedule 424 commercial customers. The estimated equation in parenthesis reflects the regression estimated of $\Delta C_{y,ROS424.c} = \alpha_0 + \alpha_1 \Delta EMP_{y-1,4County} + \epsilon_t$ using annual customer data since 2004. Annual data is used to smooth over the sometimes volatile changes in the monthly customer number. In addition, customer increases and decreases around the long-run trend tend to occur in steps. The combination of steps and month-to-month volatility creates significant economic problems when trying to model around the monthly data. For example, even with intervention variables, tests for error normality always indicated non-normal error terms with the use of monthly data.
2. $\Delta C_{y,ROS424.c}$ is the change in customers in year y (customer change between year y and y-1) and $\Delta EMP_{y-1,4County}$ is the change in total non-farm employment in Jackson, Josephine, Klamath, and Douglas counties in year y-1 (employment change between year y-1 and y-2). Staff originally suggested lagged total employment for Oregon, but the correlation between schedule 424 customers and employment for the three

county area is higher. The forecasted employment values for Jackson+Josephine County are derived from the employment growth forecasts used in the Jackson+Josephine County population forecast. The forecasts for Douglas and Klamath counties come from IHS. In IRP years, IHS forecasts for Jackson and Josephine counties will be used for the out years.

3. The annual forecast value for each year, $F(\cdot)$, is assumed to hold for each month of that year. That is: $F(C_{y,ROS424.c}) = F(C_{t,y,ROS424.c})$. Given the step-like behavior of the monthly series, this is a reasonable assumption.

4. The forecast and regressions for this schedule can be found in the Excel file folder "OR MED-ROS-KLM Sch 424c Cus" for the June 2017 forecast.

Industrial Sector, Customers:

$$[24] C_{t,y,ROS420.i} = \frac{1}{12} \sum_{j=1}^{12} C_{t-j}$$

[24] Model notes:

1. Data starts September 2009. Excluding a February 2015 outlier, the customer count fluctuates between 1 and 2 without any clear trend or seasonality.
2. Due to the Compass software conversion, February 2015 is excluded from the historical data. The conversion resulted in a double counting of customers in February 2015. Therefore, including this month leads to a significant over-forecast of customers.

$$[25] C_{t,y,ROS424.i} = \frac{1}{12} \sum_{j=1}^{12} C_{t-j}$$

[25] Model notes:

1. Schedule appears to have died. No customers are currently being reported.

9. Klamath Falls, OR forecasting models:

The forecasting models for the Klamath Falls region (Klamath County) are given below for the residential, commercial, and industrial sectors:

Residential Sector, Customers:

$$[26] C_{t,y,KLM410.r} = \beta_0 + \beta_1 POP_{t,y,KLAMATH} + \omega_{SD} D_{t,y} + \omega_{OL} D_{Nov\ 2004=1} + \omega_{OL} D_{Feb\ 2015=1} + \omega_{OL} D_{Apr\ 2015=1} + ARIMA_{\epsilon_{t,y}}(7,1,0)(0,0,0)_{12}$$

[26] Model notes:

1. POP is for Klamath County, OR.

Commercial Sector, Customers:

$$[27] C_{t,y,KLM420.c} = \beta_0 + \beta_1 C_{t,y,KLM410.r} + \omega_{SD} D_{t,y} + \omega_{OL} D_{Oct\ 2006=1} + ARIMA_{\epsilon_{t,y}}(11,1,0)(2,0,0)_{12}$$

[27] Model notes:

1. $C_{t,y,KLM410.r}$ are residential customers from residential schedule 410. They are being used as a forecast driver because of the historical positive correlation between residential and commercial customer growth. See Tables 5.1 and 5.2.

$$[28] C_{t,y,KLM424.c} = C_{y-1} + (\hat{\beta}_0 + \hat{\beta}_1 \Delta EMP_{y-1,4County})$$

[28] Model notes:

1. This model reflects a recommendation by Oregon staff in the 2016 rate case to include employment as an economic driver for schedule 424 commercial customers. The estimated equation in parenthesis reflects the regression estimated of $\Delta C_{y,KLM424.c} = \alpha_0 + \alpha_1 \Delta EMP_{y-1,4County} + \epsilon_t$ using annual customer data since 2004. Annual data is used to smooth over the sometimes volatile changes in the monthly customer number. In addition, customer increases and decreases around the long-run trend tend to occur in steps. The combination of steps and month-to-month volatility creates significant economic problems when trying to model around the monthly data. For example, even with intervention variables, tests for error normality always indicated non-normal error terms with the use of monthly data.
2. $\Delta C_{y,KLM424.c}$ is the change in customers in year y (customer change between year y and $y-1$) and $\Delta EMP_{y-1,4County}$ is the change in total non-farm employment in Jackson, Josephine, Klamath, and Douglas counties in year $y-1$ (employment change between year $y-1$ and $y-2$). Staff originally suggested lagged total employment for Oregon, but the correlation between schedule 424 customers and employment for the three

county area is higher. The forecasted employment values for Jackson+Josephine County are derived from the employment growth forecasts used in the Jackson+Josephine County population forecast. The forecasts for Douglas and Klamath counties come from IHS. In IRP years, IHS forecasts for Jackson and Josephine counties will be used for the out years.

3. The annual forecast value for each year, $F(\cdot)$, is assumed to hold for each month of that year. That is: $F(C_{y,KLM424.c}) = F(C_{t,y,KLM424.c})$. Given the step-like behavior of the monthly series, this is a reasonable assumption.

4. The forecast and regressions for this schedule can be found in the Excel file folder "OR MED-ROS-KLM Sch 424c Cus" for the June 2017 forecast.

Industrial Sector, Customers:

$$[29] C_{t,y,KLM420.i} = \frac{1}{12} \sum_{j=1}^{12} C_{t-j}$$

[29] Model notes:

1. Data starts December 2006. The customer count fluctuates between 4 and 9 without any clear trend or seasonality.

$$[30] C_{t,y,KLM424.i} = \frac{1}{12} \sum_{j=1}^{12} C_{t-j}$$

[30] Model notes:

1. Data starts April 2009. The customer count fluctuates between 1 and 4 without any clear trend or seasonality.

10. La Grande, OR forecasting models:

The forecasting models for the La Grande region (Union County) are given below for the residential, commercial, and industrial sectors:

Residential Sector, Customers:

$$[31] C_{t,y,LaG410.r} = \theta_0 + \theta_1 POP_{t,y,UNION} + \omega_{SD} D_{t,y} + \omega_{OL} D_{Oct\ 2004=1} + \omega_{OL} D_{Jul\ 2006=1} + \omega_{OL} D_{Dec\ 2009=1} + \omega_{OL} D_{Feb\ 2015=1} + ARIMA_{\epsilon_{t,y}}(9,1,0)(1,0,0)_{12}$$

[31] Model notes:

1. POP is population for Union County, OR.

Commercial Sector, Customers:

$$[32] C_{t,y,LaG420.c} = \theta_0 + \omega_{SD} D_{t,y} + \omega_{OL} D_{Jul\ 2005=1} + \omega_{OL} D_{Jan\ 2007=1} + \omega_{OL} D_{Dec\ 2008=1} + \omega_{OL} D_{Mar\ 2011=1} + \omega_{OL} D_{May\ 2011=1} + \omega_{OL} D_{Jan\ 2016=1} + ARIMA_{\epsilon_{t,y}}(12,1,0)(0,0,0)_{12}$$

[32] Model notes:

1. $C_{t,y,LaG410.r}$, residential customers from residential schedule 410, are no longer used as a forecast driver. The estimated coefficient on $C_{t,y,LaG410.r}$ was no longer statistically significant and its sign flips between positive and negative, depending on the form of the model. POP for union county was also tried as a driver, but had the same issues as $C_{t,y,LaG410.r}$.

$$[33] C_{t,y,LaG424.c} = \frac{1}{12} \sum_{j=1}^{12} C_{t-j}$$

[33] Model notes:

1. Data starts January 2007. The customer count fluctuates between 2 and 4 without any clear trend or seasonality. Changes in the customer count appear as steps after prolonged periods of stability.

$$[34] C_{t,y,LaG444.c} = \frac{1}{N} \sum_{j=1}^N (C_{t,y-j}) \text{ if } (THM/C_{t,y})_{LaG,444.c} \geq 0$$

[34] Model notes:

1. Data starts September 2011. The customer forecast is a derivative of the schedule's load forecast. The June 2017 customer forecast was used and repeated out to monthly until December 2040.

Industrial Sector, Customers:

$$\begin{aligned}
 [35] C_{t,y,LaG444,i} = & \theta_0 + \omega_{SD} D_{t,y} + \omega_{OL} D_{Aug\ 2007=1} + \omega_{OL} D_{Sept\ 2008=1} + \omega_{OL} D_{Nov\ 2009=1} + \omega_{OL} D_{Jan\ 2010=1} + \\
 & + \omega_{OL} D_{Nov\ 2010=1} + \omega_{OL} D_{Aug\ 2011=1} + \omega_{OL} D_{Aug\ 2012=1} + \omega_{OL} D_{Nov\ 2012=1} + \omega_{OL} D_{Dec\ 2012=1} + \omega_{OL} D_{Jan\ 2013=1} + \\
 & + \omega_{OL} D_{Feb\ 2013=1} + \omega_{OL} D_{Jan\ 2014=1} + \omega_{OL} D_{Oct\ 2015=1} + ARIMA \epsilon_{t,y} (10,0,0)(0,0,0)_{12}
 \end{aligned}$$

APPENDIX 2.2: CUSTOMER FORECASTS BY REGION WASHINGTON

	Washington - Expected Growth			Washington - High Growth			Washington - Low Growth		
	Residential Customers	Commercial Customers	Industrial Customers	Residential Customers	Commercial Customers	Industrial Customers	Residential Customers	Commercial Customers	Industrial Customers
Nov-17	147,093	14,591	130	148,027	14,683	130	146,161	14,498	129
Dec-17	147,522	14,666	130	148,506	14,764	130	146,539	14,568	129
Jan-18	148,039	14,678	130	149,076	14,781	130	147,006	14,576	129
Feb-18	148,149	14,716	130	149,234	14,824	131	147,067	14,609	129
Mar-18	148,048	14,718	130	149,180	14,831	131	146,920	14,606	128
Apr-18	148,092	14,700	130	149,272	14,817	131	146,916	14,583	128
May-18	148,164	14,676	130	149,393	14,798	131	146,940	14,555	128
Jun-18	148,176	14,696	129	149,453	14,823	132	146,905	14,570	128
Jul-18	148,402	14,665	129	149,726	14,796	132	147,085	14,535	127
Aug-18	148,536	14,674	129	149,906	14,809	132	147,174	14,540	127
Sep-18	148,725	14,674	129	150,141	14,814	132	147,317	14,535	127
Oct-18	149,191	14,687	129	150,656	14,831	133	147,734	14,544	127
Nov-18	149,864	14,719	129	151,380	14,868	133	148,356	14,571	126
Dec-18	150,346	14,791	129	151,913	14,945	133	148,789	14,638	126
Jan-19	150,632	14,800	129	152,247	14,959	133	149,028	14,643	126
Feb-19	150,590	14,838	129	152,250	15,002	134	148,942	14,676	126
Mar-19	150,673	14,840	128	152,379	15,008	134	148,980	14,673	125
Apr-19	150,668	14,821	128	152,420	14,993	134	148,930	14,650	125
May-19	150,707	14,797	128	152,505	14,974	134	148,925	14,622	125
Jun-19	150,634	14,816	128	152,476	14,997	135	148,808	14,636	125
Jul-19	150,721	14,785	128	152,609	14,970	135	148,848	14,601	124
Aug-19	150,854	14,794	128	152,790	14,984	135	148,935	14,606	124
Sep-19	151,160	14,795	128	153,146	14,990	135	149,192	14,602	124
Oct-19	151,606	14,808	128	153,645	15,007	136	149,587	14,611	124
Nov-19	152,244	14,840	128	154,338	15,044	136	150,171	14,638	123
Dec-19	152,667	14,912	128	154,814	15,122	136	150,543	14,705	123
Jan-20	152,907	14,922	128	155,104	15,136	136	150,734	14,710	123
Feb-20	152,959	14,960	127	155,203	15,180	137	150,740	14,743	123
Mar-20	153,025	14,962	127	155,316	15,186	137	150,758	14,741	122
Apr-20	153,008	14,943	127	155,346	15,172	137	150,696	14,717	122
May-20	152,996	14,920	127	155,381	15,153	137	150,639	14,690	122
Jun-20	152,850	14,939	127	155,279	15,177	138	150,450	14,705	122
Jul-20	152,982	14,909	127	155,461	15,151	138	150,534	14,671	121
Aug-20	153,137	14,918	127	155,666	15,164	138	150,640	14,675	121
Sep-20	153,446	14,918	127	156,028	15,169	138	150,898	14,670	121
Oct-20	153,862	14,931	127	156,499	15,187	139	151,261	14,679	121
Nov-20	154,464	14,964	127	157,158	15,225	139	151,806	14,707	120
Dec-20	154,895	15,036	127	157,644	15,303	139	152,183	14,773	120
Jan-21	155,161	15,046	126	157,963	15,318	139	152,398	14,778	120
Feb-21	155,220	15,085	126	158,072	15,362	140	152,409	14,812	120

APPENDIX 2.2: CUSTOMER FORECASTS BY REGION WASHINGTON

	Washington - Expected Growth			Washington - High Growth			Washington - Low Growth		
	Residential Customers	Commercial Customers	Industrial Customers	Residential Customers	Commercial Customers	Industrial Customers	Residential Customers	Commercial Customers	Industrial Customers
Mar-21	155,265	15,087	126	158,166	15,369	140	152,407	14,809	119
Apr-21	155,218	15,068	126	158,166	15,354	140	152,315	14,786	119
May-21	155,185	15,045	126	158,181	15,336	140	152,236	14,759	119
Jun-21	155,063	15,065	126	158,105	15,361	141	152,070	14,774	119
Jul-21	155,199	15,032	126	158,288	15,331	141	152,160	14,738	118
Aug-21	155,339	15,042	126	158,475	15,346	141	152,253	14,743	118
Sep-21	155,623	15,041	126	158,810	15,349	141	152,488	14,738	118
Oct-21	156,011	15,053	126	159,252	15,366	142	152,825	14,746	118
Nov-21	156,614	15,086	126	159,913	15,404	142	153,372	14,774	117
Dec-21	157,048	15,158	126	160,402	15,482	142	153,753	14,840	117
Jan-22	157,308	15,167	125	160,713	15,495	142	153,964	14,845	117
Feb-22	157,346	15,205	125	160,798	15,539	143	153,957	14,878	117
Mar-22	157,363	15,207	125	160,861	15,545	143	153,930	14,875	116
Apr-22	157,307	15,188	125	160,848	15,530	143	153,830	14,853	116
May-22	157,274	15,163	125	160,861	15,509	143	153,754	14,824	116
Jun-22	157,150	15,182	125	160,780	15,533	144	153,590	14,838	116
Jul-22	157,280	15,150	125	160,958	15,504	144	153,673	14,803	115
Aug-22	157,408	15,160	125	161,135	15,519	144	153,754	14,808	115
Sep-22	157,687	15,160	125	161,467	15,523	144	153,983	14,804	115
Oct-22	158,080	15,172	125	161,915	15,540	145	154,323	14,812	115
Nov-22	158,691	15,204	125	162,587	15,577	145	154,876	14,839	114
Dec-22	159,125	15,275	125	163,077	15,655	145	155,254	14,904	114
Jan-23	159,376	15,286	124	163,381	15,670	145	155,455	14,910	114
Feb-23	159,406	15,324	124	163,458	15,714	146	155,440	14,943	114
Mar-23	159,425	15,326	124	163,524	15,720	146	155,414	14,941	113
Apr-23	159,373	15,306	124	163,517	15,704	146	155,320	14,917	113
May-23	159,342	15,282	124	163,532	15,684	146	155,245	14,889	113
Jun-23	159,215	15,300	124	163,448	15,707	147	155,078	14,903	113
Jul-23	159,334	15,269	124	163,615	15,679	147	155,151	14,868	112
Aug-23	159,458	15,277	124	163,788	15,692	147	155,229	14,872	112
Sep-23	159,738	15,278	124	164,120	15,697	147	155,458	14,869	112
Oct-23	160,131	15,289	124	164,569	15,713	148	155,798	14,875	112
Nov-23	160,737	15,322	124	165,237	15,751	148	156,345	14,903	111
Dec-23	161,160	15,393	124	165,717	15,828	148	156,713	14,968	111
Jan-24	161,406	15,403	124	166,016	15,843	148	156,909	14,974	111
Feb-24	161,433	15,441	123	166,089	15,886	149	156,892	15,007	111
Mar-24	161,452	15,442	123	166,154	15,892	149	156,868	15,004	110
Apr-24	161,396	15,422	123	166,142	15,876	149	156,770	14,980	110
May-24	161,360	15,397	123	166,150	15,854	149	156,691	14,952	110
Jun-24	161,226	15,416	123	166,058	15,878	150	156,518	14,966	110

APPENDIX 2.2: CUSTOMER FORECASTS BY REGION WASHINGTON

	Washington - Expected Growth			Washington - High Growth			Washington - Low Growth		
	Residential Customers	Commercial Customers	Industrial Customers	Residential Customers	Commercial Customers	Industrial Customers	Residential Customers	Commercial Customers	Industrial Customers
Jul-24	161,347	15,385	123	166,228	15,851	150	156,593	14,932	109
Aug-24	161,474	15,393	123	166,405	15,863	150	156,673	14,935	109
Sep-24	161,755	15,393	123	166,740	15,868	150	156,903	14,931	109
Oct-24	162,148	15,405	123	167,191	15,884	151	157,240	14,939	109
Nov-24	162,752	15,438	123	167,861	15,923	151	157,783	14,967	108
Dec-24	163,176	15,509	123	168,344	16,000	151	158,150	15,031	108
Jan-25	163,424	15,519	123	168,645	16,015	151	158,346	15,037	108
Feb-25	163,454	15,556	122	168,723	16,058	152	158,332	15,069	108
Mar-25	163,473	15,559	122	168,789	16,065	152	158,307	15,067	107
Apr-25	163,417	15,539	122	168,778	16,049	152	158,209	15,044	107
May-25	163,380	15,514	122	168,786	16,027	152	158,130	15,016	107
Jun-25	163,247	15,533	122	168,695	16,052	153	157,957	15,030	107
Jul-25	163,365	15,501	122	168,862	16,023	153	158,030	14,995	106
Aug-25	163,488	15,509	122	169,033	16,035	153	158,107	14,999	106
Sep-25	163,764	15,509	122	169,363	16,039	153	158,333	14,995	106
Oct-25	164,152	15,521	122	169,808	16,056	154	158,665	15,002	106
Nov-25	164,752	15,553	122	170,474	16,093	154	159,203	15,029	105
Dec-25	165,172	15,624	122	170,954	16,171	154	159,567	15,094	105
Jan-26	165,416	15,634	122	171,252	16,186	154	159,761	15,100	105
Feb-26	165,441	15,670	122	171,323	16,227	155	159,743	15,130	105
Mar-26	165,455	15,671	122	171,382	16,233	155	159,714	15,127	104
Apr-26	165,395	15,652	121	171,366	16,217	155	159,614	15,105	104
May-26	165,353	15,627	121	171,367	16,195	155	159,532	15,077	104
Jun-26	165,218	15,646	121	171,271	16,219	156	159,358	15,091	104
Jul-26	165,334	15,614	121	171,436	16,190	156	159,429	15,057	103
Aug-26	165,454	15,622	121	171,604	16,203	156	159,504	15,060	103
Sep-26	165,727	15,622	121	171,932	16,207	156	159,726	15,056	103
Oct-26	166,112	15,633	121	172,375	16,223	157	160,056	15,063	103
Nov-26	166,710	15,665	121	173,040	16,260	157	160,591	15,090	102
Dec-26	167,129	15,736	121	173,520	16,338	157	160,954	15,155	102
Jan-27	167,370	15,744	121	173,815	16,350	157	161,145	15,158	102
Feb-27	167,393	15,782	121	173,882	16,394	158	161,124	15,191	102
Mar-27	167,405	15,783	121	173,940	16,399	158	161,095	15,188	101
Apr-27	167,343	15,763	121	173,920	16,383	158	160,994	15,165	101
May-27	167,300	15,738	120	173,920	16,361	158	160,911	15,137	101
Jun-27	167,161	15,756	120	173,820	16,384	159	160,736	15,151	101
Jul-27	167,273	15,724	120	173,980	16,355	159	160,804	15,116	100
Aug-27	167,391	15,732	120	174,146	16,367	159	160,878	15,120	100
Sep-27	167,661	15,732	120	174,470	16,371	159	161,097	15,116	100
Oct-27	168,043	15,743	120	174,911	16,387	160	161,424	15,123	100

APPENDIX 2.2: CUSTOMER FORECASTS BY REGION WASHINGTON

	Washington - Expected Growth			Washington - High Growth			Washington - Low Growth		
	Residential Customers	Commercial Customers	Industrial Customers	Residential Customers	Commercial Customers	Industrial Customers	Residential Customers	Commercial Customers	Industrial Customers
Nov-27	168,639	15,773	120	175,574	16,422	160	161,955	15,148	99
Dec-27	169,055	15,845	120	176,051	16,501	160	162,315	15,213	99
Jan-28	169,293	15,853	120	176,343	16,513	160	162,503	15,217	99
Feb-28	169,312	15,890	120	176,406	16,556	161	162,481	15,249	99
Mar-28	169,321	15,891	120	176,460	16,561	161	162,449	15,246	98
Apr-28	169,256	15,871	120	176,436	16,544	161	162,347	15,223	98
May-28	169,210	15,846	120	176,432	16,522	161	162,262	15,195	98
Jun-28	169,069	15,864	120	176,329	16,545	162	162,087	15,209	98
Jul-28	169,178	15,832	119	176,484	16,516	162	162,152	15,175	97
Aug-28	169,292	15,839	119	176,645	16,527	162	162,222	15,178	97
Sep-28	169,560	15,838	119	176,967	16,530	162	162,440	15,173	97
Oct-28	169,939	15,848	119	177,405	16,544	163	162,764	15,179	97
Nov-28	170,531	15,880	119	178,066	16,582	163	163,292	15,206	96
Dec-28	170,943	15,951	119	178,539	16,660	163	163,648	15,270	96
Jan-29	171,178	15,959	119	178,827	16,672	163	163,833	15,274	96
Feb-29	171,194	15,996	119	178,887	16,715	164	163,810	15,306	96
Mar-29	171,201	15,996	119	178,936	16,719	164	163,776	15,302	95
Apr-29	171,132	15,976	119	178,907	16,702	164	163,671	15,280	95
May-29	171,083	15,951	119	178,898	16,680	164	163,585	15,252	95
Jun-29	170,938	15,969	119	178,790	16,703	165	163,407	15,266	95
Jul-29	171,044	15,935	119	178,942	16,671	165	163,471	15,230	94
Aug-29	171,156	15,943	118	179,101	16,683	165	163,540	15,234	94
Sep-29	171,420	15,941	118	179,419	16,685	165	163,754	15,228	94
Oct-29	171,797	15,952	118	179,855	16,700	166	164,077	15,235	94
Nov-29	172,386	15,983	118	180,513	16,737	166	164,601	15,261	93
Dec-29	172,796	16,053	118	180,984	16,814	166	164,954	15,325	93
Jan-30	173,028	16,062	118	181,269	16,827	166	165,137	15,330	93
Feb-30	173,042	16,099	118	181,325	16,870	167	165,112	15,361	93
Mar-30	173,044	16,099	118	181,369	16,874	167	165,076	15,358	92
Apr-30	172,973	16,078	118	181,337	16,856	167	164,970	15,334	92
May-30	172,921	16,052	118	181,325	16,832	167	164,882	15,306	92
Jun-30	172,773	16,069	118	181,211	16,854	168	164,703	15,319	92
Jul-30	172,875	16,036	118	181,359	16,823	168	164,764	15,284	91
Aug-30	172,984	16,043	118	181,512	16,834	168	164,830	15,287	91
Sep-30	173,245	16,042	118	181,826	16,837	168	165,043	15,283	91
Oct-30	173,617	16,053	117	182,257	16,852	169	165,361	15,290	91
Nov-30	174,202	16,083	117	182,912	16,887	169	165,881	15,315	90
Dec-30	174,608	16,153	117	183,379	16,965	169	166,231	15,378	90
Jan-31	174,836	16,161	117	183,659	16,977	169	166,411	15,382	90
Feb-31	174,846	16,198	117	183,710	17,019	170	166,384	15,414	90

APPENDIX 2.2: CUSTOMER FORECASTS BY REGION WASHINGTON

	Washington - Expected Growth			Washington - High Growth			Washington - Low Growth		
	Residential Customers	Commercial Customers	Industrial Customers	Residential Customers	Commercial Customers	Industrial Customers	Residential Customers	Commercial Customers	Industrial Customers
Mar-31	174,845	16,198	117	183,750	17,023	170	166,346	15,411	89
Apr-31	174,770	16,177	117	183,711	17,005	170	166,237	15,387	89
May-31	174,714	16,150	117	183,693	16,980	170	166,147	15,358	89
Jun-31	174,563	16,167	117	183,575	17,002	171	165,967	15,371	89
Jul-31	174,663	16,134	117	183,719	16,971	171	166,026	15,336	88
Aug-31	174,768	16,141	117	183,870	16,982	171	166,090	15,340	88
Sep-31	175,027	16,140	117	184,182	16,984	171	166,301	15,335	88
Oct-31	175,398	16,150	117	184,612	16,999	172	166,617	15,342	88
Nov-31	175,980	16,180	117	185,265	17,034	172	167,134	15,367	87
Dec-31	176,384	16,250	116	185,730	17,111	172	167,482	15,430	87
Jan-32	176,611	16,258	116	186,008	17,123	172	167,661	15,434	87
Feb-32	176,619	16,294	116	186,057	17,165	173	167,632	15,465	87
Mar-32	176,615	16,294	116	186,093	17,169	173	167,592	15,462	86
Apr-32	176,538	16,273	116	186,052	17,150	173	167,483	15,438	86
May-32	176,480	16,246	116	186,031	17,125	173	167,392	15,410	86
Jun-32	176,326	16,263	116	185,909	17,147	174	167,210	15,422	86
Jul-32	176,423	16,230	116	186,049	17,116	174	167,268	15,388	85
Aug-32	176,526	16,236	116	186,197	17,126	174	167,331	15,390	85
Sep-32	176,782	16,235	116	186,504	17,128	174	167,538	15,386	85
Oct-32	177,150	16,244	116	186,931	17,141	175	167,852	15,392	85
Nov-32	177,729	16,275	116	187,581	17,177	175	168,366	15,418	84
Dec-32	178,130	16,344	116	188,044	17,254	175	168,711	15,480	84
Jan-33	178,352	16,352	116	188,317	17,266	175	168,886	15,484	84
Feb-33	178,357	16,387	115	188,361	17,306	176	168,856	15,514	84
Mar-33	178,351	16,388	115	188,394	17,311	176	168,815	15,512	83
Apr-33	178,270	16,365	115	188,348	17,290	176	168,704	15,487	83
May-33	178,210	16,339	115	188,322	17,266	176	168,611	15,459	83
Jun-33	178,053	16,356	115	188,195	17,288	177	168,428	15,472	83
Jul-33	178,148	16,322	115	188,334	17,255	177	168,484	15,437	82
Aug-33	178,247	16,328	115	188,476	17,265	177	168,544	15,439	82
Sep-33	178,500	16,327	115	188,781	17,268	177	168,750	15,435	82
Oct-33	178,865	16,336	115	189,205	17,281	178	169,061	15,441	82
Nov-33	179,442	16,366	115	189,854	17,316	178	169,572	15,466	81
Dec-33	179,839	16,435	115	190,312	17,392	178	169,914	15,528	81
Jan-34	180,059	16,442	115	190,583	17,403	178	170,088	15,532	81
Feb-34	180,062	16,478	115	190,623	17,445	179	170,056	15,562	81
Mar-34	180,053	16,477	115	190,652	17,447	179	170,013	15,558	80
Apr-34	179,970	16,455	114	190,602	17,427	179	169,901	15,534	80
May-34	179,906	16,429	114	190,573	17,403	179	169,807	15,507	80
Jun-34	179,746	16,446	114	190,441	17,425	180	169,622	15,520	80
Jul-34	179,838	16,412	114	190,576	17,392	180	169,676	15,485	79

APPENDIX 2.2: CUSTOMER FORECASTS BY REGION WASHINGTON

	Washington - Expected Growth			Washington - High Growth			Washington - Low Growth		
	Residential Customers	Commercial Customers	Industrial Customers	Residential Customers	Commercial Customers	Industrial Customers	Residential Customers	Commercial Customers	Industrial Customers
Aug-34	179,936	16,418	114	190,717	17,402	180	169,735	15,487	79
Sep-34	180,186	16,416	114	191,019	17,403	180	169,938	15,482	79
Oct-34	180,549	16,425	114	191,440	17,416	181	170,247	15,488	79
Nov-34	181,124	16,454	114	192,087	17,450	181	170,756	15,512	78
Dec-34	181,519	16,524	114	192,543	17,528	181	171,095	15,575	78
Jan-35	181,737	16,531	114	192,812	17,539	181	171,268	15,579	78
Feb-35	181,737	16,566	114	192,849	17,579	182	171,235	15,609	78
Mar-35	181,725	16,565	114	192,874	17,581	182	171,190	15,605	77
Apr-35	181,640	16,543	114	192,821	17,561	182	171,077	15,581	77
May-35	181,573	16,517	114	192,787	17,537	182	170,981	15,554	77
Jun-35	181,413	16,533	114	192,654	17,558	183	170,796	15,566	77
Jul-35	181,504	16,499	113	192,787	17,525	183	170,849	15,531	76
Aug-35	181,600	16,505	113	192,926	17,535	183	170,907	15,533	76
Sep-35	181,849	16,502	113	193,228	17,535	183	171,109	15,528	76
Oct-35	182,211	16,512	113	193,649	17,549	184	171,417	15,534	76
Nov-35	182,784	16,542	113	194,295	17,584	184	171,924	15,559	75
Dec-35	183,178	16,611	113	194,751	17,661	184	172,261	15,621	75
Jan-36	183,395	16,618	113	195,019	17,671	184	172,433	15,625	75
Feb-36	183,394	16,653	113	195,055	17,712	185	172,399	15,655	75
Mar-36	183,382	16,652	113	195,079	17,714	185	172,354	15,651	74
Apr-36	183,296	16,630	113	195,024	17,694	185	172,241	15,627	74
May-36	183,228	16,604	113	194,989	17,670	185	172,144	15,600	74
Jun-36	183,065	16,620	113	194,853	17,690	186	171,958	15,612	74
Jul-36	183,155	16,585	113	194,985	17,656	186	172,011	15,576	73
Aug-36	183,249	16,591	113	195,122	17,666	186	172,067	15,579	73
Sep-36	183,497	16,588	112	195,422	17,666	186	172,268	15,573	73
Oct-36	183,857	16,598	112	195,842	17,680	187	172,574	15,579	73
Nov-36	184,430	16,627	112	196,488	17,714	187	173,079	15,604	72
Dec-36	184,822	16,697	112	196,942	17,792	187	173,415	15,667	72
Jan-37	185,038	16,703	112	197,209	17,802	187	173,585	15,669	72
Feb-37	185,035	16,739	112	197,243	17,844	188	173,550	15,700	72
Mar-37	185,021	16,737	112	197,265	17,845	188	173,505	15,695	71
Apr-37	184,932	16,715	112	197,206	17,825	188	173,389	15,672	71
May-37	184,863	16,688	112	197,170	17,799	188	173,292	15,644	71
Jun-37	184,699	16,704	112	197,031	17,819	189	173,106	15,656	71
Jul-37	184,790	16,670	112	197,164	17,786	189	173,159	15,621	70
Aug-37	184,883	16,676	112	197,299	17,796	189	173,214	15,624	70
Sep-37	185,129	16,673	112	197,598	17,796	189	173,413	15,618	70
Oct-37	185,487	16,682	112	198,016	17,809	190	173,717	15,624	70
Nov-37	186,058	16,712	111	198,662	17,844	190	174,220	15,649	69
Dec-37	186,449	16,780	111	199,115	17,920	190	174,555	15,710	69

APPENDIX 2.2: CUSTOMER FORECASTS BY REGION

IDAHO

	Idaho - Expected Growth			Idaho - High Growth			Idaho - Low Growth		
	Residential Customers	Commercial Customers	Industrial Customers	Residential Customers	Commercial Customers	Industrial Customers	Residential Customers	Commercial Customers	Industrial Customers
Nov-17	73,590	8,874	94	74,177	8,945	94	73,005	8,803	94
Dec-17	73,890	8,909	94	74,511	8,984	94	73,272	8,834	94
Jan-18	74,021	8,917	94	74,674	8,996	94	73,370	8,839	93
Feb-18	74,021	8,924	95	74,706	9,007	95	73,340	8,842	93
Mar-18	74,022	8,915	95	74,738	9,001	95	73,310	8,829	93
Apr-18	73,986	8,914	95	74,733	9,004	95	73,243	8,824	93
May-18	73,968	8,913	95	74,746	9,007	95	73,194	8,820	93
Jun-18	73,964	8,920	95	74,774	9,018	95	73,160	8,823	93
Jul-18	74,060	8,927	95	74,901	9,028	95	73,223	8,826	92
Aug-18	74,149	8,933	95	75,023	9,038	96	73,280	8,828	92
Sep-18	74,350	8,932	95	75,258	9,041	96	73,448	8,824	92
Oct-18	74,521	8,937	96	75,463	9,050	96	73,586	8,825	92
Nov-18	74,777	8,938	96	75,754	9,055	96	73,808	8,822	92
Dec-18	75,100	8,967	96	76,113	9,088	96	74,096	8,847	92
Jan-19	75,236	8,978	96	76,283	9,103	96	74,199	8,854	91
Feb-19	75,235	8,979	96	76,314	9,108	97	74,167	8,851	91
Mar-19	75,237	8,967	96	76,348	9,099	97	74,138	8,836	91
Apr-19	75,203	8,965	96	76,345	9,101	97	74,073	8,830	91
May-19	75,186	8,968	96	76,360	9,108	97	74,025	8,829	91
Jun-19	75,185	8,971	96	76,390	9,115	97	73,992	8,829	91
Jul-19	75,283	8,985	96	76,522	9,133	97	74,057	8,839	90
Aug-19	75,375	8,992	96	76,648	9,144	98	74,116	8,842	90
Sep-19	75,579	8,992	96	76,889	9,148	98	74,285	8,838	90
Oct-19	75,753	8,993	96	77,098	9,153	98	74,424	8,835	90
Nov-19	76,012	8,995	96	77,395	9,159	98	74,647	8,833	90
Dec-19	76,338	9,023	96	77,760	9,191	98	74,935	8,857	90
Jan-20	76,477	9,033	96	77,935	9,205	98	75,040	8,863	89
Feb-20	76,479	9,035	96	77,970	9,211	99	75,010	8,861	89
Mar-20	76,484	9,025	96	78,008	9,205	99	74,983	8,848	89
Apr-20	76,453	9,022	96	78,010	9,206	99	74,921	8,841	89
May-20	76,439	9,027	96	78,029	9,215	99	74,875	8,842	89
Jun-20	76,442	9,029	96	78,064	9,221	99	74,845	8,840	89
Jul-20	76,545	9,043	96	78,203	9,239	99	74,913	8,850	88
Aug-20	76,642	9,049	96	78,337	9,249	100	74,975	8,852	88
Sep-20	76,852	9,050	96	78,586	9,254	100	75,148	8,849	88
Oct-20	77,030	9,050	96	78,803	9,258	100	75,289	8,845	88
Nov-20	77,295	9,053	96	79,109	9,265	100	75,514	8,844	88
Dec-20	77,627	9,081	96	79,483	9,298	100	75,805	8,868	88
Jan-21	77,771	9,092	96	79,666	9,314	100	75,913	8,875	87
Feb-21	77,778	9,094	96	79,708	9,320	101	75,886	8,873	87

APPENDIX 2.2: CUSTOMER FORECASTS BY REGION

IDAHO

	Idaho - Expected Growth			Idaho - High Growth			Idaho - Low Growth		
	Residential Customers	Commercial Customers	Industrial Customers	Residential Customers	Commercial Customers	Industrial Customers	Residential Customers	Commercial Customers	Industrial Customers
Mar-21	77,789	9,083	96	79,754	9,312	101	75,864	8,858	87
Apr-21	77,763	9,080	96	79,763	9,313	101	75,805	8,851	87
May-21	77,755	9,086	96	79,790	9,324	101	75,764	8,853	87
Jun-21	77,762	9,087	96	79,831	9,329	101	75,736	8,850	87
Jul-21	77,866	9,102	96	79,972	9,348	101	75,805	8,861	86
Aug-21	77,964	9,108	96	80,108	9,358	102	75,867	8,863	86
Sep-21	78,175	9,108	96	80,360	9,363	102	76,039	8,859	86
Oct-21	78,354	9,109	96	80,579	9,368	102	76,180	8,856	86
Nov-21	78,620	9,113	96	80,888	9,376	102	76,405	8,856	86
Dec-21	78,953	9,139	96	81,266	9,407	102	76,696	8,878	86
Jan-22	79,098	9,152	96	81,450	9,424	102	76,803	8,886	85
Feb-22	79,106	9,153	96	81,494	9,429	103	76,777	8,884	85
Mar-22	79,117	9,143	96	81,541	9,423	103	76,755	8,870	85
Apr-22	79,092	9,140	96	81,551	9,424	103	76,697	8,863	85
May-22	79,085	9,146	96	81,579	9,434	103	76,657	8,865	85
Jun-22	79,093	9,146	96	81,622	9,438	103	76,630	8,861	85
Jul-22	79,199	9,162	96	81,766	9,459	103	76,700	8,873	84
Aug-22	79,298	9,167	96	81,904	9,468	104	76,762	8,874	84
Sep-22	79,510	9,168	96	82,159	9,473	104	76,934	8,871	84
Oct-22	79,691	9,169	96	82,381	9,479	104	77,076	8,868	84
Nov-22	79,958	9,171	96	82,693	9,485	104	77,301	8,866	84
Dec-22	80,292	9,199	96	83,075	9,518	104	77,590	8,889	84
Jan-23	80,438	9,211	96	83,262	9,534	104	77,697	8,897	83
Feb-23	80,448	9,212	96	83,308	9,539	105	77,673	8,894	83
Mar-23	80,461	9,202	96	83,358	9,533	105	77,652	8,881	83
Apr-23	80,437	9,200	96	83,369	9,535	105	77,595	8,875	83
May-23	80,432	9,204	96	83,399	9,544	105	77,556	8,875	83
Jun-23	80,441	9,206	96	83,444	9,550	105	77,531	8,873	83
Jul-23	80,538	9,221	96	83,578	9,569	105	77,594	8,884	82
Aug-23	80,629	9,226	96	83,705	9,578	106	77,651	8,885	82
Sep-23	80,832	9,227	96	83,949	9,583	106	77,816	8,883	82
Oct-23	81,005	9,228	96	84,162	9,588	106	77,952	8,880	82
Nov-23	81,263	9,230	96	84,463	9,593	106	78,170	8,879	82
Dec-23	81,589	9,258	96	84,835	9,626	106	78,452	8,902	82
Jan-24	81,727	9,269	96	85,012	9,642	106	78,554	8,909	81
Feb-24	81,728	9,270	96	85,047	9,646	107	78,524	8,907	81
Mar-24	81,731	9,260	96	85,083	9,640	107	78,496	8,893	81
Apr-24	81,699	9,256	96	85,084	9,639	107	78,435	8,886	81
May-24	81,685	9,262	96	85,101	9,649	107	78,389	8,888	81
Jun-24	81,685	9,264	96	85,135	9,655	107	78,359	8,887	81

APPENDIX 2.2: CUSTOMER FORECASTS BY REGION IDAHO

	Idaho - Expected Growth			Idaho - High Growth			Idaho - Low Growth		
	Residential Customers	Commercial Customers	Industrial Customers	Residential Customers	Commercial Customers	Industrial Customers	Residential Customers	Commercial Customers	Industrial Customers
Jul-24	81,781	9,278	96	85,268	9,674	107	78,421	8,897	80
Aug-24	81,871	9,284	96	85,394	9,684	108	78,477	8,899	80
Sep-24	82,073	9,285	96	85,637	9,688	108	78,641	8,897	80
Oct-24	82,244	9,284	96	85,849	9,691	108	78,774	8,892	80
Nov-24	82,501	9,287	96	86,150	9,698	108	78,990	8,892	80
Dec-24	82,825	9,315	96	86,521	9,731	108	79,270	8,915	80
Jan-25	82,962	9,326	96	86,698	9,746	108	79,371	8,922	79
Feb-25	82,961	9,328	96	86,730	9,752	109	79,340	8,921	79
Mar-25	82,964	9,318	96	86,766	9,745	109	79,313	8,908	79
Apr-25	82,930	9,314	96	86,764	9,744	109	79,250	8,901	79
May-25	82,915	9,319	96	86,780	9,753	109	79,204	8,902	79
Jun-25	82,913	9,320	96	86,811	9,758	109	79,172	8,900	79
Jul-25	83,008	9,335	96	86,943	9,778	109	79,233	8,911	78
Aug-25	83,097	9,341	96	87,069	9,787	110	79,289	8,913	78
Sep-25	83,298	9,341	96	87,312	9,791	110	79,451	8,910	78
Oct-25	83,468	9,341	96	87,522	9,795	110	79,584	8,906	78
Nov-25	83,724	9,344	96	87,824	9,802	110	79,798	8,906	78
Dec-25	84,047	9,371	96	88,195	9,834	110	80,076	8,928	78
Jan-26	84,183	9,383	96	88,371	9,850	110	80,176	8,936	77
Feb-26	84,181	9,385	96	88,402	9,856	111	80,144	8,935	77
Mar-26	84,183	9,374	96	88,437	9,848	111	80,116	8,921	77
Apr-26	84,148	9,371	96	88,433	9,848	111	80,053	8,915	77
May-26	84,132	9,376	96	88,448	9,857	111	80,007	8,916	77
Jun-26	84,129	9,377	96	88,478	9,862	111	79,974	8,914	77
Jul-26	84,223	9,392	96	88,609	9,881	111	80,035	8,925	76
Aug-26	84,311	9,398	96	88,734	9,891	112	80,089	8,927	76
Sep-26	84,511	9,397	96	88,977	9,894	112	80,250	8,923	76
Oct-26	84,680	9,398	96	89,187	9,898	112	80,381	8,921	76
Nov-26	84,936	9,400	96	89,489	9,904	112	80,595	8,920	76
Dec-26	85,258	9,428	96	89,861	9,937	112	80,871	8,943	76
Jan-27	85,392	9,440	96	90,035	9,953	112	80,969	8,951	75
Feb-27	85,390	9,440	96	90,066	9,957	113	80,937	8,948	75
Mar-27	85,391	9,430	96	90,100	9,950	113	80,909	8,935	75
Apr-27	85,356	9,427	96	90,095	9,950	113	80,845	8,929	75
May-27	85,338	9,432	96	90,109	9,959	113	80,799	8,930	75
Jun-27	85,335	9,433	96	90,138	9,964	113	80,767	8,928	75
Jul-27	85,430	9,448	96	90,271	9,983	113	80,828	8,939	74
Aug-27	85,518	9,453	96	90,397	9,992	114	80,882	8,941	74
Sep-27	85,719	9,454	96	90,642	9,997	114	81,042	8,938	74
Oct-27	85,889	9,455	96	90,855	10,002	114	81,174	8,936	74

APPENDIX 2.2: CUSTOMER FORECASTS BY REGION

IDAHO

	Idaho - Expected Growth			Idaho - High Growth			Idaho - Low Growth		
	Residential Customers	Commercial Customers	Industrial Customers	Residential Customers	Commercial Customers	Industrial Customers	Residential Customers	Commercial Customers	Industrial Customers
Nov-27	86,145	9,457	96	91,158	10,007	114	81,386	8,935	74
Dec-27	86,468	9,485	96	91,533	10,041	114	81,662	8,958	74
Jan-28	86,603	9,497	96	91,709	10,057	114	81,760	8,966	73
Feb-28	86,602	9,497	96	91,742	10,061	115	81,729	8,963	73
Mar-28	86,603	9,487	96	91,776	10,054	115	81,701	8,950	73
Apr-28	86,569	9,484	96	91,772	10,054	115	81,638	8,944	73
May-28	86,552	9,489	96	91,787	10,063	115	81,593	8,945	73
Jun-28	86,549	9,490	96	91,817	10,068	115	81,561	8,943	73
Jul-28	86,645	9,504	96	91,952	10,086	115	81,622	8,953	72
Aug-28	86,735	9,510	96	92,081	10,096	116	81,677	8,955	72
Sep-28	86,937	9,511	96	92,328	10,101	116	81,838	8,953	72
Oct-28	87,107	9,511	96	92,542	10,104	116	81,969	8,950	72
Nov-28	87,364	9,514	96	92,849	10,111	116	82,181	8,950	72
Dec-28	87,688	9,542	96	93,226	10,145	116	82,456	8,973	72
Jan-29	87,824	9,553	96	93,405	10,160	116	82,554	8,980	71
Feb-29	87,824	9,554	96	93,438	10,165	117	82,525	8,977	71
Mar-29	87,826	9,544	96	93,474	10,158	117	82,497	8,965	71
Apr-29	87,793	9,540	96	93,471	10,157	117	82,435	8,958	71
May-29	87,777	9,546	96	93,488	10,167	117	82,391	8,960	71
Jun-29	87,775	9,547	96	93,519	10,172	117	82,359	8,958	71
Jul-29	87,871	9,561	96	93,655	10,190	117	82,420	8,968	70
Aug-29	87,960	9,567	96	93,783	10,200	118	82,474	8,970	70
Sep-29	88,162	9,568	96	94,032	10,205	118	82,635	8,968	70
Oct-29	88,333	9,568	96	94,248	10,209	118	82,766	8,965	70
Nov-29	88,590	9,571	96	94,555	10,215	118	82,977	8,965	70
Dec-29	88,914	9,598	96	94,935	10,248	118	83,251	8,987	70
Jan-30	89,050	9,610	96	95,114	10,264	118	83,349	8,995	69
Feb-30	89,049	9,611	96	95,146	10,269	119	83,318	8,992	69
Mar-30	89,051	9,600	96	95,182	10,261	119	83,291	8,979	69
Apr-30	89,019	9,597	96	95,181	10,261	119	83,230	8,973	69
May-30	89,002	9,603	96	95,196	10,271	119	83,185	8,975	69
Jun-30	89,000	9,603	96	95,228	10,275	119	83,154	8,972	69
Jul-30	89,099	9,619	96	95,368	10,296	119	83,216	8,984	68
Aug-30	89,192	9,624	96	95,502	10,305	120	83,273	8,985	68
Sep-30	89,397	9,624	96	95,756	10,309	120	83,435	8,982	68
Oct-30	89,570	9,625	96	95,976	10,313	120	83,566	8,980	68
Nov-30	89,831	9,628	96	96,290	10,320	120	83,779	8,979	68
Dec-30	90,157	9,655	96	96,675	10,353	120	84,053	9,001	68
Jan-31	90,297	9,667	96	96,860	10,370	120	84,153	9,009	67
Feb-31	90,299	9,669	96	96,897	10,375	121	84,125	9,008	67

APPENDIX 2.2: CUSTOMER FORECASTS BY REGION

IDAHO

	Idaho - Expected Growth			Idaho - High Growth			Idaho - Low Growth		
	Residential Customers	Commercial Customers	Industrial Customers	Residential Customers	Commercial Customers	Industrial Customers	Residential Customers	Commercial Customers	Industrial Customers
Mar-31	90,305	9,658	96	96,937	10,367	121	84,099	8,994	67
Apr-31	90,274	9,655	96	96,938	10,368	121	84,040	8,988	67
May-31	90,261	9,660	96	96,959	10,377	121	83,998	8,990	67
Jun-31	90,262	9,661	96	96,995	10,382	121	83,969	8,987	67
Jul-31	90,364	9,677	96	97,140	10,403	121	84,033	8,999	66
Aug-31	90,458	9,681	96	97,276	10,411	122	84,090	9,000	66
Sep-31	90,665	9,682	96	97,534	10,416	122	84,252	8,997	66
Oct-31	90,841	9,683	96	97,759	10,420	122	84,385	8,995	66
Nov-31	91,104	9,686	96	98,078	10,427	122	84,599	8,994	66
Dec-31	91,432	9,713	96	98,467	10,460	122	84,873	9,016	66
Jan-32	91,574	9,726	96	98,655	10,478	122	84,974	9,025	65
Feb-32	91,579	9,726	96	98,696	10,482	123	84,948	9,022	65
Mar-32	91,587	9,716	96	98,740	10,475	123	84,923	9,009	65
Apr-32	91,558	9,713	96	98,744	10,475	123	84,866	9,003	65
May-32	91,547	9,718	96	98,768	10,485	123	84,825	9,004	65
Jun-32	91,551	9,720	96	98,808	10,491	123	84,798	9,003	65
Jul-32	91,654	9,735	96	98,955	10,511	123	84,862	9,014	64
Aug-32	91,750	9,740	96	99,095	10,520	124	84,920	9,015	64
Sep-32	91,959	9,741	96	99,357	10,525	124	85,083	9,013	64
Oct-32	92,137	9,741	96	99,585	10,528	124	85,217	9,009	64
Nov-32	92,401	9,744	96	99,907	10,536	124	85,430	9,009	64
Dec-32	92,732	9,772	96	100,301	10,570	124	85,705	9,031	64
Jan-33	92,875	9,783	96	100,493	10,585	124	85,806	9,038	63
Feb-33	92,882	9,785	96	100,537	10,591	125	85,781	9,037	63
Mar-33	92,892	9,775	96	100,583	10,584	125	85,758	9,024	63
Apr-33	92,865	9,771	96	100,590	10,584	125	85,702	9,017	63
May-33	92,856	9,777	96	100,617	10,594	125	85,663	9,020	63
Jun-33	92,862	9,779	96	100,660	10,600	125	85,637	9,018	63
Jul-33	92,967	9,793	96	100,811	10,619	125	85,703	9,028	62
Aug-33	93,065	9,799	96	100,954	10,630	126	85,762	9,030	62
Sep-33	93,277	9,800	96	101,221	10,635	126	85,926	9,028	62
Oct-33	93,457	9,800	96	101,453	10,639	126	86,060	9,024	62
Nov-33	93,723	9,804	96	101,779	10,647	126	86,273	9,025	62
Dec-33	94,056	9,831	96	102,178	10,680	126	86,548	9,046	62
Jan-34	94,202	9,843	96	102,374	10,697	126	86,651	9,054	61
Feb-34	94,211	9,844	96	102,422	10,702	127	86,628	9,052	61
Mar-34	94,223	9,834	96	102,471	10,695	127	86,606	9,039	61
Apr-34	94,199	9,831	96	102,482	10,696	127	86,552	9,033	61
May-34	94,192	9,837	96	102,512	10,706	127	86,514	9,035	61
Jun-34	94,199	9,837	96	102,557	10,710	127	86,489	9,032	61
Jul-34	94,306	9,853	96	102,711	10,731	127	86,556	9,043	60

APPENDIX 2.2: CUSTOMER FORECASTS BY REGION

IDAHO

	Idaho - Expected Growth			Idaho - High Growth			Idaho - Low Growth		
	Residential Customers	Commercial Customers	Industrial Customers	Residential Customers	Commercial Customers	Industrial Customers	Residential Customers	Commercial Customers	Industrial Customers
Aug-34	94,406	9,859	96	102,858	10,742	128	86,616	9,045	60
Sep-34	94,619	9,859	96	103,128	10,746	128	86,780	9,042	60
Oct-34	94,801	9,860	96	103,364	10,751	128	86,915	9,040	60
Nov-34	95,069	9,863	96	103,694	10,758	128	87,129	9,039	60
Dec-34	95,404	9,890	96	104,098	10,791	128	87,404	9,061	60
Jan-35	95,551	9,903	96	104,296	10,809	128	87,506	9,069	59
Feb-35	95,563	9,904	96	104,346	10,814	129	87,484	9,067	59
Mar-35	95,576	9,894	96	104,399	10,807	129	87,464	9,054	59
Apr-35	95,553	9,891	96	104,412	10,808	129	87,411	9,048	59
May-35	95,548	9,897	96	104,445	10,819	129	87,375	9,050	59
Jun-35	95,557	9,897	96	104,493	10,822	129	87,351	9,047	59
Jul-35	95,666	9,913	96	104,650	10,844	129	87,419	9,058	58
Aug-35	95,769	9,918	96	104,802	10,853	130	87,481	9,060	58
Sep-35	95,984	9,919	96	105,076	10,859	130	87,645	9,057	58
Oct-35	96,168	9,920	96	105,316	10,864	130	87,780	9,055	58
Nov-35	96,439	9,923	96	105,651	10,871	130	87,995	9,054	58
Dec-35	96,776	9,951	96	106,060	10,906	130	88,270	9,076	58
Jan-36	96,926	9,963	96	106,263	10,923	130	88,375	9,084	57
Feb-36	96,940	9,964	96	106,317	10,928	131	88,354	9,082	57
Mar-36	96,955	9,954	96	106,372	10,921	131	88,335	9,069	57
Apr-36	96,935	9,951	96	106,389	10,922	131	88,285	9,063	57
May-36	96,932	9,956	96	106,425	10,931	131	88,249	9,064	57
Jun-36	96,944	9,958	96	106,478	10,937	131	88,228	9,063	57
Jul-36	97,055	9,974	96	106,639	10,959	131	88,296	9,074	56
Aug-36	97,159	9,979	96	106,793	10,968	132	88,358	9,075	56
Sep-36	97,377	9,980	96	107,072	10,974	132	88,524	9,073	56
Oct-36	97,563	9,981	96	107,316	10,979	132	88,660	9,070	56
Nov-36	97,835	9,984	96	107,655	10,986	132	88,875	9,070	56
Dec-36	98,174	10,012	96	108,067	11,021	132	89,150	9,092	56
Jan-37	98,326	10,023	96	108,275	11,037	132	89,255	9,098	55
Feb-37	98,341	10,025	96	108,330	11,043	133	89,235	9,097	55
Mar-37	98,359	10,015	96	108,390	11,036	133	89,218	9,084	55
Apr-37	98,340	10,011	96	108,409	11,036	133	89,168	9,077	55
May-37	98,340	10,017	96	108,449	11,047	133	89,135	9,079	55
Jun-37	98,353	10,019	96	108,503	11,053	133	89,114	9,078	55
Jul-37	98,466	10,034	96	108,668	11,074	133	89,184	9,088	54
Aug-37	98,572	10,040	96	108,825	11,084	134	89,247	9,090	54
Sep-37	98,791	10,041	96	109,107	11,089	134	89,412	9,088	54
Oct-37	98,978	10,042	96	109,354	11,095	134	89,548	9,085	54
Nov-37	99,252	10,045	96	109,697	11,102	134	89,763	9,085	54
Dec-37	99,592	10,073	96	110,113	11,137	134	90,038	9,107	54

APPENDIX 2.2: CUSTOMER FORECASTS BY REGION

MEDFORD

	Medford - Expected Growth			Medford - High Growth			Medford - Low Growth		
	Residential Customers	Commercial Customers	Industrial Customers	Residential Customers	Commercial Customers	Industrial Customers	Residential Customers	Commercial Customers	Industrial Customers
Nov-17	54,604	6,919	15	54,965	6,965	15	54,244	6,873	15
Dec-17	54,921	6,966	15	55,302	7,014	15	54,541	6,918	15
Jan-18	55,150	7,001	15	55,551	7,052	15	54,750	6,951	15
Feb-18	55,132	7,025	15	55,552	7,079	15	54,714	6,972	15
Mar-18	55,110	7,009	15	55,548	7,065	15	54,674	6,954	15
Apr-18	55,081	7,004	15	55,537	7,062	15	54,627	6,947	15
May-18	54,977	6,995	15	55,450	7,056	15	54,506	6,935	15
Jun-18	54,860	6,975	15	55,350	7,038	15	54,372	6,913	15
Jul-18	54,730	6,964	15	55,237	7,029	15	54,226	6,900	15
Aug-18	54,648	6,966	15	55,171	7,033	15	54,128	6,900	15
Sep-18	54,650	6,937	15	55,191	7,006	15	54,112	6,869	15
Oct-18	54,917	6,954	15	55,478	7,025	16	54,360	6,884	15
Nov-18	55,303	7,003	15	55,885	7,077	16	54,725	6,930	14
Dec-18	55,650	7,047	15	56,254	7,124	16	55,050	6,971	14
Jan-19	55,862	7,076	15	56,486	7,155	16	55,243	6,998	14
Feb-19	55,858	7,095	15	56,499	7,177	16	55,221	7,014	14
Mar-19	55,847	7,095	15	56,506	7,179	16	55,193	7,012	14
Apr-19	55,810	7,075	15	56,486	7,161	16	55,139	6,990	14
May-19	55,722	7,068	15	56,415	7,156	16	55,035	6,981	14
Jun-19	55,598	7,058	15	56,307	7,148	16	54,895	6,969	14
Jul-19	55,454	7,033	15	56,178	7,125	16	54,736	6,942	14
Aug-19	55,371	7,022	15	56,111	7,116	16	54,638	6,929	14
Sep-19	55,364	7,018	15	56,121	7,114	16	54,614	6,923	14
Oct-19	55,624	7,030	15	56,402	7,128	16	54,854	6,933	14
Nov-19	56,009	7,074	15	56,809	7,175	16	55,217	6,974	14
Dec-19	56,352	7,120	15	57,174	7,224	16	55,538	7,017	14
Jan-20	56,565	7,152	15	57,408	7,258	16	55,731	7,046	14
Feb-20	56,563	7,173	15	57,423	7,282	16	55,712	7,065	14
Mar-20	56,551	7,167	15	57,428	7,278	16	55,684	7,057	14
Apr-20	56,514	7,152	15	57,408	7,265	16	55,630	7,040	14
May-20	56,424	7,145	15	57,334	7,260	16	55,525	7,031	14
Jun-20	56,297	7,131	15	57,222	7,248	16	55,383	7,015	14
Jul-20	56,154	7,111	15	57,094	7,230	16	55,226	6,993	14
Aug-20	56,071	7,105	15	57,027	7,226	16	55,127	6,985	14
Sep-20	56,064	7,091	15	57,037	7,214	16	55,104	6,969	14
Oct-20	56,325	7,104	15	57,320	7,229	17	55,343	6,980	14
Nov-20	56,712	7,151	15	57,732	7,279	17	55,706	7,024	13
Dec-20	57,056	7,196	15	58,100	7,327	17	56,027	7,066	13
Jan-21	57,272	7,227	15	58,337	7,361	17	56,222	7,094	13
Feb-21	57,271	7,247	15	58,354	7,384	17	56,204	7,112	13

APPENDIX 2.2: CUSTOMER FORECASTS BY REGION

MEDFORD

	Medford - Expected Growth			Medford - High Growth			Medford - Low Growth		
	Residential	Commercial	Industrial	Residential	Commercial	Industrial	Residential	Commercial	Industrial
	Customers	Customers	Customers	Customers	Customers	Customers	Customers	Customers	Customers
Mar-21	57,261	7,244	15	58,362	7,383	17	56,177	7,106	13
Apr-21	57,226	7,227	15	58,344	7,368	17	56,126	7,088	13
May-21	57,138	7,220	15	58,272	7,363	17	56,022	7,079	13
Jun-21	57,011	7,207	15	58,160	7,352	17	55,881	7,064	13
Jul-21	56,867	7,186	15	58,030	7,332	17	55,723	7,041	13
Aug-21	56,783	7,178	15	57,962	7,327	17	55,624	7,031	13
Sep-21	56,776	7,168	15	57,972	7,318	17	55,600	7,019	13
Oct-21	57,036	7,180	15	58,255	7,333	17	55,838	7,029	13
Nov-21	57,422	7,226	15	58,666	7,382	17	56,199	7,072	13
Dec-21	57,766	7,271	15	59,036	7,430	17	56,519	7,114	13
Jan-22	57,981	7,301	15	59,273	7,464	17	56,713	7,141	13
Feb-22	57,980	7,322	15	59,290	7,487	17	56,695	7,160	13
Mar-22	57,969	7,318	15	59,296	7,485	17	56,667	7,154	13
Apr-22	57,933	7,302	15	59,277	7,471	17	56,615	7,136	13
May-22	57,844	7,295	15	59,203	7,466	17	56,511	7,127	13
Jun-22	57,717	7,281	15	59,091	7,454	17	56,370	7,111	13
Jul-22	57,573	7,260	15	58,961	7,435	17	56,213	7,088	13
Aug-22	57,489	7,253	15	58,892	7,430	17	56,114	7,079	13
Sep-22	57,482	7,242	15	58,902	7,421	17	56,091	7,067	13
Oct-22	57,742	7,254	15	59,186	7,435	18	56,328	7,076	13
Nov-22	58,128	7,300	15	59,600	7,485	18	56,688	7,119	12
Dec-22	58,472	7,346	15	59,970	7,534	18	57,006	7,162	12
Jan-23	58,687	7,376	15	60,208	7,568	18	57,199	7,189	12
Feb-23	58,687	7,396	15	60,226	7,590	18	57,182	7,207	12
Mar-23	58,676	7,392	15	60,233	7,588	18	57,154	7,201	12
Apr-23	58,640	7,376	15	60,213	7,574	18	57,102	7,183	12
May-23	58,551	7,369	15	60,140	7,569	18	56,999	7,174	12
Jun-23	58,424	7,356	15	60,027	7,558	18	56,858	7,159	12
Jul-23	58,271	7,334	15	59,885	7,538	18	56,695	7,136	12
Aug-23	58,178	7,326	15	59,805	7,531	18	56,590	7,126	12
Sep-23	58,161	7,315	15	59,802	7,522	18	56,559	7,114	12
Oct-23	58,411	7,327	15	60,075	7,536	18	56,787	7,124	12
Nov-23	58,788	7,372	15	60,478	7,584	18	57,139	7,166	12
Dec-23	59,122	7,417	15	60,837	7,633	18	57,449	7,208	12
Jan-24	59,328	7,447	15	61,065	7,665	18	57,635	7,234	12
Feb-24	59,317	7,467	15	61,069	7,688	18	57,609	7,252	12
Mar-24	59,298	7,463	15	61,065	7,685	18	57,576	7,246	12
Apr-24	59,252	7,446	15	61,033	7,670	18	57,517	7,228	12
May-24	59,153	7,438	15	60,947	7,664	18	57,406	7,218	12
Jun-24	59,016	7,425	15	60,821	7,652	18	57,258	7,204	12

APPENDIX 2.2: CUSTOMER FORECASTS BY REGION

MEDFORD

	Medford - Expected Growth			Medford - High Growth			Medford - Low Growth		
	Residential Customers	Commercial Customers	Industrial Customers	Residential Customers	Commercial Customers	Industrial Customers	Residential Customers	Commercial Customers	Industrial Customers
Jul-24	58,864	7,403	15	60,680	7,631	18	57,096	7,181	12
Aug-24	58,771	7,395	15	60,600	7,625	18	56,991	7,171	12
Sep-24	58,755	7,384	15	60,599	7,616	18	56,961	7,159	12
Oct-24	59,006	7,396	15	60,873	7,630	19	57,190	7,168	12
Nov-24	59,383	7,441	15	61,278	7,678	19	57,541	7,210	11
Dec-24	59,718	7,486	15	61,639	7,727	19	57,850	7,252	11
Jan-25	59,924	7,516	15	61,867	7,759	19	58,035	7,279	11
Feb-25	59,915	7,536	15	61,874	7,782	19	58,012	7,296	11
Mar-25	59,895	7,532	15	61,869	7,780	19	57,977	7,290	11
Apr-25	59,850	7,515	15	61,838	7,764	19	57,919	7,272	11
May-25	59,752	7,508	15	61,753	7,759	19	57,809	7,263	11
Jun-25	59,616	7,494	15	61,628	7,746	19	57,663	7,248	11
Jul-25	59,463	7,472	15	61,485	7,726	19	57,501	7,225	11
Aug-25	59,370	7,464	15	61,405	7,719	19	57,396	7,215	11
Sep-25	59,353	7,453	15	61,402	7,710	19	57,365	7,203	11
Oct-25	59,604	7,465	15	61,678	7,724	19	57,593	7,213	11
Nov-25	59,981	7,510	15	62,083	7,773	19	57,943	7,254	11
Dec-25	60,316	7,555	15	62,446	7,821	19	58,252	7,296	11
Jan-26	60,521	7,585	15	62,674	7,855	19	58,435	7,324	11
Feb-26	60,511	7,604	15	62,679	7,876	19	58,411	7,340	11
Mar-26	60,492	7,600	15	62,675	7,874	19	58,378	7,334	11
Apr-26	60,446	7,583	15	62,643	7,859	19	58,319	7,316	11
May-26	60,348	7,576	15	62,557	7,853	19	58,210	7,307	11
Jun-26	60,211	7,562	15	62,431	7,841	19	58,063	7,292	11
Jul-26	60,057	7,540	15	62,287	7,820	19	57,900	7,269	11
Aug-26	59,964	7,532	15	62,206	7,813	19	57,796	7,260	11
Sep-26	59,946	7,521	15	62,202	7,804	19	57,764	7,247	11
Oct-26	60,197	7,533	15	62,478	7,818	20	57,992	7,257	11
Nov-26	60,573	7,578	15	62,884	7,867	20	58,340	7,299	10
Dec-26	60,907	7,623	15	63,246	7,916	20	58,647	7,340	10
Jan-27	61,112	7,652	15	63,475	7,948	20	58,830	7,366	10
Feb-27	61,102	7,672	15	63,480	7,971	20	58,806	7,384	10
Mar-27	61,081	7,668	15	63,474	7,969	20	58,771	7,378	10
Apr-27	61,035	7,651	15	63,442	7,953	20	58,712	7,360	10
May-27	60,936	7,643	15	63,354	7,946	20	58,602	7,350	10
Jun-27	60,799	7,630	15	63,227	7,935	20	58,456	7,336	10
Jul-27	60,644	7,608	15	63,081	7,914	20	58,293	7,313	10
Aug-27	60,549	7,599	15	62,998	7,906	20	58,188	7,303	10
Sep-27	60,531	7,588	15	62,994	7,897	20	58,157	7,291	10
Oct-27	60,780	7,600	15	63,268	7,911	20	58,382	7,300	10

APPENDIX 2.2: CUSTOMER FORECASTS BY REGION

MEDFORD

	Medford - Expected Growth			Medford - High Growth			Medford - Low Growth		
	Residential Customers	Commercial Customers	Industrial Customers	Residential Customers	Commercial Customers	Industrial Customers	Residential Customers	Commercial Customers	Industrial Customers
Nov-27	61,155	7,645	15	63,674	7,960	20	58,728	7,342	10
Dec-27	61,488	7,690	15	64,036	8,009	20	59,033	7,383	10
Jan-28	61,692	7,720	15	64,264	8,042	20	59,215	7,411	10
Feb-28	61,680	7,739	15	64,267	8,064	20	59,189	7,427	10
Mar-28	61,659	7,735	15	64,260	8,062	20	59,155	7,421	10
Apr-28	61,611	7,718	15	64,226	8,046	20	59,095	7,403	10
May-28	61,511	7,710	15	64,137	8,040	20	58,985	7,394	10
Jun-28	61,373	7,696	15	64,008	8,027	20	58,838	7,379	10
Jul-28	61,216	7,674	15	63,859	8,006	20	58,674	7,356	10
Aug-28	61,120	7,666	15	63,774	7,999	20	58,568	7,346	10
Sep-28	61,099	7,655	15	63,767	7,990	20	58,535	7,334	10
Oct-28	61,347	7,667	15	64,040	8,004	21	58,759	7,344	10
Nov-28	61,720	7,712	15	64,445	8,053	21	59,102	7,385	9
Dec-28	62,052	7,756	15	64,806	8,101	21	59,406	7,426	9
Jan-29	62,254	7,787	15	65,032	8,134	21	59,586	7,453	9
Feb-29	62,240	7,806	15	65,033	8,156	21	59,559	7,470	9
Mar-29	62,217	7,802	15	65,024	8,154	21	59,523	7,464	9
Apr-29	62,168	7,785	15	64,988	8,138	21	59,462	7,446	9
May-29	62,066	7,777	15	64,896	8,131	21	59,351	7,437	9
Jun-29	61,926	7,763	15	64,764	8,119	21	59,203	7,422	9
Jul-29	61,768	7,741	15	64,614	8,097	21	59,039	7,399	9
Aug-29	61,670	7,733	15	64,526	8,091	21	58,932	7,390	9
Sep-29	61,649	7,721	15	64,518	8,080	21	58,899	7,376	9
Oct-29	61,895	7,733	15	64,790	8,095	21	59,120	7,386	9
Nov-29	62,267	7,778	15	65,194	8,144	21	59,462	7,428	9
Dec-29	62,597	7,822	15	65,555	8,191	21	59,764	7,468	9
Jan-30	62,798	7,852	15	65,780	8,225	21	59,942	7,495	9
Feb-30	62,783	7,871	15	65,779	8,247	21	59,915	7,512	9
Mar-30	62,759	7,867	15	65,769	8,244	21	59,878	7,506	9
Apr-30	62,708	7,850	15	65,730	8,229	21	59,816	7,488	9
May-30	62,605	7,842	15	65,637	8,222	21	59,704	7,479	9
Jun-30	62,464	7,828	15	65,504	8,209	21	59,556	7,464	9
Jul-30	62,304	7,806	15	65,350	8,188	21	59,391	7,441	9
Aug-30	62,204	7,797	15	65,259	8,180	21	59,283	7,431	9
Sep-30	62,181	7,786	15	65,249	8,170	21	59,248	7,419	9
Oct-30	62,425	7,797	15	65,519	8,184	22	59,468	7,428	9
Nov-30	62,795	7,842	15	65,922	8,233	22	59,807	7,469	8
Dec-30	63,123	7,887	15	66,280	8,282	22	60,107	7,510	8
Jan-31	63,322	7,917	15	66,504	8,314	22	60,283	7,537	8
Feb-31	63,305	7,936	15	66,500	8,336	22	60,254	7,553	8

APPENDIX 2.2: CUSTOMER FORECASTS BY REGION

MEDFORD

	Medford - Expected Growth			Medford - High Growth			Medford - Low Growth		
	Residential Customers	Commercial Customers	Industrial Customers	Residential Customers	Commercial Customers	Industrial Customers	Residential Customers	Commercial Customers	Industrial Customers
Mar-31	63,278	7,931	15	66,486	8,333	22	60,215	7,547	8
Apr-31	63,226	7,915	15	66,446	8,318	22	60,153	7,530	8
May-31	63,121	7,906	15	66,350	8,310	22	60,040	7,520	8
Jun-31	62,978	7,892	15	66,214	8,297	22	59,891	7,505	8
Jul-31	62,816	7,870	15	66,057	8,276	22	59,725	7,482	8
Aug-31	62,714	7,861	15	65,963	8,268	22	59,615	7,472	8
Sep-31	62,689	7,850	15	65,951	8,258	22	59,579	7,460	8
Oct-31	62,931	7,861	15	66,219	8,271	22	59,797	7,469	8
Nov-31	63,300	7,906	15	66,621	8,320	22	60,135	7,510	8
Dec-31	63,626	7,950	15	66,978	8,369	22	60,432	7,551	8
Jan-32	63,823	7,980	15	67,200	8,402	22	60,606	7,578	8
Feb-32	63,804	7,999	15	67,193	8,424	22	60,576	7,594	8
Mar-32	63,776	7,994	15	67,178	8,421	22	60,536	7,588	8
Apr-32	63,722	7,977	15	67,135	8,404	22	60,473	7,570	8
May-32	63,615	7,969	15	67,036	8,398	22	60,359	7,561	8
Jun-32	63,470	7,955	15	66,897	8,385	22	60,208	7,546	8
Jul-32	63,306	7,932	15	66,738	8,362	22	60,041	7,523	8
Aug-32	63,203	7,923	15	66,643	8,354	22	59,931	7,513	8
Sep-32	63,177	7,912	15	66,628	8,344	22	59,894	7,501	8
Oct-32	63,418	7,923	15	66,896	8,358	23	60,111	7,510	8
Nov-32	63,784	7,968	15	67,296	8,407	23	60,446	7,551	7
Dec-32	64,109	8,012	15	67,652	8,455	23	60,741	7,591	7
Jan-33	64,305	8,042	15	67,873	8,488	23	60,915	7,618	7
Feb-33	64,285	8,062	15	67,865	8,511	23	60,884	7,635	7
Mar-33	64,255	8,056	15	67,847	8,506	23	60,843	7,628	7
Apr-33	64,199	8,039	15	67,801	8,490	23	60,778	7,610	7
May-33	64,091	8,031	15	67,701	8,483	23	60,663	7,601	7
Jun-33	63,944	8,017	15	67,559	8,470	23	60,512	7,586	7
Jul-33	63,780	7,994	15	67,399	8,447	23	60,345	7,563	7
Aug-33	63,675	7,985	15	67,301	8,439	23	60,234	7,553	7
Sep-33	63,647	7,974	15	67,285	8,429	23	60,196	7,541	7
Oct-33	63,887	7,985	15	67,552	8,443	23	60,411	7,550	7
Nov-33	64,252	8,030	15	67,951	8,492	23	60,744	7,591	7
Dec-33	64,576	8,074	15	68,307	8,540	23	61,039	7,631	7
Jan-34	64,770	8,103	15	68,525	8,573	23	61,210	7,658	7
Feb-34	64,748	8,122	15	68,515	8,594	23	61,177	7,674	7
Mar-34	64,717	8,117	15	68,496	8,591	23	61,136	7,668	7
Apr-34	64,660	8,100	15	68,449	8,575	23	61,070	7,650	7
May-34	64,551	8,091	15	68,347	8,567	23	60,956	7,640	7
Jun-34	64,403	8,077	15	68,203	8,554	23	60,804	7,626	7
Jul-34	64,237	8,054	15	68,040	8,531	23	60,636	7,602	7

APPENDIX 2.2: CUSTOMER FORECASTS BY REGION

MEDFORD

	Medford - Expected Growth			Medford - High Growth			Medford - Low Growth		
	Residential Customers	Commercial Customers	Industrial Customers	Residential Customers	Commercial Customers	Industrial Customers	Residential Customers	Commercial Customers	Industrial Customers
Aug-34	64,131	8,046	15	67,941	8,524	23	60,524	7,593	7
Sep-34	64,102	8,034	15	67,923	8,513	23	60,485	7,581	7
Oct-34	64,340	8,045	15	68,188	8,526	24	60,699	7,590	7
Nov-34	64,704	8,090	15	68,587	8,575	24	61,030	7,631	6
Dec-34	65,026	8,134	15	68,941	8,624	24	61,323	7,671	6
Jan-35	65,219	8,163	15	69,158	8,656	24	61,493	7,697	6
Feb-35	65,196	8,182	15	69,147	8,678	24	61,460	7,713	6
Mar-35	65,164	8,177	15	69,126	8,675	24	61,418	7,707	6
Apr-35	65,106	8,159	15	69,078	8,657	24	61,352	7,689	6
May-35	64,995	8,151	15	68,973	8,650	24	61,236	7,680	6
Jun-35	64,845	8,136	15	68,827	8,636	24	61,083	7,664	6
Jul-35	64,679	8,114	15	68,663	8,614	24	60,915	7,642	6
Aug-35	64,573	8,105	15	68,564	8,606	24	60,804	7,632	6
Sep-35	64,543	8,093	15	68,544	8,595	24	60,764	7,620	6
Oct-35	64,781	8,104	15	68,810	8,608	24	60,977	7,628	6
Nov-35	65,145	8,149	15	69,209	8,658	24	61,308	7,669	6
Dec-35	65,467	8,193	15	69,564	8,706	24	61,600	7,709	6
Jan-36	65,660	8,223	15	69,783	8,739	24	61,770	7,736	6
Feb-36	65,637	8,242	15	69,771	8,761	24	61,737	7,752	6
Mar-36	65,604	8,237	15	69,749	8,757	24	61,694	7,746	6
Apr-36	65,545	8,219	15	69,699	8,740	24	61,627	7,728	6
May-36	65,434	8,211	15	69,594	8,733	24	61,511	7,719	6
Jun-36	65,284	8,197	15	69,448	8,720	24	61,359	7,704	6
Jul-36	65,118	8,174	15	69,284	8,697	24	61,192	7,681	6
Aug-36	65,011	8,165	15	69,182	8,689	24	61,080	7,671	6
Sep-36	64,981	8,153	15	69,163	8,678	24	61,040	7,659	6
Oct-36	65,219	8,164	15	69,429	8,691	25	61,253	7,667	6
Nov-36	65,582	8,209	15	69,829	8,740	25	61,582	7,708	5
Dec-36	65,904	8,253	15	70,184	8,789	25	61,873	7,748	5
Jan-37	66,096	8,283	15	70,402	8,822	25	62,042	7,775	5
Feb-37	66,073	8,302	15	70,390	8,844	25	62,009	7,791	5
Mar-37	66,040	8,297	15	70,368	8,840	25	61,967	7,785	5
Apr-37	65,980	8,279	15	70,317	8,823	25	61,899	7,767	5
May-37	65,869	8,271	15	70,211	8,816	25	61,784	7,758	5
Jun-37	65,719	8,257	15	70,064	8,802	25	61,632	7,743	5
Jul-37	65,553	8,234	15	69,900	8,780	25	61,465	7,720	5
Aug-37	65,445	8,225	15	69,797	8,772	25	61,352	7,710	5
Sep-37	65,415	8,213	15	69,778	8,760	25	61,313	7,698	5
Oct-37	65,651	8,224	15	70,042	8,774	25	61,523	7,707	5
Nov-37	66,014	8,269	15	70,442	8,823	25	61,852	7,747	5
Dec-37	66,334	8,313	15	70,796	8,872	25	62,141	7,787	5

APPENDIX 2.2: CUSTOMER FORECASTS BY REGION

ROSEBURG

	Roseburg - Expected Growth			Roseburg - High Growth			Roseburg - Low Growth		
	Residential Customers	Commercial Customers	Industrial Customers	Residential Customers	Commercial Customers	Industrial Customers	Residential Customers	Commercial Customers	Industrial Customers
Nov-17	13,522	2,157	2	13,606	2,171	2	13,438	2,144	2
Dec-17	13,665	2,172	2	13,755	2,186	2	13,575	2,158	2
Jan-18	13,677	2,169	2	13,772	2,184	2	13,583	2,154	2
Feb-18	13,679	2,176	2	13,778	2,192	2	13,580	2,160	2
Mar-18	13,681	2,184	2	13,785	2,201	2	13,577	2,168	2
Apr-18	13,660	2,178	2	13,768	2,195	2	13,552	2,161	2
May-18	13,641	2,174	2	13,754	2,192	2	13,528	2,156	2
Jun-18	13,562	2,171	2	13,679	2,190	2	13,446	2,152	2
Jul-18	13,533	2,163	2	13,654	2,182	2	13,413	2,144	2
Aug-18	13,468	2,153	2	13,592	2,173	2	13,344	2,133	2
Sep-18	13,486	2,157	2	13,615	2,178	2	13,358	2,137	2
Oct-18	13,571	2,155	2	13,705	2,176	3	13,438	2,134	2
Nov-18	13,686	2,165	2	13,825	2,187	3	13,548	2,143	1
Dec-18	13,812	2,182	2	13,957	2,205	3	13,668	2,159	1
Jan-19	13,854	2,184	2	14,003	2,207	3	13,706	2,160	1
Feb-19	13,854	2,190	2	14,008	2,214	3	13,702	2,166	1
Mar-19	13,856	2,192	2	14,014	2,217	3	13,699	2,167	1
Apr-19	13,837	2,185	2	13,999	2,210	3	13,676	2,159	1
May-19	13,798	2,183	2	13,964	2,209	3	13,634	2,157	1
Jun-19	13,732	2,178	2	13,901	2,204	3	13,564	2,151	1
Jul-19	13,688	2,171	2	13,861	2,198	3	13,517	2,144	1
Aug-19	13,628	2,162	2	13,804	2,190	3	13,454	2,134	1
Sep-19	13,637	2,162	2	13,817	2,190	3	13,459	2,133	1
Oct-19	13,721	2,163	2	13,906	2,192	3	13,537	2,134	1
Nov-19	13,840	2,174	2	14,031	2,204	3	13,651	2,144	1
Dec-19	13,969	2,191	2	14,166	2,222	3	13,774	2,160	1
Jan-20	14,018	2,191	2	14,220	2,223	3	13,818	2,160	1
Feb-20	14,012	2,196	2	14,218	2,229	3	13,808	2,164	1
Mar-20	14,022	2,200	2	14,232	2,233	3	13,814	2,168	1
Apr-20	13,996	2,192	2	14,210	2,226	3	13,784	2,159	1
May-20	13,961	2,191	2	14,179	2,225	3	13,746	2,157	1
Jun-20	13,892	2,186	2	14,113	2,221	3	13,674	2,152	1
Jul-20	13,844	2,179	2	14,068	2,215	3	13,622	2,144	1
Aug-20	13,785	2,170	2	14,013	2,206	3	13,560	2,135	1
Sep-20	13,790	2,171	2	14,022	2,208	3	13,561	2,135	1
Oct-20	13,879	2,171	2	14,117	2,208	3	13,644	2,134	0
Nov-20	13,996	2,182	2	14,241	2,220	4	13,755	2,145	0
Dec-20	14,130	2,199	2	14,381	2,238	4	13,882	2,161	0
Jan-21	14,179	2,201	2	14,436	2,241	4	13,926	2,161	0
Feb-21	14,176	2,205	2	14,437	2,245	4	13,919	2,165	0

APPENDIX 2.2: CUSTOMER FORECASTS BY REGION

ROSEBURG

	Roseburg - Expected Growth			Roseburg - High Growth			Roseburg - Low Growth		
	Residential Customers	Commercial Customers	Industrial Customers	Residential Customers	Commercial Customers	Industrial Customers	Residential Customers	Commercial Customers	Industrial Customers
Mar-21	14,187	2,209	2	14,453	2,250	4	13,925	2,168	0
Apr-21	14,162	2,202	2	14,432	2,244	4	13,896	2,160	0
May-21	14,128	2,200	2	14,402	2,242	4	13,859	2,158	0
Jun-21	14,056	2,195	2	14,333	2,238	4	13,784	2,152	0
Jul-21	14,010	2,188	2	14,290	2,232	4	13,734	2,145	0
Aug-21	13,948	2,179	2	14,232	2,223	4	13,669	2,135	0
Sep-21	13,954	2,180	2	14,242	2,225	4	13,671	2,135	0
Oct-21	14,043	2,180	2	14,338	2,225	4	13,753	2,135	-
Nov-21	14,161	2,191	2	14,463	2,237	4	13,865	2,145	-
Dec-21	14,296	2,208	2	14,605	2,255	4	13,992	2,161	-
Jan-22	14,345	2,209	2	14,660	2,258	4	14,036	2,162	-
Feb-22	14,344	2,213	2	14,663	2,262	4	14,030	2,165	-
Mar-22	14,355	2,217	2	14,679	2,267	4	14,037	2,168	-
Apr-22	14,331	2,210	2	14,659	2,261	4	14,009	2,161	-
May-22	14,297	2,208	2	14,629	2,260	4	13,971	2,158	-
Jun-22	14,224	2,203	2	14,559	2,255	4	13,895	2,152	-
Jul-22	14,178	2,196	2	14,517	2,249	4	13,846	2,145	-
Aug-22	14,115	2,188	2	14,457	2,241	4	13,780	2,136	-
Sep-22	14,122	2,188	2	14,469	2,242	4	13,782	2,136	-
Oct-22	14,211	2,188	2	14,565	2,243	5	13,865	2,135	-
Nov-22	14,330	2,200	2	14,691	2,256	5	13,976	2,146	-
Dec-22	14,465	2,217	2	14,835	2,274	5	14,103	2,162	-
Jan-23	14,516	2,218	2	14,892	2,275	5	14,148	2,161	-
Feb-23	14,515	2,223	2	14,896	2,281	5	14,143	2,166	-
Mar-23	14,527	2,226	2	14,913	2,285	5	14,150	2,168	-
Apr-23	14,503	2,219	2	14,893	2,278	5	14,122	2,160	-
May-23	14,469	2,217	2	14,863	2,277	5	14,084	2,158	-
Jun-23	14,397	2,213	2	14,794	2,274	5	14,010	2,153	-
Jul-23	14,350	2,206	2	14,750	2,267	5	13,959	2,146	-
Aug-23	14,288	2,197	2	14,691	2,259	5	13,894	2,136	-
Sep-23	14,294	2,198	2	14,702	2,260	5	13,896	2,136	-
Oct-23	14,383	2,198	2	14,799	2,261	5	13,978	2,136	-
Nov-23	14,502	2,209	2	14,926	2,273	5	14,089	2,146	-
Dec-23	14,637	2,226	2	15,070	2,291	5	14,215	2,162	-
Jan-24	14,688	2,227	2	15,127	2,294	5	14,260	2,162	-
Feb-24	14,688	2,231	2	15,132	2,299	5	14,256	2,165	-
Mar-24	14,700	2,235	2	15,149	2,303	5	14,263	2,169	-
Apr-24	14,676	2,228	2	15,129	2,297	5	14,235	2,161	-
May-24	14,642	2,226	2	15,099	2,296	5	14,197	2,159	-
Jun-24	14,570	2,222	2	15,030	2,292	5	14,123	2,154	-

APPENDIX 2.2: CUSTOMER FORECASTS BY REGION

ROSEBURG

	Roseburg - Expected Growth			Roseburg - High Growth			Roseburg - Low Growth		
	Residential Customers	Commercial Customers	Industrial Customers	Residential Customers	Commercial Customers	Industrial Customers	Residential Customers	Commercial Customers	Industrial Customers
Jul-24	14,523	2,214	2	14,986	2,285	5	14,072	2,145	-
Aug-24	14,461	2,206	2	14,927	2,277	5	14,008	2,137	-
Sep-24	14,467	2,206	2	14,938	2,278	5	14,009	2,136	-
Oct-24	14,556	2,207	2	15,035	2,280	6	14,091	2,137	-
Nov-24	14,675	2,218	2	15,163	2,292	6	14,201	2,147	-
Dec-24	14,810	2,235	2	15,307	2,310	6	14,327	2,162	-
Jan-25	14,861	2,236	2	15,365	2,311	6	14,372	2,162	-
Feb-25	14,861	2,241	2	15,370	2,317	6	14,367	2,166	-
Mar-25	14,873	2,244	2	15,387	2,321	6	14,374	2,168	-
Apr-25	14,850	2,237	2	15,368	2,315	6	14,347	2,161	-
May-25	14,816	2,236	2	15,338	2,314	6	14,310	2,159	-
Jun-25	14,743	2,231	2	15,267	2,310	6	14,235	2,154	-
Jul-25	14,696	2,224	2	15,223	2,303	6	14,185	2,146	-
Aug-25	14,633	2,215	2	15,163	2,295	6	14,120	2,137	-
Sep-25	14,639	2,216	2	15,174	2,297	6	14,121	2,137	-
Oct-25	14,728	2,216	2	15,271	2,297	6	14,203	2,137	-
Nov-25	14,847	2,227	2	15,399	2,309	6	14,313	2,147	-
Dec-25	14,982	2,244	2	15,544	2,328	6	14,438	2,162	-
Jan-26	15,032	2,245	2	15,601	2,330	6	14,482	2,163	-
Feb-26	15,032	2,249	2	15,606	2,335	6	14,478	2,166	-
Mar-26	15,044	2,253	2	15,623	2,340	6	14,485	2,169	-
Apr-26	15,020	2,246	2	15,603	2,333	6	14,457	2,162	-
May-26	14,986	2,244	2	15,572	2,332	6	14,420	2,159	-
Jun-26	14,913	2,239	2	15,501	2,327	6	14,345	2,154	-
Jul-26	14,866	2,232	2	15,458	2,321	6	14,295	2,146	-
Aug-26	14,804	2,224	2	15,398	2,313	6	14,231	2,138	-
Sep-26	14,811	2,224	2	15,410	2,314	6	14,233	2,137	-
Oct-26	14,900	2,225	2	15,508	2,316	7	14,314	2,138	-
Nov-26	15,019	2,236	2	15,637	2,328	7	14,423	2,147	-
Dec-26	15,155	2,253	2	15,784	2,347	7	14,549	2,163	-
Jan-27	15,206	2,253	2	15,842	2,348	7	14,593	2,163	-
Feb-27	15,206	2,258	2	15,847	2,354	7	14,589	2,167	-
Mar-27	15,218	2,261	2	15,865	2,358	7	14,595	2,169	-
Apr-27	15,195	2,255	2	15,846	2,352	7	14,569	2,162	-
May-27	15,161	2,253	2	15,816	2,351	7	14,531	2,160	-
Jun-27	15,089	2,248	2	15,746	2,346	7	14,457	2,154	-
Jul-27	15,042	2,241	2	15,702	2,340	7	14,408	2,147	-
Aug-27	14,980	2,232	2	15,642	2,331	7	14,344	2,138	-
Sep-27	14,986	2,233	2	15,653	2,333	7	14,345	2,138	-
Oct-27	15,075	2,233	2	15,751	2,334	7	14,426	2,137	-

APPENDIX 2.2: CUSTOMER FORECASTS BY REGION

ROSEBURG

	Roseburg - Expected Growth			Roseburg - High Growth			Roseburg - Low Growth		
	Residential Customers	Commercial Customers	Industrial Customers	Residential Customers	Commercial Customers	Industrial Customers	Residential Customers	Commercial Customers	Industrial Customers
Nov-27	15,194	2,245	2	15,881	2,347	7	14,535	2,148	-
Dec-27	15,330	2,262	2	16,028	2,365	7	14,660	2,164	-
Jan-28	15,381	2,263	2	16,086	2,367	7	14,704	2,163	-
Feb-28	15,381	2,268	2	16,091	2,373	7	14,700	2,167	-
Mar-28	15,393	2,271	2	16,109	2,377	7	14,706	2,170	-
Apr-28	15,370	2,264	2	16,090	2,370	7	14,680	2,162	-
May-28	15,335	2,262	2	16,059	2,369	7	14,641	2,160	-
Jun-28	15,264	2,258	2	15,989	2,365	7	14,569	2,155	-
Jul-28	15,216	2,251	2	15,944	2,359	7	14,519	2,148	-
Aug-28	15,153	2,242	2	15,883	2,350	7	14,454	2,138	-
Sep-28	15,159	2,242	2	15,894	2,351	7	14,456	2,138	-
Oct-28	15,248	2,243	2	15,992	2,352	8	14,536	2,138	-
Nov-28	15,366	2,254	2	16,121	2,365	8	14,644	2,148	-
Dec-28	15,501	2,271	2	16,268	2,383	8	14,768	2,163	-
Jan-29	15,552	2,271	2	16,326	2,384	8	14,812	2,163	-
Feb-29	15,552	2,276	2	16,331	2,390	8	14,808	2,167	-
Mar-29	15,563	2,280	2	16,348	2,395	8	14,813	2,170	-
Apr-29	15,540	2,273	2	16,328	2,389	8	14,787	2,163	-
May-29	15,505	2,271	2	16,297	2,387	8	14,749	2,161	-
Jun-29	15,433	2,266	2	16,226	2,383	8	14,676	2,155	-
Jul-29	15,385	2,259	2	16,180	2,376	8	14,626	2,148	-
Aug-29	15,321	2,250	2	16,117	2,367	8	14,561	2,139	-
Sep-29	15,327	2,251	2	16,128	2,369	8	14,563	2,139	-
Oct-29	15,415	2,251	2	16,226	2,370	8	14,642	2,138	-
Nov-29	15,533	2,262	2	16,355	2,382	8	14,750	2,148	-
Dec-29	15,668	2,279	2	16,502	2,401	8	14,874	2,164	-
Jan-30	15,718	2,281	2	16,559	2,403	8	14,917	2,164	-
Feb-30	15,717	2,285	2	16,563	2,408	8	14,912	2,168	-
Mar-30	15,728	2,289	2	16,579	2,413	8	14,918	2,171	-
Apr-30	15,704	2,282	2	16,559	2,406	8	14,890	2,164	-
May-30	15,669	2,280	2	16,527	2,405	8	14,853	2,161	-
Jun-30	15,596	2,275	2	16,455	2,400	8	14,779	2,156	-
Jul-30	15,547	2,268	2	16,407	2,393	8	14,729	2,148	-
Aug-30	15,482	2,259	2	16,342	2,384	8	14,664	2,139	-
Sep-30	15,486	2,260	2	16,350	2,386	8	14,664	2,140	-
Oct-30	15,572	2,260	2	16,445	2,386	9	14,742	2,139	-
Nov-30	15,689	2,271	2	16,573	2,399	9	14,849	2,149	-
Dec-30	15,822	2,288	2	16,718	2,417	9	14,972	2,165	-
Jan-31	15,870	2,288	2	16,772	2,418	9	15,013	2,165	-
Feb-31	15,868	2,293	2	16,774	2,424	9	15,008	2,169	-

APPENDIX 2.2: CUSTOMER FORECASTS BY REGION

ROSEBURG

	Roseburg - Expected Growth			Roseburg - High Growth			Roseburg - Low Growth		
	Residential Customers	Commercial Customers	Industrial Customers	Residential Customers	Commercial Customers	Industrial Customers	Residential Customers	Commercial Customers	Industrial Customers
Mar-31	15,877	2,296	2	16,788	2,428	9	15,013	2,171	-
Apr-31	15,852	2,289	2	16,766	2,421	9	14,985	2,164	-
May-31	15,815	2,287	2	16,731	2,420	9	14,947	2,162	-
Jun-31	15,741	2,282	2	16,656	2,415	9	14,873	2,156	-
Jul-31	15,691	2,275	2	16,607	2,408	9	14,822	2,149	-
Aug-31	15,625	2,266	2	16,541	2,399	9	14,757	2,140	-
Sep-31	15,629	2,266	2	16,549	2,400	9	14,757	2,140	-
Oct-31	15,714	2,267	2	16,643	2,401	9	14,834	2,140	-
Nov-31	15,831	2,278	2	16,771	2,413	9	14,941	2,150	-
Dec-31	15,963	2,295	2	16,915	2,432	9	15,062	2,166	-
Jan-32	16,011	2,296	2	16,970	2,433	9	15,104	2,166	-
Feb-32	16,009	2,300	2	16,971	2,438	9	15,098	2,169	-
Mar-32	16,018	2,304	2	16,985	2,443	9	15,103	2,172	-
Apr-32	15,991	2,297	2	16,960	2,436	9	15,074	2,165	-
May-32	15,954	2,295	2	16,925	2,434	9	15,036	2,163	-
Jun-32	15,879	2,290	2	16,849	2,430	9	14,962	2,157	-
Jul-32	15,829	2,283	2	16,800	2,423	9	14,911	2,150	-
Aug-32	15,763	2,274	2	16,734	2,414	9	14,846	2,141	-
Sep-32	15,767	2,274	2	16,742	2,414	9	14,846	2,141	-
Oct-32	15,852	2,274	2	16,836	2,415	10	14,923	2,140	-
Nov-32	15,968	2,286	2	16,963	2,428	10	15,029	2,151	-
Dec-32	16,100	2,302	2	17,107	2,446	10	15,150	2,166	-
Jan-33	16,148	2,303	2	17,161	2,448	10	15,191	2,167	-
Feb-33	16,145	2,307	2	17,162	2,452	10	15,185	2,170	-
Mar-33	16,154	2,310	2	17,175	2,456	10	15,190	2,172	-
Apr-33	16,128	2,303	2	17,152	2,449	10	15,162	2,165	-
May-33	16,090	2,301	2	17,115	2,448	10	15,123	2,163	-
Jun-33	16,015	2,297	2	17,039	2,444	10	15,049	2,159	-
Jul-33	15,965	2,289	2	16,990	2,436	10	14,999	2,151	-
Aug-33	15,899	2,280	2	16,923	2,427	10	14,934	2,142	-
Sep-33	15,902	2,281	2	16,930	2,429	10	14,933	2,142	-
Oct-33	15,987	2,281	2	17,024	2,429	10	15,010	2,142	-
Nov-33	16,103	2,292	2	17,151	2,441	10	15,116	2,152	-
Dec-33	16,235	2,309	2	17,296	2,460	10	15,236	2,167	-
Jan-34	16,282	2,309	2	17,349	2,461	10	15,277	2,167	-
Feb-34	16,279	2,313	2	17,350	2,466	10	15,271	2,170	-
Mar-34	16,288	2,317	2	17,363	2,470	10	15,276	2,174	-
Apr-34	16,261	2,310	2	17,338	2,464	10	15,247	2,166	-
May-34	16,223	2,308	2	17,301	2,462	10	15,208	2,164	-
Jun-34	16,148	2,303	2	17,225	2,457	10	15,135	2,159	-
Jul-34	16,097	2,296	2	17,174	2,450	10	15,084	2,152	-

APPENDIX 2.2: CUSTOMER FORECASTS BY REGION

ROSEBURG

	Roseburg - Expected Growth			Roseburg - High Growth			Roseburg - Low Growth		
	Residential Customers	Commercial Customers	Industrial Customers	Residential Customers	Commercial Customers	Industrial Customers	Residential Customers	Commercial Customers	Industrial Customers
Aug-34	16,031	2,287	2	17,108	2,441	10	15,019	2,143	-
Sep-34	16,034	2,287	2	17,114	2,442	10	15,018	2,143	-
Oct-34	16,119	2,287	2	17,209	2,442	11	15,095	2,142	-
Nov-34	16,235	2,299	2	17,336	2,455	11	15,200	2,153	-
Dec-34	16,367	2,315	2	17,481	2,473	11	15,321	2,167	-
Jan-35	16,414	2,317	2	17,535	2,475	11	15,361	2,168	-
Feb-35	16,411	2,321	2	17,535	2,480	11	15,355	2,172	-
Mar-35	16,419	2,324	2	17,548	2,484	11	15,360	2,174	-
Apr-35	16,392	2,317	2	17,522	2,477	11	15,331	2,167	-
May-35	16,355	2,315	2	17,487	2,475	11	15,293	2,165	-
Jun-35	16,279	2,310	2	17,409	2,470	11	15,219	2,160	-
Jul-35	16,229	2,303	2	17,359	2,463	11	15,169	2,153	-
Aug-35	16,162	2,294	2	17,291	2,454	11	15,103	2,144	-
Sep-35	16,165	2,295	2	17,298	2,456	11	15,103	2,144	-
Oct-35	16,251	2,295	2	17,394	2,456	11	15,180	2,144	-
Nov-35	16,366	2,306	2	17,521	2,469	11	15,284	2,153	-
Dec-35	16,498	2,323	2	17,666	2,487	11	15,404	2,169	-
Jan-36	16,546	2,323	2	17,721	2,488	11	15,446	2,169	-
Feb-36	16,543	2,327	2	17,721	2,493	11	15,439	2,172	-
Mar-36	16,551	2,331	2	17,734	2,498	11	15,444	2,175	-
Apr-36	16,524	2,324	2	17,709	2,491	11	15,415	2,168	-
May-36	16,487	2,322	2	17,673	2,489	11	15,377	2,166	-
Jun-36	16,411	2,317	2	17,595	2,485	11	15,303	2,161	-
Jul-36	16,361	2,309	2	17,545	2,477	11	15,253	2,153	-
Aug-36	16,294	2,301	2	17,477	2,469	11	15,188	2,145	-
Sep-36	16,297	2,301	2	17,484	2,469	11	15,187	2,145	-
Oct-36	16,382	2,301	2	17,579	2,470	12	15,263	2,144	-
Nov-36	16,498	2,312	2	17,707	2,482	12	15,368	2,154	-
Dec-36	16,630	2,329	2	17,852	2,501	12	15,488	2,169	-
Jan-37	16,677	2,330	2	17,906	2,502	12	15,528	2,170	-
Feb-37	16,674	2,335	2	17,907	2,508	12	15,522	2,174	-
Mar-37	16,682	2,338	2	17,919	2,511	12	15,527	2,176	-
Apr-37	16,655	2,331	2	17,894	2,504	12	15,498	2,169	-
May-37	16,618	2,329	2	17,858	2,503	12	15,461	2,167	-
Jun-37	16,542	2,324	2	17,780	2,498	12	15,387	2,162	-
Jul-37	16,492	2,317	2	17,730	2,491	12	15,337	2,155	-
Aug-37	16,425	2,308	2	17,662	2,482	12	15,271	2,146	-
Sep-37	16,428	2,308	2	17,668	2,482	12	15,271	2,145	-
Oct-37	16,513	2,308	2	17,764	2,483	12	15,347	2,145	-
Nov-37	16,629	2,320	2	17,892	2,496	12	15,451	2,156	-
Dec-37	16,761	2,336	2	18,038	2,514	12	15,571	2,170	-

APPENDIX 2.2: CUSTOMER FORECASTS BY REGION

KLAMATH FALLS

	Klamath Falls - Expected Growth			Klamath Falls - High Growth			Klamath Falls - Low Growth		
	Residential Customers	Commercial Customers	Industrial Customers	Residential Customers	Commercial Customers	Industrial Customers	Residential Customers	Commercial Customers	Industrial Customers
Nov-17	14,651	1,776	7	14,754	1,788	7	14,549	1,763	7
Dec-17	14,751	1,777	7	14,860	1,790	7	14,643	1,764	7
Jan-18	14,834	1,784	7	14,949	1,798	7	14,719	1,770	7
Feb-18	14,857	1,787	7	14,978	1,801	7	14,737	1,772	7
Mar-18	14,854	1,783	7	14,980	1,798	7	14,728	1,768	7
Apr-18	14,825	1,778	7	14,957	1,794	7	14,694	1,762	7
May-18	14,786	1,774	7	14,923	1,790	7	14,650	1,758	7
Jun-18	14,705	1,768	7	14,847	1,785	7	14,564	1,751	7
Jul-18	14,617	1,759	7	14,763	1,776	7	14,472	1,742	7
Aug-18	14,544	1,748	7	14,694	1,766	7	14,395	1,730	7
Sep-18	14,548	1,752	7	14,702	1,771	7	14,395	1,733	6
Oct-18	14,695	1,762	7	14,856	1,781	7	14,535	1,743	6
Nov-18	14,841	1,780	7	15,008	1,800	7	14,675	1,760	6
Dec-18	14,961	1,782	7	15,134	1,803	8	14,789	1,761	6
Jan-19	15,031	1,793	7	15,210	1,814	8	14,853	1,772	6
Feb-19	15,045	1,802	7	15,229	1,824	8	14,862	1,780	6
Mar-19	15,038	1,796	7	15,227	1,818	8	14,851	1,773	6
Apr-19	15,011	1,789	7	15,204	1,812	8	14,819	1,766	6
May-19	14,968	1,783	7	15,166	1,806	8	14,772	1,759	6
Jun-19	14,881	1,776	7	15,082	1,800	8	14,682	1,752	6
Jul-19	14,795	1,771	7	15,000	1,795	8	14,592	1,746	6
Aug-19	14,726	1,762	7	14,934	1,787	8	14,520	1,737	6
Sep-19	14,730	1,763	7	14,943	1,788	8	14,519	1,738	6
Oct-19	14,877	1,773	7	15,097	1,799	8	14,660	1,747	6
Nov-19	15,024	1,789	7	15,250	1,816	8	14,800	1,762	6
Dec-19	15,144	1,795	7	15,377	1,822	8	14,914	1,767	6
Jan-20	15,213	1,809	7	15,452	1,837	8	14,977	1,780	6
Feb-20	15,225	1,814	7	15,468	1,843	8	14,984	1,785	6
Mar-20	15,217	1,810	7	15,465	1,839	8	14,972	1,780	6
Apr-20	15,189	1,803	7	15,441	1,832	8	14,940	1,773	6
May-20	15,145	1,800	7	15,401	1,830	8	14,892	1,769	6
Jun-20	15,057	1,793	7	15,316	1,823	8	14,801	1,762	6
Jul-20	14,973	1,787	7	15,236	1,818	8	14,714	1,756	6
Aug-20	14,905	1,782	7	15,171	1,813	8	14,642	1,750	5
Sep-20	14,910	1,778	7	15,181	1,810	8	14,642	1,746	5
Oct-20	15,057	1,785	7	15,336	1,818	8	14,782	1,752	5
Nov-20	15,205	1,805	7	15,492	1,839	8	14,923	1,771	5
Dec-20	15,325	1,809	7	15,619	1,843	9	15,035	1,774	5
Jan-21	15,394	1,820	7	15,694	1,856	9	15,098	1,785	5
Feb-21	15,406	1,824	7	15,712	1,860	9	15,105	1,789	5

APPENDIX 2.2: CUSTOMER FORECASTS BY REGION

KLAMATH FALLS

	Klamath Falls - Expected Growth			Klamath Falls - High Growth			Klamath Falls - Low Growth		
	Residential Customers	Commercial Customers	Industrial Customers	Residential Customers	Commercial Customers	Industrial Customers	Residential Customers	Commercial Customers	Industrial Customers
Mar-21	15,399	1,820	7	15,709	1,857	9	15,093	1,784	5
Apr-21	15,371	1,814	7	15,686	1,851	9	15,061	1,778	5
May-21	15,328	1,810	7	15,647	1,848	9	15,014	1,773	5
Jun-21	15,241	1,804	7	15,563	1,842	9	14,924	1,767	5
Jul-21	15,157	1,797	7	15,482	1,836	9	14,837	1,759	5
Aug-21	15,089	1,790	7	15,418	1,829	9	14,766	1,752	5
Sep-21	15,094	1,789	7	15,428	1,829	9	14,766	1,750	5
Oct-21	15,241	1,797	7	15,583	1,838	9	14,905	1,758	5
Nov-21	15,390	1,816	7	15,741	1,858	9	15,046	1,776	5
Dec-21	15,510	1,819	7	15,869	1,861	9	15,158	1,778	5
Jan-22	15,578	1,831	7	15,944	1,874	9	15,219	1,789	5
Feb-22	15,591	1,837	7	15,962	1,881	9	15,227	1,794	5
Mar-22	15,583	1,832	7	15,959	1,876	9	15,214	1,789	5
Apr-22	15,556	1,825	7	15,936	1,870	9	15,183	1,781	5
May-22	15,513	1,821	7	15,898	1,866	9	15,136	1,777	5
Jun-22	15,426	1,815	7	15,814	1,860	9	15,046	1,770	5
Jul-22	15,342	1,808	7	15,733	1,854	9	14,960	1,763	5
Aug-22	15,275	1,801	7	15,669	1,847	9	14,889	1,755	4
Sep-22	15,280	1,800	7	15,679	1,847	9	14,889	1,754	4
Oct-22	15,427	1,809	7	15,836	1,857	9	15,027	1,762	4
Nov-22	15,576	1,827	7	15,994	1,876	9	15,168	1,779	4
Dec-22	15,696	1,831	7	16,122	1,881	9	15,279	1,782	4
Jan-23	15,765	1,844	7	16,199	1,894	10	15,341	1,794	4
Feb-23	15,777	1,849	7	16,216	1,900	10	15,348	1,798	4
Mar-23	15,771	1,844	7	16,216	1,896	10	15,337	1,793	4
Apr-23	15,744	1,838	7	16,193	1,890	10	15,306	1,786	4
May-23	15,701	1,834	7	16,154	1,886	10	15,259	1,782	4
Jun-23	15,614	1,827	7	16,070	1,880	10	15,169	1,775	4
Jul-23	15,530	1,821	7	15,989	1,874	10	15,083	1,768	4
Aug-23	15,463	1,814	7	15,925	1,868	10	15,013	1,761	4
Sep-23	15,468	1,813	7	15,935	1,867	10	15,013	1,759	4
Oct-23	15,615	1,821	7	16,092	1,876	10	15,150	1,766	4
Nov-23	15,764	1,840	7	16,251	1,896	10	15,290	1,784	4
Dec-23	15,884	1,843	7	16,380	1,900	10	15,401	1,787	4
Jan-24	15,953	1,855	7	16,457	1,914	10	15,463	1,798	4
Feb-24	15,965	1,860	7	16,474	1,920	10	15,469	1,803	4
Mar-24	15,958	1,855	7	16,473	1,915	10	15,458	1,797	4
Apr-24	15,931	1,849	7	16,450	1,910	10	15,426	1,791	4
May-24	15,888	1,845	7	16,411	1,906	10	15,380	1,786	4
Jun-24	15,801	1,839	7	16,327	1,900	10	15,290	1,780	4

APPENDIX 2.2: CUSTOMER FORECASTS BY REGION

KLAMATH FALLS

	Klamath Falls - Expected Growth			Klamath Falls - High Growth			Klamath Falls - Low Growth		
	Residential Customers	Commercial Customers	Industrial Customers	Residential Customers	Commercial Customers	Industrial Customers	Residential Customers	Commercial Customers	Industrial Customers
Jul-24	15,717	1,832	7	16,245	1,894	10	15,204	1,772	4
Aug-24	15,650	1,826	7	16,181	1,888	10	15,134	1,766	3
Sep-24	15,654	1,824	7	16,190	1,887	10	15,133	1,764	3
Oct-24	15,802	1,832	7	16,349	1,896	10	15,272	1,771	3
Nov-24	15,950	1,851	7	16,507	1,916	10	15,410	1,789	3
Dec-24	16,070	1,855	7	16,637	1,921	11	15,521	1,792	3
Jan-25	16,139	1,867	7	16,713	1,933	11	15,582	1,803	3
Feb-25	16,151	1,872	7	16,731	1,939	11	15,589	1,807	3
Mar-25	16,144	1,868	7	16,729	1,936	11	15,577	1,802	3
Apr-25	16,117	1,861	7	16,707	1,929	11	15,546	1,795	3
May-25	16,074	1,857	7	16,667	1,926	11	15,500	1,791	3
Jun-25	15,987	1,850	7	16,583	1,919	11	15,411	1,783	3
Jul-25	15,903	1,844	7	16,501	1,913	11	15,325	1,777	3
Aug-25	15,835	1,837	7	16,435	1,907	11	15,255	1,770	3
Sep-25	15,840	1,836	7	16,446	1,906	11	15,255	1,768	3
Oct-25	15,987	1,844	7	16,603	1,915	11	15,391	1,775	3
Nov-25	16,135	1,863	7	16,762	1,935	11	15,529	1,793	3
Dec-25	16,255	1,867	7	16,892	1,940	11	15,640	1,796	3
Jan-26	16,323	1,879	7	16,968	1,953	11	15,700	1,807	3
Feb-26	16,335	1,884	7	16,986	1,959	11	15,707	1,811	3
Mar-26	16,328	1,880	7	16,984	1,955	11	15,695	1,807	3
Apr-26	16,301	1,873	7	16,961	1,948	11	15,664	1,799	3
May-26	16,258	1,869	7	16,922	1,945	11	15,618	1,795	3
Jun-26	16,170	1,863	7	16,835	1,939	11	15,529	1,789	3
Jul-26	16,086	1,856	7	16,753	1,933	11	15,443	1,781	3
Aug-26	16,018	1,849	7	16,687	1,926	11	15,373	1,774	2
Sep-26	16,022	1,848	7	16,696	1,925	11	15,373	1,773	2
Oct-26	16,169	1,856	7	16,854	1,934	11	15,509	1,780	2
Nov-26	16,317	1,875	7	17,014	1,955	11	15,646	1,798	2
Dec-26	16,436	1,879	7	17,143	1,959	12	15,756	1,801	2
Jan-27	16,504	1,890	7	17,219	1,972	12	15,816	1,811	2
Feb-27	16,516	1,895	7	17,237	1,978	12	15,823	1,816	2
Mar-27	16,508	1,891	7	17,233	1,974	12	15,811	1,811	2
Apr-27	16,481	1,884	7	17,210	1,967	12	15,780	1,804	2
May-27	16,437	1,880	7	17,169	1,964	12	15,733	1,800	2
Jun-27	16,349	1,874	7	17,083	1,958	12	15,644	1,793	2
Jul-27	16,265	1,867	7	17,000	1,951	12	15,560	1,786	2
Aug-27	16,196	1,861	7	16,932	1,946	12	15,489	1,780	2
Sep-27	16,200	1,859	7	16,941	1,944	12	15,489	1,777	2
Oct-27	16,347	1,867	7	17,100	1,953	12	15,625	1,785	2

APPENDIX 2.2: CUSTOMER FORECASTS BY REGION

KLAMATH FALLS

	Klamath Falls - Expected Growth			Klamath Falls - High Growth			Klamath Falls - Low Growth		
	Residential Customers	Commercial Customers	Industrial Customers	Residential Customers	Commercial Customers	Industrial Customers	Residential Customers	Commercial Customers	Industrial Customers
Nov-27	16,494	1,886	7	17,259	1,974	12	15,761	1,802	2
Dec-27	16,613	1,890	7	17,388	1,978	12	15,870	1,806	2
Jan-28	16,681	1,902	7	17,464	1,991	12	15,930	1,816	2
Feb-28	16,692	1,907	7	17,481	1,997	12	15,936	1,820	2
Mar-28	16,684	1,903	7	17,477	1,993	12	15,924	1,816	2
Apr-28	16,656	1,896	7	17,453	1,986	12	15,893	1,809	2
May-28	16,613	1,893	7	17,413	1,984	12	15,847	1,805	2
Jun-28	16,524	1,886	7	17,324	1,977	12	15,758	1,798	2
Jul-28	16,439	1,879	7	17,239	1,970	12	15,673	1,791	2
Aug-28	16,370	1,873	7	17,171	1,964	12	15,603	1,785	1
Sep-28	16,373	1,871	7	17,179	1,963	12	15,602	1,783	1
Oct-28	16,519	1,880	7	17,336	1,973	12	15,737	1,791	1
Nov-28	16,665	1,898	7	17,494	1,992	12	15,872	1,807	1
Dec-28	16,784	1,902	7	17,623	1,997	12	15,982	1,811	1
Jan-29	16,851	1,913	7	17,698	2,010	13	16,041	1,821	1
Feb-29	16,861	1,919	7	17,713	2,016	13	16,047	1,827	1
Mar-29	16,852	1,914	7	17,708	2,012	13	16,034	1,821	1
Apr-29	16,824	1,908	7	17,683	2,006	13	16,004	1,815	1
May-29	16,779	1,904	7	17,640	2,002	13	15,957	1,811	1
Jun-29	16,690	1,897	7	17,551	1,995	13	15,868	1,804	1
Jul-29	16,604	1,890	7	17,465	1,988	13	15,783	1,797	1
Aug-29	16,534	1,884	7	17,395	1,982	13	15,713	1,791	1
Sep-29	16,536	1,882	7	17,401	1,981	13	15,711	1,788	1
Oct-29	16,681	1,891	7	17,557	1,991	13	15,845	1,797	1
Nov-29	16,827	1,909	7	17,715	2,010	13	15,981	1,813	1
Dec-29	16,945	1,913	7	17,843	2,015	13	16,089	1,817	1
Jan-30	17,011	1,925	7	17,917	2,027	13	16,148	1,827	1
Feb-30	17,021	1,931	7	17,931	2,034	13	16,154	1,833	1
Mar-30	17,012	1,926	7	17,926	2,029	13	16,142	1,827	1
Apr-30	16,982	1,920	7	17,898	2,023	13	16,110	1,821	1
May-30	16,937	1,916	7	17,855	2,020	13	16,063	1,817	1
Jun-30	16,847	1,909	7	17,764	2,013	13	15,975	1,810	1
Jul-30	16,761	1,903	7	17,677	2,007	13	15,890	1,804	1
Aug-30	16,691	1,896	7	17,607	2,000	13	15,820	1,797	0
Sep-30	16,693	1,895	7	17,613	1,999	13	15,818	1,796	0
Oct-30	16,838	1,903	7	17,770	2,008	13	15,952	1,803	0
Nov-30	16,983	1,922	7	17,926	2,029	13	16,086	1,820	0
Dec-30	17,101	1,925	7	18,055	2,032	13	16,194	1,823	0
Jan-31	17,167	1,938	7	18,129	2,046	14	16,253	1,834	0
Feb-31	17,177	1,943	7	18,143	2,052	14	16,259	1,839	0

APPENDIX 2.2: CUSTOMER FORECASTS BY REGION

KLAMATH FALLS

	Klamath Falls - Expected Growth			Klamath Falls - High Growth			Klamath Falls - Low Growth		
	Residential Customers	Commercial Customers	Industrial Customers	Residential Customers	Commercial Customers	Industrial Customers	Residential Customers	Commercial Customers	Industrial Customers
Mar-31	17,167	1,938	7	18,136	2,047	14	16,246	1,834	0
Apr-31	17,137	1,932	7	18,109	2,041	14	16,214	1,828	0
May-31	17,092	1,928	7	18,065	2,037	14	16,168	1,823	0
Jun-31	17,002	1,921	7	17,974	2,030	14	16,080	1,816	0
Jul-31	16,916	1,915	7	17,887	2,024	14	15,995	1,810	0
Aug-31	16,846	1,908	7	17,817	2,018	14	15,925	1,803	-
Sep-31	16,849	1,907	7	17,824	2,017	14	15,924	1,802	-
Oct-31	16,994	1,915	7	17,981	2,026	14	16,058	1,809	-
Nov-31	17,140	1,934	7	18,140	2,046	14	16,192	1,827	-
Dec-31	17,258	1,937	7	18,269	2,050	14	16,300	1,829	-
Jan-32	17,324	1,949	7	18,343	2,064	14	16,358	1,841	-
Feb-32	17,334	1,954	7	18,358	2,070	14	16,364	1,845	-
Mar-32	17,325	1,949	7	18,352	2,065	14	16,352	1,840	-
Apr-32	17,295	1,943	7	18,325	2,059	14	16,320	1,834	-
May-32	17,250	1,939	7	18,281	2,055	14	16,274	1,829	-
Jun-32	17,160	1,932	7	18,190	2,048	14	16,185	1,822	-
Jul-32	17,075	1,926	7	18,104	2,042	14	16,101	1,816	-
Aug-32	17,005	1,919	7	18,034	2,035	14	16,032	1,809	-
Sep-32	17,007	1,918	7	18,040	2,035	14	16,030	1,808	-
Oct-32	17,153	1,926	7	18,199	2,044	14	16,164	1,815	-
Nov-32	17,299	1,945	7	18,358	2,064	14	16,297	1,833	-
Dec-32	17,417	1,949	7	18,488	2,069	14	16,405	1,836	-
Jan-33	17,483	1,961	7	18,562	2,082	15	16,463	1,846	-
Feb-33	17,493	1,966	7	18,577	2,088	15	16,469	1,851	-
Mar-33	17,484	1,962	7	18,572	2,084	15	16,457	1,847	-
Apr-33	17,455	1,955	7	18,545	2,077	15	16,426	1,840	-
May-33	17,409	1,951	7	18,500	2,073	15	16,379	1,835	-
Jun-33	17,320	1,945	7	18,410	2,067	15	16,291	1,829	-
Jul-33	17,234	1,938	7	18,323	2,060	15	16,206	1,822	-
Aug-33	17,165	1,931	7	18,254	2,053	15	16,138	1,815	-
Sep-33	17,167	1,930	7	18,260	2,053	15	16,136	1,814	-
Oct-33	17,312	1,938	7	18,419	2,062	15	16,269	1,821	-
Nov-33	17,459	1,957	7	18,579	2,082	15	16,403	1,838	-
Dec-33	17,576	1,961	7	18,708	2,087	15	16,509	1,842	-
Jan-34	17,643	1,972	7	18,784	2,100	15	16,568	1,852	-
Feb-34	17,653	1,977	7	18,799	2,106	15	16,574	1,857	-
Mar-34	17,644	1,973	7	18,793	2,102	15	16,561	1,852	-
Apr-34	17,615	1,966	7	18,767	2,095	15	16,530	1,845	-
May-34	17,570	1,962	7	18,723	2,091	15	16,484	1,841	-
Jun-34	17,480	1,956	7	18,632	2,085	15	16,396	1,835	-
Jul-34	17,395	1,949	7	18,545	2,078	15	16,313	1,828	-

APPENDIX 2.2: CUSTOMER FORECASTS BY REGION

KLAMATH FALLS

	Klamath Falls - Expected Growth			Klamath Falls - High Growth			Klamath Falls - Low Growth		
	Residential Customers	Commercial Customers	Industrial Customers	Residential Customers	Commercial Customers	Industrial Customers	Residential Customers	Commercial Customers	Industrial Customers
Aug-34	17,325	1,943	7	18,475	2,072	15	16,243	1,822	-
Sep-34	17,327	1,941	7	18,481	2,071	15	16,242	1,820	-
Oct-34	17,472	1,949	7	18,640	2,080	15	16,374	1,827	-
Nov-34	17,618	1,968	7	18,800	2,101	15	16,507	1,844	-
Dec-34	17,736	1,972	7	18,930	2,105	15	16,614	1,848	-
Jan-35	17,802	1,984	7	19,005	2,118	16	16,672	1,858	-
Feb-35	17,812	1,989	7	19,020	2,124	16	16,677	1,862	-
Mar-35	17,803	1,985	7	19,014	2,120	16	16,665	1,858	-
Apr-35	17,774	1,978	7	18,988	2,113	16	16,634	1,851	-
May-35	17,728	1,974	7	18,943	2,109	16	16,588	1,847	-
Jun-35	17,639	1,968	7	18,852	2,103	16	16,501	1,841	-
Jul-35	17,553	1,961	7	18,764	2,096	16	16,416	1,834	-
Aug-35	17,484	1,955	7	18,695	2,091	16	16,348	1,828	-
Sep-35	17,486	1,953	7	18,701	2,089	16	16,346	1,826	-
Oct-35	17,632	1,961	7	18,862	2,098	16	16,479	1,833	-
Nov-35	17,778	1,980	7	19,022	2,119	16	16,611	1,850	-
Dec-35	17,896	1,984	7	19,153	2,123	16	16,718	1,853	-
Jan-36	17,962	1,996	7	19,228	2,136	16	16,775	1,864	-
Feb-36	17,973	2,001	7	19,244	2,142	16	16,782	1,868	-
Mar-36	17,963	1,997	7	19,238	2,139	16	16,769	1,864	-
Apr-36	17,934	1,990	7	19,212	2,132	16	16,738	1,857	-
May-36	17,889	1,987	7	19,168	2,129	16	16,692	1,854	-
Jun-36	17,800	1,980	7	19,077	2,122	16	16,605	1,847	-
Jul-36	17,714	1,973	7	18,989	2,115	16	16,521	1,840	-
Aug-36	17,645	1,967	7	18,919	2,109	16	16,453	1,834	-
Sep-36	17,647	1,965	7	18,926	2,107	16	16,451	1,832	-
Oct-36	17,792	1,974	7	19,086	2,117	16	16,582	1,840	-
Nov-36	17,939	1,992	7	19,248	2,137	16	16,715	1,856	-
Dec-36	18,056	1,996	7	19,378	2,142	16	16,821	1,859	-
Jan-37	18,123	2,008	7	19,454	2,155	17	16,879	1,870	-
Feb-37	18,133	2,014	7	19,469	2,162	17	16,885	1,875	-
Mar-37	18,124	2,009	7	19,464	2,157	17	16,872	1,870	-
Apr-37	18,095	2,003	7	19,437	2,151	17	16,842	1,864	-
May-37	18,049	1,999	7	19,392	2,147	17	16,795	1,860	-
Jun-37	17,960	1,992	7	19,301	2,140	17	16,708	1,853	-
Jul-37	17,874	1,985	7	19,213	2,133	17	16,625	1,846	-
Aug-37	17,805	1,979	7	19,143	2,127	17	16,557	1,840	-
Sep-37	17,807	1,977	7	19,149	2,126	17	16,555	1,838	-
Oct-37	17,952	1,986	7	19,310	2,136	17	16,686	1,845	-
Nov-37	18,099	2,004	7	19,472	2,156	17	16,819	1,862	-
Dec-37	18,216	2,008	7	19,603	2,160	17	16,923	1,865	-

APPENDIX 2.2: CUSTOMER FORECASTS BY REGION

LA GRANDE

	La Grande - Expected Growth			La Grande - High Growth			La Grande - Low Growth		
	Residential Customers	Commercial Customers	Industrial Customers	Residential Customers	Commercial Customers	Industrial Customers	Residential Customers	Commercial Customers	Industrial Customers
Nov-17	6,649	920	2	6,698	926	2	6,600	913	2
Dec-17	6,692	927	1	6,744	934	1	6,640	919	1
Jan-18	6,726	929	1	6,781	937	1	6,671	922	1
Feb-18	6,727	933	2	6,784	941	2	6,670	925	2
Mar-18	6,718	933	1	6,778	942	1	6,658	925	1
Apr-18	6,703	932	1	6,765	941	1	6,641	924	1
May-18	6,695	932	1	6,760	941	1	6,630	923	1
Jun-18	6,656	927	1	6,723	936	1	6,589	918	1
Jul-18	6,617	925	2	6,686	934	2	6,548	915	2
Aug-18	6,586	926	3	6,657	936	3	6,516	916	3
Sep-18	6,580	923	6	6,653	933	6	6,507	912	6
Oct-18	6,620	924	6	6,696	934	6	6,545	913	6
Nov-18	6,693	925	3	6,772	936	3	6,615	914	3
Dec-18	6,738	932	2	6,819	943	2	6,657	921	2
Jan-19	6,769	936	1	6,853	947	2	6,686	924	1
Feb-19	6,769	937	2	6,855	949	2	6,683	925	1
Mar-19	6,760	936	1	6,848	948	1	6,672	924	0
Apr-19	6,742	936	1	6,832	949	2	6,652	924	1
May-19	6,732	935	1	6,825	948	2	6,640	922	1
Jun-19	6,695	932	1	6,789	945	2	6,602	919	1
Jul-19	6,648	927	2	6,744	940	2	6,553	914	1
Aug-19	6,620	928	3	6,717	942	3	6,524	915	2
Sep-19	6,613	927	7	6,712	940	7	6,515	913	6
Oct-19	6,660	929	6	6,762	943	6	6,559	915	5
Nov-19	6,733	929	3	6,838	944	4	6,629	915	3
Dec-19	6,780	936	2	6,888	951	2	6,673	921	1
Jan-20	6,811	940	1	6,921	955	2	6,702	925	0
Feb-20	6,810	943	2	6,922	958	3	6,699	927	1
Mar-20	6,799	941	1	6,913	957	2	6,686	926	-
Apr-20	6,782	941	1	6,898	957	2	6,667	925	0
May-20	6,768	940	1	6,886	956	2	6,652	923	0
Jun-20	6,731	937	1	6,850	953	2	6,613	920	0
Jul-20	6,682	933	2	6,802	950	3	6,563	916	1
Aug-20	6,656	933	3	6,778	950	4	6,536	916	2
Sep-20	6,648	931	7	6,772	948	7	6,526	914	5
Oct-20	6,698	933	6	6,825	951	7	6,573	916	5
Nov-20	6,772	934	4	6,902	952	4	6,644	917	2
Dec-20	6,820	941	2	6,953	959	3	6,689	923	1
Jan-21	6,850	944	1	6,986	963	3	6,716	926	-
Feb-21	6,850	947	2	6,988	966	3	6,714	928	-

APPENDIX 2.2: CUSTOMER FORECASTS BY REGION

LA GRANDE

	La Grande - Expected Growth			La Grande - High Growth			La Grande - Low Growth		
	Residential Customers	Commercial Customers	Industrial Customers	Residential Customers	Commercial Customers	Industrial Customers	Residential Customers	Commercial Customers	Industrial Customers
Mar-21	6,838	946	1	6,978	965	2	6,701	927	-
Apr-21	6,820	946	1	6,961	966	3	6,681	927	-
May-21	6,806	944	1	6,949	964	3	6,665	925	-
Jun-21	6,768	941	1	6,912	961	3	6,626	921	-
Jul-21	6,718	937	2	6,863	957	3	6,575	917	0
Aug-21	6,693	938	3	6,840	959	4	6,549	918	1
Sep-21	6,685	936	7	6,834	957	8	6,539	915	5
Oct-21	6,736	938	6	6,888	959	7	6,587	917	4
Nov-21	6,810	939	4	6,965	960	5	6,658	918	2
Dec-21	6,859	946	2	7,017	967	3	6,704	924	0
Jan-22	6,889	949	1	7,050	971	3	6,731	927	-
Feb-22	6,889	952	2	7,052	974	4	6,729	929	-
Mar-22	6,877	950	1	7,042	973	3	6,715	928	-
Apr-22	6,858	950	1	7,024	974	3	6,695	928	-
May-22	6,843	949	1	7,011	972	3	6,678	926	-
Jun-22	6,805	946	1	6,974	970	3	6,639	923	-
Jul-22	6,755	942	2	6,925	965	4	6,589	919	-
Aug-22	6,730	943	3	6,901	967	5	6,562	919	1
Sep-22	6,722	940	7	6,895	965	8	6,553	917	4
Oct-22	6,773	943	6	6,949	967	8	6,601	919	4
Nov-22	6,848	943	4	7,028	968	5	6,672	919	1
Dec-22	6,897	950	2	7,080	975	4	6,718	926	-
Jan-23	6,927	954	1	7,113	979	4	6,745	929	-
Feb-23	6,927	956	2	7,115	982	4	6,743	931	-
Mar-23	6,914	955	1	7,104	981	3	6,729	929	-
Apr-23	6,896	955	1	7,087	982	4	6,709	929	-
May-23	6,880	954	1	7,073	980	4	6,692	927	-
Jun-23	6,842	951	1	7,036	978	4	6,653	924	-
Jul-23	6,792	946	2	6,986	973	4	6,603	920	-
Aug-23	6,767	947	3	6,962	975	5	6,577	921	0
Sep-23	6,759	945	7	6,956	972	9	6,567	918	4
Oct-23	6,811	947	6	7,011	975	8	6,616	920	3
Nov-23	6,885	948	4	7,089	976	6	6,686	921	1
Dec-23	6,934	955	2	7,141	983	4	6,732	927	-
Jan-24	6,964	958	1	7,174	987	4	6,759	930	-
Feb-24	6,964	961	2	7,176	990	5	6,758	932	-
Mar-24	6,952	960	1	7,165	989	4	6,744	931	-
Apr-24	6,932	960	1	7,147	990	4	6,723	931	-
May-24	6,917	958	1	7,133	988	4	6,707	929	-
Jun-24	6,878	955	1	7,095	985	4	6,667	926	-

APPENDIX 2.2: CUSTOMER FORECASTS BY REGION

LA GRANDE

	La Grande - Expected Growth			La Grande - High Growth			La Grande - Low Growth		
	Residential Customers	Commercial Customers	Industrial Customers	Residential Customers	Commercial Customers	Industrial Customers	Residential Customers	Commercial Customers	Industrial Customers
Jul-24	6,828	951	2	7,045	981	5	6,617	922	-
Aug-24	6,803	952	3	7,021	982	6	6,591	922	-
Sep-24	6,795	950	7	7,014	980	9	6,582	920	3
Oct-24	6,847	952	6	7,070	983	9	6,631	922	3
Nov-24	6,922	953	4	7,149	984	6	6,702	922	0
Dec-24	6,970	960	2	7,200	991	5	6,747	929	-
Jan-25	7,001	963	1	7,234	995	5	6,775	932	-
Feb-25	7,000	965	2	7,234	998	5	6,772	934	-
Mar-25	6,988	964	1	7,224	997	4	6,759	933	-
Apr-25	6,969	964	1	7,206	997	5	6,739	933	-
May-25	6,953	963	1	7,191	996	5	6,722	931	-
Jun-25	6,914	960	1	7,152	993	5	6,683	928	-
Jul-25	6,864	956	2	7,102	989	5	6,633	924	-
Aug-25	6,839	957	3	7,078	990	6	6,607	924	-
Sep-25	6,831	954	7	7,071	988	10	6,598	922	3
Oct-25	6,882	957	6	7,125	990	9	6,646	924	2
Nov-25	6,957	957	4	7,204	991	7	6,717	924	-
Dec-25	7,006	964	2	7,257	999	5	6,763	931	-
Jan-26	7,036	968	1	7,289	1,003	5	6,791	934	-
Feb-26	7,035	970	2	7,290	1,005	6	6,788	936	-
Mar-26	7,023	969	1	7,279	1,004	5	6,775	935	-
Apr-26	7,003	969	1	7,260	1,005	5	6,755	935	-
May-26	6,987	967	1	7,244	1,003	5	6,738	933	-
Jun-26	6,949	965	1	7,207	1,000	5	6,700	930	-
Jul-26	6,899	960	2	7,157	996	6	6,650	926	-
Aug-26	6,874	961	3	7,133	997	7	6,624	926	-
Sep-26	6,866	959	7	7,126	995	10	6,614	924	2
Oct-26	6,918	961	6	7,182	998	10	6,663	926	2
Nov-26	6,993	962	4	7,262	999	7	6,733	926	-
Dec-26	7,042	969	2	7,315	1,006	6	6,779	933	-
Jan-27	7,072	972	1	7,348	1,010	6	6,806	936	-
Feb-27	7,071	975	2	7,349	1,013	6	6,803	938	-
Mar-27	7,059	974	1	7,338	1,012	5	6,789	936	-
Apr-27	7,040	974	1	7,320	1,013	6	6,769	936	-
May-27	7,024	972	1	7,306	1,011	6	6,752	935	-
Jun-27	6,986	969	1	7,268	1,008	6	6,714	931	-
Jul-27	6,936	965	2	7,219	1,004	6	6,663	927	-
Aug-27	6,911	966	3	7,195	1,006	7	6,637	928	-
Sep-27	6,904	964	7	7,190	1,004	11	6,628	925	2
Oct-27	6,956	966	6	7,247	1,006	10	6,676	927	1

APPENDIX 2.2: CUSTOMER FORECASTS BY REGION

LA GRANDE

	La Grande - Expected Growth			La Grande - High Growth			La Grande - Low Growth		
	Residential Customers	Commercial Customers	Industrial Customers	Residential Customers	Commercial Customers	Industrial Customers	Residential Customers	Commercial Customers	Industrial Customers
Nov-27	7,031	967	4	7,328	1,007	8	6,745	927	-
Dec-27	7,080	973	2	7,381	1,015	6	6,790	934	-
Jan-28	7,111	977	1	7,416	1,019	6	6,817	937	-
Feb-28	7,111	979	2	7,419	1,022	7	6,815	939	-
Mar-28	7,099	978	1	7,409	1,021	6	6,801	937	-
Apr-28	7,080	978	1	7,391	1,021	6	6,781	937	-
May-28	7,064	977	1	7,377	1,020	6	6,763	935	-
Jun-28	7,026	974	1	7,340	1,017	6	6,724	932	-
Jul-28	6,977	970	2	7,292	1,013	7	6,675	928	-
Aug-28	6,952	971	3	7,268	1,015	8	6,648	928	-
Sep-28	6,945	968	7	7,264	1,013	11	6,639	926	1
Oct-28	6,997	971	6	7,321	1,016	11	6,686	928	1
Nov-28	7,072	971	4	7,402	1,017	8	6,755	928	-
Dec-28	7,122	978	2	7,457	1,024	7	6,801	934	-
Jan-29	7,153	982	1	7,493	1,028	7	6,828	937	-
Feb-29	7,152	984	2	7,494	1,031	7	6,824	939	-
Mar-29	7,141	983	1	7,486	1,030	6	6,811	937	-
Apr-29	7,122	983	1	7,469	1,031	7	6,790	937	-
May-29	7,106	981	1	7,455	1,030	7	6,772	935	-
Jun-29	7,068	979	1	7,418	1,027	7	6,734	932	-
Jul-29	7,019	974	2	7,369	1,023	7	6,685	928	-
Aug-29	6,994	975	3	7,345	1,024	8	6,658	928	-
Sep-29	6,987	973	7	7,340	1,022	12	6,649	926	1
Oct-29	7,039	975	6	7,398	1,025	11	6,697	928	0
Nov-29	7,114	976	4	7,479	1,026	9	6,766	928	-
Dec-29	7,163	983	2	7,533	1,034	7	6,810	934	-
Jan-30	7,194	986	1	7,568	1,038	7	6,837	937	-
Feb-30	7,194	989	2	7,571	1,041	8	6,835	939	-
Mar-30	7,182	988	1	7,561	1,040	7	6,821	938	-
Apr-30	7,163	988	1	7,544	1,040	7	6,800	938	-
May-30	7,147	986	1	7,529	1,039	7	6,783	936	-
Jun-30	7,109	983	1	7,492	1,036	7	6,744	933	-
Jul-30	7,059	979	2	7,442	1,032	8	6,695	928	-
Aug-30	7,034	980	3	7,417	1,033	9	6,669	929	-
Sep-30	7,027	978	7	7,412	1,031	12	6,660	927	0
Oct-30	7,079	980	6	7,469	1,034	12	6,708	928	-
Nov-30	7,154	981	4	7,551	1,035	9	6,777	929	-
Dec-30	7,203	987	2	7,605	1,043	8	6,821	935	-
Jan-31	7,234	991	1	7,640	1,047	8	6,848	938	-
Feb-31	7,233	993	2	7,641	1,049	8	6,845	940	-

APPENDIX 2.2: CUSTOMER FORECASTS BY REGION

LA GRANDE

	La Grande - Expected Growth			La Grande - High Growth			La Grande - Low Growth		
	Residential Customers	Commercial Customers	Industrial Customers	Residential Customers	Commercial Customers	Industrial Customers	Residential Customers	Commercial Customers	Industrial Customers
Mar-31	7,221	992	1	7,631	1,048	7	6,832	939	-
Apr-31	7,202	992	1	7,613	1,049	8	6,812	939	-
May-31	7,186	991	1	7,598	1,048	8	6,795	937	-
Jun-31	7,148	988	1	7,561	1,045	8	6,757	934	-
Jul-31	7,098	984	2	7,510	1,041	8	6,707	929	-
Aug-31	7,073	984	3	7,485	1,042	9	6,682	930	-
Sep-31	7,066	982	7	7,480	1,040	13	6,673	928	-
Oct-31	7,118	985	6	7,537	1,043	12	6,721	930	-
Nov-31	7,193	985	4	7,619	1,044	10	6,790	930	-
Dec-31	7,242	992	2	7,673	1,051	8	6,834	936	-
Jan-32	7,272	996	1	7,707	1,055	8	6,860	939	-
Feb-32	7,272	998	2	7,709	1,058	9	6,859	941	-
Mar-32	7,259	997	1	7,697	1,057	8	6,844	940	-
Apr-32	7,240	997	1	7,679	1,057	8	6,825	940	-
May-32	7,224	995	1	7,664	1,056	8	6,808	938	-
Jun-32	7,186	992	1	7,626	1,053	8	6,770	935	-
Jul-32	7,136	988	2	7,575	1,049	9	6,721	931	-
Aug-32	7,111	989	3	7,550	1,050	10	6,696	931	-
Sep-32	7,103	987	7	7,544	1,048	13	6,687	929	-
Oct-32	7,155	989	6	7,601	1,051	13	6,734	931	-
Nov-32	7,230	990	4	7,682	1,052	10	6,803	931	-
Dec-32	7,279	997	2	7,736	1,059	9	6,847	938	-
Jan-33	7,309	1,000	1	7,770	1,063	9	6,874	941	-
Feb-33	7,309	1,003	2	7,772	1,066	9	6,872	943	-
Mar-33	7,296	1,001	1	7,760	1,065	8	6,858	941	-
Apr-33	7,277	1,002	1	7,742	1,066	9	6,838	941	-
May-33	7,261	1,000	1	7,727	1,064	9	6,822	940	-
Jun-33	7,223	997	1	7,688	1,061	9	6,784	937	-
Jul-33	7,173	993	2	7,637	1,057	9	6,736	932	-
Aug-33	7,147	994	3	7,611	1,058	10	6,710	933	-
Sep-33	7,140	991	7	7,605	1,056	14	6,702	931	-
Oct-33	7,191	994	6	7,661	1,059	13	6,749	933	-
Nov-33	7,266	995	4	7,742	1,060	11	6,818	933	-
Dec-33	7,315	1,001	2	7,796	1,067	9	6,862	939	-
Jan-34	7,345	1,005	1	7,829	1,071	9	6,889	943	-
Feb-34	7,344	1,007	2	7,830	1,074	10	6,887	944	-
Mar-34	7,332	1,006	1	7,819	1,073	9	6,874	943	-
Apr-34	7,312	1,006	1	7,799	1,073	9	6,854	943	-
May-34	7,296	1,005	1	7,784	1,072	9	6,837	942	-
Jun-34	7,258	1,002	1	7,745	1,069	9	6,800	939	-
Jul-34	7,208	998	2	7,693	1,065	10	6,752	934	-

APPENDIX 2.2: CUSTOMER FORECASTS BY REGION

LA GRANDE

	La Grande - Expected Growth			La Grande - High Growth			La Grande - Low Growth		
	Residential Customers	Commercial Customers	Industrial Customers	Residential Customers	Commercial Customers	Industrial Customers	Residential Customers	Commercial Customers	Industrial Customers
Aug-34	7,182	998	3	7,667	1,066	11	6,726	935	-
Sep-34	7,175	996	7	7,661	1,064	14	6,719	933	-
Oct-34	7,226	998	6	7,717	1,066	14	6,765	935	-
Nov-34	7,301	999	4	7,798	1,067	11	6,834	935	-
Dec-34	7,349	1,006	2	7,851	1,075	10	6,877	941	-
Jan-35	7,380	1,010	1	7,886	1,079	10	6,905	945	-
Feb-35	7,379	1,012	2	7,886	1,082	10	6,903	947	-
Mar-35	7,366	1,011	1	7,874	1,081	9	6,889	946	-
Apr-35	7,347	1,011	1	7,855	1,081	10	6,870	945	-
May-35	7,331	1,009	1	7,840	1,079	10	6,854	943	-
Jun-35	7,292	1,006	1	7,800	1,076	10	6,816	940	-
Jul-35	7,242	1,002	2	7,747	1,072	10	6,768	936	-
Aug-35	7,216	1,003	3	7,721	1,073	11	6,743	937	-
Sep-35	7,209	1,001	7	7,715	1,071	15	6,735	935	-
Oct-35	7,260	1,003	6	7,771	1,074	14	6,781	937	-
Nov-35	7,335	1,004	4	7,852	1,075	12	6,850	938	-
Dec-35	7,383	1,011	2	7,905	1,082	10	6,894	944	-
Jan-36	7,414	1,014	1	7,939	1,086	10	6,922	947	-
Feb-36	7,412	1,017	2	7,938	1,089	11	6,919	949	-
Mar-36	7,400	1,015	1	7,927	1,087	10	6,907	947	-
Apr-36	7,380	1,016	1	7,907	1,089	10	6,887	948	-
May-36	7,364	1,014	1	7,891	1,087	10	6,871	946	-
Jun-36	7,325	1,011	1	7,850	1,084	10	6,833	943	-
Jul-36	7,275	1,007	2	7,798	1,079	11	6,785	939	-
Aug-36	7,250	1,008	3	7,773	1,081	12	6,761	940	-
Sep-36	7,242	1,005	7	7,765	1,078	15	6,752	937	-
Oct-36	7,293	1,008	6	7,821	1,081	15	6,799	940	-
Nov-36	7,368	1,008	4	7,903	1,081	12	6,868	940	-
Dec-36	7,416	1,015	2	7,956	1,089	11	6,911	946	-
Jan-37	7,447	1,019	1	7,990	1,093	11	6,939	950	-
Feb-37	7,445	1,021	2	7,989	1,096	11	6,936	951	-
Mar-37	7,433	1,020	1	7,978	1,095	10	6,924	950	-
Apr-37	7,413	1,020	1	7,958	1,095	11	6,904	950	-
May-37	7,397	1,019	1	7,942	1,094	11	6,888	949	-
Jun-37	7,358	1,016	1	7,901	1,091	11	6,851	946	-
Jul-37	7,308	1,011	2	7,849	1,086	11	6,803	941	-
Aug-37	7,282	1,012	3	7,822	1,087	12	6,778	942	-
Sep-37	7,275	1,010	7	7,816	1,085	16	6,770	940	-
Oct-37	7,326	1,012	6	7,872	1,087	15	6,816	942	-
Nov-37	7,401	1,013	4	7,954	1,089	13	6,885	942	-
Dec-37	7,449	1,020	2	8,006	1,096	11	6,929	949	-

APPENDIX 2.3: DEMAND COEFFICIENTS

	January	February	March	April	May	June	July	August	September	October	November	December
HEAT COEFFICIENTS												
WA Residential	0.009971	0.009053	0.008839	0.006973	0.004386	0.002250	0.001231	0.002220	0.003217	0.006604	0.008988	0.009706
WA Commercial	0.053158	0.052741	0.046207	0.034483	0.023712	0.013662	0.005341	0.021608	0.021270	0.034440	0.044822	0.052386
WA Ind FirmSale	0.152593	0.162081	0.145640	0.175492	0.171513	0.220240	0.016786	0.182679	0.220748	0.111663	0.105711	0.119724
ID Residential	0.009833	0.008896	0.009330	0.007446	0.005389	0.002417	0.001652	0.000535	0.003860	0.006948	0.009374	0.009923
ID Commercial	0.039718	0.036697	0.032312	0.023848	0.015239	0.013154	0.003409	0.029932	0.011062	0.020519	0.031871	0.038011
ID Ind FirmSale	0.170817	0.201851	0.100163	0.100872	0.138682	0.075238	0.197426	0.112444	0.110702	0.088493	0.119407	0.123984
Roseburg Residential	0.011630	0.009587	0.009809	0.007535	0.005220	0.003216	0.001616	-	0.004154	0.007913	0.010520	0.012343
Roseburg Commercial	0.050141	0.041226	0.041740	0.032942	0.025395	0.019063	0.009553	-	0.024100	0.034450	0.038878	0.048356
Roseburg Ind FirmSale	0.033368	0.190335	0.054369	0.108225	0.074334	0.152983	0.099573	-	0.107618	0.161549	0.113511	0.063067
Medford Residential	0.011013	0.010491	0.009985	0.008122	0.006630	0.004540	0.000188	-	0.003389	0.007070	0.009485	0.010848
Medford Commercial	0.041792	0.039392	0.036600	0.029937	0.023166	0.021386	-	-	0.022369	0.034150	0.037135	0.040772
Medford Ind FirmSale	0.016071	0.037925	0.031213	0.068237	0.049327	0.091332	-	-	0.191349	0.235975	0.122903	0.050094
La Grande Residential	0.009009	0.008055	0.007211	0.005277	0.004571	0.002192	0.000389	0.012638	0.000063	0.003748	0.008159	0.008895
La Grande Commercial	0.040793	0.035518	0.029200	0.018954	0.004460	0.002962	0.001004	0.075772	0.000797	0.012805	0.029008	0.037965
La Grande Ind FirmSal	-	-	-	-	-	-	11.262884	5.257084	1.806537	1.106136	0.024894	-
Klam Falls Residential	0.008258	0.007906	0.007254	0.005830	0.004592	0.002998	0.001448	0.000377	0.002152	0.004994	0.007559	0.008012
Klam Falls Commercial	0.030364	0.029036	0.025170	0.019900	0.013838	0.009614	0.005768	0.006738	0.015708	0.020117	0.027158	0.029743
Klam Falls Ind FirmSal	0.073756	0.094094	0.071758	0.084971	0.048154	0.063523	0.084896	0.252837	0.214762	0.143145	0.184839	0.098340
BASE COEFFICIENTS												
WA Residential	0.047723	0.047723	0.047723	0.047723	0.047723	0.047723	0.047723	0.047723	0.047723	0.047723	0.047723	0.047723
WA Commercial	0.382871	0.382871	0.382871	0.382871	0.382871	0.382871	0.382871	0.382871	0.382871	0.382871	0.382871	0.382871
WA Ind FirmSale	3.103665	3.103665	3.103665	3.103665	3.103665	3.103665	3.103665	3.103665	3.103665	3.103665	3.103665	3.103665
ID Residential	0.044470	0.044470	0.044470	0.044470	0.044470	0.044470	0.044470	0.044470	0.044470	0.044470	0.044470	0.044470
ID Commercial	0.392338	0.392338	0.392338	0.392338	0.392338	0.392338	0.392338	0.392338	0.392338	0.392338	0.392338	0.392338
ID Ind FirmSale	4.975098	4.975098	4.975098	4.975098	4.975098	4.975098	4.975098	4.975098	4.975098	4.975098	4.975098	4.975098
Roseburg Residential	0.034716	0.034716	0.034716	0.034716	0.034716	0.034716	0.034716	0.034716	0.034716	0.034716	0.034716	0.034716
Roseburg Commercial	0.271081	0.271081	0.271081	0.271081	0.271081	0.271081	0.271081	0.271081	0.271081	0.271081	0.271081	0.271081
Roseburg Ind FirmSale	2.233618	2.233618	2.233618	2.233618	2.233618	2.233618	2.233618	2.233618	2.233618	2.233618	2.233618	2.233618
Medford Residential	0.046948	0.046948	0.046948	0.046948	0.046948	0.046948	0.046948	0.046948	0.046948	0.046948	0.046948	0.046948
Medford Commercial	0.359543	0.359543	0.359543	0.359543	0.359543	0.359543	0.359543	0.359543	0.359543	0.359543	0.359543	0.359543
Medford Ind FirmSale	4.180638	4.180638	4.180638	4.180638	4.180638	4.180638	4.180638	4.180638	4.180638	4.180638	4.180638	4.180638
La Grande Residential	0.075894	0.075894	0.075894	0.075894	0.075894	0.075894	0.075894	0.075894	0.075894	0.075894	0.075894	0.075894
La Grande Commercial	0.423491	0.423491	0.423491	0.423491	0.423491	0.423491	0.423491	0.423491	0.423491	0.423491	0.423491	0.423491
La Grande Ind FirmSal	57.409752	57.409752	57.409752	57.409752	57.409752	57.409752	57.409752	57.409752	57.409752	57.409752	57.409752	57.409752
Klam Falls Residential	0.032439	0.032439	0.032439	0.032439	0.032439	0.032439	0.032439	0.032439	0.032439	0.032439	0.032439	0.032439
Klam Falls Commercial	0.223901	0.223901	0.223901	0.223901	0.223901	0.223901	0.223901	0.223901	0.223901	0.223901	0.223901	0.223901
Klam Falls Ind FirmSal	3.595971	3.595971	3.595971	3.595971	3.595971	3.595971	3.595971	3.595971	3.595971	3.595971	3.595971	3.595971
SUPER PEAK*												
WA Residential	0.009577	0.009577										0.009577
WA Commercial	0.052761	0.052761										0.052761
WA Ind FirmSale	0.144799	0.144799										0.144799
ID Residential	0.009551	0.009551										0.009551
ID Commercial	0.038142	0.038142										0.038142
ID Ind FirmSale	0.165551	0.165551										0.165551
Roseburg Residential	0.011186	0.011186										0.011186
Roseburg Commercial	0.046574	0.046574										0.046574
Roseburg Ind FirmSale	0.095590	0.095590										0.095590
Medford NWP Resider	0.010784	0.010784										0.010784
Medford NWP Comme	0.040652	0.040652										0.040652
Medford NWP Ind Firm	0.034696	0.034696										0.034696
La Grande Residential	0.008653	0.008653										0.008653
La Grande Commercial	0.038092	0.038092										0.038092
La Grande Ind FirmSal	-	-										-
Klam Falls Residential	0.008059	0.008059										0.008059
Klam Falls Commercial	0.029714	0.029714										0.029714
Klam Falls Ind FirmSal	0.088730	0.088730										0.088730

* Average of DEC JAN FEB heat coefficients

APPENDIX 2.3: WA BASE COEFFICIENT CALCULATION

WA
Average Actual Demand by Class

		Month <input type="button" value="v"/>
		+ 7 & 8
Year	<input type="button" value="v"/>	
2013		
Average of Res Demand	6,501	
Average of Com Demand	4,988	
Average of Ind Demand	336	
2014		
Average of Res Demand	6,347	
Average of Com Demand	5,526	
Average of Ind Demand	355	
2015		
Average of Res Demand	6,625	
Average of Com Demand	5,244	
Average of Ind Demand	394	
2016		
Average of Res Demand	7,149	
Average of Com Demand	5,908	
Average of Ind Demand	410	
2017		
Average of Res Demand	6,574	
Average of Com Demand	5,380	
Average of Ind Demand	427	
Total Average of Res Demand	6,639	
Total Average of Com Demand	5,409	
Total Average of Ind Demand	384	

		Month <input type="button" value="v"/>
		+ 7 & 8
Year	<input type="button" value="v"/>	
2013		
Average of Res Cust	135,755	
Average of Com Cust	14,185	
Average of Ind Cust	134	
2014		
Average of Res Cust	137,356	
Average of Com Cust	14,144	
Average of Ind Cust	138	
2015		
Average of Res Cust	139,093	
Average of Com Cust	14,173	
Average of Ind Cust	135	
2016		
Average of Res Cust	141,755	
Average of Com Cust	14,456	
Average of Ind Cust	130	
2017		
Average of Res Cust	145,535	
Average of Com Cust	14,551	
Average of Ind Cust	133	
Total Average of Res Cust	139,898	
Total Average of Com Cust	14,302	
Total Average of Ind Cust	134	

Base Coefficients
(Actual Average Demand/Customer Count)

0.047458	Res Base Usage
0.378215	Com Base Usage
2.874961	Ind Base Usage

APPENDIX 2.3: ID BASE COEFFICIENT CALCULATION

ID
Average Actual Demand by Class

		Month <input type="button" value="▼"/>
		+ 7 & 8
Year	<input type="button" value="▼"/>	
2013		
Average of Res Demand	3,092	
Average of Com Demand	2,886	
Average of Ind Demand	457	
2014		
Average of Res Demand	3,276	
Average of Com Demand	2,868	
Average of Ind Demand	643	
2015		
Average of Res Demand	2,979	
Average of Com Demand	3,511	
Average of Ind Demand	436	
2016		
Average of Res Demand	3,361	
Average of Com Demand	3,322	
Average of Ind Demand	509	
2017		
Average of Res Demand	3,140	
Average of Com Demand	3,464	
Average of Ind Demand	495	
Total Average of Res Demand	3,170	
Total Average of Com Demand	3,210	
Total Average of Ind Demand	508	

		Month <input type="button" value="▼"/>
		+ 7 & 8
Year	<input type="button" value="▼"/>	
2013		
Average of Res Cust	67,390	
Average of Com Cust	8,541	
Average of Ind Cust	94	
2014		
Average of Res Cust	68,329	
Average of Com Cust	8,527	
Average of Ind Cust	100	
2015		
Average of Res Cust	69,436	
Average of Com Cust	8,613	
Average of Ind Cust	100	
2016		
Average of Res Cust	71,062	
Average of Com Cust	8,751	
Average of Ind Cust	97	
2017		
Average of Res Cust	72,686	
Average of Com Cust	8,881	
Average of Ind Cust	93	
Total Average of Res Cust	69,780	
Total Average of Com Cust	8,663	
Total Average of Ind Cust	97	

Base Coefficients
(Actual Average Demand/Customer Count)

0.045423	Res Base Usage
0.370569	Com Base Usage
5.263706	Ind Base Usage

APPENDIX 2.3: MEDFORD BASE COEFFICIENT CALCULATION

Medford
Average Actual Demand by Class

		Month <input type="button" value="▼"/>
		+ 7 & 8
Year <input type="button" value="▼"/>		
2013		
Average of Res Demand	2,323	
Average of Com Demand	2,160	
Average of Ind Demand	43	
2014		
Average of Res Demand	2,290	
Average of Com Demand	2,253	
Average of Ind Demand	54	
2015		
Average of Res Demand	2,316	
Average of Com Demand	2,303	
Average of Ind Demand	60	
2016		
Average of Res Demand	2,582	
Average of Com Demand	2,487	
Average of Ind Demand	60	
2017		
Average of Res Demand	2,596	
Average of Com Demand	2,487	
Average of Ind Demand	68	
Total Average of Res Demand	2,421	
Total Average of Com Demand	2,338	
Total Average of Ind Demand	57	

		Month <input type="button" value="▼"/>
		+ 7 & 8
Year <input type="button" value="▼"/>		
2013		
Average of Res Cust	51,090	
Average of Com Cust	6,516	
Average of Ind Cust	16	
2014		
Average of Res Cust	51,662	
Average of Com Cust	6,592	
Average of Ind Cust	17	
2015		
Average of Res Cust	52,605	
Average of Com Cust	6,596	
Average of Ind Cust	15	
2016		
Average of Res Cust	53,084	
Average of Com Cust	6,796	
Average of Ind Cust	15	
2017		
Average of Res Cust	53,920	
Average of Com Cust	6,850	
Average of Ind Cust	15	
Total Average of Res Cust	52,472	
Total Average of Com Cust	6,670	
Total Average of Ind Cust	16	

Base Coefficients
(Actual Average Demand/Customer Count)

0.046145	Res Base Usage
0.350570	Com Base Usage
3.651363	Ind Base Usage

APPENDIX 2.3: ROSEBURG BASE COEFFICIENT CALCULATION

Roseburg
Average Actual Demand by Class

		Month <input type="button" value="v"/>
		+ 7 & 8
Year <input type="button" value="v"/>		
2013		
Average of Res Demand	551	
Average of Com Demand	665	
Average of Ind Demand	39	
2014		
Average of Res Demand	400	
Average of Com Demand	484	
Average of Ind Demand	26	
2015		
Average of Res Demand	430	
Average of Com Demand	557	
Average of Ind Demand	4	
2016		
Average of Res Demand	466	
Average of Com Demand	557	
Average of Ind Demand	4	
2017		
Average of Res Demand	486	
Average of Com Demand	628	
Average of Ind Demand	5	
Total Average of Res Demand	467	
Total Average of Com Demand	578	
Total Average of Ind Demand	16	

		Month <input type="button" value="v"/>
		+ 7 & 8
Year <input type="button" value="v"/>		
2013		
Average of Res Cust	13,020	
Average of Com Cust	2,120	
Average of Ind Cust	3	
2014		
Average of Res Cust	13,063	
Average of Com Cust	2,127	
Average of Ind Cust	3	
2015		
Average of Res Cust	13,227	
Average of Com Cust	2,130	
Average of Ind Cust	2	
2016		
Average of Res Cust	13,242	
Average of Com Cust	2,156	
Average of Ind Cust	2	
2017		
Average of Res Cust	13,337	
Average of Com Cust	2,141	
Average of Ind Cust	2	
Total Average of Res Cust	13,178	
Total Average of Com Cust	2,135	
Total Average of Ind Cust	2	

Base Coefficients
(Actual Average Demand/Customer Count)

0.035406	Res Base Usage
0.270835	Com Base Usage
6.521993	Ind Base Usage

APPENDIX 2.3: KLAMATH FALLS BASE COEFFICIENT CALCULATION

Klamath Falls
Average Actual Demand by Class

		Month <input type="button" value="v"/>
		+ 7 & 8
Year <input type="button" value="v"/>		
2013		
Average of Res Demand	531	
Average of Com Demand	433	
Average of Ind Demand	24	
2014		
Average of Res Demand	515	
Average of Com Demand	442	
Average of Ind Demand	22	
2015		
Average of Res Demand	531	
Average of Com Demand	484	
Average of Ind Demand	30	
2016		
Average of Res Demand	397	
Average of Com Demand	308	
Average of Ind Demand	19	
2017		
Average of Res Demand	458	
Average of Com Demand	361	
Average of Ind Demand	26	
Total Average of Res Demand	486	
Total Average of Com Demand	406	
Total Average of Ind Demand	24	

		Month <input type="button" value="v"/>
		+ 7 & 8
Year <input type="button" value="v"/>		
2013		
Average of Res Cust	13,857	
Average of Com Cust	1,646	
Average of Ind Cust	8	
2014		
Average of Res Cust	13,872	
Average of Com Cust	1,652	
Average of Ind Cust	8	
2015		
Average of Res Cust	14,106	
Average of Com Cust	1,667	
Average of Ind Cust	7	
2016		
Average of Res Cust	14,206	
Average of Com Cust	1,722	
Average of Ind Cust	7	
2017		
Average of Res Cust	14,397	
Average of Com Cust	1,762	
Average of Ind Cust	7	
Total Average of Res Cust	14,088	
Total Average of Com Cust	1,689	
Total Average of Ind Cust	7	

Base Coefficients
(Actual Average Demand/ Customer Count)

0.034518	Res Base Usage
0.240100	Com Base Usage
3.292121	Ind Base Usage

APPENDIX 2.3: LA GRANDE BASE COEFFICIENT CALCULATION

La Grande
Average Actual Demand by Class

		Month <input type="button" value="v"/>
		+ 7 & 8
Year	<input type="button" value="v"/>	
2013		
Average of Res Demand	530	
Average of Com Demand	380	
Average of Ind Demand	63	
2014		
Average of Res Demand	541	
Average of Com Demand	389	
Average of Ind Demand	165	
2015		
Average of Res Demand	554	
Average of Com Demand	441	
Average of Ind Demand	122	
2016		
Average of Res Demand	497	
Average of Com Demand	377	
Average of Ind Demand	192	
2017		
Average of Res Demand	439	
Average of Com Demand	338	
Average of Ind Demand	202	
Total Average of Res Demand	512	
Total Average of Com Demand	385	
Total Average of Ind Demand	149	

		Month <input type="button" value="v"/>
		+ 7 & 8
Year	<input type="button" value="v"/>	
2013		
Average of Res Cust	6,456	
Average of Com Cust	894	
Average of Ind Cust	4	
2014		
Average of Res Cust	6,496	
Average of Com Cust	892	
Average of Ind Cust	3	
2015		
Average of Res Cust	6,547	
Average of Com Cust	897	
Average of Ind Cust	4	
2016		
Average of Res Cust	6,529	
Average of Com Cust	919	
Average of Ind Cust	3	
2017		
Average of Res Cust	6,565	
Average of Com Cust	914	
Average of Ind Cust	3	
Total Average of Res Cust	6,518	
Total Average of Com Cust	903	
Total Average of Ind Cust	3	

Base Coefficients
(Actual Average Demand/ Customer Count)

0.078587	Res Base Usage
0.426358	Com Base Usage
48.029588	Ind Base Usage

APPENDIX 2.4: HEATING DEGREE DAY DATA MONTHLY TABLES

Temperature Pattern		WA/ID											Annual	
Gas Year	▼	Nov	Dec	Jan	Feb	Mar	Apr	May	Jun	Jul	Aug	Sep	Oct	Total
2017-2018		868	1,155	1,111	920	772	561	331	139	26	25	165	529	6,601
2018-2019		866	1,149	1,119	914	780	556	328	141	22	21	175	540	6,609
2019-2020		876	1,154	1,119	915	789	561	316	136	20	24	166	539	6,616
2020-2021		868	1,138	1,117	912	785	549	310	138	21	23	171	539	6,571
2021-2022		891	1,155	1,118	920	785	568	312	144	24	24	177	535	6,652
2022-2023		873	1,147	1,116	927	785	557	327	144	24	24	175	539	6,636
2023-2024		862	1,156	1,119	917	772	562	323	135	21	24	168	550	6,610
2024-2025		866	1,153	1,107	931	783	557	319	144	25	23	175	546	6,629
2025-2026		869	1,151	1,103	915	783	554	326	144	22	22	172	552	6,614
2026-2027		872	1,137	1,106	910	777	555	322	137	25	24	167	535	6,568
2027-2028		875	1,150	1,107	911	782	561	319	132	21	24	170	528	6,580
2028-2029		869	1,155	1,117	921	780	555	328	140	24	25	164	528	6,606
2029-2030		862	1,156	1,112	921	789	562	316	140	20	22	170	536	6,606
2030-2031		868	1,156	1,123	902	791	553	322	138	22	23	171	532	6,601
2031-2032		874	1,142	1,121	916	769	558	317	140	23	23	168	539	6,590
2032-2033		863	1,133	1,110	916	769	554	316	136	22	25	169	543	6,556
2033-2034		876	1,161	1,126	920	777	573	318	134	23	23	169	537	6,637
2034-2035		865	1,152	1,112	912	779	561	331	142	23	24	169	541	6,612
2035-2036		877	1,152	1,116	911	788	555	315	142	23	24	170	543	6,616
2036-2037		859	1,154	1,116	922	801	564	318	141	20	23	169	536	6,624

Temperature Pattern		Klamath Falls											Annual	
Gas Year	▼	Nov	Dec	Jan	Feb	Mar	Apr	May	Jun	Jul	Aug	Sep	Oct	Total
2017-2018		866	1,086	1,076	853	805	672	445	221	46	61	230	555	6,916
2018-2019		871	1,096	1,077	865	817	668	447	222	45	62	225	560	6,954
2019-2020		866	1,101	1,075	878	810	674	439	215	45	62	219	558	6,943
2020-2021		861	1,104	1,073	875	807	665	452	223	43	55	224	555	6,938
2021-2022		875	1,102	1,075	855	802	663	433	215	47	64	225	555	6,910
2022-2023		857	1,104	1,059	858	817	672	432	217	44	61	225	548	6,895
2023-2024		872	1,092	1,070	865	817	662	448	216	47	60	224	552	6,927
2024-2025		876	1,099	1,064	858	811	677	442	219	42	61	221	554	6,924
2025-2026		867	1,093	1,082	866	809	656	448	213	43	58	227	561	6,924
2026-2027		869	1,097	1,047	866	817	656	436	230	46	60	218	561	6,902
2027-2028		869	1,098	1,044	862	806	659	449	219	45	65	217	560	6,894
2028-2029		869	1,098	1,071	864	819	668	446	223	46	64	213	557	6,937
2029-2030		860	1,105	1,063	870	797	657	451	223	48	63	219	552	6,908
2030-2031		859	1,105	1,056	873	806	670	460	222	42	62	229	557	6,940
2031-2032		869	1,095	1,074	849	816	665	446	220	47	59	220	548	6,908
2032-2033		863	1,092	1,062	870	817	672	440	219	47	62	226	554	6,923
2033-2034		866	1,095	1,052	853	803	675	451	218	46	64	220	554	6,898
2034-2035		867	1,108	1,068	868	807	666	445	214	45	59	219	557	6,923
2035-2036		860	1,101	1,072	873	808	675	455	216	45	59	217	560	6,941
2036-2037		865	1,091	1,080	861	801	665	450	223	46	60	221	556	6,919

APPENDIX 2.4: HEATING DEGREE DAY DATA MONTHLY TABLES

Temperature Pattern		Medford												Annual
Gas Year	▼	Nov	Dec	Jan	Feb	Mar	Apr	May	Jun	Jul	Aug	Sep	Oct	Total
2017-2018		599	819	776	586	533	381	203	52	3	4	50	295	4,302
2018-2019		600	821	778	595	531	376	200	53	3	4	49	296	4,304
2019-2020		595	818	779	601	531	379	198	52	3	4	50	286	4,296
2020-2021		589	815	781	589	533	384	198	53	2	4	47	297	4,293
2021-2022		598	812	782	592	530	382	202	56	2	4	47	295	4,302
2022-2023		595	809	790	584	526	378	198	56	3	4	50	299	4,293
2023-2024		606	818	775	589	544	391	189	52	3	4	48	292	4,312
2024-2025		601	813	790	588	529	373	191	56	3	4	46	297	4,291
2025-2026		605	813	784	587	529	379	195	57	3	3	51	295	4,302
2026-2027		603	810	779	595	529	378	205	54	2	4	49	287	4,296
2027-2028		599	825	783	595	524	382	197	52	3	4	53	296	4,313
2028-2029		598	809	776	587	524	378	205	55	2	3	50	293	4,279
2029-2030		605	796	777	587	520	382	198	53	3	3	49	291	4,264
2030-2031		603	809	778	591	518	386	203	58	3	3	49	287	4,287
2031-2032		602	819	773	594	537	386	198	54	3	4	49	297	4,315
2032-2033		595	815	783	587	515	377	194	54	3	4	46	295	4,267
2033-2034		604	815	782	594	537	381	199	55	3	4	51	296	4,320
2034-2035		592	814	782	594	528	385	191	58	3	4	46	297	4,293
2035-2036		601	815	773	591	534	369	197	56	3	3	51	291	4,284
2036-2037		599	811	780	595	530	382	199	55	3	4	47	296	4,300

Temperature Pattern		Roseburg												Annual
Gas Year	▼	Nov	Dec	Jan	Feb	Mar	Apr	May	Jun	Jul	Aug	Sep	Oct	Total
2017-2018		531	707	675	544	506	380	223	83	5	5	56	280	3,995
2018-2019		529	710	677	556	506	384	219	81	5	4	56	276	4,003
2019-2020		525	709	686	558	505	384	219	81	5	4	56	278	4,009
2020-2021		523	710	684	546	506	381	225	79	5	5	56	282	4,001
2021-2022		528	707	689	548	502	382	226	83	5	5	56	277	4,006
2022-2023		528	700	698	539	498	379	225	78	5	4	53	275	3,981
2023-2024		535	709	679	545	517	385	216	79	5	5	56	275	4,006
2024-2025		531	700	692	545	497	383	226	85	4	5	55	270	3,993
2025-2026		534	704	691	545	502	388	214	81	5	4	53	277	3,998
2026-2027		535	701	681	551	501	386	224	82	5	4	54	281	4,007
2027-2028		529	715	687	552	499	381	221	77	6	5	56	282	4,010
2028-2029		528	701	674	544	495	395	223	77	5	4	55	280	3,980
2029-2030		534	695	682	543	493	374	217	75	5	4	56	270	3,948
2030-2031		534	703	686	546	490	376	222	78	4	4	56	275	3,974
2031-2032		535	712	674	551	508	370	220	78	5	4	56	275	3,990
2032-2033		524	705	685	543	486	385	213	80	4	4	53	272	3,955
2033-2034		535	708	683	551	506	379	209	81	5	5	55	272	3,990
2034-2035		521	705	685	552	497	382	215	79	5	4	54	282	3,981
2035-2036		529	708	677	547	504	379	216	79	5	5	54	275	3,977
2036-2037		529	702	682	554	503	370	219	75	5	5	55	273	3,972

APPENDIX 2.4: HEATING DEGREE DAY DATA MONTHLY TABLES

Temperature Pattern		La Grande											Annual	
Gas Year	▼	Nov	Dec	Jan	Feb	Mar	Apr	May	Jun	Jul	Aug	Sep	Oct	Total
2017-2018		768	1,051	1,034	810	726	554	357	156	25	34	192	518	6,224
2018-2019		768	1,049	1,022	821	717	556	353	156	21	33	189	510	6,197
2019-2020		783	1,053	1,021	816	717	551	349	157	24	34	186	515	6,205
2020-2021		776	1,054	1,022	817	721	549	361	150	24	33	190	517	6,213
2021-2022		785	1,056	1,026	818	721	556	348	150	29	34	187	513	6,224
2022-2023		778	1,053	1,032	818	723	558	356	152	28	33	192	504	6,227
2023-2024		771	1,065	1,019	808	726	564	352	148	25	36	194	514	6,222
2024-2025		785	1,056	1,030	813	713	552	352	144	24	35	189	508	6,199
2025-2026		763	1,062	1,033	818	727	554	351	152	29	34	189	517	6,231
2026-2027		768	1,058	1,028	820	720	553	357	155	26	33	188	513	6,219
2027-2028		776	1,052	1,025	808	724	556	362	156	26	35	191	519	6,229
2028-2029		784	1,056	1,032	814	722	560	358	153	24	35	192	517	6,249
2029-2030		770	1,057	1,019	809	727	553	351	155	23	33	187	512	6,197
2030-2031		763	1,054	1,017	811	718	558	350	149	26	34	187	517	6,183
2031-2032		779	1,045	1,025	810	711	553	353	150	24	35	194	504	6,185
2032-2033		770	1,054	1,016	812	718	552	353	152	24	34	189	504	6,179
2033-2034		766	1,050	1,030	819	719	559	350	150	26	34	193	508	6,203
2034-2035		772	1,050	1,035	810	720	559	353	151	24	31	189	518	6,211
2035-2036		787	1,050	1,025	812	715	555	353	148	26	35	192	514	6,213
2036-2037		762	1,045	1,018	815	709	562	352	150	27	32	192	510	6,174

APPENDIX 2.4: HEATING DEGREE DAILY MONTH BY AREA

Temperature Pattern		WA/ID										
Day	Jan	Feb	Mar	Apr	May	Jun	Jul	Aug	Sep	Oct	Nov	Dec
1	38	35	30	22	14	3	0	0	0	9	25	34
2	38	34	29	23	13	6	0	0	0	12	25	34
3	39	34	29	23	13	5	0	0	1	13	26	35
4	36	32	28	22	13	4	0	0	0	13	26	36
5	37	32	27	22	14	5	0	0	2	14	27	36
6	36	32	27	20	15	5	0	0	3	12	26	37
7	35	33	27	19	13	4	0	0	2	12	25	38
8	35	33	28	19	12	6	0	0	2	14	25	38
9	35	33	27	20	13	6	0	0	3	15	26	38
10	36	33	26	19	12	7	0	0	3	17	27	36
11	38	33	25	19	10	7	0	0	2	17	28	36
12	38	31	24	18	10	4	0	0	1	18	26	35
13	36	62	23	19	12	4	0	0	1	15	26	35
14	35	72	23	21	9	5	0	0	1	15	28	35
15	38	82	23	22	9	5	0	0	1	17	27	36
16	38	67	24	19	8	4	0	0	3	17	27	37
17	36	57	25	19	8	4	0	0	5	15	28	37
18	34	31	25	18	8	4	0	0	5	17	29	51
19	35	31	25	17	8	4	0	0	6	16	29	56
20	35	31	24	15	10	3	0	0	8	17	29	61
21	35	30	24	14	9	1	0	0	9	18	31	58
22	35	30	24	15	9	0	0	0	7	17	32	53
23	34	32	24	16	8	1	0	0	7	19	32	38
24	35	34	23	17	7	1	0	0	6	20	33	37
25	33	34	23	16	8	1	0	0	5	21	31	37
26	34	34	24	16	8	0	0	0	7	22	31	38
27	35	32	23	14	7	0	0	0	7	22	33	36
28	35	31	24	15	7	0	0	0	6	22	35	36
29	33	28	22	16	7	0	0	0	6	24	35	37
30	33	65	21	14	5	0	0	0	8	24	34	39
31	33	65	22	65	4	65	0	0	65	24	65	40
Total	1103	1243	773	614	303	164	0	0	182	528	927	1230

Temperature Pattern		Medford										
Day	Jan	Feb	Mar	Apr	May	Jun	Jul	Aug	Sep	Oct	Nov	Dec
1	26	24	19	15	8	0	0	0	0	3	15	25
2	26	22	19	15	7	0	0	0	0	6	17	24
3	28	21	21	15	7	0	0	0	0	6	16	25
4	27	21	19	15	8	0	0	0	0	6	17	26
5	26	22	20	15	9	0	0	0	0	6	17	26
6	26	21	20	13	8	0	0	0	0	5	16	25
7	23	20	20	14	7	0	0	0	0	5	16	27
8	24	23	19	14	7	1	0	0	0	6	18	26
9	25	21	18	14	8	1	0	0	0	7	20	24
10	25	22	18	13	8	2	0	0	0	9	18	26
11	24	21	16	13	7	2	0	0	0	10	18	27
12	24	20	16	13	6	0	0	0	0	10	18	25
13	26	32	15	14	5	0	0	0	0	7	18	24
14	26	36	16	16	4	0	0	0	0	7	18	25
15	26	38	16	16	4	0	0	0	0	9	19	27
16	26	32	16	13	4	0	0	0	0	7	20	27
17	26	28	18	12	4	0	0	0	0	8	21	27
18	24	20	16	12	4	0	0	0	0	9	22	50
19	24	21	15	12	5	0	0	0	0	8	20	59
20	26	20	15	10	5	0	0	0	0	10	21	61
21	25	20	14	11	5	0	0	0	0	11	22	56
22	24	21	15	10	4	0	0	0	0	10	22	55
23	24	22	16	11	3	0	0	0	0	11	23	26
24	23	20	15	11	3	0	0	0	0	12	23	27
25	22	21	17	10	3	0	0	0	0	13	21	27
26	23	22	17	10	1	0	0	0	0	13	23	27
27	25	20	17	10	3	0	0	0	0	14	24	26
28	24	20	16	10	3	0	0	0	0	13	23	25
29	23	21	15	9	2	0	0	0	0	14	24	26
30	24	65	15	8	0	0	0	0	1	13	25	27
31	25	65	15	65	0	65	0	0	65	14	65	27
Total	770	802	524	439	152	71	0	0	66	282	660	955

APPENDIX 2.4: HEATING DEGREE DAILY MONTH BY AREA

Temperature Pattern		LaGrande											
Day	Jan	Feb	Mar	Apr	May	Jun	Jul	Aug	Sep	Oct	Nov	Dec	
1	37	32	27	22	14	5	0	0	2	10	24	29	
2	35	31	25	22	14	6	0	0	3	12	22	31	
3	36	31	27	22	14	6	0	0	2	13	23	32	
4	35	28	26	21	14	4	0	0	2	14	22	32	
5	35	28	24	21	14	6	0	0	2	15	23	34	
6	34	28	26	19	14	6	0	0	3	13	21	33	
7	31	28	25	19	13	5	0	0	4	12	22	35	
8	30	29	26	19	14	7	0	0	4	13	22	34	
9	30	30	24	20	15	7	0	0	5	14	23	34	
10	32	30	23	18	14	9	0	0	4	16	23	31	
11	33	29	23	19	11	7	0	0	4	17	25	33	
12	34	28	21	17	11	6	0	0	3	17	23	32	
13	32	51	21	19	12	5	0	0	3	14	24	30	
14	32	69	21	21	10	6	0	0	3	14	25	32	
15	36	75	21	22	10	4	0	0	3	16	25	32	
16	35	74	22	19	10	5	0	0	4	15	25	34	
17	34	71	24	17	9	4	0	0	5	14	26	35	
18	31	28	23	18	8	5	0	0	6	16	27	51	
19	30	28	23	18	9	5	0	0	6	14	25	56	
20	31	27	21	16	10	3	0	0	8	16	26	60	
21	32	27	22	16	11	2	0	0	9	18	27	57	
22	33	27	22	15	10	2	0	0	9	17	28	49	
23	32	28	23	16	9	2	0	0	8	17	29	35	
24	32	29	21	18	8	2	0	0	7	19	29	35	
25	31	29	21	17	9	2	0	0	8	19	29	35	
26	32	29	24	16	9	1	0	0	8	21	28	34	
27	34	28	23	15	8	0	0	0	8	21	30	34	
28	33	27	22	16	9	0	0	0	8	19	31	32	
29	32	26	20	17	7	0	0	0	7	21	30	33	
30	30	65	21	15	7	0	0	1	7	21	30	37	
31	31	65	21	65	6	65	0	1	65	22	65	37	
Total	1015	1155	713	615	333	187	0	2	220	500	832	1138	

Temperature Pattern		Klamath											
Day	Jan	Feb	Mar	Apr	May	Jun	Jul	Aug	Sep	Oct	Nov	Dec	
1	36	33	29	25	17	8	0	0	4	13	25	32	
2	36	32	29	25	16	9	0	0	3	15	26	32	
3	36	30	30	25	16	9	0	0	4	16	26	34	
4	37	30	29	25	17	8	0	0	4	16	26	35	
5	37	31	28	25	17	9	0	0	6	15	25	35	
6	35	29	28	23	17	9	0	0	6	14	24	34	
7	32	29	28	23	16	9	0	0	4	14	25	36	
8	32	31	28	24	17	10	0	0	4	15	27	35	
9	34	31	27	24	18	10	0	0	6	16	29	34	
10	33	31	27	23	18	11	0	0	5	17	28	35	
11	34	30	25	22	16	11	0	0	3	19	28	36	
12	34	29	25	22	16	9	0	0	2	18	26	34	
13	34	45	24	23	14	8	0	0	3	15	27	33	
14	36	55	25	26	13	7	0	0	5	15	26	36	
15	35	57	23	25	13	6	0	0	7	16	26	37	
16	34	42	25	23	14	7	0	0	9	16	27	36	
17	34	35	26	22	13	7	0	0	9	17	29	37	
18	33	30	25	22	14	7	0	0	9	17	29	46.5	
19	33	32	24	21	14	7	0	0	9	17	27	62.5	
20	33	31	23	20	14	5	0	0	9	19	27	72	
21	34	29	24	20	13	4	0	0	9	19	29	66.5	
22	34	30	24	19	13	4	0	1	10	18	30	57.5	
23	33	32	26	20	12	4	0	2	10	19	31	35	
24	33	29	24	20	11	4	0	1	9	19	33	36	
25	32	31	26	20	12	4	0	1	10	21	31	35	
26	32	31	26	20	11	3	0	1	10	21	33	36	
27	34	30	26	18	12	0	0	1	8	22	33	35	
28	34	30	25	20	12	0	0	0	8	21	34	34	
29	32	33	24	19	11	0	0	0	9	22	34	35	
30	32	65	24	18	9	0	0	3	11	22	33	37	
31	34	65	25	65	7	65	0	3	65	24	65	38	
Total	1052	1098	802	727	433	254	0	13	270	548	919	1217	

APPENDIX 2.4: HEATING DEGREE DAILY MONTH BY AREA

Temperature Pattern		Roseburg											
Day	Jan	Feb	Mar	Apr	May	Jun	Jul	Aug	Sep	Oct	Nov	Dec	
1	24	21	18	16	8	2	0	0	0	4	14	21	
2	24	20	18	15	7	2	0	0	0	6	14	21	
3	24	20	19	15	8	2	0	0	0	6	15	21	
4	23	19	18	14	8	1	0	0	0	6	15	21	
5	23	19	18	15	9	2	0	0	0	5	15	21	
6	22	19	18	13	9	1	0	0	0	4	13	22	
7	20	20	18	13	8	2	0	0	0	4	16	24	
8	20	20	17	14	8	2	0	0	0	5	16	23	
9	22	20	16	14	10	3	0	0	0	6	16	21	
10	22	20	16	13	9	5	0	0	0	9	17	23	
11	22	19	15	12	8	3	0	0	0	9	16	22	
12	21	18	15	13	7	1	0	0	0	9	14	21	
13	22	32	15	13	6	1	0	0	0	7	15	22	
14	23	37	15	16	5	2	0	0	0	7	15	23	
15	23	42	15	15	6	1	0	0	0	8	15	24	
16	22	34	16	13	5	1	0	0	0	8	17	23	
17	22	28	17	12	5	0	0	0	1	8	17	23	
18	21	19	15	12	5	2	0	0	0	8	19	40	
19	21	20	15	12	6	1	0	0	0	8	16	53	
20	22	20	15	11	6	0	0	0	0	10	19	55	
21	21	19	16	11	6	0	0	0	2	10	20	46	
22	21	19	16	10	5	1	0	0	1	9	20	48	
23	21	20	15	11	4	0	0	0	1	11	21	21	
24	21	19	14	11	4	0	0	0	0	12	19	23	
25	21	20	16	11	4	0	0	0	2	13	20	23	
26	22	20	17	10	3	0	0	0	1	12	20	24	
27	22	19	16	10	4	0	0	0	0	14	22	22	
28	20	19	15	10	6	0	0	0	0	12	21	22	
29	20	20	14	10	4	0	0	0	2	12	21	23	
30	20	65	15	9	2	0	0	0	3	13	22	24	
31	21	65	15	65	1	65	0	0	65	13	65	24	
Total	673	772	498	439	186	100	0	0	78	268	585	824	

APPENDIX 2.5: DEMAND SENSITIVITIES SUMMARY OF ASSUMPTIONS – DEMAND SCENARIOS

INPUT ASSUMPTIONS	DEMAND INFLUENCING - DIRECT										PRICE INFLUENCING - INDIRECT			
	Reference Case	Reference Plus Peak Case	Low Cust Growth	High Cust Growth	Alternate Std	DSM Case	Peak plus 80% below 1990 emissions Reference Case	80% below 1990 emissions Reference Plus Peak	Alternate Historical 2 Year UPC	Alternate Historical 5 Year UPC	Expected Elasticity	Low Prices	High Prices	Carbon Legislation
Customer Growth Rate	Reference	Reference	Low Growth	High Growth	Reference									
Use per Customer	3 Year Historical										3 Year Historical			
Weather Planning Standard	20 Year Average	Coldest on Record	Coldest in 20yrs	Coldest on Record	20 Year Average	Coldest on Record	3 Year Historical less demand destruction	2 Year Historical	5 Year Historical	Coldest on Record				
Demand Side Management Programs Included	None										Expected			
Prices	None										Expected			
Price curve	None										Expected			
Price curve adder (\$/Dth)	None										None			
Elasticity	None										Expected			
RESULTS														
FIRST YEAR UNSERVED														
WA ID	N/A	2034	N/A	2029	N/A	N/A	N/A	N/A	N/A	2030	2032	N/A	N/A	N/A
Medford	N/A	N/A	N/A	N/A	N/A	N/A	N/A	N/A	N/A	N/A	N/A	N/A	N/A	N/A
Roseburg	N/A	2036	N/A	2029	N/A	N/A	N/A	N/A	N/A	2036	N/A	N/A	N/A	N/A
Klamath	N/A	2035	N/A	2031	N/A	N/A	N/A	N/A	N/A	N/A	N/A	N/A	N/A	N/A
La Grande	N/A	2034	N/A	2028	N/A	N/A	N/A	N/A	N/A	2030	2032	N/A	N/A	N/A

APPENDIX 2.5: DEMAND SCENARIOS PROPOSED SCENARIOS

Proposed Scenarios INPUT ASSUMPTIONS	Expected Case	Cold Day 20yr Weather Std	Average Case	Low Growth & High Prices	80 % below 1990 emissions	High Growth & Low Prices
Customer Growth Rate	Reference Case Cust Growth Rates			Low Growth Rate	Reference Case growth with emissions 80% below 1990 target	High Growth Rate
Use per Customer	3 yr Flat + Price Elasticity					3 yr Flat + Price Elasticity
Demand Side Management	Yes					
Weather Planning Standard	Historical Coldest Day	Coldest in 20 years	20 year average	Historical Coldest Day		
Prices Price curve	Expected			High	Low	
Carbon Legislation (\$/Metric Ton)	\$10-\$30 WA \$17.86-\$51.58 OR \$0 ID					None

RESULTS

First Gas Year Unserved

Washington	N/A	N/A	N/A	N/A	N/A	2032
Idaho	N/A	N/A	N/A	N/A	N/A	2032
Medford	N/A	N/A	N/A	N/A	N/A	2031
Roseburg	N/A	N/A	N/A	N/A	N/A	2031
Klamath	N/A	N/A	N/A	N/A	N/A	N/A
La Grande	N/A	N/A	N/A	N/A	N/A	2032

Scenario Summary

Most aggressive peak planning case utilizing Average Case assumptions as a starting point and layering in coldest weather on record. The likelihood of occurrence is low.	Evaluates adopting an alternate peak weather standard. Helps provide some bounds around our sensitivity to weather.	Case most representative of our average (budget, PGA, rate case) planning criteria.	Stagnant growth assumptions in order to evaluate if a shortage does occur. Not likely to occur.	Reduction of the use of natural gas to 80% below 1990 targets in OR and WA by 2050. The case assumes the overall reduction is an average goal before applying figures like elasticity and DSM.	Aggressive growth assumptions in order to evaluate when our earliest resource shortage could occur. Not likely to occur.
---	---	---	---	--	--

Risk Assessment

Higher or lower customer growth rates, which are heavily based on economic recovery. Higher or lower growth rates will lead to accelerated or delayed unserved demand. Looking at various growth assumptions off the Expected Case allows us to capture the risk in terms of the change in demand linked to customer growth.

Higher or lower use per customer will also lead to accelerated or delayed unserved demand. Use per customer can differ in many ways. Direct use per customer influencers, such as demand side management, NGV/CNG usage, and derivation of the use per customer starting point (i.e. one year, three year, etc.). Again, varying these assumptions under our forecasting methodology allows us to quantify the change each assumption has to our forecast.

Weather volatility and predictability are a key risk. As the most correlated direct demand influencer, varying weather assumptions is key to understanding the weather related risks.

Indirect influencers including elasticity and price are also important assumptions. The two go hand in hand, as price changes it will influence how much customers consume. If forecasted prices remain relatively stable over the planning horizon, our current elasticity assumption will not provide much decreased usage. However, price adders or an overall steepening of the price curve will trigger a greater decline in usage due to the price elastic response. The magnitude of the elasticity adjustment is also important. We are using a long run elasticity factor as calculated by the AGA. We continue to evaluate this assumption and are looking to update the study as part of our Action Plan.

APPENDIX 2.6: DEMAND FORECAST SENSITIVITIES AND SCENARIOS DESCRIPTIONS

DEFINITIONS

DYNAMIC DEMAND METHODOLOGY – Avista’s demand forecasting approach wherein we 1) identify key demand drivers behind natural gas consumption, 2) perform sensitivity analysis on each demand driver, and 3) combine demand drivers under various scenarios to develop alternative potential outcomes for forecasted demand.

DEMAND INFLUENCING FACTORS – Factors that directly influence the volume of natural gas consumed by our core customers.

PRICE INFLUENCING FACTORS – Factors that, through price elasticity response, indirectly influence the volume of natural gas consumed by our core customers.

REFERENCE CASE – A baseline point of reference that captures the basic inputs for determining a demand forecast in SENDOUT® which includes number of customers, use per customer, average daily weather temperatures and expected natural gas prices.

SENSITIVITIES – Focused analysis of a specific natural gas demand driver and its impact on forecasted demand relative to the Reference Case when underlying input assumptions are modified.

SCENARIOS – Combination of natural gas demand drivers that make up a demand forecast.

Avista evaluates each sensitivities impact.

SENSITIVITIES

The following Sensitivities were performed on identified demand drivers against the reference case for consideration in Scenario development. Note that Sensitivity assumptions reflect incremental adjustments we estimate are not captured in the underlying reference case forecast.

Following are the Demand Influencing (Direct) Sensitivities we evaluated:

REFERENCE CASE PLUS PEAK – Same assumptions as in the Reference Case with an adjustment made to normal weather to incorporate peak weather conditions. The peak weather data being the coldest day on record for each weather area.

LOW & HIGH CUSTOMER GROWTH – Discussed in detail in Appendix 2.1: Economic Outlook and Customer Count Forecast.

ALTERNATE WEATHER STANDARD (COLDEST DAY 20 YRS) – Peak Day weather temperature reduced to coldest average daily temperature (HDDs) experienced in the most recent 20 years in each region.

DSM – Reference case assumptions including Washington and Idaho DSM potential identified by the Conservation Potential Assessment provided by Applied Energy Group and Oregon DSM potential provided by Energy Trust of Oregon. See Appendix 3.1 for full assessment reports.

PEAK PLUS DSM – Reference plus peak weather assumptions including Washington and Idaho DSM potential identified by the Conservation Potential Assessment provided by Applied Energy Group and Oregon DSM potential provided by Energy Trust of Oregon. See Appendix 3.1 for full assessment reports.

80% BELOW 1990 EMISSIONS REFERENCE CASE – Reference case assumptions including reduction in Oregon and Washington consumption to 80% below 1990 emission levels by 2050. The case shows the overall risk of a scenario with the overall goal of reducing natural gas emissions, but does not consider what methods will be used to get to these levels or their costs.

80% BELOW 1990 EMISSIONS REFERENCE PLUS CASE – Reference plus peak weather assumptions including reduction in Oregon and Washington consumption to 80% below 1990 emission levels by 2050. The case shows the overall risk of a scenario with the overall goal of reducing natural gas emissions, but does not consider what methods will be used to get to these levels or their costs.

ALTERNATE HISTORICAL 2-YEAR USE PER CUSTOMER – Reference case use per customer was based upon three years of actual use per customer per heating degree day data. This sensitivity used two years of historical use per customer per heating degree day data.

ALTERNATE HISTORICAL 5-YEAR USE PER CUSTOMER – Reference case use per customer was based upon three years of actual use per customer per heating degree day data. This sensitivity used five years of historical use per customer per heating degree day data.

Following are the Price Influencing (Indirect) Sensitivities we evaluated:

EXPECTED ELASTICITY – For our Expected Elasticity Sensitivity, we incorporate reduced consumption in response to higher natural gas prices utilizing a price elasticity study prepared by the American Gas Association.

LOW & HIGH PRICES – To capture a wide band of alternative prices forecasts, an adjustment to the expected price was developed utilizing a higher and lower inflation rate. These rates were then applied to the expected price helping to maintain the symmetry of the expected price curve while producing a set of reasonable curves to help measure risk.

CARBON LEGISLATION LOW CASE – Assumes the EPA estimates on the social cost of carbon. Specifically, the low case has is a 5% discount rate average. These costs begin at \$11.40 in 2017 and increase to \$21.20 by 2037 for a metric ton of CO₂.

CARBON LEGISLATION MEDIUM CASE – The price of carbon in Oregon was based on the 2018 California annual auction reserve price of \$14.53 per greenhouse gas emissions allowance while growing by the 5% plus the rate of inflation as indicated by the program structure section 95911 of the California Cap-and-Trade Regulation.¹ The starting price for Oregon was assumed to be similar to California's cap and trade system where the initial floor was set at \$17.86 per metric tons of carbon dioxide equivalent (MTCO₂e)

¹ Article 5 California Cap on Greenhouse gas emissions and market-based compliance mechanisms. https://www.arb.ca.gov/cc/capandtrade/capandtrade/unofficial_ct_100217.pdf

and begins in January 2021² rising to \$51.58 by 2037. Washington State was modeled at \$10 per MTCO_{2e} starting in 2019 and rising to \$30 per MTCO_{2e} by 2030.

CARBON LEGISLATION HIGH CASE – Assumes the EPA estimates on the social cost of carbon. Specifically, the high case includes 95% of results at a 3% discount rate average. These costs begin at \$112.20 in 2017 and increase to \$174 by 2037 for a metric ton of CO₂.

Scenarios

After identifying the above demand drivers and analyzing the various Sensitivities, we have developed the following demand forecast Scenarios:

AVERAGE CASE – This Scenario we believe represents the most likely average demand forecast modeled. We assume service territory customer growth rates consistent with the reference case, rolling 20 year normal weather in each service territory, our expected natural gas price forecast (blend of two consultants, along with the NYMEX forward strip), expected price elasticity, the CO₂ cost adders from our **Carbon Legislation Medium Case** Sensitivity, and DSM. The Scenario does not include incremental cost adders for declining Canadian imports or drilling restrictions beyond what is incorporated in the selected price forecast.

EXPECTED CASE – This Scenario represents the peak demand forecast. We assume service territory customer growth rates consistent with the reference case, a weather standard of coldest day on record in each service territory, our expected natural gas price forecast (blend of two consultants, along with the NYMEX forward strip), expected price elasticity, DSM, and the CO₂ cost adders from our **Carbon Legislation Medium Case** Sensitivity.

HIGH GROWTH, LOW PRICE – This Scenario models a rapid return to robust growth in part spurred on by low energy prices. We assume higher customer growth rates than the reference case, coldest day on record weather standard, incremental demand from NGV/CNG, our low natural gas price forecast, expected price elasticity, DSM, and no CO₂ adders.

LOW GROWTH, HIGH PRICE – This Scenario models an extended period of slow economic growth in part resulting from high energy prices. We assume lower customer growth rates than the reference case, coldest day on record weather standard, our high natural gas price forecast, expected price elasticity, DSM, and CO₂ adders from our **Carbon Legislation Medium Case** Sensitivity.

ALTERNATE WEATHER STANDARD – This Scenario models all the same assumptions as the **Expected Case** Scenario, except for the change in the weather planning standard from coldest day on record to coldest day in 20 years for each service territory. As noted in the Sensitivity analysis, this change does not affect the Klamath Falls and La Grande service territories, which have each experienced their coldest day on record within the last 20 years.

80% BELOW 1990 EMISSIONS – This Scenario models the impact of potential consumption curtailment due to carbon legislation coupled with low energy prices. We assume a straight line reduction in Washington and Oregon consumption from reference case growth in order to meet 80% below 1990 emission levels

² Senate Bill 1070 <https://olis.leg.state.or.us/liz/2017R1/Downloads/MeasureDocument/SB1070>

by 2050, along with our low natural gas price forecast rather than our expected natural gas price forecast. All other assumptions remain the same as our **Expected Case** Scenario.

APPENDIX 2.7: ANNUAL DEMAND, AVERAGE DAY DEMAND AND PEAK DAY DEMAND (NET OF DSM) – CASE AVERAGE

Scenario	Gas Year	Klamath Falls			Klamath			La Grande			Medford/Roseburg			Peak Day Demand Total System (MDth/day)
		Annual Demand (MDth)	Daily Demand (MDth/day)	Peak Day Demand (MDth/day)	Annual Demand (MDth)	Daily Demand (MDth/day)	Peak Day Demand (MDth/day)	Annual Demand (MDth)	Daily Demand (MDth/day)	Peak Day Demand (MDth/day)	Annual Demand (MDth)	Daily Demand (MDth/day)	Peak Day Demand (MDth/day)	
Average Case	2017-2018	1,303.32	3.57	6.90	822.90	2.25	3.43	6,487.88	17.78	34.80				
Average Case	2018-2019	1,311.79	3.59	6.96	828.02	2.27	3.44	6,539.14	17.92	35.13				
Average Case	2019-2020	1,327.47	3.64	7.02	833.19	2.28	3.45	6,617.89	18.13	35.46				
Average Case	2020-2021	1,329.51	3.64	7.08	831.22	2.28	3.46	6,638.38	18.19	35.80				
Average Case	2021-2022	1,332.01	3.65	7.10	829.67	2.27	3.45	6,661.47	18.25	35.96				
Average Case	2022-2023	1,339.08	3.67	7.15	829.92	2.27	3.46	6,702.99	18.36	36.25				
Average Case	2023-2024	1,354.00	3.71	7.21	833.79	2.28	3.47	6,773.48	18.56	36.55				
Average Case	2024-2025	1,353.20	3.71	7.26	830.01	2.27	3.46	6,772.40	18.55	36.79				
Average Case	2025-2026	1,360.24	3.73	7.31	829.91	2.27	3.47	6,806.32	18.65	37.06				
Average Case	2026-2027	1,366.70	3.74	7.37	829.65	2.27	3.47	6,838.11	18.73	37.32				
Average Case	2027-2028	1,379.67	3.78	7.42	832.74	2.28	3.48	6,898.82	18.90	37.58				
Average Case	2028-2029	1,377.68	3.77	7.47	828.93	2.27	3.48	6,893.49	18.89	37.82				
Average Case	2029-2030	1,382.05	3.79	7.51	828.36	2.27	3.49	6,916.89	18.95	38.06				
Average Case	2030-2031	1,386.09	3.80	7.55	827.54	2.27	3.49	6,937.13	19.01	38.27				
Average Case	2031-2032	1,397.46	3.83	7.59	830.01	2.27	3.50	6,987.20	19.14	38.47				
Average Case	2032-2033	1,394.09	3.82	7.64	825.27	2.26	3.49	6,969.86	19.10	38.66				
Average Case	2033-2034	1,398.04	3.83	7.68	823.86	2.26	3.50	6,983.52	19.13	38.84				
Average Case	2034-2035	1,401.94	3.84	7.72	822.38	2.25	3.50	6,995.94	19.17	39.02				
Average Case	2035-2036	1,413.58	3.87	7.77	824.36	2.26	3.51	7,041.27	19.29	39.19				
Average Case	2036-2037	1,410.12	3.86	7.81	819.16	2.24	3.50	7,019.80	19.23	39.35				
Average Case	2017-2018	8,614.10	23.60	45.13	17,041.64	46.69	79.08	8,617.62	23.61	38.27	34,273.35	93.90	162.48	
Average Case	2018-2019	8,676.95	23.78	45.53	17,207.18	47.14	79.90	8,693.19	23.82	38.65	34,579.32	94.74	164.07	
Average Case	2019-2020	8,778.54	24.05	45.93	17,377.37	47.61	80.49	8,795.71	24.10	39.02	34,951.61	95.76	165.44	
Average Case	2020-2021	8,799.10	24.11	46.33	17,368.52	47.58	80.94	8,816.38	24.15	39.33	34,984.00	95.85	166.60	
Average Case	2021-2022	8,823.16	24.17	46.51	17,404.48	47.68	81.32	8,846.31	24.24	39.57	35,073.94	96.09	167.40	
Average Case	2022-2023	8,871.99	24.31	46.86	17,388.00	47.64	81.53	8,853.34	24.26	39.73	35,113.33	96.20	168.12	
Average Case	2023-2024	8,961.27	24.55	47.23	17,549.44	48.08	82.23	8,951.23	24.52	40.15	35,461.95	97.16	169.61	
Average Case	2024-2025	8,955.60	24.54	47.51	17,415.00	47.71	82.16	8,890.27	24.36	40.13	35,260.88	96.61	169.80	
Average Case	2025-2026	8,996.47	24.65	47.84	17,329.28	47.48	82.20	8,851.42	24.25	40.16	35,177.17	96.38	170.21	
Average Case	2026-2027	9,034.45	24.75	48.16	17,220.78	47.18	82.18	8,803.08	24.12	40.17	35,058.32	96.05	170.51	
Average Case	2027-2028	9,111.24	24.96	48.48	17,179.95	47.07	82.31	8,790.55	24.08	40.27	35,081.74	96.11	171.06	
Average Case	2028-2029	9,100.10	24.93	48.77	16,971.58	46.50	82.02	8,699.24	23.83	40.17	34,770.93	95.26	170.97	
Average Case	2029-2030	9,127.30	25.01	49.05	16,848.11	46.16	81.95	8,653.04	23.71	40.20	34,628.45	94.87	171.20	
Average Case	2030-2031	9,150.76	25.07	49.32	16,736.49	45.85	81.90	8,618.21	23.61	40.26	34,505.46	94.54	171.48	
Average Case	2031-2032	9,214.67	25.25	49.57	16,724.43	45.82	82.21	8,638.53	23.67	40.53	34,577.62	94.73	172.30	
Average Case	2032-2033	9,189.23	25.18	49.80	16,564.51	45.38	81.95	8,590.63	23.54	40.52	34,344.38	94.09	172.26	
Average Case	2033-2034	9,205.42	25.22	50.02	16,506.34	45.22	82.05	8,598.67	23.56	40.72	34,310.43	94.00	172.79	
Average Case	2034-2035	9,220.26	25.26	50.24	16,468.04	45.12	82.20	8,620.26	23.62	40.96	34,308.56	94.00	173.40	
Average Case	2035-2036	9,279.20	25.42	50.46	16,532.36	45.29	82.79	8,696.43	23.83	41.44	34,508.00	94.54	174.69	
Average Case	2036-2037	9,249.08	25.34	50.66	16,439.60	45.04	82.63	8,696.26	23.83	41.55	34,384.94	94.21	174.84	

APPENDIX 2.7: ANNUAL DEMAND, AVERAGE DAY DEMAND AND PEAK DAY DEMAND (NET OF DSM) – CASE HIGH

Scenario	Gas Year	Klamath Falls			Klamath			La Grande			Medford/Roseburg			Total System		
		Annual Demand (MDth)	Daily Demand (MDth/day)	Peak Day Demand (MDth/day)	Annual Demand (MDth)	Daily Demand (MDth/day)	Peak Day Demand (MDth/day)	Annual Demand (MDth)	Daily Demand (MDth/day)	Peak Day Demand (MDth/day)	Annual Demand (MDth)	Daily Demand (MDth/day)	Peak Day Demand (MDth/day)	Annual Demand (MDth)	Daily Demand (MDth/day)	Peak Day Demand (MDth/day)
High Growth & Low Prices	2017-2018	1,352.15	3.70	13.34	857.10	2.35	7.59	6,789.53	18.60	75.36	6,789.53	18.60	75.36	35,744.36	97.93	376.80
High Growth & Low Prices	2018-2019	1,367.64	3.75	13.52	873.35	2.39	7.68	6,872.10	18.83	76.47	6,872.10	18.83	76.47	36,235.58	99.28	381.76
High Growth & Low Prices	2019-2020	1,390.14	3.81	13.71	892.01	2.44	7.77	6,981.99	19.13	77.55	6,981.99	19.13	77.55	36,831.10	100.91	387.63
High Growth & Low Prices	2020-2021	1,398.99	3.83	13.90	903.77	2.48	7.86	7,033.35	19.27	78.64	7,033.35	19.27	78.64	37,089.59	101.62	393.36
High Growth & Low Prices	2021-2022	1,414.66	3.88	14.09	918.89	2.52	7.95	7,114.36	19.49	79.75	7,114.36	19.49	79.75	37,434.37	102.56	398.85
High Growth & Low Prices	2022-2023	1,430.53	3.92	14.28	933.71	2.56	8.04	7,194.21	19.71	80.86	7,194.21	19.71	80.86	37,709.93	103.31	404.12
High Growth & Low Prices	2023-2024	1,453.38	3.98	14.47	951.76	2.61	8.12	7,296.90	19.99	81.91	7,296.90	19.99	81.91	38,263.41	104.83	409.87
High Growth & Low Prices	2024-2025	1,459.79	4.00	14.65	961.31	2.63	8.19	7,324.30	20.07	82.79	7,324.30	20.07	82.79	38,366.18	105.11	418.47
High Growth & Low Prices	2025-2026	1,474.46	4.04	14.84	974.69	2.67	8.27	7,388.85	20.24	83.77	7,388.85	20.24	83.77	38,443.57	105.32	422.89
High Growth & Low Prices	2026-2027	1,488.43	4.08	15.02	988.27	2.71	8.35	7,451.51	20.42	84.75	7,451.51	20.42	84.75	38,672.90	105.95	427.54
High Growth & Low Prices	2027-2028	1,509.16	4.13	15.20	1,006.44	2.76	8.44	7,544.66	20.67	85.72	7,544.66	20.67	85.72	38,672.90	105.95	427.54
High Growth & Low Prices	2028-2029	1,513.68	4.15	15.37	1,017.38	2.79	8.53	7,568.14	20.73	86.66	7,568.14	20.73	86.66	38,672.90	105.95	427.54
High Growth & Low Prices	2029-2030	1,524.49	4.18	15.54	1,031.93	2.83	8.62	7,621.41	20.88	87.57	7,621.41	20.88	87.57	38,672.90	105.95	427.54
High Growth & Low Prices	2030-2031	1,534.78	4.20	15.69	1,045.84	2.87	8.71	7,670.47	21.01	88.44	7,670.47	21.01	88.44	38,672.90	105.95	427.54
High Growth & Low Prices	2031-2032	1,553.09	4.26	15.85	1,063.37	2.91	8.80	7,750.42	21.23	89.27	7,750.42	21.23	89.27	38,672.90	105.95	427.54
High Growth & Low Prices	2032-2033	1,555.82	4.26	16.01	1,072.15	2.94	8.88	7,758.33	21.26	90.07	7,758.33	21.26	90.07	38,672.90	105.95	427.54
High Growth & Low Prices	2033-2034	1,566.50	4.29	16.17	1,084.49	2.97	8.95	7,793.84	21.37	90.85	7,793.84	21.37	90.85	38,672.90	105.95	427.54
High Growth & Low Prices	2034-2035	1,577.15	4.32	16.33	1,096.59	3.00	9.03	7,837.69	21.47	91.61	7,837.69	21.47	91.61	38,672.90	105.95	427.54
High Growth & Low Prices	2035-2036	1,596.33	4.37	16.49	1,112.86	3.05	9.11	7,911.84	21.68	92.36	7,911.84	21.68	92.36	38,672.90	105.95	427.54
High Growth & Low Prices	2036-2037	1,599.21	4.38	16.65	1,119.83	3.07	9.17	7,914.31	21.68	93.10	7,914.31	21.68	93.10	38,672.90	105.95	427.54
High Growth & Low Prices	2017-2018	8,998.79	24.65	96.29	17,764.46	48.67	189.28	8,981.12	24.61	90.23	8,981.12	24.61	90.23	35,744.36	97.93	376.80
High Growth & Low Prices	2018-2019	9,113.10	24.97	97.68	18,014.08	49.35	192.33	9,108.41	24.95	91.76	9,108.41	24.95	91.76	36,235.58	99.28	381.76
High Growth & Low Prices	2019-2020	9,264.14	25.38	99.04	18,299.68	50.14	195.29	9,267.28	25.39	93.31	9,267.28	25.39	93.31	36,831.10	100.91	387.63
High Growth & Low Prices	2020-2021	9,336.10	25.58	100.41	18,407.06	50.43	198.09	9,346.43	25.61	94.87	9,346.43	25.61	94.87	37,089.59	101.62	393.36
High Growth & Low Prices	2021-2022	9,447.91	25.88	101.79	18,541.79	50.80	200.64	9,444.68	25.88	96.42	9,444.68	25.88	96.42	37,434.37	102.56	398.85
High Growth & Low Prices	2022-2023	9,558.45	26.19	103.18	18,629.87	51.04	203.02	9,521.60	26.09	97.92	9,521.60	26.09	97.92	37,709.93	103.31	404.12
High Growth & Low Prices	2023-2024	9,702.04	26.58	104.50	18,879.38	51.72	205.77	9,681.93	26.52	99.59	9,681.93	26.52	99.59	38,263.41	104.83	409.87
High Growth & Low Prices	2024-2025	9,745.40	26.70	105.62	18,828.27	51.58	207.58	9,679.74	26.52	100.71	9,679.74	26.52	100.71	38,263.41	104.83	409.87
High Growth & Low Prices	2025-2026	9,838.00	26.95	106.87	18,827.91	51.58	209.64	9,700.28	26.58	101.96	9,700.28	26.58	101.96	38,366.18	105.11	418.47
High Growth & Low Prices	2026-2027	9,928.21	27.20	108.12	18,803.93	51.52	211.61	9,716.17	26.74	103.16	9,716.17	26.74	103.16	38,443.57	105.32	422.89
High Growth & Low Prices	2027-2028	10,060.26	27.56	109.36	18,850.97	51.65	213.70	9,761.67	26.74	104.48	9,761.67	26.74	104.48	38,672.90	105.95	427.54
High Growth & Low Prices	2028-2029	10,099.21	27.67	110.56	18,721.01	51.29	215.35	9,728.99	26.65	105.61	9,728.99	26.65	105.61	38,672.90	105.95	427.54
High Growth & Low Prices	2029-2030	10,177.83	27.88	111.73	18,678.96	51.18	217.17	9,744.74	26.70	106.87	9,744.74	26.70	106.87	38,672.90	105.95	427.54
High Growth & Low Prices	2030-2031	10,251.09	28.09	112.85	18,647.24	51.09	218.97	9,773.57	26.78	108.20	9,773.57	26.78	108.20	38,672.90	105.95	427.54
High Growth & Low Prices	2031-2032	10,366.88	28.40	113.92	18,719.39	51.29	221.10	9,863.01	27.02	109.77	9,863.01	27.02	109.77	38,949.28	106.71	444.79
High Growth & Low Prices	2032-2033	10,366.30	28.46	114.96	18,631.71	51.05	222.62	9,878.93	27.07	111.09	9,878.93	27.07	111.09	38,949.28	106.71	444.79
High Growth & Low Prices	2033-2034	10,449.82	28.63	115.97	18,649.86	51.10	224.47	9,956.11	27.28	112.65	9,956.11	27.28	112.65	39,055.79	107.00	453.09
High Growth & Low Prices	2034-2035	10,511.43	28.80	116.97	18,686.86	51.20	226.34	10,048.56	27.53	114.28	10,048.56	27.53	114.28	39,246.84	107.53	457.58
High Growth & Low Prices	2035-2036	10,620.83	29.10	117.96	18,832.63	51.60	228.64	10,202.04	27.95	116.17	10,202.04	27.95	116.17	39,655.50	108.65	462.76
High Growth & Low Prices	2036-2037	10,633.36	29.13	118.92	18,807.81	51.53	230.17	10,271.93	28.14	117.73	10,271.93	28.14	117.73	39,713.09	108.80	466.92

APPENDIX 2.7: ANNUAL DEMAND, AVERAGE DAY DEMAND AND PEAK DAY DEMAND (NET OF DSM) – CASE LOW

Scenario	Gas Year	Annual Demand Klamath Falls (MDth)			Daily Demand Klamath (MDth/day)			Peak Day Demand Klamath (MDth/day)			Annual Demand Medford/Roseburg (MDth)			Daily Demand Medford/Roseburg (MDth/day)			Peak Day Demand Medford/Roseburg (MDth/day)					
		Annual Demand	Daily Demand	Peak Day Demand	Annual Demand	Daily Demand	Peak Day Demand	Annual Demand	Daily Demand	Peak Day Demand	Annual Demand	Daily Demand	Peak Day Demand	Annual Demand	Daily Demand	Peak Day Demand	Annual Demand	Daily Demand	Peak Day Demand			
Low Growth & High Prices	2017-2018	1,329.16	3.64	13.14	843.60	2.31	7.47	6,684.20	18.31	74.33	8,811.52	24.14	88.59	35,166.40	96.35	370.05	8,811.52	24.14	88.59	35,166.40	96.35	370.05
Low Growth & High Prices	2018-2019	1,331.66	3.65	13.20	835.49	2.29	7.44	6,710.47	18.38	74.83	8,837.33	24.21	89.11	35,316.70	96.76	372.65	8,837.33	24.21	89.11	35,316.70	96.76	372.65
Low Growth & High Prices	2019-2020	1,339.49	3.67	13.25	825.78	2.26	7.41	6,755.12	18.51	75.18	8,877.32	24.32	89.46	35,490.97	97.24	374.18	8,877.32	24.32	89.46	35,490.97	97.24	374.18
Low Growth & High Prices	2020-2021	1,333.99	3.65	13.30	812.16	2.23	7.36	6,743.24	18.47	75.55	8,837.30	24.21	89.80	35,338.61	96.82	375.57	8,837.30	24.21	89.80	35,338.61	96.82	375.57
Low Growth & High Prices	2021-2022	1,330.35	3.64	13.29	802.71	2.20	7.33	6,740.67	18.47	75.63	8,811.07	24.14	90.08	35,280.85	96.61	376.59	8,811.07	24.14	90.08	35,280.85	96.61	376.59
Low Growth & High Prices	2022-2023	1,330.70	3.65	13.34	796.18	2.18	7.32	6,755.27	18.51	76.00	8,762.42	24.01	90.30	35,134.63	96.26	377.70	8,762.42	24.01	90.30	35,134.63	96.26	377.70
Low Growth & High Prices	2023-2024	1,337.85	3.67	13.39	793.62	2.17	7.32	6,796.03	18.62	76.36	8,800.50	24.11	90.77	35,296.33	96.75	380.09	8,800.50	24.11	90.77	35,296.33	96.75	380.09
Low Growth & High Prices	2024-2025	1,330.81	3.65	13.43	784.97	2.15	7.31	6,772.01	18.55	76.66	8,605.24	23.81	90.79	34,950.43	95.75	381.25	8,605.24	23.81	90.79	34,950.43	95.75	381.25
Low Growth & High Prices	2025-2026	1,331.59	3.65	13.49	780.26	2.14	7.32	6,782.84	18.58	77.05	8,509.05	23.31	91.12	34,458.95	94.41	382.28	8,509.05	23.31	91.12	34,458.95	94.41	382.28
Low Growth & High Prices	2026-2027	1,331.95	3.65	13.55	775.91	2.13	7.32	6,791.45	18.61	77.42	8,445.77	23.14	91.36	34,330.60	94.06	383.53	8,445.77	23.14	91.36	34,330.60	94.06	383.53
Low Growth & High Prices	2027-2028	1,338.64	3.67	13.61	774.04	2.12	7.32	6,827.64	18.71	77.82	8,205.99	22.48	91.46	33,574.97	91.99	385.57	8,205.99	22.48	91.46	33,574.97	91.99	385.57
Low Growth & High Prices	2028-2029	1,330.45	3.65	13.65	764.88	2.10	7.31	6,796.34	18.62	78.11	8,086.74	22.16	92.07	33,240.23	91.07	387.04	8,086.74	22.16	92.07	33,240.23	91.07	387.04
Low Growth & High Prices	2029-2030	1,329.74	3.64	13.70	759.78	2.08	7.30	6,796.52	18.62	78.45	7,990.10	21.89	92.20	32,883.66	90.09	387.64	7,990.10	21.89	92.20	32,883.66	90.09	387.64
Low Growth & High Prices	2030-2031	1,328.92	3.64	13.75	755.71	2.07	7.30	6,824.20	18.70	79.07	7,811.07	21.68	92.54	32,716.23	89.63	388.79	7,811.07	21.68	92.54	32,716.23	89.63	388.79
Low Growth & High Prices	2031-2032	1,335.43	3.66	13.81	755.81	2.07	7.31	6,824.20	18.70	79.07	7,912.11	21.88	92.93	32,581.37	89.25	390.01	7,912.11	21.88	92.93	32,581.37	89.25	390.01
Low Growth & High Prices	2032-2033	1,328.45	3.64	13.86	749.63	2.05	7.30	6,788.70	18.60	79.36	8,053.34	22.06	93.01	32,458.95	89.76	389.76	8,053.34	22.06	93.01	32,458.95	89.76	389.76
Low Growth & High Prices	2033-2034	1,328.20	3.64	13.92	746.86	2.05	7.30	6,782.72	18.58	79.63	7,751.38	21.24	90.70	32,265.59	88.40	389.57	7,751.38	21.24	90.70	32,265.59	88.40	389.57
Low Growth & High Prices	2034-2035	1,327.92	3.64	13.97	744.23	2.04	7.31	6,775.84	18.56	79.89	8,811.52	24.14	88.59	35,166.40	96.35	370.05	8,811.52	24.14	88.59	35,166.40	96.35	370.05
Low Growth & High Prices	2035-2036	1,334.70	3.66	14.03	744.98	2.04	7.32	6,799.72	18.63	80.15	8,637.30	24.21	89.80	35,338.61	96.82	375.57	8,637.30	24.21	89.80	35,338.61	96.82	375.57
Low Growth & High Prices	2036-2037	1,327.51	3.64	14.08	739.32	2.03	7.32	6,761.32	18.52	80.40	8,811.52	24.14	88.59	35,166.40	96.35	370.05	8,811.52	24.14	88.59	35,166.40	96.35	370.05

APPENDIX 2.7: ANNUAL DEMAND, AVERAGE DAY DEMAND AND PEAK DAY DEMAND (NET OF DSM) – CASE COLDEST IN 20

Scenario	Gas Year	Annual Demand Klamath Falls (MDth)			Daily Demand Klamath (MDth/day)			Peak Day Demand Klamath (MDth/day)			Annual Demand Medford/Roseburg (MDth)			Daily Demand Medford/Roseburg (MDth/day)			Peak Day Demand Medford/Roseburg (MDth/day)		
		Annual Demand Klamath Falls (MDth)	Daily Demand Klamath (MDth/day)	Peak Day Demand Klamath (MDth/day)	Annual Demand La Grande (MDth)	Daily Demand La Grande (MDth/day)	Peak Day Demand La Grande (MDth/day)	Annual Demand Medford/Roseburg (MDth)	Daily Demand Medford/Roseburg (MDth/day)	Peak Day Demand Medford/Roseburg (MDth/day)	Annual Demand Idaho (MDth)	Daily Demand Idaho (MDth/day)	Peak Day Demand Idaho (MDth/day)	Annual Demand Total System (MDth)	Daily Demand Total System (MDth/day)	Peak Day Demand Total System (MDth/day)			
Cold Day 20Yr Weather Std	2017-2018	1,340.69	3.67	13.24	842.56	2.31	6.74	6,683.49	18.31	65.02	8,873.25	35,317.65	96.76	343.52					
Cold Day 20Yr Weather Std	2018-2019	1,349.58	3.70	13.36	847.79	2.32	6.77	6,737.07	18.46	65.71	8,952.17	35,637.29	97.64	347.41					
Cold Day 20Yr Weather Std	2019-2020	1,365.64	3.74	13.49	853.29	2.34	6.80	6,818.02	18.68	66.38	9,058.07	36,021.32	98.69	350.80					
Cold Day 20Yr Weather Std	2020-2021	1,368.08	3.75	13.62	851.21	2.33	6.82	6,840.75	18.74	67.06	9,082.26	36,065.34	98.81	353.98					
Cold Day 20Yr Weather Std	2021-2022	1,370.75	3.76	13.67	849.66	2.33	6.82	6,864.90	18.81	67.37	9,115.48	36,165.60	99.08	356.56					
Cold Day 20Yr Weather Std	2022-2023	1,378.17	3.78	13.78	849.99	2.33	6.84	6,908.40	18.93	67.97	9,125.81	36,216.07	99.22	359.19					
Cold Day 20Yr Weather Std	2023-2024	1,393.49	3.82	13.91	853.96	2.34	6.86	6,980.98	19.13	68.60	9,169.07	36,365.85	99.69	364.71					
Cold Day 20Yr Weather Std	2024-2025	1,400.46	3.84	14.14	850.26	2.33	6.87	6,981.59	19.13	68.60	9,227.18	36,576.87	100.21	362.78					
Cold Day 20Yr Weather Std	2025-2026	1,407.31	3.86	14.26	850.09	2.33	6.92	7,051.26	19.32	70.24	9,133.53	36,313.91	99.49	367.15					
Cold Day 20Yr Weather Std	2026-2027	1,420.66	3.89	14.37	853.29	2.34	6.94	7,113.93	19.49	70.80	9,088.46	36,206.66	99.20	369.46					
Cold Day 20Yr Weather Std	2027-2028	1,419.04	3.89	14.48	849.60	2.33	6.96	7,110.49	19.48	71.34	9,079.21	36,241.55	99.29	371.99					
Cold Day 20Yr Weather Std	2028-2029	1,428.15	3.91	14.59	849.14	2.33	6.99	7,157.77	19.55	71.86	9,135.74	36,576.87	100.21	362.78					
Cold Day 20Yr Weather Std	2029-2030	1,439.86	3.94	14.79	851.00	2.33	7.03	7,209.54	19.75	72.82	9,169.07	36,365.85	99.69	364.71					
Cold Day 20Yr Weather Std	2030-2031	1,438.85	3.94	14.89	846.37	2.32	7.05	7,193.85	19.71	73.26	9,227.18	36,576.87	100.21	362.78					
Cold Day 20Yr Weather Std	2031-2032	1,441.14	3.95	15.00	845.05	2.32	7.08	7,209.11	19.75	73.69	9,133.53	36,313.91	99.49	367.15					
Cold Day 20Yr Weather Std	2032-2033	1,443.39	3.96	15.10	843.68	2.31	7.06	7,223.09	19.79	74.10	9,088.46	36,206.66	99.20	369.46					
Cold Day 20Yr Weather Std	2033-2034	1,457.38	3.99	15.20	845.75	2.32	7.11	7,269.96	19.92	74.51	9,135.74	36,576.87	100.21	362.78					
Cold Day 20Yr Weather Std	2034-2035	1,454.28	3.98	15.30	840.65	2.30	7.11	7,250.03	19.86	74.92	9,169.07	36,365.85	99.69	364.71					
Cold Day 20Yr Weather Std	2035-2036																		
Cold Day 20Yr Weather Std	2036-2037																		
	Gas Year	Annual Demand Oregon (MDth)	Daily Demand Oregon (MDth/day)	Peak Day Demand Oregon (MDth/day)	Annual Demand Washington (MDth)	Daily Demand Washington (MDth/day)	Peak Day Demand Washington (MDth/day)	Annual Demand Idaho (MDth)	Daily Demand Idaho (MDth/day)	Peak Day Demand Idaho (MDth/day)	Annual Demand Total System (MDth)	Daily Demand Total System (MDth/day)	Peak Day Demand Total System (MDth/day)						
Cold Day 20Yr Weather Std	2017-2018	8,666.74	24.29	85.00	17,577.65	48.16	175.11	8,873.25	24.31	83.41	35,317.65	96.76	343.52						
Cold Day 20Yr Weather Std	2018-2019	8,934.43	24.48	85.84	17,750.68	48.63	177.19	8,952.17	24.53	84.37	35,637.29	97.64	347.41						
Cold Day 20Yr Weather Std	2019-2020	9,036.74	24.76	86.67	17,926.50	49.11	178.80	9,058.07	24.82	85.33	36,021.32	98.69	350.80						
Cold Day 20Yr Weather Std	2020-2021	9,060.05	24.82	87.50	17,923.03	49.10	180.21	9,082.26	24.88	86.27	36,065.34	98.81	353.98						
Cold Day 20Yr Weather Std	2021-2022	9,085.31	24.89	87.86	17,964.81	49.22	181.62	9,115.48	24.97	87.08	36,165.60	99.08	356.56						
Cold Day 20Yr Weather Std	2022-2023	9,136.55	25.03	88.59	17,953.70	49.19	182.78	9,125.81	25.00	87.82	36,216.07	99.22	359.19						
Cold Day 20Yr Weather Std	2023-2024	9,228.43	25.28	89.37	18,121.26	49.65	184.57	9,227.18	25.28	88.84	36,576.87	100.21	362.78						
Cold Day 20Yr Weather Std	2024-2025	9,294.87	25.27	89.98	17,991.92	49.29	185.41	9,169.07	25.12	89.32	36,365.85	99.69	364.71						
Cold Day 20Yr Weather Std	2025-2026	9,268.21	25.39	90.71	17,912.17	49.07	186.51	9,133.53	25.02	89.93	36,313.91	99.49	367.15						
Cold Day 20Yr Weather Std	2026-2027	9,308.66	25.50	91.42	17,809.53	48.79	187.53	9,088.46	24.90	90.51	36,206.66	99.20	369.46						
Cold Day 20Yr Weather Std	2027-2028	9,387.89	25.72	92.12	17,774.44	48.70	188.68	9,079.21	24.87	91.19	36,241.55	99.29	371.99						
Cold Day 20Yr Weather Std	2028-2029	9,379.13	25.70	92.79	17,571.71	48.14	189.39	8,991.22	24.63	91.67	35,942.05	98.47	373.85						
Cold Day 20Yr Weather Std	2029-2030	9,408.64	25.78	93.43	17,453.74	47.82	190.30	8,946.33	24.52	92.28	35,810.71	98.11	376.00						
Cold Day 20Yr Weather Std	2030-2031	9,434.34	25.85	94.05	17,347.49	47.53	191.20	8,916.87	24.43	92.93	35,698.70	97.80	378.18						
Cold Day 20Yr Weather Std	2031-2032	9,500.40	26.03	94.64	17,340.67	47.51	192.45	8,940.64	24.49	93.80	35,781.71	97.93	380.89						
Cold Day 20Yr Weather Std	2032-2033	9,477.06	25.96	95.20	17,488.90	47.08	193.10	8,896.25	24.37	94.41	35,589.21	97.42	382.71						
Cold Day 20Yr Weather Std	2033-2034	9,495.31	26.01	95.75	17,132.75	46.94	194.09	8,807.86	24.41	95.23	35,535.92	97.36	385.07						
Cold Day 20Yr Weather Std	2034-2035	9,512.16	26.06	96.28	17,099.38	46.85	195.12	8,933.07	24.47	96.11	35,544.61	97.38	387.51						
Cold Day 20Yr Weather Std	2035-2036	9,573.09	26.23	96.82	17,168.57	47.04	196.57	9,012.94	24.69	97.24	35,754.61	97.96	390.63						
Cold Day 20Yr Weather Std	2036-2037	9,544.95	26.15	97.33	17,080.63	46.80	197.27	9,016.52	24.70	98.01	35,642.10	97.65	392.61						

APPENDIX 2.7: ANNUAL DEMAND, AVERAGE DAY DEMAND AND PEAK DAY DEMAND (NET OF DSM) – CASE 80% BELOW 1990 EMISSIONS

Scenario	Gas Year	Klamath Falls			Klamath			La Grande			Medford/Roseburg			Peak Day Demand Total System (MDth/day)
		Annual Demand (MDth)	Daily Demand (MDth/day)	Peak Day Demand (MDth/day)	Annual Demand (MDth)	Daily Demand (MDth/day)	Peak Day Demand (MDth/day)	Annual Demand (MDth)	Daily Demand (MDth/day)	Peak Day Demand (MDth/day)	Annual Demand (MDth)	Daily Demand (MDth/day)	Peak Day Demand (MDth/day)	
80% Below 1990 Emissions	2017-2018	1,307.43	3.58	12.91	829.53	2.27	7.34	6,569.65	18.00	72.99				
80% Below 1990 Emissions	2018-2019	1,268.00	3.47	12.56	804.85	2.21	7.10	6,380.59	17.48	71.11				
80% Below 1990 Emissions	2019-2020	1,230.62	3.37	12.17	777.29	2.13	6.85	6,193.25	16.97	68.94				
80% Below 1990 Emissions	2020-2021	1,191.57	3.26	11.88	750.12	2.06	6.65	6,006.49	16.46	67.37				
80% Below 1990 Emissions	2021-2022	1,147.79	3.14	11.48	720.21	1.97	6.40	5,795.27	15.88	65.15				
80% Below 1990 Emissions	2022-2023	1,109.34	3.04	11.16	692.81	1.90	6.18	5,606.04	15.36	63.29				
80% Below 1990 Emissions	2023-2024	1,071.83	2.94	10.76	665.52	1.82	5.94	5,413.52	14.83	61.15				
80% Below 1990 Emissions	2024-2025	1,031.99	2.83	10.47	638.66	1.75	5.74	5,215.07	14.29	59.46				
80% Below 1990 Emissions	2025-2026	993.21	2.72	10.13	611.90	1.68	5.53	5,018.77	13.75	57.56				
80% Below 1990 Emissions	2026-2027	953.92	2.61	9.80	585.27	1.60	5.32	4,820.61	13.21	55.66				
80% Below 1990 Emissions	2027-2028	914.66	2.51	9.42	558.55	1.53	5.09	4,620.10	12.66	53.51				
80% Below 1990 Emissions	2028-2029	873.91	2.39	9.12	532.65	1.46	4.90	4,418.43	12.11	51.82				
80% Below 1990 Emissions	2029-2030	833.31	2.28	8.78	506.60	1.39	4.70	4,215.29	11.55	49.90				
80% Below 1990 Emissions	2030-2031	792.68	2.17	8.43	480.70	1.32	4.50	4,011.10	10.99	47.97				
80% Below 1990 Emissions	2031-2032	752.61	2.06	8.06	454.73	1.25	4.29	3,805.84	10.43	45.82				
80% Below 1990 Emissions	2032-2033	711.65	1.95	7.75	429.32	1.18	4.10	3,600.09	9.86	44.08				
80% Below 1990 Emissions	2033-2034	671.15	1.84	7.41	403.78	1.11	3.90	3,393.77	9.30	42.13				
80% Below 1990 Emissions	2034-2035	630.64	1.73	7.07	378.41	1.04	3.71	3,187.29	8.73	40.17				
80% Below 1990 Emissions	2035-2036	590.55	1.62	6.70	352.95	0.97	3.50	2,980.59	8.17	38.04				
80% Below 1990 Emissions	2036-2037	549.73	1.51	6.39	327.99	0.90	3.32	2,774.68	7.60	36.26				
Scenario	Gas Year	Oregon			Washington			Idaho			Peak Day Demand Total System (MDth/day)			
		Annual Demand (MDth)	Daily Demand (MDth/day)	Peak Day Demand (MDth/day)	Annual Demand (MDth)	Daily Demand (MDth/day)	Peak Day Demand (MDth/day)	Annual Demand (MDth)	Daily Demand (MDth/day)	Peak Day Demand (MDth/day)	Annual Demand (MDth)	Daily Demand (MDth/day)	Peak Day Demand (MDth/day)	
80% Below 1990 Emissions	2017-2018	8,706.60	23.85	93.25	17,195.16	47.11	163.27	8,898.33	24.38	89.42	34,800.09	95.34	365.95	
80% Below 1990 Emissions	2018-2019	8,453.44	23.16	90.77	16,688.85	45.72	178.30	8,977.58	24.60	90.47	34,119.86	93.48	359.55	
80% Below 1990 Emissions	2019-2020	8,201.15	22.47	87.96	16,147.71	44.24	172.54	9,083.80	24.89	91.51	33,432.67	91.60	352.00	
80% Below 1990 Emissions	2020-2021	7,948.18	21.78	85.91	15,580.08	42.69	168.02	9,108.34	24.95	92.53	32,636.60	89.42	346.46	
80% Below 1990 Emissions	2021-2022	7,663.26	21.00	83.02	14,994.69	41.08	162.95	9,149.24	25.07	93.51	31,807.20	87.14	339.47	
80% Below 1990 Emissions	2022-2023	7,408.19	20.30	80.60	14,367.76	39.36	157.74	9,167.64	25.12	94.43	30,943.60	84.78	332.77	
80% Below 1990 Emissions	2023-2024	7,150.88	19.59	77.85	13,824.94	37.88	152.30	9,269.60	25.40	95.53	30,245.42	82.86	325.68	
80% Below 1990 Emissions	2024-2025	6,885.72	18.86	75.67	13,150.17	36.03	147.29	9,213.92	25.24	96.11	29,249.82	80.14	319.06	
80% Below 1990 Emissions	2025-2026	6,623.89	18.15	73.22	12,442.81	34.09	141.86	9,178.91	25.15	96.80	28,245.60	77.39	311.88	
80% Below 1990 Emissions	2026-2027	6,359.80	17.42	70.77	11,716.25	32.10	136.37	9,134.37	25.03	97.46	27,210.42	74.55	304.60	
80% Below 1990 Emissions	2027-2028	6,093.32	16.69	68.02	10,980.25	30.08	130.50	9,125.74	25.00	98.21	26,199.30	71.78	296.73	
80% Below 1990 Emissions	2028-2029	5,824.99	15.96	65.85	10,241.92	28.06	125.34	9,038.19	24.76	98.78	25,105.09	68.78	289.97	
80% Below 1990 Emissions	2029-2030	5,555.20	15.22	63.37	9,511.63	26.06	119.86	8,995.83	24.65	99.46	24,062.67	65.93	282.70	
80% Below 1990 Emissions	2030-2031	5,284.48	14.48	60.90	9,040.16	24.77	110.09	8,964.93	24.56	100.20	23,289.56	63.81	271.19	
80% Below 1990 Emissions	2031-2032	5,013.18	13.73	58.17	8,126.39	22.26	104.28	8,989.33	24.63	101.15	22,128.89	60.63	263.60	
80% Below 1990 Emissions	2032-2033	4,741.06	12.99	55.93	7,452.47	20.42	98.59	8,945.43	24.51	101.85	21,138.95	57.91	256.37	
80% Below 1990 Emissions	2033-2034	4,468.70	12.24	53.44	6,801.19	18.63	92.99	8,957.61	24.54	102.76	20,227.50	55.42	249.19	
80% Below 1990 Emissions	2034-2035	4,196.34	11.50	50.95	6,172.05	16.91	87.49	8,983.41	24.61	103.72	19,351.80	53.02	242.17	
80% Below 1990 Emissions	2035-2036	3,924.09	10.75	48.25	5,818.49	15.94	84.04	9,063.96	24.83	104.94	18,806.54	51.52	237.23	
80% Below 1990 Emissions	2036-2037	3,652.40	10.01	45.96	4,354.21	11.93	69.70	9,068.06	24.84	105.80	17,074.67	46.78	221.46	

**APPENDIX 2.8: PEAK DAY DEMAND BEFORE AND AFTER DSM
WASHINGTON**

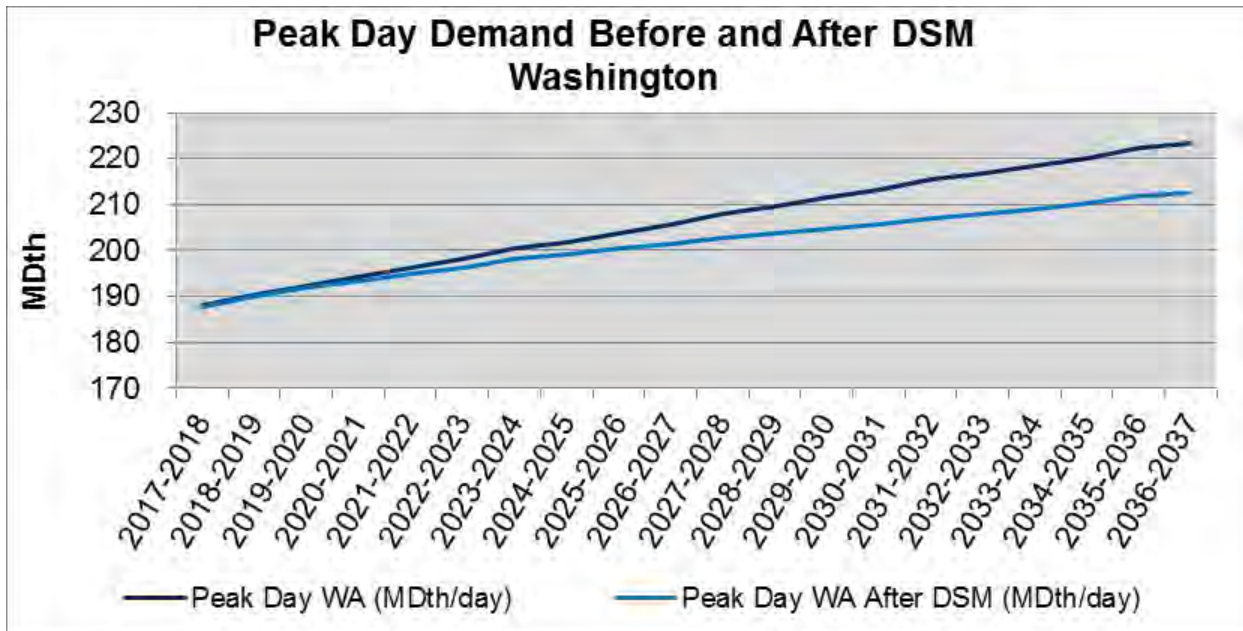
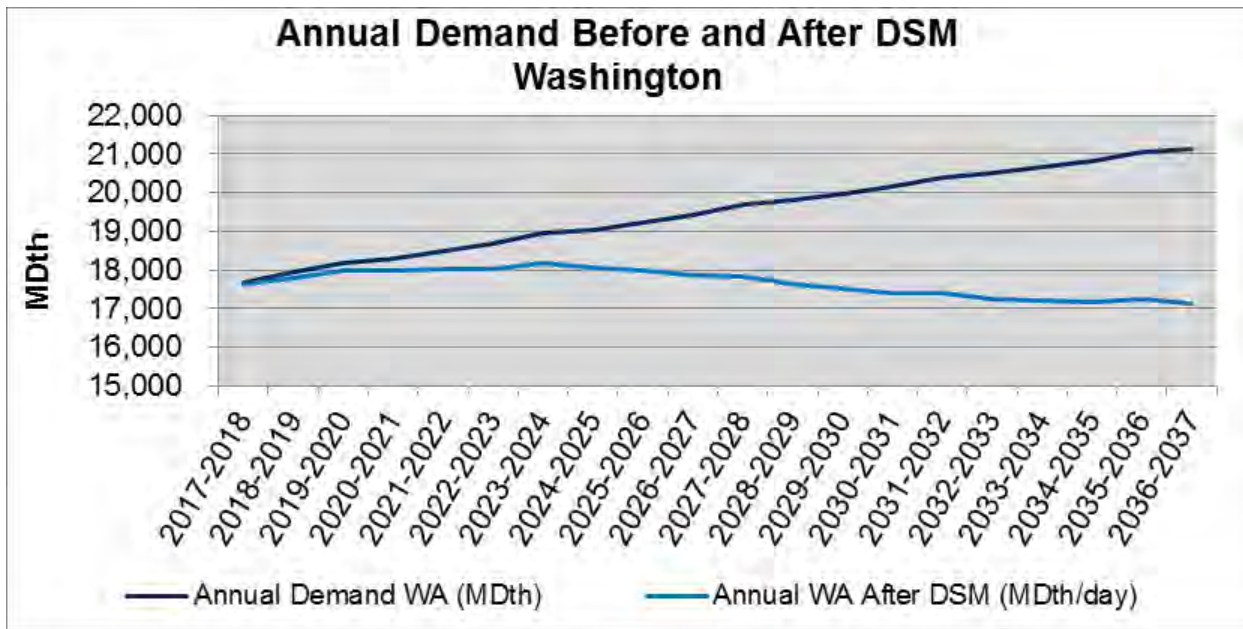

**APPENDIX 2.8: PEAK DAY DEMAND BEFORE AND AFTER DSM
IDAHO**

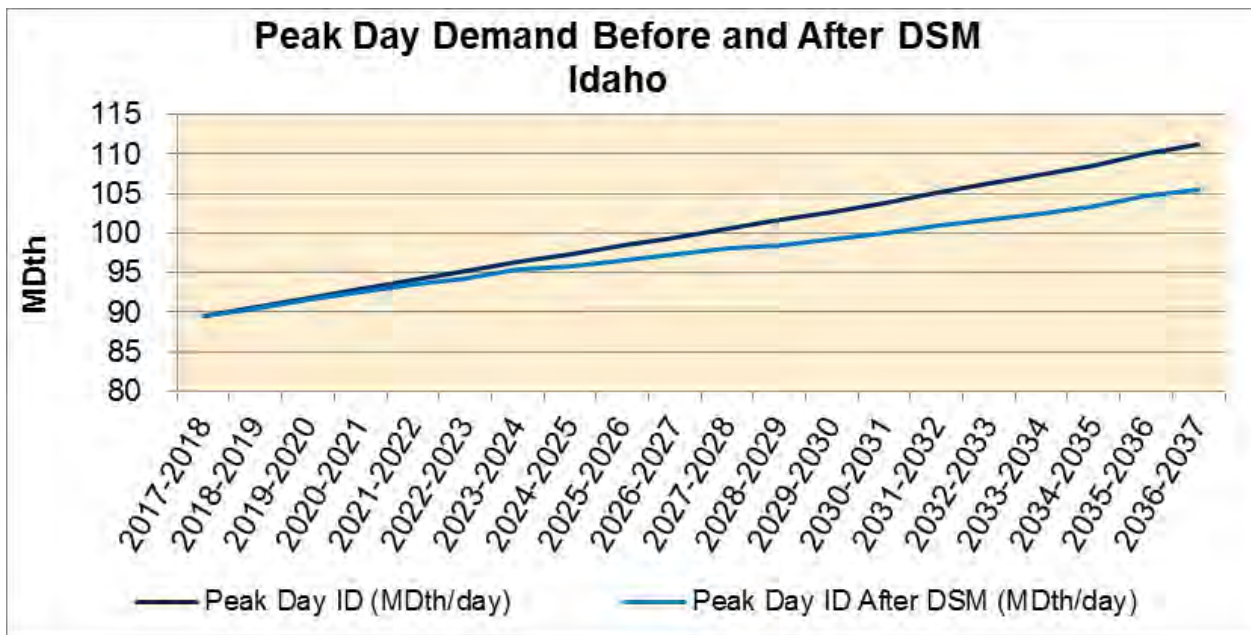
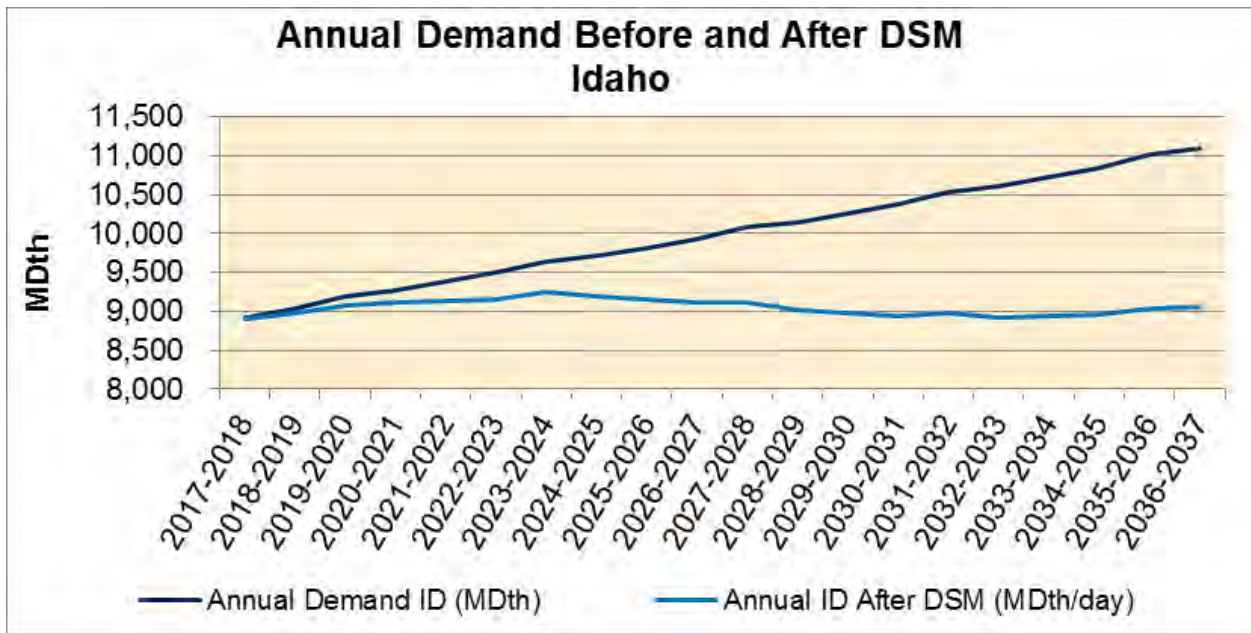

**APPENDIX 2.8: PEAK DAY DEMAND BEFORE AND AFTER DSM
MEDFORD/ROSEBURG**

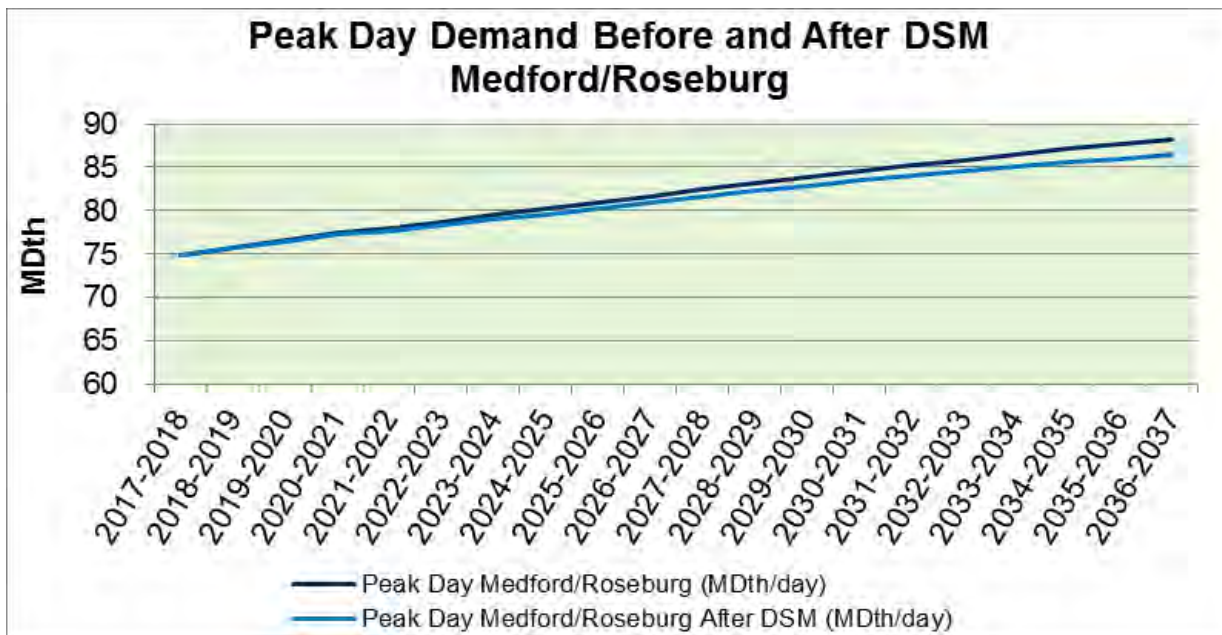
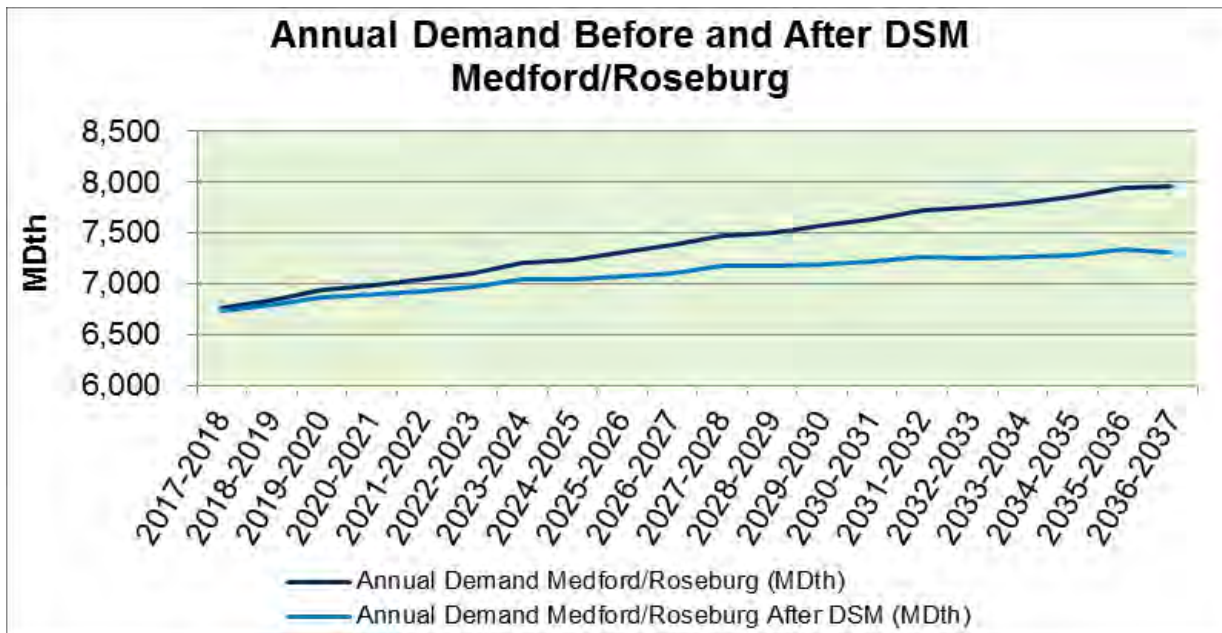

**APPENDIX 2.8: PEAK DAY DEMAND BEFORE AND AFTER DSM
KLAMATH FALLS**

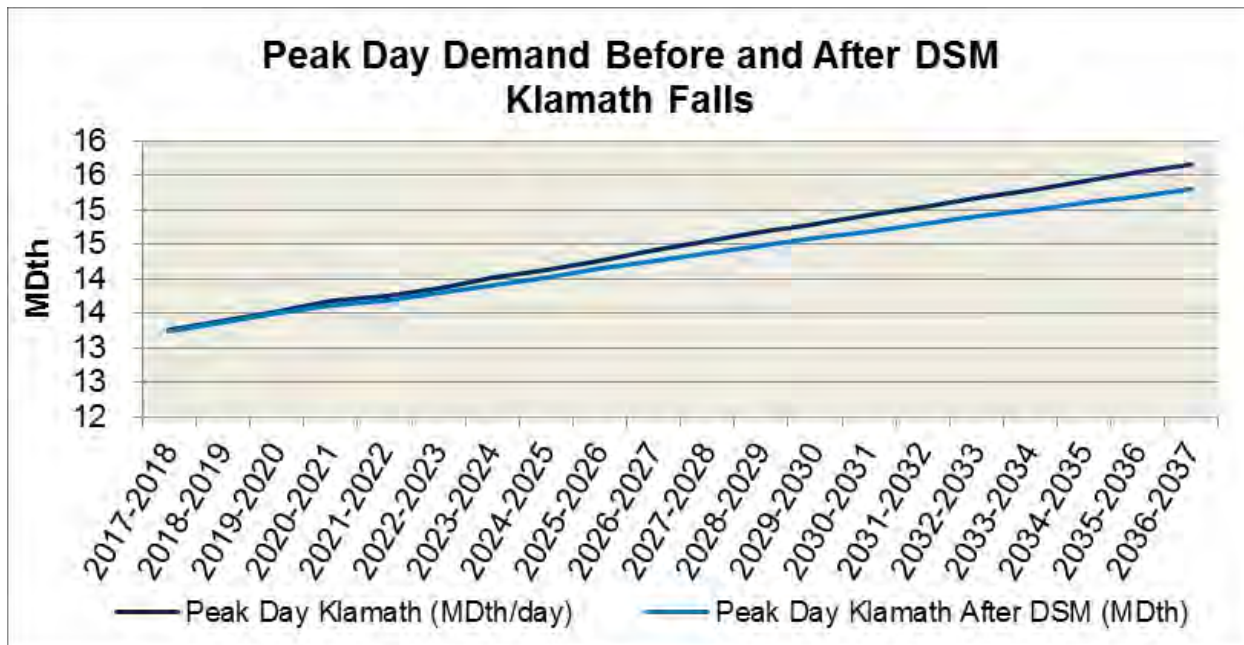
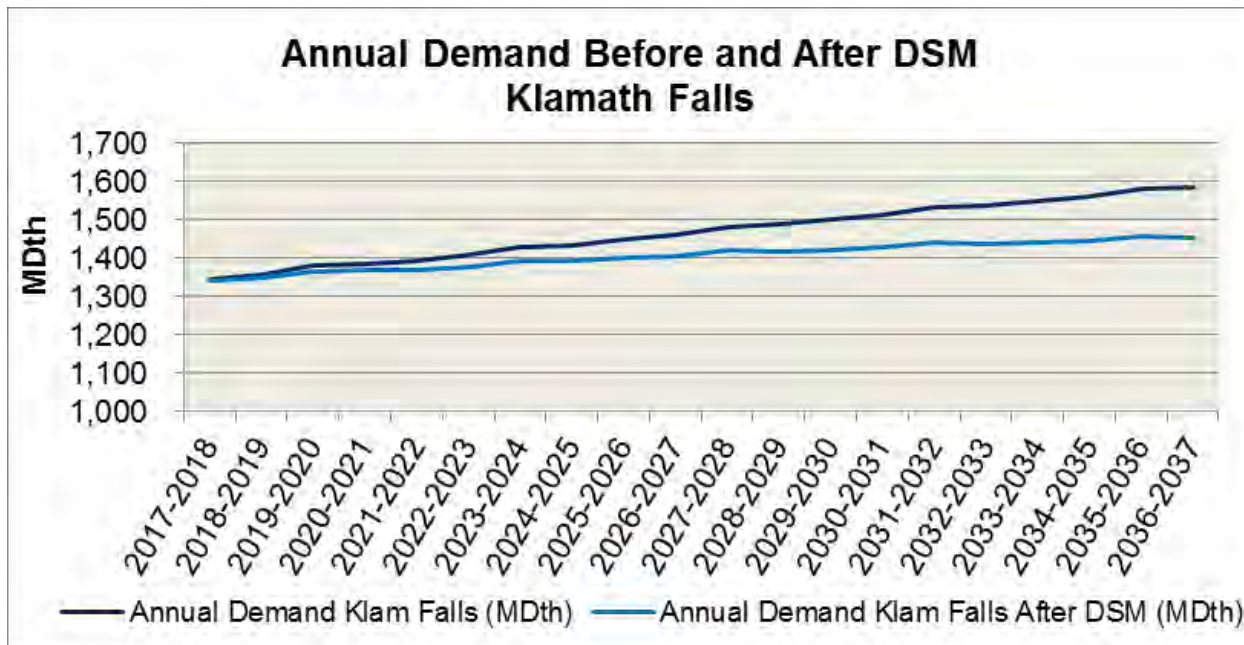

**APPENDIX 2.8: PEAK DAY DEMAND BEFORE AND AFTER DSM
LA GRANDE**

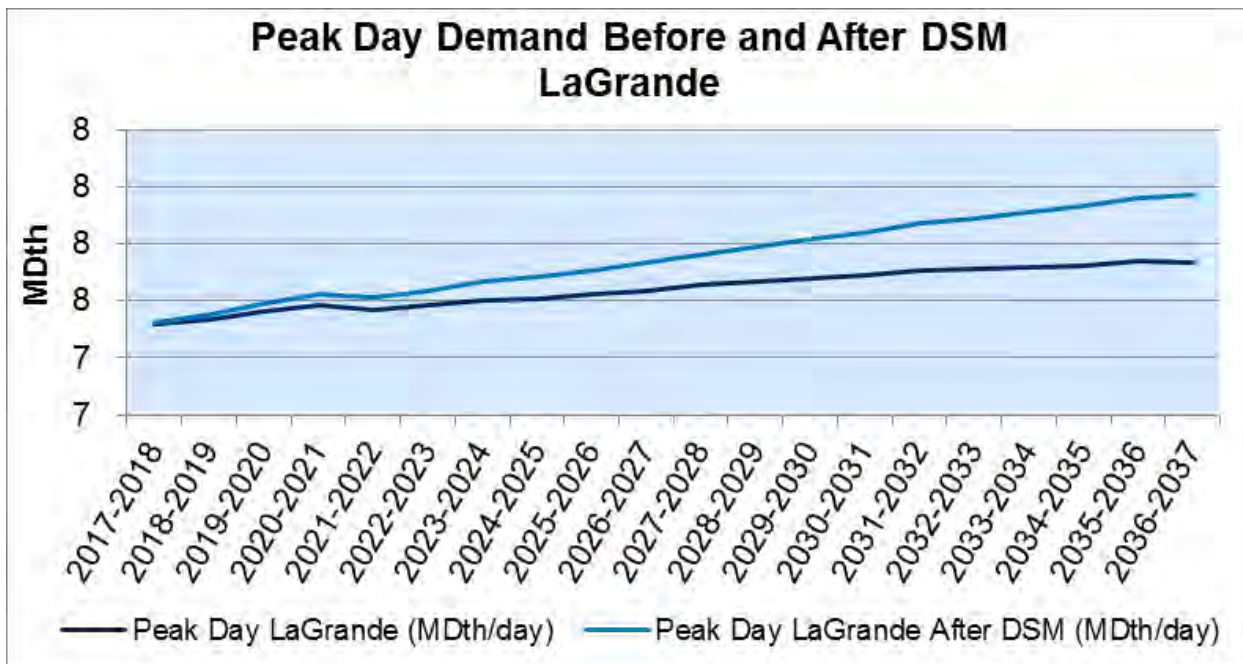
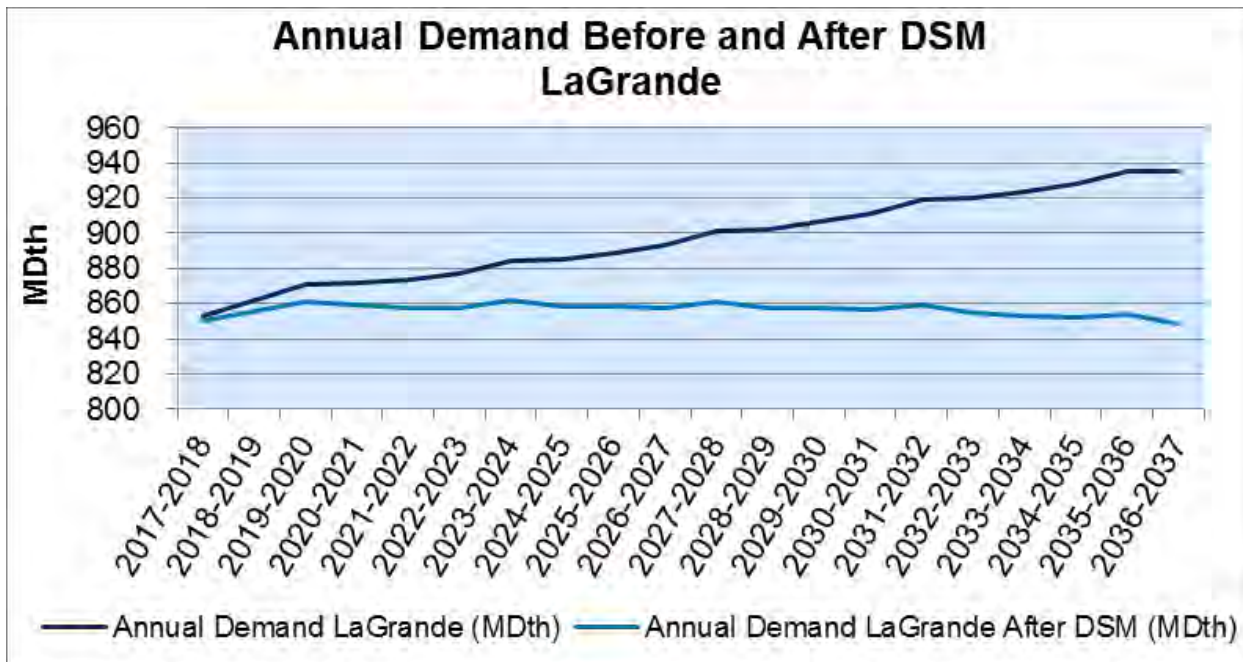

APPENDIX 2.9: DETAILED DEMAND DATA EXPECTED MIX

Area	2029-2030:		Ind FirmSale	2029-2030:		2030-2031:		Ind FirmSale	2030-2031:		2031-2032:		Ind FirmSale	2031-2032:	
	Residential	Commercial		Total	Residential	Commercial	Total		Residential	Commercial	Total	Residential		Commercial	Total
Klamath Falls	950.47	460.73	12.56	1,423.76	954.48	461.28	12.39	1,428.15	963.58	464.03	12.25	1,439.86			
La Grande	492.64	311.94	52.48	857.06	492.80	311.83	51.75	856.38	494.90	313.04	51.06	859.00			
Medford GTN	2,489.65	1,521.73	16.72	4,028.11	2,498.28	1,526.98	16.49	4,041.75	2,517.50	1,538.42	16.29	4,072.21			
Medford NWP	1,118.54	683.68	7.51	1,809.73	1,122.42	686.03	7.41	1,815.86	1,131.05	691.17	7.32	1,829.54			
Roseburg	784.40	570.95	2.13	1,357.48	788.14	569.98	2.10	1,360.23	794.90	571.34	2.08	1,368.32			
OR Sub-Total	5,835.71	3,549.03	91.40	9,476.13	5,856.12	3,556.11	90.14	9,502.37	5,901.93	3,578.00	88.99	9,568.92			
Washington Both	6,321.09	3,699.55	137.44	10,158.08	6,272.26	3,688.35	136.16	10,096.76	6,261.52	3,696.18	135.41	10,093.11			
Washington GTN	871.87	510.28	18.96	1,401.11	865.14	508.74	18.78	1,392.66	863.66	509.82	18.68	1,392.15			
Washington NWP	3,705.47	2,168.70	80.57	5,954.74	3,676.84	2,162.13	79.82	5,918.79	3,670.55	2,166.72	79.38	5,916.65			
WA Sub-Total	10,898.44	6,378.53	236.97	17,513.94	10,814.24	6,359.22	234.76	17,408.21	10,795.73	6,372.72	233.47	17,401.91			
Idaho Both	3,268.76	1,790.57	147.48	5,206.81	3,256.81	1,784.71	147.24	5,188.76	3,266.97	1,788.16	147.60	5,202.73			
Idaho GTN	450.86	246.98	20.34	718.18	449.22	246.17	20.31	715.69	450.62	246.64	20.36	717.62			
Idaho NWP	1,916.17	1,049.65	86.46	3,052.27	1,909.16	1,046.21	86.31	3,041.69	1,915.12	1,048.23	86.52	3,049.88			
ID Sub-Total	5,635.79	3,087.19	254.28	8,977.26	5,615.19	3,077.09	253.85	8,946.13	5,632.71	3,083.04	254.48	8,970.23			
Case Total	22,369.93	13,014.75	582.64	35,967.33	22,285.55	12,992.41	578.75	35,856.71	22,330.37	13,033.76	576.94	35,941.07			

Area	2032-2033:		Ind FirmSale	2032-2033:		2033-2034:		Ind FirmSale	2033-2034:		2034-2035:		Ind FirmSale	2034-2035:	
	Residential	Commercial		Total	Residential	Commercial	Total		Residential	Commercial	Total	Residential		Commercial	Total
Klamath Falls	962.62	462.23	12.00	1,436.85	966.73	462.63	11.78	1,441.14	970.81	463.02	11.56	1,445.39			
La Grande	492.75	311.56	50.11	854.41	492.54	311.37	49.21	853.13	492.28	311.24	48.28	851.79			
Medford GTN	2,512.39	1,536.46	15.97	4,064.82	2,518.22	1,540.79	15.68	4,074.69	2,523.44	1,544.92	15.39	4,083.75			
Medford NWP	1,128.75	690.29	7.17	1,826.22	1,131.38	692.24	7.05	1,830.66	1,133.72	694.09	6.92	1,834.73			
Roseburg	794.19	567.56	2.03	1,363.78	796.93	566.24	2.00	1,365.17	799.57	564.93	1.96	1,366.46			
OR Sub-Total	5,890.69	3,568.10	87.28	9,546.08	5,905.80	3,573.27	85.72	9,564.79	5,919.81	3,578.20	84.11	9,582.11			
Washington Both	6,198.50	3,671.47	133.67	10,003.64	6,172.03	3,668.62	132.45	9,973.10	6,153.87	3,668.91	131.24	9,954.03			
Washington GTN	854.97	506.41	18.44	1,379.81	851.32	506.02	18.27	1,375.60	848.81	506.06	18.10	1,372.97			
Washington NWP	3,633.60	2,152.24	78.36	5,864.20	3,618.09	2,150.57	77.64	5,846.30	3,607.44	2,150.74	76.94	5,835.12			
WA Sub-Total	10,687.07	6,330.12	230.46	17,247.65	10,641.44	6,325.20	228.36	17,195.00	10,610.13	6,325.70	226.28	17,162.11			
Idaho Both	3,253.17	1,777.22	146.80	5,177.19	3,260.50	1,777.02	146.61	5,184.12	3,274.00	1,778.52	146.42	5,198.95			
Idaho GTN	448.71	245.13	20.25	714.10	449.72	245.11	20.22	715.05	451.59	245.31	20.20	717.10			
Idaho NWP	1,907.03	1,041.82	86.05	3,034.90	1,911.33	1,041.70	85.94	3,038.97	1,919.24	1,042.58	85.83	3,047.66			
ID Sub-Total	5,608.92	3,064.18	253.10	8,926.19	5,621.56	3,063.82	252.77	8,938.15	5,644.83	3,066.42	252.46	8,963.71			
Case Total	22,186.68	12,962.40	570.83	35,719.91	22,168.80	12,962.29	566.85	35,697.94	22,174.77	12,970.32	562.85	35,707.94			

Area	2035-2036:		Ind FirmSale	2035-2036:		2036-2037:		Ind FirmSale	2036-2037:	
	Residential	Commercial		Total	Residential	Commercial	Total			
Klamath Falls	980.21	465.79	11.38	1,457.38	979.29	463.88	11.11	1,454.28		
La Grande	494.06	312.43	47.42	853.91	491.65	310.80	46.39	848.83		
Medford GTN	2,540.44	1,555.58	15.14	4,111.16	2,533.52	1,552.82	14.79	4,101.13		
Medford NWP	1,141.36	698.88	6.80	1,847.04	1,138.25	697.64	6.65	1,842.54		
Roseburg	805.94	566.14	1.93	1,374.01	804.96	562.19	1.88	1,369.04		
OR Sub-Total	5,962.01	3,598.83	82.67	9,643.50	5,947.66	3,587.34	80.82	9,615.82		
Washington Both	6,174.01	3,689.88	130.55	9,994.44	6,137.04	3,677.80	128.87	9,943.70		
Washington GTN	851.59	508.95	18.01	1,378.54	846.49	507.28	17.77	1,371.55		
Washington NWP	3,619.25	2,163.03	76.53	5,858.81	3,597.57	2,155.95	75.54	5,829.07		
WA Sub-Total	10,644.85	6,361.86	225.08	17,231.79	10,581.10	6,341.03	222.18	17,144.32		
Idaho Both	3,308.89	1,789.76	146.84	5,245.48	3,315.58	1,786.11	146.08	5,247.77		
Idaho GTN	456.40	246.86	20.25	723.52	457.32	246.36	20.15	723.83		
Idaho NWP	1,939.69	1,049.17	86.08	3,074.94	1,943.62	1,047.03	85.63	3,076.28		
ID Sub-Total	5,704.98	3,085.79	253.17	9,043.94	5,716.52	3,079.50	251.86	9,047.89		
Case Total	22,311.83	13,046.47	560.92	35,919.23	22,245.28	13,007.87	554.86	35,808.02		

APPENDIX 2.9: DETAILED DEMAND DATA LOW GROWTH HIGH PRICE

Area	2029-2030:		Ind FirmSale	2029-2030:		2030-2031:		Ind FirmSale	2030-2031:		2031-2032:		Ind FirmSale	2031-2032:	
	Residential	Commercial		Total	Residential	Commercial	Total		Residential	Commercial	Total	Residential		Commercial	Total
Klamath Falls	894.55	433.84	1.36	1,329.74	895.54	433.01	0.37	1,328.92	901.22	434.21	-	1,335.43			
La Grande	464.65	294.31	0.81	759.78	462.78	292.93	-	755.71	462.91	292.90	-	755.81			
Medford GTN	2,358.43	1,442.63	8.87	3,809.94	2,359.40	1,443.20	8.02	3,810.62	2,370.52	1,449.72	7.17	3,827.41			
Medford NWP	1,059.59	648.14	3.99	1,711.71	1,060.02	648.40	3.60	1,712.02	1,065.02	651.32	3.22	1,719.56			
Roseburg	738.26	537.64	-	1,275.90	739.10	534.78	-	1,273.88	742.96	534.26	-	1,277.22			
OR Sub-Total	5,515.48	3,356.56	15.02	8,887.06	5,516.85	3,352.32	11.99	8,881.16	5,542.63	3,362.42	10.39	8,915.44			
Washington Both	5,955.52	3,497.77	106.22	9,559.51	5,883.84	3,474.80	102.38	9,461.02	5,848.95	3,470.19	98.93	9,418.07			
Washington GTN	821.45	482.45	14.65	1,318.55	811.56	479.28	14.12	1,304.97	806.75	478.65	13.65	1,299.04			
Washington NWP	3,491.17	2,050.42	62.27	5,603.85	3,449.15	2,036.95	60.02	5,546.11	3,428.70	2,034.25	57.99	5,520.94			
WA Sub-Total	10,268.13	6,030.64	183.15	16,481.92	10,144.55	5,991.03	176.52	16,312.10	10,084.40	5,983.08	170.57	16,238.05			
Idaho Both	3,001.46	1,654.09	103.92	4,759.48	2,970.30	1,639.44	100.53	4,710.27	2,959.42	1,633.33	97.55	4,690.31			
Idaho GTN	414.00	228.15	14.33	656.48	409.70	226.13	13.87	649.69	408.20	225.29	13.46	646.94			
Idaho NWP	1,759.48	969.64	60.92	2,790.04	1,741.21	961.05	58.93	2,761.19	1,734.83	957.47	57.19	2,749.49			
ID Sub-Total	5,174.94	2,851.89	179.17	8,205.99	5,121.20	2,826.62	173.32	8,121.15	5,102.45	2,816.09	168.20	8,086.74			
Case Total	20,958.55	12,239.08	377.34	33,574.97	20,782.61	12,169.97	361.83	33,314.41	20,729.48	12,161.58	349.16	33,240.23			

Area	2032-2033:		Ind FirmSale	2032-2033:		2033-2034:		Ind FirmSale	2033-2034:		2034-2035:		Ind FirmSale	2034-2035:	
	Residential	Commercial		Total	Residential	Commercial	Total		Residential	Commercial	Total	Residential		Commercial	Total
Klamath Falls	897.36	431.09	-	1,328.45	898.18	430.02	-	1,328.20	898.98	428.94	-	1,327.92			
La Grande	459.19	290.44	-	749.63	457.53	289.33	-	746.86	455.90	288.34	-	744.23			
Medford GTN	2,358.79	1,443.66	6.25	3,808.70	2,357.52	1,443.60	5.34	3,806.46	2,355.79	1,443.42	4.42	3,803.63			
Medford NWP	1,059.75	648.60	2.81	1,711.16	1,059.18	648.57	2.40	1,710.15	1,058.40	648.49	1.99	1,708.88			
Roseburg	739.87	528.97	-	1,268.85	740.07	526.04	-	1,266.11	740.19	523.14	-	1,263.33			
OR Sub-Total	5,514.97	3,342.76	9.05	8,866.78	5,512.48	3,337.56	7.74	8,857.78	5,509.25	3,332.33	6.41	8,847.99			
Washington Both	5,765.54	3,435.25	94.74	9,295.53	5,717.44	3,421.52	90.95	9,229.91	5,677.98	3,411.19	87.17	9,176.34			
Washington GTN	795.25	473.83	13.07	1,282.14	788.61	471.93	12.54	1,273.09	783.17	470.51	12.02	1,265.70			
Washington NWP	3,379.80	2,013.77	55.54	5,449.10	3,351.60	2,005.72	53.32	5,410.64	3,328.47	1,999.67	51.10	5,379.23			
WA Sub-Total	9,940.59	5,922.84	163.35	16,026.78	9,857.65	5,899.17	156.81	15,913.63	9,789.62	5,881.37	150.29	15,821.27			
Idaho Both	2,926.48	1,613.97	93.81	4,634.26	2,912.92	1,604.60	90.48	4,607.99	2,905.00	1,596.87	87.15	4,589.02			
Idaho GTN	403.65	222.62	12.94	639.21	401.78	221.32	12.48	635.59	400.69	220.26	12.02	632.97			
Idaho NWP	1,715.52	946.12	54.99	2,716.63	1,707.57	940.63	53.04	2,701.24	1,702.93	936.09	51.09	2,690.12			
ID Sub-Total	5,045.66	2,782.70	161.74	7,990.10	5,022.27	2,766.56	155.99	7,944.82	5,008.62	2,753.22	150.26	7,912.11			
Case Total	20,501.21	12,048.31	334.14	32,883.66	20,392.40	12,003.29	320.54	32,716.23	20,307.49	11,966.92	306.96	32,581.37			

Area	2035-2036:		Ind FirmSale	2035-2036:		2036-2037:		Ind FirmSale	2036-2037:	
	Residential	Commercial		Total	Residential	Commercial	Total			
Klamath Falls	904.66	430.04	-	1,334.70	900.71	426.79	-	1,327.51		
La Grande	456.31	288.67	-	744.98	452.91	286.41	-	739.32		
Medford GTN	2,365.13	1,449.38	3.51	3,818.02	2,352.12	1,442.77	2.57	3,797.46		
Medford NWP	1,062.59	651.17	1.58	1,715.34	1,056.75	648.20	1.16	1,706.11		
Roseburg	743.76	522.59	-	1,266.35	740.50	517.26	-	1,257.76		
OR Sub-Total	5,532.45	3,341.85	5.09	8,879.39	5,502.99	3,321.44	3.73	8,828.16		
Washington Both	5,674.94	3,420.56	83.72	9,179.21	5,619.00	3,399.29	79.62	9,097.91		
Washington GTN	782.75	471.80	11.55	1,266.10	775.03	468.87	10.98	1,254.88		
Washington NWP	3,326.69	2,005.15	49.07	5,380.92	3,293.90	1,992.69	46.67	5,333.26		
WA Sub-Total	9,784.38	5,897.51	144.34	15,826.23	9,687.93	5,860.84	137.28	15,686.05		
Idaho Both	2,988.78	1,597.98	84.18	4,670.94	2,829.63	1,585.64	80.53	4,495.80		
Idaho GTN	412.25	220.41	11.61	644.27	390.29	218.71	11.11	620.11		
Idaho NWP	1,752.04	936.75	49.35	2,738.14	1,658.75	929.51	47.20	2,635.47		
ID Sub-Total	5,153.06	2,755.13	145.14	8,053.34	4,878.67	2,733.87	138.84	7,751.38		
Case Total	20,469.89	11,994.50	294.57	32,758.96	20,069.60	11,916.15	279.84	32,265.59		

APPENDIX 2.9: DETAILED DEMAND DATA HIGH GROWTH LOW PRICE

Area	2029-2030:		Ind FirmSale	2029-2030:		2030-2031:		Ind FirmSale	2030-2031:		Ind FirmSale	2031-2032:	
	Residential	Commercial		Total	Residential	Commercial	Total		Residential	Commercial		Total	
Klamath Falls	1,010.07	489.32	25.10	1,524.49	1,017.43	491.41	25.94	1,534.78	1,030.34	495.89	26.86	1,553.09	
La Grande	522.35	330.63	178.96	1,031.93	524.76	331.93	189.14	1,045.84	529.08	334.53	199.76	1,063.37	
Medford GTN	2,628.70	1,605.31	24.58	4,258.60	2,645.77	1,615.70	24.98	4,286.45	2,673.93	1,632.56	25.43	4,331.91	
Medford NWP	1,181.01	721.23	11.04	1,913.28	1,188.68	725.90	11.22	1,925.80	1,201.33	733.47	11.43	1,946.22	
Roseburg	833.56	606.36	9.61	1,449.53	840.53	607.50	10.18	1,458.21	850.51	610.96	10.80	1,472.28	
OR Sub-Total	6,175.69	3,752.85	249.30	10,177.83	6,217.18	3,772.44	261.47	10,251.09	6,285.19	3,807.41	274.28	10,366.88	
Washington Both	6,718.62	3,918.12	197.06	10,833.80	6,695.04	3,919.93	200.43	10,815.40	6,711.10	3,941.56	204.58	10,857.25	
Washington GTN	926.71	540.43	27.18	1,494.32	923.45	540.68	27.65	1,491.78	925.67	543.66	28.22	1,497.55	
Washington NWP	3,938.50	2,296.83	115.52	6,350.85	3,924.68	2,297.89	117.50	6,340.06	3,934.09	2,310.57	119.93	6,364.59	
WA Sub-Total	11,583.83	6,755.37	339.77	18,678.96	11,543.17	6,758.50	345.58	18,647.24	11,570.86	6,795.80	352.73	18,719.39	
Idaho Both	3,538.69	1,930.14	182.91	5,651.95	3,548.56	1,934.29	185.82	5,668.67	3,582.42	1,948.63	189.49	5,720.55	
Idaho GTN	488.12	266.23	25.23	779.58	489.46	266.80	25.63	781.89	494.13	268.78	26.14	789.04	
Idaho NWP	2,074.53	1,131.46	107.23	3,313.21	2,080.19	1,133.89	108.93	3,323.01	2,100.04	1,142.30	111.08	3,353.42	
ID Sub-Total	6,101.55	3,327.82	315.37	9,744.74	6,118.21	3,334.98	320.38	9,773.57	6,176.59	3,359.71	326.71	9,863.01	
Case Total	23,861.06	13,836.04	904.43	38,601.54	23,878.56	13,865.92	927.42	38,671.90	24,032.64	13,962.92	953.72	38,949.28	

Area	2032-2033:		Ind FirmSale	2032-2033:		2033-2034:		Ind FirmSale	2033-2034:		Ind FirmSale	2034-2035:	
	Residential	Commercial		Total	Residential	Commercial	Total		Residential	Commercial		Total	
Klamath Falls	1,032.66	495.59	27.57	1,555.82	1,040.47	497.65	28.37	1,566.50	1,048.27	499.71	29.16	1,577.15	
La Grande	528.69	334.15	209.31	1,072.15	530.15	335.01	219.32	1,084.49	531.43	335.86	229.30	1,096.59	
Medford GTN	2,676.20	1,635.18	25.71	4,337.09	2,689.97	1,644.38	26.05	4,360.41	2,702.98	1,653.33	26.39	4,382.70	
Medford NWP	1,202.35	734.64	11.55	1,948.55	1,208.54	738.78	11.71	1,959.02	1,214.38	742.80	11.86	1,969.04	
Roseburg	852.49	608.90	11.31	1,472.70	858.11	609.42	11.88	1,479.40	863.61	609.90	12.44	1,485.95	
OR Sub-Total	6,292.39	3,808.46	285.46	10,386.30	6,327.24	3,825.24	297.33	10,449.82	6,360.67	3,841.61	309.14	10,511.43	
Washington Both	6,670.86	3,928.30	207.23	10,806.39	6,668.63	3,937.64	210.65	10,816.92	6,674.42	3,949.89	214.08	10,838.38	
Washington GTN	920.12	541.84	28.58	1,490.54	919.81	543.12	29.06	1,491.99	920.61	544.81	29.53	1,494.95	
Washington NWP	3,910.50	2,302.80	121.48	6,334.78	3,909.20	2,308.27	123.48	6,340.95	3,912.59	2,315.45	125.49	6,353.53	
WA Sub-Total	11,501.48	6,772.94	357.29	18,631.71	11,497.64	6,789.03	363.19	18,649.86	11,507.61	6,810.15	369.10	18,686.86	
Idaho Both	3,590.58	1,947.51	191.68	5,729.78	3,621.92	1,957.98	194.65	5,774.55	3,660.20	1,970.35	197.62	5,828.16	
Idaho GTN	495.25	268.62	26.44	790.31	499.58	270.07	26.85	796.49	504.86	271.77	27.26	803.88	
Idaho NWP	2,104.83	1,141.64	112.37	3,358.84	2,123.20	1,147.78	114.10	3,385.08	2,145.64	1,155.03	115.84	3,416.51	
ID Sub-Total	6,190.66	3,357.77	330.49	9,878.93	6,244.70	3,375.82	335.60	9,956.11	6,310.69	3,397.15	340.72	10,048.56	
Case Total	23,984.53	13,939.17	973.24	38,896.94	24,069.58	13,990.10	996.11	39,055.79	24,178.98	14,048.90	1,018.96	39,246.84	

Area	2035-2036:		Ind FirmSale	2035-2036:		2036-2037:		Ind FirmSale	2036-2037:	
	Residential	Commercial		Total	Residential	Commercial	Total			
Klamath Falls	1,061.91	504.37	30.05	1,596.33	1,064.46	504.01	30.74	1,599.21		
La Grande	534.76	338.04	239.86	1,112.66	533.50	337.12	249.22	1,119.83		
Medford GTN	2,728.57	1,669.26	26.79	4,424.62	2,728.57	1,670.86	27.04	4,426.47		
Medford NWP	1,225.88	749.96	12.04	1,987.87	1,225.88	750.67	12.15	1,988.70		
Roseburg	873.16	613.12	13.06	1,499.34	874.80	610.79	13.56	1,499.14		
OR Sub-Total	6,424.27	3,874.75	321.81	10,620.83	6,427.20	3,873.46	332.70	10,633.36		
Washington Both	6,720.65	3,983.94	218.33	10,922.92	6,705.23	3,982.33	220.96	10,908.53		
Washington GTN	926.99	549.51	30.11	1,506.61	924.86	549.29	30.48	1,504.62		
Washington NWP	3,939.69	2,335.42	127.99	6,403.09	3,930.65	2,334.47	129.53	6,394.65		
WA Sub-Total	11,587.32	6,868.87	376.43	18,832.63	11,560.75	6,866.09	380.97	18,807.81		
Idaho Both	3,722.33	1,993.46	201.39	5,917.19	3,753.85	2,000.30	203.58	5,957.72		
Idaho GTN	513.42	274.96	27.78	816.16	517.77	275.90	28.08	821.75		
Idaho NWP	2,182.05	1,168.58	118.06	3,468.69	2,200.53	1,172.59	119.34	3,492.45		
ID Sub-Total	6,417.81	3,437.01	347.23	10,202.04	6,472.15	3,448.79	350.99	10,271.93		
Case Total	24,429.40	14,180.62	1,045.47	39,655.50	24,460.09	14,188.34	1,064.66	39,713.09		

APPENDIX 2.9: DETAILED DEMAND DATA AVERAGE MIX

Area	2029-2030:		Ind FirmSale	2029-2030:		2030-2031:		Ind FirmSale	2030-2031:		Ind FirmSale	2031-2032:	
	Residential	Commercial		Total	Residential	Commercial	Total		Residential	Commercial		Total	
Klamath Falls	921.16	448.47	12.42	1,382.05	924.90	448.95	12.24	1,386.09	933.73	451.63	12.10	1,397.46	
La Grande	474.69	301.19	52.48	828.36	474.75	301.03	51.75	827.54	476.76	302.19	51.06	830.01	
Medford GTN	2,386.76	1,473.38	16.61	3,876.75	2,394.53	1,478.22	16.38	3,889.13	2,412.92	1,489.27	16.18	3,918.38	
Medford NWP	1,072.31	661.95	7.46	1,741.73	1,075.80	664.13	7.36	1,747.29	1,084.07	669.09	7.27	1,760.43	
Roseburg	747.22	549.10	2.08	1,298.41	750.60	548.05	2.05	1,300.71	757.02	549.34	2.03	1,308.39	
OR Sub-Total	5,602.15	3,434.10	91.05	9,127.30	5,620.58	3,440.38	89.79	9,150.76	5,664.50	3,461.52	88.65	9,214.67	
Washington Both	6,070.21	3,567.00	134.70	9,771.91	6,018.75	3,554.98	133.43	9,707.17	6,005.44	3,562.02	132.71	9,700.17	
Washington GTN	837.27	492.00	18.58	1,347.85	830.17	490.34	18.40	1,338.92	828.34	491.31	18.30	1,337.95	
Washington NWP	3,558.40	2,091.00	78.96	5,728.36	3,528.23	2,083.95	78.22	5,690.41	3,520.43	2,088.08	77.79	5,686.30	
WA Sub-Total	10,465.88	6,150.00	232.24	16,848.11	10,377.16	6,129.27	230.06	16,736.49	10,354.21	6,141.41	228.80	16,724.43	
Idaho Both	3,139.51	1,734.45	144.80	5,018.76	3,125.75	1,728.25	144.55	4,998.56	3,134.06	1,731.37	144.91	5,010.35	
Idaho GTN	433.04	239.23	19.97	692.24	431.14	238.38	19.94	689.46	432.28	238.81	19.99	691.08	
Idaho NWP	1,840.40	1,016.75	84.88	2,942.03	1,832.34	1,013.11	84.74	2,930.19	1,837.21	1,014.94	84.95	2,937.10	
ID Sub-Total	5,412.95	2,990.43	249.66	8,653.04	5,389.23	2,979.75	249.23	8,618.21	5,403.55	2,985.12	249.85	8,638.53	
Case Total	21,480.98	12,574.53	572.94	34,628.45	21,386.97	12,549.41	569.08	34,505.46	21,422.26	12,588.05	567.31	34,577.62	

Area	2032-2033:		Ind FirmSale	2032-2033:		2033-2034:		Ind FirmSale	2033-2034:		Ind FirmSale	2034-2035:	
	Residential	Commercial		Total	Residential	Commercial	Total		Residential	Commercial		Total	
Klamath Falls	932.49	449.75	11.85	1,394.09	936.33	450.07	11.64	1,398.04	940.13	450.39	11.41	1,401.94	
La Grande	474.51	300.66	50.11	825.27	474.22	300.43	49.21	823.86	473.86	300.24	48.28	822.38	
Medford GTN	2,407.02	1,486.93	15.86	3,909.81	2,412.09	1,490.88	15.58	3,918.54	2,416.56	1,494.64	15.29	3,926.49	
Medford NWP	1,081.41	668.04	7.13	1,756.58	1,083.69	669.81	7.00	1,760.51	1,085.70	671.50	6.87	1,764.07	
Roseburg	755.99	545.50	1.99	1,303.47	758.41	544.11	1.95	1,304.47	760.73	542.73	1.91	1,305.38	
OR Sub-Total	5,651.42	3,450.88	86.93	9,189.23	5,664.74	3,455.30	85.38	9,205.42	5,677.00	3,459.50	83.76	9,220.26	
Washington Both	5,939.90	3,536.54	130.98	9,607.42	5,910.96	3,532.94	129.78	9,573.68	5,890.36	3,532.50	128.60	9,551.46	
Washington GTN	819.30	487.80	18.07	1,325.16	815.30	487.30	17.90	1,320.51	812.46	487.24	17.74	1,317.44	
Washington NWP	3,482.01	2,073.15	76.78	5,631.93	3,465.04	2,071.03	76.08	5,612.16	3,452.97	2,070.78	75.39	5,599.13	
WA Sub-Total	10,241.20	6,097.49	225.83	16,564.51	10,191.30	6,091.27	223.76	16,506.34	10,155.80	6,090.52	221.72	16,468.04	
Idaho Both	3,118.37	1,720.08	144.12	4,982.57	3,123.77	1,719.53	143.92	4,987.23	3,135.31	1,720.69	143.74	4,999.75	
Idaho GTN	430.12	237.25	19.88	687.25	430.87	237.18	19.85	687.89	432.46	237.34	19.83	689.62	
Idaho NWP	1,828.01	1,008.33	84.48	2,920.82	1,831.18	1,008.00	84.37	2,923.55	1,837.94	1,008.68	84.26	2,930.89	
ID Sub-Total	5,376.49	2,965.66	248.48	8,590.63	5,385.81	2,964.71	248.15	8,598.67	5,405.71	2,966.71	247.83	8,620.26	
Case Total	21,269.11	12,514.03	561.23	34,344.38	21,241.86	12,511.29	557.29	34,310.43	21,238.51	12,516.73	553.32	34,308.56	

Area	2035-2036:		Ind FirmSale	2035-2036:		2036-2037:		Ind FirmSale	2036-2037:	
	Residential	Commercial		Total	Residential	Commercial	Total			
Klamath Falls	949.26	453.08	11.23	1,413.58	948.06	451.10	10.96	1,410.12		
La Grande	475.56	301.38	47.42	824.36	473.07	299.70	46.39	819.16		
Medford GTN	2,432.84	1,504.94	15.03	3,952.81	2,425.20	1,501.80	14.69	3,941.69		
Medford NWP	1,093.02	676.13	6.75	1,775.90	1,089.58	674.72	6.60	1,770.91		
Roseburg	766.79	543.87	1.89	1,312.56	765.50	539.86	1.84	1,307.20		
OR Sub-Total	5,717.48	3,479.40	82.32	9,279.20	5,701.42	3,467.19	80.47	9,249.08		
Washington Both	5,908.09	3,552.76	127.92	9,588.77	5,868.74	3,539.97	126.26	9,534.97		
Washington GTN	814.91	490.04	17.64	1,322.59	809.48	488.27	17.42	1,315.17		
Washington NWP	3,463.37	2,082.65	74.99	5,621.00	3,440.30	2,075.15	74.01	5,589.46		
WA Sub-Total	10,186.37	6,125.44	220.55	16,532.36	10,118.52	6,103.39	217.69	16,439.60		
Idaho Both	3,168.20	1,731.57	144.16	5,043.93	3,172.86	1,727.57	143.40	5,043.83		
Idaho GTN	436.99	238.84	19.88	695.71	437.64	238.29	19.78	695.70		
Idaho NWP	1,857.22	1,015.06	84.51	2,956.79	1,859.95	1,012.72	84.06	2,956.73		
ID Sub-Total	5,462.41	2,985.47	248.55	8,696.43	5,470.45	2,978.57	247.24	8,696.26		
Case Total	21,366.26	12,590.31	551.42	34,508.00	21,290.39	12,549.16	545.40	34,384.94		

APPENDIX 2.9: DETAILED DEMAND DATA COLDEST IN 20 YEARS

Area	2029-2030:		Ind FirmSale	2029-2030:		2030-2031:		Ind FirmSale	2030-2031:		2031-2032:		Ind FirmSale	2031-2032:	
	Residential	Commercial		Total	Residential	Commercial	Total		Residential	Commercial	Total	Residential		Commercial	Total
Klamath Falls	950.47	460.73	12.56	1,423.76	954.48	461.28	12.39	1,428.15	963.58	464.03	12.25	1,439.86			
La Grande	487.71	308.95	52.48	849.14	487.84	308.83	51.75	848.42	489.92	310.03	51.06	851.00			
Medford GTN	2,468.33	1,511.72	16.69	3,996.74	2,476.78	1,516.88	16.46	4,010.13	2,495.83	1,528.24	16.27	4,040.33			
Medford NWP	1,108.96	679.18	7.50	1,795.64	1,112.76	681.50	7.40	1,801.65	1,121.31	686.60	7.31	1,815.22			
Roseburg	775.41	565.83	2.12	1,343.36	779.06	564.84	2.09	1,346.00	785.74	566.18	2.07	1,353.99			
OR Sub-Total	5,790.88	3,526.40	91.36	9,408.64	5,810.92	3,533.32	90.10	9,434.34	5,856.37	3,555.07	88.95	9,500.40			
Washington Both	6,298.63	3,687.37	137.17	10,123.17	6,249.56	3,676.10	135.89	10,061.54	6,238.59	3,663.85	135.14	10,057.59			
Washington GTN	868.78	508.60	18.92	1,396.30	862.01	507.05	18.74	1,387.80	860.50	508.12	18.64	1,387.25			
Washington NWP	3,692.30	2,161.56	80.41	5,934.27	3,663.54	2,154.95	79.66	5,898.15	3,657.11	2,159.50	79.22	5,895.83			
WA Sub-Total	10,859.71	6,357.54	236.50	17,453.74	10,775.10	6,338.09	234.29	17,347.49	10,756.20	6,351.47	233.00	17,340.67			
Idaho Both	3,257.34	1,785.49	147.20	5,190.03	3,245.23	1,779.60	146.95	5,171.79	3,255.23	1,783.02	147.32	5,185.57			
Idaho GTN	449.29	246.27	20.30	715.87	447.62	245.46	20.27	713.35	449.00	245.93	20.32	715.25			
Idaho NWP	1,909.47	1,046.67	86.29	3,042.43	1,902.38	1,043.21	86.15	3,031.74	1,908.24	1,045.22	86.36	3,039.82			
ID Sub-Total	5,616.10	3,078.43	253.80	8,948.33	5,595.23	3,068.27	253.37	8,916.87	5,612.47	3,074.17	253.99	8,940.64			
Case Total	22,266.69	12,962.37	581.65	35,810.71	22,181.25	12,939.69	577.76	35,698.70	22,225.04	12,980.72	575.95	35,781.71			

Area	2032-2033:		Ind FirmSale	2032-2033:		2033-2034:		Ind FirmSale	2033-2034:		2034-2035:		Ind FirmSale	2034-2035:	
	Residential	Commercial		Total	Residential	Commercial	Total		Residential	Commercial	Total	Residential		Commercial	Total
Klamath Falls	962.62	462.23	12.00	1,436.85	966.73	462.63	11.78	1,441.14	970.81	463.02	11.56	1,445.39			
La Grande	487.74	308.53	50.11	846.37	487.51	308.33	49.21	845.05	487.22	308.18	48.28	843.68			
Medford GTN	2,490.55	1,526.20	15.94	4,032.70	2,496.23	1,530.45	15.66	4,042.33	2,501.29	1,534.50	15.37	4,051.16			
Medford NWP	1,118.94	685.69	7.16	1,811.79	1,121.49	687.59	7.04	1,816.12	1,123.77	689.41	6.90	1,820.08			
Roseburg	784.95	562.39	2.03	1,349.36	787.61	561.05	1.99	1,350.66	790.17	559.72	1.95	1,351.85			
OR Sub-Total	5,844.79	3,545.03	87.24	9,477.06	5,859.57	3,550.05	85.68	9,495.31	5,873.25	3,554.84	84.07	9,512.16			
Washington Both	6,175.35	3,659.08	133.40	9,967.82	6,148.66	3,656.15	132.18	9,937.00	6,130.28	3,656.38	130.98	9,917.64			
Washington GTN	851.77	504.70	18.40	1,374.87	848.09	504.30	18.23	1,370.62	845.56	504.33	18.07	1,367.95			
Washington NWP	3,620.03	2,144.98	78.20	5,843.21	3,604.39	2,143.26	77.49	5,825.14	3,593.61	2,143.39	76.78	5,813.79			
WA Sub-Total	10,647.15	6,308.76	229.99	17,185.90	10,601.14	6,303.71	227.90	17,132.75	10,569.45	6,304.10	225.83	17,099.38			
Idaho Both	3,241.26	1,772.05	146.52	5,159.83	3,248.42	1,771.81	146.33	5,166.56	3,261.75	1,773.29	146.14	5,181.18			
Idaho GTN	447.07	244.42	20.21	711.70	448.06	244.39	20.18	712.63	449.90	244.59	20.16	714.65			
Idaho NWP	1,900.05	1,038.79	85.89	3,024.73	1,904.25	1,038.65	85.78	3,028.67	1,912.06	1,039.51	85.67	3,037.24			
ID Sub-Total	5,588.38	3,055.25	252.62	8,896.25	5,600.73	3,054.84	252.29	8,907.86	5,623.71	3,057.39	251.97	8,933.07			
Case Total	22,080.32	12,909.04	569.85	35,559.21	22,061.44	12,908.61	565.87	35,535.92	22,066.41	12,916.33	561.87	35,544.61			

Area	2035-2036:		Ind FirmSale	2035-2036:		2036-2037:		Ind FirmSale	2036-2037:	
	Residential	Commercial		Total	Residential	Commercial	Total			
Klamath Falls	980.21	465.79	11.38	1,457.38	979.29	463.88	11.11	1,454.28		
La Grande	488.98	309.36	47.42	845.75	486.55	307.72	46.39	840.65		
Medford GTN	2,518.14	1,545.09	15.12	4,078.35	2,511.07	1,542.25	14.77	4,068.09		
Medford NWP	1,131.34	694.17	6.79	1,832.30	1,128.16	692.90	6.64	1,827.69		
Roseburg	796.47	560.91	1.93	1,359.31	795.41	556.96	1.88	1,354.25		
OR Sub-Total	5,915.14	3,575.33	82.63	9,573.09	5,900.48	3,563.70	80.78	9,544.95		
Washington Both	6,150.20	3,677.29	130.28	9,957.77	6,113.02	3,665.14	128.60	9,906.76		
Washington GTN	848.30	507.21	17.97	1,373.49	843.18	505.54	17.74	1,366.45		
Washington NWP	3,605.29	2,155.65	76.37	5,837.31	3,583.49	2,148.53	75.39	5,807.41		
WA Sub-Total	10,603.80	6,340.15	224.63	17,168.57	10,539.69	6,319.20	221.73	17,080.63		
Idaho Both	3,296.46	1,784.49	146.56	5,227.51	3,302.97	1,780.81	145.80	5,229.58		
Idaho GTN	454.68	246.14	20.22	721.04	455.58	245.63	20.11	721.32		
Idaho NWP	1,932.41	1,046.08	85.91	3,064.40	1,936.23	1,043.92	85.47	3,065.62		
ID Sub-Total	5,683.55	3,076.70	252.69	9,012.94	5,694.78	3,070.36	251.38	9,016.52		
Case Total	22,202.49	12,992.17	559.94	35,754.61	22,134.95	12,953.27	553.89	35,642.10		

APPENDIX 2.9: DETAILED DEMAND DATA 80% BELOW 1990 LEVELS

Area	2029-2030:		Ind FirmSale	2029-2030:		2030-2031:		Ind FirmSale	2030-2031:		Ind FirmSale	2031-2032:	
	Residential	Commercial		Total	Residential	Commercial	Total		Residential	Commercial		Total	Residential
Klamath Falls	557.05	269.25	7.00	833.31	530.62	255.60	6.46	792.68	504.62	242.10	5.89	752.61	
La Grande	288.57	182.30	35.73	506.60	273.75	172.79	34.16	480.70	258.88	163.31	32.54	454.73	
Medford GTN	1,460.53	890.20	9.32	2,360.05	1,390.50	847.28	8.59	2,246.38	1,320.24	804.08	7.84	2,132.15	
Medford NWP	656.18	399.94	4.19	1,060.31	624.72	380.66	3.86	1,009.24	593.15	361.25	3.52	957.92	
Roseburg	460.01	333.74	1.19	794.94	438.50	315.88	1.10	755.48	416.68	298.08	1.00	715.77	
OR Sub-Total	3,422.33	2,075.44	57.43	5,555.20	3,258.08	1,972.23	54.17	5,284.48	3,093.57	1,868.82	50.80	5,013.18	
Washington Both	3,375.09	2,061.09	80.56	5,516.74	3,237.53	1,929.82	75.94	5,243.29	2,840.23	1,801.64	71.43	4,713.30	
Washington GTN	465.53	284.29	11.11	760.93	446.56	266.18	10.47	723.21	391.76	248.50	9.85	650.11	
Washington NWP	1,978.50	1,208.22	47.23	3,233.95	1,897.86	1,131.27	44.52	3,073.65	1,664.96	1,056.13	41.88	2,762.97	
WA Sub-Total	5,819.13	3,553.60	138.90	9,511.63	5,581.95	3,327.27	130.93	9,040.16	4,896.95	3,106.27	123.16	8,126.39	
Idaho Both	3,276.37	1,793.60	147.61	5,217.58	3,264.53	1,787.76	147.36	5,199.66	3,274.84	1,791.24	147.73	5,213.81	
Idaho GTN	451.91	247.39	20.36	719.67	450.28	246.59	20.33	717.19	451.70	247.07	20.38	719.15	
Idaho NWP	1,920.63	1,051.42	86.53	3,058.58	1,913.69	1,048.00	86.39	3,048.07	1,919.73	1,050.04	86.60	3,056.37	
ID Sub-Total	5,648.92	3,092.41	254.50	8,995.83	5,628.51	3,082.34	254.08	8,964.93	5,646.28	3,088.35	254.70	8,989.33	
Case Total	14,890.38	8,721.45	450.83	24,062.67	14,468.54	8,381.84	439.18	23,289.56	13,636.80	8,063.43	428.66	22,128.89	

Area	2032-2033:		Ind FirmSale	2032-2033:		2033-2034:		Ind FirmSale	2033-2034:		Ind FirmSale	2034-2035:	
	Residential	Commercial		Total	Residential	Commercial	Total		Residential	Commercial		Total	Residential
Klamath Falls	477.85	228.47	5.33	711.65	451.44	214.95	4.76	671.15	424.97	201.48	4.19	630.64	
La Grande	244.22	153.98	31.12	429.32	229.50	144.64	29.64	403.78	214.84	135.38	28.19	378.41	
Medford GTN	1,249.22	761.24	7.10	2,017.56	1,178.14	718.07	6.35	1,902.56	1,106.93	674.85	5.59	1,787.38	
Medford NWP	561.24	342.00	3.19	906.44	529.31	322.61	2.85	854.77	497.32	303.20	2.51	803.02	
Roseburg	394.71	280.48	0.91	676.09	372.66	262.96	0.81	636.43	350.57	245.60	0.71	596.89	
OR Sub-Total	2,927.24	1,766.16	47.66	4,741.06	2,761.06	1,663.22	44.42	4,468.70	2,594.63	1,560.51	41.20	4,196.34	
Washington Both	2,578.68	1,676.60	67.15	4,322.43	2,324.20	1,557.52	62.96	3,944.69	2,078.22	1,442.66	58.91	3,579.79	
Washington GTN	355.68	231.26	9.26	596.20	320.58	214.83	8.68	544.10	286.65	198.99	8.13	493.76	
Washington NWP	1,511.64	982.84	39.36	2,533.84	1,362.46	913.03	36.91	2,312.40	1,218.27	845.70	34.53	2,098.50	
WA Sub-Total	4,446.00	2,890.69	115.77	7,452.47	4,007.25	2,685.38	108.56	6,801.19	3,583.14	2,487.35	101.56	6,172.05	
Idaho Both	3,261.12	1,780.30	146.93	5,188.35	3,268.56	1,780.12	146.74	5,195.41	3,282.18	1,781.64	146.55	5,210.38	
Idaho GTN	449.81	245.56	20.27	715.63	450.84	245.53	20.24	716.61	452.71	245.74	20.21	718.67	
Idaho NWP	1,911.69	1,043.63	86.13	3,041.44	1,916.05	1,043.52	86.02	3,045.59	1,924.04	1,044.41	85.91	3,054.36	
ID Sub-Total	5,622.61	3,069.49	253.32	8,945.43	5,635.45	3,069.17	252.99	8,957.61	5,658.93	3,071.80	252.68	8,983.41	
Case Total	12,995.86	7,726.34	416.75	21,138.95	12,403.76	7,417.77	405.97	20,227.50	11,836.69	7,119.66	395.44	19,351.80	

Area	2035-2036:		Ind FirmSale	2035-2036:		2036-2037:		Ind FirmSale	2036-2037:	
	Residential	Commercial		Total	Residential	Commercial	Total		Residential	Commercial
Klamath Falls	398.81	188.13	3.61	590.55	372.02	174.65	3.06	549.73		
La Grande	200.15	126.11	26.68	352.95	185.74	116.91	25.34	327.99		
Medford GTN	1,035.86	631.31	4.82	1,672.00	964.76	588.17	4.09	1,557.02		
Medford NWP	465.39	283.63	2.17	751.19	433.44	264.25	1.84	699.53		
Roseburg	328.47	228.32	0.62	557.41	306.41	211.20	0.52	518.13		
OR Sub-Total	2,428.68	1,457.51	37.90	3,924.09	2,262.38	1,355.18	34.84	3,652.40		
Washington Both	1,988.12	1,331.66	54.93	3,374.72	1,250.54	1,223.77	51.13	2,525.44		
Washington GTN	274.22	183.68	7.58	465.48	172.49	168.80	7.05	348.34		
Washington NWP	1,165.45	780.63	32.20	1,978.29	733.08	717.38	29.97	1,480.43		
WA Sub-Total	3,427.80	2,295.97	94.72	5,818.49	2,156.10	2,109.95	88.16	4,354.21		
Idaho Both	3,317.22	1,792.91	146.97	5,257.10	3,323.99	1,789.27	146.21	5,259.47		
Idaho GTN	457.55	247.30	20.27	725.12	458.48	246.80	20.17	725.44		
Idaho NWP	1,944.58	1,051.02	86.15	3,081.75	1,948.55	1,048.88	85.71	3,083.14		
ID Sub-Total	5,719.34	3,091.23	253.40	9,063.96	5,731.03	3,084.95	252.09	9,068.06		
Case Total	11,575.82	6,844.71	386.01	18,806.54	10,149.50	6,550.08	375.08	17,074.67		



2018 AVISTA UTILITIES NATURAL GAS CONSERVATION POTENTIAL ASSESSMENT

Volume 1, Final Report

August 7, 2018

Report prepared for:
AVISTA UTILITIES

Energy Solutions. Delivered.

This work was performed by:

Applied Energy Group, Inc.
500 Ygnacio Valley Road, Suite 250
Walnut Creek, CA 94596

Project Director: I. Rohmund
Project Manager: K. Kolnowski
Lead Analyst: F. Nguyen

AEG would also like to acknowledge the valuable contributions of

Avista Utilities
1411 E Mission MSC-15
Spokane, WA 99220

Project Team: Amber Gifford
Ryan Finesilver
Tom Pardee
Kaylene Schultz

EXECUTIVE SUMMARY

In the winter of 2017, Avista Utilities (Avista) contracted with Applied Energy Group (AEG) to conduct this Conservation Potential Assessment (CPA) in support of their conservation and resource planning activities. This report documents this effort and provides estimates of the potential reductions in annual energy usage for natural gas customers in Avista's Washington and Idaho service territories from energy conservation efforts in the time period of 2018 to 2038. To produce a reliable and transparent estimate of energy efficiency (EE) resource potential, the AEG team performed the following tasks to meet Avista's key objectives:

- Used information and data from Avista, as well as secondary data sources, to describe how customers currently use gas by sector, segment, end use and technology.
- Developed a baseline projection of how customers are likely to use gas in absence of future EE programs. This defines the metric against which future program savings are measured. This projection used up-to-date technology data, modeling assumptions, and energy baselines that reflect both current and anticipated federal, state, and local energy efficiency legislation that will impact energy EE potential.
- Estimated the technical, achievable technical, and achievable economic potential at the measure level for energy efficiency within Avista's service territory over the 2018 to 2038 planning horizon.
- Delivered a fully configured end-use conservation planning model, LoadMAP, for Avista to use in future potential and resource planning initiatives

In summary, the potential study provided a solid foundation for the development of Avista's energy savings targets.

Table ES-1 summarizes the results for Avista's Washington territory at a high level. AEG analyzed potential for the residential, commercial, and industrial market sectors. First-year utility cost test (UCT) achievable economic potential in Washington is 61,279 dekatherms. This increases to a cumulative total of 133,576 dekatherms in the second year and 1,916,441 dekatherms by the eleventh year.

Table ES-1 Washington Conservation Potential by Case, Selected Years (dekatherms)

Scenario	2018	2019	2022	2028	2038
Baseline Projection (Dth)	17,221,900	17,418,177	17,878,550	18,517,630	19,498,948
Cumulative Savings (Dth)					
UCT Achievable Economic Potential	61,279	133,576	500,422	1,916,441	4,139,016
Achievable Technical Potential	86,389	186,065	655,389	2,405,890	4,901,043
Technical Potential	217,202	434,037	1,189,331	3,251,362	5,804,041
Cumulative Savings (% of Baseline)					
UCT Achievable Economic Potential	0.4%	0.8%	2.8%	10.3%	21.2%
Achievable Technical Potential	0.5%	1.1%	3.7%	13.0%	25.1%
Technical Potential	1.3%	2.5%	6.7%	17.6%	29.8%

Table ES-2 summarizes the results for Avista's Idaho territory at a high level. First-year utility cost test (UCT) achievable economic potential in Idaho is 26,340 dekatherms. This increases to a cumulative total of 58,352 dekatherms in the second year and 965,825 dekatherms by the eleventh year.

Table ES-2 Idaho Conservation Potential by Case, Selected Years (dekatherms)

Scenario	2018	2019	2022	2028	2038
Baseline Projection (Dth)	8,557,178	8,667,149	8,958,733	9,352,011	9,975,077
Cumulative Savings (Dth)					
UCT Achievable Economic Potential	26,340	58,352	235,414	965,825	2,107,684
Achievable Technical Potential	37,324	81,526	310,222	1,218,944	2,514,049
Technical Potential	103,071	206,214	582,638	1,660,809	2,993,151
Cumulative Savings (% of Baseline)					
UCT Achievable Economic Potential	0.3%	0.7%	2.6%	10.3%	21.1%
Achievable Technical Potential	0.4%	0.9%	3.5%	13.0%	25.2%
Technical Potential	1.2%	2.4%	6.5%	17.8%	30.0%

As part of this study, we also estimated total resource cost (TRC) potential, with the focus of fully balancing non-energy impacts. This includes the use of full measure costs as well as quantified and monetizable non-energy impacts and non-gas fuel impacts (e.g. electric cooling or wood secondary heating) consistent with methodology within the Seventh Northwest Conservation and Electric Power Plan (Seventh Plan). We explore this potential in more detail throughout the report.

CONTENTS

	Executive Summary	i
1	INTRODUCTION	1
	Goals of the Conservation Potential Assessment	1
	Summary of Report Contents	2
	Abbreviations and Acronyms	4
2	ANALYSIS APPROACH AND DATA DEVELOPMENT	5
	Overview of Analysis Approach	5
	Comparison with Northwest Power & Conservation Council Methodology	5
	LoadMAP Model	6
	Definitions of Potential	7
	Market Characterization	9
	Baseline Projection	10
	Energy Efficiency Measure Development	11
	Calculation of Energy Conservation Potential	14
	Data Development	16
	Data Sources	16
	Application of Data to the Analysis	19
3	MARKET CHARACTERIZATION AND MARKET PROFILES	25
	Overall Energy Use Summary	25
	Residential Sector	27
	Washington Characterization	27
	Idaho Characterization	29
	Commercial Sector	32
	Washington Characterization	32
	Idaho Characterization	35
	Industrial Sector	38
	Washington Characterization	38
	Idaho Characterization	39
4	BASELINE PROJECTION	41
	Overall Baseline Projection	42
	Washington Projection	42
	Idaho Projection	43
	Residential Sector	44
	Washington Projection	44
	Idaho Projection	45
	Commercial Sector	46
	Washington Projection	46
	Idaho Projection	47
	Industrial Sector	48
	Washington Projection	48
	Idaho Projection	49
5	OVERALL ENERGY EFFICIENCY POTENTIAL	50

Overall Energy Efficiency Potential 50
 Washington Potential 50
 Idaho Potential 54

6 SECTOR-LEVEL ENERGY EFFICIENCY POTENTIAL 57
 Residential Sector 57
 Washington Potential 57
 Idaho Potential 60
 Commercial Sector 63
 Washington Potential 63
 Idaho Potential 66
 Industrial Sector 69
 Washington Potential 69
 Idaho Potential 72
 Incorporating the Total Resource Cost Test 75

7 COMPARISON WITH CURRENT PROGRAMS 76
 Washington Comparison with 2017 Programs and 2018 Plan 76
 Residential Sector 76
 Commercial and Industrial Sectors 77
 Idaho Comparison with 2017 Programs and 2018 Plan 78
 Residential Sector 78
 Commercial and Industrial Sectors 79

8 COMPARISON WITH CURRENT PROGRAMS 80
 Residential Comparison with 2016 CPA 80
 Nonresidential Comparison with 2016 CPA 81

LIST OF FIGURES

Figure 1-1	Avista's Service Territory (courtesy Avista)	2
Figure 2-1	LoadMAP Analysis Framework	7
Figure 2-2	Approach for ECM Assessment	12
Figure 3-1	Sector-Level Natural Gas Use in Base Year 2015, Washington (annual therms, percent)	25
Figure 3-2	Sector-Level Natural Gas Use in Base Year 2015, Idaho (annual therms, percent)	26
Figure 3-3	Residential Natural Gas Use by Segment, Washington, 2015	27
Figure 3-4	Residential Natural Gas Use by End Use, Washington, 2015	28
Figure 3-5	Residential Energy Intensity by End Use and Segment, Washington, 2015 (Annual Therms/HH)	28
Figure 3-6	Residential Natural Gas Use by Segment, Idaho, 2015	30
Figure 3-7	Residential Natural Gas Use by End Use, Idaho, 2015	30
Figure 3-8	Residential Energy Intensity by End Use and Segment, Idaho, 2015 (Annual Therms/HH)	31
Figure 3-9	Commercial Natural Gas Use by Segment, Washington, 2015	33
Figure 3-10	Commercial Sector Natural Gas Use by End Use, Washington, 2015	33
Figure 3-11	Commercial Energy Usage Intensity by End Use and Segment, Washington, 2015 (Annual Therms/Sq. Ft)	34
Figure 3-12	Commercial Natural Gas Use by Segment, Idaho, 2015	36
Figure 3-13	Commercial Sector Natural Gas Use by End Use, Idaho, 2015	36
Figure 3-14	Commercial Energy Usage Intensity by End Use and Segment, Idaho, 2015 (Annual Therms/Sq. Ft)	37
Figure 3-15	Industrial Natural Gas Use by End Use, Washington, 2015	38
Figure 3-16	Industrial Natural Gas Use by End Use, Idaho, 2015	40
Figure 4-1	Baseline Projection Summary by Sector, Washington (dekatherms)	42
Figure 4-2	Baseline Projection Summary by Sector, Idaho (dekatherms)	43
Figure 4-3	Residential Baseline Projection by End Use, Washington (dekatherms)	44
Figure 4-4	Residential Baseline Projection by End Use, Idaho (dekatherms)	45
Figure 4-5	Commercial Baseline Projection by End Use, Washington (dekatherms)	46
Figure 4-6	Commercial Baseline Projection by End Use, Idaho (dekatherms)	47
Figure 4-7	Industrial Baseline Projection by End Use, Washington (dekatherms)	48
Figure 4-8	Industrial Baseline Projection by End Use, Idaho (dekatherms)	49
Figure 5-1	Summary of Energy Efficiency Potential as % of Baseline Projection, Washington (dekatherms)	52
Figure 5-2	Baseline Projection and Energy Efficiency Forecasts, Washington (dekatherms)	52
Figure 5-3	Cumulative UCT Achievable Economic Potential by Sector, Washington (% of Total)	53
Figure 5-4	Summary of Energy Efficiency Potential as % of Baseline Projection, Idaho (dekatherms)	55
Figure 5-5	Summary of Energy Efficiency Potential as % of Baseline Projection, Idaho (dekatherms)	55

Figure 5-6 Cumulative UCT Achievable Economic Potential by Sector, Idaho (% of Total) ...56

Figure 6-1 Residential Energy Conservation by Case, Washington (dekatherms)57

Figure 6-2 Residential UCT Achievable Economic Potential – Cumulative Savings by End Use, Washington (dekatherms, % of total)58

Figure 6-3 Residential Energy Conservation by Case, Idaho (dekatherms)60

Figure 6-4 Residential UCT Achievable Economic Potential – Cumulative Savings by End Use, Idaho (dekatherms, % of total)61

Figure 6-5 Commercial Energy Conservation by Case, Washington (dekatherms)63

Figure 6-6 Commercial UCT Achievable Economic Potential – Cumulative Savings by End Use, Washington (dekatherms, % of total)64

Figure 6-7 Commercial Energy Conservation by Case, Idaho (dekatherms)66

Figure 6-8 Commercial UCT Achievable Economic Potential – Cumulative Savings by End Use, Idaho (dekatherms, % of total)67

Figure 6-9 Industrial Energy Conservation Potential, Washington (dekatherms)69

Figure 6-10 Industrial UCT Achievable Economic Potential – Cumulative Savings by End Use, Washington (dekatherms, % of total)70

Figure 6-11 Industrial Energy Conservation Potential, Idaho (dekatherms)72

Figure 6-12 Industrial UCT Achievable Economic Potential – Cumulative Savings by End Use, Idaho (dekatherms, % of total)73

LIST OF TABLES

Table ES-1	Washington Conservation Potential by Case, Selected Years (dekatherms)	i
Table ES-2	Idaho Conservation Potential by Case, Selected Years (dekatherms)	ii
Table 1-1	Explanation of Abbreviations and Acronyms	4
Table 2-1	Overview of Avista Analysis Segmentation Scheme	9
Table 2-2	Example Equipment Measures for Direct Fuel Furnace – Single-Family Home, Washington	13
Table 2-3	Example Non-Equipment Measures – Existing Single Family Home, Washington ...	14
Table 2-4	Number of Measures Evaluated	14
Table 2-5	Data Applied for the Market Profiles	20
Table 2-6	Data Applied for the Baseline Projection in LoadMAP	21
Table 2-7	Residential Natural Gas Equipment Federal Standards	22
Table 2-8	Commercial and Industrial Natural Gas Equipment Standards	22
Table 2-9	Data Inputs for the Measure Characteristics in LoadMAP	23
Table 3-1	Avista Sector Control Totals, Washington, 2015	25
Table 3-2	Avista Sector Control Totals, Idaho, 2015	26
Table 3-3	Residential Sector Control Totals, Washington, 2015	27
Table 3-4	Average Market Profile for the Residential Sector, 2015	29
Table 3-5	Residential Sector Control Totals, Idaho, 2015	29
Table 3-6	Average Market Profile for the Residential Sector, 2015	31
Table 3-7	Commercial Sector Control Totals, Washington, 2015	32
Table 3-8	Average Market Profile for the Commercial Sector, Washington, 2015	34
Table 3-9	Commercial Sector Control Totals, Idaho, 2015	35
Table 3-10	Average Market Profile for the Commercial Sector, Idaho, 2015	37
Table 3-11	Industrial Sector Control Totals, Washington, 2015	38
Table 3-12	Average Natural Gas Market Profile for the Industrial Sector, Washington, 2015 ..	39
Table 3-13	Industrial Sector Control Totals, Idaho, 2015	39
Table 3-14	Average Natural Gas Market Profile for the Industrial Sector, Washington, 2015 ..	40
Table 4-1	Baseline Projection Summary by Sector, Washington, Selected Years (dekatherms)	42
Table 4-2	Baseline Projection Summary by Sector, Idaho, Selected Years (dekatherms)	43
Table 4-3	Residential Baseline Projection by End Use, Washington (dekatherms)	44
Table 4-4	Residential Baseline Projection by End Use, Idaho (dekatherms)	45
Table 4-5	Commercial Baseline Projection by End Use, Washington (dekatherms)	46
Table 4-6	Commercial Baseline Projection by End Use, Idaho (dekatherms)	47
Table 4-7	Industrial Baseline Projection by End Use, Washington (dekatherms)	48
Table 4-8	Industrial Baseline Projection by End Use, Idaho (dekatherms)	49
Table 5-1	Summary of Energy Efficiency Potential, Washington (dekatherms)	51
Table 5-2	Cumulative UCT Achievable Economic Potential by Sector, Washington, Selected Years (dekatherms)	53
Table 5-3	Summary of Energy Efficiency Potential, Idaho (dekatherms)	54

Table 5-4 Cumulative UCT Achievable Economic Potential by Sector, Idaho, Selected Years (dekatherms).....56

Table 6-1 Residential Energy Conservation Potential Summary, Washington (dekatherms) .57

Table 6-2 Residential Top Measures in 2018 and 2019, UCT Achievable Economic Potential, Washington (dekatherms)59

Table 6-3 Residential Energy Conservation Potential Summary, Idaho (dekatherms)60

Table 6-4 Residential Top Measures in 2018 and 2019, UCT Achievable Economic Potential, Idaho (dekatherms)62

Table 6-5 Commercial Energy Conservation Potential Summary, Washington.....63

Table 6-6 Commercial Top Measures in 2018 and 2019, UCT Achievable Economic Potential, Washington (dekatherms)65

Table 6-7 Commercial Energy Conservation Potential Summary, Idaho66

Table 6-8 Commercial Top Measures in 2018 and 2019, UCT Achievable Economic Potential, Idaho (dekatherms)68

Table 6-9 Industrial Energy Conservation Potential Summary, Washington (dekatherms)69

Table 6-10 Industrial Top Measures in 2018 and 2019, UCT Achievable Economic Potential, Washington (dekatherms)71

Table 6-11 Industrial Energy Conservation Potential Summary, Idaho (dekatherms).....72

Table 6-12 Industrial Top Measures in 2018 and 2019, UCT Achievable Economic Potential, Idaho (dekatherms).....74

Table 7-1 Comparison of Avista's Washington Residential Programs with 2018 UCT Achievable Economic Potential (dekatherms)76

Table 7-2 Comparison of Avista's Washington Nonresidential Accomplishments with 2018 UCT Achievable Economic Potential (dekatherms)77

Table 7-3 Comparison of Avista's Idaho Residential Programs with 2018 UCT Achievable Economic Potential (dekatherms)78

Table 7-4 Comparison of Avista's Idaho Nonresidential Accomplishments with 2018 UCT Achievable Economic Potential (dekatherms)79

Table 8-1 Comparison of Avista's Residential UCT Achievable Economic Potential between the 2016 and 2018 CPAs (dekatherms)80

Table 8-2 Comparison of Avista's Nonresidential UCT Achievable Economic Potential between the 2016 and 2018 CPAs (dekatherms)81

1

INTRODUCTION

This report documents the results of the Avista Utilities 2018-2038 Conservation Potential Assessment (CPA) as well as the steps followed in its completion. Throughout this study, AEG worked with Avista to understand the baseline characteristics of their service territory, including a detailed understanding of energy consumption in the territory, the assumptions and methodologies used in Avista's official load forecast, and recent programmatic accomplishments. Adapting methodologies consistent with the Northwest Power and Conservation Council's (Council's) Seventh Conservation and Electric Power Plan¹ for natural gas studies, AEG then developed an independent estimate of achievable, cost-effective EE potential within Avista's service territory between 2018 and 2038.

Goals of the Conservation Potential Assessment

The first primary objective of this study was to develop independent and credible estimates of EE potential achievable available within Avista's service territory using accepted regional inputs and methodologies. This included estimating technical, achievable technical, then achievable economic potential, using the Council's ramp rates as the starting point for all achievability assumptions, leveraging Northwest Energy Efficiency Alliance's (NEEA's) market research initiatives, and utilizing assumptions consistent with Seventh Plan supply curves and RTF measure workbooks when appropriate for use in natural gas planning studies.

Additionally, the CPA is intended to support the design of programs to be implemented by Avista during the upcoming years. One output of the LoadMAP model is a comprehensive summary of measures. This summary documents input assumptions and sources on a per-unit value, program applicability and achievability (ramp rates), and potential results (units, incremental potential, and cumulative potential) as well as cost-effectiveness at the UCT and TRC levels. This summary was developed in collaboration with Avista and refined throughout the project.

Finally, this study was developed to provide EE inputs into Avista's Integrated Resource Planning (IRP) process. To this end, AEG developed detailed achievable economic EE inputs by measure for input into Avista's SENDOUT planning model under the utility cost test (UCT). These inputs are highly customizable and provide potential estimates at the state level by measure and end use. We present a map of Avista's service territory in Figure 1-1.

¹ "Seventh Northwest Conservation and Electric Power Plan." Northwest Power & Conservation Council, February 10, 2015. <http://www.nwcouncil.org/energy/powerplan/7/plan/>

Figure 1-1 Avista's Service Territory (courtesy Avista)



Summary of Report Contents

The document is divided into seven additional chapters, summarizing the approach, assumptions, and results of the EE potential analysis. We describe each section below:

Volume 1, Final Report:

- **Analysis Approach and Data Development.** Detailed description of AEG's approach to conducting Avista's 2018-2038 Natural Gas CPA and documentation of primary and secondary sources used.
- **Market Characterization and Market Profiles.** Characterization of Avista's service territory in the base year of the study, 2015, including total consumption, number of customers and market units, and energy intensity. This also includes a breakdown of the energy consumption for residential, commercial, and eligible industrial customers by end use and technology.
- **Baseline Projection.** Projection of baseline energy consumption under a naturally occurring efficiency case, described at the end-use level. The LoadMAP models were first aligned with actual sales and Avista's official, weather-normalized econometric forecast and then varied to include the impacts of future federal standards, ongoing impacts of energy codes, such as the 2015 Washington State Energy Code on new construction, and future technology purchasing decisions.
- **Overall Energy Efficiency Potential.** Summary of EE potential for Avista's Washington and Idaho service territories for selected years between 2018 and 2038.
- **Sector-Level Energy Efficiency Potential.** Summary of EE potential for each market sector within Avista's service territory, including residential, commercial, and eligible industrial customers for both

Washington and Idaho. This section includes a more detailed breakdown of potential by measure type, vintage, market segment, end use, and state.

- Comparison with Current Programs Detailed comparison of potential with Avista's 2016 CPA and current Avista programs, including new opportunities for potential.
- Comparison with 2016 CPA Detailed comparison of potential with Avista's 2016 CPA, conducted by AEG.

Volume 2, Appendices:

- Market Profiles. Detailed market profiles for each market segment. Includes equipment saturation, unit energy consumption or energy usage index, energy intensity, and total consumption.
- Customer Adoption Factors. Documentation of the ramp rates used in this analysis. These were adapted from the Seventh Plan electrical power conservation supply curve workbooks for use in the estimation of achievable natural gas potential.
- Measure List. Contained in a separate spreadsheet accompanying delivery of this report. List of measures, along with example baseline definitions and efficiency options by market sector analyzed.
- Detailed Measure Assumptions. Contained in a separate spreadsheet accompanying delivery of this report. This dataset provides input assumptions, measure characteristics, cost-effectiveness results, and potential estimates for each measure permutation analyzed within the study.

Abbreviations and Acronyms

Throughout the report we use several abbreviations and acronyms. Table 1-1 shows the abbreviation or acronym, along with an explanation.

Table 1-1 Explanation of Abbreviations and Acronyms

Acronym	Explanation
AEO	Annual Energy Outlook forecast developed by EIA
B/C Ratio	Benefit to Cost Ratio
BEST	AEG's Building Energy Simulation Tool
BPA	Bonneville Power Administration
C&I	Commercial and Industrial
CBSA	NEEA's 2014 Commercial Building Stock Assessment
Council	Northwest Power and Conservation Council (NWPCC)
DHW	Domestic Hot Water
DSM	Demand Side Management
EE	Energy Efficiency
EIA	Energy Information Administration
EUL	Estimated Useful Life
EUI	Energy Usage Intensity
HVAC	Heating Ventilation and Air Conditioning
IFSA	NEEA's 2014 Industrial Facilities Site Assessment
IRP	Integrated Resource Plan
LoadMAP	AEG's Load Management Analysis and Planning™ tool
NEEA	Northwest Energy Efficiency Alliance
O&M	Operations and Maintenance
RBSA	NEEA's 2012 Residential Building Stock Assessment
RTF	Regional Technical Forum
RVT	Resource Value Test
TRC	Total Resource Cost test
UCT	Utility Cost Test
UEC	Unit Energy Consumption
UES	Unit Energy Savings
WSEC	2015 Washington State Energy Code

2

ANALYSIS APPROACH AND DATA DEVELOPMENT

This section describes the analysis approach taken for the study and the data sources used to develop the potential estimates.

Overview of Analysis Approach

To perform the potential analysis, AEG used a bottom-up approach following the major steps listed below. We describe these analysis steps in more detail throughout the remainder of this chapter.

1. Performed a market characterization to describe sector-level natural gas use for the residential, commercial, and industrial sectors for the base year, 2015. This included extensive use of Avista data and other secondary data sources from NEEA and the Energy Information Administration (EIA).
2. Developed a baseline projection of energy consumption by sector, segment, end use, and technology for 2016 through 2038.
3. Defined and characterized several hundred EE measures to be applied to all sectors, segments, and end uses.
4. Estimated technical, achievable technical, and achievable economic energy savings at the measure level for 2018-2038. Achievable economic potential was assessed using both the UCT and TRC screens.

Comparison with Northwest Power & Conservation Council Methodology

It is important to note the Council's methodology was developed for, and used, in electric CPAs. Natural gas impacts are typically assessed when they overlap with electricity measures (e.g. gas water heating impacts in an electrically heated "Built Green Washington" home). The Council's ramp rates were also developed with electric utility DSM programs in mind. Electricity is the primary focus of the regionwide potential assessed in the Council's Plans. Although Avista is a dual-fuel utility, this study focuses on natural gas measures and programs, which exhibit noticeable differences from electric programs, notably regarding avoided costs. To account for this, AEG adapted Council methodologies in some cases, rather than using them directly from the source. This is especially relevant in the development of ramp rates when achievability was determined to not be applicable to a specific natural gas measure or program. We discuss this in Section 7 of this report.

A primary objective of the study was to estimate natural gas potential consistent with the Northwest Power & Conservation Council's (NWPCC) analytical methodologies and procedures for electric utilities. While developing Avista's 2018-2038 CPA, the AEG team relied on an approach vetted and adapted through the successful completion of CPAs under the Council's Fifth, Sixth, and now Seventh Power Plans. Among other aspects, this approach involves using consistent:

- Data sources: Avista surveys, regional surveys, market research, and assumptions
- Measures and assumptions: Avista TRM, Seventh Plan supply curves and RTF work products
- Potential factors: Seventh Plan ramp rates
- Levels of potential: technical, achievable technical, and achievable economic

- Cost-effectiveness approaches: assessed potential under the UCT as well as Council's TRC method, including non-energy impacts (and non-gas energy impacts) which may be quantified and monetized as well as O&M impacts within the TRC
- Conservation credits: applied a 10% conservation credit to avoided energy costs for energy benefits was applied to the TRC calculation

LoadMAP Model

For this analysis, AEG used its Load Management Analysis and Planning tool (LoadMAP™) version 5.0 to develop both the baseline projection and the estimates of potential. AEG developed LoadMAP in 2007 and has enhanced it over time, using it for the EPRI National Potential Study and numerous utility-specific forecasting and potential studies since. Built in Excel, the LoadMAP framework (see Figure 2-1) is both accessible and transparent and has the following key features.

- Embodies the basic principles of rigorous end-use models (such as EPRI's Residential End-Use Energy Planning System (REEPS) and Commercial End-Use Planning System (COMMEND)) but in a more simplified, accessible form.
- Includes stock-accounting algorithms that treat older, less efficient appliance/equipment stock separately from newer, more efficient equipment. Equipment is replaced according to the measure life and appliance vintage distributions defined by the user.
- Balances the competing needs of simplicity and robustness by incorporating important modeling details related to equipment saturations, efficiencies, vintage, and the like, where market data are available, and treats end uses separately to account for varying importance and availability of data resources.
- Isolates new construction from existing equipment and buildings and treats purchase decisions for new construction and existing buildings separately. This is especially relevant in the state of Washington where the 2015 WSEC substantially enhances the efficiency of the new construction market.
- Uses a simple logic for appliance and equipment decisions. Other models available for this purpose embody complex customer choice algorithms or diffusion assumptions, and the model parameters tend to be difficult to estimate or observe and sometimes produce anomalous results that require calibration or even overriding. The LoadMAP approach allows the user to drive the appliance and equipment choices year by year directly in the model. This flexible approach allows users to import the results from diffusion models or to input individual assumptions. The framework also facilitates sensitivity analysis.
- Includes appliance and equipment models customized by end use. For example, the logic for water heating is distinct from furnaces and fireplaces.
- Can accommodate various levels of segmentation. Analysis can be performed at the sector level (e.g., total residential) or for customized segments within sectors (e.g., housing type, state, or income level).
- Natively outputs model results in a detailed line-by-line summary file, allowing for review of input assumptions, cost-effectiveness results, and potential estimates at a granular level. Also allows for the development of IRP supply curves, both at the achievable technical and achievable economic potential levels.

Consistent with the segmentation scheme and the market profiles we describe below, the LoadMAP model provides projections of baseline energy use by sector, segment, end use, and technology for existing and new buildings. It also provides forecasts of total energy use and energy-efficiency savings associated with the various types of potential.²

Figure 2-1 LoadMAP Analysis Framework

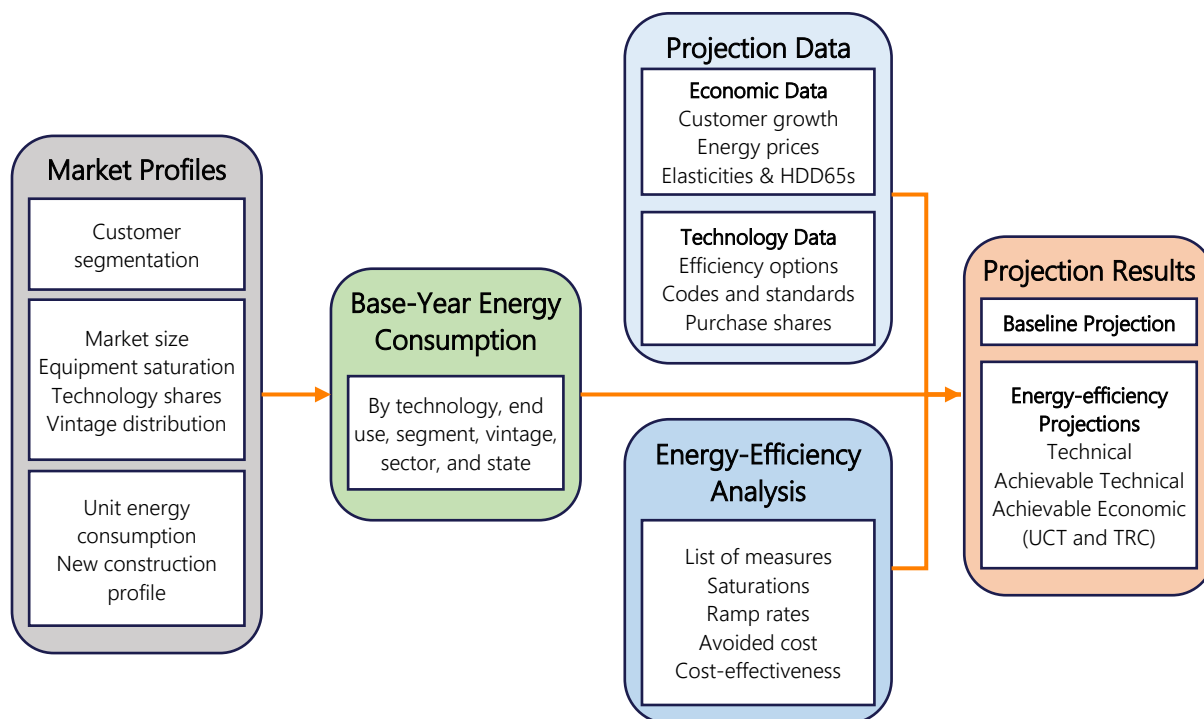

Definitions of Potential

Before we delve into the details of the analysis approach, it is important to define what we mean when discussing energy efficiency (EE) potential. In this study, the savings estimates are developed for three types of potential: technical potential, economic potential, and achievable potential. These are developed at the measure level, and results are provided as savings impacts over the 21-year forecasting horizon. The various levels are described below.

- Technical Potential is defined as the *theoretical* upper limit of EE potential. It assumes customers adopt all feasible measures regardless of their cost. At the time of existing equipment failure, customers replace their equipment with the most efficient option available. In new construction, customers and developers also choose the most efficient equipment option.

Technical potential also assumes the adoption of every other available measure, where technically feasible. For example, it includes installation of high-efficiency windows in all new construction opportunities and furnace maintenance in all existing buildings with installed furnaces. These retrofit measures are phased in over a number of years to align with the stock turnover of related equipment units, rather than modeled as immediately available all at once.

² The model computes energy forecasts for each type of potential for each end use as an intermediate calculation. Annual-energy savings are calculated as the difference between the value in the baseline projection and the value in the potential forecast (e.g., the technical potential forecast).

- Achievable Technical Potential refines technical potential by applying customer participation rates that account for market barriers, customer awareness and attitudes, program maturity, and other factors that affect market penetration of conservation measures. The customer adoption rates used in this study were the ramp rates developed for the Northwest Power & Conservation Council's Seventh Plan based on the electric-utility model, tailored for use in natural gas EE programs.
- UCT Achievable Economic Potential further refines achievable technical potential by applying an economic cost-effectiveness screen. In this analysis, primary cost-effectiveness is measured by the utility cost test (UCT), which assesses cost-effectiveness from the utility's perspective. This test compares lifetime energy benefits to the costs of delivering the measure through a utility program, excluding monetized non-energy impacts. These costs are the incentive, as a percent of incremental cost of the given efficiency measure, relative to the relevant baseline course of action (e.g. federal standard for lost opportunity and no action for retrofits), plus any administrative costs that are incurred by the program to deliver and implement the measure. If the benefits outweigh the costs (that is, if the UCT ratio is greater than 1.0), a given measure is included in the economic potential.
- TRC Achievable Economic Potential is similar to UCT achievable economic potential in that it refines achievable technical potential through cost-effectiveness analysis. The total resource cost (TRC) test assesses cost-effectiveness from a combined utility and participant perspective. As such, this test includes full measure costs but also includes non-energy impacts realized by the customer if quantifiable and monetized. In addition to non-energy impacts, we assessed the impacts of non-gas savings following Council methodology. This includes a calibration credit for space heating equipment consumption to account for secondary heating equipment present in an average home as well as other electric end-use impacts such as cooling and interior lighting as applicable on a measure-by-measure basis. As a secondary screen, we include TRC results for comparative purposes.

Market Characterization

Now that we have described the modeling tool and provided the definitions of the potential cases, the first step in the actual analysis approach is market characterization. To estimate the savings potential from energy-efficient measures, it is necessary to understand how much energy is used today and what equipment is currently in service. This characterization begins with a segmentation of Avista's natural gas footprint to quantify energy use by sector, segment, end-use application, and the current set of technologies in use. For this we rely primarily on information from Avista, augmenting with secondary sources as necessary.

Segmentation for Modeling Purposes

This assessment first defined the market segments (states, building types, end uses, and other dimensions) that are relevant in Avista's service territory. The segmentation scheme for this project is presented in Table 2-1.

Table 2-1 Overview of Avista Analysis Segmentation Scheme

Dimension	Segmentation Variable	Description
0	State	Washington and Idaho
1	Sector	Residential, Commercial, Industrial
2	Segment	Residential: Single Family, Multifamily, Mobile Home, Low Income Commercial: Office, Restaurant, Retail, Grocery, School, College, Health, Lodging, Warehouse, Miscellaneous Industrial
3	Vintage	Existing and new construction
4	End uses	Heating, secondary heating, water heating, food preparation, process, and miscellaneous (as appropriate by sector)
5	Appliances/end uses and technologies	Technologies such as furnaces, water heaters, and process heating by application, etc.
6	Equipment efficiency levels for new purchases	Baseline and higher-efficiency options as appropriate for each technology

With the segmentation scheme defined, we then performed a high-level market characterization of natural gas sales in the base year, 2015. This is the same year that the 2016 CPA began in. We started in this year for consistency but aligned the forecast (and equipment purchases) in subsequent years with weather-actual sales. This data was based on detailed baseline studies conducted by Avista as well as regional data available. This information provided control totals at a sector level for calibrating the LoadMAP model to known data for the base-year.

Market Profiles

The next step was to develop market profiles for each sector, customer segment, end use, and technology. A market profile includes the following elements:

- Market size is a representation of the number of customers in the segment. For the residential sector, the unit we use is number of households. In the commercial sector, it is floor space measured in square feet. For the industrial sector, it is number of employees.

- Saturations indicate the share of the market that is served by a particular end-use technology. Three types of saturation definitions are commonly used:
 - The conditioned space approach accounts for the fraction of each building that is conditioned by the end use. This applies to cooling and heating end uses.
 - The whole-building approach measures shares of space in a building with an end use regardless of the portion of each building that is served by the end use. Examples are commercial refrigeration and food service, and domestic water heating and appliances.
 - The 100% saturation approach applies to end uses that are generally present in every building or home and are simply set to 100% in the base year.
- UEC (Unit Energy Consumption) or EUI (Energy Usage Index) define consumption for a given technology. UEC represents the amount of energy a given piece of equipment is expected to use in one year. EUI is a UEC indexed to a non-building market unit, such as per square foot or per employee)
 - These are indices that refer to a measure of average annual energy use per market unit (home, floor space, or employee in the residential, commercial, and industrial sector, respectively) that are served by an end-use technology. UECs and EUIs embody an average level of service and average equipment efficiency for the market segment.
- Annual energy intensity for the residential sector represents the average energy use for the technology across all homes in 2015. It is computed as the product of the saturation and the UEC and is defined as therms/household for natural gas. For the commercial and industrial sectors, intensity, computed as the product of the saturation and the EUI, represents the average use for the technology across all floor space or all employees in the base year.
- Annual usage is the annual energy used by each end-use technology in the segment. It is the product of the market size and intensity and is quantified in therms or dekatherms.

The market characterization results and the market profiles are presented in Section 3 and Appendix A.

Baseline Projection

The next step was to develop the baseline projection of annual natural gas use for 2016 through 2038 by customer segment and end use in the absence of new utility energy efficiency programs.

We first aligned with Avista's official forecast. AEG incorporated assumptions and data utilized in the official utility forecast. Avista's heating degree days (base 65°F) were incorporated into the LoadMAP model to align the baseline projection with the official utility forecast. We calibrated to actual sales when available.

The end-use projection includes impacts of future federal standards that were effective as of December 2017, which drive energy consumption down through the study period.

Naturally occurring energy conservation, that is, energy conservation that is realized within the service area independent of utility-sponsored programs, is incorporated into the baseline projection consistent with the US Energy Information Administration's Annual Energy Outlook for the Pacific region. Results of the primary market research were used to calibrate these assumptions to ensure the secondary sources were relevant to Avista customers. For example, some customers will purchase and install energy conservation measures that are available in the market without a utility incentive.

As such, the baseline projection is the foundation for the analysis of savings in future conservation cases and scenarios as well as the metric against which potential savings are measured.

Inputs to the baseline projection include:

- Current economic growth forecasts (i.e., customer growth, changes in weather (Heating Degree Day, base-65°F (HDD65) normalization))
- Trends in fuel shares and equipment saturations
- Existing and approved changes to building codes and equipment standards

We present the baseline projection results for the system as a whole, and for each sector in Section 4.

Energy Efficiency Measure Development

This section describes the framework used to assess the savings, costs, and other attributes of energy efficiency measures. These characteristics form the basis for measure-level cost-effectiveness analyses as well as for determining measure-level savings. For all measures, AEG assembled information to reflect equipment performance, incremental costs, and equipment lifetimes. This information combined with Avista's avoided cost data informs the economic screens that determine economically feasible measures. In this section, AEG would like to acknowledge the work of the Avista team in detailed measure assumptions specific to the territory and region within the Avista TRM, which was provided at the outset of this study.

Figure 2-2 outlines the framework for measure characterization analysis. First, the list of measures is identified; each measure is then assigned an applicability for each market sector and segment and characterized with appropriate savings, costs and other attributes; then the cost-effectiveness screening is performed. Avista provided feedback during each step of the process to ensure measure assumptions and results lined up with programmatic experience.

We compiled a robust list of conservation measures for each customer sector, drawing upon Avista's TRM and program experience, AEG's own measure databases and building simulation models, and secondary sources, primarily the Regional Technical Forum's (RTF) UES measure workbooks and the Seventh Plan's electric power conservation supply curves. This universal list of measures covers all major types of end-use equipment, as well as devices and actions to reduce energy consumption.

Figure 2-2 Approach for ECM Assessment

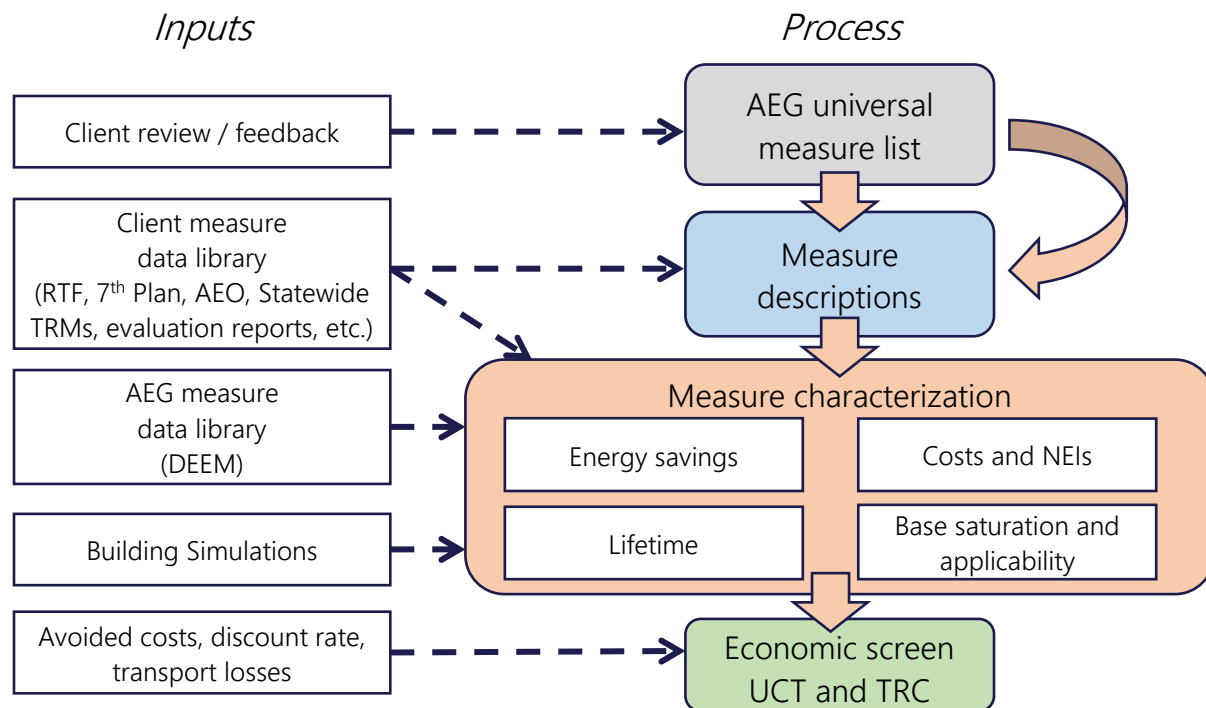

The selected measures are categorized into two types according to the LoadMAP modeling taxonomy: equipment measures and non-equipment measures.

- Equipment measures are efficient energy-consuming pieces of equipment that save energy by providing the same service with a lower energy requirement than a standard unit. An example is an ENERGY STAR® residential water heater (UEF 0.64) that replaces a standard efficiency water heater (UEF 0.58). For equipment measures, many efficiency levels may be available for a given technology, ranging from the baseline unit (often determined by a code or standard) up to the most efficient product commercially available. These measures are applied on a stock-turnover basis, and in general, are referred to as lost opportunity (LO) measures by the Council because once a purchase decision is made, there will not be another opportunity to improve the efficiency of that equipment item until its effective useful life (EUL) is reached once again.
- Non-equipment measures save energy by reducing the need for delivered energy, but do not necessarily involve replacement or purchase of major end-use equipment (such as a furnace or water heater). Measure installation is not tied to a piece of equipment reaching end of useful life, so these are generally categorized as “retrofit” measures. An example would be low-flow showerheads that modify a household’s hot water consumption. The existing showerheads can be achievable replaced without waiting for the existing showerhead to malfunction, and saves energy used by the water heating equipment. Non-equipment measures typically fall into one of the following categories:
 - Building shell (windows, insulation, roofing material)
 - Equipment controls (smart thermostats, water heater setback)
 - Whole-building design (ENERGY STAR homes)

- o Retrocommissioning and strategic energy management

We developed a preliminary list of efficient measures, which was distributed to Avista’s project team for review. Once we assembled the list of measures, the AEG team assessed their energy-saving characteristics. For each measure, we also characterized incremental cost, service life, non-energy impacts, and other performance factors. Following the measure characterization, we performed an economic screening of each measure, which serves as the basis for developing the economic and achievable potential scenarios.

Representative Measure Data Inputs

To provide an example of measure data, Table 2-2 and Table 2-3 present examples of the detailed data inputs behind both equipment and non-equipment measures, respectively, for the case of residential direct-fuel furnaces in single-family homes in Washington. Table 2-2 displays the various efficiency levels available as equipment measures, as well as the corresponding effective useful life, energy usage, and cost estimates. The columns labeled “On Market” and “Off Market” reflect equipment availability due to codes and standards or the entry of new products to the market.

Table 2-2 Example Equipment Measures for Direct Fuel Furnace – Single-Family Home, Washington

Efficiency Level	Useful Life (years)	Equipment Cost	Energy Usage (therms/yr)	On Market	Off Market
AFUE 80%	20	\$1,955	517	2015	2023
AFUE 90%	20	\$2,058	465	2015	2023
AFUE 92%	20	\$2,099	453	2015	n/a
AFUE 95%	20	\$2,778	438	2015	n/a
AFUE 98%	20	\$3,035	423	2015	n/a
Convert to NG Heat Pump	20	\$6,739	345	2015	n/a

Table 2-3 lists some of the non-equipment measures applicable to a direct-fuel furnace in an existing single-family home. All measures are evaluated for cost effectiveness based on the lifetime benefits relative to the cost of the measure. The total savings, costs, and monetized non-energy impacts are calculated for each year of the study and depend on the base year saturation of the measure, the applicability of the measure, and the savings as a percentage of the relevant energy end uses. We model two flavors of most shell insulations measures. The first is the installation of insulation where there is none (or very little). This applies to a small subset of the population (roughly 6% of the population is eligible for this measure per RBSA 2011) but has large savings impacts. This percentage is low due to the impacts of current Avista programs, strict Washington building codes, and naturally occurring efficiency. The second is an insulation upgrade measure where homes with existing insulation below the threshold but not classified as no insulation, may be upgraded to higher R-values. This applies to a much larger percentage of the market.

Table 2-3 Example Non-Equipment Measures – Existing Single Family Home, Washington³

End Use	Measure	Saturation in 2015 ⁴	Applicability	Lifetime (yrs)	Measure Installed Cost	Energy Savings (%)
Heating	Insulation - Ceiling Installation	0%	6%	45	\$1,280	31.3%
Heating	Insulation – Ceiling Upgrade	20%	88%	45	\$1,739	1.2%
Heating	Ducting Repair and Sealing	15%	50%	20	\$794	6.0%
Heating	Windows - High Efficiency	89%	100%	45	\$5,337	25.5%

Table 2-4 summarizes the number of measures evaluated for each segment within each sector.

Table 2-4 Number of Measures Evaluated

Sector	Total Measures	Measure Permutations w/ 2 Vintages	Measure Permutations w/ All Segments & States
Residential	44	88	704
Commercial	52	104	2,080
Industrial	32	64	128
Total Measures Evaluated	128	256	2,912

Calculation of Energy Conservation Potential

The approach we used for this study to calculate the energy conservation potential adheres to the approaches and conventions outlined in the National Action Plan for Energy-Efficiency (NAPEE) Guide for Conducting Potential Studies.⁵ This document represents credible and comprehensive industry best practices for specifying energy conservation potential. Three types of potential were developed as part of this effort: technical potential, achievable technical potential, and achievable economic potential (using UCT and TRC). The calculation of technical potential is a straightforward algorithm which, as described above, assumes that customers adopt all feasible measures regardless of their cost.

Stacking of Measures and Interactive Effects

An important factor when estimating potential is to consider interactions between measures when they are applied within the same space. This is important to avoid double counting and could feasibly result in savings at greater than 100% of equipment consumption if not properly accounted for.

This occurs at the population or system level, where multiple DSM actions must be stacked or layered on top of each other in succession, rather than simply summed arithmetically. These interactions are automatically handled within the LoadMAP models where measure impacts are stacked on top of each other, modifying the baseline for each subsequent measure. We first compute the total savings of each measure on a standalone basis, then also assign a stacking priority, based on levelized cost, to the measures such that “integrated” or “stacked” savings will be calculated as a percent reduction to the

³ The applicability factors consider whether the measure is applicable to a particular building type and whether it is feasible to install the measure. For instance, duct repair and sealing is not applicable to homes with zonal heating systems since there is no ductwork present to repair.

⁴ Note that saturation levels reflected increase from their base year saturation as more measures are adopted.

⁵ National Action Plan for Energy Efficiency (2007). *National Action Plan for Energy Efficiency Vision for 2025: Developing a Framework for Change*. www.epa.gov/eeactionplan.

running total of baseline energy remaining in each end use after the previous measures have been applied. This ensures that the available pie of baseline energy shrinks in proportion to the number of DSM measures applied, as it would in reality. The loading order is based on the levelized cost of conserved energy, such that the more economical measures that are more likely to be selected from a resource planning perspective will be the first to be applied to the modeled population.

We also account for exclusivity of certain measure options when defining measure assumptions. For instance, if an AFUE 95% furnace is installed in a single-family home, the model will not allow that same home to install an AFUE 98% furnace, or any other furnace, until the newly installed AFUE 95% option has reached its end of useful life. For non-equipment measures, which do not have a native applicability limit, we define base saturations and applicabilities such that measures do not overlap. For example, we model two flavors of ceiling insulation. The first assumes the installation of insulation where there previously was none. The second upgrades pre-existing insulation if it falls under a certain threshold. We used regional market research data to ensure exclusivity of these two options. NEEA's 2014 RBSA contains information on average R-values of insulation installed. The AEG team used this data to define the percent of homes that could install one measure, but not the other.

Estimating Customer Adoption

Once the technical potential is established, estimates for the market adoption rates for each measure are applied that specify the percentage of customers that will select the highest-efficiency economic option. This phases potential in over a more realistic time frame that considers barriers such as imperfect information, supplier constraints, technology availability, and individual customer preferences. The intent of market adoption rates is to establish a path to full market maturity for each measure or technology group and ensure resource planning does not overstep acquisition capabilities. We adapted the Northwest Power and Conservation Council's Seventh Plan ramp rates to develop these achievability factors for each measure. Applying these ramp rates as factors leads directly to the achievable technical potential.

Screening Measures for Cost-Effectiveness

With achievable technical potential established, the final step is to apply an economic screen and arrive at the subset of measures that are cost-effective and ultimately included in achievable economic potential.

LoadMAP performs an economic screen for each individual measure in each year of the planning horizon. This study uses the UCT test as the primary cost-effectiveness metric, which compares the lifetime hourly energy benefits of each applicable measure with the incentive and administrative costs incurred by the utility. The lifetime benefits are calculated by multiplying the annual energy savings for each measure by Avista's avoided costs and discounting the dollar savings to the present value equivalent. Lifetime costs represent incremental measure cost. The analysis uses each measure's values for savings, costs, and lifetimes that were developed as part of the measure characterization process described above.

The LoadMAP model performs this screening dynamically, considering changing savings and cost data over time. Thus, some measures pass the economic screen for some, but not all, of the years in the forecast.

It is important to note the following about the economic screen:

- The economic evaluation of every measure in the screen is conducted relative to a baseline condition. For instance, in order to determine the therm savings potential of a measure, consumption with the measure applied must be compared to the consumption of a baseline condition.

- The economic screening was conducted only for measures that are applicable to each building type and vintage; thus, if a measure is deemed to be irrelevant to a building type and vintage, it is excluded from the respective economic screen.

This constitutes the achievable economic potential and includes every program-ready opportunity for conservation savings. Potential results are presented in Sections 4 and 5. Measure-level detail is available as a separate appendix to this report.

Data Development

This section details the data sources used in this study, followed by a discussion of how these sources were applied. In general, data were adapted to local conditions, for example, by using local sources for measure data and local weather for building simulations.

Data Sources

The data sources are organized into the following categories:

- Avista-provided data
- AEG's databases and analysis tools
- Other secondary data and reports

Avista Data

Our highest priority data sources for this study were those that were specific to Avista, including the primary market research conducted specifically for this study. This data is specific to Avista's service territory and is an important consideration when customizing the model for Avista's market. This is best practice when developing CPA baselines when the data is available.

- Avista customer account database. Avista provided billing data for development of customer counts and energy use for each sector. This included a very detailed database of customer building classifications which was instrumental in the development of segmentation.
- Avista's 2013 GenPOP Residential Survey. In 2013, Avista hired The Cadmus Group to conduct a residential saturation survey, which included results from 1,051 customers. The results of this survey helped segment the residential sector and establish fuel and technology shares for the base year. This data was very useful in developing a detailed estimate of energy consumption within Avista's service territory.
- Load forecasts. Avista provided forecasts, by sector and state, of energy consumption, customer counts, weather actuals for 2015 and 2017, as well as weather-normal HDD65s.
- Economic information. Avista provided a discount rate as well as avoided cost forecasts consistent with those utilized in the IRP.
- Avista program data. Avista provided information about past and current programs, including program descriptions, goals, and measure achievements to date.
- Avista TRM. Avista provided a documented list of energy conservation measures and assumptions considered within current programs. We utilized this as a primary source of measure information, supplemented by Northwest data, AEG data, and secondary data as described below.

Northwest Regional Data

The study utilized a variety of local data and research, including research performed by the Northwest Energy Efficiency Alliance (NEEA) and analyses conducted by the Council. Most important among these are:

- Northwest Power and Conservation Council Seventh Plan and Regional Technical Forum workbooks. To develop its Power Plan, the Council maintains workbooks with detailed information about measures. This was used as a primary data source when Avista-specific program data was not available, and the data was determined to be applicable to natural gas conservation measures. The most recent data and workbooks available were used at the time of this study.
- Northwest Energy Efficiency Alliance, 2011 Residential Building Stock Assessment Single-Family, Market Research Report, <http://neea.org/docs/reports/residential-building-stock-assessment-single-family-characteristics-and-energy-use.pdf?sfvrsn=8>
- Northwest Energy Efficiency Alliance, 2011 Residential Building Stock Assessment: Manufactured Home, Market Research Report, #E13-249, January 2013. <http://neea.org/docs/default-source/reports/residential-building-stock-assessment--manufactured-homes-characteristics-and-energy-use.pdf?sfvrsn=8>
- Northwest Energy Efficiency Alliance, 2011 Residential Building Stock Assessment: Multifamily, Market Research Report, #13-263, September 2013. <http://neea.org/docs/default-source/reports/residential-building-stock-assessment--multi-family-characteristics-and-energy-use.pdf?sfvrsn=4>
- Northwest Energy Efficiency Alliance, 2014 Commercial Building Stock Assessment, December 16, 2014, http://neea.org/docs/default-source/reports/2014-cbsa-final-report_05-dec-2014.pdf?sfvrsn=12.
- Northwest Energy Efficiency Alliance, 2014 Industrial Facilities Site Assessment, December 29, 2014, <http://neea.org/resource-center/regional-data-resources/industrial-facilities-site-assessment>

Since Avista's GenPOP survey contained detailed appliance saturations, the 2011 RBSA was used more for benchmarking and comparative purposes, rather than as a primary source of data. The NEEA surveys were used extensively to develop base saturation and applicability assumptions for many of the non-equipment measures within the study. It is worth noting that NEEA's 2016 RBSA was released during the drafting of this report, following conclusion of analysis. This survey incorporates new market trends and building characteristics and is expected to be a useful source of measure baseline saturations when updating this CPA.

AEG Data

AEG maintains several databases and modeling tools that we use for forecasting and potential studies. Relevant data from these tools has been incorporated into the analysis and deliverables for this study.

- AEG Energy Market Profiles. For more than 10 years, AEG staff has maintained profiles of end-use consumption for the residential, commercial, and industrial sectors. These profiles include market size, fuel shares, unit consumption estimates, and annual energy use by fuel (natural gas and electricity), customer segment and end use for 10 regions in the U.S. The Energy Information

Administration surveys (RECS, CBECS and MECS) as well as state-level statistics and local customer research provide the foundation for these regional profiles.

- Building Energy Simulation Tool (BEST). AEG's BEST is a derivative of the DOE 2.2 building simulation model, used to estimate base-year UECs and EUIs, as well as measure savings for the HVAC-related measures.
- AEG's Database of Energy Conservation Measures (DEEM). AEG maintains an extensive database of measure data for our studies. Our database draws upon reliable sources including the California Database for Energy Efficient Resources (DEER), the EIA Technology Forecast Updates – Residential and Commercial Building Technologies – Reference Case, RS Means cost data, and Grainger Catalog Cost data.
- Recent studies. AEG has conducted more than 60 studies of EE potential in the last five years. We checked our input assumptions and analysis results against the results from these other studies, both within the region and across the country.

Other Secondary Data and Reports

Finally, a variety of secondary data sources and reports were used for this study. The main sources are identified below.

- Annual Energy Outlook. The Annual Energy Outlook (AEO), conducted each year by the U.S. Energy Information Administration (EIA), presents yearly projections and analysis of energy topics. For this study, we used data from the 2015 and 2017 AEO.
- American Community Survey. The US Census American Community Survey is an ongoing survey that provides data every year on household characteristics. <http://www.census.gov/acs/www/>
- Local Weather Data. Weather from NOAA's National Climatic Data Center for Spokane in Washington and Coure d'Alene in Idaho were used where applicable.
- EPRI End-Use Models (REEPS and COMMEND). These models provide the energy-use elasticities we apply to prices, household income, home size, heating, and cooling.
- Database for Energy Efficient Resources (DEER). The California Energy Commission and California Public Utilities Commission (CPUC) sponsor this database, which is designed to provide well-documented estimates of energy and peak demand savings values, measure costs, and effective useful life (EUL) for the state of California. We used the DEER database to cross check the measure savings we developed using BEST and DEEM.
- Other relevant resources: These include reports from the Consortium for Energy Efficiency, the EPA, and the American Council for an Energy-Efficient Economy. This also includes technical reference manuals (TRMs) from other states. When using data from outside the region, especially weather-sensitive data, AEG adapted assumptions for use within Avista's territory.

Application of Data to the Analysis

We now discuss how the data sources described above were used for each step of the study.

Data Application for Market Characterization

To construct the high-level market characterization of natural gas consumption and market size units (households for residential, floor space for commercial, and employees for industrial), we primarily used Avista's billing data as well as secondary data from AEG's Energy Market Profiles database.

Data Application for Market Profiles

The specific data elements for the market profiles, together with the key data sources, are shown in Table 2-5. To develop the market profiles for each segment, we used the following approach:

1. Develop control totals for each segment. These include market size, segment-level annual natural gas use, and annual intensity. Control totals were based on Avista's actual sales and customer-level information found in Avista's customer billing database. We used the market profiles from the 2016 CPA as a starting point.
2. Develop existing appliance saturations and the energy characteristics of appliances, equipment, and buildings using equipment flags within Avista's billing data, NEEA's 2011 RBSA, 2014 CBSA, and 2014 IFSA, DOE's 2009 RECS, the 2015 and 2017 editions of the Annual Energy Outlook, AEG's Energy Market Profile (EMP) for the Pacific region, and the American Housing Survey.
3. Ensure calibration to Avista control totals for annual natural gas sales in each sector and segment.
4. Compare and cross-check with other recent AEG studies.
5. Work with Avista staff to verify the data aligns with their knowledge and experience.

Table 2-5 Data Applied for the Market Profiles

Model Inputs	Description	Key Sources
Market size	Base-year residential dwellings, commercial floor space, and industrial employment	Avista 2015 actual sales Avista customer account database
Annual intensity	Residential: Annual use per household Commercial: Annual use per square foot Industrial: Annual use per employee	Avista customer account database AEG's Energy Market Profiles AEO 2015 – Pacific Region Other recent studies
Appliance/equipment saturations	Fraction of dwellings with an appliance/technology Percentage of C&I floor space/employment with equipment/technology	Avista 2013 GenPOP Survey 2011 RBSA, 2014 CBSA and IFSA 2014 American Community Survey AEG's Energy Market Profiles
UEC/EUI for each end-use technology	UEC: Annual natural gas use in homes and buildings that have the technology EUI: Annual natural gas use per square foot/employee for a technology in floor space that has the technology	HVAC uses: BEST simulations using prototypes developed for Avista Engineering analysis AEG DEEM AEO 2015 – Pacific Region Recent AEG studies
Appliance/equipment age distribution	Age distribution for each technology	2011 RBSA, 2014 CBSA, and recent AEG studies
Efficiency options for each technology	List of available efficiency options and annual energy use for each technology	Avista current program offerings AEG DEEM AEO 2015 through AEO 2017 CA DEER Recent AEG studies

Data Application for Baseline Projection

Table 2-6 summarizes the LoadMAP model inputs required for the baseline projection. These inputs are required for each segment within each sector, as well as for new construction and existing dwellings/buildings.

Table 2-6 Data Applied for the Baseline Projection in LoadMAP

Model Inputs	Description	Key Sources
Customer growth forecasts	Forecasts of new construction in residential and C&I sectors	Avista load forecast
Equipment purchase shares for baseline projection	For each equipment/technology, purchase shares for each efficiency level; specified separately for existing equipment replacement and new construction	Shipment data from AEO and ENERGY STAR AEO 2017 regional forecast assumptions ⁶ Appliance/efficiency standards analysis
Utilization model parameters	Price elasticities, elasticities for other variables (income, weather)	EPRI's REEPS and COMMEND models

In addition, assumptions were incorporated for known future equipment standards as of December 2017, as shown in Table 2-7 and Table 2-8. The assumptions tables here extend through 2025, after which all standards are assumed to hold steady.

⁶ We developed baseline purchase decisions using the Energy Information Agency's *Annual Energy Outlook* report (2017), which utilizes the National Energy Modeling System (NEMS) to produce a self-consistent supply and demand economic model. We calibrated equipment purchase options to match distributions/allocations of efficiency levels to manufacturer shipment data for recent years.

Table 2-7 Residential Natural Gas Equipment Federal Standards⁷

End Use	Technology	2015	2017	2018	2019	2020	2021	2022	2023	2024	2025	
Space Heating	Furnace – Direct Fuel	AFUE 80%								AFUE 92%*		
	Boiler – Direct Fuel	AFUE 82%					AFUE 84%					
Secondary Heating	Fireplace	N/A										
Water Heating	Water Heater <= 55 gal.					UEF 0.58						
	Water Heater > 55 gal.					UEF 0.76						
Appliances	Clothes Dryer					CEF 3.30						
	Stove/Oven	N/A										
Miscellaneous	Pool Heater					TE 0.82						
	Miscellaneous	N/A										

* This code was originally set to take effect in 2021 but exempts smaller systems. The comment period was also extended into 2017 and the standard will not take effect until at least 5 years after that has concluded. As a result, we modeled this standard coming online officially in 2024.

Table 2-8 Commercial and Industrial Natural Gas Equipment Standards

End Use	Technology	2015	2017	2018	2019	2020	2021	2022	2023	2024	2025
Cooling	Furnace	AFUE 80% / TE 0.80									
	Boiler	Average around AFUE 80% / TE 0.80 (varies by size)									
	Unit Heater	Standard (intermittent ignition and power venting or automatic flue damper)									
Water Heater	Water Heating	TE 0.80									

⁷ The assumptions tables here extend through 2025, after which all standards are assumed to hold steady.

Energy Conservation Measure Data Application

Table 2-9 details the energy-efficiency data inputs to the LoadMAP model. It describes each input and identifies the key sources used in the Avista analysis.

Table 2-9 Data Inputs for the Measure Characteristics in LoadMAP

Model Inputs	Description	Key Sources
Energy Impacts	The annual reduction in consumption attributable to each specific measure. Savings were developed as a percentage of the energy end use that the measure affects.	Avista TRM NWPC workbooks, RTF AEG BEST AEG DEEM AEO 2017 CA DEER Other secondary sources
Costs	Equipment Measures: Includes the full cost of purchasing and installing the equipment on a per-household, per-square-foot, or per employee basis for the residential, commercial, and industrial sectors, respectively. Non-Equipment Measures: Existing buildings – full installed cost. New Construction - the costs may be either the full cost of the measure, or as appropriate, it may be the incremental cost of upgrading from a standard level to a higher efficiency level.	Avista TRM NWPC workbooks, RTF AEG DEEM AEO 2017 CA DEER RS Means Other secondary sources
Measure Lifetimes	Estimates derived from the technical data and secondary data sources that support the measure demand and energy savings analysis.	Avista TRM NWPC workbooks, RTF AEG DEEM AEO 2017 CA DEER Other secondary sources
Applicability	Estimate of the percentage of dwellings in the residential sector, square feet in the commercial sector, or employees in the industrial sector where the measure is applicable and where it is technically feasible to implement.	2011 RBSA, 2014 CBSA 2015 WSEC for limitations on new construction AEG DEEM CA DEER Other secondary sources
On Market and Off Market Availability	Expressed as years for equipment measures to reflect when the equipment technology is available or no longer available in the market.	AEG appliance standards and building codes analysis

Data Application for Cost-effectiveness Screening

To perform the cost-effectiveness screening, a number of economic assumptions were needed. All cost and benefit values were analyzed as real dollars, converted from nominal provided by Avista. We applied Avista's long-term discount rate of 4.34% excluding inflation. LoadMAP is configured to vary this by market sector (e.g. residential and commercial) if Avista develops alternative values in the future.

Estimates of Customer Adoption

To estimate the timing and rate of customer adoption in the potential forecasts, two sets of parameters are needed:

- Technical diffusion curves for non-equipment measures. Equipment measures are installed when existing units fail. Non-equipment measures do not have this natural periodicity, so rather than installing all available non-equipment measures in the first year of the projection (instantaneous potential), they are phased in according to adoption schedules that generally align with the diffusion of similar equipment measures. For this analysis, we used the Council's retrofit ramp rates, "Retro", applied before the 85% achievability adjustment.
- Customer adoption rates, also referred to as take rates or ramp rates, are applied to measures on a year by year basis. These rates represent customer adoption of measures when delivered through a best-practice portfolio of well-operated efficiency programs under a reasonable policy or regulatory framework. Information channels are assumed to be established and efficient for marketing, educating consumers, and coordinating with trade allies and delivery partners. The primary barrier to adoption reflected in this case is customer preferences. Again, these are based on the ramp rates from the Northwest Power and Conservation Council's Seventh Plan.

The ramp rates referenced above were adapted for use for assessing natural gas measure potential. We describe this process in Section 7. The customer adoption rates used in this study are available in Appendix B.

3

MARKET CHARACTERIZATION AND MARKET PROFILES

In this section, we describe how customers in the Avista service territory use natural gas in the base year of the study, 2015. It begins with a high-level summary of energy use across all sectors and then delves into each sector in more detail.

Overall Energy Use Summary

Total natural gas consumption for all sectors for Avista's Washington territory in 2015 was 15,376,657 dekatherms. As shown in Figure 3-1 and Table 3-1, the residential sector accounts for the largest share of annual energy use at 60%, followed by the commercial sector at 37%. The industrial sector accounts for 3% of usage.

Figure 3-1 Sector-Level Natural Gas Use in Base Year 2015, Washington (annual therms, percent)

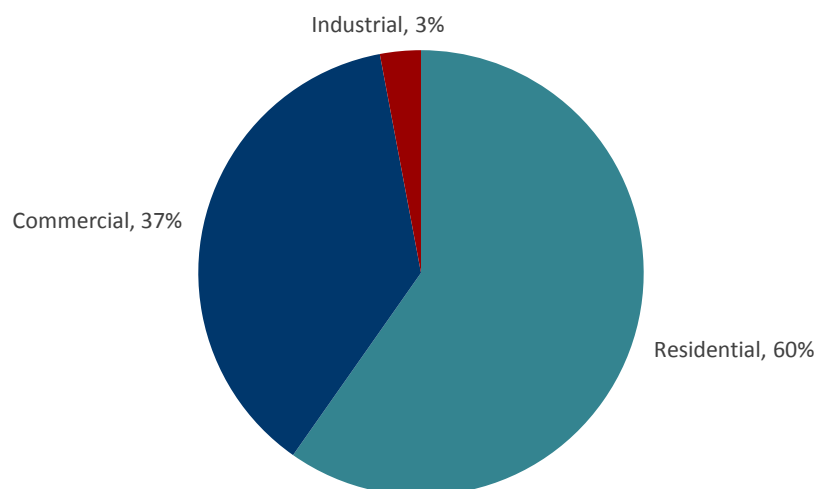

Table 3-1 Avista Sector Control Totals, Washington, 2015

Sector	Natural Gas Use (dekatherms)	% of Use
Residential	9,186,242	60%
Commercial	5,734,759	37%
Industrial	455,656	3%
Total	15,376,657	100%

Total natural gas consumption for all sectors for Avista’s Idaho territory in 2015 was 7,215,664 dekatherms. As shown in Figure 3-2 and Table 3-2, the residential sector accounts for the largest share of annual energy use at 60%, followed by the commercial sector at 34%. The industrial sector accounts for 6% of usage.

Figure 3-2 Sector-Level Natural Gas Use in Base Year 2015, Idaho (annual therms, percent)

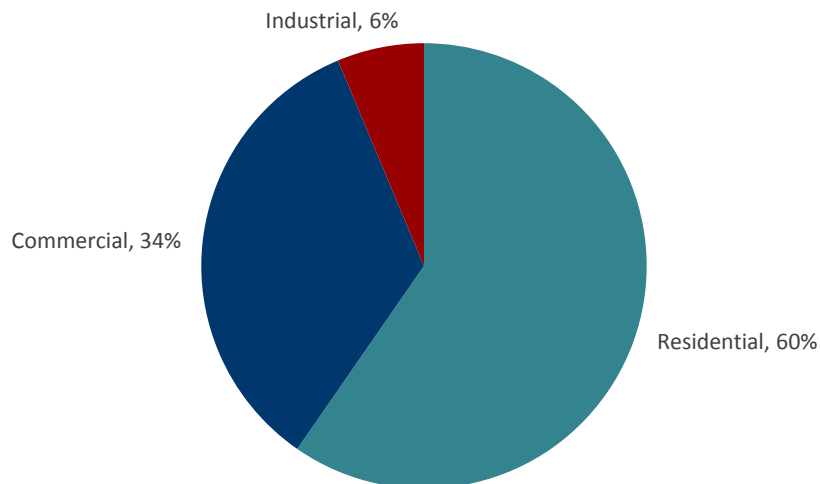

Table 3-2 Avista Sector Control Totals, Idaho, 2015

Sector	Natural Gas Use (dekatherms)	% of Use
Residential	4,303,387	60%
Commercial	2,456,621	34%
Industrial	455,656	6%
Total	7,215,664	100%

Residential Sector

Washington Characterization

The total number of households and gas sales for the service territory were obtained from Avista’s actual sales for 2015. Details, including number of households and 2015 natural gas consumption for the residential sector in Washington can be found in Table 3-3 below. In 2015, there were over 141,000 households in Avista’s Washington territory that used a total of nearly 9,186,242 dekatherms, resulting in an average use per household of 650 therms per year. This is an important number for the calibration process.

These values represent weather actuals for 2015 and were adjusted within LoadMAP to normal weather using heating degree day, base 65°F, using data provided by Avista. 2015 was an exceptionally warm year, which is reflected in lower than average consumption. When adjusting these values for normal weather in 2018, heating consumption increased significantly.

Table 3-3 Residential Sector Control Totals, Washington, 2015

Segment	Households	Natural Gas Use (dekatherms)	Annual Use/Customer (therms/HH)
Single Family	85,875	6,014,673	700
Multi-Family	7,909	348,896	441
Mobile Home	5,085	299,121	588
Low Income	42,372	2,523,553	596
Total	141,241	9,186,242	650

Figure 3-3 Residential Natural Gas Use by Segment, Washington, 2015

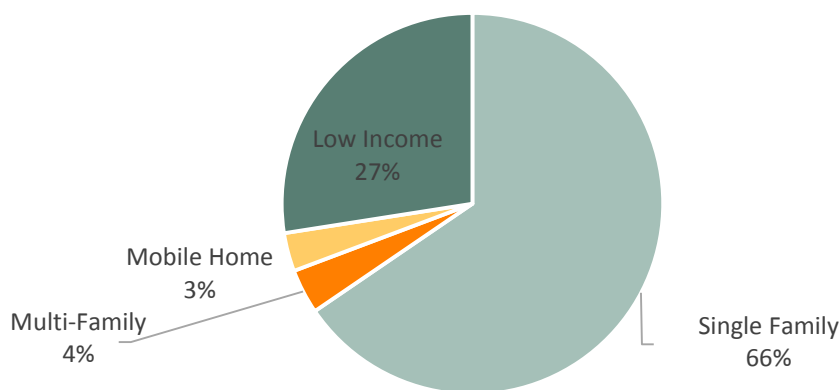
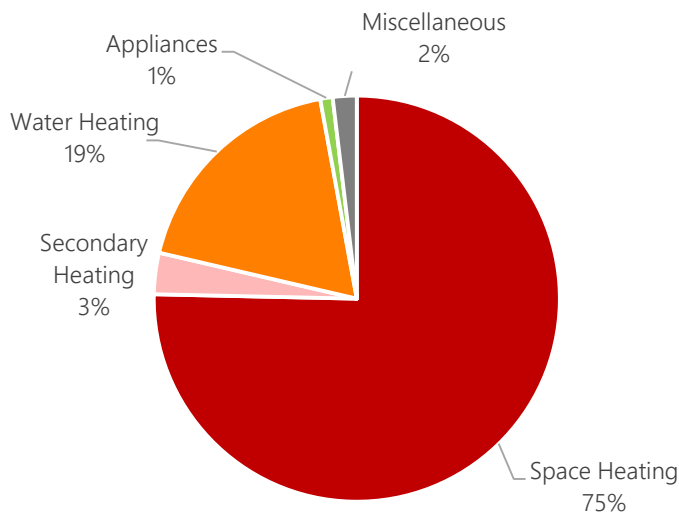

Figure 3-3 shows the distribution of annual natural gas consumption by end use for an average residential household. Space heating comprises a majority of the load at 75% followed by water heating at 19%. Miscellaneous loads make up a very small portion of the total load. This is expected for a natural gas profile as there are very few miscellaneous technologies. One example are natural gas barbecues.

Figure 3-4 Residential Natural Gas Use by End Use, Washington, 2015



Avista’s GenPOP survey informed estimates of the saturation of key equipment types, which were used to distribute usage at the technology and end use level.

Figure 3-4 presents average natural gas intensities by end use and housing type. Single family homes consume substantially more energy in space heating. This is due to two factors. The first is that single family homes are larger. The second is that more walls are exposed to the outside environment, compared to multifamily dwellings with many shared walls. This increases heat transfer, resulting in greater heating loads. Water heating consumption is higher in single family homes as well. This is due to a greater number of occupants, which increases the demand for hot water.

Figure 3-5 Residential Energy Intensity by End Use and Segment, Washington, 2015 (Annual Therms/HH)

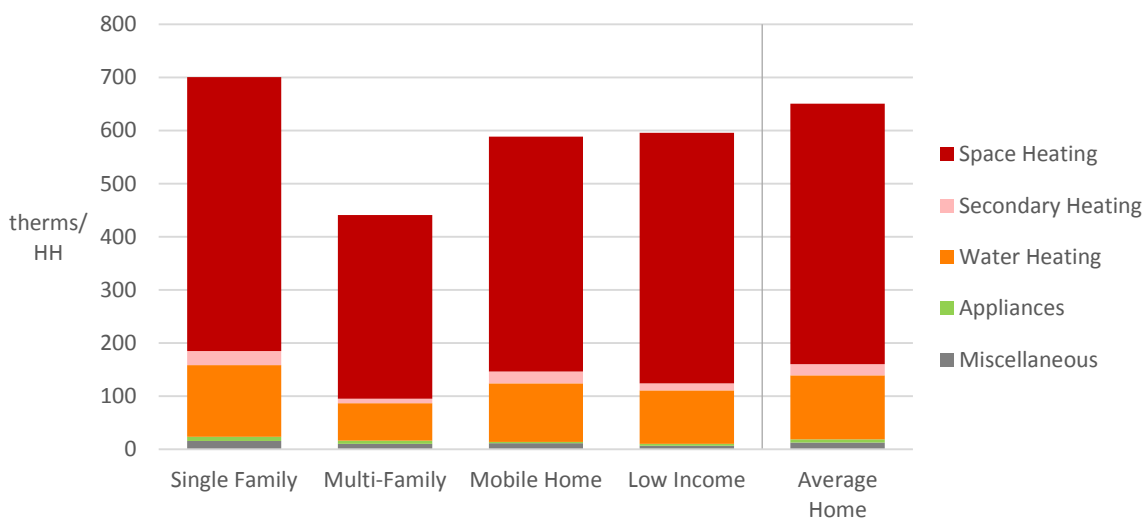

The market profile for an average home in the residential sector is presented in Table 3-4 below. An important step in the profile development process is model calibration. All consumption within an average home must sum up to the intensity extracted from billing data. This is necessary so estimates of consumption for a piece of equipment do not exceed the actual usage in a home. Since consumption in 2015 was rather low, the household intensity increased in 2018 when normalizing weather, allowing for increased consumption in space heating and secondary heating technologies.

Table 3-4 Average Market Profile for the Residential Sector, 2015

End Use	Technology	Saturation	UEC (therms)	Intensity (therms/HH)	Usage (dekatherms)
Space Heating	Furnace - Direct Fuel	88.2%	539.7	475.7	6,719,439
	Boiler - Direct Fuel	2.3%	634.0	14.3	202,114
Secondary Heating	Fireplace	20.9%	102.2	21.4	302,195
Water Heating	Water Heater <= 55 gal.	55.8%	211.9	118.3	1,671,454
	Water Heater > 55 gal.	0.7%	244.1	1.8	25,481
Appliances	Clothes Dryer	5.4%	28.4	1.5	21,782
	Stove/Oven	8.5%	57.3	4.9	68,899
Miscellaneous	Pool Heater	0.7%	217.7	1.6	22,042
	Miscellaneous	100.0%	10.8	10.8	152,837
Total				650.4	9,186,242

Idaho Characterization

Details for the residential sector in Idaho can be found in Table 3-5 below. In 2015, there were over 70,000 households in Avista's Washington territory that used a total of nearly 4,303,387 dekatherms, resulting in an average use per household of 611 therms per year. This is an important number for the calibration process.

Table 3-5 Residential Sector Control Totals, Idaho, 2015

Segment	Households	Natural Gas Use (dekatherms)	Annual Use/Customer (therms/HH)
Single Family	42,852	2,813,132	656
Multi-Family	3,454	142,782	413
Mobile Home	3,172	174,973	552
Low Income	21,003	1,172,501	558
Total	70,481	4,303,387	611

Figure 3-6 Residential Natural Gas Use by Segment, Idaho, 2015

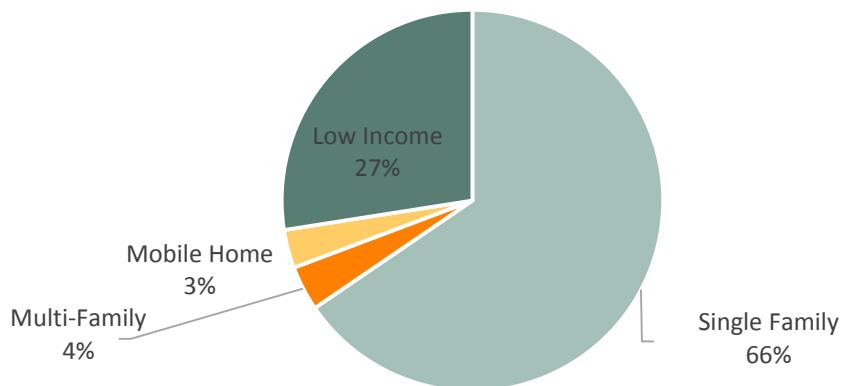
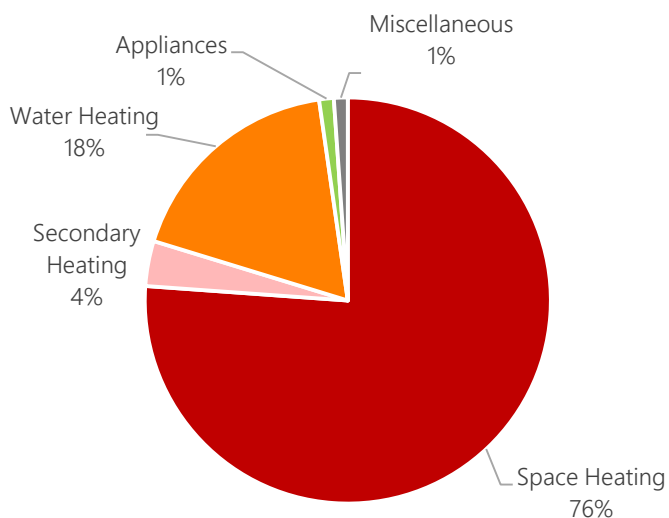

Figure 3-7 shows the distribution of annual natural gas consumption by end use for an average residential household. Space heating comprises a majority of the load at 76% followed by water heating at 18%. Miscellaneous loads make up a very small portion of the total load, as expected.

Figure 3-7 Residential Natural Gas Use by End Use, Idaho, 2015



Avista’s 2013 GenPOP survey informed estimates of the saturation of key equipment types, which were used to distribute usage at the technology and end use level.

Figure 3-8 presents average natural gas intensities by end use and housing type. Single family homes consume substantially more energy in space heating. Water heating consumption is higher in single family homes as well, due to a greater number of occupants, which increases the demand for hot water.

Figure 3-8 Residential Energy Intensity by End Use and Segment, Idaho, 2015 (Annual Therms/HH)

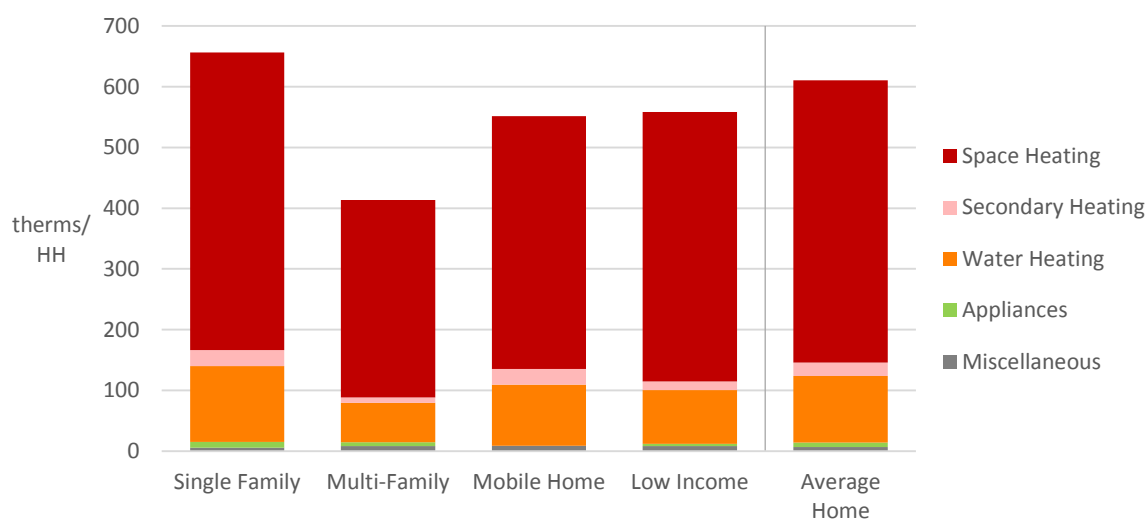

The market profile for an average home in the residential sector is presented in Table 3-6 below. An important step in the profile development process is model calibration. All consumption within an average home must sum up to the intensity extracted from billing data. This is necessary so estimates of consumption for a piece of equipment do not exceed the actual usage in a home. Since consumption in 2015 was rather low, the household intensity increased in 2018 when normalizing weather, allowing for increased consumption in space heating and secondary heating technologies.

Table 3-6 Average Market Profile for the Residential Sector, 2015

End Use	Technology	Saturation	UEC (therms)	Intensity (therms/HH)	Usage (dekatherms)
Space Heating	Furnace - Direct Fuel	84.2%	537.1	452.0	3,185,558
	Boiler - Direct Fuel	2.0%	633.6	12.9	91,149
Secondary Heating	Fireplace	21.5%	102.0	21.9	154,505
Water Heating	Water Heater <= 55 gal.	53.6%	202.0	108.2	762,884
	Water Heater > 55 gal.	0.7%	231.9	1.7	11,736
Appliances	Clothes Dryer	5.3%	30.0	1.6	11,099
	Stove/Oven	9.2%	60.1	5.5	39,043
Miscellaneous	Pool Heater	0.3%	217.7	0.6	4,139
	Miscellaneous	100.0%	6.1	6.1	43,274
Total				610.6	4,303,387

Commercial Sector

Washington Characterization

The total number of nonresidential accounts and natural gas sales for the Washington service territory were obtained from Avista's customer account database.

AEG first separated the Commercial accounts from Industrial by analyzing the SIC codes and rate codes assigned in the company's billing system. Prior to using the data, AEG inspected individual accounts to confirm proper assignment. This was done on the top accounts within each segment, but also via spot checks when reviewing the database. Energy use from accounts where the customer type could not be identified were distributed proportionally to all C&I segments.

Once the billing data was analyzed, the final segment control totals were derived by distributing the total 2015 nonresidential load to the sectors and segments according to the proportions in the billing data.

Table 3-7 below shows the final allocation of energy to each segment in the commercial sector, as well as the energy intensity on a square-foot basis. Intensities for each segment were derived from a combination of the 2014 CBSA and equipment saturations extracted from Avista's database. The CBSA intensities corresponded to spaces with lower natural gas saturations than Avista's database, so AEG increased intensities proportionally based on the additional presence of natural gas-consuming equipment.

Table 3-7 Commercial Sector Control Totals, Washington, 2015

Segment	Description	Intensity (therms/Sq Ft)	2015 Natural Gas Use (dekatherms)
Office	Traditional office-based businesses including finance, insurance, law, government buildings, etc.	0.66	671,012
Restaurant	Sit-down, fast food, coffee shop, food service, etc.	4.97	345,789
Retail	Department stores, services, boutiques, strip malls etc.	0.92	796,535
Grocery	Supermarkets, convenience stores, market, etc.	1.26	233,347
School	Day care, pre-school, elementary, secondary schools	0.40	201,308
College	College, university, trade schools, etc.	0.84	197,890
Health	Health practitioner office, hospital, urgent care centers, etc.	1.12	436,875
Lodging	Hotel, motel, bed and breakfast, etc.	0.94	272,792
Warehouse	Large storage facility, refrigerated/unrefrigerated warehouse	0.75	431,752
Miscellaneous	Catchall for buildings not included in other segments, includes churches, recreational facilities, public assembly, correctional facilities, etc.	1.55	2,147,459
Total		1.04	5,734,759

Figure 3-9 shows each segments' natural gas consumption as a percentage of the entire commercial sector energy consumption. The three segments with the highest natural gas usage in 2015 are miscellaneous, retail, and office, in descending order. As expected, the highest intensity segment is restaurant. This is based on the high presence of food preparation equipment.

Figure 3-9 Commercial Natural Gas Use by Segment, Washington, 2015

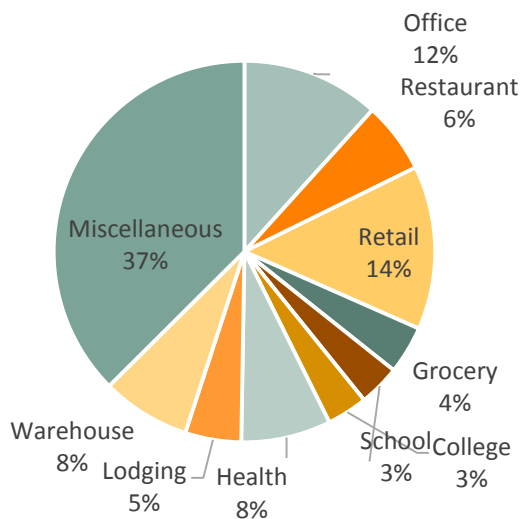

Figure 3-10 shows the distribution of natural gas consumption by end use for the entire commercial sector. Space heating is the largest end use, followed closely by food preparation and water heating. The miscellaneous end use is quite small, as expected.

Figure 3-10 Commercial Sector Natural Gas Use by End Use, Washington, 2015

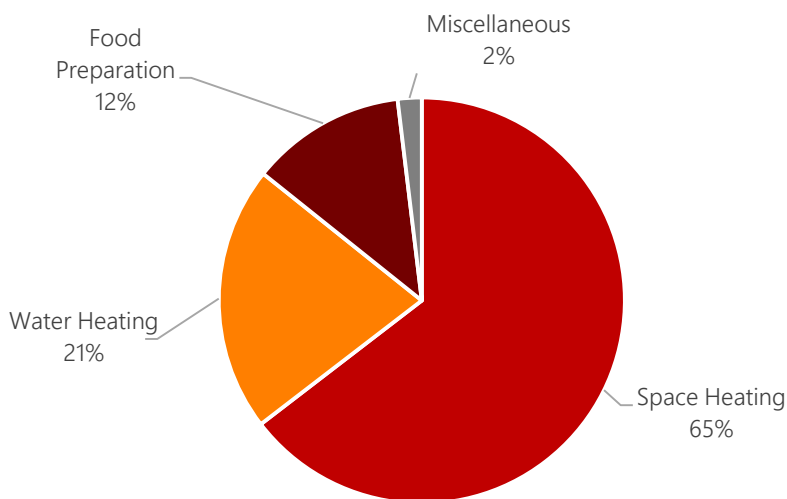
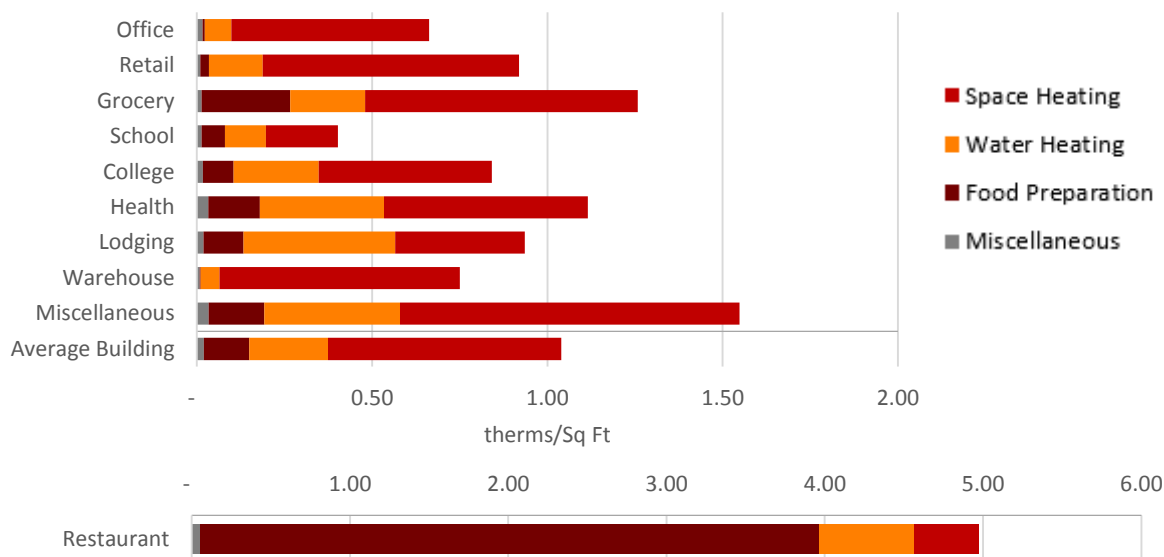

Figure 3-11 presents average natural gas intensities by end use and segment.

Figure 3-11 Commercial Energy Usage Intensity by End Use and Segment, Washington, 2015 (Annual Therms/Sq. Ft)



The total market profile for an average building in the commercial sector is presented in Table 3-8 below. Avista customer account data informed the market profile by providing information on saturation of key equipment types. Secondary data was used to develop estimates of energy intensity and square footage and to fill in saturations for any equipment types not included in the database.

Table 3-8 Average Market Profile for the Commercial Sector, Washington, 2015

End Use	Technology	Saturation	EUI (therms/Sq Ft)	Intensity (therms/Sq Ft)	Usage (dekatherms)
Heating	Furnace	54.3%	0.53	0.29	1,573,937
	Boiler	33.1%	1.00	0.33	1,828,292
	Unit Heater	4.7%	1.05	0.05	269,875
Water Heating	Water Heater	68.7%	0.33	0.22	1,240,105
Food Preparation	Oven	11.3%	0.08	0.01	49,632
	Conveyor Oven	5.6%	0.14	0.01	42,462
	Double Rack Oven	5.6%	0.21	0.01	64,508
	Fryer	7.3%	0.35	0.03	139,571
	Broiler	12.2%	0.21	0.03	140,173
	Griddle	16.4%	0.14	0.02	128,889
	Range	17.9%	0.13	0.02	133,059
	Steamer	2.1%	0.12	0.00	13,790
	Commercial Food Prep Other	0.2%	0.03	0.00	315
Miscellaneous	Pool Heater	0.9%	0.01	0.00	288
	Miscellaneous	100.0%	0.02	0.02	109,864
Total				1.04	5,734,759

Idaho Characterization

The total number of nonresidential accounts and natural gas sales for the Idaho service territory were obtained from Avista's customer account database.

Table 3-9 below shows the final allocation of energy to each segment in the commercial sector, as well as the energy intensity on a square-foot basis. Intensities for each segment were derived from a combination of the 2014 CBSA and equipment saturations extracted from Avista's database. The CBSA intensities corresponded to spaces with lower natural gas saturations than Avista's database, so AEG increased intensities proportionally based on the additional presence of natural gas-consuming equipment.

Table 3-9 Commercial Sector Control Totals, Idaho, 2015

Segment	Description	Intensity (therms/Sq Ft)	2015 Natural Gas Use (dekatherms)
Office	Traditional office-based businesses including finance, insurance, law, government buildings, etc.	0.65	255,885
Restaurant	Sit-down, fast food, coffee shop, food service, etc.	4.91	58,036
Retail	Department stores, services, boutiques, strip malls etc.	0.91	445,571
Grocery	Supermarkets, convenience stores, market, etc.	1.24	97,394
School	Day care, pre-school, elementary, secondary schools	0.45	203,476
College	College, university, trade schools, etc.	0.83	175,787
Health	Health practitioner office, hospital, urgent care centers, etc.	1.10	162,097
Lodging	Hotel, motel, bed and breakfast, etc.	0.92	113,194
Warehouse	Large storage facility, refrigerated/unrefrigerated warehouse	0.74	189,375
Miscellaneous	Catchall for buildings not included in other segments, includes churches, recreational facilities, public assembly, correctional facilities, etc.	1.53	755,805
Total		0.93	2,456,621

Figure 3-12 shows each segments' natural gas consumption as a percentage of the entire commercial sector energy consumption. The four segments with the highest natural gas usage in 2015 are miscellaneous, retail, office, and warehouse, in descending order. As expected, the highest intensity segment is restaurant. This is based on the high presence of food preparation equipment.

Figure 3-12 Commercial Natural Gas Use by Segment, Idaho, 2015

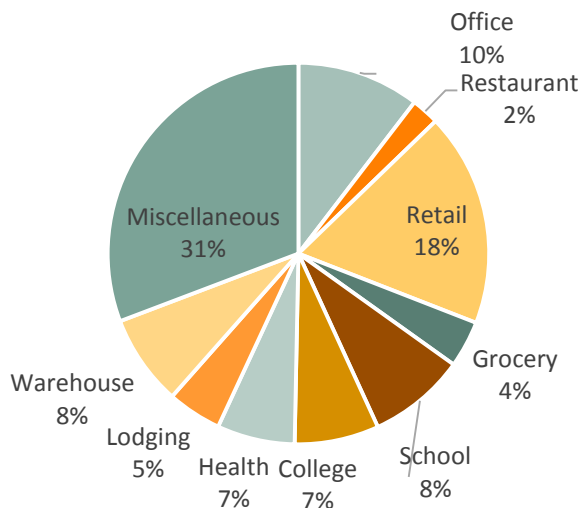

Figure 3-13 shows the distribution of natural gas consumption by end use for the entire commercial sector. Space heating is the largest end use, followed closely by food preparation and water heating. The miscellaneous end use is quite small, as expected.

Figure 3-13 Commercial Sector Natural Gas Use by End Use, Idaho, 2015

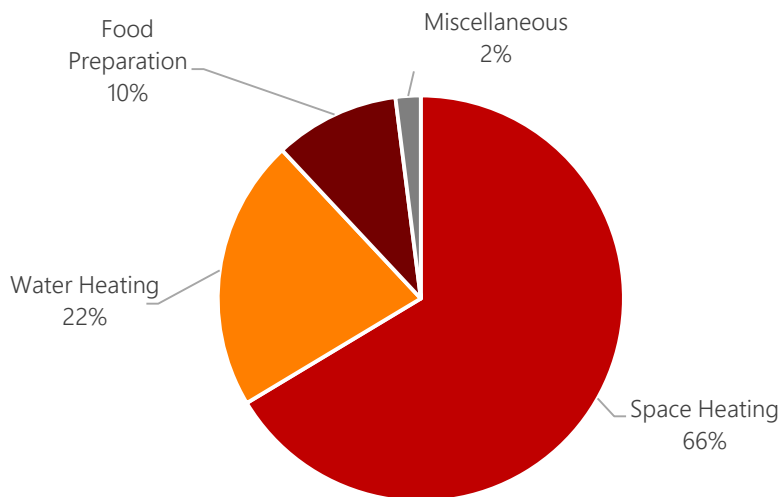
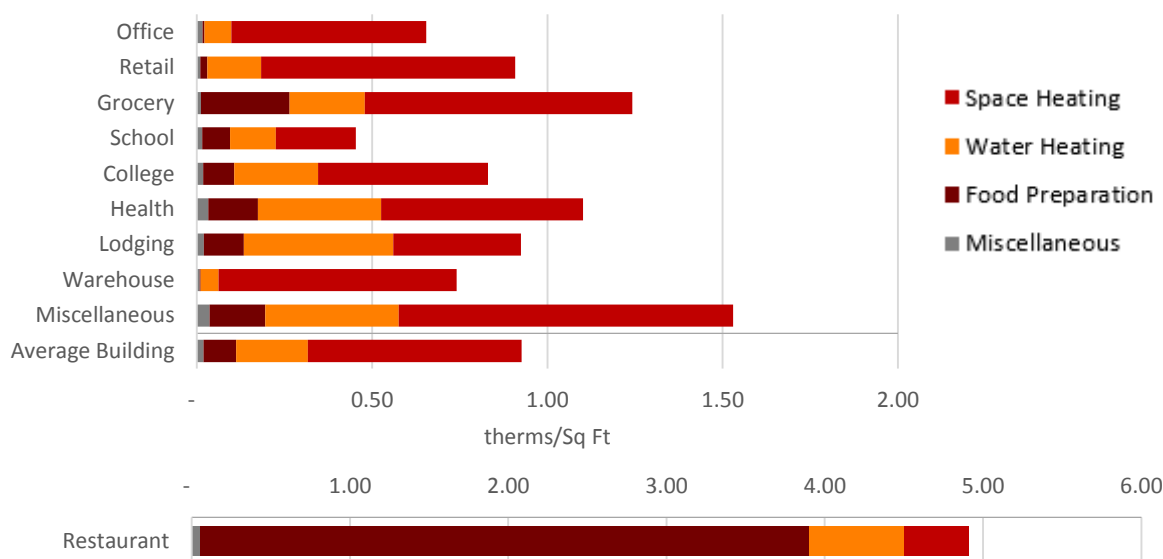

Figure 3-14 presents average natural gas intensities by end use and segment.

Figure 3-14 Commercial Energy Usage Intensity by End Use and Segment, Idaho, 2015 (Annual Therms/Sq. Ft)



The total market profile for an average building in the commercial sector is presented in Table 3-10 below. Avista customer account data informed the market profile by providing information on saturation of key equipment types. Secondary data was used to develop estimates of energy intensity and square footage and to fill in saturations for any equipment types not included in the database.

Table 3-10 Average Market Profile for the Commercial Sector, Idaho, 2015

End Use	Technology	Saturation	EUI (therms/Sq Ft)	Intensity (therms/Sq Ft)	Usage (dekatherms)
Heating	Furnace	51.2%	0.51	0.26	694,580
	Boiler	36.0%	0.83	0.30	792,880
	Unit Heater	4.9%	1.00	0.05	130,092
Water Heating	Water Heater	69.3%	0.30	0.20	543,424
Food Preparation	Oven	12.3%	0.07	0.01	21,431
	Conveyor Oven	6.1%	0.11	0.01	18,335
	Double Rack Oven	6.1%	0.17	0.01	27,854
	Fryer	7.8%	0.20	0.02	41,753
	Broiler	13.9%	0.12	0.02	44,973
	Griddle	16.4%	0.10	0.02	41,389
	Range	18.4%	0.09	0.02	44,283
	Steamer	2.9%	0.08	0.00	6,105
	Commercial Food Prep Other	0.1%	0.03	0.00	95
Miscellaneous	Pool Heater	0.8%	0.01	0.00	128
	Miscellaneous	100.0%	0.02	0.02	49,298
Total				0.93	2,456,621

Industrial Sector

Washington Characterization

The total sum of natural gas used in 2015 by Avista’s Washington industrial customers was 20,341 dekatherms. Like in the commercial sector, customer account data was used to allocate usage among segments. Energy intensity was derived from AEG’s Energy Market Profiles database.—Most industrial measures are installed through custom programs, where the unit of measure is not as necessary to estimate potential.

Table 3-11 Industrial Sector Control Totals, Washington, 2015

Segment	Intensity (therms/sq ft)	Natural Gas Usage (dekatherms)
Washington Industrial	0.75	268,452

Figure 3-15 shows the distribution of annual natural gas consumption by end use for all industrial customers. Two major sources were used to develop this consumption profile. The first was AEG’s analysis of warehouse usage as part of the commercial sector. We begin with this prototype as a starting point to represent non-process loads. We then added in process loads using our Energy Market Profiles database, which summarizes usage by end use and process type. Accordingly, process is the largest overall end use for the industrial sector, accounting for 87% of energy use. Heating is the second largest end use, and miscellaneous, non-process industrial uses round out consumption.

Figure 3-15 Industrial Natural Gas Use by End Use, Washington, 2015

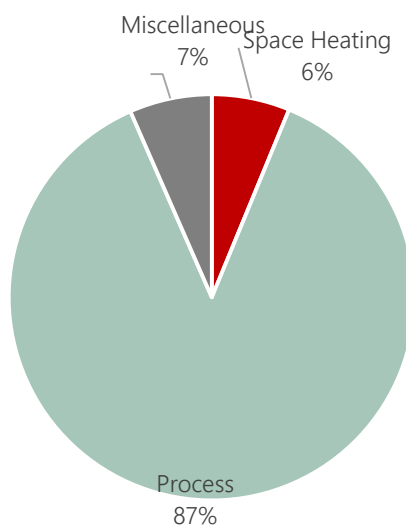

Table 3-12 shows the composite market profile for the industrial sector. Process cooling is very small and represents niche technologies such as gas-driven absorption chillers.

Table 3-12 Average Natural Gas Market Profile for the Industrial Sector, Washington, 2015

End Use	Technology	Saturation	EUI (therms/ sq ft)	Intensity (therms/ Sq ft)	Usage (dekatherms)
Heating	Furnace	65.3%	0.04	0.02	8,832
	Boiler	3.2%	0.12	0.00	1,371
	Unit Heater	23.1%	0.08	0.02	6,490
Process	Process Boiler	100.0%	0.37	0.37	131,596
	Process Heating	100.0%	0.28	0.28	100,538
	Process Cooling	100.0%	0.00	0.00	407
	Other Process	100.0%	0.00	0.00	1,580
Miscellaneous	Miscellaneous	100.0%	0.05	0.05	17,638
Total				0.75	268,452

Idaho Characterization

The total sum of natural gas used in 2015 by Avista's Idaho industrial customers was 20,341 dekatherms. Number of employees is calculated by dividing total usage by intensity. For the industrial sector, the unit of measure chosen is employment.

Table 3-13 Industrial Sector Control Totals, Idaho, 2015

Segment	Intensity (therms/sq ft)	Natural Gas Usage (dekatherms)
Idaho Industrial	0.72	187,203

Figure 3-16 shows the distribution of annual natural gas consumption by end use for all industrial customers. Two major sources were used to develop this consumption profile. The first was AEG's analysis of warehouse usage as part of the commercial sector. We begin with this prototype as a starting point to represent non-process loads. We then added in process loads using our Energy Market Profiles database, which summarizes usage by end use and process type. Accordingly, process is the largest overall end use for the industrial sector, accounting for 87% of energy use. Heating is the second largest end use, and miscellaneous, non-process industrial uses round out consumption.

Figure 3-16 Industrial Natural Gas Use by End Use, Idaho, 2015

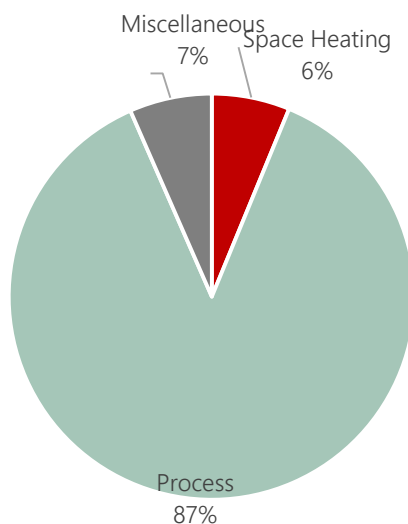

Table 3-14 shows the composite market profile for the industrial sector. Process cooling is very small and represents technologies such as gas-driven absorption chillers.

Table 3-14 Average Natural Gas Market Profile for the Industrial Sector, Washington, 2015

End Use	Technology	Saturation	EUI (therms/sq ft)	Intensity (therms/Sq ft)	Usage (dekatherms)
Heating	Furnace	65.3%	0.04	0.02	6,159
	Boiler	3.2%	0.12	0.00	956
	Unit Heater	23.1%	0.08	0.02	4,526
Process	Process Boiler	100.0%	0.35	0.35	91,768
	Process Heating	100.0%	0.27	0.27	70,109
	Process Cooling	100.0%	0.00	0.00	284
	Other Process	100.0%	0.00	0.00	1,102
Miscellaneous	Miscellaneous	100.0%	0.05	0.05	12,299
Total				0.72	187,203

4

BASELINE PROJECTION

Prior to developing estimates of energy conservation potential, we developed a baseline end-use projection to quantify what the consumption is likely to be in the future in absence of any energy conservation programs. The savings from past programs are embedded in the forecast, but the baseline projection assumes that those past programs cease to exist in the future. Thus, the potential analysis captures all possible savings from future programs.

The baseline projection incorporates assumptions about:

- 2015 energy consumption based on the market profiles
- Customer population growth
- Appliance/equipment standards and building codes already mandated
- Appliance/equipment purchase decisions
- Avista's customer forecast
- Trends in fuel shares and appliance saturations and assumptions about miscellaneous natural gas growth

Although it aligns closely, the baseline projection is not Avista's official load forecast. Rather it was developed as an integral component of our modeling construct to serve as the metric against which energy conservation potentials are measured. This chapter presents the baseline projections we developed for this study. Below, we present the baseline projections for each sector, which include projections of annual use in dekatherms. We also present a summary across all sectors.

Overall Baseline Projection

Washington Projection

Table 4-1 and Figure 4-1 provide a summary of the baseline projection for annual use by sector for the Avista’s Washington service territory. The large spike between 2015 and 2017 is due to the adjustment from 2015 actual weather to 2017 actual weather (which was a colder year).

Overall, the forecast shows modest growth in natural gas consumption, driven by the residential and commercial sectors

Table 4-1 Baseline Projection Summary by Sector, Washington, Selected Years (dekatherms)

Sector	2018	2019	2022	2028	2038	% Change ('18-'38)	Avg. Growth
Residential	10,773,426	10,971,347	11,416,777	11,959,820	12,706,478	17.9%	0.8%
Commercial	6,197,173	6,197,918	6,219,237	6,325,464	6,578,501	6.2%	0.3%
Industrial	251,300	248,912	242,536	232,346	213,968	-14.9%	-0.8%
Total	17,221,900	17,418,177	17,878,550	18,517,630	19,498,948	13.2%	0.6%

Figure 4-1 Baseline Projection Summary by Sector, Washington (dekatherms)

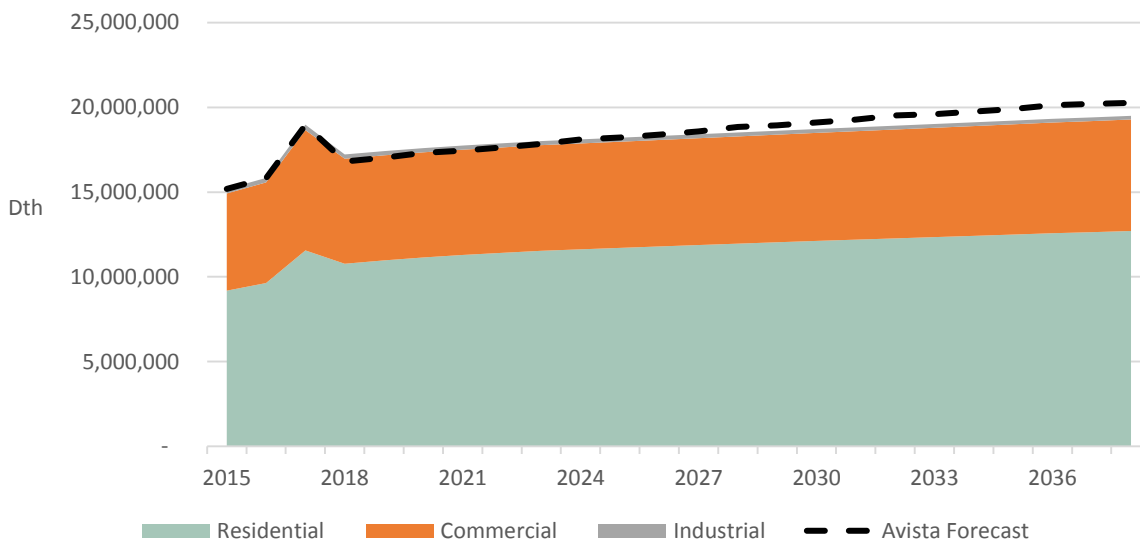

Idaho Projection

Table 4-2 and Figure 4-2 provide a summary of the baseline projection for annual use by sector for Avista’s Idaho service territory. The large spike between 2015 and 2017 is due to the adjustment from 2015 actual weather to 2017 actual weather (which was a colder year and very similar to normal weather).

Overall, the forecast shows modest growth in natural gas consumption, driven roughly equally by the residential sector. We compare change and growth rates starting in 2018 since that is the first year with weather-normal assumptions.

Table 4-2 Baseline Projection Summary by Sector, Idaho, Selected Years (dekatherms)

Sector	2018	2019	2022	2028	2038	% Change ('18-'38)	Avg. Growth
Residential	5,266,179	5,379,047	5,674,999	6,039,699	6,534,309	24.1%	1.1%
Commercial	3,050,738	3,045,031	3,039,479	3,067,352	3,197,949	4.8%	0.2%
Industrial	240,261	243,071	244,254	244,959	242,820	1.1%	0.1%
Total	8,557,178	8,667,149	8,958,733	9,352,011	9,975,077	16.6%	0.8%

Figure 4-2 Baseline Projection Summary by Sector, Idaho (dekatherms)

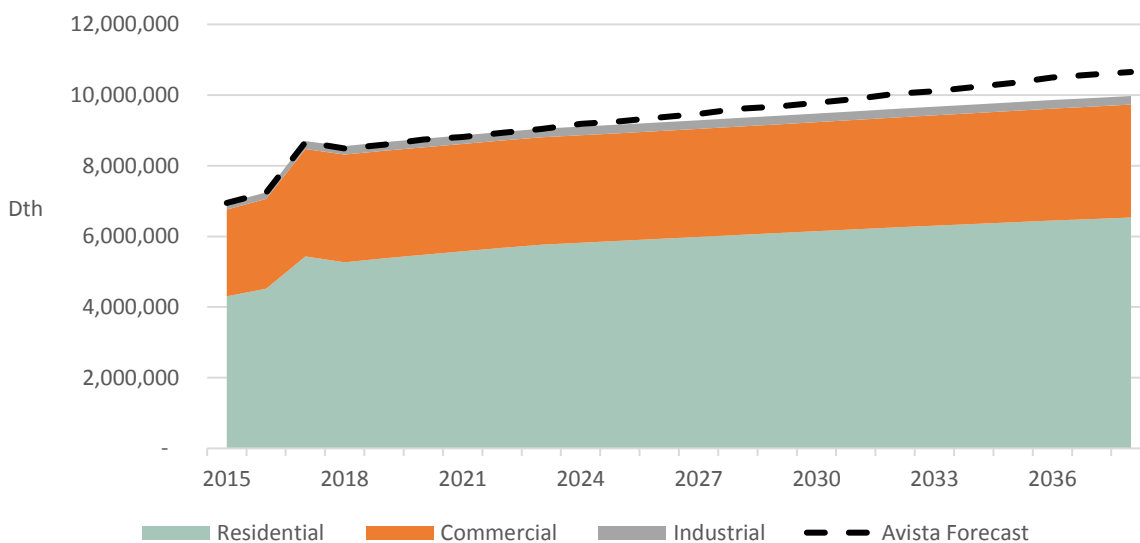

Residential Sector

Washington Projection

Table 4-3 and Figure 4-3 present the baseline projection for natural gas at the end-use level for the residential sector, as a whole. Overall, residential use increases from 10,773,426 dekatherms in 2018 to 12,706,478 dekatherms in 2038, an increase of 17.9%. There are two high-level factors affecting growth. The first is a moderate increase in number of households and customers. The second is a decrease in equipment consumption due to future standards and naturally occurring efficiency improvements (notably the AFUE upcoming 92% furnace standard). We model gas-fired fireplaces as secondary heating. These consume energy and may heat a space but are rarely relied on to be a primary heating technology. As such, they are estimated to be more aesthetic and less weather-dependent. This end use grows faster than others since new homes are more likely to install a unit, increasing fireplace stock. Miscellaneous is a very small end use in natural gas studies and includes technologies with low penetration, such as gas barbecues.

Table 4-3 Residential Baseline Projection by End Use, Washington (dekatherms)

End Use	2018	2019	2022	2028	2038	% Change ('18-'38)	Avg. Growth
Space Heating	8,412,059	8,564,268	8,896,876	9,234,926	9,676,794	15.0%	0.7%
Secondary Heating	338,235	344,941	361,556	391,980	438,702	29.7%	1.3%
Water Heating	1,749,711	1,783,530	1,867,034	2,018,550	2,241,383	28.1%	1.2%
Appliances	92,925	94,541	98,400	105,246	115,574	24.4%	1.1%
Miscellaneous	180,496	184,066	192,912	209,119	234,024	29.7%	1.3%
Total	10,773,426	10,971,347	11,416,777	11,959,820	12,706,478	17.9%	0.8%

Figure 4-3 Residential Baseline Projection by End Use, Washington (dekatherms)

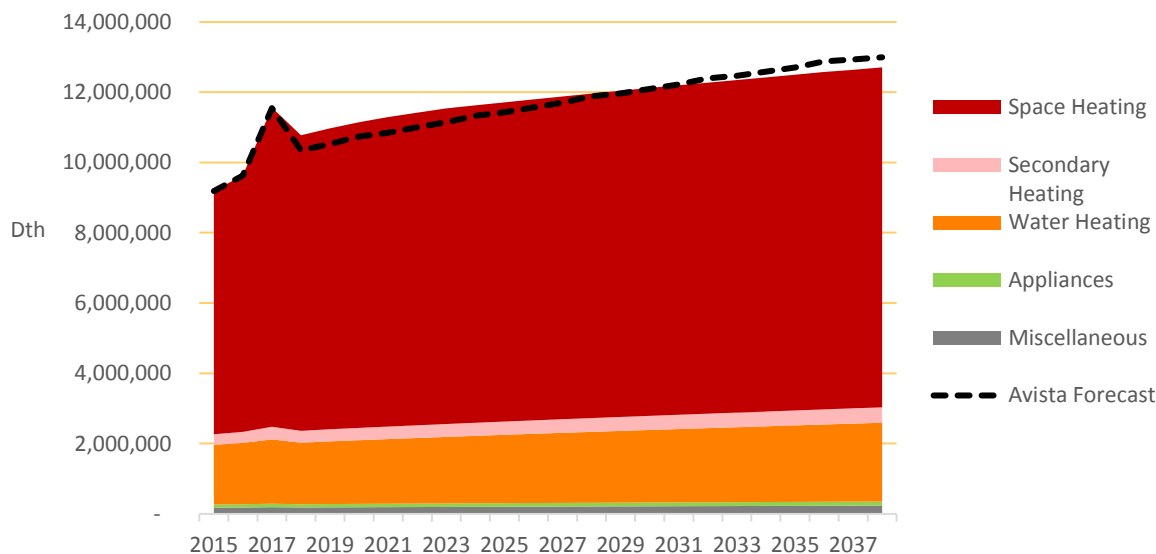

Idaho Projection

Table 4-4 and Figure 4-4 present the baseline projection for natural gas at the end-use level for the residential sector, as a whole. Overall, residential use increases from 5,266,179 dekatherms in 2018 to 6,534,309 dekatherms in 2038, an increase of 24.1%.

Table 4-4 Residential Baseline Projection by End Use, Idaho (dekatherms)

End Use	2018	2019	2022	2028	2038	% Change ('18-'38)	Avg. Growth
Space Heating	4,155,191	4,246,597	4,489,608	4,758,176	5,109,973	23.0%	1.0%
Secondary Heating	179,236	182,789	191,594	207,716	232,475	29.7%	1.3%
Water Heating	827,802	843,793	883,269	954,888	1,060,196	28.1%	1.2%
Appliances	53,227	54,141	56,314	60,149	65,893	23.8%	1.1%
Miscellaneous	50,723	51,727	54,214	58,771	65,772	29.7%	1.3%
Total	5,266,179	5,379,047	5,674,999	6,039,699	6,534,309	24.1%	1.1%

Figure 4-4 Residential Baseline Projection by End Use, Idaho (dekatherms)

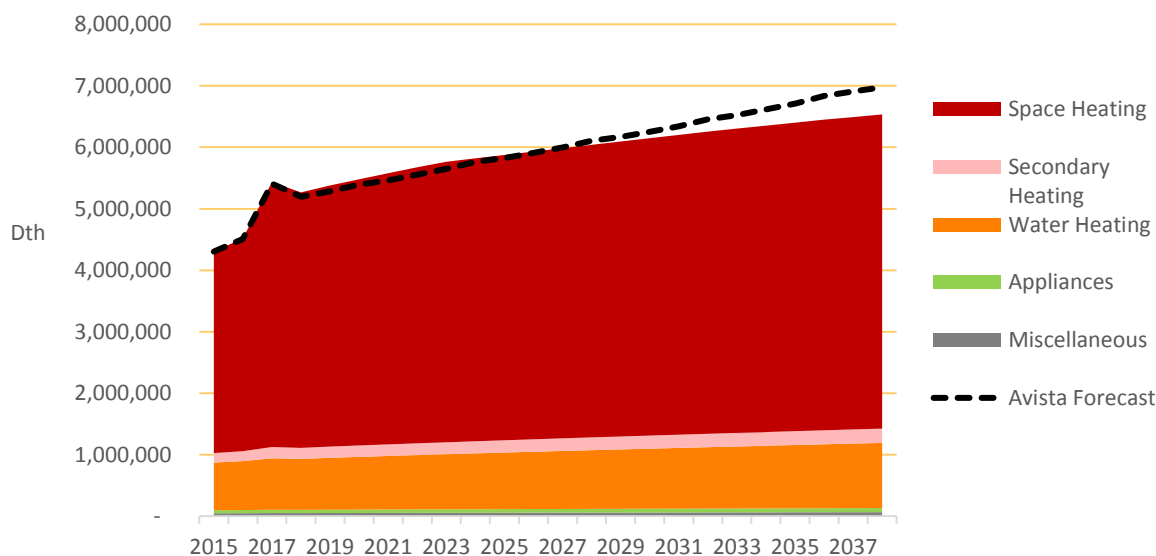

Commercial Sector

Washington Projection

Annual natural gas use in the commercial sector grows 24.7% during the overall forecast horizon, starting at 6,197,173 dekatherms in 2018, and increasing to 6,578,501 dekatherms in 2038. Table 4-5 and Figure 4-5 present the baseline projection at the end-use level for the commercial sector, as a whole. Similar to the residential sector, market size is increasing and usage per square foot is decreasing slightly. The weather normalization between 2015 and 2018 is also readily apparent in both AEG’s projection and Avista’s official load forecast.

Table 4-5 Commercial Baseline Projection by End Use, Washington (dekatherms)

End Use	2018	2019	2022	2028	2038	% Change ('18-'38)	Avg. Growth
Heating	4,196,574	4,199,252	4,221,488	4,305,032	4,481,443	6.8%	0.3%
Water Heating	1,179,697	1,171,006	1,149,673	1,133,956	1,159,165	-1.7%	-0.1%
Food Preparation	710,971	716,824	734,505	767,813	812,434	14.3%	0.7%
Miscellaneous	109,932	110,837	113,571	118,662	125,460	14.1%	0.7%
Total	6,197,173	6,197,918	6,219,237	6,325,464	6,578,501	6.2%	0.3%

Figure 4-5 Commercial Baseline Projection by End Use, Washington (dekatherms)

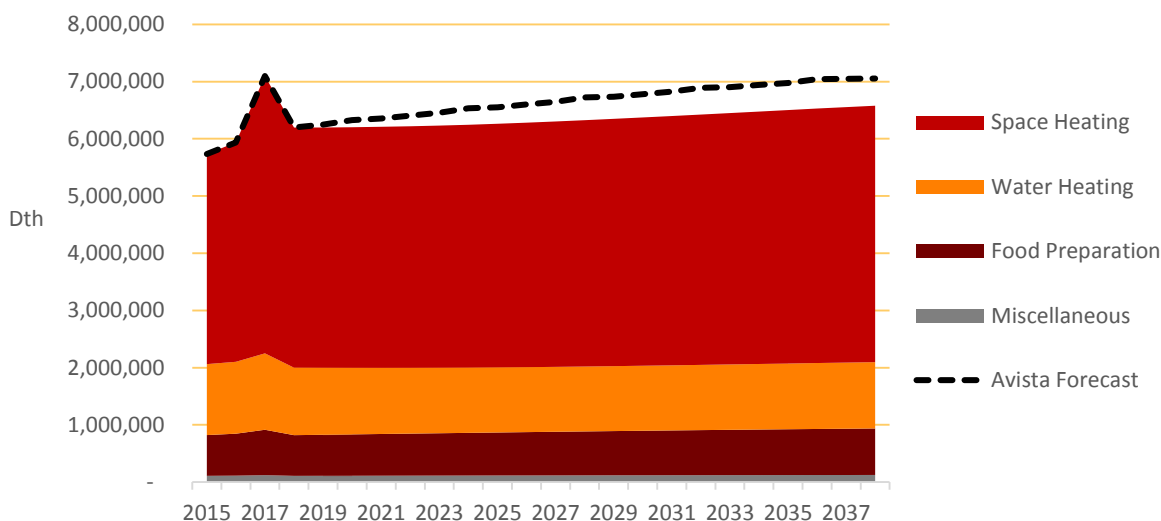

Idaho Projection

Annual natural gas use in the commercial sector grows 24.7% during the overall forecast horizon, starting at 3,050,738 dekatherms in 2018, and increasing to 3,197,949 dekatherms in 2038. Table 4-6 and Figure 4-6 present the baseline projection at the end-use level for the commercial sector, as a whole. Similar to the residential sector, market size is increasing and usage per square foot is decreasing slightly. The weather normalization between 2015 and 2018 is also readily apparent in both AEG’s projection and Avista’s official load forecast.

Table 4-6 Commercial Baseline Projection by End Use, Idaho (dekatherms)

End Use	2018	2019	2022	2028	2038	% Change ('18-'38)	Avg. Growth
Heating	2,119,893	2,117,464	2,118,692	2,145,398	2,239,540	5.6%	0.3%
Water Heating	592,484	587,087	573,650	561,613	575,786	-2.8%	-0.1%
Food Preparation	281,793	283,558	289,103	300,130	318,742	13.1%	0.6%
Miscellaneous	56,568	56,922	58,035	60,210	63,881	12.9%	0.6%
Total	3,050,738	3,045,031	3,039,479	3,067,352	3,197,949	4.8%	0.2%

Figure 4-6 Commercial Baseline Projection by End Use, Idaho (dekatherms)

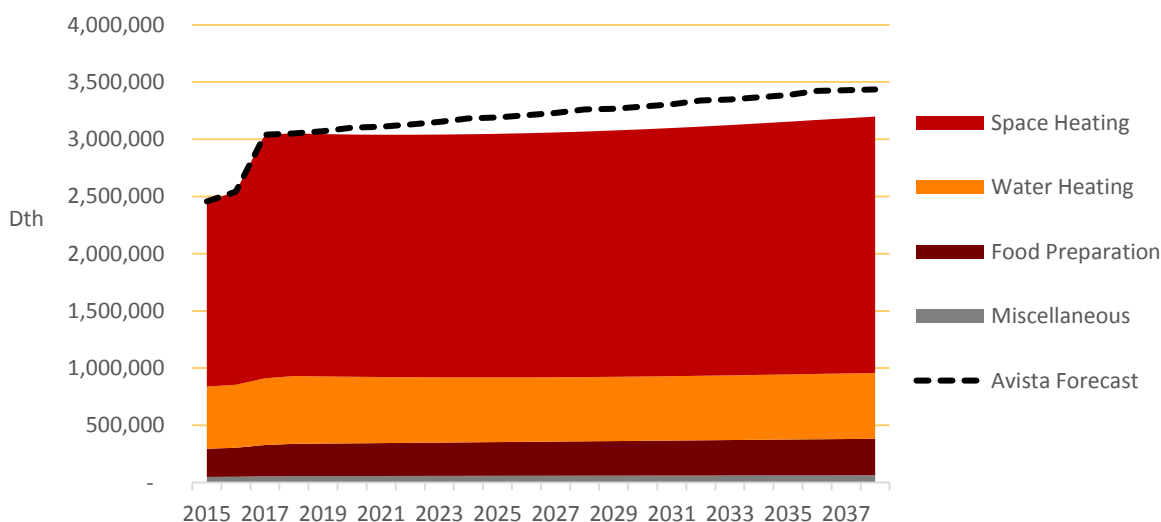

Industrial Sector

Washington Projection

Industrial sector usage increases throughout the planning horizon. Table 4-7 and Figure 4-7 present the projection at the end-use level. Overall, industrial annual natural gas use decreases from 251,300 dekatherms in 2018 to 213,968 dekatherms in 2038. Growth in most end uses is consistent at around -1.0% per year but impacts of naturally occurring efficiency lowers consumption in the space heating end use. We applied a much smaller weather normalization factor for the industrial heating end use since consumption is so heavily dominated by motors and process and a correlation to such small consumption values is much lower.

Table 4-7 Industrial Baseline Projection by End Use, Washington (dekatherms)

End Use	2018	2019	2022	2028	2038	% Change ('18-'38)	Avg. Growth
Heating	17,879	17,630	16,968	15,966	14,528	-18.7%	-1.0%
Process	217,068	215,079	209,766	201,221	185,468	-14.6%	-0.8%
Miscellaneous	16,353	16,203	15,803	15,159	13,972	-14.6%	-0.8%
Total	251,300	248,912	242,536	232,346	213,968	-14.9%	-0.8%

Figure 4-7 Industrial Baseline Projection by End Use, Washington (dekatherms)

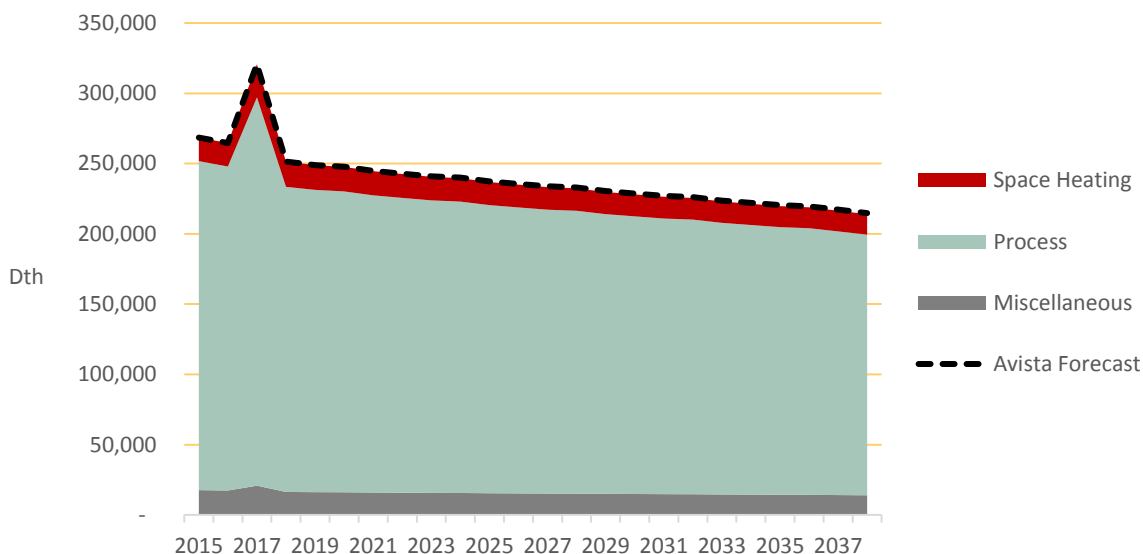

Idaho Projection

Industrial sector usage increases throughout the planning horizon. Table 4-8 and Figure 4-8 present the projection at the end-use level. Overall, industrial annual natural gas use increases from 21,822 dekatherms in 2018 to 28,137 dekatherms in 2038. We applied a much smaller weather normalization factor for the industrial heating end use since consumption is so heavily dominated by motors and process and a correlation to such small consumption values is much lower.

Table 4-8 Industrial Baseline Projection by End Use, Idaho (dekatherms)

End Use	2018	2019	2022	2028	2038	% Change ('18-'38)	Avg. Growth
Heating	17,094	17,200	17,058	16,806	16,475	-3.6%	-0.2%
Process	207,533	210,047	211,279	212,169	210,488	1.4%	0.1%
Miscellaneous	15,635	15,824	15,917	15,984	15,857	1.4%	0.1%
Total	240,261	243,071	244,254	244,959	242,820	1.1%	0.1%

Figure 4-8 Industrial Baseline Projection by End Use, Idaho (dekatherms)

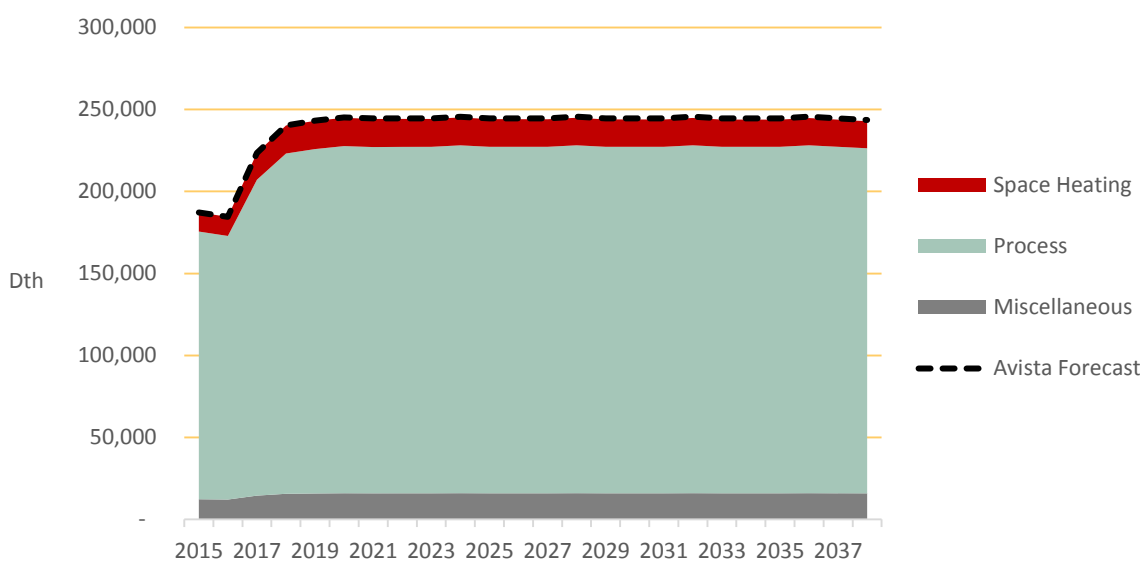

5

OVERALL ENERGY EFFICIENCY POTENTIAL

This chapter presents the measure-level energy conservation potential across all sectors for Avista's Washington and Idaho territories. This includes every possible measure that is considered in the measure list, regardless of program implementation concerns. Year-by-year savings for annual energy usage are available in the LoadMAP model and measure assumption summary, which were provided to Avista at the conclusion of the study. Please note that all savings are provided at the customer site. This section includes potential from the residential, commercial, and industrial analyses.

Overall Energy Efficiency Potential

Washington Potential

Table 5-1 and Figure 5-1 summarize the energy conservation savings in terms of annual energy use for all measures for four levels of potential relative to the baseline projection. Figure 5-2 displays the energy conservation forecasts. Savings are represented in cumulative terms, which reflect the effects of persistent savings in prior years in addition to new savings. This allows for the reporting of annual savings impacts as they actually impact each year of the forecast.

- Technical Potential reflects the adoption of all conservation measures regardless of cost-effectiveness. In this potential case, efficient equipment makes up all lost opportunity installations and all retrofit measures are installed, regardless of achievability. 2018 first-year savings are 217,202 dekatherms, or 1.3% of the baseline projection. Cumulative savings in 2028 are 3,251,362 dekatherms, or 17.6% of the baseline. By 2038, cumulative savings reach 5,804,041 dekatherms, or 29.8% of the baseline. Technical potential is useful as a theoretical construct, applying an upper bound to the potential that may be realized in any one year. Other levels of potential are based off this level which makes it an important component in the estimation of potential.
- Achievable Technical Potential refines technical potential by applying customer participation rates that account for market barriers, customer awareness and attitudes, program maturity, and other factors that affect market penetration of conservation measures. For the 2018-2038 CPA, ramp rates from the Seventh Power Plan were customized for use in natural gas programs and applied. Since the Seventh Plan does not assign ramp rates for the majority natural gas measures, we assigned these based on similar electric technologies present in the Plan as a starting point. These ramp rates may be found in Appendix B. 2018 first-year net savings are 86,389 dekatherms, or 0.5% of the baseline projection. Cumulative net savings in 2028 are 2,405,890 dekatherms, or 13.0% of the baseline. By 2038 cumulative savings reach 4,901,043 dekatherms, or 25.1% of the baseline.
- UCT Achievable Economic Potential further refines achievable technical potential by applying an economic cost-effectiveness screen. In this analysis, the cost-effectiveness is measured by the utility cost test (UCT), which compares lifetime energy benefits to the total utility costs of delivering the measure through a utility program, excluding monetized non-energy impacts. Avoided costs of energy were provided by Avista. 2018 first-year savings are 61,279 dekatherms, or 0.4% of the baseline projection. Cumulative savings in 2028 are 1,916,441 dekatherms, or 10.3% of the baseline. By 2038 cumulative savings reach 4,139,016 dekatherms, or 21.2% of the baseline.

- TRC Achievable Economic Potential further refines achievable technical potential by applying an economic cost-effectiveness screen. In this analysis, the cost-effectiveness is measured by the total resource cost (TRC) test, which compares lifetime energy benefits to the total customer and utility costs of delivering the measure through a utility program, including monetized non-energy impacts. AEG also applied benefits for non-gas energy savings, such as electric HVAC savings for weatherization and lighting savings for retrocommissioning. We also applied the Council's calibration credit to space heating savings to reflect the fact that additional fuels may be used as a supplemental heat source within an average home and may be accounted for within the TRC. Avoided costs of energy were provided by Avista. A 10% conservation credit was applied to these costs per the Council methodologies. 2018 first-year savings are 33,893 dekatherms, or 0.2% of the baseline projection. Cumulative net savings in 2028 are 1,297,679 dekatherms, or 7.0% of the baseline. By 2038 cumulative savings reach 2,420,649 dekatherms, or 12.4% of the baseline. Potential under the TRC test is lower than UCT due to the inclusion of full measure costs rather than the utility portion. For most measures, these far outweigh the quantified and monetized non-energy impacts included in the TRC.

Table 5-1 Summary of Energy Efficiency Potential, Washington (dekatherms)

Scenario	2018	2019	2022	2028	2038
Baseline Projection (Dth)	17,221,900	17,418,177	17,878,550	18,517,630	19,498,948
Cumulative Savings (Dth)					
UCT Achievable Economic Potential	61,279	133,576	500,422	1,916,441	4,139,016
TRC Achievable Economic Potential	33,893	73,100	276,379	1,297,679	2,420,649
Achievable Technical Potential	86,389	186,065	655,389	2,405,890	4,901,043
Technical Potential	217,202	434,037	1,189,331	3,251,362	5,804,041
Cumulative Savings (% of Baseline)					
UCT Achievable Economic Potential	0.4%	0.8%	2.8%	10.3%	21.2%
TRC Achievable Economic Potential	0.2%	0.4%	1.5%	7.0%	12.4%
Achievable Technical Potential	0.5%	1.1%	3.7%	13.0%	25.1%
Technical Potential	1.3%	2.5%	6.7%	17.6%	29.8%

Figure 5-1 Summary of Energy Efficiency Potential as % of Baseline Projection, Washington (dekatherms)

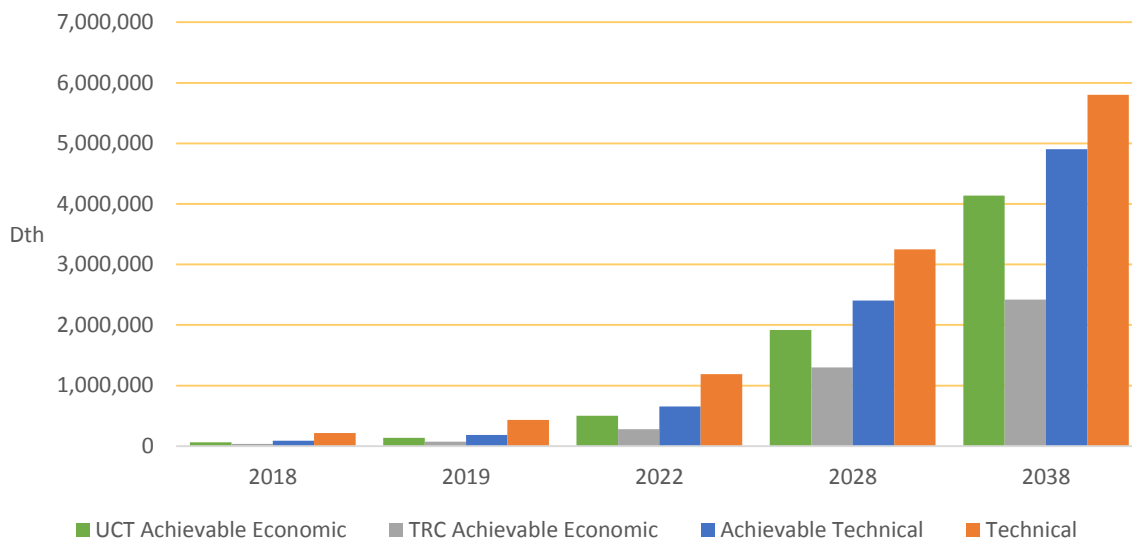

Figure 5-2 Baseline Projection and Energy Efficiency Forecasts, Washington (dekatherms)

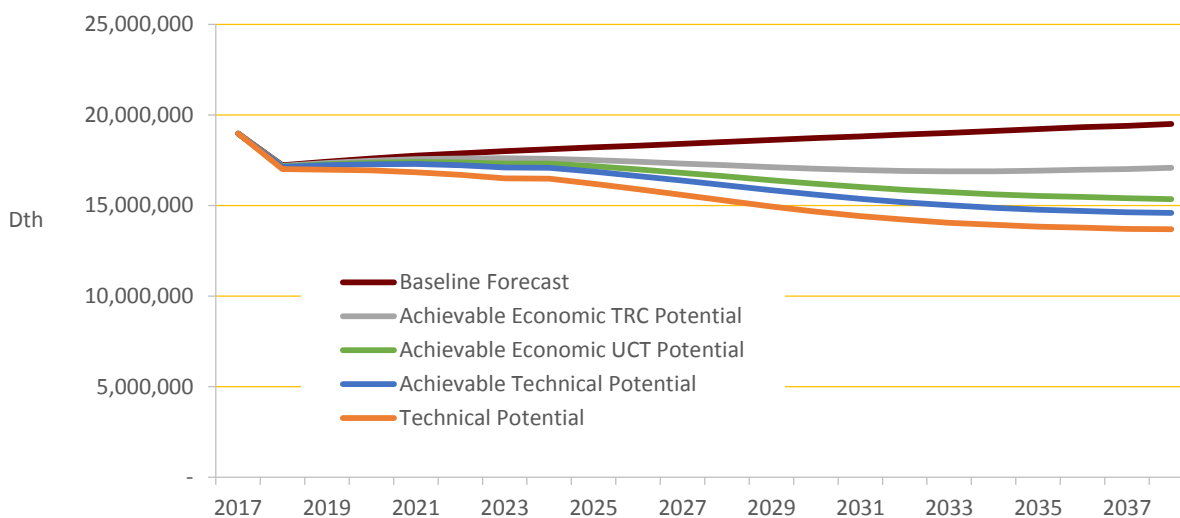

Figure 5-3 shows the cumulative UCT achievable potential by sector for the full timeframe of the analysis as percent of total. Table 5-2 summarizes UCT achievable potential by market sector for selected years.

While the residential and commercial sectors represent the lion’s share of the overall potential in the early years, by the mid-2020s, the residential sector share grows to a significant majority of savings potential. Since industrial consumption is such a low percentage of the baseline once ineligible customers have been excluded, potential for this sector makes up a lower percentage of the total. While residential and commercial potential ramps up, industrial potential is mainly retrofit in nature, and is much flatter. This is because process equipment is highly custom and most potential comes from controls modifications or process adjustments rather than high-efficiency equipment upgrades. Additionally, we model retrocommissioning to phase in evenly over the next twenty years. This measure has a maintenance

component, and not all existing facilities may be old enough to require the tune-up immediately but will be eligible at some point over the course of the study.

There is a notable downtick in residential savings around 2024. This is due to the impacts of the residential forced-air furnace standard, which raises the baseline from AFUE 80% to AFUE 92%, which is a substantial increase when the efficient option is an AFUE 95% unit.

Figure 5-3 Cumulative UCT Achievable Economic Potential by Sector, Washington (% of Total)

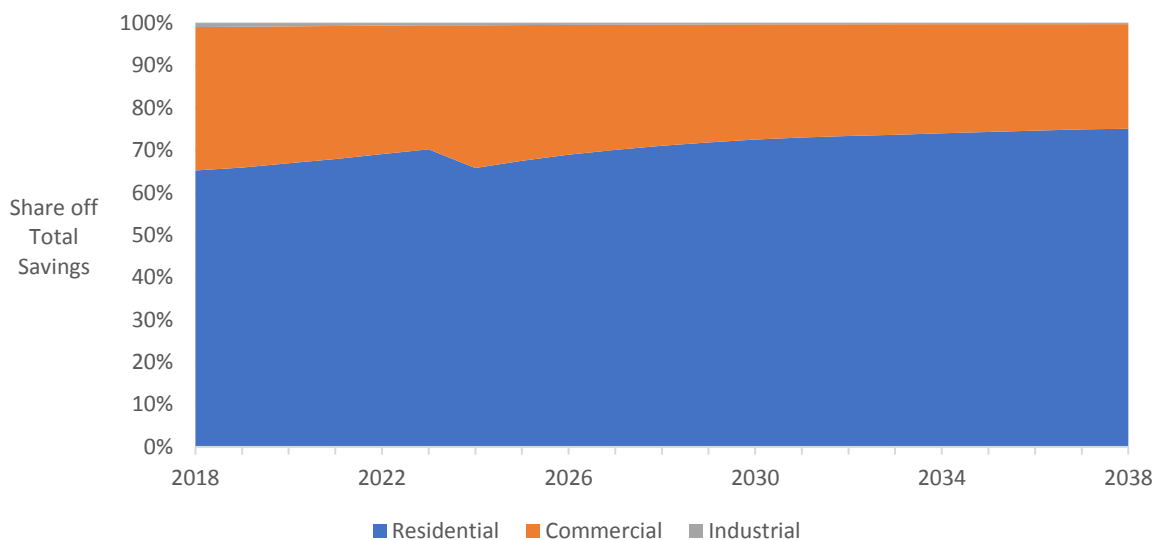

Table 5-2 Cumulative UCT Achievable Economic Potential by Sector, Washington, Selected Years (dekatherms)

Sector	2018	2019	2022	2028	2038
Residential	39,979	88,051	345,801	1,362,078	3,107,847
Commercial	20,731	44,393	151,733	547,834	1,021,211
Industrial	569	1,132	2,887	6,528	9,957
Total	61,279	133,576	500,422	1,916,441	4,139,016

Idaho Potential

Table 5-3 and Figure 5-4 summarize the energy conservation savings in terms of annual energy use for all measures for four levels of potential relative to the baseline projection. Figure 5-5 displays the energy conservation forecasts. Savings are represented in cumulative terms, which reflect the effects of persistent savings in prior years in addition to new savings. This allows for the reporting of annual savings impacts as they actually impact each year of the forecast.

- Technical Potential first-year savings in 2018 are 103,071 dekatherms, or 1.2% of the baseline projection. Cumulative savings in 2028 are 1,660,809 dekatherms, or 17.8% of the baseline. By 2038, cumulative savings reach 2,993,151 dekatherms, or 30.0% of the baseline.
- Achievable Technical Potential first-year net savings are 37,324 dekatherms, or 0.4% of the baseline projection. Cumulative net savings in 2028 are 1,218,944 dekatherms, or 13.0% of the baseline. By 2038 cumulative savings reach 2,514,049 dekatherms, or 25.2% of the baseline.
- UCT Achievable Economic Potential first-year savings are 26,340 dekatherms, or 0.3% of the baseline projection. Cumulative savings in 2028 are 965,825 dekatherms, or 10.3% of the baseline. By 2038 cumulative savings reach 2,107,684 dekatherms, or 21.1% of the baseline.
- TRC Achievable Economic Potential first-year savings are 9,846 dekatherms, or 0.1% of the baseline projection. Cumulative net savings in 2028 are 635,250 dekatherms, or 6.8% of the baseline. By 2038 cumulative savings reach 1,204,809 dekatherms, or 12.1% of the baseline. Potential under the TRC test is lower than UCT due to the inclusion of full measure costs rather than the utility portion. For most measures, these far outweigh the quantified and monetized non-energy impacts included in the TRC.

Table 5-3 Summary of Energy Efficiency Potential, Idaho (dekatherms)

Scenario	2018	2019	2022	2028	2038
Baseline Projection (Dth)	8,557,178	8,667,149	8,958,733	9,352,011	9,975,077
Cumulative Savings (Dth)					
UCT Achievable Economic Potential	26,340	58,352	235,414	965,825	2,107,684
TRC Achievable Economic Potential	9,846	22,432	108,249	635,250	1,204,809
Achievable Technical Potential	37,324	81,526	310,222	1,218,944	2,514,049
Technical Potential	103,071	206,214	582,638	1,660,809	2,993,151
Cumulative Savings (% of Baseline)					
UCT Achievable Economic Potential	0.3%	0.7%	2.6%	10.3%	21.1%
TRC Achievable Economic Potential	0.1%	0.3%	1.2%	6.8%	12.1%
Achievable Technical Potential	0.4%	0.9%	3.5%	13.0%	25.2%
Technical Potential	1.2%	2.4%	6.5%	17.8%	30.0%

Figure 5-4 Summary of Energy Efficiency Potential as % of Baseline Projection, Idaho (dekatherms)

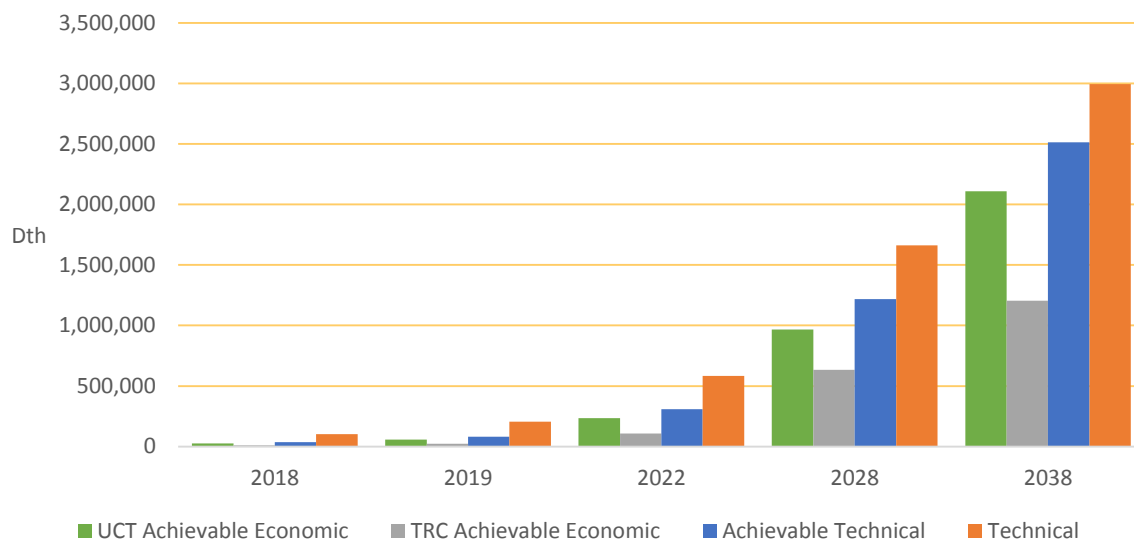

Figure 5-5 Summary of Energy Efficiency Potential as % of Baseline Projection, Idaho (dekatherms)

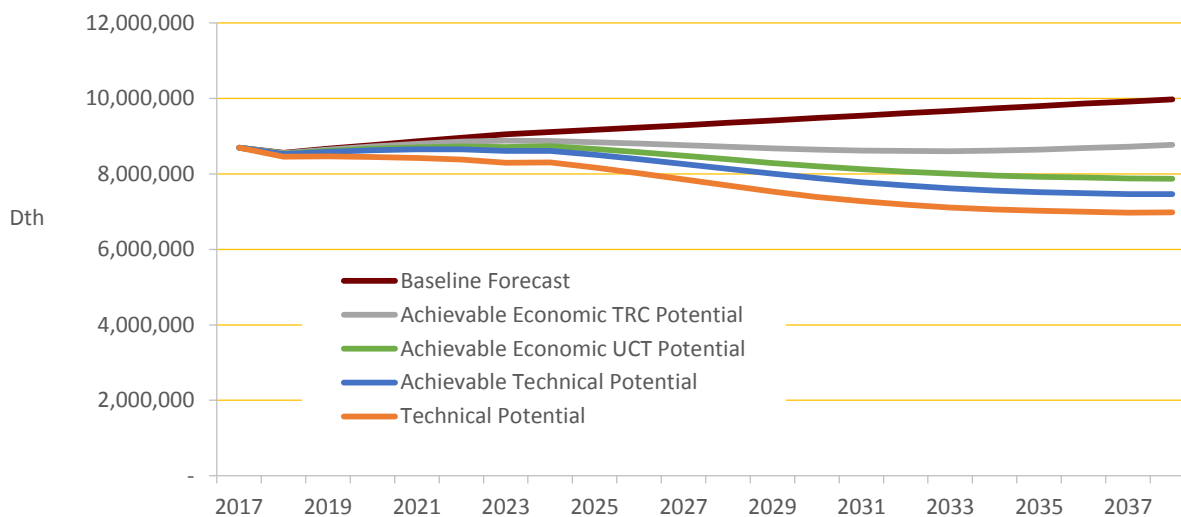

Figure 5-6 shows the cumulative UCT achievable potential by sector for the full timeframe of the analysis as percent of total. Table 5-4 summarizes UCT achievable potential by market sector for selected years.

Figure 5-6 Cumulative UCT Achievable Economic Potential by Sector, Idaho (% of Total)

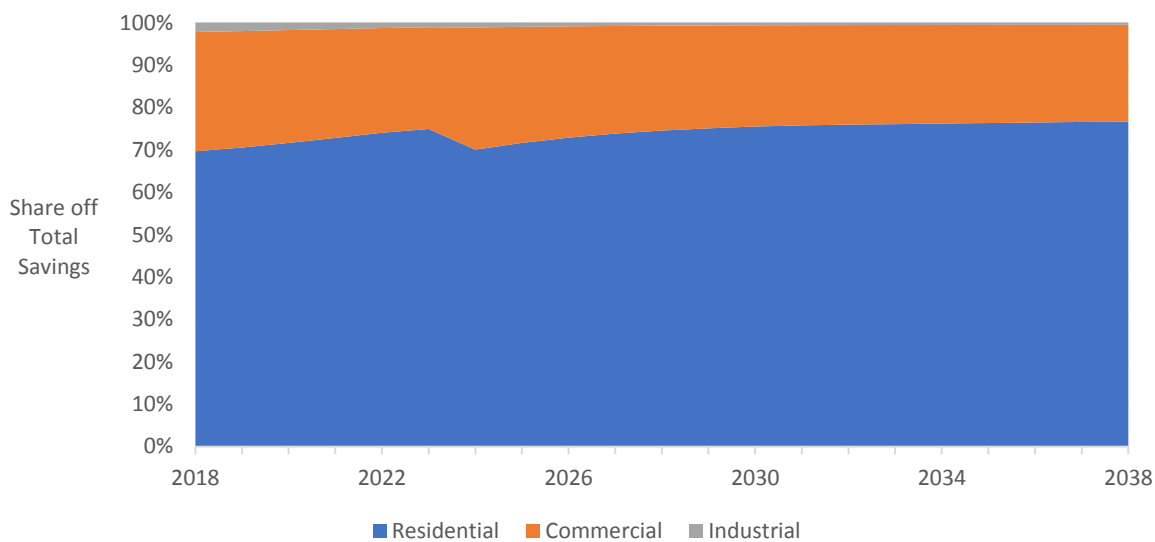

Table 5-4 Cumulative UCT Achievable Economic Potential by Sector, Idaho, Selected Years (dekatherms)

Sector	2018	2019	2022	2028	2038
Residential	18,354	41,176	174,333	720,226	1,615,844
Commercial	7,417	16,035	58,160	239,015	481,888
Industrial	569	1,140	2,922	6,584	9,952
Total	26,340	58,352	235,414	965,825	2,107,684

6

SECTOR-LEVEL ENERGY EFFICIENCY POTENTIAL

The previous section provided a summary of potential for the Avista territory at the state level. In this section, we provide details for each sector.

Residential Sector

Washington Potential

Table 6-1 and Figure 6-1 summarize the energy efficiency potential for the residential sector. In 2018, UCT achievable economic potential is 39,979 dekatherms, or 0.4% of the baseline projection. By 2028, cumulative savings are 1,362,078 dekatherms, or 11.4% of the baseline.

Table 6-1 Residential Energy Conservation Potential Summary, Washington (dekatherms)

Scenario	2018	2019	2022	2028	2038
Baseline Forecast (Dth)	10,773,426	10,971,347	11,416,777	11,959,820	12,706,478
Cumulative Savings (Dth)					
UCT Achievable Economic Potential	39,979	88,051	345,801	1,362,078	3,107,847
TRC Achievable Economic Potential	14,920	32,308	139,361	824,953	1,573,939
Achievable Technical Potential	49,298	108,161	412,455	1,653,830	3,604,150
Technical Potential	137,252	272,444	753,898	2,170,218	4,226,558
Energy Savings (% of Baseline)					
UCT Achievable Economic Potential	0.4%	0.8%	3.0%	11.4%	24.5%
TRC Achievable Economic Potential	0.1%	0.3%	1.2%	6.9%	12.4%
Achievable Technical Potential	0.5%	1.0%	3.6%	13.8%	28.4%
Technical Potential	1.3%	2.5%	6.6%	18.1%	33.3%

Figure 6-1 Residential Energy Conservation by Case, Washington (dekatherms)

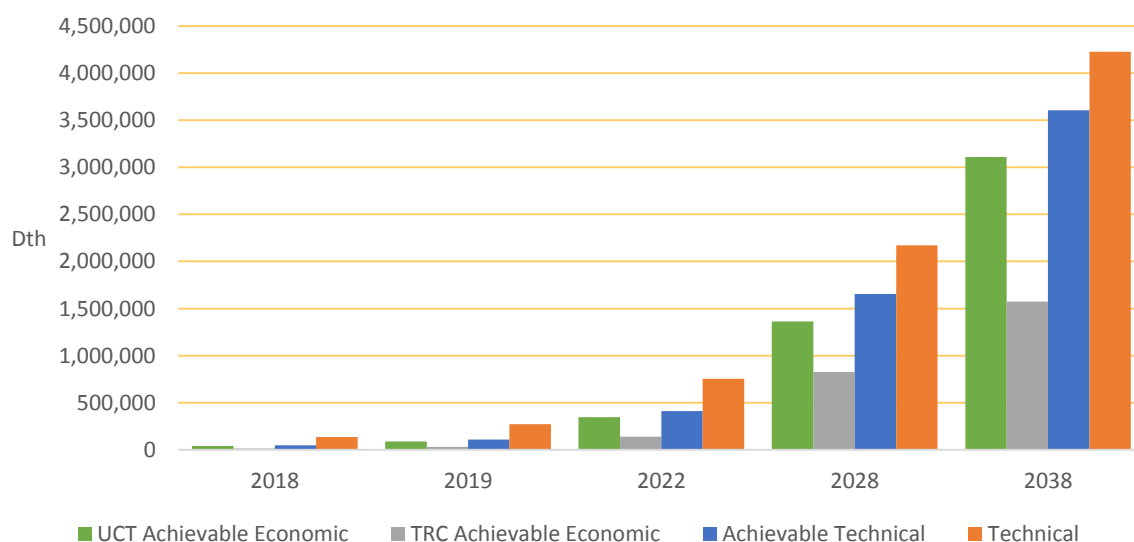

Figure 6-2 presents forecasts of energy savings by end use as a percent of total annual savings and cumulative savings. Space heating makes up a majority of potential but declines slightly in the early to mid-2020s due to the future furnace standard.

Figure 6-2 Residential UCT Achievable Economic Potential – Cumulative Savings by End Use, Washington (dekatherms, % of total)

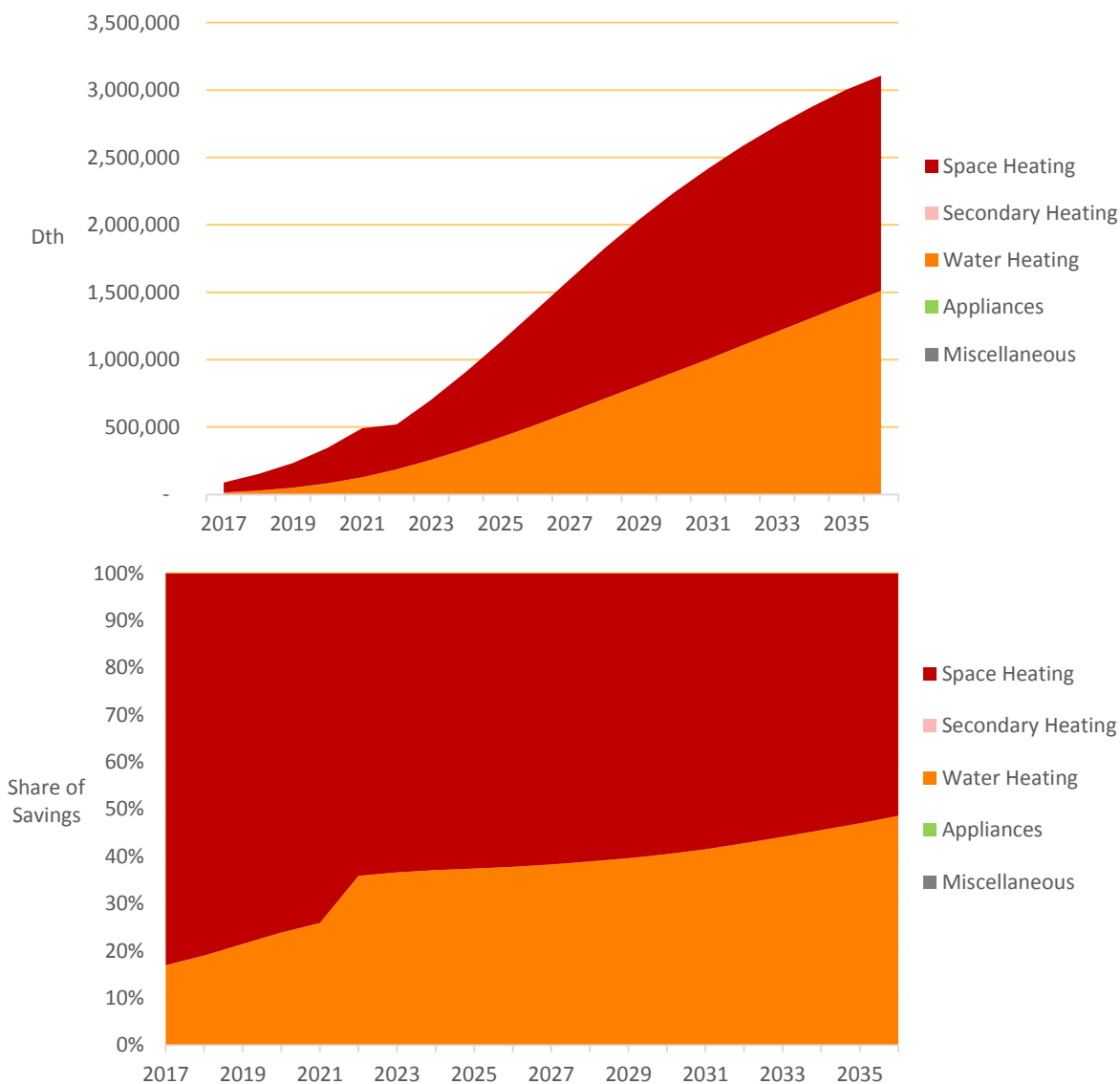

Table 6-2 identifies the top 20 residential measures by cumulative 2018 and 2019 savings. Furnaces, windows, tankless water heaters, and learning thermostats are the top measures.

Table 6-2 Residential Top Measures in 2018 and 2019, UCT Achievable Economic Potential, Washington (dekatherms)

Rank	Measure / Technology	2018 Cumulative Potential Savings (dekatherms)	% of Total	2019 Cumulative Potential Savings (dekatherms)	% of Total
1	Furnace - Direct Fuel - AFUE 95%	19,091	48%	41,449	47%
2	Windows - High Efficiency - Double Pane LowE CL22	9,426	24%	18,788	21%
3	Water Heater <= 55 gal. - Instantaneous - ENERGY STAR (UEF 0.87)	4,193	10%	10,186	12%
4	Thermostat - Wi-Fi/Interactive - Interactive/learning thermostat (ie, NEST)	1,344	3%	3,094	4%
5	Insulation - Floor/Crawlspace - R-30	1,132	3%	2,818	3%
6	Insulation - Ceiling, Installation - R-38 (Retro only)	734	2%	1,672	2%
7	Boiler - Direct Fuel - AFUE 96%	619	2%	1,321	2%
8	Insulation - Wall Cavity, Installation - R-11	572	1%	1,424	2%
9	Insulation - Ducting - duct thermal losses reduced 50%	367	1%	914	1%
10	Water Heater - Low Flow Showerhead (1.5 GPM) - 1.5 GPM showerhead	365	1%	921	1%
11	Water Heater - Faucet Aerators - 1.5 GPM faucet	349	1%	805	1%
12	Insulation - Ceiling, Upgrade - R-49	339	1%	772	1%
13	Insulation - Basement Sidewall - R-15	332	1%	827	1%
14	ENERGY STAR Homes - Built Green spec (NC Only)	294	1%	982	1%
15	Water Heater - Low Flow Showerhead (2.0 GPM) - 2.0 GPM showerhead	210	1%	529	1%
16	Water Heater - Pipe Insulation - Insulated 5' of pipe between unit and conditioned space	190	0%	438	0%
17	ENERGY STAR Clothes Washers - ENERGY STAR unit	175	0%	530	1%
18	Water Heater - Thermostatic Shower Restriction Valve - Restrictor installed, shutting off water when it is warm	149	0%	343	0%
19	Water Heater > 55 gal. - Instantaneous - ENERGY STAR (UEF 0.87)	63	0%	154	0%
20	Thermostat - Programmable - Programmed thermostat	29	0%	68	0%
Subtotal		39,974	100%	88,037	100%
Total Savings in Year		39,979	100%	88,051	100%

Idaho Potential

Table 6-3 and Figure 6-3 summarize the energy efficiency potential for the residential sector. In 2018, UCT achievable economic potential is 18,354 dekatherms, or 0.3% of the baseline projection. By 2028, cumulative savings are 720,226 dekatherms, or 11.9% of the baseline.

Table 6-3 Residential Energy Conservation Potential Summary, Idaho (dekatherms)

Scenario	2018	2019	2022	2028	2038
Baseline Forecast (Dth)	5,266,179	5,379,047	5,674,999	6,039,699	6,534,309
Cumulative Savings (Dth)					
UCT Achievable Economic Potential	18,354	41,176	174,333	720,226	1,615,844
TRC Achievable Economic Potential	3,744	9,243	62,156	458,445	833,329
Achievable Technical Potential	21,723	48,708	205,345	871,461	1,876,450
Technical Potential	65,563	130,317	376,364	1,132,377	2,199,415
Energy Savings (% of Baseline)					
UCT Achievable Economic Potential	0.3%	0.8%	3.1%	11.9%	24.7%
TRC Achievable Economic Potential	0.1%	0.2%	1.1%	7.6%	12.8%
Achievable Technical Potential	0.4%	0.9%	3.6%	14.4%	28.7%
Technical Potential	1.2%	2.4%	6.6%	18.7%	33.7%

Figure 6-3 Residential Energy Conservation by Case, Idaho (dekatherms)

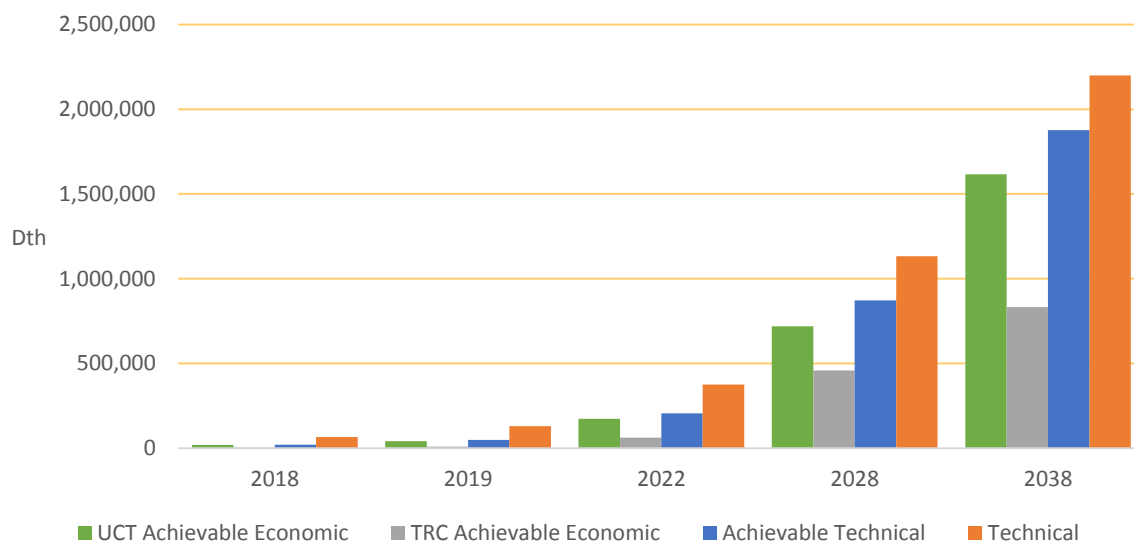

Figure 6-4 presents forecasts of energy savings by end use as a percent of total annual savings and cumulative savings. Space heating makes up a majority of potential but declines slightly in the early to mid-2020s due to the future furnace standard.

Figure 6-4 Residential UCT Achievable Economic Potential – Cumulative Savings by End Use, Idaho (dekatherms, % of total)

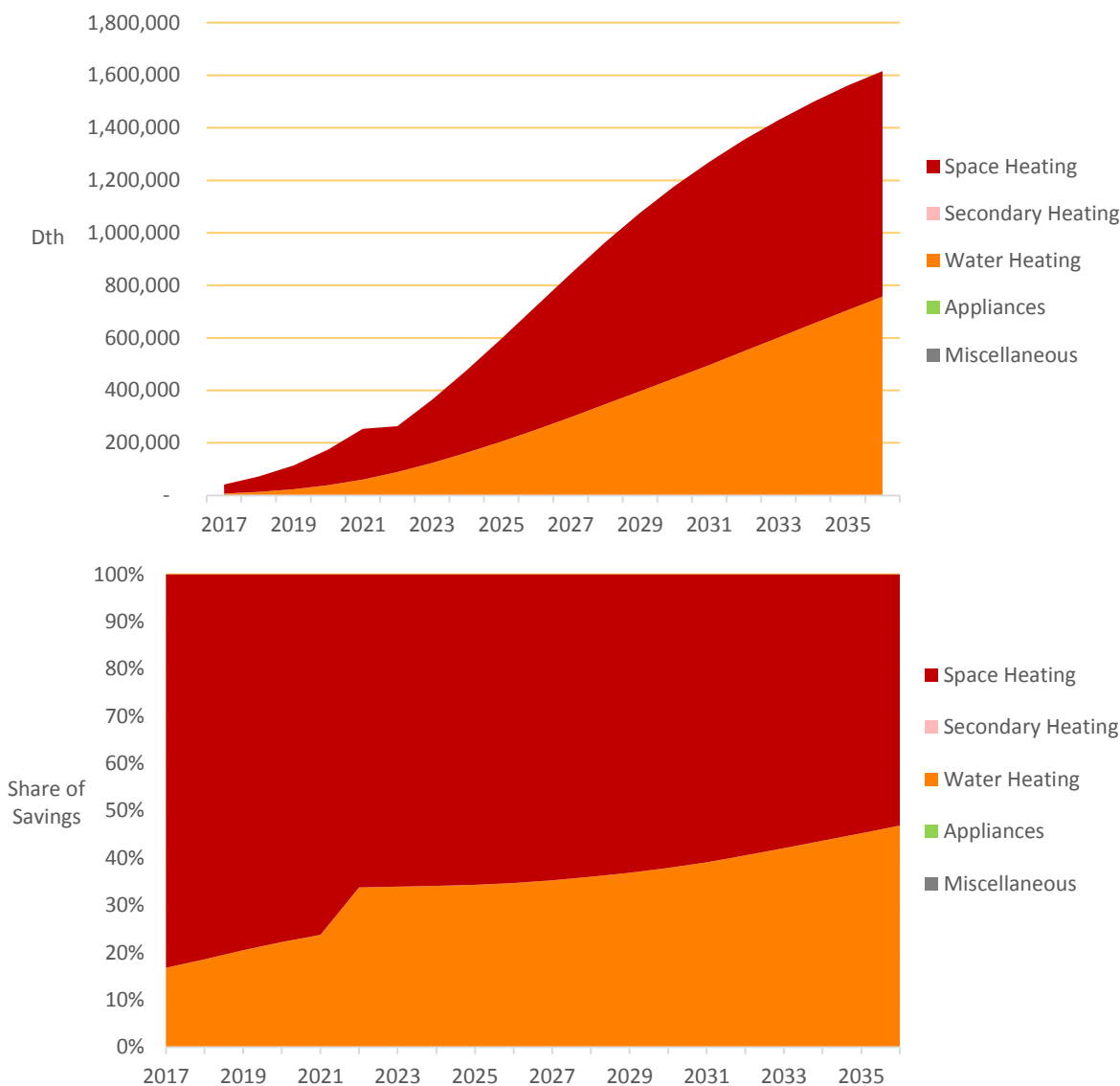

Table 6-4 identifies the top 20 residential measures by cumulative 2018 and 2019 savings. Furnaces, tankless water heaters, windows, and insulation are the top measures.

Table 6-4 Residential Top Measures in 2018 and 2019, UCT Achievable Economic Potential, Idaho (dekatherms)

Rank	Measure / Technology	2018 Cumulative Potential Savings (dekatherms)	% of Total	2019 Cumulative Potential Savings (dekatherms)	% of Total
1	Furnace - Direct Fuel - AFUE 95%	11,816	64%	25,295	61%
2	Water Heater <= 55 gal. - Instantaneous - ENERGY STAR (UEF 0.87)	1,983	11%	4,818	12%
3	Windows - High Efficiency - Double Pane LowE CL22	820	4%	2,044	5%
4	Insulation - Floor/Crawlspace - R-30	772	4%	1,925	5%
5	Thermostat - Wi-Fi/Interactive - Interactive/learning thermostat (ie, NEST)	664	4%	1,529	4%
6	Insulation - Ceiling, Installation - R-38 (Retro only)	365	2%	833	2%
7	Boiler - Direct Fuel - AFUE 96%	307	2%	653	2%
8	Insulation - Wall Cavity, Installation - R-11	285	2%	711	2%
9	Water Heater - Low Flow Showerhead (1.5 GPM) - 1.5 GPM showerhead	182	1%	458	1%
10	Insulation - Ducting - duct thermal losses reduced 50%	181	1%	450	1%
11	Water Heater - Faucet Aerators - 1.5 GPM faucet	174	1%	401	1%
12	Insulation - Ceiling, Upgrade - R-49	168	1%	383	1%
13	Insulation - Basement Sidewall - R-15	166	1%	415	1%
14	ENERGY STAR Homes - Built Green spec (NC Only)	146	1%	486	1%
15	Water Heater - Low Flow Showerhead (2.0 GPM) - 2.0 GPM showerhead	104	1%	263	1%
16	Water Heater - Pipe Insulation - Insulated 5' of pipe between unit and conditioned space	100	1%	230	1%
17	Water Heater - Thermostatic Shower Restriction Valve - Restrictor installed, shutting off water when it is warm	74	0%	171	0%
18	Water Heater > 55 gal. - Instantaneous - ENERGY STAR (UEF 0.87)	30	0%	73	0%
19	Thermostat - Programmable - Programmed thermostat	14	0%	33	0%
20	Insulation - Slab Foundation - R-11 (NC Only)	2	0%	5	0%
Subtotal		18,354	100%	41,175	100%
Total Savings in Year		18,354	100%	41,176	100%

Commercial Sector

Washington Potential

Table 6-5 and Figure 6-5 summarize the energy conservation potential for the commercial sector. In 2018, UCT achievable economic potential is 20,731 dekatherms, or 0.3% of the baseline projection. By 2028, cumulative savings are 547,834 dekatherms, or 8.7% of the baseline.

Table 6-5 Commercial Energy Conservation Potential Summary, Washington

Scenario	2018	2019	2022	2028	2038
Baseline Forecast (dekatherms)	6,197,173	6,197,918	6,219,237	6,325,464	6,578,501
Cumulative Savings (dekatherms)					
UCT Achievable Economic Potential	20,731	44,393	151,733	547,834	1,021,211
TRC Achievable Economic Potential	18,376	39,603	134,004	465,827	836,014
Achievable Technical Potential	36,328	76,386	239,042	743,027	1,283,162
Technical Potential	78,948	159,629	430,505	1,070,109	1,561,295
Energy Savings (% of Baseline)					
UCT Achievable Economic Potential	0.3%	0.7%	2.4%	8.7%	15.5%
TRC Achievable Economic Potential	0.3%	0.6%	2.2%	7.4%	12.7%
Achievable Technical Potential	0.6%	1.2%	3.8%	11.7%	19.5%
Technical Potential	1.3%	2.6%	6.9%	16.9%	23.7%

Figure 6-5 Commercial Energy Conservation by Case, Washington (dekatherms)

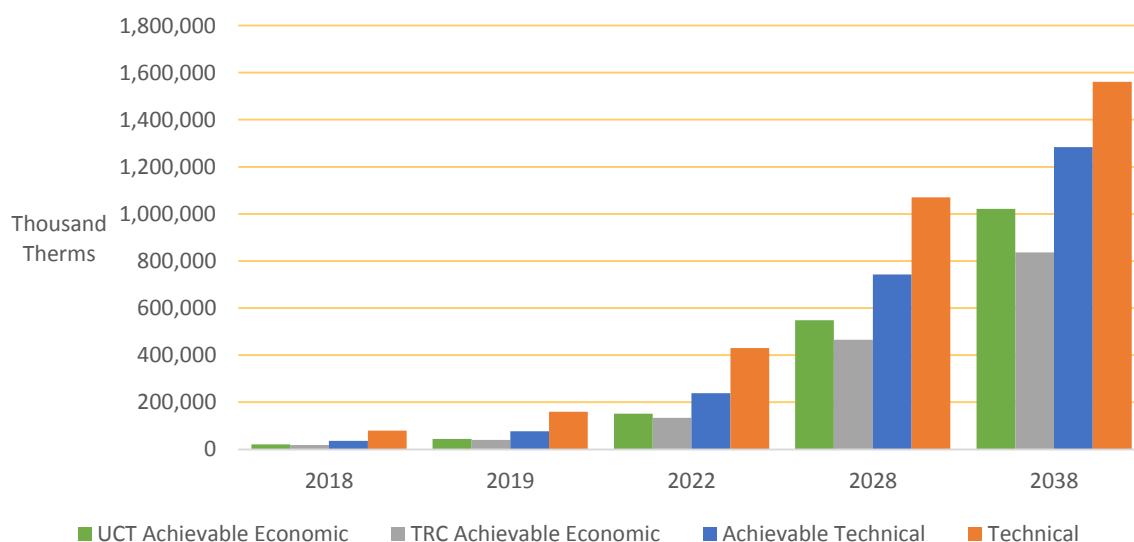

Figure 6-6 presents forecasts of energy savings by end use as a percent of total annual savings and cumulative savings. Space heating makes up a majority of the potential early, but food preparation equipment upgrades provide substantial savings opportunities in the later years.

Figure 6-6 Commercial UCT Achievable Economic Potential – Cumulative Savings by End Use, Washington (dekatherms, % of total)

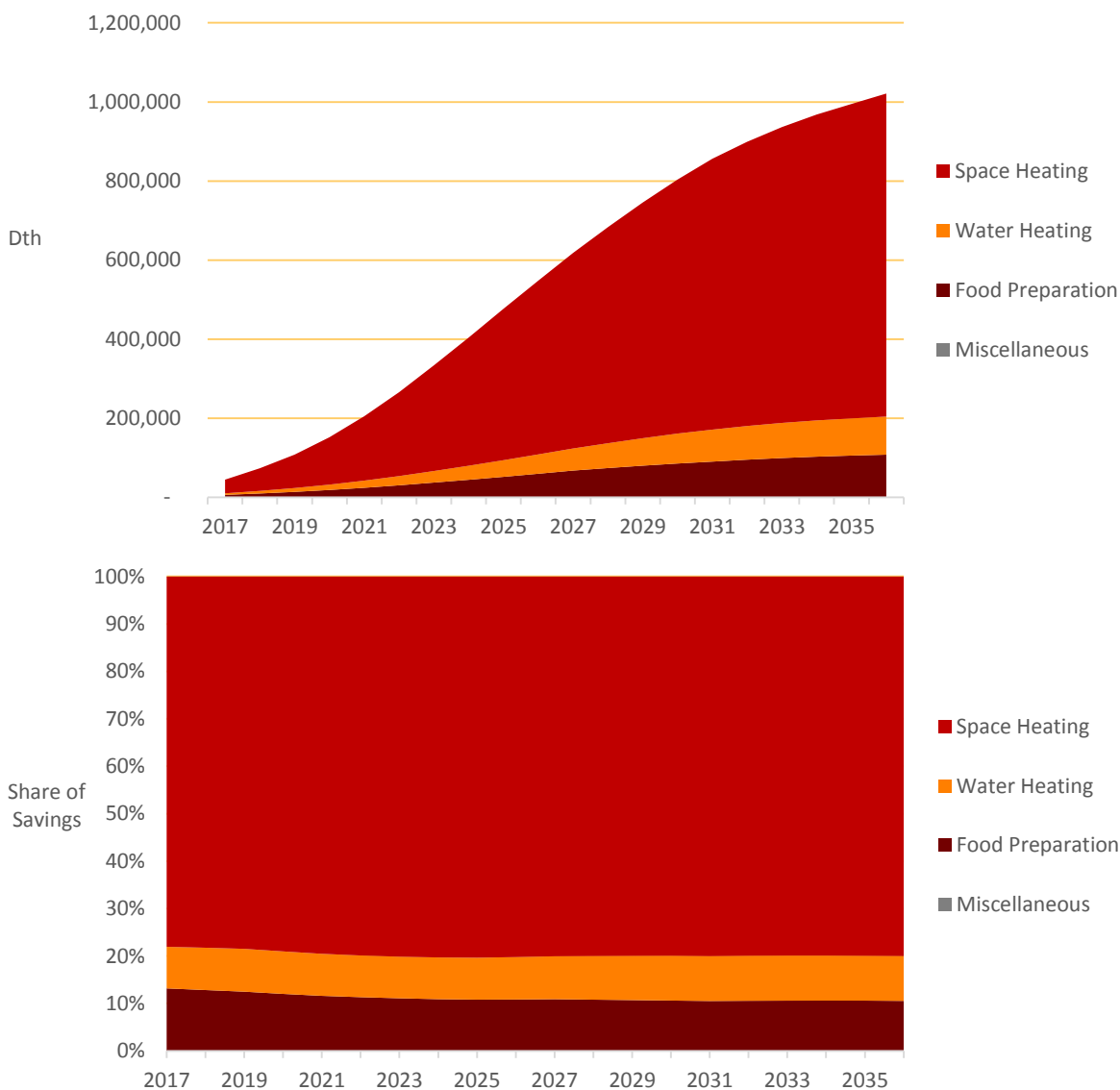

Table 6-6 identifies the top 20 commercial measures by cumulative savings in 2018 and 2019. Boilers are the top measure, food preparation and custom HVAC measures. Retrocommissioning potential is present in the top measures but is a smaller contributor due to revised savings assumptions. RCx in the commercial sector is a restoration of HVAC systems to their original, or better, conditions.

Table 6-6 Commercial Top Measures in 2018 and 2019, UCT Achievable Economic Potential, Washington (dekatherms)

Rank	Measure / Technology	2018 Cumulative Potential Savings (dekatherms)	% of Total	2019 Cumulative Potential Savings (dekatherms)	% of Total
1	Boiler - AFUE 97%	6,337	31%	13,775	31%
2	Fryer - ENERGY STAR	1,775	9%	3,653	8%
3	Gas Boiler - Insulate Steam Lines/Condensate Tank - Lines and condensate tank insulated	1,152	6%	2,262	5%
4	Gas Boiler - Hot Water Reset - Reset control installed	1,123	5%	2,333	5%
5	HVAC - Demand Controlled Ventilation - DCV enabled	1,033	5%	2,027	5%
6	Insulation - Roof/Ceiling - R-38	850	4%	2,079	5%
7	Water Heater - TE 0.94	838	4%	2,001	5%
8	Steam Trap Maintenance - Cleaning and maintenance	820	4%	1,620	4%
9	Gas Boiler - Insulate Hot Water Lines - Insulated water lines	770	4%	1,512	3%
10	Insulation - Wall Cavity - R-21	761	4%	1,862	4%
11	Retrocommissioning - HVAC - Optimized HVAC flow and controls	661	3%	1,298	3%
12	Water Heater - Central Controls - Central water boiler controls installed	573	3%	1,137	3%
13	Gas Boiler - High Turndown - Turndown control installed	526	3%	1,091	2%
14	Strategic Energy Management - Energy management system installed and programmed	412	2%	820	2%
15	Double Rack Oven - FTSC Qualified (>50% Cooking Efficiency)	405	2%	836	2%
16	Kitchen Hood - DCV/MUA - DCV/HUA vent hood	329	2%	656	1%
17	Oven - ENERGY STAR (>42% Baking Efficiency)	311	2%	669	2%
18	Building Automation System - Automation system installed and programmed	307	1%	765	2%
19	Gas Boiler - Stack Economizer - Economizer installed	282	1%	593	1%
20	Water Heater - Faucet Aerator - 1.5 GPM faucet	219	1%	453	1%
Subtotal		19,485	94%	41,442	93%
Total Savings in Year		20,731	100%	44,393	100%

Idaho Potential

Table 6-7 and Figure 6-7 summarize the energy conservation potential for the commercial sector. In 2018, UCT achievable economic potential is 7,417 dekatherms, or 0.2% of the baseline projection. By 2028, cumulative savings are 239,015 dekatherms, or 7.8% of the baseline.

Table 6-7 Commercial Energy Conservation Potential Summary, Idaho

Scenario	2018	2019	2022	2028	2038
Baseline Forecast (dekatherms)	3,050,738	3,045,031	3,039,479	3,067,352	3,197,949
Cumulative Savings (dekatherms)					
UCT Achievable Economic Potential	7,417	16,035	58,160	239,015	481,888
TRC Achievable Economic Potential	5,529	12,039	43,123	169,784	360,683
Achievable Technical Potential	14,871	31,349	101,064	338,527	623,867
Technical Potential	36,549	73,959	201,366	517,401	777,530
Energy Savings (% of Baseline)					
UCT Achievable Economic Potential	0.2%	0.5%	1.9%	7.8%	15.1%
TRC Achievable Economic Potential	0.2%	0.4%	1.4%	5.5%	11.3%
Achievable Technical Potential	0.5%	1.0%	3.3%	11.0%	19.5%
Technical Potential	1.2%	2.4%	6.6%	16.9%	24.3%

Figure 6-7 Commercial Energy Conservation by Case, Idaho (dekatherms)

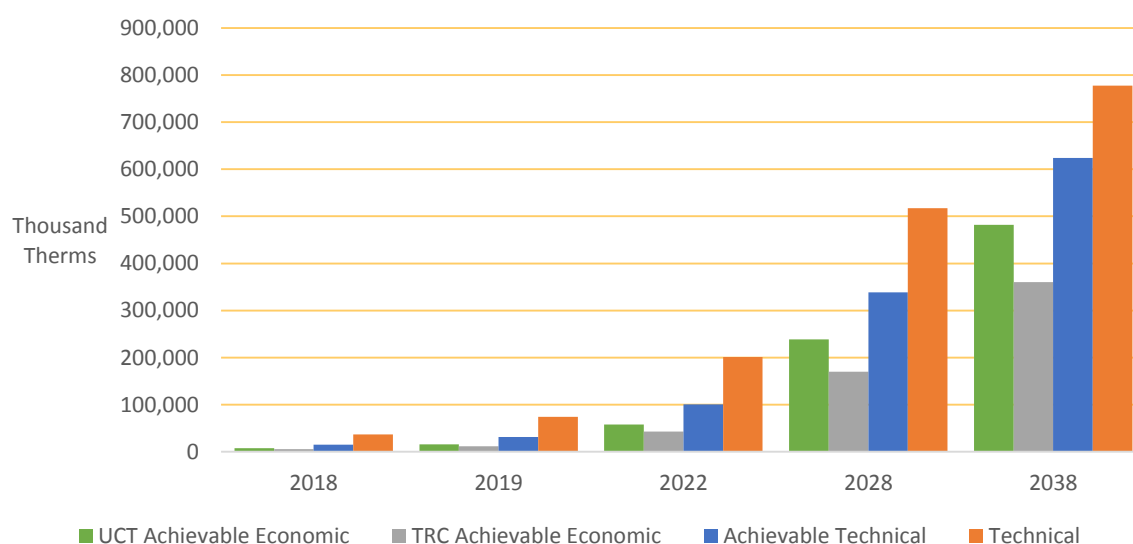

Figure 6-8 presents forecasts of energy savings by end use as a percent of total annual savings and cumulative savings. Space heating makes up a majority of the potential early, but food preparation equipment upgrades provide substantial savings opportunities in the later years.

Figure 6-8 Commercial UCT Achievable Economic Potential – Cumulative Savings by End Use, Idaho (dekatherms, % of total)

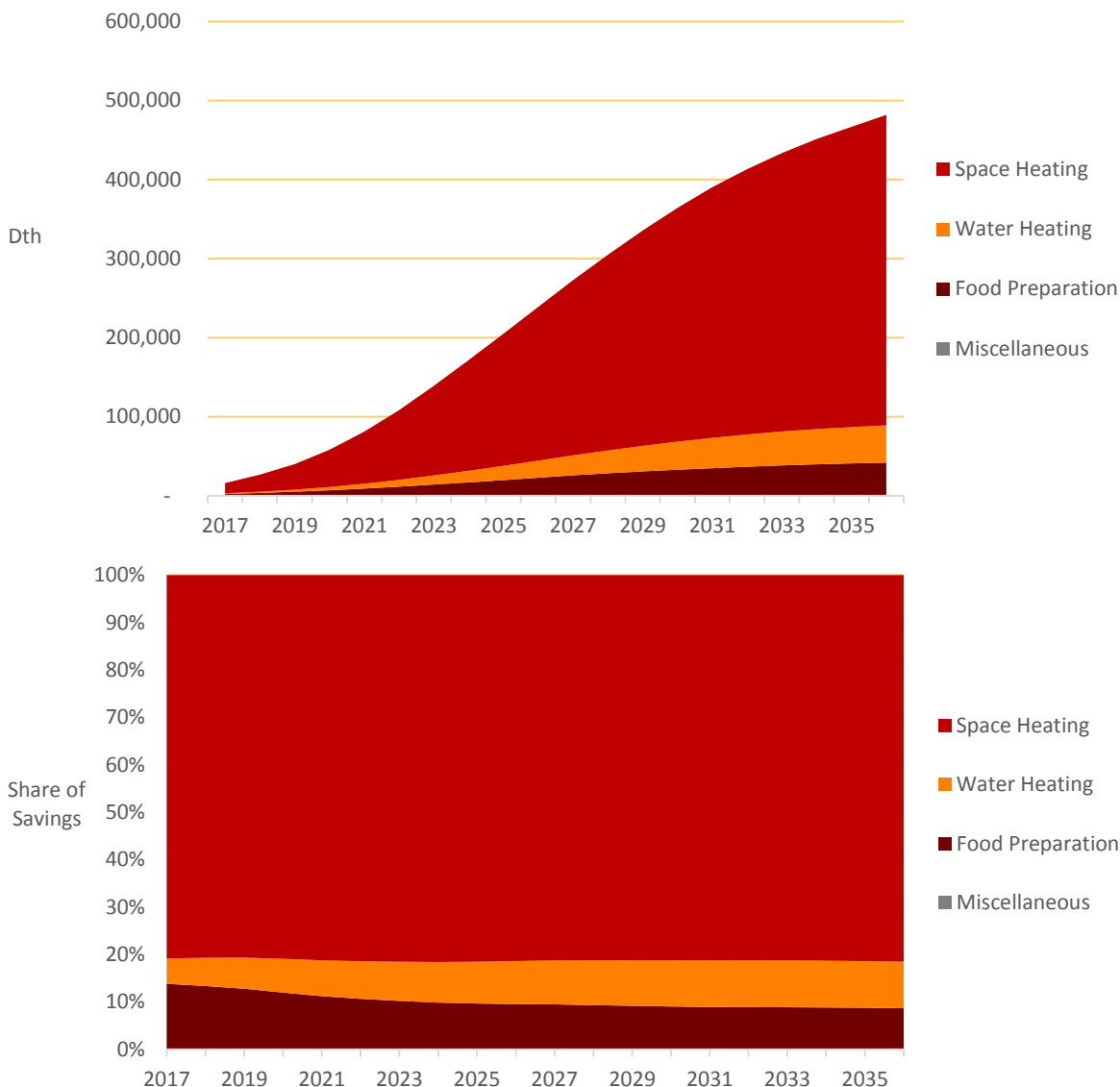

Table 6-8 identifies the top 20 commercial measures by cumulative savings in 2018 and 2019. Boilers are the top measure, followed by custom HVAC measures and food preparation. Retrocommissioning potential is present in the top measures but is a smaller contributor due to revised savings assumptions. RCx in the commercial sector is a restoration of HVAC systems to their original, or better, conditions.

Table 6-8 Commercial Top Measures in 2018 and 2019, UCT Achievable Economic Potential, Idaho (dekatherms)

Rank	Measure / Technology	2018 Cumulative Potential Savings (dekatherms)	% of Total	2019 Cumulative Potential Savings (dekatherms)	% of Total
1	Boiler - AFUE 97%	1,511	20%	3,456	22%
2	Gas Boiler - Insulate Steam Lines/Condensate Tank - Lines and condensate tank insulated	681	9%	1,339	8%
3	Fryer - ENERGY STAR	593	8%	1,220	8%
4	HVAC - Demand Controlled Ventilation - DCV enabled	580	8%	1,139	7%
5	Insulation - Roof/Ceiling - R-38	478	6%	1,171	7%
6	Gas Boiler - Insulate Hot Water Lines - Insulated water lines	456	6%	895	6%
7	Insulation - Wall Cavity - R-21	416	6%	1,019	6%
8	Steam Trap Maintenance - Cleaning and maintenance	407	5%	805	5%
9	Retrocommissioning - HVAC - Optimized HVAC flow and controls	266	4%	523	3%
10	Strategic Energy Management - Energy management system installed and programmed	265	4%	527	3%
11	Water Heater - TE 0.94	198	3%	505	3%
12	Double Rack Oven - FTSC Qualified (>50% Cooking Efficiency)	196	3%	405	3%
13	Kitchen Hood - DCV/MUA - DCV/HUA vent hood	193	3%	384	2%
14	Thermostat - Programmable - Programmable thermostat installed	189	3%	370	2%
15	Building Automation System - Automation system installed and programmed	159	2%	396	2%
16	Oven - ENERGY STAR (>42% Baking Efficiency)	149	2%	321	2%
17	Water Heater - Central Controls - Central water boiler controls installed	91	1%	190	1%
18	Gas Boiler - Maintenance - General cleaning and maintenance	76	1%	151	1%
19	Gas Boiler - Hot Water Reset - Reset control installed	73	1%	163	1%
20	Gas Furnace - Maintenance - General cleaning and maintenance	67	1%	132	1%
Subtotal		7,043	95%	15,111	94%
Total Savings in Year		7,417	100%	16,035	100%

Industrial Sector

Washington Potential

Table 6-9 and Figure 6-9 summarize the energy conservation potential for the core industrial sector. In 2018, UCT achievable economic potential is 569dekatherms, or 0.2% of the baseline projection. By 2028, cumulative savings reach 6,528 dekatherms, or 2.8% of the baseline. Industrial potential is a lower percentage of overall baseline compared to the residential and commercial sectors. While large, custom process optimization and controls measures are present in potential, these are not applicable to all processes which limits potential at the technical level. Additionally, since the largest customers were excluded from this analysis due to their status as transport-only customers making them ineligible to participate in energy efficiency programs for the utility, the remaining customers are smaller and tend to have lower process end-use shares, further lowering industrial potential. As seen in the figure below, industrial potential is substantially lower due to the smaller sector size and process uses.

Table 6-9 Industrial Energy Conservation Potential Summary, Washington (dekatherms)

Scenario	2018	2019	2022	2028	2038
Baseline Forecast (dekatherms)	251,300	248,912	247,616	232,346	213,968
Cumulative Savings (dekatherms)					
UCT Achievable Economic Potential	569	1,132	1,709	6,528	9,957
TRC Achievable Economic Potential	597	1,188	1,785	6,899	10,696
Achievable Technical Potential	762	1,518	2,288	9,034	13,731
Technical Potential	1,002	1,964	2,942	11,035	16,187
Energy Savings (% of Baseline)					
UCT Achievable Economic Potential	0.2%	0.5%	0.7%	2.8%	4.7%
TRC Achievable Economic Potential	0.2%	0.5%	0.7%	3.0%	5.0%
Achievable Technical Potential	0.3%	0.6%	0.9%	3.9%	6.4%
Technical Potential	0.4%	0.8%	1.2%	4.7%	7.6%

Figure 6-9 Industrial Energy Conservation Potential, Washington (dekatherms)

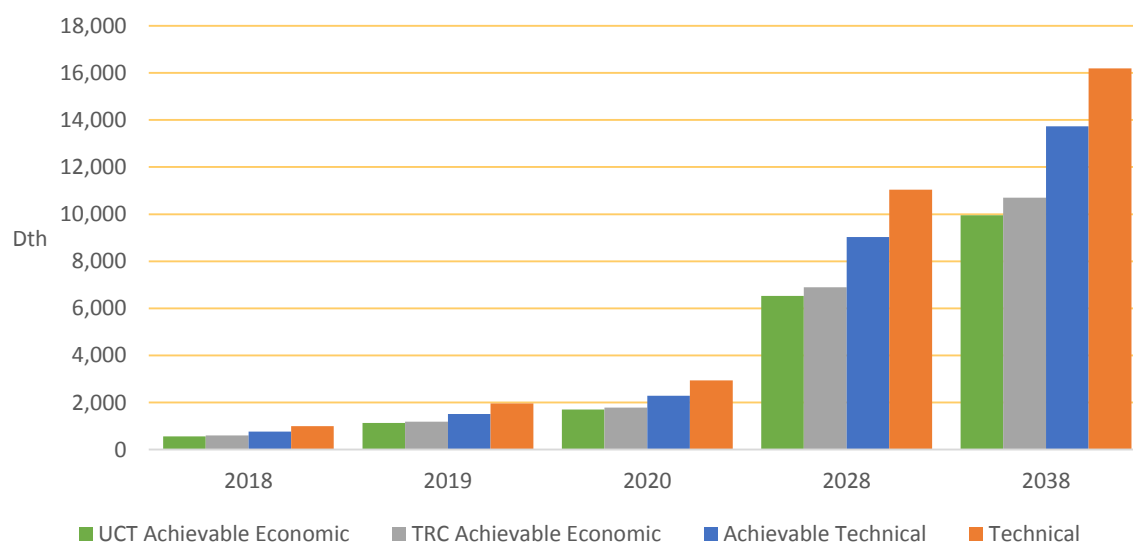

Figure 6-10 presents forecasts of energy savings by end use as a percent of total annual savings and cumulative savings.

Figure 6-10 Industrial UCT Achievable Economic Potential – Cumulative Savings by End Use, Washington (dekatherms, % of total)

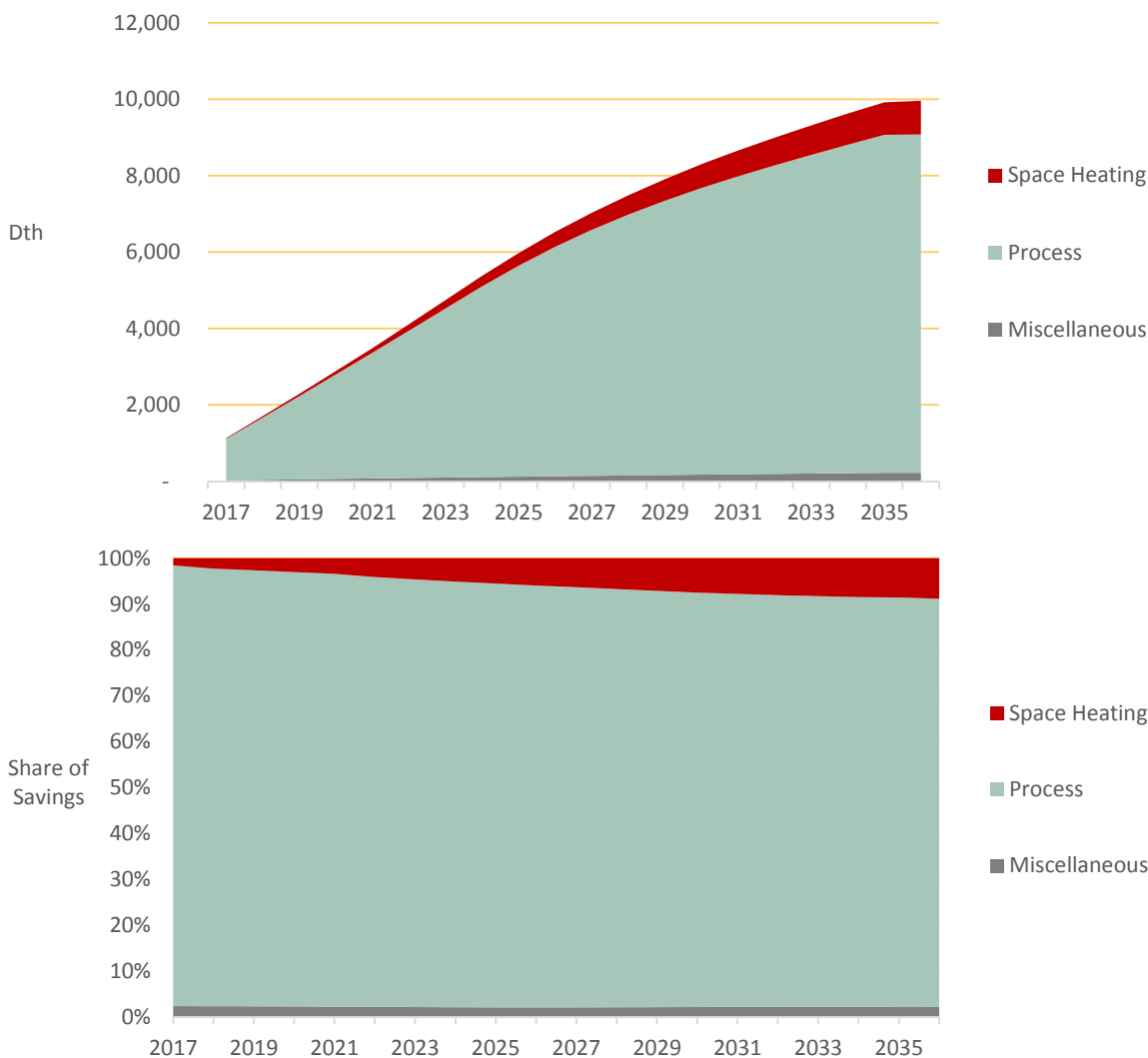

Table 6-10 identifies the top 20 industrial measures by cumulative 2018 and 2019 savings. Strategic energy management and retrocommissioning are top measures in the industrial sector. Strategic energy management of industrial process applications is the highest measure by total savings. For smaller industrial customers, this measure typically involves a cohort of between five to ten customers who form a working group facilitated by an energy management expert. One or more employees at each facility are designated an energy conservation “champion” who work to integrate efficient energy-consuming behavior into the company’s culture. Many of these measures are more custom in nature, such as strategic energy management and retrocommissioning. These results in behavior-based and low-cost/no-cost measures but result in larger custom projects. We estimate that this potential will be captured within these measures/delivery mechanisms.

Table 6-10 Industrial Top Measures in 2018 and 2019, UCT Achievable Economic Potential, Washington (dekatherms)

Rank	Measure / Technology	2018 Cumulative Potential Savings (dekatherms)	% of Total	2019 Cumulative Potential Savings (dekatherms)	% of Total
1	Strategic Energy Management - Energy management system installed and programmed	191	34%	380	34%
2	Retrocommissioning - Optimized process design and controls	129	23%	255	23%
3	Gas Boiler - High Turndown - Turndown control installed	82	14%	162	14%
4	Gas Boiler - Hot Water Reset - Reset control installed	68	12%	142	12%
5	Steam Trap Maintenance - Cleaning and maintenance	49	9%	97	9%
6	Gas Boiler - Maintenance - General cleaning and maintenance	41	7%	76	7%
7	Gas Boiler - Burner Control Optimization - Optimized burner controls	4	1%	9	1%
8	Gas Furnace - Maintenance - General cleaning and maintenance	3	1%	6	1%
9	Unit Heater - Infrared Radiant	2	0%	4	0%
10	Boiler - AFUE 97%	1	0%	3	0%
11	Furnace - AFUE 96%	0	0%	0	0%
12	Insulation - Roof/Ceiling - R-38	0	0%	0	0%
13	Insulation - Wall Cavity - R-21	0	0%	0	0%
14	Insulation - Ducting - 50% reduction in thermal losses	0	0%	0	0%
15	HVAC - Duct Repair and Sealing - 30% reduced duct leaking	0	0%	0	0%
16	Windows - High Efficiency - U-.22 or better	0	0%	0	0%
17	HVAC - Demand Controlled Ventilation - DCV enabled	0	0%	0	0%
18	Gas Boiler - Stack Economizer - Economizer installed	0	0%	0	0%
Subtotal		569	100%	1,132	100%
Total Savings in Year		569	100%	1,132	100%

Idaho Potential

Table 6-11 and Figure 6-11 summarize the energy conservation potential for the core industrial sector. In 2018, UCT achievable economic potential is 569 dekatherms, or 0.2% of the baseline projection. By 2028, cumulative savings reach 6,584 dekatherms, or 2.7% of the baseline. Industrial potential is a lower percentage of overall baseline compared to the residential and commercial sectors. While large, custom process optimization and controls measures are present in potential, these are not applicable to all processes which limits potential at the technical level. Additionally, since the largest customers were excluded from this analysis due to their status as transport-only customers making them ineligible to participate in energy efficiency programs for the utility, the remaining customers are smaller and tend to have lower process end-use shares, further lowering industrial potential. As seen in the figure below, industrial potential is substantially lower due to the smaller sector size and process uses.

Table 6-11 Industrial Energy Conservation Potential Summary, Idaho (dekatherms)

Scenario	2018	2019	2022	2028	2038
Baseline Forecast (dekatherms)	240,261	243,071	244,930	244,959	242,820
Cumulative Savings (dekatherms)					
UCT Achievable Economic Potential	569	1,140	1,718	6,584	9,952
TRC Achievable Economic Potential	573	1,150	1,738	7,021	10,797
Achievable Technical Potential	730	1,469	2,225	8,956	13,732
Technical Potential	959	1,939	2,921	11,030	16,205
Energy Savings (% of Baseline)					
UCT Achievable Economic Potential	0.2%	0.5%	0.7%	2.7%	4.1%
TRC Achievable Economic Potential	0.2%	0.5%	0.7%	2.9%	4.4%
Achievable Technical Potential	0.3%	0.6%	0.9%	3.7%	5.7%
Technical Potential	0.4%	0.8%	1.2%	4.5%	6.7%

Figure 6-11 Industrial Energy Conservation Potential, Idaho (dekatherms)

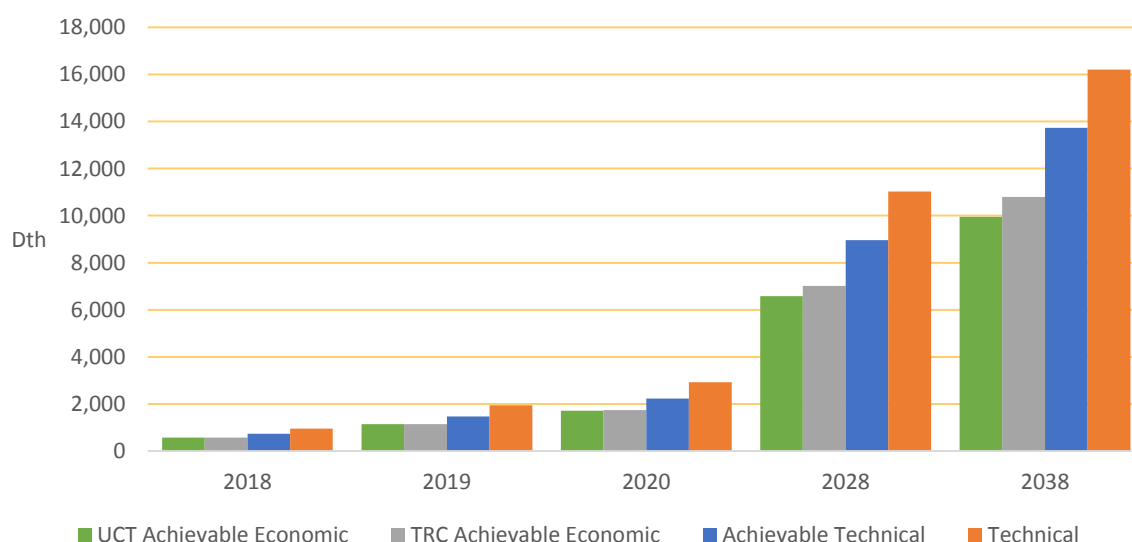

Figure 6-12 presents forecasts of energy savings by end use as a percent of total annual savings and cumulative savings.

Figure 6-12 Industrial UCT Achievable Economic Potential – Cumulative Savings by End Use, Idaho (dekatherms, % of total)

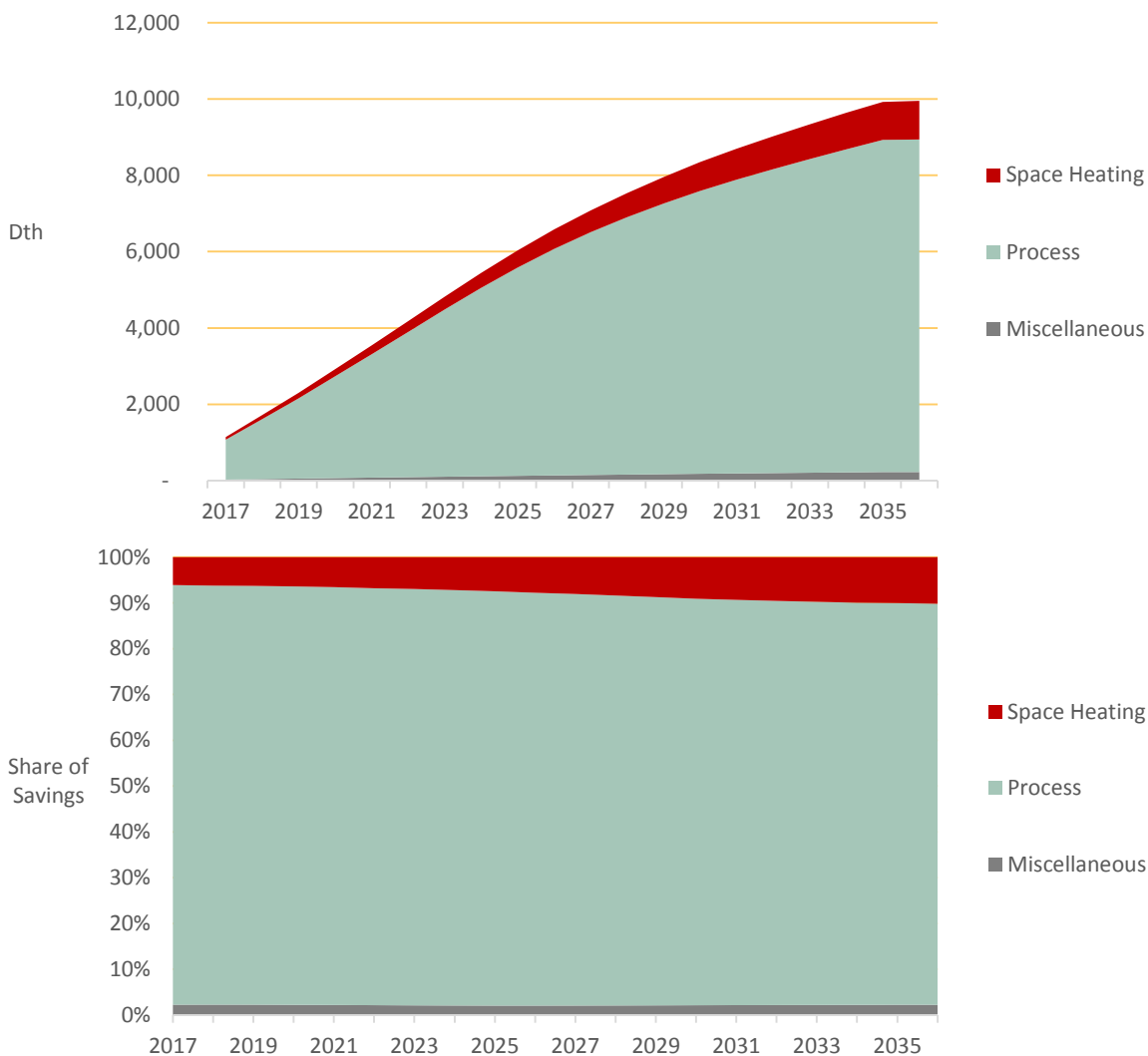

Table 6-12 identifies the top 20 industrial measures by cumulative 2018 and 2019 savings. Strategic energy management and retrocommissioning are top measures in the industrial sector. Strategic energy management of industrial process applications is the highest measure by total savings. For smaller industrial customers, this measure typically involves a cohort of between five to ten customers who form a working group facilitated by an energy management expert. One or more employees at each facility are designated an energy conservation “champion” who work to integrate efficient energy-consuming behavior into the company’s culture. Many of these measures are more custom in nature, such as strategic energy management and retrocommissioning. These results in behavior-based and low-cost/no-cost measures but result in larger custom projects. We estimate that this potential will be captured within these measures/delivery mechanisms.

Table 6-12 Industrial Top Measures in 2018 and 2019, UCT Achievable Economic Potential, Idaho (dekatherms)

Rank	Measure / Technology	2018 Cumulative Potential Savings (dekatherms)	% of Total	2019 Cumulative Potential Savings (dekatherms)	% of Total
1	Strategic Energy Management - Energy management system installed and programmed	197	35%	397	35%
2	Retrocommissioning - Optimized process design and controls	123	22%	244	21%
3	Gas Boiler - High Turndown - Turndown control installed	78	14%	154	14%
4	Gas Boiler - Hot Water Reset - Reset control installed	65	11%	135	12%
5	Steam Trap Maintenance - Cleaning and maintenance	47	8%	94	8%
6	Gas Boiler - Maintenance - General cleaning and maintenance	39	7%	72	6%
7	Retrocommissioning - Optimized HVAC flow and controls	10	2%	20	2%
8	Gas Boiler - Burner Control Optimization - Optimized burner controls	4	1%	9	1%
9	Gas Furnace - Maintenance - General cleaning and maintenance	3	1%	5	0%
10	Unit Heater - Infrared Radiant	2	0%	6	0%
11	Boiler - AFUE 97%	1	0%	3	0%
12	Furnace - AFUE 96%	0	0%	0	0%
13	Insulation - Roof/Ceiling - R-38	0	0%	0	0%
14	Insulation - Wall Cavity - R-21	0	0%	0	0%
15	Insulation - Ducting - 50% reduction in thermal losses	0	0%	0	0%
16	HVAC - Duct Repair and Sealing - 30% reduced duct leaking	0	0%	0	0%
17	Windows - High Efficiency - U-.22 or better	0	0%	0	0%
18	HVAC - Demand Controlled Ventilation - DCV enabled	0	0%	0	0%
Subtotal		569	100%	1,140	100%
Total Savings in Year		569	100%	1,140	100%

Incorporating the Total Resource Cost Test

In addition to the UCT, LoadMAP has been configured to evaluate potential using the TRC. This test focuses on impacts for both the utility and customer, which is an alternative frame of reference from the UCT. The TRC includes the full measure cost (incremental for lost opportunities, full cost for retrofits), which is generally substantially higher than the incentive cost included within the UCT. The TRC does include one additional value stream that the UCT does not, non-energy impacts. This test is fully incorporated into LoadMAP and prepared for Avista to use in the event the Company feels a “fully balanced” TRC is identified.

In accordance with Council methodology, these impacts must be quantified and monetized, meaning impacts such as personal comfort, which are difficult to assign a value to, are not included. What this does include are additional savings including water reductions due to low-flow measures or reduced detergent requirements to wash clothes in a high-efficiency clothes washer. AEG has incorporated these impacts as they are available in source documentation, such as RTF UES workbooks.

Some impacts are already included within Avista’s avoided costs. These include the 10% conservation credit applied by the Council for infrastructure benefits of efficiency. The future prices of carbon are also included. Per TRC methodology, as these impacts are already captured within the avoided costs provided to AEG, we did not incorporate them a second time outside the costs.

Another set of impacts captured within Council methodology include the Simplified Energy Enthalpy Model (SEEM) “calibration credits”. The Council calibrates this energy model using metered end-use energy consumption to reflect actual conditions. While these are technically energy impacts, they are not captured as a benefit to a natural-gas utility as they are instead an impact on the customer. The Council then assumes the difference between the uncalibrated and calibrated models represents the impacts of secondary heating by different fuels present in the home. In the Council’s case, these could be small gas heaters or wood stoves present alongside an electric forced-air furnace. For Avista, AEG followed a similar methodology, but instead applied the calibration percent impact to estimated gas-heating savings rather than electric. To monetize these impacts, we incorporated the latest Mid C energy prices, including carbon impacts, from the RTF’s website, adjusted for differences in efficiency between electric and natural gas heating equipment (e.g. converted therm savings from an AFUE 80% baseline to kWh savings from an EF 0.97 resistance heater baseline). We applied these impacts to many non-equipment measures with space heating impacts in all sectors as well as to residential space heating equipment, which was the primary use for the Council.

Finally, AEG identified additional non-gas end uses which may be impacted by gas efficiency measures. These include impacts from other end uses, such as cooling savings due to efficient shell measures or lighting savings due to a comprehensive retrocommissioning or strategic energy management program. Like the calibration credit above, these do not have a benefit to a natural-gas utility but do to the customer. It is worth a note of caution when incorporating these impacts. Certain comprehensive building measures, such as retrocommissioning and strategic energy management have very large electric impacts that may be greater than the original estimated gas impacts. LED lighting is a very popular technology within electric utility-programs and can have massive impacts. Commercial HVAC retrocommissioning (RCx) includes both cooling and ventilation electric impacts, which could outweigh the gas space heating impacts. To realize these cost-effective savings, Avista would need to offer a comprehensive RCx program affecting both electric and natural gas end uses.

7

COMPARISON WITH CURRENT PROGRAMS

One of the goals of this study is to inform targets for future programs, including the current calendar-year, 2018. As such, AEG conducted an in-depth comparison of the CPA's 2018 UCT Achievable Economic Potential with Avista's 2017 accomplishments and 2018 plan at the sector-level. This involved assigning each measure within the CPA to an existing Avista program. C

Washington Comparison with 2017 Programs and 2018 Plan

Residential Sector

Table 7-1 summarizes Avista's 2017 residential accomplishments, 2018 plan, and the 2018 UCT Achievable Economic potential estimates from LoadMAP. The LoadMAP estimate of 39,979 dekatherms is lower than Avista's 2017 accomplishments at 62,156 dekatherms and lower than Avista's 2018 plan at 50,402 therms.

Table 7-1 Comparison of Avista's Washington Residential Programs with 2018 UCT Achievable Economic Potential (dekatherms)

Program Group	2017 Accomplishments (dekatherms)	2018 Plan (dekatherms)	LoadMAP 2018 UCT (dekatherms)
Furnace	40,003	28,600	19,091
Boiler	453	0	619
Water Heater	6,621	1,042	4,257
ENERGY STAR Homes	122	365	294
Smart Thermostat	4,884	2,340	1,344
Programmable Thermostat	0	55	0
Ceiling Insulation	540	280	1,072
Wall Insulation	218	240	904
Floor Insulation	66	266	1,135
Doors	40	63	0
Windows	8,911	15,940	9,426
Air Sealing	207	112	0
Duct Insulation	30	144	367
Duct Sealing	48	0	0
Showerheads	0	954	575
Miscellaneous	14	0	893
Program Total	62,156	50,402	39,979

The main reason that potential is lower is that the baseline assumed for forced-air furnaces is adjusted in the following ways.

- The 2015 Washington State Energy Code (WSEC) prescribes very efficient building shell requirements, which substantially reduces the consumption of a new home. Since every new home requires a lost opportunity purchasing decision when constructed, they make up a large portion of the potential. The lower unit energy savings in new homes due to lower heating requirements reduces the unit energy savings (UES) from this measure.
- Another reason is the incorporation of a market baseline, which assumes not everyone purchases the minimum federal standard in the absence of efficiency programs. This results in approximately 20% of customers purchasing an AFUE 90% and 5% purchasing an AFUE 92% in the baseline, which reduces the average unit energy consumption upon which savings for an AFUE 95% are based,

Additional descriptions for other measure differences are provided below:

- Potential for ENERGY STAR Homes has been reduced due to WSEC 2015. The efficient shell requirements lower space heating savings from the prior estimate, which was made before this code went into effect.

Commercial and Industrial Sectors

Table 7-2 summarizes Avista's 2017 commercial and industrial accomplishments, 2018 plan, and the 2018 UCT Achievable Economic potential estimates from LoadMAP. The LoadMAP estimate of 21,300 dekatherms is very similar to Avista's 2017 accomplishments at 22,405 dekatherms and 2018 plan at 20,251 dekatherms.

Table 7-2 Comparison of Avista's Washington Nonresidential Accomplishments with 2018 UCT Achievable Economic Potential (dekatherms)

Program Group	2017 Accomplishments (dekatherms)	2018 Plan (dekatherms)	LoadMAP 2018 UCT (dekatherms)
HVAC	14,000	3,214	11,925
Weatherization	1,657	2,080	1,694
Appliances	380	0	838
Food Preparation	3,987	4,956	2,761
Custom	2,381	10,000	4,082
Program Total	22,405	20,251	21,300

The following are key drivers in commercial potential:

- The HVAC category includes both efficient equipment (e.g. boilers) as well as custom HVAC measures. The 2018 Plan includes the latter in the "Custom" category, but 2017 accomplishments imply that these are realized through the HVAC program group.
- Fryer and convection oven potential is substantial due to the high gas consumption of restaurants and Avista's current success with this program. This measure was heavily accelerated in LoadMAP.

Idaho Comparison with 2017 Programs and 2018 Plan

Residential Sector

Table 7-3 summarizes Avista's 2017 residential accomplishments, 2018 plan, and the 2018 UCT Achievable Economic potential estimates from LoadMAP. The LoadMAP estimate of 18,354 dekatherms is very similar to Avista's 2017 accomplishments at 18,158 dekatherms and Avista's 2018 plan at 17,311 therms.

Table 7-3 Comparison of Avista's Idaho Residential Programs with 2018 UCT Achievable Economic Potential (dekatherms)

Program Group	2017 Accomplishments (dekatherms)	2018 Plan (dekatherms)	LoadMAP 2018 UCT (dekatherms)
Furnace	12,783	11,716	11,816
Boiler	134	0	307
Water Heater	1,775	2,077	2,014
ENERGY STAR Homes	41	41	146
Smart Thermostat	1,628	1,040	664
Programmable Thermostat	0	0	0
Ceiling Insulation	129	56	534
Wall Insulation	17	102	452
Floor Insulation	29	119	774
Doors	11	19	0
Windows	1,407	1,708	820
Air Sealing	87	48	0
Duct Insulation	56	153	181
Duct Sealing	59	0	0
Showerheads	0	233	286
Miscellaneous	2	0	362
Program Total	18,158	17,311	18,354

Potential for most measures is very similar to both accomplishments and the 2018 plan. In contrast to Washington, Idaho's energy code does not cannibalize a large portion of the HVAC-related savings, resulting in a much steadier range of potential.

Commercial and Industrial Sectors

Table 7-4 summarizes Avista's 2017 commercial and industrial accomplishments, 2018 plan, and the 2018 UCT Achievable Economic potential estimates from LoadMAP. The LoadMAP estimate of 7,986 dekatherms is substantially higher than Avista's 2017 accomplishments at 3,987 dekatherms but similar to the 2018 plan at 7,336 dekatherms.

Table 7-4 Comparison of Avista's Idaho Nonresidential Accomplishments with 2018 UCT Achievable Economic Potential (dekatherms)

Program Group	2017 Accomplishments (dekatherms)	2018 Plan (dekatherms)	LoadMAP 2018 UCT (dekatherms)
HVAC	1,390	805	3,769
Weatherization	874	940	941
Appliances	35	0	198
Food Preparation	1,359	1,490	1,045
Custom	0	4,100	2,033
Program Total	3,657	7,336	7,986

This is due to a "ramp up" period between 2017 and 2018 resulting from a recent-year restart of programs. Similar to Washington, many custom HVAC measures were included within the HVAC category to reflect actual accomplishments.

8

COMPARISON WITH CURRENT PROGRAMS

One of the goals of this study is to inform targets for future programs, including the current calendar-year, 2018. As such, AEG conducted an in-depth comparison of the CPA's 2018 UCT Achievable Economic Potential with Avista's 2017 accomplishments and 2018 plan at the sector-level. This involved assigning each measure within the CPA to an existing Avista program. C

Residential Comparison with 2016 CPA

Table 8-1 compares first-year residential potential between Avista's 2016 and 2018 Natural Gas CPAs conducted by AEG. In both cases, first-year potential is estimated to be higher.

Table 8-1 Comparison of Avista's Residential UCT Achievable Economic Potential between the 2016 and 2018 CPAs (dekatherms)

Program Group	Washington		Idaho	
	2017	2018	2017	2018
Furnace	9,524	19,091	3,209	11,816
Boiler	251	619	112	307
Water Heater	718	4,257	254	2,014
ENERGY STAR Homes	0	294	0	146
Smart Thermostat	445	1,344	213	664
Programmable Thermostat	0	0	0	0
Ceiling Insulation	1,218	1,072	577	534
Wall Insulation	0	904	0	452
Floor Insulation	0	1,135	0	774
Doors	0	0	0	0
Windows	8,491	9,426	4,044	820
Air Sealing	0	0	0	0
Duct Insulation	0	367	0	181
Duct Sealing	939	0	0	0
Showerheads	1,627	575	736	286
Miscellaneous	4,387	893	1,992	362
CPA Total	27,598	39,979	11,138	18,354

Increases in potential are due to a few factors:

- The update in ramp rates to Seventh Plan values. Some of these start as high as 40% achievability in the first year.

- Due to program accomplishments, particularly in HVAC. AEG accelerated key measures such as furnace upgrades, to the faster ramp rates to align with program success.
- Measure savings, costs, and/or incentives have been updated for some measures, resulting in additional cost-effective measures. New measures include ENERGY STAR homes as well as wall and floor insulation.

Nonresidential Comparison with 2016 CPA

Table 8-2 compares first-year nonresidential potential between Avista's 2016 and 2018 Natural Gas CPAs conducted by AEG. In Washington, the potential is similar, while it is lower in Idaho.

Table 8-2 Comparison of Avista's Nonresidential UCT Achievable Economic Potential between the 2016 and 2018 CPAs (dekatherms)

Program Group	Washington		Idaho	
	2017	2018	2017	2018
HVAC	8,065	11,925	3,400	3,769
Weatherization	1,636	1,694	540	941
Appliances	953	838	453	198
Food Preparation	577	2,761	228	1,045
Custom	12,130	4,082	4,997	2,033
CPA Total	23,362	21,300	9,618	7,986

In addition to changes in ramp rates, differences in potential are due to a few factors:

- HVAC potential is similar to the previous study but accelerated slightly.
- Food preparation potential has been heavily accelerated.
- Potential has been lowered in the "Custom" category for both states due the revisions in the commercial retrocommissioning savings assumptions. The Seventh Plan assumed a 15% heating energy savings from commercial retrocommissioning programs. When AEG inspected this assumption further, we discovered that the conversion from an assumption of 5% of building use was being converted using a heating percentage of use of roughly 33%, much lower than AEG's market characterization analysis. By applying an Avista-specific conversion, AEG calculated a savings of closer to 7% of heating use.

Applied Energy Group, Inc.
500 Ygnacio Valley Road, Suite 250
Walnut Creek, CA 94596

P: 510.982.3525

APPENDIX 3.2: ENVIRONMENTAL EXTERNALITIES OVERVIEW (OREGON JURISDICTION ONLY)

The methodology for determining avoided costs from reduced incremental natural gas usage considers commodity and variable transportation costs only. These avoided cost streams do not include environmental externality costs related to the gathering, transmission, distribution or end-use of natural gas.

Per traditional economic theory and industry practice, an environmental externality factor is typically added to the avoided cost when there is an opportunity to displace traditional supply-side resources with an alternative resource with no adverse environmental impact.

REGULATORY GUIDANCE

The Oregon Public Utility Commission (OPUC) issued Order 93-965 (UM-424) to address how utilities should consider the impact of environmental externalities in planning for future energy resources. The Order required analysis on the potential natural gas cost impacts from emitting carbon dioxide (CO₂) and nitric-oxide (NO_x).

The OPUC's Order No. 07-002 in Docket UM 1056 (Investigation Into Integrated Resource Planning) established the following guideline for the treatment of environmental costs used by energy utilities that evaluate demand-side and supply-side energy choices:

UM 1056, Guideline 8 - Environmental Costs

“Utilities should include, in their base-case analyses, the regulatory compliance costs they expect for carbon dioxide (CO₂), nitrogen oxides (NO_x), sulfur oxides (SO₂), and mercury (Hg) emissions. Utilities should analyze the range of potential CO₂ regulatory costs in Order No. 93-695, from \$0 - \$40 (1990\$). In addition, utilities should perform sensitivity analysis on a range of reasonably possible cost adders for nitrogen oxides (NO_x), sulfur dioxide (SO₂), and mercury (Hg), if applicable.

In June 2008, the OPUC issued Order 08-338 (UM1302) which revised UM1056, Guideline 8. The revised guideline requires the utility should construct a base case portfolio to reflect what it considers to be the most likely regulatory compliance future for the various emissions. Additionally the guideline requires the utility to develop several compliance scenarios ranging from the present CO₂ regulatory level to the upper reaches of credible proposals and each scenario should include a time profile of CO₂ costs. The utility is also required to include a “trigger point” analysis in which the utility must determine at what level of carbon costs its selection of portfolio resources would be significantly different.

ANALYSIS

Unlike electric utilities, environmental cost issues rarely impact a natural gas utility's supply-side resource options. This is because the only supply-side energy resource is natural gas. The utility cannot choose between say "dirty" coal-fired generation and "clean" wind energy sources. The supply-side implication of environmental externalities generally relates to combustion of fuel to move or compress natural gas. Avista's direct gas distribution system infrastructure relies solely on the upstream line pressure of the interstate pipeline transportation network to distribute natural gas to its customers and thus does not directly combust fuels that result in any CO₂, NO_x, SO₂, or Hg emissions.

Upstream gas system infrastructure (pipelines, storage facilities, and gathering systems), however, do produce CO₂ emissions via compressors used to pressurize and move natural gas. Accessing CO₂ emissions data on these upstream activities to perform detailed meaningful analysis is challenging. In the 2009 Natural Gas IRP there was significant momentum regarding GHG legislation and the movement towards the creation of carbon cap and trade markets or tax structure. Additionally, the pricing level of the framework has been greatly reduced. Whichever structure ultimately gets implemented, Avista believes the cost pass through mechanisms for upstream gas system infrastructure will not make a difference in supply-side resource selection although the amount of cost pass through could differ widely.

Table 3.2.1 summarizes a range of environmental cost adders we believe capture several compliance futures including our expected scenario. The CO₂ cost adders reflect outlooks we obtained from one of our consultants, and following discussion and feedback from the TAC, have been incorporated into our Expected, Low Growth/High Price, and Alternate Planning Standard portfolios.

The guidelines also call for a trigger point analysis that reflects a “turning point” at which an alternate resource portfolio would be selected at different carbon cost adders levels. Because natural gas is the only supply resource applicable to LDC’s any alternate resource portfolio selection would be a result of delivery methods of natural gas to customers. Conceptually, there could be differing levels of cost adders applicable to pipeline transported supply versus in service territory LNG storage gas. From a practical standpoint however, the differences in these relative cost adders would be very minor and would not change supply-side resource selection regardless of various carbon cost adder levels. We do acknowledge there is influence to the avoided costs which would impact the cost effectiveness of demand-side measures in the DSM business planning process.

CONSERVATION COST ADVANTAGE

For this IRP, we also incorporated a 10 percent environmental externality factor into our assessment of the cost-effectiveness of existing demand-side management programs. Our assessment of prospective demand-side management opportunities is based on an avoided cost stream that includes this 10 percent factor.

Environmental externalities were evaluated in the IRP by adding the cost per therm equivalent of the externality cost values to supply-side resources as described in OPUC Order No. 93-965. Avista found that the environmental cost adders had no impact on the company’s supply-side choices, although they did impact the level of demand-side measures that could be cost-effective to acquire.

REGULATORY FILING

Avista will file revised cost-effectiveness limits (CEs) based upon the updated avoided costs available from this IRP process within the prescribed regulatory timetable.

TABLE 3.2.1: ENVIRONMENTAL EXTERNALITIES COST ADDER ANALYSIS (2015\$)

		2020	2025	2030	2035	
Expected Carbon Case	NOx – Annual	\$/short ton	\$ 2	\$ 2	\$ 2	\$ 2
		\$/lb	\$ 0.00	\$ 0.00	\$ 0.00	\$ 0.00
		lbs/therm	0.008	0.008	0.008	0.008
		NOx Adder				
		\$/therm	\$ 0.00	\$ 0.00	\$ 0.00	\$ 0.00
	NOx – Seasonal	\$/short ton	\$ 216	\$ 216	\$ 216	\$ 216
		\$/lb	\$ 0.11	\$ 0.11	\$ 0.11	\$ 0.11
		lbs/therm	\$ 0.01	\$ 0.01	\$ 0.01	\$ 0.01
		NOx Adder				
		\$/therm	\$ 0.00	\$ 0.00	\$ 0.00	\$ 0.00
	CO2	\$/ton	\$ -	\$ 23.36	\$ 32.72	\$ 45.91
		\$/lb	\$ -	\$ 0.012	\$ 0.016	\$ 0.023
		lbs/therm	11.64	11.64	11.64	11.64
CO2 Adder						
\$/therm		\$ -	\$ 0.14	\$ 0.19	\$ 0.27	
		2020	2025	2030	2035	
High Carbon Case	NOx – Annual	\$/short ton	\$ 2	\$ 2	\$ 2	\$ 2
		\$/lb	\$ 0.00	\$ 0.00	\$ 0.00	\$ 0.00
		lbs/therm	0.008	0.008	0.008	0.008
		NOx Adder				
		\$/therm	\$ 0.00	\$ 0.00	\$ 0.00	\$ 0.00
	NOx – Seasonal	\$/short ton	\$ 216	\$ 216	\$ 216	\$ 216
		\$/lb	\$ 0.11	\$ 0.11	\$ 0.11	\$ 0.11
		lbs/therm	\$ 0.008	0.008	0.008	0.008
		NOx Adder				
		\$/therm	\$ 0.00	\$ 0.00	\$ 0.00	\$ 0.00
	CO2	\$/ton	\$ 118.26	\$ 120.17	\$ 119.88	\$ 120.01
		\$/lb	\$ 0.059	\$ 0.060	\$ 0.060	\$ 0.060
		lbs/therm	11.64	11.64	11.64	11.64
CO2 Adder						
\$/therm		\$ 0.69	\$ 0.70	\$ 0.70	\$ 0.70	
		2020	2025	2030	2035	
Low Carbon Low NOx	NOx – Annual	\$/short ton	\$ 2	\$ 2	\$ 2	\$ 2
		\$/lb	\$ 0.00	\$ 0.00	\$ 0.00	\$ 0.00
		lbs/therm	0.008	0.008	0.008	0.008
		NOx Adder				
		\$/therm	\$ 0.00	\$ 0.00	\$ 0.00	\$ 0.00
	NOx – Seasonal	\$/short ton	\$ 216	\$ 216	\$ 216	\$ 216
		\$/lb	\$ 0.11	\$ 0.11	\$ 0.11	\$ 0.11
		lbs/therm	0.008	0.008	0.008	0.008
		NOx Adder				
		\$/therm	\$ 0.00	\$ 0.00	\$ 0.00	\$ 0.00
	CO2	\$/ton	\$ 11.54	\$ 12.19	\$ 12.62	\$ 12.86
		\$/lb	\$ 0.006	\$ 0.006	\$ 0.006	\$ 0.006
		lbs/therm	11.64	11.64	11.64	11.64
CO2 Adder						
\$/therm		\$ 0.07	\$ 0.07	\$ 0.07	\$ 0.07	

APPENDIX 4.1: CURRENT TRANSPORTATION/STORAGE RATES AND ASSUMPTIONS

Current Tariff Rates (1)			
	<u>Reservation</u>	<u>Commodity</u>	<u>Fuel Rate</u>
TransCanada NGTL System Firm Rates (2)			
FT-D Demand Rate Alberta-B.C. Border	\$4.77CAD/GJ/month	N/a	N/a
TransCanada Foothills BC System Firm Rates (3)			
FT A/BC to Kingsgate	\$2.32CAD/GJ/month	N/a	1.70%
GTN FTS-1 Rates			
Mileage Based - Representative Example			
Kingsgate to Spokane	\$0.081391/Dth/day	\$0.001733/Dth/day	0.0042% per Dth/mile
Kingsgate to Malin	\$0.300201/Dth/day	\$0.009799/Dth/day	0.0042% per Dth/mile
Medford Lateral	\$0.247709/Dth/day	\$0.002291/Dth/day	N/a
Spectra Energy/Westcoast System Firms Rates (4)			
Postage Stamp Rates			
Station 2 to Huntingdon/Sumas	\$477.81CAD/10 ³ m ³ /month	N/a	N/a
Williams NWP			
Postage Stamp Rates			
TF-1	\$0.39294/Dth/day	\$0.00832/Dth/day	1.16%
TF-2	\$0.39294/Dth/day	\$0.00832/Dth/day	1.16%
SGS-2F	\$0.01562/Dth/day	\$0.00057/Dth/day	0.17%
(1) Rates and Fuel reported are from current tariffed rates in the established currency and energy units of each pipeline			
(2) Rate does not reflect current term-differentiation or Abandonment Surcharge			
(3) Rate does not include Abandonment Surcharge			
(4) Rate changes annually			

APPENDIX 6.1: MONTHLY PRICE DATA BY BASIN

EXPECTED PRICE

Scenario	Index	Gas Year	Nominal\$											
			Nov	Dec	Jan	Feb	Mar	Apr	May	Jun	Jul	Aug	Sep	Oct
Expected Case	AECO	2017-2018	\$ 1.79	\$ 1.56	\$ 1.66	\$ 2.13	\$ 0.93	\$ 1.06	\$ 1.03	\$ 1.02	\$ 1.07	\$ 1.08	\$ 1.03	\$ 1.08
Expected Case	AECO	2018-2019	\$ 1.49	\$ 1.66	\$ 1.72	\$ 1.72	\$ 1.59	\$ 1.23	\$ 1.21	\$ 1.30	\$ 1.38	\$ 1.38	\$ 1.30	\$ 1.33
Expected Case	AECO	2019-2020	\$ 1.69	\$ 1.88	\$ 1.97	\$ 1.93	\$ 1.75	\$ 1.47	\$ 1.47	\$ 1.48	\$ 1.53	\$ 1.56	\$ 1.51	\$ 1.57
Expected Case	AECO	2020-2021	\$ 1.79	\$ 1.94	\$ 2.18	\$ 2.13	\$ 2.03	\$ 1.74	\$ 1.72	\$ 1.76	\$ 1.85	\$ 1.86	\$ 1.78	\$ 1.84
Expected Case	AECO	2021-2022	\$ 2.13	\$ 2.26	\$ 2.38	\$ 2.40	\$ 2.33	\$ 2.01	\$ 2.02	\$ 2.01	\$ 2.07	\$ 2.09	\$ 2.11	\$ 2.12
Expected Case	AECO	2022-2023	\$ 2.28	\$ 2.44	\$ 2.52	\$ 2.48	\$ 2.43	\$ 2.12	\$ 2.18	\$ 2.21	\$ 2.22	\$ 2.29	\$ 2.28	\$ 2.28
Expected Case	AECO	2023-2024	\$ 2.57	\$ 2.76	\$ 2.85	\$ 2.85	\$ 2.81	\$ 2.60	\$ 2.60	\$ 2.57	\$ 2.70	\$ 2.82	\$ 2.79	\$ 2.84
Expected Case	AECO	2024-2025	\$ 2.95	\$ 3.03	\$ 3.09	\$ 3.10	\$ 2.95	\$ 2.77	\$ 2.80	\$ 2.89	\$ 2.96	\$ 2.99	\$ 2.94	\$ 2.94
Expected Case	AECO	2025-2026	\$ 3.00	\$ 3.10	\$ 3.20	\$ 3.18	\$ 3.03	\$ 2.87	\$ 2.93	\$ 3.01	\$ 3.12	\$ 3.15	\$ 3.07	\$ 3.12
Expected Case	AECO	2026-2027	\$ 3.17	\$ 3.31	\$ 3.41	\$ 3.41	\$ 3.32	\$ 3.19	\$ 3.17	\$ 3.28	\$ 3.39	\$ 3.42	\$ 3.36	\$ 3.38
Expected Case	AECO	2027-2028	\$ 3.48	\$ 3.70	\$ 3.77	\$ 3.67	\$ 3.59	\$ 3.50	\$ 3.48	\$ 3.63	\$ 3.72	\$ 3.77	\$ 3.64	\$ 3.68
Expected Case	AECO	2028-2029	\$ 3.77	\$ 3.93	\$ 3.99	\$ 4.06	\$ 3.93	\$ 3.82	\$ 3.83	\$ 3.86	\$ 3.98	\$ 4.02	\$ 3.93	\$ 4.03
Expected Case	AECO	2029-2030	\$ 4.12	\$ 4.34	\$ 4.36	\$ 4.37	\$ 4.18	\$ 4.07	\$ 4.11	\$ 4.16	\$ 4.29	\$ 4.35	\$ 4.27	\$ 4.31
Expected Case	AECO	2030-2031	\$ 4.30	\$ 4.51	\$ 4.60	\$ 4.61	\$ 4.43	\$ 4.23	\$ 4.31	\$ 4.35	\$ 4.53	\$ 4.59	\$ 4.50	\$ 4.53
Expected Case	AECO	2031-2032	\$ 4.52	\$ 4.65	\$ 4.76	\$ 4.69	\$ 4.54	\$ 4.35	\$ 4.40	\$ 4.45	\$ 4.61	\$ 4.68	\$ 4.61	\$ 4.70
Expected Case	AECO	2032-2033	\$ 4.67	\$ 4.93	\$ 5.00	\$ 5.00	\$ 4.82	\$ 4.63	\$ 4.65	\$ 4.70	\$ 4.92	\$ 4.96	\$ 4.86	\$ 4.87
Expected Case	AECO	2033-2034	\$ 4.93	\$ 5.14	\$ 5.18	\$ 5.21	\$ 4.97	\$ 4.79	\$ 4.80	\$ 4.88	\$ 5.11	\$ 5.12	\$ 4.99	\$ 5.04
Expected Case	AECO	2034-2035	\$ 5.13	\$ 5.29	\$ 5.43	\$ 5.40	\$ 5.22	\$ 5.05	\$ 4.99	\$ 5.07	\$ 5.27	\$ 5.34	\$ 5.21	\$ 5.13
Expected Case	AECO	2035-2036	\$ 5.02	\$ 5.14	\$ 5.51	\$ 5.58	\$ 5.40	\$ 5.20	\$ 5.21	\$ 5.36	\$ 5.74	\$ 5.89	\$ 5.62	\$ 5.60
Expected Case	AECO	2036-2037	\$ 5.67	\$ 5.97	\$ 6.06	\$ 6.10	\$ 5.75	\$ 5.38	\$ 5.39	\$ 5.51	\$ 5.88	\$ 5.96	\$ 5.65	\$ 5.54
Expected Case	Malin	2017-2018	\$ 2.75	\$ 2.61	\$ 2.75	\$ 3.29	\$ 2.13	\$ 2.06	\$ 2.13	\$ 2.18	\$ 2.26	\$ 2.29	\$ 2.21	\$ 2.23
Expected Case	Malin	2018-2019	\$ 2.36	\$ 2.65	\$ 2.69	\$ 2.65	\$ 2.49	\$ 2.15	\$ 2.07	\$ 2.11	\$ 2.19	\$ 2.21	\$ 2.18	\$ 2.14
Expected Case	Malin	2019-2020	\$ 2.46	\$ 2.72	\$ 2.77	\$ 2.71	\$ 2.61	\$ 2.38	\$ 2.37	\$ 2.48	\$ 2.55	\$ 2.33	\$ 2.30	\$ 2.33
Expected Case	Malin	2020-2021	\$ 2.55	\$ 2.74	\$ 2.94	\$ 2.90	\$ 2.67	\$ 2.50	\$ 2.45	\$ 2.47	\$ 2.62	\$ 2.66	\$ 2.64	\$ 2.64
Expected Case	Malin	2021-2022	\$ 2.89	\$ 3.04	\$ 3.10	\$ 3.09	\$ 2.87	\$ 2.67	\$ 2.64	\$ 2.63	\$ 2.76	\$ 2.78	\$ 2.82	\$ 2.78
Expected Case	Malin	2022-2023	\$ 3.00	\$ 3.18	\$ 3.23	\$ 3.21	\$ 3.06	\$ 2.79	\$ 2.77	\$ 2.80	\$ 2.88	\$ 2.96	\$ 2.97	\$ 2.96
Expected Case	Malin	2023-2024	\$ 3.30	\$ 3.48	\$ 3.53	\$ 3.53	\$ 3.38	\$ 3.19	\$ 3.17	\$ 3.16	\$ 3.31	\$ 3.39	\$ 3.37	\$ 3.37
Expected Case	Malin	2024-2025	\$ 3.63	\$ 3.74	\$ 3.79	\$ 3.80	\$ 3.62	\$ 3.43	\$ 3.38	\$ 3.43	\$ 3.52	\$ 3.55	\$ 3.55	\$ 3.50
Expected Case	Malin	2025-2026	\$ 3.67	\$ 3.78	\$ 3.86	\$ 3.87	\$ 3.68	\$ 3.53	\$ 3.49	\$ 3.50	\$ 3.62	\$ 3.64	\$ 3.62	\$ 3.60
Expected Case	Malin	2026-2027	\$ 3.74	\$ 3.93	\$ 4.00	\$ 4.00	\$ 3.82	\$ 3.69	\$ 3.64	\$ 3.73	\$ 3.91	\$ 3.89	\$ 3.88	\$ 3.86
Expected Case	Malin	2027-2028	\$ 4.08	\$ 4.24	\$ 4.37	\$ 4.29	\$ 4.17	\$ 4.01	\$ 3.94	\$ 4.07	\$ 4.15	\$ 4.15	\$ 4.12	\$ 4.10
Expected Case	Malin	2028-2029	\$ 4.30	\$ 4.46	\$ 4.57	\$ 4.55	\$ 4.40	\$ 4.25	\$ 4.22	\$ 4.25	\$ 4.38	\$ 4.40	\$ 4.37	\$ 4.41
Expected Case	Malin	2029-2030	\$ 4.58	\$ 4.79	\$ 4.86	\$ 4.86	\$ 4.73	\$ 4.54	\$ 4.51	\$ 4.55	\$ 4.67	\$ 4.69	\$ 4.71	\$ 4.74
Expected Case	Malin	2030-2031	\$ 4.86	\$ 5.02	\$ 5.15	\$ 5.11	\$ 4.95	\$ 4.71	\$ 4.72	\$ 4.77	\$ 4.95	\$ 4.99	\$ 4.91	\$ 4.93
Expected Case	Malin	2031-2032	\$ 5.06	\$ 5.17	\$ 5.32	\$ 5.28	\$ 5.13	\$ 4.89	\$ 4.87	\$ 4.93	\$ 5.11	\$ 5.15	\$ 5.10	\$ 5.13
Expected Case	Malin	2032-2033	\$ 5.25	\$ 5.45	\$ 5.51	\$ 5.51	\$ 5.35	\$ 5.15	\$ 5.12	\$ 5.18	\$ 5.42	\$ 5.43	\$ 5.33	\$ 5.33
Expected Case	Malin	2033-2034	\$ 5.47	\$ 5.67	\$ 5.75	\$ 5.77	\$ 5.57	\$ 5.39	\$ 5.32	\$ 5.42	\$ 5.62	\$ 5.61	\$ 5.52	\$ 5.59
Expected Case	Malin	2034-2035	\$ 5.73	\$ 5.88	\$ 6.02	\$ 6.02	\$ 5.80	\$ 5.62	\$ 5.52	\$ 5.61	\$ 5.78	\$ 5.85	\$ 5.75	\$ 5.76
Expected Case	Malin	2035-2036	\$ 5.73	\$ 5.88	\$ 6.25	\$ 6.28	\$ 6.06	\$ 5.85	\$ 5.81	\$ 5.90	\$ 6.25	\$ 6.31	\$ 6.09	\$ 6.13
Expected Case	Malin	2036-2037	\$ 6.36	\$ 6.73	\$ 6.76	\$ 6.79	\$ 6.42	\$ 6.02	\$ 5.95	\$ 6.00	\$ 6.33	\$ 6.38	\$ 6.09	\$ 6.15
Expected Case	Rockies	2017-2018	\$ 2.70	\$ 2.50	\$ 3.07	\$ 3.23	\$ 2.05	\$ 1.99	\$ 2.04	\$ 2.09	\$ 2.15	\$ 2.18	\$ 2.10	\$ 2.13
Expected Case	Rockies	2018-2019	\$ 2.28	\$ 2.55	\$ 2.75	\$ 2.59	\$ 2.44	\$ 2.09	\$ 2.01	\$ 2.05	\$ 2.10	\$ 2.12	\$ 2.09	\$ 2.05
Expected Case	Rockies	2019-2020	\$ 2.37	\$ 2.62	\$ 2.83	\$ 2.65	\$ 2.55	\$ 2.32	\$ 2.31	\$ 2.42	\$ 2.46	\$ 2.24	\$ 2.21	\$ 2.24
Expected Case	Rockies	2020-2021	\$ 2.47	\$ 2.64	\$ 3.00	\$ 2.84	\$ 2.61	\$ 2.45	\$ 2.38	\$ 2.40	\$ 2.51	\$ 2.54	\$ 2.53	\$ 2.52
Expected Case	Rockies	2021-2022	\$ 2.77	\$ 2.92	\$ 2.98	\$ 2.98	\$ 2.81	\$ 2.61	\$ 2.57	\$ 2.57	\$ 2.64	\$ 2.67	\$ 2.70	\$ 2.66
Expected Case	Rockies	2022-2023	\$ 2.87	\$ 3.05	\$ 3.10	\$ 3.08	\$ 2.98	\$ 2.67	\$ 2.68	\$ 2.70	\$ 2.75	\$ 2.83	\$ 2.84	\$ 2.82
Expected Case	Rockies	2023-2024	\$ 3.16	\$ 3.34	\$ 3.38	\$ 3.38	\$ 3.30	\$ 3.09	\$ 3.06	\$ 3.06	\$ 3.18	\$ 3.24	\$ 3.23	\$ 3.22
Expected Case	Rockies	2024-2025	\$ 3.44	\$ 3.58	\$ 3.63	\$ 3.64	\$ 3.46	\$ 3.28	\$ 3.27	\$ 3.30	\$ 3.38	\$ 3.40	\$ 3.39	\$ 3.35
Expected Case	Rockies	2025-2026	\$ 3.47	\$ 3.62	\$ 3.71	\$ 3.71	\$ 3.53	\$ 3.38	\$ 3.35	\$ 3.37	\$ 3.47	\$ 3.49	\$ 3.47	\$ 3.45
Expected Case	Rockies	2026-2027	\$ 3.59	\$ 3.78	\$ 3.84	\$ 3.85	\$ 3.67	\$ 3.55	\$ 3.51	\$ 3.61	\$ 3.76	\$ 3.74	\$ 3.73	\$ 3.71
Expected Case	Rockies	2027-2028	\$ 3.92	\$ 4.08	\$ 4.20	\$ 4.12	\$ 4.01	\$ 3.86	\$ 3.85	\$ 3.98	\$ 4.00	\$ 4.00	\$ 3.97	\$ 3.94
Expected Case	Rockies	2028-2029	\$ 4.14	\$ 4.30	\$ 4.40	\$ 4.38	\$ 4.25	\$ 4.12	\$ 4.13	\$ 4.16	\$ 4.23	\$ 4.24	\$ 4.20	\$ 4.24
Expected Case	Rockies	2029-2030	\$ 4.40	\$ 4.60	\$ 4.67	\$ 4.67	\$ 4.58	\$ 4.41	\$ 4.41	\$ 4.43	\$ 4.52	\$ 4.52	\$ 4.53	\$ 4.56
Expected Case	Rockies	2030-2031	\$ 4.67	\$ 4.83	\$ 4.95	\$ 4.92	\$ 4.80	\$ 4.60	\$ 4.61	\$ 4.66	\$ 4.76	\$ 4.80	\$ 4.72	\$ 4.74
Expected Case	Rockies	2031-2032	\$ 4.86	\$ 4.97	\$ 5.11	\$ 5.07	\$ 4.96	\$ 4.78	\$ 4.75	\$ 4.81	\$ 4.96	\$ 4.97	\$ 4.91	\$ 4.93
Expected Case	Rockies	2032-2033	\$ 5.05	\$ 5.24	\$ 5.30	\$ 5.30	\$ 5.16	\$ 5.03	\$ 5.00	\$ 5.05	\$ 5.26	\$ 5.25	\$ 5.13	\$ 5.13
Expected Case	Rockies	2033-2034	\$ 5.26	\$ 5.45	\$ 5.53	\$ 5.55	\$ 5.38	\$ 5.26	\$ 5.19	\$ 5.29	\$ 5.45	\$ 5.42	\$ 5.31	\$ 5.38
Expected Case	Rockies	2034-2035	\$ 5.52	\$ 5.66	\$ 5.80	\$ 5.79	\$ 5.60	\$ 5.48	\$ 5.38	\$ 5.47	\$ 5.61	\$ 5.65	\$ 5.54	\$ 5.54
Expected Case	Rockies	2035-2036	\$ 5.50	\$ 5.65	\$ 6.02	\$ 6.05	\$ 5.86	\$ 5.71	\$ 5.66	\$ 5.75	\$ 6.07	\$ 6.10	\$ 5.87	\$ 5.90
Expected Case	Rockies	2036-2037	\$ 6.13	\$ 6.49	\$ 6.52	\$ 6.55	\$ 6.20	\$ 5.87	\$ 5.80	\$ 5.84	\$ 6.14	\$ 6.17	\$ 5.87	\$ 5.92

APPENDIX 6.1: MONTHLY PRICE DATA BY BASIN

EXPECTED PRICE

			Nominal\$											
Expected Case	Stanfield	2017-2018	\$2.68	\$2.60	\$2.80	\$3.26	\$2.04	\$1.96	\$2.01	\$2.03	\$2.12	\$2.16	\$2.08	\$2.07
Expected Case	Stanfield	2018-2019	\$2.33	\$2.62	\$2.65	\$2.61	\$2.46	\$2.04	\$1.96	\$2.01	\$2.03	\$2.03	\$2.03	\$1.99
Expected Case	Stanfield	2019-2020	\$2.42	\$2.69	\$2.73	\$2.68	\$2.51	\$2.29	\$2.28	\$2.38	\$2.39	\$2.15	\$2.14	\$2.17
Expected Case	Stanfield	2020-2021	\$2.51	\$2.70	\$2.90	\$2.86	\$2.60	\$2.43	\$2.35	\$2.36	\$2.45	\$2.47	\$2.48	\$2.50
Expected Case	Stanfield	2021-2022	\$2.85	\$3.00	\$3.06	\$3.05	\$2.79	\$2.58	\$2.55	\$2.54	\$2.60	\$2.60	\$2.65	\$2.63
Expected Case	Stanfield	2022-2023	\$2.96	\$3.14	\$3.19	\$3.17	\$3.02	\$2.70	\$2.68	\$2.70	\$2.71	\$2.77	\$2.80	\$2.82
Expected Case	Stanfield	2023-2024	\$3.26	\$3.44	\$3.49	\$3.49	\$3.34	\$3.13	\$3.11	\$3.10	\$3.14	\$3.22	\$3.24	\$3.27
Expected Case	Stanfield	2024-2025	\$3.59	\$3.69	\$3.75	\$3.75	\$3.57	\$3.38	\$3.34	\$3.37	\$3.37	\$3.36	\$3.41	\$3.38
Expected Case	Stanfield	2025-2026	\$3.62	\$3.74	\$3.81	\$3.82	\$3.64	\$3.46	\$3.41	\$3.44	\$3.45	\$3.45	\$3.48	\$3.46
Expected Case	Stanfield	2026-2027	\$3.70	\$3.89	\$3.95	\$3.96	\$3.78	\$3.61	\$3.57	\$3.68	\$3.73	\$3.70	\$3.75	\$3.72
Expected Case	Stanfield	2027-2028	\$4.04	\$4.22	\$4.33	\$4.25	\$4.13	\$3.94	\$3.86	\$3.99	\$3.96	\$3.96	\$3.97	\$3.95
Expected Case	Stanfield	2028-2029	\$4.26	\$4.42	\$4.55	\$4.50	\$4.35	\$4.16	\$4.14	\$4.17	\$4.19	\$4.20	\$4.18	\$4.23
Expected Case	Stanfield	2029-2030	\$4.56	\$4.73	\$4.81	\$4.81	\$4.68	\$4.44	\$4.41	\$4.45	\$4.46	\$4.49	\$4.52	\$4.55
Expected Case	Stanfield	2030-2031	\$4.81	\$4.97	\$5.09	\$5.08	\$4.90	\$4.61	\$4.60	\$4.66	\$4.74	\$4.78	\$4.71	\$4.73
Expected Case	Stanfield	2031-2032	\$5.01	\$5.14	\$5.29	\$5.22	\$5.07	\$4.78	\$4.75	\$4.81	\$4.91	\$4.94	\$4.89	\$4.92
Expected Case	Stanfield	2032-2033	\$5.19	\$5.39	\$5.45	\$5.45	\$5.28	\$5.02	\$5.00	\$5.05	\$5.21	\$5.22	\$5.12	\$5.13
Expected Case	Stanfield	2033-2034	\$5.41	\$5.64	\$5.71	\$5.74	\$5.51	\$5.25	\$5.19	\$5.30	\$5.41	\$5.40	\$5.30	\$5.38
Expected Case	Stanfield	2034-2035	\$5.68	\$5.85	\$5.99	\$5.99	\$5.73	\$5.48	\$5.38	\$5.47	\$5.56	\$5.63	\$5.53	\$5.54
Expected Case	Stanfield	2035-2036	\$5.64	\$5.84	\$6.22	\$6.21	\$5.97	\$5.72	\$5.68	\$5.77	\$6.02	\$6.08	\$5.86	\$5.90
Expected Case	Stanfield	2036-2037	\$6.30	\$6.65	\$6.68	\$6.71	\$6.34	\$5.87	\$5.80	\$5.83	\$6.10	\$6.15	\$5.86	\$5.92
Expected Case	Sumas	2017-2018	\$2.69	\$2.78	\$2.72	\$3.20	\$1.98	\$1.80	\$1.75	\$1.80	\$1.98	\$2.01	\$2.01	\$2.10
Expected Case	Sumas	2018-2019	\$2.60	\$2.93	\$2.95	\$2.81	\$2.37	\$1.79	\$1.77	\$1.93	\$2.14	\$2.13	\$2.13	\$2.17
Expected Case	Sumas	2019-2020	\$2.54	\$3.08	\$3.10	\$2.88	\$2.36	\$1.94	\$1.92	\$1.91	\$2.05	\$2.08	\$2.07	\$2.19
Expected Case	Sumas	2020-2021	\$2.52	\$2.83	\$2.91	\$2.73	\$2.45	\$2.00	\$1.99	\$2.00	\$2.22	\$2.23	\$2.20	\$2.26
Expected Case	Sumas	2021-2022	\$2.68	\$3.07	\$3.11	\$3.00	\$2.74	\$2.19	\$2.19	\$2.16	\$2.34	\$2.36	\$2.42	\$2.46
Expected Case	Sumas	2022-2023	\$2.80	\$3.21	\$3.22	\$3.07	\$2.82	\$2.30	\$2.32	\$2.33	\$2.47	\$2.54	\$2.58	\$2.62
Expected Case	Sumas	2023-2024	\$3.09	\$3.51	\$3.57	\$3.44	\$3.21	\$2.82	\$2.80	\$2.76	\$3.02	\$3.15	\$3.15	\$3.19
Expected Case	Sumas	2024-2025	\$3.41	\$3.71	\$3.75	\$3.63	\$3.31	\$2.98	\$3.00	\$3.08	\$3.30	\$3.35	\$3.32	\$3.34
Expected Case	Sumas	2025-2026	\$3.48	\$3.79	\$3.85	\$3.70	\$3.40	\$3.09	\$3.14	\$3.24	\$3.50	\$3.52	\$3.46	\$3.51
Expected Case	Sumas	2026-2027	\$3.64	\$4.05	\$4.06	\$3.88	\$3.62	\$3.39	\$3.36	\$3.40	\$3.69	\$3.72	\$3.69	\$3.71
Expected Case	Sumas	2027-2028	\$3.95	\$4.43	\$4.46	\$4.22	\$3.94	\$3.68	\$3.66	\$3.78	\$4.00	\$4.06	\$3.96	\$4.01
Expected Case	Sumas	2028-2029	\$4.24	\$4.66	\$4.71	\$4.64	\$4.32	\$4.03	\$4.04	\$4.04	\$4.30	\$4.34	\$4.28	\$4.39
Expected Case	Sumas	2029-2030	\$4.61	\$5.10	\$5.09	\$4.98	\$4.60	\$4.32	\$4.34	\$4.38	\$4.64	\$4.70	\$4.66	\$4.71
Expected Case	Sumas	2030-2031	\$4.84	\$5.30	\$5.36	\$5.23	\$4.85	\$4.49	\$4.56	\$4.59	\$4.90	\$4.95	\$4.90	\$4.93
Expected Case	Sumas	2031-2032	\$5.08	\$5.46	\$5.52	\$5.31	\$4.97	\$4.60	\$4.64	\$4.68	\$4.97	\$5.04	\$5.00	\$5.10
Expected Case	Sumas	2032-2033	\$5.22	\$5.73	\$5.76	\$5.62	\$5.24	\$4.89	\$4.90	\$4.92	\$5.30	\$5.33	\$5.27	\$5.28
Expected Case	Sumas	2033-2034	\$5.47	\$5.94	\$5.94	\$5.82	\$5.38	\$5.03	\$5.04	\$5.10	\$5.46	\$5.48	\$5.37	\$5.42
Expected Case	Sumas	2034-2035	\$5.66	\$6.09	\$6.17	\$6.01	\$5.62	\$5.27	\$5.21	\$5.27	\$5.61	\$5.67	\$5.58	\$5.50
Expected Case	Sumas	2035-2036	\$5.58	\$5.93	\$6.25	\$6.18	\$5.79	\$5.43	\$5.43	\$5.57	\$6.08	\$6.22	\$5.99	\$5.97
Expected Case	Sumas	2036-2037	\$6.19	\$6.74	\$6.79	\$6.69	\$6.15	\$5.61	\$5.62	\$5.70	\$6.21	\$6.29	\$6.02	\$5.94

APPENDIX 6.1: MONTHLY PRICE DATA BY BASIN

HIGH GROWTH LOW PRICE

Scenario	Index	Gas Year	Nominal\$											
			Nov	Dec	Jan	Feb	Mar	Apr	May	Jun	Jul	Aug	Sep	Oct
High Growth & Low Prices	AECO	2017-2018	\$1.79	\$1.56	\$1.66	\$2.13	\$0.93	\$1.06	\$1.03	\$1.02	\$1.07	\$1.08	\$1.03	\$1.08
High Growth & Low Prices	AECO	2018-2019	\$1.32	\$1.48	\$1.54	\$1.55	\$1.42	\$1.07	\$1.05	\$1.14	\$1.22	\$1.22	\$1.13	\$1.17
High Growth & Low Prices	AECO	2019-2020	\$1.35	\$1.52	\$1.61	\$1.57	\$1.41	\$1.15	\$1.15	\$1.16	\$1.20	\$1.23	\$1.18	\$1.23
High Growth & Low Prices	AECO	2020-2021	\$1.26	\$1.39	\$1.61	\$1.56	\$1.48	\$1.23	\$1.22	\$1.25	\$1.32	\$1.33	\$1.25	\$1.30
High Growth & Low Prices	AECO	2021-2022	\$1.38	\$1.49	\$1.59	\$1.61	\$1.55	\$1.29	\$1.30	\$1.29	\$1.33	\$1.35	\$1.35	\$1.37
High Growth & Low Prices	AECO	2022-2023	\$1.31	\$1.43	\$1.49	\$1.46	\$1.42	\$1.18	\$1.23	\$1.25	\$1.26	\$1.30	\$1.29	\$1.29
High Growth & Low Prices	AECO	2023-2024	\$1.40	\$1.55	\$1.63	\$1.62	\$1.59	\$1.44	\$1.42	\$1.40	\$1.50	\$1.58	\$1.56	\$1.60
High Growth & Low Prices	AECO	2024-2025	\$1.57	\$1.63	\$1.67	\$1.67	\$1.55	\$1.43	\$1.45	\$1.51	\$1.57	\$1.59	\$1.55	\$1.56
High Growth & Low Prices	AECO	2025-2026	\$1.49	\$1.56	\$1.63	\$1.60	\$1.49	\$1.37	\$1.42	\$1.49	\$1.57	\$1.58	\$1.52	\$1.58
High Growth & Low Prices	AECO	2026-2027	\$1.50	\$1.59	\$1.65	\$1.65	\$1.59	\$1.50	\$1.48	\$1.53	\$1.62	\$1.63	\$1.58	\$1.62
High Growth & Low Prices	AECO	2027-2028	\$1.57	\$1.71	\$1.74	\$1.66	\$1.61	\$1.55	\$1.54	\$1.63	\$1.70	\$1.72	\$1.62	\$1.67
High Growth & Low Prices	AECO	2028-2029	\$1.68	\$1.77	\$1.81	\$1.86	\$1.77	\$1.69	\$1.68	\$1.69	\$1.77	\$1.78	\$1.71	\$1.80
High Growth & Low Prices	AECO	2029-2030	\$1.83	\$1.95	\$1.95	\$1.94	\$1.79	\$1.73	\$1.75	\$1.79	\$1.87	\$1.90	\$1.84	\$1.87
High Growth & Low Prices	AECO	2030-2031	\$1.81	\$1.94	\$1.98	\$1.98	\$1.87	\$1.73	\$1.78	\$1.79	\$1.90	\$1.93	\$1.88	\$1.90
High Growth & Low Prices	AECO	2031-2032	\$1.84	\$1.92	\$1.96	\$1.91	\$1.81	\$1.69	\$1.72	\$1.76	\$1.85	\$1.88	\$1.83	\$1.91
High Growth & Low Prices	AECO	2032-2033	\$1.83	\$1.96	\$2.00	\$1.99	\$1.87	\$1.77	\$1.75	\$1.78	\$1.91	\$1.92	\$1.86	\$1.87
High Growth & Low Prices	AECO	2033-2034	\$1.84	\$1.96	\$1.97	\$1.97	\$1.82	\$1.71	\$1.71	\$1.74	\$1.86	\$1.86	\$1.79	\$1.82
High Growth & Low Prices	AECO	2034-2035	\$1.84	\$1.92	\$1.98	\$1.94	\$1.86	\$1.75	\$1.69	\$1.72	\$1.83	\$1.84	\$1.78	\$1.73
High Growth & Low Prices	AECO	2035-2036	\$1.65	\$1.68	\$1.82	\$1.88	\$1.78	\$1.67	\$1.65	\$1.74	\$1.91	\$2.00	\$1.88	\$1.87
High Growth & Low Prices	AECO	2036-2037	\$1.81	\$1.90	\$1.95	\$1.98	\$1.81	\$1.64	\$1.63	\$1.69	\$1.89	\$1.93	\$1.78	\$1.71
High Growth & Low Prices	Malin	2017-2018	\$2.75	\$2.61	\$2.75	\$3.29	\$2.13	\$2.06	\$2.13	\$2.18	\$2.26	\$2.29	\$2.21	\$2.23
High Growth & Low Prices	Malin	2018-2019	\$2.19	\$2.47	\$2.51	\$2.47	\$2.32	\$1.99	\$1.92	\$1.95	\$2.02	\$2.05	\$2.01	\$1.97
High Growth & Low Prices	Malin	2019-2020	\$2.11	\$2.37	\$2.40	\$2.35	\$2.26	\$2.06	\$2.05	\$2.16	\$2.22	\$2.00	\$1.97	\$1.99
High Growth & Low Prices	Malin	2020-2021	\$2.02	\$2.19	\$2.37	\$2.34	\$2.12	\$1.99	\$1.94	\$1.96	\$2.10	\$2.13	\$2.11	\$2.10
High Growth & Low Prices	Malin	2021-2022	\$2.14	\$2.27	\$2.31	\$2.29	\$2.10	\$1.95	\$1.92	\$1.91	\$2.03	\$2.05	\$2.07	\$2.03
High Growth & Low Prices	Malin	2022-2023	\$2.03	\$2.17	\$2.20	\$2.19	\$2.05	\$1.85	\$1.82	\$1.84	\$1.92	\$1.97	\$1.98	\$1.96
High Growth & Low Prices	Malin	2023-2024	\$2.14	\$2.28	\$2.30	\$2.30	\$2.16	\$2.03	\$2.00	\$1.99	\$2.10	\$2.15	\$2.14	\$2.13
High Growth & Low Prices	Malin	2024-2025	\$2.25	\$2.33	\$2.36	\$2.37	\$2.22	\$2.08	\$2.03	\$2.05	\$2.13	\$2.15	\$2.15	\$2.12
High Growth & Low Prices	Malin	2025-2026	\$2.16	\$2.25	\$2.29	\$2.29	\$2.14	\$2.03	\$1.98	\$1.98	\$2.07	\$2.07	\$2.07	\$2.05
High Growth & Low Prices	Malin	2026-2027	\$2.08	\$2.21	\$2.24	\$2.24	\$2.09	\$2.00	\$1.95	\$1.99	\$2.14	\$2.10	\$2.11	\$2.10
High Growth & Low Prices	Malin	2027-2028	\$2.17	\$2.25	\$2.34	\$2.28	\$2.19	\$2.06	\$2.00	\$2.06	\$2.13	\$2.11	\$2.10	\$2.09
High Growth & Low Prices	Malin	2028-2029	\$2.21	\$2.30	\$2.39	\$2.34	\$2.23	\$2.12	\$2.07	\$2.09	\$2.18	\$2.17	\$2.16	\$2.18
High Growth & Low Prices	Malin	2029-2030	\$2.29	\$2.40	\$2.45	\$2.43	\$2.34	\$2.20	\$2.15	\$2.18	\$2.25	\$2.24	\$2.28	\$2.30
High Growth & Low Prices	Malin	2030-2031	\$2.37	\$2.45	\$2.53	\$2.49	\$2.39	\$2.22	\$2.19	\$2.21	\$2.32	\$2.33	\$2.29	\$2.31
High Growth & Low Prices	Malin	2031-2032	\$2.38	\$2.44	\$2.52	\$2.50	\$2.40	\$2.23	\$2.19	\$2.24	\$2.35	\$2.35	\$2.32	\$2.34
High Growth & Low Prices	Malin	2032-2033	\$2.40	\$2.48	\$2.52	\$2.50	\$2.40	\$2.29	\$2.22	\$2.26	\$2.40	\$2.39	\$2.32	\$2.33
High Growth & Low Prices	Malin	2033-2034	\$2.39	\$2.49	\$2.53	\$2.52	\$2.42	\$2.30	\$2.23	\$2.28	\$2.37	\$2.35	\$2.31	\$2.38
High Growth & Low Prices	Malin	2034-2035	\$2.44	\$2.51	\$2.57	\$2.56	\$2.43	\$2.31	\$2.21	\$2.25	\$2.33	\$2.35	\$2.32	\$2.36
High Growth & Low Prices	Malin	2035-2036	\$2.35	\$2.42	\$2.57	\$2.58	\$2.45	\$2.32	\$2.25	\$2.27	\$2.43	\$2.42	\$2.35	\$2.40
High Growth & Low Prices	Malin	2036-2037	\$2.51	\$2.66	\$2.66	\$2.67	\$2.48	\$2.28	\$2.19	\$2.19	\$2.34	\$2.35	\$2.23	\$2.31
High Growth & Low Prices	Rockies	2017-2018	\$2.70	\$2.50	\$3.07	\$3.23	\$2.05	\$1.99	\$2.04	\$2.09	\$2.15	\$2.18	\$2.10	\$2.13
High Growth & Low Prices	Rockies	2018-2019	\$2.11	\$2.37	\$2.57	\$2.41	\$2.26	\$1.93	\$1.85	\$1.89	\$1.94	\$1.96	\$1.92	\$1.88
High Growth & Low Prices	Rockies	2019-2020	\$2.03	\$2.26	\$2.47	\$2.30	\$2.20	\$2.00	\$1.99	\$2.10	\$2.13	\$1.91	\$1.88	\$1.90
High Growth & Low Prices	Rockies	2020-2021	\$1.94	\$2.09	\$2.43	\$2.28	\$2.06	\$1.94	\$1.88	\$1.89	\$1.98	\$2.01	\$2.00	\$1.99
High Growth & Low Prices	Rockies	2021-2022	\$2.02	\$2.15	\$2.19	\$2.19	\$2.03	\$1.89	\$1.85	\$1.85	\$1.91	\$1.93	\$1.95	\$1.91
High Growth & Low Prices	Rockies	2022-2023	\$1.91	\$2.05	\$2.08	\$2.06	\$1.97	\$1.73	\$1.73	\$1.74	\$1.79	\$1.84	\$1.85	\$1.83
High Growth & Low Prices	Rockies	2023-2024	\$2.00	\$2.13	\$2.16	\$2.16	\$2.08	\$1.92	\$1.89	\$1.89	\$1.97	\$2.00	\$2.00	\$1.98
High Growth & Low Prices	Rockies	2024-2025	\$2.07	\$2.18	\$2.21	\$2.21	\$2.07	\$1.94	\$1.92	\$1.93	\$1.99	\$2.00	\$2.00	\$1.96
High Growth & Low Prices	Rockies	2025-2026	\$1.97	\$2.08	\$2.14	\$2.13	\$1.99	\$1.89	\$1.84	\$1.84	\$1.92	\$1.92	\$1.92	\$1.90
High Growth & Low Prices	Rockies	2026-2027	\$1.92	\$2.05	\$2.09	\$2.08	\$1.94	\$1.86	\$1.82	\$1.87	\$1.99	\$1.95	\$1.96	\$1.94
High Growth & Low Prices	Rockies	2027-2028	\$2.01	\$2.09	\$2.17	\$2.11	\$2.03	\$1.91	\$1.91	\$1.97	\$1.98	\$1.95	\$1.94	\$1.93
High Growth & Low Prices	Rockies	2028-2029	\$2.05	\$2.14	\$2.22	\$2.17	\$2.08	\$1.99	\$1.98	\$2.00	\$2.02	\$2.00	\$1.99	\$2.01
High Growth & Low Prices	Rockies	2029-2030	\$2.11	\$2.22	\$2.27	\$2.24	\$2.19	\$2.07	\$2.06	\$2.06	\$2.10	\$2.06	\$2.10	\$2.12
High Growth & Low Prices	Rockies	2030-2031	\$2.19	\$2.26	\$2.34	\$2.30	\$2.24	\$2.11	\$2.08	\$2.10	\$2.13	\$2.14	\$2.10	\$2.12
High Growth & Low Prices	Rockies	2031-2032	\$2.18	\$2.24	\$2.32	\$2.30	\$2.23	\$2.12	\$2.07	\$2.12	\$2.20	\$2.17	\$2.13	\$2.14
High Growth & Low Prices	Rockies	2032-2033	\$2.20	\$2.27	\$2.30	\$2.29	\$2.22	\$2.17	\$2.10	\$2.14	\$2.24	\$2.21	\$2.12	\$2.13
High Growth & Low Prices	Rockies	2033-2034	\$2.18	\$2.27	\$2.31	\$2.31	\$2.23	\$2.18	\$2.10	\$2.14	\$2.21	\$2.16	\$2.11	\$2.17
High Growth & Low Prices	Rockies	2034-2035	\$2.23	\$2.28	\$2.35	\$2.33	\$2.23	\$2.18	\$2.08	\$2.11	\$2.16	\$2.15	\$2.11	\$2.14
High Growth & Low Prices	Rockies	2035-2036	\$2.13	\$2.19	\$2.34	\$2.35	\$2.24	\$2.18	\$2.10	\$2.12	\$2.24	\$2.21	\$2.13	\$2.17
High Growth & Low Prices	Rockies	2036-2037	\$2.27	\$2.42	\$2.41	\$2.42	\$2.26	\$2.14	\$2.04	\$2.03	\$2.15	\$2.14	\$2.00	\$2.08

APPENDIX 6.1: MONTHLY PRICE DATA BY BASIN

HIGH GROWTH LOW PRICE

		Nominal\$												
High Growth & Low Prices	Stanfield	2017-2018	\$2.68	\$2.60	\$2.80	\$3.26	\$2.04	\$1.96	\$2.01	\$2.03	\$2.12	\$2.16	\$2.08	\$2.07
High Growth & Low Prices	Stanfield	2018-2019	\$2.16	\$2.45	\$2.47	\$2.44	\$2.29	\$1.88	\$1.80	\$1.85	\$1.87	\$1.87	\$1.87	\$1.82
High Growth & Low Prices	Stanfield	2019-2020	\$2.08	\$2.33	\$2.37	\$2.32	\$2.17	\$1.97	\$1.95	\$2.06	\$2.06	\$1.82	\$1.81	\$1.84
High Growth & Low Prices	Stanfield	2020-2021	\$1.98	\$2.16	\$2.33	\$2.30	\$2.05	\$1.92	\$1.85	\$1.85	\$1.93	\$1.94	\$1.94	\$1.96
High Growth & Low Prices	Stanfield	2021-2022	\$2.10	\$2.23	\$2.27	\$2.25	\$2.01	\$1.86	\$1.83	\$1.82	\$1.86	\$1.86	\$1.90	\$1.88
High Growth & Low Prices	Stanfield	2022-2023	\$1.99	\$2.13	\$2.16	\$2.14	\$2.01	\$1.77	\$1.73	\$1.75	\$1.75	\$1.79	\$1.80	\$1.83
High Growth & Low Prices	Stanfield	2023-2024	\$2.10	\$2.23	\$2.26	\$2.26	\$2.12	\$1.96	\$1.94	\$1.92	\$1.93	\$1.98	\$2.01	\$2.03
High Growth & Low Prices	Stanfield	2024-2025	\$2.21	\$2.29	\$2.32	\$2.32	\$2.17	\$2.03	\$1.98	\$2.00	\$1.98	\$1.96	\$2.02	\$1.99
High Growth & Low Prices	Stanfield	2025-2026	\$2.12	\$2.20	\$2.24	\$2.24	\$2.10	\$1.96	\$1.91	\$1.91	\$1.90	\$1.88	\$1.93	\$1.92
High Growth & Low Prices	Stanfield	2026-2027	\$2.04	\$2.16	\$2.20	\$2.19	\$2.05	\$1.93	\$1.89	\$1.93	\$1.96	\$1.90	\$1.97	\$1.96
High Growth & Low Prices	Stanfield	2027-2028	\$2.13	\$2.22	\$2.30	\$2.24	\$2.15	\$1.99	\$1.92	\$1.99	\$1.94	\$1.91	\$1.94	\$1.94
High Growth & Low Prices	Stanfield	2028-2029	\$2.17	\$2.26	\$2.36	\$2.30	\$2.18	\$2.02	\$1.99	\$2.00	\$1.98	\$1.97	\$1.97	\$2.01
High Growth & Low Prices	Stanfield	2029-2030	\$2.27	\$2.35	\$2.40	\$2.38	\$2.29	\$2.10	\$2.05	\$2.07	\$2.05	\$2.04	\$2.09	\$2.11
High Growth & Low Prices	Stanfield	2030-2031	\$2.32	\$2.40	\$2.48	\$2.46	\$2.34	\$2.11	\$2.07	\$2.10	\$2.12	\$2.13	\$2.09	\$2.11
High Growth & Low Prices	Stanfield	2031-2032	\$2.33	\$2.41	\$2.50	\$2.45	\$2.34	\$2.12	\$2.07	\$2.12	\$2.15	\$2.14	\$2.11	\$2.13
High Growth & Low Prices	Stanfield	2032-2033	\$2.35	\$2.42	\$2.45	\$2.44	\$2.34	\$2.16	\$2.10	\$2.14	\$2.19	\$2.18	\$2.11	\$2.12
High Growth & Low Prices	Stanfield	2033-2034	\$2.33	\$2.46	\$2.50	\$2.49	\$2.36	\$2.17	\$2.09	\$2.16	\$2.16	\$2.13	\$2.10	\$2.17
High Growth & Low Prices	Stanfield	2034-2035	\$2.39	\$2.48	\$2.54	\$2.53	\$2.36	\$2.18	\$2.08	\$2.11	\$2.11	\$2.13	\$2.10	\$2.14
High Growth & Low Prices	Stanfield	2035-2036	\$2.27	\$2.38	\$2.53	\$2.51	\$2.35	\$2.19	\$2.12	\$2.14	\$2.20	\$2.19	\$2.12	\$2.17
High Growth & Low Prices	Stanfield	2036-2037	\$2.45	\$2.58	\$2.57	\$2.58	\$2.40	\$2.14	\$2.04	\$2.02	\$2.11	\$2.12	\$2.00	\$2.08
High Growth & Low Prices	Sumas	2017-2018	\$2.69	\$2.78	\$2.72	\$3.20	\$1.98	\$1.80	\$1.75	\$1.80	\$1.98	\$2.01	\$2.01	\$2.10
High Growth & Low Prices	Sumas	2018-2019	\$2.44	\$2.76	\$2.77	\$2.63	\$2.20	\$1.63	\$1.61	\$1.77	\$1.98	\$1.97	\$1.97	\$2.01
High Growth & Low Prices	Sumas	2019-2020	\$2.20	\$2.73	\$2.74	\$2.52	\$2.01	\$1.62	\$1.60	\$1.59	\$1.73	\$1.74	\$1.74	\$1.85
High Growth & Low Prices	Sumas	2020-2021	\$1.99	\$2.28	\$2.34	\$2.16	\$1.90	\$1.49	\$1.48	\$1.49	\$1.69	\$1.70	\$1.67	\$1.72
High Growth & Low Prices	Sumas	2021-2022	\$1.93	\$2.30	\$2.32	\$2.21	\$1.97	\$1.47	\$1.47	\$1.44	\$1.61	\$1.62	\$1.67	\$1.71
High Growth & Low Prices	Sumas	2022-2023	\$1.83	\$2.20	\$2.19	\$2.05	\$1.81	\$1.37	\$1.37	\$1.37	\$1.51	\$1.55	\$1.59	\$1.63
High Growth & Low Prices	Sumas	2023-2024	\$1.92	\$2.30	\$2.35	\$2.21	\$1.99	\$1.65	\$1.63	\$1.58	\$1.81	\$1.92	\$1.92	\$1.95
High Growth & Low Prices	Sumas	2024-2025	\$2.03	\$2.31	\$2.32	\$2.19	\$1.91	\$1.63	\$1.64	\$1.71	\$1.91	\$1.95	\$1.93	\$1.95
High Growth & Low Prices	Sumas	2025-2026	\$1.97	\$2.26	\$2.27	\$2.11	\$1.85	\$1.60	\$1.64	\$1.72	\$1.95	\$1.95	\$1.91	\$1.96
High Growth & Low Prices	Sumas	2026-2027	\$1.97	\$2.33	\$2.30	\$2.11	\$1.89	\$1.71	\$1.67	\$1.66	\$1.91	\$1.93	\$1.92	\$1.95
High Growth & Low Prices	Sumas	2027-2028	\$2.04	\$2.44	\$2.43	\$2.20	\$1.96	\$1.73	\$1.71	\$1.78	\$1.98	\$2.01	\$1.94	\$2.00
High Growth & Low Prices	Sumas	2028-2029	\$2.15	\$2.50	\$2.53	\$2.44	\$2.15	\$1.90	\$1.89	\$1.88	\$2.09	\$2.10	\$2.07	\$2.16
High Growth & Low Prices	Sumas	2029-2030	\$2.33	\$2.71	\$2.69	\$2.54	\$2.21	\$1.98	\$1.99	\$2.01	\$2.23	\$2.25	\$2.23	\$2.27
High Growth & Low Prices	Sumas	2030-2031	\$2.36	\$2.73	\$2.75	\$2.61	\$2.29	\$2.00	\$2.04	\$2.03	\$2.27	\$2.29	\$2.27	\$2.31
High Growth & Low Prices	Sumas	2031-2032	\$2.40	\$2.73	\$2.73	\$2.53	\$2.24	\$1.95	\$1.96	\$1.99	\$2.21	\$2.24	\$2.23	\$2.31
High Growth & Low Prices	Sumas	2032-2033	\$2.37	\$2.76	\$2.76	\$2.61	\$2.30	\$2.02	\$2.00	\$2.00	\$2.28	\$2.29	\$2.26	\$2.28
High Growth & Low Prices	Sumas	2033-2034	\$2.39	\$2.76	\$2.72	\$2.58	\$2.24	\$1.95	\$1.94	\$1.95	\$2.21	\$2.21	\$2.16	\$2.20
High Growth & Low Prices	Sumas	2034-2035	\$2.37	\$2.72	\$2.72	\$2.55	\$2.25	\$1.97	\$1.91	\$1.92	\$2.16	\$2.17	\$2.15	\$2.11
High Growth & Low Prices	Sumas	2035-2036	\$2.20	\$2.46	\$2.56	\$2.48	\$2.18	\$1.90	\$1.87	\$1.94	\$2.25	\$2.33	\$2.25	\$2.24
High Growth & Low Prices	Sumas	2036-2037	\$2.33	\$2.68	\$2.68	\$2.57	\$2.21	\$1.87	\$1.86	\$1.89	\$2.22	\$2.26	\$2.15	\$2.10
High Growth & Low Price	Kingsgate	2017-2018	\$2.59	\$2.43	\$3.39	\$3.25	\$2.04	\$1.90	\$1.91	\$1.86	\$1.97	\$2.08	\$2.08	\$2.09
High Growth & Low Price	Kingsgate	2018-2019	\$2.23	\$2.37	\$2.42	\$2.41	\$2.22	\$1.93	\$1.88	\$1.89	\$1.94	\$1.90	\$1.92	\$1.97
High Growth & Low Price	Kingsgate	2019-2020	\$2.15	\$2.27	\$2.28	\$2.24	\$1.98	\$1.85	\$1.80	\$1.80	\$1.85	\$1.82	\$1.83	\$1.84
High Growth & Low Price	Kingsgate	2020-2021	\$2.02	\$2.11	\$2.18	\$2.16	\$1.92	\$1.81	\$1.74	\$1.75	\$1.83	\$1.84	\$1.84	\$1.84
High Growth & Low Price	Kingsgate	2021-2022	\$1.99	\$2.09	\$2.12	\$2.11	\$1.88	\$1.76	\$1.72	\$1.71	\$1.76	\$1.75	\$1.77	\$1.76
High Growth & Low Price	Kingsgate	2022-2023	\$1.91	\$2.02	\$2.04	\$2.03	\$1.90	\$1.66	\$1.63	\$1.67	\$1.64	\$1.68	\$1.70	\$1.75
High Growth & Low Price	Kingsgate	2023-2024	\$1.98	\$2.09	\$2.11	\$2.11	\$1.99	\$1.85	\$1.83	\$1.85	\$1.86	\$1.91	\$1.93	\$1.92
High Growth & Low Price	Kingsgate	2024-2025	\$2.09	\$2.14	\$2.16	\$2.17	\$2.04	\$1.92	\$1.87	\$1.88	\$1.90	\$1.85	\$1.94	\$1.91
High Growth & Low Price	Kingsgate	2025-2026	\$2.00	\$2.05	\$2.08	\$2.09	\$1.96	\$1.89	\$1.83	\$1.84	\$1.82	\$1.77	\$1.81	\$1.80
High Growth & Low Price	Kingsgate	2026-2027	\$1.91	\$2.01	\$2.03	\$2.04	\$1.91	\$1.81	\$1.77	\$1.82	\$1.81	\$1.77	\$1.84	\$1.83
High Growth & Low Price	Kingsgate	2027-2028	\$2.01	\$2.07	\$2.13	\$2.08	\$2.00	\$1.84	\$1.76	\$1.87	\$1.78	\$1.77	\$1.81	\$1.81
High Growth & Low Price	Kingsgate	2028-2029	\$2.04	\$2.12	\$2.25	\$2.16	\$2.05	\$1.88	\$1.83	\$1.84	\$1.86	\$1.83	\$1.88	\$1.92
High Growth & Low Price	Kingsgate	2029-2030	\$2.14	\$2.21	\$2.26	\$2.24	\$2.20	\$1.95	\$1.89	\$1.90	\$1.88	\$1.94	\$1.95	\$2.02
High Growth & Low Price	Kingsgate	2030-2031	\$2.22	\$2.26	\$2.34	\$2.32	\$2.21	\$1.96	\$1.90	\$1.92	\$1.95	\$1.98	\$1.94	\$2.01
High Growth & Low Price	Kingsgate	2031-2032	\$2.19	\$2.27	\$2.35	\$2.30	\$2.21	\$1.96	\$1.95	\$1.94	\$1.98	\$1.99	\$1.97	\$1.99
High Growth & Low Price	Kingsgate	2032-2033	\$2.20	\$2.28	\$2.29	\$2.30	\$2.20	\$2.00	\$1.93	\$1.96	\$2.02	\$2.03	\$2.02	\$1.98
High Growth & Low Price	Kingsgate	2033-2034	\$2.19	\$2.31	\$2.30	\$2.35	\$2.22	\$2.01	\$1.92	\$1.98	\$1.99	\$1.98	\$2.00	\$2.02
High Growth & Low Price	Kingsgate	2034-2035	\$2.25	\$2.34	\$2.40	\$2.38	\$2.22	\$2.07	\$1.90	\$1.93	\$1.94	\$2.03	\$2.01	\$1.99
High Growth & Low Price	Kingsgate	2035-2036	\$2.12	\$2.21	\$2.35	\$2.36	\$2.21	\$2.02	\$1.94	\$1.95	\$2.08	\$2.08	\$2.02	\$2.01
High Growth & Low Price	Kingsgate	2036-2037	\$2.30	\$2.38	\$2.39	\$2.43	\$2.25	\$2.02	\$1.91	\$1.83	\$1.99	\$2.00	\$1.84	\$1.93

APPENDIX 6.1: MONTHLY PRICE DATA BY BASIN

LOW GROWTH HIGH PRICE

Scenario	Index	Gas Year	Nominal\$											
			Nov	Dec	Jan	Feb	Mar	Apr	May	Jun	Jul	Aug	Sep	Oct
Low Growth_High Prices	AECO	2017-2018	\$ 1.79	\$ 1.56	\$ 1.66	\$ 2.13	\$ 0.93	\$1.06	\$1.03	\$1.02	\$ 1.07	\$ 1.08	\$1.03	\$1.08
Low Growth_High Prices	AECO	2018-2019	\$ 1.66	\$ 1.83	\$ 1.90	\$ 1.90	\$ 1.76	\$1.38	\$1.37	\$1.46	\$ 1.54	\$ 1.55	\$1.46	\$1.50
Low Growth_High Prices	AECO	2019-2020	\$ 2.04	\$ 2.23	\$ 2.33	\$ 2.28	\$ 2.10	\$1.79	\$1.79	\$1.80	\$ 1.86	\$ 1.89	\$1.84	\$1.90
Low Growth_High Prices	AECO	2020-2021	\$ 2.32	\$ 2.48	\$ 2.75	\$ 2.69	\$ 2.58	\$2.25	\$2.23	\$2.27	\$ 2.37	\$ 2.40	\$2.32	\$2.38
Low Growth_High Prices	AECO	2021-2022	\$ 2.88	\$ 3.04	\$ 3.17	\$ 3.20	\$ 3.10	\$2.73	\$2.74	\$2.73	\$ 2.80	\$ 2.83	\$2.86	\$2.87
Low Growth_High Prices	AECO	2022-2023	\$ 3.24	\$ 3.45	\$ 3.55	\$ 3.51	\$ 3.45	\$3.06	\$3.13	\$3.16	\$ 3.18	\$ 3.28	\$3.27	\$3.28
Low Growth_High Prices	AECO	2023-2024	\$ 3.73	\$ 3.96	\$ 4.08	\$ 4.08	\$ 4.03	\$3.77	\$3.77	\$3.74	\$ 3.91	\$ 4.05	\$4.02	\$4.08
Low Growth_High Prices	AECO	2024-2025	\$ 4.32	\$ 4.44	\$ 4.52	\$ 4.54	\$ 4.35	\$4.12	\$4.16	\$4.26	\$ 4.35	\$ 4.39	\$4.33	\$4.33
Low Growth_High Prices	AECO	2025-2026	\$ 4.50	\$ 4.64	\$ 4.78	\$ 4.76	\$ 4.58	\$4.37	\$4.43	\$4.53	\$ 4.68	\$ 4.72	\$4.62	\$4.67
Low Growth_High Prices	AECO	2026-2027	\$ 4.84	\$ 5.04	\$ 5.17	\$ 5.18	\$ 5.04	\$4.88	\$4.85	\$5.02	\$ 5.16	\$ 5.21	\$5.14	\$5.15
Low Growth_High Prices	AECO	2027-2028	\$ 5.39	\$ 5.69	\$ 5.80	\$ 5.68	\$ 5.57	\$5.45	\$5.43	\$5.63	\$ 5.74	\$ 5.82	\$5.66	\$5.69
Low Growth_High Prices	AECO	2028-2029	\$ 5.86	\$ 6.09	\$ 6.17	\$ 6.27	\$ 6.10	\$5.95	\$5.98	\$6.02	\$ 6.19	\$ 6.26	\$6.14	\$6.25
Low Growth_High Prices	AECO	2029-2030	\$ 6.41	\$ 6.72	\$ 6.76	\$ 6.81	\$ 6.57	\$6.42	\$6.47	\$6.53	\$ 6.71	\$ 6.80	\$6.70	\$6.75
Low Growth_High Prices	AECO	2030-2031	\$ 6.78	\$ 7.08	\$ 7.21	\$ 7.23	\$ 6.98	\$6.72	\$6.83	\$6.91	\$ 7.16	\$ 7.24	\$7.12	\$7.15
Low Growth_High Prices	AECO	2031-2032	\$ 7.20	\$ 7.38	\$ 7.55	\$ 7.46	\$ 7.27	\$7.01	\$7.08	\$7.14	\$ 7.37	\$ 7.48	\$7.39	\$7.49
Low Growth_High Prices	AECO	2032-2033	\$ 7.52	\$ 7.89	\$ 7.99	\$ 8.00	\$ 7.76	\$7.50	\$7.55	\$7.61	\$ 7.94	\$ 8.00	\$7.87	\$7.87
Low Growth_High Prices	AECO	2033-2034	\$ 8.01	\$ 8.32	\$ 8.40	\$ 8.46	\$ 8.12	\$7.87	\$7.89	\$8.03	\$ 8.35	\$ 8.39	\$8.19	\$8.25
Low Growth_High Prices	AECO	2034-2035	\$ 8.42	\$ 8.67	\$ 8.88	\$ 8.86	\$ 8.59	\$8.35	\$8.30	\$8.43	\$ 8.72	\$ 8.85	\$8.64	\$8.52
Low Growth_High Prices	AECO	2035-2036	\$ 8.40	\$ 8.60	\$ 9.20	\$ 9.28	\$ 9.01	\$8.73	\$8.77	\$8.99	\$ 9.56	\$ 9.78	\$9.37	\$9.34
Low Growth_High Prices	AECO	2036-2037	\$ 9.53	\$10.04	\$10.16	\$10.23	\$ 9.69	\$9.12	\$9.15	\$9.32	\$ 9.86	\$ 9.99	\$9.52	\$9.38
Low Growth_High Prices	Malin	2017-2018	\$ 2.75	\$ 2.61	\$ 2.75	\$ 3.29	\$ 2.13	\$2.06	\$2.13	\$2.18	\$ 2.26	\$ 2.29	\$2.21	\$2.23
Low Growth_High Prices	Malin	2018-2019	\$ 2.53	\$ 2.82	\$ 2.86	\$ 2.82	\$ 2.66	\$2.31	\$2.23	\$2.27	\$ 2.35	\$ 2.38	\$2.34	\$2.30
Low Growth_High Prices	Malin	2019-2020	\$ 2.80	\$ 3.08	\$ 3.13	\$ 3.07	\$ 2.95	\$2.70	\$2.69	\$2.81	\$ 2.87	\$ 2.66	\$2.63	\$2.66
Low Growth_High Prices	Malin	2020-2021	\$ 3.08	\$ 3.29	\$ 3.51	\$ 3.47	\$ 3.22	\$3.01	\$2.95	\$2.98	\$ 3.15	\$ 3.19	\$3.18	\$3.18
Low Growth_High Prices	Malin	2021-2022	\$ 3.64	\$ 3.82	\$ 3.89	\$ 3.88	\$ 3.65	\$3.39	\$3.36	\$3.36	\$ 3.49	\$ 3.52	\$3.57	\$3.53
Low Growth_High Prices	Malin	2022-2023	\$ 3.97	\$ 4.19	\$ 4.26	\$ 4.23	\$ 4.07	\$3.72	\$3.72	\$3.76	\$ 3.84	\$ 3.95	\$3.96	\$3.95
Low Growth_High Prices	Malin	2023-2024	\$ 4.47	\$ 4.69	\$ 4.75	\$ 4.76	\$ 4.60	\$4.36	\$4.34	\$4.34	\$ 4.52	\$ 4.62	\$4.60	\$4.60
Low Growth_High Prices	Malin	2024-2025	\$ 5.00	\$ 5.15	\$ 5.22	\$ 5.23	\$ 5.01	\$4.77	\$4.74	\$4.80	\$ 4.91	\$ 4.95	\$4.94	\$4.89
Low Growth_High Prices	Malin	2025-2026	\$ 5.17	\$ 5.32	\$ 5.44	\$ 5.45	\$ 5.23	\$5.03	\$4.99	\$5.02	\$ 5.17	\$ 5.21	\$5.17	\$5.14
Low Growth_High Prices	Malin	2026-2027	\$ 5.41	\$ 5.65	\$ 5.75	\$ 5.77	\$ 5.55	\$5.38	\$5.32	\$5.48	\$ 5.69	\$ 5.68	\$5.66	\$5.63
Low Growth_High Prices	Malin	2027-2028	\$ 5.99	\$ 6.23	\$ 6.40	\$ 6.30	\$ 6.15	\$5.96	\$5.89	\$6.07	\$ 6.17	\$ 6.20	\$6.14	\$6.11
Low Growth_High Prices	Malin	2028-2029	\$ 6.39	\$ 6.62	\$ 6.75	\$ 6.75	\$ 6.57	\$6.38	\$6.37	\$6.42	\$ 6.59	\$ 6.64	\$6.58	\$6.63
Low Growth_High Prices	Malin	2029-2030	\$ 6.87	\$ 7.17	\$ 7.27	\$ 7.29	\$ 7.12	\$6.88	\$6.87	\$6.92	\$ 7.08	\$ 7.14	\$7.14	\$7.18
Low Growth_High Prices	Malin	2030-2031	\$ 7.34	\$ 7.59	\$ 7.76	\$ 7.73	\$ 7.51	\$7.21	\$7.25	\$7.33	\$ 7.57	\$ 7.64	\$7.54	\$7.55
Low Growth_High Prices	Malin	2031-2032	\$ 7.74	\$ 7.91	\$ 8.11	\$ 8.06	\$ 7.86	\$7.55	\$7.55	\$7.62	\$ 7.87	\$ 7.95	\$7.88	\$7.92
Low Growth_High Prices	Malin	2032-2033	\$ 8.09	\$ 8.41	\$ 8.51	\$ 8.51	\$ 8.29	\$8.01	\$8.02	\$8.09	\$ 8.44	\$ 8.47	\$8.33	\$8.33
Low Growth_High Prices	Malin	2033-2034	\$ 8.55	\$ 8.85	\$ 8.96	\$ 9.02	\$ 8.72	\$8.47	\$8.41	\$8.56	\$ 8.87	\$ 8.88	\$8.72	\$8.81
Low Growth_High Prices	Malin	2034-2035	\$ 9.02	\$ 9.25	\$ 9.47	\$ 9.48	\$ 9.16	\$8.92	\$8.82	\$8.96	\$ 9.23	\$ 9.35	\$9.18	\$9.15
Low Growth_High Prices	Malin	2035-2036	\$ 9.10	\$ 9.34	\$ 9.94	\$ 9.98	\$ 9.67	\$9.38	\$9.37	\$9.53	\$10.07	\$10.20	\$9.83	\$9.86
Low Growth_High Prices	Malin	2036-2037	\$10.22	\$10.80	\$10.87	\$10.92	\$10.35	\$9.76	\$9.72	\$9.81	\$10.32	\$10.41	\$9.96	\$9.98
Low Growth_High Prices	Rockies	2017-2018	\$ 2.70	\$ 2.50	\$ 3.07	\$ 3.23	\$ 2.05	\$1.99	\$2.04	\$2.09	\$ 2.15	\$ 2.18	\$2.10	\$2.13
Low Growth_High Prices	Rockies	2018-2019	\$ 2.45	\$ 2.72	\$ 2.93	\$ 2.77	\$ 2.61	\$2.25	\$2.16	\$2.21	\$ 2.26	\$ 2.29	\$2.25	\$2.21
Low Growth_High Prices	Rockies	2019-2020	\$ 2.72	\$ 2.98	\$ 3.19	\$ 3.01	\$ 2.90	\$2.64	\$2.63	\$2.74	\$ 2.79	\$ 2.57	\$2.54	\$2.57
Low Growth_High Prices	Rockies	2020-2021	\$ 2.99	\$ 3.18	\$ 3.57	\$ 3.41	\$ 3.16	\$2.96	\$2.89	\$2.91	\$ 3.03	\$ 3.08	\$3.06	\$3.06
Low Growth_High Prices	Rockies	2021-2022	\$ 3.52	\$ 3.70	\$ 3.77	\$ 3.78	\$ 3.58	\$3.33	\$3.29	\$3.29	\$ 3.38	\$ 3.40	\$3.45	\$3.41
Low Growth_High Prices	Rockies	2022-2023	\$ 3.84	\$ 4.06	\$ 4.13	\$ 4.10	\$ 3.99	\$3.60	\$3.63	\$3.66	\$ 3.71	\$ 3.82	\$3.83	\$3.81
Low Growth_High Prices	Rockies	2023-2024	\$ 4.32	\$ 4.54	\$ 4.61	\$ 4.61	\$ 4.52	\$4.26	\$4.24	\$4.24	\$ 4.39	\$ 4.48	\$4.46	\$4.46
Low Growth_High Prices	Rockies	2024-2025	\$ 4.82	\$ 4.99	\$ 5.06	\$ 5.08	\$ 4.86	\$4.63	\$4.63	\$4.68	\$ 4.77	\$ 4.80	\$4.79	\$4.74
Low Growth_High Prices	Rockies	2025-2026	\$ 4.98	\$ 5.16	\$ 5.28	\$ 5.30	\$ 5.07	\$4.88	\$4.86	\$4.89	\$ 5.03	\$ 5.06	\$5.02	\$5.00
Low Growth_High Prices	Rockies	2026-2027	\$ 5.26	\$ 5.50	\$ 5.60	\$ 5.61	\$ 5.40	\$5.24	\$5.20	\$5.35	\$ 5.54	\$ 5.53	\$5.51	\$5.47
Low Growth_High Prices	Rockies	2027-2028	\$ 5.83	\$ 6.07	\$ 6.23	\$ 6.14	\$ 5.99	\$5.81	\$5.80	\$5.98	\$ 6.02	\$ 6.04	\$5.99	\$5.95
Low Growth_High Prices	Rockies	2028-2029	\$ 6.23	\$ 6.46	\$ 6.58	\$ 6.59	\$ 6.41	\$6.26	\$6.29	\$6.33	\$ 6.44	\$ 6.47	\$6.41	\$6.46
Low Growth_High Prices	Rockies	2029-2030	\$ 6.69	\$ 6.98	\$ 7.08	\$ 7.11	\$ 6.97	\$6.75	\$6.77	\$6.81	\$ 6.93	\$ 6.97	\$6.97	\$7.00
Low Growth_High Prices	Rockies	2030-2031	\$ 7.16	\$ 7.40	\$ 7.57	\$ 7.54	\$ 7.36	\$7.10	\$7.14	\$7.22	\$ 7.39	\$ 7.45	\$7.35	\$7.36
Low Growth_High Prices	Rockies	2031-2032	\$ 7.54	\$ 7.70	\$ 7.91	\$ 7.85	\$ 7.69	\$7.43	\$7.43	\$7.50	\$ 7.71	\$ 7.77	\$7.68	\$7.72
Low Growth_High Prices	Rockies	2032-2033	\$ 7.89	\$ 8.20	\$ 8.29	\$ 8.30	\$ 8.11	\$7.89	\$7.89	\$7.97	\$ 8.27	\$ 8.29	\$8.13	\$8.13
Low Growth_High Prices	Rockies	2033-2034	\$ 8.35	\$ 8.63	\$ 8.74	\$ 8.80	\$ 8.53	\$8.34	\$8.28	\$8.43	\$ 8.70	\$ 8.68	\$8.51	\$8.60
Low Growth_High Prices	Rockies	2034-2035	\$ 8.81	\$ 9.03	\$ 9.25	\$ 9.25	\$ 8.96	\$8.79	\$8.68	\$8.82	\$ 9.05	\$ 9.15	\$8.97	\$8.94
Low Growth_High Prices	Rockies	2035-2036	\$ 8.88	\$ 9.11	\$ 9.71	\$ 9.75	\$ 9.47	\$9.24	\$9.22	\$9.38	\$ 9.89	\$ 9.99	\$9.61	\$9.64
Low Growth_High Prices	Rockies	2036-2037	\$ 9.99	\$10.56	\$10.63	\$10.67	\$10.14	\$9.61	\$9.56	\$9.66	\$10.13	\$10.20	\$9.73	\$9.75

APPENDIX 6.1: MONTHLY PRICE DATA BY BASIN

LOW GROWTH HIGH PRICE

		Nominal\$												
Low Growth_High Prices	Stanfield	2017-2018	\$ 2.68	\$ 2.60	\$ 2.80	\$ 3.26	\$ 2.04	\$1.96	\$2.01	\$2.03	\$ 2.12	\$ 2.16	\$2.08	\$2.07
Low Growth_High Prices	Stanfield	2018-2019	\$ 2.50	\$ 2.80	\$ 2.83	\$ 2.79	\$ 2.63	\$2.19	\$2.12	\$2.17	\$ 2.20	\$ 2.20	\$2.19	\$2.15
Low Growth_High Prices	Stanfield	2019-2020	\$ 2.77	\$ 3.05	\$ 3.10	\$ 3.04	\$ 2.86	\$2.61	\$2.60	\$2.70	\$ 2.72	\$ 2.48	\$2.47	\$2.51
Low Growth_High Prices	Stanfield	2020-2021	\$ 3.04	\$ 3.25	\$ 3.47	\$ 3.43	\$ 3.15	\$2.94	\$2.86	\$2.87	\$ 2.98	\$ 3.00	\$3.01	\$3.03
Low Growth_High Prices	Stanfield	2021-2022	\$ 3.60	\$ 3.78	\$ 3.85	\$ 3.84	\$ 3.57	\$3.30	\$3.27	\$3.26	\$ 3.33	\$ 3.34	\$3.41	\$3.38
Low Growth_High Prices	Stanfield	2022-2023	\$ 3.93	\$ 4.15	\$ 4.22	\$ 4.19	\$ 4.03	\$3.64	\$3.63	\$3.66	\$ 3.67	\$ 3.76	\$3.79	\$3.81
Low Growth_High Prices	Stanfield	2023-2024	\$ 4.43	\$ 4.65	\$ 4.71	\$ 4.71	\$ 4.56	\$4.29	\$4.29	\$4.27	\$ 4.34	\$ 4.46	\$4.47	\$4.51
Low Growth_High Prices	Stanfield	2024-2025	\$ 4.96	\$ 5.10	\$ 5.18	\$ 5.19	\$ 4.97	\$4.73	\$4.69	\$4.75	\$ 4.76	\$ 4.76	\$4.80	\$4.76
Low Growth_High Prices	Stanfield	2025-2026	\$ 5.13	\$ 5.27	\$ 5.39	\$ 5.40	\$ 5.18	\$4.96	\$4.92	\$4.96	\$ 5.00	\$ 5.02	\$5.03	\$5.01
Low Growth_High Prices	Stanfield	2026-2027	\$ 5.37	\$ 5.61	\$ 5.71	\$ 5.72	\$ 5.51	\$5.30	\$5.26	\$5.42	\$ 5.51	\$ 5.49	\$5.52	\$5.49
Low Growth_High Prices	Stanfield	2027-2028	\$ 5.95	\$ 6.21	\$ 6.36	\$ 6.26	\$ 6.11	\$5.88	\$5.81	\$5.99	\$ 5.98	\$ 6.00	\$5.99	\$5.96
Low Growth_High Prices	Stanfield	2028-2029	\$ 6.35	\$ 6.58	\$ 6.73	\$ 6.71	\$ 6.52	\$6.29	\$6.29	\$6.33	\$ 6.39	\$ 6.44	\$6.39	\$6.46
Low Growth_High Prices	Stanfield	2029-2030	\$ 6.85	\$ 7.12	\$ 7.21	\$ 7.24	\$ 7.07	\$6.78	\$6.77	\$6.82	\$ 6.88	\$ 6.94	\$6.95	\$6.99
Low Growth_High Prices	Stanfield	2030-2031	\$ 7.29	\$ 7.54	\$ 7.70	\$ 7.70	\$ 7.46	\$7.10	\$7.13	\$7.22	\$ 7.37	\$ 7.44	\$7.33	\$7.35
Low Growth_High Prices	Stanfield	2031-2032	\$ 7.68	\$ 7.88	\$ 8.08	\$ 8.00	\$ 7.80	\$7.44	\$7.43	\$7.50	\$ 7.66	\$ 7.74	\$7.67	\$7.71
Low Growth_High Prices	Stanfield	2032-2033	\$ 8.04	\$ 8.35	\$ 8.45	\$ 8.46	\$ 8.23	\$7.88	\$7.89	\$7.97	\$ 8.23	\$ 8.26	\$8.12	\$8.13
Low Growth_High Prices	Stanfield	2033-2034	\$ 8.49	\$ 8.82	\$ 8.93	\$ 8.99	\$ 8.66	\$8.33	\$8.28	\$8.45	\$ 8.66	\$ 8.66	\$8.50	\$8.60
Low Growth_High Prices	Stanfield	2034-2035	\$ 8.97	\$ 9.22	\$ 9.44	\$ 9.45	\$ 9.09	\$8.78	\$8.68	\$8.82	\$ 9.01	\$ 9.13	\$8.96	\$8.93
Low Growth_High Prices	Stanfield	2035-2036	\$ 9.02	\$ 9.30	\$ 9.91	\$ 9.91	\$ 9.58	\$9.25	\$9.23	\$9.40	\$ 9.85	\$ 9.97	\$9.61	\$9.63
Low Growth_High Prices	Stanfield	2036-2037	\$10.16	\$10.72	\$10.79	\$10.84	\$10.28	\$9.61	\$9.56	\$9.64	\$10.09	\$10.18	\$9.73	\$9.75
Low Growth_High Prices	Sumas	2017-2018	\$ 2.69	\$ 2.78	\$ 2.72	\$ 3.20	\$ 1.98	\$1.80	\$1.75	\$1.80	\$ 1.98	\$ 2.01	\$2.01	\$2.10
Low Growth_High Prices	Sumas	2018-2019	\$ 2.77	\$ 3.11	\$ 3.13	\$ 2.98	\$ 2.54	\$1.95	\$1.93	\$2.09	\$ 2.31	\$ 2.29	\$2.30	\$2.33
Low Growth_High Prices	Sumas	2019-2020	\$ 2.89	\$ 3.44	\$ 3.47	\$ 3.24	\$ 2.70	\$2.26	\$2.24	\$2.24	\$ 2.38	\$ 2.41	\$2.40	\$2.52
Low Growth_High Prices	Sumas	2020-2021	\$ 3.04	\$ 3.38	\$ 3.48	\$ 3.29	\$ 3.00	\$2.51	\$2.50	\$2.52	\$ 2.74	\$ 2.76	\$2.73	\$2.80
Low Growth_High Prices	Sumas	2021-2022	\$ 3.43	\$ 3.85	\$ 3.91	\$ 3.80	\$ 3.52	\$2.91	\$2.92	\$2.89	\$ 3.08	\$ 3.10	\$3.17	\$3.21
Low Growth_High Prices	Sumas	2022-2023	\$ 3.77	\$ 4.22	\$ 4.25	\$ 4.09	\$ 3.84	\$3.24	\$3.27	\$3.29	\$ 3.43	\$ 3.53	\$3.57	\$3.61
Low Growth_High Prices	Sumas	2023-2024	\$ 4.25	\$ 4.72	\$ 4.80	\$ 4.67	\$ 4.43	\$3.98	\$3.98	\$3.93	\$ 4.22	\$ 4.39	\$4.39	\$4.43
Low Growth_High Prices	Sumas	2024-2025	\$ 4.79	\$ 5.12	\$ 5.17	\$ 5.06	\$ 4.70	\$4.33	\$4.35	\$4.46	\$ 4.69	\$ 4.76	\$4.72	\$4.72
Low Growth_High Prices	Sumas	2025-2026	\$ 4.98	\$ 5.33	\$ 5.42	\$ 5.28	\$ 4.94	\$4.59	\$4.65	\$4.76	\$ 5.05	\$ 5.08	\$5.01	\$5.05
Low Growth_High Prices	Sumas	2026-2027	\$ 5.31	\$ 5.78	\$ 5.81	\$ 5.64	\$ 5.34	\$5.08	\$5.05	\$5.14	\$ 5.46	\$ 5.51	\$5.47	\$5.48
Low Growth_High Prices	Sumas	2027-2028	\$ 5.86	\$ 6.42	\$ 6.49	\$ 6.23	\$ 5.92	\$5.63	\$5.60	\$5.78	\$ 6.02	\$ 6.10	\$5.99	\$6.02
Low Growth_High Prices	Sumas	2028-2029	\$ 6.33	\$ 6.82	\$ 6.89	\$ 6.85	\$ 6.49	\$6.17	\$6.19	\$6.21	\$ 6.51	\$ 6.58	\$6.49	\$6.62
Low Growth_High Prices	Sumas	2029-2030	\$ 6.90	\$ 7.48	\$ 7.50	\$ 7.41	\$ 6.99	\$6.66	\$6.70	\$6.75	\$ 7.06	\$ 7.16	\$7.09	\$7.15
Low Growth_High Prices	Sumas	2030-2031	\$ 7.32	\$ 7.87	\$ 7.97	\$ 7.85	\$ 7.41	\$6.98	\$7.09	\$7.15	\$ 7.53	\$ 7.60	\$7.52	\$7.55
Low Growth_High Prices	Sumas	2031-2032	\$ 7.76	\$ 8.19	\$ 8.32	\$ 8.08	\$ 7.70	\$7.26	\$7.32	\$7.37	\$ 7.73	\$ 7.84	\$7.78	\$7.89
Low Growth_High Prices	Sumas	2032-2033	\$ 8.06	\$ 8.69	\$ 8.75	\$ 8.62	\$ 8.19	\$7.75	\$7.79	\$7.84	\$ 8.31	\$ 8.37	\$8.27	\$8.29
Low Growth_High Prices	Sumas	2033-2034	\$ 8.55	\$ 9.12	\$ 9.15	\$ 9.07	\$ 8.53	\$8.11	\$8.13	\$8.24	\$ 8.70	\$ 8.74	\$8.57	\$8.64
Low Growth_High Prices	Sumas	2034-2035	\$ 8.95	\$ 9.46	\$ 9.62	\$ 9.47	\$ 8.98	\$8.58	\$8.51	\$8.62	\$ 9.05	\$ 9.18	\$9.01	\$8.90
Low Growth_High Prices	Sumas	2035-2036	\$ 8.95	\$ 9.39	\$ 9.94	\$ 9.88	\$ 9.41	\$8.96	\$8.99	\$9.20	\$ 9.90	\$10.11	\$9.73	\$9.71
Low Growth_High Prices	Sumas	2036-2037	\$10.04	\$10.81	\$10.90	\$10.82	\$10.08	\$9.35	\$9.38	\$9.52	\$10.19	\$10.32	\$9.88	\$9.77

APPENDIX 6.2: WEIGHTED AVERAGE COST OF CAPITAL

Avista Corporation Capital Structure and Overall Rate of Return				
WASHINGTON				
From 2015 Rate Case Settlement				
Cost of Capital	Percent of Total Capital	Cost	Component	After Tax
L/T Debt	51.50%	5.20%	2.68%	1.74%
Common Equity	48.50%	9.50%	4.61%	4.61%
TOTAL	100.00%		7.29%	6.35%
IDAHO				
From 2017 Rate Case Settlement				
Cost of Capital	Percent of Total Capital	Cost	Component	
L/T Debt	50.00%	5.72%	2.86%	1.86%
Common Equity	50.00%	9.50%	4.75%	4.75%
TOTAL	100.00%		7.61%	6.61%
OREGON				
From 2016 Rate Case Settlement				
Cost of Capital	Percent of Total Capital	Cost	Component	
L/T Debt	50.00%	5.30%	2.65%	1.72%
Common Equity	50.00%	9.40%	4.70%	4.70%
TOTAL	100.00%		7.35%	6.42%
Gas Net Rate Base AMA Thru November 2017				
WA	\$ 311,457	45%		
ID	\$ 146,468	21%		
OR	\$ 227,301	33%		
	\$ 685,226			
System Weighted Average Cost of Capital (Nominal)*				6.45%
GDP price deflator				2.00%
Real After Tax WACC				4.36%

APPENDIX 6.3: POTENTIAL SUPPLY SIDE RESOURCE OPTIONS

Additional Resource	Size	Cost/Rates			Availability	Notes
Unsubscribed GTN Capacity	Up to 50,000 Dth	GTN Rate			Now	Currently available unsubscribed capacity from Kingsgate to Spokane
Medford Lateral Exp	50,000 Dth / Day	\$35M capital + GTN Rate			2019	Additional compression to facilitate more gas to flow from mainline GTN to Medford
Hydrogen	166 Dth / Day	WA	ID	OR	2020	Cost estimates obtained from a consultant; levelized cost includes revenue requirements, expected carbon adder and assumed retail power rate
		\$48 / Dth	\$40 / Dth	\$46 / Dth		
Renewable Natural Gas – Distributed Landfill	635 Dth / Day	WA	ID	OR	2020	Costs estimates obtained from a consultant for each specific type of RNG; levelized costs include revenue requirements, distribution costs, and projected carbon intensity adder/(savings)
Renewable Natural Gas – Centralized Landfill	1,814 Dth / Day	WA	ID	OR	2020	
Renewable Natural Gas – Dairy	635 Dth / Day	WA	ID	OR	2020	
Renewable Natural Gas – Waste Water	513 Dth / Day	WA	ID	OR	2020	
Renewable Natural Gas – Food Waste to (RNG)	298 Dth / Day	WA	ID	OR	2020	
		\$13 / Dth	\$13 / Dth	\$13 / Dth		
		\$11 / Dth	\$11 / Dth	\$12 / Dth		
		\$34 / Dth	\$39 / Dth	\$33 / Dth		
		\$19 / Dth	\$18 / Dth	\$19 / Dth		
		\$38 / Dth	\$39 / Dth	\$38 / Dth		
Plymouth LNG	241,700 Dth w/70,500 Dth deliverability	NWP Rate			2018	Provides for peaking services and alleviates the need for costly pipeline expansions Pair with excess pipeline MDDO's to create firm transport

Future Supply Resources	Size	Cost/Rates	Availability	Notes
Co. Owned LNG	600,000 Dth w/ 150,000 of deliverability	\$75 Million plus \$2 Million annual O&M	2024	On site, in service territory liquefaction and vaporization facility
Various pipelines – Pacific Connector, Cross-Cascades, etc.	Varies	Precedent Agreement Rates	2022	Requires additional mainline capacity on NWPL or GTN to get to service territory
Large Scale LNG	Varies	Commodity less Fuel	2024	Speculative, needs pipeline transport
In Ground Storage	Varies	Varies	Varies	Requires additional mainline transport to get to service territory
Satellite LNG	Varies	\$13M capital cost plus 665k O&M	2022	provides for peaking services and alleviates the need for costly pipeline expansions. \$3,000 per m3 with O&M assumed at 5.4%.

APPENDIX 6.4: EXPECTED CASE AVOIDED COST

Annual Avoided Costs 1/																
Scenario	Gas Year	Nominal\$														
		ID Both	ID GTN	ID NWP	Klam Falls	La Grande	Medford	Medford GTN	Medford NWP	Roseburg	WA Both	WA GTN	WA NWP	ID Annual	WA Annual	OR Annual
Expected Case	2017-2018	\$ 1.41	\$ 1.31	\$ 2.66	\$ 1.42	\$ 2.71	\$ 1.42	\$ 1.42	\$ 1.42	\$ 1.42	\$ 1.41	\$ 1.31	\$ 2.66	\$ 1.79	\$ 1.79	\$ 1.68
Expected Case	2018-2019	\$ 1.59	\$ 1.47	\$ 2.72	\$ 1.60	\$ 2.75	\$ 1.60	\$ 1.60	\$ 1.60	\$ 1.60	\$ 1.77	\$ 1.65	\$ 2.90	\$ 2.06	\$ 2.10	\$ 1.83
Expected Case	2019-2020	\$ 1.80	\$ 1.68	\$ 2.70	\$ 1.81	\$ 2.73	\$ 1.81	\$ 1.81	\$ 1.81	\$ 1.81	\$ 2.33	\$ 2.21	\$ 3.23	\$ 2.93	\$ 2.59	\$ 1.99
Expected Case	2020-2021	\$ 2.04	\$ 1.92	\$ 2.65	\$ 2.81	\$ 3.47	\$ 2.81	\$ 2.81	\$ 2.81	\$ 2.81	\$ 2.66	\$ 2.54	\$ 3.26	\$ 2.20	\$ 2.82	\$ 2.95
Expected Case	2021-2022	\$ 2.28	\$ 2.20	\$ 2.69	\$ 3.30	\$ 3.73	\$ 3.30	\$ 3.30	\$ 3.30	\$ 3.30	\$ 3.01	\$ 2.93	\$ 3.42	\$ 2.39	\$ 3.12	\$ 3.39
Expected Case	2022-2023	\$ 2.44	\$ 2.36	\$ 2.85	\$ 3.52	\$ 3.95	\$ 3.52	\$ 3.52	\$ 3.52	\$ 3.52	\$ 3.27	\$ 3.19	\$ 3.68	\$ 2.55	\$ 3.38	\$ 3.61
Expected Case	2023-2024	\$ 2.89	\$ 2.78	\$ 3.37	\$ 4.04	\$ 4.54	\$ 4.04	\$ 4.04	\$ 4.04	\$ 4.04	\$ 3.83	\$ 3.72	\$ 4.31	\$ 3.02	\$ 3.95	\$ 4.14
Expected Case	2024-2025	\$ 3.12	\$ 3.01	\$ 3.68	\$ 4.35	\$ 4.92	\$ 4.35	\$ 4.35	\$ 4.35	\$ 4.35	\$ 4.35	\$ 4.05	\$ 4.72	\$ 3.27	\$ 4.31	\$ 4.46
Expected Case	2025-2026	\$ 3.24	\$ 3.13	\$ 3.78	\$ 4.56	\$ 5.11	\$ 4.56	\$ 4.56	\$ 4.56	\$ 4.56	\$ 4.39	\$ 4.28	\$ 4.93	\$ 3.38	\$ 4.53	\$ 4.67
Expected Case	2026-2027	\$ 3.49	\$ 3.38	\$ 3.92	\$ 4.90	\$ 5.33	\$ 4.90	\$ 4.90	\$ 4.90	\$ 4.90	\$ 4.75	\$ 4.64	\$ 5.17	\$ 3.60	\$ 4.85	\$ 4.99
Expected Case	2027-2028	\$ 3.82	\$ 3.71	\$ 4.26	\$ 5.32	\$ 5.77	\$ 5.32	\$ 5.32	\$ 5.32	\$ 5.32	\$ 5.18	\$ 5.07	\$ 5.62	\$ 3.93	\$ 5.29	\$ 5.41
Expected Case	2028-2029	\$ 4.11	\$ 4.01	\$ 4.49	\$ 5.74	\$ 6.10	\$ 5.74	\$ 5.74	\$ 5.74	\$ 5.74	\$ 5.57	\$ 5.47	\$ 5.95	\$ 4.20	\$ 5.67	\$ 5.81
Expected Case	2029-2030	\$ 4.42	\$ 4.33	\$ 4.79	\$ 6.18	\$ 6.52	\$ 6.18	\$ 6.18	\$ 6.18	\$ 6.18	\$ 5.99	\$ 5.90	\$ 6.36	\$ 4.51	\$ 6.09	\$ 6.25
Expected Case	2030-2031	\$ 4.63	\$ 4.54	\$ 4.99	\$ 6.52	\$ 6.84	\$ 6.52	\$ 6.52	\$ 6.52	\$ 6.52	\$ 6.22	\$ 6.13	\$ 6.58	\$ 4.72	\$ 6.31	\$ 6.58
Expected Case	2031-2032	\$ 4.77	\$ 4.67	\$ 5.19	\$ 6.78	\$ 7.18	\$ 6.78	\$ 6.78	\$ 6.78	\$ 6.78	\$ 6.52	\$ 6.26	\$ 6.78	\$ 4.88	\$ 6.47	\$ 6.86
Expected Case	2032-2033	\$ 5.02	\$ 4.93	\$ 5.44	\$ 7.18	\$ 7.56	\$ 7.18	\$ 7.18	\$ 7.18	\$ 7.18	\$ 6.61	\$ 6.52	\$ 7.03	\$ 5.13	\$ 6.72	\$ 7.26
Expected Case	2033-2034	\$ 5.21	\$ 5.11	\$ 5.67	\$ 7.51	\$ 7.94	\$ 7.51	\$ 7.51	\$ 7.51	\$ 7.51	\$ 6.80	\$ 6.70	\$ 7.26	\$ 5.33	\$ 6.92	\$ 7.60
Expected Case	2034-2035	\$ 5.41	\$ 5.31	\$ 5.90	\$ 7.88	\$ 8.32	\$ 7.88	\$ 7.88	\$ 7.88	\$ 7.88	\$ 7.01	\$ 6.90	\$ 7.49	\$ 5.54	\$ 7.13	\$ 7.97
Expected Case	2035-2036	\$ 5.66	\$ 5.55	\$ 6.14	\$ 8.32	\$ 8.71	\$ 8.32	\$ 8.32	\$ 8.32	\$ 8.32	\$ 7.25	\$ 7.14	\$ 7.73	\$ 5.78	\$ 7.37	\$ 8.40
Expected Case	2036-2037	\$ 5.94	\$ 5.85	\$ 6.21	\$ 8.76	\$ 9.14	\$ 8.76	\$ 8.76	\$ 8.76	\$ 8.76	\$ 7.53	\$ 7.44	\$ 8.02	\$ 6.00	\$ 7.59	\$ 8.79
Winter Avoided Costs 1/																
Scenario	Gas Year	Nominal\$														
		ID Both	ID GTN	ID NWP	Klam Falls	La Grande	Medford	Medford GTN	Medford NWP	Roseburg	WA Both	WA GTN	WA NWP	ID Annual	WA Annual	OR Annual
Expected Case	2017-2018	\$ 2.00	\$ 1.71	\$ 2.57	\$ 2.10	\$ 2.65	\$ 2.10	\$ 2.10	\$ 2.10	\$ 2.10	\$ 2.00	\$ 1.71	\$ 2.57	\$ 2.10	\$ 2.10	\$ 2.21
Expected Case	2018-2019	\$ 1.91	\$ 1.61	\$ 2.67	\$ 2.07	\$ 2.76	\$ 2.07	\$ 2.07	\$ 2.07	\$ 2.07	\$ 1.91	\$ 1.61	\$ 2.67	\$ 2.06	\$ 2.06	\$ 2.21
Expected Case	2019-2020	\$ 2.11	\$ 1.82	\$ 2.77	\$ 2.29	\$ 2.84	\$ 2.29	\$ 2.29	\$ 2.29	\$ 2.29	\$ 2.65	\$ 2.35	\$ 3.30	\$ 2.24	\$ 2.77	\$ 2.40
Expected Case	2020-2021	\$ 2.18	\$ 1.90	\$ 2.65	\$ 2.30	\$ 2.74	\$ 2.30	\$ 2.30	\$ 2.30	\$ 2.30	\$ 2.71	\$ 2.43	\$ 3.19	\$ 2.25	\$ 2.78	\$ 2.39
Expected Case	2021-2022	\$ 2.47	\$ 2.24	\$ 2.70	\$ 3.51	\$ 3.77	\$ 3.51	\$ 3.51	\$ 3.51	\$ 3.51	\$ 3.11	\$ 2.88	\$ 3.34	\$ 2.47	\$ 3.11	\$ 3.56
Expected Case	2022-2023	\$ 2.63	\$ 2.41	\$ 2.86	\$ 3.74	\$ 3.98	\$ 3.74	\$ 3.74	\$ 3.74	\$ 3.74	\$ 3.37	\$ 3.15	\$ 3.61	\$ 2.63	\$ 3.38	\$ 3.79
Expected Case	2023-2024	\$ 2.97	\$ 2.71	\$ 3.31	\$ 4.16	\$ 4.46	\$ 4.16	\$ 4.16	\$ 4.16	\$ 4.16	\$ 3.82	\$ 3.56	\$ 4.16	\$ 3.00	\$ 3.85	\$ 4.22
Expected Case	2024-2025	\$ 3.31	\$ 3.05	\$ 3.63	\$ 4.58	\$ 4.84	\$ 4.58	\$ 4.58	\$ 4.58	\$ 4.58	\$ 4.26	\$ 4.00	\$ 4.58	\$ 3.33	\$ 4.28	\$ 4.63
Expected Case	2025-2026	\$ 3.39	\$ 3.11	\$ 3.74	\$ 4.75	\$ 5.02	\$ 4.75	\$ 4.75	\$ 4.75	\$ 4.75	\$ 4.45	\$ 4.17	\$ 4.80	\$ 3.41	\$ 4.47	\$ 4.80
Expected Case	2026-2027	\$ 3.58	\$ 3.31	\$ 3.86	\$ 4.98	\$ 5.23	\$ 4.98	\$ 4.98	\$ 4.98	\$ 4.98	\$ 4.75	\$ 4.47	\$ 5.02	\$ 3.58	\$ 4.75	\$ 5.03
Expected Case	2027-2028	\$ 3.93	\$ 3.66	\$ 4.20	\$ 5.41	\$ 5.65	\$ 5.41	\$ 5.41	\$ 5.41	\$ 5.41	\$ 5.20	\$ 4.94	\$ 5.48	\$ 3.93	\$ 5.21	\$ 5.45
Expected Case	2028-2029	\$ 4.19	\$ 3.93	\$ 4.44	\$ 5.79	\$ 5.98	\$ 5.79	\$ 5.79	\$ 5.79	\$ 5.79	\$ 5.57	\$ 5.31	\$ 5.82	\$ 4.19	\$ 5.57	\$ 5.83
Expected Case	2029-2030	\$ 4.56	\$ 4.31	\$ 4.78	\$ 6.28	\$ 6.44	\$ 6.28	\$ 6.28	\$ 6.28	\$ 6.28	\$ 6.04	\$ 5.80	\$ 6.27	\$ 4.55	\$ 6.04	\$ 6.31
Expected Case	2030-2031	\$ 4.74	\$ 4.49	\$ 4.97	\$ 6.61	\$ 6.77	\$ 6.61	\$ 6.61	\$ 6.61	\$ 6.61	\$ 6.33	\$ 6.08	\$ 6.57	\$ 4.74	\$ 6.33	\$ 6.64
Expected Case	2031-2032	\$ 4.93	\$ 4.68	\$ 5.14	\$ 6.92	\$ 7.07	\$ 6.92	\$ 6.92	\$ 6.92	\$ 6.92	\$ 6.52	\$ 6.27	\$ 6.73	\$ 4.92	\$ 6.51	\$ 6.95
Expected Case	2032-2033	\$ 5.14	\$ 4.89	\$ 5.41	\$ 7.28	\$ 7.47	\$ 7.28	\$ 7.28	\$ 7.28	\$ 7.28	\$ 6.74	\$ 6.49	\$ 7.01	\$ 5.15	\$ 6.74	\$ 7.32
Expected Case	2033-2034	\$ 5.38	\$ 5.13	\$ 5.62	\$ 7.65	\$ 7.82	\$ 7.65	\$ 7.65	\$ 7.65	\$ 7.65	\$ 6.97	\$ 6.72	\$ 7.21	\$ 5.38	\$ 6.97	\$ 7.69
Expected Case	2034-2035	\$ 5.56	\$ 5.31	\$ 5.84	\$ 8.00	\$ 8.17	\$ 8.00	\$ 8.00	\$ 8.00	\$ 8.00	\$ 7.16	\$ 6.91	\$ 7.43	\$ 5.57	\$ 7.16	\$ 8.03
Expected Case	2035-2036	\$ 5.47	\$ 5.18	\$ 6.08	\$ 8.21	\$ 8.52	\$ 8.21	\$ 8.21	\$ 8.21	\$ 8.21	\$ 7.06	\$ 6.77	\$ 7.67	\$ 5.57	\$ 7.17	\$ 8.27
Expected Case	2036-2037	\$ 6.19	\$ 5.94	\$ 6.43	\$ 8.97	\$ 9.14	\$ 8.97	\$ 8.97	\$ 8.97	\$ 8.97	\$ 7.78	\$ 7.53	\$ 8.02	\$ 6.18	\$ 7.78	\$ 9.00

1/ Avoided costs are before Environmental Externalities adder.

APPENDIX 6.4: LOW GROWTH CASE AVOIDED COST

Annual Avoided Costs 1/																			
Scenario	Gas Year	Nominal\$																	
		ID Both	ID GTN	ID NWP	Klam Falls	La Grande	Medford GTN	Medford NWP	Roseburg	WA Both	WA GTN	WA NWP	ID Annual	WA Annual	OR Annual				
Low Growth & High Prices	2017-2018	\$ 1.41	\$ 1.31	\$ 2.79	\$ 1.42	\$ 2.83	\$ 1.42	\$ 1.42	\$ 1.42	\$ 1.42	\$ 1.42	\$ 1.42	\$ 1.42	\$ 1.41	\$ 1.31	\$ 2.79	\$ 1.84	\$ 1.84	\$ 1.70
Low Growth & High Prices	2018-2019	\$ 1.76	\$ 1.64	\$ 2.86	\$ 1.76	\$ 2.89	\$ 1.76	\$ 1.76	\$ 1.76	\$ 1.76	\$ 1.76	\$ 1.76	\$ 1.76	\$ 1.63	\$ 1.52	\$ 3.04	\$ 2.09	\$ 2.27	\$ 1.98
Low Growth & High Prices	2019-2020	\$ 2.14	\$ 2.03	\$ 2.97	\$ 2.13	\$ 2.99	\$ 2.13	\$ 2.13	\$ 2.13	\$ 2.13	\$ 2.13	\$ 2.13	\$ 2.13	\$ 1.97	\$ 1.82	\$ 3.50	\$ 2.38	\$ 2.91	\$ 2.31
Low Growth & High Prices	2020-2021	\$ 2.56	\$ 2.47	\$ 3.15	\$ 2.35	\$ 3.06	\$ 2.35	\$ 2.35	\$ 2.35	\$ 2.35	\$ 2.35	\$ 2.35	\$ 2.35	\$ 1.88	\$ 1.71	\$ 3.77	\$ 2.72	\$ 3.34	\$ 3.47
Low Growth & High Prices	2021-2022	\$ 3.02	\$ 2.97	\$ 3.41	\$ 2.46	\$ 3.44	\$ 2.46	\$ 2.46	\$ 2.46	\$ 2.46	\$ 2.46	\$ 2.46	\$ 2.46	\$ 1.75	\$ 1.59	\$ 4.14	\$ 3.13	\$ 3.86	\$ 4.14
Low Growth & High Prices	2022-2023	\$ 3.42	\$ 3.36	\$ 3.82	\$ 2.43	\$ 3.42	\$ 2.43	\$ 2.43	\$ 2.43	\$ 2.43	\$ 2.43	\$ 2.43	\$ 2.43	\$ 1.65	\$ 1.50	\$ 4.65	\$ 3.53	\$ 4.36	\$ 4.61
Low Growth & High Prices	2023-2024	\$ 4.11	\$ 4.01	\$ 4.59	\$ 2.78	\$ 3.57	\$ 2.78	\$ 2.78	\$ 2.78	\$ 2.78	\$ 2.78	\$ 2.78	\$ 2.78	\$ 1.55	\$ 1.40	\$ 5.33	\$ 4.24	\$ 5.18	\$ 5.38
Low Growth & High Prices	2024-2025	\$ 4.52	\$ 4.43	\$ 5.08	\$ 3.14	\$ 3.92	\$ 3.14	\$ 3.14	\$ 3.14	\$ 3.14	\$ 3.14	\$ 3.14	\$ 3.14	\$ 1.45	\$ 1.30	\$ 6.13	\$ 4.68	\$ 5.72	\$ 5.89
Low Growth & High Prices	2025-2026	\$ 4.79	\$ 4.70	\$ 5.30	\$ 3.41	\$ 4.19	\$ 3.41	\$ 3.41	\$ 3.41	\$ 3.41	\$ 3.41	\$ 3.41	\$ 3.41	\$ 1.35	\$ 1.20	\$ 6.45	\$ 4.93	\$ 6.08	\$ 6.24
Low Growth & High Prices	2026-2027	\$ 5.24	\$ 5.15	\$ 5.63	\$ 3.69	\$ 4.47	\$ 3.69	\$ 3.69	\$ 3.69	\$ 3.69	\$ 3.69	\$ 3.69	\$ 3.69	\$ 1.25	\$ 1.10	\$ 6.89	\$ 5.34	\$ 6.60	\$ 6.76
Low Growth & High Prices	2027-2028	\$ 5.82	\$ 5.74	\$ 6.25	\$ 3.98	\$ 4.76	\$ 3.98	\$ 3.98	\$ 3.98	\$ 3.98	\$ 3.98	\$ 3.98	\$ 3.98	\$ 1.15	\$ 1.00	\$ 7.61	\$ 5.94	\$ 7.30	\$ 7.46
Low Growth & High Prices	2028-2029	\$ 6.30	\$ 6.23	\$ 6.66	\$ 4.27	\$ 5.05	\$ 4.27	\$ 4.27	\$ 4.27	\$ 4.27	\$ 4.27	\$ 4.27	\$ 4.27	\$ 1.05	\$ 0.90	\$ 8.13	\$ 6.40	\$ 7.86	\$ 8.04
Low Growth & High Prices	2029-2030	\$ 6.83	\$ 6.76	\$ 7.17	\$ 4.56	\$ 5.34	\$ 4.56	\$ 4.56	\$ 4.56	\$ 4.56	\$ 4.56	\$ 4.56	\$ 4.56	\$ 0.95	\$ 0.80	\$ 8.75	\$ 6.92	\$ 8.50	\$ 8.69
Low Growth & High Prices	2030-2031	\$ 7.23	\$ 7.17	\$ 7.55	\$ 4.85	\$ 5.63	\$ 4.85	\$ 4.85	\$ 4.85	\$ 4.85	\$ 4.85	\$ 4.85	\$ 4.85	\$ 0.85	\$ 0.70	\$ 9.15	\$ 7.32	\$ 8.91	\$ 9.22
Low Growth & High Prices	2031-2032	\$ 7.52	\$ 7.46	\$ 7.91	\$ 5.14	\$ 5.92	\$ 5.14	\$ 5.14	\$ 5.14	\$ 5.14	\$ 5.14	\$ 5.14	\$ 5.14	\$ 0.75	\$ 0.60	\$ 9.50	\$ 7.63	\$ 9.22	\$ 9.66
Low Growth & High Prices	2032-2033	\$ 8.00	\$ 7.94	\$ 8.37	\$ 5.43	\$ 6.21	\$ 5.43	\$ 5.43	\$ 5.43	\$ 5.43	\$ 5.43	\$ 5.43	\$ 5.43	\$ 0.65	\$ 0.50	\$ 9.96	\$ 8.10	\$ 9.69	\$ 10.27
Low Growth & High Prices	2033-2034	\$ 8.40	\$ 8.35	\$ 8.81	\$ 5.72	\$ 6.50	\$ 5.72	\$ 5.72	\$ 5.72	\$ 5.72	\$ 5.72	\$ 5.72	\$ 5.72	\$ 0.55	\$ 0.40	\$ 10.40	\$ 8.52	\$ 10.11	\$ 10.85
Low Growth & High Prices	2034-2035	\$ 8.82	\$ 8.77	\$ 9.21	\$ 6.01	\$ 6.79	\$ 6.01	\$ 6.01	\$ 6.01	\$ 6.01	\$ 6.01	\$ 6.01	\$ 6.01	\$ 0.45	\$ 0.30	\$ 10.80	\$ 8.93	\$ 10.52	\$ 11.43
Low Growth & High Prices	2035-2036	\$ 9.33	\$ 9.26	\$ 9.82	\$ 6.30	\$ 7.08	\$ 6.30	\$ 6.30	\$ 6.30	\$ 6.30	\$ 6.30	\$ 6.30	\$ 6.30	\$ 0.35	\$ 0.20	\$ 11.41	\$ 9.47	\$ 11.06	\$ 12.12
Low Growth & High Prices	2036-2037	\$ 9.87	\$ 9.85	\$ 10.15	\$ 6.59	\$ 7.37	\$ 6.59	\$ 6.59	\$ 6.59	\$ 6.59	\$ 6.59	\$ 6.59	\$ 6.59	\$ 0.25	\$ 0.10	\$ 11.74	\$ 9.96	\$ 11.55	\$ 12.81
Winter Avoided Costs 1/																			
Scenario	Gas Year	Nominal\$																	
		ID Both	ID GTN	ID NWP	Klam Falls	La Grande	Medford GTN	Medford NWP	Roseburg	WA Both	WA GTN	WA NWP	ID Annual	WA Annual	OR Annual				
Low Growth & High Prices	2017-2018	\$ 1.99	\$ 1.71	\$ 2.72	\$ 2.12	\$ 2.78	\$ 2.12	\$ 2.12	\$ 2.12	\$ 2.12	\$ 2.12	\$ 2.12	\$ 2.12	\$ 1.99	\$ 1.71	\$ 2.72	\$ (2.14)	\$ (2.14)	\$ (2.26)
Low Growth & High Prices	2018-2019	\$ 2.08	\$ 1.78	\$ 2.82	\$ 2.18	\$ 2.89	\$ 2.18	\$ 2.18	\$ 2.18	\$ 2.18	\$ 2.18	\$ 2.18	\$ 2.18	\$ 2.08	\$ 1.78	\$ 2.82	\$ (2.23)	\$ (2.23)	\$ (2.32)
Low Growth & High Prices	2019-2020	\$ 2.45	\$ 2.18	\$ 2.92	\$ 2.53	\$ 2.99	\$ 2.53	\$ 2.53	\$ 2.53	\$ 2.53	\$ 2.53	\$ 2.53	\$ 2.53	\$ 2.98	\$ 2.71	\$ 3.45	\$ (2.52)	\$ (3.05)	\$ (2.62)
Low Growth & High Prices	2020-2021	\$ 2.72	\$ 2.45	\$ 3.09	\$ 2.77	\$ 3.16	\$ 2.77	\$ 2.77	\$ 2.77	\$ 2.77	\$ 2.77	\$ 2.77	\$ 2.77	\$ 3.25	\$ 2.98	\$ 3.62	\$ (2.75)	\$ (3.28)	\$ (2.85)
Low Growth & High Prices	2021-2022	\$ 3.19	\$ 3.02	\$ 3.37	\$ 4.20	\$ 4.40	\$ 4.20	\$ 4.20	\$ 4.20	\$ 4.20	\$ 4.20	\$ 4.20	\$ 4.20	\$ 3.83	\$ 3.66	\$ 4.01	\$ (3.19)	\$ (3.83)	\$ (4.24)
Low Growth & High Prices	2022-2023	\$ 3.68	\$ 3.41	\$ 3.78	\$ 4.66	\$ 4.87	\$ 4.66	\$ 4.66	\$ 4.66	\$ 4.66	\$ 4.66	\$ 4.66	\$ 4.66	\$ 4.32	\$ 4.16	\$ 4.52	\$ (3.59)	\$ (4.33)	\$ (4.70)
Low Growth & High Prices	2023-2024	\$ 4.17	\$ 3.92	\$ 4.53	\$ 5.03	\$ 5.66	\$ 5.03	\$ 5.03	\$ 5.03	\$ 5.03	\$ 5.03	\$ 5.03	\$ 5.03	\$ 5.02	\$ 4.77	\$ 5.38	\$ (4.21)	\$ (5.06)	\$ (5.40)
Low Growth & High Prices	2024-2025	\$ 4.71	\$ 4.47	\$ 5.03	\$ 5.96	\$ 6.24	\$ 5.96	\$ 5.96	\$ 5.96	\$ 5.96	\$ 5.96	\$ 5.96	\$ 5.96	\$ 5.67	\$ 5.42	\$ 5.99	\$ (4.74)	\$ (5.69)	\$ (6.01)
Low Growth & High Prices	2025-2026	\$ 4.90	\$ 4.66	\$ 5.25	\$ 6.25	\$ 6.53	\$ 6.25	\$ 6.25	\$ 6.25	\$ 6.25	\$ 6.25	\$ 6.25	\$ 6.25	\$ 5.96	\$ 5.72	\$ 6.31	\$ (4.94)	\$ (6.00)	\$ (6.30)
Low Growth & High Prices	2026-2027	\$ 5.27	\$ 5.03	\$ 5.56	\$ 6.67	\$ 6.92	\$ 6.67	\$ 6.67	\$ 6.67	\$ 6.67	\$ 6.67	\$ 6.67	\$ 6.67	\$ 6.43	\$ 6.20	\$ 6.73	\$ (5.29)	\$ (6.46)	\$ (6.72)
Low Growth & High Prices	2027-2028	\$ 5.88	\$ 5.65	\$ 6.20	\$ 7.36	\$ 7.64	\$ 7.36	\$ 7.36	\$ 7.36	\$ 7.36	\$ 7.36	\$ 7.36	\$ 7.36	\$ 7.15	\$ 6.93	\$ 7.47	\$ (5.91)	\$ (7.18)	\$ (7.42)
Low Growth & High Prices	2028-2029	\$ 6.32	\$ 6.10	\$ 6.60	\$ 7.90	\$ 8.14	\$ 7.90	\$ 7.90	\$ 7.90	\$ 7.90	\$ 7.90	\$ 7.90	\$ 7.90	\$ 7.70	\$ 7.48	\$ 7.98	\$ (6.34)	\$ (7.72)	\$ (7.95)
Low Growth & High Prices	2029-2030	\$ 6.88	\$ 6.69	\$ 7.12	\$ 8.58	\$ 8.75	\$ 8.58	\$ 8.58	\$ 8.58	\$ 8.58	\$ 8.58	\$ 8.58	\$ 8.58	\$ 8.36	\$ 8.18	\$ 8.60	\$ (6.90)	\$ (8.38)	\$ (8.61)
Low Growth & High Prices	2030-2031	\$ 7.24	\$ 7.07	\$ 7.52	\$ 9.12	\$ 9.30	\$ 9.12	\$ 9.12	\$ 9.12	\$ 9.12	\$ 9.12	\$ 9.12	\$ 9.12	\$ 8.83	\$ 8.66	\$ 9.11	\$ (7.28)	\$ (8.87)	\$ (9.15)
Low Growth & High Prices	2031-2032	\$ 7.61	\$ 7.43	\$ 7.86	\$ 9.62	\$ 9.77	\$ 9.62	\$ 9.62	\$ 9.62	\$ 9.62	\$ 9.62	\$ 9.62	\$ 9.62	\$ 9.21	\$ 9.03	\$ 9.45	\$ (7.63)	\$ (9.23)	\$ (9.65)
Low Growth & High Prices	2032-2033	\$ 8.02	\$ 7.86	\$ 8.33	\$ 10.14	\$ 10.34	\$ 10.14	\$ 10.14	\$ 10.14	\$ 10.14	\$ 10.14	\$ 10.14	\$ 10.14	\$ 9.61	\$ 9.45	\$ 9.92	\$ (8.07)	\$ (9.66)	\$ (10.18)
Low Growth & High Prices	2033-2034	\$ 8.49	\$ 8.32	\$ 8.76	\$ 10.79	\$ 10.95	\$ 10.79	\$ 10.79	\$ 10.79	\$ 10.79	\$ 10.79	\$ 10.79	\$ 10.79	\$ 10.08	\$ 9.92	\$ 10.35	\$ (8.52)	\$ (10.11)	\$ (10.82)
Low Growth & High Prices	2034-2035	\$ 8.88	\$ 8.71	\$ 9.14	\$ 11.37	\$ 11.52	\$ 11.37	\$ 11.37	\$ 11.37	\$ 11.37	\$ 11.37	\$ 11.37	\$ 11.37	\$ 10.47	\$ 10.30	\$ 10.74	\$ (8.91)	\$ (10.50)	\$ (11.40)
Low Growth & High Prices	2035-2036	\$ 8.89	\$ 8.67	\$ 9.61	\$ 11.68	\$ 12.05	\$ 11.68	\$ 11.68	\$ 11.68	\$ 11.68	\$ 11.68	\$ 11.68	\$ 11.68	\$ 10.48	\$ 10.26	\$ 11.20	\$ (9.06)	\$ (10.65)	\$ (11.75)
Low Growth & High Prices	2036-2037	\$ 10.05	\$ 9.98	\$ 10.32	\$ 13.00	\$ 13.14	\$ 13.00	\$ 13.00	\$ 13.00	\$ 13.00	\$ 13.00	\$ 13.00	\$ 13.00	\$ 11.64	\$ 11.57	\$ 11.91	\$ (10.12)	\$ (11.71)	\$ (13.02)

1/ Avoided costs are before Environmental Externalities added.

APPENDIX 6.4: HIGH GROWTH CASE AVOIDED COST

Annual Avoided Costs 1/																
Scenario	Gas Year	Nominals														
		ID Both	ID GTN	ID NWP	Klam Falls	La Grande	Medford GTN	Medford NWP	Roseburg	WABoth	WAGTN	WANWP	ID Annual	WA Annual	OR Annual	
High Growth & Low Prices	2017-2018	\$ 1.42	\$ 1.31	\$ 2.67	\$ 1.44	\$ 2.72	\$ 1.44	\$ 1.44	\$ 1.44	\$ 1.44	\$ 1.44	\$ 1.44	\$ 1.44	\$ 1.42	\$ 1.31	\$ 2.67
High Growth & Low Prices	2018-2019	\$ 1.43	\$ 1.30	\$ 2.63	\$ 1.45	\$ 2.67	\$ 1.45	\$ 1.45	\$ 1.45	\$ 1.45	\$ 1.45	\$ 1.45	\$ 1.45	\$ 1.43	\$ 1.30	\$ 2.63
High Growth & Low Prices	2019-2020	\$ 1.47	\$ 1.34	\$ 2.44	\$ 1.48	\$ 2.47	\$ 1.48	\$ 1.48	\$ 1.48	\$ 1.48	\$ 1.48	\$ 1.48	\$ 1.48	\$ 1.47	\$ 1.34	\$ 2.44
High Growth & Low Prices	2020-2021	\$ 1.51	\$ 1.38	\$ 2.18	\$ 1.49	\$ 2.22	\$ 1.49	\$ 1.49	\$ 1.49	\$ 1.49	\$ 1.49	\$ 1.49	\$ 1.49	\$ 1.51	\$ 1.38	\$ 2.18
High Growth & Low Prices	2021-2022	\$ 1.56	\$ 1.44	\$ 2.00	\$ 1.53	\$ 2.06	\$ 1.53	\$ 1.53	\$ 1.53	\$ 1.53	\$ 1.53	\$ 1.53	\$ 1.53	\$ 1.56	\$ 1.44	\$ 2.00
High Growth & Low Prices	2022-2023	\$ 1.47	\$ 1.35	\$ 1.88	\$ 1.44	\$ 1.96	\$ 1.44	\$ 1.44	\$ 1.44	\$ 1.44	\$ 1.44	\$ 1.44	\$ 1.44	\$ 1.47	\$ 1.35	\$ 1.88
High Growth & Low Prices	2023-2024	\$ 1.69	\$ 1.56	\$ 2.17	\$ 1.67	\$ 2.22	\$ 1.67	\$ 1.67	\$ 1.67	\$ 1.67	\$ 1.67	\$ 1.67	\$ 1.67	\$ 1.69	\$ 1.56	\$ 2.17
High Growth & Low Prices	2024-2025	\$ 1.73	\$ 1.59	\$ 2.30	\$ 1.68	\$ 2.36	\$ 1.71	\$ 1.68	\$ 1.68	\$ 1.68	\$ 1.68	\$ 1.68	\$ 1.68	\$ 1.73	\$ 1.59	\$ 2.30
High Growth & Low Prices	2025-2026	\$ 1.69	\$ 1.56	\$ 2.27	\$ 1.68	\$ 2.31	\$ 1.68	\$ 1.68	\$ 1.68	\$ 1.68	\$ 1.68	\$ 1.68	\$ 1.68	\$ 1.69	\$ 1.56	\$ 2.27
High Growth & Low Prices	2026-2027	\$ 1.74	\$ 1.61	\$ 2.24	\$ 1.76	\$ 2.28	\$ 1.76	\$ 1.76	\$ 1.76	\$ 1.76	\$ 1.76	\$ 1.76	\$ 1.76	\$ 1.74	\$ 1.61	\$ 2.24
High Growth & Low Prices	2027-2028	\$ 1.81	\$ 1.68	\$ 2.24	\$ 1.81	\$ 2.28	\$ 1.81	\$ 1.81	\$ 1.81	\$ 1.81	\$ 1.81	\$ 1.81	\$ 1.81	\$ 1.81	\$ 1.68	\$ 2.24
High Growth & Low Prices	2028-2029	\$ 1.91	\$ 1.79	\$ 2.26	\$ 1.92	\$ 2.32	\$ 1.92	\$ 1.92	\$ 1.92	\$ 1.92	\$ 1.92	\$ 1.92	\$ 1.92	\$ 1.91	\$ 1.79	\$ 2.26
High Growth & Low Prices	2029-2030	\$ 2.01	\$ 1.89	\$ 2.40	\$ 2.02	\$ 2.41	\$ 2.02	\$ 2.02	\$ 2.02	\$ 2.02	\$ 2.02	\$ 2.02	\$ 2.02	\$ 2.01	\$ 1.89	\$ 2.40
High Growth & Low Prices	2030-2031	\$ 2.04	\$ 1.92	\$ 2.41	\$ 2.05	\$ 2.44	\$ 2.05	\$ 2.05	\$ 2.05	\$ 2.05	\$ 2.05	\$ 2.05	\$ 2.05	\$ 2.04	\$ 1.92	\$ 2.41
High Growth & Low Prices	2031-2032	\$ 2.05	\$ 1.88	\$ 2.50	\$ 2.02	\$ 2.53	\$ 2.02	\$ 2.02	\$ 2.02	\$ 2.02	\$ 2.02	\$ 2.02	\$ 2.02	\$ 2.05	\$ 1.88	\$ 2.50
High Growth & Low Prices	2032-2033	\$ 2.08	\$ 1.92	\$ 2.49	\$ 2.06	\$ 2.51	\$ 2.06	\$ 2.06	\$ 2.06	\$ 2.06	\$ 2.06	\$ 2.06	\$ 2.06	\$ 2.08	\$ 1.92	\$ 2.49
High Growth & Low Prices	2033-2034	\$ 2.04	\$ 1.88	\$ 2.54	\$ 2.02	\$ 2.56	\$ 2.02	\$ 2.02	\$ 2.02	\$ 2.02	\$ 2.02	\$ 2.02	\$ 2.02	\$ 2.04	\$ 1.88	\$ 2.54
High Growth & Low Prices	2034-2035	\$ 2.04	\$ 1.86	\$ 2.54	\$ 2.01	\$ 2.58	\$ 2.01	\$ 2.01	\$ 2.01	\$ 2.01	\$ 2.01	\$ 2.01	\$ 2.01	\$ 2.04	\$ 1.86	\$ 2.54
High Growth & Low Prices	2035-2036	\$ 2.01	\$ 1.83	\$ 2.52	\$ 2.03	\$ 2.57	\$ 2.03	\$ 2.03	\$ 2.03	\$ 2.03	\$ 2.03	\$ 2.03	\$ 2.03	\$ 2.01	\$ 1.83	\$ 2.52
High Growth & Low Prices	2036-2037	\$ 2.02	\$ 1.85	\$ 2.28	\$ 2.00	\$ 2.36	\$ 5.01	\$ 5.01	\$ 5.01	\$ 5.01	\$ 5.01	\$ 5.01	\$ 5.01	\$ 2.02	\$ 1.85	\$ 2.28
Winter Avoided Costs 1/																
Scenario	Gas Year	Nominals														
		ID Both	ID GTN	ID NWP	Klam Falls	La Grande	Medford GTN	Medford NWP	Roseburg	WABoth	WAGTN	WANWP	ID Annual	WA Annual	OR Annual	
High Growth & Low Prices	2017-2018	\$ 2.01	\$ 1.71	\$ 2.62	\$ 2.17	\$ 2.69	\$ 2.17	\$ 2.17	\$ 2.17	\$ 2.17	\$ 2.17	\$ 2.17	\$ 2.17	\$ 2.01	\$ 1.71	\$ 2.62
High Growth & Low Prices	2018-2019	\$ 1.75	\$ 1.43	\$ 2.63	\$ 2.02	\$ 2.71	\$ 2.02	\$ 2.02	\$ 2.02	\$ 2.02	\$ 2.02	\$ 2.02	\$ 2.02	\$ 1.75	\$ 1.43	\$ 2.63
High Growth & Low Prices	2019-2020	\$ 1.78	\$ 1.46	\$ 2.64	\$ 2.03	\$ 2.68	\$ 2.03	\$ 2.03	\$ 2.03	\$ 2.03	\$ 2.03	\$ 2.03	\$ 2.03	\$ 1.78	\$ 1.46	\$ 2.64
High Growth & Low Prices	2020-2021	\$ 1.65	\$ 1.35	\$ 2.29	\$ 1.86	\$ 2.35	\$ 1.86	\$ 1.86	\$ 1.86	\$ 1.86	\$ 1.86	\$ 1.86	\$ 1.86	\$ 1.65	\$ 1.35	\$ 2.29
High Growth & Low Prices	2021-2022	\$ 1.76	\$ 1.46	\$ 2.09	\$ 1.86	\$ 2.24	\$ 1.86	\$ 1.86	\$ 1.86	\$ 1.86	\$ 1.86	\$ 1.86	\$ 1.86	\$ 1.76	\$ 1.46	\$ 2.09
High Growth & Low Prices	2022-2023	\$ 1.71	\$ 1.40	\$ 1.93	\$ 1.75	\$ 2.14	\$ 1.75	\$ 1.75	\$ 1.75	\$ 1.75	\$ 1.75	\$ 1.75	\$ 1.75	\$ 1.71	\$ 1.40	\$ 1.93
High Growth & Low Prices	2023-2024	\$ 1.83	\$ 1.51	\$ 2.15	\$ 1.95	\$ 2.32	\$ 1.95	\$ 1.95	\$ 1.95	\$ 1.95	\$ 1.95	\$ 1.95	\$ 1.95	\$ 1.83	\$ 1.51	\$ 2.15
High Growth & Low Prices	2024-2025	\$ 1.95	\$ 1.63	\$ 2.29	\$ 2.09	\$ 2.45	\$ 2.09	\$ 2.09	\$ 2.09	\$ 2.09	\$ 2.09	\$ 2.09	\$ 2.09	\$ 1.95	\$ 1.63	\$ 2.29
High Growth & Low Prices	2025-2026	\$ 1.89	\$ 1.56	\$ 2.30	\$ 2.05	\$ 2.41	\$ 2.05	\$ 2.05	\$ 2.05	\$ 2.05	\$ 2.05	\$ 2.05	\$ 2.05	\$ 1.89	\$ 1.56	\$ 2.30
High Growth & Low Prices	2026-2027	\$ 1.90	\$ 1.58	\$ 2.26	\$ 2.03	\$ 2.38	\$ 2.03	\$ 2.03	\$ 2.03	\$ 2.03	\$ 2.03	\$ 2.03	\$ 2.03	\$ 1.90	\$ 1.58	\$ 2.26
High Growth & Low Prices	2027-2028	\$ 1.99	\$ 1.68	\$ 2.24	\$ 2.04	\$ 2.34	\$ 2.04	\$ 2.04	\$ 2.04	\$ 2.04	\$ 2.04	\$ 2.04	\$ 2.04	\$ 1.99	\$ 1.68	\$ 2.24
High Growth & Low Prices	2028-2029	\$ 2.07	\$ 1.77	\$ 2.27	\$ 2.13	\$ 2.39	\$ 2.13	\$ 2.13	\$ 2.13	\$ 2.13	\$ 2.13	\$ 2.13	\$ 2.13	\$ 2.07	\$ 1.77	\$ 2.27
High Growth & Low Prices	2029-2030	\$ 2.23	\$ 1.93	\$ 2.43	\$ 2.28	\$ 2.47	\$ 2.28	\$ 2.28	\$ 2.28	\$ 2.28	\$ 2.28	\$ 2.28	\$ 2.28	\$ 2.23	\$ 1.93	\$ 2.43
High Growth & Low Prices	2030-2031	\$ 2.22	\$ 1.92	\$ 2.46	\$ 2.30	\$ 2.53	\$ 2.30	\$ 2.30	\$ 2.30	\$ 2.30	\$ 2.30	\$ 2.30	\$ 2.30	\$ 2.22	\$ 1.92	\$ 2.46
High Growth & Low Prices	2031-2032	\$ 2.25	\$ 1.92	\$ 2.47	\$ 2.31	\$ 2.52	\$ 2.31	\$ 2.31	\$ 2.31	\$ 2.31	\$ 2.31	\$ 2.31	\$ 2.31	\$ 2.25	\$ 1.92	\$ 2.47
High Growth & Low Prices	2032-2033	\$ 2.26	\$ 1.93	\$ 2.48	\$ 2.35	\$ 2.55	\$ 2.35	\$ 2.35	\$ 2.35	\$ 2.35	\$ 2.35	\$ 2.35	\$ 2.35	\$ 2.23	\$ 1.93	\$ 2.48
High Growth & Low Prices	2033-2034	\$ 2.27	\$ 1.94	\$ 2.50	\$ 2.36	\$ 2.55	\$ 2.36	\$ 2.36	\$ 2.36	\$ 2.36	\$ 2.36	\$ 2.36	\$ 2.36	\$ 2.24	\$ 1.94	\$ 2.50
High Growth & Low Prices	2034-2035	\$ 2.25	\$ 1.92	\$ 2.51	\$ 2.38	\$ 2.59	\$ 2.38	\$ 2.38	\$ 2.38	\$ 2.38	\$ 2.38	\$ 2.38	\$ 2.38	\$ 2.25	\$ 1.92	\$ 2.51
High Growth & Low Prices	2035-2036	\$ 2.06	\$ 1.70	\$ 2.52	\$ 2.32	\$ 2.62	\$ 2.32	\$ 2.32	\$ 2.32	\$ 2.32	\$ 2.32	\$ 2.32	\$ 2.32	\$ 2.06	\$ 1.70	\$ 2.52
High Growth & Low Prices	2036-2037	\$ 2.23	\$ 1.90	\$ 2.48	\$ 2.37	\$ 2.73	\$ 2.41	\$ 2.41	\$ 2.41	\$ 2.41	\$ 2.41	\$ 2.41	\$ 2.41	\$ 2.23	\$ 1.90	\$ 2.48

1/ Avoided costs are before Environmental Externalities adder.

APPENDIX 6.4: AVERAGE CASE AVOIDED COST

Annual Avoided Costs 1/																
Scenario	Gas Year	Nominals\$														
		ID Both	ID GTN	ID NWP	Klam Falls	La Grande	Medford	Medford GTN	Medford NWP	Roseburg	WA Both	WA GTN	WA NWP	WA NWP	ID Annual	WA Annual
Average Case	2017-2018	\$ 1.40	\$ 1.31	\$ 2.63	\$ 1.39	\$ 2.64	\$ 1.39	\$ 1.39	\$ 1.39	\$ 1.39	\$ 1.40	\$ 1.31	\$ 2.63	\$ 1.78	\$ 1.78	\$ 1.64
Average Case	2018-2019	\$ 1.57	\$ 1.47	\$ 2.68	\$ 1.56	\$ 2.70	\$ 1.56	\$ 1.56	\$ 1.56	\$ 1.56	\$ 1.75	\$ 1.65	\$ 2.86	\$ 1.91	\$ 2.09	\$ 1.78
Average Case	2019-2020	\$ 1.78	\$ 1.68	\$ 2.69	\$ 1.76	\$ 2.70	\$ 1.76	\$ 1.76	\$ 1.76	\$ 1.76	\$ 2.31	\$ 2.21	\$ 3.22	\$ 2.05	\$ 2.58	\$ 1.95
Average Case	2020-2021	\$ 2.03	\$ 1.92	\$ 2.65	\$ 2.77	\$ 3.45	\$ 2.77	\$ 2.77	\$ 2.77	\$ 2.77	\$ 2.64	\$ 2.54	\$ 3.27	\$ 2.20	\$ 2.82	\$ 2.91
Average Case	2021-2022	\$ 2.28	\$ 2.20	\$ 2.69	\$ 3.26	\$ 3.70	\$ 3.26	\$ 3.26	\$ 3.26	\$ 3.26	\$ 3.00	\$ 2.93	\$ 3.41	\$ 2.39	\$ 3.11	\$ 3.35
Average Case	2022-2023	\$ 2.42	\$ 2.36	\$ 2.82	\$ 3.49	\$ 3.90	\$ 3.49	\$ 3.49	\$ 3.49	\$ 3.49	\$ 3.49	\$ 3.49	\$ 3.65	\$ 2.53	\$ 3.36	\$ 3.57
Average Case	2023-2024	\$ 2.88	\$ 2.78	\$ 3.37	\$ 4.00	\$ 4.52	\$ 4.00	\$ 4.00	\$ 4.00	\$ 4.00	\$ 3.82	\$ 3.72	\$ 4.31	\$ 3.01	\$ 3.95	\$ 4.10
Average Case	2024-2025	\$ 3.11	\$ 3.01	\$ 3.65	\$ 4.30	\$ 4.88	\$ 4.30	\$ 4.30	\$ 4.30	\$ 4.30	\$ 4.15	\$ 4.05	\$ 4.69	\$ 3.26	\$ 4.30	\$ 4.42
Average Case	2025-2026	\$ 3.23	\$ 3.13	\$ 3.76	\$ 4.51	\$ 5.07	\$ 4.51	\$ 4.51	\$ 4.51	\$ 4.51	\$ 4.38	\$ 4.28	\$ 4.91	\$ 3.37	\$ 4.52	\$ 4.62
Average Case	2026-2027	\$ 3.48	\$ 3.38	\$ 3.91	\$ 4.86	\$ 5.32	\$ 4.86	\$ 4.86	\$ 4.86	\$ 4.86	\$ 4.74	\$ 4.64	\$ 5.17	\$ 3.59	\$ 4.85	\$ 4.95
Average Case	2027-2028	\$ 3.81	\$ 3.71	\$ 4.24	\$ 5.29	\$ 5.75	\$ 5.29	\$ 5.29	\$ 5.29	\$ 5.29	\$ 5.17	\$ 5.07	\$ 5.60	\$ 3.92	\$ 5.28	\$ 5.38
Average Case	2028-2029	\$ 4.10	\$ 4.01	\$ 4.47	\$ 5.71	\$ 6.08	\$ 5.71	\$ 5.71	\$ 5.71	\$ 5.71	\$ 5.57	\$ 5.47	\$ 5.94	\$ 4.19	\$ 5.66	\$ 5.79
Average Case	2029-2030	\$ 4.40	\$ 4.33	\$ 4.77	\$ 6.16	\$ 6.49	\$ 6.16	\$ 6.16	\$ 6.16	\$ 6.16	\$ 5.98	\$ 5.90	\$ 6.34	\$ 4.50	\$ 6.07	\$ 6.22
Average Case	2030-2031	\$ 4.62	\$ 4.54	\$ 4.97	\$ 6.50	\$ 6.82	\$ 6.50	\$ 6.50	\$ 6.50	\$ 6.50	\$ 6.21	\$ 6.13	\$ 6.57	\$ 4.71	\$ 6.30	\$ 6.56
Average Case	2031-2032	\$ 4.77	\$ 4.67	\$ 5.18	\$ 6.76	\$ 7.16	\$ 6.76	\$ 6.76	\$ 6.76	\$ 6.76	\$ 6.36	\$ 6.26	\$ 6.78	\$ 4.87	\$ 6.46	\$ 6.84
Average Case	2032-2033	\$ 5.01	\$ 4.93	\$ 5.42	\$ 7.16	\$ 7.53	\$ 7.16	\$ 7.16	\$ 7.16	\$ 7.16	\$ 6.80	\$ 6.52	\$ 7.02	\$ 5.12	\$ 6.71	\$ 7.23
Average Case	2033-2034	\$ 5.21	\$ 5.11	\$ 5.67	\$ 7.50	\$ 7.93	\$ 7.50	\$ 7.50	\$ 7.50	\$ 7.50	\$ 6.80	\$ 6.70	\$ 7.26	\$ 5.33	\$ 6.92	\$ 7.58
Average Case	2034-2035	\$ 5.40	\$ 5.31	\$ 5.86	\$ 7.87	\$ 8.28	\$ 7.87	\$ 7.87	\$ 7.87	\$ 7.87	\$ 7.00	\$ 6.90	\$ 7.45	\$ 5.52	\$ 7.12	\$ 7.95
Average Case	2035-2036	\$ 5.65	\$ 5.55	\$ 6.12	\$ 8.31	\$ 8.69	\$ 8.31	\$ 8.31	\$ 8.31	\$ 8.31	\$ 7.24	\$ 7.14	\$ 7.71	\$ 5.77	\$ 7.36	\$ 8.39
Average Case	2036-2037	\$ 5.89	\$ 5.85	\$ 6.15	\$ 8.74	\$ 8.94	\$ 8.74	\$ 8.74	\$ 8.74	\$ 8.74	\$ 7.48	\$ 7.44	\$ 7.74	\$ 5.96	\$ 7.55	\$ 8.77
Winter Avoided Costs 1/																
Scenario	Gas Year	Nominals\$														
		ID Both	ID GTN	ID NWP	Klam Falls	La Grande	Medford	Medford GTN	Medford NWP	Roseburg	WA Both	WA GTN	WA NWP	WA NWP	ID Annual	WA Annual
Average Case	2017-2018	\$ 1.97	\$ 1.71	\$ 2.54	\$ 1.93	\$ 2.54	\$ 1.93	\$ 1.93	\$ 1.93	\$ 1.93	\$ 1.97	\$ 1.71	\$ 2.54	\$ 2.07	\$ 2.07	\$ 2.05
Average Case	2018-2019	\$ 1.87	\$ 1.61	\$ 2.64	\$ 1.84	\$ 2.66	\$ 1.84	\$ 1.84	\$ 1.84	\$ 1.84	\$ 1.87	\$ 1.61	\$ 2.64	\$ 2.04	\$ 2.04	\$ 2.00
Average Case	2019-2020	\$ 2.08	\$ 1.82	\$ 2.74	\$ 2.02	\$ 2.76	\$ 2.02	\$ 2.02	\$ 2.02	\$ 2.02	\$ 2.61	\$ 2.35	\$ 3.27	\$ 2.21	\$ 2.74	\$ 2.17
Average Case	2020-2021	\$ 2.16	\$ 1.90	\$ 2.65	\$ 2.05	\$ 2.68	\$ 2.05	\$ 2.05	\$ 2.05	\$ 2.05	\$ 2.69	\$ 2.43	\$ 3.18	\$ 2.24	\$ 2.77	\$ 2.18
Average Case	2021-2022	\$ 2.47	\$ 2.24	\$ 2.68	\$ 3.29	\$ 3.66	\$ 3.29	\$ 3.29	\$ 3.29	\$ 3.29	\$ 3.10	\$ 2.88	\$ 3.32	\$ 2.46	\$ 3.10	\$ 3.36
Average Case	2022-2023	\$ 2.59	\$ 2.41	\$ 2.78	\$ 3.52	\$ 3.82	\$ 3.52	\$ 3.52	\$ 3.52	\$ 3.52	\$ 3.33	\$ 3.15	\$ 3.52	\$ 2.59	\$ 3.33	\$ 3.58
Average Case	2023-2024	\$ 2.96	\$ 2.71	\$ 3.30	\$ 3.91	\$ 4.41	\$ 3.91	\$ 3.91	\$ 3.91	\$ 3.91	\$ 3.81	\$ 3.56	\$ 4.15	\$ 2.99	\$ 3.84	\$ 4.01
Average Case	2024-2025	\$ 3.30	\$ 3.05	\$ 3.59	\$ 4.30	\$ 4.77	\$ 4.30	\$ 4.30	\$ 4.30	\$ 4.30	\$ 4.25	\$ 4.00	\$ 4.55	\$ 3.31	\$ 4.27	\$ 4.40
Average Case	2025-2026	\$ 3.38	\$ 3.11	\$ 3.71	\$ 4.47	\$ 4.96	\$ 4.47	\$ 4.47	\$ 4.47	\$ 4.47	\$ 4.44	\$ 4.17	\$ 4.77	\$ 3.40	\$ 4.46	\$ 4.57
Average Case	2026-2027	\$ 3.57	\$ 3.31	\$ 3.85	\$ 4.76	\$ 5.19	\$ 4.76	\$ 4.76	\$ 4.76	\$ 4.76	\$ 4.74	\$ 4.47	\$ 5.02	\$ 3.58	\$ 4.74	\$ 4.84
Average Case	2027-2028	\$ 3.92	\$ 3.66	\$ 4.19	\$ 5.20	\$ 5.62	\$ 5.20	\$ 5.20	\$ 5.20	\$ 5.20	\$ 5.20	\$ 4.94	\$ 5.47	\$ 3.93	\$ 5.20	\$ 5.28
Average Case	2028-2029	\$ 4.19	\$ 3.93	\$ 4.42	\$ 5.63	\$ 5.95	\$ 5.63	\$ 5.63	\$ 5.63	\$ 5.63	\$ 5.57	\$ 5.31	\$ 5.80	\$ 4.18	\$ 5.56	\$ 5.69
Average Case	2029-2030	\$ 4.53	\$ 4.31	\$ 4.73	\$ 6.16	\$ 6.36	\$ 6.16	\$ 6.16	\$ 6.16	\$ 6.16	\$ 6.02	\$ 5.80	\$ 6.22	\$ 4.52	\$ 6.01	\$ 6.20
Average Case	2030-2031	\$ 4.73	\$ 4.49	\$ 4.94	\$ 6.48	\$ 6.69	\$ 6.48	\$ 6.48	\$ 6.48	\$ 6.48	\$ 6.32	\$ 6.08	\$ 6.53	\$ 4.72	\$ 6.31	\$ 6.52
Average Case	2031-2032	\$ 4.92	\$ 4.68	\$ 5.14	\$ 6.82	\$ 7.00	\$ 6.82	\$ 6.82	\$ 6.82	\$ 6.82	\$ 6.52	\$ 6.27	\$ 6.73	\$ 4.91	\$ 6.50	\$ 6.85
Average Case	2032-2033	\$ 5.14	\$ 4.89	\$ 5.39	\$ 7.15	\$ 7.38	\$ 7.15	\$ 7.15	\$ 7.15	\$ 7.15	\$ 6.73	\$ 6.49	\$ 6.98	\$ 5.14	\$ 6.73	\$ 7.20
Average Case	2033-2034	\$ 5.38	\$ 5.13	\$ 5.62	\$ 7.56	\$ 7.75	\$ 7.56	\$ 7.56	\$ 7.56	\$ 7.56	\$ 6.97	\$ 6.72	\$ 7.21	\$ 5.37	\$ 6.97	\$ 7.60
Average Case	2034-2035	\$ 5.56	\$ 5.31	\$ 5.79	\$ 7.95	\$ 8.14	\$ 7.95	\$ 7.95	\$ 7.95	\$ 7.95	\$ 7.15	\$ 6.91	\$ 7.38	\$ 5.55	\$ 7.15	\$ 7.99
Average Case	2035-2036	\$ 5.42	\$ 5.18	\$ 6.05	\$ 8.16	\$ 8.49	\$ 8.16	\$ 8.16	\$ 8.16	\$ 8.16	\$ 7.02	\$ 6.77	\$ 7.65	\$ 5.55	\$ 7.15	\$ 8.23
Average Case	2036-2037	\$ 6.09	\$ 5.94	\$ 6.23	\$ 8.88	\$ 9.01	\$ 8.88	\$ 8.88	\$ 8.88	\$ 8.88	\$ 7.68	\$ 7.53	\$ 7.82	\$ 6.09	\$ 7.68	\$ 8.91

1/ Avoided costs are before Environmental Externalities added.

APPENDIX 6.4: COLD DAY 20 YR WEATHER STANDARD AVOIDED COST

Annual Avoided Costs 1/																
Scenario	Gas Year	Nominal\$														
		ID Both	ID GTN	ID NWP	Klam Falls	La Grande	Medford	Medford GTN	Medford NWP	Roseburg	WA Both	WA GTN	WA NWP	ID Annual	WA Annual	OR Annual
Cold Day 20yr Weather Std	2017-2018	\$ 1.41	\$ 1.31	\$ 2.66	\$ 1.41	\$ 2.70	\$ 1.41	\$ 1.41	\$ 1.41	\$ 1.41	\$ 1.41	\$ 1.31	\$ 2.66	\$ 1.79	\$ 1.79	\$ 1.67
Cold Day 20yr Weather Std	2018-2019	\$ 1.59	\$ 1.47	\$ 2.71	\$ 1.60	\$ 2.75	\$ 1.60	\$ 1.60	\$ 1.60	\$ 1.60	\$ 1.60	\$ 1.65	\$ 2.89	\$ 1.92	\$ 2.10	\$ 1.83
Cold Day 20yr Weather Std	2019-2020	\$ 1.80	\$ 1.68	\$ 2.70	\$ 1.80	\$ 2.73	\$ 1.80	\$ 1.80	\$ 1.80	\$ 1.80	\$ 1.80	\$ 2.21	\$ 3.23	\$ 2.06	\$ 2.59	\$ 1.99
Cold Day 20yr Weather Std	2020-2021	\$ 2.04	\$ 1.92	\$ 2.65	\$ 2.81	\$ 3.47	\$ 2.81	\$ 2.81	\$ 2.81	\$ 2.81	\$ 2.81	\$ 2.65	\$ 3.26	\$ 2.20	\$ 2.82	\$ 2.94
Cold Day 20yr Weather Std	2021-2022	\$ 2.28	\$ 2.20	\$ 2.69	\$ 3.29	\$ 3.73	\$ 3.29	\$ 3.29	\$ 3.29	\$ 3.29	\$ 3.29	\$ 3.01	\$ 3.42	\$ 2.39	\$ 3.12	\$ 3.38
Cold Day 20yr Weather Std	2022-2023	\$ 2.43	\$ 2.36	\$ 2.83	\$ 3.52	\$ 3.94	\$ 3.52	\$ 3.52	\$ 3.52	\$ 3.52	\$ 3.52	\$ 3.19	\$ 3.66	\$ 2.54	\$ 3.37	\$ 3.60
Cold Day 20yr Weather Std	2023-2024	\$ 2.89	\$ 2.78	\$ 3.37	\$ 4.04	\$ 4.54	\$ 4.04	\$ 4.04	\$ 4.04	\$ 4.04	\$ 4.04	\$ 3.83	\$ 4.31	\$ 3.01	\$ 3.95	\$ 4.14
Cold Day 20yr Weather Std	2024-2025	\$ 3.12	\$ 3.01	\$ 3.67	\$ 4.35	\$ 4.92	\$ 4.35	\$ 4.35	\$ 4.35	\$ 4.35	\$ 4.35	\$ 4.05	\$ 4.72	\$ 3.27	\$ 4.31	\$ 4.46
Cold Day 20yr Weather Std	2025-2026	\$ 3.24	\$ 3.13	\$ 3.78	\$ 4.55	\$ 5.11	\$ 4.55	\$ 4.55	\$ 4.55	\$ 4.55	\$ 4.55	\$ 4.28	\$ 4.93	\$ 3.38	\$ 4.53	\$ 4.67
Cold Day 20yr Weather Std	2026-2027	\$ 3.49	\$ 3.38	\$ 3.91	\$ 4.90	\$ 5.33	\$ 4.90	\$ 4.90	\$ 4.90	\$ 4.90	\$ 4.90	\$ 4.64	\$ 5.17	\$ 3.60	\$ 4.85	\$ 4.98
Cold Day 20yr Weather Std	2027-2028	\$ 3.82	\$ 3.71	\$ 4.26	\$ 5.32	\$ 5.77	\$ 5.32	\$ 5.32	\$ 5.32	\$ 5.32	\$ 5.32	\$ 5.07	\$ 5.62	\$ 3.93	\$ 5.29	\$ 5.41
Cold Day 20yr Weather Std	2028-2029	\$ 4.11	\$ 4.01	\$ 4.49	\$ 5.74	\$ 6.10	\$ 5.74	\$ 5.74	\$ 5.74	\$ 5.74	\$ 5.74	\$ 5.47	\$ 5.95	\$ 4.20	\$ 5.67	\$ 5.81
Cold Day 20yr Weather Std	2029-2030	\$ 4.42	\$ 4.33	\$ 4.79	\$ 6.18	\$ 6.52	\$ 6.18	\$ 6.18	\$ 6.18	\$ 6.18	\$ 6.18	\$ 5.90	\$ 6.36	\$ 4.51	\$ 6.09	\$ 6.24
Cold Day 20yr Weather Std	2030-2031	\$ 4.63	\$ 4.54	\$ 4.99	\$ 6.52	\$ 6.84	\$ 6.52	\$ 6.52	\$ 6.52	\$ 6.52	\$ 6.52	\$ 6.13	\$ 6.58	\$ 4.72	\$ 6.31	\$ 6.58
Cold Day 20yr Weather Std	2031-2032	\$ 4.77	\$ 4.67	\$ 5.19	\$ 6.78	\$ 7.18	\$ 6.78	\$ 6.78	\$ 6.78	\$ 6.78	\$ 6.78	\$ 6.26	\$ 6.78	\$ 4.88	\$ 6.47	\$ 6.86
Cold Day 20yr Weather Std	2032-2033	\$ 5.02	\$ 4.93	\$ 5.43	\$ 7.18	\$ 7.55	\$ 7.18	\$ 7.18	\$ 7.18	\$ 7.18	\$ 7.18	\$ 6.61	\$ 7.02	\$ 5.12	\$ 6.72	\$ 7.25
Cold Day 20yr Weather Std	2033-2034	\$ 5.21	\$ 5.11	\$ 5.67	\$ 7.51	\$ 7.94	\$ 7.51	\$ 7.51	\$ 7.51	\$ 7.51	\$ 7.51	\$ 6.80	\$ 7.26	\$ 5.33	\$ 6.92	\$ 7.60
Cold Day 20yr Weather Std	2034-2035	\$ 5.41	\$ 5.31	\$ 5.90	\$ 7.87	\$ 8.32	\$ 7.87	\$ 7.87	\$ 7.87	\$ 7.87	\$ 7.87	\$ 7.01	\$ 7.49	\$ 5.54	\$ 7.13	\$ 7.96
Cold Day 20yr Weather Std	2035-2036	\$ 5.66	\$ 5.55	\$ 6.14	\$ 8.32	\$ 8.71	\$ 8.32	\$ 8.32	\$ 8.32	\$ 8.32	\$ 8.32	\$ 7.25	\$ 7.73	\$ 5.78	\$ 7.37	\$ 8.40
Cold Day 20yr Weather Std	2036-2037	\$ 5.94	\$ 5.85	\$ 6.21	\$ 8.75	\$ 9.14	\$ 8.75	\$ 8.75	\$ 8.75	\$ 8.75	\$ 8.75	\$ 7.53	\$ 7.81	\$ 6.00	\$ 7.59	\$ 8.79
Winter Avoided Costs 1/																
Scenario	Gas Year	Nominal\$														
		ID Both	ID GTN	ID NWP	Klam Falls	La Grande	Medford	Medford GTN	Medford NWP	Roseburg	WA Both	WA GTN	WA NWP	ID Annual	WA Annual	OR Annual
Cold Day 20yr Weather Std	2017-2018	\$ 2.00	\$ 1.71	\$ 2.57	\$ 2.04	\$ 2.65	\$ 2.04	\$ 2.04	\$ 2.04	\$ 2.04	\$ 2.00	\$ 1.71	\$ 2.57	\$ 2.10	\$ 2.10	\$ 2.16
Cold Day 20yr Weather Std	2018-2019	\$ 1.91	\$ 1.61	\$ 2.67	\$ 2.03	\$ 2.76	\$ 2.03	\$ 2.03	\$ 2.03	\$ 2.03	\$ 1.91	\$ 1.61	\$ 2.67	\$ 2.06	\$ 2.06	\$ 2.18
Cold Day 20yr Weather Std	2019-2020	\$ 2.11	\$ 1.82	\$ 2.77	\$ 2.26	\$ 2.84	\$ 2.26	\$ 2.26	\$ 2.26	\$ 2.26	\$ 2.26	\$ 2.35	\$ 3.30	\$ 2.24	\$ 2.77	\$ 2.38
Cold Day 20yr Weather Std	2020-2021	\$ 2.18	\$ 1.90	\$ 2.65	\$ 2.27	\$ 2.74	\$ 2.27	\$ 2.27	\$ 2.27	\$ 2.27	\$ 2.27	\$ 2.43	\$ 3.19	\$ 2.25	\$ 2.78	\$ 2.37
Cold Day 20yr Weather Std	2021-2022	\$ 2.47	\$ 2.24	\$ 2.70	\$ 3.47	\$ 3.77	\$ 3.47	\$ 3.47	\$ 3.47	\$ 3.47	\$ 3.11	\$ 2.88	\$ 3.34	\$ 2.47	\$ 3.11	\$ 3.53
Cold Day 20yr Weather Std	2022-2023	\$ 2.60	\$ 2.41	\$ 2.80	\$ 3.70	\$ 3.95	\$ 3.70	\$ 3.70	\$ 3.70	\$ 3.70	\$ 3.34	\$ 3.15	\$ 3.54	\$ 2.60	\$ 3.35	\$ 3.75
Cold Day 20yr Weather Std	2023-2024	\$ 2.97	\$ 2.71	\$ 3.31	\$ 4.14	\$ 4.46	\$ 4.14	\$ 4.14	\$ 4.14	\$ 4.14	\$ 3.82	\$ 3.56	\$ 4.16	\$ 3.00	\$ 3.85	\$ 4.20
Cold Day 20yr Weather Std	2024-2025	\$ 3.31	\$ 3.05	\$ 3.63	\$ 4.56	\$ 4.84	\$ 4.56	\$ 4.56	\$ 4.56	\$ 4.56	\$ 4.26	\$ 4.00	\$ 4.58	\$ 3.33	\$ 4.28	\$ 4.61
Cold Day 20yr Weather Std	2025-2026	\$ 3.39	\$ 3.11	\$ 3.74	\$ 4.73	\$ 5.02	\$ 4.73	\$ 4.73	\$ 4.73	\$ 4.73	\$ 4.45	\$ 4.17	\$ 4.80	\$ 3.41	\$ 4.47	\$ 4.79
Cold Day 20yr Weather Std	2026-2027	\$ 3.58	\$ 3.31	\$ 3.86	\$ 4.96	\$ 5.23	\$ 4.96	\$ 4.96	\$ 4.96	\$ 4.96	\$ 4.75	\$ 4.47	\$ 5.02	\$ 3.58	\$ 4.75	\$ 5.01
Cold Day 20yr Weather Std	2027-2028	\$ 3.93	\$ 3.66	\$ 4.20	\$ 5.39	\$ 5.65	\$ 5.39	\$ 5.39	\$ 5.39	\$ 5.39	\$ 5.20	\$ 4.94	\$ 5.48	\$ 3.93	\$ 5.21	\$ 5.44
Cold Day 20yr Weather Std	2028-2029	\$ 4.19	\$ 3.93	\$ 4.44	\$ 5.78	\$ 5.98	\$ 5.78	\$ 5.78	\$ 5.78	\$ 5.78	\$ 5.57	\$ 5.31	\$ 5.82	\$ 4.19	\$ 5.57	\$ 5.82
Cold Day 20yr Weather Std	2029-2030	\$ 4.56	\$ 4.31	\$ 4.78	\$ 6.27	\$ 6.44	\$ 6.27	\$ 6.27	\$ 6.27	\$ 6.27	\$ 6.04	\$ 5.80	\$ 6.27	\$ 4.55	\$ 6.04	\$ 6.30
Cold Day 20yr Weather Std	2030-2031	\$ 4.74	\$ 4.49	\$ 4.97	\$ 6.60	\$ 6.77	\$ 6.60	\$ 6.60	\$ 6.60	\$ 6.60	\$ 6.33	\$ 6.08	\$ 6.57	\$ 4.74	\$ 6.33	\$ 6.63
Cold Day 20yr Weather Std	2031-2032	\$ 4.93	\$ 4.68	\$ 5.14	\$ 6.91	\$ 7.07	\$ 6.91	\$ 6.91	\$ 6.91	\$ 6.91	\$ 6.52	\$ 6.27	\$ 6.73	\$ 4.92	\$ 6.51	\$ 6.94
Cold Day 20yr Weather Std	2032-2033	\$ 5.14	\$ 4.89	\$ 5.39	\$ 7.27	\$ 7.45	\$ 7.27	\$ 7.27	\$ 7.27	\$ 7.27	\$ 6.73	\$ 6.49	\$ 6.99	\$ 5.14	\$ 6.74	\$ 7.30
Cold Day 20yr Weather Std	2033-2034	\$ 5.38	\$ 5.13	\$ 5.62	\$ 7.64	\$ 7.82	\$ 7.64	\$ 7.64	\$ 7.64	\$ 7.64	\$ 6.97	\$ 6.72	\$ 7.21	\$ 5.38	\$ 6.97	\$ 7.68
Cold Day 20yr Weather Std	2034-2035	\$ 5.56	\$ 5.31	\$ 5.84	\$ 7.98	\$ 8.17	\$ 7.98	\$ 7.98	\$ 7.98	\$ 7.98	\$ 7.16	\$ 6.91	\$ 7.43	\$ 5.57	\$ 7.16	\$ 8.02
Cold Day 20yr Weather Std	2035-2036	\$ 5.47	\$ 5.18	\$ 6.08	\$ 8.20	\$ 8.52	\$ 8.20	\$ 8.20	\$ 8.20	\$ 8.20	\$ 7.06	\$ 6.77	\$ 7.67	\$ 5.57	\$ 7.17	\$ 8.26
Cold Day 20yr Weather Std	2036-2037	\$ 6.19	\$ 5.94	\$ 6.43	\$ 8.95	\$ 9.14	\$ 8.95	\$ 8.95	\$ 8.95	\$ 8.95	\$ 7.78	\$ 7.53	\$ 8.02	\$ 6.18	\$ 7.78	\$ 8.98

1/ Avoided costs are before Environmental Externalities adder.

APPENDIX 6.4: 80% BELOW 1990 EMISSIONS AVOIDED COST

Annual Avoided Costs 1/																	
Scenario	Gas Year	Nominal\$															
		ID Both	ID GTN	ID NWP	Klam Falls	La Grande	Medford GTN	Medford NWP	Roseburg	WA Both	WA GTN	WA NWP	ID Annual	WA Annual	OR Annual		
80% Below 1990 Emissions	2017-2018	\$ 1.40	\$ 1.31	\$ 2.63	\$ 1.39	\$ 2.66	\$ 1.39	\$ 1.39	\$ 1.39	\$ 1.39	\$ 1.40	\$ 1.31	\$ 2.63	\$ 1.78	\$ 1.78	\$ 1.65	
80% Below 1990 Emissions	2018-2019	\$ 1.40	\$ 1.30	\$ 2.55	\$ 1.37	\$ 2.57	\$ 1.37	\$ 1.37	\$ 1.37	\$ 1.37	\$ 1.58	\$ 1.48	\$ 2.73	\$ 1.75	\$ 1.93	\$ 1.61	
80% Below 1990 Emissions	2019-2020	\$ 1.44	\$ 1.34	\$ 2.33	\$ 1.40	\$ 2.34	\$ 1.40	\$ 1.40	\$ 1.40	\$ 1.40	\$ 1.40	\$ 1.87	\$ 2.86	\$ 1.70	\$ 2.23	\$ 1.59	
80% Below 1990 Emissions	2020-2021	\$ 1.47	\$ 1.38	\$ 2.07	\$ 2.22	\$ 2.87	\$ 2.22	\$ 2.22	\$ 2.22	\$ 2.22	\$ 2.09	\$ 2.00	\$ 2.69	\$ 1.64	\$ 2.26	\$ 2.35	
80% Below 1990 Emissions	2021-2022	\$ 1.51	\$ 1.44	\$ 1.91	\$ 2.49	\$ 2.93	\$ 2.49	\$ 2.49	\$ 2.49	\$ 2.49	\$ 2.23	\$ 2.16	\$ 2.63	\$ 1.62	\$ 2.34	\$ 2.57	
80% Below 1990 Emissions	2022-2023	\$ 1.42	\$ 1.35	\$ 1.84	\$ 2.47	\$ 2.93	\$ 2.47	\$ 2.47	\$ 2.47	\$ 2.47	\$ 2.25	\$ 2.18	\$ 2.67	\$ 1.54	\$ 2.37	\$ 2.56	
80% Below 1990 Emissions	2023-2024	\$ 1.58	\$ 1.56	\$ 1.93	\$ 2.75	\$ 3.09	\$ 2.75	\$ 2.75	\$ 2.75	\$ 2.75	\$ 2.52	\$ 2.49	\$ 2.87	\$ 1.69	\$ 2.63	\$ 2.82	
80% Below 1990 Emissions	2024-2025	\$ 1.62	\$ 1.59	\$ 1.98	\$ 2.86	\$ 3.22	\$ 2.86	\$ 2.86	\$ 2.86	\$ 2.86	\$ 2.66	\$ 2.64	\$ 3.02	\$ 1.73	\$ 2.77	\$ 2.93	
80% Below 1990 Emissions	2025-2026	\$ 1.58	\$ 1.56	\$ 1.99	\$ 2.91	\$ 3.31	\$ 2.91	\$ 2.91	\$ 2.91	\$ 2.91	\$ 2.73	\$ 2.71	\$ 3.14	\$ 1.71	\$ 2.86	\$ 2.99	
80% Below 1990 Emissions	2026-2027	\$ 1.63	\$ 1.61	\$ 2.00	\$ 3.05	\$ 3.41	\$ 3.05	\$ 3.05	\$ 3.05	\$ 3.05	\$ 2.88	\$ 2.87	\$ 3.26	\$ 1.75	\$ 3.00	\$ 3.12	
80% Below 1990 Emissions	2027-2028	\$ 1.69	\$ 1.68	\$ 2.04	\$ 3.22	\$ 3.54	\$ 3.22	\$ 3.22	\$ 3.22	\$ 3.22	\$ 3.05	\$ 3.04	\$ 3.40	\$ 1.80	\$ 3.16	\$ 3.28	
80% Below 1990 Emissions	2028-2029	\$ 1.79	\$ 1.79	\$ 2.13	\$ 3.43	\$ 3.74	\$ 3.43	\$ 3.43	\$ 3.43	\$ 3.43	\$ 3.26	\$ 3.25	\$ 3.60	\$ 1.90	\$ 3.37	\$ 3.50	
80% Below 1990 Emissions	2029-2030	\$ 1.89	\$ 1.89	\$ 2.25	\$ 3.65	\$ 3.97	\$ 3.65	\$ 3.65	\$ 3.65	\$ 3.65	\$ 3.47	\$ 3.46	\$ 3.82	\$ 2.01	\$ 3.58	\$ 3.71	
80% Below 1990 Emissions	2030-2031	\$ 1.92	\$ 1.91	\$ 2.32	\$ 3.80	\$ 4.16	\$ 3.80	\$ 3.80	\$ 3.80	\$ 3.80	\$ 3.62	\$ 3.61	\$ 3.91	\$ 2.05	\$ 3.65	\$ 3.87	
80% Below 1990 Emissions	2031-2032	\$ 1.89	\$ 1.88	\$ 2.31	\$ 3.89	\$ 4.28	\$ 3.89	\$ 3.89	\$ 3.89	\$ 3.89	\$ 3.48	\$ 3.47	\$ 3.90	\$ 2.03	\$ 3.62	\$ 3.97	
80% Below 1990 Emissions	2032-2033	\$ 1.92	\$ 1.91	\$ 2.30	\$ 4.06	\$ 4.40	\$ 4.06	\$ 4.06	\$ 4.06	\$ 4.06	\$ 3.52	\$ 3.50	\$ 3.89	\$ 2.04	\$ 3.64	\$ 4.13	
80% Below 1990 Emissions	2033-2034	\$ 1.88	\$ 1.87	\$ 2.27	\$ 4.17	\$ 4.52	\$ 4.17	\$ 4.17	\$ 4.17	\$ 4.17	\$ 3.48	\$ 3.46	\$ 3.86	\$ 2.01	\$ 3.60	\$ 4.24	
80% Below 1990 Emissions	2034-2035	\$ 1.87	\$ 1.86	\$ 2.20	\$ 4.31	\$ 4.61	\$ 4.31	\$ 4.31	\$ 4.31	\$ 4.31	\$ 3.46	\$ 3.45	\$ 3.79	\$ 1.98	\$ 3.57	\$ 4.37	
80% Below 1990 Emissions	2035-2036	\$ 1.84	\$ 1.83	\$ 2.17	\$ 4.43	\$ 4.73	\$ 4.43	\$ 4.43	\$ 4.43	\$ 4.43	\$ 3.43	\$ 3.42	\$ 3.76	\$ 1.95	\$ 3.54	\$ 4.49	
80% Below 1990 Emissions	2036-2037	\$ 1.85	\$ 1.85	\$ 2.00	\$ 4.60	\$ 4.73	\$ 4.57	\$ 4.57	\$ 4.57	\$ 4.57	\$ 3.44	\$ 3.44	\$ 3.60	\$ 1.90	\$ 3.49	\$ 4.60	
Winter Avoided Costs 1/																	
Scenario	Gas Year	Nominal\$															
		ID Both	ID GTN	ID NWP	Klam Falls	La Grande	Medford GTN	Medford NWP	Roseburg	WA Both	WA GTN	WA NWP	ID Annual	WA Annual	OR Annual		
80% Below 1990 Emissions	2017-2018	\$ 1.98	\$ 1.71	\$ 2.54	\$ 2.03	\$ 2.62	\$ 2.03	\$ 2.03	\$ 2.03	\$ 2.03	\$ 1.98	\$ 1.71	\$ 2.54	\$ 2.08	\$ 2.08	\$ 2.14	
80% Below 1990 Emissions	2018-2019	\$ 1.71	\$ 1.43	\$ 2.64	\$ 1.65	\$ 2.69	\$ 1.65	\$ 1.65	\$ 1.65	\$ 1.65	\$ 1.65	\$ 1.71	\$ 1.43	\$ 2.64	\$ 1.93	\$ 1.93	\$ 1.86
80% Below 1990 Emissions	2019-2020	\$ 1.73	\$ 1.46	\$ 2.50	\$ 1.63	\$ 2.54	\$ 1.63	\$ 1.63	\$ 1.63	\$ 1.63	\$ 1.63	\$ 2.26	\$ 1.99	\$ 3.03	\$ 1.90	\$ 2.43	\$ 1.81
80% Below 1990 Emissions	2020-2021	\$ 1.61	\$ 1.35	\$ 2.19	\$ 1.50	\$ 2.24	\$ 1.50	\$ 1.50	\$ 1.50	\$ 1.50	\$ 2.14	\$ 1.89	\$ 2.72	\$ 1.72	\$ 2.25	\$ 1.65	
80% Below 1990 Emissions	2021-2022	\$ 1.69	\$ 1.46	\$ 1.98	\$ 2.52	\$ 3.00	\$ 2.52	\$ 2.52	\$ 2.52	\$ 2.52	\$ 2.32	\$ 2.10	\$ 2.62	\$ 1.71	\$ 2.35	\$ 2.62	
80% Below 1990 Emissions	2022-2023	\$ 1.60	\$ 1.40	\$ 1.87	\$ 2.50	\$ 2.95	\$ 2.50	\$ 2.50	\$ 2.50	\$ 2.50	\$ 2.34	\$ 2.14	\$ 2.61	\$ 1.62	\$ 2.36	\$ 2.59	
80% Below 1990 Emissions	2023-2024	\$ 1.62	\$ 1.51	\$ 1.85	\$ 2.68	\$ 2.99	\$ 2.68	\$ 2.68	\$ 2.68	\$ 2.68	\$ 2.47	\$ 2.36	\$ 2.70	\$ 1.66	\$ 2.51	\$ 2.75	
80% Below 1990 Emissions	2024-2025	\$ 1.72	\$ 1.63	\$ 1.96	\$ 2.86	\$ 3.16	\$ 2.86	\$ 2.86	\$ 2.86	\$ 2.86	\$ 2.68	\$ 2.59	\$ 2.92	\$ 1.77	\$ 2.73	\$ 2.92	
80% Below 1990 Emissions	2025-2026	\$ 1.63	\$ 1.56	\$ 1.98	\$ 2.85	\$ 3.25	\$ 2.85	\$ 2.85	\$ 2.85	\$ 2.85	\$ 2.69	\$ 2.62	\$ 3.05	\$ 1.72	\$ 2.78	\$ 2.93	
80% Below 1990 Emissions	2026-2027	\$ 1.62	\$ 1.58	\$ 2.00	\$ 2.95	\$ 3.34	\$ 2.95	\$ 2.95	\$ 2.95	\$ 2.95	\$ 2.79	\$ 2.75	\$ 3.17	\$ 1.73	\$ 2.90	\$ 3.03	
80% Below 1990 Emissions	2027-2028	\$ 1.71	\$ 1.68	\$ 2.01	\$ 3.14	\$ 3.44	\$ 3.14	\$ 3.14	\$ 3.14	\$ 3.14	\$ 2.98	\$ 2.95	\$ 3.29	\$ 1.80	\$ 3.07	\$ 3.20	
80% Below 1990 Emissions	2028-2029	\$ 1.79	\$ 1.77	\$ 2.08	\$ 3.34	\$ 3.59	\$ 3.34	\$ 3.34	\$ 3.34	\$ 3.34	\$ 3.17	\$ 3.15	\$ 3.46	\$ 1.88	\$ 3.26	\$ 3.39	
80% Below 1990 Emissions	2029-2030	\$ 1.95	\$ 1.93	\$ 2.20	\$ 3.61	\$ 3.82	\$ 3.61	\$ 3.61	\$ 3.61	\$ 3.61	\$ 3.44	\$ 3.42	\$ 3.68	\$ 2.03	\$ 3.51	\$ 3.65	
80% Below 1990 Emissions	2030-2031	\$ 1.95	\$ 1.92	\$ 2.32	\$ 3.71	\$ 4.06	\$ 3.71	\$ 3.71	\$ 3.71	\$ 3.71	\$ 3.54	\$ 3.51	\$ 3.91	\$ 2.06	\$ 3.65	\$ 3.78	
80% Below 1990 Emissions	2031-2032	\$ 1.95	\$ 1.92	\$ 2.37	\$ 3.83	\$ 4.23	\$ 3.83	\$ 3.83	\$ 3.83	\$ 3.83	\$ 3.55	\$ 3.51	\$ 3.97	\$ 2.08	\$ 3.67	\$ 3.91	
80% Below 1990 Emissions	2032-2033	\$ 1.96	\$ 1.93	\$ 2.32	\$ 3.97	\$ 4.30	\$ 3.97	\$ 3.97	\$ 3.97	\$ 3.97	\$ 3.52	\$ 3.52	\$ 3.91	\$ 2.07	\$ 3.66	\$ 4.04	
80% Below 1990 Emissions	2033-2034	\$ 1.97	\$ 1.94	\$ 2.33	\$ 4.12	\$ 4.46	\$ 4.12	\$ 4.12	\$ 4.12	\$ 4.12	\$ 3.56	\$ 3.53	\$ 3.92	\$ 2.08	\$ 3.67	\$ 4.19	
80% Below 1990 Emissions	2034-2035	\$ 1.95	\$ 1.92	\$ 2.27	\$ 4.24	\$ 4.55	\$ 4.24	\$ 4.24	\$ 4.24	\$ 4.24	\$ 3.54	\$ 3.51	\$ 3.86	\$ 2.05	\$ 3.64	\$ 4.30	
80% Below 1990 Emissions	2035-2036	\$ 1.74	\$ 1.70	\$ 2.21	\$ 4.18	\$ 4.65	\$ 4.18	\$ 4.18	\$ 4.18	\$ 4.18	\$ 3.33	\$ 3.29	\$ 3.80	\$ 1.88	\$ 3.47	\$ 4.28	
80% Below 1990 Emissions	2036-2037	\$ 1.91	\$ 1.90	\$ 2.20	\$ 4.52	\$ 4.78	\$ 4.52	\$ 4.52	\$ 4.52	\$ 4.52	\$ 3.50	\$ 3.49	\$ 3.79	\$ 2.00	\$ 3.59	\$ 4.57	

1/ Avoided costs are before Environmental Externalities adder.

APPENDIX 6.4: LOW GROWTH – HIGH PRICE MONTHLY DETAIL

Scenario	Gas Year	Month	Monthly Avoided Costs 1/ Nominal\$													ID Annual	WA Annual	OR Annual
			ID Both	ID GTN	ID NWP	Klam Falls	La Grande	Medford GTN	Medford NWP	Roseburg	WABoth	WAGTN	WANWP					
Low Growth_High Prices	2033-2034	Jan	\$ (8.80)	\$ (8.56)	\$ (8.80)	\$ (11.00)	\$ (11.08)	\$ (11.00)	\$ (11.00)	\$ (11.00)	\$ (11.00)	\$ (10.40)	\$ (10.15)	\$ (10.40)	\$ (8.72)	\$ (10.31)	\$ (11.02)	
Low Growth_High Prices	2033-2034	Feb	\$ (8.71)	\$ (8.62)	\$ (8.79)	\$ (11.06)	\$ (11.15)	\$ (11.06)	\$ (11.06)	\$ (11.06)	\$ (11.06)	\$ (10.30)	\$ (10.21)	\$ (10.38)	\$ (8.71)	\$ (10.30)	\$ (11.08)	
Low Growth_High Prices	2033-2034	Mar	\$ (8.27)	\$ (8.27)	\$ (8.76)	\$ (10.71)	\$ (11.04)	\$ (10.71)	\$ (10.71)	\$ (10.71)	\$ (10.71)	\$ (9.87)	\$ (9.87)	\$ (10.35)	\$ (8.44)	\$ (10.03)	\$ (10.77)	
Low Growth_High Prices	2033-2034	Apr	\$ (8.02)	\$ (8.02)	\$ (8.77)	\$ (10.45)	\$ (11.05)	\$ (10.45)	\$ (10.45)	\$ (10.45)	\$ (10.45)	\$ (9.61)	\$ (9.61)	\$ (10.36)	\$ (8.27)	\$ (9.86)	\$ (10.57)	
Low Growth_High Prices	2033-2034	May	\$ (8.04)	\$ (8.04)	\$ (8.78)	\$ (10.47)	\$ (11.06)	\$ (10.47)	\$ (10.47)	\$ (10.47)	\$ (10.47)	\$ (9.64)	\$ (9.64)	\$ (10.37)	\$ (8.29)	\$ (9.88)	\$ (10.59)	
Low Growth_High Prices	2033-2034	Jun	\$ (8.18)	\$ (8.18)	\$ (8.79)	\$ (10.61)	\$ (11.07)	\$ (10.61)	\$ (10.61)	\$ (10.61)	\$ (10.61)	\$ (9.77)	\$ (9.77)	\$ (10.38)	\$ (8.38)	\$ (9.98)	\$ (10.70)	
Low Growth_High Prices	2033-2034	Jul	\$ (8.51)	\$ (8.51)	\$ (8.80)	\$ (10.95)	\$ (11.08)	\$ (10.95)	\$ (10.95)	\$ (10.95)	\$ (10.95)	\$ (10.11)	\$ (10.11)	\$ (10.40)	\$ (8.61)	\$ (10.20)	\$ (10.98)	
Low Growth_High Prices	2033-2034	Aug	\$ (8.55)	\$ (8.55)	\$ (8.82)	\$ (10.99)	\$ (11.09)	\$ (10.99)	\$ (10.99)	\$ (10.99)	\$ (10.99)	\$ (10.14)	\$ (10.14)	\$ (10.41)	\$ (8.64)	\$ (10.23)	\$ (11.01)	
Low Growth_High Prices	2033-2034	Sep	\$ (8.35)	\$ (8.35)	\$ (8.83)	\$ (10.78)	\$ (11.10)	\$ (10.78)	\$ (10.78)	\$ (10.78)	\$ (10.78)	\$ (9.94)	\$ (9.94)	\$ (10.42)	\$ (8.51)	\$ (10.10)	\$ (10.85)	
Low Growth_High Prices	2033-2034	Oct	\$ (8.41)	\$ (8.41)	\$ (9.06)	\$ (10.85)	\$ (11.33)	\$ (10.85)	\$ (10.85)	\$ (10.85)	\$ (10.85)	\$ (10.00)	\$ (10.00)	\$ (10.65)	\$ (8.63)	\$ (10.22)	\$ (10.95)	
Low Growth_High Prices	2034-2035	Nov	\$ (8.58)	\$ (8.58)	\$ (9.12)	\$ (11.08)	\$ (11.41)	\$ (11.08)	\$ (11.08)	\$ (11.08)	\$ (11.08)	\$ (10.17)	\$ (10.17)	\$ (10.71)	\$ (8.76)	\$ (10.35)	\$ (11.15)	
Low Growth_High Prices	2034-2035	Dec	\$ (9.17)	\$ (8.83)	\$ (9.17)	\$ (11.65)	\$ (11.63)	\$ (11.65)	\$ (11.65)	\$ (11.65)	\$ (11.65)	\$ (10.76)	\$ (10.42)	\$ (10.76)	\$ (9.06)	\$ (10.65)	\$ (11.65)	
Low Growth_High Prices	2034-2035	Jan	\$ (9.22)	\$ (9.05)	\$ (9.22)	\$ (11.66)	\$ (11.68)	\$ (11.66)	\$ (11.66)	\$ (11.66)	\$ (11.66)	\$ (10.82)	\$ (10.64)	\$ (10.82)	\$ (9.17)	\$ (10.76)	\$ (11.66)	
Low Growth_High Prices	2034-2035	Feb	\$ (9.13)	\$ (9.04)	\$ (9.20)	\$ (11.64)	\$ (11.74)	\$ (11.64)	\$ (11.64)	\$ (11.64)	\$ (11.64)	\$ (10.72)	\$ (10.63)	\$ (10.79)	\$ (9.12)	\$ (10.71)	\$ (11.66)	
Low Growth_High Prices	2034-2035	Mar	\$ (8.75)	\$ (8.75)	\$ (9.16)	\$ (11.35)	\$ (11.60)	\$ (11.35)	\$ (11.35)	\$ (11.35)	\$ (11.35)	\$ (10.34)	\$ (10.34)	\$ (10.75)	\$ (8.89)	\$ (10.48)	\$ (11.40)	
Low Growth_High Prices	2034-2035	Apr	\$ (8.51)	\$ (8.51)	\$ (9.17)	\$ (11.11)	\$ (11.61)	\$ (11.11)	\$ (11.11)	\$ (11.11)	\$ (11.11)	\$ (10.10)	\$ (10.10)	\$ (10.77)	\$ (8.73)	\$ (10.33)	\$ (11.21)	
Low Growth_High Prices	2034-2035	May	\$ (8.45)	\$ (8.45)	\$ (9.18)	\$ (11.05)	\$ (11.62)	\$ (11.05)	\$ (11.05)	\$ (11.05)	\$ (11.05)	\$ (10.05)	\$ (10.05)	\$ (10.78)	\$ (8.70)	\$ (10.29)	\$ (11.17)	
Low Growth_High Prices	2034-2035	Jun	\$ (8.59)	\$ (8.59)	\$ (9.20)	\$ (11.19)	\$ (11.63)	\$ (11.19)	\$ (11.19)	\$ (11.19)	\$ (11.19)	\$ (10.18)	\$ (10.18)	\$ (10.79)	\$ (8.79)	\$ (10.38)	\$ (11.28)	
Low Growth_High Prices	2034-2035	Jul	\$ (8.89)	\$ (8.89)	\$ (9.21)	\$ (11.50)	\$ (11.64)	\$ (11.50)	\$ (11.50)	\$ (11.50)	\$ (11.50)	\$ (10.48)	\$ (10.48)	\$ (10.80)	\$ (9.00)	\$ (10.59)	\$ (11.53)	
Low Growth_High Prices	2034-2035	Aug	\$ (9.02)	\$ (9.02)	\$ (9.22)	\$ (11.62)	\$ (11.65)	\$ (11.62)	\$ (11.62)	\$ (11.62)	\$ (11.62)	\$ (10.61)	\$ (10.61)	\$ (10.81)	\$ (9.08)	\$ (10.68)	\$ (11.63)	
Low Growth_High Prices	2034-2035	Sep	\$ (8.81)	\$ (8.81)	\$ (9.23)	\$ (11.41)	\$ (11.67)	\$ (11.41)	\$ (11.41)	\$ (11.41)	\$ (11.41)	\$ (10.40)	\$ (10.40)	\$ (10.82)	\$ (8.95)	\$ (10.54)	\$ (11.46)	
Low Growth_High Prices	2034-2035	Oct	\$ (8.69)	\$ (8.69)	\$ (9.38)	\$ (11.29)	\$ (11.82)	\$ (11.29)	\$ (11.29)	\$ (11.29)	\$ (11.29)	\$ (10.28)	\$ (10.28)	\$ (10.97)	\$ (8.92)	\$ (10.51)	\$ (11.40)	
Low Growth_High Prices	2035-2036	Nov	\$ (8.56)	\$ (8.56)	\$ (9.48)	\$ (11.23)	\$ (11.91)	\$ (11.23)	\$ (11.23)	\$ (11.23)	\$ (11.23)	\$ (10.15)	\$ (10.15)	\$ (11.07)	\$ (8.86)	\$ (10.46)	\$ (11.37)	
Low Growth_High Prices	2035-2036	Dec	\$ (9.21)	\$ (8.77)	\$ (9.74)	\$ (12.11)	\$ (12.18)	\$ (12.11)	\$ (12.11)	\$ (12.11)	\$ (12.11)	\$ (10.81)	\$ (10.36)	\$ (11.33)	\$ (9.24)	\$ (10.83)	\$ (12.13)	
Low Growth_High Prices	2035-2036	Jan	\$ (9.70)	\$ (9.37)	\$ (9.74)	\$ (12.13)	\$ (12.33)	\$ (12.13)	\$ (12.13)	\$ (12.13)	\$ (12.13)	\$ (11.29)	\$ (10.96)	\$ (11.34)	\$ (9.60)	\$ (11.20)	\$ (12.17)	
Low Growth_High Prices	2035-2036	Feb	\$ (9.56)	\$ (9.46)	\$ (9.79)	\$ (12.22)	\$ (12.44)	\$ (12.22)	\$ (12.22)	\$ (12.22)	\$ (12.22)	\$ (11.15)	\$ (11.05)	\$ (11.39)	\$ (9.60)	\$ (11.20)	\$ (12.26)	
Low Growth_High Prices	2035-2036	Mar	\$ (9.18)	\$ (9.18)	\$ (9.77)	\$ (11.94)	\$ (12.35)	\$ (11.94)	\$ (11.94)	\$ (11.94)	\$ (11.94)	\$ (10.78)	\$ (10.78)	\$ (11.36)	\$ (9.38)	\$ (10.97)	\$ (12.02)	
Low Growth_High Prices	2035-2036	Apr	\$ (8.90)	\$ (8.90)	\$ (9.78)	\$ (11.65)	\$ (12.36)	\$ (11.65)	\$ (11.65)	\$ (11.65)	\$ (11.65)	\$ (10.49)	\$ (10.49)	\$ (11.37)	\$ (9.19)	\$ (10.78)	\$ (11.79)	
Low Growth_High Prices	2035-2036	May	\$ (8.94)	\$ (8.94)	\$ (9.79)	\$ (11.69)	\$ (12.37)	\$ (11.69)	\$ (11.69)	\$ (11.69)	\$ (11.69)	\$ (10.53)	\$ (10.53)	\$ (11.38)	\$ (9.22)	\$ (10.82)	\$ (11.83)	
Low Growth_High Prices	2035-2036	Jun	\$ (9.17)	\$ (9.17)	\$ (9.80)	\$ (11.92)	\$ (12.38)	\$ (11.92)	\$ (11.92)	\$ (11.92)	\$ (11.92)	\$ (10.76)	\$ (10.76)	\$ (11.39)	\$ (9.38)	\$ (10.97)	\$ (12.02)	
Low Growth_High Prices	2035-2036	Jul	\$ (9.74)	\$ (9.74)	\$ (9.98)	\$ (12.51)	\$ (12.47)	\$ (12.47)	\$ (12.47)	\$ (12.47)	\$ (12.47)	\$ (11.33)	\$ (11.33)	\$ (11.48)	\$ (9.79)	\$ (11.38)	\$ (12.47)	
Low Growth_High Prices	2035-2036	Aug	\$ (9.97)	\$ (9.97)	\$ (10.11)	\$ (12.74)	\$ (12.69)	\$ (12.69)	\$ (12.69)	\$ (12.69)	\$ (12.69)	\$ (11.56)	\$ (11.56)	\$ (11.70)	\$ (10.02)	\$ (11.61)	\$ (12.70)	
Low Growth_High Prices	2035-2036	Sep	\$ (9.55)	\$ (9.55)	\$ (9.84)	\$ (12.31)	\$ (12.42)	\$ (12.31)	\$ (12.31)	\$ (12.31)	\$ (12.31)	\$ (11.14)	\$ (11.14)	\$ (11.43)	\$ (9.64)	\$ (11.24)	\$ (12.33)	
Low Growth_High Prices	2035-2036	Oct	\$ (9.51)	\$ (9.51)	\$ (10.06)	\$ (12.28)	\$ (12.64)	\$ (12.28)	\$ (12.28)	\$ (12.28)	\$ (12.28)	\$ (11.11)	\$ (11.11)	\$ (11.65)	\$ (9.70)	\$ (11.29)	\$ (12.35)	
Low Growth_High Prices	2036-2037	Nov	\$ (9.71)	\$ (9.71)	\$ (10.26)	\$ (12.55)	\$ (12.68)	\$ (12.55)	\$ (12.55)	\$ (12.55)	\$ (12.55)	\$ (11.30)	\$ (11.30)	\$ (11.86)	\$ (9.90)	\$ (11.49)	\$ (12.61)	
Low Growth_High Prices	2036-2037	Dec	\$ (10.37)	\$ (10.23)	\$ (10.37)	\$ (13.43)	\$ (13.39)	\$ (13.43)	\$ (13.43)	\$ (13.43)	\$ (13.43)	\$ (11.97)	\$ (11.83)	\$ (11.97)	\$ (10.33)	\$ (11.92)	\$ (13.42)	
Low Growth_High Prices	2036-2037	Jan	\$ (10.38)	\$ (10.36)	\$ (10.38)	\$ (13.29)	\$ (13.29)	\$ (13.29)	\$ (13.29)	\$ (13.29)	\$ (13.29)	\$ (11.97)	\$ (11.95)	\$ (11.97)	\$ (10.37)	\$ (11.97)	\$ (13.29)	
Low Growth_High Prices	2036-2037	Feb	\$ (10.51)	\$ (10.43)	\$ (10.52)	\$ (13.36)	\$ (13.47)	\$ (13.36)	\$ (13.36)	\$ (13.36)	\$ (13.36)	\$ (12.11)	\$ (12.02)	\$ (12.11)	\$ (10.49)	\$ (12.08)	\$ (13.38)	
Low Growth_High Prices	2036-2037	Mar	\$ (9.88)	\$ (9.88)	\$ (10.49)	\$ (12.80)	\$ (13.23)	\$ (12.80)	\$ (12.80)	\$ (12.80)	\$ (12.80)	\$ (11.47)	\$ (11.47)	\$ (12.08)	\$ (10.08)	\$ (11.67)	\$ (12.88)	
Low Growth_High Prices	2036-2037	Apr	\$ (9.29)	\$ (9.29)	\$ (9.70)	\$ (12.21)	\$ (12.43)	\$ (12.21)	\$ (12.21)	\$ (12.21)	\$ (12.21)	\$ (10.88)	\$ (10.88)	\$ (11.29)	\$ (9.43)	\$ (11.02)	\$ (12.25)	
Low Growth_High Prices	2036-2037	May	\$ (9.33)	\$ (9.33)	\$ (9.71)	\$ (12.24)	\$ (12.45)	\$ (12.24)	\$ (12.24)	\$ (12.24)	\$ (12.24)	\$ (10.92)	\$ (10.92)	\$ (11.30)	\$ (9.46)	\$ (11.05)	\$ (12.28)	
Low Growth_High Prices	2036-2037	Jun	\$ (9.50)	\$ (9.50)	\$ (9.72)	\$ (12.42)	\$ (12.46)	\$ (12.42)	\$ (12.42)	\$ (12.42)	\$ (12.42)	\$ (11.09)	\$ (11.09)	\$ (11.31)	\$ (9.57)	\$ (11.17)	\$ (12.42)	
Low Growth_High Prices	2036-2037	Jul	\$ (10.05)	\$ (10.05)	\$ (10.19)	\$ (12.98)	\$ (12.93)	\$ (12.93)	\$ (12.93)	\$ (12.93)	\$ (12.93)	\$ (11.65)	\$ (11.65)	\$ (11.78)	\$ (10.10)	\$ (11.69)	\$ (12.94)	
Low Growth_High Prices	2036-2037	Aug	\$ (10.18)	\$ (10.18)	\$ (10.32)	\$ (13.11)	\$ (13.06)	\$ (13.06)	\$ (13.06)	\$ (13.06)	\$ (13.06)	\$ (11.77)	\$ (11.77)	\$ (11.92)	\$ (10.23)	\$ (11.82)	\$ (13.07)	
Low Growth_High Prices	2036-2037	Sep	\$ (9.70)	\$ (9.70)	\$ (9.87)	\$ (12.62)	\$ (12.60)	\$ (12.60)	\$ (12.60)	\$ (12.60)	\$ (12.60)	\$ (11.29)	\$ (11.29)	\$ (11.46)	\$ (9.75)	\$ (11.35)	\$ (12.61)	
Low Growth_High Prices	2036-2037	Oct	\$ (9.56)	\$ (9.56)	\$ (10.25)	\$ (12.48)	\$ (12.98)	\$ (12.48)	\$ (12.48)	\$ (12.48)	\$ (12.48)	\$ (11.15)	\$ (11.15)	\$ (11.84)	\$ (9.79)	\$ (11.38)	\$ (12.58)	

1/ Avoided costs are before Environmental Externalities adder.

APPENDIX 6.4: EXPECTED MONTHLY DETAIL

Monthly Avoided Costs 1/ Nominal\$																
Scenario	Gas Year	Month	ID Both	ID GTN	ID NWP	Klam Falls	La Grande	Medford GTN	Medford NWP	Roseburg	WABoth	WAGTN	WANWP	ID Annual	WA Annual	OR Annual
Expected Case	2033-2034	Jan	\$ (5.68)	\$ (5.28)	\$ (5.68)	\$ (7.66)	\$ (8.02)	\$ (7.66)	\$ (7.66)	\$ (7.66)	\$ (7.28)	\$ (6.88)	\$ (7.28)	\$ (5.55)	\$ (7.14)	\$ (7.74)
Expected Case	2033-2034	Feb	\$ (5.63)	\$ (5.31)	\$ (5.65)	\$ (7.70)	\$ (7.97)	\$ (7.70)	\$ (7.70)	\$ (7.70)	\$ (7.22)	\$ (6.91)	\$ (7.24)	\$ (5.53)	\$ (7.12)	\$ (7.75)
Expected Case	2033-2034	Mar	\$ (5.07)	\$ (5.07)	\$ (5.64)	\$ (7.44)	\$ (7.91)	\$ (7.44)	\$ (7.44)	\$ (7.44)	\$ (6.66)	\$ (6.66)	\$ (7.23)	\$ (5.26)	\$ (6.85)	\$ (7.54)
Expected Case	2033-2034	Apr	\$ (4.88)	\$ (4.88)	\$ (5.65)	\$ (7.25)	\$ (7.92)	\$ (7.25)	\$ (7.25)	\$ (7.25)	\$ (6.47)	\$ (6.47)	\$ (7.24)	\$ (5.14)	\$ (6.73)	\$ (7.39)
Expected Case	2033-2034	May	\$ (4.89)	\$ (4.89)	\$ (5.66)	\$ (7.27)	\$ (7.93)	\$ (7.27)	\$ (7.27)	\$ (7.27)	\$ (6.48)	\$ (6.48)	\$ (7.25)	\$ (5.15)	\$ (6.74)	\$ (7.40)
Expected Case	2033-2034	Jun	\$ (4.98)	\$ (4.98)	\$ (5.67)	\$ (7.35)	\$ (7.95)	\$ (7.35)	\$ (7.35)	\$ (7.35)	\$ (6.57)	\$ (6.57)	\$ (7.26)	\$ (5.21)	\$ (6.80)	\$ (7.47)
Expected Case	2033-2034	Jul	\$ (5.20)	\$ (5.20)	\$ (5.68)	\$ (7.58)	\$ (7.96)	\$ (7.58)	\$ (7.58)	\$ (7.58)	\$ (6.80)	\$ (6.80)	\$ (7.27)	\$ (5.36)	\$ (6.95)	\$ (7.66)
Expected Case	2033-2034	Aug	\$ (5.22)	\$ (5.22)	\$ (5.69)	\$ (7.60)	\$ (7.97)	\$ (7.60)	\$ (7.60)	\$ (7.60)	\$ (6.82)	\$ (6.82)	\$ (7.28)	\$ (5.38)	\$ (6.97)	\$ (7.68)
Expected Case	2033-2034	Sep	\$ (5.09)	\$ (5.09)	\$ (5.70)	\$ (7.46)	\$ (7.98)	\$ (7.46)	\$ (7.46)	\$ (7.46)	\$ (6.68)	\$ (6.68)	\$ (7.29)	\$ (5.29)	\$ (6.88)	\$ (7.57)
Expected Case	2033-2034	Oct	\$ (5.13)	\$ (5.13)	\$ (5.81)	\$ (7.51)	\$ (8.08)	\$ (7.51)	\$ (7.51)	\$ (7.51)	\$ (6.73)	\$ (6.73)	\$ (7.40)	\$ (5.36)	\$ (6.95)	\$ (7.63)
Expected Case	2034-2035	Nov	\$ (5.31)	\$ (5.23)	\$ (5.82)	\$ (7.71)	\$ (8.11)	\$ (7.71)	\$ (7.71)	\$ (7.71)	\$ (6.90)	\$ (6.82)	\$ (7.42)	\$ (5.45)	\$ (7.05)	\$ (7.79)
Expected Case	2034-2035	Dec	\$ (5.81)	\$ (5.40)	\$ (5.85)	\$ (8.27)	\$ (8.23)	\$ (8.27)	\$ (8.27)	\$ (8.27)	\$ (7.41)	\$ (6.99)	\$ (7.44)	\$ (5.69)	\$ (7.28)	\$ (8.26)
Expected Case	2034-2035	Jan	\$ (5.92)	\$ (5.53)	\$ (5.92)	\$ (8.08)	\$ (8.43)	\$ (8.08)	\$ (8.08)	\$ (8.08)	\$ (7.51)	\$ (7.12)	\$ (7.51)	\$ (5.79)	\$ (7.38)	\$ (8.15)
Expected Case	2034-2035	Feb	\$ (5.86)	\$ (5.51)	\$ (5.89)	\$ (8.05)	\$ (8.37)	\$ (8.05)	\$ (8.05)	\$ (8.05)	\$ (7.45)	\$ (7.10)	\$ (7.48)	\$ (5.75)	\$ (7.34)	\$ (8.12)
Expected Case	2034-2035	Mar	\$ (5.32)	\$ (5.32)	\$ (5.87)	\$ (7.86)	\$ (8.31)	\$ (7.86)	\$ (7.86)	\$ (7.86)	\$ (6.92)	\$ (6.92)	\$ (7.46)	\$ (5.51)	\$ (7.10)	\$ (7.95)
Expected Case	2034-2035	Apr	\$ (5.15)	\$ (5.15)	\$ (5.88)	\$ (7.68)	\$ (8.32)	\$ (7.68)	\$ (7.68)	\$ (7.68)	\$ (6.74)	\$ (6.74)	\$ (7.47)	\$ (5.39)	\$ (6.98)	\$ (7.81)
Expected Case	2034-2035	May	\$ (5.09)	\$ (5.09)	\$ (5.89)	\$ (7.62)	\$ (8.28)	\$ (7.62)	\$ (7.62)	\$ (7.62)	\$ (6.88)	\$ (6.88)	\$ (7.48)	\$ (5.36)	\$ (6.95)	\$ (7.76)
Expected Case	2034-2035	Jun	\$ (5.17)	\$ (5.17)	\$ (5.90)	\$ (7.71)	\$ (8.34)	\$ (7.71)	\$ (7.71)	\$ (7.71)	\$ (6.76)	\$ (6.76)	\$ (7.49)	\$ (5.42)	\$ (7.01)	\$ (7.84)
Expected Case	2034-2035	Jul	\$ (5.38)	\$ (5.38)	\$ (5.91)	\$ (7.92)	\$ (8.35)	\$ (7.92)	\$ (7.92)	\$ (7.92)	\$ (6.97)	\$ (6.97)	\$ (7.51)	\$ (5.56)	\$ (7.15)	\$ (8.00)
Expected Case	2034-2035	Aug	\$ (5.45)	\$ (5.45)	\$ (5.93)	\$ (7.99)	\$ (8.36)	\$ (7.99)	\$ (7.99)	\$ (7.99)	\$ (7.04)	\$ (7.04)	\$ (7.52)	\$ (5.61)	\$ (7.20)	\$ (8.06)
Expected Case	2034-2035	Sep	\$ (5.31)	\$ (5.31)	\$ (5.94)	\$ (7.85)	\$ (8.37)	\$ (7.85)	\$ (7.85)	\$ (7.85)	\$ (6.90)	\$ (6.90)	\$ (7.53)	\$ (5.52)	\$ (7.11)	\$ (7.96)
Expected Case	2034-2035	Oct	\$ (5.23)	\$ (5.23)	\$ (5.95)	\$ (7.77)	\$ (8.38)	\$ (7.77)	\$ (7.77)	\$ (7.77)	\$ (6.82)	\$ (6.82)	\$ (7.54)	\$ (5.47)	\$ (7.06)	\$ (7.89)
Expected Case	2035-2036	Nov	\$ (5.20)	\$ (5.12)	\$ (6.06)	\$ (7.82)	\$ (8.50)	\$ (7.82)	\$ (7.82)	\$ (7.82)	\$ (6.79)	\$ (6.71)	\$ (7.65)	\$ (5.46)	\$ (7.05)	\$ (7.96)
Expected Case	2035-2036	Dec	\$ (5.73)	\$ (5.24)	\$ (6.09)	\$ (8.59)	\$ (8.55)	\$ (8.59)	\$ (8.59)	\$ (8.59)	\$ (7.32)	\$ (6.83)	\$ (7.68)	\$ (5.69)	\$ (7.28)	\$ (8.58)
Expected Case	2035-2036	Jan	\$ (6.01)	\$ (5.61)	\$ (6.10)	\$ (8.67)	\$ (8.79)	\$ (6.07)	\$ (6.07)	\$ (6.07)	\$ (7.60)	\$ (7.21)	\$ (7.69)	\$ (5.91)	\$ (7.50)	\$ (8.69)
Expected Case	2035-2036	Feb	\$ (6.09)	\$ (5.69)	\$ (6.14)	\$ (8.38)	\$ (8.77)	\$ (6.38)	\$ (6.38)	\$ (6.38)	\$ (7.68)	\$ (7.28)	\$ (7.73)	\$ (5.97)	\$ (7.56)	\$ (8.46)
Expected Case	2035-2036	Mar	\$ (5.50)	\$ (5.50)	\$ (6.11)	\$ (8.19)	\$ (8.69)	\$ (8.19)	\$ (8.19)	\$ (8.19)	\$ (7.09)	\$ (7.09)	\$ (7.70)	\$ (5.70)	\$ (7.30)	\$ (8.29)
Expected Case	2035-2036	Apr	\$ (5.30)	\$ (5.30)	\$ (6.12)	\$ (7.99)	\$ (8.70)	\$ (7.99)	\$ (7.99)	\$ (7.99)	\$ (6.89)	\$ (6.89)	\$ (7.71)	\$ (5.57)	\$ (7.17)	\$ (8.13)
Expected Case	2035-2036	May	\$ (5.31)	\$ (5.31)	\$ (6.13)	\$ (8.00)	\$ (8.71)	\$ (8.00)	\$ (8.00)	\$ (8.00)	\$ (6.90)	\$ (6.90)	\$ (7.72)	\$ (5.59)	\$ (7.18)	\$ (8.14)
Expected Case	2035-2036	Jun	\$ (5.47)	\$ (5.47)	\$ (6.14)	\$ (8.16)	\$ (8.72)	\$ (8.16)	\$ (8.16)	\$ (8.16)	\$ (7.06)	\$ (7.06)	\$ (7.73)	\$ (5.69)	\$ (7.29)	\$ (8.27)
Expected Case	2035-2036	Jul	\$ (5.85)	\$ (5.85)	\$ (6.15)	\$ (8.54)	\$ (8.74)	\$ (8.54)	\$ (8.54)	\$ (8.54)	\$ (7.44)	\$ (7.44)	\$ (7.75)	\$ (5.95)	\$ (7.54)	\$ (8.58)
Expected Case	2035-2036	Aug	\$ (6.01)	\$ (6.01)	\$ (6.17)	\$ (8.70)	\$ (8.75)	\$ (8.70)	\$ (8.70)	\$ (8.70)	\$ (7.60)	\$ (7.60)	\$ (7.76)	\$ (6.06)	\$ (7.65)	\$ (8.71)
Expected Case	2035-2036	Sep	\$ (5.73)	\$ (5.73)	\$ (6.18)	\$ (8.43)	\$ (8.76)	\$ (8.43)	\$ (8.43)	\$ (8.43)	\$ (7.32)	\$ (7.32)	\$ (7.77)	\$ (5.88)	\$ (7.47)	\$ (8.49)
Expected Case	2035-2036	Oct	\$ (5.71)	\$ (5.71)	\$ (6.28)	\$ (8.40)	\$ (8.87)	\$ (8.40)	\$ (8.40)	\$ (8.40)	\$ (7.30)	\$ (7.30)	\$ (7.88)	\$ (5.90)	\$ (7.49)	\$ (8.49)
Expected Case	2036-2037	Nov	\$ (5.90)	\$ (5.78)	\$ (6.38)	\$ (8.59)	\$ (8.98)	\$ (8.59)	\$ (8.59)	\$ (8.59)	\$ (7.49)	\$ (7.37)	\$ (7.97)	\$ (6.02)	\$ (7.61)	\$ (8.67)
Expected Case	2036-2037	Dec	\$ (6.47)	\$ (6.09)	\$ (6.47)	\$ (9.32)	\$ (9.29)	\$ (9.32)	\$ (9.32)	\$ (9.32)	\$ (8.06)	\$ (7.68)	\$ (8.06)	\$ (6.34)	\$ (7.94)	\$ (9.32)
Expected Case	2036-2037	Jan	\$ (6.48)	\$ (6.17)	\$ (6.48)	\$ (9.35)	\$ (9.45)	\$ (9.35)	\$ (9.35)	\$ (9.35)	\$ (8.08)	\$ (7.77)	\$ (8.08)	\$ (6.38)	\$ (7.97)	\$ (9.37)
Expected Case	2036-2037	Feb	\$ (6.51)	\$ (6.22)	\$ (6.51)	\$ (9.08)	\$ (9.30)	\$ (9.08)	\$ (9.08)	\$ (9.08)	\$ (8.10)	\$ (7.81)	\$ (8.10)	\$ (6.41)	\$ (8.01)	\$ (9.12)
Expected Case	2036-2037	Mar	\$ (5.86)	\$ (5.86)	\$ (6.54)	\$ (8.71)	\$ (9.28)	\$ (8.71)	\$ (8.71)	\$ (8.71)	\$ (7.45)	\$ (7.45)	\$ (8.13)	\$ (6.09)	\$ (7.68)	\$ (8.83)
Expected Case	2036-2037	Apr	\$ (5.48)	\$ (5.48)	\$ (5.92)	\$ (8.33)	\$ (8.65)	\$ (8.33)	\$ (8.33)	\$ (8.33)	\$ (7.08)	\$ (7.08)	\$ (7.51)	\$ (5.63)	\$ (7.22)	\$ (8.39)
Expected Case	2036-2037	May	\$ (5.49)	\$ (5.49)	\$ (5.92)	\$ (8.34)	\$ (8.66)	\$ (8.34)	\$ (8.34)	\$ (8.34)	\$ (7.09)	\$ (7.09)	\$ (7.52)	\$ (5.64)	\$ (7.23)	\$ (8.40)
Expected Case	2036-2037	Jun	\$ (5.61)	\$ (5.61)	\$ (5.94)	\$ (8.46)	\$ (8.67)	\$ (8.46)	\$ (8.46)	\$ (8.46)	\$ (7.21)	\$ (7.21)	\$ (7.53)	\$ (5.72)	\$ (7.31)	\$ (8.50)
Expected Case	2036-2037	Jul	\$ (5.99)	\$ (5.99)	\$ (6.04)	\$ (8.84)	\$ (8.77)	\$ (8.78)	\$ (8.78)	\$ (8.78)	\$ (7.58)	\$ (7.58)	\$ (7.63)	\$ (6.01)	\$ (7.60)	\$ (8.79)
Expected Case	2036-2037	Aug	\$ (6.07)	\$ (6.07)	\$ (6.13)	\$ (8.93)	\$ (8.86)	\$ (8.86)	\$ (8.86)	\$ (8.86)	\$ (7.67)	\$ (7.67)	\$ (7.72)	\$ (6.09)	\$ (7.68)	\$ (8.88)
Expected Case	2036-2037	Sep	\$ (5.76)	\$ (5.76)	\$ (5.87)	\$ (8.61)	\$ (8.61)	\$ (8.61)	\$ (8.61)	\$ (8.61)	\$ (7.35)	\$ (7.35)	\$ (7.46)	\$ (5.80)	\$ (7.39)	\$ (8.61)
Expected Case	2036-2037	Oct	\$ (5.65)	\$ (5.65)	\$ (6.37)	\$ (8.50)	\$ (9.10)	\$ (8.50)	\$ (8.50)	\$ (8.50)	\$ (7.24)	\$ (7.24)	\$ (7.96)	\$ (5.89)	\$ (7.48)	\$ (8.62)

1/ Avoided costs are before Environmental Externalities adder.

APPENDIX 6.4: HIGH GROWTH – LOW PRICE MONTHLY DETAIL

Scenario	Gas Year	Month	Monthly Avoided Costs 1/ Nominal\$												ID Annual	WA Annual	OR Annual
			ID Both	ID GTN	ID NWP	Klam Falls	La Grande	Medford GTN	Medford NWP	Roseburg	WA Both	WA GTN	WANWP				
High Growth_Low Prices	2033-2034	Jan	\$ (2.47)	\$ (2.01)	\$ (2.52)	\$ (2.49)	\$ (2.69)	\$ (2.49)	\$ (2.49)	\$ (2.49)	\$ (2.47)	\$ (2.01)	\$ (2.52)	\$ (2.33)	\$ (2.33)	\$ (2.53)	
High Growth_Low Prices	2033-2034	Feb	\$ (3.00)	\$ (2.04)	\$ (3.01)	\$ (2.12)	\$ (3.05)	\$ (2.12)	\$ (2.12)	\$ (2.12)	\$ (3.00)	\$ (2.04)	\$ (3.01)	\$ (2.68)	\$ (2.68)	\$ (2.31)	
High Growth_Low Prices	2033-2034	Mar	\$ (1.87)	\$ (1.86)	\$ (2.49)	\$ (1.90)	\$ (2.49)	\$ (1.90)	\$ (1.90)	\$ (1.90)	\$ (1.87)	\$ (1.86)	\$ (2.49)	\$ (2.07)	\$ (2.07)	\$ (2.02)	
High Growth_Low Prices	2033-2034	Apr	\$ (1.74)	\$ (1.74)	\$ (2.49)	\$ (1.78)	\$ (2.49)	\$ (1.78)	\$ (1.78)	\$ (1.78)	\$ (1.74)	\$ (1.74)	\$ (2.49)	\$ (1.99)	\$ (1.99)	\$ (1.92)	
High Growth_Low Prices	2033-2034	May	\$ (1.74)	\$ (1.74)	\$ (2.49)	\$ (1.78)	\$ (2.49)	\$ (1.78)	\$ (1.78)	\$ (1.78)	\$ (1.74)	\$ (1.74)	\$ (2.49)	\$ (1.99)	\$ (1.99)	\$ (1.92)	
High Growth_Low Prices	2033-2034	Jun	\$ (1.77)	\$ (1.77)	\$ (2.49)	\$ (1.81)	\$ (2.49)	\$ (1.81)	\$ (1.81)	\$ (1.81)	\$ (1.77)	\$ (1.77)	\$ (2.49)	\$ (2.01)	\$ (2.01)	\$ (1.95)	
High Growth_Low Prices	2033-2034	Jul	\$ (1.89)	\$ (1.89)	\$ (2.49)	\$ (1.94)	\$ (2.49)	\$ (1.94)	\$ (1.94)	\$ (1.94)	\$ (1.89)	\$ (1.89)	\$ (2.49)	\$ (2.09)	\$ (2.09)	\$ (2.05)	
High Growth_Low Prices	2033-2034	Aug	\$ (1.90)	\$ (1.90)	\$ (2.49)	\$ (1.94)	\$ (2.49)	\$ (1.94)	\$ (1.94)	\$ (1.94)	\$ (1.90)	\$ (1.90)	\$ (2.49)	\$ (2.10)	\$ (2.10)	\$ (2.05)	
High Growth_Low Prices	2033-2034	Sep	\$ (1.82)	\$ (1.82)	\$ (2.49)	\$ (1.86)	\$ (2.46)	\$ (1.86)	\$ (1.86)	\$ (1.86)	\$ (1.82)	\$ (1.82)	\$ (2.49)	\$ (2.05)	\$ (2.05)	\$ (1.98)	
High Growth_Low Prices	2033-2034	Oct	\$ (1.86)	\$ (1.86)	\$ (2.55)	\$ (1.90)	\$ (2.55)	\$ (1.90)	\$ (1.90)	\$ (1.90)	\$ (1.86)	\$ (1.86)	\$ (2.55)	\$ (2.09)	\$ (2.09)	\$ (2.03)	
High Growth_Low Prices	2034-2035	Nov	\$ (2.06)	\$ (1.88)	\$ (2.50)	\$ (2.15)	\$ (2.50)	\$ (2.15)	\$ (2.15)	\$ (2.15)	\$ (2.06)	\$ (1.88)	\$ (2.50)	\$ (2.14)	\$ (2.14)	\$ (2.22)	
High Growth_Low Prices	2034-2035	Dec	\$ (2.44)	\$ (1.96)	\$ (2.53)	\$ (2.59)	\$ (2.68)	\$ (2.59)	\$ (2.59)	\$ (2.59)	\$ (2.44)	\$ (1.96)	\$ (2.53)	\$ (2.31)	\$ (2.31)	\$ (2.61)	
High Growth_Low Prices	2034-2035	Jan	\$ (2.48)	\$ (2.02)	\$ (2.53)	\$ (2.50)	\$ (2.76)	\$ (2.50)	\$ (2.50)	\$ (2.50)	\$ (2.48)	\$ (2.02)	\$ (2.53)	\$ (2.34)	\$ (2.34)	\$ (2.55)	
High Growth_Low Prices	2034-2035	Feb	\$ (3.00)	\$ (2.02)	\$ (3.04)	\$ (2.11)	\$ (3.09)	\$ (2.11)	\$ (2.11)	\$ (2.11)	\$ (3.00)	\$ (2.02)	\$ (3.04)	\$ (2.69)	\$ (2.69)	\$ (2.31)	
High Growth_Low Prices	2034-2035	Mar	\$ (1.94)	\$ (1.89)	\$ (2.49)	\$ (1.94)	\$ (2.49)	\$ (1.94)	\$ (1.94)	\$ (1.94)	\$ (1.94)	\$ (1.89)	\$ (2.49)	\$ (2.11)	\$ (2.11)	\$ (2.05)	
High Growth_Low Prices	2034-2035	Apr	\$ (1.78)	\$ (1.78)	\$ (2.49)	\$ (1.82)	\$ (2.49)	\$ (1.82)	\$ (1.82)	\$ (1.82)	\$ (1.78)	\$ (1.78)	\$ (2.49)	\$ (2.02)	\$ (2.02)	\$ (1.96)	
High Growth_Low Prices	2034-2035	May	\$ (1.72)	\$ (1.72)	\$ (2.49)	\$ (1.76)	\$ (2.49)	\$ (1.76)	\$ (1.76)	\$ (1.76)	\$ (1.72)	\$ (1.72)	\$ (2.49)	\$ (1.98)	\$ (1.98)	\$ (1.91)	
High Growth_Low Prices	2034-2035	Jun	\$ (1.75)	\$ (1.75)	\$ (2.49)	\$ (1.79)	\$ (2.49)	\$ (1.79)	\$ (1.79)	\$ (1.79)	\$ (1.75)	\$ (1.75)	\$ (2.49)	\$ (2.00)	\$ (2.00)	\$ (1.93)	
High Growth_Low Prices	2034-2035	Jul	\$ (1.86)	\$ (1.86)	\$ (2.49)	\$ (1.90)	\$ (2.49)	\$ (1.90)	\$ (1.90)	\$ (1.90)	\$ (1.86)	\$ (1.86)	\$ (2.49)	\$ (2.07)	\$ (2.07)	\$ (2.02)	
High Growth_Low Prices	2034-2035	Aug	\$ (1.88)	\$ (1.88)	\$ (2.49)	\$ (1.92)	\$ (2.49)	\$ (1.92)	\$ (1.92)	\$ (1.92)	\$ (1.88)	\$ (1.88)	\$ (2.49)	\$ (2.08)	\$ (2.08)	\$ (2.03)	
High Growth_Low Prices	2034-2035	Sep	\$ (1.82)	\$ (1.82)	\$ (2.49)	\$ (1.86)	\$ (2.48)	\$ (1.86)	\$ (1.86)	\$ (1.86)	\$ (1.82)	\$ (1.82)	\$ (2.49)	\$ (2.04)	\$ (2.04)	\$ (1.98)	
High Growth_Low Prices	2034-2035	Oct	\$ (1.77)	\$ (1.77)	\$ (2.51)	\$ (1.81)	\$ (2.51)	\$ (1.81)	\$ (1.81)	\$ (1.81)	\$ (1.77)	\$ (1.77)	\$ (2.51)	\$ (2.02)	\$ (2.02)	\$ (1.95)	
High Growth_Low Prices	2035-2036	Nov	\$ (1.87)	\$ (1.68)	\$ (2.50)	\$ (2.03)	\$ (2.50)	\$ (2.03)	\$ (2.03)	\$ (2.03)	\$ (1.87)	\$ (1.68)	\$ (2.50)	\$ (2.01)	\$ (2.01)	\$ (2.13)	
High Growth_Low Prices	2035-2036	Dec	\$ (2.24)	\$ (1.72)	\$ (2.53)	\$ (2.61)	\$ (2.74)	\$ (2.61)	\$ (2.61)	\$ (2.61)	\$ (2.24)	\$ (1.72)	\$ (2.53)	\$ (2.16)	\$ (2.16)	\$ (2.63)	
High Growth_Low Prices	2035-2036	Jan	\$ (2.32)	\$ (1.86)	\$ (2.53)	\$ (2.50)	\$ (2.89)	\$ (2.50)	\$ (2.50)	\$ (2.50)	\$ (2.32)	\$ (1.86)	\$ (2.53)	\$ (2.23)	\$ (2.23)	\$ (2.58)	
High Growth_Low Prices	2035-2036	Feb	\$ (2.95)	\$ (1.97)	\$ (3.04)	\$ (2.07)	\$ (3.12)	\$ (2.07)	\$ (2.07)	\$ (2.07)	\$ (2.95)	\$ (1.97)	\$ (3.04)	\$ (2.65)	\$ (2.65)	\$ (2.28)	
High Growth_Low Prices	2035-2036	Mar	\$ (1.86)	\$ (1.82)	\$ (2.48)	\$ (1.86)	\$ (2.48)	\$ (1.86)	\$ (1.86)	\$ (1.86)	\$ (1.86)	\$ (1.82)	\$ (2.48)	\$ (2.05)	\$ (2.05)	\$ (1.98)	
High Growth_Low Prices	2035-2036	Apr	\$ (1.70)	\$ (1.70)	\$ (2.45)	\$ (1.74)	\$ (2.45)	\$ (1.74)	\$ (1.74)	\$ (1.74)	\$ (1.70)	\$ (1.70)	\$ (2.45)	\$ (1.95)	\$ (1.95)	\$ (1.88)	
High Growth_Low Prices	2035-2036	May	\$ (1.69)	\$ (1.69)	\$ (2.45)	\$ (1.72)	\$ (2.45)	\$ (1.72)	\$ (1.72)	\$ (1.72)	\$ (1.69)	\$ (1.69)	\$ (2.45)	\$ (1.94)	\$ (1.94)	\$ (1.87)	
High Growth_Low Prices	2035-2036	Jun	\$ (1.77)	\$ (1.77)	\$ (2.46)	\$ (1.81)	\$ (2.45)	\$ (1.81)	\$ (1.81)	\$ (1.81)	\$ (1.77)	\$ (1.77)	\$ (2.46)	\$ (2.00)	\$ (2.00)	\$ (1.94)	
High Growth_Low Prices	2035-2036	Jul	\$ (1.95)	\$ (1.95)	\$ (2.46)	\$ (1.99)	\$ (2.46)	\$ (1.99)	\$ (1.99)	\$ (1.99)	\$ (1.95)	\$ (1.95)	\$ (2.46)	\$ (2.12)	\$ (2.12)	\$ (2.09)	
High Growth_Low Prices	2035-2036	Aug	\$ (2.04)	\$ (2.04)	\$ (2.46)	\$ (2.09)	\$ (2.46)	\$ (2.09)	\$ (2.09)	\$ (2.09)	\$ (2.04)	\$ (2.04)	\$ (2.46)	\$ (2.18)	\$ (2.18)	\$ (2.16)	
High Growth_Low Prices	2035-2036	Sep	\$ (1.92)	\$ (1.92)	\$ (2.46)	\$ (1.96)	\$ (2.40)	\$ (1.96)	\$ (1.96)	\$ (1.96)	\$ (1.92)	\$ (1.92)	\$ (2.46)	\$ (2.10)	\$ (2.10)	\$ (2.05)	
High Growth_Low Prices	2035-2036	Oct	\$ (1.90)	\$ (1.90)	\$ (2.51)	\$ (1.95)	\$ (2.51)	\$ (1.95)	\$ (1.95)	\$ (1.95)	\$ (1.90)	\$ (1.90)	\$ (2.51)	\$ (2.10)	\$ (2.10)	\$ (2.06)	
High Growth_Low Prices	2036-2037	Nov	\$ (2.04)	\$ (1.85)	\$ (2.46)	\$ (2.12)	\$ (2.46)	\$ (2.12)	\$ (2.12)	\$ (2.12)	\$ (2.04)	\$ (1.85)	\$ (2.46)	\$ (2.12)	\$ (2.12)	\$ (2.19)	
High Growth_Low Prices	2036-2037	Dec	\$ (2.42)	\$ (1.94)	\$ (2.50)	\$ (2.62)	\$ (2.98)	\$ (38.11)	\$ (38.11)	\$ (38.11)	\$ (2.42)	\$ (1.94)	\$ (2.50)	\$ (2.29)	\$ (2.29)	\$ (23.99)	
High Growth_Low Prices	2036-2037	Jan	\$ (2.45)	\$ (1.99)	\$ (2.49)	\$ (2.46)	\$ (2.91)	\$ (2.46)	\$ (2.46)	\$ (2.46)	\$ (2.45)	\$ (1.99)	\$ (2.49)	\$ (2.31)	\$ (2.31)	\$ (2.55)	
High Growth_Low Prices	2036-2037	Feb	\$ (3.00)	\$ (2.09)	\$ (3.00)	\$ (2.14)	\$ (3.09)	\$ (2.14)	\$ (2.14)	\$ (2.14)	\$ (3.00)	\$ (2.09)	\$ (3.00)	\$ (2.70)	\$ (2.70)	\$ (2.33)	
High Growth_Low Prices	2036-2037	Mar	\$ (1.89)	\$ (1.85)	\$ (2.55)	\$ (1.89)	\$ (2.55)	\$ (1.89)	\$ (1.89)	\$ (1.89)	\$ (1.89)	\$ (1.85)	\$ (2.55)	\$ (2.10)	\$ (2.10)	\$ (2.02)	
High Growth_Low Prices	2036-2037	Apr	\$ (1.67)	\$ (1.67)	\$ (2.14)	\$ (1.71)	\$ (2.14)	\$ (1.71)	\$ (1.71)	\$ (1.71)	\$ (1.67)	\$ (1.67)	\$ (2.14)	\$ (1.83)	\$ (1.83)	\$ (1.80)	
High Growth_Low Prices	2036-2037	May	\$ (1.66)	\$ (1.66)	\$ (1.97)	\$ (1.70)	\$ (1.97)	\$ (1.70)	\$ (1.70)	\$ (1.70)	\$ (1.66)	\$ (1.66)	\$ (1.97)	\$ (1.76)	\$ (1.76)	\$ (1.75)	
High Growth_Low Prices	2036-2037	Jun	\$ (1.73)	\$ (1.73)	\$ (1.97)	\$ (1.77)	\$ (1.97)	\$ (1.77)	\$ (1.77)	\$ (1.77)	\$ (1.73)	\$ (1.73)	\$ (1.97)	\$ (1.81)	\$ (1.81)	\$ (1.81)	
High Growth_Low Prices	2036-2037	Jul	\$ (1.93)	\$ (1.93)	\$ (1.97)	\$ (1.97)	\$ (1.97)	\$ (1.97)	\$ (1.97)	\$ (1.97)	\$ (1.93)	\$ (1.93)	\$ (1.97)	\$ (1.94)	\$ (1.94)	\$ (1.97)	
High Growth_Low Prices	2036-2037	Aug	\$ (1.97)	\$ (1.97)	\$ (1.97)	\$ (2.01)	\$ (1.98)	\$ (1.97)	\$ (1.97)	\$ (1.97)	\$ (1.97)	\$ (1.97)	\$ (1.97)	\$ (1.97)	\$ (1.97)	\$ (1.98)	
High Growth_Low Prices	2036-2037	Sep	\$ (1.82)	\$ (1.82)	\$ (1.86)	\$ (1.86)	\$ (1.86)	\$ (1.86)	\$ (1.86)	\$ (1.86)	\$ (1.82)	\$ (1.82)	\$ (1.86)	\$ (1.83)	\$ (1.83)	\$ (1.86)	
High Growth_Low Prices	2036-2037	Oct	\$ (1.74)	\$ (1.74)	\$ (2.49)	\$ (1.78)	\$ (2.49)	\$ (1.78)	\$ (1.78)	\$ (1.78)	\$ (1.74)	\$ (1.74)	\$ (2.49)	\$ (1.99)	\$ (1.99)	\$ (1.92)	

1/ Avoided costs are before Environmental Externalities added.

APPENDIX 7.1: HIGH GROWTH CASES SELECTED RESOURCES VS. PEAK DAY DEMAND EXISTING PLUS EXPECTED AVAILABLE

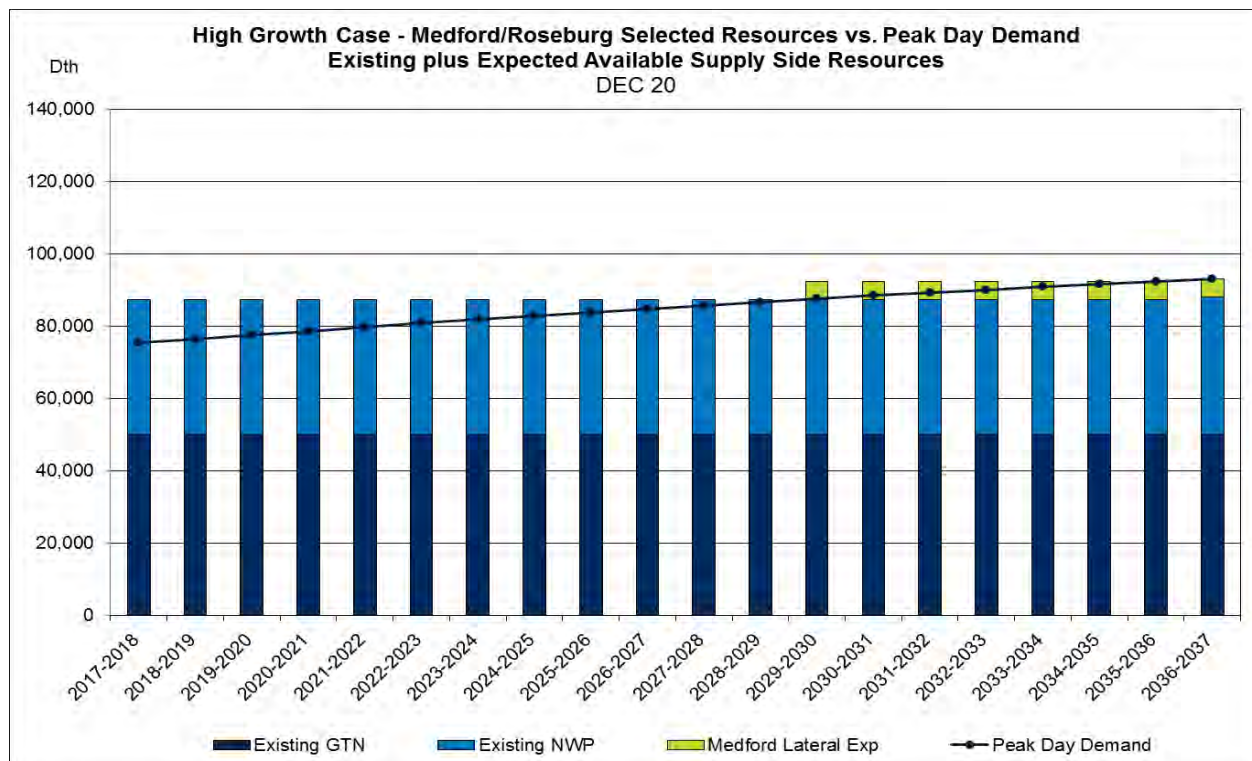
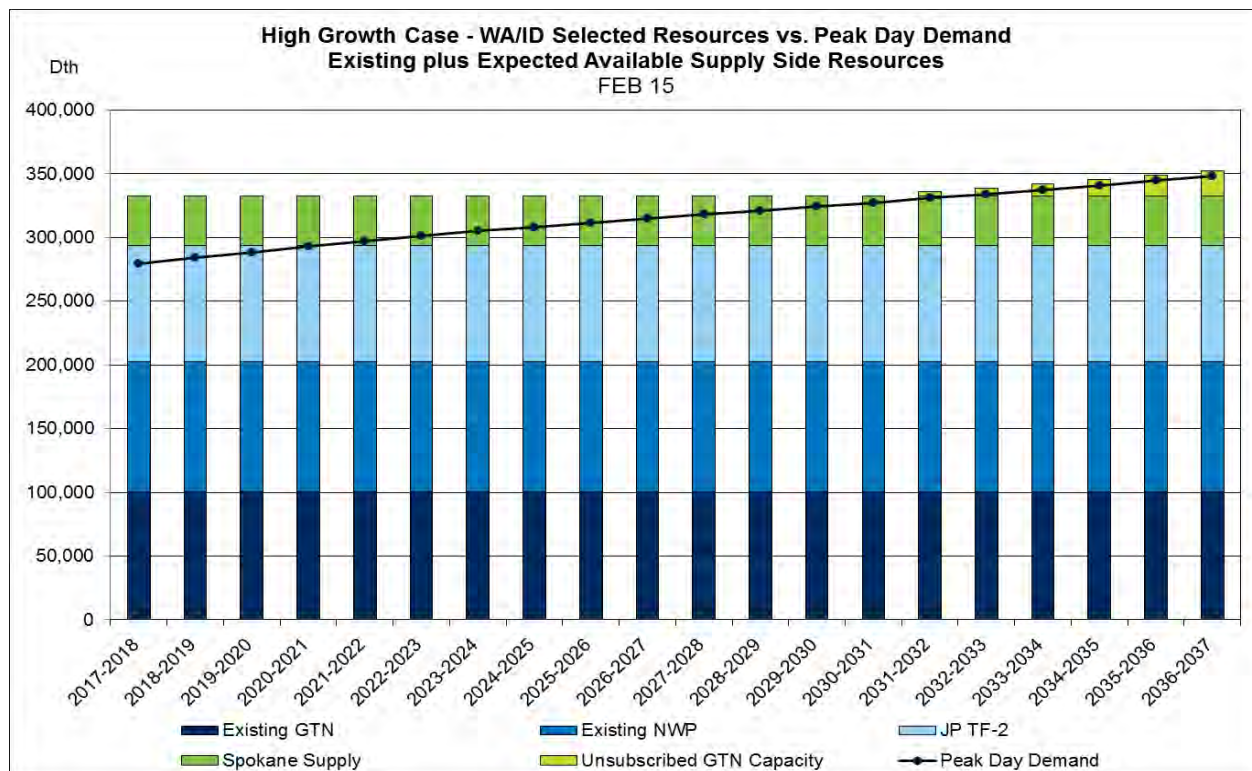

APPENDIX 7.1: HIGH GROWTH CASES SELECTED RESOURCES VS. PEAK DAY DEMAND EXISTING PLUS EXPECTED AVAILABLE

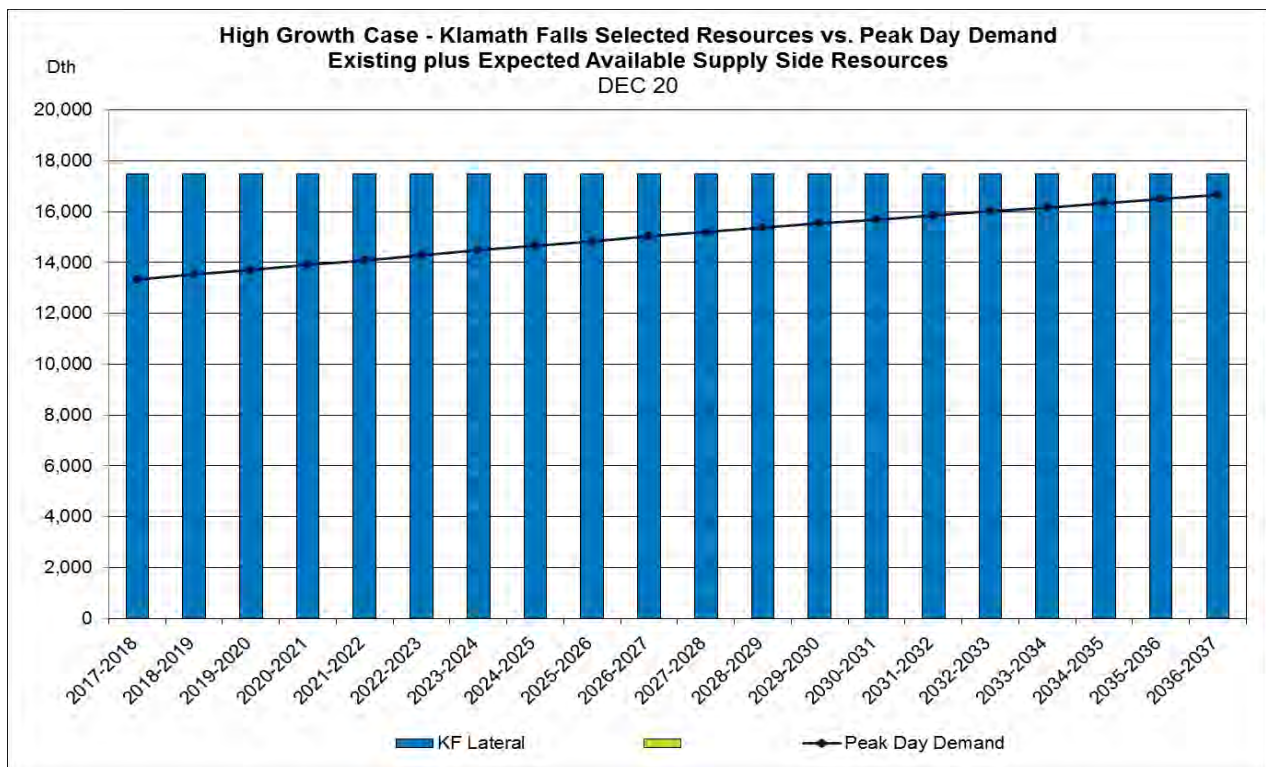
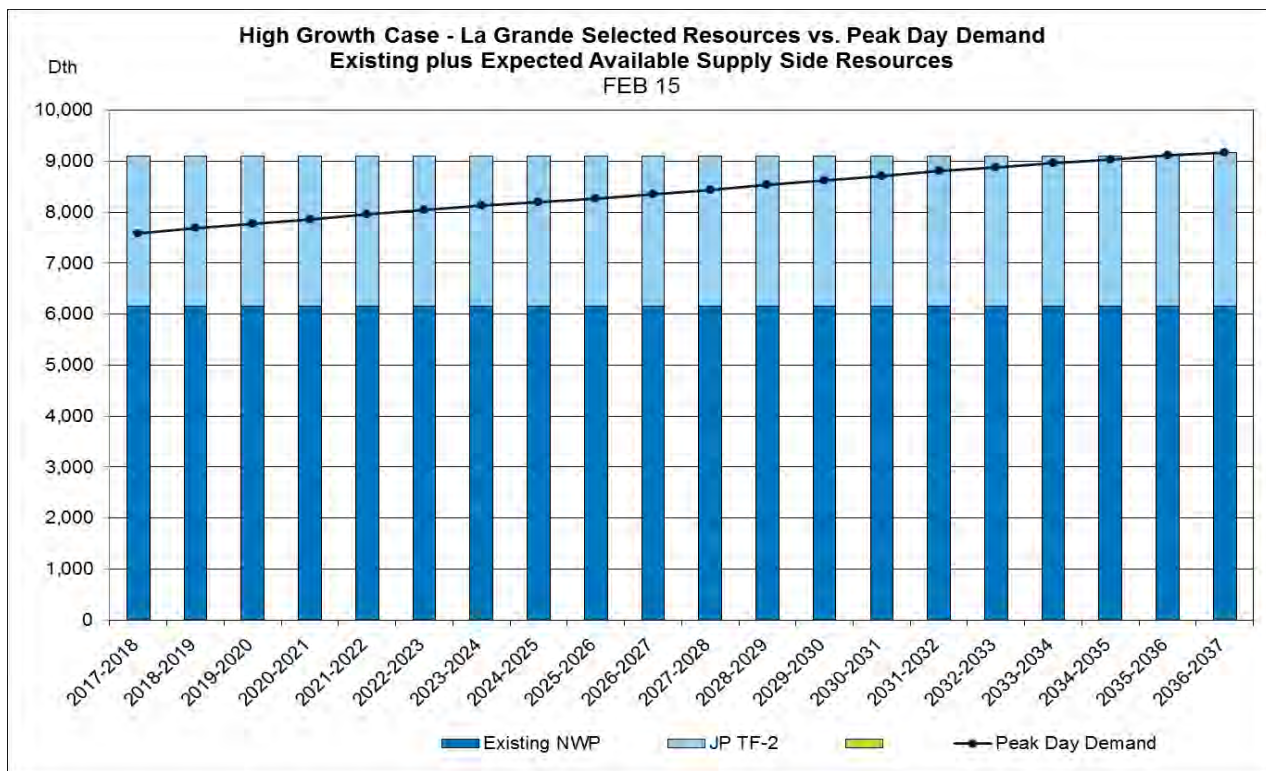

APPENDIX 7.2: PEAK DAY DEMAND TABLE HIGH GROWTH

Peak Day Demand - Served and Unserved (MDth/d)													
Before Resource Additions & Net of DSM Savings													
Scenario	Gas Year	LaGrande			LaGrande % of Peak Day	WA			WA % of Peak Day	ID		ID % of Peak Day	
		Served	Unserved	Total		Served	Unserved	WA Total		Served	Unserved		ID Total
High Growth_Low Prices	2017-2018	7.59	-	7.59	100%	189.28	-	189.28	100%	90.23	-	90.23	100%
High Growth_Low Prices	2018-2019	7.68	-	7.68	100%	192.33	-	192.33	100%	91.76	-	91.76	100%
High Growth_Low Prices	2019-2020	7.77	-	7.77	100%	195.29	-	195.29	100%	93.31	-	93.31	100%
High Growth_Low Prices	2020-2021	7.86	-	7.86	100%	198.09	-	198.09	100%	94.87	-	94.87	100%
High Growth_Low Prices	2021-2022	7.95	-	7.95	100%	200.64	-	200.64	100%	96.42	-	96.42	100%
High Growth_Low Prices	2022-2023	8.04	-	8.04	100%	203.02	-	203.02	100%	97.92	-	97.92	100%
High Growth_Low Prices	2023-2024	8.12	-	8.12	100%	205.77	-	205.77	100%	99.59	-	99.59	100%
High Growth_Low Prices	2024-2025	8.19	-	8.19	100%	207.58	-	207.58	100%	100.71	-	100.71	100%
High Growth_Low Prices	2025-2026	8.27	-	8.27	100%	209.64	-	209.64	100%	101.96	-	101.96	100%
High Growth_Low Prices	2026-2027	8.35	-	8.35	100%	211.61	-	211.61	100%	103.16	-	103.16	100%
High Growth_Low Prices	2027-2028	8.44	-	8.44	100%	213.70	-	213.70	100%	104.48	-	104.48	100%
High Growth_Low Prices	2028-2029	8.53	-	8.53	100%	215.35	-	215.35	100%	105.61	-	105.61	100%
High Growth_Low Prices	2029-2030	8.62	-	8.62	100%	217.17	-	217.17	100%	106.87	-	106.87	100%
High Growth_Low Prices	2030-2031	8.71	-	8.71	100%	218.97	-	218.97	100%	108.20	-	108.20	100%
High Growth_Low Prices	2031-2032	6.65	2.15	8.80	76%	219.84	1.26	221.10	99%	109.77	-	109.77	100%
High Growth_Low Prices	2032-2033	6.65	2.23	8.88	75%	222.62	-	222.62	100%	107.22	3.87	111.09	97%
High Growth_Low Prices	2033-2034	6.65	2.30	8.95	74%	217.46	7.01	224.47	97%	112.65	-	112.65	100%
High Growth_Low Prices	2034-2035	6.65	2.38	9.03	74%	216.11	10.23	226.34	95%	114.28	-	114.28	100%
High Growth_Low Prices	2035-2036	6.65	2.46	9.11	73%	214.55	14.08	228.64	94%	116.17	-	116.17	100%
High Growth_Low Prices	2036-2037	9.17	-	9.17	100%	223.92	6.25	230.17	97%	104.53	13.20	117.73	89%

Scenario	Gas Year	Klamath			Klamath Falls % of Peak Day	Medford/ Roseburg			Medford/ Roseburg % of Peak Day
		Falls Served	Falls Unserved	Falls Total		Roseburg Served	Roseburg Unserved	Roseburg Total	
High Growth_Low Prices	2017-2018	13.34	-	13.34	100%	75.36	-	75.36	100%
High Growth_Low Prices	2018-2019	13.52	-	13.52	100%	76.47	-	76.47	100%
High Growth_Low Prices	2019-2020	13.71	-	13.71	100%	77.55	-	77.55	100%
High Growth_Low Prices	2020-2021	13.90	-	13.90	100%	78.64	-	78.64	100%
High Growth_Low Prices	2021-2022	14.09	-	14.09	100%	79.75	-	79.75	100%
High Growth_Low Prices	2022-2023	14.28	-	14.28	100%	80.86	-	80.86	100%
High Growth_Low Prices	2023-2024	14.47	-	14.47	100%	81.91	-	81.91	100%
High Growth_Low Prices	2024-2025	14.65	-	14.65	100%	82.79	-	82.79	100%
High Growth_Low Prices	2025-2026	14.84	-	14.84	100%	83.77	-	83.77	100%
High Growth_Low Prices	2026-2027	15.02	-	15.02	100%	84.75	-	84.75	100%
High Growth_Low Prices	2027-2028	15.20	-	15.20	100%	85.72	-	85.72	100%
High Growth_Low Prices	2028-2029	15.37	-	15.37	100%	86.66	-	86.66	100%
High Growth_Low Prices	2029-2030	15.54	-	15.54	100%	87.57	-	87.57	100%
High Growth_Low Prices	2030-2031	15.69	-	15.69	100%	87.96	0.48	88.44	99%
High Growth_Low Prices	2031-2032	15.85	-	15.85	100%	87.97	1.30	89.27	99%
High Growth_Low Prices	2032-2033	16.01	-	16.01	100%	87.96	2.10	90.07	98%
High Growth_Low Prices	2033-2034	16.17	-	16.17	100%	87.97	2.89	90.85	97%
High Growth_Low Prices	2034-2035	16.33	-	16.33	100%	87.96	3.64	91.61	96%
High Growth_Low Prices	2035-2036	16.49	-	16.49	100%	87.97	4.39	92.36	95%
High Growth_Low Prices	2036-2037	16.65	-	16.65	100%	87.96	5.14	93.10	94%

APPENDIX 7.2: PEAK DAY DEMAND TABLE

LOW GROWTH

Peak Day Demand - Served and Unserved (MDth/d)														
Before Resource Additions & Net of DSM Savings														
Scenario	Gas Year	LaGrande			LaGrande % of Peak				WA % of Peak Day			ID		ID % of Peak Day
		Served	Unserved	Total	Served	WA Served	WA Unserved	WA Total	Served	Served	Unserved	ID Total	Served	
Low Growth_High Prices	2017-2018	7.47	-	7.47	100%	186.53	-	186.53	100%	88.59	-	88.59	100%	
Low Growth_High Prices	2018-2019	7.44	-	7.44	100%	188.06	-	188.06	100%	89.11	-	89.11	100%	
Low Growth_High Prices	2019-2020	7.41	-	7.41	100%	188.88	-	188.88	100%	89.46	-	89.46	100%	
Low Growth_High Prices	2020-2021	7.36	-	7.36	100%	189.55	-	189.55	100%	89.80	-	89.80	100%	
Low Growth_High Prices	2021-2022	7.33	-	7.33	100%	190.26	-	190.26	100%	90.08	-	90.08	100%	
Low Growth_High Prices	2022-2023	7.32	-	7.32	100%	190.74	-	190.74	100%	90.30	-	90.30	100%	
Low Growth_High Prices	2023-2024	7.32	-	7.32	100%	191.70	-	191.70	100%	90.77	-	90.77	100%	
Low Growth_High Prices	2024-2025	7.31	-	7.31	100%	191.90	-	191.90	100%	90.79	-	90.79	100%	
Low Growth_High Prices	2025-2026	7.32	-	7.32	100%	192.41	-	192.41	100%	90.97	-	90.97	100%	
Low Growth_High Prices	2026-2027	7.32	-	7.32	100%	192.85	-	192.85	100%	91.12	-	91.12	100%	
Low Growth_High Prices	2027-2028	7.32	-	7.32	100%	193.42	-	193.42	100%	91.36	-	91.36	100%	
Low Growth_High Prices	2028-2029	7.31	-	7.31	100%	193.37	-	193.37	100%	91.30	-	91.30	100%	
Low Growth_High Prices	2029-2030	7.30	-	7.30	100%	193.72	-	193.72	100%	91.46	-	91.46	100%	
Low Growth_High Prices	2030-2031	7.30	-	7.30	100%	194.08	-	194.08	100%	91.67	-	91.67	100%	
Low Growth_High Prices	2031-2032	7.31	-	7.31	100%	194.79	-	194.79	100%	92.07	-	92.07	100%	
Low Growth_High Prices	2032-2033	7.30	-	7.30	100%	194.91	-	194.91	100%	92.20	-	92.20	100%	
Low Growth_High Prices	2033-2034	7.30	-	7.30	100%	195.39	-	195.39	100%	92.54	-	92.54	100%	
Low Growth_High Prices	2034-2035	7.31	-	7.31	100%	195.91	-	195.91	100%	92.93	-	92.93	100%	
Low Growth_High Prices	2035-2036	7.32	-	7.32	100%	196.87	-	196.87	100%	91.40	-	91.40	100%	
Low Growth_High Prices	2036-2037	7.32	-	7.32	100%	197.07	-	197.07	100%	90.70	-	90.70	100%	

Scenario	Gas Year	Klamath			Klamath Falls % of Peak				Medford/Roseburg		Medford/Roseburg % of Peak Day
		Served	Unserved	Falls Total	Served	Medford/Roseburg Served	Medford/Roseburg Unserved	Medford/Roseburg Total	Served		
Low Growth_High Prices	2017-2018	13.14	-	13.14	100%	74.33	-	74.33	100%		
Low Growth_High Prices	2018-2019	13.20	-	13.20	100%	74.83	-	74.83	100%		
Low Growth_High Prices	2019-2020	13.25	-	13.25	100%	75.18	-	75.18	100%		
Low Growth_High Prices	2020-2021	13.30	-	13.30	100%	75.55	-	75.55	100%		
Low Growth_High Prices	2021-2022	13.29	-	13.29	100%	75.63	-	75.63	100%		
Low Growth_High Prices	2022-2023	13.34	-	13.34	100%	76.00	-	76.00	100%		
Low Growth_High Prices	2023-2024	13.39	-	13.39	100%	76.36	-	76.36	100%		
Low Growth_High Prices	2024-2025	13.43	-	13.43	100%	76.66	-	76.66	100%		
Low Growth_High Prices	2025-2026	13.49	-	13.49	100%	77.05	-	77.05	100%		
Low Growth_High Prices	2026-2027	13.55	-	13.55	100%	77.44	-	77.44	100%		
Low Growth_High Prices	2027-2028	13.61	-	13.61	100%	77.82	-	77.82	100%		
Low Growth_High Prices	2028-2029	13.65	-	13.65	100%	78.11	-	78.11	100%		
Low Growth_High Prices	2029-2030	13.70	-	13.70	100%	78.45	-	78.45	100%		
Low Growth_High Prices	2030-2031	13.75	-	13.75	100%	78.77	-	78.77	100%		
Low Growth_High Prices	2031-2032	13.81	-	13.81	100%	79.07	-	79.07	100%		
Low Growth_High Prices	2032-2033	13.86	-	13.86	100%	79.36	-	79.36	100%		
Low Growth_High Prices	2033-2034	13.92	-	13.92	100%	79.63	-	79.63	100%		
Low Growth_High Prices	2034-2035	13.97	-	13.97	100%	79.89	-	79.89	100%		
Low Growth_High Prices	2035-2036	14.03	-	14.03	100%	80.15	-	80.15	100%		
Low Growth_High Prices	2036-2037	14.08	-	14.08	100%	80.40	-	80.40	100%		

APPENDIX 7.2: PEAK DAY DEMAND TABLE COLDEST IN 20 YEARS

Peak Day Demand - Served and Unserved (MDth/d)														
Before Resource Additions & Net of DSM Savings														
Scenario	Gas Year	LaGrande			LaGrande % of Peak		WA		WA Total	WA % of Peak Day		ID		ID % of Peak Day
		Served	Unserved	Total	Served	Unserved	Served	Unserved		Served	Unserved	Total	Served	
Cold Day 20yr Weather Std	2017-2018	6.74	-	6.74	100%	175.11	-	175.11	100%	83.41	-	83.41	100%	
Cold Day 20yr Weather Std	2018-2019	6.77	-	6.77	100%	177.19	-	177.19	100%	84.37	-	84.37	100%	
Cold Day 20yr Weather Std	2019-2020	6.80	-	6.80	100%	178.80	-	178.80	100%	85.33	-	85.33	100%	
Cold Day 20yr Weather Std	2020-2021	6.82	-	6.82	100%	180.21	-	180.21	100%	86.27	-	86.27	100%	
Cold Day 20yr Weather Std	2021-2022	6.82	-	6.82	100%	181.62	-	181.62	100%	87.08	-	87.08	100%	
Cold Day 20yr Weather Std	2022-2023	6.84	-	6.84	100%	182.78	-	182.78	100%	87.82	-	87.82	100%	
Cold Day 20yr Weather Std	2023-2024	6.86	-	6.86	100%	184.57	-	184.57	100%	88.84	-	88.84	100%	
Cold Day 20yr Weather Std	2024-2025	6.87	-	6.87	100%	185.41	-	185.41	100%	89.32	-	89.32	100%	
Cold Day 20yr Weather Std	2025-2026	6.90	-	6.90	100%	186.51	-	186.51	100%	89.93	-	89.93	100%	
Cold Day 20yr Weather Std	2026-2027	6.92	-	6.92	100%	187.53	-	187.53	100%	90.51	-	90.51	100%	
Cold Day 20yr Weather Std	2027-2028	6.94	-	6.94	100%	188.68	-	188.68	100%	91.19	-	91.19	100%	
Cold Day 20yr Weather Std	2028-2029	6.96	-	6.96	100%	189.39	-	189.39	100%	91.67	-	91.67	100%	
Cold Day 20yr Weather Std	2029-2030	6.99	-	6.99	100%	190.30	-	190.30	100%	92.28	-	92.28	100%	
Cold Day 20yr Weather Std	2030-2031	7.01	-	7.01	100%	191.20	-	191.20	100%	92.93	-	92.93	100%	
Cold Day 20yr Weather Std	2031-2032	7.03	-	7.03	100%	192.45	-	192.45	100%	93.80	-	93.80	100%	
Cold Day 20yr Weather Std	2032-2033	7.05	-	7.05	100%	193.10	-	193.10	100%	94.41	-	94.41	100%	
Cold Day 20yr Weather Std	2033-2034	7.06	-	7.06	100%	194.09	-	194.09	100%	95.23	-	95.23	100%	
Cold Day 20yr Weather Std	2034-2035	7.08	-	7.08	100%	195.12	-	195.12	100%	96.11	-	96.11	100%	
Cold Day 20yr Weather Std	2035-2036	7.11	-	7.11	100%	196.57	-	196.57	100%	97.24	-	97.24	100%	
Cold Day 20yr Weather Std	2036-2037	7.11	-	7.11	100%	197.27	-	197.27	100%	98.01	-	98.01	100%	

Scenario	Gas Year	Klamath			Klamath Falls % of Peak Day		Medford/Roseburg		Medford/Roseburg % of Peak Day
		Served	Unserved	Total	Served	Unserved	Served	Unserved	
Cold Day 20yr Weather Std	2017-2018	13.24	-	13.24	100%	65.02	-	65.02	100%
Cold Day 20yr Weather Std	2018-2019	13.36	-	13.36	100%	65.71	-	65.71	100%
Cold Day 20yr Weather Std	2019-2020	13.49	-	13.49	100%	66.38	-	66.38	100%
Cold Day 20yr Weather Std	2020-2021	13.62	-	13.62	100%	67.06	-	67.06	100%
Cold Day 20yr Weather Std	2021-2022	13.67	-	13.67	100%	67.37	-	67.37	100%
Cold Day 20yr Weather Std	2022-2023	13.78	-	13.78	100%	67.97	-	67.97	100%
Cold Day 20yr Weather Std	2023-2024	13.91	-	13.91	100%	68.60	-	68.60	100%
Cold Day 20yr Weather Std	2024-2025	14.02	-	14.02	100%	69.09	-	69.09	100%
Cold Day 20yr Weather Std	2025-2026	14.14	-	14.14	100%	69.67	-	69.67	100%
Cold Day 20yr Weather Std	2026-2027	14.26	-	14.26	100%	70.24	-	70.24	100%
Cold Day 20yr Weather Std	2027-2028	14.37	-	14.37	100%	70.80	-	70.80	100%
Cold Day 20yr Weather Std	2028-2029	14.48	-	14.48	100%	71.34	-	71.34	100%
Cold Day 20yr Weather Std	2029-2030	14.59	-	14.59	100%	71.86	-	71.86	100%
Cold Day 20yr Weather Std	2030-2031	14.69	-	14.69	100%	72.35	-	72.35	100%
Cold Day 20yr Weather Std	2031-2032	14.79	-	14.79	100%	72.82	-	72.82	100%
Cold Day 20yr Weather Std	2032-2033	14.89	-	14.89	100%	73.26	-	73.26	100%
Cold Day 20yr Weather Std	2033-2034	15.00	-	15.00	100%	73.69	-	73.69	100%
Cold Day 20yr Weather Std	2034-2035	15.10	-	15.10	100%	74.10	-	74.10	100%
Cold Day 20yr Weather Std	2035-2036	15.20	-	15.20	100%	74.51	-	74.51	100%
Cold Day 20yr Weather Std	2036-2037	15.30	-	15.30	100%	74.92	-	74.92	100%

APPENDIX 7.2: PEAK DAY DEMAND TABLE

80% BELOW 1990 EMISSIONS

Peak Day Demand - Served and Unserved (MDth/d)														
Before Resource Additions & Net of DSM Savings														
Scenario	Gas Year	LaGrande			LaGrande % of Peak			WA			WA % of Peak Day			ID % of Peak Day
		Served	Unserved	Total	Served	Unserved	WA Total	Served	Unserved	ID Total	Served	Unserved	Served	
80% Below 1990 Emissions	2017-2018	7.34	-	7.34	100%	-	183.27	-	183.27	100%	89.42	-	89.42	100%
80% Below 1990 Emissions	2018-2019	7.10	-	7.10	100%	-	178.30	-	178.30	100%	90.47	-	90.47	100%
80% Below 1990 Emissions	2019-2020	6.85	-	6.85	100%	-	172.54	-	172.54	100%	91.51	-	91.51	100%
80% Below 1990 Emissions	2020-2021	6.65	-	6.65	100%	-	168.02	-	168.02	100%	92.53	-	92.53	100%
80% Below 1990 Emissions	2021-2022	6.40	-	6.40	100%	-	162.95	-	162.95	100%	93.51	-	93.51	100%
80% Below 1990 Emissions	2022-2023	6.18	-	6.18	100%	-	157.74	-	157.74	100%	94.43	-	94.43	100%
80% Below 1990 Emissions	2023-2024	5.94	-	5.94	100%	-	152.30	-	152.30	100%	95.53	-	95.53	100%
80% Below 1990 Emissions	2024-2025	5.74	-	5.74	100%	-	147.29	-	147.29	100%	96.11	-	96.11	100%
80% Below 1990 Emissions	2025-2026	5.53	-	5.53	100%	-	141.86	-	141.86	100%	96.80	-	96.80	100%
80% Below 1990 Emissions	2026-2027	5.32	-	5.32	100%	-	136.37	-	136.37	100%	97.46	-	97.46	100%
80% Below 1990 Emissions	2027-2028	5.09	-	5.09	100%	-	130.50	-	130.50	100%	98.21	-	98.21	100%
80% Below 1990 Emissions	2028-2029	4.90	-	4.90	100%	-	125.34	-	125.34	100%	98.78	-	98.78	100%
80% Below 1990 Emissions	2029-2030	4.70	-	4.70	100%	-	119.86	-	119.86	100%	99.46	-	99.46	100%
80% Below 1990 Emissions	2030-2031	4.50	-	4.50	100%	-	110.09	-	110.09	100%	100.20	-	100.20	100%
80% Below 1990 Emissions	2031-2032	4.29	-	4.29	100%	-	104.28	-	104.28	100%	101.15	-	101.15	100%
80% Below 1990 Emissions	2032-2033	4.10	-	4.10	100%	-	98.59	-	98.59	100%	101.85	-	101.85	100%
80% Below 1990 Emissions	2033-2034	3.90	-	3.90	100%	-	92.99	-	92.99	100%	102.76	-	102.76	100%
80% Below 1990 Emissions	2034-2035	3.71	-	3.71	100%	-	87.49	-	87.49	100%	103.72	-	103.72	100%
80% Below 1990 Emissions	2035-2036	3.50	-	3.50	100%	-	84.04	-	84.04	100%	104.94	-	104.94	100%
80% Below 1990 Emissions	2036-2037	3.32	-	3.32	100%	-	69.70	-	69.70	100%	105.80	-	105.80	100%

Scenario	Gas Year	Klamath				Medford/Roseburg			Medford/Roseburg % of Peak Day Served
		Klamath Falls Served	Klamath Falls Unserved	Klamath Falls Total	Falls % of Peak Day Served	Medford/Roseburg Served	Medford/Roseburg Unserved	Medford/Roseburg Total	
80% Below 1990 Emissions	2017-2018	12.91	-	12.91	100%	72.99	-	72.99	100%
80% Below 1990 Emissions	2018-2019	12.56	-	12.56	100%	71.11	-	71.11	100%
80% Below 1990 Emissions	2019-2020	12.17	-	12.17	100%	68.94	-	68.94	100%
80% Below 1990 Emissions	2020-2021	11.88	-	11.88	100%	67.37	-	67.37	100%
80% Below 1990 Emissions	2021-2022	11.48	-	11.48	100%	65.15	-	65.15	100%
80% Below 1990 Emissions	2022-2023	11.14	-	11.14	100%	63.29	-	63.29	100%
80% Below 1990 Emissions	2023-2024	10.76	-	10.76	100%	61.15	-	61.15	100%
80% Below 1990 Emissions	2024-2025	10.47	-	10.47	100%	59.46	-	59.46	100%
80% Below 1990 Emissions	2025-2026	10.13	-	10.13	100%	57.56	-	57.56	100%
80% Below 1990 Emissions	2026-2027	9.80	-	9.80	100%	55.66	-	55.66	100%
80% Below 1990 Emissions	2027-2028	9.42	-	9.42	100%	53.51	-	53.51	100%
80% Below 1990 Emissions	2028-2029	9.12	-	9.12	100%	51.82	-	51.82	100%
80% Below 1990 Emissions	2029-2030	8.78	-	8.78	100%	49.90	-	49.90	100%
80% Below 1990 Emissions	2030-2031	8.43	-	8.43	100%	47.97	-	47.97	100%
80% Below 1990 Emissions	2031-2032	8.06	-	8.06	100%	45.82	-	45.82	100%
80% Below 1990 Emissions	2032-2033	7.75	-	7.75	100%	44.08	-	44.08	100%
80% Below 1990 Emissions	2033-2034	7.41	-	7.41	100%	42.13	-	42.13	100%
80% Below 1990 Emissions	2034-2035	7.07	-	7.07	100%	40.17	-	40.17	100%
80% Below 1990 Emissions	2035-2036	6.70	-	6.70	100%	38.04	-	38.04	100%
80% Below 1990 Emissions	2036-2037	6.39	-	6.39	100%	36.26	-	36.26	100%

APPENDIX 7.2: PEAK DAY DEMAND TABLE AVERAGE CASE

Peak Day Demand - Served and Unserved (MDth/d) Before Resource Additions & Net of DSM Savings													
Scenario	Gas Year	LaGrande			% of Peak Day Served	WA			WA % of Peak Day Served	ID		ID Total	ID % of Peak Day Served
		Served	Unserved	Total		Served	Unserved	WA Total		Served	Unserved		
Average Case	2017-2018	3.43	-	3.43	100%	79.08	-	79.08	100%	38.27	-	38.27	100%
Average Case	2018-2019	3.44	-	3.44	100%	79.90	-	79.90	100%	38.65	-	38.65	100%
Average Case	2019-2020	3.45	-	3.45	100%	80.49	-	80.49	100%	39.02	-	39.02	100%
Average Case	2020-2021	3.46	-	3.46	100%	80.94	-	80.94	100%	39.33	-	39.33	100%
Average Case	2021-2022	3.45	-	3.45	100%	81.32	-	81.32	100%	39.57	-	39.57	100%
Average Case	2022-2023	3.46	-	3.46	100%	81.53	-	81.53	100%	39.73	-	39.73	100%
Average Case	2023-2024	3.47	-	3.47	100%	82.23	-	82.23	100%	40.15	-	40.15	100%
Average Case	2024-2025	3.46	-	3.46	100%	82.16	-	82.16	100%	40.13	-	40.13	100%
Average Case	2025-2026	3.47	-	3.47	100%	82.20	-	82.20	100%	40.16	-	40.16	100%
Average Case	2026-2027	3.47	-	3.47	100%	82.18	-	82.18	100%	40.17	-	40.17	100%
Average Case	2027-2028	3.48	-	3.48	100%	82.31	-	82.31	100%	40.27	-	40.27	100%
Average Case	2028-2029	3.48	-	3.48	100%	82.02	-	82.02	100%	40.17	-	40.17	100%
Average Case	2029-2030	3.49	-	3.49	100%	81.95	-	81.95	100%	40.20	-	40.20	100%
Average Case	2030-2031	3.49	-	3.49	100%	81.90	-	81.90	100%	40.26	-	40.26	100%
Average Case	2031-2032	3.50	-	3.50	100%	82.21	-	82.21	100%	40.53	-	40.53	100%
Average Case	2032-2033	3.49	-	3.49	100%	81.95	-	81.95	100%	40.52	-	40.52	100%
Average Case	2033-2034	3.50	-	3.50	100%	82.05	-	82.05	100%	40.72	-	40.72	100%
Average Case	2034-2035	3.50	-	3.50	100%	82.20	-	82.20	100%	40.96	-	40.96	100%
Average Case	2035-2036	3.51	-	3.51	100%	82.79	-	82.79	100%	41.44	-	41.44	100%
Average Case	2036-2037	3.50	-	3.50	100%	82.63	-	82.63	100%	41.55	-	41.55	100%

Scenario	Gas Year	Klamath			% of Peak Day Served	Medford/Roseburg			Medford/Roseburg % of Peak Day Served
		Falls Served	Falls Unserved	Falls Total		Peak Day Served	Roseburg Unserved	Roseburg Total	
Average Case	2017-2018	6.90	-	6.90	100%	34.80	-	34.80	100%
Average Case	2018-2019	6.96	-	6.96	100%	35.13	-	35.13	100%
Average Case	2019-2020	7.02	-	7.02	100%	35.46	-	35.46	100%
Average Case	2020-2021	7.08	-	7.08	100%	35.80	-	35.80	100%
Average Case	2021-2022	7.10	-	7.10	100%	35.96	-	35.96	100%
Average Case	2022-2023	7.15	-	7.15	100%	36.25	-	36.25	100%
Average Case	2023-2024	7.21	-	7.21	100%	36.55	-	36.55	100%
Average Case	2024-2025	7.26	-	7.26	100%	36.79	-	36.79	100%
Average Case	2025-2026	7.31	-	7.31	100%	37.06	-	37.06	100%
Average Case	2026-2027	7.37	-	7.37	100%	37.32	-	37.32	100%
Average Case	2027-2028	7.42	-	7.42	100%	37.58	-	37.58	100%
Average Case	2028-2029	7.47	-	7.47	100%	37.82	-	37.82	100%
Average Case	2029-2030	7.51	-	7.51	100%	38.06	-	38.06	100%
Average Case	2030-2031	7.55	-	7.55	100%	38.27	-	38.27	100%
Average Case	2031-2032	7.59	-	7.59	100%	38.47	-	38.47	100%
Average Case	2032-2033	7.64	-	7.64	100%	38.66	-	38.66	100%
Average Case	2033-2034	7.68	-	7.68	100%	38.84	-	38.84	100%
Average Case	2034-2035	7.72	-	7.72	100%	39.02	-	39.02	100%
Average Case	2035-2036	7.77	-	7.77	100%	39.19	-	39.19	100%
Average Case	2036-2037	7.81	-	7.81	100%	39.35	-	39.35	100%

APPENDIX 7.2: ALTERNATE SUPPLY RESOURCES

Additional Resource	Size	Cost/Rates			Availability	Notes
Unsubscribed GTN Capacity	Up to 50,000 Dth	GTN Rate			Now	Currently available unsubscribed capacity from Kingsgate to Spokane
Medford Lateral Exp	50,000 Dth / Day	\$35M capital + GTN Rate			2019	Additional compression to facilitate more gas to flow from mainline GTN to Medford
Hydrogen	166 Dth / Day	WA	ID	OR	2020	Cost estimates obtained from a consultant; levelized cost includes revenue requirements, expected carbon adder and assumed retail power rate
		\$48 / Dth	\$40 / Dth	\$46 / Dth		
Renewable Natural Gas – Distributed Landfill	635 Dth / Day	WA	ID	OR	2020	Costs estimates obtained from a consultant for each specific type of RNG; levelized costs include revenue requirements, distribution costs, and projected carbon intensity adder/(savings)
Renewable Natural Gas – Centralized Landfill	1,814 Dth / Day	WA	ID	OR	2020	
Renewable Natural Gas – Dairy	635 Dth / Day	WA	ID	OR	2020	
Renewable Natural Gas – Waste Water	513 Dth / Day	WA	ID	OR	2020	
Renewable Natural Gas – Food Waste to (RNG)	298 Dth / Day	WA	ID	OR	2020	
		\$13 / Dth	\$13 / Dth	\$13 / Dth		
		\$11 / Dth	\$11 / Dth	\$12 / Dth		
		\$34 / Dth	\$39 / Dth	\$33 / Dth		
		\$19 / Dth	\$18 / Dth	\$19 / Dth		
		\$38 / Dth	\$39 / Dth	\$38 / Dth		
Plymouth LNG	241,700 Dth w/70,500 Dth deliverability	NWP Rate			2018	Provides for peaking services and alleviates the need for costly pipeline expansions Pair with excess pipeline MDDO's to create firm transport

Future Supply Resources	Size	Cost/Rates	Availability	Notes
Co. Owned LNG	600,000 Dth w/ 150,000 of deliverability	\$75 Million plus \$2 Million annual O&M	2024	On site, in service territory liquefaction and vaporization facility
Various pipelines – Pacific Connector, Cross-Cascades, etc.	Varies	Precedent Agreement Rates	2022	Requires additional mainline capacity on NWPL or GTN to get to service territory
Large Scale LNG	Varies	Commodity less Fuel	2024	Speculative, needs pipeline transport
In Ground Storage	Varies	Varies	Varies	Requires additional mainline transport to get to service territory
Satellite LNG	Varies	\$13M capital cost plus 665k O&M	2022	provides for peaking services and alleviates the need for costly pipeline expansions. \$3,000 per m3 with O&M assumed at 5.4%.

APPENDIX 8.1: DISTRIBUTION SYSTEM MODELING

OVERVIEW

The primary goal of distribution system planning is to design for present needs and to plan for future expansion in order to serve demand growth. This allows Avista to satisfy current demand-serving requirements, while taking steps toward meeting future needs. Distribution system planning identifies potential problems and areas of the distribution system that require reinforcement. By knowing when and where pressure problems may occur, the necessary reinforcements can be incorporated into normal maintenance. Thus, more costly reactive and emergency solutions can be avoided.

COMPUTER MODELING

When designing new main extensions, computer modeling can help determine the optimum size facilities for present and future needs. Undersized facilities are costly to replace, and oversized facilities incur unnecessary expenses to Avista and its customers.

THEORY AND APPLICATION OF STUDY

Natural gas network load studies have evolved in the last decade to become a highly technical and useful means of analyzing the operation of a distribution system. Using a pipeline fluid flow formula, a specified parameter of each pipe element can be simultaneously solved. Through years of research, pipeline equations have been refined to the point where solutions obtained closely represent actual system behavior.

Avista conducts network load studies using GL Noble Denton's Synergi® 4.8.0 software. This computer-based modeling tool runs on a Windows operating system and allows users to analyze and interpret solutions graphically.

CREATING A MODEL

To properly study the distribution system, all natural gas main information is entered (length, pipe roughness and size) into the model. "Main" refers to all pipelines supplying services. Nodes are placed at all pipe intersections, beginnings and ends of mains, changes in pipe diameter/material, and to identify all large customers. A model element connects two nodes together. Therefore, a "to node" and a "from node" will represent an element between those two nodes. Almost all of the elements in a model are pipes.

Regulators are treated like adjustable valves in which the downstream pressure is set to a known value. Although specific regulator types can be entered for realistic behavior, the expected flow passing through the actual regulator is determined and the modeled regulator is forced to accommodate such flows.

FLUID MECHANICS OF THE MODEL

Pipe flow equations are used to determine the relationships between flow, pressure drop, diameter and pipe length. For all models, the Fundamental Flow equation (FM) is used due to its demonstrated reliability.

Efficiency factors are used to account for the equivalent resistance of valves, fittings and angle changes within the distribution system. Starting with a 95 percent factor, the efficiency can be changed to fine tune the model to match field results.

Pipe roughness, along with flow conditions, creates a friction factor for all pipes within a system. Thus, each pipe may have a unique friction factor, minimizing computational errors associated with generalized friction values.

LOAD DATA

All studies are considered steady state; all natural gas entering the distribution system must equal the natural gas exiting the distribution system at any given time.

Customer loads are obtained from Avista's customer billing system and converted to an algebraic format so loads can be generated for various conditions. Customer Management Module (CMM), an add-on application for Synergi, processes customer usage history and generates a base load (non-temperature dependent) and heat load (varying with temperature) for each customer.

In the event of a peak day or an extremely cold weather condition, it is assumed that all curtailable loads are interrupted. Therefore, the models will be conducted with only core loads.

DETERMINING NATURAL GAS CUSTOMERS' MAXIMUM HOURLY USAGE

DETERMINING DESIGN PEAK HOURLY LOAD

The design peak hourly load for a customer is estimated by adding the hourly base load and the hourly heat load for a design temperature. This estimate reflects highest system hourly demands, as shown in Table 1:

Table 1 - Determining Peak* Hourly Load			
Peak Hourly Base Load	+	Peak Hourly Heat Load	= Peak Hourly Load

This method differs from the approach that is used for IRP peak day load planning. The primary reason for this difference is due to the importance of responding to hourly peaking in the distribution system, while IRP resource planning focuses on peak day requirements to the city gate.

APPLYING LOADS

Having estimated the peak loads for all customers in a particular service area, the model can be loaded. The first step is to assign each load to the respective node or element.

GENERATING LOADS

Temperature-based and non-temperature-based loads are established for each node or element, thus loads can be varied based on any temperature (HDD). Such a tool is necessary to evaluate the difference in flow and pressure due to different weather conditions.

GEOGRAPHIC INFORMATION SYSTEM (GIS)

Several years ago Avista converted the natural gas facility maps to GIS. While the GIS can provide a variety of map products, the true power lies in the analytical capabilities. A GIS consists of three components: spatial operations, data association and map representation.

A GIS allows analysts to conduct spatial operations (relating a feature or facility to another geographically). A spatial operation is possible if a facility displayed on a map maintains a relationship to other facilities. Spatial relationships allow analysts to perform a multitude of queries, including:

- Identify electric customers adjacent to natural gas mains who are not currently using natural gas
- Display the number of customers assigned to particular pipes in Emergency Operating Procedure zones (geographical areas defined to aid in the safe isolation in the event of an emergency)
- Classify high-pressure pipeline proximity criteria

The second component of the GIS is data association. This allows analysts to model relationships between facilities displayed on a map to tabular information in a database. Databases store facility information, such as pipe size, pipe material, pressure rating, or related information (e.g., customer databases, equipment databases and work management systems). Data association allows interactive queries within a map-like environment.

Finally, the GIS provides a means to create maps of existing facilities in different scales, projections and displays. In addition, the results of a comparative or spatial analysis can be presented pictorially. This allows users to present complex analyses rapidly and in an easy-to-understand method.

BUILDING SYNERGI® MODELS FROM A GIS

The GIS can provide additional benefits through the ease of creation and maintenance of load studies. Avista can create load studies from the GIS based on tabular data (attributes) installed during the mapping process.

MAINTENANCE USING A GIS

The GIS helps maintain the existing distribution facility by allowing a design to be initiated on a GIS. Currently, design jobs for the company's natural gas system are managed through Avista's Maximo tool. Once jobs are completed, the as-built information is automatically updated on GIS, eliminating the need to convert physical maps to a GIS at a later date. Because the facility is updated, load studies can remain current by refreshing the analysis.

DEVELOPING A PRESENT CASE LOAD STUDY

In order for any model to have accuracy, a present case model has to be developed that reflects what the system was doing when downstream pressures and flows are known. To establish the present case, pressure recording instruments located throughout the distribution system are used.

These field instruments record pressure and temperature throughout the winter season. Various locations recording simultaneously are used to validate the model. Customer loads on Synergi® are generated to correspond with actual temperatures recorded on the instruments. An accurate model's downstream pressures will match the corresponding field instrument's pressures. Efficiency factors are adjusted to further refine the model's pressures and better match the actual conditions.

Since telemetry at the gate stations record hourly flow, temperature and pressure, these values are used to validate the model. All loads are representative of the average daily temperature and are defined as hourly flows. If the load generating method is truly accurate, all natural gas entering the actual system (physical) equals total natural gas demand solved by the simulated system (model).

DEVELOPING A PEAK CASE LOAD STUDY

Using the calculated peak loads, a model can be analyzed to identify the behavior during a peak day. The efficiency factors established in the present case are used throughout subsequent models.

ANALYZING RESULTS

After a model has been balanced, several features within the Synergi® model are used to interpret results. Color plots are generated to depict flow direction, pressure, and pipe diameter with specific break points. Reinforcements can be identified by visual inspection. When user edits are completed and the model is re-balanced, pressure changes can be visually displayed, helping identify optimum reinforcements.

PLANNING CRITERIA

In most instances, models resulting in node pressures below 15 psig indicate a likelihood of distribution low pressure, and therefore necessitate reinforcements. For most Avista distribution systems, a minimum of 15 psig will ensure deliverability as natural gas exits the distribution mains and travels through service pipelines to a customer's meter. Some Avista distribution areas operate at lower pressures and are assigned a minimum pressure of 5 psig for model results. Given a lower operating pressure, service pipelines in such areas are sized accordingly to maintain reliability.

DETERMINING MAXIMUM CAPACITY FOR A SYSTEM

Using a peak day model, loads can be prorated at intervals until area pressures drop to 15 psig. At that point, the total amount of natural gas entering the system equals the maximum capacity before new construction is necessary. The difference between natural gas entering the system in this scenario and a peak day model is the maximum additional capacity that can be added to the system.

Since the approximate natural gas usage for the average customer is known, it can be determined how many new customers can be added to the distribution system before necessitating system reinforcements. The above models and procedures are utilized with new construction proposals or pipe reinforcements to determine the potential increase in capacity.

FIVE-YEAR FORECASTING

The intent of the load study forecasting is to predict the system's behavior and reinforcements necessary within the next five years. Various Avista personnel provide information to determine where and why certain areas may experience growth.

By combining information from Avista's demand forecast, IRP planning efforts, regional growth plans and area developments, proposals for pipeline reinforcements and expansions are evaluated with Synergi®.



Appendix 8.2

Oregon Public Utility Commission Order No. 16-109 (the Order) included the following language:

Finally, as part of the IRP-vetting process and subsequent rate proceedings, we expect that Avista conduct and present comprehensive analyses of its system upgrades. Such analyses should provide: (1) a comprehensive cost-benefit analysis of whether and when the investment should be built; (2) evaluation of a range of alternative build dates and the impact on reliability and customer rates; (3) credible evidence on the likelihood of disruptions based on historical experience; (4) evidence on the range of possible reliability incidents; (5) evidence about projected loads and customers in the area; and (6) adequate consideration of alternatives, including the use of interruptibility or increased demand-side measures to improve reliability and system resiliency.

In order to address this portion of the Order, Avista has prepared this appendix, which includes documentation addressing the six points above for each of the natural gas distribution system enhancements included in the 2018 Natural Gas Integrated Resource Plan (IRP) for Avista's Oregon service territory. Each of these three enhancement projects represents a significant, discrete project which is out of the ordinary course of business (that is to say, different from ongoing capital investment to address Federal or State regulatory requirements, relocation of pipe or facilities as requested by others, failed pipe or facilities, etc., all of which occur routinely over time and which are discussed below).

The routine, ongoing capital investments can be loosely classified in the following categories (which are not mutually exclusive):

- Safety – Ongoing safety related capital investment includes the repair or replacement of obsolete or failed pipe and facilities. This category includes, but is not necessarily limited to, investment to address deteriorated or isolated steel pipe, cathodic protection, and the replacement of pipeline which has been built over, as well as the remedy of shallow pipe or the repair or replacement of leaking pipe.
- System Maintenance – Ongoing capital investment related to system maintenance includes replacement of facilities or pipe that has reached the end of their useful lives, as well as other general investment required to maintain Avista's ability to reliably serve customers.
- Relocation Requested by Others – Ongoing capital investment related to relocation requested by others falls primarily into two categories, relocation requested by other parties which is required under the terms of our franchise agreements (such as

relocations required to accommodate road or highway construction or relocation), or relocation requested by customers or others (in which case the customer would be responsible for the cost of the immediate request, but in which case Avista may perform additional work, such as the replacement of a steel service with polyethylene to reduce future maintenance or cathodic protection requirements on that pipe).

- Mandated System Investment – Ongoing capital investment in this category is driven by Federal or State regulatory requirements, such as investment that results from TIMP/DIMP programs, among other programs.

Avista's Aldyl-A replacement program has been addressed in substantial detail in Oregon Public Utility Commission Docket UG-246, Avista/500-501.



2018 Avista Natural Gas IRP

Technical Advisory Committee Meeting
January 25, 2018

Agenda

- Introductions & Logistics
- Safety Moment
- Purpose of IRP and Avista's IRP Process
- System Wide Peak Day
- Avista's Demand Overview and 2016 IRP Revisited
- Economic Outlook and Customer Count Forecast
- Demand Forecast Methodology
- Dynamic Demand Forecasting
- Demand Side Management
- Questions/Wrap Up

Safety Moment



Make it Safe, Make it Personal, Make it Home

2018 IRP Timeline

- **August 31, 2017** – Work Plan filed with WUTC
- **January through May 2018** – Technical Advisory Committee meetings. Meeting topics will include:
 - **TAC 1: Thursday, January 25, 2018:** TAC meeting expectations, review of 2016 IRP acknowledgement letters, customer forecast, and demand-side management (DSM) update.
 - **TAC 2: Thursday, February 22, 2018:** Weather analysis, environmental policies, market dynamics, price forecasts, cost of carbon.
 - **TAC 3: Thursday, March 29, 2018:** Distribution, supply-side resources overview, overview of the major interstate pipelines, RNG overview and future potential resources.
 - **TAC 4: Thursday, May 10, 2018:** DSM results, stochastic modeling and supply-side options, final portfolio results, and 2020 Action Items.
- **June 1, 2018** – Draft of IRP document to TAC
- **June 29, 2018** – Comments on draft due back to Avista
- **July 2018** – TAC final review meeting (if necessary)
- **August 31, 2018** – File finalized IRP document

IRP Calendar

2018

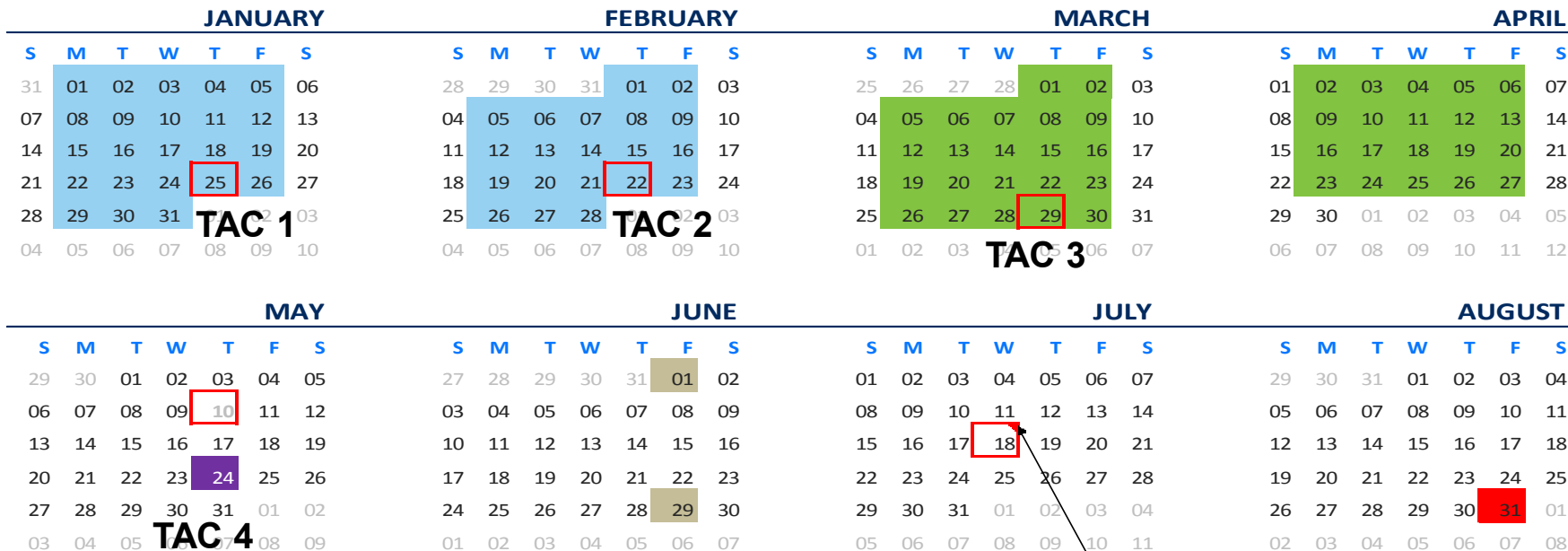

TAC 5 - if necessary

- ETO & AEG DSM Analysis
- 2018 Avista Scenario Analysis
- TAC Meetings
- Draft Sent out/due for TAC Members
- Draft IRP sections due to Tom by COB
- IRP Filing Date in ID, OR, WA

Purpose of Integrated Resource Planning

- Comprehensive long-range resource planning tool
- Fully integrates forecasted demand requirements with potential demand side and supply side resources
- Process determines the least cost, risk adjusted means for meeting demand requirements for our firm residential, commercial and industrial customers
- Responsive to Idaho, Oregon and Washington rules and/or orders

Avista's IRP Process

- Comprehensive analysis bringing demand forecasting and existing and potential supply-side and demand-side resources together into a 20-year, risk adjusted least-cost plan
- Considers:
 - Customer growth and usage
 - Weather planning standard
 - Demand-side management opportunities
 - Existing and potential supply-side resource options
 - Risk
 - Public participation through Technical Advisory Committee meetings (TAC)
 - Distribution upgrades
- 2016 IRP filed in all three jurisdictions on

7

Avista Corp. 2018 Natural Gas IRP Appendix
August 31, 2016 and acknowledged

The Natural Gas System

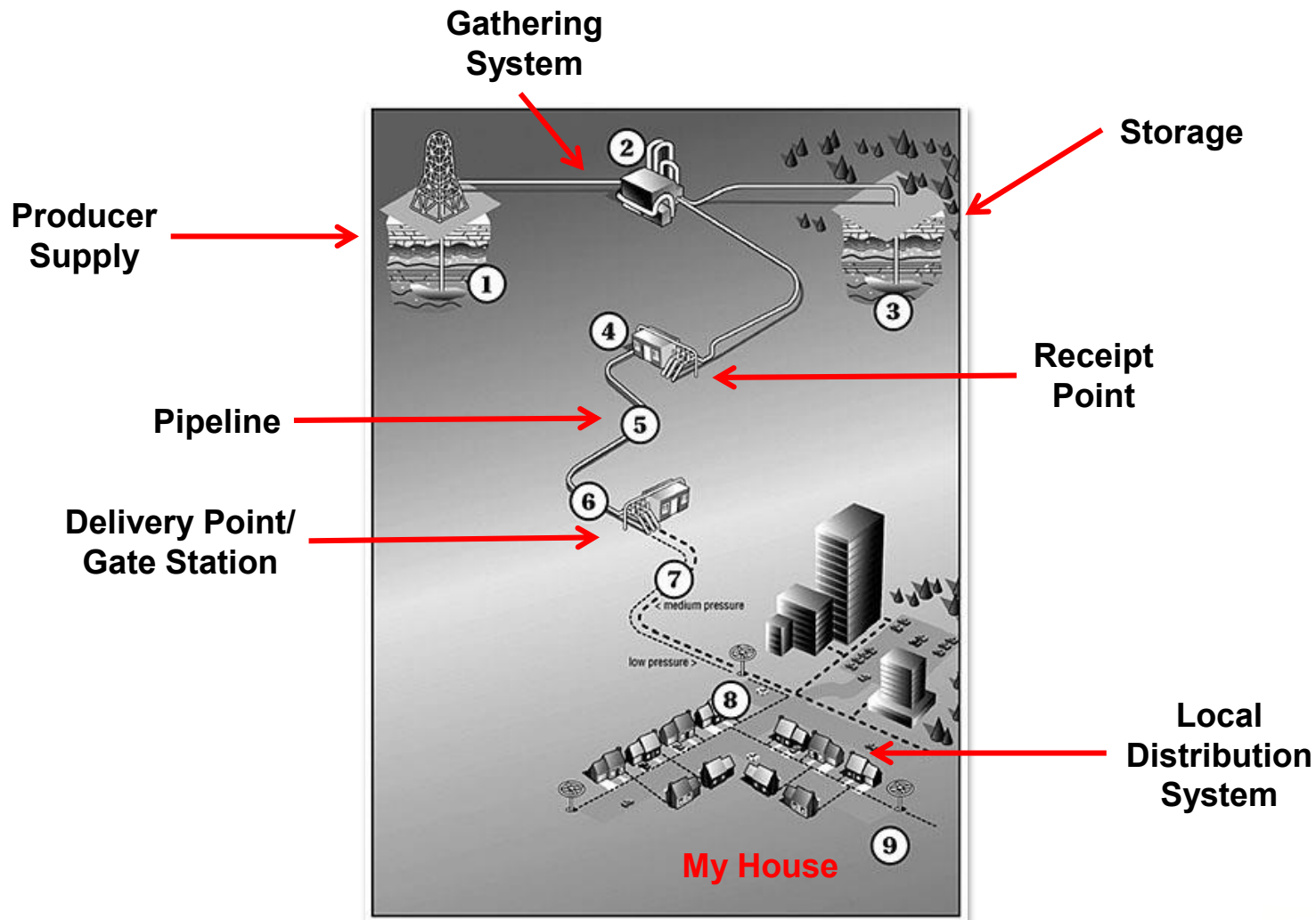



Avista's Demand Overview and 2016 IRP Re-Visited

Tom Pardee
Manager of Natural Gas Planning

Avista's Demand Overview

Service Territory and Customer Overview

- Serves electric and natural gas customers in eastern Washington and northern Idaho, and natural gas customers in southern and eastern Oregon
 - Population of service area 1.5 million
 - ▶ 371,000 electric customers
 - ▶ 348,000 natural gas customers
- Has one of the smallest carbon footprints among America's 100 largest investor-owned utilities
- Committed to environmental stewardship and efficient use of resources



State	Total Customers	% of Total
Washington	163,000	47%
Oregon	102,000	29%
Idaho	83,000	24%
Total	348,000	100%

Avista Corp

2018 Natural Gas IRP Appendix

263 AVISTA

2017 Customer Make Up and Demand Mix

**WA/ID
Customer
Make up**

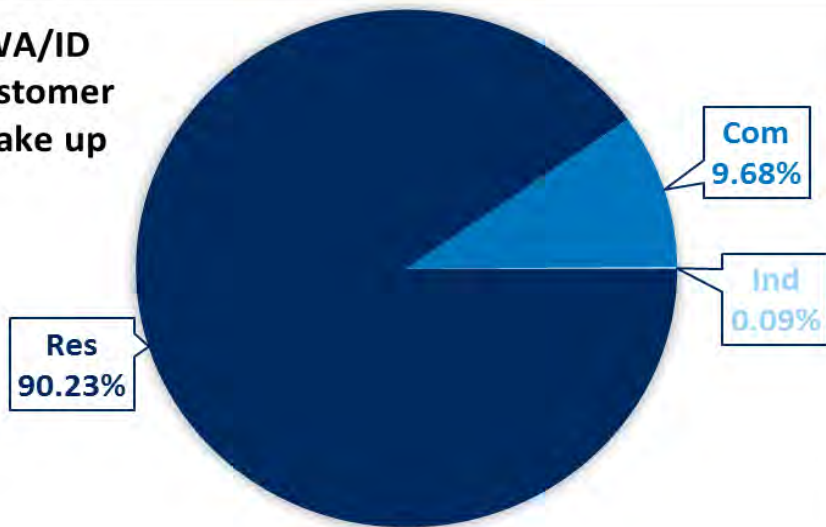

**Oregon
Customer
Make up**

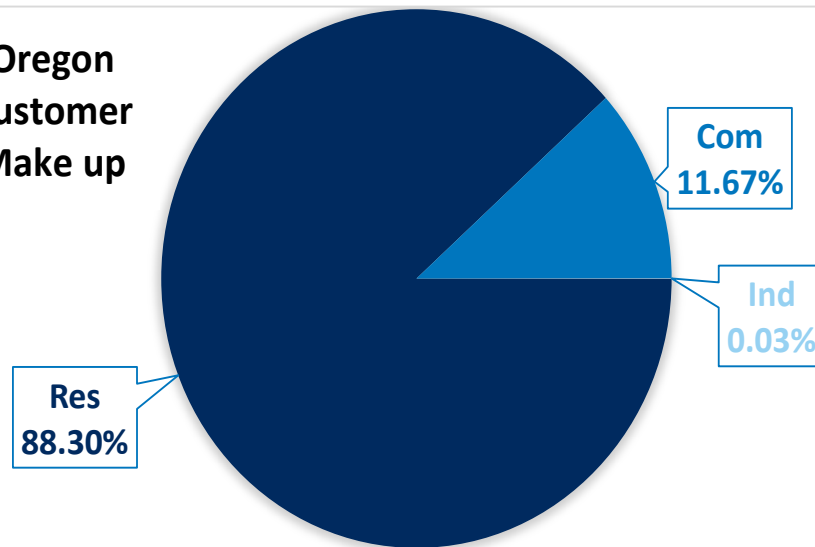

**WA/ID
Customer
Demand**

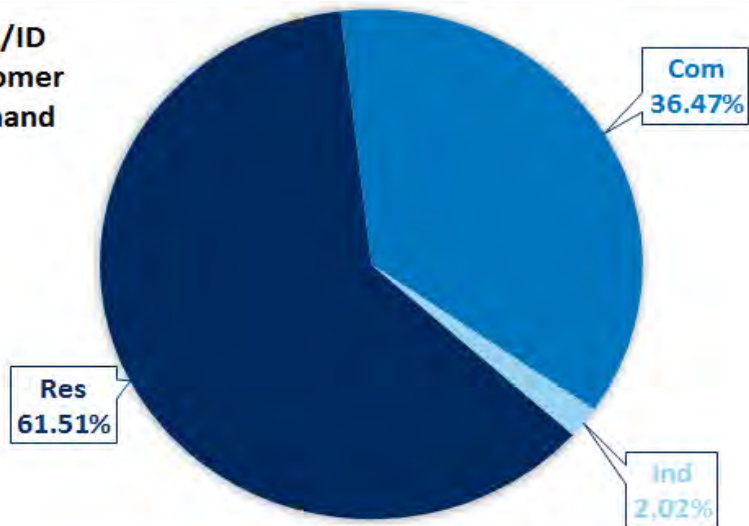

**Oregon
Customer
Demand**

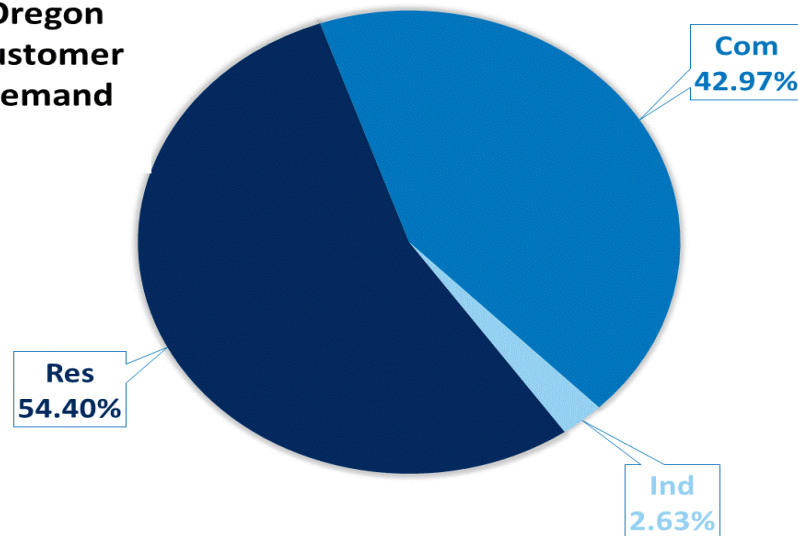

Seasonal Demand Profiles

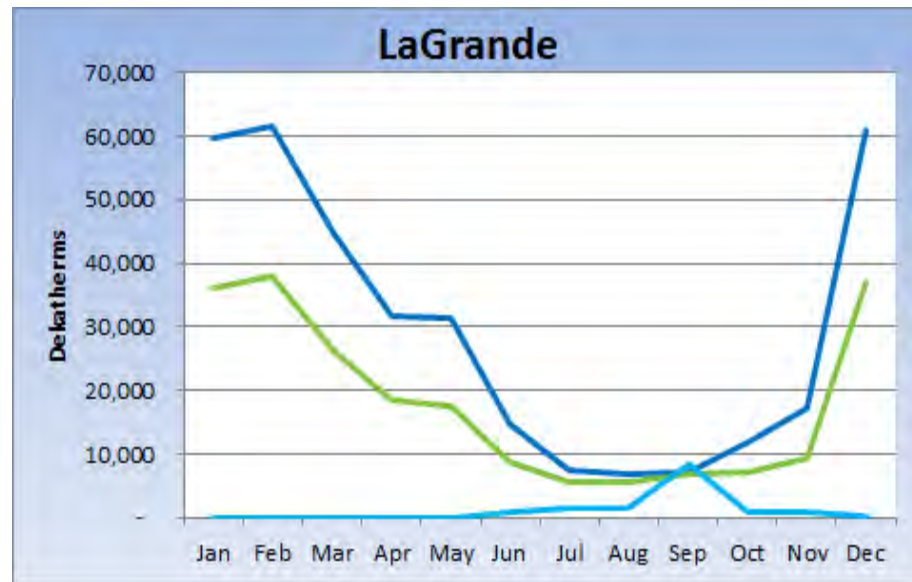
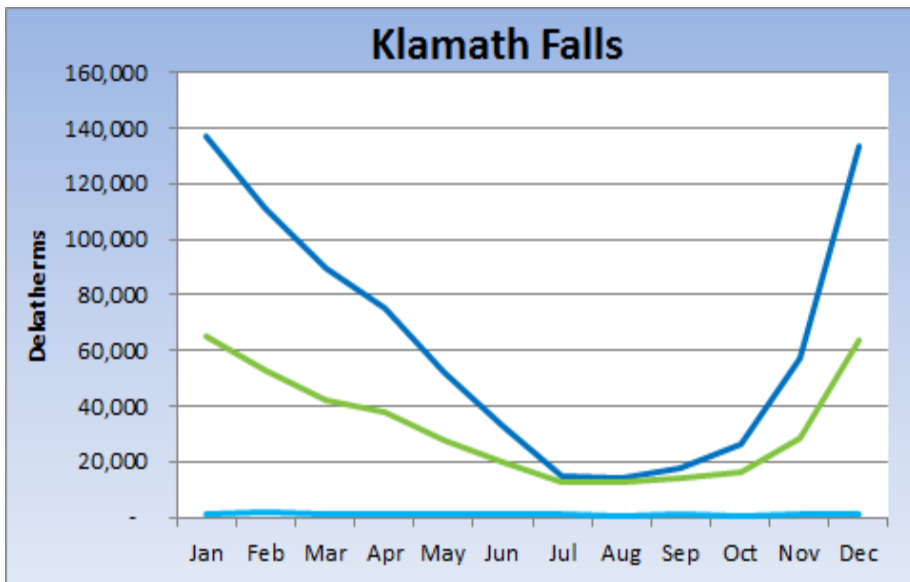
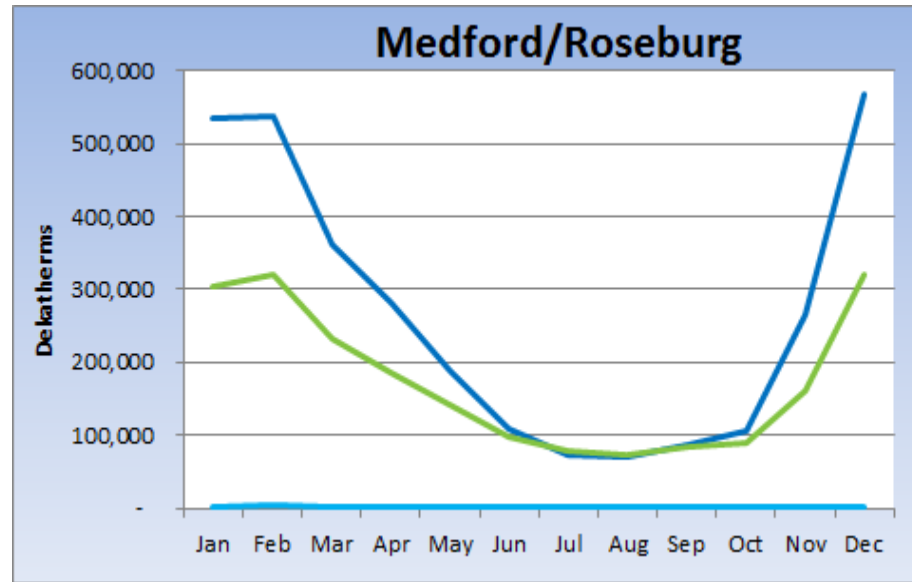
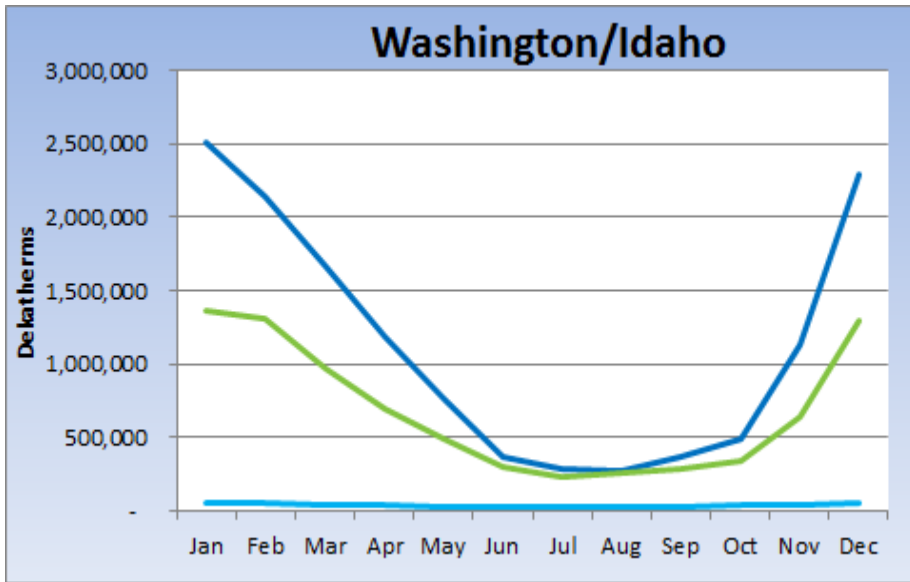

OR Daily Demand Profiles

Medford
Daily Demand

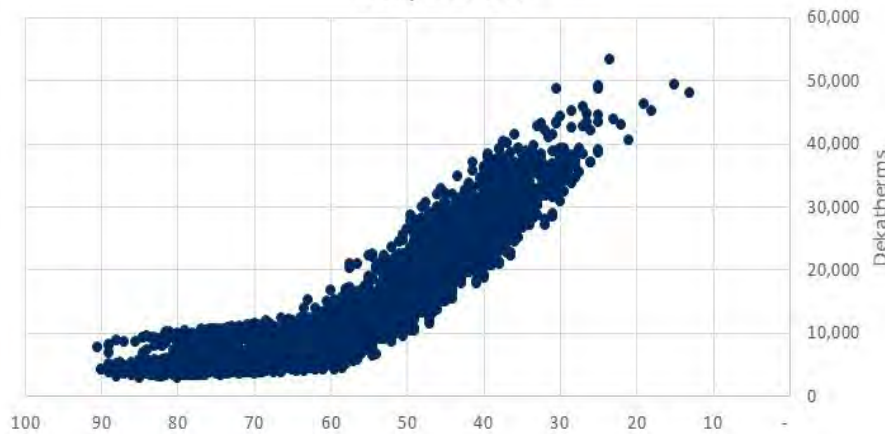

Roseburg
Daily Demand

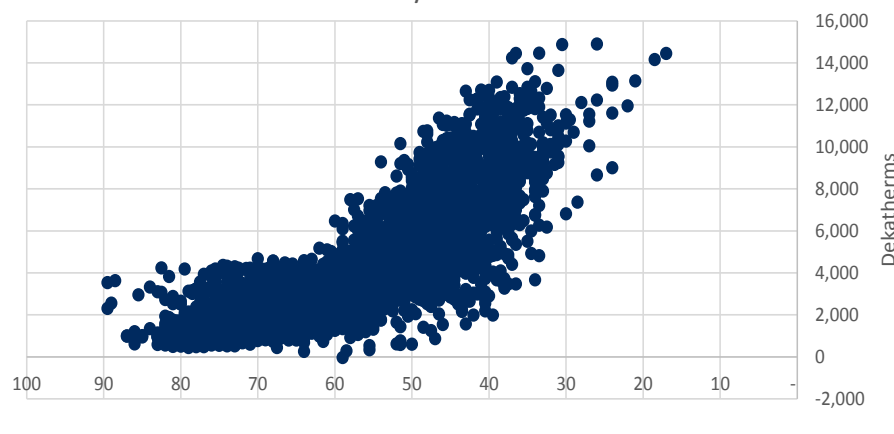

Klamath Falls
Daily Demand

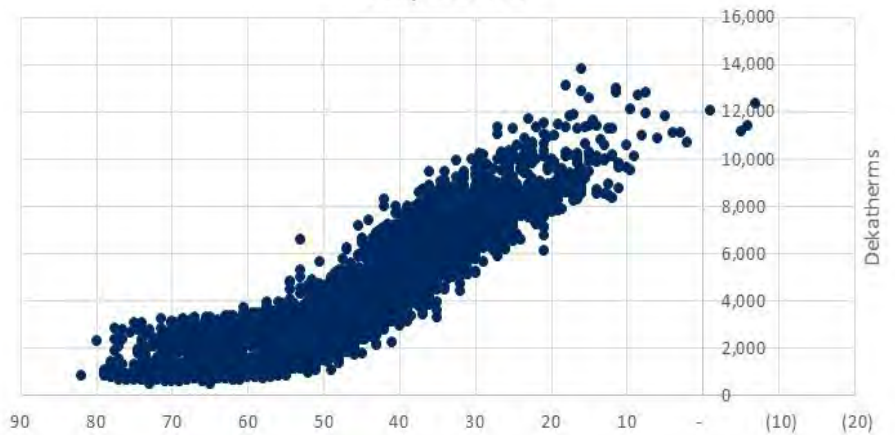

LaGrande
Daily Demand

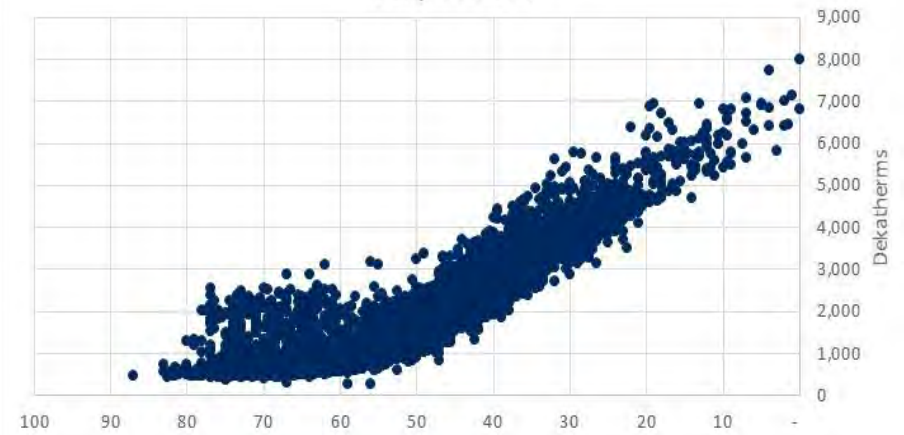

WA-ID Daily Demand Profiles

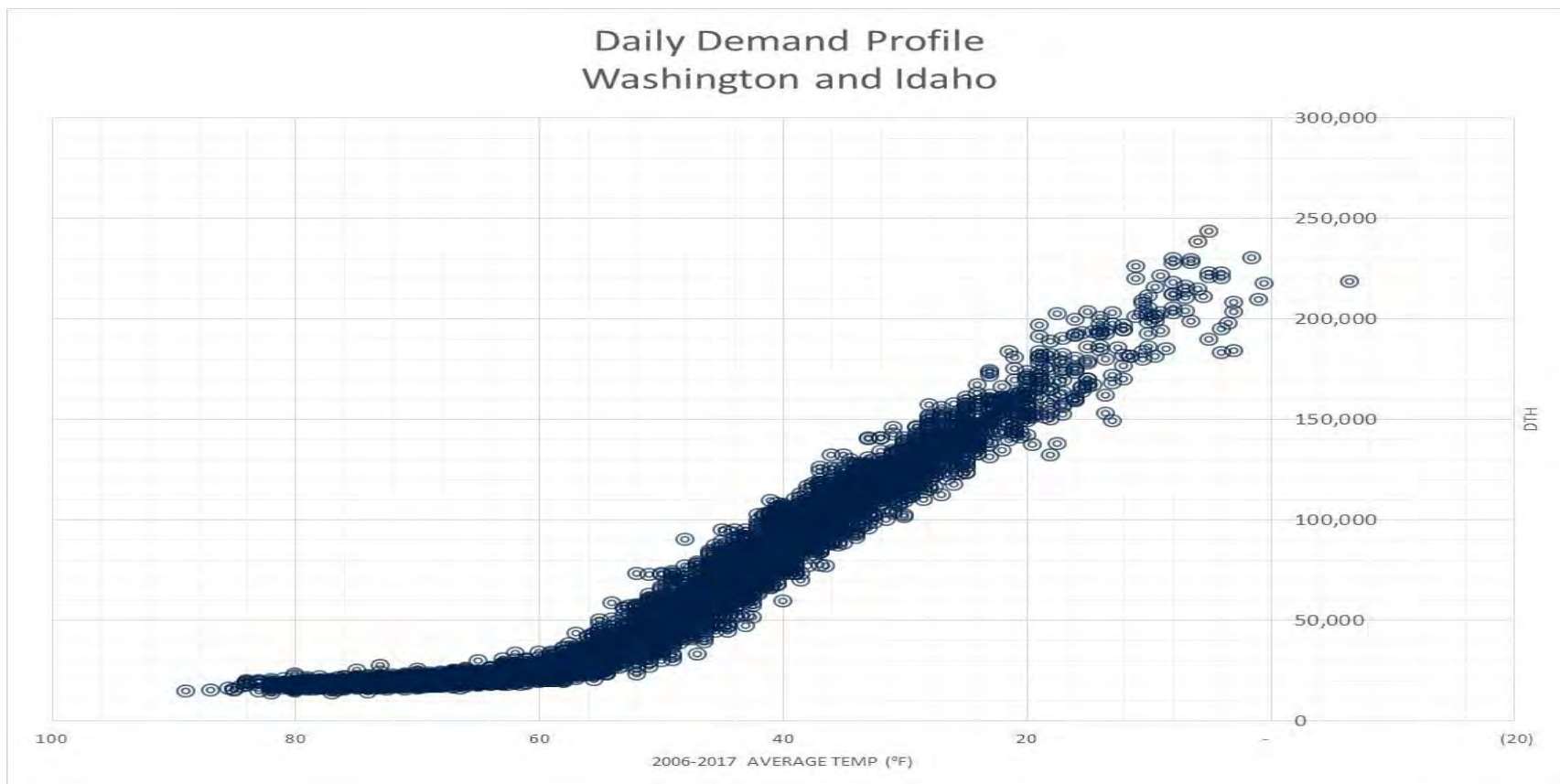

System Wide Peak Day

January 5, 2017

AREA_CODE	Min	Max	Average	HDD
Spokane	-3	14	6	59
La Grande	-9	9	0	65
Klamath Falls	-19	8	-6	71
Medford	14	32	23	42
Roseburg	19	35	27	38

Area	Coldest in 20 Year HDD	Coldest on Record HDD
WA-ID	76	82
Klamath Falls	72	72
La Grande	74	74
Medford	54	61
Roseburg	48	55

System Wide Peak Day – 1/5/2017

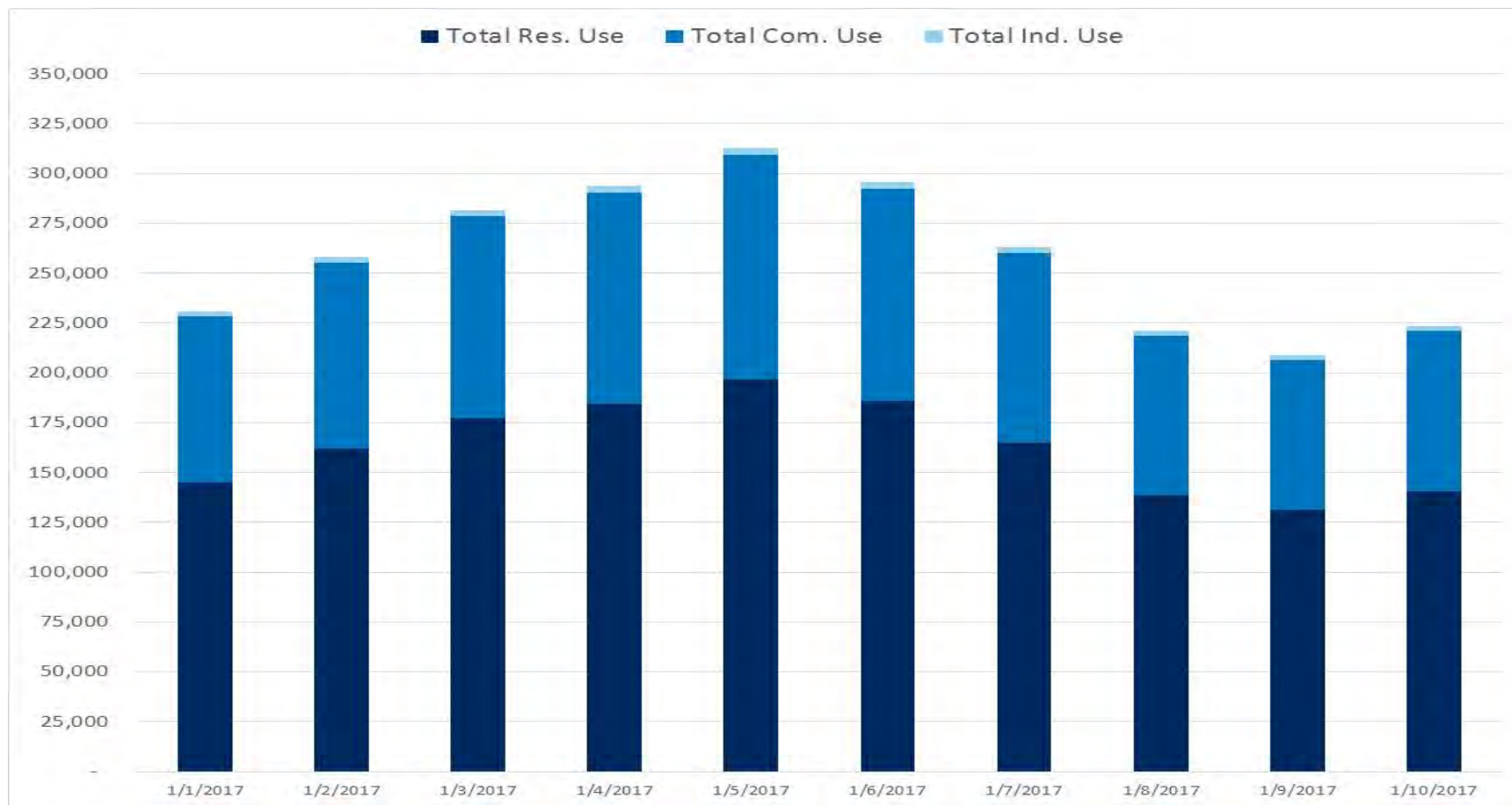

System Wide Peak Day – 1/5/2017 by class

Avista Residential

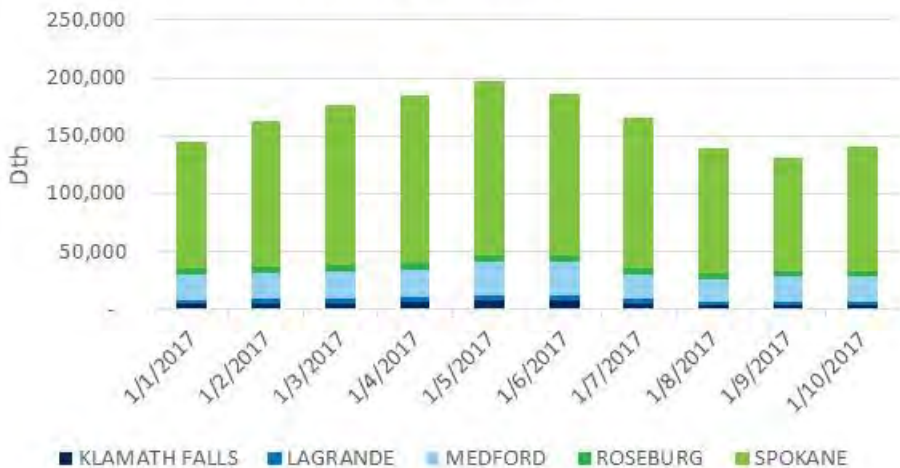

Avista Commercial



Avista Industrial

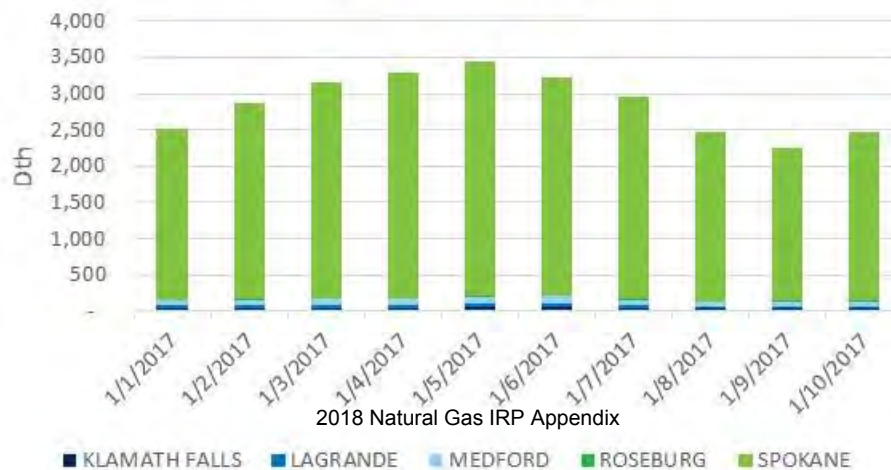

2018 Natural Gas IRP Appendix

Avista's 2016 Natural Gas IRP Re-Visited

Washington/Idaho IRP Forecast vs. Actual (Residential Use per Customer and Customer Count)

Exh. JM-2

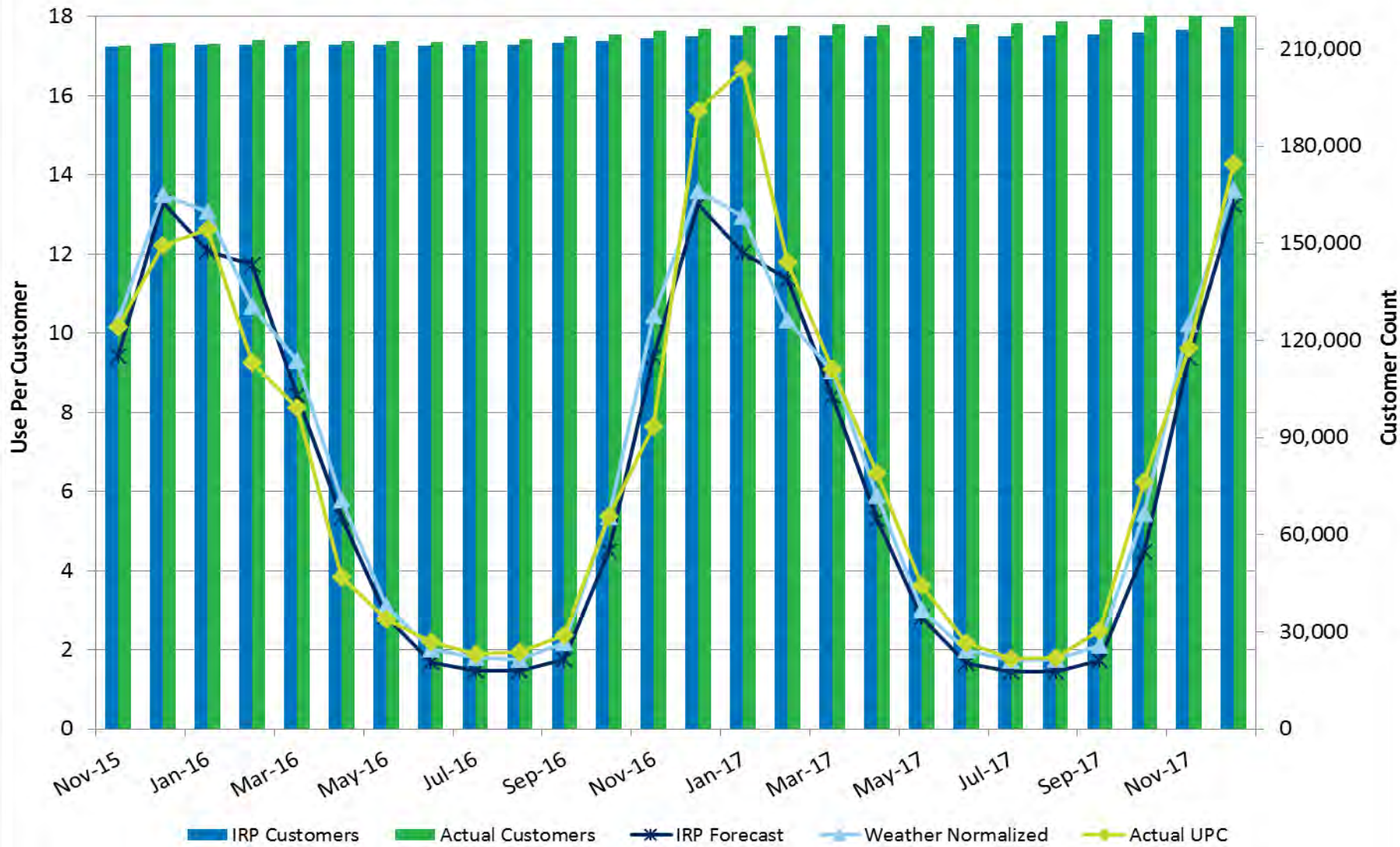

Oregon IRP Forecast vs. Actual

(Residential Use per Customer and Customer Count)

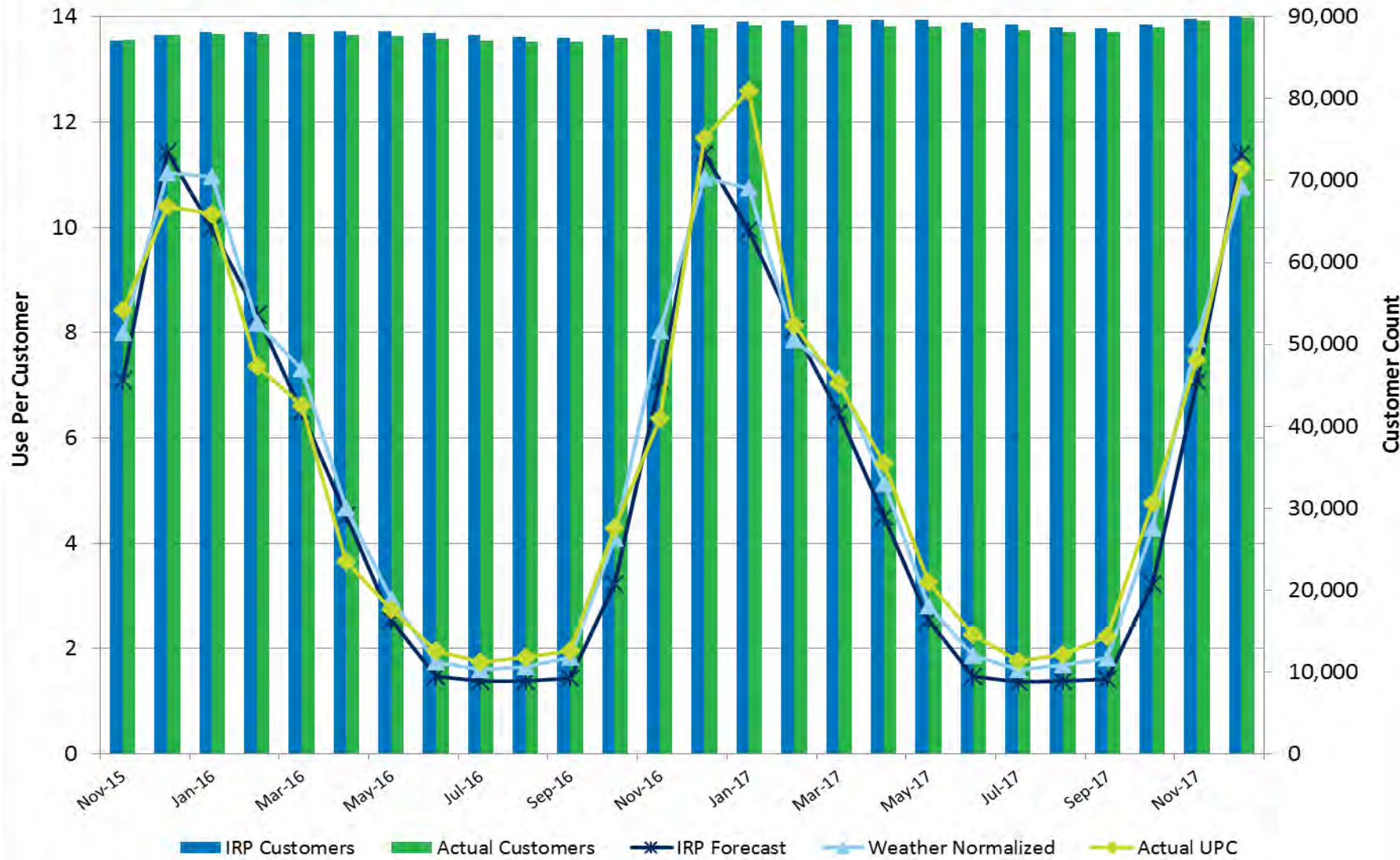

Washington/Idaho IRP Forecast vs. Actual (Commercial Use per Customer and Customer Count)

Exh. JM-2

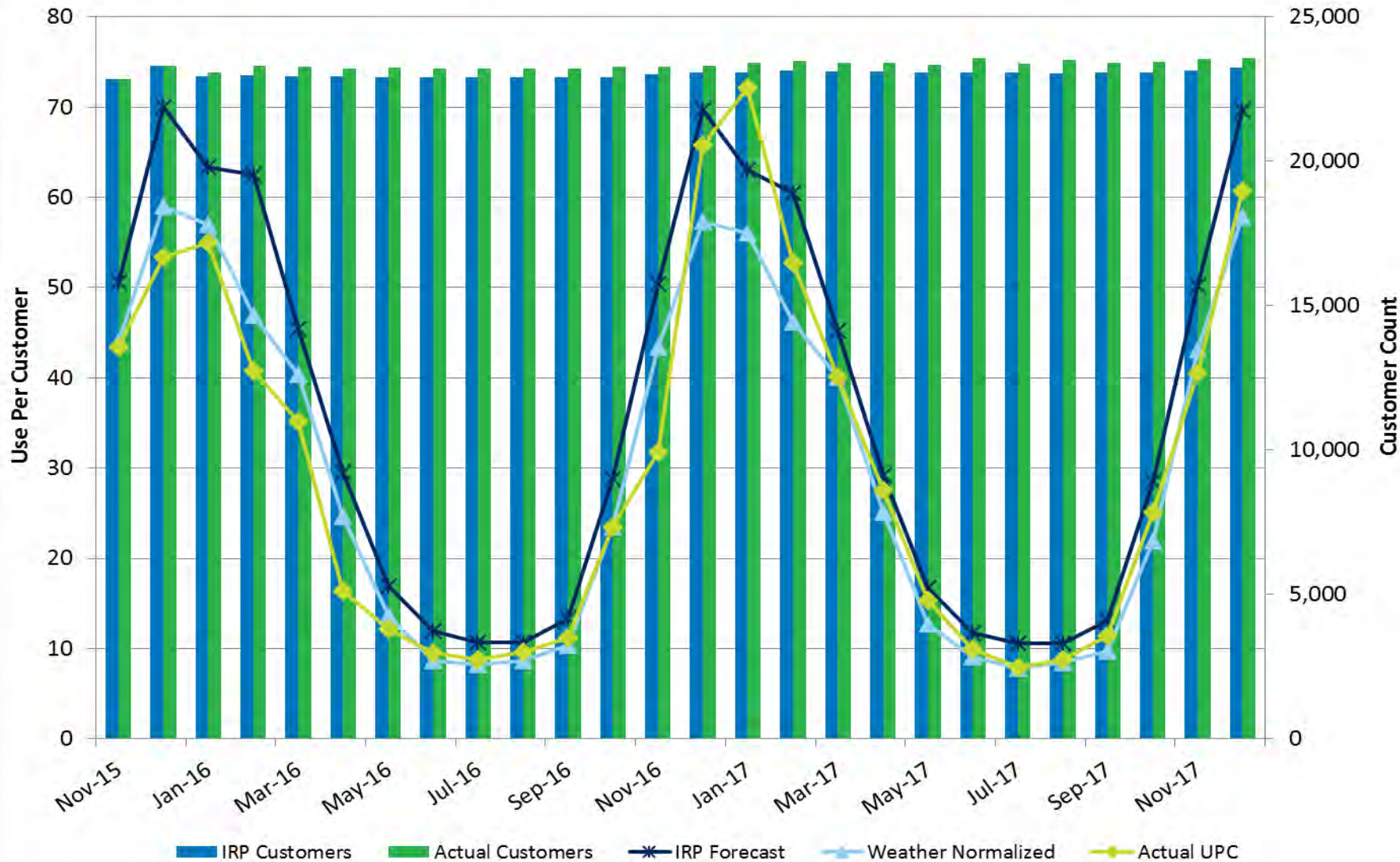

Oregon IRP Forecast vs. Actual

(Commercial Use per Customer and Customer Count)

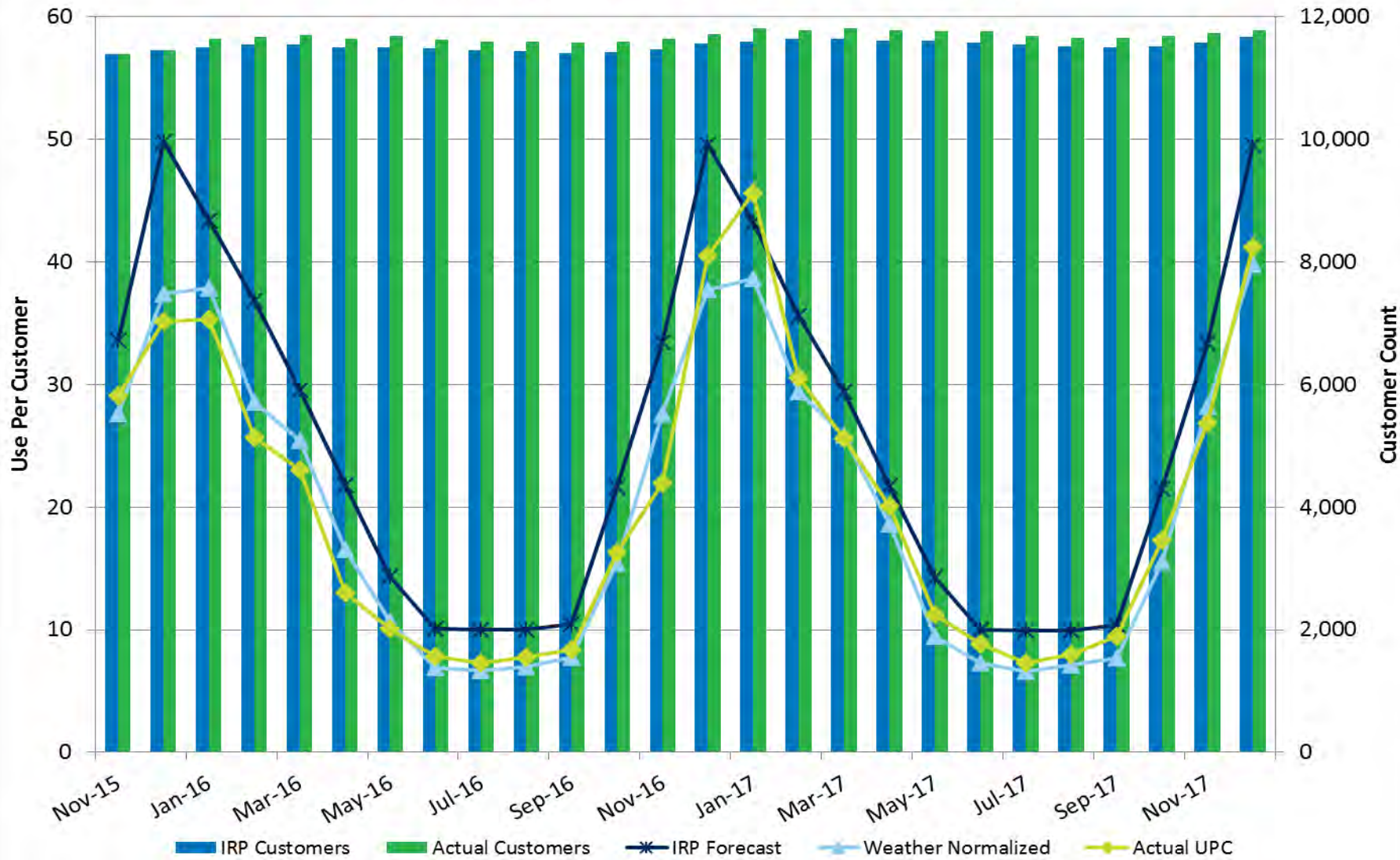

Washington/Idaho IRP Forecast vs. Actual (Industrial Use per Customer and Customer Count)

Exh. JM-2

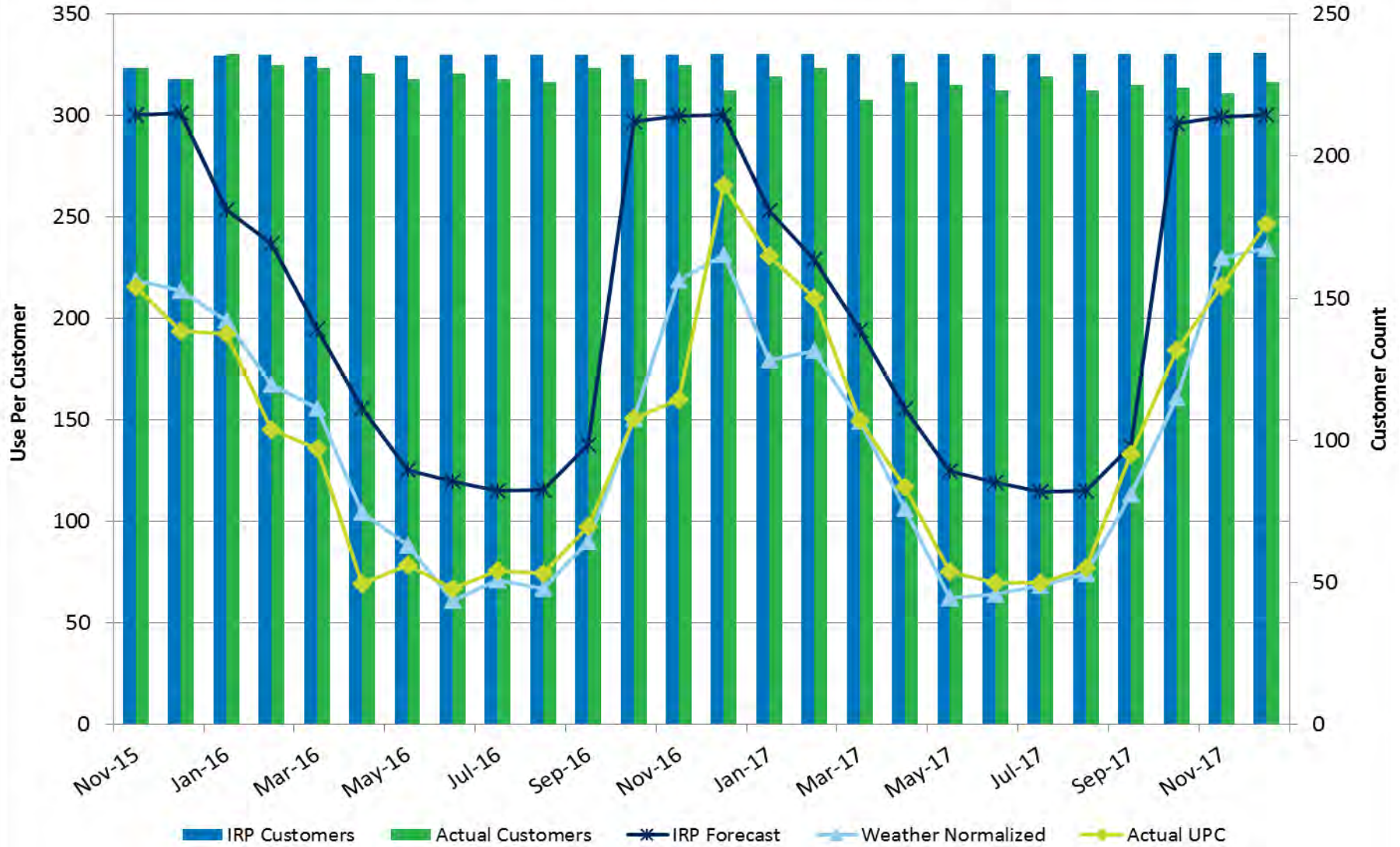

Oregon IRP Forecast vs. Actual (Industrial Use per Customer and Customer Count)

Exh. JM-2

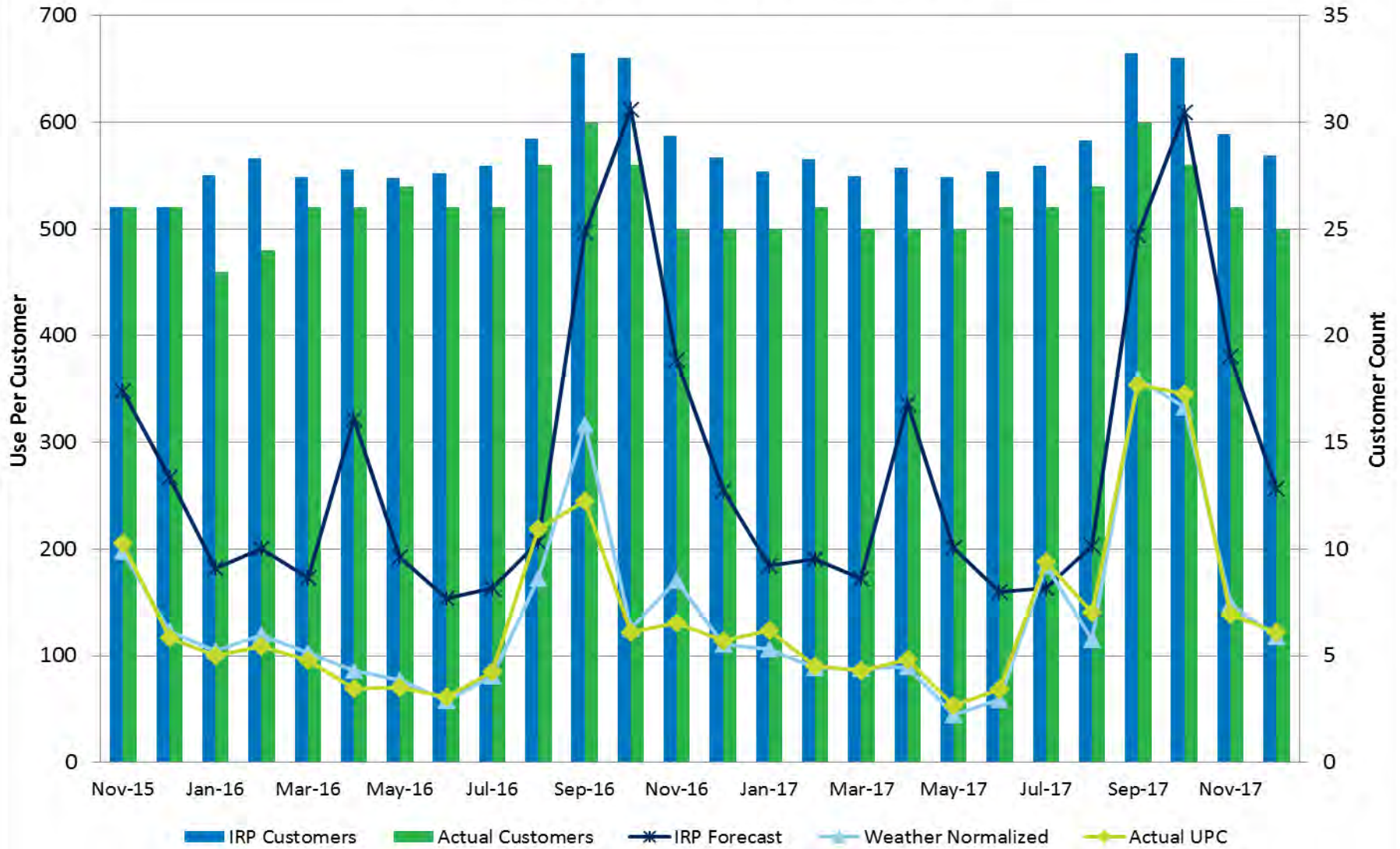

First Year Peak Demand Not Met with Existing Resources Scenario Comparisons

Exh. JM-2

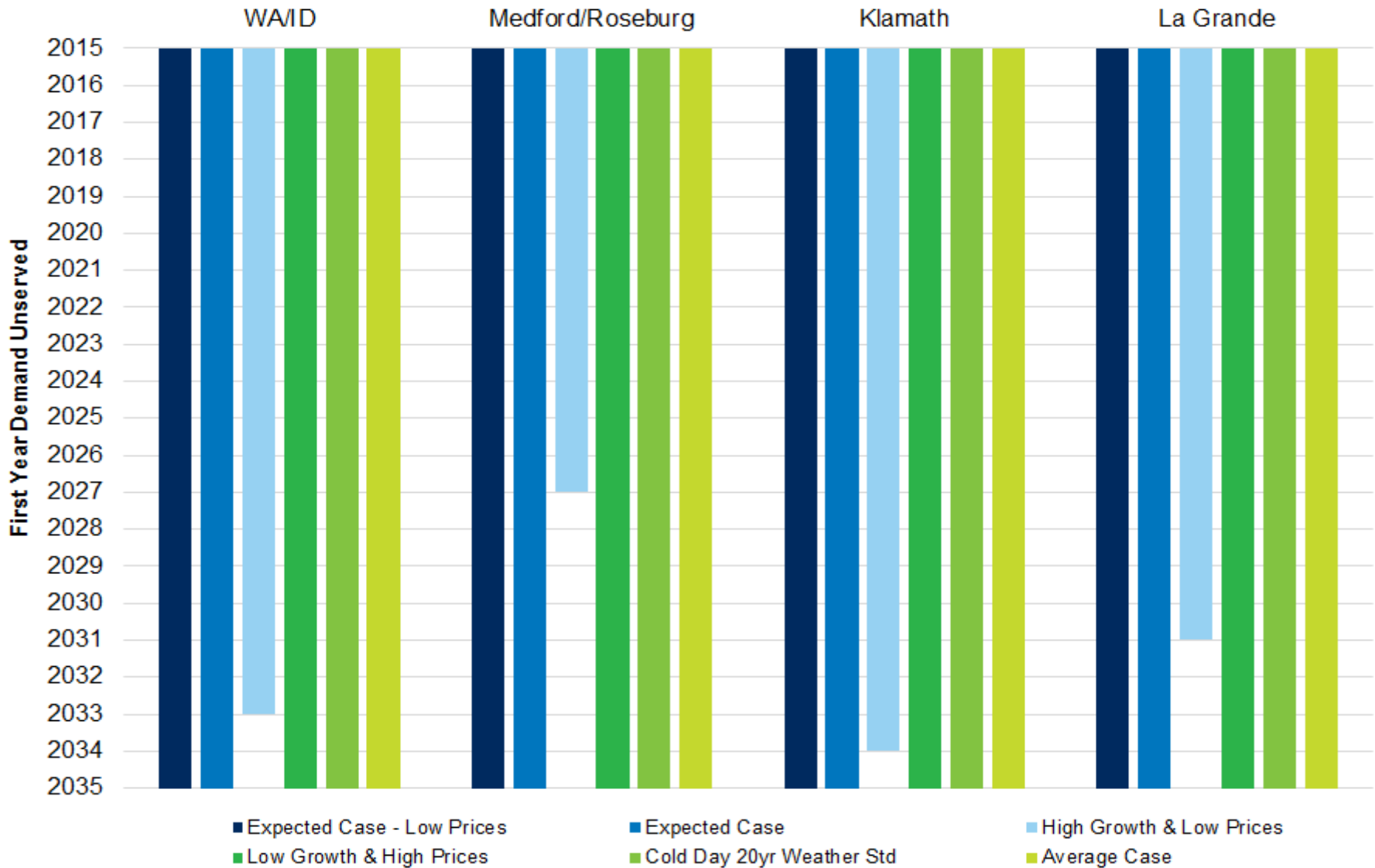

Existing Resources vs. Peak Day Demand

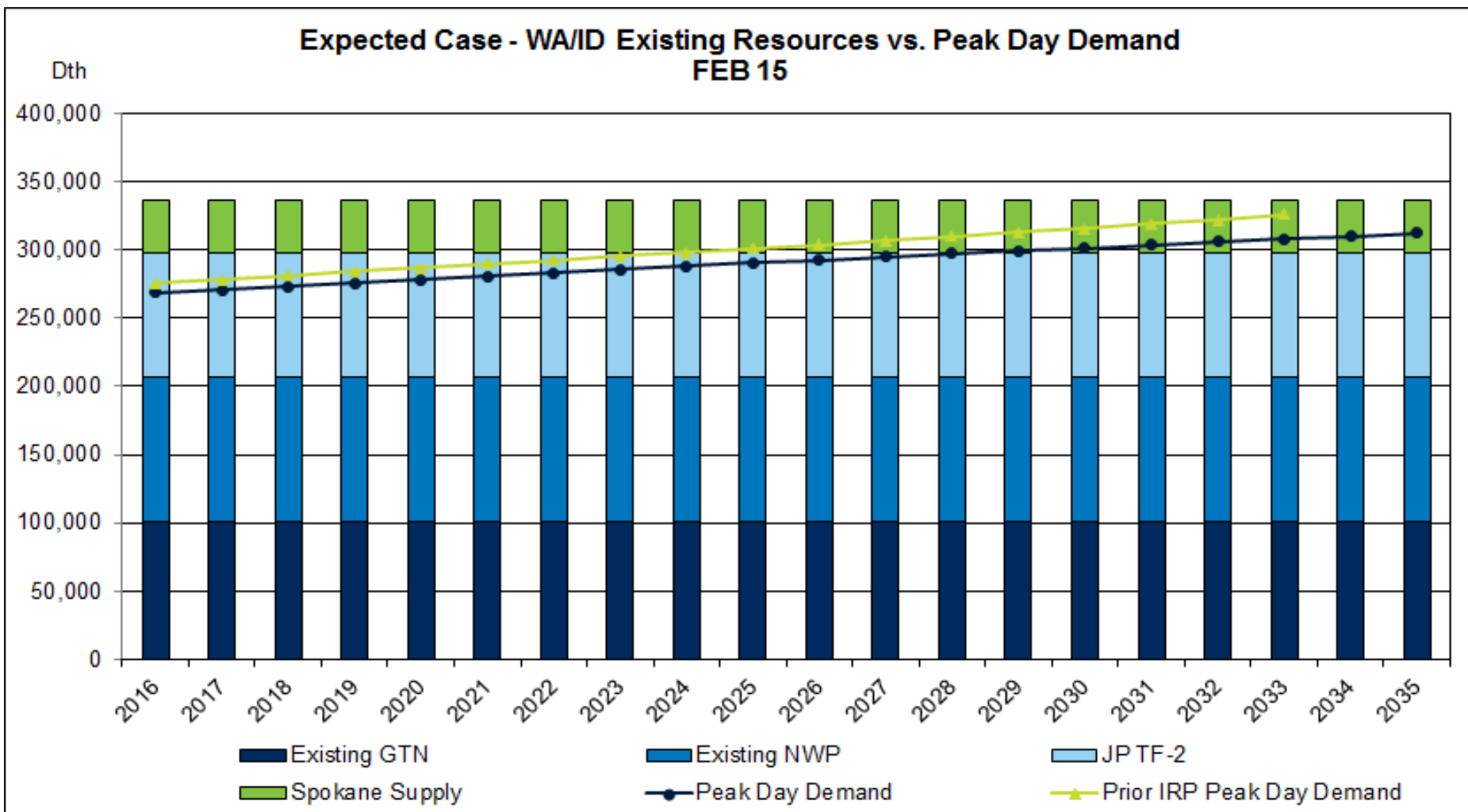

Existing Resources vs. Peak Day Demand

Expected Case – Medford/Roseburg

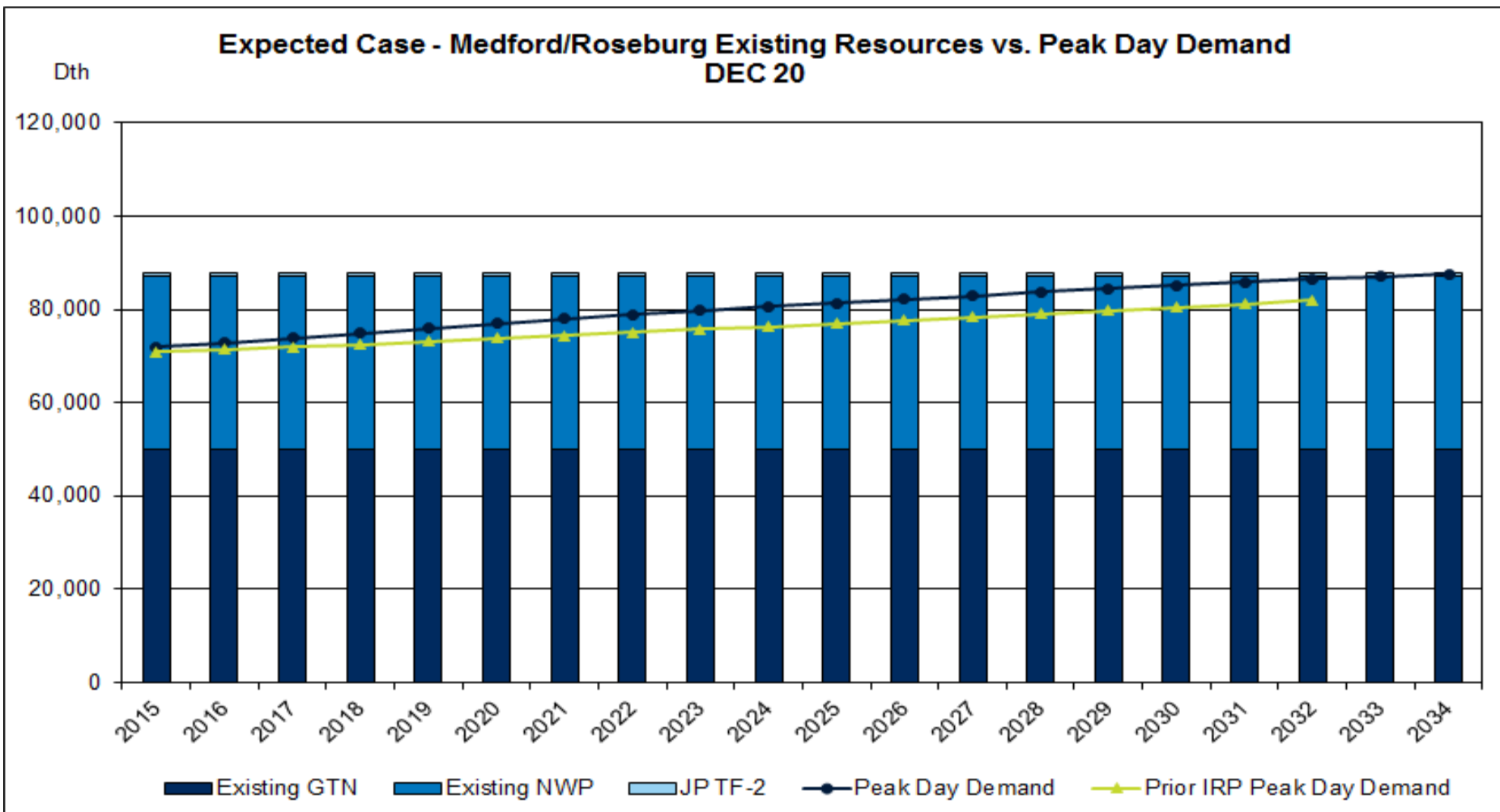

Existing Resources vs. Peak Day Demand

Expected Case – Klamath Falls

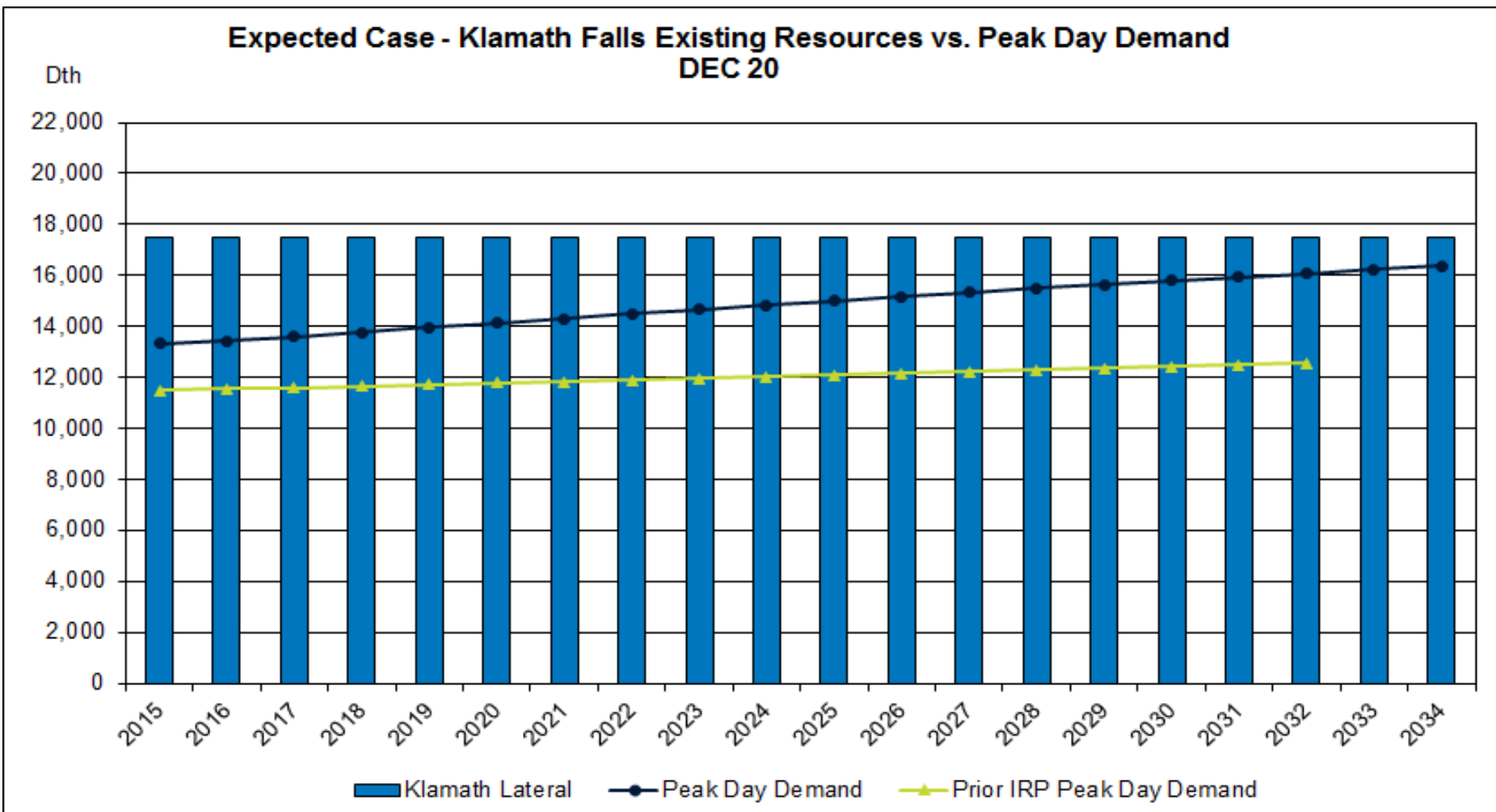

Existing Resources vs. Peak Day Demand

Expected Case – La Grande

Expected Case - La Grande Existing Resources vs. Peak Day Demand
FEB 15

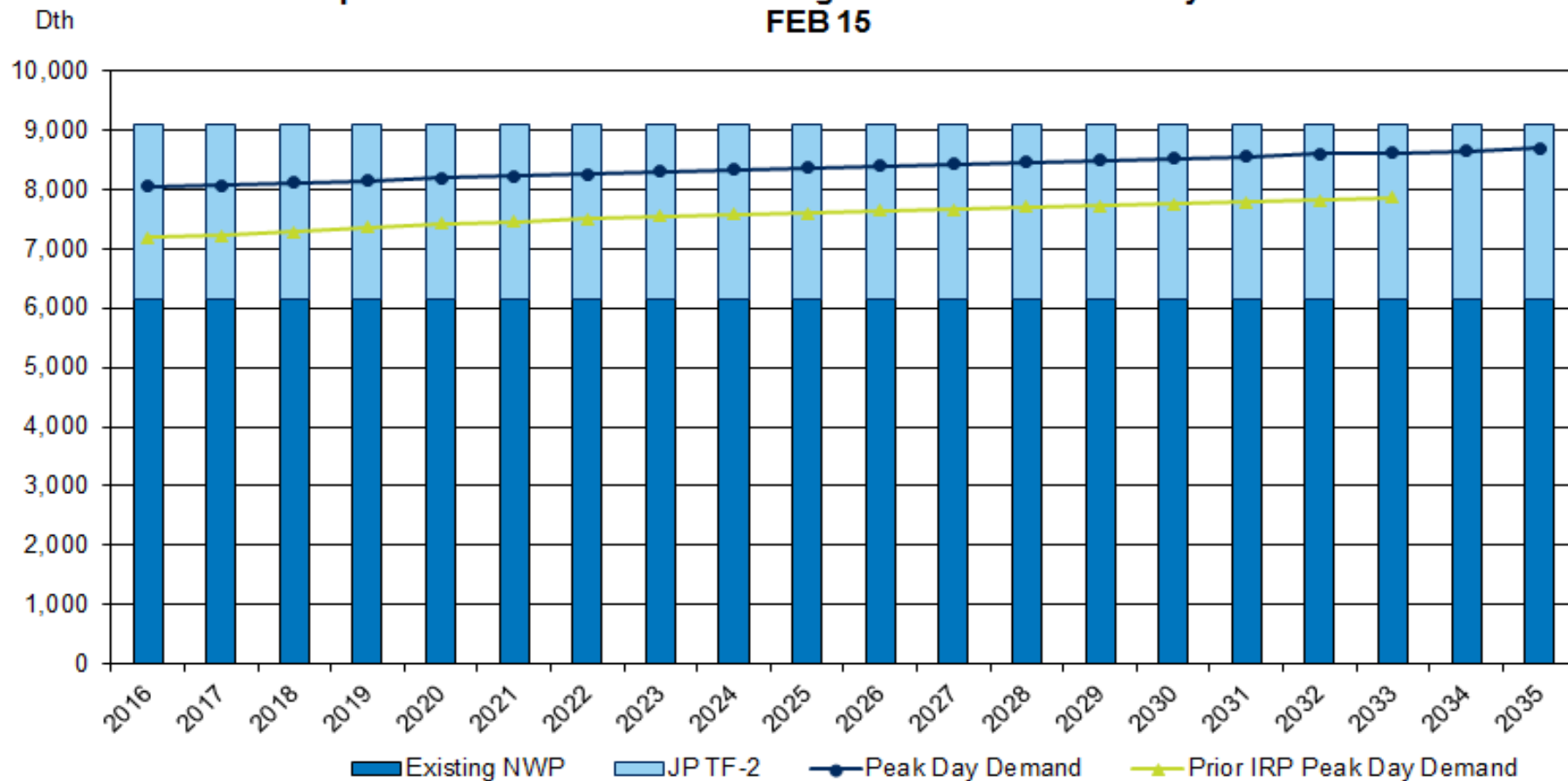

Our Biggest Risk Last IRP

“Flat Demand” Risk

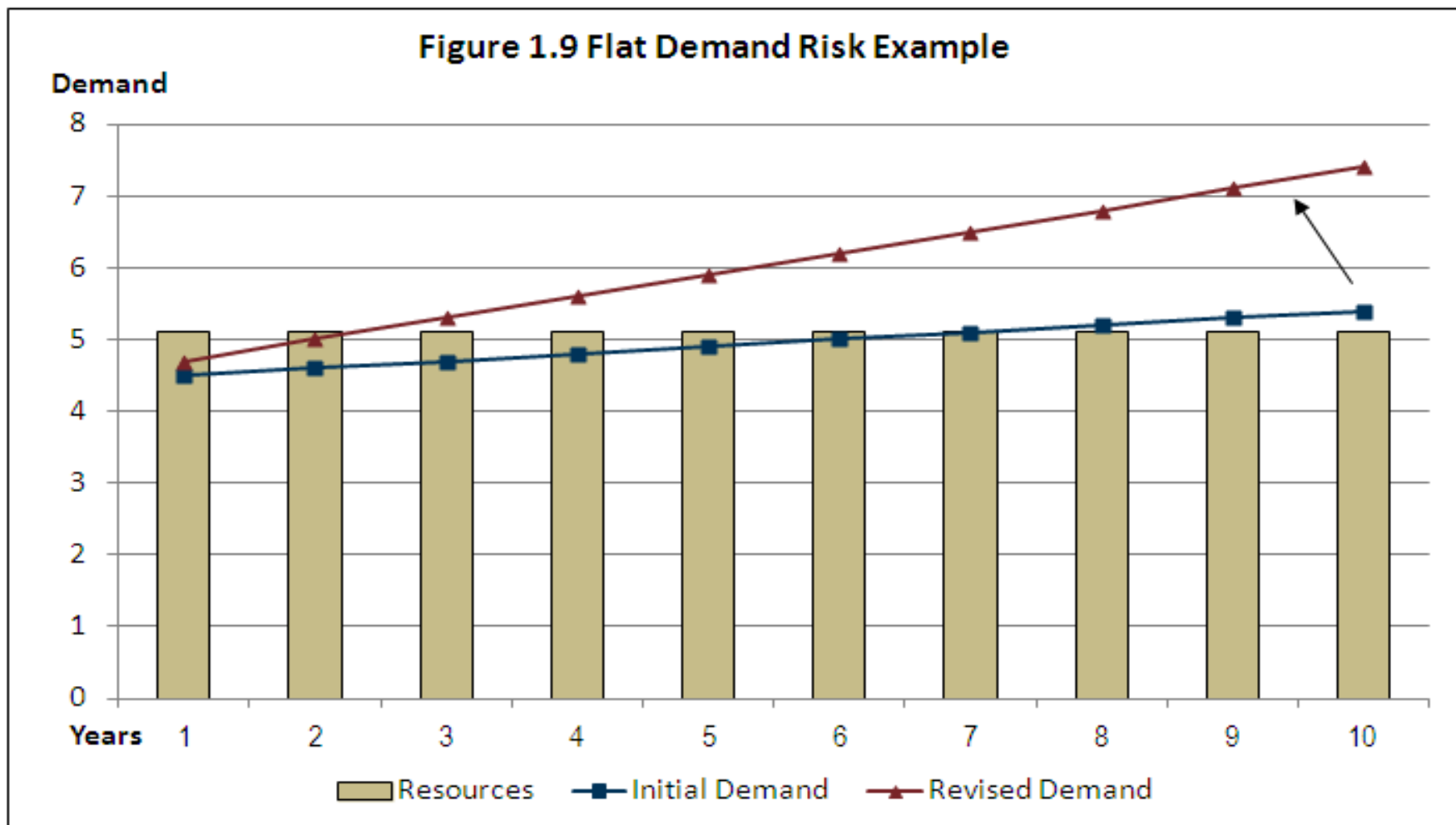



2016 IRP Final Action Items

IPUC

- Staff believes public participation could be further enhanced through “bill stuffers, public flyers, local media, individual invitations, and other methods.”
- **Result: Avista utilized it’s Regional Business Managers in addition to digital communications and newsletters in all states in order to try and gain more public participation. Previous IRP’s relied on website data and word of mouth.**
 - eCommunity newsletter was sent out on January 15, 2018

OPUC

- Staff Recommendation No. 1
 - Staff recommends in Avista's 2018 IRP that Avista pursue an updated methodology, wherein the low/high gas price curves continue to be based on low (high) historic prices in a Monte Carlo setting, but are inflated to match the growth rate (yr/yr) of the expected price curve. The resulting curves would be based on historic prices and also produce symmetric risk profiles throughout the time horizon.
- Staff Recommendation No. 2
 - Staff recommends that Avista forecast its number of customers using at least two different methods and to compare the accuracy of the different methods using actual data as a future task in its next IRP.
 - **Result: Avista analyzed the data, but there was nothing material discovered the come up with a meaningful forecast alternative.**
- Staff Recommendation No. 3
 - Avista's 2018 IRP will contain a dynamic DSM program structure in its analytics.
 - In, prior IRPs, it was a deterministic method based on Expected Case assumptions, in the 2018 IRP, each portion will have the ability to select conservation to meet unserved customer demand, Avista will explore methods to enable a dynamic analytical process for the evaluation of conservation potential within individual portfolios and will work with Energy Trust of Oregon in the development of this process and in producing any final results for its 2018 IRP for Oregon customers.

OPUC cont.

- Staff Recommendation No. 4
 - Staff recommends that Avista provide Staff and stakeholders with updates regarding its discussions and analysis regarding possible regional pipeline projects that may move forward.
- Staff Recommendation No. 5
 - Staff recommends that in its 2018 IRP process Avista work with Staff and stakeholders to establish and complete stochastic analysis that considers a range of alternative portfolios for comparison and consideration of both cost and risk.
- Staff Recommendation No. 6
 - Environmental Considerations
 - 1. Carbon Policy including federal and state regulations, specifically those surrounding the Washington Clean Air Rule and federal Clean Power Plan;
 - 2. Weather analysis specific to Avista's service territories;
 - 3. Stochastic Modeling and supply resources; and
 - 4. Updated DSM methodology including the integration of ETO

WUTC

- Include a section that discusses impacts of the Clean Air Rule (CAR).
 - In its 2018 IRP expected case, Avista should model specific CAR impacts as well as consider the costs and risk of additional environmental regulations, including a possible carbon tax.
- Provide more detail on the company's natural gas hedging strategy, including information on upper and lower pricing points, transactions with counterparties, and how diversification of the portfolio is achieved.
- Ensure that the entity performing the CPA evaluates and includes the following information:
 - All conservation measures excluded from the CPA, including those excluded prior to technical potential determination
 - The rationale for excluding any measure
 - A description of Unit Energy Savings (UES) for each measure included in the CPA, specifying how it was derived and the source of the data
 - The rationale for any difference in economic and achievable potential savings, including how the Company is working towards an achievable target of 85 percent of economic potential savings.
 - A description of all efforts to create a fully-balanced cost effectiveness metric within the planning horizon based on the TRC.

WUTC cont.

- Discuss with the TAC:
 - The results of Northwest Energy Efficiency Alliance (NEEA) coordination, including non-energy benefits to include in the CPA.
 - The appropriateness of listing and mapping all prospective distribution system enhancement projects planned on the 20 year horizon, and comparing actual projects completed to prospective projects listed in previous IRP's.
- Provide a rationale for any difference in economic and achievable potential savings

2017 – 2018 Avista's Action Plan

- The price of natural gas has dropped significantly since the 2014 IRP. This is primarily due to the amount of economically extractable natural gas in shale formations, more efficient drilling techniques, and warmer than normal weather. Wells have been drilled, but left uncompleted due to the poor market economics. This is depressing natural gas prices and forcing many oil and natural gas companies into bankruptcy. Due to historically low prices Avista will research market opportunities including procuring a derivative based contract, 10-year forward strip, and natural gas reserves.
- **Result:** After exploring the opportunity of some type of reserves ownership, it was determined the price as compared to risk of ownership was inappropriate to go forward with at this time. As an ongoing aspect of managing the business, Avista will continue to look for opportunities to help stabilize rates and/or reduce risk to our customers.
- Monitor actual demand for accelerated growth to address resource deficiencies arising from exposure to “flat demand” risk. This will include providing Commission Staff with IRP demand forecast-to-actual variance analysis on customer growth and use-per-customer at least bi-annually.
- **Result:** actual demand was closely tracked and shared with Commissions in semi-annual or quarterly meetings.

Ongoing Activities

- Continue to monitor supply resource trends including the availability and price of natural gas to the region, LNG exports, methanol plants, supply and market dynamics and pipeline and storage infrastructure availability.
- Monitor availability of resource options and assess new resource lead-time requirements relative to resource need to preserve flexibility.
- Meet regularly with Commission Staff to provide information on market activities and significant changes in assumptions and/or status of Avista activities related to the IRP or natural gas procurement practices.
- Appropriate management of existing resources including optimizing underutilized resources to help reduce costs to customers.



Avista Natural Gas Forecasting

Grant D. Forsyth, Ph.D.
Chief Economist
Grant.Forsyth@avistacorp.com

Load Forecasts-Two Step Process

- First, forecast customers (C) by month by schedule (s) by residential (r), commercial (c), industrial (i)—for example, $C_{t,y,s,r}$
- Forecast use per customer (U) by month by schedule by class—for example, $U_{t,y,s,r}$
- Load forecast (L) is the product of the two:

$$L_{t,y,s,r} = C_{t,y,s,r} \times U_{t,y,s,r}$$

For weather sensitive schedules a 20-yr MA defines normal weather.

The Basic Forecast Approach

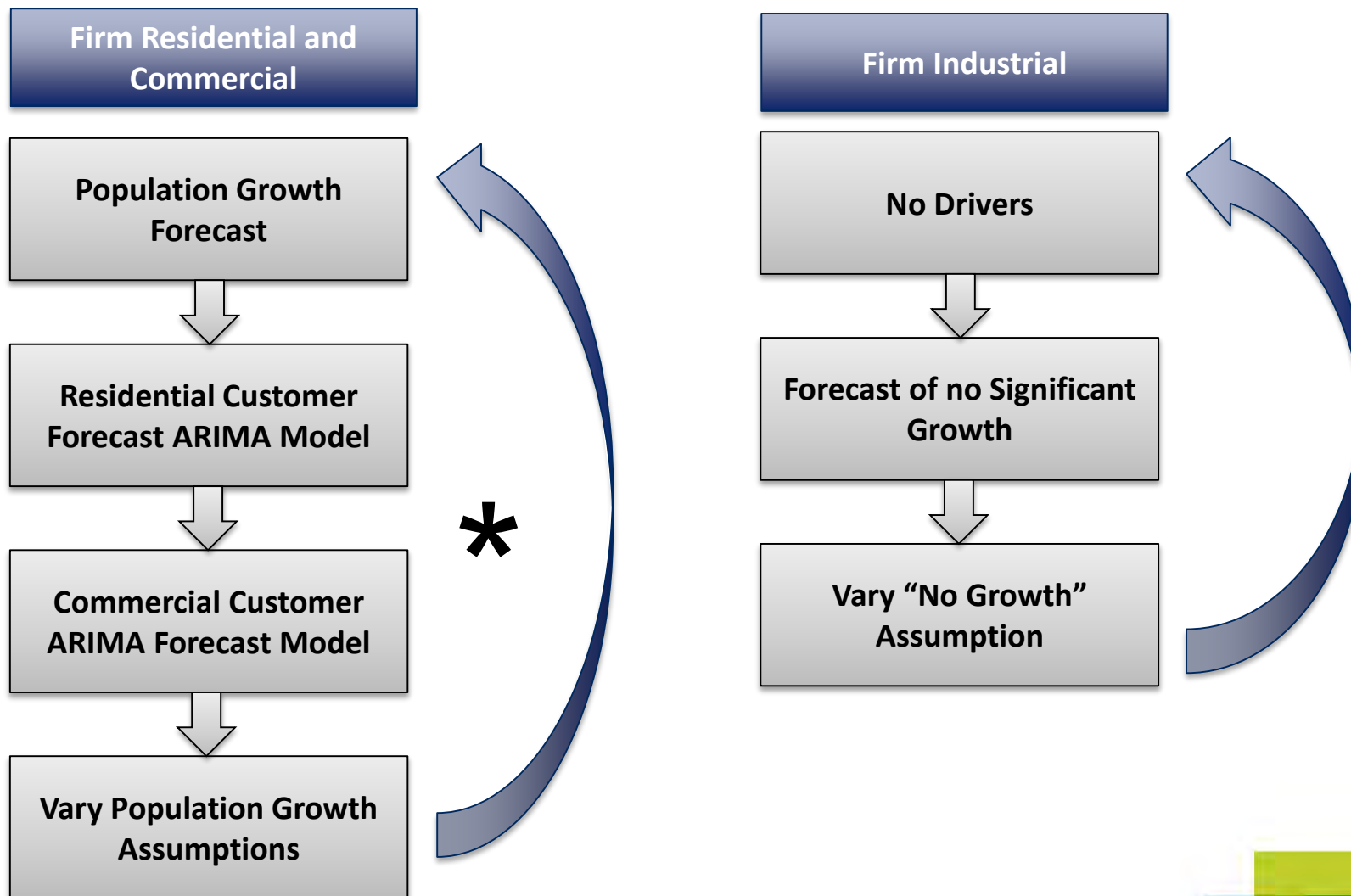

System Industrial Customers, 2004-2017

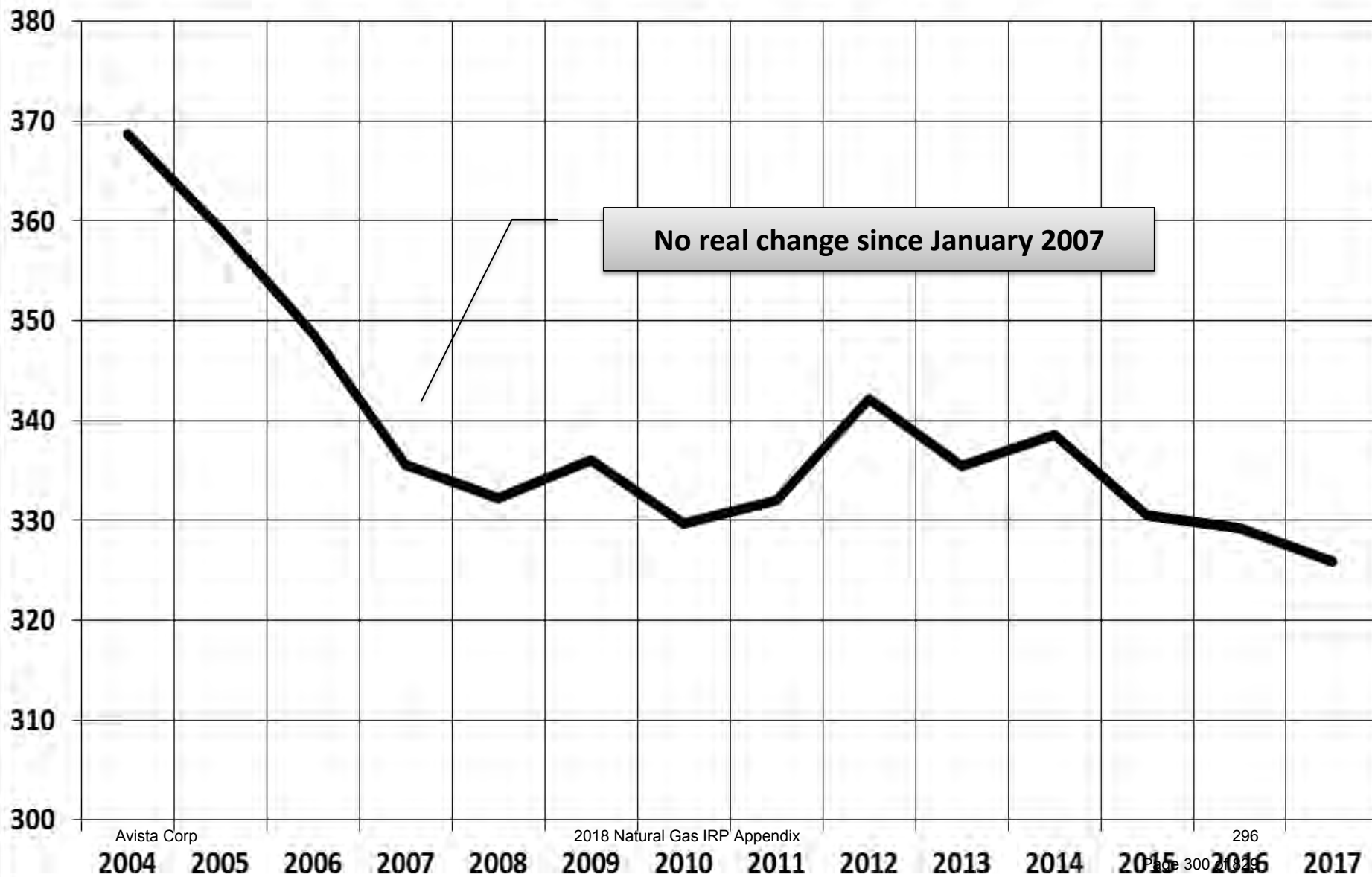

Getting to Population as a Driver, 2018-2023 & 2024-2037

2018-2023 For Spokane, WA; Kootenai, ID, and Jackson, OR counties

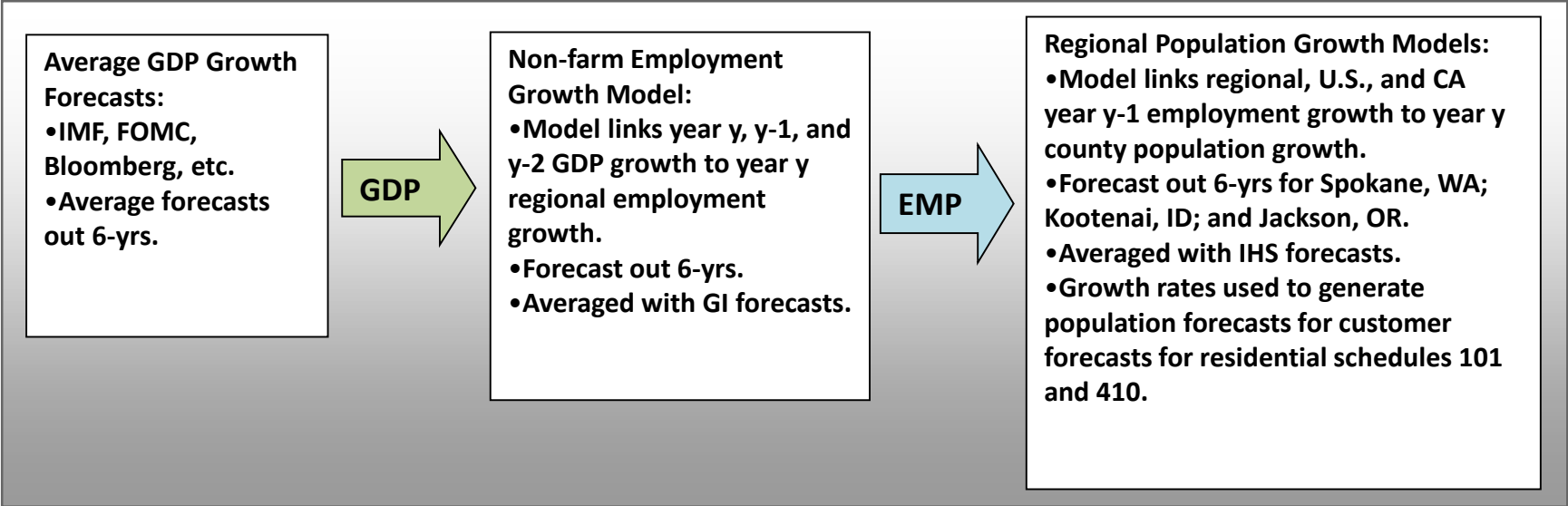

Kootenai and Jackson: IHS population growth forecasts for 2024-2037

Spokane: OFM population growth forecasts for 2024-2037

OR Union, Klamath, and Douglas counties: IHS population growth forecasts for 2018-2037

Interpolation assumes: $P_N = P_0 e^{rN}$

The Relationship Between Classes

Residential customer growth is approximately equal to population growth in the long-run.

Commercial customer growth is highly correlated with residential growth in the long-run.

Year-over-year Growth, Gas Correlations by Class, Jan. 2005-Jan 2016

Customers	Residential	Commercial	Industrial		Load	Residential	Commercial	Industrial
Residential	1.00				Residential	1.00		
Commercial	0.80	1.00			Commercial	0.94	1.00	
Industrial	-0.38	-0.23	1.00		Industrial	0.21	0.24	1.00

Industrial's correlation to residential is lower and negative. Customer numbers stable or slightly declining.

WA-ID Region Firm Customers: 2018 IRP and 2016 IRP

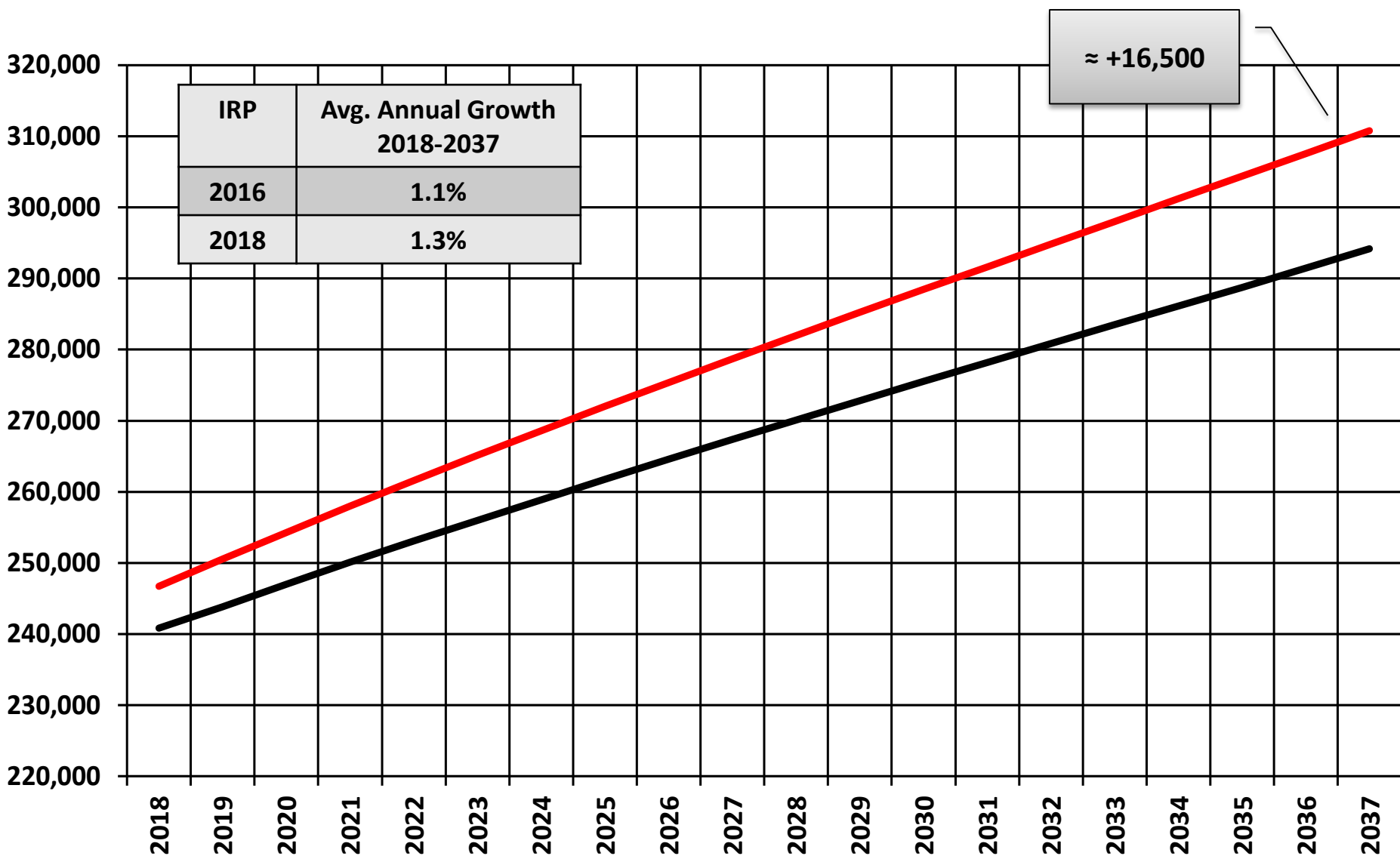

OR Region Firm Customers: 2018 IRP and 2016 IRP

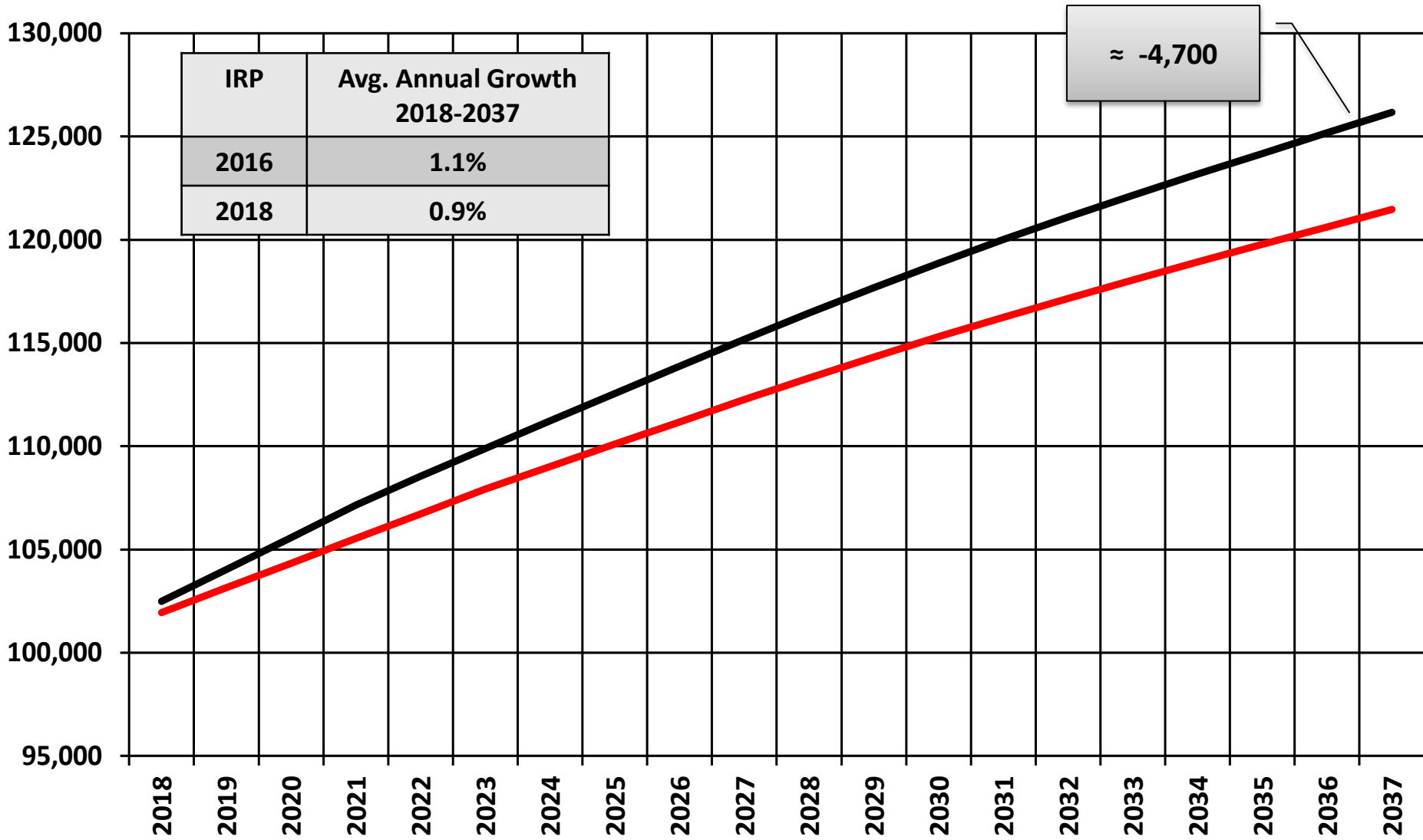

IRP	Avg. Annual Growth 2018-2037
2016	1.1%
2018	0.9%

≈ -4,700

Medford, OR Region Firm Customers: 2018 IRP and 2016 IRP

Exh. JM-2

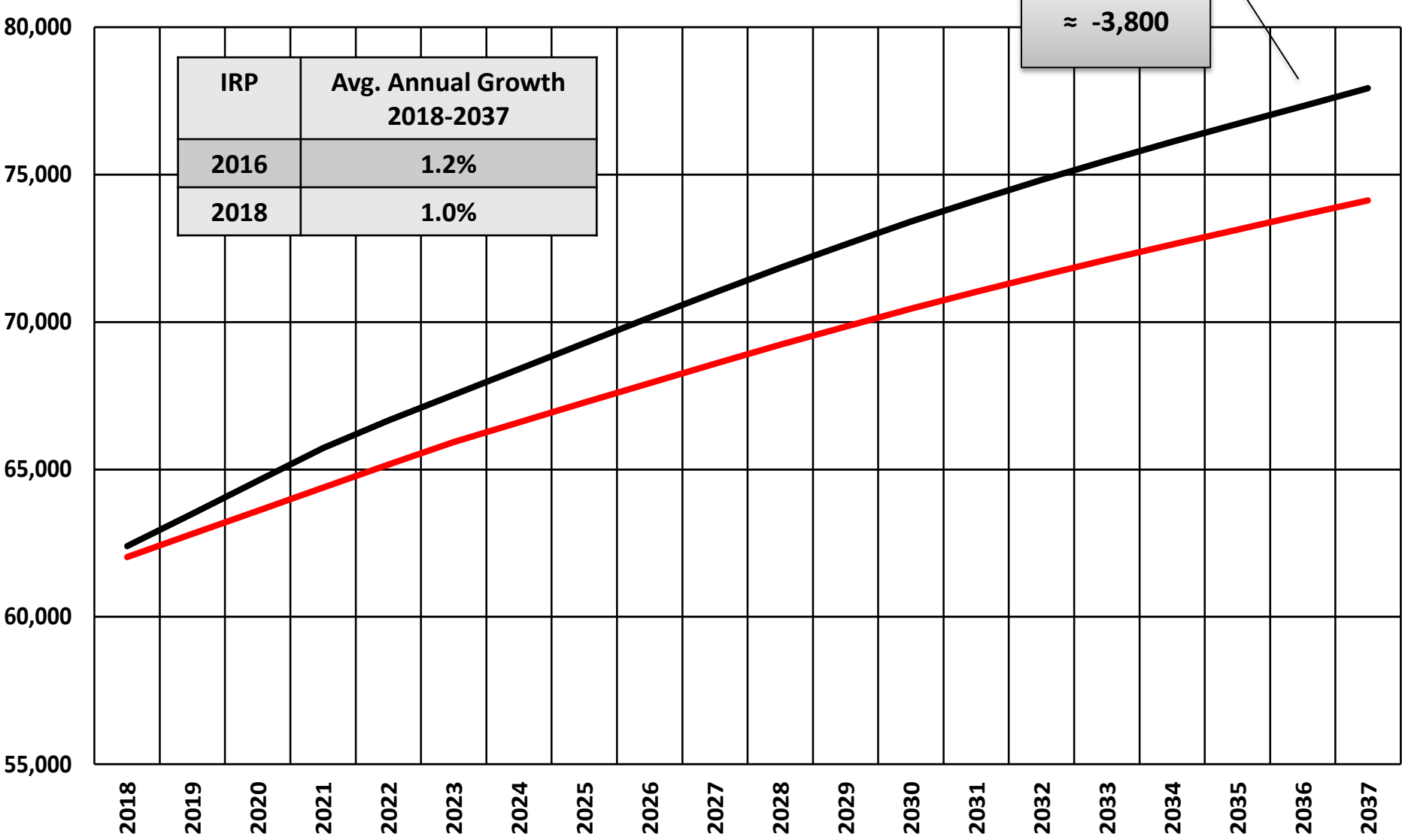

IRP	Avg. Annual Growth 2018-2037
2016	1.2%
2018	1.0%

≈ -3,800

Roseburg, OR Region Firm Customers: 2018 IRP and 2016 IRP

Exh. JM-2

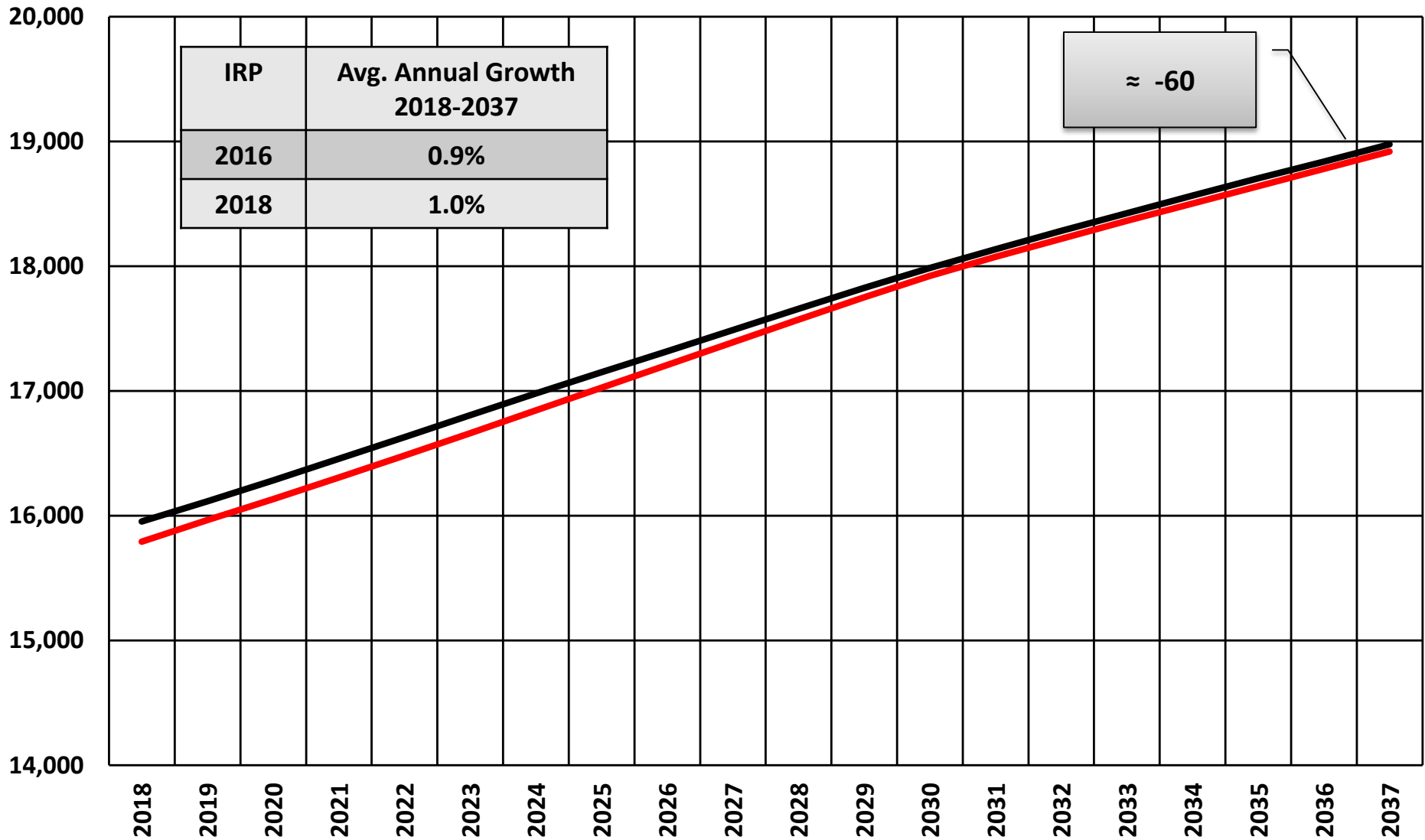

IRP	Avg. Annual Growth 2018-2037
2016	0.9%
2018	1.0%

≈ -60

Klamath, OR Region Firm Customers: 2018 IRP and 2016 IRP

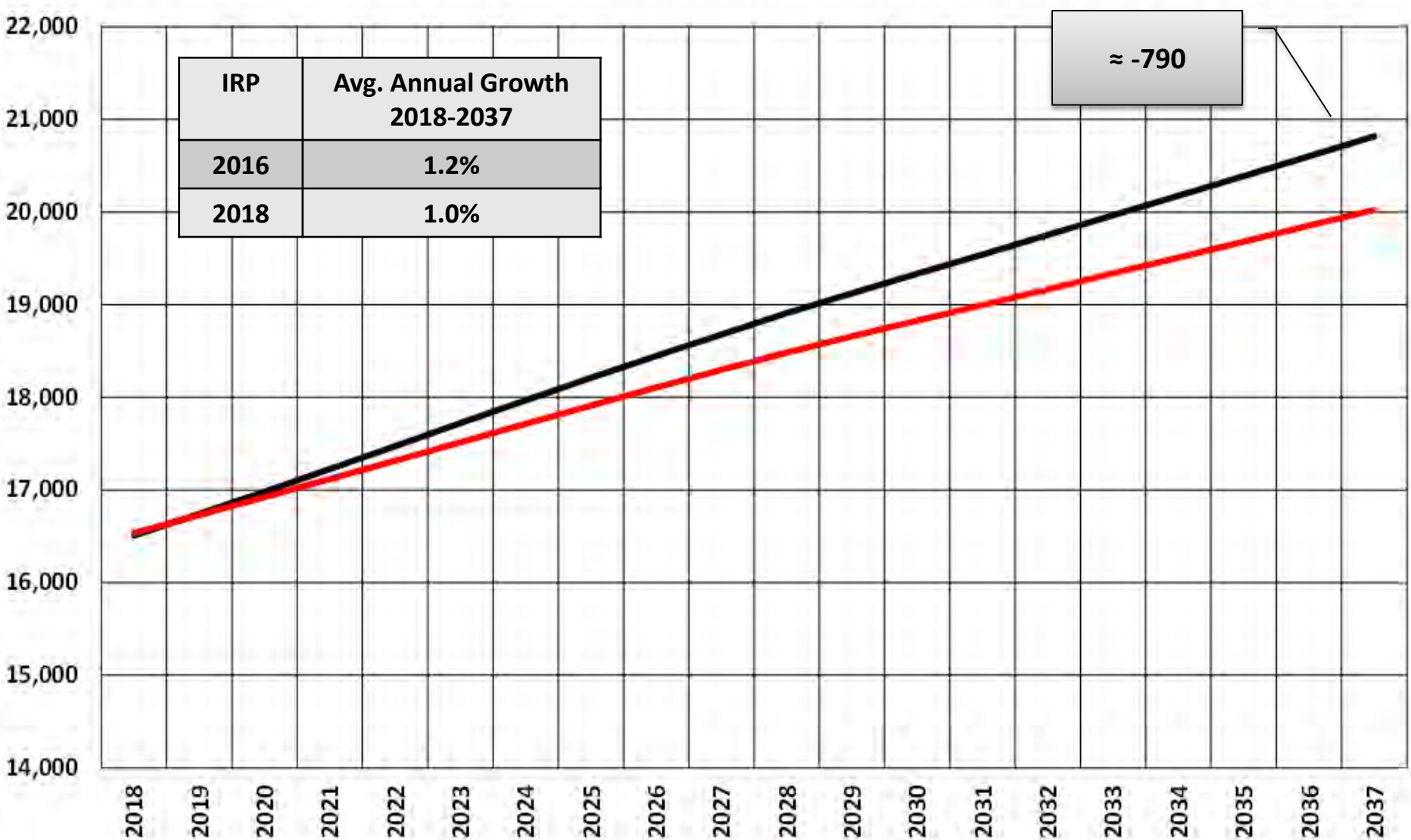

IRP	Avg. Annual Growth 2018-2037
2016	1.2%
2018	1.0%

≈ -790

La Grande, OR Region Firm Customers: 2018 IRP and 2016 IRP

Exh. JM-2

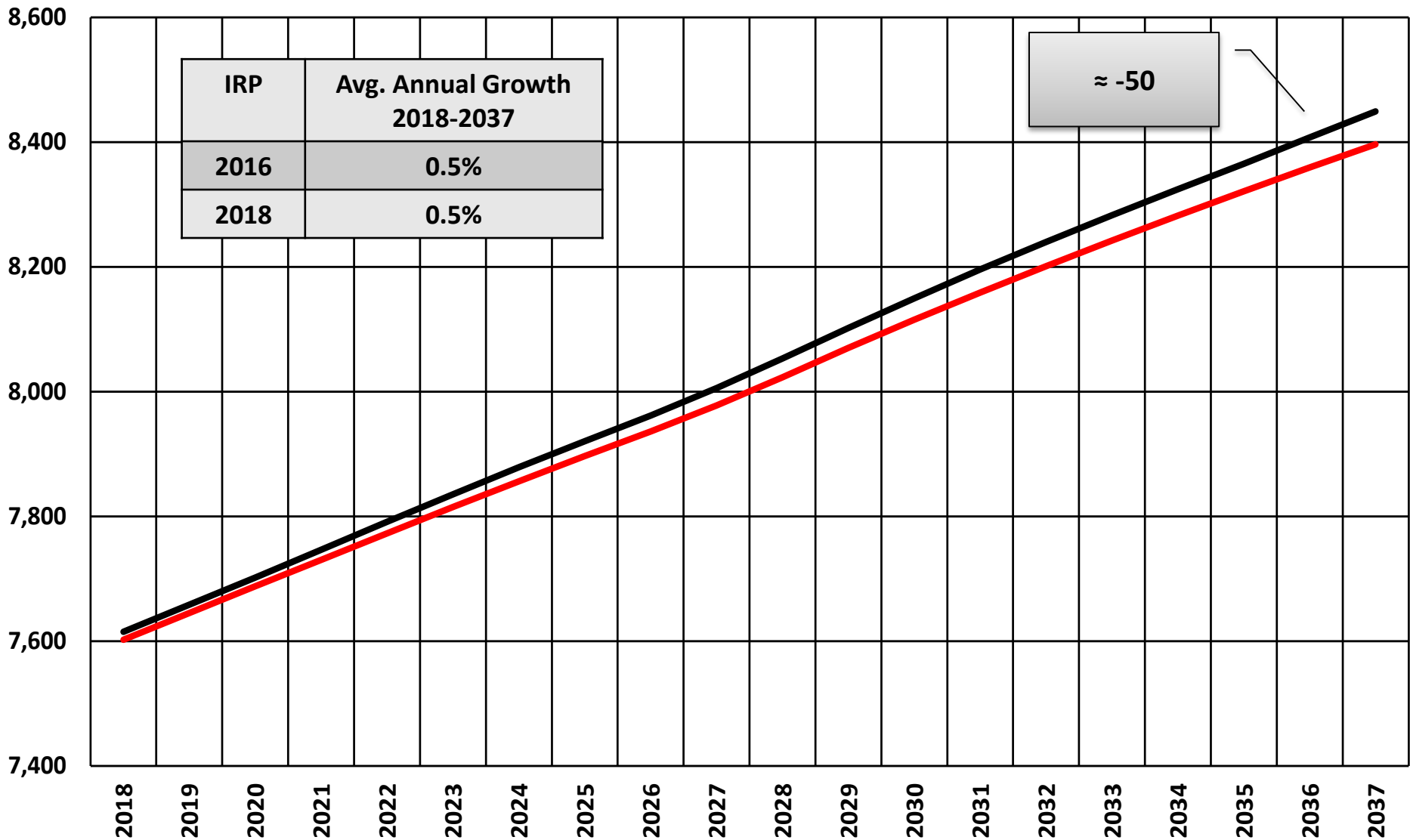

IRP	Avg. Annual Growth 2018-2037
2016	0.5%
2018	0.5%

≈ -50

System Firm Customers: 2018 IRP and 2016 IRP

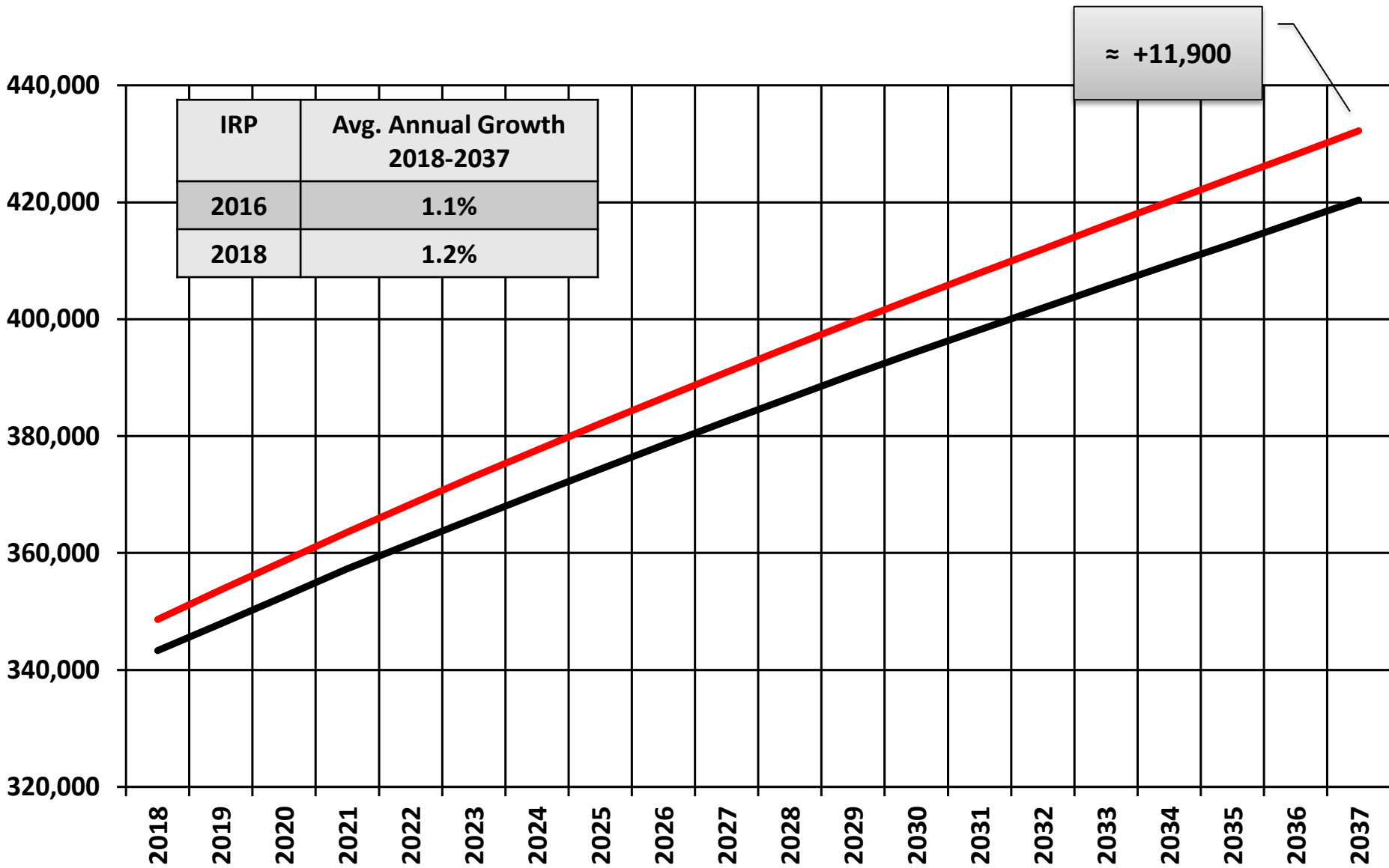

≈ +11,900

WA-ID Region Firm Customer Range, 2018-2037

Variable	Low Growth	Base Growth	High Growth
WA-ID Customers	0.9%	1.3%	1.6%
WA Population	0.5%	0.8%	1.1%
ID Population	1.1%	1.6%	2.1%
WA-ID Population	0.6%	0.9%	1.3%

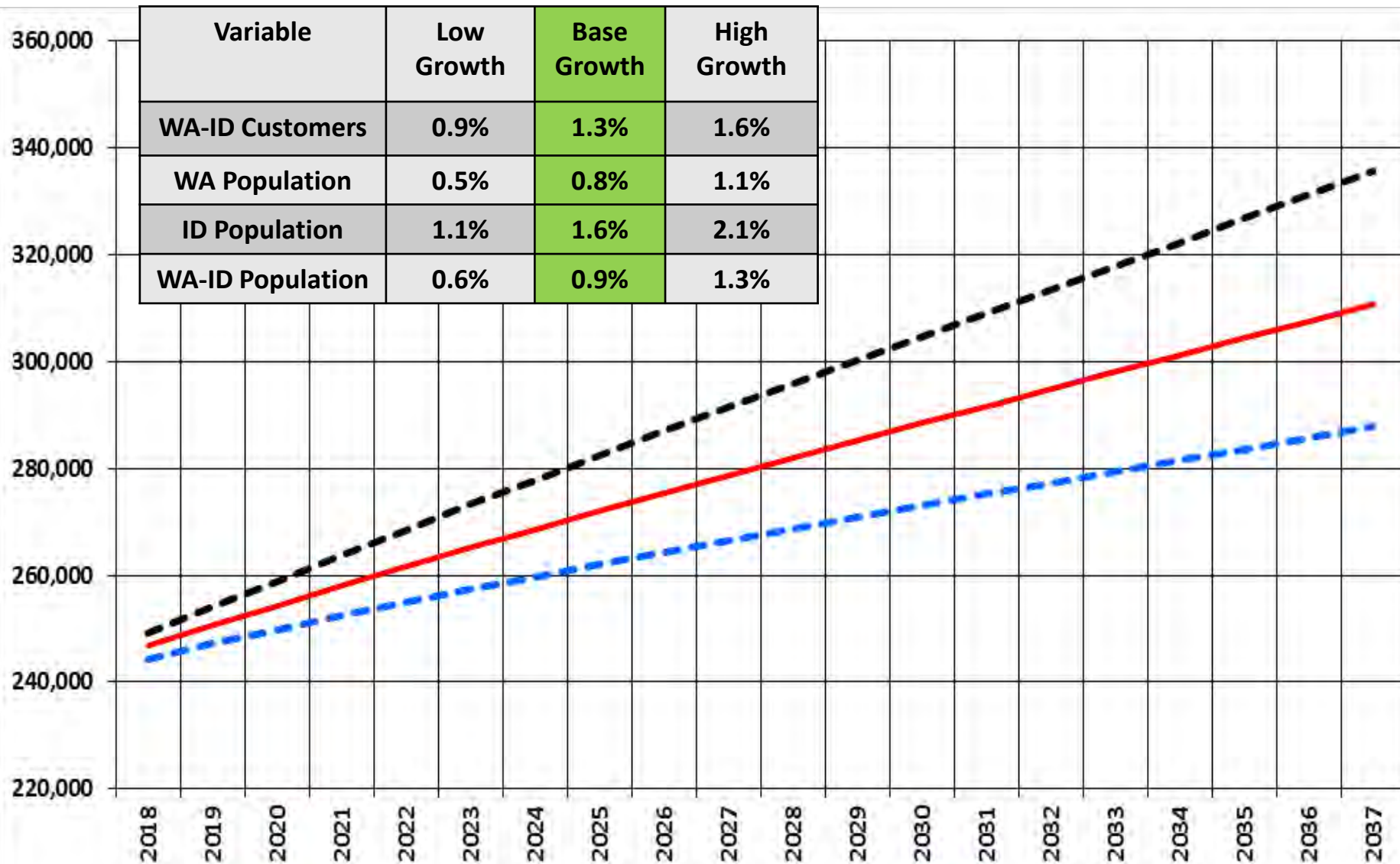

OR Region Firm Customer Range, 2018-2037

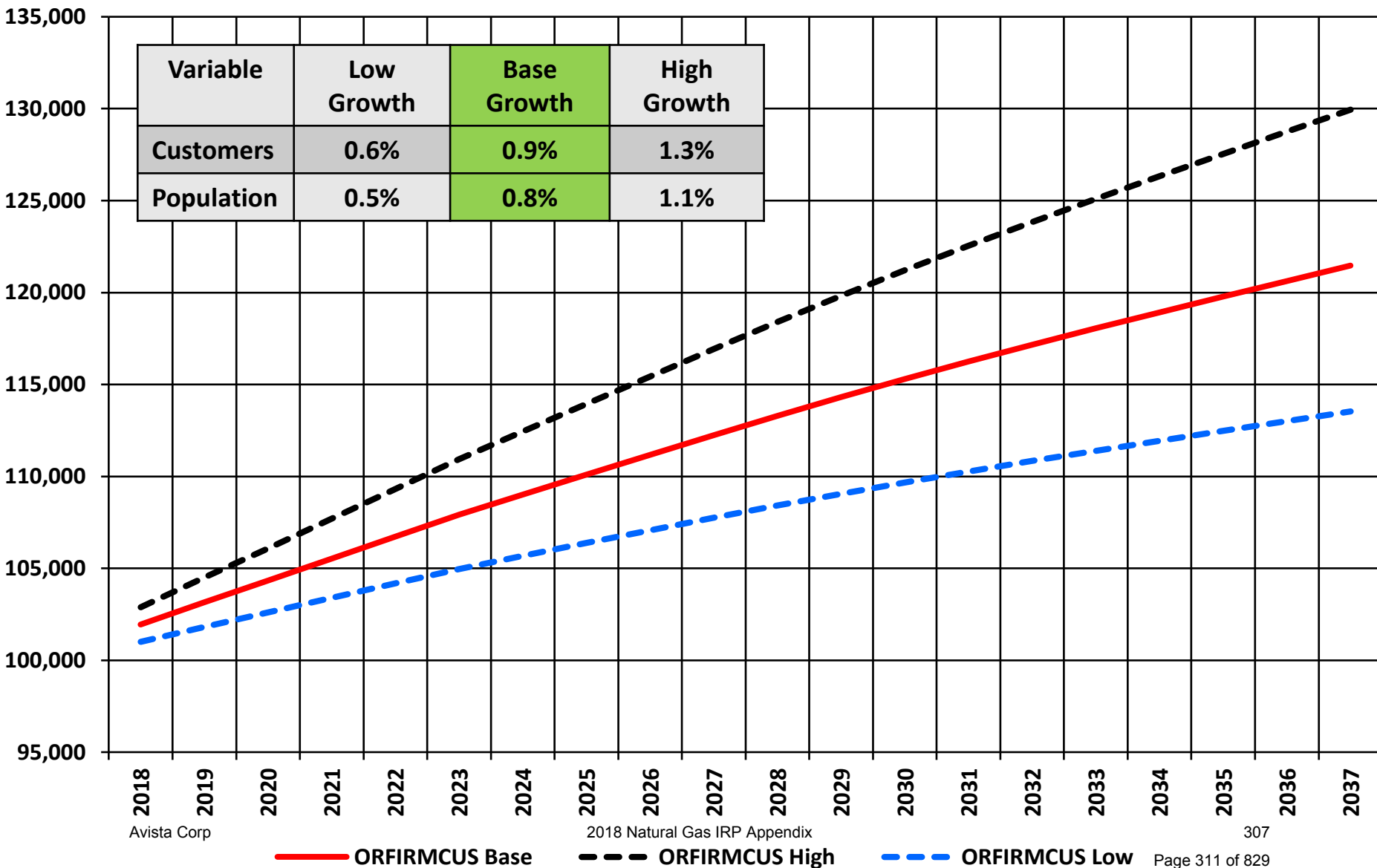

System Firm Customer Range, 2018-2037

Variable	Low Growth	Base Growth	High Growth
Customers	0.8%	1.2%	1.5%
Population	0.5%	0.9%	1.2%

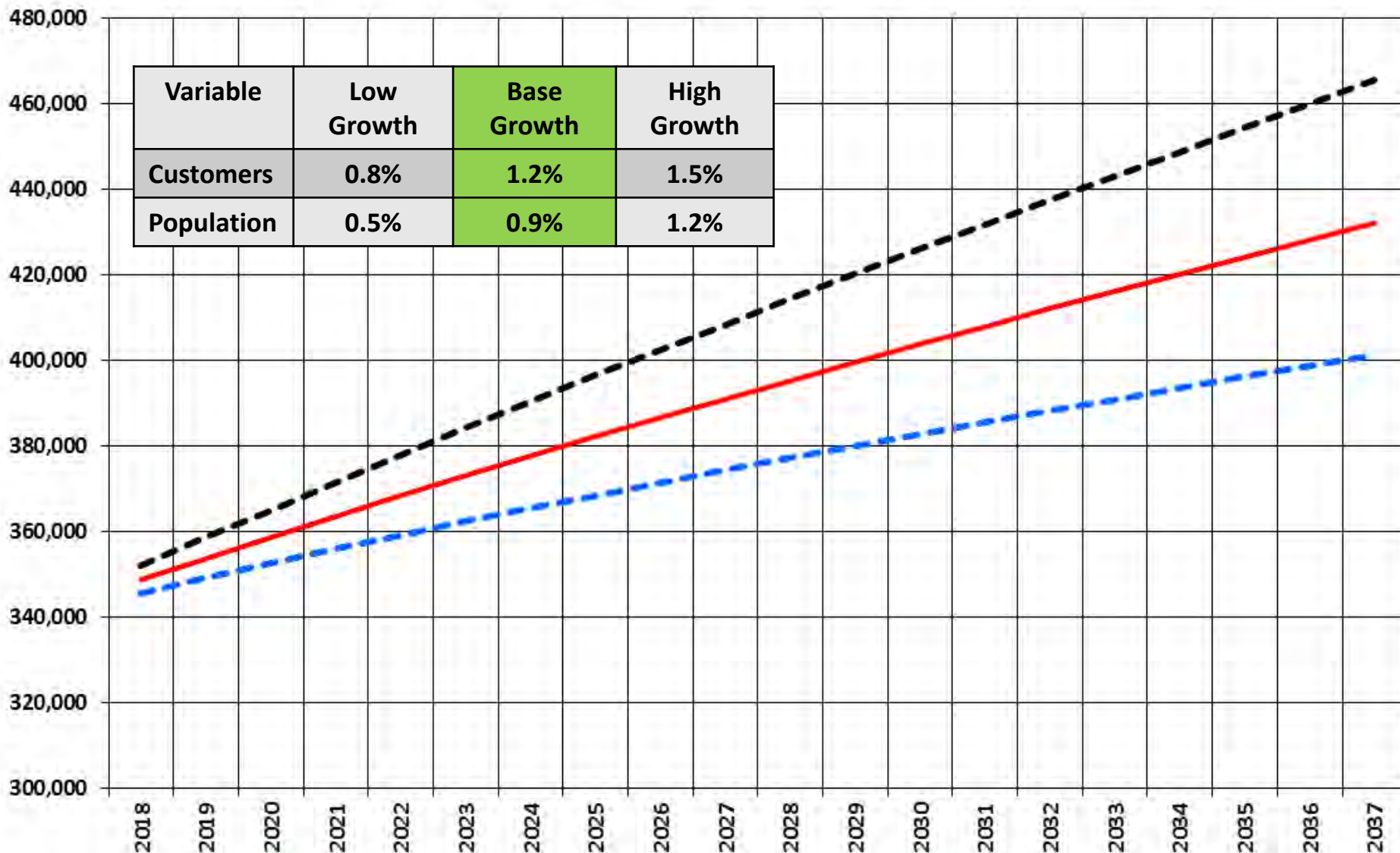

Summary of Growth Rates

System	Base-Case	High	Low
Residential	1.2%	1.6%	0.9%
Commercial	0.7%	1.0%	0.3%
Industrial	-0.3%	2.2%	-3.3%
Total	1.2%	1.5%	0.8%
WA	Base-Case	High	Low
Residential	1.2%	1.5%	0.9%
Commercial	0.7%	1.0%	0.4%
Industrial	-0.8%	1.9%	-3.1%
Total	1.2%	1.5%	0.8%
ID	Base-Case	High	Low
Residential	1.5%	2.0%	1.0%
Commercial	0.6%	1.1%	0.1%
Industrial	0.1%	1.7%	-2.7%
Total	1.4%	1.9%	0.9%
OR	Base-Case	High	Low
Residential	1.0%	1.3%	0.6%
Commercial	0.7%	1.1%	0.4%
Industrial	0.1%	4.7%	-7.8%
Total	0.9%	1.3%	0.6%

Forecasting with Permits or Housing Starts

- Potential data sources have poor coverage in our service territory or series are not long enough. This is especially a problem for non-MSA areas like Roseburg, Klamath, and La Grande.
- IHS has annual and quarterly housing start data only for MSAs. IHS's MSA housing starts are estimates:

“We then use the permits-to-starts ratio for the national and regional level from the Census that is released every year to derive the starts. Unfortunately, until recently, the census only has these ratios at the national and regional level. As a consequence, we use this ratio for any county, metro and state within the region to derive our starts from.”

- Prior use of IHS housing start forecasts resulted in significant over forecasting of customers.
- NAHB also produces a housing start series, but their data only covers fairly large MSAs.

Estimating the IMPACT of LEAP in WA: Residential Customers

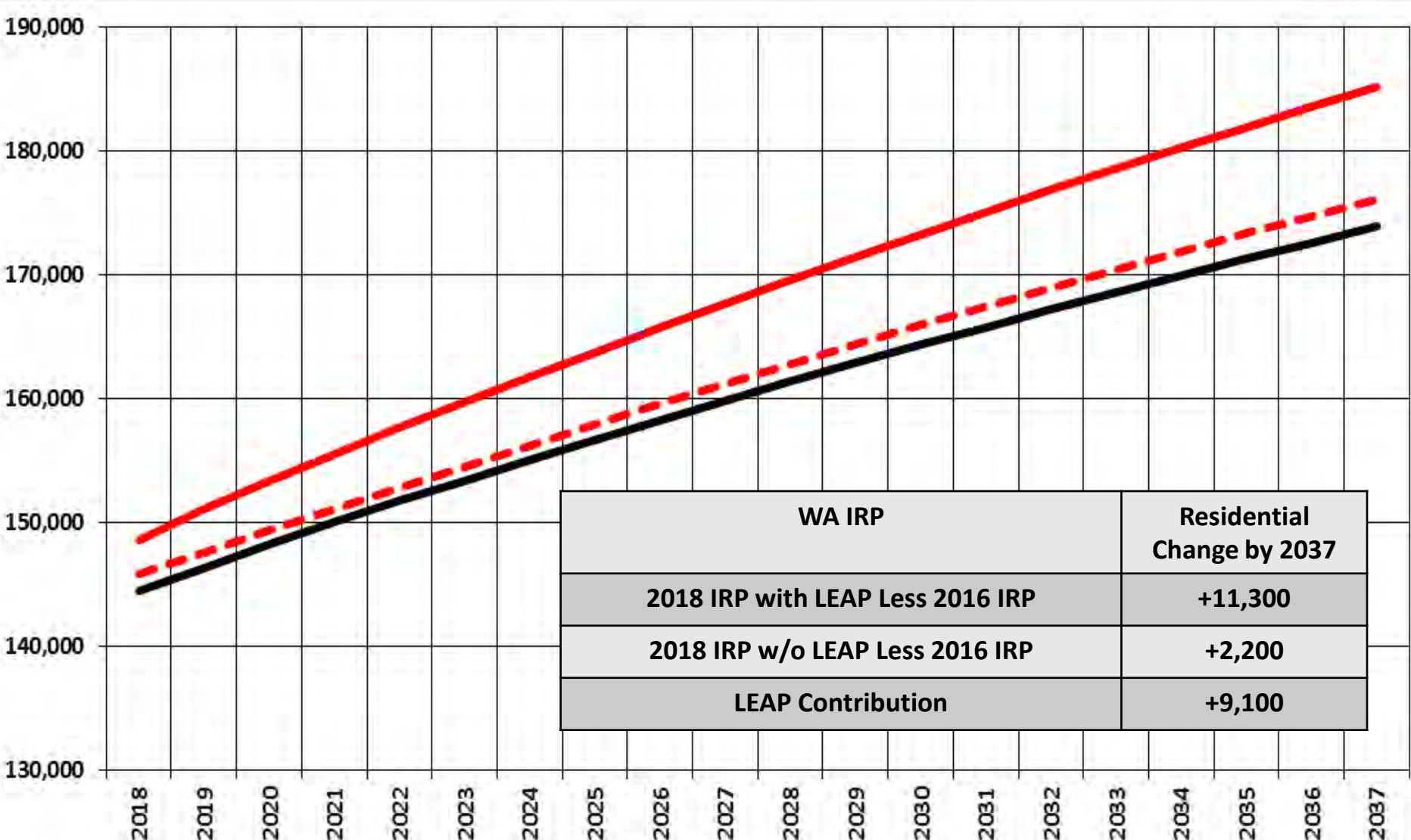

WA IRP	Residential Change by 2037
2018 IRP with LEAP Less 2016 IRP	+11,300
2018 IRP w/o LEAP Less 2016 IRP	+2,200
LEAP Contribution	+9,100

Estimating the IMPACT of LEAP in WA: Residential Growth Rates

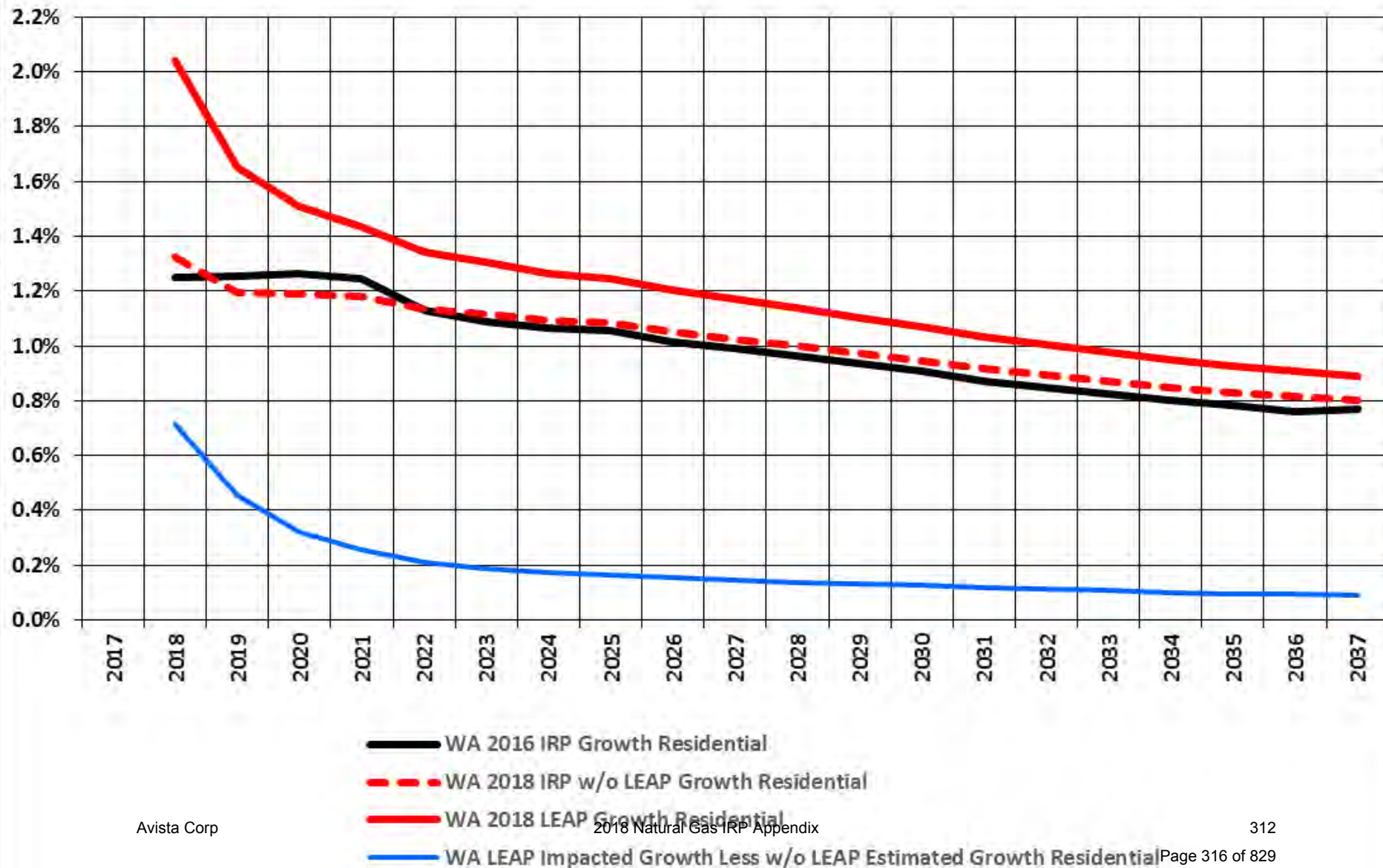



Demand Forecast Methodology

Tom Pardee
Manager of Natural Gas Planning

Temperature & Degree Days

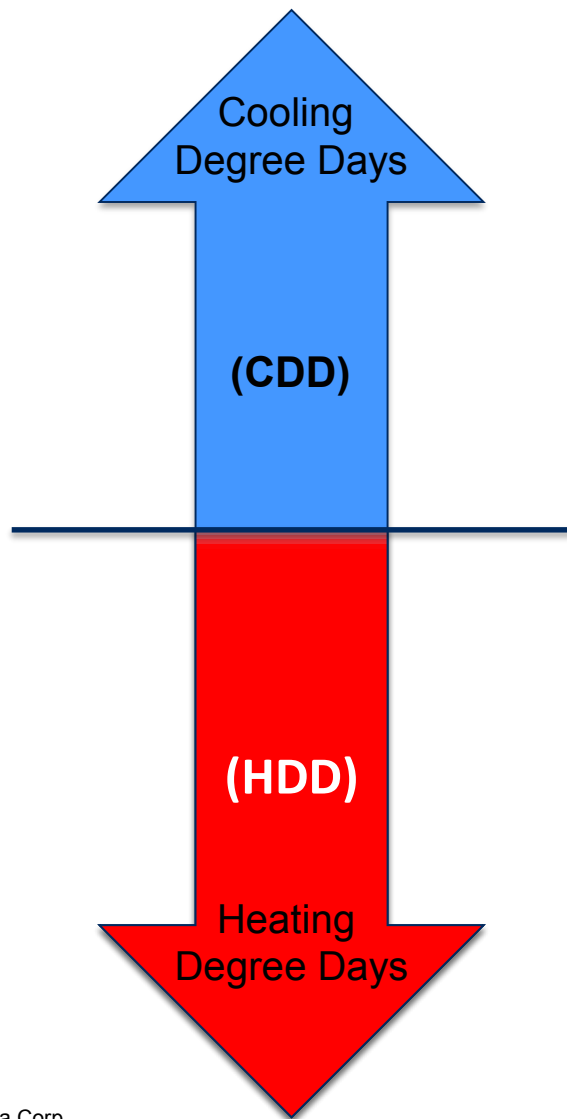

Temp (°F)	=	Degree Days
100	=	35
90	=	25
80	=	15
70	=	5
65	=	0
60	=	5
50	=	15
40	=	25
30	=	35
20	=	45
10	=	55
0	=	65
-10	=	75
-20	=	85

Natural Gas Demand Forecasting

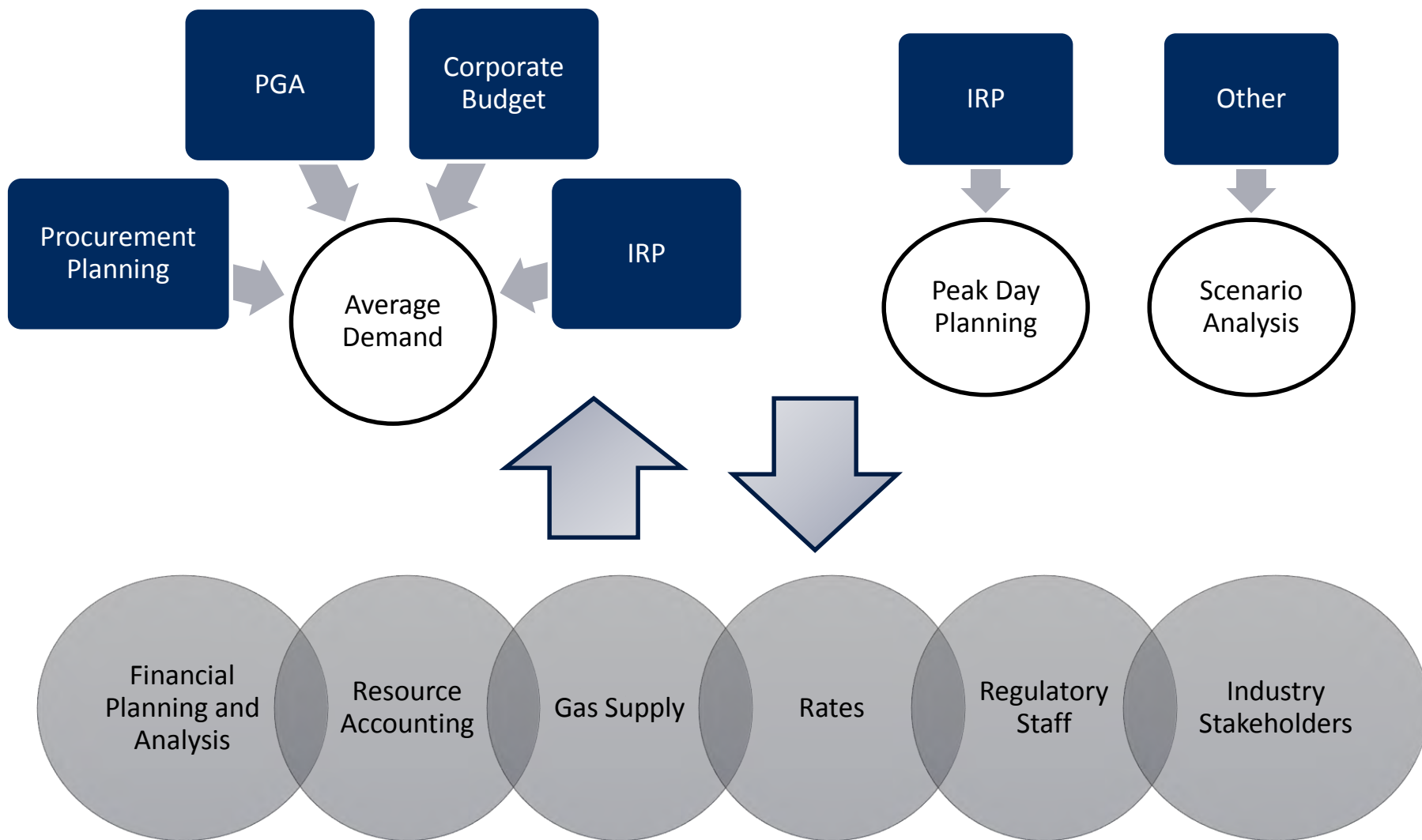

Weather

- NOAA 20 year actual average daily HDD's (1998-2017)
- Peak weather includes two winter storms (5 day duration), one in December and one in February
- Planning Standard – coldest day on record
- Sensitivity around planning standard including
 - Normal/Average
 - Coldest in 20 years
 - Monte Carlo simulation

The Use per Customer Forecast cont.

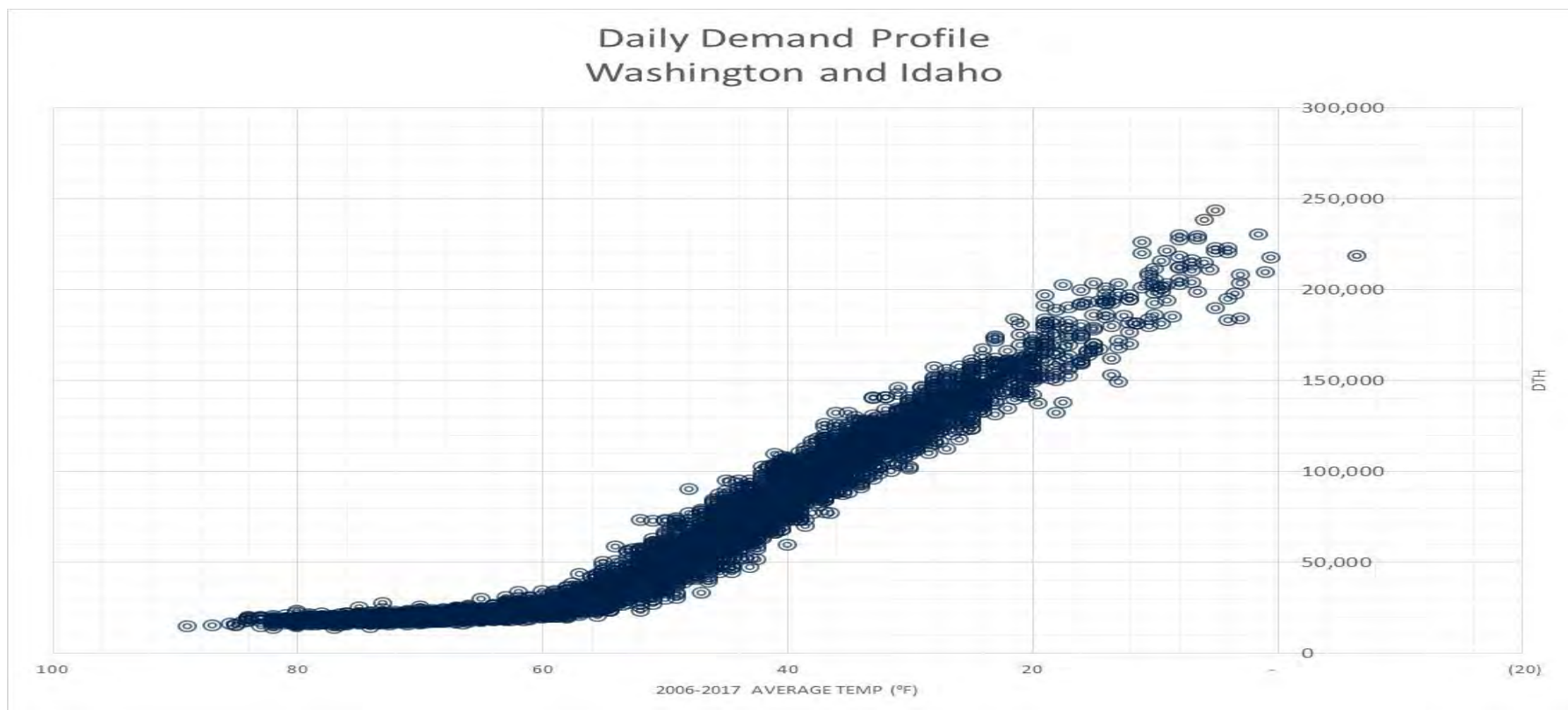

- Historical data is used to determine initial base and heat coefficients.
- Adjustments are made to incorporate DSM and price elastic responses.

Residential – UPC and Weather

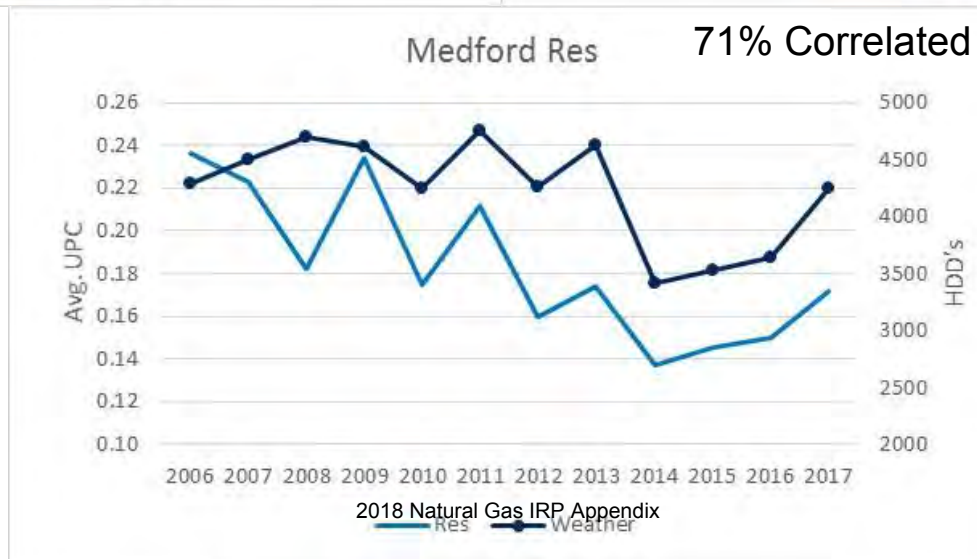
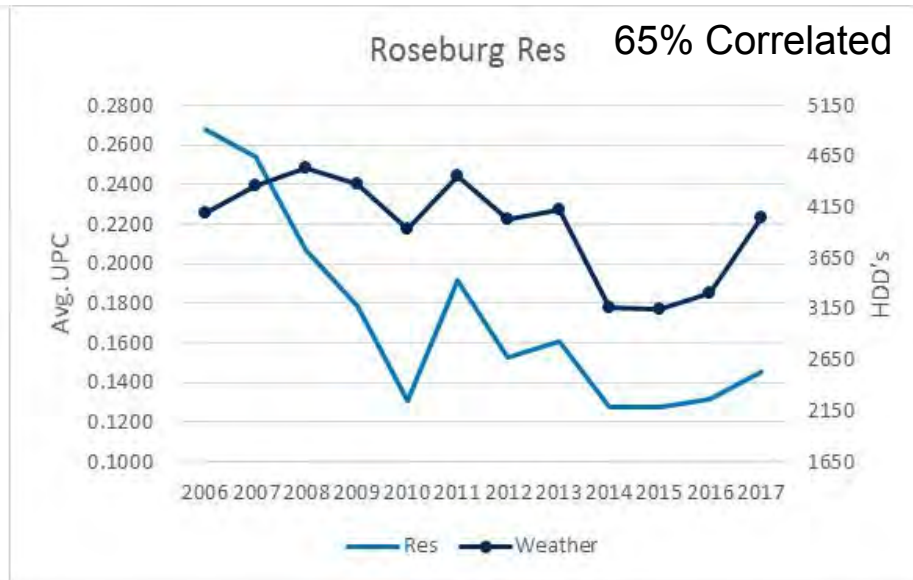
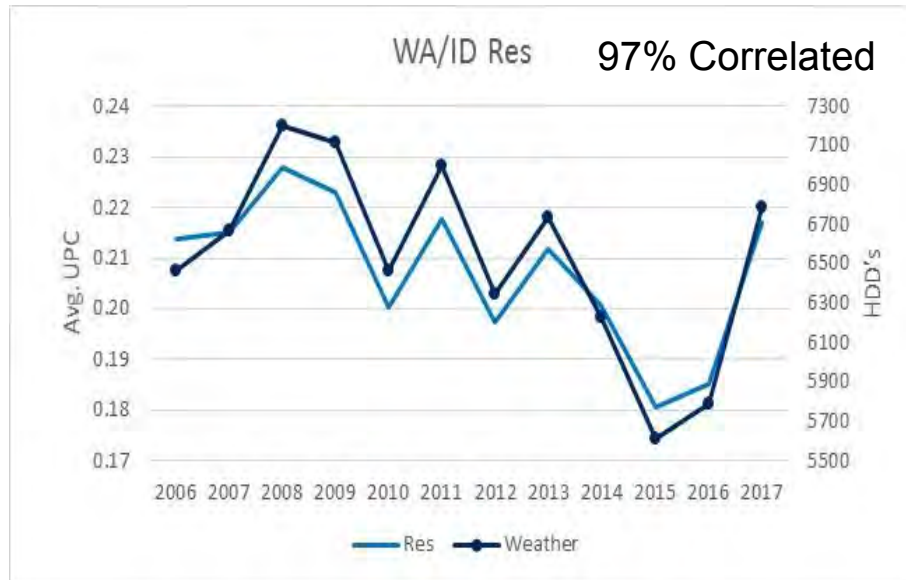

Residential – UPC and Weather

Klamath Falls Res 71% Correlated

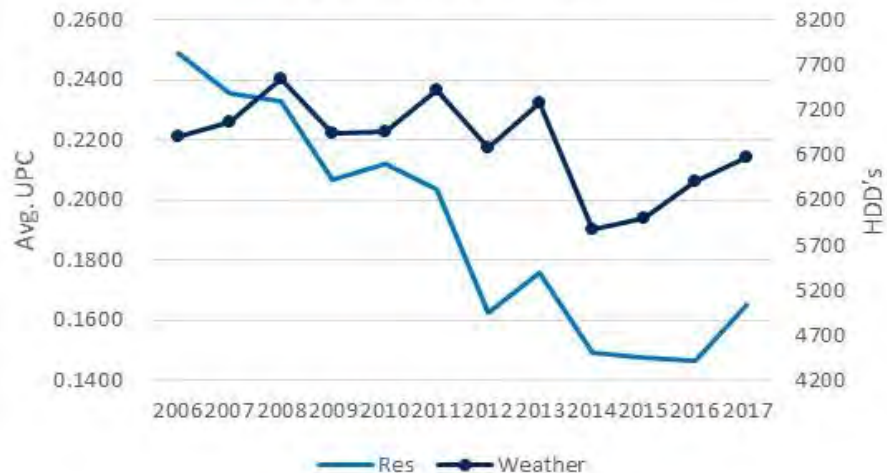

La Grande Res 83% Correlated



Base Coefficients

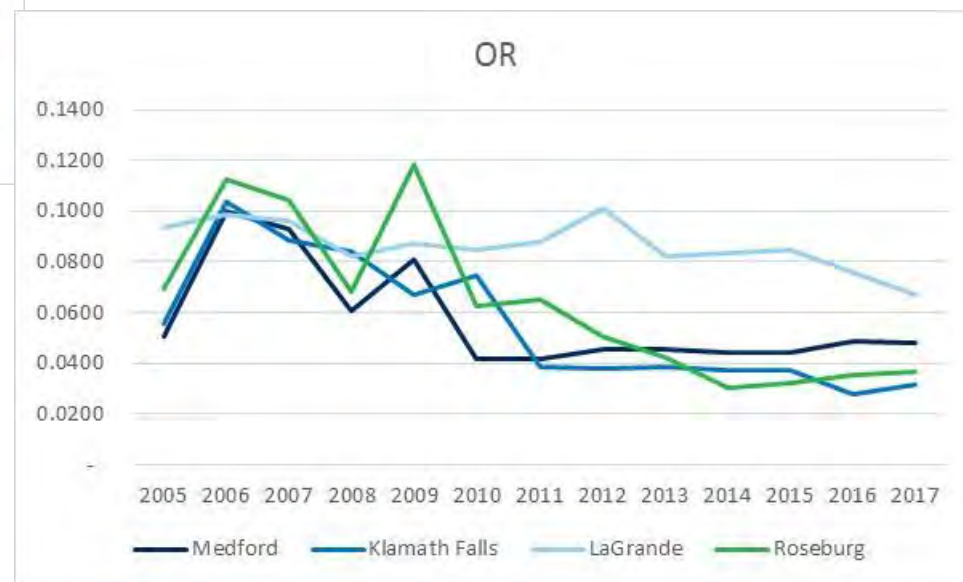

Demand Modeling Equation – a closer look

SENDOUT® requires inputs expressed in the below format to compute daily demand in dekatherms. The **base** and **weather sensitive** usage (degree-day usage) factors are developed outside the model and capture a variety of demand usage assumptions.

Table 3.2 Basic Demand Formula

$$\begin{aligned} & \# \text{ of customers } \times \text{ Daily } \mathbf{base} \text{ usage} / \text{ customer} \\ & \mathbf{Plus} \\ & \# \text{ of customers } \times \text{ Daily } \mathbf{weather \ sensitive} \text{ usage} / \text{ customer} \end{aligned}$$

Developing a Reference Case

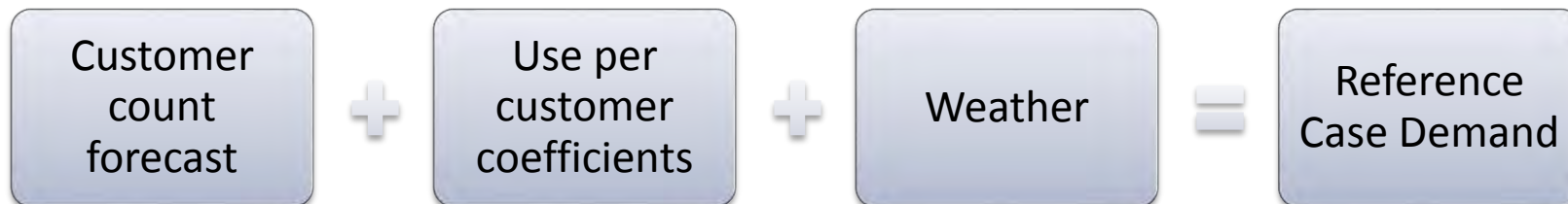

1. Expected customer count forecast by each of the 5 areas
2. Use per customer coefficients – Flat all classes, 5 year, 3 year or last year average use per HDD per customer
3. Weather planning standard – coldest day on record
 - WA/ID 82; Medford 61; Roseburg 55; Klamath 72; La Grande 74



Dynamic Demand Methodology

Tom Pardee
Manager of Natural Gas Planning

Dynamic Demand Methodology

Demand Influencing

- Conditions that **DIRECTLY** affect core customer volume consumed



Price Influencing

- *PRICE SENSITIVE* conditions that, through price elasticity, **INDIRECTLY** affect core customer volume consumed



Demand Drivers

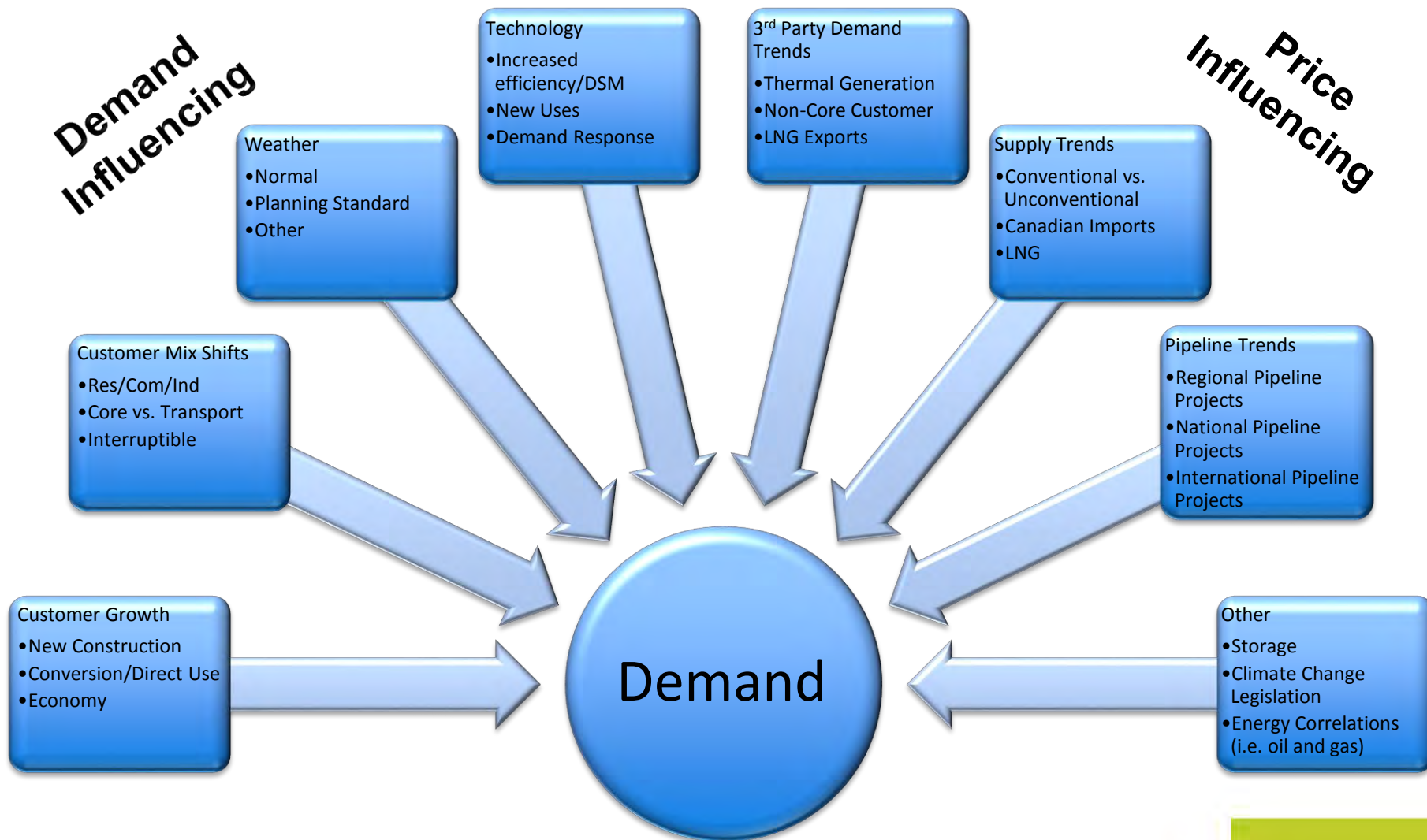

Customer Growth and Mix – Demand Influencing

- Key driver in demand growth
- Can change the timing and/or location of resource needs
- Currently we model expected, high, and low growth scenarios
- New construction vs. conversions
- Residential/Commercial/Industrial vs. Transportation
- New uses – CNG/NGV

Weather Standard – Demand Influencing

- Has the potential to significantly change timing of resource needs
- Significant qualitative considerations
 - No infrastructure response time if standard exceeded
 - Significant safety and property damage risks
- Current Peak HDD Planning Standards
 - WA/ID 82
 - Medford 61
 - Roseburg 55
 - Klamath 72
 - La Grande 74

Technology – Demand Influencing

- Demand side management initiatives will reduce demand **HOWEVER**, it is dependent upon customers willingness/ability to participate.
- Development of new uses for natural gas
 - CNG
 - NGV
 - LNG
 - ???NG
- Demand response (Smart Grid)
- New technologies in Demand Side Management

Price Elasticity Factors Defined

- Price elasticity is usually expressed as a numerical factor that defines the relationship of a consumer's consumption change in response to price change.
- Typically, the factor is a **negative** number as consumers normally **reduce** their consumption in response to **higher** prices or will **increase** their consumption in response to **lower** prices.
- For example, a price elasticity factor of -0.13 means:
 - A 10% price **increase** will prompt a 1.3% consumption **decrease**
 - A 10% price **decrease** will prompt a 1.3% consumption **increase**

Price Elasticity

- Establishes factors for use in other price influencing scenarios
- Very complex relationship – we use historical data however.....
 - Historical data has DSM, rate changes (PGA, general rate, etc.), economic conditions, technological changes, etc.
 - History is not necessarily the best predictor of future behavior

Price Elasticity Assumptions From 2018 IRP

Elasticity Assumption	Real Price annual increase within 30%
High	Negative .20
Expected	Negative .10
Low	No response

3rd Party Demand Trends – Price Influencing

- Gas fired generation
- Coal plant retirements driving gas for power
- CNG/NGV Transportation Fleets
- Export LNG
- Non-firm customer trends
- Mexico Exports

Supply Trends – Price Influencing

- Shale is Everywhere
- LNG Export

- Associated gas from Oil – 25% of overall US production

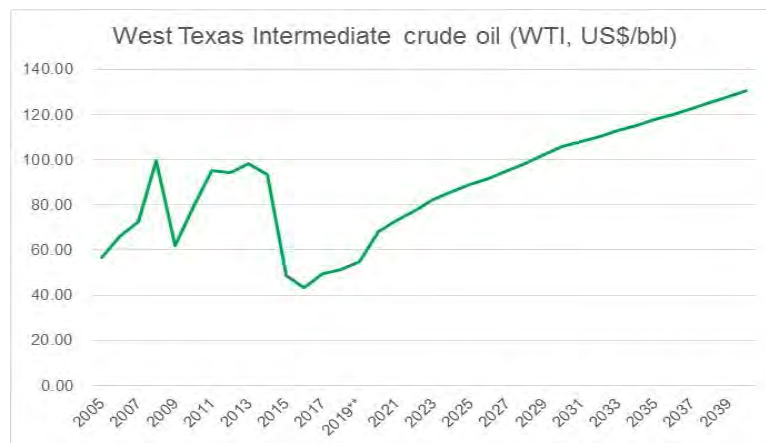

Pipeline Trends – Price Influencing

- Regional Pipeline Proposals
 - Sumas Express
 - Pacific Connector – from Jordan Cove LNG
 - Trail West/N-Max (GTN to NWP – Molalla area)
- National Pipeline Proposals
- International Pipeline Proposals
 - T-South Looping
 - NGTL Westpath Expansion
 - Southern Crossing Expansion



Other Supply Issues – Price Influencing

- Storage
- Climate Change and Carbon Legislation
- Energy Correlations
- Extraction cost

Sensitivities, Scenarios, Portfolios

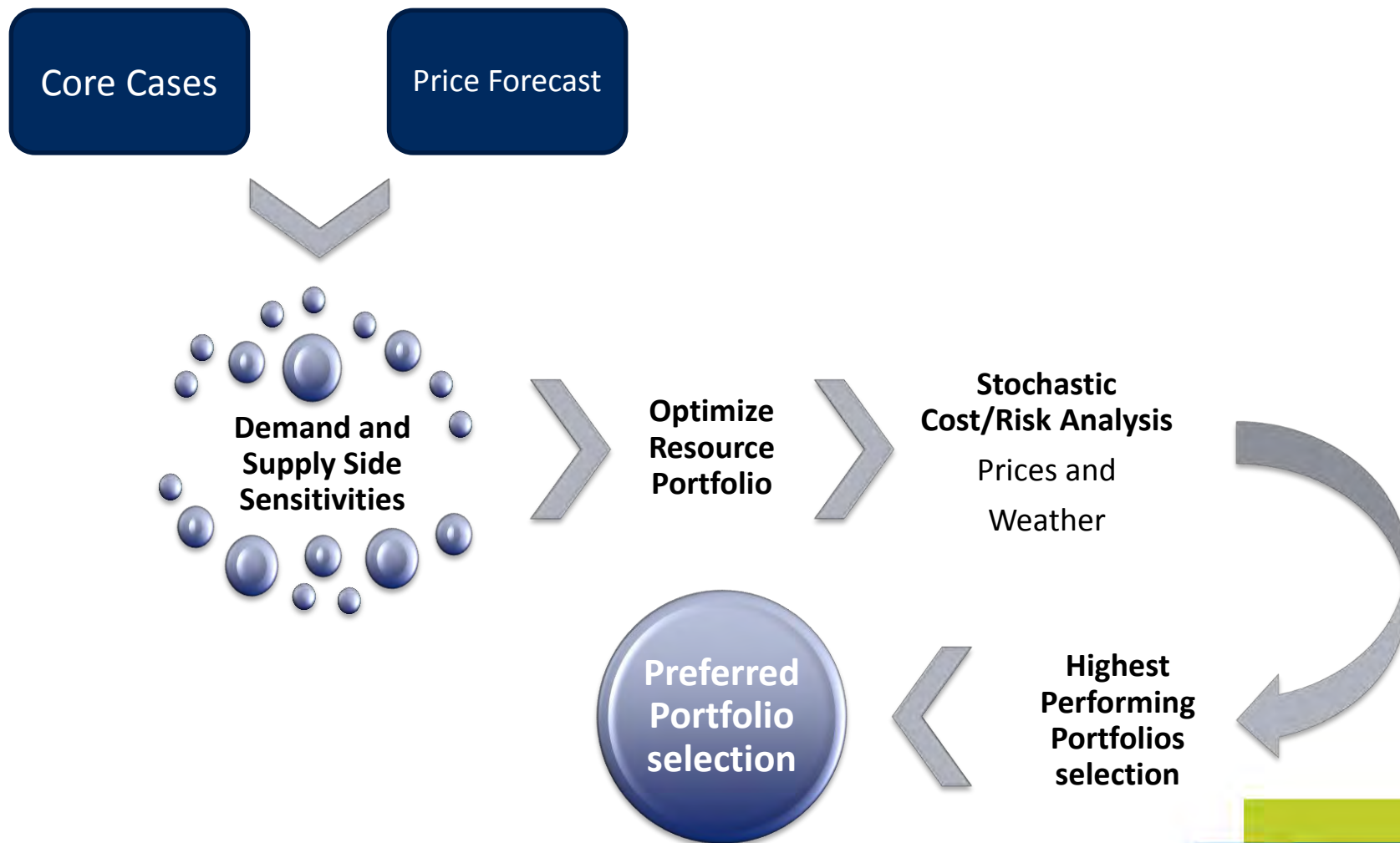

Sensitivities for 2018 IRP

INPUT ASSUMPTIONS	Reference Case	Reference Plus Peak Case	DEMAND INFLUENCING - DIRECT									PRICE INFLUENCING - INDIRECT					
			Low Cust Growth	High Cust Growth	No Conversion to natural gas Growth	Alternate Weather Std	DSM Case	Peak plus DSM Case	Demand Destruction Reference Case	Demand Destruction Reference Plus Peak	Alternate Historical UPC Case	Expected Elasticity	Low Prices	High Prices	Carbon Legislation		
Customer Growth Rate	Reference	Reference Plus	Low Growth	High Growth	Reference minus LEAP	Reference	Reference	Reference	Reference	Reference	Reference	Reference	Reference	Reference	Reference	Reference	
Use per Customer	3 Year Historical	3 Year Historical	3 Year Historical	3 Year Historical	3 Year Historical	3 Year Historical	3 Year Historical	3 Year Historical	3 Year Historical less demand destruction	3 Year Historical less demand destruction	5 Year Historical	3 Year Historical	3 Year Historical	3 Year Historical	3 Year Historical	3 Year Historical	
Weather																	
Planning Standard	20 Year Normal	Coldest on Record	Coldest on Record	Coldest on Record	Coldest on Record	Coldest in 20yrs	Normal	Coldest on Record	Normal	Coldest on Record	Coldest on Record	Coldest on Record	Coldest on Record	Coldest on Record	Coldest on Record	Coldest on Record	
Demand Side Management																	
Programs Included	No	No	No	No	No	No	Expected	Expected	No	No	No	No	No	No	No	No	
Prices																	
Price curve	Expected	Expected	Expected	Expected	Expected	Expected	Expected	Expected	Expected	Expected	Expected	Expected	Expected	Low	High	High/Medium/Low	
Price curve adder (\$/Dth)	None	None	None	None	None	None	None	None	None	None	None	None	None			High/Medium/Low	
Elasticity	None	None	None	None	None	None	None	None	None	None	None	None	None	Expected	Expected	Expected	Expected



2018 Natural Gas IRP DSM - Energy Efficiency

Amber Gifford & Ryan Finesilver
First Technical Advisory Committee Meeting
January 25, 2018

Demand Side Management (DSM)

The process of helping customers use energy more efficiently.

The term DSM is used interchangeably with Energy Efficiency and Conservation.

DSM Programs benefit the IRP by contributing to the deferral of plant assets.

Team Roles

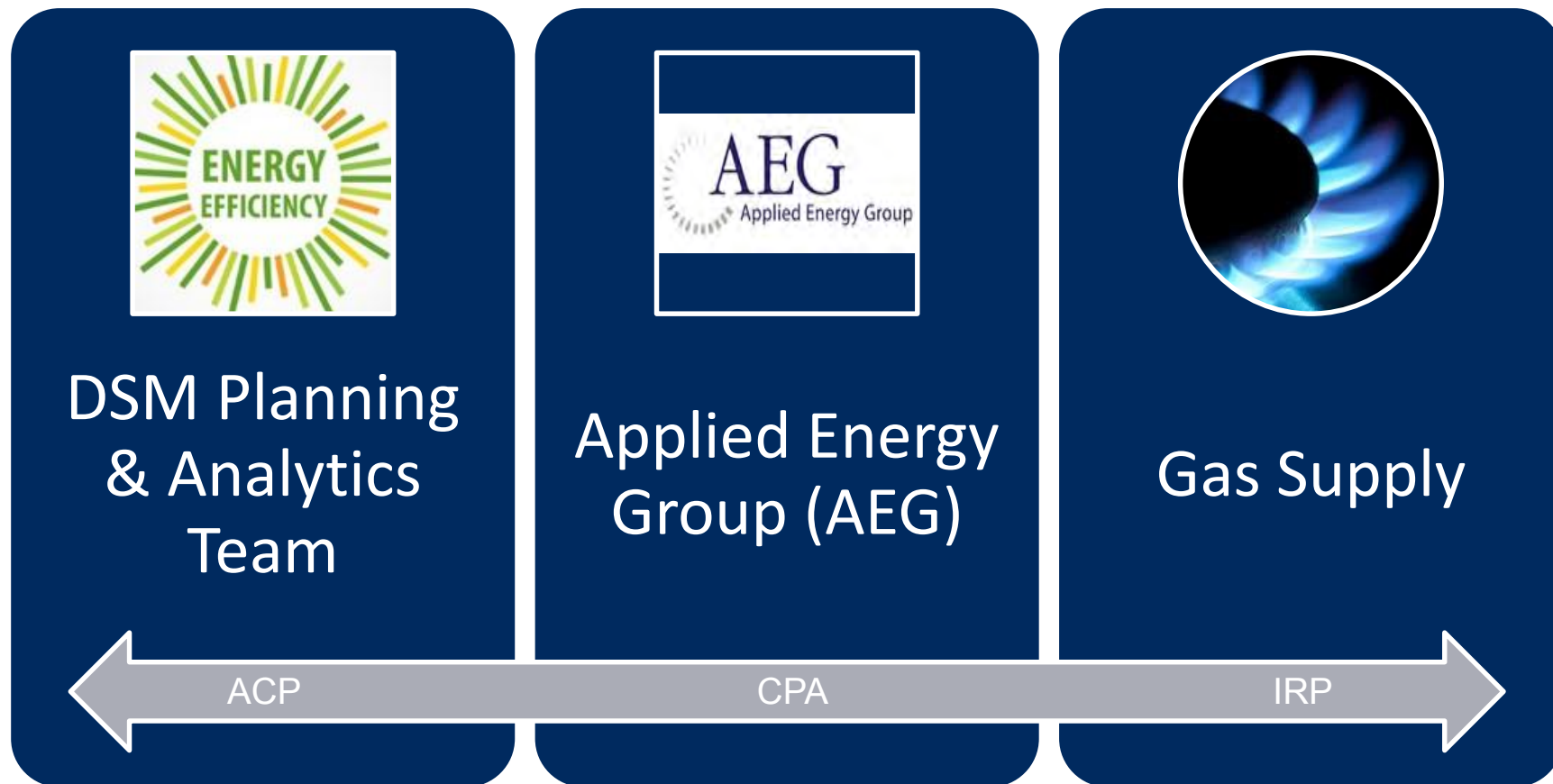

EnergyTrust
of Oregon

Oregon DSM Programs

Who DSM Serves

Three Jurisdictions

- Washington
- Idaho
- Oregon (ETO except for Low-Income)



Multiple Customer Segments

- Residential
- Industrial/Commercial
- Low-Income Residential

The Company's Infrastructure

- Aids in reducing overall capacity
- Defers capital investments



DSM Funding – Natural Gas

SCHEDULE 191
DEMAND SIDE MANAGEMENT RATE ADJUSTMENT - WASHINGTON

APPLICABLE:
To Customers in the State of Washington where the Company has natural gas service available. This Demand Side Management Rate Adjustment or Rate Adjustment shall be applicable to all retail customers taking service under Schedules 101, 111, 112, 121, 122, 131, and 132. This Rate Adjustment is designed to recover costs incurred by the Company associated with providing Demand Side Management services and programs to customers.

MONTHLY RATE:
The energy charges of the individual rate schedules are to be increased by the following amounts:

Schedule 101	\$0.03472 per Therm
Schedule 111 & 112	\$0.02475 per Therm

Tariff percentage of customer bill by state:

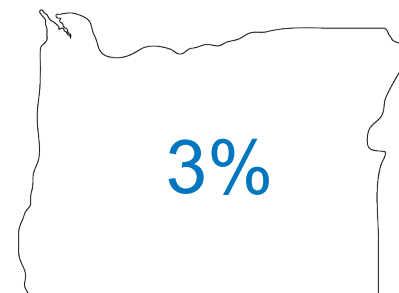
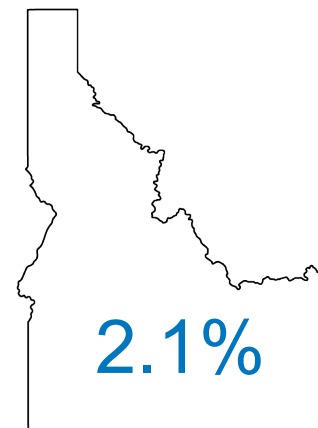
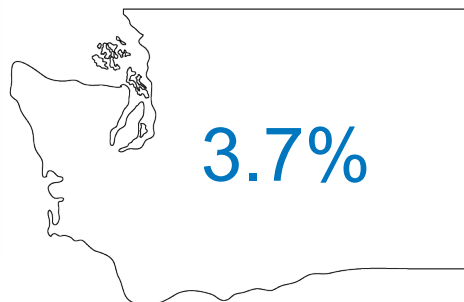

\$8.5 Million
Annual
Funding
(2017)



WA Gas Targets to Actual Savings

■ Business Plan Target ■ IRP Target ■ Actual

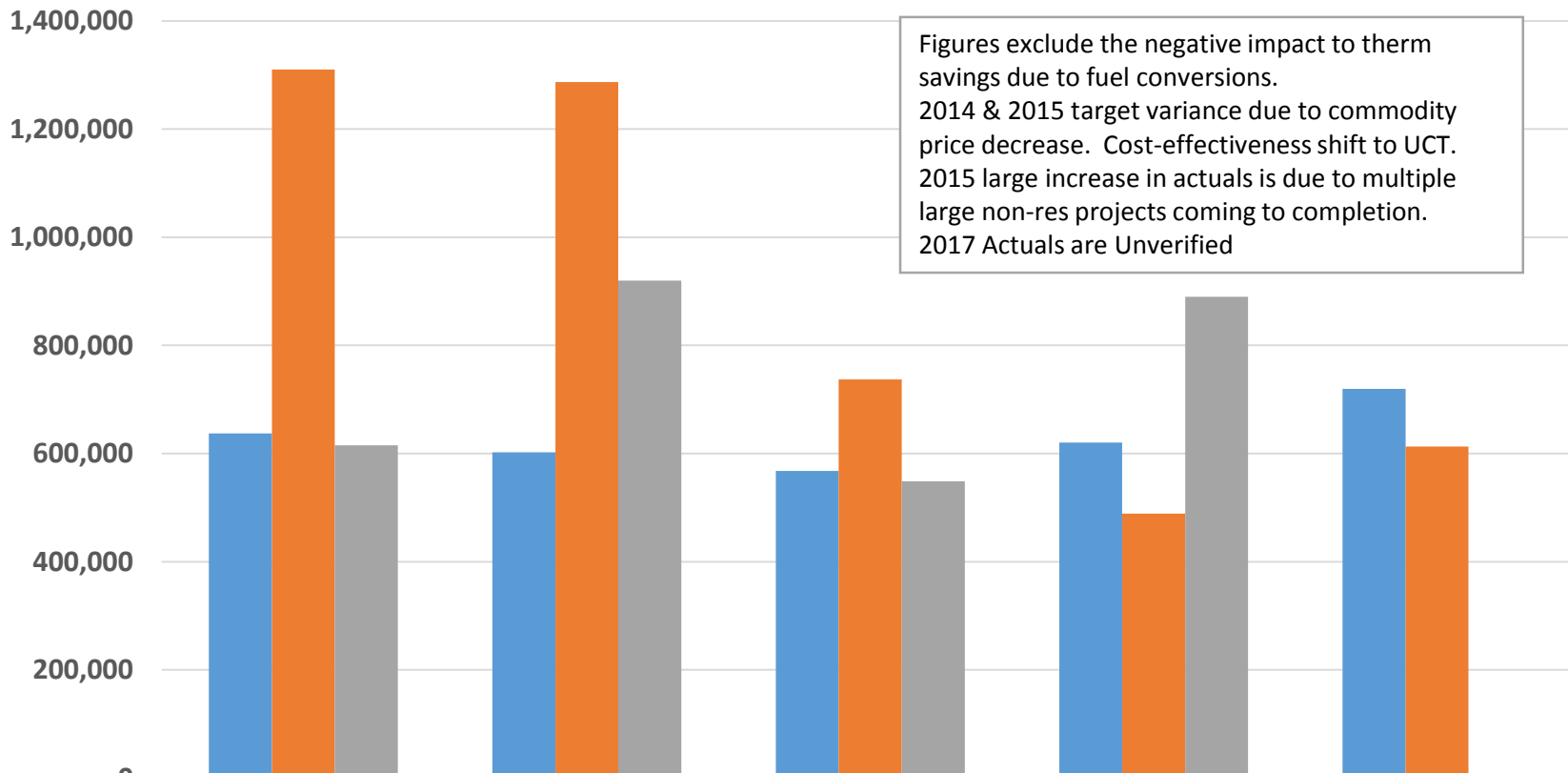

Figures exclude the negative impact to therm savings due to fuel conversions.
 2014 & 2015 target variance due to commodity price decrease. Cost-effectiveness shift to UCT.
 2015 large increase in actuals is due to multiple large non-res projects coming to completion.
 2017 Actuals are Unverified

	2014	2015	2016	2017	2018
■ Business Plan Target	637,042	602,010	567,653	620,310	719,451
■ IRP Target	1,310,000	1,287,000	737,000	489,110	612,830
■ Actual	615,418	919,892	548,756	889,776	

ID Gas Targets to Actual Savings

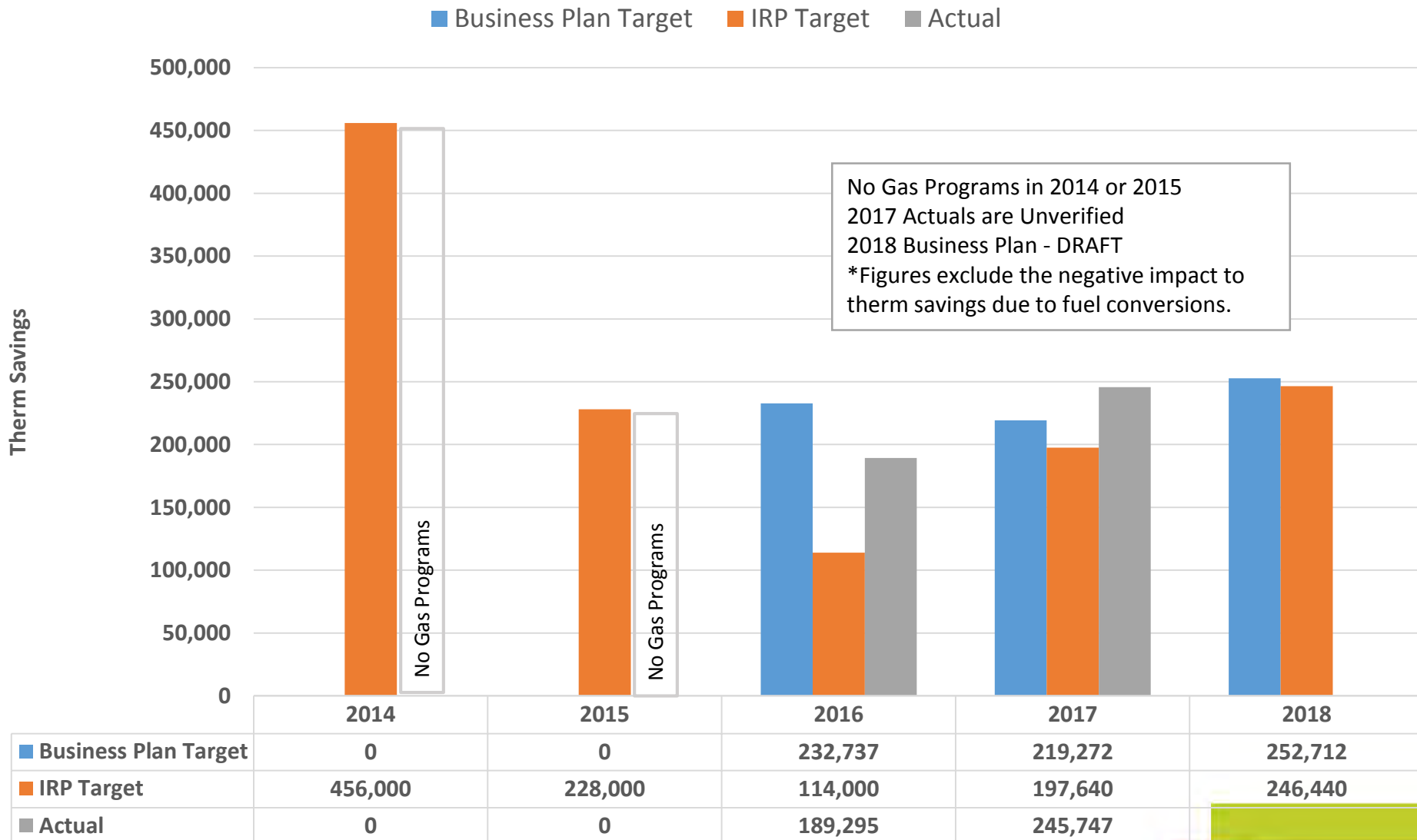



DSM Business Planning

Conservation Potential Assessment (CPA)

- Primary Objectives
 - Meet legislative and regulatory requirements
 - Support integrated resource planning
 - Identify opportunities for savings; key measures in target segments
- Key Deliverables
 - 20-year conservation potential
 - Individual measures
 - IRP target

Conservation Potential Assessment

Technical Potential

- Theoretical upper limit of conservation
- All efficiency measures are phased in regardless of cost

Achievable Technical Potential

- Realistically achievable, accounting for adoption rates and how quickly programs can be implemented
- Does not consider cost-effectiveness of measures

Achievable Potential

- Includes economic screening of measures (cost effectiveness)
- Informs our IRP Target

Business Planning Process

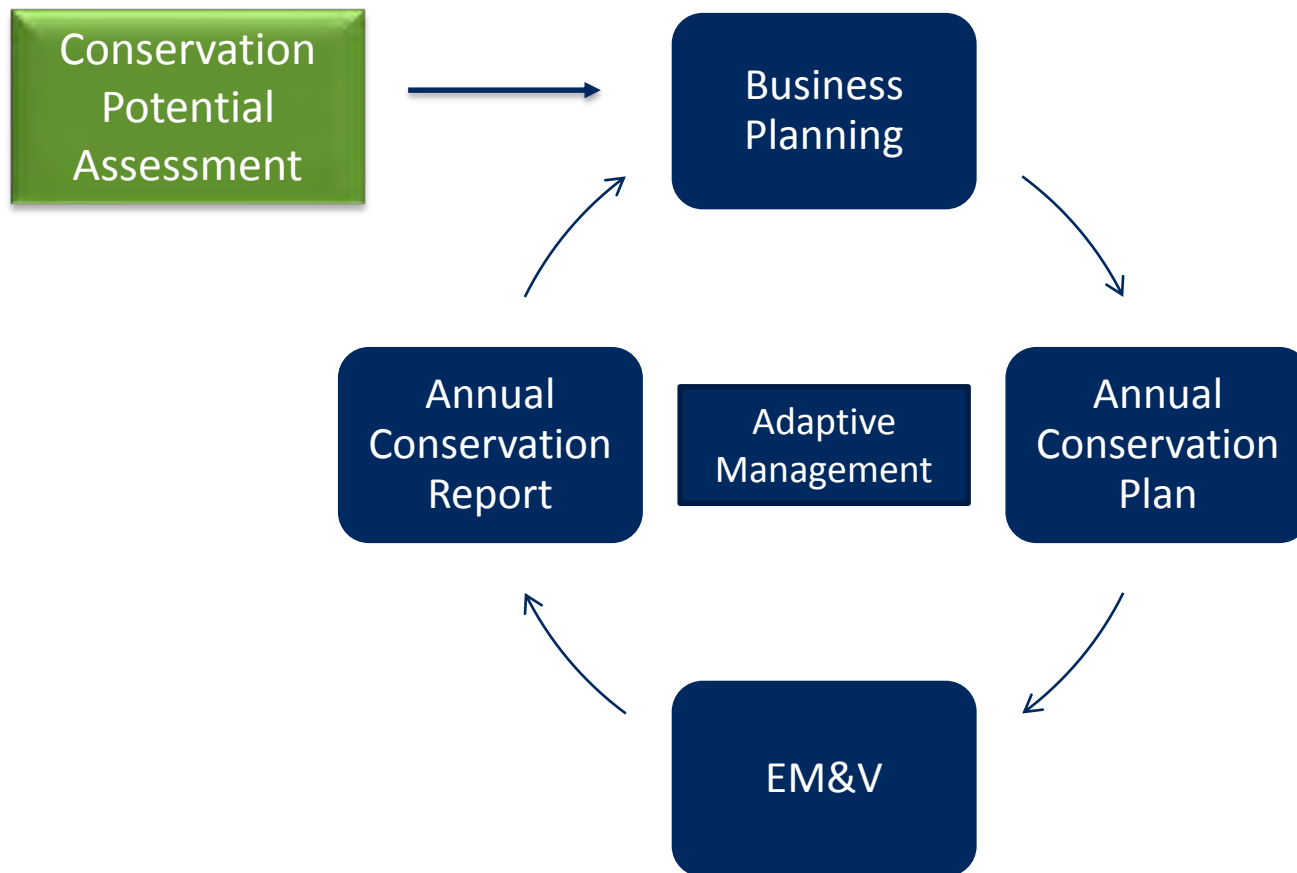

Business Planning Process

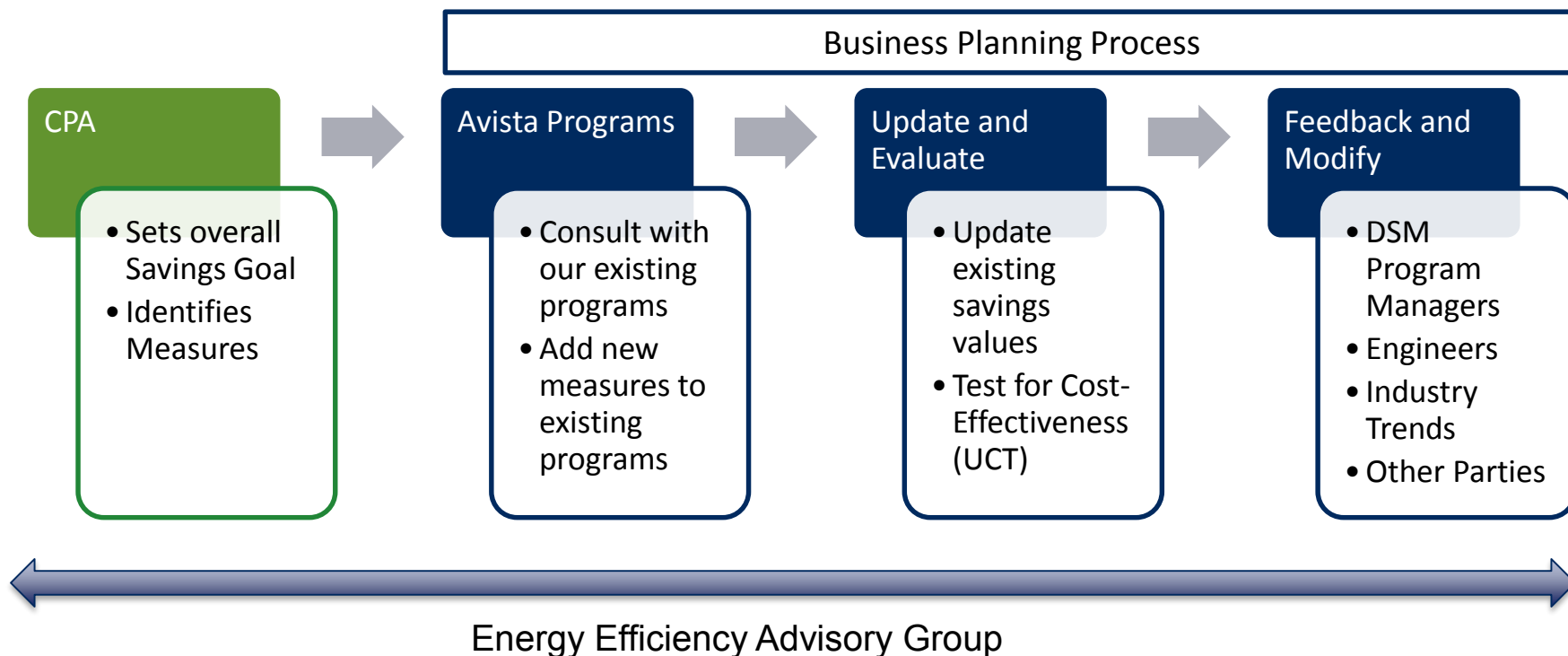

Incentive Setting

Cost-Effective Test

Utility Cost Test (UCT)

Must have a UCT of 1.0 or Higher



Decide Incentive Level

\$3 per Therm

70% of CIC

UCT Impact

Portfolio Alignment



Significant Costs and Benefits

COSTS

- **Administration**

(e.g., program design, development, operations, maintenance, overhead, customer service, marketing & outreach, sales, IT infrastructure, customer education, program evaluation, measurement & verification)

- **Measure (Capital) Costs**

(equipment costs incurred by the utility and participants)

- **Incentives**

- **Revenue Loss**

(bill reductions)

- **Participant Costs**

(Other than capital costs – value of service lost & transaction costs)

BENEFITS

- **Avoided Costs**

(complex)

- **Tax Credits**

(currently available for DG only)

- **Market/Reliability Benefits**

- **Non-energy benefits**

- **Incentives**

- **Bill reductions**

Questions?

2018 IRP Timeline

- **August 31, 2017** – Work Plan filed with WUTC
- **January through May 2018** – Technical Advisory Committee meetings. Meeting topics will include:
 - **TAC 1: Thursday, January 25, 2018: TAC meeting expectations, review of 2016 IRP acknowledgement letters, customer forecast, and demand-side management (DSM) update.**
 - **TAC 2: Thursday, February 22, 2018: Weather analysis, environmental policies, market dynamics, price forecasts, cost of carbon.**
 - **TAC 3: Thursday, March 29, 2018** : Distribution, supply-side resources overview, overview of the major interstate pipelines, RNG overview and future potential resources.
 - **TAC 4: Thursday, May 10, 2018:** DSM results, stochastic modeling and supply-side options, final portfolio results, and 2020 Action Items.
- **June 1, 2018** – Draft of IRP document to TAC
- **June 29, 2018** – Comments on draft due back to Avista
- **July 2018** – TAC final review meeting (if necessary)
- **August 31, 2018** – File finalized IRP document



2018 Avista Natural Gas IRP

Technical Advisory Committee Meeting
February 22, 2018
Spokane, WA

Agenda

Time	Length	Topic
9:30 AM	<i>10 minutes</i>	Introductions & Logistics
9:40 AM	<i>10 minutes</i>	Safety Moment
9:50 AM	<i>30 minutes</i>	Weather Analysis
10:20 AM	<i>60 minutes</i>	Market dynamics
11:20 AM	<i>10 minutes</i>	break
11:30 AM	<i>30 minutes</i>	Procurement Planning
12:00 PM	<i>60 minutes</i>	Lunch
1:00 PM	<i>30 minutes</i>	Emissions and Clean Air Rule
1:30 PM	<i>30 minutes</i>	Carbon policies
2:00 PM	<i>45 minutes</i>	Price forecasts and Carbon Adders
2:45 PM	<i>15 minutes</i>	wrap-up

2018 IRP Timeline

- **August 31, 2017** – Work Plan filed with WUTC
- **January through May 2018** – Technical Advisory Committee meetings. Meeting topics will include:
 - **TAC 1: Thursday, January 25, 2018: TAC meeting expectations, review of 2016 IRP acknowledgement letters, customer forecast, and demand-side management (DSM) update.**
 - **TAC 2: Thursday, February 22, 2018: Weather analysis, environmental policies, market dynamics, price forecasts, cost of carbon.**
 - **TAC 3: Thursday, March 29, 2018** : Distribution, supply-side resources overview, overview of the major interstate pipelines, RNG overview and future potential resources.
 - **TAC 4: Thursday, May 10, 2018: DSM results, stochastic modeling and supply-side options, final portfolio results, and 2020 Action Items.**
- **June 1, 2018** – Draft of IRP document to TAC
- **June 29, 2018** – Comments on draft due back to Avista
- **July 2018** – TAC final review meeting (if necessary)
- **August 31, 2018** – File finalized IRP document

Safety Moment

- Cold Weather Slips



Weather Analysis

Kaylene Schultz

Planning Standard Assumptions

Area	Coldest in 20 Year HDD	Coldest on Record HDD
WA-ID	76	82
Klamath Falls	72	72
La Grande	74	74
Medford	54	61
Roseburg	48	55

Coldest on Record Dates

WA/ID – December 30, 1968

Medford – December 9, 1972

Roseburg – December 22, 1990

Klamath Falls – December 8, 2013

La Grande – December 23, 1983

Spokane

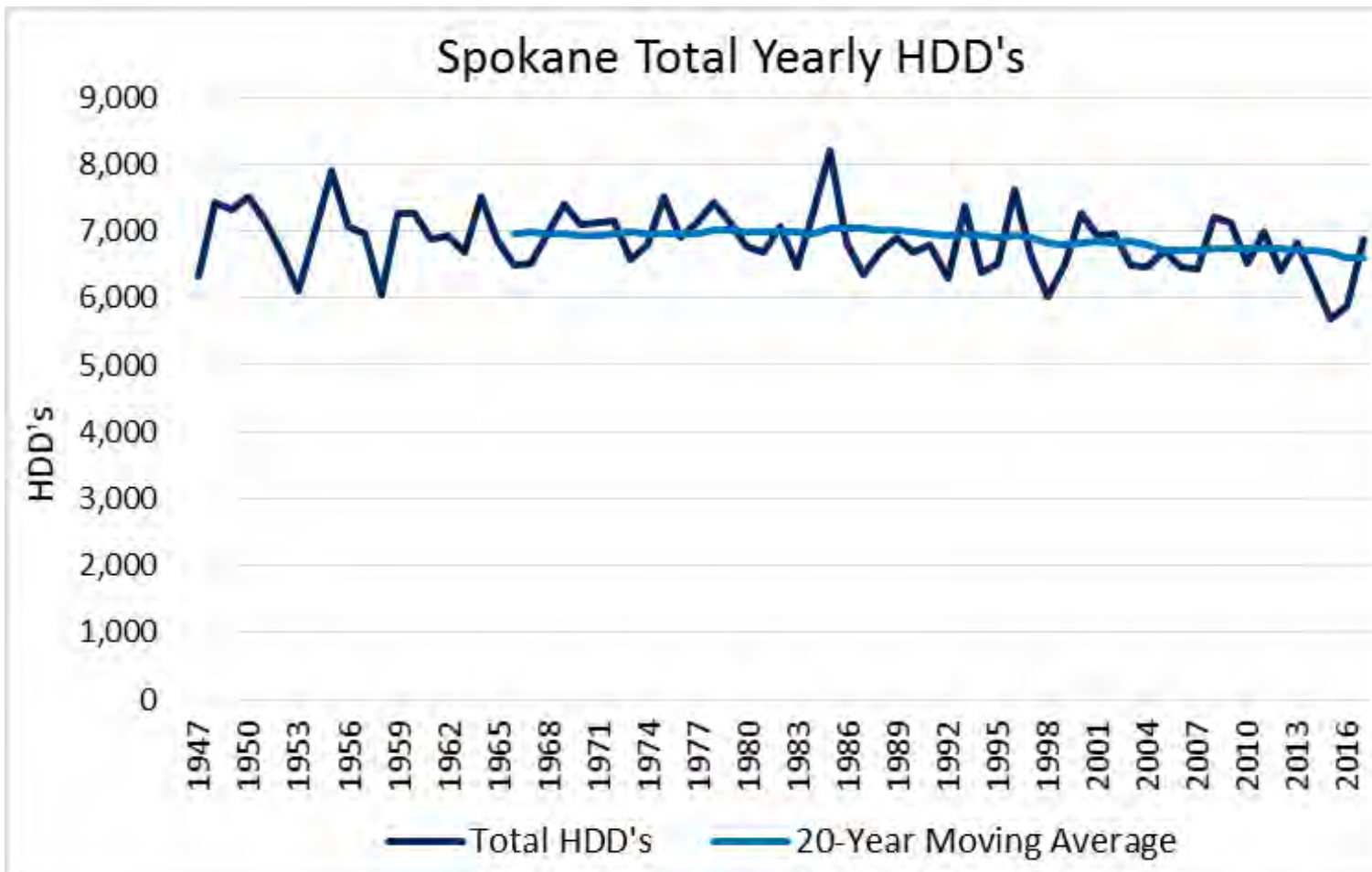

	HDD's
Min	5,681
Max	8,215
Avg.	6,853
Stdev	465
2017	6,875

*1947 - 2017

Medford

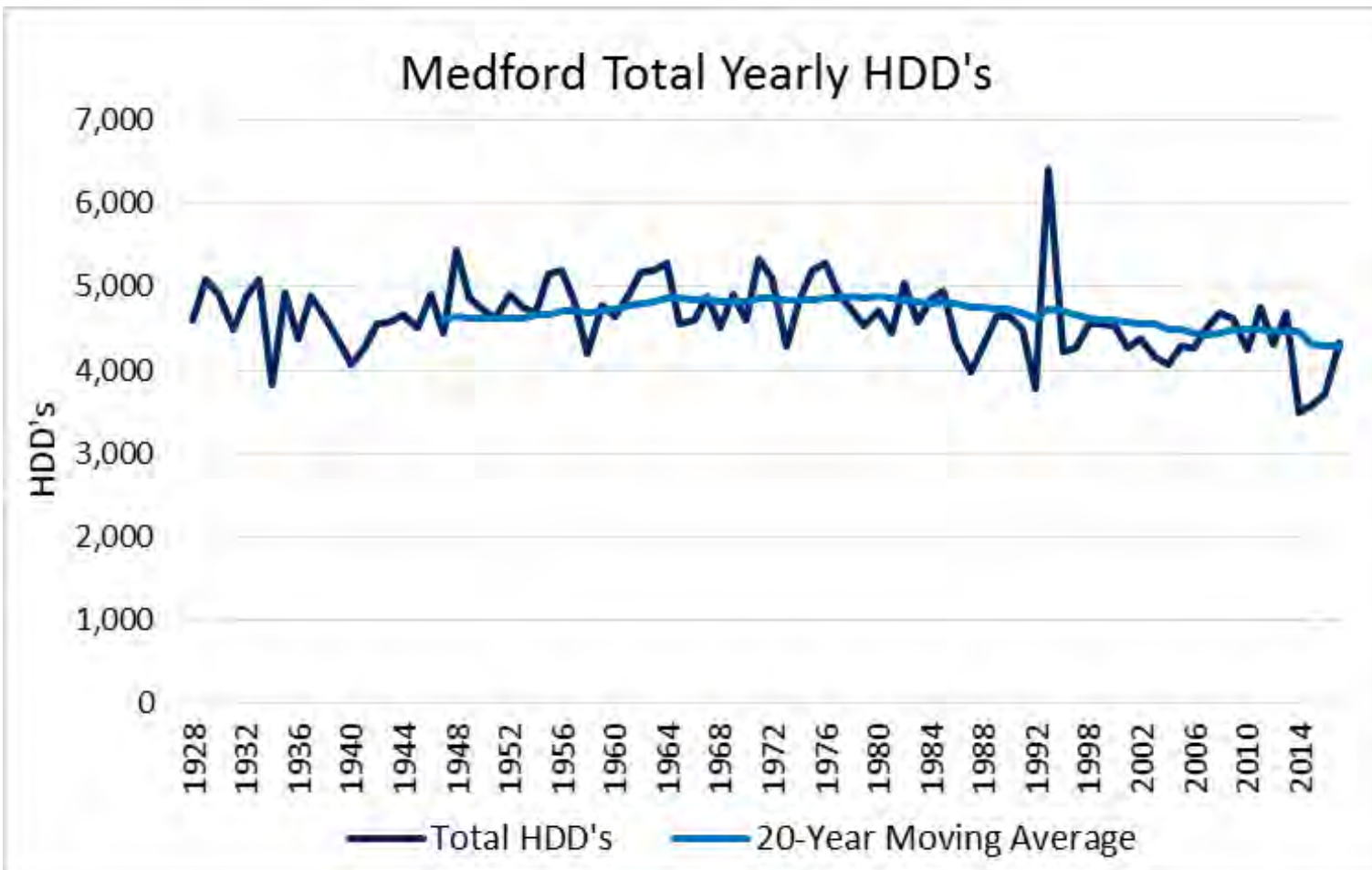

	HDD's
Min	3,482
Max	6,414
Avg.	4,629
Stdev	435
2017	4,325

*1928 - 2017

La Grande

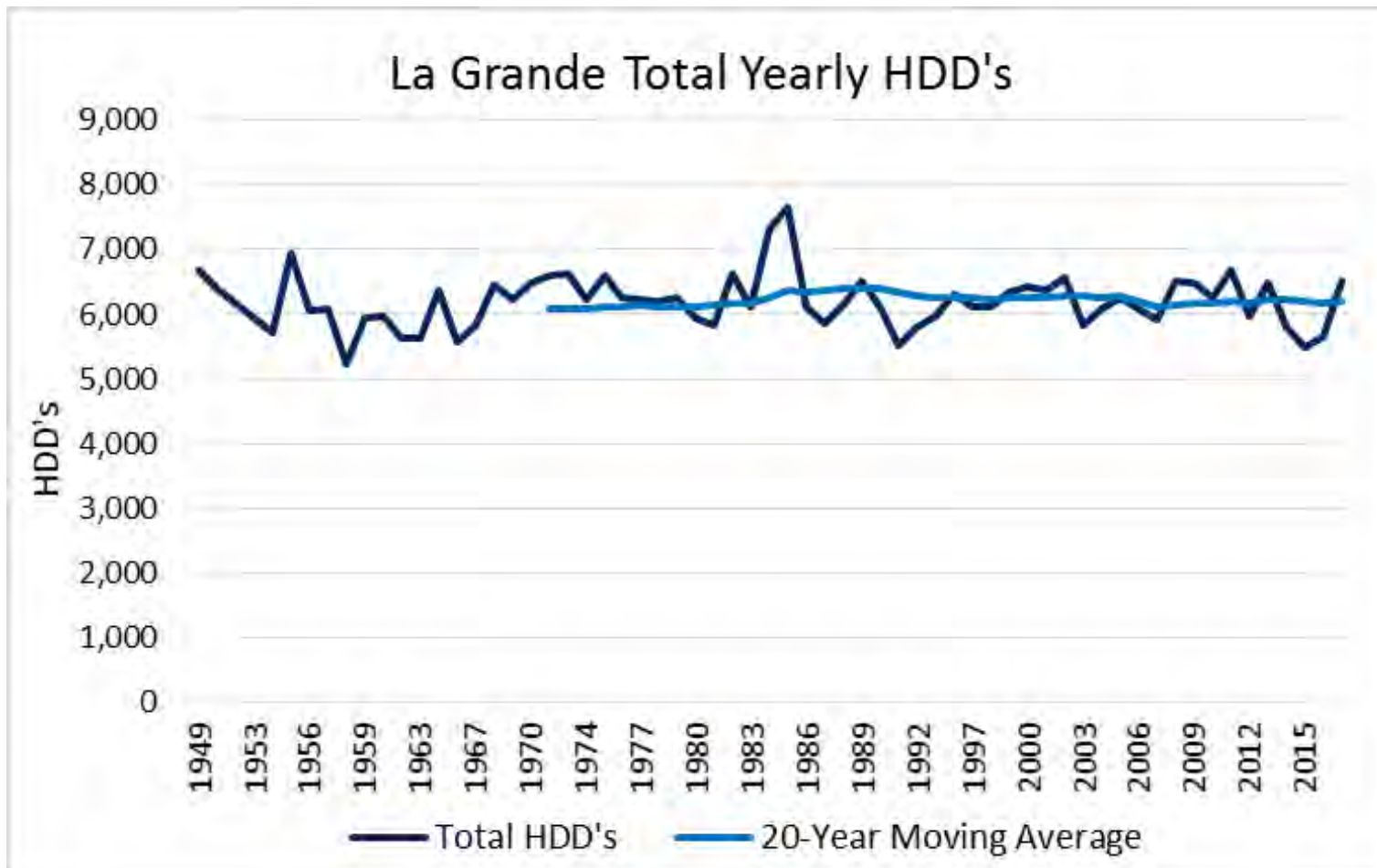

	HDD's
Min	5,224
Max	7,656
Avg.	6,192
Stdev	416
2017	6,507

*1949 - 2017

Klamath Falls

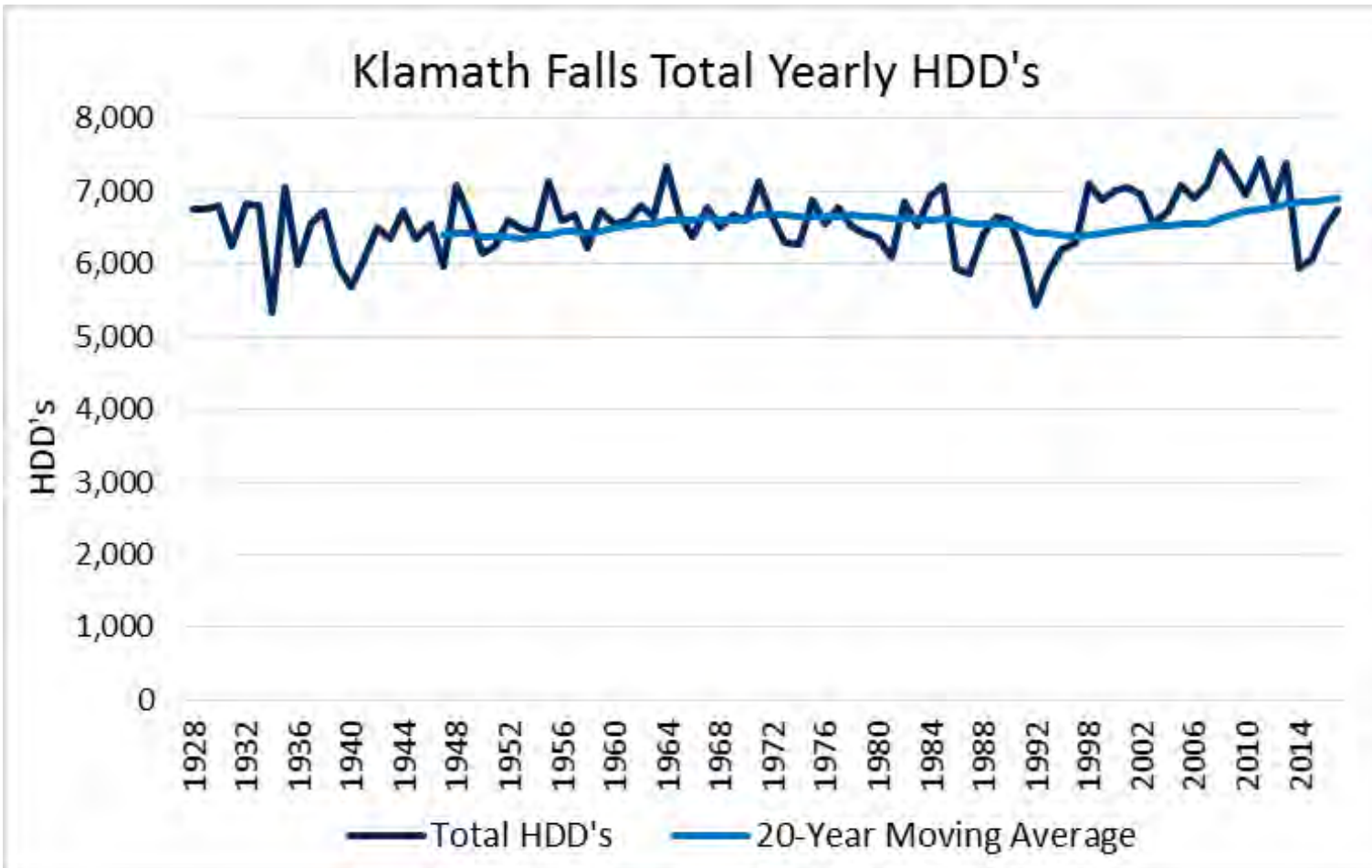

	HDD's
Min	5,334
Max	7,548
Avg.	6,584
Stdev	426
2017	6,760

*1928 - 2017

Roseburg

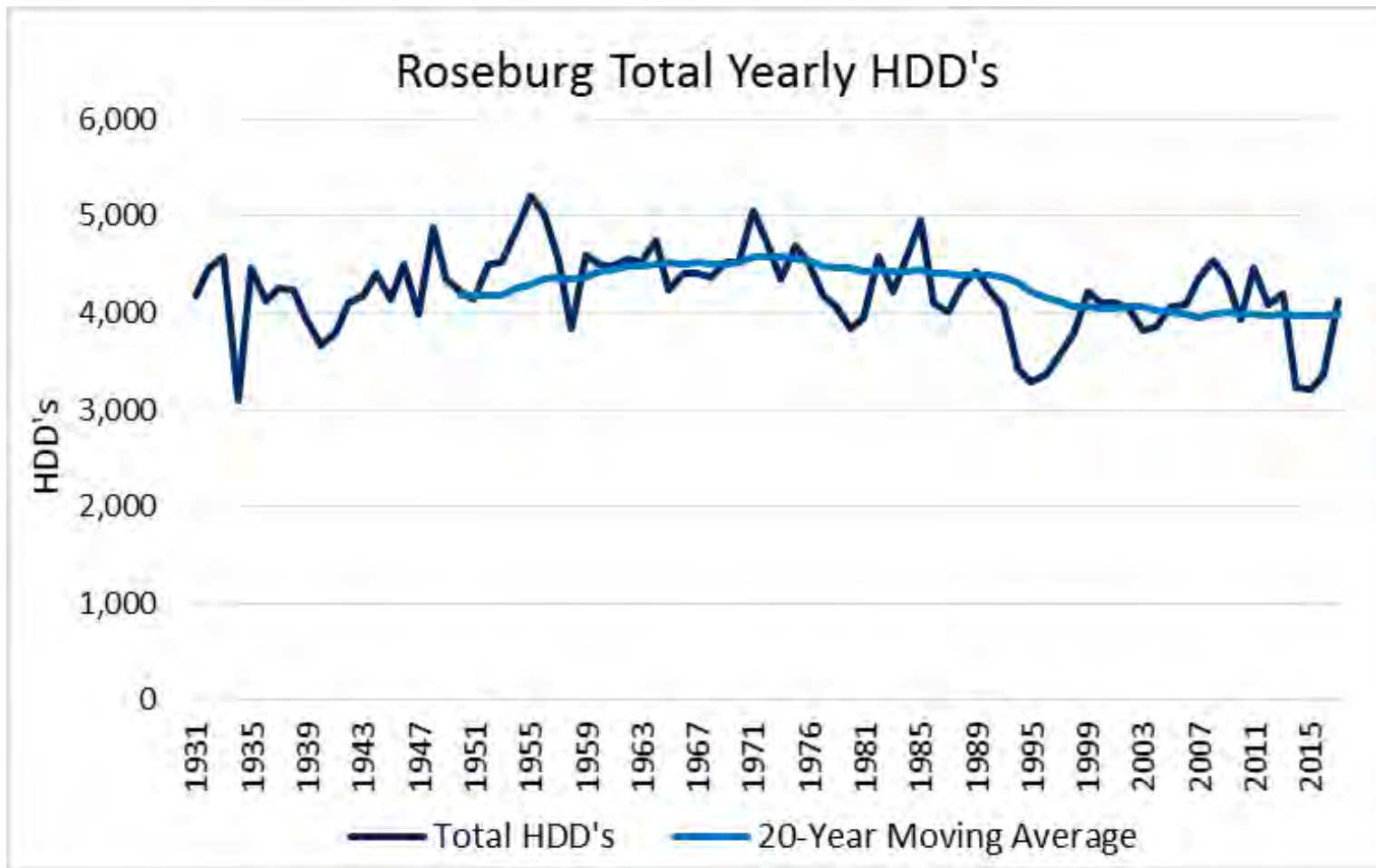

	HDD's
Min	3,100
Max	5,213
Avg.	4,224
Stdev	426
2017	4,123

*1931 - 2017

Temperature Anomaly Distribution

NASA Temperature Anomaly Distribution for Northern Hemisphere

Temperature Anomaly Distribution

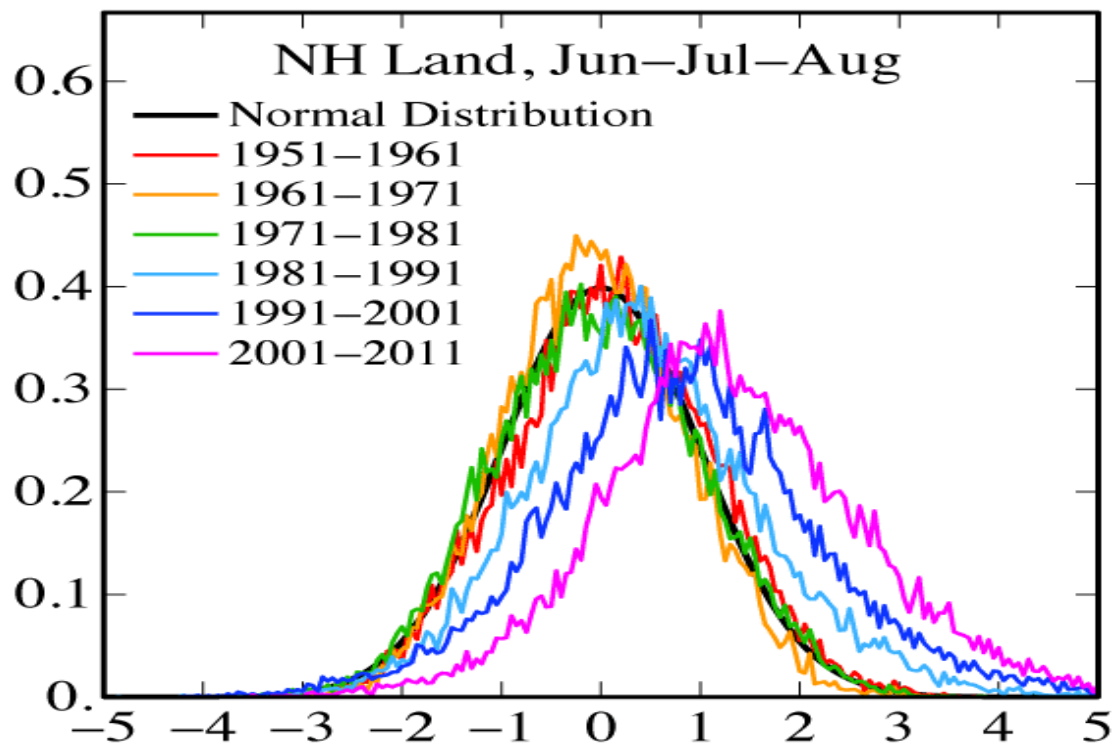

Temperature anomaly distribution: The frequency of occurrence (vertical axis) of local temperature anomalies (relative to 1951-1980 mean) in units of local standard deviation (horizontal axis). Area under each curve is unity. Image credit: NASA/GISS.

Normal Distribution: Base Reference Period 1951-1980

Avista Corp

2018 Natural Gas IRP Appendix

Source: Hansen, J., R. Ruedy, M. Sato, and K. Lo (2010), Global surface temperature change, Rev. Geophys., 48, RG4004, doi:10.1029/2010RG000345. This research has been updated and can be found at http://www.giss.nasa.gov/research/briefs/hansen_17/.

Spokane

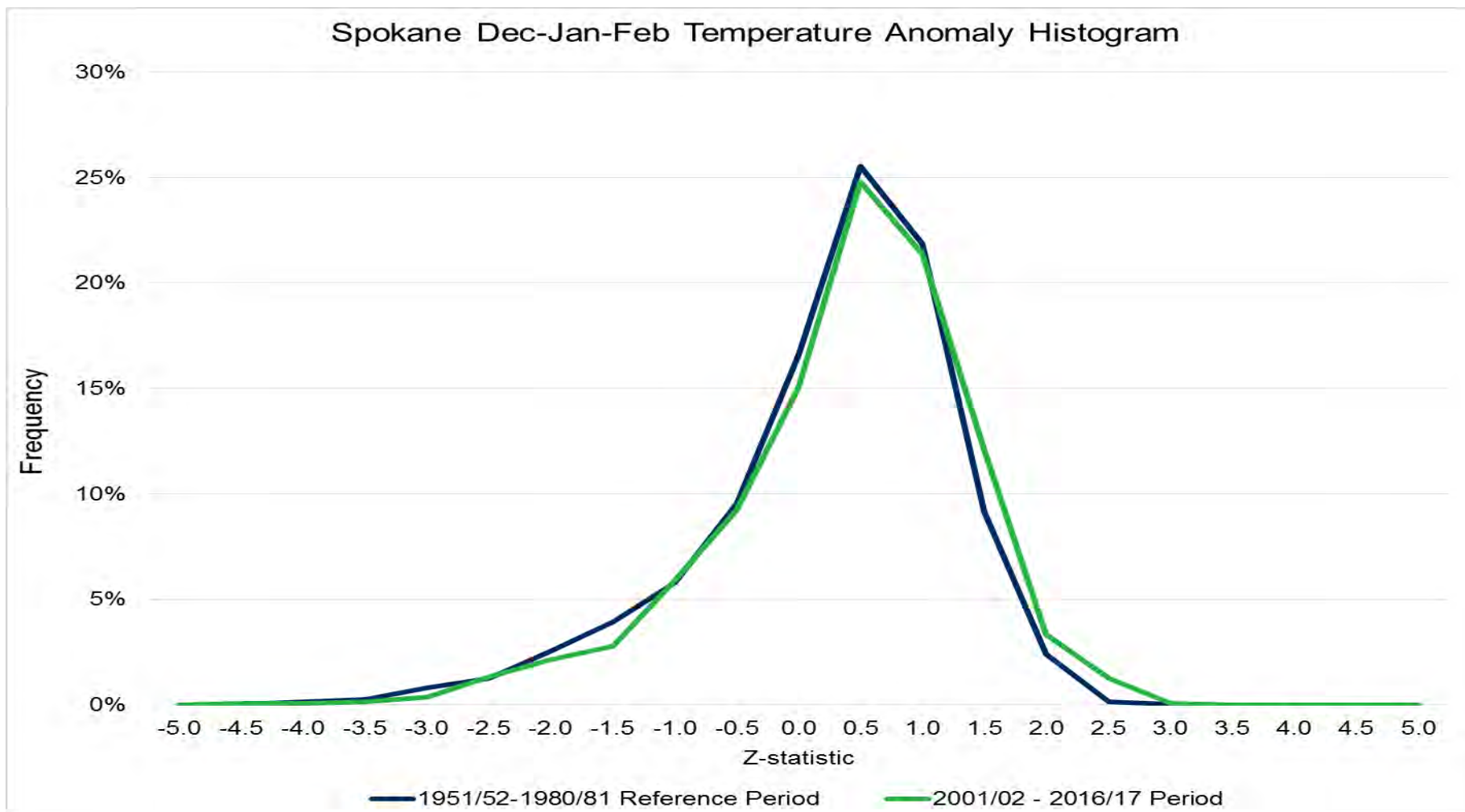

Medford

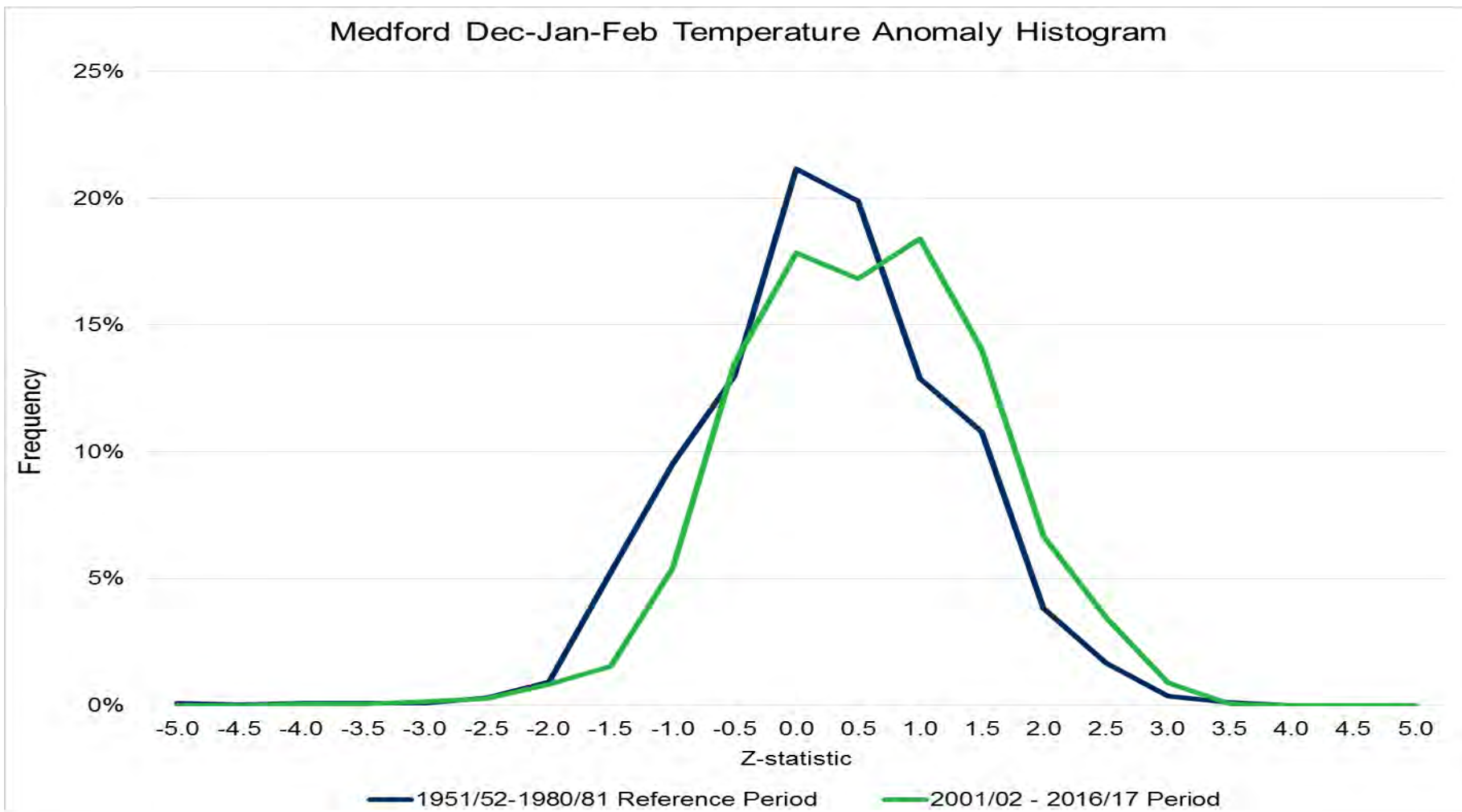

La Grande

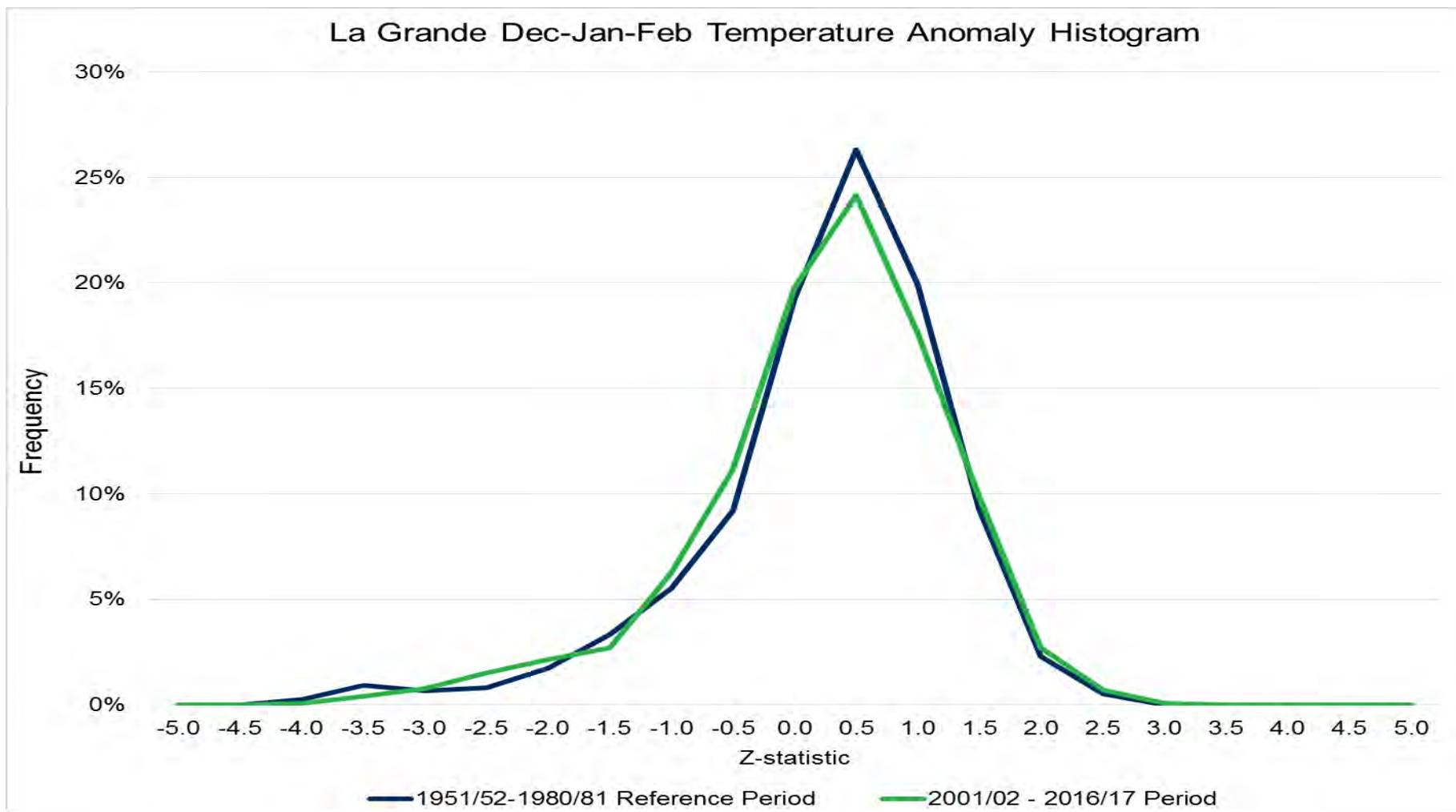

Klamath Falls

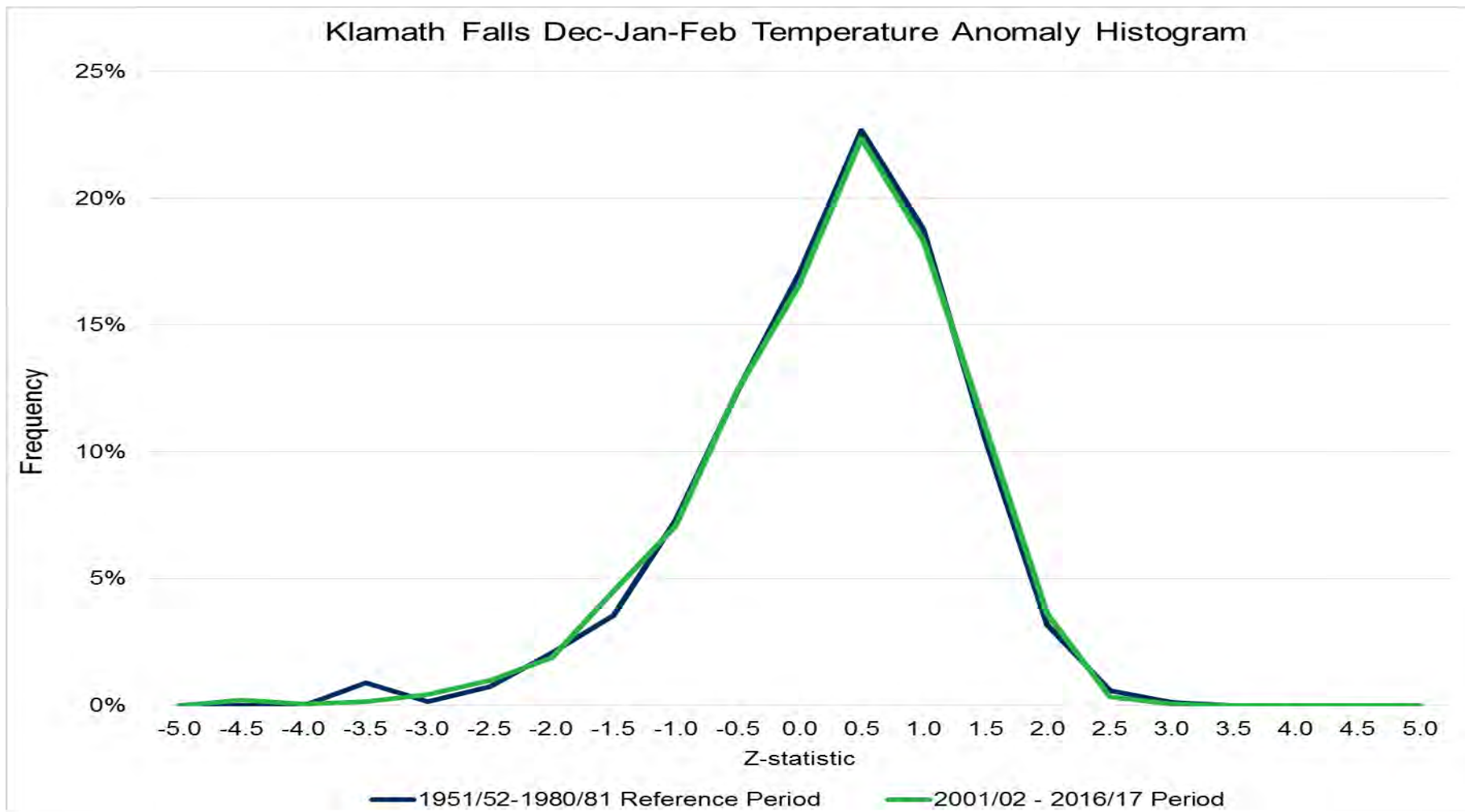

Roseburg

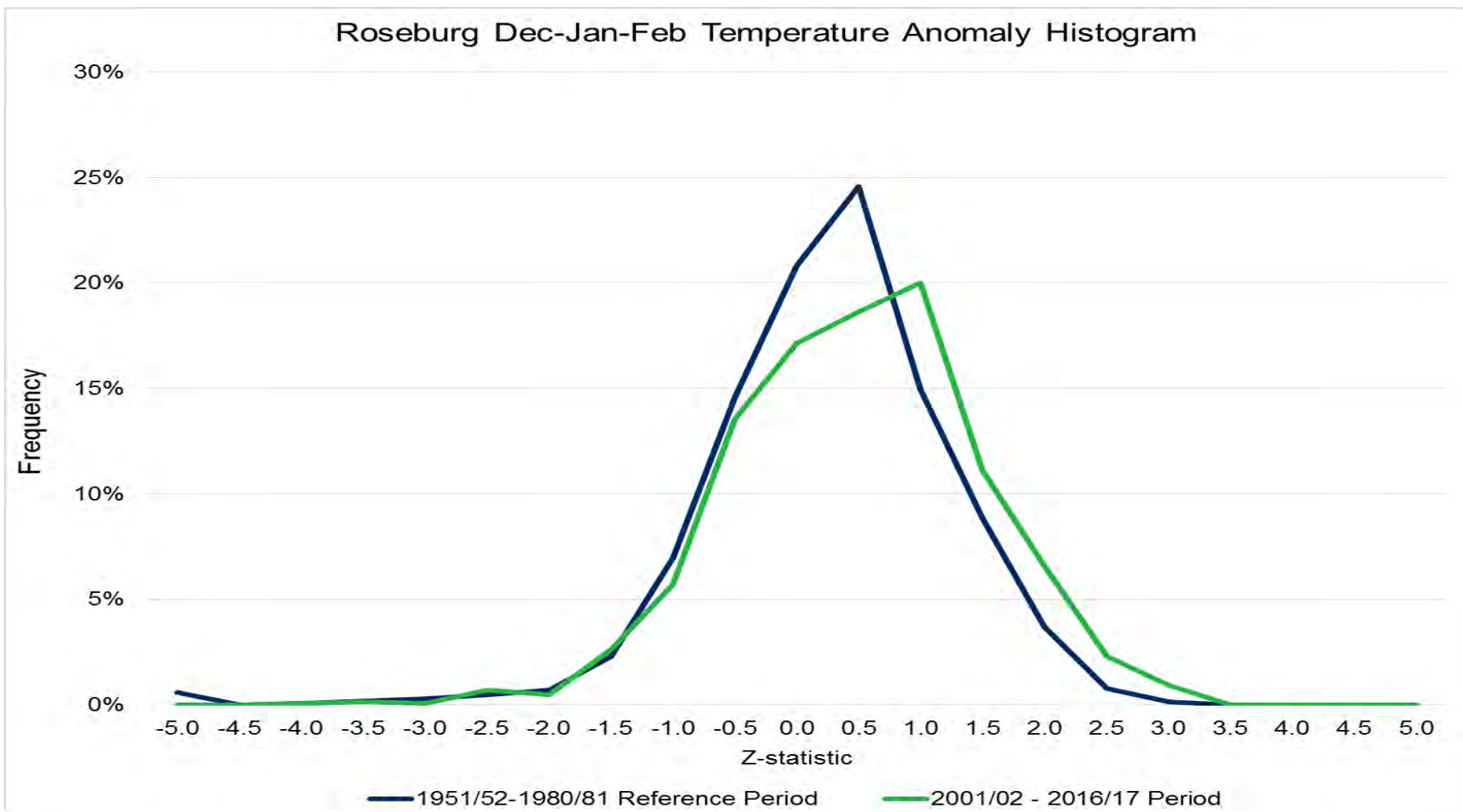



Market Dynamics

Tom Pardee
Manager of Natural Gas Planning

Assumptions about the size of U.S. resources and the improvement in technology affect domestic oil and natural gas prices—

North Sea Brent oil price
2017 dollars per barrel

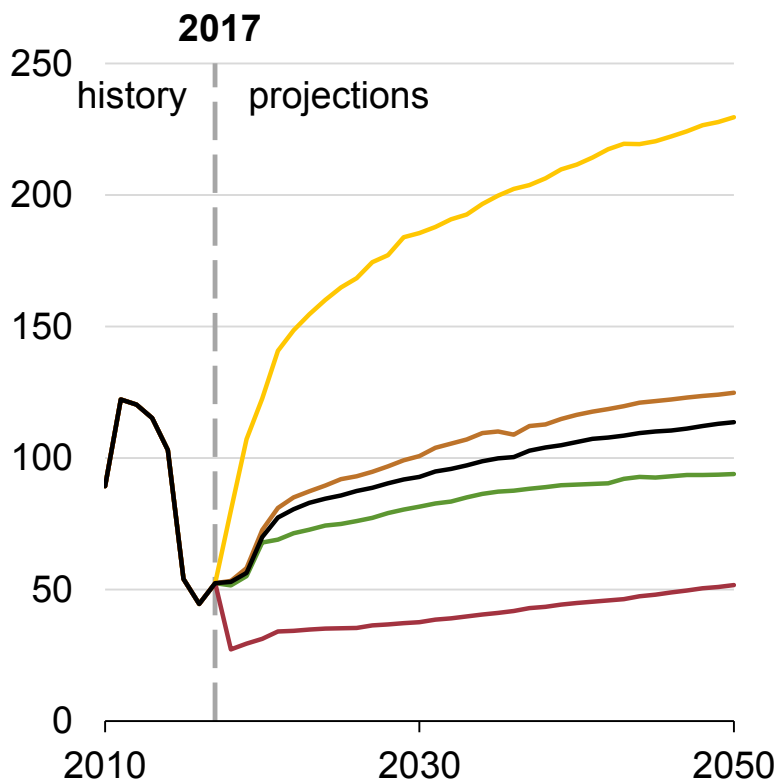

Henry Hub natural gas price
2017 dollars per million Btu

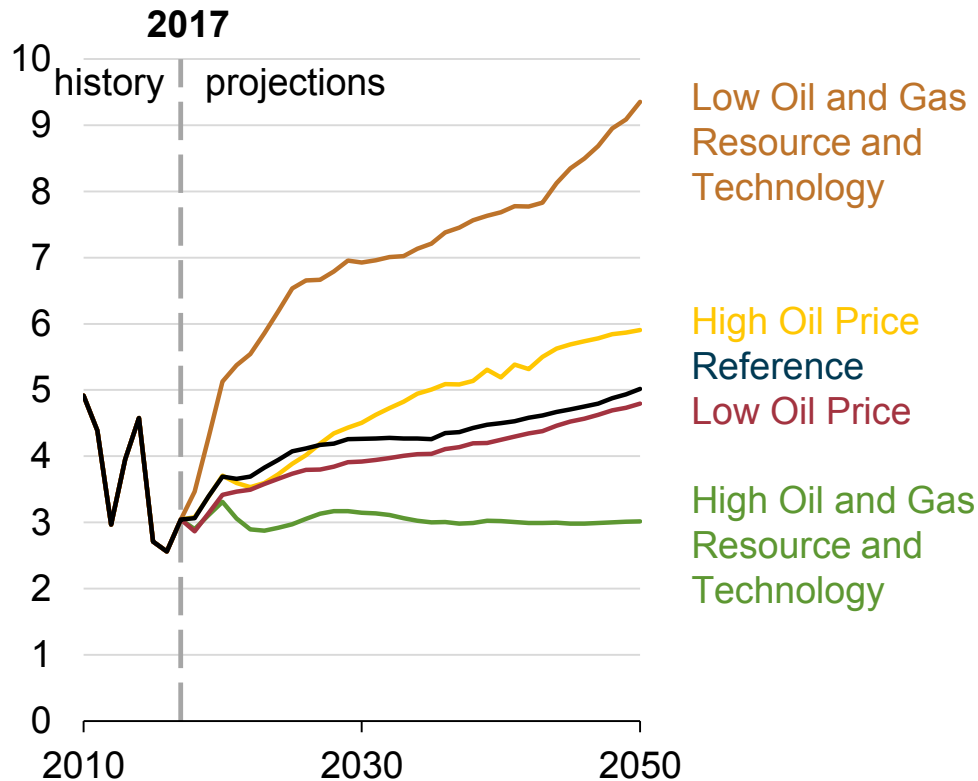

Henry Hub Forecast (Nominal \$)

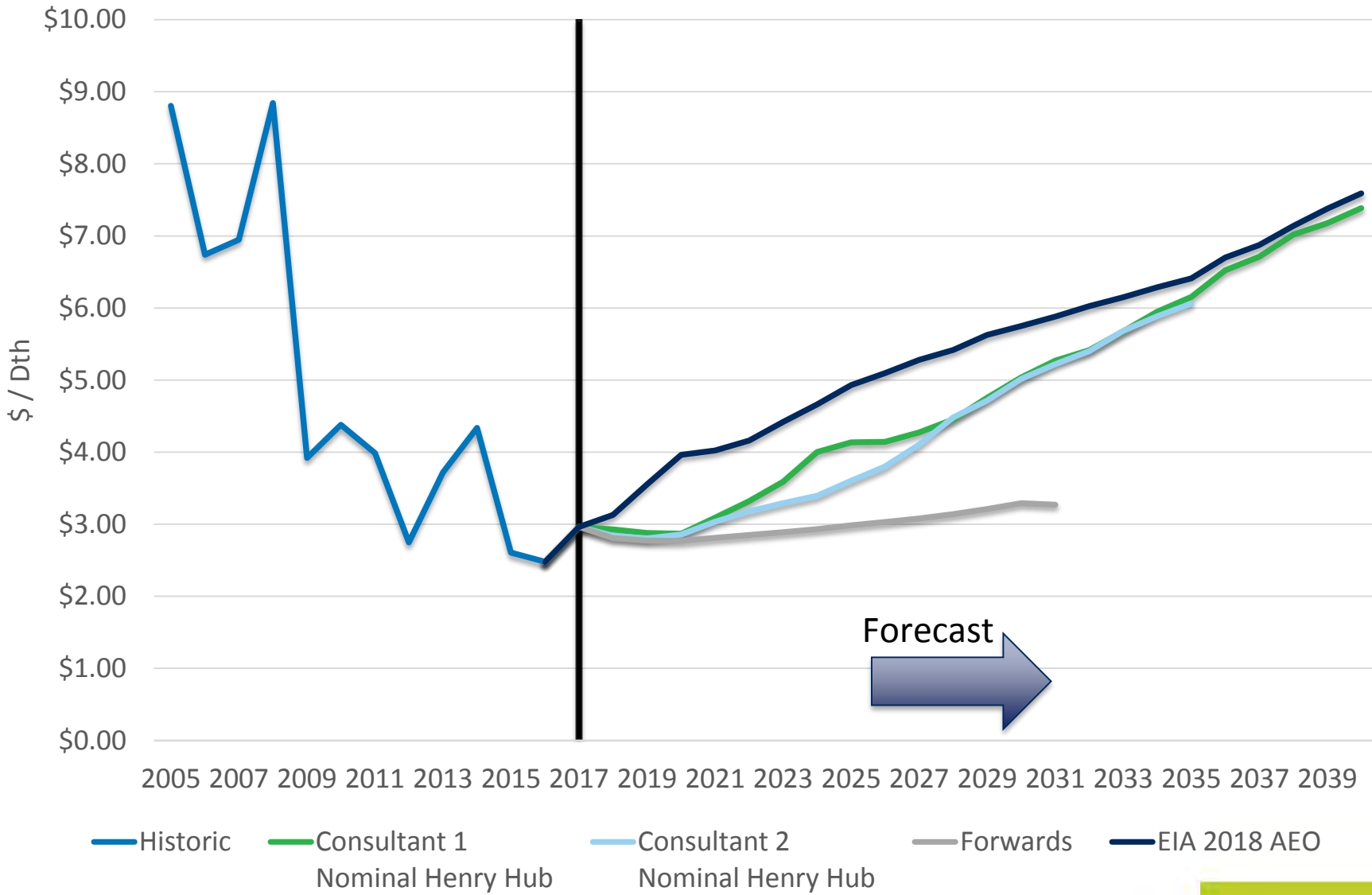

US NATURAL GAS PRODUCTION

Exh. JM-2

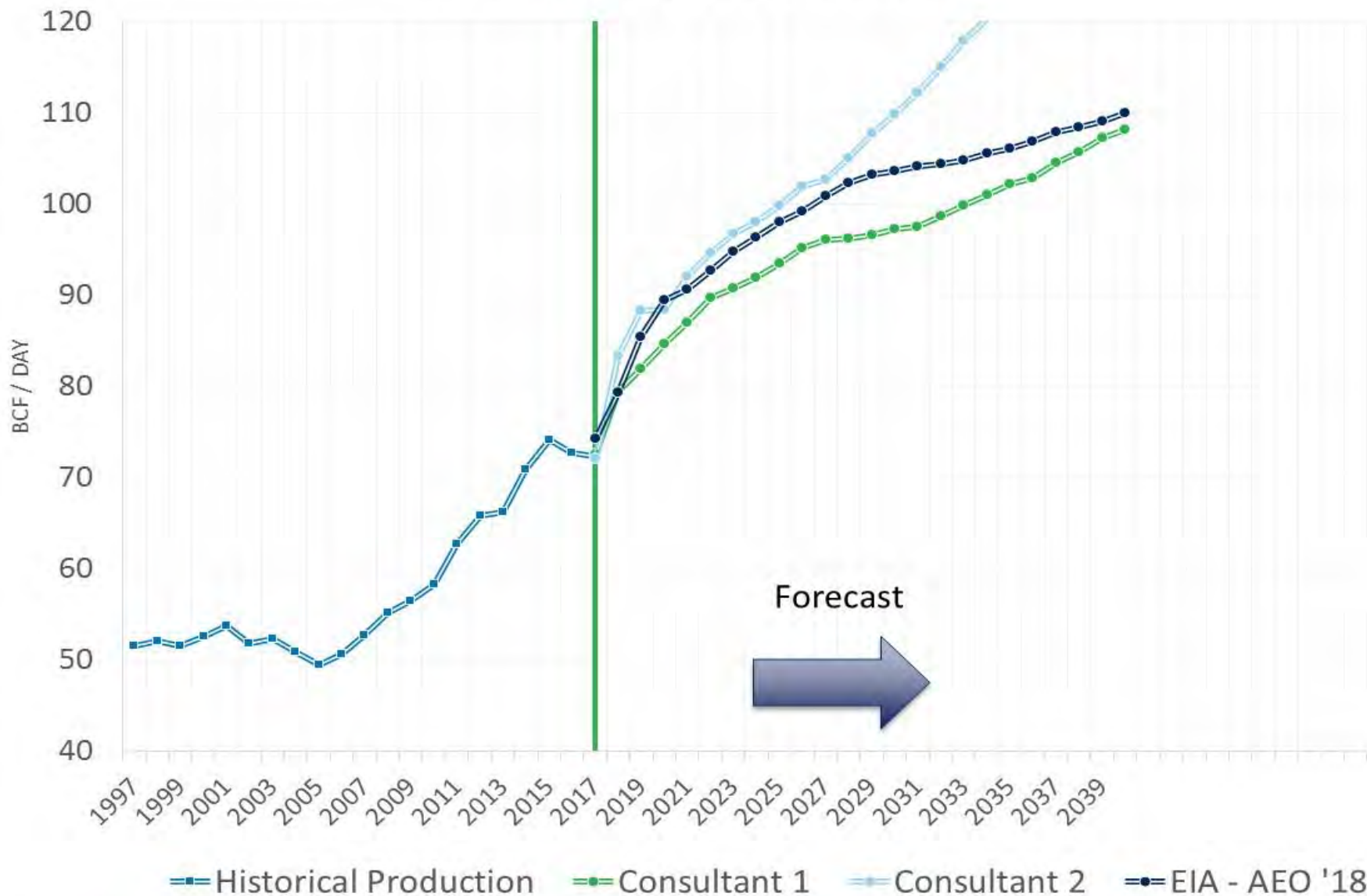

US Storage

Region	Stocks billion cubic feet (Bcf)				Historical Comparisons			
	02/09/18	02/02/18	net change	implied flow	Year ago (02/09/17)		5-year average (2013-17)	
					Bcf	% change	Bcf	% change
East	432	488	-56	-56	485	-10.9	500	-13.6
Midwest	468	543	-75	-75	648	-27.8	581	-19.4
Mountain	122	131	-9	-9	151	-19.2	142	-14.1
Pacific	213	213	0	0	205	3.9	233	-8.6
South Central	649	703	-54	-54	972	-33.2	861	-24.6
Salt	178	184	-6	-6	333	-46.5	238	-25.2
Nonsalt	472	518	-46	-46	639	-26.1	623	-24.2
Total	1,884	2,078	-194	-194	2,461	-23.4	2,317	-18.7

TOTAL U.S. INVENTORIES

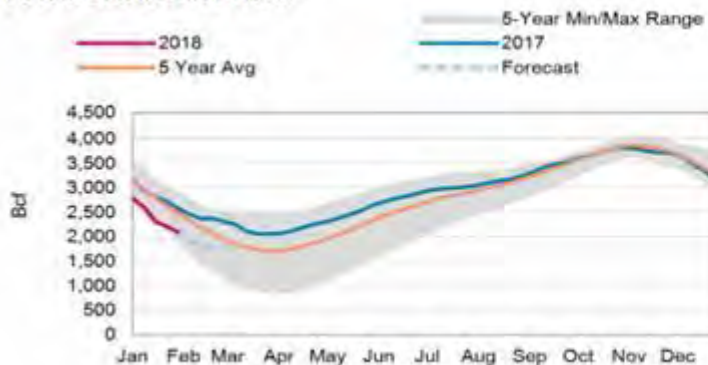

CANADIAN STORAGE INVENTORIES (Bcf)

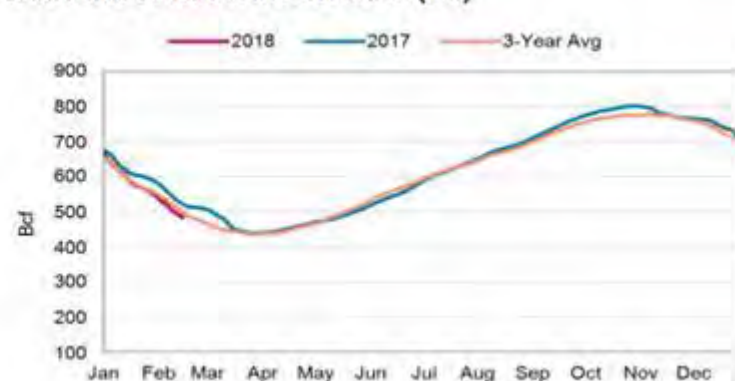

Monthly dry shale gas production

billion cubic feet per day

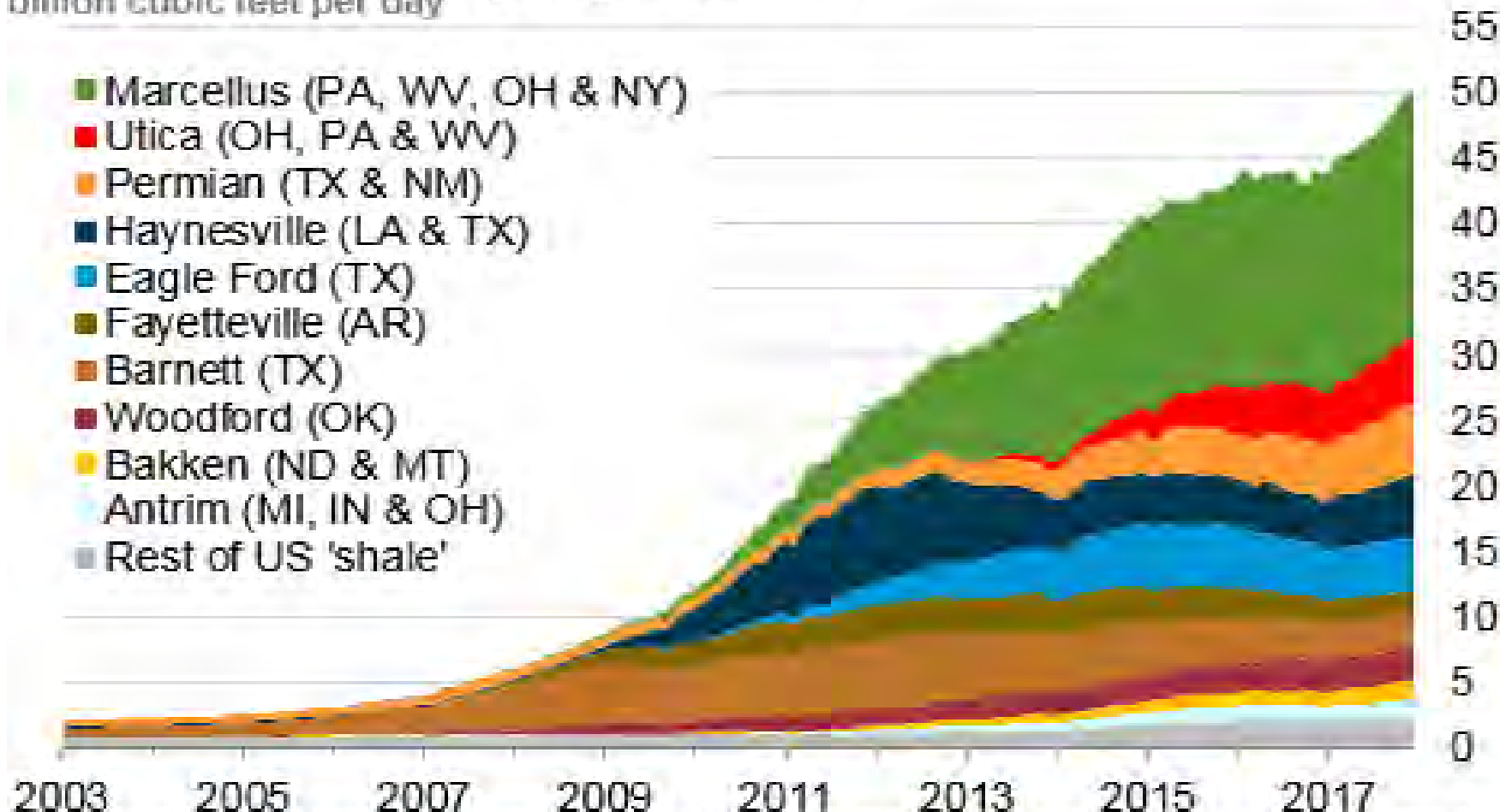

Sources: EIA derived from state administrative data collected by DrillingInfo Inc. Data are through December 2017 and represent EIA's official shale gas estimates, but are not survey data. State abbreviations indicate primary state(s).



Industrial and electric power demand drives natural gas consumption growth—

Natural gas consumption by sector

trillion cubic feet

billion cubic feet per day

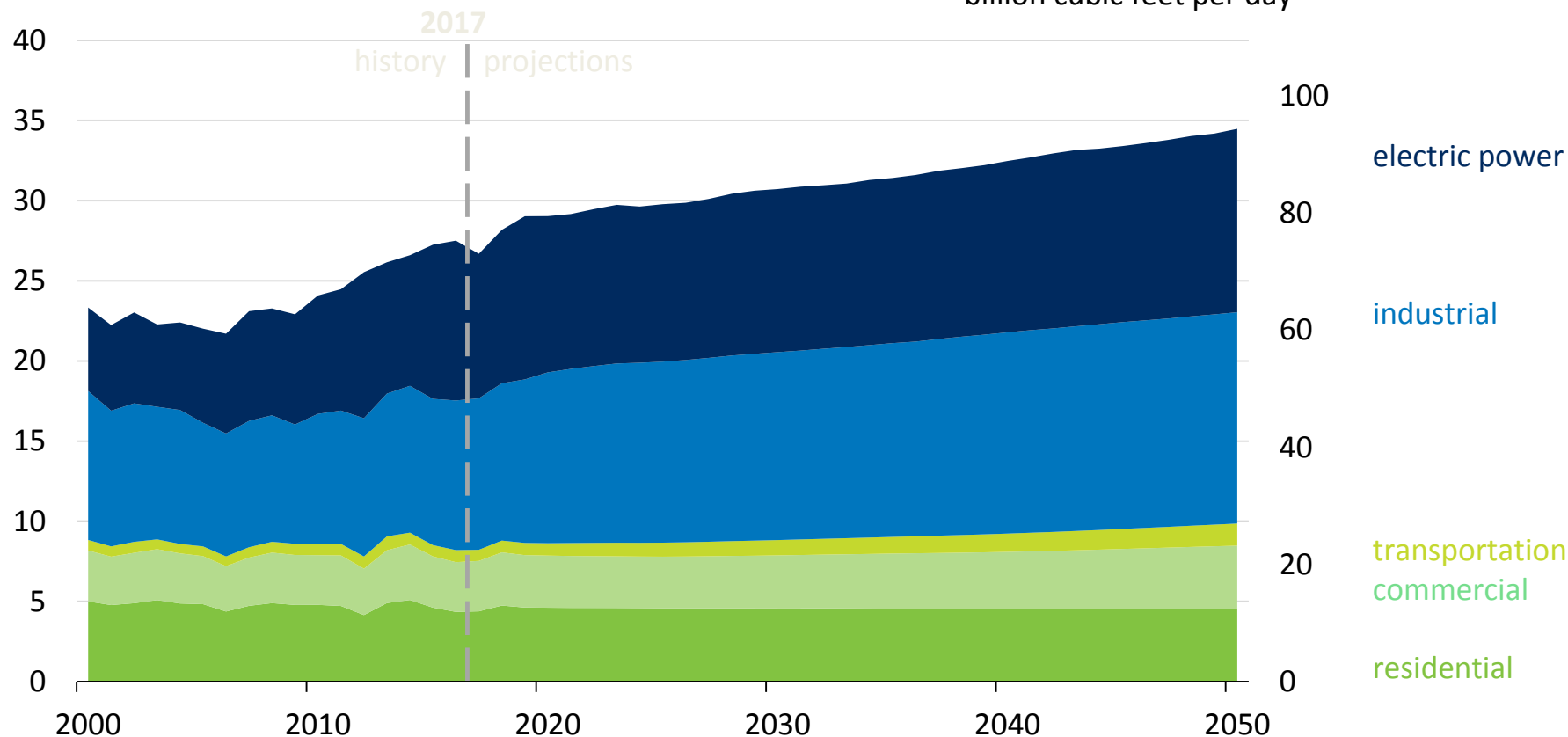

The United States is a net natural gas exporter in the Reference case because of near-term export growth and continued import decline —

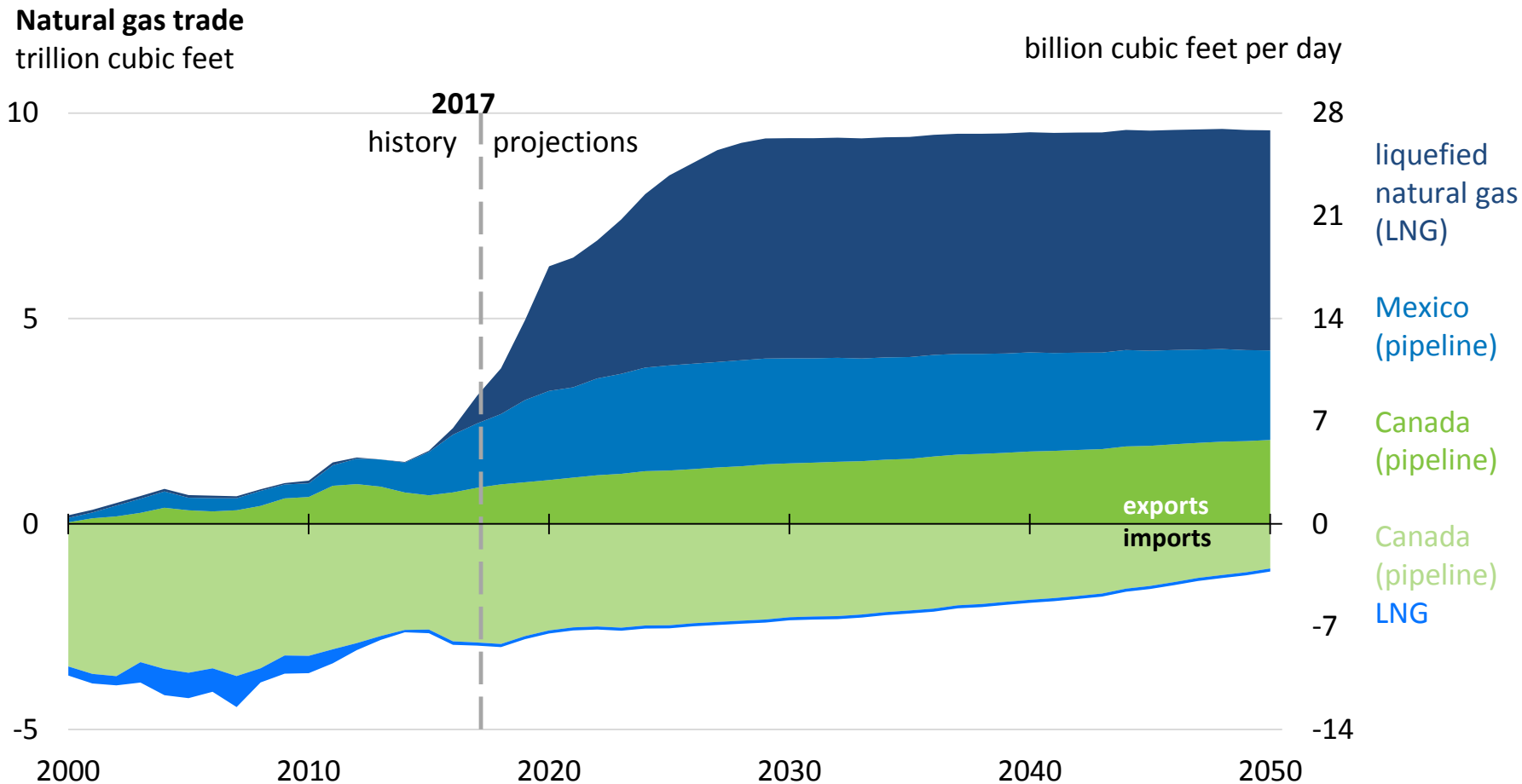

Exports

U.S. net natural gas trade (1990-2050)

billion cubic feet per day

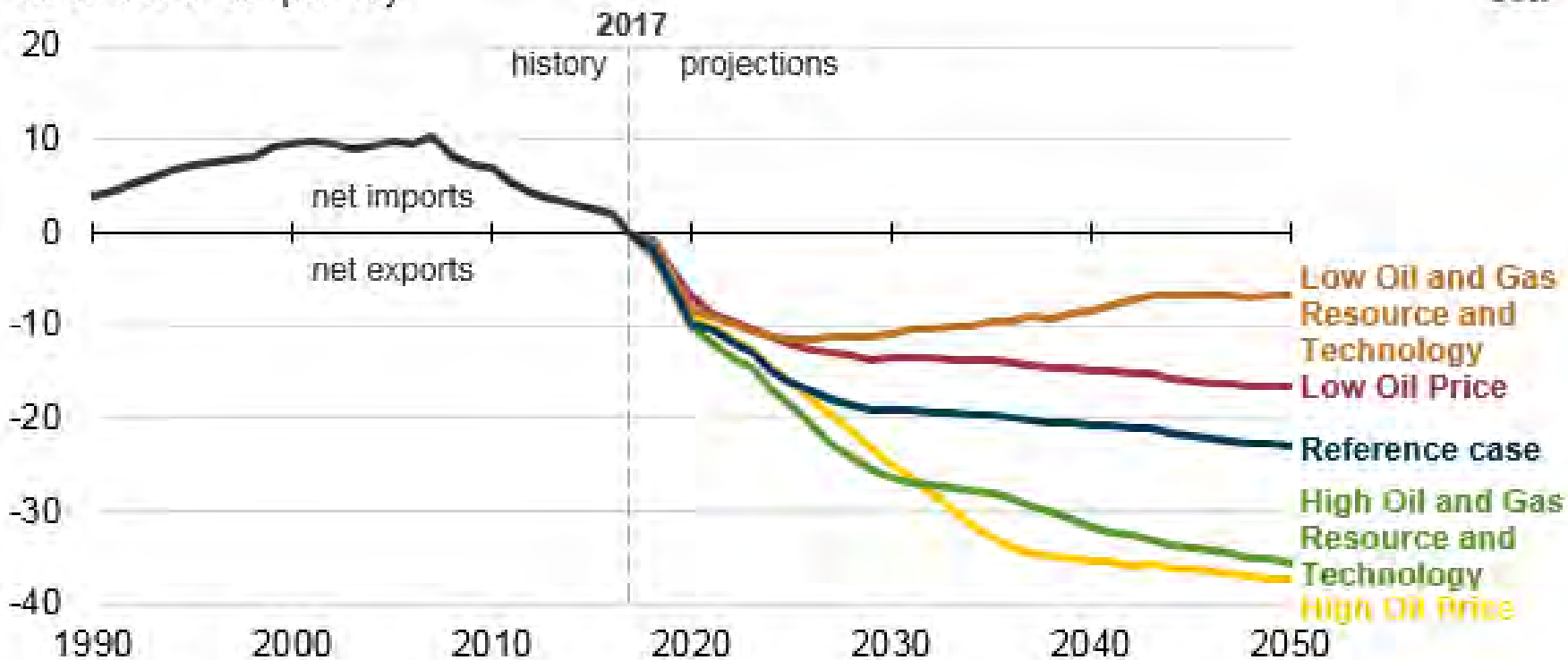

Reference Case: 23 Bcf per day by 2050
Driven by LNG and Mexico Exports

Mexico Exports

3.77 Bcf/d average

U.S. Natural Gas Pipeline Exports to Mexico

 DOWNLOAD

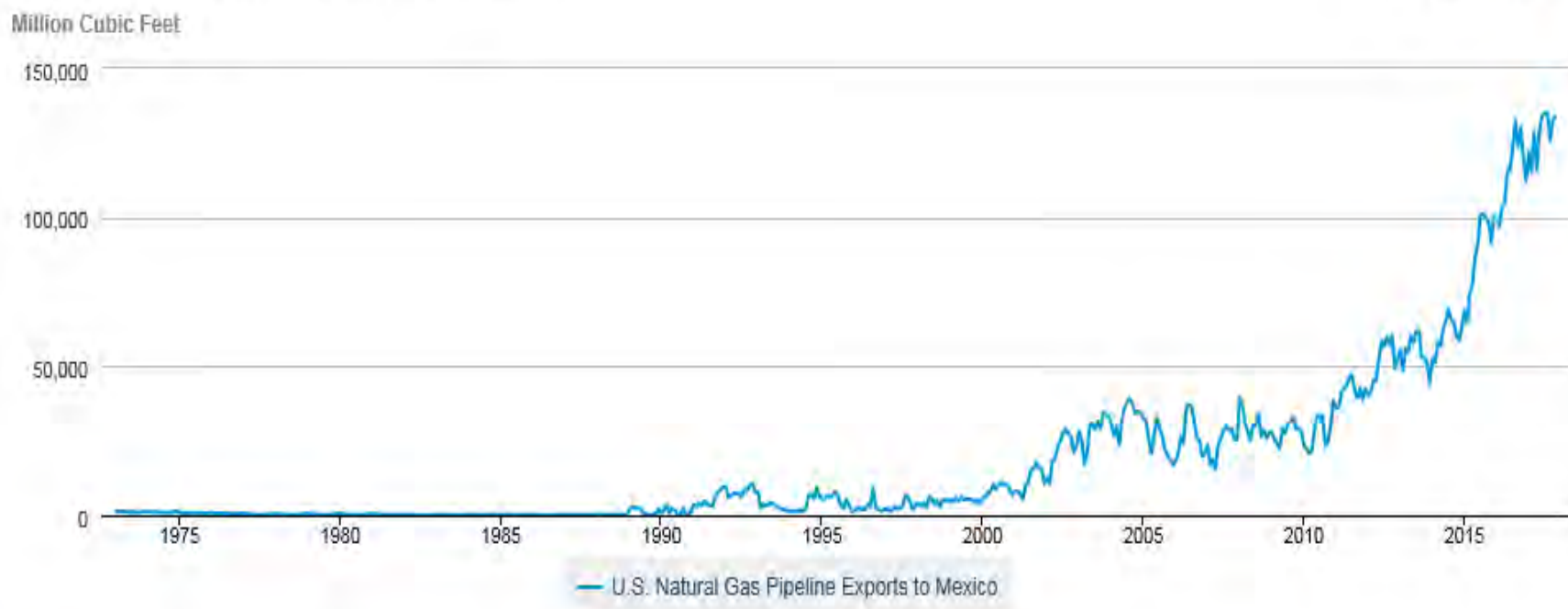

 Source: U.S. Energy Information Administration

North American LNG Import/Export Terminals

Exh. JM-2

Existing

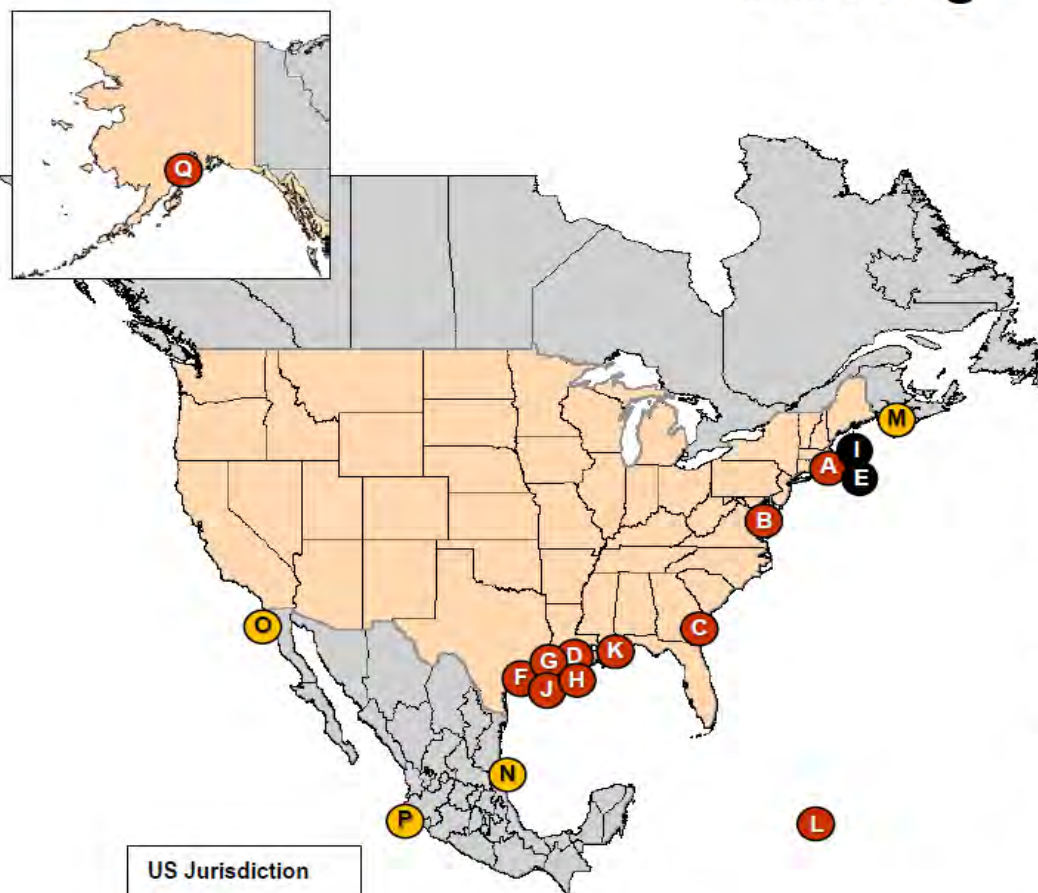

US Jurisdiction

- FERC
- MARAD/USCG

As of January 24, 2018

★ Authorized to re-export delivered LNG

Import Terminals

U.S.

- A. Everett, MA: 1.035 Bcf/d (GDF SUEZ - DOMAC)
- B. Cove Point, MD: 1.8 Bcf/d (Dominion - Cove Point LNG)
- C. Elba Island, GA: 1.6 Bcf/d (El Paso - Southern LNG)
- D. Lake Charles, LA: 2.1 Bcf/d (Southern Union - Trunkline LNG)
- E. Offshore Boston: 0.8 Bcf/d (Excelerate Energy - Northeast Gateway) ★
- F. Freeport, TX: 1.5 Bcf/d (Cheniere/Freeport LNG Dev.) ★
- G. Sabine, LA: 4.0 Bcf/d (Cheniere/Sabine Pass LNG) ★
- H. Hackberry, LA: 1.8 Bcf/d (Sempra - Cameron LNG)
- I. Offshore Boston, MA: 0.4 Bcf/d (GDF SUEZ - Neptune LNG)
- J. Sabine Pass, TX: 2.0 Bcf/d (ExxonMobil - Golden Pass) (Phase I & II)
- K. Pascagoula, MS: 1.5 Bcf/d (El Paso/Crest/Sonangol - Gulf LNG Energy LLC)
- L. Peñuelas, PR: 0.3 Bcf/d (EcoElectrica)

Canada

- M. Saint John, NB: 1.0 Bcf/d (Repsol/Fort Reliance - Canaport LNG)

Mexico

- N. Altamira, Tamulipas: 0.7 Bcf/d (Shell/Total/Mitsui - Altamira LNG)
- O. Baja California, MX: 1.0 Bcf/d (Sempra - Energia Costa Azul)
- P. Manzanillo, MX: 0.5 Bcf/d (KMS GNL de Manzanillo)

Export Terminals

U.S.

- Q. Kenai, AK: 0.2 Bcf/d (ConocoPhillips)
- G. Sabine, LA: 2.8 Bcf/d (Cheniere/Sabine Pass LNG - Trains 1, 2, 3 & 4)

North American LNG Export Terminals Proposed

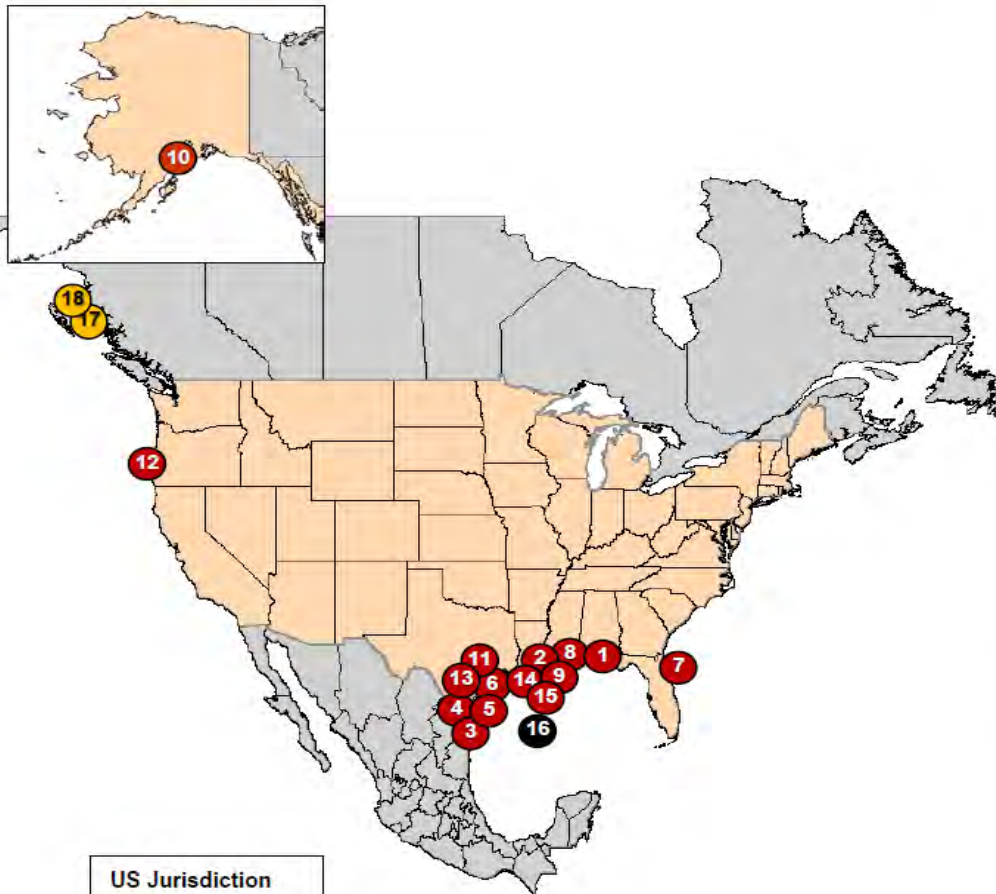

US Jurisdiction

- FERC
- MARAD/USCG

As of January 24, 2018

PROPOSED TO FERC

Pending Applications:

1. Pascagoula, MS: 1.5 Bcfd (Gulf LNG Liquefaction) (CP15-521)
2. Cameron Parish, LA: 1.41 Bcfd (Venture Global Calcasieu Pass) (CP15-550)
3. Brownsville, TX: 0.55 Bcfd (Texas LNG Brownsville) (CP16-116)
4. Brownsville, TX: 3.6 Bcfd (Rio Grande LNG – NextDecade) (CP16-454)
5. Brownsville, TX: 0.9 Bcfd (Annova LNG Brownsville) (CP16-480)
6. Port Arthur, TX: 1.86 Bcfd (Port Arthur LNG) (CP17-20)
7. Jacksonville, FL: 0.132 Bcf/d (Eagle LNG Partners) (CP17-41)
8. Plaquemines Parish, LA: 3.40 Bcfd (Venture Global LNG) (CP17-66)
9. Calcasieu Parish, LA: 4.0 Bcfd (Driftwood LNG) (CP17-117)
10. Nikiski, AK: 2.63 Bcfd (Alaska Gasline) (CP17-178)
11. Freeport, TX: 0.72 Bcfd (Freeport LNG Dev) (CP17-470)
12. Coos Bay, OR: 1.08 Bcfd (Jordan Cove) (CP17-494)

Projects in Pre-filing:

13. Corpus Christi, TX: 1.86 Bcfd (Cheniere – Corpus Christi LNG) (PF15-26)
14. Cameron Parish, LA: 1.18 Bcfd (Commonwealth, LNG) (PF17-8)
15. LaFourche Parish, LA: 0.65 Bcfd (Port Fourchon LNG) (PF17-9)

PROPOSED TO U.S.-MARAD/COAST GUARD

16. Gulf of Mexico: 1.8 Bcfd (Delfin LNG)

PROPOSED CANADIAN SITES

17. Kitimat, BC: 1.28 Bcfd (Apache Canada Ltd.)
18. Douglas Island, BC: 0.23 Bcfd (BC LNG Export Cooperative)

What Drives the Natural Gas Market?

Natural Gas Spot Prices (Henry Hub)

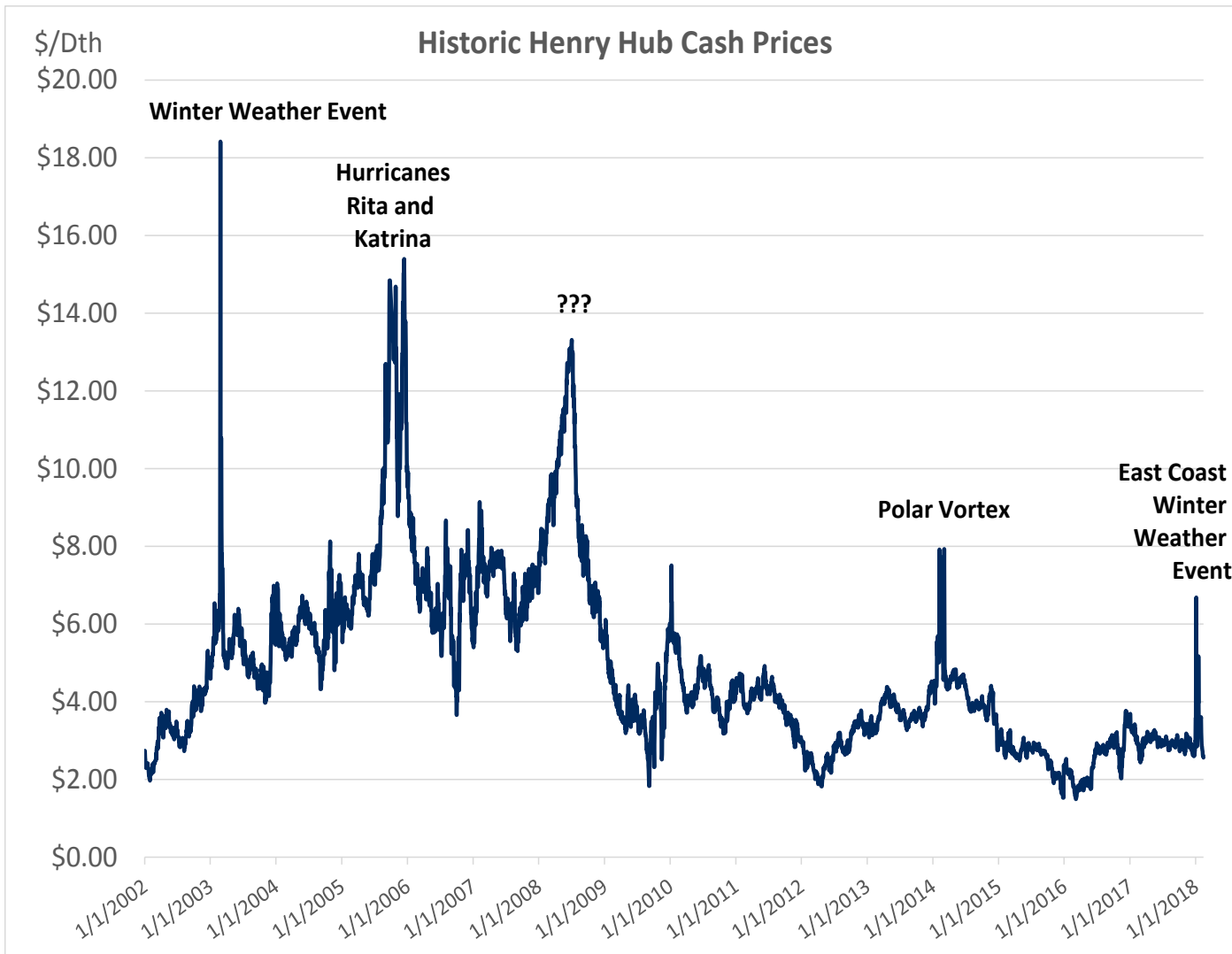

- ▶ **Supply**
 - Type: Conventional vs. Non-conventional
 - Location
 - Cost
- ▶ **Demand**
 - Residential/Commercial/Industrial
 - Power Generation
 - Natural Gas Vehicles
- ▶ **Legislation**
 - Environmental
- ▶ **Energy Correlations**
 - Oil vs. Gas
 - Coal vs. Gas
 - Natural Gas Liquids
- ▶ **Weather**
- ▶ **Storage**

AECO Gas Daily Prices

Exh. JM-2

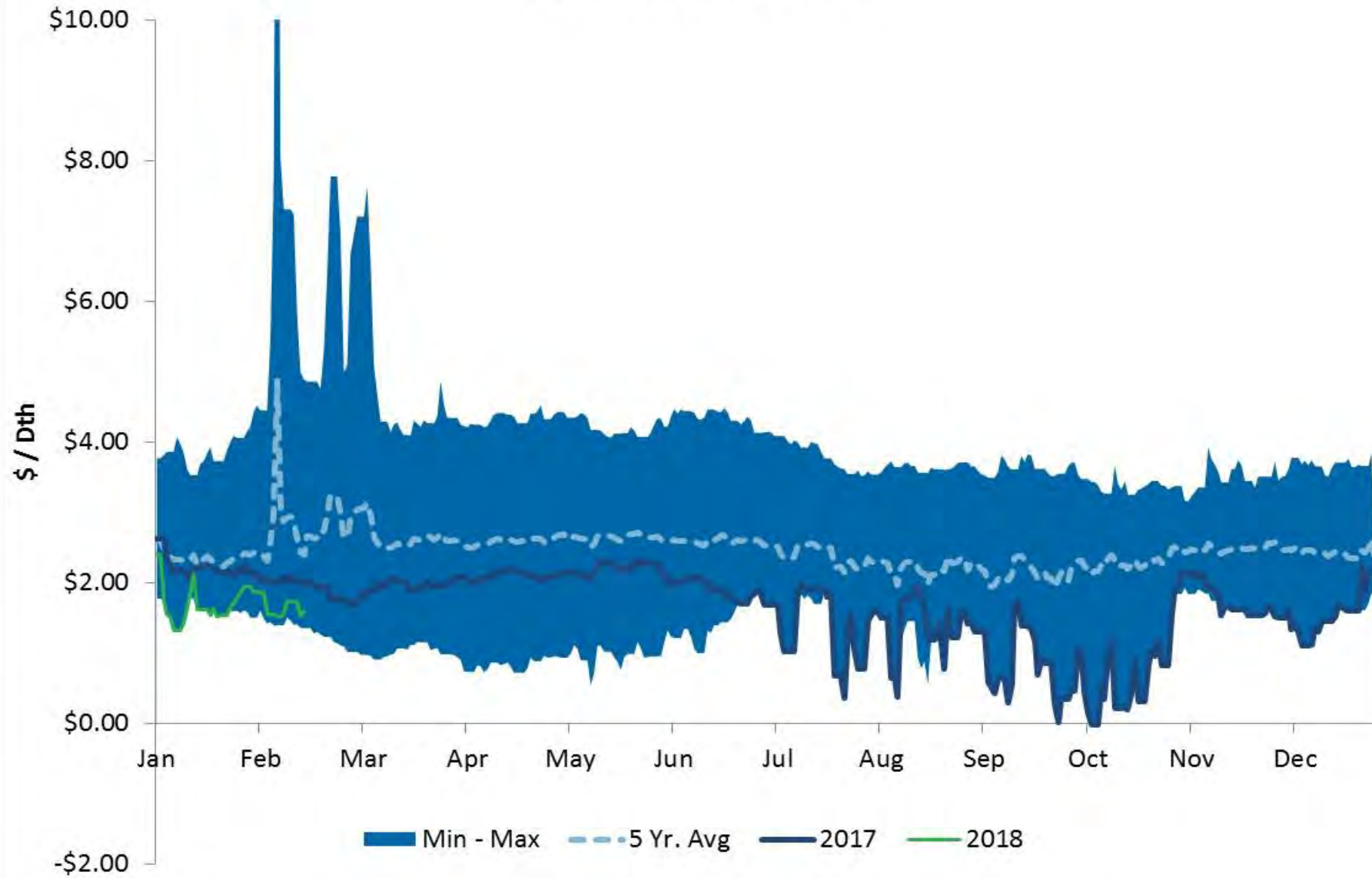

AECO Winter Forwards vs. Cash

Exh. JM-2

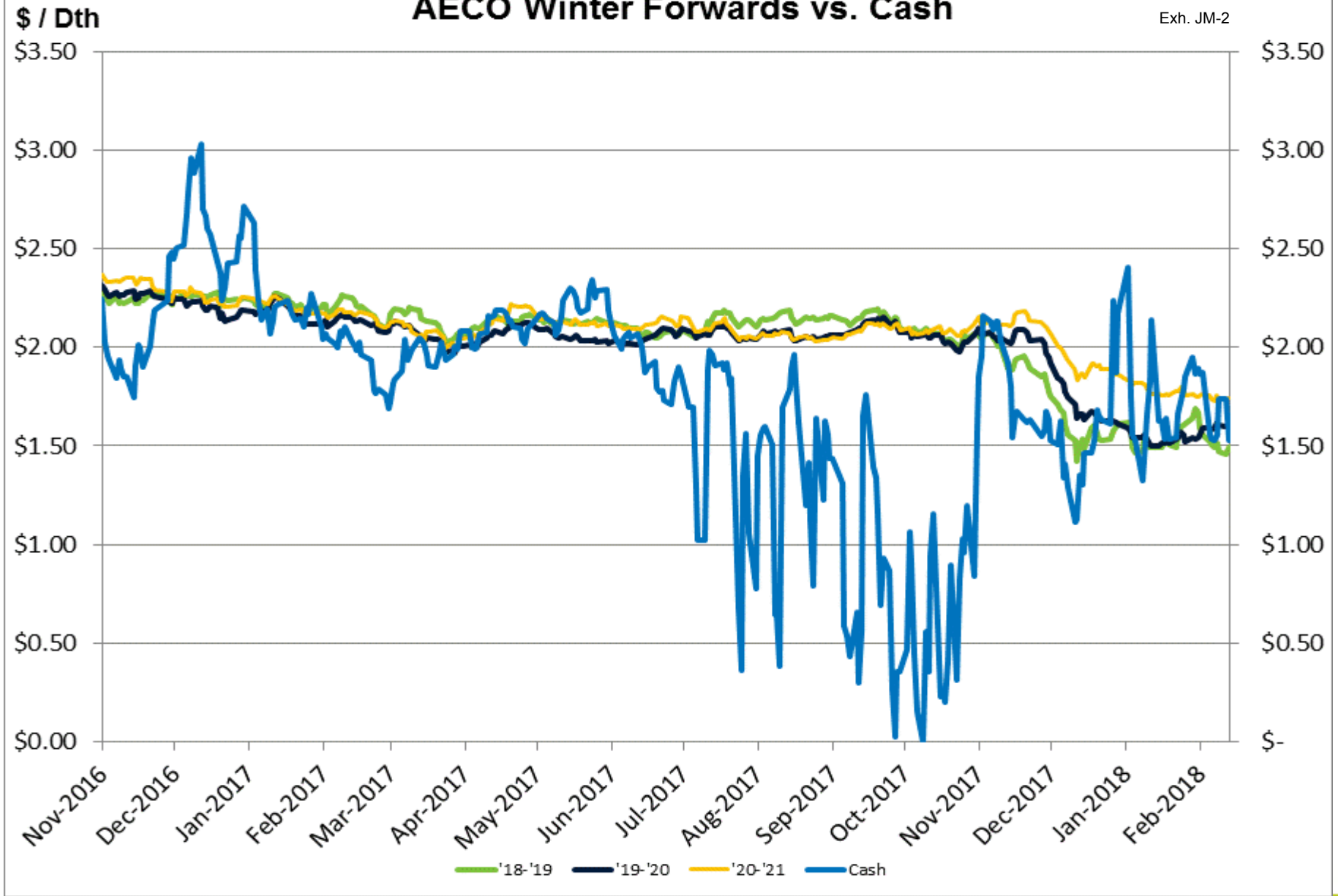

TransCanada System

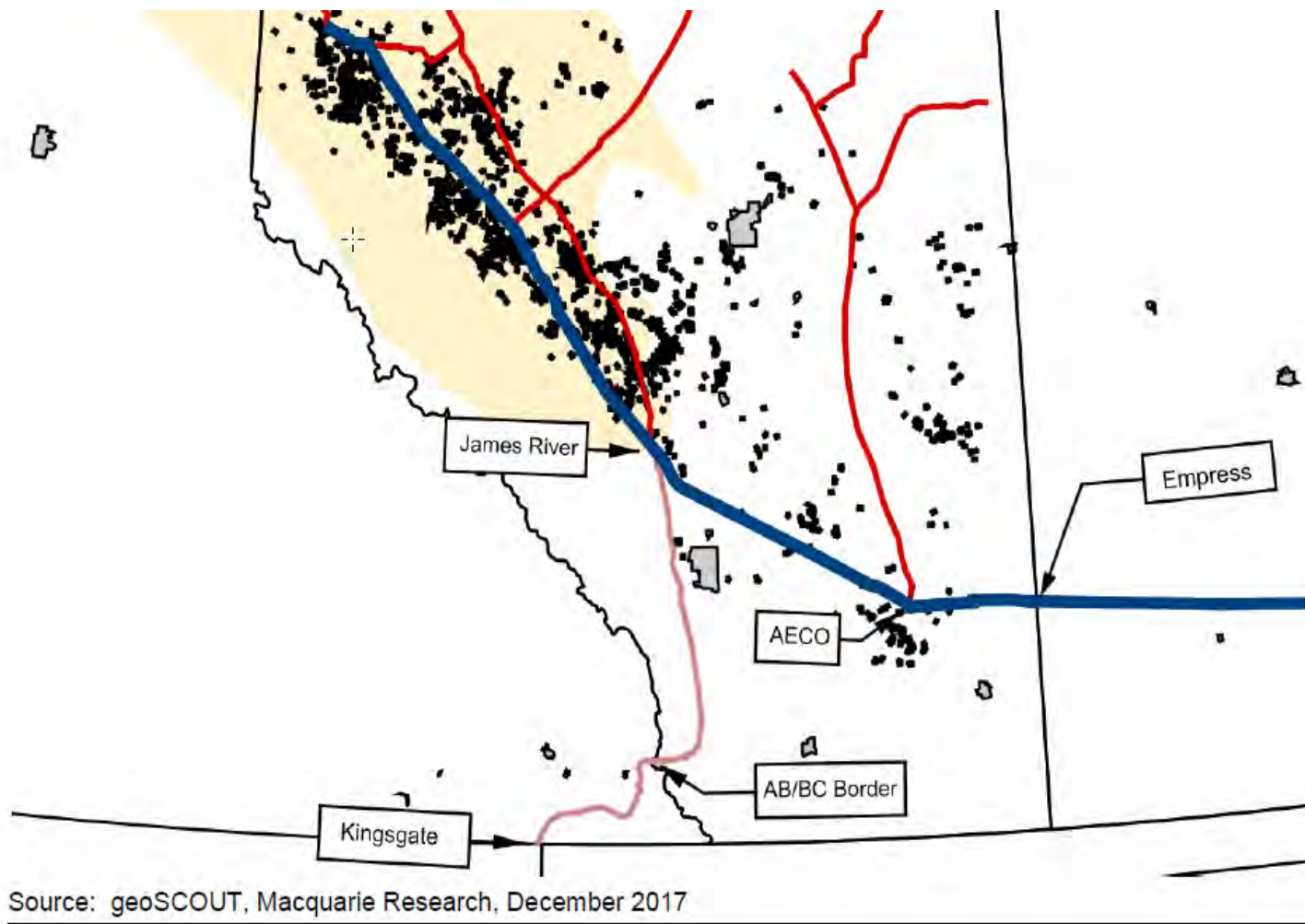

Source: geoSCOUT, Macquarie Research, December 2017

Sources of Congestion

- **AECO – Empress**
 - Capacity through this corridor has been reduced over the years as production has moved north and west, reducing pressure
 - Newly contracted mainline firm contracts have used up uncontracted capacity
 - Storage owners (mainly between AECO and Empress) rely on IT to inject/withdraw
- **James River – ABC**
 - TransCanada has upgraded the capacity of the gathering system north of James river.
 - Capacity for JR- ABC remains limited to 2.3 bcf/d while GTN has room for up to 2.9 bdf/d.

How will Alberta supply/demand rebalance?

- Demand:
 - Incremental expansions in 2018, 2019 and 2020 will increase James River – ABC capacity by roughly 700 mmcf/d to match GTN takeaway capacity.
 - Oil sands expansion expected to increase demand as several new projects come on line in 2018.
 - Talk of AECO – Empress expansion. Thus far no action.
- Supply:
 - Sustained low prices have already led to a decrease in producer CAPEX budgets for 2018 and 2019.

Canadian Supply

Natural Gas Production and Price - Reference Case

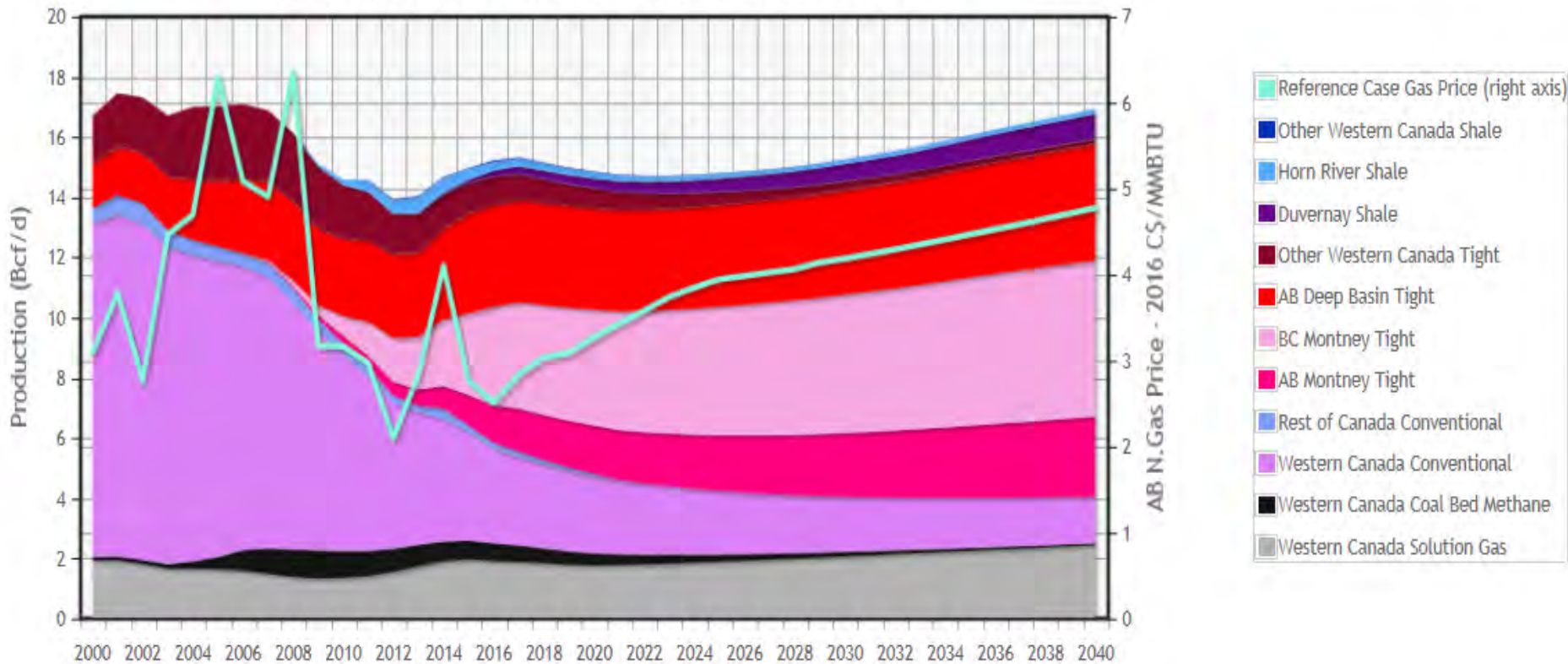

Natural Gas Rig Count

Weekly natural gas rig count

active rigs

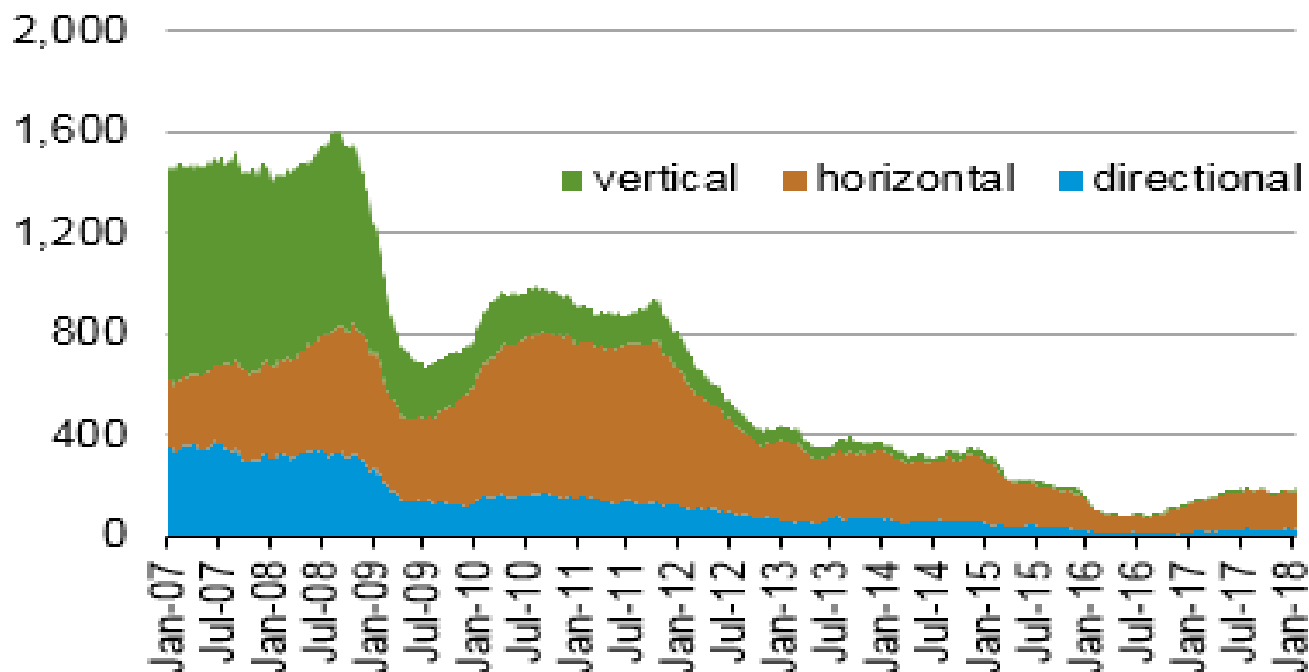

Source: Baker Hughes

181 Active Rigs

Rig Type

Vertical well

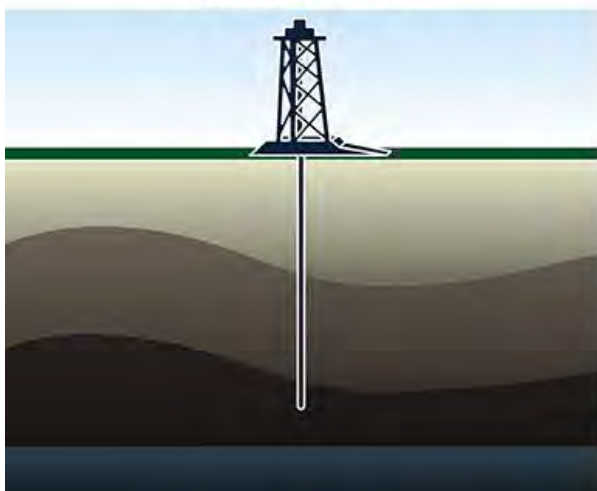

Horizontal well

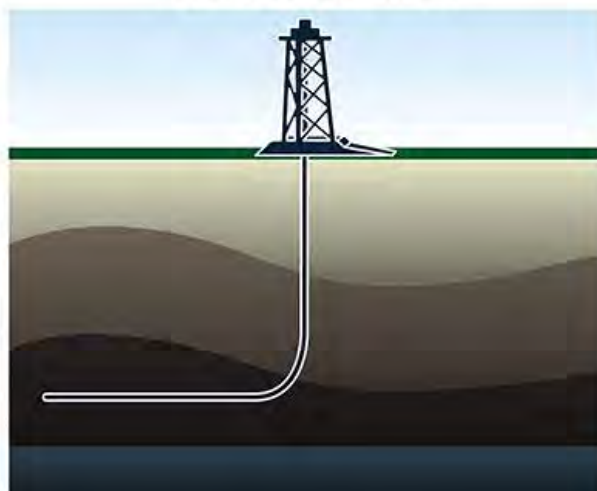

Directional well

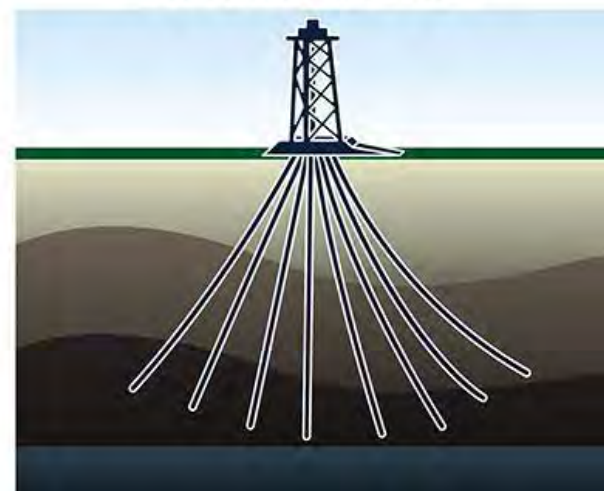

US drilling

7 Major drilling regions in US

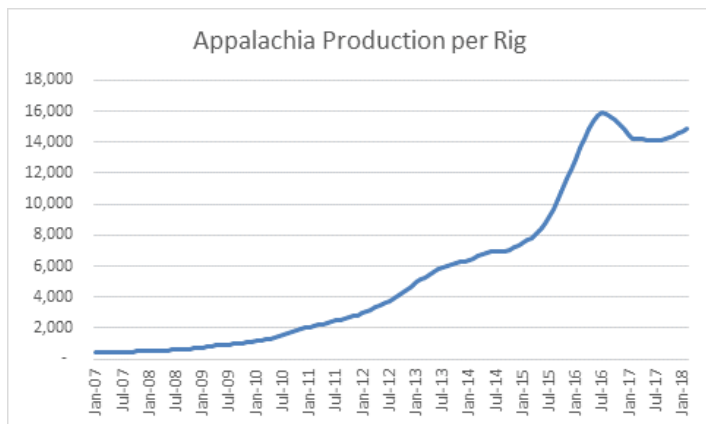
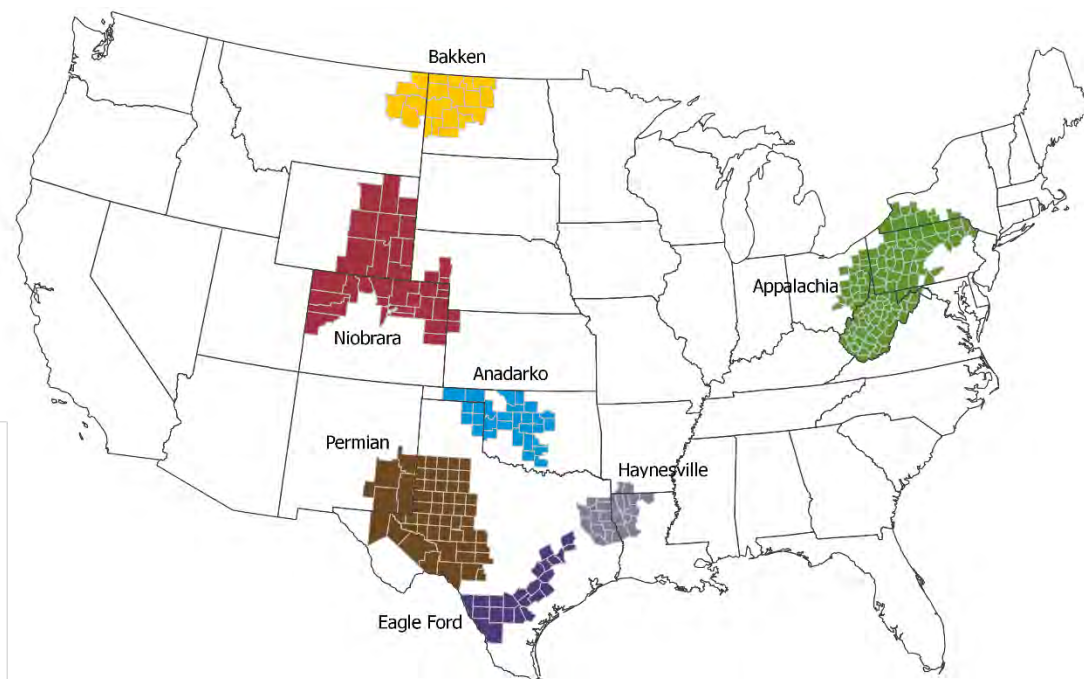

*Appalachia Production per rig increase of almost **3500%** per rig since Jan. 2007

Rig efficiency and production

New-well oil production per rig

barrels/day

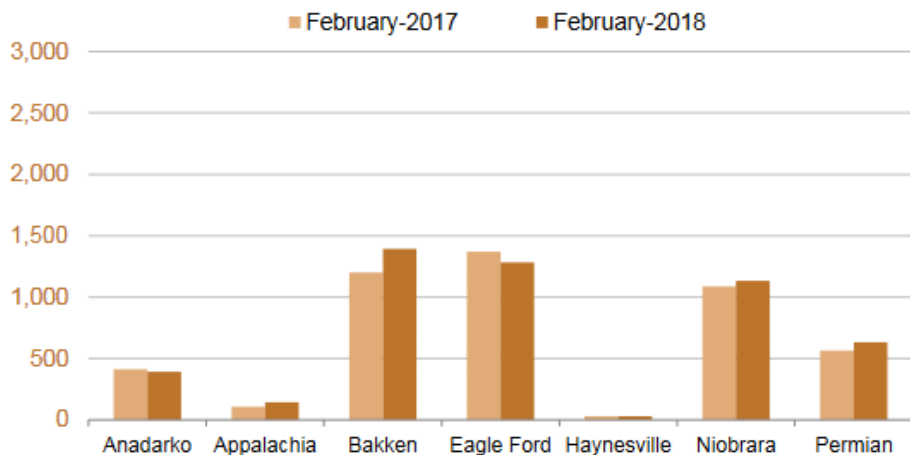

New-well gas production per rig

thousand cubic feet/day

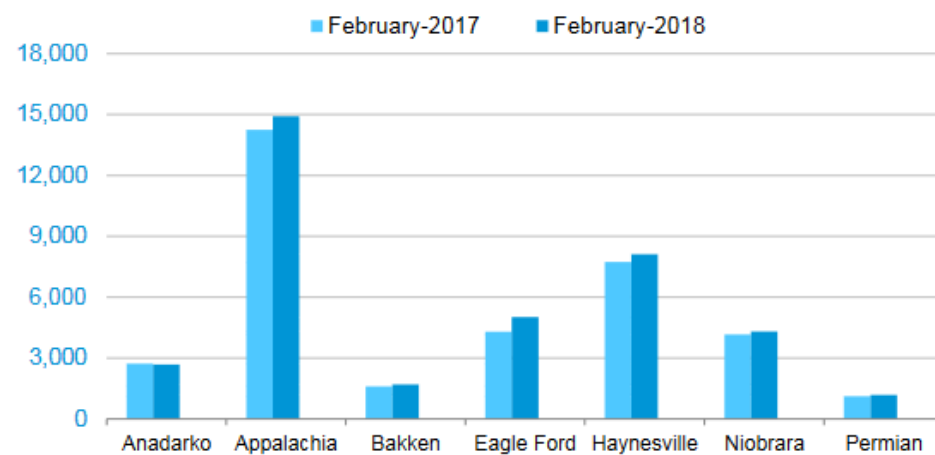

Oil production

thousand barrels/day

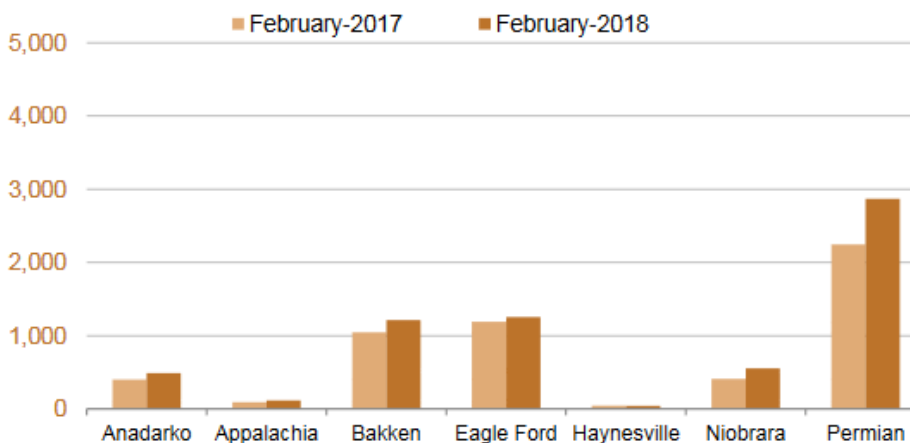

Natural gas production

million cubic feet/day

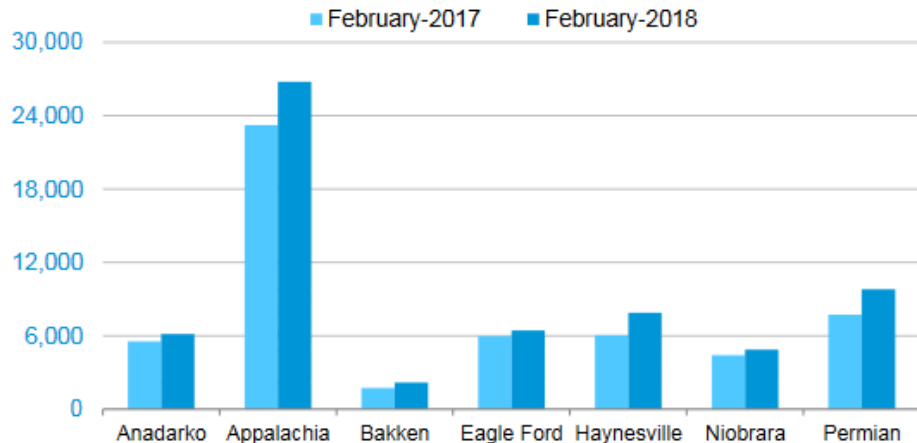

Drilled but uncompleted wells

Exh. JM-2

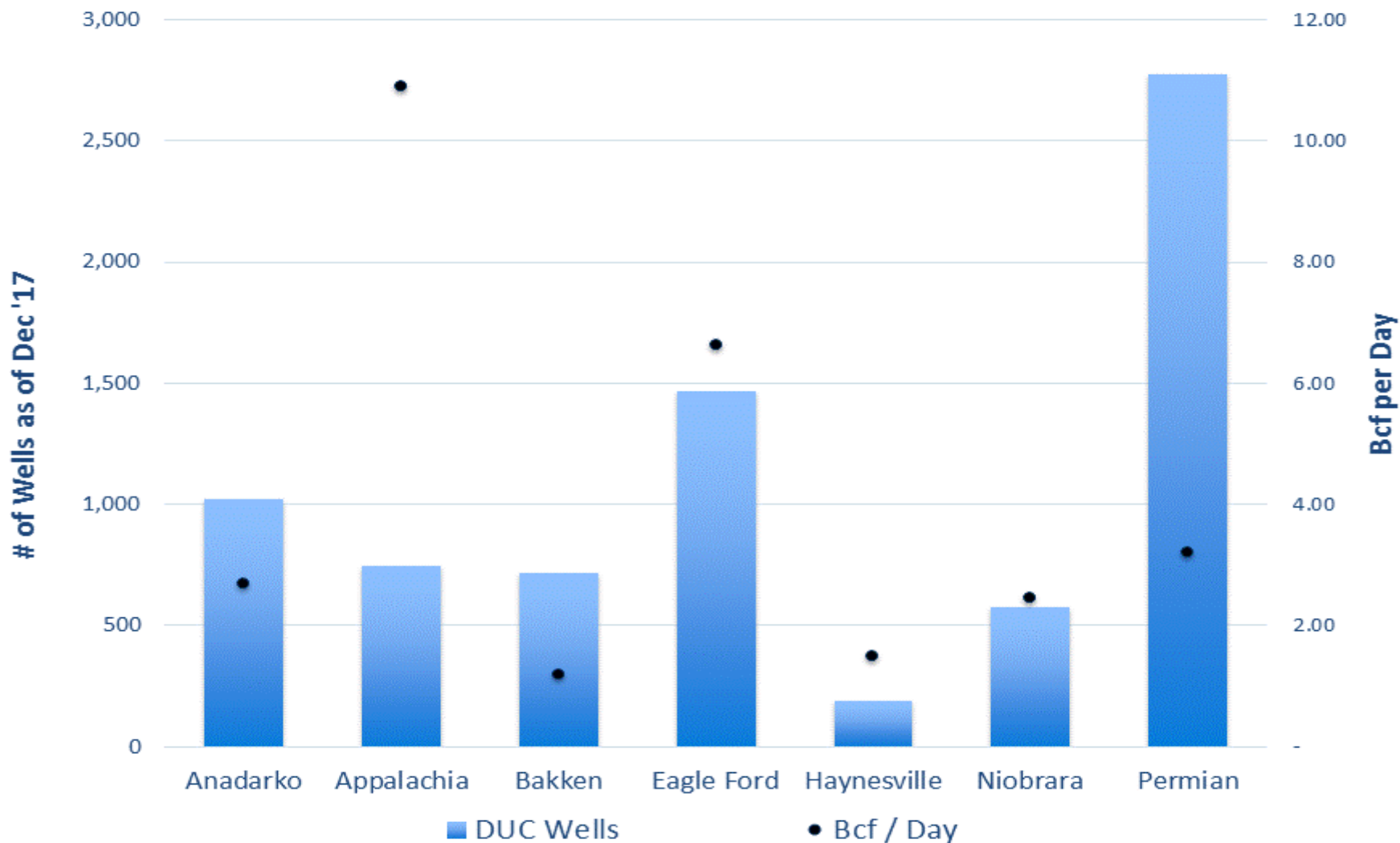

***Almost 29 Bcf/d waiting to come online**

Break (10 minutes)



Procurement Planning

Tom Pardee, Manager of Natural Gas Planning

Procurement Plan Philosophy

•Mission

•To provide a diversified portfolio of reliable supply and a level of price certainty in volatile markets.

- We cannot accurately predict what natural gas prices will do, however we can use experience, market intelligence, and fundamental market analysis to structure and guide our procurement strategies.
- Our goal is to develop a plan that utilizes customer resources (storage and transportation), layers in pricing over time for stability (time averaging), allows discretion to take advantage of pricing opportunities should they arise, and appropriately manages risk.

Oversight and Control

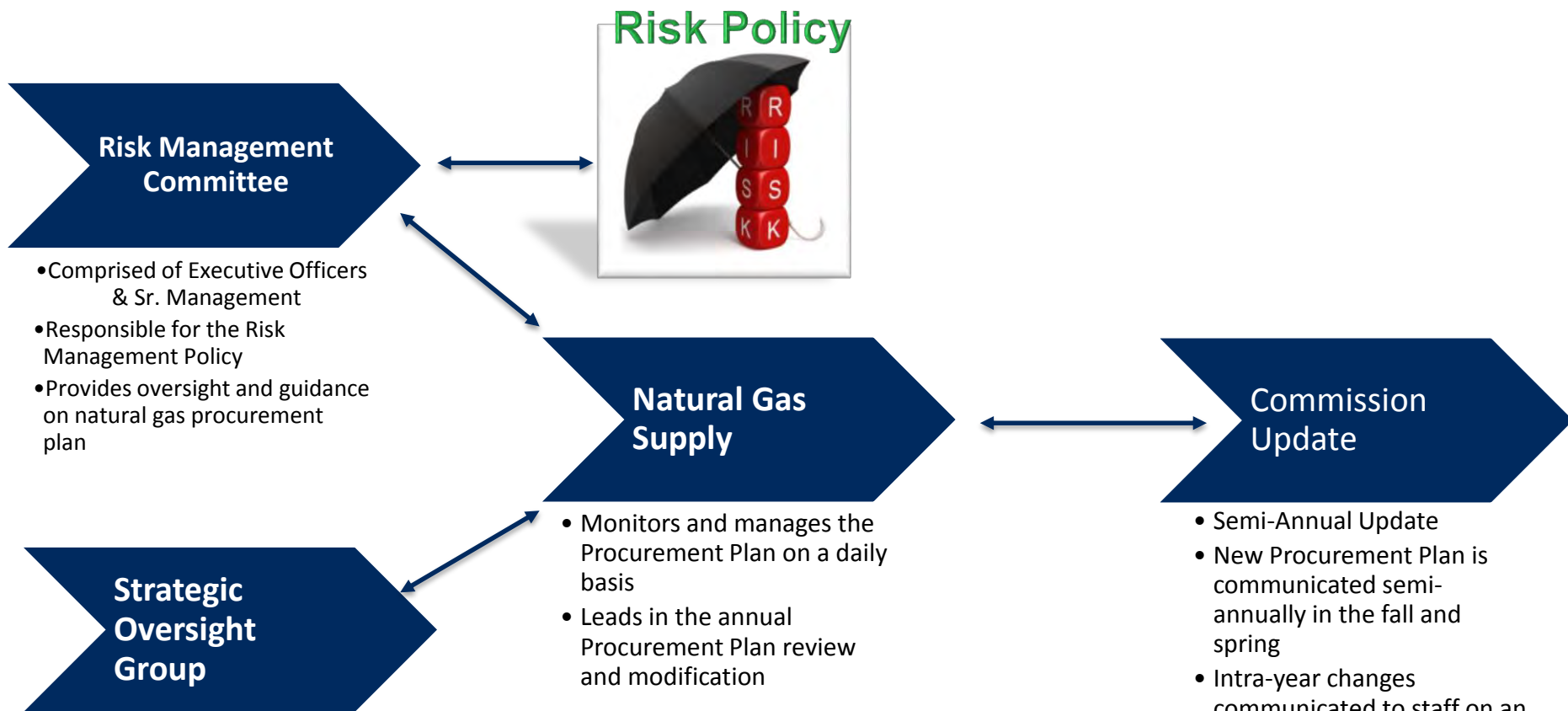

Comprehensive Review of Previous Plan

Review conducted with SOG includes:

- Mission statement and approach
- Current and future market dynamics
- Hedge type and percentage
- Resources available (i.e. storage and transportation)
- Hedge windows (how many, how long)
- Long term hedging approach
- Storage utilization
- Analysis (volatility, past performance, scenarios, etc.)
- Market opportunities



A Thorough Evaluation of Risks



Procurement Plan Structure

- The procurement plan incorporates a portfolio approach that is diversified in terms of:
 - **Components:** The plan utilizes a mix of index, fixed price, and storage transactions.
 - **Transaction Dates:** Hedge windows are developed to distribute the transactions throughout the plan.
 - **Supply Basins:** Plan to primarily utilize AECO, execute at lowest price basis at the time.
 - **Delivery Periods:** Hedges are completed in annual and/or seasonal timeframes. Long-term hedges may be executed.
- Transactions are executed pursuant to a plan and process; however, the procurement plan allows Avista to be flexible to market conditions and opportunistic when appropriate.

Avista's Procurement Plan Composition

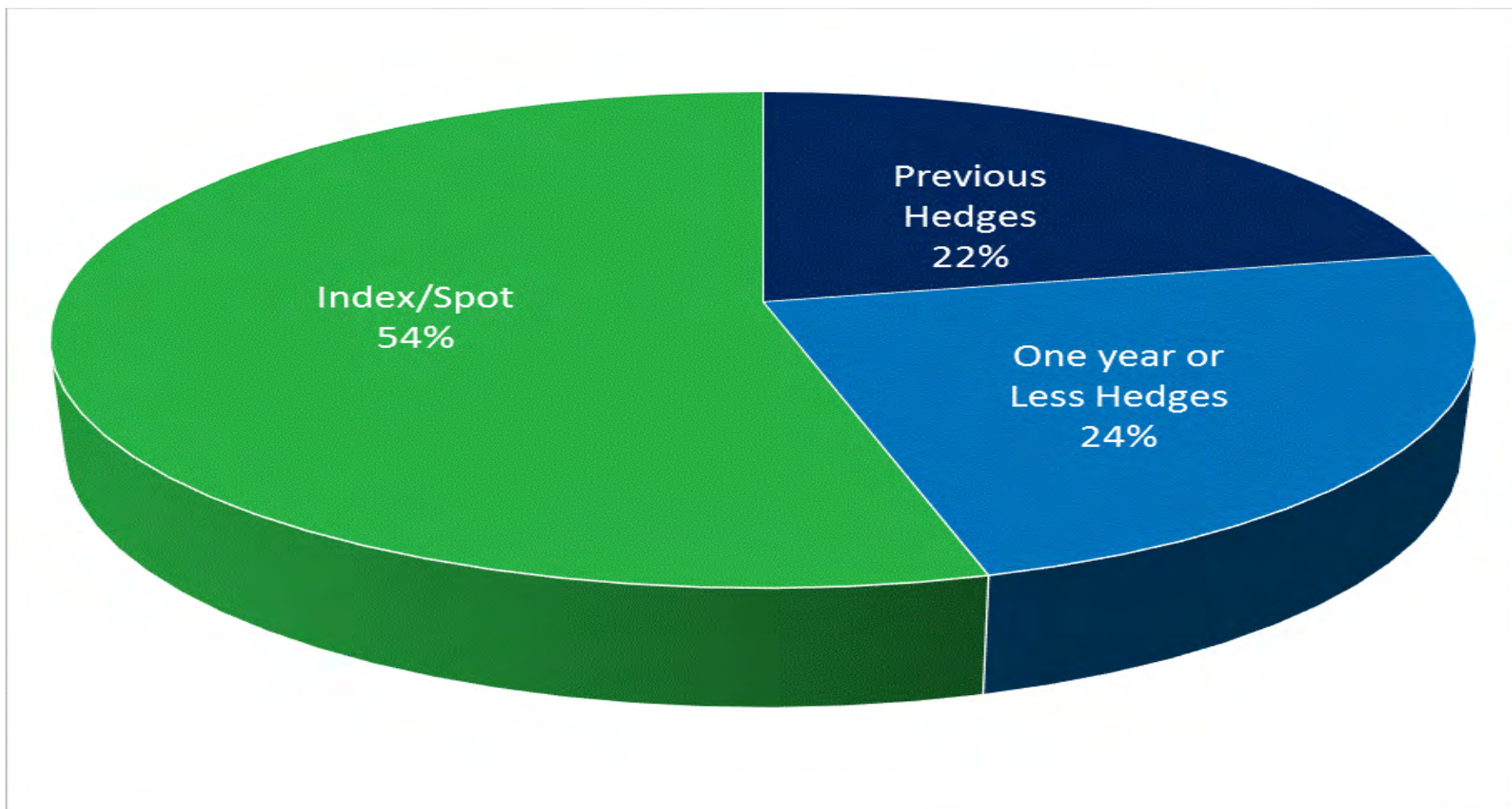

Natural Gas Procurement Plan vs. System Demand November 2017 through October 2018

Exh. JM-2

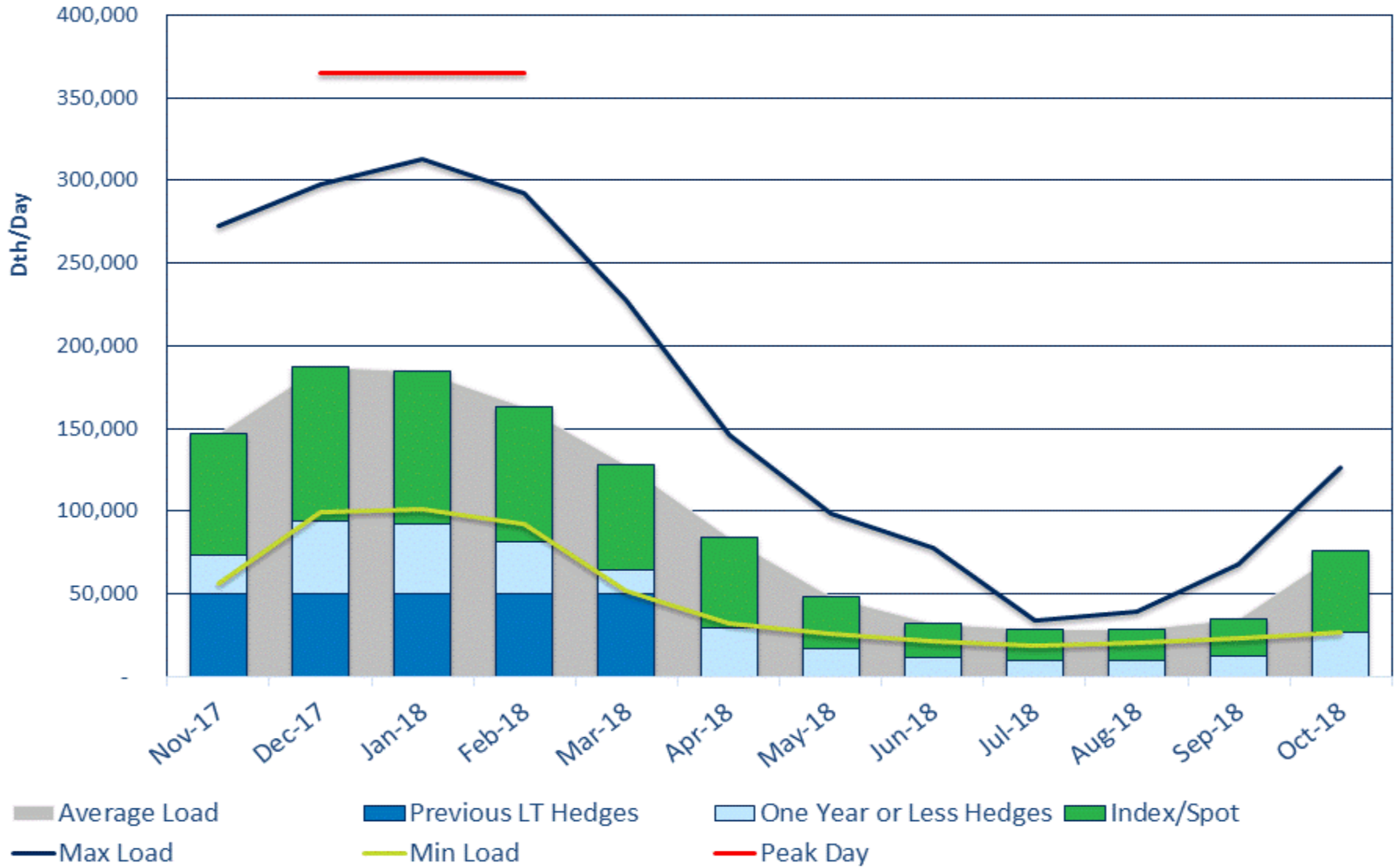

Procurement Plan

- Window mechanism with upper and lower bands that will adjust to the price of the current month of gas depending on the volatility and length of the window.
- We hedge out up to 36 months from prompt month
 - Market is liquid during this timeframe on ICE
 - Intercontinental Exchange
- 46% of annual firm customer load hedged within plan.

Hedge window Example

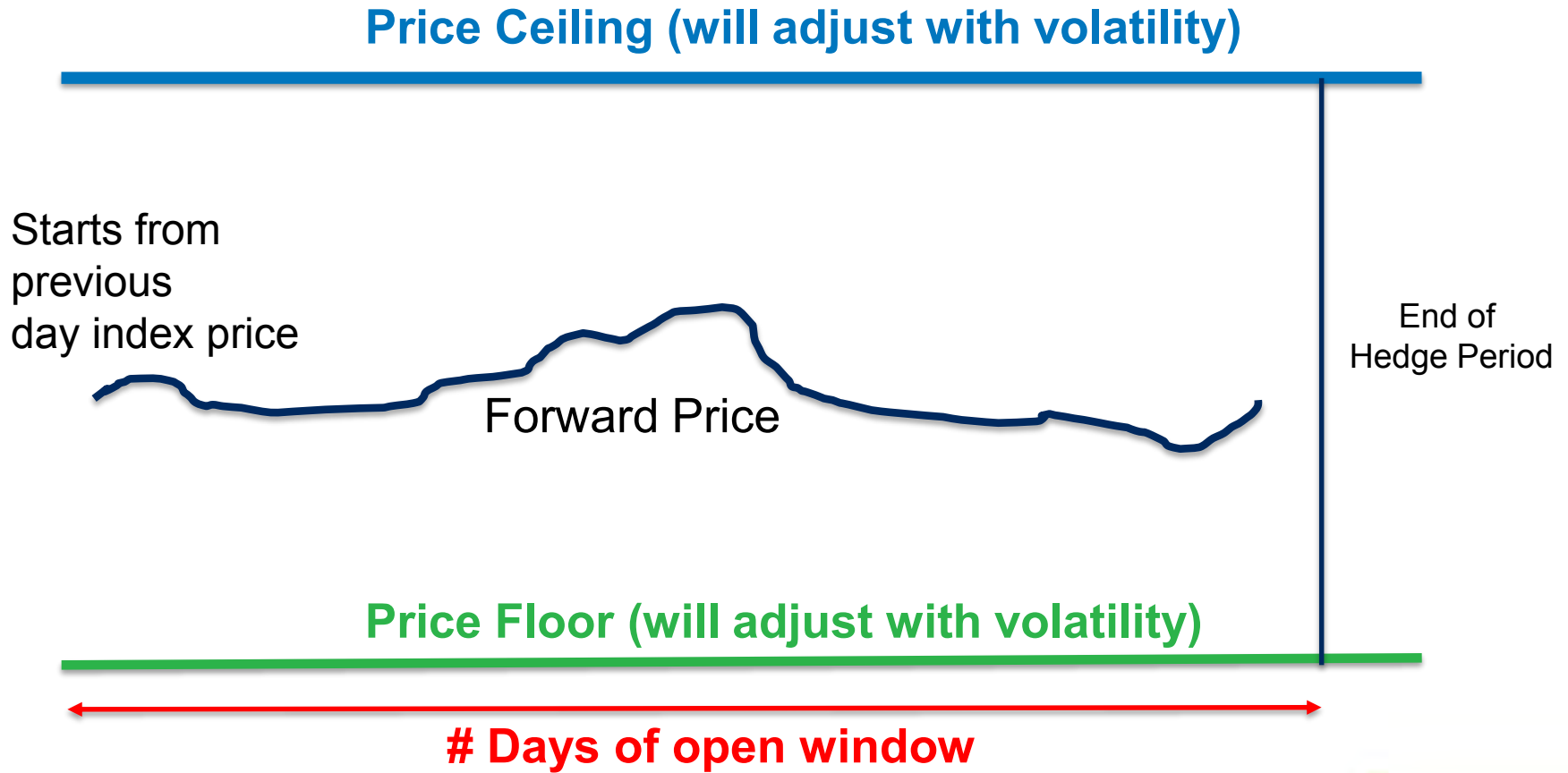

Risk Responsive Hedging Tool (in development)

- Incorporates monthly financial positions, along with market volatility to determine VaR
- The RRHT is in addition to programmatic hedging
- Inputs: all utility purchase/sale transactions, estimated customer load, storage injections and withdrawals
- Currently in testing/evaluation phase
- Anticipate reducing the amount hedged programmatically

Storage Optimization

- Utilize our Jackson Prairie facility to arbitrage spreads between daily and future gas prices.
- Maintain a peak day capability in order to serve needed demand from the facility during a peak event.
- Historic value of storage (Intrinsic)
 - buy in the summer when prices are historically lower and storing this gas until the winter when prices are historically higher
- We optimize storage by locking in spreads between any month during the program horizon.

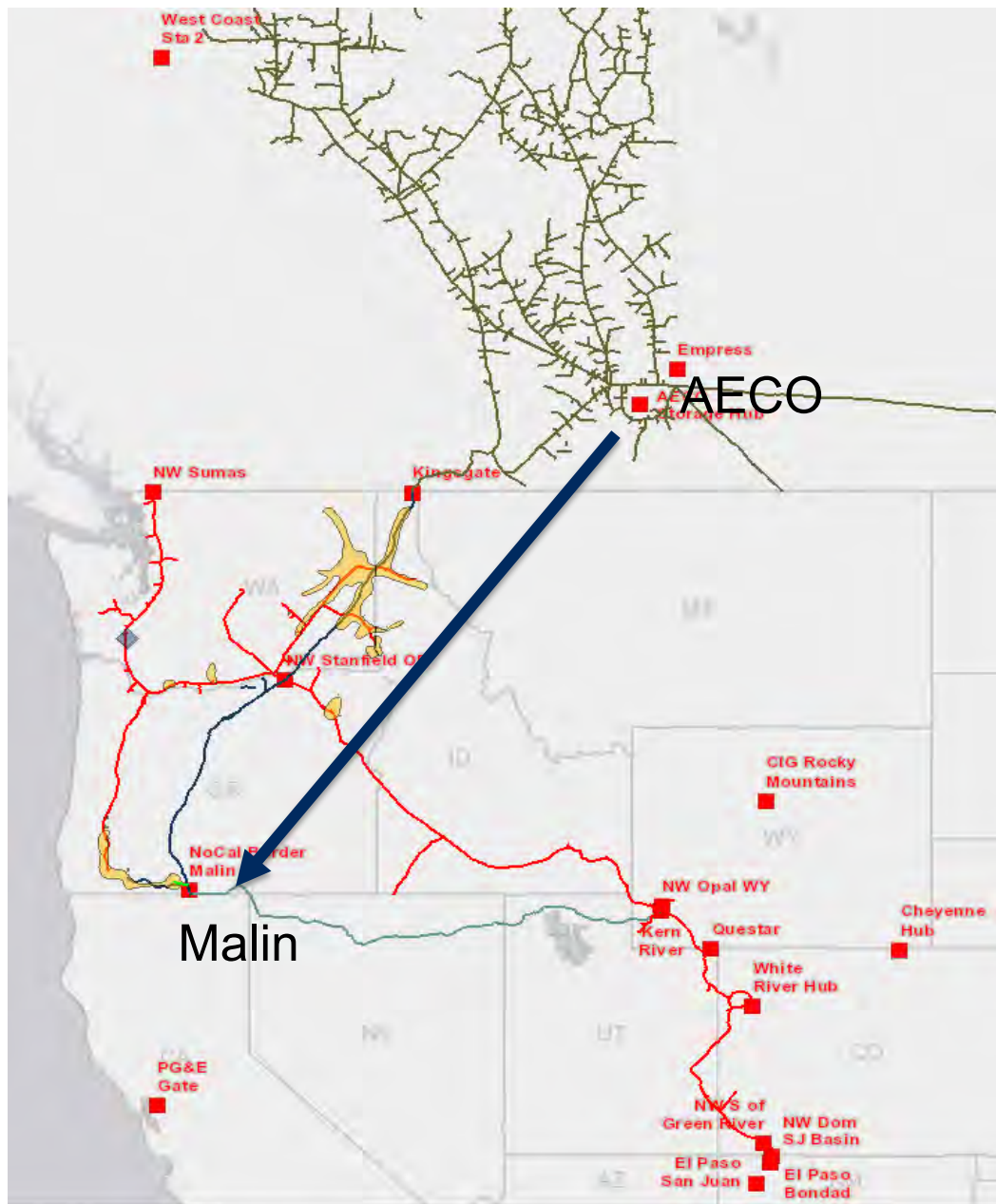

Transportation Optimization

AECO to MALIN

Demand \$.45
 Cost to transport .10

*AECO = \$1.45
 MALIN = \$2.00

$\$.55 - \$.10 = \$.45$

Lowered cost to ratepayers by \$.45

This is referred to as a location spread.

Transport Optimization - GTN

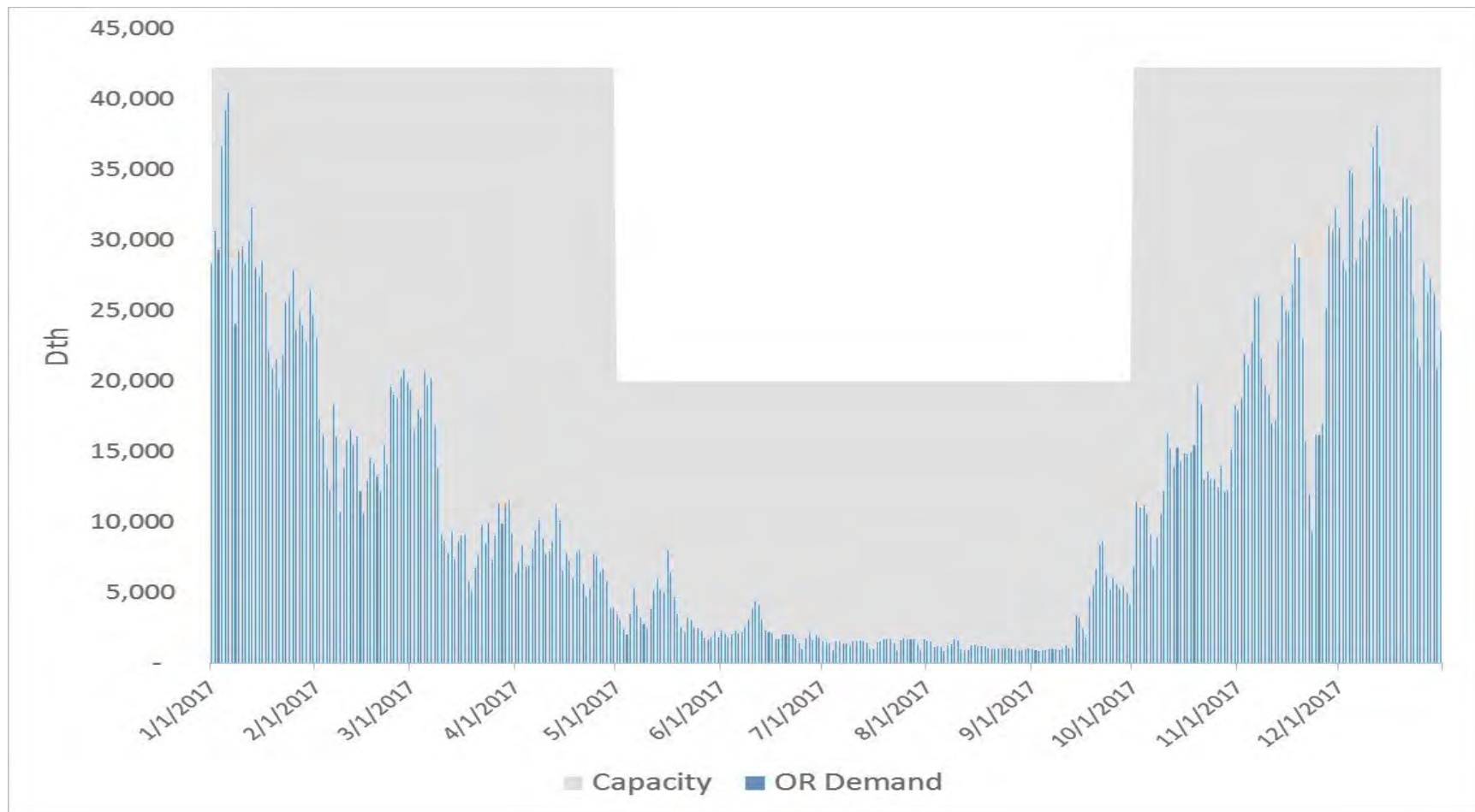

Why do we optimize?

- Combine all optimization to create more value
- Optimization has the following effects on rates:
 - WA/ID
 - For every \$2.5M of optimization, rates decrease by ~1%
 - OR
 - For every \$1M of optimization, rates decrease by ~1%

Lunch – 60 Minutes



Emissions

Tom Pardee

Avista and Carbon

Avista President Dennis Vermillion:

“We are fortunate that Washington, with its abundance of renewable hydropower generation, is already among the cleanest states in the country, but that doesn’t mean we can’t do more. Legislation that appropriately balances the interests of our customers, the economy, and the environment can effectively get us there.

“Under the Governor’s proposed climate change legislation, electric and natural gas utilities will have the ability to invest the carbon tax. Avista welcomes the opportunity to work with the Governor and the Legislature on an approach that supports our customer’s needs, creates technological advances, and considers the economic impact, even beyond the state’s borders, with the goal to improve our environment.”

BLM rule repeal

- Trump administration repealed a hydraulic fracturing regulations covering oil and gas wells on federal and tribal lands.
- The repeal, which took effect Dec. 29, 2017
- required producers to obtain BLM approval of fracturing operations, verify cementing, conduct pressure tests, and list non-proprietary fracturing chemicals on FracFocus.
- The rule, finalized in 2015, never took effect, following a stay imposed by the U.S. District Court for Wyoming, which ruled in 2016 that BLM lacked authority to adopt the regulation.

Natural Gas vs. Coal emissions

- IEA assumes a tonne of methane = 28 – 36 tonnes of CO₂ when considering its impact over a 100-year timeframe
- For gas to have higher emissions than coal, we calculate that more than 10-11% of the produced gas would need to be lost along the value chain assuming a 100 year Global Warming Potential (GWP).
- This is equal to 35 bcfd
 - Almost $\frac{3}{4}$ of the daily European demand or $\frac{1}{2}$ US demand.

Source: <https://www.woodmac.com/news/opinion/do-fugitive-emissions-of-methane-make-natural-gas-more-emissions-intensive-than-coal>

Natural Gas vs. Coal emissions cont.

- Losses are assumed to be from direct leakage into atmosphere in the form of methane.
- If Shell had an estimated 10.5% loss of it's production it would lose over \$1 billion a year in profits and \$12.5 billion in corporate value.

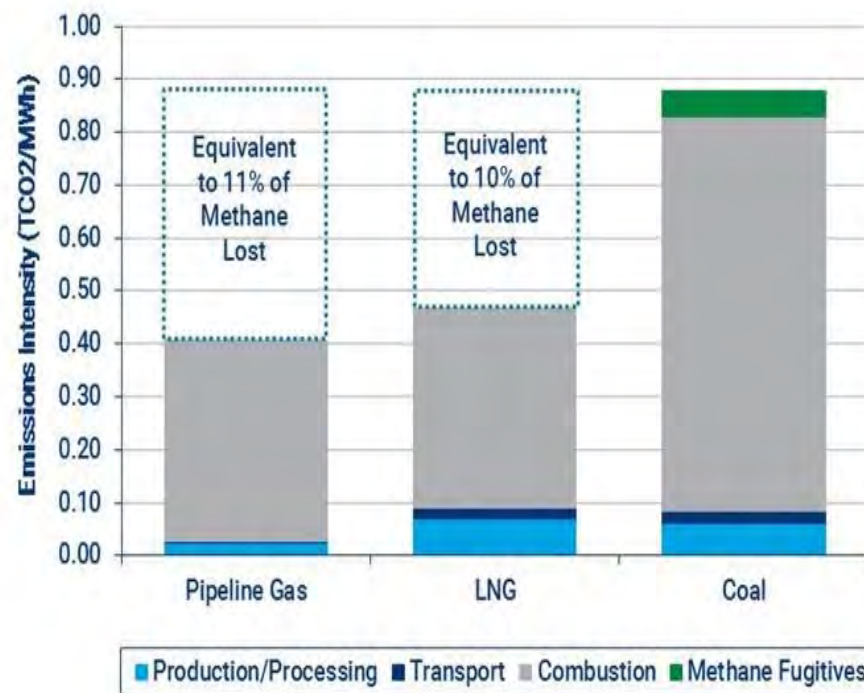

Source: Source: Wood Mackenzie
 * Assumes 100 year GWP of 34. Losses would be around 44.5% assuming

Source: <https://www.woodmac.com/news/opinion/do-fugitive-emissions-of-methane-make-natural-gas-more-emissions-intensive-than-coal>

GAS EMISSIONS AND SINKS 1990 - 2015

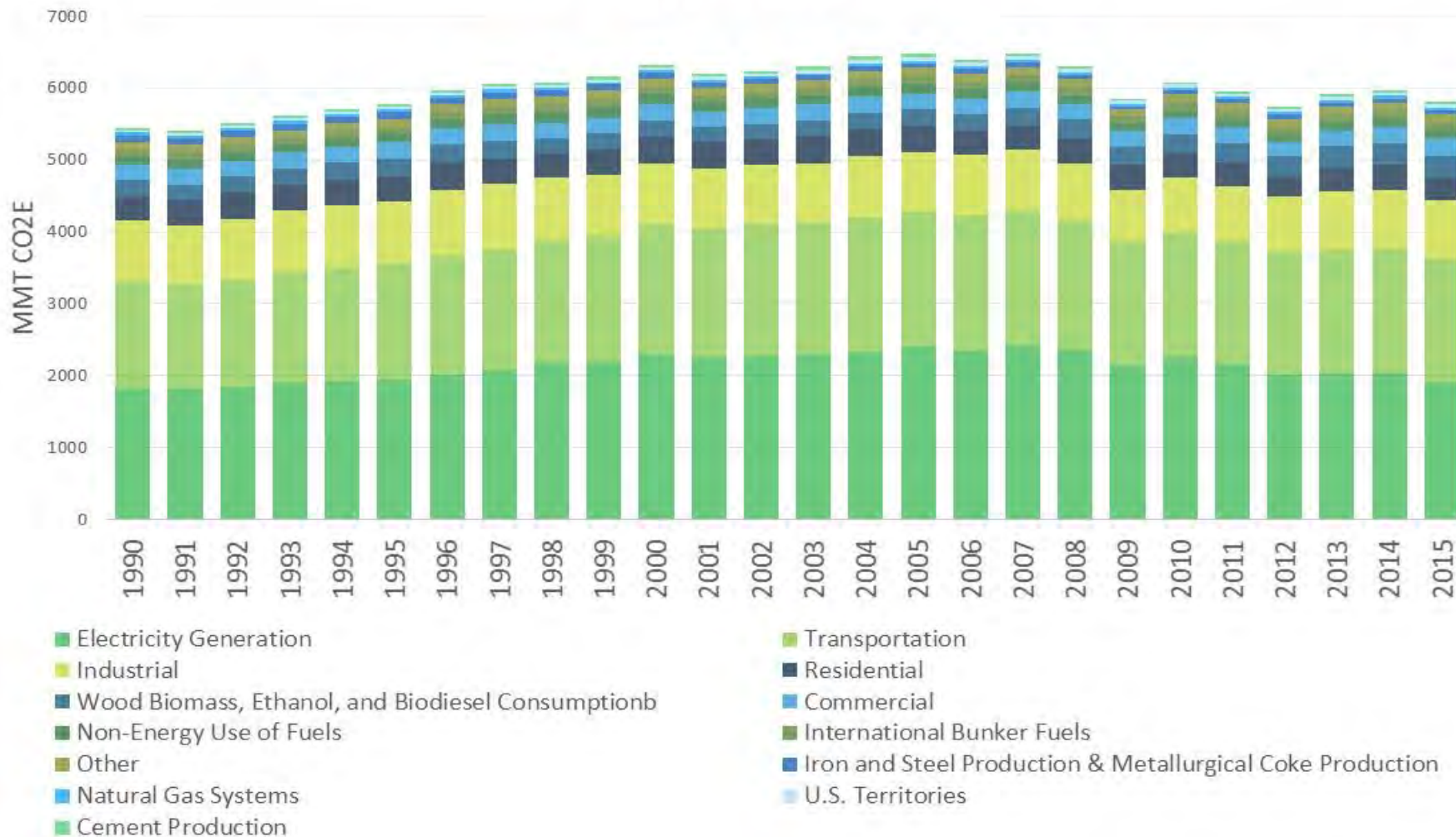

<https://www.epa.gov/ghgemissions/inventory-us-greenhouse-gas-emissions-and-sinks-1990-2015>

Environmental Protection Agency (EPA)

On April 17, 2012, the U.S. Environmental Protection Agency (EPA) issued cost-effective regulations to reduce harmful air pollution from the oil and natural gas industry.

A key component of the final rules is expected to yield a nearly 95 percent reduction in Volatile Organic Compounds emitted from more than 11,000 new hydraulically fractured gas wells each year. This significant reduction would be accomplished primarily through the use of a proven process – known as a “reduced emissions completion” or “green completion” -- to capture natural gas that currently escapes to the air.

In a green completion, special equipment separates gas and liquid hydrocarbons from the flowback that comes from the well as it is being prepared for production. The gas and hydrocarbons can then be treated and used or sold, avoiding the waste of natural resources that cannot be renewed.

Natural Gas STAR Program

- EPA pollution prevention
- The Natural Gas STAR Program provides a framework for partner companies with U.S. oil and gas operations to implement methane reducing technologies and practices and document their voluntary emission reduction activities. By joining the Program, partners commit to:
 - 1) evaluate their methane emission reduction opportunities,
 - 2) implement methane reduction projects where feasible,
 - 3) annually report methane emission reduction actions to the EPA.
- <https://www.epa.gov/sites/production/files/2016/06/documents/partnerlist.pdf>

Natural Gas STAR Methane Challenge Program – Avista

- Avista Utilities has agreed to pursue a Best Management Practice (BMP) commitment in the NG Distribution-Excavation Damages category.
- Avista plans for continuous improvement in reducing dig in damages and has been pursuing a program for reducing such damages since 2007. This program has no scheduled end date and Avista is committed to achieving the lowest possible dig in rates in our service areas.
- Avista accumulates the number of dig-in damages that occur within each natural gas operating district on a monthly basis. The number of locate tickets generated in each of these districts are tallied also by district and by month. A report is generated which then details the number of dig-in damages per 1000 locate tickets for each district.

Avista Locates vs Dig In's

Company Wide: Locates vs Dig In's

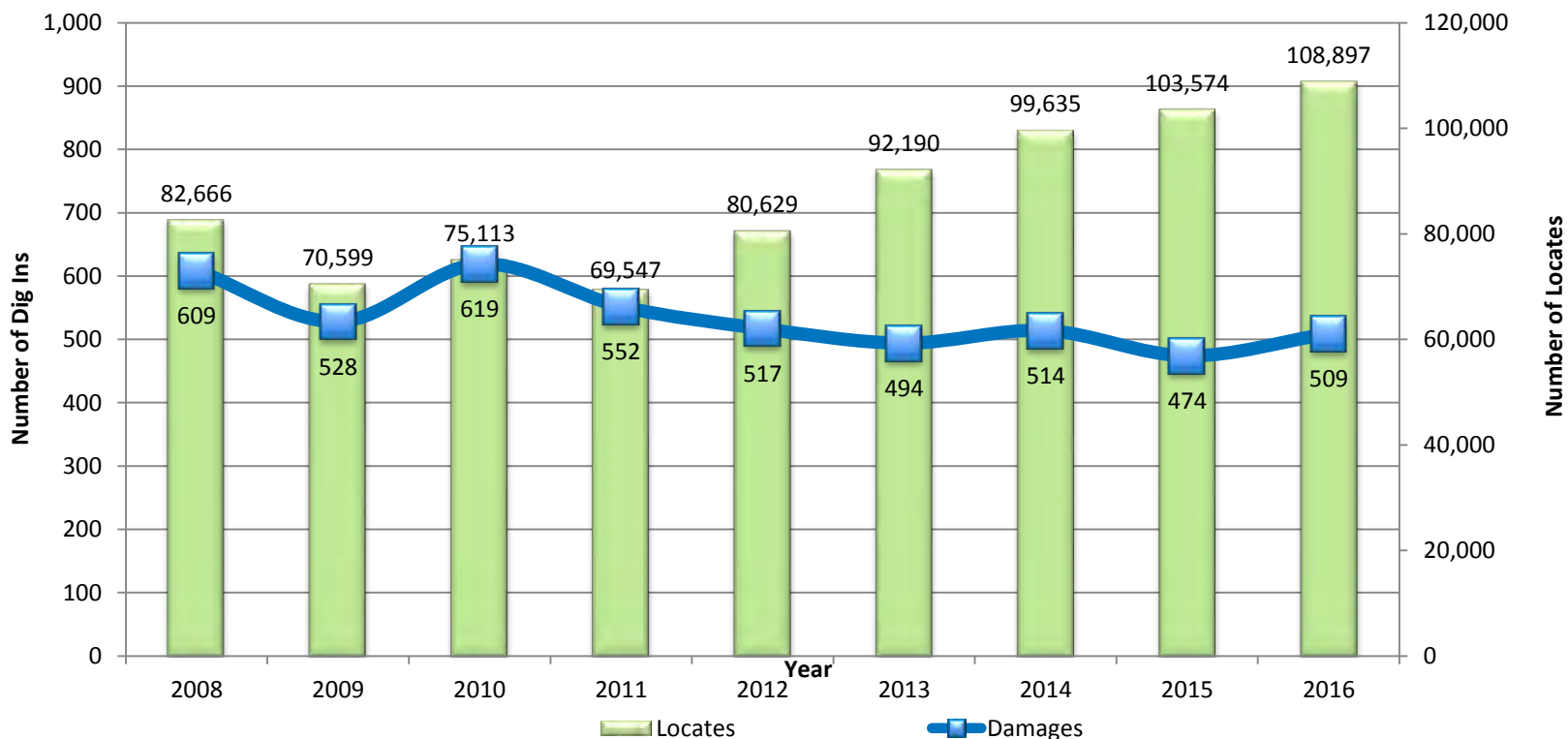

Avista Locates vs Dig In's

Damages per 1000 locates

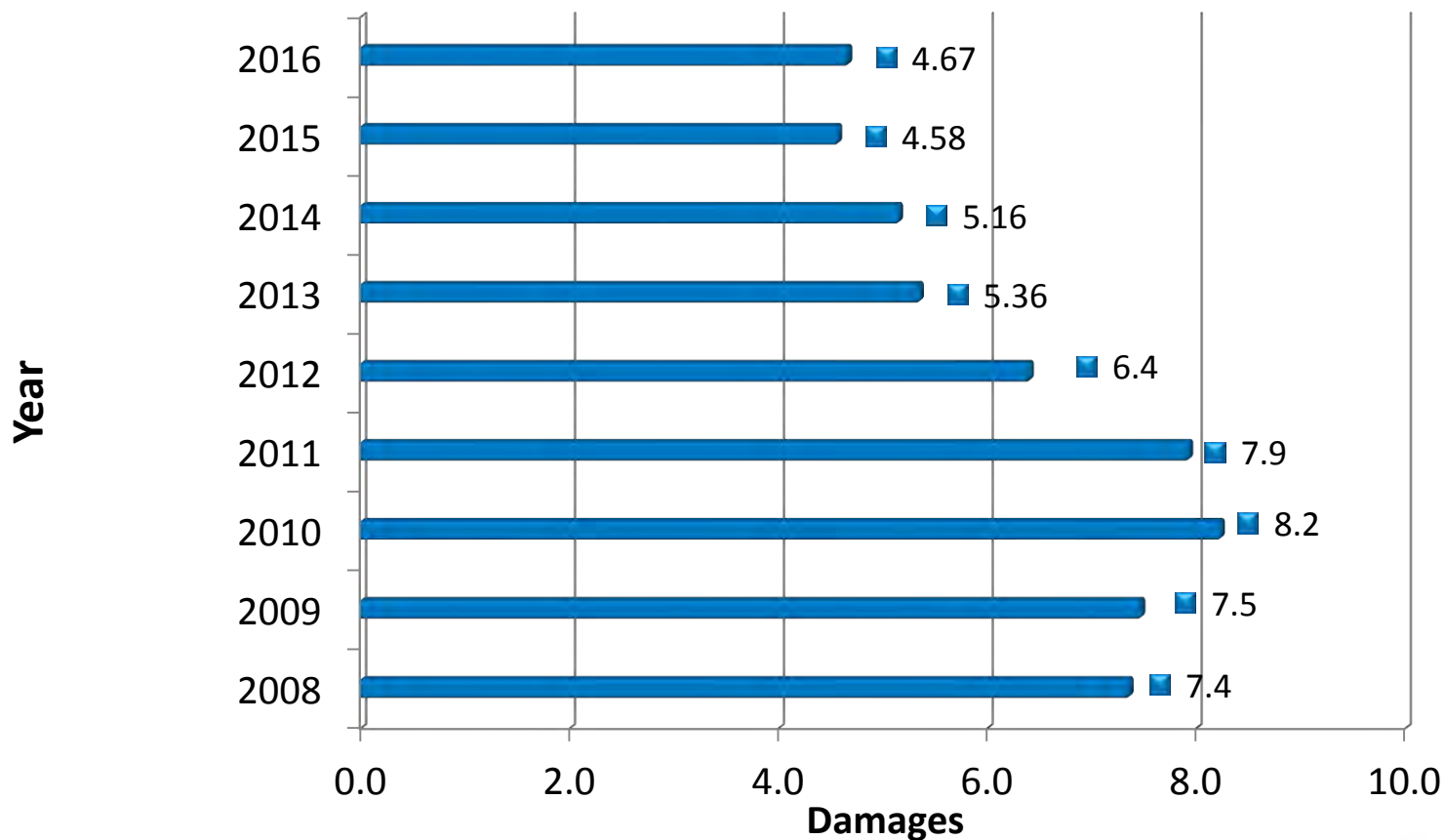

Fracking

- Fracking remains a potential risk if more robust data shows higher than known emissions or environmental pollution is caused by hydraulic fracking. This may cause more policies to be put in place making drilling less economic or halt production all together in some areas.
- *Most companies report the chemicals used in the process of hydraulically fractured wells.

Video:

<http://www.youtube.com/watch?v=2PBCTXHqZec&feature=share&list=UUMdjBoSXSeV38gd3xCparmA>

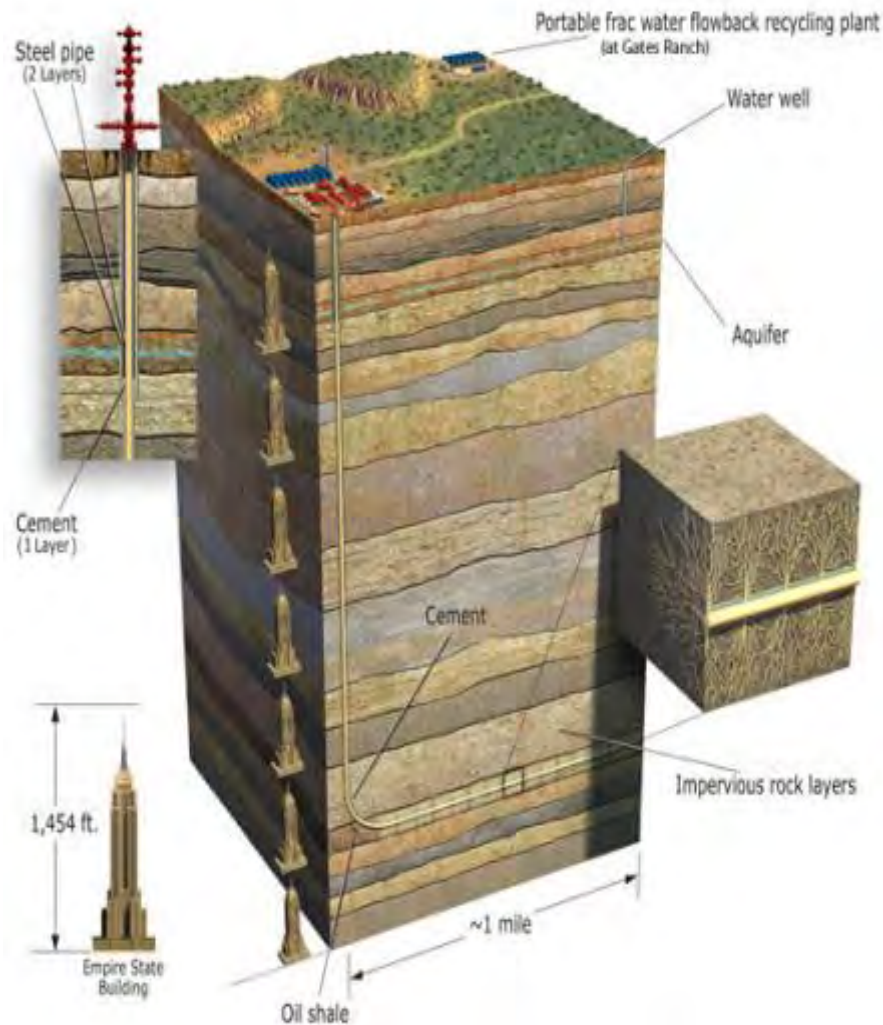

Clean Air Rule

Terms

- **"Emission reduction unit" or "ERU"** is an accounting unit representing the emission reduction of one metric ton of CO₂e.
- **Renewable Energy Certificates (RECs)** are tradable, non-tangible energy commodities in the United States that represent proof that 1 megawatt-hour (MWh) of electricity was generated from an eligible renewable energy resource (renewable electricity) and was fed into the shared system of power lines which transport energy.

72 $1 \text{ ERU} = 2.25 \text{ RECs}$

Overview

- In 2015, Governor Inslee directed the Department of Ecology to develop the Clean Air Rule (CAR) to cap and reduce carbon emissions under Washington's Clean Air Act authority.
- Includes entities with 100,000 metric tons of CO₂e emissions annually and lowers the threshold to 70,000 metric tons by 2035.
- Covers natural gas distributors and power plants, as well as other facilities –baseline will be set by Ecology using five years of data due on March 31, 2017. (2012-2016)
- The CAR went into effect on October 17, 2016.
- Annual emission reductions will equal:
 - 1.7% of baseline CO₂e emissions
 - 5% over the three year compliance period
 - Reductions are shown by banking emissions reduction units (ERUs) in the registry

Overview cont.

- ERU must originate from reductions in Washington unless derived from allowances and must be retired when used for compliance
- Generate ERUs by:
 - Actual emissions reductions beyond annual compliance requirements
 - Emission reduction projects, programs or activities
- ERU banking – 10 Year Banking Provision
- Exchange ERUs through established registry
- Kaiser is excluded from Avista's emissions baseline

Activities and programs recognized as generating ERU's

- Transportation activities;
- Combined heat and power activities;
- Energy activities;
- Livestock and agricultural activities;
- Waste and wastewater activities;
- Industrial sector activities;
- Certain Energy Efficiency Site Evaluation Council (EFSEC) recognized emission reductions; and
- Ecology approved emission reductions

Percentage Limits on Use of Allowances per compliance period

Compliance Period (Calendar year)	Report to EPA Due December 31	Report to Ecology Due July 28
2017 through 2019	2020	2021
2020 through 2022	2023	2024
2023 through 2025	2026	2027
2026 through 2028	2029	2030
2029 through 2031	2032	2033
2032 through 2034	2035	2036
2035 through 2037	2038	2039
Every 3 years	Every 3 years	Every 3 years

Compliance Period	Upper Limit
2017-22	100%
2023-25	50%
2026-28	25%
2029-31	15%
2032-34	10%
2035 and beyond	5%

CAR Allowances

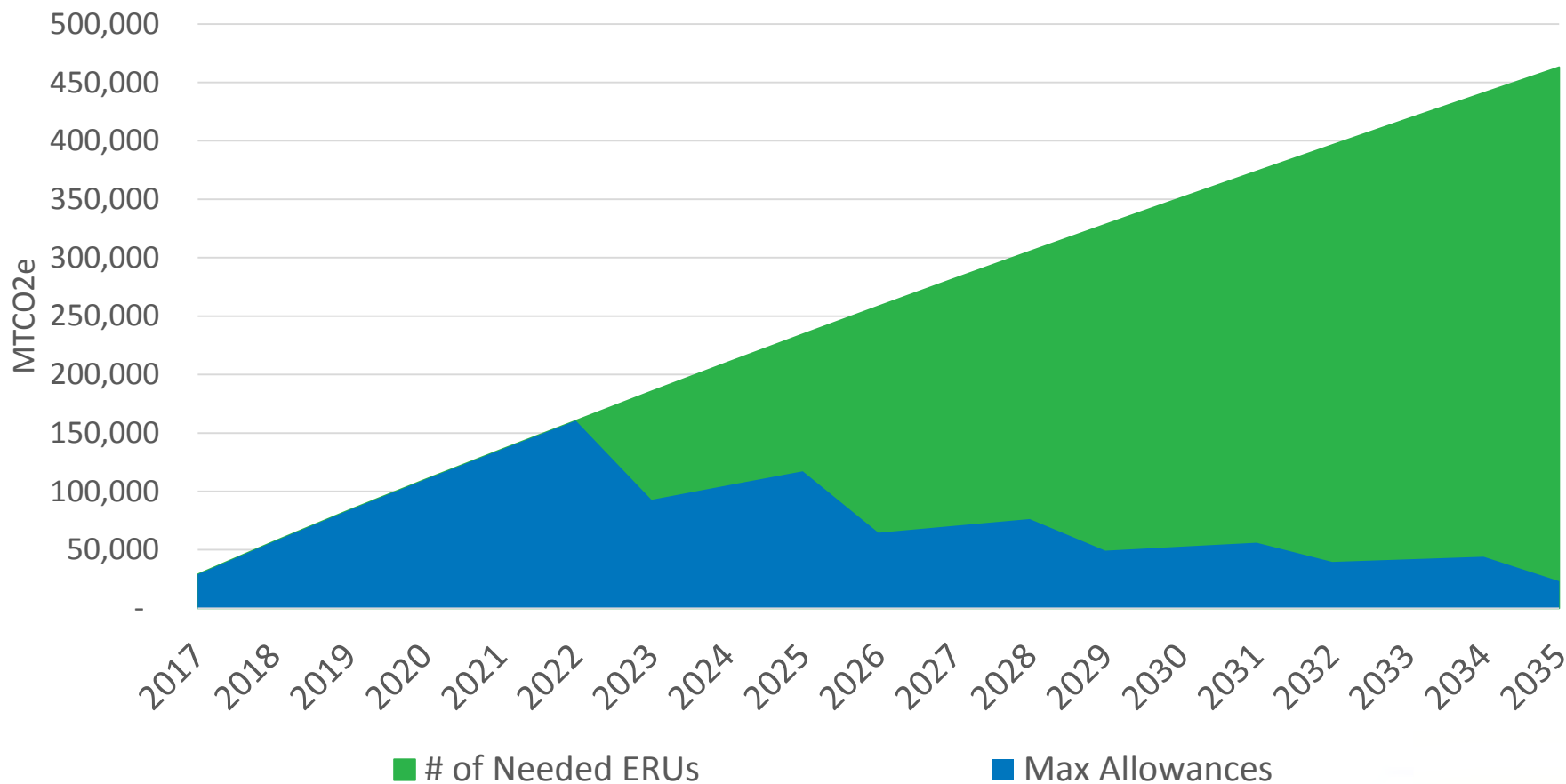

Avista WA CAR goal

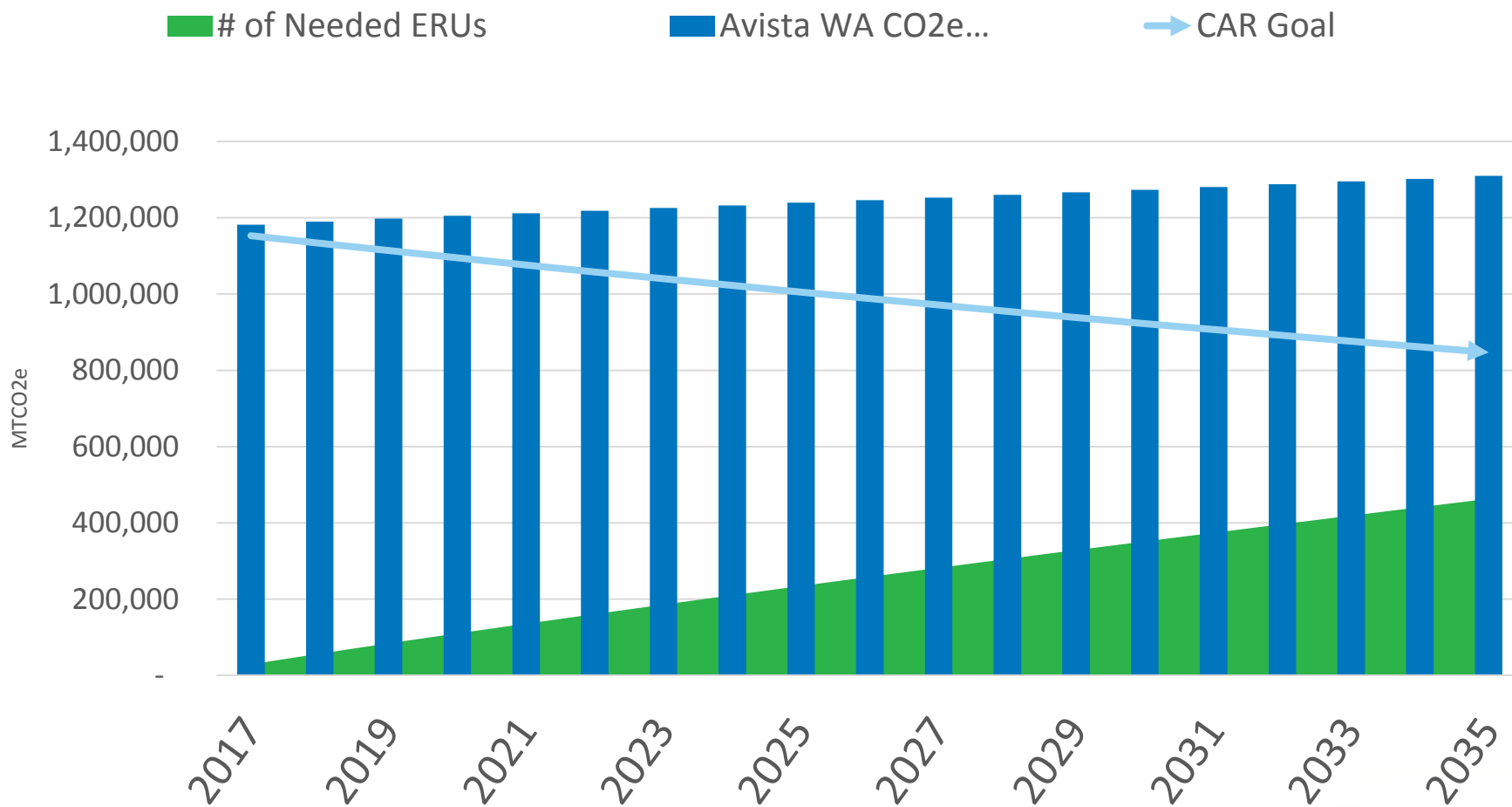

Potential Supply for CAR compliance

- RNG
- Solar
- Wind
- DSM



- Gas Customers, without a reduction in use, would likely be required to purchase electric generation resources in Washington State to offset emissions.



2018 Natural Gas IRP Carbon Policy Overview

John Lyons, Ph.D.
Second Technical Advisory Committee Meeting
February 22, 2018

Carbon Laws and Regulations

- Big changes at the federal level with the Trump administration
- More activity at the state and local levels
- Three main areas for carbon emissions:
 1. Regulatory mandates
 2. Cap and trade programs
 3. Carbon taxes
- Focus still on electric generation, but many states are expanding to natural gas and other fuels

Federal

- Current federal focus under a regulatory model through the Clean Air Act (CAA)
- Clean Power Plan (CPP) – reduce greenhouse gas emissions from covered existing power plants 32 percent below 2005 levels by 2030 under section 111(d) of the CAA.
 - Regulates power generation, but would impact natural gas use.
 - CPP stayed by US Supreme Court on February 9, 2016 and oral arguments June 2, 2016 at DC Circuit Court of Appeals.
 - April 4, 2017, EPA announced review to determine a new proceeding to “suspend, revise or rescind the Clean Power Plan.”
 - 10/16/17 – EPA proposed to repeal the CPP
 - Public comment period reopened to April 26, 2018 and additional listening sessions in February and March 2018

Idaho

- No active or proposed greenhouse gas legislation
- Provided comments about the CPP and the federal implementation plan
- Were working towards a state implementation plan by September 2016, but work stopped with the Supreme Court stay
- Will update after EPA makes a final decision on the CPP

Oregon

- Last IRP, “Clean Electricity, Coal Transition” law set a 50% renewable goal by 2040 and the elimination of coal power in rates by 2030
- **HB 4001 & SB 1507:** both bills create a cap and trade system for entities emitting over 25,000 metric tons carbon annually.
- In 2021, the Oregon Environmental Quality Commission would set a statewide emissions on about 100 companies who would need to reduce emissions or buy allowances.
- Revenue would be invested in clean energy or emissions mitigation programs.
- Emissions under both bills would drop 20% below 1990 levels by 2025, 45% by 2035, and 80% by 2050.

Oregon

- HB 4001 moved from House Energy & Environment Committee and referred to the Joint Committee on Ways & Means with no scheduled action for the bill.
- SB 1507 was voted out of the Senate Environment & Natural Resources Committee and referred to the Joint Committee on Ways & Means with no currently scheduled action for the bill.
- The House bill mirrors California's and the Senate bill tries to complement the "Clean Electricity, Coal Transition" bill by giving utilities free allowances for coal emissions.
- The biggest question from legislators has been the cost, which were estimated between \$400 and \$700 million annually in a Senate Committee on Environment and Natural Resources debate on February 12, but a final cost hasn't been issued yet.

Washington

- Clean Air Rule – invalidated 12/15/17
- SSB 6203: Current version is \$12/metric ton from use of fossil fuels and emissions from electric sector, increasing \$1.80/year until reaching \$30/ton in 2030
 - Originally \$20 with 3.5% plus inflation, changed to \$10 and \$2 annual increase
 - Exempts many energy intensive, trade-exposed manufacturers
 - Allows utilities a full tax credit for investing in projects and programs to reduce emissions or mitigate costs to low-income customers. This provision phases out for coal-fired generation.
 - Possible ballot initiative if the measure fails
- **SHB 2839 – allows alternative regulation by the UTC and requires utilities to factor in a “carbon adder” starting at \$40/ton in resource and conservation planning if a carbon price is enacted. Failed to meet the cutoff.**

Washington

- SB 6253 requires electric utilities to remove coal-fired generation costs from rates by 2030, and reduce carbon emitting resources until 100% renewable by 2045 or face a \$100/ton cost for exceeding emission targets. Failed to meet the chamber of origin cutoff.
- HB 2580, Rep. Morris Requires the WSU Extension Energy Program and Department of Commerce to identify opportunities and cost estimates for renewable natural gas and provide recommendations by September 1, 2018. Failed to meet the chamber of origin cutoff.
- HB 2402 for 50% RPS for investor-owned utilities by 2040, consumer-owned utilities purchase non-emitting resources for future needs, and sets minimum conservation 2% of electric load and 1.5% for natural gas load. Failed to meet the chamber of origin cutoff.
- Elements of bills failing to meet the chamber of origin cutoff may still be incorporated into other bills.



Price Forecasts and Carbon Adders

Henry Hub Forecast (Nominal \$)

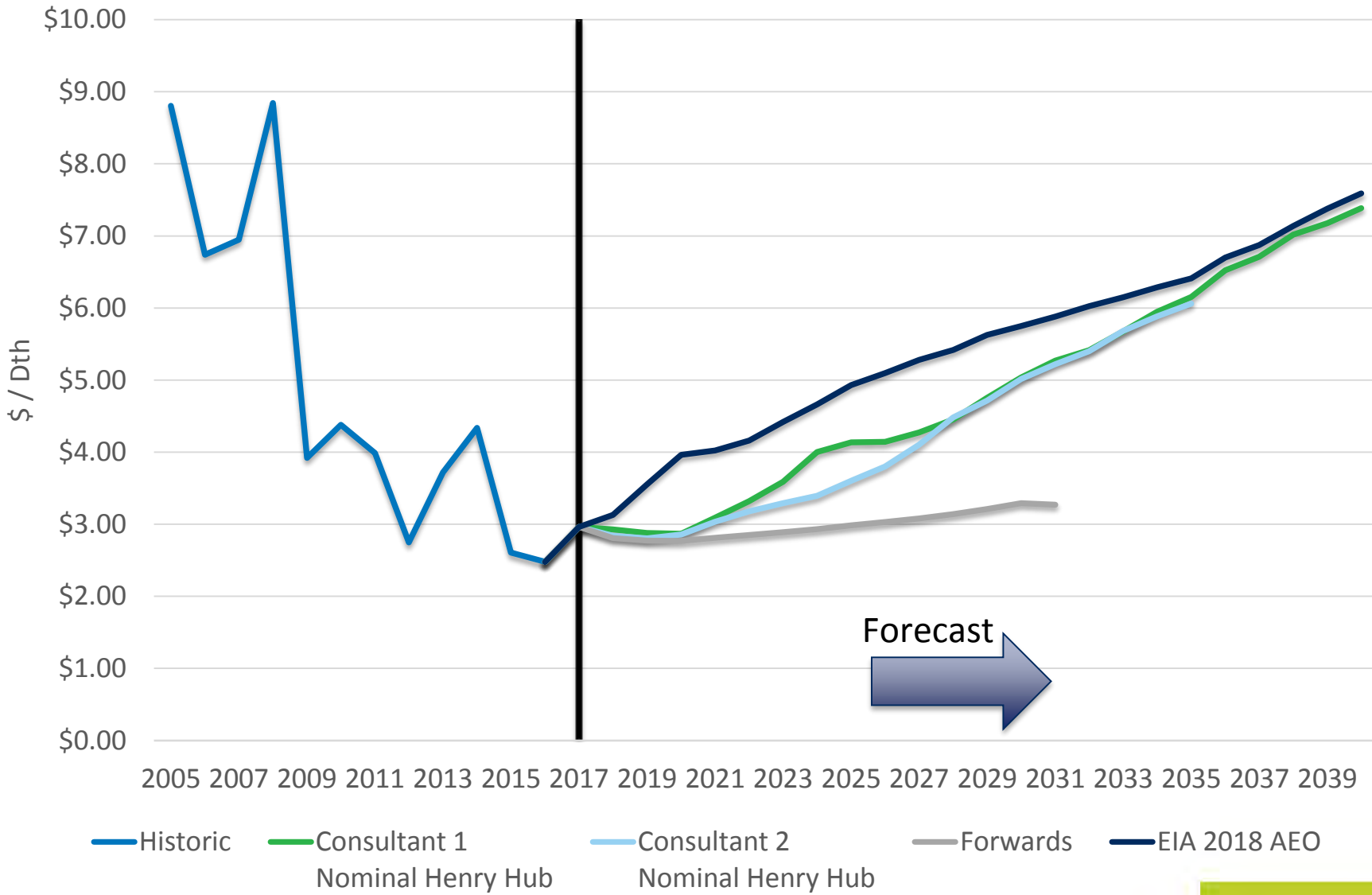

How prices affect IRP Planning?

- Major component of the total cost
- Change in price **can** trigger price elastic response
- **THE** major piece of avoided costs and therefore cost effectiveness of DSM
- Can change resource selection based on basin differentials
- Storage utilization

IRP Natural Gas Price Forecast Methodology

1. Two fundamental forecasts (Consultant #1 & Consultant #2)
2. Forward prices
3. Year 1 - forward price only
4. Year 2 - 75% forward price / 25% average consultant forecasts
5. Year 3 - 50% forward price / 50% average consultant forecasts
6. Year 4 – 6 25% forward price / 75% average consultant forecasts
7. Year 7 - 50% average consultant without CO2 / 50% average consultant with CO2

Expected Price forecast methodology curves

Nominal \$

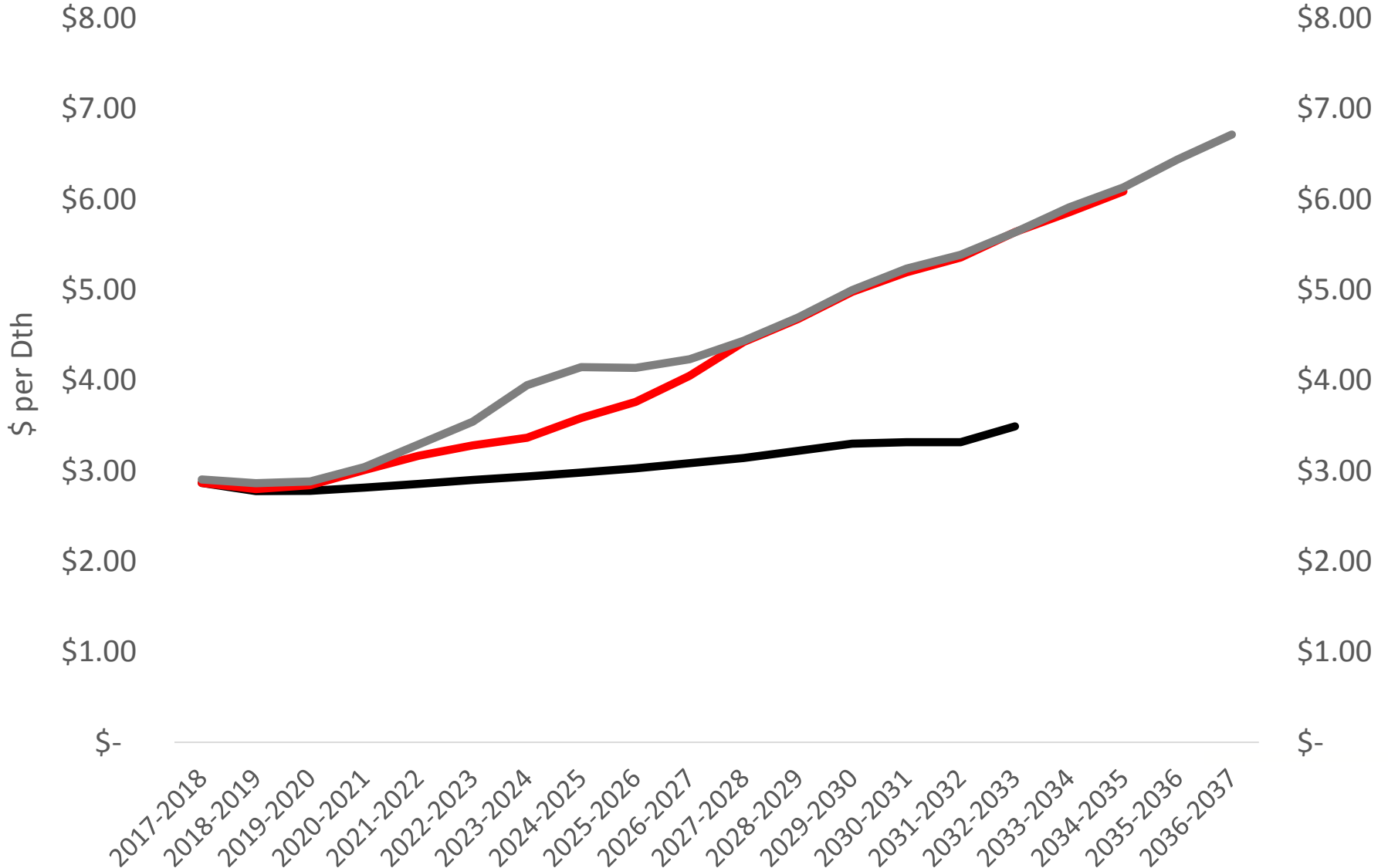

2018 Henry Hub Prices - Nominal

Exh. JM-2

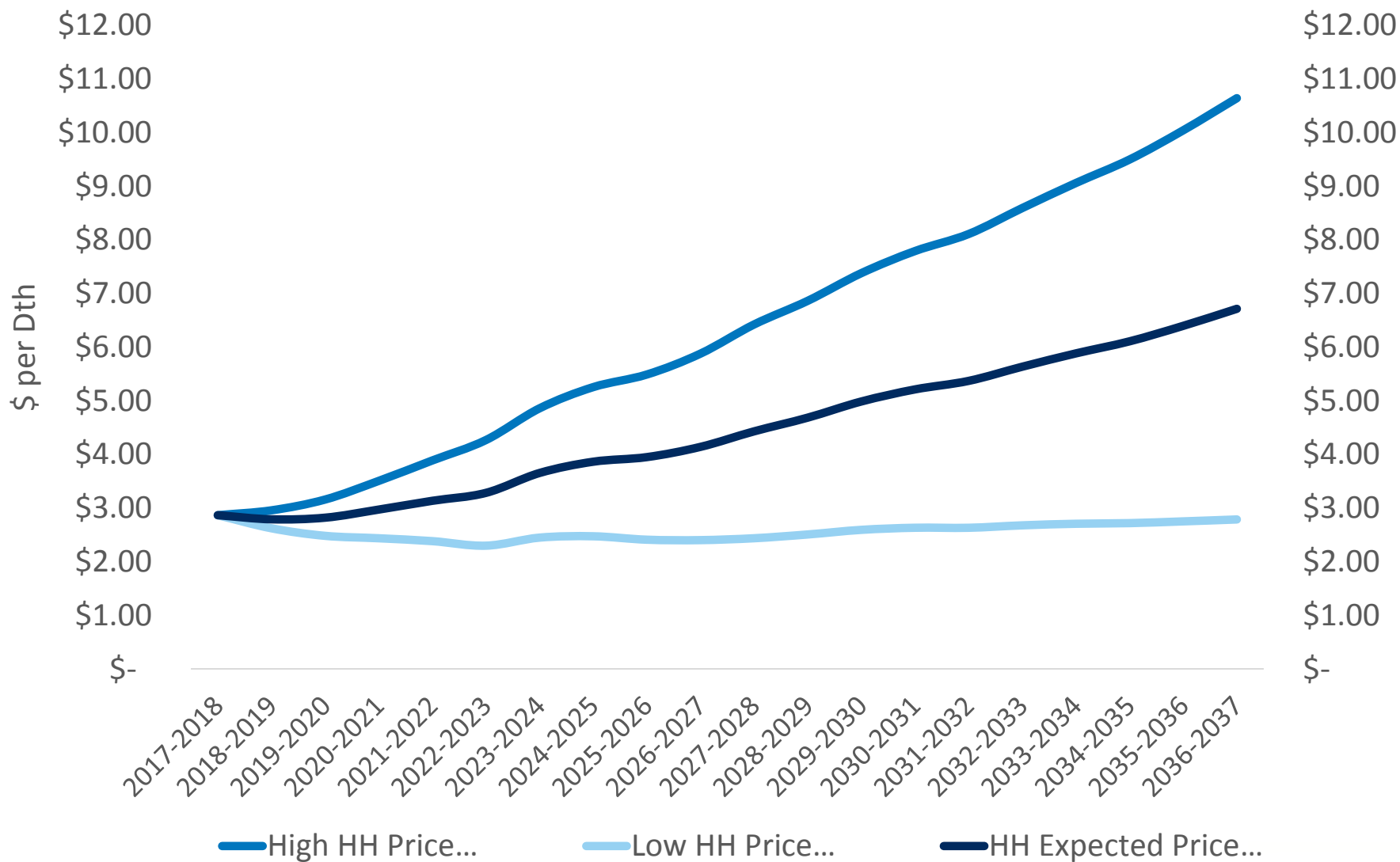

Pricing starts at the expected price for the first year

Years 2-6 price deviates by 6% per year from the expected price to create the high and low

Years 7-11 price deviates by 3% per year from the expected price to create the high and low

Years 12 – 20 the price deviates by 1.5% per year from the expected price

Price per MTCO2

Exh. JM-2

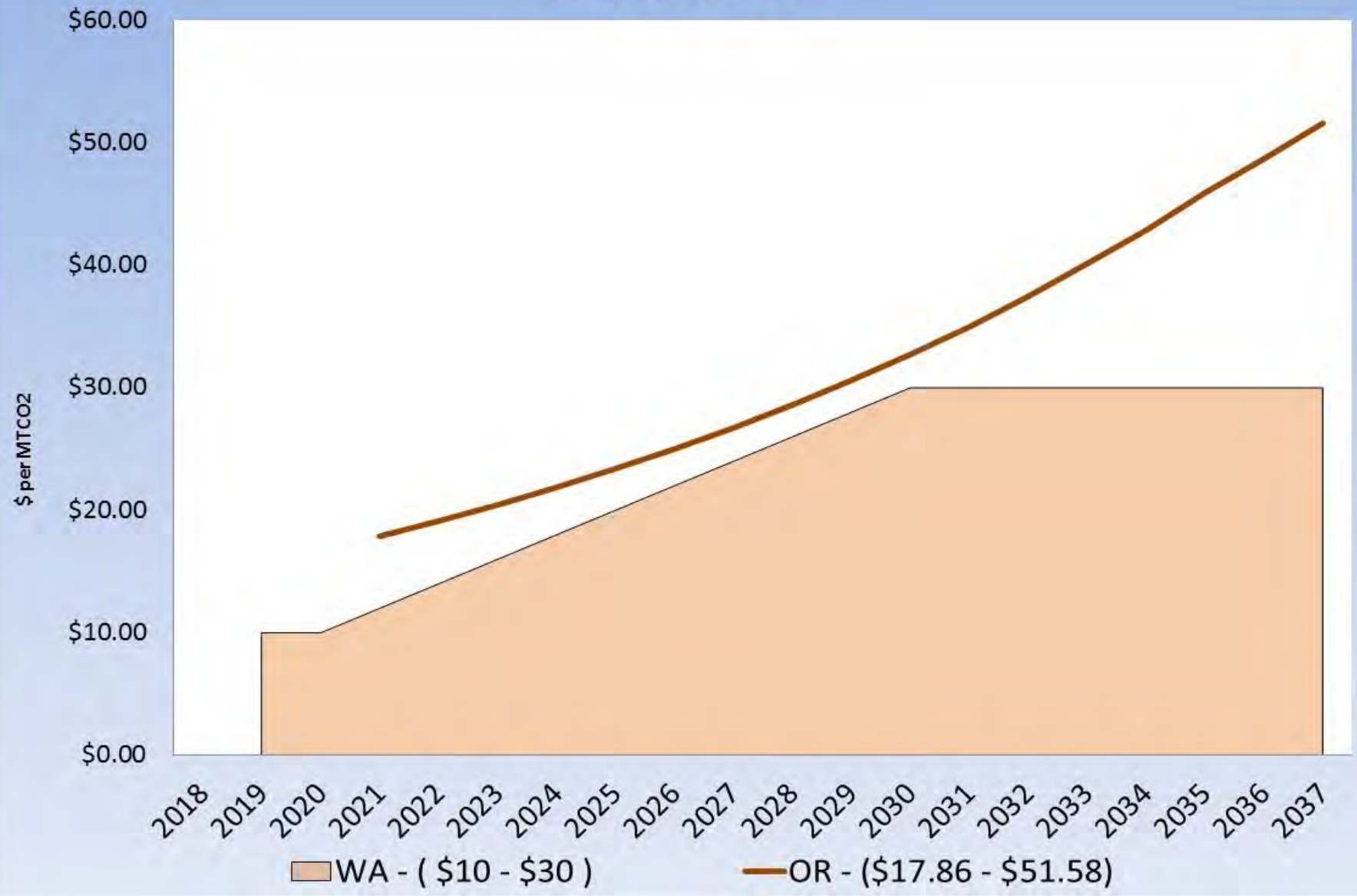

*nominal dollars

Carbon Price by Jurisdiction

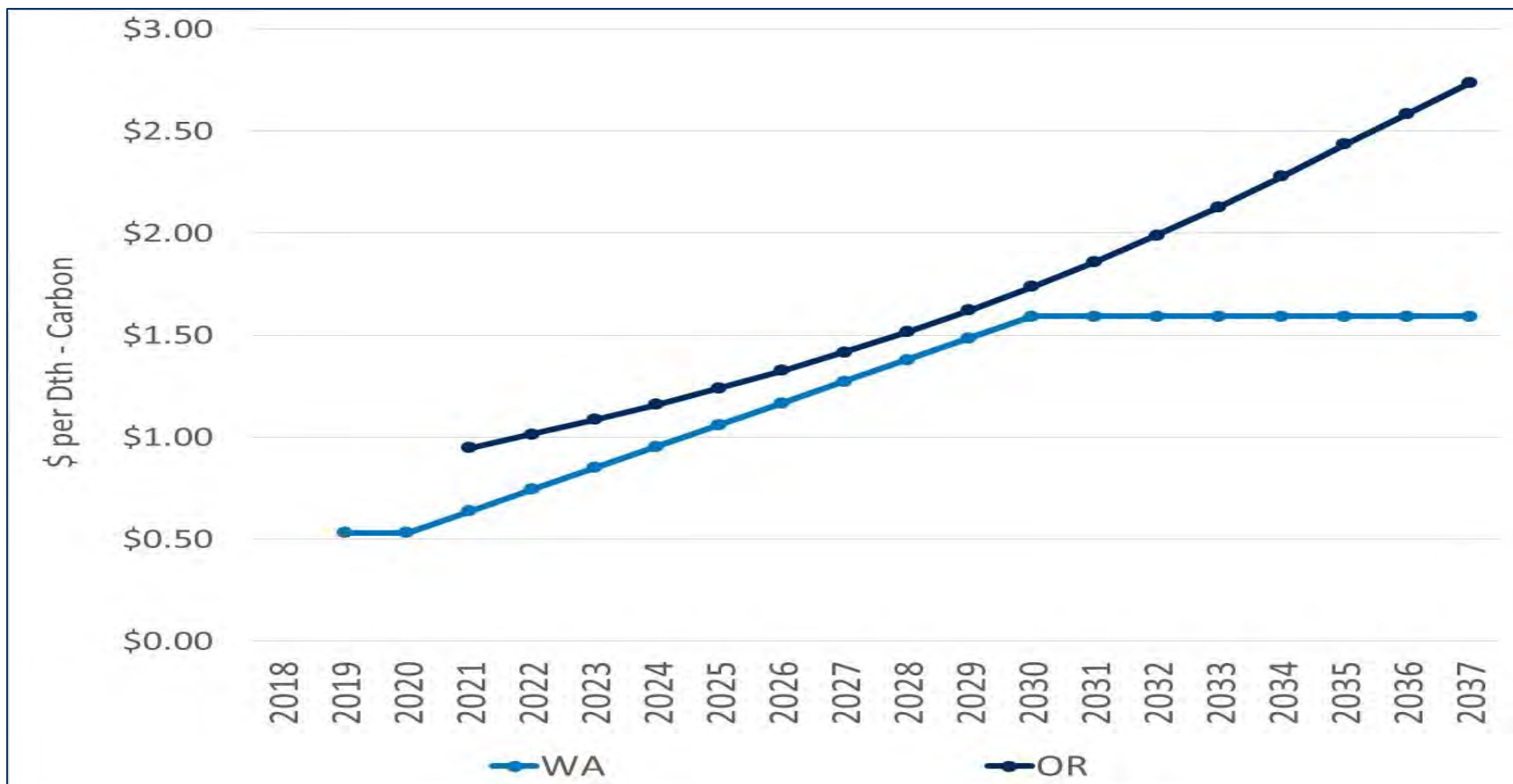

*Idaho has no carbon price adder

Carbon Tax Summary

- ID – None
- OR – Cap and Investment Program SB1070
 - Avista's price assumption are based on CA cap and trade program
 - Increases by 5% + inflation each year
- WA – Governor Inslee proposed Carbon tax (SB 6203)
 - Starts at \$10 per MTCO₂e in July 2019 and starting in 2021 adds \$2 per year until capping at \$30 in 2030.

2018 ID IRP Prices

Low – Expected – High

No Carbon Adders

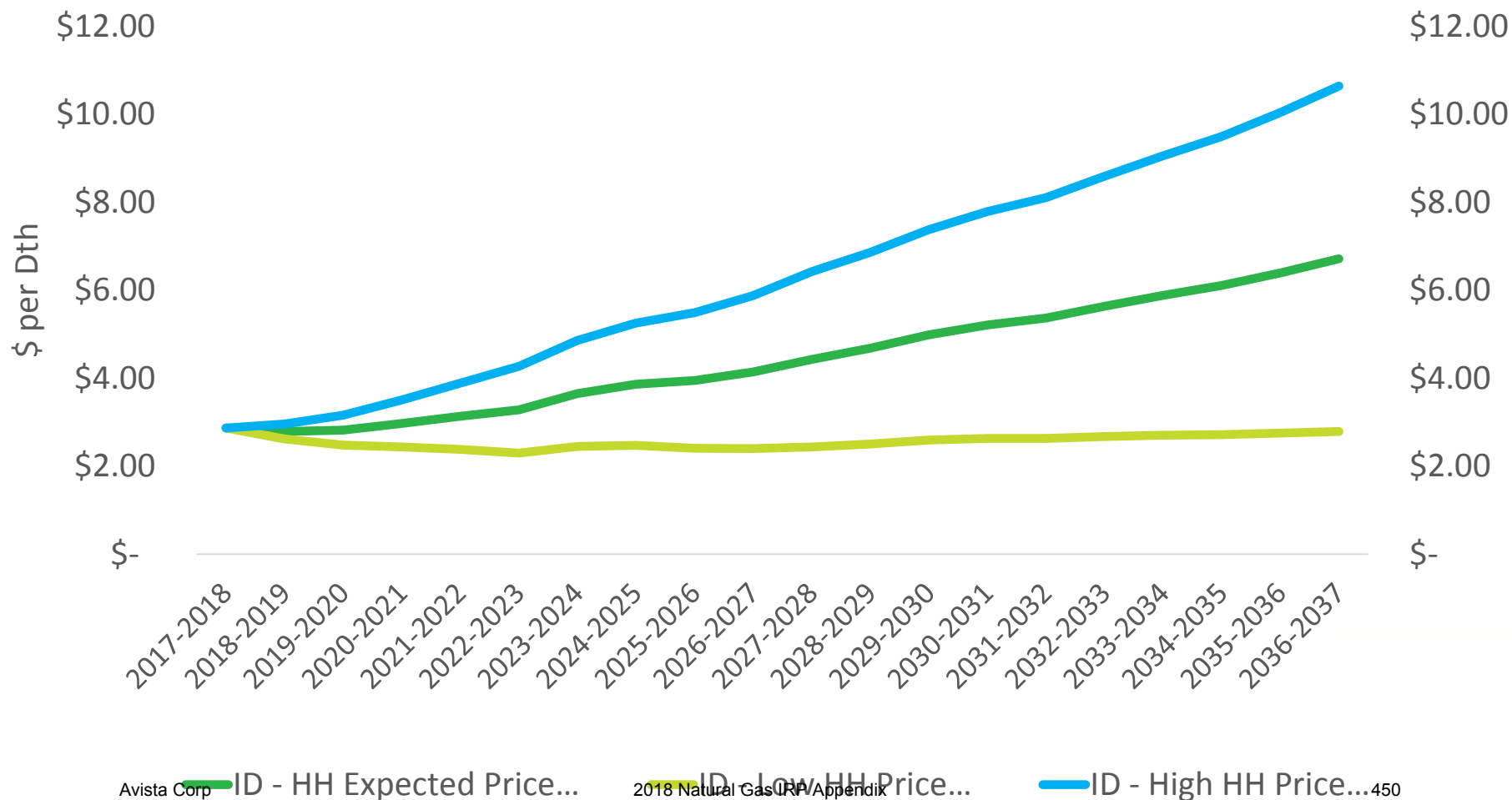

2018 OR IRP prices

Low – Expected – High

Including Carbon Adders

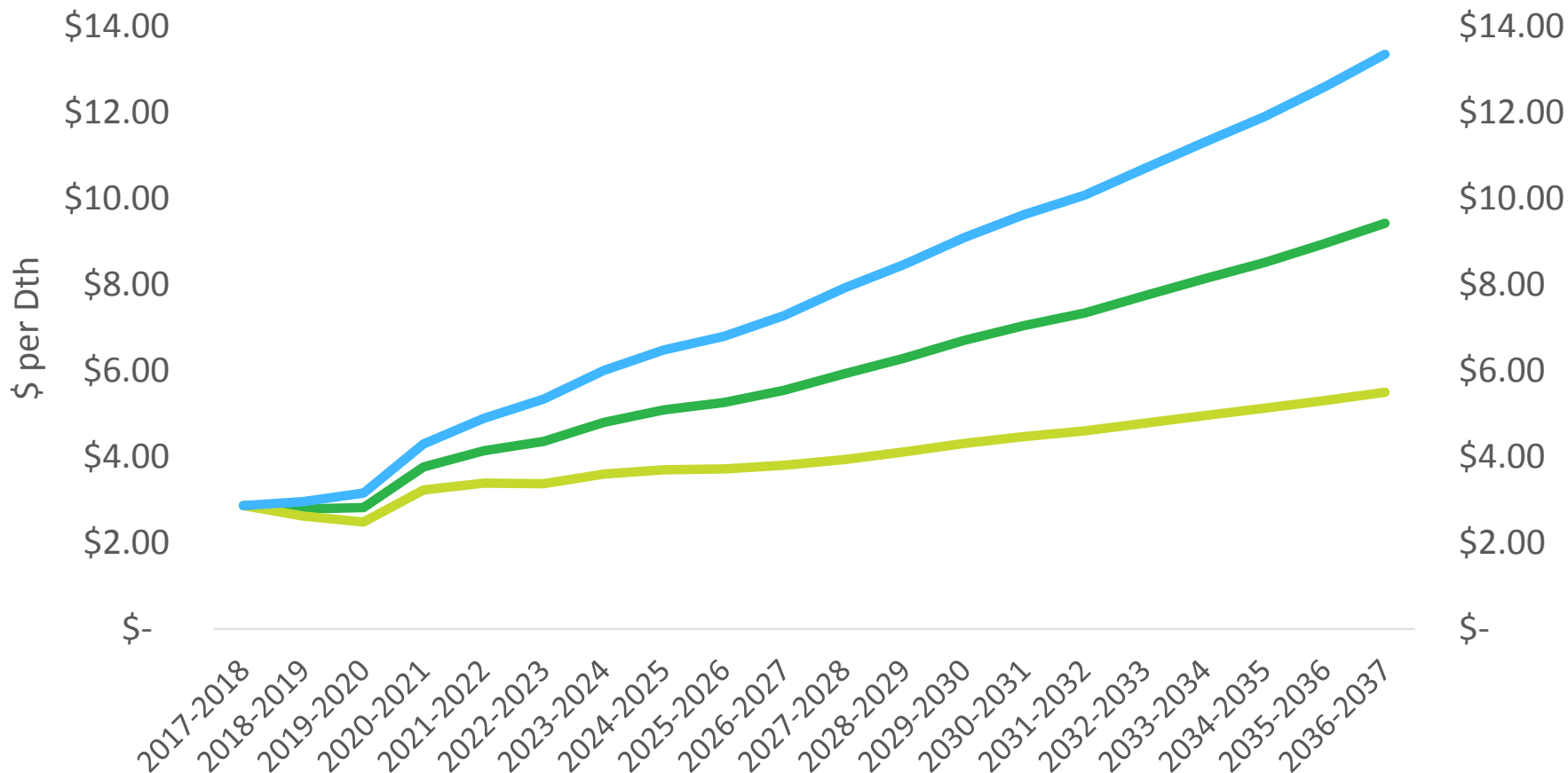

Avista Corp OR - HH Expected Price...

2018 Natural Gas IRP Appendix OR - Low HH Price...

OR - High HH Price... 451

2018 WA IRP Prices

Low – Expected – High

Including Carbon Adders



2018 Henry Hub Expected Price Including Carbon Adders by State

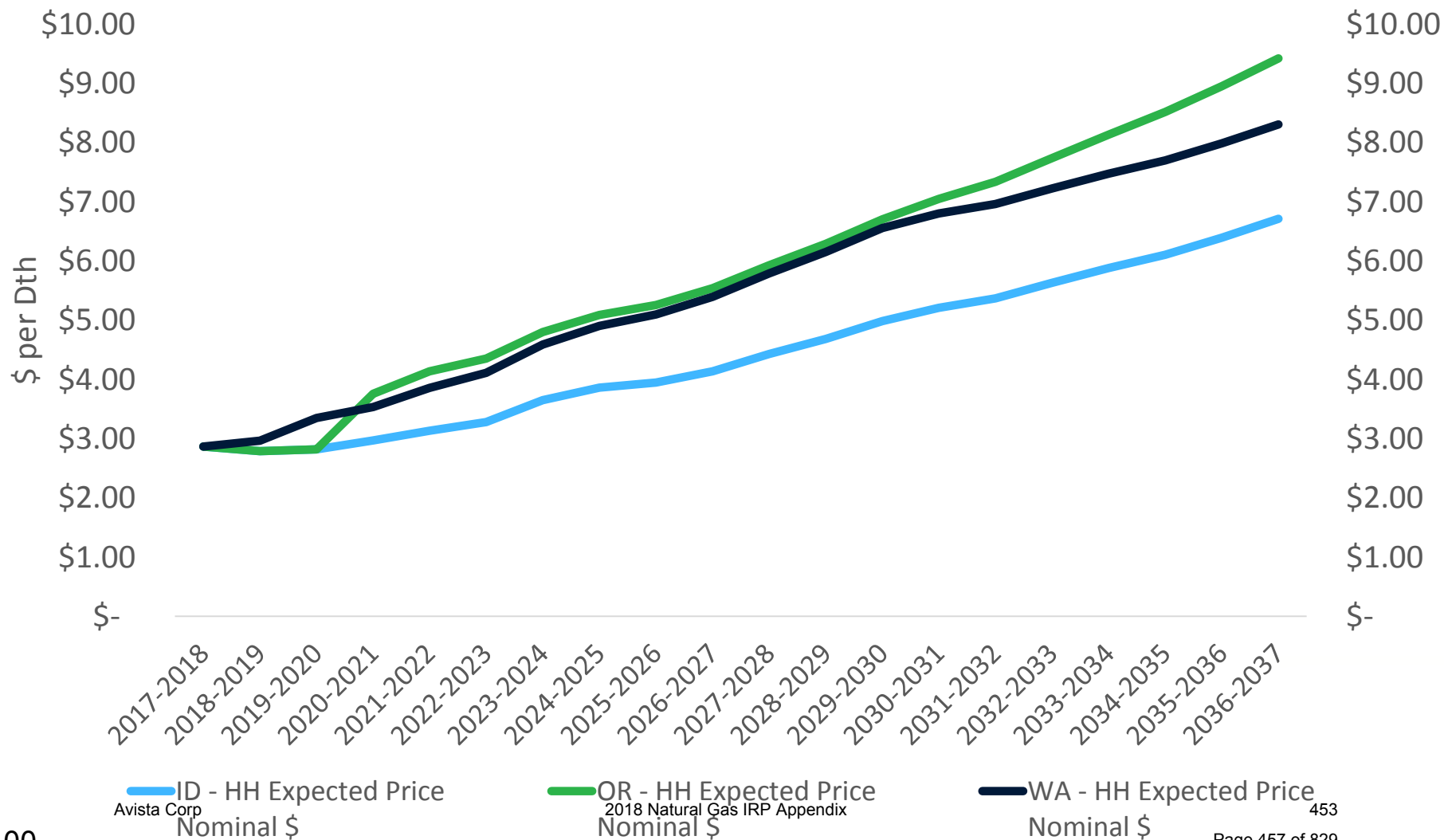



Wrap Up

IPUC

- Staff believes public participation could be further enhanced through “bill stuffers, public flyers, local media, individual invitations, and other methods.”
- Result: Avista utilized it’s Regional Business Managers in addition to digital communications and newsletters in all states in order to try and gain more public participation. Previous IRP’s relied on website data and word of mouth.
 - eCommunity newsletter was sent out on January 15, 2018

OPUC

- Staff Recommendation No. 1
 - Staff recommends in Avista's 2018 IRP that Avista pursue an updated methodology, wherein the low/high gas price curves continue to be based on low (high) historic prices in a Monte Carlo setting, but are inflated to match the growth rate (yr/yr) of the expected price curve. The resulting curves would be based on historic prices and also produce symmetric risk profiles throughout the time horizon.
 - **Result: Avista updated its method as recommended by the Oregon commission. This new method deviates from the expected price by the following method:**
 - **Pricing starts at the expected price for the first year**
 - Years 2-6 the high and low price deviate +/- 6% per year from the expected price
 - Years 7-11 the high and low price deviate by +/- 3% per year from the expected price
 - Years 12 – 20 the high and low price deviate by +/- 1.5% per year from the expected price
 - By the 20 year mark the high and low deviate from the expected price by +/- 58.5%
- Staff Recommendation No. 2
 - Staff recommends that Avista forecast its number of customers using at least two different methods and to compare the accuracy of the different methods using actual data as a future task in its next IRP.
 - Result: Avista analyzed the data, but there was nothing material discovered the come up with a meaningful forecast alternative.
- Staff Recommendation No. 3
 - Avista's 2018 IRP will contain a dynamic DSM program structure in its analytics.
 - In, prior IRPs, it was a deterministic method based on Expected Case assumptions, in the 2018 IRP, each portion will have the ability to select conservation to meet unserved customer demand, Avista will explore methods to enable a dynamic analytical process for the evaluation of conservation potential within individual portfolios and will work with Energy Trust of Oregon in the development of this process and in producing any final results for its 2018 IRP for Oregon customers.

OPUC cont.

- Staff Recommendation No. 4
 - Staff recommends that Avista provide Staff and stakeholders with updates regarding its discussions and analysis regarding possible regional pipeline projects that may move forward.
- Staff Recommendation No. 5
 - Staff recommends that in its 2018 IRP process Avista work with Staff and stakeholders to establish and complete stochastic analysis that considers a range of alternative portfolios for comparison and consideration of both cost and risk.

OPUC cont.

- Staff Recommendation No. 6
 - Environmental Considerations
 - 1. Carbon Policy including federal and state regulations, specifically those surrounding the Washington Clean Air Rule and federal Clean Power Plan;
 - Result: Carbon Policy including the Clean Power Plan and Clean Air Rule were both reviewed and included in TAC 2 Meeting materials on 2/22/2018. An indicator of where Avista's carbon reduction requirements under the CAR was also included. Since the CAR was invalidated on 12/15/2017 in Thurston County Superior Court this analysis is intended to meet the action item in addition to showing the potential impacts of similar policies.
 - 2. Weather analysis specific to Avista's service territories;
 - Result: A weather analysis was included and reviewed in TAC 2 meeting materials on 2/22/2018
 - 3. Stochastic Modeling and supply resources; and
 - 4. Updated DSM methodology including the integration of ETO

WUTC

- Include a section that discusses impacts of the Clean Air Rule (CAR).
 - In its 2018 IRP expected case, Avista should model specific CAR impacts as well as consider the costs and risk of additional environmental regulations, including a possible carbon tax.
 - **Result:**
 - Carbon Policy including the Clean Power Plan and Clean Air Rule were both reviewed and included in TAC 2 Meeting materials on 2/22/2018. An indicator of where Avista's carbon reduction requirements under the CAR was also included. Since the CAR was invalidated on 12/15/2017 in Thurston County Superior Court this analysis is intended to meet the action item in addition to showing the potential impacts of similar policies.
 - For the 2018 IRP Avista is utilizing SB6203 from the WA Senate energy committee on Feb. 1 as a proxy of a possible carbon tax in Washington State.

WUTC

- Provide more detail on the company's natural gas hedging strategy, including information on upper and lower pricing points, transactions with counterparties, and how diversification of the portfolio is achieved.
 - Avista's natural gas hedging strategy was discussed during the TAC 2 Meeting on 2/22/2018. The upper and lower pricing points in Avista's programmatic hedges is controlled by taking into consideration the volatility over the past year for the specific hedging period. This volatility is weighted toward the more recent volatility. The window length and quantity of windows is also a part of the equation. Avista transacts on ICE with counterparties meeting our credit rating criteria. The diversification of the portfolio is achieved through the following methods:
 - **Components:** The plan utilizes a mix of index, fixed price, and storage transactions.
 - **Transaction Dates:** Hedge windows are developed to distribute the transactions throughout the plan.
 - **Supply Basins:** Plan to primarily utilize AECO, execute at lowest price basis at the time.
 - **Delivery Periods:** Hedges are completed in annual and/or seasonal timeframes. Long-term hedges may be executed.

WUTC cont.

- Ensure that the entity performing the CPA evaluates and includes the following information:
 - All conservation measures excluded from the CPA, including those excluded prior to technical potential determination
 - The rationale for excluding any measure
 - A description of Unit Energy Savings (UES) for each measure included in the CPA, specifying how it was derived and the source of the data
 - The rationale for any difference in economic and achievable potential savings, including how the Company is working towards an achievable target of 85 percent of economic potential savings.
 - A description of all efforts to create a fully-balanced cost effectiveness metric within the planning horizon based on the TRC.

WUTC cont.

- Discuss with the TAC:
 - The results of Northwest Energy Efficiency Alliance (NEEA) coordination, including non-energy benefits to include in the CPA.
 - The appropriateness of listing and mapping all prospective distribution system enhancement projects planned on the 20 year horizon, and comparing actual projects completed to prospective projects listed in previous IRP's.
- Provide a rationale for any difference in economic and achievable potential savings

2017 – 2018 Avista's Action Plan

- The price of natural gas has dropped significantly since the 2014 IRP. This is primarily due to the amount of economically extractable natural gas in shale formations, more efficient drilling techniques, and warmer than normal weather. Wells have been drilled, but left uncompleted due to the poor market economics. This is depressing natural gas prices and forcing many oil and natural gas companies into bankruptcy. Due to historically low prices Avista will research market opportunities including procuring a derivative based contract, 10-year forward strip, and natural gas reserves.
 - Result: After exploring the opportunity of some type of reserves ownership, it was determined the price as compared to risk of ownership was inappropriate to go forward with at this time. As an ongoing aspect of managing the business, Avista will continue to look for opportunities to help stabilize rates and/or reduce risk to our customers.
- Monitor actual demand for accelerated growth to address resource deficiencies arising from exposure to “flat demand” risk. This will include providing Commission Staff with IRP demand forecast-to-actual variance analysis on customer growth and use-per-customer at least bi-annually.
 - Result: actual demand was closely tracked and shared with Commissions in semi-annual or quarterly meetings.

2018 IRP Timeline

- **August 31, 2017** – Work Plan filed with WUTC
- **January through May 2018** – Technical Advisory Committee meetings. Meeting topics will include:
 - **TAC 1: Thursday, January 25, 2018: TAC meeting expectations, review of 2016 IRP acknowledgement letters, customer forecast, and demand-side management (DSM) update.**
 - **TAC 2: Thursday, February 22, 2018: Weather analysis, environmental policies, market dynamics, price forecasts, cost of carbon.**
 - **TAC 3: Thursday, March 29, 2018 : Distribution, supply-side resources overview, overview of the major interstate pipelines, RNG overview and future potential resources.**
 - **TAC 4: Thursday, May 10, 2018: DSM results, stochastic modeling and supply-side options, final portfolio results, and 2020 Action Items.**
- **June 1, 2018** – Draft of IRP document to TAC
- **June 29, 2018** – Comments on draft due back to Avista
- **July 2018** – TAC final review meeting (if necessary)
- **August 31, 2018** – File finalized IRP document



2018 Avista Natural Gas IRP

Technical Advisory Committee Meeting
March 29, 2018
Spokane, WA

Agenda

- Introductions & Logistics
- Williams update
- TransCanada update
- Avista's Supply Side Resources
- Distribution
- Renewable Natural Gas
- Power to Gas
- Initial sensitivity results & proposed scenarios

➤ Lunch will be around 12pm

2018 IRP Timeline

- **August 31, 2017** – Work Plan filed with WUTC
- **January through May 2018** – Technical Advisory Committee meetings. Meeting topics will include:
 - **TAC 1: Thursday, January 25, 2018: TAC meeting expectations, review of 2016 IRP acknowledgement letters, customer forecast, and demand-side management (DSM) update.**
 - **TAC 2: Thursday, February 22, 2018: Weather analysis, environmental policies, market dynamics, price forecasts, cost of carbon.**
 - **TAC 3: Thursday, March 29, 2018 : Distribution, supply-side resources overview, overview of the major interstate pipelines, RNG overview and future potential resources.**
 - **TAC 4: Thursday, May 10, 2018: DSM results, stochastic modeling and supply-side options, final portfolio results, and 2020 Action Items.**
- **June 1, 2018** – Draft of IRP document to TAC
- **June 29, 2018** – Comments on draft due back to Avista
- **July 2018** – TAC final review meeting (if necessary)
- **August 31, 2018** – File finalized IRP document



WE MAKE ENERGY HAPPEN

Exh. JM-2

Avista TAC Meeting #3

March 29, 2018

NYSE: WMB
williams.com



Mastio Survey

- > **Rated No. 2 in the Mega and Major Pipeline categories and No. 3 in the overall Interstate Pipeline category**

- > **Northwest was ranked #1 in the following areas:**
 - competitive rates
 - diverse supply & markets
 - likelihood to recommend

- > **Northwest was ranked #2 in the following areas:**
 - honest communications
 - effectiveness of contract negotiations
 - expertise of reps to solve your needs
 - value received for the money paid
 - flexibility of gas flows
 - flexibility of transport options

Northwest System – Strategically Located

> Low-cost, primary service provider in the Pacific Northwest

- 3,900-mile system with 3.8 Bcf/d peak design capacity
- ~120 Bcf of access to storage along pipeline, with high injection and deliverability capability in market area
- Fully Contracted with > 9 year average contract life

> Bi-directional design

- Provides flexibility (Rockies to market and Sumas to market)
- Cheapest supply drives flow patterns
- Provides operational efficiencies through displacement

> Supply and market flexibility

- 65 receipt points totaling 11.6 Bcf/d of supply from Rockies, Sumas, WCSB, San Juan, emerging shales
- 366 delivery points totaling 9.7 Bcf/d of delivery capacity

> Solution oriented

- History of working with our customers both creatively and collaboratively to serve their needs





Supply Diversity

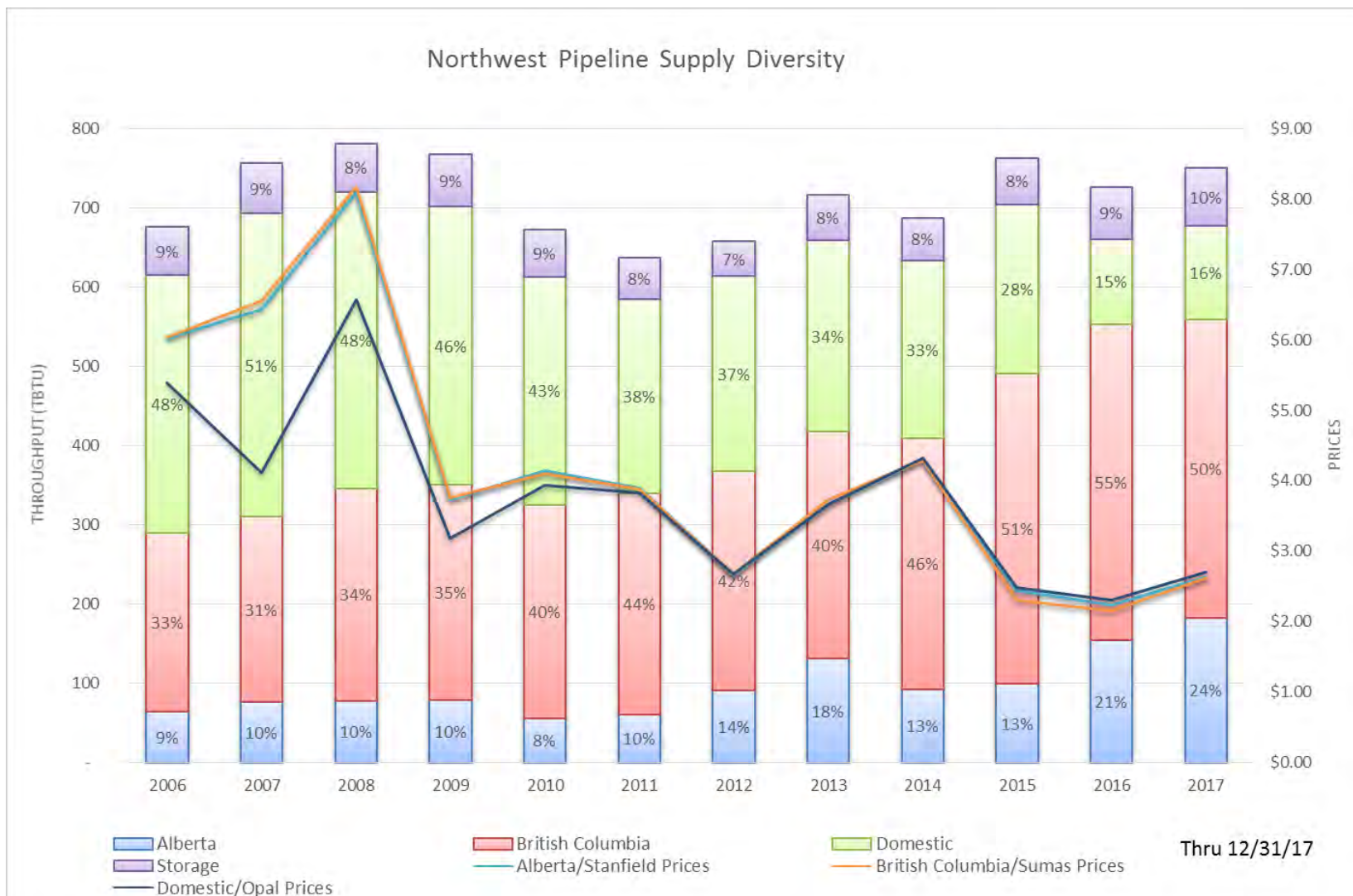

Supply Diversity – South End

LA Plata B Compressor Thruput (3 years)

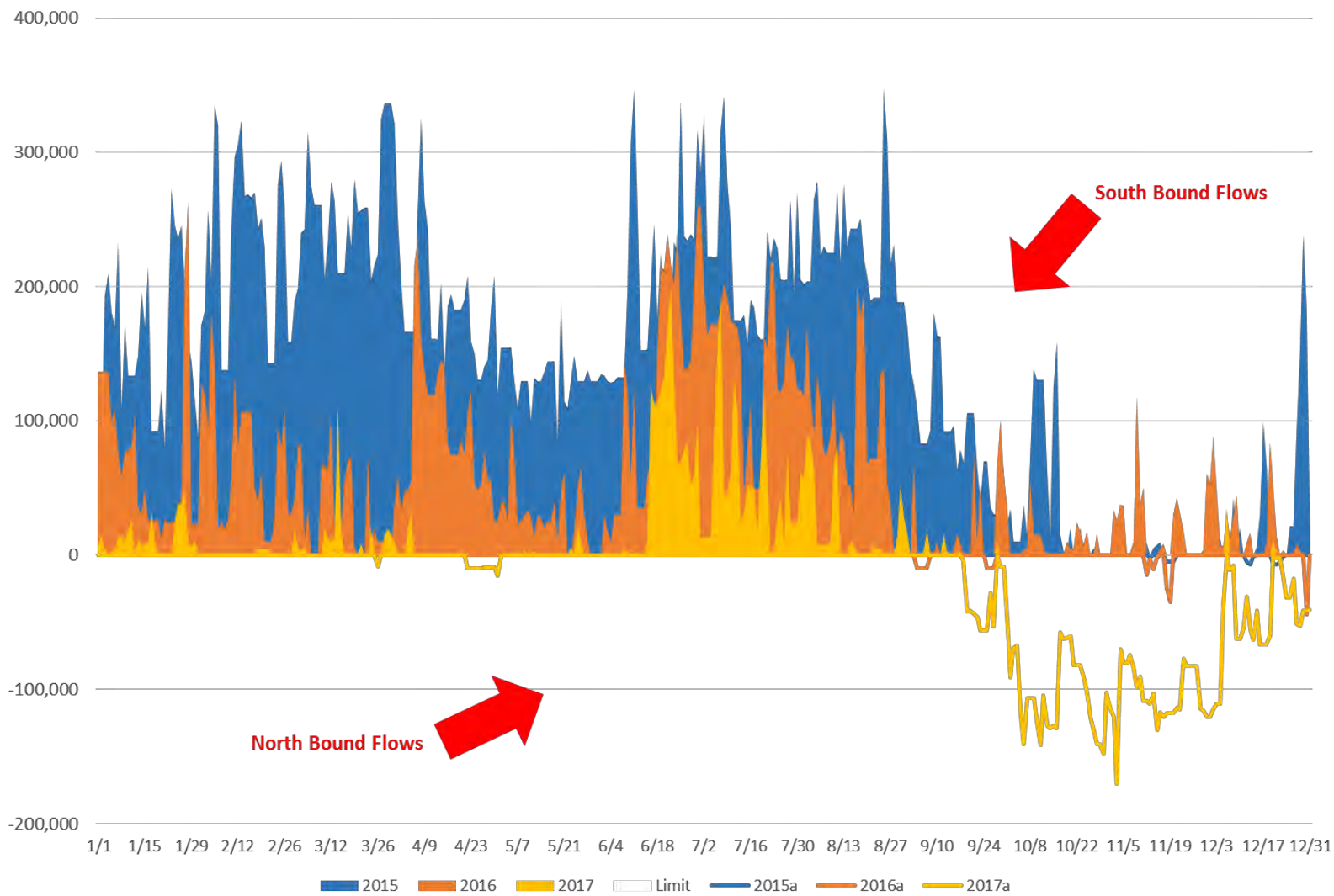

Sumas South Historical



Chehalis Historical (Avg Dth/d)

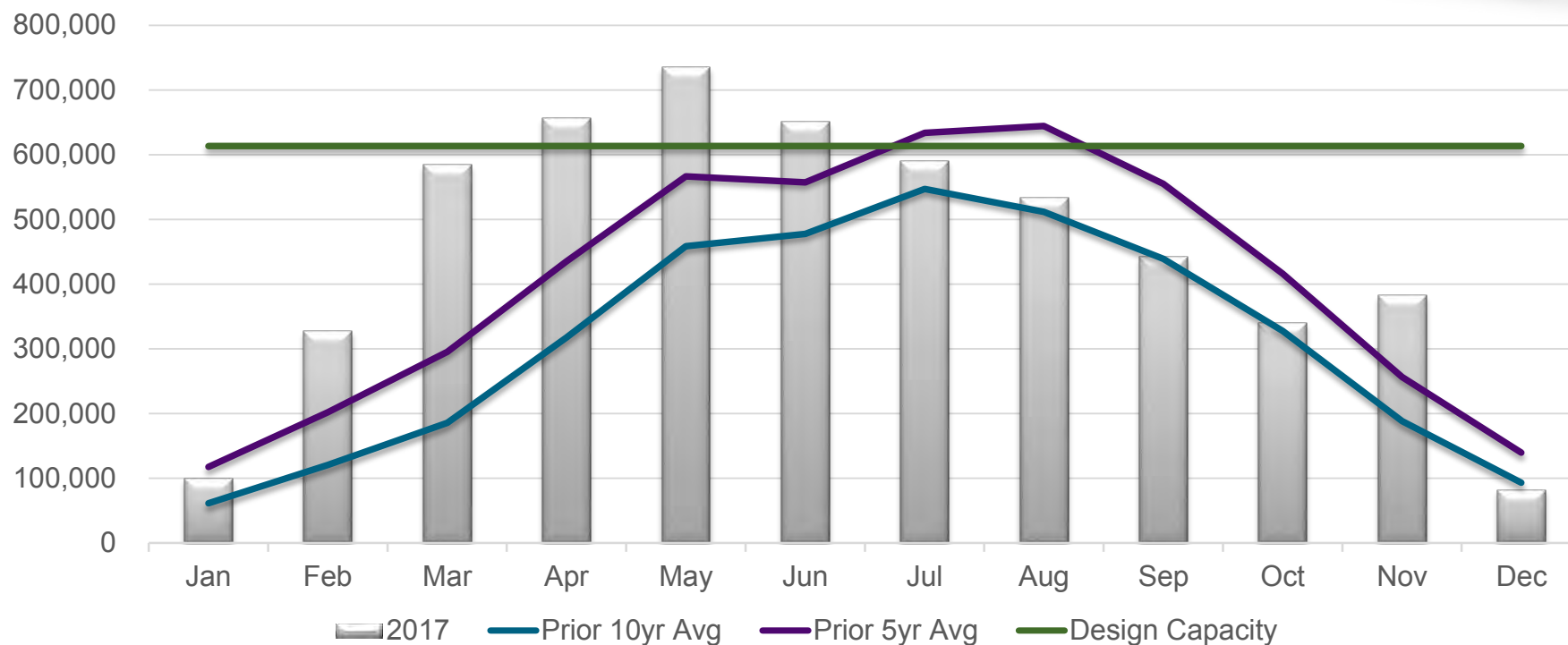

Stanfield West Historical



Roosevelt Historical (Avg Dth/d)

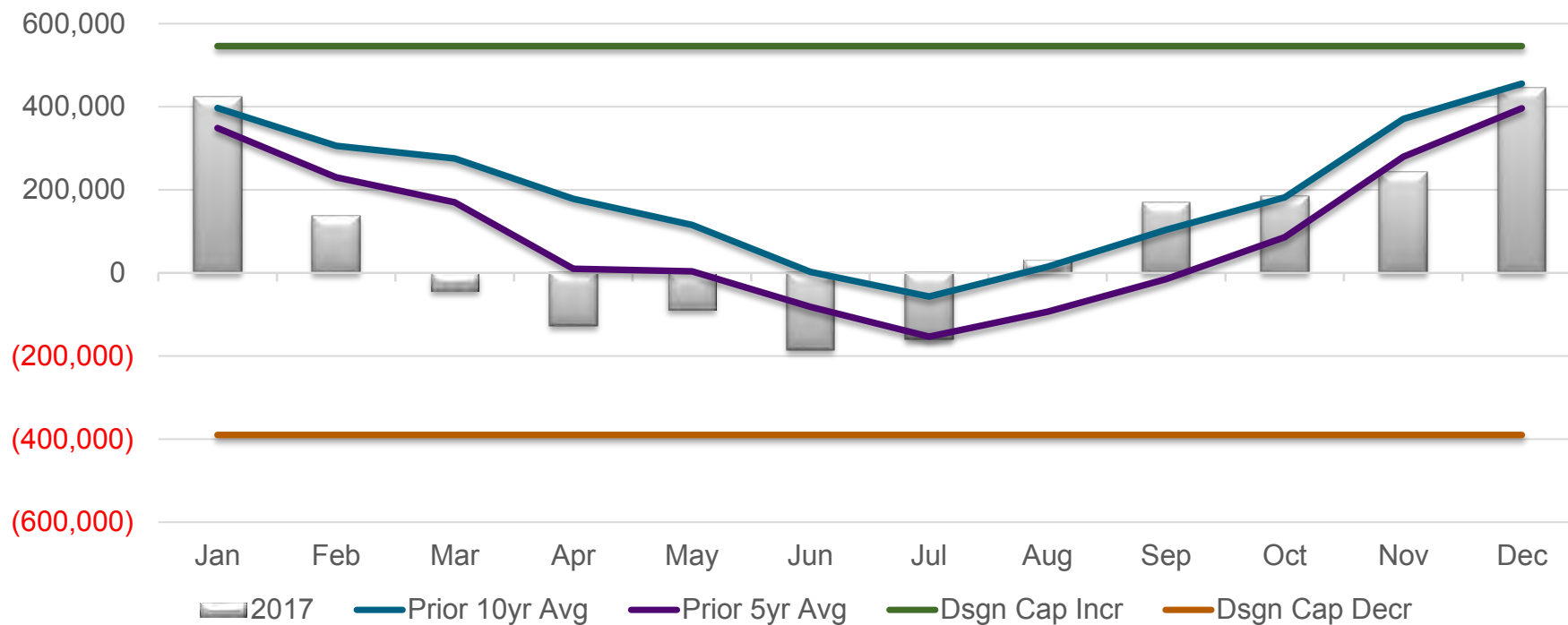



Jackson Prairie Withdrawal Deliverability Curve

NOTE: Deliverability curve is based on a beginning seasonal quantity of 25.6 MMDth. Withdrawal capacity starts out at 1.2 MMDth/d and declines by 2 percent for each 1 percent the capacity drops below 60 percent.

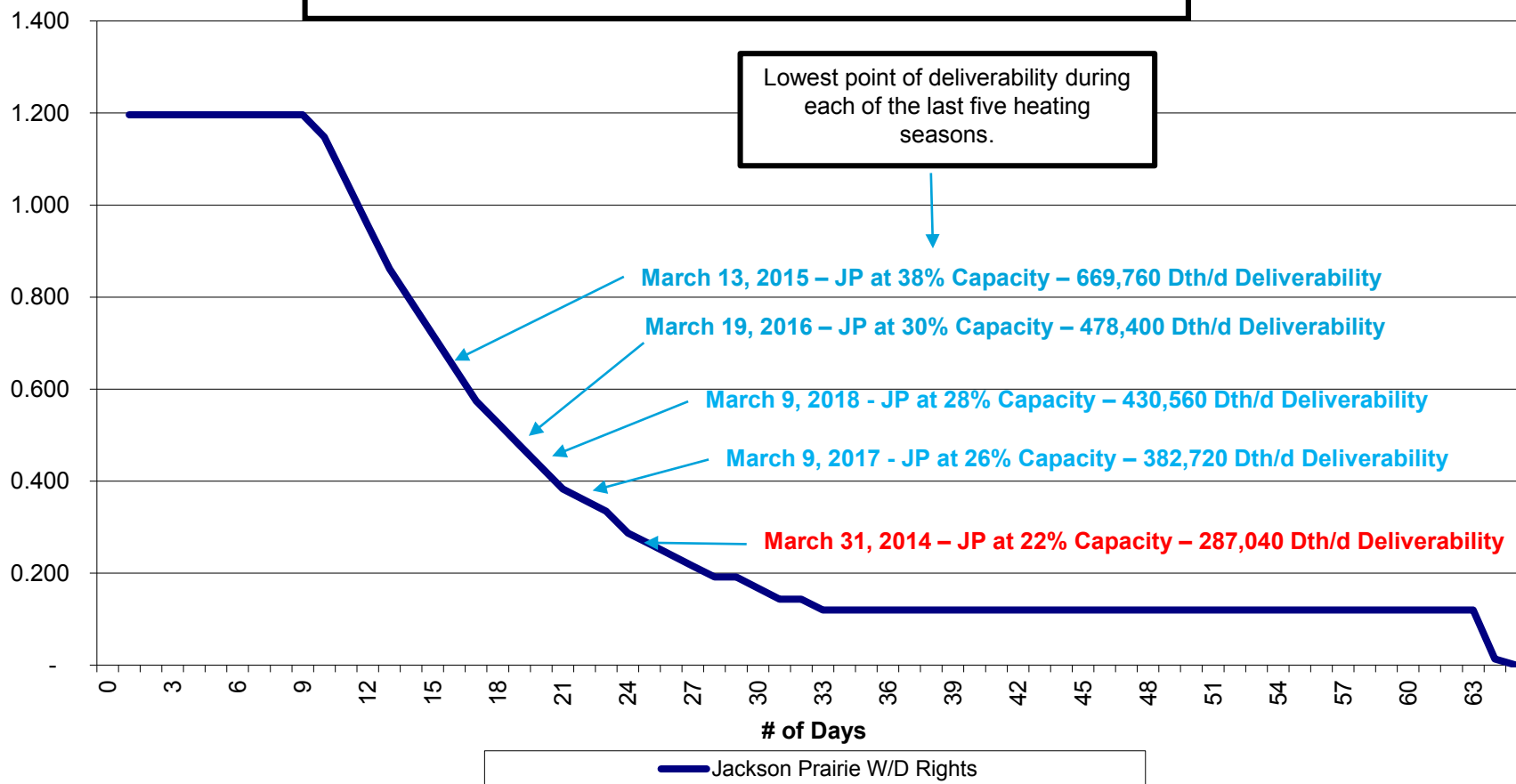

Weather Forecast – February 26, 2014

February 26 forecast for March 1 through 3, 2014

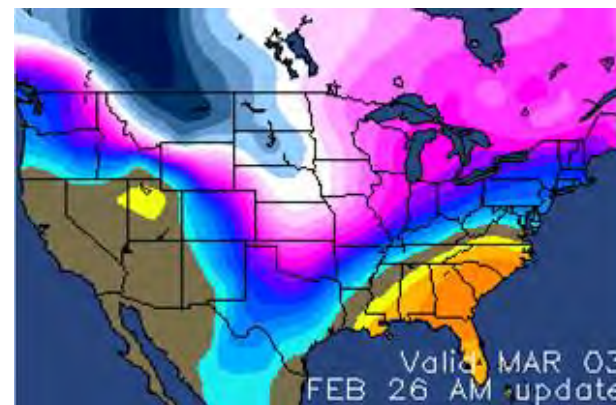
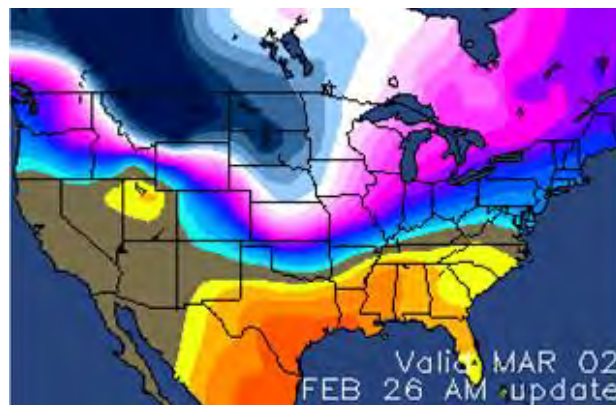
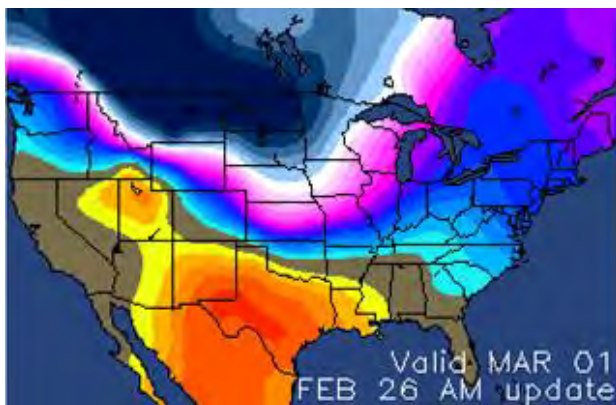

Daily and Period Temperature Anomaly Key (F)



Tariff Rates

Base Tariff Rates

	Effective 12/31/2017	Effective 1/1/2018	Effective 10/1/2018	Comeback Rates Effective 1/1/2023
TF-1 Reservation (Large Customer)	0.41000	0.39294	0.39033	?
TF-1 Volumetric (Large Customer)	0.03000	0.00832	0.00832	?
Small Customer	0.72155	0.69427	0.69427	?

Avista's Net Effective Rate

Net Effective Rate							
	Contract	Daily Contract Demand	Released Amount	Receipt	Delivery	Rate	Reservation Charge
Base Contract	Various	190,416				0.39294	\$ 27,310,053
Incremental CD through Segmentations to themselves							
Avista	137286	9,211		Starr Road	Coeur D'Alene	-	\$ -
Segmented Releases to Third Parties							
IGI	110203		10,000	Rockies	Idaho	0.39294	\$ (1,434,231)
	110192		10,000	Rockies	Meridian/Boise	0.39294	\$ (1,434,231)
Clark PUD	140788		2,841	Stanfield	River Road	0.39294	\$ (407,465)
	140787		6,709	Stanfield	River Road	0.39294	\$ (962,226)
	142230		17,394	Sumas	River Road	0.39294	\$ (2,494,701)
Puget Sound	141549		8,056	Sumas	JP Delivery	0.39294	\$ (1,155,416)
							\$ (7,888,271)
Net Effective Rate		199,627				0.26655	\$ 19,421,783

Peak Day Load Effective Rate							
	Contract	Daily Contract Demand	Annual Contract Quantity	Receipt	Receipt / Delivery	Daily Rate	Reservation Charge
Avista	100314	91,200	2,906,266	JP Receipt	Various	0.03431	\$ 1,141,935
	100315	2,623	94,462	JP Receipt	Various	0.03431	\$ 37,147
							\$ 1,179,081
Peak Day Effective Rate		293,450				0.19234	\$ 20,600,864

Avista's Segmentation to Themselves

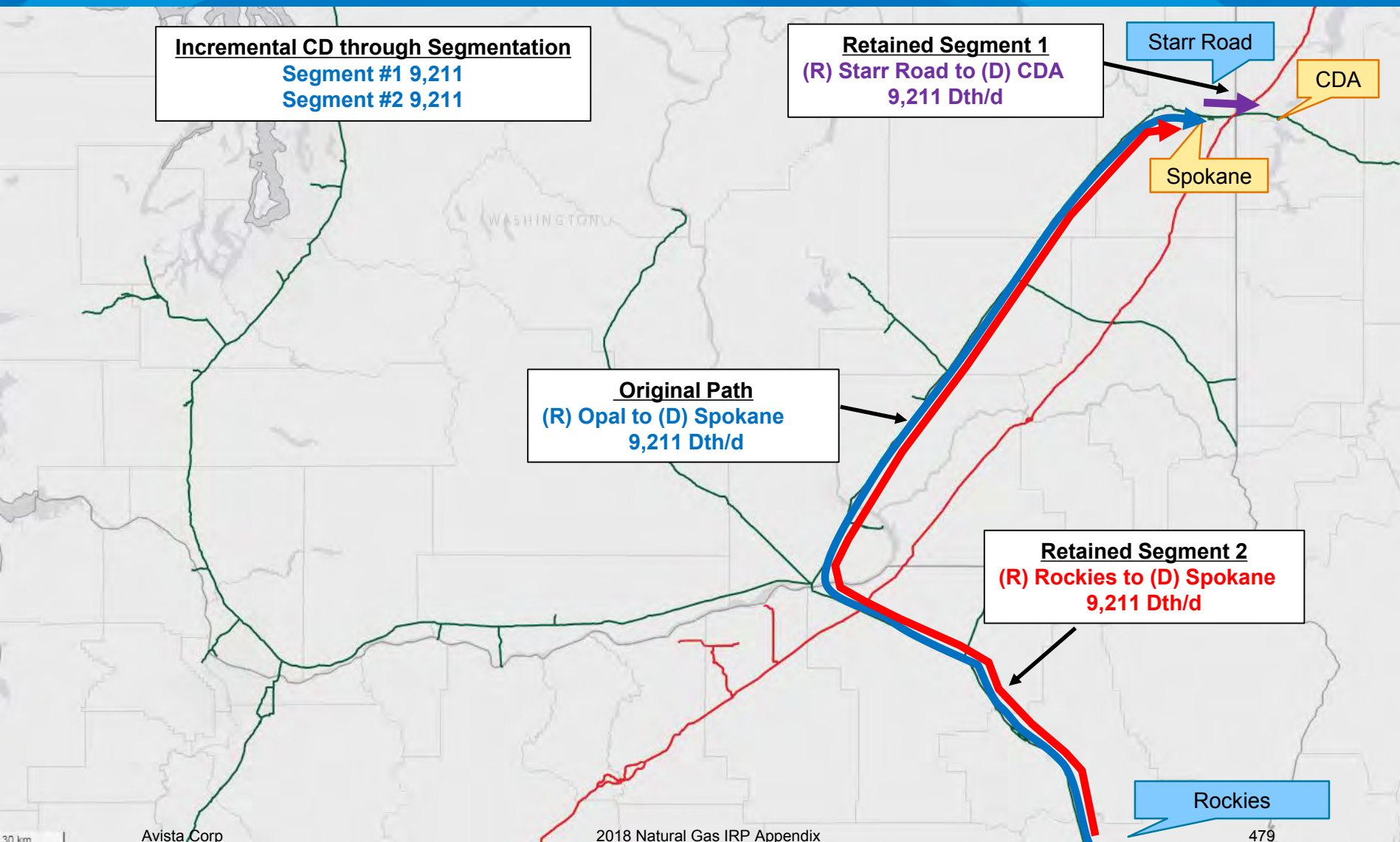

Avista's Segmented Release No. 1

Annual Cost Savings
Segment #1 ~\$3.0m

Retained Segment 1
(R) Stanfield to (D) Spokane
20,000 Dth/d

Original Path
(R) Rockies to (D) Spokane
20,000 Dth/d

Stanfield Receipt

Released Segment 1
(R) Rockies to (D) Idaho
20,000 Dth/d

Spokane

Idaho

Rockies

Avista's Segmented Release No. 2

Annual Cost Savings

Segment #1 ~\$3.0m

Segment #2 ~\$1.4m

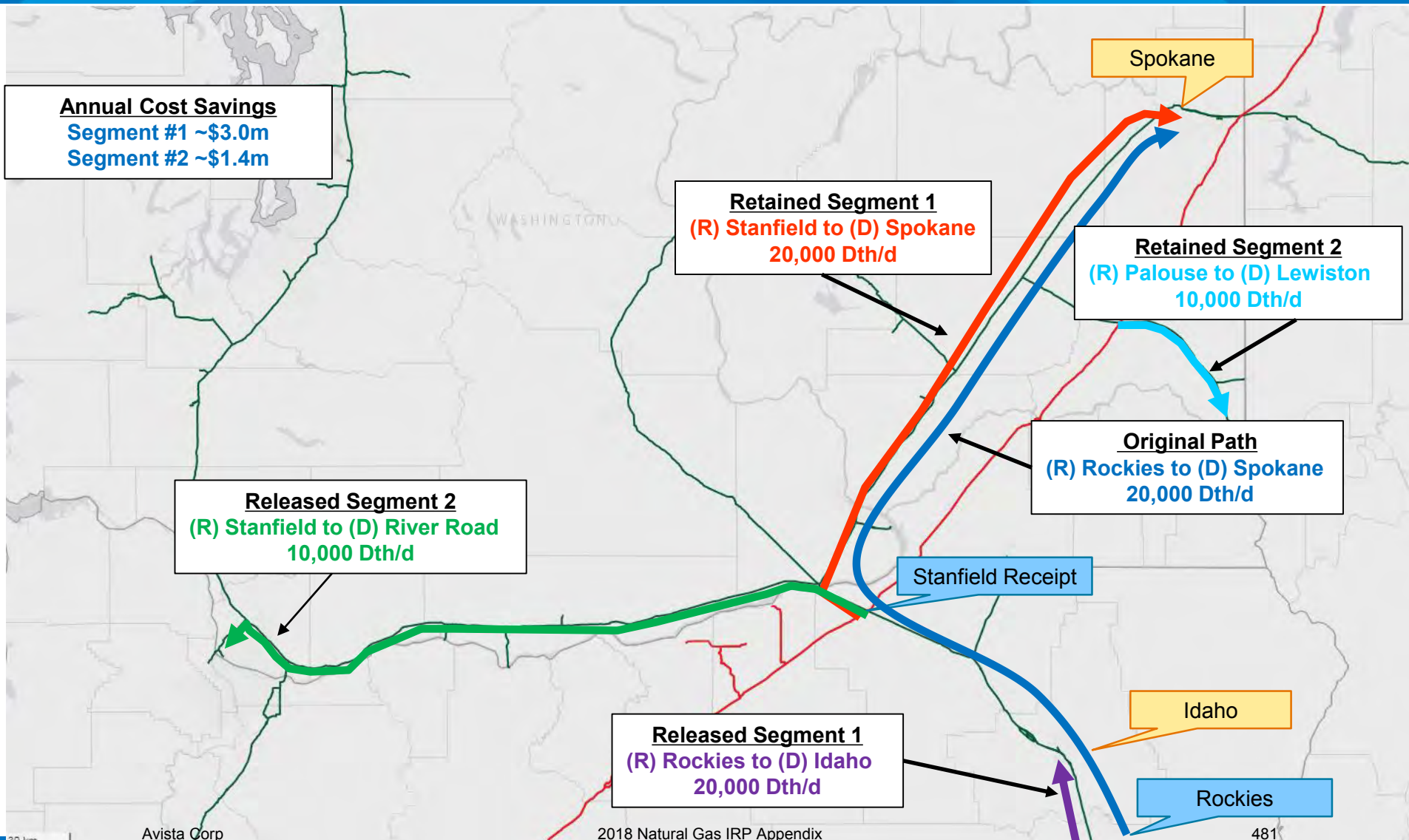

Avista's Segmented Release No. 3

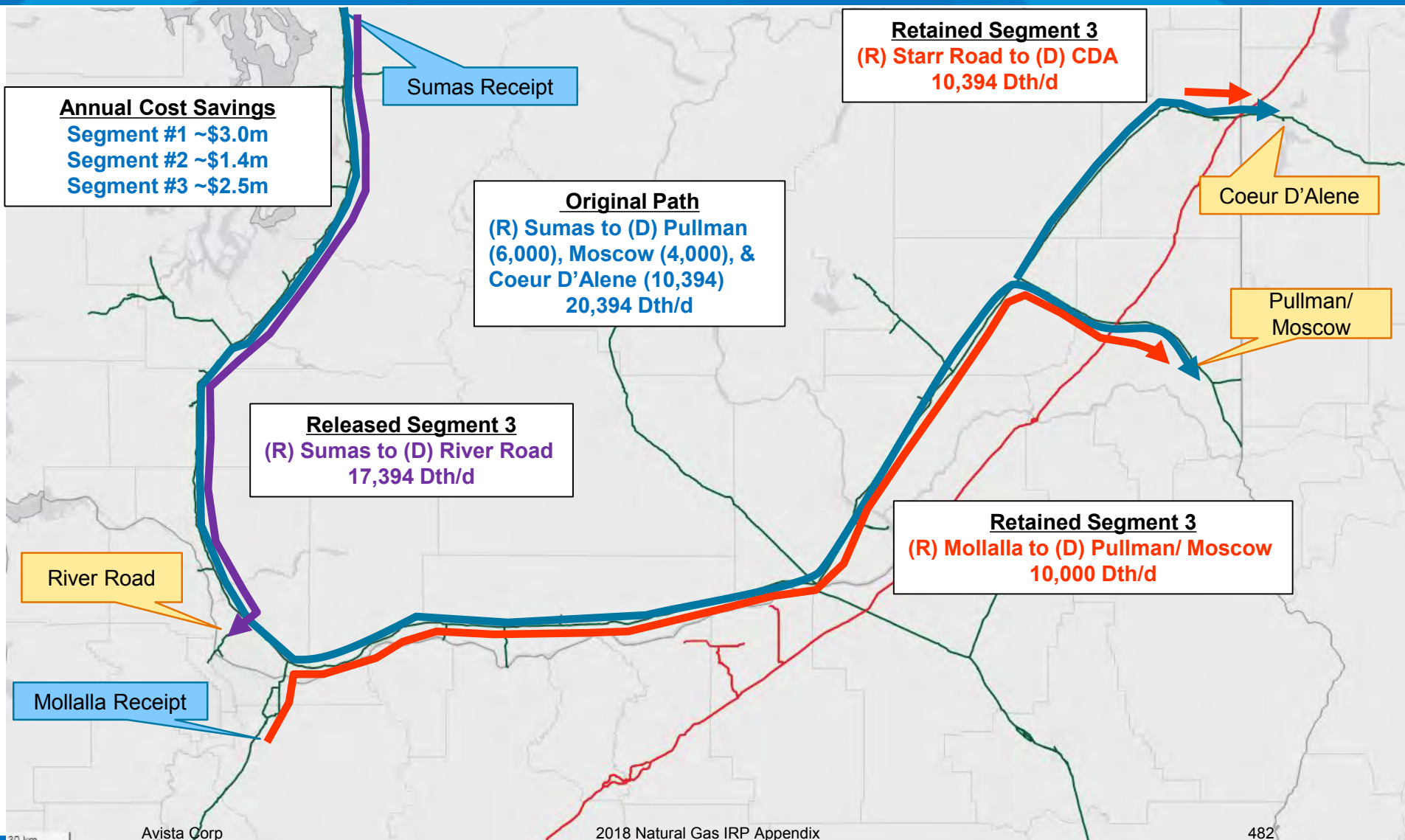

Avista's Segmented Release No. 4

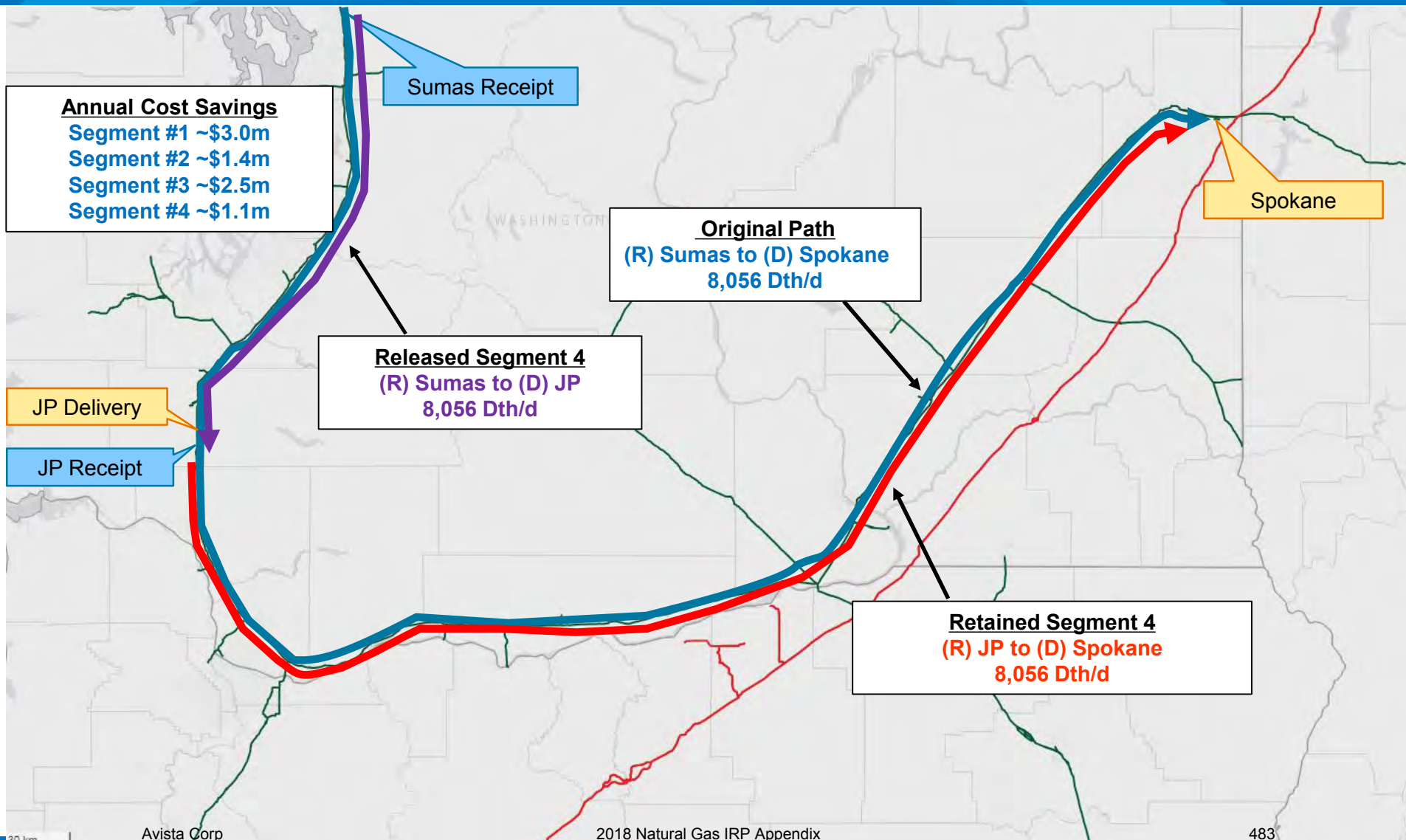

One Williams. One Mission.



Our Mission

- **Operate safely** in everything we do, every day.
- **Execute** on our commitments exceptionally well.
- **Collaborate** to rapidly deliver our best solutions.
- **Grow** our business, our people and our industry.
- **Improve** our operations and business performance continuously.

Our Vision

Be the premier provider of large-scale infrastructure connecting the growing supply of North American natural gas and natural gas products to growing global demand for clean fuels and feedstocks.

Firm Reliability

- 2014 – 99.9 percent
- 2015 – 100 percent
- 2016 – 99.9 percent
- 2017 – 100 percent

> To determine customer impact, firm reliability percentage is calculated on flows prior, during and after posted maintenance

Reliability and Integrity Programs

> Integrity Management

- In-line Inspections
- Requalifications
- Cathodic Protection

> Geo Hazard

- Strain Gauge
- River Crossing
- Land Movement

> Mainline Valve Automation



Integrity Management Program

- > An Integrity Management Program based on an effective framework
 - Prevention, detection and remediation
 - Designed to address safety, reliability and compliance related risks in a comprehensive and systematic way
 - Plan maintenance focused on minimizing customer impacts

- > Three major pipeline integrity recurring programs
 - Assessment Program
 - In-Line Inspection (smart pigging)
 - Department of Transportation Requalification Program
 - Cathodic Protection Program

Integrity Management Program (cont.)

Assessments

- > In-Line Inspection Program (smart pigging)
 - > The preferred assessment method to address most integrity threats
 - > Means of complying with the Pipeline Safety Improvement Act (PSIA) of 2002
- > Integrity Hydro-test
- > Direct Assessments



Integrity Management Program (cont.)

In-Line Inspection (ILI) Program

> **Tools:**

- Gauge plate pig
- Cleaning pig
- Geometry pig (dents, obstructions)
- Magnetic Flux Leakage pig (MFL)

} Standard suite of tools

> **Specialty Tools**

- Circumferential/Spiral Magnetic Flux Leakage Pig (CMFL)
- ElectroMagnetic Acoustic Transducer (EMAT)

Integrity Management Program (cont.)

In-Line Inspection Program – Preparing the line for inspection

- > **Cleaning pig:**
 - remove liquids and debris from line and prepares line for inspection

- > **Gauge Plate Pig:**
 - inspect for obstructions such as severe dents or bends that could stop an instrumented tool

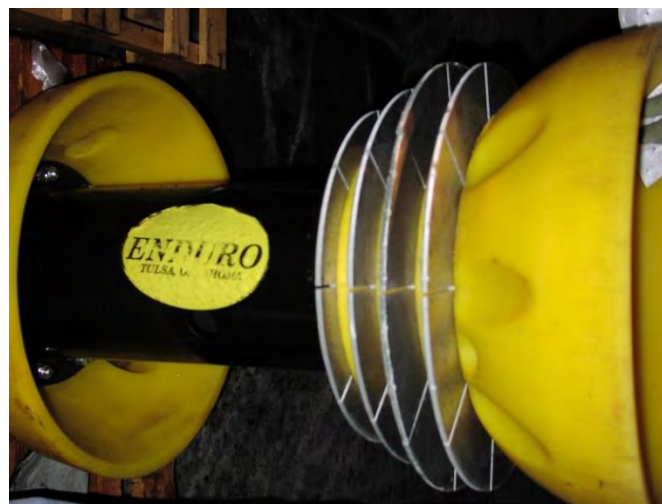

Integrity Management Program (cont.)

In-Line Inspection Program - Standard Instrumented In-line Inspection Tools

Geometry Tool:

- Locate and size dents, bends, ovality due to construction or third-party damage



> MFL Tool:

- inspect for internal/external corrosion or metal loss



Integrity Management Program (cont.)

In-Line Inspection Program - Specialty Tools

- > **Circumferential/Spiral Magnetic Flux Leakage Pig (CMFL):**
 - Locate and size axially oriented anomalies

- > **Electro Magnetic Acoustic Transducer (EMAT) Tool:**
 - Locate and size cracking including stress corrosion cracking (SCC)



Integrity Management Program (cont.)

Benefits of Utilizing ILI Technology for Integrity Assessment

- > It can assess for anomalies for the entire length of a pipeline segment vs. just the HCA locations as a hydro test
- > The line does not need to be taken out of service to complete the assessment
- > It can find features that would not be found in a hydro test,(e.g. pending failures)
- > Data can be compared against prior runs to determine if features are growing

Integrity Assessment Program

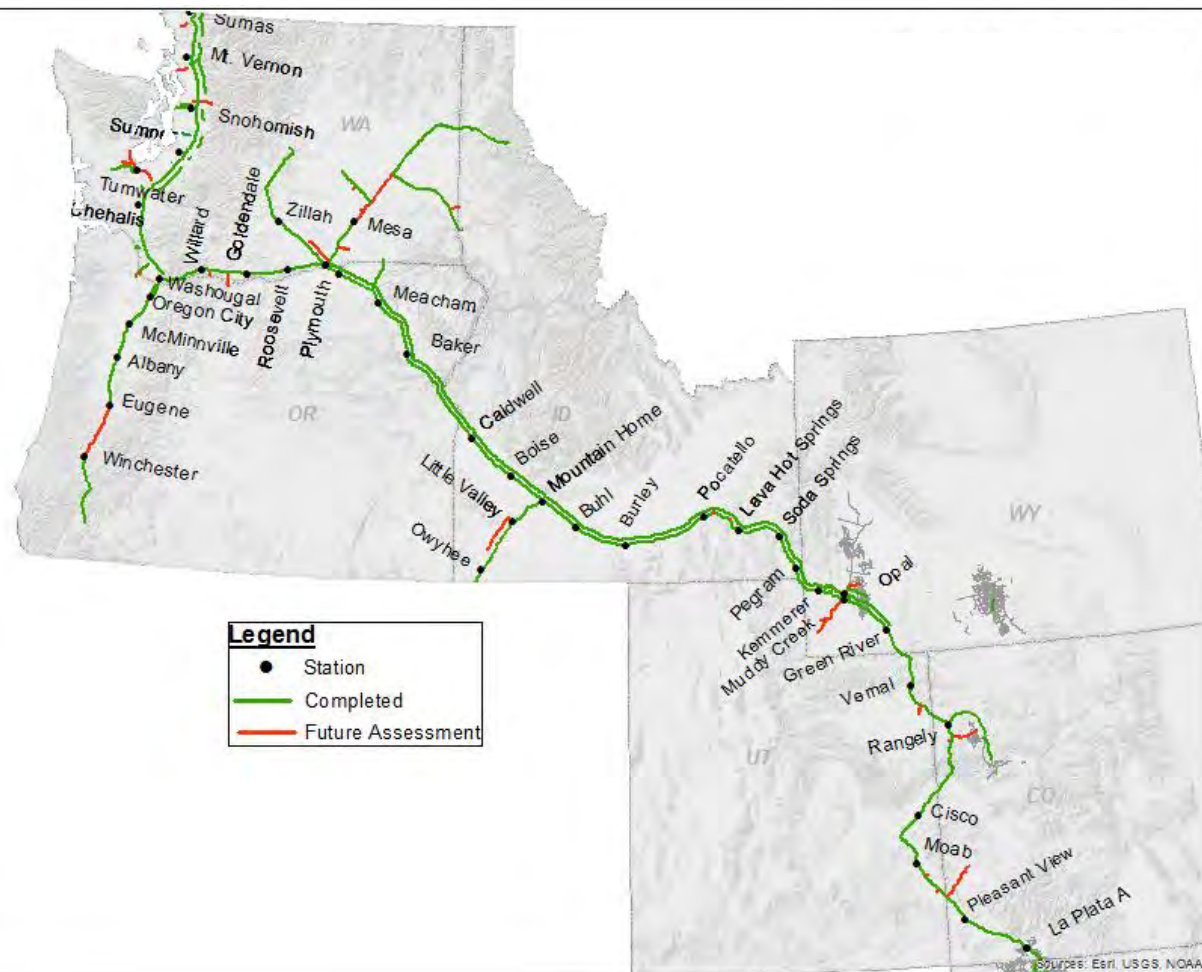

> Asset integrity

- 3,201 (83.8%) miles of first time assessment
- 177 (98.6%) miles of High Consequence Area (HCA) first time assessment
- Reassess HCA's every 7 years

DOT Compliance Program

Department of Transportation Requalification Program

- > Class location change based on population density and buildings near pipeline
- > If class location changes, then either:
 - Reduce pressure
 - Perform a hydrostatic test
 - Replace pipeline



Cathodic Protection & Recoat Program

> Purpose

- Protect the pipeline against corrosion
 - Williams uses impressed current systems to protect against corrosion
 - All current levels are evaluated annually
 - Coating protects against corrosion by providing a physical barrier from the elements as well as making the cathodic protection current more efficient
 - Recoat areas determined primarily by inline inspection run-to-run comparisons

Geologic Hazards Program

- > Monitoring pipe strain at strategic locations
- > Monitoring land movement in several ways

Strain Gauge



River Crossing



Land Movement



Reliability Programs

Northwest Geotechnical Monitoring

- > Strain gauge database
- > ILI strain analysis
- > Inclinometers
- > Aerial surveys
- > River crossing monitoring program
- > GIS geotechnical hazards database
- > LIDAR data



Department of Transportation Mainline Valve Program

- > The purpose of the program is to ensure that Northwest Pipeline is in compliance with the Department of Transportation required mainline valve spacing requirements.



> Questions??



TransCanada Supply Update– J. Story
AVISTA – IRP/TAC Meeting
March 29, 2018

2017 Supply and Market Outlook



- North American Supply and Demand
- NGTL Expansions
- Impact on GTN Supply and Capacity

North American Demand

2017 TransCanada Outlook

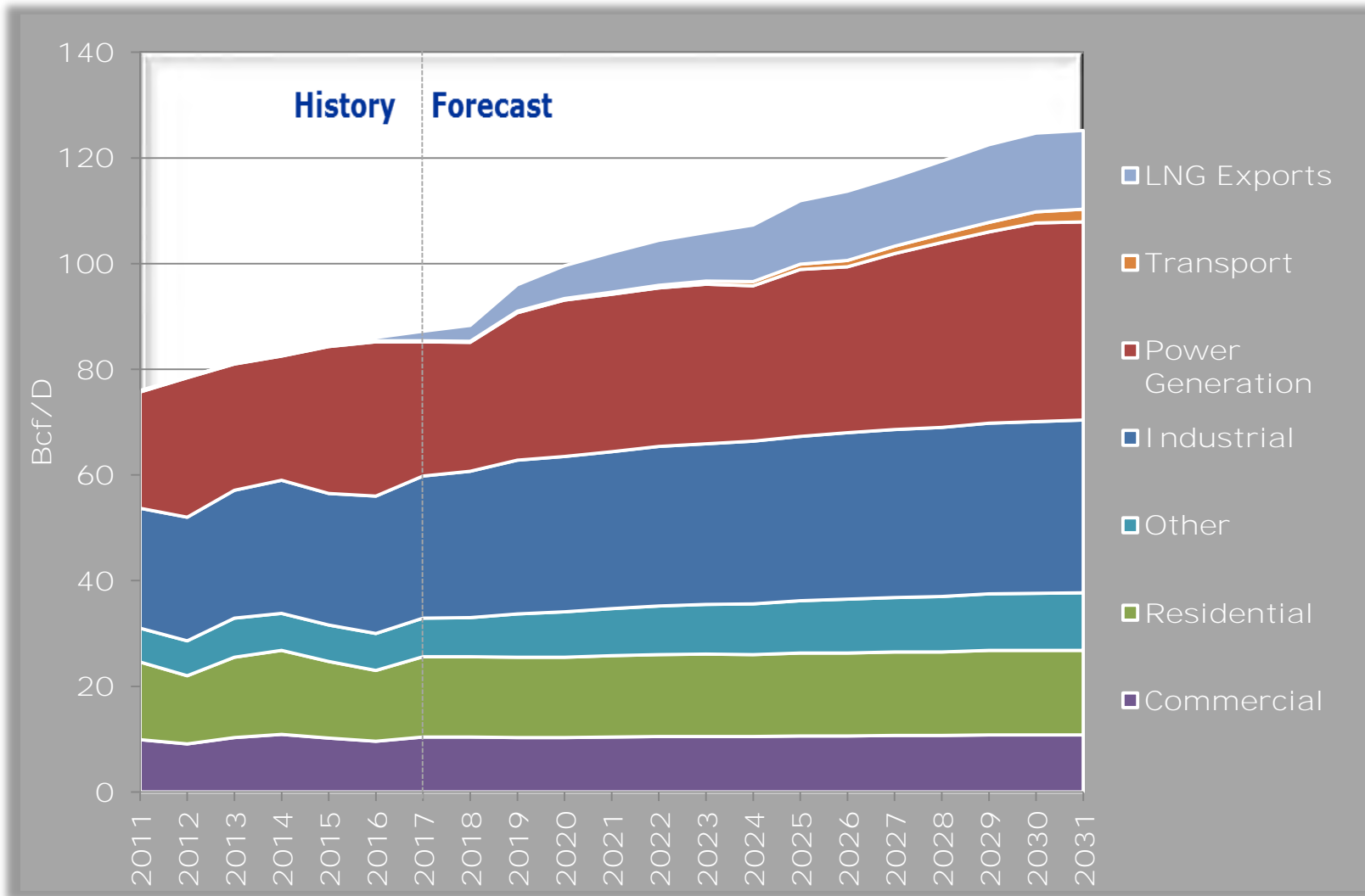

North American Supply

2017 TransCanada Outlook

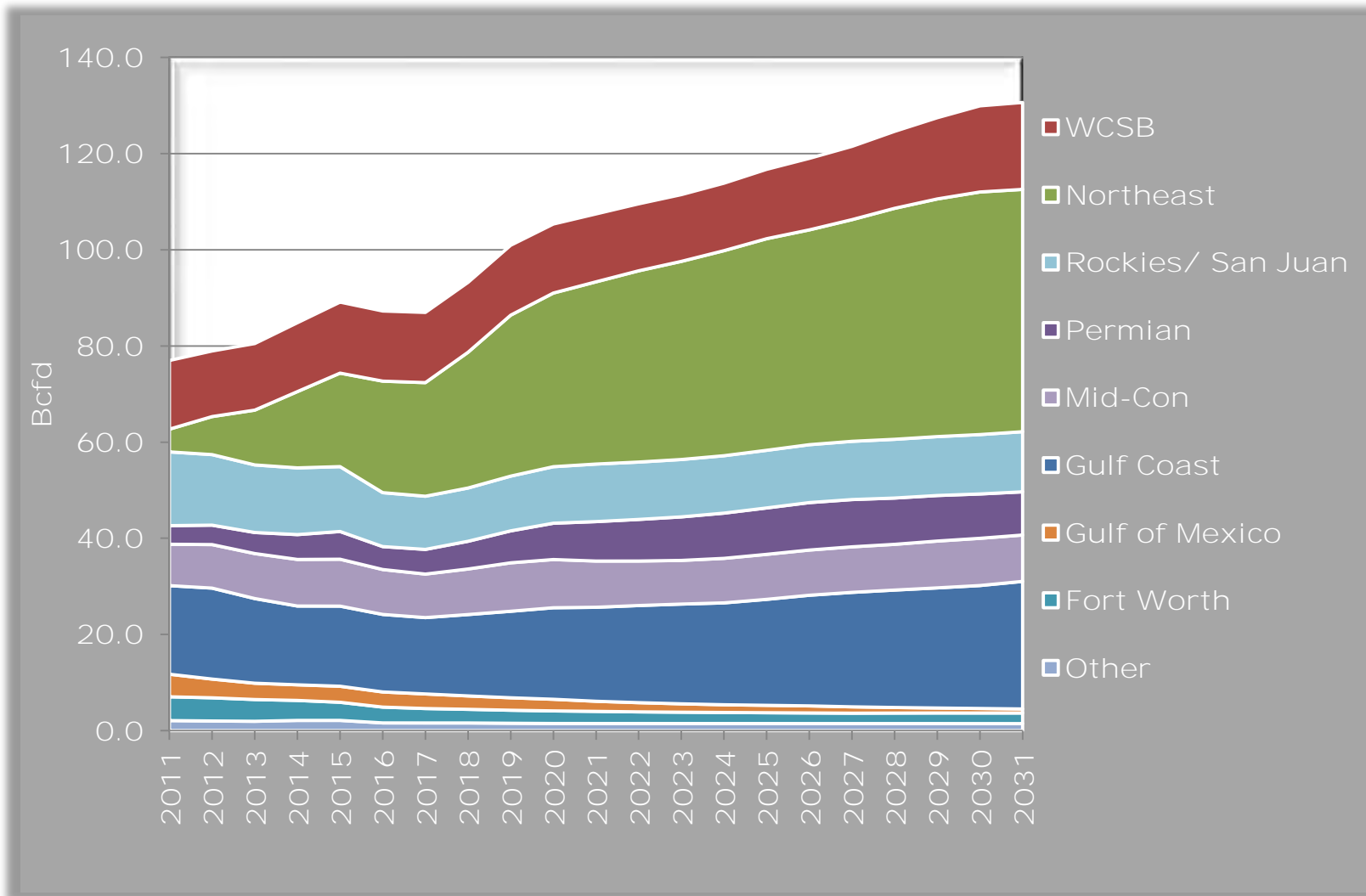

WCSB Production Seeking Markets

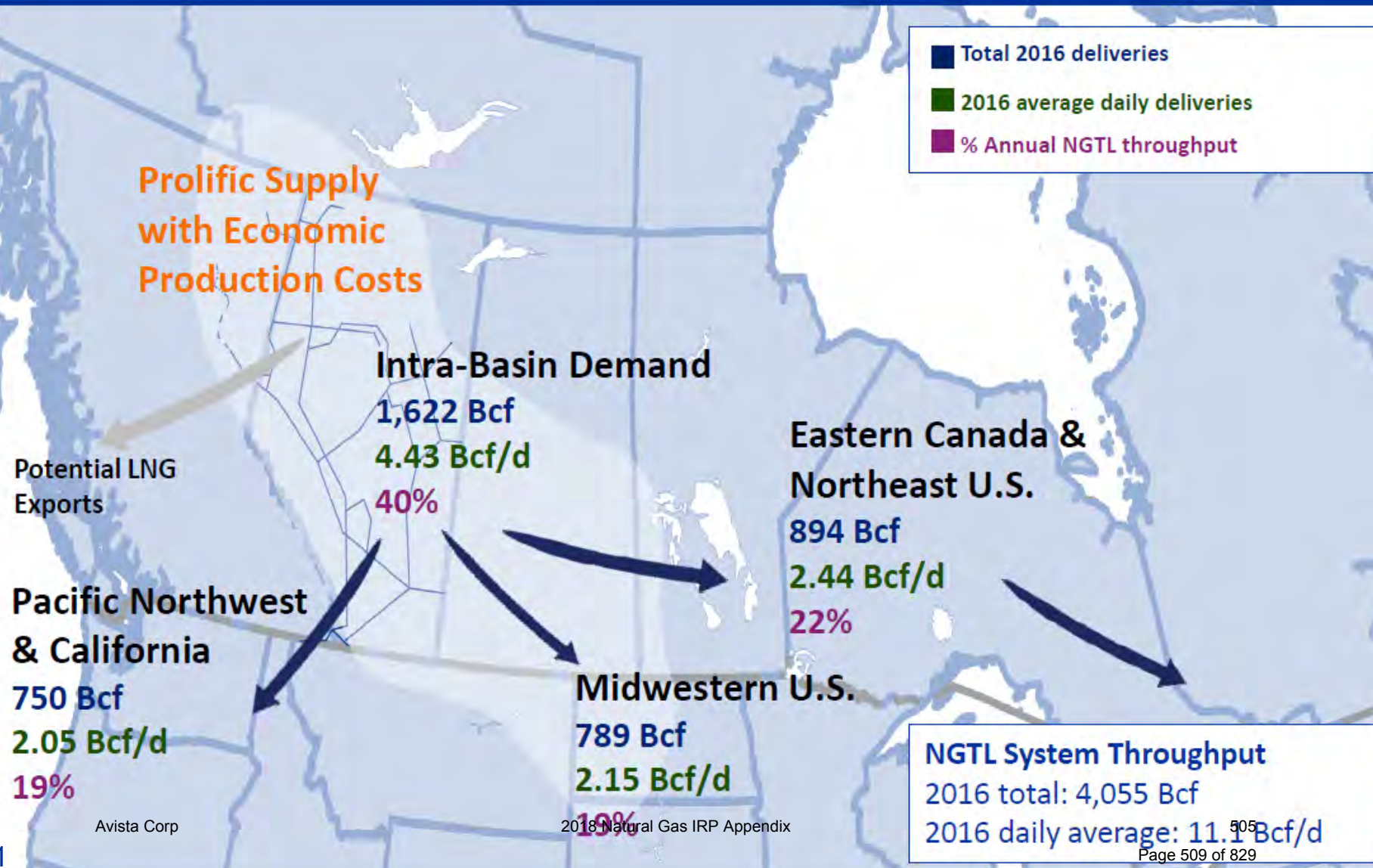

Western Canadian Sedimentary Basin Gas Supply

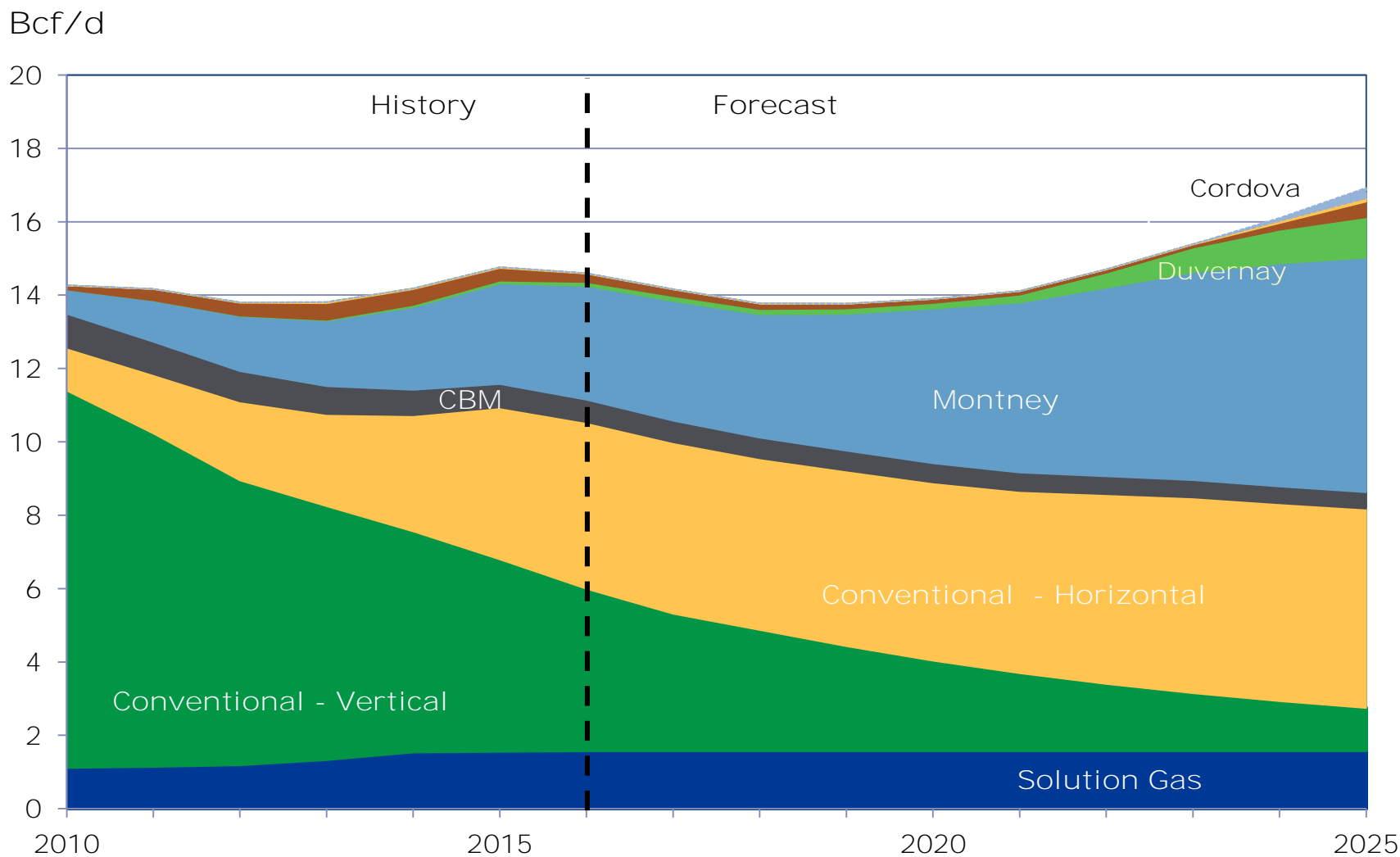

Western Canadian Production (Bcf)

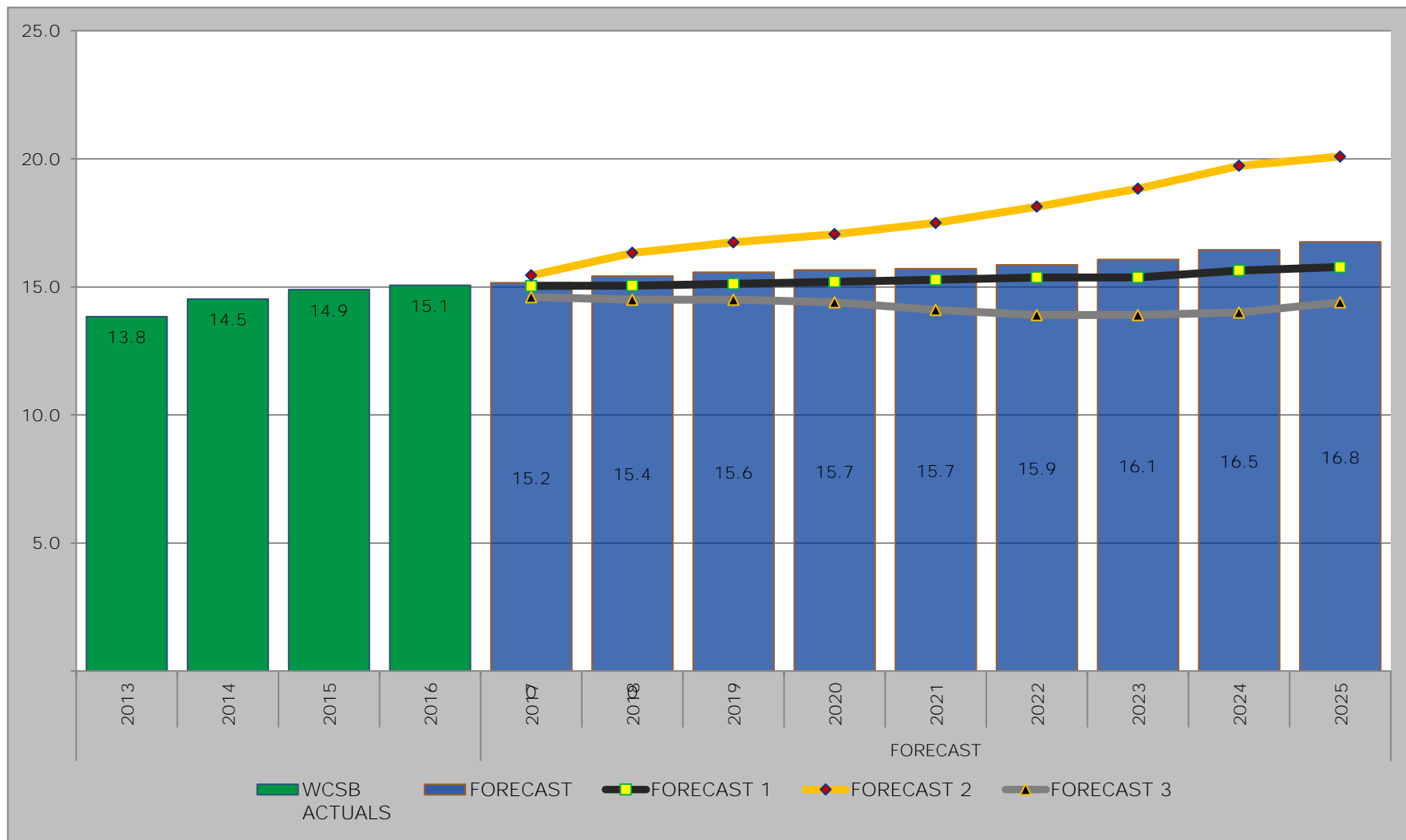

Western Canadian Sedimentary Basin

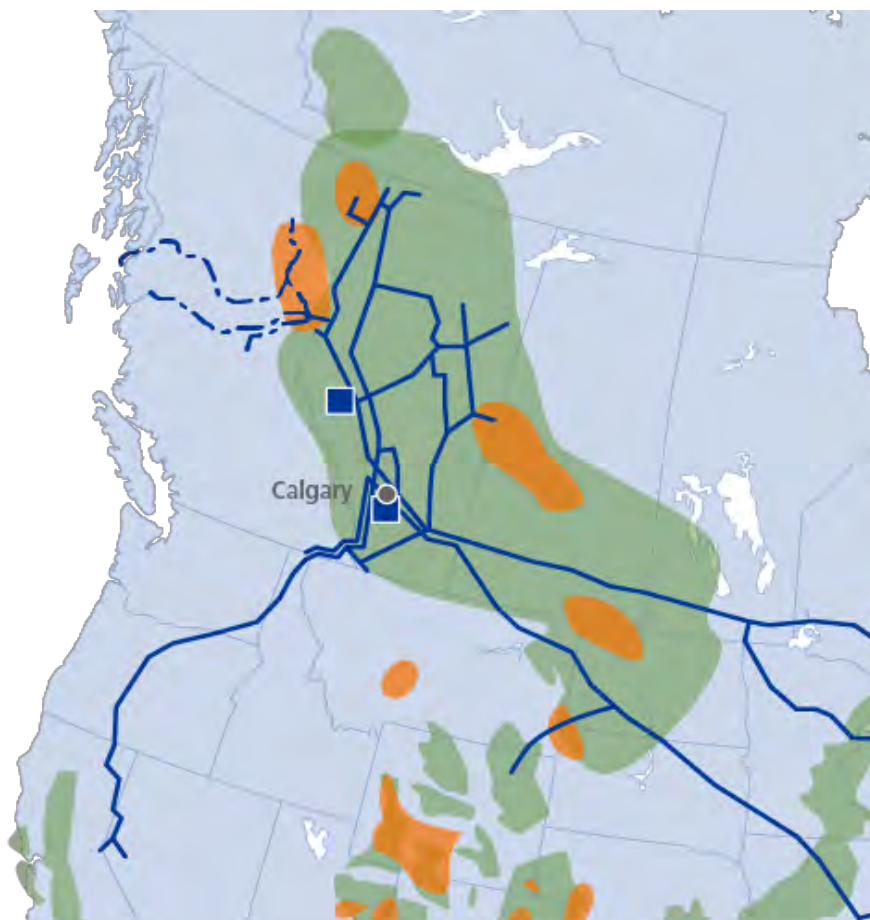

- WCSB:
 - Prolific and competitive resource
 - Economic production in Montney and Deep Basin resources

- NGTL System:
 - Dominant basin position, capturing 75% of WCSB production
 - Strongly connected to substantive supply and intra and ex-basin markets
 - Supply to GTN and Northern Border
 - 400+ Bcf of gas storage
 - 50+ Bcf/d of NIT trading liquidity

Evolving System Supply Distribution

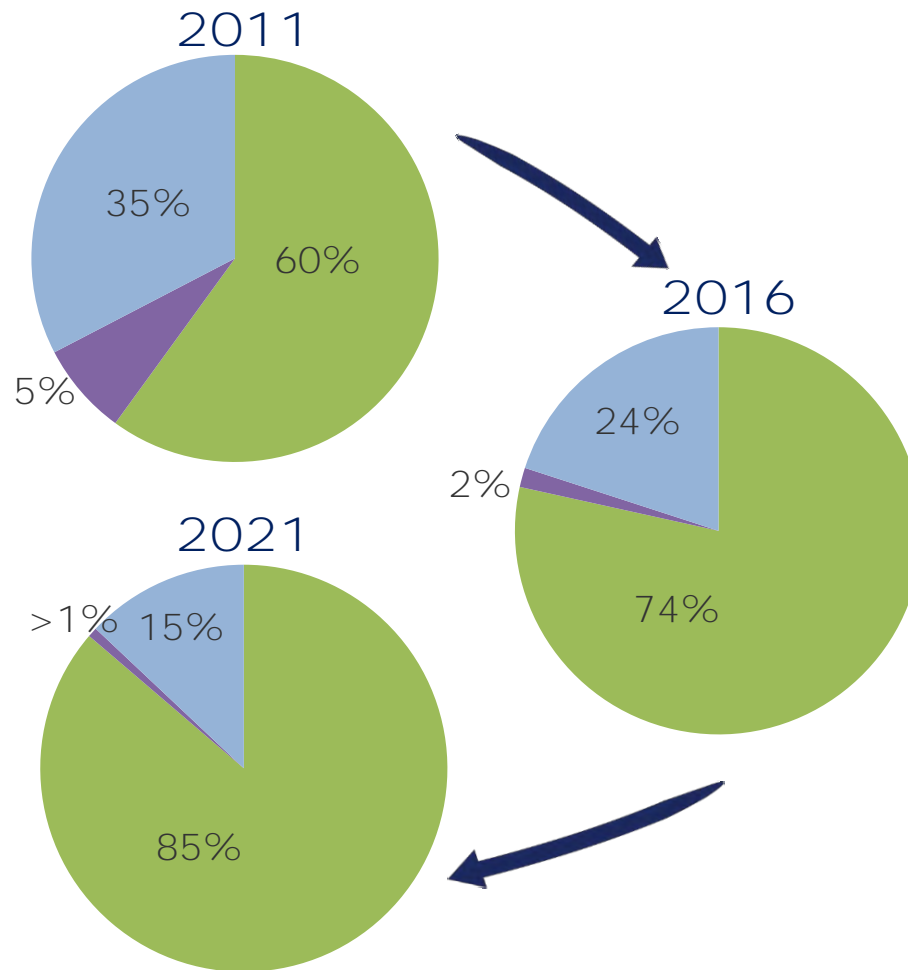
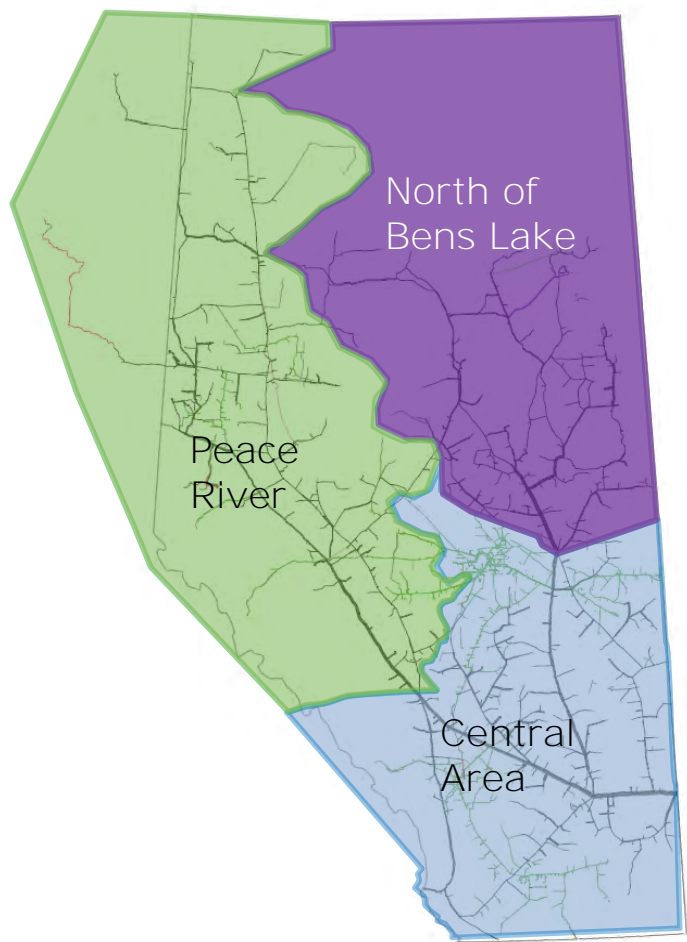

West Path

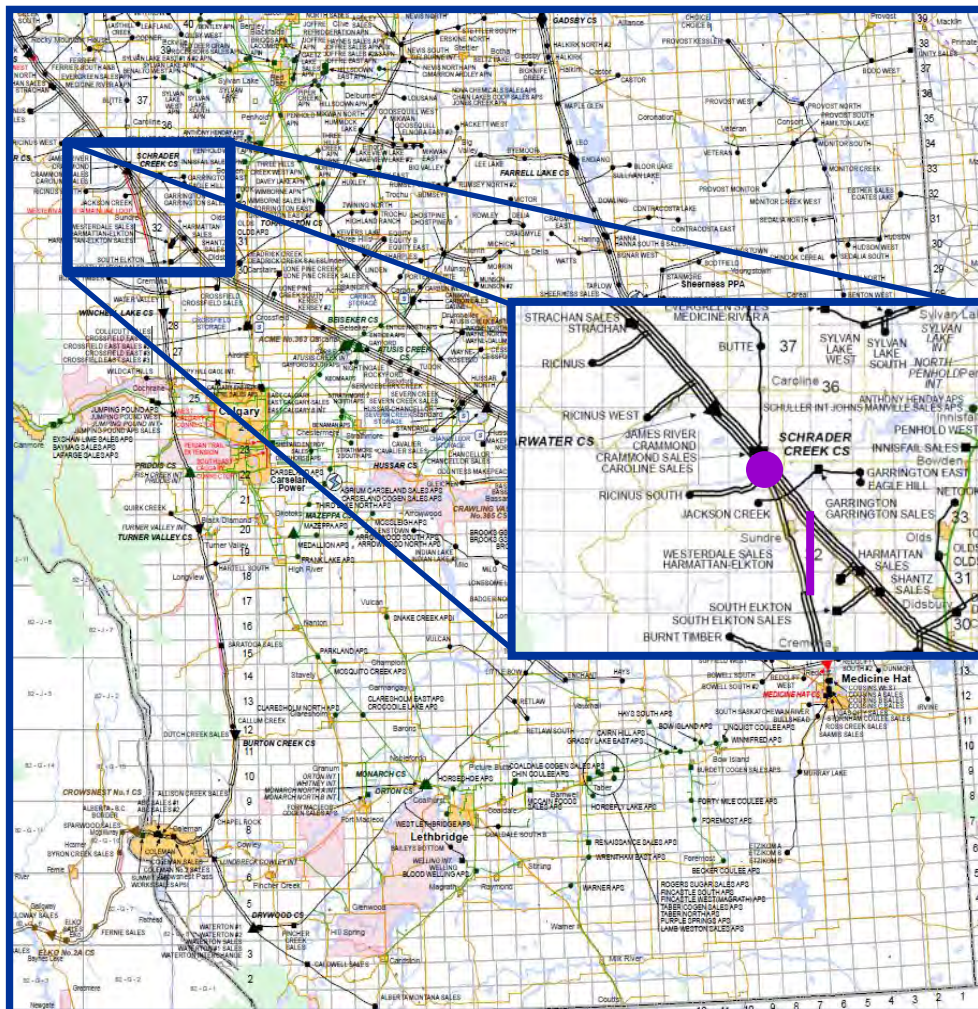

James River By-Pass

- Open Seasons in 2015
- Onstream June 2016
- Pipeline modification Project
- ~150 TJ/d of capacity
- ABC Border Design Capability: ~2.2 Bcf/d

Sundre Crossover

- Open Seasons in January and June 2016
- Onstream 2018
- ~20km of NPS 42 pipeline loop of WAS Mainline
- ABC Border Design Capability: ~2.45 Bcf/d

NGTL Mainline Expansions



2017 Expansions

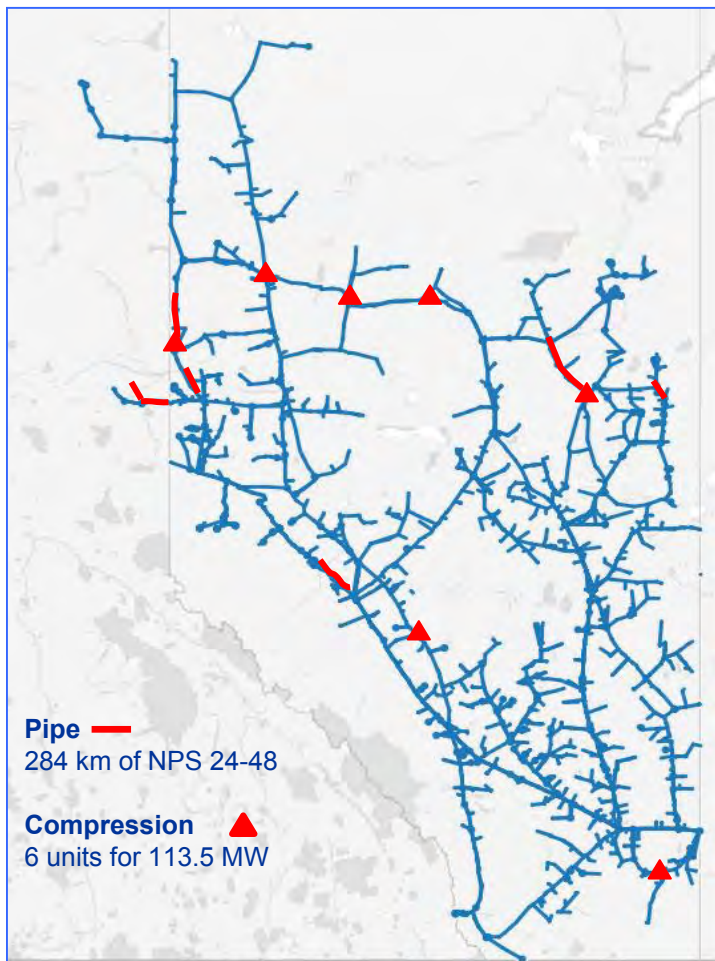

Planned 2017 Facilities

Avista Corp

2018-19 Expansions

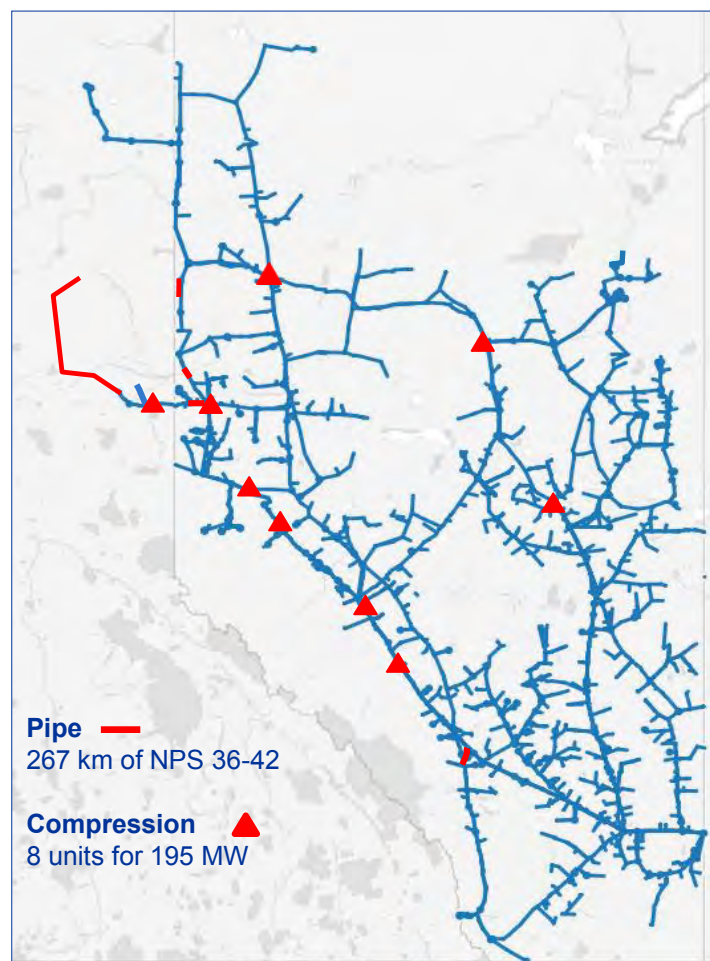

Planned 2018-19 Facilities

2018 Natural Gas IRP Appendix

2019/2020 West Path Expansion

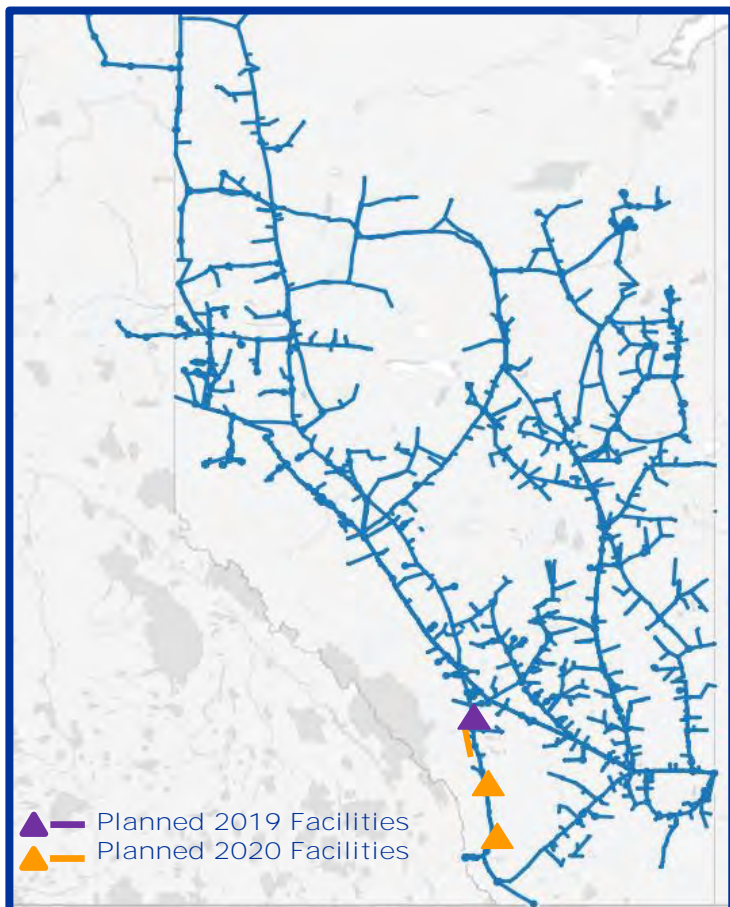

AB-BC Border Expansion Capacity Open Season

Expansion Capacity:	408 TJ/d
Service Commencement Dates:	
Nov 2019	120 TJ/d
Jun 2020	288 TJ/d
Bid Evaluation:	Length of Requested Term
Minimum Term:	8 years
FT-D1 Pricing Discount:	10%
Closing Date:	May 31, 2017

- Full alignment of TransCanada assets serving PacNW and Western states.
- Economic production from the WCSB resources is a good fit for Western US markets

GTN Overview

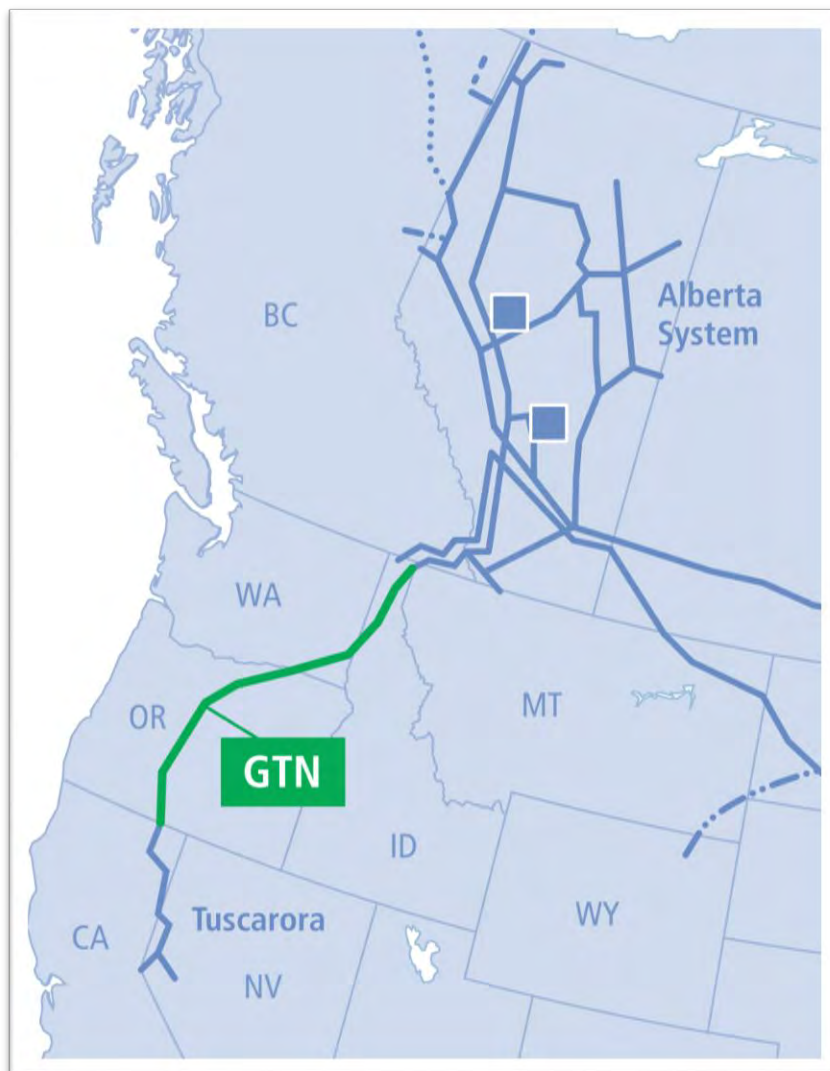

- Positioned to serve markets throughout California, Nevada, and the Pacific Northwest
- Consists of 1,350 miles of pipeline
- Kingsgate best efforts receipt capability of approx. 2.87 Bcfd and throughput capability of approx. 2 Bcfd thru Sta. 14
- Deliveries of up to 1.5 Bcfd to non-California Markets
- Long-term contracts extending out as far as 2039
- Volume throughput continues to be strong and should continue to grow in 2018
- NGTL continues to address the export capability at ABC to bring into alignment with downstream systems

Demand Projections Pacific Northwest & California

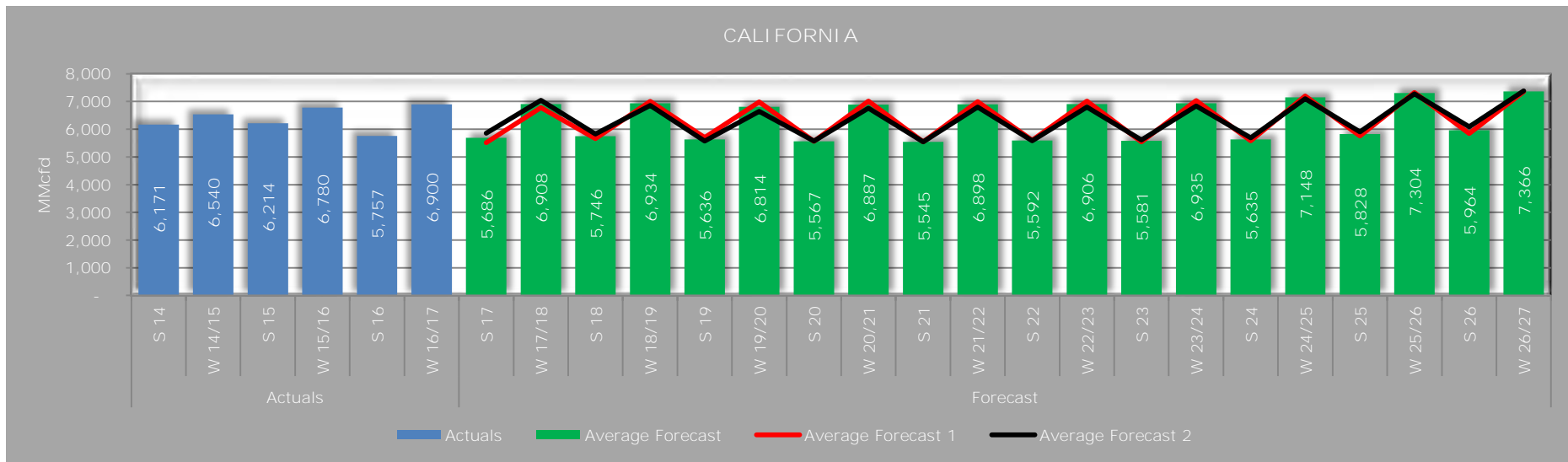
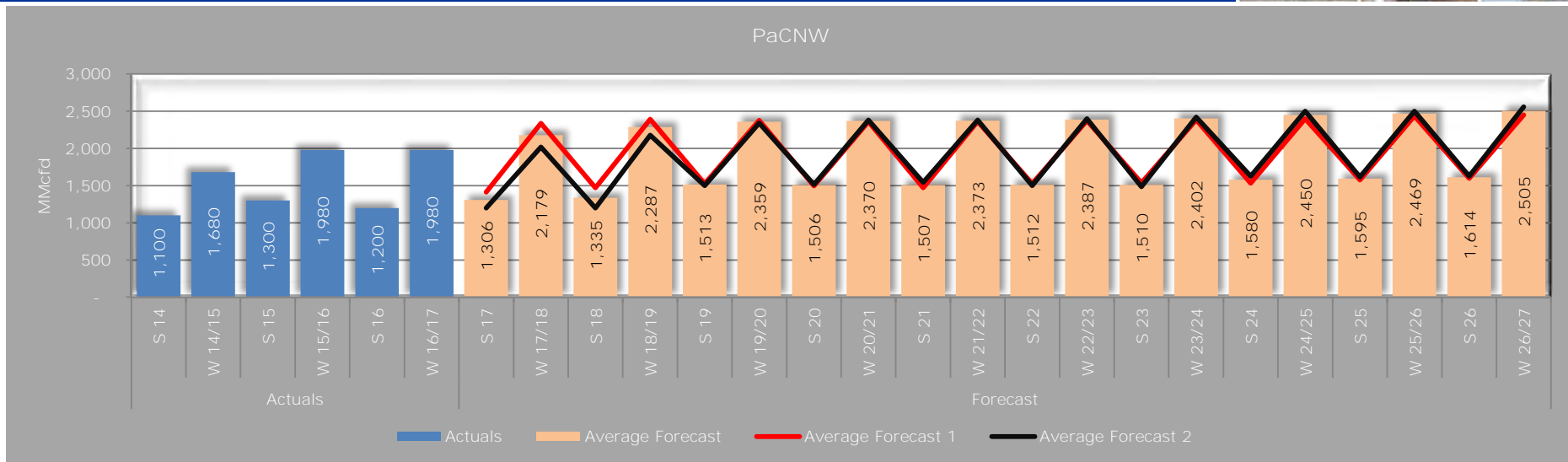

NGTL West Path Expansion Summary



- James River By-Pass
 - ISD - June 2016
 - 150,000 GJ/d
 - A/BC Border Capability – 2.2 Bcf/d
- Sundre Crossover
 - ISD - April 2018
 - 245,000 GJ/d
 - A/BC Border Capability – 2.43 Bcf/d
- Winchell Unite Addition
 - ISD – November 2019
 - 120,000 GJ/d
 - Estimated A/BC Border Capability – 2.54 Bcf/d
- West Path Expansion
 - ISD – June 2020
 - 288,000 GJ/d
 - Estimated A/BC Border Capability – 2.81 Bcf/d

Impact on Kingsgate Supply



- Total Available at Kingsgate May Vary Depending upon Foothills Markets and Fuel Usage

- Daily Kingsgate Supply Available estimated:
 - Early 2018 2.33 Bcf/d*
 - November 2019 2.44 Bcf/d*
 - June 2020 2.71 Bcf/d*

- * (estimates approx. 100,000dth/d scheduled on FTBC system)

- Current GTN Kingsgate Receipt Capability:
 - Best Efforts – 2.87 Bcf/d
 - Capability impacted by seasonal ambient temps and physical flow path

Impact of Kingsgate Supply on GTN



- Recent GTN Open Seasons to Contract Available Capacity
 - Open Seasons Process Ran– December 2017 thru January 2018
- Pre-arranged – Kingsgate to Malin Path
 - **8 “Packages” totaling approx. 348,610 Dth/d**
 - Contract Start Dates of Nov. 2019 and Nov. 2020
 - All contracted long-term
 - All Capacity Awarded to Pre-arranged Entities
- Remaining Available Capacity – Kingsgate to Malin Path
 - 139,400 dth/d
 - Effective Date(s) – Any Date April 1, 2018 or Later
 - Unlimited Term
 - All Offered Capacity Awarded

Impact of Kingsgate Supply on GTN



- Considerable Interest in Additional Kingsgate Sourced GTN Capacity
 - GTN Exploring Expansion Options
 - **“Market Pull” Required**
 - Mainline
 - New Pipelines or Laterals – Trail West
 - ROFR Open Season Process
 - Contract Renewals
 - 2023 Contract Cliff
- GTN Rate Case Update
 - GTN Full Haul Rate Drops to \$0.285 Effective 1/1/2020 thru 12/31/2021
 - Kingsgate to Stanfield - \$0.146 Dth/d
 - Kingsgate to Spokane - \$0.076 Dth/d
 - **“Come Back” Provision Requires New Rates Effective 1/1/2022**
 - Rate Case Preparation in 2021
 - Recent Contracting and Facility Upgrades will Impact Rates



NGTL and Foothills Pipelines Update



Avista - Supply Side Resources

Eric Scott
Manager of Natural Gas Resources

Interstate Pipeline Resources

- The Integrated Resource Plan (IRP) brings together the various components necessary to ensure proper resource planning for reliable service to utility customers.
- One of the key components for natural gas service is interstate pipeline transportation. Low prices, firm supply and storage resources are rendered meaningless to a utility customer without the ability to transport the gas reliably during cold weather events.
- Acquiring firm interstate pipeline transportation provides the most reliable delivery of supply.

Pipeline Overview

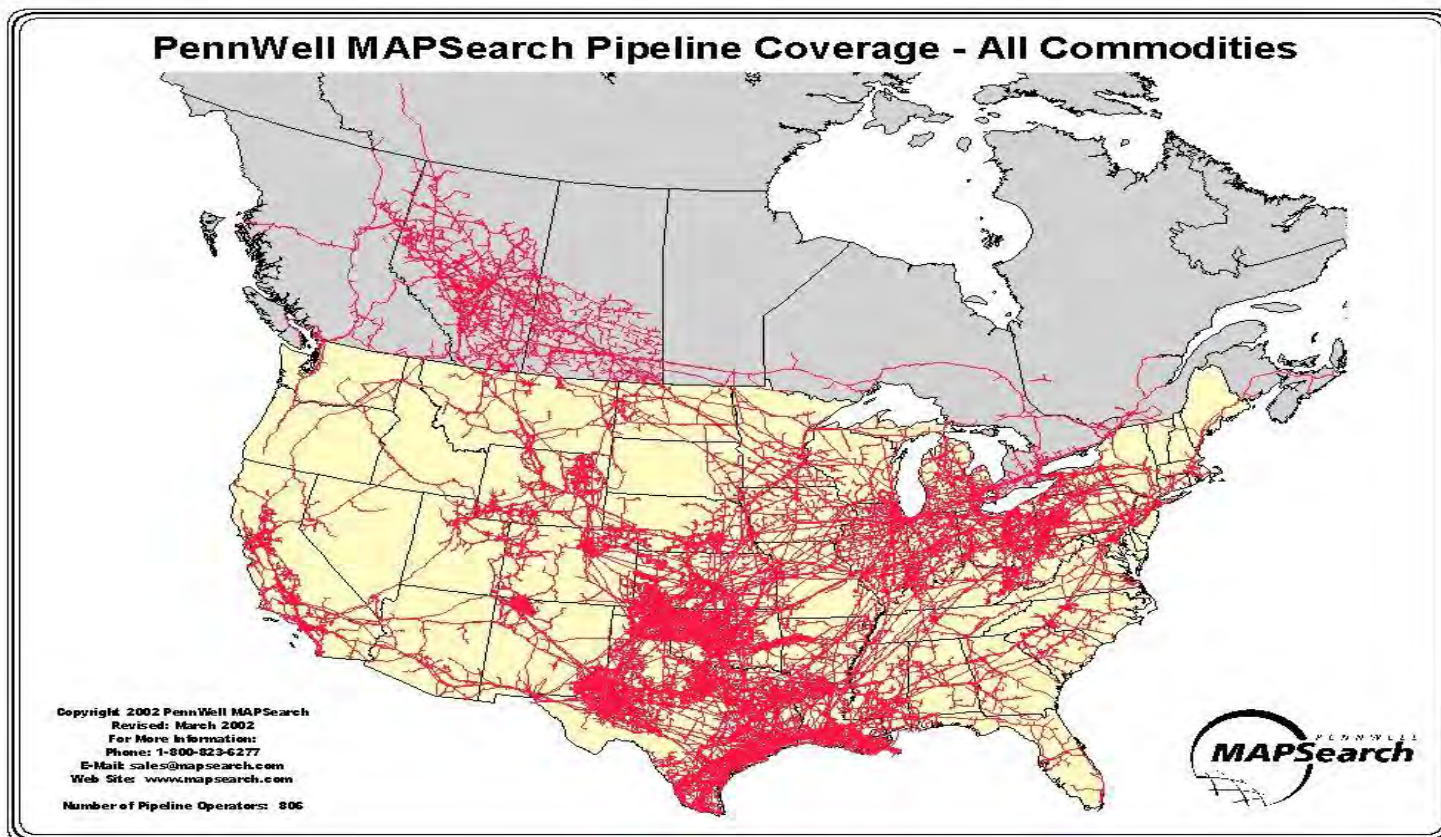

Pipeline Overview



Avista's Transportation Contract Portfolio

Avista holds firm transportation capacity on 6 interstate pipelines:

Pipeline	Expirations	Base Capacity Dth
Williams NWP	2019 – 2042 (2035)	290,000
Westcoast (Enbridge)	2026	10,000
TransCanada - NGTL	2019-2028	208,000
TransCanada - Foothills	2020-2028	204,000
TransCanada - GTN	2023-2028	240,000 – 321,000 166,000 – 212,000
TransCanada - Tuscarora	2020	200

Contract Provisions - NWP

- Grandfathered Unilateral Evergreen (TF-1, TF-2, SGS-2F)
 - Roll-over 1 year
 - Shipper has sole option to extend or renew
- Standard Unilateral Evergreen
 - Roll-over 1 year
 - 5 year termination provision
- Standard Bilateral Evergreen
 - Either transporter OR shipper may terminate
- Right of First Refusal (ROFR)
 - Provides “last look”

Contract Provisions - GTN

- Unilateral Evergreen
 - Shipper alone may terminate contract
- Bilateral Evergreen
 - Either transporter OR shipper may terminate contract
- Right of First Refusal (ROFR)
 - Provides “last look”

Pipeline Contracting

Simply stated: The right to move (transport) a specified amount of gas from Point A to Point B



Contract Types

- Firm transport
 - Point A to Point B
- Alternate firm
 - Point C to Point D
- Seasonal firm
 - Point A to Point B but only in winter
- Interruptible
 - Maybe it flows, maybe it doesn't

Rate Design

- Postage stamp (NWP)
 - 1 mile or a thousand miles – same price
 - Plus variable
- Mileage (GTN)
 - Fee per mile
 - Plus variable

NWP Rate Case Settlement

- New rates in effect January 1, 2018
 - Good through September 30, 2018
- Rates further reduced October 1, 2018 – December 31, 2022
- Mandatory come-back – January 1, 2023
- No stay-out after October 2, 2018

GTN Rate Case Settlement

- New rates in effect January 1, 2016
 - Good through December 31, 2019
- Rates further reduced January 2020 – December 2021
- Mandatory come-back – January 1, 2022
- No stay-out

Pipeline Capacity – Segmented Releases Example



Effective Rate - #100010

Contract	CD	Rate	Path	Annual \$
#100010	19,432 Dth	\$0.40	Sumas - Spokane	\$2,837,000
Released	(19,432 Dth)	\$0.40	Sumas - Spokane	(\$2,837,000)
#1	19,432 Dth	\$0.40	JP - Spokane	\$2,837,000
#2	19,432 Dth	-0-	Sumas - JP	-0-
Released	(19,432 Dth)	-0-	Sumas - JP	-0-
#2a	19,432 Dth	-0-	Sumas - Sipi	-0-
#2b	19,432 Dth	-0-	Sipi - JP	-0-
Total	58,296 Dth			\$2,837,000

Northwest Pipeline Tariff Rate: \$0.400

Effective rate – segmentation example: \$0.133

Capacity Releases

Time	Duration	Rate
Annual	1 year	Full rate
Long-term	1+ year – 31.5 years	Full rate

During 2017, AVA received **\$9.6mm** in release “revenue”

Example:

AVA released 35,000 Dths/day at full tariff rate to Clark PUD until 10/31/2025 recapturing over \$5.2mm annually all of which goes to customers.

Storage – A valuable asset

- Peaking resource
- Improves reliability
- Enables capture of price spreads between time periods
- Enables efficient counter cyclical utilization of transportation (i.e. summer injections)
- May require transportation to service territory
- In-service territory storage offers most flexibility

Avista's Storage Resources

Washington and Idaho Owned Jackson Prairie

- 7.7 Bcf of Capacity with approximately 346,000 Dth/d of deliverability

Oregon

Owned Jackson Prairie

- 823,000 Dth of Capacity with approximately 52,000 Dth/d of deliverability

Leased Jackson Prairie

- 95,565 Dth of Capacity with approximately 2,654 Dth/d of deliverability

The Facility

- Jackson Prairie is a series of deep, underground reservoirs – basically thick, porous sandstone deposits.
- The sand layers lie approximately 1,000 to 3,000 feet below the ground surface.
- Large compressors and pipelines are employed to both inject and withdraw natural gas at 54 wells spread across the 3,200 acre facility.

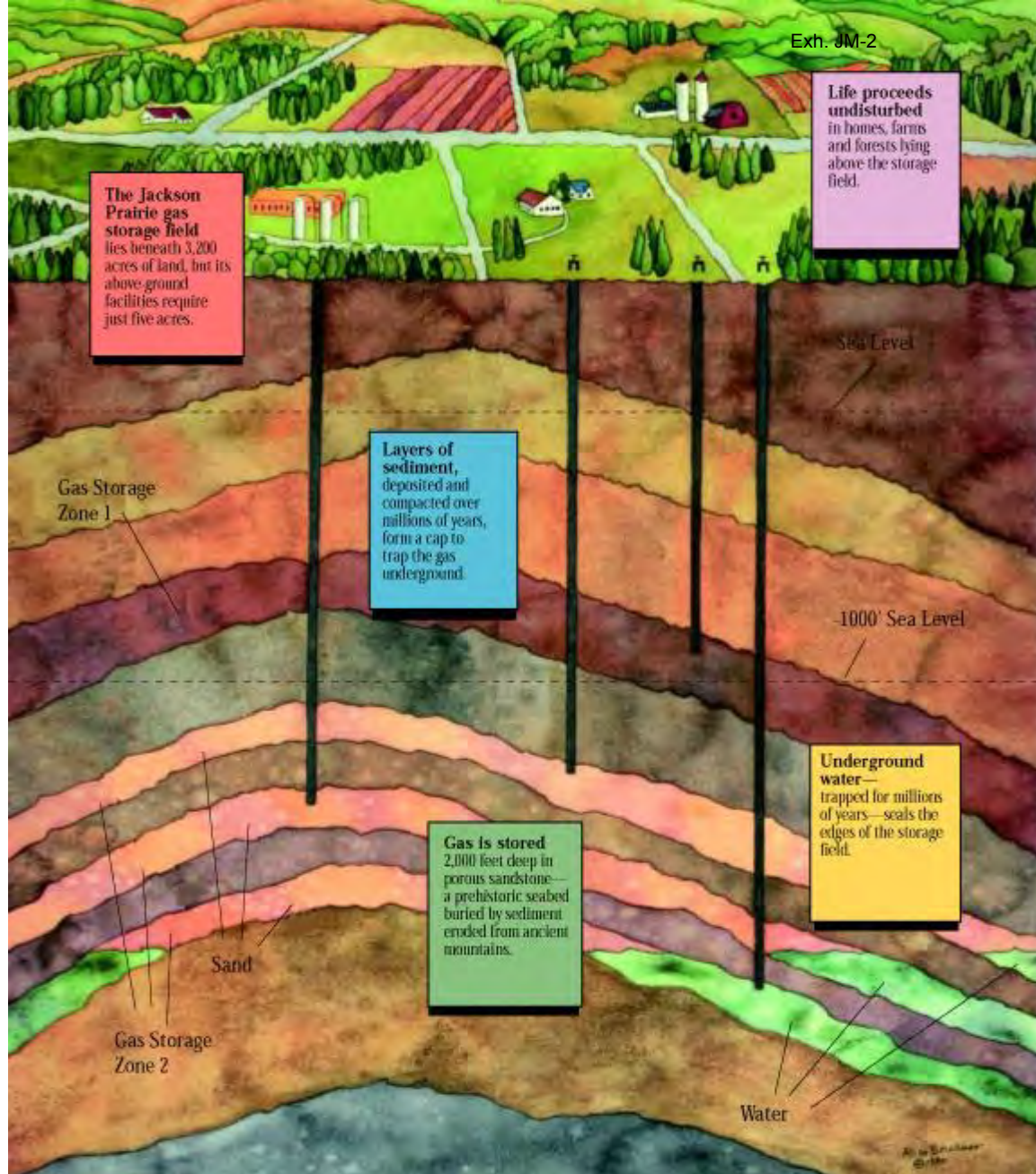

Jackson Prairie Interesting Energy Comparisons

1.2 Bcf per day (energy equivalent)

- 10 coal trains with 100 - 50 ton cars each
- 29 - 500 MW gas-fired power plants
- 13 Hanford-sized nuclear power plants
- 2 Grand Coulee-sized hydro plants (biggest in US)

46 Bcf of stored gas

- 12" pipeline 11,000,000 miles long (226,000 miles to the moon)
- 1,400 Safeco Fields (Baseball Stadiums)
- Average flow of the Columbia River for 2 days
- Cube - 3,550 feet on a side

Natural Gas Liquids - Extraction



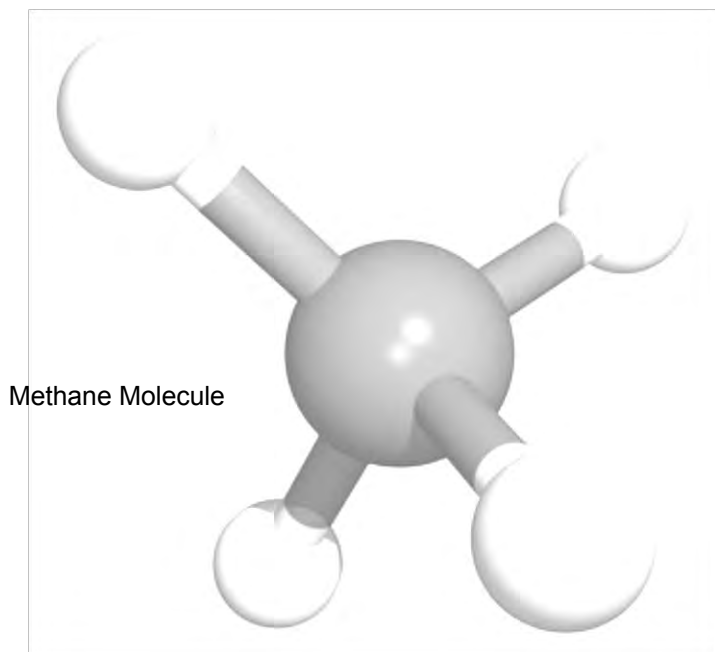

- Gas from the Western Canadian Sedimentary Basin has many “liquids” that can be extracted and sold
- Nearly **\$2,100,000**



Methane Molecule

Avista Corp

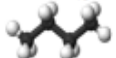
2018 Natural Gas IRP Appendix

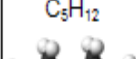
NGL Attribute Summary				
Natural Gas Liquid	Chemical Formula	Applications	End Use Products	Primary Sectors
Ethane	C_2H_6 	Ethylene for plastics production; petrochemical feedstock	Plastic bags; plastics; anti-freeze; detergent	Industrial
Propane	C_3H_8 	Residential and commercial heating; cooking fuel; petrochemical feedstock	Home heating; small stoves and barbeques; LPG	Industrial, Residential, Commercial
Butane	C_4H_{10} 	Petrochemical feedstock; blending with propane or gasoline	Synthetic rubber for tires; LPG; lighter fuel	Industrial, Transportation
Isobutane	C_4H_{10} 	Refinery feedstock; petrochemical feedstock	Alkylate for gasoline; aerosols; refrigerant	Industrial
Pentane	C_5H_{12} 	Natural gasoline; blowing agent for polystyrene foam	Gasoline; polystyrene; solvent	Transportation
Pentanes Plus*	Mix of C_5H_{12} and heavier	Blending with vehicle fuel; exported for bitumen production in oil sands	Gasoline; ethanol blends; oil sands production	Transportation



Distribution System Planning

Terrence Browne PE,
Senior Gas Planning Engineer

Mission

- Using technology to plan and design a safe, reliable, and economical distribution system

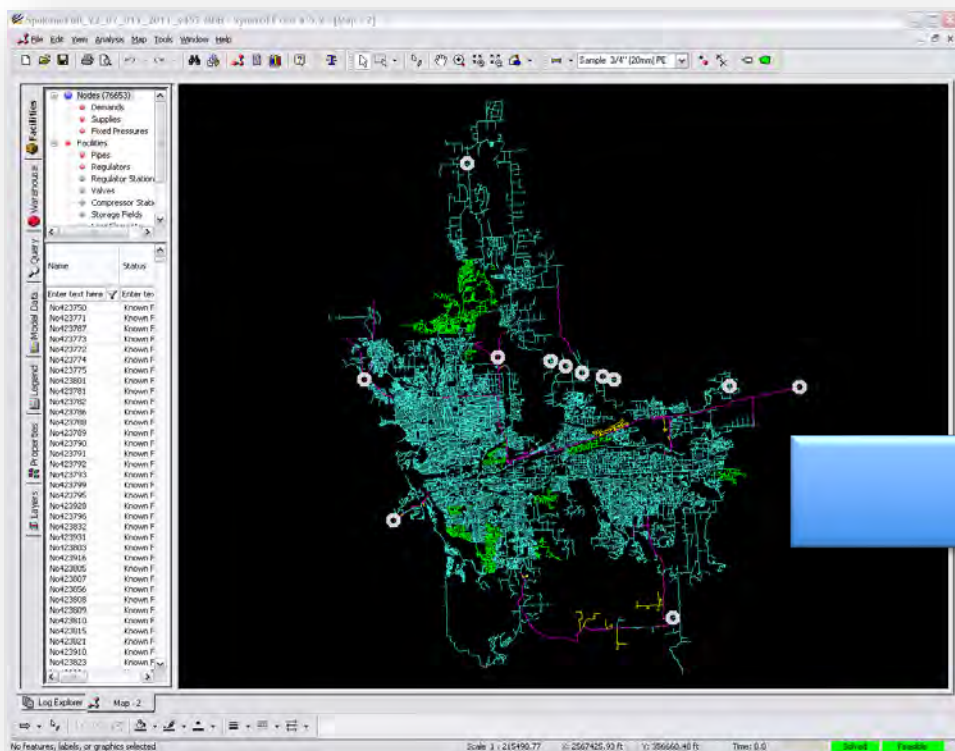

Gas Distribution Planning

- Service Territory and Customers
- Scope of Gas Distribution Planning
- SynerGi Load Study Tool
- Planning Criteria
- Interpreting Results
- Long-term Planning Objectives
- Historical Temperatures
- Monitoring Our System
- Solutions
- Gate Station Capacity Review
- Project Examples

Service Territory and Customer Overview

- Serves electric and natural gas customers in eastern Washington and northern Idaho, and natural gas customers in southern and eastern Oregon
 - Population of service area 1.5 million
 - ▶ 371,000 electric customers
 - ▶ 348,000 natural gas customers

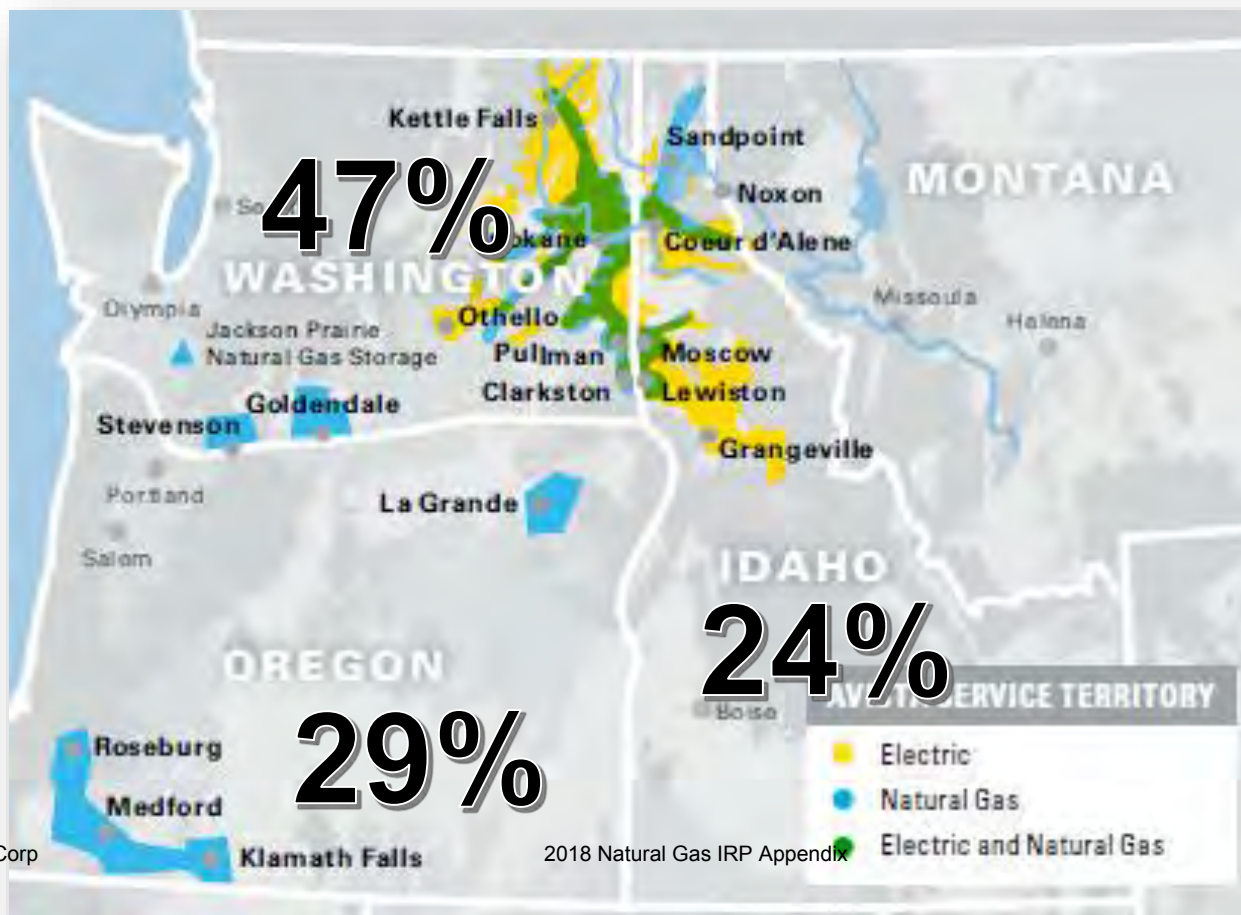

Seasonal Demand Profiles

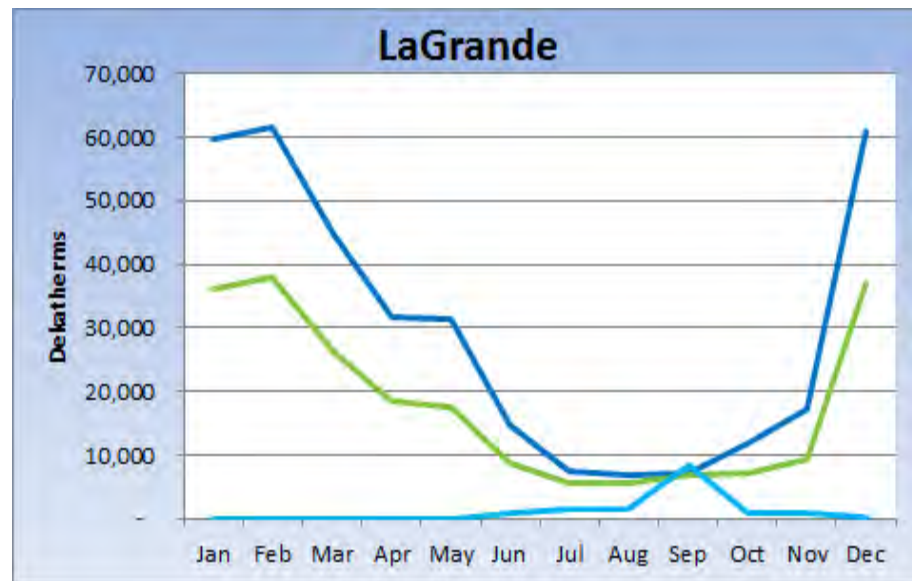
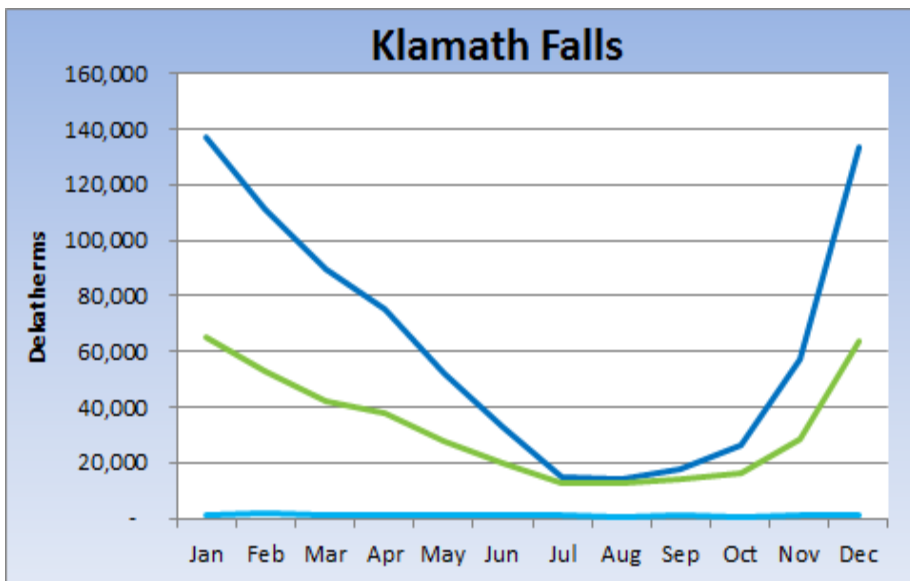
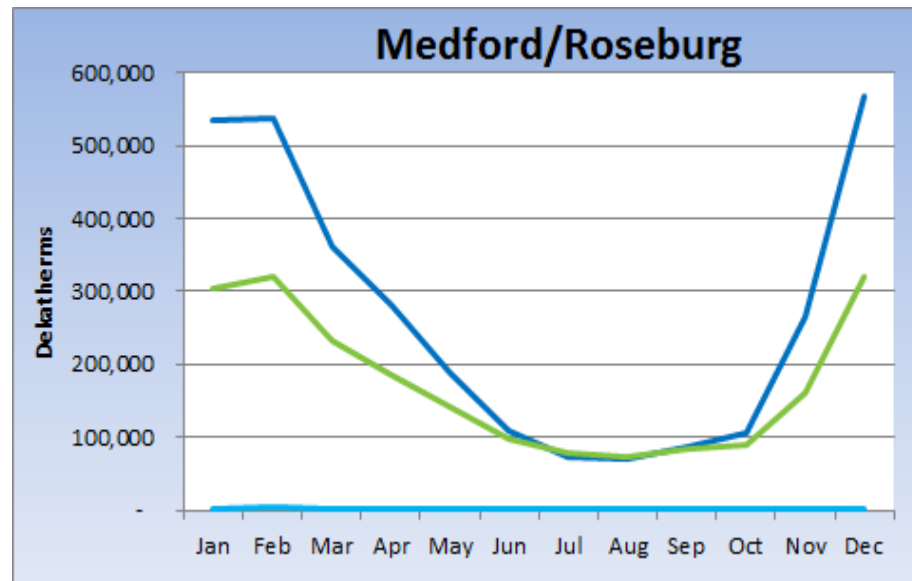
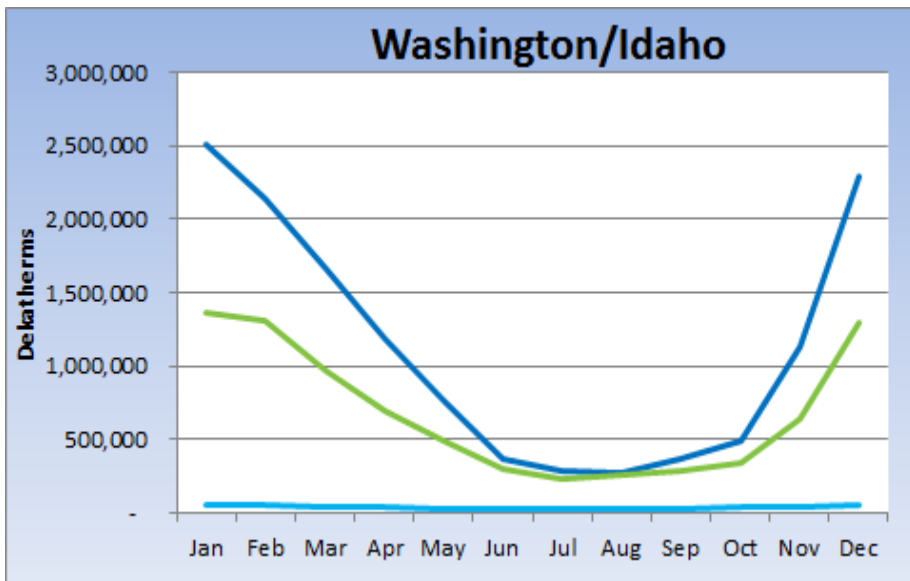

Our Planning Models

- 122 cities
- 40 load study models

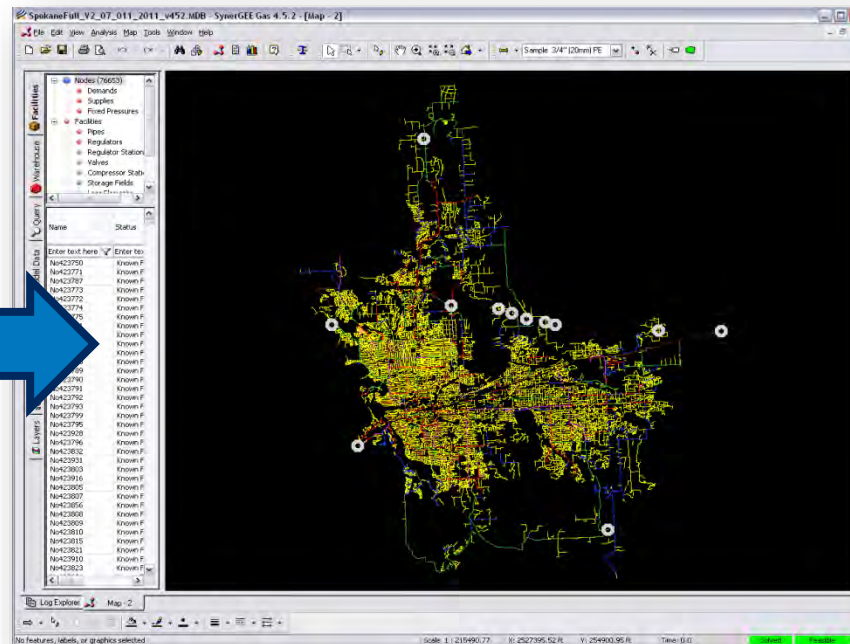
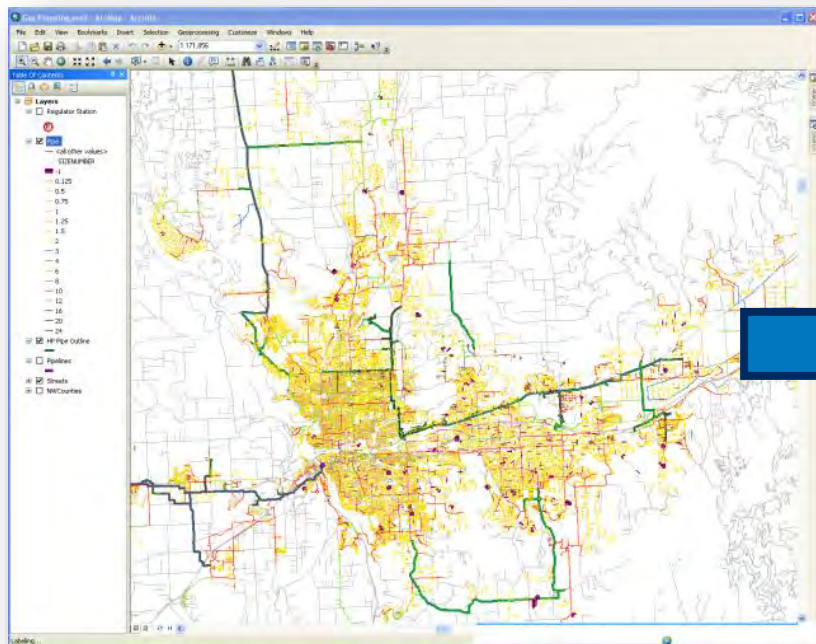

5 Variables for Any Given Pipe

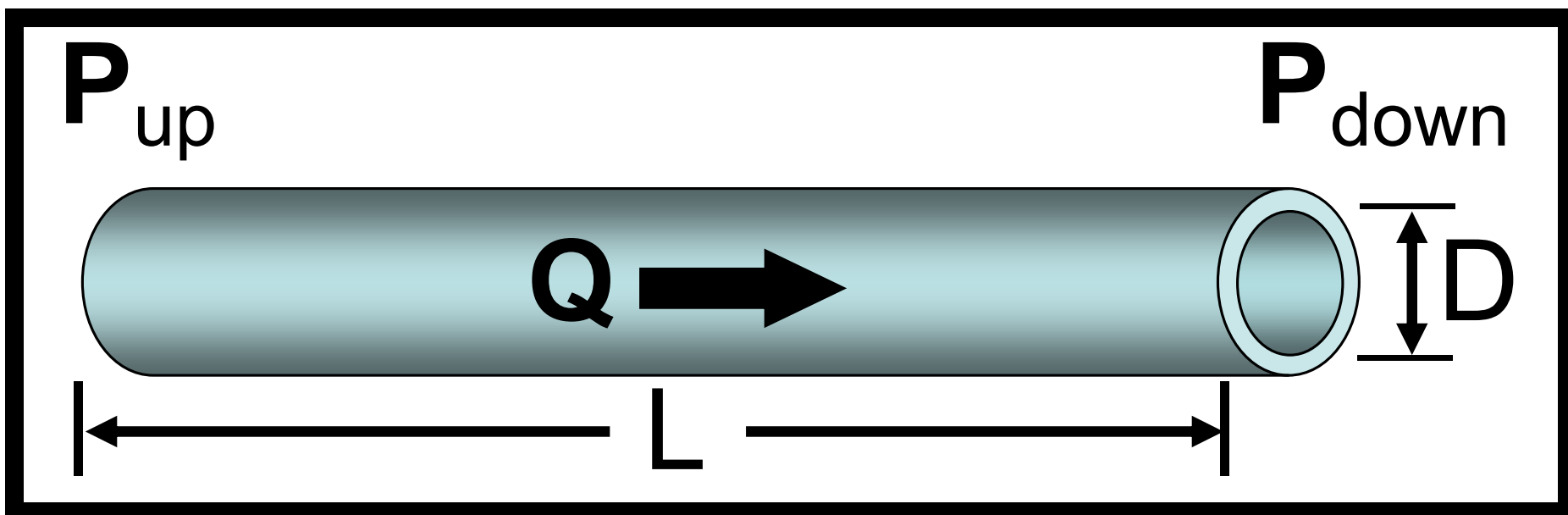

Scope of Gas Distribution Planning

Supplier Pipeline

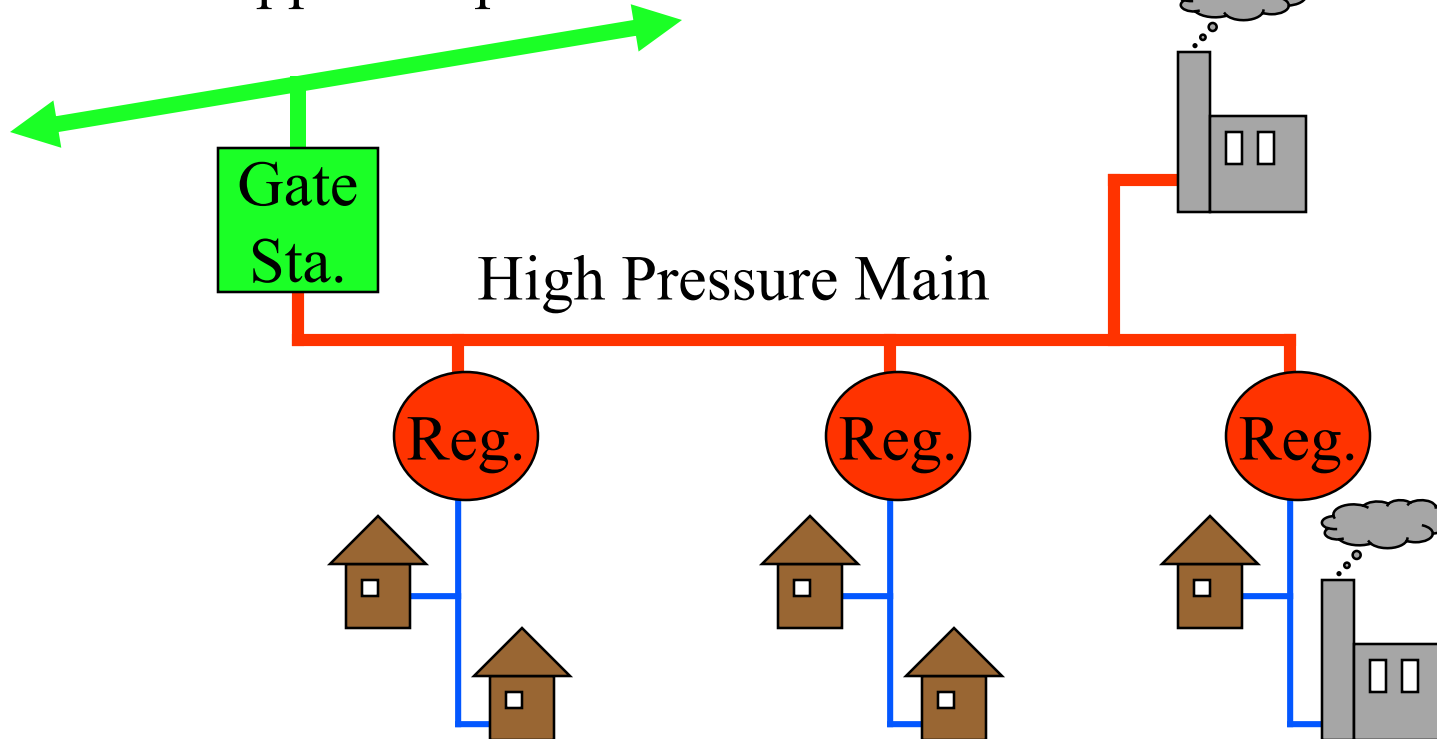

Distribution Main and Services

Scope of Gas Distrib. Planning cont.

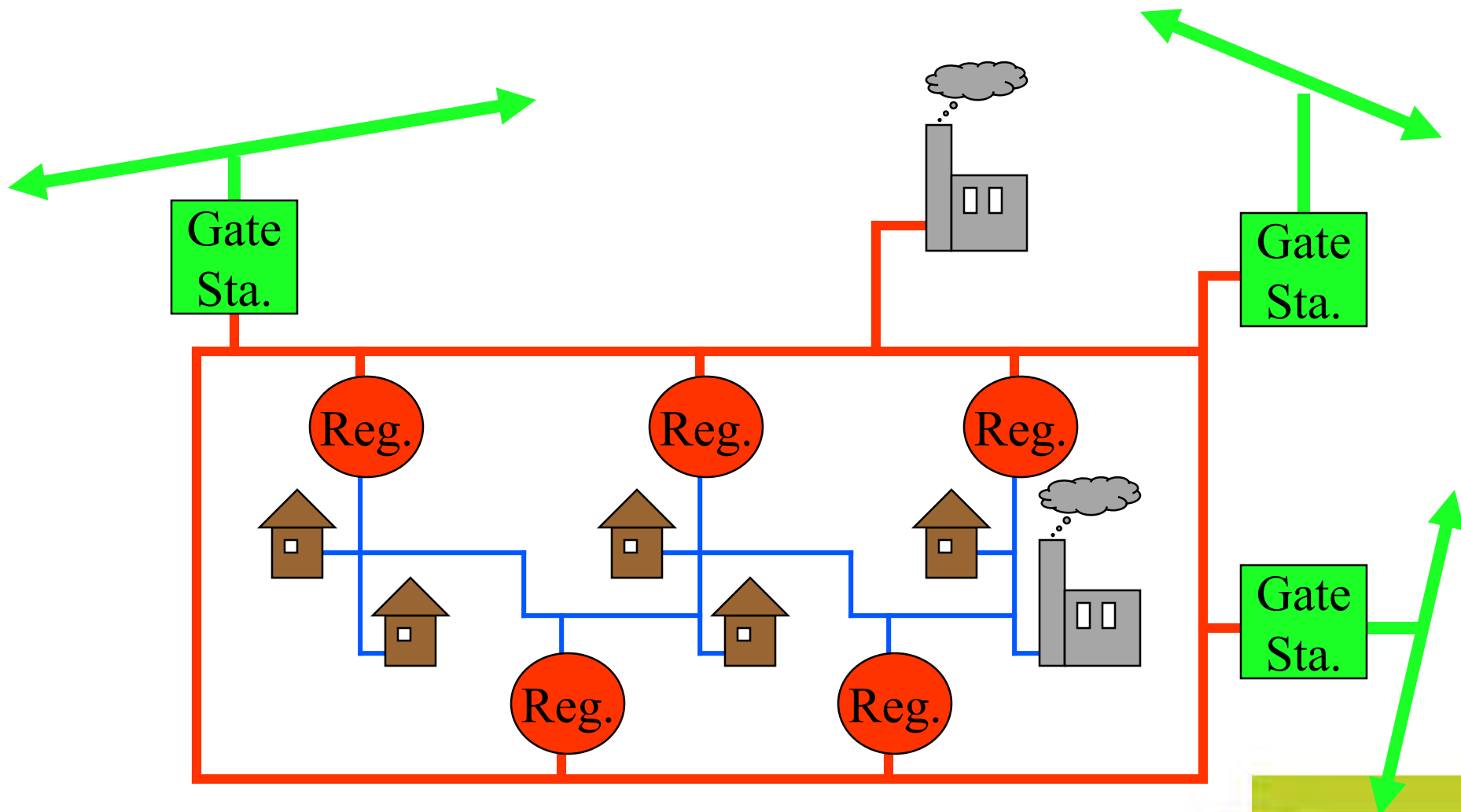

SynerGi (SynerGEE, Stoner) Load Study

- Simulate distribution behavior
- Identify low pressure areas
- Coordinate reinforcements with expansions
- Measure reliability

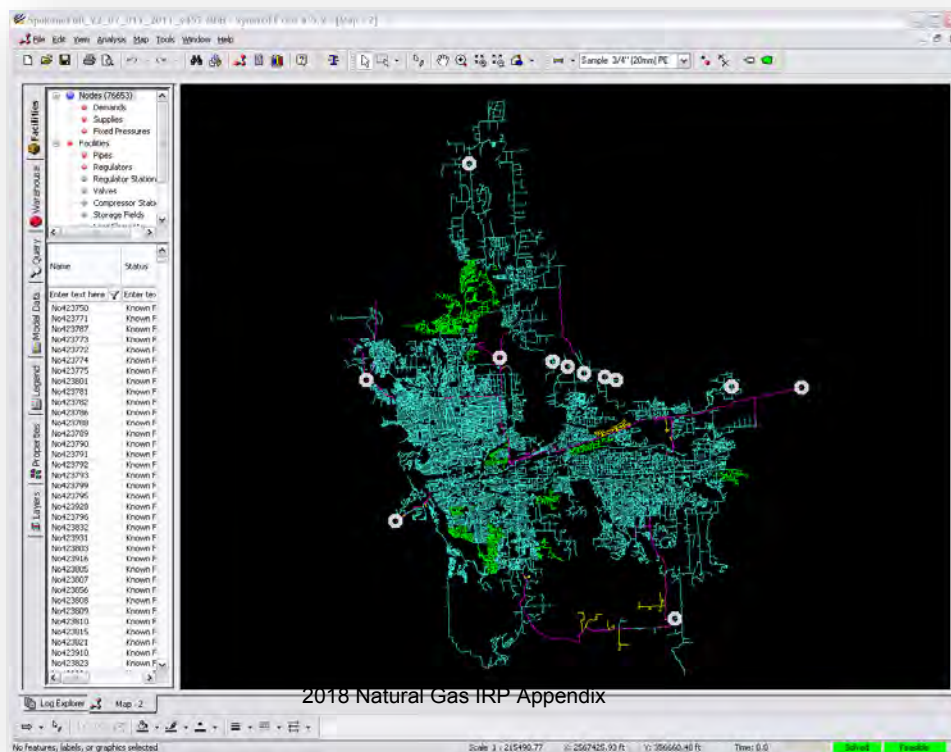



Legend

PRESSURE (PSIG)

---RANGE---	COUNT
BELOW 25.00	0
25.00 35.00	6
35.00 45.00	336
45.00 65.00	525
ABOVE 65.00	40

MIN = 34.96
MAX = 200.00

ANNOTATION:
NODE OFF
NODE OFF
NODE OFF
ELEM OFF

Corners: (FEET)

35 DD

30' F

Preparing a Load Study

- Estimating Customer Usage
- Creating a Pipeline Network
- Join Customer Loads to Pipes
- Convert to Load Study



Estimating Customer Usage

- Gathering Data
 - Days of service
 - Degree Days
 - Usage
 - Name, Address, Revenue Class, Rate Schedule...



Estimating Customer Usage cont.

- Degree Days
 - Heating (HDD)
 - Cooling (CDD)
- Temperature - Usage Relationship
 - Load vs. HDD's
 - Base Load (constant)
 - Heat Load (variable)
 - High correlation with residential

Avg. Daily Temperature ('Fahrenheit)	Heating Degree Days (HDD)	Cooling Degree Days (CDD)
85		20
80		15
75		10
70		5
65	0	0
60	5	
55	10	
50	15	
45	20	
40	25	
35	30	
30	35	
25	40	
20	45	
15	50	
10	55	
5	60	
4	61	
0	65	
-5	70	
-10	75	
-15	80	
-17	82	



K11 =

A	B	C	D	E	F	G	H	I
Begin Date	Read Date	RBC	Dys Svc	Deg Dys	Usage	Therm/Day	DD/day	mcfh/day
01-23-2002	02-22-2002	RR	30	971	2775	92.5	32.36667	0.58
12-21-2001	01-23-2002	RR	33	1195	2567	77.78788	36.21212	0.49
11-20-2001	12-21-2001	RR	31	1028	2547	82.16129	33.16129	0.51
10-24-2001	11-20-2001	RR	27	586	1379	51.07407	21.7037	0.32
09-24-2001	10-24-2001	RR	30	491	1208	40.26667	16.36667	0.25
08-22-2001	09-24-2001	RR	33	67	715	21.66667	2.030303	0.14
07-24-2001	08-22-2001	RY	29	19	432	14.89655	0.655172	0.09
06-22-2001	07-24-2001	RR	32	41	611	19.09375	1.28125	0.12
05-24-2001	06-22-2001	RR	29	219	736	25.37931	7.551724	0.16
04-23-2001	05-24-2001	RY	31	368	1301	41.96774	11.87097	0.26
03-23-2001	04-23-2001	RR	31	734	1913	61.70968	23.67742	0.39
02-22-2001	03-23-2001	RR	29	826	2538	87.51724	28.48276	0.55
01-24-2001	02-22-2001	RY	29	1113	3153	108.7241	38.37931	0.68
12-19-2000	01-24-2001	RY	36	1347	3668	101.8889	37.41667	0.64
11-16-2000	12-19-2000	RY	33	1340	3573	108.2727	40.60606	0.68
10-18-2000	11-16-2000	RR	29	884	2424	83.58621	30.48276	0.52
09-20-2000	10-18-2000	RR	28	408	1738	62.07143	14.57143	0.39
08-22-2000	09-20-2000	RY	29	169	1139	39.27586	5.827586	0.25

Avista Corp

2018 Natural Gas IRP Appendix

554

Load vs. Temperature

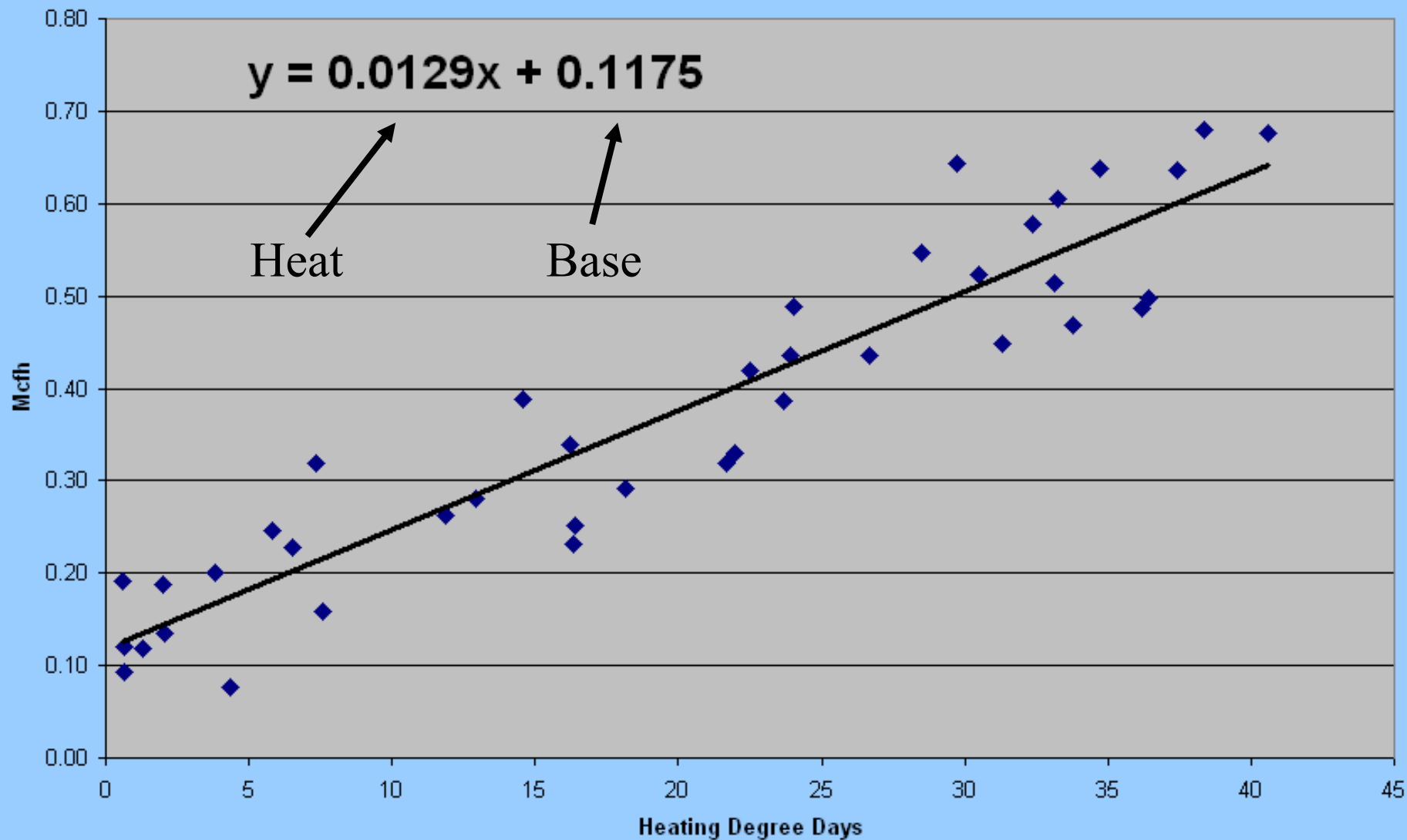

Estimating Customer Usage cont.

- Peaking Factor
 - Peaking Factor = 6.25% of daily load
 - “Observed ratio” of greatest hourly flow to total daily flow at Gate Stations
- Industrial Customers
 - Model maximum hourly usage per Contractual Agreement
 - Firm Transportation customers only
 - Low Temperature-Usage correlation

Creating a Pipeline Model

- Elements
 - Pipes, regulators, valves
 - Attributes: Length, internal diameter, roughness
- Nodes
 - Sources, usage points, pipe ends
 - Attributes: Flow, pressure

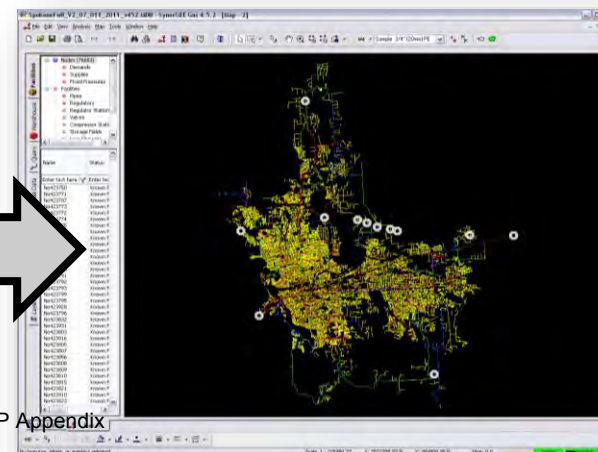
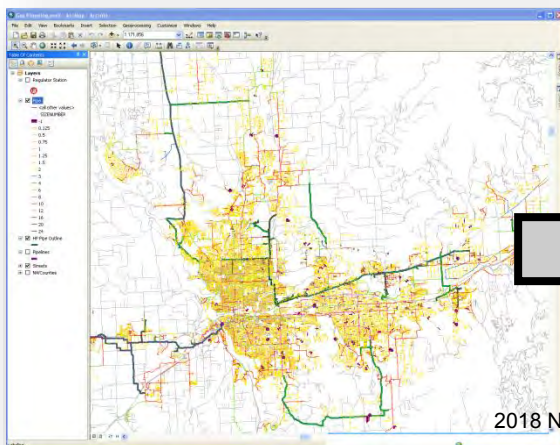

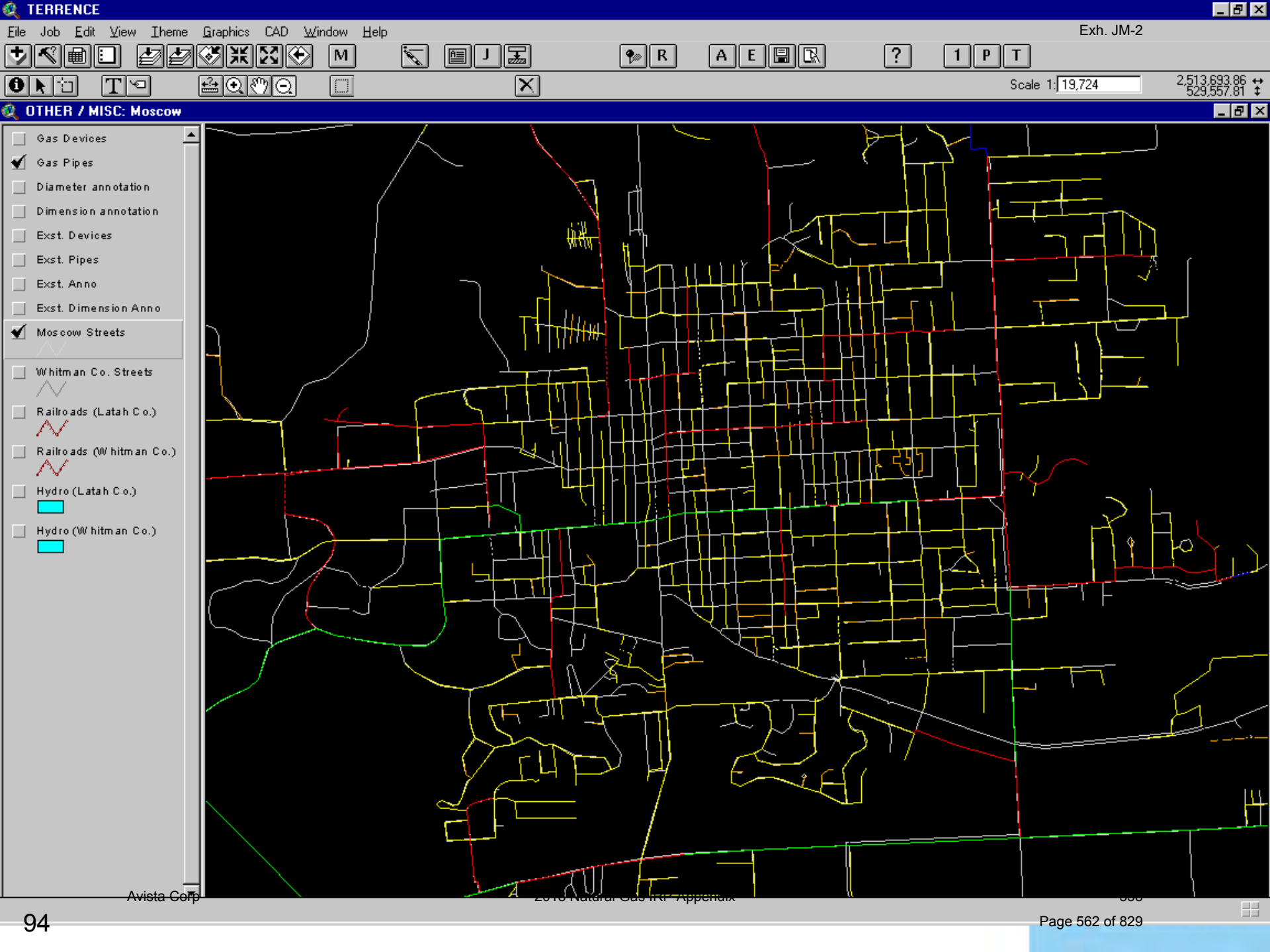

OTHER / MISC: Moscow

- Gas Devices
- Gas Pipes
- Diameter annotation
- Dimension annotation
- Exst. Devices
- Exst. Pipes
- Exst. Anno
- Exst. Dimension Anno
- Moscow Streets
- Whitman Co. Streets
- Railroads (Latah Co.)
- Railroads (Whitman Co.)
- Hydro (Latah Co.)
- Hydro (Whitman Co.)

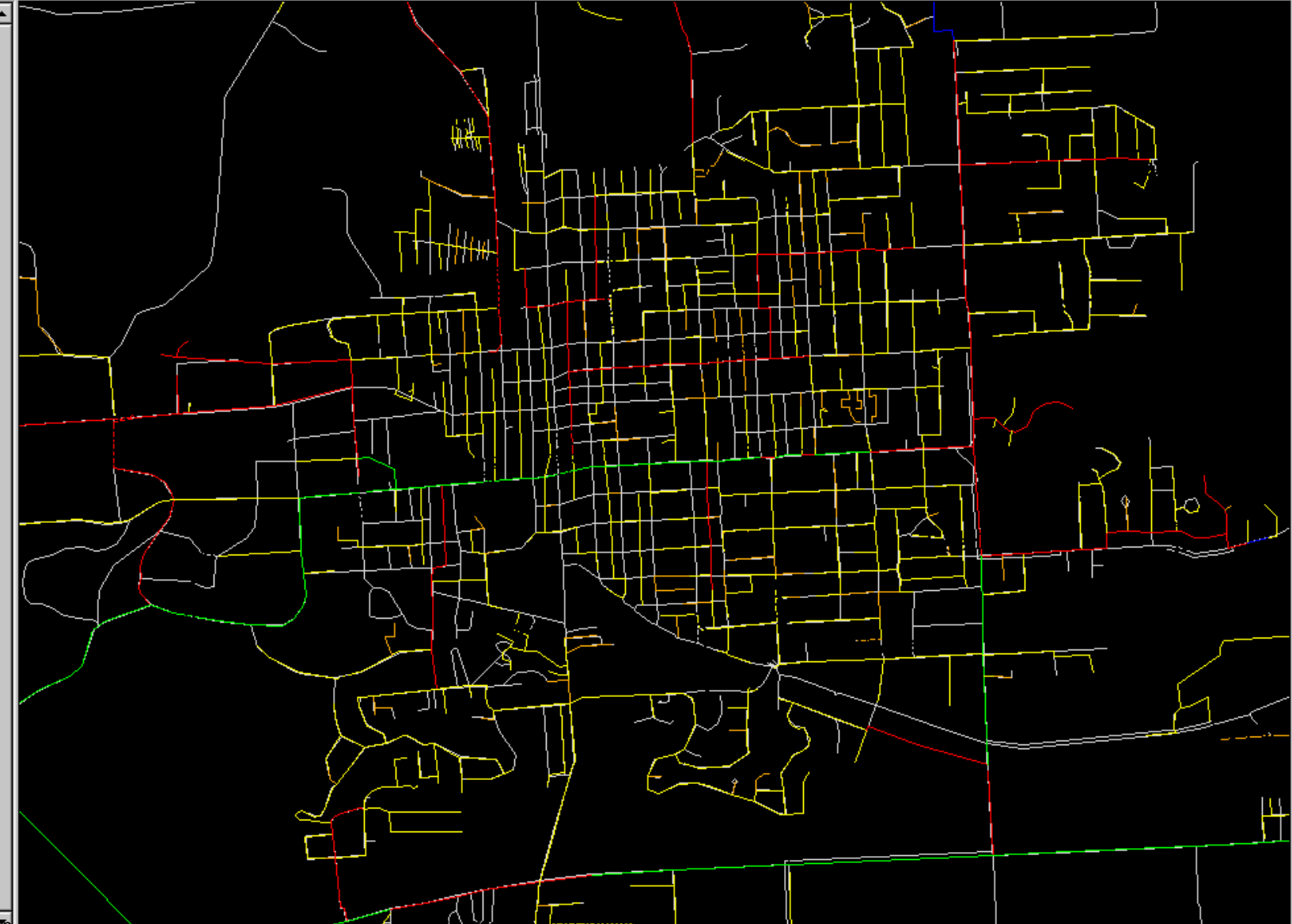

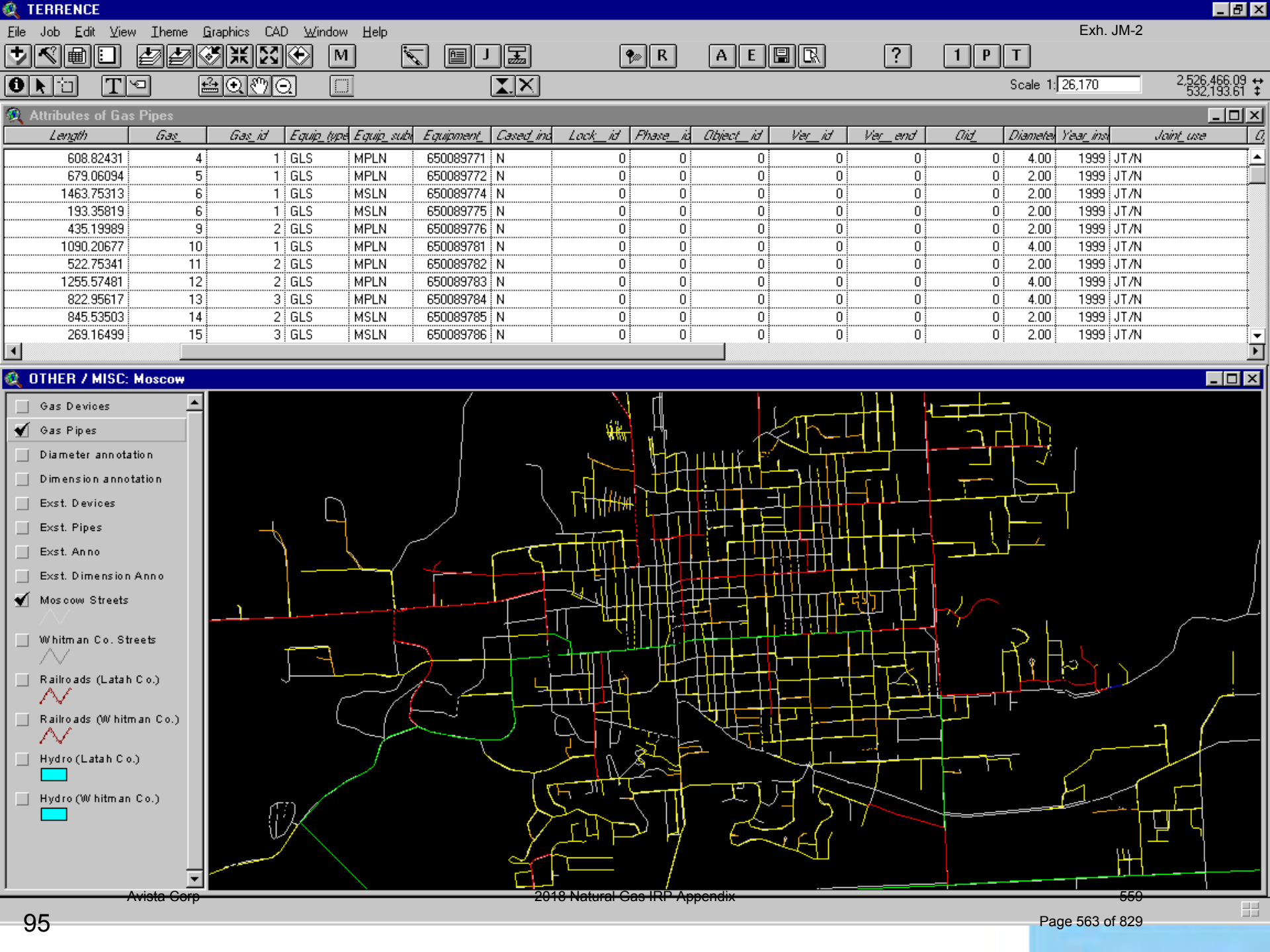

Scale 1:26,170 2,526,466.09 532,193.61

Attributes of Gas Pipes

Length	Gas	Gas_id	Equip_type	Equip_sub	Equipment	Cased_inc	Lock_id	Phase_id	Object_id	Ver_id	Ver_end	Did	Diameter	Year_inst	Joint_use	
608.82431	4	1	GLS	MPLN	650089771	N	0	0	0	0	0	0	4.00	1999	JT/N	
679.06094	5	1	GLS	MPLN	650089772	N	0	0	0	0	0	0	2.00	1999	JT/N	
1463.75313	6	1	GLS	MSLN	650089774	N	0	0	0	0	0	0	2.00	1999	JT/N	
193.35819	6	1	GLS	MSLN	650089775	N	0	0	0	0	0	0	2.00	1999	JT/N	
435.19989	9	2	GLS	MPLN	650089776	N	0	0	0	0	0	0	2.00	1999	JT/N	
1090.20677	10	1	GLS	MPLN	650089781	N	0	0	0	0	0	0	4.00	1999	JT/N	
522.75341	11	2	GLS	MPLN	650089782	N	0	0	0	0	0	0	2.00	1999	JT/N	
1255.57481	12	2	GLS	MPLN	650089783	N	0	0	0	0	0	0	4.00	1999	JT/N	
822.95617	13	3	GLS	MPLN	650089784	N	0	0	0	0	0	0	4.00	1999	JT/N	
845.53503	14	2	GLS	MSLN	650089785	N	0	0	0	0	0	0	2.00	1999	JT/N	
269.16499	15	3	GLS	MSLN	650089786	N	0	0	0	0	0	0	2.00	1999	JT/N	

OTHER / MISC: Moscow

- Gas Devices
- Gas Pipes
- Diameter annotation
- Dimension annotation
- Exst. Devices
- Exst. Pipes
- Exst. Anno
- Exst. Dimension Anno
- Moscow Streets
- Whitman Co. Streets
- Railroads (Latah Co.)
- Railroads (Whitman Co.)
- Hydro (Latah Co.)
- Hydro (Whitman Co.)

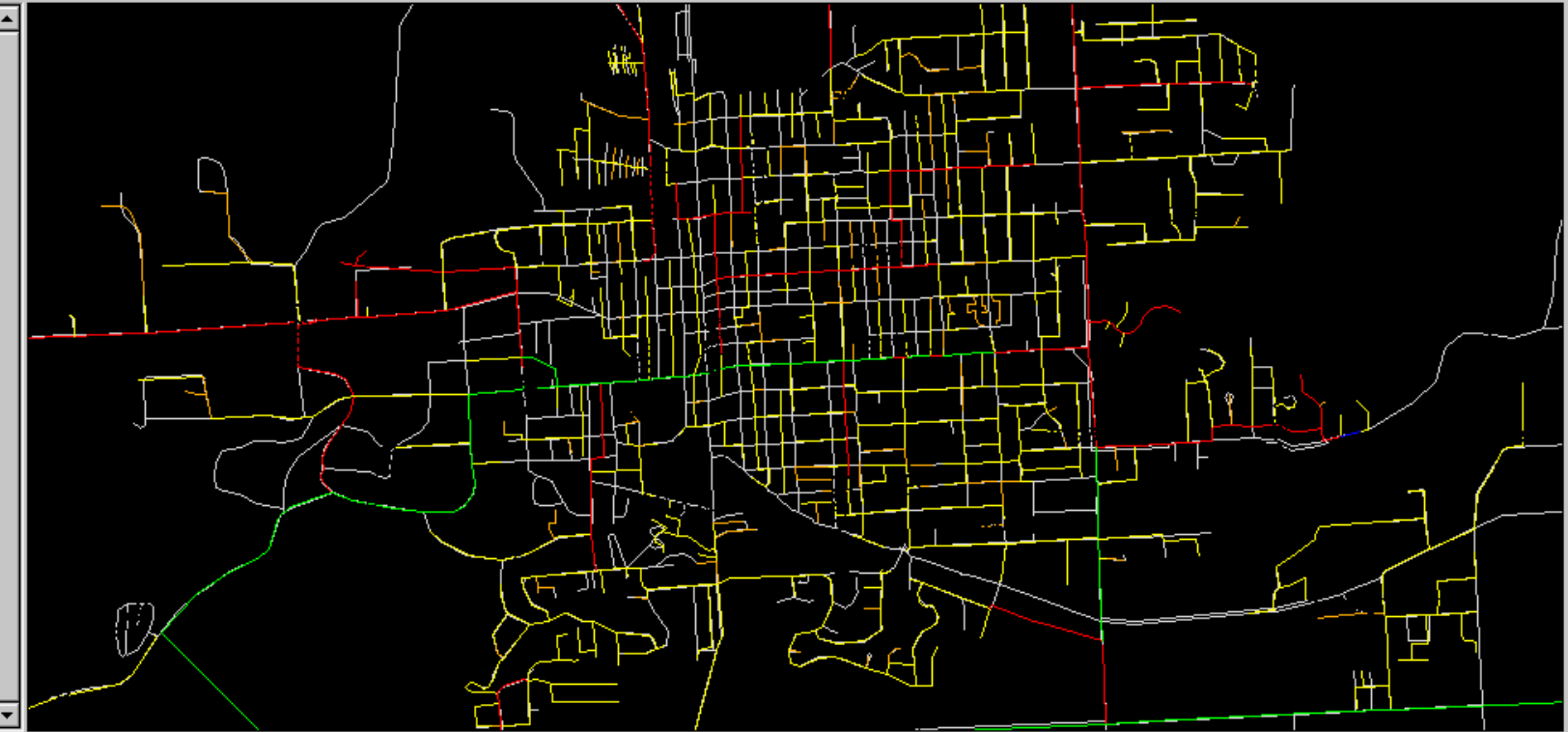

Join Customer Loads to a Model

- Residential and commercial loads are assigned to ***pipes***
- Industrial or other large loads are assigned to ***nodes***

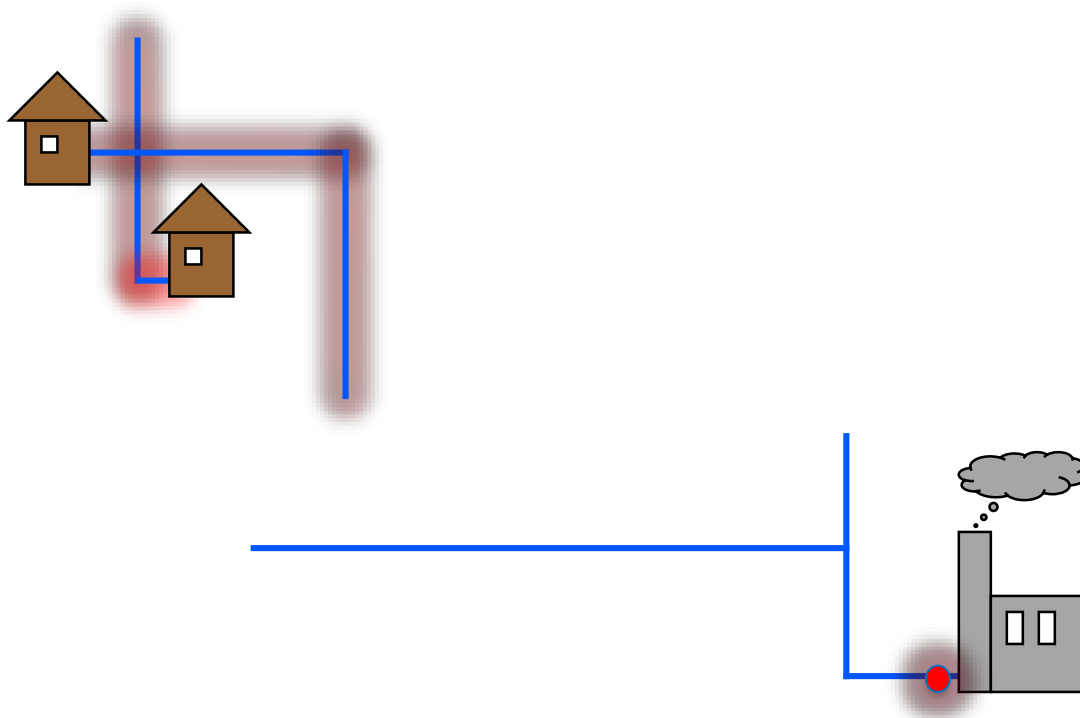

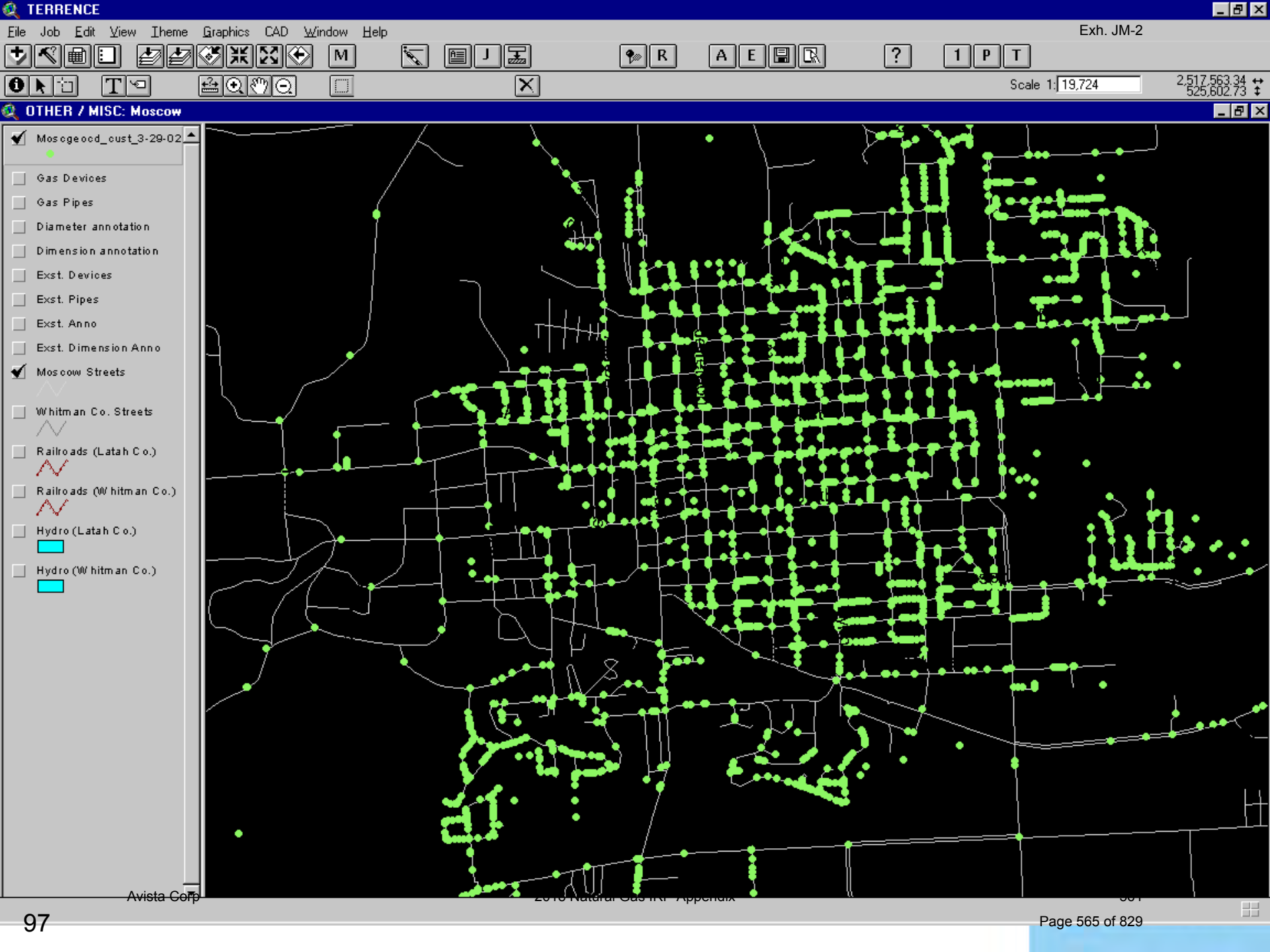

OTHER / MISC: Moscow

- Mosogood_cust_3-29-02
- Gas Devices
- Gas Pipes
- Diameter annotation
- Dimension annotation
- Exst. Devices
- Exst. Pipes
- Exst. Anno
- Exst. Dimension Anno
- Moscow Streets
- Whitman Co. Streets
- Railroads (Latah Co.)
- Railroads (Whitman Co.)
- Hydro (Latah Co.)
- Hydro (Whitman Co.)



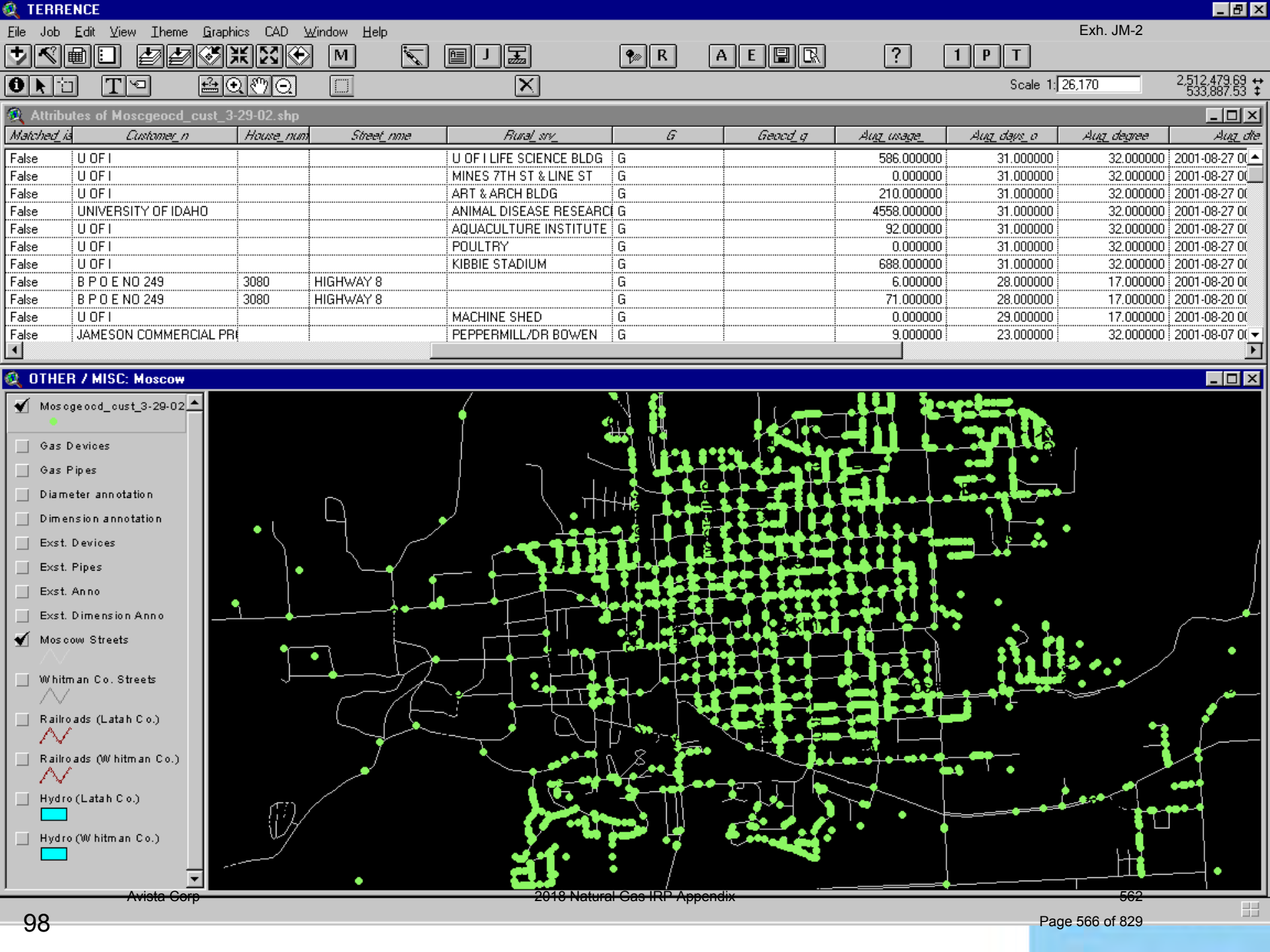

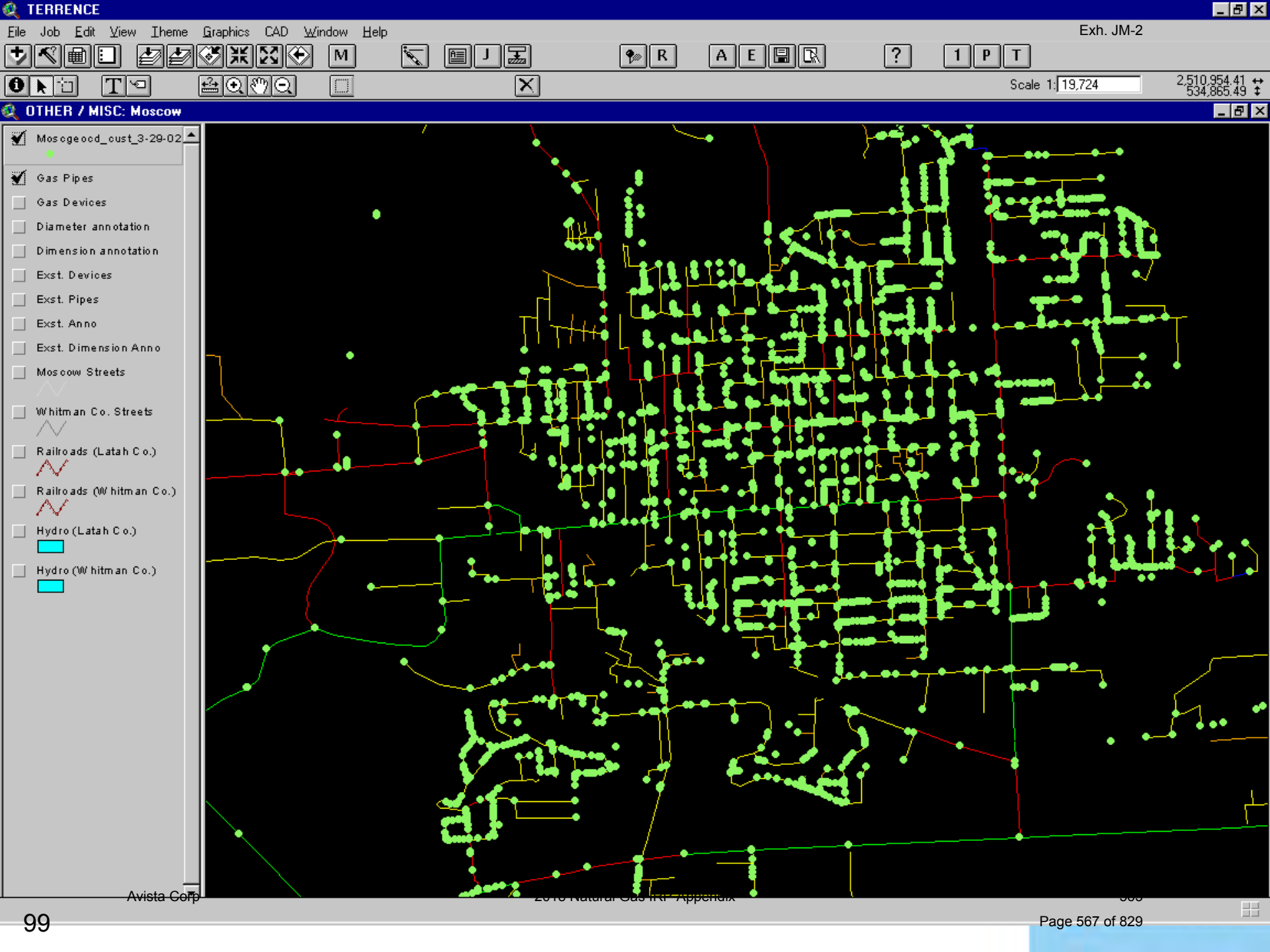

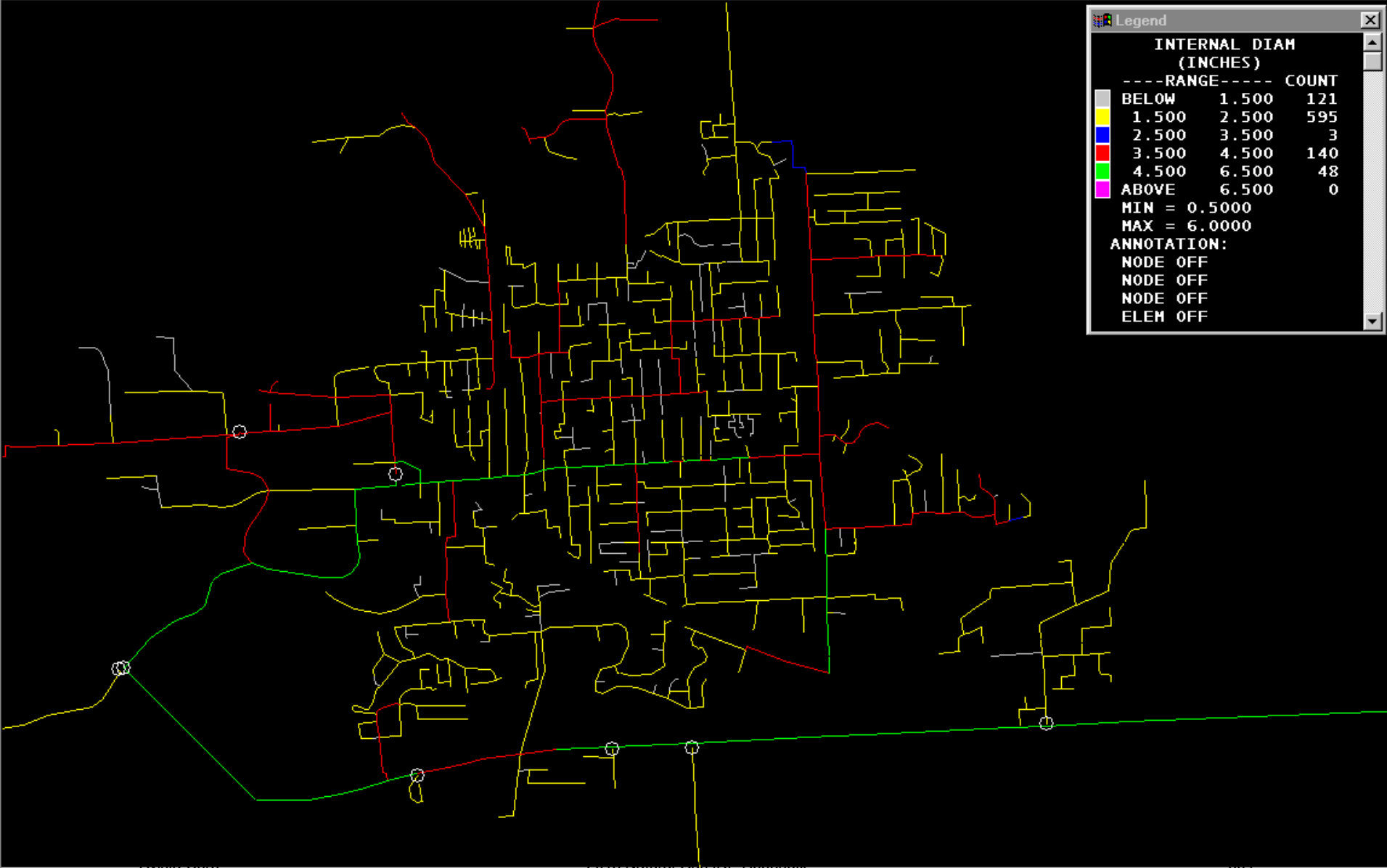

Legend

INTERNAL DIAM (INCHES)

---	RANGE	---	COUNT
	BELOW 1.500		121
	1.500 2.500		595
	2.500 3.500		3
	3.500 4.500		140
	4.500 6.500		48
	ABOVE 6.500		0

MIN = 0.5000
MAX = 6.0000

ANNOTATION:

NODE OFF
NODE OFF
NODE OFF
ELEM OFF

Balancing Model

- Simulate system for any temperature
 - HDD's
- Solve for pressure at all nodes





Legend

PRESSURE (PSIG)

---RANGE---	COUNT
BELOW 25.00	0
25.00 35.00	6
35.00 45.00	336
45.00 65.00	525
ABOVE 65.00	40

MIN = 34.96
MAX = 200.00

ANNOTATION:
NODE OFF
NODE OFF
NODE OFF
ELEM OFF

Corners: (FEET)

35 DD

30° F

Validating Model



Validating Model cont.

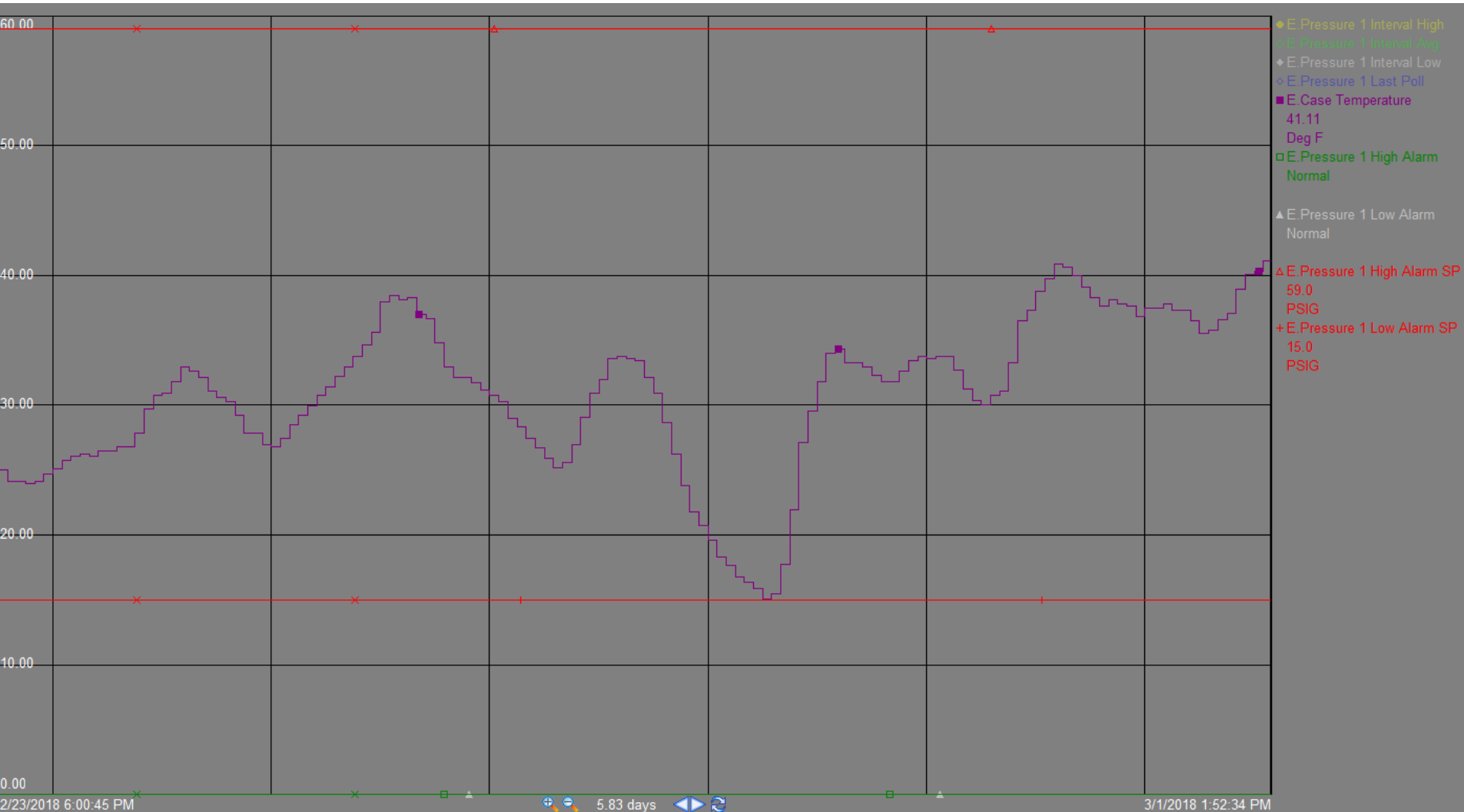

Validating Model cont.

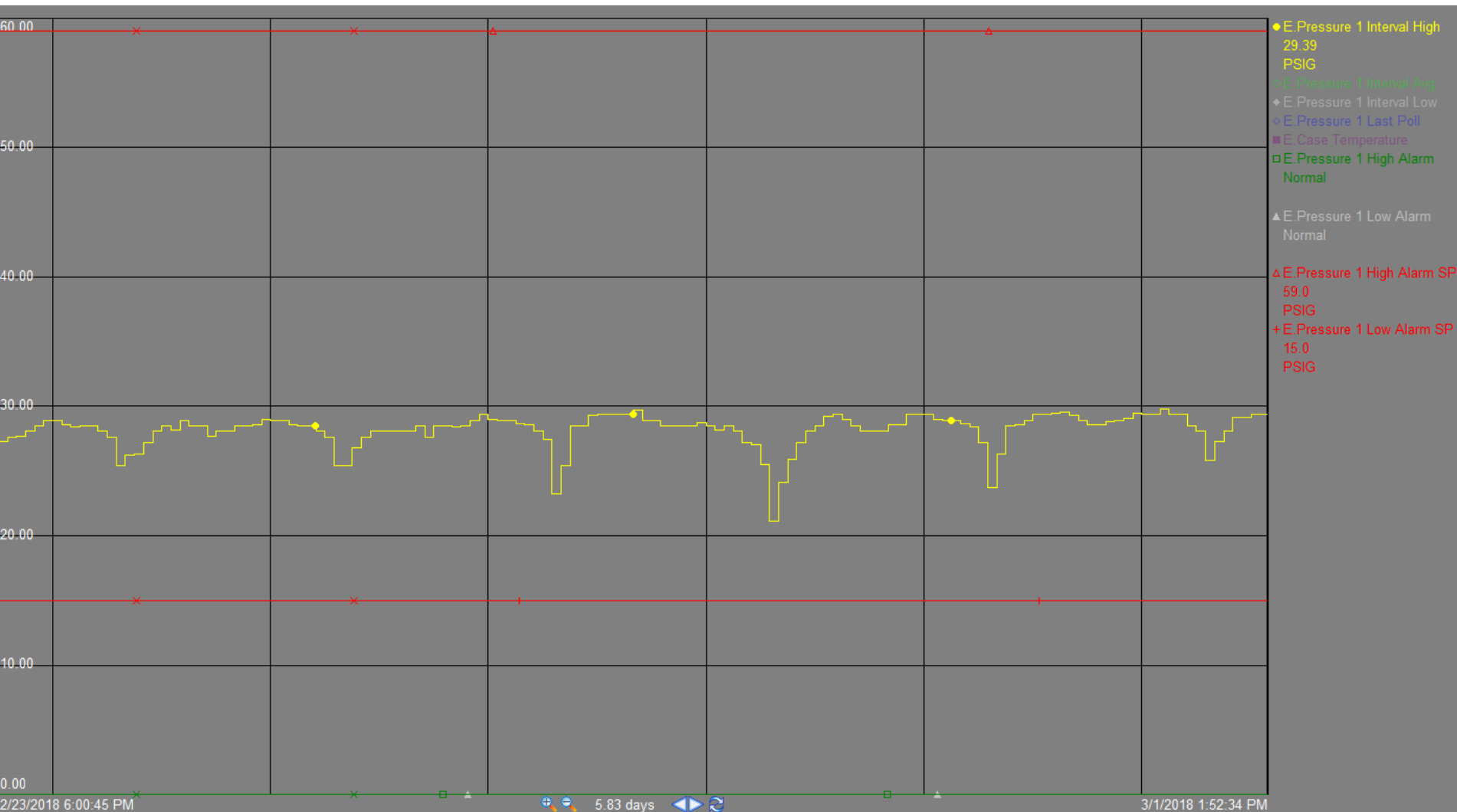

Validating Model cont.

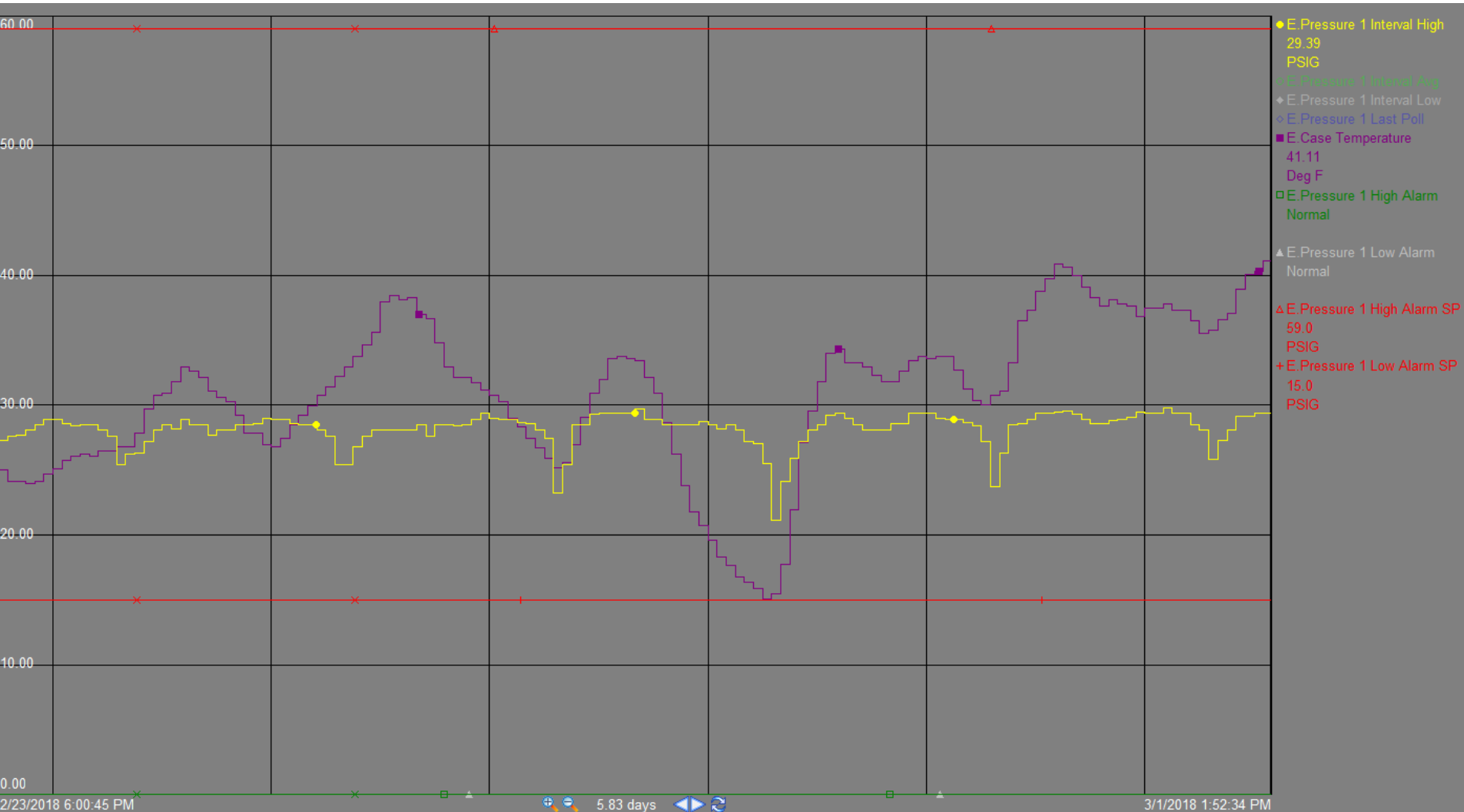

Validating Model cont.

- Simulate recorded condition
- Electronic Pressure Recorders
 - Do calculated results match field data?
- Gate Station Telemetry
 - Do calculated results match source data?
- Possible Errors
 - Missing pipe
 - Source pressure changed
 - Industrial loads

Planning Criteria

- Reliability during design HDD
 - Spokane 82 HDD
 - Medford 61 HDD
 - Klamath Falls 72 HDD
 - La Grande 74 HDD
 - Roseburg 55 HDD
- Maintain minimum of 15 psig in system at all times
 - 5 psig in lower MAOP areas

Planning Criteria

- Reliability during design HDD
 - Spokane **82 HDD** (*avg. daily temp. -17' F*)
 - Medford **61 HDD** (*avg. daily temp. 4' F*)
 - Klamath Falls **72 HDD** (*avg. daily temp. -7' F*)
 - La Grande **74 HDD** (*avg. daily temp. -9' F*)
 - Roseburg **55 HDD** (*avg. daily temp. 10' F*)
- Maintain minimum of 15 psig in system at all times
 - 5 psig in lower MAOP areas



Legend

PRESSURE (PSIG)

---RANGE---	COUNT
BELOW 25.00	0
25.00 35.00	6
35.00 45.00	336
45.00 65.00	525
ABOVE 65.00	40

MIN = 34.96
MAX = 200.00

ANNOTATION:
NODE OFF
NODE OFF
NODE OFF
ELEM OFF

Corners: (FEET)

35 DD

30° F



Legend

PRESSURE (PSIG)

---	RANGE	---	COUNT
[Red]	BELOW 25.00		0
[Yellow]	25.00 35.00		332
[Green]	35.00 45.00		383
[Cyan]	45.00 65.00		152
[Magenta]	ABOVE 65.00		40

MIN = 31.08
MAX = 200.00

ANNOTATION:
NODE OFF
NODE OFF
NODE OFF
ELEM OFF

Corners: (FEET)

50 DD

15° F

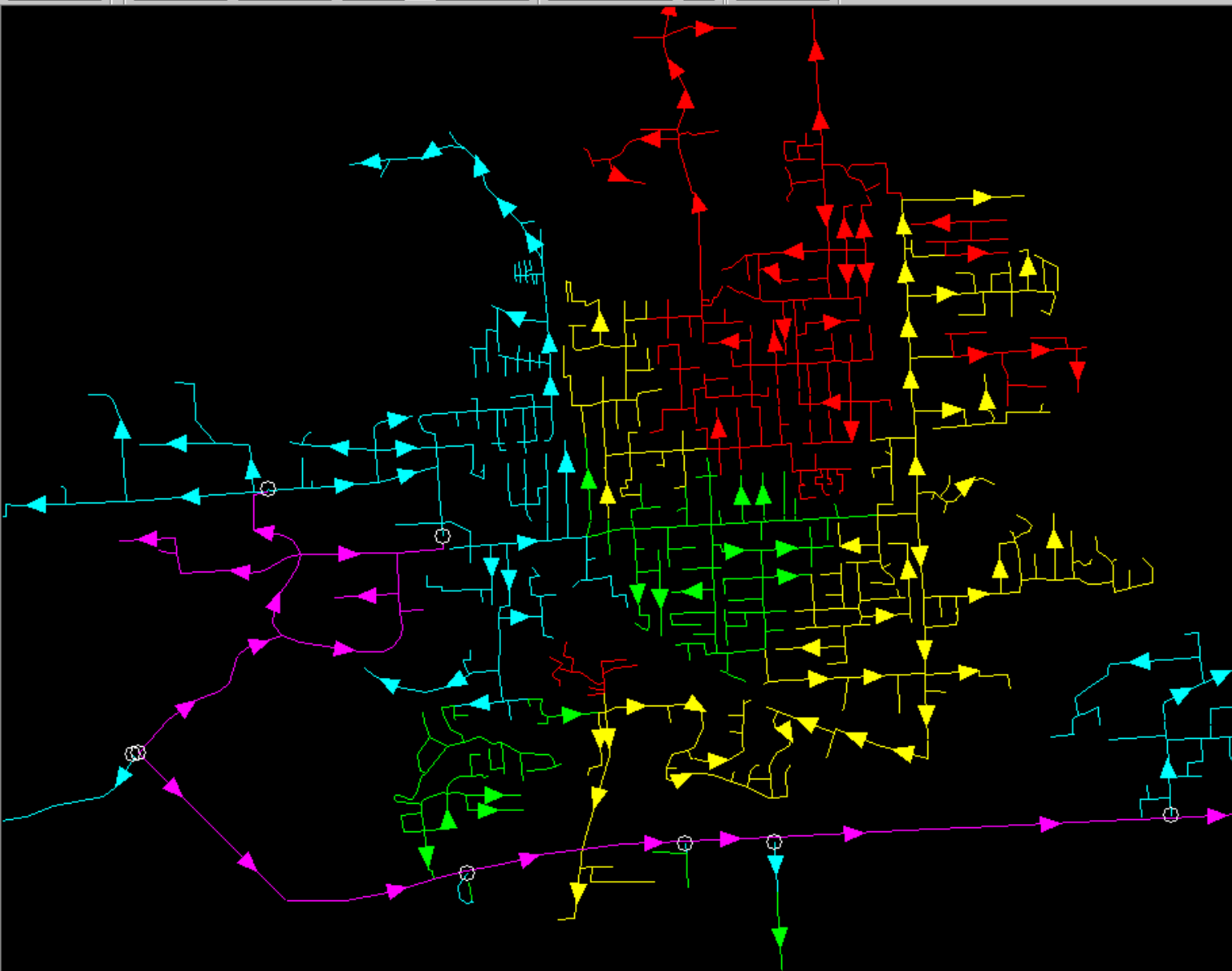

Legend

PRESSURE (PSIG)

---RANGE---	COUNT
BELOW 15.00	225
15.00 25.00	257
25.00 35.00	162
35.00 65.00	223
ABOVE 65.00	40

MIN = 5.896
MAX = 200.000

ANNOTATION:
NODE OFF
NODE OFF
NODE OFF
ELEM OFF

Corners: (FEET)

65 DD

0° F

Interpreting Results

- Identify Low Pressure Areas
 - Number of feeds
 - Proximity to source
- Looking for Most Economical Solution
 - Length (minimize)
 - Construction obstacles (minimize)
 - Customer growth (maximize)



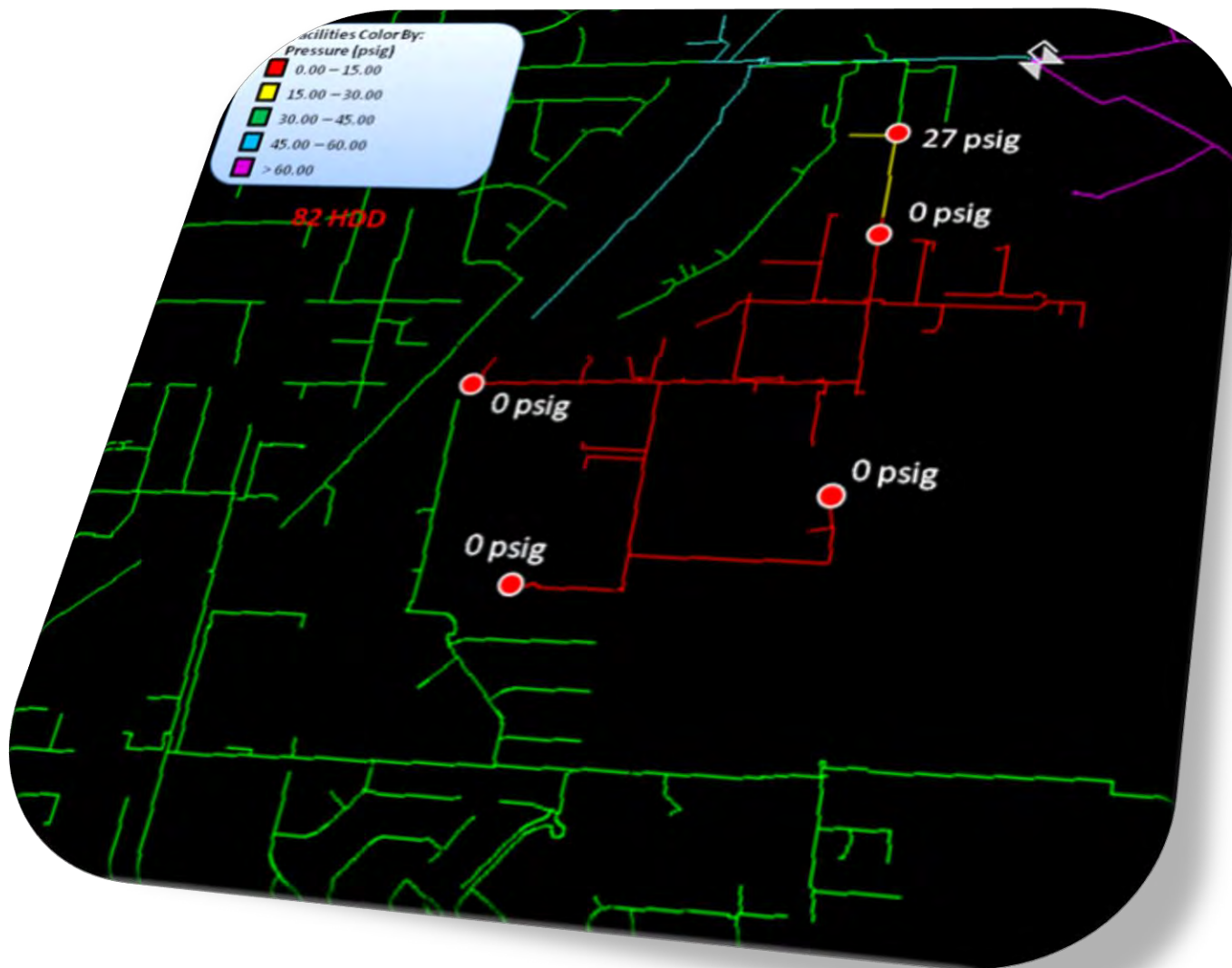

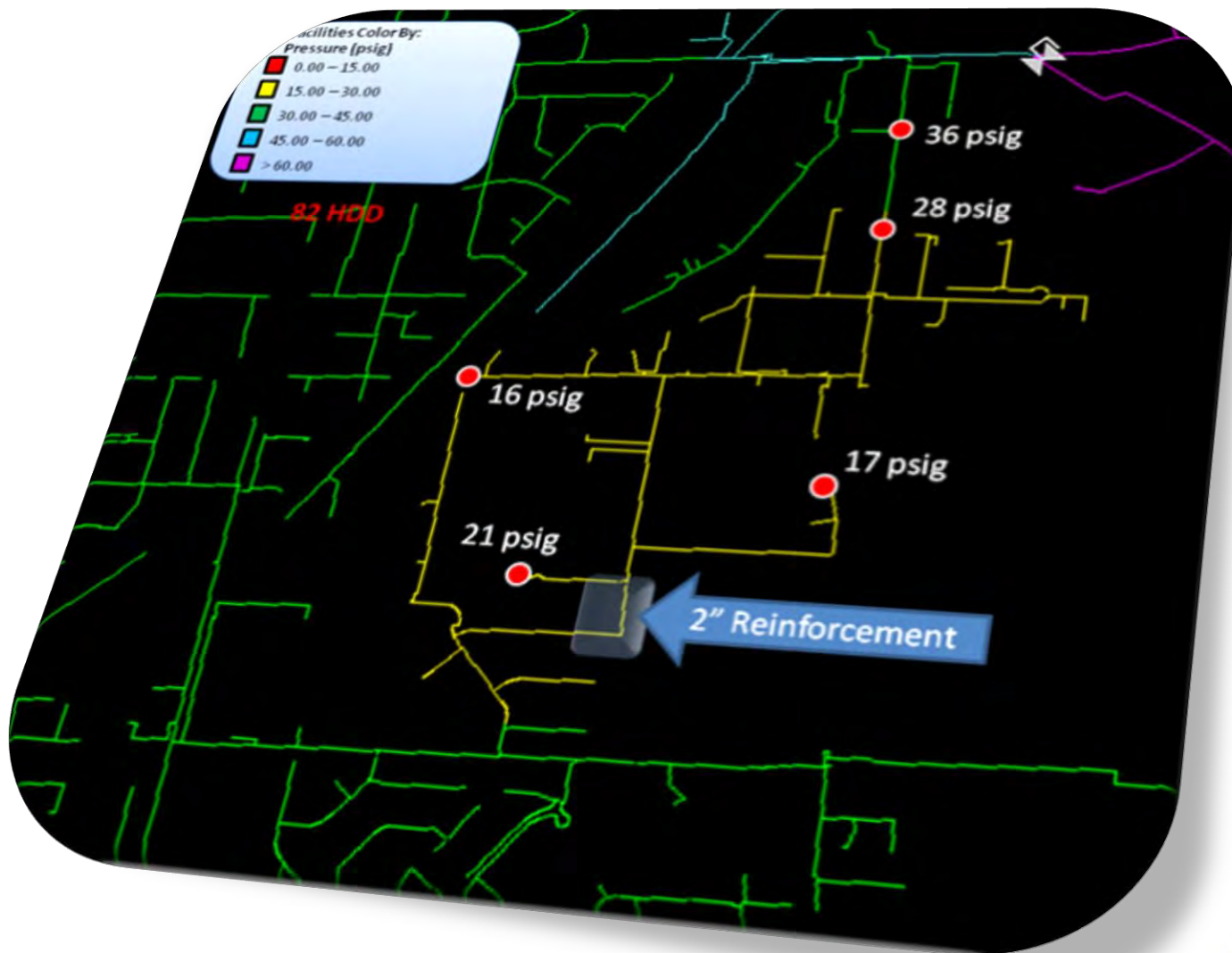

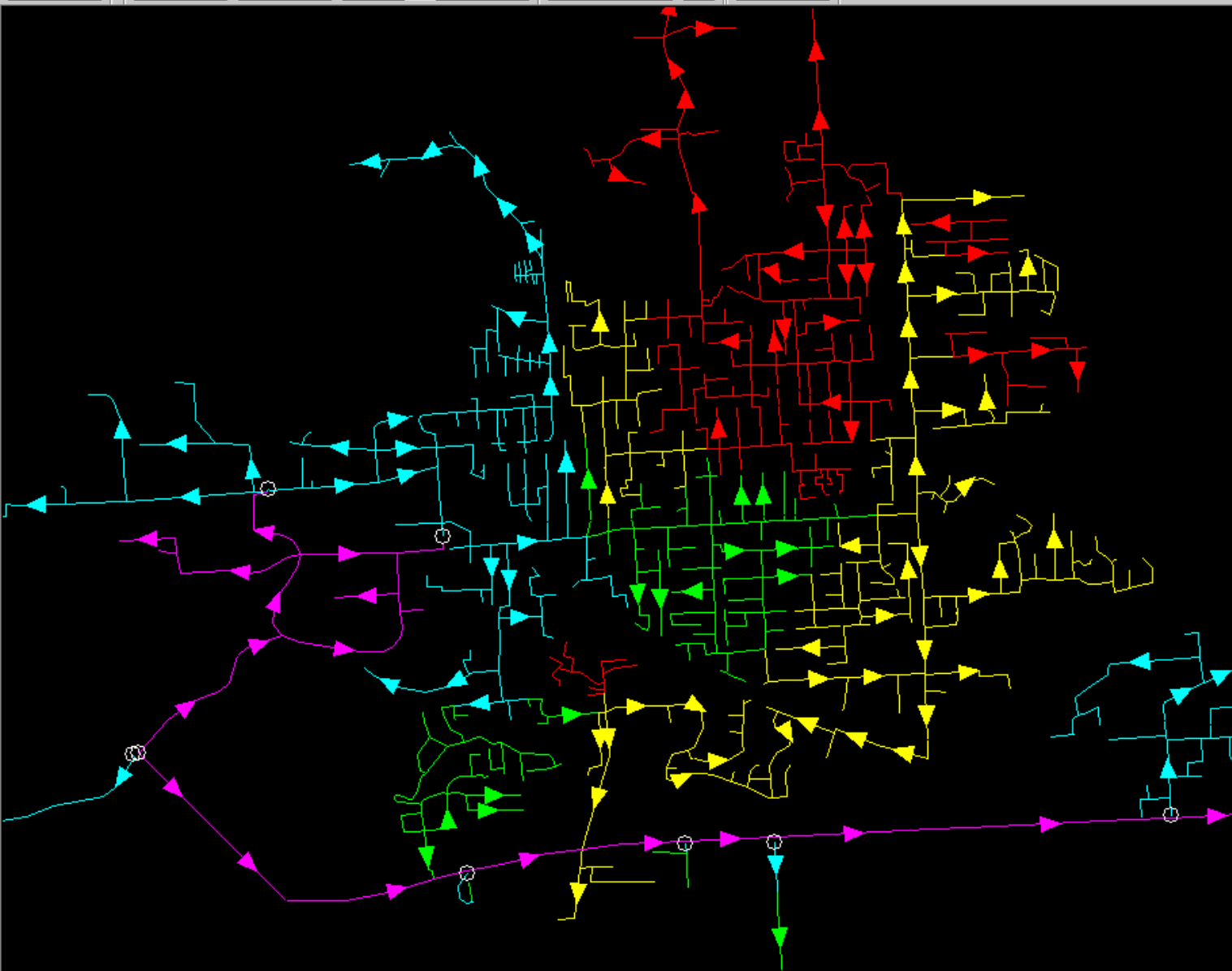

Legend

PRESSURE (PSIG)

---RANGE---	COUNT
BELOW 15.00	225
15.00 25.00	257
25.00 35.00	162
35.00 65.00	223
ABOVE 65.00	40

MIN = 5.896
MAX = 200.000

ANNOTATION:
NODE OFF
NODE OFF
NODE OFF
ELEM OFF

Corners: (FEET)

65 DD

0' F

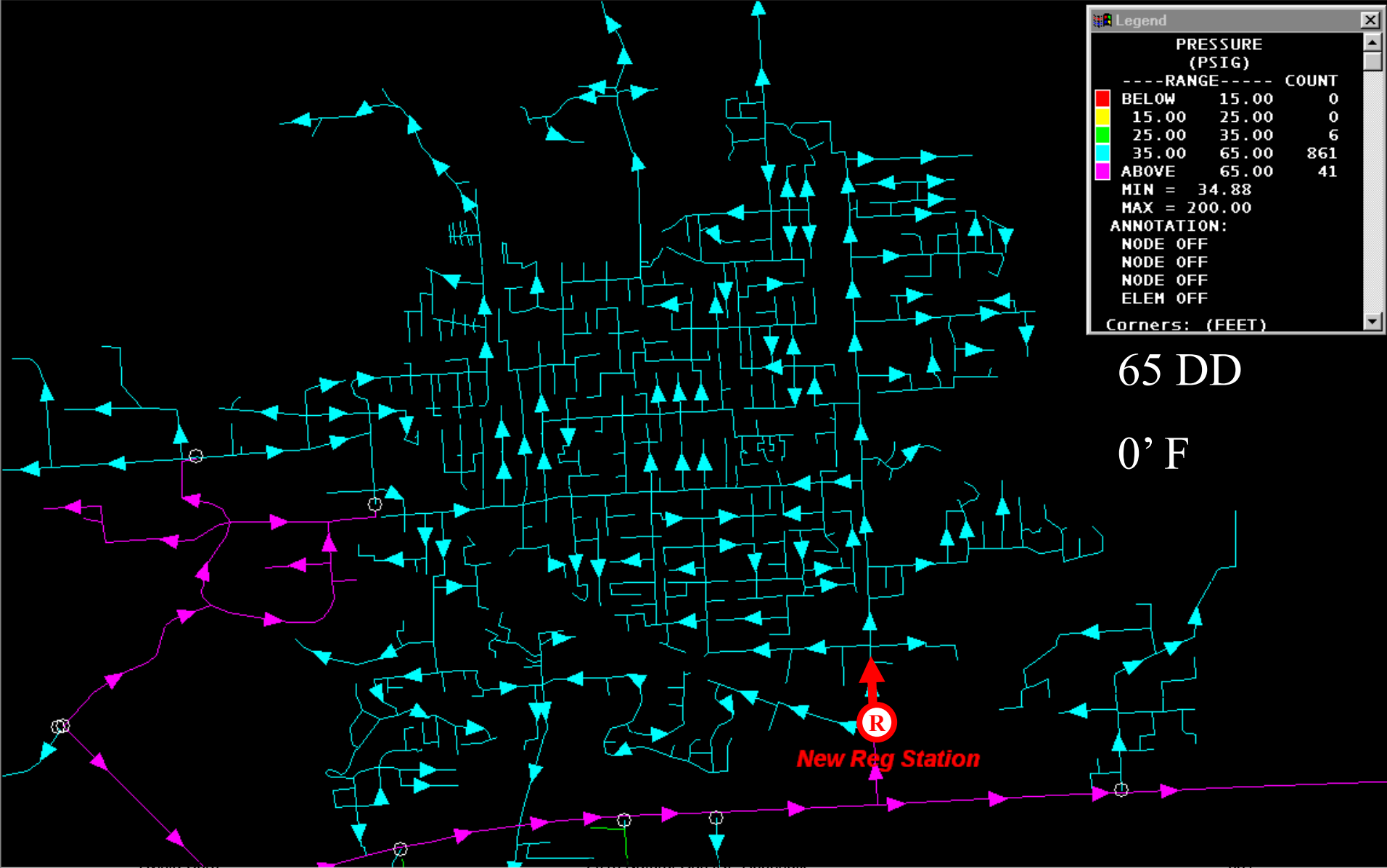

Legend

PRESSURE (PSIG)

---RANGE---	COUNT
BELOW 15.00	0
15.00 25.00	0
25.00 35.00	6
35.00 65.00	861
ABOVE 65.00	41

MIN = 34.88
MAX = 200.00

ANNOTATION:
NODE OFF
NODE OFF
NODE OFF
ELEM OFF

Corners: (FEET)

65 DD

0' F

R
New Reg Station



Legend

PRESSURE (PSIG)		
--- RANGE ---		COUNT
BELOW 15.00	15.00	0
15.00 25.00	25.00	16
25.00 35.00	35.00	324
35.00 65.00	65.00	527
ABOVE 65.00	65.00	41
MIN = 24.09		
MAX = 200.00		
ANNOTATION:		
NODE OFF		
NODE OFF		
NODE OFF		
ELEM OFF		
Corners: (FEET)		

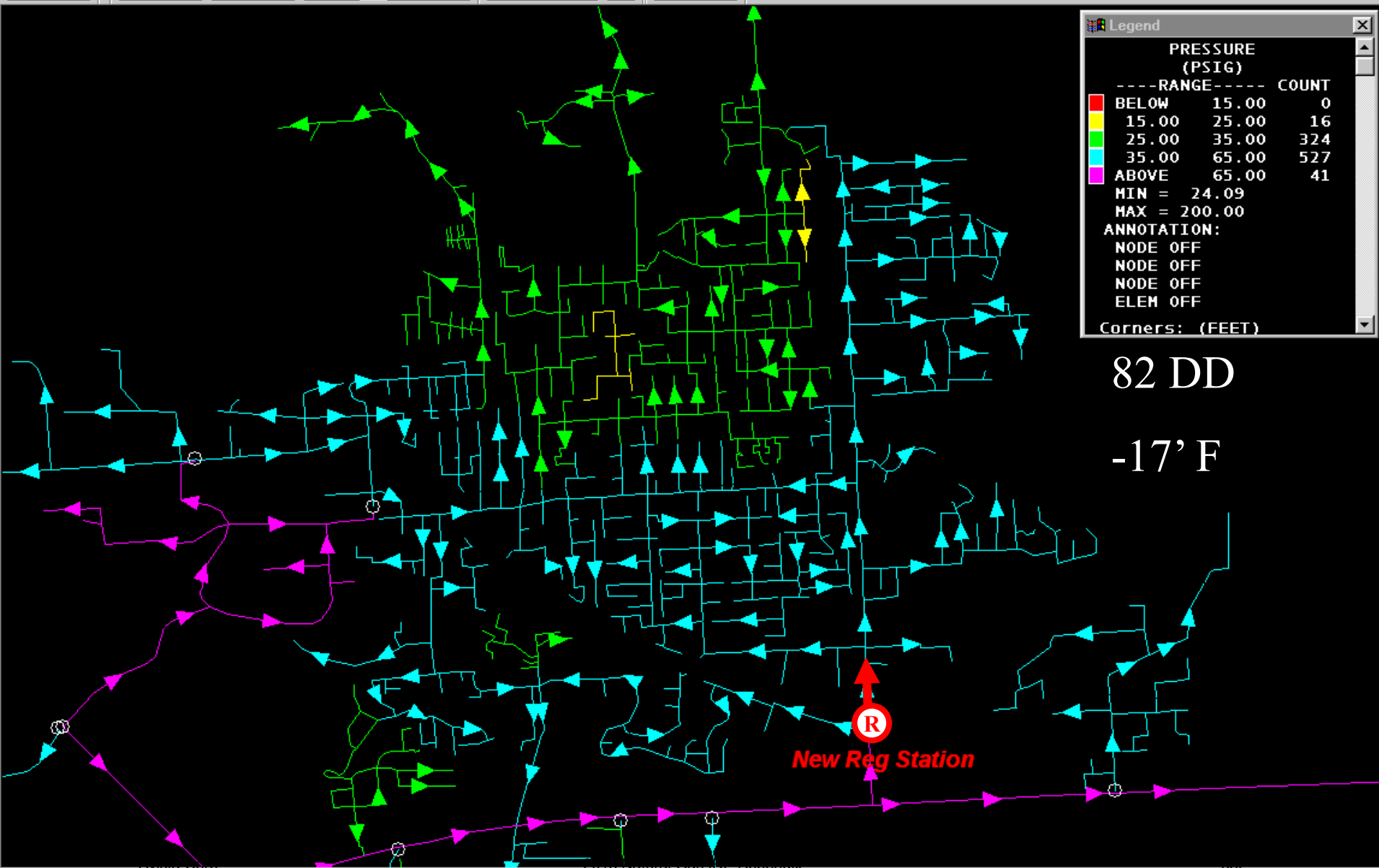

82 DD
-17' F

R
New Reg Station

Long-term Planning Objectives

- Future Growth/Expansion
- Design Day Conditions
- Facilitate Customer Installation Targets



Historical Temperatures



Historical Temperatures

- Spokane **82 HDD**
 - *11/23/10: 64 HDD “Artic Blast”*
- Medford **61 HDD**
- Klamath Falls **72 HDD**
- La Grande **74 HDD**
- Roseburg **55 HDD**

Historical Temperatures

- Spokane **82 HDD**
 - 11/23/10: 64 HDD “Arctic Blast”
 - 12/6/13 and 12/8/13: 58 HDD “Polar Vortex”
- Medford **61 HDD**
 - 12/8/13: 52 HDD “Polar Vortex”
- Klamath Falls **72 HDD**
 - 12/8/13: 72 HDD “Polar Vortex”
- La Grande **74 HDD**
 - 12/8/13: 65 HDD “Polar Vortex”
- Roseburg **55 HDD**
 - 12/8/13: 44 HDD “Polar Vortex”

Historical Temperatures

- Spokane **82 HDD**
 - 11/23/10: 64 HDD “Arctic Blast”
 - 12/6/13 and 12/8/13: 58 HDD “Polar Vortex”
 - 1/1/16: 55 HDD
- Medford **61 HDD**
 - 12/8/13: 52 HDD “Polar Vortex”
- Klamath Falls **72 HDD**
 - 12/8/13: 72 HDD “Polar Vortex”
 - 1/2/16: 62 HDD
- La Grande **74 HDD**
 - 12/8/13: 65 HDD “Polar Vortex”
- Roseburg **55 HDD**
 - 12/8/13: 44 HDD “Polar Vortex”

Historical Temperatures

- Spokane **82 HDD**
 - 11/23/10: 64 HDD “Arctic Blast”
 - 12/6/13 and 12/8/13: 58 HDD “Polar Vortex”
 - 1/1/16: 55 HDD
 - 1/5/17: 59 HDD
- Medford **61 HDD**
 - 12/8/13: 52 HDD “Polar Vortex”
 - 1/5/17: 42 HDD
- Klamath Falls **72 HDD**
 - 12/8/13: 72 HDD “Polar Vortex”
 - 1/2/16: 62 HDD
 - 1/5/17: 71 HDD
- La Grande **74 HDD**
 - 12/8/13: 65 HDD “Polar Vortex”
 - 1/5/17: 65 HDD
- Roseburg **55 HDD**
 - 12/8/13: 44 HDD “Polar Vortex”
 - 1/5/17: 38 HDD

Monitoring Our System

- Electronic Pressure Recorders
 - Daily Feedback
 - Real time if necessary
- Validates our Load Studies



Real-time Pressure & Flow Monitoring

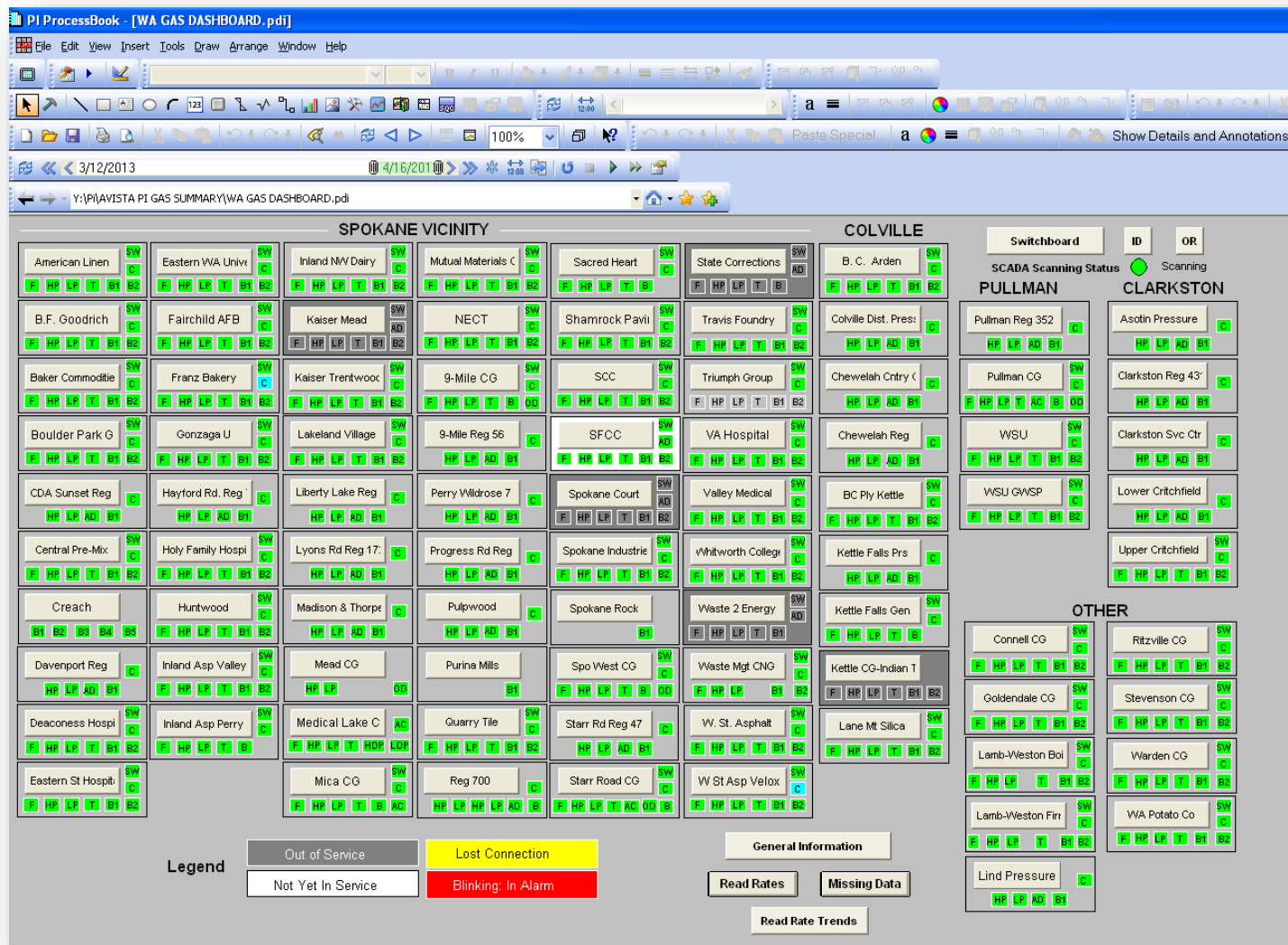

ERX #015

Loon Lake, WA



ERX #015: Loon Lake, WA



ERX #007

West Medford 6 psig System

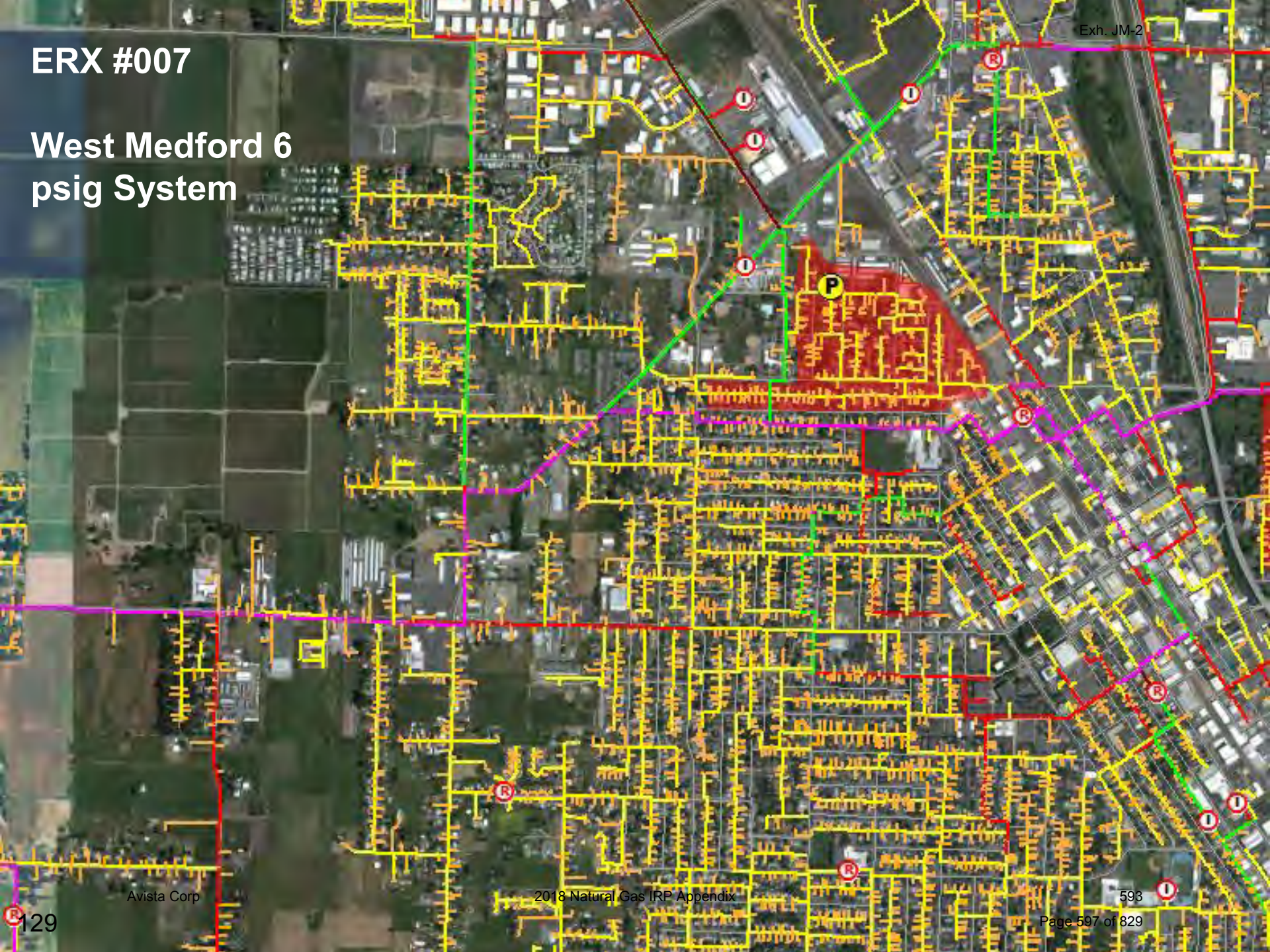

ERX #007: West Medford 6 psig System, OR



12/6/2016 5:33:18 PM Avista Corp

12/18/2016

41.94 days 2018 Natural Gas IRP Appendix

1/17/2017 4:10:05 PM 594

Solutions: short-term



Solutions: long-term

State	Feet of pipe
Idaho	37,800
Oregon	62,300
Washington	121,100

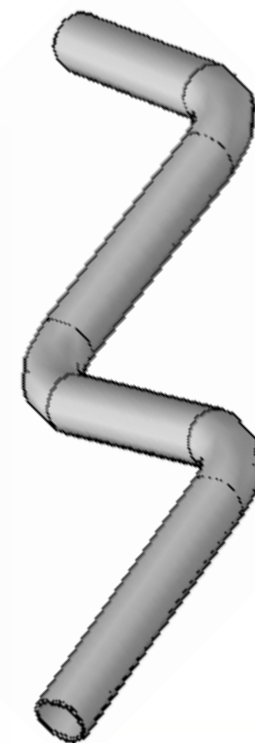

Gas Planning Layers

- Gas Planning Proposals
- Gas Planning AOI

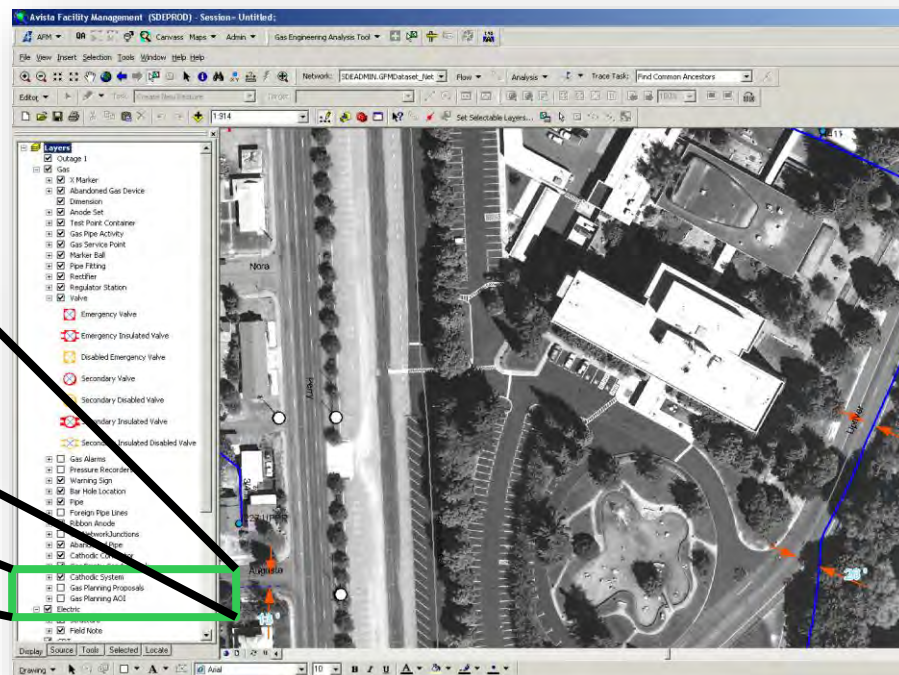
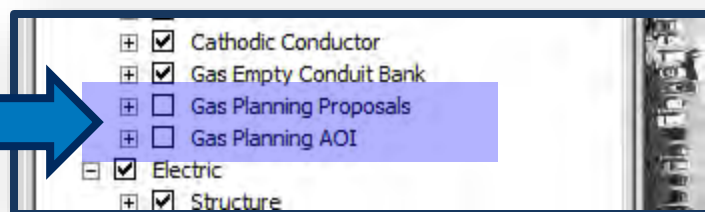

Gas Planning Proposals

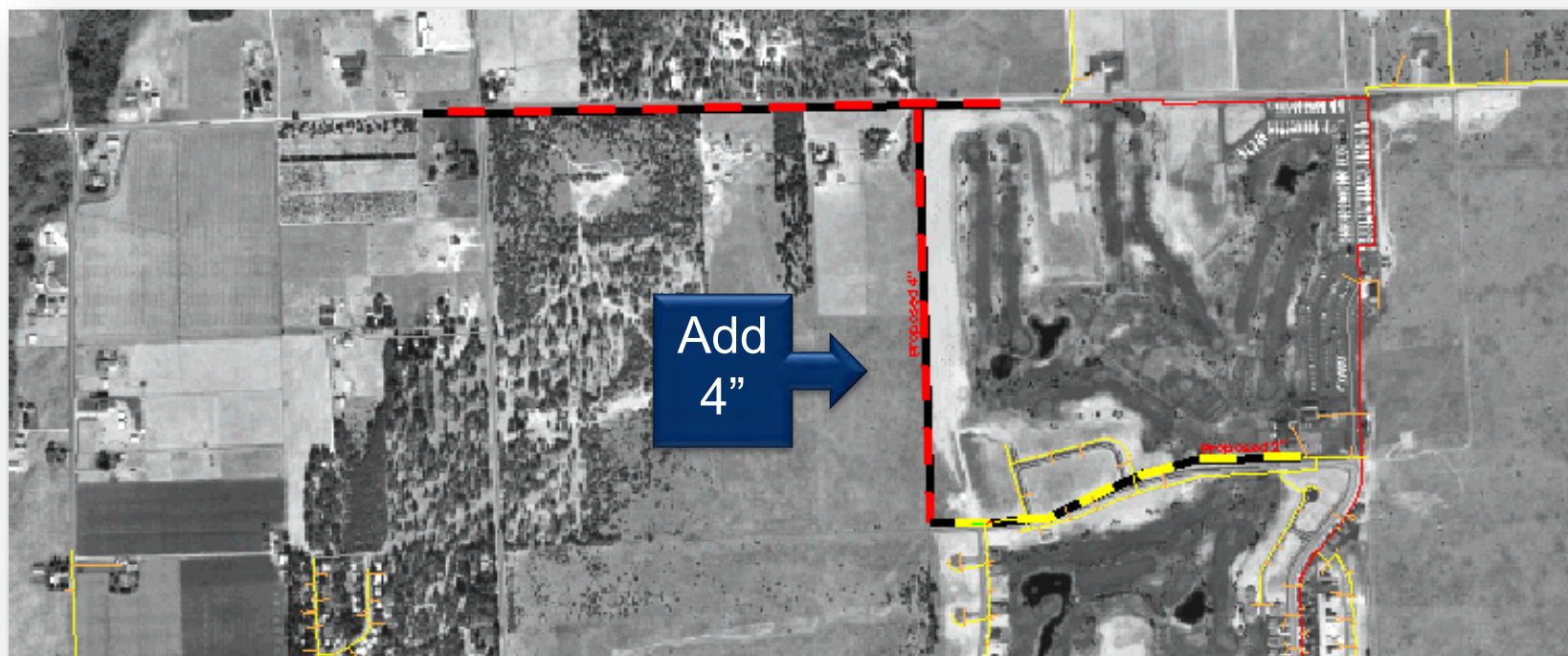

Gas Planning AOI

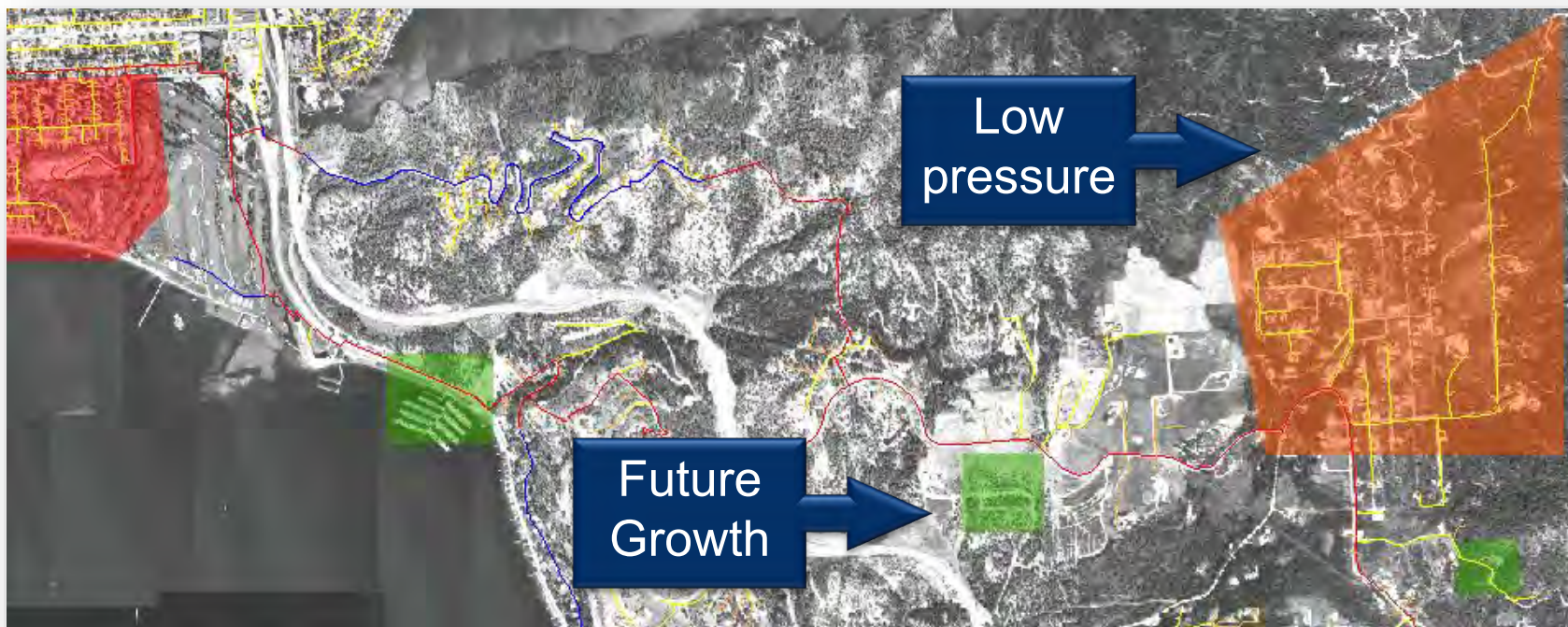

- Gas Planning AOI
 - Area Type
 - Critical Pressure
 - Low Pressure
 - Miscellaneous
 - New Developments
- Avista Corp

Gate Station Capacity Review

Exh. JM-2



**NORTHWEST PIPELINE GP
DELIVERY AND RECEIPT POINT SYSTEM MAP**
DWG. NO. 1000.3-68 - February 2011



DELIVERY POINTS				DELIVERY POINTS			
NO.	NAME	STATE	COORDINATES	NO.	NAME	STATE	COORDINATES
1	1
2	2
3	3
4	4
5	5
6	6
7	7
8	8
9	9
10	10
11	11
12	12
13	13
14	14
15	15
16	16
17	17
18	18
19	19
20	20
21	21
22	22
23	23
24	24
25	25
26	26
27	27
28	28
29	29
30	30
31	31
32	32
33	33
34	34
35	35
36	36
37	37
38	38
39	39
40	40
41	41
42	42
43	43
44	44
45	45
46	46
47	47
48	48
49	49
50	50
51	51
52	52
53	53
54	54
55	55
56	56
57	57
58	58
59	59
60	60
61	61
62	62
63	63
64	64
65	65
66	66
67	67
68	68
69	69
70	70
71	71
72	72
73	73
74	74
75	75
76	76
77	77
78	78
79	79
80	80
81	81
82	82
83	83
84	84
85	85
86	86
87	87
88	88
89	89
90	90
91	91
92	92
93	93
94	94
95	95
96	96
97	97
98	98
99	99
100	100

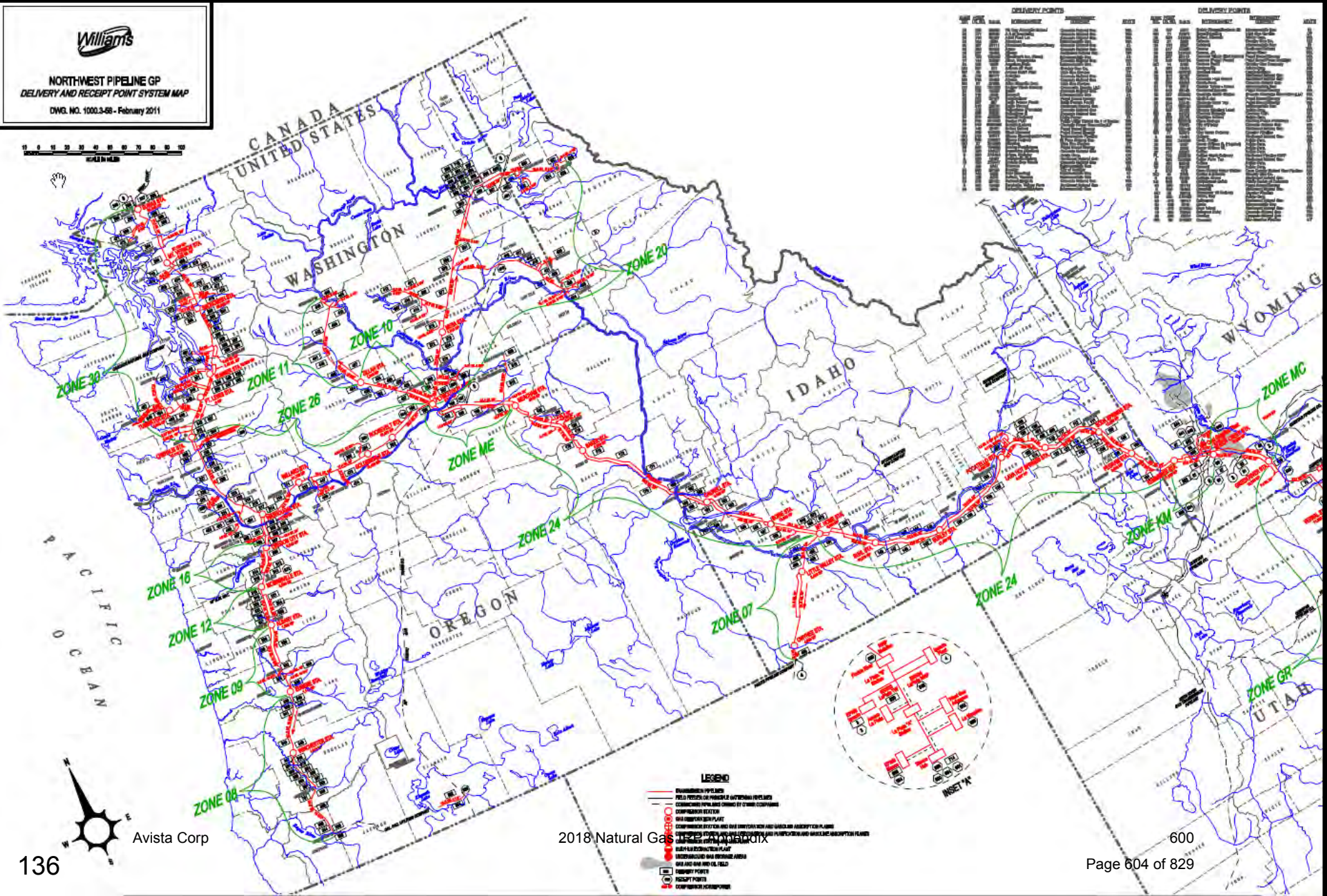

Avista Corp

2018 Natural Gas TRANSMISSION

600

Gate Station Capacity Review (example)

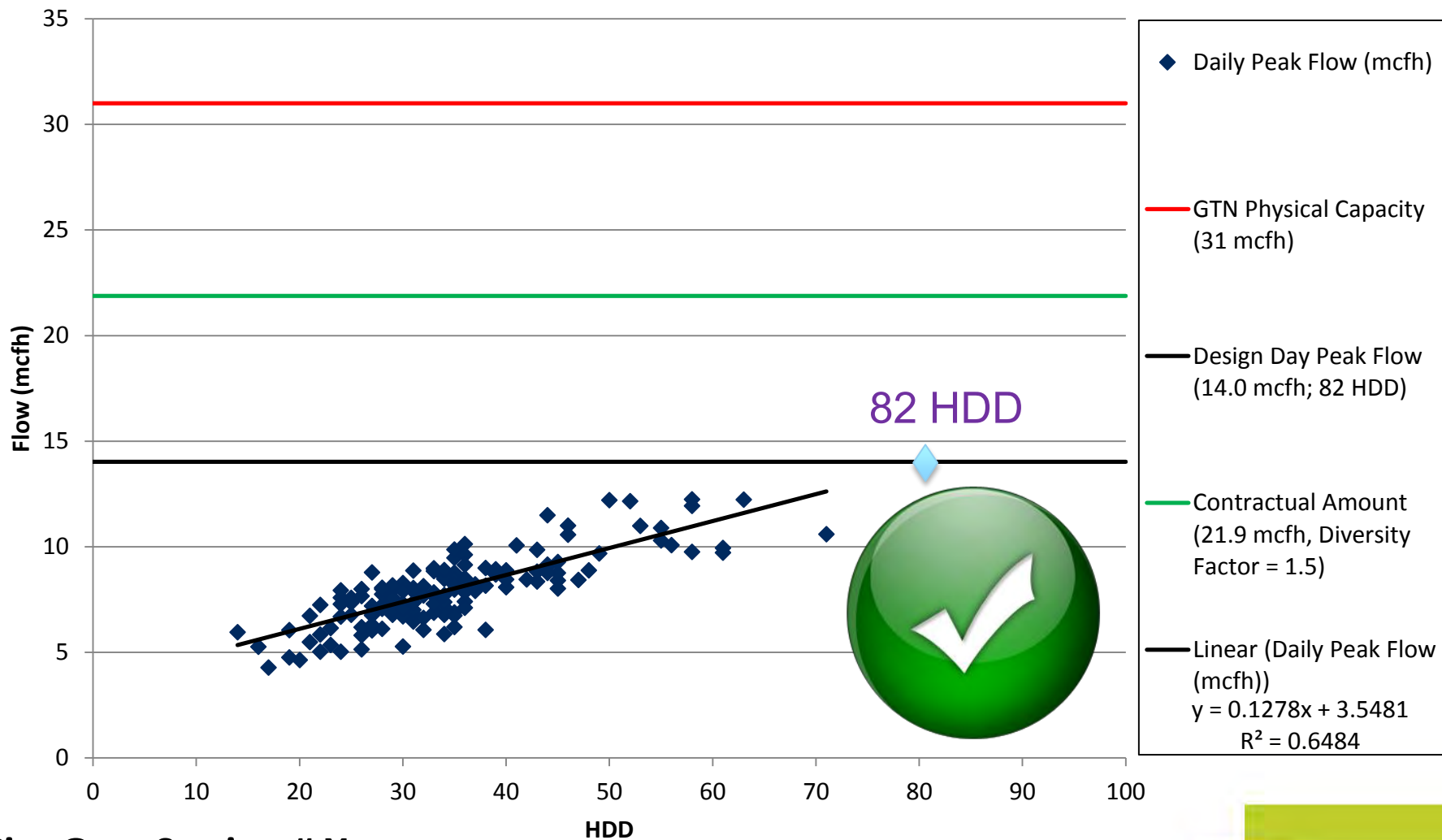

City Gate Station # X

Gate Station Capacity Review (example)

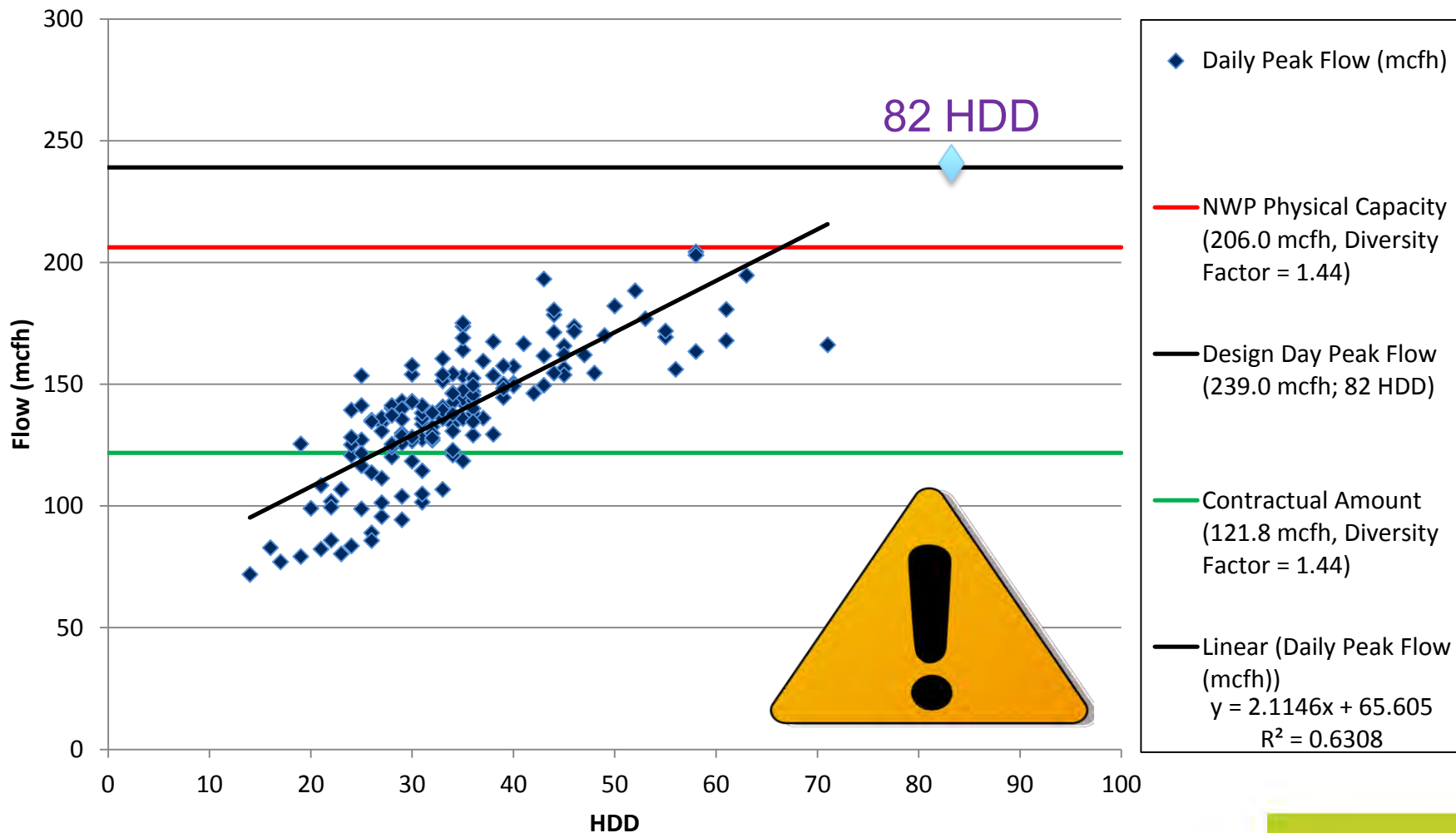

City Gate Station # Y



Current Projects and Examples



Hayden Lake High Pressure Reinforcement

Coeur d'Alene, ID

Hayden Lake
Completed Proposal:
17,300' 6" HP steel
2 new regulator
stations

**Facilities Color By:
Internal Diameter (inches)**

- < 1.900
- 1.900 – 2.800
- 2.800 – 3.670
- 3.670 – 5.400
- 5.400 – 7.900
- 7.900 – 10.000
- 10.000 – 12.000
- 12.000 – 13.000
- > 13.000

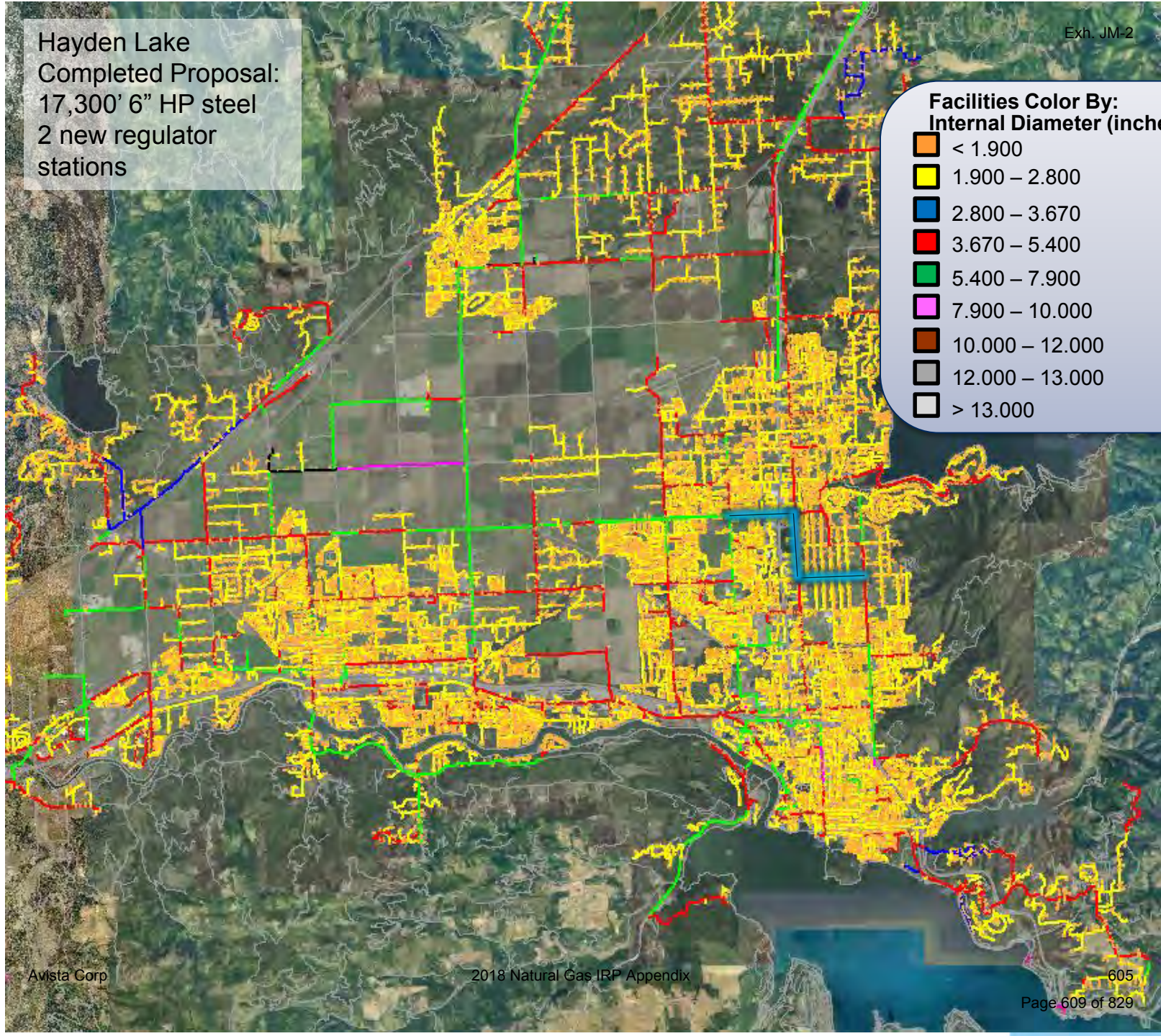



End of existing 6" HP

Prairie Ave

Ramsey Rd

Hwy 95

Hanley Rd

Government Way

15th St



Tie-in to 4" IP Main



Tie-in to 4" IP Main

17,300' of 6" Steel HP and two regulator stations

Coeur d'Alene Lake HP Reinforcement Before reinforcement

0 HDD

Exh. JM 2

Facilities Color By:
Pressure (psig)

White	0.00
Red	0.01 – 15.00
Yellow	15.01 – 30.00
Green	30.01 – 45.00
Blue	45.01 – 60.00
Magenta	> 60.01

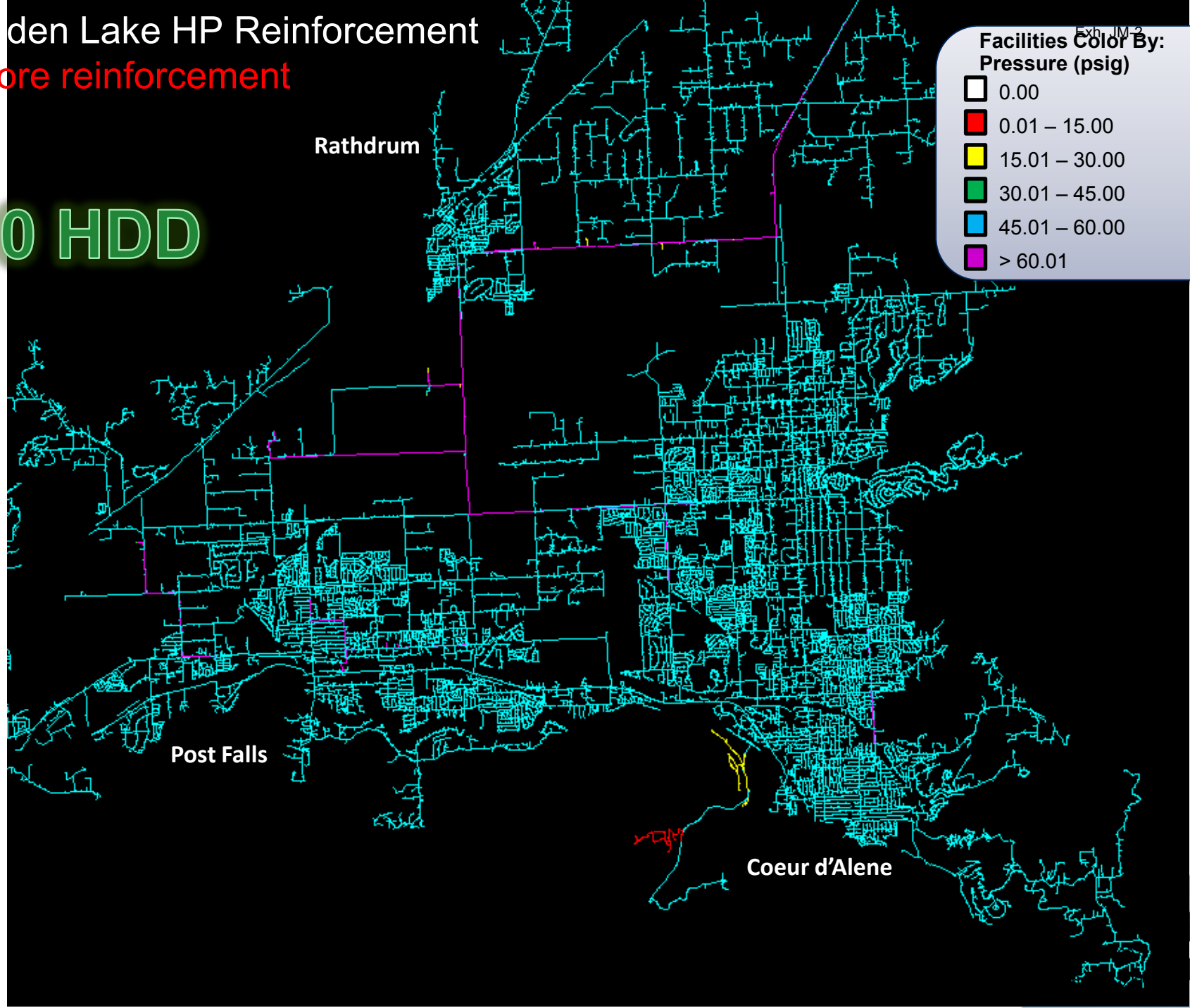

Idaho Lake HP Reinforcement Before reinforcement

20 HDD

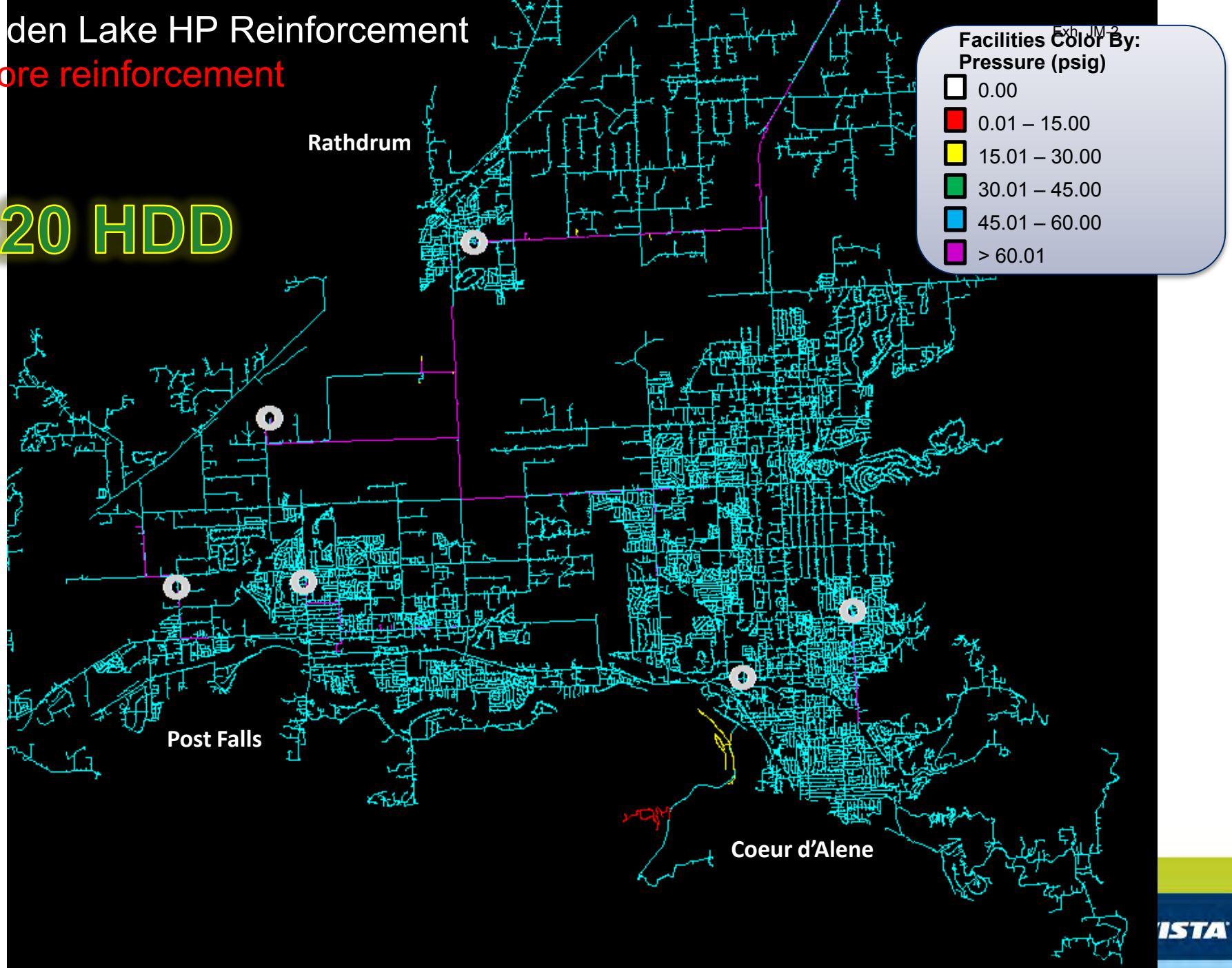

Idaho Lake HP Reinforcement Before reinforcement

40 HDD

Exhibit JM 2

Facilities Color By:
Pressure (psig)

White	0.00
Red	0.01 – 15.00
Yellow	15.01 – 30.00
Green	30.01 – 45.00
Cyan	45.01 – 60.00
Magenta	> 60.01

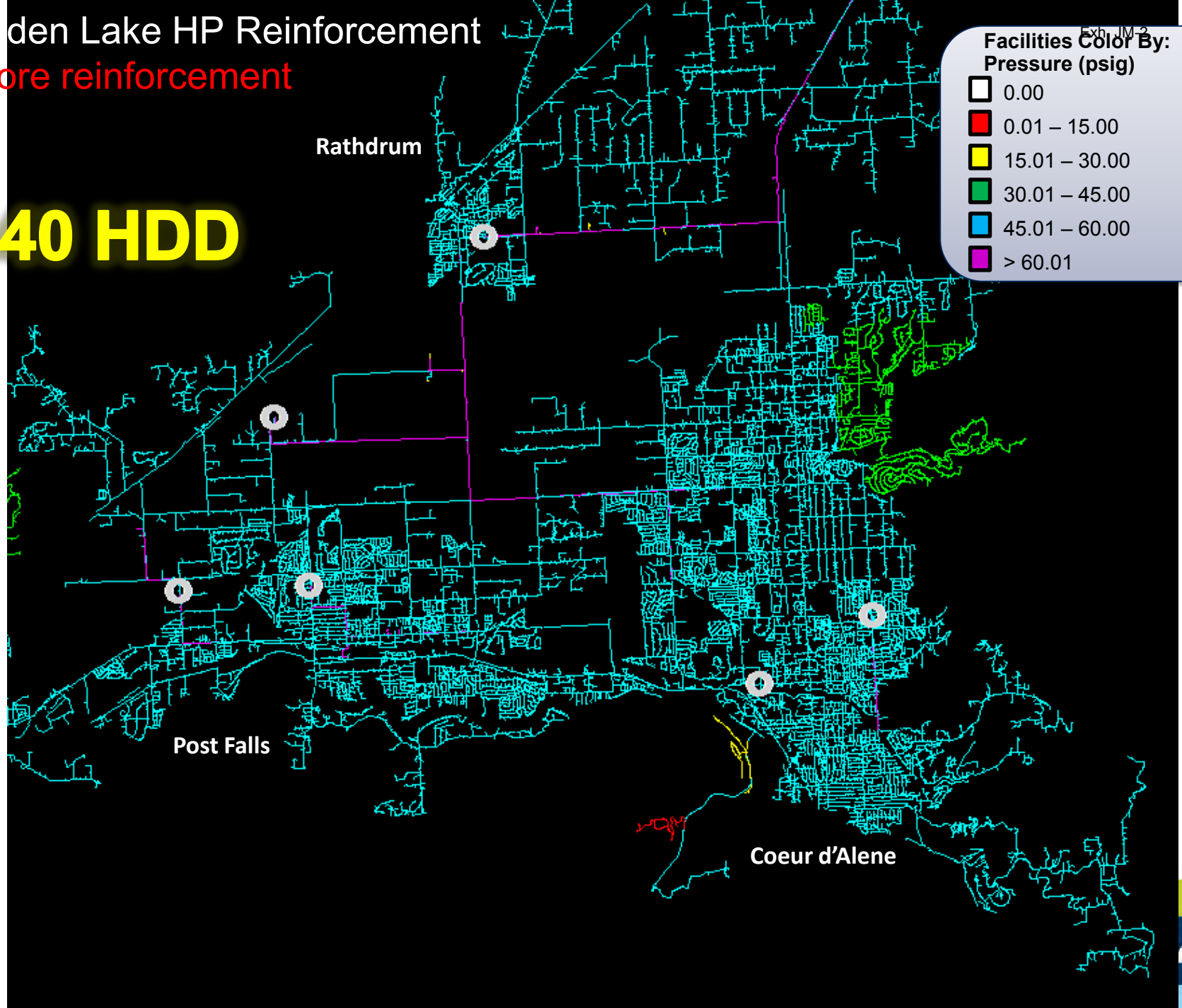

den Lake HP Reinforcement Before reinforcement

60 HDD

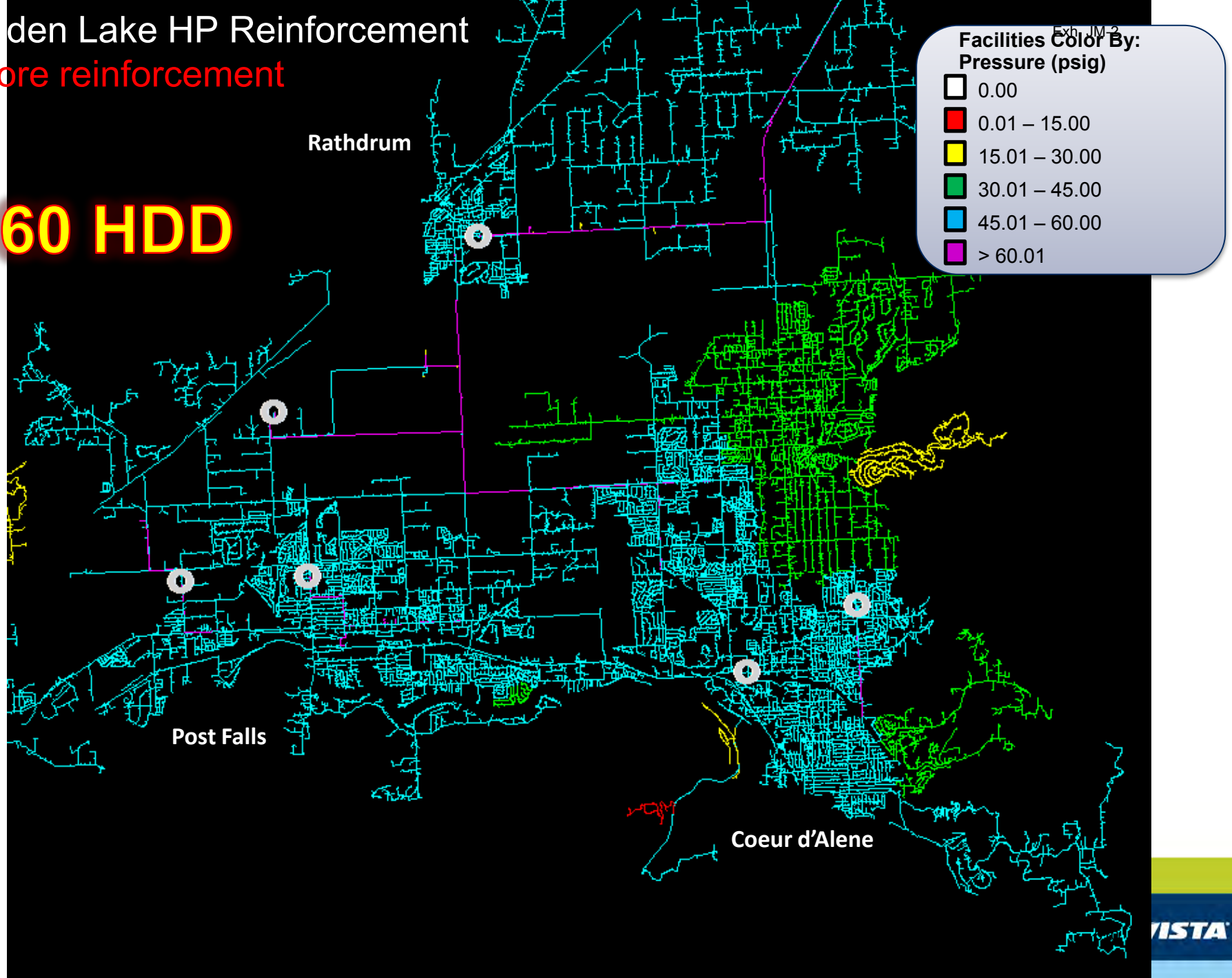

den Lake HP Reinforcement

Before reinforcement

77 HDD

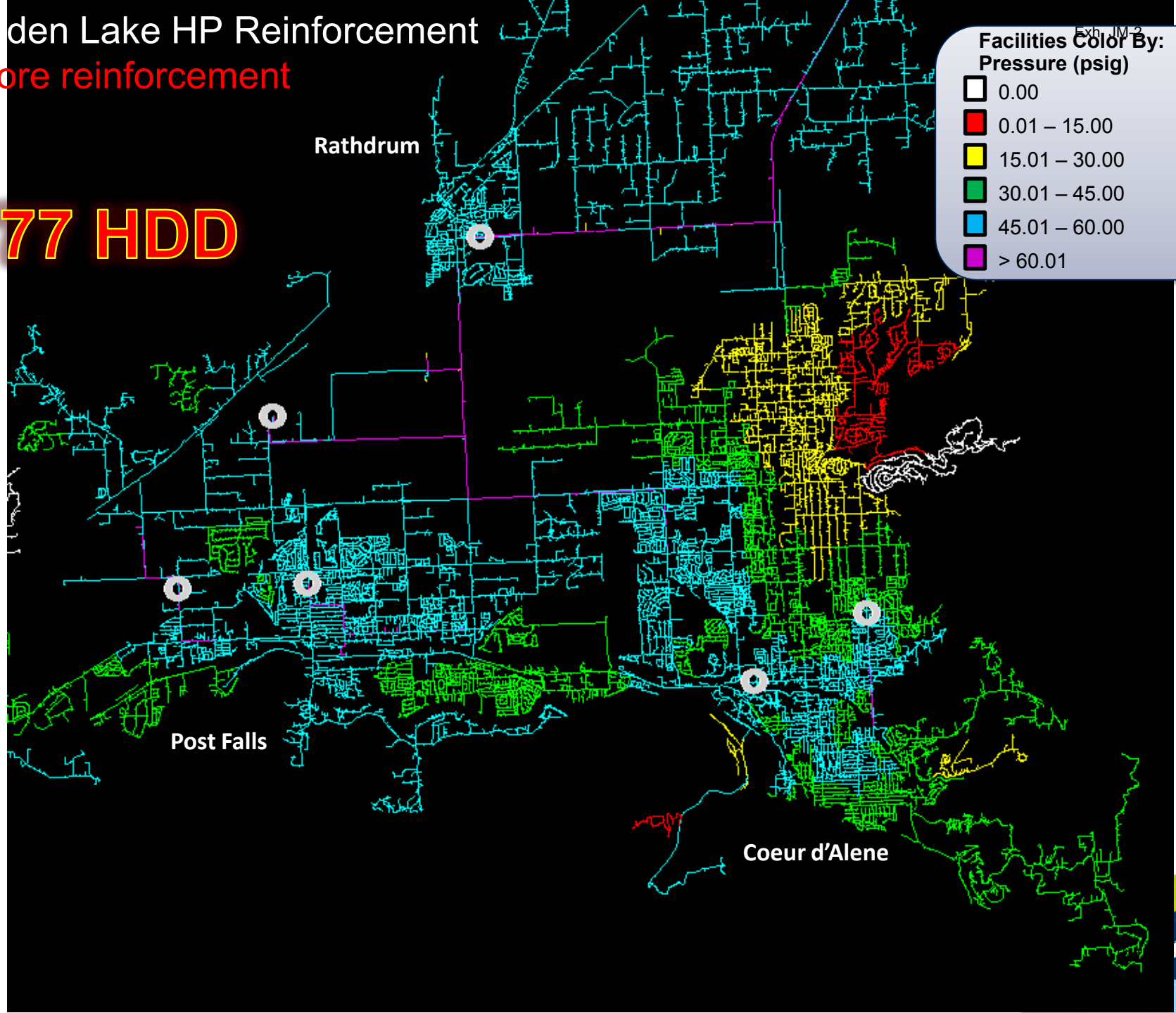

den Lake HP Reinforcement After reinforcement

60 HDD

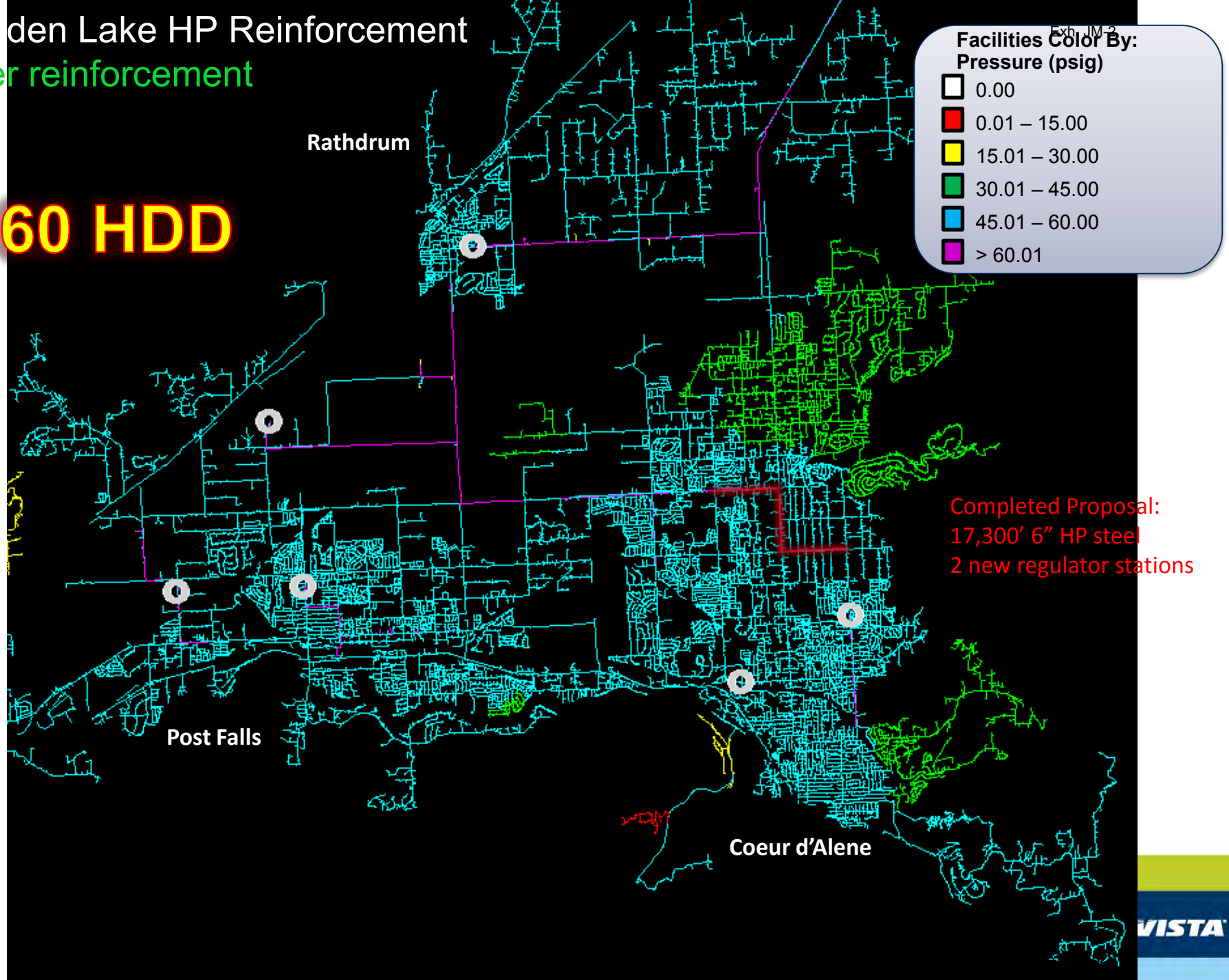

den Lake HP Reinforcement After reinforcement

77 HDD

Exhibit JM 2

**Facilities Color By:
Pressure (psig)**

- 0.00
- 0.01 – 15.00
- 15.01 – 30.00
- 30.01 – 45.00
- 45.01 – 60.00
- > 60.01

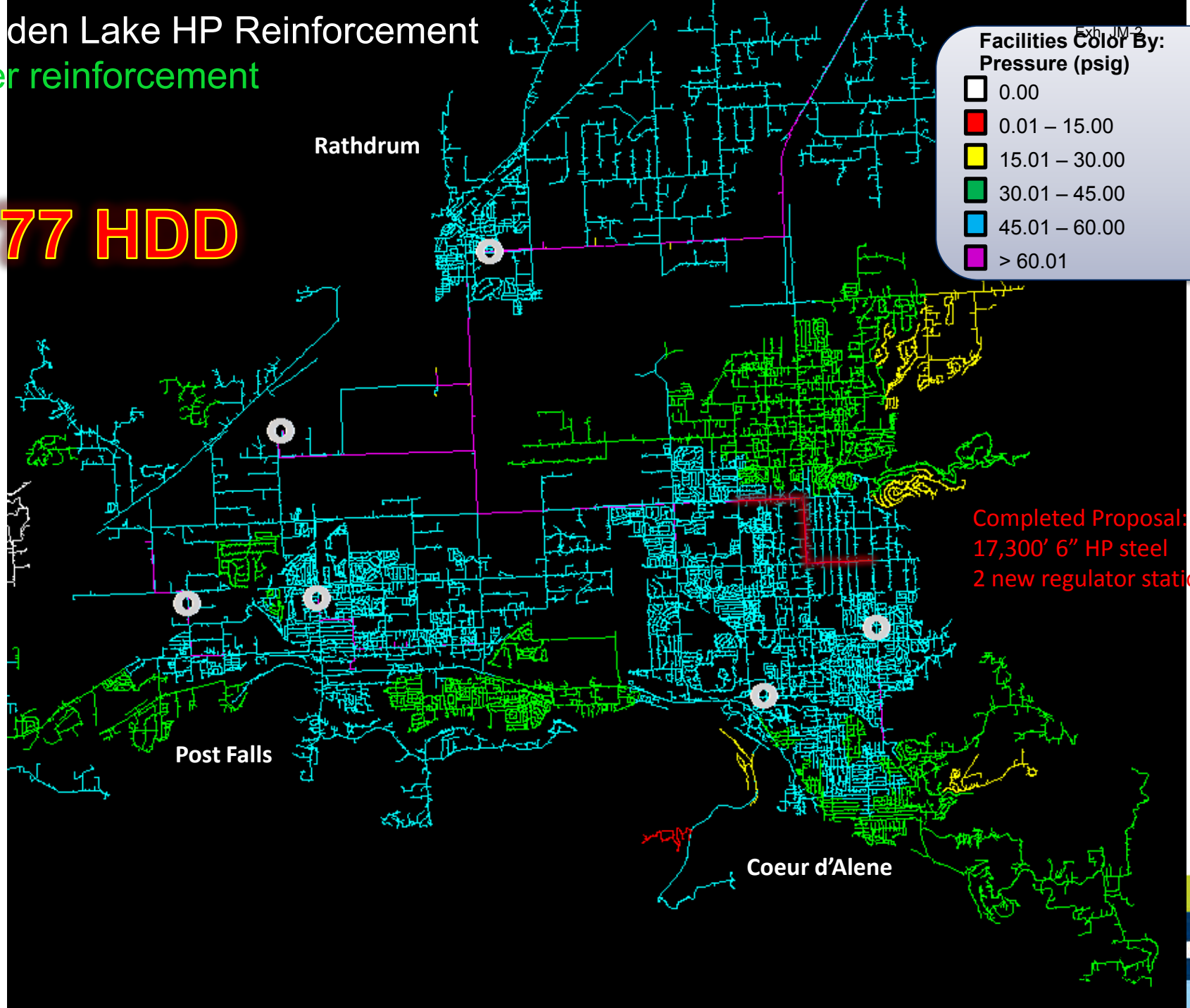

Completed Proposal:
17,300' 6" HP steel
2 new regulator stations

Portable Pressure Monitor

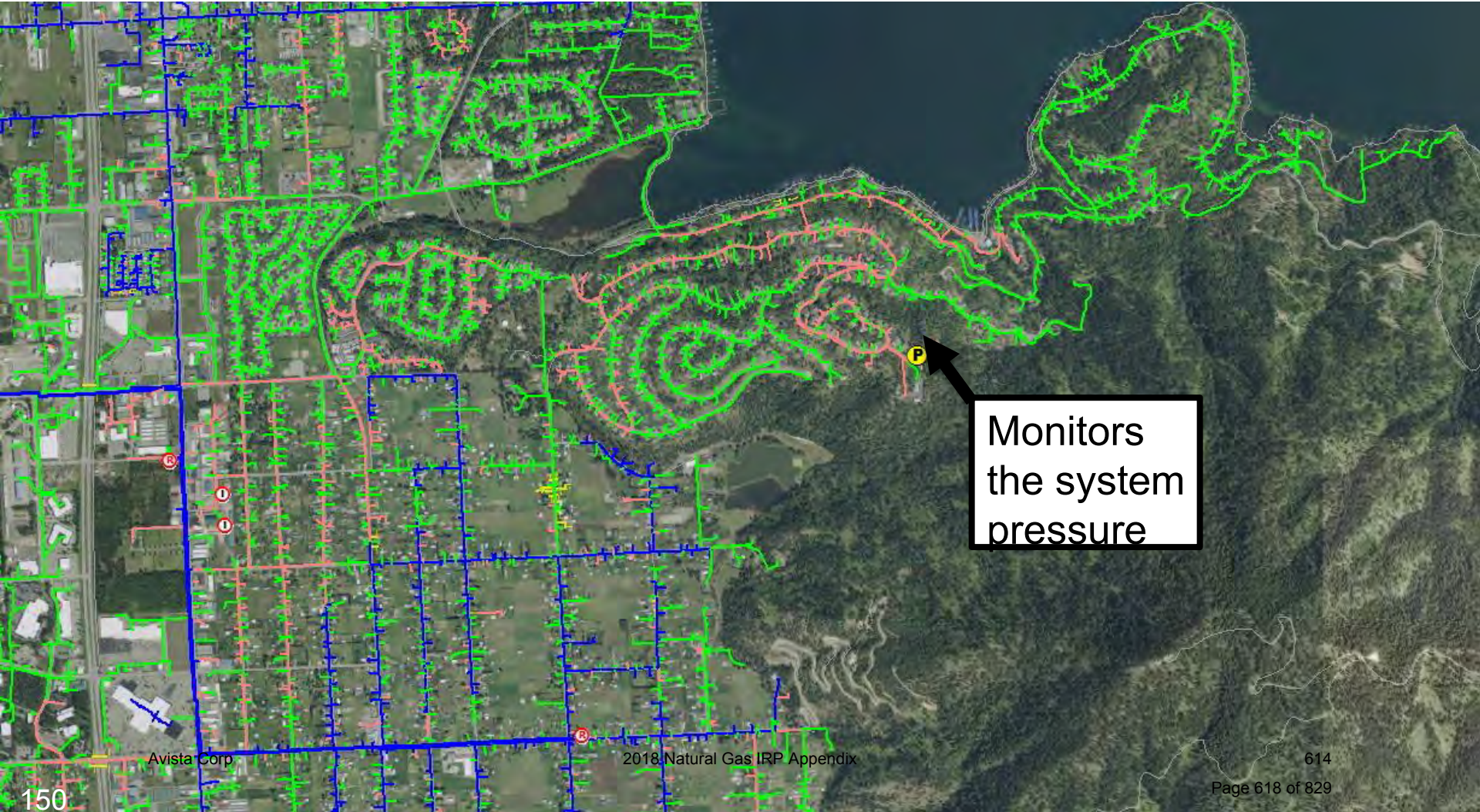

Hayden Lake Pressures Before & After

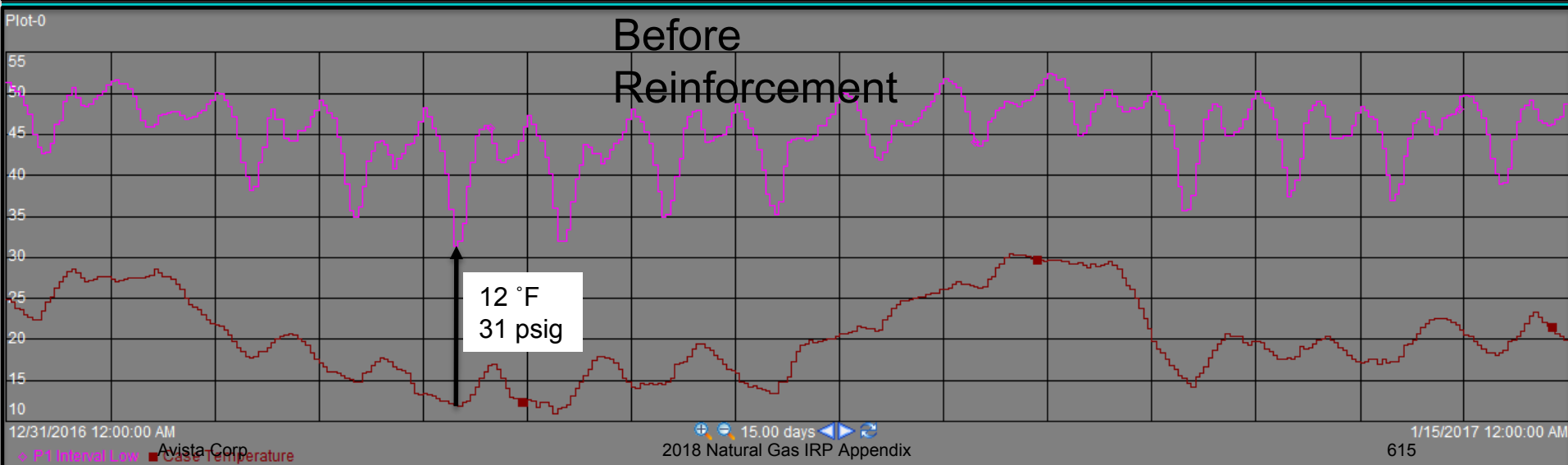
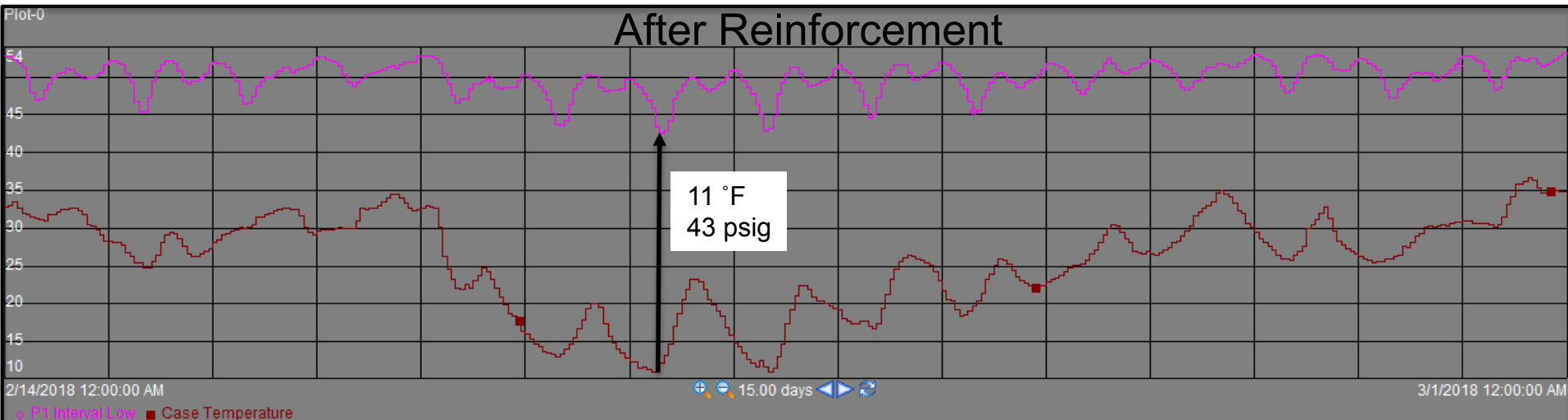

Hayden Lake H.P. Reinforcement





East Medford H.P. Reinforcement

Medford, OR

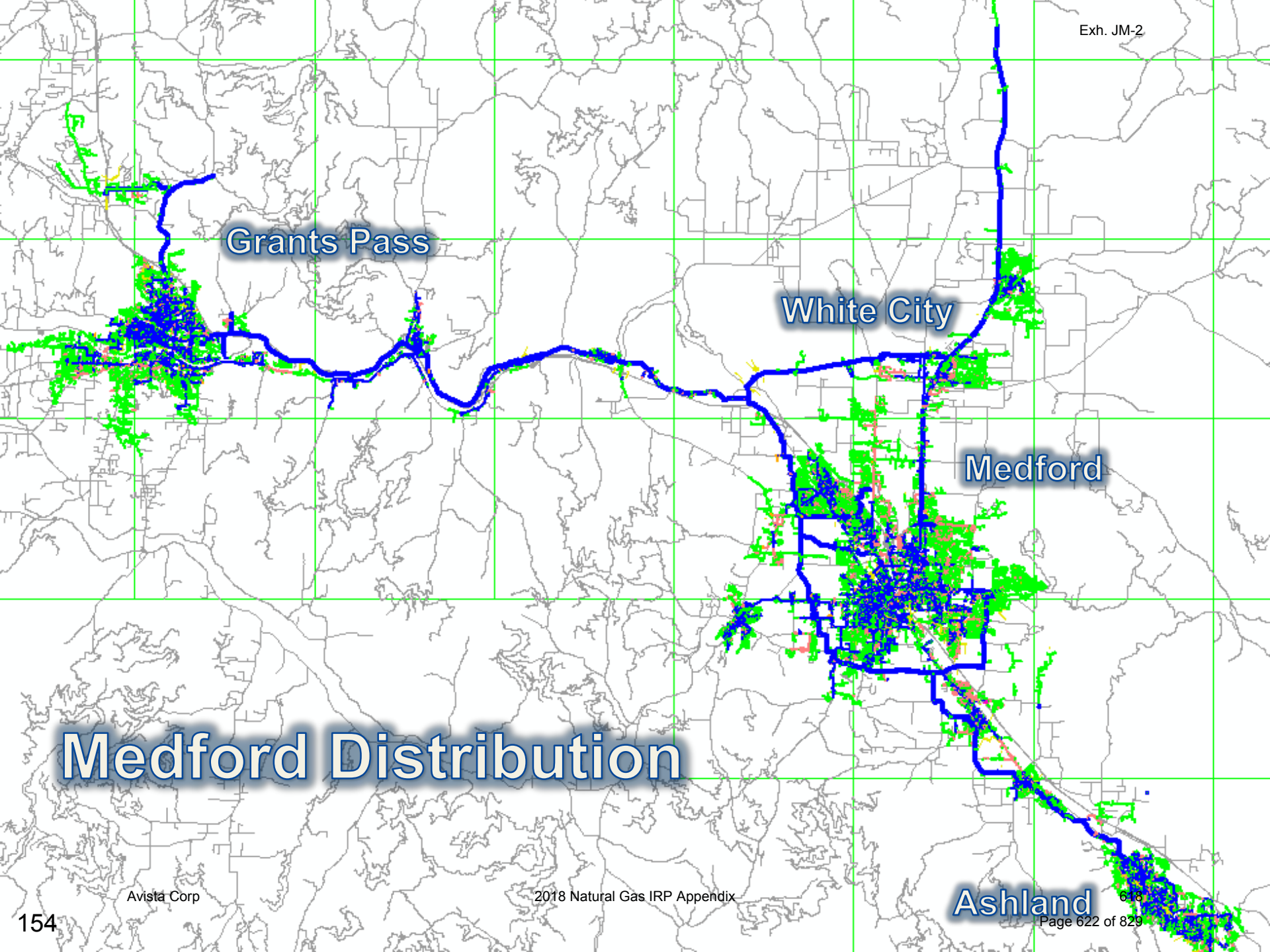

Grants Pass

White City





Medford

Medford Distribution

Ashland

Medford
Completed
Proposal:
16,000' 12" HP steel

**Facilities Color By:
Internal Diameter (inches)**

-  < 1.900
-  1.900 – 2.800
-  2.800 – 3.670
-  3.670 – 5.400
-  5.400 – 7.900
-  7.900 – 10.000
-  10.000 – 12.000
-  12.000 – 13.000
-  > 13.000

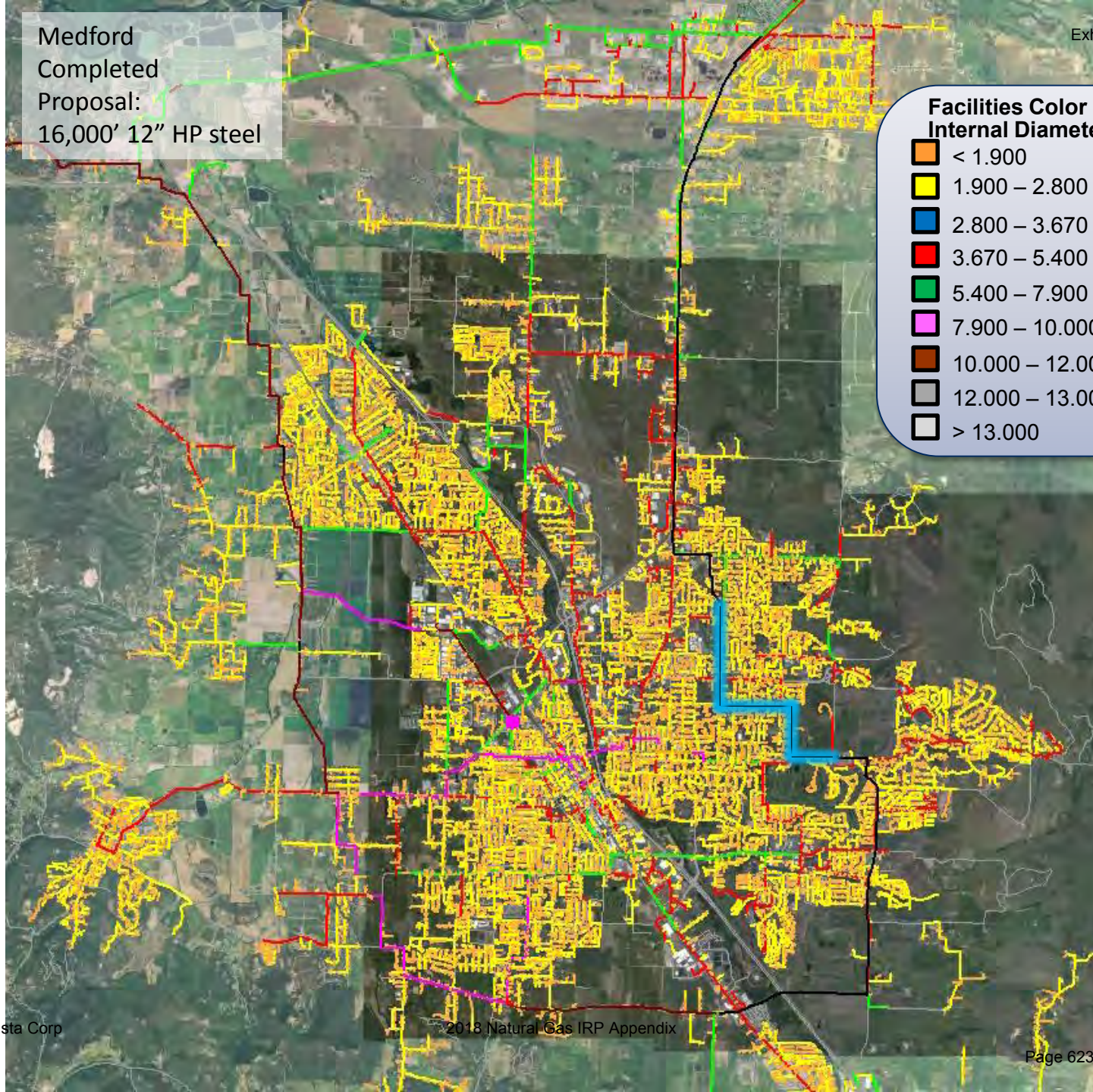

Ord HP Reinforcement

Exh. JM-2

Before reinforcement

0 HDD

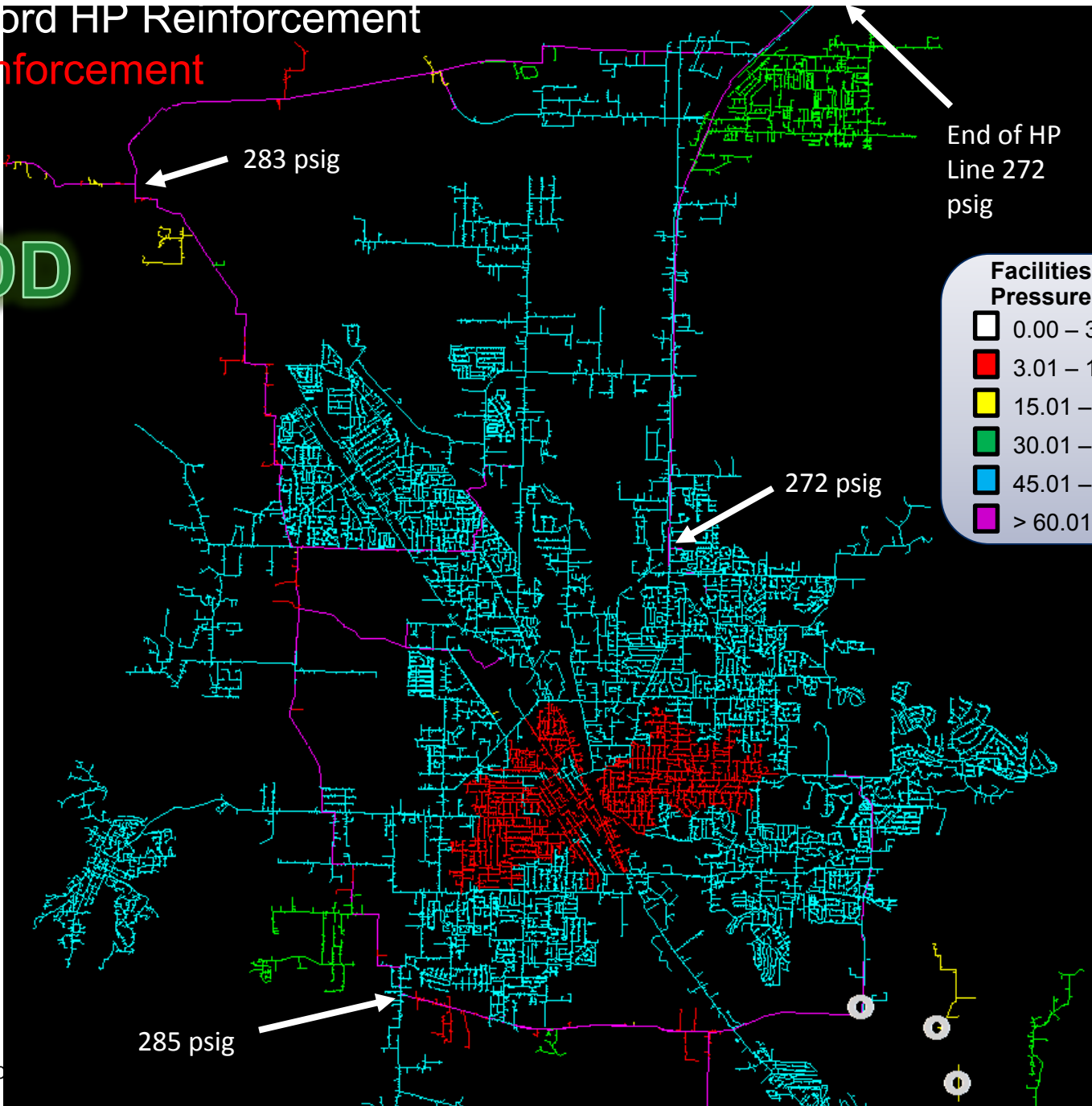

ord HP Reinforcement

Exh. JM-2

Before reinforcement

20 HDD

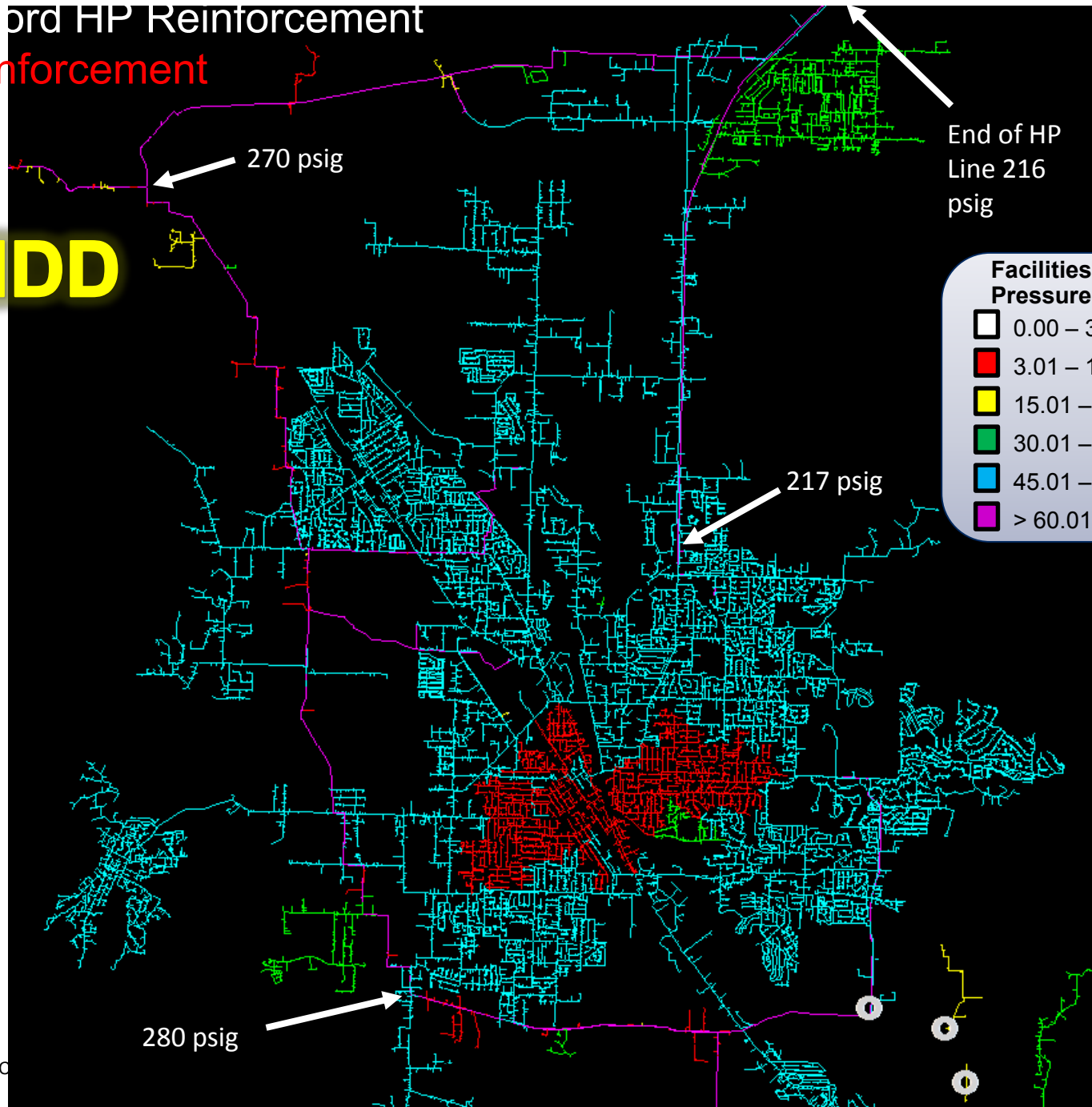

Facilities Color By: Pressure (psig)

- 0.00 – 3.00
- 3.01 – 15.00
- 15.01 – 30.00
- 30.01 – 45.00
- 45.01 – 60.00
- > 60.01

Avista C



ord HP Reinforcement

Exh. JM-2

Before reinforcement

**40 HDD
(MAX)**

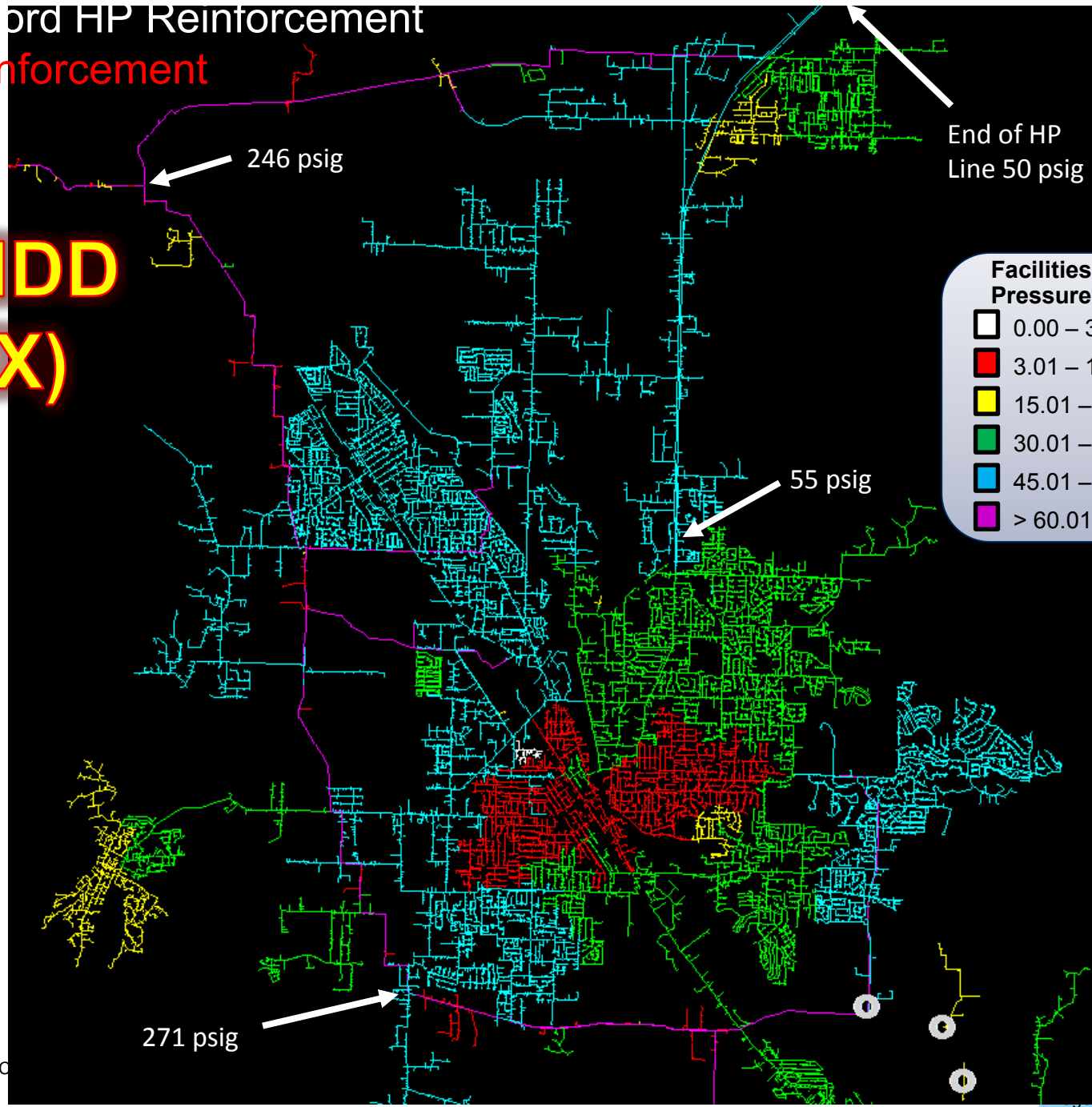

**Facilities Color By:
Pressure (psig)**

White	0.00 – 3.00
Red	3.01 – 15.00
Yellow	15.01 – 30.00
Green	30.01 – 45.00
Cyan	45.01 – 60.00
Magenta	> 60.01

Medford HP Reinforcement

After reinforcement

40 HDD

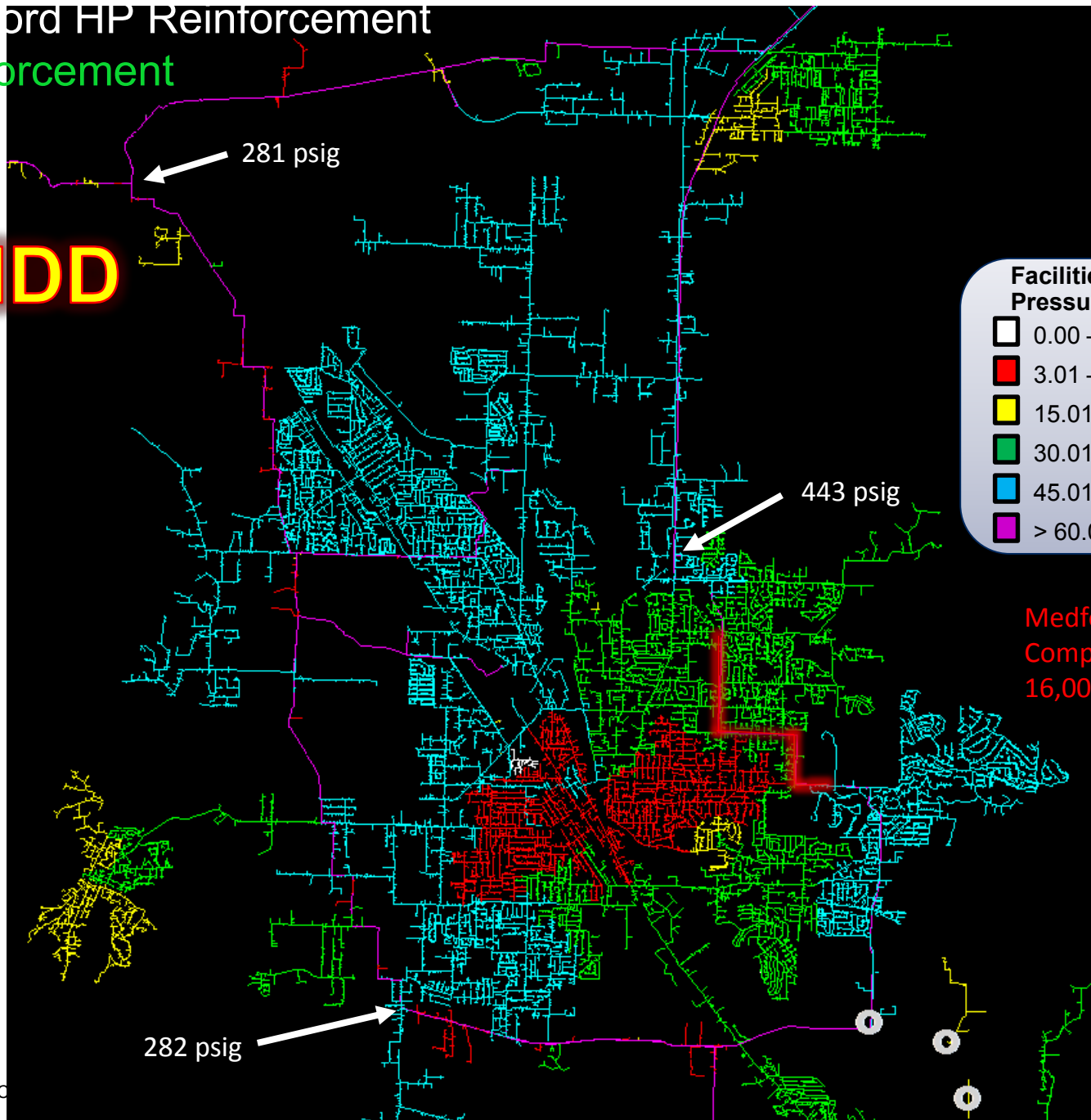

Medford
Completed Proposal:
16,000' 12" HP steel

After reinforcement

61 HDD

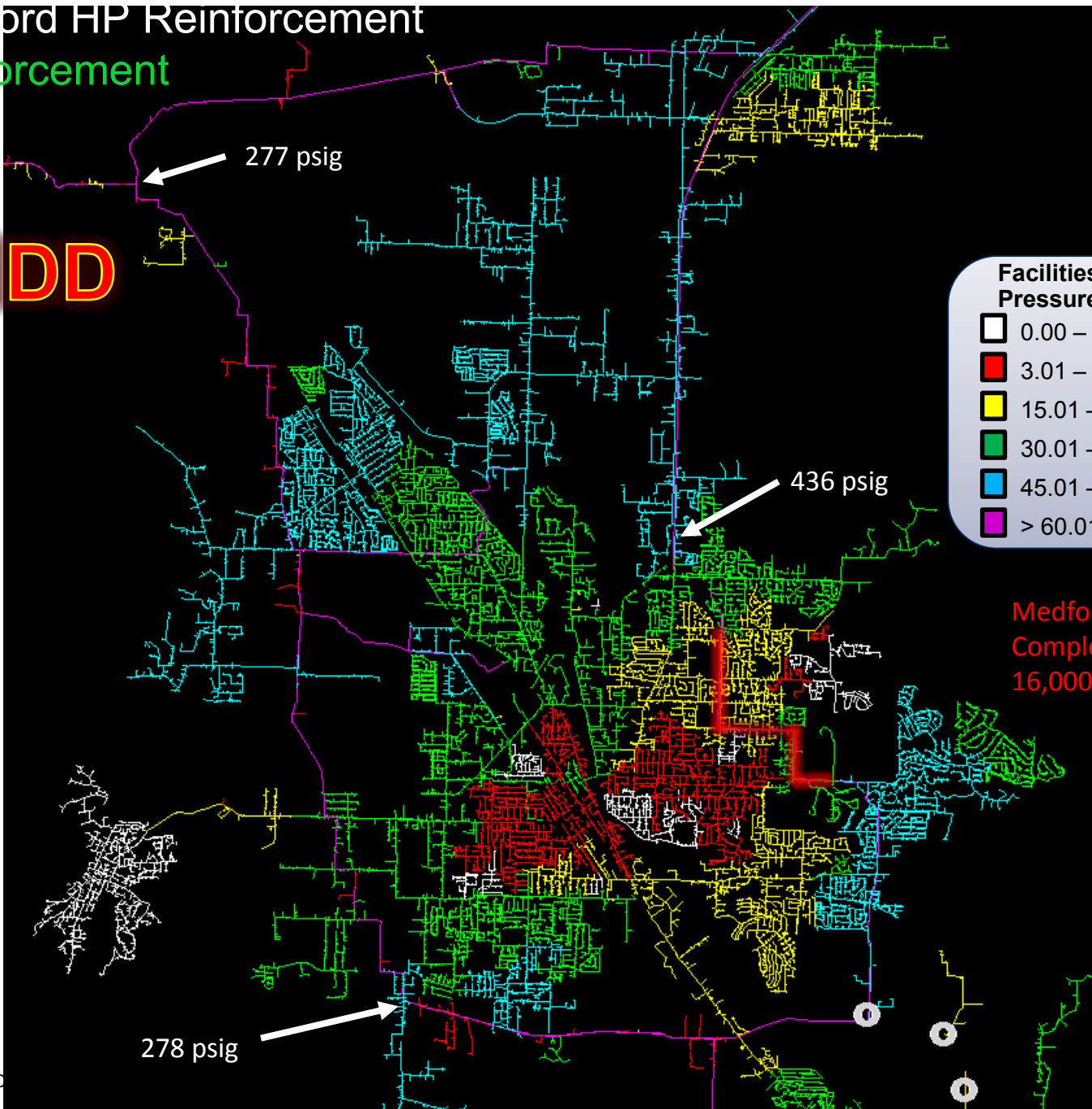

Facilities Color By: Pressure (psig)

- 0.00 – 3.00
- 3.01 – 15.00
- 15.01 – 30.00
- 30.01 – 45.00
- 45.01 – 60.00
- > 60.01

Medford
Completed Proposal:
16,000' 12" HP steel

East Medford H.P. Reinforcement





North Spokane H.P. Reinforcement

Spokane, WA

North Spokane
Completed Proposal:
11,500' 8" HP steel
1 new regulator station

**Facilities Color By:
Internal Diameter (inches)**

-  < 1.900
-  1.900 – 2.800
-  2.800 – 3.670
-  3.670 – 5.400
-  5.400 – 7.900
-  7.900 – 10.000
-  10.000 – 12.000
-  12.000 – 13.000
-  > 13.000

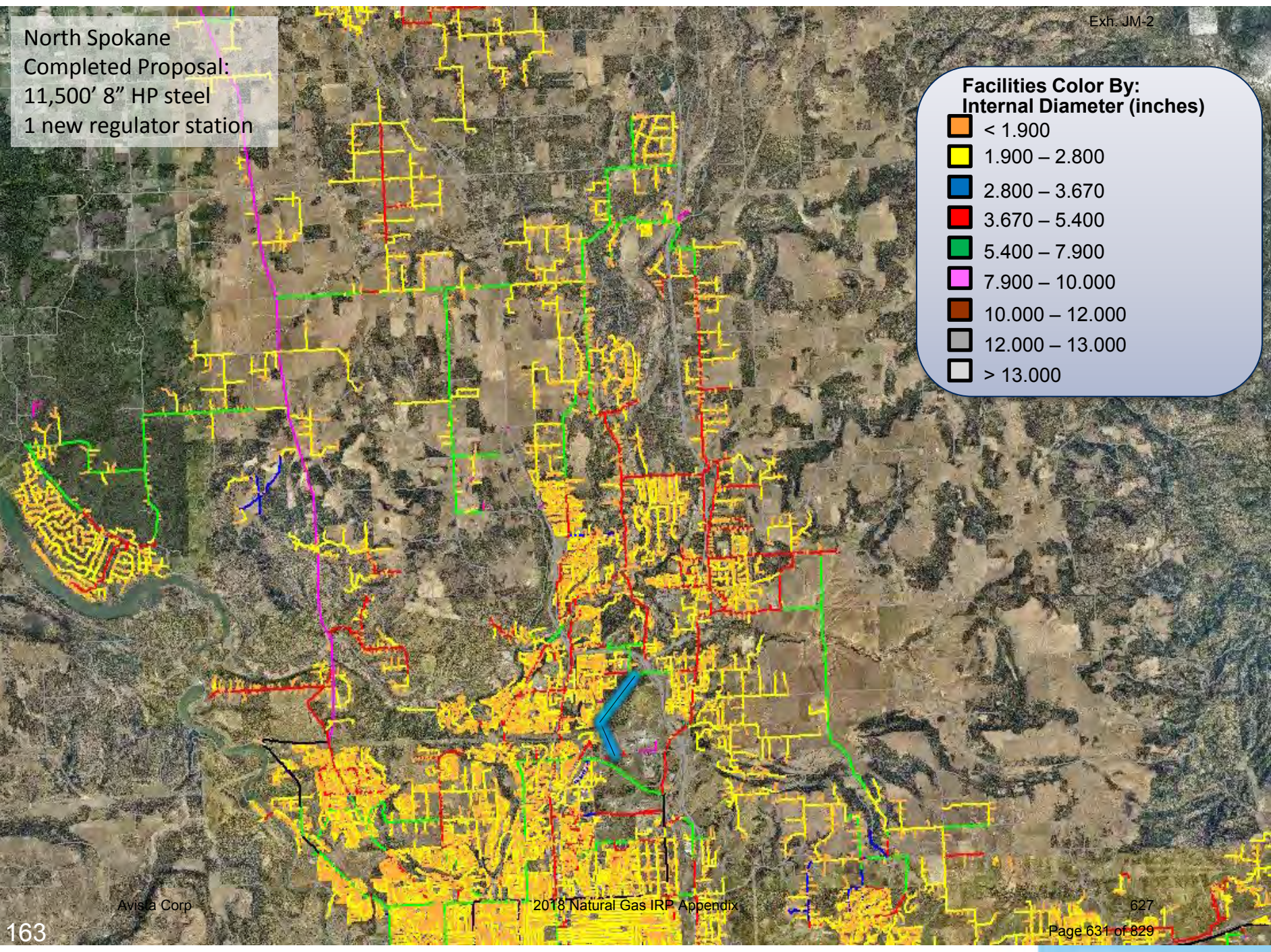

North Spokane
 Proposed 6" route
 (approx. 2 miles)

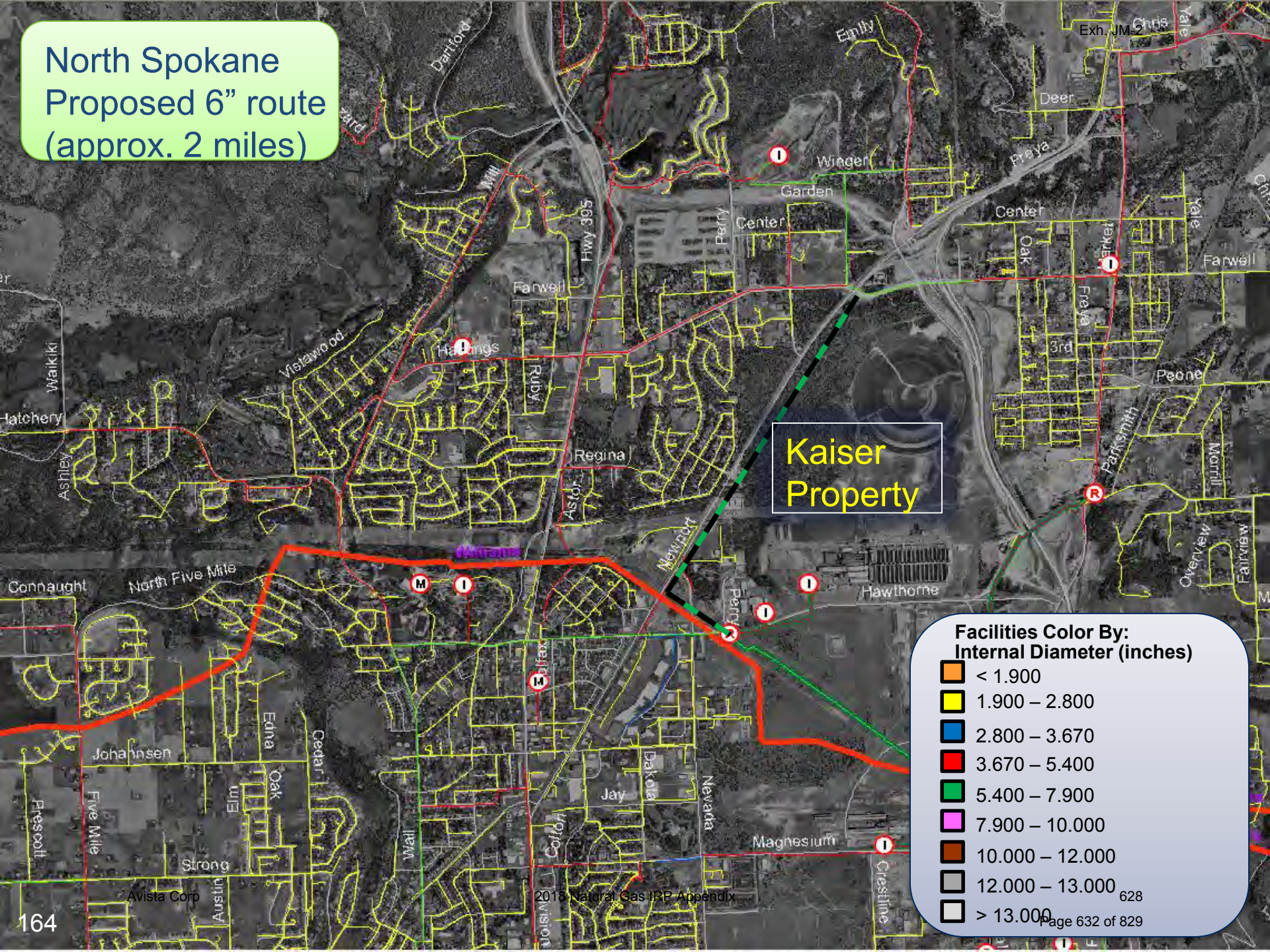

Kaiser
 Property

**Facilities Color By:
 Internal Diameter (inches)**

- < 1.900
- 1.900 – 2.800
- 2.800 – 3.670
- 3.670 – 5.400
- 5.400 – 7.900
- 7.900 – 10.000
- 10.000 – 12.000
- 12.000 – 13.000
- > 13.000

North Spokane HP Reinforcement

Before reinforcement

0 HDD

**Facilities Color By:
Pressure (psig)**

0.00
0.01 – 15.00
15.01 – 30.00
30.01 – 45.00
45.01 – 60.00
> 60.01

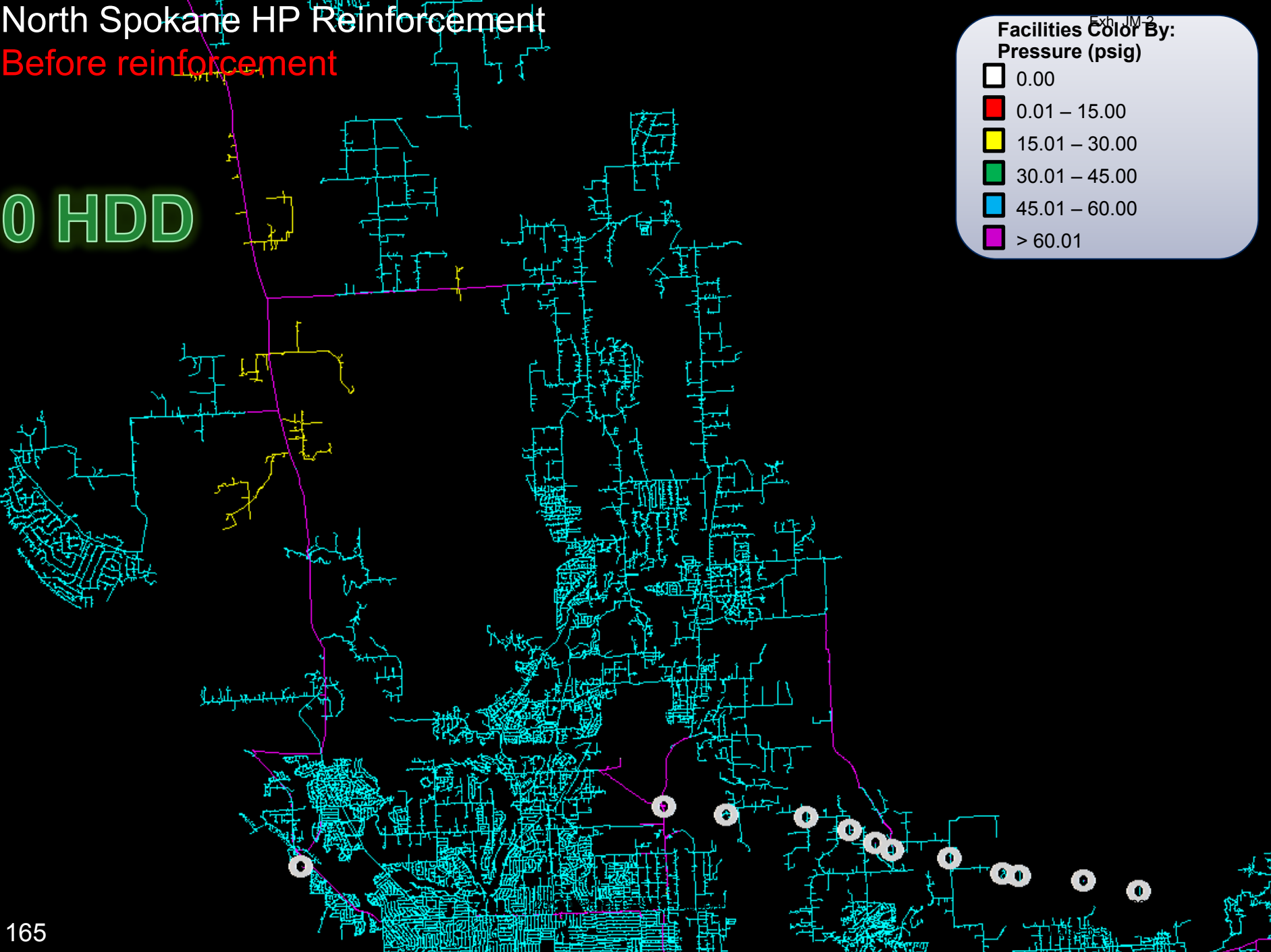

North Spokane HP Reinforcement

Before reinforcement

20 HDD

**Facilities Color By:
Pressure (psig)**

White	0.00
Red	0.01 – 15.00
Yellow	15.01 – 30.00
Green	30.01 – 45.00
Cyan	45.01 – 60.00
Magenta	> 60.01

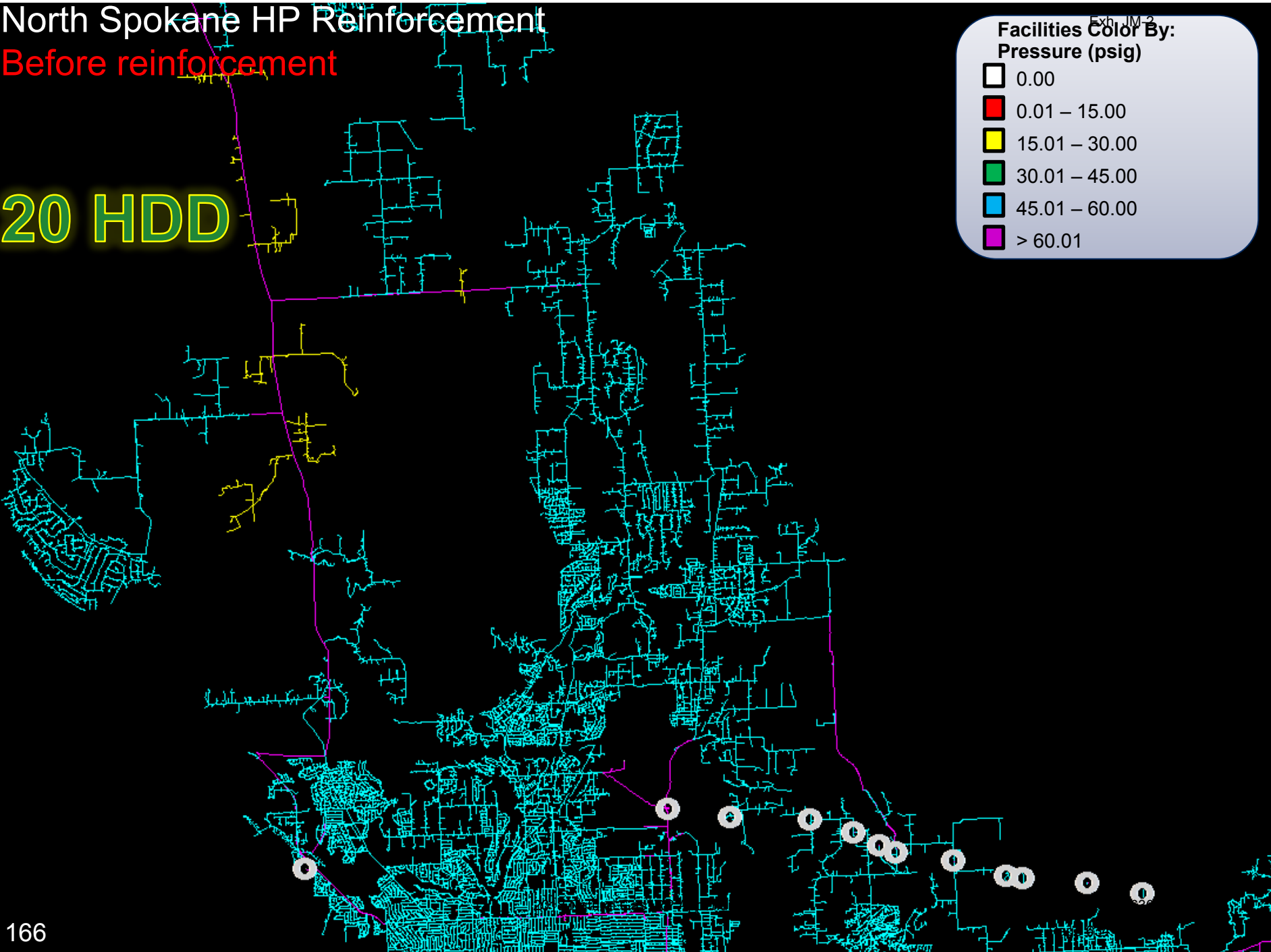

North Spokane HP Reinforcement

Before reinforcement

40 HDD

**Facilities Color By:
Pressure (psig)**

0.00
0.01 – 15.00
15.01 – 30.00
30.01 – 45.00
45.01 – 60.00
> 60.01

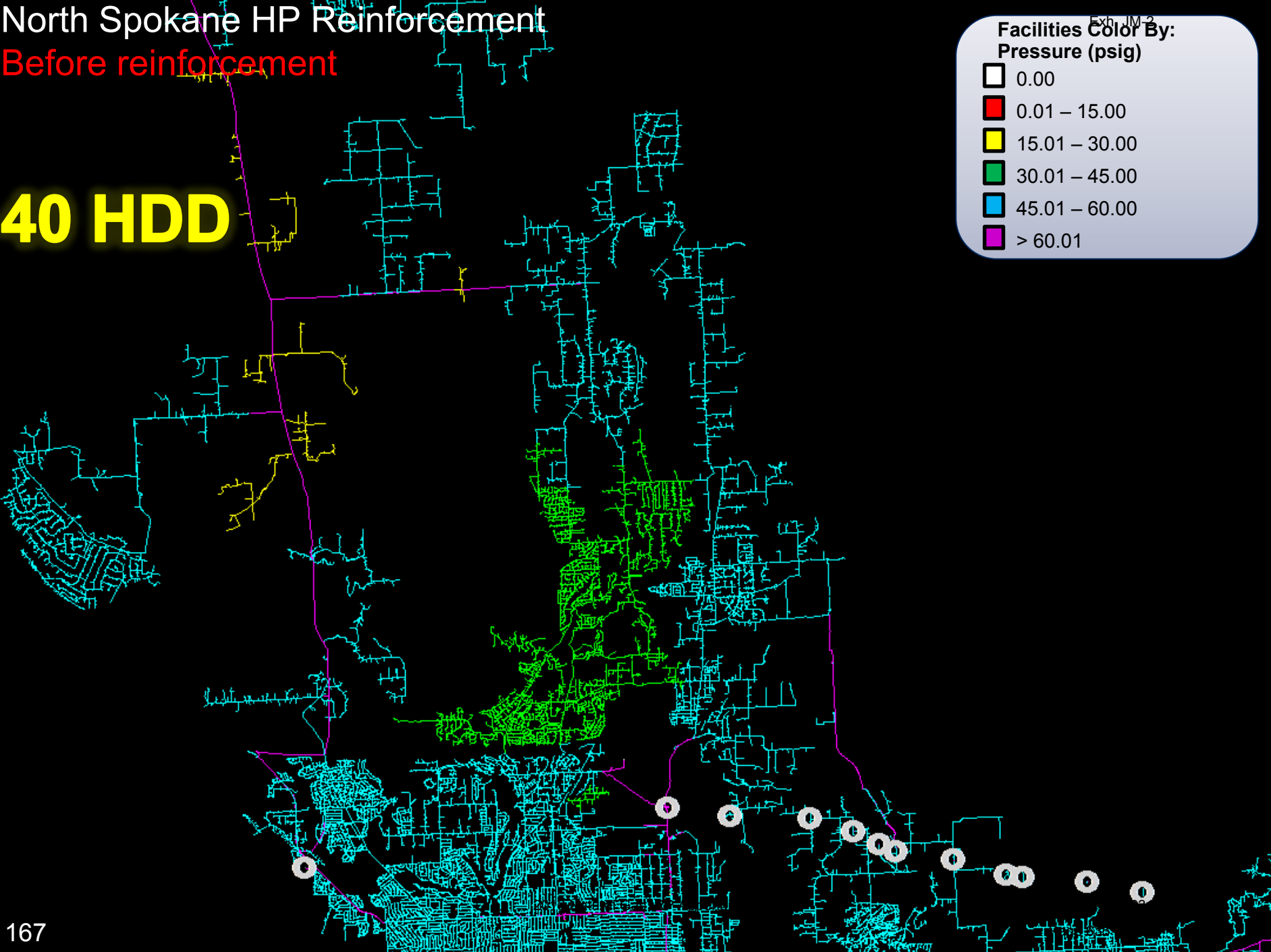

North Spokane HP Reinforcement

Before reinforcement

60 HDD

Exhibit 2

Facilities Color By:
Pressure (psig)

0.00
0.01 – 15.00
15.01 – 30.00
30.01 – 45.00
45.01 – 60.00
> 60.01

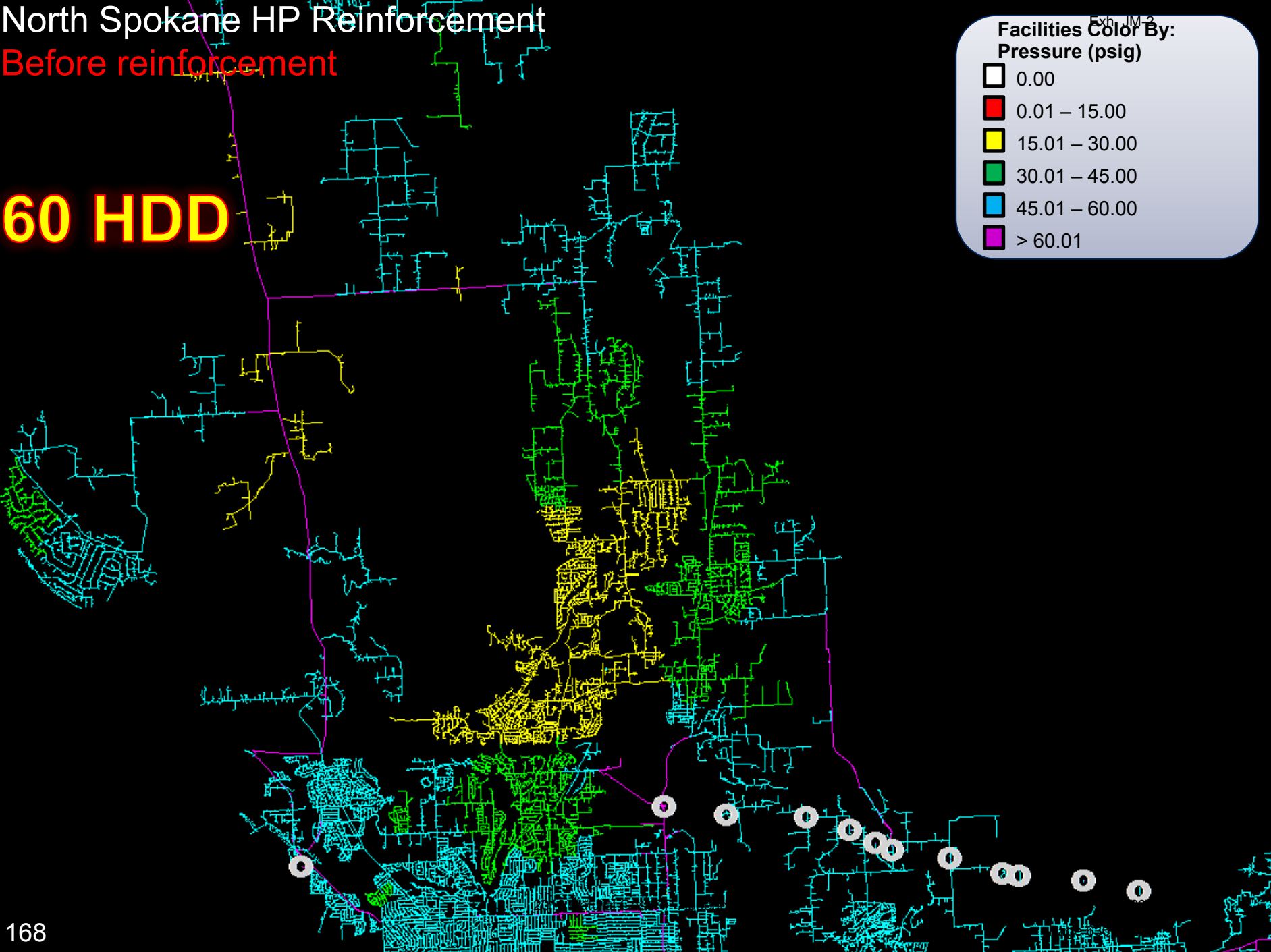

North Spokane HP Reinforcement

Before reinforcement

71 HDD
(MAX)

Exh JM 2

Facilities Color By:
Pressure (psig)

0.00
0.01 – 15.00
15.01 – 30.00
30.01 – 45.00
45.01 – 60.00
> 60.01

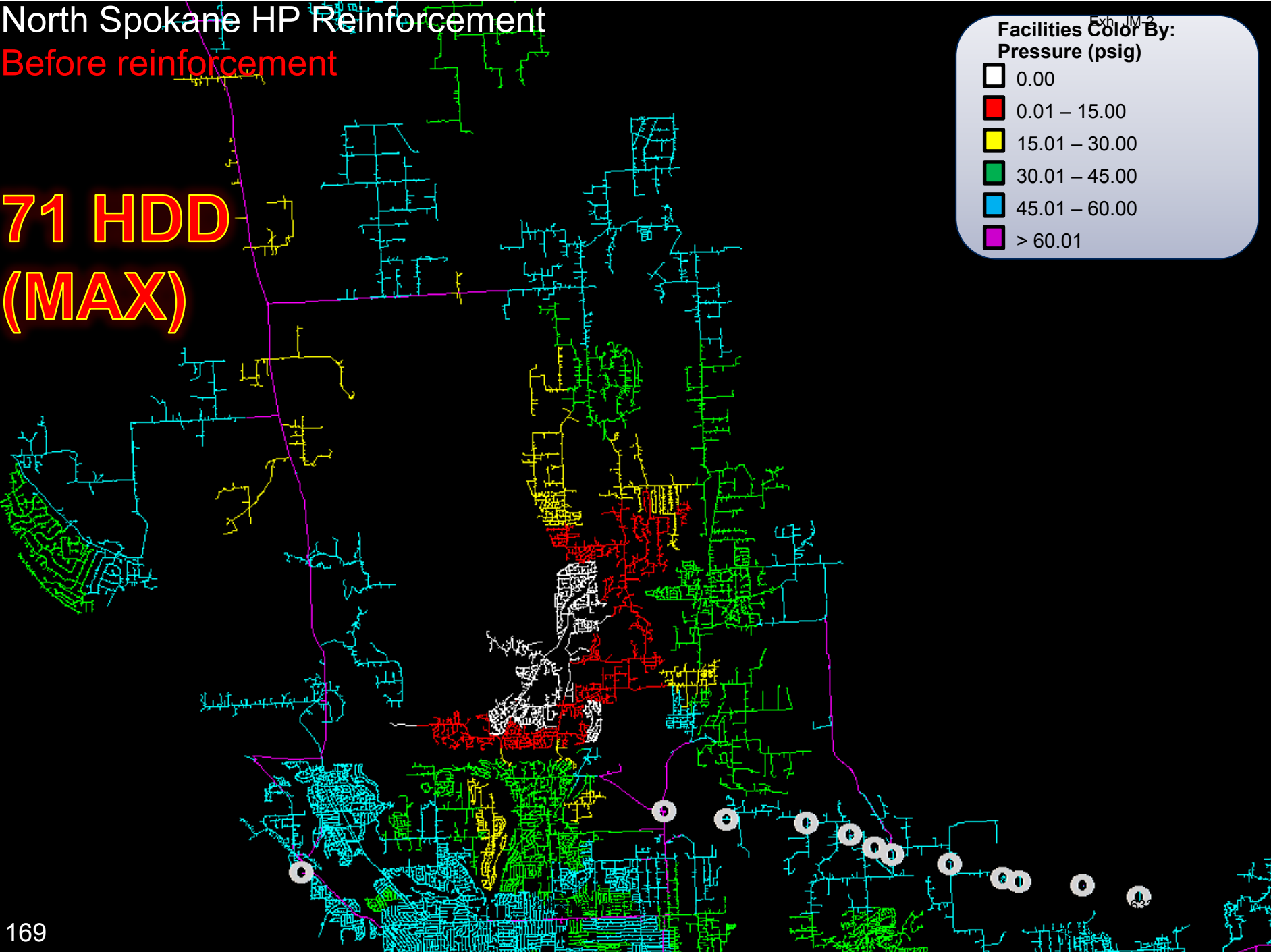

North Spokane HP Reinforcement

After reinforcement

60 HDD

Facilities Color By: Pressure (psig)

0.00
0.01 – 15.00
15.01 – 30.00
30.01 – 45.00
45.01 – 60.00
> 60.01

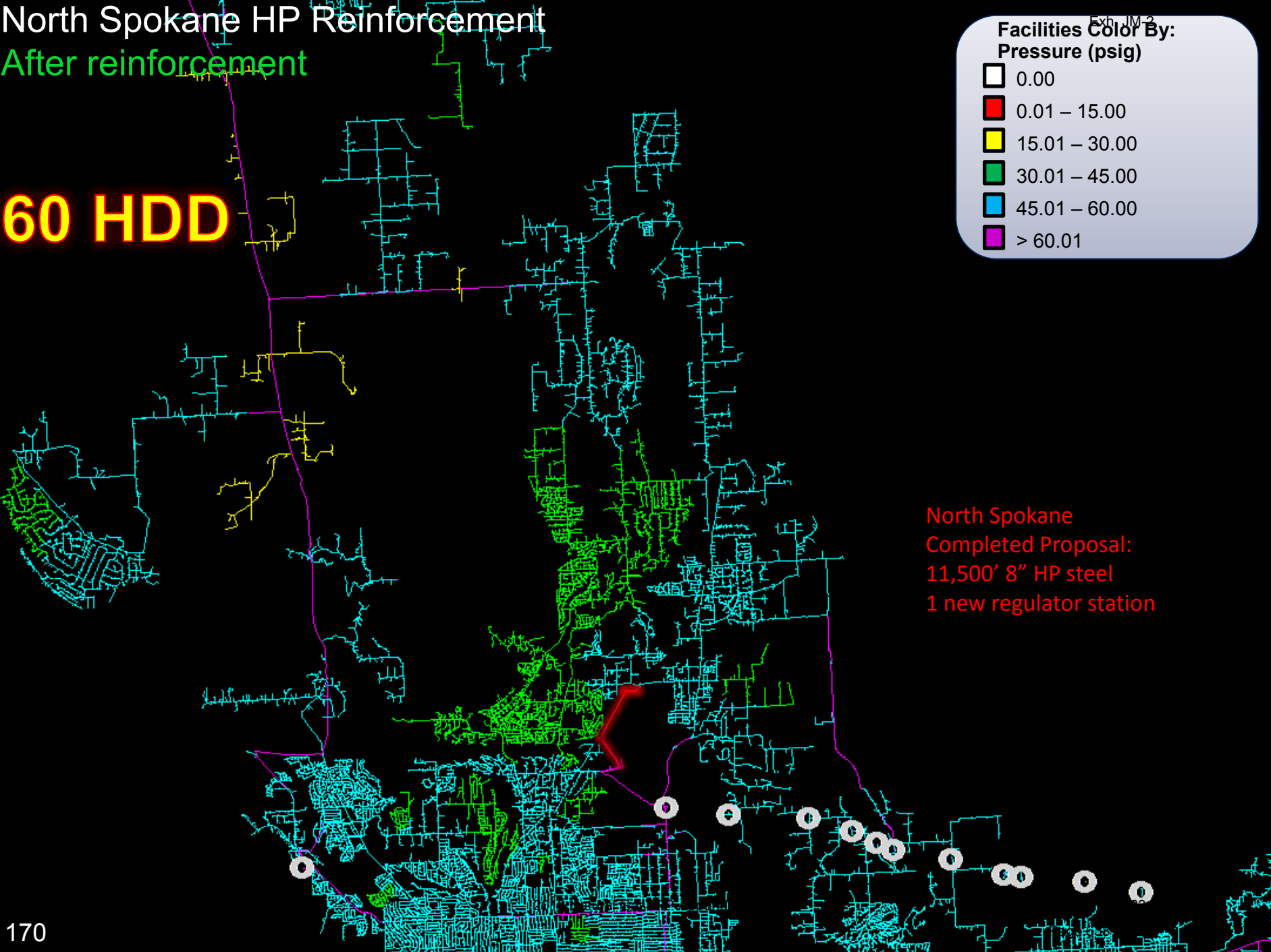

North Spokane
 Completed Proposal:
 11,500' 8" HP steel
 1 new regulator station

North Spokane HP Reinforcement After reinforcement

77 HDD

**Facilities Color By:
Pressure (psig)**

- 0.00
- 0.01 – 15.00
- 15.01 – 30.00
- 30.01 – 45.00
- 45.01 – 60.00
- > 60.01

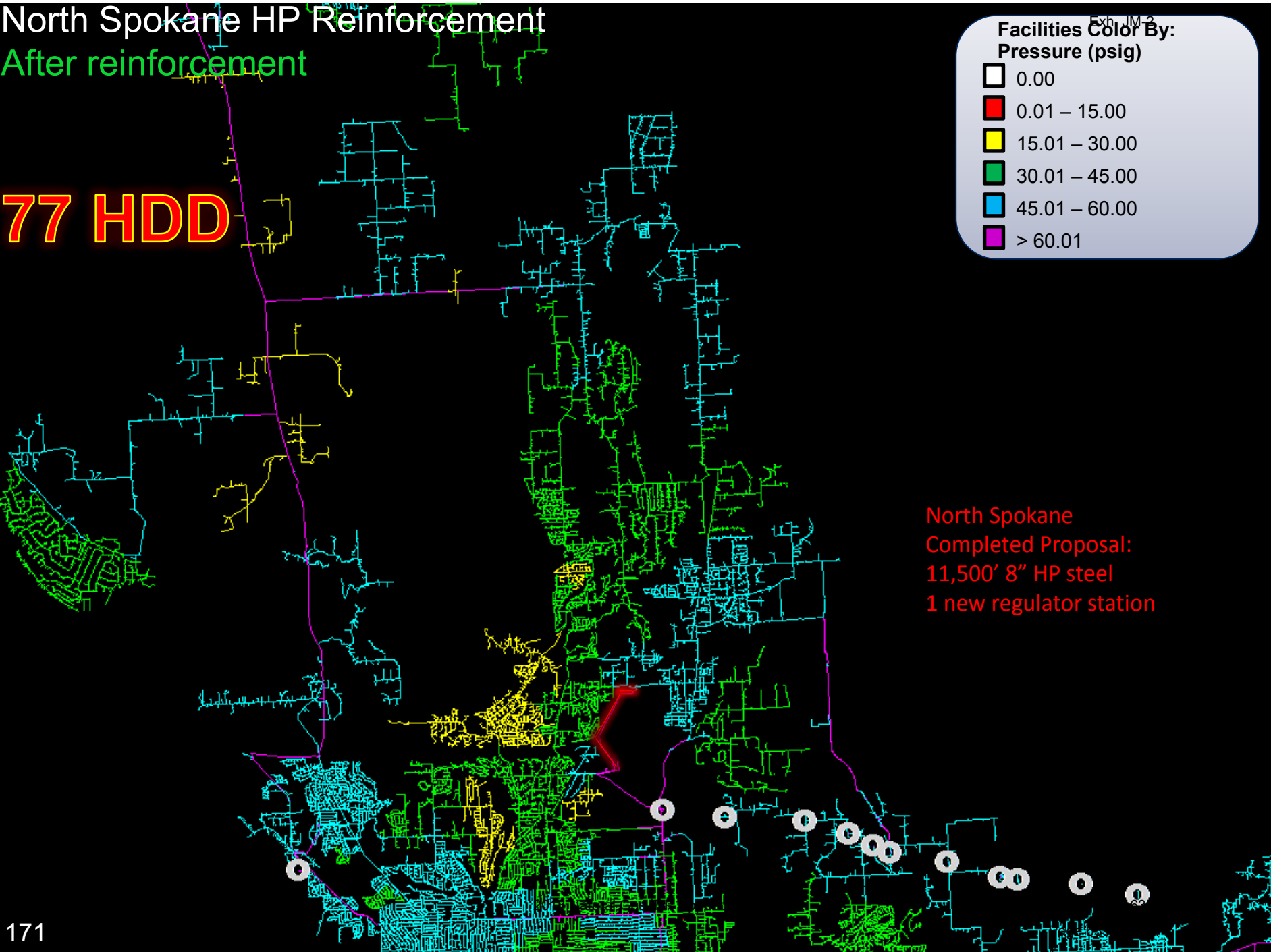

North Spokane
Completed Proposal:
11,500' 8" HP steel
1 new regulator station

North Spokane H.P. Reinforcement



Questions and Discussion

Mission

Using technology to plan and design a safe, reliable, and economical distribution system





Renewable Natural Gas

Jody Morehouse
Director of Natural Gas



What is Renewable Natural Gas (RNG)?

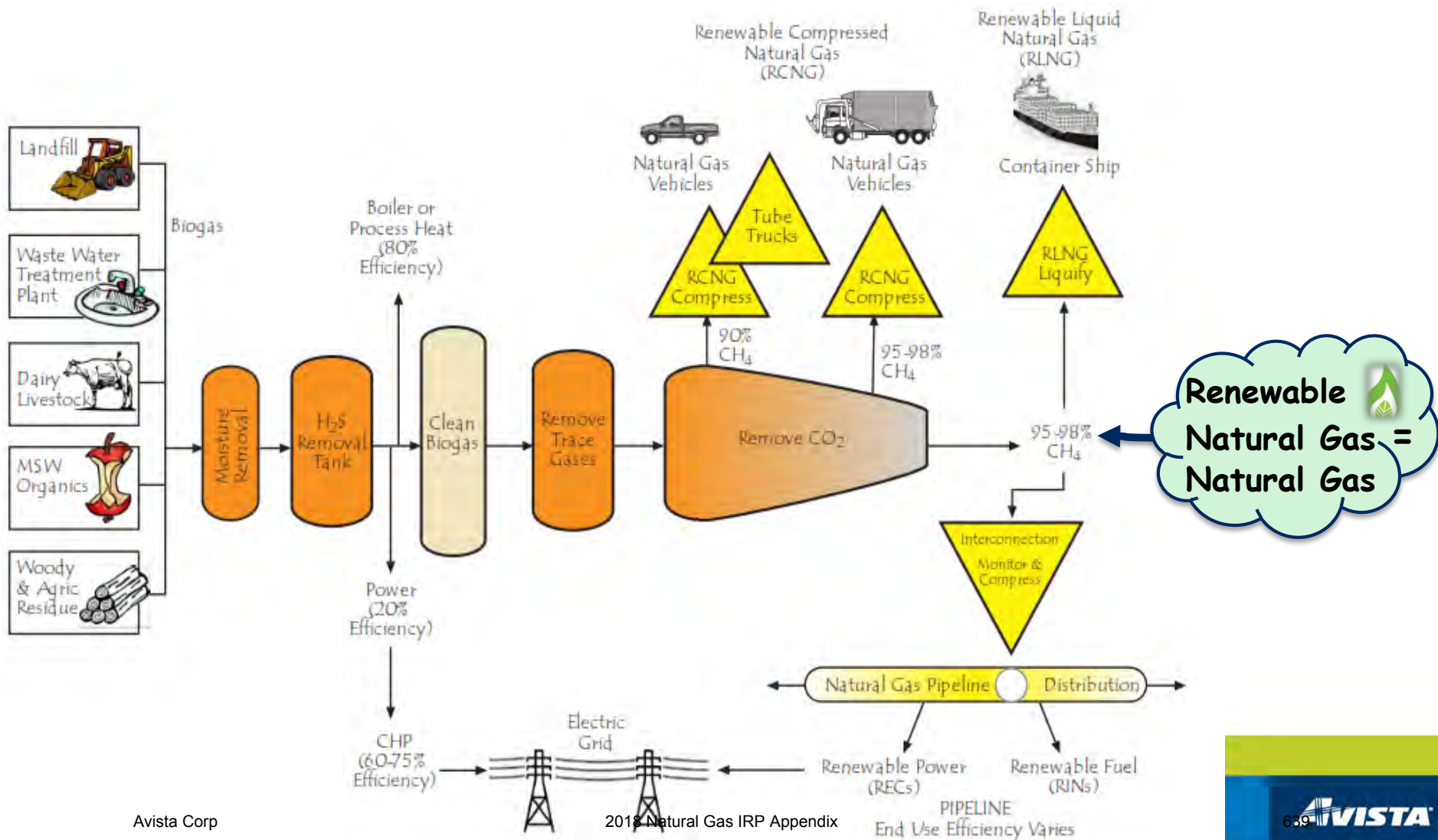

Why does RNG matter?

Carbon (CO₂) Emission Reduction

- Carbon reduction
 - LDC pathway to reduce emissions through “de-carbonized” gas stream
 - Can provide customers a new energy choice
 - Gives communities another means in meeting ambitious climate change commitments

- Renewable Fuel Standard (RFS) & Low Carbon Fuel Standards (LCFS)
 - Significant value for RNG in transportation sector in CA and OR

Washington State GHG Targets
(Percentage of 1990 Emissions)

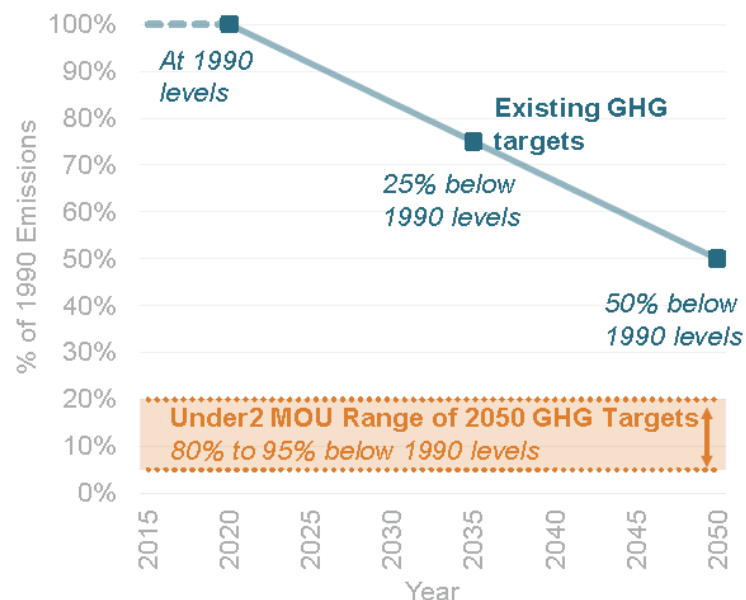

Source: State of Washington Deep Decarbonization Pathways Project 12/16/2016



Other Benefits of RNG

Other

- Reduces waste remediation costs
- Reduces odors, water & air pollution, pathogens originating from waste streams
- Creates local jobs and generates revenue for cities and businesses
- New local sources for gas supply



“It reminds me of the Mr. Fusion Home Energy Reactor in the movie Back to the Future”

Dan Kirschner, NWGA Executive Director, on WA HB 2580 RNG Bill

Federal Renewable Fuel Standard Program

 Mandates renewable fuel to replace % of petroleum-based transportation fuel

Lifecycle Greenhouse Gas (GHG) Emissions

GHG emissions must take into account direct and significant indirect emissions, including land use change.

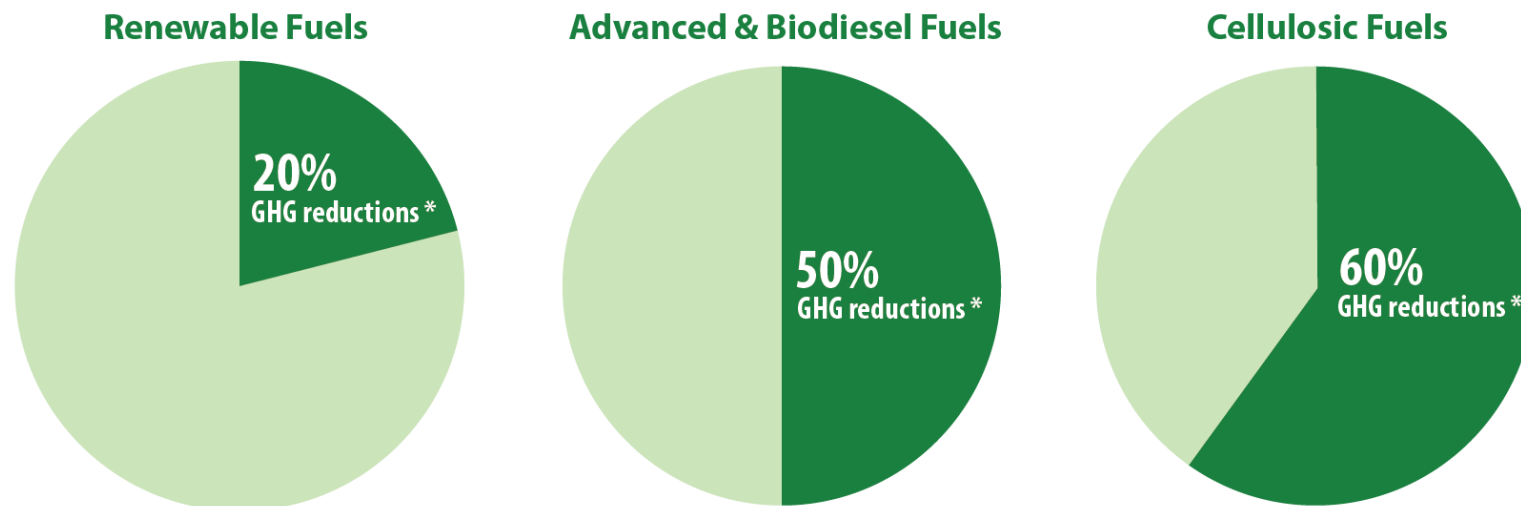

* compared to a 2005 petroleum baseline

****D6**

****D4-
D5**

****D3**

** D-codes are an approximation; actual code determined by EPA formula



RFS and LCFS Effect on RNG Value

Estimated LCFS Incentives by Fuel Source (January 2017 Credit Prices)

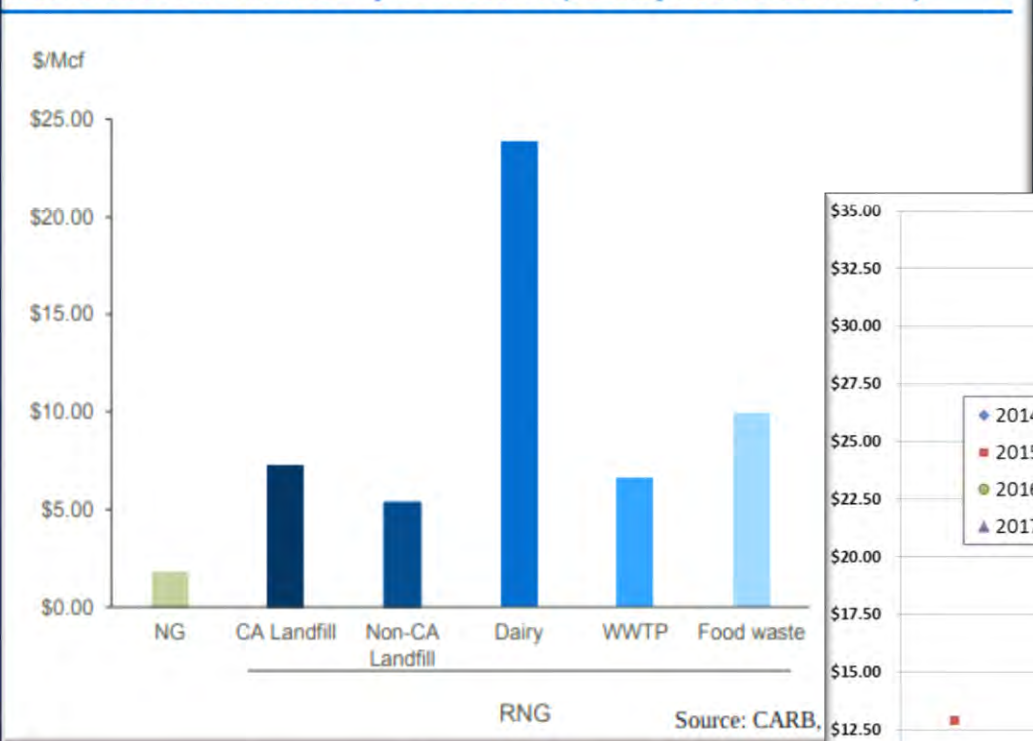

Source: CARB

RIN = renewable identification number

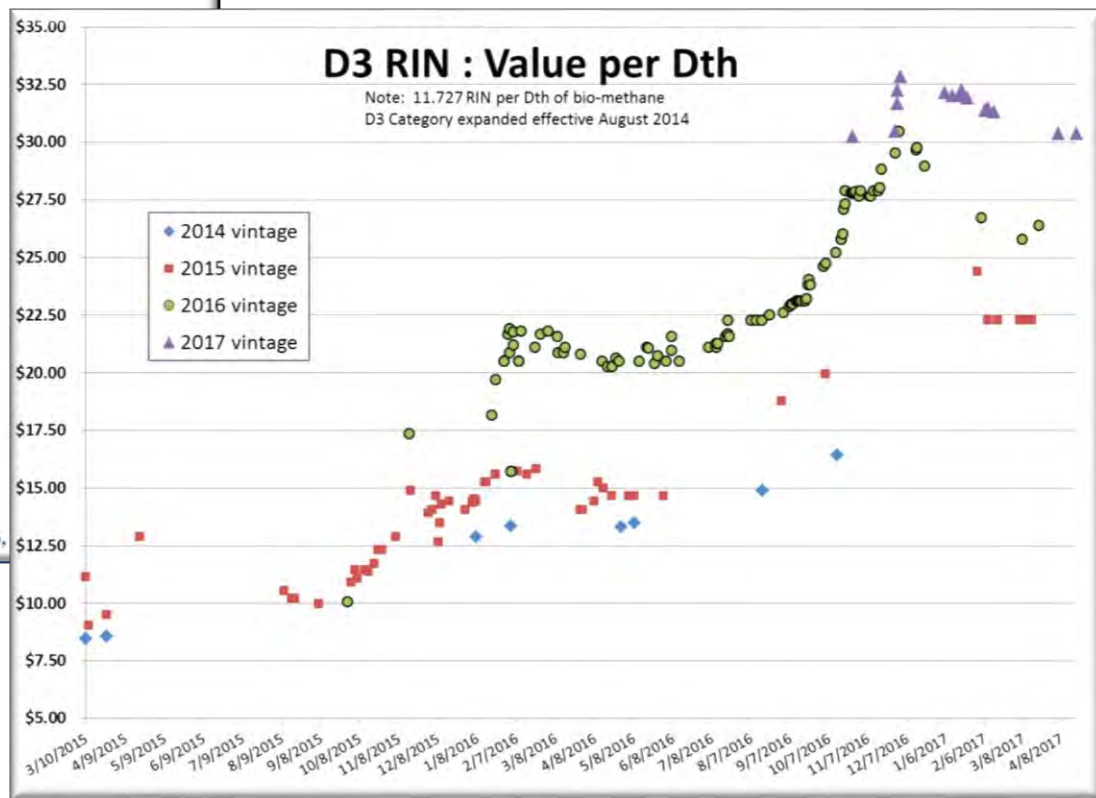

Source: EPA 2018 Natural Gas IRP Appendix

GHG CO₂ Reductions

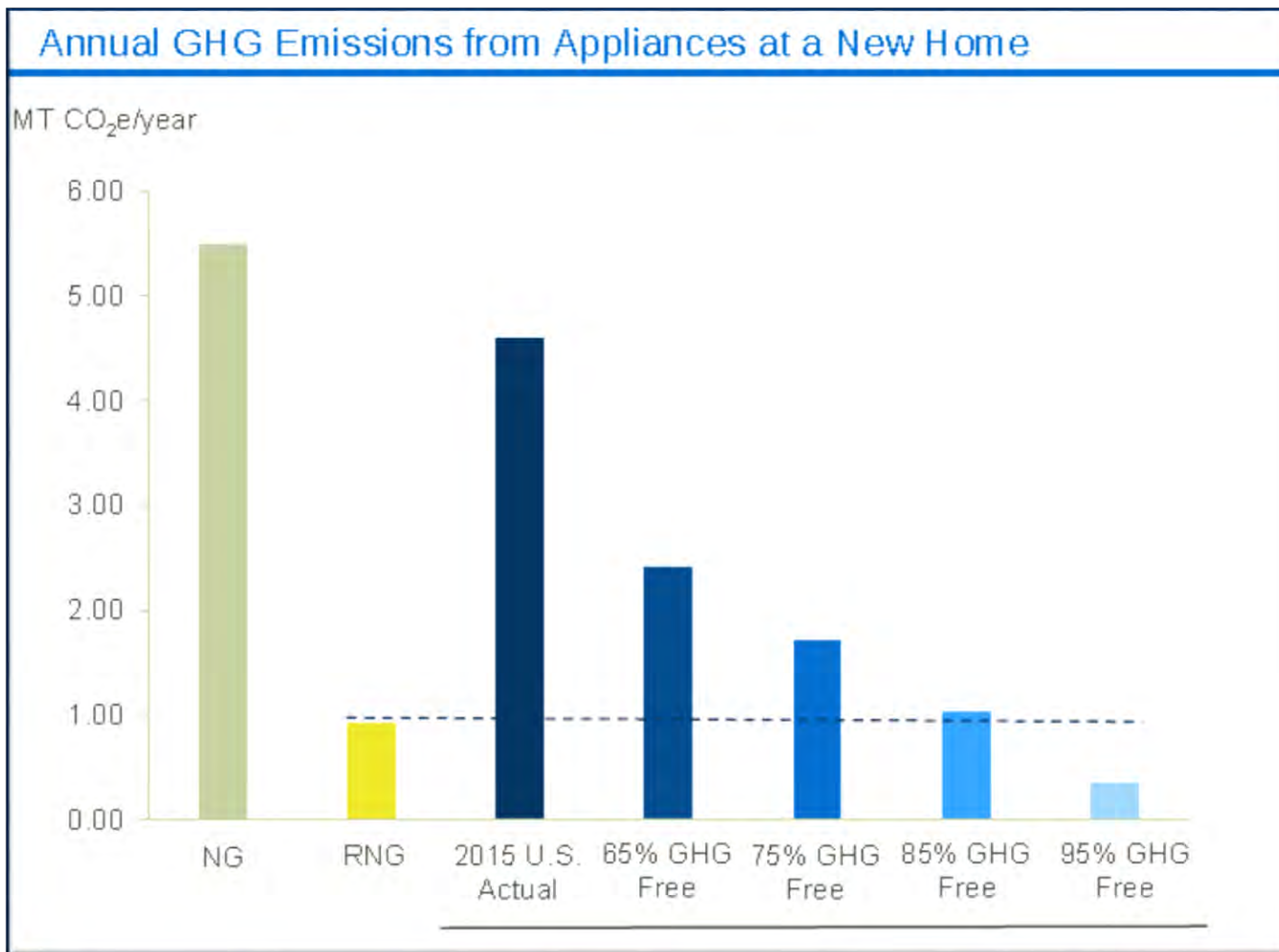

Source: AGA, MJB&A analysis
Avista Corp

2018 Natural Gas IRP Appendix



Potential RNG Production

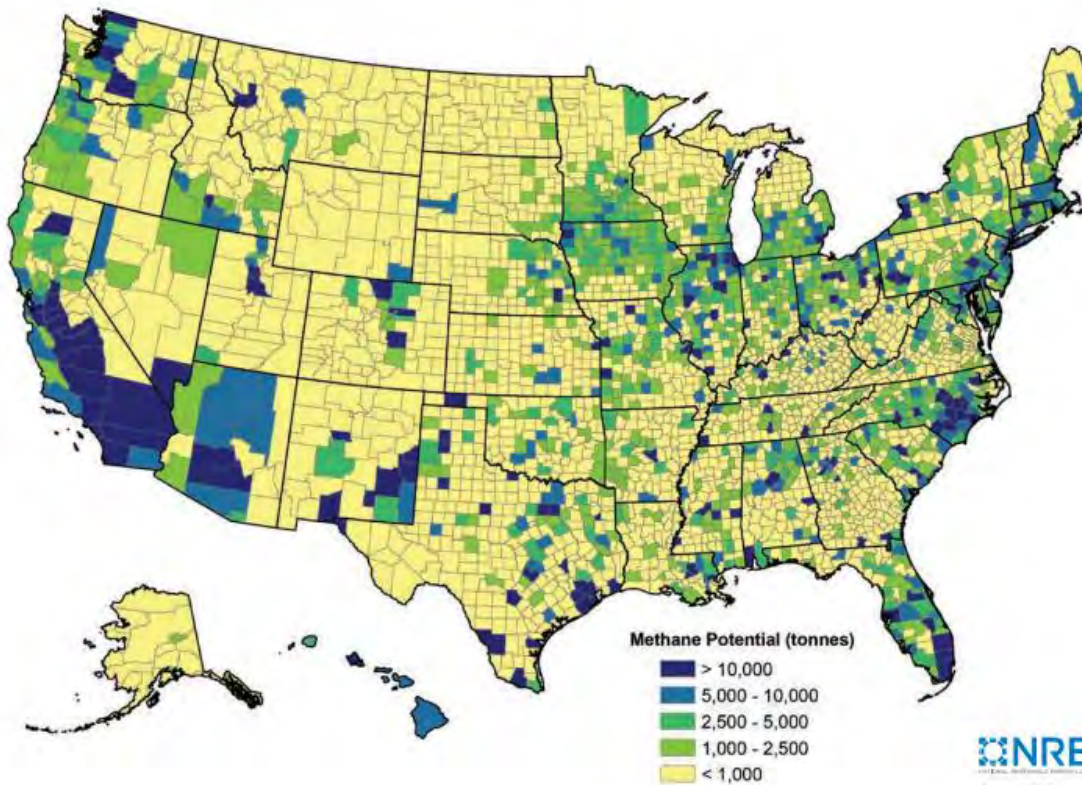

Estimated Methane Generation Potential for Select Biogas Sources in the United States

Source	Methane Potential (tonnes/yr)
Wastewater	2,339,339
Landfills*	2,454,974
Animal manure	1,905,253
IIC organic waste	1,157,883
Total	7,857,449

About 420 Bcf

* Includes candidate landfills only as defined by the EPA's Landfill Methane Outreach Program



August 2013

Estimated methane generation potential for select biogas sources by county

RNG Projects in North America

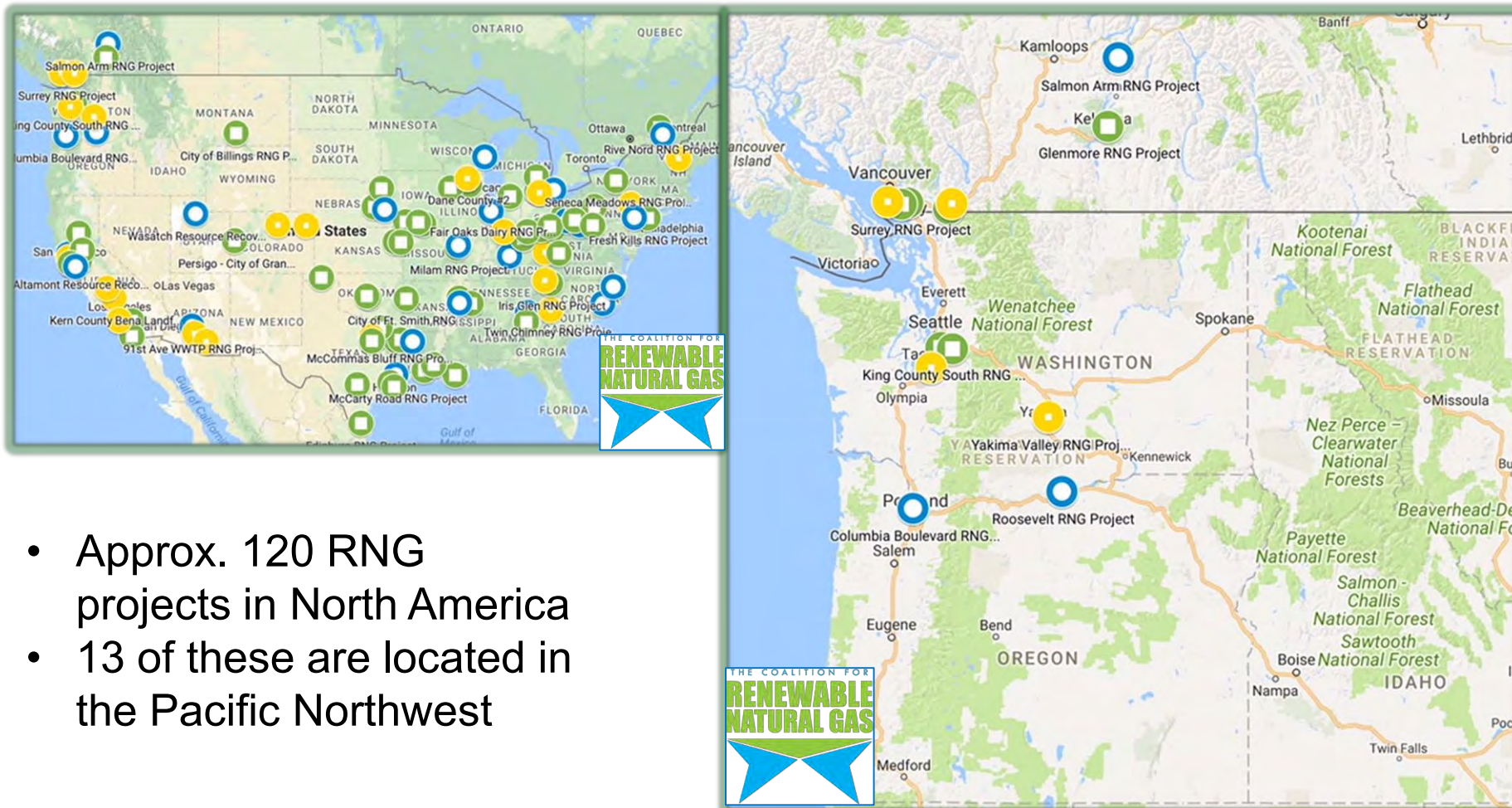

- Approx. 120 RNG projects in North America
- 13 of these are located in the Pacific Northwest

Oregon SB 344 DOE RNG Update

Oregon Department of Energy

*Leading Oregon to a safe, clean,
and sustainable energy future*

The Biogas / RNG
Inventory – Advisory
Committee



As a means toward feasible **reductions in greenhouse gas emissions**, committee to provide recommendations to ODOE regarding:

- Development of an inventory of RNG resources
- Characterization of the opportunities
- Identify barriers to production and utilization
- Policies to promote RNG and remove barriers
- **Report due by September 2018**

Washington SB 2580 RNG Bill

- Requires the Washington State University Extension Energy Program and the Department of Commerce, in consultation with the Utilities and Transportation Commission, to submit recommendations on how to promote the sustainable development of RNG to the Governor and the Legislature by September 1, 2018

“Governor Inslee and Department of Commerce were pleased to request this bill, which received near unanimous, bipartisan support from the Legislature,” said Peter Moulton, Energy Policy Section Manager, Washington Department of Commerce.

- Requires the Department of Commerce, in consultation with natural gas utilities and other state agencies, to explore the development of voluntary gas quality standards for the injection of RNG into the state’s natural gas pipeline systems
- Reinstate and expand incentives in order to stimulate investment in biogas capture and conditioning, compression, nutrient recovery, and use of RNG for heating, electricity generation and transportation fuel



Oregon and Washington RNG Studies

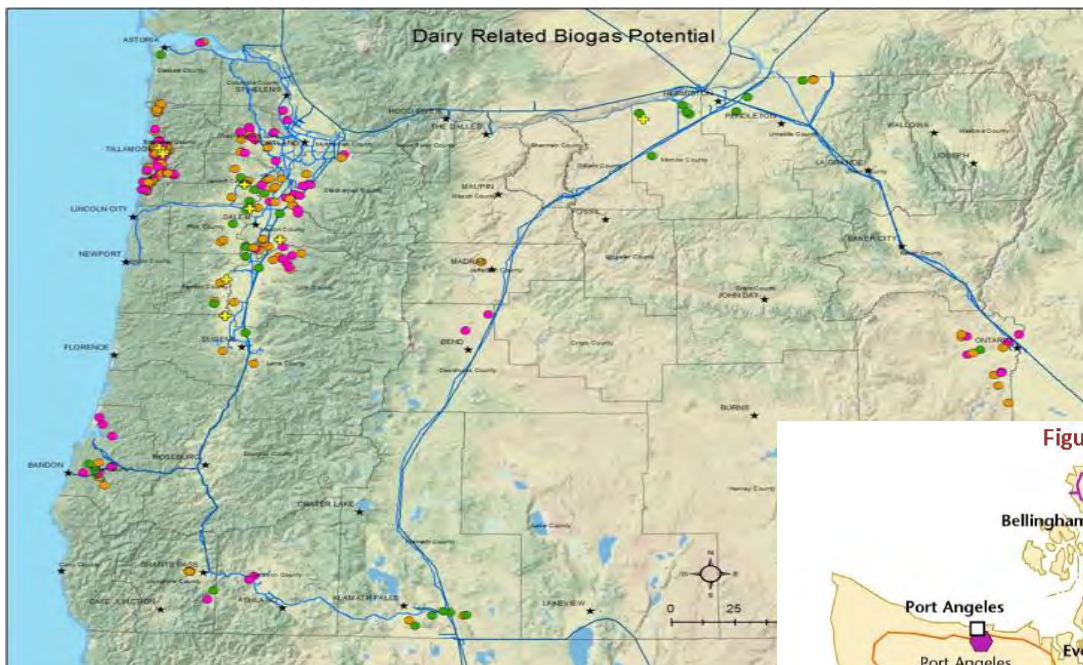

Source: ODOE RNG Feb. 22, 2018 Presentation

Oregon and Washington RNG Production Potential Info Coming Soon

Figure 4. Washington Landfills and Major Natural Gas Pipelines

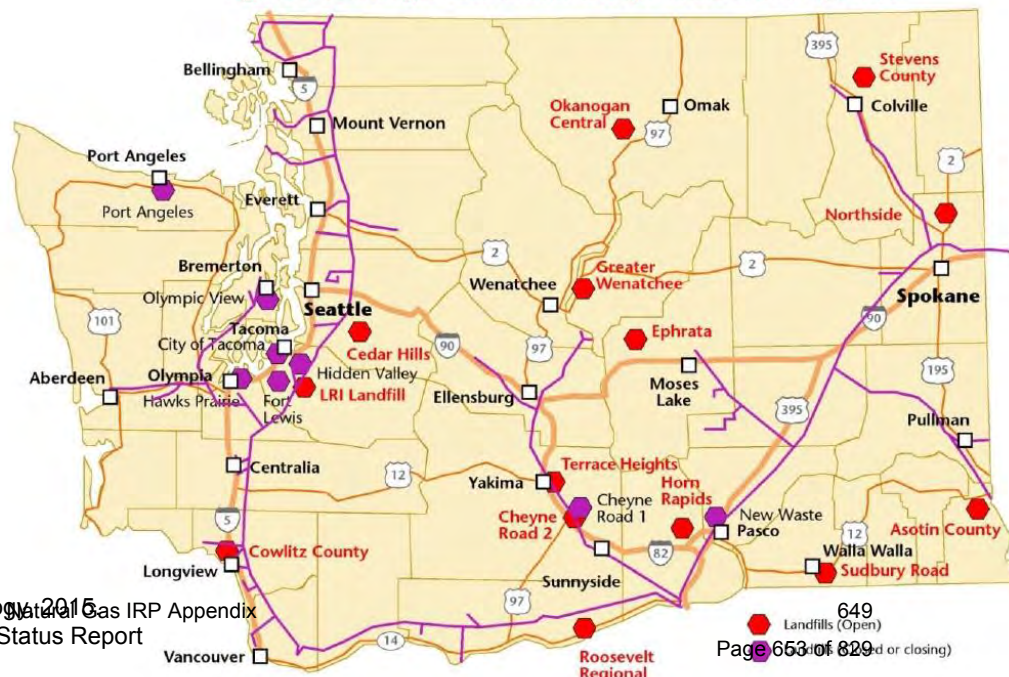

Regional RNG Policies

- California SB 1383: Goal to reduce the economic uncertainty associated with RNG. Requires LDCs to interconnect at least five dairy projects to the natural gas pipeline system by January 1, 2018.
 - Allows LDCs to recover the costs associated with projects
- British Columbia Green House Gas Reduction Regulation
 - Allows for 5% RNG on LDC system
 - Allows LDCs to invest and recover costs associated with projects

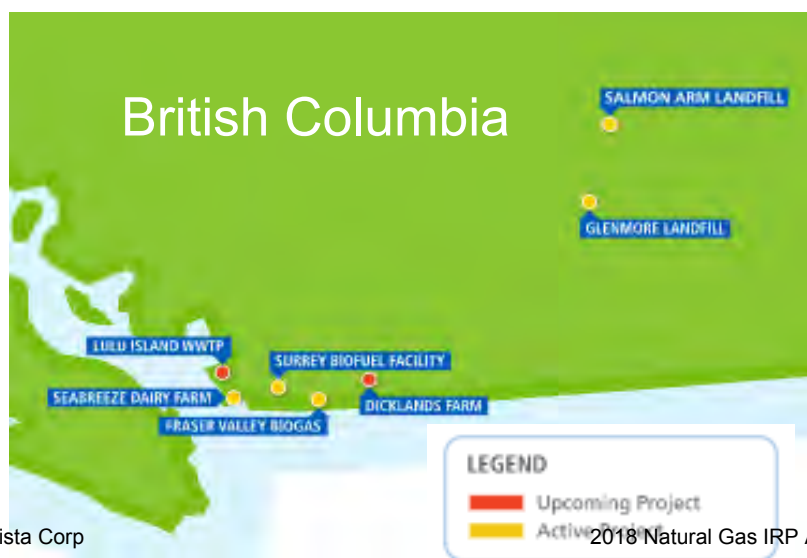

Are Avista customers interested in RNG?

- Rogue Disposal
- Rogue Valley Transit
- Southern Oregon University
- City of Medford
- City of Ashland
- US Postal Service
- United Parcel Service
- DSU Peterbilt
- Butler Ford

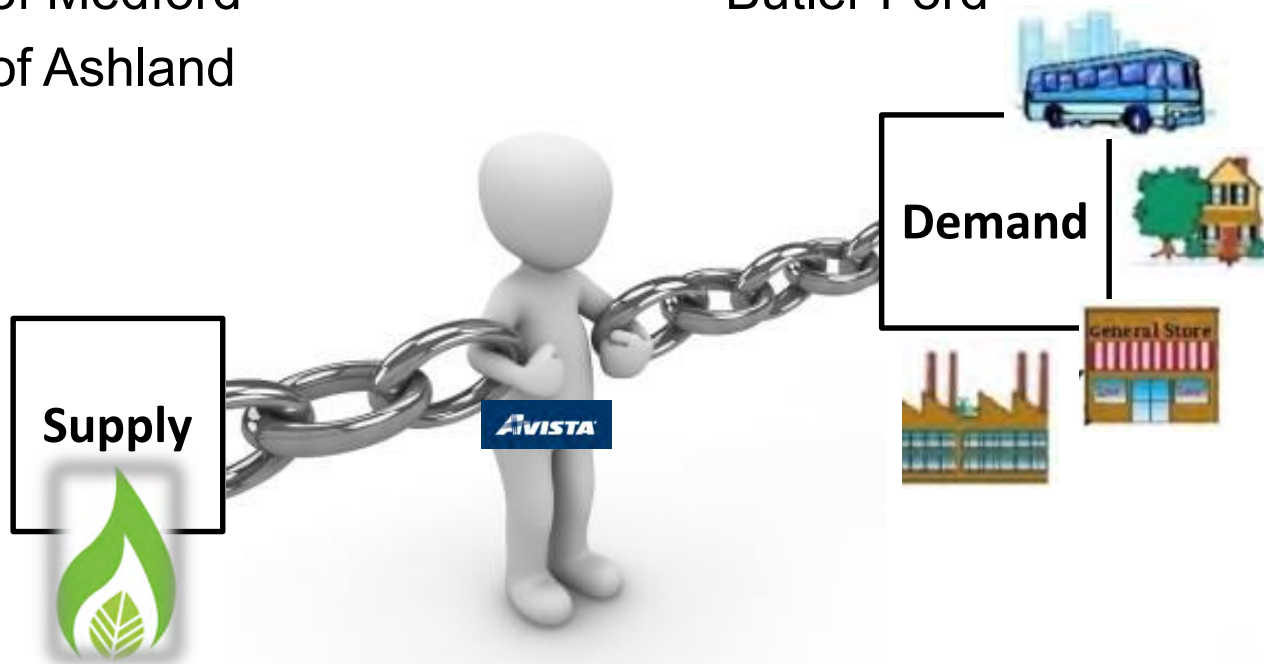

What are the challenges & barriers?

- California RNG market (\$30/Dth v. \$2/Dth)
 - Vehicle emission incentives shut-out other potential end users
 - RIN market is volatile
 - No forward pricing for RNG RINs in carbon market
 - RFS future beyond 2022 uncertain
 - Vehicle market may be approaching saturation in CA
 - Too expensive for LDCs to purchase; LDCs could produce RNG cheaper
- Financing for producers challenging
 - Future RNG value unknown
 - Producer/LDC partnerships for product
- Policies for LDC cost recovery or purchase of not least cost fuel source

Next Steps for RNG

- Model various RNG scenarios for 2018 IRP
- Participate in ODOE SB 344 Advisory Council
- Support efforts with WSU and WA SB 2580
- Evaluate customer interest in RNG products
- Evaluate potential RNG projects in Avista service territory



Power to Gas

Tom Pardee
Manager of Natural Gas Planning

Power to Gas

- Power to Gas (PtG) is a process using power to separate water into hydrogen and oxygen
- Both hydrogen and methane can be stored, as a % of gas, in the existing gas grid or used in the mobility sector (blend up to 20%)
- PtG can help to balance excess power from intermittent sources like wind and solar
- PtG can decarbonize the direct use of natural gas
- PtG economics will advance as more renewables are added and the technology matures
- Short term and seasonal energy storage
- Stored in the existing gas pipeline

PtG Process



Hydrogen

- The energy factor of H₂ Low Heating Value (LHV) is roughly equivalent to a gallon of gasoline or 114,000btu
 - This equates to 8.78 kg of H₂_{LHV} per Dth
- Most H₂ is currently made from reforming natural gas
- The US Department of Energy expects that over the long term the production of hydrogen will be increased with production from renewables

Water Electrolysis for PtG

- Water electrolysis is a mature and well understood technology with 3 different types of electrolysis technologies in these PtG processes
 - Alkaline electrolysis (AEL)
 - Most mature and well understood technology
 - Best when coupled with an intermittent power supply
 - Polymer electrolyte membrane (PEM)
 - Fast cold start with a high purity of H₂
 - Limited Life expectancy
 - Solid oxide electrolysis (SOEC)
 - High electrical efficiency
 - Currently not as stable when paired with intermittent power supply

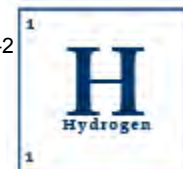

PtG Comparison

Benefits

- Cleans up the grid using excess power
- Stores the energy for future use
- Hydrogen is relatively safe as if it is released it quickly dilutes into a non-flammable concentration

Obstacles

- High cost (currently) when compared to energy in a Dth combined with current prices of natural gas
- Hydrogen can only be stored in the pipeline as a % of gas though this is primarily caused by end-use restrictive conditions
 - Risks increase significantly if over 50% mix
- Hydrogen is lighter than air and diffuses rapidly (3.8x faster than natural gas) making it more difficult to contain

Cost Status and Targets: Dispensed H₂

Targets



Early Market Target

\$7/kg

Ultimate Target

\$4/kg

Cost Status

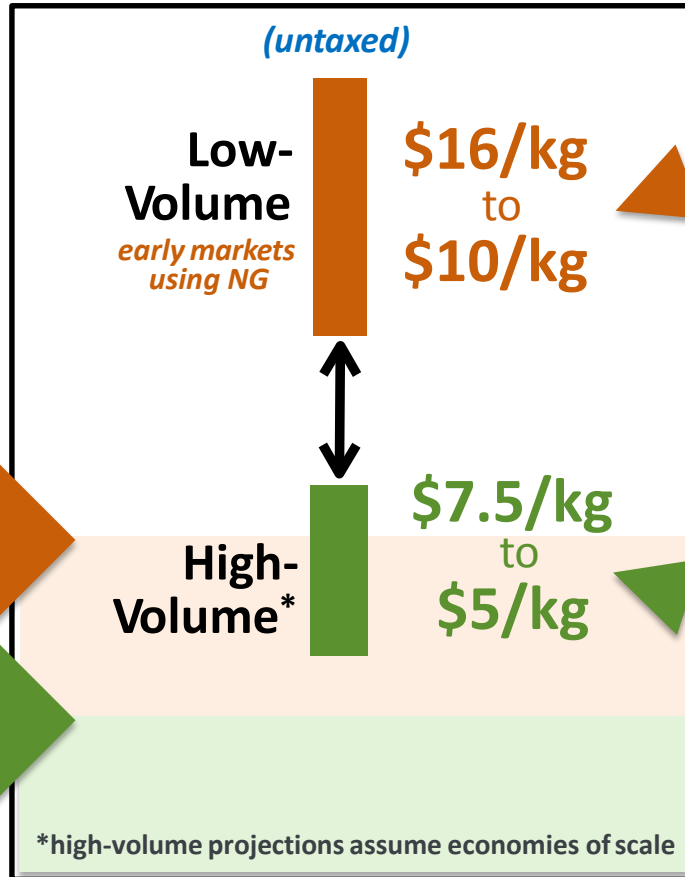

LOW-VOLUME

- Early market status based on low-cost H₂ from NG (<\$2/kg) plus delivery & dispensing
- R&D innovations are essential to reduce H₂ delivery & dispensing costs

HIGH-VOLUME

- Projected status based on large-scale deployments of a portfolio of H₂ production, delivery & dispensing options
- R&D of diverse, sustainable hydrogen production pathways remains vital

Continued R&D is needed to reduce H₂ production & delivery costs

Next Steps

- Model at an estimated rate of \$4 per kg of H₂ based on DOE technical target by 2020
 - This is the untaxed cost of hydrogen produced, delivered, and dispensed to the vehicle
 - It does not include off-board cooling or regeneration of chemical hydrogen storage materials
 - Source: <https://www.energy.gov/eere/fuelcells/doe-technical-targets-onboard-hydrogen-storage-light-duty-vehicles>
- Look for a consultant or ways to more accurately estimate the cost of H₂ in Avista's territory



Initial Results and Proposed Scenarios

Kaylene Schultz
Natural Gas Analyst

First Year Peak Demand Unserved Washington

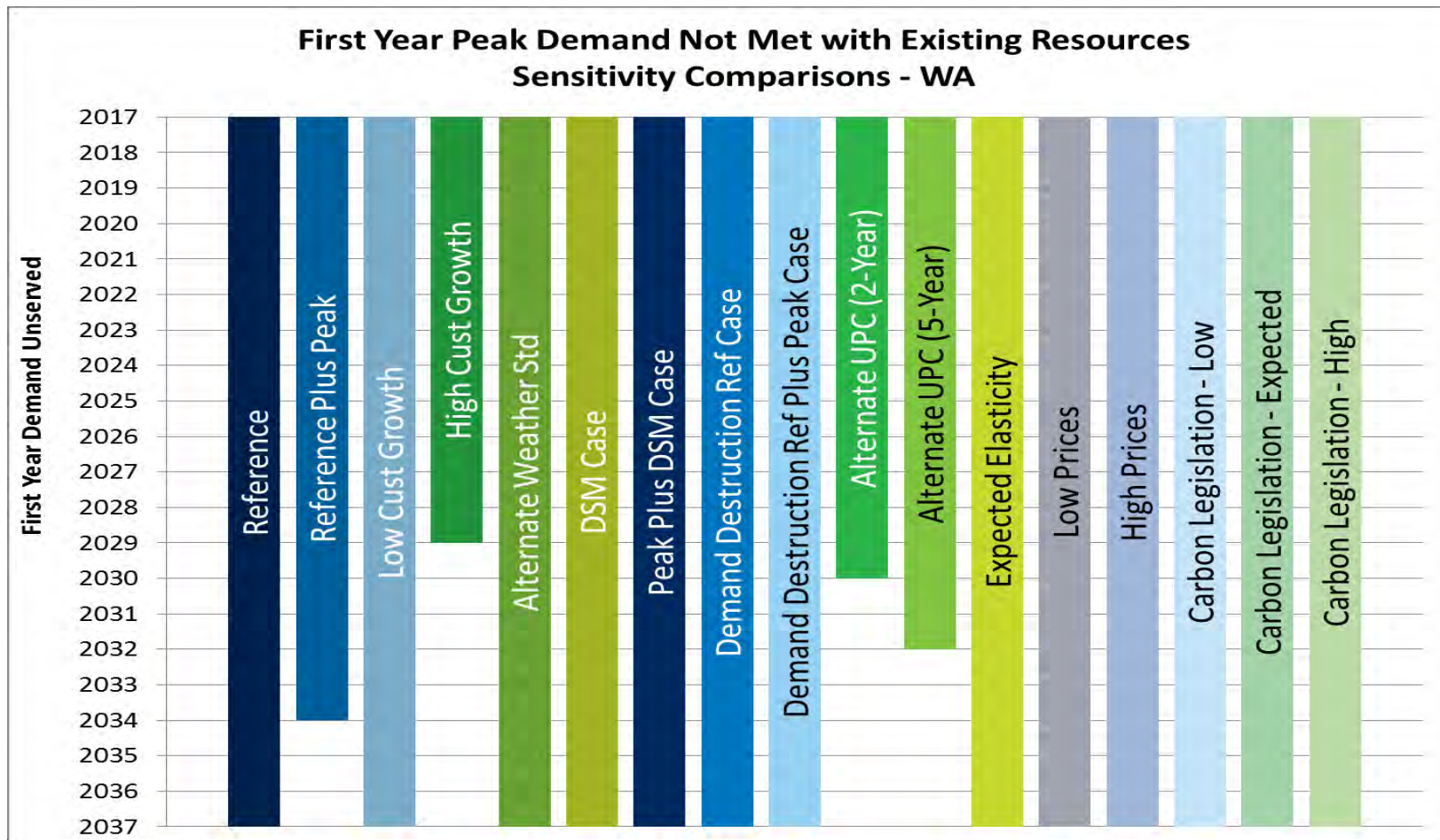

First Year Peak Demand Unserved Idaho

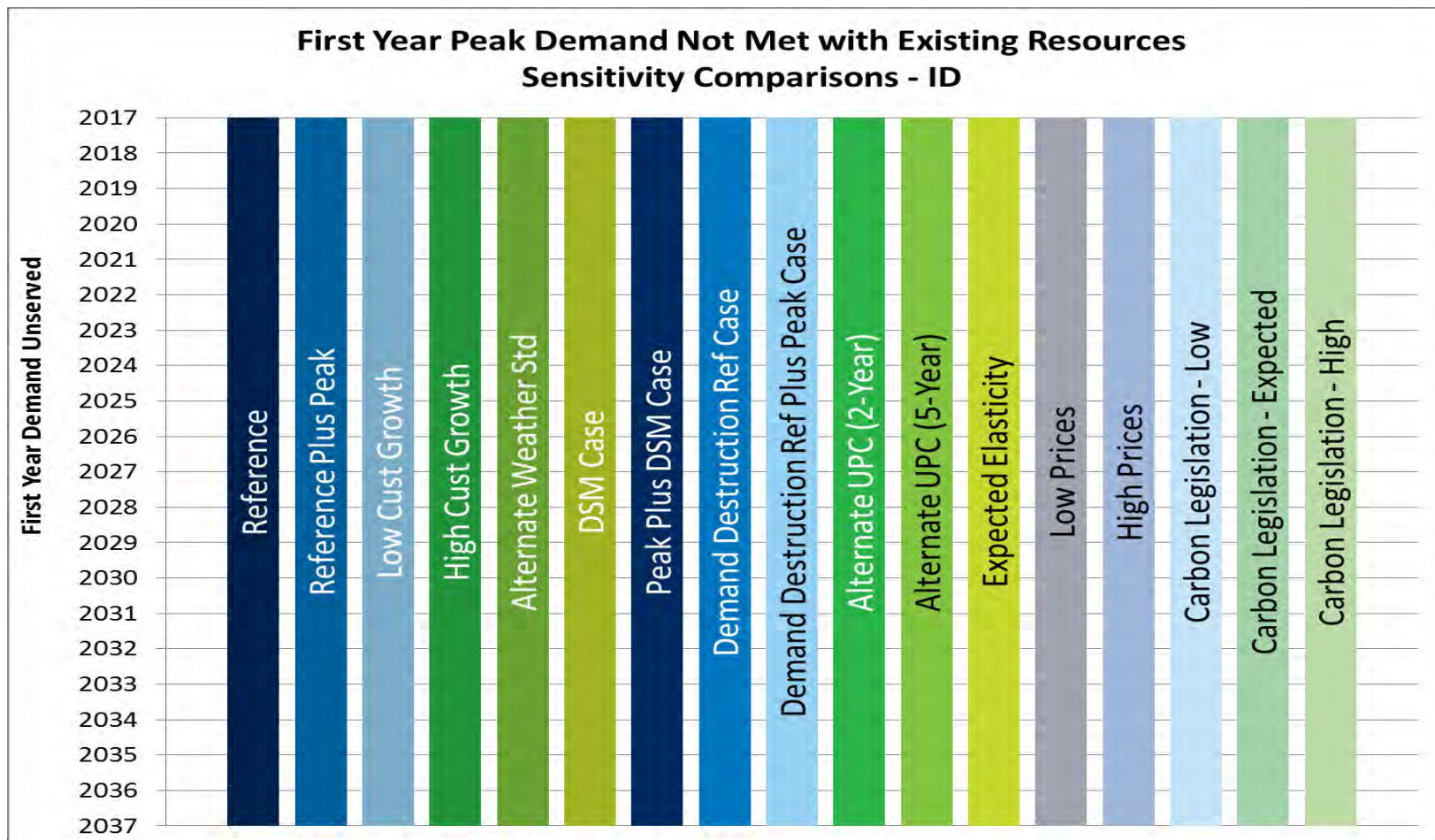

First Year Peak Demand Unserved Medford

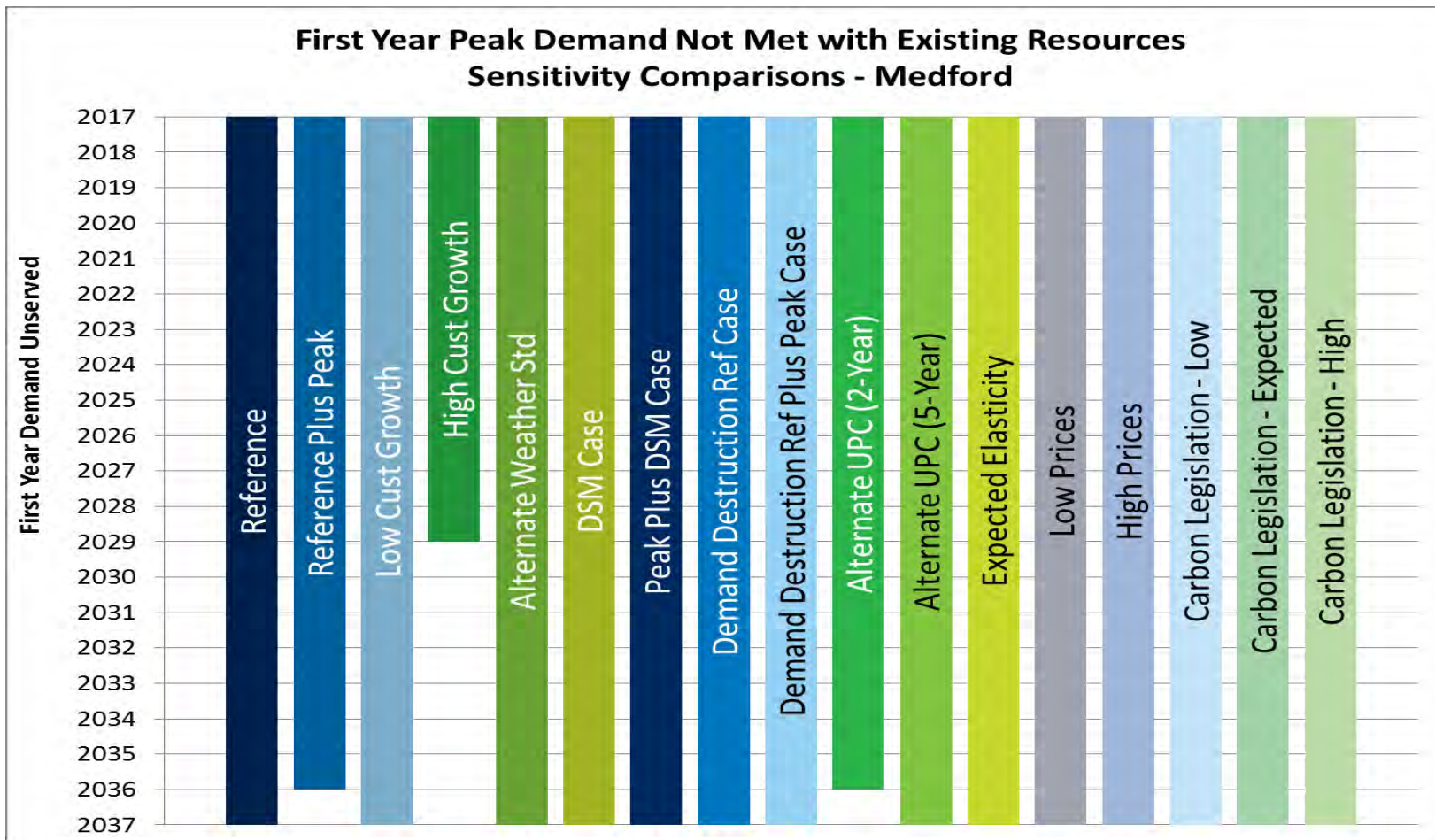

First Year Peak Demand Unserved Roseburg

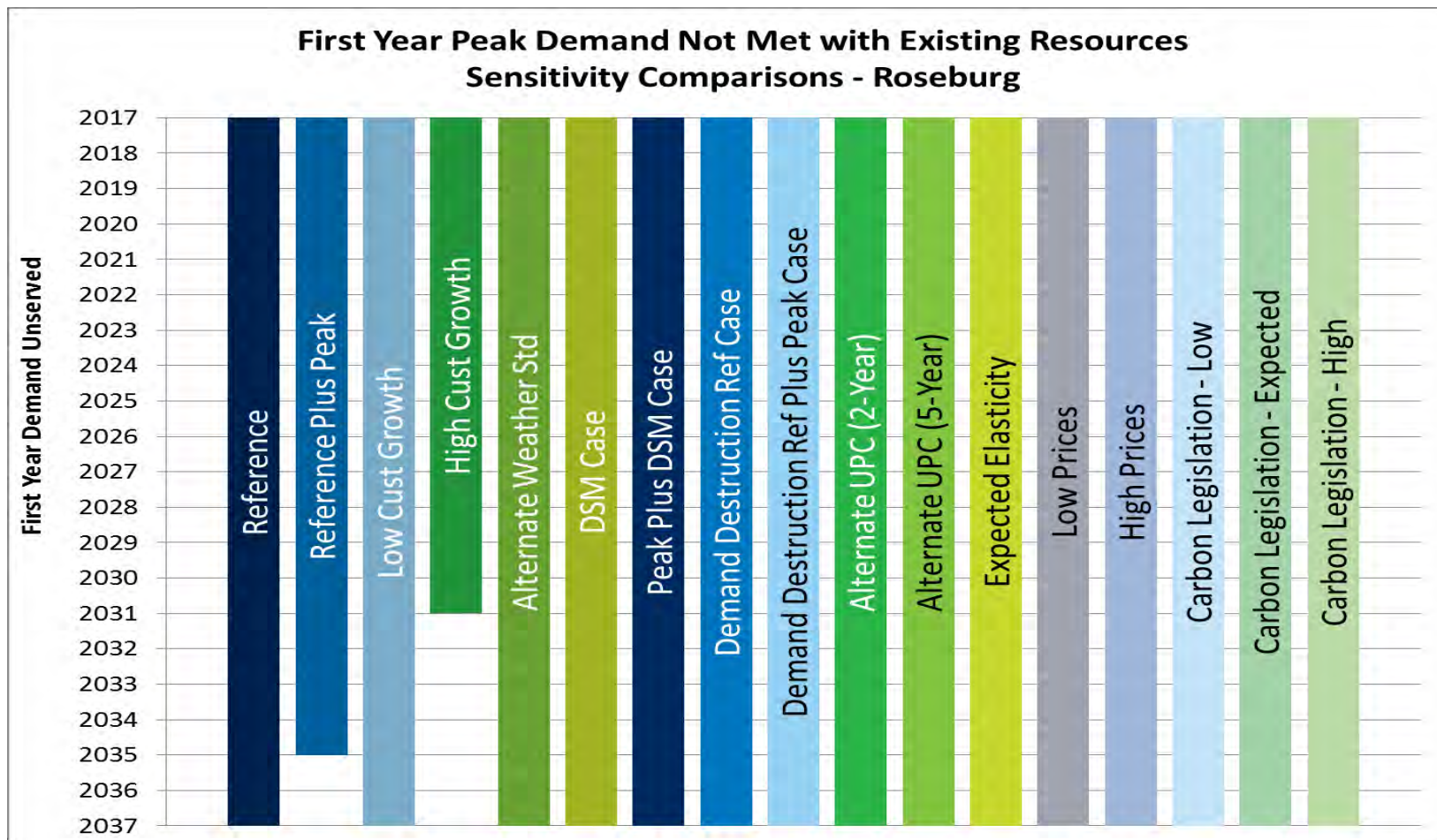

First Year Peak Demand Unserved Klamath Falls

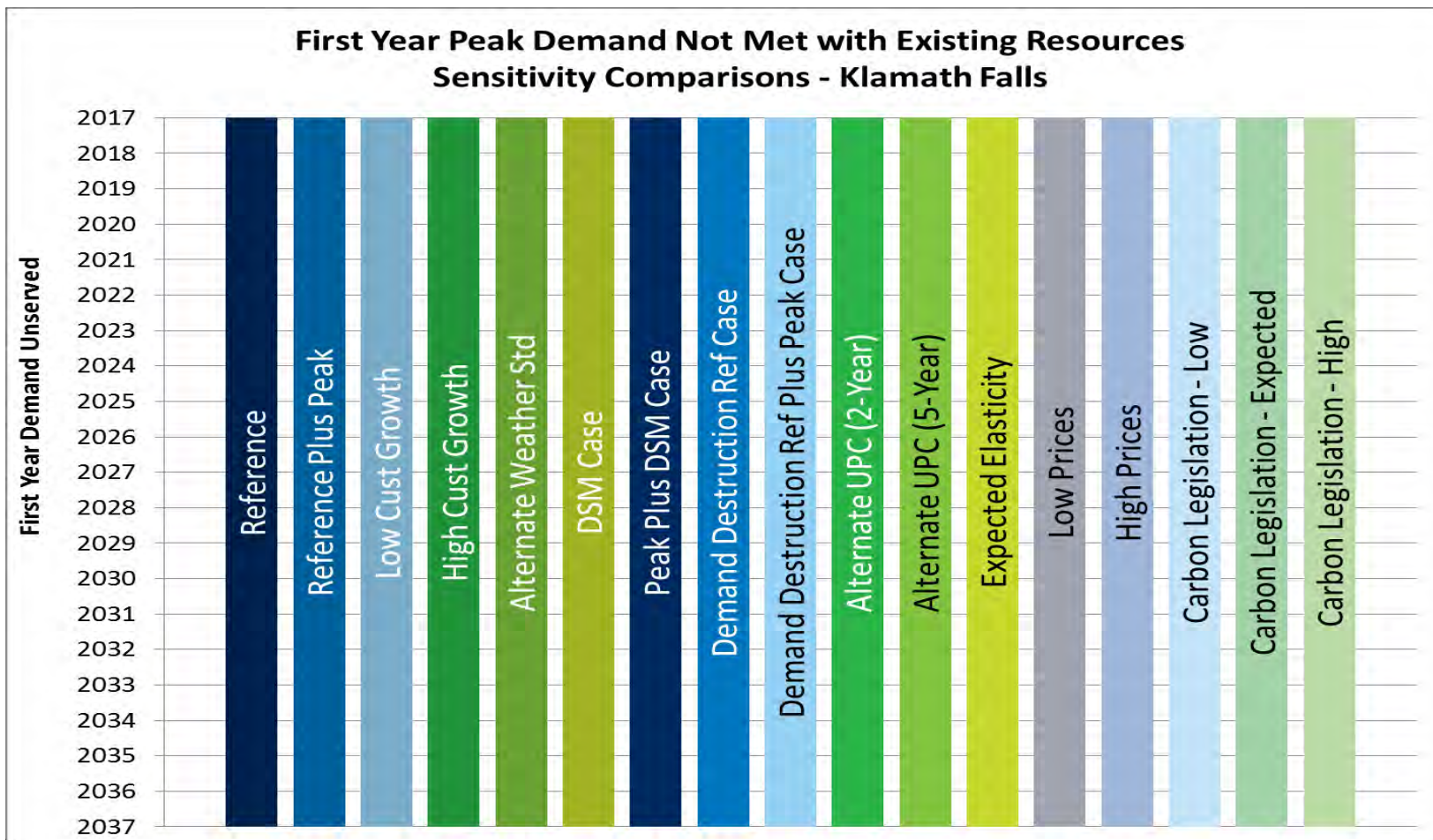

First Year Peak Demand Unserved La Grande

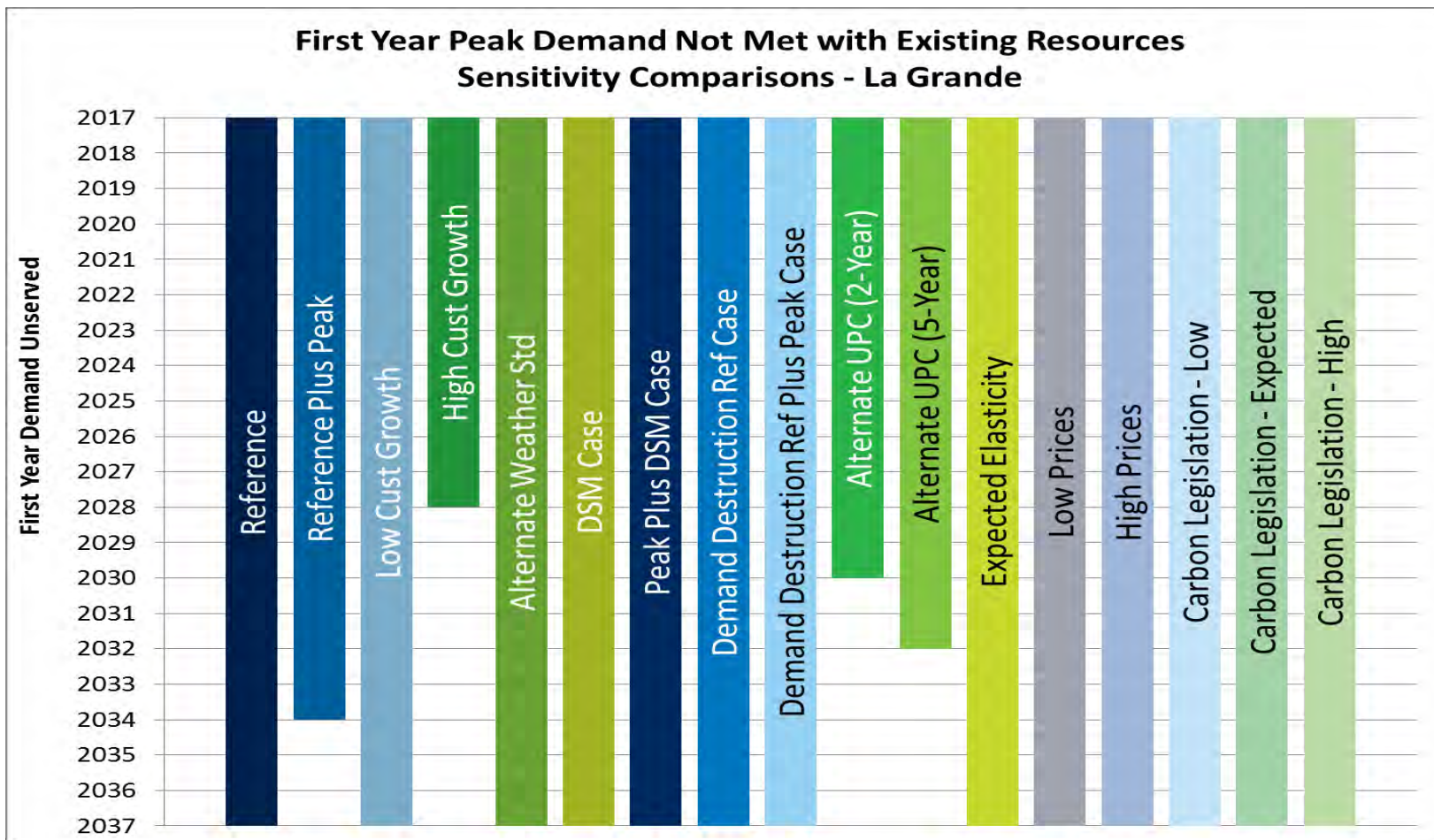

2018 Demand Sensitivities Annual Demand - Total System

Exh. JM-2

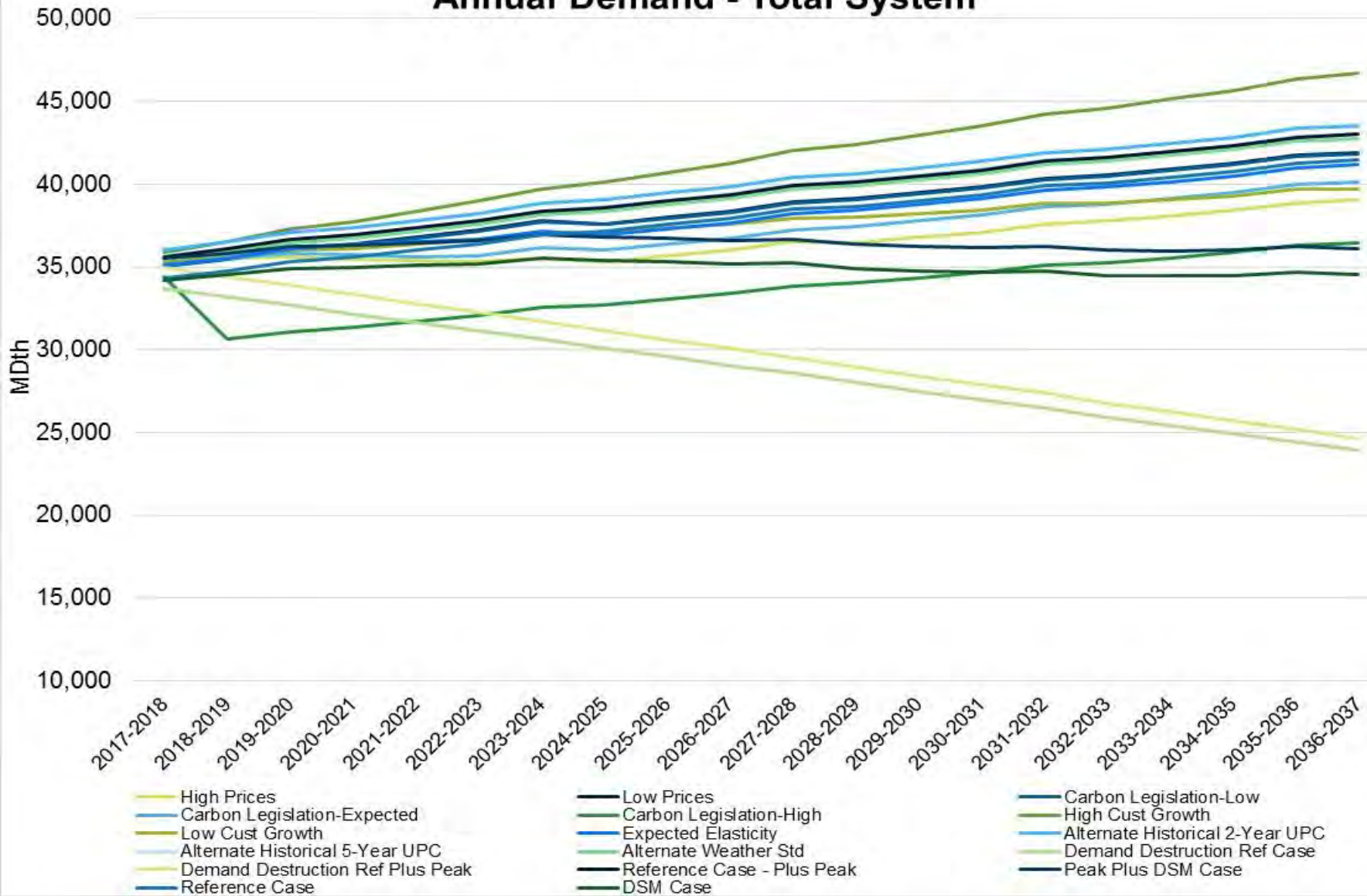

2018 Demand Sensitivities - DSM Annual Demand - Total System

Exh. JM-2

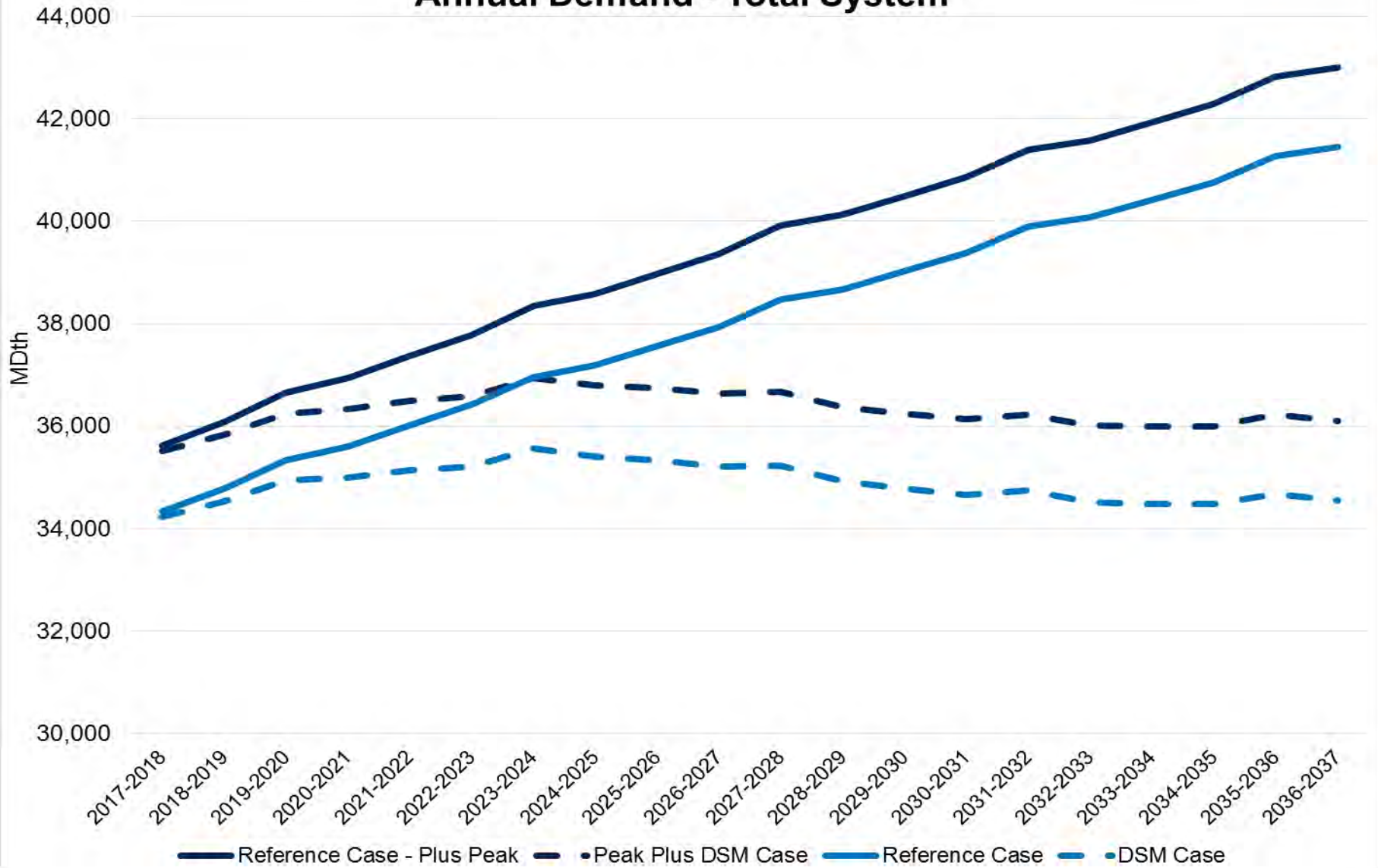

2018 Demand Growth Sensitivities Annual Demand - Total System

Exh. JM-2

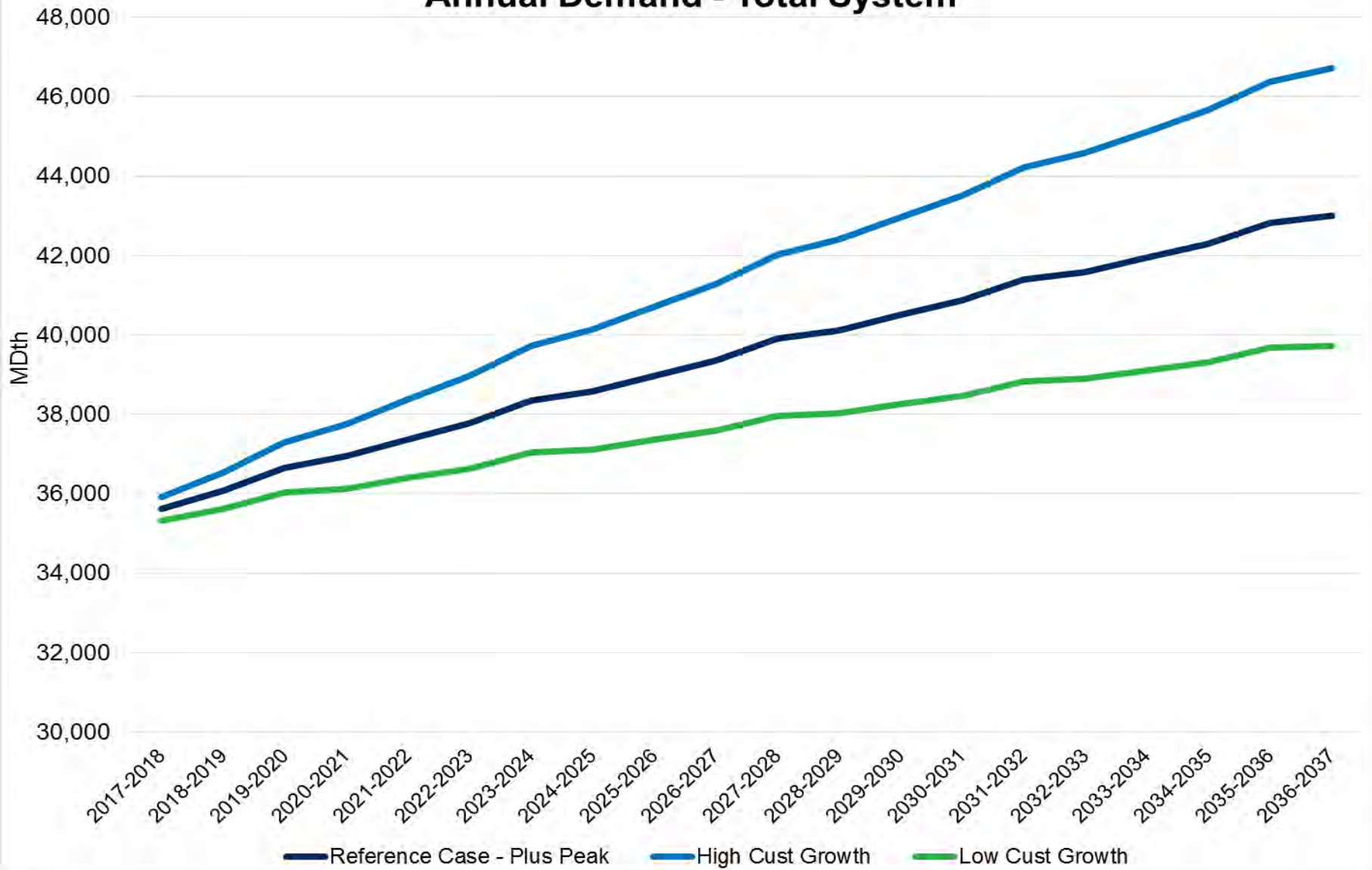

2018 Demand Alternate UPC Sensitivities Annual Demand - Total System

Exh. JM-2

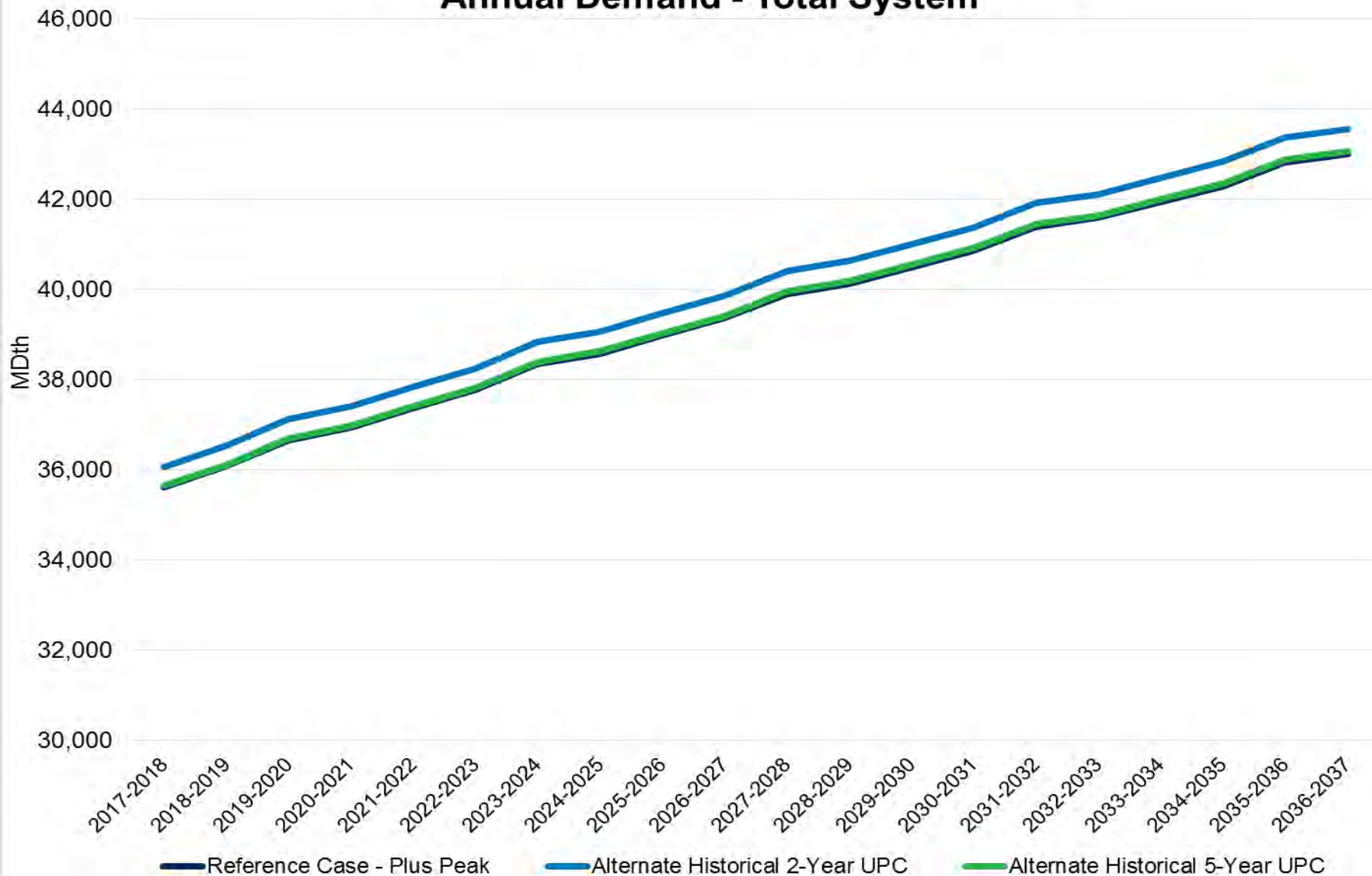

2018 Demand Alternate Weather Sensitivities Annual Demand - Total System

Exh. JM-2

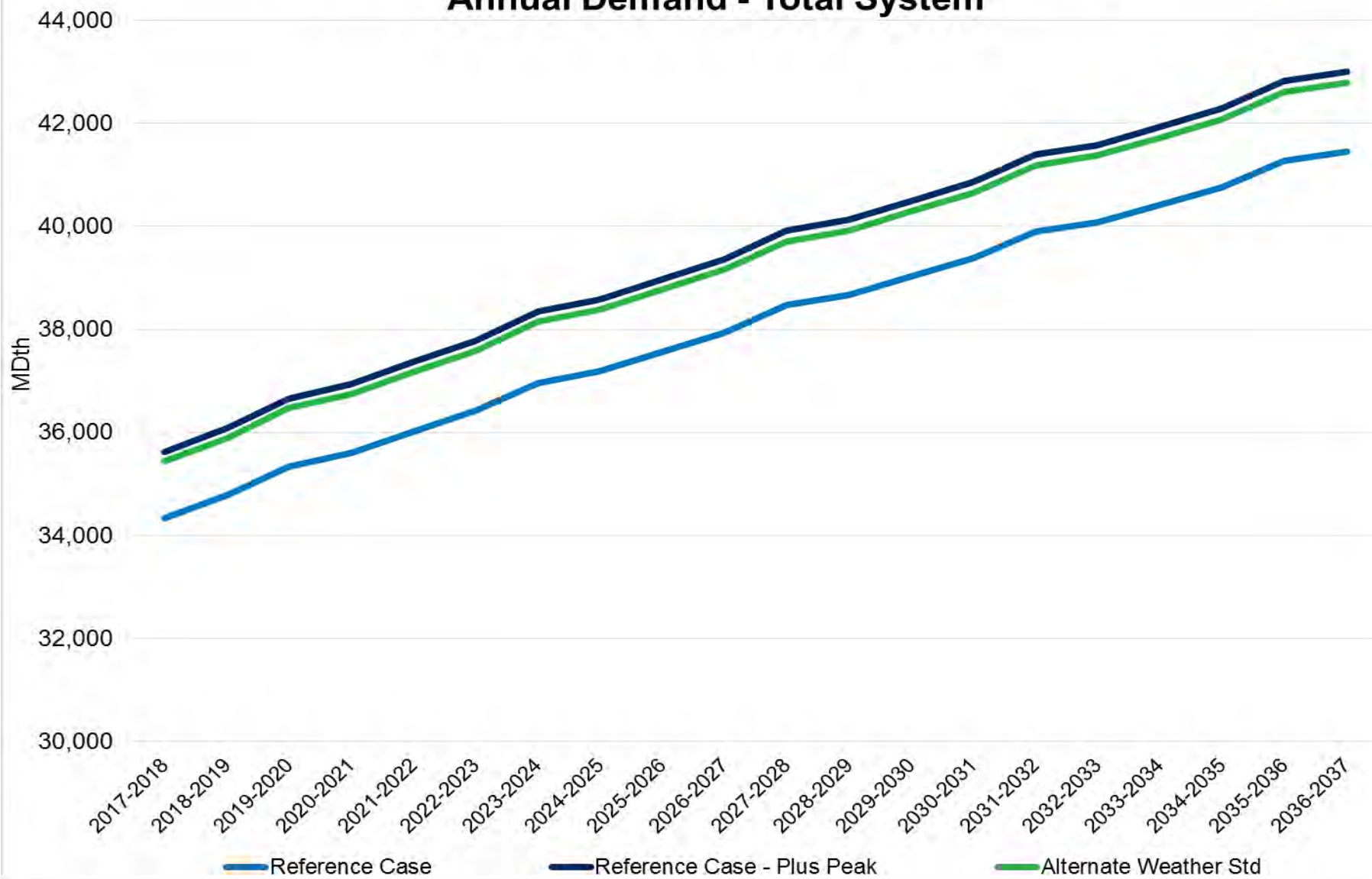

2018 Demand Sensitivities - Price Influencing Annual Demand - Total System

Exh. JM-2

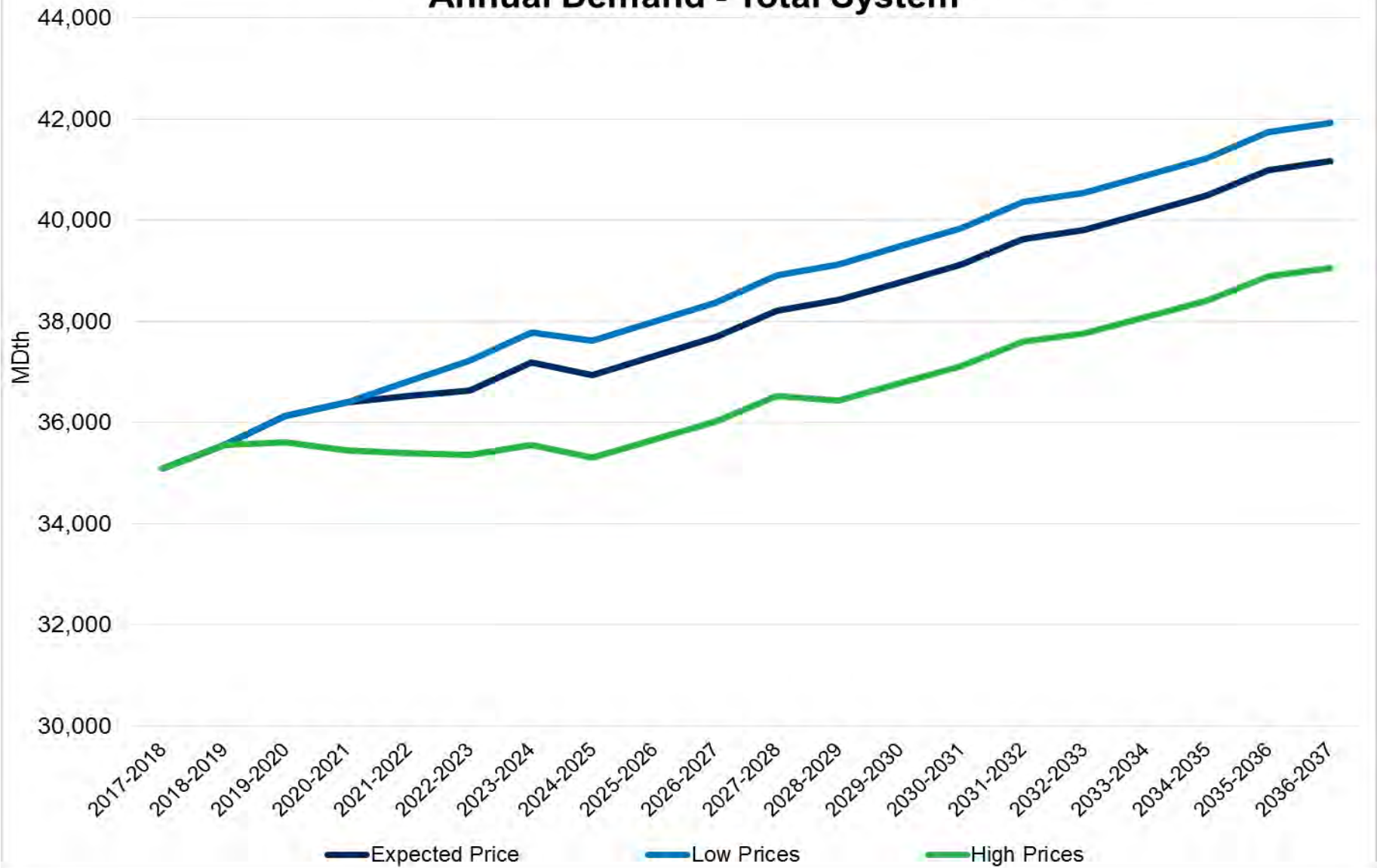

2018 Demand Sensitivities - Carbon Legislation Annual Demand - Total System

Exh. JM-2

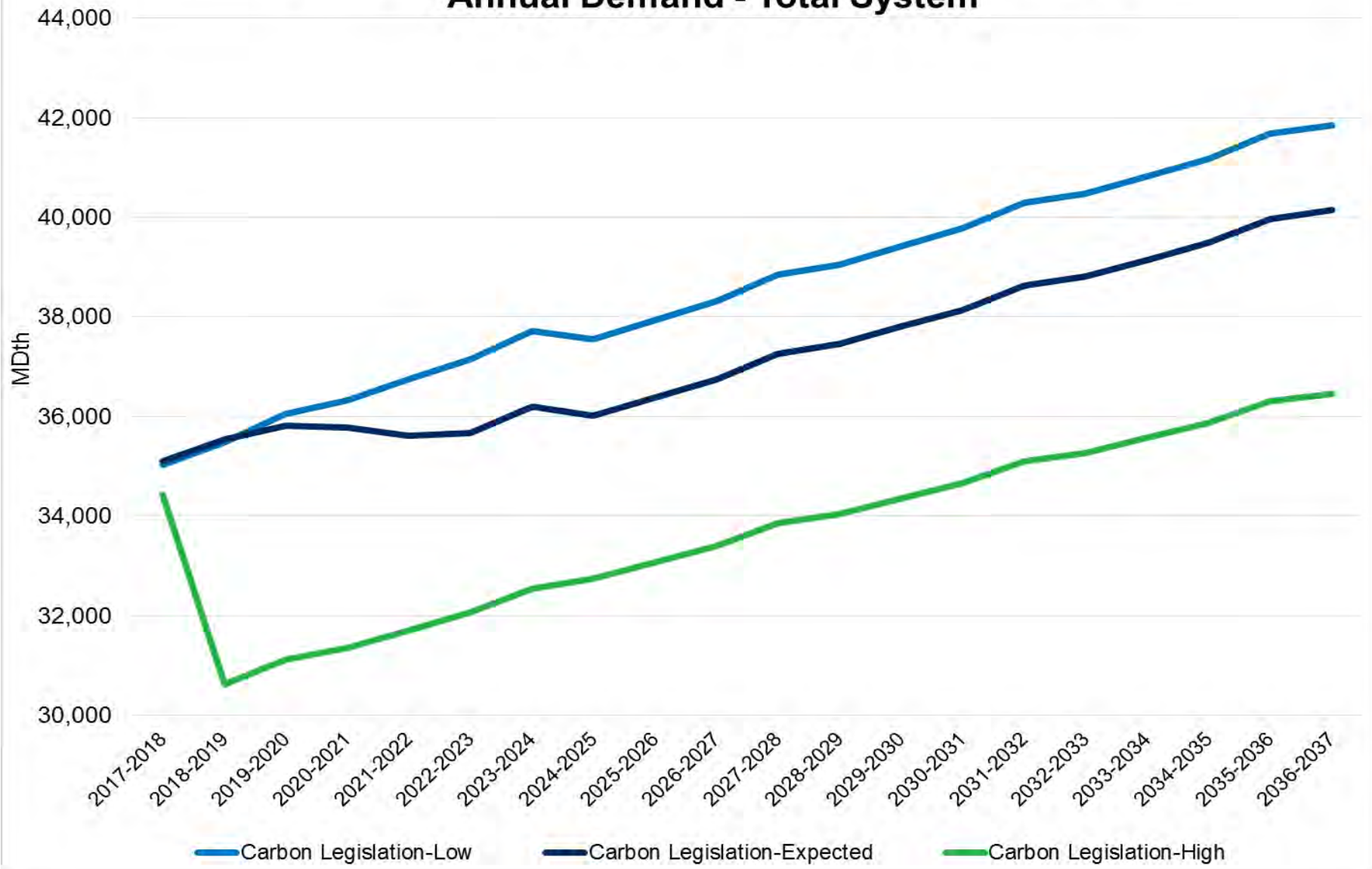

2018 Demand Sensitivities - Demand Destruction Annual Demand - Total System

Exh. JM-2

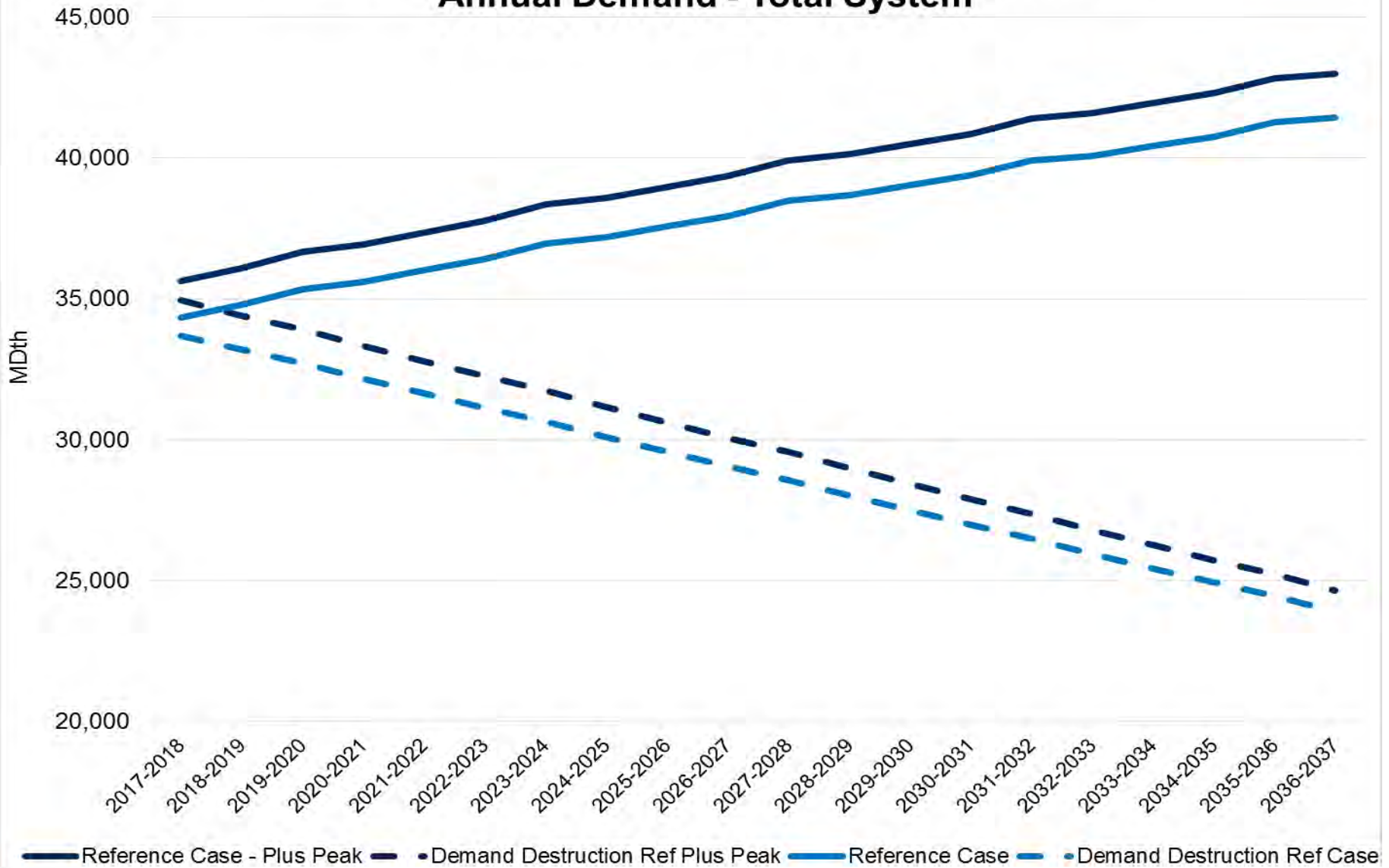

*Assumes average yearly reduction starting in 2018 to achieve 2050 target of 80% below 1990 emissions

2018 Proposed Scenarios

Proposed Scenarios INPUT ASSUMPTIONS	Expected Case	Cold Day 20yr Weather Std	Average Case	Low Growth & High Prices	Demand Destruction	High Growth & Low Prices
Customer Growth Rate	Reference Case Cust Growth Rates			Low Growth Rate	Reference Case minus	High Growth Rate
Use per Customer	3 yr Flat + Price Elasticity					3 yr Flat + Price Elasticity+CNG / NGV
Demand Side Management	Yes					
Weather Planning Standard	Historical Coldest Day	Coldest in 20 years	20 year average	Historical Coldest Day		
Prices	Expected			High	Low	
Price curve						
Carbon Legislation (\$/Metric Ton)				\$10-\$30 WA \$17.86-\$51.58 OR \$0 ID		None

2018 IRP Timeline

- **August 31, 2017** – Work Plan filed with WUTC
- **January through May 2018** – Technical Advisory Committee meetings. Meeting topics will include:
 - **TAC 1: Thursday, January 25, 2018: TAC meeting expectations, review of 2016 IRP acknowledgement letters, customer forecast, and demand-side management (DSM) update.**
 - **TAC 2: Thursday, February 22, 2018: Weather analysis, environmental policies, market dynamics, price forecasts, cost of carbon.**
 - **TAC 3: Thursday, March 29, 2018 : Distribution, supply-side resources overview, overview of the major interstate pipelines, RNG overview and future potential resources.**
 - **TAC 4: Thursday, May 10, 2018: DSM results, stochastic modeling and supply-side options, final portfolio results, and 2020 Action Items.**
- **June 1, 2018** – Draft of IRP document to TAC
- **June 29, 2018** – Comments on draft due back to Avista
- **July 2018** – TAC final review meeting (if necessary)
- **August 31, 2018** – File finalized IRP document

Questions?



2018 Avista Natural Gas IRP

Technical Advisory Committee Meeting # 4

May 10, 2018

Olympia, WA

Agenda

- Introductions
- AEG – Idaho and Washington DSM
- ETO – Oregon DSM
- Lunch
- Dynamic DSM
- Sendout Modeling
- Assumptions Review
- Solving for Unserved Demand
- Stochastics
- 2016 IRP Action Items
- 2018 Highlights
- Wrap-Up and Review schedule

2018 IRP Timeline

- **August 31, 2017** – Work Plan filed with WUTC
- **January through May 2018** – Technical Advisory Committee meetings. Meeting topics will include:
 - **TAC 1: Thursday, January 25, 2018: TAC meeting expectations, review of 2016 IRP acknowledgement letters, customer forecast, and demand-side management (DSM) update.**
 - **TAC 2: Thursday, February 22, 2018: Weather analysis, environmental policies, market dynamics, price forecasts, cost of carbon.**
 - **TAC 3: Thursday, March 29, 2018** : Distribution, supply-side resources overview, overview of the major interstate pipelines, RNG overview and future potential resources.
 - **TAC 4: Thursday, May 10, 2018: DSM results, stochastic modeling and supply-side options, final portfolio results, and 2020 Action Items.**
 - **June 21, 2018**– TAC final review meeting to review final stochastics (if necessary)
- **July 2, 2018** – Draft of IRP document to TAC
- **July 13, 2018** – Comments on draft due back to Avista
- **August 31, 2018** – File finalized IRP document



2018 CONSERVATION POTENTIAL ASSESSMENT

Study Results, Prepared for the Avista DSM Advisory Group

CPA-Related Action Plan Activities

- Measure Screening
- Measure Documentation
- Fully-Balanced TRC
- Barriers To DSM Uptake

Potential Study Summary

- LoadMAP Modeling Approach
- Levels of Potential

Potential Results

- Summary of Potential
- Comparison with Existing Programs
- Comparison with 2016 CPA

Sector-Level Potential, WA and ID (Supplemental Slide Deck)

- *Residential*
- *Commercial*
- *Industrial*



CPA-Related Action Plan Activities

Discussion of Action Items

2017-2018 ACTION PLAN

New Activities for 2018 IRP

In the 2018 IRP, ensure that the entity performing the Conservation Potential Assessment (CPA) evaluates and includes the following information:

- All conservation measures excluded from the CPA, including those excluded prior to technical potential determination;
- Rationale for excluding any measure;
- Description of Unit Energy Savings (UES) for each measure included in the CPA; specify how it was derived and the source of the data;
- Explain the efforts to create a fully-balanced TRC cost effectiveness metric within the planning horizon. Additionally, while evaluating the effort to eventually revert back to the TRC, Avista should consult the DSM Advisory Group and discuss appropriate non-energy benefits to include in the CPA.

In developing the 2018 IRP, discuss with the TAC:

- Discuss the barriers surrounding the uptake of DSM and how Avista can improve an increased level of achievable potential. (percentage of baseline dropped from 1.2 (economic) to 0.3 (achievable))

MEASURE SCREENING

Exclusions from CPA

Recommended Activity:

In the 2018 IRP, ensure that the entity performing the Conservation Potential Assessment (CPA) evaluates and includes the following information:

- All conservation measures excluded from the CPA, including those excluded prior to technical potential determination;
- Rationale for excluding any measure;

Handling in CPA:

- Very few measures were excluded from the current CPA prior to estimation of technical potential. Those explicitly excluded were highly custom commercial and industrial controls/process measures that were instead captured under a retrocommissioning or strategic energy management program.
- Measures that did not pass the economic screen were still counted in within achievable technical potential, allowing Avista to review for inclusion in programs if portfolio-level cost-effectiveness allows.

MEASURE SCREENING

Achievable Technical Top Measures in 2018

Rank	Measure / Technology	Achiev. Technical	UCT Achiev. Economic	Difference
1	Res - Furnace - Direct Fuel - AFUE 95%	22,707	19,091	3,616
2	Res - Windows - High Efficiency - Double Pane LowE CL22	9,426	9,426	-1
3	Com - Thermostat - WiFi Enabled - Wi-Fi/interactive thermostat installed	7,719	0	7,719
4	Com - Boiler - AFUE 97%	6,337	6,337	0
5	Res - Water Heater <= 55 gal. - Instantaneous - ENERGY STAR (UEF 0.87)	4,193	4,193	0
6	Com - Retrocommissioning - HVAC - Optimized HVAC flow and controls	2,809	661	2,148
7	Res - Gas Furnace - Maintenance - Restored to nameplate 80% AFUE	2,203	0	2,203
8	Com - Water Heater - Solar System - Solar system installed	1,812	0	1,812
9	Com - Fryer - ENERGY STAR	1,775	1,775	0
10	Com - Destratification Fans (HVLS) - Fans Installed	1,494	0	1,494
11	Res - Thermostat - Wi-Fi/Interactive - Interactive/learning thermostat	1,343	1,344	-1
12	Com - Gas Boiler - Insulate Steam Lines/Condensate Tank	1,152	1,152	0
13	Res - Insulation - Floor/Crawlspace - R-30	1,132	1,132	0
14	Com - Gas Boiler - Hot Water Reset - Reset control installed	1,123	1,123	0
15	Com - HVAC - Demand Controlled Ventilation - DCV enabled	1,033	1,033	0
16	Com - Thermostat - Programmable - Programmable thermostat installed	937	0	937
17	Res - Water Heater - Solar System - 40 sq ft supplemental solar system	858	0	858
18	Com - Insulation - Roof/Ceiling - R-38	847	850	-3
19	Com - Water Heater - TE 0.94	838	838	0
20	Com - Steam Trap Maintenance - Cleaning and maintenance	820	820	0
Subtotal		70,558	49,774	20,784
Total Savings in Year		86,389	61,279	25,110

MEASURE DOCUMENTATION

Documentation of Savings and Other Assumptions

Recommended Activity:

- Description of Unit Energy Savings (UES) for each measure included in the CPA; specify how it was derived and the source of the data;

Handling in CPA:

- The measure list developed during the CPA includes descriptions of each measure included. AEG will provide this as an appendix to the final report.
- Source documentation for assumptions, including UES, lifetime, and costs (including NEIs) may be found in the “Measure Summary” spreadsheet delivered as an appendix to the final report.
 - This will include the name of the source and version (if applicable)

FULLY-BALANCED TRC

Non-Energy Impacts

Recommended Activity:

- Explain the efforts to create a fully-balanced TRC cost effectiveness metric within the planning horizon. Additionally, while evaluating the effort to eventually revert back to the TRC, Avista should consult the DSM Advisory Group and discuss appropriate non-energy benefits to include in the CPA.

Addressed in CPA:

- As we will discuss throughout this presentation, TRC potential was estimated alongside UCT for each measure analyzed. In this study, we expanded the scope of non-energy/non-gas impacts to include the following:
 1. 10% Conservation Credit in Washington
 2. Quantified and monetized non-energy impacts (e.g. water, detergent, wood)
 3. Projected cost of carbon in Washington
 4. Heating calibration credit for secondary fuels (12% for space heating, 6% for secondary heating)
 5. Electric benefits for applicable measures (e.g. cooling savings for smart thermostats, lighting and refrigeration savings for retrocommissioning)

BARRIERS TO DSM UPTAKE

Non-Energy Impacts

Recommended Activity:

- Discuss the barriers surrounding the uptake of DSM and how Avista can improve an increased level of achievable potential. (percentage of baseline dropped from 1.2 (economic) to 0.3 (achievable))

Addressed in CPA:

- In 2018, Washington achievable technical potential is at 40% of technical, compared to roughly 25% in the 2016 CPA.
- By 2038, Washington achievable technical potential is at 84% following the Council's 85% long-term achievability assumption.
 - Idaho potential is slightly lower due to a program start-up period
- Many measures currently in Avista programs are on fast ramp rates (such as heating and food preparation equipment)
 - Others may be newer programs or experience substantial implementation barriers (contractors may be less willing to install measures that require crawlspace work)
- Barriers may possibly be alleviated by bundling measures, "cross-selling" additional measures to active participants, and assisting in market transformation initiatives



Potential Study Summary

Overview of Objectives, Approach, and Levels of Potential

LOADMAP MODELING APPROACH

Overview

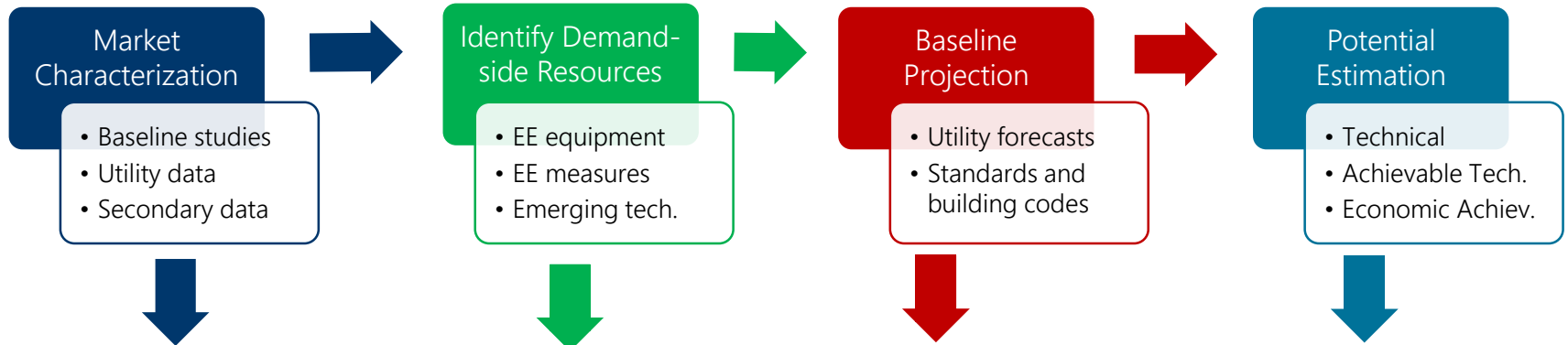

Residential Gas Use by End Use, 2015

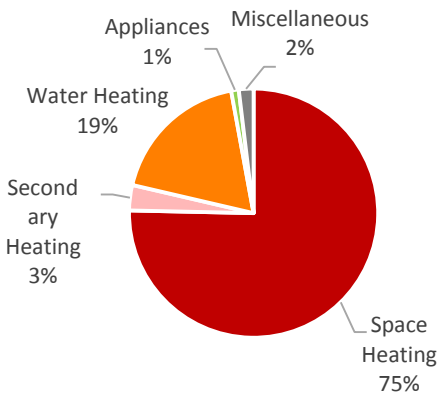

Avista Corp



2018 Natural Gas IRP Appendix

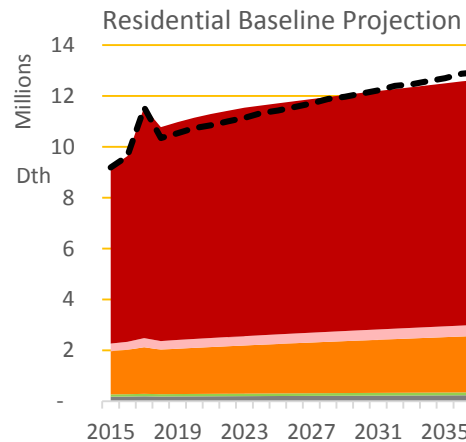

Residential Cumulative Natural Gas Savings

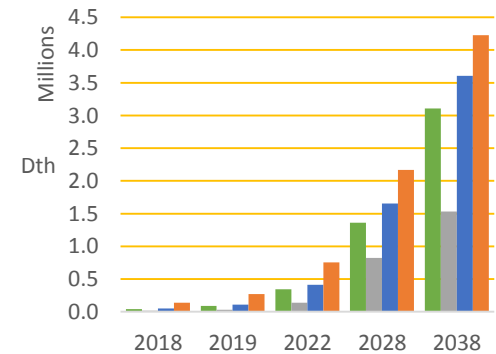

693

LEVELS OF POTENTIAL

We estimate three levels of potential. These are standard practice for CPAs in the Northwest:

- **Technical:** everyone chooses the efficient option when equipment fails regardless of cost
- **Achievable Technical** is a subset of technical that accounts for achievable participation within utility programs as well as non-utility mechanisms, such as regional initiatives and market transformation
- **Achievable Economic** is a subset of achievable technical potential that includes only cost-effective measures. Tests considered within this study include UCT, and TRC.

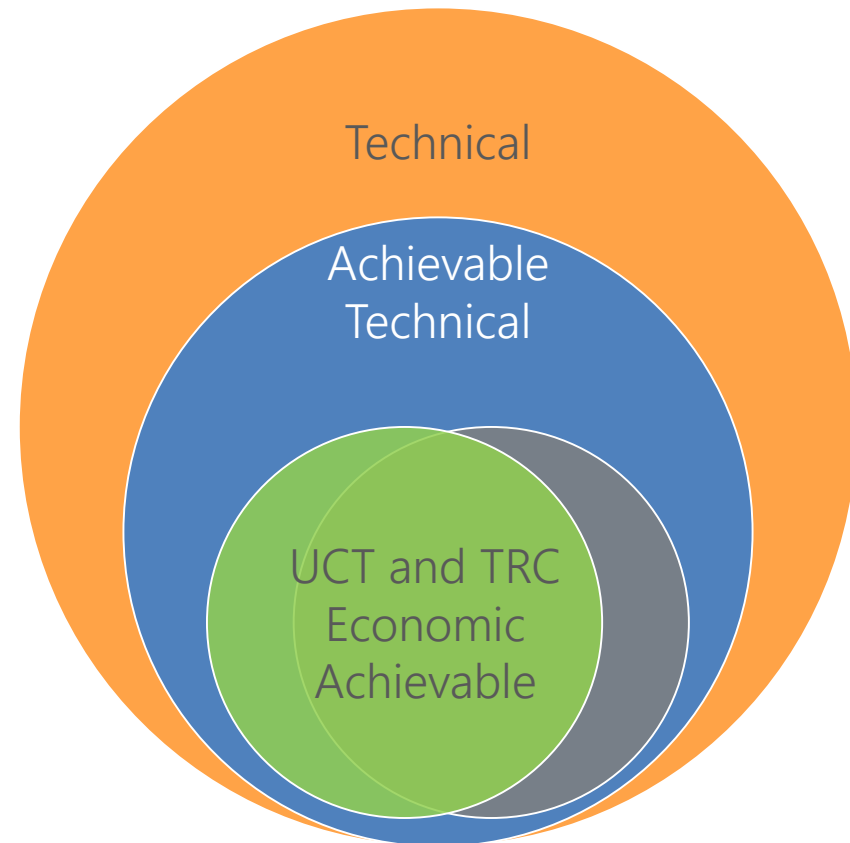

ECONOMIC SCREENING

Three Cost-Effectiveness Tests

In assessing cost-effective, achievable potential within Avista’s Washington and Idaho territories, AEG utilized two cost tests:

- **Utility Cost Test (UCT):** Assesses cost-effectiveness from a utility or program administrator’s perspective.
- **Total Resource Cost Test (TRC):** Assesses cost-effectiveness from the utility’s and participant’s perspectives. Includes non-energy impacts if they can be quantified and monetized.

Component	UCT	TRC
Avoided Energy	Benefit	Benefit
Non-Energy Benefits*		Benefit
Incremental Cost		Cost
Incentive	Cost	
Administrative Cost	Cost	Cost
Non-Energy Costs* (e.g. O&M)		Cost

*Council methodology includes monetized impacts on other fuels within these categories



Potential Results

Combined Results Avista's Residential, Commercial, and Industrial Sectors

DEFINITIONS OF POTENTIAL

Cumulative and Incremental

Over the following slides, we will display potential both as a **cumulative** impact on baseline as well as in annual **increments**

Cumulative potential includes the impacts of potential acquired from the first year of the study period (2018) through the year of interest, including effects of measures persistence

- We begin in 2018 for alignment with the current IRP period and to capture similarities with Avista programs and accomplishments
- This is particularly important in Idaho where programs are restarting and ramping up

Incremental potential summarizes new impacts realized in any given year of interest, excluding the effects of measure repurchases

Due to the effect of repurchases, the sum of incremental savings will always be greater than or equal to the cumulative potential in any given year

POTENTIAL ESTIMATES

Achievability

All potential “ramps up” over time – all ramp rates are based on those found within the NWPCC’s Seventh Power Plan

Achievable technical potential reaches 85% of technical by the end of the study, consistent with the Council assumptions

- **Please note** Power Council’s ramp rates include potential realized from outside of utility DSM programs, including regional initiatives and market transformation

POTENTIAL ESTIMATES

Total Avista Washington, Cumulative Potential

Scenario	2018	2019	2022	2028	2038
Baseline Forecast (Dth)	17,221,900	17,418,177	17,878,550	18,517,630	19,498,948
Cumulative Savings (Dth)					
UCT Achievable Economic	61,279	133,576	500,422	1,916,441	4,139,016
TRC Achievable Economic	33,893	73,100	276,379	1,297,679	2,420,649
Achievable Technical	86,389	186,065	655,389	2,405,890	4,901,043
Technical	217,202	434,037	1,189,331	3,251,362	5,804,041
Energy Savings (% of Baseline)					
UCT Achievable Economic Potential	0.4%	0.8%	2.8%	10.3%	21.2%
TRC Achievable Economic Potential	0.2%	0.4%	1.5%	7.0%	12.4%
Achievable Technical Potential	0.5%	1.1%	3.7%	13.0%	25.1%
Technical Potential	1.3%	2.5%	6.7%	17.6%	29.8%

POTENTIAL ESTIMATES

Total Avista Idaho, Cumulative Potential

Scenario	2018	2019	2022	2028	2038
Baseline Forecast (Dth)	8,557,178	8,667,149	8,958,733	9,352,011	9,975,077
Cumulative Savings (Dth)					
UCT Achievable Economic	26,340	58,352	235,414	965,825	2,107,684
TRC Achievable Economic	9,846	22,432	108,249	635,250	1,204,809
Achievable Technical	37,324	81,526	310,222	1,218,944	2,514,049
Technical	103,071	206,214	582,638	1,660,809	2,993,151
Energy Savings (% of Baseline)					
UCT Achievable Economic Potential	0.3%	0.7%	2.6%	10.3%	21.1%
TRC Achievable Economic Potential	0.1%	0.3%	1.2%	6.8%	12.1%
Achievable Technical Potential	0.4%	0.9%	3.5%	13.0%	25.2%
Technical Potential	1.2%	2.4%	6.5%	17.8%	30.0%

POTENTIAL BY SECTOR

Total Avista Washington, Cumulative Potential

As the largest sector, residential represents the largest portion of **cumulative** UCT achievable economic potential (AEP) throughout the study period.

The industrial sector only includes customers eligible for programs, which represent a very small percentage of total industrial consumption.

Some residential measures are not cost-effective on a TRC basis. This is due to the use of full measure costs rather than just a utility's portion. Inclusion of a heating calibration credit and non-gas impacts somewhat mitigates this effect.

UCT AEP Share of Total Savings by Sector

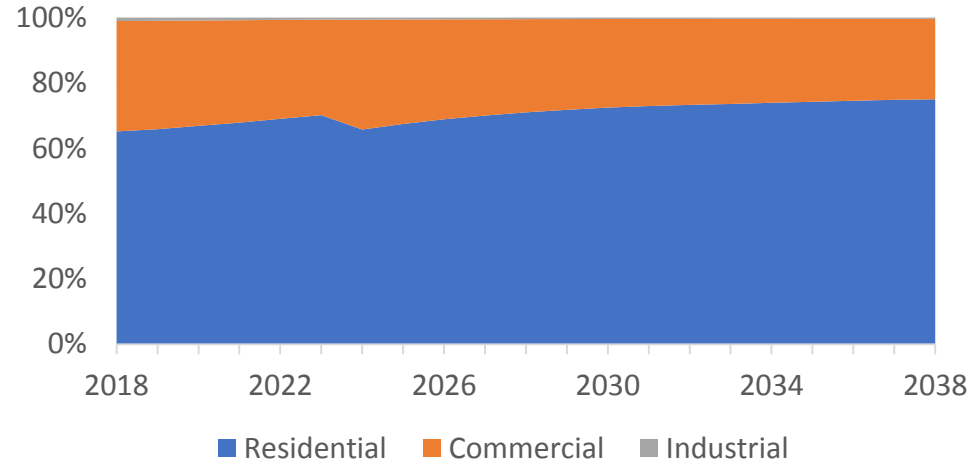

UCT Savings (Dth)	2018	2019	2022	2028	2038
Residential	39,979	88,051	345,801	1,362,078	3,107,847
Commercial	20,731	44,393	151,733	547,834	1,021,211
Industrial	569	1,132	2,887	6,528	9,957
Total	61,279	133,576	500,422	1,916,441	4,139,016

TRC Savings (Dth)	2018	2019	2022	2028	2038
Residential	14,920	32,308	139,361	824,953	1,573,939
Commercial	18,376	39,603	134,004	465,827	836,014
Industrial	597	1,188	1,785	6,899	10,696
Total	33,893	73,100	276,379	1,297,679	2,420,649

POTENTIAL BY SECTOR

Total Avista Idaho, Cumulative Potential

As the largest sector, residential represents the largest portion of **cumulative** UCT achievable economic potential (AEP) throughout the study period. This is slightly larger in Idaho than Washington.

The industrial sector only includes customers eligible for programs, which represent a very small percentage of total industrial consumption.

Some residential measures are not cost-effective on a TRC basis. This is due to the use of full measure costs rather than just a utility's portion. Inclusion of a heating calibration credit and non-gas impacts somewhat mitigates this effect.

UCT AEP Share of Total Savings by Sector

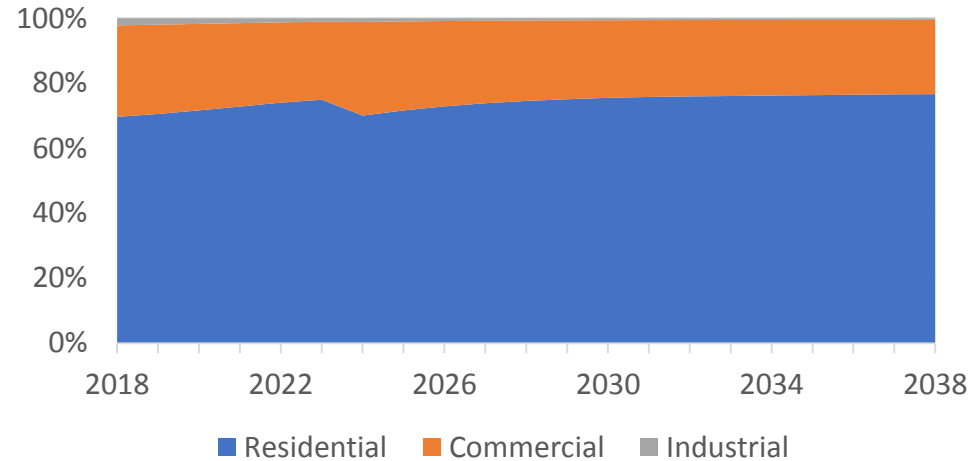

UCT Savings (Dth)	2018	2019	2022	2028	2038
Residential	18,354	41,176	174,333	720,226	1,615,844
Commercial	7,417	16,035	58,160	239,015	481,888
Industrial	569	1,140	2,922	6,584	9,952
Total	26,340	58,352	235,414	965,825	2,107,684

TRC Savings (Dth)	2018	2019	2022	2028	2038
Residential	3,744	9,243	62,156	458,445	833,329
Commercial	5,529	12,039	43,123	169,784	360,683
Industrial	573	1,150	1,738	7,021	10,797
Total	9,846	22,432	108,249	635,250	1,204,809

RESIDENTIAL ACCOMPLISHMENTS

Washington, Comparison with Current Avista Programs

2018 UCT achievable economic estimates are lower than Avista’s 2017 accomplishments and 2018 Plan

- Furnaces potential is lower, but unit installations are similar to current levels - indicating a drop in unit energy savings due to new construction installations and the 2015 WSEC.
- Smart thermostat potential is mapped to the Council’s electric ramp rate
- Windows represent substantial potential, in line with 2017 accomplishments.
- ENERGY STAR home savings in Washington have are lower due to the impacts of 2015 WSEC – but not to the level of the RTF, who assumes everyone will be installing high-efficiency water heaters
 - Anecdotal evidence from builders indicates that this is not the case

2018 UCT Achievable Economic (Dth)	2017 Accomplish	2018 Plan	LoadMAP 2018 ATP
Furnace	40,003	28,600	19,091
Boiler	453	0	619
Water Heater	6,621	1,042	4,257
ENERGY STAR Homes	122	365	294
Smart Thermostat	4,884	2,340	1,344
Programmable TStat.	0	55	0
Ceiling Insulation	540	280	1,072
Wall Insulation	218	240	904
Floor Insulation	66	266	1,135
Doors	40	63	0
Windows	8,911	15,940	9,426
Air Sealing	207	112	0
Duct Insulation	30	144	367
Duct Sealing	48	0	0
Showerheads	0	954	575
Miscellaneous	14	0	893
Total	62,156	50,402	39,979

2015 WASHINGTON ENERGY CODE

Impact on Residential New Construction

Effective since the middle of 2016, the 2015 WSEC results in a much more efficient new construction baseline

- Mandatory, very efficient, shell measures substantially reduce heating loads, which lowers furnace usage by 30%
 - e.g. $650 \times .7 = 455$ therms
- Since usage is down, savings from upgrading to an efficient system are reduced proportionally

Credits are also required to meet section R406.2

- Although high efficiency equipment is allowed under this section, we have heard that builders are opting for cheaper methods of compliance, such as designing homes with interior ductwork

For a new home of average size:

- Ceiling Insulation: R49
- Wall Insulation: R21
- Floor Insulation: R30 – R38
- Window U-Factor: 0.28-0.30
- Air Leakage: 3-5 ACH50

For optional credits, the following may be utilized:

- 94% AFUE furnace
- 0.95 EF water heater
- 1.75 GPM showerheads
- Inside ducting

RTF Analysis: <https://rtf.nwcouncil.org/standard-protocol/new-homes>

RESIDENTIAL ACCOMPLISHMENTS

Idaho, Comparison with Current Avista Programs

2018 UCT achievable economic estimates are very similar to Avista’s 2018 Plan and 2017 accomplishments

- Furnace potential is very similar to current accomplishments – mainly due to new construction potential
- Smart thermostats and windows pass UCT screening
- ENERGY STAR Homes reflect Idaho building codes, which do not lower space heating savings due to a substantially tighter building shell

2018 UCT Achievable Economic (Dth)	2017 Accomplish	2018 Plan	LoadMAP 2018 ATP
Furnace	12,783	11,716	11,816
Boiler	134	0	307
Water Heater	1,775	2,077	2,014
ENERGY STAR Homes	41	41	146
Smart Thermostat	1,628	1,040	664
Programmable Tstat.	0	0	0
Ceiling Insulation	129	56	534
Wall Insulation	17	102	452
Floor Insulation	29	119	774
Doors	11	19	0
Windows	1,407	1,708	820
Air Sealing	87	48	0
Duct Insulation	56	153	181
Duct Sealing	59	0	0
Showerheads	0	233	286
Miscellaneous	2	0	362
Total	18,158	17,311	18,354

C&I ACCOMPLISHMENTS

Washington, Comparison with Current Avista Programs

Program potential is similar to current Avista programs

- LoadMAP UCT Achievable Economic is between 2017 accomplishments and 2018 plan
- Even with very high ramp rates, food preparation potential is lower than current programs (LO50Fast)
- Many HVAC-specific measures would be considered “Custom” but assigned to this category since that is where those savings are ultimately realized
- Industrial adds an additional 569 Dth to the “Custom” program in the 2018 LoadMAP Projections

2018 UCT Achievable Economic (Dth)	2017 Accomplish	2018 Plan	LoadMAP 2018 UCT AEP
HVAC	14,000	3,214	11,925
Weatherization	1,657	2,080	1,694
Appliances	380	0	838
Food Preparation	3,987	4,956	2,761
Custom	2,381	10,000	4,082
Total	22,405	20,251	21,300

C&I ACCOMPLISHMENTS

Idaho, Comparison with Current Avista Programs

Program potential is higher than 2017 accomplishments and similar to 2018 plan

- Idaho programs ramped up between 2017 and 2018 due to recent restarting of offerings
- Industrial adds an additional 569 Dth to the “Custom” program in the 2018 LoadMAP Projections (similar to WA when rounded)

2018 UCT Achievable Economic (Dth)	2017 Accomplish	2018 Plan	LoadMAP 2018 UCT AEP
HVAC	1,390	805	3,769
Weatherization	874	940	941
Appliances	35	0	198
Food Preparation	1,359	1,490	1,045
Custom	0	4,100	2,033
Total	3,657	7,336	7,986

COMPARISON WITH 2016 CPA

Residential, First-Year Potential

Comparison of first-year UCT Achievable economic potential between 2016 and 2018 CPAs for the residential sector

Measures mapped to current Avista programs similarly to current CPA

Program	Washington		Idaho		Notes
	2017	2018	2017	2018	
Furnace	9,524	19,091	3,209	11,816	Accelerated from 2017 per Avista accomplishments
Boiler	251	619	112	307	
Water Heater	718	4,257	254	2,014	Accelerated from 2017 per Avista accomplishments
ENERGY STAR Homes	0	294	0	146	Now passing cost-effectiveness
Smart Thermostat	445	1,344	213	664	More mature measure, higher starting point
Programmable Thermostat	0	0	0	0	
Ceiling Insulation	1,218	1,072	577	534	
Wall Insulation	0	904	0	452	Now cost-effective
Floor Insulation	0	1,135	0	774	Now cost-effective
Doors	0	0	0	0	
Windows	8,491	9,426	4,044	820	\$/sqft is low as percent of measure cost, slowed in ID as a result, but demand for measure appears high in WA
Air Sealing	0	0	0	0	
Duct Insulation	0	367	0	181	
Duct Sealing	939	0	0	0	
Showerheads	1,627	575	736	286	No accomplishments in 2017, allowing time for program to "ramp up"
Miscellaneous	4,387	893	1,992	362	Maintenance measures no longer cost-effective due to updated labor cost calculations.
Total	27,598	39,979	11,138	18,354	

COMPARISON WITH 2016 CPA

C&I, First-Year Potential

Comparison of first-year UCT Achievable economic potential between 2016 and 2018 CPAs for the commercial sector

Custom measures reduce the most. This was due to retrocommissioning, which was cost-effective in the prior CPA

Program	Washington		Idaho		Notes
	2017	2018	2017	2018	
HVAC	8,065	11,925	3,400	3,769	Similar to prior study, slightly accelerated
Weatherization	1,636	1,694	540	941	
Appliances	953	838	453	198	
Food Preparation	577	2,761	228	1,045	Heavily accelerating measures due to program accomplishments, particularly fryers and ovens
Custom	12,130	4,082	4,997	2,033	Retrocommissioning was a top measure in prior CPA, but no longer cost-effective after to UES update.
Total	23,362	21,300	9,618	7,986	

COMPARISON WITH 2016 CPA

10-year Cumulative UCT Achievable Potential

	Current Study: 2027 Potential (Dth)	Prior Study: 2026 Potential (Dth)	Change from Prior Study (Dth)
Washington			
Residential	1,131,013	497,074	633,939
Commercial	476,648	413,219	63,429
Industrial	5,974	4,050	1,924
WA Total	1,613,635	914,343	699,292
Idaho			
Residential	596,450	208,875	387,575
Commercial	205,064	170,883	34,181
Industrial	6,034	4,411	1,623
ID Total	807,547	384,169	423,378
Avista			
Residential	1,727,462	705,949	1,021,513
Commercial	681,712	584,102	97,610
Industrial	12,007	8,461	3,546
Avista Total	2,421,181	1,298,512	1,122,669

- 10-year cumulative UCT Achievable Potential increased substantially
- In the prior CPA, we gradually increased ramp rates over time and did not max out ramp rates at 85%
- This is causing a spike in mid-year potential since many of the faster rates are already at 85%



Ingrid Rohmund, Senior Vice President
irohmund@appliedenergygroup.com

Kurtis Kolnowski, Senior Project Manager
kkolnowski@appliedenergygroup.com

Ken Walter, Senior Analyst
kwalter@appliedenergygroup.com



Energy Trust of Oregon Energy Efficiency Resource Assessment Study

Avista Corp
May 10th, 2018

2018 Natural Gas IRP Appendix

Agenda

- About Energy Trust
- 2017 Achieved Savings
- Resource Assessment Overview and Background
- Methodology
- Results
- Questions/Discussion

About us

Independent
nonprofit

Serving 1.6 million customers of
Portland General Electric,
Pacific Power, NW Natural,
Cascade Natural Gas and Avista

Providing access
to affordable
energy

Generating
homegrown,
renewable power

Building a
stronger Oregon
and SW
Washington

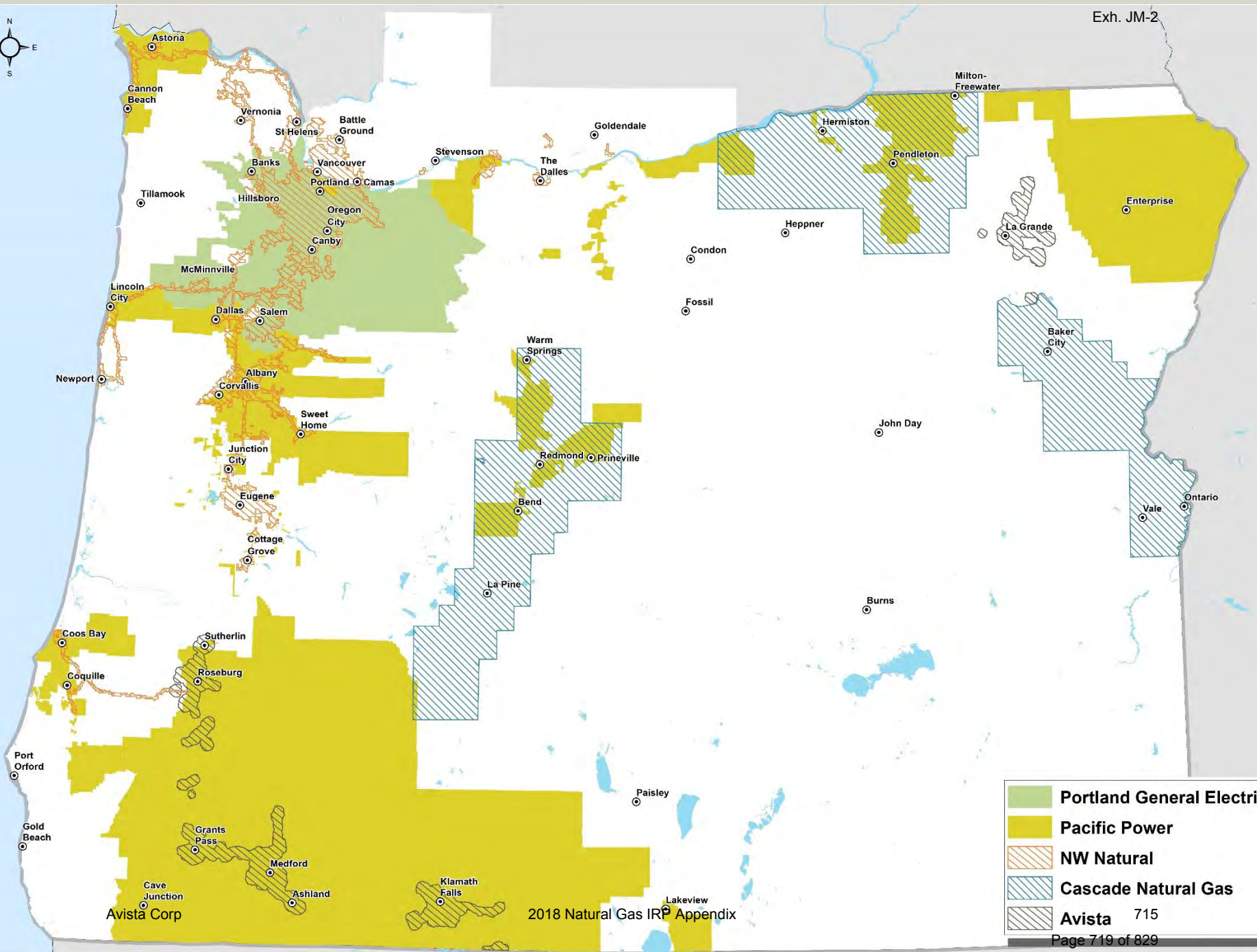

	Portland General Electric
	Pacific Power
	NW Natural
	Cascade Natural Gas
	Avista 715

15 years of affordable energy

From Energy Trust's investment of \$1.5 billion in utility customer funds:



Nearly 660,000 sites transformed into energy efficient, healthy, comfortable and productive homes and businesses



10,000 clean energy systems generating renewable power from the sun, wind, water, geothermal heat and biopower



\$6.9 billion in savings over time on participant utility bills from their energy-efficiency and solar investments



20 million tons of carbon dioxide emissions kept out of our air, equal to removing 3.5 million cars from our roads for a year

A clean energy power plant

607 average megawatts saved

121 aMW generated

52 million annual therms saved

Enough energy to power **564,000** homes
and heat **100,000** homes for a year

Avoided **20** million tons of carbon dioxide

Energy Trust's 2017 Achievements for Avista

Energy Trust Savings Achievements – 2017

- Our first full year serving Avista customers in Oregon
- Overall achieved 107% of goal
 - Goal 318k Therms
 - Achieved 341k Therms
- Anticipate continued success as we move into year 2 and Trade Ally networks expand

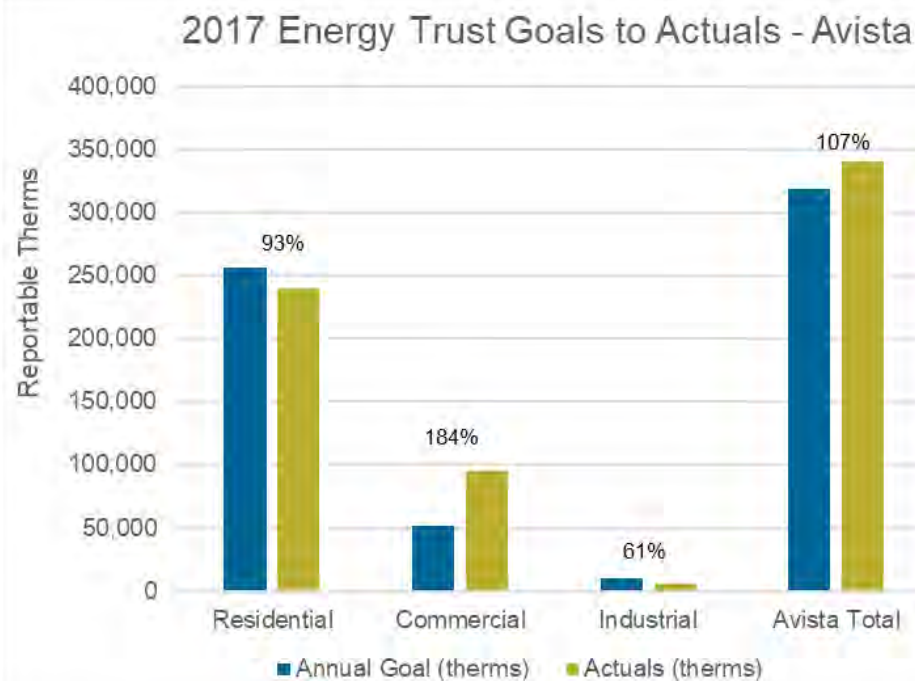

Energy Trust achieved 107% of goal in Avista service territory

Resource Assessment: Purpose, Overview and Background

Resource Assessment (RA) Purpose

- Provides estimates of energy efficiency potential that will result in a reduction of load on Avista's system for use in Avista's Integrated Resource Plan (IRP).
- The purpose is to help Avista strategically plan future investment in both supply side and demand side resources.
- Estimates of energy efficiency potential are in 'gross' savings, not 'net', as gross savings are what will be reflected on the Avista system.





Resource Assessment Overview

- What is a resource assessment?
 - Model that provides an estimate of energy efficiency resource potential achievable over a 20-year period
 - ‘Bottom-up’ approach to estimate potential starting at the measure level and scaling to a service territory
- Energy Trust uses a model in *Analytica* that was developed by Navigant Consulting in 2014
 - The *Analytica* RA Model calculates Technical, Achievable and Cost-Effective Achievable Energy Efficiency Potential.
 - Final program/IRP targets are established via a deployment protocol exogenous of the model.
- Data inputs and assumptions in the model are updated in conjunction with IRP about every two years.

Additional RA Background

- Informs utility IRP work & Energy Trust strategic and program planning.
- Does not dictate source or measure mix of annual energy savings acquired by programs
- Does not set incentive levels



20-Year Forecast Methodology

Forecasted Potential Types

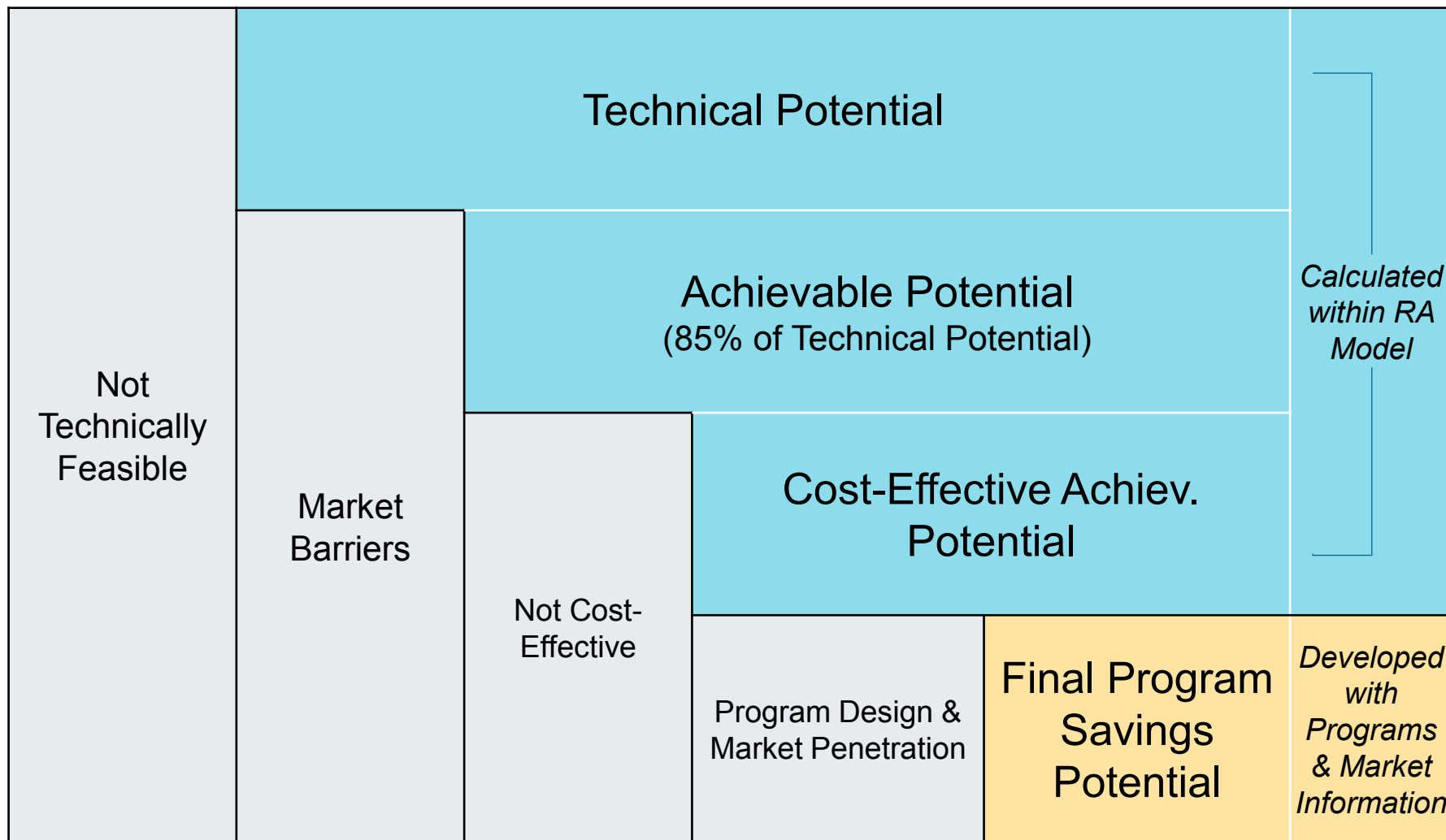

20-Year IRP EE Forecast Flow Chart

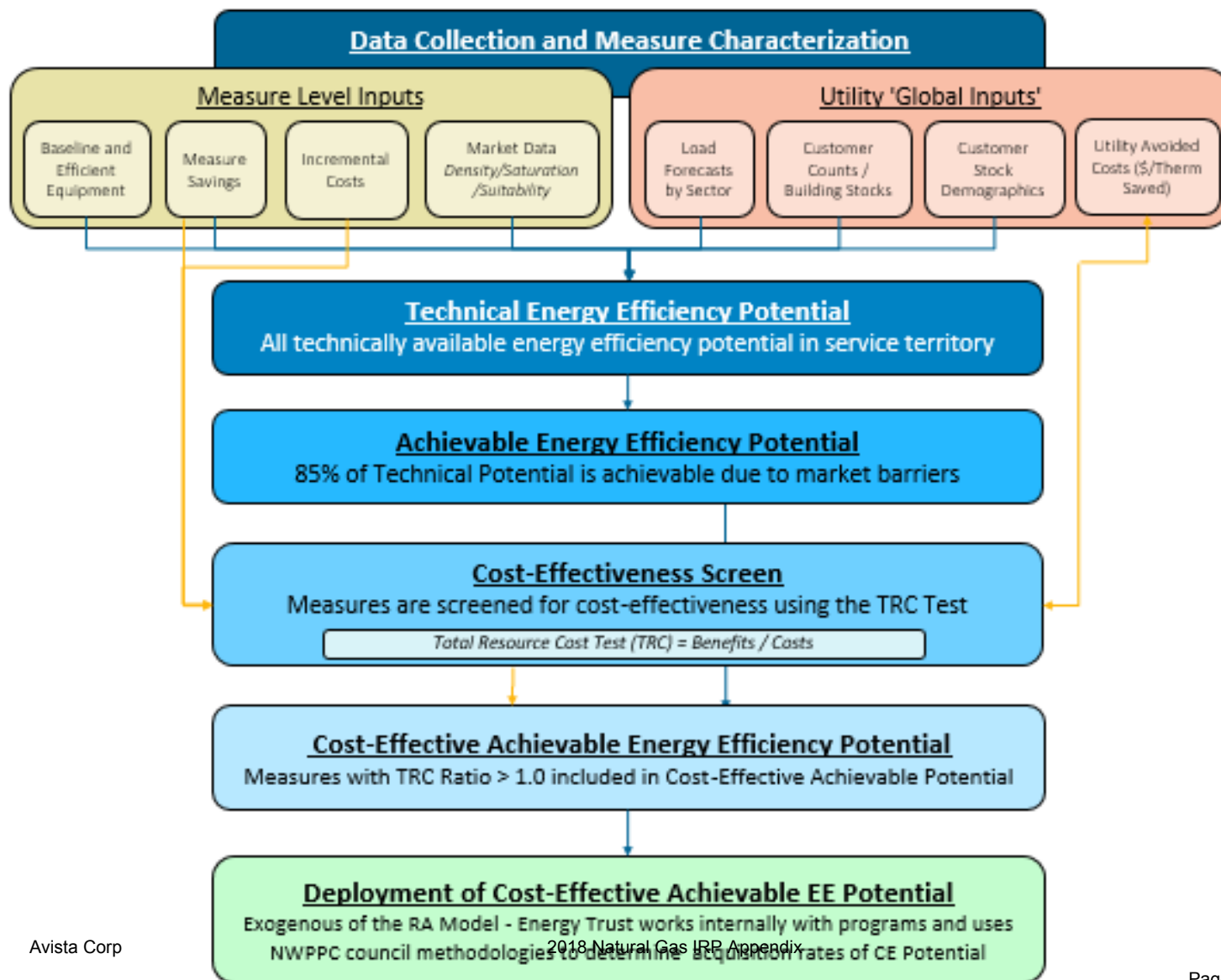

RA Model inputs

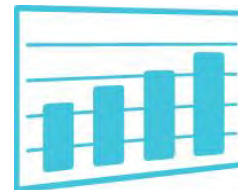

Measure Level Inputs

Measure Definition and Application:

- Baseline/Efficient equip. definition
- Applicable customer segments
- Installation type (RET/ROB/NEW)*
- Measure Life

Measure Savings

Measure Cost

- Incremental cost for ROB/NEW measures
- Full cost for retrofit measures

Market Data (for scaling)

- Density
- Baseline/efficient equipment saturations
- Suitability

Utility 'Global' Inputs

Customer and Load Forecasts

- Used to scale measure level savings to a service territory
 - Residential Stocks: # of homes
 - Commercial Stocks: 1000s of Sq.Ft.
 - Industrial Stocks: Customer load

Avoided Costs (provided by Avista)

Customer Stock Demographics:

- Heating fuel splits
- Water heat fuel splits

* RET = Retrofit; ROB = Replace on Burnout; NEW = New Construction



Model Updates

- The RA Model is a ‘living’ model and Energy Trust makes continuous improvements to it.
- Measure updates, new measures and new emerging technologies included in model
- More alignment with high-level NWPCC 7th Power Plan deployment methodologies to obtain cost-effective achievable savings within market sectors and replacement types.
- Cost-effective potential may be realized through programs or codes and standards.

Example Measure: Residential Gas Tank Water Heater (>0.70 EF)

Key Measure Inputs:



- Baseline: 0.60 EF gas water heater
- Replacement Type: Replacement on Burnout / New
- Measure Incremental Cost: \$193
- Conventional (not emerging, no risk adjustment)
- Lifetime: 13 years
- Savings: 31.5 therms (annual)
- Non-Energy Benefits: \$5.95
- Customer Segments: SF, MF, MH
- Density, Saturation, Suitability
- Competing Measures: All efficient gas water heaters

Incremental Measure Savings Approach (Competition groups – Gas water heaters)

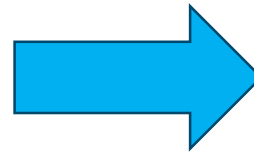
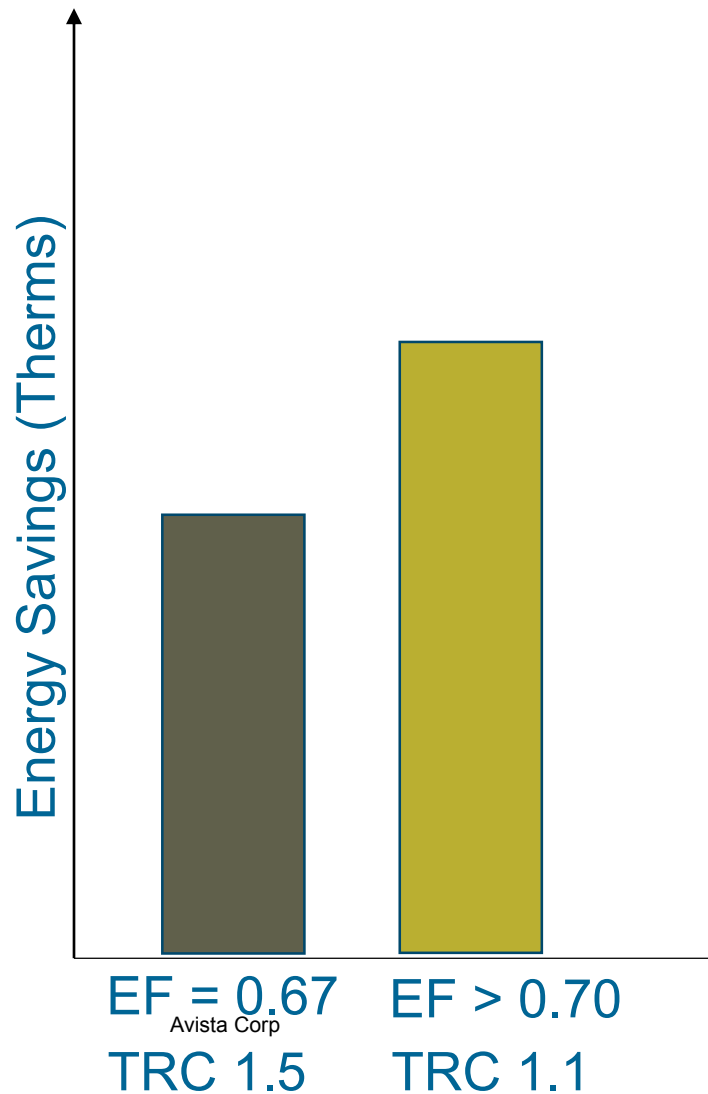

(Numbers are for illustrative purposes only)

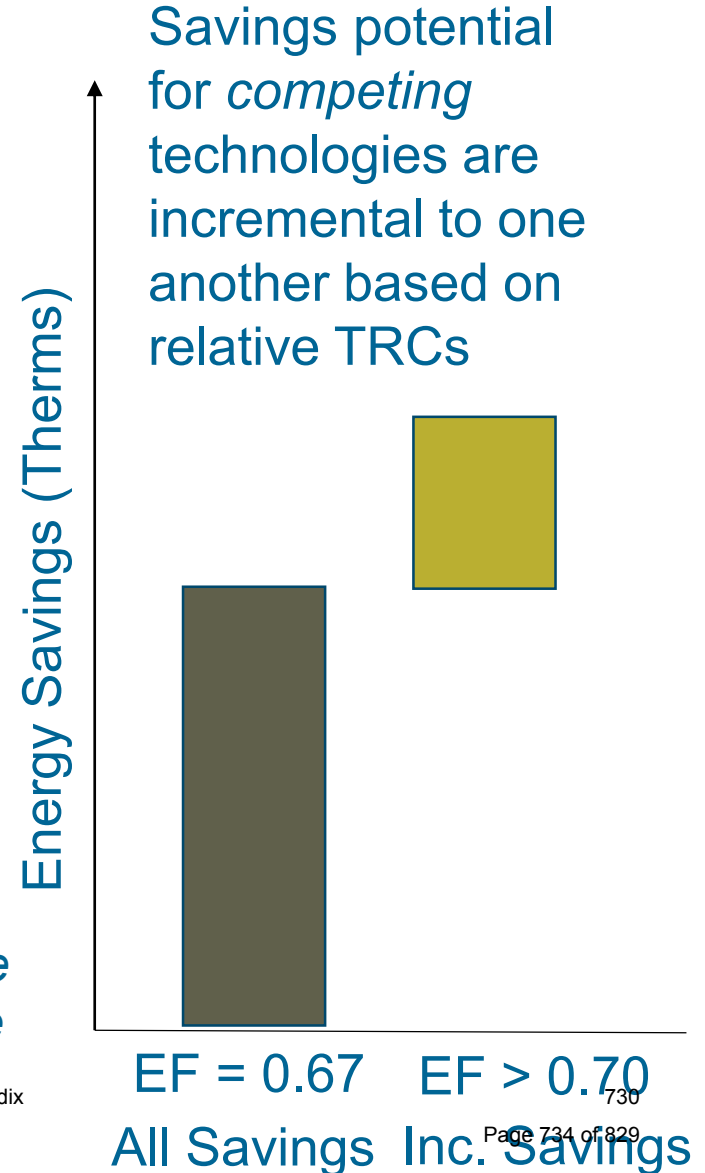



Cost-Effectiveness Screen

- Energy Trust utilizes the Total Resource Cost (TRC) test to screen measures for cost effectiveness

$$\text{TRC} = \frac{\text{Measure Benefits}}{\text{Total Measure Cost}}$$

- If TRC is > 1.0, it is cost-effective
- Measure Benefits:
 - Avoided Costs (provided by Avista)
 - Annual measure savings x NPV avoided costs per therm
 - Quantifiable Non-Energy Benefits
 - Water savings, etc.

Total Measure Costs:

- The customer cost of installing an EE measure (full cost if retrofit, incremental over baseline if replacement)

Cost-Effectiveness Override in Model

Energy Trust applied this feature to measures found to be NOT Cost-Effective in the model but are offered through Energy Trust programs.

Reasons:

1. Blended avoided costs may produce different results than utility specific avoided costs
2. Measures offered under an OPUC exception per UM 551 criteria.

The following measures had the CE override applied (all under OPUC exception):

- Res Insulation (ceiling, floor, wall)
- Res Tank Water Heater (0.67-0.69 only)

Emerging Technologies

Residential	Commercial	Industrial
<ul style="list-style-type: none"> • Path 5 Emerging Super Efficient Whole Home • Window Replacement (U<.20), Gas SF • Absorption Gas Heat Pump Water Heaters • Advanced Insulation • Behavior Competitions 	<ul style="list-style-type: none"> • Advanced Ventilation Controls • DOAS/HRV - GAS Space Heat • DHW Circulation Pump • Gas-fired HP HW • Gas-fired HP, Heating • Zero Net Energy Path • AC Heat Recovery, HW 	<ul style="list-style-type: none"> • Gas-fired HP Water Heater • Wall Insulation- VIP, R0-R35

- Model includes savings potential from emerging technologies
- Factors in changing performance, cost over time
- Use risk factors to hedge against uncertainty

Risk Factors for Emerging Technologies

Exh. JM-2

Risk Category	10%	30%	50%	70%	90%
Market Risk (25% weighting)	Requires new/changed business model Start-up, or small manufacturer Significant changes to infrastructure Requires training of contractors. Consumer acceptance barriers exist.		Training for contractors available. Multiple products in the market.	Trained contractors Established business models Already in U.S. Market Manufacturer committed to commercialization	
Technical Risk (25% weighting)	Prototype in first field tests. A single or unknown approach	Low volume manufacturer. Limited experience	New product with broad commercial appeal	Proven technology in different application or different region	Proven technology in target application. Multiple potentially viable approaches.
Data Source Risk (50% weighting)	Based only on manufacturer claims	Manufacturer case studies	Engineering assessment or lab test	Third party case study (real world installation)	Evaluation results or multiple third party case studies

Results

Outputs of Potential Type

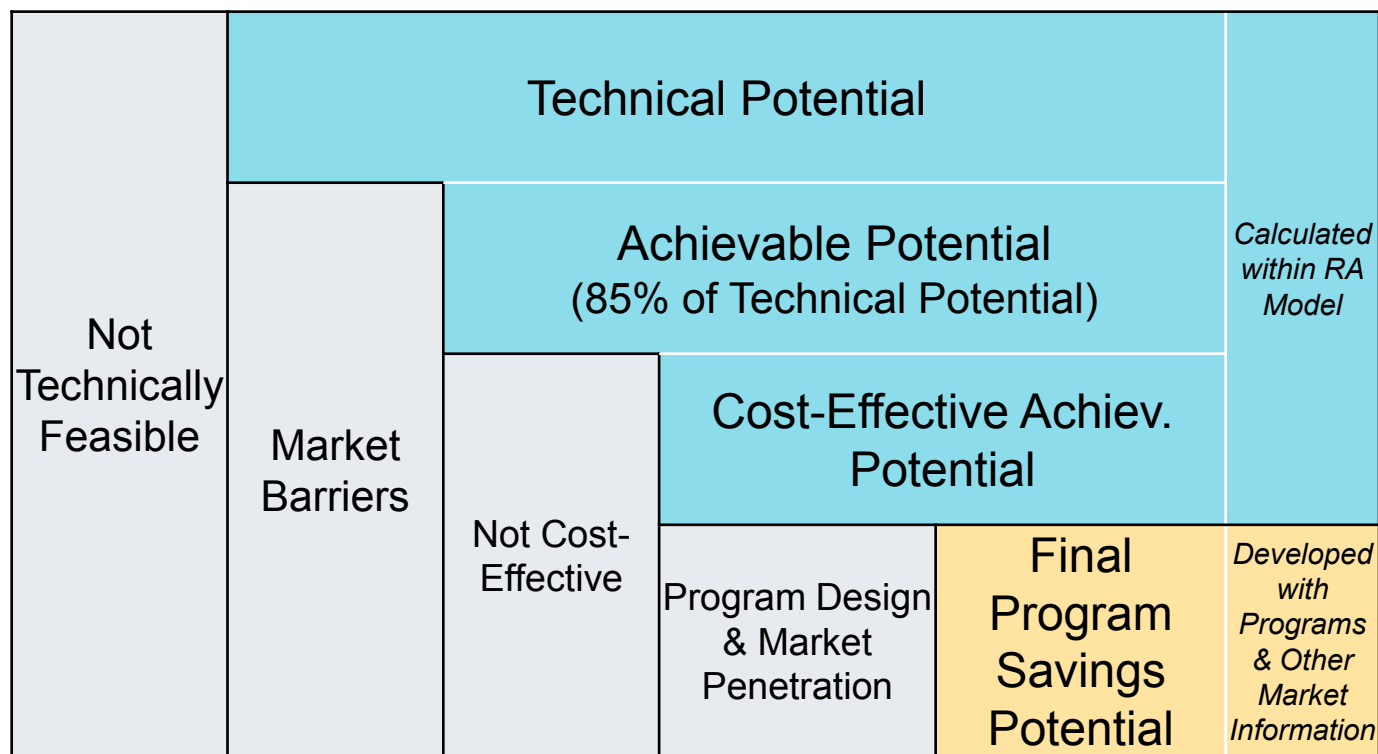

The RA Model estimates the in Technical, Achievable and Cost-Effective Achievable potential

Final Program Savings Potential is deployed exogenously of the model using the Cost-Effective Achievable potential from the RA model in combination with program expertise on what can actually be achieved

Overall Cumulative Savings Results – Millions of Therms

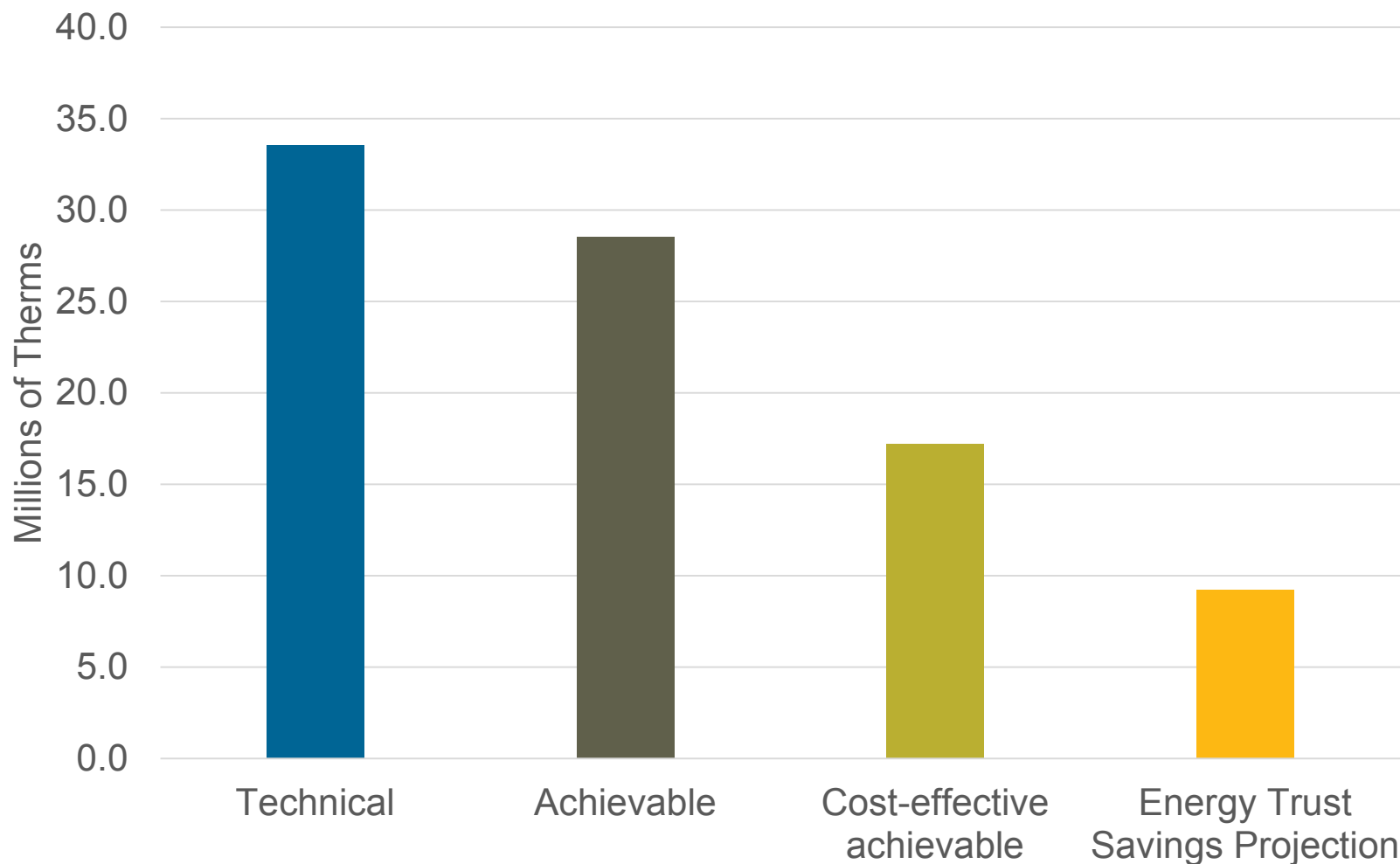

RA Model Results

Technical, Achievable, and Cost-Effective

Model Output Cumulative Potential by Type and Year (2018-2037)

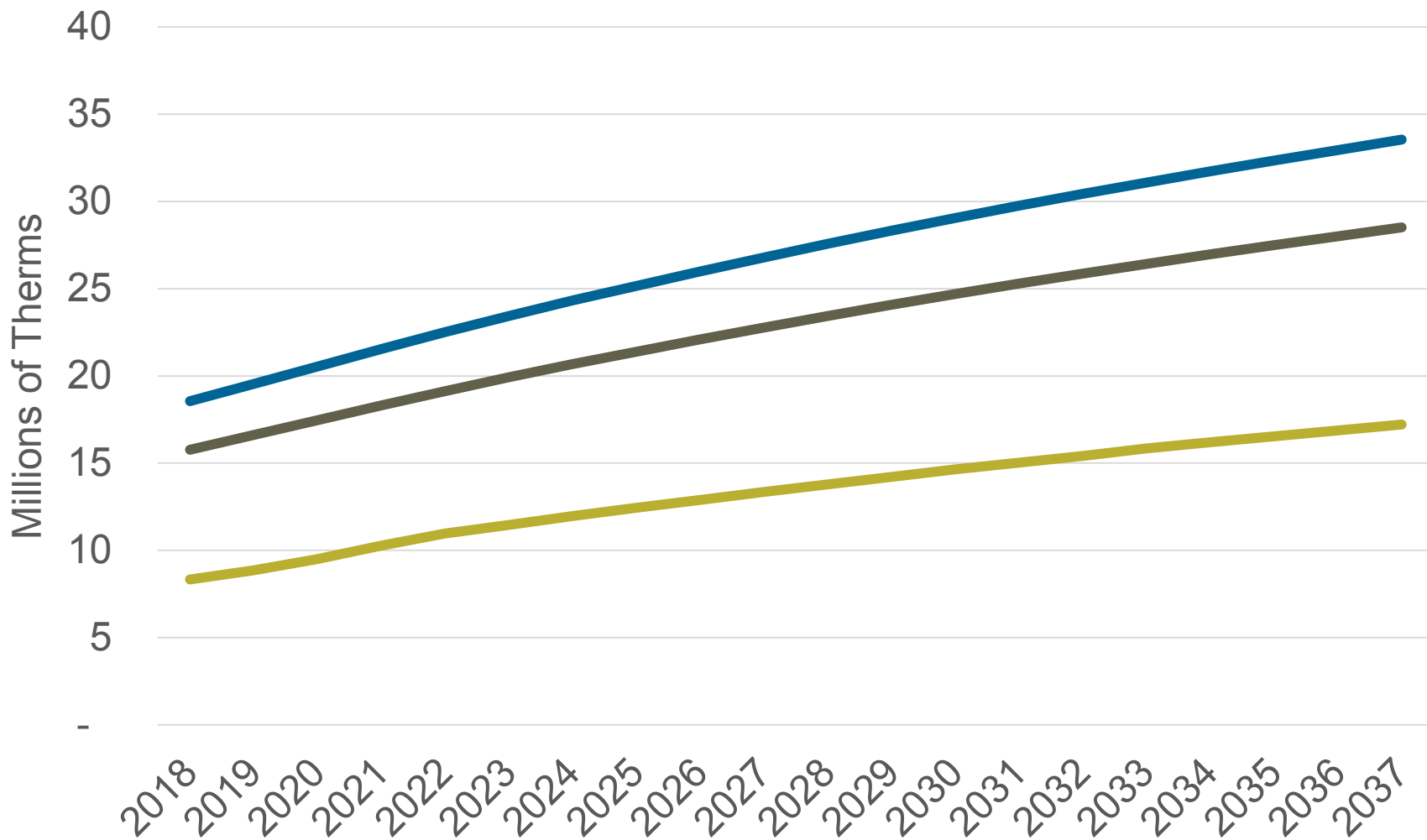

Cumulative Emerging Technology Contribution – Millions of Therms

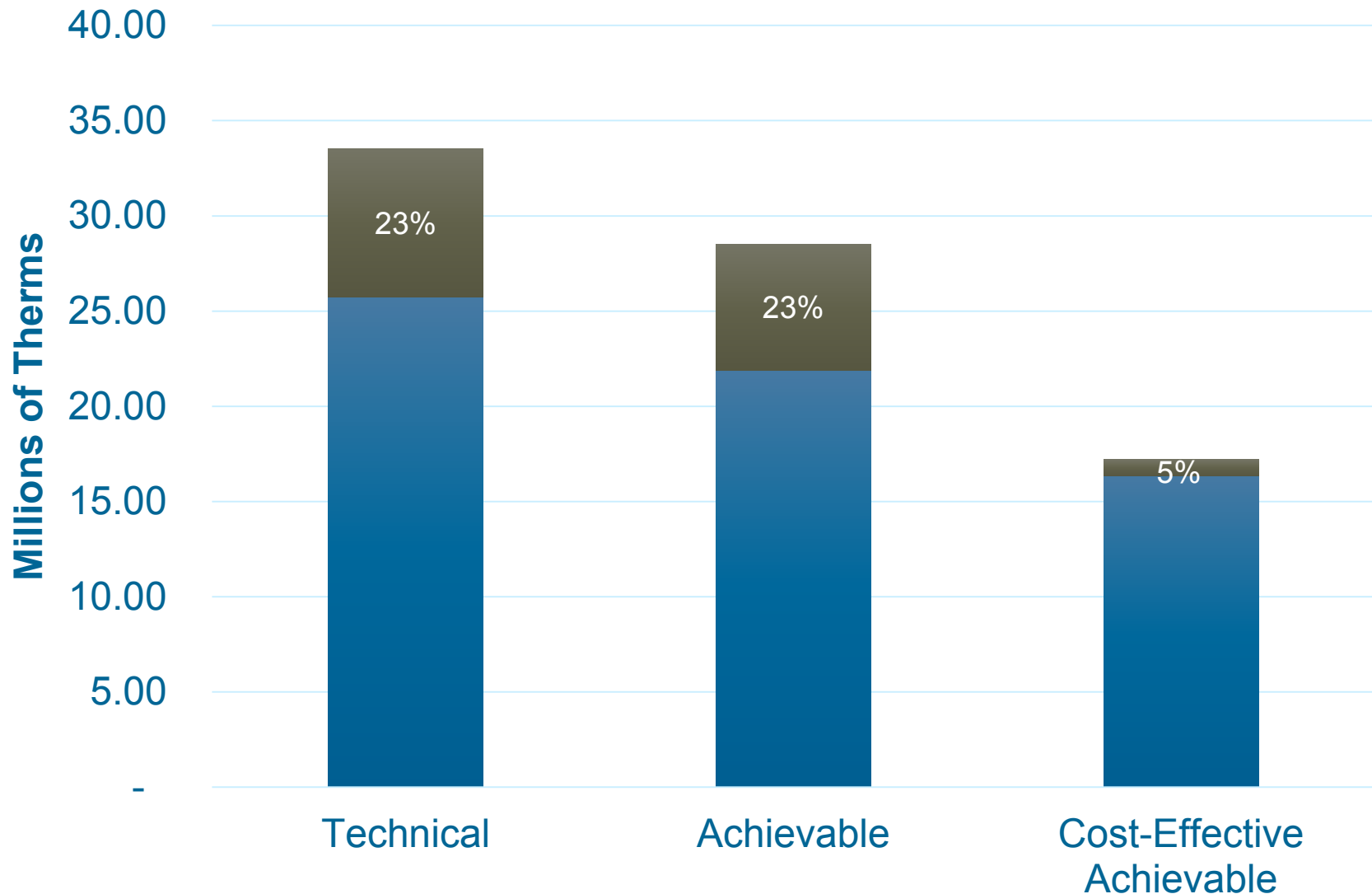

Cumulative Potential by Sector and Type – Millions of Therms

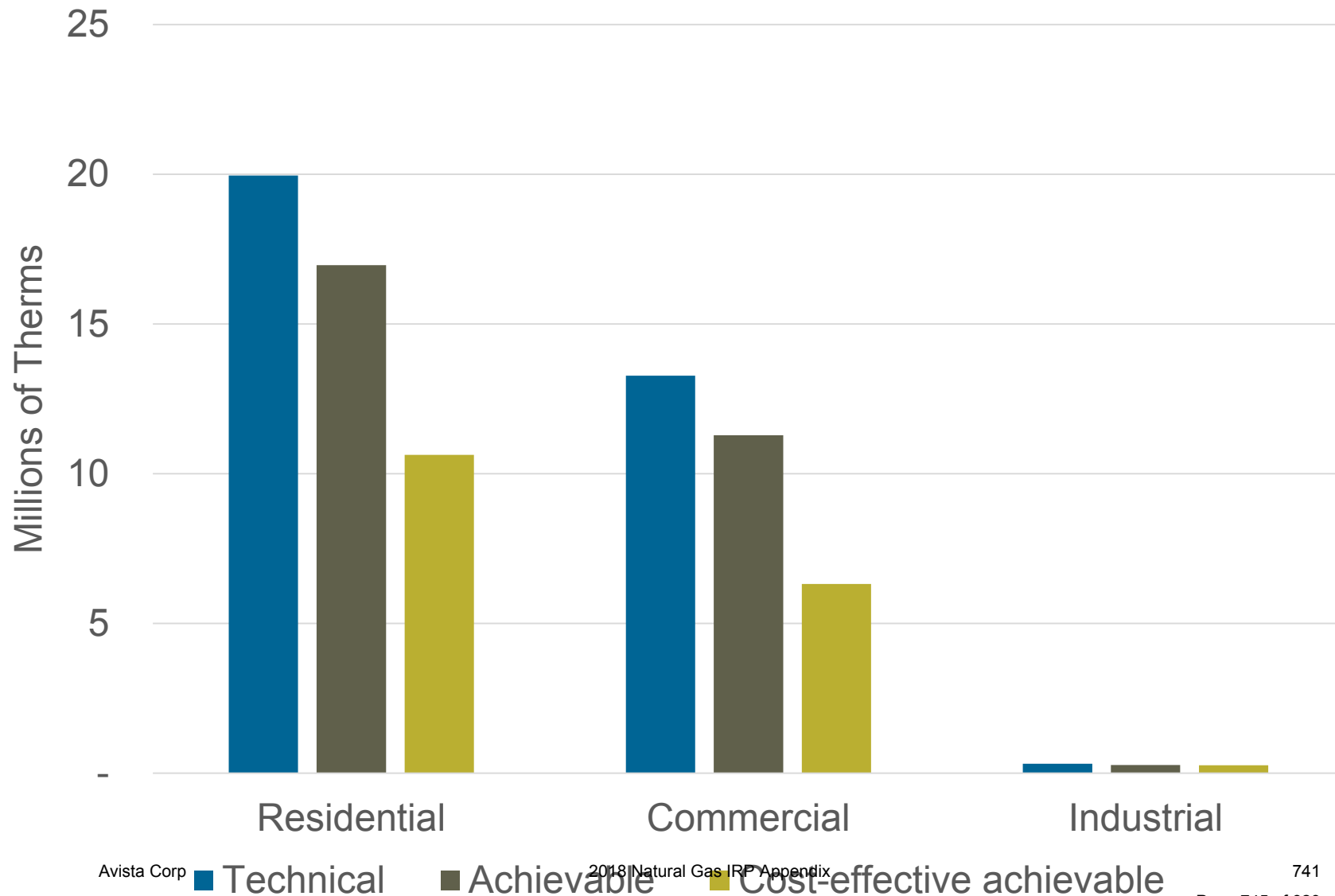

Proportion of Cumulative Cost-effective Potential by End Use

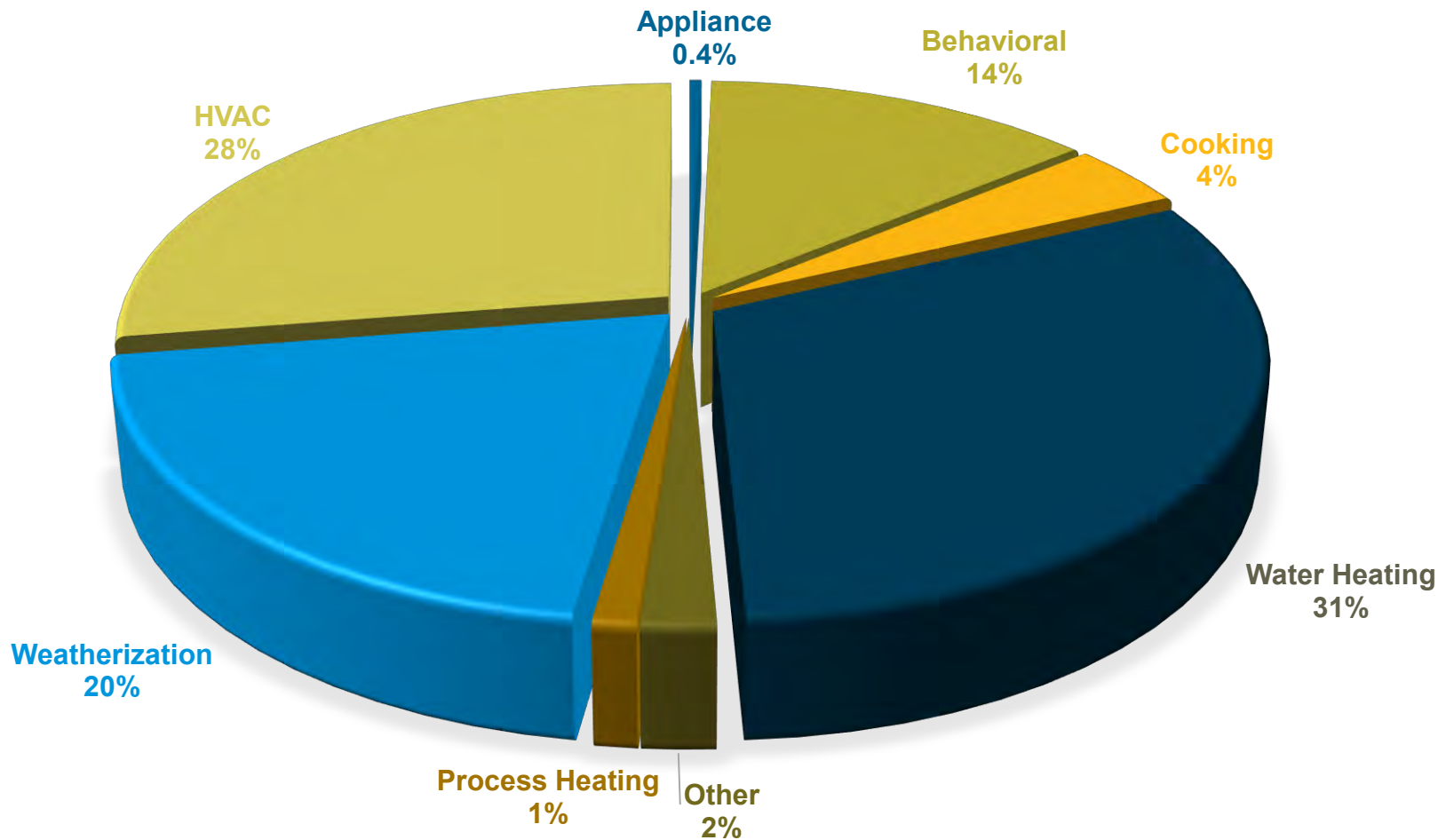

Cost-Effective Override Effect – Cumulative CE Potential (Millions of Therms)

Sector	Potential with CE Override	Potential with NO CE Override	Difference (total CE potential with override)
Residential	10.63	8.33	2.3
Commercial	6.32	6.32	-
Industrial	0.26	0.26	-
Total DSM:	17.21	14.91	2.30

Measures with CE Override in Model

- Res Insulation (ceiling, floor, wall)
- Res Tank Water Heater (0.67-0.69 only)

Top-20 Measures – Cost-Effective Cumulative Potential

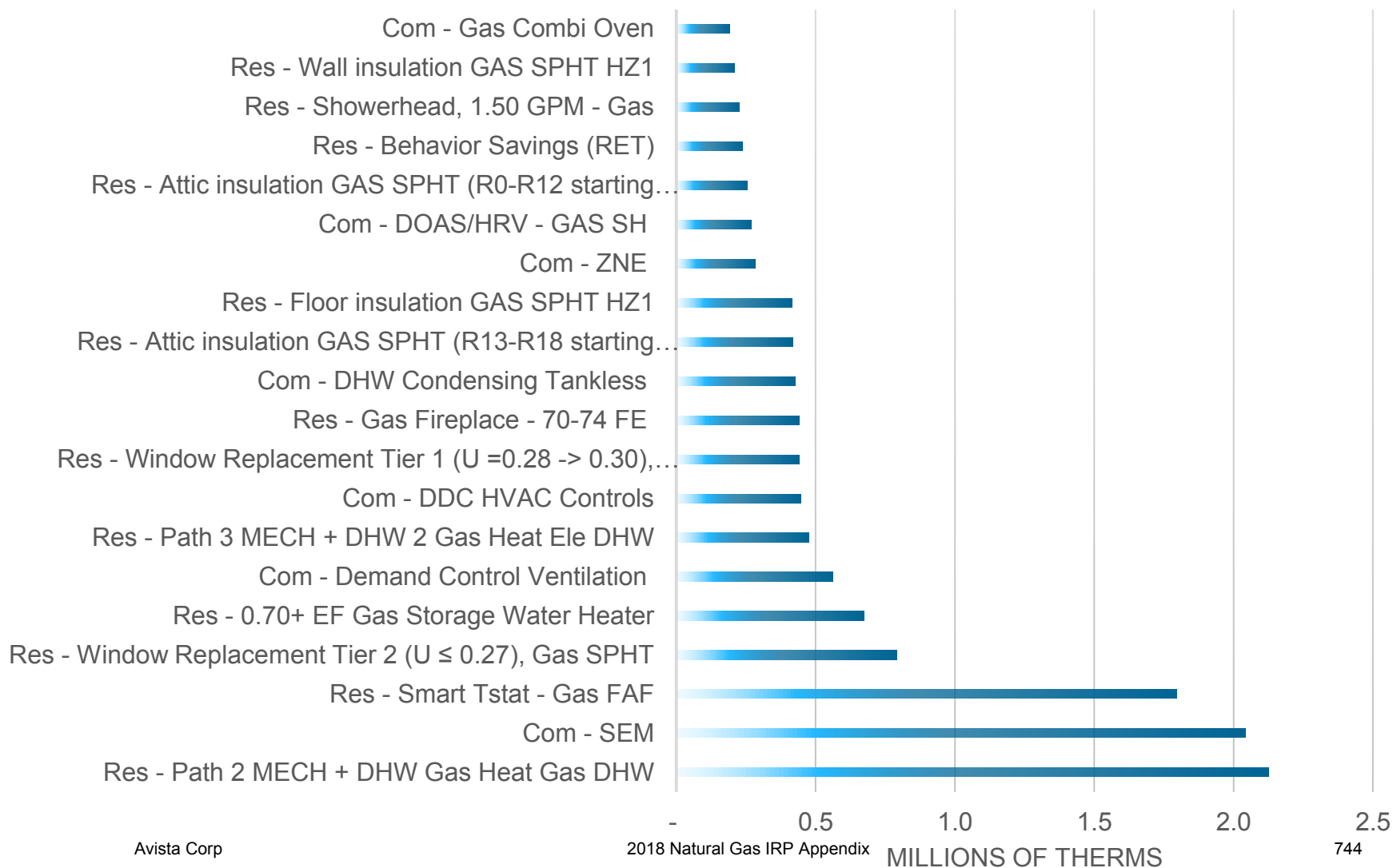

Final Savings Projections - Deployed Results

Final Savings Projection Methodology

Energy Trust sets the first five years of energy efficiency acquisition to program performance and budget goals.

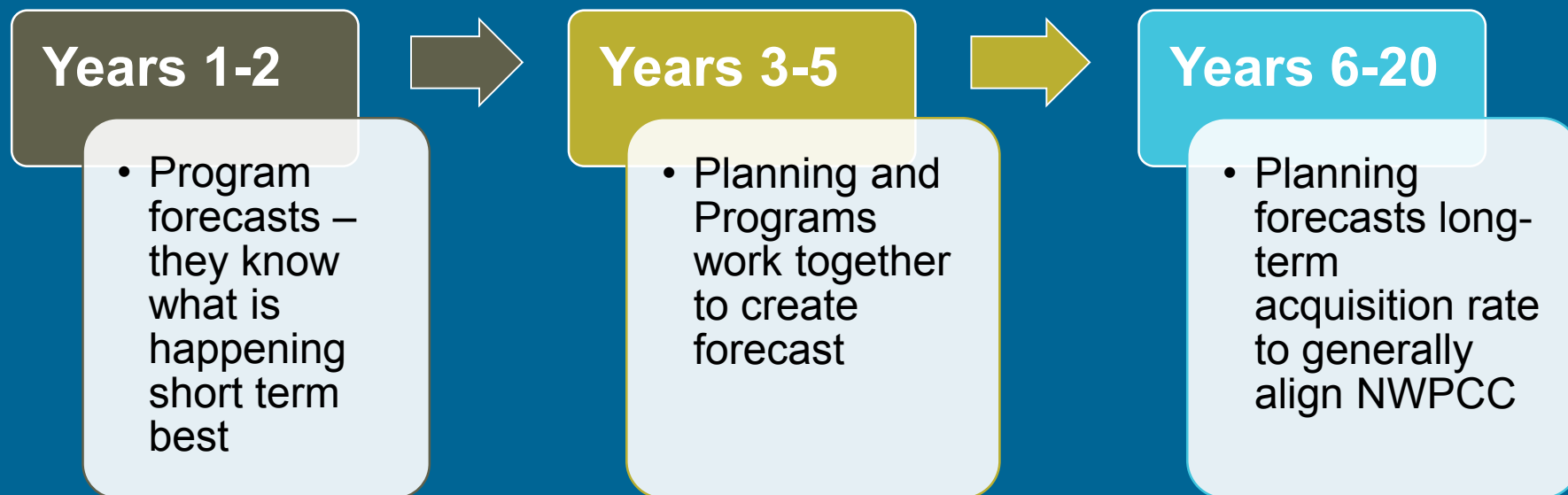

20-Year Cumulative Potential by Type – Millions of Therms

	Technical Potential	Achievable Potential	Ach. Cost-Effective Potential	Energy Trust Savings Projection
Residential	20.0	17.0	10.6	5.7
Commercial	13.3	11.3	6.3	3.3
Industrial	0.3	0.3	0.3	0.2
All Sectors	33.5	28.5	17.2	9.2

Not all Cost-Effective Potential is projected to be achieved because:

- Lost opportunity with 'Replacement' and 'New Constr.' measures
- Hard to reach measures (e.g. insulation)
- Other market barriers identified by programs & new service territory

Cost-Effective Avista Savings Projection 2018-2037 – Millions of Therms

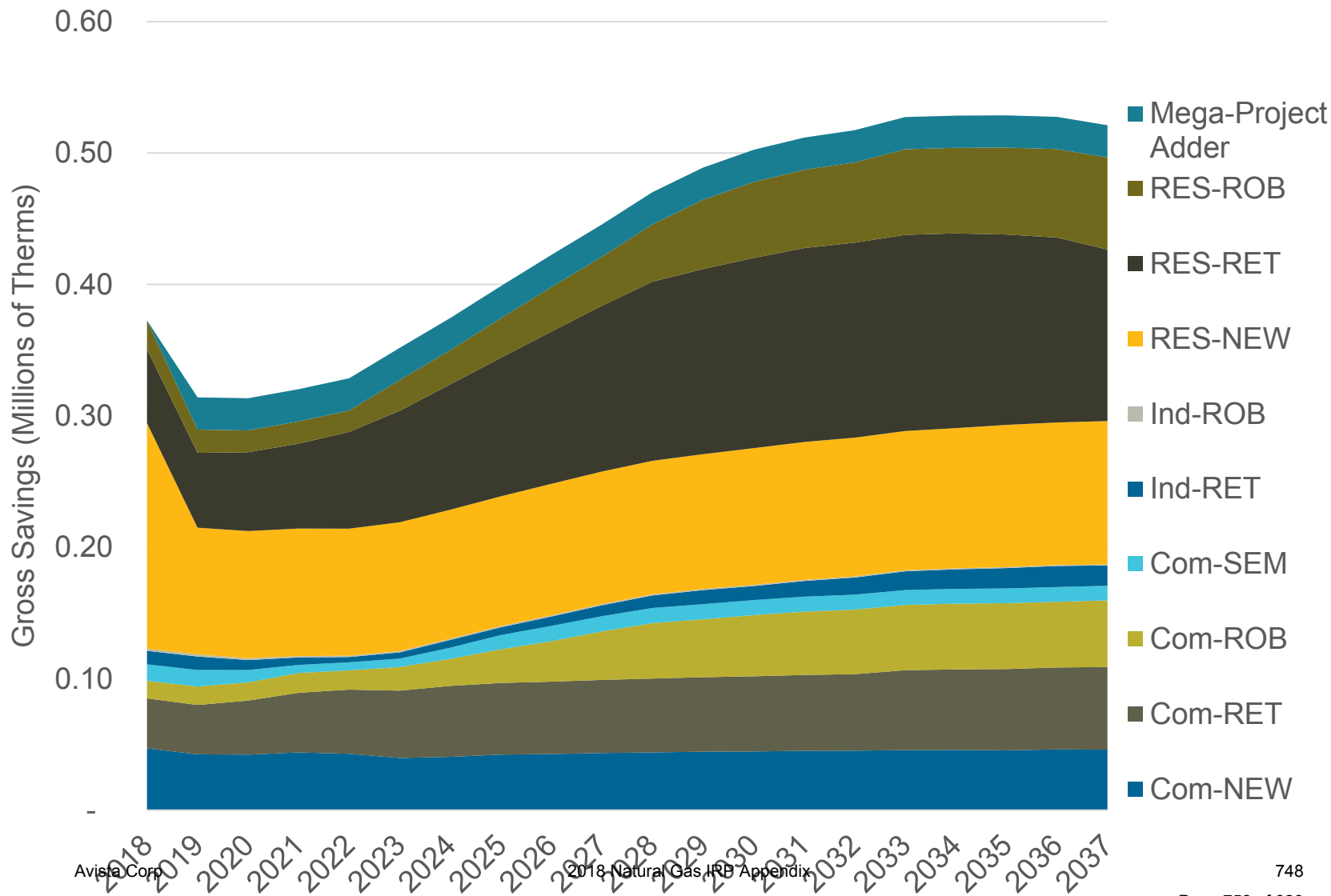

Annual Projected Savings as Percent of Avista's Annual Load Forecasts

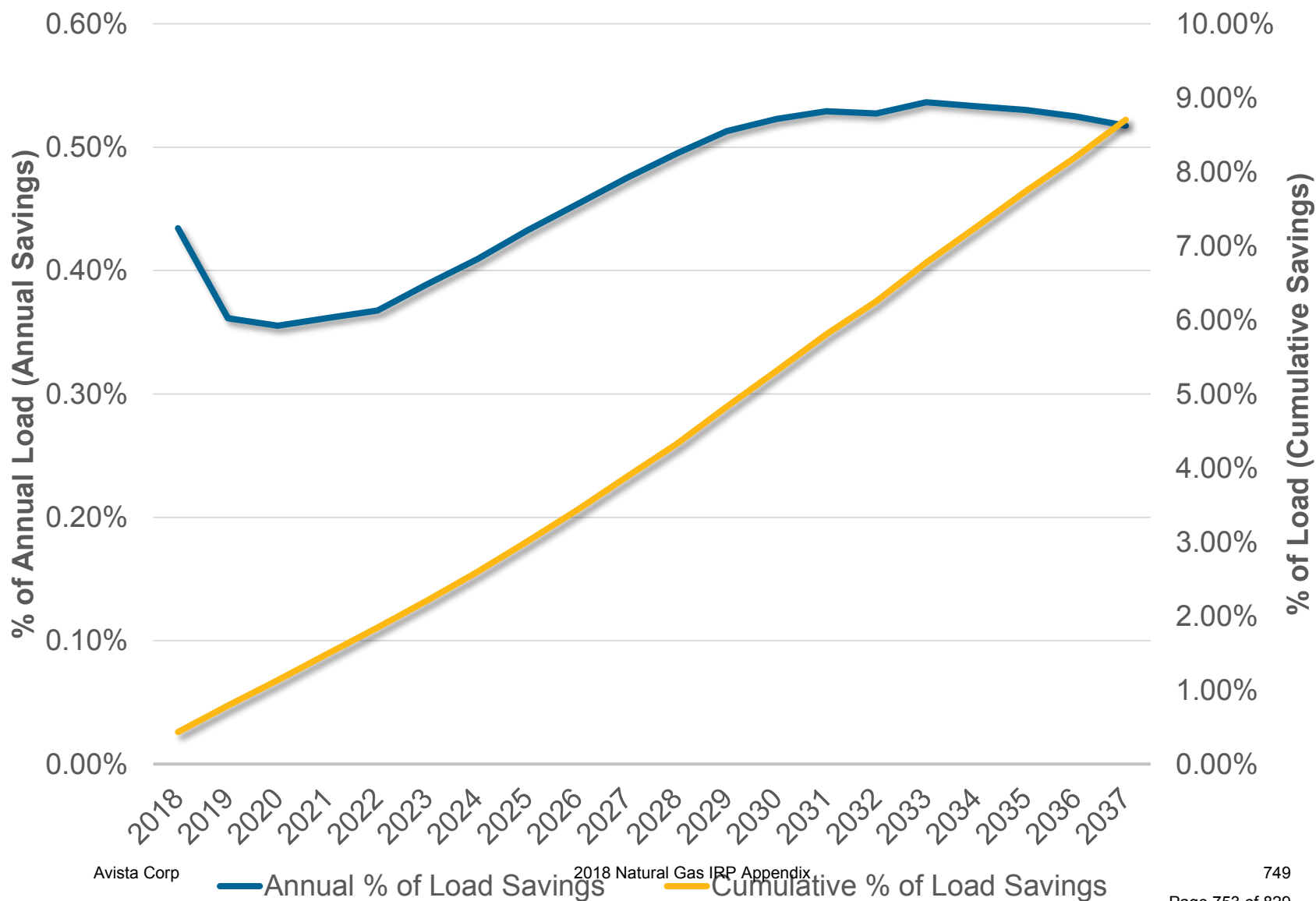

2018 Supply Curve – 20 Year Technical Potential by Levelized Cost of Energy (\$/Therm)

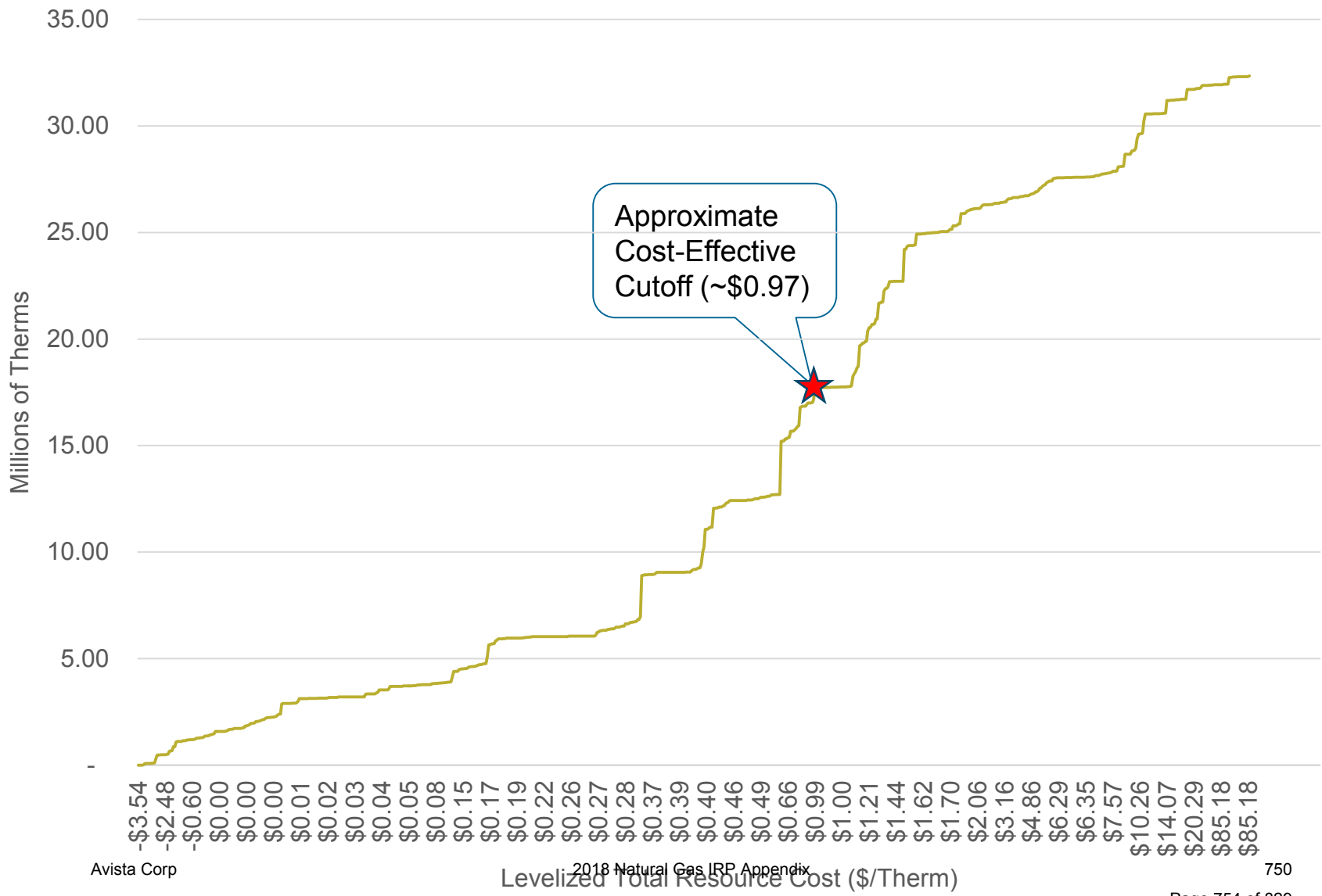

Thank you

Jack Cullen
Sr. Project Manager, Planning

Jack.Cullen@energytrust.org
503.548.1596



WUTC 2016 IRP comments

- Discuss with the TAC:
 - The results of Northwest Energy Efficiency Alliance (NEEA) coordination, including non-energy benefits to include in the CPA.
 - The appropriateness of listing and mapping all prospective distribution system enhancement projects planned on the 20 year horizon, and comparing actual projects completed to prospective projects listed in previous IRP's.



Dynamic DSM

Kaylene Schultz

Sendout and Dynamic DSM

- Action Plan: Avista's 2018 IRP will contain a dynamic DSM program structure in its analytics. In prior IRP's, it was a deterministic method based on Expected Case assumptions. In the 2018 IRP, each portfolio will have the ability to select conservation to meet unserved customer demand. Avista will explore methods to enable a dynamic analytical process for the evaluation of conservation potential within individual portfolios.

DSM Example

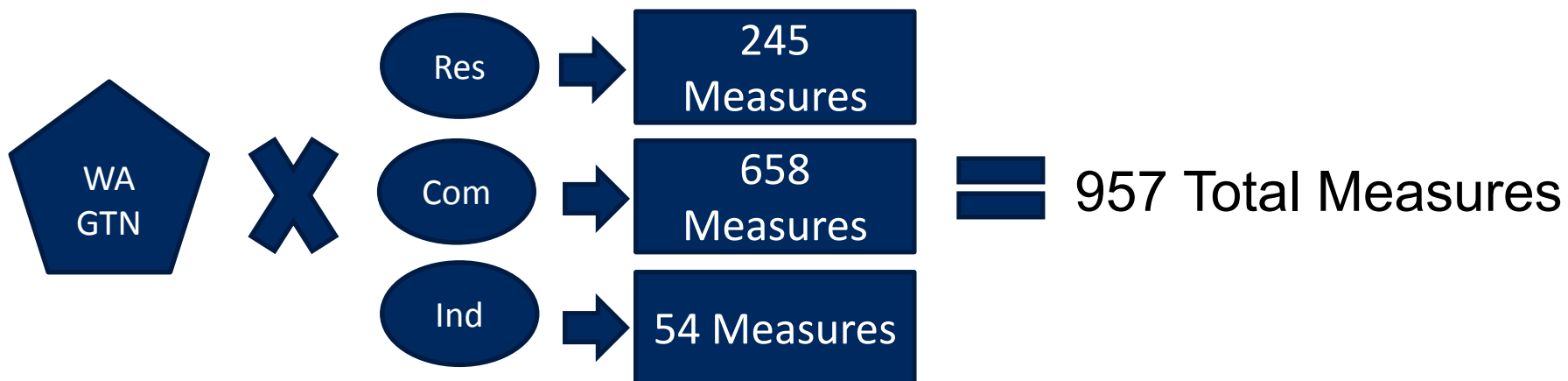

Needed Measures

Demand Areas

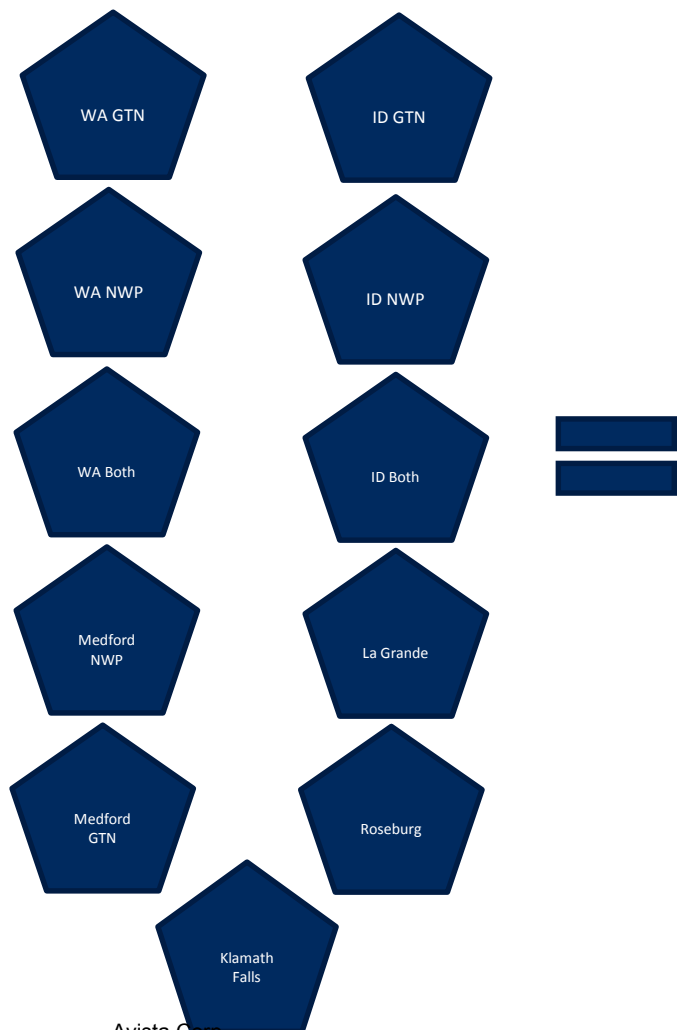

11 demand areas X 957 measures per area = 10,527 needed measures to solve

Sendout and DSM Issues

- Attempts to group measures
 - Unique measures can have different curves and device lives
 - Intent of modeling DSM as a resource is to provide individual resources the ability to fill demand along the demand curve and not lump assumptions
 - As the model works today, we would have to solve for individual area and class, each in a separate model; this would miss the mark on system optimization and peak day events

2020 Action Plan

- Avista will use the same software our electric IRP team has as a solution to this action plan
 - The solution is outside of the Sendout model in an enhanced Excel solver, meaning we will rebuild our system model in Sendout into excel
 - This solution is known to our WA and ID commissions as “PRiSM”, which is used to solve and create Avista’s DSM goals in each jurisdiction



Modeling in Sendout

Kaylene Schultz

Modeling Transportation In SENDOUT®

- Start with a point-in-time look at each jurisdiction's resources
 - Contracts – Receipt and Delivery Points
 - Rates
- Contractual vs. Operational
 - Contractual can be overly restrictive
 - Operational can be overly flexible
- Incorporating operational realities into our modeling can defer the need to acquire new resources
- Gas Supply's job is to get gas from the supply basin to the pipeline citygate
- Gas Engineering/Distribution's job is to take gas from the pipeline citygate to our customers
- The **major** limiting factor is receipt quantity – how much can you bring into the system?

Modeling Challenges

- Supply needs to get gas to the gate
- Contracts were created years ago, based on demand projections at that point in time
- Stuff happens (i.e. growth differs from forecast)
- Sum of receipt quantity and aggregated delivery quantity don't identify resource deficiency for quite some time however.....
- The aggregated look can mask individual city gate issues, and the disaggregated look can create deficiencies where they don't exist
- In many cases, operational capacity is greater than contracted
- Transportation resources are interconnected (two pipes can serve one area)
- **WARNING** – we need to be mindful of the modeling limitations

What is in SENDOUT®?

Inside:

- Demand forecasts at an aggregated level
- Existing firm transportation resources and current rates
 - Receipt point to aggregated delivery points/“zone”
 - Jurisdictional considerations
 - Long term capacity releases
- Potential resources, both supply and demand side

What is outside SENDOUT®?

Outside:

- Gate station analysis
 - Forecasted demand behind the gate
 - Growth rates consistent with IRP assumptions
 - Actual hourly/daily city gate flow data
 - Gate station MDDO's
 - Gate station operational capacities

Supply

Interconnect

Demand

Transport

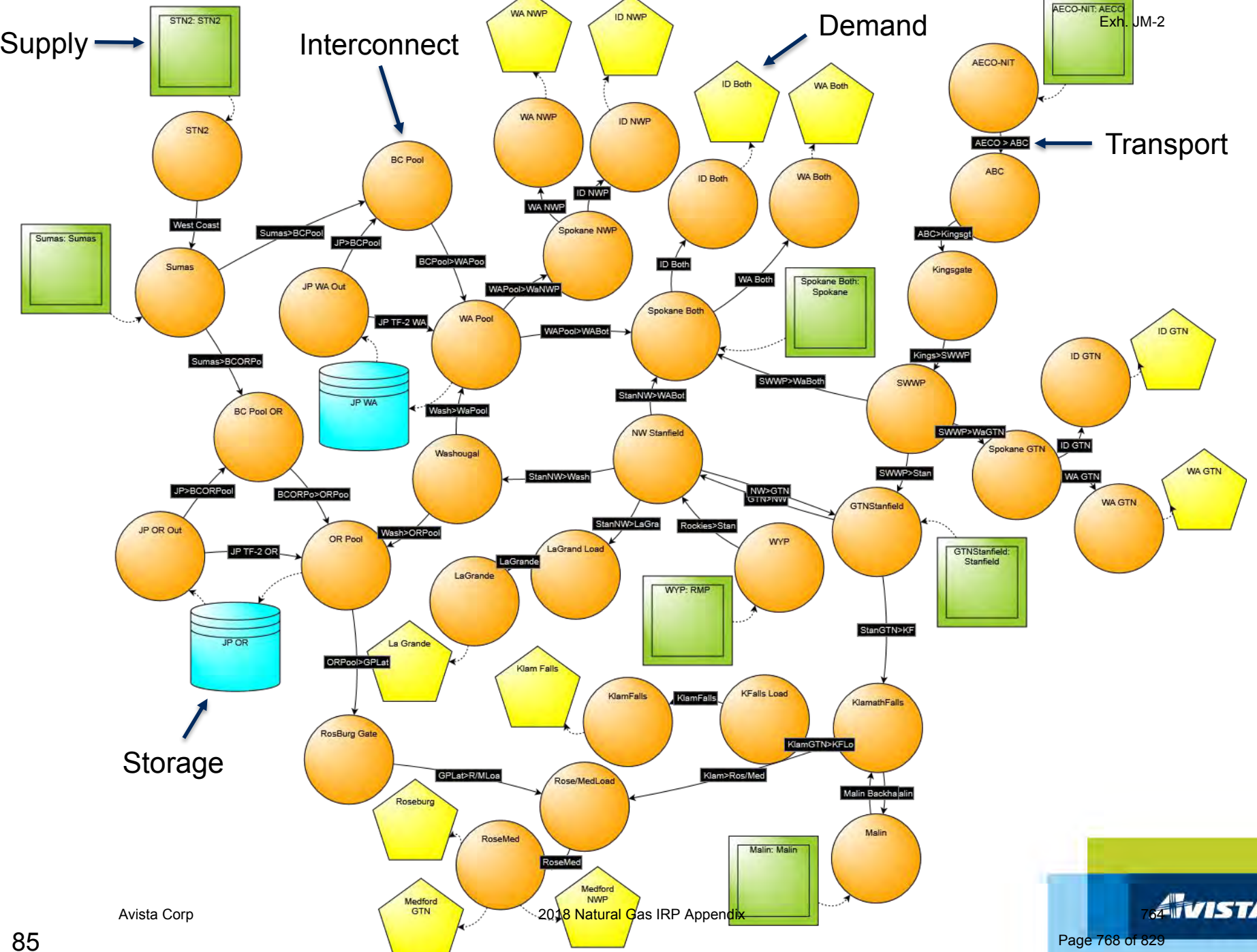



Assumptions Review

Developing a Reference Case

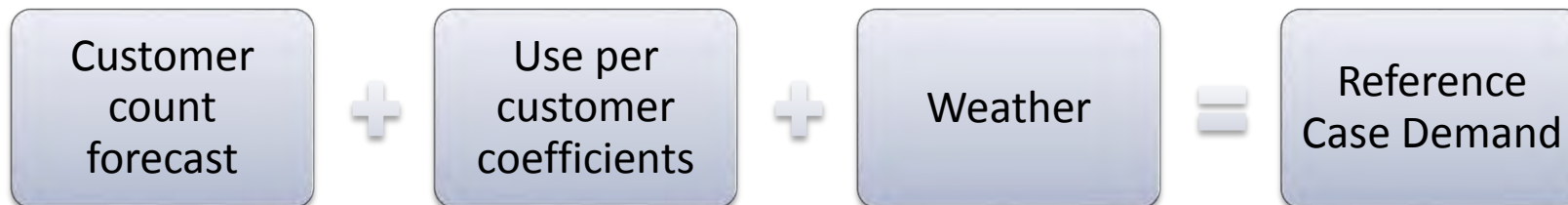

1. Customer annual growth rates:

System	Base-Case	High	Low
Residential	1.2%	1.6%	0.9%
Commercial	0.7%	1.0%	0.3%
Industrial	-0.3%	2.2%	-3.3%
Total	1.2%	1.5%	0.8%
WA	Base-Case	High	Low
Residential	1.2%	1.5%	0.9%
Commercial	0.7%	1.0%	0.4%
Industrial	-0.8%	1.9%	-3.1%
Total	1.2%	1.5%	0.8%
ID	Base-Case	High	Low
Residential	1.5%	2.0%	1.0%
Commercial	0.6%	1.1%	0.1%
Industrial	0.1%	1.7%	-2.7%
Total	1.4%	1.9%	0.9%
OR	Base-Case	High	Low
Residential	1.0%	1.3%	0.6%
Commercial	0.7%	1.1%	0.4%
Industrial	0.1%	4.7%	-7.8%
Total	0.9%	1.3%	0.6%

2. Use per customer coefficients –3 year average use per HDD per customer

3. Weather planning standard – coldest day on record

- WA/ID 82; Medford 61; Roseburg 55; Klamath 72; La Grande 74

WA-ID Region Firm Customers: 2018 IRP and 2016 IRP

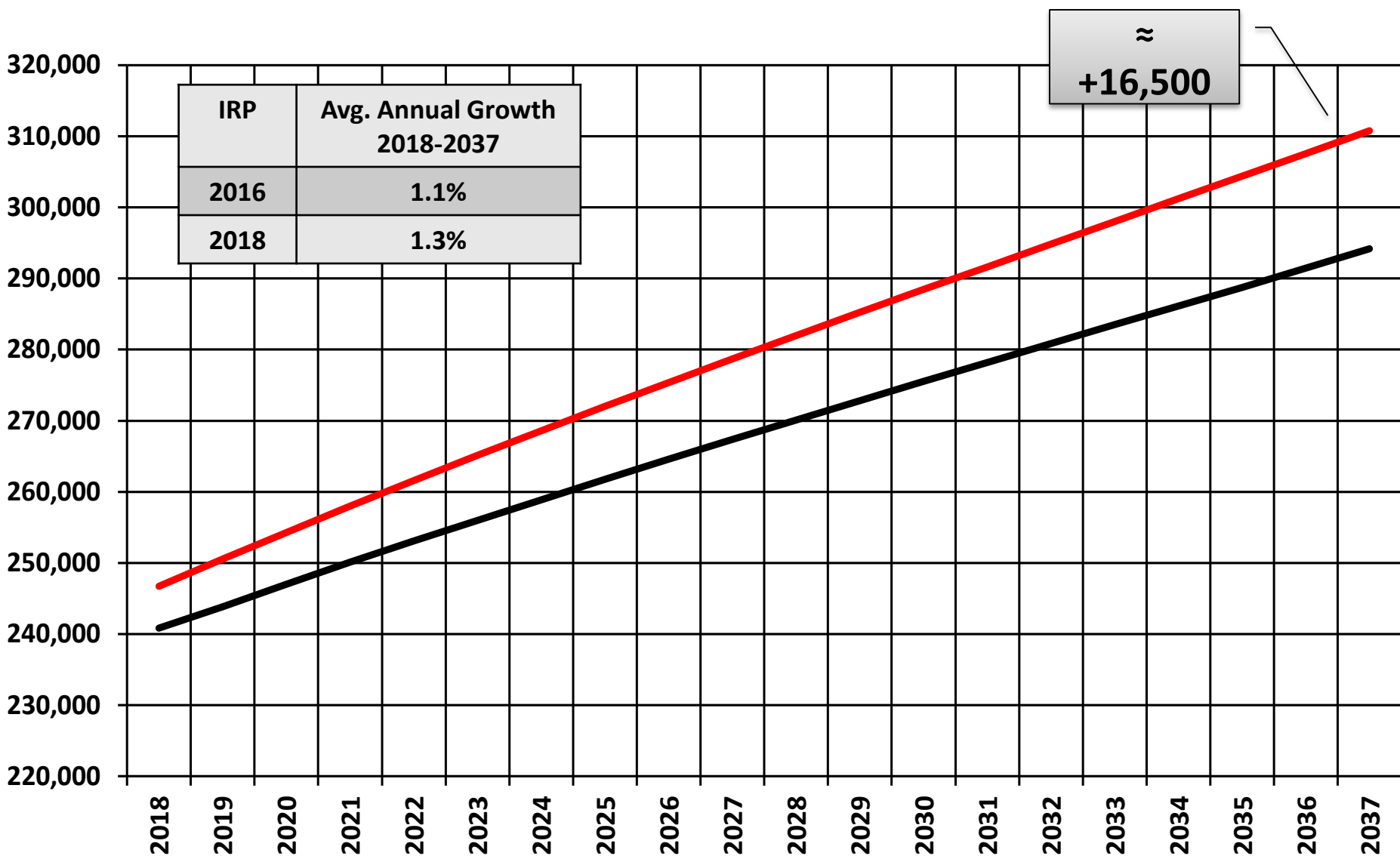

OR Region Firm Customers: 2018 IRP and 2016 IRP

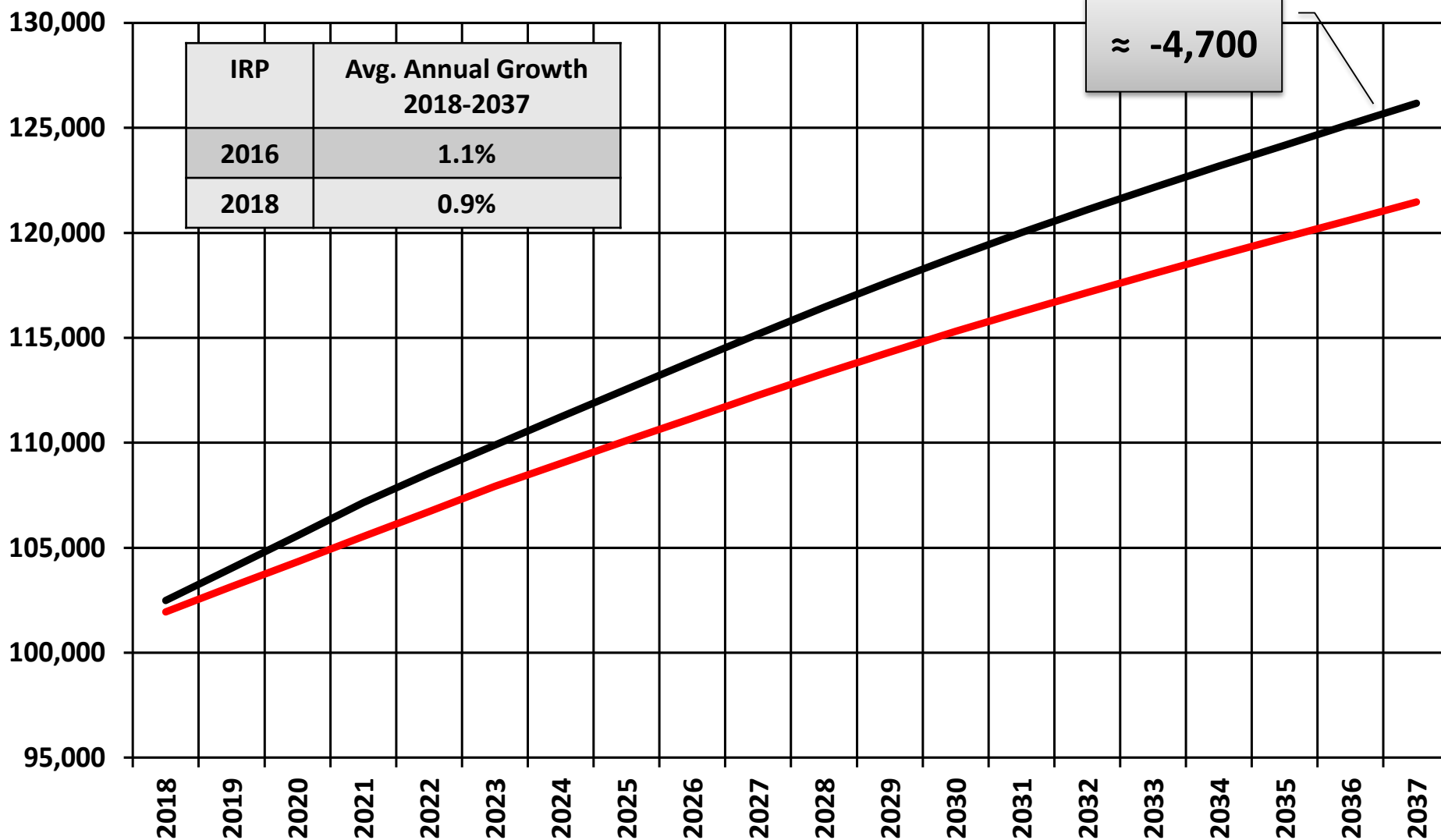

System Firm Customer Range, 2018-2037

Variable	Low Growth	Base Growth	High Growth
Customers	0.8%	1.2%	1.5%
Population	0.5%	0.9%	1.2%

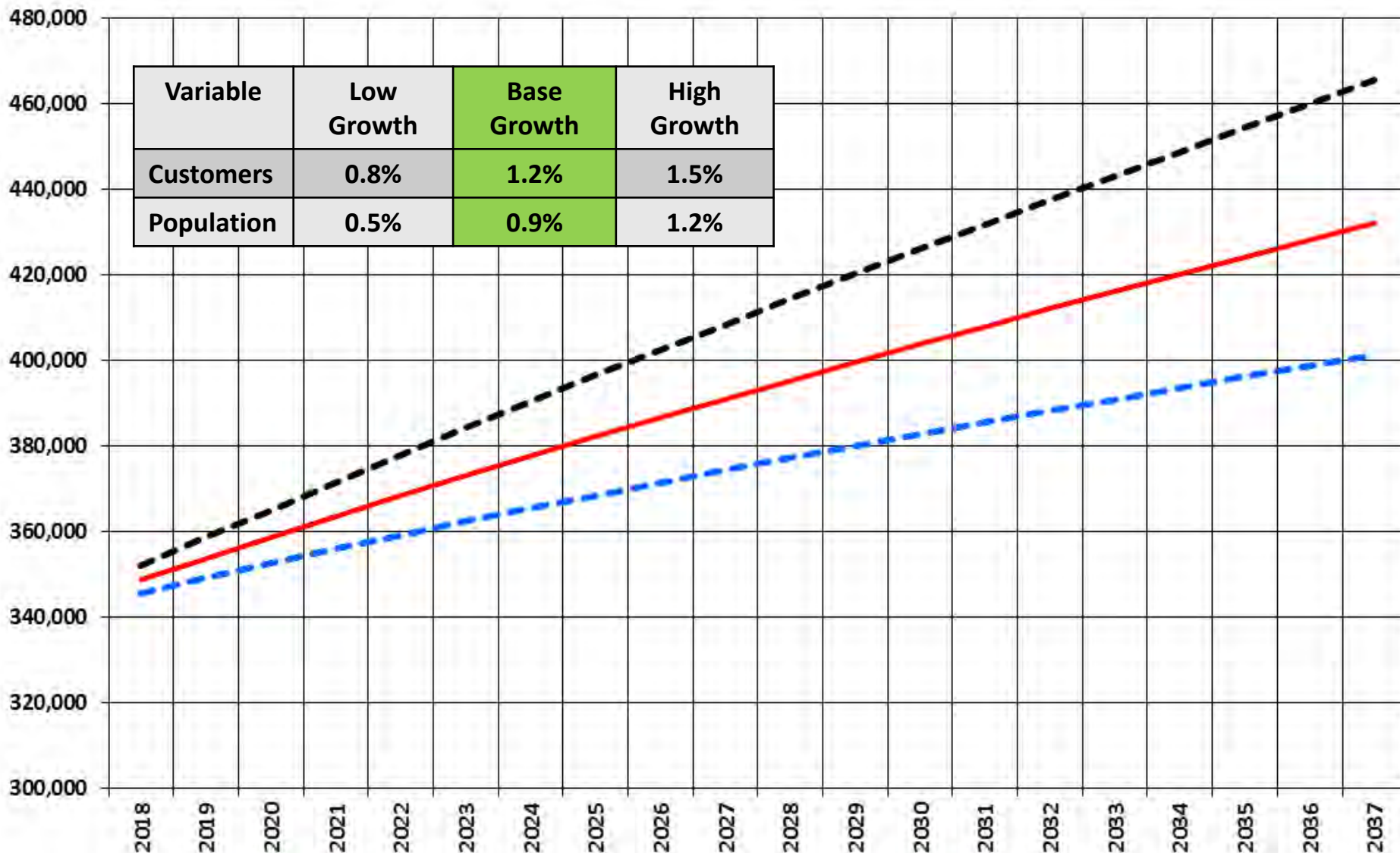

Base Coefficients

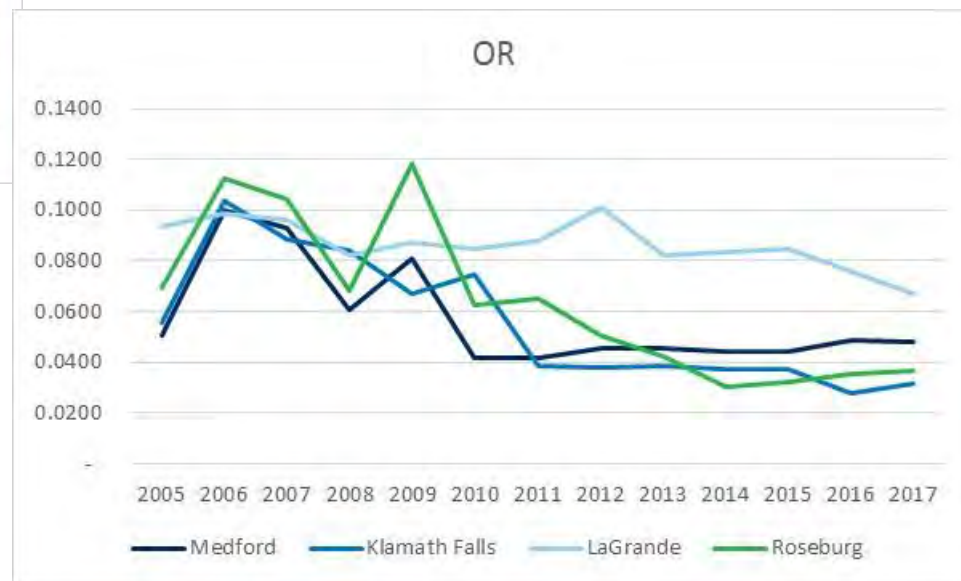

2018 Henry Hub Prices - Nominal

Exh. JM-2

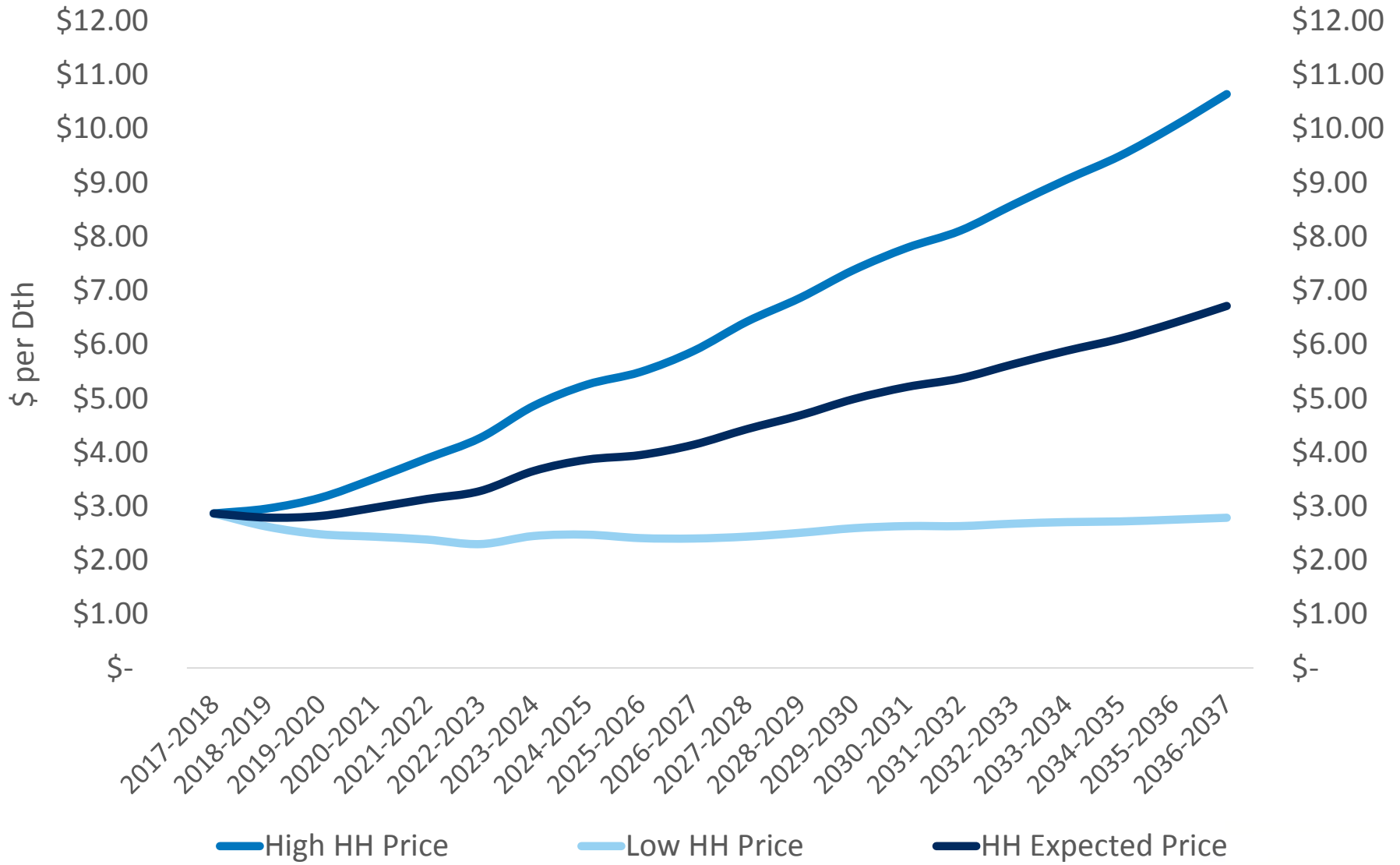

Price Elasticity: What does the research show?

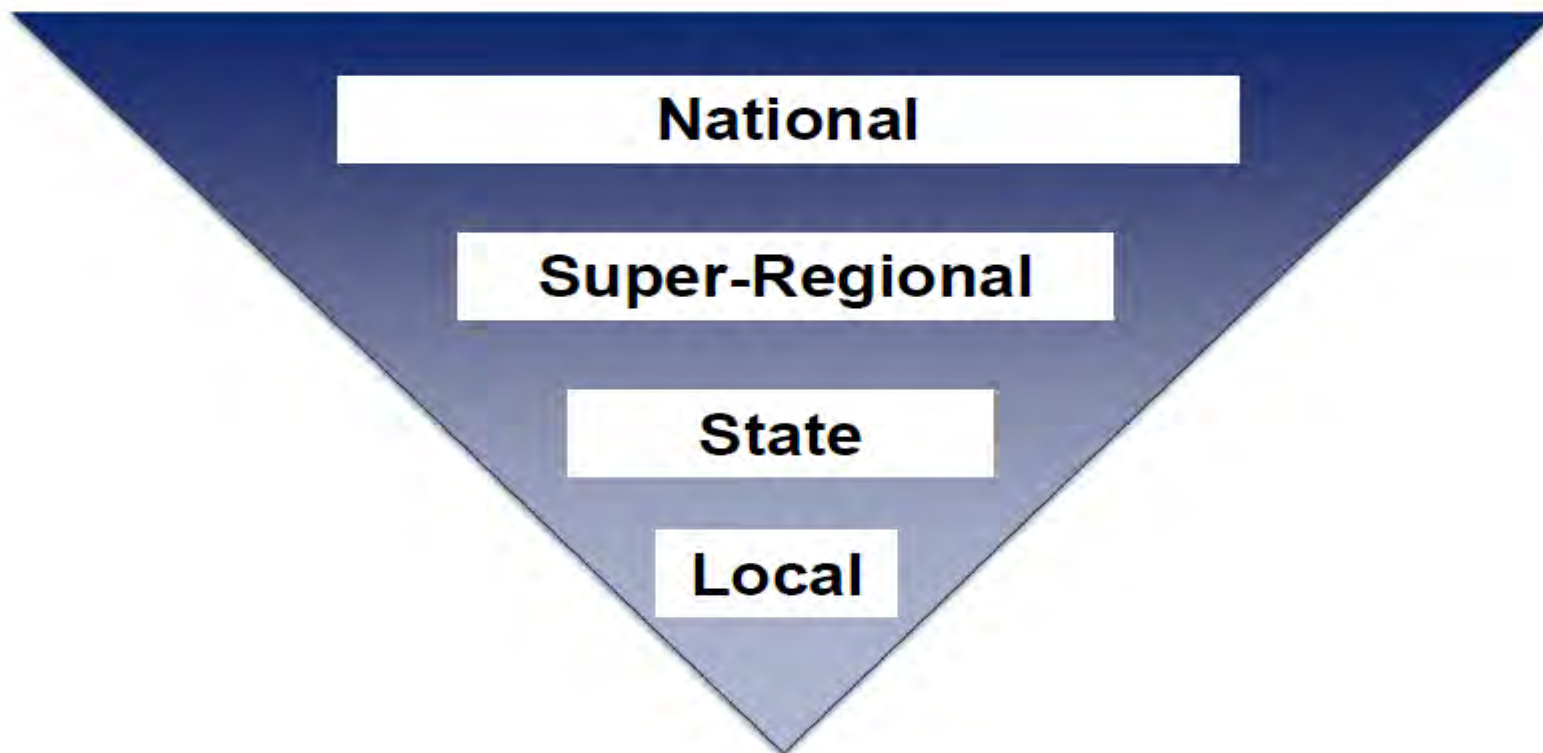

Statistical significance of own-price becomes more uncertain as geographic area of measurement shrinks.*

*Bernstein, M.A. and J. Griffin (2005). *Regional Differences in Price-Elasticity of Demand for Energy*, Rand Corporation

Price Elasticity Proposed Assumptions

- The data is a mixed bag at best:
 - 8 of 9 super regions have statistically significant short and long run elasticity's.
 - At a state level only 10 of 50 show statistical significant elasticity's.
 - In some cases, the estimated elasticity's are positive.
- We incorporated a $-.10$ price elastic response for our expected elasticity assumption as found in our Medford and Roseburg service areas.

Carbon Tax Summary

- ID – None
- OR – Cap and Investment Program SB1070
 - Avista's price assumption are based on CA cap and trade program (2018 annual price of \$14.53)
 - Begins in 2021 at \$17.86 and increases by 5% plus inflation each year until reaching \$51.58 in 2037
- WA – Governor Inslee proposed Carbon tax (SB 6203)
 - Starts at \$10 per MTCO₂e in July 2019 and in 2021 adds \$2 per year until capping at \$30 in 2030.

Carbon Price by Jurisdiction

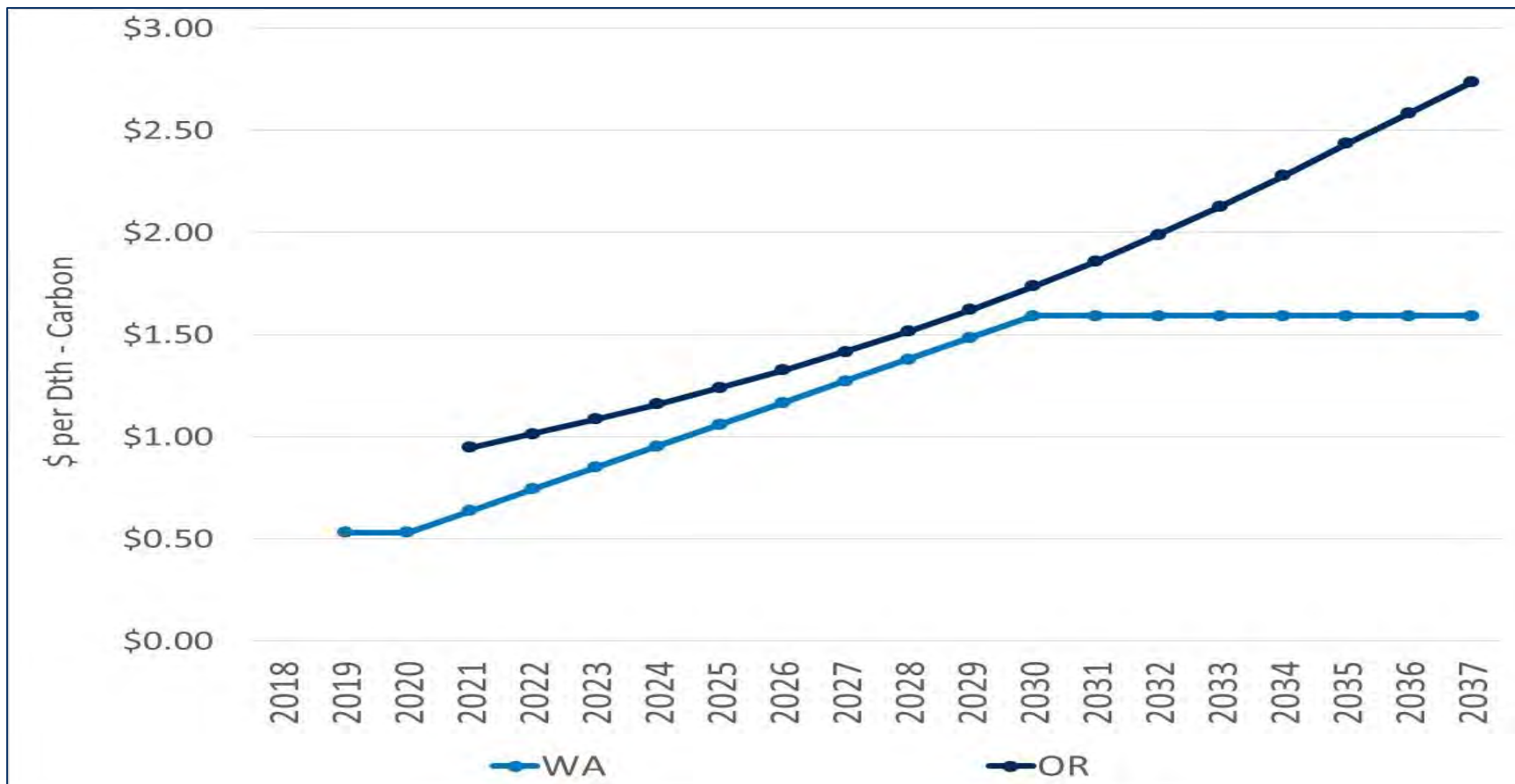

*Idaho has no carbon price adder

2018 Henry Hub Expected Price Including Carbon Adders by State

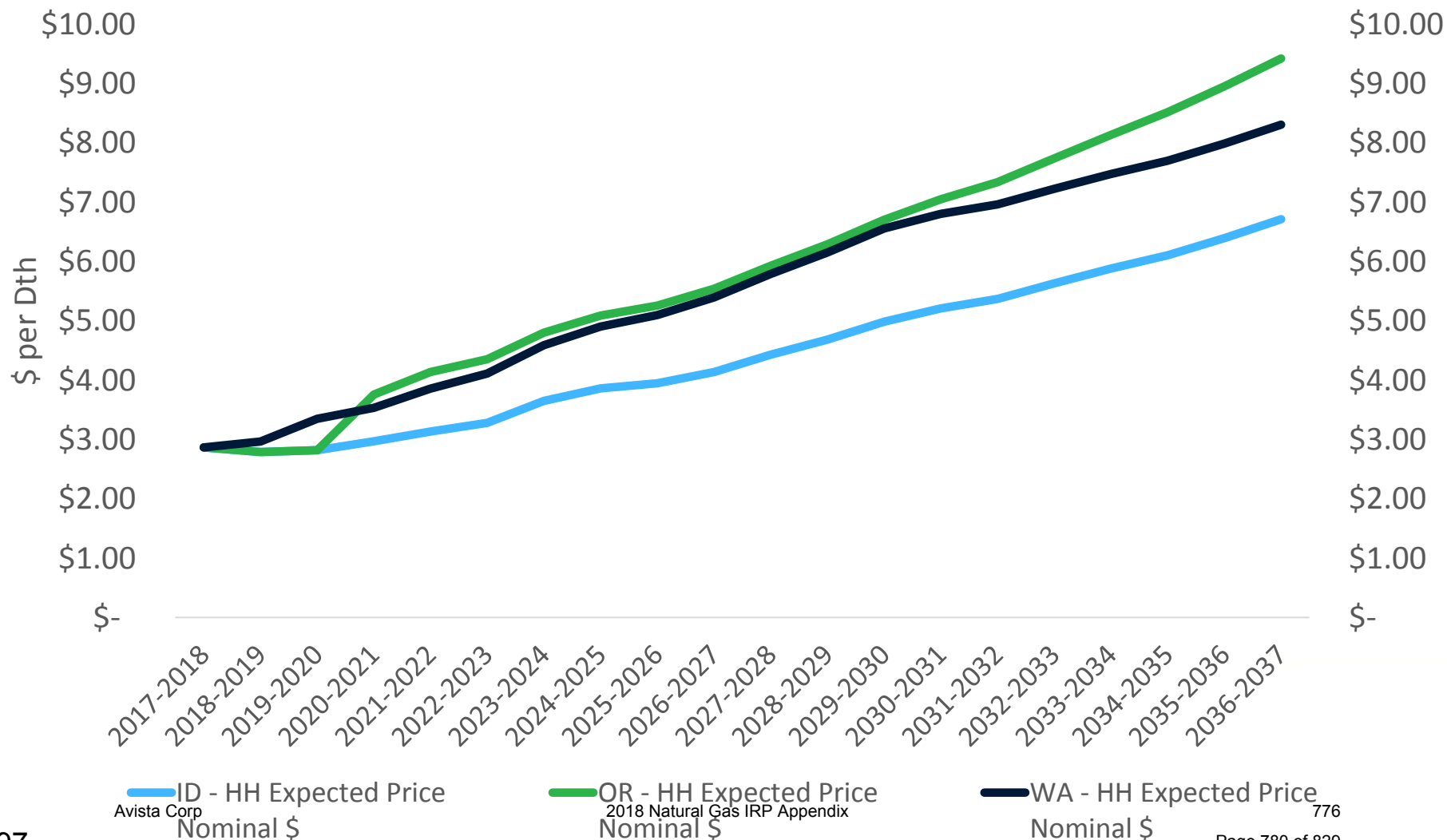

Planning Standard Assumptions

Area	Coldest in 20 Year HDD	Coldest on Record HDD
WA-ID	76	82
Klamath Falls	72	72
La Grande	66	74
Medford	52	61
Roseburg	48	55

Coldest on Record Dates

WA/ID – December 30, 1968

Medford – December 9, 1972

Roseburg – December 22, 1990

Klamath Falls – January 6, 2017

La Grande – January 23, 1996

Avoided Cost Comparison 2016 IRP vs. 2018 IRP

Exh. JM-2

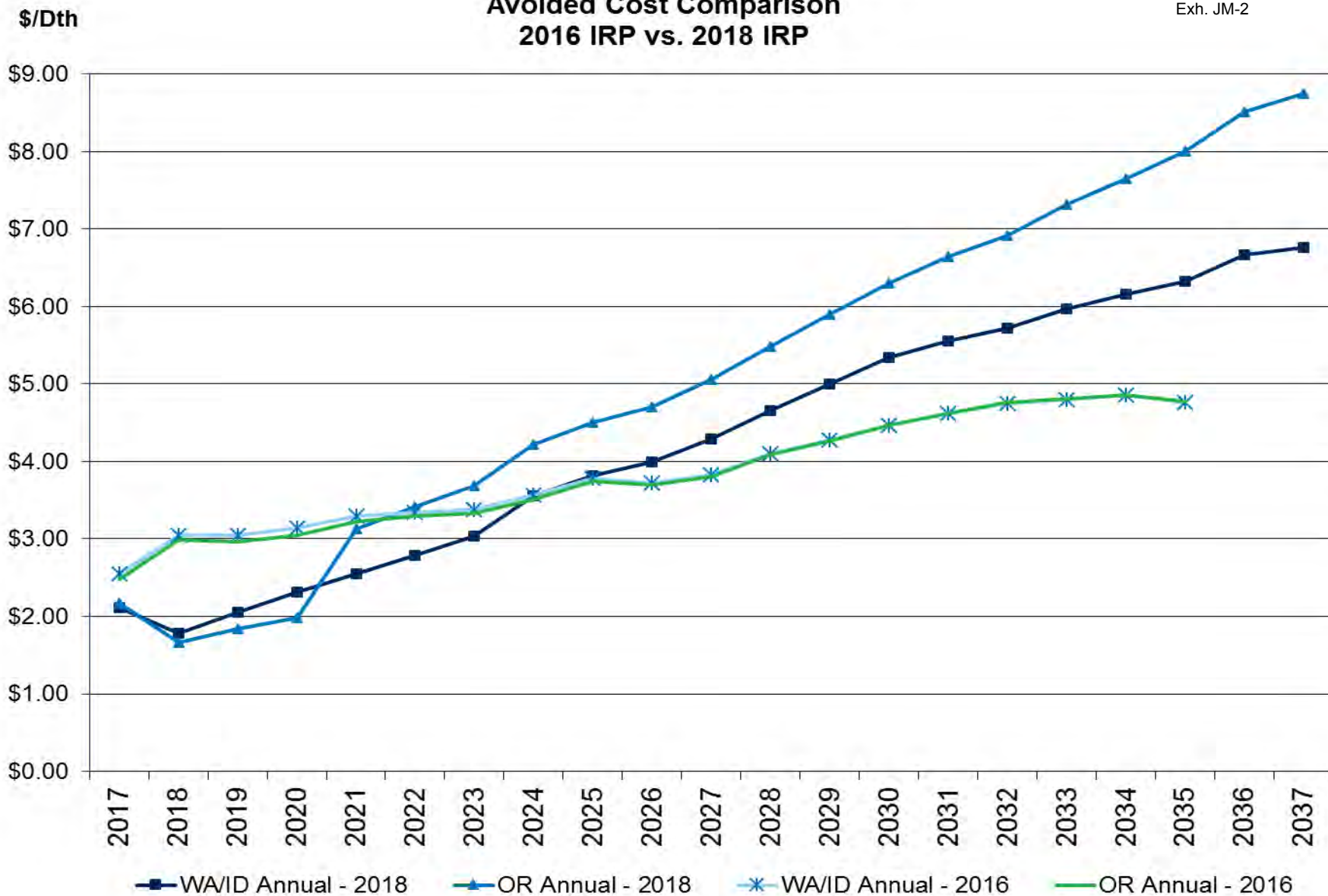

Avoided Cost Comparison 2018 IRP

Exh. JM-2

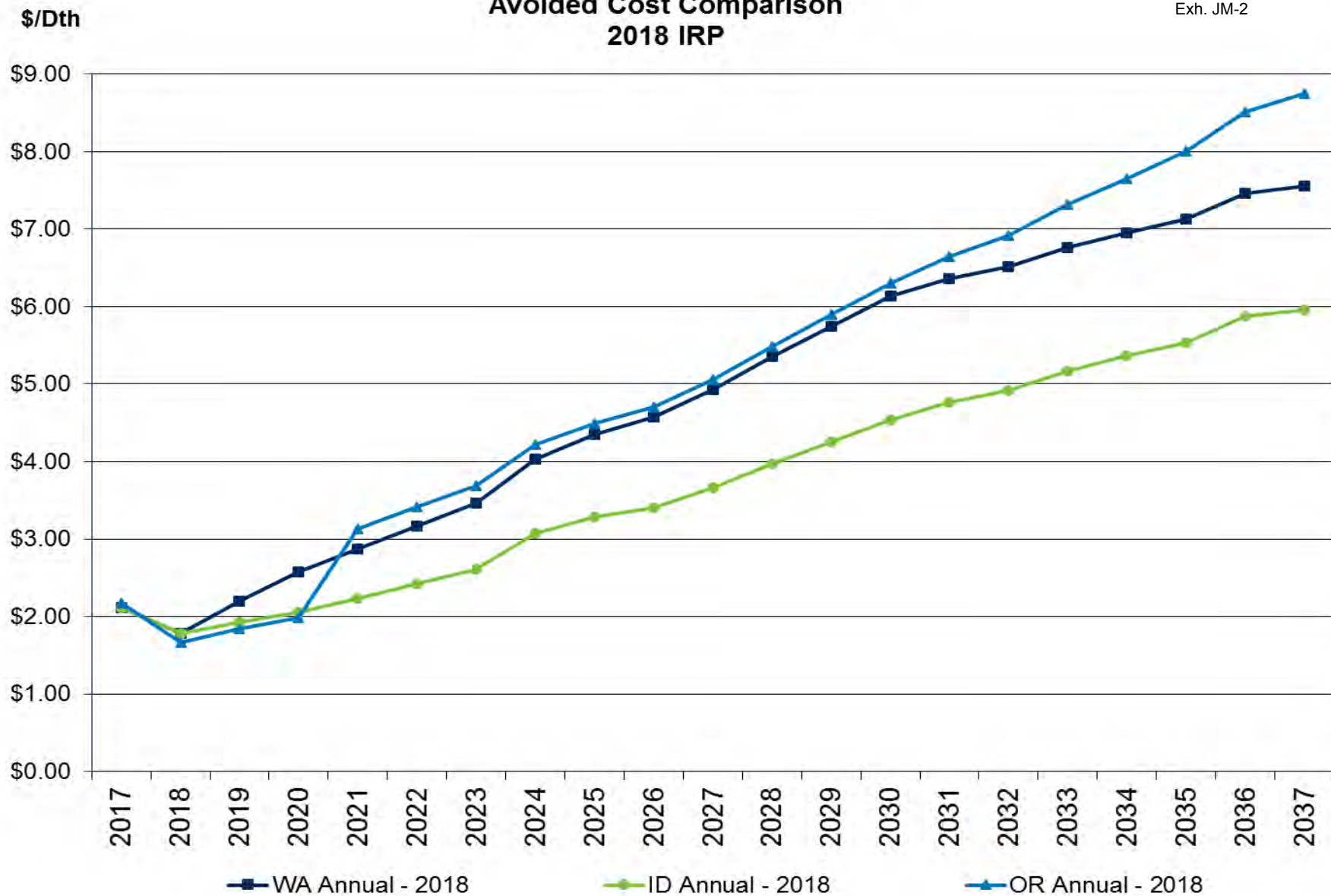

Scenario Analysis

2018 Proposed Scenarios

Proposed Scenarios	Expected	Cold Day 20yr	Average	Low Growth	80 % below 1990 emissions (Oregon and Washington only)	High Growth
INPUT ASSUMPTIONS	Case	Weather Std	Case	& High Prices		& Low Prices
Customer Growth Rate	Reference Case Cust Growth Rates			Low Growth Rate	Reference Case growth with emissions 80% below 1990 target	High Growth Rate
Use per Customer	3 yr Flat + Price Elasticity					3 yr Flat + Price Elasticity
Demand Side Management	Yes					
Weather Planning Standard	Historical Coldest Day	Coldest in 20 years	20 year average	Historical Coldest Day		
Prices	Expected			High	Low	
Price curve						
Carbon Legislation (\$/Metric Ton)				\$10-\$30 WA \$17.86-\$51.58 OR \$0 ID	None	

RESULTS

First Gas Year Unserviced						
WA/ID	N/A	N/A	N/A	N/A	N/A	2032
Medford	N/A	N/A	N/A	N/A	N/A	2031
Roseburg	N/A	N/A	N/A	N/A	N/A	2031
Klamath	N/A	N/A	N/A	N/A	N/A	N/A
La Grande	N/A	N/A	N/A	N/A	N/A	2032

Scenario Summary

Most aggressive peak planning case utilizing Average Case assumptions as a starting point and layering in coldest weather on record. The likelihood of occurrence is low.	Evaluates adopting an alternate peak weather standard. Helps provide some bounds around our sensitivity to weather.	Case most representative of our average (budget, pga, rate case) planning criteria.	Stagnant growth assumptions in order to evaluate if a shortage does occur. Not likely to occur.	Reduction of the use of natural gas to 80% below 1990 targets in OR and WA by 2050. The case assumes the overall reduction is an average goal before applying figures like elasticity and dsm.	Aggressive growth assumptions in order to evaluate when our earliest resource shortage could occur. Not likely to occur.
---	---	---	---	--	--

Existing Resources vs. Peak Day Demand

Expected Case – Washington/Idaho (DRAFT)

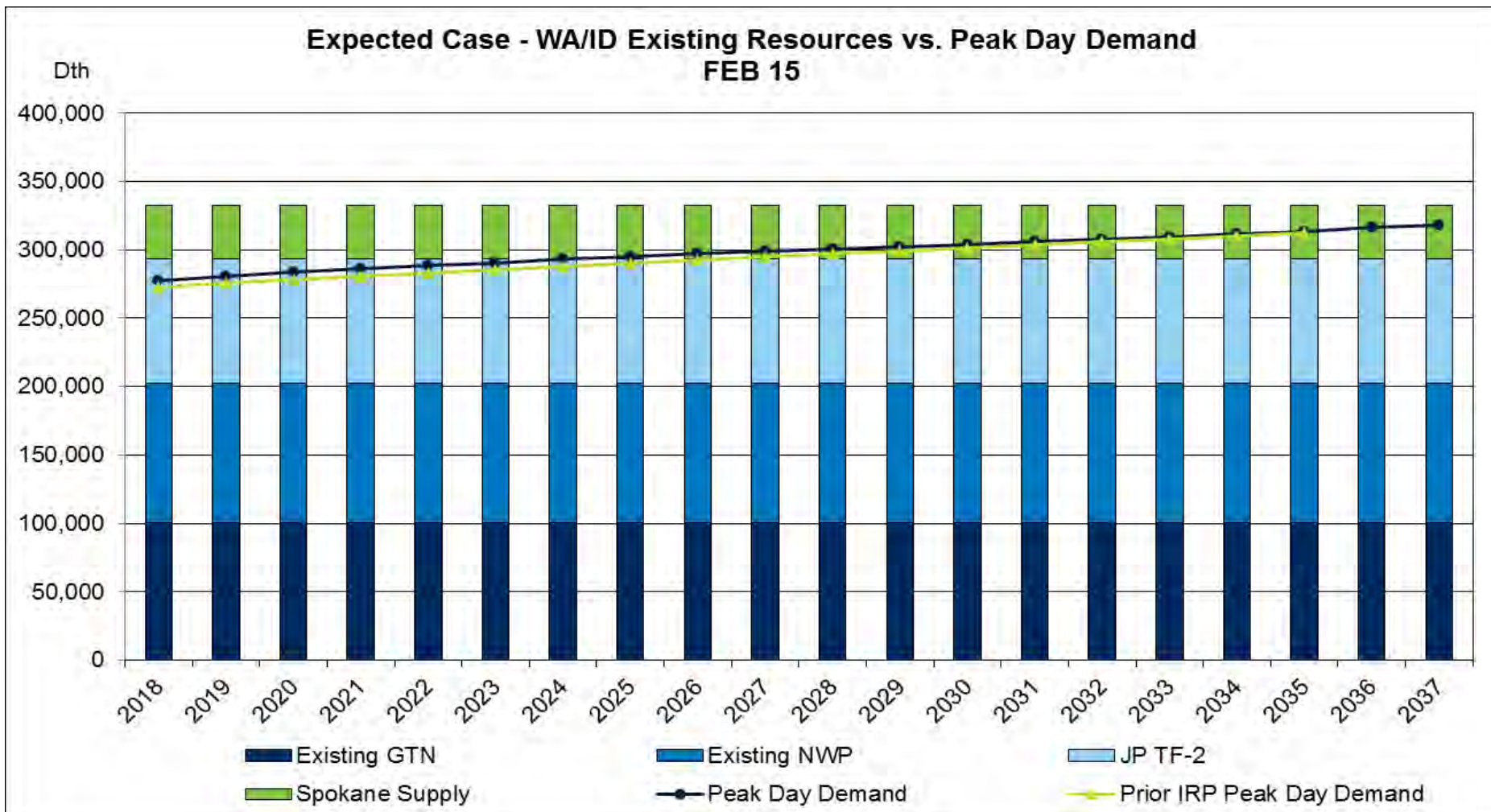

Existing Resources vs. Peak Day Demand

Expected Case – Medford/Roseburg (DRAFT)

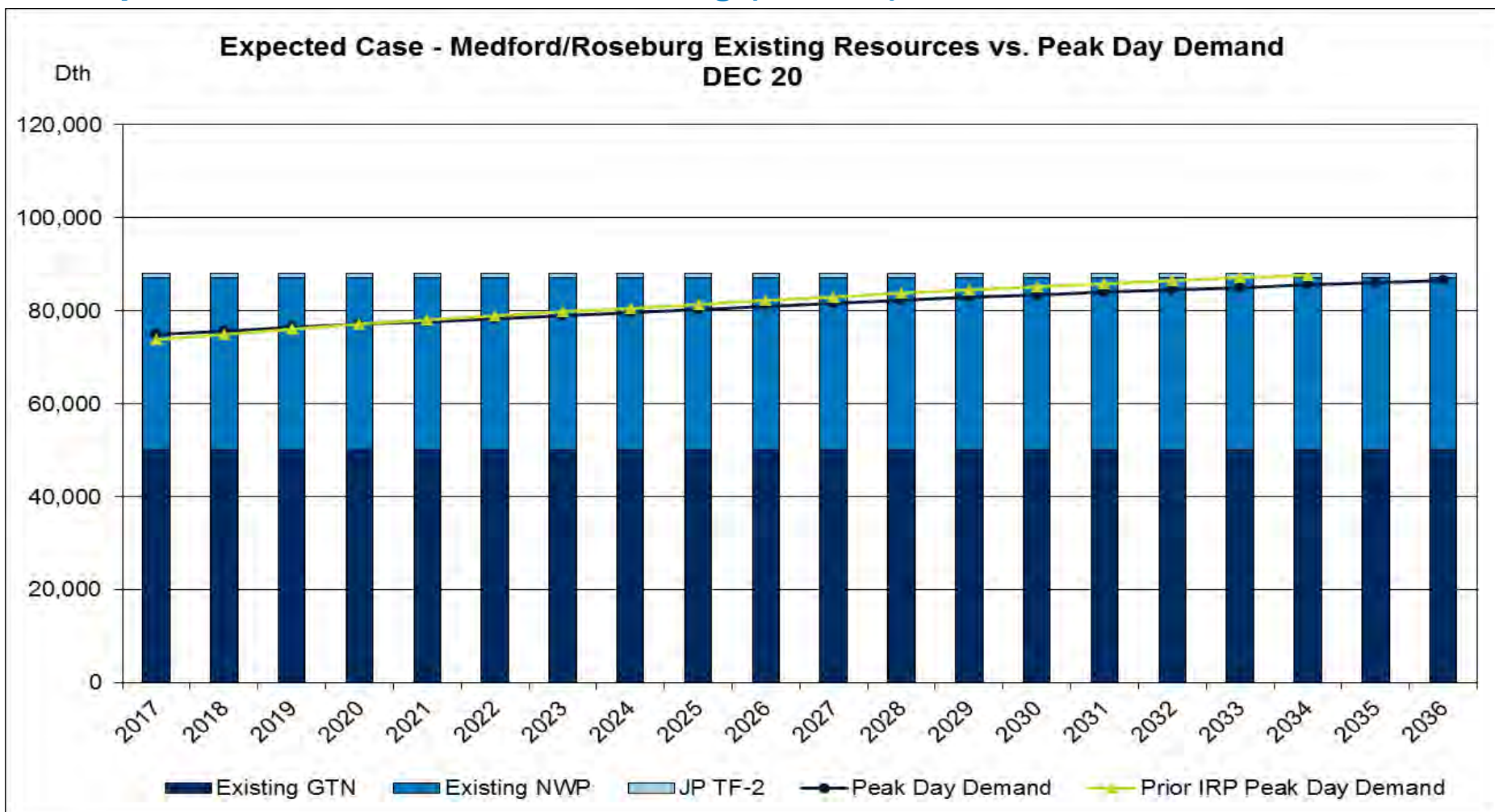

Existing Resources vs. Peak Day Demand

Expected Case – Klamath Falls (DRAFT)

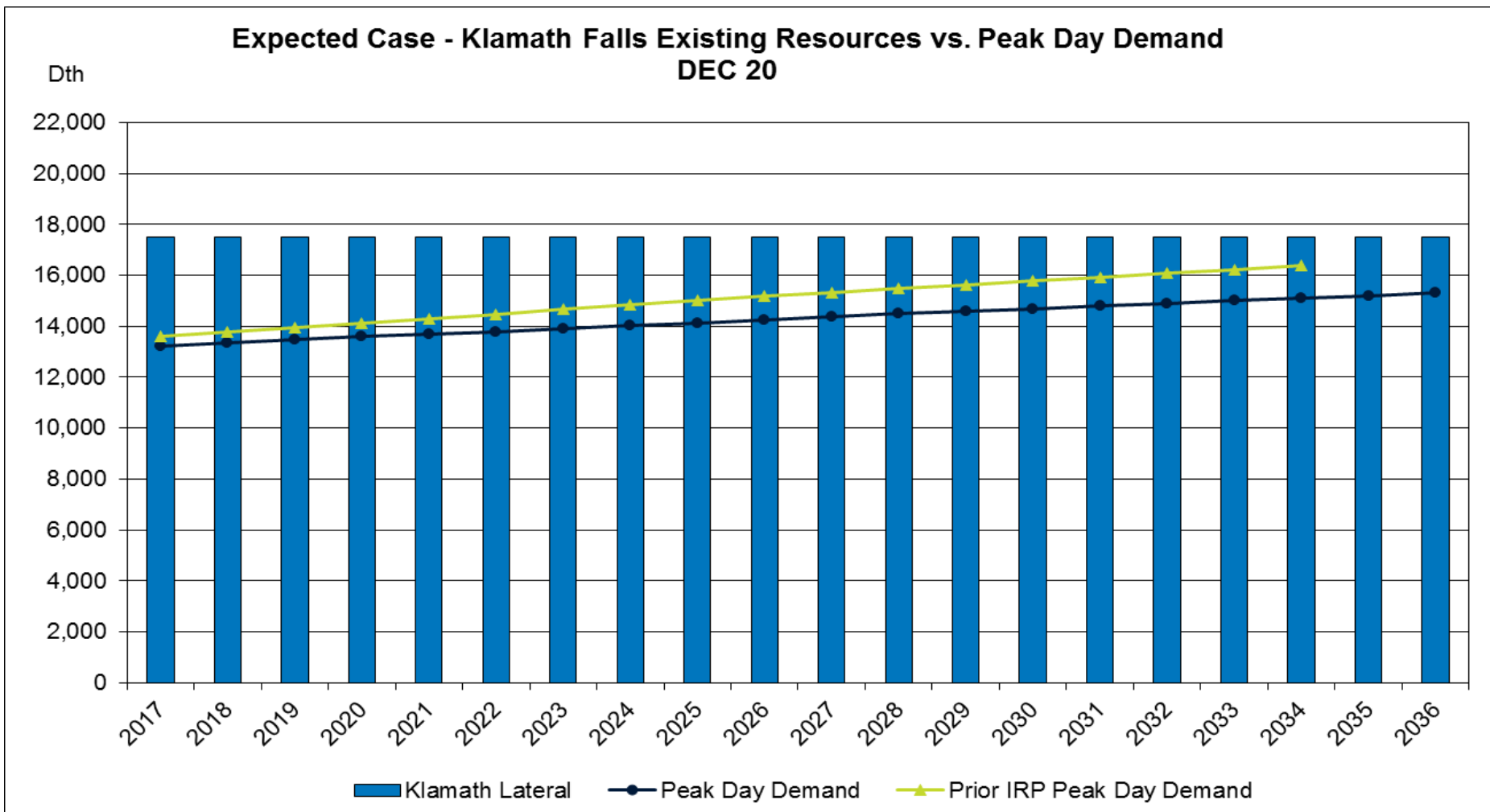

Existing Resources vs. Peak Day Demand

Expected Case – La Grande (DRAFT)

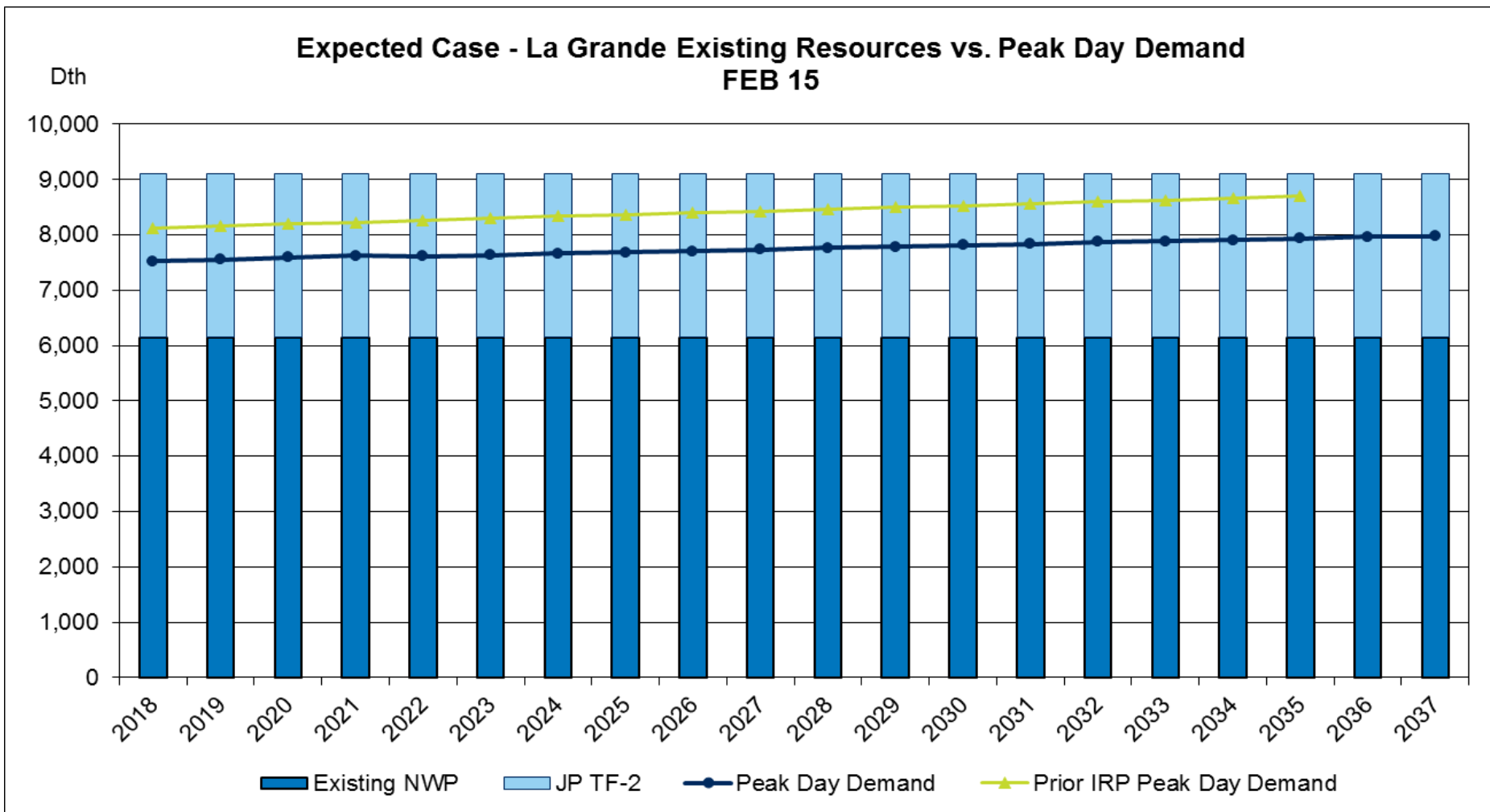

Peak Day (Feb 15) - 2018 IRP Demand Scenarios WA/ID

Exh. JM-2

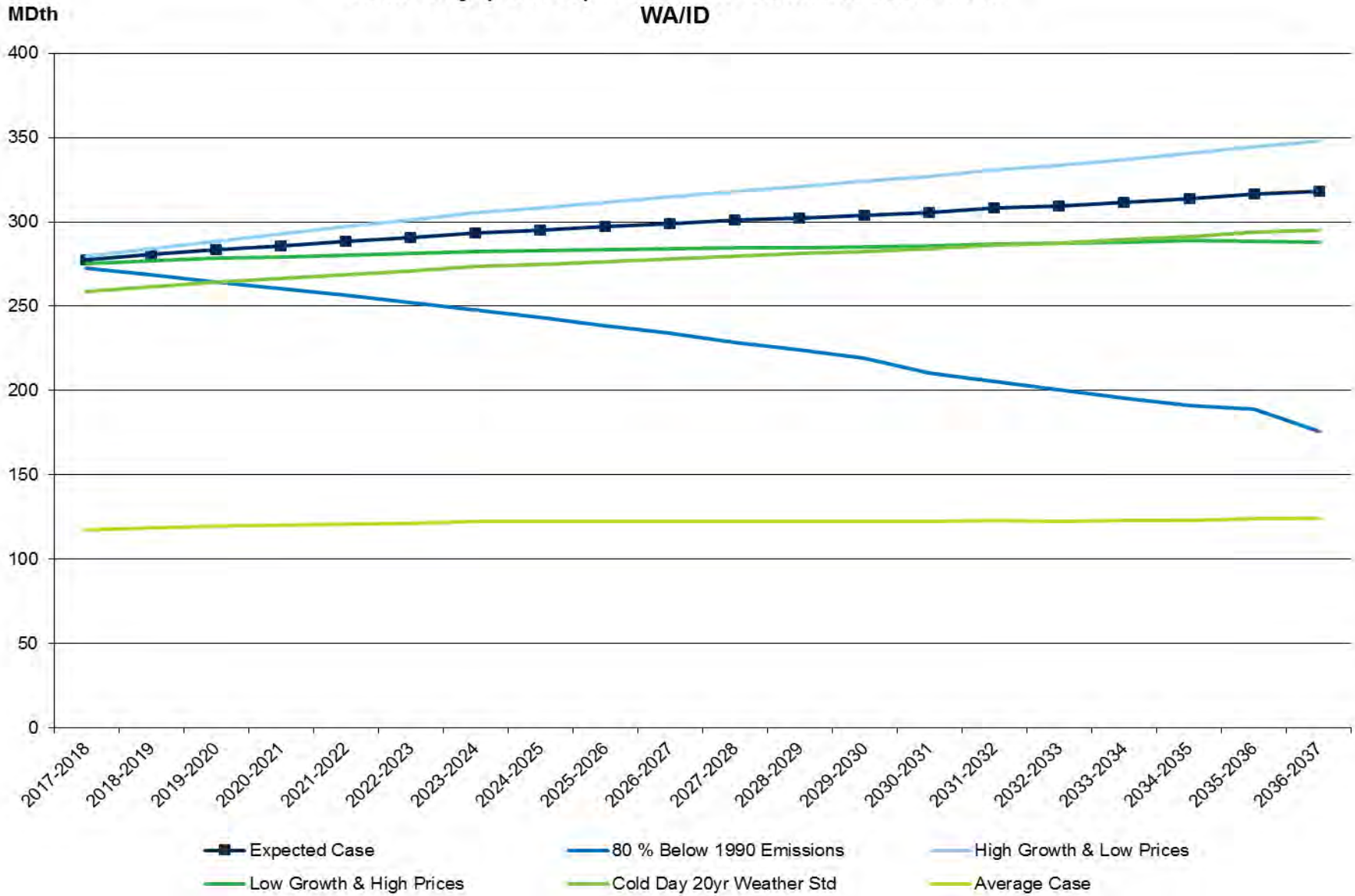

Peak Day (Dec 20) - 2018 IRP Demand Scenarios Medford/Roseburg

Exh. JM-2

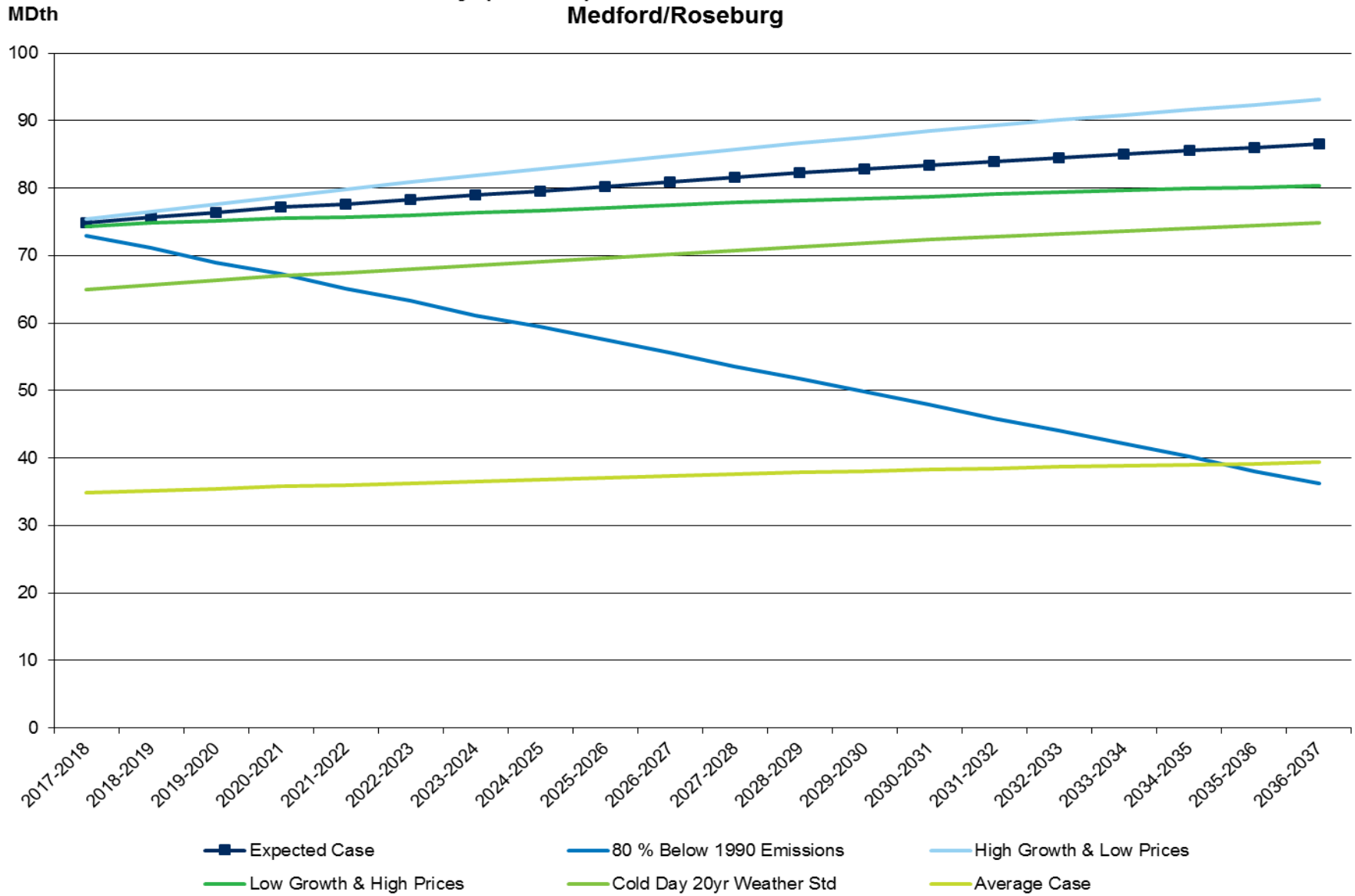

First Year Peak Demand Not Met with Existing Resources Scenario Comparisons

Exh. JM-2

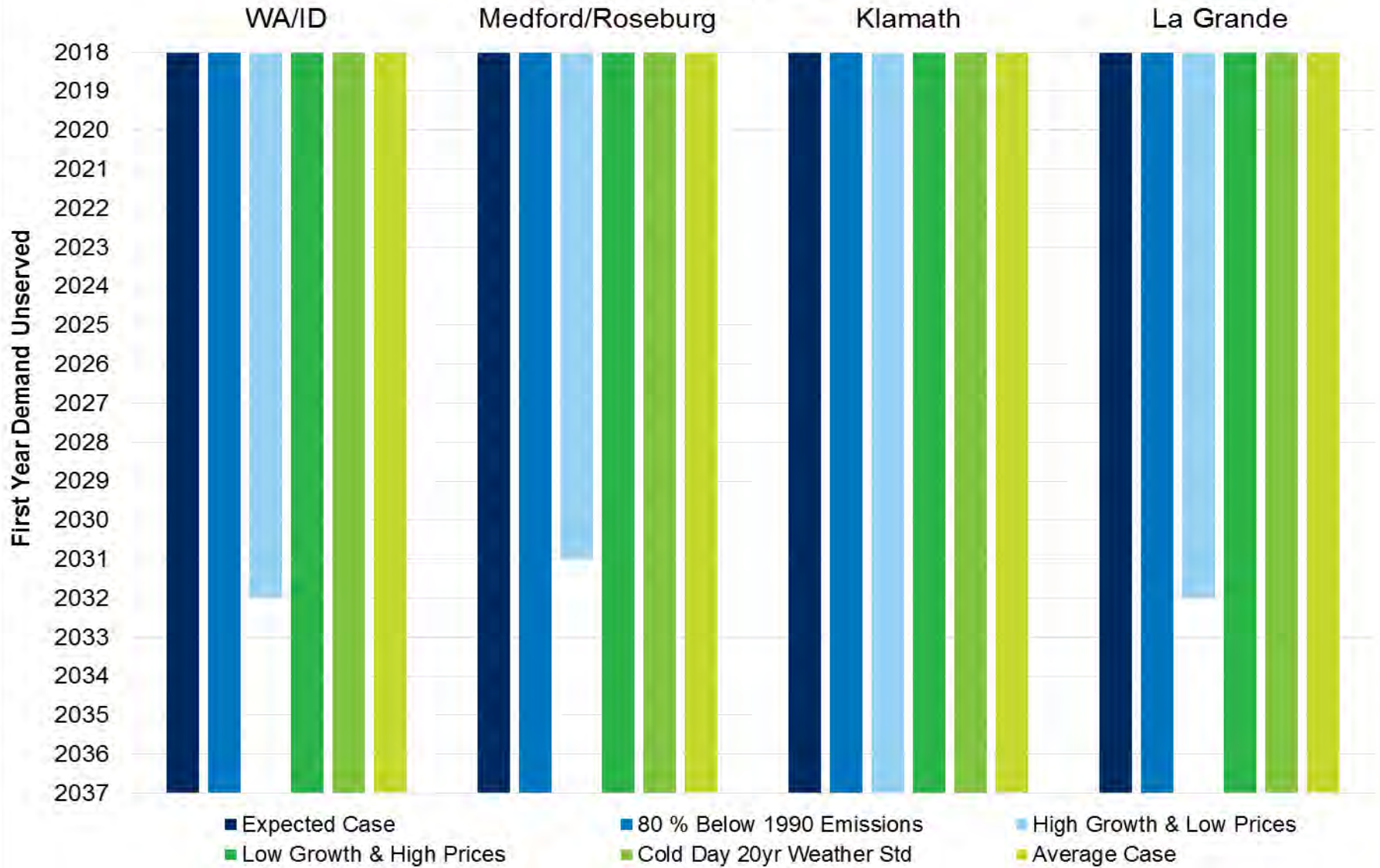



Solving for unserved demand

Tom Pardee

When unserved demand does show up.....

There are a few questions we need to ask:

1. Why is the demand unserved?
2. What is the magnitude of the short? (i.e Are we 1 Dth or 1000 Dth's short?)
3. What are my options to meet it?

When current resources don't meet demand what could we consider?

- Transport capacity release recalls
- “Firm” backhauls
- Contract for existing available transportation
- Expansions of current pipelines
- Peaking arrangements with other utilities (swaps/mutual assistance agreements) or marketers
- In-service territory storage
- Satellite/Micro LNG (storage inside service territory)
- Large scale LNG with corresponding pipeline build into our service territory
- Structured products/exchange agreements delivered to city gates
- Biogas (assume it's inside Avista's distribution)
- Hydrogen blend (assume it's inside Avista's distribution)
- Avista distribution system enhancements
- Demand side management

New Resource Risk Considerations

- Does it get supply to the gate?
- Is it reliable/firm?
- Does it have a long lead time?
- How much does it cost?
 - New build vs. depreciated cost
 - The rate pancake
- Is it a base load resource or peaking?
- How many dekatherms do I need?
- What is the “shape” of resource?
- Is it tried and true technology, new technology, or yet to be discovered?
- Who else will be competing for the resource?

Potential New Supply Resources Considerations

- Availability
 - By Region – which region(s) can the resource be utilized?
 - Lead time considerations – when will it be available?
- Type of Resource
 - Peak vs. Base load
 - Firm or Non-Firm
 - “Lumpiness”
- Usefulness
 - Does it get the gas where we need it to be?
 - Last mile issues
- Cost

\$ per kg vs \$ per Dth

*1 kg is roughly equivalent to a gallon of gasoline
LHV

\$ per kg	\$ per DTh
\$ 1.00	\$ 8.78
\$ 2.00	\$ 17.55
\$ 3.00	\$ 26.33
\$ 4.00	\$ 35.11
\$ 5.00	\$ 43.88
\$ 6.00	\$ 52.66
\$ 7.00	\$ 61.44
\$ 8.00	\$ 70.21
\$ 9.00	\$ 78.99
\$ 10.00	\$ 87.77

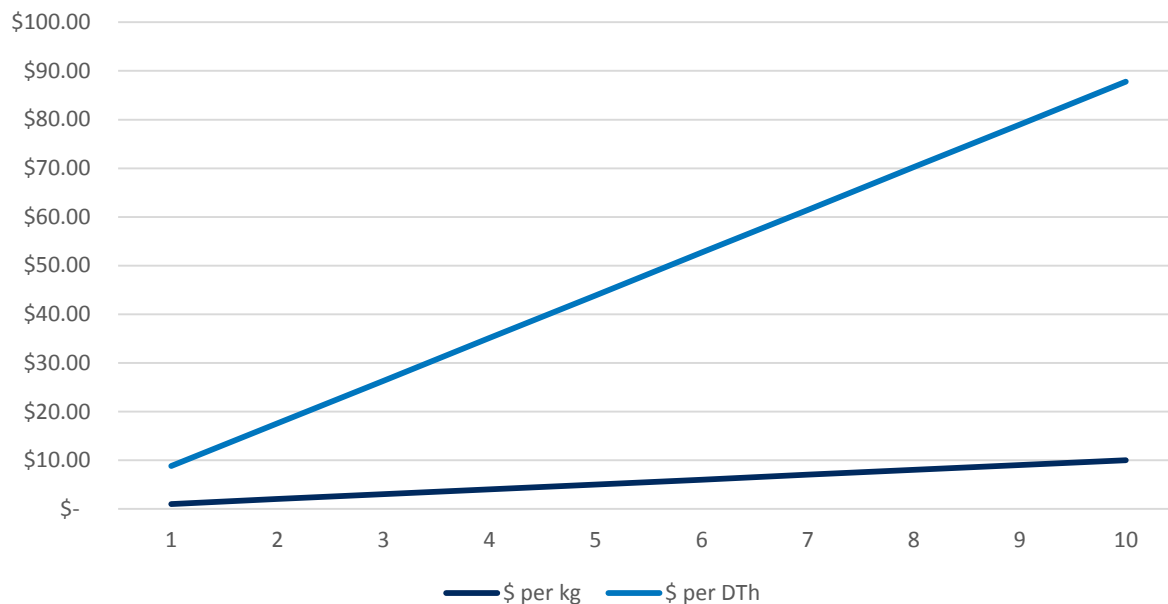

National Renewable Energy Laboratory (NREL) estimates hydrogen fuel prices from around \$8 - \$10 per kg by 2020 to 2025 period.

USDOE target is below \$4 (excludes compression and delivery)

Supply Resources - Modeled

Additional Resource	Size	Cost/Rates	Availability	Notes
Unsubscribed GTN Capacity	Up to 50,000 Dth	GTN Rate	Now	Currently available unsubscribed capacity from Kingsgate to Stanfield
Medford Lateral Exp	50,000 Dth / Day	\$35M capital + GTN Rate	2018	Additional compression to facilitate more gas to flow from mainline GTN to Medford.
*Hydrogen	20% of heat content of a Dth or 200,000 btu	\$10 kg 1 LHV kg = 113,937 btu	2030	Roughly 20% of yearly gas demand to mix with natural gas in current pipeline. Cost is from the DOE target for cost of Hydrogen. Costs from a consultant will be utilized in the final document, but were unavailable for modeling in time for TAC #4
*Renewable Natural Gas – Landfill, Dairy, Waste Water, Food waste to (RNG)	1,370 Dth / Day	\$10, \$12, \$14, \$16/ Dth equivalent	2030	Dairy Farm estimate. Costs from a consultant for each specific type of RNG will be utilized in the final document, but were unavailable for modeling in time for TAC #4
Plymouth LNG	241,700 Dth w/70,500 Dth deliverability		2018	Provides for peaking services and alleviates the need for costly pipeline expansions. -Pair with excess pipeline MDDO's to create firm transport

Avista Corp *Avista has retained a consultant to estimate costs for RNG & Hydrogen and will be included in Avista's 2018 IRP
 2018 Natural Gas IRP Appendix

Future Supply Resources – Not Modeled

Other Resources to Consider

Additional Resource	Size	Cost/Rates	Availability	Notes
Co. Owned LNG	600,000 Dth w/ 150,000 of deliverability	\$75 Million plus \$2 Million annual O&M	2022	On site, in service territory liquefaction and vaporization facility
Various pipelines – Pacific Connector, Trails West, NWP Expansion, GTN Expansion, etc.	Varies	Precedent Agreement Rates	2020	Requires additional mainline capacity on NWPL or GTN to get to service territory
Large Scale LNG	Varies	Commodity less Fuel	2020	Speculative, needs pipeline transport
In Ground Storage	Varies	Varies	Varies	Requires additional mainline transport to get to service territory



Stochastic Analysis

First Year Peak Demand Not Met with Existing Resources Scenario Comparisons

Exh. JM-2

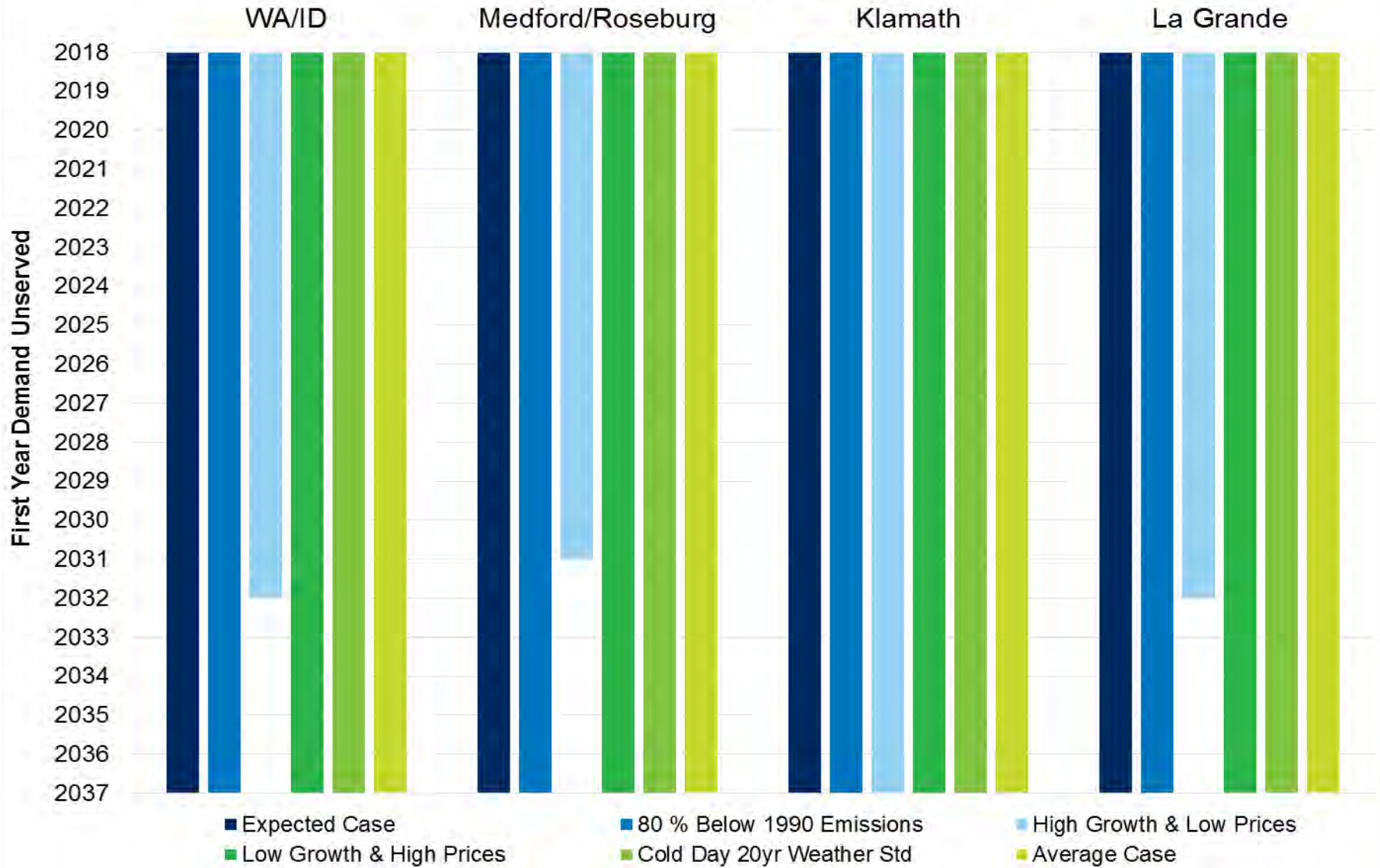

Monte Carlo Simulations

- A way to estimate the probability of potential future outcomes by allowing for a random set of variables
- Uses historical price and weather data
- Avista's Sendout model uses RMIX to help choose an optimal resource stack and costs under varying conditions

Unserved Demand and Stochastic Analysis

- Avista has no unserved demand in its resource stack using a deterministic analysis in our Expected case (coldest on record every year in every location for 20 years)
- In order to show how we would solve for a shortage we will utilize our high growth & low prices case
 - This models new potential resources and allows Sendout to solve using an resource mix (RMIX) option to select a least cost portfolio and run it through a monte carlo simulation at 200 draws to measure risk and uncertainty

Expected Case distribution

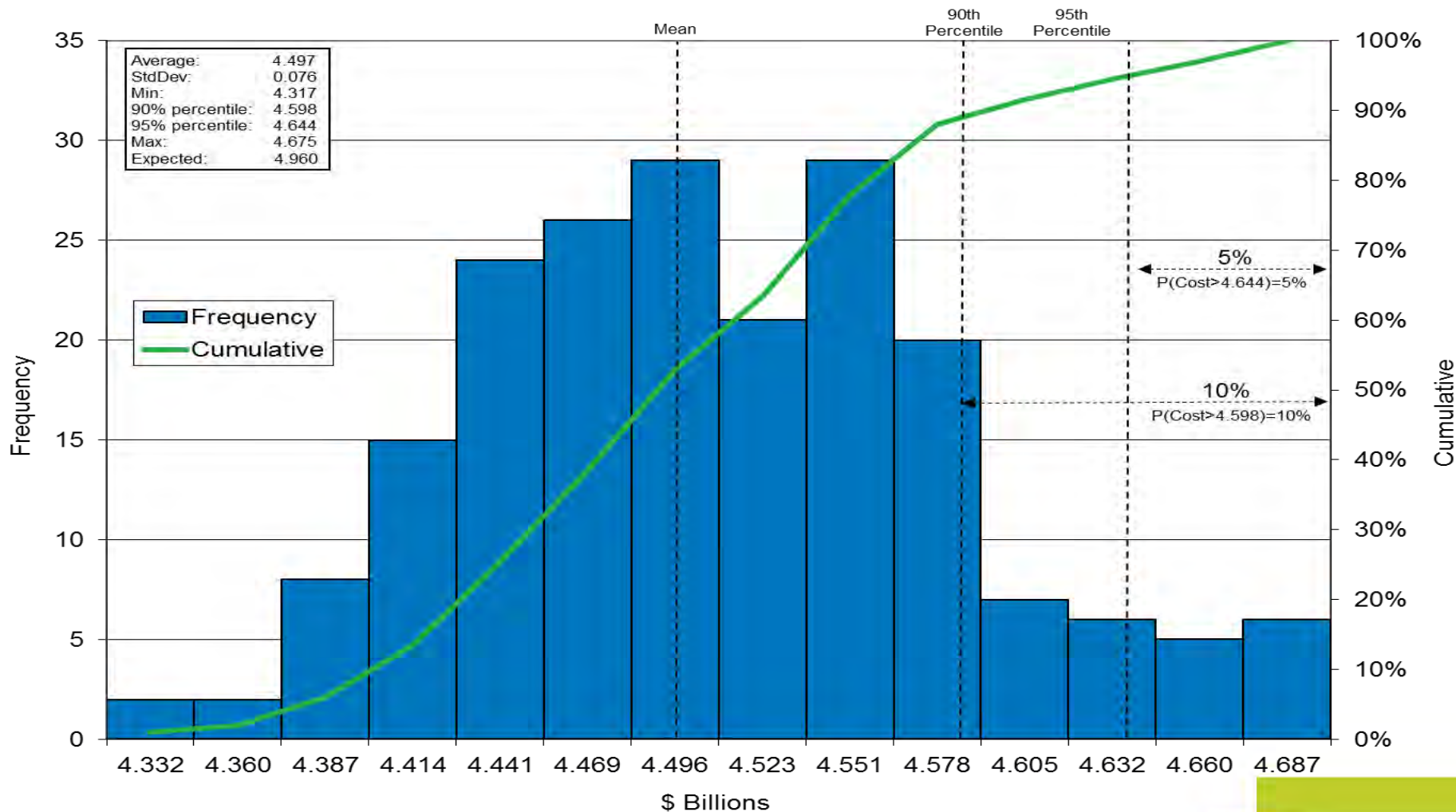

High Growth and Low Prices Scenario

(Example of determining additional resources to unserved demand)

Spokane Weather Monte Carlo example

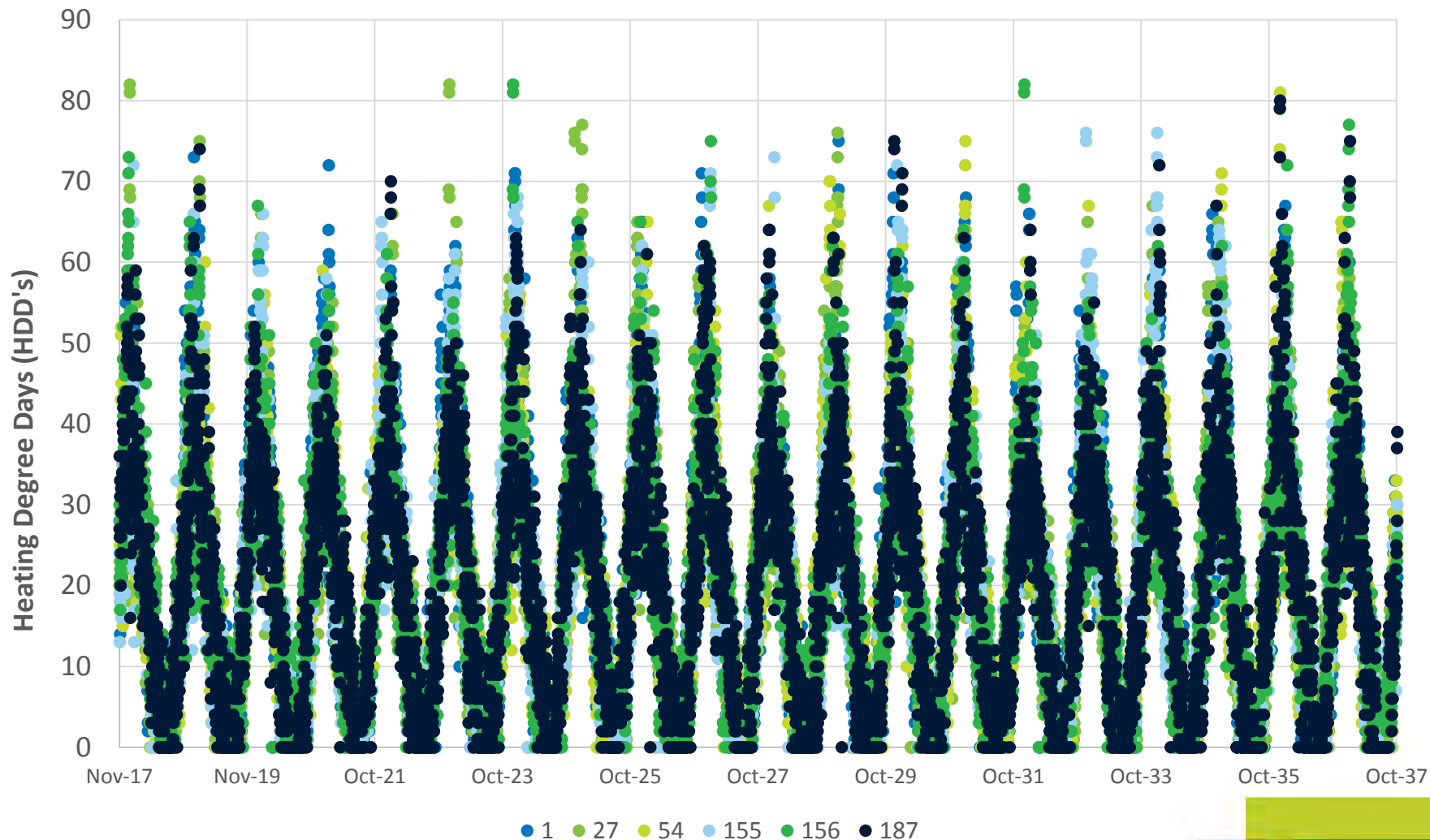

Draw #
2018 Natural Gas IRP Appendix

Monte Carlo weather draw examples

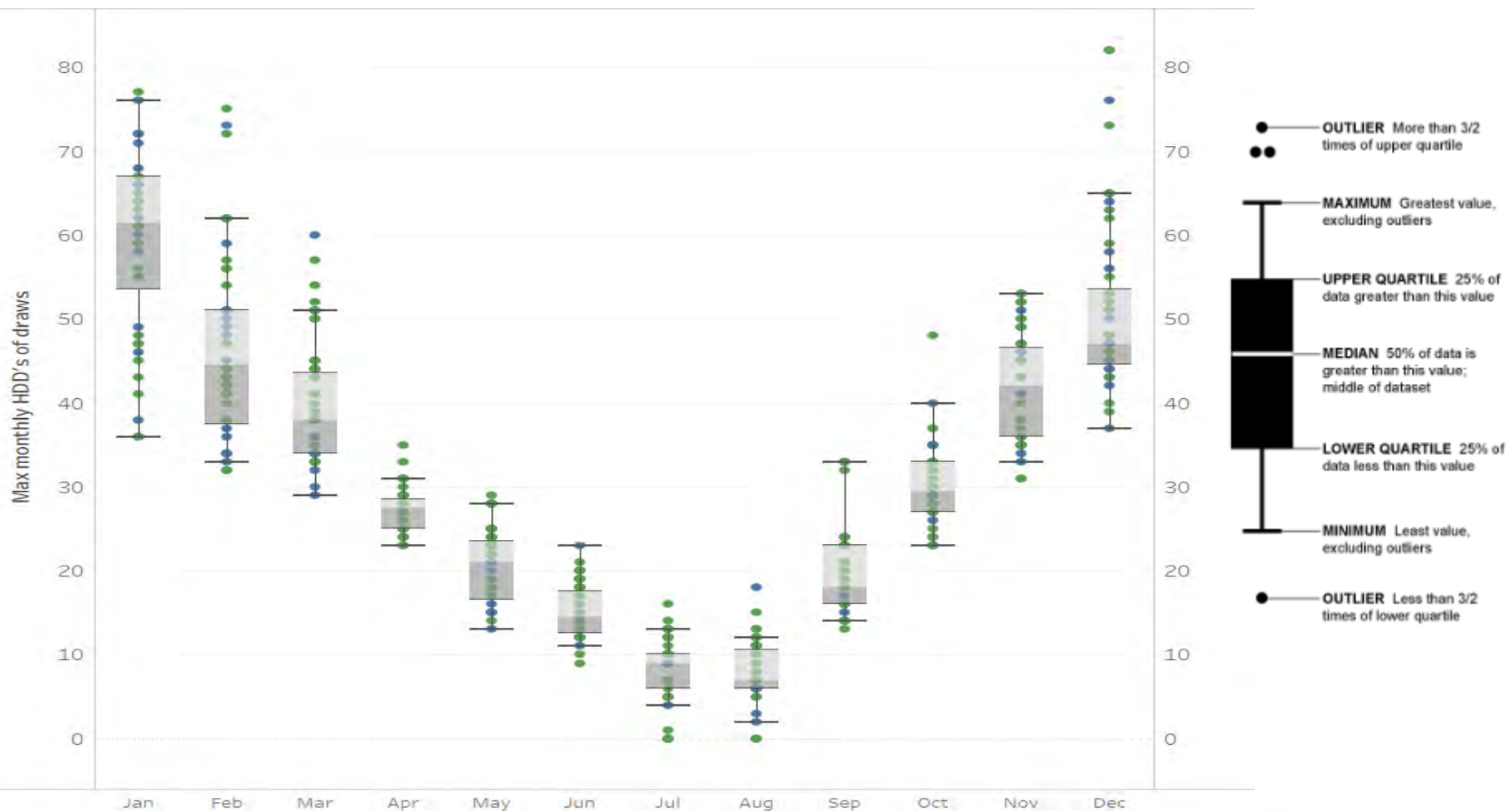

Max of Draw 155
Max of Draw 156

2018 Natural Gas IRP Appendix

AECO Monte Carlo Draw Example

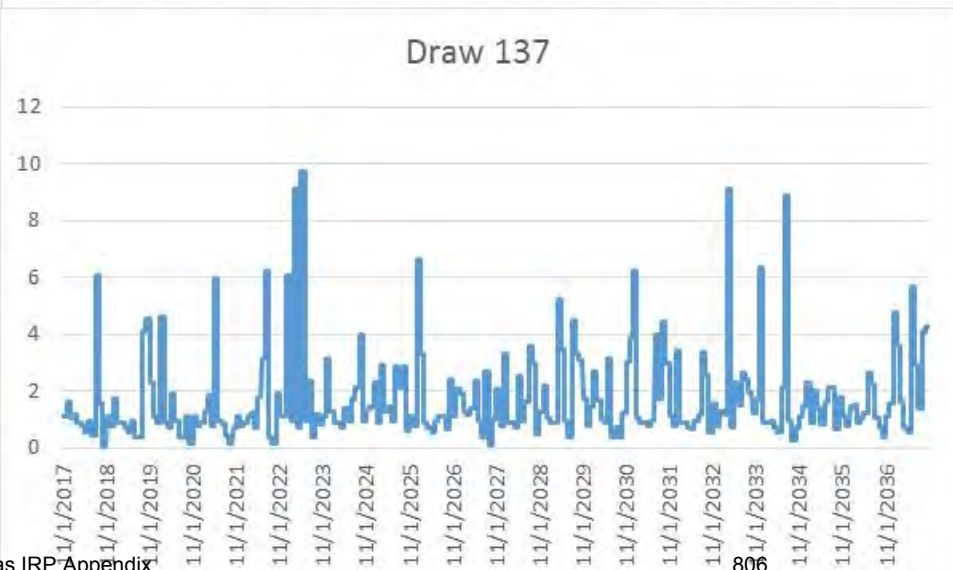
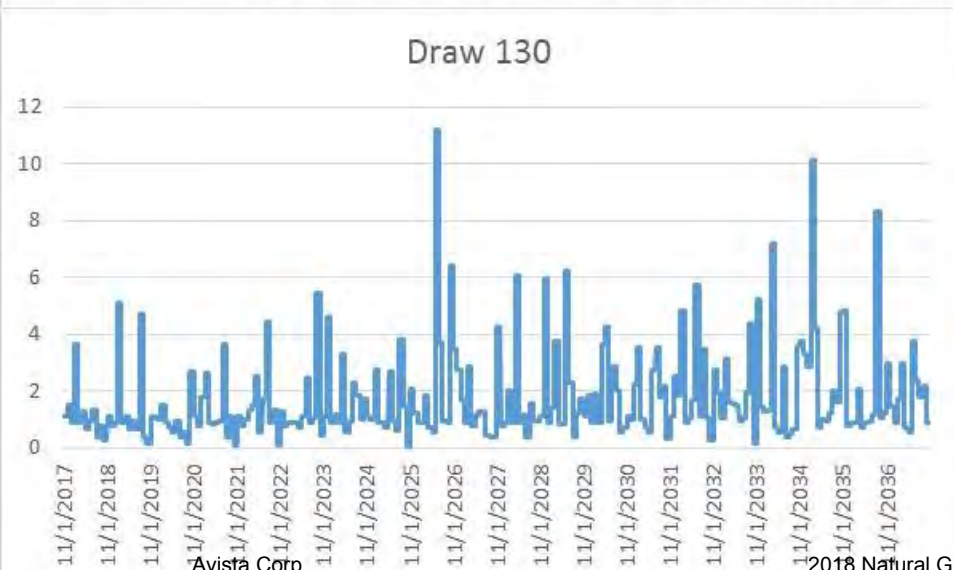
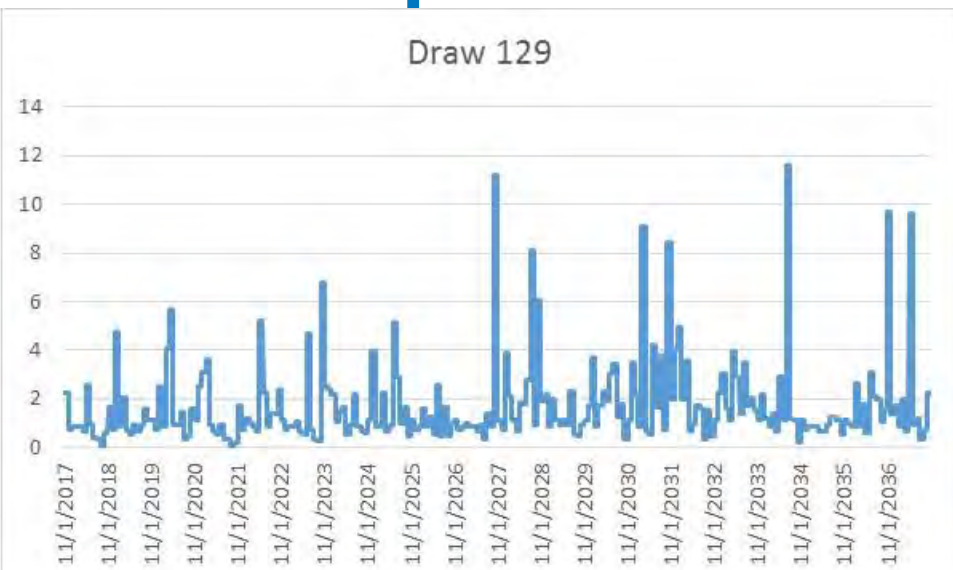
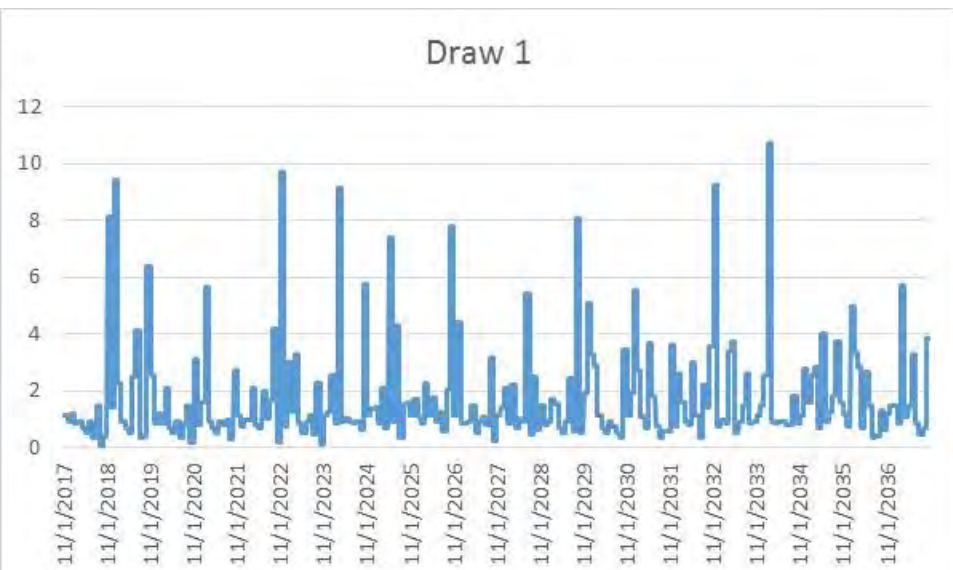

High Growth & Low Prices

200 Draws

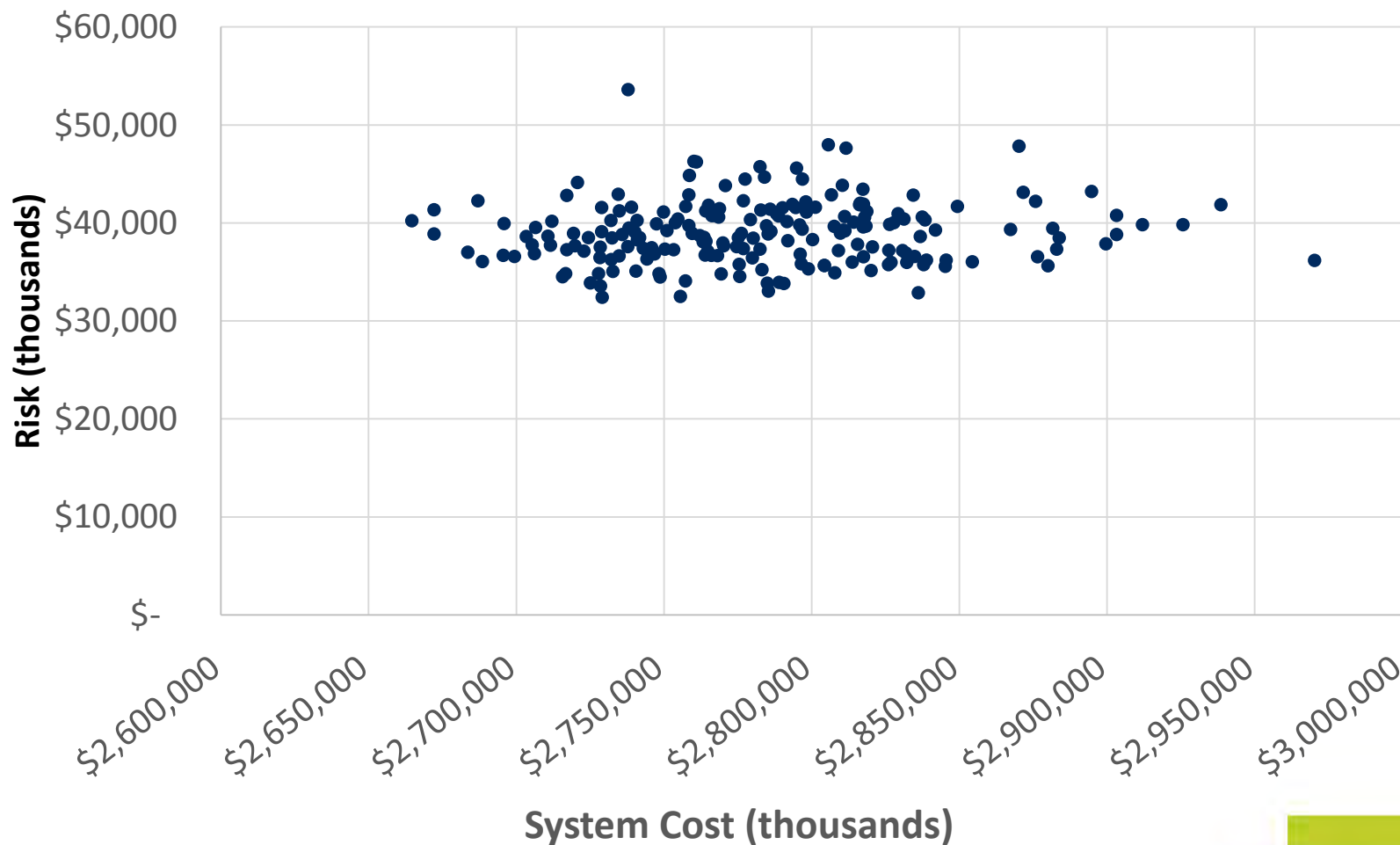

- 2017-2018
- 2018-2019
- 2019-2020
- 2020-2021
- 2021-2022
- 2022-2023
- 2023-2024
- 2024-2025
- 2025-2026
- 2026-2027
- 2027-2028
- 2028-2029
- 2029-2030
- 2030-2031
- 2031-2032
- 2032-2033
- 2033-2034
- 2034-2035
- 2035-2036
- 2036-2037

High Growth & Low Prices

Variability by Month by Gas Year

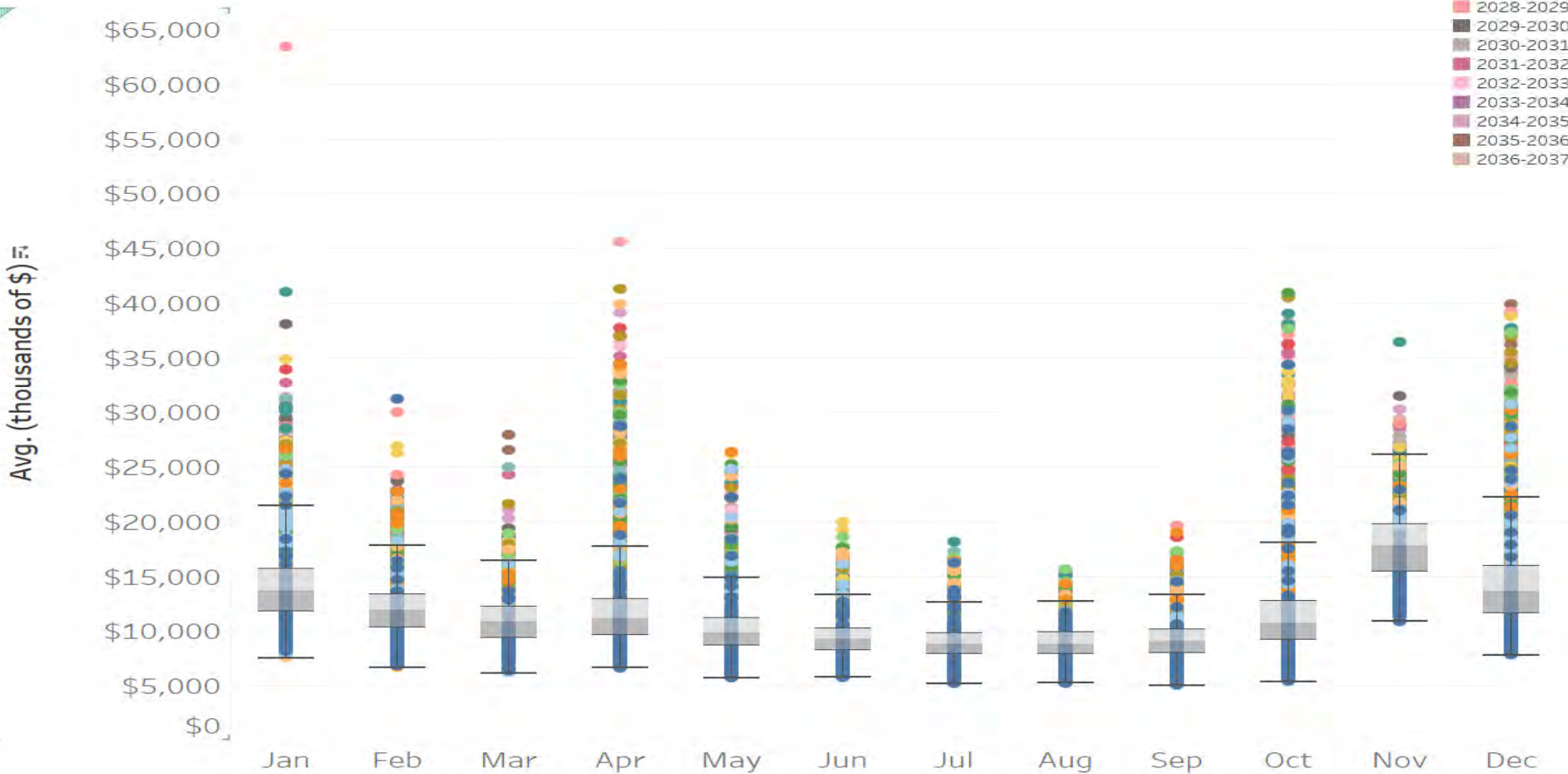

High Growth & Low Prices

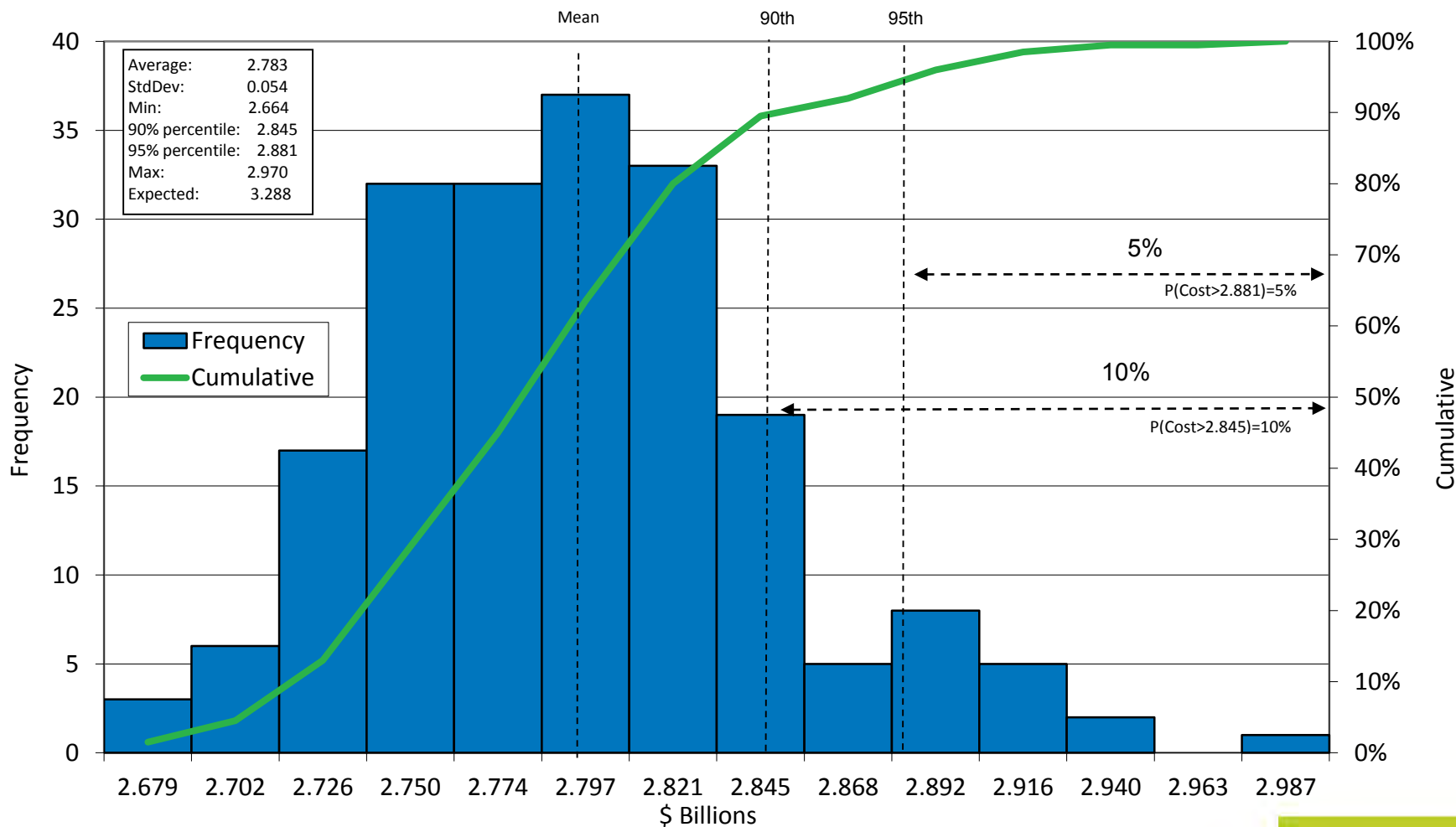

Supply by source and Area December 20th

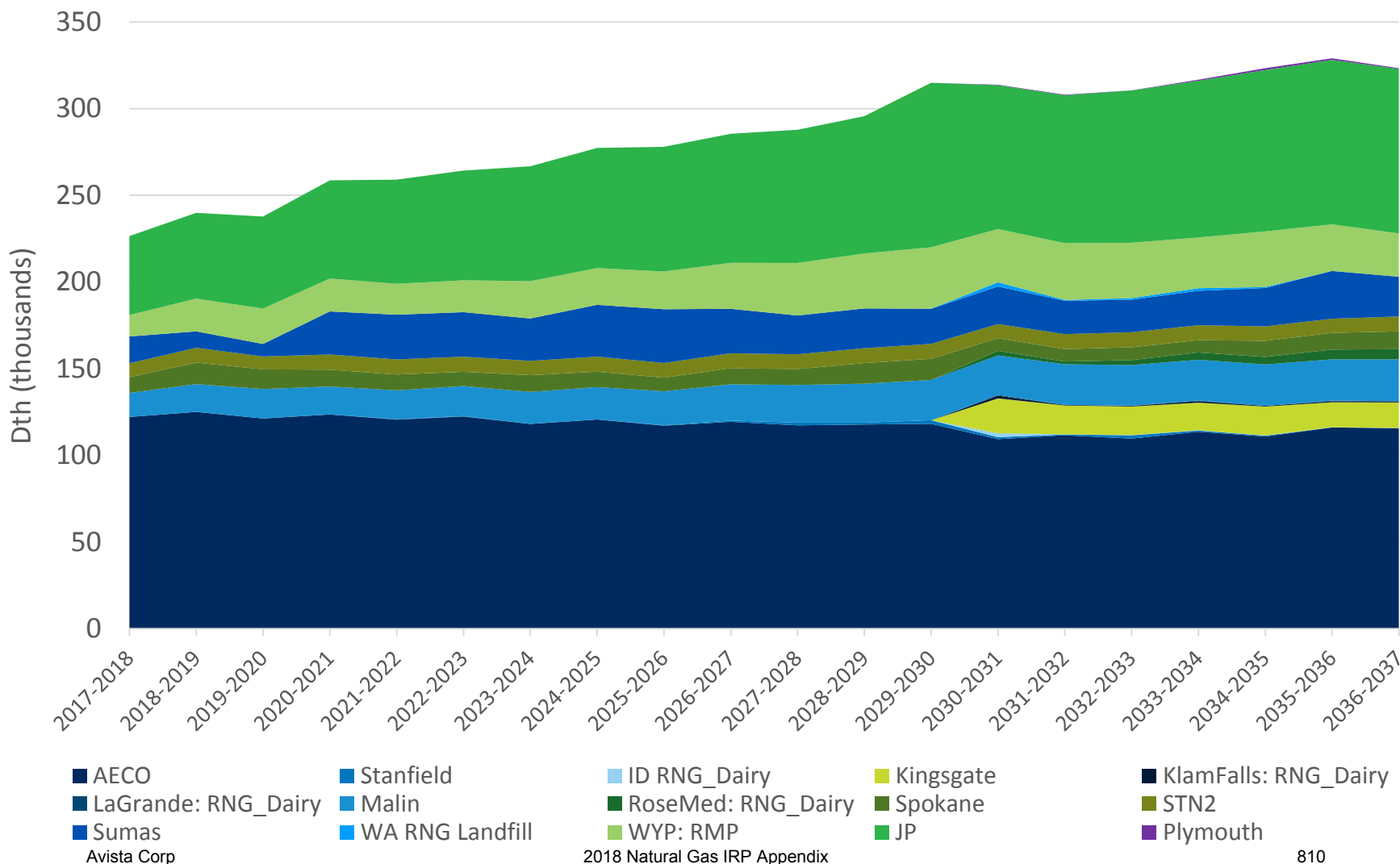

Supply by source and Area February 15th

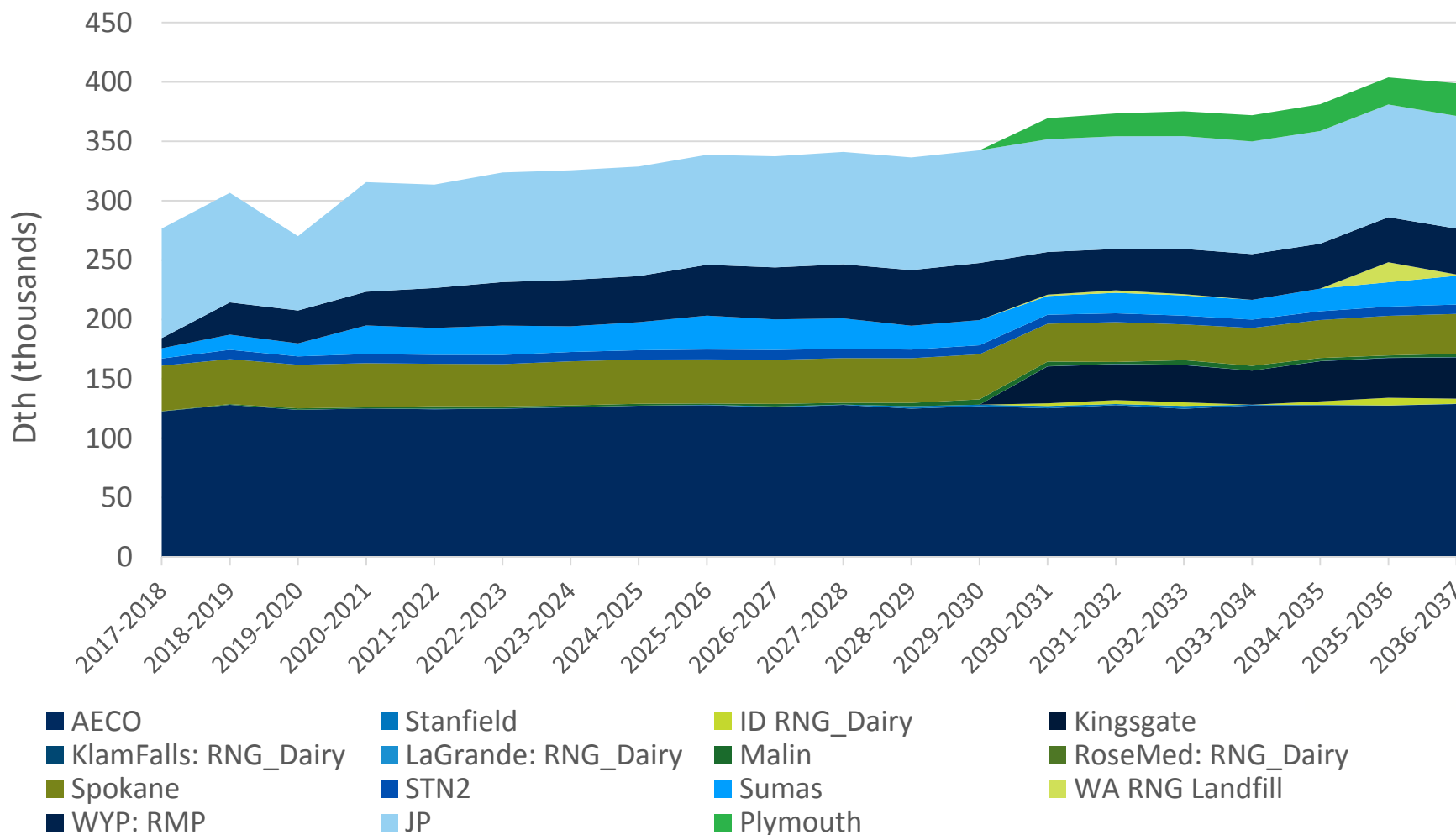

Summary

- Plymouth, Kingsgate and RNG are selected as a solve to unserved demand
- Another 200 draw simulation of the High Growth & Low prices case will be done once final costs are provided by consultant

*This information will be provided in the draft IRP unless the TAC would like to review during an additional meeting



Key Issues / Document Discussion

IPUC

- Staff believes public participation could be further enhanced through “bill stuffers, public flyers, local media, individual invitations, and other methods.”
- Result: Avista utilized it’s Regional Business Managers in addition to digital communications and newsletters in all states in order to try and gain more public participation. Previous IRP’s relied on website data and word of mouth.
 - eCommunity newsletter was sent out on January 15, 2018

OPUC

- Staff Recommendation No. 1
 - Staff recommends in Avista's 2018 IRP that Avista pursue an updated methodology, wherein the low/high gas price curves continue to be based on low (high) historic prices in a Monte Carlo setting, but are inflated to match the growth rate (yr/yr) of the expected price curve. The resulting curves would be based on historic prices and also produce symmetric risk profiles throughout the time horizon.
 - Result: Avista updated its method as recommended by the Oregon commission. This new method deviates from the expected price by the following method:
 - Pricing starts at the expected price for the first year
 - Years 2-6 the high and low price deviate +/- 6% per year from the expected price
 - Years 7-11 the high and low price deviate by +/- 3% per year from the expected price
 - Years 12 – 20 the high and low price deviate by +/- 1.5% per year from the expected price
 - By the 20 year mark the high and low deviate from the expected price by +/- 58.5%
- Staff Recommendation No. 2
 - Staff recommends that Avista forecast its number of customers using at least two different methods and to compare the accuracy of the different methods using actual data as a future task in its next IRP.
 - Result: Avista analyzed the data, but there was nothing material discovered the come up with a meaningful forecast alternative.

OPUC cont.

- Staff Recommendation No. 3
 - Avista's 2018 IRP will contain a dynamic DSM program structure in its analytics.
 - In, prior IRPs, it was a deterministic method based on Expected Case assumptions, in the 2018 IRP, each portion will have the ability to select conservation to meet unserved customer demand, Avista will explore methods to enable a dynamic analytical process for the evaluation of conservation potential within individual portfolios and will work with Energy Trust of Oregon in the development of this process and in producing any final results for its 2018 IRP for Oregon customers.
 - Result – After attempting to get dynamic dsm into the Sendout model we determined an alternate method is necessary.
 - 1 – The total dsm measures has a maximum of 999 measures. If we were to model our areas as is combined with 400 measures by area we would come up with a total need of 4400 measures.
 - 2 – If we were able to group them by dollars or efficiency levels it takes away the desired approach of measure by measure.
 - 3 – We have every bit of data both ETO and AEG can provide and the model is not acting appropriately and cannot determine a stopping point for taking a single measure. This means it would take the maximum, if cheaper than gas, to fill the entire demand. Clearly, this won't work. There are other issues with the program we will discuss during TAC 4. Another factor in this decision is the vendor does not know the dsm module and cannot provide assistance. We cannot see the code behind the application so it's all a guess as to how to input the measures.
 - 4 – The output data from ETO and AEG is very different and we need to understand it better before modeling. Avista has used AEG in some form for the past 4 IRPs so we are comfortable with it. ETO, in Oregon only, has a different model and method and is still rather foreign to us.
- Staff Recommendation No. 4
 - Staff recommends that Avista provide Staff and stakeholders with updates regarding its discussions and analysis regarding possible regional pipeline projects that may move forward.
 - Regional pipeline projects were discussed during TAC #3 meeting on March 29th, 2018. Avista does not have a shortage of resources for the 2018 Expected case. The regional pipelines take many years to place into service affording Avista the time to consider resources should they come into our territory. New pipeline builds are expensive with unofficial quotes averaging \$1 / Dth.
- **Staff Recommendation No. 5**
 - **Staff recommends that in its 2018 IRP process Avista work with Staff and stakeholders to establish and complete stochastic analysis that considers a range of alternative portfolios for comparison and consideration of both cost and risk.**
 - **Result – This was shown in detail and with risk and cost in TAC 4 on May 10, 2018. Potential resources were**

OPUC cont.

- Staff Recommendation No. 6
 - Environmental Considerations
 - 1. Carbon Policy including federal and state regulations, specifically those surrounding the Washington Clean Air Rule and federal Clean Power Plan;
 - Result: Carbon Policy including the Clean Power Plan and Clean Air Rule were both reviewed and included in TAC 2 Meeting materials on 2/22/2018. An indicator of where Avista's carbon reduction requirements under the CAR was also included. Since the CAR was invalidated on 12/15/2017 in Thurston County Superior Court this analysis is intended to meet the action item in addition to showing the potential impacts of similar policies.
 - 2. Weather analysis specific to Avista's service territories;
 - Result: A weather analysis was included and reviewed in TAC 2 meeting materials on 2/22/2018
 - 3. Stochastic Modeling and supply resources; and
 - 4. Updated DSM methodology including the integration of ETO

WUTC

- Include a section that discusses impacts of the Clean Air Rule (CAR).
 - In its 2018 IRP expected case, Avista should model specific CAR impacts as well as consider the costs and risk of additional environmental regulations, including a possible carbon tax.
 - Result:
 - Carbon Policy including the Clean Power Plan and Clean Air Rule were both reviewed and included in TAC 2 Meeting materials on 2/22/2018. An indicator of where Avista’s carbon reduction requirements under the CAR was also included. Since the CAR was invalidated on 12/15/2017 in Thurston County Superior Court this analysis is intended to meet the action item in addition to showing the potential impacts of similar policies.
 - For the 2018 IRP Avista is utilizing SB6203 from the WA Senate energy committee on Feb. 1 as a proxy of a possible carbon tax in Washington State.

WUTC

- Provide more detail on the company's natural gas hedging strategy, including information on upper and lower pricing points, transactions with counterparties, and how diversification of the portfolio is achieved.
 - Avista's natural gas hedging strategy was discussed during the TAC 2 Meeting on 2/22/2018. The upper and lower pricing points in Avista's programmatic hedges is controlled by taking into consideration the volatility over the past year for the specific hedging period. This volatility is weighted toward the more recent volatility. The window length and quantity of windows is also a part of the equation. Avista transacts on ICE with counterparties meeting our credit rating criteria. The diversification of the portfolio is achieved through the following methods:
 - **Components:** The plan utilizes a mix of index, fixed price, and storage transactions.
 - **Transaction Dates:** Hedge windows are developed to distribute the transactions throughout the plan.
 - **Supply Basins:** Plan to primarily utilize AECO, execute at lowest price basis at the time.
 - **Delivery Periods:** Hedges are completed in annual and/or seasonal timeframes. Long-term hedges may be executed.

WUTC cont.

- Ensure that the entity performing the CPA evaluates and includes the following information:
 - All conservation measures excluded from the CPA, including those excluded prior to technical potential determination
 - The rationale for excluding any measure
 - A description of Unit Energy Savings (UES) for each measure included in the CPA, specifying how it was derived and the source of the data
 - The rationale for any difference in economic and achievable potential savings, including how the Company is working towards an achievable target of 85 percent of economic potential savings.
 - A description of all efforts to create a fully-balanced cost effectiveness metric within the planning horizon based on the TRC.

WUTC cont.

- Discuss with the TAC:
 - The results of Northwest Energy Efficiency Alliance (NEEA) coordination, including non-energy benefits to include in the CPA.
 - The appropriateness of listing and mapping all prospective distribution system enhancement projects planned on the 20 year horizon, and comparing actual projects completed to prospective projects listed in previous IRP's.
- Provide a rationale for any difference in economic and achievable potential savings

2017 – 2018 Avista's Action Plan

- The price of natural gas has dropped significantly since the 2014 IRP. This is primarily due to the amount of economically extractable natural gas in shale formations, more efficient drilling techniques, and warmer than normal weather. Wells have been drilled, but left uncompleted due to the poor market economics. This is depressing natural gas prices and forcing many oil and natural gas companies into bankruptcy. Due to historically low prices Avista will research market opportunities including procuring a derivative based contract, 10-year forward strip, and natural gas reserves.
 - **Result:** After exploring the opportunity of some type of reserves ownership, it was determined the price as compared to risk of ownership was inappropriate to go forward with at this time. As an ongoing aspect of managing the business, Avista will continue to look for opportunities to help stabilize rates and/or reduce risk to our customers.
- Monitor actual demand for accelerated growth to address resource deficiencies arising from exposure to “flat demand” risk. This will include providing Commission Staff with IRP demand forecast-to-actual variance analysis on customer growth and use-per-customer at least bi-annually.
 - **Result:** actual demand was closely tracked and shared with Commissions in semi-annual or quarterly meetings.

Avista's 2020 IRP Action Plan

- Avista's 2020 IRP will contain a dynamic DSM program structure in its analytics. In prior IRP's, it was a deterministic method based on based on Expected Case assumptions. In the 2020 IRP, each portfolio will have the ability to select conservation to meet unserved customer demand. Avista will explore methods to enable a dynamic analytical process for the evaluation of conservation potential within individual portfolios.
- Work with Staff to get clarification on types of natural gas distribution system analyses for possible inclusion in the 2020 IRP
- Work with Staff to clarify types of distribution system costs for possible inclusion in our avoided cost calculation

Highlights of the 2018 IRP

- No resource needs in the Expected Case
- Higher long term customer growth rates
- Increased DSM potential and resultant avoided costs
- Carbon costs broken out by jurisdiction
 - Higher for WA and OR as compared to the 2016 IRP
- Washington and Idaho separated in Sendout
- Lower use per customer

2018 IRP Timeline

- **August 31, 2017** – Work Plan filed with WUTC
- **January through May 2018** – Technical Advisory Committee meetings. Meeting topics will include:
 - **TAC 1: Thursday, January 25, 2018: TAC meeting expectations, review of 2016 IRP acknowledgement letters, customer forecast, and demand-side management (DSM) update.**
 - **TAC 2: Thursday, February 22, 2018: Weather analysis, environmental policies, market dynamics, price forecasts, cost of carbon.**
 - **TAC 3: Thursday, March 29, 2018** : Distribution, supply-side resources overview, overview of the major interstate pipelines, RNG overview and future potential resources.
 - **TAC 4: Thursday, May 10, 2018: DSM results, stochastic modeling and supply-side options, final portfolio results, and 2020 Action Items.**
 - **June 21, 2018– TAC final review meeting to review final stochastics (if necessary)**
- **July 2, 2018** – Draft of IRP document to TAC
- **July 13, 2018** – Comments on draft due back to Avista
- **August 31, 2018** – File finalized IRP document