



Avista Corp.

# Electric Vehicle Supply Equipment Pilot Final Report

*Front Cover – Avista’s DC fast charging site installation in partnership with Kendall Yards in Spokane, Washington*



*Huntington Park, Spokane, Washington*

## About Avista

Avista Corporation is an energy company involved in the production, transmission and distribution of energy as well as other energy-related businesses. Its largest subsidiary, Avista Utilities, serves more than 600,000 electric and natural gas customers across 30,000 square miles in eastern Washington, northern Idaho and parts of southern and eastern Oregon.

Avista’s legacy begins with the renewable energy we’ve generated since our founding in 1889, and grows with our mission to improve customers’ lives through innovative energy solutions.

*Avista – Better Energy for Life!*

## Avista Authors

Rendall Farley, P.E. – Electric Transportation Manager

Mike Vervair – Electric Transportation Engineer

Jon Czerniak – Data Analyst

October 18, 2019

Submitted to the Washington Utilities and Transportation Commission (UTC)

## Contact

[rendall.farley@avistacorp.com](mailto:rendall.farley@avistacorp.com)

## Acknowledgments

The following groups are recognized for their many contributions essential to the EVSE pilot's accomplishments

Colvico, Inc.  
GEM Electric NW, Inc.  
Washington State Transportation Electrification  
Stakeholder Group  
Spokane Transit Authority  
Washington Trust Bank  
Town of Rosalia  
City of Liberty Lake  
City of Colville  
Port of Clarkston  
Town of Garfield  
City of Palouse  
City of Pullman  
City of Spokane  
Spokane Regional Health District  
Transitions for Women

Whitworth University  
Gonzaga University  
Washington State University  
Alliance for Transportation Electrification  
Electric Power Research Institute  
Edison Electric Institute  
Energy + Environmental Economics (E3)  
Forth  
Pacific NW Utility Transportation Electrification  
Collaborative  
California Electric Transportation Association  
Greenlots  
FleetCarma  
Efacec  
BTC  
ClipperCreek

300+ Residential and Commercial Customers

# Contents

Executive Summary.....	2
Background .....	10
Light-Duty EV Adoption and Forecasts .....	14
Education and Outreach .....	19
Community and Low-Income.....	22
Customer Surveys .....	24
Installations and Costs .....	28
Residential AC Level 2 EVSE .....	29
Commercial AC Level 2 EVSE.....	33
DC Fast Charger EVSE.....	36
Reliability and O&M Costs .....	39
Utilization, Load Profiles & Data Analysis.....	48
Residential AC Level 2 EVSE .....	53
Commercial AC Level 2 EVSE.....	62
DC Fast Charging .....	71
Telematics Data and Analysis .....	76
Load Management .....	82
Grid and Economic Impacts .....	90
Expenses and Revenues.....	100
Conclusions and Recommendations.....	102
References .....	105
Appendix A: Glossary of Terms & Abbreviations.....	107
Appendix B: Data Validation .....	114
Appendix C: Explanation of Box Plots .....	116
Appendix D: Assorted Charging Profiles .....	117
Appendix E: Charge Session Box Plots for Workplace Charging sample Group .....	120
Appendix F: Avista EVSE Network Energy Usage.....	125
Appendix G: Interoperability.....	128
Appendix H: Economic Modeling Details.....	131

## Executive Summary

### Report Objectives:

- Provide a comprehensive overview of the EVSE pilot's intent and activities
- Present detailed findings and lessons learned
- Lay the groundwork for effective future programs

Avista launched its Electric Vehicle Supply Equipment (EVSE) pilot in 2016, with the main objectives of understanding (1) light-duty electric vehicle (EV) load profiles, grid impacts, costs, and benefits, (2) how the utility may better serve all customers in the electrification of transportation, and (3) begin to support early EV adoption in its service territories.

A total of 439 EVSE charging ports were installed in a variety of locations, including 226 residential, 123 workplace, 24 fleet, 20 multiple-unit dwelling, and 7 DC fast charging sites, through a three year pilot program ending in June, 2019. These EVSE are owned and maintained by Avista, located on residential and commercial property downstream of the customer's meter, except for DC fast charging sites where the utility owns all equipment from the transformer to the EVSE. A combination of both networked and non-networked EVSE from six different manufacturers were installed to compare costs, performance, and customer satisfaction.

Networked EVSE allowed for data collection at all locations and direct load management experiments at residential and workplace locations, through the Electric Vehicle Supply Provider (EVSP) that managed the network. Customers accepted this arrangement without a time-of-use (TOU) rate or further incentives, which allowed Avista to gather data for both uninfluenced load profiles, and those altered via direct control of EVSE output subject to customer notifications and demand response (DR) event opt-outs. A total of \$3.1 million in capital investments and \$740k in operations and maintenance expenses were incurred for the pilot program, which was under budget and in-line with expectations. An estimated 1,319 Avista customers with EVs in Washington will contribute over \$323k utility revenue from EV charging in 2019.

Support for EV adoption was accomplished through (1) education and outreach efforts, (2) a program benefiting low-income customers, (3) dealer engagement including a referral program, (4) residential EVSE offerings, and (5) chargers installed at workplace, fleet, multiple-unit dwelling (MUD) and public sites, with the intent to help establish a backbone of EVSE infrastructure in eastern Washington. This activity has correlated with an increasing adoption rate starting at 23% in 2016 and rising to a projected rate of 41% in 2019, which has caught up to the Washington State average. Workplace charging in particular has supported



Figure 1: Residential EVSE charging

adoption, resulting in an over 200% increase in EV commuters at reported locations. However, the number of EVs and per capita ownership remain low compared to western Washington, and future adoption rates remain uncertain, subject to a number of factors including the availability of EVs, purchase costs, gasoline prices, public awareness, dealer engagement, and EVSE infrastructure. While Avista's pilot program supported EV adoption and achieved positive results, it is clear that a sustained and increased effort in partnership with local governments, customers, non-profits and policymakers is needed for continued progress and EV market transformation.

The Company initiated a trial program to directly benefit disadvantaged and low-income groups by collaborating with local stakeholders, evaluating proposals, and implementing EV transportation for a local non-profit and government agency serving these groups. In both cases, Avista provided an EV and an EVSE that was used for a variety of beneficial purposes including transport to critical medical services, job skills training, shuttle services for overnight shelter, and food deliveries. Since implementation, the organizations reported transportation cost savings of 57% and 82%, leveraged to provide additional transportation and other services, as well as additional benefits such as positive education and awareness among employees, and an interest in expanded EV fleets. This year, the Spokane Transportation Collaborative was formed, with broad stakeholder membership from area government agencies and non-profits, recognizing the need to address transportation issues among the disadvantaged, as the most serious issue following the lack of adequate housing. Avista intends to collaborate with this group to most effectively understand transportation issues and how they may be addressed with future electric transportation and mobility programs supported by Avista.

A series of online customer surveys followed immediately after initial EVSE installation and semi-annually thereafter, which showed high customer satisfaction with EVs at 98%, and with the EVSE performance at 98% for non-networked EVSE and 85% for networked EVSE at residential locations. Common feedback included a need for more public EVSE in the region, especially DC fast chargers, and improvement in the reliability and customer experience of networked EVSE at both residential and commercial locations.

## EVSE Costs and Performance

Installation and operation and maintenance (O&M) costs show that networked EVSE are significantly more expensive to install and maintain, and have a higher rate of failures requiring troubleshooting and repair, as shown in the following table.<sup>1</sup>

---

<sup>1</sup> Note that % uptime is defined as the percent of time an EVSE is able to provide a charge, while % online is the percent of time the EVSE is online and communicating with the network. In many cases a networked EVSE may be able to provide a charge even if offline with the network.

Table 1: Average EVSE installation cost, O&M expenses and performance

	Installation cost per port	Annual O&M per port	% uptime	% online
Residential AC Level 2 - networked	\$2,445	\$370	98%	66%
Commercial AC Level 2 - networked	\$6,035	\$600	86% - 93%	76% - 86%
DC fast charging site	\$128,084	\$1,550	87%	87%
Residential AC Level 2 – non-networked	\$1,766	\$5	100%	NA
Commercial AC Level 2 – non-networked	\$4,472	\$185	99%	NA

It is expected that networked EVSE performance and costs will continue to improve as the industry matures. In any case, it is also clear that non-networked EVSE are preferable from a customer experience and cost perspective, unless a networked EVSE is required for data collection, point-of-use fee transactions, or DR capability. EVSE-to-network interoperability through the use of industry standards such as the Open Charge Point Protocol (OCPP) is critical to reduce the risk of stranded assets and take advantage of performance and cost improvements in the market.

## EVSE Utilization and Load Profiles

Over 53,000 charging sessions were analyzed to determine EVSE utilization and load profiles, based on different locations and driver types including commuters, non-commuters, and vehicle categories of all-battery (BEVs) and plug-in hybrid (PHEVs). Analysis shows that the great majority of charging occurs at residential locations coinciding with system peaks in the late afternoon and early evening, followed by workplace charging which can coincide with morning peaks during colder winter temperatures. Charging behaviors according to EV and driver types showed similar load profile shapes, with higher consumption for battery-electric vehicles (BEVs), commuters, and on weekdays. A smaller dataset for long-range BEVs such as the Tesla model 3 showed an 85% increase in peak demand and a 78% increase in energy consumption compared to average residential charging from other vehicle types, such as shorter-range BEVs and plug-in hybrid vehicles (PHEVs). This may represent a closer approximation of future loads from EV charging, as the industry is expected to produce BEVs with larger batteries that enable longer driving ranges in the years ahead.

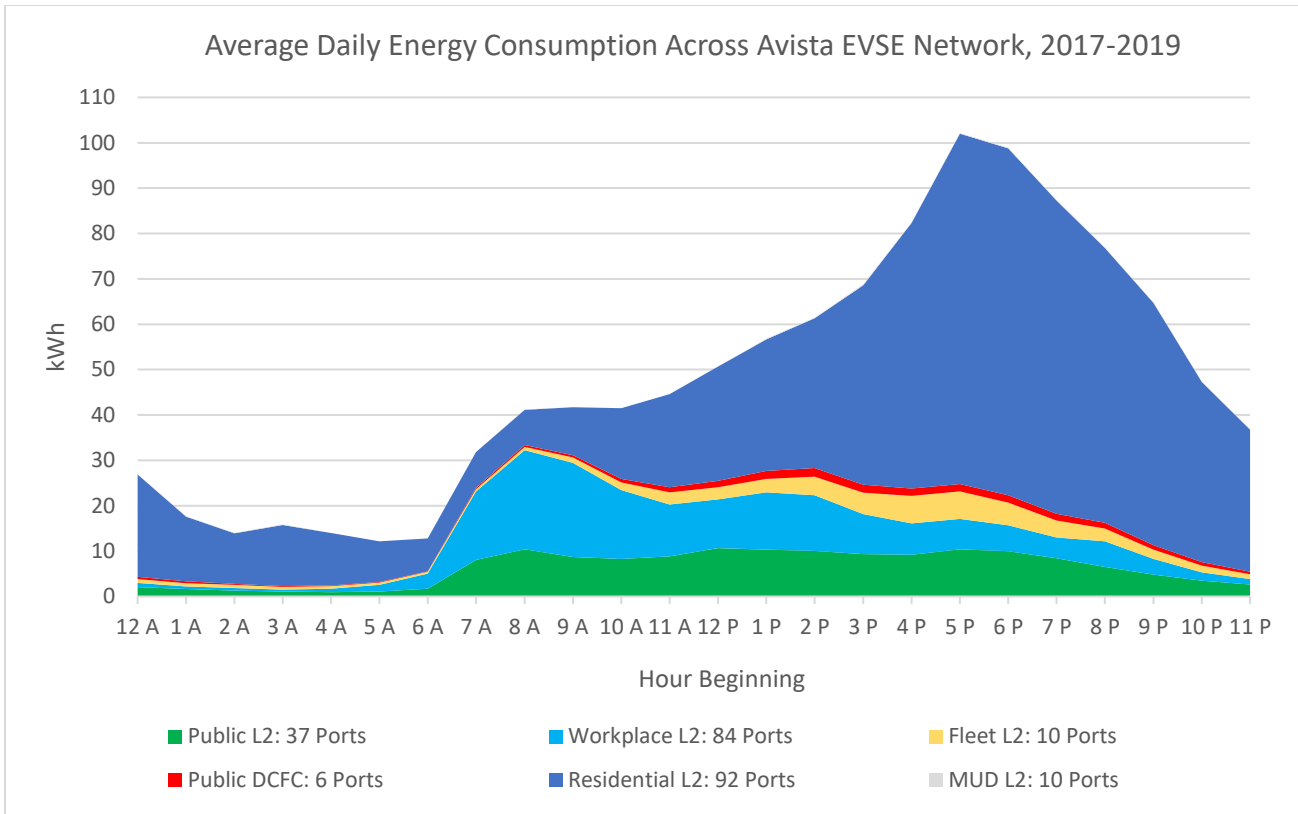

Figure 2: Average daily energy consumption across Avista’s networked EVSE

EV commuters with both workplace and residential charging availability charged less at home than those with only residential charging, causing reduced evening peak load. However, this also increased peak load from workplace charging in the morning during colder winter temperatures. Utilization varied considerably, with the most observed at residential, fleet and workplace locations at over 17 sessions per month and average sessions consuming over 7 kWh per session in 1.6 hours, typically charging at 3.3 kW or 6.6 kW. DCFC utilization grew by 19% over the last year, but is still relatively low given the state of early EV adoption in the region. Analysis of DCFC O&M costs, meter billing, and user fee revenue highlight the need to consider alternative rate designs, as demand charges averaged 67% of total bills – making it difficult for revenue to cover ongoing expenses, let alone capital investments.

### Load Management

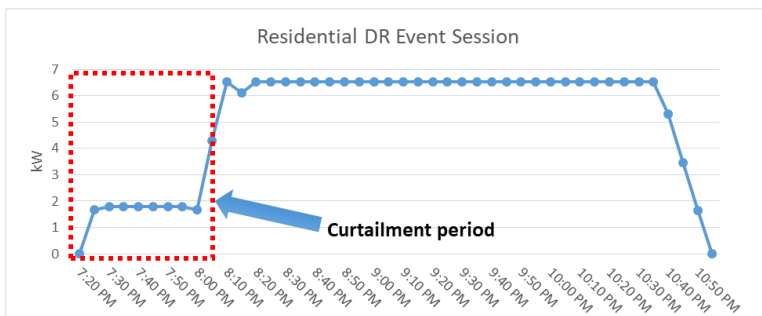

Figure 3: Example DR charging session with 75% peak load reduction

Avista’s direct load management experiments using DR technologies at home and at work showed that customers accepted 75% peak load reductions via remote utility controls, without negative effects on driving habits or overall satisfaction ratings. This is because the hourly charging requirements of EVs are



very flexible, especially at residential locations where virtually all AC Level 2 charging may be accomplished in the late night and very early morning hours, which coincide with year-round off-peak hours. Even higher rates of peak load reduction through DR may be possible, but require further technology development to attempt and substantiate. Costs to implement DR must also be dramatically reduced in order to provide net grid benefits and the ability to reliably scale up. This effort should continue, with development and experimentation in a variety of methods and technologies, as it will become ever more important to integrate and optimize EV loads in the future as a flexible grid resource.

## Grid Impacts and Economic Modeling

Consistent with other studies, Avista’s grid impact modeling indicates that light-duty EVs will have little effect on the distribution system over the next decade, even at high adoption rates. To illustrate, only 6% of service transformers were overloaded assuming nearly 25% EV adoption. In contrast, generation capacity costs could factor substantially in the added costs to serve this new load starting in 2027, when Avista is projected to become short on generation capacity. However, base-case modeling indicates that EVs provide \$1,206 per EV in net grid benefits, as the billing revenue exceeds utility costs over its service life. This may be increased by another \$463 per EV when load management shifts peak loads to off-peak, as was operationally demonstrated in the EVSE pilot.

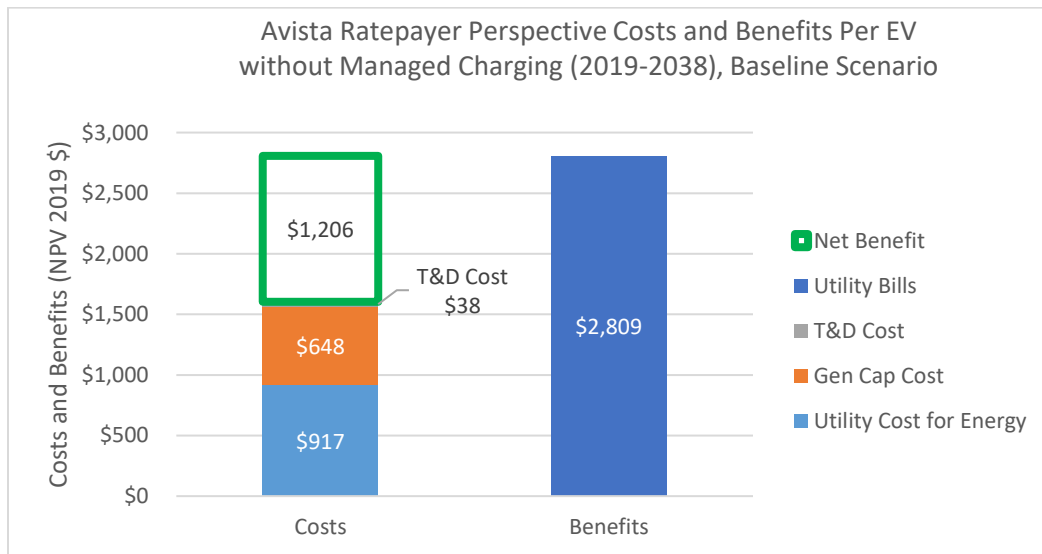

Figure 4: Ratepayer Perspective costs and benefits per EV, without managed charging 2019-2038

In addition, from a regional perspective each EV provides a net benefit of \$1,661, mostly due to the substantial fuel cost savings of EV customers. This can have a tremendous ripple effect on the local economy at scale.<sup>2</sup> Perhaps most importantly, each EV avoids close to 4 tons of CO2 emissions per year, an 80% reduction from the average light-duty vehicle powered by gasoline. This offers a tremendous

<sup>2</sup> Note that these results incorporate information and assumptions from Avista’s 2017 Electric Integrated Resource Plan, and do not yet incorporate increased costs that may occur to reach newly established carbon neutrality goals for utility power supply.

societal benefit and return on investment in the effort to reduce harmful greenhouse gas emissions and other air pollutants.

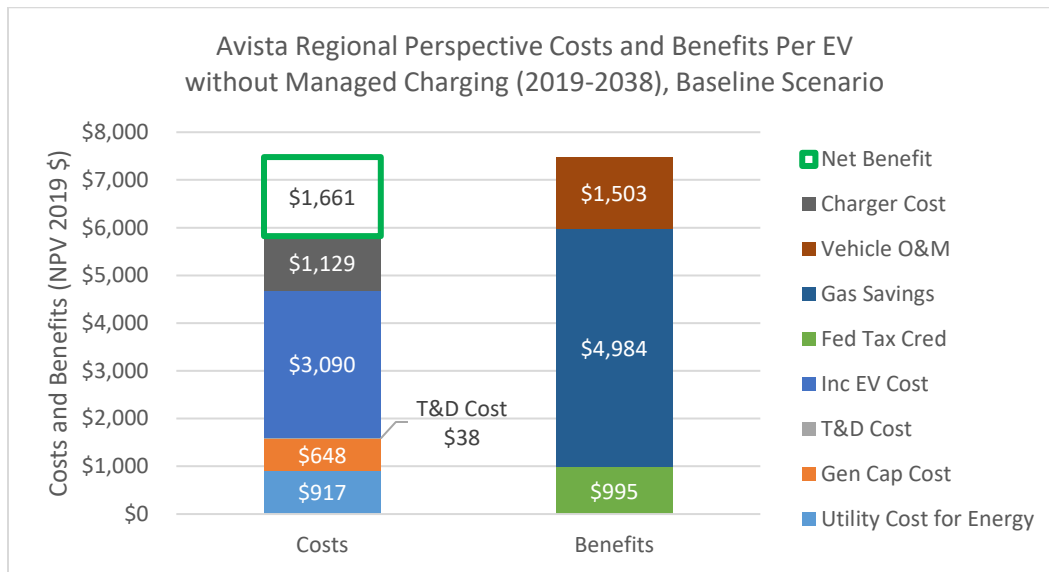

Figure 5. Regional perspective costs and benefits per EV without managed charging 2019-2038

It cannot be over-emphasized that although EVs may be very manageable over the near term, grid impacts and costs resulting from EV peak loads could become significant over longer time horizons, with higher EV adoption, and as other loads and the grid change. The EVSE pilot represents a good start in the Company’s ongoing effort to understand how EV loads can affect the grid and how they may be optimally integrated and managed, in an evolving system that brings the most benefit to all customers.

## Conclusions and Recommendations

Through the EVSE pilot the Company gained valuable experience, achieving its learning objectives while effectively supporting early EV adoption. Light-duty EV loads will be manageable from a grid perspective over at least the next decade, and EVs offer the potential to provide significant economic and environmental benefits for the long term to both EV drivers as well as all other customers. Participants were highly satisfied with the pilot programs, and Avista is now in an excellent position to propose a comprehensive Transportation Electrification Plan in both Washington and Idaho service territories, that includes major areas of education & outreach, dealer engagement, community & low-income, EVSE infrastructure, load management, commercial fleets, rate design, internal programs, planning, and grid integration. Through this long-term effort, Avista intends to innovate and serve all customers and communities in electrifying the transportation sector, building a better energy future in partnership with industry, customers, local governments and policymakers.

## Key Takeaways from the EVSE Pilot

1. Data and analysis show that grid impacts from light-duty EVs are very manageable over at least the next decade, net economic benefits can extend to all customers, and significant reductions of greenhouse gas emissions (GGE) and other harmful air pollutants may be achieved with EVs. However, grid impacts and costs resulting from EV peak loads could become significant over longer time horizons, with higher EV adoption, and as other loads and the grid change. The EVSE pilot represents a good start in the Company's ongoing effort to understand how EV loads may be optimally integrated and managed, in an evolving system that brings the most benefit to all customers.
2. Avista was able to cost-effectively install EVSE, resulting in high customer satisfaction, and the pilot correlated with a significant increase in the rate of EV adoption in the area, demonstrating that utility programs can be effective in supporting and enabling beneficial EV growth. Partnerships with industry providers, a focus on providing value for the customer, and contractor performance were keys to success.
3. Workplace charging stands out as a powerful catalyst for EV adoption, while simultaneously providing grid benefits from reduced EV charging at home during the evening peak hours.
4. Low dealer engagement, a lack of EV inventories, and persistent customer awareness and perception issues continue to be a major barrier to mainstream EV adoption in the region. The utility can help overcome these issues with robust education and outreach programs, including dealer engagement.
5. Avista successfully demonstrated the use of EVs to reduce operating costs for a local non-profit and government agency serving disadvantaged customers. The Company expects local stakeholder engagement to continue in the development and expansion of similar programs, as well as other innovative ways to serve communities and low-income customers, consistent with the UTC Policy Statement.
6. Surveys showed a widespread desire for more public AC Level 2 and DC fast charging sites, which may be supported in future utility programs and rate designs. A new rate should be developed to address operational cost barriers resulting from traditional demand charges, while reasonably recovering utility costs.

## Key Takeaways (continued)

7. Networked EVSE reliability, uptime, costs, and customer experience are all important opportunities for improvement, reinforcing the importance of utilizing interoperable networked EVSE. Non-networked EVSE are very reliable and cost effective, and should be utilized wherever possible unless data collection, user fee transactions, remote monitoring, or other requirements necessitate the use of networked EVSE.
8. Load management experiments showed that the utility may remotely curtail residential peak EV loads by 75%, while maintaining customer satisfaction and without a TOU rate or additional incentives other than the installation of the EVSE owned and operated by the utility. More DR experimentation may show the feasibility to shift an even higher percentage of peak loads. While EVSE load management utilizing DR and V1G technology appears acceptable from a customer perspective, reliability and costs must be significantly improved to attain net grid benefits and enable practical application at scale.
9. Data and analysis were somewhat limited by the available pool of participants and EVSE sites, however results compared well with other studies using larger population samples, and EVSE data was satisfactorily replicated and verified by telematics data. As the industry evolves, light-duty EVs with larger battery packs may become the norm. In this respect, the EV load profiles developed and examined in this study may under-predict electric consumption and peak loads to some degree.

## Background

On April 28, 2016 the Washington Utility and Transportation Commission (UTC) issued Order 01 in Docket UE-160882 approving Avista’s tariff Schedule 77 for its EVSE Pilot Program. The initial two-year installation term of the program began with the first residential EVSE installation on July 20, 2016.

On June 14, 2017, the UTC issued a “Policy and Interpretive Statement Concerning Commission Regulation of Electric Vehicle Charging Stations.”<sup>3</sup> It provides background and guidance principles for utility EV charging as a regulated service, and notes that the purpose of Avista’s pilot program is to obtain data and experience that will inform future EVSE programs and rate designs.

On February 8, 2018, the UTC issued Order 02 in Docket UE-160882 approving Avista’s proposed revisions to tariff Schedule 77. This included extending the installation period of the program with additional EVSE installations through June 30, 2019, as well as adding a program benefiting low-income customers and a few other minor adjustments. Following the installation period, ongoing program management continued including EVSE maintenance, data collection and demand response (DR) through direct load management (V1G) experimentation.

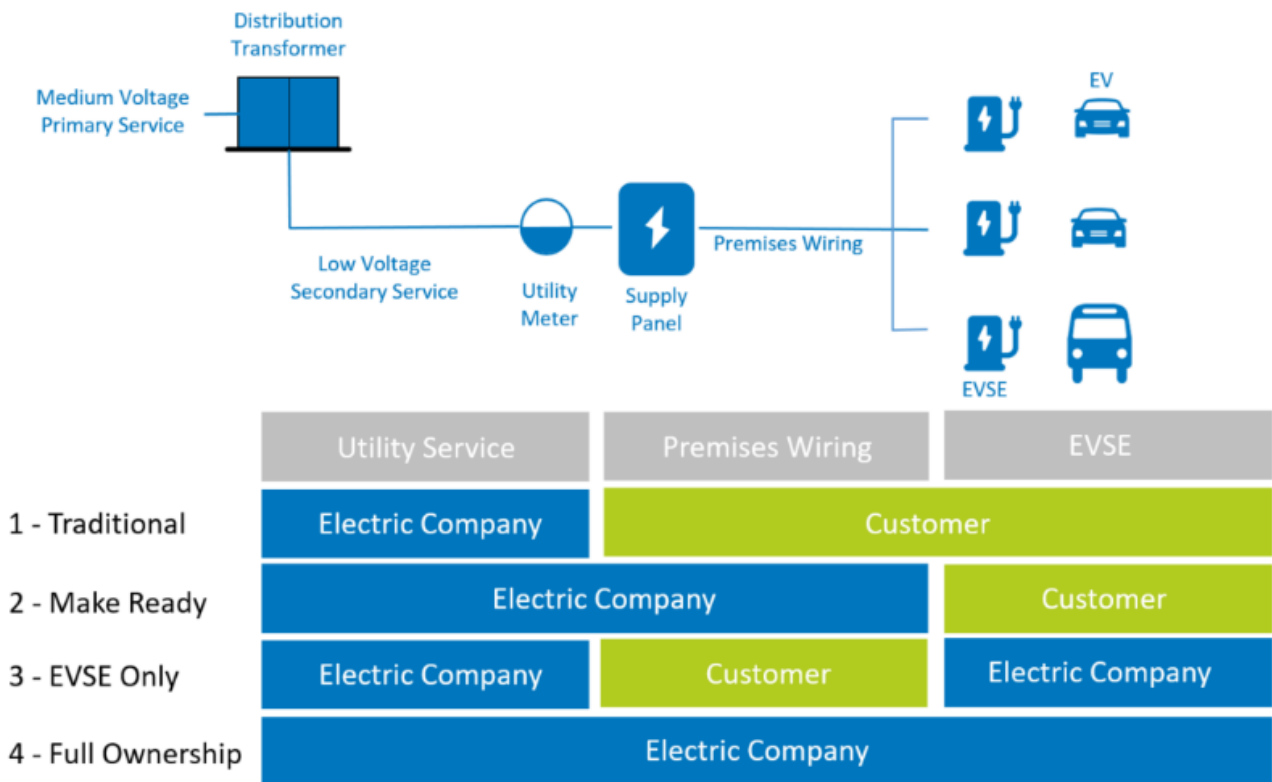

Figure 6: Ownership models for utility and customer EVSE infrastructure

<sup>3</sup> Docket UE-160799 (June 14, 2017).

AC Level 2 EVSE owned and maintained by Avista were installed on residential and commercial sites downstream of the customer’s meter and electrical supply panel, while DC fast charging sites involved full utility ownership of all equipment from the transformer to the EVSE. The figure illustrates electrical infrastructure and four basic types of EVSE ownership models between the utility and the customer. Avista’s AC Level 2 installations followed the “EVSE only” model in both residential and commercial locations, and DC fast charging sites followed the “full ownership” model.

A simple EVSE rebate program is an example of the “traditional” business model, where nothing is owned by the utility beyond the meter and conditional rebates from the utility are provided for EVSE purchased and installed by the customer. A “make ready” program typically involves new utility commercial service, including dedicated meters and premises wiring or supply infrastructure that is owned and maintained by the utility, stubbed out to the EVSE location. In “make ready” models, the EVSE itself is owned and maintained by the customer, and in some cases the utility may provide subsidies to the customer for EVSE purchase, installation and/or maintenance. Full ownership involves a dedicated transformer, meter, supply infrastructure and the EVSE itself, all owned and maintained by the utility. Public AC Level 2 or DC fast charging sites can fall in this category, with EVSE user fees applied and subject to regulatory oversight.

Avista chose the “EVSE Only” and “Full Ownership” models for the EVSE pilot as an alternative to other more common utility EVSE rebate and make ready programs. It was felt that by utilizing existing supply panels and other supply infrastructure in residential and commercial locations in the “EVSE Only” model, costs could be much lower than comparable “make ready” installations with new dedicated services and infrastructure. Further, it seemed possible that utility EVSE ownership and maintenance might be an effective way to provide the most value and satisfaction for customers in terms of reducing the costs, risks and difficulties of installing EVSE, while providing a means for effective DR without the need for further incentives or a time-of-use (TOU) rate to shift peak loads. Due to the more substantial investments and effort to implement DCFC sites and maintain them, the full utility ownership model was chosen to ensure long-term DCFC operability and public access.

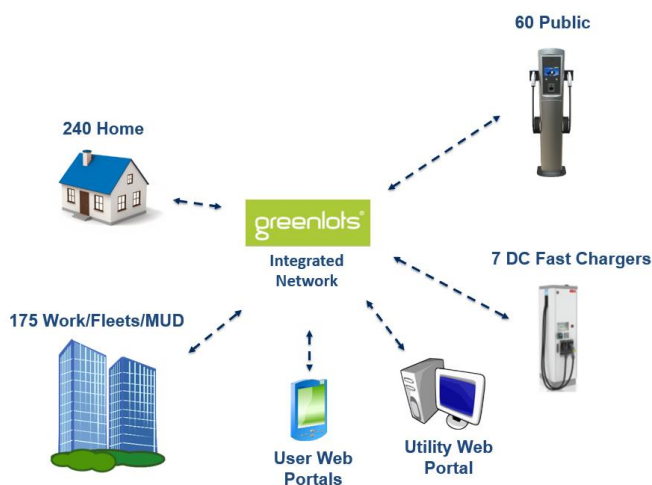

Figure 7: Integrated EVSE network design

In order to comprehensively understand EV charging behavior and electrical loads from different locations, it was necessary to build an EVSE “ecosystem” that was integrated by a single network, capturing the charging data for individual EV drivers wherever they might charge – at home, at work, or in the public, for both AC Level 2 and DC fast charging. It was important to incorporate hardware and software that was “interoperable”, using industry standard communication protocols such as the OCPP standard, so that risks and operational flexibility could be well managed. This enables “plug and play” deployment of alternative

EVSE or EVSP providers in the future as the competitive market and products mature. The overall design is depicted here, with the maximum allowed number of ports in each major category.

The numbers and proportions of EVSE in each category were carefully chosen to accomplish learning objectives and begin to support EV adoption in Avista’s service territory, while containing costs to a modest level. Uninfluenced load profiles for different EV driver types and in different locations could be reasonably established in the first phase of the pilot, followed by direct load management of networked AC Level 2 EVSE at residential, workplace, fleet and multiple unit dwellings (MUD) locations.<sup>4</sup> These comparisons allow for a better understanding of customer behaviors and more robust grid impact and economic modeling, influencing future program designs. The proportional targets were also informed by the literature, showing different volumes and supporting roles that EV charging plays in each segment. As shown by the “Charging Pyramid”, all types of charging

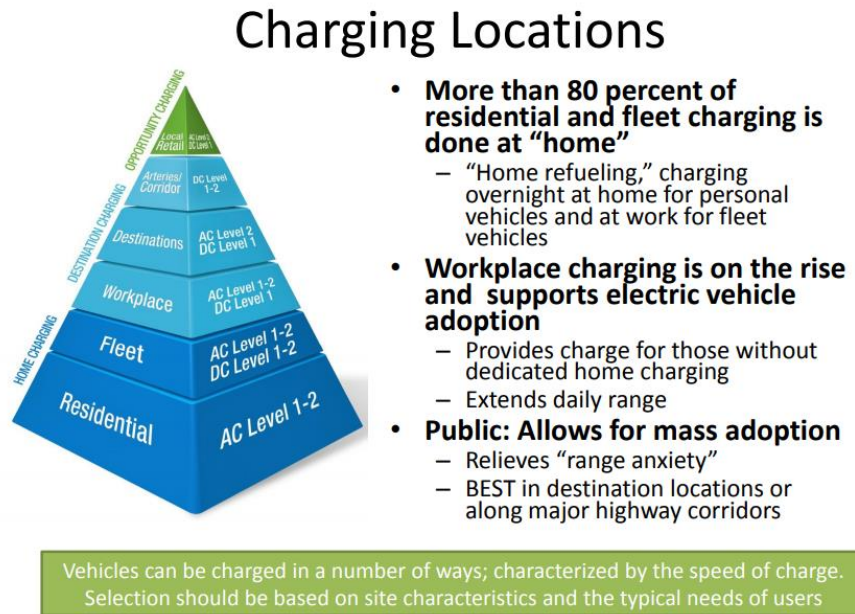

Figure 8: The Charging Pyramid (courtesy EPRI)

are important in the overall light-duty EV “ecosystem”, but as much as 90% or more of all charging occurs at residences, fleet locations, and at the workplace, where EVs are parked for long periods of time and may charge at lower power levels and at reduced costs. This is especially so if the charging may be reliably and economically shifted to off-peak times, maximizing benefits for all utility customers.

Program design also incorporated the objective of providing support for early EV adoption. This could be accomplished by addressing the barriers of low awareness and lack of EVSE infrastructure, through initial education & outreach efforts, dealer engagement including a referral program and residential EVSE offerings, as well as commercial EVSE buildout at workplace, fleet, and public locations, all intended to help form the first substantial backbone of EVSE infrastructure in eastern Washington.

Finally, with the backdrop of legislation passed in Washington State in 2015 and 2019<sup>5</sup> and growing consensus and support on a global scale, a societal purpose has been established for the reduction of greenhouse gas emissions (GGEs). It is recognized that the transportation sector is the largest

<sup>4</sup> Load management of public AC Level 2 and DC fast chargers is not feasible as EV drivers need maximum charge for limited periods of time at public locations.

<sup>5</sup> See Washington State HB1853 (2015), HB2042 (2019), and SB5116 (2019). <https://app.leg.wa.gov/billinfo/>

contributor of GGEs and other hazardous air pollutants, that electrification of the transportation sector can provide a high return on investment in reducing emissions, and that utilities must be fully engaged to play a key role in this transformation. The EVSE pilot was therefore launched as a starting point to explore how the Company may better serve all customers, achieving major economic and environmental benefits in the long-term effort to electrify transportation, partnering with industry, customers, local governments and policymakers.



## Light-Duty EV Adoption and Forecasts

The chart below shows the growth in registered light-duty, plug-in electric passenger vehicles from 2015 to 2019 in Avista’s service territories in Washington and Idaho. Registration data in Washington is taken from the Washington Department of Licensing,<sup>6</sup> and in Idaho from extrapolation of early data provided by the Electric Power Research Institute (EPRI).

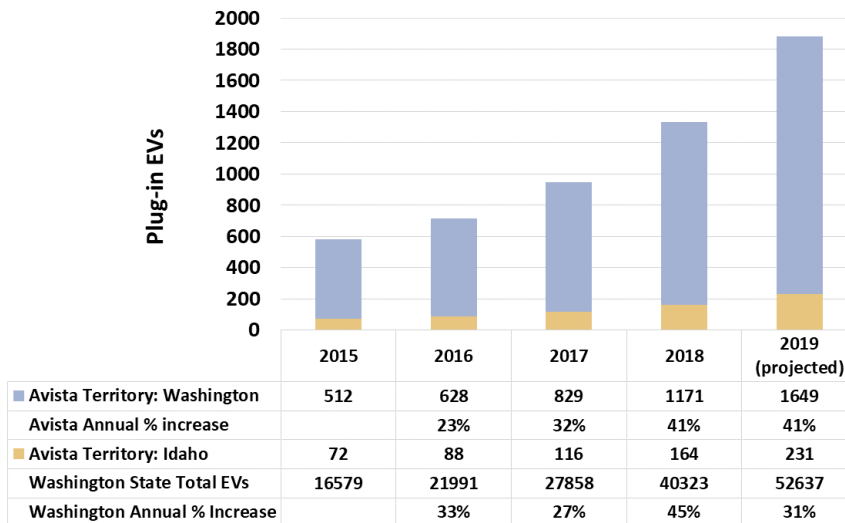

This shows that EV adoption in Avista’s service territories initially lagged behind Washington State as a whole in 2016, a 23% annual increase compared to the State’s overall increase of 33% that year. Since then, adoption has risen to a comparable level and has surpassed the State average to date in 2019, at 41% increase compared to 31%.

Figure 9: Light-duty EV Adoption in Avista Service Territory

Although the rate of local EV adoption is now on par with the State average, the overall number of EVs in Avista’s service territory is still relatively small, with lower per-capita adoption. For example, according to Atlas EV Hub, Spokane County currently has 1.8 EVs per 1,000 population, compared to 11.9 in King county and 6.3 for the State.<sup>7</sup> This compares to a total of 2,900,000 automobiles serving a population of 7.5 million in Washington State, or 387 automobiles per 1,000 population.<sup>8</sup> In terms of vehicles registered by Avista’s 379,000 residential electric customers in Washington and Idaho, given an estimated range of 1.5 to 1.9 vehicles per household, yields a total of 570,000 to 720,000 light duty vehicles in the current fleet. In addition to this are an unknown number of light-duty commercial vehicles, as well as medium and heavy duty vehicles that over time may transition to electric transportation.

Local sales data are not currently available, however Washington State EV sales increased from 7,068 in 2017 to 12,650 in 2018, increasing in overall vehicle market share from 2.5% to 4.3% of total vehicle sales. This compares to national sales of 199,826 in 2017 to 361,307 in 2018, and 2.1% market share.

<sup>6</sup> Washington Department of Licensing website <https://data.wa.gov/Transportation/Electric-Vehicle-Population-Data/f6w7-q2d2>

<sup>7</sup> Atlas EV hub website <https://www.atlasevhub.com/materials/state-ev-registration-data/>

<sup>8</sup> US Department of Transportation, Federal Highway Administration data: <https://www.fhwa.dot.gov/policyinformation/statistics/2017/pdf/mv1.pdf>.

Recent U.S. sales data for 2019 indicate a flat to slightly negative year-over-year change in EV sales through the third quarter.<sup>9</sup>

Globally, China has taken the lead with more light-duty EV sales than all other countries combined in 2018, followed by Europe, which is led by countries such as Norway where EV sales reached 46% of vehicle market share. The chart below shows forecasts for EV adoption by global regions over both the short and long term, according to Bloomberg New Energy Finance.<sup>10</sup> Many industry experts predict a dramatic increase in EV adoption in the 2023-2024 timeframe, as a number of new makes and models, and investments in EV production capacity are brought to market.

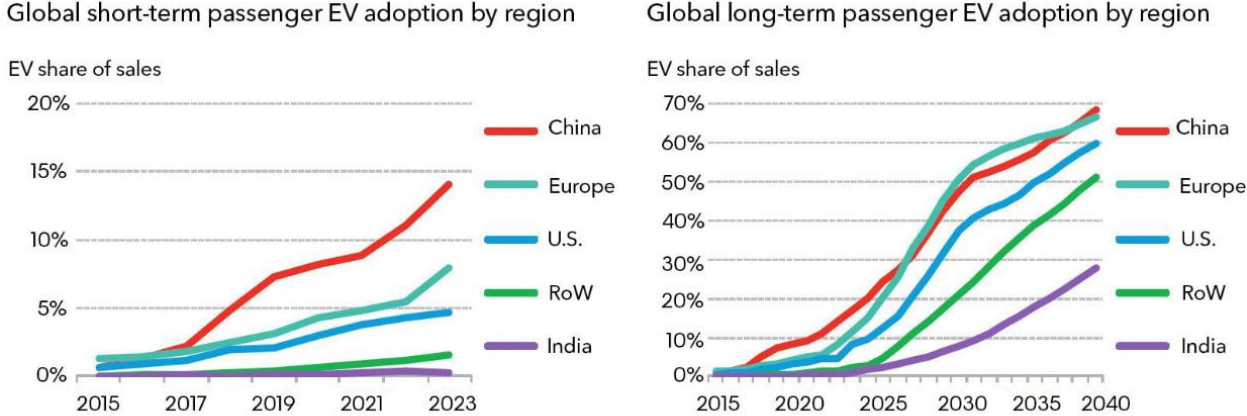

Figure 10: Global EV adoption by region (source Bloomberg NEF)

Based on residential customer applications for Avista’s EVSE pilot, a breakdown of EV makes and models is shown below. Most recently, of the 39 applications received in 2019, Nissan LEAF owners accounted for 12 applications (30%), followed by seven Tesla Model 3 applications (17%), among a total of 20 different EV makes and models. This indicates a continued high variety of EV sales in the local area, with relatively strong engagement by one of the area Nissan dealerships. The percentage of Tesla participants in Avista’s EVSE program (15%) is also markedly lower than the national percentage of Tesla cumulative EV sales (35%), which saw a dramatic increase since the third quarter of 2018 following the launch of the Model 3. The table below shows statistics for Avista’s EVSE pilot participants compared to cumulative sales for different EV types, makes and models at the regional and national level.

<sup>9</sup> Atlas EV hub: <https://www.atlasevhub.com/materials/state-ev-registration-data/>  
<sup>10</sup> Bloomberg New Energy Finance: <https://about.bnef.com/electric-vehicle-outlook/#toc-viewreport>

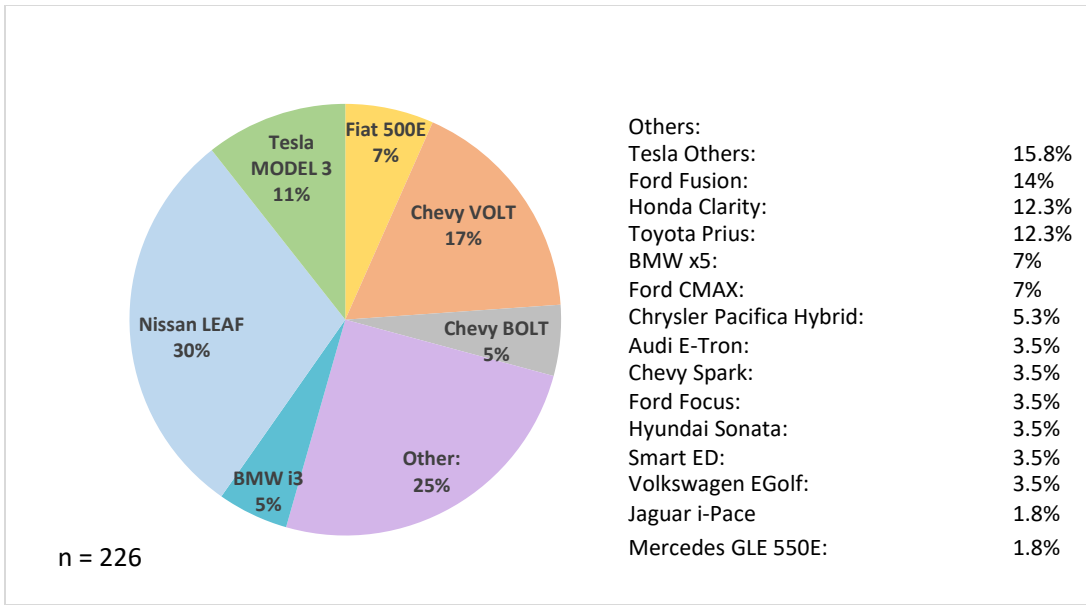

Figure 11: Avista pilot participation by EV Make and Model

	Avista EVSE pilot	Spokane Co.	WA State	US
<b>BEV</b>	66%	58%	69%	59%
<b>PHEV</b>	44%	62%	31%	41%
<b>Tesla</b>	15%	25%	33%	35%
<b>GM</b>	23%	23%	15%	17%
<b>Nissan</b>	30%	22%	24%	11%

Table 2: Cumulative EV sales statistics

Due to uncertainty in the large number of variables involved and the important dynamic effects between them, it is not possible to forecast EV adoption with any reasonable level of confidence. This is demonstrated by a survey of reputable EV forecasts in the literature, which show a wide range of outcomes.<sup>11</sup> As part of an effort to model and understand the

range of possible effects, Avista worked with Energy and Environmental Economics (E3) to develop plausible forecasts for high, low and base case EV adoption scenarios in Avista’s service territory, as shown below. A forecast through 2036 was selected to coincide with and compare results to a separate E3 grid impact analysis for the Pacific Northwest region as a whole.<sup>12</sup>

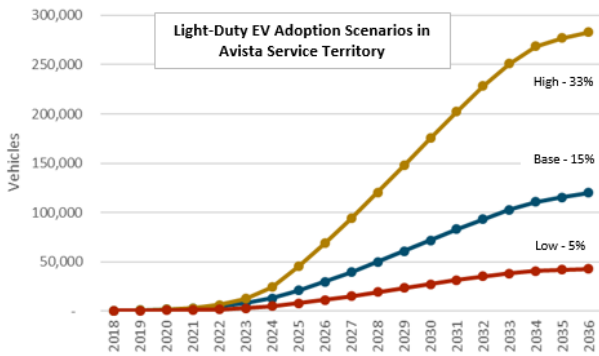

Figure 12: Light duty EV adoption scenarios

Note that these projections are for light-duty passenger vehicles on the road, owned by Avista’s residential customers in Washington and Idaho, out of an assumed 600,000 vehicle fleet starting in 2018, not including commercial light-duty, medium and heavy duty vehicles of various applications. With assumed 2% annual growth, this fleet increases to a total of 857,000 vehicles by 2036. In the high scenario, 33%

<sup>11</sup> Bloomberg New Energy Finance: <https://about.bnef.com/electric-vehicle-outlook/#toc-viewreport>

<sup>12</sup> Economic & Grid Impacts of Electric Vehicle Adoption in Washington & Oregon (2017)

of the operational fleet are EVs by 2036, followed by 15% in the base scenario, and 5% in the low scenario. Given that fleet turnover may be gradual due to typical vehicle service lives of ten or more years, a high percentage of EV sales especially in the later years is required to reach higher levels of adoption.<sup>13</sup> As shown, the rate of adoption begins to decrease in the 2033 timeframe. Alternatively, if EVs eventually dominate, then a continued steep increase beyond 2030 could be expected rather than the beginning of the classic “S” curve, where adoption starts to become saturated in the mainstream market.

Key factors that increase EV adoption include policy support, lower upfront purchase costs, greater vehicle variety, availability and inventory levels, technology advances, superior operational performance and customer experience, greater driving range, adequate charging infrastructure, and higher gasoline prices that translate to more EV operational savings. In at least the near term, higher personal incomes and population density are also factors with high correlation to EV ownership. Avista serves a population with relatively lower personal incomes, and more rural geographies with lower population densities. This may continue to dampen EV adoption in the Company’s service territories. As such, it could be reasonably argued that without market interventions such as Avista’s EVSE pilot, actual adoption would track somewhere between the low and base scenarios.

Although the future is uncertain, Avista may prepare for a variety of plausible scenarios, with the goal to support market transformation and optimize grid integration, so that benefits and costs are optimized for all customers and communities served. From this perspective, a longer term, very high adoption scenario is also considered.

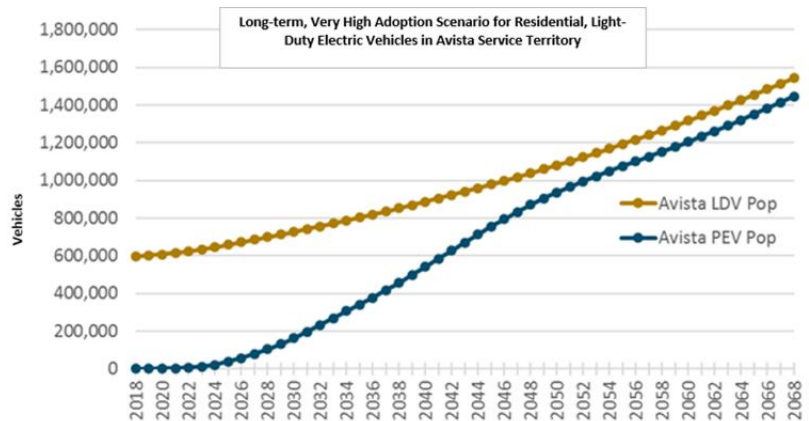

In this scenario, the transportation sector undergoes a major transformation away from petroleum fuel over the next three decades, reaching 90% of EV fleet adoption by 2050. Assuming 2% annual growth of the 2018 fleet of 600,000 vehicles owned by Avista residential electric customers, by 2050 nearly 950,000 EVs would be registered out of 1,130,00 total vehicles. This scenario is intended to represent an upper bound of transportation electrification in the light-duty sector, which could occur but the likelihood of which is unknown. Of course, a number of other factors could affect the total number of fleet vehicles and energy consumption over several decades, including societal changes in work and living habits, and the availability of autonomous EVs, which could greatly alter driving behaviors, vehicle ownership and total energy

<sup>13</sup> For example, assuming an average fleet turnover every 15 years and 600,000 vehicles in the fleet, this equates to 40,000 new vehicles entering the fleet each year, approximately 25,000 of which must be EVs each year by 2030 in the high adoption scenario – a sales rate of 60% or more.

consumption.<sup>14</sup> Note that as before, these figures do not include commercial light-duty, medium and heavy duty vehicles of various applications, e.g. forklifts, parcel delivery, school and mass transit buses, etc. Nor does it include other modes of freight and passenger movement such as rail, aviation and marine transportation, which may also become electrified to some degree.

---

<sup>14</sup> RethinkX – Rethinking Transportation: <https://www.rethinkx.com/transportation>

## Education and Outreach

As stated in the UTC Policy Statement,<sup>15</sup> Education and Outreach is an important element of utility support for EV adoption, in order to help address issues of low awareness and negative perceptions of EVs. The Company accomplished this in a number of areas during the EVSE pilot, and continues to provide related support resources for customers as outlined below.

Avista provides information on its customer webpage<sup>16</sup> to help answer FAQs related to electric vehicles, charging needs and installations, vehicle purchase and operational cost comparison tools, web links to other sources of helpful information, and contact information via email and phone for more detailed inquiries.<sup>17</sup> During the pilot customers could also review program information, as well as download and electronically submit applications from the website. Incoming phone calls and email to the main service centers are routed through customer service representatives and appropriate staff to assist with more detailed inquiries. This may involve email correspondence, discussions over the phone, as well as in-person meetings and consultations.

Throughout the course of the EVSE pilot, Avista received a number of media requests which helped raise public awareness, promulgating important information about the benefits of electric transportation and Avista's programs through various media channels, including TV, radio, print and social media. Utility

bill inserts were sent to customers once in 2017 and a second time in 2018, which also helped raise awareness. However, word-of-mouth referrals accounted for the majority of source information on Avista's programs for residential customers.

In turn, residential customers were by far the most productive source for qualified commercial leads and contacts via their respective employers, resulting in a satisfactory level of workplace charging installations in the program. This had the added benefit of providing an important dataset for those participants with AC Level 2 charging available at both home and at work,

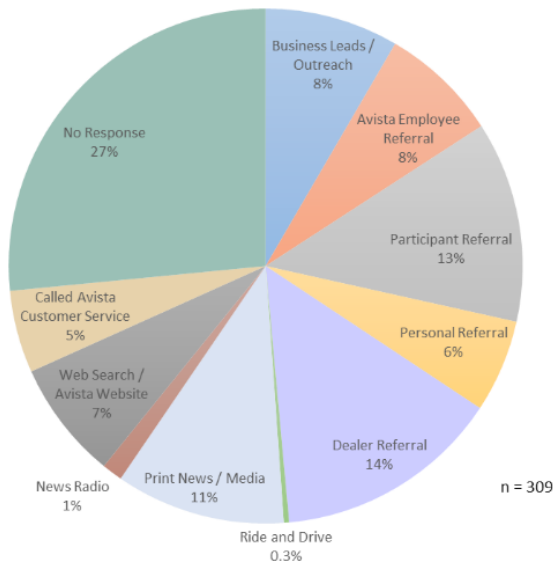

Figure 13: Information Sources for Residential Applicants

<sup>15</sup> p. 41

<sup>16</sup> Avista electric transportation webpage: [myavista.com/transportation](https://myavista.com/transportation)

<sup>17</sup> Webpage information links: <https://www.plugshare.com>, <https://pluginamerica.org>, <https://gis.its.ucdavis.edu/evexplorer/#!/locations/start>

useful in drawing comparisons and contrasts to other participants that did not have access to either home or workplace charging.

Since 2015, the Company supported five EV Ride & Drive events led by local volunteers, as part of National Drive Electric Week.<sup>18</sup> In 2018, Avista partnered with Forth, a non-profit EV research and support organization, Kendall Yards private development, auto dealerships, and other local volunteers, coordinating a large EV Ride & Drive event in downtown Spokane that was well attended and received. EV Ride & Drive events can be very positive and help raise public awareness in an enjoyable atmosphere. However, in terms of EVSE program participants they were the reported source of only one residential program application, and while clearly beneficial it is unclear to what degree they can increase EV adoption.

During the course of the pilot, a concerted effort was also made to engage with auto dealers, including meetings with owners, general and sales managers, presenting at sales staff meetings, providing informational materials for customers, and an initial offering of \$100 to sales staff for each customer referral. The referral was valued as a way to raise public awareness and participation levels in the EVSE pilot, as well as identify residential locations of early EV adoption. It was also hoped that by partnering with auto dealers in this way, EV sales would benefit by mitigating customer concerns about charging, while providing an additional sales incentive.<sup>19</sup>

For the first 18 months of the pilot program, a total of 16 dealer referrals were received. The incentive amount was increased to \$200 for the remaining 18 months of the program, resulting in 22 referrals – an increased number but still well short of initial expectations – yielding a total of \$6,000 paid over three years out of a maximum \$25,000 budgeted. Speaking with dealer management and staff, as well as other subject matter experts, it is apparent that while the customer referral and Avista’s EVSE program add value and assist the sales process, they are inadequate by themselves to surmount a number of issues. On the dealer side these include limited new and used EV inventory stock, high sales force turnover, and higher levels of work with low initial return on investment, and on the customer side persistent low awareness of the benefits and risk perceptions of EVs.

---

<sup>18</sup> National Drive Electric Week webpage: <https://driveelectricweek.org/>

<sup>19</sup> The referral process involved obtaining customer consent and sending a completed form with contact information to Avista. Upon receipt, Avista contacted the customer and discussed the EVSE pilot, initiated the application and EVSE installation process as chosen by the customer, and mailed payment for the referral in the form of a check to the respective sales representative.

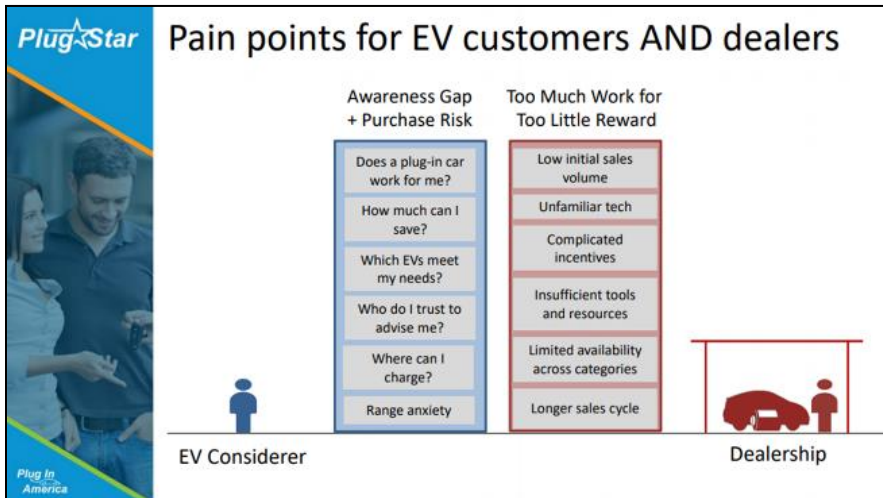

Figure 14: EV Sales Issues (courtesy Plug-In America)

As a trusted energy advisor with strong community and customer relationships, it is clear that the local utility can play an important role to help overcome these obstacles. However it is also clear that a deeper understanding of the issues and effective strategies to overcome them must be undertaken, in partnership with dealers and other stakeholders. Consequently, Avista has initiated consultation with Plug-

In America’s Plugstar program and Chargeway, to help develop a more comprehensive understanding of the market situation, and effective education and outreach strategies.<sup>20</sup>

Installations of commercial AC Level 2 EVSE available for public use also provided greater public visibility and awareness, especially in smaller rural towns where it was often the first sign of electric transportation options and charging availability for area residents.

Finally, Avista continues to present information in a variety of forums including community events and meetings with local government, industry groups and non-profit organizations, and online public webinars, as a way to help raise education & outreach in the area.



Figure 15: Public EVSE installation in partnership with the City of Colville

<sup>20</sup> See [www.chargeway.net](http://www.chargeway.net), and [www.plugstar.com](http://www.plugstar.com)



## Community and Low-Income

The Company initially held a meeting in late 2017, with attending representatives from 15 local agencies and non-profit organizations serving low-income and disadvantaged individuals and community groups. Discussion topics included basic information about EVs and charging, ideas on how electric transportation could serve disadvantaged individuals and communities, and a request for proposals to Avista. Six proposals were received and competitively evaluated based on cost and benefit criteria, with the top two proposals selected for implementation from the Spokane Regional Health District (SRHD), and Transitions for Women organizations. In both cases, the Company provided an EV and an EVSE used for a variety of beneficial purposes including transport to critical medical services, job skills training, shuttle services for overnight shelter, and food deliveries. Each organization secured insurance and accepted responsibility for vehicle maintenance and operational costs.

Since implementation, both organizations were able to increase the volume of transportation services while realizing substantial cost savings. Performance and comparisons are listed in the table below for the one year period from June 16, 2018 through June 15, 2019.

*Table 3. EV use and operational cost savings for Transitions and SRHD, June 2018 – June 2019*

	<b>Transitions for Women</b>	<b>Spokane Regional Health District</b>
vehicle	Mitsubishi Outlander (PHEV)	Nissan LEAF (BEV)
# trips	408	443
# total miles driven	4,592	6,576
# e-miles driven	2,672	6,576
average passengers per trip	1.7	1.3
gasoline fuel	\$354	\$0
electricity fuel	\$89	\$219
maintenance & repairs	\$100	\$0
insurance	\$1,332	\$1,200
average monthly operational costs	\$156	\$118
2018-19 EV operating cost per passenger-mile	\$0.24	\$0.16
2017 (non-EV) operating cost per passenger-mile	\$0.56	\$0.89
<b>operational cost savings</b>	<b>57%</b>	<b>82%</b>

Additionally, the organizations reported EV educational benefits for both staff and customers using the EVs, as they are introduced and become accustomed to the benefits of driving and riding in EVs. This has created stronger interest in purchasing EVs for personal and fleet use. Also in the case of Transitions staff utilizing the PHEV, a higher percentage of electric miles driven were realized after drivers were

educated on the lower costs and emissions of driving electric, how to charge the vehicle after each trip, and minimize the use of gasoline.

Avista staff hosted a follow-up meeting in early 2019, with attending representatives from the Spokane Regional Transportation Council, Spokane Transit Authority, Spokane Housing Ventures, Spokane Neighborhood Action Partners (SNAP), and Habitat for Humanity. Discussion topics included a review of pilot activity with Transitions and SRHD, and ideas for future programs taking into account demographics, access, cost effectiveness, and awareness issues. Since that time, the Spokane Transportation Collaborative has been formed, led by a volunteer steering committee and with broad stakeholder membership from area government agencies and non-profits. This has come about due to heightened awareness of the need to address transportation issues among the disadvantaged, recognized as the most serious issue following the lack of adequate housing. Avista intends to collaborate with this group to most effectively understand transportation issues and how they may be addressed with future electric transportation and mobility programs supported by Avista, and in partnership with the Collaborative's members. Additionally, Avista may work with local government and non-profits outside of the Spokane area with future experiments and programs tailored to their needs and opportunities. This may include building on the success of the pilot with SRHD and Transitions by utilizing a similar approach with other organizations, partnering with organizations such as Envoy for car-sharing services, and other innovative programs that may be developed.

With regard to providing greater availability of public EVSE in low-income communities and multiple unit dwellings, this may become a more effective benefit when the EV market matures over time and more low-income residents drive EVs. However, EVSE in these communities that may be utilized by EVs on transportation network company (TNC) platforms such as Uber and Lyft, could arise more quickly as a way to provide direct or indirect benefits. The EVSE pilot has also shown that public EVSE installed in smaller rural towns with relatively high percentages of low-income populations such as Rosalia, Garfield, and Palouse, are broadly supported by the local community and are felt to provide benefits in terms of public visibility and business development as part of the regional public EVSE infrastructure, as well as in many cases the lone public EVSE available for early EV adopters in those municipalities.

## Customer Surveys

Two different online surveys were utilized, each tailored for residential and commercial customers – the first to gauge experience with the installation process and EV purchase decisions immediately following EVSE installation, and the second to solicit periodic feedback at semi-annual intervals, primarily related to EV and EVSE use and satisfaction. A final set of surveys was completed in July, 2019, following conclusion of the pilot program’s EVSE installations. Overall response rates were as follows, with much higher response rates from residential compared to commercial customers.

Table 4: Customer survey response rates

Customer	Post-installation	Semi-Annual
Residential	47% (107 of 226)	56% (362 of 646)
Commercial	13% (11 of 86)	35% (60 of 170)

General comments and suggestions were very positive overall and encouraged more utility programs beyond the EVSE pilot. Constructive feedback included the need for more public charging (especially DC fast charging) and workplace charging, informing and educating the public about EVs and EVSE locations, and improving the reliability and user experience of networked EVSE.

One notable result was the difference in residential customer satisfaction of networked EVSE compared to non-networked EVSE in the quarterly survey. 98% of customers were satisfied with their non-networked EVSE (either satisfied or very satisfied) and 0% were dissatisfied, compared to 85% satisfaction and 6% dissatisfaction with the networked EVSE. This was due to the more hassle-free experience of non-networked EVSE that do not have connectivity issues, occasionally resulting in troubleshooting with the EVSP and EVSE manufacturer.

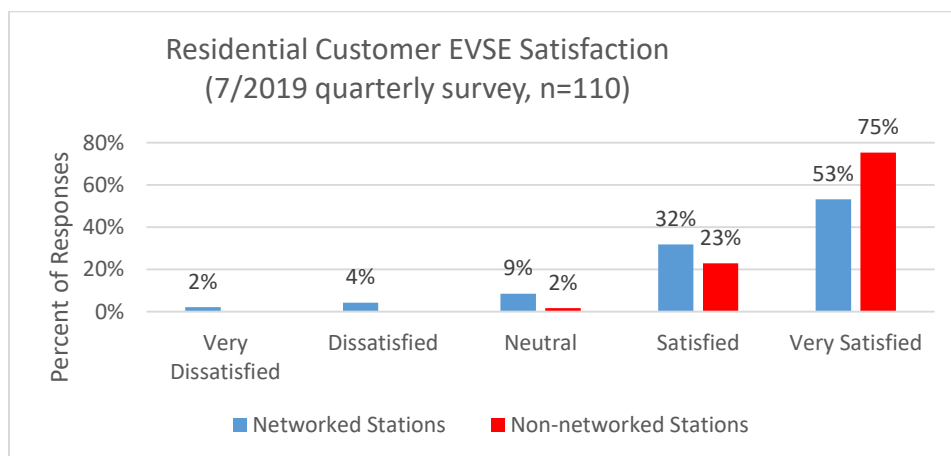

Figure 16: Residential Customer EVSE Satisfaction

While all but one residential customer was satisfied with their non-networked EVSE, eight of these 61 customers indicated that they would like to know how much electricity their EV was using. Electricity consumption may be approximated given the miles driven and an estimated efficiency of 3.3 kWh/mile, but cannot be captured and reported to the customer by a non-networked EVSE.

When contacted by phone, 11 of 21 commercial customers indicated they would be interested in installing more EVSE at the same or different facility locations. Survey responses from employers that installed workplace charging (16 responses out of 87 customers with workplace charging) also showed a significant increase in EV adoption at their facilities. From this sample with a total of 43 workplace ports installed, employees commuting with EVs increased from 31 to 63, a 203% increase over an average 1.4 year period, significantly higher than the average increase of overall EV adoption. Even with this relatively small sample of survey responses, it supports strong evidence in the literature that workplace charging is an effective catalyst for EV adoption, as it can “make or break” the EV purchase decision for many commuters.<sup>21</sup>

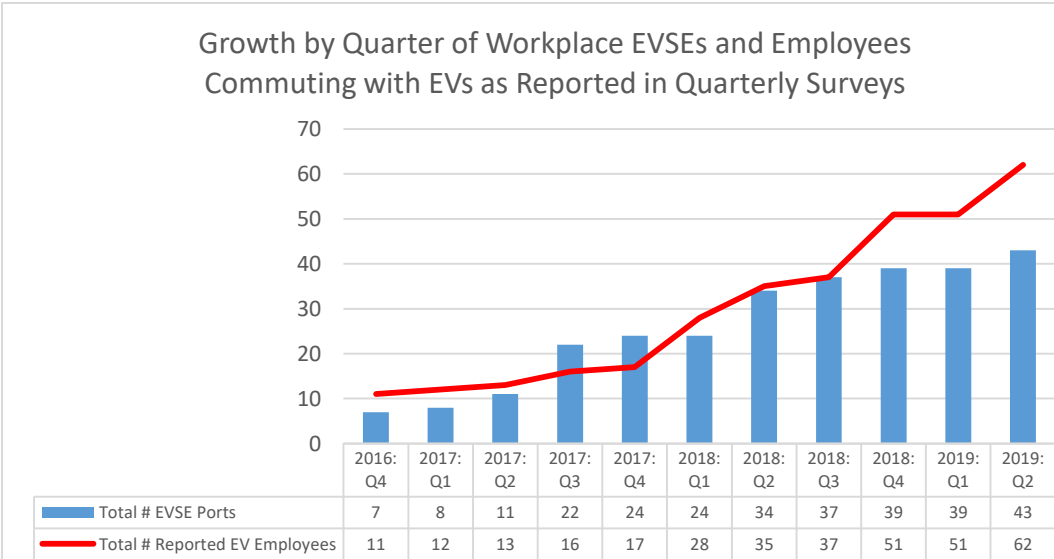
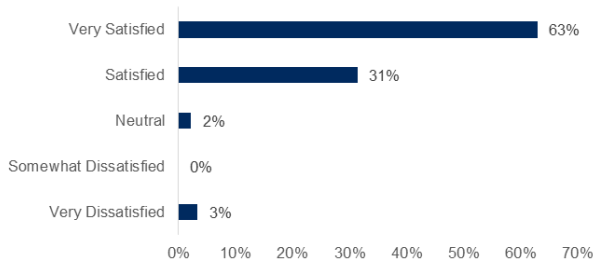

Figure 17. Workplace EVSE and User Growth by Quarter as reported in Quarterly Surveys

Other highlights of the customer surveys are illustrated in the charts that follow.

<sup>21</sup> See USDOE workplace charging challenge documentation, [https://afdc.energy.gov/fuels/electricity\\_charging\\_workplace.html](https://afdc.energy.gov/fuels/electricity_charging_workplace.html)

**Residential Install**  
Overall Satisfaction with EV Charger Application and Installation Process



**How Important were the following items in your decision to purchase an EV?**

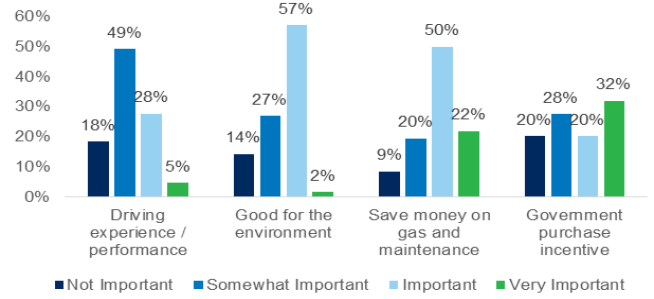

**Commercial Install**  
Overall Satisfaction with EV Charger Application and Installation Process

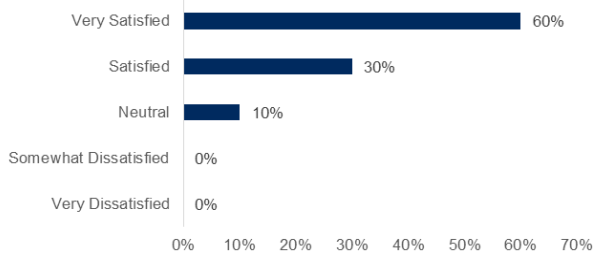

**What is your overall satisfaction with your EV?**

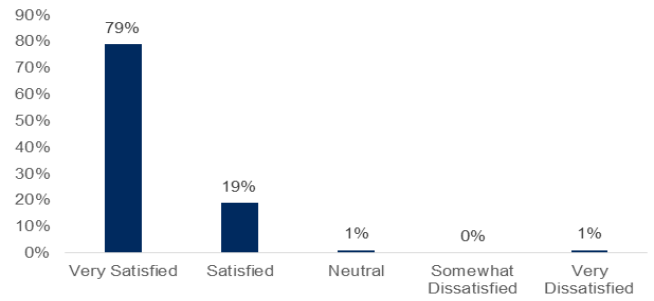

**How many members are in your household?**

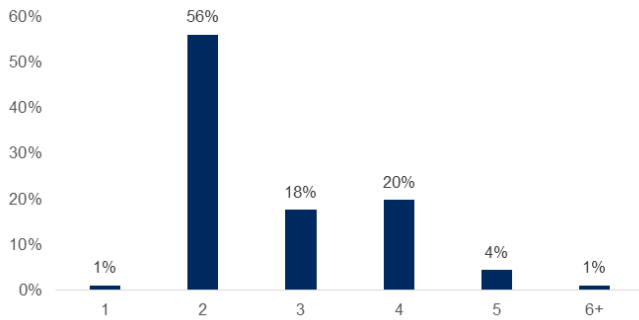

**What is your work commute round trip miles?**

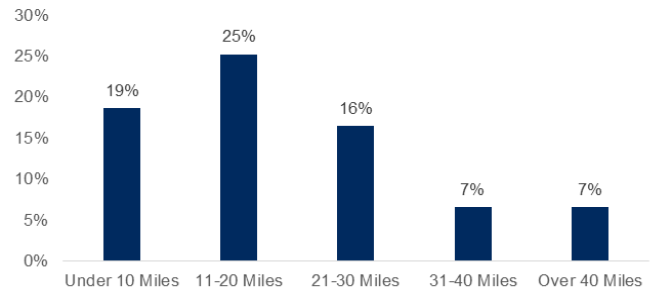

**What is your annual household income?**

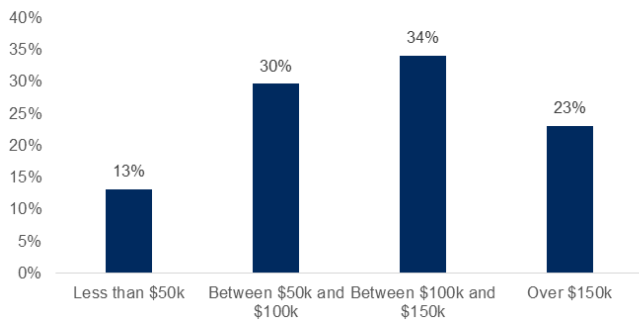

**What is the importance of AC Level 2 charging availability to you?**

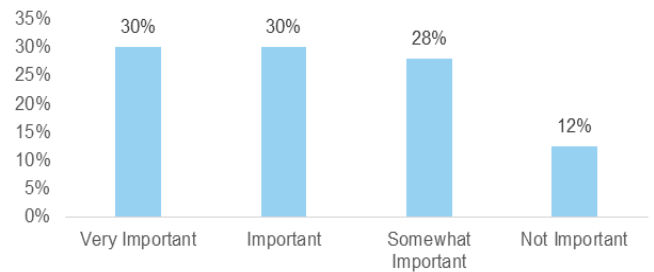

**What is your satisfaction with AC Level 2 charging availability?**

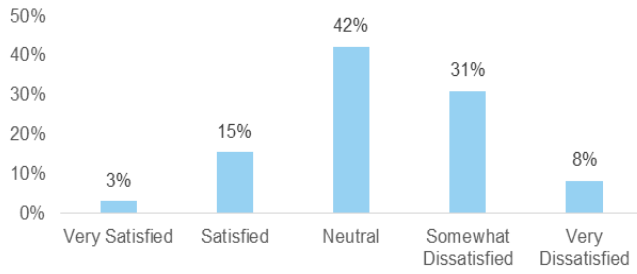

**What is your satisfaction with DC Fast Charging availability?**

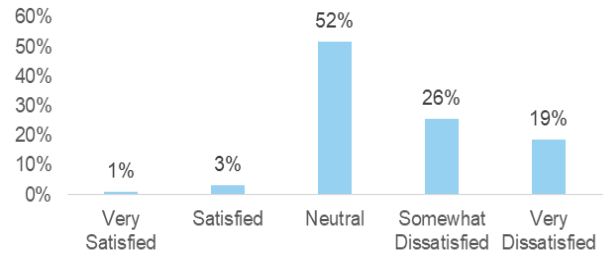

**What is the importance of DC Fast Charging availability to you?**

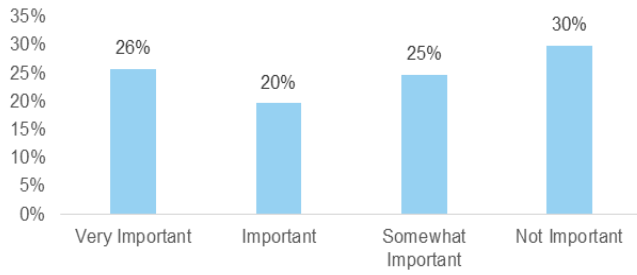

## Installations and Costs

EVSE installations were completed through June 30, 2019 as follows:

	<b>Max Allowed Port Installations</b>	<b># Ports Installed &amp; In-Service</b>
<b>ACL2 Residential</b>	240	206
<b>ACL2 Workplace\Fleet\MUD</b>	175	167
<b>ACL2 Public</b>	60	46
<b>DC Fast Chargers (DCFC)</b>	7	7

*Table 5: Overall EVSE Installations*

Note that in some cases commercial AC Level 2 EVSE may be used for more than one purpose (workplace, fleet, MUD, or public). For example, an employer may have workplace charging for employees installed in a location that is also available to the public, or shared with a fleet vehicle. However, the installed and in-service ports listed above reflect primary use. AC Level 2 EVSE installed in residential locations were rated between 24 and 32 amps, supplied by a 40A, 240VAC protected circuit to a standard NEMA 6-50 receptacle. This allowed EVSE with plug options to be wall-mounted nearby and plugged into the receptacle, rather than hard-wired to the circuit in the junction box. AC Level 2 EVSE installed in commercial locations were rated from 30A to 50A, supplied by 208/240 VAC with dedicated circuit breaker protection, and mounted either directly on building walls or on pedestals usually anchored to small concrete pads in the ground. At DC fast charging sites, DCFC rated at 50kW and backup AC Level 2 EVSE were supplied by three-phase, 480 VAC from a dedicated 225kVA transformer, service meter and supply panel, with capacity for future expansion of an additional 150kW DCFC and dispenser units. Avista coordinated installations with two local electrical contractors, GEM Electric and Colvico that performed the work and coordinated local permitting and inspections. Contractor performance was excellent and proved to be a critical factor in meeting cost and customer satisfaction goals.



*Figure 18: Fleet installation*

The heat maps below show the geographic dispersion and concentrations of commercial EVSE (blue) and residential EVSE (red), in eastern Washington and concentrated in the area surrounding Spokane.

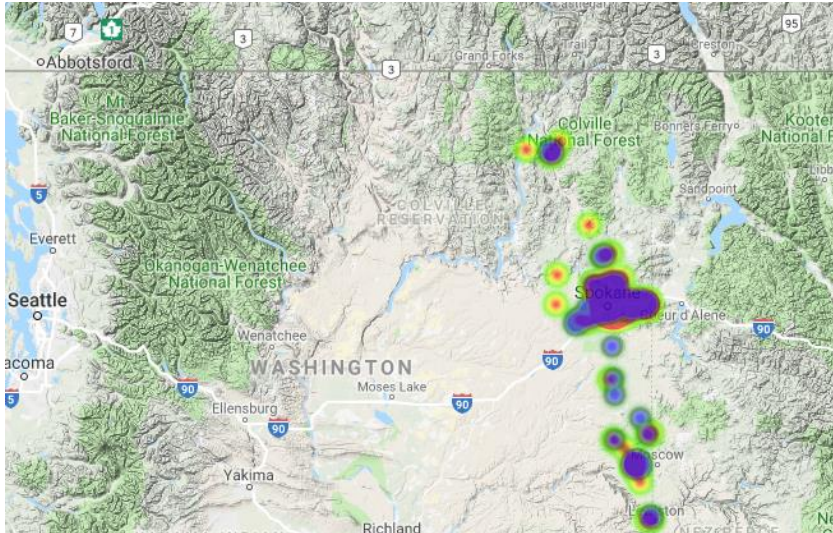

Figure 19: EVSE installed in E. Washington

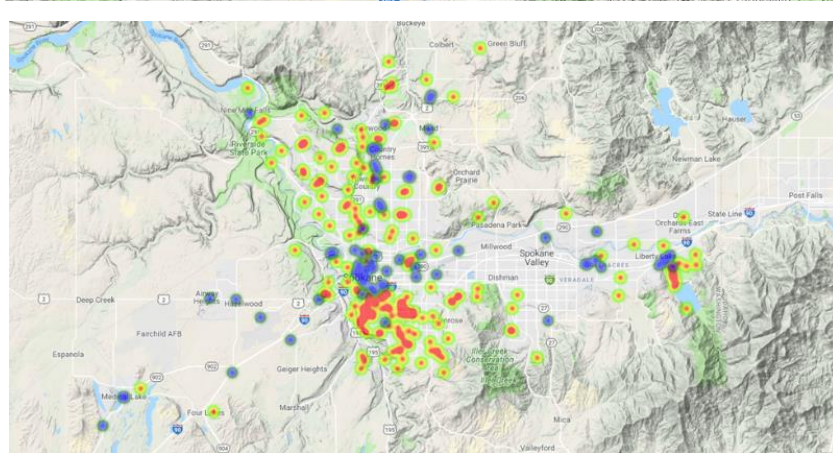

Figure 20: EVSE installed in the Spokane area

In the Spokane region, commercial EVSE are somewhat concentrated in the downtown core, with some dispersion to the east and north, while residential EVSE is more concentrated to the south. DCFC on the north, east and west outskirts, and in the downtown core support longer distance travel on the I-90 and US-395/195 corridors, as well as rapid urban charging. South of Spokane in the Palouse region, two DCFC installs and multiple workplace, fleet and public installations have begun to enable EV driving between Spokane, Pullman and Clarkston. To the north, Avista partnered with site hosts to install public charging in Deer Park and as far north as Colville.

In order to gain operational experience and comparison of costs, reliability, and customer satisfaction, a variety of EVSE from six different manufacturers were utilized. This included both non-networked and networked EVSE with direct load

management (demand response, V1G) capability. Networked EVSE communications were implemented via WiFi using the customer’s internet broadband connection, or cellular communications depending on location and site host capabilities.

The remainder of this section details EVSE installations and upfront costs categorized by residential, commercial, and DC fast charging locations. The subsequent section provides reliability results for the various EVSE, as well as estimates of ongoing operations and maintenance (O&M) costs.

### Residential AC Level 2 EVSE

The following chart shows the status of residential EVSE installations as of September 15, 2019, by categories of Battery Electric Vehicle (BEV) Commuter, BEV Non-Commuter, Plug-In Hybrid Electric (PHEV) Vehicle Commuter, and PHEV Non-Commuter.



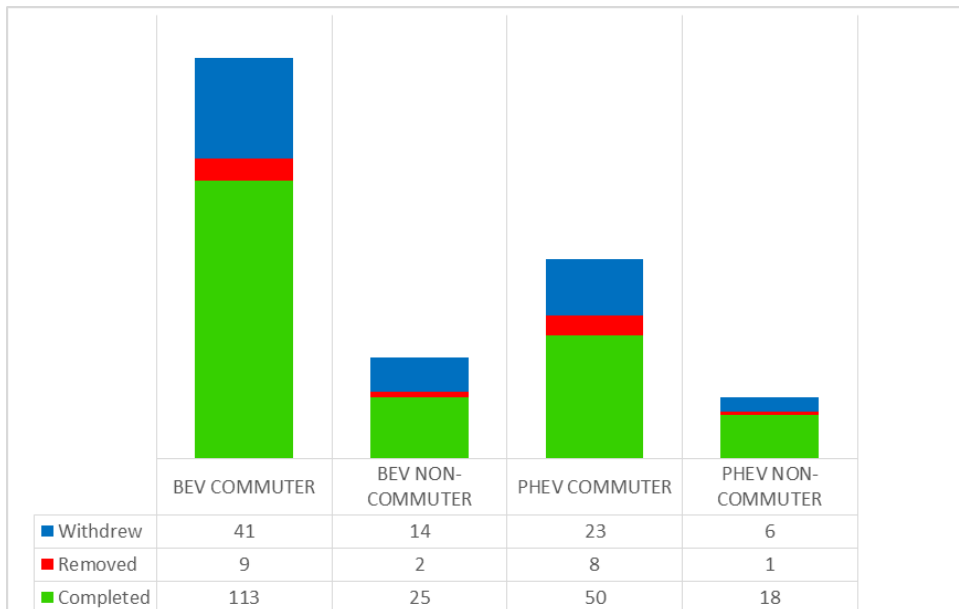

Figure 21: Residential AC Level 2 EVSE Installs by Driver Categories

At least 20 installations in each category are desired in order to attain a significant level of statistical sampling of the overall EV population, for both installation cost and load profile analysis. This has been met and exceeded for both BEV and PHEV commuter categories, and marginally met for the non-commuter category. Note that in addition to 206 residential EVSE installations currently in service, 20 additional installations were completed over the course of the pilot and later removed as customers moved to a new residence. This is expected to continue at a rate of approximately 5% each year.

Residential customers were eligible for participation if they were an Avista electric customer in Washington, and either owned an EV or could show ownership pending delivery. After reviewing application information and verifying eligibility, Avista staff discussed the program and process with the customer, prior to coordinating installation with a 3<sup>rd</sup> party contractor. A positive customer experience and lower operational costs were achieved by streamlining effective communications and process steps, reducing lead-time and minimizing customer inconvenience. For example, application review and approvals for installation in most cases occurred within one business day, and an onsite quote and EVSE installation was completed in a single site visit at a time and date chosen by the customer. A large number of installations were relatively low cost, when the supply panel was located in an unfinished garage and the EVSE could be located near the panel with a short and direct circuit run. On a few rare occasions, existing 240V circuits and receptacles were available for use, incurring zero or very minimal premises wiring costs.

A total of 84 out of 310 residential customers (27%) approved for installation withdrew from the installation process for a variety of reasons. The most common reason was due to higher cost estimates from required supply panel upgrades, work interferences from household goods, and/or extensive installation work involving long circuits requiring many floor and wall penetrations, disturbance and restoration of finished interiors, outdoor conduit, etc. In these situations, roughly 65% of customers

opted to withdraw, while the remaining 35% chose to proceed with the installation. This required the customer to bear a higher percentage of the premises wiring costs, above and beyond Avista’s maximum reimbursement of \$1,000. The data shows that 17 out of 226 installations with more extensive work averaged \$2,659 total installation costs, compared to the average of \$1,197 for all other installations – an average increase of 122%. Older homes with 100A to 125A service generally required panel upgrades, while homes built since the 1970s typically had 200A or larger service panels that did not require upgrades to install a new 40A, 240V circuit for the EVSE. Based on conversations with area electricians, an estimated 30% of residential homes in the region have older service less than 200A capacity.

Overall, residential installation costs met expectations and compare well to costs reported in other studies, even with several years separation between them. <sup>22,23,24</sup>

Program/Study	Timeframe	Installations	Average Install Cost
Avista EVSE Pilot	2016 - 2019	226	\$1,316
EV Project	2012 - 2013	4,777	\$1,375
EPRI	2009 - 2013	214	\$1,613
North Carolina	2011 - 2012	143	\$1,098

Figure 22: Comparison of Average Costs for Residential Installations (not including EVSE)

Geography is a significant cost factor. For example, the Idaho National Laboratory’s EV Project reported 2013 average installation costs of \$1,828 in Los Angeles, \$775 in Atlanta, and \$1,338 in Seattle.

In comparing networked -vs- non-networked EVSE installs, networked installations including the cost of the EVSE averaged \$2,427, which is 38% higher than the non-networked average of \$1,775. The majority of the cost differential is accounted for by the EVSE itself, with networked EVSE more than double the cost of non-networked EVSE. Premises wiring costs were not significantly different. Direct installation costs for networked EVSE were slightly higher, reflecting the additional work to establish EVSE connectivity via the customer’s WiFi, and typically requiring a boost to the WiFi signal in the garage using a repeater or wireless access point.

Table 6: Average Residential EVSE Install Costs

	Premises Wiring Cost	Direct Installation Cost	Total Installation Cost	EVSE Cost	Total Costs Installation + EVSE
<b>Networked (110)</b>	\$946	\$438	\$1,384	\$1,061	\$2,445
<b>Non-networked (113)</b>	\$1,016	\$237	\$1,251	\$515	\$1,766

<sup>22</sup> Brazell, M., Joffe, E., & Schurhoff R. Electric Vehicle Supply Equipment Installed Cost Analysis. Electric Power Research Institute (2013)

<sup>23</sup> Idaho National Laboratory. How do Residential Level 2 Charging Installation Cost Vary by Geographic Location. The EV Project (2015)

<sup>24</sup> North Carolina EV Taskforce, “Plug-in Electric Vehicle (EV) Roadmap for North Carolina.” (2013)

Given the relatively early stage of the market, EVSE purchase costs may decrease somewhat over time with market competition, product improvements and higher production volumes, while installation costs could be expected to gradually rise with labor and material cost inflation. Changes to new building codes could also result in lower lifecycle costs, for future EVSE installations.

The box plots below show the distribution of residential installation costs (not including the cost of EVSE), when utilizing networked and non-networked EVSE.<sup>25</sup>

Residential Networked EVSE: Premises Wiring Cost

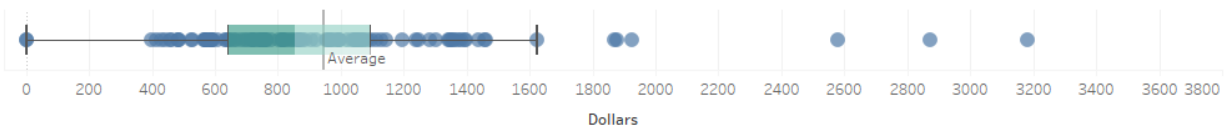

Residential Networked EVSE: Direct EVSE Install and Hardware Costs



Residential Networked EVSE: Total Installation Cost

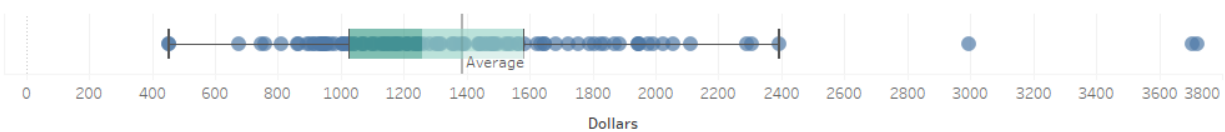

Residential Non-Networked EVSE: Premises Wiring Cost

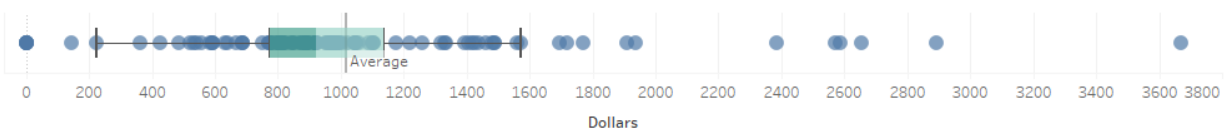

Residential Non-Networked EVSE: Direct EVSE Install and Hardware Costs



Residential Non-Networked EVSE: Total Installation Cost

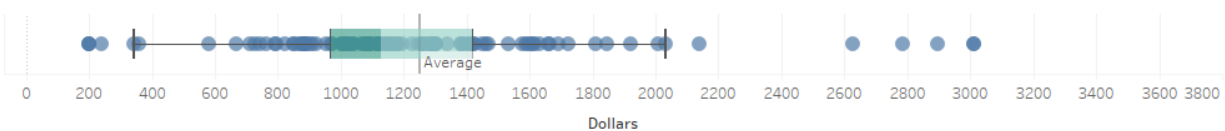

<sup>25</sup> Box plots are a useful way to visualize data and statistics, grouped by “quartiles” of the data set, and outlier data points. See Appendix C for a more detailed explanation of box plot information.

## Commercial AC Level 2 EVSE

The following chart shows the number of commercial EVSE installations in service as of September 15, 2019, by usage categories of workplace, public, fleet, and MUDs.

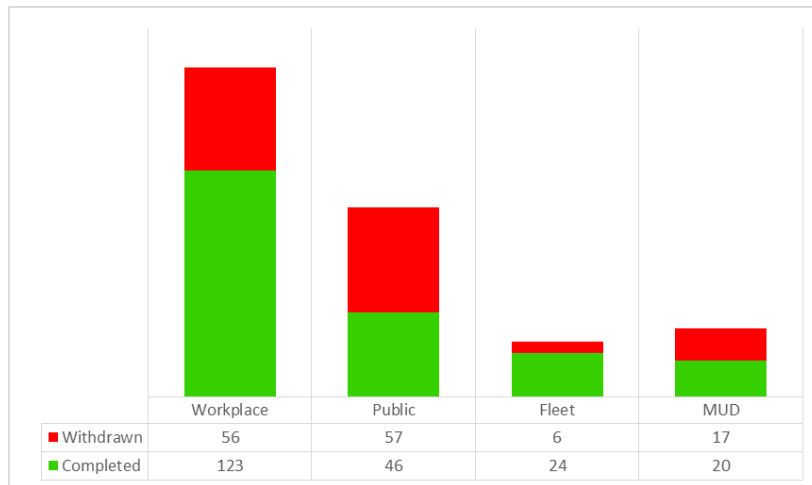

Figure 23: Commercial AC Level 2 EVSE Ports Installed, by Usage Categories

Typically, significant outreach and consulting work is required to inform and assist commercial customers to install an AC Level 2 EVSE on their property. Some of the concerns include the projected cost of electricity billing, liability risks, and potentially adverse impacts on parking areas that are highly utilized. In some cases, contract negotiations and revisions to the customer site agreement resulted in significant legal work and delays. The application through installation process for commercial customers was

very similar to the residential process, but usually involved one or more site visits and consultations before installation. The number of ports installed at each facility was limited by estimated initial utilization and growth, averaging 2.5 ports per site. In the case of public installations, the proximity of amenities for drivers and geographic location was also taken into consideration in the application and approval process, as well as guiding outreach efforts. For example, EVSE at urban shopping centers and the smaller towns throughout eastern Washington were identified as highly desirable locations, in order to establish an effective regional network of public EVSE.

Compared to residential EVSE, a higher percentage of commercial customers withdrew from the installation process (39%), and no commercial EVSE have been removed after installation. Again, the most common reason for withdrawal was due to higher installation costs where the maximum reimbursement of \$2,000 for premises wiring per port was reached and additional costs beyond the 50% reimbursement were borne by the customer. Prior to 2018, the Company was allowed to reimburse commercial customers 80% of premises wiring costs between the meter and the EVSE, up to a maximum of \$2,000 per port connection. This was reduced to a rate of 50% for installs in 2018 and 2019, up to the same maximum of \$2,000 per port. This change did not significantly change the rate of



Figure 24: Public EVSE installation

withdrawals, as the \$2,000 limit was the more important factor. Public installations saw the highest rate of withdrawals at 55%, correlating with the higher costs associated with many public installations requiring extensive trenchwork and electrical upgrades. For example, an installation with a very desirable location at a large shopping mall was withdrawn, as concrete and asphalt trenchwork over one hundred feet into the parking lot and electrical upgrades in the building resulted in an estimated cost of more than \$15,000 per EVSE port – more than double the average cost of other networked installations as shown in the table below.

Category	# of sites	Premises Wiring Cost	Direct Install Cost	Total Install Cost	EVSE Cost <sup>26</sup>	Total Cost EVSE + Installation	Avg. # Ports	Total Cost per Port
All	86	\$5,270	\$3,062	\$8,332	\$4,781	\$13,113	2.5	\$5,544
Networked	59	\$5,703	\$3,195	\$8,898	\$5,963	\$14,861	2.5	\$6,035
Non-networked	27	\$4,325	\$2,771	\$7,095	\$2,198	\$9,293	2.4	\$4,472

Table 7: Average Commercial EVSE Install Costs

Significant cost variations resulted from a wider variety of site conditions and installation configurations, compared to residential installations. Networked cost per port at \$6,035 were 35% greater than non-networked cost per port at \$4,472. Lower costs correspond to simpler installations avoiding service upgrades and trench work, lower cost non-networked EVSE, and/or a smaller number of port connections. Conversely, higher costs are associated with multiple installed EVSE ports and networking, required upgrades to supply panels, and/or trench work, which in many cases involved concrete and asphalt trenching and restoration. Wall mounted EVSE often require no trench work and reduce the length of both above-ground and underground conduit, while pedestal mounted EVSE typically require trench work and relatively longer conduit lengths. In order to minimize costs, where practical the Company advised customers to utilize wall mounted EVSE, and to minimize trenching and conduit lengths by locating the EVSE as close as practicable to the nearest power source. Other factors such as desired location, accessibility, communication signal strength, and safety concerns are also of high importance when consulting with commercial customers on EVSE siting and configuration determinations. The Company also advised customers to install additional conduit where feasible, to allow for inexpensive future expansion.

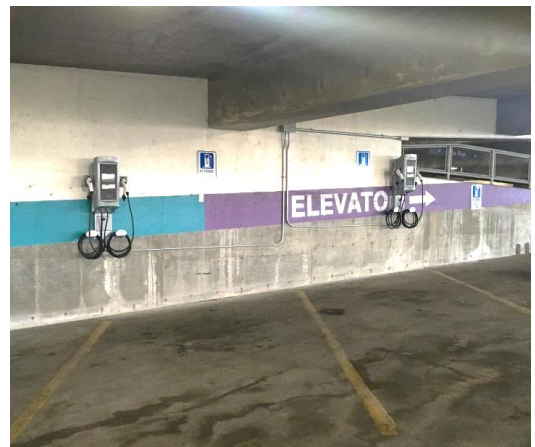
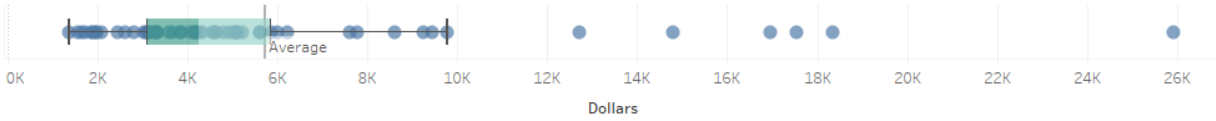

Figure 25: Low-cost wall mounted EVSE in mall parking garage

<sup>26</sup> EVSE cost includes pedestal hardware, where applicable

The box plots below show the distribution of costs and ports installed for networked and non-networked commercial installations.

Networked Commercial EVSE: Premises Wiring



Networked Commercial EVSE: Direct EVSE Install + Hardware Cost



Networked Commercial EVSE: Total Installation Cost per Port



Non-Networked Commercial EVSE: Premises Wiring



Non-Networked Commercial EVSE: Direct EVSE Install + Hardware Cost



Non-Networked Commercial EVSE: Total Installation Cost per Port



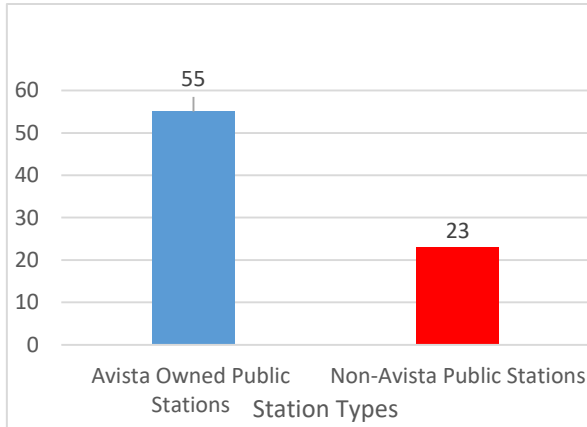

Figure 26: Avista and non-Avista EVSE stations available for public use in Avista’s Washington service territory

The Company installed 46 charging ports used primarily for public access. In addition, some workplace, fleet and MUD site hosts agreed to open their EVSE for public use, listing them on station locator services such as PlugShare, Google Maps and Chargeway. A review of these locator services and the USDOE Alternative Fuels Data Center show that a total of 78 locations in Avista’s service territory have EVSE available for public use (J1772 connectors), 23 of which (29%) are owned and operated outside of Avista’s network.

### DC Fast Charger EVSE

The Company installed DCFC at seven different sites in the region from early 2017 through mid-2019, with a goal of establishing the first backbone of public DCFC in eastern Washington that begins to enable rapid charging in urban core areas and longer distance EV trips. In consultation with WSDOT and outreach with local EV owners, strategic locations were identified along the I-90 and US-395/195 travel corridors and in the downtown of Spokane, the largest population center in the region. Specific sites within these areas were then determined based on criteria of cost, site host partnership, easy access, and nearby amenities.<sup>27</sup> Two of the sites are positioned east and west of Spokane’s outskirts on the I-90 corridor, one north of Spokane on US-395, and two to the south on US-195 in Rosalia and Pullman. Future DCFC installations may extend both east-west along I-90 eventually linking Idaho to western Washington, and north-south along US-395/195 linking Canada to southeast Washington and Oregon, along with adequate buildout in urban areas proportional to localized EV adoption.

<sup>27</sup> For DCFC siting best practices, see Pacific Gas & Electric’s EPIC Final Report, Appendix A – Expert Siting Criteria [https://www.pge.com/pge\\_global/common/pdfs/about-pge/environment/what-we-are-doing/electric-program-investment-charge/EPIC-1.25.pdf](https://www.pge.com/pge_global/common/pdfs/about-pge/environment/what-we-are-doing/electric-program-investment-charge/EPIC-1.25.pdf)

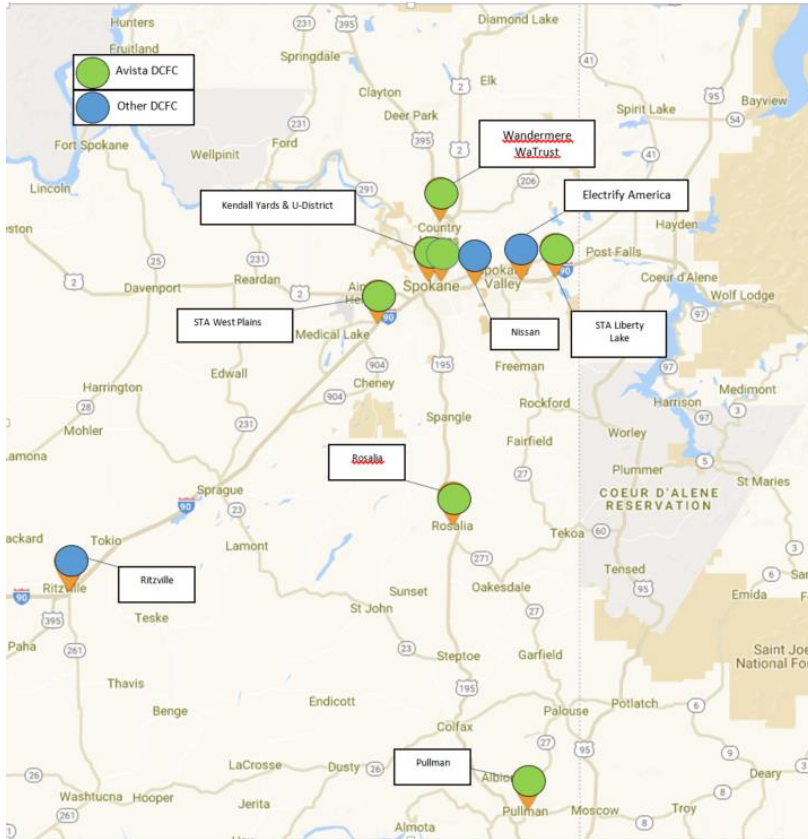

Figure 27: DCFC sites in eastern Washington, September 2019 (courtesy Plugshare)

Avista adopted a standard DCFC site design that included an operational 50kW DCFC with both CCS and CHAdeMO connectors, and a dual-port AC Level 2 EVSE as a backup. The installations required adequate property easements and/or site agreements for future expansion, supplied by three-phase, 480 VAC from a dedicated 225kVA transformer, service meter and supply panel, and conduits with capacity for low-cost future expansion of an additional 150kW DCFC and dispenser units.

The Company has found public DCFC installations to pose a number of challenges requiring extra attention compared to public AC Level 2 installations. Most notable of these was the site acquisition process, which did not significantly impact direct costs

but required substantial effort and caused extended delays. Much of this was similar to AC Level 2 installations in terms of overcoming site hosts' unfamiliarity and perceived risks of various issues, multiplied by the added concern of committing to long-term obligations in the form of property easements and access agreements.

Lead times for DCFC site design, equipment procurement and construction were generally under two months, while site acquisition including contracts and property easements typically took six months or longer to complete. Three of the seven DCFC sites were constructed on private property with relatively shorter site acquisition lead times, and no payments required for access easements. The remaining four were constructed on public property, in collaboration with local government and transit agencies.



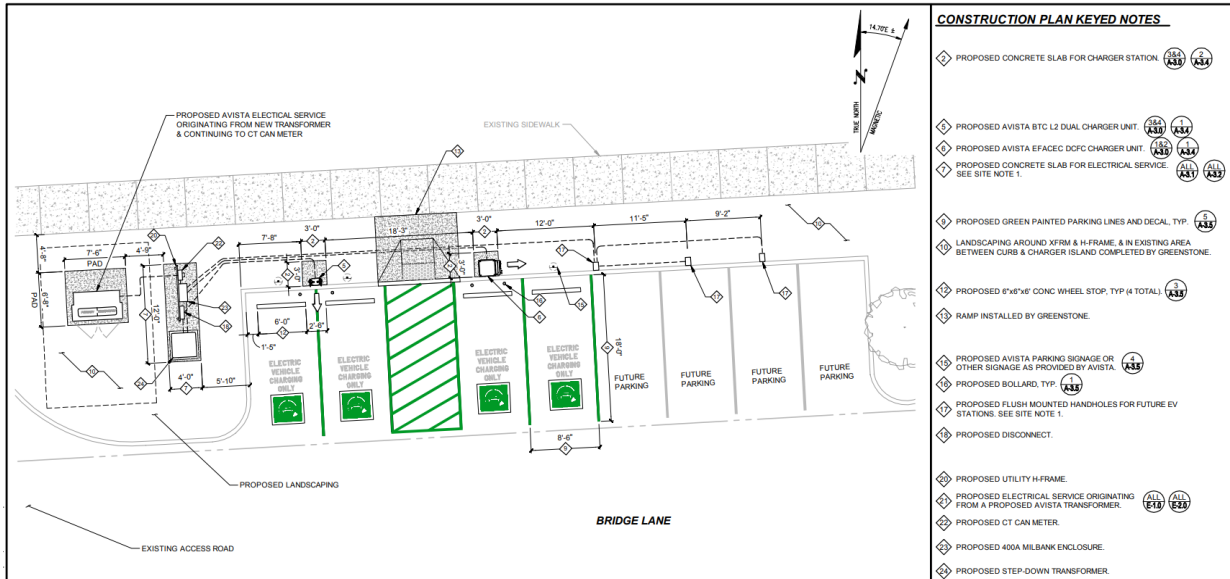

Figure 28: example DCFC standard site design

DCFC costs averaged \$128,084 per site. The availability of nearby three phase power and minimized construction disturbances such as asphalt and concrete tear-out and restoration are the most important factors in reducing costs. Cost components for DCFC sites were distributed as follows:

Table 8: DCFC average cost categories

Construction Labor & Materials	49%
Utility Labor & Materials	19%
EVSE	25%
Project Management	3%
Engineering & Design	3%
Site acquisition	2%



## Reliability and O&M Costs

EVSE reliability is critical to customer satisfaction and EV adoption, especially in the early stages of market development where relatively few EVSE may be available. Particularly for DC fast charging sites, EV drivers may be travelling longer distances and depend upon them to provide a charge when needed, or face long trip delays. In addition, the frequency, type and severity of problem occurrences, and lead times to correct them directly influence operations and maintenance (O&M) expenses. Specific knowledge and operational capabilities are required to maintain EVSE reliability at satisfactory levels while minimizing O&M expenses. These include prompt and effective problem notifications, response and repair lead times with both remote and onsite technician resources, optimized spare parts inventories, etc.

The following table shows the percent uptime categorized by the type and number of deployed EVSE ports, as tracked from October 28, 2018 through September 18, 2019. “Uptime” is defined as the percent of time that the EVSE is able to provide a charge, as opposed to the percent “downtime” where the EVSE is in a faulted condition and unable to provide a charge. These faulted conditions include a number of possible software and hardware or physical problems with the EVSE itself, as well as possible network issues in the case of networked EVSE.

EVSE Type	Networked ports / % uptime	Non-networked ports / % uptime	Overall % uptime	WiFi connections	Cellular connections	% networked	% online
<b>Residential L2</b>	92 98%	114 99.9%	99%	92	0	45%	66%
<b>Workplace L2</b>	84 78%	43 100%	85%	11	26	66%	86%
<b>Fleet L2</b>	10 83%	12 99.3%	92%	1	5	45%	85%
<b>MUD L2</b>	10 68%	8 100%	82%	2	4	56%	76%
<b>Public L2</b>	37 78%	9 100%	82%	1	24	80%	86%
<b>Public DCFC</b>	7 87%	-	87%	0	7	100%	87%

Note that networked EVSE in residential locations were able to maintain a high uptime of 98%, despite being online with the network only 66% of the time due to issues maintaining connectivity via homeowner WiFi, which were isolated to the EVSE. This is because the networked residential EVSE were programmed to initiate a charge upon physical connection to the vehicle regardless of network connectivity, rather than requiring user authentication via smartphone app or RFID card, as was the case for EVSE located outside the home. This was possible for residential EVSE as the user was known and captured by default in the dataset for home charging, and no payment transaction was needed to initiate a charge. Other networked commercial AC Level 2 performed at 68% to 83% uptime, and DCFC at 87%. Non-networked EVSE were highly reliable in all respects, at 99% uptime or greater across all locations.

While many customer ratings on [Plugshare.com](https://www.plugshare.com) are positive for EVSE both on and outside Avista’s network in the region, negative ratings and comments indicating the customer was unable to get a charge or was otherwise inconvenienced are common, rather than the rare exception. While industry standards have not been well established for uptime performance of AC Level 2 EVSE, consultation with EV drivers indicate that high uptime per site location and fast problem resolution are necessary to achieve customer satisfaction and support EV growth in the mainstream market segment – perhaps 95% or greater, especially for DCFC sites. This is because the EV fueling experience must meet or exceed the fueling experience of gasoline vehicles that customers are accustomed to. Consider from personal experience upon arriving at a gas station, how often fuel is unavailable at any of the gas pumps – and if that were to occur, how likely it would be to quickly arrive at another nearby gas station with fuel availability. The state of EVSE uptime in the 85% range – particularly at sites where there is no EVSE redundancy – must be dramatically improved to meet or exceed this standard. Thus far, only non-networked EVSE have demonstrated this level of performance outside the home.

**Problem Tracking and O&M Expenses**

<b>Problem severity</b>	<b>Criteria</b>
Urgent	DCFC or high-use L2 EVSE, no site redundancy, safety issue
High	High use, remote location, limited redundancy
Medium	Lower use, adequate redundancy
Low	Safely functional, minor issue

Determining the priority of problem resolution depends upon the severity of the issues involved, which may include station type, redundancy or backup in the immediate vicinity, utilization, and public visibility. Based on these factors Avista developed a matrix to help categorize and prioritize issues, establish goals including corrective lead times, and efficiently deploy resources in partnership with the EVSP, equipment manufacturers and local electrical technicians. Safety issues and EVSE that are unable to provide a charge fall into the Urgent, High or Medium categories, while EVSE that have minor issues but can still safely provide a charge fall in the Low category.

*Table 9: Prioritization matrix for EVSE issues*

Starting in the fall of 2018, Avista staff recorded problems that could not be immediately or remotely resolved, tracking details from the initial time of notification through the full resolution process. The

table below summarizes these issues according to problem severity, including issues at both DCFC and AC Level 2 installation sites.

Problem severity	# of occurrences	Annual rate of occurrences per port	Mean time to repair (days)	Average cost to repair
Urgent	24	0.2	15	\$214
High	45	0.4	18	\$481
Medium	39	0.3	48	\$553
Low	12	0.1	104	\$224

Table 10: Problems tracked from October 28, 2018 through September 18, 2019

Problem notifications were received by the EVSP, email or phone calls from site hosts and EV drivers, periodic on-site inspections and testing, as well as online monitoring of sources such as PlugShare.com and a local EVSE Facebook group. In addition to these recorded occurrences, approximately five issues per week for networked EVSE are resolved by power cycling the unit (similar to rebooting a computer), and an unknown number of other minor problems and resolutions may occur without notification to Avista.<sup>28</sup> Note that repair costs listed above are inclusive of both warranty and non-warranty labor and material costs, whether direct or indirect in resolving the problem.<sup>29</sup> This results in an annual cost of \$435 per port overall for unplanned problem resolutions. Out of 120 recorded problems, 101 were attributed to sites with networked ACL2, six to non-networked ACL2, and 19 to DCFC. Thus far, most of these problems were partially if not entirely covered under warranty. Many also appear to be issues related to new technology and systems that may be eliminated over time, as EVSE and network service quality matures and improves. As there is limited EVSE performance history, it is uncertain how problem types and occurrence frequency may change as the equipment ages. Considering the experience gained thus far and consulting with industry experts on problem types, frequency and expected costs, the following table reflects best estimates of annual O&M costs per port. This includes maintenance of various EVSE and sites over their assumed 10-year service life, assuming moderate to high utilization and some product improvements and scaling efficiencies as the market matures.<sup>30</sup>

Table 11: Annual O&M costs per port, not including electric billing

	DCFC	Commercial Networked ACL2	Commercial Non-Networked ACL2	Residential Networked ACL2	Residential Non-Networked ACL2
Network support & communications	\$250	\$250	\$0	\$250	\$0

<sup>28</sup> Annual inspections and testing are recommended for each EVSE site, to help uncover unreported problems with the EVSE and site conditions

<sup>29</sup> Technician labor time on-site, travel costs, and equipment or component purchases are examples of direct costs, while office staff time on the phone to help discuss and resolve a problem is an example of indirect cost.

<sup>30</sup> Not inclusive of spares inventory costs and electric meter billing, net of any user fees applied by the site host.

Planned maintenance	\$400	\$0	\$0	\$0	\$0
Unplanned repairs (non-warranty)	\$500	\$100	\$35	\$70	\$5
Minor connectivity restoration	\$50	\$50	\$0	\$50	\$0
Tests & inspections	\$200	\$100	\$50	\$0	\$0
Site & access maintenance <sup>31</sup>	\$150	\$100	\$100	\$0	\$0
<b>Total</b>	<b>\$1,550</b>	<b>\$600</b>	<b>\$185</b>	<b>\$370</b>	<b>\$5</b>

In addition to these O&M expenses, the table below lists average electric usage and meter billing for utility energy charges by EVSE type, as derived from recent EVSP data.

Table 12: Average electricity usage and billing by EVSE type, per port (March 2019 – May 2019)

EVSE type	kWh per session	Monthly sessions	Monthly kWh	Energy billing rate <sup>32</sup> per kWh	Monthly energy billing
Residential ACL2	7.6	20.8	158.0	\$ 0.090	\$ 14.20
Workplace ACL2	8.8	16.6	145.9	\$ 0.105	\$ 15.30
Fleet ACL2	12.2	17.4	212.6	\$ 0.105	\$ 22.30
Public ACL2	9.4	9.6	90.4	\$ 0.105	\$ 9.50
MUD ACL2	9.1	0.7	6.4	\$ 0.105	\$ 0.70
DCFC	13.6	9.8	131.1	\$ 0.105	\$ 13.80

No basic charge is included in these figures, as residential and commercial ACL2 EVSE are supplied by existing meters and panels, and no offsets are included here for commercial ACL2 and DCFC that may collect user fees. If separately metered, a basic charge of \$20 per month would apply to commercial customers. In addition, some demand charges may be expected for larger commercial ACL2 installations

<sup>31</sup> Site and access maintenance activities such as snow plowing and trash removal may already be in place and are not necessarily additive with the installation of the EVSE

<sup>32</sup> Based on current Avista rate schedules 001 for residential service and 011 for commercial general service. Does not include basic charge, tiered energy charges (which may apply when added to other building loads), or demand charges for schedule 011.

with higher utilization, when demand from all metered loads at a given facility rise above the 20kW threshold established in Schedule 011.

DCFC sites are equipped with dedicated service and meters that supply both a 50kW DCFC and a dual port ACL2. Review of 107 monthly meter bills for DCFC results in the following minimum and maximum total bills for all sites since commissioning from January 2017 through June 2019, and more recent average monthly billing from January through June of 2019.

Table 13: DCFC monthly meter billing, all sites (Jan 2017 – June 2019)

	kWh energy consumption	kW peak demand	basic charge	energy charge	demand charge	total bill	% demand charge	effective energy charge per kWh
min	80	0	\$18	\$ 9.29	\$ 0	\$ 27.29	0%	\$0.34
max	1058	66.2	\$20	\$126.35	\$300.04	\$446.39	67%	\$0.42
avg	473.9	43.6	\$20	\$ 56.81	\$161.84	\$238.65	64%	\$0.63

Note the % demand charge of the total bill, and the effective energy charge per kWh which is determined by dividing the total bill by the kWh energy consumption. Although the average 64% demand charge coincides with a \$0.63/kWh effective energy charge, in one month a DCFC site saw only a few DCFC sessions resulting in low energy consumption, 86% demand charges out of the total bill of \$224, and an effective energy charge of \$1.87/kWh. This shows that in cases of lower utilization a competitive user fee of \$0.35/kWh cannot recover electric billing costs, let alone other O&M expenses estimated at \$1,550 per year to maintain service, and installation capital averaging over \$128,000 per DCFC site. Under current commercial rates and average DCFC charging sessions at 13.6 kWh and \$5.05 user fee revenue, breakeven with electric billing occurs at 55 charge sessions per month, and at 91 sessions per month to cover both billing and other O&M expenses. This is far higher than even the most utilized DCFC in the network at Kendall Yards, now averaging 27 charges per month. These results highlight the need to consider alternative utility rate schedules to support DCFC operated by Avista and other customers, as DCFC are a critical component of the overall “charging pyramid”, essential for sustained EV adoption and market transformation.

### Analysis of Problem Types and Solutions

As stated earlier, the rate of non-networked EVSE problems was dramatically less than networked EVSE, with simpler designs allowing for faster repairs and less external support. Electronic components, network communication, and software integration issues in networked EVSEs require more technical training and/or assistance from EVSE manufacturers and EVSPs, either remotely or onsite in more problematic cases. Further analysis of tracked issues shows that software integration and component failures were the most common, followed by remote start integration issues. These three types

represented 77% of all tracked issues, with 76 of the 78 problems in these categories involving networked EVSE.

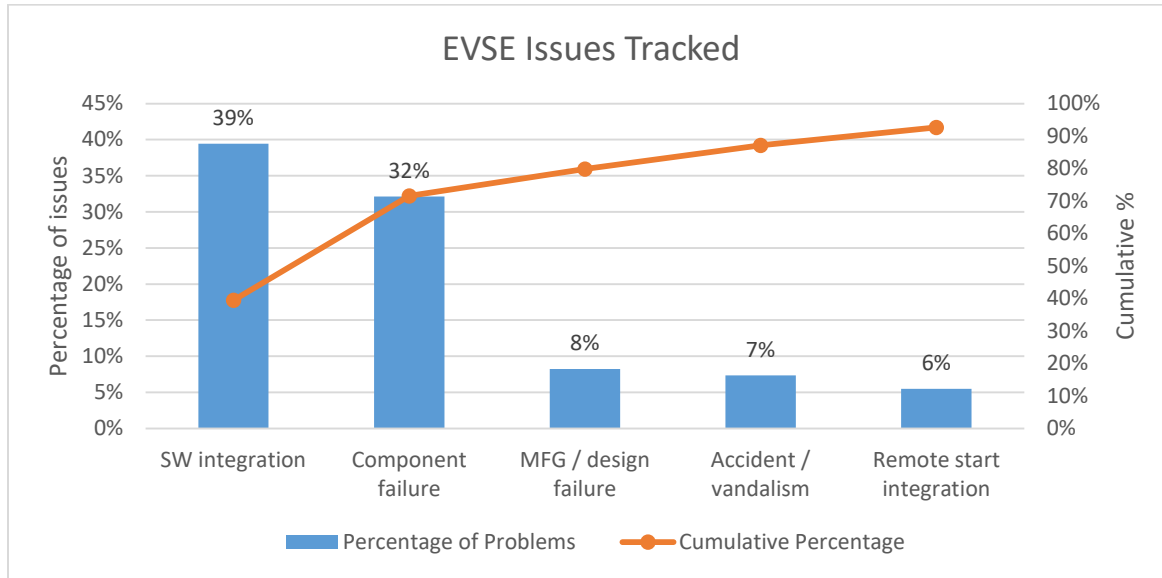

Figure 29. EVSE Issues Tracked

A few problems involved defective manufacturing and design, preventable with improved production methods and processes. Examples include improper seating of electronics connectors, insecure compression sleeve fittings for charging cables, or outsourced subcomponents that do not meet required working tolerances.



Figure 30. Example J1772 connector plate-to-latch tolerance

An example of an avoidable manufacturing issue, and how it can create additional problems, is found in the case of a J1772 connector. As shown, the distance from the back plate to the latch inner surface is within tolerance and will properly connect with a vehicle or EVSE holster. A very small reduction in this required distance however, prevents the connector from fully clipping into the EV connector pins when plugged in, and does not allow a charge to initiate.<sup>33</sup> Additionally when the connector is inserted into the station’s connector holster, the retainer latch will not fully clip in and the user may apply extra force causing it to fracture or to damage the connector pins on the EV itself. This is a good example of product defects that are expected to be resolved and eliminated with

<sup>33</sup> SAE 1772 standard available at [https://www.sae.org/standards/content/j1772\\_201001/](https://www.sae.org/standards/content/j1772_201001/)

improved manufacturing and best practices in the field.

Accidents and vandalism causing physical damage were infrequent, but did occur on a few occasions. Examples include cut connector cables, damaged user interface screens, and in one case a tour bus backing into the EVSE, narrowly missing the protective bollard. Vandalism occurred at three different sites, all open to the public and not actively monitored. Vandalism is somewhat dependent on location and site conditions and may be difficult to prevent, although video monitoring with some warning signage can help mitigate risk.

Effective problem resolution, root cause analysis and systematic improvement for prevention requires full engagement and coordination between the manufacturer, EVSP and network manager.

In terms of problem resolutions, power cycling addressed 33% of the total tracked issues, however on many occasions problems resurfaced and multiple power cycles were required, and in 35% of cases another solution was needed to permanently resolve the issue.

22% of solutions involved component repair or replacement, and 13% full EVSE replacement. In one example, a DCFC had persistent connectivity issues that were temporarily resolved by power cycling, which would resurface within a few days. Working with the manufacturer and EVSP over multiple site visits, the EVSE was checked for properly seated connections, acceptable cellular signal strength, and excessive EMF interference. Ultimately, a faulty modem was identified as the root cause of the issue and, once replaced, permanently resolved the issue.



*Figure 31. EVSE damage from a vehicle impact*



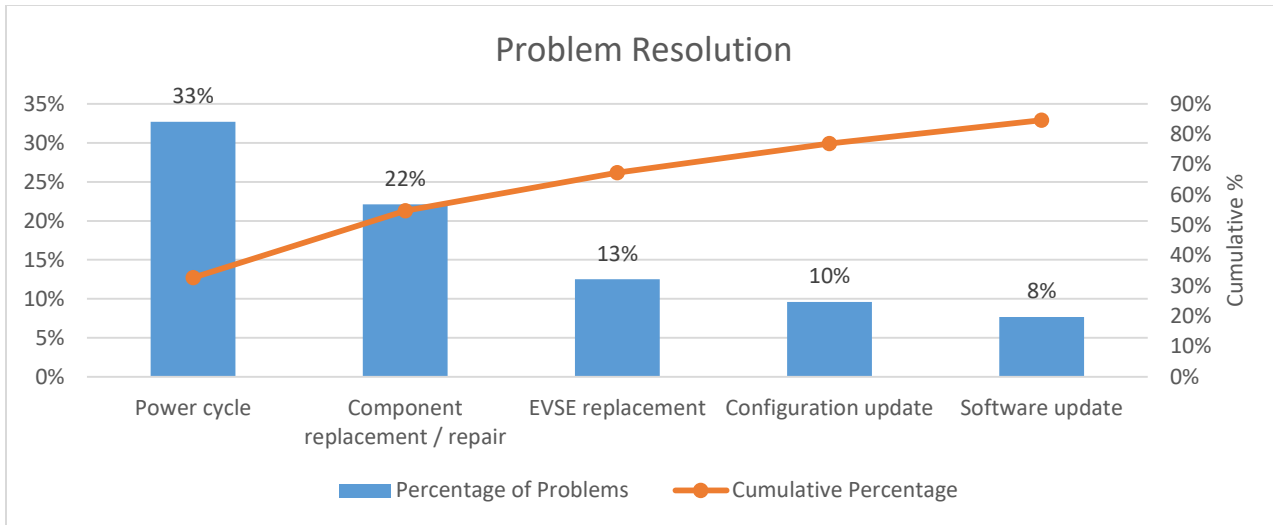

Figure 32. Avista network tracked issues resolution

Configuration and software updates accounted for 18% of solutions and were accomplished remotely, with some exceptions. Given the experience of EVSE issues and resolutions over the course of the EVSE pilot, the overall impression is that some of the physical issues relevant to all EVSE, and most of the problems relevant to only networked EVSE are preventable – and may be eliminated with improved production, integration, and remote monitoring capabilities of EVSP and EVSE industry partners.

Problems with connectivity did not affect uptime in residential installations, but were common in both residential and commercial EVSE installations, making data collection and analysis more difficult. Internet broadband connections, WiFi, and cellular communications will periodically fluctuate in available speed and signal strength due to interferences and other factors. Hardware and software of networked EVSE must be robustly designed and tested to accommodate these conditions within specific limits that are known and verified prior to EVSE installation. In the case of residential and some commercial installations, this required a boost to the WiFi signal in the garage using a repeater or wireless access point. In the case of commercial installations utilizing cellular communications, signal strength was verified prior to EVSE installation. Even so, cellular communications were a frequent problem due to internal modem issues and fluctuating signal strength.

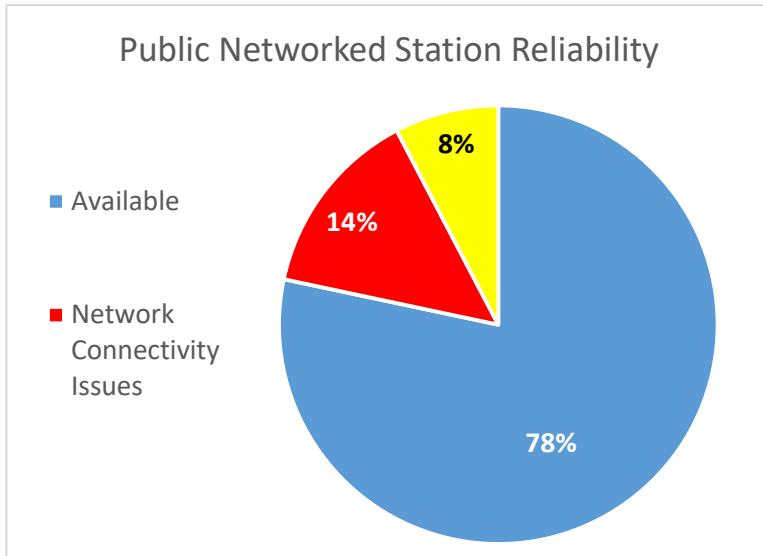

Figure 33. Public networked EVSE availability

Another way of categorizing reliability problems with networked EVSE is in terms of (1) EVSE-to-server communications issues, and (2) local issues related to EVSE physical, hardware and software problems, which may be undetectable by remote EVSP monitoring.

Faulty modem communications that render the EVSE offline with the EVSP and/or manufacturer’s server, and software bugs in smartphone apps that affect uptime are examples of the former, while internal breaker trips, control unit malfunctions, and physical damage are examples of the latter. Open source

communication protocols such as OCPP, with adequate integration and testing between the EVSE manufacturer and the EVSP, can enable detection of many if not all physical, hardware and software issues. This is especially important for public EVSE, which over the course of 18,785 days in service were unavailable 3,476 days due to network connectivity issues and 1,441 days due to undetectable local issues, resulting in an uptime of 78%.

As EVSP remote monitoring and notifications do not occur for undetectable local issues, site hosts and EVSE owner/operators will instead receive problem notifications from customers through a variety of communication channels, often with significant delays from the time that the problem surfaces. In order to maximize uptime and a positive customer experience, continuous improvement effort is essential to identify and eliminate root causes, including an effort to increase the number of remotely detectable issues. Site hosts and owner/operators should coordinate EVSE inspection and testing at appropriate frequency to identify undetectable problems, particularly for more underutilized EVSE. Finally, coordinated staffing and standard processes must continuously work to minimize corrective lead times, from problem occurrence through notification, response, and final resolution.

## Utilization, Load Profiles & Data Analysis

Data analysis begins with a raw dataset of 64,574 charging sessions logged by networked EVSE from January 1, 2017, through May 24, 2019. Of the 64,574 sessions, 11,218 were removed due to data anomalies. The remaining 53,356 sessions were utilized for analysis of user and location load profiles across networked residential, workplace, public, fleet, MUD and DCFC sites. High confidence in the accuracy and validity of the dataset provided by the EVSP was established by close comparison with a sample of identical charging sessions captured separately by vehicle telematics devices, as detailed in Appendix B.

Residential stations logged the most charge sessions with 68% of the total. Workplace came in second at 16%, followed by public and fleet at 11% and 4%, respectively. A smaller number of MUD installations were completed with relatively low utilization, resulting in 0.3% of the dataset. 90% of public charging sessions occurred at public L2, with 10% at DCFC.

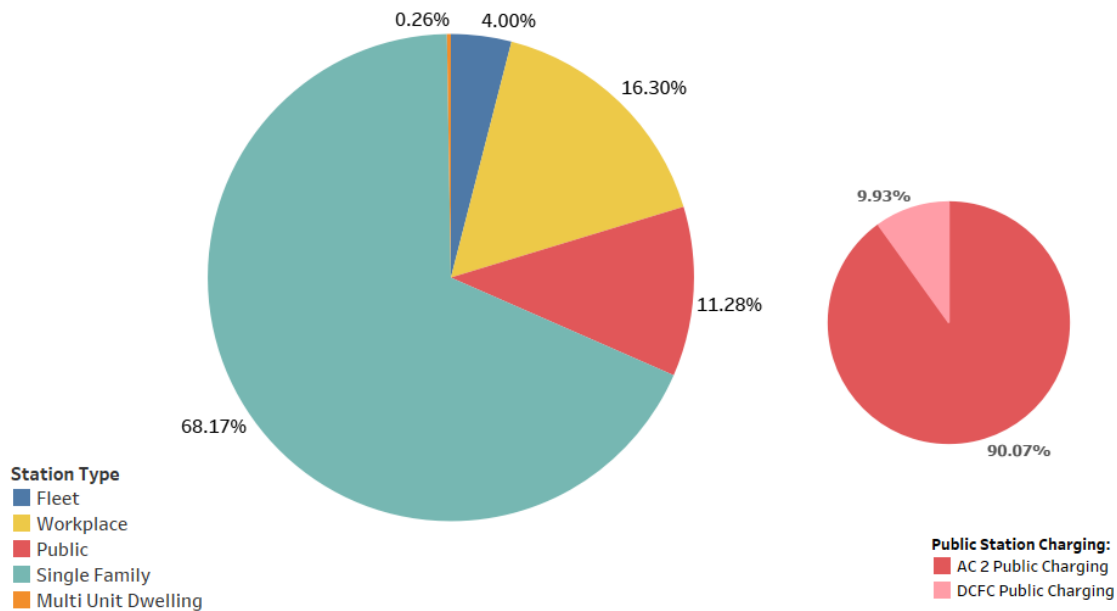

Figure 34. Percent of Charge Sessions by Station Type

### Overall Load Profile

Residential charging comprised the majority of demand, except between the hours of 7am to 10:30am, where workplace charging was the largest source of demand and accounted for 48% to 53% of total energy consumption across networked EVSE. Combined energy consumption for all station categories peaked during the 5pm to 6pm hour, with residential L2 accounting for 76% of the total at that time.

See Appendix E for values of hour-by-hour energy consumption in the various categories. The chart below shows average charging over nearly 2.5 years of EVSE installations and utilization. Note that this differs from the current state of the network as a proportionately higher number of networked residential EVSE were installed in the earlier phases of the pilot program, with more workplace, fleet, public L2 and DCFC installed in later phases. In addition, some inaccuracies exist in use categorization as EVSE primarily used for one type of charging are on occasion used for another type. For example, a charging station primarily used for “public” charging and designated as such, may on occasion be effectively used as “workplace” charging, etc. The Avista data also does not include any L1 charging, which is currently used by some EV drivers in the larger population for residential charging, and to a lesser extent in other types of use.

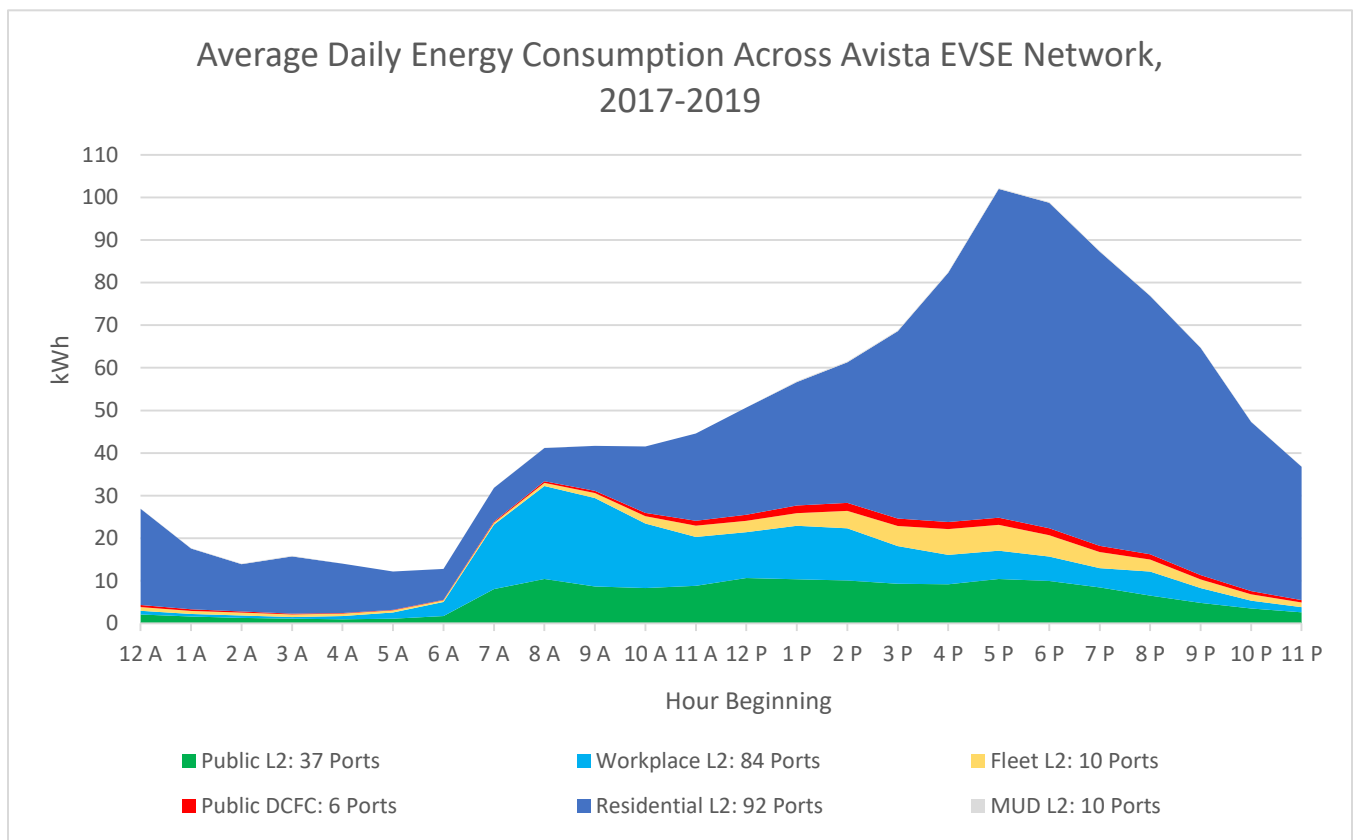

Figure 35. Average daily energy consumption across Avista’s networked stations

### Comparison with E3 Modeling

Average daily electricity consumption from Avista’s EVSE data compares well with modeling completed by Energy + Environmental Economics (E3),<sup>34</sup> in terms of the overall shape and composition of EV load from different use categories. E3’s load profile data was developed using inputs from five different

<sup>34</sup> Economic & Grid Impacts of Electric Vehicle Adoption in Washington & Oregon. E3 (2017)

regional utilities serving the Pacific Northwest region. These inputs included empirical data as well as load profile projections based on adoption rates, vehicle types, energy rates and a variety of other factors that produced the 2020 Base Case in the figure below. Comparing this with Avista’s EV load profile provides some general confidence in both the validity of E3’s model and Avista’s data. After factoring out MUD and fleet data from Avista’s network, similarities include overall and peak demand dominated by residential charging, with roughly 90% of peak load from residential L1 and L2 occurring between 6pm and 10pm, compared to 82% of peak load from residential L2 in the Avista network from 5pm to 8pm. Furthermore, E3’s morning workplace model showed a peak between 9am and 1pm with 58% of total energy usage from workplace charging, while Avista’s workplace demand data showed a peak between 7am and 10:30 am, accounting for 48% of total energy usage.<sup>35</sup> Note that between the two charts, Avista’s data is shown with an “hour beginning” convention, while the E3 model uses an “hour ending” convention.

Figure 36: E3 Pacific Northwest modeled EV energy consumption in 2020 (E3)

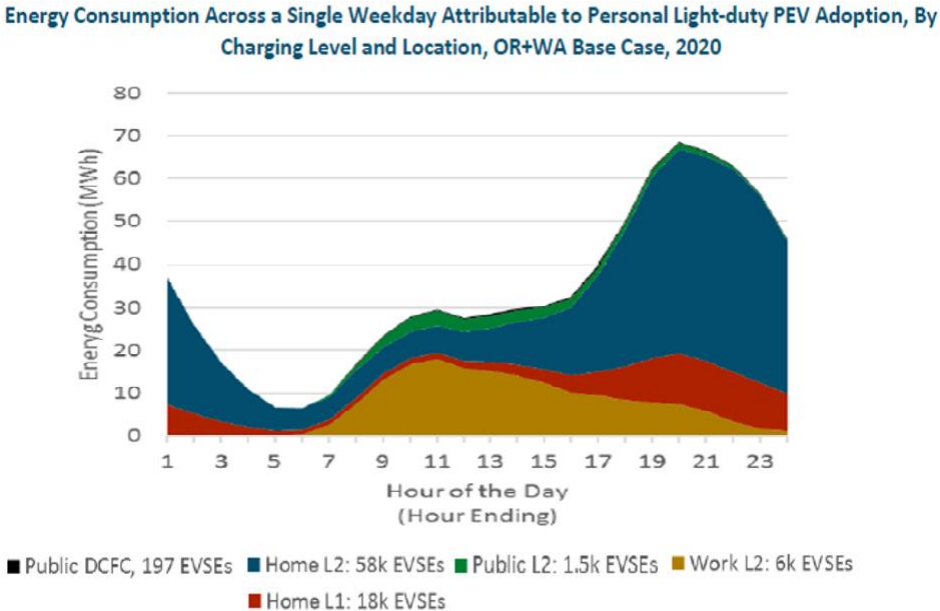

Two notable differences between E3’s model and Avista’s data, are that the E3 model shows a peak occurring later in the evening and has significantly more residential charging occurring later in the evening and early morning timeframe, compared to Avista’s data. This could be due to E3 modeling charge sessions starting later in the day, and a slower overall rate of L2 charging as well as L1 charging, which results in longer charge sessions lasting into the early morning hours.

**AC Level 2 EVSE Charging Session Characteristics**

Analysis of connection times for EVSE types revealed that fleet and residential EVSE have the longest connection times with an average of 16 hours and 10 hours, respectively, and with larger ranges.

<sup>35</sup> See Appendix E for tables of hourly energy usage and distribution comparisons

Remaining EVSE types showed substantially shorter connection times averaging below 5 hours, and narrower ranges.

*Connection Time by EVSE Type*

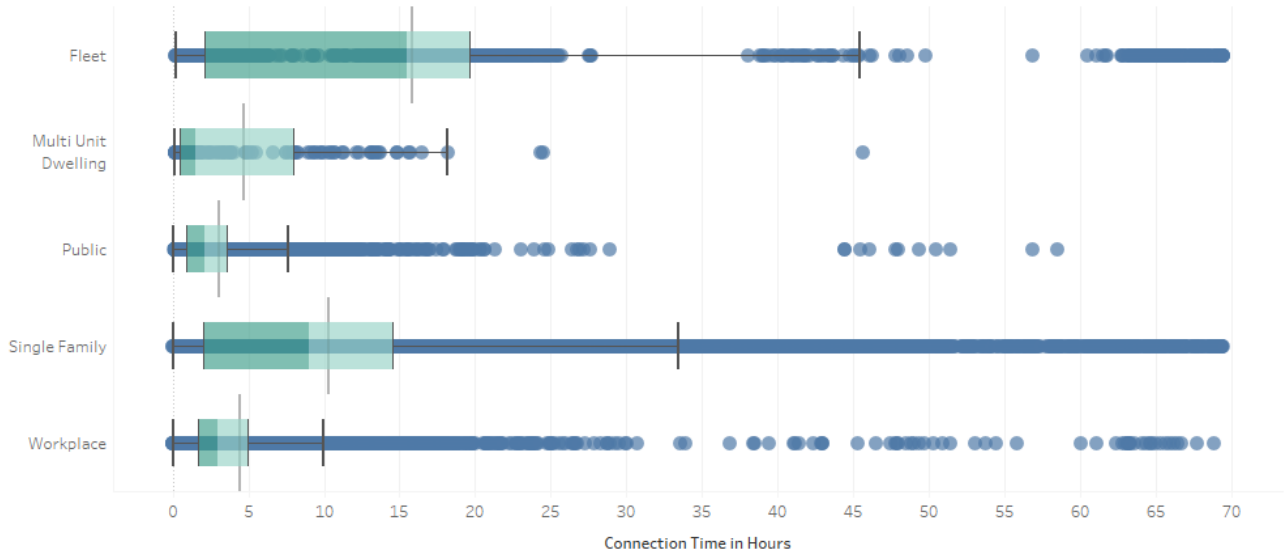
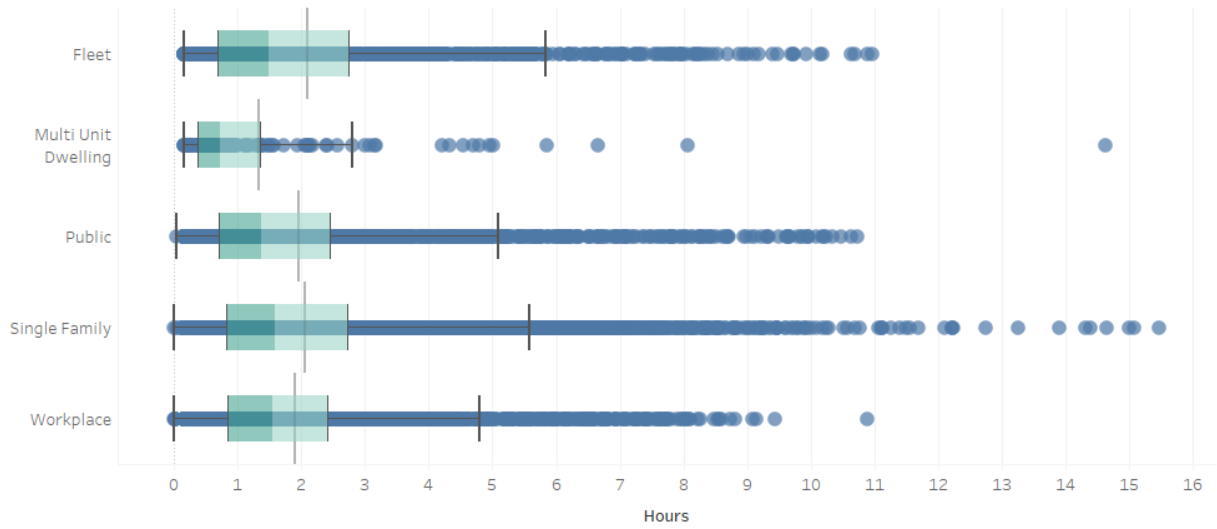

Figure 37. EVSE Connection Time by Station Type

Session charging times revealed close averages between the different EVSE types, at approximately 1.6 hours per session, and similar ranges from roughly 1.3 hours to 1.7 hours for the majority of sessions, other than the MUD category which had a much smaller number of recorded sessions.

### Session Charge Time by EVSE Type



Nsessions = 52,285

Figure 38: Charging Time by EVSE Type

Session energy usage is also very similar across different EVSE categories.

### Session Energy Usage by EVSE Type

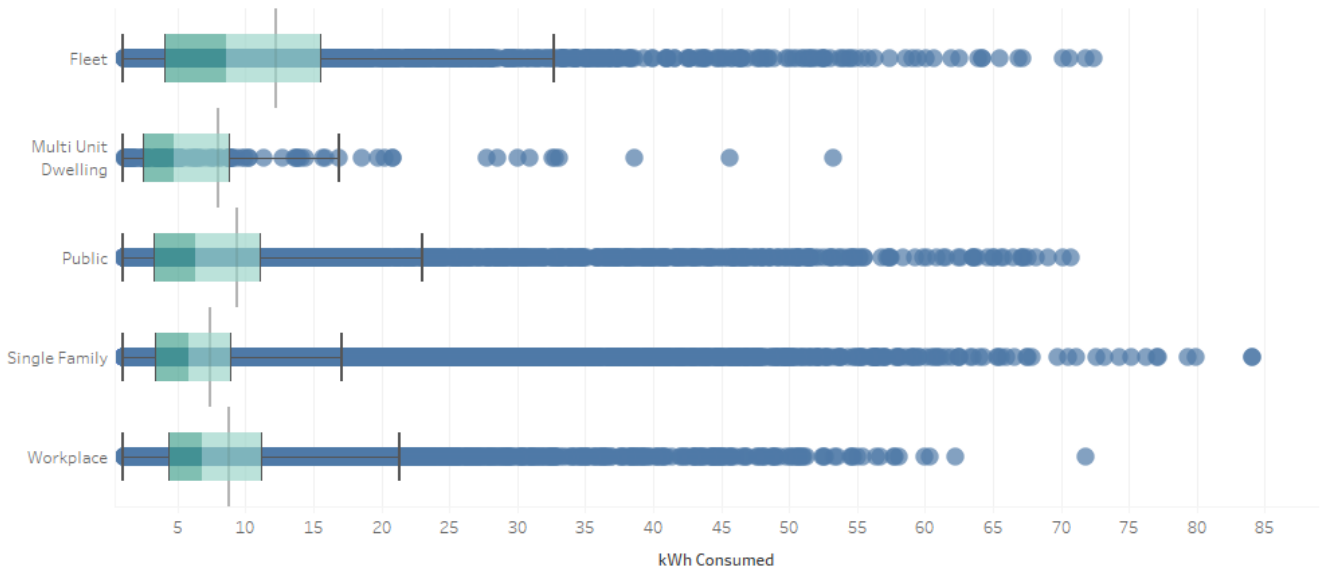

Nsessions = 52,285

Figure 39. Session Energy by Station Type

## Residential AC Level 2 EVSE

Below is a visualization of two different EV charging sessions, typical of session data coinciding with EV drivers that routinely arrive home in the afternoon or early evening, and initiate a charge.

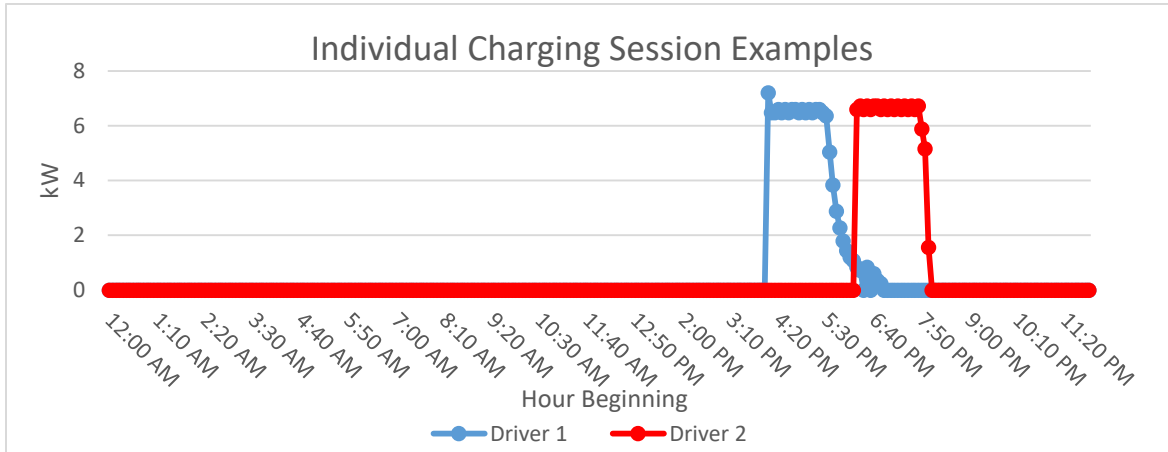

Figure 40. Example of individual residential EV charging sessions

In these charging sessions, the charge rate of the vehicle rapidly ramps up to the maximum allowed by the EV's rectifier at 6.6kW in this case, and charges for 1 to 2 hours at this level, with a ramp-down period of 45 to 60 minutes when the battery approaches a state of full charge. When taken together with other coincident loads in a given neighborhood, a total load on the local distribution transformer, feeders and substation may be determined.

An average daily load profile for an EV may be determined by combining all charging sessions such as the ones illustrated above, divided by the number of operating days over a given period of time. When the average load profile is multiplied by the total number of EVs in a given service area, the total expected energy on a per hour basis is determined for the system, which is important to understand from a generation capacity or power supply perspective. The average load profile includes many days where no charging occurs, and EV drivers have different charging habits that vary daily by location, time and amount of energy consumed. Combining all charging sessions in this way results in an aggregated, average daily profile per EV. Using the same procedure, load profiles may be specified for different types of EVs and usage, as well as by location type. Note that care must be taken to properly account for any days where the EVSE was offline and no data was transmitted. These days must be removed from consideration rather than assumed that no charging occurred.



## Residential EVSE Daily Profile

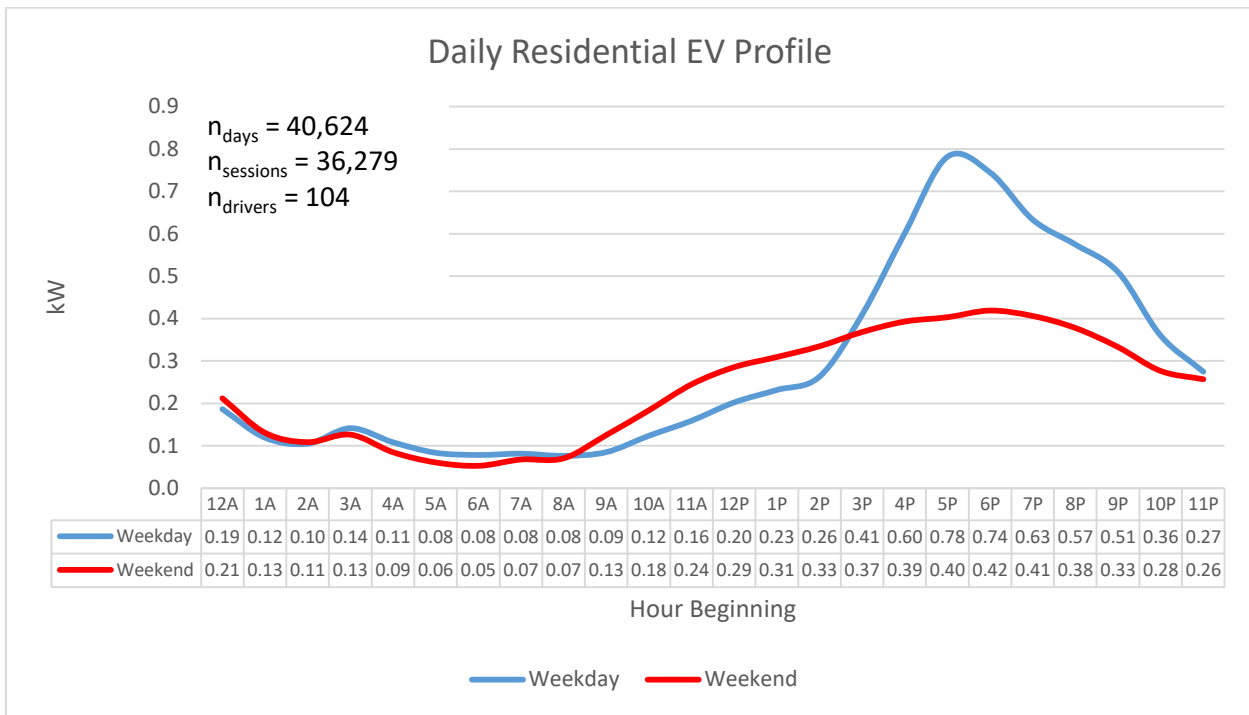

Figure 41. Residential EV aggregate load profile

The load profile above includes both weekday and weekend charging sessions, with an afternoon peak reaching an average of 0.78 kW per EV between 5pm and 6pm, coinciding with a large number of drivers arriving home in late afternoon and early evening. Demand drops to 0.36 kW by 10pm on weekdays and continues to decline to 0.12 kW by 1am, until beginning to rise again near 8am. Weekends have less consumption overall and a more gradual rise to a lower peak value of 0.42 kW at 6pm.

Trip distances, driving patterns, destination arrival times and charge initiation, the distribution of vehicle types, use of workplace and public charging, EVSE and rectifier ratings, and battery sizes in the overall EV population all have an effect on daily load profiles.

### Comparison to the EV Project Residential Data

The 2015 EV Project (EVP) is the most extensive study of light-duty EVs published to date, analyzing charging patterns from thousands of drivers over a multi-year period.<sup>36</sup> An aggregated profile from Washington State residential weekday charging was adjusted for the 658 EVSEs in the EVP Washington network using Q4 2013 data. Washington EVP drivers consisted of 82% Nissan Leafs and 18% Chevy Volts.

<sup>36</sup> Francfort, J. et al. "The EV Project." Idaho National Laboratory, (2015).

In the chart below, the EVP load profile is compared to Avista’s weekday residential profile. While the load profile shapes are similar, the EVP’s profile peaks during the 7pm to 8pm hour, one hour later than Avista’s profile peak. The Avista peak was also lower than the EVP peak by 12%, at 0.79 kW compared to 0.91 kW. Average weekday energy consumption for Avista residential customers was also lower, at 6.9 kWh compared to average EVP drivers’ consumption of 8.6 kWh – a difference of 1.7 kWh, or 20%.

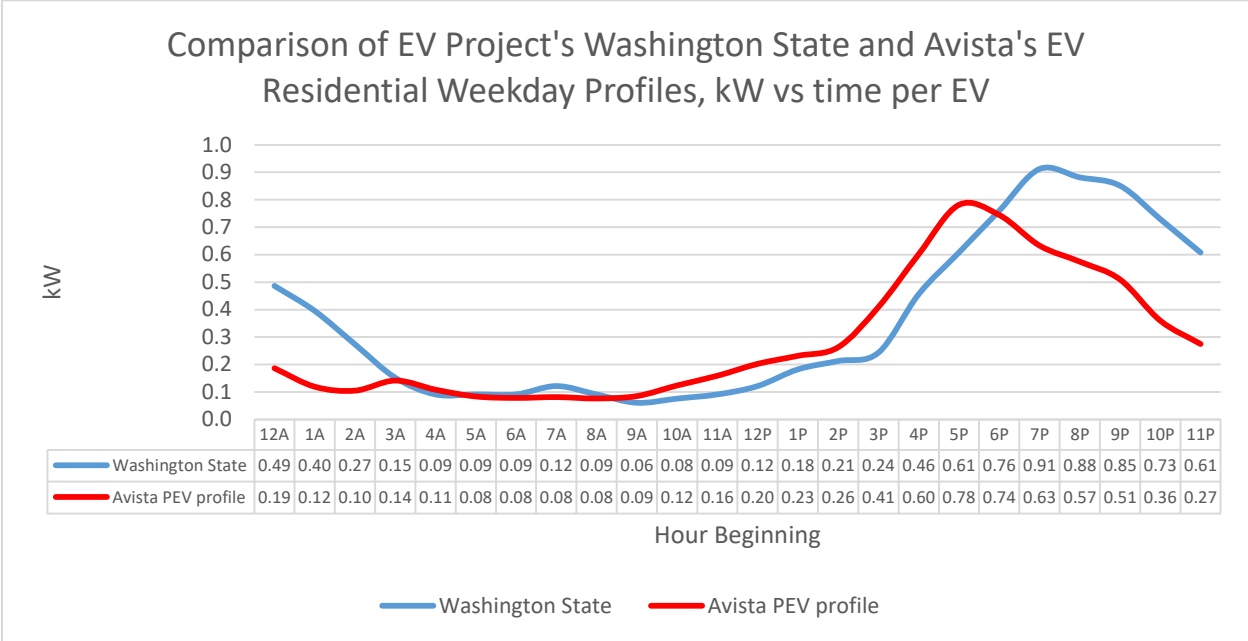

Figure 42. Comparison of Avista and the EV Project's Weekday Profiles

Many factors may affect the profiles, however driving patterns and rectifier capacity may be the most important in explaining the differences in consumption and load shape between the two curves. While both datasets originated from customers in Washington State, EVP drivers were exclusively in western Washington while Avista’s pilot customers were in eastern Washington. Lower miles driven each day could account for the lower energy consumption in the Avista profile, as Avista commuters averaged 21 miles roundtrip compared to 27.4 miles for EVP Washington commuters. With a difference of 6.4 miles per round trip commute and assuming fuel efficiency of 3.35 miles per kWh, on average Washington EVP commuters would use an additional 1.9 kWh compared to Avista’s EV commuters, which closely approximates the observed 1.8 kWh difference between the two profiles. Also the EVP peak occurs a little later in the evening and load is noticeably shifted to the later evening and early morning hours. This could be due to later arrivals in the evening for the overall EVP population, as well as lower EVSE output and older EVs with smaller rectifier ratings, such that charging sessions take longer to complete.

Overall, the similarities between the two datasets lend credibility to the studies, while observed differences highlight the value of more detailed information that can apply to unique utility service territories and systems – even within the same state – that will change to some degree as EVs and driving behaviors evolve.

## Residential Driver Type Usage

Average weekday energy consumption is highest for BEV and PHEV commuters at over 7.4 kWh, followed by PHEV and BEV non-commuters at 5.5 kWh and 4.5 kWh, respectively. Daily energy consumption in all categories is lower on the weekend compared to weekdays as seen in the chart below.

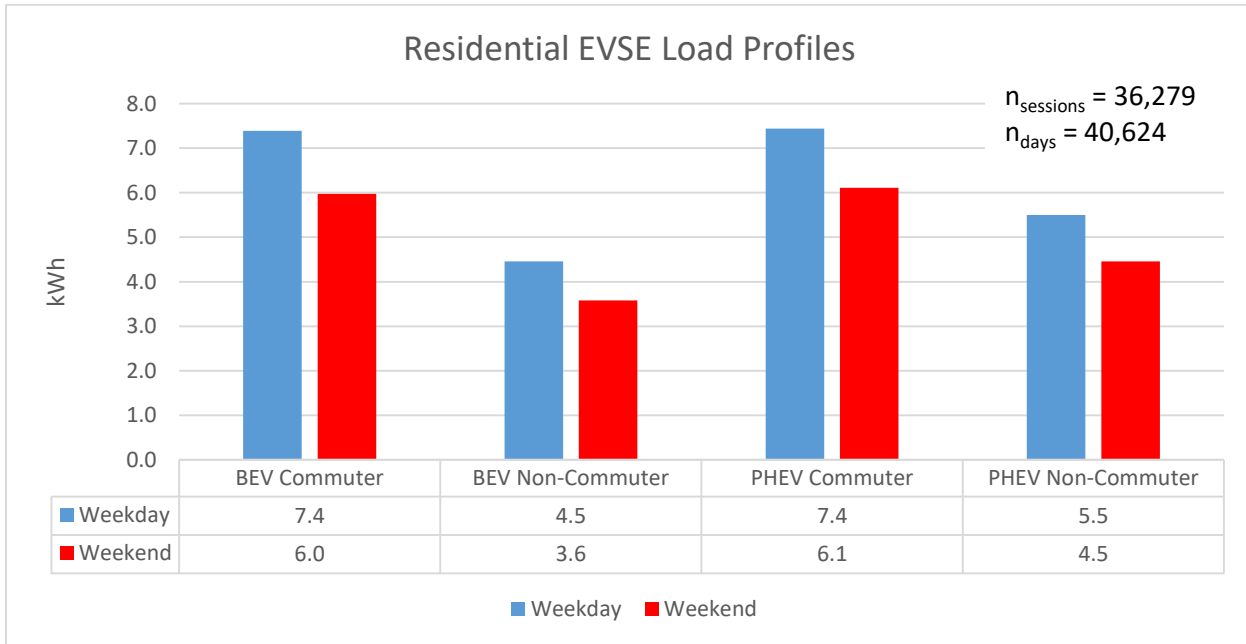

Figure 43. Average daily residential energy consumption by driver type

Detailed load profiles for each driver type are shown in the figures that follow. Within each category, the weekday and weekend load profiles tend to be similar during off-peak hours, and then diverge during peak times in the afternoons and evenings. BEV commuters have the highest peak weekday demand of 0.9 kW, occurring during the 5 pm hour. With BEV commuters, weekend demand is lower and steadily increases throughout the day, peaking at 0.4 kW at 6 pm. Other profiles have lower weekend peaks and flatter afternoon demand. Both BEV and PHEV non-commuters have sharp increases in both weekday and weekend power demand occurring earlier in the afternoon than commuters. The data shows that commuter charging behavior is more noticeably different between the weekday and weekend, compared to non-commuters. BEV non-commuter power demand is also the lowest during the weekday of the different driver types, at 0.3 kW. BEV non-commuters were also the only driver type to have higher average weekend peak demand than on the weekday. This could be influenced by the fact that most of the BEV non-commuters were retirees, charged less frequently than other driver types and had the fewest networked stations of all groups.

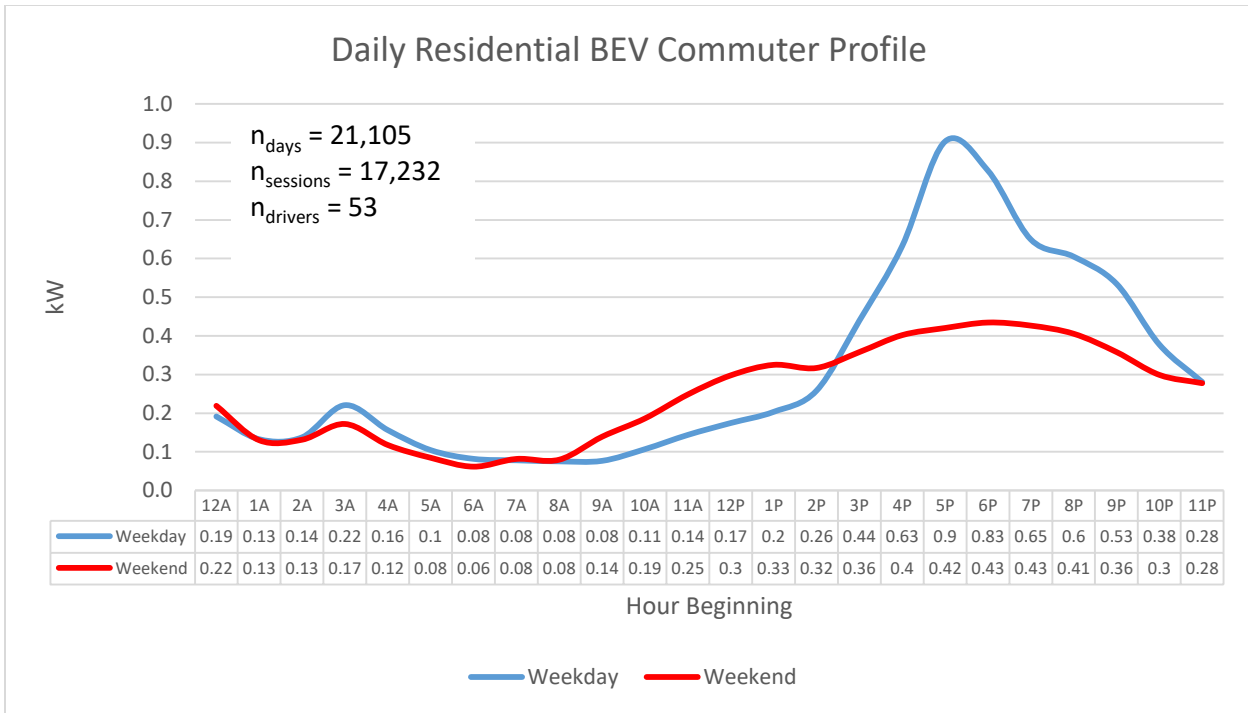

Figure 44. Residential BEV commuter aggregate load profile

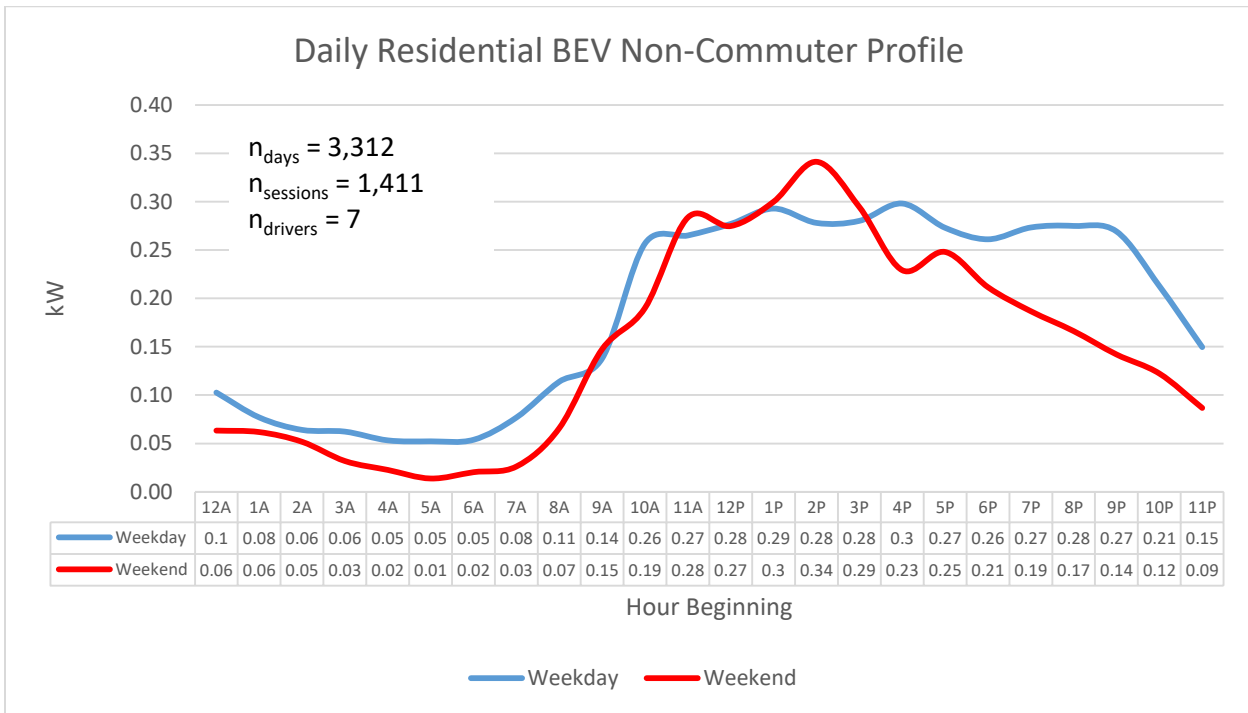

Figure 45. Residential BEV non-commuter aggregate load profile

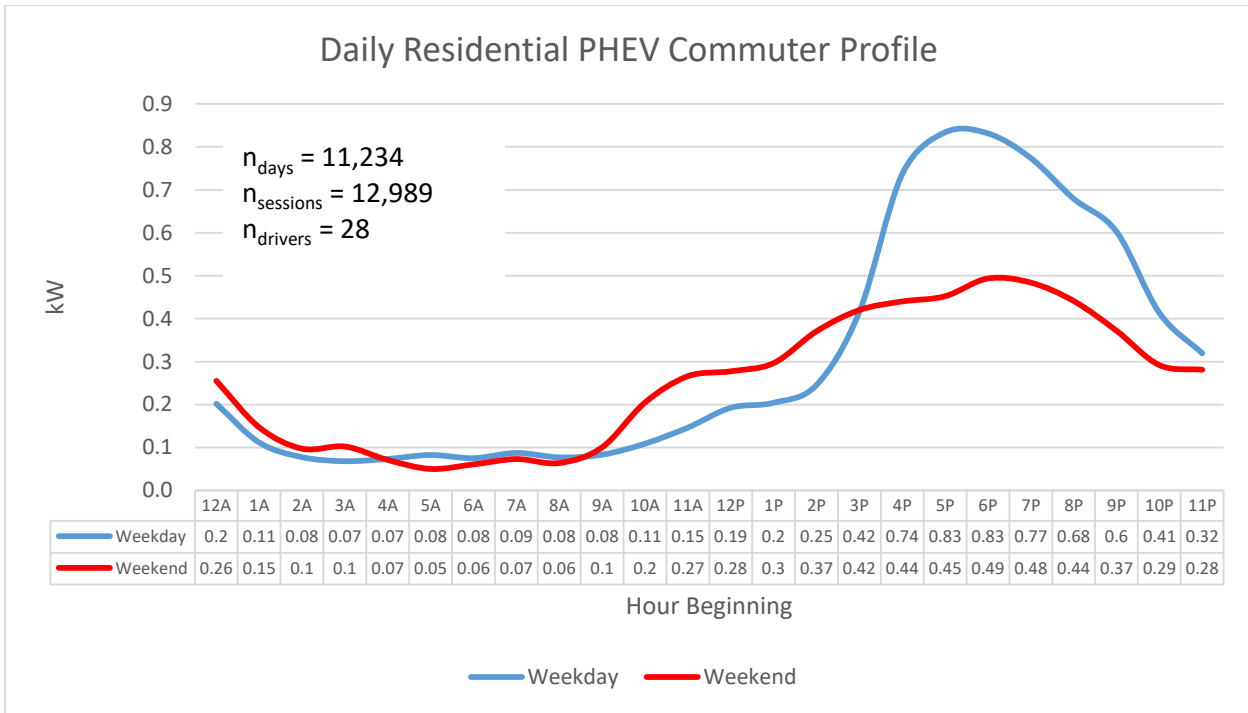

Figure 46. Residential PHEV commuter aggregate load profile

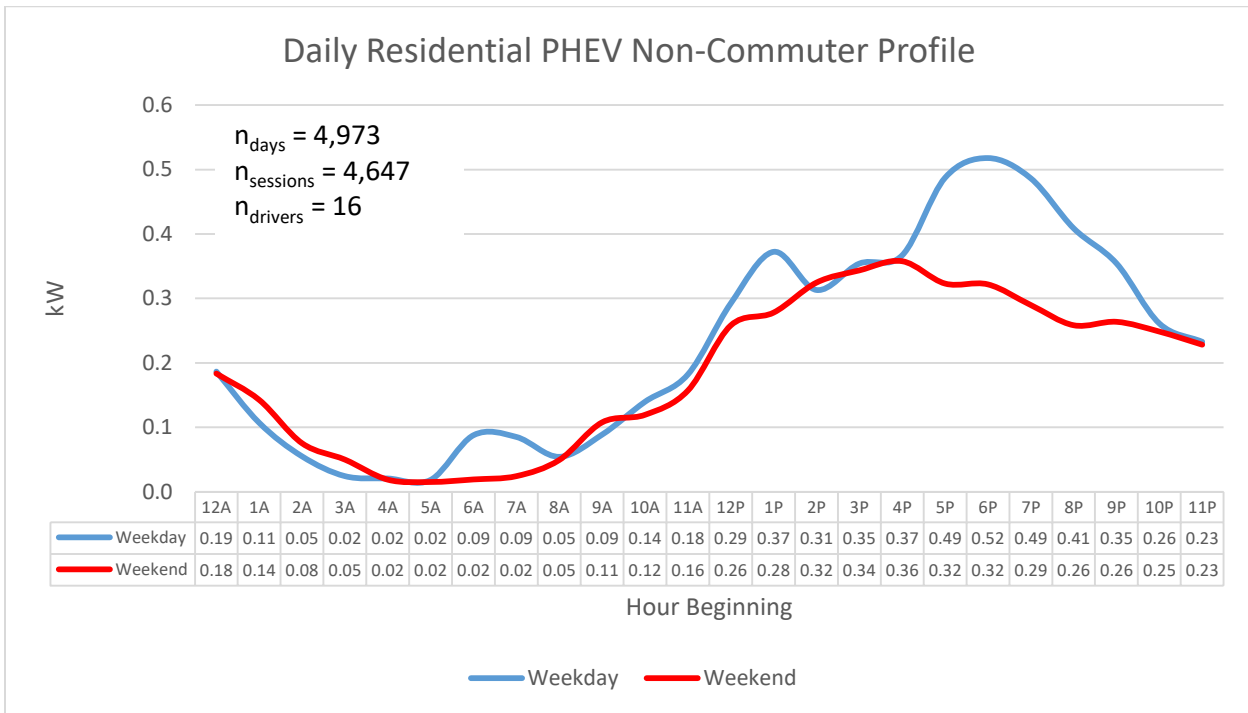

Figure 47. Residential PHEV non-commuter aggregate load profile

## Residential Long Range BEV (LRBEV) Daily Profile

BEVs with larger batteries allowing over 200 miles driving on a single charge are considered LRBEVs. Although Avista had only 11 LRBEV drivers with reliable residential EVSE data in the program, there was a distinct difference in this driver group compared to the average EV driver.

LRBEV drivers had higher residential energy and power demands than those with shorter range BEVs, and charged at home with slightly more frequency. LRBEV drivers had peak demand of 1.4 kW occurring during the 5pm to 6pm hour – resulting in an 85% increase above the overall EV residential peak. For LRBEV drivers, total energy consumption of 12.3 kWh per day was also 78% higher compared to the average EV driver. Reasons for this higher usage include longer commute distances than average for two participants, a higher proportion of commuters (9 of 11 LRBEVs were commuters), and a smaller LRBEV sample size potentially skewing the results somewhat. LRBEV drivers also averaged 5.6 sessions per week, compared to shorter range BEV drivers that averaged 4.9 sessions per week. This subset of the EV fleet is important and will likely grow as auto manufacturers supply more LRBEV models with larger batteries and longer driving ranges in the future.

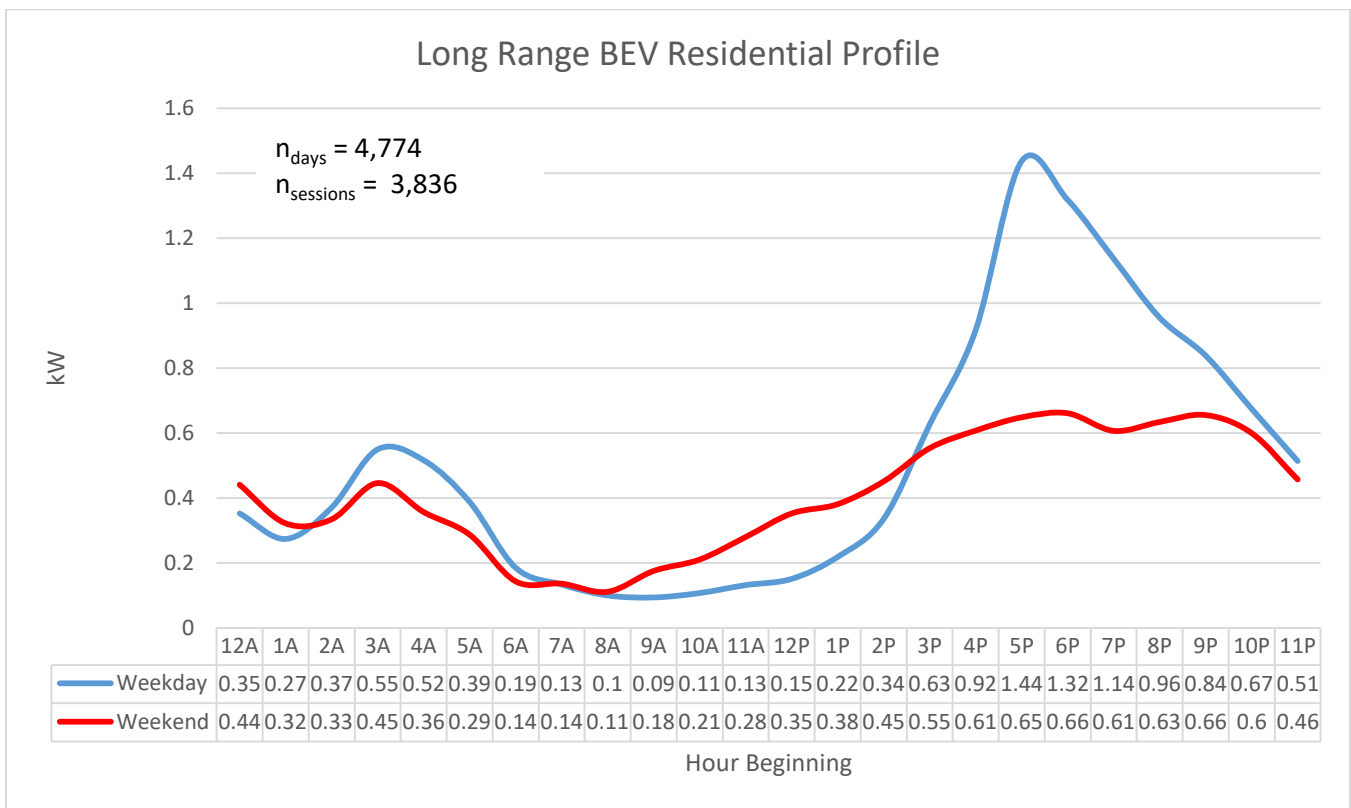

Figure 48. Residential long range BEV aggregate load profile

### Residential Charging Sessions by Commuter Type

Residential session data was analyzed by examining the charge times, connection time, and the energy consumed in each of the four driver categories. Of the 36,281 sessions logged by all four commuter types, BEV commuters logged 47% of the sessions, followed by PHEV commuters at 36%, PHEV non-commuter at 13%, and finally BEV non-commuters at 4%.

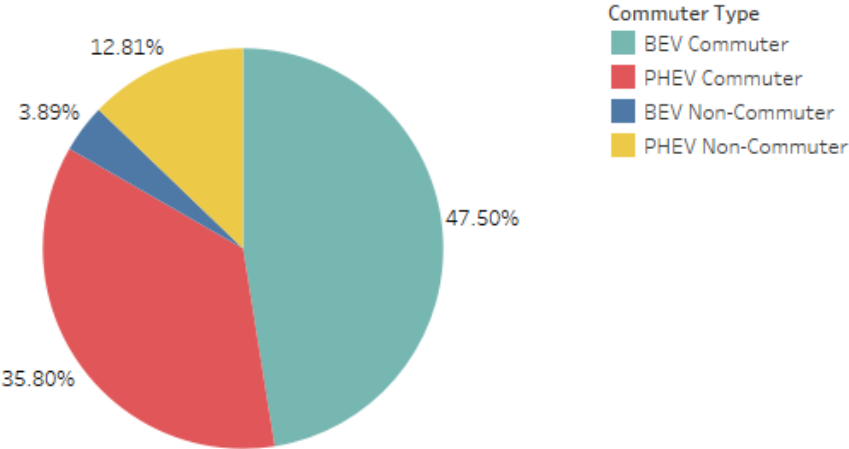

Figure 49. Residential Sessions by Commuter Type

Analysis of connection time revealed average times ranging from 9.4 hours to 11 hours with BEV commuters displaying the highest average connection time, and BEV non-commuters displaying the lowest average connection time.

### Residential Session EVSE Connection Duration by Commuter Type

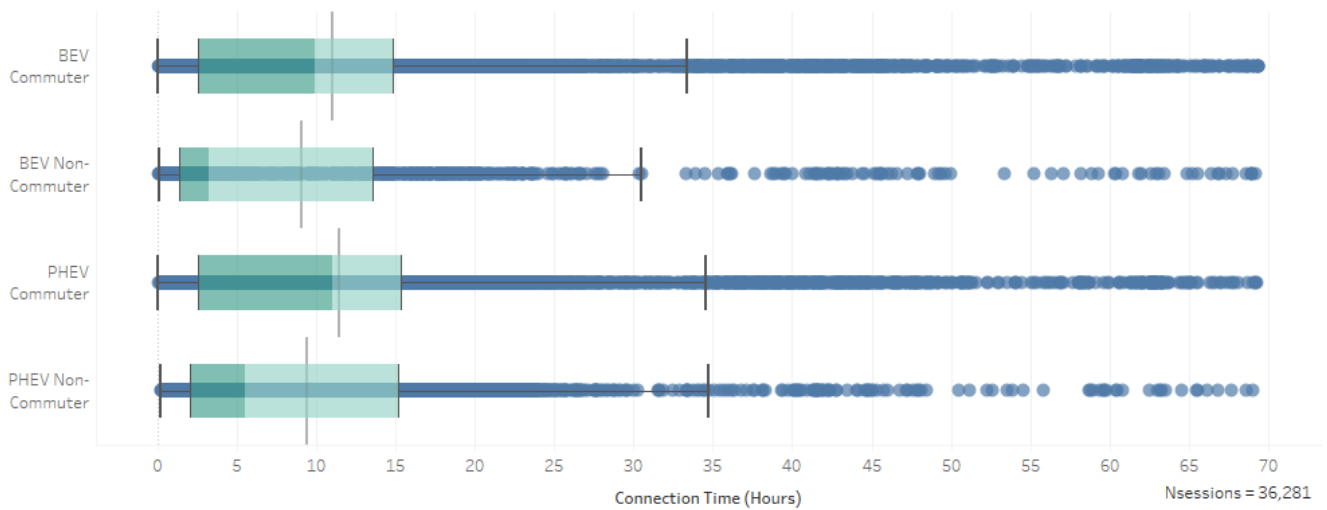

Figure 50. Residential EVSE Session Connection Duration by Commuter Type

The Average charge time ranged between 1.9 hours and 3 hours, with BEV Commuters displaying the longest average charge time and PHEV Non-Commuters the shortest.

### Residential Session Charge Duration by Driver Type

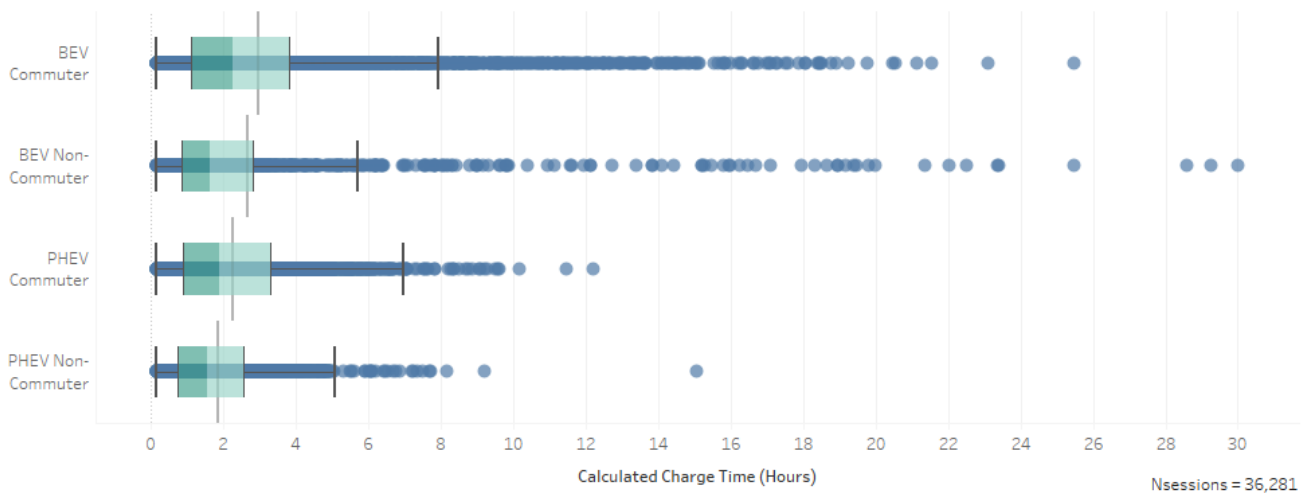

Figure 51. Residential EVSE Session Charge Duration by Driver Type

Considering session energy usage, on average BEV drivers consume more energy than PHEV drivers, and commuters consume more than non-commuters. Increased session energy usage can be attributed to greater average distances per trip logged by BEV and PHEV commuters. According to responses from quarterly surveys, BEV and PHEV commuters tend to drive on average 9 miles more than non-commuters per day.



### Residential Session Energy Usage by Driver Type

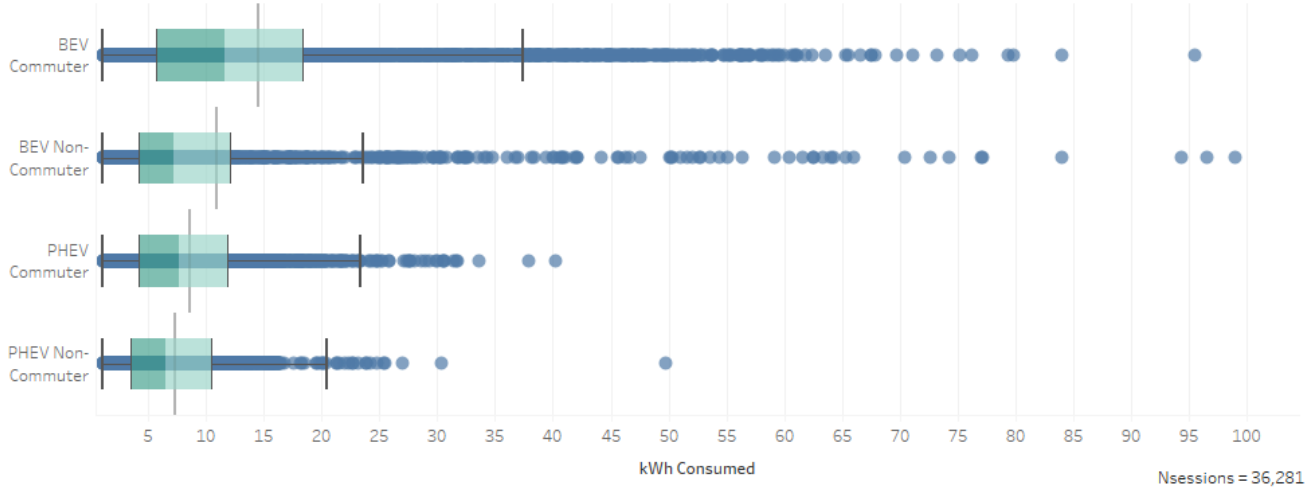

Figure 52. Residential EVSE Session Energy Provided by Driver Type

On average BEV non-commuters consume the most average energy at 14.6 kWh per charge session followed by the next highest average from BEV commuters at 11 kWh per session. PHEV commuters and non-commuters have lower average energy consumption rates of 8.5 kWh and 7.3 kWh respectively.

### Commercial AC Level 2 EVSE

Workplace charging is the largest of the four commercial components in Avista’s pilot project with 50 charging sites and a total of 123 L2 ports. Of these, 97% of ports require no fee for employees to charge their EVs while at work. When surveyed, multiple employers commented that they saw the charging station as a low cost benefit for employees. Averaged among all workplace stations in the Avista network, electricity consumption per workplace charging session was 8.7 kWh. This equates to \$0.96 per session in electricity billing to the employer. Each employee charged an average of 17 times per month at work, resulting in an electricity cost of under \$17 per month, per employee. This in turn provides a leveraged benefit for employees of over 3x transportation cost savings as well as a 79% reduction of CO<sub>2</sub> emissions compared to driving a vehicle powered by gasoline.<sup>37</sup>

Only two charging locations on the network require a fee for workplace charging, in both cases choosing a fee of \$0.13 per kWh intended to offset the cost of meter billing. Comparing these fee-based sites with two other similar free sites, all with active commuters, shows that free sites have significantly higher weekday usage at 2.4 kWh per port compared to 0.8 kWh per port for the fee-based sites. As a result of

<sup>37</sup>Assuming 26 mpg and \$3/gal for fuel costs, cost of driving 100 miles is \$11.55 for gasoline powered passenger vehicle. At \$.12 / kWh and 3.29 mi/kWh, driving 100 miles electric is \$3.65 (3.2x cost savings). 4.9 tons of CO<sub>2</sub> annually for gasoline vehicles vs 1.0 tons of CO<sub>2</sub> annually for EVs from Avista Corp generation mix, at 0.27 metric tons of CO<sub>2</sub> per MWh compared to 19.4 pounds of CO<sub>2</sub> per gallon of gasoline <https://www.epa.gov/energy/greenhouse-gases-equivalencies-calculator-calculations-and-references>

higher utilization, morning peaks are higher by more than three times (0.4 kW vs 0.1 kW) during the 9am hour for the free station group.

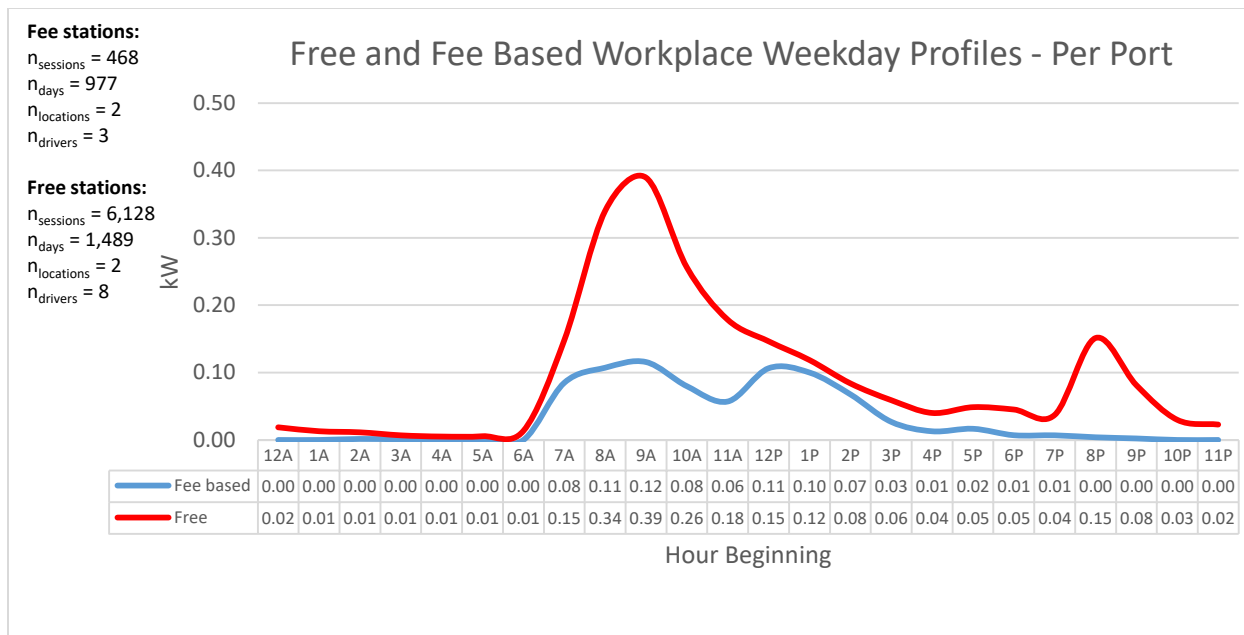

Figure 53. Comparison of fee-based and free workplace load profiles

As expected, the 178 sessions per year at each free port was much higher than the 21 sessions per year for each fee-based port. Even given the small sample size of fee-based ports, the implication is that fee-based charging significantly reduces the utilization of workplace EVSE.

Workplace charging is a major catalyst for EV adoption and was the most popular of the commercial programs offered by the Company. Avista workplace EVSEs logged 8,675 workplace charge sessions. Of the 8,675 charge sessions occurring at workplace chargers, 5,667 sessions, or 65% are logged by “visitors” – those not participating in the program with a networked residential EVSE installed at their home. Some of these visitors have non-networked EVSE at home and others do not have any EVSE at home, to an unknown degree.

## Workplace Charging for Avista Residential Pilot Program Participant Vs. Non-Participant

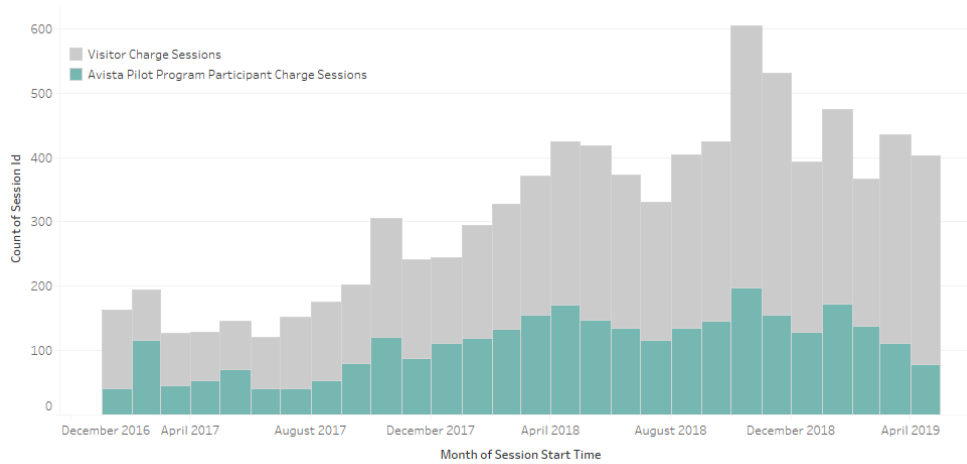

Figure 54. Public EVSE Session Usage

Data from 12 drivers had both home and workplace networked EVSE that were consistently online and transmitting data from both locations. The 12 drivers within this sample group logged 2,571 charging sessions and used 23,253 kWh at workplace chargers over 5,596 operating days. These participants also logged 4,013 charge sessions consuming 30,626 kWh of energy over 6,169 operating days of residential charging sessions. When aggregated into a daily load profile, workplace charging peaks at 0.64 kW per vehicle and residential charging peaks at 0.54 kW per vehicle. See Appendix E for charge session data distributions for connection time, charge time, and energy usage of this subset group. Drivers with networked EVSE at home who did not utilize workplace EVSE logged 26,009 days of charge sessions at home, resulting in 195,311 kWh of energy consumed.

To understand how workplace charging can impact the grid, we consider energy consumption from commuters with and without workplace charging availability. Commuters without workplace charging are limited to their home and a small number of public EVSE. Data shows most charging for this group occurs between 4pm and 8pm, creating a daily peak of 0.8 kW per EV between 5pm and 6pm.

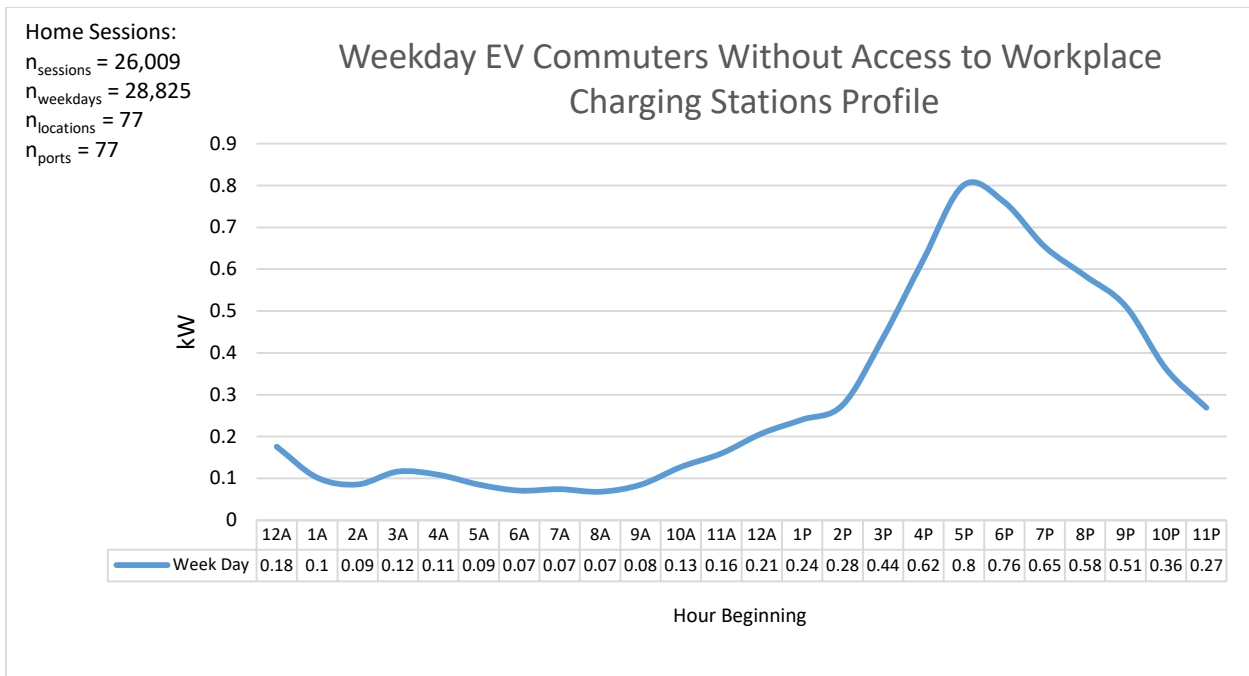

Figure 55. Residential Only Commuters Weekday Charge Profile

Commuters with workplace charging create two peaks during an average workday. The highest peak of 0.7 kW occurs at workplace chargers at 8 am, with a second smaller peak of 0.46 kW occurring at home, at 5 pm.

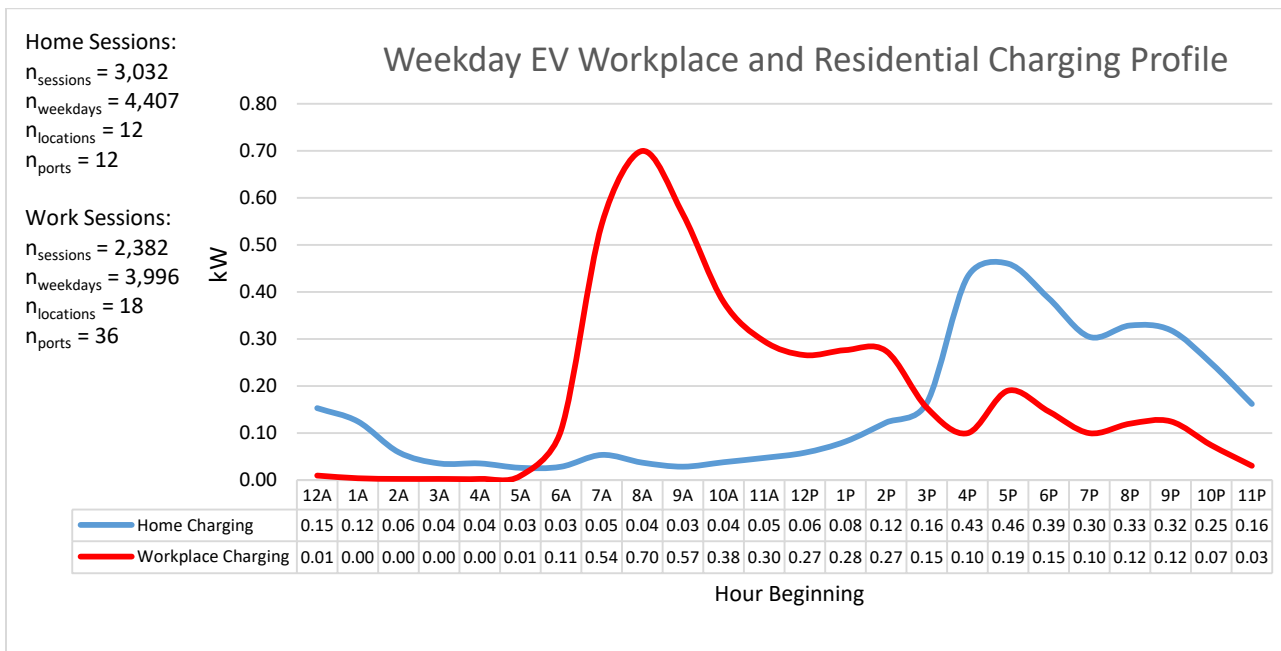

Figure 56. Workplace Charger Sample Group: Workplace and Residential Charging Profile

As a result, the availability and use of workplace chargers reduces the average residential peak demand by 0.15 kW in the evening, but also increases the morning peak by 0.63 kW.

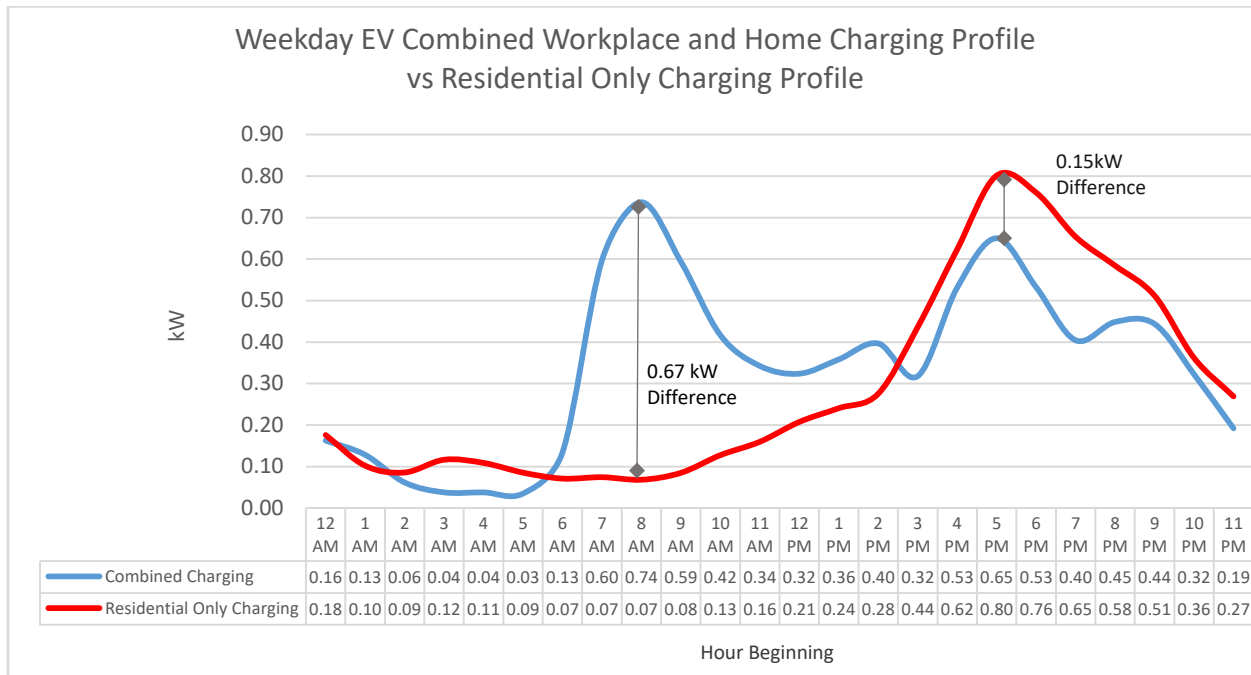

Figure 57: Workplace charging effect on residential charging

From spring through summer and fall, Avista’s system peaks between the hours of 3pm to 7pm, while in the winter it peaks both in the morning between 7am and 10am, and in the evening between 5pm and 8pm. When compared to seasonal peak system demand it can be argued that workplace charging provides an automatic system benefit year-round in the evening, by reducing evening EV peak demand by 19%, even in the absence of networked EVSE and load management, TOU rates, or other methods to influence EV load.

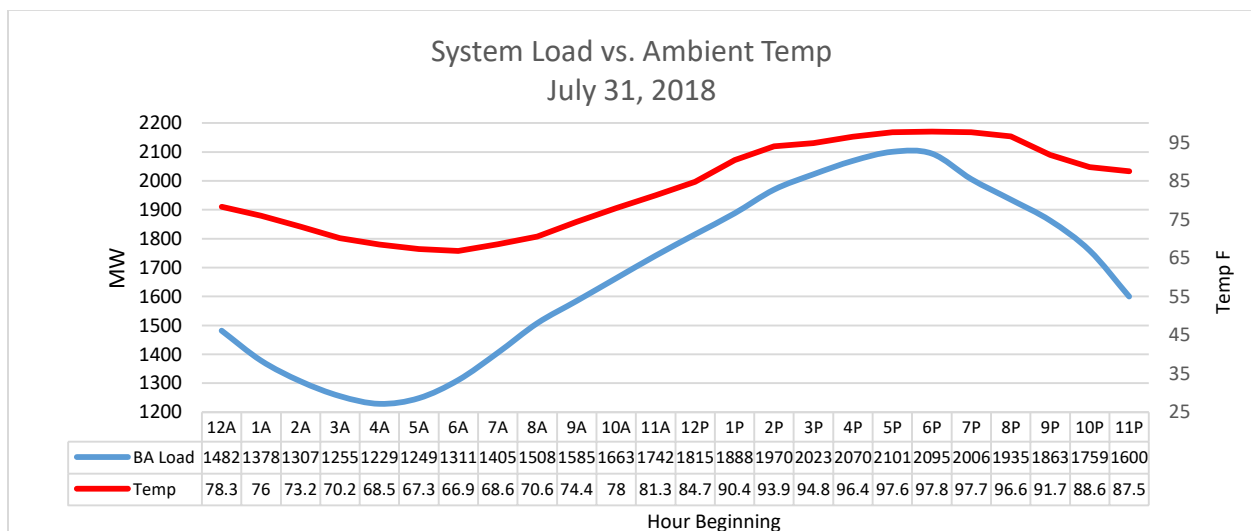

Figure 58. System Load Vs Ambient Temperature, July 31, 2018

However, the use of workplace chargers also creates an average demand of 0.74 kW per EV at 8am, coinciding with the winter morning peak and 0.67 kW higher than the weekday residential load profile alone from customers without workplace charging. Workplace charging peaks could be reduced through load management and the use of EVSE with lower power output, e.g. using 3.3kW output instead of the 6.6kW used in the pilot would cut the peak load in half. Even without further peak reductions from the load profiles shown, modeling indicates that over the long term workplace charging in addition to residential charging provides net grid benefits greater than residential alone. This benefit increases over time with the expected increase in solar generation as WA moves toward 100% clean energy, as EVs can utilize additional solar power during the day if charging at workplace locations.

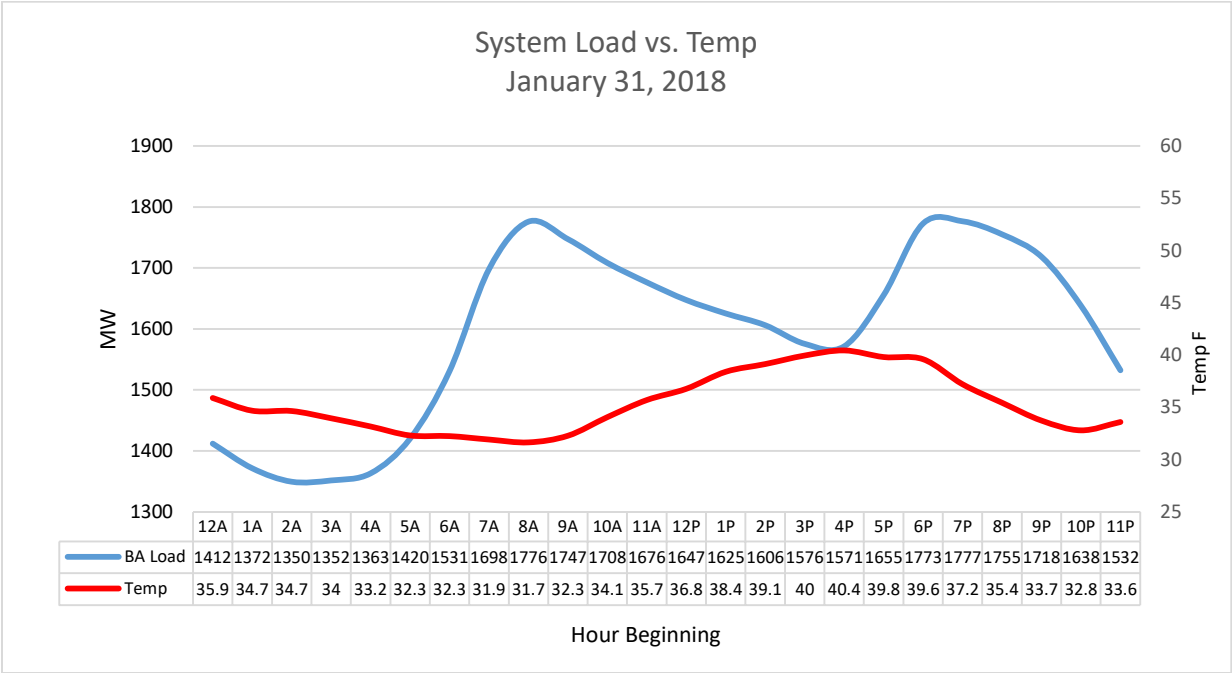

Figure 59. System Load vs. Ambient Temperature January 31, 2018

### Fleet Analysis

Regionally, commercial fleet EVs are a relatively small component of the light-duty market. Participants utilizing a total of 14 fleet EVs included government, social services and healthcare organizations. Growth potential is apparent, as 74% of commercial applicants (28 of 38), indicated they would be interested in EVs for future fleet use.

Within the fleet program, five of the ten locations have networked EVSEs, providing insights on charging session characteristics, load profiles and cost savings. Daily energy demand for fleet EVs ranged from 1.5 kWh to 11.3 kWh per EV, corresponding to high variability in daily driving. Load profiles were similar to each other with demand peaking between 4pm – 8pm. The highest average daily demand occurred during the 6pm hour at 1.4 kW. Note that this is the average daily demand per EV at the location, as opposed to usage on a per EVSE port basis.

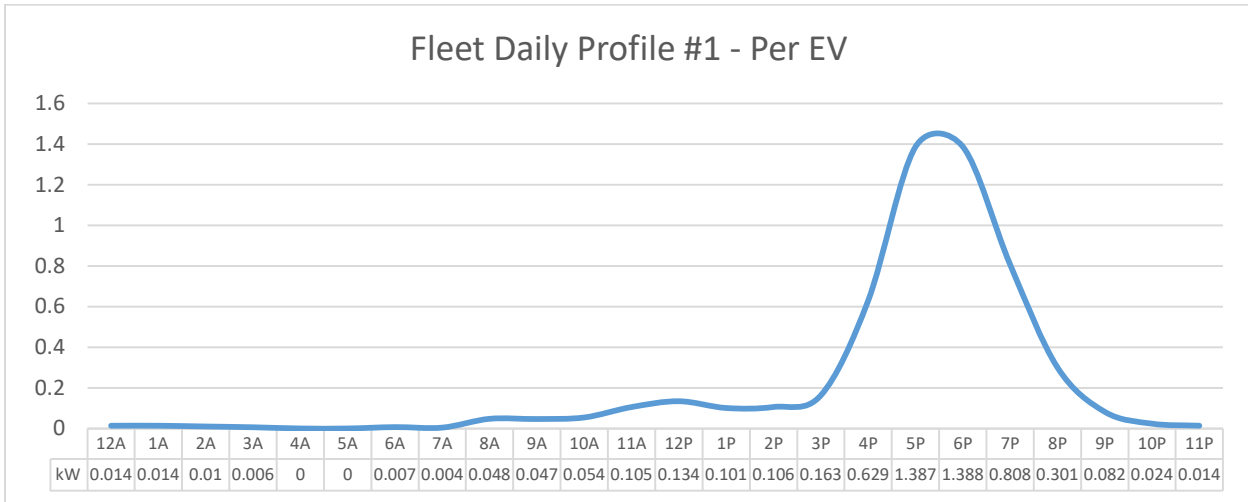

Figure 60. Daily fleet load profile at a single location

Based on load profiles, fleet EVs resulted in an avoided 68 to 524 gallons of fuel per EV, with fuel cost savings and reduced emissions. At \$3.00 per gallon of gas and \$0.115 per kWh, fleet vehicles driving approximately 3,250 to 13,600 miles annually saw fuel savings per EV of between \$178 and \$1,378. At the highest usage location, a fleet of four EVs saved over \$5,512 per year in fuel costs, avoiding 2,472 gallons of gasoline consumption and 24 tons of CO<sub>2</sub> emissions.<sup>38</sup>

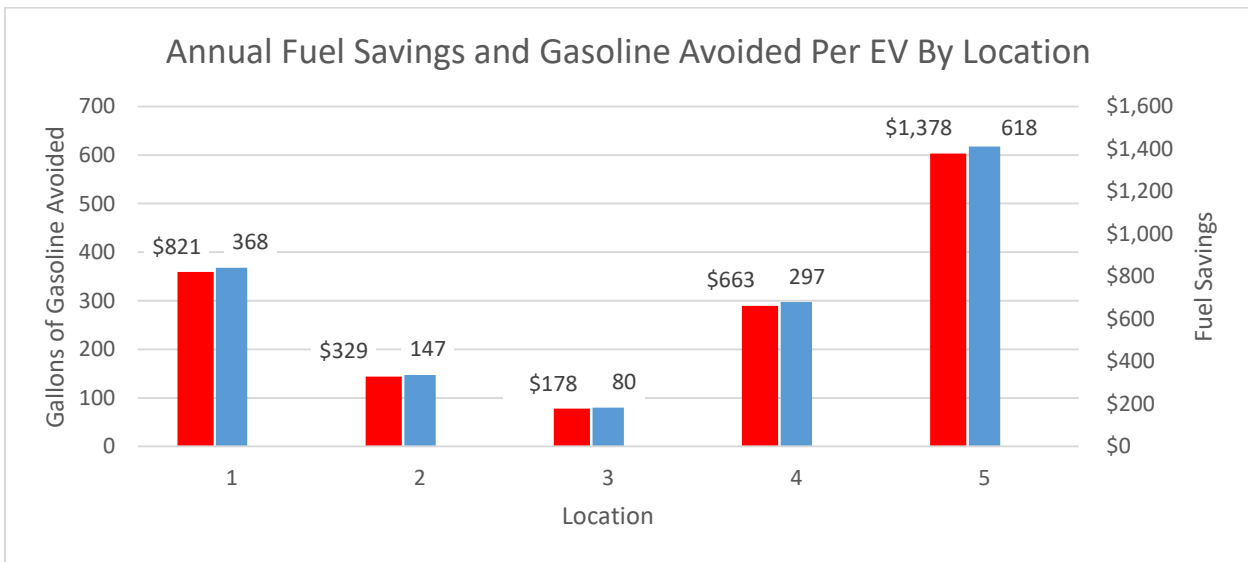

Figure 61. Fleet fuel savings and gasoline avoided per EV, at various locations

<sup>38</sup>At 19.4 pounds of CO<sub>2</sub> per gas gallon \* 2,472 gas gallons = 47,957 pounds of CO<sub>2</sub> <https://www.epa.gov/energy/greenhouse-gases-equivalencies-calculator-calculations-and-references>

## Public Analysis

Thus far, data shows low utilization of public EVSE in terms of both charging frequency and dispensed energy. Nevertheless, it is clear that public EVSE have great value and importance in the minds of EV drivers. For example, driver surveys showed 78% dissatisfaction with the availability of public charging and suggested more public installations are needed near shopping centers and along highways in outlying areas. Avista installed 24 public ports at 14 stations in rural areas near regional highways, and 16 ports in six higher traffic retail locations in Spokane. Public EVSE outside the Avista network has grown very slowly, with only three locations outside Spokane. Utilization and loads will vary substantially by location and can be expected to grow over time with higher EV adoption, as illustrated by the various load profiles in Appendix D. The high traffic downtown location shown below provides an example of this growth, more than doubling in one year.

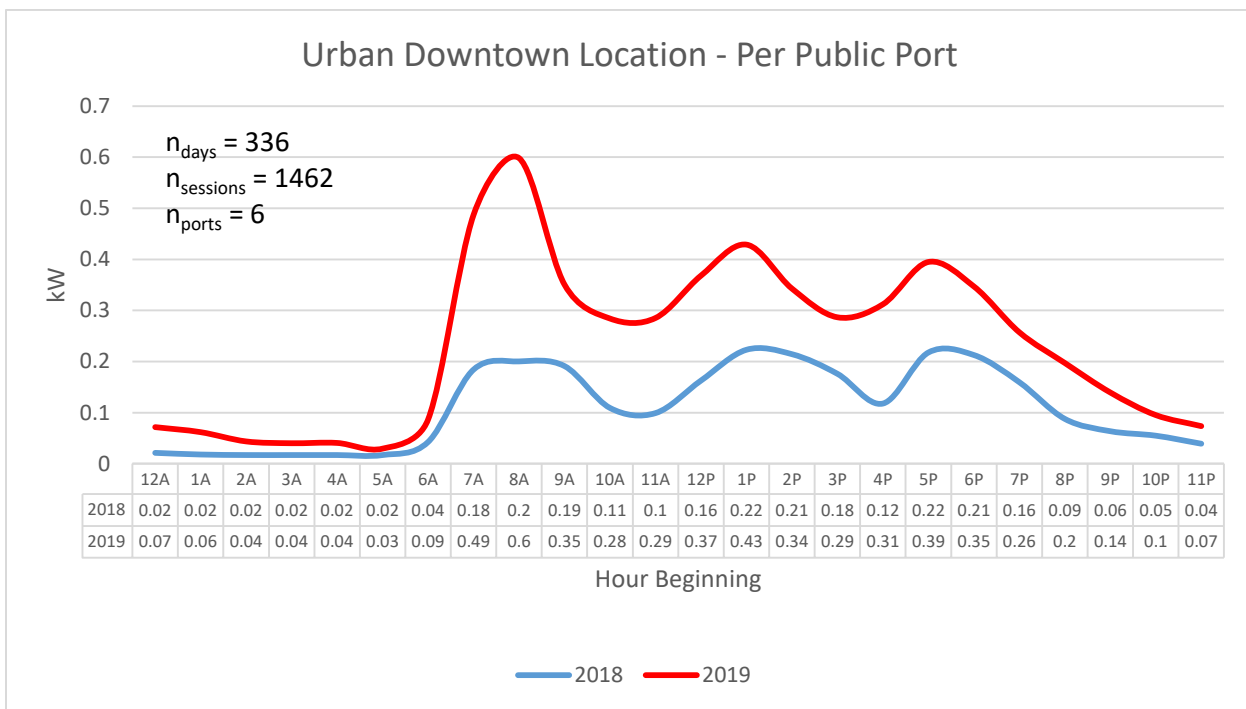

Figure 62. Load growth at downtown public location

At this public location, increased morning use is actually correlated with “workplace” charging for two employees that park during the day, in addition to an over 50% increase in the number of discrete drivers and frequency of “public” charging events lasting less than three hours.



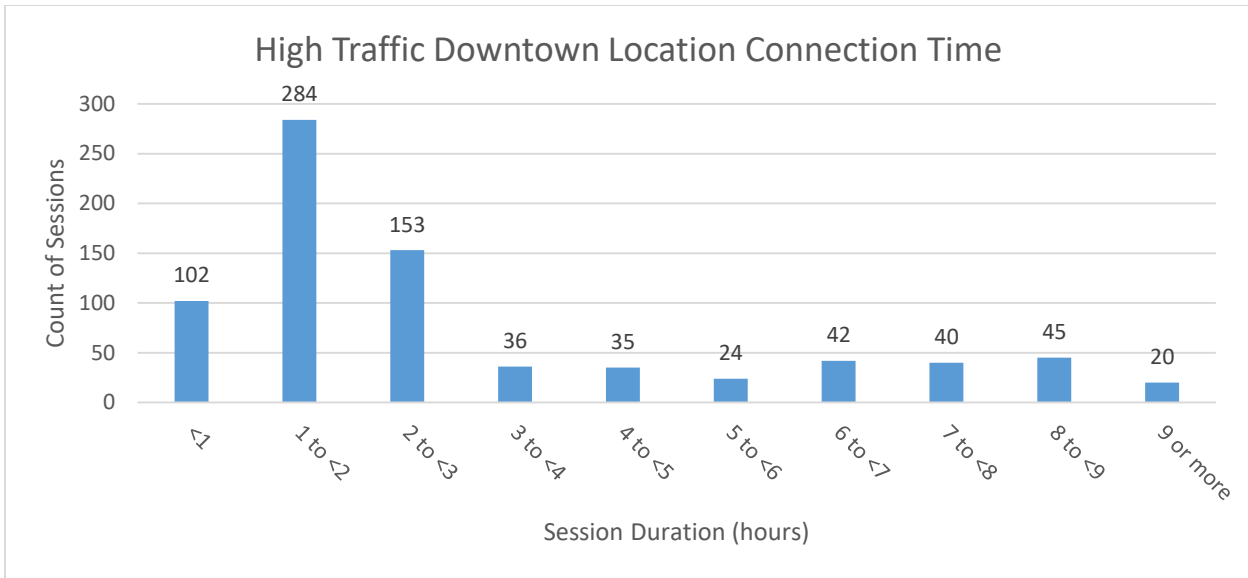

Figure 63. Public station dwell time at downtown location

At public locations, there has been a steady increase of charge sessions completed by individuals not participating in the EVSE Pilot Program. Of the 53,356 sessions recorded during the pilot program, 14,218 or 26% of all sessions were logged by visitors.

Public Charging Station Session Usage by Visitors by Month

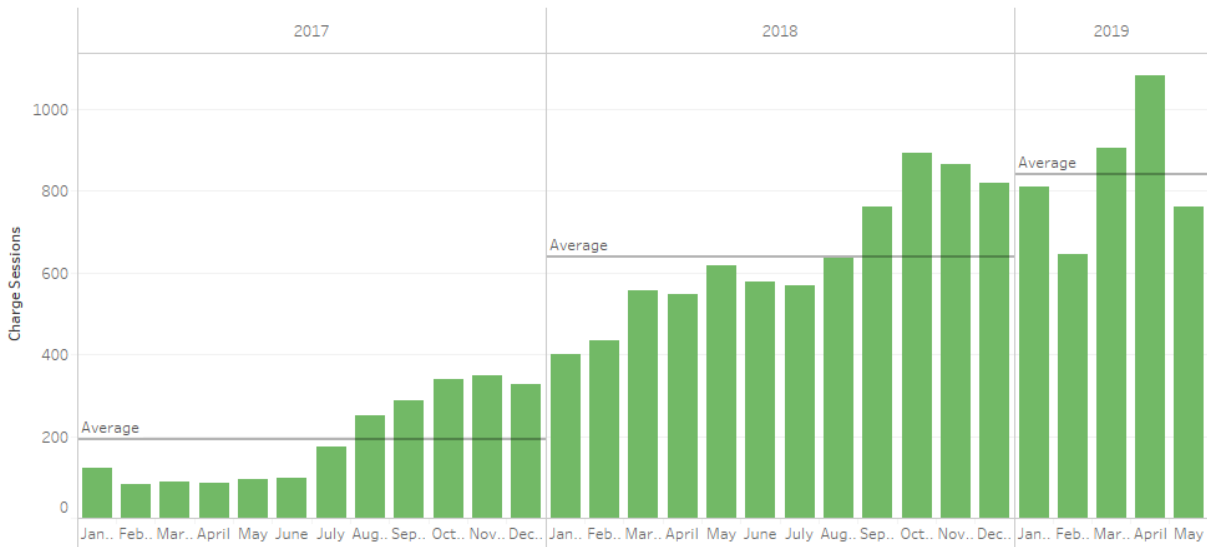

Figure 64. Public Charging Station Usage by Visitors by Month

Due to relatively low impact of station operating expenses resulting from low electricity costs and regional EV adoption, site hosts have almost entirely opted to free use of public charging, which may be expected to change in the future as utilization increases.

Looking more closely at three public stations in the Spokane area located near businesses with EV commuters, just four EV commuters out of a total of 186 visitors to these locations caused morning peak

demand to increase 375% to 0.15 kW, compared to 0.04 kW without the commuters. Depending on site host objectives, a networked EVSE may be used to require an energy fee, time-based fees and limit penalties, and permission controls.

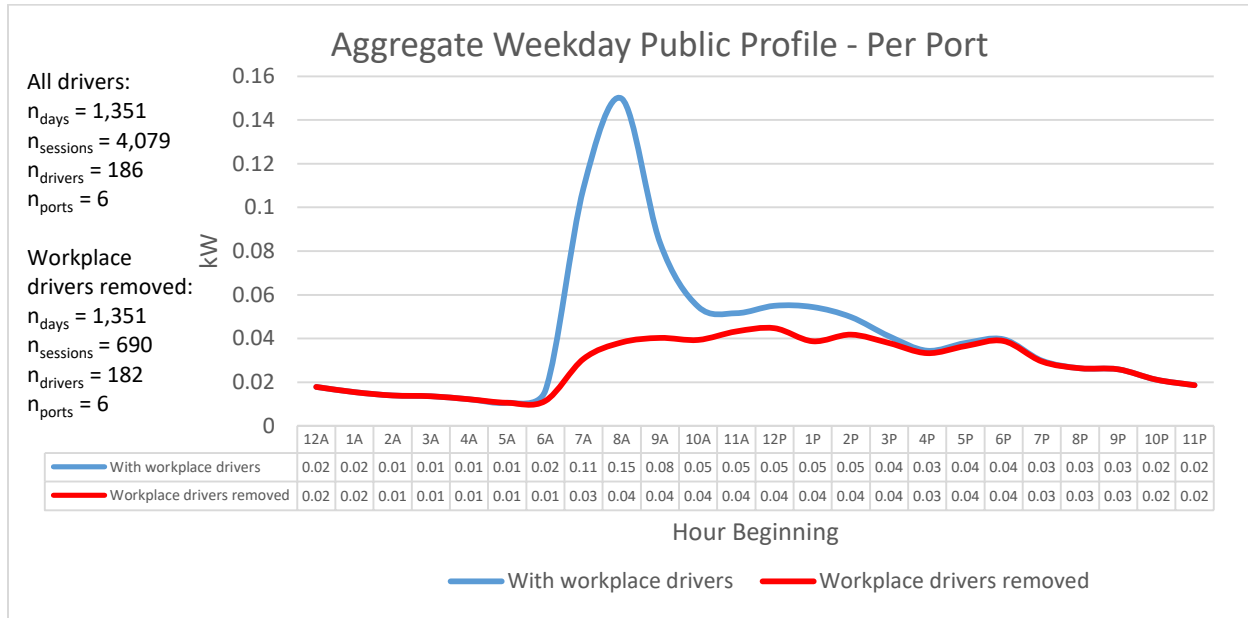

Figure 65. Workplace driver charging impact at public station

## DC Fast Charging

DCFC utilization varies significantly from site to site. Kendall Yards remains the most utilized, due to its location in the urban core of Spokane and along main East/West and North/South travel corridors. Other sites such as Rosalia are less utilized due to their distance from population centers, however they are of great value in enabling longer distance EV driving due to their strategic locations along inter-city travel corridors. The table below shows monthly DCFC charging sessions at each site, which grew by 19% in the last year. Increasing utilization is expected in the future, commensurate with greater EV adoption in the area. Note that downtime issues resulted in lower utilization in early 2019 for the West Plains, Pullman and Wandermere sites.

Table 14: Monthly DCFC sessions

Month	Rosalia	Kendall Yards	Pullman	Liberty Lake	Wander-mere	West Plains	U-District / GU
Commissioned	1/18/2017	9/14/2017	12/15/2017	1/12/2018	9/14/2018	9/18/2018	7/12/2019
Jan-Dec 2017	64	38	2	-	-	-	-
Jan-Dec 2018	55	179	86	99	61	14	-
Jan-2019	4	23	9	7	23	0	-
Feb	10	12	3	12	6	1	-
March	4	34	1	6	2	5	-
April	8	29	7	2	9	2	-
May	3	25	3	3	22	21	-
June	9	32	9	15	8	11	-
July	2	24	10	9	3	10	-
<b>Total</b>	157	396	130	153	134	64	-

Analysis of DCFC charging sessions using one-minute interval data shows a rapid ramp-up period to the maximum power level where it plateaus, between 20kW and 50 kW, followed by a longer ramp-down period that reduces the power level as the battery nears full capacity. DCFC connection and charging times are often the same, as the driver unplugs the vehicle when satisfied with the charge level rather than wait for a much longer period through the ramp-down phase to 100% state-of-charge. These observations are illustrated below, for one week of charging sessions at the Kendall Yards DCFC site.

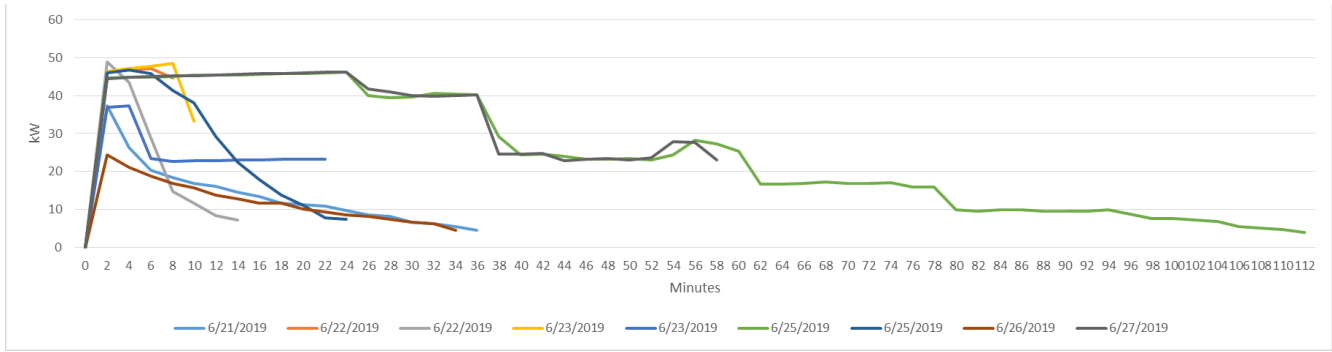

Figure 66: DCFC charging session load profiles

DCFC charging power may be limited by the EV and its battery state-of-charge, such that the delivered power level is often much less than the DCFC rating of 50kW. Accordingly, DCFC user fees should be applied on a per kWh basis, at least until the battery is well into its ramp-down period. Otherwise drivers that unavoidably draw lower power levels may pay unacceptably high rates, if charged on a per minute basis. With the extension of the pilot program in early 2018, DCFC fees were changed from \$0.30/minute to \$0.35/kWh, which is roughly equivalent to the cost of gasoline in terms of fuel cost per mile of driving range. This change received positive feedback from EV drivers and correlated with higher DCFC utilization thereafter. Beyond the ramp down period however, fees applied on a time basis and/or penalties for time beyond certain thresholds – at 60 minutes for example – may be necessary to free up the DCFC and avoid unnecessary wait times for other drivers.

Average energy consumption of 13.6 kWh per DCFC charging session was higher than all ACL2 types. The majority of charging times were between 15 and 45 minutes, averaging just over 30 minutes. Box plots of the DCFC session data show a fair amount of variability between the different DCFC sites, in terms of connection time and energy consumption.

average kWh per session	13.6
average minutes per session	30.2
average revenue per session	\$5.05

Table 15: DCFC session statistics, Jan2017 - May2019

### DCFC Session Connection Time Duration

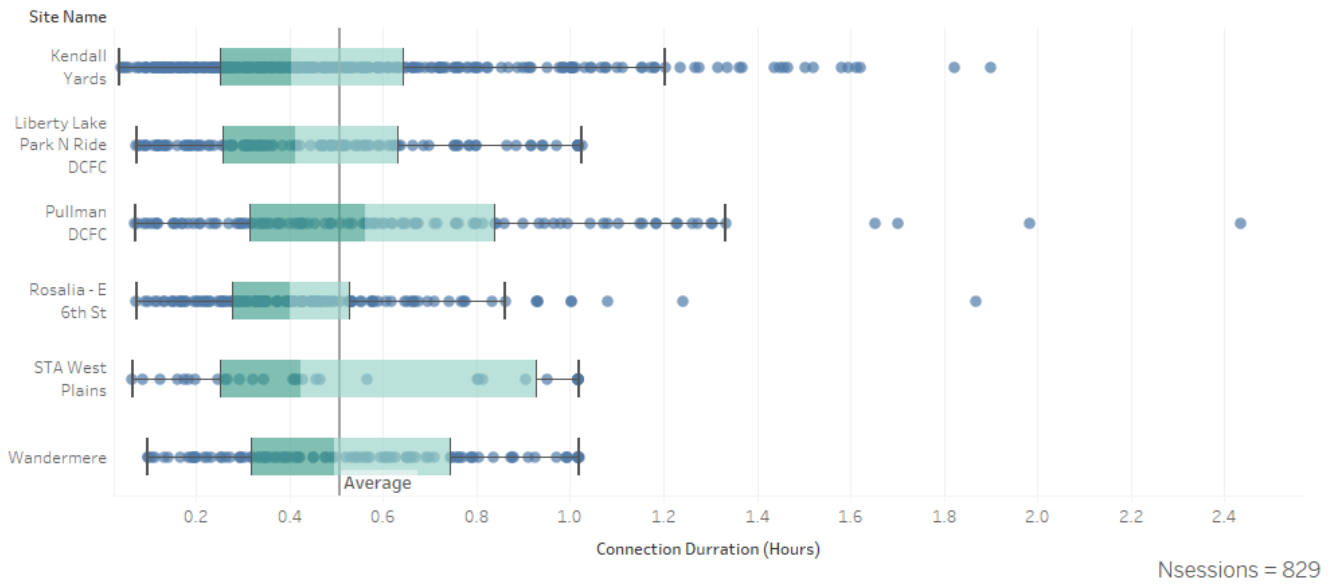

### Energy Use (kWh) for DCFC Charge Session

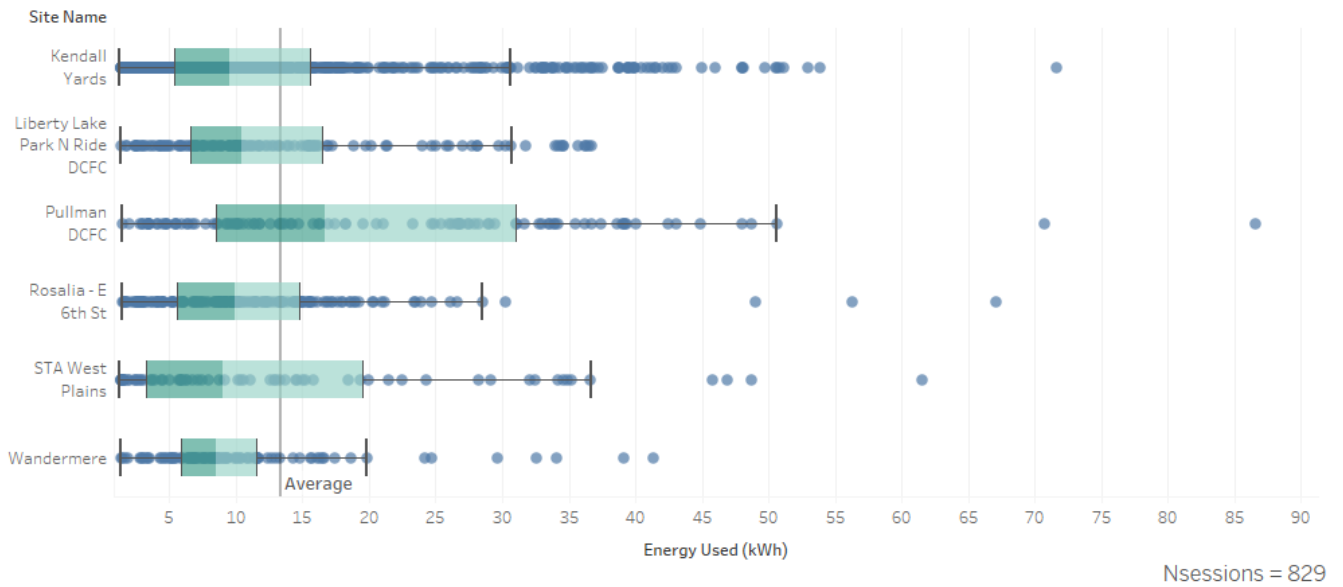

By intent, three DCFC were installed with credit card readers, and four were installed without them to test customer use and preferences. To date, no customer complaints or suggestions have been received

regarding the lack of credit cards on the four without them. At these stations, charging is initiated by either the EVSP smartphone app or an RFID card loaded with the customer’s credit card information. For the three DCFC with credit card readers, 57% of charging sessions were initiated by the smartphone app or RFID, and 43% by credit card swipe. Note that unique customer ID cannot be captured in the network dataset when initiating by credit card, limiting the ability to understand individual charging patterns across the network.

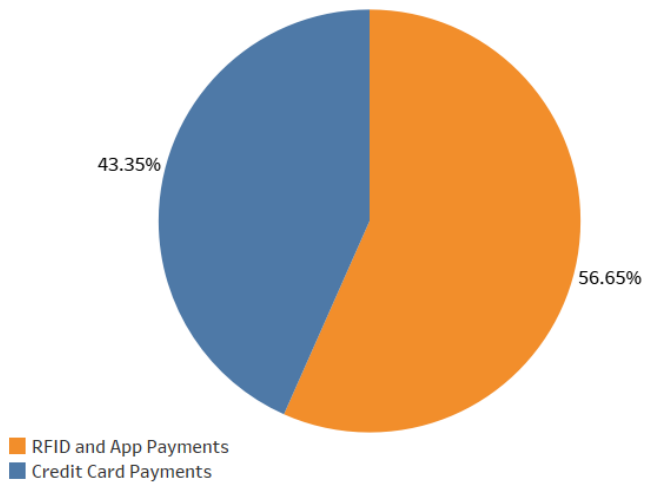

Figure 67: Credit card vs. RFID and Smartphone app payments at DCFC

## Telematics Data and Analysis

To better understand driver behaviors and validate Greenlots' EVSE data, several customers participating in Avista's EVSE program agreed to installation of Fleetcarma telematics devices (C2 devices) in their EVs. The telematics device captures charging data, battery state of charge, battery efficiency, trip distance and speed, as well as energy losses from rectification and auxiliary loads.

Telematics devices were installed on 9 different vehicles. The use of these vehicles ranged from regular commuters, non-commuters, and fleet vehicles. Total trip break downs for these vehicles are as follows:

*Table 16: Number of Trips per Vehicle Type and Make/Model*

	Chevy Bolt	Nissan Leaf	Tesla Model S	Mitsubishi Outlander	Hyundai Sonata	Chevy Volt	Total Trips by Vehicle Type
PHEV Commuter	0	0	0		0	1259	1259
PHEV Non-Commuter	0	0	0	0	2335	0	2335
BEV Commuter	2461	834	4963	0	0	0	8258
BEV Non-Commuter	0	0	0	0	0	0	0
Fleet Vehicles	1358	0	0	1234	0	0	2592
Total Trips per Vehicle	3819	834	4963	1234	2335	1259	14444

Individuals with telematics devices in their vehicles also participated in the EVSE pilot program, providing a set of overlapping session data. 610 sessions were compared between the Greenlots and FleetCarma data sources, showing an average difference in power consumption of 1.6%, and the largest percent difference at 4.2%. A more thorough explanation of the telematics validation is available in Appendix B.

In total, FleetCarma telematics devices recorded 6,437 charge sessions, capturing data on charge duration, energy provided, state of charge at the beginning and end of each session, losses from rectifiers and auxiliary loads, and vehicle location in latitude and longitude coordinates.

### Telematics Data: Charge Duration

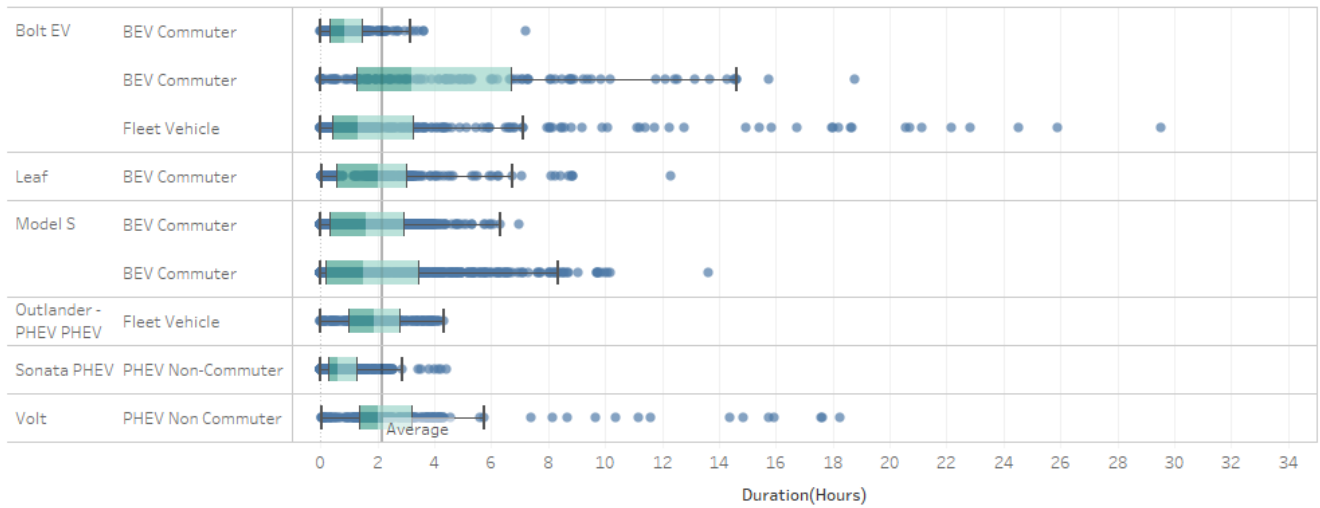

Figure 68. Telematics Data: EVSE Charge Duration

Data from the C2 telematics data shows that the average charge duration is 2.2 hours.

### Telematics Data: State of Charge at Beginning of Charge Session

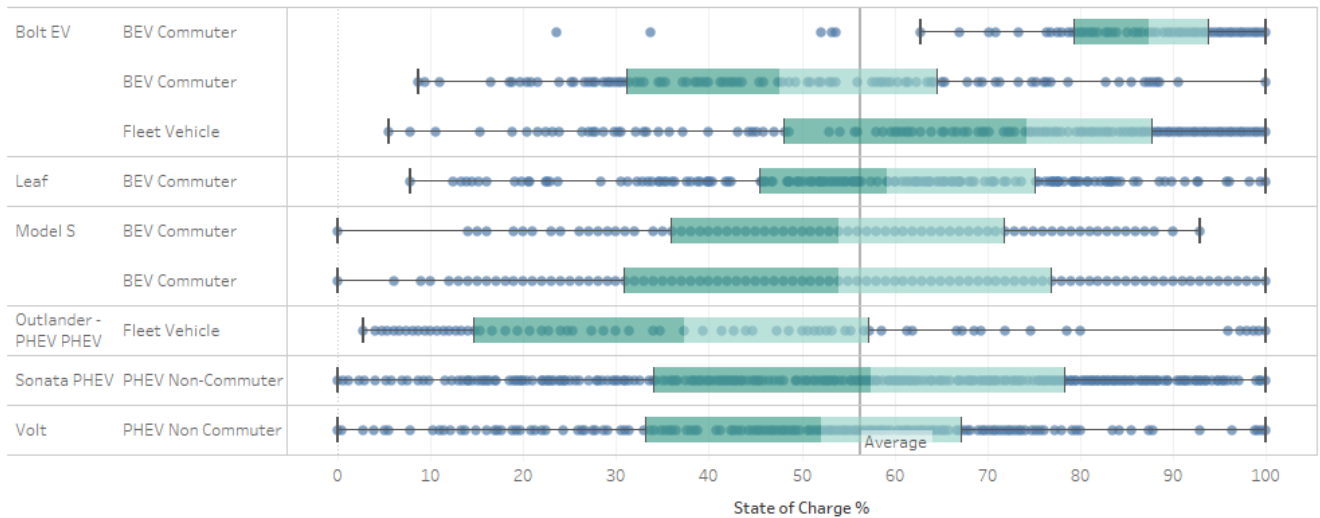

Figure 69. Telematics Data: State of Charge at the Beginning of Charge Session

The state of charge measures the percent of remaining battery power from a 100% full state. The above graph illustrates the different levels of remaining charge when a charging session was initiated. On average, batteries were at 56% state of charge when a session started.



### Telematics Data: Energy Provided per Charge Session

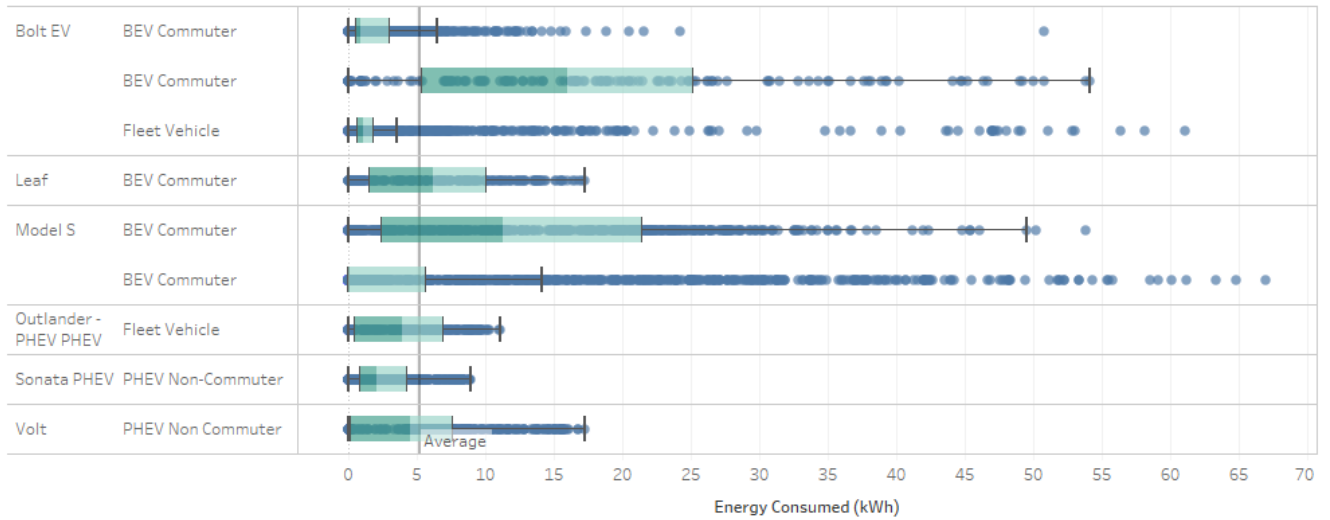

Figure 70. Telematics Data: Energy Provided per Charge Session

The average energy provided per charge session was 9.8 kWh.

### Telematics Data: Rectifier Loss per Charge Session

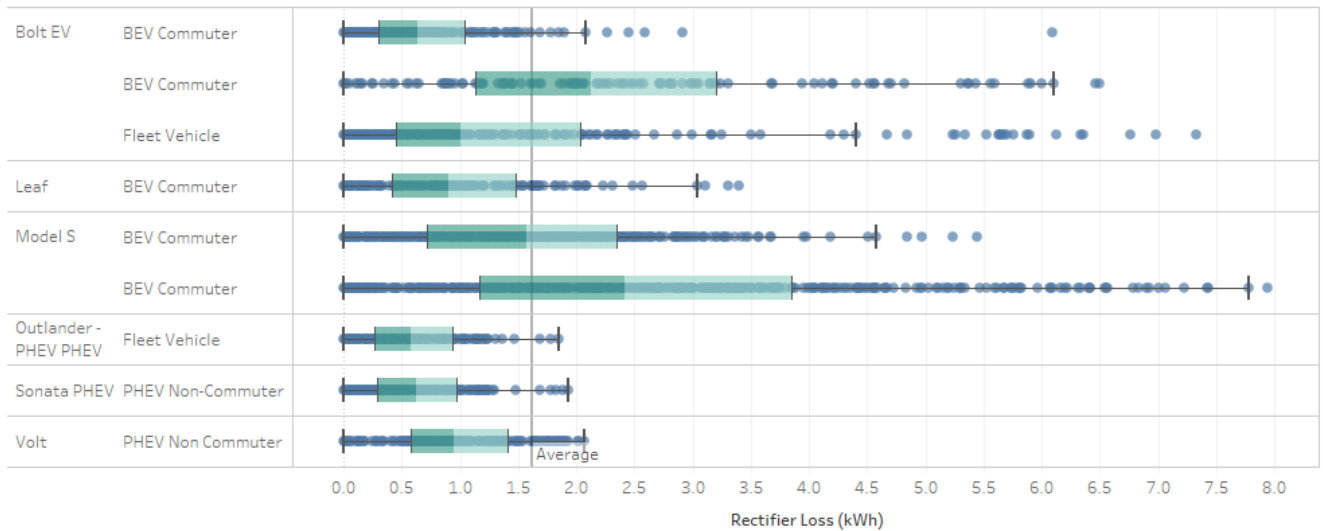

Figure 71. Telematics Data: Rectifier Loss per Charge Session

Finally, telematics provided the energy lost during each charging session. Charge loss is the difference between energy entering the EV charging port and the energy provided to the battery after current rectification, as well as losses resulting from other sources such as accessory electronics, cabin

environment controls, and/or battery conditioning when available. According to the C2 data, on average each charging session lost 1.7 kWh, or 13.7% of total energy delivered by the EVSE to rectification and other auxiliary loads.

The C2 devices also recorded location of charging sessions with latitude and longitude coordinates. Location data allowed for the identification of charge sessions that did not occur within the Avista network, which made up 9% of total sessions.

Telematics data allowed for an analysis of battery efficiency in BEVs, with data from 9,406 trips collected. Trip lengths ranged from less than one mile to approximately 196 miles. As shown in the chart below, at shorter trip distances there is a wide range of battery efficiency. This could be due to a combination of regenerative braking, more variability in motor speed, greater idle times, and/or auxiliary components operating at non-steady states. As trip length increases and vehicle functions become less variable, battery efficiency converges between 3 and 4 miles per kWh. When filtering trip distances over 25 miles (264 data points), the average efficiency is 3.35 miles per kWh with a standard deviation of 0.6, which includes the rectifier and EVSE losses. This is an important parameter to use in modeling average EV energy consumption and resulting grid impacts, given assumptions of EVs on the system and annual driving distance per EV.

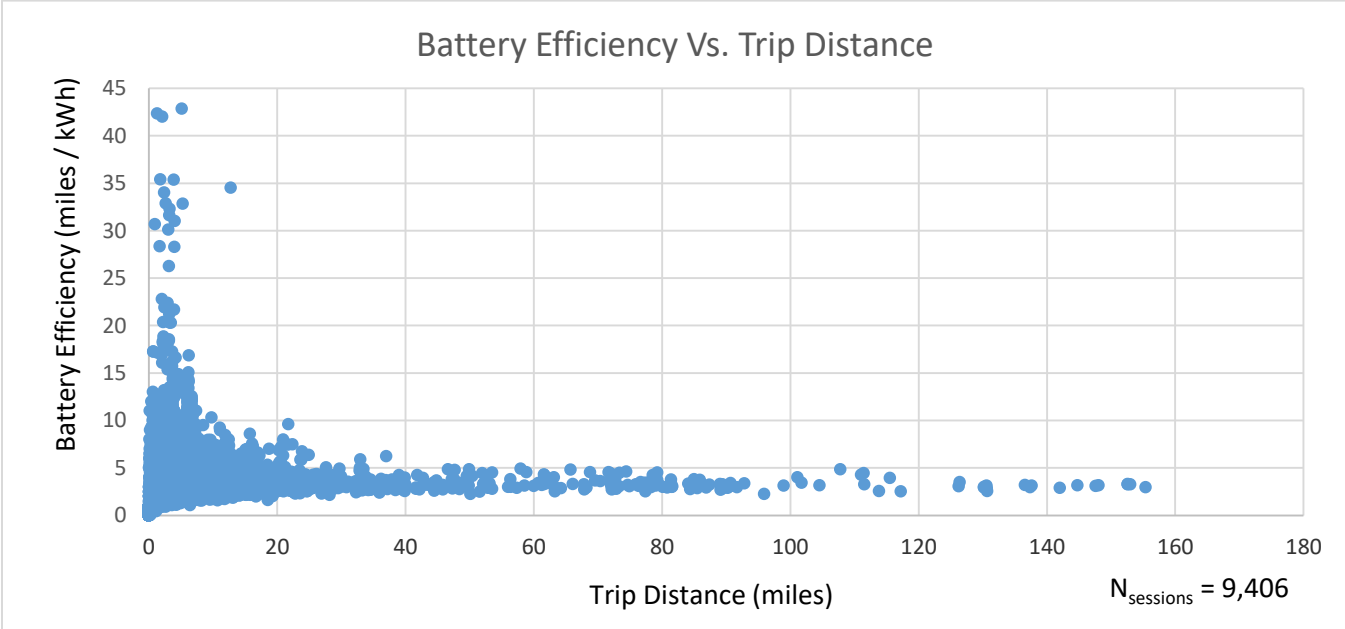

Figure 72. BEV Battery Efficiency Vs Trip Distance

Ambient temperature also has a major effect on battery efficiency. The table below shows battery efficiency versus temperature roughly corresponding with winter, spring/fall, and summer temperatures. Average trip efficiency increases from 2.6 miles per kWh during winter temperatures to 3.7 miles per kWh during summer temperatures.

Table 17. BEV Battery Efficiency VS. Ambient Temperature

Outdoor Temperature		
Temperature Range (°F)	Average Efficiency (miles / kWh)	Trip Count
less than 45	2.6	3,705
Between 45 and 65	3.5	2,921
greater than 65	3.7	2,783

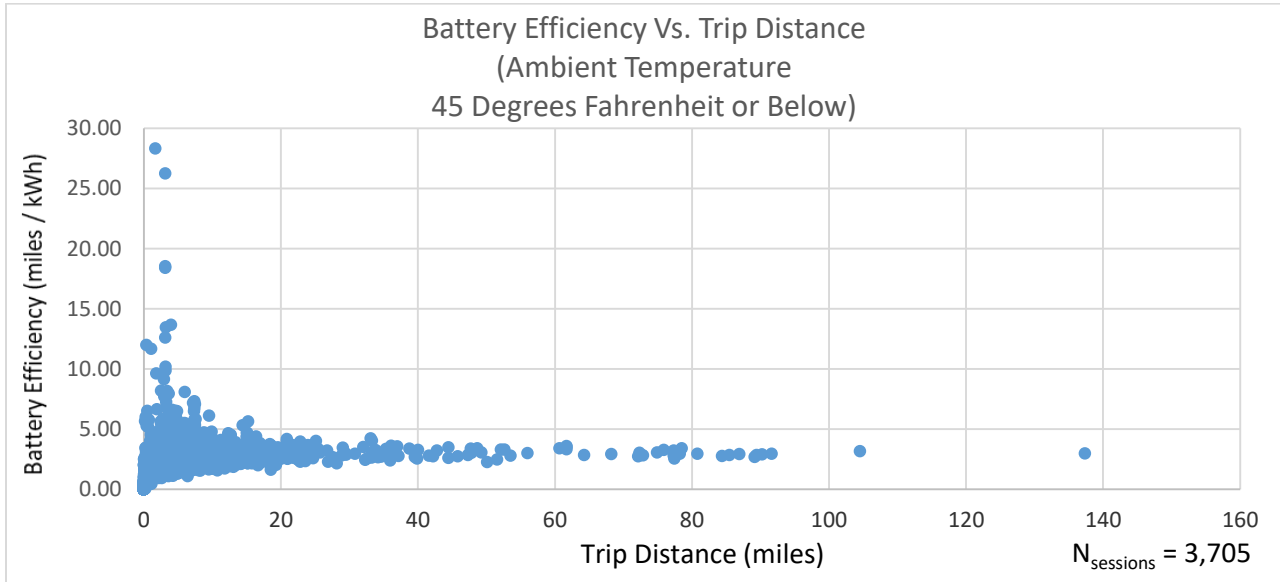

Figure 73. BEV Battery Efficiency Vs Trip Distance (Ambient Temperature 45 Degrees or Below)

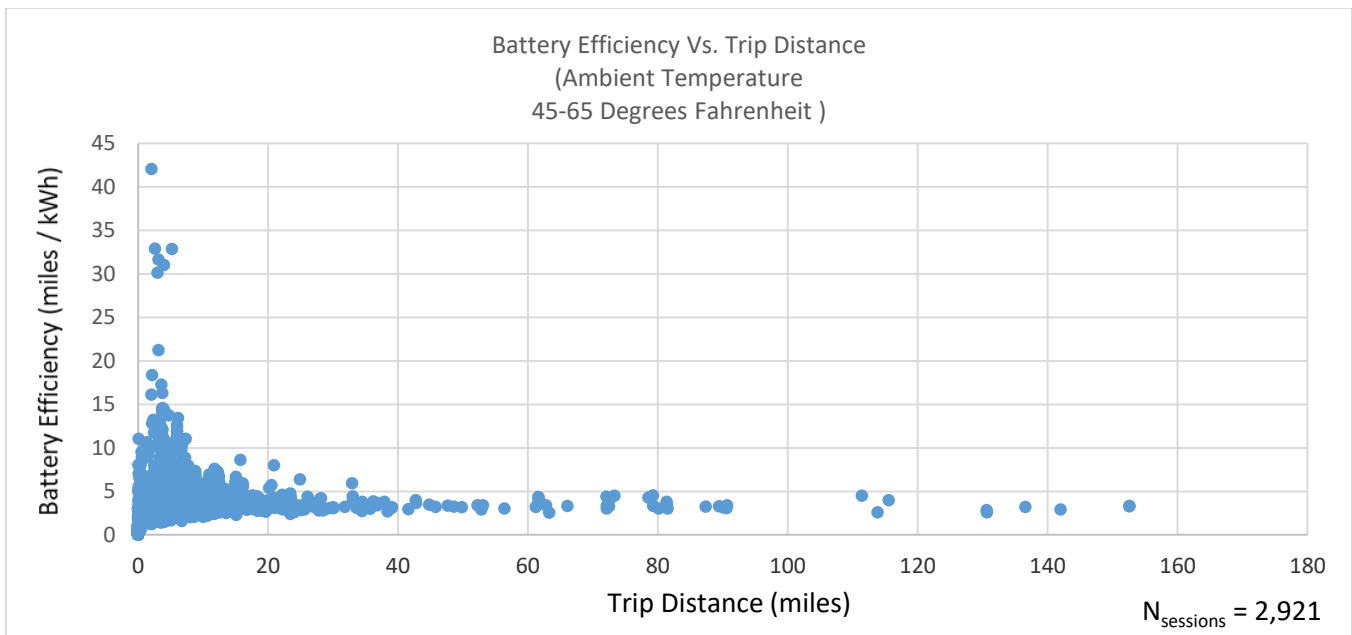

Figure 74. BEV Battery Efficiency Vs. Trip Distance (Ambient Temperature 45-65 Degrees)

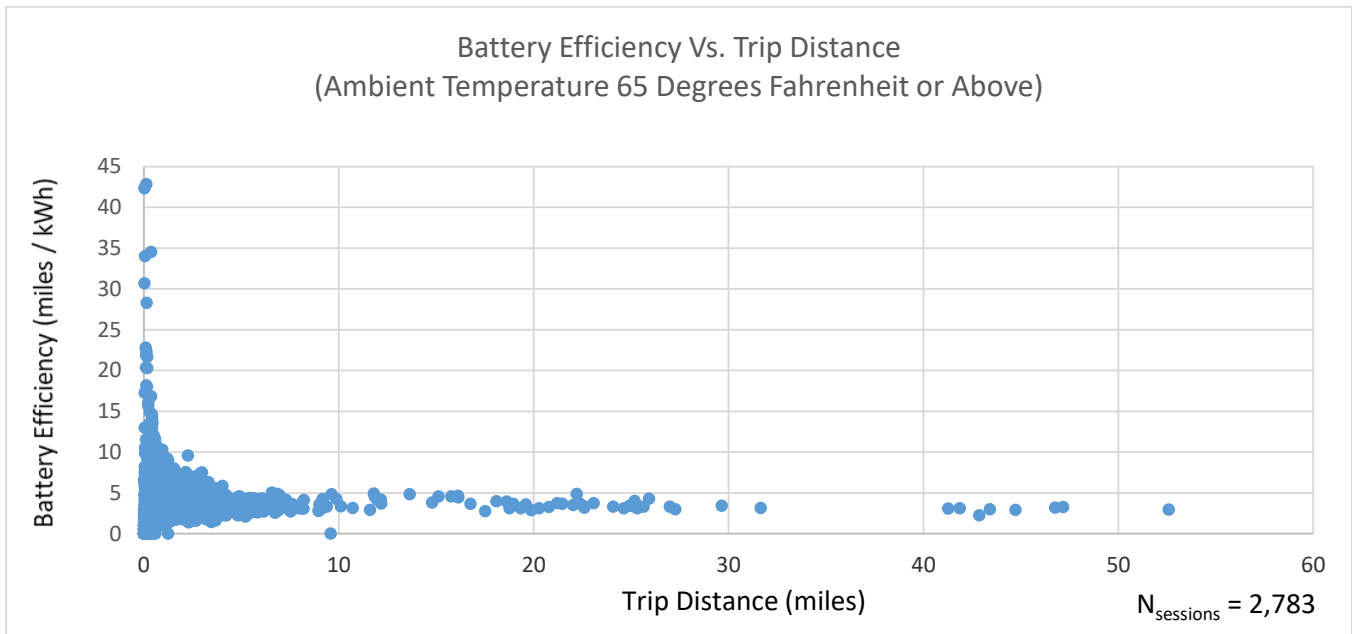

Figure 75. BEV Battery Efficiency Vs. Trip Distance (Ambient Temperature 65 Degrees or Above)

Efficiencies in the above table and graphs represent power consumed from the battery, upstream of the rectifier. In addition, EVSE losses typically vary between 0.1% to 1.5%, depending on current.<sup>39</sup>

<sup>39</sup> Apostolaki, Codani, Kempton. "Measurement of power loss during electric vehicle charging and discharging." <https://www.sciencedirect.com/science/article/pii/S0360544217303730>

# Load Management

## Residential Demand Response (DR)

Avista began DR experimentation in September 2018 with a small test group, expanding to all customers with networked residential EVSE by May 2019. The initial goal was to test if 75% of evening peak loads could be shifted to off-peak while maintaining high customer satisfaction. The new load profiles were then used in economic modeling to determine grid benefits from DR. Initially, DR events were set to 75% curtailment to maximum 1.8 kW output between 4pm and 8pm.

Special attention was given to frequent and open customer communications during the DR program. The rollout occurred over six phases, with the fourth and fifth phases experiencing delays due to software bugs eventually corrected by the EVSP. Note that while 92 stations are sent daily DR commands, due to connectivity issues between the EVSE and the server only 51 stations reliably receive them. More recently, EVSE from a different manufacturer have been used in several residential locations have demonstrated greatly improved connectivity, but are still in the early stages of testing.

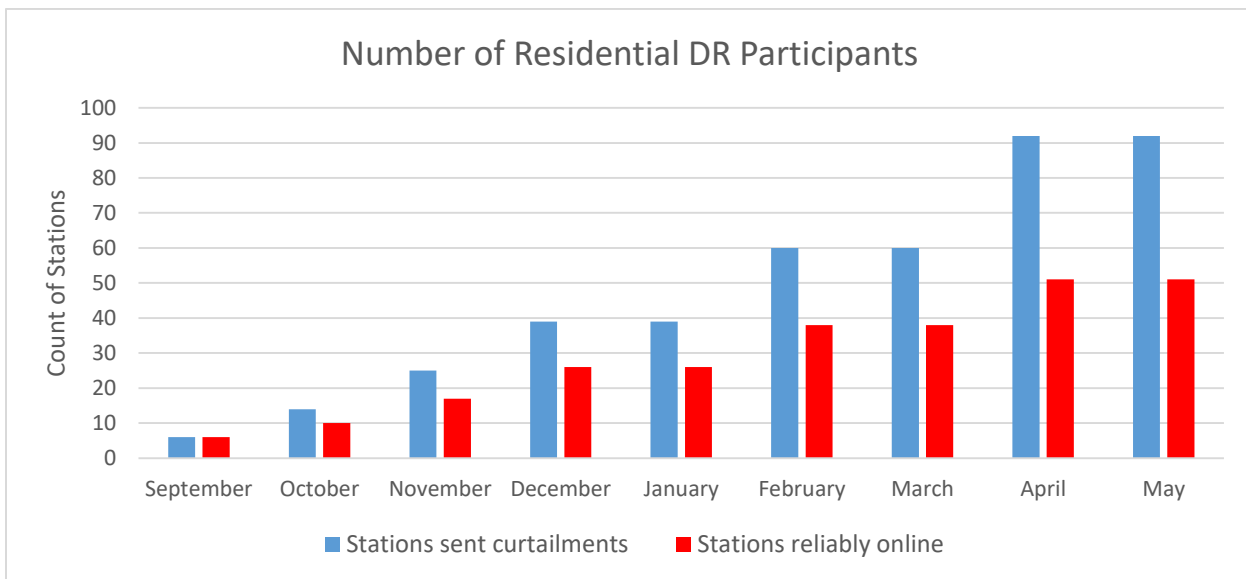

Figure 76. Implementation of residential DR program

Customers were given the ability to opt out of events through a “DR Event” feature on the EVSP phone app. When an event is initiated, the customer is sent a message a day ahead of time through their phone notifications, which they may choose to accept or reject. Customers also have the ability to set DR default preferences in the app. From September 2018 to July 2019, customers accepted or “opted in” to 85% of DR events. When surveyed about the impact of DR on daily driving, all customers stated that DR events had no effect on when or how they used their EV, and overall levels of satisfaction with the EVSE remained high. Session data backs up these surveys, showing that prior to DR, EVs would fully charge their battery in 59.6% of sessions, compared to 61.4% after DR. Customer feedback to improve

the opt-out process included the ability to opt-out through email, change opt-in or opt-out status after the initial selection, and a physical button on the EVSE to opt-out at any time.

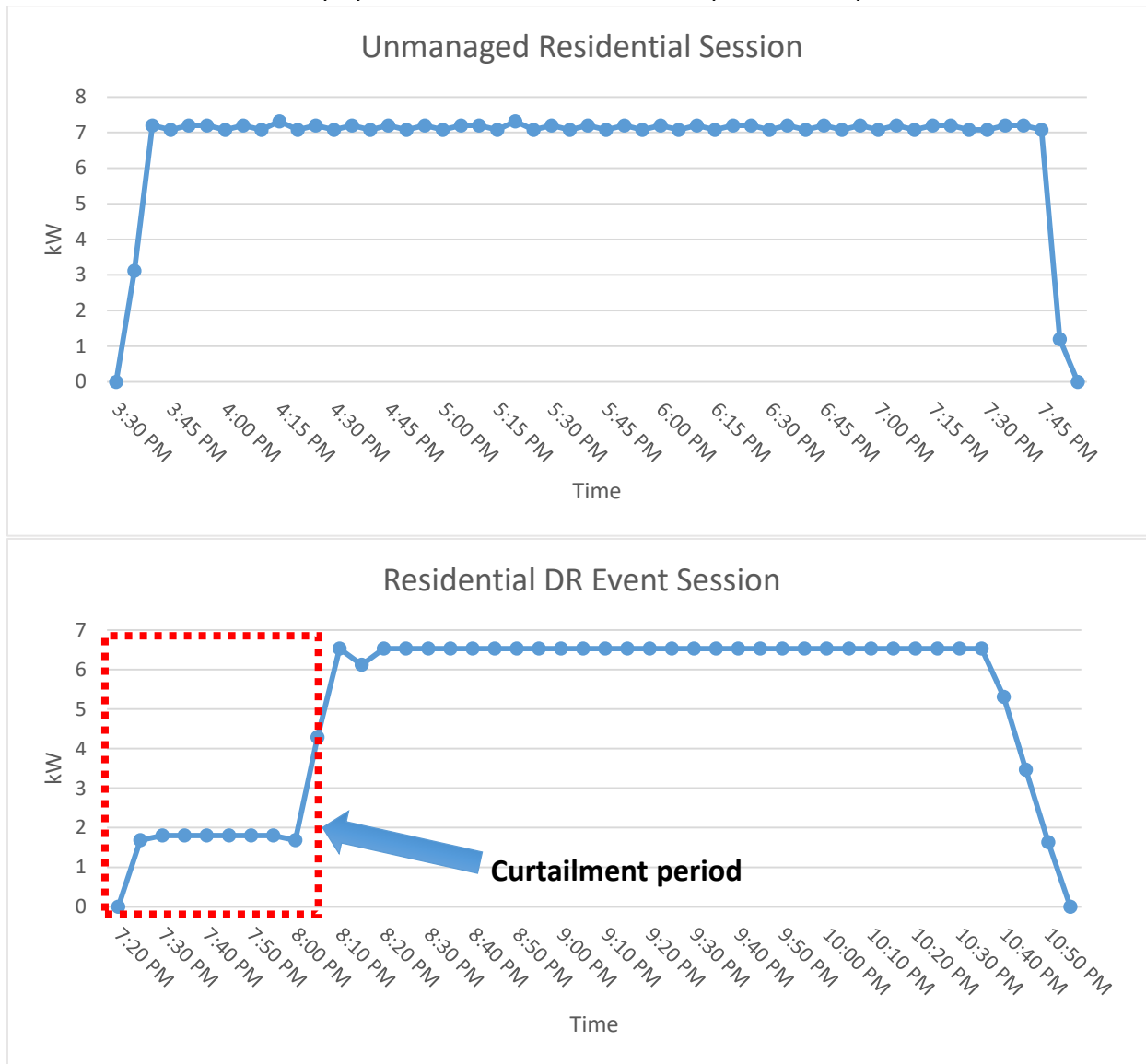

Figure 77. Example residential sessions before and after DR

As shown above, 75% curtailment of EVSE output results in 1.8kW delivered from 4pm to 8pm. When aggregated, the average load profile from 1,876 DR sessions demonstrated a 49% drop in peak demand compared to the uninfluenced load profile. Note that over a longer period of time, the accumulation of more DR sessions would further reduce the aggregated load profile’s peak demand, to a limit governed by the output curtailment and the rate of DR opt-outs. After 8pm the DR event is concluded and a demand spike occurs, due to EVSE output rising back to the 6.6kW level. This effect is similar to what can occur at the beginning of a time of use (TOU) rate time window, as a large number of EVs begin charging at the same time to take advantage of the lower rate. Such spikes could adversely affect distribution infrastructure in high EV adoption scenarios, even during off-peak periods. Possible

solutions to minimize such demand spikes include “randomizing” features when applying DR, or in the case of TOU utilizing dynamic rates.

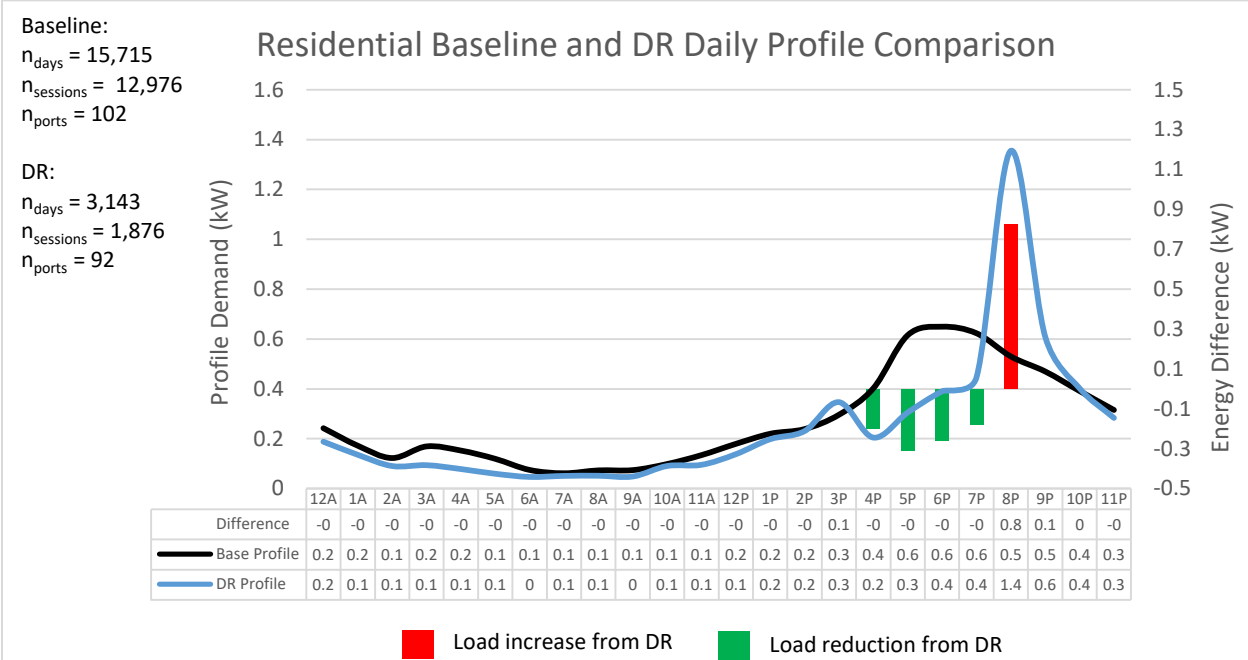

Figure 78. Residential aggregated load profiles before and after DR implementation with load change

The Company intends to pursue ongoing DR experiments, eventually with 100% curtailments and over longer time periods, to further determine the effects and practical limits of shifting EV loads utilizing DR, including the rate of customer opt-outs and satisfaction levels. Experiments to date demonstrate the acceptability of 75% peak load shifts for 85% of residential charging sessions, from a customer perspective. The practicality of utilizing networked EVSE for DR at scale, however, in a reliable and economically beneficial way will depend on much lower EVSE and networking capital and O&M costs, high uptime and online performance, and high customer participation rates. Integration with utility AMI systems could help reduce communication costs and improve reliability, however this will require industry technology and product development, as no commercially available systems currently exist that Avista may implement. In spite of these challenges, the Company feels that the effort to understand and effectively manage EV loads, consistent with the UTC Policy Statement, is important and should continue. This may involve the development and experimentation in a variety of methods and technologies, as it will become ever more important to integrate and optimize growing EV loads in the future as a flexible grid resource. In this regard, the inherent benefits of utilizing workplace charging to effectively minimize peak loads as well as support beneficial EV adoption, stand out as a focus area with excellent potential.

## Residential DR Comparison with other TOU studies

A 2014 study completed by DTE and EPRI<sup>40</sup> compared the charging habits of customers given the choice of a flat rate for \$40 per month, and a TOU rate of \$0.18 on peak from 9am to 11pm on weekdays, and \$0.07 off peak from 11pm to 9am on weekdays and all-day on weekends. Results showed a shift from 22% of EV charging energy consumed off peak in the flat rate, up to 62% off-peak with the TOU rate, comparable to Avista’s DR group with 64% consumed off-peak.

A 2015 study completed by the utility Pepco also in conjunction with EPRI,<sup>41</sup> examined residential load profiles of EVs with a TOU rate in effect. Customers were given the option of TOU rates applied to the entire home, or just the EV. The on-peak period applied from noon to 8pm and all other hours were off-peak, with a rate differential between \$0.10 and \$0.11. Customers choosing the EVSE-only TOU rate consumed 93.7% of charging kWh during off-peak hours, significantly higher than the 77% of energy consumed off-peak in Avista’s DR program, and the 62% consumed off peak in DTE’s TOU program. This appears to be most likely due to individual education about the TOU rate and its benefits with participants, demonstrating the potential results of effective customer outreach and education.

	Time period	% of total energy consumption
DTE flat rate	On-peak (9am - 11pm weekdays)	78%
	Off-peak (11pm – 9am & weekends)	22%
DTE TOU rate	On-peak (9am - 11pm weekdays)	38%
	Off-peak (11pm – 9am & weekends)	62%
Pepco TOU rate	On-peak (12am - 8pm)	6%
	Off-peak (8pm – 12pm)	94%
Avista no DR	On-peak (4pm – 8pm)	36%
	Off-peak (8pm – 4pm)	64%
Avista DR /V1G	On-peak (4pm – 8pm)	23%
	Off-peak (8pm – 4pm)	77%

Table 18: Comparison of On-Peak and Off-Peak Charging in DTE, Pepco, and Avista studies

With more time and expanded experimentation, it is expected that Avista’s DR/V1G could approach 90% off-peak consumption, comparable to Pepco’s study. Overall, these results represent a preliminary comparison between the effectiveness of TOU compared to DR/V1G in shifting peak loads, from a customer behavior and acceptance perspective.<sup>42</sup> Cost effectiveness must take into account other factors, such as the reliability and costs to implement each method, e.g. separate metering, EVSP support and communication fees, etc.

The 2015 EV Project (EVP) collected data from 869 EVSE in San Francisco, with an off-peak TOU rate available starting at midnight. As a proxy for DR, the EVP’s San Francisco residential weekday charging profile is compared to Avista’s residential DR profile, where Avista’s 8pm conclusion of DR coincides with

<sup>40</sup> EPRI, DTE. “DTE Energy: Driving the Motor City Toward PEV Readiness” (2013)

<sup>41</sup> EPRI, Pepco. “Pepco Demand Management Pilot for Plug-In Vehicle Charging in Maryland” (2015)

<sup>42</sup> Pepco’s study had a sample size of 35 participants enrolled in the EVSE-only TOU rate, compared to 51 participants in Avista’s DR study after accounting for connectivity issues. In contrast, the much larger DTE study was carried out with 2,500 participants.



the EVP 12am TOU start time. One similarity between the two profiles is the demand spike that occurs immediately after the delayed charging event, at 1.3 kW for Avista’s profile compared to 1.4 kW for EVP’s profile.

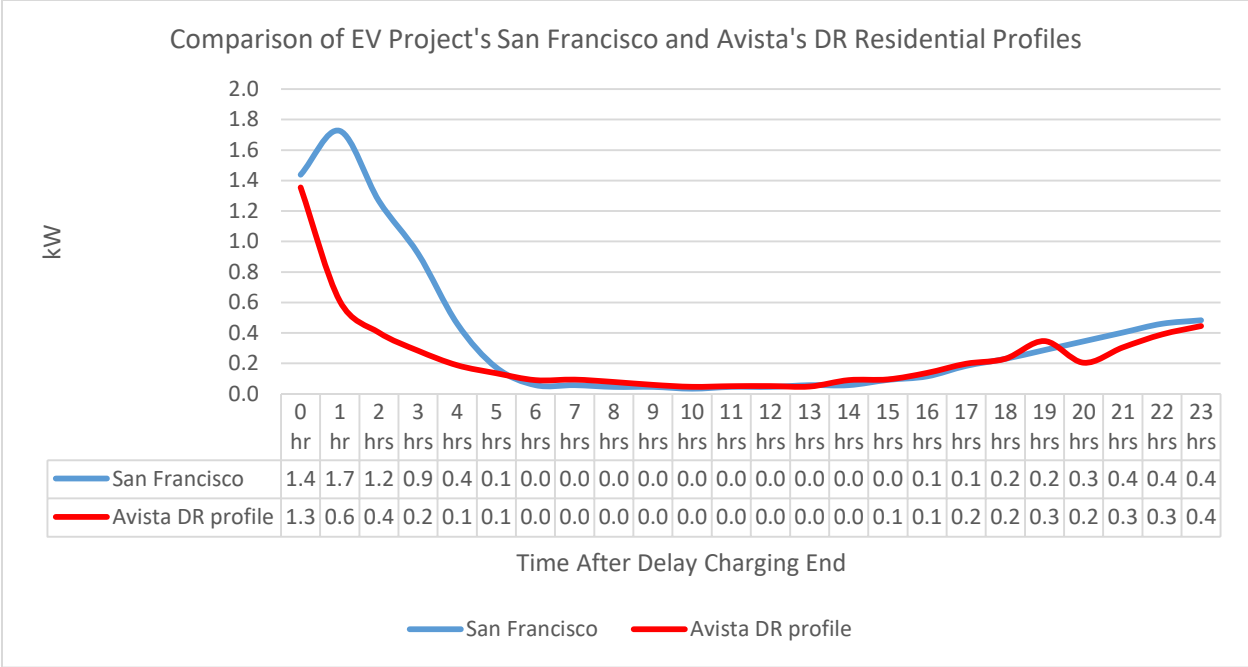

Figure 79. Comparison of Avista and the EV Project's Profiles with Delayed Charging

One difference is that Avista’s load drops by 55% over the first hour, while the EVP profile increases by 21%. This could be due to an increasing number of drivers nearing full battery capacity in the Avista study, while EVP drivers could conceivably start EV charging sessions sometime after the TOU rate starts at midnight. Also noteworthy is that the EVP study showed higher energy consumption averaging 9.0 kWh per day for the San Francisco group, compared to 6.0 kWh daily residential consumption for Avista’s DR group.

### Commercial DR

Avista implemented its commercial DR program at eight charging ports starting in the fall of 2017 at two different locations, one fleet with four fleet BEVs, and the other a workplace location with four regular EV commuters. A curtailment of 75% to 1.8kW output was applied to a large time window from 5:30am to 10:30pm. Similar to the residential DR experiments, once outside the curtailment window the EVSE could charge up to the maximum rate of 6.6kW until charging was complete. Examples of actual unmanaged and managed sessions are shown below.

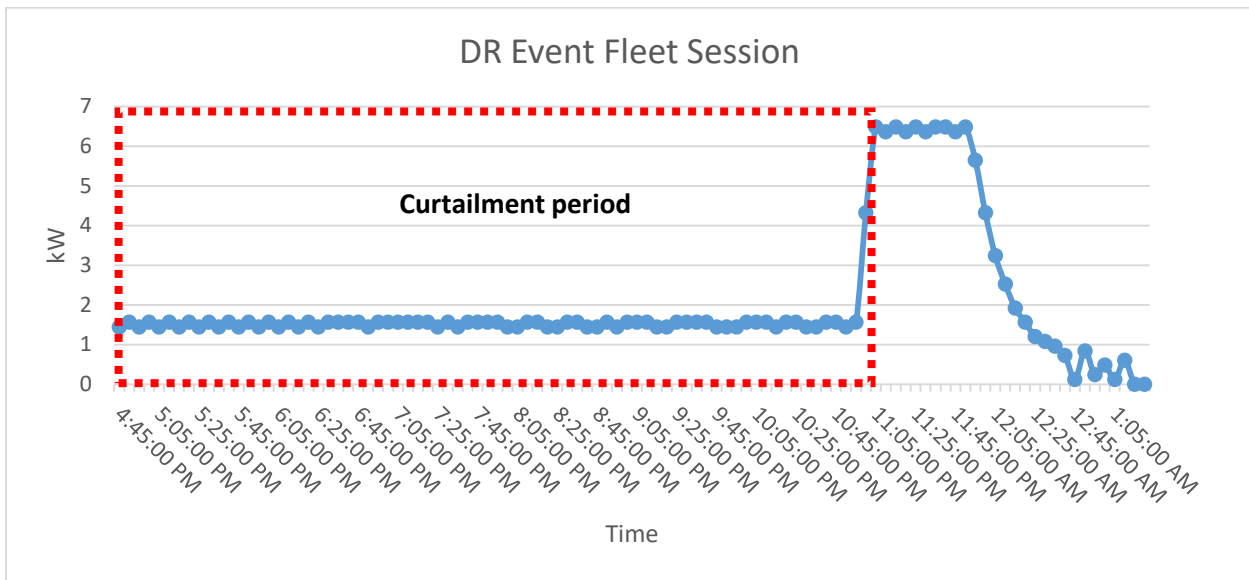
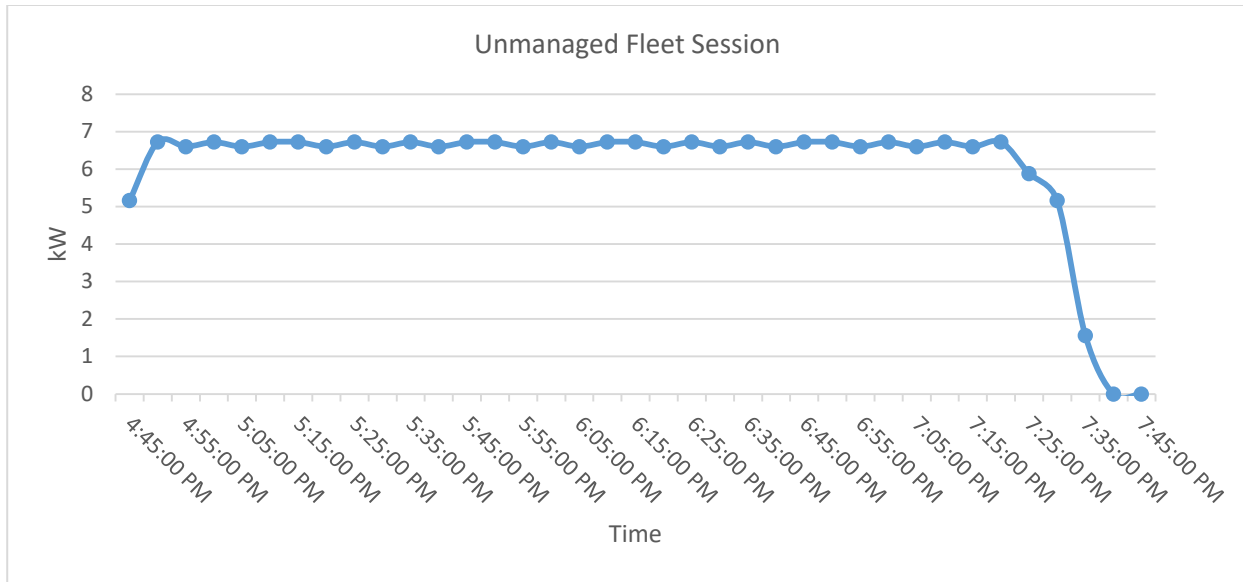

Figure 80. Example fleet sessions before and after DR

The chart below shows the aggregate load profile for the fleet site with four EVSE ports and four long range BEVs that regularly utilized the charging ports. Initially the baseline profile had two peaks consisting of a peak of 1.4 kW at 12pm and a second, larger peak of 1.5 kW at 5pm. Average daily energy usage totaled 11.3 kWh. At 12pm, DR lowered demand by 71% compared to baseline, and at 5pm demand dropped by 43%. DR was successful in shifting the peak load to off-peak overnight hours, with demand at the 11pm hour peaking at 1.3 kW. Baseline consumption between 11pm to 5am averaged 0.1 kWh, compared to DR consumption at 3.2 kWh.

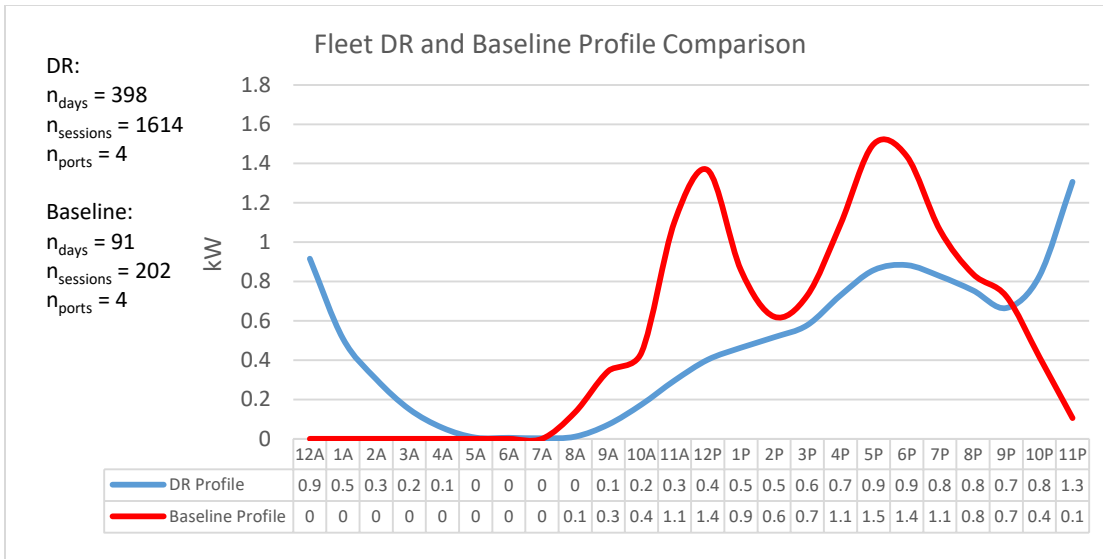

Figure 81. Aggregated fleet daily load profiles before and after DR

The workplace location is a large medical center open 24 hours with staff and visitors charging throughout the day and night. Initially the baseline profile showed two peaks at 8am and 3pm. After implementing DR, the station’s profile flattened out significantly, and similar to the fleet DR results, energy consumption was dramatically shifted to the offpeak period from 11pm to 5am. Note that the workplace baseline profile was collected before October 2017 when there were four drivers consistently charging, and the DR profile that followed had at least seven drivers consistently charging.

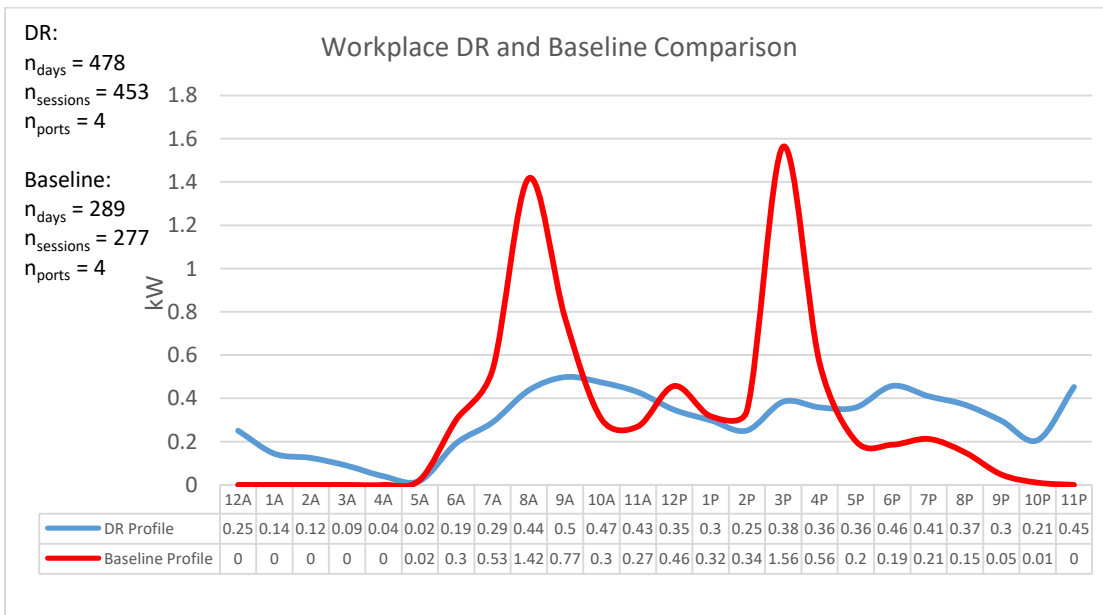

Figure 82. Aggregated workplace daily load profiles before and after DR

While both of these locations were successful in reducing peaks and increasing off-peak demand, one major difference was the impact of DR on fully charging EV batteries. Before DR, EVs would be fully charged by the end of the session 78% and 84% of the time for fleet and workplace locations,

respectively. After implementation of DR events, the workplace location saw the proportion of sessions where the EV was fully charged drop to 42%, and the fleet location saw a reduction to 72%. This difference could be caused by the more limited dwell time of the workplace location compared to the fleet location, i.e. fleet stations have EVs that are fixed at their locations and capable of charging overnight for a larger proportion of sessions, allowing EVs to fully recharge more often. Note that the data only represents individual charging sessions, i.e. an EV that is charged in the morning, leaves during the lunch hour and returns to complete charging for the day in a second session, would indicate one session that did not fully recharge, and a second that did. In any case, the significant drop at the workplace location warrants further investigation to verify information, determine causes, the effect on customer satisfaction, and if warranted, possible remedies.

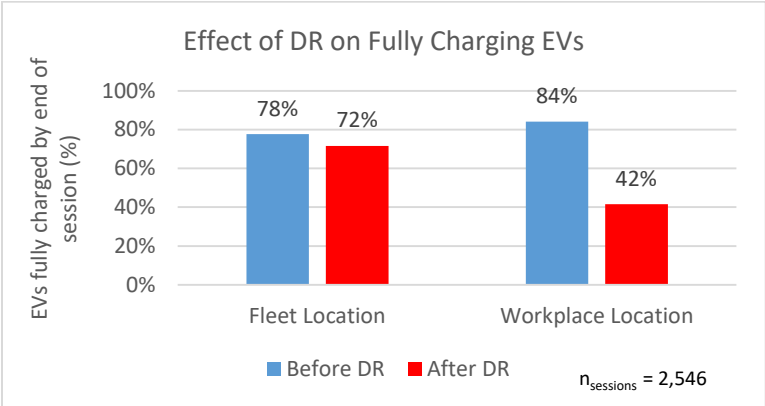

Figure 83. Comparison of fully charged batteries before and after DR at workplace and fleet locations

## Grid and Economic Impacts

The utility grid is delineated by three major systems – generation, transmission, and distribution. On Avista’s grid, generation power is stepped up to high AC voltages of 115kV or more, traveling long distances on the transmission system before the voltage is stepped down in distribution substations, typically to 13.5kV using 30MVA transformers. Each substation commonly has one to three feeder distribution lines that each usually run 3 to 5 miles in urban areas and 15 to 20 miles in rural areas. Power is distributed on these feeders from the substation to service transformers that step down voltage again and supply one or more service points, which are defined as the connection point at the customer

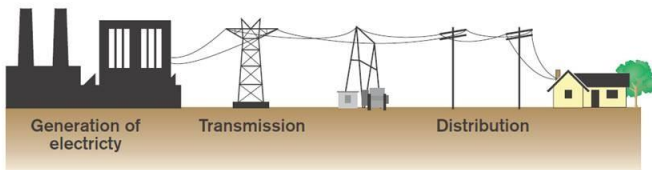

Figure 84: Utility grid - generation, transmission, and distribution systems (source: USDOE)

meter. Most service transformers on Avista’s system serve one to ten service points in residential neighborhoods, with an average of four.

Modeling by E3 for the Pacific Northwest region and independently by Avista for its service territory indicates that light-duty EV adoption at baseline or higher levels over the next 20 years will provide net benefits over costs, in terms of both regional economic and utility ratepayer perspectives. Regional economic benefits are mostly due to major fuel savings of EVs. Both regional and ratepayer costs are dominated by the additional generation capacity required to serve new EV loads, with a small contribution from distribution costs, and no transmission costs. The analysis that follows includes details of distribution grid impacts, the results of E3s Pacific Northwest economic modeling, and comparisons with Avista’s independent economic modeling. However, these are the results of 1<sup>st</sup>-order analysis that do not take into account important 2<sup>nd</sup>-order effects such as distribution feeder “backfeeding”, and depend on system loading and cost assumptions contained in the Company’s current IRP, which could change – perhaps dramatically – in the future. As such, this should be viewed as a good first step in the Company’s ongoing effort to understand how EV loads may be optimally integrated and managed, in an evolving system that brings the most benefit to all customers.

Peak Native Load	1,716 MW
Total Generation Capability	1,858 MW
Circuit miles of Transmission Lines	2,770
# of Distribution Substations	170
Circuit Miles of Distribution Feeders	5,429
# of Service Transformers	88,783
# of Retail Electric Meters	384,838
Annual kWh per Residential Customer	10,658

Table 19: Avista's Electric Grid - Quick Facts

### Distribution Grid Impacts

A first order analysis of light-duty EV loads on distribution transformers was conducted for three different scenarios. The first scenario assumed a single EV load of 6.6kW serviced by each transformer

in addition to existing loads, which equates to a roughly 25% EV adoption rate. The second scenario assumed 50% of service points with an added EV load of 6.6kW, and the third with 100%.

The electrical power demand on a service transformer from EVs is modeled as:

$$P_{EV\_aggregate} = n_{EV} * EV_{SE} * CF$$

Where:

$P_{EV\_aggregate}$  = Additional power demand created by simultaneous EV charging

$n_{EV}$  = number of EVs downstream of a given service transformer

$EV_{SE}$  = Power required to charge a single EV = 6.6 kW

CF = coincidence factor = 0 to 1

The CF is the percentage of simultaneous EV loads on a given transformer, compared to the sum of all potential loads. As more EVs are served by a single transformer, the maximum load on the transformer increases up to a limit governed by the CF. The CF curves used for transformer loading are based on industry and utility standards, and are directly related to the number of service points with EVs served by the transformer.

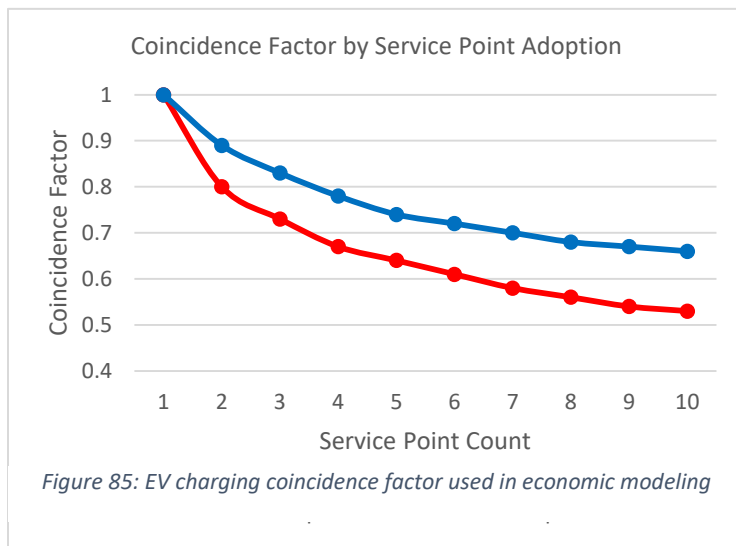

Estimated transformer replacement costs of \$3,516 for underground transformers and \$2,318 for overhead transformers include material and labor costs but do not include additional costs such as replacing or installing new pole arms, cutouts, arrestors, brackets or upsized distribution poles which may occur depending on the situation.

In the first scenario, a single EV load of 6.6 kW during peak hours was appended to each transformer’s existing peak load, for 88,783 transformers sized between 15 to 100 kVA, each with 10 or fewer service points. A single

EV served by each transformer is equivalent to an overall EV adoption rate of 23%. As a result of this load, 5.9% (5,280 of 88,783) of residential transformers exceeded their overloading limits as determined by IEEE Std C57.91.<sup>43</sup>

In the second and third scenarios, applying EV loads to 50% of service points on all transformers caused the peak load to exceed the failure threshold on 19.7% of transformers, compared to a 30% failure rate for the scenario with 100% EV service points. Upgrade costs for the 50% and 100% adoption scenarios were \$46.9 million and \$72.6 million, respectively.

<sup>43</sup> IEEE C57.91-2011 – Guide for Loading Transformers and Step-Voltage Regulators. [https://standards.ieee.org/standard/C57\\_91-2011.html](https://standards.ieee.org/standard/C57_91-2011.html)

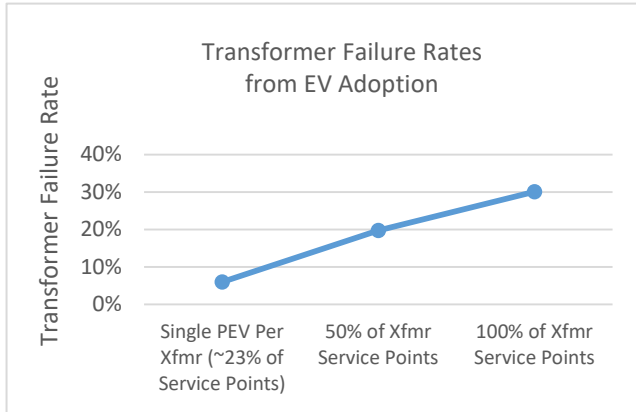

Figure 86: Failure rate of residential transformers from EV loads

Note that unusual situations that could alter charging behavior were not modeled. For example, a higher level of EV charging might occur before a major storm if customers felt there was a risk of pending power outages, which could cause additional transformer overloads and failures. Also, it was assumed that only one EV will charge at a time at a given residence, even though at high EV adoption rates many households would have more than one EV, and some of them may choose to install multiple EVSE so that both EVs could charge simultaneously.

Feeders are typically designed and built with 10 MVA capacity, ideally operating at 6 MVA with overload concerns at 8 MVA. This is done to allow for feeder “backfeeding”, where a given feeder may take on some of the load from other feeders in the event of issues and repairs. Assuming uninfluenced EV load profiles, first-order analysis of a sample of Avista’s feeders showed 33% reached the 8MVA threshold and were therefore considered “overloaded”, assuming baseline EV adoption and all other existing loads held constant, rising to 47% overloaded with 50% EV adoption and 67% with 100% adoption. Reconductor costs for urban feeders average \$400k per mile, compared to \$300k per mile for rural feeders. In turn, impacts to feeders can result in impacts to substations, with the need to increase the number of feeders or in some cases build a new substation, at an average cost of \$2.5M per substation. Note that detailed information at many points in the distribution system for existing loads and forecasts, and sophisticated modeling is required to take in to account important 2<sup>nd</sup>-order effects such as feeder backfeeds and cascading impacts to substations with more certainty.

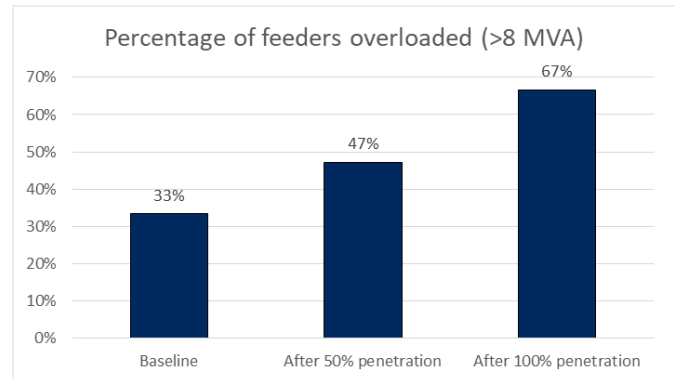

Figure 87: Distribution feeder overloads from EV loads, assuming all other loads held constant

Based on analysis of detailed feeder-level data for four utilities in the Pacific Northwest, E3’s study showed an average distribution cost of \$27 net present value (NPV) per EV over the 2017-2036 time period. In other words, an NPV of \$27 represents the total additional costs to the distribution system over the 20-year time frame of the study, for each EV during that time. Avista’s analysis indicates an average distribution cost of \$38 NPV per EV over a similar 2019-2038 time period. In both studies, similar

assumptions were used for baseline EV adoption, EV purchase costs, fuel costs, etc., as detailed in Appendix H. However, the model’s calculation methods and algorithms were developed independently.

The relatively low EV impacts on the distribution grid as predicted by both models reflect the assumptions of modest baseline EV adoption, historically established system cost escalations, and reduced distribution peak loads over time as a result of energy conservation.<sup>44,45</sup> Higher levels of EV adoption and the sensitivity to cost and energy conservation assumptions must be further explored, as well as important second-order effects on the distribution system beyond a first-order analysis.

### E3’s Pacific Northwest EV Study (2017 – 2036)

In 2017, E3 completed a detailed study of EV grid and economic impacts in the Pacific Northwest, sponsored by six regional utilities. The study’s objectives were to support an understanding of how EV adoption could result in costs and benefits from both a “regional” and a “ratepayer” perspective, sensitivity to assumptions, the value of managed charging, CO<sub>2</sub> reductions, and implications for utility planning. In the “regional” perspective, monetized EV costs and benefits that flow in and out of the region are considered, while in the “ratepayer” perspective the marginal EV costs and benefits are isolated to the effects on customer utility rates. Over the study’s 20-year time horizon, calculated cash flows for each year are translated to an equivalent net present value (NPV) in 2017, using a discount rate of 4.9%. When the NPV of total costs is less than the NPV of total benefits for a given scenario, a net benefit results, and vice versa. For more detail including the analytical approach, input variables, and how they are applied in the regional and ratepayer perspectives, see the E3 study and Appendix H of this report.

From a regional perspective, E3 concluded that all regions in the Pacific Northwest showed a net benefit from EV adoption, calculated at \$1,941 NPV per EV for the regional base case scenario. These net

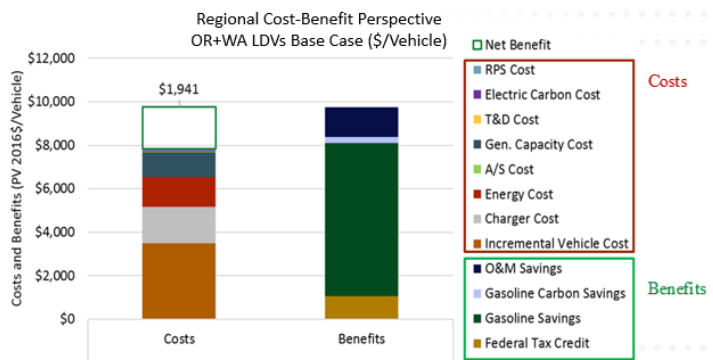

Figure 88: E3 Regional Cost-Benefit

benefits were also shown to be most strongly influenced by assumptions of EV adoption, EV purchase costs relative to gasoline vehicles, and gasoline prices. These assumptions result in the largest cost component of incremental vehicle cost, and the largest benefit component of gasoline fuel savings. The analysis further showed that generation capacity cost was nearly equal to energy cost, and distribution costs

<sup>44</sup> E3 (p.54)

<sup>45</sup> Avista Electric Integrated Resource Plan (2017)



were not significant. When examining the benefits of managed charging, E3 estimated an additional \$500 to \$1,700 regional net benefit per EV, with 70% to 90% of the added value from reduced generation capacity costs, and the smaller remainder from energy cost savings. Note that the E3 model is linear and therefore does not include important “interactive” or dynamic effects between input variables, i.e. feedback loops. For example, lower EV purchase costs and higher gas prices would result in higher EV adoption, and vice versa, which greatly affects the cost-benefit result. In reality, these feedback loops are asymmetric in that negative effects such as utility energy and generation capacity costs are mitigated by lower EV adoption, while positive effects such as the benefits of gasoline fuel savings are amplified by higher adoption.

In the “ratepayer perspective”, E3 showed that EV adoption would create ratepayer net benefits for the region as a whole, but that results could vary greatly from one utility service territory to the next

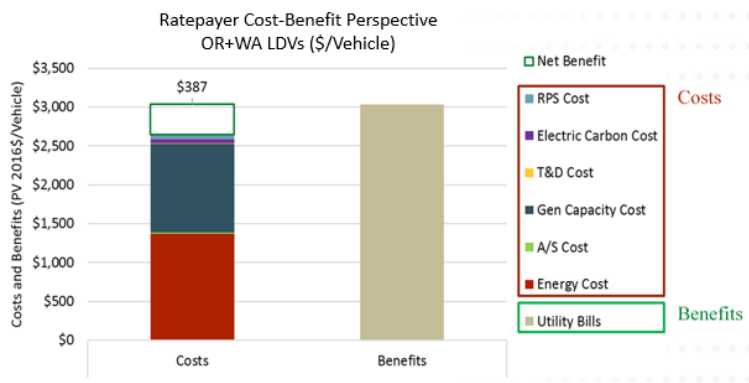

Figure 89: E3 Ratepayer Cost-Benefit

depending on that utility’s reserve generation capacity. Wholesale electricity prices were also found to have a significant influence on net results, as they impact generation capacity cost. Utility revenue from the additional metered billing of EVs results in a net benefit over total costs of \$387 NPV per EV. When considering the potential value of managed charging, E3 calculated an additional NPV of \$400 to \$1,600 per EV, as a result of reducing EV

loads that occur during “peak” hours, causing increased generation capacity costs. Distribution costs were not significant in either case, as modeled in the base case adoption scenario from 2017 through 2036.

### Avista’s Study (2019 – 2038)

Following E3’s study for the Pacific Northwest, Avista independently developed an economic model that would also calculate EV costs and benefits for the regional and ratepayer perspectives, but specific to Avista’s grid and service territories, and with the flexibility to alter inputs such as the EV load profiles gathered from the EVSE pilot. E3 was consulted to confirm input variables over a 20-year time horizon for the Avista model, analogous with the baseline input variables used in E3’s Pacific Northwest EV study where EVs reach 15% of light-duty vehicle sales in 2030 (see Appendix H). A discount rate of 6.58% was used to model Avista’s weighted cost of capital.

In this way, Avista’s results may be compared to E3’s, using similar inputs and independent modeling methods. If the model outputs are reasonably matched, then a form of independent replication is achieved, establishing additional confidence in both E3’s and Avista’s modeling and results. In addition to the 20-year baseline scenario with and without managed charging, Avista’s model was used to analyze a 50-year study of accelerated, very-high EV adoption, where light-duty EVs reach 90% of registered vehicles by 2050.

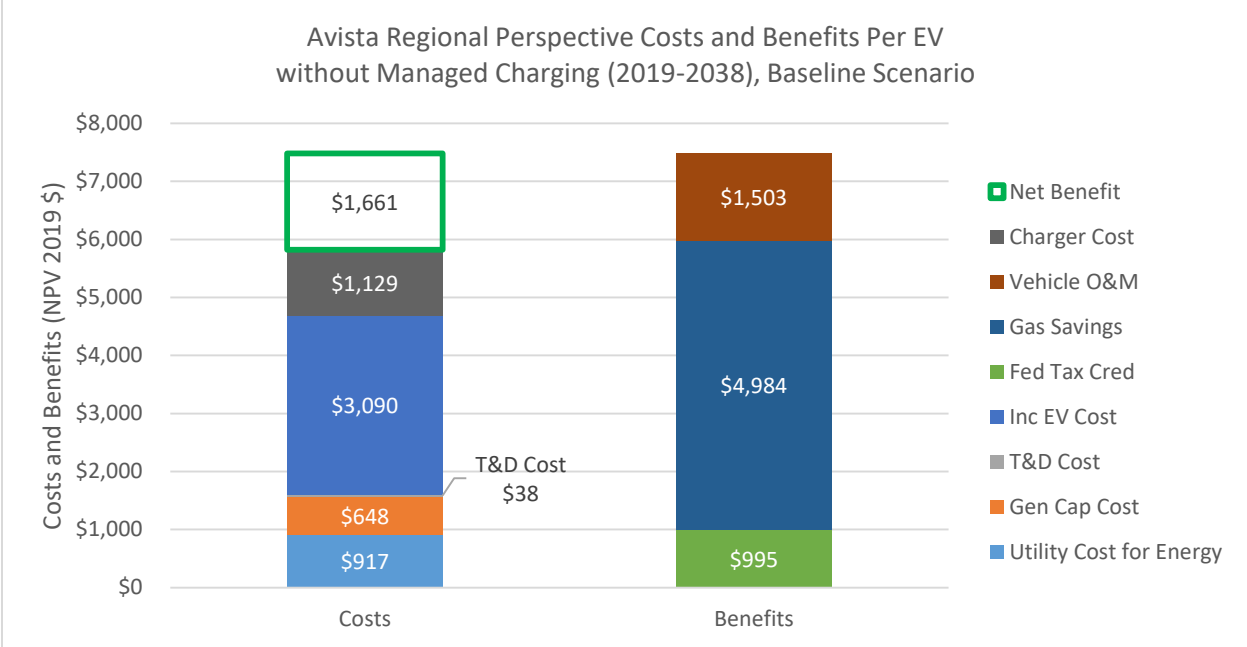

Figure 90. Regional perspective costs and benefits per EV without managed charging 2019-2038

In the regional perspective, Avista’s model results in a net benefit of \$1,661 per EV without managed charging, comparable to the E3 result of \$1,941 per EV for the Pacific Northwest region. Note that in Avista’s model, costs for renewable portfolio standards (RPS), electric carbon cost, and ancillary services (A/S) are not considered, as they were shown to be negligible in E3s results. Similar to the E3 study, Avista’s regional costs are dominated by the incremental EV cost, and benefits from fuel savings. In addition to the embedded utility energy costs consistent with Avista’s IRP assumptions, additional utility costs to serve the new EV loads come primarily from generation capacity costs at \$648 per EV, with only \$38 per EV from distribution costs. Note that while they are tangible and important benefits to the region, this study does not include a monetized value for societal and health benefits resulting from reduced GGE emissions and local air pollutants.

When managed charging is included, regional net benefits increase \$464 per EV to a total benefit of \$2,125 per EV. This assumed 75% of the residential load was shifted to off-peak from the hours of 4pm to 8pm year round, as was demonstrated in the EVSE pilot. Most of the additional benefit comes from reduced generation capacity costs. This is comparable but slightly below the range of E3’s regional net

benefit from managed charging, at \$500 to \$1,700 additional benefit per EV. Additional benefits in the Avista model could be realized with more peak load shifting, as may be possible. Nominally divided by an assumed 10 year life of an EV, these results mean that the cost to implement load management per EV must be less than \$46 per year using Avista’s result, or between \$50 and \$170 per year using E3’s results, in order to achieve additional regional net benefits from managed charging.

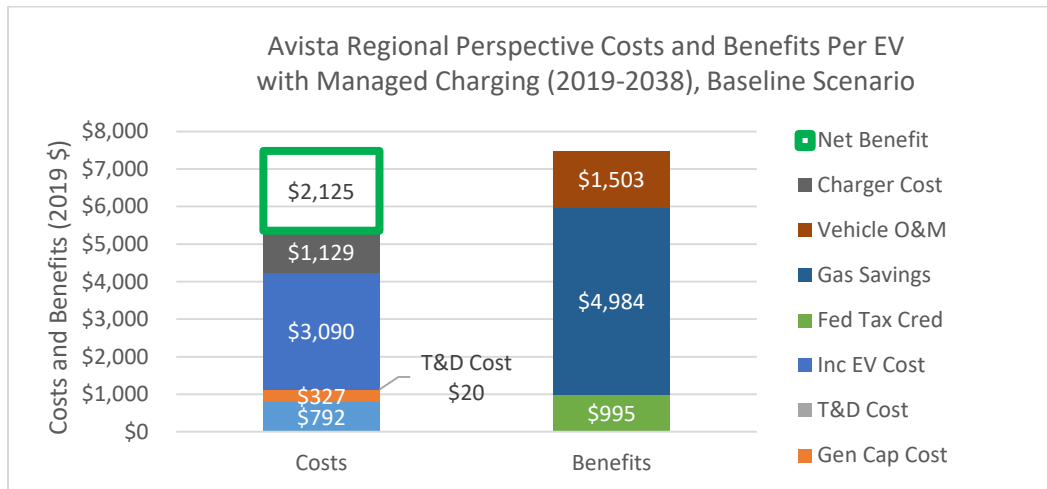

Figure 91: Regional perspective costs and benefits per EV with managed charging 2019-2038

Using Avista’s model for the Ratepayer Perspective baseline scenario without managed charging, a net benefit of \$1,206 per vehicle is realized, significantly higher than E3’s result of \$387 per vehicle. This is due mostly to the lower generation capacity costs in Avista’s model, where Avista is long on generation capacity until 2027.

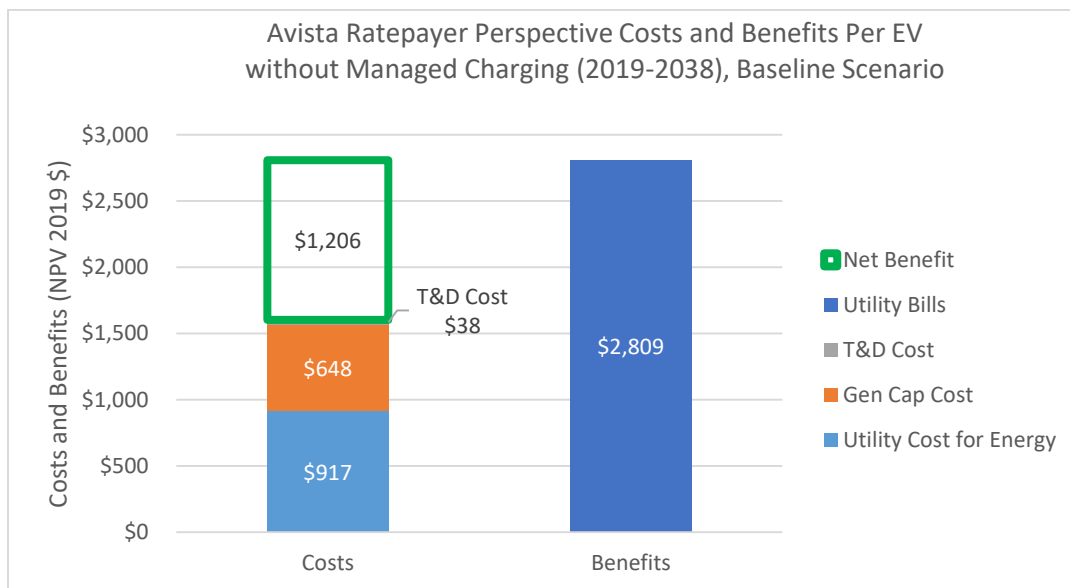

Figure 92: Ratepayer Perspective costs and benefits per EV, without managed charging 2019-2038

Considering the Ratepayer Perspective with managed charging, Avista’s model results in additional net benefits of \$463 per EV. Again, this is mostly due to reduced costs of generation capacity, assuming 75% reduction of residential peak loads from 4pm to 8pm. Given the assumed 10-year service life of EVs, actual costs to implement load management would reduce the net benefit, and would need to be less than \$46 per EV per year, to result in a net benefit increase. Note that similar cost reductions that could result from implementing a TOU rate, would also have the effect of reducing benefits from utility billing revenue and corresponding net benefits.

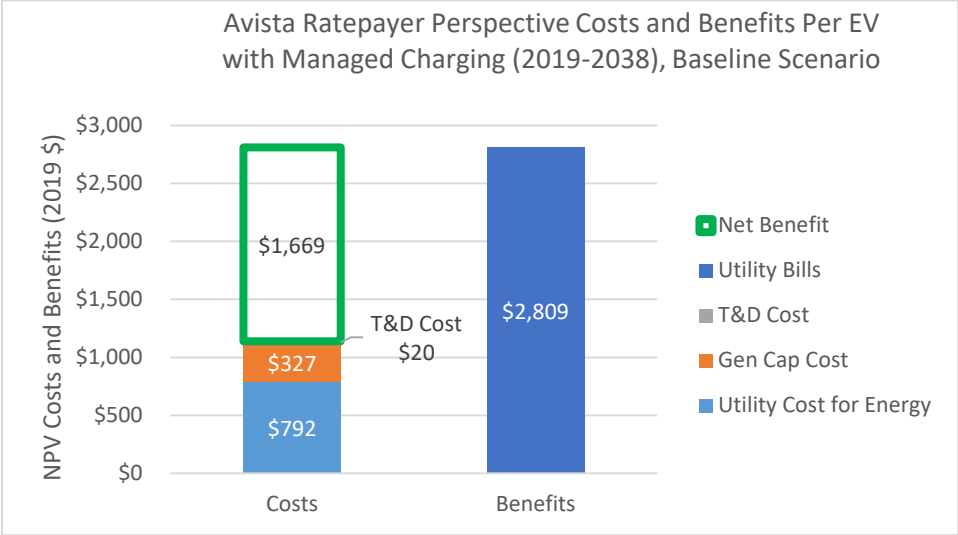

Figure 93. Ratepayer Perspective costs and benefits per EV, with managed charging 2019-2038

As the scenarios considered thus far represent relatively modest baseline adoption, the Avista model was used to consider a scenario of very high EV adoption over a longer timeframe, where EVs reach 90% of registered light duty vehicles by 2050, and 95% of light-duty vehicles by 2068, as shown below. E3 was consulted to develop an adoption curve and model input variables over this longer timeframe.

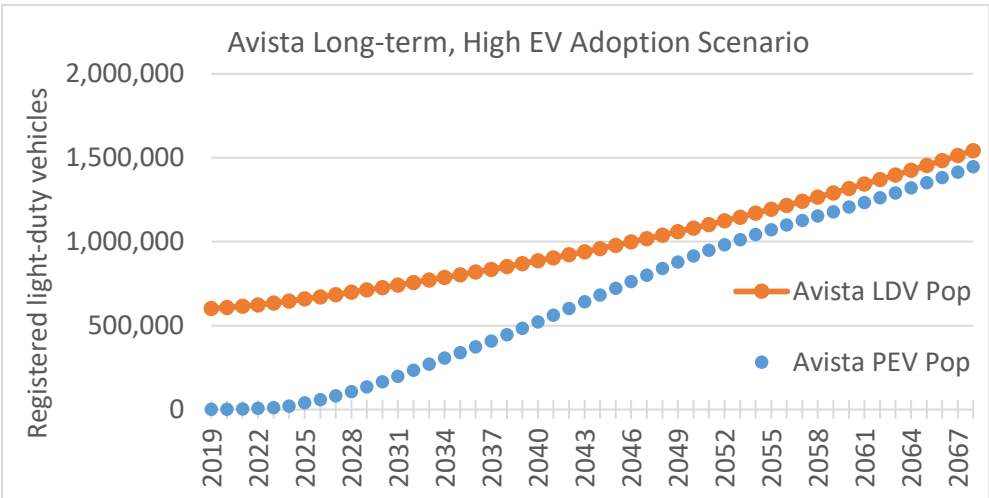

Figure 94: Long-term, High EV adoption scenario in Avista Washington service territory

In the long-term, very high adoption scenario, results for the Regional Perspective show a significant increase of 75% in net benefits compared to the baseline scenario, and a large but relatively smaller increase of 33% for the Ratepayer Perspective. This is due to the effect of lower EV purchase costs over time in the Regional Perspective, and higher utility revenue in the Ratepayer Perspective.

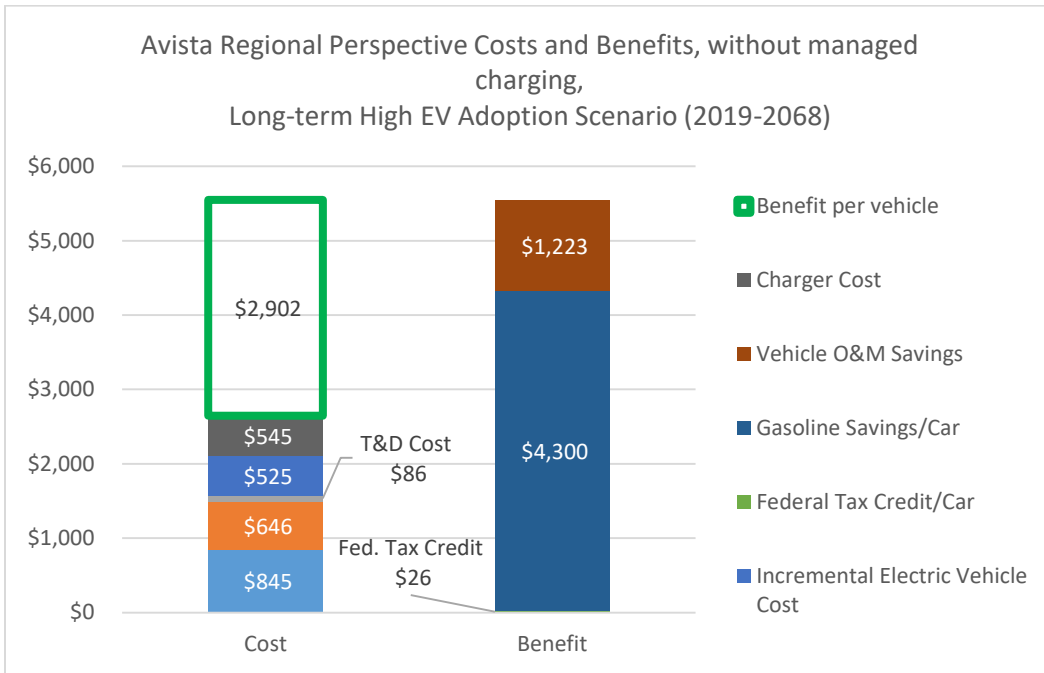

Figure 95. Avista Regional perspective NPV costs and benefits per EV for long term, high EV adoption scenario, 2019-2068

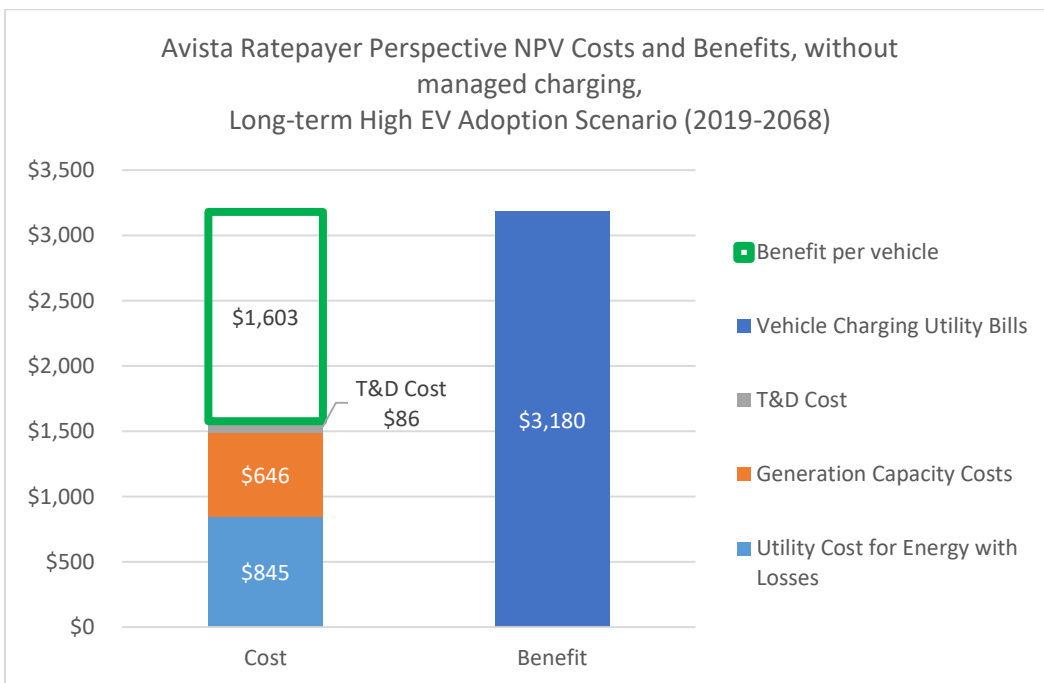

Figure 96. Avista Ratepayer perspective NPV costs and benefits per EV for long term, high EV adoption scenario, 2019-2068

Given the longer time horizon in this study, there is a larger uncertainty in model inputs and results, particularly as Distribution feeder and substation costs are assumed to be negligible as was the case for the baseline model. As was stated previously, the impact of other loads, second-order effects, and managed charging over this longer timeframe could conceivably have a significant negative or additional net-positive result. As such, this analysis and results should be viewed as a good starting point that must be further advanced and refined as EVs and the grid as whole evolves, rather than a definitive set of conclusions that will not change or are not subject to a number of uncertainties.

## Expenses and Revenues

Expenditures from the beginning of the EVSE pilot (Schedule 077) on May 2, 2016, through September 15, 2019, totaled \$3,851,124. Detailed expenses by category and type are as follows:

Expenditure Category / Type		Capital	O&M	Total	% of Total
Residential AC Level 2 EVSE	Design & Installation	\$245,648	\$0	\$245,648	6.4%
	Hardware	\$248,908	\$0	\$248,908	6.5%
	Maintenance & Repairs	\$0	\$13,586	\$13,586	0.4%
	Premises Wiring Reimbursements	\$0	\$138,551	\$138,551	3.6%
	<b>Total</b>	<b>\$494,557</b>	<b>\$152,137</b>	<b>\$646,693</b>	<b>16.8%</b>
Workplace-Fleet-MUD AC Level 2 EVSE	Design & Installation	\$347,791	\$0	\$347,791	9.0%
	Hardware	\$413,270	\$0	\$413,270	10.7%
	Maintenance & Repairs	\$0	\$8,980	\$8,980	0.2%
	Premises Wiring Reimbursements	\$0	\$193,471	\$193,471	5.0%
	<b>Total</b>	<b>\$761,061</b>	<b>\$202,451</b>	<b>\$963,512</b>	<b>25.0%</b>
Public AC Level 2 EVSE	Design & Installation	\$259,805	\$0	\$259,805	6.7%
	Hardware	\$212,075	\$0	\$212,075	5.5%
	Maintenance & Repairs	\$0	\$26,726	\$26,726	0.7%
	Premises Wiring Reimbursements	\$0	\$57,934	\$57,934	1.5%
	<b>Total</b>	<b>\$471,880</b>	<b>\$84,660</b>	<b>\$556,540</b>	<b>14.5%</b>
DC Fast Charging Stations	Design & Installation	\$613,852	\$0	\$613,852	15.9%
	Hardware	\$282,738	\$0	\$282,738	7.3%
	Maintenance & Repairs	\$0	\$2,474	\$2,474	0.1%
	Meter Billing	\$0	\$28,664	\$28,664	0.7%
	<b>Total</b>	<b>\$896,590</b>	<b>\$31,138</b>	<b>\$927,728</b>	<b>24.1%</b>
Other Project Expenses	Education & Outreach	\$17,500	\$31,114	\$48,614	1.3%
	Community & Low-Income Programs	\$0	\$60,433	\$60,433	1.6%
	EVSE Network & Data Management	\$469,578	\$0	\$469,578	12.2%
	Misc General Expenses	\$0	\$16,537	\$16,537	0.4%
	Auto Dealer Referrals	\$0	\$6,000	\$6,000	0.2%
	Project Management & Analysis	\$0	\$155,490	\$155,490	4.0%
	<b>Total</b>	<b>\$487,078</b>	<b>\$269,573</b>	<b>\$756,651</b>	<b>19.6%</b>
<b>Total</b>	<b>\$3,111,165</b>	<b>\$739,959</b>	<b>\$3,851,124</b>		

Table 20: EVSE Pilot Expenditure Details

Expenses were in-line with expectations, and under budget. New EVSE installations concluded on June 30, 2019. Ongoing operational expenses include network support, load management experiments

(V1G), and EVSE maintenance, estimated at \$180,000 per year for the 419 AC Level 2 ports and 7 DCFC sites currently deployed.

Utility revenues from light-duty EVs include electric meter billing from residential and commercial EV customers, as well as DCFC user fees regulated by the UTC, currently set at \$0.35/kWh for the seven DCFC on the area network. The table below provides estimated annual revenues from light duty EVs operated by Avista customers in Washington, based on average consumption data and billing rates, and DCFC session data.

<b>Year</b>	<b>EVs</b>	<b>Annual Billing Revenue</b>	<b>DCFC User Fees</b>	<b>Total</b>
<b>2016</b>	502	\$121,581	\$0	\$121,581
<b>2017</b>	663	\$160,494	\$665	\$161,159
<b>2018</b>	937	\$226,706	\$2,548	\$229,254
<b>2019 (projected)</b>	1319	\$319,246	\$4,500	\$323,746

*Table 21: Annual utility revenue from Avista electric customers in Washington with EVs*

Avista customers in Idaho as well as customers of other local utilities can contribute to utility revenue in Washington, from their potential use of AC Level 2 EVSE located in Washington at workplace and public locations, as well as public DCFC.



## *Conclusions and Recommendations*

The Company gained valuable experience through the EVSE pilot, achieving its learning objectives while effectively supporting early EV adoption. Light-duty EV loads will be manageable from a grid perspective over at least the next decade, and EVs offer the potential to provide significant economic and environmental benefits for the long term. Customers were highly satisfied with Avista's pilot program that installed a variety of EVSE at both residential and commercial locations, which correlated with growing EV adoption in the region. Improvements and areas of focus were identified, including the need for more public charging, improved reliability of networked EVSE, strong education & outreach programs including dealer engagement, and workplace charging that provides grid benefits by mitigating evening peak loads on the system, while acting as a major catalyst for EV adoption.

Avista is now in an excellent position to propose a comprehensive Transportation Electrification Plan in both Washington and Idaho service territories, that includes major areas of education & outreach, dealer engagement, community & low-income, EVSE infrastructure, load management, commercial fleets, rate design, internal programs, planning, and grid integration. Through this long-term effort, the Company intends to innovate and serve our customers and communities in electrifying the transportation sector, building a better energy future for all in partnership with industry, customers, local governments and policymakers.

### Key Takeaways from the EVSE pilot:

1. Empirical data collected from the EVSE pilot and economic modeling of light-duty EV load profiles show that grid impacts over at least the next decade are very manageable and that net economic benefits can extend to all customers – from both a regional and ratepayer perspective, not just to those driving EVs. In addition, significant reductions of GGE emissions and other harmful air pollutants may be achieved with EVs. These economic and environmental benefits may be further increased with effective load management that shifts more electric load to off-peak periods. However, grid impacts and costs resulting from EV peak loads could become significant over longer time horizons, with higher EV adoption, and as other loads and the grid change. The EVSE pilot represents a good start in the Company's ongoing effort to understand how EV loads may be optimally integrated and managed, in an evolving system that brings the most benefit to all customers.
2. Avista was able to cost-effectively install EVSE for a wide variety of uses and locations, resulting in high customer satisfaction for both residential and commercial customers. In addition, the EVSE pilot program and activities correlated with a significant increase in the rate of EV adoption in the area. This provides strong evidence that utility programs supporting EV adoption, including EVSE owned and maintained by the utility, are viable and effective in supporting and enabling beneficial EV

growth. Flexible and committed partnerships with industry providers, a focus on providing value for the customer, and installation contractor performance were keys to success in Avista's pilot.

3. Workplace charging stands out as a powerful catalyst for EV adoption, while simultaneously providing grid benefits from reduced EV charging at home coincident with evening peak demand, that occurs year-round. Workplace charging can also increase peak loads during cold winter mornings, which may be mitigated by utilizing EVSE with lower power output that is adequate and satisfactory for the customer, and other load management strategies.
4. Low dealer engagement, a lack of EV inventories, and persistent customer awareness and perception issues continue to be a major barrier to mainstream EV adoption in the region. With its strong customer and community relationships, the utility can help overcome these issues with robust education and outreach programs, including dealer engagement.
5. Avista successfully demonstrated the use of EVs to reduce operating costs for a local non-profit and government agency serving disadvantaged customers. The Company expects local stakeholder engagement to continue in the development and expansion of similar programs, as well as other innovative ways to serve communities and low-income customers, consistent with the UTC Policy Statement.
6. Customer survey responses and comments showed a widespread desire for more public AC Level 2 and DC fast charging sites, which may be supported in future utility programs and rate designs. EVSE operating costs are an important factor to address, in order to gain broader support and sustainable expansion that serves a growing EV fleet. In particular, analysis of DCFC utilization, monthly meter billing, and user fee revenue illustrates that operating expenses may not be recovered under existing rate schedules and the traditional application of demand charges, thereby posing a significant barrier to DCFC expansion and EV adoption. A new rate design should be developed to address these issues while reasonably recovering utility costs.
7. Networked EVSE reliability, uptime, costs, and customer experience are all important opportunities for improvement, and should be pursued by Avista in partnership with EVSE and EVSP providers. Experience gained from the EVSE pilot has reinforced the importance of utilizing interoperable networked EVSE, avoiding closed systems that can lead to stranded assets and low return on investment. In contrast, non-networked EVSE are extremely reliable and cost effective, and should be utilized wherever possible unless data collection, user fee transactions, remote monitoring, or other requirements necessitate the use of networked EVSE.
8. Load management experiments showed that residential customers remained satisfied while the utility curtailed peak EV loads by 75%, without additional compensation or incentives other than the installation of the EVSE owned and operated by the utility. More DR experimentation may show the feasibility to shift an even higher percentage of peak load. While load management utilizing DR and V1G technology and methods appears acceptable from a customer perspective, reliability and costs must be significantly improved to attain net grid benefits and enable practical application at scale.

9. Data and analysis were somewhat limited by the available pool of participants and EVSE sites, however results compared well with other studies using larger population samples, and EVSE data was satisfactorily verified by telematics data. As the industry evolves, a greater variety of light-duty EVs with larger battery packs may become the norm. In this respect, the EV load profiles developed and examined in this study may under-predict electric consumption and peak loads to some degree. The Company should monitor and stay abreast of industry developments and implications as they may affect the grid and the opportunity to best serve customers in the electrification of transportation.

## References

- Apostolaki-Iosifidou, E. & Codani, P. & Kempton, W. "Measurement of power loss during electric vehicle charging and discharging." *Energy*, Vol. 127 (2017).
- Dunckley, J. & Gonzalez, B. et al. "PEPCO Demand Management Pilot for Plug-In Vehicle Charging in Maryland". EPRI (2014).
- Duval, M. & Asgeirsson, H. & Menke, T. "DTE Energy: Driving the Motor City Toward PEV Readiness". EPRI (2014)
- Francfort, J. et al. "The EV Project." Idaho National Laboratory (2015).
- Grant, C. et al. "Transportation Electrification Strategies for Electric Utilities." Forth (2019).
- "Guidelines for Infrastructure Planning: An Explanation of the EPRI Red Line/Blue Line Model." Publication No. 3002004096. EPRI (2014).
- Hledik, R. and Weiss, J. "Increasing Electric Vehicle Fast Charging Deployment: Electricity Rate Design and Site Host Options." EEI (2019).
- Herter, K. & Okuneva, Y. "SMUD's EV Innovators Pilot – Load Impact Evaluation." SMUD (2014).
- Howell, D. & Boyd, S. & Cunningham, B. & Gillard, S. & Slezak, L. "Enabling Fast Charging: A Technology Gap Assessment." USDOE, (2017).
- "IMF Working Paper. Riding the Energy Transition: Oil Beyond 2040." IMF, (2017).
- "Interoperability of Public Electric Vehicle Charging Infrastructure." EPRI, (2019).
- Jones, P. et al. "The Future of Transportation Electrification: Utility, Industry and Consumer Perspectives". Future Electric Utility Regulation, Report No. 10 (2018).
- Lowell, D. et al. "Accelerating Investment in Electric Vehicle Charging Infrastructure." Ceres, (2017).
- Lutsey, N. & Nicholas, M. "Update on electric vehicle costs in the United States through 2030." ICCT, (2019).
- Mai, T. et al. "National Economic Value Assessment of Plug-In Electric Vehicles." NREL, (2016).

- Mai, T. et al. "Electrification Futures Study: Scenarios of Electric Technology Adoption and Power Consumption for the United States." NREL, (2018).
- McKenzie, L. et al. "Economic & Grid Impacts of Electric Vehicle Adoption in Washington & Oregon." E3, (2017) Cherif, R. & Hasanov, F. & Pande, A.
- Myers, Erika H. "A Comprehensive Guide to Electric Vehicle Managed Charging". Smart Electric Power Alliance, (2019).
- Nigro, N. et al. "Assessing the Electric Vehicle Charging Network in Washington State." Center for Climate and Energy Solutions, (2014).
- Singer, M. "Consumer Views on Plug-in Electric Vehicles – National Benchmark Report." NREL, (2016).
- "U.S. National Electrification Assessment." EPRI, (2018).
- Wood, E., et al. "National Plug-In Electric Vehicle Infrastructure Analysis." USDOE, Office of Energy Efficiency & Renewable Energy, (2017).

## Appendix A: Glossary of Terms & Abbreviations

Sources: Altas HUB, Alliance for Transportation Electrification, Wikipedia, and from SEPA as adapted from the California Public Utilities Commission (CPUC) Vehicle Grid Integration Communications Protocol Working Group Glossary of Terms (<http://www.cpuc.ca.gov/vgi/>), 2017. These definitions are “working definitions” and are not meant to be formal or conclusive, with some editing by the authors.

**AC, DC: alternating current, direct current.** The U.S. electricity grid generally operates on AC. A typical household outlet is 110–120 VAC (volts alternating current). Larger home appliances use 240 VAC. Electric car batteries operate on DC.

**AC Level 2 Charger:** An AC Level 2 (L2) charger can be found in both commercial and residential locations. They provide power at 220V-240V and various amperages resulting in power output ranging from 3.3kW to 19.2kW.

**AFDC:** U.S. DOE Alternative Fuel Data Center website containing a wealth of information on alternative fuels and vehicles.

**Aggregator:** An aggregator is a third party intermediary linking electric vehicles to grid operators. Increasingly, aggregators are stepping into a role of facilitating interconnections to entities that provide electricity service. Broadly, aggregators serve two roles: downstream, they expand the size of charging networks that electric vehicle (EV) customers can access seamlessly, facilitating back-office transactions and billing across networks; upstream, they aggregate a number of EVs and Charging Station Operators (CSO) to provide useful grid services to Distribution Network Operators (DNO) and Transmission System Operators (TSO).

**AV:** Autonomous Vehicle is a vehicle that can guide itself without human input. There are various levels of autonomous technology as defined by SAE from level 0 (no driving automation) to level 5 (full driving automation).

**BEV (Battery Electric Vehicle):** Battery Electric Vehicle is a vehicle with a drivetrain that is only powered by an onboard battery and electric motor(s).

**CAV:** Connected Autonomous Vehicle is an autonomous vehicle that has vehicle-to-vehicle or vehicle-to-infrastructure capabilities.

**C2 Device** - a telematics hardware device, from FleetCarma, that is capable of logging driving and charging data from electric vehicles.

**CCS:** The Combined Charging System is a charging method for electric vehicles from the SAE J1772 connector. The plug contains a DC and AC option and is also referred to as a Combo connector. The automobile manufacturers supporting this standard include BMW, Daimler, FCA, Ford, General Motors, Hyundai, Jaguar, Tesla, and Volkswagen.

**Charger:** A layperson’s term for the on-board or off-board device that interconnects the EV battery with the electricity grid and manages the flow of electrons to recharge the battery. Also known as Electric Vehicle Supply Equipment (EVSE).

**Charge Session:** A charge session is period of time an electric vehicle (EV) is actively charging its battery through the connection with a charger (EVSE).

**Charging:** Charging is the process of recharging the onboard battery of an electric vehicle.

**Charging Level:** The terms, AC Level 1, AC Level 2, and DC Fast describe how energy is transferred from the electrical supply to the car's battery. Level 1 is the slowest charging speed. DC Fast is the fastest. Charging rate varies within each charging level, depending on a variety of factors including the electrical supply and the car's capability.

**Charging Station:** The physical site where the Electric Vehicle Supply Equipment (EVSE) (also known as the charger) or inductive charging equipment is located. A charging station typically includes parking, one or more chargers, and any necessary "make-ready equipment" (i.e., conduit, wiring to the electrical panel, etc.) to connect the chargers to the electricity grid, and can include ancillary equipment such as a payment kiosk, battery storage, or onsite generation.

**Charger:** A layperson's term for on-board or off-board device that interconnects the EV battery with the electricity grid and manages the flow of electrons to recharge the battery. Also known as Electric Vehicle Supply Equipment (EVSE).

**CHAdEMO:** "CHArge de MOVe" is the trade name of a quick charging method formed by Tokyo Electric Power Company, Nissan, Mitsubishi, Fuji Heavy Industries, and later joined by Toyota.

**Connector:** The plug that connects the electricity supply to charge the car's battery. J-1772 is the standard connector used for Level 1 and Level 2 charging. CCS or "Combo" connectors are used for DC Fast charging on most American and European cars. CHAdE-MO is the connector used to DC Fast charge some Japanese model cars.

**Demand Response (V1G, direct load management, controlled charging, intelligent charging, adaptive charging, or smart charging):** Central or customer control of EV charging to provide vehicle grid integration (VGI) offerings, including wholesale market services. Includes ramping up and ramping down of charging for individual EVs or multiple EVs whether the control is done at the EVSE, the EV, the EV management system, the parking lot EV energy management system or the building management system, or elsewhere.

**DER:** Distributed Energy Resource

**DERMS:** Distributed Energy Resource Management System

**Direct Current Fast Charger (DCFC):** Direct Current Fast Charging equipment is designed to rapidly deliver direct current to a vehicle's onboard battery. DCFCs commonly have power ratings of 50kW or higher.

**Direct Install Costs:** Corresponding to the direct costs associated with the installation of an EVSE. These costs include labor and materials for mounting the EVSE, wiring connections, network connections, signage, EVSE testing, and work to complete required permitting and inspections.

**DOE:** Department of Energy is commonly used to refer to the U.S. energy agency or a State energy agency.

**DOT:** Department of Transportation is commonly used to refer to the U.S. Dept of Transportation or a State transportation agency.

**DR:** Demand Response (see Demand Response)

**DRMS:** Demand Response Management System

**E&O:** Education and Outreach

**Electric Vehicle Service Provider (EVSP):** Electric Vehicle Service Provider also known as a Network Service Provider (NSP), provides services related to chargers, such as data communications, billing, maintenance, reservations, and other non-grid information. The EVSP sends grid commands or messages to the EV or EVSE (e.g., rates information or grid information based on energy, capacity or ancillary services markets; this is sometimes called an electricity grid network services provider). The EVSP may send non-grid commands (e.g., reservations, billing, maintenance checks), and may receive data or grid commands from other entities, as well as send data back to other entities.

**Electric Vehicle Supply Equipment (EVSE):** Electric Vehicle Supply Equipment, also often called an EV charger, is standalone equipment used to deliver power to the input port connection on an EV. This device includes the ungrounded, grounded, and equipment grounding conductors, the electric vehicle connectors, attachment plugs, and all other fittings, devices, power outlets or apparatus associated with the device, but does not include Premises Wiring.

**ENERGY STAR for EVSE:** Compliance standards for electric vehicle supply equipment to receive ENERGY STAR certification.

**EPA:** Environmental Protection Agency is commonly used to refer to the U.S. environmental protection agency or a State environmental protection agency

**EPRI:** Electric Power Research Institute conducts research, development, and demonstration projects to benefit the public in the United States and internationally.

**EV:** Electric Vehicle is the commonly used name for vehicles with the capability to propel the vehicle fully or partially with onboard battery power and contains a mechanism to recharge the battery from an external power source. EVs can include full battery-electric vehicles (BEVs) and plug-in hybrid electric vehicles (PHEVs).

**EVSE:** see Electric Vehicle Supply Equipment

**EVSP:** see Electric Vehicle Service Provider

**Fleet EVSE:** EVSE for use by business owned vehicles.

**GGE:** Greenhouse Gas Emissions

**GHG:** Greenhouse Gas

**GMS:** Grid Management System is based on an architecture and guiding principles to proactively support changing requirements while minimizing disruption to existing operations, consumer commitments, and regulatory requirements.

**GSE:** Ground Support Equipment is equipment used in airports such as belt loaders, luggage tags, and water trucks.

**HDV:** Heavy-Duty Vehicles have a gross vehicle weight above 26,000 pounds.

**ICE (Internal Combustion Engine):** ICE is an acronym for Internal Combustion Engine. ICE vehicles typify the majority of gasoline/diesel/natural gas vehicles that make up the majority of automotive fleet.

**ICCT:** International Council on Clean Transportation. ICCT is a research group and has published several reports transportation electrification

**IEEE:** Institute of Electrical and Electronics Engineers is a professional association whose objectives are the educational and technical advancement of electrical and electronic engineering, telecommunications, computer engineering and allied disciplines.



**IEEE 2030.5:** IEEE 2030.5 is a standard for communications between the smart grid and consumers. The standard is built using Internet of Things (IoT) concepts and gives consumers a variety of means to manage their energy usage and generation.

**IEEE P2690:** This standard defines communications between Electric Vehicle Charging Systems and a device, network, and services management system, which is typically based "in the cloud" but could also include interfaces to site-specific components or systems (e.g., building energy management systems).

**IGP:** Integrated Grid Planning

**Interoperability:** The ability of devices, systems, or software provided by one vendor or service provider to exchange and make use of information, including payment information, between devices, systems, or software provided by a different vendor or service provider.

**IOU:** Investor-Owned Utility

**ISO 15118-1:2013:** ISO 15118 specifies the communication between EV and the EVSE.

**J1772:** also known as a "J plug", is a North American standard for electrical connectors for electric vehicles maintained by the Society of Automotive Engineers (SAE) International, and has the formal title "SAE Surface Vehicle Recommended Practice J1772, SAE Electric Vehicle Conductive Charge Coupler". It covers the general physical, electrical, communication protocol, and performance requirements for the electric vehicle conductive charge system and coupler.

**L2 Station:** See AC Level 2 Charger.

**LBEV (Long Range Battery Electric Vehicles):** LBEVs are BEVs (see BEV) that have an average driving range greater than 200 miles for a full battery charge.

**LDV:** Light-Duty Vehicles have a gross vehicle weight at or below 14,000 pounds

**Level 1:** Level 1 is part of the charging standard defined by the SAE for charging equipment using standard 120V household electricity.

**Level 2:** Level 2 is part of the charging standard defined by the SAE for charging equipment using 208V or 240V electricity, similar to the power level used for ovens and clothes dryers.

**Load Curves:** A load curve or load profile is a graph of electrical load over time. This is useful for utilities to determine how much electricity will need to be available at a given time for efficiency and reliability of power transmission.

**Make-ready:** Make-ready describes the installation and supply infrastructure up to, but not including the charging equipment. The customer procures and pays for the charging equipment, which could be funded by a separate rebate or other incentive by the electric company or other entity.

**Managed Charging:** Managed charging allows an electric utility or a third-party to control the charging of an EV remotely. This entity could enable or disable charging, or could control the power level for charging.

**MDV:** Medium-Duty Vehicles have a gross vehicle weight more than 14,000 and less than 26,001 pounds.

**MUD:** Multi-Unit Dwellings are a type of residence in which multiple housing units are located within a single building or building complex (e.g., an apartment complex, duplex, condos, etc). This is synonymous with a multi dwelling unit (MDU). EVSE at MUDs are intended for use by MUD residents. EVSE located on hotel or motel properties are also included within MUD session data in this report.

**NEMA:** National Electric Manufacturers Association

**Networked EVSE:** These devices are connected to the Internet via a cable or wireless technology and can communicate with the computer system that manages a charging network or other software systems, such as a utility demand response management system (DRMS) or system that provides charging data to EV drivers on smartphones. This connection to a network allows EVSE owners or site hosts to manage who can access EVSE and how much it costs drivers to charge.

**NGO:** Non-Governmental Organization

**Non-networked EVSE:** These devices are not connected to the internet and provide basic charging functionality without remote communications capabilities. For example, most Level 1 EVSE are designed to simply charge a vehicle; they are not networked and do not have additional software features that track energy use, process payment for a charging session, or determine which drivers are authorized to use the EVSE. Secondary systems that provide these features can be installed to supplement non-networked EVSE.

**NREL:** National Renewable Energy Laboratory

**NPV:** Net Present Value is the sum of future cash flows using a discount rate, such that it takes into the account of the time value of money.

**OATI:** Open Access Technology International, Inc.

**OEM:** Original Equipment Manufacturer, commonly used to refer to automobile manufacturers.

**OpenADR 2.0b:** Open Automated Demand Response (OpenADR) is an open and standardized way for electricity providers and system operators to communicate DR signals with each other and with their customers using a common language over any existing IP-based communications network, such as the Internet.

**OCPP:** The goal for the Open Charge Point Protocol (OCPP) is to offer a uniform solution for the method of communication between charge point and central system.

**PEV (Plug-in Electric Vehicle or PEV):** see EV

**PHEV (Plug-in Hybrid Electric Vehicle):** Plug-in Hybrid Electric Vehicle is a plug-in electric vehicle that can be powered by either or both a gasoline/diesel engine or an onboard battery.

**Platform:** The base hardware and software upon which software applications run.

**Port:** see Connector

**Premises Wiring:** electrical supply panel and dedicated 208/240VAC circuits that supply electricity directly to EVSE. This includes the protective breaker at the supply panel, wiring, final junction box, receptacle and all attachments and connections.

**Proprietary Protocol:** A protocol that is owned and used by a single organization or individual company.

**Protocol:** Set of rules and requirements that specify the business process and data interactions between communicating entities, devices, or systems. Most protocols are voluntary in the sense that they are offered for adoption by people or industry without being mandated in law. Some protocols become mandatory when they are adopted by regulators as legal requirements. A standard method of exchanging data that is used between two communicating layers.

**Public EVSE:** Public EVSE can be found in multiple types of locations including but not limited to business parking lots, public buildings, or adjacent to public right-of-way. Public AC Level 2 EVSE have a standard J1772 connector, while DCFC have a CHAdeMO and/or CCS connectors. Tesla vehicles may utilize public EVSE with an adapter, however other EVs cannot use Tesla EVSE, as no adapters are available.

**Residential EVSE:** located within a person’s home, most often in a garage, residential EVSE are usually used by 1 or 2 EVs intended only for use by the home owner.

**Ride and Drive:** Event where individuals are given the opportunity to look at EVs, talk with EV drivers, and ride in or drive an EV.

**RPS:** Renewable Portfolio Standard

**OCPP (Open Charge Point Protocol):** An application protocol for communication between EVSEs and EVSP servers.

**Standard:** An agreed upon method or approach of implementing a technology that is developed in an open and transparent process by a neutral, non-profit party. Standards can apply to many types of equipment (e.g., charging connectors, charging equipment, batteries, communications, signage), data formats, communications protocols, technical or business processes (e.g., measurement, charging access), cybersecurity requirements, and so on. Most standards are voluntary in the sense that they are offered for adoption by people or industry without being mandated in law. Some standards become mandatory when they are adopted by regulators as legal requirements.

**Standardization:** Process where a standard achieves a dominant position in the market due to public acceptance, market forces, or a regulatory mandate.

**State of Charge (SOC):** The level of charge of an electric battery relative to its capacity.

**TCO:** Total Cost of Ownership is a financial estimate that accounts for both purchase price and continued, variable operating costs of an asset.

**TE:** Transportation Electrification

**Telematics:** In the context of EV charging, including managed charging, telematics refers to the communication of data between a data center (or “cloud”) and an EV, including sending control commands and retrieving charging session data.

**TNC:** Transportation Network Company is a company that connects passengers with drivers via a mobile app or website. Example companies include Uber and Lyft.

**TOU (Time of Use) Rate:** Time-of-use often refers to electricity rates that can vary by the time of day. TOU rates can also be structured to vary by season.

**TRU:** Truck Refrigeration Unit is a device that is installed in a truck to refrigerate a truck’s storage compartment.

**Use Case:** Defines a problem or need that can be resolved with one or more solutions (technical and/or non-technical) and describes the solutions. The use case is a characterization of a list of actions or event steps, typically defining the interactions, describing the value provided and identifying the cost.

**Uptime:** Defines the amount of time an EVSE is functionally able to provide a charge when requested, as opposed to a faulted state where no charge may occur. Depending on configuration settings, networked EVSE may still be able to provide a charge and maintain uptime status when offline from the network connection.

**Workplace EVSE:** Workplace EVSE are located on business property, primarily intended for use by employees. However, often the business owner will allow use by visitors or the public, if it is located in an accessible location.

**V1G:** V1G refers to vehicles only capable of receiving power from the electrical grid to the onboard battery. This can also commonly be referred to as demand response for EVs

**V2B:** Vehicle-to-Building refers to vehicles capable of sending power from the onboard battery to a building.

**V2G:** Vehicle-to-Grid refers to vehicles capable of receiving power to the onboard battery from the electrical grid and vice-versa.

**V2H:** Vehicle-to-Home refers to vehicles capable of sending power from the onboard battery to a home.

**VMT:** Vehicle Miles Traveled

**VPP:** Virtual Power Plant (VPP) is a cloud-based distributed power plant that aggregates the capacities of heterogeneous energy resources for the purposes of enhancing power generation, as well as trading or selling power on the open market.

**ZEV:** Zero Emission Vehicle is a vehicle with no tailpipe emissions and includes battery electric vehicles and hydrogen fuel cell electric vehicles.

## Appendix B: Data Validation

The primary dataset used for analysis includes 64,574 charging sessions logged by networked EVSE from January 1, 2017 through May 24, 2019. Of the 64,578 sessions, approximately 10,391 recorded less than 1 kWh of consumed energy and were removed from the study. Additionally, 827 logged connection times greater than 70 days were removed from the data set. The remaining 53,356 sessions were utilized for analysis of various load profiles across networked residential, workplace, public, fleet, and multi-unit dwelling EVSE. High confidence in the accuracy and validity of EVSE session data was established by close comparison with a separate dataset of identical sessions obtained from a smaller number of vehicle telematics devices, as detailed below

### Greenlots Data

Charging session data from EVSE networked to the Greenlots SKY server included user ID, EV make and model, station ID, station location, session start/stop time, station type, power level, consumed energy, collected fees, payment method, DR event start/stop time, and DR opt-out. Unregistered users such as visitors that did not participate as residential customers in the pilot program or those that used credit cards at DCFC, were recorded as “anonymous” user IDs with unknown EV make/model.

Actual charging time differs from connection time especially in the case of AC Level 2 sessions where the vehicle is parked for long periods of time and often charges to full battery capacity, such as at home and at work. Rather than using detailed interval data for charging time analysis, the charging time for AC Level 2 sessions were calculated by using the recorded energy consumed in the session, distributed by hour using the charge rate of the EV. For example, a charge duration of 2 hours is calculated from a reported 13.2 kWh consumption and an EV rectified at 6.6 kWh. Time remainders are rounded up to the nearest hour, approximating the typical ramp-down period of 45 to 60 minutes as the battery nears a full state of charge. Note that consumed energy data from the networked EVSE does not include EVSE energy losses, conservatively estimated at 1.5%.

### Validation of EVSE Data

To better understand driver behaviors and validate data from Greenlots, several customers participating in Avista’s EVSE program agreed to install a FleetCarma telematics device in their EV. The telematics device captures charging data as well as battery state of charge, battery efficiency, trip distance and speed, and energy losses from rectification and auxiliary loads.

Comparison and analysis of identical session data from four drivers in over 610 charging sessions, an average, absolute difference of 1.6% was calculated between the FleetCarma and Greenlots EVSE dataset, with a median absolute difference of 1.5%. The histogram below clarifies the distribution of the difference seen in these 643 sessions, with 99.5% of sessions showing an energy measurement

difference of less than 4%, and three of the 610 charging sessions as outliers with a 4% or greater difference.

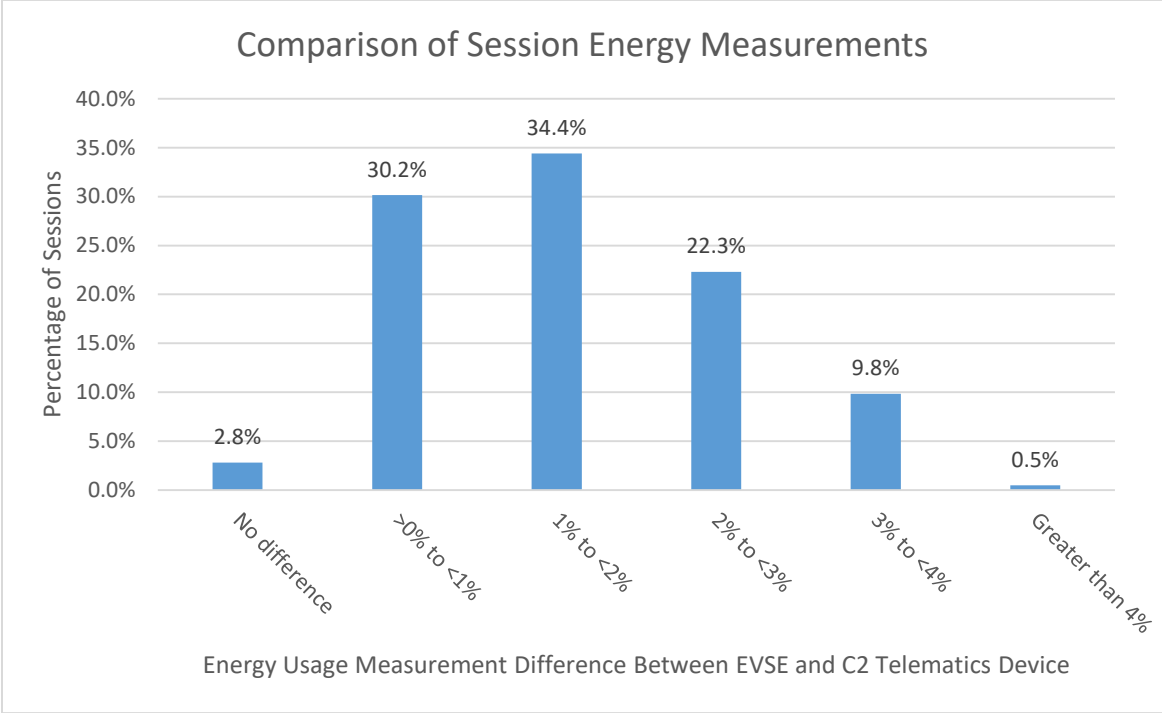

Ambient conditions, EVSE losses, and some uncertainty in rectification losses contribute to the observed differences. For some vehicles, FleetCarma estimates rectification losses as a percentage of energy measured entering the battery. Since rectification losses vary based on speed of charging and other factors, this would account for some of the observed differences seen in the measurements. While both the EVSE and C2 devices measure power by taking periodic measurements of voltage and amperage, the C2 does so by reading signals from the EV’s controllers while the EVSE uses its internal metrology equipment. Therefore, some loss differences between the EVSE’s metrology equipment and the EV accounts for some difference in energy measured between the two devices, typically between 0.1% to 1.5%.<sup>46</sup> These differences also vary based on ambient temperature, voltage and amperage, state of the EVSE connector and cable, internal EV systems, and other factors.

Overall, the relatively small average difference of less than 2%, and relatively narrow distribution over 610 sessions provides high confidence in the accuracy and validity of session data and derivative analyses provided in this report.

<sup>46</sup> Apostolaki-Iosifidou, Codani and Kempton. “Measurement of power loss during electric vehicle charging and discharging.” Energy 127 (2017) 730-742.

## Appendix C: Explanation of Box Plots

Many box plots are utilized in this report to help illustrate distribution of data. They are a statistical visualization tool that separates the data set into 4 quartile groups of “non-outlier” data, and outlier data below the 1<sup>st</sup> quartile and above the 4<sup>th</sup> quartile limits.

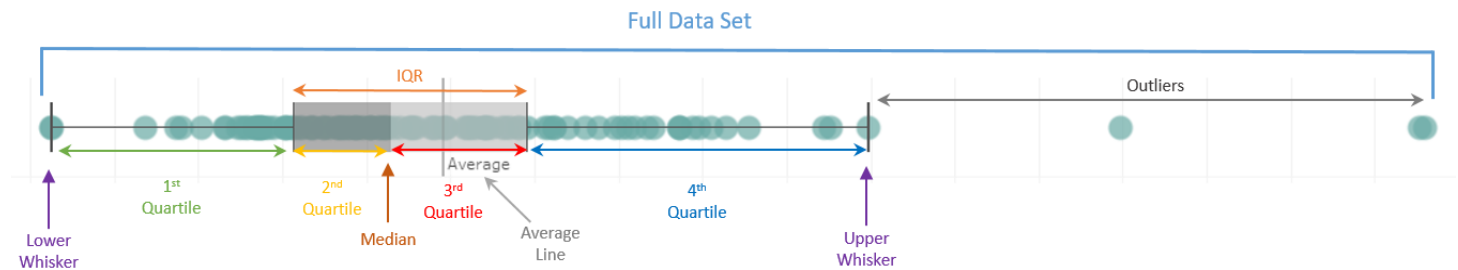

**Interquartile Range (IQR):** Represented by the shaded boxes near the middle of the data set. The IQR is the middle 50% of the recorded values in the entire data set, and by definition includes the 2<sup>nd</sup> and 3<sup>rd</sup> quartiles of non-outlier data. This range also contains the median value, and usually the average. Mathematically, the IQR is defined as  $IQR = Q_{3MAX} - Q_{2MIN}$

**Median:** The median value is defined as the value separating the lower and upper 50% of the data values. Also considered to be the ‘middle value’ or the value that separates the 2<sup>nd</sup> and 3<sup>rd</sup> quartiles.

**Average Line:** The average line represents the calculated average of all the values within the full data set including the outliers. The average is calculated by taking the sum of all the data values within the data set and dividing by the number of data values, and is usually within the IQR.

**Whiskers:** Visually represented by a horizontal line ending at an intersection with a vertical line, the whiskers represent the boundary between the “outlier” and “non-outlier” data coinciding with the limits of the 1<sup>st</sup> and 4<sup>th</sup> quartiles. The two values are calculated as:

$$\text{Upper Whisker (UW)} = Q_{3MAX} + (IQR * 1.5)$$

$$\text{Lower Whisker (LW)} = Q_{2MIN} - (IQR * 1.5)$$

(the Lower Whisker defaults to 0 if the calculated value is less than 0 and there are no values in the sample less than 0)

**Outliers:** Outliers are values beyond the minimum and maximum established by the 1<sup>st</sup> and 4<sup>th</sup> quartiles. Outlier data may provide clues into unusual circumstances within the dataset that need additional attention, or the possible existence of invalid or “bad data” which should be investigated and eliminated from the data set, as appropriate.

# Appendix D: Assorted Charging Profiles

Strip Mall Location - Per Port

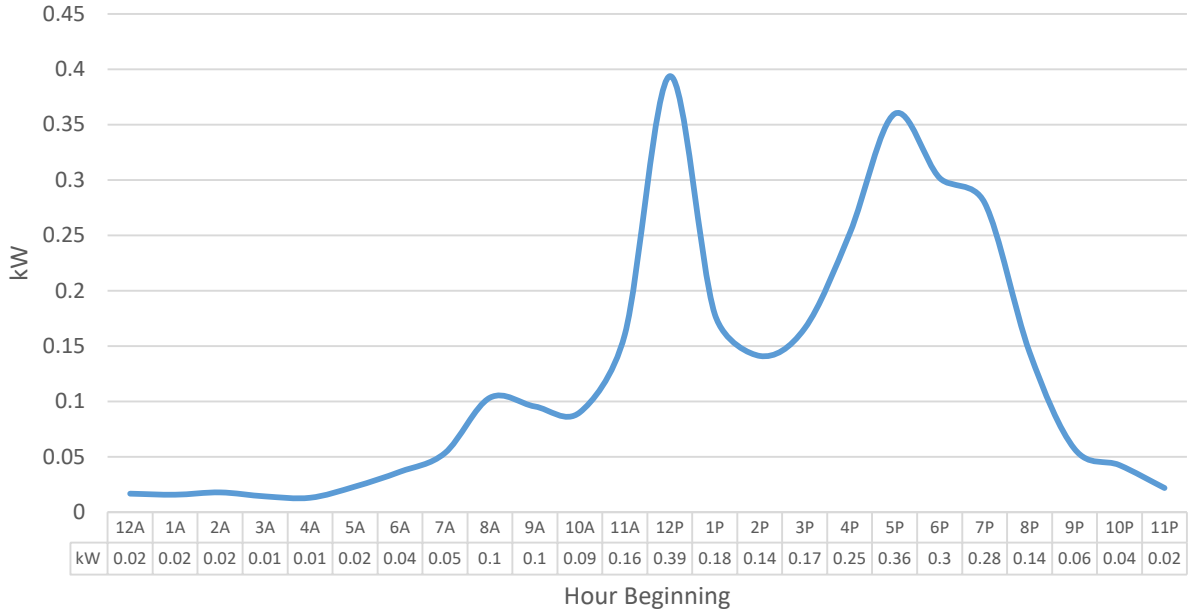

Suburban Grocer - Per Port

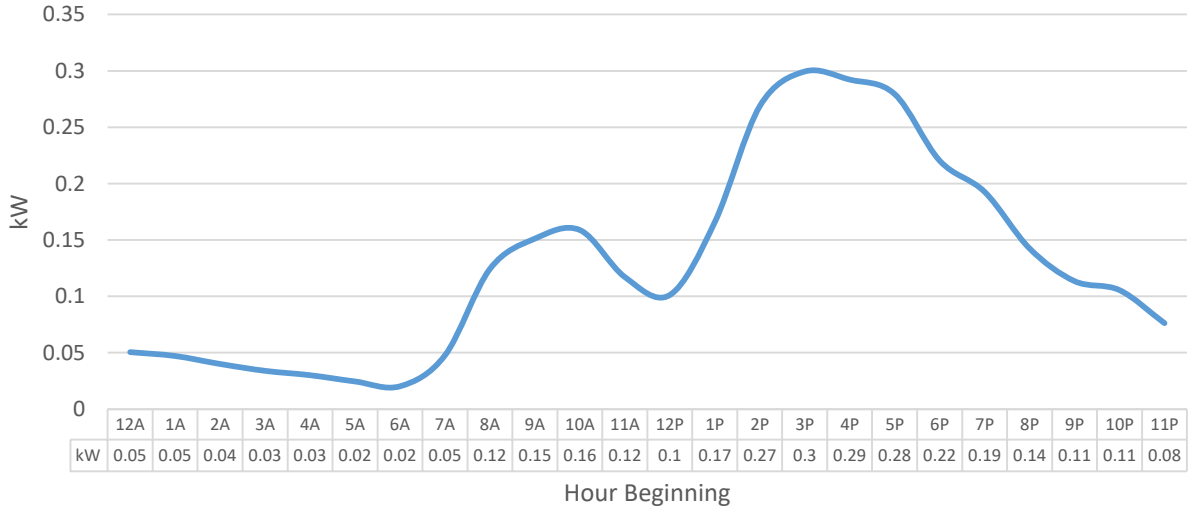



### Suburban Park Location - Per Public Port

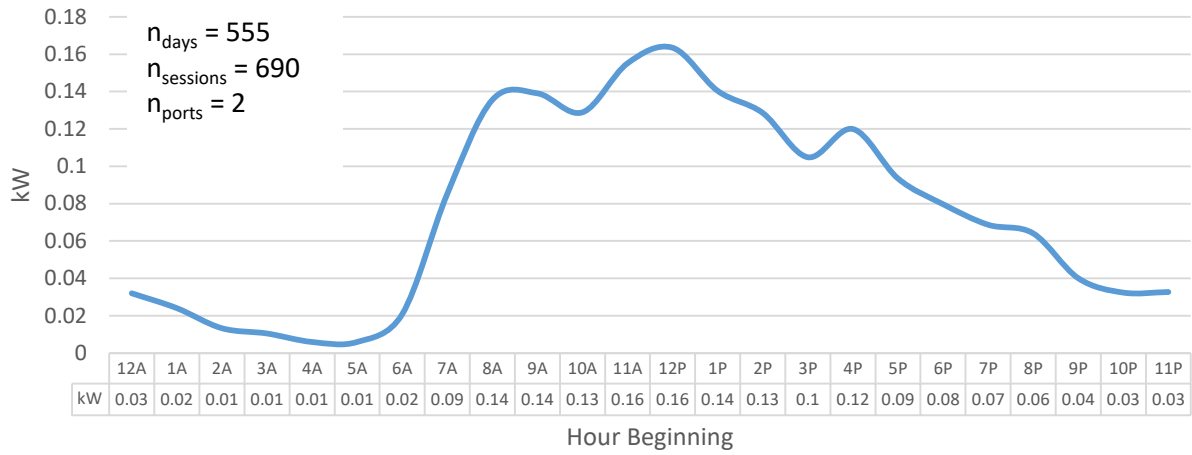

### High Traffic Retail Location - Per Public Port

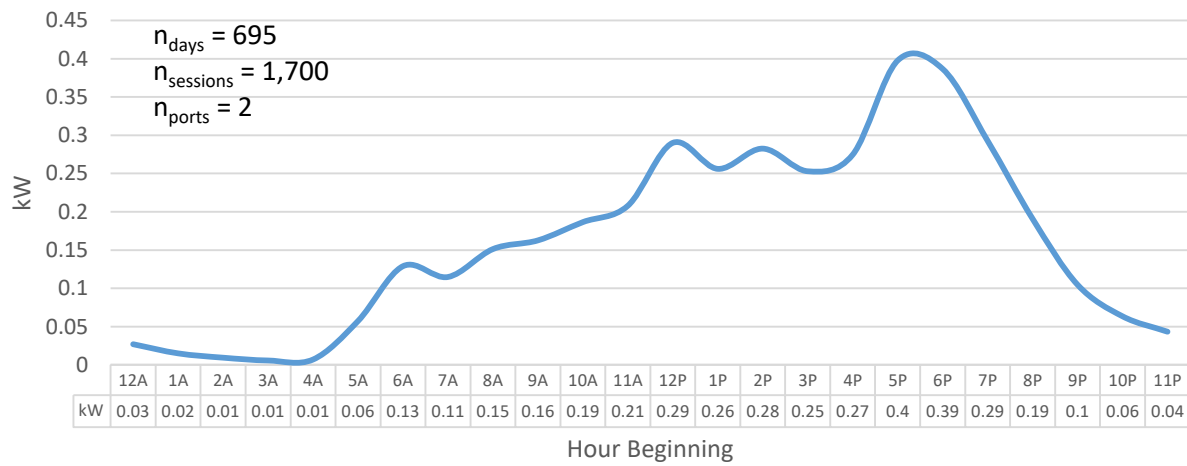

### Rural Public Location - Per Public Port

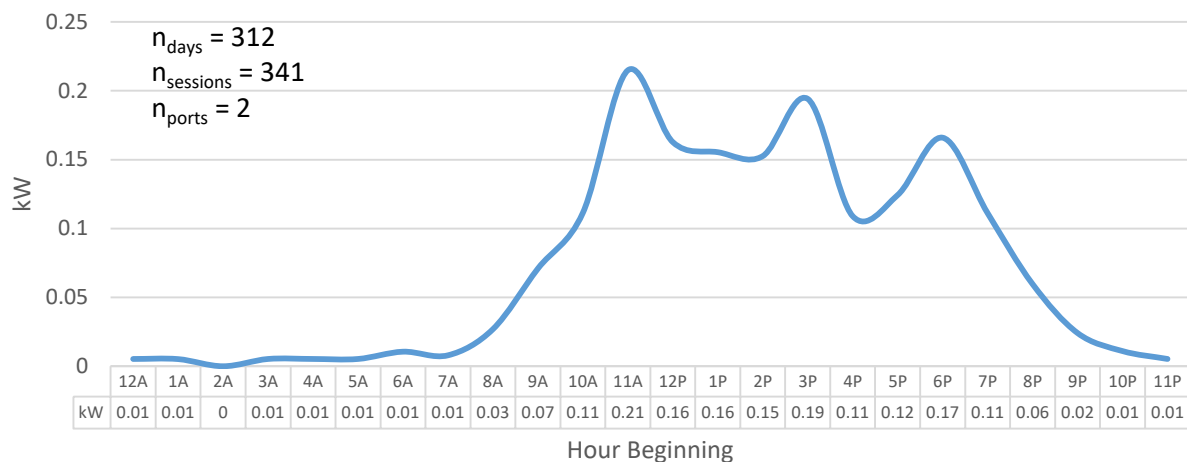

### High Traffic Downtown Public Location - Per Port

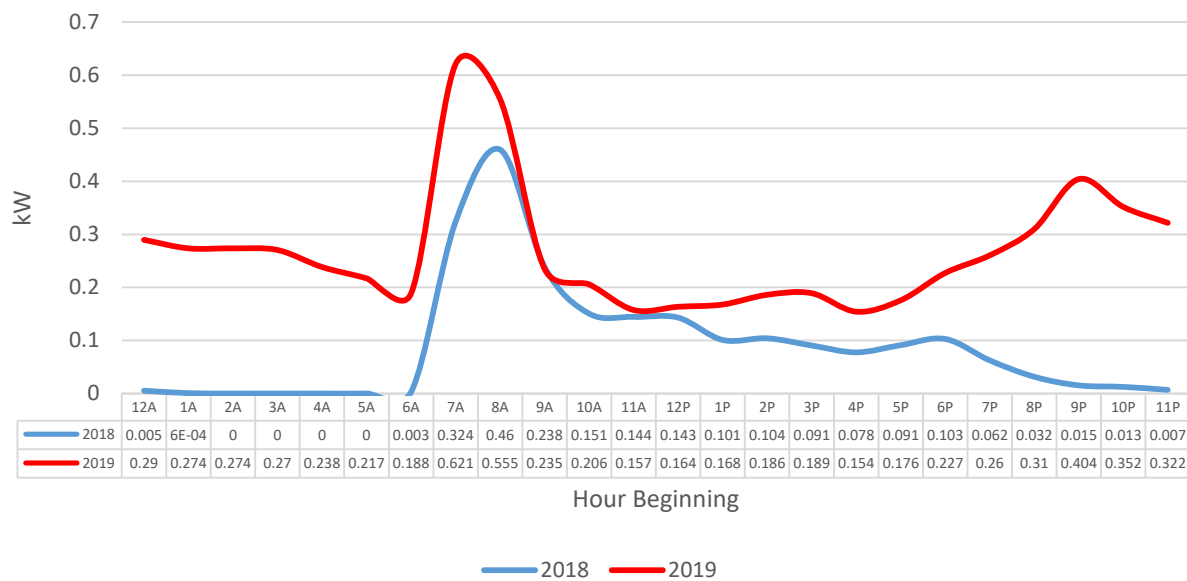

## Appendix E: Charge Session Box Plots for Workplace Charging sample Group

Appendix E provides session data for the 12 networked EV drivers within the sample workplace charging group who regularly charged at their workplaces. Drivers within this sample group initiated charge sessions at designated workplace EVSE approximately 2.3 times per week. Data from workplace charging sessions show an average connection time of 3.8 hours, with substantial variation from driver to driver.

### Workplace EVSE Session Connection Duration

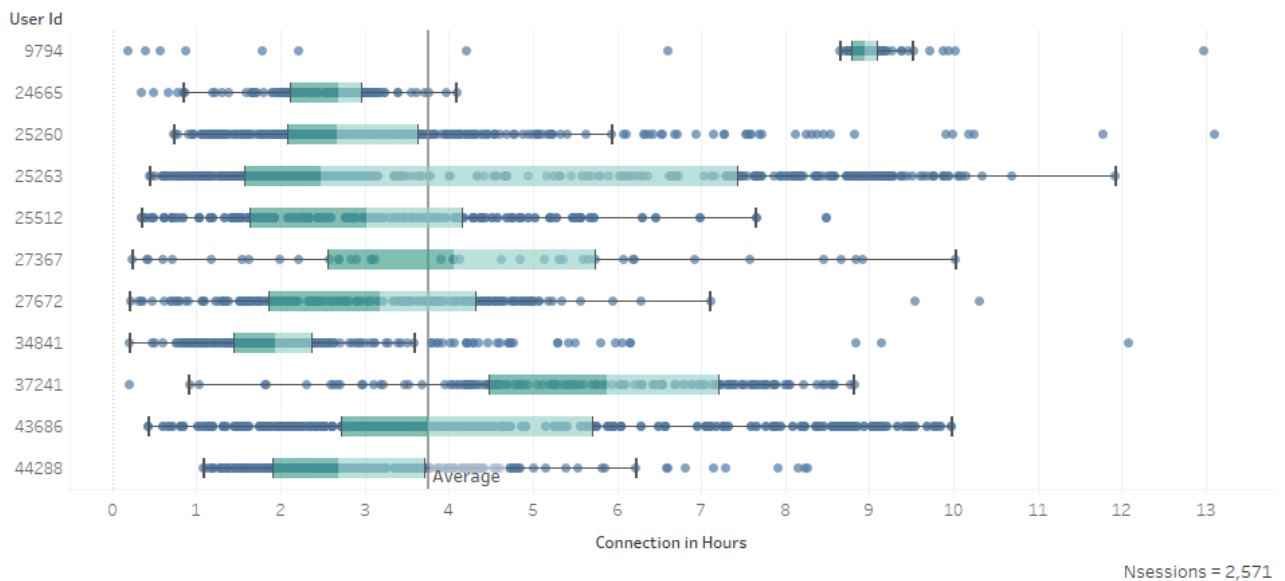

Figure 97. Workplace EVSE Session Connection Duration

### Workplace Charge Duration

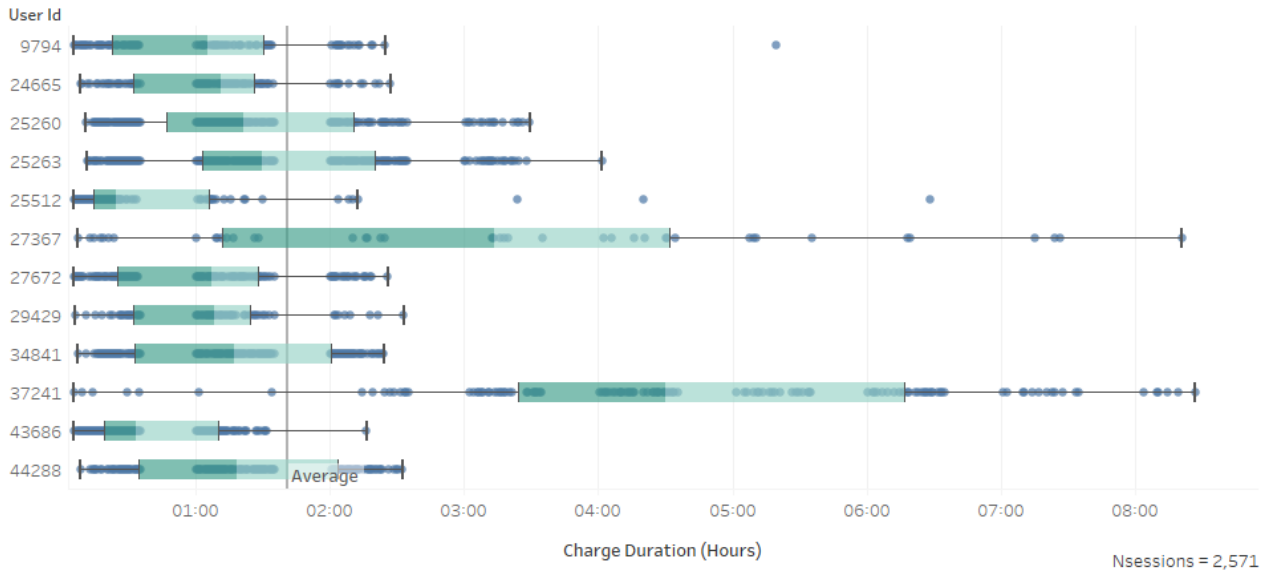

Figure 98. Workplace EVSE Charge Duration

Average energy consumption for the sample group was 8.1 kWh per workplace charging session, again with the two drivers showing significantly different characteristics.

### Workplace Energy Usage (kWh) per Charging Session

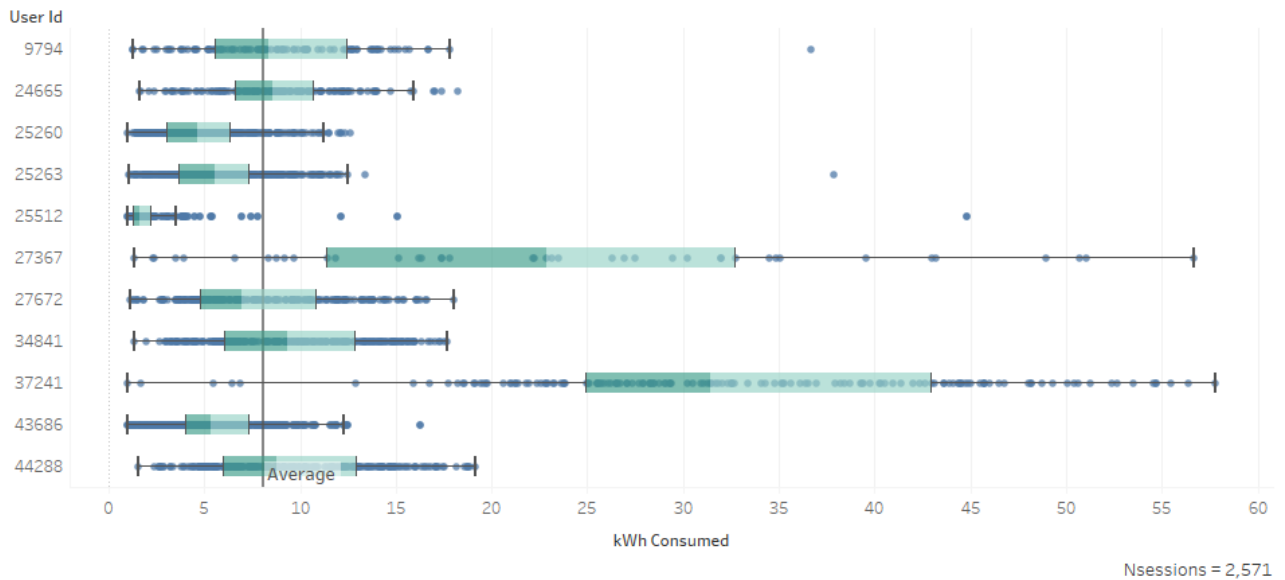
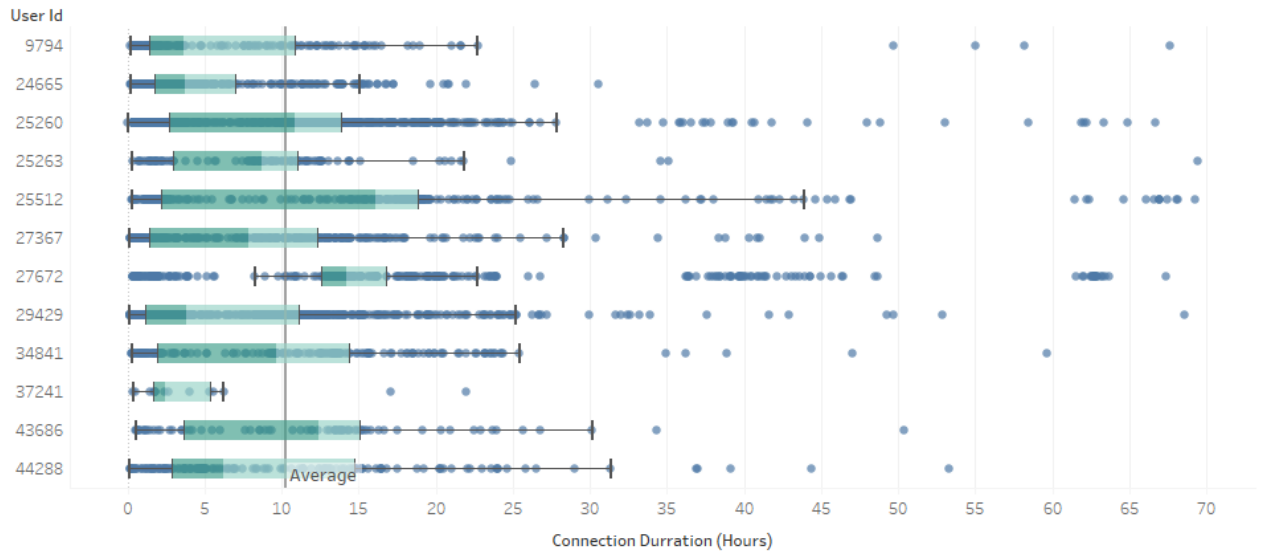

Figure 99. Workplace EVSE Energy Usage per Charge Session

In addition to the workplace charge sessions, the sample group also logged 4,013 charge sessions with their networked residential AC2 charger over 6,169 days.

*Workplace Chargers: Residential EVSE Session Connection Duration*



Nsessions = 4,014

Figure 100. Workplace Charger Sample Group: Residential EVSE Connection Duration

### Workplace Chargers: Residential Charge Duration

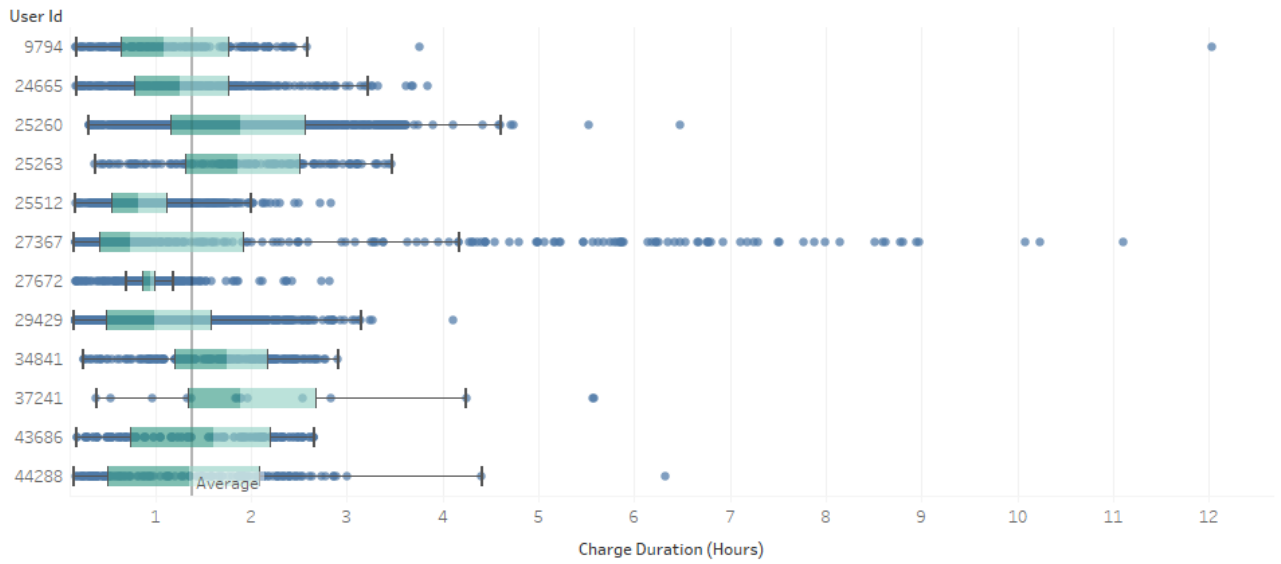

Nsessions = 4,014

Figure 101. Workplace Charger Sample Group: Residential EVSE Session Charge Duration

### Workplace Chargers: Energy Usage (kWh) per Residential Charging Session

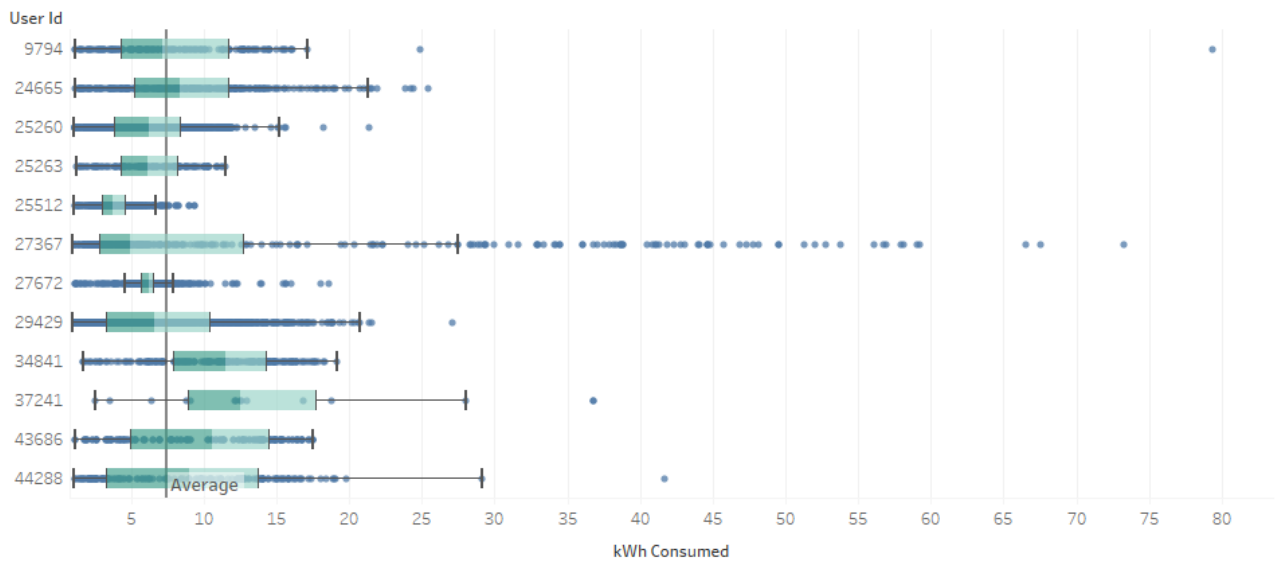

Nsessions = 4,014

Figure 102. Workplace Charger Sample Group: Residential EVSE Session Energy Usage

### Residential Only Commuters: Residential EVSE Session Connection Time Duration

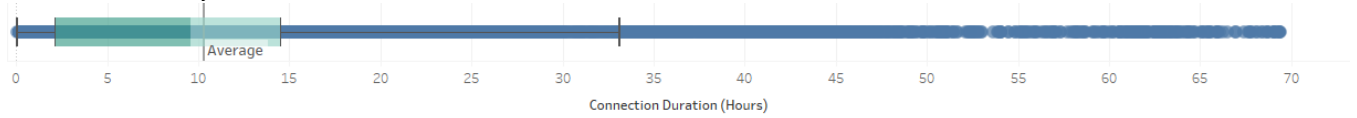

### Residential Only Commuters: Residential Charge Duration

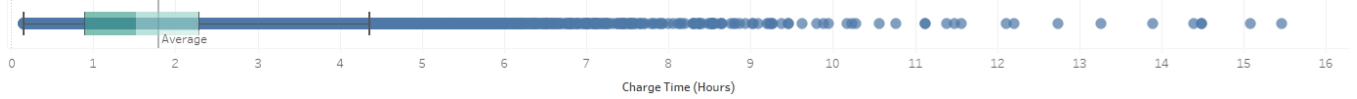

### Residential Only Commuters: Residential Energy Use

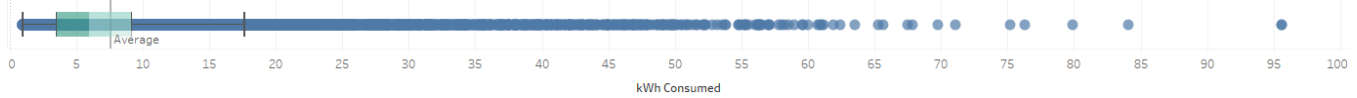

Figure 103. Residential Only Commuters: EVSE Charge Session Characteristics

The average time the sample group remained connected to their residential AC2 unit was 10.6 hours, with an average charge duration of 1.4 hours, and average energy consumption of 7.4 kWh per session. In comparison, session data from the BEV and PHEV commuters without workplace charging had an average residential session connection time of 10.3 hours, a charge duration of 1.8 hours, and energy use of 7.6 kWh.

## Appendix F: Avista EVSE Network Energy Usage

Avista Average Daily Hourly Energy Consumption (kWh)					
Hour Beginning	Public L2: 35 Ports	Workplace L2: 58 Ports	Fleet L2: 10 Ports	Public DCFC: 6 Ports	Residential L2: 102 Ports
12:00 AM	2.1	0.9	0.9	0.5	22.6
1:00 AM	1.6	0.6	0.7	0.4	14.3
2:00 AM	1.3	0.6	0.7	0.3	11.1
3:00 AM	1.1	0.4	0.6	0.2	13.4
4:00 AM	1.0	0.8	0.6	0.1	11.6
5:00 AM	1.1	1.5	0.5	0.1	9.0
6:00 AM	1.7	3.3	0.4	0.1	7.3
7:00 AM	8.1	15.1	0.5	0.2	7.9
8:00 AM	10.4	21.8	0.7	0.4	7.8
9:00 AM	8.7	20.8	1.2	0.5	10.6
10:00 AM	8.3	15.1	1.7	0.8	15.6
11:00 AM	8.8	11.5	2.6	1.2	20.5
12:00 PM	10.6	10.8	2.7	1.4	25.2
1:00 PM	10.4	12.6	3.0	1.8	29.0
2:00 PM	10.1	12.3	4.1	1.9	33.0
3:00 PM	9.3	8.8	4.7	1.8	44.0
4:00 PM	9.2	6.9	6.1	1.7	58.5
5:00 PM	10.4	6.7	6.1	1.7	77.2
6:00 PM	10.0	5.7	5.0	1.6	76.4
7:00 PM	8.4	4.5	3.8	1.5	69.1
8:00 PM	6.5	5.6	2.8	1.2	60.6
9:00 PM	4.8	3.5	2.0	1.0	53.3
10:00 PM	3.5	1.8	1.5	0.8	39.7
11:00 PM	2.6	1.2	1.1	0.6	31.3

E3 Approximate Daily Energy Consumption (MWh)					
Hour Beginning	Home L1	Home L2	Work L2	Public L2	Public DCFC
12:00:00 AM	7	30	0	0	0
1:00:00 AM	5	21	0	0	0
2:00:00 AM	4	14	0	0	0
3:00:00 AM	2	8	0	0	0
4:00:00 AM	1	7	0	0	0



5:00:00 AM	1	6	0	0	0
6:00:00 AM	0.5	7	2	0	0
7:00:00 AM	0.5	7	6	0.5	0
8:00:00 AM	0.5	7	13	1	0
9:00:00 AM	0.5	7	17	3	0.1
10:00:00 AM	0.5	7	18	4	0.1
11:00:00 AM	1	8	17	4	0.2
12:00:00 PM	2	9	15	3	0.1
1:00:00 PM	2	9	14	3	0.1
2:00:00 PM	2	10	13	2	0.1
3:00:00 PM	3	14	10	2	0.1
4:00:00 PM	4	21	9	1	0.2
5:00:00 PM	7	32	8	1	0.2
6:00:00 PM	10	42	7	0.5	0.3
7:00:00 PM	12	48	7	1	0.3
8:00:00 PM	12	47	5	0.5	0.2
9:00:00 PM	12	47	3	0.5	0
10:00:00 PM	12	42	2	0	0
11:00:00 PM	11	36	1	0	0

Average Daily Hourly Energy Consumption Distribution Comparison – Avista and E3						
Hour Beginning	Source	Home L1	Home L2	Work L2	Public L2	Public DCFC
12:00:00 AM	E3	18.9%	81.1%	0.0%	0.0%	0.0%
	Avista	0.0%	86.8%	8.0%	3.3%	1.9%
1:00:00 AM	E3	19.2%	80.8%	0.0%	0.0%	0.0%
	Avista	0.0%	84.6%	9.6%	3.5%	2.3%
2:00:00 AM	E3	22.2%	77.8%	0.0%	0.0%	0.0%
	Avista	0.0%	84.0%	9.8%	4.2%	2.0%
3:00:00 AM	E3	20.0%	80.0%	0.0%	0.0%	0.0%
	Avista	0.0%	89.0%	7.3%	2.5%	1.2%
4:00:00 AM	E3	12.5%	87.5%	0.0%	0.0%	0.0%
	Avista	0.0%	86.3%	7.1%	5.7%	0.9%
5:00:00 AM	E3	14.3%	85.7%	0.0%	0.0%	0.0%
	Avista	0.0%	77.1%	9.4%	12.5%	1.0%
6:00:00 AM	E3	5.3%	73.7%	21.1%	0.0%	0.0%
	Avista	0.0%	58.5%	13.9%	26.7%	0.9%

7:00:00 AM	E3	3.6%	50.0%	42.9%	3.6%	0.0%
	Avista	0.0%	25.2%	25.7%	48.3%	0.8%
8:00:00 AM	E3	2.3%	32.6%	60.5%	4.7%	0.0%
	Avista	0.0%	19.3%	25.8%	54.0%	1.0%
9:00:00 AM	E3	1.8%	25.5%	61.8%	10.4%	0.5%
	Avista	0.0%	26.1%	21.4%	51.3%	1.3%
10:00:00 AM	E3	1.7%	23.7%	61.0%	13.1%	0.5%
	Avista	0.0%	39.2%	20.8%	38.0%	1.9%
11:00:00 AM	E3	3.3%	26.7%	56.7%	12.8%	0.5%
	Avista	0.0%	48.9%	21.0%	27.4%	2.7%
12:00:00 PM	E3	6.9%	31.0%	51.7%	9.8%	0.5%
	Avista	0.0%	52.4%	22.2%	22.4%	3.0%
1:00:00 PM	E3	7.1%	32.1%	50.0%	10.2%	0.5%
	Avista	0.0%	54.0%	19.3%	23.4%	3.4%
2:00:00 PM	E3	7.4%	37.0%	48.1%	6.9%	0.5%
	Avista	0.0%	57.7%	17.6%	21.4%	3.3%
3:00:00 PM	E3	10.3%	48.3%	34.5%	6.4%	0.5%
	Avista	0.0%	68.8%	14.6%	13.8%	2.7%
4:00:00 PM	E3	11.4%	60.0%	25.7%	2.4%	0.5%
	Avista	0.0%	76.7%	12.0%	9.1%	2.2%
5:00:00 PM	E3	14.6%	66.7%	16.7%	1.6%	0.5%
	Avista	0.0%	80.5%	10.9%	6.9%	1.7%
6:00:00 PM	E3	16.8%	70.6%	11.3%	0.8%	0.5%
	Avista	0.0%	81.5%	10.6%	6.1%	1.7%
7:00:00 PM	E3	17.6%	70.6%	10.3%	1.0%	0.5%
	Avista	0.0%	82.7%	10.1%	5.4%	1.7%
8:00:00 PM	E3	18.6%	72.9%	7.8%	0.3%	0.5%
	Avista	0.0%	81.9%	8.8%	7.6%	1.7%
9:00:00 PM	E3	19.2%	75.2%	4.8%	0.8%	0.0%
	Avista	0.0%	85.1%	7.7%	5.6%	1.6%
10:00:00 PM	E3	21.4%	75.0%	3.6%	0.0%	0.0%
	Avista	0.0%	86.7%	7.6%	4.0%	1.7%
11:00:00 PM	E3	22.9%	75.0%	2.1%	0.0%	0.0%
	Avista	0.0%	87.8%	7.3%	3.4%	1.6%

## Appendix G: Interoperability

While EVSE infrastructure has grown in a fragmented way, there is support for standardizing the framework for EV charging to simplify and improve customer experience. This framework for interoperable systems can be broken down into four categories: 1) physical charging EVSE interface, 2) EVSE-to-network systems, 3) network-to-network systems and 4) vehicle-grid systems.<sup>47</sup> Interoperability in EV charging is an important element as it allows for a reliable, standardized and easy refueling experience for the driver. It also helps site hosts and utilities to minimize the risk of stranding assets that aren't capable of functioning on different vehicles and charging networks, while also supporting the development of vehicle grid integration.

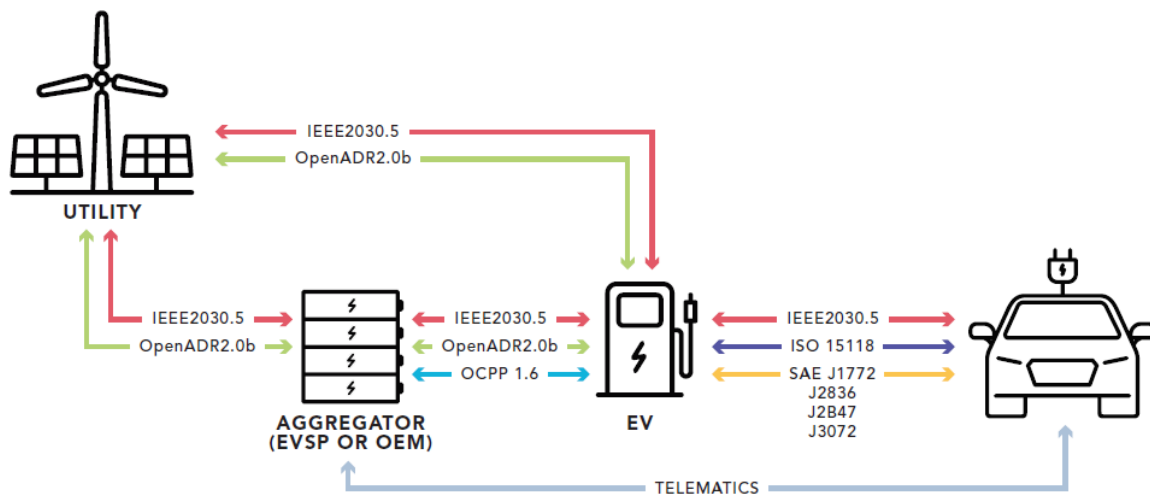

Figure 104: Interoperable EV Charging

Within the U.S., SAE J1772 is the prominent standard for communication between the EVSE and EV. The J1772 plug is used by all major EV manufacturers – except for Tesla – in AC L2 charging. DCFCs have three different DC charging ports consisting of the Tesla combo plug, the CCS combo plug used by most American and European manufacturers, and the CHAdeMO plug used by many Asian manufacturers.<sup>48</sup> The variety of DCFC port standards places an extra burden on site hosts and charge station owners as it requires them to purchase stations with multiple port types – or exclude certain port types. The driver is also burdened by this variety as they might be required to carry costly adaptors to use a station with a different plug type, an experience common for Tesla owners at non-Tesla DCFC sites. Conversely, non-Tesla drivers can't use Tesla's Supercharger network, as no adaptors exist for Tesla stations. This is currently the greatest roadblock to physical infrastructure interoperability, and a single DCFC connection standard is essential as the EV industry moves towards mass adoption.

<sup>47</sup> "Interoperability of Public Electric Vehicle Charging Infrastructure." EPRI (2019)

<sup>48</sup> See [https://afdc.energy.gov/fuels/electricity\\_infrastructure.html](https://afdc.energy.gov/fuels/electricity_infrastructure.html) for explanation of plug types

Many different network types are available to support communications between the EVSE and the EVSP. Currently OCPP is the de facto standard for EVSE-to-network communication as it is openly developed, widely implemented and potentially reduces the risk of “vendor lock-in” that can lead to stranded assets and low return on investment. Hardware manufacturers are often responsible for updating software and resolving hardware-software integration issues, and the manufacturer’s support team is often required when advanced software troubleshooting or diagnostics are needed. In the event that the hardware manufacturer becomes unresponsive or under-resourced, long lead times to repair may result. An emphasis on strong engineering and technical capability is required by network service providers and manufacturers to improve individual station reliability, given the higher frequency EV drivers interact with refueling equipment relative to ICE drivers.<sup>49,50</sup>

Ultimately, precise and transparent protocols guiding EVSE hardware-software integration are needed when the EVSE is independently manufactured. As an example, fault detection is within the scope of OCPP,<sup>51</sup> but the degree to which detection capabilities are fully integrated is highly variable. Adding clarity to existing protocols, creating new protocols based on field experience, and clarifying support roles and performance metrics are all essential for satisfactory EVSE-to-network interoperability. Migrating an EVSE from one EVSP to another usually requires minor hardware changes, e.g. swapping SIM cards if a cellular connection is used, but it avoids major changes and allows site hosts and managers to avoid being locked into any one EVSP. Ultimately the ability to choose and switch EVSPs provides evidence of the success of interoperability’s intended outcomes and supports competition – to the benefit of drivers and utility ratepayers. Avista is currently in the process of testing EVSP migration for a small test group of EVSE, in order to verify cost and required effort.

In the past two years, network-to-network interoperability has improved through roaming agreements between EVSPs. This is important for drivers and site hosts, as it allows customers to easily charge between networks without requiring multiple network subscriptions.

Currently vehicle-grid interoperability is the least developed of the four interoperability components, but holds the key to realizing utility and customer grid benefits over the long term. OpenADR is an open-source protocol that can be used to integrate the grid with DERs, aggregators and grid loads,<sup>52</sup> which can enable a variety of automated demand response programs that could prove economical and practical at scale.

---

<sup>49</sup> Public networked stations in Avista’s network were available for use an average of only 78% of the time. See the Reliability section of this report for more details.

<sup>50</sup> Assuming average annual miles driven of 12,000, fuel efficiency of 22 mpg, gas tank size of 16 gallons and completely refueling the gas tank when at 20% tank capacity for ICE vehicles, drivers interact with a gas station every 8.5 days, or roughly 43 times per vehicle per year. This compares with commuters charging at work over two days a week and the typical EV driver charging at home five times a week on average.

<sup>51</sup> See <https://www.openchargealliance.org/downloads> for OCPP 1.6 and 2.0 specifications

<sup>52</sup> See <https://www.openadr.org/specification-download> for OpenADR 2.0 specifications, examples and architecture

Looking forward, promising standards such as ISO 15118 will allow vehicles to communicate with EVSEs, EVSPs or the utility directly. ISO 15118 also provides the architecture for more advanced VGI such as V2G. Other protocols like EPRI's OVGIP similarly allow the EV to authenticate transactions through the OEM simply by plugging in the connector. SEP 2.0 is a smart grid protocol based on IEEE 2030.5 standard that can help utilities manage peak loads through a home gateway – potentially interacting with the EVSE or EV through OpenADR, ISO 15118, OCPP, or directly.<sup>53</sup> Research, development, and demonstration projects as well as personnel technical skills and knowledge will be required in partnership between EVSE manufacturers, EVSPs, vehicle OEMs, and utilities to make VGI a reality and realize net grid benefits for customers.

---

<sup>53</sup> Electric Vehicles and the California Grid. Next10. <https://next10.org/sites/default/files/evs-ca-grid-op.pdf>

## Appendix H: Economic Modeling Details

Detailed here are the different components used for costs and benefits in Avista’s economic modeling in the “regional” and “ratepayer” perspectives. Note that all variable components listed in the figure were used in the E3 model, but in order to simplify analysis several were removed from consideration in the Avista model, after it was shown they would have little to no effect on results. E3 was consulted to develop similar inputs for Avista’s model, comparable to E3’s “WA+OR” baseline results. However, Avista’s model algorithms were independently developed. The descriptions that follow further detail the variable inputs used in Avista’s study.

### Federal Tax Credit

The federal tax credit included in this assessment runs through 2022 and provides a benefit of up to \$7,500 per EV purchased. Following this tax credit’s expiration, no other credits are included.

### Generation Capacity Costs

Generation capacity was determined based on Avista’s 2017 IRP. Due to power purchase agreements (PPA) and conservation measures, Avista has sufficient capacity of these adoption scenarios until 2027 without requiring additional generation capacity. That is, the additional load from electric vehicle charging on Avista’s system through year 2026 is less than the additional capacity available for system load growth. Under the assumption that the addition of EV charging was still less than the planned capacity through 2026, the generation capacity costs during these years were considered to be zero. Following 2027, generation cost is based on the levelized cost for an advanced small frame combustion turbine with annual cost growth of 2% per year.

### Energy Cost with Losses

Energy costs were modeled from Avista’s IRP, which was derived from historical demand and load growth using established costs from commercially available resources in Avista’s generation mix. The compounded annual growth rate of average yearly energy costs escalate 1.9% in real terms during this

	Regional Perspective	Ratepayer Perspective
<b>Electricity Supply Costs</b>		
Electric Energy Generation (incl. Losses)	-	-
Generation Capacity Cost	-	-
T&D Cost	-	-
Ancillary Services Cost	-	-
RPS Cost	-	-
Electric Carbon Cost	-	-
<b>PEV Costs and Benefits</b>		
Incremental Electric Vehicle Cost	-	
Federal Tax Credit	+	
Gasoline Savings	+	
Gasoline Carbon Savings	+	
Vehicle O&M Savings	+	
<b>Charging Costs</b>		
Charger Cost	-	
Vehicle Charging Utility Bills		+

Figure 105: Variable impacts on economic models (source: E3)

period. Energy costs fluctuate with demand seasonally and daily, with peaks occurring during in the afternoon year-round and in the morning hours during the winter. For this model, average daily energy costs were determined by using empirical charging data from Avista’s EVSE pilot. Using the weighted average of on-peak to off-peak EV energy consumption produced the weighted annual costs used in this analysis.

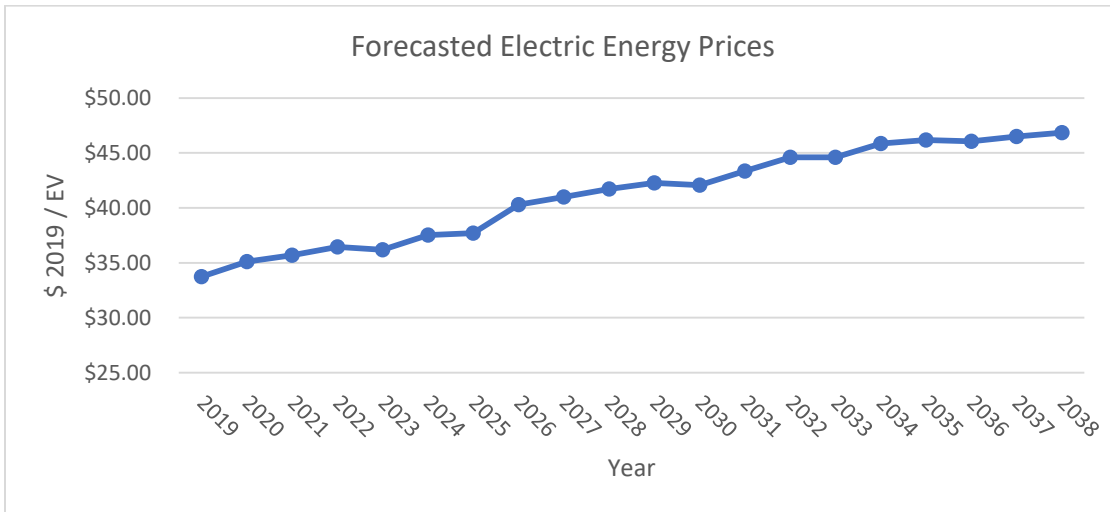

Figure 106. Forecasted electric energy prices used in model

### EV Population

Annual EV population is a function of newly purchased and replacement EVs to the existing EV stock minus any retired EVs. In the base case model, the population trajectory is based on new technology adoption models, with EVs reaching 15% of new LDV sales in 2030. The assumed lifetime of an EV in this model is ten years and the age of each vehicle in the existing population is tracked. While replacements and new EV sales are added to the population during the first 20 years of the study, beginning in 2038 no new EVs are sold and none of the retiring stock is replaced. As a result the EV population declines to zero in 2048 where no additional costs or benefits are realized in the model.

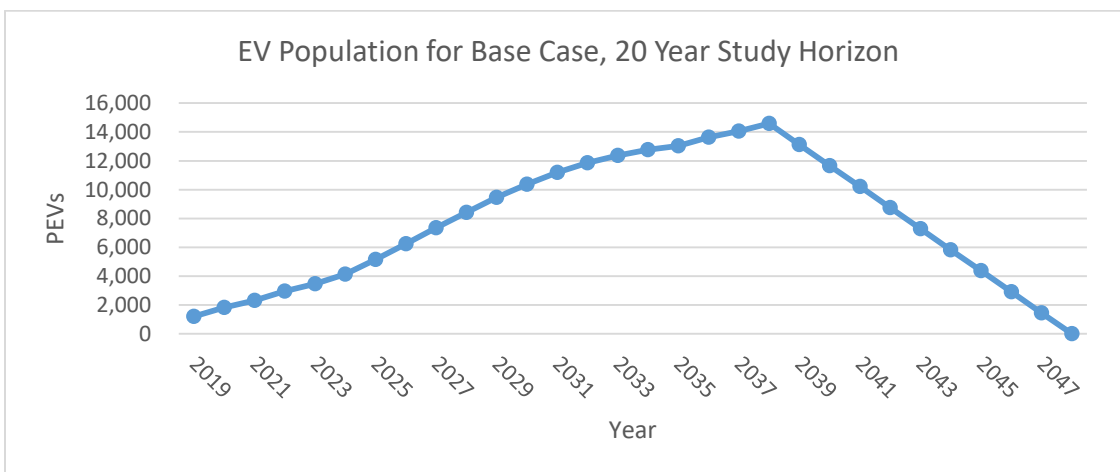

Figure 107. Forecasted baseline EV population in Avista Washington service territory used in model

## **EVSE Infrastructure**

EVSE sales are driven by new EV sales and replacements. In this model, EVSEs have the same ten year useful life as EVs. EVSEs are distributed between residential, public and workplace sites in proportions derived from Avista's EVSE pilot data. This equates to EVSE port distribution of approximately 55% residential, 25% workplace and 20% public per EV sold. Since new and replacement EV sales cease in 2038, no additional EVSEs are purchased beginning that year. The cost per EV is based on current market prices and decreases on average 2.1% per year. The total cost of EVSEs is a function of this cost, EV sales and the proportion of EVSEs purchased per EV. While infrastructure requirements change based on EV mix (BEV, PHEV) due to different charging needs, this model treats the EVSE infrastructure mix consistently.

## **T&D Costs**

T&D replacement costs were derived by first determining each residential transformer's peak demand as a percentage of maximum transformer rated capacity on a system-wide basis. The analysis then assumed coincident load from a single EV charging occurred during each transformer's peak historical demand. This gave the worst case transformer load total, as the existing peak plus EV load. When the transformer's peak plus EV load exceeded 125% of the transformer's capacity, it was considered due for replacement. Performing this analysis on Avista's transformer assets showed a need to replace transformers due to EV load 5.2% of the time. That is, approximately one transformer would need to be replaced for every 20 EVs added to Avista's system due to exceeding the transformer's peak capacity threshold. Only one EV per transformer was assumed, and this assumption is in line with empirical data Avista has collected as part of its pilot program to date. As adoption increases this will change as EV adoption tends to occur in clusters. However the EV penetration will need to reach at least 1 in 5 households – without any demand response measures – before making any meaningful impact on this transformer replacement percentage. This study has front loaded transformer upgrades during the first year due to prior EVs in Avista's service territory being treated as new additions. Feeder and substation impacts were not included as detailed in the report, due to uncertainty in modeling and the likelihood of minimal impacts given the low level of transformer replacements. Additional investigation is warranted for cases of higher adoption rates and to examine important second-order effects.

## **Incremental Vehicle Cost**

The cost of current EVs today is higher than comparable ICE vehicles. The trend of this cost over time is expected to decline as shown below over the next 18 years, according to E3.



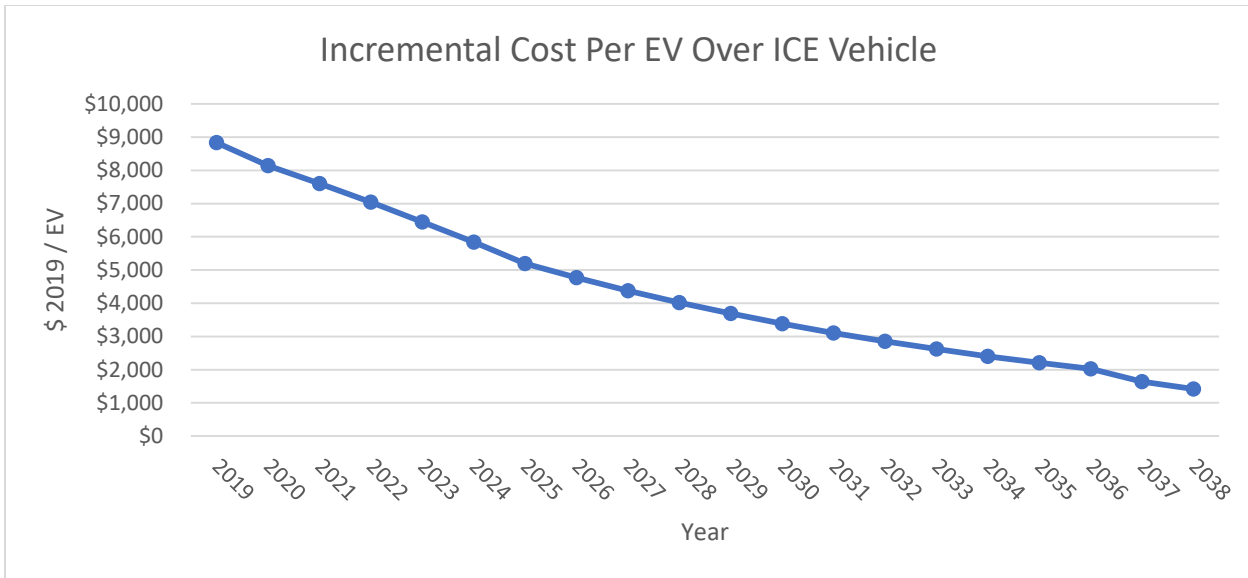

Figure 108: Forecasted incremental EV cost compared to ICE vehicles

**Vehicle O&M Cost**

EV's typically require much less maintenance over their service life compared to ICE vehicles. Estimated savings from money saved on maintenance and repairs over a EV's lifetime relative to the same cost for a comparable ICE vehicle.

**Charger Cost**

There is a cost associated with providing adequate infrastructure to support EV adoption. EV chargers are necessary to support this adoption. The cost of chargers per vehicle is dependent on the magnitude of EV adoption, the price of the charger, and the number of chargers needed for each EV (Impacts of EV Adoption in WA & OR, 58-59). This cost is expected to decrease over the 20-year forecast shown below.

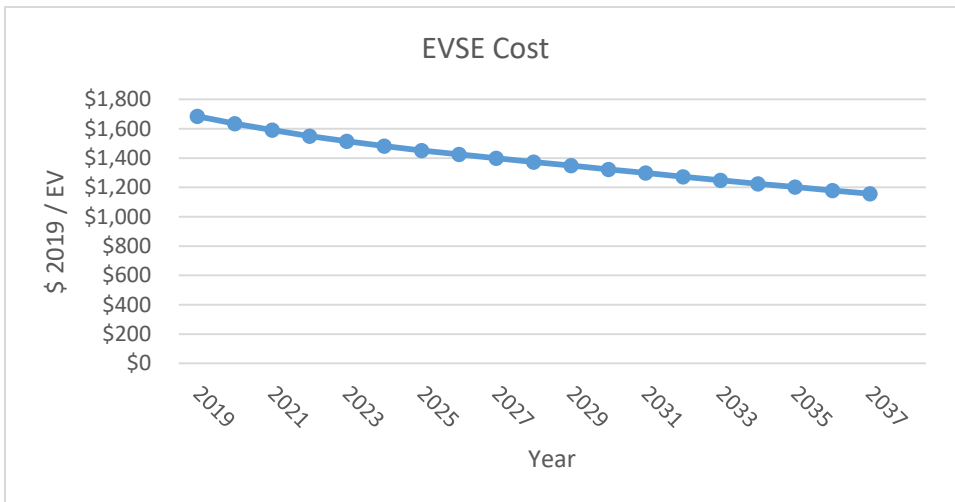

Figure 109. Forecasted EVSE cost used in model

### Vehicle Charging Utility Bills

Utility bills were based on current electric rates for residential Avista customers, along with historical and expected load growth found in Avista’s IRP. Projected rates include costs of generation resources as power delivery costs on Avista’s system. No time-of-use (TOU) or special EV charging energy rates were incorporated into this study. Additionally, no demand charges as a result of residential EV charging were included in the EV charging bill revenue model. Each EV was assumed to drive 11,181 miles per year, with 3.3 miles per kWh of electricity consumption.

### Gasoline Savings per EV

Gasoline savings per EV value is calculated each year based on the difference in costs between the electric utility bill and the cost of driving an ICE vehicle the same distance of 11,181 miles. Model inputs assume gasoline fuel efficiency increases from 34 mpg in 2019 to 48 mpg in 2036, and the price of gasoline modestly increases from \$2.58/gal to \$3.50 over the same timeframe.

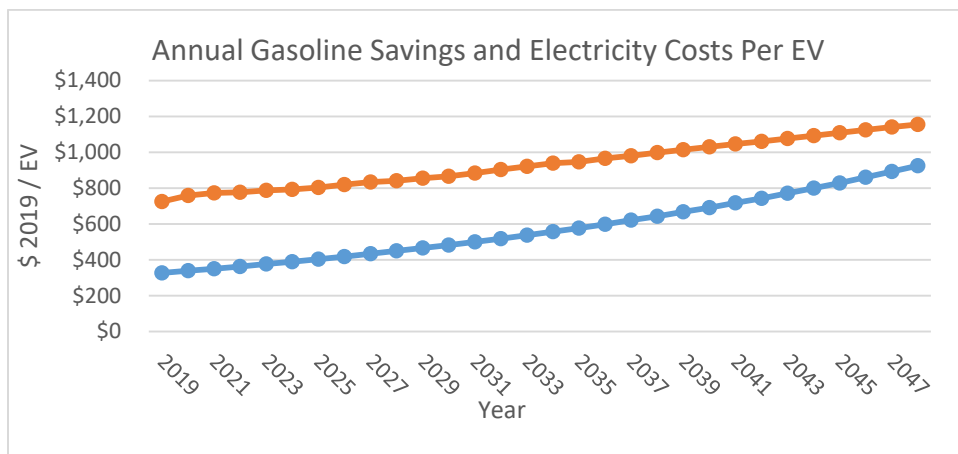

Figure 110. Forecasted gas savings and electricity fueling costs per EV used in model



*Avista's first DC fast charging site in partnership with the town of Rosalia, Washington (2017)*