



# Challenges and Opportunities For New Pumped Storage Development

A White Paper Developed by NHA's Pumped Storage Development Council

## 1.0 EXECUTIVE SUMMARY

An essential attribute of our nation’s electric power system is grid reliability - ensuring that electric generation matches electric demand in real-time. The primary challenge in ensuring reliability is that electricity has no shelf life - it must be generated when needed - and electricity demand continually changes, especially between daytime periods of peak demand and night-time periods of low demand.

Electric transmission grid operators have long met this challenge on a real-time basis with a limited number of generation technologies - specifically hydropower and gas-fired combustion turbines - that have the ability to start up quickly and/or vary their electric output as the demand changes.

However, these solutions may not be enough as we move into a world with far greater amounts of renewable energy on the grid. In that new reality, reliable, affordable and grid-scale storage of energy must be on the table. Fortunately, a technology exists that has been providing grid-scale energy storage at highly affordable prices for decades: hydropower pumped storage. Indeed, for the foreseeable future hydropower pumped storage stands alone as the only commercially proven technology available for grid-scale energy storage.

---

***Hydropower pumped storage is the only commercially proven technology available for grid-scale energy storage.***

---

The last decade has seen tremendous growth of wind and solar generation in response to favorable tax incentives and other policies. While increasing the amount of renewables on the grid is a good thing,

the variability of wind and solar generation increase the need for energy storage.

Developing additional hydropower pumped storage, particularly in areas with recently increased wind and solar capacity, would significantly improve grid reliability while reducing the need for construction of additional fossil-fueled generation. Grid scale storage could also reduce the amount of new transmission required to support many states’ goals of 20-33% renewable generation by the year 2020.

---

***Developing additional hydropower pumped storage, particularly in areas with recently increased wind and solar capacity, would significantly improve grid reliability while reducing the need for construction of additional fossil-fueled generation.***

---

Pumped storage hydropower has a long history of successful development in the U.S. and around the world. Energy storage has been a part of the U.S. electric industry since the first hydropower projects,

primarily through the flexible storage inherent in reservoirs. In the U.S., there are 40 existing pumped storage projects providing over 22,000 MWs of storage, with largest projects in Virginia, Michigan and California (Bath County, Ludington and Helms, respectively). Additionally, there currently are 51,310 MWs representing over 60 pumped storage projects in the FERC queue for licensing and permitting. Globally, there are approximately 270 pumped storage plants either operating or under construction, representing a combined generating capacity of over 127,000 megawatts (MW). As a proven technology, it been shown to be cost effective, highly efficient, and operationally flexible. This grid scale storage technology has been used extensively to both store and redistribute electricity from periods of excess supply to periods of peak demand and provide grid reliability services in generation mode. . Similar to the U.S., European energy policy is also focused on adding clean, renewable energy to the grid. And the significant amounts of wind and solar being brought on-line is the motivating force that is driving new pumped storage development noted above.

The National Hydropower Association (NHA) believes that expanding deployment of hydropower pumped storage energy storage is a proven, affordable means of supporting greater grid reliability and bringing clean and affordable energy to more areas of the country.

---

***Hydropower pumped storage is “astoundingly efficient...In this future world where we want renewables to get 20%, 30%, or 50% of our electricity generation, you need pumped hydro storage. It’s an incredible opportunity and it’s actually the lowest cost clean energy option.” – U.S. Energy Secretary Dr. Steven Chu, September 2009***

---

While benefits of expanding pumped storage capacity are clear, current market structures and regulatory frameworks do not present an effective means of achieving this goal. Policy changes are needed to support the timely development of additional grid-scale energy storage. To this end, NHA has developed a series of recommendations to guide the energy industry and policy makers. NHA’s key policy recommendations are presented in detail in Section 4 of this paper, and include:

- Create market products that allow flexible resources to provide services that help meet electric grid requirements, including very fast responding systems that provide critical capacity during key energy need periods.
- Level the policy playing field for pumped storage hydropower with other storage technologies to encourage the development and deployment of all energy storage technologies.
- Recognize the regional differences within the U.S. generation portfolio and the unique roles energy storage technologies play in different regions.
- Recognize the energy security role pumped storage hydropower plays in the domestic electric grid.

- Establish an alternative, streamlined licensing process for low-impact pumped storage hydropower, such as off-channel or closed-loop projects.
- Improve integration of Federal and state agencies into the early-stage licensing processes for pumped storage hydropower.
- Facilitate an energy market structure where transmission providers benefit from long-term agreements with energy storage facility developers.

This paper includes two supporting appendices that present additional detail on historic and current trends in pumped storage hydropower development (Appendix A) and provide a brief summary of advancements in equipment technology (Appendix B) which may provide further benefits to the integration of additional variable renewable energy resources.

## 1.1 INTRODUCTION - THE NEED FOR PUMPED STORAGE

### Pumped Storage: An Overview

Pumped storage hydropower is a modified use of conventional hydropower technology to store and manage energy or electricity<sup>1</sup>. As shown on Figure 1, pumped storage projects store electricity by moving water between an upper and lower reservoir.<sup>2</sup> Electric energy is converted to potential energy and stored in the form of water at an upper elevation. Pumping the water uphill for temporary storage “recharges the battery” and, during periods of high electricity demand, the stored water is released back through the turbines and converted back to electricity like a conventional hydropower station. In fact, at many existing pumped storage projects, the pump-turbines are already being used to meet increased transmission system demands for reliability and system reserves. Current pumped storage round-trip or cycle energy efficiencies exceed 80%, comparing favorably to other energy storage technologies and thermal technologies<sup>3</sup>. This effectively shifts, stores, and reuses energy generated until there is the corresponding demand for system reserves and variable energy integration. This shifting can also occur to avoid transmission congestion periods, to help more efficiently manage the transmission grid, and to avoid potential interruptions to energy supply. New adjustable-speed technology also allows pumped storage to provide fast ramping, both up and down, and frequency regulation services in both the generation and pump modes. This is important because many of the renewable energy resources being developed (e.g., wind and solar) are generated at times of low demand and off-peak energy demand periods are still being met with fossil fuel resources, often at inefficient performance levels that increase the release of greenhouse gas emissions.

---

<sup>1</sup> “Pumped storage” as it is used in this document is primarily for the purpose of storing electricity, although “energy storage” is a commonly used term throughout. “Energy storage” is commonly differentiated to primarily include thermal, natural gas and various forms of chemical processes. In pumped storage hydropower, previously generated electricity is converted to potential energy when pumped uphill and stored in the form of water at an upper elevation (reservoir), where it later flows downhill to a lower reservoir through turbine and converted back to electricity.

<sup>2</sup> Pumped storage projects generally involve an upper and lower reservoir; however, there are other project design concepts under consideration that would locate one or both reservoirs below ground (sub-surface) to take advantage of abandoned mines, caverns, or other storage reservoirs. These types of projects could be attractive due to their perceived site availability and their potential for reduced environmental impacts.

<sup>3</sup> Round trip or cycle efficiency can vary significantly for different energy storage technologies, depending on application (battery, flywheel, etc.), number of cycles, and duration of usage. In general, distributed energy storage technologies (flywheels, batteries) have cycle efficiency ranging from 60%-95%, and bulk energy storage systems (pumped hydro and CAES) ranging from 70% to 85%. As a comparison, simple cycle and combined cycle gas turbine plants have cycle efficiency ranging from 30%-60% (Alstom Power Data Base).

Additional information related the historical development, operational characteristics, and worldwide function of pumped storage is provided in Appendix A.

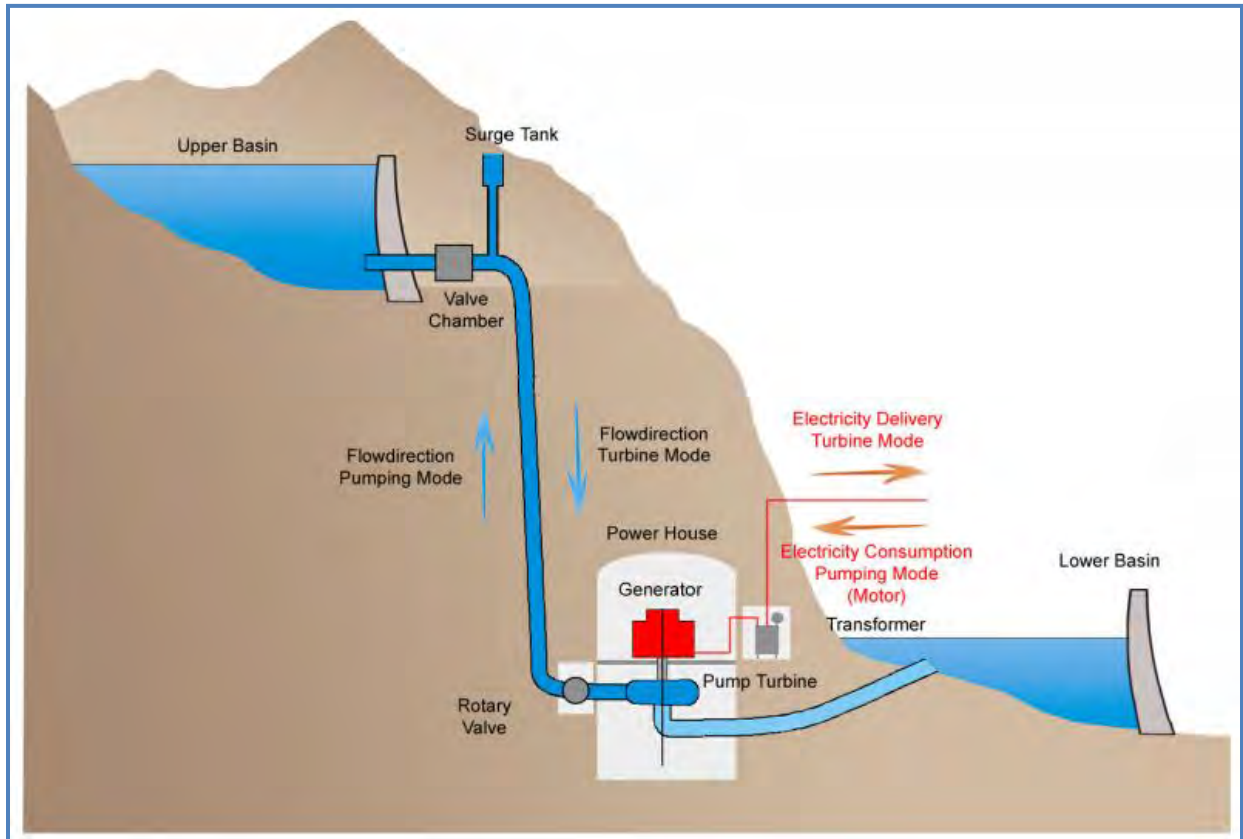

Figure 1: Typical Pumped Storage Plant Arrangement (Source: Alstom Power).

Hydropower, including pumped storage, is critical to the national economy and the overall energy reliability because it is:

- The least expensive source of electricity, not requiring fossil fuel for generation;
- An emission-free renewable source;
- Able to shift loads to provide peaking power without requiring ramp-up time like combustion technologies; and
- Often designated as a “black start” source, able to restore network interconnections if a power blackout occurs.

Source: U.S. Department of Energy and Homeland Security – Dams and Energy Sectors Interdependency Study, September 2011.

## The Need for Bulk Storage

During the last decade, variable renewable energy projects (primarily wind and solar-based technologies) have gained strong momentum in response to favorable tax incentives and the social preference for renewable energy without the potentially harmful environmental impacts of carbon-based generation. However, these resources increase the need for system reserves (i.e., firming resources) to satisfy existing grid requirements and the variable nature of many renewable energy technologies. These firming resources typically include coal-fired and natural gas plants, and the existing fleet of hydropower facilities. As the capacity of available firming resources reaches the limit to support variable renewable energy resources, the U.S. electric industry has commonly turned to construction of new natural gas plants because of their short permitting process and relatively low fuel cost. The increased fleet of natural gas peaking plants can result in excess or underutilized facility capacity. This condition is frequently inefficient and can result in costly idling of these resources during low consumer demand periods or periods of peak variable renewable energy generation. More critically, these firming resources must be operated at an inefficient partial load to provide that system flexibility, even when the power is not needed. In some areas of the Pacific Northwest or Southwest, the impact of having excess amounts of electricity is becoming a significant concern for electric grid operations and these conditions will only be exacerbated by continued development of variable renewable energy. Bulk storage, such as pumped storage hydropower, could significantly reduce the need for conventional reserve generation capacity, support the development and optimal integration of renewable energy resources, and reduce the amount of new transmission required to support the goal of 20-33% renewable generation in these regions by the year 2020.

Since deregulation of the electric industry, there is no regulatory mechanism or market price incentive for the effective integration of new generation, energy storage, and transmission (Miller, 2010). Yet these are three components of a reliable energy generation and transmission system that require coordinated, long-term planning. In addition, in certain market regions, large amounts of variable renewable energy generation are creating new challenges for the overall transmission system and its grid operators. Bulk energy storage could alleviate some of these difficulties and promote the development of new variable energy because it would be able to shift renewable energy generated during low demand periods to higher demand periods, thereby maximizing the value of these projects. The fast ramping capability of current technology can also manage hourly and intra-hour changes in generation. Because bulk energy storage can be used to optimize the transmission grid and reduce the amount of new transmission required, NHA believes it should be included in regional transmission planning processes under Federal Energy Regulatory Commission (FERC) Order 1000<sup>4</sup>.

---

<sup>4</sup> FERC Order 1000: *Transmission Planning and Cost Allocation by Transmission Owning and Operating Public Utilities* (July 21, 2011).

## **Renewable Energy Growth – Driving the Need for Energy Storage**

In 2010, renewable energy generation accounted for 8% of the total energy supply in the U.S. (Energy Information Administration [EIA], April 2011). Hydropower, biomass, and geothermal energy are capable of providing predictable, consistent generation; however, wind and solar generation, while less variable with adequate geographic diversity, can present new challenges for U.S. grid reliability and stability. The power output for these plants can fluctuate widely as weather patterns change and, while the changing weather patterns may be well understood, the magnitude of renewable energy generation ramps (in particular, when not in correlation with changing load) can be challenging to grid operators when renewable energy resources are a large component of their generation portfolio. This variable output can lead to frequency and voltage fluctuations, which adversely affect grid stability. In geographic regions without a significant hydroelectric generation base, this variability is most commonly managed with fossil fuel-based thermal generation.

According to the American Wind Energy Association (AWEA), over 1,100 megawatts (MW) of wind power capacity were installed during the first quarter of 2011 – more than double the capacity installed in the first quarter of 2010 (RenewableEnergyWorld.com, 2011). The U.S. wind industry had 40,181 MW of wind power capacity installed at the end of 2010, which produced 2.3% of the electricity in the U.S. (increased from 1.8% in 2009). The U.S. wind industry has added over 35% of all new generating capacity over the past four years, second only to natural gas generation (EIA, April 2011). The EIA also projects that non-hydropower renewable energy generation sources will increase from approximately 47,000 MW in 2009 to over 100,000 MW in 2035, with the majority of this projected increase attributed to wind-powered generation (EIA, April 2011). NHA fully acknowledges the significant benefits that wind and other renewable energy sources can provide with regards to domestic energy security; however, without adequate system planning, including bulk storage, the integration challenges of more renewable energy resources are likely to be in conflict with electric grid operators' goals to provide stable, secure, and reliable energy to consumers.



*“... when the wind generation on BPA’s system is operating at full capacity (which typically occurs at night), wind output alone approaches the total load within BPA’s balancing area....The result has been increasing generation-following charges and major curtailments of wind generation. The BPA experience foreshadows what will happen around the country as balancing authorities tackle the challenge of integrating wind and solar. Even more serious, regional transmission organizations such as the Midwest Independent System Operator and the Southwest Power Pool have begun imposing major curtailments on the output of wind generators due to transmission congestion and minimum generation events, situations that are only likely to worsen if the penetration of intermittent renewable energy resources increases... If we are to achieve renewable energy goals, the Federal government needs to clear away barriers to grid-scale energy storage that the Federal government itself has raised.”*

*Source: Eagle Crest Energy - White Paper on Removing Federal Barriers to Grid-Scale Energy Storage, November 2011.*

---

## 1.2 2.0 MAJOR CHALLENGES TO PUMPED STORAGE IN THE U.S.

### Environmental Issues for Pumped Storage Siting

Significant environmental misconceptions face many pumped storage developers today. In the past, almost all of the operating pumped storage projects required the construction of at least one dam along main stem rivers, altering the ecology of the river system. Enhanced awareness of the impacts from construction of large dams and storage reservoirs on existing river systems generally precludes further consideration of these large projects, or developers work directly with the environmental community to try to reduce or mitigate project impacts. The majority of existing pumped storage project owners (typically investor/publically owned utilities or the Federal government) has attempted to address these impacts through significant post-construction efforts to improve habitat or provide project-specific mitigation measures. In today’s pumped storage development community, project proponents attempt to minimize these issues by focusing on new project sites where proposed construction would have minimal environmental impacts, rather than attempting post-construction mitigation measures.

A relatively new approach for developing pumped storage projects is to locate the reservoirs in areas that are physically separated from existing river systems. These projects are termed “closed-loop” pumped storage, because they present minimal to no impact to existing river systems. After the initial filling of the reservoirs, the only additional water requirement is minimal operational make-up water required to offset evaporation or seepage losses. By avoiding existing complex aquatic systems entirely, these types of projects have the potential to greatly reduce the most significant aquatic impacts associated with project development. In addition, because closed-loop pumped storage systems do not need to be located near an existing river system or body of water, with the right topographical features, they can be located where needed to support the grid.

## **Regulatory Treatment of Pumped Storage**

Another significant challenge facing pumped storage project developers is the regulatory timeline for development of new projects. Under Section 10(a) of the U.S. Federal Power Act, any non-Federal pumped storage developer must obtain a FERC license, as well as multiple other state or Federal permits. Under the current FERC licensing process, obtaining a new project license to construct can take three to five years, or even longer before the developer will have the authority to begin project construction. There is currently no alternative licensing approach for low-impact or closed-loop sites to shorten this time frame. In addition, a three- to five-year construction period is common for most large projects; furthermore, environmentally benign projects being developed to support renewable energy integration could take six to 10 years or longer to construct. Very few financial institutions are willing to finance these types of long-lead projects through the licensing timeframe. NHA and the hydropower industry are continuing to work closely with the FERC to streamline the licensing process for those projects with obvious minimal environmental constraints, especially when many new projects can help support the development and integration of additional renewable energy resources.

***At the IQPC 6th Annual Energy Storage Summit meeting in San Francisco on March 27, 2012 FERC Commissioner John Norris said storage should and probably will play a wider role in policy and planning. Policy and regulatory initiatives and the technology itself need to be lined up, but "the time for storage to be integrated in plans is now."***

***Commissioner John Norris acknowledged that the lack of any national policy makes life more difficult for storage advocates, most clearly in navigating the vast differences between operating in areas with organized markets and regions without them.***

***"All the reports I read walk up to the same line and then stop: Is it transmission, distribution, generation or all three? The answer is yes," Norris said. "We have to find ways to compensate storage for all its benefits." Generally speaking, FERC's goal is to remove barriers to the development of storage projects that would provide benefits to consumers, he said. "I can't speak for the other commissioners, but I think you can read the tea leaves," he said. "Our rulings indicate a unified commission that is supportive of storage."***

***Source: K. Bleskan, SNL Financial LC, "FERC's Norris Promises Special Attention to Storage", March 28, 2012.***

---

## Existing Market Rules and Impact on Energy Storage Value

In today's electric market, pumped storage has the potential to bring added value through ancillary services, beyond time-shift of energy delivery. However, a lack of a national energy policy may lead to changing independent system operators (ISO) market rules and product definitions that may have a significant impact on the value of ancillary services, including those related to energy storage. FERC Orders 890 and 719 required ISOs to modify their tariffs and market rules so all non-generating resources, such as demand response and energy storage, can fully participate in established markets. However, these are typically real-time or day-ahead markets and there are no long-term value streams where a bulk storage project can attract investors seeking revenue certainty through long-term power purchase agreements or defined value streams (EPRI, 2010).

## Struggle over Generation or Transmission - Concept of Storage as a New Asset Class

While the previous sections of this paper focused on generation sources and how pumped storage fits into the energy market, energy storage technologies have the ability to provide components of transmission assets along with their ability to supply ancillary services and alleviate congestion by absorbing excess generation. Market rules generally prohibit transmission assets from participating in wholesale energy and ancillary service markets to maintain the independence of grid operators and avoid the potential for market manipulation, whether real or perceived. Furthermore, FERC requires market power studies to be performed when third parties provide ancillary services at market-based rates to transmission providers

(i.e. *Avista Restriction*<sup>5</sup>). In addition, the policy prohibits sales of ancillary services by a third-party supplier to a public utility that is purchasing ancillary services to satisfy its own obligations to customers under its open access transmission tariff. This restriction removes one of the largest potential markets for bulk-scale storage. This clear distinction between transmission and generation assets is problematic for energy storage (EPRI, 2010), because pumped storage or other energy storage projects have components of both transmission and generation.

Some industry participants are interested in presenting bulk energy storage as a new asset class that could be similar to the existing gas storage asset class recognized by the FERC. NHA supports further evaluation of this issue.

FERC Order 1000 introduces robust regional planning into the transmission process. It also mandates coordination among neighboring transmission planning regions with their interconnection. Because Order 1000 establishes requirements for reforming transmission cost allocation processes, it creates an opening for energy storage to be included in the transmission planning process and in changes in regional and interregional cost allocation processes. If, as a result of the transmission planning process, a project is accepted into a regional plan it would therefore appear to meet the threshold requirements of Section 219 of the Federal Power Act, making it eligible for incentive rate treatment. In addition, having storage included in transmission planning could enable a developer seeking to sell a variety of storage-only services to be deemed eligible for long-term incentive rate recovery, similar to transmission assets. Energy storage does not generate energy, but only stores and returns it to the market when needed, so there would be no potential of “over recovery” by having the facility used as both transmission and generation.

Lacking an energy storage asset class, some storage providers have applied to the FERC or their respective ISOs to be considered as a transmission asset, with rate-based cost recovery included in transmission tariffs or grid charges. For example, proponents have argued that battery energy storage serves a reliability function similar to substation equipment, such as large electricity capacitors, which are used in many wholesale transmission system facilities (FERC, 2009). The FERC has approved the inclusion of storage as a transmission asset (Isser, 2010), but has been careful to limit its rulings to the specific assets in question, based on the reliability and operational benefits they provide to the grid.<sup>6</sup> However, these limited decisions on small storage facilities do not address the issue of grid-scale energy storage technologies such as pumped storage. The possibility of establishing bulk energy storage as a new asset class are being discussed with the FERC and other regulatory bodies, and will evolve along with market needs and preferences.

---

<sup>5</sup> *Avista Corp. Rehearing Order*, 89 FERC ¶ 61,136 at 61,391 (1999).

<sup>6</sup> For the WGD proposal, all FERC incentives were approved on the condition that CAISO approve the projects as part of its transmission planning process (EPRI, 2010).

## **1.3 OTHER FACTORS SUPPORTING THE CASE FOR PUMPED STORAGE**

### **Energy Storage Technology Cost Comparison**

Modern pumped storage hydropower project costs can vary based on site-specific conditions such as site geology, water availability, access to the transmission grid, and overall construction cost. A feasible project site would include an approximate cost estimate range from \$1,500/kilowatt (kW) to \$2,500/kW, based on an estimated 1,000 MW sized project. A smaller project typically does not have the same economies of scale and could result in higher unit costs (in \$/kW) than a large project. These costs are representative for all project aspects except transmission interconnection charges, which can range from very minor charges to several hundred million dollars, based on factors such as existing line capacity or size and distance of new lines. According to an Electric Power Research Institute (EPRI) report (EPRI, 2010), the levelized cost of pumped storage and compressed air energy storage (CAES), the only other large grid-scale energy storage technology, represent the lowest cost forms of energy storage technologies.

### **New Technology Developments Affecting Current and Future Pumped Storage Projects**

Pumped storage technology has advanced significantly since its original introduction and now includes improved efficiencies with modern reversible pump-turbines, adjustable-speed pumped turbines<sup>7</sup>, new equipment controls such as static frequency converters and generator insulation systems, as well as improved underground tunneling construction methods and design capabilities. Overall, the pumping/generating cycle efficiency has increased pump-turbine generator efficiency by as much as 5% in the last 25 years, resulting in energy conversion or cycle efficiencies greater than 80% (MWH, 2009).

Globally, there are approximately 270 pumped storage plants either operating or under construction, representing a combined generating capacity of over 127,000 MW. Of these total installations, 36 units consist of adjustable-speed machines, 17 of which are currently in operation (totaling 3,569 MW) and 19 of which are under construction (totaling 4,558 MW). Adjustable -speed pump-turbines have been used since the early 1990s in Japan and the late 1990s in Europe. A main reason that adjustable speed pumped storage was developed in Japan in the early 1990's was the realization that significant quantities of oil burned in combustion turbines could be reduced by shifting the responsibility for regulation to pumped storage plants. Another advantage of adjustable-speed units is the increase in overall unit efficiency due to the fact that the turbine can be operated at its peak efficiency point under all head conditions, resulting in increased energy generated on the order of 3% annually. The current U.S. fleet of operating (single-

---

<sup>7</sup> In Japan the use of the term “variable speed” is common, where in Europe and other parts of the world, the term “adjustable speed” is often used. See Appendix B for additional information.

speed<sup>8</sup>) pumped storage plants does not provide regulation in the pump mode because the pumping power is “fixed” – a project must pump in “blocks” of power. The number and magnitude of blocks is dependent on the number and size of the plant’s units. However, adjustable-speed pumped storage units, while similar to single speed units in most aspects, are able to modulate input pumping power for each unit and provide significant quantities of frequency regulation. This can be very attractive to project owners since regulation service prices are a valuable ancillary service.

Another expanded new key ancillary service opportunity in the U.S. is the added need for load following and regulation (generally known as system reserves) at night to accommodate variable renewable energy inputs. In particular, the need for system reserves at night is increasing to ensure adequate grid stability with higher percentages of variable renewable energy generation, including the demand for energy absorption capabilities during periods of high wind generation during low load (demand) periods. In addition to energy absorption needs, with the increased amounts of variable renewable energy being supplied at night while load is decreasing, there is a complimentary greater need for load following and regulation services to accommodate the greater changes to net load on the system. Thermal generating units typically operate at minimum load during low energy demand periods such as late night or early morning, and wind is commonly increasing output during these periods, creating a greater need for a physical asset to provide system reserves to manage the resulting energy imbalance (Kirby et al., 2009). Additional discussion of the value of adjustable-speed technology is presented in Appendix B.

## **Market Drivers behind International Pumped Storage Development**

Globally, there are currently over 60 pumped storage projects under construction, with the majority of these projects being constructed in Europe, India, China, and Japan. The momentum behind this growth is founded in energy policies that balance the growth of intermittent renewable energy generation with energy storage growth. This is driven by a number of significant factors, including a common understanding of required grid flexibility, a desire to reduce the effects of greenhouse gases on the environment, stronger policies for valuation of ancillary services, creative energy storage policies that include financial incentives to provide long-term revenue stream certainty, and a desire to reduce reliance on limited access to hydrocarbon resources. It is important to note that for many areas outside of North America, the access to inexpensive, reliable sources of natural gas is a significant concern, thereby enhancing the development of policies promoting energy storage development.

It is also worth noting that the existing pumped storage projects in the U.S. were developed in the absence of detailed system operations models and ancillary service revenue structures. System planners understood the grid to be a careful balancing act requiring an integrated approach to demand forecasting and associated generation, transmission, and energy storage. Today, pumped storage systems are pumped

---

<sup>8</sup> The term “single speed” is used to describe conventional pumped storage units with synchronous speed machines. Additional detail on single and adjustable speed units are presented in Appendix B.

storage systems to provide electric grid support through ancillary services such as network frequency control, grid stabilization, reserve generation, and integration of variable renewables is significantly broadening the value of pumped storage technology.

---

***There are several reasons why Europe and other parts of the world are developing new pumped storage projects; some are directly applicable to the U.S., and some are not. Primary drivers include:***

- Some areas of Europe have stronger, well-defined ancillary service markets.
  - High volatility between on-peak/off-peak electricity prices drives energy arbitrage opportunities.
  - Pumped storage is often considered the only proven grid-scale energy storage technology.
  - Europe lacks the natural gas reserves that are available in the U.S., and therefore must incorporate long-term system integration planning.
  - The strong push for “carbon free generation” leads to advances in solar, wind and other renewables, which causes the need for energy storage products.
  - There are various incentives for energy storage, including capacity payments and reduce transmission interconnection fees.
  - Regulated utilities build and operate pumped storage plants as a key load management element of their operations.
- 

## **1.4 4.0 NHA RECOMMENDATIONS TO ADDRESS PUMPED STORAGE DEVELOPMENT CHALLENGES**

NHA has developed policy recommendations to stimulate new pumped storage development. Providing better recognition of pumped storage benefits and services will provide the needed market signals for these projects. In addition, several existing regulatory challenges should be addressed to streamline the long approval times. In general, new hydropower projects take twice as long to permit as other energy sources including solar, wind, or natural gas projects. Improving the current licensing process for low-impact pumped storage projects (closed-loop or off-channel systems) similar to how FERC has recently addressed other hydropower development opportunities would reduce this disparity<sup>9</sup>.

---

<sup>9</sup> This includes recently enacted MOUs with state and Federal agencies to streamline the FERC licensing process.

## Policy Recommendations

- 1) *Create market products that allow flexible resources to provide services that help meet electric grid requirements, including very fast responding systems that provide critical capacity during key energy needs.*<sup>10</sup>

Energy storage systems have multi-functional characteristics, which complicate rules for ownership and operation among various stakeholders. Regulatory agencies have not defined ownership structures and flexible business models in which storage can be used for both generation and grid support purposes. Policy rules regarding allocation of costs incurred by adding energy storage systems to the grid need to be more clearly developed.

Energy storage applications could enable bi-directional energy flows, creating potential revenue recognition challenges for current tariff, billing, and metering approaches. The results of future policy discussions should help inform the development of new market structures and rules to accommodate and capture the benefits of pumped storage and other energy storage technologies.

Policies should take into account the ability of a storage technology to support the electric grid, including speed of response. Recent studies in California recommend definitions as 5 MW/sec (fast) and 15 MW/sec (ultrafast) at the plant level (i.e. FERC Order 755). Many of the existing ISOs/Regional Transmission Organizations (RTOs) such as CAISO, PJM, and others have products and markets that allow resources, such as energy storage, to earn revenues by providing services to the system. To the extent that non-RTO regions do not allow resources to participate and provide system benefits, we encourage these regions to create products that they can procure from flexible resources and provide payment for those services. In addition, NHA recommends further evaluation of treating bulk energy storage as a separate and distinct electricity infrastructure asset class (i.e., Balancing Asset or Compensating Asset), capable of relieving grid stresses through the absorption of excess energy during low demand periods or rapidly providing capacity during periods of peak demand.

- 2) *Level the policy playing field for pumped storage hydropower with other storage technologies.*

While pumped storage hydropower can meet many of the grid-scale energy storage needs, no single storage system can meet all grid demands. A wide variety of storage technology options is being proposed and evaluated for utility-scale storage and end-user energy management applications. Still, greater than 98% of the worldwide energy storage is in the form of pumped storage hydropower. As a proven technology, pumped storage has been shown to be cost effective, highly efficient, and operationally

---

<sup>10</sup> One example of this important step includes FERC's Order 755 (*Frequency Regulation Compensation in the Organized Wholesale Power Markets*), which supports the use of energy storage facilities for ancillary services (October 20, 2011).



flexible. The FERC and other regulatory agencies have treated pumped storage primarily as a generating resource and have not included it in many significant energy storage discussions.

NHA recommends that any new market rules, incentives for development, as well as other policies should recognize and treat pumped storage the same as other forms of energy storage.

***3) Recognize regional differences in the nation’s generation portfolio and the different roles storage technologies play in different regions.***

Pumped storage and energy storage in general can play very different roles in different regions of the U.S. In regions with high percentages of variable generating (non-firm) renewables such as wind and solar, pumped storage hydropower can function as a renewable integration tool. This is the current European model behind the construction of new pumped storage hydropower plants, projected to total more than 27 gigawatts of capacity by 2020 in Europe (Ecoprog, 2011). In regions with large coal-fired or nuclear steam plants, pumped storage plays a levelizing role and peaking role. This is the case of the existing pumped storage hydropower fleet in the eastern U.S., as well as countries such as Japan and France.

***4) Recognize the energy security role pumped storage hydropower plays in the domestic electric grid.***

In the U.S., pumped storage has been typically built on the 1,000 MW scale but in actuality can be built to virtually any scale. The generating capacity of existing plants worldwide range from less than 1 MW to approximately 2,700 MW (e.g., Bath County Pumped Storage Project, Virginia). Larger capacity plants are currently under consideration globally. As the primary grid-scale storage technology in the world, pumped storage plays a critical energy security role, but there is currently no recognized revenue stream for providing this key service. Existing pumped storage plants in every region become a key “energy security” plant within a given control or balancing area. In the event of a major disturbance such as a major steam unit trip or a transmission line failure, pumped storage black start capability or spinning reserve can be called upon to restart or stabilize the grid on very short notice. Full generation from the project can be accomplished to cover the energy deficit for longer periods, depending on reservoir level and size. Pumped storage can also respond to decremental needs such as a significant wind ramping event during low consumer demand periods, maintaining grid stability by rapidly responding to generation oversupply in the pumping mode. In addition, pumped storage facilities are resilient to unexpected changes in weather patterns, including drought or low water years, because the water used for generation is recycled from upper to lower reservoir, and not released to the natural stream flow (U.S. DOE/Homeland Security, 2011). These are critical energy security functions that often go unrecognized, underappreciated, and most notably, undercompensated.

***5) Establish an alternative, streamlined licensing process for low-impact pumped storage hydropower such as off-channel or closed-loop projects.***

In general, new hydropower projects take twice as long to permit as other energy sources including solar, wind, or natural gas projects. NHA suggests that FERC consider changes to the current licensing process

for low-impact pumped storage projects similar to how they have recently streamlined other hydropower development projects. In particular, there are certain categories of pumped storage projects that would have a minimal effect on the environment such as off-channel projects or closed-loop projects. In these instances, environmental review and conditions should be limited to the project’s proposed changes to current conditions, and the FERC approval process could mimic the FERC exemption program to streamline project permitting. Broadening the scope of projects that could move through a streamlined process would help lower approval costs and provide greater licensing certainty without compromising environmental protections. Under the FERC’s comprehensive development standard stemming from 10(a) of the Federal Power Act (FPA), the FERC can approve a hydroelectric project provided it is “best adapted to a comprehensive plan for improving or developing a waterway.” If the water source used for filling and providing make-up water for a closed-loop pumped storage project comes from a non-riverine water source such as groundwater or recycled wastewater, there would be no waterway affected by the project. In these cases, the FERC should consider these projects in a new, minimal-impact category to reduce the length and complexity of the licensing process. The FERC could advance the licensing process through a shorter process but have “off-ramps” if unanticipated issues arise. NHA is encouraged to hear that FERC is currently considering a two-year licensing process for these types of projects and new regulations could codify this process. Other relatively low-impact proposed pumped storage projects, such as those utilizing two existing reservoirs, may also be appropriate candidates for future consideration of a shortened licensing process.

***6) Improve integration of Federal and state agencies into the early-stage licensing processes for pumped storage hydropower.***

NHA and the overall hydropower industry continue to work closely with FERC to streamline the licensing process for those projects with obvious minimal environmental constraints; however, additional efficiency can be realized through process improvements related to coordination with other Federal and state agencies. By implementing the Integrated Licensing Process, FERC has helped licensees coordinate with many agencies; however, in some areas of the country, there continue to be overlapping regulatory processes that cause significant delays in the licensing process. These challenges should be streamlined for development of environmentally favorable pumped storage sites, and resource agencies should be encouraged to participate early in development reviews. This would minimize additional information requests, resolve disagreements early in the process, and allow for speedy processing of permit applications later in the process for those projects that clearly have minimal environmental impacts. All resource agencies performing their own environmental reviews should be encouraged to work concurrently with the FERC process to coordinate and not duplicate the environmental review process.

***7) Facilitate an energy market structure where transmission providers benefit from long-term agreements with energy storage facility developers.***

NHA requests that FERC develop policies that allow RTOs and ISOs to enter into long-term fixed-price contracts with energy storage project owners, including pumped storage facilities. One such policy would

be to lift or modify the *Avista Restriction* for grid-scale energy storage projects providing storage-only services. These policies could include fixed-price contracts that provide the procurer long-term ancillary services for the term of the contract and the benefit of energy storage services uniquely suited to manage the growing penetration of variable energy generation.

For such facilities to be financed, transmission providers need authorization to enter long-term agreements with energy storage facility developers. Pumped storage facilities built decades ago were primarily built as rate-base cases by regulated utilities; however, in most areas of the country except the southeastern U.S., this model no longer applies. Today, much of the nation’s energy infrastructure is now being developed by independent power producers who lack utility rate base cost-recovery structures. Transmission organizations and ISOs are most able to realize the full value of grid-scale energy storage facilities. Unfortunately, FERC precedent poses a major barrier to long-term contracting with such users of storage services (ECE, 2011).<sup>11</sup>

---

<sup>11</sup> In their 2011 paper, ECE detailed FERC’s previous challenges with encouraging transmission organizations and ISOs to use new and more efficient technologies while dealing with pumped storage projects, and maintaining the separation of generation and transmission markets [*Nevada Hydro Co.*, 122 FERC ¶ 61,272 (2008), and *Western Grid Development, LLC*, 130 FERC ¶ 61,056 (2010)]

## **1.5 REFERENCES**

- Alstom Power (2012), Internal Database for Equipment Performance.
- CAISO (2006), Isemonger, A.G., “The Competitive Procurement of Voltage Support” June 2006, White Paper.
- CAISO (2009), Discussion Paper Renewable Integration: Market and Product Review. July 2009, <http://www.caiso.com/27cd/27cdeb8548450.pdf>
- CAISO (2010), Market Issues & Performance 2009 Annual Report, Department of Market Monitoring, California Independent System Operator Corp. April 2010.
- CEATI International (2011), The Hydroelectric Industry’s Role in Integrating Wind Energy, February 2011.
- DeCesaro, J. (2009), Wind Energy and Power System Operations: A Review of Wind Integration Studies to Date, NREL, Golden, Colorado: 2009.
- Eagle Crest Energy (2011), White Paper on Removing Federal Barriers to Grid-Scale Energy Storage, November 2011.
- Ecoprog, The European Market for Pumped-Storage Power Plants 2011/2012, March 2011.
- EPRI (1995), Application of Adjustable-Speed Machines in Conventional and Pumped-Storage Hydro Projects (Principal Investigator Peter Donalek), Palo Alto, CA: November 1995. 105542
- EPRI (2008), Market Requirements and Opportunities for Distributed Energy Storage Systems in the Commercial Sector Leveraging Energy Efficiency Initiatives, Palo Alto, CA: November 2008. 1016015.
- EPRI (2009a), A Feasibility Analysis of Limited Energy Storage for Regulation Service, Palo Alto, CA: November 2009. 1020399.
- EPRI (2009b), Economic and Greenhouse Gas Emission Assessment of Utilizing Energy Storage Systems in ERCOT, Palo Alto, CA: September 2009. 1017824.
- EPRI (2009c), Energy Storage Market Opportunities: Application Value Analysis and Technology Gap Assessment, Palo Alto, CA: 2009. 1017813.
- EPRI (2009d), Prism/MERGE Analyses: 2009 Update, Palo Alto, CA. 1020389.
- EPRI (2009e), The Power to Reduce CO2 Emissions: The Full Portfolio, Palo Alto, CA: 2009. 1019563.
- EPRI (2010a), Analysis of Energy Storage Systems to Address Regional Wind Penetration: Cases Studies in PJM, NYISO, and ERCOT, Palo Alto. 1020082.

- EPRI (2010b), Energy Storage Technology and Application Cost and Performance Database, Palo Alto, CA. 1020071
- EPRI (2010c), Functional Requirements for Electric Energy Storage Applications on the Power System Grid, Palo Alto, CA: 2010. 1020075.
- EPRI (2010d), Reference Designs of 50-MW/250-MWh Energy Storage Systems, Palo Alto, CA. 1021117.
- FERC (2012), <http://ferc.gov/industries/hydropower/gen-info/licensing/pump-storage.asp>
- HDR (2011), Internal database of existing pumped storage projects and project under development.
- HDR (2010), Hydroelectric Pumped Storage for Enabling Variable Energy Resources within the Federal Columbia River Power System, Bonneville Power Administration
- Hocker, C. (1992), “Pumped Hydroelectric at its Peak,” Hydro Review, July 1992.
- Ingram, E. (2010), Worldwide Pumped Storage Activity, HRW, Spetember 2010.
- International Energy Agency (2009), Holttinen, H., et al., Design and Operation of Power Systems with Large Amounts of Wind Power Final Report. IEA Wind Task 25, Phase One. [Online] URL: <http://goodcompanyassociates.com/files/manager/StoragePaper20100120.pdf>.
- Isser, S. (2010), Electricity Storage White Paper – Submitted to the Renewables Technology Working Group, ERCOT, Updated January 20, 2010.
- KEMA (2007a), Emissions Comparison for a 20-MW Flywheel-based Frequency Regulation Power Plant, Raleigh, NC: January 2007 (Project: BPC0.0003.001)
- KEMA (2007b), Cost Comparison for a 20 MW Flywheel-based Frequency Regulation Power Plant, KEMA, Inc. Consulting, Raleigh, NC: 2007
- KEMA (2008), Two Megawatt Advanced Lithium-ion BESS Successfully Demonstrates Potential for Utility Applications, KEMA, Inc. Consulting: 2008
- Kirby, B., Starker, M., Adhikari, S. Oak Ridge National Laboratory (2009), NYISO Industrial Load Response Opportunities: Resource and Market Assessment, New York State Energy Research and Development Authority.
- Kraemer, S. (2011), “How Denmark Will Integrate 50% Wind Power by 2025”.
- Levine, J.G. (2007), “Pumped Hydroelectric Energy Storage and Spatial Diversity of Wind Resources as Methods of Improving Utilization of Renewable Energy Sources” December 2007, Masters Thesis, University of Colorado.

- Miller, R. and M. Winters (2010), Opportunities in PS Hydropower: Supporting Attainment of Our Renewable Energy Goals”.
- MWH (2009), Technical Analysis of PS and Integration with Wind Power in the Pacific Northwest, August 2009 report to USACE HDC.
- Pacific Northwest National Laboratory (2008), Assessing the Value of Regulation Resources Based on Their Time Response Characteristics, Richland, WA: 2008.
- Pasteris Energy, Inc (2009), Cost of New Entry Combustion Turbine Power Plant Revenue Requirements, Additional CONE Area Evaluation for PJM Interconnection, Yardley, PA.
- Patton, D. (2009), State of the Market Report, NYISO Electricity Markets Presentation. Patomac Economics, April 2010.
- RenewableEnergyWorld.com (2011), [Online] URL: <http://www.renewableenergyworld.com/rea/partner/american-wind-energy-association/news/article/2011/04/u-s-wind-industry-reports-enduring-growth-in-first-quarter-of-2011>.
- Sandia National Laboratories (2010), Energy Storage for the Electricity Grid: Benefits and Market Potential Assessment Guide, Albuquerque, NM: February 2010.
- Silverstein, K. (2011), “Wind Shortfalls Make Grid Guys Nervous” [Online] URL: [energyBiz: http://www.energybiz.com/article/11/02/wind-shortfalls-make-grid-guys-nervous](http://www.energybiz.com/article/11/02/wind-shortfalls-make-grid-guys-nervous).
- Smith, J. C., et al. (2007), Utility Wind Integration and Operating Impact State of the Art. IEEE Transactions On Power Systems 22.3 (2007): 900-08.
- Smith, A. (2010), Quantifying Exports and Minimizing Curtailment: From 20% to 50% Wind Penetration in Denmark” BIEE 2010, by Andrew Smith, Director, London Analytics.
- Suul, J. A, (2008), Variable Speed Pumped Storage Hydropower For Integration of Wind Power in Isolated Power Systems, Norwegian University of Science and Technology, Norway, June 2008.
- U.S. Department of Energy (DOE, 2009), Open Access Technology International Inc., "Assessment of Historical Transmission Congestion in the Eastern Interconnection," July 2009, version 1.2
- U.S. Department of Energy (2011), and Homeland Security – Dams and Energy Sectors Interdependency Study, September 2011.
- U.S. Energy Information Administration (2011a), Annual Energy Outlook 2011 With Projects to 2035, April 2011. [Online] URL: <http://www.eia.gov/forecasts/archive/aeo11/>.
- U.S. Energy Information Administration (2011b), International Energy Outlook, September 2011. [Online] URL: [http://www.eia.gov/forecasts/ieo/pdf/0484\(2011\).pdf](http://www.eia.gov/forecasts/ieo/pdf/0484(2011).pdf).

Yang, C-J and Jackson, R. B. (2010), Opportunities and barriers to pumped-hydro energy storage in the United States, Duke University.

---

**List of Primary Authors:**

**Michael Manwaring, HDR  
Debbie Mursch, Alstom Power  
Kelly Tilford, Mead & Hunt**

**NHA Pumped Storage Development Council Chair  
NHA PSDC Co-Chair  
PSDC Member**

**A special thanks to the following who contributed significantly to this white paper:  
Don Erpenbeck and Matt Crane (MWH), Rick Miller (HDR), Kim Johnson (Riverbank Power),  
and the numerous comments received by the hydropower and energy storage industries.**

---

## **1.6 Appendix A – Historical Development and Future of Pumped Storage**

### **A.1 Historical Pumped Storage Development, Historical Operational Characteristics and Function**

Since the first pumped storage project came on-line in Europe in the early 1900s and in the U.S. around 1930, pumped storage hydropower has provided significant benefits to the energy transmission and power supply system including energy storage, load balancing, frequency control, and reserve peak power generation.<sup>12</sup>

Historically, a pumped storage project's primary function has been to balance load on a system and allow large, thermal generating sources to optimize generation by running near peak production. As described in the main body of this paper, this process allowed pumped storage to take advantage of excess off-peak energy from these large (thermal or nuclear) generators and store the energy for release during peak demand. Accordingly, the primary development of pumped storage power occurred in the 1960s, 1970s, and early 1980s in parallel with the construction of a large number of nuclear power stations. The worldwide evolution of the total installed nuclear power and the total installed pumped storage power over the last 45 years is depicted in Figure A-1.

---

<sup>12</sup> The earliest known use of pumped storage technology was in Switzerland in 1882. For nearly a decade, a pump and turbine operated with a small reservoir as a hydro-mechanical storage system. Beginning in the early 1900s, several small pumped storage plants were constructed in Europe, mostly in Germany. The first unit in North America was the Rocky River Pumped Storage plant, constructed in 1929 on the Housatonic River in Connecticut.



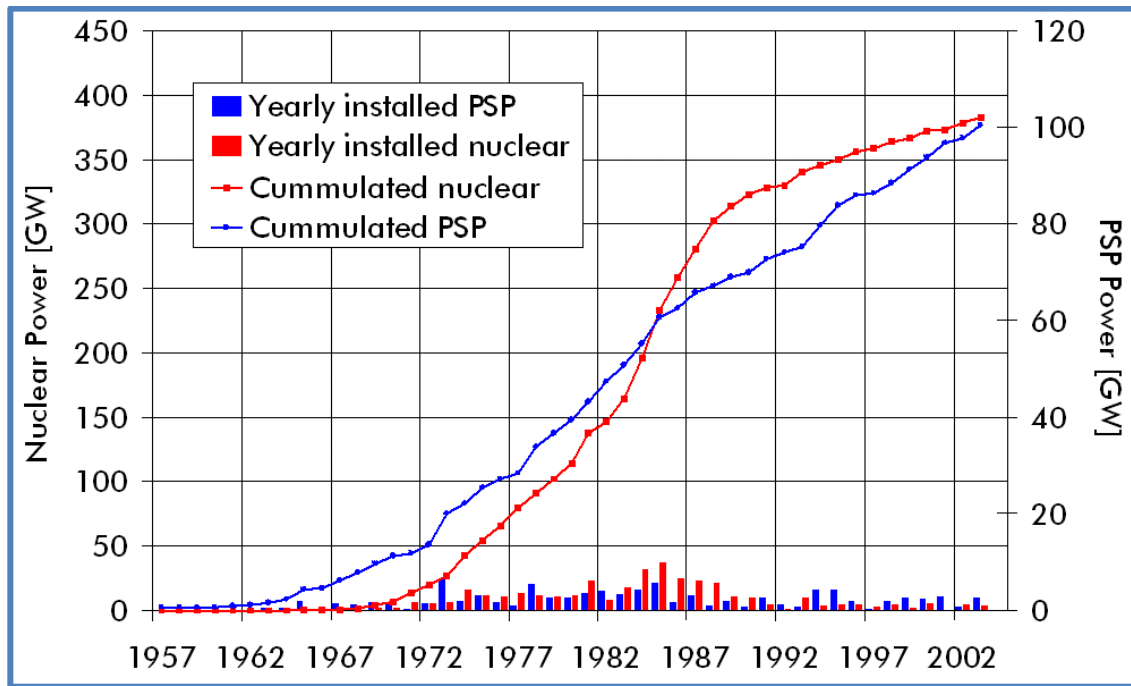

**Figure A-1: Worldwide Installed Nuclear and Pumped Storage Project Development History (Source: Alstom Power and UDI database).**

The next major breakthrough, the adjustable-speed design, was developed mainly in Japan. Whereas, with single speed units, the only known variable available to the operator for most of the early designs was water flow, which was controlled by moving the wicker gates. However an adjustable-speed motor-generator allows the shaft rotation rate to change as well. By optimizing the two variables, the unit can be dispatched at optimum efficiency over a large power range. The first adjustable speed system, Yagasawa Unit 2, was constructed for the Tokyo Electric Power Company (TEPCO) and became operational in 1990.

It is worth noting that existing U.S. pumped storage projects were developed in the absence of detailed system operations models and ancillary service revenue structures. System planners understood the grid to be a careful balancing act requiring an integrated approach to demand forecasting and associated generation, transmission and storage. Today, pumped storage systems are becoming recognized as much more than simply load shifting energy storage projects. The ability of pumped storage systems to provide electric grid support through ancillary services such as network frequency control, grid stabilization, reserve generation, *and* integration of variable renewables is significantly broadening the value of pumped storage technology.

## A.2 Summary of Operating Pumped Storage Facilities Worldwide

While other energy storage technologies have been developed and many are being investigated, pumped storage hydropower is by far the most widely used energy storage application, with more than 127,000 MW installed worldwide (EPRI, 2010). This worldwide total is expected to exceed 203,000 MW by 2014, representing an annual growth rate of 10% (Ingram, 2010). The current geographic distribution of the worldwide pumped storage fleet is depicted in Figure A-2.

In comparison, there are currently 40 pumped storage projects operating in the U.S. providing more than 20,000 MW, or nearly 2%, of the capacity for our nation’s energy supply system as shown in Figure A-3 (HDR, 2011). The most recent project constructed in the U.S. was completed in 2011, a 40 MW pumped storage facility developed in southern California as part of a larger water supply project. The majority of the other 39 projects were constructed more than 30 years ago, in coordination with large thermal or nuclear facilities.

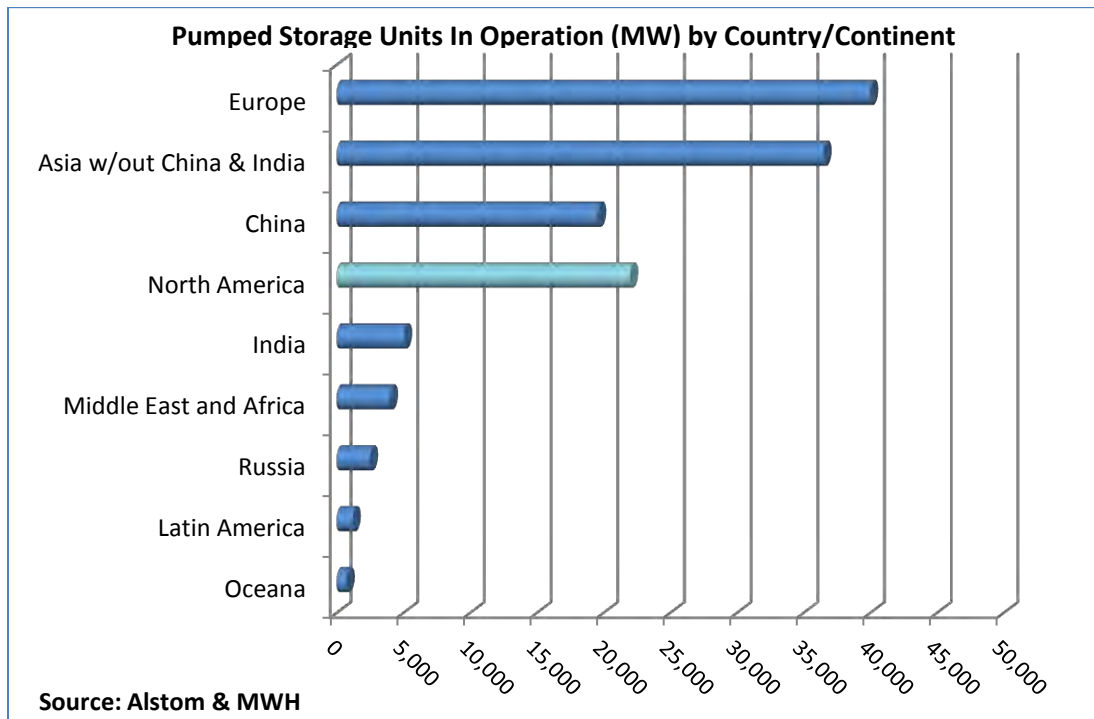

Figure A-2: International Distribution of Pumped Storage by Country/Continent.<sup>13</sup>

<sup>13</sup> Japanese pumped storage project is included above in Figure A-2, in the “Asia without China and India” category, it is estimated that Japan has approximately 26 GW of installed pumped storage capacity.

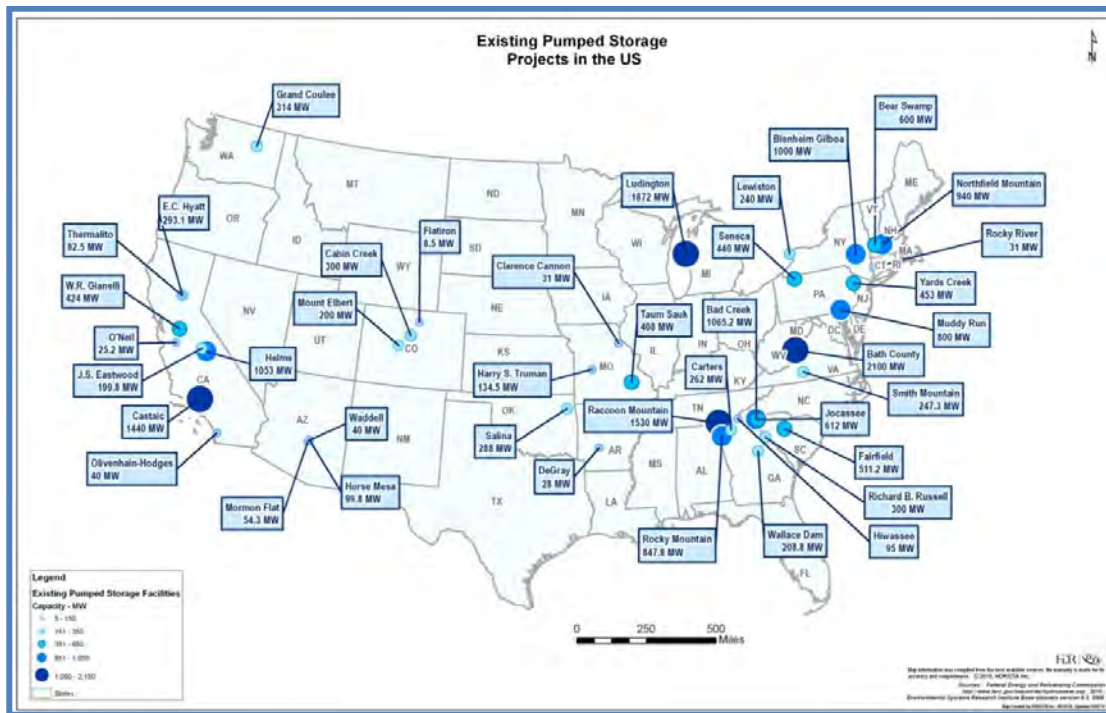
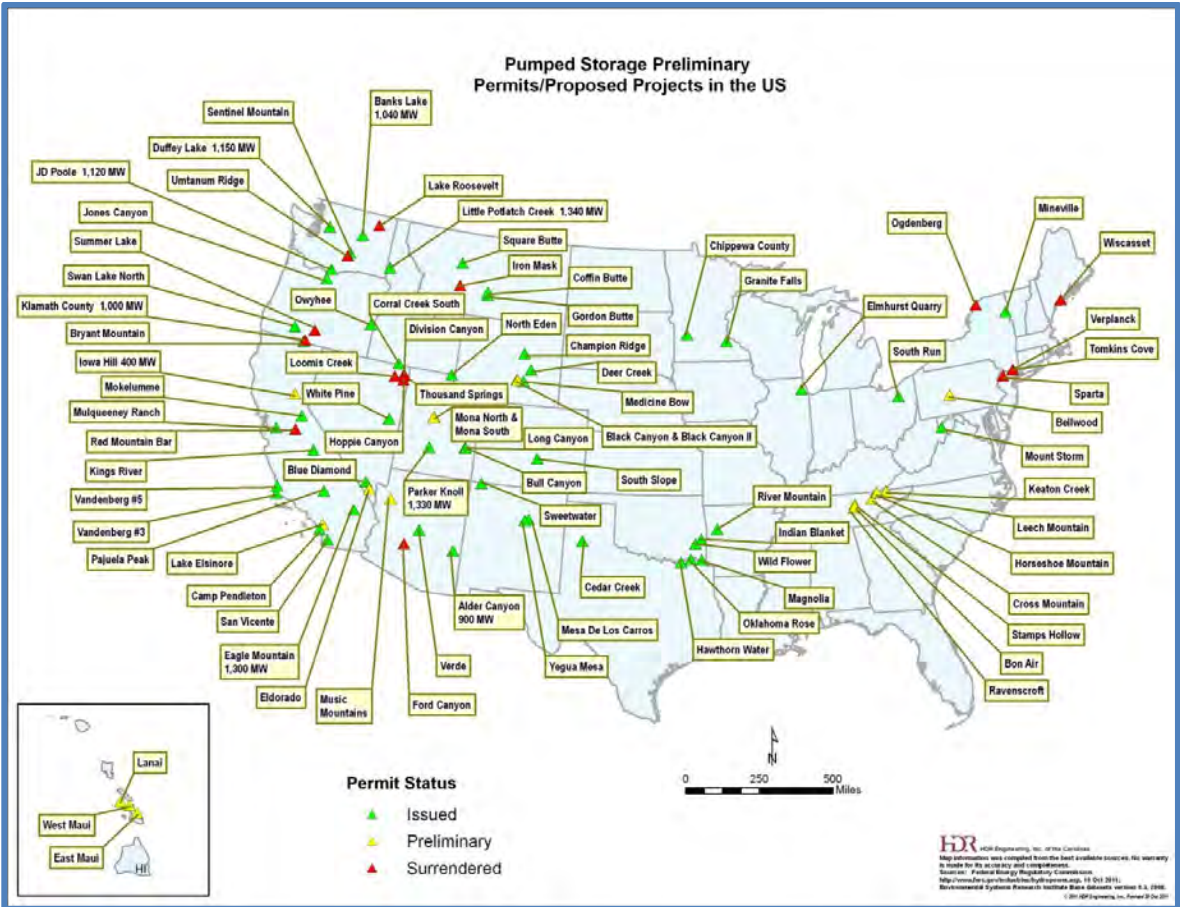

Figure A-3: Existing Pumped Storage Projects in the U.S. (HDR, 2011).

### A.3 Current Planned Pumped Storage in the U.S.

In the last few years, there has been a significant increase in the number of preliminary permit applications filed with FERC for pumped storage projects. While a preliminary permit does not authorize construction, it is a strong indication of the interest in new pumped storage development. As of January 2012, FERC has granted preliminary permit applications for more than 34,000 MW of new pumped storage projects in 22 states, with greater than 66% of current permits are for closed-loop sites. Figure A-4 presents pumped storage projects currently under development in the U.S. and Figure A-5 shows the increase in recent pumped storage project permit applications with FERC (highlighting closed-loop-type projects).

While there is significant interest in developing pumped storage projects, there remain significant challenges facing the completion of new projects, ranging from licensing, environmental misconceptions, the regulatory treatment of pumped storage versus traditional hydropower projects, and a lack of long-term markets needed for large capital investments. The main body of this paper discussing these challenges in detail, and provides recommendations for addressing each issue. In addition, NHA has been working with FERC and the U.S. Department of Energy on resolving many of the challenges facing pumped storage development in the hope of facilitating the growth of this key domestic energy security resource.



1.7

Figure A-4. Pumped Storage Projects under Development in the U.S. (HDR, 2011).

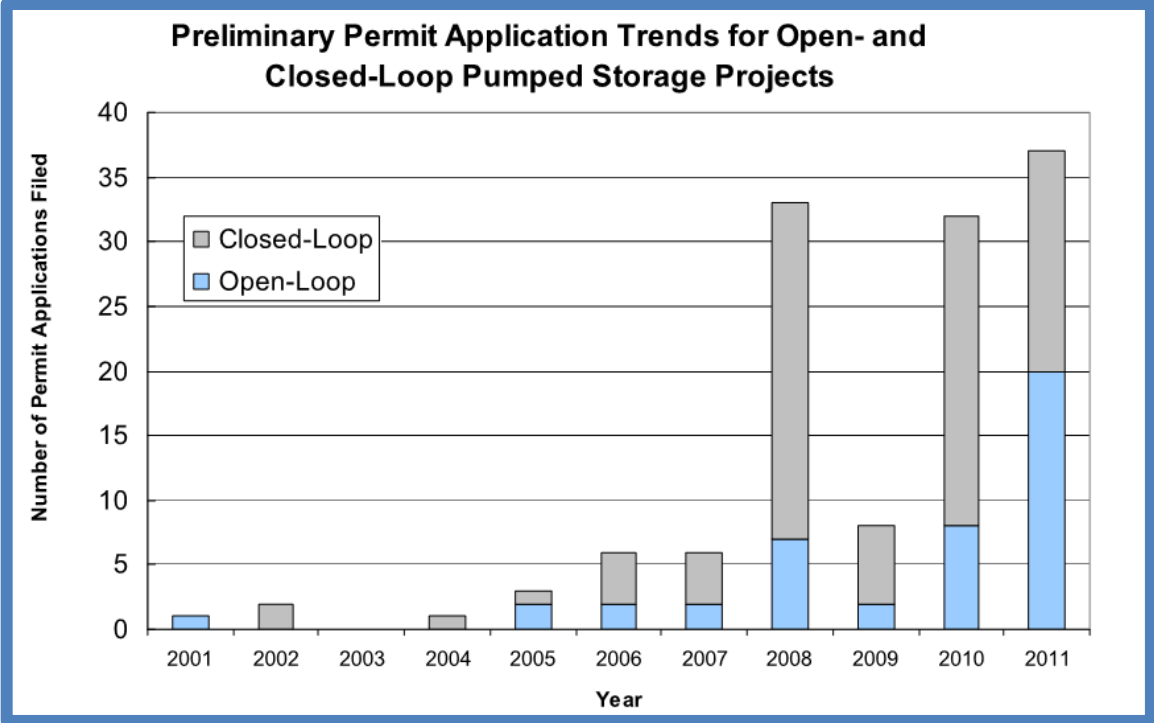

Figure A-5: Preliminary Permit Application Trends for Pumped Storage Projects (FERC, 2012).

## **1.8 Appendix B – Adjustable-Speed Pumped Storage and the Value to the Overall Electric Grid**

Globally, there are approximately 270 pumped storage plants either operating or under construction, representing a combined generating capacity of over 127,000 MW. While the majority of the plants use single-speed pump-turbine machines<sup>14</sup>, 36 utilize adjustable-speed machines - 17 of these are currently in operation (totaling 3,569 MW) and 19 are under construction (totaling 4,558 MW). All of these units are located in Europe, China, India, or Japan<sup>15</sup>. As stated in the main body of this paper, adjustable-speed generation units are able to modulate input pumping power and provide significant quantities of frequency regulation. A new key ancillary service opportunity that may be realized through adjustable-speed technology is the added need for regulation at night to accommodate variable renewable energy inputs. The ability to provide regulation service in both pumping and generating modes also has a benefit in the form of reduced carbon fuel consumption and climate change (reduced warming). In this regard pumped storage is an in-kind compliment to renewable energy technologies. The more energy supplied by renewable energy sources that are used to pump means less carbon based fuel energy is used for pumping. Therefore, when the pumped storage unit is providing regulation service in generation mode it is more likely to be using energy that has come from renewables. On the other hand, if combustion turbines or coal units are used for regulation, then as more renewable energy sources are connected to the grid there is a greater use of natural gas and coal for regulation – which somewhat counter acts the benefits of increased energy from renewables. A representation of the benefits of adjustable-speed technology is presented graphically in Figure B-1.

### **B.1 Features of Adjustable-Speed Pumped Storage**

The traditional pump-turbine equipment design in the U.S. is the reversible single-stage Francis pump-turbine, which acts as a pump in one direction and as a turbine in the other. Although this technology is proven and has worked well for over six decades, there are limitations to its performance, particularly when it comes to the pump mode. While design enhancements over the years have improved unit efficiency and power output, frequency regulation while in the pump mode is not possible with single-speed equipment because traditional synchronous machines are directly connected to the grid and operate at a constant speed and constant input pumping power. In the turbine mode, the energy produced by each unit can vary, but does not operate at peak efficiency during part load. Adjustable-speed machines enable

---

<sup>14</sup> The term “single speed” is used to describe conventional pumped storage units with synchronous speed machines.

<sup>15</sup> In Japan the use of the term “variable speed” is common, where in Europe and other parts of the world, the term “adjustable speed” is often used. It is noted that early technical papers in Japan do use the term “adjustable speed”. [Example: Kita, E., Mitsuhashi, K., Juwabara, T. and Shibuya A.,; “Design of Dynamic Response of 400 MW Adjustable Speed Pumped Storage Unit and Field Test Results for Ohkawachi Power Station”, presented July 27, 1995; IEEE-PES Summer Meeting, San Francisco, CA.]

the power consumed in the pumping mode to be varied over a range of outputs. Modifying the speed also allows the turbine to operate at peak efficiency over a larger portion of its operating band. Because adjustable-speed technology is well suited to integration of variable renewable generation, many of the proposed new pumped storage projects are considering adjustable-speed machines.

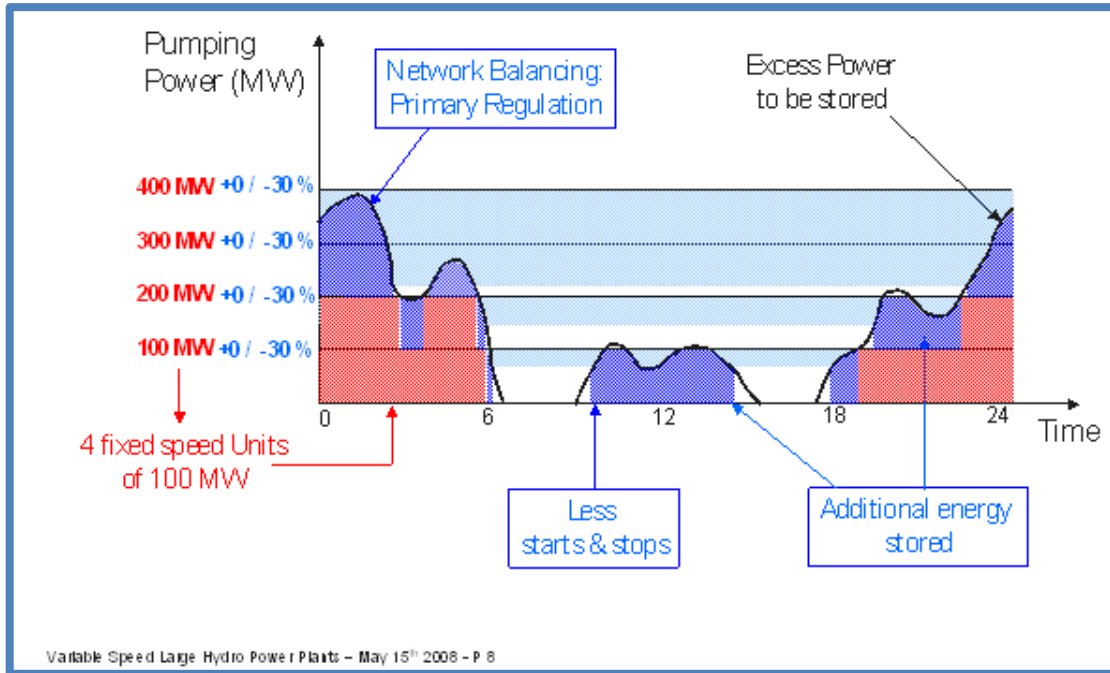

**Figure B-1: System Reserve and Power Storage from Adjustable-Speed Pumped Storage (Source: Alstom Power).**

Adjustable-speed pump-turbines have been used since the early to mid-1990s in Japan and the late 1990s in Europe. A main reason that adjustable speed pumped storage was developed in Japan in the early 1990's was the realization that significant quantities of oil burned in combustion turbines could be reduced by shifting the responsibility for regulation to pumped storage plants. In a conventional, single-speed pump-turbine, the magnetic field of the stator and the magnetic field of the rotor always rotate with the same speed and the two are coupled. In an adjustable-speed machine, those magnetic fields are decoupled. Either the stator field is decoupled from the grid using a frequency converter between the grid and the stator winding, or the rotor field is decoupled from the rotor body by a multi-phase rotor winding fed from a frequency converter connected to the rotor.

A cycloconverter was an early adjustable-speed technology implemented and provides the rotating magnetic field in the rotor (see Figure B-2). There are some limitations with this type of adjustable-speed machine. Cycloconverters cannot be used to start the unit in the pumping mode, which means that an additional static frequency converter is required in the powerhouse to start the unit. Cycloconverters also absorb reactive power, which needs to be compensated by converters or provided by the generator. Recently there have been improvements in large voltage source inverters that enable the stator magnetic

field to be decoupled from the grid. This type of conversion is often more popular than the cycloconverter, as this method does not absorb reactive power and the inverters can be used to start the project in the pumping mode.

A double-fed induction motor (DFIM)-generator is the current standard design for adjustable-speed machines. Generally, generator-motors are larger in size and have smaller air gaps than conventional machines. The stator is similar to that of a conventional generator-motor. The rotor requires additional features including at least one slip ring per phase (for three phases) and additional protection from mechanical stresses. This protection is in reinforcement of the rotor winding overhang and rotor rim. The rotor rim of an adjustable-speed machine carries an alternating magnetic field which may require additional design considerations. As the voltage and current ratings of gate-controlled switches (GTOs, GCTs, IGBTs) have increased, back-to-back voltage source converters have become relevant for feeding rotor windings of the DFIM.<sup>16</sup>

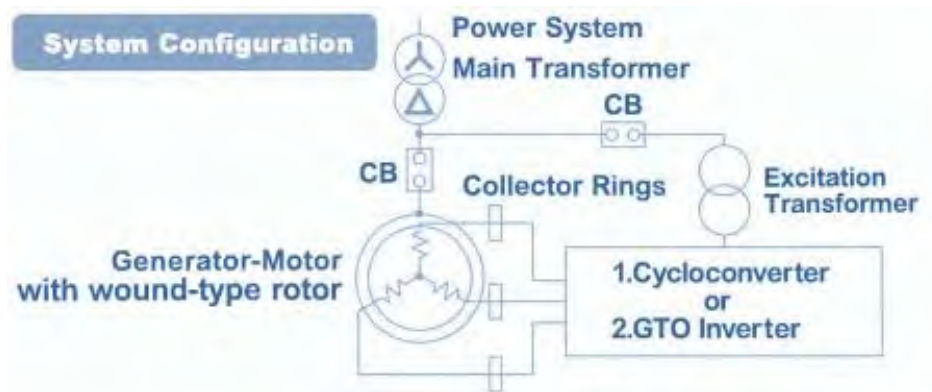

**Figure B-2: Schematic of a Cycloconverter or Inverter-Style Adjustable-Speed Motor-Generator (Source: Toshiba).**

## B.2 Summary of Adjustable-Speed Benefits

Adjustable-speed pumping enables tuning of the grid frequency at night or during system disturbances or anomalies, as well as the use of fluctuating renewable wind or solar energies to pump water to the upper reservoir. The principal feature of the adjustable-speed units is that the input power is adjustable when carrying out automatic frequency control (AFC) while filling the upper reservoirs. This flexibility is frequently employed by adjusting the speed of units during light load periods such as the middle of the night and during holidays. In addition, pump operation with adjustable-speed units is extended in comparison to single-speed units, enabling more real-time response to grid conditions.

<sup>16</sup> Various sources; including personal communication (Peter Donalek, MWH) and Suul, J. A.; “Variable Speed Pumped Storage Hydropower For Integration of Wind Power in Isolated Power Systems”, Norwegian University of Science and Technology, Norway, June 2008.



As discussed above, globally, there are 270 pumped storage stations either operating or under construction, with 36 units consisting of adjustable-speed machines (8,127 MW). While several projects in the U.S. in licensing, initial design or planning phase are evaluating the use of adjustable-speed technology, all of the existing projects (including those under construction) are located in Europe, China, India, or Japan. To gain acceptance of this technology in the U.S., the added cost of adjustable-speed technology must be offset by valuation in the ancillary services market, which is one of the key market points of this paper.

Table B-1 presents a summary of the various features and benefits of adjustable-speed pumped storage technology, including technological and economical advantages.<sup>17</sup>

**Table B-1: Features and Benefits of Adjustable-Speed Pumped Storage Technology.**

<i>Feature</i>	<i>Technological Advantages</i>	<i>Economic Advantages</i>
<b>Adjustable pumping power</b>	Frequency regulation in pumping mode by accommodating variable supply	Additional ability to quickly ramp up and down to support more variable renewable energy resources
	More efficient use of equipment, reducing the need for thermal plant cycling; critical for avoiding greenhouse gas emissions	Operations and maintenance cost reduction and increase of equipment lifespan; greenhouse gas offsets if market develops
	Able to take advantage of shifts in grid dynamics to effectively manage variable energy supply and capture and store lower cost energy	Cost minimization and operation of existing units at peak efficiency; support growth of additional renewable energy resources
	There is an increase in energy generation due to the fact that the turbine can be operated at its peak efficiency point a under all head conditions.	This results in an estimated increase in energy generated on the order of 3% annually.
<b>Faster power adjustment and reaction time</b>	Improved balancing of variable energy units (wind/solar) and coordination of overall energy mix	More stable equipment translates into risk reduction and increased reliability of the domestic electric grid

<sup>17</sup> Note: While there are significant advantages with adjustable-speed pump-turbines, the majority of pumped storage projects under development around the world continue to be single-speed pump-turbines. A primary reason for this is that there remains substantial grid flexibility in many regions of the world where there are strong transmission interconnections and unconstrained hydropower operations, two conditions that typically do not exist in the U.S.