



2 0 2 3

# Natural Gas Integrated Resource Plan



## Safe Harbor Statement

This document contains forward-looking statements. Such statements are subject to a variety of risks, uncertainties and other factors, most of which are beyond the Company's control, and many of which could have a significant impact on the Company's operations, results of operations and financial condition, and could cause actual results to differ materially from those anticipated.

For a further discussion of these factors and other important factors, please refer to the Company's reports filed with the Securities and Exchange Commission. The forward-looking statements contained in this document speak only as of the date hereof. The Company undertakes no obligation to update any forward-looking statement or statements to reflect events or circumstances that occur after the date on which such statement is made or to reflect the occurrence of unanticipated events. New risks, uncertainties and other factors emerge from time to time, and it is not possible for management to predict all of such factors, nor can it assess the impact of each such factor on the Company's business or the extent to which any such factor, or combination of factors, may cause actual results to differ materially from those contained in any forward-looking statement.

# Production Credits

## Primary Natural Gas IRP Team

Name	Title	Contribution
James Gall	Manager of Integrated Resource Planning	IRP Core Team
Tom Pardee	Natural Gas Planning Manager	IRP Core Team
Michael Brutocao	Natural Gas Analyst	IRP Core Team
John Lyons	Sr. Policy Analyst	IRP Core Team
Lori Hermanson	Sr. Power Supply Analyst	IRP Core Team
Mike Hermanson	Sr. Power Supply Analyst	IRP Core Team
Grant Forsyth	Chief Economist	Load Forecast
Ryan Finesilver	Mgr. of Energy Efficiency, Planning & Analysis	Energy Efficiency
Lisa McGarity	Energy Efficiency Program Manager	Oregon Energy Efficiency
Leona Haley	Energy Efficiency Program Manager	Demand Response
Terrence Browne	Sr. System Planning Engineer	Gas Engineering
Justin Dorr	Natural Gas Resources Manager	Power Supply

## Natural Gas IRP Contributors

Name	Title	Contribution
Scott Kinney	VP of Energy Resources	Power Supply
Kevin Holland	Director of Energy Supply	Power Supply
Clint Kalich	Sr. Manager of Resource Analysis	Power Supply
Shawn Bonfield	Sr. Manager of Regulatory Policy	Regulatory
Amanda Ghering	Regulatory Affairs Analyst	Regulatory
Annie Gannon	Communications Manager	Communications
Mary Tyrie	Manager Corporate Communications	Communications
Jeff Webb	Manager of Gas Design, Measuring and Planning	Gas Engineering
Michael Whitby	Renewable Natural Gas Program Manager	Clean Energy

Contact contributors via email by placing their names in this email address format:  
first.last@avistacorp.com



## Table of Contents

<b>1.</b>	<b>Introduction and Planning Environment</b> .....	<b>1-1</b>
	Customers .....	1-3
	Integrated Resource Planning .....	1-5
	Planning Model .....	1-8
	Planning Environment .....	1-9
<b>2.</b>	<b>Demand Forecasts</b> .....	<b>2-1</b>
	Demand Areas .....	2-1
	Customer Forecasts .....	2-1
	Electrification of Natural Gas Customers .....	2-3
	Use-per-Customer Forecast .....	2-4
	Weather Forecast .....	2-6
	Peak Day Design Temperature .....	2-9
	Load Forecast .....	2-17
	Scenario Analysis .....	2-22
	Alternative Forecasting Methodologies .....	2-23
	Key Issues .....	2-23
<b>3.</b>	<b>Demand Side Resources</b> .....	<b>3-1</b>
	Avoided Cost .....	3-1
	Idaho and Washington Conservation Potential Assessment .....	3-3
	Pursuing Cost-Effective Energy Efficiency .....	3-3
	Washington and Idaho Energy Efficiency Potential .....	3-4
	Demand Response .....	3-10
	Building Electrification .....	3-14
<b>4.</b>	<b>Current Resources and New Resource Options</b> .....	<b>4-1</b>
	Natural Gas Commodity Resources .....	4-1
	Transportation Resources .....	4-8
	Storage Resources .....	4-13
	Incremental Supply-Side Resource Options .....	4-14
	Alternative Fuel Supply Options .....	4-16
	Project Evaluation - Build or Buy .....	4-18
	Avista's Natural Gas Procurement Plan .....	4-30
	Market-Related Risks and Risk Management .....	4-31
<b>5.</b>	<b>Policy Issues</b> .....	<b>5-1</b>
	Avista's Environmental Objective .....	5-1
	Natural Gas Greenhouse Gas System Emissions .....	5-1
	Local Distribution Pipeline Emissions - Methane Study .....	5-3
	State and Regional Level Policy Considerations .....	5-3
	Idaho .....	5-3
	Oregon .....	5-4
	Washington .....	5-8
	Federal Legislation .....	5-13
	Customer Market study .....	5-14
	Key Takeaways .....	5-15
	Equity Considerations .....	5-18
<b>6.</b>	<b>Preferred Resource Strategy</b> .....	<b>6-1</b>
	PLEXOS® Planning Model .....	6-1
	Stochastic Analysis .....	6-7
	Resource Integration .....	6-7
	Carbon Policy Resource Utilization Summary .....	6-8
	Resource Utilization .....	6-10
	Demand and Deliverability Balance .....	6-14
	New Resource Options and Considerations .....	6-18
	Energy Efficiency Resources .....	6-20

Preferred Resource Strategy (PRS)..... 6-22  
 Monte Carlo Risk Analysis ..... 6-29  
 Estimated Price Impacts ..... 6-32  
**7. Alternate Scenarios ..... 7-1**  
 Alternate Demand Scenarios ..... 7-1  
 Deterministic – Portfolio Evaluation and Scenario Results ..... 7-1  
 Demand ..... 7-2  
 PRS Scenarios ..... 7-2  
 Electrification Scenarios ..... 7-5  
 Supply Scenarios ..... 7-8  
 Other Scenarios ..... 7-10  
 Washington Climate Commitment Act Allowances ..... 7-12  
 Oregon Community Climate Investments ..... 7-13  
 Natural Gas Use ..... 7-14  
 Synthetic Methane..... 7-15  
 Renewable Natural Gas ..... 7-16  
 Emissions ..... 7-17  
 Cost Comparison..... 7-18  
 Regulatory Requirements ..... 7-21  
**8. Distribution Planning ..... 8-1**  
 Distribution System Planning ..... 8-1  
 Network Design Fundamentals ..... 8-2  
 Computer Modeling ..... 8-2  
 Determining Peak Demand ..... 8-3  
 Distribution System Enhancements ..... 8-3  
 Conservation Resources ..... 8-5  
 Distribution Scenario Decision-Making Process ..... 8-5  
 Planning Results ..... 8-8  
 Non-Pipe Alternatives..... 8-9  
**9. Action Plan ..... 9-1**  
 2021 IRP OPUC Recommendations ..... 9-1  
 Avista’s 2021 IRP Action Items ..... 9-4  
 2023-2024 Action Plan ..... 9-5

## Table of Figures

Figure 1.1: Avista's Natural Gas Service Territory .....	1-1
Figure 1.2: Avista's Natural Gas Customer Counts.....	1-2
Figure 1.3: Firm Customer Mix.....	1-3
Figure 1.4: 2021 Percent of Demand by Area and Class.....	1-4
Figure 1.5: Total System Average Daily Load.....	1-5
Figure 1.6: Poll Question 1 .....	1-7
Figure 1.7: Poll Question 2 .....	1-8
Figure 2.1: Customer Forecast Scenarios.....	2-3
Figure 2.2: Electrification Scenario Customer Forecast .....	2-4
Figure 2.3: Example Demand vs. Temperature – 2022 .....	2-4
Figure 2.4: Monthly Demand of Transport Customers (MMBTU) .....	2-5
Figure 2.5: Usage Based on 2-year, 3-year, and 5-year Coefficient.....	2-6
Figure 2.6: Impact of RCP 4.5 Temperature Data on Load Forecast .....	2-9
Figure 2.7: Spokane Weather Station – Weather Planning Standard Comparison .....	2-10
Figure 2.8: Spokane Historical Temperature Distribution.....	2-11
Figure 2.9: Medford Historical Temperatures .....	2-12
Figure 2.10: La Grande Historical Temperatures .....	2-12
Figure 2.11: Klamath Falls Historical Temperatures .....	2-13
Figure 2.12: Roseburg Historical Temperatures .....	2-13
Figure 2.13: Frequency of Peak Day Occurrences – Spokane .....	2-15
Figure 2.14: Frequency of Peak Day Occurrences – Medford.....	2-15
Figure 2.15: Frequency of Peak Day Occurrences – Roseburg .....	2-16
Figure 2.16: Frequency of Peak Day Occurrences – Klamath Falls .....	2-16
Figure 2.17: Frequency of near Peak Day Occurrences – La Grande.....	2-17
Figure 2.18: System Demand – 1,000 Dth (500 Draws) .....	2-20
Figure 2.19: Idaho Demand – 1,000 Dth (500 Draws) .....	2-20
Figure 2.20: Oregon Demand – 1,000 Dth (500 Draws) .....	2-21
Figure 2.21: Washington Demand – 1,000 Dth (500 Draws) .....	2-21
Figure 3.1: Annual Avoided Cost (by jurisdiction) .....	3-2
Figure 3.2: Winter Avoided Cost (by jurisdiction) .....	3-2
Figure 3.3: Program Characterization Process .....	3-11
Figure 3.4: Space Heat Efficiency by Degrees Fahrenheit and Fuel .....	3-15
Figure 3.5: Energy Conversion Efficiency therms to kWh .....	3-16
Figure 3.6: Estimated Conversion Costs.....	3-17
Figure 3.7: Electric Rate Assumption by Area by Class.....	3-18
Figure 3.8: Conversion Costs and Energy Costs for Space Heat .....	3-19
Figure 3.9: Space Heat Levelized Costs by Area for Residential Electrification .....	3-20
Figure 3.10: Water Heat Levelized Costs by Area for Residential Electrification .....	3-20
Figure 3.11: Space Heat Levelized Costs by Area for Commercial Electrification .....	3-21
Figure 3.12: Water Heat Levelized Costs by Area for Commercial Electrification .....	3-21
Figure 4.1: Monthly Index Prices .....	4-3
Figure 4.2: Henry Hub Forecasted Price (Nominal \$/Dekatherm) .....	4-5
Figure 4.3: Expected Price with Allocated Price Forecast .....	4-6
Figure 4.4: Henry Hub Forecasts for IRP Low/ Expected/ High Forecasted Price .....	4-7
Figure 4.5: Regional Price as a compared to the Henry Hub Price .....	4-8
Figure 4.6: AECO - \$ per Dth (500 Draws) .....	4-8
Figure 4.7: Regional Pipeline and Storage Capacity.....	4-9
Figure 4.8: Direct-Connect Pipelines.....	4-11
Figure 4.9: Participants by State .....	4-19
Figure 4.10: Avista RNG Development and Procurement Decision Tree – Part 1 .....	4-20
Figure 4.11: Avista RNG Development and Procurement Decision Tree – Part 2 .....	4-21
Figure 4.12: RNG Price by Source (nominal \$).....	4-23
Figure 4.13: Production Types of Hydrogen:.....	4-24

Figure 4.14: Green Hydrogen Cost Estimates ..... 4-25

Figure 4.15: Synthetic Methane cost estimates ..... 4-26

Figure 4.16: RNG Landfill RNG - \$ per Dth (500 Draws) ..... 4-27

Figure 4.17: Dairy RNG - \$ per Dth (500 Draws) ..... 4-28

Figure 4.18: Food Waste RNG - \$ per Dth (500 Draws) ..... 4-28

Figure 4.19: Wastewater Treatment RNG - \$ per Dth (500 Draws) ..... 4-29

Figure 4.20: Hydrogen (500 Draws) ..... 4-29

Figure 4.21: Synthetic Methane - \$ per Dth (500 Draws) ..... 4-30

Figure 5.1: Oregon Customers Annual Emissions Compliance Cap ..... 5-5

Figure 5.2: Oregon Emissions by Class for 2022 ..... 5-5

Figure 5.3: Maximum Available CCI Compared to the Reduction Goal ..... 5-6

Figure 5.4: Community Climate Investment (\$ per MTCO<sub>2e</sub>) ..... 5-7

Figure 5.5: Business as Usual Emission Forecast vs. Utility Goal ..... 5-7

Figure 5.6: Climate Commitment Act Coverage ..... 5-9

Figure 5.7: Avista’s Estimated Annual Emissions Cap ..... 5-10

Figure 5.8: Emissions Reductions from Offset Projects ..... 5-11

Figure 5.9: Expected CCA Allowance Prices ..... 5-12

Figure 5.10: Bill Increase and Carbon-Neutral or Carbon-Free Options ..... 5-15

Figure 5.11: Importance of “Green” ..... 5-16

Figure 5.12: An Increased Bill and Possible Actions from Customers ..... 5-17

Figure 5.13: Customer Concerns with Fuel Switching ..... 5-17

Figure 6.1: PLEXOS® Idaho System Map ..... 6-2

Figure 6.2: PLEXOS® Washington System Map ..... 6-3

Figure 6.3: PLEXOS® Oregon System Map ..... 6-3

Figure 6.4: PLEXOS® Washington Transport Customer Map ..... 6-4

Figure 6.5: PLEXOS® Oregon Transport Customer Map ..... 6-4

Figure 6.6: Modeling Workflow Diagram ..... 6-6

Figure 6.7: Total System Average Daily Load (Average, Minimum and Maximum) ..... 6-8

Figure 6.8: Carbon Legislation Sensitivities ..... 6-9

Figure 6.9: Existing Firm Transportation Resources ..... 6-10

Figure 6.10: Average Demand Compared to Storage & Transport Rights for February 28th .... 6-15

Figure 6.11: Average Demand Compared to Storage & Transport Rights for December 20th . 6-15

Figure 6.12: Expected Peak Day Demand Compared to Storage & Transport Rights for February 28<sup>th</sup> ..... 6-16

Figure 6.13: Expected Peak Day Demand Compared to Storage & Transport Rights for December 20th ..... 6-16

Figure 6.14: Washington Emissions Forecast Compared to CCA Cap ..... 6-17

Figure 6.15: Emissions Forecast Compared to CPP Cap ..... 6-17

Figure 6.16: Resource Options and Costs in PLEXOS Model ..... 6-19

Figure 6.17: Idaho Preferred Resource Strategy ..... 6-23

Figure 6.18: Natural Gas Basin Least Cost - Idaho ..... 6-23

Figure 6.19: Oregon Preferred Resource Strategy ..... 6-24

Figure 6.20: Natural Gas Basin Least Cost – Oregon ..... 6-24

Figure 6.21: Community Climate Investment Quantity – (MTCO<sub>2e</sub>) ..... 6-26

Figure 6.22: Washington Preferred Resource Strategy ..... 6-27

Figure 6.23: Natural Gas Basin Least Cost - Washington ..... 6-27

Figure 6.24: CCA Allowances/Offsets Quantity Needed (MTCO<sub>2e</sub>) ..... 6-29

Figure 6.25: System Annual Costs – 1,000 of \$ (500 Draws) ..... 6-30

Figure 6.26: Idaho Annual Costs – 1,000 of \$ (500 Draws) ..... 6-30

Figure 6.27: Oregon Annual Costs – 1,000 of \$ (500 Draws) ..... 6-31

Figure 6.28: Washington Annual Costs – 1,000 of \$ (500 Draws) ..... 6-31

Figure 6.29: Residential Price Impact (\$ of therm) ..... 6-32

Figure 6.30: Commercial Price Impact (\$ per therm) ..... 6-32

Figure 6.31: Industrial Price Impact (\$ per therm) ..... 6-33

Figure 6.32: Transport Price Impact (\$ per therm) ..... 6-33

Figure 7.1: Demand by Scenario ..... 7-2

Figure 7.2: PRS Scenarios - Annual System Costs ..... 7-3

Figure 7.3: Annual Electrification Levelized Costs by Source ..... 7-6

Figure 7.4: Electrification as a Demand-Side Resource by Scenario and State ..... 7-8

Figure 7.5: Supply Scenarios vs PRS - Annual System Costs ..... 7-9

Figure 7.6: Other Scenarios vs PRS - Annual System Costs ..... 7-11

Figure 7.7: Allowance Demand by Scenario – Washington CCA ..... 7-13

Figure 7.8: CCI Demand by Scenario – Oregon CPP ..... 7-14

Figure 7.9: Natural Gas Supply ..... 7-15

Figure 7.10: Annual Synthetic Methane Volumes by 2045 ..... 7-15

Figure 7.11: Oregon RNG Volumes Across Scenarios ..... 7-16

Figure 7.12: Washington RNG Volumes Across Scenarios ..... 7-17

Figure 7.13: System Emissions by Scenario by 2030 ..... 7-18

Figure 7.14: PRS Alternative Scenario Cost Comparison..... 7-19

Figure 7.14: Residential Customer Price Impact (\$ per dekatherm) ..... 7-19

Figure 7.14: Commercial Customer Price Impact (\$ per dekatherm)..... 7-20

Figure 7.14: Industrial Customer Price Impact (\$ per dekatherm) ..... 7-20

Figure 7.14: Transport Only Customer Price Impact (\$ per dekatherm) ..... 7-20

Figure 8.1: Distribution Scenario Process ..... 8-7



## Table of Tables

Table 1.1: TAC Member Participation .....	1-6
Table 1.2: Summary of Changes from the 2021 IRP .....	1-10
Table 2.1: Geographic Demand Classifications .....	2-1
Table 2.2: Customer Growth Scenarios .....	2-2
Table 2.3: Comparison of Temperature Increases by Representative Concentration Pathway ..	2-8
Table 2.4: Peak Day Design Temperature .....	2-11
Table 2.5: Example of Monte Carlo Weather Inputs – Spokane .....	2-14
Table 2.6: Load Forecast (Thousand Dekatherms).....	2-18
Table 2.7: Peak Day Load Forecast (Thousand Dekatherms).....	2-19
Table 2.8: Demand Scenarios .....	2-22
Table 2.9: Annual Demand – 2023 IRP Scenarios (000 dth) .....	2-23
Table 3.1: Cost Effectiveness Test.....	3-4
Table 3.2: Washington Energy Efficiency Potential by Case (dekatherms) .....	3-5
Table 3.3: Idaho Energy Efficiency Potential by Case (dekatherms) .....	3-5
Table 3.4: Washington 2024-2025 Conservation Target by Sector, (therms).....	3-6
Table 3.5: Idaho 2024-2025 Conservation Target by Sector, (therms).....	3-6
Table 3.6: Summary of Oregon Low-Income Energy Efficiency Potential .....	3-8
Table 3.7: Summary of Oregon Interruptible Industrial Energy Efficiency Potential .....	3-8
Table 3.8: Summary of Oregon Interruptible Commercial Energy Efficiency Potential.....	3-9
Table 3.9: Summary of Oregon Transport Industrial Energy Efficiency Potential .....	3-9
Table 3.10: 20-Year Cumulative Savings Potential by Type (Millions of Therms) .....	3-10
Table 3.11: NGDR Program Options by Market Segment .....	3-11
Table 3.12: NGDR Program Steady-State Participation Rates .....	3-13
Table 3.13: System Program Cost and Potential .....	3-14
Table 4.1 : Price Blend Methodology.....	4-6
Table 4.2: Firm Transportation Resources Contracted (Dth/Day).....	4-10
Table 4.3: Carbon Intensity .....	4-16
Table 4.4: All resource price comparison \$/Dth .....	4-26
Table 5.1: Avista Specific LDC Natural Gas Emissions .....	5-2
Table 5.2: Global Warming Potential (GWP) in CO2 Equivalent .....	5-2
Table 5.3: National Greenhouse Gas Pricing Forecast.....	5-4
Table 6.1: New Supply-Side and Demand-Side Resource Options.....	6-18
Table 6.2: Annual Demand Served by Energy Efficiency .....	6-21
Table 6.3: Average Daily Demand Served by Energy Efficiency .....	6-21
Table 6.4: Average Daily Resource Quantities by Year .....	6-25
Table 6.5: Average Daily Resource Quantities by Year – Washington.....	6-28
Table 7.1: 2023 IRP Scenarios.....	7-1
Table 7.2: PRS Scenarios - Portfolio Selections .....	7-4
Table 7.3: Electrification Scenarios - Portfolio Selections .....	7-7
Table 7.4: Supply Scenarios – Portfolio Selection .....	7-10
Table 7.5: Other Scenarios – Portfolio Selection .....	7-12
Table 8.1: High Pressure - Distribution Planning Capital Projects .....	8-9
Table 8.2: City Gate Station Upgrades.....	8-9
Table 9.1: Oregon Distribution Projects .....	9-5

## Executive Summary

Avista's 2023 Natural Gas Integrated Resource Plan (IRP) identifies a Preferred Resource Portfolio (PRS) to meet system energy demand and emissions compliance in Washington under the Climate Commitment Act (CCA) and Oregon under Climate Protection Plan (CPP). Avista considered resource capacity needs on a peak day combined with weather futures to consider a warming trend and its impact on demand. The total system load is illustrated in Figure 1 by month to help depict the seasonality of firm customer demand on the natural gas distribution infrastructure.

**Figure 1: Total System Average Daily Load (Average, Minimum and Maximum)**

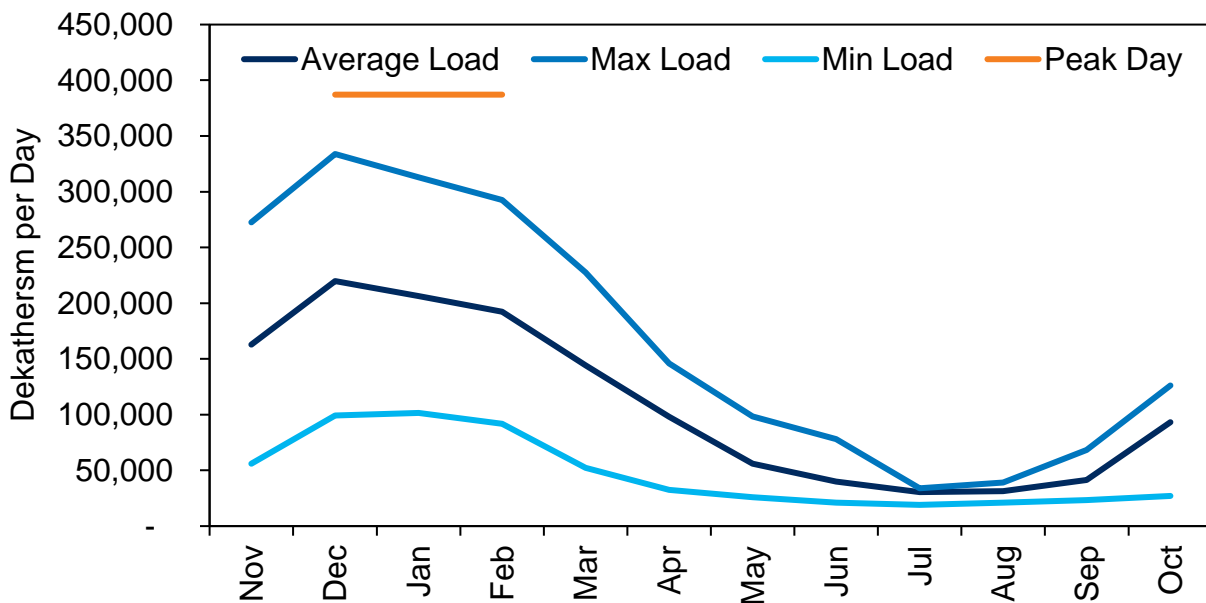

Customer forecasts are increasingly difficult to model based on a variety of rules and codes passed since the 2021 IRP. In Washington, a building code update will go into effect on July 1, 2023, requiring heat pump technology for space and water heating in all new residential and commercial buildings. Line extension programs to assist customers with natural gas have been decreased or planned for elimination and new programs have been passed to help customers consider more efficient equipment. With the risk of uncertainty brought into the future state of customers and demand, fourteen scenarios were developed to consider a range of different futures and resource selections. Avista is still long transport rights, consistent with prior IRP expectations. Peak Day criteria is important as it protects our customers and their structures during extreme weather.

Emissions compliance under the CCA and CPP tells a different story for resource need. Greenhouse gas emissions compliance considers program constraints of the CCA and CPP, plus these regulations require planning for transport customers where past plans did not. In both Figure 2 and Figure 3, equivalent emissions from Firm customers and transport customers can be found in the stacked bar chart with the cap for the respective

program as a line. These charts clearly show noncompliance if no actions are taken to offset emissions or other options per program rules, where the total emissions in the blue and green bars exceed the cap shown in orange. These shortages occur in 2023 and continue through the end of the study in 2045.

**Figure 2: Washington Emissions Forecast Compared to CCA Cap**

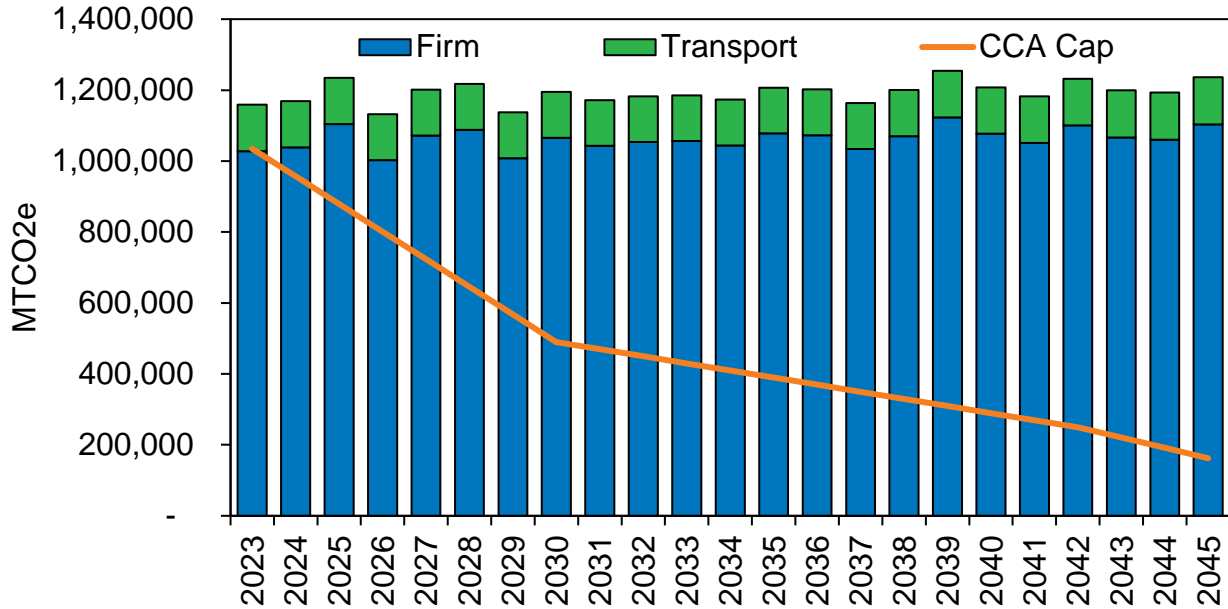

**Figure 3: Emissions Forecast Compared to CPP Cap**

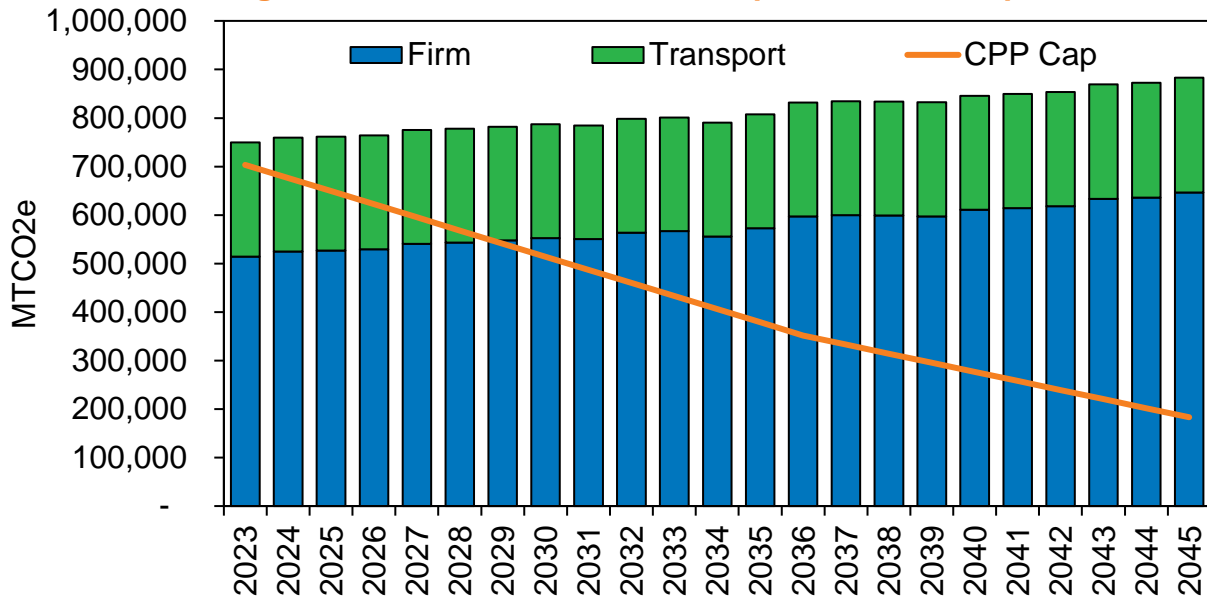

## Idaho Preferred Resource Strategy

The Idaho PRS continues to utilize the least cost natural gas basin, and storage, combined with energy efficiency to meet energy demand as illustrated in Figure 4. Natural gas will be acquired on a least cost basis from the available hubs.

Figure 4: Idaho Preferred Resource Strategy

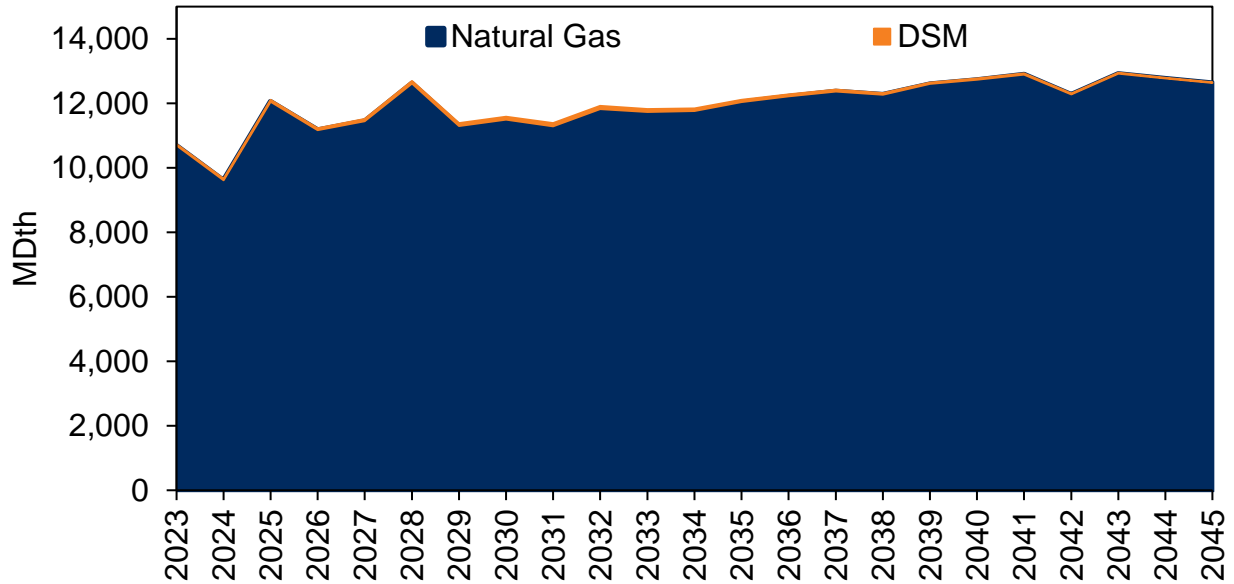

## Oregon Preferred Resource Strategy

Oregon’s PRS has drastically changed as compared to the 2021 IRP. Changes adhere to the new environmental goals of the CPP and the estimated energy demand. In the near-term, the new resource need is acquired via a combination of RNG from Landfill Gas (LFG), Wastewater Treatment Plants (WWTP), energy efficiency, Community Climate Investments (CCIs), and conventional natural gas. Synthetic methane is added to the resource mix beginning in the 2030’s, as illustrated in Figure 5. In each figure, the dark blue area at the bottom of the chart depicts natural gas with no emissions instrument for compliance, essentially the cap of the CPP.

**Figure 5: Oregon Preferred Resource Strategy**

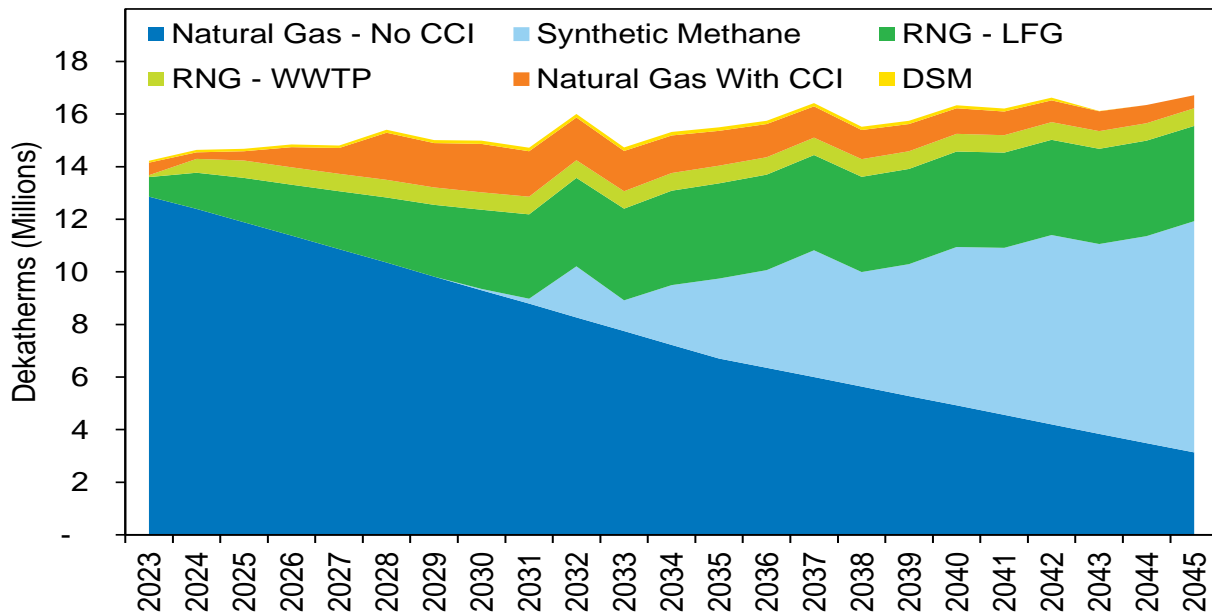

## Washington Preferred Resource Strategy

Washington’s PRS has also changed dramatically from the 2021 IRP. The CCA has introduced a cap-and-trade program with the ability to cover emissions with an allowance or offset. Allowance and offset prices may drive a different PRS than the one illustrated in Figure 6. The range of allowance prices for 2023 is \$22 to \$82 USD. The PRS shows conventional natural gas and energy efficiency as the primary energy source options until the end of the study horizon (2044), when synthetic methane is chosen. The darker blue area in the chart is the CCA program cap and would not require any type of program instruments. The lighter blue area represents natural gas as an energy source, requiring an offset or an allowance as it is above the cap. Natural gas will continue to be procured from the least cost supply basin.

**Figure 6: Washington Preferred Resource Strategy**

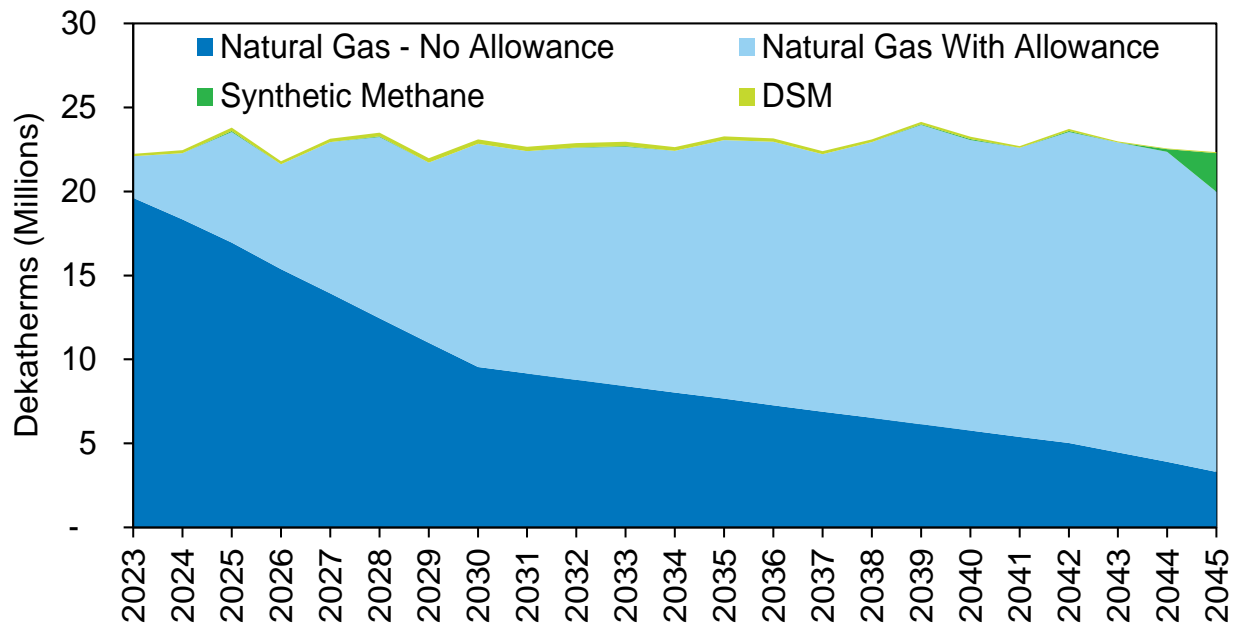

This Page Intentionally Left Blank

# 1. Introduction and Planning Environment

Avista is an investor-owned utility involved in the production, transmission, and distribution of natural gas and electricity, as well as other energy-related businesses. Avista, founded in 1889 as Washington Water Power, has been providing reliable, efficient, and reasonably priced energy to customers for over 130 years.

Avista entered the natural gas business with the purchase of Spokane Natural Gas Company in 1958. In 1970, it expanded into natural gas storage with Washington Natural Gas (now Puget Sound Energy) and El Paso Natural Gas (its interest subsequently purchased by Northwest Pipeline) to develop the Jackson Prairie natural gas underground storage facility near Chehalis, Washington. In 1991, Avista added 63,000 customers with the acquisition of CP National Corporation’s Oregon and California properties. Avista sold the California properties and its 18,000 South Lake Tahoe customers to Southwest Gas in 2005. Figure 1.1 shows where Avista currently provides natural gas service to approximately 377,000 customers in eastern Washington, northern Idaho, and several communities in northeast and southwest Oregon. Figure 1.2 shows the number of firm natural gas customers by state.

**Figure 1.1: Avista’s Natural Gas Service Territory**

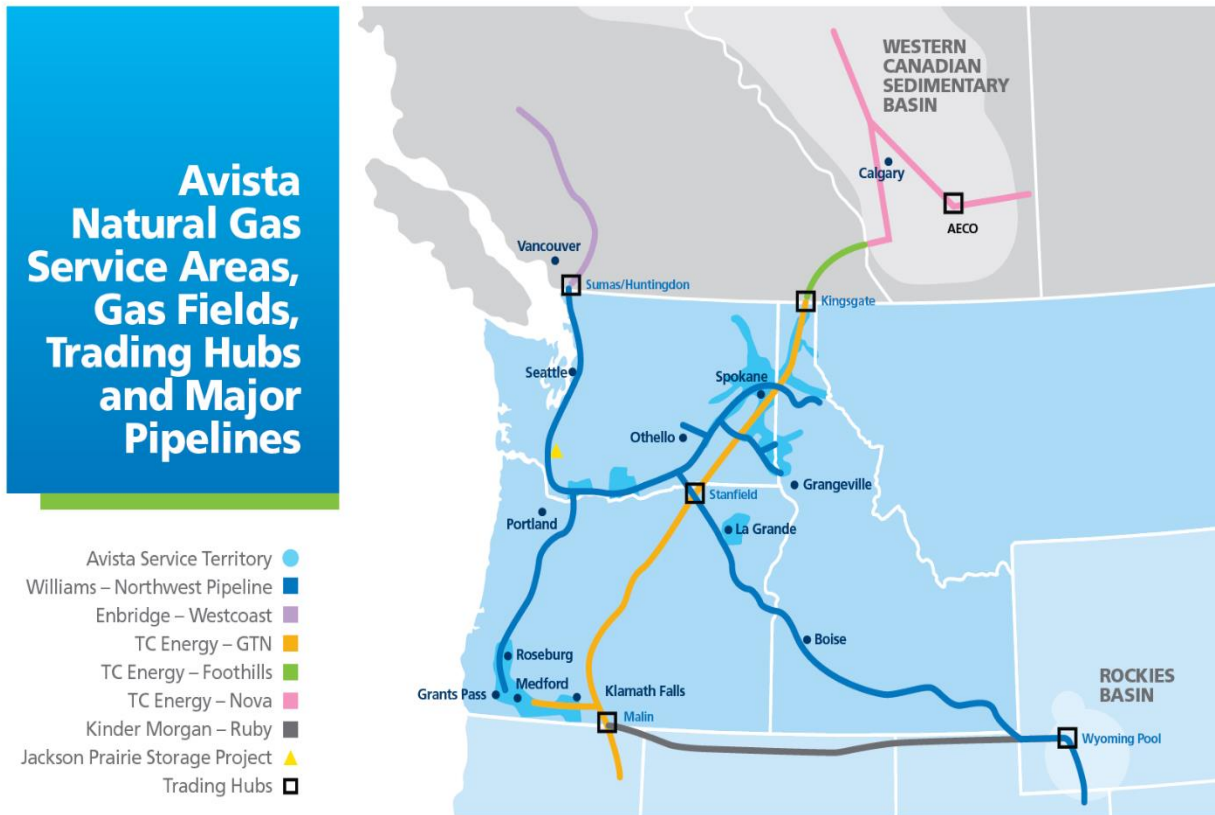



**Figure 1.2: Avista’s Natural Gas Customer Counts**

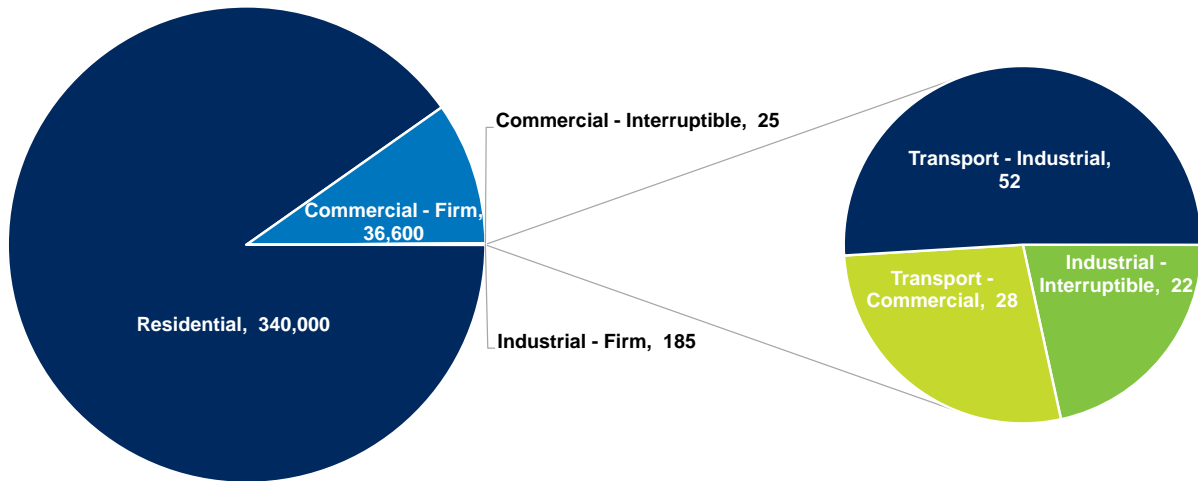

Avista’s natural gas operations covers 30,000 square miles, with a population of 1.6 million people. Avista manages its natural gas operation through the North and South operating divisions:

- The North Division includes Avista’s eastern Washington and northern Idaho service area. It includes urban areas, farms, timberlands, and the Coeur d’Alene mining district. Spokane is the largest metropolitan area with a regional population of approximately 546,000<sup>1</sup> followed by the Lewiston, Idaho/Clarkston, Washington, and Coeur d’Alene, Idaho, areas. The North Division has about 75 miles of natural gas transmission pipeline and 5,800 miles in the distribution system in Washington and 3,300 miles in Idaho. The North Division receives natural gas at more than 40 connection points along interstate pipelines for distribution to over 270,000 customers.
- The South Division serves four counties in southern Oregon and one county in eastern Oregon. The combined population of these areas is over 585,000 residents. The South Division includes urban areas, farms, and timberlands. The Medford, Ashland and Grants Pass areas, located in Jackson and Josephine Counties, is the largest single area served in this division with a regional population of approximately 312,000. The South Division consists of approximately 15 miles of natural gas transmission main and 3,700 miles of distribution pipelines. Avista receives natural gas at more than 20 connection points along interstate pipelines and distributes it to nearly 106,000 customers.

<sup>1</sup> <https://www.census.gov/quickfacts/fact/table/spokanecountywashington,WA/PST045221>

## Customers

Avista provides natural gas services to both core and transportation-only customer classes. Core or retail customers purchase natural gas directly from Avista with delivery to their home or business under a bundled rate. Core customers on firm rate schedules are entitled to receive any volume of natural gas they require. Some core customers are on interruptible rate schedules. These customers pay a lower rate than firm customers because their service can be interrupted. Interruptible customers are not considered in peak day IRP planning.

Transportation-only customers purchase natural gas from third parties who deliver the purchased gas to our distribution system. Avista delivers this natural gas to its business charging a distribution rate only. Avista can interrupt the delivery service when following the priority of service tariff. However, new environmental programs in Oregon and Washington require Avista to comply for these emissions for the interruptible and transport customers. These new programs are discussed in Chapter 5 with resource selection in Chapter 6.

Avista’s core or retail customers include residential, commercial, and industrial categories. Most of Avista’s customers are residential, followed by commercial and relatively few industrial accounts (Figure 1.3).

**Figure 1.3: Firm Customer Mix**

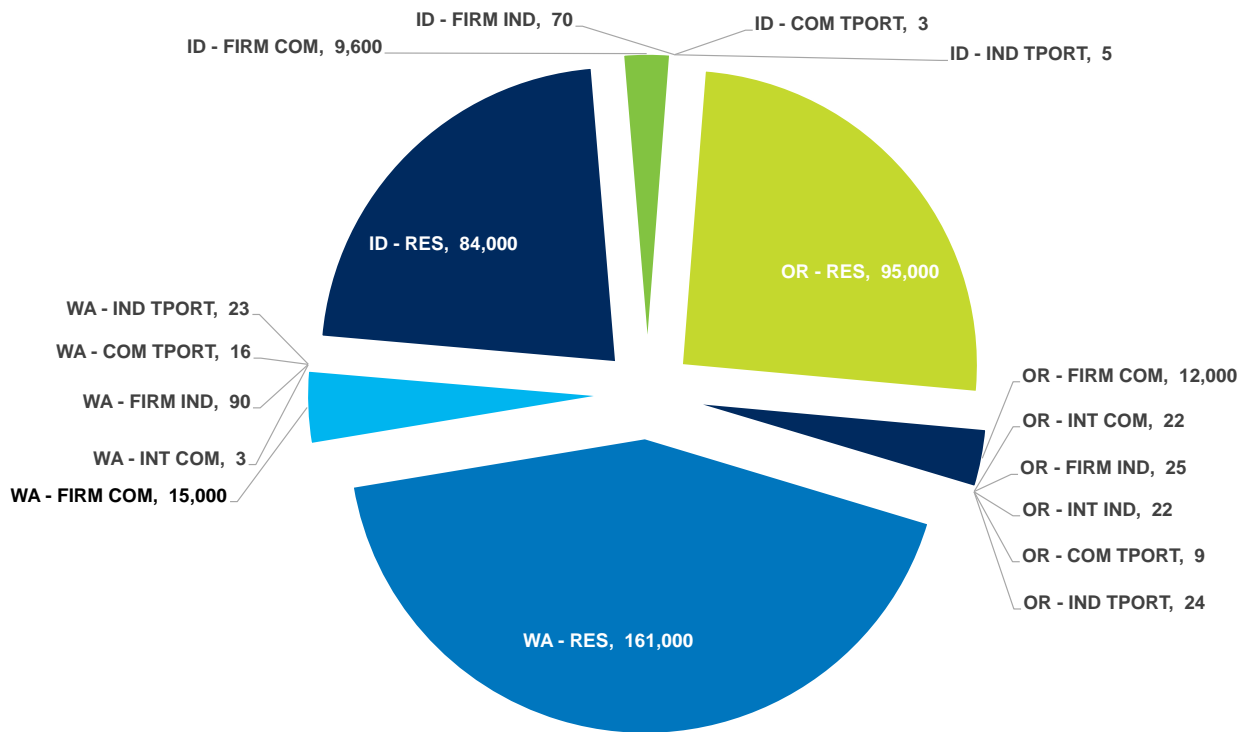

The customer mix is found mostly in the residential and commercial accounts on an annual volume basis (Figure 1.4). Volume consumed by core industrial customers is not significant to the total, partly because most industrial customers in Avista’s service territories are transportation-only customers. These customers, however, will require a compliance mechanism or alternative fuels to meet emissions targets.

**Figure 1.4: 2021 Percent of Demand by Area and Class**

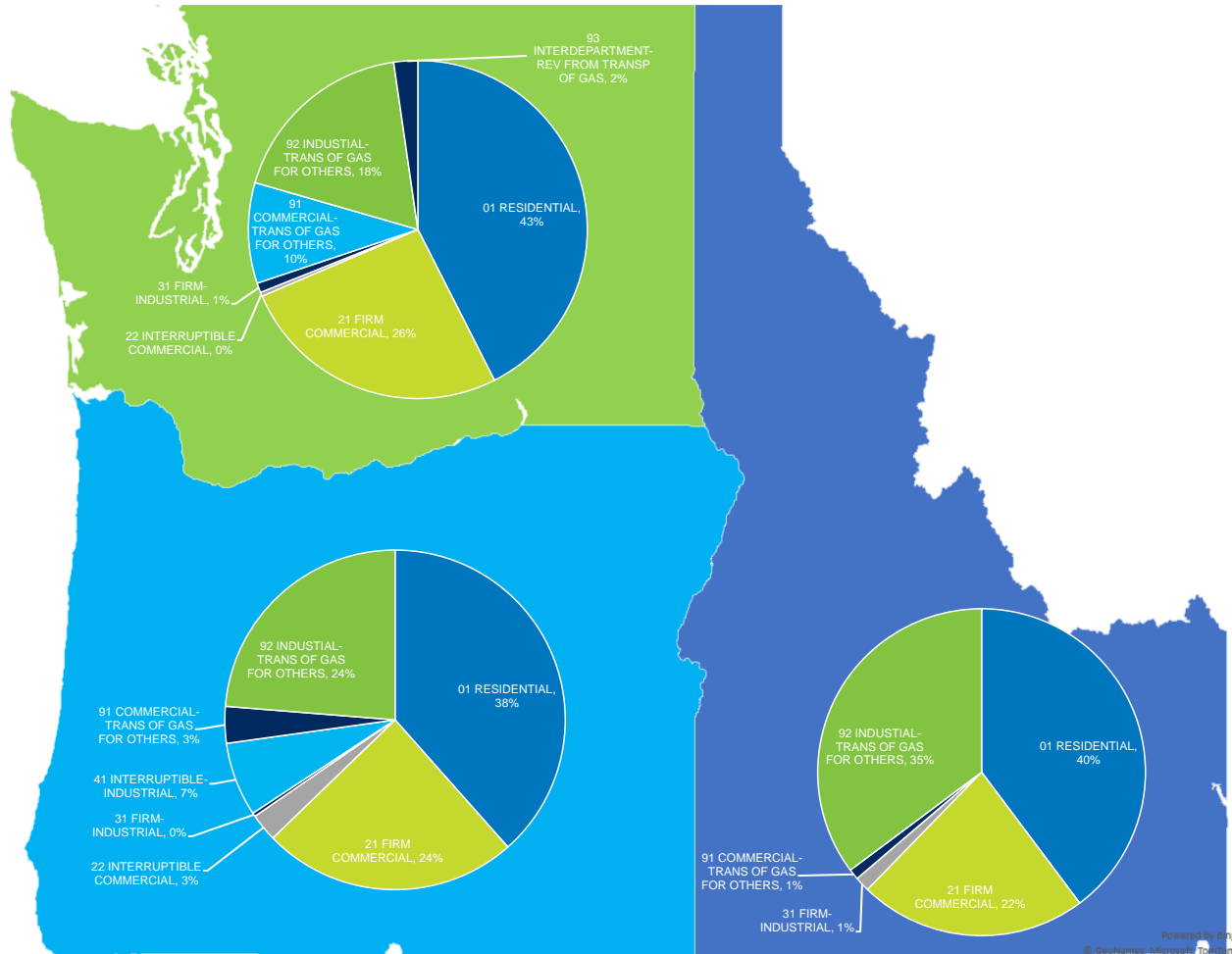

The seasonal nature of weather in the Pacific Northwest can drastically alter the amount of energy demanded from the natural gas system (Figure 1.5). Industrial demand, which is typically not weather sensitive, has very little seasonality. However, the La Grande service territory has several industrially classified agricultural processing facilities producing a late summer seasonal demand spike.

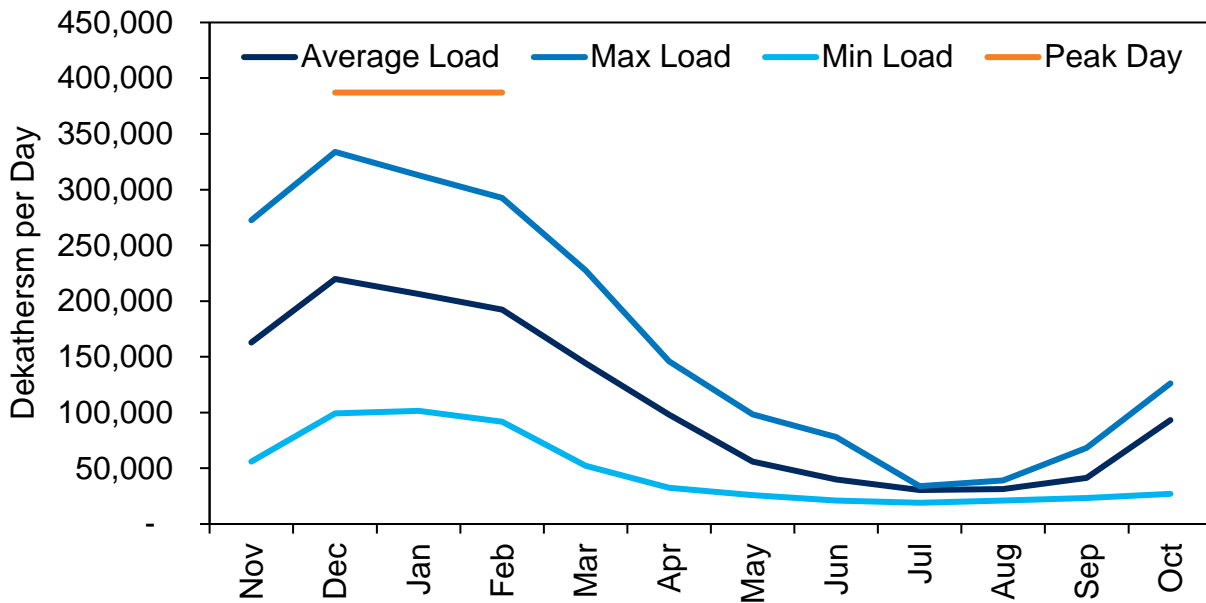
**Figure 1.5: Total System Average Daily Load**

## Integrated Resource Planning

Avista's IRP involves a comprehensive analytical process to ensure the core firm customers receive long-term reliable natural gas service in extreme weather. The IRP evaluates, identifies, and plans for the acquisition of an optimal combination of existing and future resources using expected costs and associated risks to meet stage environmental policies, average daily and peak-day demand delivery requirements over a 20-year planning horizon.

### Purpose of the Natural Gas IRP

- Provides a comprehensive long-range planning tool;
- Fully integrates forecasted requirements with existing and potential resources;
- Determines the most cost-effective and risk-adjusted means for meeting future demand requirements;
- Meets Washington, Idaho, and Oregon regulations, commission orders, environmental programs and other applicable guidelines.

### Avista's IRP Process Considerations

- Customer growth and usage;
- Weather planning standard;
- Energy Efficiency opportunities;
- Existing and potential supply-side resource options;
- Current and potential legislation/regulation;
- Greenhouse gas emissions reductions and compliance mechanisms;

- Risk; and
- Least cost mix of supply and conservation.

**Public Participation**

Avista’s Technical Advisory Committee (TAC) members play a key role and have a significant impact in developing the IRP. TAC members include Commission Staff, peer utilities, government agencies, and other interested parties. TAC members provide input on modeling, planning assumptions, and the general direction of the planning process.

Avista sponsored five public TAC meetings to facilitate stakeholder involvement in the 2023 IRP. The first meeting convened in February 2022 and the last meeting occurred in December 2022. Each meeting included a broad spectrum of stakeholders. The meetings focused on specific planning topics, reviewing the progress of planning activities, and soliciting input on IRP development and results. Avista appreciates the time and effort TAC members contributed to the IRP process as they provided valuable input through their participation. A list of these organizations can be found below (Table 1.1).

**Table 1.1: TAC Member Participation**

Cascade Natural Gas	Northwest Energy Coalition	Oregon Public Utility Commission
Fortis	Northwest Natural Gas	Alliance of Western Energy Consumers
Idaho Public Utilities Commission	Biomethane, LLC	Washington State Office of the Attorney General
Northwest Gas Association	Washington Utilities and Transportation Commission	Citizens Utility Board of Oregon
Washington State Department of Commerce	Northwest Power and Conservation Council	Energy Trust of Oregon
Intermountain Gas Company	Energy Strategies	RNG Coalition
Lewis and Clark Law School	Eastern Washington University	Applied Energy Group
Oregon Department of Energy	San Francisco Bay Area Planning and Urban Research Association (SPUR)	DecisionWare Group

**Public Meetings**

Two public meetings were held on March 8<sup>th</sup>, 2023 at noon and 5 pm lasting an hour each. In each meeting Avista reviewed the preferred resources selected in both the electric and natural gas IRPs to meet energy demand and/or energy policy compliance.

An email was sent to TAC members and customers in all jurisdictions informing them of the opportunity to participate and provide feedback. Avista also included a recorded video of its resource planning process and resource strategies. During the public meeting, summary level results by jurisdiction were presented to the participants. The public

meeting structure is important as one does not have to be versed in the technical side of energy, statistics, math, chemistry, or other potential topics as discussed in TAC meetings. It also provides direct access to Avista subject matter experts to ask questions and provide feedback about topics most important to each customer. These comments and questions can be found in Appendix 1 and the recordings for each session are available on the Avista IRP website<sup>2</sup>.

A set of five poll questions were asked to meeting participants surrounding topics including emissions compliance pathways for natural gas, equity, demand response, and ranking the overall importance of planning considerations when compared with a variety of options valued in IRPs. The two poll questions directly related to natural gas are illustrated in Figure 1.6 and 1.7.

Generally, participants were engaged in the conversation representing many viewpoints of how Avista serves its customers. A common theme of concerns are related to cost impacts of environmental policy, how other states policies effect non-participating states, and whether or not natural gas will continue to be available.

**Figure 1.6: Poll Question 1**

How should Avista meet state policy objectives to lessen greenhouse gas emissions on the natural gas system?

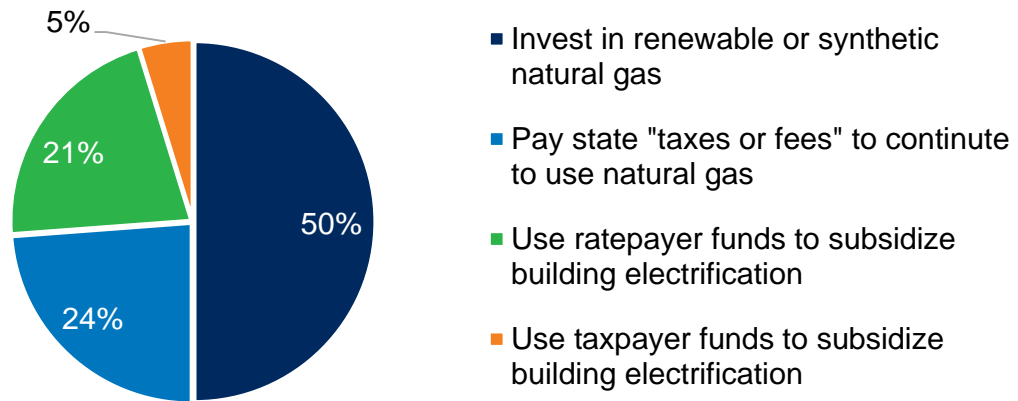

<sup>2</sup> <https://www.myavista.com/about-us/integrated-resource-planning>

**Figure 1.7: Poll Question 2**

What would you prioritize among the choices below, acknowledging they are all important?

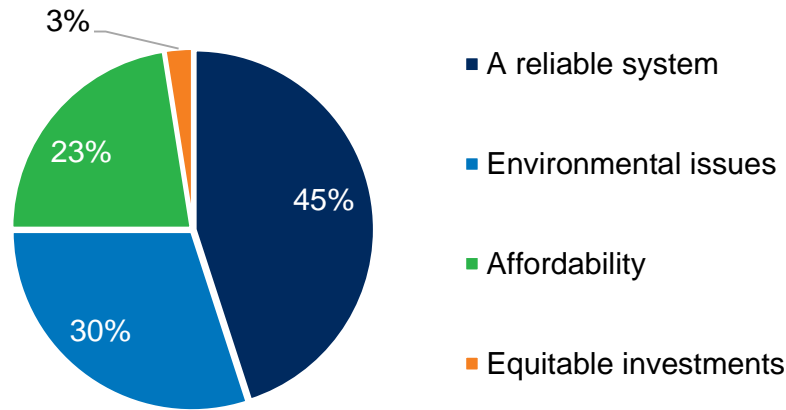

### Regulatory Requirements

Avista submits a natural gas IRP to the public utility commissions in Idaho, Oregon, and Washington every two years as required by state law or rule. There is a statutory obligation to provide reliable natural gas service to customers at rates, terms, and conditions that are fair, just, reasonable, and sufficient. Avista regards the IRP as a means for identifying methodologies and processes for the evaluation of potential resource options and as a process to establish an Action Plan for resource decisions. Ongoing investigation, analysis, and research may result in determining alternative resources are more cost effective than resources reviewed and selected in this IRP. Avista will continue to review and refine its understanding of resource options and will act to secure these risk-adjusted, least-cost options when appropriate.

### Planning Model

New to the 2023 IRP, Avista used the PLEXOS® planning model to perform comprehensive natural gas supply planning and analysis in place of the old software from ABB Sendout. PLEXOS®, from Energy Exemplar, provides unlimited flexibility in its ability to run scenarios, constraints, variables, horizons, and environmental constraints. This model uses a nodal and zonal analysis with:

- Customer growth and customer natural gas usage to form demand forecasts;
- Existing and potential transportation and storage options and associated costs;
- Existing and potential natural gas supply availability and pricing;
- Revenue requirements on all new asset additions;
- Weather assumptions; and
- Conservation.

Avista incorporated stochastic modeling in PLEXOS® to incorporate weather and price uncertainty. Some examples of the types of stochastic analysis provided include:

- Stochastics futures where five future scenarios are solved simultaneously with a single set of resource selections;
- Price and weather probability distributions;
- Probability distributions of costs (i.e. system costs, storage costs, commodity costs); and
- Resource mix (optimally sizing a contract or asset level of competing resources).

These computer-based planning tools were used to develop the 20-year best cost/risk resource portfolio plan to serve customers.

## Planning Environment

Even though Avista publishes an IRP every two years, the process is ongoing with new information and industry related developments occurring regularly. In normal circumstances, the process can become complex as underlying assumptions evolve, impacting previously completed analyses. Widespread agreement on the availability of shale gas and the ability to produce it at lower prices has increased interest in the use of natural gas for LNG and Mexico exports as well as industrial uses. One of the most prominent risks in the IRP involves policies meant to decrease the use of natural gas as outlined in Chapter 5. However, there is uncertainty about the timing and size of those policy decisions.

### IRP Planning Strategy

Planning for an uncertain future requires robust analysis encompassing a wide range of possibilities. Avista has determined the planning approach needs to:

- Adhere to new environmental laws and policies in Oregon and Washington;
- Recognize historical trends may be fundamentally altered;
- Critically review all modeling assumptions;
- Pursue a spectrum of scenarios;
- Develop a flexible analytical framework to accommodate changes; and
- Maintain a long-term perspective combined with a near term resource plan.

With these objectives in mind, Avista developed a strategy encompassing all required planning criteria. This produced an IRP that effectively analyzes risks and resource options, which sufficiently ensures customers will receive safe and reliable energy delivery services with the best-risk, lease-cost, long-term solutions. The following chart summarizes significant changes from the 2021 IRP (Table 1.2).



**Table 1.2: Summary of Changes from the 2021 IRP**

Subject	Area	2023 Natural Gas IRP	2021 Natural Gas IRP
Demand	System Growth	1.10%	1.00%
Demand	System Growth	Washington building code requirements for residential and commercial homes to use a heat pump for space and water heat beginning in July 2023	None
Demand	Weather and Design Day Peak	99% probability of a temperature occurring based on the coldest temperature each year for the past 30 years combined with weather forecasted temperatures and trended from the historic peak day	99% probability of a temperature occurring based on the coldest temperature each year for the past 30 years
Demand	Weather and Design Day Peak	Climate Change future weather predictions incorporated into analysis	20 year rolling average weather utilized
Demand	Energy Efficiency	Cumulative Savings over 20 years:	Cumulative Savings over 20 years:
Demand	Energy Efficiency	ID: 12.7 Million Therms	ID: 21.4 Million Therms
Demand	Energy Efficiency	OR: 16.1 Million Therms	OR: 14.8 Million Therms
Demand	Energy Efficiency	WA: 25.3 Million Therms	WA: 37.7 Million Therms
Demand	Energy Efficiency	A higher price curve with less potential	A lower price curve and slightly less conservation potential
Demand	Energy Efficiency	CPA for Demand Response (DR)	None
Demand	Energy Efficiency	CPA for Transport Customers in Oregon and Washington	None
Demand	Energy Efficiency	CPA for Low Income Customers in Oregon	None
Demand	Energy Efficiency	ID: National Carbon Tax beginning in 2030 (\$12.00 - \$62.08) per MTCO <sub>2e</sub>	No Program or Cost
Demand	Energy Efficiency	OR: Social Cost of Carbon @ 2.5% discount rate (\$92.68 - \$185.07) per MTCO <sub>2e</sub>	California Cap and Trade - (\$15.83 – \$97.90)
Demand	Energy Efficiency	WA: Social Cost of Carbon @ 2.5% discount rate (\$92.68 - \$185.07) per MTCO <sub>2e</sub>	WA – Social Cost of Carbon @ 2.5% discount rate (\$79.86 - \$158.06)
Supply	Energy Prices	Synthetic Methane Evaluated	None

Supply	Energy Prices	Electrification by Area and End Use Evaluated	None
Supply	Energy Prices	RNG by type evaluated combined with volumetric expectations	None
Supply	Energy Prices	A higher price curve at \$4.50 / Dth levelized cost in real 2022 US \$	A lower price curve at \$3.73 / Dth levelized cost in real 2019 US \$
Policy	CCA	Climate Commitment Act (CCA) - Washington	No Program
Policy	CCA	Allowance Floor Price of CCA	No Program
Policy	CCA	Allowance Ceiling Price of CCA	No Program
Policy	CCA	Emissions Compliance to CCA	No Program
Policy	CPP	Climate Protection Plan (CPP) - Oregon	No Program
Policy	CPP	Community Climate Investment (CCI)	No Program
Policy	CPP	Emissions Compliance to CPP	No Program
Policy	IRA	Inflation Reduction Act included	No Program
Scenario	Resource Shortage	Due to the new climate policies in Oregon and Washington all scenarios require new resources.	There are two cases where resource deficiencies occur, the High Growth/Low Price scenario and the Carbon Reduction scenario. The High Growth/Low Price scenario is solved by adding RNG landfill within the city gate. The Carbon Reduction scenario looks to reduce emissions and Dairy RNG provides the greatest amount of carbon intensity/carbon capture of RNG sources.
Scenario	New Scenario	Electrification Scenarios	None
Scenario	New Scenario	Hybrid Scenario	None

This Page Intentionally Left Blank

## 2. Demand Forecasts

The IRP process begins with a demand forecast. Understanding and analyzing key demand drivers and their potential impact on forecasts is vital to the planning process. Utilization of historical data provides a reliable baseline; however, forecasting will always have uncertainties regardless of methodology and data integrity. This IRP mitigates the uncertainty by considering a range of scenarios to evaluate and prepare for a broad spectrum of potential outcomes.

### Demand Areas

Avista defines eleven demand areas, structured around the pipeline's ability to serve them within the PLEXOS® model (Table 2.1). These demand areas are aggregated into five service territories and further summarized as North or South divisions for presentation throughout this IRP.

**Table 2.1: Geographic Demand Classifications**

Demand Area	Service Territory	Division
Washington NWP	Spokane	North
Washington GTN	Spokane	North
Washington Both	Spokane	North
Idaho NWP	Coeur D' Alene	North
Idaho GTN	Coeur D' Alene	North
Idaho Both	Coeur D' Alene	North
Medford NWP	Medford/Roseburg	South
Medford GTN	Medford/Roseburg	South
Roseburg	Medford/Roseburg	South
Klamath Falls	Klamath Falls	South
La Grande	La Grande	South

### Customer Forecasts

Avista's customer base includes firm residential, commercial, and industrial categories. For each of the customer categories, Avista develops customer forecasts incorporating national economic forecasts and regional economies. The key economic drivers to forecast customer growth are U.S. Gross Domestic Product (GDP) growth, national and regional employment growth, and regional population growth expectations. A detailed description of the customer forecast is found in Appendix 2.1. Avista combines this data with local knowledge about sub-regional construction activity, age and other demographic trends, and historical data to develop the 20-year customer forecasts.

The customer forecast in the 2023 IRP assumes growth based on historic trends. These trends were evaluated against electrification end uses to consider conversion based on economics. A price elasticity was not incorporated in this analysis so there may be

additional movement from natural gas customers to electric end uses simply due to increases in price to comply with climate programs.

Forecasting customer growth is an inexact science, so it is important to consider different forecasts. Two alternative growth forecasts were developed for this IRP. Avista developed High and Low Growth forecasts to provide potential paths and test resource adequacy. Appendix 2.1 contains a description of how these alternatives were developed. However, it is important to understand these forecasts reflect the “status quo” and do not fully reflect emerging natural gas connection restrictions in Washington and Oregon. Avista added a customer scenario to measure building electrification to consider potential impacts based on movement from natural gas to an alternative fuel source. After the completion of this forecast Washington added restrictions to new residential and commercial natural gas connects through new construction building codes. It is unclear at this point how those new codes will impact the accumulation of new gas customers. Avista will carefully follow implications for these codes and incorporate a forecast in the 2025 IRP to better reflect these fundamental changes.

Table 2.2 shows the three customer growth forecasts. The expected case customer counts are lower than the last 2021 IRP. Lower customer growth relates to lower forecasted demand from both the average and peak day perspective. Detailed customer count data by region and class for all three scenarios is in Appendix 2.2. In comparison to Avista’s 2021 IRP, the base forecast for customer growth increases by just over 22,000 new customers. This sharp change reflects (1) a stronger than expected recovery from the 2020 pandemic induced recession; (2) stronger than expected in-migration, especially to our Washington and Idaho service territories; and (3) higher population growth forecasts compared to the 2021 IRP, especially in Avista’s Washington and Idaho service territories. Rules and policy are changing quickly with natural gas usage as discussed in Chapter 5. In consideration of these fundamental changes in Oregon and Washington, a scenario for electrification was developed to consider a lower than expected customer growth based on historic trends. Figure 2.1 illustrates the average annual customer forecasts used in the 2023 IRP.

**Table 2.2: Customer Growth Scenarios**

Variable	Base Growth	High Growth	Low Growth
Customers	1.1%	1.4%	0.7%
Population	0.7%	0.9%	0.3%

Figure 2.1: Customer Forecast Scenarios

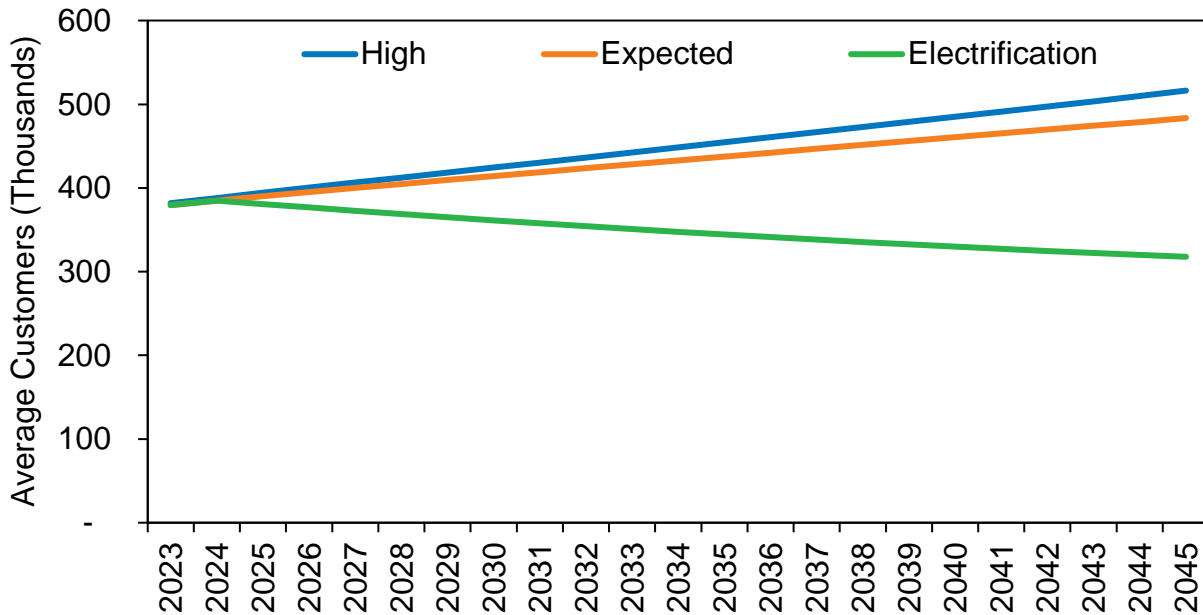

## Electrification of Natural Gas Customers

In 2022, Washington's<sup>1</sup> Building Council passed new commercial and residential construction building code changes to essentially require heat pumps for space and water heat beginning July 1, 2023. For residential buildings, codes do not require a specific fuel source if heat pump technology is utilized. Oregon does not currently have any codes or policies requiring building electrification.

To help quantify a loss of demand on the natural gas system, a building electrification scenario was created to consider a loss of customers as compared to the expected number of customers in Oregon and Washington with an average reduction of 98% from the prior year for the same month, by area and class as illustrated in Figure 2.2. In total an estimated 33% reduction in residential customers occurs in both jurisdictions by 2045. This equates to a loss of natural gas system demand of 6.9 million dekatherms per over the 23-year timeframe. Further discussion of this scenario is discussed in Chapter 7.

<sup>1</sup> [Digital Codes \(iccsafe.org\)](https://www.iccsafe.org/)

**Figure 2.2: Electrification Scenario Customer Forecast**

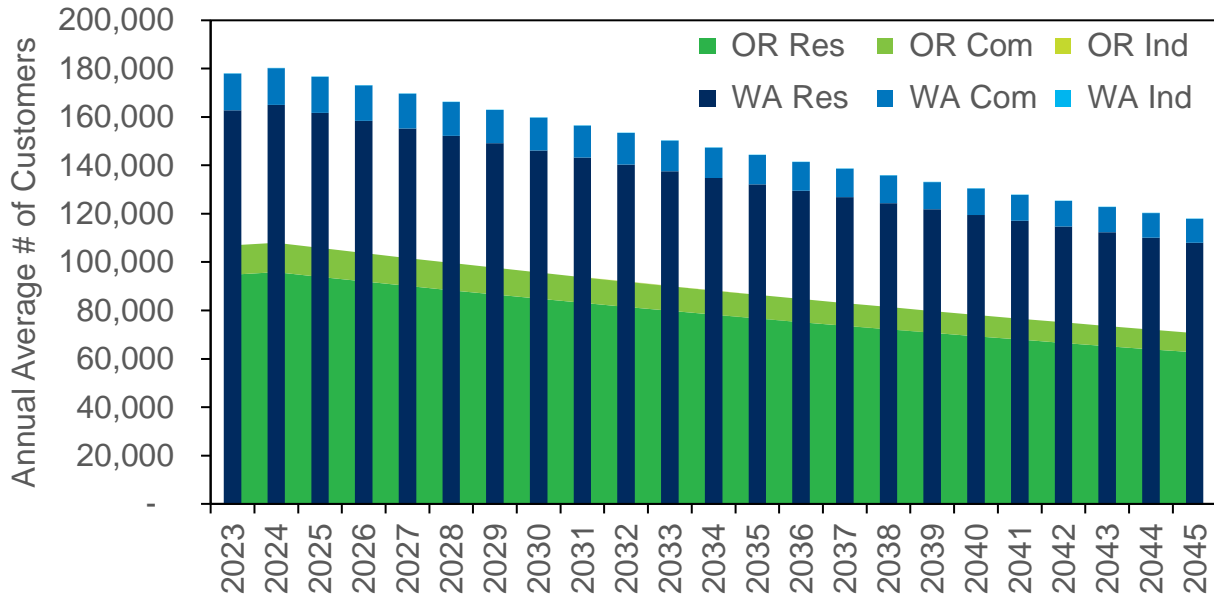

### Use-per-Customer Forecast

The goal for a use-per-customer forecast is to develop base and weather sensitive demand coefficients to be applied to heating degree day (HDD) weather parameters to reflect average use-per-customer. This produces a reliable forecast because of the high correlation between usage and temperature as depicted in the scatter plot in Figure 2.3. This figure is intended to show how linear the relationship in usage with increased HDDs but may look skewed as it considers total load by area instead of a use per customer per HDD.

**Figure 2.3: Example Demand vs. Temperature – 2022**

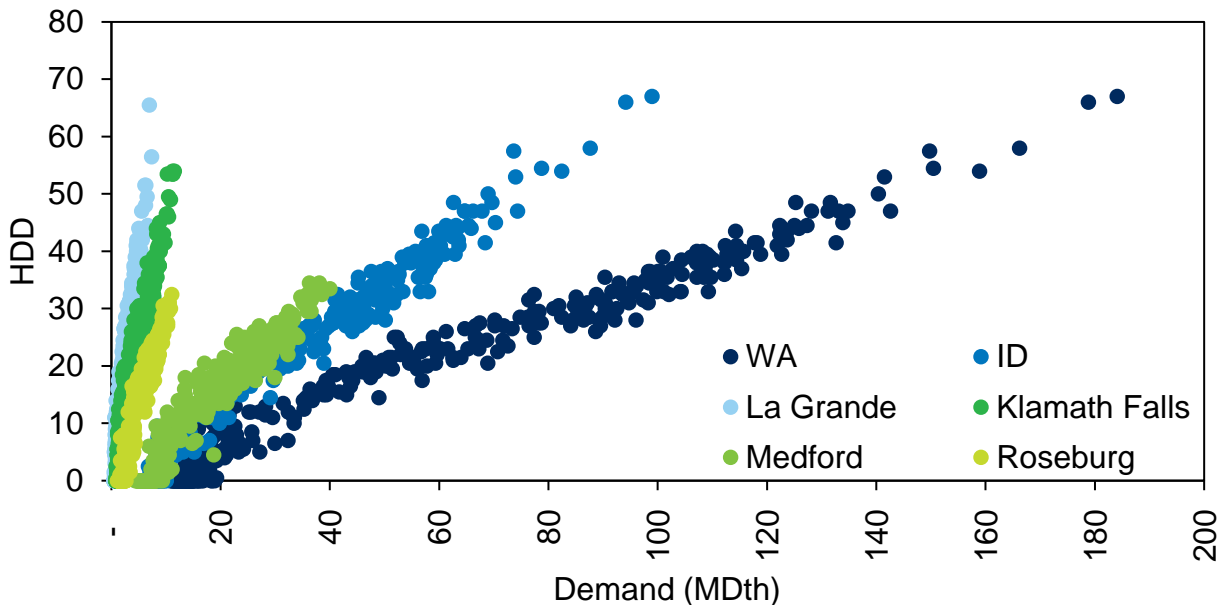

This forecast considers up to five years of historical city gate data, sorted by service territory/temperature zone, and then by month. The three-year coefficient most closely aligns with economic expectations and use within Avista’s territories in the short-term forecasting in Idaho, Oregon, and Washington. However, Oregon territories include a five-year demand coefficient based on the OPUC staff’s recommendation 1 discussed in Chapter 9. Specifically, the Oregon five-year coefficient is lower than expected usage by over four hundred thousand dekatherms annually from 2023 to 2027. Without this action item, Avista would have utilized a three-year coefficient across all jurisdictions.

Avista only includes Transportation tariff customer demand for emissions compliance programs in Oregon and Washington. Avista assumes the average usage based on the historic baseline in each program. Figure 2.4 is an example of demand for transport customers from the PLEXOS® model.

**Figure 2.4: Monthly Demand of Transport Customers (MMBTU)**

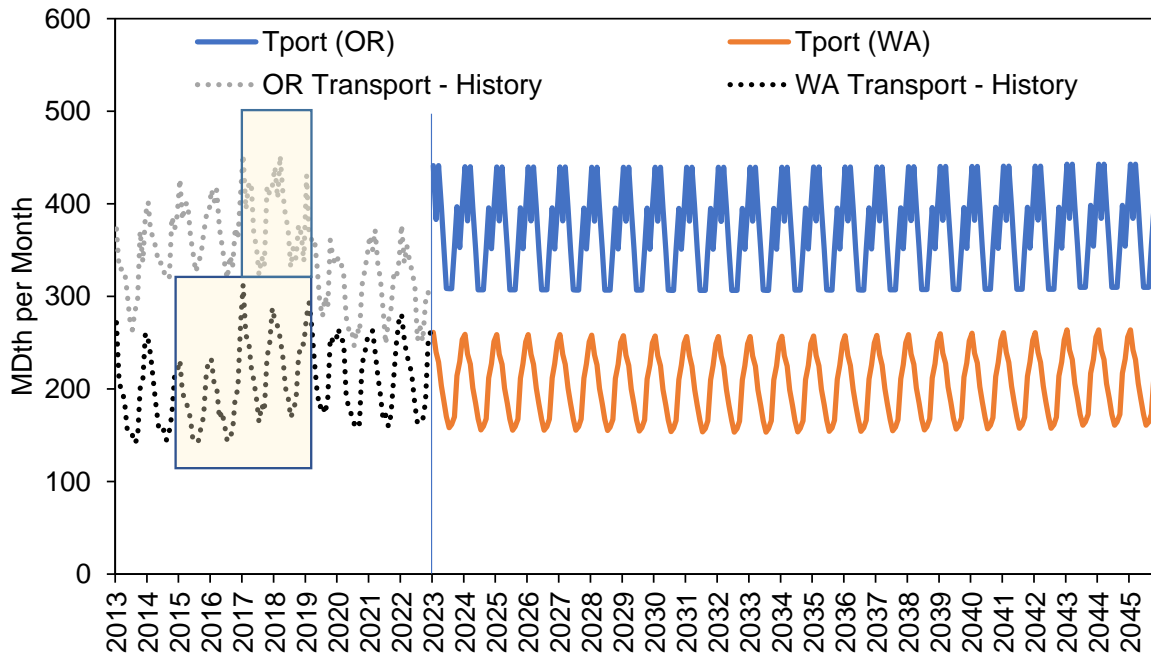

The forecast uses coefficients for each degree day plus base usage. The base usage per customer calculation uses three or five years of July and August data, depending on the jurisdiction. Average usage in these months divided by the average number of customers provides the base usage coefficient input into PLEXOS®. This calculation is done for each area and customer class based on customer billing data demand ratios to reflect demand without a weather sensitivity.

To derive weather sensitive demand coefficients for each month, Avista removed base usage from the total and plotted usage by HDD in a scatter plot chart to verify correlation visually. The process included the application of a linear regression to the data by month



to capture the linear relationship of usage to HDD. The slopes of the resulting lines are the monthly weather sensitive demand coefficients inputs for PLEXOS®. Again, this calculation is done by area and by customer class using allocations based on customer billing data demand ratios. Demand by location is illustrated in Figure 2.5.

**Figure 2.5: Usage Based on 2-year, 3-year, and 5-year Coefficient**

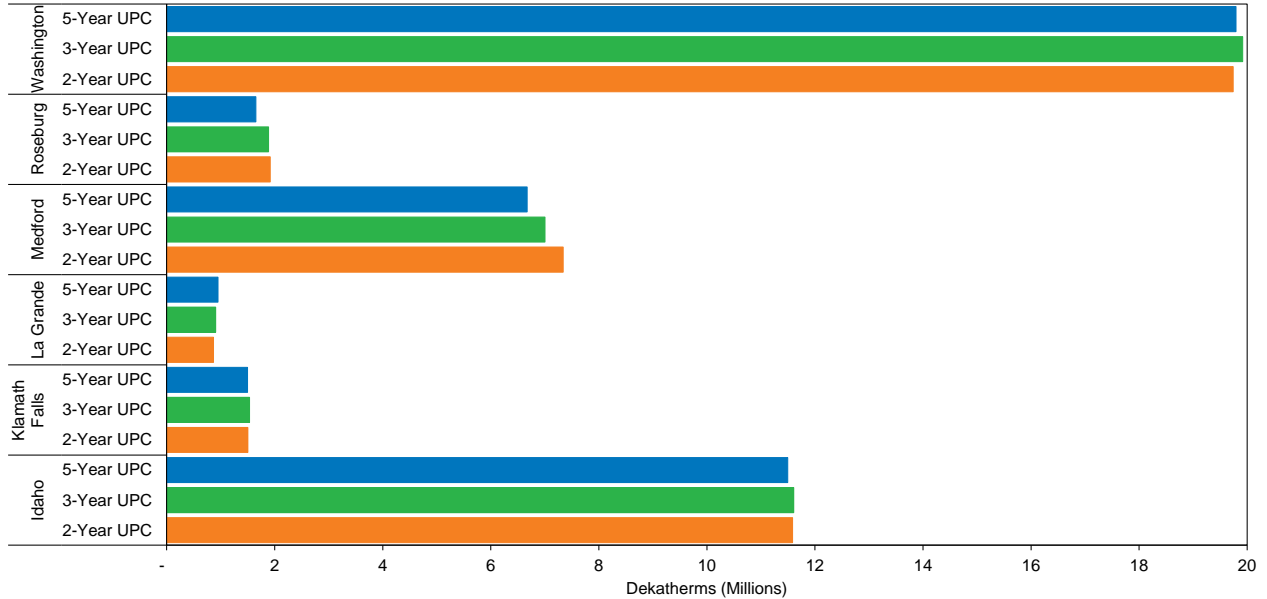

## Weather Forecast

The weather forecast is a critical piece of the planning process. It is used to calculate expected demand by planning area when combined with use per customer and number of customers and drives the resource strategy selection to meet energy and emissions requirements. The 2023 IRP combines historic temperatures and a temperature forecast to create a daily temperature by planning area. These sets of historic and forecasted temperature data are then used to create a design day peak.

### Historic Temperature

The most current 20 years of daily weather data (minimums and maximums) from the National Oceanic and Atmospheric Administration (NOAA) is used to compute an average for each day. NOAA data is obtained from five weather stations, corresponding to the areas where Avista provides natural gas services (four in Oregon and one for Washington and Idaho), where this same rolling 20-year daily average weather computation is completed for all five areas. The HDD weather patterns between the Oregon areas are uncorrelated, while the HDD weather patterns amongst eastern Washington and northern Idaho portions of the service area are correlated. Thus, Spokane Airport weather data is used for all Washington and Idaho demand areas.

The NOAA 20-year average weather serves as the base weather forecast to prepare the annual average demand forecast. The peak day demand forecast includes adjustments to average weather to reflect a five-day cold weather event. The weather history for the Avista territories modeled within this IRP uses over 70 years of historical temperatures and contains minimum, maximum, and average weather data.

### Forecasted Temperatures

The temperature forecast uses data developed for the Columbia River Basin by the River Management Joint Operating Committee (RMJOC)<sup>2</sup> comprised of the Bonneville Power Administration (BPA), United States Army Corps of Engineers, and United States Bureau of Reclamation. There is significant uncertainty in projecting future temperature. The RMJOC used an ensemble approach to capture a range of potential outcomes.

Given the sheer volume of data, a method to select a representative set from the 172 modeling combinations was needed. Fortunately, BPA conducted this exercise and selected a subset of modeling combinations representing a sufficient cross section of outcomes to calculate generation. The subset represents 19 modeling combinations for both RCP 4.5 and RCP 8.5.

Representative Concentration Pathways (RCPs) represent different greenhouse gas (GHG) emission scenarios varying from no future GHG reductions to significant GHG reductions. The Intergovernmental Panel on Climate Change (IPCC) describes the scenarios as follows:

- RCP 2.6 – stringent mitigation scenario
- RCP 4.5 & RCP 6.0 – intermediate scenarios
- RCP 8.5 – very high GHG scenarios

RCP 4.5 and RCP 6.0 represent growth in greenhouse gas emissions, but the growth is lower in comparison to RCP8.5 due to mitigation strategies. In the time horizon of the IRP the increase in global mean surface temperature for RCP4.5 and RCP6.5 are 1.4 and 1.3 degrees Celsius, respectively, and therefore have a similar impact on the IRP analysis.

Table 2.3 provides a comparison of the temperature increases projected under the various scenarios.

---

<sup>2</sup> Climate and Hydrology Datasets for RMJOC Long-Term Planning Studies: Second Edition (RMJOC-II)

**Table 2.3: Comparison of Temperature Increases by Representative Concentration Pathway**

	Scenario	2046-2065	2081-2100		
		Mean	Likely range	Mean	Likely range
Global Mean Surface Temperature Change (°C)	RCP 2.6	1.0	0.4 to 1.6	1.0	0.3 to 1.7
	<b>RCP 4.5</b>	<b>1.4</b>	<b>0.9 to 2.0</b>	<b>1.8</b>	<b>1.1 to 2.6</b>
	<b>RCP 6.0</b>	<b>1.3</b>	<b>0.8 to 1.8</b>	<b>2.2</b>	<b>1.4 to 3.1</b>
	RCP 8.5	2.0	1.4 to 2.6	3.7	2.6 to 4.8

The results of the RCP 4.5 and RCP 6.0 scenarios are similar during the 2023 IRP planning horizon. Given the RCP 8.5 is at the high end of potential future GHG emissions where there are significant worldwide efforts to mitigate GHG emissions removes this future as a realistic option. The lower RCP 2.6 was not chosen due to the extreme levels of emission reductions which did not seem probable, therefore the intermediate scenarios with similar results during the 2023 IRP planning horizon were the focus. Avista selected the RCP 4.5 modeling for use in this IRP.

Warming temperatures will impact average demand yet maintain a peak risk and require flexible resources to meet these extreme temperatures in each planning area. Specifically, there will be less heating required in the winter.

HDDs are inputs to the PLEXOS® model. A 20-year moving average of the HDDs is used. The 2021 IRP the baseline forecast used the average of the most recent 20 years as a static input for all forward forecast years. In this analysis, the median daily average temperature of the RCP 4.5 model is used as the temperature data set compared to the 20-year moving average for each forecast year. Figure 2.6 presents the net change in load resulting from using the RCP 4.5 data in the forecast model compared to using the most recent 20-year average held constant over all future years. The net change is presented in Figure 2.6. The demand decreases as warming temperatures are incorporated into the 20-year moving average.

Figure 2.6: Impact of RCP 4.5 Temperature Data on Load Forecast

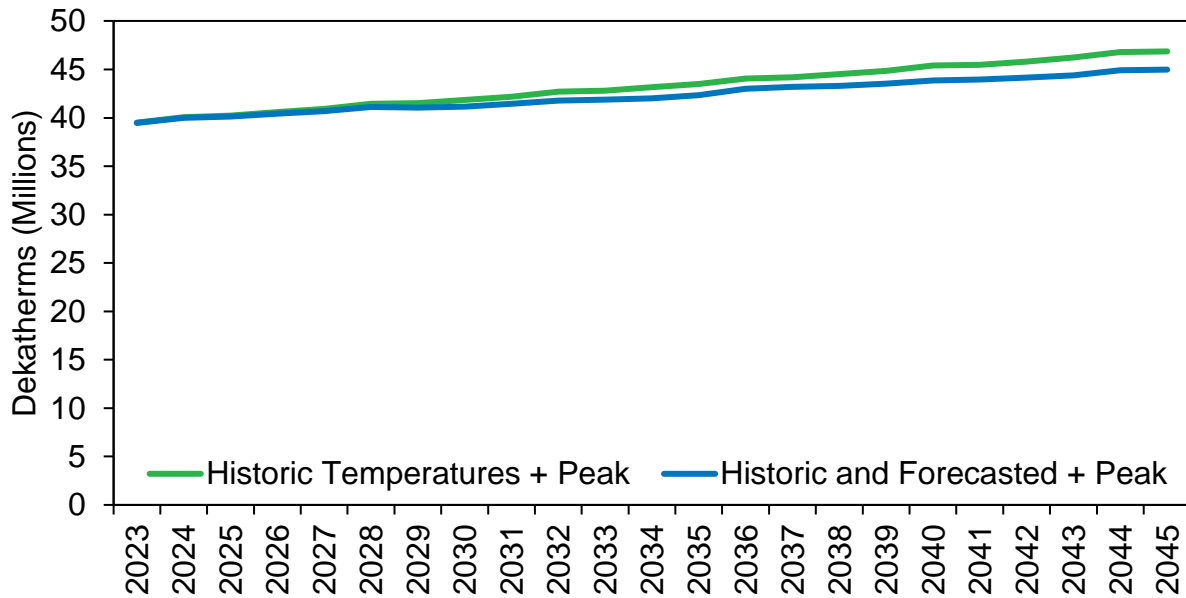

## Peak Day Design Temperature

The weather planning standard is an important piece of system planning for resources in an IRP because it sets the amount of firm delivery requirements to procure. In prior IRP's a coldest on record approach was considered the planning standard. This IRP uses a different approach, first the coldest average daily temperature for each year is calculated for the past thirty years, by planning area. For future years, the 99<sup>th</sup> percentile of the cold weather daily temperature from the RCP 4.5 model is used to reflect probable cold days. Then the forecasted peak day uses a rolling 30 years of data and including both historic temperature and forecasted peak day temperatures. As shown in Figure 2.7, the volatile nature of the 99<sup>th</sup> percentile as calculated for each year with the prior 30 years of data creates volatility in future planning temperatures. For example, the 2024 the calculated peak temperature for Spokane is -12 degrees Fahrenheit but drops to -14 degrees Fahrenheit in 2027. To smooth out the whipsaw effect of these values, and subsequent overbuilding or underbuilding of the required resources, a smoothing calculation was used which utilizes the coldest on record temperature and the peak temperature calculation in 2045 and connects the two linearly.

**Figure 2.7: Spokane Weather Station – Weather Planning Standard Comparison**

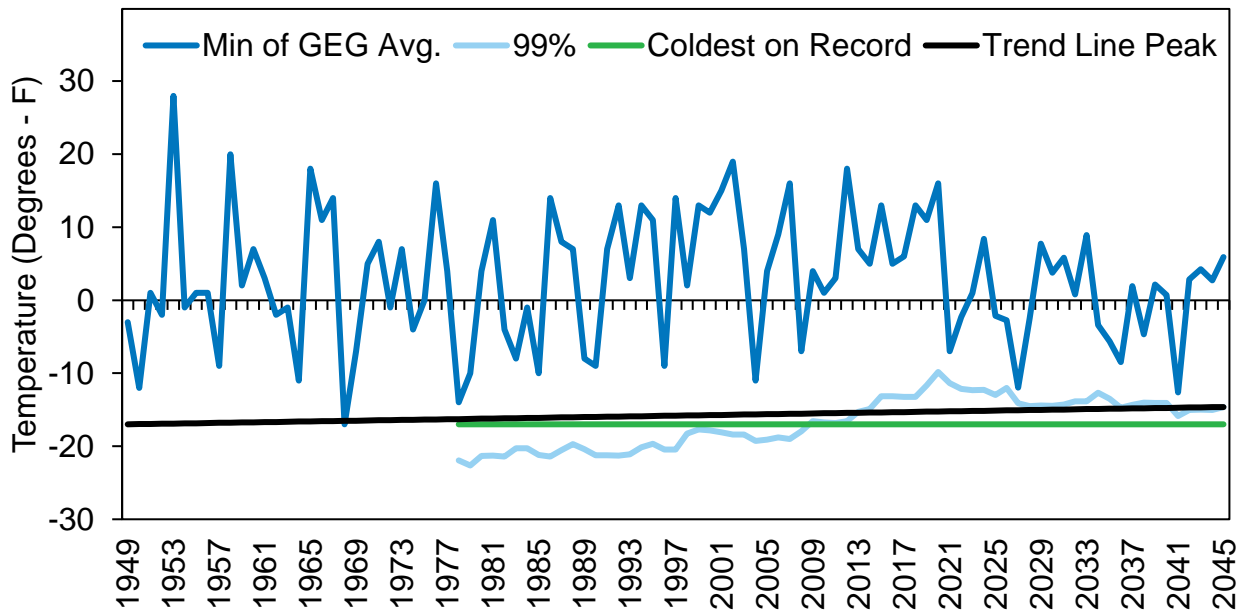

The new weather planning standard utilizes a five-day cold weather event by service territory while adjusting the two days on either side of the planning standard to temperatures colder than average. For the Washington, Idaho, and La Grande service territories, the model assumes this event on and around February 28<sup>th</sup> each year to safeguard the availability of resources to serve customers in late season cold weather events. With supply side resources in the Pacific Northwest growing further constrained, managing supply along with the ability to serve cold days is paramount. For the southwestern Oregon service territories (Medford, Roseburg, and Klamath Falls), the model assumes this event on and around December 20<sup>th</sup> each year. The following section provides a comparison of prior IRP planning standard versus the updated methodology (Table 2.4).

**Table 2.4: Peak Day Design Temperature**

Area	Coldest on Record (Prior IRP's)	99% Probability Avg. Temp (by 2045)
La Grande	-10	-8.0
Klamath Falls	-7	-5.1
Medford	4	11.7
Roseburg	10	11.7
Spokane	-17	-14.6

When considering changing weather in our service territories, a historic comparison is helpful. This Z-statistic analysis is used to compare the deviation from an average temperature over each stated timeframe. Distributions of these daily deltas as compared to the average daily weather over the timeframe will emerge. The Spokane weather area maintains the same shape from reference period where a coldest on record set of temperatures occurred. A slight deviation to the positive side of the Z-statistic points to a general warming trend as compared to the reference period. Movement towards the right on the X axis points to an increased deviation as compared to the reference period indicating a shift to warmer weather. The following figures illustrate a period of 30-year weather compared to recent weather by planning region for December, January, and February.

**Figure 2.8: Spokane Historical Temperature Distribution**

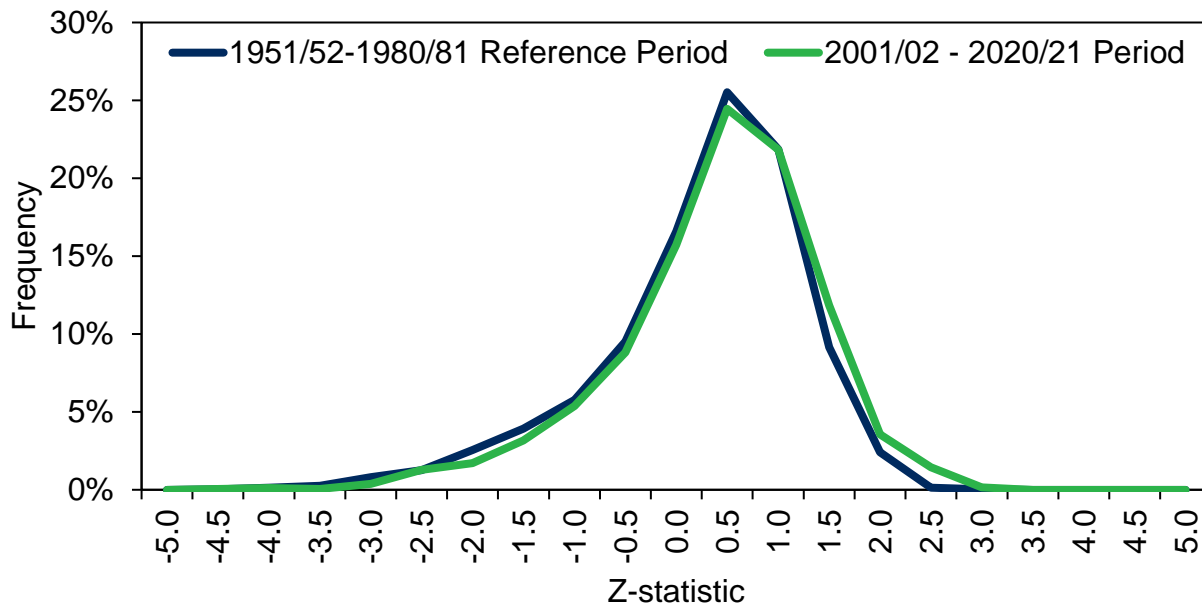

**Figure 2.9: Medford Historical Temperatures**

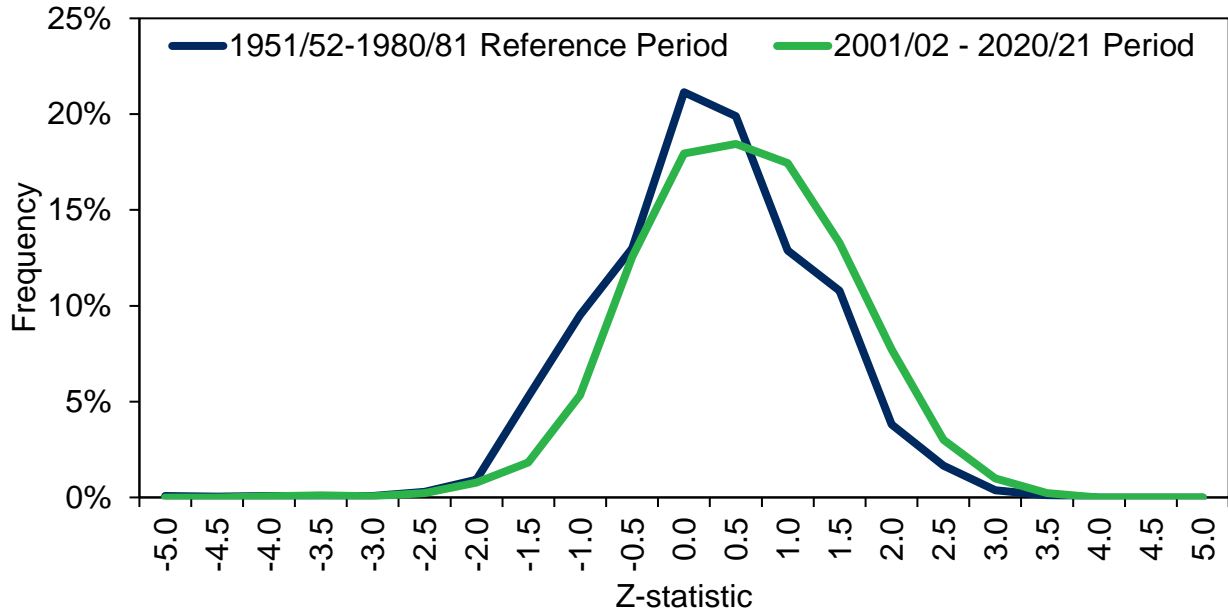

**Figure 2.10: La Grande Historical Temperatures**

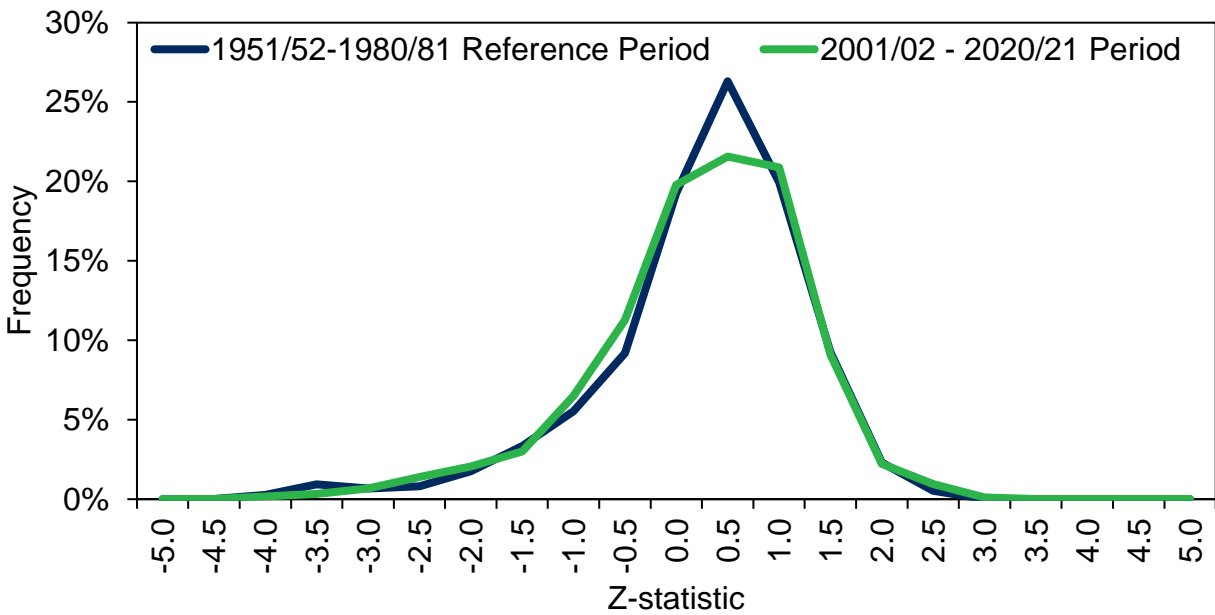

**Figure 2.11: Klamath Falls Historical Temperatures**

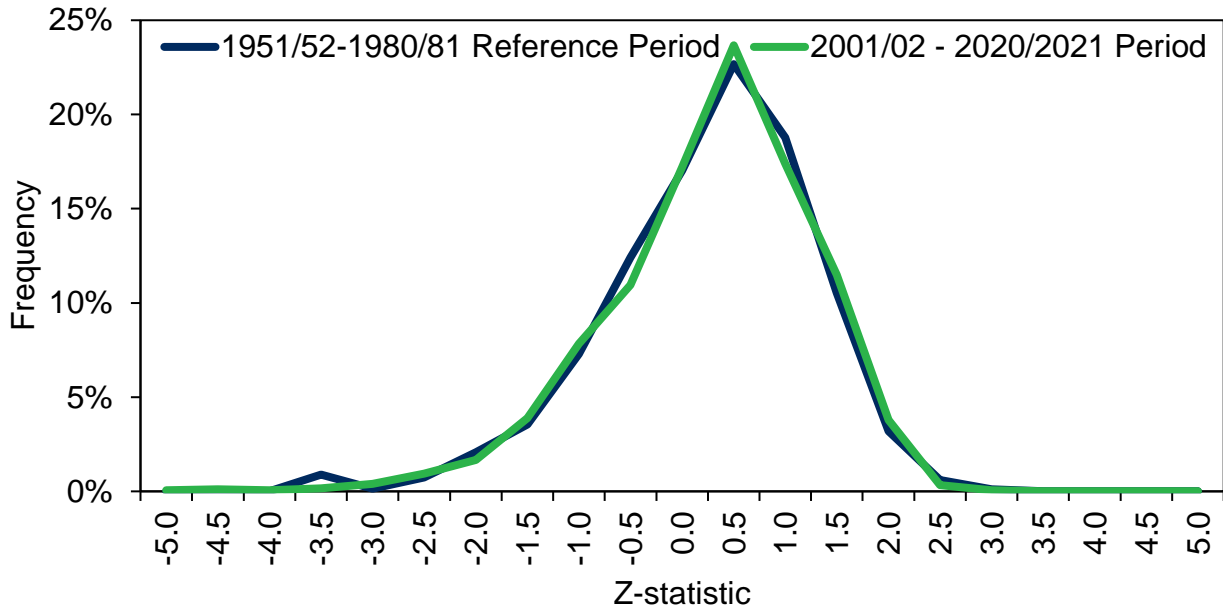

**Figure 2.12: Roseburg Historical Temperatures**

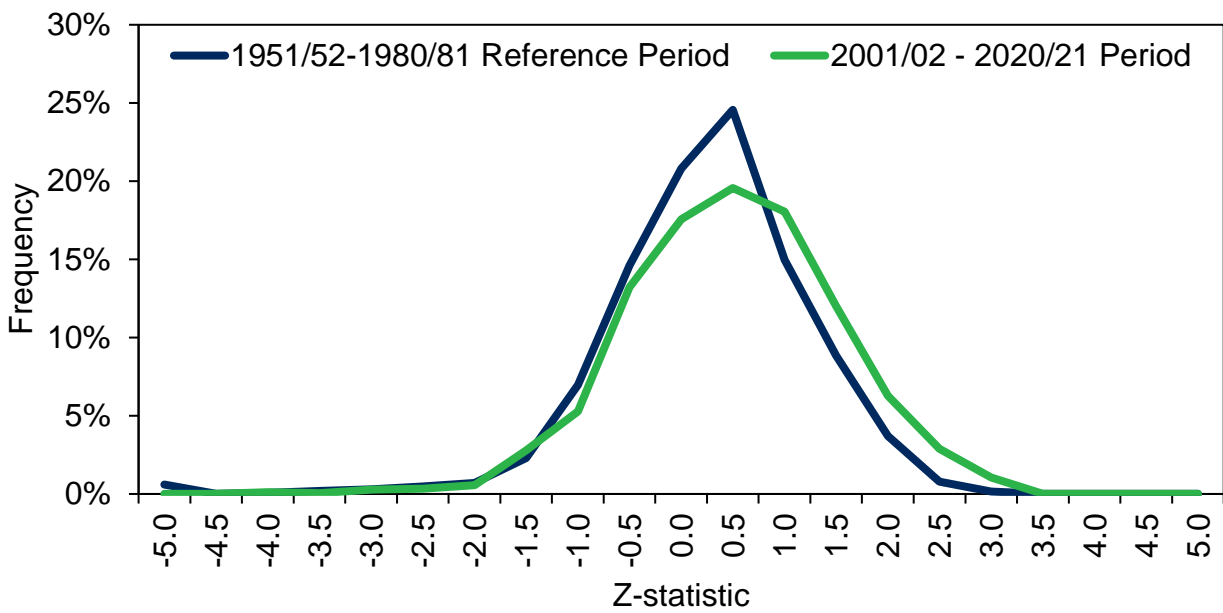



## Weather

In order to evaluate weather and its effect on the portfolio, Avista developed 500 simulations (draws) using PLEXOS®'s stochastic capabilities. Unlike deterministic scenarios or sensitivities, the stochastic draws have more variability from month-to-month and year-to-year. In the model, random monthly total HDD draw values (subject to Monte Carlo parameters – see Table 2.5) are distributed on a daily basis for a month in history with similar HDD totals. The resulting draws provide a weather pattern with variability in the total HDD values, as well as variability in the shape of the weather pattern. This provides a more robust basis for stress testing the deterministic analysis.

**Table 2.5: Example of Monte Carlo Weather Inputs – Spokane**

	Nov	Dec	Jan	Feb	Mar	Apr	May	Jun	Jul	Aug	Sep	Oct
HDD Mean	867	1,110	1,170	935	799	541	318	140	31	40	194	523
HDD Std Dev	111	133	179	129	99	87	81	51	26	31	73	86
HDD Max	1,374	1,519	1,759	1,389	1,059	740	494	260	168	144	363	695
HDD Min	609	839	850	703	561	269	146	12	-	-	59	334

The model considers five weather areas: Spokane, Medford, Roseburg, Klamath Falls and La Grande. A new weather planning standard was introduced in the 2021 IRP, and Avista assessed the frequency of when the weather planning standard peak day occurs in each area from the simulation data. The stochastic analysis shows that in over 500, 20-year simulations, a peak day (or more) occurs with enough frequency to utilize the new planning standard for this IRP. This topic remains a subject of continued analysis.

See Figure 2.13 through Figure 2.17 for the number of peak day occurrences by weather area. To help explain the number of peak day occurrences, Avista looks to the process itself. Monte Carlo simulations use historic data to obtain randomly generated weather events. Due to the change in planning standard, no peak days were simulated above the historic coldest on record temperature. Though due to the number of peak days occurring in the past 30 years, probability sees it is a higher likelihood of occurrence.

**Figure 2.13: Frequency of Peak Day Occurrences – Spokane**

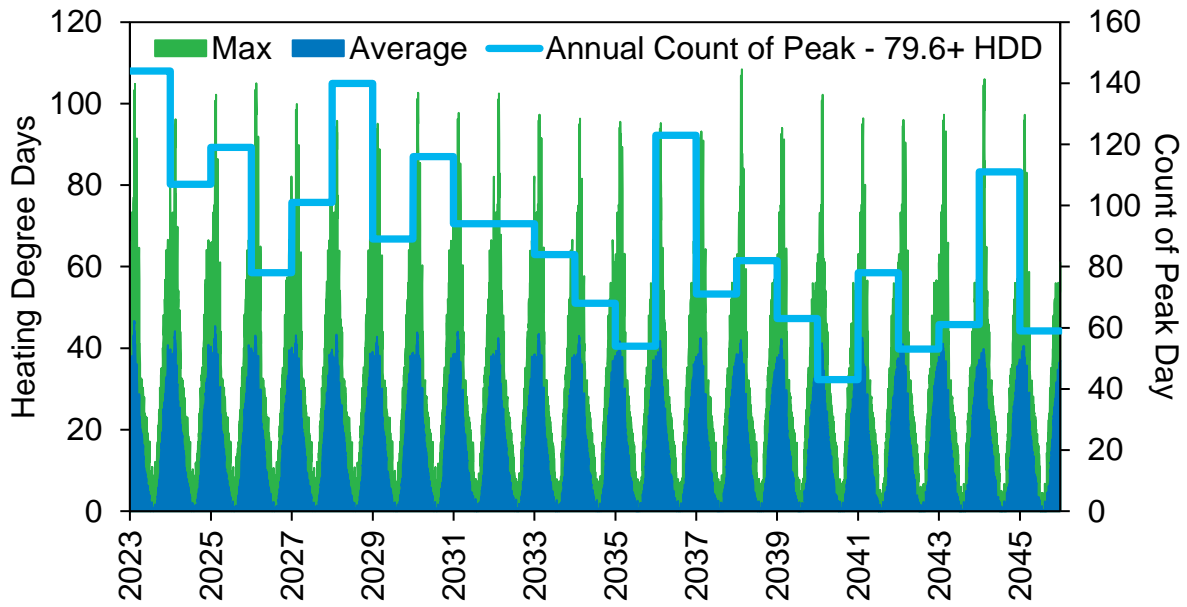

**Figure 2.14: Frequency of Peak Day Occurrences – Medford**

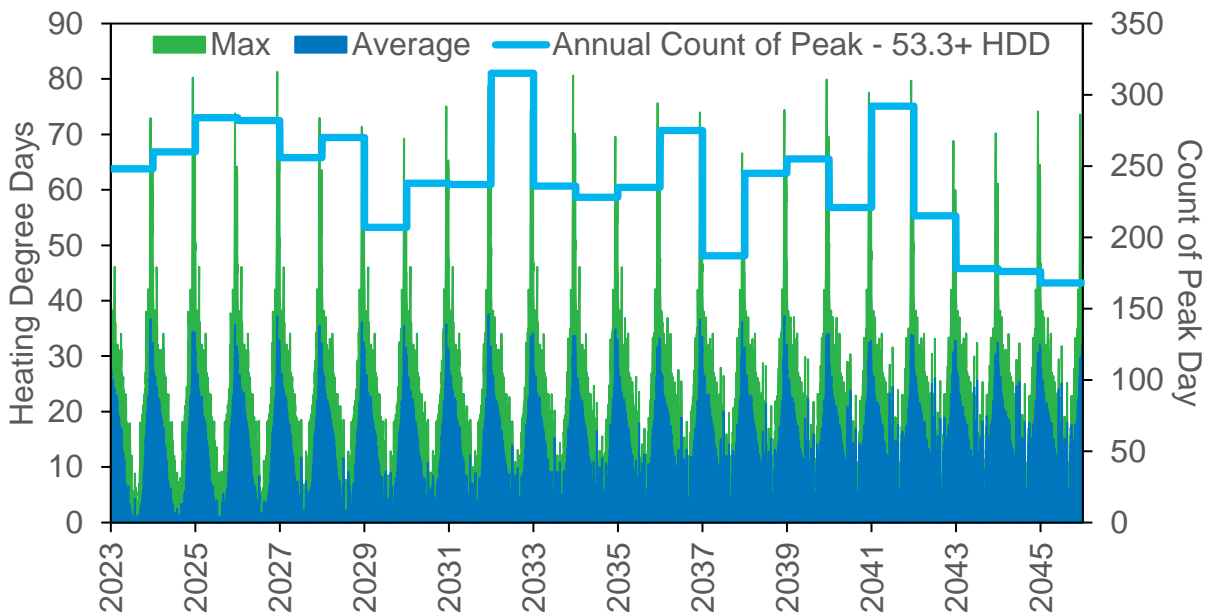

**Figure 2.15: Frequency of Peak Day Occurrences – Roseburg**

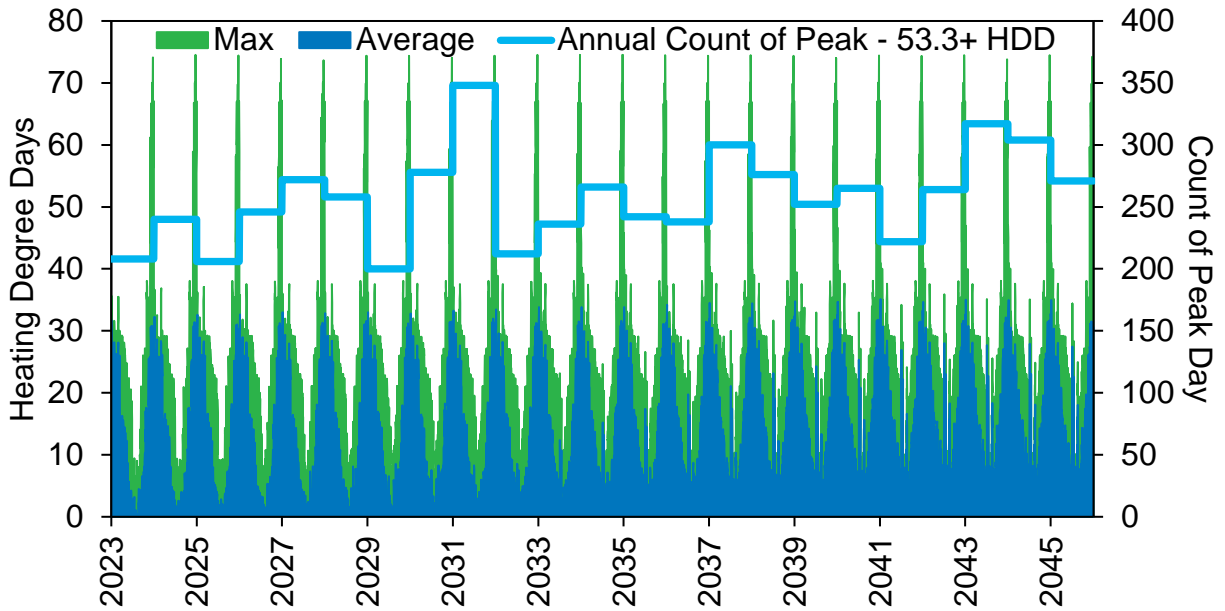

**Figure 2.16: Frequency of Peak Day Occurrences – Klamath Falls**

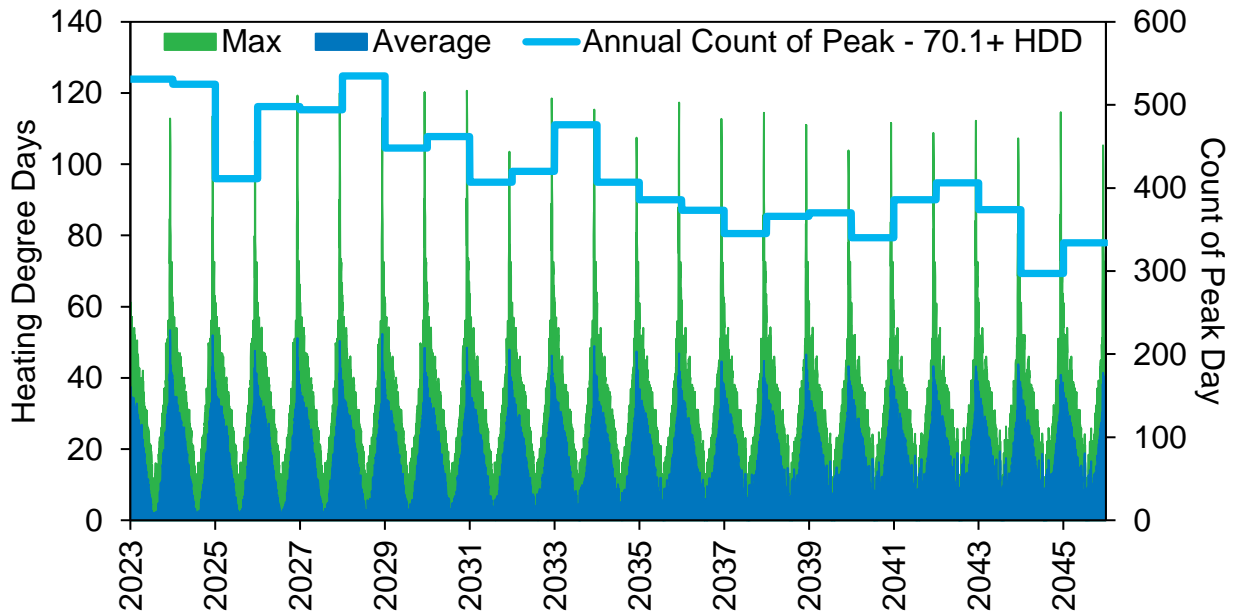

**Figure 2.17: Frequency of near Peak Day Occurrences – La Grande**

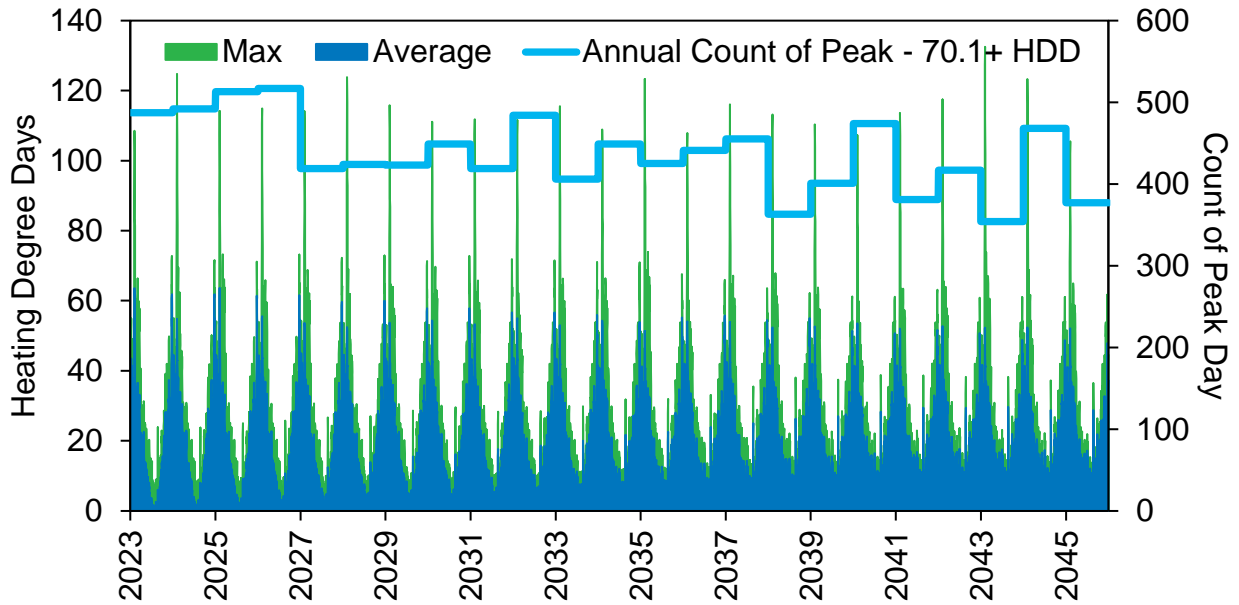

### Load Forecast

The combination of the elements discussed in this chapter produce an estimated energy need as illustrated in Table 2.6: Load Forecast. The forecast is broken out by jurisdiction, separated by firm and transport only expectations.

**Table 2.6: Load Forecast (Thousand Dekatherms)**

Year	Washington	Idaho	Oregon	Washington Transport	Oregon Transport	Total	Total w/ Transport
2023	19,436	10,441	9,597	2,479	4,441	39,475	46,394
2024	19,604	10,644	9,759	2,451	4,425	40,007	46,884
2025	19,549	10,724	9,845	2,448	4,424	40,118	46,990
2026	19,620	10,855	9,968	2,448	4,424	40,443	47,315
2027	19,657	10,956	10,069	2,448	4,423	40,682	47,553
2028	19,816	11,118	10,202	2,443	4,421	41,136	48,000
2029	19,675	11,128	10,237	2,435	4,420	41,040	47,895
2030	19,652	11,192	10,316	2,430	4,419	41,159	48,008
2031	19,726	11,295	10,429	2,426	4,418	41,451	48,295
2032	19,821	11,422	10,544	2,424	4,418	41,786	48,628
2033	19,790	11,475	10,604	2,425	4,419	41,869	48,713
2034	19,785	11,549	10,672	2,427	4,420	42,006	48,854
2035	19,864	11,665	10,819	2,432	4,422	42,348	49,203
2036	20,122	11,867	11,014	2,434	4,423	43,003	49,860
2037	20,130	11,947	11,109	2,440	4,425	43,186	50,051
2038	20,082	12,005	11,201	2,450	4,427	43,289	50,167
2039	20,128	12,106	11,300	2,461	4,430	43,533	50,424
2040	20,209	12,216	11,436	2,466	4,431	43,861	50,758
2041	20,173	12,270	11,507	2,473	4,432	43,950	50,855
2042	20,193	12,356	11,607	2,474	4,433	44,155	51,062
2043	20,210	12,440	11,732	2,510	4,457	44,382	51,348
2044	20,424	12,624	11,864	2,510	4,457	44,912	51,879
2045	20,398	12,698	11,885	2,510	4,457	44,981	51,948

The peak load demand forecast is included in Table 2.7. This forecast is analyzed to measure capacity needs on a peak day by demand area. Firm service customers rely on this capacity on the coldest of days to deliver the necessary energy to keep customers and their assets safe.

**Table 2.7: Peak Day Load Forecast (Thousand Dekatherms)**

Year	Washington	Idaho	Oregon	Washington Transport	Oregon Transport	Total	Total w/ Transport
2023	219.89	111.89	90.11	8.57	14.24	378.37	400.62
2024	221.98	113.86	90.96	8.35	14.20	382.50	403.86
2025	224.00	115.68	91.76	8.48	14.19	387.11	409.22
2026	226.17	117.40	92.59	8.49	14.19	391.42	413.54
2027	228.09	118.91	93.25	8.48	14.19	395.42	417.53
2028	230.01	120.40	94.03	8.33	14.18	398.71	420.03
2029	231.84	121.83	94.62	8.45	14.18	402.47	424.54
2030	233.77	123.22	95.36	8.44	14.18	406.13	428.18
2031	235.75	124.63	95.94	8.42	14.18	410.08	432.12
2032	237.77	126.10	96.58	8.28	14.18	413.76	435.02
2033	239.76	127.55	97.24	8.42	14.18	417.06	439.10
2034	241.80	129.02	97.91	8.43	14.18	421.29	443.33
2035	243.83	130.49	98.65	8.44	14.19	425.34	447.40
2036	245.85	131.97	99.23	8.31	14.19	429.59	450.89
2037	247.83	133.42	99.89	8.46	14.19	433.40	455.49
2038	249.84	134.87	100.46	8.49	14.20	436.76	458.89
2039	251.80	136.32	101.13	8.52	14.21	439.47	461.64
2040	253.75	137.75	101.86	8.39	14.21	442.56	463.98
2041	255.68	139.15	102.55	8.55	14.21	446.40	468.61
2042	257.58	140.55	103.14	8.56	14.22	450.20	472.41
2043	259.53	141.99	104.08	8.65	14.28	454.17	476.55
2044	261.44	143.42	104.65	8.51	14.28	457.25	478.85
2045	263.32	144.92	105.23	8.65	14.28	460.21	482.59

Measuring risk in weather is done through a statistical approach of analyzing each of these measures to reflect the uncertain nature of a future outcome. Risk can be measured by the variation of cost outcome of resources in addition to unknown weather events and the ability to serve customer demand. This analytical perspective provides confidence in the conclusions and stress tests the robustness of the selected portfolio of resources, thereby mitigating analytical risks. The system demand for these 500 futures from 2023 to 2045 is illustrated in Figure 2.18 with demand by jurisdiction in Figures 2.19 to 2.21.

**Figure 2.18: System Demand – 1,000 Dth (500 Draws)**

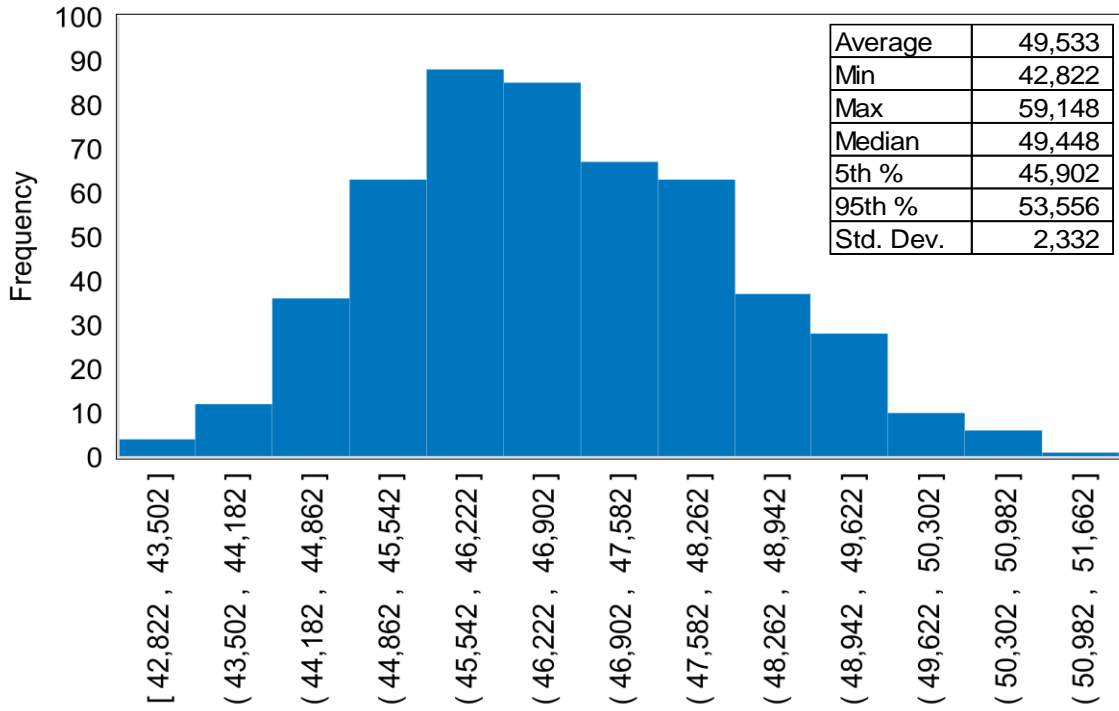

**Figure 2.19: Idaho Demand – 1,000 Dth (500 Draws)**

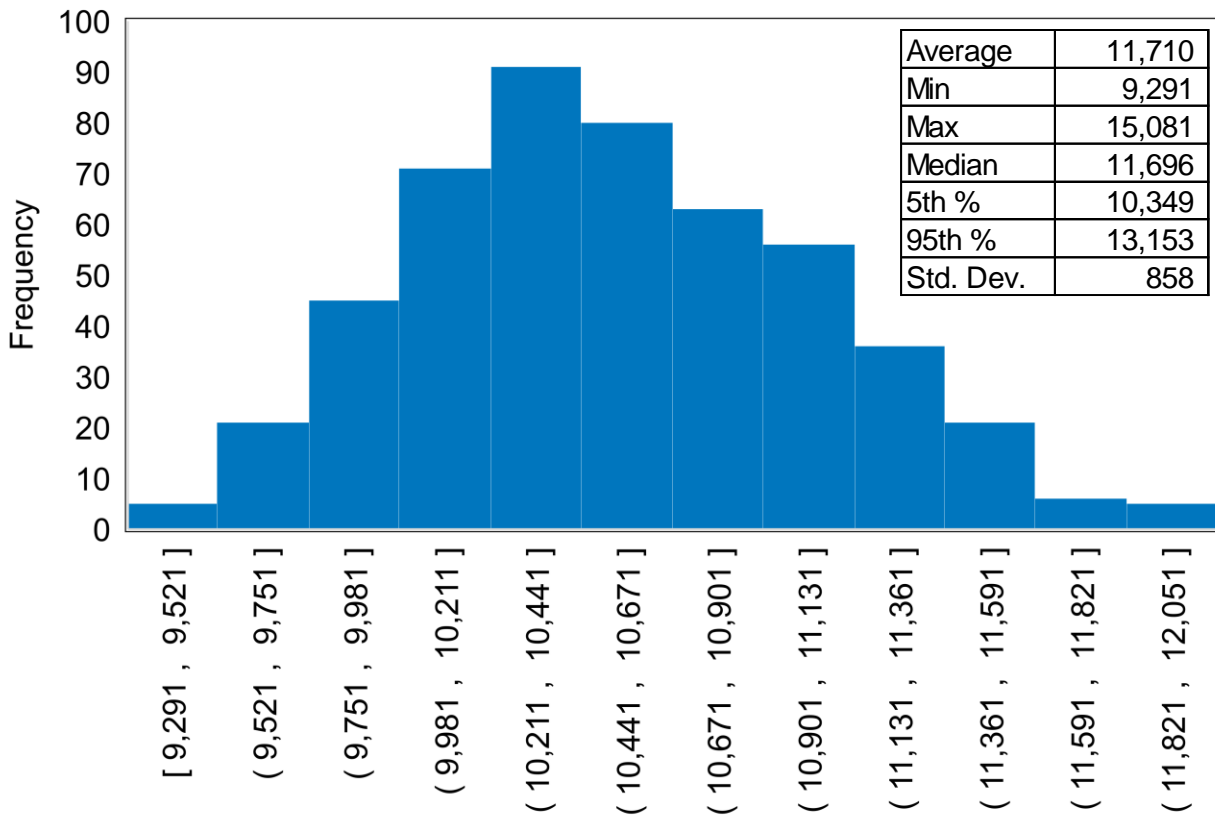

Figure 2.20: Oregon Demand – 1,000 Dth (500 Draws)

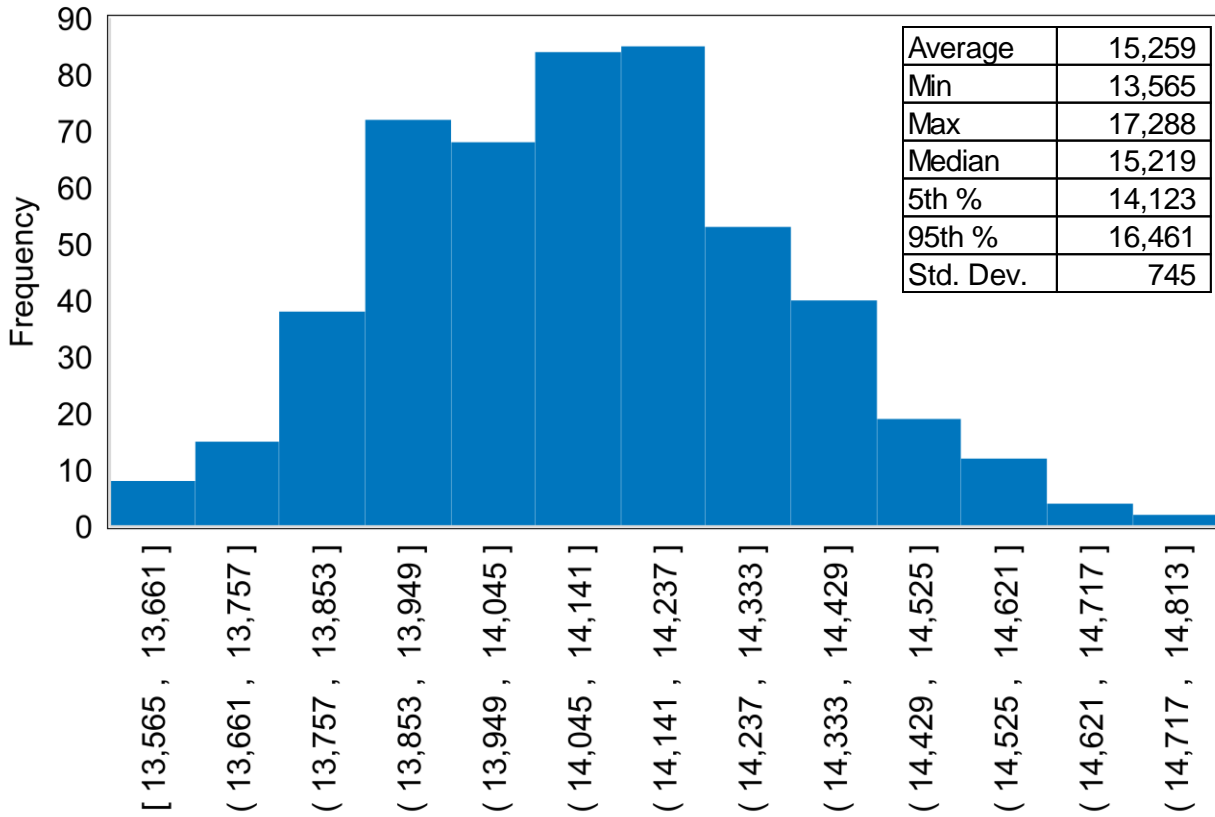
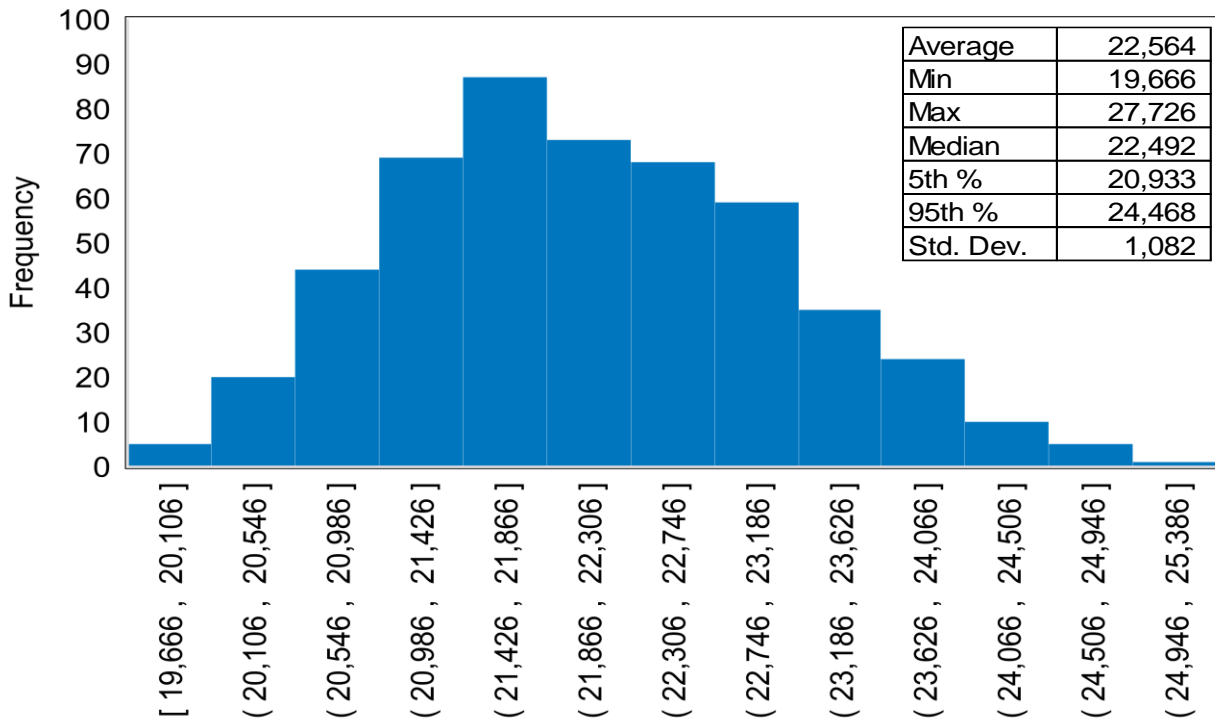

Figure 2.21: Washington Demand – 1,000 Dth (500 Draws)





## Scenario Analysis

Demand is becoming more difficult to forecast due to the policy updates in both Oregon and Washington and building code updates in Washington. Changes in total demand can drastically change both the timing and resources selected, making it necessary to look at different future expectations based on demand, costs, and resource availability. Table 2.7 identifies the scenarios developed for this IRP. The Average Case represents the case used for normal planning purposes, such as corporate budgeting, procurement planning, PGAs, and General Rate Cases. The Preferred Resource Case reflects the expected demand and available costs and resources Avista believes is most likely given expected peak weather conditions. All other scenarios represent a different set of future expectations and range of possible outcomes based on current policies, codes, and customer demand. Each scenario provides a “what if” analysis given the volatile nature of key assumptions, including weather and price.

**Table 2.8: Demand Scenarios**

<b>Preferred Resource Case</b> – Our expected case based on assumptions and costs with a least risk and least cost resource selection	<b>High Customer Case</b> – A high demand case to measure risk of additional customer and meeting our emissions and energy obligations
<b>Electrification Expected Conversion Costs</b> – Expected conversion costs case to show the risk involved with energy delivered through the natural gas infrastructure moving to the electric system	<b>Average Case</b> – Non climate change projected 20-year history of average daily weather and excludes peak day
<b>Hybrid Case</b> – Natural Gas used for space heat below 40° F while transferring all other usage to electricity.	

During 2023, the Average Case demand forecast indicates Avista will serve an average of 379,669 core natural gas customers with 38,871,519 Dth of natural gas. By 2042, Avista projects 469,703 core natural gas customers with an annual energy demand of 45,082,213 Dth. In Washington/Idaho, the projected number of customers increases at an average annual rate of 1.22%, with demand growing at a compounded average annual rate of 0.78%. In Oregon, the projected number of customers increases at an average annual rate of 0.89%, with demand growing 0.80% per year.

The Expected Case demand forecast indicates Avista will serve an average of 379,669 core natural gas customers with 39,518,082 Dth of natural gas in 2023. By 2042, Avista projects 469,703 core natural gas customers with an annual demand of 44,199,537 Dth.

Table 2.8 shows system forecasted demand for the demand scenarios on an average daily basis for each year.<sup>3</sup>

<sup>3</sup> Appendix 2.1 shows gross demand, conservation savings and net demand.

**Table 2.9: Annual Demand – 2023 IRP Scenarios (000 dth)**

Scenario	2025	2035	2045
Hybrid Case	46,702	45,155	44,772
Average Case	46,406	49,612	53,042
Electrification - Expected Conversion Costs	46,270	41,447	38,368
Electrification - High Conversion Costs			
Electrification - Low Conversion Costs			
PRS - High Prices	46,933	49,122	51,909
PRS	46,990	49,203	51,948
PRS - Allowance Price Ceiling			
Limited RNG Availability			
Carbon Intensity			
Social Cost of Carbon			
Interrupted Supply			
PRS - Low Prices	47,011	49,217	51,950
High Customer Case	47,456	50,913	55,089

The IRP balances forecasted demand with existing and new supply alternatives. Since new supply sources include conservation resources, which reduce demand reduction, the demand forecasts prepared and described in this section include existing energy efficiency standards and normal market acceptance levels. The methodology for modeling energy efficiency initiatives is in Chapter 3.

## Alternative Forecasting Methodologies

There are many forecasting methods available and used throughout different industries. Avista uses methods to enhance forecast accuracy, facilitate meaningful variance analysis, and allows for modeling flexibility to incorporate different assumptions. Avista believes the IRP statistical methodology to be sound and provides a robust range of demand considerations while allowing for the analysis of different statistical inputs by considering both qualitative and quantitative factors unless there are fundamental changes to the industry. These factors come from data, surveys of market information, fundamental forecasts, and industry experts. Avista is always open to new methods of forecasting natural gas demand and will continue to assess alternative methodologies for possible inclusion in the dynamic demand forecasting methodology.

## Key Issues

Demand forecasting is a critical component of the IRP requiring careful evaluation of the current methodology and use of scenario planning to understand how changes to the underlying assumptions will affect the results. The evolution of demand forecasting over recent years has been dramatic, causing a heightened focus on variance analysis and trend monitoring. Current techniques have provided sound forecasts with appropriate variance capabilities. However, Avista is mindful of the importance of the assumptions driving current forecasts and understands there will be change over time. Therefore,

monitoring key assumptions driving the demand forecast is an ongoing effort and will be shared with the TAC as they develop. Avista intends to explore the use of an end-use model to help forecast demand in future IRPs.<sup>4</sup>

---

<sup>4</sup> Action # 9 in Chapter 9 - Action Plan

## 3. Demand Side Resources

Avista is committed to offering natural gas energy efficiency (EE) programs to residential, low income, commercial and industrial customer segments when it is feasible to do so in a cost-effective manner as prescribed within each jurisdiction. Avista began offering natural gas EE programs in 1995. Program delivery has grown over the years with an emphasis on increasing customer participation. Avista's program design includes both prescriptive and site-specific offerings. Recent expansion includes additional programs such as On-Bill Repayment, Home Energy Audits, and incentives offered through midstream channels. Programs are designed to provide cash incentives for products such as the installation of qualifying high-efficiency heating equipment, building weatherization, smart controls, and data informed approaches to savings energy.

Over the years, Avista has seen the most significant impacts in the residential market with the installation of high efficiency HVAC measures, such as furnaces, tanked and tankless water heaters, and the use of smart thermostats. These programs have historically produced the highest levels of EE, however, Avista strives to continue offering programs appealing to all customer segments. With the introduction of the House Bill 1444 in Washington, known as the Clean Buildings Act, Avista anticipates more non-residential programs and increased participation in future years.

### Avoided Cost

The preliminary cost-effective energy efficiency potential is determined by applying the stream of annual natural gas avoided costs to the Avista-specific supply curve for EE resources. These costs include commodity costs, distribution cost adders, storage costs, social cost of greenhouse gas at 2.5%, fuel costs to move the gas from point A to point B, and a 10% preference adder for EE among others discussed in Chapters 4 & 5. A quantity of EE acquisition is provided by Applied Energy Group (AEG) for Idaho and Washington and while the Energy Trust of Oregon (ETO) handles the analysis and program delivery for Oregon. The estimated results are then decremented from Avista's load forecast. As the model changes based on updated assumptions and costs, updated avoided costs are considered by AEG and ETO to estimate total potential in the CPA. The resulting avoided costs were provided to AEG to use in selecting cost-effective EE potential within Avista's service territories.

The avoided-cost figures represent the unit cost to serve the next unit of demand with a supply-side resource option during a given period. If an energy efficiency measure's total resource cost (Oregon and Washington), or utility cost (Idaho), is less than this avoided cost, it will be cost effective to reduce customer demand and Avista can avoid commodity, storage, transportation, and other supply resource costs while reducing the risk of unserved demand in peak weather.

PLEXOS® calculates marginal cost data by day, month, and year for each demand area. A summary graphical depiction of avoided annual and winter costs for each jurisdictional

area is in Figure 3.1 and 3.2. The detailed data is in Appendix 6.4. Appendix 3.2 describes this concept more fully and includes specific requirements required in modeling for the Oregon service territory.

**Figure 3.1: Annual Avoided Cost (by jurisdiction)**

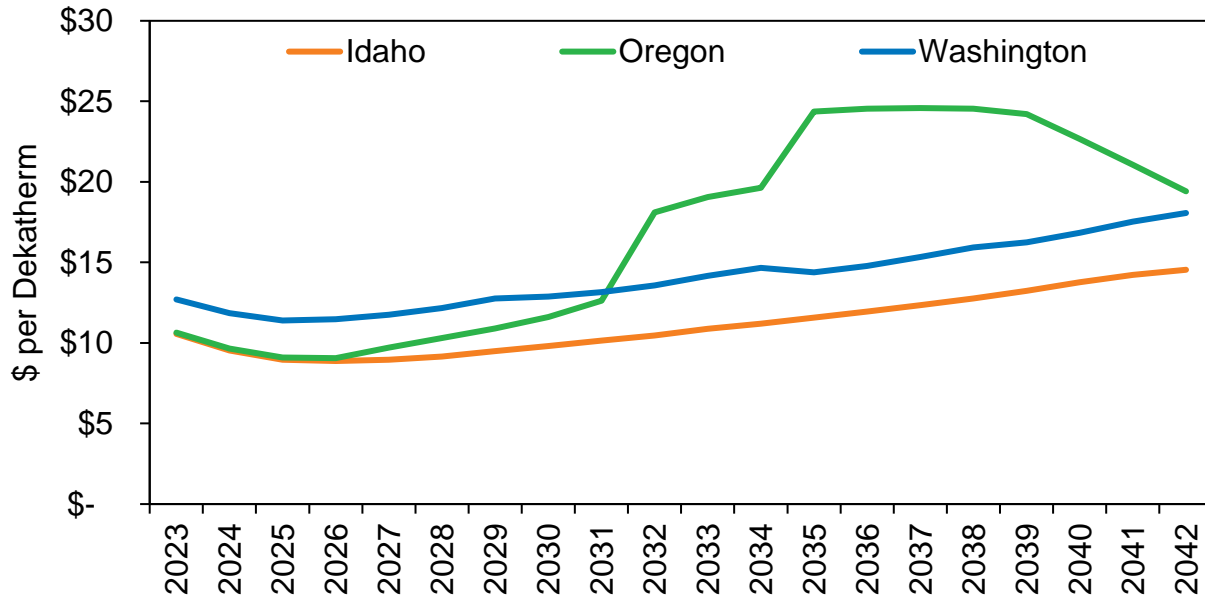

**Figure 3.2: Winter Avoided Cost (by jurisdiction)**

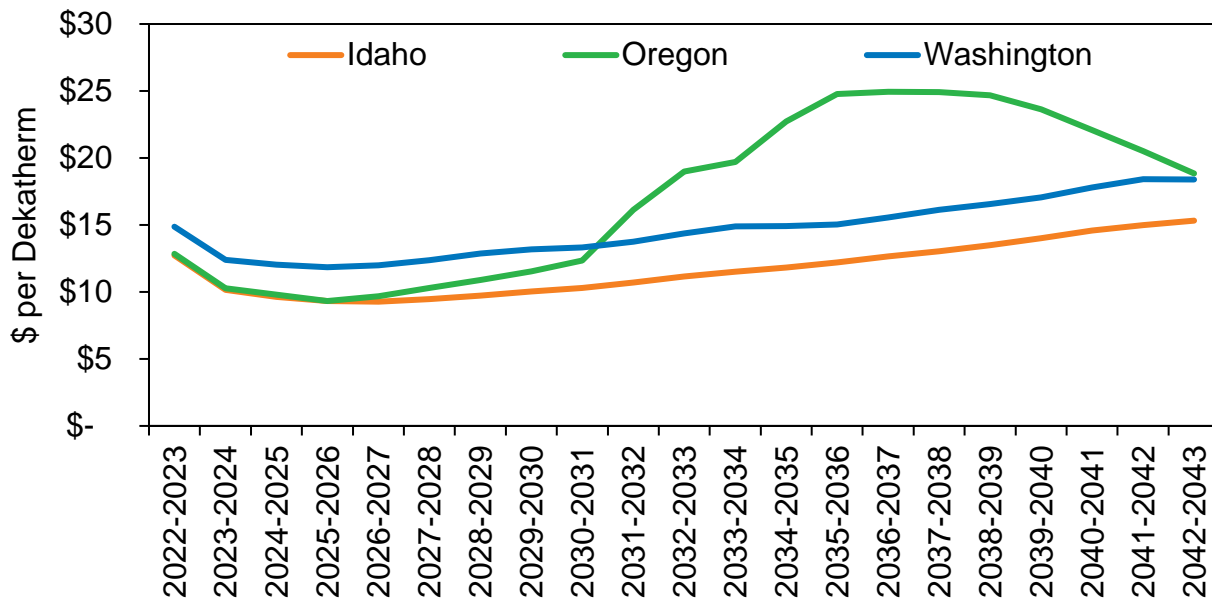

## Idaho and Washington Conservation Potential Assessment

As part of its process for identifying its Conservation Potential Assessment (CPA), also known as an EE potential assessment, Avista issued an RFP to identify qualified third parties to estimate potential EE savings opportunities. Avista chose Applied Energy Group (AEG) to perform an independent CPA for Washington and Idaho natural gas. The CPA is Avista's tool to identify the level of energy efficiency it anticipates achieving over a 20-year period. Moreover, the CPA is used to identify the conservation target for each jurisdiction that it operates in.

AEG's CPA report documents this effort and provides estimates of the potential reductions in annual energy usage for natural gas customers in Avista's Washington and Idaho service territories from EE efforts from 2023 to 2042. To produce a reliable and transparent estimate of EE resource potential, the AEG team performed the following tasks to meet Avista's key objectives:

- Used information and data from Avista, as well as secondary data sources, to describe how customers currently use natural gas by sector, segment, end use and technology.
- Develop a baseline projection of how customers are likely to use natural gas in absence of future EE programs.
- Define the metrics future program savings are measured against. This projection used up-to-date technology data, modeling assumptions, and energy baselines that reflect both current and anticipated federal, state, and local EE legislation that will impact EE potential.
- Estimate the technical, achievable technical, and achievable economic potential at the measure level for EE within Avista's service territory over the 2023 to 2045 planning horizon.
- Deliver a fully configured end-use conservation planning model, LoadMAP, for Avista to use in future potential and resource planning initiatives.
- Focused on the potential study to provide a solid foundation for the development of Avista's energy savings targets.

## Pursuing Cost-Effective Energy Efficiency

Avista's approach is to pursue all cost-effective EE with reliable and feasible program opportunities for the benefit to our customers and the system. Resource planning relies on the EE program's ability to reach its targets but also to ensure they contribute to an optimized strategy of providing the lowest cost resource.

Cost-effectiveness analysis considers the net benefit derived from EE programs with both the definition of "benefits" and "costs" differing between jurisdictions. The cost-effectiveness of EE programs can be viewed from a variety of perspectives, each of which lead to a specific standardized cost-effectiveness test. The section below outlines and describes the various perspectives.

### Total Resource Cost Test

Total resource cost (TRC) is from the cost perspective of the entire customer class of a particular utility. This includes not only what customers individually and directly pay for efficiency (through the incremental cost associated with higher efficiency options) but also the utility costs customers will indirectly bear through their utility bill. The TRC considers the impacts from energy benefits, non-energy benefits, administrative costs, and the incremental costs between standard and high efficiency equipment.

### Utility Cost Test

The Utility Cost Test (UCT) or Program Administrator Cost Test (PAC) compares the reduced utility avoided cost and the full cost (incentive and non-incentive cost) of delivering the utility program. The UCT is also known as the program administrator cost test (PAC). As part of the CPA, each cost test is applied to the jurisdictions according to the jurisdictions primary cost test methodology. Idaho and Washington have traditionally use the UCT while Oregon has used a modified TRC Test.

Washington's EE program evaluation will transition away from the UCT to the TRC method as its primary cost effectiveness test. As a condition to Avista's 2022-23 Natural Gas Biennial Conservation Plan<sup>1</sup>, Avista agreed to conduct a TRC analysis assesses all costs and all benefits of EE measures. Also included in the conditions is the requirement to include the costs of greenhouse gas emissions per RCW 80.28.380. Since the UCT does not include these in their calculation, the requirement necessitates a change in the primary cost-effectiveness test. Therefore, for this CPA, Avista requested that AEG prepare the Washington level of EE on the TRC basis. Table 3.1 summarizes the cost tests used by each jurisdiction.

**Table 3.1: Cost Effectiveness Test**

State	Total Resource Cost	Utility Cost Test
Idaho		X
Oregon	X	
Washington	X	

## Washington and Idaho Energy Efficiency Potential

First-year TRC achievable economic potential in Washington is 111,992 dekatherms. This increases to a cumulative total of 225,734 dekatherms in the second year and 2,497,540 dekatherms by 2045. Table 3.2 summarizes the results for Avista's Washington service territory at a high level. AEG analyzed the EE potential for the residential, commercial, and industrial market sectors.

<sup>1</sup> UG-210827 Order No. 01, Attachment A.

**Table 3.2: Washington Energy Efficiency Potential by Case (dekatherms)<sup>2</sup>**

Scenario	2023	2024	2025	2035	2045
<b>Baseline Forecast (Dth)</b>	19,632,329	19,782,233	19,934,947	21,966,934	24,576,214
<b>Cumulative Savings (Dth)</b>					
<b>TRC Economic Potential</b>	111,992	225,734	361,485	1,833,863	2,497,540
<b>Achievable Technical Potential</b>	191,654	423,238	686,518	3,774,115	4,938,238
<b>Technical Potential</b>	429,564	884,194	1,375,956	6,455,295	8,637,218
<b>Energy Savings (% of Baseline)</b>					
<b>TRC Economic Potential</b>	0.6%	1.1%	1.8%	8.3%	10.2%
<b>Achievable Technical Potential</b>	1.0%	2.1%	3.4%	17.2%	20.1%
<b>Technical Potential</b>	2.2%	4.5%	6.9%	29.4%	35.1%

Table 3.3 summarizes the results for Avista’s Idaho service territory at a high level. First-year UCT achievable economic potential in Idaho is 46,414 dekatherms. This increases to a cumulative total of 96,705 dekatherms in the second year and 1,278,511 dekatherms by 2045.

**Table 3.3: Idaho Energy Efficiency Potential by Case (dekatherms)**

Scenario	2023	2024	2025	2035	2045
<b>Baseline Forecast (Dth)</b>	9,781,790	9,893,452	10,003,402	11,501,243	13,451,001
<b>Cumulative Savings (Dth)</b>					
<b>UCT Economic Potential</b>	46,414	96,705	155,748	906,240	1,278,511
<b>Achievable Technical Potential</b>	105,612	228,853	371,295	2,144,539	2,885,725
<b>Technical Potential</b>	254,213	498,497	772,091	3,673,174	5,060,646
<b>Energy Savings (% of Baseline)</b>					
<b>UCT Economic Potential</b>	0.5%	1.0%	1.6%	7.9%	9.5%
<b>Achievable Technical Potential</b>	1.1%	2.3%	3.7%	18.6%	21.5%
<b>Technical Potential</b>	2.6%	5.0%	7.7%	31.9%	37.6%

<sup>2</sup> See Appendix Chapter 3



### Washington and Idaho Energy Efficiency Targets

The methodology for setting EE targets in Washington and Idaho are consistent with the most immediate two years of the study used to set EE targets. While the current CPA includes 2023 in its analysis, the cycle for establishing annual EE targets begins in 2024 and runs through 2025 as a biennial period. Therefore, for the purpose of target setting, cumulative values are used with the first year of the study, 2023, removed. An additional CPA for Avista’s Washington transport customer group was conducted. The entire CPA report including the methodology can be found in Appendix 3.

Table 3.4 and 3.5 summarizes the 2024 and 2025 targets for Washington and Idaho respectively as a result of the CPA. As stated above the 2023 estimates were removed from the overall cumulative value to arrive at the 2024 and 2025 incremental targets.

**Table 3.4: Washington 2024-2025 Conservation Target by Sector, (therms)**

Customer Segment	2024	2025	Total
<b>Low Income</b>	119,407	160,534	279,941
<b>Residential</b>	368,556	498,644	867,199
<b>Commercial</b>	627,625	676,226	1,303,851
<b>Industrial</b>	19,874	20,193	40,067
<b>Total</b>	<b>1,135,461</b>	<b>1,355,596</b>	<b>2,491,058</b>

**Table 3.5: Idaho 2024-2025 Conservation Target by Sector, (therms)**

Customer Segment	2024	2025	Total
<b>Low Income</b>	25,176	31,788	56,964
<b>Residential</b>	256,634	319,784	576,418
<b>Commercial</b>	204,566	222,235	426,802
<b>Industrial</b>	15,422	15,530	30,952
<b>Total</b>	<b>501,799</b>	<b>589,337</b>	<b>1,091,136</b>

Avista made one adjustment to the CPA impacting its overall EE target. The measure “Gas Furnace – Maintenance” was included in the study provided by AEG and was also included in the economic screen to inform the overall targets for each state. While other measures included in the study focus on efficiency, controls, commissioning or weatherization, the maintenance measure is intended to return existing equipment to its “nameplate” or as-designed efficiency level. The feasibility of reaching the level of potential outlined in the study is unlikely since there are no available sources for a deemed savings value for this measure that can be vetted and relied upon. In addition, the evaluation of a maintenance-type program creates difficulty since individual unit service needs vary substantially from project to project, and in many cases, may not result in efficiency gains. Since savings values within the potential do not have an adequate level of certainty, the maintenance measure has been removed from the economic potential.

The impact of this adjustment is a reduction of 386,757 therms for Washington over the two-year period and 220,820 therms for Idaho over the two-year period.

### Oregon Energy Efficiency Targets

As technologies and EE policies evolve over the IRP timeline the Company works with the Oregon Public Utility Commission, Community Action Agencies, Energy Trust of Oregon, and other stakeholders to adjust offerings to maximize EE savings. AEG conducted a CPA for Avista's Oregon low-income, interruptible and transport customer groups to enable the Company to better understand potential when designing programs for these customers. Energy Trust of Oregon (ETO) conducted a CPA for Avista's residential, small, and large commercial customer groups which they have served with energy efficiency programs since 2017. The entire CPA report including the methodology can be found in Appendix 3.

The Company has exclusively worked with Community Action Agencies (CCAs) to implement the Avista Oregon Low Income Energy Efficiency (AOLIEE) Program. Agency primarily install shell measures, air and duct sealing for our low-income customers. The results of identified top EE measures were discussed with the CCAs and ETO to determine the measures that are readily deployable in the near term, but no measures have been removed from the overall potential. Throughout 2022, Avista engaged the CCAs that administer the AOLIEE Program, as well as several other organizations to serve its low-income households,<sup>3</sup> via meetings, email correspondence, and telephone conversations to gain community perspective and collaboratively discuss new ways to possibly increase customer participation in the Program. As noted in the Company's 2021 AOLIEE Report, Avista also partnered with a third-party contractor, *Empower Dataworks*,<sup>4</sup> to complete an Energy Burden Assessment (Assessment) in 2022.<sup>5</sup> This Assessment informs the Company of existing gaps in Program structure and provides data needed to better target Avista's energy burdened customers needing weatherization services.

These engagements provide the basis for the Company's requested modifications to its AOLIEE Program for 2023, which were approved by the Commission in Docket No. ADV 1452/Advice No. 22-11-G. These modifications for the 2023 Program year, are intended to expand the reach of the existing Program and to prioritize energy burdened customers within these communities to ensure energy efficiency services available are reaching those that need them most. Avista will continue to work with interested parties including Energy Trust of Oregon to ramp up EE programs to reduce the energy burden for low-income customers. Table 3.6 summarizes the potential results for low-income customers.

---

<sup>3</sup> Such organizations include Federally Recognized Tribes and Saint Vincent de Paul.

<sup>4</sup> *Empower Dataworks*, a third-party consultant specializing in data, informed marketing, and engineering analytical services, was hired by the Company in 2021 to perform an Energy Burden Assessment. See <https://empowerdataworks.com/> for more detail regarding *Empower Dataworks*.

<sup>5</sup> <https://apps.puc.state.or.us/edockets/edocs.asp?FileType=HAH&FileName=um2211hah135626.pdf&DocKetID=23122&numSequence=66>

**Table 3.6: Summary of Oregon Low-Income Energy Efficiency Potential**

	2023	2024	2025	2035	2045
<b>Baseline Projection (Dth)<sup>[1]</sup></b>	914,784	919,566	924,873	999,238	1,128,049
<b>Cumulative Savings (Dth)</b>					
Achievable Economic Potential	3,816	7,383	12,114	60,487	99,838
Achievable Technical Potential	8,877	18,471	30,274	165,088	205,045
Technical Potential	14,319	28,147	44,987	226,689	295,472
<b>Cumulative Savings (% of Baseline)</b>					
Achievable Economic Potential	0.4%	0.8%	1.3%	6.1%	8.9%
Achievable Technical Potential	1.0%	2.0%	3.3%	16.5%	18.2%
Technical Potential	1.6%	3.1%	4.9%	22.7%	26.2%

Avista has not offered carbon reduction programs via EE for transport and interruptible customers in previous years. The results of top efficiency measures were shared and discussed with ETO; Through these discussions, the ETO will offer EE programs to interruptible customers starting in March of 2023. Measures such as shell measures, equipment upgrades, strategic energy management, and custom projects<sup>6</sup> are available. The Company will continue to work with interested parties to determine appropriate EE programs for transport customers with an estimated start date mid-2023. Interruptible and transport customers' energy savings potential is shown in Table 3.7, 3.8, and 3.9 below.

**Table 3.7: Summary of Oregon Interruptible Industrial Energy Efficiency Potential**

<b>Summary of Energy Savings (Dth), Selected Years</b>	2023	2024	2027	2032	2042
<b>Reference Baseline (Dth)</b>	1,509,283	1,507,701	1,503,695	1,499,146	1,494,147
<b>Cumulative Savings (Dth)</b>					
Achievable Economic	7,690	20,982	63,008	141,741	252,992
Achievable Technical	8,252	22,265	66,441	148,323	262,025
Technical Potential	12,571	31,598	89,499	189,969	322,829
<b>Energy Savings (% of Baseline)</b>					
Achievable Economic	0.5%	1.4%	4.2%	9.5%	16.9%
Achievable Technical	0.5%	1.5%	4.4%	9.9%	17.5%
Technical Potential	0.8%	2.1%	6.0%	12.7%	21.6%

<sup>6</sup> <https://www.energytrust.org/industry-agriculture/>

**Table 3.8: Summary of Oregon Interruptible Commercial Energy Efficiency Potential**

Summary of Energy Savings (Dth), Selected Years	2023	2024	2027	2032	2042
<b>Reference Baseline (Dth)</b>	389,600	386,846	380,130	373,268	367,372
<b>Cumulative Savings (Dth)</b>					
Achievable Economic	904	2,441	8,398	23,243	47,598
Achievable Technical	1,336	3,499	11,632	30,283	58,455
Technical Potential	5,998	12,666	32,618	66,549	103,852
<b>Energy Savings (% of Baseline)</b>					
Achievable Economic	0.2%	0.6%	2.2%	6.2%	13.0%
Achievable Technical	0.3%	0.9%	3.1%	8.1%	15.9%
Technical Potential	1.5%	3.3%	8.6%	17.8%	28.3%

**Table 3.9: Summary of Oregon Transport Industrial Energy Efficiency Potential**

Summary of Energy Savings (Dth), Selected Years	2023	2024	2027	2032	2042
<b>Reference Baseline (Dth)</b>	2,782,962	2,782,624	2,781,477	2,779,303	2,775,037
<b>Cumulative Savings (Dth)</b>					
<b>Achievable Economic</b>	9,534	28,080	84,925	184,338	361,139
<b>Achievable Technical</b>	9,531	28,086	84,876	183,737	359,563
<b>Technical Potential</b>	12,498	35,485	105,602	225,654	436,548
<b>Energy Savings (% of Baseline)</b>					
<b>Achievable Economic</b>	0.3%	1.0%	3.1%	6.6%	13.0%
<b>Achievable Technical</b>	0.3%	1.0%	3.1%	6.6%	13.0%
<b>Technical Potential</b>	0.4%	1.3%	3.8%	8.1%	15.7%

As implementor of EE programs for the Company's residential, small, and large commercial customers. ETO provides a full suite of energy efficiency measures<sup>7</sup> . including a moderate-income residential program. Avista supports acquiring all cost-effective potential identified in the CPA and approved by the ETO Board of Directors in the annual Budget and Action Plan<sup>8</sup>. Table 3.10 below shows potential results over a 20-year horizon.

<sup>7</sup> <https://www.energytrust.org/>

<sup>8</sup> <https://www.energytrust.org/about/reports-financials/budget-action-plan/>

**Table 3.10: 20-Year Cumulative Savings Potential by Type (Millions of Therms)**

	Technical Potential	Achievable Potential	Cost-Effective Achievable Potential	Energy Trust Deployed Savings Projection
Residential	20.3	16.2	15.9	9.9
Commercial	6.9	5.8	5.5	3.8
Industrial	0.4	0.3	0.3	0.3
Exogenous <sup>9</sup>	-	-	-	1.4
<b>Total</b>	<b>27.6</b>	<b>22.3</b>	<b>21.6</b>	<b>15.3</b>

Additionally, in 2023 Avista will meet with ETO, and other utilities to explore a hybrid heating pilot with planning beginning during the second quarter. The company will also explore during 2023 whether to implement in 2024 a targeted EE distribution project in the natural gas system which is discussed further in Chapter 8 of the IRP.

## Demand Response

Electric demand response (DR) programs are well known in electricity markets to provide capacity at times when wholesale prices are unusually high, when a shortfall of generation or transmission occurs, or during an emergency grid-operation situation. These types of programs have not garnered much interest in the natural gas markets. However, some pilot programs have emerged throughout the U.S. generating industry attention. The same reasons hold true for considering Natural Gas Demand Response (NGDR) programs as electric DR programs.

While Avista has historical electric DR experience, NGDR programs have not been reviewed prior to this IRP. Avista retained AEG to perform the first NGDR potential assessment study for Avista's Oregon, Washington, and Idaho service territories.

### Demand Response Potential Assessment Study

AEG's study estimates the potential magnitude, timing, and cost of a variety of NGDR programs likely available to Avista during winter peak loads over the 23-year planning horizon (2023-2045). These estimates are then modeled in the IRP to determine the value and cost effectiveness of each program on Avista's system.

Figure 3.1 outlines AEG's approach to determine potential DR programs in Avista's service territories. All NGDR pricing programs and behavioral programs included in this study require Advanced Metering Infrastructure (AMI) as an enabling technology. Currently Washington is the only state in Avista's service territory with AMI.

<sup>9</sup> The final deployed savings projection includes savings calculated outside of the modeling process consisting of the large project adder and unclaimed market savings.

AEG used the same market characterization for this potential assessment study as used in the CPA. This became the basis for customer segmentation to determine the number of eligible customers in each market segment for potential NGDR program participation and provided consideration for NGDR program interactions with EE programs. The study then compares Avista’s market segments to national NGDR programs to identify relevant NGDR programs for analysis.

**Figure 3.3: Program Characterization Process**

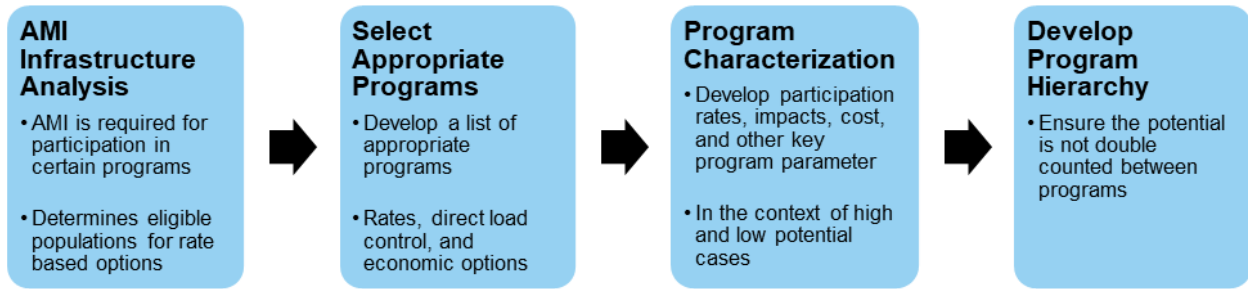

This process identified the five NGDR program options shown in Table 3.11. The different types of NGDR programs include two broad classifications: curtailable/controllable NGDR and rate design programs. Except for the behavioral program, curtailable/controllable NGDR programs represent firm, dispatchable and reliable resources to meet peak-period loads. Rate design options offer non-firm load reductions that might not be available when needed but create a reliable pattern of potential load reduction. Pricing options include time-of-use and variable peak pricing. Each option requires a new rate tariff for each state in Avista’s service territories.

**Table 3.11: NGDR Program Options by Market Segment**

DR Program		Participating Market Segment		
Program Type	Program Option	Residential	Commercial	Industrial
Curtailable Controllable DR	DLC Smart Thermostat	X	X	
	Third Party Contracts		X	X
	Behavioral*	X	X	
Rates	Time-of-Use Opt-in*	X	X	X
	Variable Peak Pricing Rates*	X	X	X

**Demand Response Program Descriptions**

**Direct Load Control Smart Thermostats**

Direct Load Control (DLC) Smart Thermostat programs leverage residential and commercial customer’s smart thermostat installation to cycle heating end uses. This program relies on the customer’s WiFi for communications. Typically, DLC programs take

five years to ramp up to maximum participation levels. Customer participation rate assumptions along with program costs and potential are detailed in Tables 3.9 and 3.10.

### **Third Party Contracts - Firm Curtailment**

Customers participating in a firm curtailment program agree to reduce demand by a specific amount or to a pre-specified consumption level during the event in exchange for fixed incentive payments. Customers receive payments while participating in the program even if they never receive a load curtailment request while enrolled in the program. The capacity payment typically varies with the firm reliability-commitment level. In addition to fixed capacity payments, participants receive compensation for reduced their consumption. Because the program includes a contractual agreement for a specific level of load reduction, enrolled loads have the potential to be counted toward installed capacity requirements. Customer participation rate assumptions along with program costs and potential are detailed in Tables 3.9 and 3.10.

Customers with large process and heating loads that have flexibility in their operations are attractive candidates for firm curtailment programs. However, customers with operations requiring continuous processes, or with relatively inflexible obligations, such as schools and hospitals, generally are not good candidates for curtailment programs. The NGDR study factors in these assumptions to determine the eligible population for participation in this program and assumes a third party would administer all aspects of the program.

### **Behavioral**

A behavioral program is a voluntary usage reduction in response to digital behavioral messaging. These programs typically occur in conjunction with EE behavioral reporting programs and communicate the request to customers to reduce usage via text or email messages. Customer participation rate assumptions along with program costs and potential are detailed in Tables 3.9 and 3.10.

### **Time of Use Rates (Opt-In)**

A Time of Use (TOU) rate is a time-varying rate. Relative to a revenue-equivalent flat rate, the rate during on-peak hours is higher, while the rate during off-peak hours is lower. This provides customers with an incentive to shed or shift consumption out of the higher-price on-peak hours to the lower cost off-peak hours. TOU is not an NGDR option, per se, but rather a permanent load shedding or shifting opportunity. Large price differentials are generally more effective than smaller differentials for TOU programs. This study assumes an opt-in rate, where participants voluntarily enroll in the rate program. Customer participation rate assumptions along with program costs and potential are detailed in Tables 3.9 and 3.10.

### **Variable Peak Pricing**

The Variable Peak Pricing (VPP) amount changes daily to reflect system conditions and costs for peak hours. Under a variable peak pricing program, on-peak prices for each

weekday are made available the previous day. Through a VPP program customers are billed for their actual consumption during the billing cycle at these prices. Over time, establishment of event-trigger criteria enables customers to anticipate events based on extreme weather or other factors. System contingencies and emergency needs are good candidates for VPP events. VPP program participants are required to be enrolled in a TOU rate option. Customer participation rate assumptions along with program costs and potential are detailed in Tables 3.9 and 3.10.

### Natural Gas Demand Response Program Participation

The steady-state participation assumptions rely on AEG’s database of existing program information and insights from market research results representing “best-practice” estimates for program participation.

Once initiated, NGDR options require time to ramp up to a steady state because of the time needed for customer education, outreach, and recruitment; in addition to the physical implementation and installation of any hardware, software, telemetry, or other enabling equipment. NGDR programs included in the AEG study have ramp rates generally with a three- to five-year timeframe before reaching a steady state.

Table 3.12 shows the steady-state participation rate assumptions for each NGDR program option. Eligible customers for each customer class are calculated based on market characterization and equipment end use saturation. The values shown are considered maximum participation rates with a ramp rate of 5 years. AEG used derated electric participation rates for natural gas DR programs rather than a direct comparison to the pilot programs described above.

**Table 3.12: NGDR Program Steady-State Participation Rates  
(Percentage of Eligible Customers)**

DR Program	Residential	Commercial	Industrial
Smart Thermostats DLC Heating	9%	9%	-
Third Party Contracts	-	5%	13%
Behavioral*	12%	12%	-
Time-of-Use*	8%	8%	8%
Variable Peak Pricing*	15%	15%	15%

\*Requires AMI and only available in WA State

### Cost and Potential Assumptions

Each NGDR program used in this evaluation was assigned an average load reduction per participant per event, an estimated duration of each event, and a total number of event hours per year. Costs were also assigned to each NGDR program for annual marketing, recruitment, incentives, program development, and administrative support. These resulted in potential demand savings and total cost estimates for each program independently and on a standalone basis.



If Avista offers more than one program, the potential for double counting exists. To address this possibility, a participation hierarchy was assumed and defines the order customers take the programs for an integrated approach. These savings and costs results were then used in Avista’s modeling. Additional detail on NGDR resource assumptions can be found in AEG’s Natural Gas CPA report, Appendix 3.

The estimated savings for reach program and its levelized costs are shown in Table 3.13. The cost of the programs within these tables represents the on-going operations and capital cost required to start and maintain these programs. The capital costs are amortized and recovered over a 10-year period. These tables include the estimated potential dekatherm savings for 2030 and 2045 for illustrative purposes of program potential. These estimates are the expected amount of demand reduction and net savings from all program participants.

**Table 3.13: System Program Cost and Potential**

Program	Costs \$/Dth year	Winter (Dth) Potential	
		2030	2045
Smart Thermostats DLC Heating	\$5,756	3,336.53	4,000.84
Third Party Contracts	\$135,937	25.38	29.71
Behavioral*	\$11,849	304.66	364.53
Time-of-Use*	\$18,883	232.21	280.69
Variable Peak Pricing*	\$4,474	1,192.69	1,440.26
<b>Total Potential</b>		<b>5,091.47</b>	<b>6,116.02</b>

## Building Electrification

State policies in Oregon and Washington may lead customers to electrify their natural gas space and water heating to reduce greenhouse gas emissions. This IRP does not include fuel switching in the demand forecast, but rather includes specific fuel use electrification as a resource option for both commercial and residential customers. Industrial customers are not considered in this analysis due to the variety of processes and needs toward the product being produced. Avista does not have many industrial customers in its territories, with the overall system use of industrial customer around one percent of system demand. Electrification, if cost effective, must always be selected for the remaining study horizon. This is built on the assumption of a customer switching end uses and equipment is unlikely to return to the natural gas system within the study horizon.

Estimating building electrification costs is not a simple analysis as electrification costs vary by structure size, efficiency, shell efficiency, and geographical location in respect to weather. Individual homes at a discrete level and factors may find costs lower than these estimates, while others may be higher based on home size, location, or complexity of heating systems. Further, customers may find extrinsic value in natural gas for resilience benefits and its superior performance compared to electric options. Also, customers may choose to continue to use natural gas fireplaces, clothes dryers, and stoves, even if

uneconomic. Another concern with fuel switching is affordability, where low-income customers may not have the ability to pay for an end use conversion creating an equity issue. A second equity issue concern is if higher income customers leave the system, the cost per customer for those that remain on the system would go up, resulting in low-income customers paying a higher cost per customer. This will be further discussed in Chapter 7.

To begin the analysis the customer type, class and major end use must be separated. Residential and Commercial customers electrification choices are broken into three separate categories.

- Space Heat
- Water Heat
- Other (Cooking, clothes dryer)

### End Use Efficiency

The estimated values for these sources are used from the CPA studies provided by AEG and ETO. The second set of assumptions is built around demand variability and certain sets of temperature groupings. As an example, if a customer’s furnace is running constantly at 65 Heating Degree Days (HDD’s), it does not run more if the HDD’s increase with colder temperatures. Efficiency estimates are illustrated in Figure 3.4 and indicate expected electric space heating efficiency is higher than natural gas space heat efficiency. Implications of these efficiencies will come into focus when paired with weather regions, expected energy costs, and conversion costs.

**Figure 3.4: Space Heat Efficiency by Degrees Fahrenheit and Fuel**

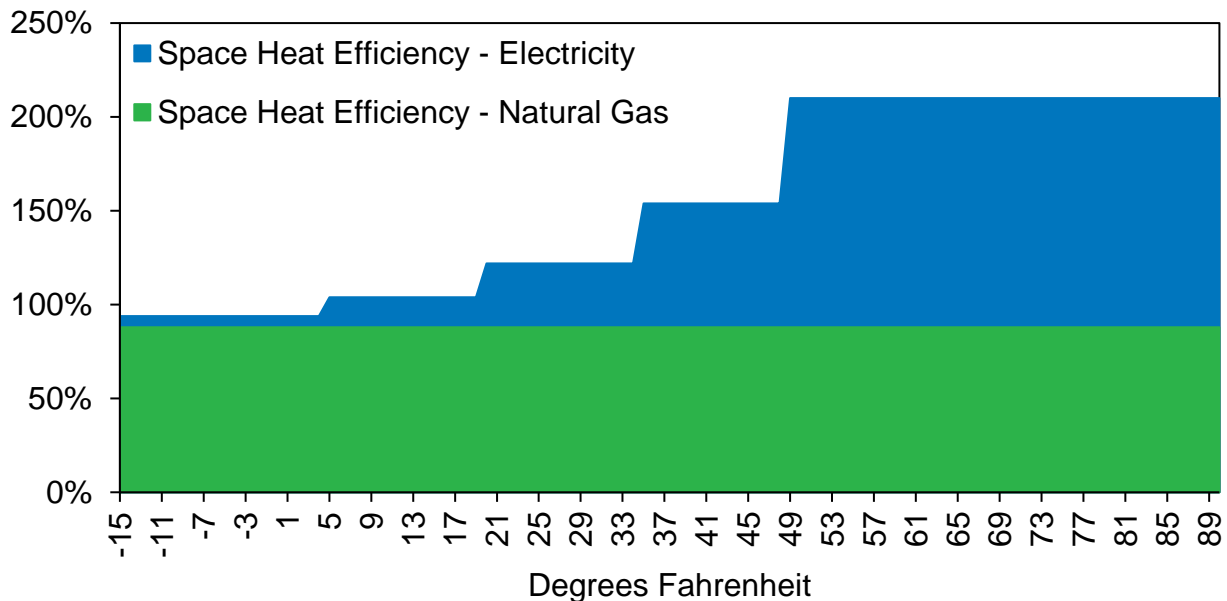

### Energy Demand

A daily demand forecast is important when considering electrification, otherwise the capacity to serve a peak day is ignored and the system value is not measured appropriately. This method considers daily temperatures as explained in Chapter 2. A demand per customer class and area considers a use per customer energy needed in therms and utilizes the conversion coefficient to estimate efficiency gains from switching to electricity. Efficiency is considered as a generic value across equipment and does not represent ultra-high efficiency units or old lower-efficiency units. These values are then rolled up into a monthly average to consider conversion efficiency and demand by planning area. In Figure 3.5, the bars indicate before and after efficiencies in Roseburg, Oregon in 2023 per Commercial customer while the area chart illustrates before and after efficiencies per Residential customer. These totals include the average customer monthly demand and all end uses to illustrate the energy needed on the electric grid versus the natural gas system.

**Figure 3.5: Energy Conversion Efficiency therms to kWh  
Roseburg, Oregon**

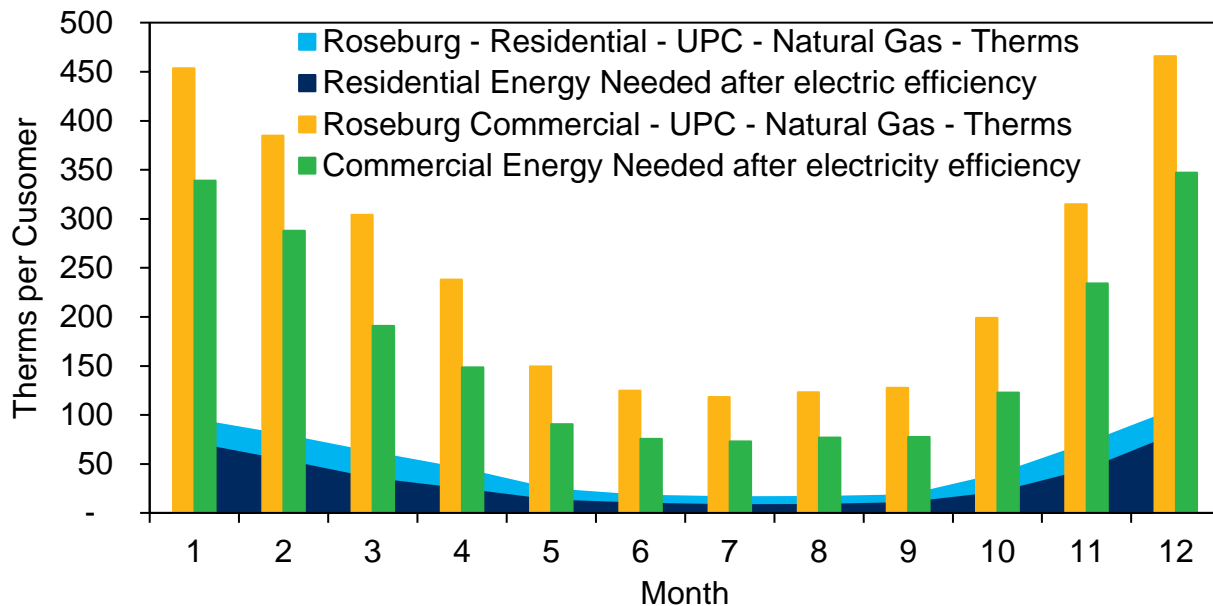

### Conversion Costs

Conversion costs can vary widely by study, location, building size, and structure. Avista used a study by Home Innovation Research Labs<sup>10</sup> to understand estimated costs by area to help address these ranges. Although the study provides an estimate by major area, no areas were in the Avista natural gas service territory. To help account for these wide-ranging study estimates, Avista considered the generic cost “total to a remodeler”. The low-cost conversion is 50% of this estimated remodel cost and the high cost of

<sup>10</sup> Cost and Other Implications of Electrification Policies on Residential Construction, February 2021

conversion is 150%. This cost information from this study is illustrated in Figure 3.6 along with the specific efficiency considerations.

Incentives and grants are estimated based on known programs such as the Inflation Reduction Act which is discussed further in Chapter 5. These costs are treated as being removed from the overall conversion cost. Also, these conversion costs are estimated to be recovered over a 5- year timeframe with an interest rate by jurisdiction (OR – 6.1%, WA – 6.58%). Payments are recovered monthly and in equal amounts like a mortgage payment. The estimated impact within the study is roughly half of the cost by end use and would be discounted, recovered by the customer or refundable and is removed from the total before the monthly payment is estimated.

**Figure 3.6: Estimated Conversion Costs**

**Retrofit Cost of Gas Equipment and Appliances for an Existing Gas Baseline House:  
96 AFUE GF; 16 SEER AC; Tankless Condensing 0.93 UEF WH**

Component	Unit	Material	Labor	Total	w/O&P	Quantity	Cost
Demo and Install GF, labor	EA				377.00	1	377
Demo and Install AC system, labor	EA				943.00	1	943
Demo and Install WH, labor	EA				499.00	1	499
Reclaim old refrigerant	LB		8.40	8.40	13.75	5	69
Install new Refrigerant piping	EA	204.00	21.50	225.50	261.00	1	261
GF materials, est.	EA	200.00		200.00	220.00	1	220
AC materials, est.	EA	200.00		200.00	220.00	1	220
WH materials, est.	EA	100.00		100.00	110.00	1	110
96 AFUE GF	EA	1,295.00		1,295.00	1,424.50	1	1,425
GF Vent piping, PVC, 2" dia.	LF	3.45	2.97	6.42	8.65	40	346
GF 2" concentric vent kit	EA	59.95		59.95	65.95	1	66
16 SEER AC	EA	1,346.00		1,346.00	1,480.60	1	1,481
Coil	EA	439.00		439.00	482.90	1	483
Tankless condensing 0.93 UEF WH	EA	1,039.00		1,039.00	1,142.90	1	1,143
WH Vent piping, PVC, 2" dia.	LF	3.45	2.97	6.42	8.65	20	173
WH 2" PVC concentric vent kit	EA	22.49		22.49	24.74	1	25
WH Gas piping, 1"	LF	7.80	6.15	13.95	18.60	7	130
WH 15-amp circuit, toggle, 40' #14/2 NM	EA	57.00	83.50	140.50	199.00	1	199
WH GFCI 15-amp, 1-pole breaker	EA	41.99		41.99	46.19	1	46
Remove and install range, labor	EA				138.00	1	138
Remove and install dryer, labor	EA				297.90	1	298
Gas Range	EA	542.00		542.00	596.20	1	596
Gas Dryer	EA	528.00		528.00	580.80	1	581
<b>Total to Remodeler</b>							<b>9,828</b>
<b>Total to Consumer</b>							<b>12,786</b>
<b>Houston</b>						0.99	<b>12,658</b>
<b>Baltimore</b>						1.02	<b>13,041</b>
<b>Denver</b>						1.05	<b>13,425</b>
<b>Minneapolis</b>						1.00	<b>12,786</b>

### Energy Costs

Monthly costs from conversions are included with the energy demand per kWh. The rate per kWh uses current rates by area and inflates Pacific Power customers, Klamath Falls-Medford-Roseburg, by the same estimated percentage Avista rates would see in meeting 100% clean goals by 2045. La Grande is served by Oregon Trail Electric and is mainly powered by hydro power from the Bonneville Power Administration (BPA) and assumes a lower rate increase of 3% annually. This 3% estimate is broken out as 2% inflation and 1% for new transmission and distribution projects. The Washington territory estimates include 75% of natural gas customers moving to Avista for their electricity needs and 25% lost to other public power providers such as Inland Power & Light. The assumed escalation curves for energy per kWh are included in Figure 3.7. Base costs are not included as it is assumed a gas customer is currently using the local electric provider.

**Figure 3.7: Electric Rate Assumption by Area by Class**

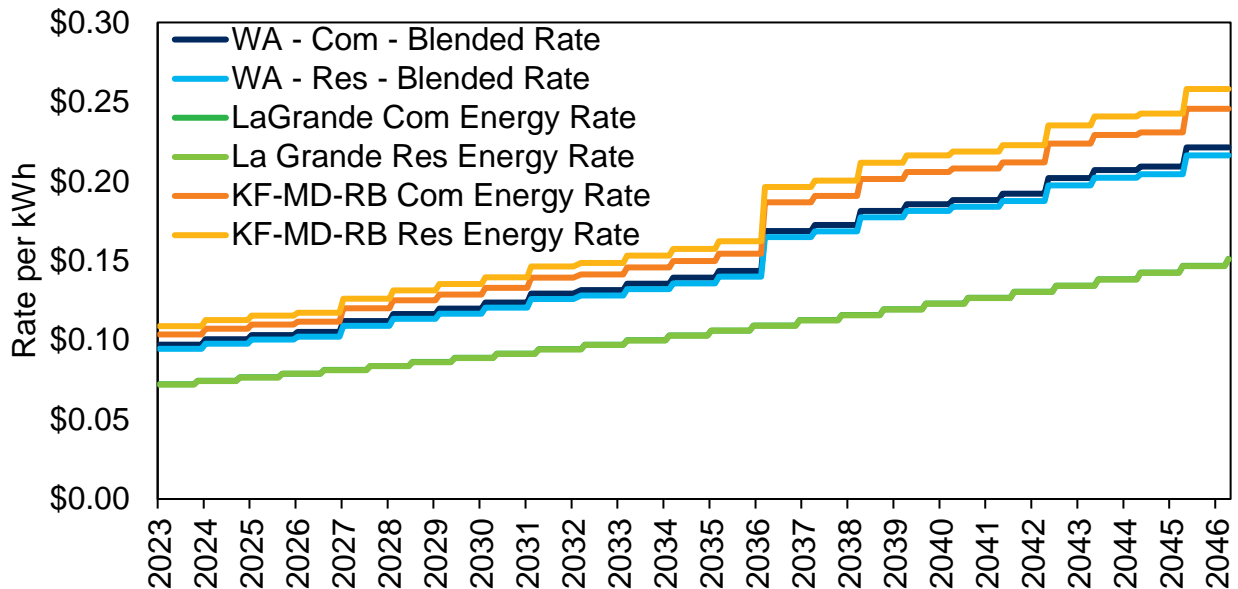

### Rate Impact

When pairing the cost of energy with the conversion rate in the initial 5 years, a consistent monthly charge is included, even when energy is not being used in times of low demand such as July and August as illustrated in Figure 3.8. In the warmer months the cost for electrification of space heat is from converting the equipment over. In the colder months when more energy is used, the efficiency of electric end uses help to conserve energy.

**Figure 3.8: Conversion Costs and Energy Costs for Space Heat Washington Residential**

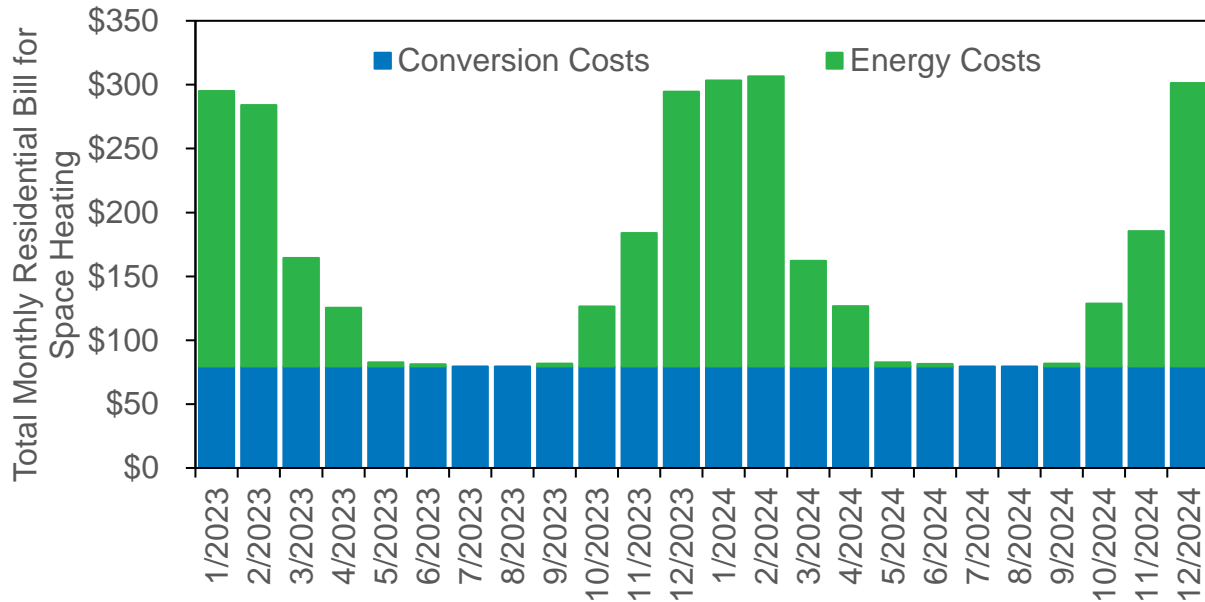

Each step of the analysis process is summarized below:

1. Estimated demand by area by customer class by end use of natural gas.
2. Conversion efficiency by area and class by temperature.
3. Conversion cost of the building by class.
4. Rate impact by area and class to meet regional carbon reduction goals and includes additional supply resources, transmission, and distribution cost estimates to provide the energy.
5. Levelized costs per year to consider conversion costs specific to that year for 5 years repayment and expected energy costs for the study horizon.

### Levelized Costs

The figures below (Figure 3.9 to 3.12) illustrate the final costs used in the model by end use and class.

**Figure 3.9: Space Heat Levelized Costs by Area for Residential Electrification**

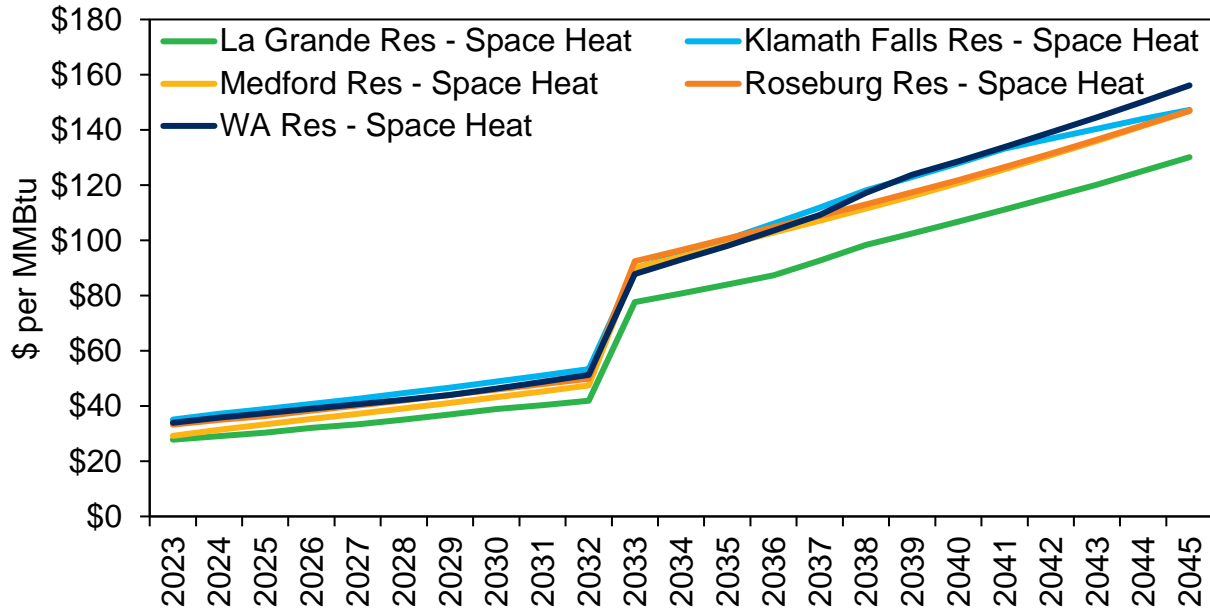

**Figure 3.10: Water Heat Levelized Costs by Area for Residential Electrification**

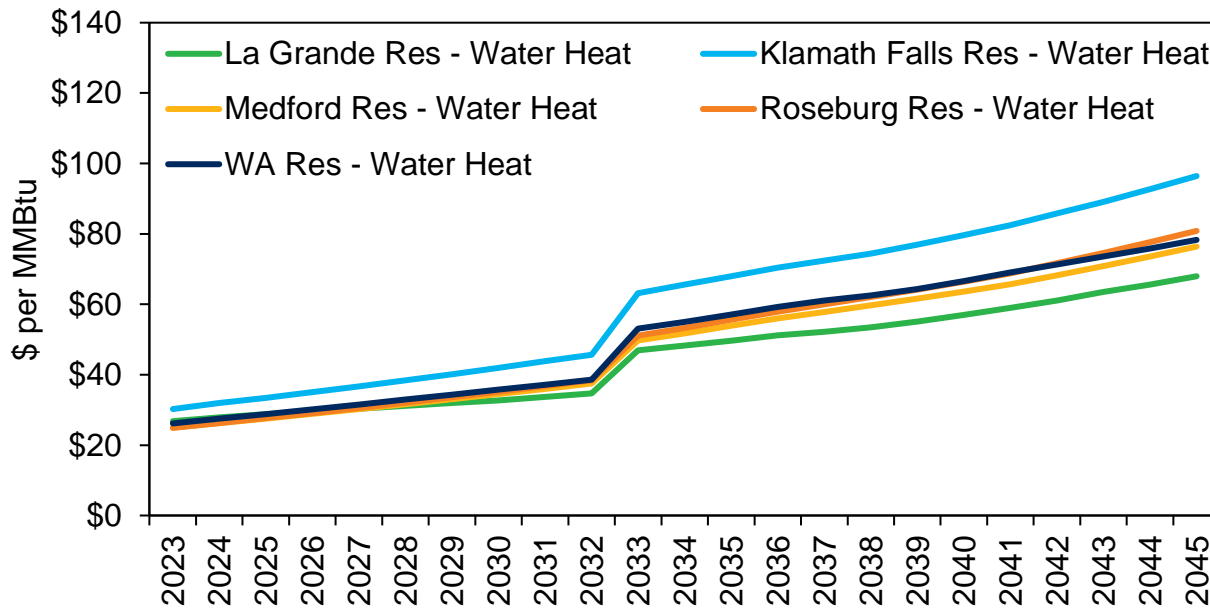

**Figure 3.11: Space Heat Levelized Costs by Area for Commercial Electrification**

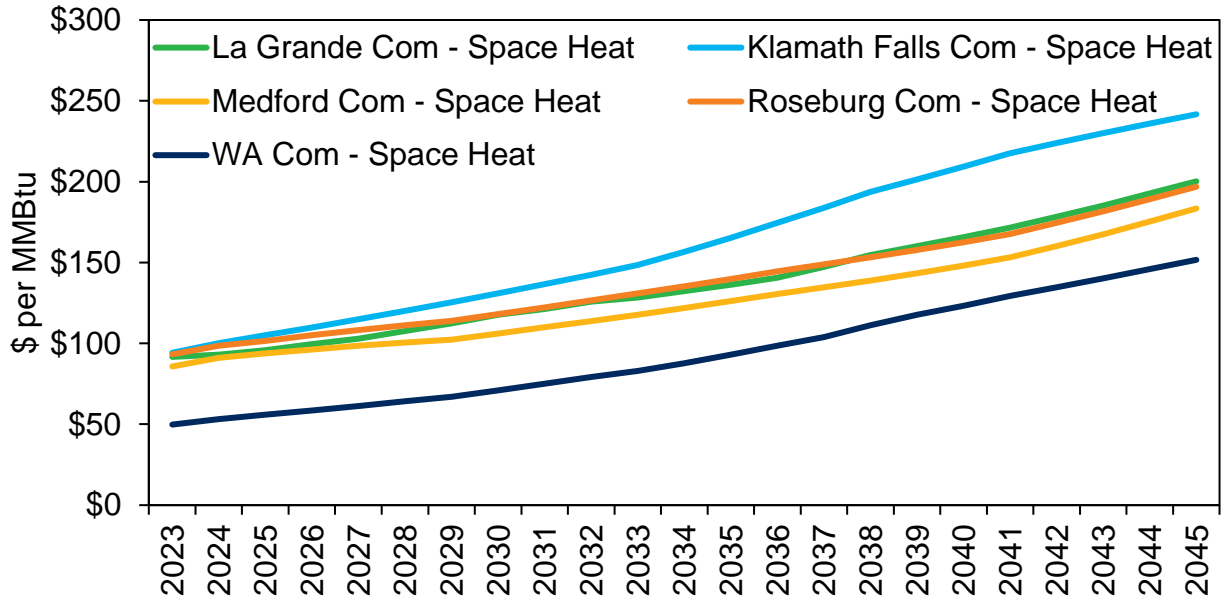

**Figure 3.12: Water Heat Levelized Costs by Area for Commercial Electrification**

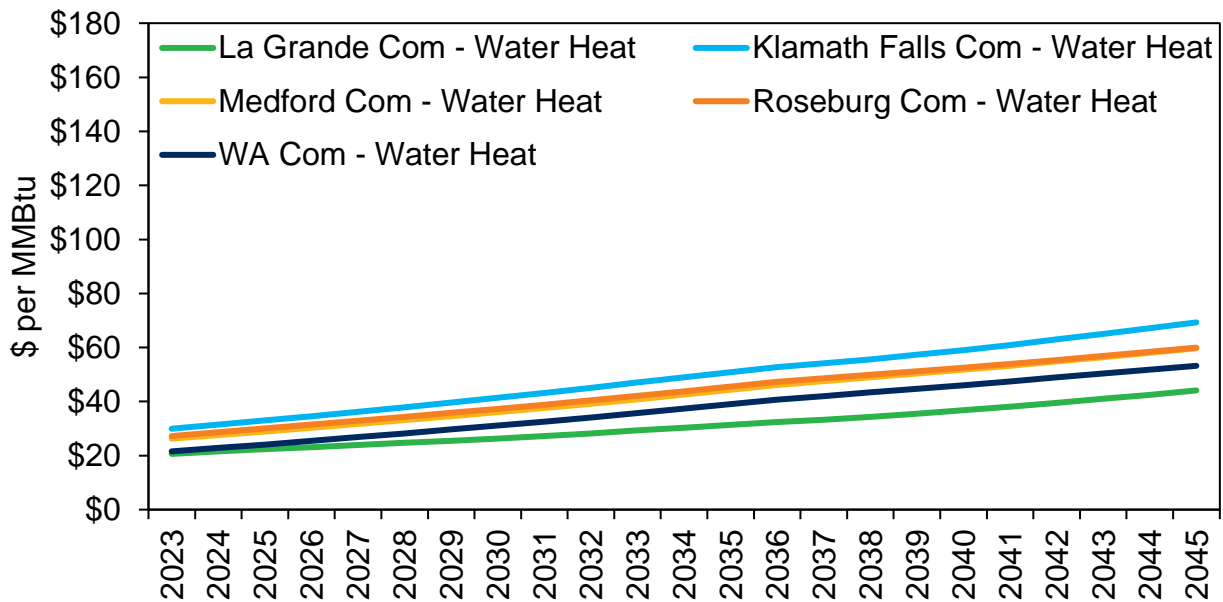



This Page Is Intentionally Left Blank

## 4. Current Resources and New Resource Options

This chapter discusses fuel supply options to meet future net energy demand. Avista's objective is to provide reliable natural gas service at reasonable prices. To help achieve this objective, Avista evaluates a variety of supply-side resources and attempts to build a diversified natural gas supply portfolio. The resource acquisition and commodity procurement programs resulting from the evaluation of physical and financial risks, market-related risks, and procurement execution risks; and identifies methods to mitigate these risks.

Avista manages natural gas procurement and related activities on a system-wide basis with several regional supply options available to serve core customers. Supply options include firm and non-firm supplies, firm, and interruptible transportation on six interstate pipelines, and storage. Because Avista's core customers span three states, the diversity of delivery points and demand requirements adds to the options available to meet customers' needs. The utilization of these resources varies depending on demand and operating conditions. This chapter discusses the available regional commodity resources and Avista's procurement plan strategies, the regional pipeline resource options available to deliver the commodity to customers, and the storage resource options available to provide additional supply diversity, enhanced reliability, favorable price opportunities, and flexibility to meet a varied demand profile. Carbon reducing supplies, such as renewable natural gas (RNG) and hydrogen (H<sub>2</sub>) are also considered.

### Natural Gas Commodity Resources

#### Supply Basins

The Northwest continues to enjoy a low-cost commodity environment with abundant supply availability, especially when compared to other regions across the globe. This is primarily due to the production in areas of the Northeast and Southern United States. This supply is serving an increasing amount of demand in the population heavy areas in the middle and eastern portions of Canada and the U.S displacing supplies previously delivered from the Western Canadian Sedimentary Basis (WCSB).

Current forecasts show a long-term regional price advantage for Western Canada and Rockies natural gas basins as the need for this gas diminishes. High Canadian production paired with limited options for flowing natural gas into demand areas has created a generally discounted commodity in the Northwest when compared to the Henry Hub. Access to these abundant supplies of natural gas and to major markets across the continent has also led to the construction of multiple LNG plants. These LNG plants will be a large demand addition to North American supply. The Canadian project is known as LNG Canada and is in Kitimat B.C. This facility is one of the largest investments in Canadian history and is currently under construction. Its initial capacity is, roughly 1 Bcf per day, but contains an option for up to 3.5 Bcf per day in total. Additionally, WoodFibre LNG located in Squamish, BC will come online in 2027 removing potentially 0.3 Bcf from supply to the Pacific Northwest. The large increase of natural gas demand by either of

these facilities moving forward could cause pressure on commodity prices with the limited infrastructure in the Pacific Northwest. An LNG facility in Oregon known as Jordan Cove was approved by FERC, however, was officially abandoned in December 2021 due to the continued uncertainties around state environmental permits.

Exports to Mexico continue to impact US natural gas demand forecasts. In 2013, Mexico reformed its energy sector allowing new market participants, innovative technologies, and foreign investment. This market reformation opened new opportunities for natural gas export to Mexico. Since these market changes, Mexican imports which were historically less than 2 Bcf per day have more than doubled to over 5.5 Bcf per day on average.

### Regional Market Hubs

There are numerous regional market hubs in the Pacific Northwest where natural gas is traded extending from the two primary basins. These regional hubs are typically located at pipeline interconnects. Avista is located near, and transacts at, most of the Pacific Northwest regional market hubs, enabling flexible access to geographically diverse supply points. These supply points include:

- **AECO** – The AECO-C/Nova Inventory Transfer market center located in Alberta is a major connection region to long-distance transportation systems taking natural gas to points throughout Canada and the United States. Alberta is the primary Canadian exporter of natural gas to the U.S. and historically produces 90 percent of Canada's natural gas.
- **Rockies** – This pricing point represents several locations on the southern end of the NWP system in the Rocky Mountain region. The system draws on Rocky Mountain natural gas-producing areas clustered in areas of Colorado, Utah, New Mexico, and Wyoming.
- **Sumas/Huntingdon** – The Sumas, Washington pricing point is on the U.S./Canadian border where the northern end of the NWP system connects with Enbridge's Westcoast Pipeline and predominantly markets Canadian natural gas from Northern British Columbia.
- **Malin** – This pricing point is at Malin, Oregon, on the California/Oregon border where TransCanada's Gas Transmission Northwest (GTN) and Pacific Gas & Electric Company connect.
- **Station 2** – Located at the center of the Enbridge's Westcoast Pipeline system connecting to northern British Columbia natural gas production.
- **Stanfield** – Located near the Washington/Oregon border at the intersection of the NWP and GTN pipelines.
- **Kingsgate** – Located at the U.S./Canadian (Idaho) border where the GTN pipeline connects with the TransCanada Foothills pipeline.

Natural gas pricing is often compared to the Henry Hub price given the ability to transport natural gas across North America. Henry Hub, located in Louisiana, is the primary natural gas pricing point in the U.S. and is the trading point used in NYMEX futures contracts.

Figure 4.1 shows historic natural gas prices for first-of-month index physical purchases at AECO, Station 2, Rockies, and Henry Hub. The figure has changed in recent years due to an alteration in flows of natural gas specifically coming from Western Canada.

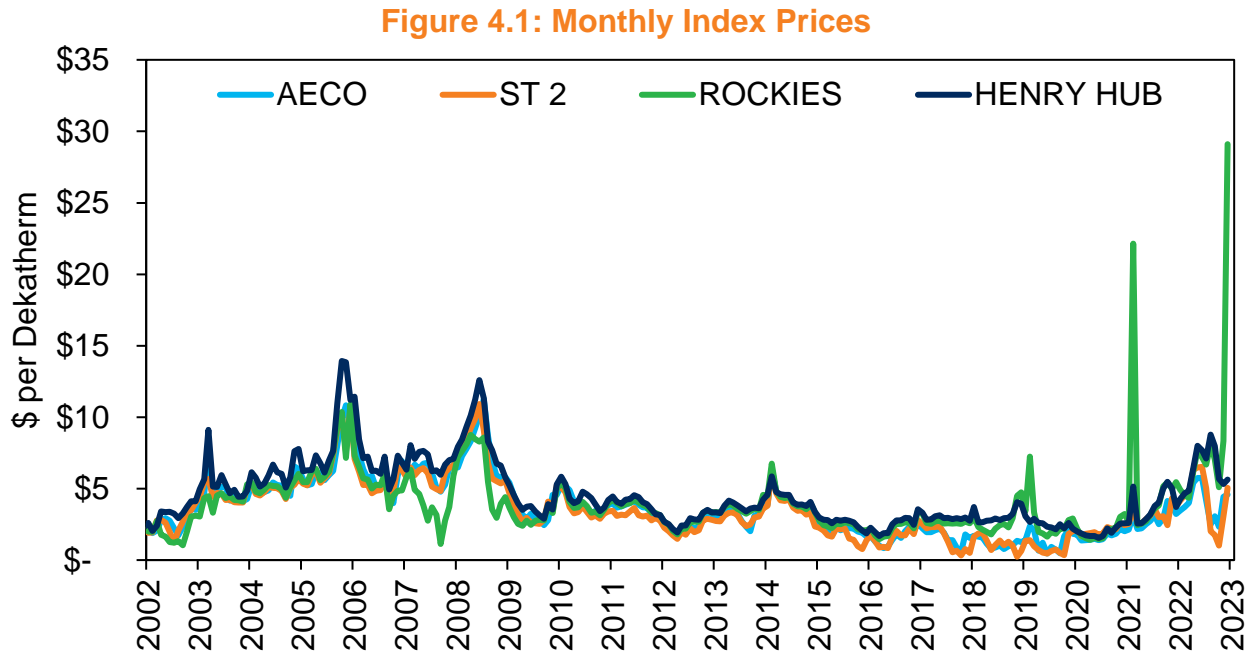

Northwest regional natural gas prices typically move together; however, the basis differential can change depending on market or operational factors. This includes differences in weather patterns, pipeline constraints, and the ability to shift supplies to higher-priced delivery points in the U.S. or Canada. By monitoring these price shifts, Avista can often purchase at the lowest-priced trading hubs on a given day, subject to operational and contractual constraints.

Liquidity is generally sufficient in the day-markets at most Northwest supply points. AECO continues to be the most liquid supply point, especially for longer-term transactions. Sumas has historically been the least liquid of the four major regional supply points (AECO, Rockies, Sumas, and Malin). This illiquidity contributes to generally higher relative prices in the high demand winter months.

Avista procures natural gas with contracts. Contract specifics vary from transaction-to-transaction, and many of those terms or conditions affect commodity pricing. Some of the terms and conditions include:

- **Firm versus Non-Firm:** Most term contracts specify the supply is firm except for force majeure conditions. In the case of non-firm supplies, the standard provision is the supply can be cut for reasons other than force majeure conditions.
- **Fixed versus Floating Pricing:** The agreed-upon price for the delivered gas may be fixed or based on a daily or monthly index.

- **Physical versus Financial:** Certain counterparties, such as banking institutions, may not trade physical natural gas, but are still active in the natural gas markets. Rather than managing physical supplies, those counterparties choose to transact financially rather than physically. Financial transactions provide another way for Avista to financially hedge price.
- **Load Factor/Variable Take:** Some contracts have fixed reservation charges assessed during each of the winter months, while others have minimum daily or monthly take requirements. Depending on the specific provisions, the resulting commodity price will contain a discount or premium compared to standard terms.
- **Liquidated Damages:** Most contracts contain provisions for symmetrical penalties for failure to take or supply natural gas.

For this IRP, Avista assumes natural gas purchases under a firm, physical, fixed-price contract, regardless of contract execution date and type of contract. Avista pursues a variety of contractual terms and conditions to capture the most value for customers. Avista's natural gas buyers actively assess the most cost-effective way to meet customer demand and optimize unutilized resources.

### Natural Gas Price Forecasts

Natural gas prices play an integral role in the development of the IRP. It is the most significant variable in determining the cost-effectiveness of energy efficiency measures and of procuring new resources. The natural gas price outlook has changed dramatically in recent years in response to several influential events and trends affecting the industry, including improved drilling methods and technology used in oil and natural gas production, increasing exports to Mexico, and LNG, and policies towards the continued use of natural gas. These factors, in addition to more stringent renewable energy standards and increased need for natural gas-fired generation to back up such resources, are contributing to the rapidly changing natural gas environment. The uncertainty in predicting future events and trends requires modeling a range of forecasts.

Many additional factors influence natural gas pricing and volatility, such as regional supply and demand issues, weather conditions, storage levels, natural gas-fired generation, infrastructure disruptions, and infrastructure additions, such as new pipelines and LNG terminals. Renewable fuels used in place of fossil natural gas and demand loss from policy implications will alter the variables affecting future natural gas prices. Estimates of these supply resource changes vary between studies as does the study date and ultimately drive the primary differences between sources in pricing expectations.

Although Avista closely monitors these factors, we cannot accurately predict future prices across the 20-year horizon of this IRP. As a result, several price forecasts from credible industry experts were used in developing the price forecasts considered in this IRP. Figure 4.2 depicts the annual average prices of these combined forecasts in nominal dollars and includes the expected price resulting from a blending technique.

**Figure 4.2: Henry Hub Forecasted Price (Nominal \$/Dekatherm)**

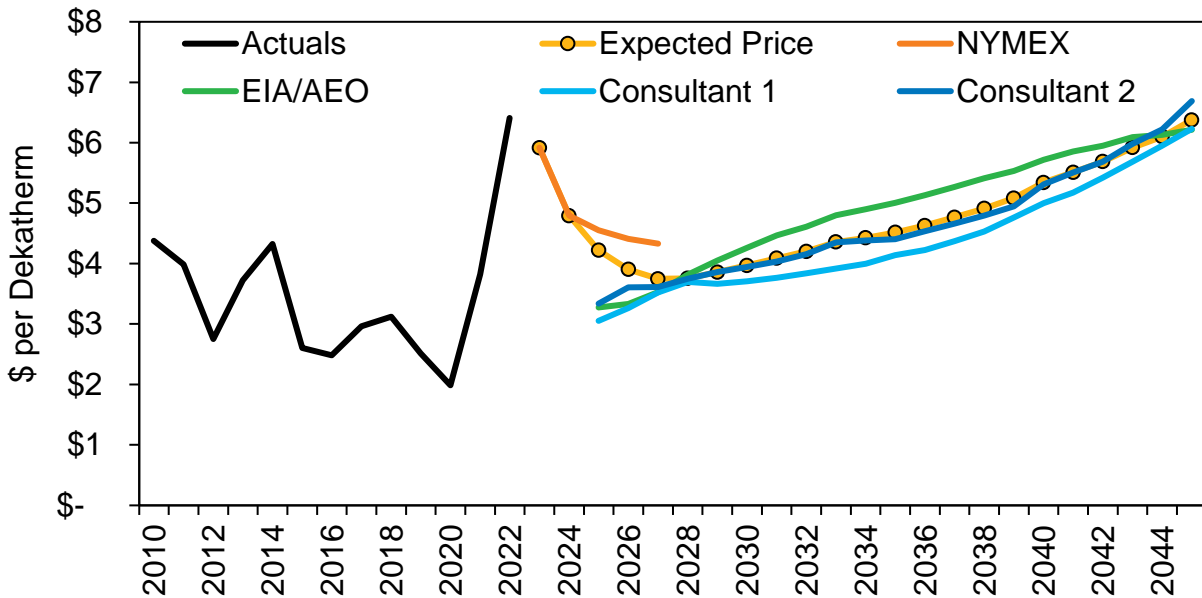

Expected prices at Henry Hub were derived through a blend of forecasts from four sources, including the New York Mercantile Exchange (NYMEX) forward strip on July 26, 2022, the Energy Information Administration’s (EIA) 2022 Annual Energy Outlook (AEO), and two reputable market consultants. Combining multiple forecasts improves the accuracy of our model based on the aggregate market knows more than any single entity or model.

The weightings applied to each source vary throughout the twenty-year forecasting horizon. Due to the high volume of market transactions, expected prices align completely with those of the NYMEX forward strip in the first two years. From 2025 through 2027, market activity and speculation on the NYMEX deteriorate significantly, so forecasts from the other three sources, proportionally, are applied incrementally more weighting. By the year 2028, and through the end of our forecasting horizon, the expected price is the result of an equally weighted blend of forecasts from the EIA’s AEO and our two market consultants. The specific weightings applied are described in Table 4.1 and the resulting annual average expected price at Henry Hub is depicted in Figure 4.3 below.

**Table 4.1 : Price Blend Methodology**

Years	Price Blend Methodology
2023 & 2024	forward price only
2025	75% forward price / 25% average consultant forecasts
2026	50% forward price / 50% average consultant forecasts
2027	25% forward price / 75% average consultant forecasts
2028 - 2042	100% average consultant forecasts

**Figure 4.3: Expected Price with Allocated Price Forecast**

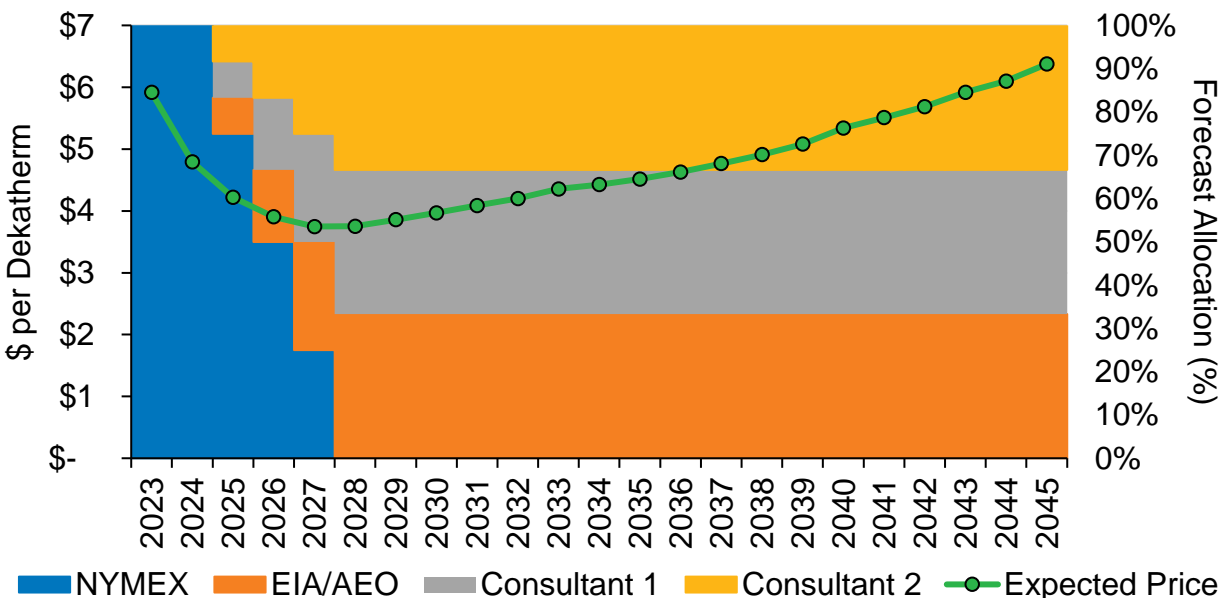

To accommodate for the likelihood the expected prices at Henry Hub do not perfectly reflect future natural gas prices and to help measure price risk in resource planning, a stochastic analysis of 500 possible futures were modeled based on the expected price forecast. Each future contains unique monthly price movements throughout the twenty-year forecasting horizon. With the assistance of the TAC, Avista selected the 95<sup>th</sup> and 25<sup>th</sup> highest prices in each month from the stochastic results to determine high and low-price curves, respectively. The high, expected, and low-price curves in nominal dollars are illustrated in Figure 4.4.

**Figure 4.4: Henry Hub Forecasts for IRP Low/ Expected/ High Forecasted Price**

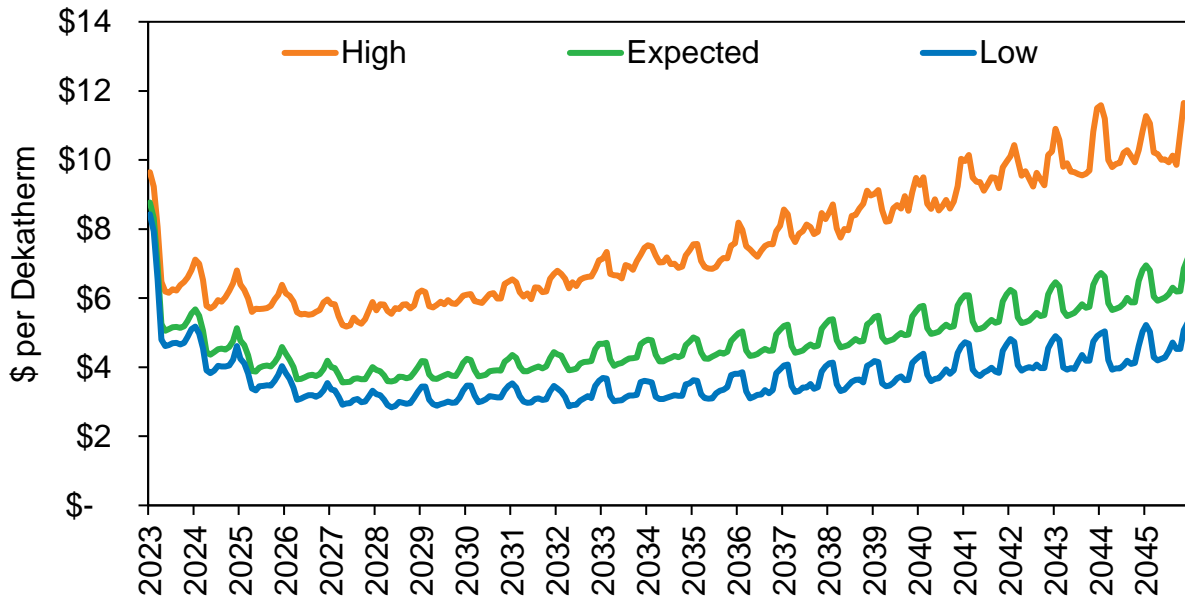

Henry Hub is in southeastern Louisiana, near the Gulf of Mexico. It is recognized as the most important pricing point in the U.S. due to its proximity to a large portion of U.S. natural gas production and the sheer volume traded in the daily, spot, and forward markets via the NYMEX futures contracts. Consequently, prices at other trading points tend to follow the Henry Hub with a positive or negative basis differential. Of the two market consultants Avista uses, only one forecasts basis pricing at the gas hubs modeled throughout the twenty-year horizon.

The natural gas hubs at Sumas, AECO, and the Rockies (and other secondary regional market hubs) determine Avista’s costs. Prices at these points typically trade at a discount in the summer, or negative basis differential, and flip to a higher cost as compared to the Henry Hub in the winter. This is based on supply constraints in the major demand areas such as Seattle, WA and Portland, OR. Figure 4.5 below shows the resulting regional prices as compared to the Henry Hub and Figure 4.6 shows the resulting price distribution for AECO for the 500 future simulations



**Figure 4.5: Regional Price as a compared to the Henry Hub Price**

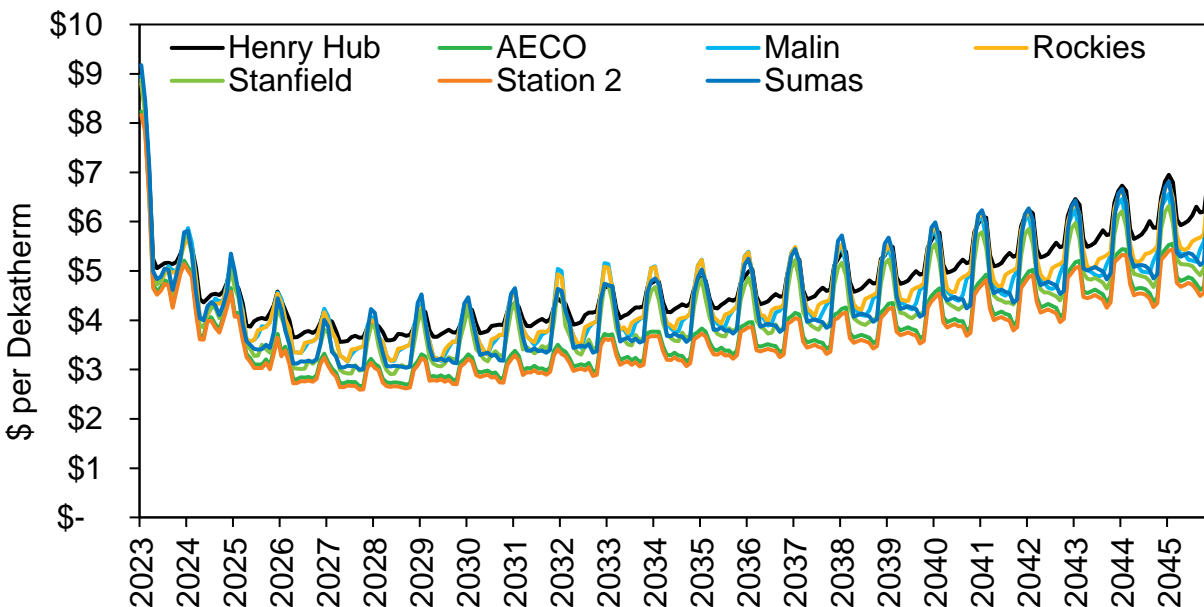

**Figure 4.6: AECO - \$ per Dth (500 Draws)**

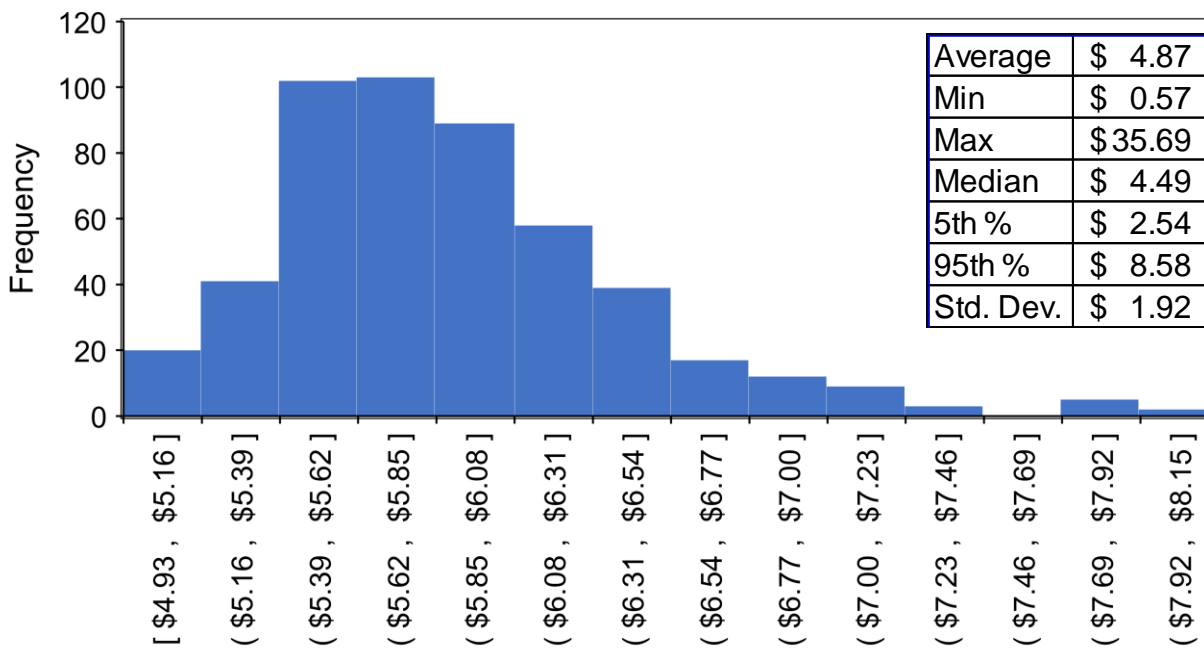

## Transportation Resources

Although proximity to liquid market hubs is important from a cost perspective, supplies are only as reliable as the pipeline transportation from the hubs to Avista’s service territories. Capturing favorable price differentials and mitigating price and operational risk can also be realized by holding multiple pipeline transportation options. Avista contracts for enough diversified firm pipeline capacity from various receipt and delivery points

(including storage facilities), to ensure firm deliveries will meet peak day demand. This combination of firm transportation rights to Avista’s service territory, storage facilities and access to liquid supply basins ensure peak supplies are available to serve core customers. The regional map, from the Northwest Gas Association (NWGA), shows the relative capacity of the pipelines and storage capacity (Figure 4.7).

**Figure 4.7: Regional Pipeline and Storage Capacity**

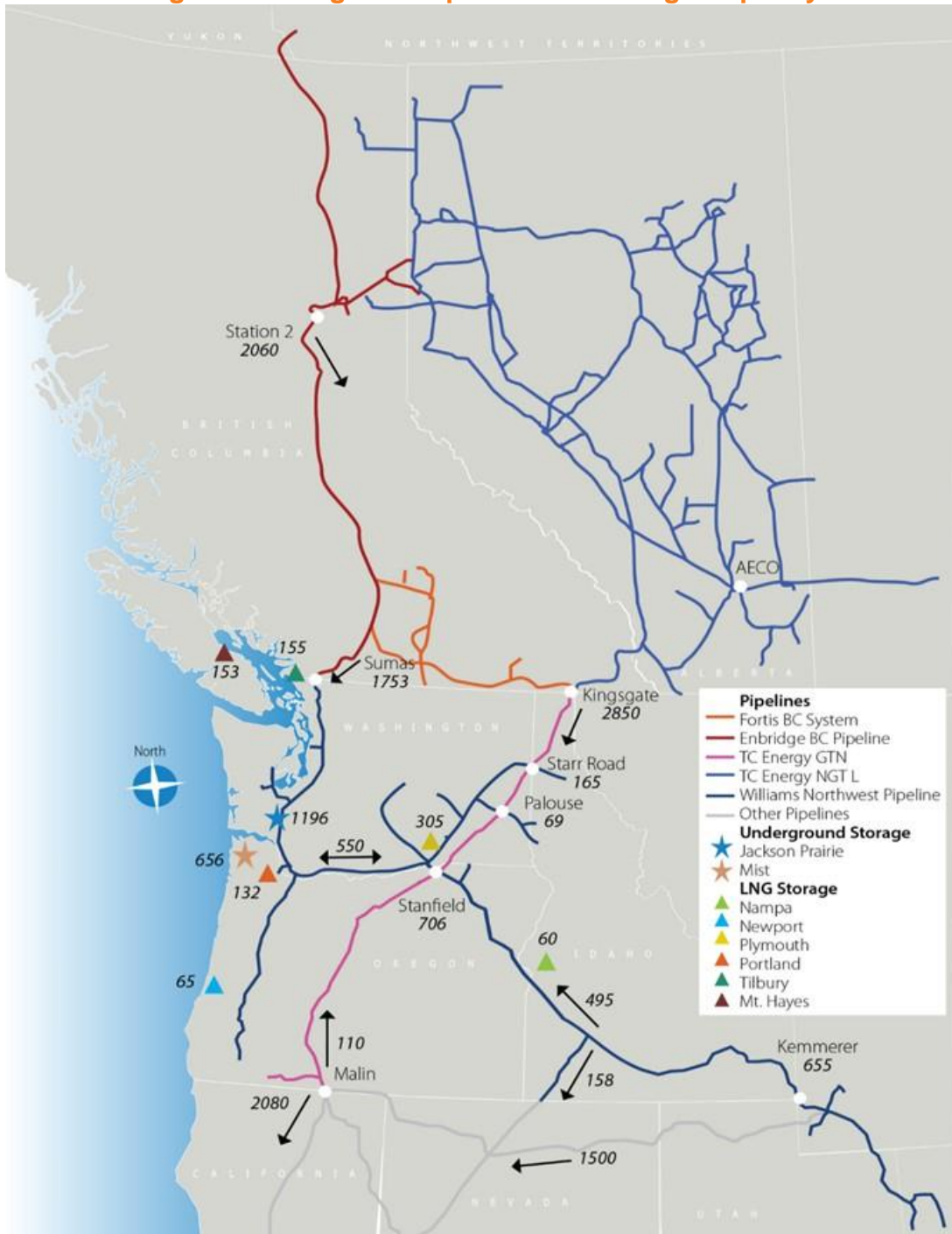

The major pipelines servicing the region include:

- **Williams - Northwest Pipeline (NWP):**  
A natural gas transmission pipeline serving the Pacific Northwest moving natural gas from the U.S./Canadian border in Washington and from the Rocky Mountain region of the U.S.
- **TransCanada Gas Transmission Northwest (GTN):** A natural gas transmission pipeline originating at Kingsgate, Idaho, (Canadian/U.S. border) and terminating at the California/Oregon border close to Malin, Oregon.
- **TransCanada Alberta System (NGTL):** This natural gas gathering and transmission pipeline in Alberta, Canada, delivers natural gas into the TransCanada Foothills pipeline at the Alberta/British Columbia border.
- **TransCanada Foothills System:** This natural gas transmission pipeline delivers natural gas between the Alberta - British Columbia border and the Canadian/U.S. border at Kingsgate, Idaho.
- **TransCanada Tuscarora Gas Transmission:** This natural gas transmission pipeline originates at Malin, Oregon, and terminates at Wadsworth, Nevada.
- **Enbridge - Westcoast Pipeline:** This natural gas transmission pipeline originates at Fort Nelson, British Columbia, and terminates at the Canadian/U.S. border at Huntington, British Columbia/Sumas, Washington.
- **El Paso Natural Gas - Ruby pipeline:** This natural gas transmission pipeline brings supplies from the Rocky Mountain region of the U.S. to interconnections near Malin, Oregon.

Avista has contracts with all the above pipelines (with the exception of Ruby Pipeline) for firm transportation to serve core customers. Table 4.2 details the firm transportation/resource services contracted by Avista. These contracts are of different vintages with different expiration dates; however, all have the right to be renewed by Avista. This gives Avista and its customer’s available capacity to meet existing core demand now and in the future.

**Table 4.2: Firm Transportation Resources Contracted (Dth/Day)**

Firm Transportation	Avista North		Avista South	
	Winter	Summer	Winter	Summer
NWP TF-1	157,869	157,869	42,699	42,699
GTN T-1	100,605	75,782	42,260	20,640
NWP TF-2	91,200		2,623	
<b>Total</b>	<b>349,674</b>	<b>233,651</b>	<b>87,582</b>	<b>63,339</b>
<b>Firm Storage Resources - Max Deliverability</b>				
Jackson Prairie	346,667		54,623	

*\*Represents original contract amounts after releases expire*

Avista defines two categories of interstate pipeline capacity. Direct-connect pipelines deliver supplies directly to Avista’s local distribution system from production areas, storage facilities or interconnections with other pipelines. Upstream pipelines deliver natural gas to the direct-connect pipelines from remote production areas, market centers and out-of-area storage facilities. Firm Storage Resources - Max Deliverability is specifically tied to Avista’s withdrawal rights at the Jackson Prairie storage facility and is based on the Company’s one third ownership rights. This number only indicates how much Avista can withdraw from the facility, as transport on NWP is needed to move it from the facility itself. Figure 4.8 illustrates the direct-connect pipeline network relative to Avista’s supply sources and service territories.<sup>1</sup>

**Figure 4.8: Direct-Connect Pipelines**

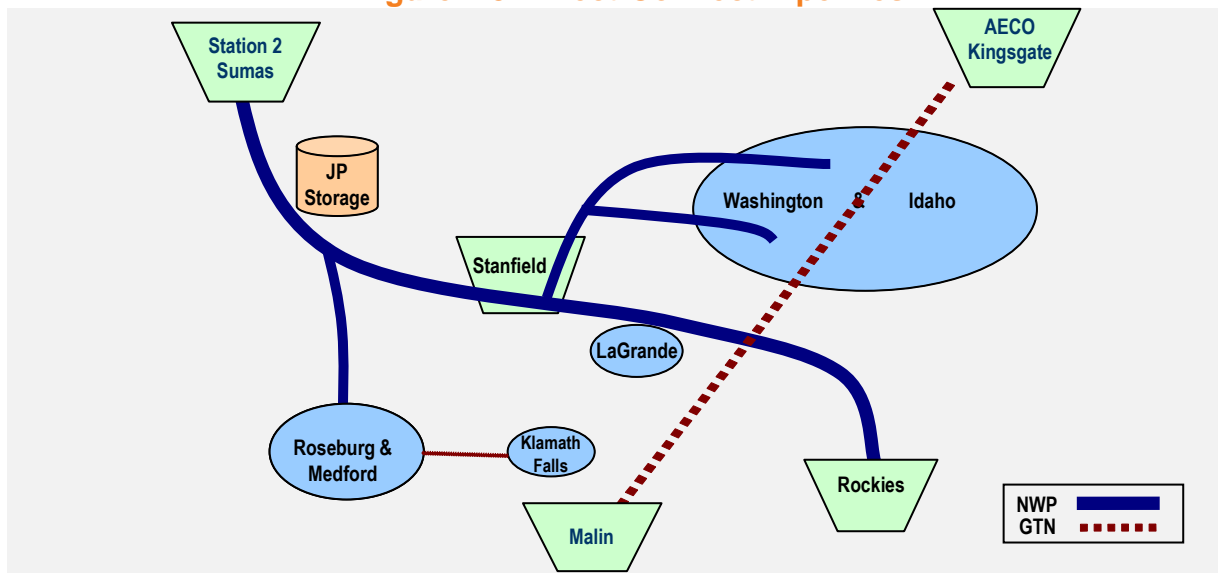

Supply-side resource decisions focus on where to purchase natural gas and how to deliver it to customers. Each LDC has distinct service territories and geography relative to supply sources and pipeline infrastructure. Solutions delivering supply to service territories among regional LDCs are similar but are rarely identical.

The NWP system is effectively a fully contracted pipeline. Except for La Grande, OR, Avista’s service territories lie at the end of NWP pipeline laterals. The Spokane, Coeur d’Alene, and Lewiston laterals serve Washington and Idaho load, and the Grants Pass lateral serves Roseburg and Medford. Capacity expansions of these laterals would be lengthy and costly endeavors resulting in Avista customers to likely bear most of the incremental costs.

<sup>1</sup> Avista has a small amount of pipeline capacity with TransCanada Tuscarora Gas Transmission, a natural gas transmission pipeline originating at Malin, Oregon, to service a small number of Oregon customers near the southern border of the state.

The GTN system, also fully contracted, runs from the Kingsgate trading point on the Idaho-Canadian border to Malin on the Oregon-California border. This pipeline runs directly through or near most of Avista's service territories. Mileage based rates provide an attractive option for securing incremental resource needs.

Peak day planning aside, both pipelines provide an array of options to flexibly manage daily operations. The NWP and GTN pipelines directly serve Avista's two largest service territories, providing diversification and risk mitigation with respect to supply source, price and reliability. NWP provides direct access to Rockies and British Columbia supplies and facilitates optionality for storage facility management. The Stanfield interconnect of the two lines is also geographically well situated to Avista's service territories.

The rates used in the planning model start with filed rates currently in effect (See Appendix 4.1 – Current Transportation/Storage Rates and Assumptions). Forecasting future pipeline rates is challenging. Assumptions for future rate changes are the result of market information on comparable pipeline projects, prior rate case experience, and informal discussions with regional pipeline owners. Pipelines will file to recover costs at rates equal to their cost of service.

NWP and GTN also offer interruptible transportation services. Interruptible transportation is subject to curtailment when pipeline capacity constraints limit the amount of natural gas that may be moved. Although the commodity cost per dekatherm transported is generally the same as firm transportation, there are no demand or reservation charges in these transportation contracts. Avista does not rely on interruptible capacity to meet peak day core demand requirements.

Avista's transportation acquisition strategy is to contract for firm transportation to serve core customers on a peak day in the planning horizon. Since contracts for pipeline capacity are often lengthy and core customer demand needs can vary over time, determining the appropriate level of firm transportation is a complex analysis. The analysis includes the projected number of firm customers and their expected annual and peak day demand, opportunities for future pipeline or storage expansions, and relative costs between pipelines and upstream supplies. This analysis is done on semi-annual basis and through the IRP. Active management of underutilized transportation capacity either through the capacity release market or engaging in optimization transactions to recover some transportation costs, keeps Avista's portfolio flexible while minimizing costs to customers. Timely analysis is also important to maintain an appropriate time cushion to allow for required lead times should the need for securing new capacity arise (See Chapter 6 for a description of the management of underutilized pipeline resources).

Avista manages existing resources through optimization to mitigate the costs incurred by customers until the resource is required to meet demand. The recovery of transportation costs is often market based with rules governed by FERC. The management of long- and short-term resources ensures the goal to meet firm customer demand in a reliable and

cost-effective manner. Unutilized resources like supply, transportation, storage and capacity can be combined to create products that capture more value than the individual pieces. Avista has structured long-term arrangements with other utilities allowing available resource's utilization and provide products that no individual component can satisfy. These products provide more cost recovery of the fixed charges incurred for the resources. Another strategy to mitigate transportation costs is to participate in the daily market to assess if any unutilized capacity has value. Avista seeks daily opportunities to purchase natural gas, transport it on existing unutilized capacity, and sell it into a higher priced market to capture the cost of the natural gas purchased and recover some pipeline charges. The recovery is market dependent and may or may not recover all pipeline costs but mitigates pipeline costs to customers.

## Storage Resources

Storage is a valuable strategic resource enabling Avista to manage seasonal and varied demand profiles. Storage benefits include:

- Flexibility to serve peak period needs;
- Access to typically lower cost off-peak supplies;
- Reduced need for higher cost annual firm transportation;
- Improved utilization of existing firm transportation via off-season storage injections;
- Additional supply point diversity.

While there are several storage facilities available in the region, Avista's existing storage resources consist solely of ownership and leasehold rights at the Jackson Prairie Storage facility. Avista optimizes storage as part of its asset management program. This helps to ensure a controlled cost mechanism is in place to manage the large supply found within the storage facility. An example of this storage optimization is selling today at a cash price and buying a forward month contract or selling between different forward months. Since forward months have risks or premiums built into the price the result is Avista locking in the spread. Storage optimization takes place while maintaining the peak day deliverability, at a not to exceed level, to plan for this cost-effective resource to serve customer needs. All optimization of assets directly reduce customers monthly billing.

### Jackson Prairie Storage (JP)

Avista is one-third owner, with Williams (NWP<sup>2</sup>) and Puget Sound Energy (PSE) of the Jackson Prairie Storage Project for the benefit of its core customers in all three states. Jackson Prairie Storage is an underground reservoir facility located near Chehalis, Washington approximately 30 miles south of Olympia, Washington. The total working natural gas capacity of the facility is approximately 25 Bcf. Avista's current share of this capacity for core customers is approximately 8.5 Bcf and includes 398,667 Dth of daily deliverability rights. Besides ownership rights, Avista leased an additional 95,565 Dth of

---

<sup>2</sup> Northwest Pipe

Jackson Prairie capacity with 2,623 Dth of deliverability from NWP to serve Oregon customers.

## Incremental Supply-Side Resource Options

Avista's existing portfolio of supply-side resources provides a mix of assets to manage demand requirements for average and peak day events. Avista monitors the following potential resource options to meet future requirements in anticipation of changing demand requirements. When considering or selecting a transportation resource, the appropriate natural gas supply pairs with the transportation resource and the PLEXOS® model prices the resources accordingly.

### Capacity Release Recall

Pipeline capacity not utilized to serve core customer demand is available to sell to other parties or optimized through daily or term transactions. Released capacity is generally marketed through a competitive bidding process and can be on a short-term (month-to-month) or long-term basis. Avista actively participates in the capacity release market with short-term and long-term capacity releases. Avista assesses the need to recall capacity or extend a release of capacity on an on-going basis. The IRP process evaluates if or when to recall some or all long-term releases.

### Existing Available Capacity

The GTN interconnection with the Ruby Pipeline provides GTN the physical capability to provide a limited amount of firm back-haul service from Malin with minor modifications to their system. Fees for utilizing this service are under the existing Firm Rate Schedule (FTS-1) and currently include no fuel charges. Additional requests for back-haul service may require additional facilities and compression (i.e., fuel).

This service can provide an interesting solution for Oregon customers. For example, Avista can purchase supplies at Malin, Oregon and transport those supplies to Klamath Falls or Medford. Malin-based natural gas supplies typically include a higher basis differential to AECO supplies but are generally less expensive than the cost of forward-haul transporting traditional supplies south and paying the associated demand charges. The GTN system is a mileage-based system, so Avista pays only a fraction of the rate if it is transporting supplies from Malin to Medford and Klamath Falls. The GTN system is approximately 612 miles long and the distance from Malin to the Medford lateral is only about 12 miles.

### In-Ground Storage

In-ground storage provides advantages when natural gas from storage can be delivered to Avista's city-gates. It enables deliveries of natural gas to customers during peak cold weather events. It also facilitates potentially lower-cost supply for customers by capturing peak/non-peak pricing differentials and potential arbitrage opportunities within individual months. Although additional storage can be a valuable resource, without deliverability to

Avista's service territory, this storage cannot be an incremental firm peak serving resource.

### **Jackson Prairie**

Jackson Prairie is a potential resource for expansion opportunities. Any future storage expansion capacity does not include transportation and therefore cannot be considered an incremental peak day resource. However, Avista will continue to look for exchange and transportation release opportunities to fully utilize these additional resource options. When an opportunity presents itself, Avista assesses the financial and reliability impact to customers. Due to the growth in the region, and the need for new resources, a future expansion is possible, though a robust analysis would be required to determine feasibility. Currently, there are no plans for immediate expansion of Jackson Prairie.

### **Other In-Ground Storage**

Other regional storage facilities exist and may be cost effective. Additional capacity at Northwest Natural's Mist facility, capacity at one of the Alberta area storage facilities, Questar's Clay Basin facility in northeast Utah, Ryckman Creek in Uinta County, Wyo., and northern California storage are all possibilities. Transportation to and from these facilities to Avista's service territories continues to be the largest impediment to these options. Avista will continue to look for exchange and transportation release opportunities while monitoring daily metrics of load, transport, and the market environment.

### **Compressed Natural Gas (CNG)**

CNG is another resource option for meeting demand peaks and is operationally similar to LNG. Natural gas could be compressed offsite and delivered to a distribution supply point or compressed locally at the distribution supply point if sufficient natural gas supply and power for compression is available during non-peak times.

### **Avista-Owned Liquefaction LNG**

Avista could construct a liquefaction LNG facility in the service area. Doing so could use excess transportation during off-peak periods to fill the facility, avoid tying up transportation during peak weather events, and it may avoid additional annual pipeline charges.

Construction would depend on regulatory and environmental approval as well as cost-effectiveness requirements. Preliminary estimates of the construction, environmental, right-of-way, legal, operating and maintenance, required lead times, and inventory costs indicate company-owned LNG facilities have significant development risks. Due to the changing direction in policy and fossil fuels, Avista did not model this resource in the current IRP.



## Alternative Fuel Supply Options

### Renewable Natural Gas (RNG)

Renewable Natural Gas, or biogas, typically refers to a mixture of gases produced by the biological breakdown of organic matter in the absence of oxygen. RNG can be produced by anaerobic digestion or fermentation of biodegradable materials such as woody biomass, manure or sewage, municipal waste, green waste, and energy crops. Depending on the type of RNG there are different factors to quantify methane saved by its capture as methane up to 34<sup>3</sup> times the greenhouse gas intensity as compared to carbon dioxide. Each type of RNG has a different carbon intensity as compared to natural gas as shown in Table 4.3.

**Table 4.3: Carbon Intensity<sup>4</sup>**

Source	Current Carbon Intensity (g CO <sub>2</sub> e/MJ)	Estimated Percent of Carbon reduction as compared to natural gas
Natural Gas	78.37	
Landfill	46.42	41%
Dairy	-276.24	-452%
Wastewater	19.34	75%
Solid Waste	-22.93	-129%

RNG is a renewable fuel, so it may qualify for renewable energy subsidies. Once processed, RNG can be used by boilers for heat, as power generation, compressed natural gas vehicles for transportation or directly injected into the natural gas grid. The further down this line, the greater the need for pipeline quality gas. Avista modeled RNG with the option to inject into JP rather than use in low demand months and will help with the intrinsic value compared to natural gas. Geography is also generic geographically as understanding exact location and instruments will be modeled in a detailed manner.

RNG projects are unique, so reliable cost estimates are difficult to obtain. However, Avista has released a Request For Proposal (RFP) for RNG resources in Q4 of 2022 and pricing will come into focus for environmental attributes or as a bundled product including both energy and the environmental attributes. Project sponsorship has many complex issues, and the more likely participation in such a project is as a long-term contracted purchaser. Avista considered biogas as a resource in this planning cycle and depending on the location of the facility it may be cost effective. This is especially the case when found within Avista's internal distribution system where transportation and fuel costs can be avoided. For more information about RNG and its potential uses in energy policy within Avista territories please see Chapter 5.

<sup>3</sup> <https://www.ipcc.ch/>

<sup>4</sup> California Air Resources Board

### RNG Program Considerations

As Avista prepares to move forward with RNG, some of the primary considerations given are as follows:

- Evaluate available RNG procurement options.
- Pursue potential RNG development opportunities from local RNG feedstock resources under new legislation (Washington House Bill 1257 & Oregon Senate Bill 98).
- Develop an understanding of RNG development cost, cost recovery impacts to customers, resulting supply volumes and RNG costs.
- Evaluate potential RNG customer market demands vs. supply.
- Participation in RNG rule making and policy determinations, such as:
  - Participation in House Bill 1257 Policy development.
  - Participation in Senate Bill 98 Policy Rulemaking via OPUC Docket AR 632 informal and formal.
- Cost recovery proposal led by NWGA with input from all four Washington LDC's.
- Collaborative RNG Gas Quality Framework established across four Washington LDC's.

### Utility RNG Projects

Fuel feedstocks are not always readily available nor are feedstock owners who are willing to partner with an LDC to develop renewable natural gas. Even with potential willing feedstock partners, Avista recognizes many practical complexities associated with developing RNG projects as well as the many benefits. The following examples are based on what the Company has learned during its business development efforts;

- Legislation allows LDC's to invest in RNG infrastructure projects with feedstock partners.
- LDC's are credit worthy partners offering long term off-take contracts to feedstock owners.
- Each RNG project is unique with respect to capital development costs & resulting RNG costs.
- Each RNG project will vary in size, location, and distance to interconnection pipeline, feedstock type, gas conditioning equipment and requirements, and operating costs.
- Low volume biogas opportunities face economic challenges because of economies of scale.
- The utility cost of service model is typically a foreign concept to feedstock owners, requiring an educational process to get them comfortable.
- Feedstock owners over-valuing their biogas can degrade project economics.
- New RNG Projects can take three to four years to develop given myriad factors. A new RNG project is a multi-year endeavor involving the usual phases expected for major capital construction projects, coupled with many first ever discussions between the utility and the feedstock owner, a new regulatory process and

program requirements, the identification of customer cost impacts, environmental benefits, and the tracking process just to name a few.

- Customers have paid for pipeline infrastructure that can be utilized for a cleaner future by transitioning to cleaner fuel and keeping the pipeline infrastructure.

## Project Evaluation - Build or Buy

Avista recognizes the two primary options to procure RNG; build RNG project(s) or buy RNG. In the build scenario, new RNG facilities are developed, and the costs are recovered through the General Rate Case. Avista can also buy RNG from other RNG producers and pass the costs through the Gas Purchase Adjustment (GPA).

### Build

Both Oregon's Senate Bill 98 and Washington's House Bill 1257 are focused on decarbonization and support the development of new RNG infrastructure and resources by allowing LDC's to build RNG resources and deliver the RNG. Also, local projects contribute to improved local air quality, and support the local economy during construction and operations.

Naturally, feedstock biogas royalties are expected to be a key factor in project economics, as well as operating costs including power, conditioning equipment type, interconnection pipeline distance and cost. Since utilities companies are institutional credit worthy partners with the ability to be a long term off-taker for biogas, it is expected these types of build arrangements will be desirable with feedstock owners, and long-term arrangements will temper biogas royalty pricing.

### Buy

Competition for environmental attributes pits utility companies against the transportation sector for credits such as the LCFS<sup>5</sup> and RIN<sup>6</sup> markets. These markets create a cost competition for producers where selling RNG volumes into these markets can be lucrative yet risky if markets for these credits move lower than expected.

At Avista, the voluntary RNG program demands will likely have limited volume requirements and be short-term in nature. Since a short-term, low-volume off-take purchase scenario is unlikely to be attractive to producers typically seeking long-term off-take agreements, the expectation is higher RNG costs. Given the nature of this temporary interim situation, a short-term voluntary pilot program in which off-take volumes may be procured from a local producer with excess supply, at a negotiated price may be advantageous.

This strategy allows Avista to ramp-up and learn more about the demand from its voluntary RNG program in the near-term, while minimizing risk until the Company can

---

<sup>5</sup> <https://ww2.arb.ca.gov/our-work/programs/low-carbon-fuel-standard>

<sup>6</sup> <https://www.epa.gov/renewable-fuel-standard-program/renewable-identification-numbers-rins-under-renewable-fuel-standard>

supply RNG under a longer-term purchase at a lower price. Figure 4.9 illustrates the number of participants by state in Avista’s voluntary RNG program, as of November 2022

**Figure 4.9: Participants by State**

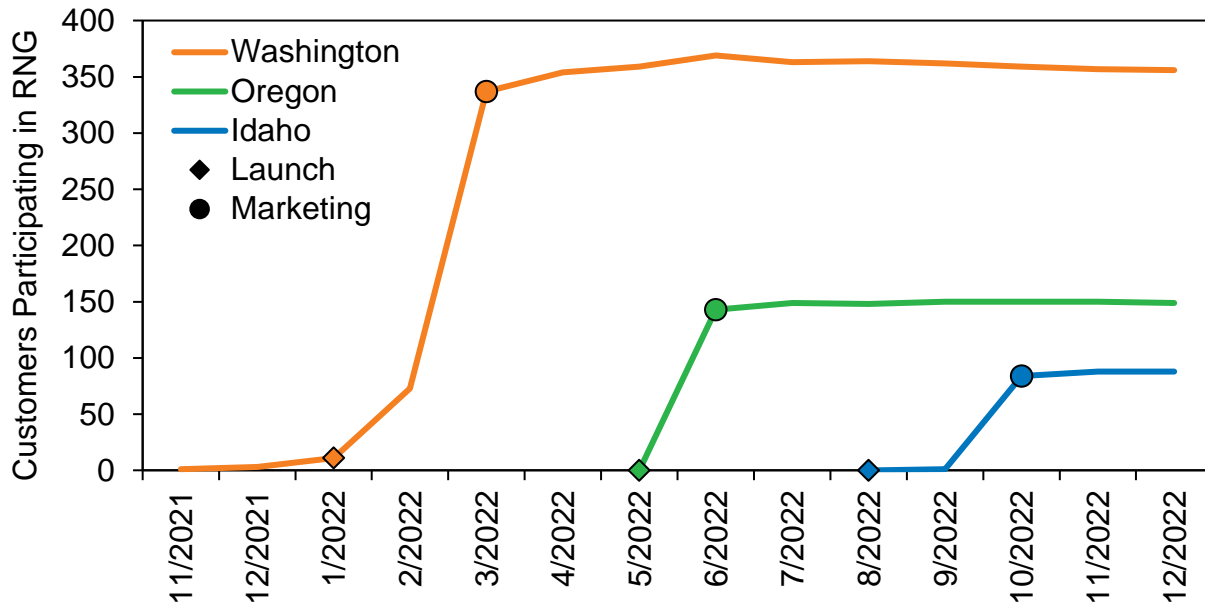

**Cost Effective Evaluation Methodology**

Avista’s methodology utilizes costs for projects on a levelized basis as compared to other resources as found in the Plexos model for the IRP. Incorporating just the attribute of RNG requires a pairing with the energy such as brown gas or gas that has no associated environmental attribute. To date, the methodology shown is derived from OPUC Docket UM2030, also referenced in the OPUC Senate Bill 98 rulemaking as described in Chapter 5. The evaluation method shown herein is subject to input, refinement, and reconsideration (Figure 4.10 and Figure 4.11). In-depth descriptions of the calculations and components used in the Avista Renewable Resource Development and Procurement Decision Tree are in Appendix 5.

Figure 4.10: Avista RNG Development and Procurement Decision Tree – Part 1<sup>7</sup>

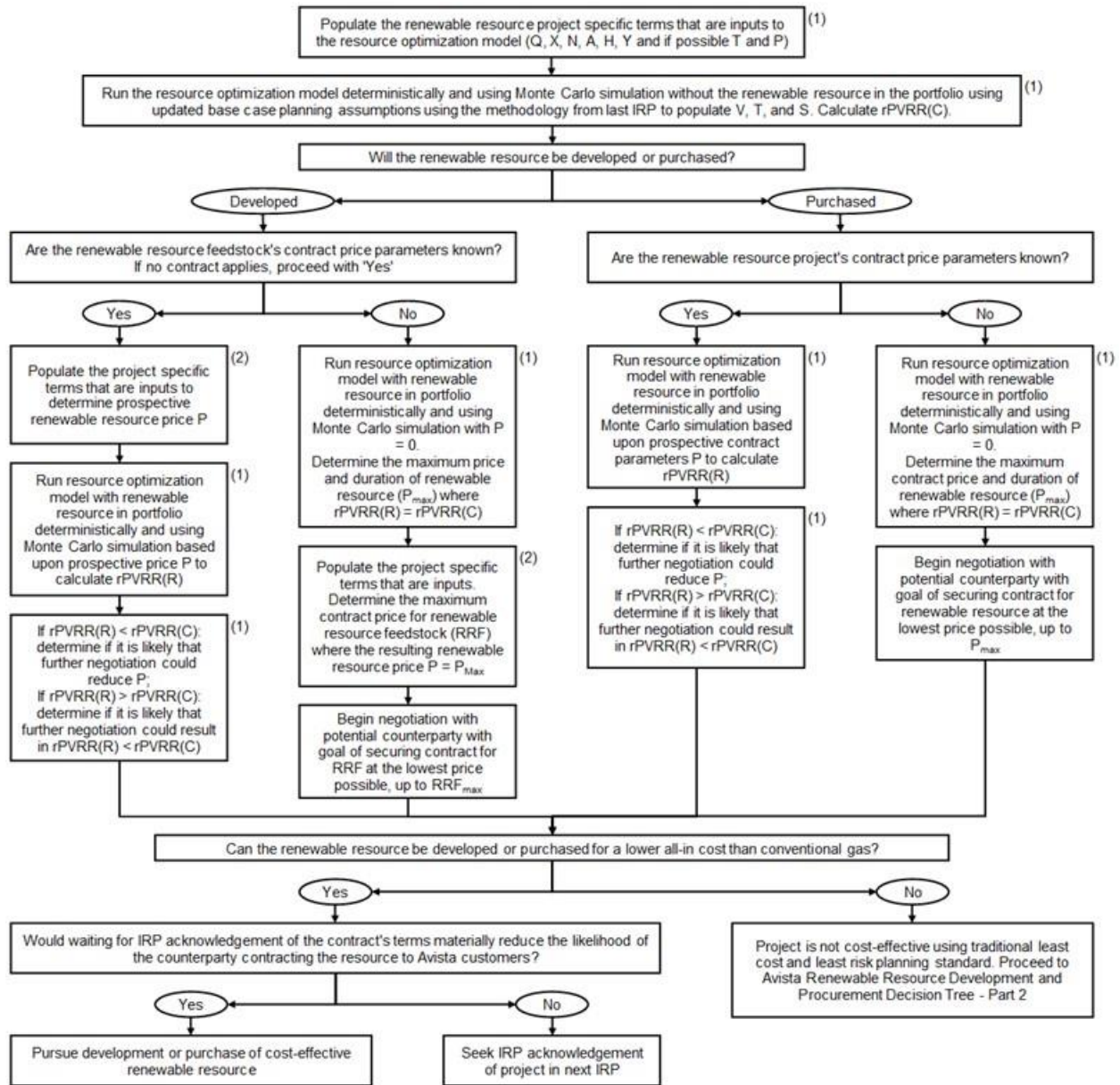

(1) Avista Renewable Resource Least Cost/Least Risk Evaluation Criteria and Calculations  
 (2) Avista Renewable Resource Project Revenue Requirement Model

7 The Avista Renewable Resource Development and Procurement Decision Tree described above is a work in progress and is subject to change at any time.

Figure 4.11: Avista RNG Development and Procurement Decision Tree – Part 2

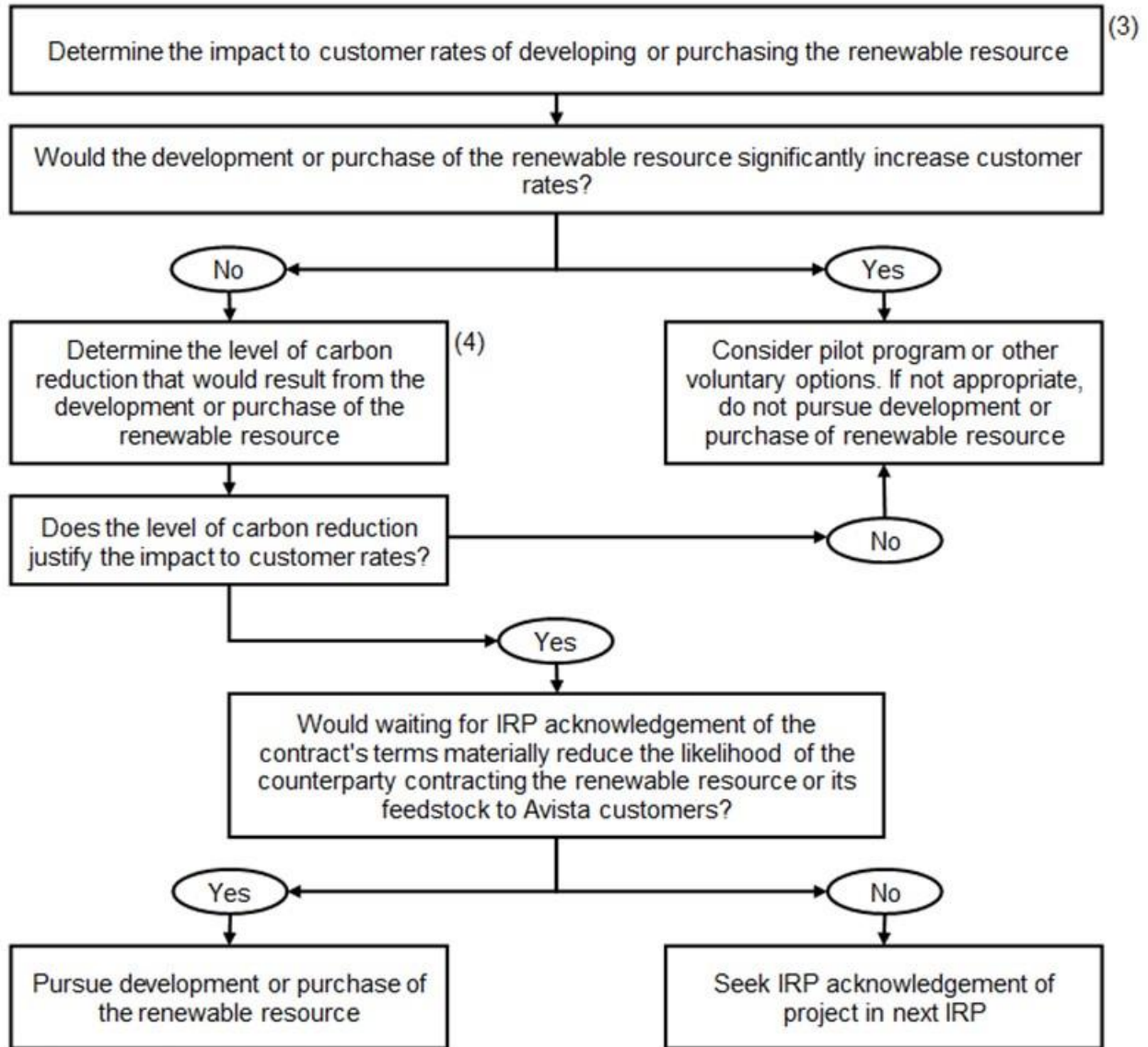

(3) Avista Renewable Resource Project Rate Impact Analysis

(4) Avista Renewable Resource Project Carbon Reduction Calculation

### Environmental Attribute Tracking

Oregon Senate Bill 98 specifies M-RETS<sup>8</sup> as the third-party entity designated to manage environmental attribute tracking and banking for RNG. M-RETS will utilize a proprietary transparent electronic certificate tracking system where one renewable thermal certificate (RTC) is equal to one dekatherm (Dth) of RNG. Given the Oregon requirement, and in lieu of contracting with another vendor for the tracking and banking of Washington environmental attributes, Avista will likely use M-RETS for Washington RNG attributes.

The California RNG market will continue to be a major demand for renewable resources due to the low carbon fuel standard (LCFS) in addition to the federal Renewable Identification Number (RIN)<sup>9</sup> market. These incentives can drive the value of these specific renewable resource attributes to many multiples of conventional natural gas prices. While the market has volatility based on demand, the primary issue of bringing additional projects into the market are based on the unknowns as it related to the market itself. There are currently no forward prices for these renewable credits and the environmental attribute value for local markets is unidentified. These are some of the major obstacles potential producers may encounter when looking for financing of their projects.

A potential solution to some of these unknowns in the market is through utility RNG projects. Feedstock owners would now be able to partner with LDC's to cultivate new RNG projects. Financing becomes less of an issue as most LDC's are credit worthy and can provide a measure of certainty with long term offtake agreements.

Developing a generic cost for RNG based on feedstock will require several assumptions as each specific RNG project will have its own capital development costs. Each RNG project will vary in size, location, and distance to interconnection with the pipeline, feedstock type, gas conditioning equipment and requirements and operating costs. In general terms, new RNG projects can take two to three years to develop depending on project size and scope.

RNG costs can deviate greatly by source, location, and capital costs. These RNG costs are considered by research done for Avista by Black and Veach. This paper considers cost estimates for averages by RNG type and Hydrogen project size. RNG is considered an option at increments of twenty environmental attributes known as Renewable Thermal Credits in the PLEXOS model. To bridge the gap between ownership or purchasing from a producer, it was made available in the model to assume a quantity taken in a given year carries forward thru the end of the study. Price estimates are illustrated in Figure 4.12 and assume both the RTC and brown gas as a bundled price. It should be noted that RTCs can be purchased separately from the energy. The current RFP should help value RTCs compared with a bundled product.

---

<sup>8</sup> <https://www.mrets.org/>

<sup>9</sup> <https://www.epa.gov/renewable-fuel-standard-program/renewable-identification-numbers-rins-under-renewable-fuel-standard>

Figure 4.12: RNG Price by Source (nominal \$)

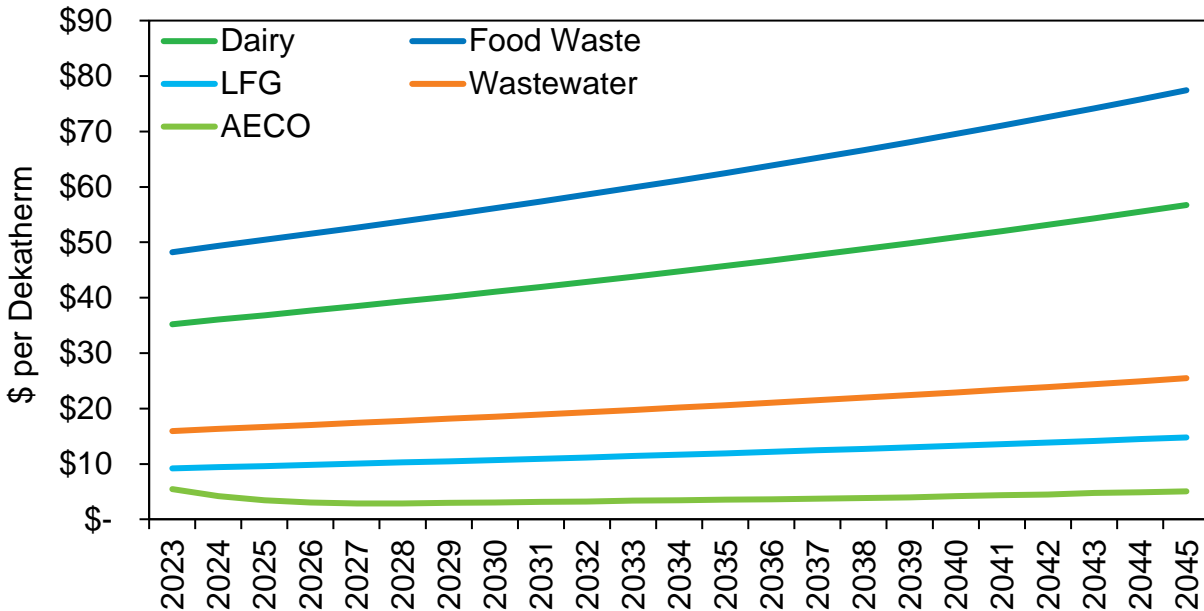

### Hydrogen

Hydrogen (H<sub>2</sub>) is a fuel source with a long history and a great potential to help solve future energy needs. Its energy factor, as measured in a kilogram (kg) of low heating value (LHV), is roughly equivalent to a gallon of gasoline. Hydrogen can be made from any energy source including nuclear (pink H<sub>2</sub>) and electric renewables (green H<sub>2</sub>). With expanding renewable electricity production, the ability to create green H<sub>2</sub> from this energy is moving from concept to market throughout the world. Some drawbacks to hydrogen include needing 3 times the volume to provide the same energy as natural gas. With a maximum blend rate in the pipelines assumed at 20%<sup>10</sup>, the energy blend can reduce current pipeline capacity. Hydrogen can also impact functionality of appliances and end uses based on the ability to contain the lightest element on earth combined with less energy delivered on a cubic foot basis when compared to natural gas. This process of using power to separate water into hydrogen and oxygen is known as power to gas through electrolysis and can provide energy storage, a critical piece to electric grid decarbonization yet to be developed on a large enough or cost-effective scale. Most hydrogen is currently made by reforming natural gas, also known as grey H<sub>2</sub> as shown in Figure 4.13. Further, implications for demand from highly intensive processes altering the availability of supply have not been studied at this time.

<sup>10</sup> <https://www.prnewswire.com/news-releases/socalgas-among-first-in-the-nation-to-test-hydrogen-blending-in-real-world-infrastructure-and-appliances-in-closed-loop-system-301389186.html>



**Figure 4.13: Production Types of Hydrogen:**

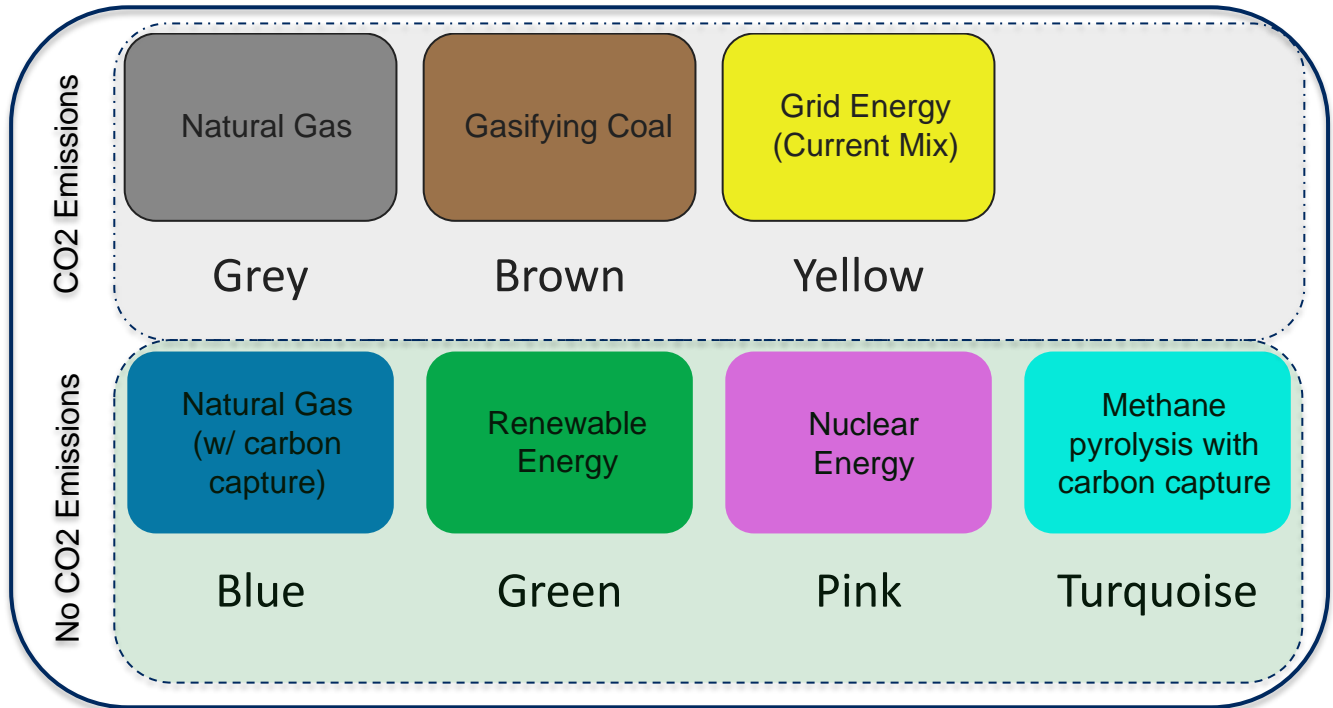

The high cost of hydrogen has been the primary barrier to an accelerated use and adoption. Maturation of these technologies is assumed based on the federal policy known as Inflation Reduction Act (IRA) and other potential state and county policy. Cost estimates include a reduction from these renewable energy technologies as seen in wind and solar<sup>11</sup>. Incentives from the IRA are assumed in these costs at a full level of \$3 per kg of green hydrogen. Further details of the IRA are discussed in Chapter 5. Several studies<sup>12</sup> were considered to value the cost of green hydrogen in the model as depicted in Figure 4.14. These costs are assumed to be located at or near load centers in Avista owned distribution.

<sup>11</sup> <https://www.lazard.com/perspective/levelized-cost-of-energy-levelized-cost-of-storage-and-levelized-cost-of-hydrogen/>

<sup>12</sup> Lazard, Black & Veatch, Bloomberg

**Figure 4.14: Green Hydrogen Cost Estimates**

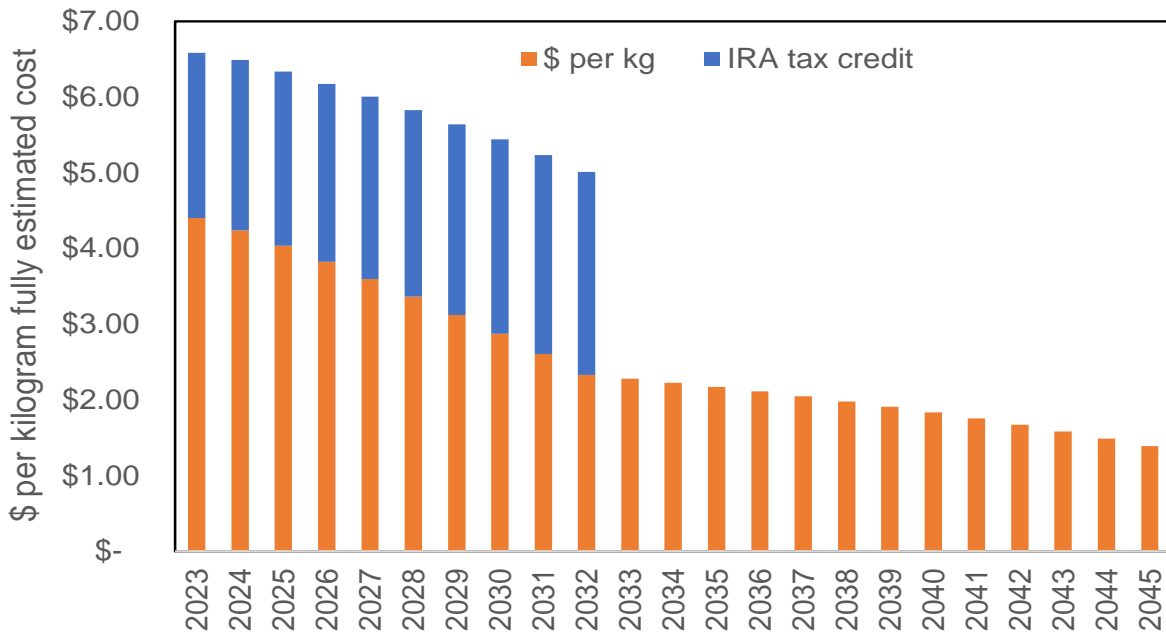

### Synthetic Methane

Synthetic methane is a fuel beginning to come into focus as an option for cleaner supply side resources. This fuel can be used in the current natural gas system infrastructure without any upgrades or alterations as it is, in essence, natural gas. The process would use a form of carbon capture either directly from the air or from waste and combines green hydrogen and reacted to create synthetic methane. The potential for new sources of grants, loans, or funds from programs such as the CCA, CPP or IRA should help drive the costs of these sources further down as seen in solar and wind projects over the past 30 years. The potential size of this resource is limited to the quantify of hydrogen available, a carbon source, and cost. Depending on if those elements are available, the economic synthetic methane has the potential to supply a 1:1 conversion from the natural gas from fossil sources. This fuel can also help bridge the gap for excess electricity and act as a storage of energy to a period of higher demand. Carbon capture costs are estimated between \$94 and \$414 per MTCO<sub>2</sub>e depending on source and technology<sup>13</sup>. Green hydrogen costs are discussed above and provide the energy portion of synthetic methane. Synthetic methane is a combination of green hydrogen and carbon capture costs per dekatherm. Cost estimates for synthetic methane are included in Figure 4.15. Finally, a summary of all new resource options is illustrated in Table 4.4.

<sup>13</sup> Science Direct, Science Daily

**Figure 4.15: Synthetic Methane cost estimates**

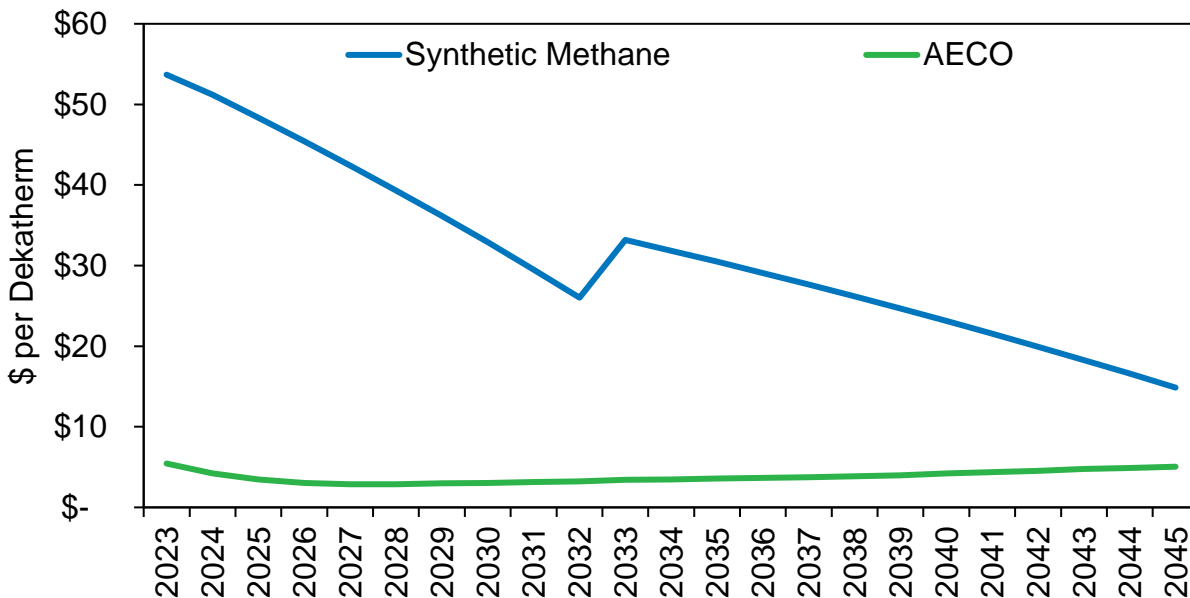

**Table 4.4: All resource price comparison \$/Dth**

Year	Hydrogen	Dairy	Food Waste	LFG	Wastewater	Synthetic Methane	AECO
2025	\$35.43	\$36.84	\$50.43	\$9.62	\$16.68	\$48.35	\$3.43
2030	\$25.20	\$41.05	\$56.15	\$10.72	\$18.54	\$32.90	\$3.03
2035	\$19.05	\$45.72	\$62.49	\$11.93	\$20.60	\$30.48	\$3.55
2040	\$16.09	\$50.92	\$69.56	\$13.28	\$22.91	\$23.13	\$4.19
2045	\$12.19	\$56.71	\$77.43	\$14.79	\$25.47	\$14.84	\$5.05

**Alternative Fuel Supply Price Risk**

While weather is an important driver for the IRP, price is also important. As seen in recent years, significant price volatility can affect the portfolio. In deterministic modeling, a single price curve for each scenario is used for analysis. There is risk that the price curve in the scenario will not reflect actual results.

Avista used Monte Carlo simulation to test the portfolio and quantify the risk to customers when prices do not materialize as forecast. Avista performed a simulation of 500 draws, varying prices, to investigate whether the PRS Case total portfolio costs from the deterministic analysis is within the range of occurrences in the stochastic analysis. This simulation of prices is done for natural gas, RNG by anaerobic production type (dairy, landfill, solid waste, and waste water), hydrogen and synthetic methane. Figure 4.16 to Figure 4.21 show the average yearly price per dekatherm, per draw and resource, for each of the 500 draws. Statistics are also provided with each histogram and represent the raw data results.

Figure 4.16: RNG Landfill RNG - \$ per Dth (500 Draws)

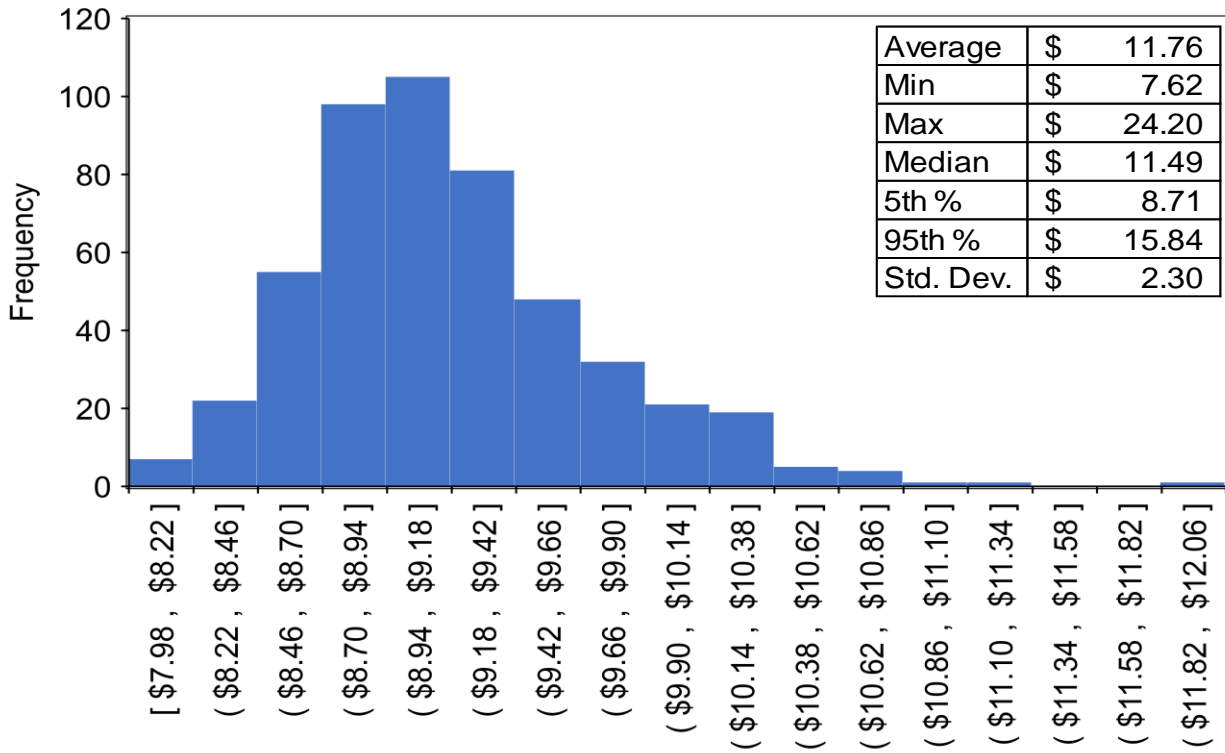

**Figure 4.17: Dairy RNG - \$ per Dth (500 Draws)**

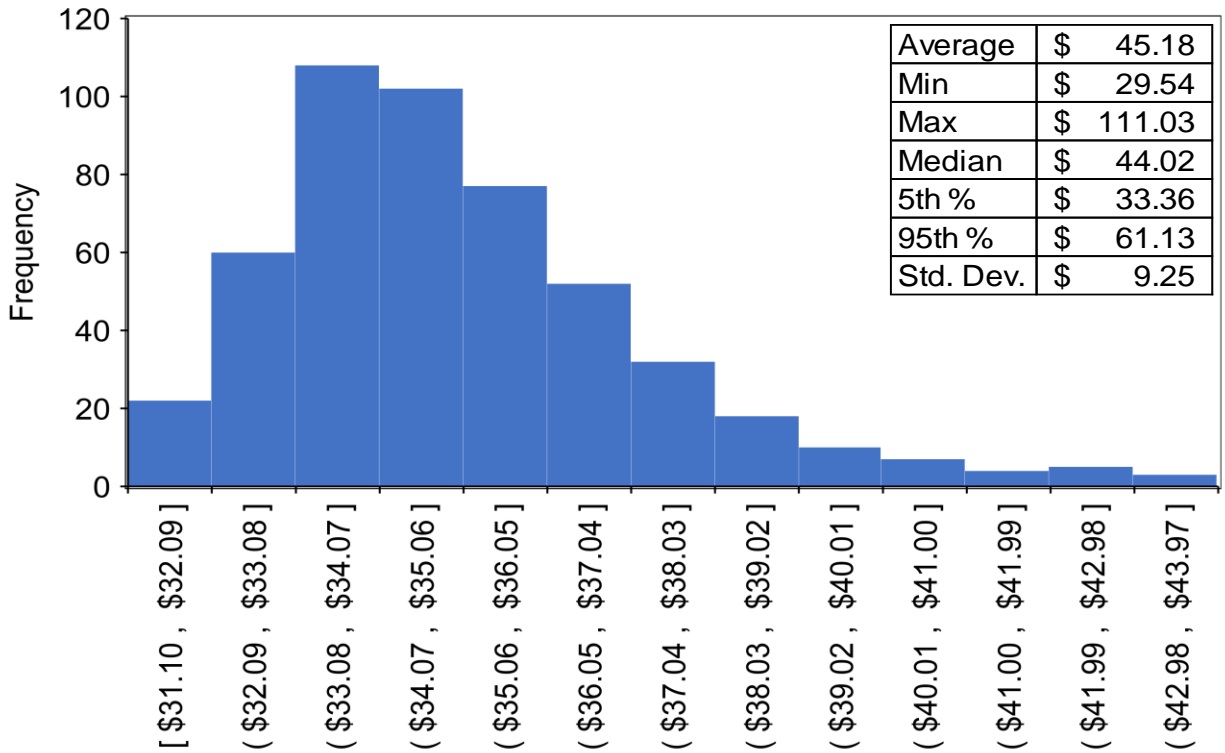

**Figure 4.18: Food Waste RNG - \$ per Dth (500 Draws)**

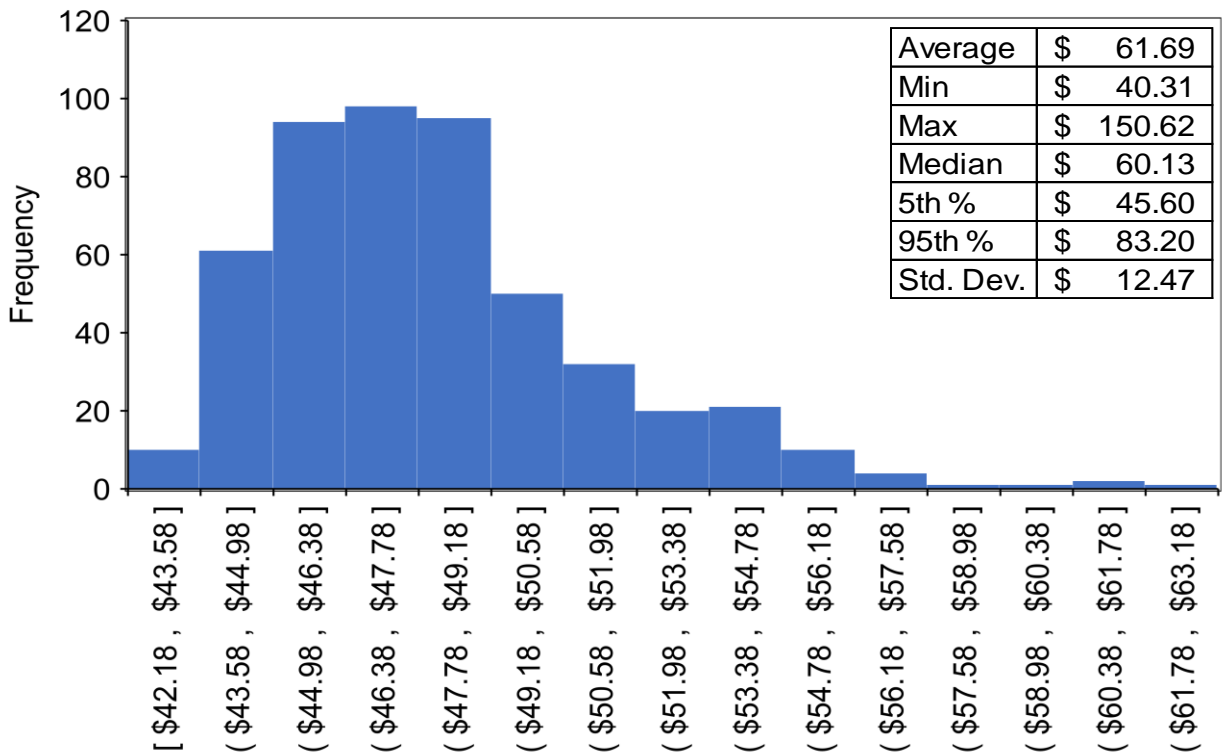

Figure 4.19: Wastewater Treatment RNG - \$ per Dth (500 Draws)

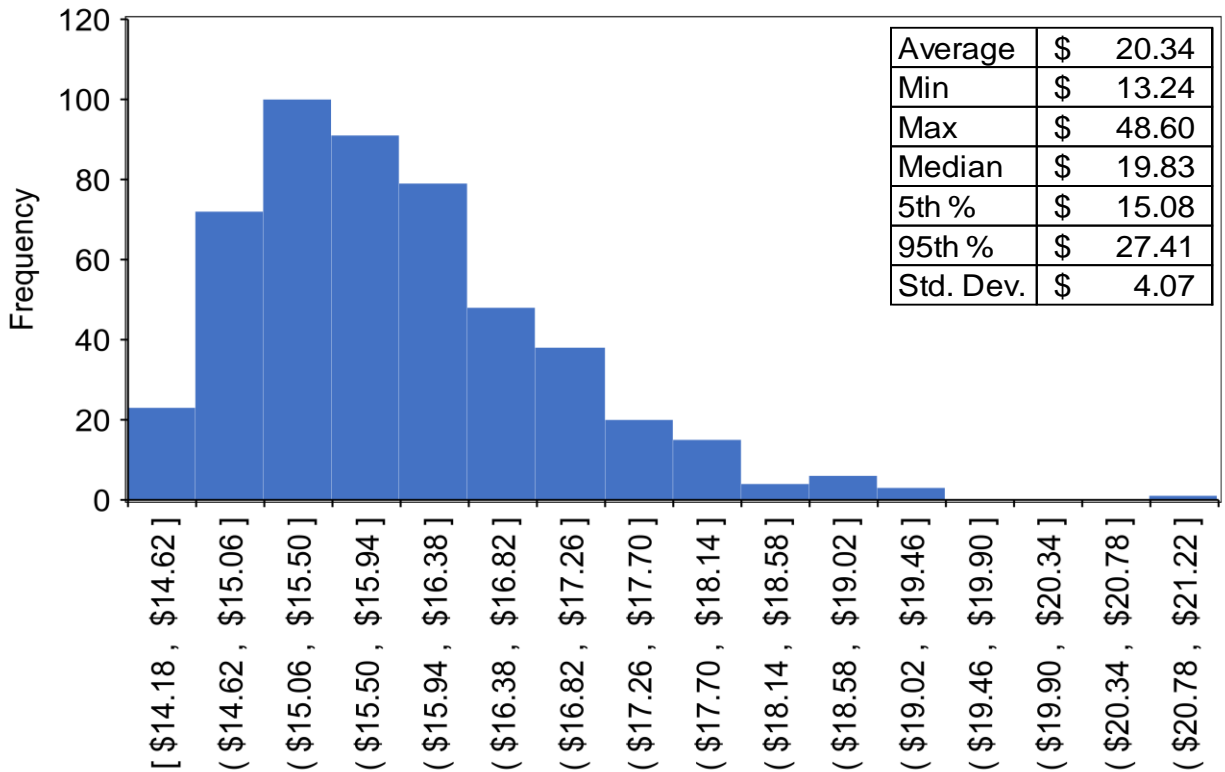
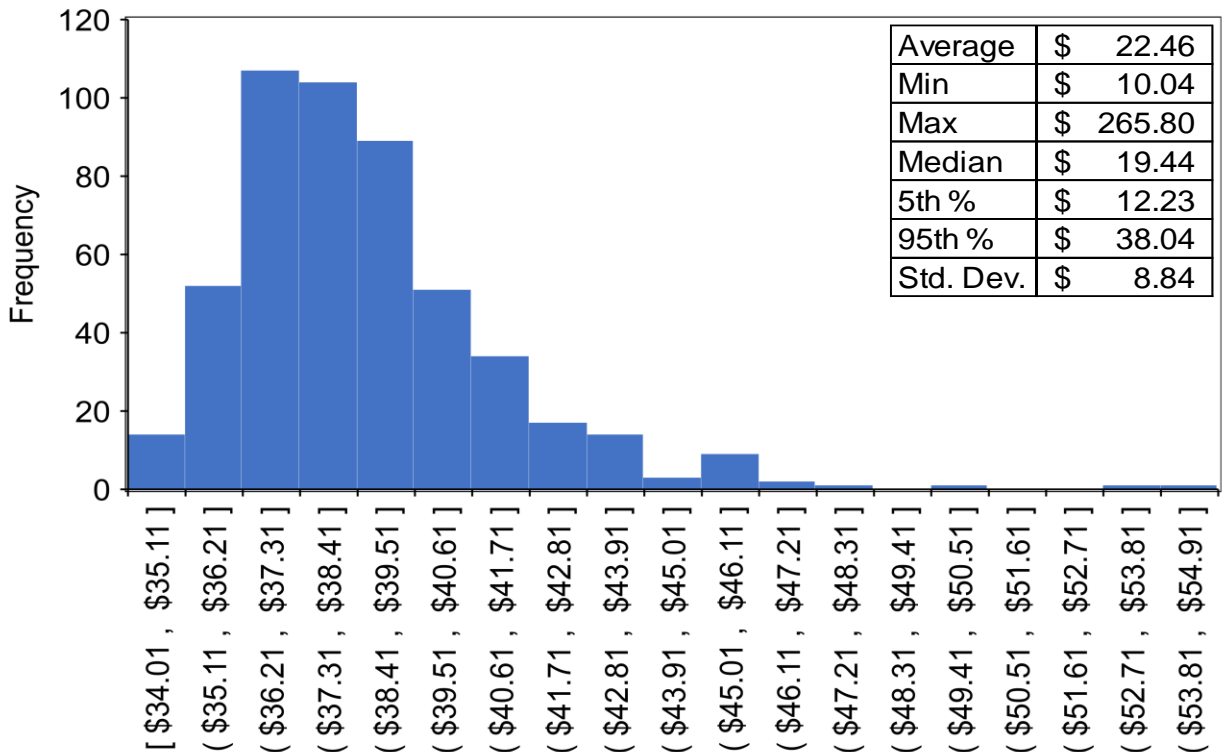
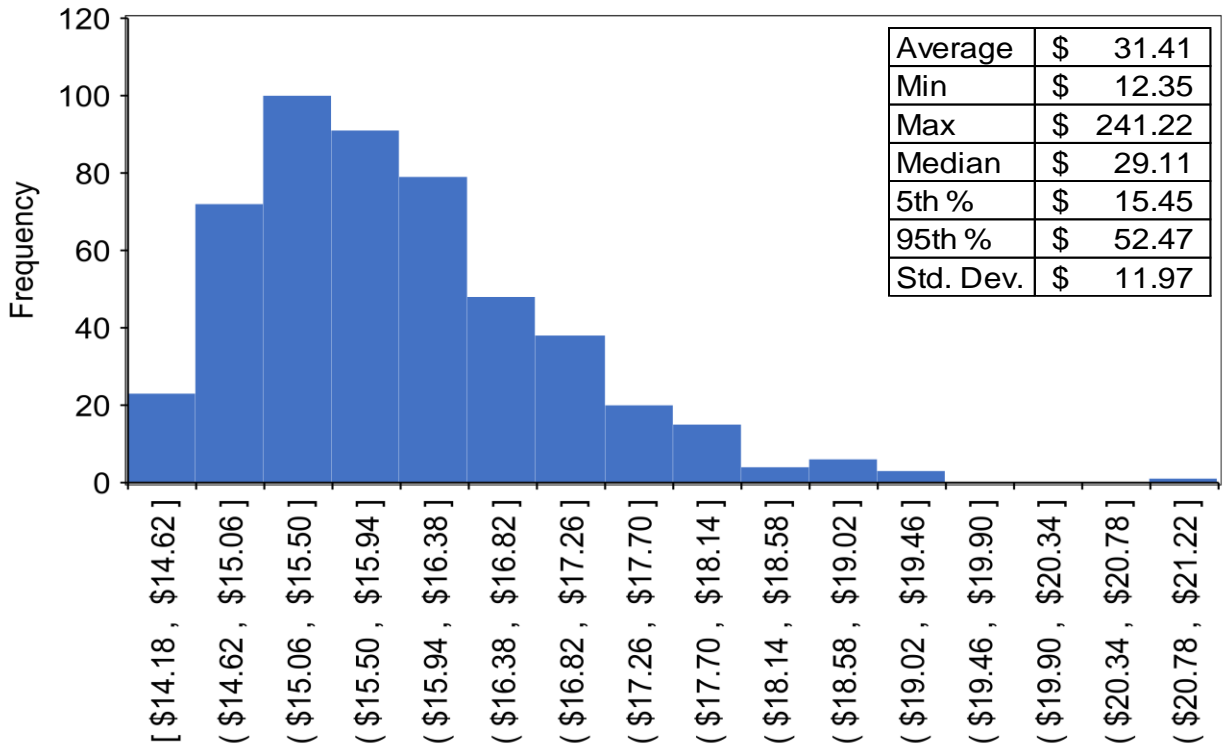

Figure 4.20: Hydrogen (500 Draws)



**Figure 4.21: Synthetic Methane - \$ per Dth (500 Draws)**



### Avista’s Natural Gas Procurement Plan

Avista’s foundational purpose/goal of the natural gas procurement plan is to provide a diversified portfolio of reliable supply while at the same time managing cost volatility. Avista manages the procurement plan by layering in purchases over time based on expected demand per month. Avista does not measure the success of this plan based on a certain cost or loss risk, rather it is considered successful when Avista has secured firm load at a reasonable price while addressing risk inherent within these markets. The measurable objectives monitored toward this goal include a daily financial position of the overall portfolio, tracking of all new and previously transacted hedges, and the tracking of remaining hedges yet to be purchased based on a percentage of forecasted load as specified in the procurement plan.

No company can accurately predict future natural gas prices, however, market conditions and experience help shape Avista’s overall approach to natural gas procurement. The Avista procurement plan seeks to acquire natural gas supplies while reducing exposure to short-term price and load volatility. This is done by utilizing a combination of strategies to reduce the impacts of changing natural gas prices in a volatile market. A portion of hedges will be focused on the concentration risk of fixed-price natural gas purchases by utilizing Hedge Windows, and another portion of hedges will target reducing risk in a volatile market by utilizing Risk Responsive methods. This allows Avista to set a risk level to help reduce exposure to events outside of our control such as the Energy Crisis in the

early 2000's or the Enbridge pipeline rupture in 2018 or most recently the COVID-19 pandemic and the oil price collapse.

Hedge transactions may be executed for a period of one-month through thirty-six months prior to delivery period and are for the Local Distribution Customer (LDC) only. Due to Avista's geographic location, transactions may be executed at different supply basins in order to reduce our overall portfolio risk. This procurement plan is disciplined, yet flexible, allowing for modifications due to changing market conditions, demand, resource availability, or other opportunities. Should economic or other factors warrant, any material changes are communicated to senior management and Commission Staff.

In addition to hedges, the Company's procurement plan includes storage utilization and daily/monthly index purchases. It is diversified through time, location, and counterparty in accordance with Risk Management credit terms.

## **Market-Related Risks and Risk Management**

There are several types of risk and approaches to risk management. The 2023 IRP focuses on three areas of risk: the financial risk of the cost of natural gas system fuel options to supply customers will be unreasonably high or volatile, emissions compliance cost and options in Oregon and Washington and the physical risk that there may not be enough natural gas system resources (either transportation capacity or the commodity) to serve core customers.

Avista's Risk Management Policy describes the policies and procedures associated with financial and physical risk management. The Risk Management Policy addresses issues related to management oversight and responsibilities, internal reporting requirements, documentation and transaction tracking, and credit risk.

Two internal organizations assist in the establishment, reporting and review of Avista's business activities as they relate to management of natural gas business risks:

- The Risk Management Committee includes corporate officers and senior-level management. The committee establishes the Risk Management Policy and monitors compliance. They receive regular reports on natural gas activity and meet regularly to discuss market conditions, hedging activity and other natural gas-related matters.
- The Strategic Oversight Group coordinates natural gas matters among internal natural gas-related stakeholders and serves as a reference/sounding board for strategic decisions, including hedges, made by the Natural Gas Supply department. Members include representatives from the Gas Supply, Accounting, Regulatory, Credit, Power Resources, and Risk Management departments. While the Natural Gas Supply department is responsible for implementing hedge transactions, the Strategic Oversight Group provides input and advice.



### Strategic Initiatives

Strategic Initiatives are generally defined as the means a vision is translated into practice. These initiatives are a group of projects and programs that are outside of the organizations daily operational activities and help an organization achieve a targeted performance.

The two primary roles of the Energy Resources Department (including Natural Gas Supply) is now two-fold:

- Serve Load – Assure adequate and reliable energy supplies for Avista Utilities natural gas customers.
- Manage Resources – Exercise prudent stewardship of Avista Utilities energy supply facilities and related Company resources.

A thorough review and filing is done annually by Avista for a retrospective hedging report submitted to the Washington Utilities and Transportation Commission<sup>14</sup> (2022 filing UG-220670). This report provides a detailed summary of current plan elements and performance over the past year and is filed along with a tariff revision filing of the annual PGA rates.

---

<sup>14</sup> <https://apiproxy.utc.wa.gov/cases/GetDocument?docID=5&year=2022&docketNumber=220670>

## 5. Policy Issues

Regulatory environments regarding energy topics such as renewable energy, carbon reduction, carbon intensity, and greenhouse gas regulation continue to evolve since publication of the last IRP. Current and proposed regulations by federal and state agencies, coupled with political and legal efforts, have implications for the reduction of carbon in the natural gas stream. Avista is challenged with trying to balance Affordability, Reliability, and the Environment with its resource planning solution.



### Avista's Environmental Objective

Avista has always been on the forefront of clean energy and innovation. Founded on clean, renewable hydro power on the banks of the Spokane River, Avista has maintained an electric generation portfolio with more than half the generation from renewable resources, while continuously making investments in new renewable energy, advancing the efficient use of electricity and natural gas, and driving technology innovation that has enabled and will continue to become the platform and gateway to a clean energy future.

### Environmental Issues

The evolving and sometimes contradictory nature of environmental regulation from state and federal perspectives creates challenges for resource planning. The IRP cannot add renewables or reduce emissions in isolation from topics such as system reliability, least cost requirements, price mitigation, financial risk management, and meeting changing environmental requirements. All resource choices have costs and benefits requiring careful consideration of the utility and customer needs being fulfilled, their location, and the regulatory and policy environment at the time of procurement.

### Natural Gas Greenhouse Gas System Emissions

System emissions include any emission found upstream of the point of combustion and includes production, processing, transmission, and equipment. This designation becomes important when placing a tax or cost of emissions on the price per MMBtu. Avista

assumes these emissions are measured at the standard 100-year Global Warming Potential (GWP) meaning a 34 multiplier of methane from natural gas for the same mass of carbon dioxide. The levels of upstream emissions in this plan are determined by production region, specifically in Canada and the Rockies in the United States and multiplied by the associated emissions estimate.

Avista assumes a 0.77% upstream emissions rate for Canadian production<sup>1</sup> and 1.0% rate from the Rockies as calculated in the EIA sinks and emissions estimates. Over the past five years, nearly 90% of Avista's natural gas was sourced from Canadian production leaving roughly 10% of estimated upstream emissions to the Rockies region. The EIA upstream emissions estimate<sup>2</sup> is updated on a yearly basis and will show gains and losses as they occur as compared to a point in time study. These upstream emissions are included in the Carbon Intensity and Social Cost of Carbon scenarios as emissions in Oregon and Washington are governed and valued against the CPP and CCA respectively other than for energy efficiency as explained in Chapter 3.

The final upstream emissions from methane (CH<sub>4</sub>) in carbon equivalents add nearly 10.66 pounds per MMBtu as shown in Table 5.1:

**Table 5.1: Avista Specific LDC Natural Gas Emissions**

Combustion	Avista Specific Natural Gas	
	lbs. GHG/MMBtu	lbs. CO <sub>2</sub> e/MMBtu
CO <sub>2</sub>	116.88	116.88
CH <sub>4</sub>	0.0022	0.0748
N <sub>2</sub> O	0.0022	0.6556
Total Combustion		117.61
<b>Upstream</b>		
CH <sub>4</sub>	0.313406851	10.66
<b>Total</b>		<b>128.27</b>

Table 5.2 illustrates the Global Warming Potential; the Intergovernmental Panel on Climate Change released their 5<sup>th</sup> assessment study defining these impacts to global warming in units of CO<sub>2</sub>e.

**Table 5.2: Global Warming Potential (GWP) in CO<sub>2</sub> Equivalent<sup>3</sup>**

Greenhouse Gas	GWP – 100 Year	GWP – 20 Year
CO <sub>2</sub>	1	1
CH <sub>4</sub>	34	86
N <sub>2</sub> O	298	268

<sup>1</sup> as calculated in a study for the Tacoma LNG project

<sup>2</sup> Inventory of U.S. Greenhouse Gas Emissions and Sinks | Greenhouse Gas (GHG) Emissions | US EPA

<sup>3</sup> From the 5th Assessment of the Intergovernmental Panel on Climate Change

## Local Distribution Pipeline Emissions - Methane Study

In a study led by Washington State University (WSU) and sponsored by the Environmental Defense Fund (EDF) and others, an estimate of utility pipeline distribution systems leakage found the overall levels of leakage were around 0.1% to 0.2% of methane delivered nationwide. The study goes on to state the Eastern regions of the United States contribute much more methane to the total as compared to the Western regions, where Western regions account for only 5% of total emissions. The study theorizes eastern US system's older infrastructure and material types are the likely culprit, but also goes on to attribute regulations and better infrastructure and monitoring by utilities for these decreased Western emissions. It found that "out of 230 measurements, three large leaks accounted for 50 percent of the total measured emissions from pipelines leaks. In these types of emission studies, a few leaks accounting for a large fraction of total emissions are not unusual."<sup>4</sup> Such levels within Avista's distribution system from July 2019 – June 2022 average 0.51%.

## State and Regional Level Policy Considerations

The lack of a comprehensive federal greenhouse gas policy has encouraged states, such as California, to develop their own climate change laws and regulations. Over the past few years both Oregon and Washington have added state policies, impacting the overall trajectory of Avista's resource needs and future rates. Comprehensive climate change policies can include multiple components, such as renewable portfolio standards, energy efficiency standards, and emission performance standards.

## Idaho

Avista does not anticipate any greenhouse gas policies in Idaho for the planning horizon. Although, Idaho customers are at risk of a federal policy regulating of greenhouse gas emissions, therefore, this plan includes a risk adder of a federal policy. This risk is evaluated by the inclusion of a national carbon tax beginning in 2030 and increases yearly through 2045 as shown in Table 5.3. The national pricing is based on a national energy consultant's estimate of a nationally accepted price passed by congress. As implications from programs in California, Oregon and Washington come into focus, a better idea of indirect cost impacts will be measured through national or regional natural gas prices. This may include a lower demand for natural gas with a potential to push against high natural gas prices and lack of pipeline infrastructure growth.

---

<sup>4</sup> <https://methane.wsu.edu>

**Table 5.3: National Greenhouse Gas Pricing Forecast**

Year	\$ per MTCO <sub>2e</sub>
Pre-2030	\$0
2030	\$12.00
2031	\$15.03
2032	\$17.69
2033	\$20.47
2034	\$23.36
2035	\$26.38
2036	\$29.52
2037	\$32.79
2038	\$36.19
2039	\$39.74
2040	\$43.43
2041	\$46.63
2042	\$50.08

## Oregon

The State of Oregon has a history of greenhouse gas emissions and renewable portfolio standards legislation. For this IRP, the Climate Protection Program (CPP) is the driving greenhouse gas reduction policy.

In March of 2020, Governor Brown signed Executive Order (EO) 20-04 requiring the reduction of greenhouse gas emissions to at least 45% below 1990 levels by 2035 and 80 percent below 1990 levels by 2050. EO 20-04 requires statewide reductions by all carbon emitting sources and managed by the respective emissions sources governing agencies. State agencies are directed to exercise all authority to achieve GHG emissions reduction goals expeditiously. The CPP is the primary program being used to meet EO 20-04 and is being administered by the Oregon Department of Environmental Quality (DEQ) under rule DEQ 27-2021, Chapter 340 (effective on December 17, 2021)<sup>5</sup>. In it, annual reduction amounts between 2022 and 2035 is equal to 27,000 metric tons of carbon equivalent (MTCO<sub>2e</sub>) or 50% of Avista's natural gas customer's emissions. In the following timeframe, 2036 – 2050, nearly 19,000 MTCO<sub>2e</sub> annually reductions leads to the final 40% reduction from the program baseline goal leaving a 10% total carbon emissions equivalent by 2050. This program will require natural gas utilities to meet annual emissions goals in Oregon as illustrated in Figure 5.1.

<sup>5</sup> <https://www.oregon.gov/deq/rulemaking/Pages/rghgcr2021.aspx>

**Figure 5.1: Oregon Customers Annual Emissions Compliance Cap**

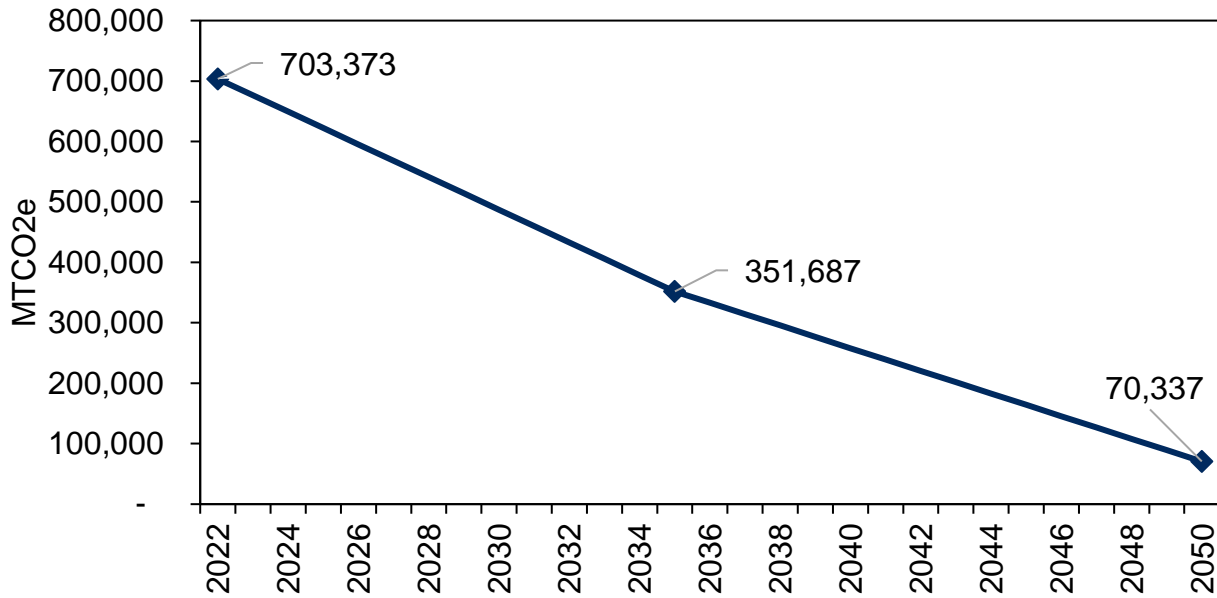

DEQ’s final rules declare Avista’s annual carbon compliance levels. Within these final rules, the CPP directs Avista with compliance responsibility for all emissions from our infrastructure regardless of customer class or source natural gas. This requirement includes transport customer class emissions where, historically speaking, Avista only charges a small fee for use of the distribution system but does not procure the energy or resources to get this energy to the city gate. As such, the requirement adds an additional 48.81% to Avista’s emissions. Refer to Figure 5.2, for an understanding of emissions by class in 2022.

**Figure 5.2: Oregon Emissions by Class for 2022<sup>6</sup>**

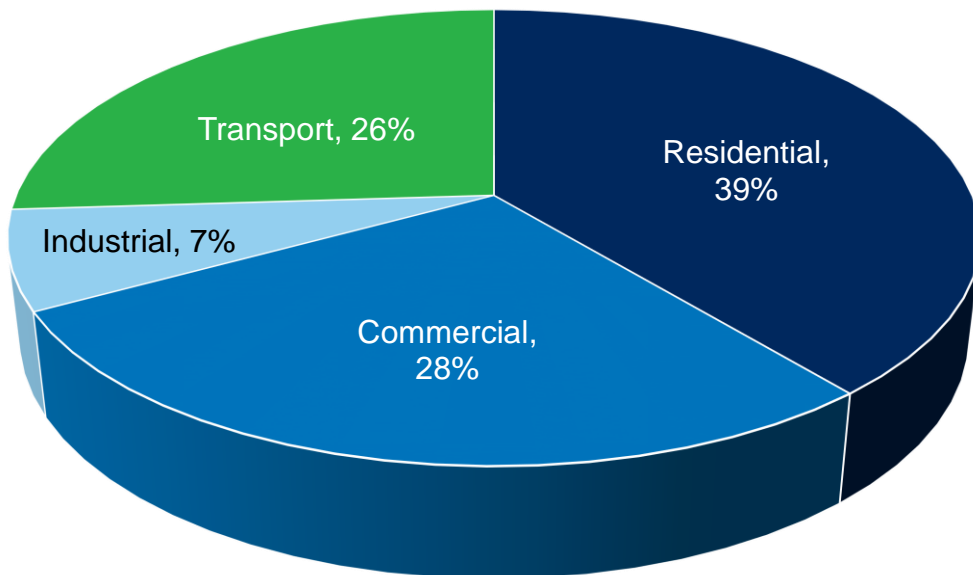

<sup>6</sup> Emission percentages are from 2022 billed data actuals

### Program Compliance

DEQ’s rules assume a carbon footprint of 117 pounds per MMBtu for natural gas, but bundled RNG with renewable thermal credit (RTC) or obtaining just the RTC does not include any greenhouse gas emissions regardless of its actual emissions intensity profile. Unlike the California program, the CPP does not include carbon intensity by source so higher emitting sources such as dairies do not provide additional emissions benefits over a landfill. Further, RNG does not have to be physically sourced in the state of Oregon, so the total potential volume drastically increases with the increase in geography. Another element of the program are compliance instruments known as Community Climate Investments (CCI). These instruments allow an entity such as Avista to offset a portion of actual emissions through the purchase of CCIs. The quantity available is directly related to the allowed emissions under the CPP. In years 2022 to 2024 the quantity of CCIs available is equal to 10 percent of the emissions limit, followed by 15% in 2025 to 2027 and finally 20% of the emissions cap from 2028 going forward as show in Figure 5.3. Avista must purchase these CCI’s at the nominal prices shown in Figure 5.4.

**Figure 5.3: Maximum Available CCI Compared to the Reduction Goal**

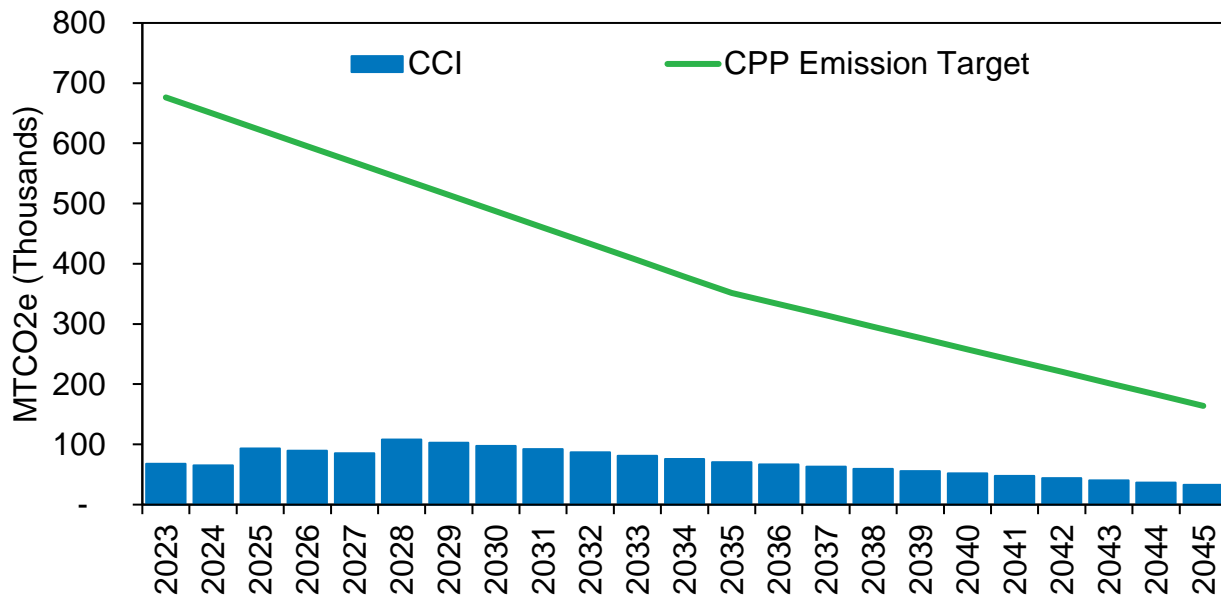

**Figure 5.4: Community Climate Investment (\$ per MTCO<sub>2</sub>e)**

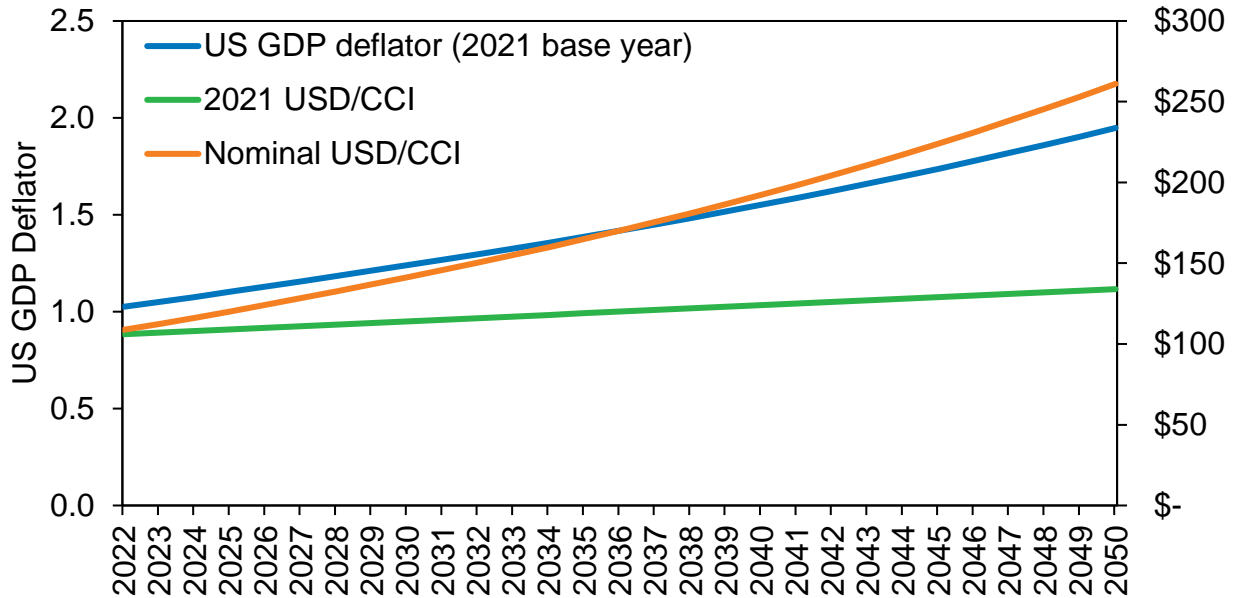
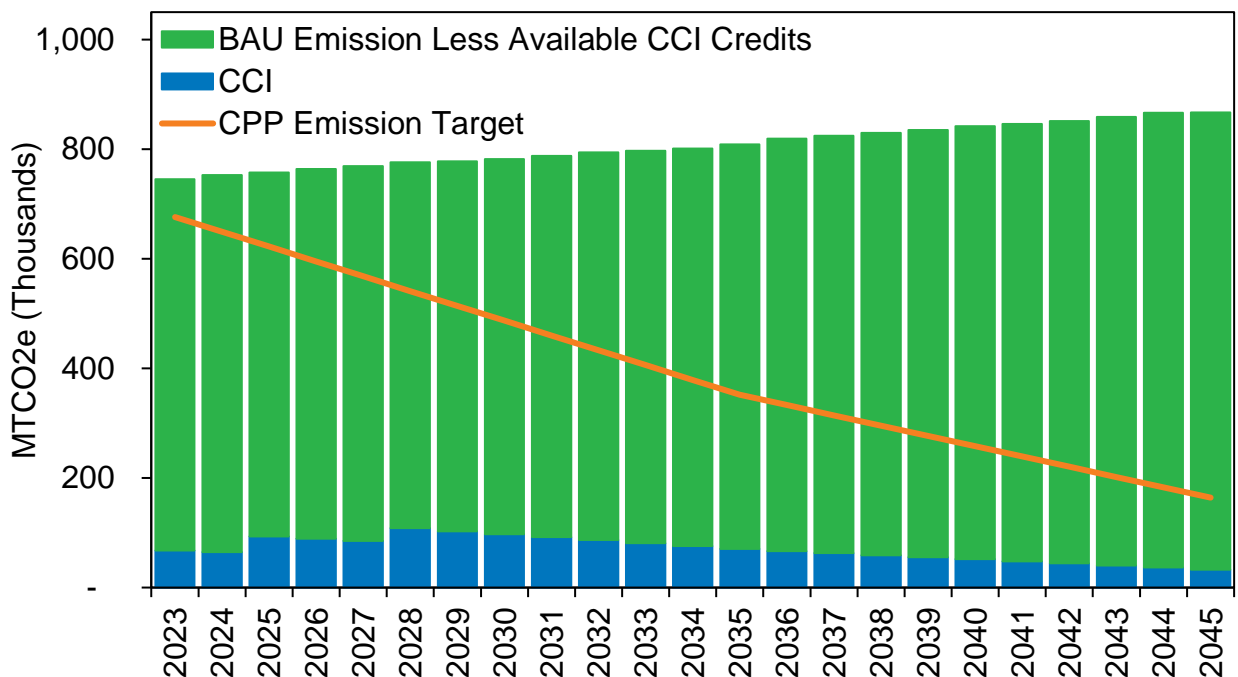

Figure 5.5 combines expected emissions from serving load with natural gas as compared to the comparative number of CCI instruments available to offset these emissions. In Figure 5.5, the area above the “CPP Emissions Target” line will require additional reduction instruments, load reduction, or alternative natural gas sources to meet CPP goals. The resource mix to meet these carbon emissions cap will be discussed in Chapter 6.

**Figure 5.5: Business as Usual Emission Forecast vs. Utility Goal**





### Oregon Senate Bill 334

Senate Bill 334 was passed in 2017 to help develop, update, and maintain the biogas inventory available. This includes the sites and potential production quantities available in addition to the quantity of RNG available for use to reduce greenhouse gas emissions. This bill will also help promote RNG and identify the barriers and removal of barriers to develop and utilize RNG. In September 2018 the Oregon Department of Energy issued the report to the Oregon legislature titled “Biogas and Renewable Natural Gas Inventory.”

### Oregon Senate Bill 844

Senate Bill 844 passed in 2013 with rulemaking following OPUC Docket AR 580, with rules going into effect in December of 2014. This bill directed the OPUC to establish a voluntary emission reduction program and criteria for the purpose of incentivizing public natural gas utilities to invest in emission reducing projects providing benefits to their respective customers. The public utility, without the emission reduction program, would not invest in the project in the ordinary course of business.

To date, this legislation has not yielded any emission reducing projects. Avista is aware that Governor Brown’s Executive Order 20-04 has the OPUC reconsidering the usefulness of SB844.

### Oregon Senate Bill 98

Senate Bill 98 was passed during the 2019 regular session and mandates the OPUC “to adopt by rule a renewable natural gas program for natural gas utilities to recover prudently incurred qualified investments in meeting certain targets for including renewable natural gas purchases for distribution to retail natural gas customers.”

The OPUC initiated a rulemaking to implement Senate Bill 98 under Docker AR 632 in late 2019 with final rules taking effect on July 17, 2020. In order to participate in a SB 98 RNG Program, a petition to participate is required. Small utilities desiring to participate are required to define their respective percent of revenue requirement per year needed to support potential project investment costs. The bill allows investment in gas conditioning equipment without RFP process. Per the OPUC’s rules, the RNG attributes will be tracked by the M-RETS system as renewable thermal certificates (RTC) in which (1) RTC = (1) Dekatherm of RNG.

## Washington

### Washington State Policy Considerations<sup>7</sup>

In December 2020 a Washington State Energy Strategy was released as a roadmap committing Washington to reducing greenhouse gas emissions, as follows:

- By 2030 a 45% reduction below 1990 levels
- By 2040 a 70% reduction below 1990 levels
- By 2050 a 95% reduction below 1990 levels and net-zero emissions

<sup>7</sup> <https://www.commerce.wa.gov/growing-the-economy/energy/2021-state-energy-strategy/>

### Climate Commitment Act

The Washington legislature passed its largest environmental program in 2021, the Climate Commitment Act (CCA) into state law (RCW 70A.45.020). This CCA is administered by Washington Department of Ecology with the program beginning January 1, 2023. The CCA creates a state-wide emissions cap and trade program where emissions are to be reduced by 95 percent by 2050. The CCA will also expand the air quality monitoring in overburdened communities with evaluation every two years to ensure pollutants and greenhouse gases are being reduced. Initial covered entities under the CCA include industrial facilities, certain fuel suppliers, natural gas distributors, and in state electricity suppliers. Figure 5.6 illustrates the CCA coverage by percent of emissions and industry type for included covered entities.

**Figure 5.6: Climate Commitment Act Coverage<sup>8</sup>**

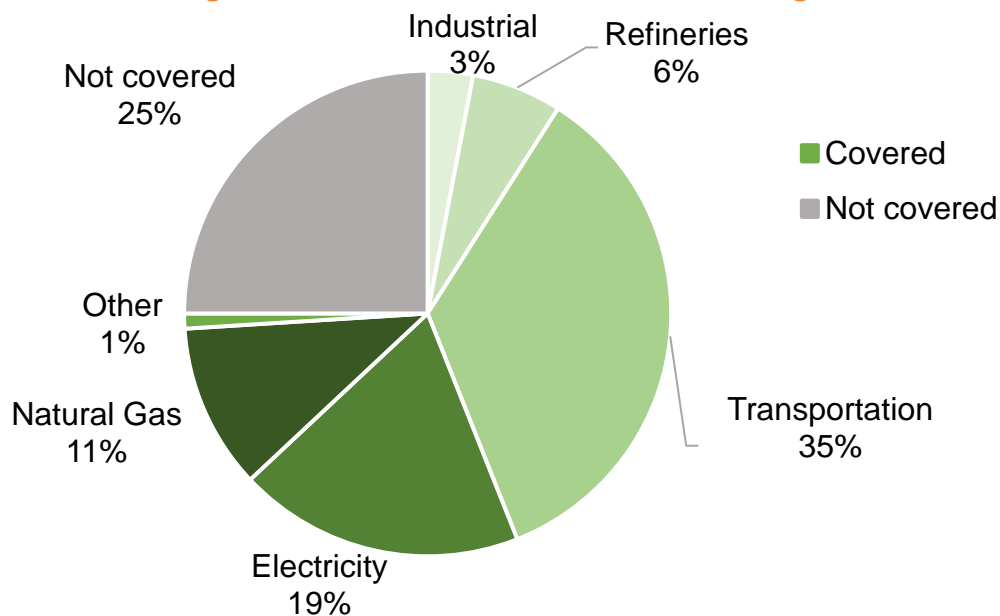

Future participants will be added in 2027 with the inclusion of waste-to-energy plants and in 2031 with railroad companies, and solar and wind power at the Wild Horse wind farm. The cap for the CCA reduces emissions beginning 2023 by 7 percent annually until 2030. The cap decreases by 1.8 percent annually from 2031 to 2042. Finally, the cap decreases by 2.6 percent in the years 2043 to 2049 to fully meet the 95 percent below 1990 reduction state goal noted above. A summary of the prorata share of this reduction to Avista's LDC emissions are shown in Figure 5.7.

<sup>8</sup> Washington State Department of Ecology produced graphic

Figure 5.7: Avista's Estimated Annual Emissions Cap

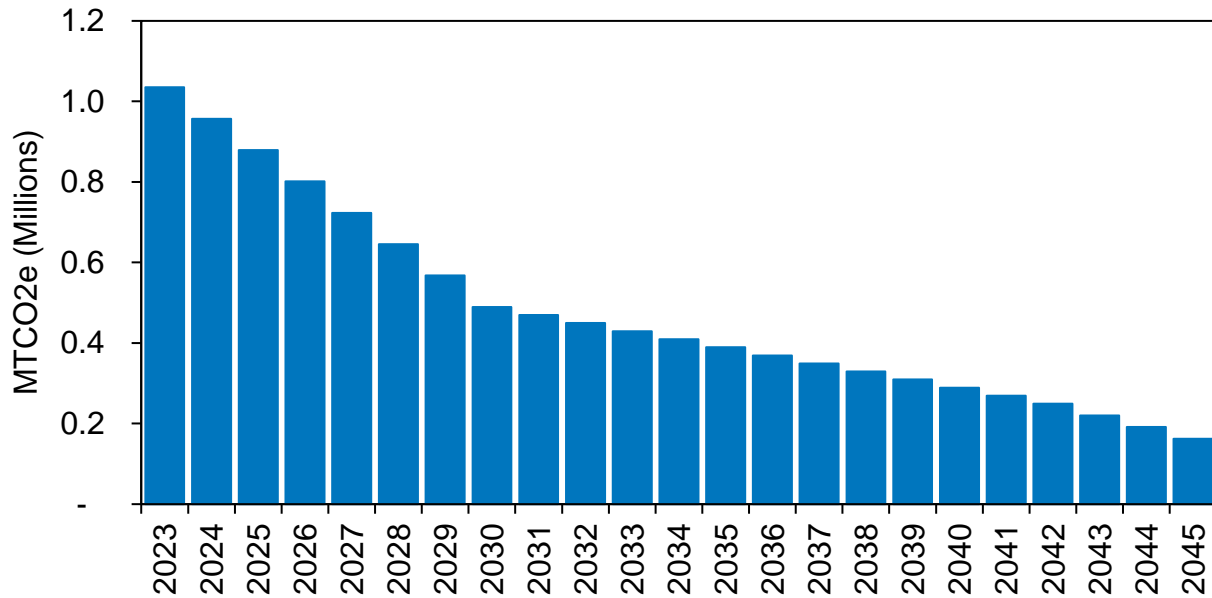

All covered entities are required to obtain allowances or offsets to cover their emissions. Offsets are projects that reduce, remove, or avoid greenhouse gas emissions and are verified through audits. Offsets can be used in place of allowances beginning in the first compliance period of 2023 – 2026 with 5 percent of their emissions from general offset projects and 3% from Tribally support projects. Offsets are below the cap meaning allowance and offsets are interchangeable and should be procured on a least cost or least risk basis. Program design elements are intended to provide linkage to similar programs in other jurisdictions. These offsets drop after this initial timeframe to 4% general offsets and 2% Tribal offsets going forward starting 2027. Please see Figure 5.8 to understand potential emissions offsets available to Avista through Offset projects.

Figure 5.8: Emissions Reductions from Offset Projects

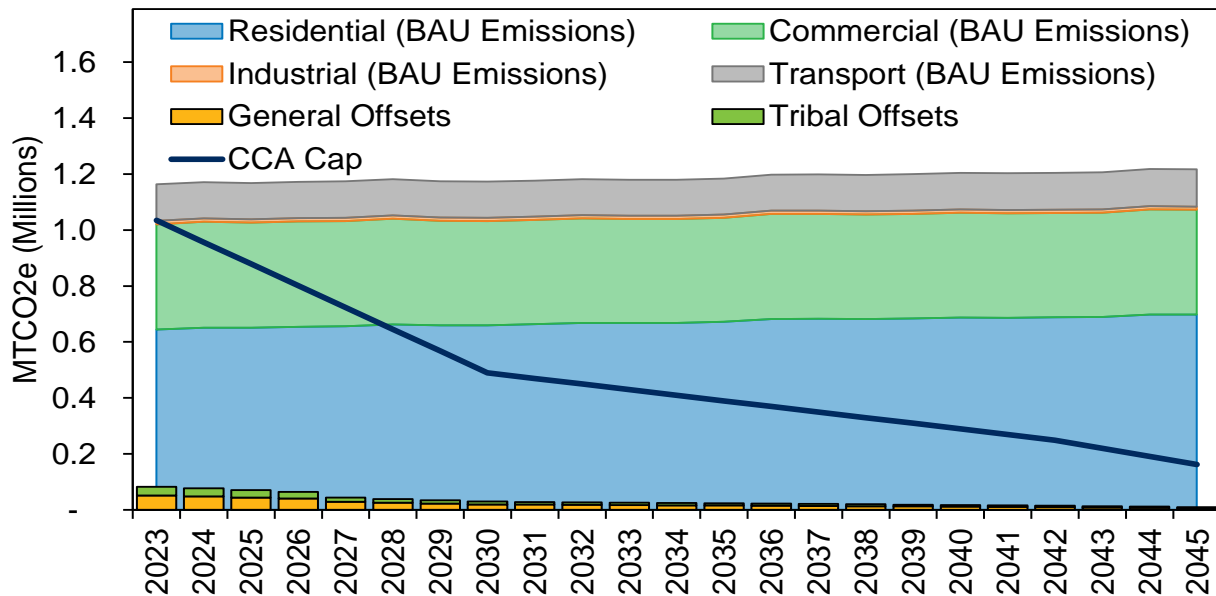

These program participants will be required to cover their emissions by the purchase of “allowances” acquired through state auction or by purchasing offsets in the secondary market. Electric utilities are also required to offset their emissions but will be given free allowances to cover most of their emissions. Electric utilities are already covered under the Clean Energy Transformation Act which requires 100% clean energy by 2045. The full impacts of the CCA are not known at this time. The intent of this legislation allows for the Washington State program to join California and the Quebec markets to increase “allowance” liquidity possibly as early as 2025. California and Quebec still need to approve the addition of Washington to their program. The law also focuses on using proceeds from state allowance auctions to improve over-burdened communities and tribes, but also incent a clean energy transformation of Washington to electrify transportation and heating.

Allowances are available through quarterly auctions or traded on a secondary market. Allowances will decrease over time to meet goals state statutory limits. All proceeds from allowances must be used for clean energy transition. This transition includes bill assistance, clean transportation, and climate resiliency projects promoting climate justice with a minimum of 35 percent of funds to provide direct benefit to overburdened communities. Allowances price estimates used for evaluation are illustrated in Figure 5.9.

Figure 5.9: Expected CCA Allowance Prices

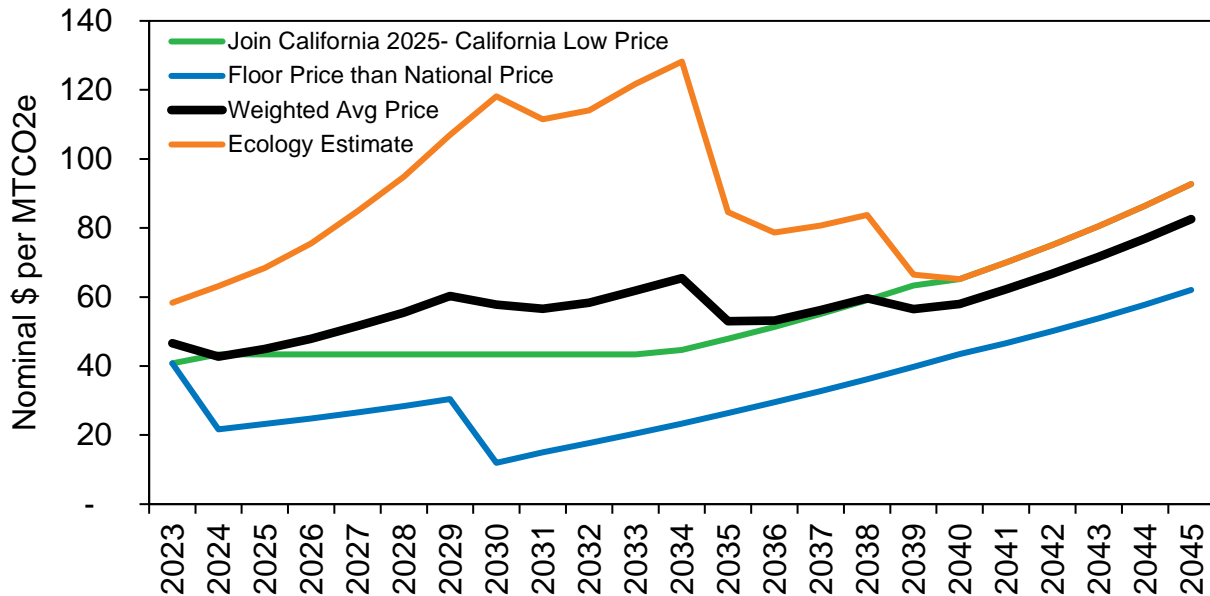

### Washington HB 2580

House Bill 2580 was signed by Governor Jay Inslee on March 22, 2018 and became effective on July 1, 2018 bringing into law a bill to help encourage production of RNG. This bill requires the Washington State University Extension Energy Program and the Department of Commerce (DOC) along with the consulting of the WUTC, to submit recommendations on promoting the sustainable development of RNG. The DOC will consult with natural gas utilities and other state agencies to explore developing voluntary gas quality standards for the injection of RNG into natural gas pipeline systems in the state.

### Washington HB 1257

The bill was passed during the 2019 Regular Session, coined the “Building Energy Efficiency” bill, mandating that each gas company must offer by tariff a voluntary renewable natural gas service. The bill also allows for LDCs to create an RNG program to supply a portion of the natural gas it delivers to its customers. This program is subject to review and approval by the WUTC. With regard to natural gas distribution companies, this bill was designed for the purpose of establishing the following:

*“efficiency performance requirements for natural gas distribution companies, recognizing the significant contribution of natural gas to the state’s greenhouse gas emissions, the role that natural gas plays in heating buildings and powering equipment within buildings across the state, and the greenhouse gas reduction benefits associated with substituting renewable natural gas for fossil fuels.”*

Section 12 of the bill “finds and declares:

- a) Renewable natural gas provides benefits to natural gas utility customers and to the public;
- b) The development of RNG resources should be encouraged to support a smooth transition to a low carbon energy economy in Washington;
- c) It is the policy of the state to provide clear and reliable guidelines for gas companies that opt to supply RNG resources to serve their customers and that ensure robust ratepayer protections.”

Section 13 of the bill allows LDC’s to propose an RNG program under which the company would supply RNG for a portion of the natural gas sold or delivered to its retail customers. Section 14 of the bill states that LDC’s must offer by tariff a voluntary RNG service available to all customers to replace any portions of the natural gas that would otherwise be provided by the gas company.

House Bill 1257 provided limited direction and the necessary details to advance RNG programs and projects. As such, there has been an effort on behalf of the impacted utilities to provide the commission with feedback and clarity with respect to gas quality and cost treatment. More specifically, the Northwest Gas Association (NWGA) has collaborated with Washington LDC’s to develop a common Gas Quality Standard Framework, and proposed language defining the treatment of RNG program costs.

On December 16, 2020, the Washington UTC issued a Policy Statement to provide guidance with respect to the following elements of HB 1257 as follows; General Program Design, RNG Program cost cap, Voluntary Program cost treatment, gas quality standards, and pipeline safety, environmental attributes and carbon intensity, renewable thermal credit (RTC) tracking, banking, and verification.

## Federal Legislation

Various federal agencies, including the Consumer Product Safety Commission, Department of Energy, Department of Housing and Urban Development and Environmental Protection Agency, have been petitioned to, or are either considering new regulation of natural gas appliances, or are considering banning the use of fossil fuels in federal buildings and subsidized public housing. To date, no new regulations from the federal level have been adopted in this regard.

## Inflation Reduction Act

Signed into law in August 2022, the Inflation Reduction Act (IRA) provides support in the form of grants, loans, rebates, incentives, and other investments for clean energy and climate action. The IRA includes over \$300 billion in available funding and tax credits to be used for climate and energy programs starting in 2023 thru 2032. This program both extends and expands the renewable electricity production tax credit and the energy tax credit and provides for a “technology neutral” clean electricity production and investment

credit. Credits range from zero-emissions nuclear power production credit, carbon capture and storage, clean hydrogen to energy manufacturing credits.

There are bonus credits with projects meeting certain prevailing wage and apprenticeship requirements with an additional 10 percent credit bonus if produced domestically with domestic products. The credits discussed below assume direct impact on prices and technology maturity as discussed in Chapter 4.

Various tax credits may apply to renewable energy production including wind, geothermal, solar, RNG, hydropower and all forms of renewable energy for facilities placed into service after December 25, 2022. Additionally, these facilities must have begun construction prior to January 1, 2025. This is assumed to impact the overall build of renewable sources and green hydrogen production and the availability of carbon to react synthetic methane. Carbon capture technologies include ranges of incentives based on type.

Direct Carbon Capture Facilities must capture a minimum of 1,000 metric tons of carbon dioxide during the tax year. The base rate starts at \$36 per metric ton with a higher rate of \$180 for carbon dioxide captured for storage in geologic formations. If the carbon is captured and used by the taxpayer a rate of \$26 to \$130 per metric ton is applicable. A final credit is available for carbon captured and used for enhanced oil recovery or other use but is not included or considered in this IRP.

A credit applies to clean hydrogen production after December 31, 2022 for a facility that began construction before 2033. The credit includes a base of 60 cents per kilogram and is multiplied by the lifecycle greenhouse emissions rate percentage with a bonus credit for prevailing wages, domestic materials, and investment. A full credit in the amount of \$3 per kilogram is attainable considering meeting each credit criteria. Avista assumes this \$3 per kilogram in its price forecasts for green hydrogen.

Finally, a buildings and end use efficiency credit in the IRA includes incentives for homeowners' investment in energy efficiency. It includes a tax credit for upgrading end use equipment including insulation, windows, doors, and end use equipment. We assume a 50% direct credit to the homeowner for costs to convert from natural gas to electric end use.

## Customer Market study

In the 2021 Natural Gas IRP a recommendation was included, from OPUC, to conduct market research with Avista customers for sentiments around costs and carbon policies. "Recommendation 9: Prior to the next IRP, conduct market research to reflect the willingness of Oregon customers to pay for various carbon reduction strategies. Present results at a TAC meeting."

In light of climate policy and the potential impact to all jurisdictions served with natural gas or electricity by Avista, the study was broadened to understand these elements in

Idaho, Oregon, and Washington. Some study highlights are below and with the entire study available on Avista’s IRP website.<sup>9</sup>

The overall objective of this study was to determine the willingness to pay for the implementation of clean energy among Avista customers. Establishment of a baseline of environmental concerns, tradeoffs between bill increases and carbon emissions goals, explore perceptions specific to natural gas preferences and tradeoffs and perceptions associated with Avista and investing in carbon-neutral or carbon-free emissions sources. This survey was delivered through the web with Avista customers and sourced randomly by email and was conducted in April of 2022. The sample size was 1,100 participants. Participants were required to be above 18 years of age, responsible for household finance or utility bill and cannot be employed or affiliated by Avista.

## Key Takeaways

### Price is Important

“When faced with tradeoffs, price is the prevailing factor. While the majority of customers find importance in sourcing green or local energy, they are only willing to pay so much. Anything beyond a 10% monthly bill increase shows significant declines in popularity. If bill increases to invest in carbon-free or carbon-neutral options are kept below 10%, the specific energy goal, timeframe, local vs. regional source are less important.” An example of one question related to price is illustrated in Figure 5.10.

**Figure 5.10: Bill Increase and Carbon-Neutral or Carbon-Free Options**

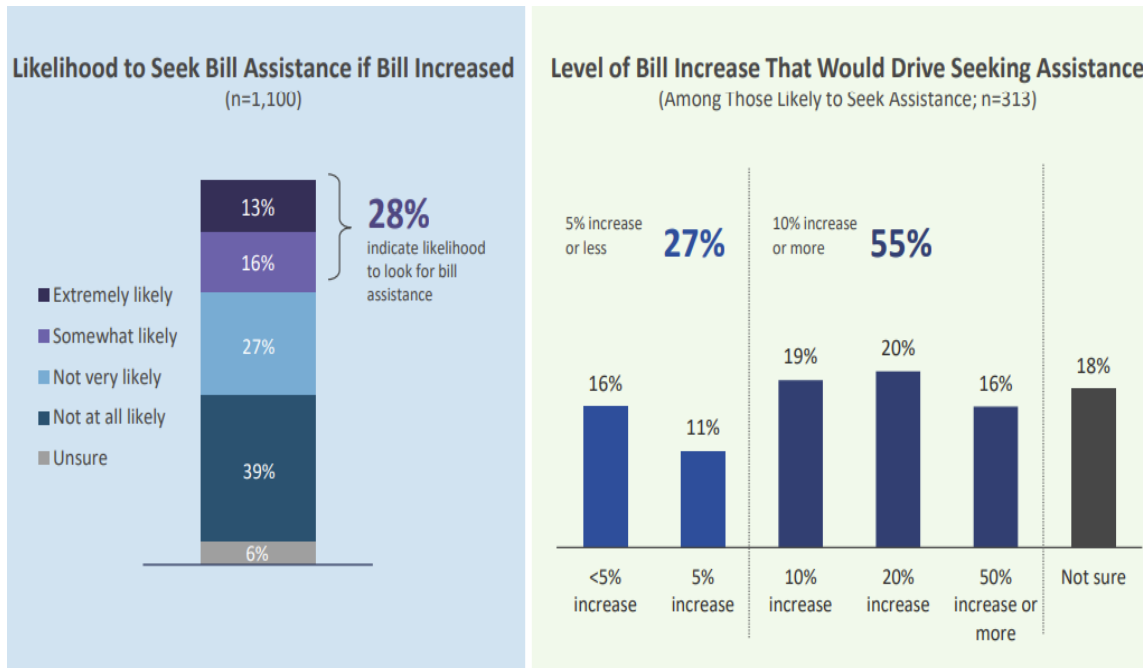

<sup>9</sup><https://www.myavista.com/-/media/myavista/content-documents/about-us/our-company/irp-documents/natural-gas-irp-documents/avista-irp-clean-energy-research-tac.pdf>



### Some Customers See Beyond Price

“Increases beyond 10% monthly still appeal to a certain subset of customers, particularly those who place great importance on “green,” and/or when the goal can be achieved within the next 10 years.” Figure 5.11 provides an example of customers seeing beyond price.

**Figure 5.11: Importance of “Green”**

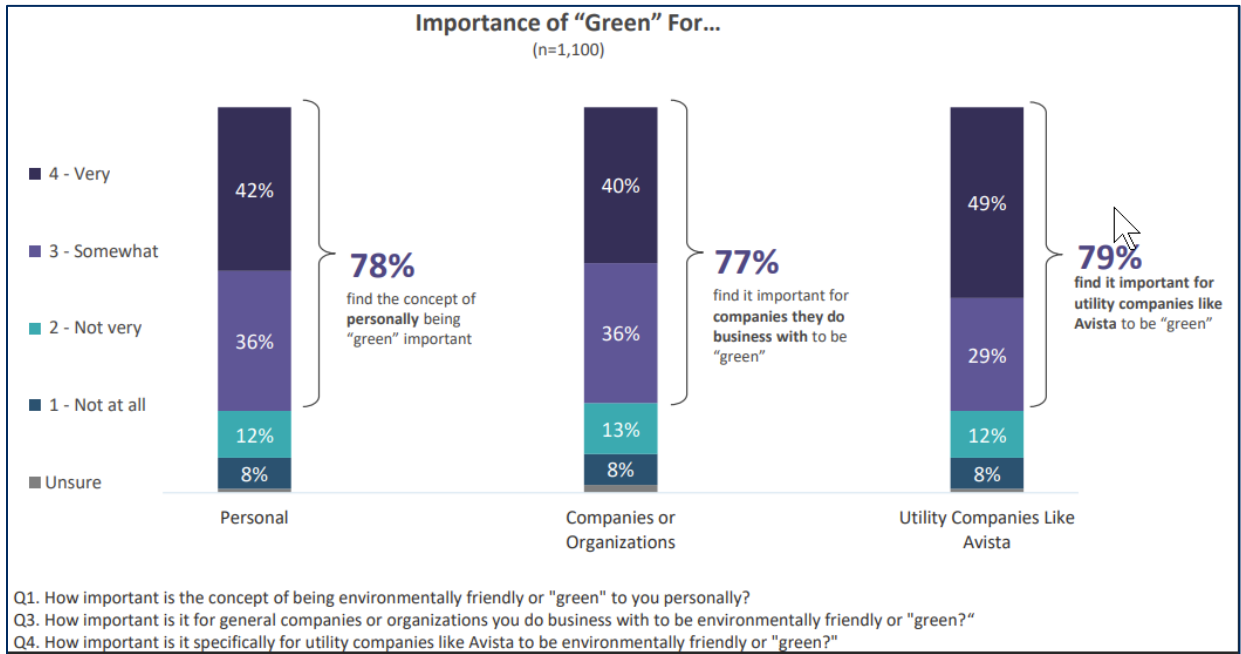

### Any increase to invest in “green” energy will alienate some customers.

“Overall, roughly one in five do not find importance in being “green” When evaluating various green investment options, 17 percent reject all, including more ambitious outcomes for just a 2 percent increase. Three in ten say they would be likely to seek bill assistance or consider moving to another state if bill were to increase due to Avista investing in carbon-free or carbon-neutral energy.”

**Figure 5.12: An Increased Bill and Possible Actions from Customers**

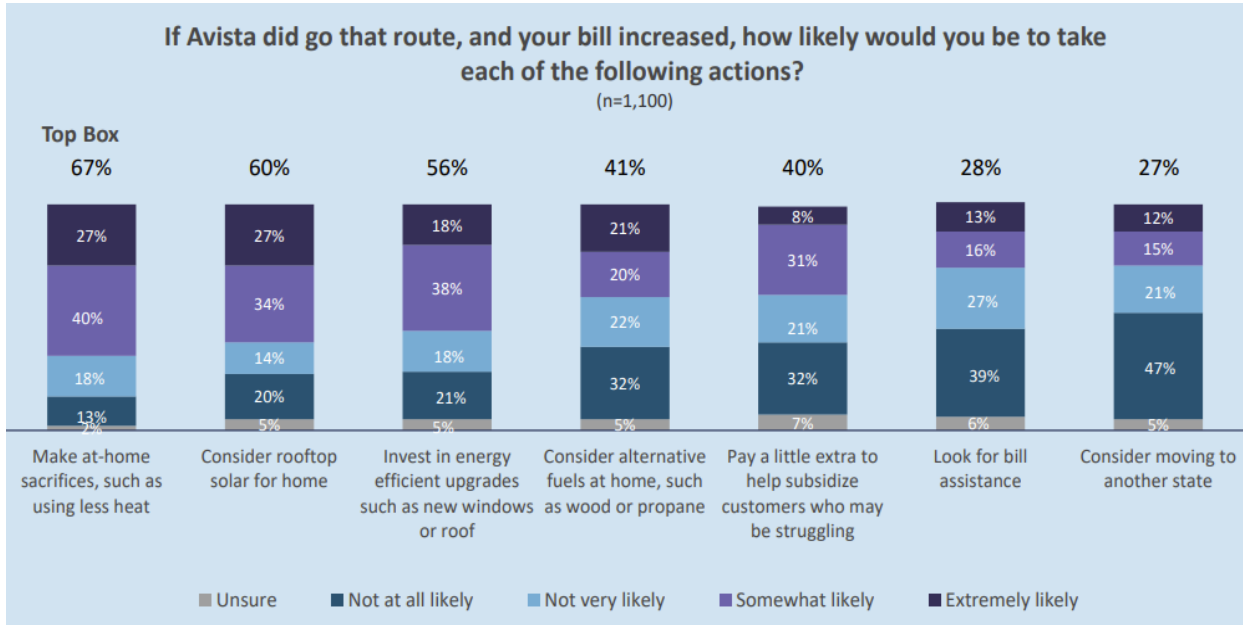

Finally, we have nearly half of our customers that would not consider switching from natural gas to help reduce carbon emissions. While nearly 75 percent of these customers agree that eliminating natural gas should be entirely voluntary as shown in Figure 5.13.

**Figure 5.13: Customer Concerns with Fuel Switching**

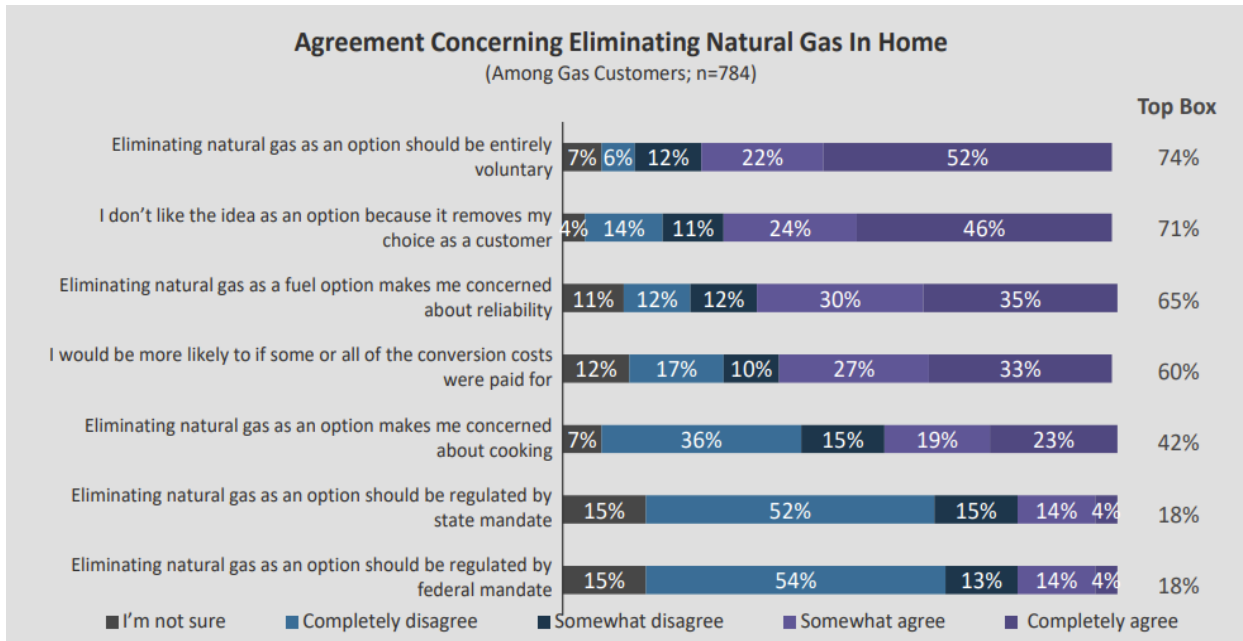

## Equity Considerations

Equity has been a newer piece of the IRP process in Washington, for electric investor-owned utilities, as introduced from Clean Energy Transformation Act (CETA) and other legislation or WUTC policies. Equity focuses on the energy justice, through metrics, to consider benefits and burdens of living near resources. Avista intends to incorporate increased equity considerations in the 2025 natural gas IRP and utilize lessons from our electric IRP process to assist in the development of metrics and use in analytics.

## 6. Preferred Resource Strategy

This chapter combines the previously discussed IRP components within the PLEXOS® model to determine resource deficiencies during the 20 plus years planning horizon. The foundation for integrated resource planning is the criteria used for developing demand forecasts. The weather planning standard is updated in this IRP. The new planning standard has Avista moving away from coldest day on record and into a 99% probability of a daily temperature occurring. This new standard has been combined with forecasted future weather data for each planning area as discussed in Chapter 2. Avista plans to serve the expected peak day in each demand region with firm resources. Firm resources include natural gas and distributed renewable supplies, firm pipeline transportation, and storage resources. In addition to peak requirements, Avista also plans for non-peak periods such as winter, shoulder months (April and October) and summer demand. The modeling process includes an optimization for every day of the 20-year planning period.

The IRP assumes on a peak day all interruptible customers have left the system to provide service to firm customers. Avista does not make firm commitments to serve interruptible customers, therefore this IRP analysis only includes the firm residential, commercial, and industrial classes. Using the weather planning standard, a blended price curve of three studies developed by industry experts, and an academically backed customer forecast all work together to develop stringent planning criteria.

Forecasted demand represents the amount of energy needed. Delivering this forecasted demand requires an additional 1% to 3% on both an annual and peak-day basis to account for additional natural gas supplies purchased primarily for pipeline compressor station fuel. The range of 1% to 3% (known as fuel), varies depending on the pipeline. This fuel is used to move the gas from point A on the pipeline to point B or the delivery point. The FERC and National Energy Board approved tariffs govern the percentage of required additional fuel supply.

Other fuels like RNG may or may not require this additional fuel as it is location dependent. If a renewable fuel is within Avista's distribution system, the current design does not include any compressors and is pressure driven (Chapter 8).

### PLEXOS® Planning Model

PLEXOS® is a mixed integer programming model used to solve natural gas supply and transportation optimization questions. Mixed integer programming is a proven technique to solve minimization/maximization problems. PLEXOS® analyzes the complete problem at one time within the study horizon, while accounting for physical limitations, carbon equivalent emissions, and contractual constraints. The software analyzes thousands of variables and evaluates possible solutions to generate a least cost solution given a set of constraints. The model considers the following variables:

- Demand data, such as customer count forecasts and demand coefficients by customer type (e.g., residential, commercial, industrial, and transport).
- Weather data, including minimum, maximum, and average temperatures.
- Existing and potential transportation data describes the network for physical movement of natural gas and associated pipeline costs.
- Existing and potential supply options including supply basins, revenue requirements as the key cost metric for all asset additions and prices.
- Natural gas storage options with injection/withdrawal rates, capacities, and costs.
- Energy Efficiency potential.

Figures 6.1 through 6.5 are PLEXOS® network diagrams of Avista’s demand centers and resources (including supply resource options). This diagram illustrates current transportation and storage assets, flow paths and constraint points.

**Figure 6.1: PLEXOS® Idaho System Map**

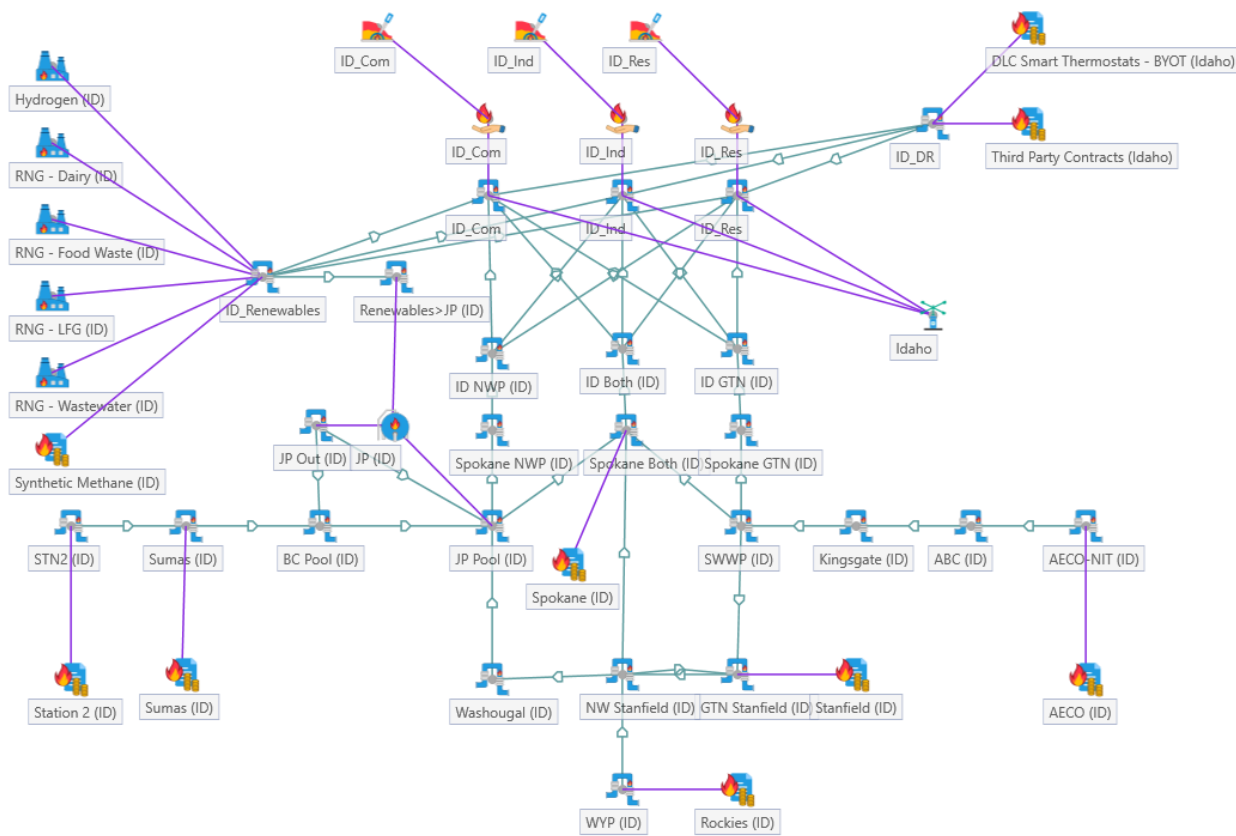



Figure 6.4: PLEXOS® Washington Transport Customer Map

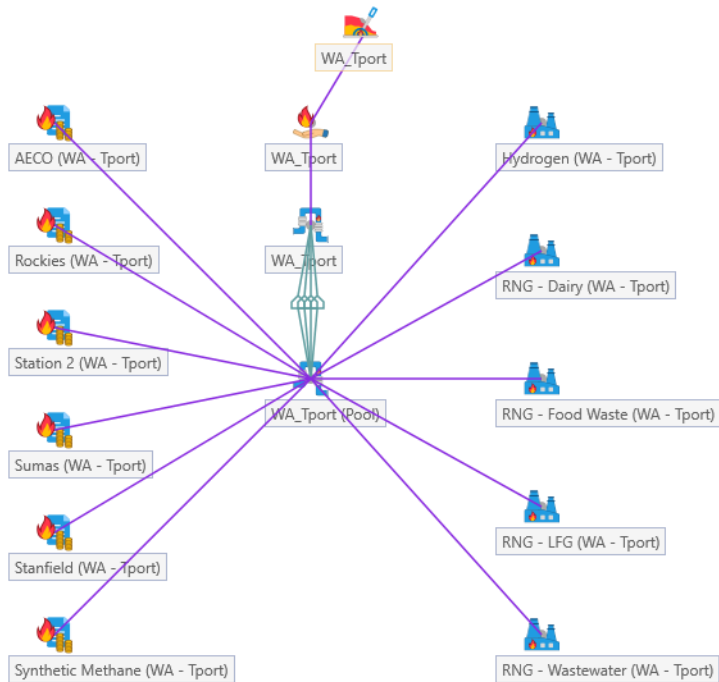
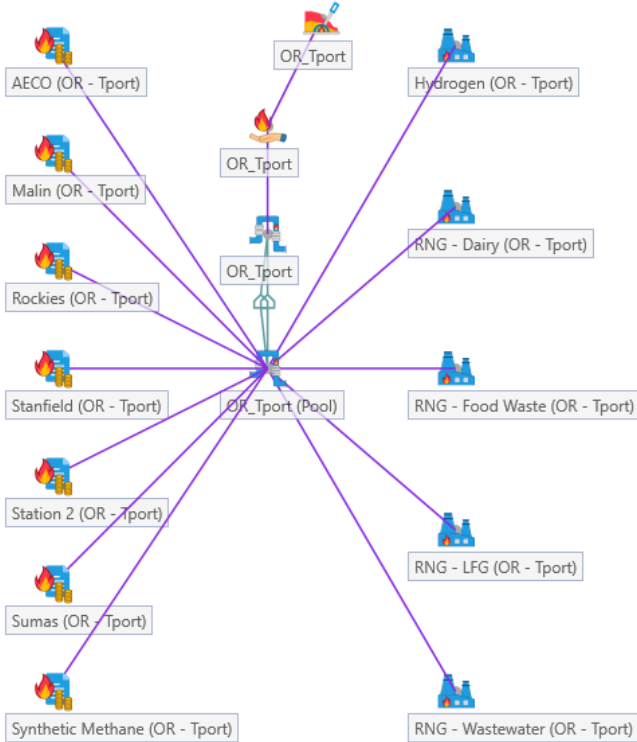

Figure 6.5: PLEXOS® Oregon Transport Customer Map



The PLEXOS® model provides a flexible tool to analyze scenarios such as:

- Pipeline capacity needs and capacity releases;
- Effects of different weather patterns upon demand;
- Effects of natural and renewable gas price increases upon total gas costs;
- Emission constraints by planning zone;
- Storage optimization studies;
- Resource mix analysis for conservation;
- Weather pattern testing and analysis;
- Transportation cost analysis;
- Avoided cost calculations; and
- Short-term planning comparisons.

PLEXOS® also includes Stochastic modeling and Monte Carlo capabilities to facilitate price and demand uncertainty modeling and detailed portfolio optimization techniques to produce probability distributions. The PLEXOS® model is used by LDC's across the U.S. and has replaced Avista's use of SENDOUT®, as it became increasingly outdated for the current regulatory environment when it comes to greenhouse gas reduction. Figure 6.6 provides a summary view of inputs and modeling flow.



Figure 6.6: Modeling Workflow Diagram

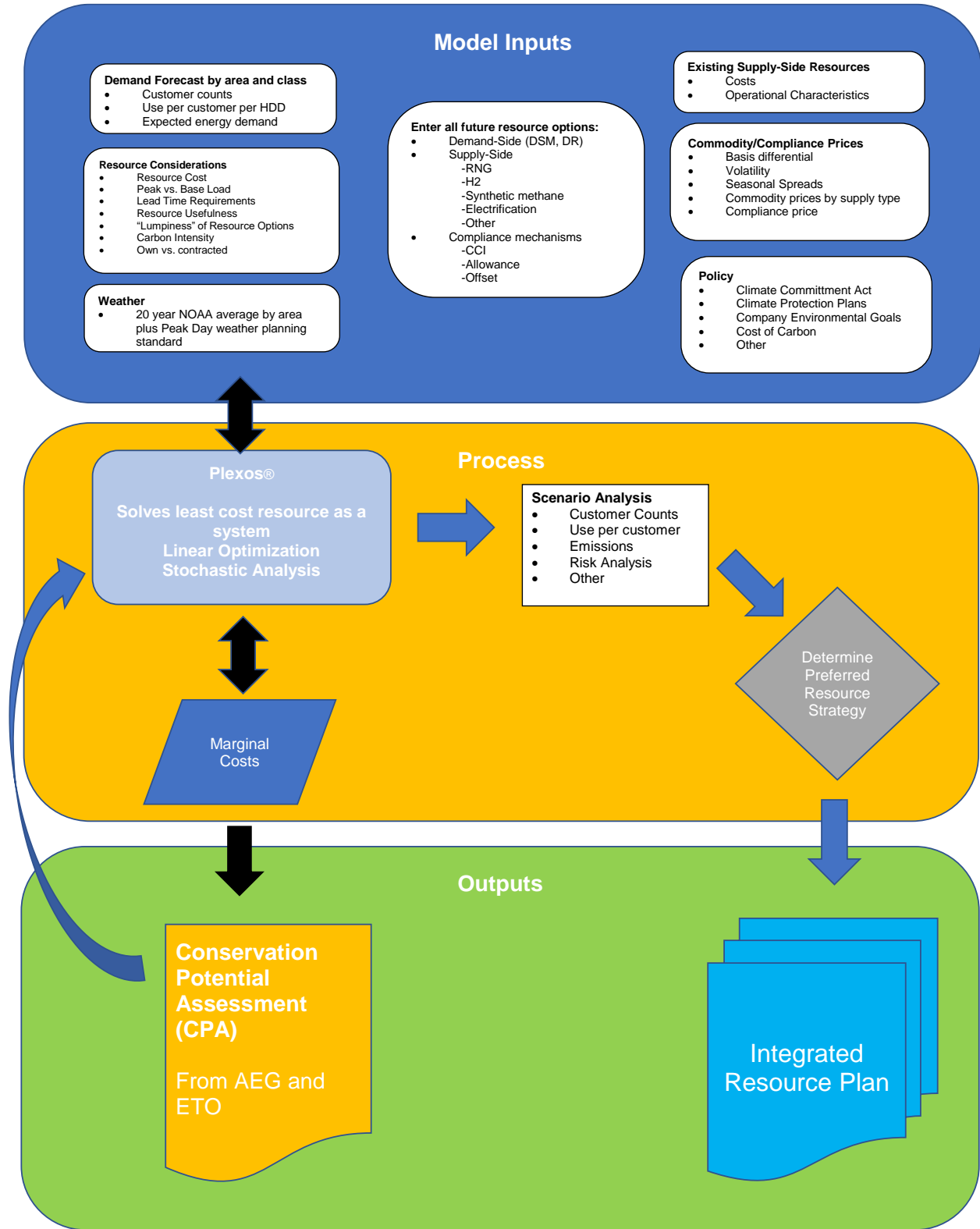

## Stochastic Analysis<sup>1</sup>

The scenario (deterministic) analysis described earlier in this chapter represents specific what if situations based on predetermined expected assumptions, including price and weather. These factors are an integral part of scenario analysis. To understand how each scenario will respond to cost and risk, through price and weather, Avista applied stochastic analysis to generate a variety of price and weather events.

Deterministic analysis is a valuable tool for selecting an optimal portfolio yet only considers one set of data such as the most probably future. The model selects resources to meet peak weather conditions in each of the 20 years. However, due to the recurrence of design conditions in each of the 20 years, total system costs over the planning horizon can be overstated because of annual recurrence of design conditions and the recurrence of price increases in the forward price curve. As a result, deterministic analysis does not provide a comprehensive look at future events. Utilizing stochastic simulation and Monte Carlo simulation in conjunction with deterministic analysis provides a more complete picture of portfolio variability of price risk and weather created risks.

A deterministic resource mix is performed allowing the model to solve the demand based on the optimal least cost solution for the system. Avista then performs five stochastic simulations on the Preferred Resource Strategy (PRS) where PLEXOS® solves for all five futures at the same time occurring in a single best set of resources to solve the energy and emissions goals.

## Resource Integration

The following sections summarize the comprehensive analysis bringing demand forecasting and existing and potential supply and demand-side resources together to form the 20-year, least-cost plan. Chapter 2 describes Avista’s demand forecasting approach.

Avista forecasts eleven service areas with distinct weather and demand patterns for each area and pipeline infrastructure dynamics. The areas are Washington and Idaho (each state is disaggregated into three sub-areas because of pipeline flow limitations and the ability to physically deliver gas to an area); Medford (disaggregated into two sub-areas because of pipeline flow limitations); and Roseburg, Klamath Falls, and La Grande. In addition to area distinction, Avista also models demand by customer class within each area. The relevant firm customer classes are residential, commercial, and industrial customers.

Customer demand is highly weather-sensitive. Avista’s customer demand is not only highly seasonable, but also highly variable. Figure 6.7 captures this variability showing firm customer monthly system-wide average demand, minimum demand day observed

---

<sup>1</sup> PLEXOS® uses Monte Carlo simulation to support stochastic analysis, which is a mathematical technique for evaluating risk and uncertainty. Monte Carlo simulation is a statistical modeling method used to imitate future possibilities that exist with a real-life system.

by month, maximum demand day observed in each month, and winter projected peak day demand for the first year of the PRS forecast as determined in PLEXOS®.

**Figure 6.7: Total System Average Daily Load (Average, Minimum and Maximum)**

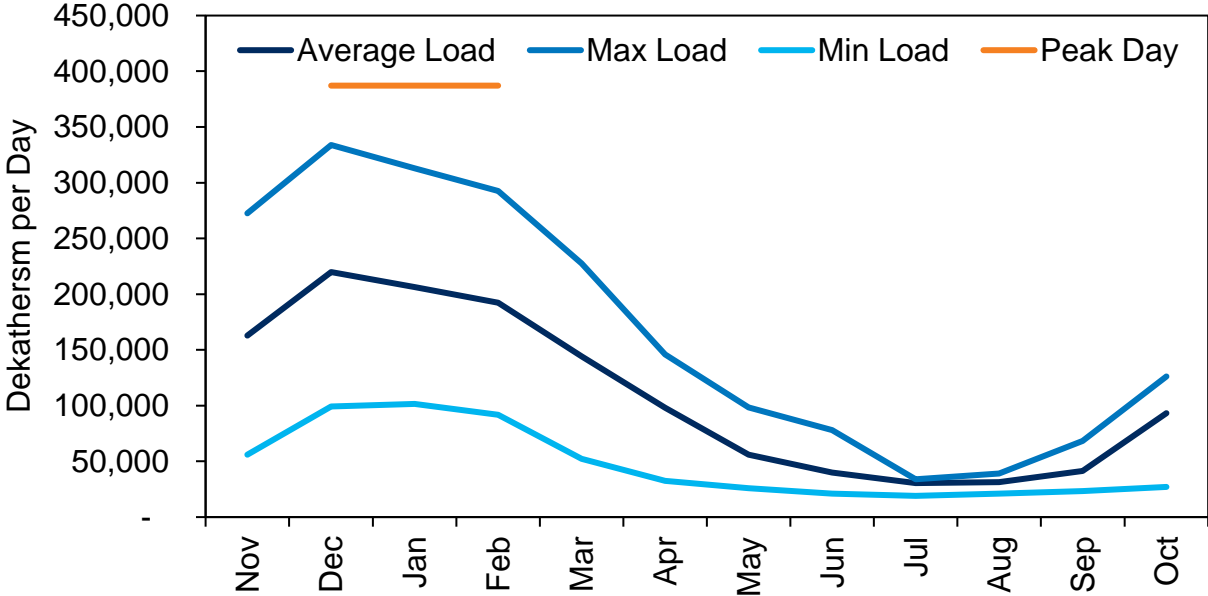

**Carbon Policy Resource Utilization Summary**

Avista uses an estimated carbon price as an incremental adder to address any potential policy. Carbon price adders increase the price of a dekatherm of natural gas and impact resource selections and are summarized in Figure 6.8. Oregon and Washington were assumed to have a social cost of carbon (SCC) at a 2.5% carbon adder price and based on carbon tax figures built on the requirement to utilize SCC at 2.5% discount estimates from the Environmental Protection Agency (EPA), as required by RCW 80.28.395 and per the 2021 IRP Chapter 9, Recommendation 7. For the State of Idaho, Avista considered a national carbon tax beginning in 2030 running through the end of study timeframe in 2045. SCC is used to value energy efficiency (EE) as described in Chapter 3. Compliance to the Climate Commitment Act and Climate Protection Plan (CPP) occurs through instruments in each program, with the attributed carbon costs of compliance valued against supply side resources.

**Figure 6.8: Carbon Legislation Sensitivities**

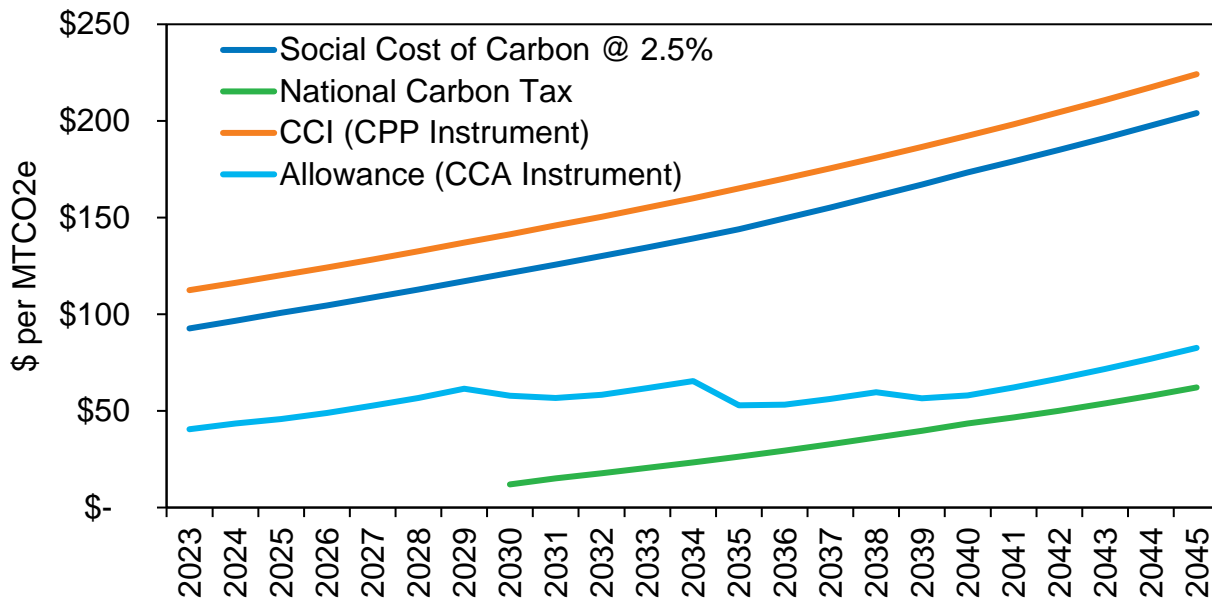

**Transportation and Storage**

Valuing natural gas supplies is a critical first step in resource integration. Equally important is capturing all costs to deliver the natural gas to customers. Daily capacity of existing transportation resources (described in Chapter 4) is represented by the firm resource duration curves depicted in Figures 6.9 and 6.10.

Current rates for capacity are in Appendix 6.1. Forecasting future pipeline rates can be challenging because of the need to estimate the amount and timing of rate changes. Avista’s estimates and timing of future pipeline rate increases are based on knowledge obtained from industry discussions and participation in pipeline rate cases. This IRP assumes pipelines will file to recover costs at rates equal to increases in GDP (see Appendix 6.2).

Figure 6.9: Existing Firm Transportation Resources

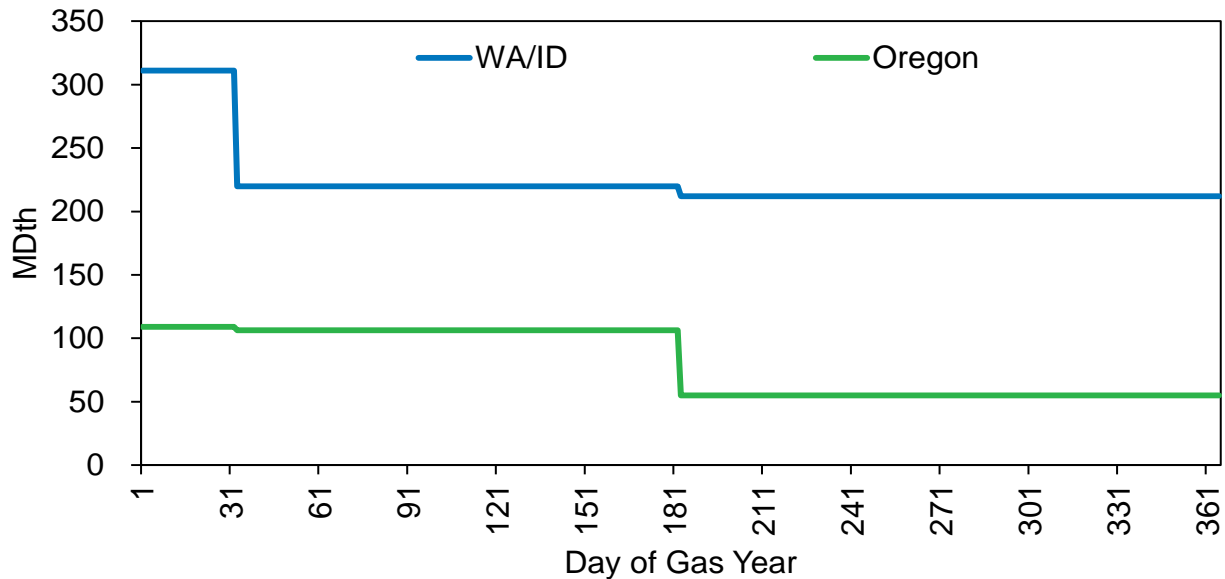

## Resource Utilization

Avista plans to meet firm customer demand requirements in a cost-effective manner. This goal encompasses a range of activities from meeting peak day requirements in the winter to acting as a responsible steward of resources during periods of lower resource utilization. As the analysis presented in this IRP indicates, Avista has ample transportation resources to meet highly variable energy demand under multiple scenarios, including peak weather events. New to the 2023 IRP is the requirement to meet greenhouse emissions targets in both Oregon and Washington creating a resource clean energy deficiency.

Avista acquired most of its upstream pipeline capacity during the deregulation or unbundling of the natural gas industry. Pipelines were required to allocate capacity and costs to their existing customers as they transitioned to transportation only service providers. The FERC allowed a rate structure for pipelines to recover costs through a Straight Fixed Variable rate design. This structure is based on a higher reservation charge to cover pipeline costs whether natural gas is transported or not, and a much smaller variable charge which is incurred only when natural gas is transported. An additional fuel charge is assessed to account for the compressors required to move the natural gas to customers. Avista maintains enough firm capacity to meet peak day requirements under the Expected Case in this IRP. This requires pipeline capacity contracts at levels more than the average and above minimum load requirements. Given this load profile and the Straight Fixed Variable rate design, Avista incurs ongoing pipeline costs during non-peak periods.

Avista chooses to have an active, hands-on management of resources to mitigate upstream pipeline and commodity costs for customers when the capacity is not utilized for system load requirements. This management simultaneously deploys multiple long-

and short-term strategies to meet firm demand requirements in a cost-effective manner. These strategies and plan are discussed in detail in Chapter 4. The resource strategies addressed are:

- Emissions compliance;
- Pipeline contract terms;
- Pipeline capacity;
- Storage;
- Commodity and transport optimization; and
- Combination of available resources.

### Pipeline Contract Terms

Some pipeline costs are incurred whether the capacity is utilized or not. Winter demand must be satisfied, and peak days must be met. Ideally, capacity could be contracted from pipelines only for the time and days it is required. Unfortunately, this is not how pipelines are contracted or built. Long-term agreements at fixed volumes are usually required for building or acquiring firm transport. This assures the pipeline of long-term, reasonable cost recovery.

Avista has negotiated and contracted for several seasonal transportation agreements. These agreements allow volumes to increase during the demand intensive winter months and decrease over the lower demand summer period. This is a preferred contracting strategy because it eliminates costs when demand is low. Avista refers to this as a front-line strategy because it attempts to mitigate costs prior to contracting the resource. Not all pipelines offer this option. Avista seeks this type of arrangement where available. Avista currently has some seasonal transportation contracts on TransCanada GTN in addition to contracted volumes of TF2 on NWP. This is a storage specific contract and matches up the withdrawal capacity at Jackson Prairie with pipeline transport to Avista's service territories. TF2 is a firm service and allows for contracting a daily amount of transportation for a specified number of days rather than a daily amount on an annual basis as is usually required. For example, one of the TF2 agreements allows Avista to transport 91,200 Dth/day for 31 days. This is a more cost-effective strategy for storage transport than contracting for an annual amount. Through NWP's tariff, Avista maintains an option to increase and decrease the number of days this transportation option is available. More days correspond to increased costs, so balancing storage, transport, and demand is important to ensure an optimal blend of cost and reliability.

### Pipeline Capacity

After contracting for pipeline capacity, its management and utilization determine the actual costs. The worst-case economic scenario is to do nothing and simply incur the costs associated with this transport contract over the long-term to meet current and future peak demand requirements. Avista develops strategies to ensure this does not happen on a regular basis if possible.

### Capacity Release

Through the pipeline unbundling of transportation, the FERC establishes rules and procedures to ensure a fair market developed to manage pipeline capacity as a commodity. This evolved into the capacity release market and is governed by FERC regulations through individual pipelines. The pipelines implement the FERC's posting requirements to ensure a transparent and fair market is maintained for the capacity. All capacity releases are posted on the pipelines Bulletin Boards and, depending on the terms, may be subject to bidding in an open market. This provides the transparency sought by the FERC in establishing the release requirements. Avista utilizes the capacity release market to manage both long-term and short-term transportation capacity.

For capacity under contract that may exceed current demand, Avista seeks other parties that may need it and arranges for capacity releases to transfer rights, obligations, and costs. This shifts all or a portion of the costs away from Avista's customers to a third party until it is needed to meet customer demand.

Many variables determine the value of natural gas transportation. Certain pipeline paths are more valuable, and this can vary by year, season, month, and day. The term, volume and conditions present also contribute to the value recoverable through a capacity release. For example, a release of winter capacity to a third party may allow for full cost recovery; while a release for the same period that allows Avista to recall the capacity for up to 10 days during the winter may not be as valuable to the third party, but of high value to us. Avista may be willing to offer a discount to retain the recall rights during high demand periods. This turns a seasonal-for-annual cost into a peaking-only cost. Market terms and conditions are negotiated to determine the value or discount required by both parties.

Avista has several long-term releases, some extending multiple years, providing full recovery of all the pipeline costs. These releases maintain Avista's long-term rights to the transportation capacity without incurring the costs of waiting until demand increases. As the end of these release terms near, Avista surveys the market against the IRP to determine if these contracts should be reclaimed or released, and for what duration. Through this process, Avista retains the rights to vintage capacity without incurring the costs or having to participate in future pipeline expansions that will cost more than current capacity.

On a shorter term, excess capacity not fully utilized on a seasonal, monthly, or daily basis can also be released. Market conditions often dictate less than full cost recovery for shorter-term requirements. Mitigating some costs for an unutilized, but required resource reduces costs to our customers.

### Segmentation

Through a process called segmentation, Avista creates new firm pipeline capacity for the service territory. This doubles some of the capacity volumes at no additional cost to

customers. With increased firm capacity, Avista can continue some long-term releases, or even reduce some contract levels, if the release market does not provide adequate recovery. An example of segmentation is if the original receipt and delivery points are from Sumas to Spokane. Avista can alter this path from Sumas to Sipi, Sipi to Jackson Prairie, Jackson Prairie to Spokane. This segmentation allows Avista to flow three times the amount of natural gas on most days or non-peak weather events. In the event of a peak day, and the transport needs to be firm, the transportation can be rolled back up to ensure the natural gas will be delivered into the original firm path.

### **Storage**

As a one-third owner of the Jackson Prairie Storage facility, Avista holds an equal share of capacity (space available to store natural gas) and delivery (the amount of natural gas that can be withdrawn daily).

Storage allows lower summer-priced natural gas to be stored and used in the winter during high demand or peak day events. Like transportation, unneeded capacity and delivery can be optimized by selling into a future higher priced market. This allows Avista to manage storage capacity and delivery to meet growing peak day requirements when needed.

The injection of natural gas into storage during the summer utilizes existing pipeline transport and helps increase the utilization factor of pipeline agreements. Avista employs several storage optimization strategies to mitigate costs. Revenue from this activity flows through the annual PGA process.

### **Commodity and Transportation Optimization**

Another strategy to mitigate transportation costs is to participate in the daily market to assess if unutilized capacity has value. Avista seeks daily opportunities to purchase natural gas, transport it on existing unutilized capacity, and sell it into a higher priced market to capture the cost of the natural gas purchased and recover some pipeline charges. The amount of recovery is market dependent and may or may not recover all pipeline costs but does mitigate pipeline costs to customers.

### **Combination of Resources**

Unutilized resources like supply, transportation, storage, and capacity can combine to create products that capture more value than the individual pieces. Avista has structured long-term arrangements with other utilities that allow available resource utilization and provide products that no individual component can satisfy. These products provide more cost recovery of the fixed charges incurred for the resources while maintaining the rights to utilize the resource for future customer needs.

### **Resource Utilization Summary**

Avista manages the existing resources to mitigate the costs incurred by customers until the resource is required to meet demand. The recovery of costs is often market based



with rules governed by the FERC. Avista is recovering full costs on some resources and partial costs on others. The management of long- and short-term resources meets firm customer demand in a reliable and cost-effective manner.

### **Demand and Deliverability Balance**

After incorporating the above data into the PLEXOS® model, Avista generated an assessment of demand compared to existing deliverability resource sources (Transport Right) for several scenarios. Any underutilized resources will be optimized to mitigate the costs incurred by customers until the resource is required to meet demand. This management, of both long- and short-term resources, ensures the goal to meet firm customer demand in a reliable and cost-effective manner as described in Chapter 4.

Figures 6.10 and 6.11 provide graphic summaries of the deterministic results for the Average Scenario and Preferred Resource Strategy (PRS). Average Case demand (black line) as compared to existing storage and transport rights on a peak day. This demand is net of energy efficiency savings and shows the adequacy of Avista's transport rights under normal weather conditions. For this case, current resources exceed demand needs over the planning horizon. Considerations as to the importance of average demand are discussed above when optimizing resources and releasing capacity to mitigate costs along with contract type and terms for delivering gas in times of need. These resources vary in ownership by state and area and must match or exceed volume of expected demand.

Figures 6.12 and 6.13 details peak day demand compared to existing resources. This demand is also net of energy efficiency savings. Avista is still long transport rights, consistent with prior IRP expectations. Peak Day criteria is important as it protects our customers and their structures during extreme weather.

**Figure 6.10: Average Demand Compared to Storage & Transport Rights for February 28th**

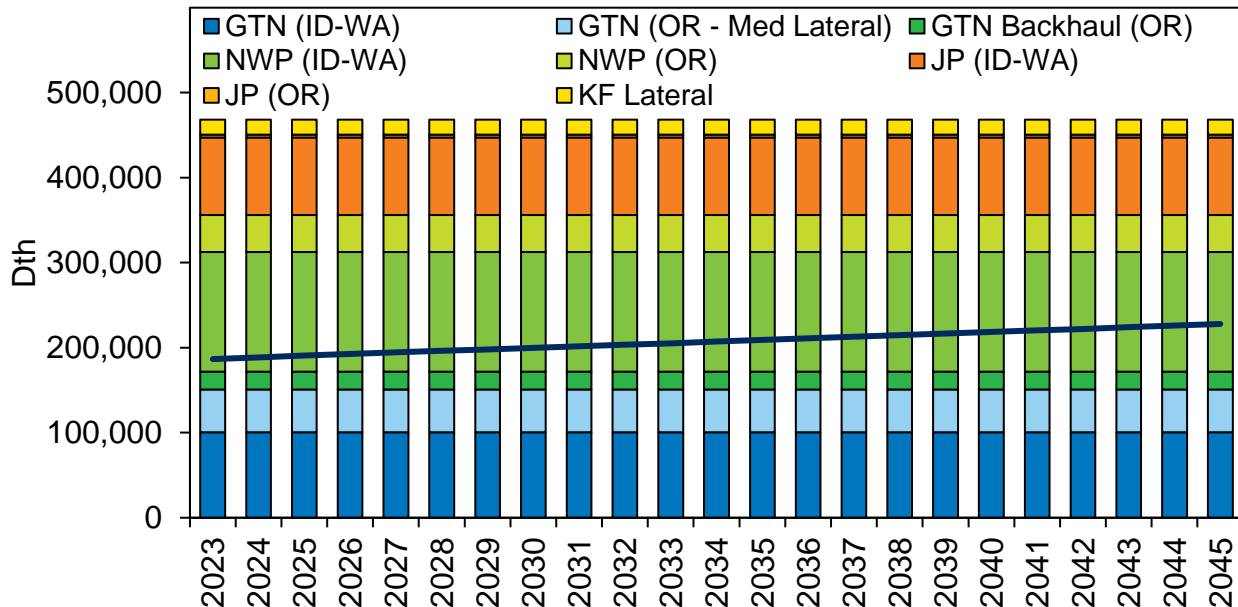

**Figure 6.11: Average Demand Compared to Storage & Transport Rights for December 20th**

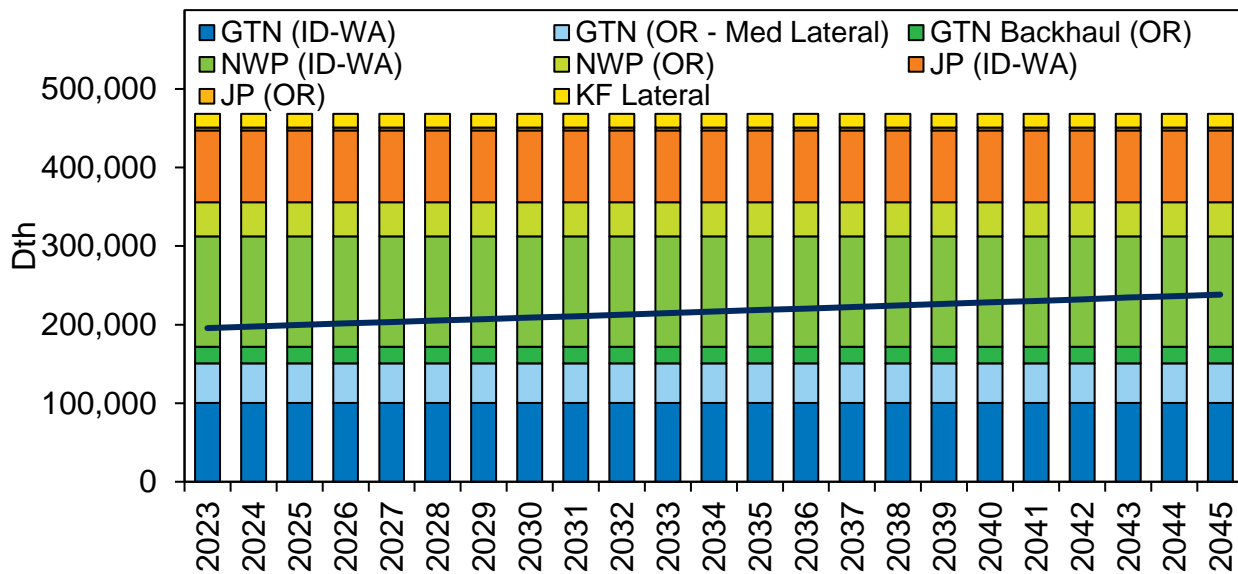

**Figure 6.12: Expected Peak Day Demand Compared to Storage & Transport Rights for February 28<sup>th</sup>**

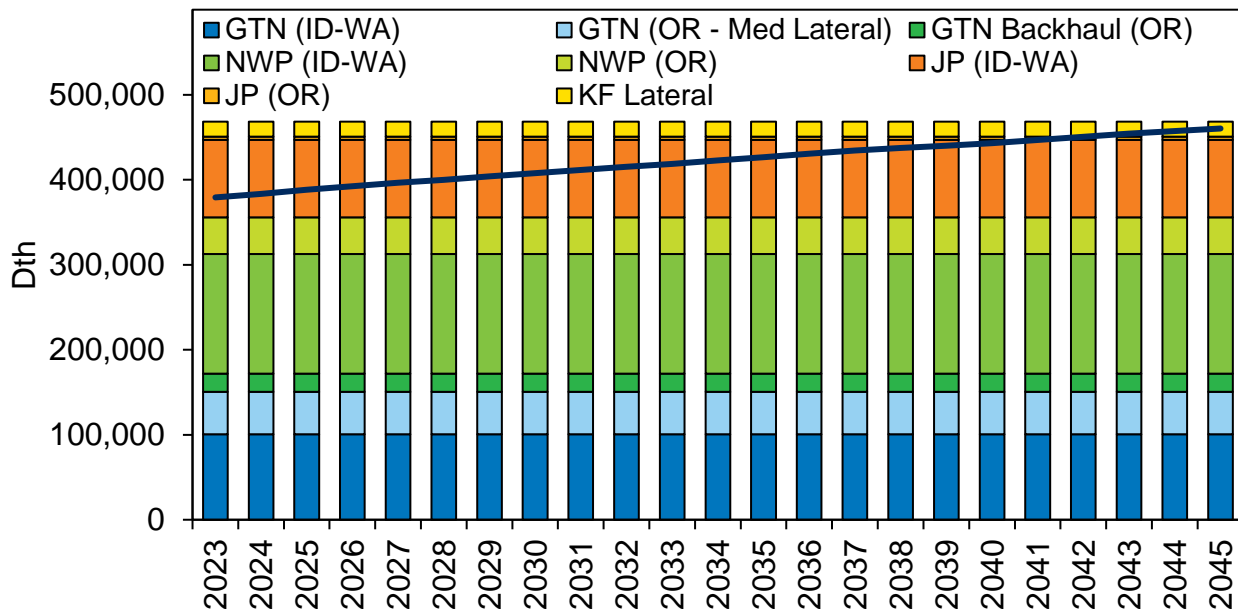

**Figure 6.13: Expected Peak Day Demand Compared to Storage & Transport Rights for December 20th**

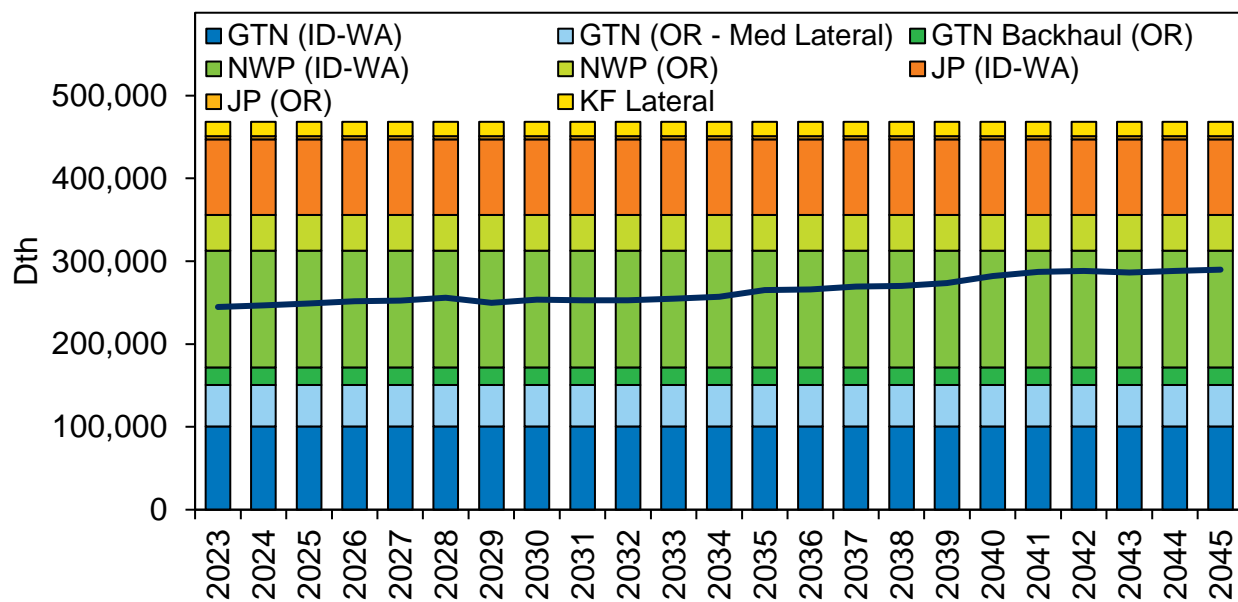

When considering emissions compliance under the CCA and CPP, a different story emerges when comparing to transportation rights. Greenhouse gas emissions compliance addresses program constraints of the CCA and CPP, plus these regulations require planning for transport customers where past plans did not. In both Figure 6.14 and Figure 6.15, equivalent emissions from firm customers and transport customers can be found in the stacked bar chart with the cap for the respective program as illustrated in

by the line. These charts clearly show noncompliance if no actions are taken to offset emissions or other options per program rules, where the total emissions in the blue and green bars exceed the cap shown in orange. These shortages occur in 2023 and continue through the end of the study in 2045. Further study is required to determine demand and price in an unknown future.

**Figure 6.14: Washington Emissions Forecast Compared to CCA Cap**

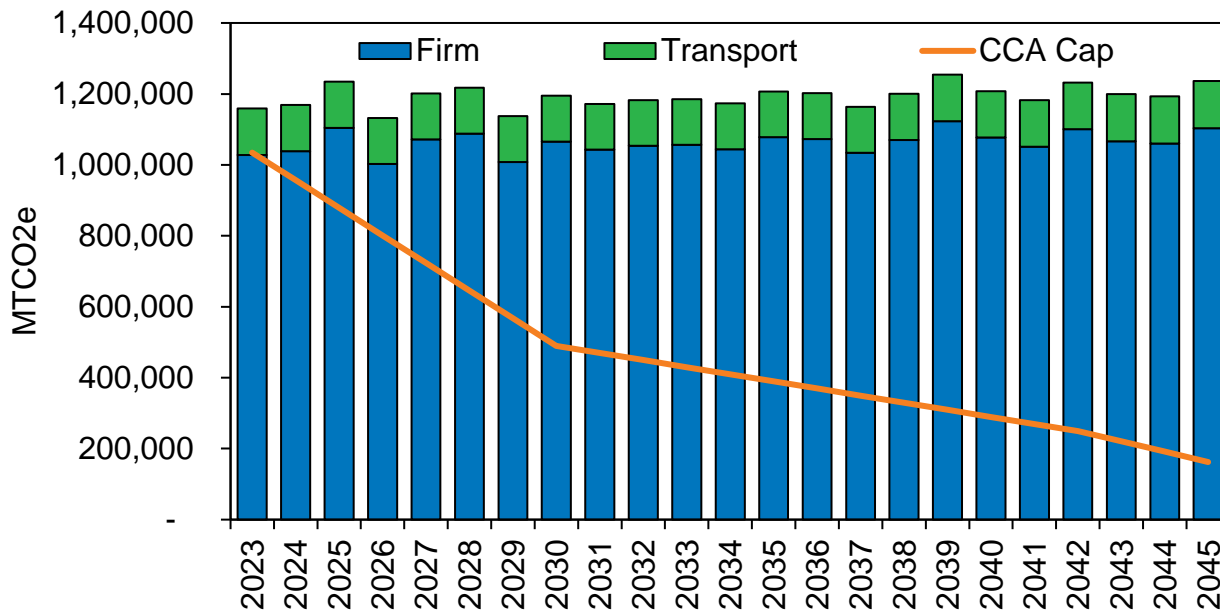

**Figure 6.15: Emissions Forecast Compared to CPP Cap**

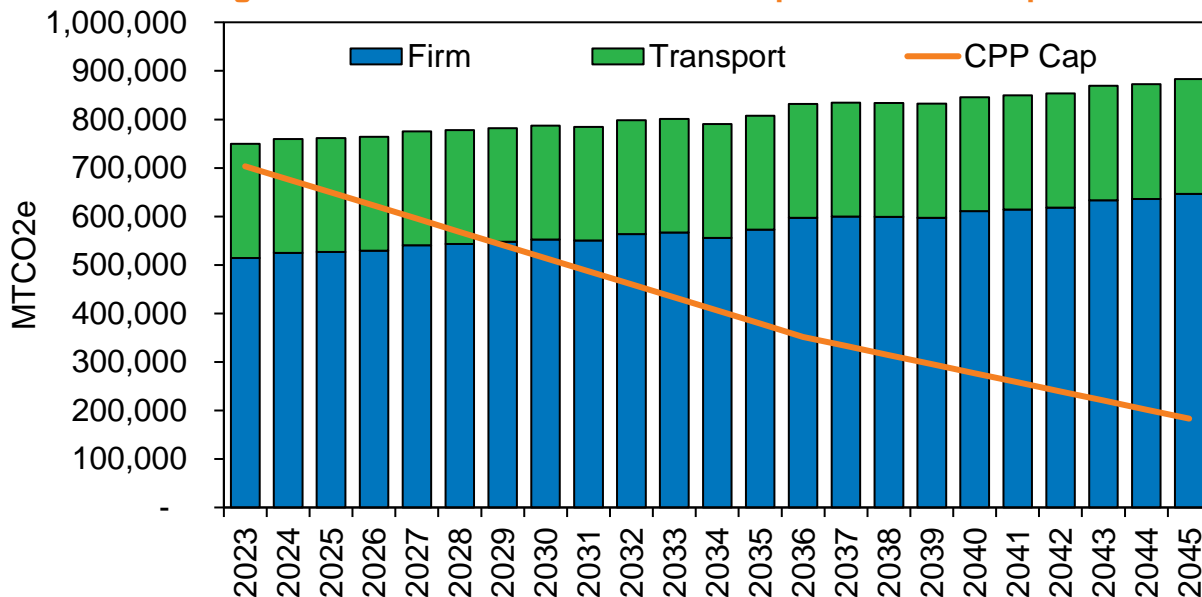

## New Resource Options and Considerations

All scenarios analyzed in this IRP process contain resource needs based on the climate policy in Oregon and Washington. These options have been input into the PLEXOS® model to help solve the energy demand and emissions goals. Table 6.1 highlights supply-side and demand-side resource options as discussed in prior chapters.

**Table 6.1: New Supply-Side and Demand-Side Resource Options**

Supply-Side Resource Options	Demand-Side Resource Options
Natural Gas + Compliance Instrument in OR (CCI) and WA (allowance or offset)	Demand Response by program
Green Hydrogen	Electrification – Space Heat
Synthetic Methane	Electrification – Water Heat
RNG by source (Dairy, Landfill, Solid Waste, and Waste Water)	Electrification - Other
Natural Gas	Energy Efficiency (CPA from AEG and ETO)

Resource cost is the primary consideration when evaluating resource options, although other factors mentioned below also influence resource decisions. Newly constructed resources are typically more expensive than existing resources, but existing resources are in shorter supply. Newly constructed resources provided by a third party, such as a pipeline, may require a significant contractual commitment. However, newly constructed resources are often less expensive per unit, if a larger facility is constructed, because of economies of scale. Resource cost estimates can be found in Chapter 4. A full set of resource options is provided in Figure 6.16 to help illustrate resource costs in comparison to one another over time. These costs exclude electrification options as found in Chapter 3, mostly as they skew the chart making the natural gas options difficult to view.

Figure 6.16: Resource Options and Costs in PLEXOS Model

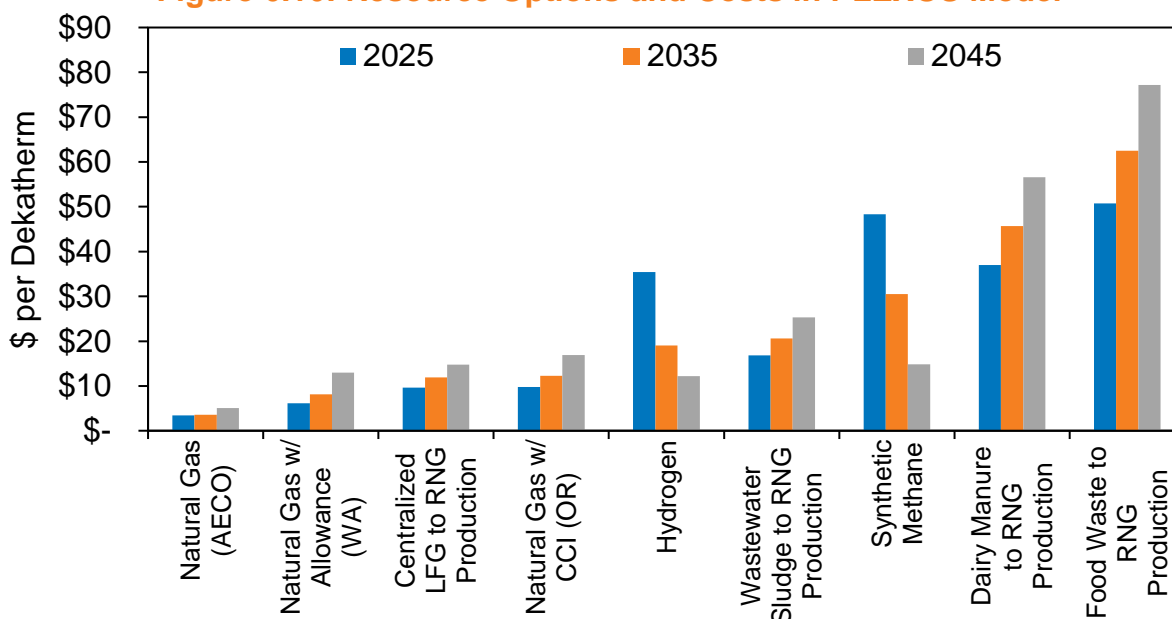

### Lead Time Requirements

New resource options can take up to five or more years to put in service. Open season processes to determine interest in proposed pipelines, planning and permitting, environmental review, design, construction, and testing contribute to lead time requirements for new facilities. Recalls of released pipeline capacity typically require advance notice of up to one year. Even energy efficiency programs can require significant time from program development and rollout to the realization of natural gas savings.

### Peak versus Base Load

Avista's planning efforts include the ability to serve firm natural gas loads on a peak day, as well as all other demand periods. Avista's core loads are considerably higher in the winter than the summer. Due to the winter-peaking nature of Avista's demand, resources that cost-effectively serve the winter load without an associated summer commitment may be preferable. Alternatively, it is possible that the costs of a winter-only resource may exceed the cost of annual resources after capacity release or optimization opportunities are considered.

### Resource Usefulness

Available resources must effectively deliver supply to the intended region. Given Avista's unique service territories, it is often impossible to deliver resources from a resource option, such as storage, without acquiring additional pipeline transportation. Pairing resources with transportation increases cost. Other key factors that can contribute to the usefulness of a resource are viability and reliability along with carbon intensity. If the potential resource is either not available currently (e.g., new technology) or not reliable on a peak day (e.g., firm), they may not be considered as an option for meeting unserved demand.

### “Lumpiness” of Resource Options

Newly constructed resource options are often “lumpy.” This means the new resources may only be available in larger-than-needed quantities and only available every few years. This lumpiness of resources is driven by the cost dynamics of new construction, where lower unit costs are available with larger expansions and the economics of expansion of existing pipelines or the construction of new resources dictate additions infrequently. The lumpiness of new resources provides a cushion for future growth. Economies of scale for pipeline construction provide the opportunity to secure resources to serve future demand increases. Part of this problem can be met by contracting out the excess resources until needed to serve load growth.

### Competition

LDCs, end-users and marketers compete for regional resources. The Northwest has efficiently utilized existing resources and has an appropriately sized system. Currently, the region can accommodate the regional energy demand needs. However, future needs vary, and regional LDCs may find they are competing with other parties to secure firm resources for customers. RNG resources specifically will have an increased amount of competition as the drive for carbon-reducing supplies increases with associated policy.

### Risks and Uncertainties

Investigation, identification, and assessment of risks and uncertainties are critical considerations when evaluating supply resource options. For example, resource costs are subject to degrees of estimation, partly influenced by the expected timeframe of the resource need and rigor determining estimates, or estimation difficulties because of the uniqueness of a resource. Lead times can have varying degrees of certainty ranging from securing currently available transport (high certainty) to building underground storage (low certainty).

## Energy Efficiency Resources

### Integration by Price

As described in Chapter 3, Avista determines energy efficiency cost effectiveness without future energy efficiency programs in the load forecast. This preliminary study provides an avoided cost curve for both Applied Energy Group (AEG) and Energy Trust of Oregon (ETO) to evaluate the cost effectiveness of energy efficiency programs against the initial avoided cost curve using the Utility Cost Test, Program Administrator Costs Test, Total Resource Cost Test, and Participant Cost Test. The therm savings and associated program costs are incorporated into the PLEXOS® model therefore reducing the load forecast.

### Energy Efficiency Selection

Using the avoided cost thresholds, AEG selected all potential cost-effective energy efficiency programs for the Idaho and Washington service areas, while ETO performed the CPA study for Oregon. Tables 6.2 and 6.3 show potential energy efficiency savings in dekatherms for each region from the resource potential for the Expected Case. The

energy efficiency annual demand served begins to decline after reaching a peak in 2032 as a total system as measures require replacement.

**Table 6.2: Annual Demand Served by Energy Efficiency**

Case	Year	Klamath Falls	La Grande	Medford/Roseburg	Oregon	Idaho	Washington	Total System
PRS	2023	8,194	4,466	44,889	57,549	46,414	111,991	273,503
PRS	2024	8,504	4,635	46,586	59,725	52,700	122,712	294,863
PRS	2025	8,864	4,831	48,555	62,249	59,890	137,682	322,070
PRS	2026	9,008	4,909	49,347	63,264	55,234	123,902	305,664
PRS	2027	9,431	5,140	51,661	66,232	64,711	139,450	336,624
PRS	2028	10,110	5,510	55,382	71,002	74,970	152,821	369,795
PRS	2029	10,914	5,948	59,786	76,647	83,106	171,273	407,674
PRS	2030	11,614	6,330	63,622	81,566	89,337	177,730	430,199
PRS	2031	12,288	6,697	67,317	86,302	91,496	175,688	439,788
PRS	2032	12,839	6,997	70,332	90,168	90,704	171,846	442,886
PRS	2033	13,263	7,228	72,656	93,147	85,561	160,872	432,727
PRS	2034	13,521	7,369	74,066	94,955	78,470	146,895	415,276
PRS	2035	13,307	7,252	72,898	93,458	71,431	131,483	389,830
PRS	2036	13,059	7,117	71,535	91,711	64,587	119,970	367,979
PRS	2037	12,805	6,979	70,147	89,930	56,419	107,079	343,358
PRS	2038	12,610	6,872	69,078	88,561	49,196	91,981	318,299
PRS	2039	12,375	6,744	67,793	86,913	43,787	82,345	299,957
PRS	2040	12,210	6,654	66,886	85,750	40,163	76,356	288,019
PRS	2041	12,032	6,557	65,913	84,503	35,109	67,940	272,055
PRS	2042	11,753	6,405	64,384	82,543	34,459	64,851	264,396

**Table 6.3: Average Daily Demand Served by Energy Efficiency**

Case	Year	Klamath Falls	La Grande	Medford/Roseburg	Oregon	Idaho	Washington	Total System
PRS	2023	22.45	12.24	122.98	157.67	127.16	306.83	749.32
PRS	2024	23.24	12.66	127.28	163.18	143.99	335.28	805.64
PRS	2025	24.28	13.23	133.03	170.55	164.08	377.21	882.38
PRS	2026	24.68	13.45	135.20	173.33	151.33	339.46	837.44
PRS	2027	25.84	14.08	141.54	181.46	177.29	382.05	922.26
PRS	2028	27.62	15.05	151.32	193.99	204.84	417.54	1,010.37
PRS	2029	29.90	16.30	163.80	209.99	227.69	469.24	1,116.92
PRS	2030	31.82	17.34	174.31	223.47	244.76	486.93	1,178.63
PRS	2031	33.67	18.35	184.43	236.44	250.67	481.34	1,204.90
PRS	2032	35.08	19.12	192.16	246.36	247.83	469.53	1,210.07
PRS	2033	36.34	19.80	199.06	255.20	234.41	440.74	1,185.55
PRS	2034	37.04	20.19	202.92	260.15	214.99	402.45	1,137.74
PRS	2035	36.46	19.87	199.72	256.05	195.70	360.23	1,068.03
PRS	2036	35.68	19.44	195.45	250.58	176.47	327.79	1,005.41
PRS	2037	35.08	19.12	192.18	246.38	154.57	293.37	940.71
PRS	2038	34.55	18.83	189.26	242.63	134.78	252.00	872.05
PRS	2039	33.91	18.48	185.73	238.12	119.97	225.60	821.80
PRS	2040	33.36	18.18	182.75	234.29	109.74	208.62	786.94
PRS	2041	32.97	17.97	180.58	231.51	96.19	186.14	745.36
PRS	2042	32.20	17.55	176.40	226.14	94.41	177.67	724.37



## Preferred Resource Strategy (PRS)

The PRS considers current supply-side resources and new resource options to solve the energy and carbon program goals. The resources Avista modeled for the current IRP include five types of RNG, hydrogen, synthetic methane, and demand side options of demand response (DR) as discussed in Chapter 4, and electrification of major end uses such as space heat, water heating and cooking detailed in Chapter 3. The cost risk for each of these selected resources can be found in Chapter 4.<sup>2</sup> Electrification end uses are treated as a resource and if any amount is taken, future years must take this same amount as a minimum as it's considered permanent demand loss. Demand Response is treated in a similar fashion as if a program is selected, program costs, and demand savings must be used going forward.

To solve for unserved demand and emissions goals, a set of resources options are available to meet the requirements of energy, capacity and emissions constraints as determined from these stochastic draws. This stochastic evaluation is a deviation from prior resource plans and has been introduced to not over procure new resources, while maintaining compliance to emission reduction programs. Using deterministic results would create a yearly energy peak and may increase risks in the over investment in resources. As discussed in Chapter 2, weather and demand will vary as shown historically, and planning for new resource must be considered on a stochastic basis.

### Idaho PRS

The Idaho PRS continues to utilize the least cost natural gas basin, and storage, combined with energy efficiency to meet energy demand as illustrated in Figure 6.17. Natural gas will be acquired on a least cost basis from the available hubs as illustrated in Figure 6.18. This figure displays a combination of purchases from the connected hubs available with the primary choice coming from the AECO basin. This basin is geographically closest to Avista's Idaho territory and is where the Company's largest amount of pipeline capacity is located.

---

<sup>2</sup> Chapter 4 – Current Supply-Side Resources and New Resource Options.

Figure 6.17: Idaho Preferred Resource Strategy

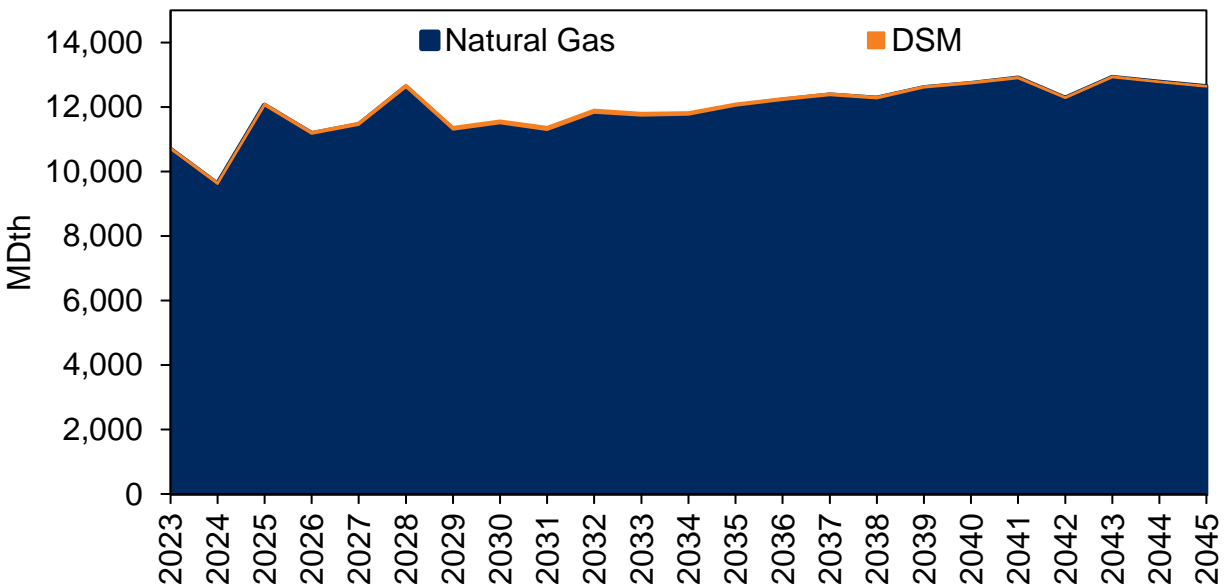
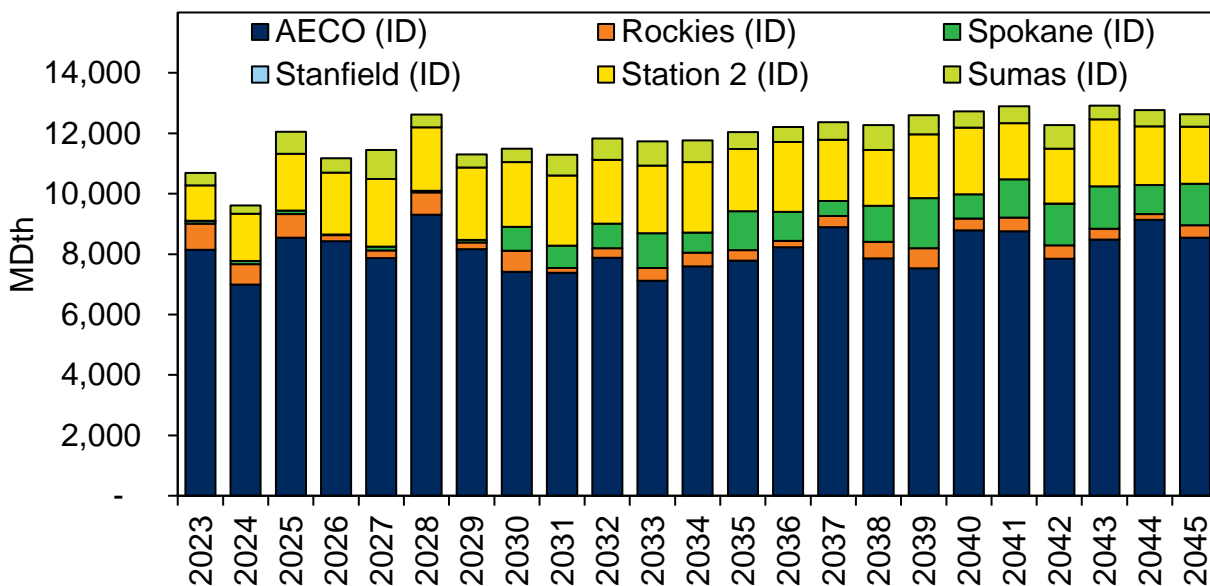

Figure 6.18: Natural Gas Basin Least Cost - Idaho



**Oregon PRS**

Oregon’s PRS has drastically changed as compared to the 2021 IRP. Changes adhere to the new environmental goals of the CPP and the estimated energy demand. In the near-term, the new resource need is acquired via a combination of RNG from Landfill Gas (LFG), Wastewater Treatment Plants (WWTP), energy efficiency, Community Climate Investments (CCIs), and conventional natural gas. Synthetic methane is added to the resource mix beginning in the 2030’s, as illustrated in Figure 6.19. Least cost natural gas basin is illustrated in Figure 6.20. In each figure, the dark blue area at the bottom of the

chart depicts natural gas with no emissions instrument for compliance, essentially the cap of the CPP.

**Figure 6.19: Oregon Preferred Resource Strategy**

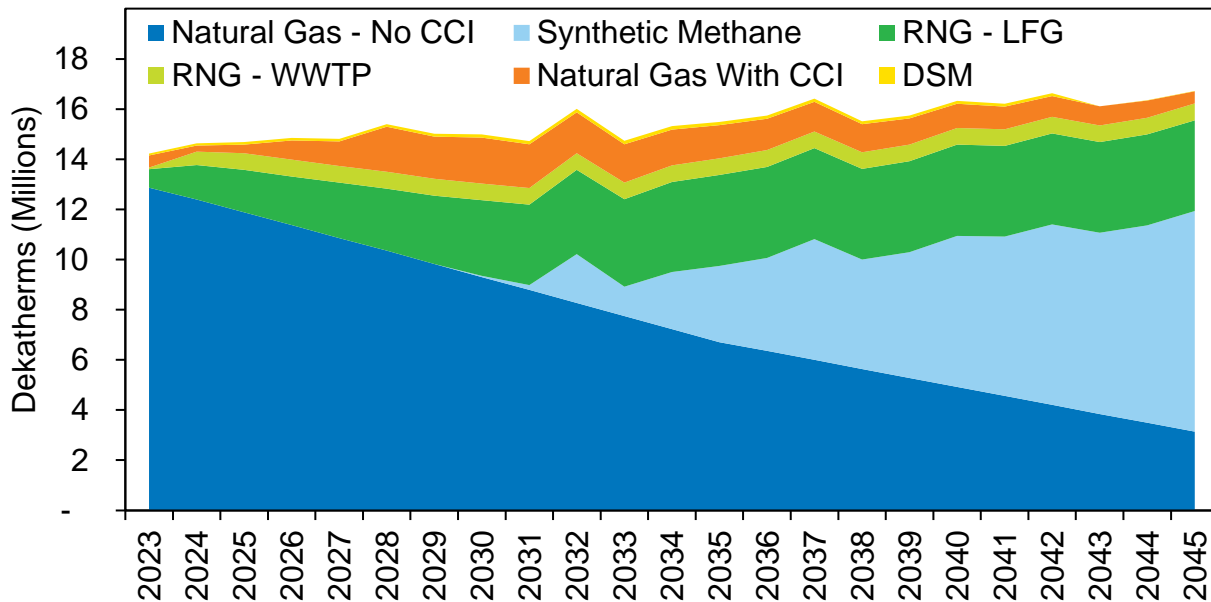

**Figure 6.20: Natural Gas Basin Least Cost – Oregon**

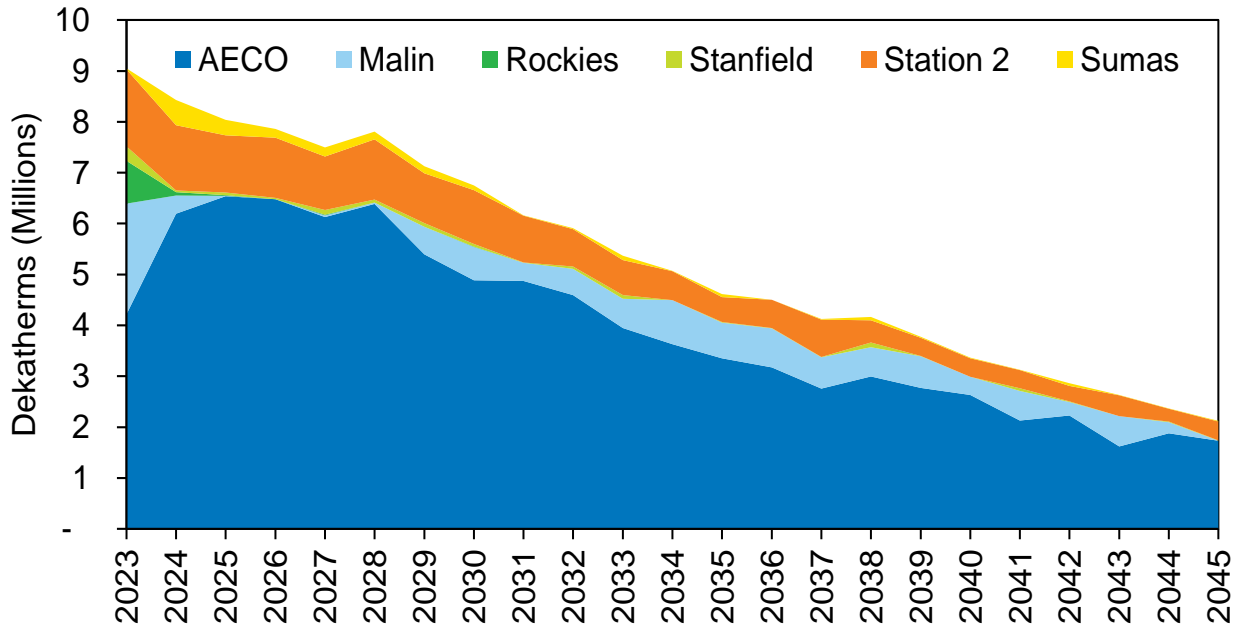

As discussed in Chapter 5, the number of CCIs available to Avista declines with the cap each year. To backfill these lost CCIs additional resources need to be brought onto the system on an annual basis through the end of the study timeframe. This will lead to an increased number of renewable energy sources needed as depicted in Table 6.4.

**Table 6.4: Average Daily Resource Quantities by Year**

Year	Natural Gas - No CCI	Synthetic Methane	RNG - LFG	RNG - WWTP	Natural Gas with CCI (Dth equivalent)
2023	35,237	-	2,024	196	1,310
2024	33,960	-	3,762	1,460	666
2025	32,568	-	4,619	1,824	955
2026	31,173	-	5,306	1,824	2,095
2027	29,747	-	6,038	1,824	2,681
2028	28,375	-	6,773	1,829	4,923
2029	26,908	-	7,474	1,824	4,613
2030	25,491	138	8,240	1,824	5,028
2031	24,082	517	8,800	1,824	4,748
2032	22,654	5,329	9,208	1,829	4,469
2033	21,219	3,205	9,559	1,823	4,190
2034	19,795	6,229	9,837	1,824	3,910
2035	18,377	8,337	9,918	1,824	3,631
2036	17,405	10,172	9,947	1,827	3,437
2037	16,430	13,210	9,920	1,823	3,244
2038	15,448	11,936	9,920	1,824	3,050
2039	14,462	13,748	9,920	1,824	2,856
2040	13,486	16,507	9,946	1,828	2,663
2041	12,491	17,401	9,920	1,824	2,469
2042	11,523	19,717	9,920	1,824	2,276
2043	10,533	19,778	9,920	1,824	2,082
2044	9,563	21,552	9,947	1,829	1,888
2045	8,597	24,093	9,920	1,824	1,356

CCIs are expected to be a least cost solution when compared to renewable resource options, due to the ability to pair CCIs with natural gas as a low quantity solution. Low carbon resource fuels will be needed to serve a consistent demand of energy and emissions. Also, due to the divergent weather locations, the risk of needed CCIs is volatile. The coldest weather is found in La Grande and Klamath Falls where peak days have been observed in the past 30 years. In contrast, Medford and Roseburg are warmer climates and do not get the extreme temperatures. Figure 6.21 illustrates the range in CCIs required given the potential for weather variance. In the near term the CCIs have a wide range of volumes required. Beginning in 2030, the range disappears as the certainty of the demand for these instruments in meeting CPP emission compliance is necessary to procure the entire amount available within the program. Finally, the study points to

more uncertainty for CCIs as alternative fuels may become more cost effective in the 2042 and beyond time horizon.

**Figure 6.21: Community Climate Investment Quantity – (MTCO<sub>2</sub>e)**

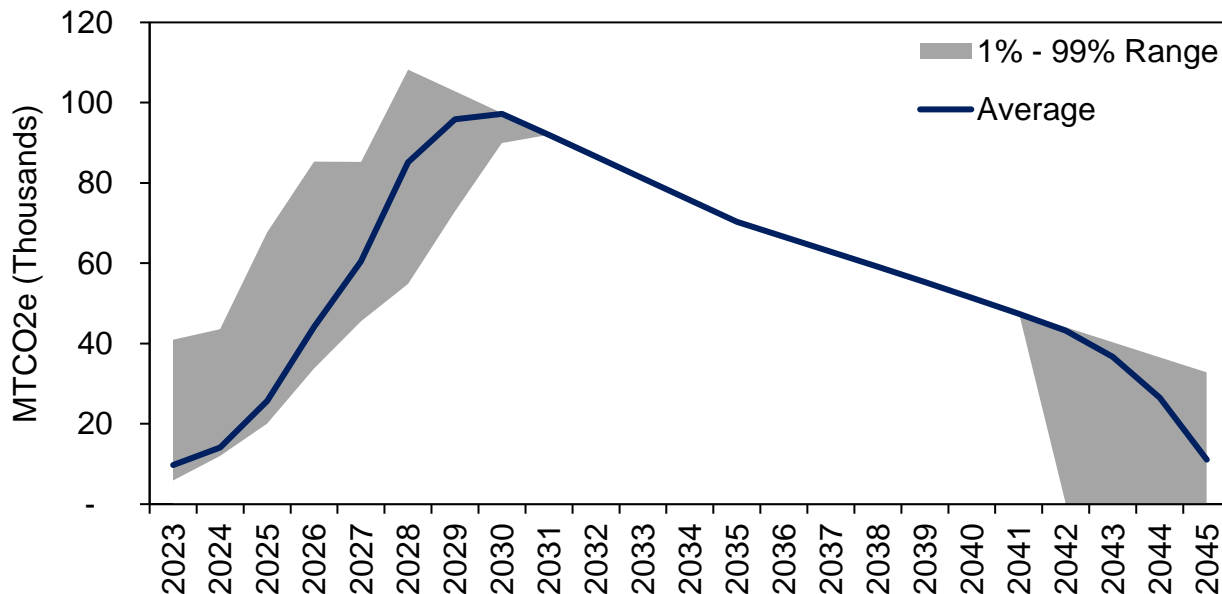

**Washington PRS**

Washington’s PRS has also changed dramatically from the 2021 IRP. The CCA has introduced a cap-and-trade program with the ability to cover emissions with an allowance or offset. Allowance and offset prices may drive a different PRS than the one illustrated in Figure 6.22. The range of allowance prices for 2023 is \$22 to \$82 USD. The PRS shows conventional natural gas and energy efficiency as the primary energy source options until the end of the study horizon (2044), when synthetic methane is chosen. The darker blue area in the chart is the CCA program cap and would not require any type of program instruments. The lighter blue area represents natural gas as an energy source, requiring an offset or an allowance as it is above the cap. Natural gas will continue to be procured from the least cost supply basin as shown in Figure 6.23.

**Figure 6.22: Washington Preferred Resource Strategy**

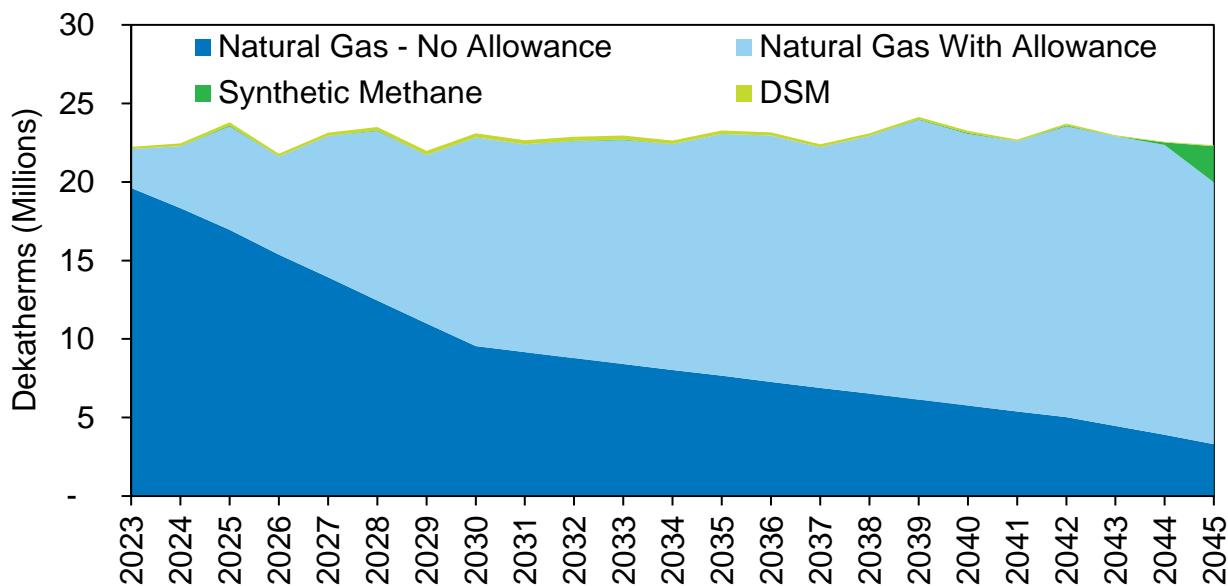

**Figure 6.23: Natural Gas Basin Least Cost - Washington**

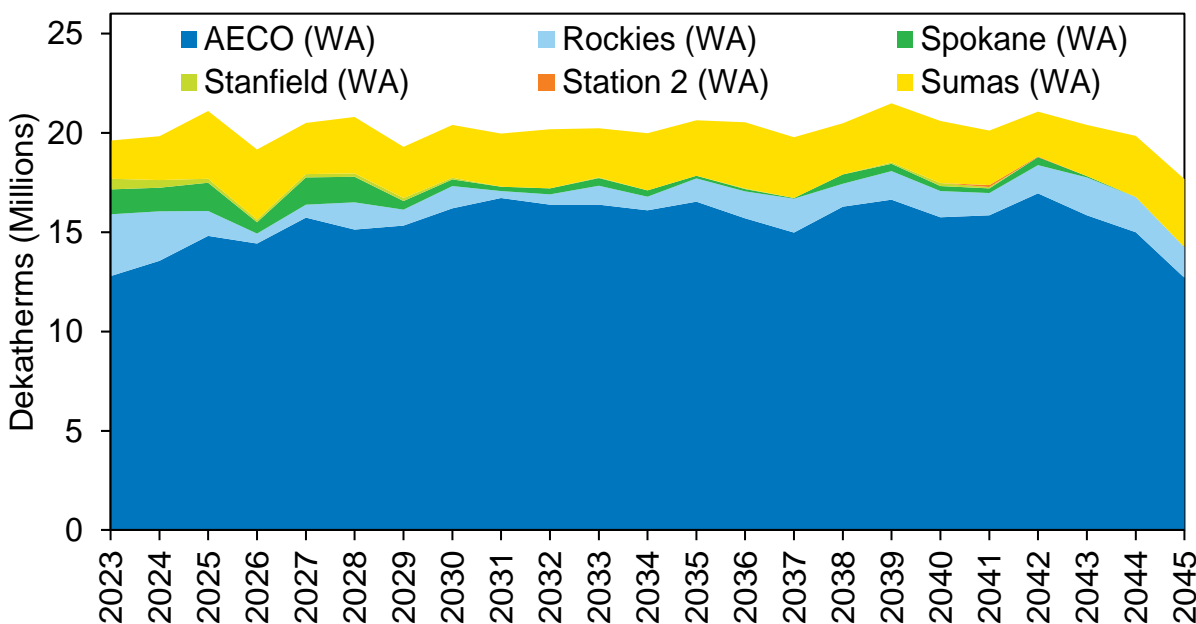

The specific resource selection by year is shown in Table 6.5. Avista does not expect a significant reduction in traditional natural gas use with the CCA prices assumed in this expected case. Chapter 7 identifies how reduction in traditional natural gas may occur either by way of higher CCA prices or non-cost-effective electrification.

**Table 6.5: Average Daily Resource Quantities by Year – Washington**

Year	Energy Efficiency	Natural Gas	Synthetic Methane	Allowances DTh Equivalent	Natural Gas - No allowance	Natural Gas with allowance
2023	404	60,537	-	6,807	53,730	6,807
2024	507	60,881	-	10,804	50,077	10,804
2025	558	64,507	136	18,075	46,432	18,075
2026	519	59,228	-	17,105	42,122	17,105
2027	563	62,859	-	24,688	38,171	24,688
2028	612	63,497	119	29,472	34,026	29,472
2029	685	59,521	3	29,412	30,109	29,412
2030	717	62,552	0	36,417	26,135	36,417
2031	723	61,364	-	36,236	25,128	36,236
2032	717	61,759	52	37,748	24,011	37,748
2033	686	62,066	141	39,023	23,043	39,023
2034	641	61,415	-	39,422	21,994	39,422
2035	585	63,193	3	42,210	20,983	42,210
2036	546	62,735	-	42,884	19,851	42,884
2037	496	60,887	5	42,055	18,833	42,055
2038	427	62,836	20	44,967	17,869	44,967
2039	372	65,626	157	48,772	16,854	48,772
2040	340	63,017	177	47,287	15,730	47,287
2041	300	61,895	20	47,151	14,744	47,151
2042	287	64,523	159	50,754	13,769	50,754
2043	154	62,775	14	50,559	12,217	50,559
2044	136	61,087	428	50,438	10,649	50,438
2045	129	54,741	6,313	45,678	9,063	45,678

Allowances and offsets will be considered interchangeably and compared to one another with available options at the time of purchase. In the event Avista can obtain offsets at a lower price than allowances, offsets will be purchased in place of allowances. The PRS selects program instruments each year as shown in Figure 6.24 with bounds to address the potential need for more or less allowances. Similar to CCIs in Oregon, the range of allowance volumes beginning in 2040 becomes volatile as alternative resources become cost effective in comparison to natural gas paired with an allowance.

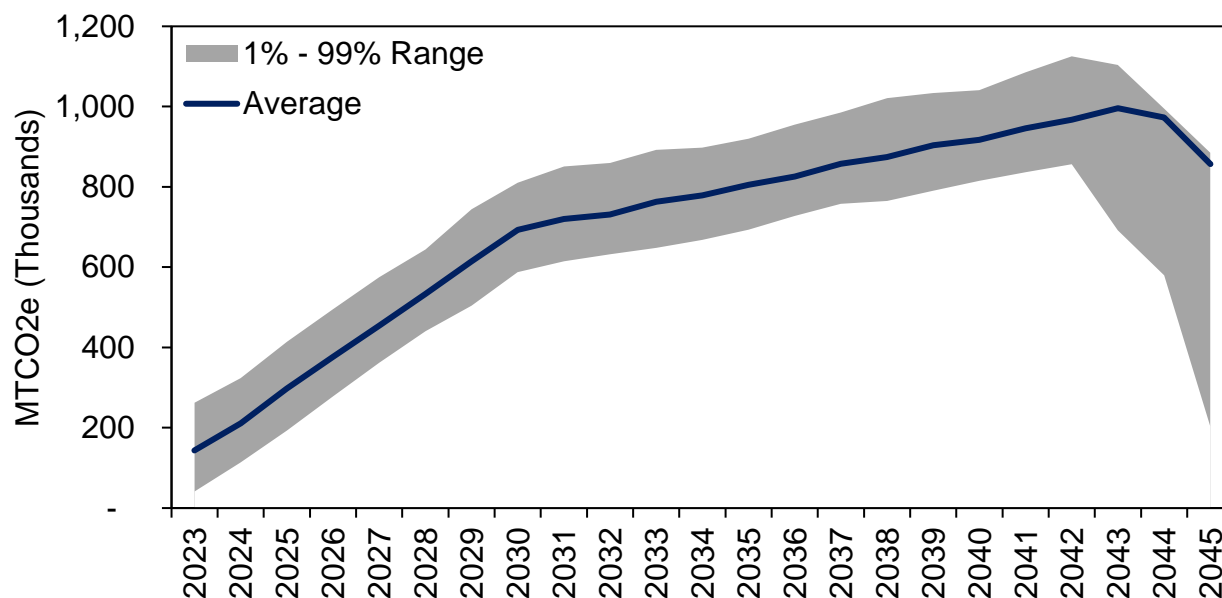
Figure 6.24: CCA Allowances/Offsets Quantity Needed (MTCO<sub>2</sub>e)

## Monte Carlo Risk Analysis

Avista uses 500 Monte Carlo draws (23-year futures, 2023 – 2045) to measure the statistical risk of varying elements such as price and demand based on the new resources selected from the five stochastic simulations. Weather and price risk related to costs of our PRS case are put through a Monte Carlo simulation based on the stochastic scenario solve. The Monte Carlo simulation in PLEXOS® can vary index price and weather simultaneously. This simulates the effects each have on the other. Monte Carlo solves resources and demand need for each year based on least cost pricing.

Avista performed stochastic modeling for estimating probability distributions of potential outcomes by allowing for random variation in natural and renewable gas prices, Allowance prices, the occurrence of a national carbon tax applied to Idaho beginning in 2030, and weather based on fluctuations in historical data. This statistical analysis, in conjunction with the deterministic analysis, enabled statistical quantification of risk from reliability and cost perspectives related to resource portfolios under varying price and weather conditions.

Annual system demand costs are summarized in Figure 6.25 and illustrate the cost volatility across the system. Some costs such as CCIs for compliance with the CPP are known, other than inflation, so there is little risk in the movement of costs from year to year. The costs of allowances or offsets to comply with the CCA are not known and can move between the floor and ceiling on an annual basis. Figures 6.25 through 6.28 illustrate the specific cost information based on jurisdiction.



**Figure 6.25: System Annual Costs – 1,000 of \$ (500 Draws)**

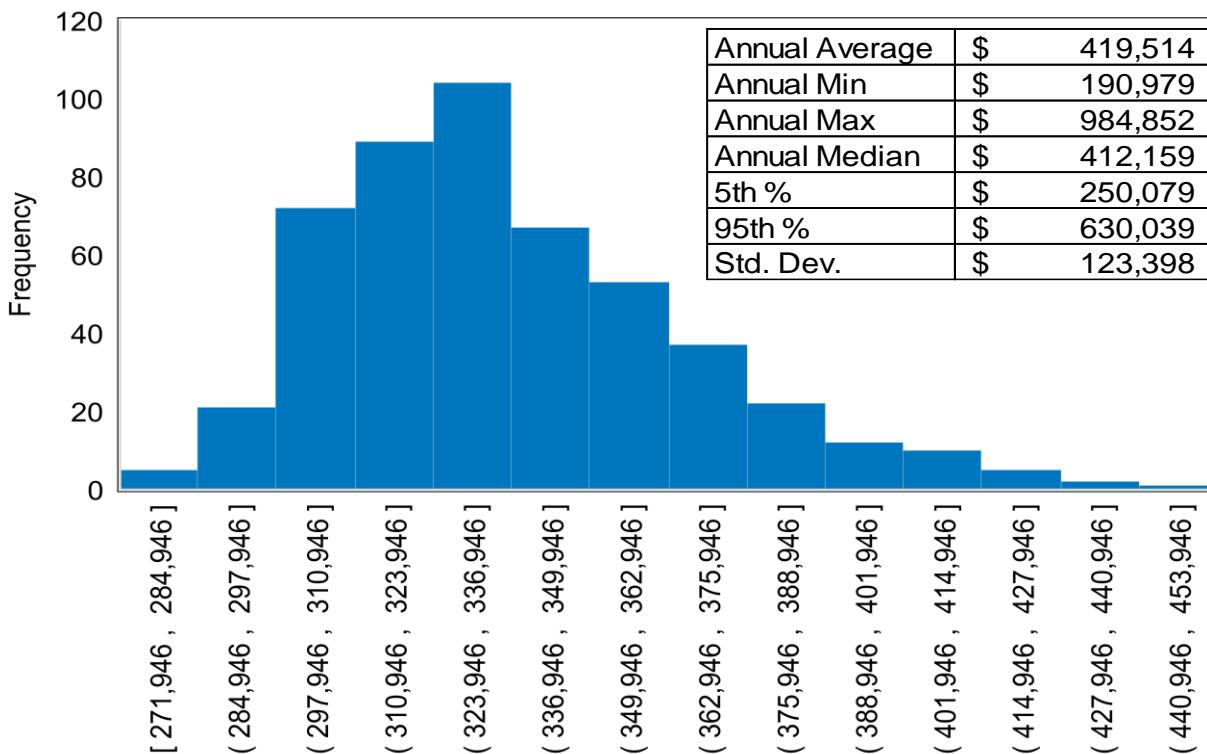

**Figure 6.26: Idaho Annual Costs – 1,000 of \$ (500 Draws)**

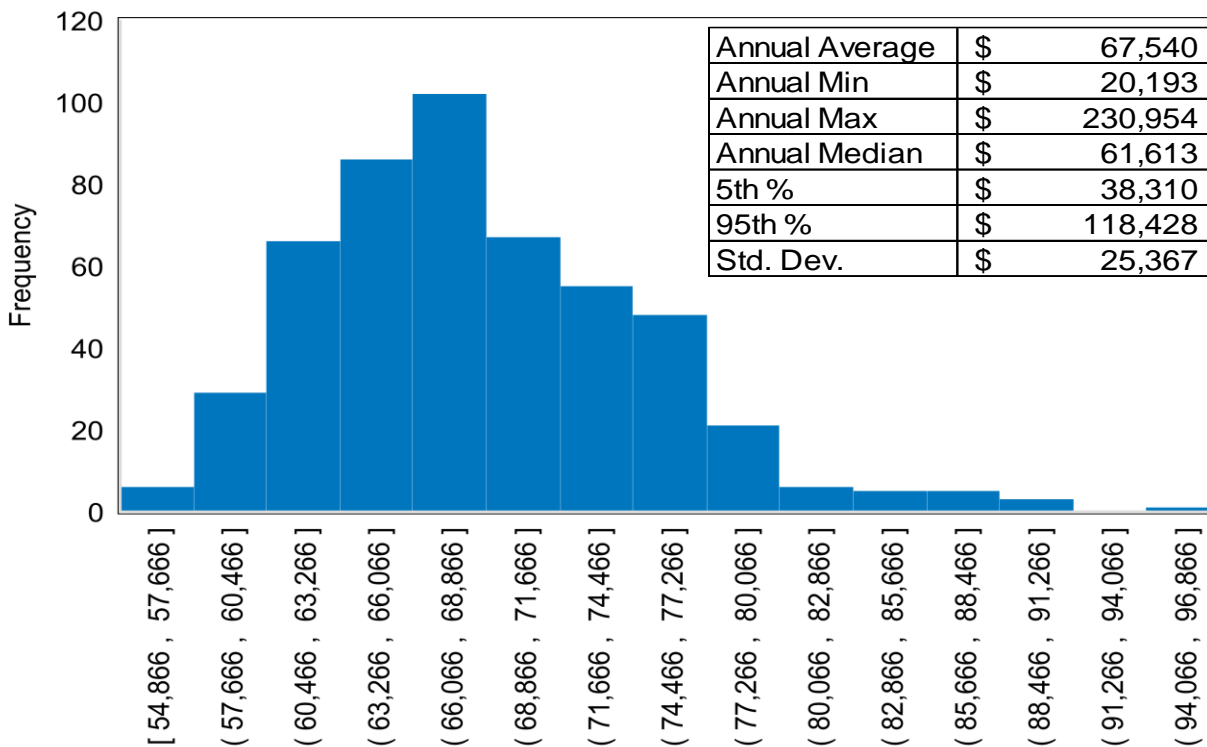

Figure 6.27: Oregon Annual Costs – 1,000 of \$ (500 Draws)

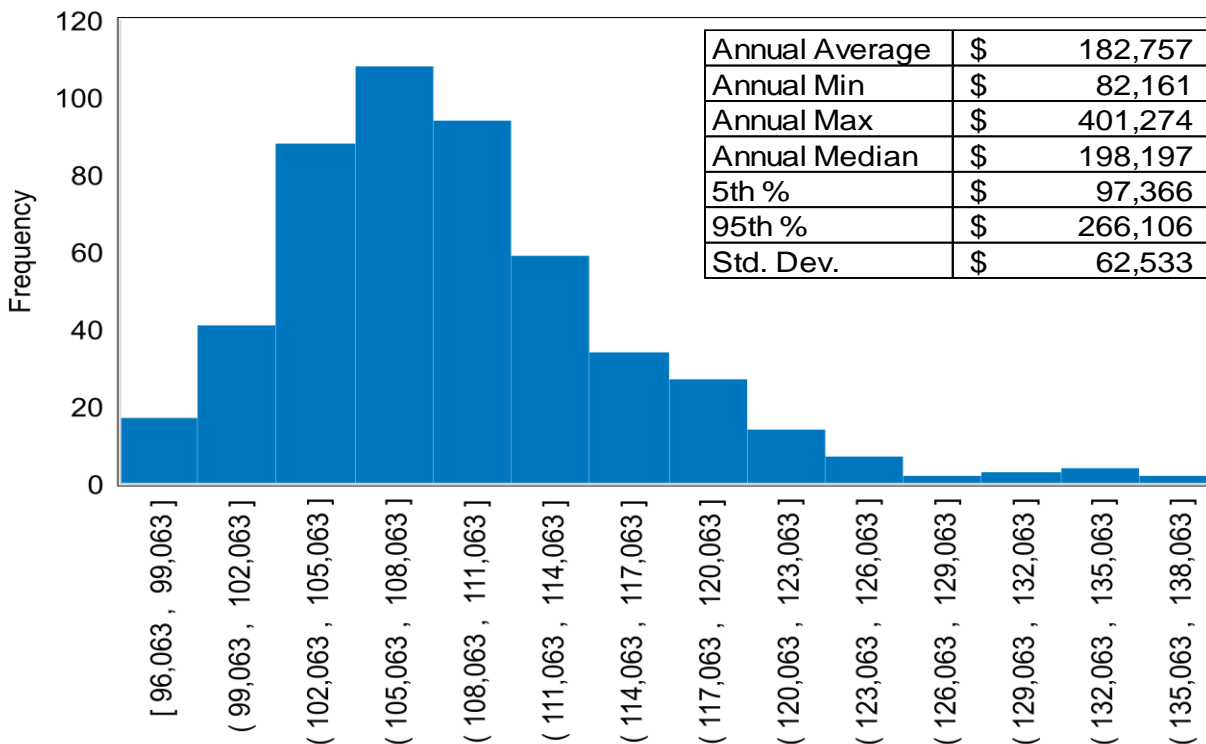
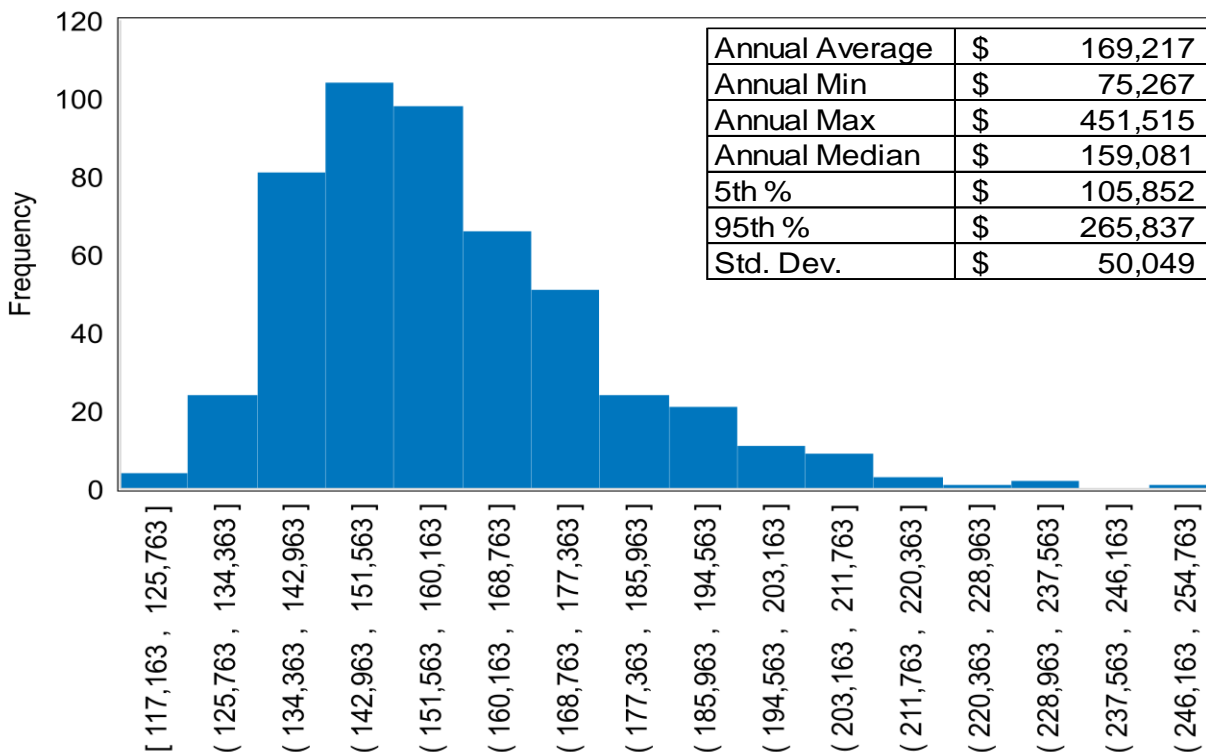

Figure 6.28: Washington Annual Costs – 1,000 of \$ (500 Draws)



## Estimated Price Impacts

The estimated rate impacts are intended to give a commodity only estimate of impacts to meet the energy demand and emissions goals. Specifically, these price estimates include contracted, owned, or leased infrastructure resources, the energy and any fuel needed to move the energy (if required). The price impacts by specific customer class, like low-income residential customers in Washington, will differ from non-low-income customers. These are just for illustrative purposes to general area and class. General and administrative costs of providing energy, office support, and its infrastructure are not included in these overall estimates. Figure 6.29 through Figure 6.32 illustrate price impacts by generic class and jurisdiction.

**Figure 6.29: Residential Price Impact (\$ of therm)**

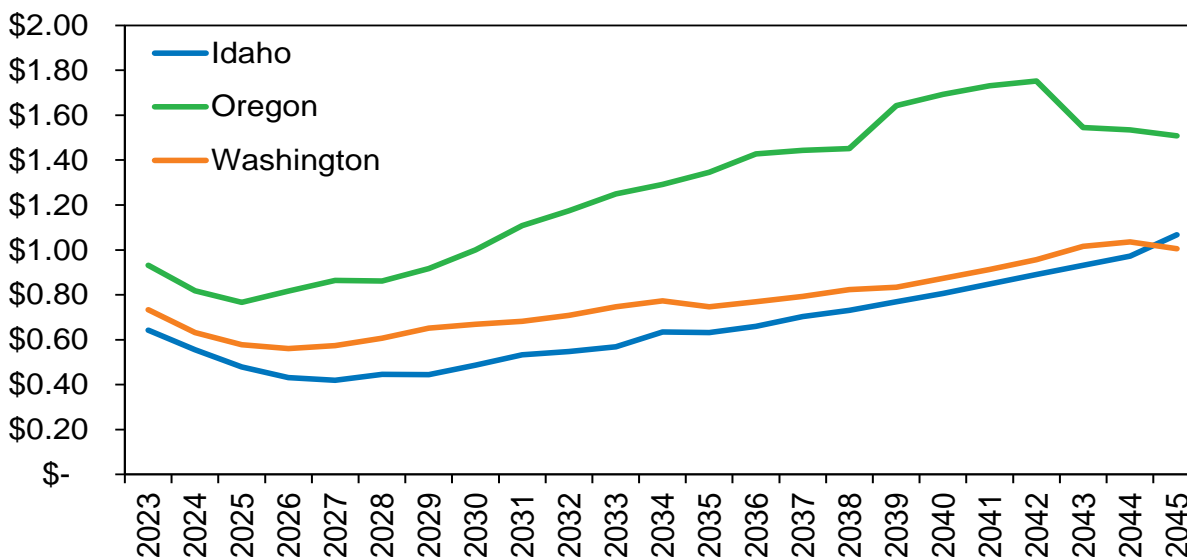

**Figure 6.30: Commercial Price Impact (\$ per therm)**

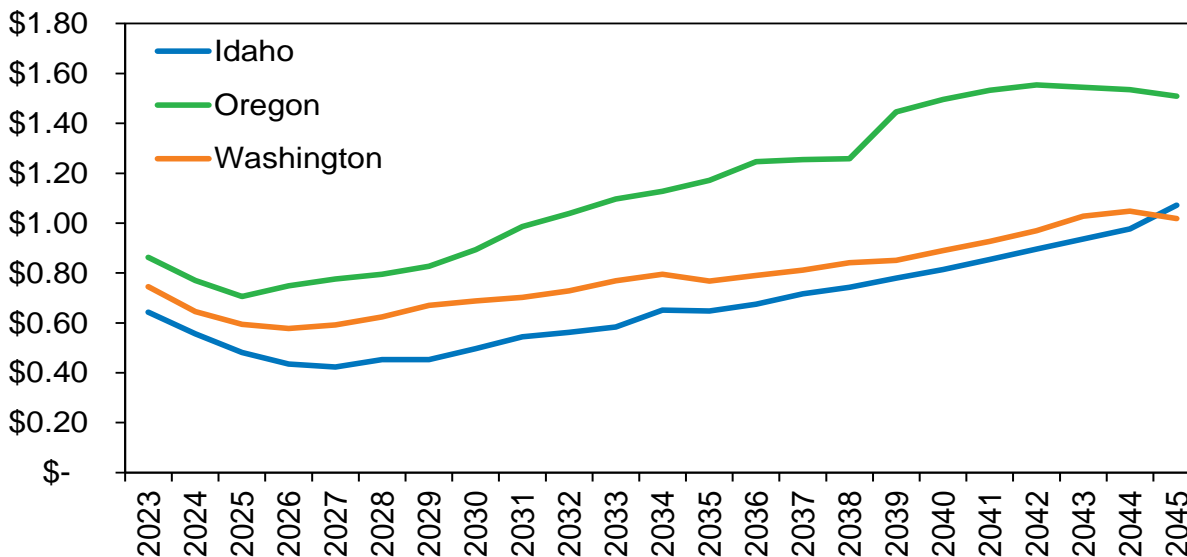

Figure 6.31: Industrial Price Impact (\$ per therm)

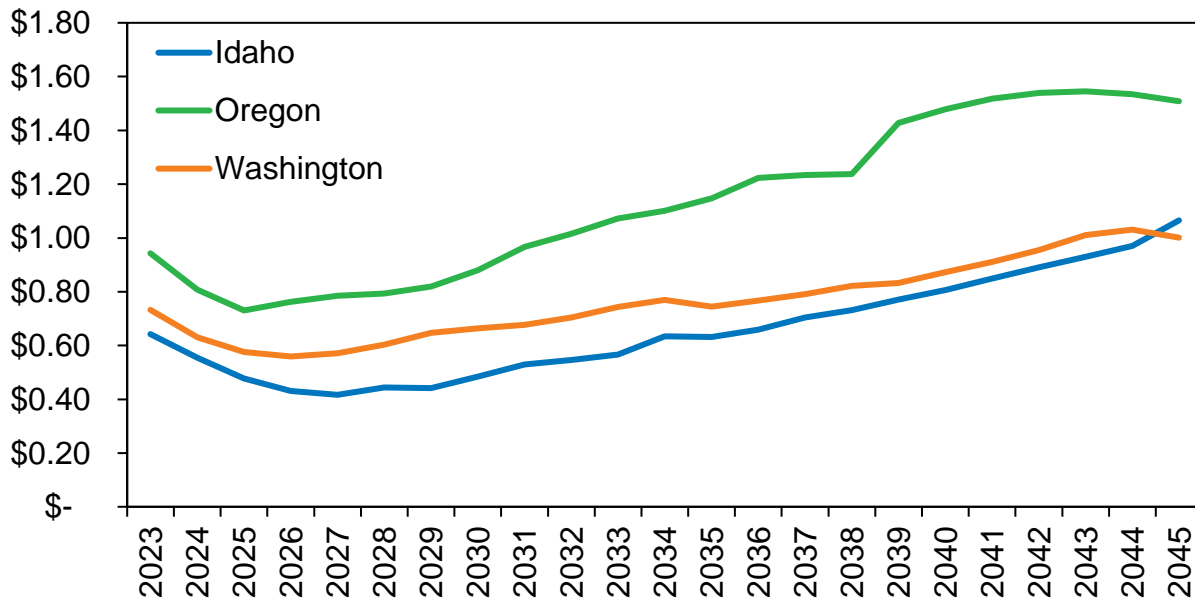
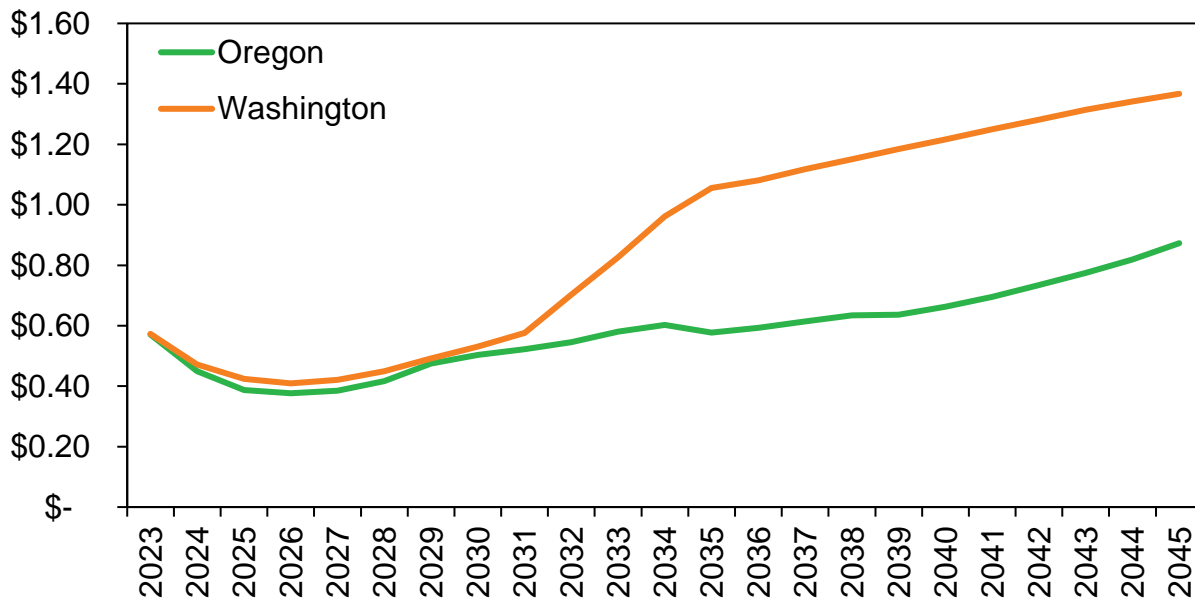

Figure 6.32: Transport Price Impact (\$ per therm)



This Page Intentionally Left Blank

## 7. Alternate Scenarios

Avista applied the Preferred Resource Strategy and Risk analysis in Chapter 6 to alternate demand and supply resource scenarios to develop a range of alternate portfolios. This modeling approach considered different underlying assumptions vetted with the TAC members to develop a consensus about the number of cases to model. These scenarios help in the understanding of the PRS results and to provide insight of the costs and benefits with policy changes.

### Alternate Demand Scenarios

As discussed in Chapter 2, Avista identified alternate scenarios for detailed analysis to capture a range of possible outcomes over the planning horizon. The scenarios consider different demand and price-influencing factors as shown in Table 7.1.

**Table 7.1: 2023 IRP Scenarios**

2023 IRP Scenarios	Natural Gas Prices	DSM Potential	CCA	Customer Growth	Electrification Conversion Costs	Renewable Prices	Renewable Supply	Pipeline Outages	Carbon Intensity Natural Gas	Carbon Intensity Renewables	Cost of Carbon	Weather	UPC	CPP
PRS	Expected	Expected	Expected Price (Allowances)	Expected	Expected	Expected	Expected	None	117 lbs. per Dekatherm	0 lbs. per Dekatherm	Carbon Tax Beginning 2030 Idaho Only	Climate Change	5-Year UPC - OR 3-Year UPC - ID 3-Year UPC WA	Emission Targets + CCI Prices
PRS - Low Prices	Low	Low												
PRS - High Prices	High	High	Ceiling Price (Allowances)	Expected	Expected	Expected	Expected	None	117 lbs. per Dekatherm	0 lbs. per Dekatherm	Carbon Tax Beginning 2030 Idaho Only	Climate Change	Space Heat Demand Only for New Residential + New Commercial Customers in Washington	Emission Targets + CCI Prices
PRS - Allowance Price Ceiling	High	High												
Electrification - Expected Conversion Costs	Expected	Expected	Expected Price (Allowances)	Electrification	Expected	Expected	Expected	50% Capacity Station 2, Sumas, and Rockies	128.27 lbs. per Dekatherm	Carbon Intensity	Social Cost of Carbon @ 2.5%	20 Year Average	Space Heat Demand Only for Hybrid Customers	Emission Targets + CCI Prices
Electrification - High Conversion Costs					High									
Electrification - Low Conversion Costs					Low									
High Customer Case					High									
Limited RNG Availability	Expected	Expected	Expected Price (Allowances)	Expected	Expected	Expected	Expected	None	117 lbs. per Dekatherm	0 lbs. per Dekatherm	Carbon Tax Beginning 2030 Idaho Only	Climate Change	Space Heat Demand Only for Hybrid Customers	Emission Targets + CCI Prices
Interrupted Supply														
Carbon Intensity														
Social Cost of Carbon	Expected	Expected	Expected Price (Allowances)	Expected	Expected	Expected	Expected	None	117 lbs. per Dekatherm	0 lbs. per Dekatherm	Carbon Tax Beginning 2030 Idaho Only	Climate Change	Space Heat Demand Only for Hybrid Customers	Emission Targets + CCI Prices
Average Case														
Hybrid Case	Expected	Expected	Expected Price (Allowances)	Expected	Expected	Expected	Expected	None	117 lbs. per Dekatherm	0 lbs. per Dekatherm	Carbon Tax Beginning 2030 Idaho Only	Climate Change	Space Heat Demand Only for Hybrid Customers	Emission Targets + CCI Prices

### Deterministic – Portfolio Evaluation and Scenario Results

A deterministic evaluation was used to consider alternative scenarios. These alternate demand and supply scenarios are placed in the model as predicted future conditions for supply portfolio to satisfy with least cost and least risk resources. This creates bounds for analyzing the Preferred Resource Scenario by creating high and low boundaries for customer count, weather, and pricing. Each portfolio runs through PLEXOS® where the supply resources, demand resources and energy efficiency are compared and selected on a least cost basis. Results are not all directly comparable as different demand and price assumptions change least cost results.

## Demand

Demand profiles, for firm customers and net of DSM measures, over the planning horizon for each of the scenarios shown in Figure 7.1. illustrate the demand risks from the alternate scenarios. The demand for our High Customer Case shows the greatest expected system demand with the Electrification Cases showing the lowest expected demand. As discussed in previous chapters, demand is the greatest risk in this IRP and has fundamentally changed due to building codes and climate programs. The PRS, and associated scenarios, all show an increasing demand through the study horizon while the Electrification scenarios assume a steady conversion of natural gas customers to the electric grid. Further analysis will be necessary to carefully consider impacts to future demand expectations and resources to meet those needs.

**Figure 7.1: Demand by Scenario**

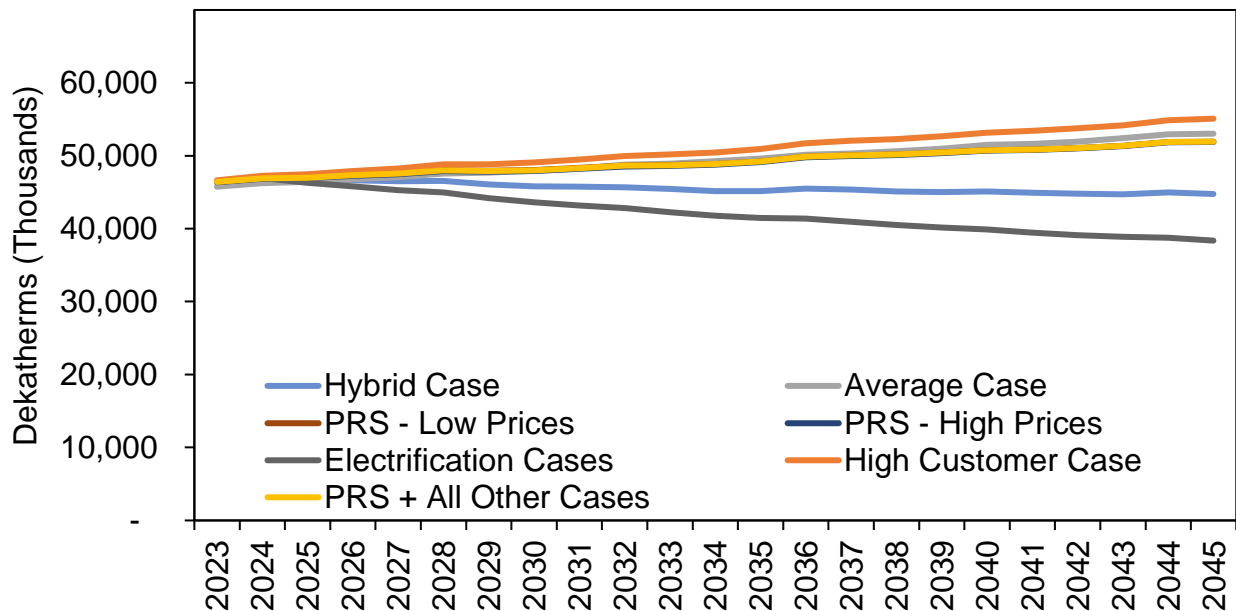

## PRS Scenarios

The PRS Alternative Scenarios measure the same basic assumptions as the PRS, but study different cost implications for modeled resources options. These scenarios consider lower and higher natural gas prices and the ceiling price for the CCA to help determine a crossover point for different resources. The costs for these resources can vary for a myriad of reasons such as supply issues, inflation, or policy. Individual descriptions are provided below by scenario. Figure 7.2 illustrates the alternative PRS scenarios as compared to the PRS costs.

**Preferred Resource Strategy (PRS)**

Included in Chapter 7 to illustrate the different outcomes for prices and demand based on different scenarios. A full description of the PRS can be found in Chapter 6.

**Preferred Resource Strategy – Low Prices**

Considers both lower price expectations by resource, as discussed in Chapter 4 and a resulting lower avoided cost curve and DSM potential, as described in Chapter 3. This will help determine a least cost supply and demand side resource selection assuming natural gas prices are lower than our expected price curve.

**Preferred Resource Strategy – High Prices**

Considers a higher resource price combined with a higher DSM potential. A new set of supply and demand side resources and compliance instruments for the CCA and CPP are selected to maintain emissions compliance.

**Preferred Resource Strategy – Allowance Price Ceiling**

A scenario to consider a ceiling price in the CCA program in Washington State. The auction process and quantity of allowances available and an unknown amount of demand for these instruments creates a risk to the IRP considerations if the allowance price is higher than expected. This scenario considers a ceiling allowance price and resource selection alternatives to acquire a set of least cost and risk portfolio.

Annual system costs for alternative future scenarios compared to the PRS are illustrated in Figure 7.2.

**Figure 7.2: PRS Scenarios - Annual System Costs**

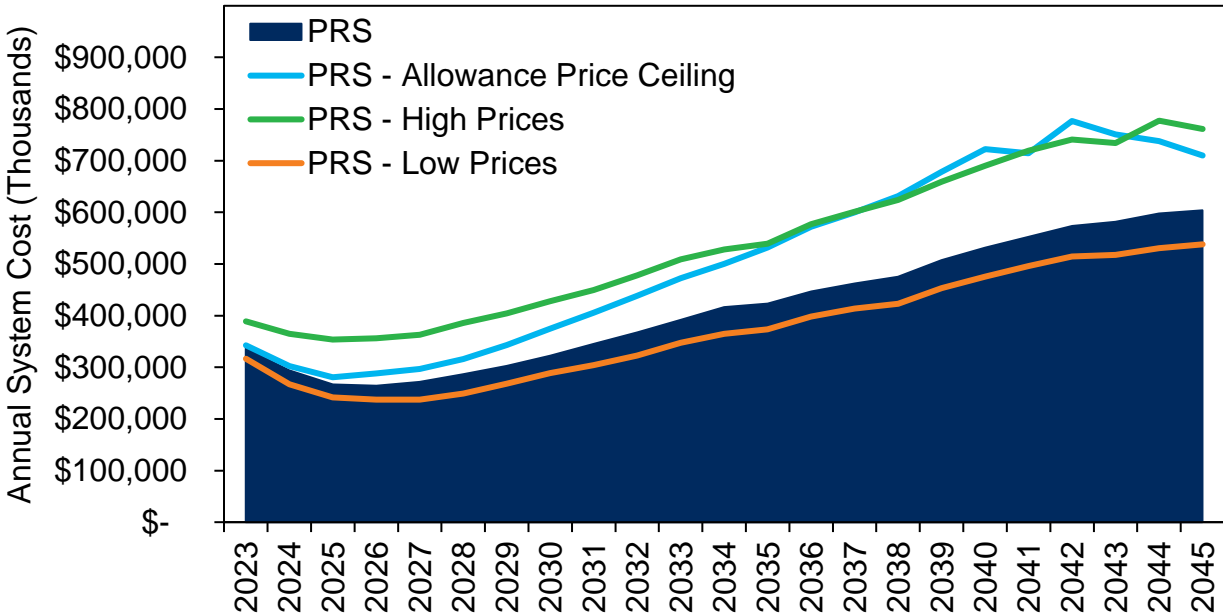



In Table 7.2, the portfolio selections for these alternative scenarios can be compared to the PRS where energy resources are in thousands of dekatherms and compliance instruments are in metric tons of carbon dioxide equivalent (MTCO<sub>2e</sub>). Quantities are similar across the three PRS scenario alternatives other than the quantity of natural gas selected.

**Table 7.2: PRS Scenarios - Portfolio Selections**

Scenario	Category	2025	2035	2045
PRS	Synthetic Methane (,000s of Dth)	93	146	5,191
PRS	OR - Renewables (,000s of Dth)	2,000	7,295	8,973
PRS	Natural Gas (,000s of Dth)	45,485	42,403	37,022
PRS	CCI (MTCO <sub>2e</sub> )	16,758	70,337	-
PRS	Allowances (MTCO <sub>2e</sub> )	283,273	793,898	884,819
PRS - Allowance Price Ceiling	Synthetic Methane (,000s of Dth)	93	146	24,009
PRS - Allowance Price Ceiling	OR - Renewables (,000s of Dth)	1,927	7,210	8,560
PRS - Allowance Price Ceiling	WA - Renewables (,000s of Dth)	29	24	555
PRS - Allowance Price Ceiling	Natural Gas (,000s of Dth)	45,685	42,676	18,645
PRS - Allowance Price Ceiling	CCI (MTCO <sub>2e</sub> )	16,758	70,337	-
PRS - Allowance Price Ceiling	Allowances (MTCO <sub>2e</sub> )	283,273	793,898	-
PRS - High Prices	Synthetic Methane (,000s of Dth)	91	145	6,913
PRS - High Prices	OR - Renewables (,000s of Dth)	2,621	7,225	8,966
PRS - High Prices	WA - Renewables (,000s of Dth)	-	-	-
PRS - High Prices	Natural Gas (,000s of Dth)	45,094	42,533	35,258
PRS - High Prices	CCI (MTCO <sub>2e</sub> )	-	70,337	-
PRS - High Prices	Allowances (MTCO <sub>2e</sub> )	282,841	792,175	860,762
PRS - Low Prices	Synthetic Methane (,000s of Dth)	94	146	5,175
PRS - Low Prices	OR - Renewables (,000s of Dth)	1,745	7,288	8,981
PRS - Low Prices	Natural Gas (,000s of Dth)	45,907	42,047	36,777
PRS - Low Prices	CCI (MTCO <sub>2e</sub> )	38,441	70,337	-
PRS - Low Prices	Allowances (MTCO <sub>2e</sub> )	283,889	794,288	884,819

## Electrification Scenarios

Avista uses four scenarios to identify impacts to the natural gas and power system if space and water heating is electrified in the Oregon and Washington service areas, specifically for the residential and commercial customers. Industrial customers are not considered as each process would require an individual analysis to determine if electrification is possible or if an alternative fuel would be a better option.

A loss of demand is expected on the natural gas system in each scenario. These scenarios also estimate cost impacts to convert and replace the energy moved to the power grid combined with remaining costs for program compliance and energy on the natural gas system. Chapter 2 explains methodology to remove demand from the natural gas system and Chapter 3 explains methodology for conversion costs and power costs.

### Electrification – Expected Conversion Cost

This scenario considers a loss of customers in Oregon and Washington at roughly 2% annually. All remaining assumptions remain consistent with the PRS scenario. Additional electrification is available to the model and compared to other resources available as a least cost option.

### Electrification – Low Conversion Cost

An alternate scenario to our Electrification – Expected Conversion Cost, to consider the impacts of lower-than-expected conversion costs, 50% of expected costs, and the potential resources selected. The model is forced to reduce at 2% per year in Oregon and Washington. Additional electrification is available to the model in a least cost option.

### Electrification – High Conversion Cost

An alternate scenario to our Electrification – Expected Conversion Cost, to consider the impacts of higher-than-expected conversion costs, 150% of expected costs, and the potential resources selected. The model is forced to reduce at 2% per year in Oregon and Washington. Additional electrification is available to the model in a least cost option.

### Hybrid Case

The Hybrid Case considers the use of the natural gas system for peak heating needs with non-peak electrified for heat sensitive usage below 40 degrees Fahrenheit. This scenario assumes the conversion to a hybrid system utilizing the same decreasing customer trajectory as the electrification scenarios and only for Oregon and Washington. Rather than a total loss of these customers, a customer would remain on the natural gas system for use with back up heating. Like the Electrification scenarios, after converting estimated demand from natural gas to electricity from Oregon and Washington with efficiencies estimated in Chapter 3, the remaining price impact is added to account for total costs of the electric and natural gas systems. All other assumptions remain consistent to the PRS. In Figure 7.3, the annual levelized costs by major end source are provided. These major end sources include costs from the natural gas system, conversion costs for incremental customers, and the cost of electricity for these converted end sources.

**Figure 7.3: Annual Electrification Levelized Costs by Source**

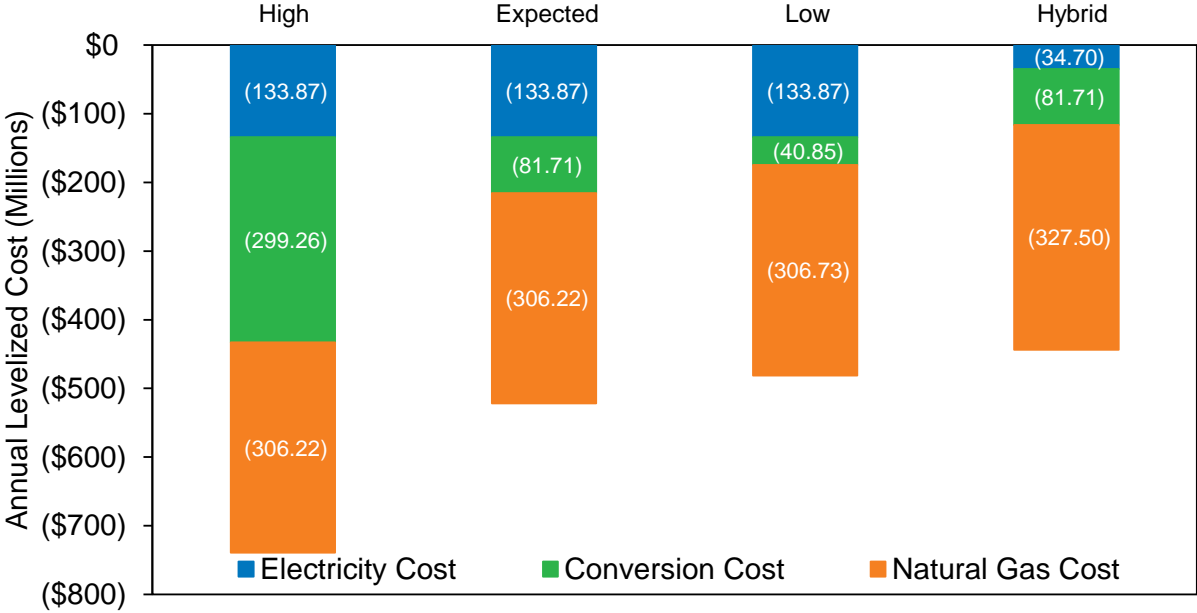

Portfolio selections by scenario and category are shown in Table 7.3. Energy is in thousands of dekatherms and allowances and CCIs are in Metric Tons of Carbon Dioxide equivalent (MTCO<sub>2</sub>e).

**Table 7.3: Electrification Scenarios - Portfolio Selections**

Scenario	Category	2025	2035	2045
Elec. - Expected Conversion Costs	Synthetic Methane (,000s of Dth)	81	42	2,057
Elec. - Expected Conversion Costs	OR - Renewables (,000s of Dth)	1,694	4,044	5,975
Elec. - Expected Conversion Costs	Natural Gas (,000s of Dth)	45,195	37,759	29,218
Elec. - Expected Conversion Costs	CCI (MTCO <sub>2</sub> e)	24,894	70,337	-
Elec. - Expected Conversion Costs	Allowances (MTCO <sub>2</sub> e)	260,407	538,955	555,307
Elec. - High Conversion Costs	Synthetic Methane (,000s of Dth)	81	42	2,057
Elec. - High Conversion Costs	OR - Renewables (,000s of Dth)	1,694	4,044	5,975
Elec. - High Conversion Costs	Natural Gas (,000s of Dth)	45,188	37,759	29,225
Elec. - High Conversion Costs	CCI (MTCO <sub>2</sub> e)	24,506	70,337	-
Elec. - High Conversion Costs	Allowances (MTCO <sub>2</sub> e)	260,407	538,955	555,705
Elec. - Low Conversion Costs	Synthetic Methane (,000s of Dth)	85	42	1,434
Elec. - Low Conversion Costs	OR - Electrification (,000s of Dth)	934	934	932
Elec. - Low Conversion Costs	OR - Renewables (,000s of Dth)	1,467	3,774	5,667
Elec. - Low Conversion Costs	Natural Gas (,000s of Dth)	44,711	37,453	29,151
Elec. - Low Conversion Costs	CCI (MTCO <sub>2</sub> e)	99	53,709	-
Elec. - Low Conversion Costs	Allowances (MTCO <sub>2</sub> e)	260,407	538,955	551,783
Hybrid Case	Synthetic Methane (,000s of Dth)	93	140	2,820
Hybrid Case	OR - Renewables (,000s of Dth)	1,694	4,570	6,459
Hybrid Case	Natural Gas (,000s of Dth)	45,541	40,831	34,820
Hybrid Case	CCI (MTCO <sub>2</sub> e)	24,506	70,337	-
Hybrid Case	Allowances (MTCO <sub>2</sub> e)	279,381	705,858	825,407

### Electrification Selected as a Resource

Electrification as a selected resource occurred in two scenarios as illustrated in Figure 7.4. The first in the Limited RNG Availability with the second in our Electrification – Low Conversion Costs case, both selections are for Avista’s Oregon territory. Limited RNG creates a resource issue to meet emissions goals and is the only scenario that selects electrification based on our estimated costs per Dth as described in Chapter 3. The model selected electrification in the first available year, removing 1.5 million dekatherms of demand per year for the study horizon. No additional electrification was selected after 2023 as the model is given a choice to add additional electrification to reduce load as a least cost, meaning no other electrification was least cost past the first year. The Electrification – Low Conversion Costs case shows the potential for electrification as a demand side resource. The Medford Residential customers select space heat electrification as a resource removing 934,400 dekatherms of demand annually beginning in 2023. As in the Limited RNG Availability Case, no additional electrification is selected after 2023 as a least cost option. These results show a potential to alter demand for electric end uses if conversion costs are lower than expected through grants, tax incentive or discounts.

Figure 7.4: Electrification as a Demand-Side Resource by Scenario and State

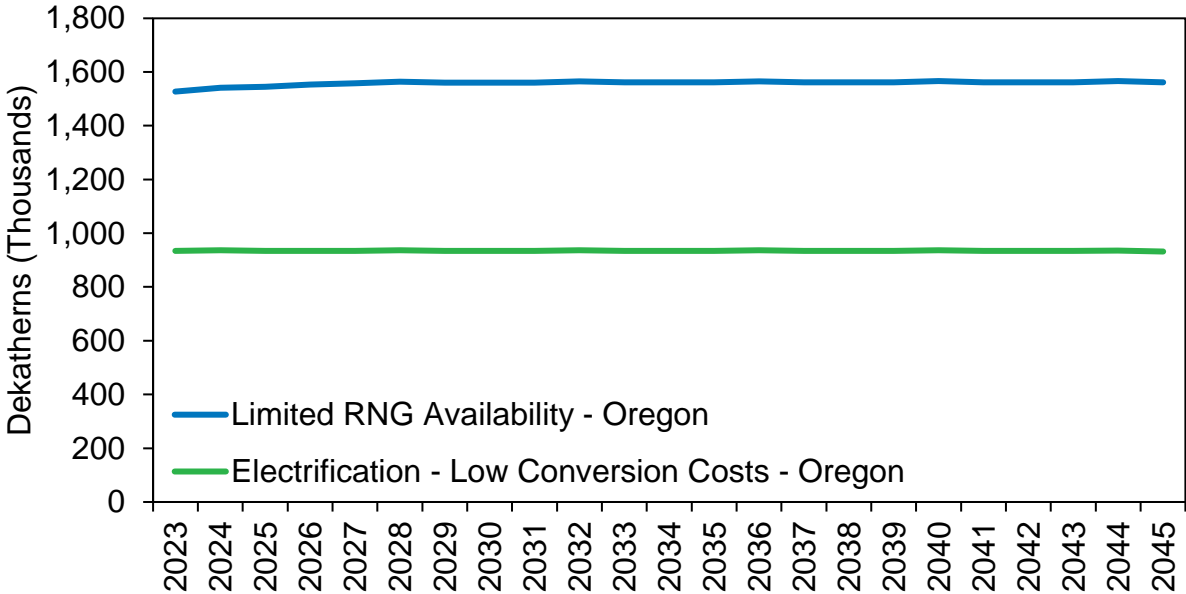

### Supply Scenarios

The supply scenarios help to illustrate implications of physical impacts to the system, impacts to program compliance or resource availability. Outages and expected volume availability of resources such as RNG pose a risk to serving demand and meeting emissions compliance. These scenarios are Limited RNG availability, Interrupted supply and Carbon Intensity and help demonstrate potential pathways for program compliance with resource risk.

### Carbon Intensity

Carbon Intensity is considered in the event the Washington CCA or Oregon CPP alter program methodologies or combine with the California Cap and Trade program. The only change from the PRS is the carbon intensity of RNG resources. Cost Impact and RNG source and quantity selected is a primary measure of this scenario. This scenario also considers carbon intensity in the natural gas fuel from upstream emissions at 128.27 pounds per dekatherm. In the California cap and trade program anaerobic sources are valued by carbon intensity meaning a dairy project may be considered as the value of reduced methane from the capture of these sources brings the cost down by over 400 percent (Chapter 4, Table 4.2 Carbon Intensity).

### Limited RNG Availability

The availability of RNG in sufficient quantities to meet CCA and CPP emissions targets is measured in this scenario. This scenario constrains the expected RNG volumes to 50% with high RNG prices as discussed in Chapter 4.

**Interrupted Supply**

The Interruptible Supply case considers constraints of 50% availability at major supply points on the Northwest Pipeline system to measure risk of unserved demand. This scenario looks solve a least cost resource selection due to the risk of pipeline outages, equipment failure such as compressors or pipeline rupture as experienced in 2018 with the Enbridge pipeline. All other factors are consistent with PRS.

Figure 7.5 illustrates the annual system cost in comparison to the PRS. The Carbon Intensity scenario shows a lower system cost in the outer years but is not currently within CCA or CPP program rules and is included as an estimate of rule changes.

**Figure 7.5: Supply Scenarios vs PRS - Annual System Costs**

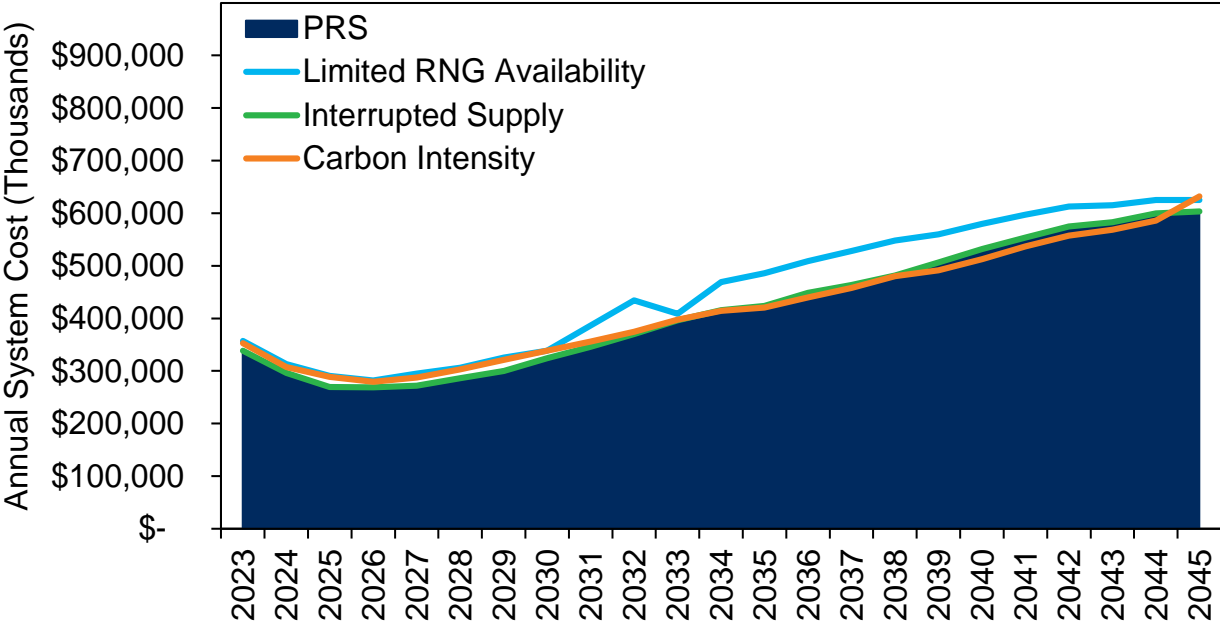

The portfolio selections for these Supply Scenarios include least cost resources provided to the model based on Carbon Intensity, Interrupted supply and Limited RNG as illustrated by Scenario and Category in Table 7.4. Energy is in thousands of dekatherms and allowances and CCIs are in MTCO<sub>2</sub>e.

**Table 7.4: Supply Scenarios – Portfolio Selection**

Scenario	Category	2025	2035	2045
<b>Carbon Intensity</b>	Synthetic Methane (,000s of Dth)	98	153	5,477
<b>Carbon Intensity</b>	OR – Renewables (,000s of Dth)	927	2,212	4,157
<b>Carbon Intensity</b>	WA – Renewables (,000s of Dth)	-	-	44
<b>Carbon Intensity</b>	Natural Gas (,000s of Dth)	47,126	47,799	42,385
<b>Carbon Intensity</b>	CCI (MTCO <sub>2</sub> e)	-	624	-
<b>Carbon Intensity</b>	Allowances (MTCO <sub>2</sub> e)	395,722	907,878	884,819
<b>Interrupted Supply</b>	Synthetic Methane (,000s of Dth)	120	181	5,137
<b>Interrupted Supply</b>	OR - Renewables (,000s of Dth)	1,993	7,232	8,982
<b>Interrupted Supply</b>	Natural Gas (,000s of Dth)	45,653	42,468	36,944
<b>Interrupted Supply</b>	CCI (MTCO <sub>2</sub> e)	17,146	70,337	-
<b>Interrupted Supply</b>	Allowances (MTCO <sub>2</sub> e)	283,273	793,898	884,819
<b>Limited RNG Availability</b>	Synthetic Methane (,000s of Dth)	98	2,552	9,075
<b>Limited RNG Availability</b>	OR - Electrification (,000s of Dth)	1,545	1,561	1,562
<b>Limited RNG Availability</b>	OR - Renewables (,000s of Dth)	774	3,368	3,526
<b>Limited RNG Availability</b>	Natural Gas (,000s of Dth)	45,479	42,642	37,023
<b>Limited RNG Availability</b>	CCI (MTCO <sub>2</sub> e)	16,758	70,337	-
<b>Limited RNG Availability</b>	Allowances (MTCO <sub>2</sub> e)	283,273	793,898	884,819

## Other Scenarios

The Average Case is a key scenario to show peak demand versus the demand used to plan for an average use scenario. It considers average 20-year historic weather without climate futures to quantify the impacts of future temperatures and resource needs. This Average Case scenario uses historic temperatures from its planning areas to estimate demand based on weather and use per customer. The High Customer Case is exceedingly unlikely due to policy in Oregon and Washington but is also important as a perspective to understand costs of resources and environmental compliance given a higher than expected demand. Our Idaho territory may have a greater potential for this risk given the above system average growth combined with no current policy restricting the use of natural gas. Finally, the Social Cost of Carbon is considered as a method to value system costs using impacts as estimated through the Social Cost of Carbon at 2.5%.

## High Customer Growth

Measuring risk includes a higher-than-expected case for customer growth in our natural gas territories. While Oregon and Washington have policy and programs making this unlikely, Idaho is experiencing strong growth as discussed in Chapter 2.

**Social Cost of Carbon**

Assumes PRS inputs with a SCGHG at the 2.5% discount rate for all resources to compare in supply side resource selection. This cost overrides the costs of compliance in the CCA and CPP programs.

**Average Case**

The Average Case uses only the average daily weather for the past 20 years as compared to the PRS. All other assumptions are used from the PRS, excluding a peak day. This helps to show average demand as seen historically to compare to cases where demand is impacted from resources, weather forecasts, or peak day.

A cost comparison is provided in Figure 7.6 and compares these “Other” scenarios to the PRS annual system costs. In Table 7.5, selected resources by portfolio are included by Scenario and Category.

**Figure 7.6: Other Scenarios vs PRS - Annual System Costs**

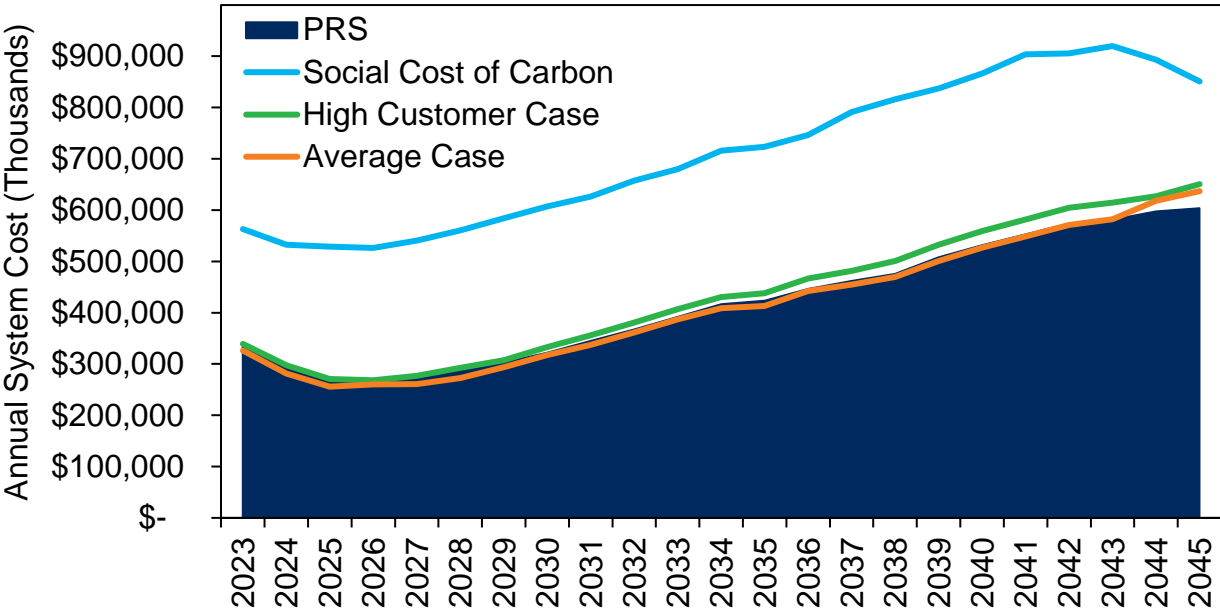

A portfolio selection is provided in Table 7.5 for these other scenarios. Energy is in thousands of dekatherms and allowances and CCIs are in MTCO<sub>2</sub>e. Renewable energy increases drastically in the Social Cost of Carbon case as higher costs lead to greater demands for carbon free fuels. The model must take the same quantity of RNG once chosen for the remainder of the study. If, for example, 10 dekatherms were chosen in 2025, the model must take this same amount of volume through the end of the study. This method creates a more realistic consideration of obtaining RNG. Due to additional uptake in RNG, CCIs have less demand and is replaced by additional RNG.



**Table 7.5: Other Scenarios – Portfolio Selection**

Scenario	Category	2025	2035	2045
<b>Average Case</b>	Synthetic Methane (,000s of Dth)	-	-	8,487
<b>Average Case</b>	OR - Renewables (,000s of Dth)	1,686	6,638	8,313
<b>Average Case</b>	WA - Renewables (,000s of Dth)	7	2	204
<b>Average Case</b>	Natural Gas (,000s of Dth)	45,249	43,506	36,140
<b>Average Case</b>	CCI (MTCO <sub>2</sub> e)	18,631	70,337	-
<b>Average Case</b>	Allowances (MTCO <sub>2</sub> e)	271,571	822,730	884,819
<b>High Customer Case</b>	Synthetic Methane (,000s of Dth)	99	181	6,901
<b>High Customer Case</b>	OR - Renewables (,000s of Dth)	2,139	7,672	9,514
<b>High Customer Case</b>	Natural Gas (,000s of Dth)	45,818	43,582	38,436
<b>High Customer Case</b>	CCI (MTCO <sub>2</sub> e)	16,758	70,337	-
<b>High Customer Case</b>	Allowances (MTCO <sub>2</sub> e)	290,676	816,701	884,819
<b>Social Cost of Carbon</b>	Synthetic Methane (,000s of Dth)	87	146	42,344
<b>Social Cost of Carbon</b>	OR - Renewables (,000s of Dth)	3,482	7,299	9,028
<b>Social Cost of Carbon</b>	WA - Renewables (,000s of Dth)	-	-	497
<b>Social Cost of Carbon</b>	Natural Gas (,000s of Dth)	45,069	42,261	-
<b>Social Cost of Carbon</b>	CCI (MTCO <sub>2</sub> e)	-	70,337	-
<b>Social Cost of Carbon</b>	Allowances (MTCO <sub>2</sub> e)	283,273	793,898	-

### Washington Climate Commitment Act Allowances

The Carbon Intensity scenario has the highest requirement for allowances through 2030, though the lines generally converge in the 2030 timeframe with similar quantity estimates. PRS is included to show the variation of resources needed to help reduce emissions or meet emissions targets. In the Social Cost of Carbon scenario, higher costs lead to a higher RNG demand by 2025 reducing the need for allowances. All other scenarios are generally within the blue area depicting the PRS results. The Hybrid Case has the lowest quantity of allowances due to the reduced demand and energy supplied by the natural gas system. By 2042 the PRS – Allowance Price Ceiling case and 2043 the Social Cost of Carbon case both show allowance requirements fall to zero as synthetic methane becomes the least cost resource for the CCA. The variability of allowances is illustrated in Figure 7.7.

Figure 7.7: Allowance Demand by Scenario – Washington CCA

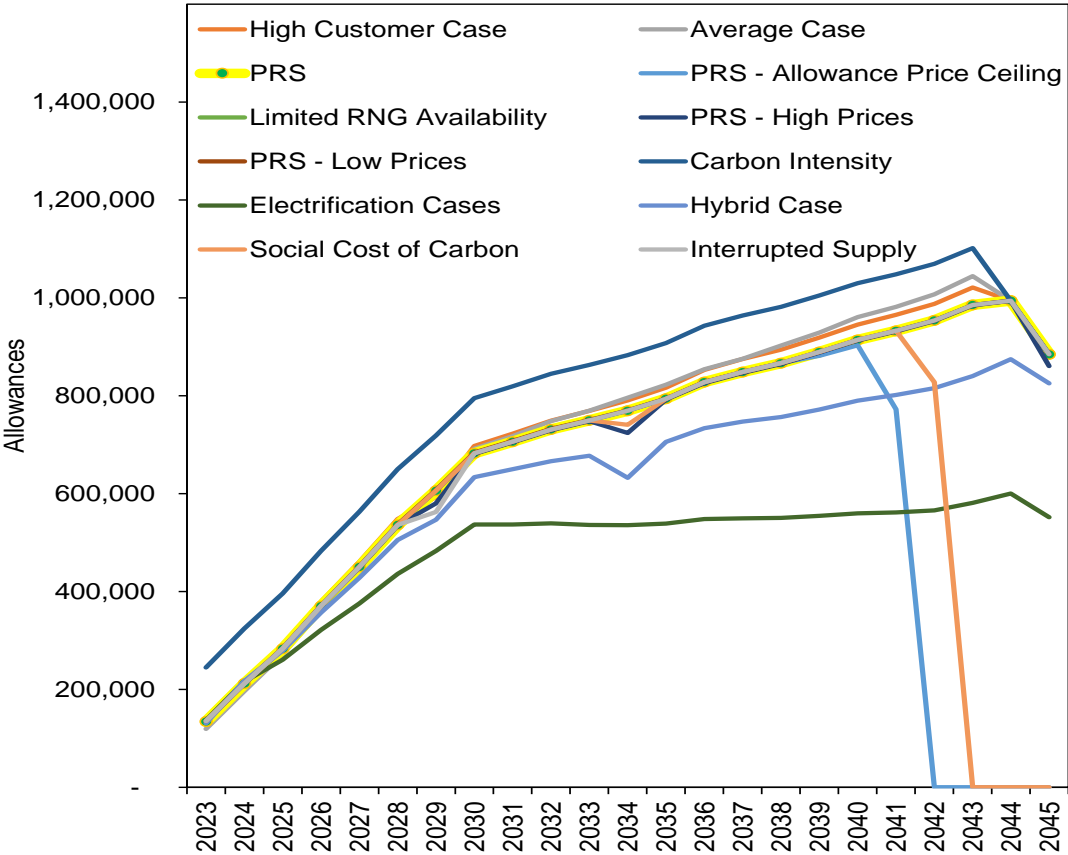

### Oregon Community Climate Investments

Community Climate Investments show a greater range of required quantities for compliance. In Figure 7.8, the maximum amount of CCIs available beginning in 2023 can be found in the gray area. The steps are based on the quantity of CCIs available in each timeframe as allowed per the rules (Chapter 5). The PRS acquires near the cap by 2026 with many scenarios following a similar pathway. The Electrification scenarios generally require fewer instruments in the near term due to a loss of demand on the natural gas system which removes the larger CCIs needed. The Social Cost of Carbon scenario acquires a higher level of renewable fuels and removes the need for more CCIs to pair with natural gas. Finally, the most interesting result is from our Carbon Intensity scenario. The demand for CCIs does not generally come around until 2040 and only for a few years until future renewable resources are brought onto the system.

Figure 7.8: CCI Demand by Scenario – Oregon CPP

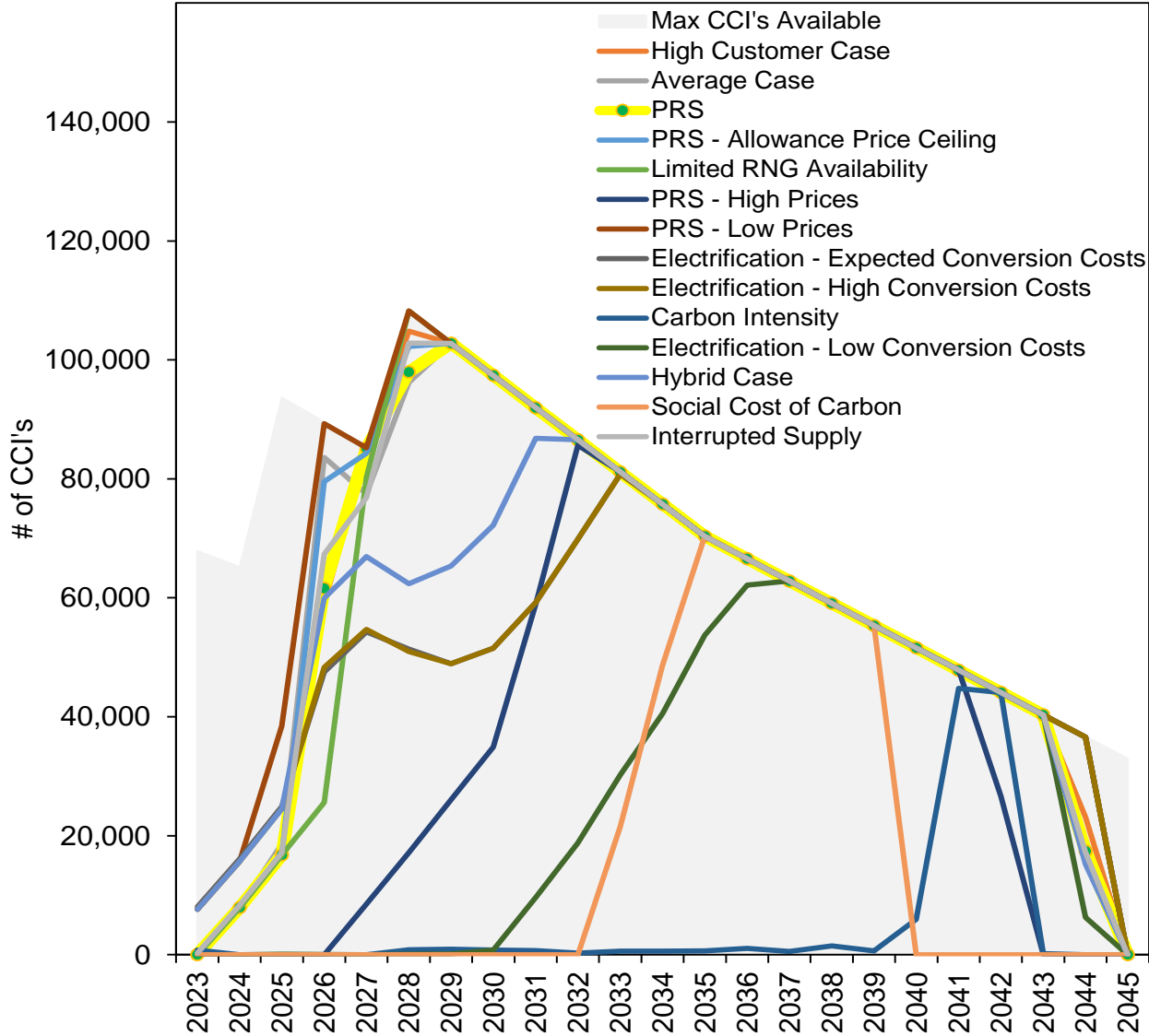

### Natural Gas Use

The demand for natural gas decreases across all studied scenarios in this IRP. The scenario with the greatest decline is the Social Cost of Carbon case where by 2045 it eliminates natural gas from its resource selection. This case is followed by the PRS – Allowance Price Ceiling with only 41% of energy being filled by natural gas. The overall decrease across these fourteen scenarios is an average of 31% by 2045 as compared to 2025. Figure 7.9 illustrates the use of natural gas across all scenarios in 2025, 2035 and 2045. The future of natural gas is facing a fundamental change at Avista, the Pacific Northwest and nations in the climate pledge with the goal to reduce global emissions.<sup>1</sup>

<sup>1</sup> <https://www.ipcc.ch/about/>

Figure 7.9: Natural Gas Supply

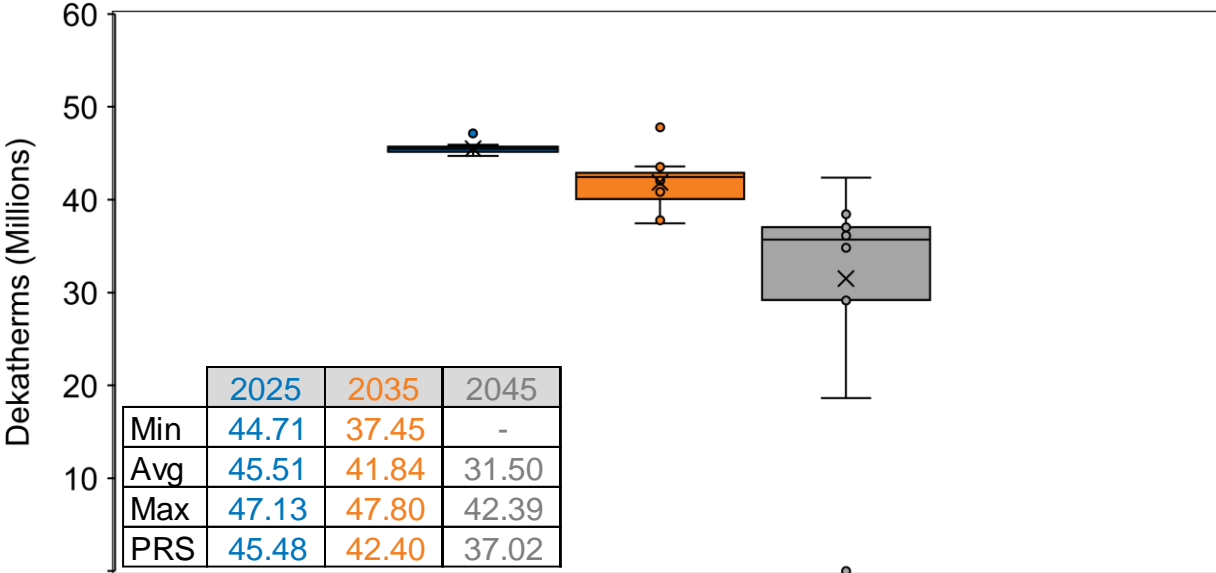

### Synthetic Methane

Synthetic methane has been chosen as a resource across all scenarios as illustrated in Figure 7.10. Reducing emissions is key to the selection of synthetic methane with cost expectations around carbon capture and green hydrogen reducing over time as discussed in Chapter 4, this energy source may prove to be an important fuel in emissions compliance programs. Further studies and lifecycle analysis will be necessary if selected as a resource or through a request for procurement (RFP). Important pieces to consider include waste from the process to create hydrogen or carbon capture, permitting for a water supply in the electrolysis process and waste.

Figure 7.10: Annual Synthetic Methane Volumes by 2045

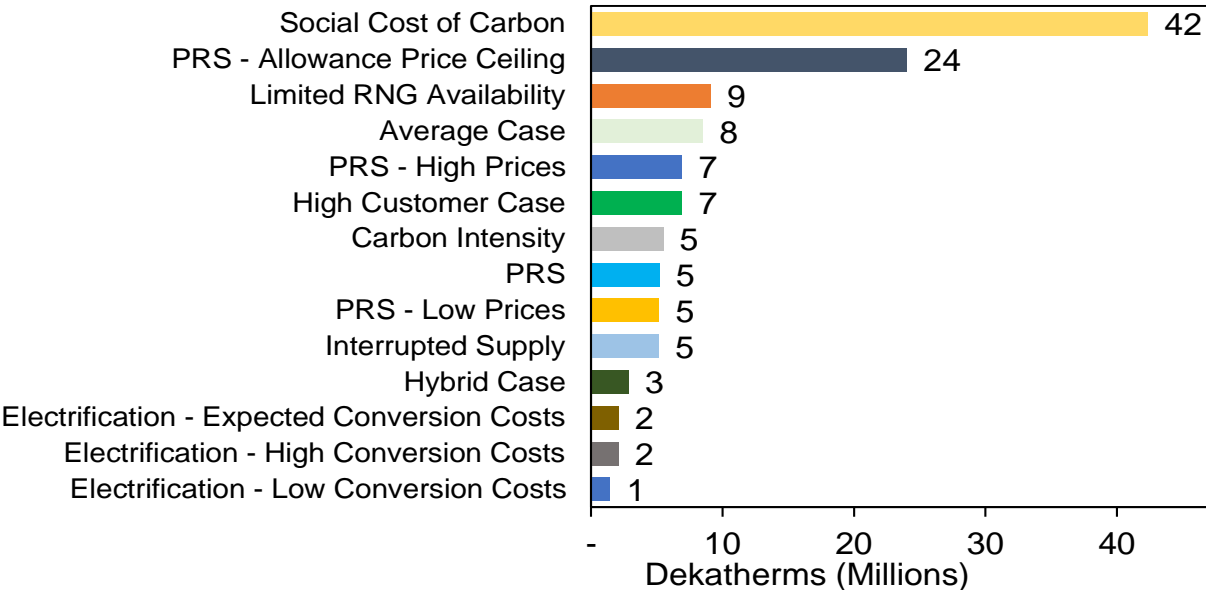

### Renewable Natural Gas

Renewable Natural Gas is considered a necessary energy and emissions reduction tool for the CCA and CPP. While costs vary by project, location, and size, RNG is necessary to meet initial needs of emissions reduction until other resource options can be further matured and advanced. Idaho does not select any RNG under any scenario even when considering a national carbon tax as discussed in in Chapter 5. Oregon, under the CPP, chooses RNG consistently across all scenarios as illustrated in Figure 7.11. The variability occurs with different costs and system customers. RNG is also considered an important fuel to consider for the replacement of natural gas in industrial processes as these processes can be more difficult to electrify.

Figure 7.11: Oregon RNG Volumes Across Scenarios

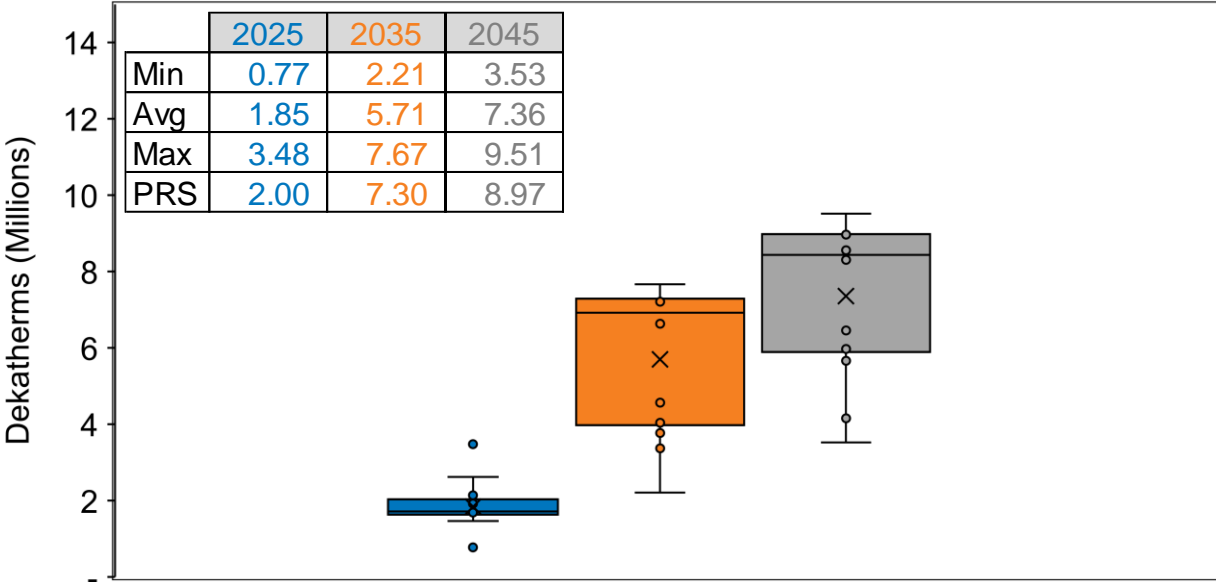

Currently, Washington is considering linkage to the California cap and trade program. In the event program rules change under the CCA or CPP, RNG may provide for the ability to reduced emissions program costs with the use of higher carbon intensive RNG sources. With the expected price of allowances relatively low in the first years of the CCA, RNG has a limited uptake across most scenarios. As previously discussed, if cost assumptions due to inflation and its impact on allowance prices, allowance availability, changes to compliance resources may change. Figure 7.12 illustrates all studied scenarios in this IRP where RNG was chosen.

Figure 7.12: Washington RNG Volumes Across Scenarios

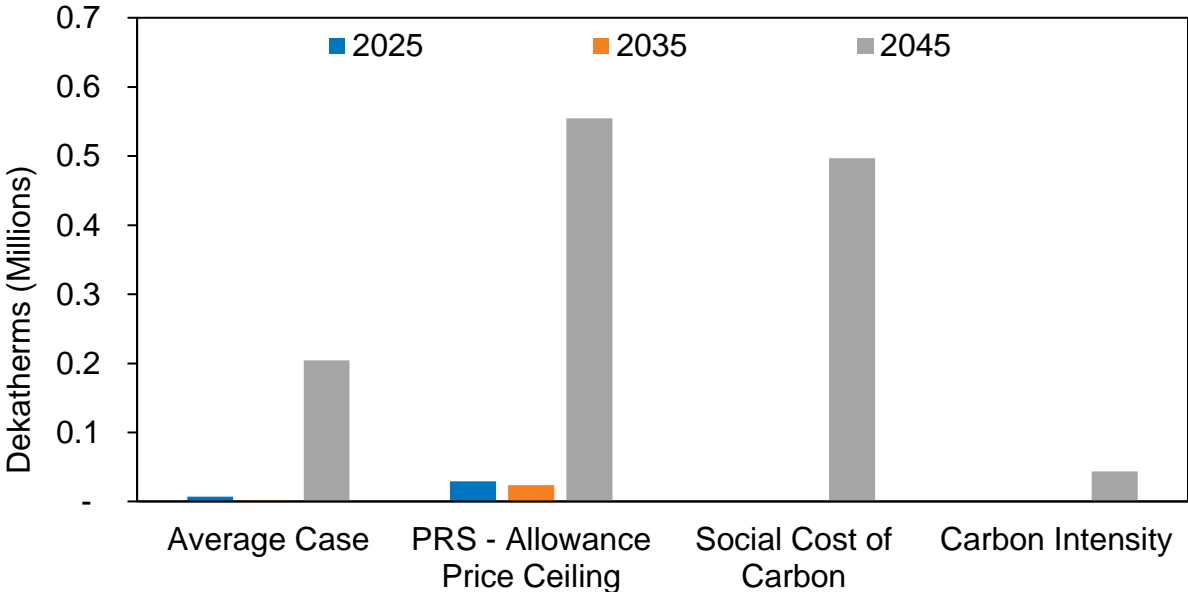

### Emissions

Emissions compliance to the CCA and CPP have been met in all scenarios studied in the 2023 IRP. These scenarios consider a sizeable range of future outcomes including the loss of customers from policy, regulation, and customer choice. The resultant outcomes depict a varying level of emissions based on selected resources and demand reduction. When considering the primary reasons for reducing emissions, the cap in each program creates a requirement to meet stated targets. The Carbon Intensity scenario highlights additional carbon in Idaho from upstream emissions, while the other scenarios mostly follow a similar trajectory. This is illustrated in Figure 7.13 and only vary slightly based on the number of customers on the system with growth occurring in Idaho in all scenarios.

Figure 7.13: System Emissions by Scenario by 2030

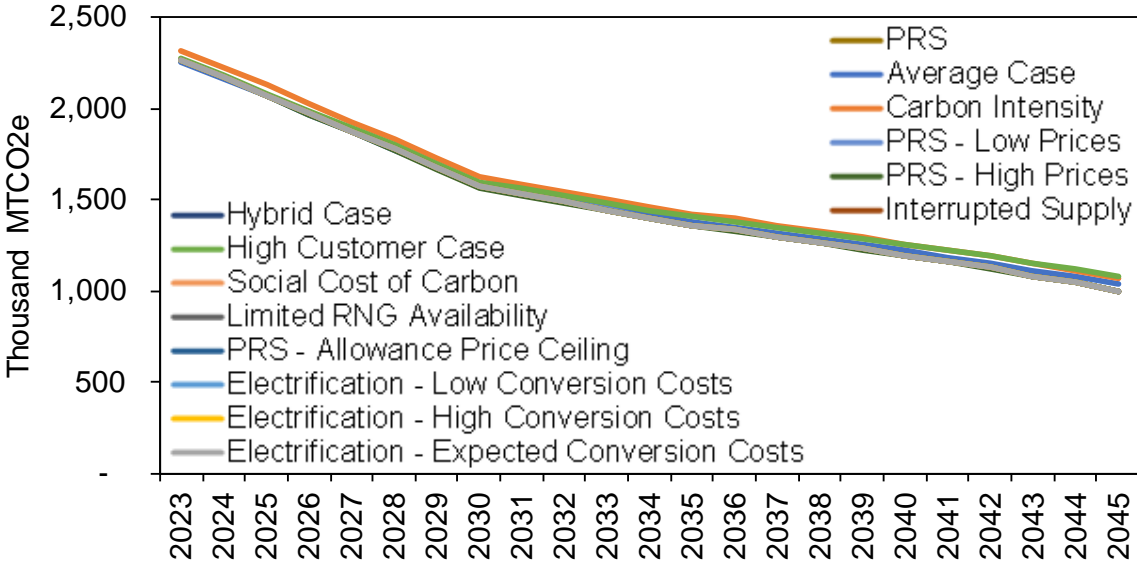

### Cost Comparison

When we consider costs of these scenarios, there are two with a cost lower than the PRS. The first is the Average Case and the second is PRS – Low Prices. The Average Case is like the PRS with two primary differences, price assumptions for energy and weather futures. Recall the Average Case does not include peak weather and should be used as a reference to all scenarios considered. The overall lower demand creates less energy supplied and lower emissions to meet compliance in compliance in the CCA and CPP. The PRS – Low Prices is measuring the same demand as the PRS with just lower costs than expected. Electrification costs include incremental conversion costs of customers and energy costs from the power grid as discussed in Chapter 3. These electrification costs are included in all three Electrification scenarios and the Hybrid Case. These levelized costs consider twenty years as CPA estimates are not available from the ETO past this mark as illustrated in Figure 7.14.

**Figure 7.14: PRS Alternative Scenario Cost Comparison  
Annual Levelized Costs (2023 – 2042)**

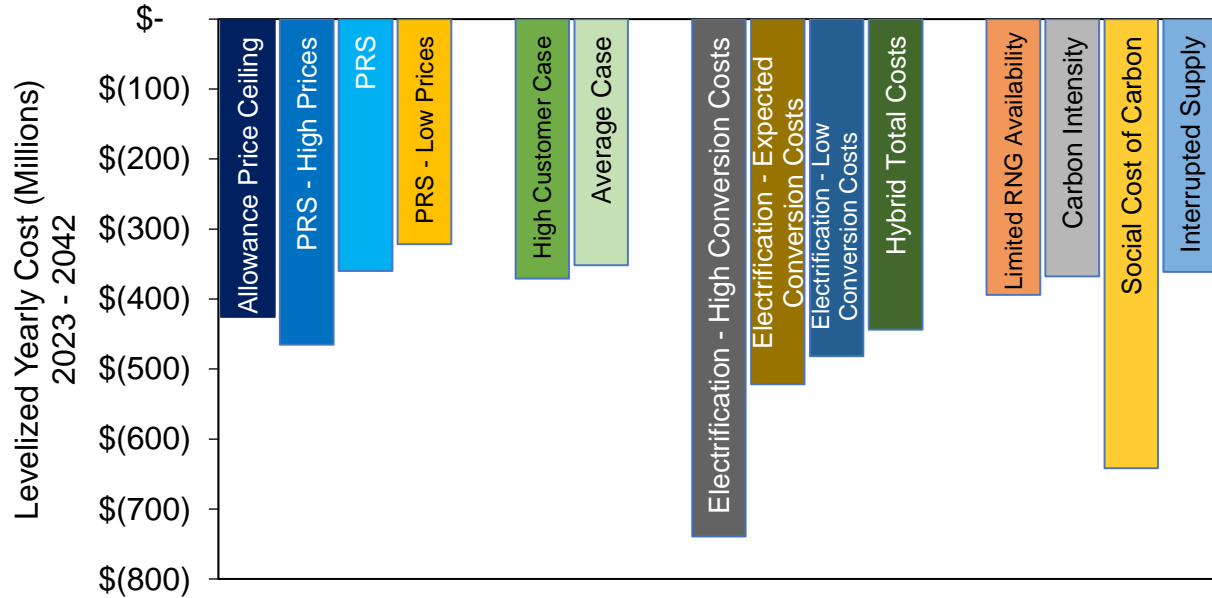

The estimated price impact by scenario by generic class and area are included in Figure 7.15 to 7.19.

**Figure 7.15: Residential Customer Price Impact (\$ per dekatherm)**

	Idaho Residential			Oregon Residential			Washington Residential		
	2025	2035	2045	2025	2035	2045	2025	2035	2045
Average Case	3.76	5.54	8.75	10.06	25.28	14.37	6.28	7.06	14.66
Carbon Intensity	4.60	6.07	9.09	7.50	10.84	14.41	7.54	7.89	14.68
Electrification - Expected Conversion Costs	4.57	5.50	8.77	10.19	23.94	12.98	7.03	6.89	9.80
Electrification - High Conversion Costs	4.57	5.50	8.77	10.19	23.94	12.98	7.03	6.89	9.80
Electrification - Low Conversion Costs	4.57	5.50	8.78	5.06	12.47	13.22	7.03	6.89	9.81
High Customer Case	4.61	6.21	8.86	10.18	24.77	14.62	7.32	7.97	14.63
Hybrid Case	4.60	5.88	9.02	10.41	23.87	14.43	7.45	7.58	10.31
Interrupted Supply	4.60	6.20	8.96	10.17	24.72	14.58	7.31	7.96	14.40
Limited RNG Availability	4.60	5.84	8.94	9.15	30.14	14.74	7.32	7.59	14.39
PRS	4.60	5.95	8.94	10.19	24.82	14.59	7.31	7.64	14.39
PRS - Allowance Price Ceiling	4.45	5.85	8.70	10.17	24.94	14.61	9.72	14.77	14.81
PRS - High Prices	6.32	8.65	13.27	9.77	24.93	14.51	9.02	10.33	14.50
PRS - Low Prices	4.06	4.82	7.19	9.69	24.74	14.61	6.78	6.52	14.37
Social Cost of Carbon	9.93	12.17	14.79	9.42	24.03	14.34	12.62	15.24	14.82



**Figure 7.16: Commercial Customer Price Impact (\$ per dekatherm)**

	Idaho Commercial			Oregon Commercial			Washington Commercial		
	2025	2035	2045	2025	2035	2045	2025	2035	2045
Average Case	3.72	5.49	8.69	10.02	25.11	14.18	6.27	7.05	14.64
Carbon Intensity	4.49	5.98	9.02	7.44	10.80	14.35	7.51	7.87	14.66
Electrification - Expected Conversion Costs	4.46	5.44	8.69	10.16	23.91	12.93	6.98	6.86	9.76
Electrification - High Conversion Costs	4.46	5.44	8.69	10.16	23.91	12.93	6.98	6.86	9.76
Electrification - Low Conversion Costs	4.46	5.44	8.71	5.03	12.45	13.19	6.98	6.86	9.77
High Customer Case	4.50	6.10	8.78	10.13	24.59	14.55	7.30	7.96	14.61
Hybrid Case	4.49	5.79	8.93	10.40	23.85	14.33	7.38	7.56	10.29
Interrupted Supply	4.49	6.09	8.87	10.11	24.57	14.48	7.29	7.94	14.38
Limited RNG Availability	4.49	5.69	8.85	9.10	29.65	14.58	7.29	7.55	14.37
PRS	4.49	5.86	8.86	10.13	24.66	14.49	7.29	7.63	14.37
PRS - Allowance Price Ceiling	4.36	5.77	8.63	10.11	24.81	14.52	9.70	14.75	14.81
PRS - High Prices	6.21	8.56	13.16	9.72	24.80	14.39	9.00	10.31	14.47
PRS - Low Prices	3.95	4.73	7.11	9.64	24.58	14.52	6.75	6.50	14.35
Social Cost of Carbon	9.83	12.10	14.77	9.36	23.84	14.14	12.60	15.22	14.81

**Figure 7.17: Industrial Customer Price Impact (\$ per dekatherm)**

	Idaho Industrial			Oregon Industrial			Washington Industrial		
	2025	2035	2045	2025	2035	2045	2025	2035	2045
Average Case	3.62	5.38	8.55	9.83	24.23	13.24	6.06	6.76	14.32
Carbon Intensity	4.09	5.72	8.88	7.11	10.58	14.06	6.84	7.28	14.33
Electrification - Expected Conversion Costs	4.07	5.29	8.53	9.81	23.79	12.56	6.59	6.70	9.57
Electrification - High Conversion Costs	4.07	5.29	8.53	9.81	23.79	12.56	6.59	6.70	9.57
Electrification - Low Conversion Costs	4.07	5.29	8.55	4.67	12.31	12.52	6.59	6.70	9.59
High Customer Case	4.09	5.77	8.62	9.81	23.89	14.24	6.61	7.22	14.23
Hybrid Case	4.09	5.52	8.72	9.81	23.56	12.76	6.61	6.96	9.76
Interrupted Supply	4.09	5.77	8.69	9.79	23.85	14.03	6.61	7.22	13.94
Limited RNG Availability	4.09	5.32	8.66	9.01	29.69	14.55	6.62	6.77	13.91
PRS	4.09	5.59	8.68	9.81	23.91	14.04	6.61	7.02	13.93
PRS - Allowance Price Ceiling	4.01	5.55	8.49	9.81	24.22	14.11	9.10	14.23	14.71
PRS - High Prices	5.83	8.29	12.96	9.40	24.16	13.82	8.34	9.72	13.98
PRS - Low Prices	3.55	4.45	6.93	9.31	23.84	14.11	6.07	5.89	13.91
Social Cost of Carbon	9.47	11.88	14.72	9.09	22.93	13.20	11.98	14.72	14.73

**Figure 7.18: Transport Only Customer Price Impact (\$ per dekatherm)**

	Oregon Transport			Washington Transport		
	2025	2035	2045	2025	2035	2045
Average Case	9.56	24.93	14.21	5.85	6.30	13.97
Carbon Intensity	3.39	12.77	14.11	6.08	6.57	13.98
Electrification - Expected Conversion Costs	9.56	23.51	14.62	5.85	6.30	9.20
Electrification - High Conversion Costs	9.56	23.51	14.62	5.85	6.30	9.20
Electrification - Low Conversion Costs	9.56	12.17	14.21	5.85	6.30	9.23
High Customer Case	9.56	24.42	14.21	5.85	6.30	13.80
Hybrid Case	9.56	23.27	14.22	5.85	6.30	9.23
Interrupted Supply	9.56	24.26	14.21	5.85	6.30	13.44
Limited RNG Availability	9.56	29.76	14.65	5.85	5.95	13.41
PRS	9.56	24.42	14.21	5.85	6.30	13.44
PRS - Allowance Price Ceiling	9.56	24.42	14.61	8.44	13.56	14.67
PRS - High Prices	5.11	6.14	14.07	7.56	8.97	13.47
PRS - Low Prices	9.02	24.37	14.24	5.31	5.17	13.44
Social Cost of Carbon	8.74	23.56	14.68	11.19	13.93	14.69

## Regulatory Requirements

IRP regulatory requirements in Idaho, Oregon, and Washington call for several key components. The completed plan must demonstrate that the IRP:

- Examines a range of demand forecasts.
- Examines feasible means of meeting demand with both supply-side and demand-side resources.
- Treats supply-side and demand-side resources equally.
- Describes the long-term plan for meeting expected demand growth.
- Describes the plan for resource acquisitions between planning cycles.
- Takes planning uncertainties into consideration.
- Involves the public in the planning process.

Avista addressed the applicable requirements throughout this document. Appendix 1.2 – IRP Guideline Compliance Summaries lists the specific requirements and guidelines of each jurisdiction and describes Avista’s compliance.

The IRP is also required to consider risks and uncertainties throughout the planning and analytical processes. Avista’s approach in addressing this requirement was to identify factors that could cause significant deviation from the expected outcomes in planning conclusions. From this, Avista created a total of fourteen demand scenario alternatives, which incorporated different customer growth, resource availability, use-per-customer, weather, and price assumptions.

Avista analyzed peak day weather planning standard, performing sensitivity on HDDs and modeling an alternate weather-planning standard using the coldest day in 20 years. Stochastic analysis using Monte Carlo simulations in PLEXOS® supplemented this analysis. Avista also used simulations from PLEXOS® to analyze price uncertainty and the effect on total portfolio cost.

Avista examined risk factors and uncertainties that could affect expectations and assumptions with respect to DSM programs and supply-side scenarios. From this, Avista assessed the expected available supply-side resources and potential conservation savings for evaluation.

The investigation, identification, and assessment of risks and uncertainties in our IRP process should reasonably mitigate surprise outcomes.

This Page Intentionally Left Blank

## 8. Distribution Planning

Avista's IRP evaluates the safe, economical, and reliable full-path delivery of natural gas from basin to the customer meter. Securing adequate natural gas supply and ensuring sufficient pipeline transportation capacity to Avista's city gates become secondary issues if distribution system growth behind the city gates increases faster than expected and the system becomes severely constrained. Important parts of the distribution planning process include forecasting local demand growth, determining potential distribution system constraints, analyzing possible solutions and estimating costs for eliminating constraints.

Analyzing resource needs to this point has focused on ensuring adequate capacity to the city gates, especially during a peak event. Distribution planning focuses on determining if there will be adequate pressure during a peak hour. Despite this altered perspective, distribution planning shares many of the same goals, objectives, risks, and solutions as integrated resource planning.

Avista's natural gas distribution system consists of approximately 3,300 miles of distribution main and service pipelines in Idaho, 3,700 miles in Oregon and 5,800 miles in Washington; as well as numerous regulator stations, service distribution lines, monitoring and metering devices, and other equipment. Currently, there are no storage facilities or compression systems within Avista's distribution system. Distribution network pipelines and regulating stations operate and maintain system pressure solely from the pressure provided by the interstate transportation pipelines.

### Distribution System Planning

Avista conducts two primary types of evaluations in its distribution system planning efforts: capacity requirements and integrity assessments.

Capacity requirements include distribution system reinforcements and expansions. Reinforcements are upgrades to existing infrastructure or new system additions, which increase system capacity, reliability, and safety. Expansions are new system additions to accommodate new demand. Collectively, these reinforcements and expansions are distribution enhancements.

Ongoing evaluations of each distribution network in the five primary service territories identify strategies for addressing local distribution requirements resulting from customer growth. Customer growth assessments are made based on factors including IRP demand forecasts, monitoring gate station flows and other system metering, new service requests, field personnel discussion, and inquiries from major developers.

Avista regularly conducts integrity assessments of its distribution systems. Ongoing system evaluation can indicate distribution-upgrading requirements for system maintenance needs rather than customer and load growth. In some cases, the timing for

system integrity upgrades coincides with growth-related expansion requirements. These planning efforts provide a long-term planning and strategy outlook and integrate into the capital planning and budgeting process, which incorporates planning for other types of distribution capital expenditures and infrastructure upgrades.

Gas Engineering planning models are also compared with capacity limitations at each city gate station. Referred to as city gate analysis, the design day hourly demand generated from planning analyses must not exceed the actual physical limitation of the city gate station. A capacity deficiency found at a city gate station establishes a potential need to rebuild or add a new city gate station.

## Network Design Fundamentals

Natural gas distribution networks rely on pressure differentials to flow natural gas from one place to another. When pressures are the same on both ends of a pipe, the natural gas does not move. As natural gas exits the pipeline network, it causes a pressure drop due to its movement and friction. As customer demand increases, pressure losses increase, reducing the pressure differential across the pipeline network. If the pressure differential is too small, flow stalls, and the network could run out of pressure.

It is important to design a distribution network to ensure intake pressure from gate stations and/or regulator stations within the network is high enough to maintain an adequate pressure differential when natural gas leaves the network.

Not all natural gas flows equally throughout a network. Certain points within the network constrain flow and restrict overall network capacity. New network constraints can occur as demand requirements evolve. Anticipating these demand requirements, identifying potential constraints, and forming cost-effective solutions with sufficient lead times without overbuilding infrastructure are the key challenges in network design.

## Computer Modeling

Developing and maintaining effective network design is aided by computer modeling for network demand studies. Demand studies have evolved with technology to become a highly technical and powerful means of analyzing distribution system performance. Using a pipeline fluid flow formula, a specified parameter for each pipe element can be simultaneously solved. Many pipeline equations exist, each tailored to a specific flow behavior. These equations have been refined through years of research to the point where modeling solutions closely resemble actual system behavior.

Avista conducts network load studies using DNV GL's Synergi software. This modeling tool allows users to analyze and interpret solutions graphically.

## Determining Peak Demand

Avista's distribution network is comprised of high pressure (90-500 psig) and intermediate pressure (5-60 psig) mains. Avista operates its intermediate networks at a maximum pressure of 60 psig or less for ease of maintenance and operation, public safety, reliable service, and cost considerations. Since most distribution systems operate through relatively small diameter pipes, there is essentially no line-pack capability for managing hourly demand fluctuations. Line pack is the difference between the natural gas contents of the pipeline under packed (fully pressurized) and unpacked (depressurized) conditions. Line pack is negligible in Avista's distribution system due to the smaller diameter pipes and lower pressures. In transmission and inter-state pipelines, line-pack contributes to the overall capacity due to the larger diameter pipes and higher operating pressures.

Core demand typically has a morning peaking period between 6 a.m. and 10 a.m. and the peak hour demand for these customers can be as much as 50% above the hourly average of daily demand. Because of the importance of responding to hourly peaking in the distribution system, planning capacity requirements for distribution systems uses peak hour demand.<sup>1</sup>

## Distribution System Enhancements

Demand studies facilitate modeling multiple demand forecasting scenarios, constraint identification and corresponding optimum combinations of pipe modification, and pressure modification solutions to maintain adequate pressures throughout the network. Distribution system enhancements do not reduce demand, nor do they create additional supply. However, enhancements increase the overall capacity of a distribution pipeline system while utilizing existing gate station supply points. The two broad categories of distribution enhancement solutions are pipelines and regulators.

### Pipelines

Pipeline solutions consist of looping, upsizing, and uprating. Pipeline looping is the most common method of increasing capacity in an existing distribution system. Looping involves constructing new pipe parallel to an existing pipeline to relieve the constraint point. Constraint points inhibit flow capacities downstream of the constraint creating inadequate pressures during periods of high demand. When the parallel line connects to the system, this alternative path allows natural gas flow to bypass the original constraint and bolsters downstream pressures. Looping can also involve connecting previously unconnected mains. The feasibility of looping a pipeline depends upon the location where the pipeline will be constructed. Installing natural gas pipelines through private easements, residential areas, existing paved surfaces, and steep or rocky terrain can increase the cost to a point where alternative solutions are more cost effective.

---

<sup>1</sup> This method differs from the approach that Avista uses for IRP peak demand planning, which focuses on peak day requirements to the city gate.

Pipeline upsizing involves replacing existing pipe with a larger size pipe. The increased pipe capacity due to increased cross-sectional area of the pipe, results in less friction, and therefore a lower pressure drop. This option is usually pursued when there is damaged pipe or where pipe integrity issues exist. If the existing pipe is otherwise in satisfactory condition, looping augments existing pipe, which remains in use.

Pipeline uprating increases the maximum allowable operating pressure of an existing pipeline. This enhancement can be a quick and relatively inexpensive method of increasing capacity in the existing distribution system before constructing more costly additional facilities. However, safety considerations and pipe regulations may prohibit the feasibility or lengthen the time before completion of this option. Also, increasing line pressure may produce leaks and other pipeline damage creating costly repairs. A thorough review is conducted to ensure pipeline integrity and safety are accounted for before pressure is increased.

### Regulators

Regulators, or regulator stations, reduce pipeline pressure at various stages in the distribution system. Regulation provides a specified and constant outlet pressure before natural gas continues its downstream travel to a city's distribution system, customer's property, or natural gas appliance. Regulators also ensure flow requirements are met at a desired pressure regardless of pressure fluctuations upstream of the regulator. Regulators are at city gate stations, district regulator stations, farm taps and customer services.

### Compression

Compressor stations present a capacity enhancing option for pipelines with significant natural gas flow and the ability to operate at higher pressures. For pipelines experiencing a relatively high and constant flow of natural gas, a large volume compressor installation along the pipeline boosts downstream pressure.

A second option is the installation of smaller compressors located close together or strategically placed along a pipeline. Multiple compressors accommodate a large flow range and use smaller and very reliable compressors. These smaller compressor stations are well suited for areas where natural gas demand is growing at a slower and steady pace, allowing for installation of less expensive compressors over time to serve growing customer demand into the future.

Compressors can be a cost-effective option to resolving system constraints; however, regulatory, and environmental approvals to install a compressor station, along with engineering and construction time can be a significant deterrent. Adding compressor stations typically involves considerable capital expenditure. Based on Avista's detailed knowledge of the distribution system, there are no foreseeable plans to add compressors to the distribution network.

## Conservation Resources

The evaluation of distribution system constraints includes consideration of targeted conservation resources to reduce or delay distribution system enhancements. The consumer is still the ultimate decision-maker regarding the purchase of a conservation measure. Because of this, Avista attempts to influence energy efficiency through the measures discussed in Chapter 3 but does not depend on estimates of peak day demand reductions from energy efficiency to eliminate near-term distribution system constraints. Over the longer-term, targeted energy efficiency programs may provide a cumulative benefit that could offset potential constraint areas and may be an effective strategy.

## Distribution Scenario Decision-Making Process

After achieving a working load study, analyses are performed on every system at design day conditions to identify areas where potential outages may occur due to inadequate capacity.

Avista's design Heating Degree Day (HDD) for distribution system modeling is determined using a 99% statistical probability method for each given service area as discussed in Chapter 2. This practice is consistent with the peak day demand forecast utilized in other sections of Avista's Natural Gas IRP.

Utilizing a peak planning standard based on a statistical probability method of historical temperatures may seem aggressive since extreme temperatures are rare. Given the potential impacts of an extreme weather event on customers' personal safety and potential damage to customer's appliances and Avista's infrastructure, it is a prudent and regionally accepted planning standard.

These areas of concern are then risk ranked against each other to ensure the highest risk areas are corrected first. Within a given area, projects/reinforcements are selected using the following criteria:

- The shortest segment(s) of pipe that improves the deficient part of the distribution system.
- The segment of pipe with the most favorable construction conditions, such as ease of access or rights or traffic issues.
- Minimal to no water, railroad, major highway crossings.
- The segment of pipe that minimizes environmental concerns including minimal to no wetland involvement, and the minimization of impacts to local communities and neighborhoods.
- The segment of pipe that provides opportunity to add additional customers.
- Total construction costs including restoration.



Once a project/reinforcement is identified, the design engineer or construction project coordinator begins a more thorough investigation by surveying the route and filing for permits. This process may uncover additional impacts such as moratoriums on road excavation, underground hazards, discontent among landowners, etc., resulting in another iteration of the above project/reinforcement selection criteria. Figure 8.1 provides a schematic representation of the distribution scenario process

# Distribution Scenario Process

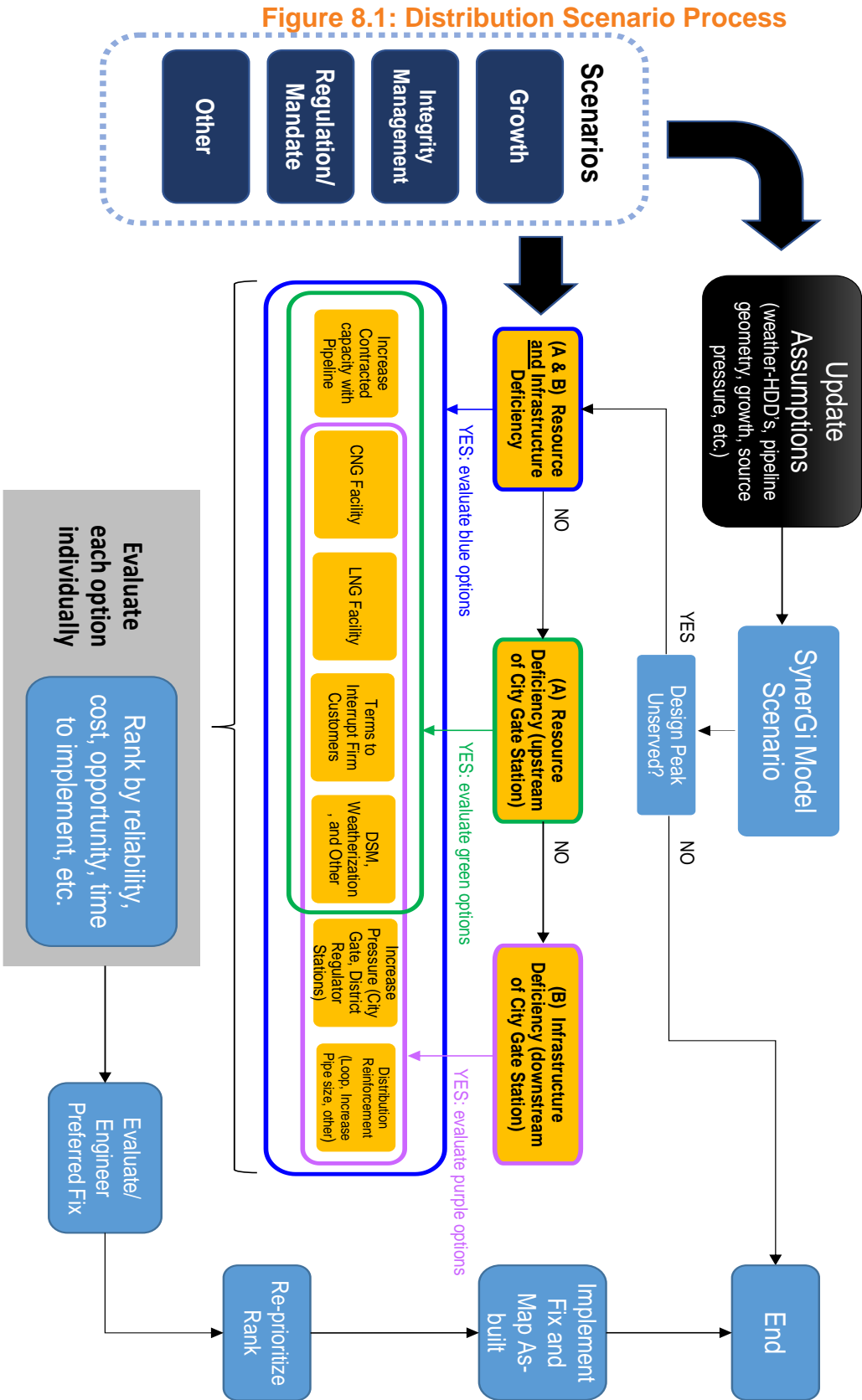

## Planning Results

Table 8.1 summarizes the cost and timing, as of the publication date of this IRP, of major distribution system enhancements addressing growth-related system constraints, system integrity issues and the timing of expenditures.

The Distribution Planning Capital Projects criteria includes:

- Prioritized need for system capacity (necessary to maintain reliable service);
- Scale of project (large in magnitude and will require significant engineering and design support);
- Budget approval (will require approval for capital funding); and,
- Projects are subject to change and will be reviewed on a regular basis.

These projects are preliminary estimates of timing and costs of major reinforcement solutions whose costs exceed \$500,000 in any year. The scope and needs of distribution system enhancement projects generally evolve with new information requiring ongoing reassessment. Actual solutions may differ due to differences in actual growth patterns and/or construction conditions that differ from the initial assessment and timing of planned completion may change based on the ongoing reassessment of information. The following discussion provides information about key near-term projects.

**Kettle Falls High Pressure Reroute, WA:** The Kettle Falls high pressure line is approximately 80 miles long and serves the communities of Addy, Chewelah, Colville, Deer Park, Kettle Falls, and some additional rural towns. This project is considered an integrity driven project, not a capacity project. Sections of this high-pressure pipeline are currently classified as “transmission” due to the operating conditions and physical pipe characteristics. This pipeline is in close proximity to high occupancy dwellings and businesses (high consequence areas or HCA’s), making it necessary for Avista to either lower the pressure or reroute these sections. This project will introduce a new high-pressure pipeline along a different route, allowing Avista to maintain capacity needs and eliminate “transmission” high pressure mains in any HCA’s. Project design will begin in 2026 with construction anticipated in 2027.

**Pullman High Pressure Reinforcement, WA:** The Pullman high pressure reinforcement will connect both the Moscow and Pullman’s high-pressure systems. This would bring Moscow gas to Pullman, avoiding the need to rebuild the Pullman City Gate Station which is currently exceeding its physical capacity. Additionally, this interconnection would increase reliability as both Moscow and Pullman would then have two sources of gas. Design is tentatively scheduled for 2023 with construction anticipated in 2024. Construction timelines may change due to customer growth expectations.

**Table 8.1: High Pressure - Distribution Planning Capital Projects**

Location	2023	2024	2025	2026	2027+
Kettle Falls High Pressure Reroute, WA (compliance-driven)	---	---	---	\$100,000	\$2,000,000
Pullman High Pressure Reinforcement, WA	\$100,000	\$6,700,000	---	---	---

Table 8.2 shows city gate stations identified as possibly over utilized or under capacity. Estimated cost, year, and the plan to remediate the capacity concern are shown.

These projects are preliminary estimates of timing and costs of city gate station upgrades. The scope and needs of each project generally evolve with new information requiring ongoing reassessment. Final solutions may change due to differences in actual growth patterns and/or construction conditions that differ from the initial assessment. The city gate station projects in Table 8.2 are periodically reevaluated to determine if upgrades need to be accelerated or delayed. Those assigned a TBD year have relatively small capacity constraints, and thus will be monitored. There are no plans to rebuild or upgrade TBD city gate stations at this time.

**Table 8.2: City Gate Station Upgrades**

Location	Gate Station	Project to Remediate	Cost	Year
Rathdrum ID	Chase #5000	Increase capacity	\$1,000,000	2023
Coeur d'Alene, ID	CDA East #221	Rebuild for reliability	\$200,000	2023
Colton, WA	Colton #315	TBD	-	TBD
Medford, OR	Medford #2431	TBD		TBD
Pullman, WA	Pullman #350	Pullman High Pressure Reinforcement, WA	\$6,800,000	2024
Sutherlin, OR	Sutherlin #2626	TBD	-	TBD

## Non-Pipe Alternatives

An evaluation of non-pipe alternatives is considered against pipeline capacity reinforcements, when not related to safety, compliance, or road moves. Non-pipe alternatives will only be considered when the cost of an upgrade is at a level high enough where a non-pipe alternative may be cost-effective (i.e., greater than \$500,000), can be accomplished prior to the time the upgrade is needed, and can lead to a great enough reduction of demand to defer or eliminate the need for the upgrade. Possible non-pipe alternatives include, but are not limited to, the following: uprating (raising) the existing pipeline pressure, energy efficiency efforts including encouraging customers to adopt more efficient appliances and equipment, and potentially electrification of natural gas appliances. A non-pipe alternative must address any capacity concerns at a lower cost versus the pipeline reinforcement to be considered a viable strategy.

This Page Intentionally Left Blank

## 9. Action Plan

Action items position Avista to provide the best cost/risk resource portfolio to support and improve IRP planning going forward. The Action Plan identifies supply and demand side resource needs and highlights key analytical needs in the near term. It also highlights essential ongoing planning initiatives and natural gas industry trends Avista will monitor as a part of its planning processes. The Oregon Public Utility Commission (OPUC) provided a majority of the recommendations based on the Company's 2021 IRP, while others were derived from Washington and Idaho Commission Staff and Avista's proposed Action Plan items.

### 2021 IRP OPUC Recommendations

**Recommendation 1:** In the next IRP, use at least five years of historic data for modeling use per customer.

*This IRP utilizes a five-year use per customer coefficient for all Oregon territories in the 2023 IRP across all scenarios. For reference, a three-year coefficient was used for Idaho and Washington.*

**Recommendation 2:** Include a No Growth scenario in the next IRP.

*Four scenarios were studied with no growth. These scenarios consider Electrification with no new customers starting in 2024 and a hybrid heating scenario where electric heat pumps are used with natural gas supplying supplemental heat in cold temperatures. The results of these scenarios are in Chapter 7.*

**Recommendation 3:** In future IRPs, provide a comparison between the current CPA and the last CPA, including a narrative explanation of major changes in the potential.

*Please refer to Chapter 3 for a complete description of current and prior IRP CPA reports.*

**Recommendation 4:** Discuss demand response as a demand side resource option at a TAC meeting before filing the next IRP.

*Demand response studies were completed by Applied Energy Group (AEG) and presented to the August and December 2022 TAC meetings. At this time demand response is not cost effective and is not selected in any scenario. Please refer to Chapters 6 and 7 for results of this analysis.*

**Recommendation 5:** Discuss long-term transport procurement strategies at a TAC meeting before the next IRP.

*Long-term transport procurement strategies were discussed in TAC 2 on May 3, 2022. This discussion included current supply side resources and contract expiration dates along with renewal strategies.*

**Recommendation 6:** Host a workshop within two months of the publishing of DEQ's Clean Power Plan Rules, to discuss challenges and opportunities to incentivize near-term actions to reduce GHGs to meet Clean Power Plan targets, including consideration of SB 98 and SB 844 programs.

*Avista held a TAC meeting in February 2022 to review the final CPP and its implications to Avista including the challenges and opportunities of this program.*

**Recommendation 7:** Provide a workshop in the next IRP development process to discuss the possibility of using the social cost of carbon to help inform carbon risks in its portfolios.

*Avista utilized the social cost of greenhouse gas (SCGHG) for its energy efficiency CPA in all three states. Additionally, a scenario using the SCC to value natural gas versus other supply side resource options was performed and analyzed. Results are in Chapter 7 and were presented during the TAC 4 meeting within the Demand Side Management (DSM) and CPA presentations.*

**Recommendation 8:** Include a non-zero carbon risk value for its Idaho customers.

*In the 2023 IRP considers a national carbon cost for Idaho beginning in 2030. Materials were presented in the TAC 4 meeting in September 2022. The values used in this study are in Chapter 5.*

**Recommendation 9:** Prior to the next IRP, conduct market research to reflect the willingness of Oregon customers to pay for various carbon reduction strategies. Present results at a TAC meeting.

*Market research was conducted by Clean Energy Research and shared with our TAC members in the August 10, 2022, meeting. The more significant results are shown in Chapter 5.*

**Recommendation 10:** Work with stakeholders and Staff to identify information that should be included in an RNG project pipeline update and provide an update on the Company's RNG project pipeline as part of the next IRP Update, including, but not limited to consumer risks and costs assessment associated with buy vs build RNG options.

*The TAC was updated at the February 16, 2022 and December 15<sup>th</sup>, 2022 TAC meetings. TAC members provided no feedback at those times. Chapter 4 provides details around the project pipeline and process.*

**Recommendation 11:** In the next IRP, provide an analysis of the capabilities of Avista’s system to accommodate hydrogen, where upgrades would be required to accommodate hydrogen, and estimated costs of those upgrades.

*As discussed during TAC meeting 5 held in December 2022, Avista can accommodate a hydrogen supplier if the resultant gas meets existing tariff quality standards and industry maximum blending percentages. Avista may inject the hydrogen supply into a contained system where the end use customers have equipment capable of accepting a hydrogen-blended gas. Avista will also require metering and pressure regulation equipment at any interconnect point to measure volume and gas quality and control supply pressure. Avista has an Interconnection Agreement and application process ready for a hydrogen supplier. Avista has not had any committed suppliers at this time. Any cost and/or upgrade will depend on the proximity of the supplier to our distribution system.*

**Recommendation 12:** In the next IRP, describe the assumptions for changes to renewable technologies and their impact on future levelized costs in the text of the next IRP.

*Avista anticipates a reduction in green hydrogen and synthetic methane costs over time. Demand for these renewable technologies from state and federal policies along with industry demand should increase overall demand for these carbon free options. Also supporting programs and incentives such as the IRA, CCA, and CPP all help to provide grants, loans, incentives, or equipment to help meet these goals.*

**Recommendation 13:** Work with TAC to develop a scenario with a future large scale supply interruption, like the October 2018 Enbridge incident

*This IRP includes a supply interruption scenario, where an outage starting north of Sumas at Enbridge and dropping down through Sumas. The scenario assumes North capacity at 50% of available transport capacity rights. Included in this scenario is an additional outage from the South at the Rocky Mountain region with a 25% assumed outage. Results are found in Chapter 7. These scenarios were discussed throughout the majority of the 2023 TAC meetings with additional attention provided during the TAC 4 and 5 meetings.*

**Recommendation 14:** In the next IRP, Avista should continue to keep the Commission apprised of the Sutherlin and Klamath Falls city gate projects. The Company should also provide a list of areas or projects where the Company is monitoring for capacity or pressure issues.

*Avista holds quarterly meetings with OPUC Staff where information such as this is discussed. This list of projects was also formally presented to TAC members during the TAC 5 meeting in December 2022. Please refer to Chapter 8 for a full listing of projects Avista is monitoring at this time.*



## Avista's 2021 IRP Action Items

1. Further model carbon reduction in Oregon and Washington.

*The PLEXOS model includes all carbon zero fuels and options in addition to program elements to meet climate goals in Oregon and Washington.*

2. Investigate new resource plan modeling software and integrate Avista's system into software to run in parallel with Sendout.

*Avista procured a commercial off the shelf product called PLEXOS® from Energy Exemplar in May 2021. This software was built and verified using Sendout for initial model build. As mentioned during the TAC process the additional complexity brought into the natural gas model with the climate policies in Oregon and Washington made a parallel run impossible. The additional functionality of PLEXOS® to model these new program requirements was a primary reason Avista made the investment in the PLEXOS® application.*

3. Model all requirements as directed in Executive Order 20-04

*This plan includes the CPP by including yearly emission constraints, community climate investments and zero carbon fuels as energy choices.*

4. Avista will ensure the Energy Trust (ETO) has sufficient funding to acquire therm savings of the amount identified and approved by the Energy Trust Board.

*The ETO has received the necessary funding to acquire therm savings as identified and then approved by the OPUC and ETO Board.*

5. Explore the feasibility of using projected future weather conditions in its design day methodology.

*Avista utilizes a rolling 20-year average for both the demand and peak forecasts using average temperatures projected for future weather conditions from the River Management Joint Operating Committee (RMJOC). The RMJOC includes BPA, US Army Corps of Engineers and the US Bureau of Reclamation. The research team for these studies included the University of Washington and Oregon State University. The data for these studies were provided for Spokane, Medford, La Grande, and Klamath Falls to develop 19 different weather futures.*

6. Provide an update to the Oregon distribution projects referenced in Table 9.1 from the 2021 IRP to understand capital costs outside of 2021 IRP expectations.

**Table 9.1: Oregon Distribution Projects**

Location	Gate Station	Project to Remediate	Cost	Year
Klamath Falls, OR	Klamath Falls #2703	TBD	-	2023+
Sutherlin, OR	Sutherlin #2626	TBD	-	2023+

*Large High-pressure distribution and City Gas projects did not occur since the 2021 IRP. Quarterly updates with OPUC Staff and other interested parties will occur to ensure any change in projects is known along with reasons for any major changes in expected capital expenditures.*

## 2023-2024 Action Plan

1. Purchase Community Climate Investments for compliance to the Climate Protection Plan for years 2022, 2023, 2024, 2025 and 2026 to comply with Executive Order 20-04.
2. ETO identified 546,000 therms in the 2023 IRP versus 427,000 therms of planned savings in the 2023 ETO Budget and Action Plan. Avista will work with ETO to meet IRP gross savings target of 568,000 therms in 2024.
3. New program offered by ETO for interruptible customers in 2023 to save 15,000 therms.
4. Engage Oregon stakeholders to explore additional new offerings for interruptible, transport, and low-income customers to work towards identified savings of 375,000 therms in 2024.
5. In Oregon, acquire 8.64 million therms of RNG in 2023 and 21.80 million therms of RNG in 2024.
6. In Washington purchase allowances or offsets for compliance to the Climate Commitment Act for years 2023, 2024, 2025 and 2026 to comply with emissions reduction targets.
7. Begin to offer a Washington transport customer EE program by 2024 with the goal of saving 35,000 therms
8. Explore methods for using Non-Energy Impact (NEI) values in future IRP analysis to account for social costs in Washington to ensure equitable outcomes.
9. Explore using end use modeling techniques for forecasting customer demand.
10. Consider contracting with an outside entity to help value supply side resource options such as synthetic methane, renewable natural gas, carbon capture, and green hydrogen.

11. Regarding high pressure distribution or city gate station capital work, Avista does not expect any supply side or distribution resource additions to be needed in our Oregon territory for the next four years, based on current projections. However, should conditions warrant that capital work is needed on a high-pressure distribution line or city gate station in order to deliver safe and reliable services to our customers, the Company is not precluded from doing such work. Examples of these necessary capital investments include the following:

- Natural gas infrastructure investment not included as discrete projects in IRP
  - Consistent with the preceding update, these could include system investment to respond to mandates, safety needs, and/or maintenance of system associated with reliability
    - Including, but not limited to Aldyl A replacement, capacity reinforcements, cathodic protection, isolated steel replacement, etc.
  - Anticipated PHMSA guidance or rules related to 49 CFR Part §192 that will likely require additional capital to comply
    - Officials from both PHMSA and the AGA have indicated it is not prudent for operators to wait for the federal rules to become final before improving their systems to address these expected rules.
  - Other special contract projects not known at the time the IRP was published
- Other non-IRP investments common to all jurisdictions that are ongoing, for example:
  - Enterprise technology projects & programs
  - Corporate facilities capital maintenance and improvements