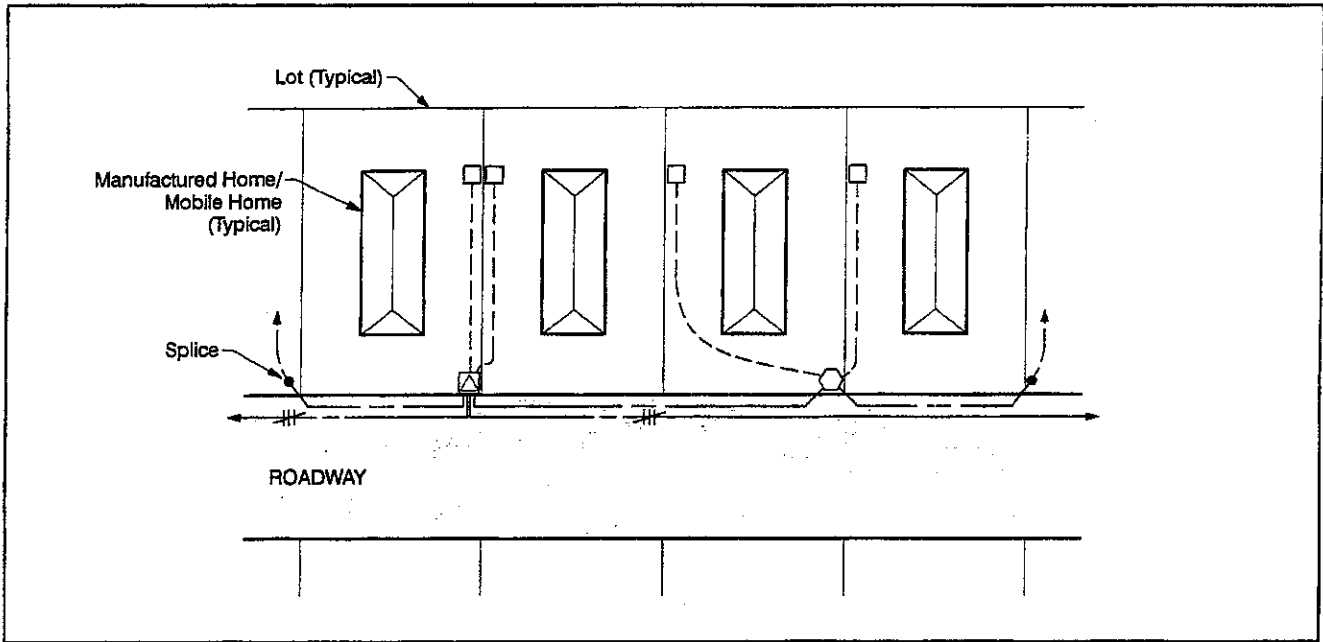

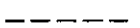

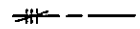



**EXHIBIT B**

**PSE Exhibit No. \_\_\_(GZ-3)**

# Typical Mobile Home/Manufactured Home Park Plan View



-  Transformer
-  Handhole
-  Customer-Owned Service Cable
-  Customer-Owned Meter Pedestal
-  PSE Primary Voltage Cable
-  PSE Secondary Service Cable

# Typical Mobile Home/Manufactured Home Park Side View

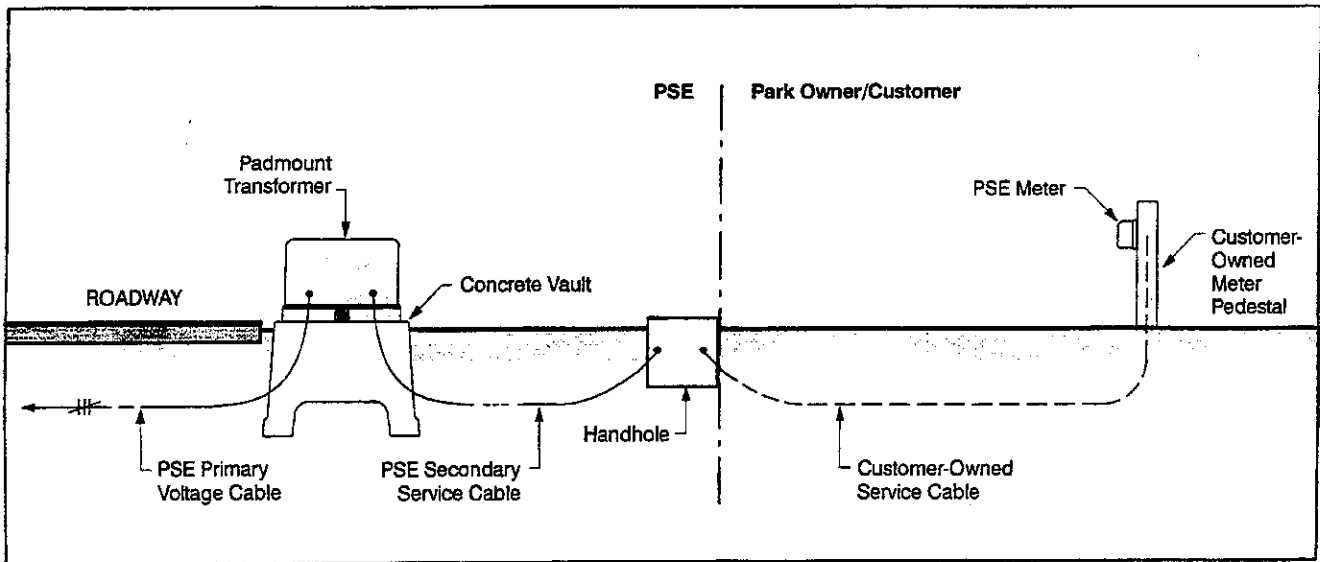

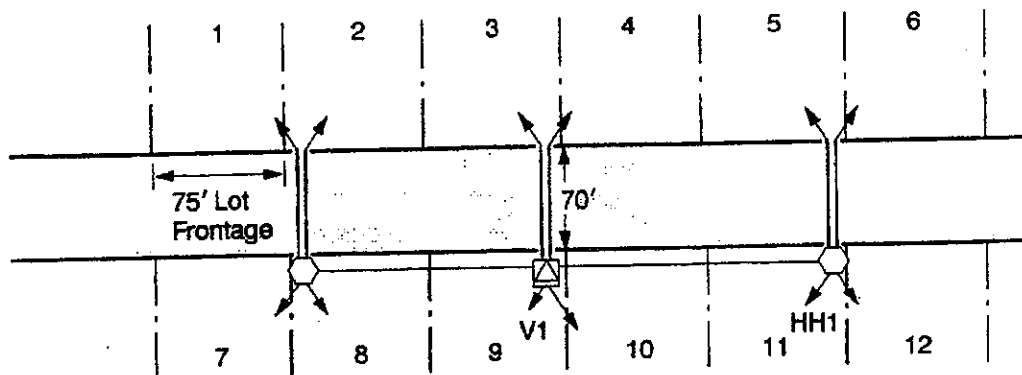

- Service to Home
- Secondary Conductor
- ☒ Transformer
- ⬡ Handhole
- HH1 = Handhole No. 1
- V1 = Vault No. 1