

**From:** [Mark Wahl](#)  
**To:** [UTC DL Records Center](#)  
**Subject:** Submission for Docket U-180117  
**Date:** Wednesday, March 7, 2018 2:02:59 PM  
**Attachments:** [WUTC Comments on Customer Choice.docx](#)  
[The reason for higher electric bills by Bathgate.pdf](#)  
[Getting Smarter About The Smart Grid1.pdf](#)

---

From Mark Wahl, Langley WA 98260  
Date Submitted: March 7, 2018  
Title: **Comments for UTC Docket U-180117 Staff Investigation of Policy of Customer Choice in Smart Meter Installation [Document with two additional attachments]**

State Of WASH.  
UTIL. AND TRANSP.  
COMMISSION

03/07/18 14:09

Received  
Records Management



# Getting Smarter About the Smart Grid

*Why are federal government stimulus programs underwriting billions of dollars of 'dumb' smart meters for utility companies—with taxpayer dollars—meters that will soon be obsolete and not integrate with, or enable, the 'smart grid' of the future on which U.S. energy sustainability depends?*



Authored by a veteran communications technology expert, in collaboration with the National Institute for Science, Law & Public Policy, “Getting Smarter About the Smart Grid” offers a roadmap to a truly “smart” decentralized electricity grid capable of integrating “distributed” power generation and renewable energy sources without the privacy, security, reliability, economic, or potential public health impacts of our present 20th century centralized and wasteful utility infrastructure investment approach.

**National Institute for Science,  
Law & Public Policy**

**August 2012**



“ If discussion surrounding energy strategies and policies can move beyond shallow thinking— such as the notion that a new utility meter represents a foundational element on the path to sustainability—and move toward comprehensive and clear thinking about the objectives and means available, transforming the electricity system can be only the first step in a greater transformation to a new energy future that is sustainable, secure, and a source of economic wealth. We are in a critical historical moment when the stakes are high and the opportunities are great—as are the hazards. The only option not realistically on the table is continuation of the status quo. ”

# Getting Smarter About the Smart Grid

*Why are federal government stimulus programs underwriting billions of dollars of “dumb” smart meters for utility companies—with taxpayer dollars—meters that will soon be obsolete and not integrate with, or enable, the “smart grid” of the future on which U.S. energy sustainability depends?*



Authored by a veteran communications technology expert, in collaboration with the National Institute for Science, Law and Public Policy, *Getting Smarter About the Smart Grid* offers a roadmap to a truly “smart” decentralized electricity grid capable of integrating distributed power generation and renewable energy sources without the privacy, security, reliability, economic, or potential public health impacts of our present 20th century centralized and wasteful utility infrastructure investment approach.

**National Institute for Science,  
Law & Public Policy**

November 2012

“The so called ‘smart grid’ that is as vulnerable as what we’ve got is not smart at all. It’s a really, really stupid grid.”

—Former CIA Director, James Woolsey

## **Author**

Timothy Schoechle, Ph.D.

Dr. Schoechle is an international consultant in computer and communications engineering and in technical standards development. He presently serves as Secretary of ISO/IEC SC25 Working Group 1, the international standards committee for Home Electronic System and is a technical co-editor of several new international standards related to the smart grid. He also serves as Secretariat of ISO/IEC SC32 Data Management and Interchange, and he currently participates in a range of national and international standards bodies related to smart grid technology and policy issues.

As an entrepreneur, he has engineered the development of electric utility gateways and energy management systems for over 25 years and has played a role in the development of standards for home networks and for advanced metering infrastructure (AMI). He is a former faculty member of the University of Colorado College of Engineering and Applied Science. He is considered an expert on the international standards system, the topic of his 2009 book, *Standardization and Digital Enclosure*. Dr. Schoechle was a co-founder of BI Incorporated, a pioneer developer of RFID technology. He holds an M.S. in telecommunications engineering (1995) and a Ph.D. in communication policy (2004) from the University of Colorado, Boulder.

## **Publisher**

National Institute for Science, Law and Public Policy

*Getting Smarter About the Smart Grid* has been published by the National Institute for Science, Law & Public Policy (NISLAPP) under the direction of Camilla Rees, MBA. NISLAPP is a 501(c)(3) non-profit organization based in Washington, D.C., whose mission is to reconcile legal and scientific concerns in the formulation of intelligent, safe and sensible public policy.

## **Website**

[www.GettingSmarterAbouttheSmartGrid.org](http://www.GettingSmarterAbouttheSmartGrid.org)

## Abstract

In recent years, the notion of the “smart grid” has emerged—first using information technology as a means of improving electricity reliability—then more recently to improve efficiency, reduce pollution, and to incorporate more renewable generation. But the public face of this smart grid has too often become the deployment of vast networks of remotely readable electric meters by utilities, often with large government subsidies. In the name of the smart grid, billions of taxpayer and ratepayer dollars are being spent on these so-called “smart meters.” But now the utilities and their smart meters are experiencing increasing public pushback.

In reality, these meters and their dedicated networks are primarily for the benefit of utilities, reducing their operating costs and increasing profits by firing meter readers—ironically with federal stimulus funds—while doing essentially nothing to advance what should be the real goal of the smart grid: balancing supply and demand and integrating more renewable sources. Instead, the meter networks squander vast sums of money, create enormous risks to privacy and security, introduce known and still unknown possible risks to public health, and sour the public on the true promise of the smart grid.

This paper examines the technical shortcomings of the smart meter strategy along with its related economic, privacy, security, and potential health risks—explaining why this approach cannot lead to energy sustainability. It analyzes the failures of both federal grid policy and state regulation. It further explores and explains the technical challenges and economic potential of a *true* smart grid. Finally, it proposes a roadmap for a transformation to a renewable, sustainable electricity economy that could lead the way to a clean energy future.

“ Much early rhetoric about the smart grid and its potential was visionary and grandiose, but what has been delivered has been less impressive, offering little or no public benefit but much public expense. ”

## Contents

Abstract .....	i
Contents .....	ii
Author .....	iv
Foreword .....	v
Prologue .....	1
Executive summary .....	2
I. Introduction: the present U.S. energy challenge .....	4
The ailing U.S. electricity grid .....	4
The promise of renewable energy technologies .....	6
The promise .....	6
The barriers .....	6
Localization .....	7
The conventional utility business model .....	7
Renewables—characteristics and impediments .....	8
Baseload .....	8
Technology leadership—funding the right future .....	10
A bottom-up grass-roots rebellion? .....	10
A new utility business model? .....	10
Present smart meter approach is irresponsible .....	11
The wrong technology .....	12
Strategic investments needed now .....	13
Creative destruction .....	14
The “financial brownout” .....	14
II. The smart meter canard: a misguided focus on the smart meter .....	16
Technical reasons – unneeded and inappropriate technology .....	16
Who is the gatekeeper? .....	16
Data for what? .....	17
Muddying the waters .....	18
Economic reasons – unbalanced costs and benefits .....	19
State officials push back .....	19
Rate burdens and overcharges .....	20
Privacy reasons – privacy and “progress” collide .....	21
What data are we talking about? .....	21
Why is this data being collected/transmitted? .....	23
The gateway alternative .....	23
Public health and radiation reasons – “collateral damage”? .....	24
Health risk .....	24
Radio noise pollution and interference .....	28
Alternatives are available .....	28
Structural reasons – diversion of resources .....	29
The smart meter network market pyramid .....	29
III. Federal smart grid policy: What’s wrong with it? .....	31
Misguided and confused policy leadership at the top .....	31
A federal “Smart Grid Policy Framework”? .....	31
The “four pillars” .....	31
Key failings of the NSTC policy framework .....	32
Confusing electricity policy with energy policy .....	32
Electricity supply issues not mentioned .....	32
Report relies on unclear grand transformative language .....	34
Missing mention of imminent changes in utility business models and regulatory focus .....	34
Fuel price trends and business implications .....	35
Missing discussion of dependency on baseload generation .....	35
“Secure the Grid” chapter misses the target .....	36
Inordinate dependency on regulatory policy approaches. ....	37



Conclusions about the NSTC Smart Grid Policy Framework.....	37
IV. Blueprint for a new energy economy: Roadmap for transformation .....	39
Technologies to create a true smart grid and decentralized power generation.....	39
Key 1—Renewable generation .....	39
Key 2—Flexible generation and storage .....	40
Key 3—Advanced supply/demand response/transactional energy.....	40
Needed policy and institutional shifts .....	41
The new grid.....	41
Citizen action at the state and local level.....	41
Getting beyond the gridlock .....	42
Action plan — Refocusing investment on sustainability .....	42
Immediate action recommendations .....	42
Medium-term action recommendations .....	43
Longer-term action recommendations .....	43
V. Conclusion: pressing need for new energy strategy .....	44
A new vision of a clean energy future .....	44
From smart grid to “Intergrid” .....	44
References .....	46

“ In the face of popular hopes and imagination, moving the U.S. electricity grid to renewable energy faces formidable barriers— technological, institutional, social, political, and economic. Among the most formidable of these barriers is the misfit between the characteristics of renewable technologies (i.e., primarily wind and solar), on the one hand, and industry practices, business models, and their institutional forms, on the other hand— particularly the organization of the current utility industry around “baseload” generation within a centralized generation-transmission-distribution paradigm, and the associated regulatory and financial relationships. For example, wind and solar are inherently distributed sources for which economic efficiency is maximized at much smaller scales than for conventional generation.”



## Foreword

By Duncan Campbell, Esq.

Dr. Timothy Schoechle has been a friend and colleague for nearly twenty-five years. I served as corporate legal counsel when he founded a company whose primary focus was on designing home automation systems and specifically on developing communication gateways and energy management systems employing demand response. He was also involved in the early development of standards for, and testing of, smart meters including Advanced Metering Infrastructure (AMI). He became a pioneer of such energy management systems—and gateways—with his early cutting edge SMARTHOME 1™ product. His extensive knowledge and wisdom in systems thinking in this area has been garnered in large part from his deep involvement in smart grid technology and in taking a leading role in the development and writing of formal national and international standards for close to thirty years. As such, he is uniquely qualified to have formulated this exceptional and game-changing critical analysis, *Getting Smarter About the Smart Grid*.

This paper is a current, thoroughly researched, and extensively documented work that is clearly-expressed and presented in an easily-understood framework. The paper ventures further than many landmark studies in that it lays out both the problems with *and* offers solutions for a lasting “fix” regarding the inaptly named “smart grid” in its centralized form and the currently accepted energy policies surrounding it. Dr. Schoechle examines and explains the prevailing confusion about the “smart grid” and offers a clear path forward, lucidly showing an alternative to patching up our overly-complex, vulnerable, and increasingly expensive energy system—thus creating a truly smart and genuinely sustainable electricity system.

In his 2011 landmark book *Reinventing Fire*, Amory Lovins, considered by many to be one of the world’s leading energy visionaries, observes that “...as we rebuild our dirty, insecure, obsolete-in-many-ways-electricity system, which we have to do anyway over the next 40 years, it’s going to cost about \$6 trillion net present value, no matter what we build...” Lovins concludes that building a distributed renewable-based system is the clear choice for minimizing risk and maximizing sustainability. Lovins contends that this is eminently affordable and doable at the cost of a \$150 billion/year over the next four decades to move to a system of distributed renewables (the same price required in attempting to prop up the insecure and increasingly dangerous centralized “business as usual” electricity industry that is inherently incapable of widespread integration of renewables). So why not make the truly smart and wise choice before time runs out?

Dr. Schoechle’s *Getting Smarter About the Smart Grid* takes Lovins’ work a step further, not only expanding on the specific questions and problems with current energy technology and policy but also offering timely, affordable, practical, and economically viable technical and policy solutions to the current problem of the centralized “smart grid” and how such solutions could help fulfill Lovins’ proposition. The present “smart meter”—which itself benefits only the centralized utilities at the expense of the consumer—has thus become the symbol and focus of rapidly-amplifying public pushback. This pushback is now opening the door to growing public support for the necessary re-thinking of the entire electricity and energy system while a truly wise, affordable, and economically and environmentally sustainable solution is still possible.

At the end—or beginning—of the day, what it comes down to is simply this: In order to establish an abundant and hospitable world for ourselves and a sustainable and empowering future for all



generations, we cannot—and need not—wait for our formally elected politicians to find the right energy policy. It is time for each of us to stand up for our home, our family, and our planet—and to make an end run around the failing archaic centralized grid policy and the disempowering intrusion of the smart meter. It is time for all of us to take the next wise empowering steps together, as Dr. Schoechle suggests at the conclusion of *Getting Smarter About the Smart Grid*.

—Boulder, Colorado, September 2012

Duncan Campbell, Esq. is host of the weekly public radio and Internet program, *Living Dialogues*, which examines a range of current topics related to personal, societal, and political evolution and transformation—including the importance of co-creative dialogue and the pressing societal need for the democratization of the energy economy. He holds degrees from Yale College and Harvard Law School.

## Getting smarter about the smart grid

### Prologue

Scenes of protesters being arrested in the streets might be expected in association with demonstrations related to wars, human rights, or economic crises—but not often in opposition to the activities of utility companies and their seemingly mundane electric meters. However, such scenes of protest occurred recently in California when demonstrators blocked PG&E trucks installing “smart meters” in Marin County. Subsequently, the Marin County Board of Supervisors unanimously passed an ordinance that deemed the installation of smart meters to be a public nuisance (Kahin, 2011). Similar occurrences of rebellion against smart meters are occurring across the continent. Are these situations anomalies, or could they be harbingers of a broad and spreading grassroots rebellion against the utility industry that may herald an epochal transformation of the political economy of energy?



Credit: Tim Porter Photography - [www.photography.timporter.com/](http://www.photography.timporter.com/)

“ The demarcation between monopoly utility space and customer market space was clarified over two decades ago

in the case of wire-line telephone monopolies with the decisions and policy changes culminating in the divestiture of AT&T.

One result was enormous market growth in new markets for premises equipment and services. The electricity grid today is facing the same demarcation inflection point as the telephone network experienced. The gateway belongs to the consumer, not to the electric utility. ”

## **Executive summary**

### *The promise of the smart grid*

In recent years, the notion of the “smart grid” has emerged—first using information technology as a means of improving electricity reliability—and then more recently—to improve efficiency, reduce pollution, and to incorporate more renewable and sustainable sources of generation.

Congress, state and local governments, as well as ratepayers, have been misled about the potential energy and cost saving benefits of the new “smart” meters, paid for in large part with taxpayer dollars, as well as ratepayer dollars. This report makes the case that the smart meters have become confused and conflated with the much broader concept of the smart grid, and that the undue emphasis on meters diverts resources badly needed to develop and bring forward the key elements of a true smart grid technology that can integrate distributed renewable energy.

### *Public pushback*

A growing grass roots rebellion against smart meters now happening in 18 states, such as CA, VT, AZ, TX, FL, PA, ME, IL, OR and the District of Columbia, is only the “tip of the iceberg”—one that conceals a deeply dysfunctional energy economy needing urgent federal, state and local attention. Ratepayers’ desire to “opt-out” of the new meters on privacy, security, reliability, cost, and potential public health grounds could signify rebellion against the electric utility industry that may herald an epochal transformation of the political economy of energy.

### *Conventional utility business model*

The 100 year-old monopoly utility business model contains inherent conflicts and is de-incentivized from taking the necessary steps toward renewable energy and sustainability. Regulated utilities sell electricity as a commodity at profitable regulated rates and, more importantly, can charge back their capital assets to ratepayers at a guaranteed 10-13% annual rate of return. Thus they have no incentive to sell less electricity, yet a strong incentive to build excessive and inappropriate infrastructure (e.g., generation, transmission, meter networks, etc.).

### *Renewables vs. baseload*

Coal plants must run at near capacity to achieve necessary economies of scale, known as “baseload” generation. Adding wind or solar to the power mix may in fact be cost-additive for utilities and ratepayers, because the renewables, if overproducing on top of the baseload, are “curtailed” or wasted (i.e., must turn off the wind to burn more coal). Thus, there is an inherent conflict between baseload generation, the dominant means of electricity generation in the United States, and a transition to renewable energy. Baseload dependency must be decreased or entirely eliminated.

### *New utility business model needed*

Regulators tend inevitably to be “captured” by the utility interests they regulate. In a deregulated and renewable-powered world, utilities must become service companies—maintaining wires and poles—no longer producers or asset builders. Every electricity user could also be a producer.

### *The smart meter canard*

The meter networks squander vast sums of money, create enormous risks to privacy and security, introduce known and still unknown possible risks to public health, and sour the public on the true promise of the smart grid. Data to be collected by the smart meters, including intimate personal



details of citizens' lives, is not necessary to the basic purpose of the smart grid—supply/demand balancing, demand response (DR), dynamic pricing, renewable integration, or local generation and storage—as promoters of the meters, and uninformed parties, routinely claim. Instead, the meter data is serving to create an extraneous market for consumer data mining and advertising (i.e., “big data” analytics). Even those critical of smart meter deployments often seem to uncritically accept the myth that the meters somehow help manage electricity supply and demand.

The allocation of stimulus dollars to subsidize smart meters has also been a net job destroyer, eliminating meter readers and creating manufacturing jobs overseas, while being an egregious waste of federal resources that only supports corporate interests and delays the needed transformation of the electricity grid. In fact, efforts to further develop and standardize those technologies that could achieve those basic purposes have languished, while investments with stimulus funding have instead been made in technologies that merely serve the short-term economic interests of the utility industry and its suppliers instead of the interests of a true smart grid which could economically integrate renewable technologies and distributed, or decentralized, power generation.

#### *Federal policy failure*

Although some federal laboratories have pioneered key advanced smart grid technologies, the highest levels of federal leadership reflect the mistaken belief that the basic solutions involve fixing or modernizing the existing electricity grid, rather than complete structural transformation of electricity service—going beyond any particular “smart” technology. In reality, shaving peak energy usage by shifting loads may actually increase energy bills as well as CO<sup>2</sup> emissions by increasing dependency on coal baseload generation, especially as electric vehicles emerge.

#### *Power to the people*

Leadership in the energy sector is unlikely to come from the top, due to “regulatory capture” and an entrenched “electricity-industrial complex.” At present, there appears to be little evidence that utilities and their regulators want to or know how to make the needed changes to the utility business model, leaving it to the American public, through community-based initiatives and municipalization efforts, to drive the needed change toward renewable technologies and distributed, non-centralized power generation.

#### *Blueprint for new energy economy*

Key technologies must be further developed, including renewable generation and storage. This report recommends a national move away from dependency on baseload generation, particularly coal, as quickly as possible to facilitate renewable integration and to reach our potential for energy independence. This can be aided by a move to flexible generation and storage, and to advanced (non-baseload) demand response and transactional energy smart grid technologies.

Key policy initiatives include those that foster localization and distributed generation—and especially—establishing a clear “demarcation” between monopoly utility space and competitive customer premises market space—as occurred decades ago with the deregulation of the telephone industry.

Electricity grids have become too big and too complex to fail. Yet they will inevitably fail—as recent extreme weather or other events have shown—putting society increasingly at risk.

## **I. Introduction: the present U.S. energy challenge**

The backlash against smart meters (Barringer, 2011) in Marin County, in other parts of California—as well as in Connecticut, Florida, Hawaii, Illinois, Maine, Maryland, Oregon, Texas, Vermont, and other parts of the United States and Canada—seem on the surface to be attributable to at least three issues: health concerns<sup>1</sup>, personal privacy, and cost (Jepsen, 2011). But it is likely that the roots of the backlash go much deeper. Meters have become the “tip of an iceberg”—the public face of an increasingly dysfunctional energy economy characterized by an out-of-date electricity grid and repeated and persistent failures of public policy. The elements of this dysfunction that are most evident to the public are oft-reported health, privacy, and cost concerns.<sup>2</sup>

This paper will explore the nature and roots of today’s energy economy dysfunction, focusing on the electricity grid, a dysfunction symbolized in large part by the smart meter, and will identify an alternative path to a new sustainable energy future based on strategic and rational investment of the nation’s resources. The problems of electricity grid dysfunction include aging infrastructure, unmanageable complexity, rising costs, increasing pollution, accelerating climate change, increasing grid vulnerability, uncertain electricity reliability, loss of consumer control, institutional dependency, declining middle class incomes, and economic unsustainability. These problems are increasingly urgent but solvable. The path to sustainable and renewable energy becomes obvious if mapped by rational and scientific analysis, but the present smart meter approach is a diversion from that path. However, there is an approach that leads to a sustainable path. A grassroots rebellion against meters is indeed taking place, and it is beginning to morph into a bottom-up, community-based revolution in electricity and energy that could re-shape society.

Such a bottom-up revolution may be what has been characterized by economist and author Jeremy Rifkin as “lateral power,” a force that is bringing about a “third industrial revolution” (Rifkin, 2011).<sup>3</sup> Rifkin argues that the implications of the shift to renewable energy are as profound as those associated with the introduction of coal-based steam power and subsequent shift to petroleum that enabled both the “first” and “second” industrial revolutions respectively.

### ***The ailing U.S. electricity grid***

Today’s grid is an over-100 year-old system based on centralized power generation and long distance downstream transport of electricity from generator to user. In recent years, it has been increasingly plagued by blackouts and other reliability problems (Amin, 2011). Most recently, pressures and concerns associated with climate change, environmental pollution, diminishing water resources, economic crisis, national security, and international conflicts over fossil fuel resources have come together with the increasing improvement and availability of wind and solar generation technology to create increased public expectation and demand for renewable energy.<sup>4</sup> But, the old grid is not well suited to the incorporation of renewable energy. The sun and the wind are inherently distributed and not subject to supply-side economies of scale as are coal and nuclear. Thus they do not fit well with the business models, regulatory regimes, and broader paradigm associated with centralized utility architectures (Farrell, 2011; Fox-Penner, 2009).<sup>5</sup>

Several years ago, the term “smart grid” entered the public lexicon, as a proposed solution to concerns about transmission reliability. The term has become increasingly prominent through lavish promotion by utilities and government, feeding public expectations of improved

efficiency, balancing of supply and demand, and integration of renewable energy sources. One generic functional definition of the smart grid describes “an intelligent, auto-balancing, self-monitoring power grid that accepts any source of fuel (coal, sun, wind) and transforms it into a consumer’s end use (heat, light, warm water) with minimal human intervention” (Xcel, 2008).

Smart meters have become the poster child for the smart grid, but the poster is no longer as pretty as it was.<sup>6</sup> A key question has emerged concerning the relationship of these meters to the overall purposes of the smart grid concept and asks, what are those purposes? Is the smart meter controversy a proxy for deeper social, economic, and political problems? If so, how can we solve and move beyond these problems?

Much early rhetoric about the smart grid and its potential was visionary and grandiose, but what has been delivered has been less impressive, offering little or no public benefit but much public expense (Fehrenbacher, 2010). The meter has come to symbolize a “bait-and-switch” situation, mainly to the benefit the utility industry and its vendors as well as to politicians and bureaucrats. In their present form, smart meters offer few or no benefits to consumers, but pose significant risks and costs to them and to society.

This paper finds that the underlying reasons for public disenchantment with smart meters, and by association, with the smart grid, fall into the following categories, ranked by overall national policy significance:

1. Economic reasons – Billions have been expended in public funds and in consumer payments buried in utility rate structures, with little or no benefits from such investment to consumers and ratepayers. The utility industry cuts jobs and improves its bottom line (with the complicity of regulators and the federal underwriting of smart meter deployments) while the potential for benefits to the public from smart grid-managed integration of renewable energy is squandered.<sup>7</sup>
2. Privacy reasons – Privacy and progress collide as the smart grid comes to be perceived as a surveillance tool—invading personal space only to the benefit of third party data miners, promoters, intrusive law enforcement, and tangential commercial interests. Smart meter data can reveal intimate details of personal life such as what and when appliances are used and how many people are in the household.
3. Public health reasons – Some meter networks are radio-based and emit electromagnetic fields. The biological effects of electromagnetic fields (EMFs) are poorly understood. With the pervasive deployment of electromagnetic radiation sources, the potential for “collateral damage” is high, while the meter networks offer little or no benefit to the public. No pre-market health testing was required or performed prior to the wide-scale introduction of these radiation-emitting technologies, and increasing concern about the risks of EMFs are being voiced by citizens, international scientists, physicians groups, governments, and the World Health Organization’s International Agency for Research on Cancer (IARC).

Because it so clearly exemplifies the failure of industry and of public policy to meet the challenge of a new energy future, the case of the smart meter serves as a means of addressing the following questions:

- Where are the failures of government?
- Where are the failures of industry?
- What should the *true* smart grid look like?
- How can we move the right technologies forward to a sustainable energy future?

Although poor investment choices have been made by utilities and by government, it is time to move forward expeditiously. Consumer and national interests must be served, keeping the end goal in mind not simply by short-term stimulus tactics—investment for its own sake—but rather by developing long-term strategic technology investment plans and policies that assure the nation’s energy independence and economic sustainability, as well as security for its people, individually and on a national level.

### ***The promise of renewable energy technologies***

In recent years, public concern over climate change and the environmental consequences of global warming have added to anxieties surrounding issues of pollution, oil addiction, national security, war, water resources, trade competitiveness, the economy, and jobs. At the center of all of these issues is the global energy economy and its present dependence on carbon-based sources of energy. Since its genesis over a century ago, the U.S. electric power system has been based primarily on the burning of coal.<sup>8</sup> Calls for reassessment and transformation of the U.S. electricity system have taken on added urgency in response to degradation and pollution of air and water from the mining and burning of coal, increasing demand for U.S. coal from the developing world, depletion of domestic supplies, and rising prices and costs (Glustrom, 2009).

#### *The promise*

In the face of these rising concerns, the successful development and mass deployment of wind and solar technologies in other parts of the world (e.g., Denmark, Germany) have raised public interest in moving electricity generation to renewable sources in pursuit of a sustainable energy future. Citizen initiatives in 30 states have led to the adoption of Renewable Portfolio Standards (RPS) mandating the percentage of renewable energy that utilities must utilize. The promise of a new energy economy based on renewable and sustainable resources offers the key to addressing the national and global problems cited above. Energy sustainability also offers an appealing sense of right livelihood and integrity to our relationship with the environment,<sup>9</sup> which has long been missing with industrialization. Today, the possibility of clean renewable energy presents a bright spot in an otherwise bleak economic and environmental picture.

#### *The barriers*

In the face of popular hopes and imagination, moving the U.S. electricity grid to renewable energy faces formidable barriers—technological, institutional, social, political, and economic. Among the most formidable of these barriers is the misfit between the characteristics of renewable technologies (i.e., primarily wind and solar), on the one hand, and industry practices, business models, and their institutional forms, on the other hand—particularly the organization of the current utility industry around “baseload” generation within a centralized generation-transmission-distribution paradigm, and the associated regulatory and financial relationships. For example, wind and solar are inherently distributed sources for which economic efficiency is maximized at much smaller scales than for conventional generation.<sup>10</sup> Efforts to build wind and solar at “utility scale” (e.g., large wind farms, concentrating solar plants, etc.) create problems



related to the need for more transmission lines, efficiency losses, land and water issues, and increasing capital costs and risks. Compelling arguments and analyses have been put forth that these renewable technologies make more sense if they are “democratized” or distributed, contrary to the model espoused by the traditional centralized industry paradigm (Farrell, 2011). But utilities will never make the change to renewable energy if it kills their core business model. This is the fundamental barrier to making the infrastructural changes required to move toward a smart grid architecture that serves a broad public interest. There is simply no feasible way to fulfill the promise of a new energy economy within the present “baseload” electricity system.

### *Localization*

A new terminology of “localization” and “distributed energy resources” (DER) has recently emerged around the idea of generating electricity close to where it is used and shifting control to the local or community level. The proposed benefits of electric power localization include jobs (Brookings, 2011), the 3.5 x multiplier effect of keeping the money in a community (GAO, 2004)<sup>11</sup>, reduced transmission losses, economic feasibility at a smaller scale (Farrell, 2011), enhanced grid reliability, regulatory and policy responsiveness, and local and national security in the face of natural or other disasters (Woolsey and Korin, 2007).

Another benefit of localization is improving the stability and security of electricity supply. A localized and distributed electricity supply would risk less vulnerability to securities traders, investment bankers, and exploitive resellers who would find it more difficult to manipulate and misuse electricity markets. The bitter experience of California consumers, industry, shareholders, and governments during the infamous 2001 Enron scandal, when many \$ billions were lost, showed the risks of a centralized and capital-intensive electricity system. If deregulation of generation were accompanied by decentralization, no utility industry player would be in the position of such price manipulation or of being “too big to fail.”

### *The conventional utility business model*

One of the biggest obstacles to renewable energy is a utility industry business model structured around revenues based on the sale of kilowatt-hours (kWh) as a commodity and on a double-digit rate-of-return (ROR) on assets —both guaranteed by state regulators and paid for by ratepayers. This half-century-old system was established in the early days of electrification as an incentive to spur the growth of the needed infrastructure for generation, transmission, and distribution without relying on general tax revenues. Electrification was viewed as a public good and ROR on assets created a mechanism for its subsidization through a regulated rate base.<sup>12</sup> In effect, it made electricity a *commodity* rather than a *service*, and it moved the financial risk of infrastructure construction from the utility to the ratepayer. This distinction means that the more electricity that can be sold and the more infrastructure that can be constructed, the more profit the utility can make. Perversely, in today’s environment, increasing efficiency or reducing demand reduces profits. Unfortunately, the present system essentially guarantees utility profits and removes incentives for energy efficiency and for the incorporation of renewable energy.

States and regulators have attempted to meet public calls for better energy efficiency and cleaner sources by creating various incentives and mandates for utilities (e.g., to accept some level of renewable power and provide efficient light bulbs, appliance rebates, solar rebates, demand response products, smart grids, etc.). However, these measures attempt to “swim upstream”

against a basic utility business model that remains based on the sale of electricity kWh as a commodity and on guaranteed ROR on assets.

The commodity sale of electricity and double-digit ROR on assets has resulted in a system historically dependent on “baseload” generation<sup>13</sup> within a big-grid and big-transmission centralized structure. This means that to be economical, large centralized generating plants (primarily coal, nuclear or some types of natural gas fired plants) must run at a fixed optimum output level known as the baseload. Because the supply and demand for energy on the grid must be instantaneously matched, second by second, hourly variation in demand above the baseload supply curve is met by “peaking plants” (usually natural gas) that are more expensive to operate but can be quickly turned on or off.

Another method of dealing with variation in supply is known as demand-side management or “demand response” (DR). Demand response includes various techniques to manage demand to better match supply. DR offers ways to quickly shift peak demand by sending control signals that turn off or limit specific industrial or residential load devices (e.g., air conditioners, water heaters, etc.). However DR systems require communication pathways and special premises equipment in order to be implemented—products and services that are not yet standardized, fully developed, or readily available.<sup>14</sup> Unfortunately, DR employed in a baseload system, while shaving peaks and improving system efficiency, may perversely serve to increase dependency on relatively dirtier baseload sources (e.g., coal, nuclear, etc.) and thus can actually result in higher pollution and CO<sub>2</sub> emissions.<sup>15</sup> However, properly implemented, new forms of DR (e.g., “transactive energy”) can play a crucial role in renewable integration if the resulting system is cheap, ubiquitous, and easy to use.

### *Renewables—characteristics and impediments*

Renewable energy sources are inherently incompatible with a conventional baseload generation-based electricity system. When variable and unpredictable power from wind and/or solar is fed into a baseload-supplied grid, occasionally too much electricity may be produced relative to demand. The electricity system requires that supply and demand be perfectly balanced second-by-second. If supply and demand become mismatched, even momentarily, the grid may become unstable and could quickly and completely fail. For both technical and economic reasons, baseload plant operators prefer to operate at a fixed optimal output level. Rather than turn down the baseload plants, operators prefer instead to “curtail” the renewable energy (Regelson, 2011; Farrell, 2011, p. 26).<sup>16</sup> In such situations, ratepayers end up paying for both the baseload *and* the curtailed (i.e., wasted) renewable power. The higher the proportion of renewable energy available to the system, the bigger this problem becomes.<sup>17</sup> Conventional baseload-oriented utilities are cautious about adding too much renewable energy because beyond a certain level, doing so raises total costs, which wastes energy and/or threatens to de-stabilize their grid.

### *Baseload*

Figure 1 compares baseload vs. renewable characteristic supply/demand on a typical daily cycle, illustrating the paradigm shift in electricity supply. Demand for electricity changes throughout the day, beginning low in the early morning and often reaching a peak in the late afternoon. In a baseload supply system such as depicted in Figure 1a, demand is met by a conventional combination of continuous level baseload power (e.g., coal or nuclear) and, as required,

additional peaking supply from other sources that can respond quickly (e.g., natural gas combined cycle plants, fast peaking hydro plants or natural gas turbines).

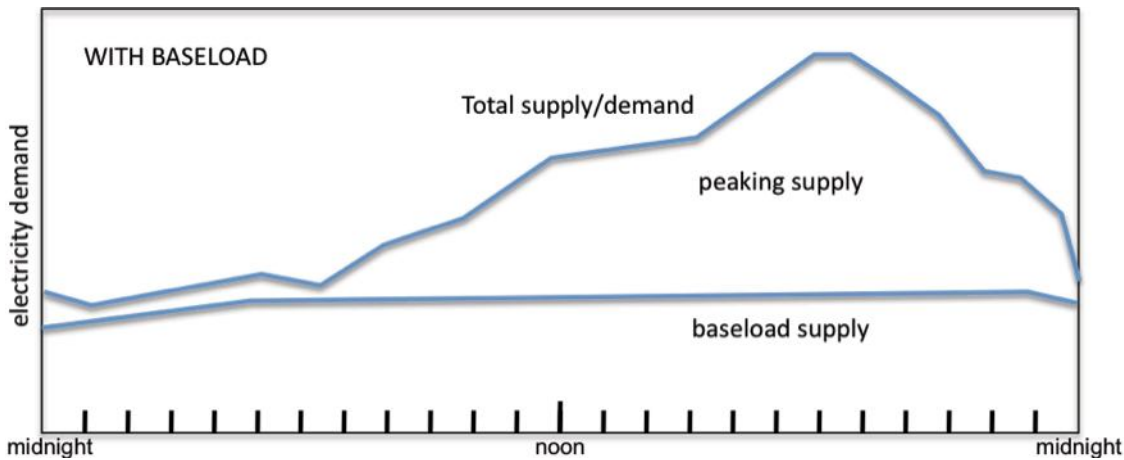

*Figure 1a—Conventional baseload electricity supply system*

But baseload is not essential for meeting demand. In Figure 1b the same total supply/demand profile is met by a combination of renewable (variable) supply and peaking supply. This figure is oversimplified to merely show how variable renewable generation might replace baseload generation and still match the same total supply/demand profile.

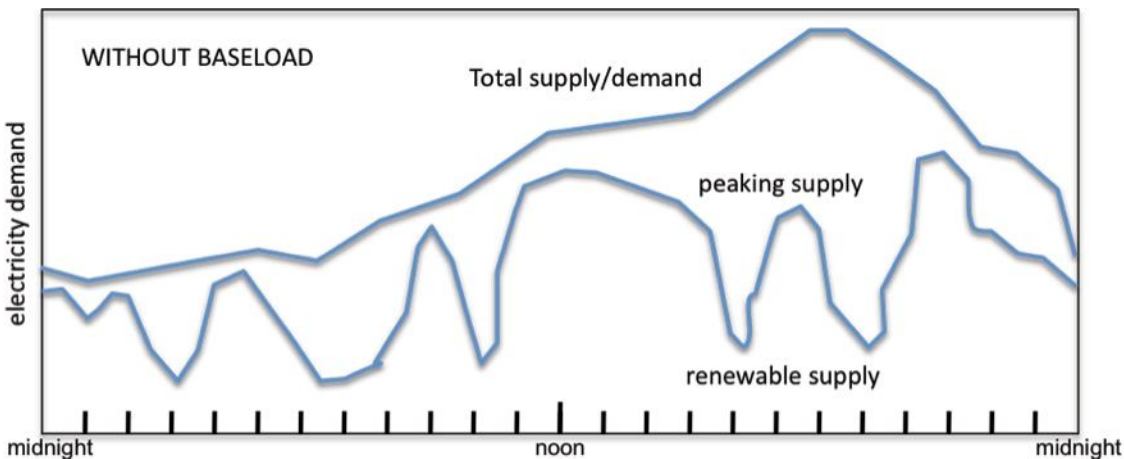

*Figure 1b—Renewable non-baseload electricity supply system*

In the baseload system (figure 1a), the unpredictable nature of some renewable sources (e.g., wind and solar) will sometimes overload the system with too much power when added on top of the fixed baseload. This means that power may be wasted (or “curtailed”). The renewable non-baseload supply system depicted in Figure 1b does not waste power but does, however, present significant technical challenges requiring careful and rapid rebalancing by quick response to changes in supply and demand—either by quickly adding fast peaking sources (e.g., hydro, storage sources, natural gas turbines) when needed or by quickly reducing or shifting demand

(e.g., demand response). This rapid rebalancing represents the essential promise, and challenge, of smart grid technology.<sup>18</sup>

### *Technology leadership—funding the right future*

It does not appear that utilities and their regulators can or want to make basic changes to the utility industry business model, so prospects for change from the top down do not look promising. Regulators primarily tend to serve the needs of those they regulate and have established comfortable, long-standing relationships with the industry, and they are not likely to initiate changes in their business model.<sup>19</sup> Investor-owned utilities tend to be large state employers and elected officials have little incentive to challenge them. Utilities historically have enjoyed solid profits guaranteed by regulators. Federal energy policy has been gridlocked for years and does not provide much reason for optimism.<sup>20</sup> Fossil fuel industry interests are enormous and have enjoyed decades of success securing legislation and subsidies cemented with solid political support. Carbon tax and cap-and-trade legislation have been stymied.<sup>21</sup> Meaningful policy leadership is unlikely to come from the top, unless caused by some clearly catastrophic event or consequence. Federal funding priorities need to be re-oriented. Specific recommendations are made in the “blueprint” provided below—but first, it is useful to critically examine the problem.

#### *A bottom-up grass-roots rebellion?*

In his most recent book, *Reinventing Fire*, longtime energy technology and policy expert Amory Lovins (2011) lays out a detailed plan for freeing society of its addiction to fossil fuels by saving energy through the implementation of efficient vehicles, buildings, and manufacturing plants, and by producing energy through renewable sources such as windmills and rooftop solar. Lovins anticipates that local economic forces and state and local initiatives generated from the bottom-up by people “fed up with gridlock” will make an “end-run around gridlock.” In a recent interview, Lovins commented,

...policies are needed to unlock or speed the transition, but they don’t require an act of Congress. So we’re end-running Washington gridlock, and we’re doing that by using the most effective institutions we have. Free enterprise, its co-evolution with civil society and accelerated by military innovation, to end-run the ineffective institutions, notably Congress. (Flatow, 2011).

Of course it would be most desirable if the federal government would keep its eye on the ball and provide long-term policy and technology guidance and leadership to effect the transition that Lovins advocates. Unfortunately, this is unlikely. Short-term thinking, politics, and conflicts of interest prevail, making gridlock a well-institutionalized status quo. The nuclear power chimera has wasted enormous resources for decades. More recently, “tight oil” and natural gas “fracking” are in vogue and heavily subsidized, diverting financial and technical resources while risking vast unknown and unintended consequences. It will likely be left to the people to reinvent the electricity system largely from the bottom up community initiatives, motivated by desire for a clean energy future, control of energy costs, economic growth, and local control of environmental, health, and privacy factors.

#### *A new utility business model?*

A new utility business model will be needed soon. A sharp decline in energy demand has resulted in cancellation or delay of new power plants and transmission facilities. Industry

analysts and executives see a “...shift in the utility industry created by increased energy efficiency, small generation projects, such as rooftop solar, and changes in public policy...” and suggest that “We are entering a new era...Everyone is looking for power in their backyards.” (Jaffe, 2011).

In recent testimony before the Colorado Public Utilities Commission (PUC), Xcel Energy changed its seven-year resource plan (filed October 31, 2011), cutting its estimated need for additional generation to 292 megawatts—down from the nearly 1000 megawatts<sup>22</sup> forecast just a year earlier (Haeger, 2011, p. 4). The Xcel testimony stated “A combination of a very weak economy and the success of our DSM [demand side management] and *Solar Rewards*<sup>TM</sup><sup>23</sup> programs has resulted in a reduction of over 500 megawatts of generation capacity in just the past year” (p. 5). Xcel does not see a significant need to increase renewable energy until 2028 (p. 13)—its investment in coal generation being simply too great.

The United States’ utility system has grown fat and complacent, shielded by an indulgent regulatory system that has masked market realities, insulating utilities from the consumer. But when the situation finally reaches a tipping point, change may come with shocking rapidity. When investor-owned utilities can no longer conceal or veil increasing fuel costs, face declining revenues, and cannot provide a path toward a renewable and sustainable energy future, their customers may bypass them or bolt outright. When such a process begins, it can become self-reinforcing. On November 1, 2011, voters in the City of Boulder, Colorado, passed ballot measures to move toward municipalizing the city’s electricity grid. The measures passed in spite of nearly \$1 million in campaign funds spent by Xcel Energy to defeat them—a level of spending ten times that of citizen groups supporting the measures. It is not clear what will happen as utility investments in obsolete systems become stranded and can no longer be protected by regulators. What is clear however is that the will of people to secure their energy future may be stronger than powerful utilities ever imagined.

In his book *Smart Power*, utility industry economist Peter Fox-Penner (2010) provides an insightful and comprehensive analysis that predicts the collapse of the old utility business model based on the sale of commodity kWh and on ROR on assets, with utilities enjoying a guaranteed ten percent profit. Fox-Penner explores two potential alternative “evolutionary” business models for the utility industry. These models include 1) the “smart integrator” model, and 2) the “energy services utility” model. The smart integrator is a utility that retrenches into a distribution company that manages smart pipes and wires. The smart integrator is therefore a network operator and not a commodity seller. The energy services utility is a utility that becomes customer service centric and incentivized to energy efficiency, which generates or buys electricity for its customers. Fox-Penner notes that migration to these models will likely be crisis-driven, and that the industry is not yet in crisis. However, that situation may soon be changing.

### ***Present smart meter approach is irresponsible***

The smart grid may yet be an important key to a new energy economy, but the current smart meter approach is irresponsible—financially, politically, and technologically. This is because the smart meter emphasis does not contribute to the balancing of supply and demand or to the integration of renewable sources, while sapping the resources needed for true progress and squandering public support. Over the last year, utilities around the country have installed an

estimated two million smart meters. These were included as part of \$3.4 billion in federal stimulus funding to “modernize” the nation’s power grid. The Edison Institute (IEE) estimates that 65 million smart meters will be deployed by 2015, representing 54% of U.S. households, and that as of September 2011, 27 million smart meters had been installed (IEE, 2011). The presumed contribution of these meters to the goals of the smart grid deserves close examination.

In 2010, The *Smart Grid Investment Grant Program*, part of the *American Reinvestment and Recovery Act*, provided matching funds to utility projects. In rolling out the money, President Obama spoke about how the program would “...spur the nation’s transition to a smarter, stronger, more efficient and reliable electric system” that would “promote energy-saving choices for consumers, increase efficiency, and foster the growth of renewable energy sources like wind and solar” (Obama, 2009). The main elements of the program are identified in the quote below:

**Empowering Consumers to Save Energy and Cut Utility Bills** — \$1 billion. These investments will create the infrastructure and expand access to smart meters and customer systems so that consumers will be able to access dynamic pricing information and have the ability to save money by programming smart appliances and equipment to run when rates are lowest...

**Integrating and Crosscutting Across Different “Smart” Components of a Smart Grid** — \$2 billion...funding a range of projects...including smart meters, smart thermostats and appliances, synchrophasors, automated substations, plug in hybrid electric vehicles, renewable energy sources, etc. (Obama, 2009).

Thus was the intention. Over the ensuing two years, a number of valuable smart grid research and demonstration projects were initiated and useful transmission and distribution automation improvements were implemented with a portion of the federal money. These actions worked to the benefit of utilities and their customers—mainly by bringing about increased reliability and efficiency through improvements in distribution, transmission and generation (EnerNex, 2010).<sup>24</sup> However, the unfortunate reality is that very little progress has been made toward moving the grid toward distributed renewable energy or enabling the other goals proclaimed in the program goals cited above. Disproportionate benefit from the funding has accrued to utilities and meter and metering network manufacturers (e.g., Elster, GE, Itron, Landis+Gyr, Oncor, Sensus, Silver Spring Networks, etc.) rather than to consumers. The meters have killed local jobs while the promise of smart thermostats, smart appliances, usage displays, and renewable energy source integration continues to languish.

### *The wrong technology*

Following the initial hype about smart grid and all of the benefits it could bring, the smart meter rapidly became “low hanging fruit” that would provide “two-way communication” to the end user that could deliver all the wonderful benefits of the smart grid. So the narrative went. But this starry-eyed account turned out to be wrong. In reality, the smart meter delivered unemployed meter readers<sup>25</sup> and a deluge of meter data that utilities had no idea what to do with. It delivered little or nothing of value to the consumer. The smart meter also delivered a public increasingly soured on the smart *grid*, which came to be perceived as a “bait-and-switch” by industry and politicians.

The digital smart meter is a twenty-year old technology that was rapidly seized on because it was off-shelf and relatively quick and easy to install<sup>26</sup> and because it offered to cut labor costs. But the technologies and standards needed to implement a true smart grid were not available—and

are still not available. The requisite technologies and standards are difficult to develop and putting them in place will require much research, development, standardization, product engineering, and marketing, along with new business models.

One of the supposed benefits of smart meters is the enabling of time-based rates. In reality, smart meters and dedicated smart meter networks are not necessary for this purpose—there are better technical approaches.<sup>27</sup> Moreover, time based variable rates are not effective or equitable without automated customer in-home or on-premises equipment to respond to them and manage usage (and perhaps on-premises generation or storage) accordingly. Additionally, time-based rates must take into account the situation of lower-income users who may not be able to purchase expensive automated energy-management equipment. Without proper implementation, time-based rates risk being seen as nothing but subterfuge for rate increases, further souring the public on the smart grid.

In recent blog discussions, utility engineers commented that some elements of the smart grid—such as distribution automation and monitoring, outage isolation, voltage optimization, remote meter reading, billing, and back-office operations—have yielded operational efficiencies and benefits. But bloggers went on to comment that the “heavy lifting” requisite to realize the smart grid promise of load balancing, demand response, and renewable integration has yet to be seriously undertaken. One engineer wrote “...home area networks, customer load controls, real-time usage monitoring, load shifting are all very costly and time consuming to manage and implement. The [utility] business case just isn’t there” (Damiano, 2011). The message here is that the utility industry is not equipped or incentivised to develop and produce the range of products and services needed to realize the full promise and expectation of the smart grid.

Finally, serious questions have been raised concerning the proper role of utilities in dealing with users’ personal data—reaching into consumers’ homes to extract meter data and to exercise control over their appliances and their lives—a topic that will be considered in detail later in this paper, as will the limitations and misconceptions surrounding smart meters and the dereliction of policy makers in allowing this situation to develop.

#### *Strategic investments needed now*

Much federal smart grid spending is motivated by the need to stimulate the economy, but more care could be taken to make sure funding is directed in a manner that serves this outcome. Spending on infrastructure that will actually transform the energy economy will pay off in jobs and global competitiveness. This will require independent energy policy and strategic thinking and not continuation of the status quo service to established industry interests. In *Reinventing Fire*, Lovins (2011) makes the business case for a new approach to energy that would cost less and provide more—and that gets the nation off of coal, oil, and nuclear energy by 2050. In a recent interview, Lovins commented

...as we rebuild our dirty, insecure, obsolete-in-many-ways electricity system, which we have to do anyway over the next 40 years, it’s going to cost about \$6 trillion net present value, no matter what we build...

So we're going to have to rebuild the electricity system, anyway, and we are rebuilding it day by day. But if we look at what we could rebuild, we could do business as usual. We could do a new nuclear and so-called clean coal scenario. We could do centralized renewables, distributed



renewables. And surprisingly, these four scenarios differ only immaterially in cost, but they differ profoundly in risk (Flatow, 2011).

Lovins' point is that if we choose investment in a modernized electricity grid that integrates distributed renewable energy technologies, the total investment will not be measurably different, but the benefits will be vastly greater and risks lower because we will have created a sustainable carbon-free energy economy that will, in turn, benefit the broader economy.

### *Creative destruction*

Joseph Schumpeter, the early 20th century economist and a prophet of free-market capitalism, described economic progress in terms of “creative destruction”<sup>28</sup> wherein market forces eliminate obsolete and less productive legacy industries to make room for investment in more innovative, economic, and productive technologies and industries (Schumpeter, 1942). Accordingly, investments in obsolete or unproductive industries are (and should be) written off and discarded. But in the entrenched carbon energy economy, this is not likely to occur. Regulators have been propping up investor-owned utilities (IOUs) for a long time. But this may be drawing to an end and the result may be impending crisis. In the event of a collapsing energy industry, powerful energy and financial interests would likely demand their own Troubled Assets Relief Program (TARP) or E.U.-style taxpayer bailout to protect the interests of private stockholders and/or bondholders.

The following examples illustrate that ratepayers, consumers, and taxpayers, are currently being asked to prop up financially unsustainable utilities—a situation that may be approaching its limits.

### *The “financial brownout”*

In November of 2011, Xcel Energy told the Colorado PUC that the company's projected 7-year demand had dramatically dropped by 994 megawatts (a drop equal to the total output of Xcel's new \$1 billion Comanche unit 3 coal plant in Pueblo just completed last year) and that Xcel does not anticipate the need for more renewables until 2028 (Jaffe, 2011). Then, within two weeks, Xcel asked the PUC for a \$142 million rate increase that would raise the average household electricity bill by \$4 (Jaffe, 2011a).

In a contemporaneous case, Duke Energy announced that the company would take a \$220 million charge against earnings<sup>29</sup> to cover some of the massive cost of building its new marquee “clean coal” plant at Edwardsport, Indiana. Duke now projects the plant's cost at \$3 billion—\$1 billion more than originally forecast (Smith, 2011). The Indiana Utility Regulatory Commission has allowed the utility to charge customers \$2.35 billion so far, and probably will allow more such charges before the plant is completed. The \$220 million charge (loss) follows a \$44 million third quarter charge taken by Duke (and its shareholders) on the plant the previous year. In essence, as costs escalate and benefits become more dubious, regulators who are subject to political forces may become less willing to continue to simply pass all costs through to ratepayers—thus stranding more utility investments over time.

These are but two examples illustrating that IOUs are on an unsustainable collision course with a financial iceberg—as projects become less and less economically viable, regulators may come under increasing pressure to disallow charges to ratepayers, thus raising financial risks to the

utilities and their shareholders and bondholders. The political economics of utility coal are crowding out renewable energy. Ratepayers, consumers, and taxpayers are being asked to prop up a business model that is financially unsustainable and already failing—the model is effectively “browning out.” Renewable energy is held hostage to coal and utility profits, and the ransom may ultimately require a public bailout—buying out the stranded IOU-owned coal plants and decommissioning them in order to shift the grid from baseload coal to renewables.

## II. The smart meter canard: a misguided focus on the smart meter

The smart meter is a canard—a story or a hoax based on specious and grandiose claims about energy benefits ostensibly derived from the promise of “two-way” communication with the customer. Specifically, these supposed benefits are held to derive from display of energy use data, control of energy appliances, knowledge of grid load distribution, supply/demand balancing, renewable integration, lower bills, and other “hand-waving.” These energy benefits have not been delivered, or have been only minimally delivered by the meter networks. The present smart meter focus is wholly misguided for reasons that are technical, economic, privacy-related, public health-related, and structural (i.e., related to a dysfunctional industry/market structure).

### *Technical reasons – unneeded and inappropriate technology*

First of all, smart meters have failed to deliver smart grid benefits for fundamentally technical reasons. Examples include that 1) the networks do not generally provide full two-way communication, 2) customer usage display was, in most cases, of stale data (24 hour delayed) on a third-party website—on-site real-time display is not feasible using most meter backhaul networks—and 3) smart meters and their networks cannot or are ill-equipped to implement demand response load control strategies.<sup>30</sup>

Meter networks generally are not true two-way communication networks—they are intended for polling meters and not designed to handle in-bound signaling for demand response (DR) strategies or to communicate with home automation systems, in-home devices, or smart appliances.<sup>31</sup> Even if meter networks were able to do so, the back-office software to support such applications is not available or is in a primitive state of development and not standardized. These networks do not provide a full-function open premises information “gateway” to the home. Even if the meters did provide a gateway function, they would likely be implementing a top-down centralized control strategy (ACORE, 2011).<sup>32</sup> Such an approach is not well understood, would not operate practically on a large scale due to its complexity, and would not likely be acceptable to consumers due to its intrusiveness. The old centralized control paradigm is inconsistent with the concept of distributed energy resources (DER), with consumer autonomy, and with state-of-the-art smart grid technology.<sup>33</sup>

### *Who is the gatekeeper?*

Another important limitation to the centralized utility approach is that it positions the utility as the “gatekeeper” and controller of the “gateway” to the consumer and his home. The demarcation between monopoly utility space and customer market space was clarified over two decades ago in the case of wire-line telephone monopolies with the decisions and policy changes culminating in the divestiture of AT&T. One result was enormous market growth in new markets for premises equipment and services. The electricity grid today is facing the same demarcation inflection point as the telephone network experienced. The gateway belongs to the consumer, not to the electric utility. A demarcation and opening of the consumer premises space to market competition could unleash the creative energy of the consumer electronics industry, the home appliance industry, and others. Full two-way smart grid communication among premises-based systems, products, and services—facilitated by a consumer-controlled gateway device and already available data services (i.e., Internet and Web access via DSL, cable, fiber, etc.)—would

free the smart grid from the stifling control of utilities and their proprietary meter-reading networks. The gateway alternative is further described below in relation to the topic of privacy.

### *Data for what?*

Meter data is not necessary to the basic purpose of a smart grid (e.g., supply/demand balancing, DR, and renewable integration). The original motivation behind remote meter reading (including AMI) was the elimination of meter readers and automation of back-office billing systems.<sup>34</sup> Currently, however, data is collected primarily because it can be. Utilities do not know what to do with all the meter data and probably did not ask for it in the first place. The accumulation of data was simply a consequence of the process of automated remote meter reading. Recent discussions on the blog operated by the utility think-tank *UtiliPoint* reflect this quandary. “Utilities are becoming paralyzed with the storage and attempted manipulation of such large quantities of data...we must look past the initial pain to discover what we can do with the data” (Warsaw, 2011; 2011a). These data were initially an ancillary and largely unintended by-product of remote meter reading, but third-party jackals have begun craving the data for tangential marketing and promotion and other forms of commercialization, as has occurred with the Internet and Web (e.g., Facebook, Google, Amazon, etc.).

What is almost always assumed or alluded to by meter advocates, but never explained, is how reading meters, however frequently, can serve the goals of functions of the smart grid—i.e., balancing supply and demand. Never explained is how granular personal meter data helps manage the grid. It is believed by some that consumer electricity usage behavior data may be useful to utilities or to consumers. But it is not clear how such data would actually be applied, nor is it clear that there are not cheaper and more benign ways to acquire it. SCADA<sup>35</sup> networks already provide utilities with the aggregate transformer or substation load data needed to assess distribution loads and conditions. A premises meter is not needed, or would be impractically cumbersome to use, to aggregate data to derive distribution grid load information. The notion that a utility supercomputer could somehow centrally micromanage a vast network of individual household appliances is fantastical—the stuff of science fiction scenarios.

In contrast, management of premises demand response, supply/demand balancing or control/monitoring of solar systems, electric vehicles (EVs), or batteries would be better accomplished by distributed control through intelligent energy management devices and transactional control strategies. What is needed is not meter data flowing *out of the premises*, but rather grid load, time-of-use signals, or electricity transactional data flowing *into the premises* so that the premises can manage its own energy. This would require full two-way communication via a gateway with premises-based equipment such as home automation systems (HA), smart inverters, smart appliances, energy management systems, etc. that do the job of managing energy on-premises.

Present day meters do not provide such a gateway. The meters generally do not provide data directly to the customer, but rather upload it to the utility, which may or may not provide it later to customers via a third-party web portal (usually delayed by at least 24 hours). Customer usage displays would need to be real-time or near real-time to be useful to consumers<sup>36</sup> and even then the best displays are no substitute for premises-based automated energy management equipment that would act on behalf of consumer priorities and do so entirely within their own homes.

### *Muddying the waters*

Smart metering systems are highly arcane and non-engineers tend to assume unquestioningly that the smart meter is a vital part of smart grid technology. Such an assumption is commonplace even among those vocal in raising challenges to the meters on privacy grounds and other bases. For example, in a key paper on the topic of smart grid data privacy by the Privacy Commissioner of Ontario, Canada, the necessity of collecting granular meter data (including details about personal electricity and appliance usage) was unquestioningly accepted, thus conflating the smart grid with smart meter.

The Smart Grid has the potential to deliver substantial value, but is a significant endeavour that will require privacy risk mitigation measures to be taken. The infrastructure that will support the Smart Grid will be capable of collecting detailed information on energy consumption use and patterns within the most private of places – our homes (Cavoukian, 2011).

Another example of this mistaken assumption is a widely cited landmark paper by Elias Quinn (2009) that initially and thoroughly revealed the privacy risks of highly granular meter data. Even Quinn erroneously views such data as essential to the smart grid:

Proper management of this new information pool could support energy efficiency efforts and demand-side management (DSM) initiatives... The more information gathered, the better supported DSM initiatives, efficiency investments, and conservation efforts (p. v).

Essentially, an electric utility could capitalize on the information to facilitate more efficient network management, peak load reduction, load shaping, and any number of other such uses. (p. 4).

[Meter data facilitates] provision of electricity usage information in real-time, allowing dynamic response to changing prices or environmental signals, and the ability to identify household activities (p. 7).

Left unexplained in most discussion of smart meter data is exactly how these data serve the proclaimed purpose. The confusion may be understandable, in part because both Cavoukian and Quinn have backgrounds in policy and law, not in engineering. Unfortunately, those sufficiently knowledgeable to understand the technical details of how the metering systems work and how they are applied by the utility industry are often reticent about raising questions regarding the actual role and value of the meters. Ironically, even those who should know better perpetuate this confusion: “The major benefit provided by the Smart Grid, i.e. the ability to get richer data to and from customer meters and to other electric devices, is also its Achilles’ heel from a privacy viewpoint” (NIST, 2009, p. 84). This quote not only misstates the benefit of the meter, but thoroughly conflates and confuses the smart meter with the smart grid.

### *Green Button magic*

In an attempt to establish some perception of value in the growing river of metering data, the National Institute of Standards and Technology (NIST) and the U.S. Department of Energy (DOE) embarked on a major push in the Fall of 2011 known as the “Green Button”—an effort to solve the data display standardization problem. The Green Button was inspired by the successful “Blue Button”, which standardized the format for provision of health information for veterans through a simple one-click website button. The Green Button standardized the format of energy consumption data (including meter data) summaries, presumably for display on smart

thermostats and other in-home devices or websites, and for automated machine-to-machine exchanges. The Green Button standardization appears to have been broadly adopted, although unfortunately, it still did not address the meter data delay problem.

Based on this author's discussions with some of those individuals involved in the Green Button initiative, it was a promotion based on a theory that could be critically paraphrased as follows: "we don't really know what to do with all this data or how to use it, but if we put it in a standardized format and make it readily available, third party geeks and nerds (i.e., creative entrepreneurs) will figure out how to do something useful with it—and maybe save some energy somehow." By this magic, government officials and utilities may be perceived by the public as retrospectively accomplishing something of value with their meters. Unfortunately, the Green Button ultimately is likely to serve mainly as a temporary substitute for automated in-home energy management systems while feeding a superfluous market for data and potential invasions of consumer privacy.

### ***Economic reasons – unbalanced costs and benefits***

The smart meter push has begun to sour consumers on the potential of the smart grid and has led to cynicism concerning the ability of the government and utility industry to promote energy policy to serve the public interest. At the same time, observers are coming to realize that government and industry are wasting billions of taxpayer and ratepayer dollars that could be put to productive use creating a sustainable electricity grid.

Following are some of the economic arguments supporting the position that investment in smart meters is misguided. Smart meters:

- do not reduce electric bills but may actually increase them (due to introduction of dynamic pricing schemes, rate recovery of deployment costs, etc.),
- do burden consumers with costly meters and proprietary meter networks rather than utilize already existing communication networks, while costs are passed to ratepayers by regulators through rate increases and generous guaranteed ROR on assets,
- do not improve or manage consumer energy use or facilitate supply/demand balancing, consumer demand response, or integration of renewable energy,
- do destroy local jobs, and
- do divert or squander dollars that could have brought us closer to a renewable-based electricity infrastructure.

It is important to remember that the *Smart Grid Investment Grant Program* awarded matching funds that required equal matching by grantees—a cost generally passed on to ratepayers.

### ***State officials push back***

Illinois Governor Pat Quinn recently vetoed legislation that would have paid for the widespread installation of smart meters and other electricity grid "improvements." According to Quinn in a recent *Smart Grid News* article,

...utilities are trying to change the rules to guarantee themselves annual rate increases and eliminate accountability. I will not support a bill that contains sweetheart deals for big utilities, which could leave struggling consumers to pick up the tab for costs such as lobbying fees and executive bonuses (Berst, 2011).

Governor Quinn added that the state could ensure continued innovation and investment in the electricity grid and create new jobs "...without compromising core safeguards for Illinois consumers." Attorney General Lisa Madigan commented "This bill would have been devastating for consumers."

Another example of pushback by state authorities on economic grounds is the Brief of George Jepson, Attorney General of Connecticut before the state Department of Utility Control (CDUP) urging rejection of Connecticut Light & Power's (CL&P) plan to install 1.2 million new smart meters. CL&P had conducted a pilot study of 1,251 residential and 1,186 commercial meters in 2009. Jepson said,

CL&P's proposal would force the company's ratepayers to spend at least \$500 million on new meters that are likely to provide few benefits in return. ...The pilot results showed no beneficial impact on total energy usage and the savings that were seen in the pilot were limited to certain types of customers and would be far outweighed by the cost of installing the new meter systems. ...Also the existing meters, installed between 1994 and 2005 have a useful life of 20 years and replacing them early would incur additional costs for customers. (Jepson, 2011)

Jepson's brief went on to say that CL&P

...should install the technology at its own expense and then demonstrate during a full rate proceeding...the costs are known and measureable and the meters are used and useful, that its expenditure for this purpose was prudently incurred. Only then, should the DPUC consider whether, and to what extent, those costs should be included in rates.

Jepson also commented that dynamic (i.e., time-based) rates (a justification for smart meters) are punitive to certain types of customers, including many elderly, those with sick or young children at home, those who work second or third shifts, and many small businesses. The Governor added that while time-based rates can be useful and should remain an option for electric customers, these rates can be handled in better ways and customers should not be forced to their economic detriment.

Pushback due to costs and benefits has emerged in other states as well. In 2010, Maryland regulators blocked a utility's smart meter proposal, citing inadequate planning and potential cost to customers. In California, class-action litigation against PG&E asserted that due to a hasty rollout, old billing systems were merged with new smart meters, frequently resulting in erroneous overcharges (Zeller, 2010).

#### *Rate burdens and overcharges*

Claims of overcharging have emerged in Texas and other states. Some have questioned the accuracy of digital smart meters. And as illustrated above, additional problems come about when (as is more often than not the case) the switch to smart meters is accompanied by rate increases to pay for them or, more subtly, meters are bundled with dynamic pricing that results in higher rates. Ratepayers in Colorado experienced four electric rate increases in three years, including a rate hike to pay for Xcel's *SmartGridCity*<sup>TM</sup> project in Boulder—a smart meter network that replaced less than half the meters in town but still enjoyed a \$45 million retroactive rate recovery award from the Colorado PUC (Fehrenbacher, 2010). In addition, the system, installed in 2008, failed to deliver the promised in-home devices for demand response, home automation, displays, renewable integration, and other promised greenery.<sup>37</sup>



Some regulators are beginning to wake up. The Hawaii Public Utilities Commission rejected a \$115 million smart grid project that relied on the installation of wireless smart meters. The state Division of Consumer Advocacy said, “Our office was concerned that the investment would be made but ratepayers wouldn’t see the benefits. ...The utility should create a comprehensive plan for upgrading the electricity grid before it makes another attempt to use ratepayer money to put advanced electric meters in homes and businesses” (Niese, 2010).

It is becoming increasingly recognized that the costs of smart meter networks exceed the benefits—over and above the lost opportunity cost (i.e., the lost opportunity to invest the same money more wisely). Such benefits as actually accrue are primarily to utility operations and result from the elimination of meter reader jobs, reduction of truck rolls, expediting of back-office billing systems, etc. Consumer benefits are obscure and very indirect. For example, an exhaustive DoE-funded report filed with the Illinois PUC found all “customer benefits [were] realized indirectly through utility [benefits]” (EnerNex, 2010, p. 59). With respect to a claimed “societal benefit,” the report found “...reduced CO<sup>2</sup> emissions...attributable directly to meter installation is likely to be minor and...is obtained by the reduction in the use of vehicles by the utility for its meter-reading workforce” (p. 61). This would seem to be a less than salutary benefit. Further, it does not consider the emissions and costs of producing, installing, and maintaining extraneous networks and meters. Additionally, much of the electronics is likely to be sourced abroad.

### ***Privacy reasons – privacy and “progress” collide***

Smart meters enable an unnecessary invasion of consumer privacy that offers no (or highly dubious) associated benefits. The issue of smart meter data privacy was brought to the fore by the circulation of a landmark paper by Elias Quinn (2009). Quinn’s report was addressed to the Colorado Public Utilities Commission and subsequently resulted in an ongoing inquiry. The paper also found its way around the world and was partially included (with its diagrams) in a national policy report by the Cyber Security Working Group, *Privacy and the Smart Grid* (NIST, 2010).

#### *What data are we talking about?*

Although various types of data may be involved, the term “smart grid data” fundamentally refers to detailed, highly granular meter data (e.g., 1, 5, or 15 minute interval recordings)<sup>38</sup> collected by meters and showing the aggregate electric usage from a customer premises. Subsequent data processing/disaggregation is capable of identifying individual appliances (load signatures) and discerning usage patterns (customer habits). In this sense, the data become personally identifiable information (PII) for each particular user/customer. The privacy and security implications of the Quinn paper were far-reaching and troubling. Figure 2 below shows a typical household electricity demand profile and has been reproduced in the CSWG report (NIST, 2010, p 13) and appears often in other reports.

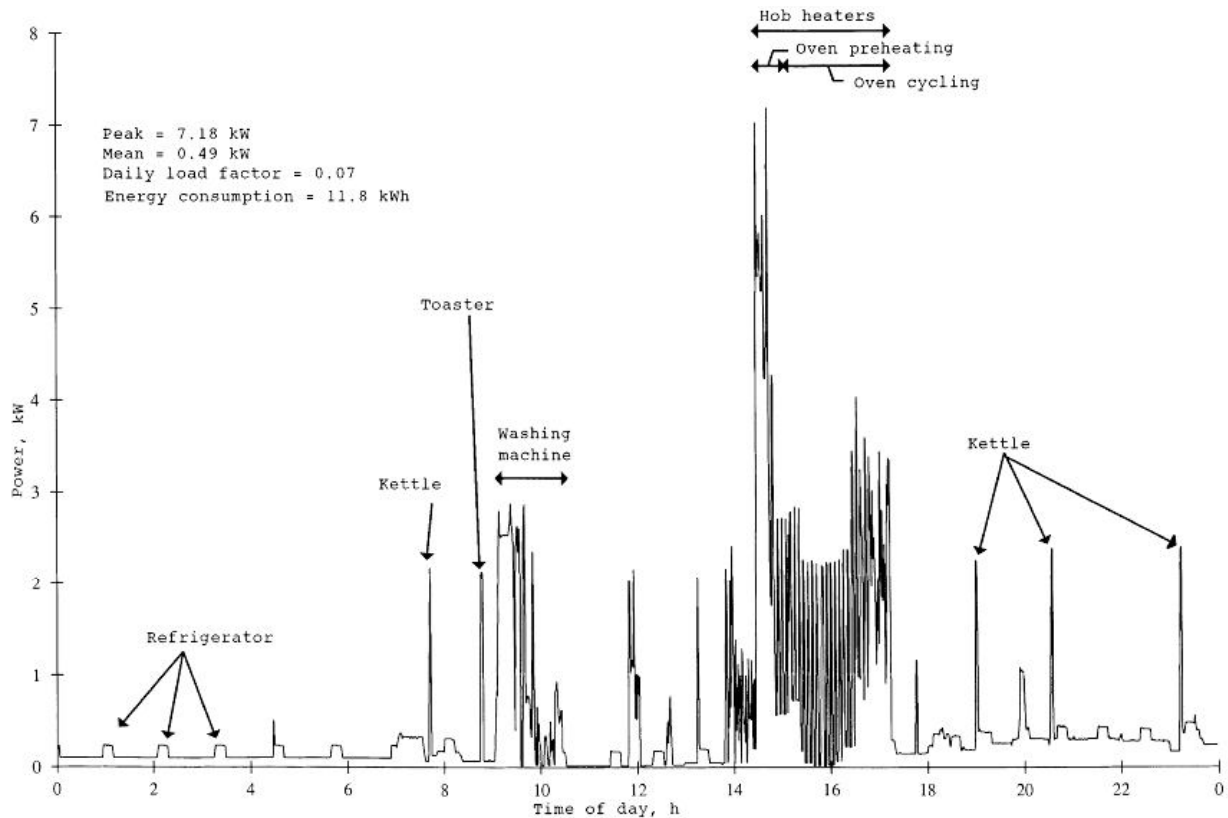

Figure 2 — Household electricity demand profile recorded on a 1-minute time base

Quinn comments on the implications of such data mapping capabilities

...the massive deployment of smart meters across the country and the trend toward finer and finer interval data means that more and more information will be discernable about more and more people. While the raw information about when an appliance event occurred in a given home may not seem to be sensitive information, it could be used to construct a detailed picture of residential life. Tracking appliance events means smart grid information could tell you the answer to questions like

- How often does a given customer eat microwave dinners as opposed to cooking three-pot meals?
- How many hours of TV does a resident watch? What kind of TV is it?
- When does a resident normally shower (and so cue an electricity draw from the water heater)? (Quinn, 2009, p 9)

The list of questions of interest to third-parties is potentially infinite: How many people live in the house? When do they go to bed? When do they get up? When do they have coffee? What brand of coffee pot do they have? What brand and model of refrigerator do they have? How old is it?

Quinn raised privacy as a regulatory issue but he also saw a trade-off between privacy and economic opportunity, viewing smart meter data, if properly managed, as a potentially transformational mechanism for utility business models, which could be decoupled from the sale

of commodity kWh, and on guaranteed ROR on assets, to electricity management (i.e., an alternative way to make money by exploiting or selling the meter data and/or creating new services). It could be argued that, although laudable in its motivation, this notion is naïve in view of the recent history of Internet data privacy abuse, but that is the subject for another paper.<sup>39 40</sup>

In a more recent paper, Doran and Quinn (2010) continue to see “...societal benefits such as grid reliability and energy efficiency...” in granular meter data, demonstrating their continuing lack of understanding of the technical application of meter data in utility practice.

In summary, granular meter data reveal intimate details about consumers’ personal lives while providing little or no value with respect to achievement of the potential benefits of a smart grid. The existence of such data constitutes a significant threat to personal privacy, perpetuates extraneous and tangential technical development, diverts resources, stimulates consumer pushback against the smart grid, and builds a constituency for unnecessary and potentially harmful and/or redundant metering networks and for the development of applications that may be detrimental to consumer and societal interests.

#### *Why is this data being collected/transmitted?*

The purpose of collecting meter data is usually stated, or assumed to be, electricity management (e.g., demand-side load management, efficiency consulting, energy savings, customer feedback/display, etc.). More likely, data collection occurs simply because it can be easily and cheaply done by remote metering technology (i.e., an adjunct artifact) originally deployed to reduce meter-reading costs. It is not clear exactly how such fine-grained data collected on such a large scale can be used effectively for electricity management or other stated purposes of the smart grid. Nonetheless, the idea that the data constitute an effective tool for electricity management is a virtually unchallenged seemingly “commonsense” notion that is pervasive throughout promotional, policy, and academic literature.

#### *The gateway alternative*

Much spending on smart meters has been predicated on the expectation that the meters will or can serve as communication gateways for other premises energy management equipment and applications. But this is not a likely long-term outcome. European and international standards and regulators are moving away from the idea that consumer data should be under the control of utility companies due to privacy and economic concerns. Moreover, consumers are increasingly unlikely to favor such an idea.

Recent regulatory initiatives in Germany and The Netherlands mandate an *independent* standardized gateway that controls and manages all access to all metering devices to assure consumer data privacy and security (BSI, 2011; NN, 2011). Such a gateway is to be considered under the control of the customer and not the utility, and includes a special security/encryption module that controls data access and policy (e.g., restrict the frequency of meter reads, the amount and type of data read, data retention, data use, etc.). The standardized gateway also provides communication access between various external service providers and in-home devices (e.g. home automation systems, energy management systems, etc.) using home area networks (HANs)<sup>41</sup> that communicate with various smart appliances. This same gateway concept was also

suggested by the Cyber Security Working Group report (NIST, 2010) as a method to mitigate security and privacy risks.

There are other methods that use demand response for distributed load control where the utility or third-party service provider delivers pricing and energy data to a consumer Energy Management System (EMS) through a gateway. Intelligent appliances and/or the consumer EMS use this pricing and energy information to optimize energy consumption according to consumer preferences. With the insertion of a gateway and local intelligence, any feedback to the utility could be load control results for the entire household, rather than by an appliance... Thus it is possible to protect consumer privacy at the macro level by choosing a system design that minimizes frequent access to granular data from outside the consumer site (p 37-38).

The use of a gateway as a “firewall” to structurally separate and protect networks is well known in the information technology industry. It is axiomatic in the data security industry that the best way to limit security risk is to simply not collect, transmit, or store information except where necessary. If information can be effectively processed and utilized within a local network, it need not be passed to another. A further reason to take the gateway/EMS approach to security and privacy is to make smart devices into consumer electronic products. With appropriate industry standards in place, home energy systems and appliances, un-tethered from utilities and grid operators, could spawn a mass market such as occurred for television, home entertainment, telephone, and computer products (Schurr, 2012). A consumer market for energy management devices and smart appliances, including energy-related applications and services, could dramatically advance the diffusion of distributed renewable energy (Wacks, 2011; 2012).<sup>42</sup>

### ***Public health and radiation reasons – “collateral damage”?***

Thirdly, many smart meter networks installed today use wireless mesh technology, a constant source of electromagnetic radiation in the microwave frequency spectrum. This radiation has largely unpredictable propagation characteristics and unknown long-term health effects. The biological effects of electromagnetic fields (EMF) are not fully understood and have become an established matter of public concern and active scientific inquiry. Public concern over smart meter EMF radiation has become a primary factor fueling public resistance to smart meter installation. In California, more than 57 cities and counties have demanded that utilities halt smart meter installation and a dozen local governments have passed ordinances prohibiting them (Hart, 2011).<sup>43 44</sup> In July, 2012, the Maine Supreme Court unanimously ruled against the PUC, ordering reconsideration of smart meter safety issues (Sharp, 2012). Potential health risks, radio noise pollution, and possible alternative technologies are considered below.

### ***Health risk***

It is obvious from decades of research on a wide range of frequencies within the radiofrequency (RF) spectrum that EMFs have biological effects, and associated health effects are likely. But the nature and extent of such effects (including cumulative effects) and any associated risk is not clear. Such effects have not been well researched for all frequencies and power densities, including those relevant to smart meters. For example, mobile phone radiation has long been a matter of concern and some scientific controversy. The World Health Organization (WHO) had conducted a study of cancer risk in cellphone users, known as the *Interphone Study*, begun in the late 1990s and sponsored by thirteen nations, various cellphone manufacturers, and other industry groups (Interphone, 2012).<sup>45</sup> WHO has reportedly been assuring consumers that no

adverse health effects had been established (Dellorto, 2011). However, in May of 2011, a review of the research by WHO's International Agency for Research on Cancer (IARC) found evidence that mobile phone users display significantly increased incidence of glioma and acoustic neuroma brain cancer (Dellorto, 2011). After reviewing the WHO *Interphone Study* and other evidence, IARC classified radiofrequency radiation as a Class 2B "possible carcinogen"—thus listing cell phone use, and other RF emitting devices and equipment, in the same "carcinogenic hazard" category as lead, engine exhaust, and chloroform.<sup>46</sup> In regard to the WHO review of the research, one cancer researcher referencing one form of risk—that from *thermal* effects (i.e., tissue heating)—noted the following.<sup>47</sup>

What microwave radiation does in most simplistic terms is similar to what happens to food in microwaves, essentially cooking the brain... So in addition to leading to a development of cancer and tumors, there could be a whole host of other effects like cognitive memory function, since the memory temporal lobes are where we hold our cell phones (Dellorto, 2011).

Other criticisms of the Interphone Study have also emerged, including that the evidence for risk may have been understated due to design flaws by as much as 25% (Morgan, 2010).

Then in October, 2011, a large government-funded study by Danish researchers found no increased risk of brain cancer associated with mobile device use, although the study was criticized because "brain tumors can take a long time to develop" (Cheng, 2011), and because of serious design flaws in this ongoing study that would serve to underestimate risk<sup>48</sup> (BMJ, 2012; ElectromagneticHealth.org, 2011; 2011a).

Although both involve microwave frequency radiation, it is difficult to draw a comparison between cellular telephones and smart meters. Cellphones are used intermittently and held close to the head, while (mesh network) meters operate continuously, and the radiation generated may or may not be in close proximity to residents. Moreover, propagation characteristics vary widely. An added complication with cellphone measurements is that newer cellphones employ adaptive power control techniques. This means that actual transmitted maximum power levels can vary over orders of magnitude depending on conditions. Nevertheless, many utility customers in several states have reported a variety of harmful effects including sleep disorders, headaches, nausea, neurological diseases, heart irregularities, cognitive impairment, fetal risks, etc.

In response to health concerns of the California legislature, the California Council on Science and Technology (CCST) produced a report that found, in part

1. Wireless smart meters, when installed and properly maintained, result in much smaller levels of radio frequency (RF) exposure than many existing common household electronic devices, particularly cell phones and microwave ovens.
2. The current FCC standard provides an adequate factor of safety against *known thermally* induced health impacts of existing common household electronic devices and smart meters.
3. To date, scientific studies have not identified or confirmed negative health effects from *potential non-thermal* impacts of RF emissions such as those produced by existing common household electronic devices and smart meters.
4. Not enough is currently known about *potential non-thermal* impacts of radio frequency emissions to identify or recommend additional standards for such impacts (CCST, 2011, p. 4).

Critics of this report responded that it “minimized” some risks and failed to provide modeling or actual measurements of smart meters (Maret, 2011, p. 1), and that “...rather than being an independent science-based study, the CSST [report] largely cuts and pastes estimates from a brochure by the Electric Power Research Institute (EPRI), an industry group, issued some weeks earlier” (Hirsch, 2011, p. 1). Hirsch, a nuclear policy analyst at the University of California, also challenged the report’s failure to consider the relative duty cycles of smart meters, cellphones, and microwave ovens, and he contended that the cumulative whole body exposure from meters could actually, under some circumstances, be 100 times higher when appropriate corrections are made.

Other critics of the CSST Report challenge the third and fourth findings (above), i.e., that there is a lack of evidence of non-thermal health effects from RF radiation. The presently accepted measure of EMF dose is the thermally-based specific absorption rate (SAR)—the rate at which electromagnetic energy is absorbed by tissue. Columbia University cellular biologists Blank and Goodman (2012) propose that the SAR value used to set the safety standard for EMF “...fails as a standard for predicting cancer risk...because cancers are believed to arise from mutations in DNA...” They argue that such DNA changes can be induced at electromagnetic radiation levels that are orders of magnitude lower than those observed SAR thermal effects. They propose that changes in DNA induced by interaction with EMF could be a better measure of the biologically effective dose...” They also propose a specific mechanism of non-thermal energy absorption based on the properties of DNA acting as a “fractal antenna” structure with an extremely wide frequency range (Blank and Goodman, 2011).<sup>49</sup>

Another contrast between cellphones and meters is that cellphone use is optional and under control of those being exposed, whereas smart meters are not. In an interview related to the CCST report, Hirsch commented accordingly.

Interviewer: “What is the risk to the public?”

Hirsch: “We don’t know. At the moment it is uncertain what is the health effect of RF radiation. It could turn out to be significant. It could turn out to be insignificant. It is a large experiment on a very large population. A big chunk of that experiment is involuntary. I choose to use a cellphone. If I live in a house, I don’t choose to have a smart meter. Whole body cumulative exposure of a smart meter is one hundred times that of a cellphone. It may be another asbestos [situation]” (Hirsch, 2011).

In summary, the CCST Report offers a highly problematic basis for steering public policy for a number of reasons. In any case, it seems clear that more study is needed on the effects of wireless smart meters if they are to be installed in peoples’ homes on a large scale. An array of scientific opinions have been advanced and no general consensus has emerged on the question of whether significant EMF health risk exists from exposure to smart meters. Following are some examples of positions on both sides of the question, starting with some that accept EMF risks as being plausible or likely.

Olle Johansson, PhD, Associate Professor, Department of Neuroscience, Karolinska Institute in Sweden, and Professor, Royal Institute of Technology, argues that an array of health effects and disorders have been demonstrated to result from non-thermal levels of EMF and that utility meters and other emitting appliances should be hard-wired (Johansson, 2012).<sup>50</sup>

Karl Maret, MD, a physician specializing in electrical and biomedical engineering, has similarly argued that EMF health effects are likely and should be mitigated by shifting to hard-wiring meters (Maret, 2012).<sup>51</sup> In recent testimony to the Senate Finance Committee in the Vermont State Legislature, Dr. Maret emphasized the need to hard-wired meters, saying, “With the wired meters our health long-term would be more assured. There would be no radiation whatsoever, and I think that’s the core issue here.” (Caruso, 2012)

On the other side of the issue, some have argued that EMF health risks from smart meters are likely minimal or absent and should not be a matter of concern. Dr. Harry Chen, the Vermont state health commissioner and an emergency medicine physician, told Vermont lawmakers not to worry about the radiation emitted by wireless smart meters, suggesting that meters “emit less than 1 percent of the radiation emitted by cell phones” (VPR, 2012). Chen’s testimony contrasted with a recent report on smart meter risks commissioned by the Santa Cruz County Board of Supervisors in California, as well as with a recent report on smart meter risks by the American Academy of Environmental Medicine (AAEM, 2012).

Santa Cruz Health Officer Poki Stewart Namkung concluded that too few scientific studies have been conducted on smart meter and radiofrequencies’ long-term effects to assess the health risks. Namkung commented, “The public health issue of concern is the involuntary exposure of households to electromagnetic field (EMF) radiation” (KSBW.com, 2011). Her report resulted in the Board of Supervisors vote extending the county’s moratorium on PG&E’s wireless meters.

The American Academy of Environmental Medicine (AAEM) adopted a resolution in January 2012 calling for a halt to wireless smart meters based on a review of the scientific and medical literature. The resolution stated, “Chronic exposure to wireless radiofrequency radiation is a preventable environmental hazard that is sufficiently well documented to warrant immediate preventative public health action” (AAEM, 2012, p 1). The resolution affirmed that the FCC guidelines consider only thermal exposures and so are inadequate for application to public health standards. The AAEM resolution stated

The literature raises serious concern regarding the levels of radiofrequency (RF – 3KHz-300GHz) or extremely low frequency (ELF-0-300Hz) exposures produced by smart meters to warrant an immediate and complete moratorium on their use and deployment until further study can be performed. ... The current medical literature raises credible questions about genetic and cellular effects, hormonal effects, male fertility, blood/brain barrier damage and increased risk from certain types of cancers from RF and ELF levels similar to those emitted by “smart meters.” Children are placed at particular risk for altered brain development, and impaired learning and behavior. ... Given the widespread, chronic and essentially inescapable ELF/RF exposure of everyone living near a “smart meter”, the Board of the American Academy of Environmental Medicine finds it unacceptable from a public health standpoint to implement this technology until these serious medical concerns are resolved (p 1).

Due to protests and dissent in the United Kingdom over smart meter health risks, including a recent 265-page report on the subject published by the charity Radiation Research Trust, a £12 billion government program to install smart meters underwent modification to allow people to “opt out” (Jamieson, 2012). “Opt-out” rights have also been approved by regulators at locations in numerous U.S. states, including California, Michigan, Illinois, Vermont, Maine, Oregon, and Nevada, and a federal lawsuit has been brought by the City of Naperville, IL over the utility-imposed installation of smart meters on homes. The Maine Supreme Court recently decided that



the PUC had not given adequate consideration to radiation risk and ordered reconsideration of the challenges to smart meter installations (Sharp, 2012).

In the face of widespread and growing health concerns, the unavoidable question arises: why invest in something with known potential for harm that would impact millions of people—especially when there are other viable and arguably superior alternatives?

#### *Radio noise pollution and interference*

Even utility grid operators recognize a certain level of risk associated with EMFs. With the growing use of devices such as cardiac pacemakers and defibrillators, power companies have become concerned about the potential for electromagnetic interference in the workplace. To address this concern, the Electric Power Research Institute (EPRI) has developed a personal electromagnetic field monitor for utility workers who wear implanted medical devices on the job (EPRI, 2011).

Homes are subject to increasing levels of radio noise introduced by products such as compact fluorescent lamps, switched-mode power supplies (e.g., for computers and electronic devices), Wi-Fi routers, remote control systems, cordless phones, baby monitors, and computers. Adding smart meters to the mix raises the level of electromagnetic cacophony and introduces new opportunities for interference and mis-operation. Pacific Gas and Electric has determined that certain models of Ground Fault Interrupter (GFI) circuit breakers, safety devices intended to protect from electrocution, may malfunction if they are installed in close proximity to smart meters and have asked smart meter manufacturers to develop transmitters with lower power output for such situations (Sage, 2011a).

There seems to be little justification for adding the constant chatter of mesh networks to ambient EMF pollution. This added pollution potentially interferes with sensors and other, possibly more important appliances as well as with critical communications (e.g., in particular, with a new genre of ultra-low power battery-less radio sensor devices known as “energy harvesting” devices that may prove useful for medical monitoring, security, and safety applications).

#### *Alternatives are available*

Alternatives for metering, including other methods of communicating energy data to or from the home, that produce much less radiation, are effective, readily available, and often already in place. These include conventional cable, DSL, cellular radio (GPRS), optical fiber, and powerline carrier networks. The introduction of dedicated meter networks when less costly and risky alternatives already exist may have less to do with data communication than with profits and business strategies predicated on control of the market and the customer. Obviously, more research on the health and biological effects of EMFs is needed<sup>52</sup>, but meanwhile, it would seem that the default choice should be on the side of caution and safety—known as the *precautionary principle*. The risks associated with smart meter implementation, added to privacy risks and to the costs of new dedicated and proprietary communications networks, are not justified in the face of the dubious benefits to be had. The potential for significant collateral damage to public health, unnecessary interference, and the availability of adequate or superior alternatives for meter communication with utilities, argue strongly for consideration.

**Structural reasons – diversion of resources**

A fourth and final reason the smart meter approach is misguided is structural—i.e., related to the industry market structure and a mis-direction of resources and benefits. The smart meter has spawned a parasitic market pyramid structure that diverts financial resources, regulatory policy, and technical innovation onto ancillary and unproductive paths.

*The smart meter network market pyramid*

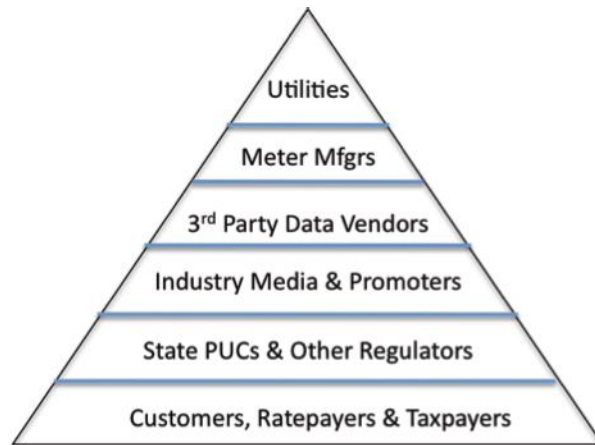

*Figure 2 — Smart meter network market dependency pyramid*

The “false promise” of the smart meter and its data has created a dependency pyramid or “food chain” tangential to smart grid and energy policy goals. This pyramid is shown in Figure 2. Actors at each level of the pyramid benefit from the activities of the levels above and below, as in a food chain. At the top of the pyramid are the utilities, satisfying their immediate goals of reducing labor and billing costs. Further down the pyramid we find the meter and network manufacturers, third-party data and MDMS vendors, media, and regulators, progressively feeding on the spin-off business. Finally, the consumer (and ratepayer or taxpayer) is at the base of the pyramid (and of the food chain), ultimately paying the costs. None of this activity significantly advances the declared goals of a smart grid, which is to balance supply and demand and to create a viable energy economy, but instead provides substantial benefits that flow to the actors at each level of the pyramid as shown in table 1.

*Table 1 — Smart meter pyramid actors and benefits*

Level	Institutional actor	Benefits enjoyed	Examples
1	Utilities	Reduce labor and billing costs, truck rolls; perpetuate the centralized control/generation/transmission grid architecture; federal subsidies and grants	PG&E, Duke Energy, Xcel Energy
2	Meter and metering network manufacturers	Immediate sales of equipment, software, and consulting to utilities	GE, Itron, Landis+Gyr, Oncor; Silver Spring Networks, Siemens

3	Third-party data aggregators, Meter Data Management System (MDMS) vendors	Create a new market: commodification of personal data; sell data aggregation and management software and services	OPower, Symbiotics, GridPoint, Current Group, Tendril, HP, Oracle, Cisco, Siemens
4	Industry media and promoters	Promotional opportunities, conferences, reports, advertising revenue	Smart Grid News, UtiliPoint, Forbes, Smart Grid Today, Pike Research
5	State PUCs and other regulators	Appearance of action, protecting utility clients	California PUC
6	Consumers, ratepayers, and taxpayers	Paying the tab (some may feel good—as if something worthwhile is being done)	All electricity users, customers, and ratepayers

“ Federal smart grid policy at the highest levels seems confused and suffering from a fundamental lack of understanding of the problems associated with the future of electricity and energy. Policy statements reflect the belief that the basic solutions involve fixing or modernizing the existing electricity grid rather than addressing the pressing need for complete structural transformation of electrical service that goes beyond particular “smart” technologies. ”

### III. Federal smart grid policy: What's wrong with it?

Federal smart grid policy at the highest levels seems confused and suffering from a fundamental lack of understanding of the problems associated with the future of electricity and energy. Policy statements reflect the belief that the basic solutions involve fixing or modernizing the existing electricity grid rather than addressing the pressing need for complete structural transformation of electrical service that goes beyond particular “smart” technologies. The design of the smart grid could shape how the entire electricity grid is transformed.

#### *Misguided and confused policy leadership at the top*

This fundamental misunderstanding of the problem is illustrated in last sentence of the Obama press announcement quoted earlier (Obama, 2009).

**Empowering Consumers to Save Energy and Cut Utility Bills** — \$1 billion. These investments will create the infrastructure and expand access to smart meters and customer systems so that consumers will be able to access dynamic pricing information and have the ability to save money by programming smart appliances and equipment to run when rates are lowest. *This will help reduce energy bills for everyone by helping drive down “peak demand” and limiting the need for “stand-by” power plants – the most expensive power generation there is.* [emphasis added]

The statement above implies that the energy solution is based on use of the smart grid to shave peak electric energy usage by shifting loads thus increasing baseload dependency—exactly the wrong approach! Rather, the answer is precisely the opposite—that “stand-by” power plants need to be engaged, along with renewable energy sources and smart grid technology, to completely eliminate baseload generation. The administration policy approach would not “reduce energy bills,” but rather would *increase* them<sup>53</sup> as well as increase CO<sup>2</sup> emissions and other pollution. This is because it is precisely baseload generation that is “the most expensive power generation there is,” if one considers the consequences and the totality of subsidies and externalized costs.

#### *A federal “Smart Grid Policy Framework”?*

In June, the National Science and Technology Council (NSTC) of the Executive office of the President issued a white paper entitled *Policy Framework for the 21st Century Grid: Enabling Our Secure Energy Future* (NSTC, 2011). This report represents the latest high-level policy statement on electricity from the Obama administration. It was developed by a committee of the NSTC based on input derived from ten executive agencies, six offices within the White House, and three independent agencies. The report drew as well from a range of corporations, the utility industry, a public blog, two DoE requests for information (RFIs), and responses from a selection of stakeholders to outreach efforts.

This NSTC Report provides an opportune framework for a critique of prevailing national policy thinking about the smart grid. It encapsulates and exemplifies what is wrong—and what could be made right—with U.S. energy and electricity policy.

#### *The “four pillars”*

The essential “four pillars” of the proposed policy put forward in the NSTC *Policy Framework* report are briefly summarized below.

### Pillar 1 — “Enable cost-effective smart grid investment” (Chapter 3)

- State and federal regulatory policies to incentivize and influence utility business models.
- Federal investment in smart grid R&D and demonstration projects.
- Information sharing to encourage investment and avoid duplication.

### Pillar 2 — “Unlock innovation” (Chapter 4)

- Federal encouragement and support for development of open standards.
- Federal, state, and local action to reduce peak generation costs and expand demand management.
- Federal and state monitoring to protect consumers and prevent anticompetitive practices.

### Pillar 3 — “Empower consumers” (Chapter 5)

- Provide information and education to consumers about smart grid technologies and options.
- Standardized machine-readable consumer energy consumption data (i.e., meter data display).
- Regulatory initiatives encouraging user-friendly data usage tools and in-home devices.
- Regulatory encouragement of consumer meter data privacy protection.
- Regulatory/policies for consumer protection (billing, health/safety, disputes, disconnect, etc.).

### Pillar 4 — “Secure the grid” (Chapter 6)

- Federal support for development of open standards for cybersecurity and risk assessment.
- Federal and stakeholder cybersecurity culture, simulation, vulnerability & risk management.

### ***Key failings of the NSTC policy framework***

The key failings of the proposed NSTC policy framework and of the entire report are identified and discussed below.

#### *Confusing electricity policy with energy policy*

The title of this report from the office of the federal chief executive, *Policy Framework for the 21<sup>st</sup> Century Grid: Enabling Our Secure Energy Future*, conflates and confuses two topics—*energy* and *electricity*. Electricity is a subset of energy. How does a better electricity grid “enable” a secure energy future? This is unexplained and the unfortunate conflation of terms represents a lost opportunity. The report does not tie electricity policy to energy policy and so fails to provide a “big picture” strategy. By conflating the relationship between the two topics, the report misses the key relationship between *energy* and *electricity* policy and becomes myopic, lacking a broader perspective from which the means to transform the energy economy could be examined.

#### *Electricity supply issues not mentioned*

Presumably, “smart grid” implies the use of information technology (IT) to improve our electricity supply, so it becomes incumbent to show the relationship between the grid and its supply. The report completely neglects to address supply issues, most of which are critical factors. Several of these supply-related issues are discussed briefly below.

#### 1. Fossil fuel market dysfunctions not addressed

Electricity is a subset of “energy.” The report neglects to make this clear. For example, the report could have considered impacts on electricity market/system of coal subsidies, externalization of

environmental and social costs of fossil fuels, fossil fuel subsidization, interlocking relationships between coal suppliers and utilities, lack of any comprehensive congressional energy policy, etc.

## 2. Coal dependency and market issues not discussed

The NSTC Report lacks any mention of the inordinate dependency of electricity on coal. One would expect to see some mention of the vulnerability of the electrical power supply to limits on coal supplies and cost projections (see Glustrom, 2009). Also missing is mention of the increasing cost of coal due to mounting Asian demand for U.S. coal, environmental problems and pollutants (e.g., Sulfur, Mercury, CO<sup>2</sup>, etc.), and competition for water resources.

## 3. Electric vehicle increases coal dependency

Moving the transportation system from petroleum fuels to electricity could create even more dependency on coal within the present structure. Therefore, getting electricity off of coal could have a critical impact on the broader energy picture. This topic deserved some discussion in the NSTC Report, especially because the electrification of vehicles will require a smart grid to coordinate the integration of such a massive additional demand for electricity.

## 4. Baseload dependency of today's grid

Moving toward renewables requires reduction of baseload dependency and possibly an increased use of natural gas (peaking generation)—at least as a transitional fuel (pending advances in energy storage technologies). Increased use of natural gas brings its own set of economic, environmental and social costs that should have been considered in the report. What are the implications of such a shift in terms of national energy policy? What about the costs of renewable “curtailment” by utilities to protect baseload investments? The topic of baseload dependency is completely missing from the NSTC Report.

## 5. Fuel cost projections and need for distributed generation

A convincing case has been made by various analysts that wind and solar generation are already at parity with natural gas—and even with coal generation—in terms of actual cost per unit generated (Farrell, 2011). The success of rooftop solar photovoltaic feed-in tariffs in Germany stands as an example, being in part responsible for bringing Germany to a total of approximately 18% renewable overall. The topics of “localization” of renewable generation and of fuel cost projections, and their critical implications, are not addressed in the NSTC Report. With reference to these critical topics, the NSTC Report provides only a brief paragraph concerning distributed energy resources (DER).

## 6. Nuclear power issues

Nuclear power is a form of baseload generation that provides approximately 20% of U.S. electricity generation. What are the limits of nuclear power in the overall future electricity picture? This topic should have been mentioned in the NSTC report under the pillar on grid security, along with associated risks (e.g., vulnerability to solar flare electromagnetic disturbances, hacker attacks, grid outages, severe weather phenomena, earthquakes, tsunamis, etc.).



### *Report relies on unclear grand transformative language*

The NSTC Report uses grandiose visionary language to invoke the “promise a smarter grid” in terms that have become commonplace but remain ill-defined. See for example the celebratory promises in *Xcel Energy Smart Grid: A White Paper* (Xcel, 2008). This sort of visionary rhetoric has been in use long enough to evoke broad skepticism among informed readers and listeners and accordingly should be toned down or used with great caution in official policy statements.

#### 1. Dubious reliance on smart meters

There seems to be an inordinate emphasis in the NSTC Report on “smart meters” and their assumed functions/benefits, implying that these devices are somehow essential to the smart grid. Questions addressed in this paper concerning what benefits these devices actually provide, and to whom, are left completely unexplained.

#### 2. Mounting public pushback

The NSTC Report does not acknowledge that there is mounting pushback on the smart grid from the public, states, regulators, and public officials based on objections to smart meters. Ignoring dissident positions on smart meters could result in poorly-informed public policy and may further inspire a growing grassroots rebellion.

#### 3. Perception of “bait & switch”

The NSTC Report fails to engage public skepticism about the supposed benefits of smart meters that unfortunately may spill over to skepticism about necessary development of a viable smart grid. The increasingly common notion that smart grid policy is fundamentally about benefits to the utility industry and its political supporters and raises costs to consumers—the notion of smart meter “bait and switch”—may be exacerbated rather than alleviated by the NSTC Report.

#### 4. Wasted money and opportunity

Some aspects of federal policy reinforced by the report may impede—and may have already impeded—the development of a genuine smart grid that could serve national energy goals. Federal policy has created problems by introducing tangential factors such as too much stimulus money chasing too few actual installable smart grid products, causing an inordinate emphasis on smart meters and their dubious benefits, instead of doing the research needed for a real smart grid. This has resulted in public pushback to the detriment of DER and the true thrust of the smart grid vision. It would seem that any frank and honest federal policy assessment should face this issue and propose solutions.

### *Missing mention of imminent changes in utility business models and regulatory focus*

The NSTC Report fails to engage the possibility of pending failure of the electrical system and industry or to propose any transformation of the conventional IOU business model (i.e., based on sale of commodity kilowatt hours and on return on assets). Moreover, the focus of the NSTC Report is mostly on conventional regulatory incentives that swim upstream against the basic utility business model. It would have been appropriate to address the basic problems associated with the current unsustainable utility business model and discuss alternative business models and associated legislation and/or regulatory policies that could be introduced to create a new

environment. This topic has gained some attention in recent years and is well documented (Fox-Penner, 2009), yet it is not mentioned in the NSTC Report.

#### *Fuel price trends and business implications*

NSTC Report fails to provide discussion of the effects of fuel price trend curves on business models and market choices (e.g., increasing costs of carbon & nuclear vs. declining costs of solar, wind, and other renewables) or of the effects of diseconomies of scale between technologies (e.g., solar & wind lack conventional economies of scale and thus are unappealing to capital-intensive utility rate recovery and to centralized management strategies).

#### *Missing discussion of dependency on baseload generation*

The NSTC Report completely misses what is perhaps the most important single policy issue of all in bringing renewable energy into the grid—baseload dependency.

##### 1. Curtailing the wind and the sun

Absent from the NSTC Report is analysis of the fundamental conflict between renewables (variable) and baseload (constant) generation and of the increasing need by utilities for wind/solar “curtailment” to protect their baseload investments. What lies beyond baseload and how can this dependency be broken? The question is not addressed.

##### 2. Distributed energy resources

There is very little discussion in the NSTC Report of renewable integration, especially DER. Only a single paragraph in the report is devoted to the topic of DER, providing only lip service and little serious consideration or analysis. No discussion is provided concerning how DER could defer or eliminate the need for expanded transmission line investments and thus address associated environmental, financial, and political problems and the problem of vulnerability to catastrophic system failure from numerous possible causes.

##### 3. Pitfalls of demand response with baseload generation

By shifting loads from peaks to valleys of the daily demand curve, demand response flattens the curve and can make the system more efficient by raising the total proportion of baseload generation. Although more efficient, this flattening of the curve has a downside in that it allows and encourages increased levels of baseload generation by dirty coal sources. This increased dependency on baseload generation makes renewable integration even more difficult. The NSTC Report misses any consideration of this fundamental problem.

##### 4. Advances in demand response and transactive control strategies

The NSTC Report mentions only three methods of (demand response) load control: largely obsolete direct load control (DLC), time-of-use (ToU) techniques, and manual intervention by consumers. No mention is made of leading edge research in demand response strategies such as “transactive energy” research by DoE/Pacific Northwest National Laboratories (PNNL). These promising state-of-the-art methods for supply/demand balancing and renewable integration were pioneered in 2007 by the DoE (i.e., the PNNL Olympic Peninsula Trial) and are currently being further developed in DoE-sponsored large scale trials funded under the 2010 Smart Grid

Investment Grant Program (i.e., the Pacific Northwest Smart Grid Demonstration Project (Ambrosio, 2008)).

#### 5. Distributed premises-based controls

The NSTC Report provides no discussion of premises-based energy controls, products and systems that can play major roles in DER and renewable integration. These include premises gateways, energy management systems (EMS), home automation (HA), premises power management, smart inverters, smart appliances, rooftop solar, storage, and advanced supply/demand response (transactive control strategies *vs.* simple demand response), or transactional energy.

#### 6. Electric vehicles

There is very little discussion in the NSTC Report about the introduction of electric vehicles (EVs). Only a single paragraph in the report is devoted to the topic of EVs, providing only cursory mention of the topic. Several major car manufacturers are rolling out EVs of various types in the next two years and the implications—both negative and positive—for the electricity grid are enormous. EVs represent a major challenge and opportunity for the smart grid and should have been considered in the NSTC Report.

*“Secure the Grid” chapter misses the target*

The section of the NSTC Report devoted to the topic of electricity and grid security misses the most important aspect—decentralization of the electricity supply, including DER—while focusing almost entirely on a relatively minor aspect—information technology and encryption, known as “cybersecurity.” Following are some important aspects of electricity security that are missing from the report.

##### 1. Security through decentralization

The NSTC Report provides no discussion of former CIA Director, James Woolsey’s well-known decentralization approach to grid security and to energy security (Woolsey, 2007). In a recent interview, Woolsey stated “There is no one in charge of security for the grid...A so-called ‘smart grid’ that is as vulnerable as what we’ve got is not smart at all. It’s a really, really stupid grid” (Woolsey, 2011).

##### 2. Vulnerability of top-down policy perspective

The NSTC Report does not consider the vulnerabilities and shortcomings associated with reliance on centralized top-down information technology approaches to addressing generation/transmission and grid management/control security issues.

##### 3. Security through gateways and firewalls

The NSTC Report is missing any discussion of structural approaches such as premises gateways and firewall architectures, which are mentioned as important approaches to security and privacy in the key NISTIR 7628 Report *Guidelines for Smart Grid Cyber Security from the Cyber Security working group*, vol. 2 (NIST, 2010, p. 37-8). This NISTIR 7628 report recognizes that an important approach to grid security is to not collect or transmit unnecessary information and

to insulate subsystems (e.g., homes and buildings) through gateways and firewalls. This approach is entirely missing from the NSTC Report.

#### 4. Vulnerability of centralized generation and transmission to catastrophic events

The NSTC Report provides no discussion of “worst case” risks associated with the present grid architecture, such as from the projected increase in severe weather events, from solar flares and resulting electromagnetic disturbances (Kappenman, 2012), and from nuclear reactors stranded without power for backup cooling. Meter networks could be susceptible to hacking and virus attacks that could remotely turn off millions of customers. How can these risks and vulnerabilities be addressed by a smarter grid?

#### *Inordinate dependency on regulatory policy approaches.*

The NSTC Report depends inordinately on regulatory policy approaches. Regulatory strategies as substitutes for market activity may be appropriate where market failure has occurred, but they are not substitutes for viable business models. As mentioned previously, sometimes within a system of market capitalism the “creative destruction” of obsolete businesses and institutions is needed to transform failed business models and revitalize market competition (Schumpeter, 1942).

#### 1. Limitations of regulatory approaches

It is well established that regulators are susceptible to chronic “regulatory capture” by those that they regulate (Peltzman, 1976), and that public officials have a tendency to serve their own interests rather than those of the public (known as “public choice” theory). Regulatory capture and public choice theory are well-developed topics in policy research.<sup>54</sup> The NSTC Report’s reliance on regulatory policy and regulatory initiatives fails to recognize the limits on what they can accomplish in transforming institutional models and the electricity system.

#### 2. Non-regulatory approaches

The NSTC Report could have considered the possibility that the era of the regulated monopoly electric utility is coming to an end and examined questions concerning what alternative non-regulatory forces/approaches are (or could be) in play, what new models are under discussion (e.g., as suggested in *Smart Power*, Fox-Penner, 2009), and whether useful parallels can be drawn from the experience of telecommunications deregulation. The NSTC Report provides no such guidance or examination and makes no mention of such questions.

#### ***Conclusions about the NSTC Smart Grid Policy Framework***

The Four pillars of the *NSTC policy framework* are wobbly. Overall, the report is disappointingly superficial, myopic, un-critical, and regulatory-centric. Although the report contains some valuable points and some useful topical place-keepers, they are generally not examined in depth or treated with appropriate seriousness.

The NSTC Report’s faults are surprising given the resources that such a high level council could have mustered. The listing of resources at the end of the report (and common knowledge about how energy policy is written in Washington) indicates that the report’s input is likely to have come largely from industry-related sources and insiders—not the most auspicious approach to

find innovative ideas and challenge an entrenched century-old industry paradigm. This top-level federal government report on electricity policy provides a valuable lesson in why effective policy leadership is not likely to come from the top—from individuals and institutions with commitments to or vested interests in the existing paradigm.

On the other hand, a critical examination of the NSTC Report and its shortcomings offers a plausible basis from which to develop a more thorough and rigorous policy framework with a proper vision of what the smart grid could become. Although inadequate to support a “temple” of energy policy for the future, the four “pillars” may be better seen as legs on a stool if provided with appropriate cross-bracing. These four legs can be strengthened by filling the gaps identified above to provide a more solid and complete policy framework.

The next section of this paper will explain the elements necessary for a new economy of electricity that will avoid the economic, privacy, security, reliability, and potential public health impacts of the present approach.

#### **IV. Blueprint for a new energy economy: Roadmap for transformation**

This Paper proposes a “blueprint” for a new economy of electricity. Its principal goal is the transformation of the economy of electricity from carbon to renewable and sustainable sources of energy. Such a transformation of electricity is prerequisite to transformation of the transportation network, as well as the rest of the energy economy. The blueprint includes technical and institutional elements to serve as foundational building blocks of policy. Many of the technical elements already exist and some are in use and undergoing commercialization. However some are not yet commercialized and some are not yet fully developed or standardized. For the blueprint to be put in place, substantial policy and institutional changes need to occur. These changes will occur, deliberately or forced by political economic circumstances. The present situation is simply not sustainable. It would be best for all concerned if these changes could be undertaken willingly and intelligently before they are forced by escalating crises.

In *Reinventing Fire*, Amory Lovins (2011) makes the case that businesses and ordinary people, not federal policy makers, will drive the transition to an intelligent energy future and that there is much that can be done on a local level. Lovins makes the case that this transition is possible—and can even be profitable—an idea that runs counter to commonplace media accounts of the burdensome cost penalty of moving to renewable and sustainable energy technologies. Tremendous opportunities lie ahead, if we can see past the archaic centralized electricity generation model, which can no longer sustain contemporary economies and societies, to a more economical and efficient scenario whereby free, renewable sources are prioritized and local opportunities for power generation are pursued.

If discussion surrounding energy strategies and policies can move beyond shallow thinking—such as the notion that a new utility meter represents a foundational element on the path to sustainability—and move toward comprehensive and clear thinking about the objectives and means available, transforming the electricity system can be only the first step in a greater transformation to a new energy future that is sustainable, secure, and a source of economic wealth. We are in a critical historical moment when the stakes are high and the opportunities are great—as are the hazards. The only option not realistically on the table is continuation of the status quo.

#### ***Technologies to create a true smart grid and decentralized power generation***

The key technical changes needed to enable transformation to a new sustainable energy economy focus on 1) designing and implementing the means to replace baseload generation with renewable generation—preferably distributed and localized, and augmented by renewables with 2) flexible generation and storage, and 3) advanced supply/demand response smart grid technology, including end-user situated power and storage management technologies and transactional control strategies.

#### ***Key 1—Renewable generation***

The renewable generation sources considered in this discussion are primarily wind and solar, although an array of other renewable and sustainable technologies may also be applied. Solar photovoltaic (PV) technology enjoys the same declining “silicon” cost curve as computers and

electronics. Electricity from PV is now at or near cost parity with coal, especially when externalized costs and subsidies are taken into account (Farrell, 2011; Lovins, 2011). Windmills (especially small scale) also enjoy substantial economies of mass production (like appliance manufacturing) and produce power at nearly the same efficiency, regardless of scale.<sup>55</sup> For wind and solar, the fuel is free and unlimited.

Studies conducted by DoE's Lawrence Berkeley National Laboratory (Mills and Wiser, 2010) show that problems of wind and solar variability can be mitigated by geographical distribution of smaller installations rather than by concentration in large solar farms.

Traditionally, the reliability of small PV systems' power output has been a concern for utilities, project developers and grid operators, since all it takes is a few clouds to disrupt the power flow of a small array. But the Berkeley Lab study suggests that when PV plant arrays are spread out over a geographic area, the variability in power output is largely eliminated. (Stroud, 2010).

Economies of scale tend to be flat for both wind and solar, so there is little economic advantage in building large farms. Additionally, distributed generation mitigates transmission line construction capital costs and transmission inefficiencies,<sup>56</sup> as well as environmental and political problems. Wind and solar are somewhat complementary in that they tend to have opposite daily cycles (i.e., the wind blows more at night in many regions and the sun shines during the day). Predictive weather modeling technologies can effectively inform load and wind/solar forecasting. For example, the National Center for Atmospheric Research (NCAR) in Boulder, Colorado, developed a system of weather data sets and prediction models that resulted in a 35 percent improvement in localized wind forecasts, saving Xcel Energy an estimated \$6 million in 2010 (Snider, 2011).

### *Key 2—Flexible generation and storage*

Flexible generation, sometimes called “peaking” generation, refers to quick response sources that fill in gaps and dips in the daily supply/demand curve that shifts when wind and solar (or other variable or unpredictable sources) are not producing power. Flexible generation is currently provided primarily by natural gas-fired turbines (large, small, and micro scale), but such generation may also be provided by hydro (large, small, and micro scale)<sup>57</sup>, diesel or gas reciprocating generators and other sources that can be turned on or off quickly. Storage technologies include pumped hydro, batteries (conventional and advanced), electric vehicles, flywheels, compressed air, thermal (including hot water), and an array of other technologies currently under development.<sup>58</sup>

### *Key 3—Advanced supply/demand response/transactional energy*

Advanced supply/demand response, or transactional energy, refers to smart grid technology that uses locally available communication media and protocols (e.g., Internet access via cable, DSL, fiber optic, wireless, etc.) to facilitate real-time coordination of supply and demand among grid users (including utilities, independent producers, electricity customers, electric vehicles, homes, and other buildings). Such protocols are in development (Cazalet, 2011) and can be applied to facilitate “transactive control strategies” (including variable pricing, time-based pricing, etc.).<sup>59</sup> This communication would employ household or building information gateway devices connected to premises-based energy management systems (EMS) and power conditioning

equipment (e.g., smart inverters, chargers, batteries, power factor compensation devices, home automation systems, smart appliances, electric vehicles, smart meters, feedback displays, etc.).<sup>60</sup>

All of the above items could be economically produced according to appropriate industry standards and distributed by consumer electronics, home appliance, building and construction, solar installation, and related industries through existing retail channels. Similarly, commercial and industrial buildings and facilities could be served through established conventional distribution channels. Energy-related communication and management services could create massive opportunities for Web service providers and consumer electronics and appliance manufacturers and serve to accelerate the diffusion of advanced supply/demand response into the grid.

The overall benefit of advanced supply/demand response is the facilitation of renewable integration with the grid, filling gaps in variable and/or unpredictable wind and solar sources and also minimizing the need for flexible “peaking” generation sources.

### *Needed policy and institutional shifts*

The most important policy and institutional change needed to bring about the transition to a new energy economy is the dismantling of the legacy “natural monopoly” electricity business model based on the “cost of service” regulatory paradigm (see Lovins, 2011). This transformation can be undertaken mostly at a state and local level and is accomplished by deregulating electricity generation—enabling every user to be a generator, and possibly seller of energy back into the grid.<sup>61</sup> The local electricity grid (including the smart grid) is a public resource—as are public streets or the water and sewer infrastructures—and state and local legislators can act. Why should the grid be under the control of a monopoly utility? The traditional conception of “natural monopoly” was based on now-obsolete economies of scale in coal-based generation and transmission/distribution and large capital investment that characterized the early Edison companies. Distributed renewable and smart grid technologies have rendered the concept of natural monopoly policy no longer applicable, necessary, or beneficial for electrical generation and transmission.

### *The new grid*

A new conception of “the grid” is needed (Farrell, 2011). If state and local governments take action to deregulate generation, and “feed-in” is opened to all, market forces can act and the needed institutional shifts can occur. A new conception of “the utility” is also needed, and those utilities that adapt to it will survive (see Fox-Penner, 2009; Schurr, 2012). Required is a shift of the utility business model from a commodity model to a service model based on maintaining local distribution lines and transformers—not on building and operating generating plants, transmission lines and other capital projects.

### *Citizen action at the state and local level*

What specifically needs to occur at the state and local level? The first step is for states and localities to open the market for generation. Every user should be a potential producer. This is the strategy that has been successfully implemented in Germany and other parts of Europe. Similar deregulation of generation and reregulation of distribution has begun in parts of the United States, partly in the form of state laws that allow “community choice aggregation”—



allowing localities to choose the source supplier of their local grid, even if the grid is operated by a local monopoly utility. Such laws and regulatory policies should make a clear “demarcation” that *the customer premises (including the meter) are also deregulated, are clearly the domain of the consumer, and are open to market competition.*

Another necessary step is the implementation of state laws and regulatory policies that facilitate the transition of utilities to grid service providers (i.e., maintaining the wires and poles) that no longer depend on the commodity sale of kWh and on ROR on assets. A further step is for localities to “municipalize” by condemning and taking over their local power grid, and forming their own municipal utilities that serve the needs of communities rather than the needs of utility investors and managers.

### *Getting beyond the gridlock*

The future will be driven by economic forces and local markets—*all electrons are local*—aligning the grid with society’s needs rather than with the interests, investment choices, guaranteed profits, and guaranteed return on capital of private corporations. Regulatory bodies are inherently vulnerable to capture; therefore reliance on them must be minimized and confined only to true market failure situations.

Unlocking the grid can be accomplished by policy choices that can be made largely at the state and local level. If intelligent choices are not made, the present trajectory of coal and environmental economics will unavoidably cause the regulated utility monopolies to financially self-destruct, such that the public will be asked to pay ever higher costs and eventually finance industry bailouts.

### ***Action plan — Refocusing investment on sustainability***

An immediate restructuring of investment is needed for the transformation of electricity and of the grid, including a re-definition of the smart grid as more than, and other than, metering. Short-term and long-term actions must be taken. These actions require changes in both technology and policy. Some of the necessary technology is already available and other technology remains to be developed. The most basic change required is a re-orientation toward distributed energy resources and renewable energy integration—moving away from dependency on baseload generation, particularly coal, as quickly as possible.

The above program is essentially the vision articulated by Farrell (2011) and by Lovins (2011). Although neither Farrell nor Lovins deal specifically with smart grid technology, the design and implementation of a viable smart grid can and must be a key element in the transformation that they envision. The following recommended actions will eliminate or mitigate the problems relating to privacy, security, reliability, economic inefficiencies, and potential public health impacts that are associated with the current paradigm of electric provision and metering and will form a new focus for private and government investment.

### *Immediate action recommendations*

- Stop deploying smart meters and dedicated smart meter networks. Conventional metering is adequate and existing Internet broadband networking (e.g., DSL, cable, fiber, etc.) will be satisfactory for future remote meter-reading and smart grid applications (cutting jobs should not be a priority).

- Shutdown or convert baseload coal plants to renewables or to non-baseload natural gas<sup>62</sup> as rapidly as possible. This should include directing investment away from illusory “clean coal” or nuclear power baseload generation and toward renewable and distributed generation.
- Focus incentives on installation of rooftop solar PV and other distributed energy resources (including local windmills and small scale hydro) through financial incentives and policy incentives such as net metering and feed-in tariffs.
- Initiate action at the local and state levels through appropriate legislation and regulatory policies (e.g., deregulation of generation, local renewable subsidies, net-metering tariffs, feed-in tariffs, solar gardens, efficiency programs, unified and simplified building codes for solar installation, etc.).<sup>63</sup>

#### *Medium-term action recommendations*

- Move forward with development of technology and standards to support commoditization of home and building communication gateways and energy management devices (e.g., household gateways, EMS devices, smart appliances, smart inverters, cheap batteries, EV chargers, supply/demand response protocols, transactive control protocols, etc.).
- Engage the consumer electronics and appliance industries in commoditization of the above elements.
- Implement policies, requirements, and procedures for assuring product safety, including limitation of unnecessary EMF emissions.
- Continue developing technology and standards to support SCADA (i.e., distribution grid) interoperability, including the enabling of distribution networks to function as microgrids and accept local generation.
- Support development of technology and standards to support the emerging EV industry and charging infrastructure.
- Develop new technology and standards for consumer and industrial smart grid apps, including trials and demonstration projects to test these.
- Reconsider and carefully reevaluate the economic viability and environmental costs of large wind farm or solar farm and transmission projects.

#### *Longer-term action recommendations*

- Fund electricity storage technology research and development and commercialization.
- Develop new technology and standards for consumer and industrial smart grid apps.
- Continue funding research and development for hydrogen fuel cell and related technology that could expand the range of clean energy generation and storage options.

“ The present situation is simply not sustainable.

It would be best for all concerned if these changes could be undertaken willingly and intelligently before they are forced by escalating crises.

Tremendous opportunities lie ahead, if we can see past the archaic centralized electricity generation model, which can no longer sustain contemporary economies and societies, to a more economical and efficient scenario whereby free, renewable sources are prioritized and local opportunities for power generation are pursued. ”

*You never change things by fighting existing reality.  
To change something, build a new model that makes  
the existing model obsolete.*

—Buckminster Fuller

## **V. Conclusion: pressing need for new energy strategy**

America and the world are facing not only an industrial transformation, but a social transformation as well. Big corporations, governments, and large institutions have left the people behind in pursuit of wealth and power. But people are adapting and organizing around new media and institutions of lateral power.<sup>64</sup> The utility industry is facing (potentially) “creative destruction” as its traditional business model fails—the industry has become too big, too unwieldy, too unmanageable, and too ungovernable to function. It has become part of a massive “electricity-industrial complex”<sup>65</sup> analogous to the military-industrial complex famously noted by President Eisenhower in 1961. Its technology has now become too complicated and beset with too much socio-technical risk.<sup>66</sup>

Utility meter networks intrude into homes and distract and divert attention and resources from the real task at hand while bringing unnecessary risks. Granular meter data expose intimate details of individual lives but do not facilitate the advantages claimed by meter proponents, such as demand response, dynamic pricing, or local generation and storage. Data should flow into the home—rather than out of the home—to distribute the generation and control of electricity. It is time for government, industry, and communities to move away from smart meters and baseload dependency to get on with the work of developing technology and standards for distributed renewable integration, in-home devices, smart appliances, and other innovative products and services that can unburden an electricity grid that has become overly complex, vulnerable, and uneconomical.

### *A new vision of a clean energy future*

Although there are notable exceptions within some agencies, the federal government has generally failed to provide needed leadership and vision. Congress and high level policymakers seem to be committed more to protecting established industrial and financial interests than to plotting a viable course for the future. At the state level, PUCs and other public officials are tied to large corporate interests in carbon, to lobbyists, and to political careers. Too often, ratepayers, citizens, and communities are abandoned to their own resources. It is left to the people to “occupy” the grid and transform it to shape a sustainable clean energy future for the United States and for the world.

### *From smart grid to “Intergrid”*

Due to emerging public skepticism and pushback, manufacturers, service providers, grid operators, and policymakers at all levels should begin by abandoning the term “smart grid” in favor of a more appropriate term. *Intergrid* was suggested by Jeremy Rifkin in his recent visionary work on energy, *The Third Industrial Revolution* (Rifkin, 2011). Rifkin compares the grid with the Internet, where intelligence is distributed to the periphery. He envisions that in the future, people will be “...generating their own green energy in their homes, offices, and factories and sharing it with one another across intelligent distributed electricity networks—an Intergrid—

just like people now create their own information and share it on the Internet” (p. 36). This transformation took place in telecommunications well over a decade ago, bringing competition and the creativity of the market to the telephone network and customer premises. Now it is the time for electricity to do the same. America was a leader in the genesis of telephony and electricity. America now has an opportunity to be a leader in taking electricity and society to a new, clean, economically viable, and sustainable energy future.

## References

- AAEM (2012). Members of the Board, American Academy of Environmental Medicine. *Decision Proposed Decision of Commissioner Peevy (Mailed 11/22/2011) Before the Public Utilities Commission of the state of California On the proposed decision 11-03-014*. January 19. <<http://emfsafetynetwork.org/wp-content/uploads/2009/11/AAEM-Resolution.pdf>>
- ACORE (2011). "Integration of Renewables into the Smart Grid." *Renewable Energy Teleconference Series*, American Council on Renewable Energy (ACORE), October 19 <<http://renewableenergyinfo.org/index.php/archives/8-archives/55-wednesday-october-19-2011>>
- Ambrosio, Ronald, 2008. "The GridWise Olympic Peninsula Project: real-time price controls of distributed energy resources dramatically reduced stress on local distribution systems," Case Studies, Customers and Markets, IBM Research, 2008. <[www.UtilitiesProject.com/documents.asp?d\\_4610#](http://www.UtilitiesProject.com/documents.asp?d_4610#)>
- Amin, S. Massoud (2011). "U.S. Electrical Grid Gets Less Reliable: Since 1995, outages have steadily increased as R&D steadily declined." *IEEE Spectrum*. January <<http://spectrum.ieee.org/energy/policy/us-electrical-grid-gets-less-reliable>>
- Baan, Robert (2012). Personal communication. February 2.
- Barringer, Felicity (2011). "New Electricity Meters Stir Fears," *New York Times*, January 30.
- Berst, Jesse (2011). "Ouch! Illinois governor dumps smart grid bill." *Smart Grid News*. September 13. <[http://www.smartgridnews.com/artman/publish/Business\\_Policy\\_Regulation/Ouch-Illinois-governor-dumps-smart-grid-bill-3995.html](http://www.smartgridnews.com/artman/publish/Business_Policy_Regulation/Ouch-Illinois-governor-dumps-smart-grid-bill-3995.html)>
- Blank, Martin, and Reba Goodman (2011). "DNA is a fractal antenna in electromagnetic fields." *International Journal of Radiation Biology*. Vol. 87, pp. 409-15
- Blank, Martin, and Reba Goodman (2012). "Electromagnetic fields and health: DNA-based dosimetry." *Electromagnetic Biology and Medicine*. Early Online: 1–7, 2011 Copyright Q Informa Healthcare USA, Inc. ISSN: 1536-8378 print / 1536-8386 online DOI: 10.3109/15368378.2011.624662
- BMJ (2012). "Use of mobile phones and risk of brain tumours: update of Danish cohort study." *Recent Rapid Responses: British Medical Journal*. 20 January. <<http://www.bmj.com/content/343/bmj.d6387?tab=responses>>
- Brookings (2011). "Sizing the Clean Economy: A National and Regional Green Jobs Assessment." *Metropolitan Policy Program at Brookings*. <[http://www.brookings.edu/metro/clean\\_economy.aspx](http://www.brookings.edu/metro/clean_economy.aspx)>
- Brooks, David (2011). "Where the jobs aren't." (*New York Times*) *Daily Camera*. September 8. P. 8A.
- BSI (2011). *Protection Profile for the Gateway of a Smart Metering System*. Bundesamt für Sicherheit in der Informationstechnik [Federal Office for Information Security]. Bonn, Germany, August 8. <<http://www.bsi.bund.de>>
- Caruso, Aimee (2012). "Introducing the Meter: Qualms Accompany New 'Smart' Devices." *Valley News*. February 3. <<http://www.vnews.com/02032012/8325038.htm>>
- Cavoukian, Ann (2011). "Privacy by Design: Best Practices for Privacy and the Smart Grid." in *ISSE 2010 Securing Electronic Business Processes: Highlights of the Information Security Solutions Europe 2010 Conference*. Norbert Pohlmann, Helmut Reimer and Wolfgang Schneider, Eds. pp 260-270.
- Cazalet, Edward (2011). "Automated Transactive Energy (TeMIX)". *Grid-Interop 2011*. Phoenix, December 5. <<http://www.pointview.com/data/files/2/1062/2143.pdf>>.
- CCST (2011). *Health Impacts of Radio Frequency from Smart Meters*. California Council on Science and Technology. April, 52 pages. <<http://www.ccst.us/publications/2011/2011smart-final.pdf>>

- Cheng, Maria (2011). "Can you hear me now: Study finds no cellphone-cancer links." *Associated Press, Daily Camera* October 21, p. 16A.
- Damiano, Richard (2011). "Are utilities retreating from the smart grid front lines?", *Smart Grid News*, November 8. <<http://www.smartgridnewstalk.com/showthread.php/350-Are-utilities-retreating-from-the-smart-grid-front-lines>>
- Dal Bó, Ernesto (2006). "Regulatory Capture: A Review." *Oxford Review of Economic Policy*. Oxford: Oxford University Press, vol. 22, no. 2. pp 203-225.
- Dellorto, Danielle (2011). "WHO: Cell phone use can increase possible cancer risk." *CNN Health* <<http://www.cnn.com/2011/HEALTH/05/31/who.cell.phones/index.html>>
- Doran, Kevin and Elias Quinn (2010). "Consumer Privacy and the Smart Grid." in Kevin Doran, Frank Barnes, and Puneet Pasrich (Eds.), *Smart Grid Deployment in Colorado: Challenges and Opportunities*. Boulder: University of Colorado at Boulder, June 2010. p. 42. <<http://cees.colorado.edu/sgreport.pdf>>
- ElectromagneticHealth.org (2011). "British Medical Journal's Upcoming Cell Phone Study Deeply Flawed, Say Experts." <<http://electromagnetichealth.org/electromagnetic-health-blog/british-medical-journal-study-flawed/>>.
- ElectromagneticHealth.org (2011a). "Critical Comments by Leading Experts on Danish Study Claiming to Find No Link Between Cell Phone Use and Brain Tumors." <<http://electromagnetichealth.org/electromagnetic-health-blog/critical-comments-danish-study/>>.
- EnerNex (2010). "Collaborative Report." *Illinois Statewide Smart Grid Collaborative*. Compiled by EnerNex Corporation. September, 30 <<http://www.ilgridplan.org/Shared Documents/ISSGC Collaborative Report.pdf>>
- EPRI (2011). *State of the Technology 2011*. Report 1023459, Electric Power Research Institute. Palo Alto <[www.epri.com](http://www.epri.com)>
- Farrell, John (2011). *Democratizing the Electricity System: A Vision for the 21<sup>st</sup> Century Grid*. Minneapolis: New Rules Project, June, <<http://www.newrules.org>>
- Fehrenbacher, Katie (2010). "SmartGridCity is a Smart Grid Flop", *Cleantech News and Analysis*, August 4, <<http://gigaom.com/cleantech/smargridcity-is-a-smart-grid-flop/>>
- Flatow, Ira (2011). "Reinventing Fire: Getting Beyond Fossil Fuels", *Science Friday*, National Public Radio, interview with Amory Lovins, broadcast October 21. <<http://www.sciencefriday.com/program/archives/201110215>>
- Fox-Penner, Peter (2010). *Smart Power: Climate Change, the Smart Grid, and the Future of Electric Utilities*, Island Press.
- Fox-Penner, Peter (2011). *Smart Power: Climate Change, the Smart Grid, and the Future of Electric Utilities*. Web Seminar. Fulbright & Jaworski LLP. July 13. <[http://www.fulbright.com/index.cfm?fuseaction=seminars.detail&eventID=5833&site\\_id=492](http://www.fulbright.com/index.cfm?fuseaction=seminars.detail&eventID=5833&site_id=492)>
- GAO (2004). U.S. General Accounting Office. *Renewable Energy: Wind Power's Contribution to Electric Power Generation and Impact on Farms and Rural Communities*. September <<http://www.gao.gov/new.items/d04756.pdf>>
- Glustrom, Leslie (2009). *Coal—Cheap and Abundant—Or Is It? Why Americans Should Stop Assuming that the US Has a 200-Year Supply of Coal*. Version 1.1. Released February <[http://cleanenergyaction.files.wordpress.com/2011/10/coal\\_supply\\_constraints\\_cea\\_0212091.pdf](http://cleanenergyaction.files.wordpress.com/2011/10/coal_supply_constraints_cea_0212091.pdf)>
- Haeger, Kurtis J. (2011). "Direct Testimony and Exhibits of Kurtis J. Haeger on behalf of Public Service Company of Colorado," *Docket 11A-325E*, Public Utilities Commission of the State of Colorado. October 31.
- Hart, Joshua (2011). "Smart Meters threaten our health, civil liberties." *Santa Cruz Sentinel*. September 11. <[http://www.santacruzsentinel.com/opinion/ci\\_18871318](http://www.santacruzsentinel.com/opinion/ci_18871318)>

- Hirsch, Daniel (2011). *Comments on the Draft Report by the California Council on Science and Technology "Health Impacts of Radio Frequency Smart Meters."* January 31. <[http://www.committeetobridgethegap.org/pdf/110212\\_RFrad\\_comments.pdf](http://www.committeetobridgethegap.org/pdf/110212_RFrad_comments.pdf)>
- Hirsch, Daniel (2011a). *Factsnow*. Interview by Devra Davis. April 23. <<http://www.youtube.com/watch?v=IsT-pN-5uWQ>>
- IEC (2011). "IEC supports renewable energies: wind, water and sun come into play." *e-tech: news & views from the IEC*. October. p. 41. <<http://www.iec.ch/etech>>
- IEE (2011). *Utility-Scale Smart Meter Deployments, Plans & Proposals*. Edison Institute for Electric Efficiency. September. <[http://www.edisonfoundation.net/IEE/issueBriefs/Smart\\_Meter\\_Rollouts\\_0911.pdf](http://www.edisonfoundation.net/IEE/issueBriefs/Smart_Meter_Rollouts_0911.pdf)>
- Interphone (2012). *The INTERPHONE Study*. World Health Organization, International Agency for Research on Cancer. <<http://interphone.iarc.fr/>>.
- Jaffe, Mark (2011). "Utilities power down on building plans" *Denver Post*, November 6, page 1-K <[http://www.denverpost.com/business/ci\\_19270103](http://www.denverpost.com/business/ci_19270103)>
- Jaffe, Mark (2011a). "Xcel Energy files for \$142 million rate increase, would raise the average household electricity bill by \$4." *Denver Post*, November 22, <[http://www.denverpost.com/business/ci\\_19393293](http://www.denverpost.com/business/ci_19393293)>
- Jamieson, Isaac (2012). *Smart Meters—Smarter Practices: Solving emerging problems*. EM-Radiation Trust. January. <[http://www.radiationresearch.org/images/Documents/001-006\\_SM\\_Cover\\_Contents\\_Intro\\_0120130.pdf](http://www.radiationresearch.org/images/Documents/001-006_SM_Cover_Contents_Intro_0120130.pdf)>
- Jepsen, George (2011). "Brief of George Jepsen, Attorney General for the State of Connecticut," State of Connecticut Department of Utility Control. *Docket No. 05-10-03RE04*. February 8.
- Johansson, Olle (2012). Personal communication. February 3.
- Kahin, Debra (2011). "Calif. County Criminalizes Smart-Meter Installations," *New York Times*, 5 January. <<http://nytimes.com/gwire/2011/01/05/05greenwire-calif-c...>>
- Kappenman, John (2012). "A Perfect Storm of Planetary Proportions: The approach of the solar maximum is an urgent reminder that power grids everywhere are more vulnerable than ever to geomagnetic effects," *IEEE Spectrum*, February <<http://spectrum.ieee.org/energy/the-smarter-grid/a-perfect-storm-of-planetary-proportions>>
- KSBW.com (2012). "Santa Cruz Health Officer Discloses Findings on Smart Meters." January 30. <<http://www.ksbw.com/Santa-Cruz-Health-Officer-Discloses-Findings-On-Smart-Meters/-/1824/8762562/-/ew4e4bz/-/index.html>>
- Lovins, Amory (2011). *Reinventing Fire: Bold Business Solutions for the New Energy Era*. Chelsea Green Publishing.
- Maret, Karl (2011). *Commentary on the California Council on Science and Technology Report. "Health Impacts of Radio Frequency from Smart Meters."* January 30. <<http://sagereports.com/smart-meter-rf/?p=368>>
- Maret, Karl (2012). Personal communication. March 1.
- Mills, Andrew and Ryan Wiser (2010). *Implications of Wide-Area Geographic Diversity for Short-Term Variability of Solar Power*. Lawrence Berkeley National Laboratory. September. 48 pages. <<http://eetd.lbl.gov/ea/reports/lblnl-3884e.pdf>>
- Morgan, Lloyd (2010). "Re-evaluation of the Interphone Study: Application of a Correction Factor." *32nd Annual Bioelectromagnetics Society conference*. Seoul, Korea, June. <<http://electromagnetichealth.org/electromagnetic-health-blog/risk-of-brain-cancer-from-cell-phone-use-underestimated>>
- Niese, Mark (2010). "Hawaii, Maryland opt out of smart meters." *Business Week*. July 28. <<http://www.businessweek.com/ap/financialnews/D9H84CT00.htm>>



- NN (2011). *Privacy and Security of the Advanced Metering Infrastructure*. Privacy and Security Working Group, Netbeheer Nederland. Anahem, The Netherlands. September
- NIST (2009). *NIST Framework and Roadmap for Smart Grid Interoperability Standards (Release 1.0)*. September 2009. Gaithersburg, MD: National Institute of Standards and Technology.
- NIST (2010). *NISTIR 7628 Report—Guidelines for Smart Grid Cyber Security: Vol. 2, Privacy and the Smart Grid*, The Smart Grid Interoperability Panel (SGIP)—Cyber Security Working Group, August 2010. Gaithersburg, MD: National Institute of Standards and Technology.
- NSTC (2011). *Policy Framework for the 21st Century Grid: Enabling Our Secure Energy Future*. National Science and Technology Council (NSTC) Executive office of the President. June. <<http://www.whitehouse.gov/sites/default/files/microsites/ostp/nstc-smart-grid-june2011.pdf>>
- Obama, Barack (1009). *President Obama Announces \$3.4 Billion Investment to Spur Transition to Smart Energy Grid*. The White House, Office of the Press Secretary, October 27. <<http://www.whitehouse.gov/the-press-office/president-obama-announces-34-billion-investment-spur-transition-smart-energy-grid>>
- Peltzman, S. (1976). “Toward a More General Theory of Regulation,” *Journal of Law and Economics*. 19, pp. 2211-48.
- Quinn, Elias (2009). *Smart Metering & Privacy: Existing Law and Competing Policies*, Spring. available at <[http://www.dora.state.co.us/puc/DocketsDecisions/DocketFilings/09I-593EG/09I-593EG\\_Spring2009Report-SmartGridPrivacy.pdf](http://www.dora.state.co.us/puc/DocketsDecisions/DocketFilings/09I-593EG/09I-593EG_Spring2009Report-SmartGridPrivacy.pdf)>.
- Regelson, Kenneth (2011). *Boulder Light and Power Utility: Colorado’s 30<sup>th</sup> City Electric Utility*. Presentation of August 24.
- Regelson, Kenneth (2012). “Modeling Electricity and Renewables v1.1.xlsx.” April. <[http://www.energyshouldbe.org/download\\_files/Modeling Electricity and Renewables v1.1.xlsx](http://www.energyshouldbe.org/download_files/Modeling%20Electricity%20and%20Renewables%20v1.1.xlsx)>
- Rifkin, Jeremy (2011). *The Third Industrial Revolution: How Lateral Power is Transforming Energy, the Economy, and the World*. New York: Macmillan.
- Sage (2011). *Assessment of Radiofrequency Microwave Radiation Emissions from Smart Meters*. Sage Associates Environmental Consultants. Santa Barbara, CA: Sage Associates, January 1. <<http://sagereports.com/smart-meter-rf/>>
- Sage (2011a). *Assessment of the EPRI Technical Report: An Investigation of Radiofrequency Fields Associated with the Itron Smart Meter*. Sage Associates Environmental Consultants. Santa Barbara, CA: Sage Associates, November 11.
- Schumpeter, Joseph (1942). *Capitalism, Socialism and Democracy*.
- Schurr, Alan (2012). “Why Smarter Energy is inevitable, but utilities’ role is not.” *Parks Energy Summit 2012*. Austin, Texas. February 28–March 1. <<http://www.parksassociates.com/ibm-webcast-2012-attendees>>.
- Sharan, Sunil (2011). “The lesson from Solyndra: It’s time to deregulate the energy market.” *Washington Post*. October 17 <[http://www.washingtonpost.com/national/on-innovations/the-lesson-from-solyndra-its-time-to-deregulate-the-energy-market/2011/09/14/gIQANaBFrL\\_story.html](http://www.washingtonpost.com/national/on-innovations/the-lesson-from-solyndra-its-time-to-deregulate-the-energy-market/2011/09/14/gIQANaBFrL_story.html)>
- Sharp, David (2012). “Maine Public Utilities Commission didn’t address smart meter safety, court says.” *Bangor Daily News*, July 12. <<http://bangordailynews.com/2012/07/12/business/maine-public-utilities-commission-didnt-address-smart-meter-safety-court-says/>>
- Smith, Rebecca (2011). “Duke to Take \$220 Million Charge on ‘Clean Coal’ Plant.” *Wall Street Journal*. October 21. <<http://online.wsj.com/article/SB10001424052970203752604576643483260915402.html>>
- Snider, Laura (2011). “NCAR helps forecast wind output,” *Daily Camera*, Friday, November 11. p. 1B.

Stroud, Sara (2010). “DOE: Big Utilities Can Get Reliable Power from Small Solar PV Arrays.” *Reuters*. <<http://www.reuters.com/article/2010/09/28/idUS373896815920100928>>.

VPR (2012). “Health Chief Says Smart Meters Are Safe.” *VPR News*. Vermont Public Radio. January 27. <[http://www.vpr.net/news\\_detail/93211/health-chief-says-smart-meters-are-safe/](http://www.vpr.net/news_detail/93211/health-chief-says-smart-meters-are-safe/)>

Wacks, Kenneth (2011). “Smart Grid Impact on Consumer Electronics.” *CABA iHomes & Buildings*. Winter, volume 8, number 4. pp 12-15. <<http://www.caba.org/ihomesandbuildings>>

Wacks, Kenneth (2012). “Sync your home: Smart grid standards for residential customers.” *ISO Focus*. June, pp 18-21. <[http://www.iso.org/iso/home/news\\_index/iso-magazines/isofocusplus\\_index/isofocusplus\\_2012/isofocusplus\\_2012-06.htm](http://www.iso.org/iso/home/news_index/iso-magazines/isofocusplus_index/isofocusplus_2012/isofocusplus_2012-06.htm)>

Warsaw, Rand (2011). “‘Sandy’ Data from Smart and Automated Meters.” *UtiliPoint Issue Alert*, July 29. <<http://www.utilipoint.com/IssueAlert/article.asp?id=3331&Print=true>>

Warsaw, Rand (2011a). “Finding Truth in the Smart Grid Data.” *UtiliPoint Issue Alert*, August 24. <<http://www.utilipoint.com/IssueAlert/article.asp?id=3340&Print=true>>

Woolsey, R. James and Anne Korin (2007). “Turning Oil into Salt: We must become independent—not just of imported oil, but of oil itself.” *National Review*, September 25. <<http://article.nationalreview.com/>>

Woolsey, James (2011). *EnergyNOWnews*. Interview with Thalia Assuras. August 11. <[http://www.youtube.com/watch?v=aQImZpKW\\_lo](http://www.youtube.com/watch?v=aQImZpKW_lo)>

Xcel (2008). *Xcel Energy Smart Grid: A White Paper*. Xcel Energy Inc. 1 February, p 2 <<http://cleanefficientenergy.org/resource/xcel-energy-smart-grid-white-paper>>

Zeller, Tom Jr. (2010). “‘Smart’ Meters Draw Complaints of Inaccuracy”. *New York Times*. November 12. <<http://www.nytimes.com/2011/11/13/business/13meter.html>>

---

<sup>1</sup> specifically, concerns regarding health and biological effects of electromagnetic fields, for example (Sage, 2011).

<sup>2</sup> even some state regulators are blocking smart meter deployments pending better justification (Zeller, 2010).

<sup>3</sup> Rifkin contrasts “lateral” political power with centralized hierarchical political power, attributed in part to transformations in media and communication technology (e.g., Internet, social media, etc.).

<sup>4</sup> Although solar and wind are emphasized here because of their broad development, a range of other promising renewable/sustainable sources could also be included such as geothermal, ocean thermal, wave, small scale hydro, etc.

<sup>5</sup> As explained later in this paper, conventional utility business models depend on the sale of electricity as a commodity, on return on assets, and on regulatory protection of strong economic interests. These dependencies push investment toward baseload generation (e.g., coal, nuclear, baseload natural gas) and away from distributed, and variable and less predictable sources (e.g., solar, wind, etc.). Some other countries have been successful in deploying renewable sources because these economic interests are less influential.

<sup>6</sup> during a mid-2011 industry webinar, utility economist Peter Fox-Penner commented that the smart meter was not a good “poster child” for the smart grid: that the meters had been deployed too rapidly and too broadly, and that it was a “mistake” by industry (Fox-Penner, 2011).

- 
- <sup>7</sup> This multi-billion dollar investment in present generation smart meters has likely been wasted on obsolete technology that is unable to facilitate integration of renewable energy. There is essentially no possibility that most smart meters or meter networks will lead to greater sustainability. They are not “smart” in any relevant sense, and the metering function they perform can be better accomplished by other means including use of existing networks, as will be explored later in this paper.
- <sup>8</sup> Coal is used to produce 45% of U.S. electricity and 41% of world electricity (Lovins, 2011, p. 6). According to Lovins, “More than 70% of U.S. coal plants—half of U.S. coal capacity—are more than 30 years old, and 33% are more than 40. If they can all be affordably maintained and run until age 60, twice their normal accounting life, 94% of today’s coal capacity will still have to be retired by 2050 through sheer old age” (p. 175).
- <sup>9</sup> Such concerns and anxieties have been reflected in various writings notably including economist E.F. Schumacher’s influential work on decentralized and “appropriate” technologies, including his 1973 collection of essays, *Small is Beautiful: a study of economics as if people mattered*.
- <sup>10</sup> In 2010, about 95% of the solar photovoltaic power in Germany (17 gigawatts or 6% of the total electricity supply) is installed on individual rooftops.
- <sup>11</sup> A 2004 U.S. General Accounting Office study (GAO, 2004) showed that local ownership can generate significantly higher impacts for a county. For example, a single 40MW wind project built in Pipestone County, Minnesota, would generate about \$650,000 in new income for the county annually. In contrast, that same 40MWs locally owned, would generate about \$3.3 million annually in the same county. The GAO evaluation looked at three counties in Iowa and two in Minnesota. For these five counties, local ownership provided 2.5 times more jobs and 3.7 times more total local area dollar impact. There are additional environmental benefits and technology development economic benefits to the local area.
- <sup>12</sup> Guaranteed profits and double-digit ROR on assets also made utilities a relatively safe and stable investment in public securities markets, suitable for a wide range of investors.
- <sup>13</sup> “Baseload generation” is electricity primarily produced by large, fixed-output generators (usually coal or nuclear plants) that can (and must) run at full capacity most of the time to be efficient. Baseload plants offer significant economies of scale and require large investments (and thus yield large returns on that investment through rate-of-return (ROR) regulation).
- <sup>14</sup> Examples of such products and services include smart appliances, home energy management systems, smart inverters, economical battery storage equipment, communication gateways, and standardized demand response protocols and service providers.
- <sup>15</sup> The true value of demand response is realized when employed in a (non-baseload) renewable (but variable, such as wind and solar) source system when it can be used to shift peaks and valleys to quickly balance supply and demand.
- <sup>16</sup> Farrell (2011, p. 26) notes that “...long term power supply contracts from centralized baseload resources (e.g., coal) can cause variable (solar and wind) resources to be curtailed if there is no local load and no excess capacity on the grid. Thus today and in the short run, new renewables displace intermediate and peaking plants such as hydro generators or natural gas plants.”
- <sup>17</sup> It is interesting to note that in Germany, “feed-in” tariffs mandated by law the opposite situation: renewables have priority and it is baseload generation that must be curtailed. Nevertheless, as renewable percentages rise in any grid, new technical approaches are needed to balance supply and demand.

- 
- <sup>18</sup> For a more thorough explanation of the relationship between renewables and baseload and an easy-to-use spreadsheet-based graphic model that shows the effect of adding renewable generation with or without baseload, using actual historical renewable data from Boulder, Colorado and other sites in Colorado, see Regelson (2012).
- <sup>19</sup> The academic policy studies literature is well known on the topic of “regulatory capture” and “public choice theory” (see Wikipedia).
- <sup>20</sup> Some notable exceptions are DoE research programs that have produced valuable technology and analytics (e.g., Pacific Northwest National Laboratory (PNNL), National Renewable Energy Laboratory (NREL), Pacific Northwest Smart Grid Demonstration Project, National Institute of Standards and Technology (NIST) *Smart Grid Roadmap*, some regulatory changes by the Federal Energy Regulatory Commission (FERC), etc.).
- <sup>21</sup> Carbon trading schemes, including carbon offsets and renewable energy credits (RECs), are primarily “feel good” schemes for polluters that mainly benefit financial market traders. They function, as did medieval indulgences for polluters, as gratuities for influential players in developing countries, and as an income source for consultants and certifiers. Their influence on carbon emissions is impossible to track or quantify since they are aimed at the *carbon user* rather than at the carbon source. Only a direct carbon tax *at the carbon source* would be likely to have a meaningful effect on emissions.
- <sup>22</sup> Xcel estimates that energy savings in its seven year plan will equal as much as 994 megawatts—equal to the size of its new \$1 billion Comanche unit #3 coal plant just completed last year (Jaffee, 2011).
- <sup>23</sup> *Solar Rewards*™ is a rate-payer funded rebate incentive program largely for rooftop solar installations and net-metering. It has installed solar panels on approximately 10,000 homes creating 89 megawatts of generation (Jaffee, 2011).
- <sup>24</sup> Some benefits that have been realized include 1) increased electricity grid reliability, efficiency, and safety through improved distribution management and automation; including the improving the interoperability of SCADA networks, 3) improved operational efficiency by reduction of utility labor and operating costs; and 3) improved outage detection, location and correction.
- <sup>25</sup> Sunil Sharan, a former director of the Smart Grid initiative at General Electric wrote in the *Washington Post* that the Smart Grid, while efficient and environmentally beneficial, will be a net job destroyer. For example, 28,000 meter-reading jobs will be replaced by the Smart [Meter] (Brooks, 2011; Sharan, 2011).
- <sup>26</sup> Advanced Metering Infrastructure (AMI) was initially a set of standards known as ANSI C12 originally developed during the early 1990s to define data formats (i.e., data tables) and protocols for automatic meter reading (AMR).
- <sup>27</sup> A more effective and comprehensive approach to time-based rates include employing premises gateways, energy management systems (EMS), and transactive control strategies described later in this paper. Implementing time-based rates with simply a meter without automatic load control equipment is probably worse than nothing because it disadvantages some customers and may alienate many. If such equipment is in place, the meter is ancillary.
- <sup>28</sup> Schumpeter borrowed the term “creative destruction” from Karl Marx, but popularized it and linked it to entrepreneurship and economic innovation in his most important work, *Capitalism, Socialism and Democracy* (1942).
- <sup>29</sup> Normally regulated monopolies are allowed to charge capital costs of construction assets against ratepayers. In the highly unusual Edwardsport case cited, the \$220 millions ratepayer charge was

---

disallowed by the regulators and Duke had to make a charge against its earnings (i.e., profits), and thus against its shareholders.

- <sup>30</sup> for example, after \$100 million spent, Xcel's *SmartGridCity*<sup>TM</sup> could not even do the most primitive form of demand response, so they are still employing their old cellular radio-based *Saver's Switch*<sup>TM</sup> technology to control air conditioners. Their long-promised small-scale in-home device trial finally being installed in 2012 consists of *EnergyHub*<sup>TM</sup>, a complete third-party product that uses Internet and has no connection to the celebrated and costly *SmartGridCity*<sup>TM</sup> hybrid fiber/BPL smart meter network.
- <sup>31</sup> In particular, the radio "mesh" networks being widely deployed for metering (e.g., Silver Spring Networks) are extremely slow and suffer from addressing and transmission latency limitations that make them technically impractical for general-purpose point-to-point data communications services that a true gateway would require.
- <sup>32</sup> The complexity and pitfalls of utility centralized renewable integration and demand response control strategies, including such concerns as grid stability, how to use the coming meter data "tsunami", and changing business models with control implications were discussed by Jeff Taft, and Charlie Mathys during a utility industry webinar on renewable integration (ACORE, 2011).
- <sup>33</sup> State-of-the-art smart grid research and testing is being conducted by the DoE Pacific Northwest National Laboratory and other federal labs. This research has developed advanced supply/demand response methods including transactive control strategies, however these are not yet standardized or commercialized, and thus not yet supportable by off-the-shelf consumer products or appliances.
- <sup>34</sup> This author participated in the development of AMI standards during the early 1990s.
- <sup>35</sup> SCADA (System Control and Data Acquisition) is an array of communication protocols that have been employed by the utility industry for decades, primarily for substation monitoring and distribution automation purposes, and are now considered to be a central element of the smart grid.
- <sup>36</sup> Display of usage data would presumably lead consumers to change their energy use behavior—a problematic assumption for a number of reasons.
- <sup>37</sup> As noted earlier, a belated and diminished trial of third party in-home devices began to be installed in early 2012 following continued insistence by the Colorado PUC. This trial, called the "*SmartGridCity*<sup>TM</sup> In-Home Device Pilot," did not actually utilize the *SmartGridCity*<sup>TM</sup> metering network infrastructure for which the Colorado ratepayers had been asked to pay \$45 million.
- <sup>38</sup> Here, "interval" refers to the time interval over which the data are collected, not the interval of their transmission to the utility.
- <sup>39</sup> Quinn compares data mining applications to "attracting flies".
- <sup>40</sup> For detailed accounts of many data mining and Internet privacy abuses see the series of articles "Who Knows" published by the *Wall Street Journal*.
- <sup>41</sup> Examples of HANs include Ethernet, WiFi<sup>TM</sup>, Zigbee<sup>TM</sup>, HomePlug<sup>TM</sup>, LonTalk<sup>TM</sup>, Z-Wave<sup>TM</sup>, BACnet<sup>TM</sup>, Bluetooth<sup>TM</sup>, Echonet<sup>TM</sup>, and many others.
- <sup>42</sup> A robust and diverse consumer market for premises energy devices and apps could open the way to utilize alternatives to conventional wireless networking (e.g., optical fiber, power-over-Ethernet, low-voltage lighting, DC appliances and lighting, energy harvesting sensor network devices and applications, etc.).
- <sup>43</sup> A list of opposed local governments can be found at <<http://stopsmartmeters.org/how-you-can-stop-smart-meters/sample-letter-to-local-government/ca-local-governments-on-board>>.

- 
- <sup>44</sup> In Vermont, a new Senate Bill S214 is calling for utilities to obtain written consent from residents to install a smart meter that emits radiofrequency radiation, and to swap out meters that have been installed with analog meters at no cost to ratepayers, if requested. Thus far, “opt-out” options have been adopted by public utility commissions in California, Maine and Vermont though at a monthly cost to ratepayers.
- <sup>45</sup> *INTERPHONE* was initiated as an international set of case-control studies focusing on four types of tumours in tissues that most absorb radiofrequency energy emitted by mobile phones: tumours of the brain (glioma and meningioma), parotid gland and acoustic nerve (schwannoma). The objective was to determine whether mobile phone use increases the risk of these tumours and, specifically, whether radiofrequency energy (RF) emitted by mobile phones is tumourigenic (Interphone, 2012).
- <sup>46</sup> In a personal letter clarifying the IARC decision to the Collaborative for Health and the Environment EMF Working Group, Dr. Robert Baan, principal author of the IARC statement on Radiofrequency Radiation, stated: “The classification 2B, possibly carcinogenic, holds for all types of radiation within the radiofrequency part of the electromagnetic spectrum, including the radiation emitted by base-station antennas, radio/TV towers, radar, Wi-Fi, smart meters, etc” (Baan, 2012).
- <sup>47</sup> In addition to risks from *thermal* (heating) effects from microwave radiation, there are also documented biological effects at *non-thermal* levels of radiation exposure that some consider to be of equal or more importance than the heating effects, as well as possible effects from exposure to EMFs from the phone’s battery.
- <sup>48</sup> For example, business subscribers were classified as “non-users” as was any person who started using a cellphone after 1995. The proportion of the Danish population who had a cellphone subscription rose from 10% in 1995 to 95% in 2004 – all these people were also incorrectly still classified as being “non-users” in the latest analysis.
- <sup>49</sup> The implications of the DNA mutation mechanism and fractal antenna absorption mechanism proposed by Blank and Goodman are far-reaching—i.e., that there may be no “safe” EMF dose, and that the only practical safety standard methodology may involve moving from SAR-based limits to the “as low as reasonably achievable” (ALARA) levels presently applied with respect to nuclear radiation. These mechanisms could also offer a plausible explanation for the surprisingly wide range of both adult and childhood health disorders being attributed to EMF exposure.
- <sup>50</sup> According to Johansson, “Wireless smart meters emit pulsed radiofrequency radiation (microwaves) continuously throughout the day, sometimes many times a minute. We know this radiation has biological effects and that it travels through building walls. Studies have linked the presence of radiofrequency radiation at non-thermal levels of exposure with impairment in the immune system, the neurological system, cognitive function, memory, as well as with heart irregularities, depression, fatigue, sleep disturbance, headache, skin disorders, visual and hearing disruptions, movement difficulties, difficulty concentrating, as well as with DNA damage and with cancers. Studies have sometimes shown a paradoxical effect, where the less the power the greater certain biological effects, such as neuron death and blood brain barrier permeability. In the interest of preserving health, as well as preventing a public health catastrophe from excessive acute and chronic wireless radiation exposures, residential and commercial utility meters, as well as other smart grid technologies and appliances, should always be hard-wired and properly shielded” (Johansson, 2012).
- <sup>51</sup> According to Maret, “Wireless smart meters utilize non-thermal, pulsed microwave radiation to transmit power usage information between houses in a mesh network which are then relayed to the utility. This adds to the ever-increasing level of background microwave radiation in the

---

environment. The current exposure guidelines enforced by the FCC are only concerned with thermal damage caused by microwave radiation and are inadequate to protect our long-term health based on non-thermal exposures, which these meters produce. Because human beings are vulnerable to pulsed microwave radiation at non-thermal exposures, especially when it is produced chronically throughout the day, and also in the night when we are to heal and regenerate our bodies, there may be significant adverse effects on our health from installing wireless meters in our communities. Currently we are seeing a number of symptoms in electrically hypersensitive individuals after wireless Smart Meters were installed. When banks of these meters are installed in apartment complexes adjacent to sleeping and working quarters, there may be greater risk to health and well being. Hard-wired analog meters worked perfectly well to collect electricity usage data previously and should have been left in place” (Maret, 2012).

- <sup>52</sup> Some of the latest research as of this writing was presented at the *2012 Workshop on EMF & Health Risk Research* held from October 21–25 at Monte Verità, Ascona, Switzerland, where more than 120 participants gathered for the second “EMF Health Risk Research: Lessons Learned and Recommendations for the Future” workshop. This year's focus was on reproducible effects of low-level electromagnetic fields (EMF) on organisms, and on mechanisms of interaction between weak EMFs and human tissues. <<http://www1.itis.ethz.ch/mv-2/>> and <<http://betweenrockandhardplace.wordpress.com/2012/10/31/impressions-from-monte-verita/>>
- <sup>53</sup> Bills would increase because of the financial and economic trajectory of coal generation as discussed in an earlier section regarding new coal plants and rate increases by Xcel and Duke.
- <sup>54</sup> A comprehensive review of the academic literature on regulatory capture has been prepared by Dal Bó (2006).
- <sup>55</sup> In contrast to solar PV, windmills may benefit somewhat from improved efficiency in regard to maintenance cost when clustered together.
- <sup>56</sup> Transmission power losses can amount to approximately 10%, depending on the situation.
- <sup>57</sup> The international Electrotechnical Commission (IEC) defines “small hydro power” (SHP) systems including “micro” (5 to 100 kW), “mini” (100 kW to 1 MW) and “small” (1 to 50 MW) projects that can be run-of-river or reservoir-based. They are “reliable, have minimal operating costs, a small environmental impact and use scaled-down versions of existing large hydro turbines” (IEC, 2011). These hydro generators can be integrated with domestic water supply systems where appropriate.
- <sup>58</sup> The storage does not necessarily need to be large to significantly help stabilize the grid. Much benefit can be gained from momentary surge assistance providing time for other sources to ramp up or down to match supply/demand.
- <sup>59</sup> *Transactive* control is control based on an automated negotiation among users (in contrast to centralized command/control methods), often employing a “price” mechanism (Cazalet, 2011).
- <sup>60</sup> Such communication could be accomplished without predominant reliance on wireless technologies.
- <sup>61</sup> Although solar panels and windmills already feed some power into the grid, their variability and unpredictability limit the percent of power that can be effectively integrated with baseload generation. Advanced supply/demand response enables higher percentages.
- <sup>62</sup> At the same time, it must be recognized that any reliance on natural gas is only as a temporary transition or “bridge” solution, and the full costs of natural gas must be taken into account—especially the environmental and social issues related to the practice of “fracking.”

---

<sup>63</sup> Net metering is the ability of the customer to buy or sell electricity (depending on availability of locally generated power —usually solar) to the grid at some specified rate (i.e., to run the meter “backwards”). Feed-in tariffs provide for selling locally generated power (usually solar) directly to the grid at some specified ongoing rate (tariff).

<sup>64</sup> Lateral power is peer power or authority and stands in contrast with hierarchial (top down) power or authority.

<sup>65</sup> “Complex” means the network of contracts, procurement, and flows of money, resources, and obligations among individuals as well as politicians, regulators, corporations, and institutions.

<sup>66</sup> Such socio-technical risks include exposure to known and unknown health risks (e.g., environmental and EMF pollution), climate change risks, nuclear-related risks, personal privacy risks, security risks from accidental or deliberate grid vulnerability, financial risks, and risks from “normal” (inevitable) accidents that can occur in large complex technological systems (e.g., securities trading system failures, transmission grid blackouts, Three Mile Island, Fukushima, etc.).



“ It is not clear what will happen as utility investments in obsolete systems become stranded and can no longer be protected by regulators. What is clear however is that the will of people to secure their energy future may be stronger than powerful utilities ever imagined. ”



### **Author**

Timothy Schoechle, Ph.D.

Dr. Schoechle is an international consultant in computer and communications engineering and in technical standards development. He presently serves as Secretary of ISO/IEC SC25 Working Group 1, the international standards committee for Home Electronic System and is a technical co-editor of several new international standards related to the smart grid. He also serves as Secretariat of ISO/IEC SC32 Data Management and Interchange, and he currently participates in a range of national and international standards bodies related to smart grid technology and policy issues.

As an entrepreneur, he has engineered the development of electric utility gateways and energy management systems for over 25 years and has played a role in the development of standards for home networks and for advanced metering infrastructure (AMI). He is a former faculty member of the University of Colorado College of Engineering and Applied Science. He is considered an expert on the international standards system, the topic of his 2009 book, *Standardization and Digital Enclosure*. Dr. Schoechle was a co-founder of BI Incorporated, a pioneer developer of RFID technology. He holds an M.S. in telecommunications engineering (1995) and a Ph.D. in communication policy (2004) from the University of Colorado, Boulder.

### **Publisher**

National Institute for Science, Law and Public Policy

*Getting Smarter About the Smart Grid* has been published by the National Institute for Science, Law & Public Policy (NISLAPP) under the direction of Camilla Rees, MBA. NISLAPP is a 501(c)(3) non-profit organization based in Washington, D.C., whose mission is to reconcile legal and scientific concerns in the formulation of intelligent, safe and sensible public policy.

### **Website**

[www.GettingSmarterAbouttheSmartGrid.org](http://www.GettingSmarterAbouttheSmartGrid.org)



**National Institute for Science,  
Law and Public Policy**

1400 16<sup>th</sup> Street, Suite #101, NW  
Washington, D.C. 20036  
202-462-8800

[info@GettingSmarterAbouttheSmartGrid.org](mailto:info@GettingSmarterAbouttheSmartGrid.org)  
[www.GettingSmarterAbouttheSmartGrid.org](http://www.GettingSmarterAbouttheSmartGrid.org)

# The reason for higher electric bills

---

William S. Bathgate, BS EE  
10909 Pinckney, MI  
256-570-5434  
Bill.Bathgate@gmail.com



# What do these transients look like? (at my home)

The RED lines are your normal 60 cycle (Hz) 120 volt power wires. (actual peak is 167 volts)

The YELLOW lines are Transient volts (16 Volts) that are injected on to the power wires from the SMPS – These are not normal and should not be there. So these volts are being added to the measured value of the meter, in this case we see about a 10% error that will be calculated. This was done with few appliances running except a refrigerator and a few lights on. The Heat was off. This transient increases as additional load is demanded

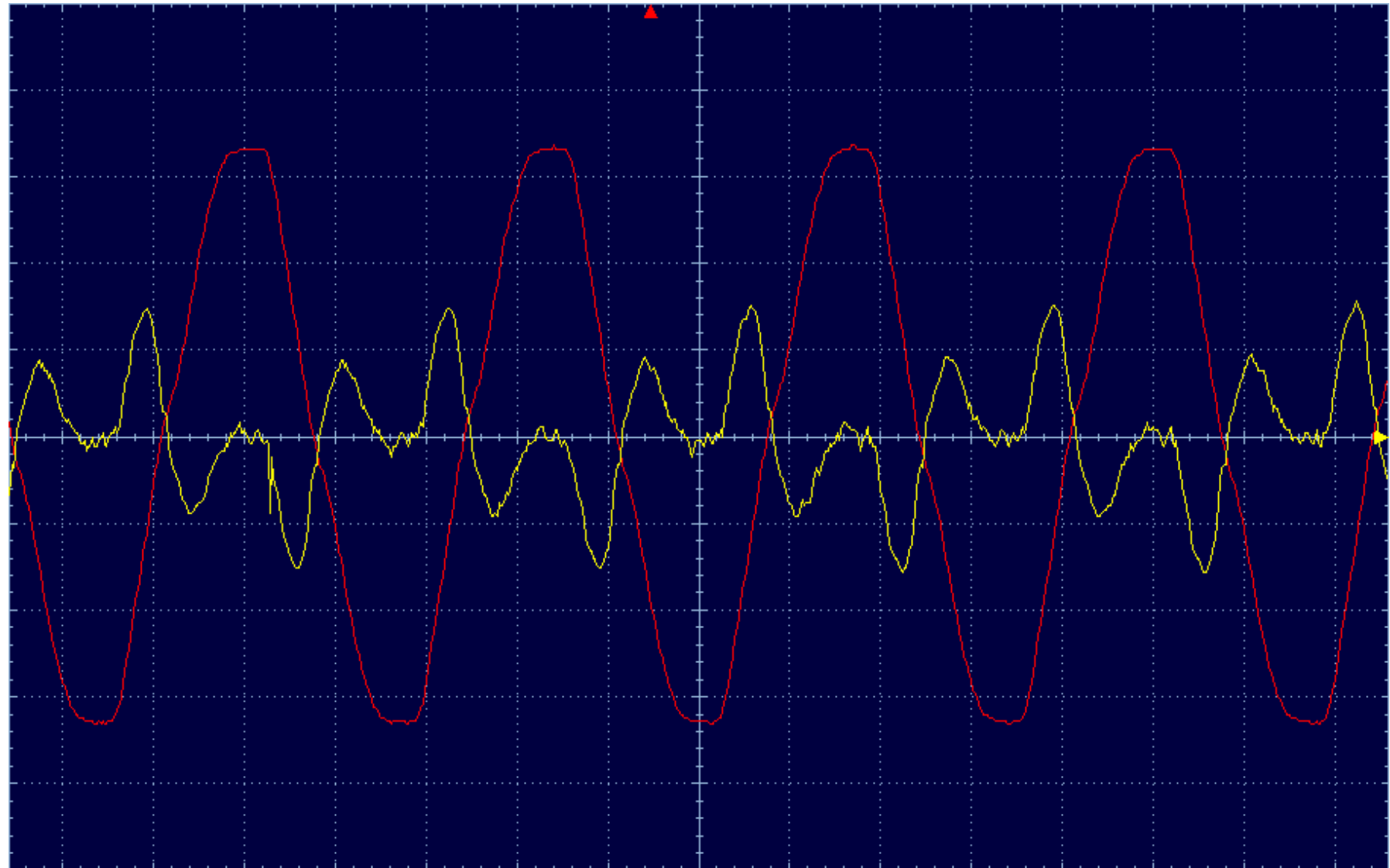

# What do these transients look like?

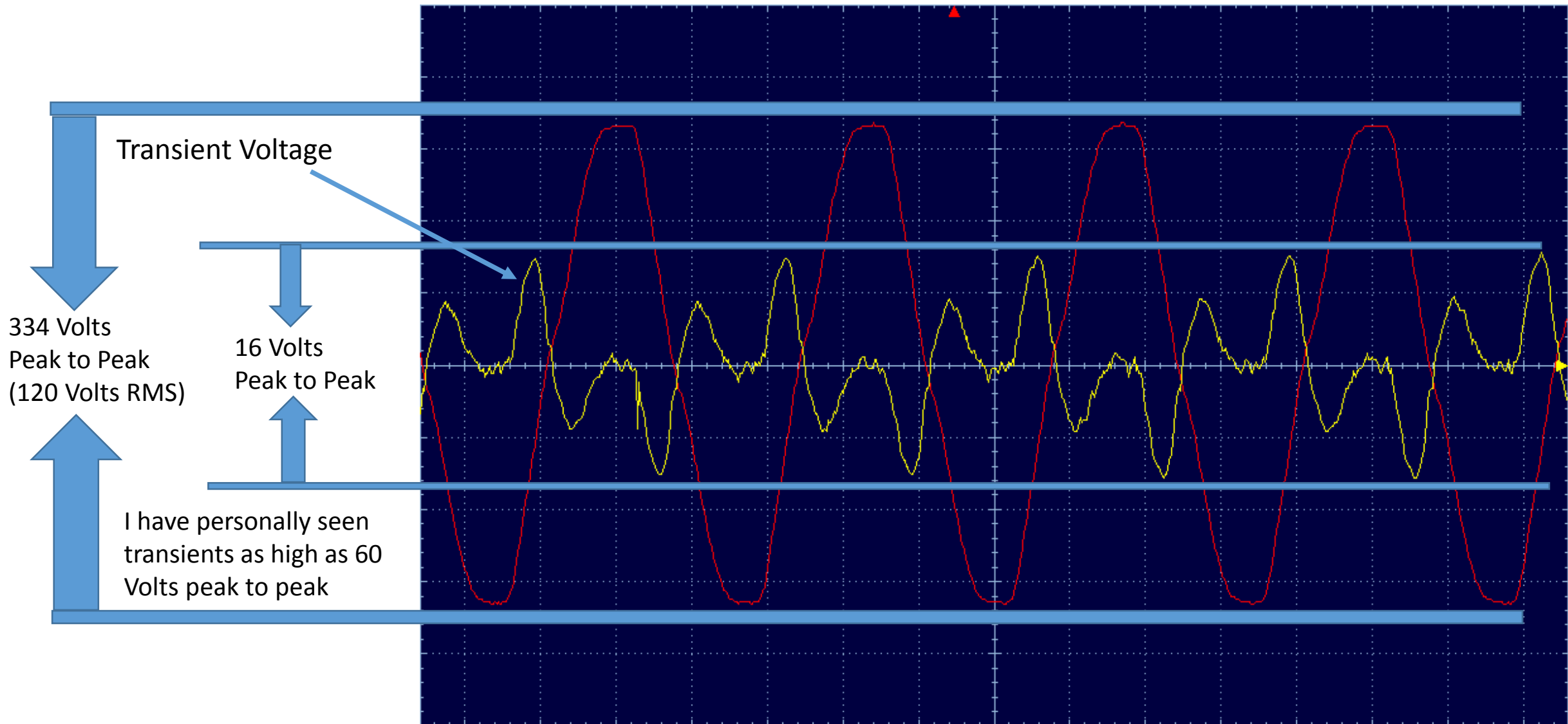

# But wait, what about my cell charger, or other electronic devices, don't they do the same thing?

## The simple answer is NO

The meter manufactures left out a very simple thing that is in all your other household devices, it is called an EMC filter.

AN EMC filter looks like this diagram and picture:

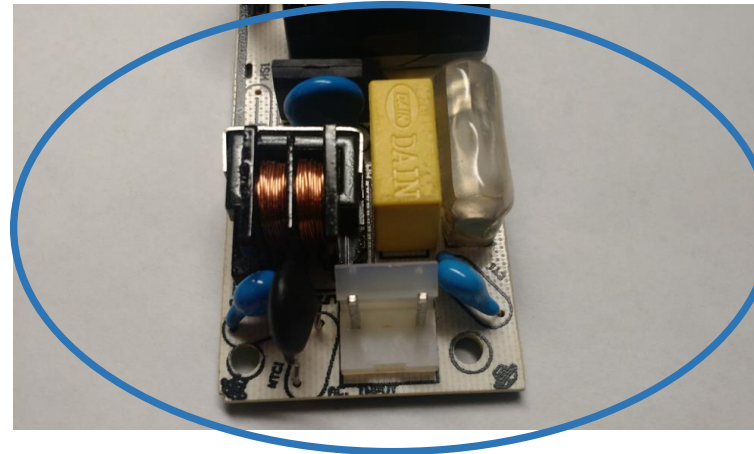
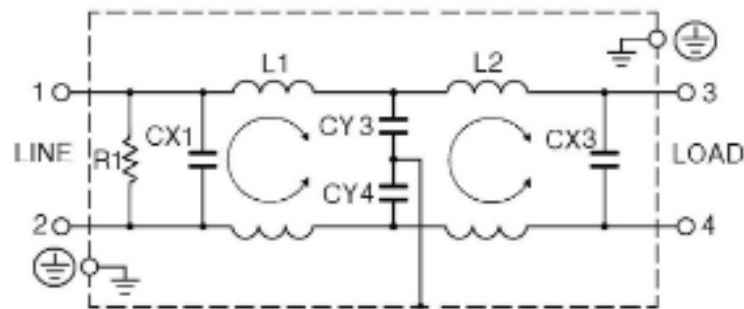

If the meter manufactures had added this type of filter it would have cost the meter manufacturers about \$2.00 to add this to every meter power supply and all these voltage transients would have been prevented. So, all these people complaining about sudden higher than ever bills can be in part be attributed to the design of the SMPS and the overall meter architecture.



# But Wait, I thought the new meters we more accurate?

	<b>Accuracy</b>	<b>Precision</b>
<b>Definition</b>	The degree of conformity and correctness of something when compared to a true or absolute value.	A state of strict exactness — how often something is strictly exact.
<b>Measurements</b>	Single factor or measurement	Multiple measurements or factors are needed
<b>Relationship</b>	Something can be accurate on occasion as a fluke. For something to be consistently and reliably accurate, it must also be precise.	Results can be precise without being accurate. Alternatively, results can be precise AND accurate.

So to be accurate I must hit the bullseye 1 time, to be precise, I must hit the same target spot repeatedly. The AMI meters meet the ANSI standard for accuracy, but they only have to hit the reference measurement once to be declared accurate according to the ANSI Test. They do not have to be precise and repeat the same measurement, over and over. ANSI is an industry funded standards body, it is not independent government body as the NIST actually is.

# Why is the Bill Higher?

## It depends on how it is calculated

### Totalized versus Average of the Peaks

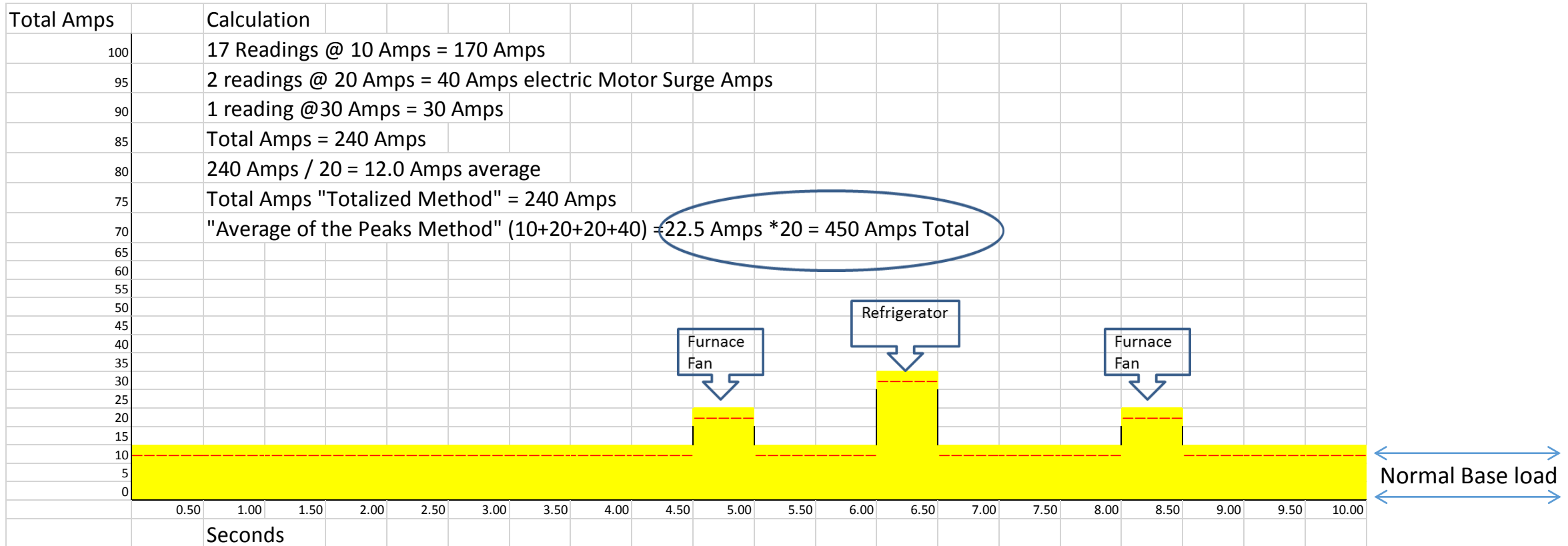

The utilities will not likely reveal how they are doing this calculation, unless forced under court order, this method can be electronically changed at will by the utility with no transparency to the consumer

# Summary - The consumer is at the mercy of a computer calculation not in their control

- The consumer is at the total mercy of the utilities, the consumer has no tangible means to challenge an inaccurate reading, even the utility cannot confirm whether a meter is accurate, they do not have the equipment or personnel.
- The utilities and meter manufacturers have created and deployed a product that by design creates inaccuracies in measurements from harmonic distortion called voltage transients/harmonics.
- Transients/Harmonic distortions are well documented to create measurement inaccuracies in multiple studies, one of these is Applied Electrometric Technology AEMT conference of April 2014 G201 “Analysis of Harmonic Distortion Effect on Deviation Measurement of Electric Energy in a kWh Meter. I learned this basic concept in my electrical engineering classes over 40 years ago.

## Comments for UTC Docket U-180117 Staff Investigation of Policy of Customer Choice in Smart Meter Installation

Dear members of the committee investigating customer choice with smart meter installations,

My wife and I, in our 70's, are 30-year dwellers of Whidbey Island, which we have learned of late is being eyed by PSE for an AMI smart meter mesh installation later in 2018. We and others here have researched smart meters in some detail and have found some features and shortcomings of programs like these around the country (and world) that concern us. We have also learned that in many places a smart meter opt-out is one of the first fall-backs offered when a population of a city or county expresses opposition to the smart meter change. This option is often thought by the companies and authorities to be a simple, tension-reducing offer a company can make (usually including a one-time installation fee for a "non-communicating meter" and a monthly add-on to the utility bill) that will soothe those who strongly object to the meter change as well as nullify any objections to the whole program a community or groups may have. This is perhaps why you are considering "customer choice" now, very possibly anticipating to PSE's upcoming push to install smart meters throughout their service area, which includes us.

A lot of this paper will focus on the opt-out option, the main "customer choice" offered with smart meters, and why it is so full of inequities and contradictions and why it doesn't really cure the real problems with the rollouts of smart meter systems. We, and others, have strong objections to allowing a smart meter placed on our dwelling, but we also don't consider reasonable or adequate the opt-out options that contain any extra charges. Hopefully this document will provide some viewpoints and information that will be useful in your considerations of this tricky, internationally occurring, issue of smart meter programs and the customer choices offered.

Let's start with the simple and obvious and move up in complexity:

### **1. Cost:**

□ **Unfair customer fees** stemming from inaccurate company information about actual costs. These make opt-out fees quite simply a penalty for choosing not to have a smart meter. Let's work from an illustrative real-life example: Seattle's current model that PSE might look to emulate: An opt-out fee consisting of a meter charge (\$125 - \$200) plus a \$17/month (\$204/yr) extra fee. Further startup costs can be inflicted on someone opting out if a current meter pedestal has any defects (as have been found for several houses in Seattle) that require sometimes expensive owner-financed repairs before workers can even proceed to install a substitute "non-communicating" meter.

The thesis of the opt-out fee structure is that the utility incurs more cost to provide the same level of service with an analog as that given with the smart meter. There is mostly falsity in this. It's true that the readings have to be done by a person, not a remote signal, but it is wrongly implied that replacement with non- "smart" meters (often labelled "non-standard" incorrectly, as the present analog ones are the standard) are costly. In fact they are cheaper. First, the labor of replacement doesn't count here as all meter replacements are to be paid by the pool of rate-payers. The \$125-\$200 fee is strictly for the meter and is made exorbitant compared to analog meter prices. (Analog meters cost only about \$60.) Furthermore, since replacement of sturdy analogs is always done only every 20-40 years, it is likely that a customer's meter has many more years on it, making immediate replacement unnecessary and the opt-out potentially free. Companies often object that they *must* replace the "obsolete" meter with one they can read (as they have done for years!) or that is a more accurate one. The reality is that analogs, developed over *many* decades, are the gold standard of accuracy. (Later in this paper as well as in attachments, we will authenticate the chronic inaccuracy of smart meters.) So the only real bump in

cost for the company is the meter-reading itself, which sometimes needs to be done by a reader but in the case of PSE it is done mostly by impulses sent through the transmission lines from modules in the analog meters—no drivers, no extra cost to speak of, certainly *not* \$17/month. \$204/year/customer is then a *penalty* to discourage those who feel compelled to opt-out for a variety of reasons discussed further below.

More about the “non-communicating AMI” forced on the opt-outer. This is just the same meter with the transmit-receive chip disabled, with the company’s hope that it can be turned on fully later. In effect it is consigning a less-accurate instrument to the objector, with yet another problem: it will work for only about 1/4 as long as an analog meter before it needs replacing again! AMI meters have been shown by experts (and observed in actual programs around the US) to need replacement every 5-7 years!<sup>1</sup>

Tests of several international brands of meters at the University reveal their often gross inaccuracies, to be expected when testing by the manufacturers uses only “ideal” conditions with banks of lightbulbs! Also it is far more common for smart meters to register higher usage than analogs due to their industry-secret algorithms confronting very complex wave-forms and averaging them inadequately.<sup>2</sup> (We are also attaching a PDF technical paper by highly credentialed electrical systems engineer Bill Bathgate, also quoted in footnote 2, who presented it to the Michigan legislature on why smart meters read high.) Yet the power companies typically keep this fact well hidden, touting the “accuracy improvement” as reason that the power bills predictably rise after meter installations. For instance, the Orcas Power and Light Cooperative (OPALCO), Orcas Island, adopted in 2011 a smart meter system. They informed their ratepayers that they should expect their electricity bills to rise after the meters were installed because their analog meters had worn and were measuring lower than actual consumption. But now this would be more fairly accurately done by smart meters. No doubt the electric bills did rise but not for the reason given but because the error of most smart meters is to read too high. (Common complaints among Seattle City Light customers after their meter swap center on a 12% bill increase. Seattle has hired a crisis-management firm to field all of the complaints.) To repeat, analog meters involving wheels and gears only, are well known for sustained accuracy and smart meters are well known for erroneous measurement, usually on the high side, commonly causing billing increases after deployment. Also for longevity, companies wrongly (and conveniently) claim a smart meter life of 20-25 years in order to lower depreciation figures for the system and thus portray the expenses of a smart meter program as far cheaper than it is. Then opt-outs are portrayed as a money-drain on the program, costing rate-payers. Thus “dissenters” need to pay dearly.

□ **Smart meters are a financial drain on ratepayers.** Besides individual meters misreading the electric usage on the high side, whole smart meter programs have been found to contribute to rate rises. Many expert auditors and analysts in different states concluded that the programs are simply mathematically unable, to manifest the predicted operational savings, efficiency, and energy savings to finance themselves. They thus must be financed on the backs of ratepayers through initial and periodic rate increases.<sup>3</sup> Those opting out wish to avoid all the associated fees, but unfortunately even an opt-out household is still subjected unfairly to the rate increases that the smart meter program deflects onto ratepayers as a group.

**2. Renters are excluded.** The opt-out is not even an offered option for many people. Any renter cannot generally opt out if the landlord doesn’t agree. Large apartment complexes make it impossible for a dissenting renter to opt out because when landlords are pulled between those wanting to have the cheapest fees (smart meter) and those wanting out and incurring expensive opt-out fees, the landlord will go with the flow and install the smart meter “upgrade.” This also means that in a multi-unit apartment, one renter often is stuck with a bank of smart meters on an outside wall of his/her apartment, all emitting extremely strong emf’s. The testimony of Silicon Valley civil engineer Jeromy Johnson

about his severe debilitation after such a smart meter bank was mounted outside his apartment bedroom wall (<https://www.emfanalysis.com/about/>) is just one of numerous testimonials about adverse health effects from smart meters.

**3. Harms of smart meters** that power companies try to minimize in order to portray opt-outers as complainers, obstructionists, and resisters of progress.<sup>4</sup>

□ **EMF sensitivity** is exacerbated by 24/7 exposure and smart meter emfs are **cancer-causing** as well. Many experience small and large physical and mental symptoms in electromagnetic fields of the strength manifested by smart meters. And there is much evidence that the exposure is cumulative in the same way x-rays are. (See <https://www.emfanalysis.com/smart-meter-health-effects/>) Some companies will insist that smart meters only transmit a few times a day (actually not true) or that the total time of their transmission is about 4 minutes a day. This masks the fact that the meters are making many high-intensity milli-second-length bursts as much as 150,000 times a day. The strong bursts and UHF modulations are the cause of cell damage more than the duration. The power-intensity of smart meter radiation is commonly at least 200 uW/m<sup>2</sup> at 10 feet distance outdoors and can be even more at an indoor wall behind the meter. This is far beyond the safe levels advocated by the 2012 International Bioinitiative Report done by 29 experts (<http://www.bioinitiative.org/>) and the Supplement to the Standard of Building Biology Testing Methods 2015 calling anything above 10 UW/m<sup>2</sup> the start of definite biological effects like chromosome damage, especially so with extremely sharply modulated spikes 24/7 in duration. Additionally there are proven “dirty” wave forms injected into household AC by smart meters (even those mounted a distance from the house) that cause house wiring to radiate UHF frequencies (See the Bathgate PDF document attached and see <https://youtu.be/4NTSejgsjTc> where an electrical expert displays on an oscilloscope the dirty UHF superimposed on the house 60-cycle waveform by a smart meter.)

Numerous peer reviewed published studies (<https://ehtrust.org/science/research-on-wireless-health-effects/>), including the latest release of the NTP, National Toxicological Report. Otis W. Brawley, M.D., American Cancer Society Chief Medical Officer said, “The NTP report linking radio frequency radiation (RFR) to two types of cancer marks a paradigm shift in our understanding of radiation and cancer risk. The findings are unexpected; we wouldn’t reasonably expect non-ionizing radiation to cause these tumors.” (The radiation mice were subjected to in this peer-reviewed multi-year experiment was akin to that of smart meters).

<https://www.biorxiv.org/content/early/2016/05/26/055699> Note that US FCC standards say radiation is only too intense if it cooks flesh, a standard formulated in the 1980s before cell phones and certainly before smart meters that use these frequencies existed. The report above disproved the adequacy of the extremely high-threshold US standard (higher than most countries in the world).

#### □ **Security Risk**

As the Microsoft website succinctly pronounces on a Windows help forum: “There is no way to guarantee complete security on a wireless network.” Experts have examined the smart grid circuitry and networking strategy at length and have concluded that every smart meter introduces a new nodal point through which a hacker can enter the network and proceed toward the whole customer data and information repository of the company. Furthermore experts assert that the instant-switching ability of the smart meters combined with their multiple interactions with other meters in a “mesh” could enable a hacker to instantly switch off power to a whole area of a city. This wreaks havoc, yes, but even worse, switching all back on at once then causes a massive power draw at the generators, transformers and lines that could destroy or severely damage this equipment.<sup>5</sup> Those who opt-out are still subjected to this danger.



□ **Privacy Vulnerability:** The stored data that will be sold or made available to authorities exposes individuals to invasion of their meta data revealing various habits they have, times of sleep, waking, cooking, computer use, etc. using different device use parameters and usage waveforms. This exposes them to related targeted advertising and ultimately to detailed surveillance of daily habits by security and law-enforcement if they one day are displeasing the powers that be. The Onzo company in England in the footnote is one example of the sophistication such data use can be put to.<sup>6</sup>

**Conclusions:** The opt-out customer choice offered by companies is usually quite unfairly priced and heavily conditioned. It only solves part of the problems for a customer concerned about the smart meter system issues and extra costs outlined above. For example: the air in the neighborhood is still filled with the microwave-smog of thousands of small transmitters going 24/7 for smart meter users and opt-outers. ( The meter-opt-outer would experience this more strongly in outdoor activities, but at more distance and less intensely indoors while the meter-user would live 24/7 with a strong emf field nearer and dirtier ambient voltages in house electric wires). But the opt-out customer is still subject to the rate-raising effects of a “non-communicating smart-meter” and of the non-self sustaining programs. Thus we see no truly satisfactory alternative for customers concerned by the many problems outlined above except full exclusion of smart meters as they are currently intended for use, by the Utilities Commission. It is the Utilities Commission’s statutory responsibility to regulate to protect the public’s health and prevent unwarranted costs to the rate-payers. These meters simply have not been proven safe. They have not been proven to save money or to save energy. The years of lawsuits, disputes, financial costs, and health costs do not warrant progressing with installation of these meters. The time is now to lay the burden of real proof and financial accountability at the feet of PSE and other utilities proposing these. Full exclusion has been done with 50 cities in France, some cities in Canada, and some cities in California, for example, with others lamenting their choice. The Public Utility Districts in Port Angeles and Port Townsend, Washington have postponed any adoption until further study. Work on the real Green Grid is what will move us forward toward energy efficiency in the face of climate change. This has been done with 50 cities in France, some cities in Canada, and some cities in California (where legislation is still being tested in this regard).

Electric companies will continue to argue that the smart meter is the key to developing a “smart grid.” Actually the true Smart Grid or Green Grid is what must be developed first if anything like “smart meters” are to have any use at all. The system originally envisioned and called the “Smart Grid” could integrate energy from all distributed sources (like individually owned solar and wind) and would enable every consumer to have a home regulator that would track and adjust usage according to energy availability. There is so far *no* such infrastructure like this developed by the energy companies as they clamored in 2009 for Smart Grid research money allocated by the Obama administration, used it to purchase huge numbers of older-designed digital meters, coined the term “smart” for them, and claimed they could bring the “Smart Grid” into fruition. The cart was, and still is, before the horse. When a truly Green Grid will someday be developed, it is highly likely that the current “smart” meters will appear like very dumb “paggers”. They will all have to be redesigned and updated and, instead of microwave linked, most likely made to interact with fiber-optic cable, a much faster and non electro-smog-generating option advocated by the experts.<sup>7</sup> [See the PDF attachment: *Getting Smarter About the Smart Grid*].

## FOOTNOTES

<sup>1</sup>The extremely short life of "smart" meters has been confirmed by Bennett Gaines, Senior Vice President, Corporate Services and Chief Information Officer of FirstEnergy (the nation's largest investor owned utility with 6 million customers). Testifying in October, 2015 before a joint hearing of the U.S. House Subcommittee on Energy and the U.S. House Subcommittee on Research and Technology, he said: "[Smart meters don't have the life of an existing meter which is 20 to 30 years. [They]... have a life of between 5 to 7 years."

<https://smartgridawareness.org/2015/10/29/smart-meters-have-life-of-5-to-7-years/>

Also, Arizona Power Service (with 1.25 M customers) admits thousands of meters "failed to communicate" and, after an average life of just 4 years, were replaced as follows: 2014 - 19,203 meters replaced; 2015 - 22,287 meters replaced and (Stats up to 10/2016) - 20,172 meters replaced. The "failure to communicate" is a problem that is ongoing. APS documents say: "This specific communication issue was first identified in 2014 and continues to be an issue today." Equipment depreciation figures put forward by power companies often assign and figure from a life of 20-25 years (with no proof) for their smart meters. This makes these figures off by a factor of 4, making the expense projections of the program vastly underpriced.

<sup>2</sup> **William Bathgate** holds an electrical engineering and mechanical engineering degree from Univ. of Illinois and Iowa State University. While at Emerson Electric he was the Senior Program Manager for Power Distribution Systems and in charge of RF and IP based digitally controlled high power AC power switching system product lines in use in over 100 countries. He says the following about inaccuracies in "smart" (AMI) meters:

"The AMI measured current does not have a one for one relationship between current consumed and indicated reading. This must be measured via an electronic sensor, converted to a digital signal and then a computer calculation averages all of the sensor input and posts the data in computer memory and the reading on the LCD display. There is a manipulation of the indicated reading that can be affected by many factors.

Most of the components on the Landis+Gyr meter are 5% rated, with the current transformers rated at 1% accuracy within the permitted range of temperatures....(this 1% is only related to *temperature* not the *measured load characteristic*). This is important because testing at the University of Twente [Netherlands] in 2016 (<http://sciencebulletin.org/archives/10940.html>) showed all AMI meters with readings **as high as 582% higher than actual measured consumption**. From this study meters with current transformers, such as in the Landis+Gyr meters, are generally accurate to within  $\pm 10\%$ . That is a 20% range. So professions that the AMI is more accurate is **highly suspect and only true in a very tightly controlled setting** such as ten 100 watt incandescent bulbs. Not with electronic appliances, motors, CFL's, LED's etc.

...The meters don't have a turning wheel, only electronic instantaneous readings that are averaged. If something (refrigerator) starts with a current spike this is averaged over all the low time, raising all the reading for that time. Type of appliance causes different challenges for averaging. Most industry tests are with light bulbs.

More about study of the inaccuracy of smart meters: A *study, Static Energy Meter Errors Caused by Conducted Electromagnetic Interference* (Exhibit U), performed last year by the University of Twente and the Amsterdam University of Applied Sciences, and published in the scientific journal, IEEE Electromagnetic Compatibility Magazine, proves that smart meters are not accurate.

Nine different "smart" meters were tested and compared with the readings of an electro-mechanical (analog) meter. Five of the nine, gave consistent readings much higher than the actual amount of power consumed, up to 582% higher, while two of the meters gave readings that were 30% lower than the actual amount of power consumed. The study found the very design of the meters to be flawed. Of note



to solar customers is the following quote from the study: "... in several cases [smart] electricity meters registered only a part of the energy factually fed into the public supply network from a PV inverter."

- <sup>3</sup> **a.** In a Brief based on a "smart" meter pilot project that involved thousands of people and which was filed with the Connecticut Department of Public Utility Control, Connecticut Attorney General George Jepsen found that the costs associated with the full deployment of AMI meters are huge and cannot be justified by energy savings achieved. "Many customers do not want or cannot use the new AMI meters. Under the Company's plan, however, these customers will nonetheless be forced to subsidize the cost of the meters for the few customers who will use them.
- b.** From the Michigan Attorney General's comments of January 12, 2012 following a full study of the proposed smart meter program for Detroit: "A net economic benefit to electric utility ratepayers from Detroit Edison's and Consumers smart meter programs has yet to be established. In the absence of such demonstrated benefit, the Attorney General has opposed, and will oppose, any Commission action that unjustly and unreasonably imposes the costs of such programs upon ratepayers."
- c.** As a result of a cost/benefit analysis performed by Ernst & Young, Germany's Economy Ministry proclaimed the European Union's proposal for 80% of homes to be "smart" metered by 2020 to be "inadvisable" since installation costs would be greater than energy saved.
- d.** From testimony of Maximillian Chang Principal Associate with Synapse Energy Economics, an energy consulting company located in Cambridge, Massachusetts:  
[RE:]... APPLICATION OF BALTIMORE GAS AND ELECTRIC CO. FOR ADJUSTMENTS TO ITS ELECTRIC AND GAS BASE RATES February 8, 2016, p. 6 CONCLUSIONS AND FINDINGS  
"My analysis indicates that the Company's Smart Grid Initiative has present value benefit-cost ratio of 0.75 [Meaning that return on investment is at best 75% of what is invested, i.e., a losing proposition.] ... Benefits from the Initiative are substantially less than the Company's projections. [One aspect is that] the Company's reported failure rate of its Smart Grid Meters is twice the rate originally anticipated by the Company. Based on the findings from our benefit cost analysis showing that the Company's Smart Grid Initiative is not cost-effective, I recommend that the Commission disallow the \$193 million difference between our estimates of costs and benefits of the Company's Smart Grid Initiative [to] ensure that the Company's Smart Grid Initiative will cause no harm to ratepayers."

<sup>4</sup> An extreme example of the attitude with which a power company can tend to treat opting-out customers is that of the Public Service Company of Oklahoma. They must sign an "acknowledgement, release and indemnification" that states the following: "Customer hereby agrees to release, hold harmless, and indemnify AEP/PSO, American Power Company, Inc., and all of their affiliated companies, and any of their officers, directors, employees, and agents from and against losses, liabilities, costs, expenses, suits, actions, and claims, including claims arising out of injuries to person or damage to property, caused by or in any way attributable to or related to Customer's request for a non-standard meter, the removal of an advanced meter, and/or the subsequent installation of non-standard meter." (Actually, it would be more appropriate if the company signed such a release for each customer, given the several dangers of smart meters I present in this document.)

<sup>5</sup>May 3, 2016: Nick Hunn of WiFore Consulting Ltd presented testimony at the UK House of Commons' Science and Technology's "evidence check" and inquiry into the country's smart metering initiative. He said "The concern I have is that every smart meter has an isolation switch so it can be remotely connected from the supply. ... If somebody could hack into that or just by mistake turn off

very large numbers of meters, that sudden shock of taking them off the grid, and even worse be able to turn back on at the same time, would cause **significant damage**. And to me that's an **unnecessary risk**."

<sup>6</sup>The Onzo Company of Great Britain (<http://www.onzo.com/about-us/>) is an example of the potential of invading privacy of the power user to aid marketing. An account from their participation in a conference on marketing: "What do fast-moving consumer goods (detergent, shampoo, toiletries, etc.) have in common with energy analytics? ...Representing ONZO, I worked on a team exploring how wireless sensor technology and sophisticated data analytics could enable subscription models for goods such as laundry detergent and dishwasher tablets. This could help the producers establish a direct-to-consumer relationship, as well as allow them to target millennials, who tend to have very low brand loyalty, but who are more likely than other groups to sign up to online subscription services.

Where does ONZO's expertise come in? The answer is that the goal of our team's concept was to achieve auto-replenishment, i.e. delivering a new package of product just as the current one is running out. To do that, the idea was to capture the machine's electricity consumption and use ONZO's analytics to obtain an estimate of the number (and perhaps also the type) of cycles run, which would be an obvious help in determining when to dispatch a new shipment of product to the consumer."

<sup>7</sup> In a January 17, 2014 filing before the Massachusetts Department of Public Utilities, Northeast Utilities stated:

*"An Advance Metering System is not a basic technology platform for grid modernization and is not needed to realize all of the benefits of grid modernization."* To extract from its statement: The Department identified four objectives for grid modernization, all of which can be achieved without the implementation of an advanced metering system. Meters do not reduce the number of outages, metering systems are not the only option for optimizing demand or reducing system and customer costs, and metering systems are not necessary to integrate distributed resources or to improve workforce and asset management. Therefore, it is not correct that advanced metering functionality is a "basic technology platform" that must be in place before all of the benefits of grid modernization can be fully realized by the DPU.

In fact, there are non-metering technologies that power companies have implemented, or can implement in the future within a grid-modernization plan, that would tangibly advance the grid-modernization objectives set by the DPU. For example, utilizing SCADA-enabled smart switches will both reduce outages and mitigate the effects that outages have on customers. Substation monitoring, remote controls and microprocessor relays can mitigate the impact of widespread outages, manage load constraints, and help to optimize the use of assets in real time. As a means to optimize demand, the installation of automated capacitor banks increases system efficiency and reduces costs. Direct control of load or generation can be employed to manage system peaks. In order to allow for the integration of distributed resources, sensors and systems for advanced load flow models that allow for more distributed resources on a circuit can be installed. As for improving workforce and asset management, next-generation mapping and outage management systems help. Best that companies be able to identify and implement a suite of non-meter technologies and processes, in addition to those already implemented, in order to advance the grid modernization objectives without the implementation of an advanced metering system. An industry study conducted by entities such as the Electric Power Research Institute shows that the electric distribution grid will require substantial investment to be positioned for the integration of distributed energy resources.

Therefore, grid-modrnization efforts have to be closely coordinated with policies that are encouraging the growth of distributed energy resources. Finite capital resources available for grid modernization should be aimed at this integration effort before any additional monies are expended on metering capabilities that provide limited and/or speculative incremental benefits over current metering technology (following many years of investment in those systems). Moreover, the growth of distributed generation and current subsidies results in the bypass of the electric distribution system by potential electric customers leaving fewer and fewer customers to pay for it. This creates a pricing crisis in practical terms for both residential and business customers remaining on the system. Huge additional investments to the distribution system will only have the effect of exacerbating the pricing issue for customers.